

ALL ABOUT THOSE DISTANT STATIONS (See page 221)

# MODERN WIRELESS

1/-

VOL: XVII. N°63

MARCH 1932



IN THIS ISSUE  
*The* ECKERSLEY  
ADAPTOR  
FOR YOUR SET  
AND  
The "BI-BAND"  
THREE

## INTERESTED IN THE FOREIGNERS ?

THEN YOU SHOULD READ

- On the Medium Wave-lengths
- Station Information
- Radio Spotlights
- Listening to the Long-Wavers
- Station Alterations
- Getting the Americans
- What the Distant Stations are Doing
- Etc., Etc., Etc.

OUR FOREIGN-STATION SUPPLEMENT TELLS YOU HOW, WHEN AND WHERE TO TUNE THEM IN

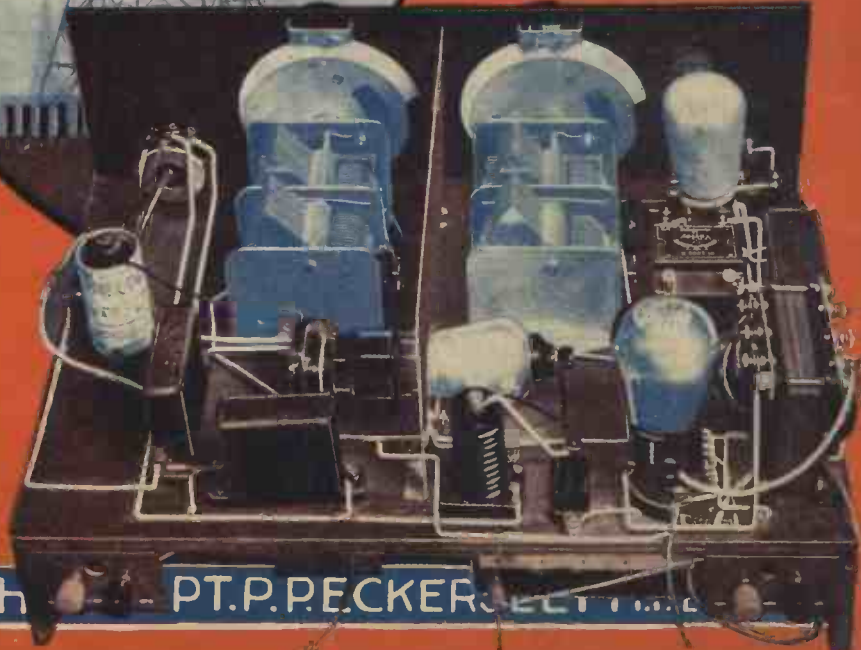

RADIO CONSULTANT-IN-CHARGE - PT. P. PECKER



## BLUE SPOT PERMANENT MAGNET SPEAKER

*complete with Transformer*

This speaker is unique. It sets a new standard for Permanent Magnet performance.

The specially designed magnet has a high flux density and is therefore able to achieve a high degree of sensitivity, even with very small inputs. This magnet is an exclusive BLUE SPOT feature. In exhaustive tests the BLUE SPOT Permanent Magnet Speaker behaved with consistent excellence, showing great flexibility and a liquid clarity of tone that will captivate all who hear it. Distortion is completely absent, voices are natural and clear in enunciation, music of all kinds is brilliantly reproduced. Send for Catalogue M.W.14.

Price, complete with chassis and transformer: 75/-

Complete in cabinet of solid walnut of superb design and finish . . . . . 110/-

**IF YOU ARE GOING TO BUY A WIRELESS SET** you will do well to consider an all-electric BLUE SPOT Set for A.C. Mains. This 4-valve screened-grid receiver brings in Foreign Stations in a manner you'd never believe to be possible—until you hear BLUE SPOT. Write for Catalogue No. M.W.14a.

**THE BRITISH BLUE SPOT COMPANY LTD**  
BLUE SPOT HOUSE · 94/96 ROSOMAN STREET · ROSEBERY AVENUE · LONDON · E.C.4

Telephone: Clerkenwell 3570.  
Telegrams: "Bluospot, Islitig-  
London."

Distributors for Northern  
England, Scotland and North  
Wales: H. C. RAWSON  
(Sheffield and London) Ltd.,  
100, London Road, Sheffield;  
22, St. Mary's Parsonage,  
Manchester; 183, George  
Street, Glasgow.

**BRITISH MADE**



TRADE MARK

Hutchinson

# B.I. ENAMEL COVERED WIRES

B.I. Enamelled wires are unequalled for the field windings of small motors, measuring instruments, radio transformers, and other pieces of electrical apparatus where space is all-important. They are produced throughout in our own works, from the raw material to the finished wire, and every phase of manufacture is under the strictest control as regards quality of material and accuracy of gauge. B.I. Enamelled Wire is unexcelled for its high insulation, dielectric strength, flexibility of enamel, and general dependability. We regularly manufacture Enamelled wire as fine as .002" dia.



## BRITISH INSULATED CABLES

LIMITED

PRESCOT-LANCS

Makers of B.I. Cables

Telephone No.: PRESCOT 6571.

London Office: Surrey House, Embankment, W.C.2

Telephone No.: Temple Bar 4793, 4, 5 & 6.

# CONTENTS

Vol. XVII. No. 63.

MODERN WIRELESS.

MARCH, 1932.

	Page		Page
Editorial	203	The "M.W." "Cabinet" Two	257
What Radio Might Do For British Trade	204	At Your Service	263
The Standby Rejector	207	The New B.E.C. Dance Band	265
Power From Low-Voltage Mains	210	Trouble Tracking	266
How H.T. Batteries Are Made	211	On the Test Bench	268
How to Make Your Set Selective	214	Recent Record Releases	270
Round the Turntable	220	Operating the D.C. "Super-Quad"	271
Picking Your Valves	237	On the Short Waves	275
The New News Arrangements	239	Power Valve Problems	278
Do Constructors Score?	241	In Passing	279
The "Bi-Band" Three	242	Headphone Reception on Multi-Valvers	282
My Broadcasting Diary	251	That Air Gap	283
A Radio Reckoner	253	Those Mains Sets	286
Questions Answered	256	More Selectivity	287
		Radio Notes and News	290
		Loud Speaker Differences	293

**SPECIAL SECTION, "THE WORLD'S PROGRAMMES," PAGES 221-236**  
(Please see page 221 for contents of this supplement).

*As some of the arrangements and specialties described in this Journal may be the subject of Lett's Patent the amateur and trader would be well advised to obtain permission of the patentee to use the patents before doing so.*

Edited by **NORMAN EDWARDS.**

Technical Editor: **G. V. DOWDING, Associate I.E.E.**

Radio Consultant-in-Chief: **Capt. P. P. ECKERSLEY, M.I.E.E.**

Scientific Adviser: **J. H. T. ROBERTS, D.Sc., F.Inst.P.**

**POLAR**  
for  
Ganged  
Condensers

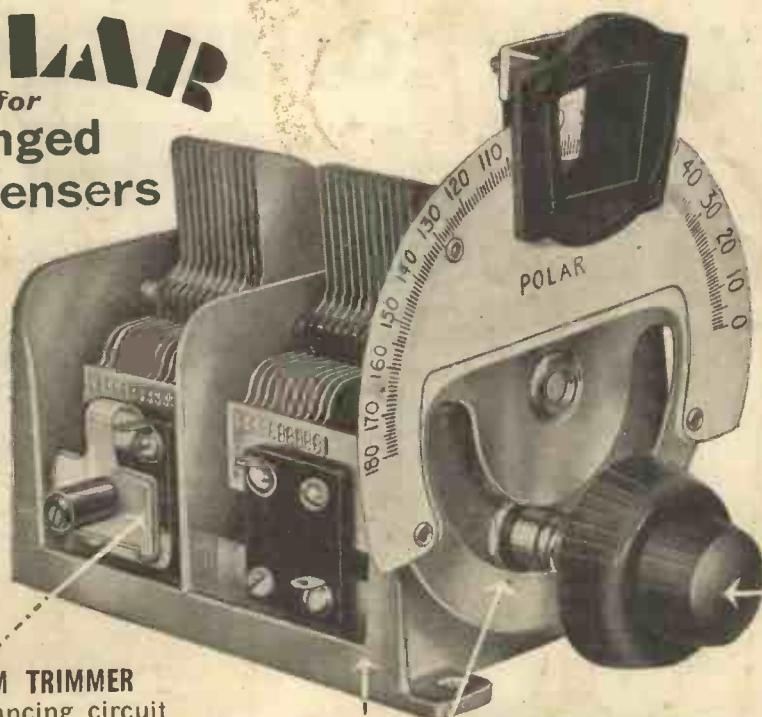

The  
**"UNIKNOB"**  
TWO-GANG  
CONDENSER  
Specified for the  
**"BI-BAND"  
THREE**

PRICE - - - **21/-**

★ **MINIMUM TRIMMER**  
For balancing circuit capacities.

★ **DIE-CAST FRAME**  
Ensuring rigidity under all conditions.

★ **SLOW-MOTION DRIVE**  
Fitted with illuminated scale.

★ **AIR-DIELECTRIC TRIMMER**  
Controlled by centre knob ensuring the same degree of accuracy as that obtained by two single tuning condensers, but with greater ease and simplicity of operation.

Specified by the technical press... Standardised by leading set manufacturers.  
24-page Catalogue "M" free.

WINGROVE & ROGERS, LTD., 188-9, STRAND, LONDON, W.C.2. POLAR WORKS, OLD SWAN, LIVERPOOL.



# Here is the **MICA BRIDGE**

which ensures

# EFFICIENCY and CONSISTENCY

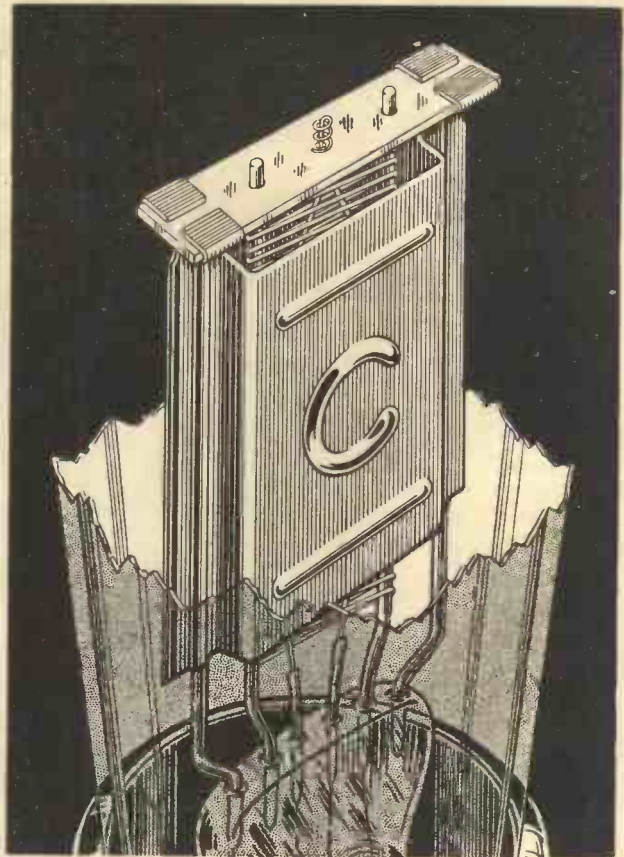

**T**HE Cossor Mica Bridge principle is to-day accepted as a notable contribution to the radio industry. By its use a much higher standard of valve efficiency is attained. Better radio is now available for all who fit Cossor Valves to their Receivers.

In the assembly of every Cossor Valve, the elements are rigidly secured in

absolute life-long alignment by the mica bridge as shown above. In some types, four, and in others, two bridges are used. No variation is possible—either during or after manufacture. Therefore a remarkably consistent performance is ensured throughout the life of the valve.

A copy of the 72 page Cossor Wireless Book B11 will be sent you free on application to A. C. Cossor Ltd., Melody Dept., Highbury Grove, London, N.5.

Get one of the new Cossor Station Charts price 2d. Ask your dealer for a copy of this useful novelty or write to us enclosing 2d. stamp.

## Cossor Valves for "M.W." Sets.

"Bi-Band" Three, \*215SG, \*210HL, 230PT.  
"M.W." "Cabinet" Two, \*210HL, 230KPT.  
Eckersley Adaptor, 210HL.

### BACK NUMBER SETS.

October, "M.W." "Super-Quad," 210DG.  
\*215SG, \*210HL, 230XP.  
October, "M.W." "Uni-Coil" 3, 210DET.  
210LF, 230XP.  
December, "M.W." "Alpha," \*215SG,  
210DET, 220P.  
January "W.L.S. 1932 Short-Waver,"  
220SG, 220FA.  
January "Eckersley Star" Three, \*210HL,  
210LF, 220P.

\*Metallised.

# COSSOR

## ALL-BRITISH VALVES

A. C. Cossor Ltd., Highbury Grove, London, N.5. Depots at Birmingham, Bristol, Glasgow, Leeds, Liverpool, Manchester, Newcastle, Sheffield and Dublin.

45 9818

# MODERN WIRELESS



Vol. XVII. No. 63.

BRITAIN'S LEADING RADIO MAGAZINE.

MARCH, 1932.

*The Editor draws your attention to the leading features in this issue and discusses an inquisitorial action on the part of the B.B.C.*

**I**N the past few months we have received many letters from readers asking for constructional details of a double band-pass receiver, and in consequence the Research Department have concentrated on the production of the "Bi-Band" Three, which is fully described in this issue.

This set constitutes a distinct break-away in receiver design, and is for the reader who wants unusually good quality and powers of "distance getting" from his three valves, with a logical application of the band-passing method for obtaining super-selectivity. Readers will note that the "Bi-Band" Three has several distinctive points; and even if you are not wanting to construct a new three-valver, you will find the descriptive article on the set of unusual interest, and, from the technical point of view, highly instructive.

### *The Eckersley Tuner Unit*

**A**NOTHER feature in this issue to which we should like to draw your attention is the article dealing with the Eckersley Tuner Unit.

There must be many constructors who, while fully realising the technical advantages of the Eckersley Tuner, are unable to use it because the Tuner is beyond their means, or because they have, at the moment, no inclination to build a completely new set.

But the Tuner Unit should interest them, for it provides a solution to the problem—it is an Adaptor which is not only cheap and easy to build, but is immediately applicable to any existing set.

### *Other Outstanding Features*

**T**wo other features of outstanding interest are the "M.W." Cabinet Two, and the "Standby" Rejector. The former is a very compact and easy-to-make set of the console type which incorporates a built-in loud speaker that presents no constructional difficulties; and space is also available in the home-made cabinet for all necessary batteries.

The "Standby" Rejector is quite an easy device to make. And it is definitely cheap in cost—a shilling or two. It is primarily a very efficient wave-trap, but in a few seconds it can be transformed into a useful crystal set for

the reception of local stations independent of the receiver with which it is employed.

### *The B.B.C. Becomes Inquisitive*

**T**IMES out of number the B.B.C. has had to stand the racket of severe newspaper attacks, but of all the offensives undertaken by Fleet Street few have equalled in intensity the attack on what is called the B.B.C.'s "Paul Pry Scheme."

The B.B.C.'s plan for a comprehensive investigation into family life is the result of an arrangement with Sir William Beveridge, representing the London School of Economics, and although the B.B.C. states that it will confine its expenditure of public money in connection with the inquiry to the cost of postage of its inquisition forms, there is no doubt that the scheme has aroused a feeling of widespread hostility.

And, frankly, it serves the B.B.C. right. There is absolutely no need for the B.B.C. to poke its nose into British family life.

The inquiry was planned on the grounds that the B.B.C. wanted a scheme which would interest listeners and make them think.

Well, the scheme chosen was most unfortunate. Not for nothing does the Englishman take pride in the fact that "his home is his castle." As it is, his home—if fitted with a wireless set—is invaded by a good deal of tosh and nonsense emanating from Savoy Hill, and now that the B.B.C. intends sending out inquiry forms concerning the privacy of the home and the citizen's more intimate social life, the joke is becoming a little strained.

The B.B.C. would be well advised to drop the scheme—or at least to withdraw from the silly position it has put itself in by co-operating with the London School of Economics in a scheme which can, at best, provide little useful data, and even then only at a cost of annoying a good many thousands of the B.B.C.'s paying clients.

The enquiry form will be sent by the B.B.C. to all who ask for them—together with a stamped and addressed envelope. If thousands of listeners avail themselves of this offer the bill for stamps will be a substantial one, and it will be paid out of listeners' licence fees.



# *Sir Herbert* *on—What Radio* *British*

**A**t this time, when Great Britain is facing a steep uphill gradient back to prosperity and plenty, an exceptional opportunity occurs for British radio to help the nation in the climb.

For although its potential powers as a trade asset have so far been untried, the British Broadcasting Corporation might be so ordered that, with a nominal alteration in its present programme and that alteration an improvement, it could bring millions of pounds more each year to be spent in Great Britain, and also vastly stimulate the sales of our goods abroad.

### *A Timely and Practical Suggestion*

Think, for instance, of the opportunities which occur when a British-built machine makes an attempt on any

*In this article, one of Britain's most successful business men expresses his views on a very interesting subject. Sir Herbert suggests that the B.B.C. should erect a special station for the express purpose of boosting British goods, and telling Continental listeners in their own tongues why they should spend their holidays in this country.*

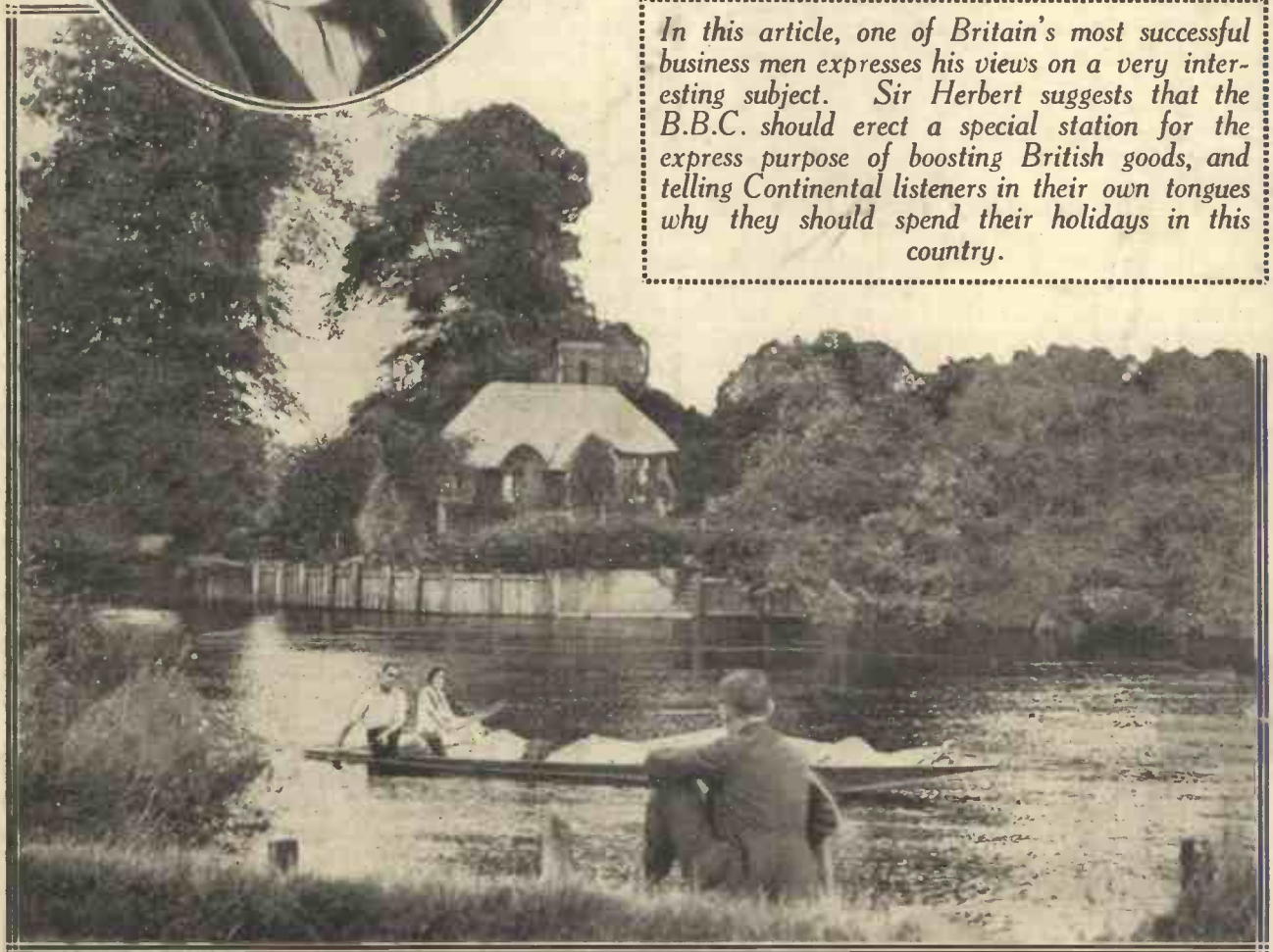

One of the beauty spots of England, the river at Runnymede. It is such places as this that would attract foreigners to this country if Sir Herbert Austin's scheme were put into practice.

# Austin, K.B.E. Might Do For Trade!

existing speed or reliability record on land, sea or air. For three years we have held the Schneider Trophy, thus demonstrating the slogan that English aeroplanes are best; we have motor-racing records, motor-boating records, transatlantic records, long-distance records—and yet we permit the foreigner to supply the greater part of the world market in machines of many descriptions.

### *Why Not Tell the World?*

It seems to me that whenever a Britisher or a home-built machine breaks a record, not only our own public should be told about it, but the world. Instead of an almost apologetic reference in the news bulletin, let us have a broadcast in all the European languages from one station or another—or, better still, construct a powerful station with a wave-length specially selected for Continental suitability, and use it for advertising Britain and for no other purpose.



(Top) A fair French listener with one of the powerful super-het receivers that are so popular on the Continent. (Below) The Prince of Wales speaking from the Birmingham studio on the occasion of his "Buy British" broadcast.

## “ . . . and Radio is in a Unique Position ”

Whenever we have a great trade show, like the Motor Show, for instance, or the Artificial Silk Exhibition, tell all the chief nations of the world about it by radio, not in English but in their own tongues.

Whenever there is a trades exhibition, or anything in the nature of the Wembley Exhibition, explain to the foreigner everything we can tell him about it, advise his buyers to come over here and try our bargains, give him facts and figures about the competitive values England is offering—and, as a result, increase our export trade to an enormous extent.

In addition, why not use radio to attract to this country a hugely increased number of foreign visitors? American visitors here alone, two years ago, spent nearly forty million pounds in England, but they spent more than five times that amount in the same year in France, according to official figures. We who have the same language should have a greater proportion of them than that!

### *Our Publicity in Their Homes*

And we should have more Continental visitors than we do—Germans, Frenchmen, Italians and the rest. Once we can bring them here, not only do they put the money for their holidays into England's pocket, but we have them in our national shop, and we can show them the excellence of our home-made goods.

It is a fact that foreigners are very ready buyers once they learn that British-made commodities are more soundly built and more lasting than their slightly cheaper Continental parallels; and radio can both tell them in their own homes that this is so, and persuade them to come over here and discover the fact for themselves.

A motor-tour of England, particularly now the rates of exchange make foreign money worth more here, should be an attractive proposition for thousands of Continental

business men this coming summer. Because the pound is at a low value, foreign money should pour into the country if only an incentive is given.

Why not, then, broadcast specially for France, Germany, and so on, and in appropriate languages recount the delights of certain suggested attractive motor tours of England, giving routes, costs, and mentioning historic places to see en route? Mention of the delights of our beauty-spots, which surely can compete with Ostend or Deauville, emphasise the cheapness of such a vacation under present circumstances, and as a result there would be millions of pounds more circulating in England during next year, making work for our unemployed.

### *Coyness and Modesty Misplaced!*

If a special broadcasting station for advertising British goods were set up it might profitably say something about the amounts of our raw materials exported for manufacture abroad, and, by showing how good raw materials make for good goods, both please our Continental buyers and increase the foreign demand for such articles as are made abroad from our products.

It is not the least use nowadays, when we have fierce and able competition from half a dozen other nations, to follow our traditional policy of coyness and modesty about the value of the goods we want to sell to the world. That was all right when England was top dog commercially; now, instead, we should be blatantly proud of our ability to make trustworthy, efficient articles of all sorts, and we should use radio to tell the world all about it.

If the B.B.C. spent a small proportion of its annual profits being stridently British about the goods that British commerce produces for the world, our unemployed total would shrink almost out of sight; and if this course were financially impossible I am certain that British trade would get together and completely finance such a scheme

*(Continued on page 299.)*

### THE FIRST OF A FAMOUS “ FAMILY ”

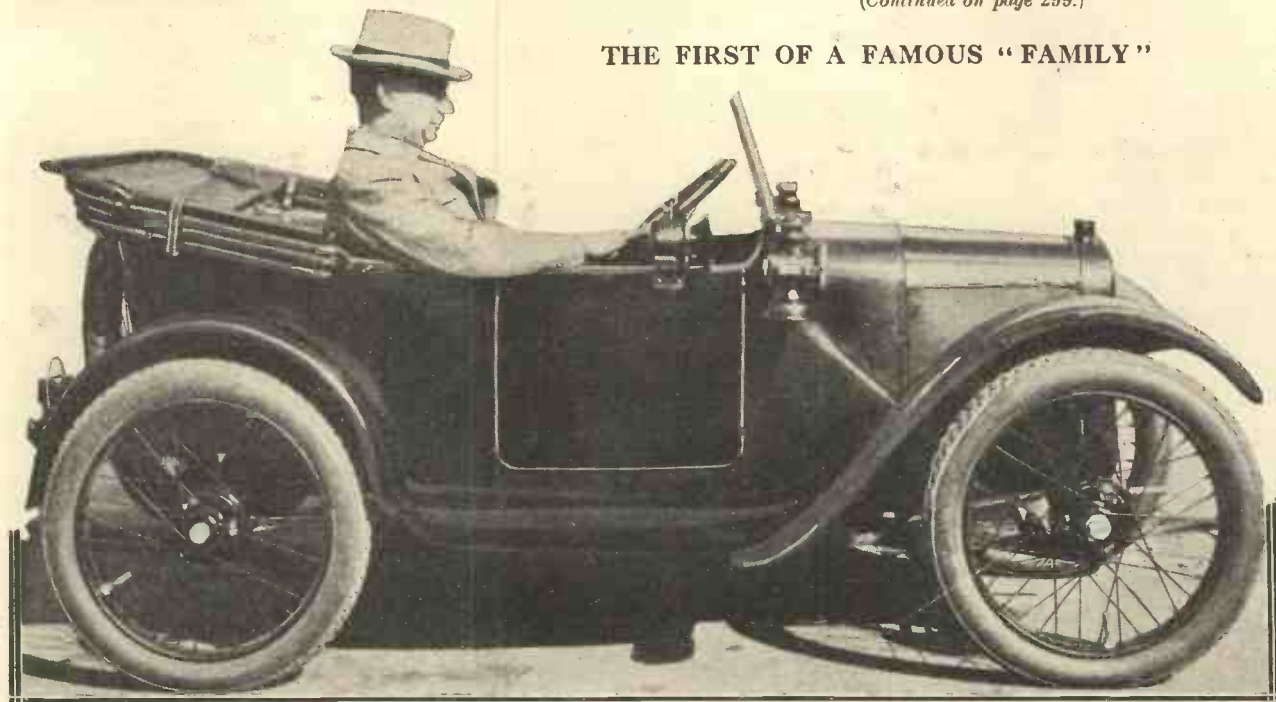

Sir Herbert Austin in the very first “ Austin Seven.” By introducing this little car he gave an enormous fillip to British trade, and his vigorously expressed views on the usefulness of radio in an extensive “ Buy British ” campaign make inspiring reading.



# The STAND-BY REJECTOR



THE "Stand-by" Rejector is designed to carry out two very diverse requirements—the provision of reception where there is none, and the prevention of reception when this latter is taking place. Sounds absurd, doesn't it? But it is not so contradictory or nonsensical as it appears, for the little gadget is both a crystal set and a rejector.

**Designed and Described by the "M.W." Research Dept.**

*Here is a very easy-to-make little device costing but a shilling or two which practically every radio enthusiast should find of vital use. It is primarily an extremely efficient wave-trap, but in a matter of seconds it can be transformed into an effective crystal set for receiving the local stations independently of the receiver with which it is employed as rejector.*

### WHAT YOU WANT

#### CONDENSERS

- 1 '00075-mfd. solid-dielectric (Telsen, Ready Radio).
- 1 '0003-mfd. max. compression type (Sovereign, Goltone, Formo, Lewcos).

#### SWITCH

- 1 on-off switch (Red Diamond, Telsen, Ready Radio, Bulgin, Wearite, Colvern, Goltone, Igranic, Lotus, Graham Farish, Peto-Scott).

#### MISCELLANEOUS

- 1 Crystal detector (Red Diamond).
- 4 Terminals (Bulgin, Belling & Lee, Eelox, Igranic, Goltone, Chix).
- 1 Terminal strip, 7 x 1 1/2 in.
- 1 Coil-former, 3 in. dia., 8 1/2 in. long (Pirtold, Paxolin).
- 2 ozs. of No. 24 D.C.C. wire.
- 2 ozs. of No. 30 D.S.C. wire.
- Wooden panel, 7 x 4 x 1/4 in. thick.
- Baseboard, 7 x 4 x 1/4 in. thick.
- 1 Crocodile clip (Bulgin, Goltone).
- Wire, flex, screws, etc.

Thus it can act either as a radio receiver or as a programme preventer. It can give you good reception from one or other of your local stations, or it can prevent those self-same stations butting in on your reception of more distant programmes.

### A Typical Story

Let us take an imaginary, but none the less practical and typical, case of the average local listener who on occasion likes to hear some of the continental broadcasts. His set, being a simple one, is not too selective, and when he wishes to pick up a programme from foreigners operating on wavelengths near those of his two powerful locals he cannot do so because of interference from the aforesaid locals.

He has also, besides his receiver, a wife, a non-scientific lady who listens to the morning cookery broadcasts,

the tea-time music and provides the two tiny tots with their children's hour on daddy's set.

Such is the picture we will conjure up—of a typical household with its home-constructed set and its band of happy and care-free listeners.

### When Something Happens

Care-free did we say? Yes, until that memorable night when paterfamilias returned home looking forward to listening to Sir Bertram Bloggs who was to deliver a broadcast lecture on a topic near to the heart of "our hero."

He is, however, greeted with the news that "the set's gone wrong," its failure to deliver Jack Payne's 5.15 broadcast having already caused disappointment to three members of the

household. A hurried search for the trouble reveals nothing—and Sir Bertram is "off."

### A NOVEL CIRCUIT

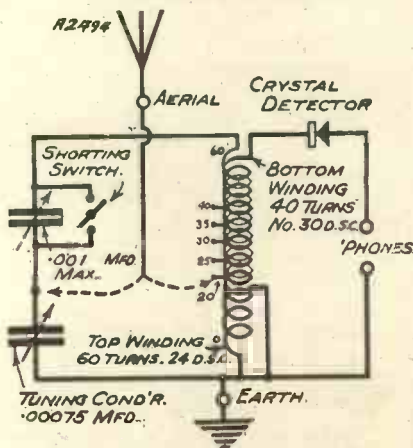

The rejection of unwanted stations is accomplished by an application of the famous "M.W." "Brookmans" principle, while the crystal detector circuit is brought into operation through an "Inductocryc" coupling.

A simple story, yet one that is all too common. How often do we find that the L.T. or H.T. has run down

### ALWAYS AVAILABLE

### A DOUBLE-DUTY DEVICE



The "Stand-by" can be connected permanently to the aerial, where it will improve the general selectivity of your set, cut out any badly interfering station and work as an independent crystal-set for telephone receivers.

just before we want to hear a particularly attractive item!

The Stand-by crystal set will prevent that kind of disappointment by providing, as its name suggests, an adequate stand-by in cases of dire emergency.

Furthermore, it acts as a valuable check on the set. You need not wonder "if they are on" because you hear nothing on your set. Turn to the "S.-B." crystal set and check up.

**"S.-B." to the Rescue**

Yet another picture. The same family—or another, just as you wish—trying to listen to a Continental broadcast of particularly attractive type, with the local supplying an unwanted obligato of annoying clearness and persistence.

**EASY TO BUILD**

**TWO-LAYER COIL CONSTRUCTION**

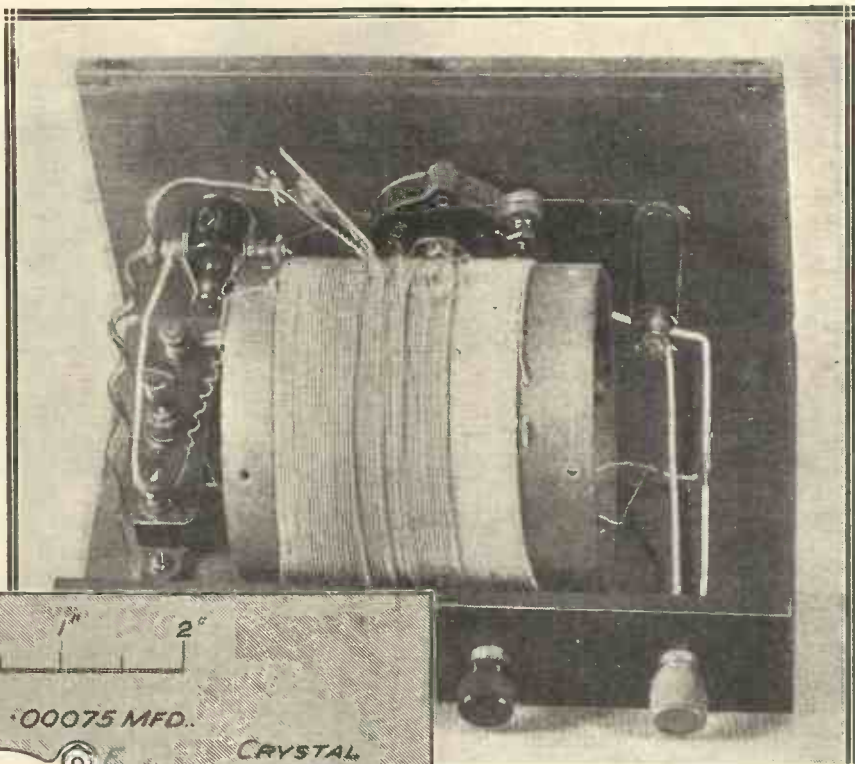

In this back view of the instrument the special tapped coil is well to the fore. The crystal detector is mounted on the panel to the right of this coil.

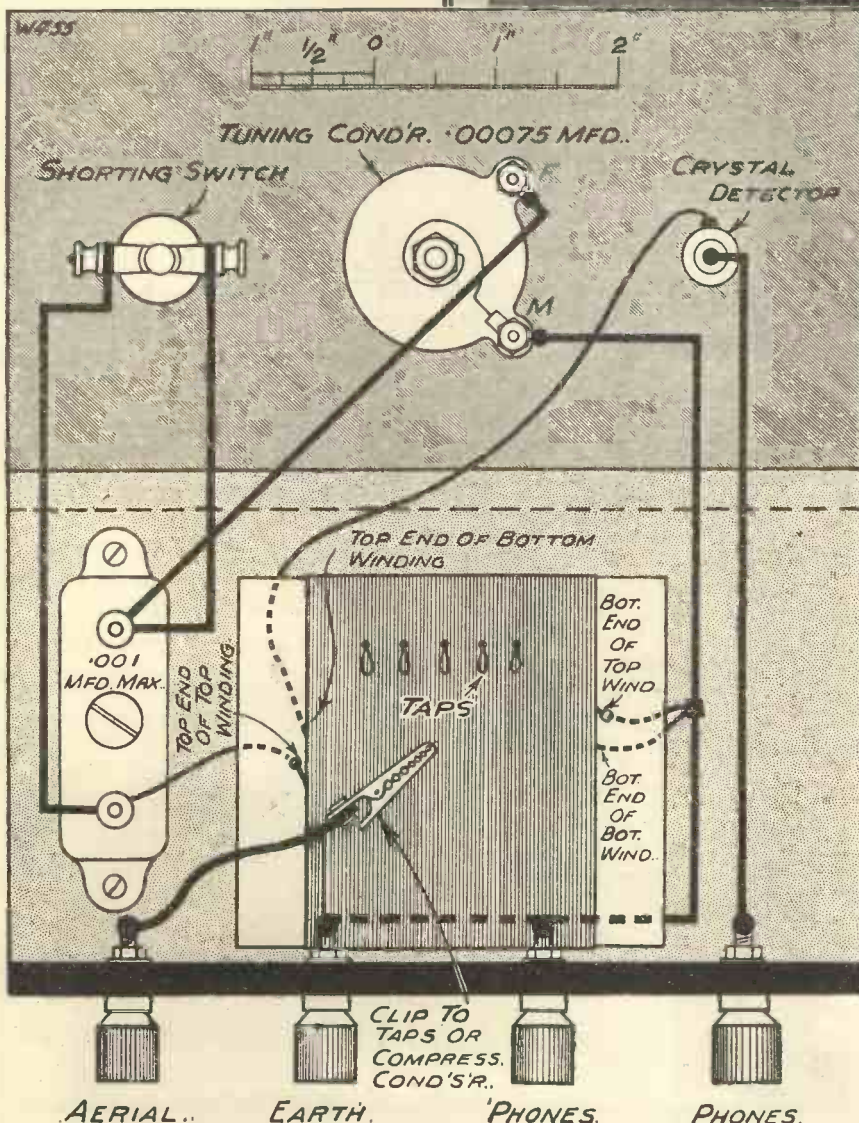

The construction of this interesting little unit is perfectly straightforward, and the arrangement of the various components is shown in detail in this diagram. It makes as good a crystal set as it does a rejector unit.

Here, again, the "S.-B." crystal set would help matters by completely eliminating the local interference and allowing the coveted programme to be obtained free from such interruption.

It is, indeed, a unit that should have a wide love. It is easy to work, and its double role makes it particularly welcome.

The circuit is simplicity itself. We have two windings—on the same former—tightly coupled. One acts as the tuned aerial inductance for the crystal set, and also as the tuned inductance for the rejector circuit, while the other winding is an untuned secondary for the crystal-phones circuit.

**Removing Damping**

It is, of course, partly tuned by reason of the tight coupling between the two circuits, but it isolates the damping of the crystal circuit from the tuned circuit sufficiently to allow of adequately sharp tuning for both reception and rejector purposes, and enables a particularly sensitive form of crystal set to be constructed.

The construction will take about half an hour; just the time required to wind a couple of coils and mount

## A Two-Purpose Unit of Unique Construction

a few components on a wooden "panel" and baseboard.

The "panel" is of thin wood (not more than  $\frac{1}{4}$  in. thick, mounted on the usual  $\frac{3}{8}$ -in. baseboard, but much smaller, of course), while a terminal strip  $1\frac{1}{2}$  in. wide, with four terminals, completes the structural part of the unit.

centre of the baseboard, the compression condenser at one end of it. Now you can connect up as shown in the wiring diagram.

In use the unit is operated as follows: As a crystal set you connect between aerial and earth in the usual way, place the 'phones across the 'phone terminals, and with the crocodile clip on one of the

tappings tune with the .00075 variable condenser. The on-off switch should be pulled out.

A little experiment with the tapping points will soon enable you to find the best results on your particular local station. The unit does not, of course, cover the long waves, being for medium wave-band only.

### Stopping Jamming

Now tune your set to the interfering station and then adjust the rejector. The compression condenser should be about half-in, and careful tuning of the .00075 condenser should enable you to find a point where the interference vanishes. Then adjustment of both condensers should be made till the point of sharpest diminution is found. But a little experience will soon enable you to cut out the undesired transmission, and your stand-by crystal set will be fulfilling the second of its two purposes.

If you live up in the north you may find that you can with advantage add ten or a dozen turns to the top winding of the unit, as you will not need to tune down to wave-lengths quite so low as that of the London National.

### ONLY THREE PANEL COMPONENTS

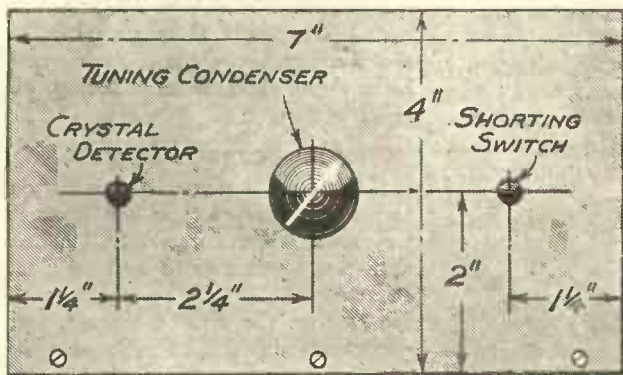

A2493

PANEL LAYOUT.

The panel carries the crystal detector, tuning condenser and shorting switch, all of which are of the one-hole-fixing variety.

On the panel are, central, a .00075-mfd. dielectric condenser, and on one side a crystal detector of the semi-permanent type, and on the other an ordinary on-off switch.

The baseboard "furniture" consists of the coil, on a 3-in. pirtoid or paxolin former, and one compression-type condenser.

The first step is to mount the components on the panel and fix this to the baseboard. Likewise the terminal strip with its four terminals.

Next wind on the former, starting  $\frac{1}{2}$  in. from one end, 40 turns of 30 D.S.C. wire. Anchor at each end, and then wind above it, starting at the same place, 60 turns of 24 D.C.C. wire, tapped at 20, 25, 30, 35, and 40 turns.

### Using the Unit

Thus you wind 20 turns and make a loop, wind another five and make another loop, another five and a loop, and two more fives and two more loops, then continue a further twenty turns to the end of the winding. Anchor the ends.

The loops are bared and left ready for the crocodile clip to make contact. There are now five contact points and four ends to the coil unit, two "beginnings" and two "ends."

Mount the coil on its side in the

When you want to use the unit as a rejector, you can leave the 'phones

### READY TO "REJECT" THAT UNWANTED PROGRAMME

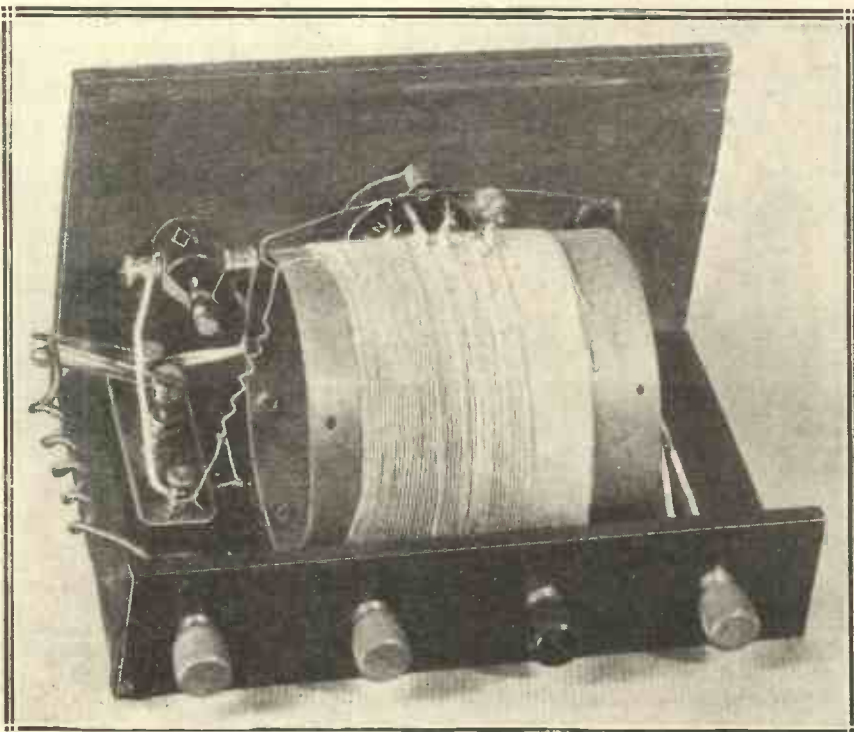

In this photograph the unit is shown with the crocodile clip on the pre-set condenser, ready for duty as a rejector. The arrangement of the double-layer winding is also clearly indicated.

**POWER FROM LOW-VOLTAGE MAINS**

*There are a number of private lighting plants about the country giving from 32 to 100 volts, and this article tells you how to make full use of these for your radio.*

**By the Hon. MICHAEL NORTON.**

**T**HERE must be a great many people in this country who are not within reach of the mains, but who have access to a private electric lighting plant. This plant probably gives direct current at either 32, 50, or 100 volts.

**A Rotary Convertor.**

If this is the case with regard to your own electric supply you probably find it inadvisable to use electric fires or a refrigerator. But what about your wireless? For an additional outlay of a few pounds you can run any A.C. mains set from your home plant.

I am going to try and show that it is well worth the extra cost.

In order to run an A.C. set from direct current of any voltage you require a rotary transformer. This may be bought for about ten pounds and can be obtained to give almost any A.C. voltage.

Many wireless dealers seem to be rather suspicious of these trans-

formers and may tell you that it is not worth your while to buy one. Most people seem to think that they cause a terrific hum in the loud speaker unless it is "installed" in the coal cellar or in some equally remote quarter. They are also under the delusion that it uses more current than the most powerful electric lamp.

If you buy one of these machines, there is no "installing" necessary. The instrument is about the size of an ordinary wireless set, and is in a metal case; which is, of course, for the purpose of screening it from your set. You can, therefore, place the transformer as near the receiver as you like.

**Easy to Install**

One side of the transformer is then connected to a lamp holder or wall plug, while the other is connected to your set. The metal case should be earthed, though this is not always necessary.

Unless your set is very large you will not find that it will take more

current than a 60-watt lamp, so that the running costs of the set will be very moderate, probably far cheaper in the long run than accumulator and batteries.

As for the hum caused by the convertor, this will be less noticeable than if the set were run off A.C. mains. You have, therefore, the best type of set for quality, volume and distance, without its disadvantage, namely, audible hum.

I have no interest in any firm manufacturing rotary transformers, but I have one of these instruments in constant use. My own A.C. set was tested on the A.C. mains in the nearest big town, and gave more hum there than when working off my transformer.

**For Larger Plants**

If your plant gives 100 volts you can run an all-electric set from it without any transformer. In America there are sets made to operate from 100 volts D.C. I do not think there are any on the British market, but you should be able to make one for yourself, or you may alter your present one.

Ordinary H.F. valves (if they are not of the screened-grid type), also the detector and first stages of L.F., will operate well from 100 volts D.C. If you are wondering how you can deal with the last or output stage of the set if you have only 100 volts H.T., remember that the difficulty is solved by using two L.F. valves in push-pull.

**GANDHI MAKES A GRAMOPHONE RECORD**



While Gandhi was staying at Kingsley Hall, London, at the end of last year, the Columbia people took along a portable recorder for the Mahatma to record his world message. The photograph shows Gandhi speaking into the instrument.

**OILING YOUR RADIO-GRAM MOTOR**  
*A useful tip which will help you to get oil in awkward places.*

**W**HEN oiling your radio-gram motor you may find that it is a difficult task to get the nozzle of your only available oil-can down into the "innards" of the motor.

Do not despair, however. The job is more easily accomplished than perhaps you may have thought.

Merely wrap two or three turns of No. 22 bare wire tightly round the oil-can nozzle, leaving about three inches of wire projecting in front of the nozzle.

On squeezing the can, oil will be exuded from the nozzle, but it will not drop away from the latter. On the contrary, it will trickle along the projecting wire, and by this device therefore oil may be guided into the most inaccessible parts of the radio-gram motor efficiently and cleanly.

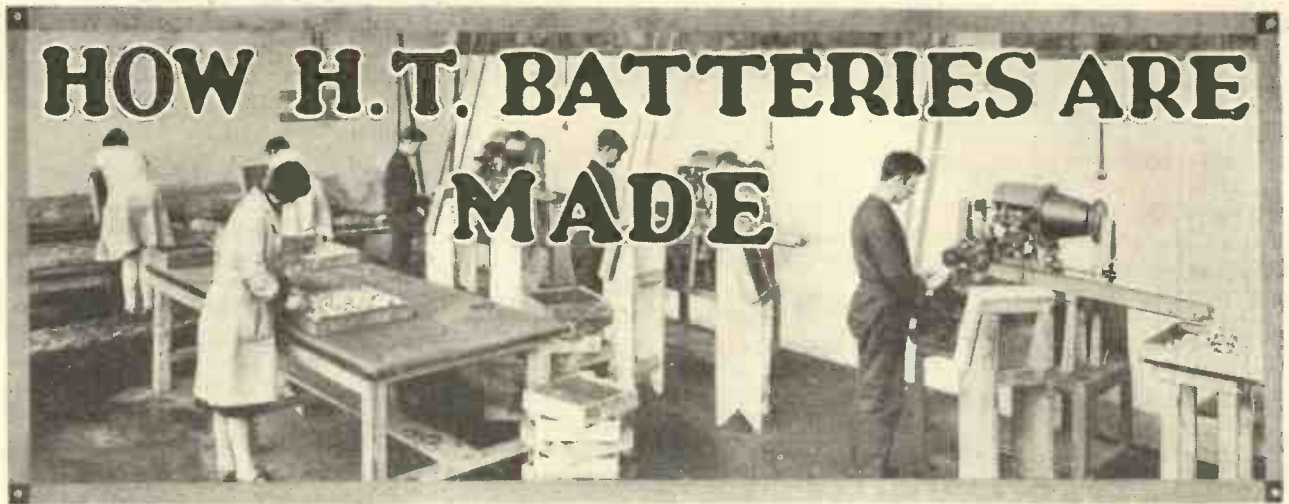

*In this unique article our contributor describes the "secret of life" of the dry battery in all its details, from the raw materials dug out of huge mountains, to the finished product.*

**T**HE object of the present article is to give the reader an insight into that "mysterious box," the H.T. battery. True, after use the battery may be opened, but examination will only show up a few of the manufacturing details. And invariably with one's hands in a filthy state one wonders whether the small amount of knowledge gained was really worth while? It is to avoid this extremely unpleasant "post mortem" that the present article has been penned.

**Important Ingredient**

Constructionally, all batteries are much the same—that is to say, they look alike except for a few details.

The block battery consists of a number of miniature cells joined together in series, and pitched into a container, and the manufacturing processes involved, together with an insight into the nature of the raw materials used, will be given in the order that the maker generally deals with them.

By far the most important material from an efficiency point of view is manganese dioxide. This is found in various parts of the world, but from the battery standpoint by far the most important source is the Caucasus Mountains.

**In All Sizes**

Known mineralogically as pyrolusite, this material commonly contains a dioxide content varying from 60 to 95 per cent. It's found in nodules graduating from a pinhead size to relatively huge pieces weighing several tons. Its commercial value for battery manufacture depends on the available oxygen content, together with as small an iron and copper content as possible.

The latter two impurities render a sample useless should analysis prove it to contain more than 1 per cent. Opinions differ as to whether the efficiency of manganese is due to chemical or physical reasons, but it has definitely been proved that the shape of the mined

sample would make a battery having a generally poor efficiency.

Whilst good synthetic manganese dioxide can be prepared in the laboratory, cost is prohibitive, and a compromise has to be made by blending artificial and natural in such a manner that a healthy combination

**FORCING THE CHEMICALS ON TO THE POSITIVE ELEMENTS**

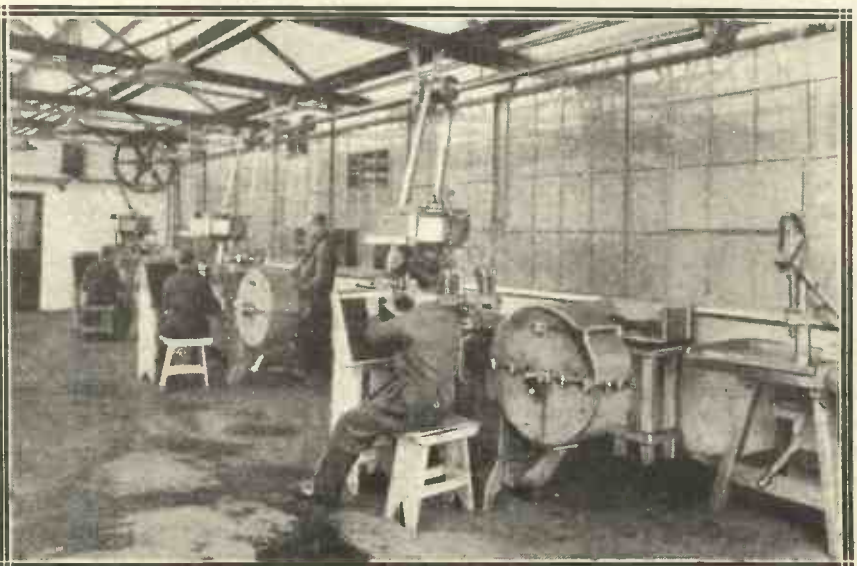

All H.T. dry batteries are made up of a large number of small cells connected in series. The positive pole of each separate cell consists of a tiny carbon rod, around which the various chemicals are pressed. The machines seen in this photograph are used for forcing some of these chemicals around the rods. Each machine is capable of turning out about 3,000 "dollies" (as the completed positive elements are called) per hour.

nodules has an influence upon the efficiency of a battery.

**A Peculiarity**

It has been known to mine two samples from the same locality, one bearing an angular structure and the other a rounded appearance. Analytically, the available oxygen content in each case is identical, yet the latter

may be made. The successful manufacturer understands this material in such a way that relative efficiency is combined with cheapness.

Next on the list is carbon; for dry cell manufacture graphite is the form of carbon selected. It is safe to say that the qualities available run into hundreds, mined from places all over the world; its value

depends largely on the ash content, which must be small.

Sal-ammoniac is added to the depolarising mixture to assist in the setting of the "dollie," and also to maintain the concentration of the electrolyte. This is generally manufactured either by passing ammonia gas into dilute hydrochloric acid or else by subliming a mixture of common salt and ammonium sulphate.

### Making Electrolyte

In the latter process the mixture is heated and dense white smoke is given off through dissociation, the chlorine radical present in common salt being exchanged for the sulphate content of the ammonium sulphate.

troubles which arise through alterations of specific gravity when the cell is working, and consequently assists the even corrosion of zinc which is responsible for the working of the cell.

Another important property of zinc chloride is that it readily absorbs free ammonia gas and returns into solution the double salt, zinc ammonium chloride, which, in its turn, is again used in the exchange of chemical for electrical energy. The presence of the ammonia gas in the Leclanché cell represses voltage, and as a result the full voltage of the cell is unobtainable.

In view of this the importance of zinc chloride will be realised. On the

Chapelle areas, and another very fine quality is that known as Silesian muffle. Zinc ores are always found associated with a metal called cadmium.

### Purifying Zinc

By the Silesian process the zinc ore is put into long, flat "D"-shaped retorts. A curved tube passes from the mouth of the retort into a vertical cast-iron tube which acts as a condenser. A mixture of zinc ore and coal is heated to a temperature at which the cadmium present volatilises off, whilst the zinc remains behind.

When this impurity has all been expelled, the temperature of the furnace is increased and the purified metallic zinc then distils over into the condenser. Even in the purest of commercial zincs small amounts of foreign bodies are revealed by analysis.

### Amalgamation

These unwanted constituents are responsible for shortcomings in the behaviour of the finished cells, to a certain extent, and will often mar the performance of an otherwise perfectly constructed battery. Mercury is added to the electrolyte and in this manner a thin coating of pure zinc is constantly offered to the action of sal-ammoniac, whilst the impurities are kept in the background out of harm's way.

This phenomena of metal solution in mercury appears to be closely analogous to the solution of salts in water; the characteristics of an amalgamated zinc are entirely different from the virgin metal, and experimentally it is found that whilst dilute sulphuric acid will readily attack the untouched variety, the amalgamated zinc is dissolved sparsely. On the other hand, if an amalgamated zinc is made into a battery using dilute sulphuric acid as the electrolyte, on closing the circuit the action is vigorous.

### The Chemical Exchange of Energy

The primary battery is not a generator of current in the true sense of the word, but merely an exchange of one form of energy for another. For simplicity, it may be said that energy is imprisoned in the metallic zinc and it is through the dissolving of the metal that such energy is liberated. Thus the cell is the means by which the current passes out of the decomposing body, in just the same way that an exercised human body dissipates surplus energy in the

### WRAPPING THE "DOLLIES" IN MUSLIN!

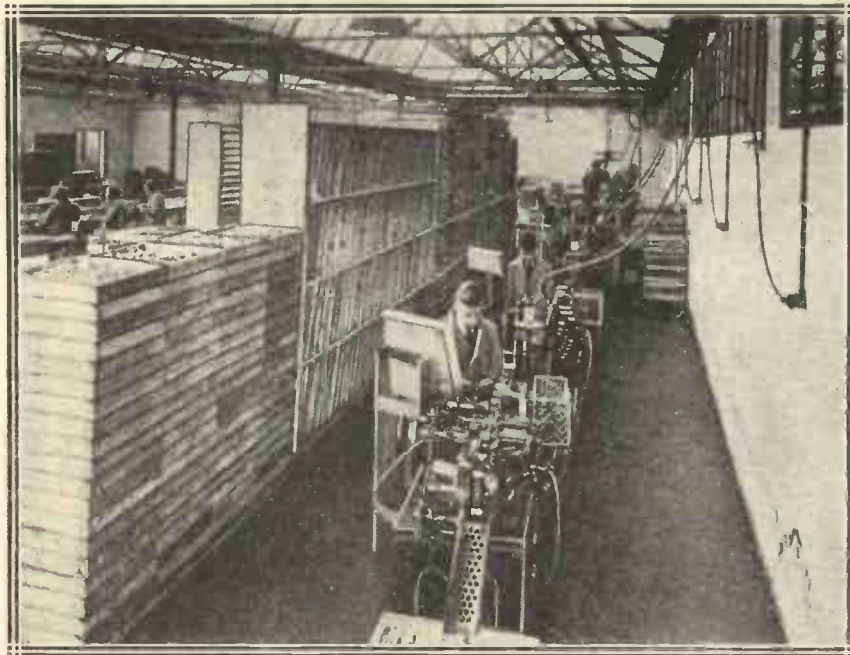

When the "dollies" have been thoroughly seasoned and hardened they are passed through these machines, which carefully wrap each one in a small piece of muslin and ingeniously tie it up with string.

By this sublimation process, invariably a small percentage of ammonium sulphate is found in the chloride as impurity.

Zinc chloride is also a constituent of the electrolyte, its addition being advantageous as it tends to keep the cell in a moist state, and to a large extent prevents local action. On the surface this is difficult to believe, but research has proved that a reasonably dilute solution of ammonium chloride attacks zinc more readily than does the concentrated solution.

### Extremely Soluble

Zinc chloride is extremely soluble in water, and will even dissolve in a saturated solution of ammonium chloride. This tends to eradicate

other hand, should the percentage of zinc chloride be in excess, there will be formed insoluble complex salts of zinc which are so voluminous that the cell will burst, giving rise to the presence of moisture on the separators, in the nest or container, thereby creating an internal short-circuit which results in an early breakdown.

It is expedient that even corrosion of the zinc takes place. Whilst chemically pure zinc is out of the question from the battery point of view, the margin of impurities permissible is very small. Commercial zinc varies to a large extent, and samples analyse with a zinc content varying from 92 to 99.5 per cent.

Probably the finest zincs obtainable are smelted in the Liege and Aix-le-

## Providing Volts for Your Radio Receiver

### BUILDING UP THE BATTERIES

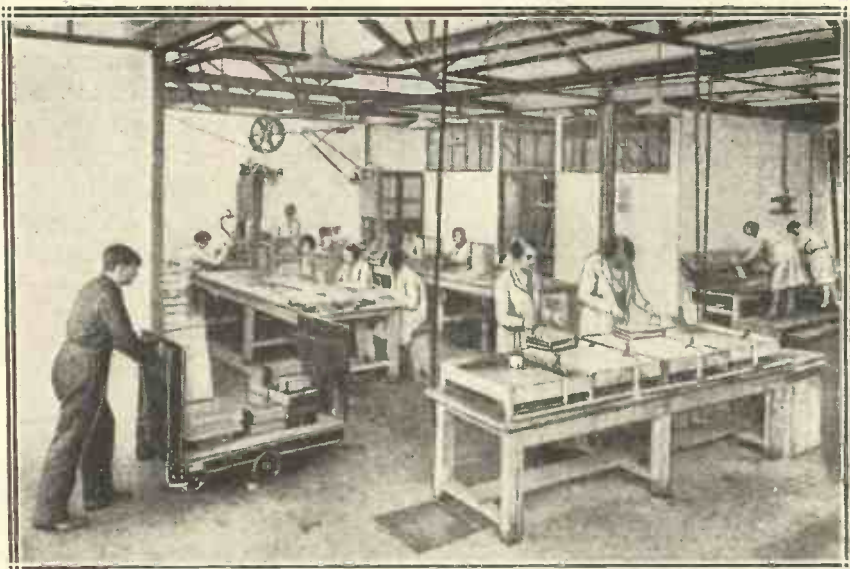

In the background is the machinery which delivers just the right amount of electrolyte mixture necessary to fill each cell. After they have been filled the cells are "cooked" at a temperature of about 90° C. They are then assembled in the form of batteries, the number varying according to the voltage required.

form of heat which directly emanates from food consumed.

This will naturally suggest to the reader that the manufacture of a battery is a simple matter, and just a mechanical mixture of various ingredients, to give efficiency. It has been found that this is not the case, and although production is purely a mechanical proposition, the chemist is constantly working in the background testing and selecting material both from the chemical and physical standpoints, and it is only by such supervision that the efficient battery of to-day has become a possibility.

#### Battery Faults

Numbers of faults are developed in dry batteries, but very little is known by the purchaser as to the particular reasons governing such defects. Dealers adopt a pedantic attitude and often create a false impression, with the result that an otherwise perfect name is unnecessarily condemned. Manufacturers can tell by internal examination the cause of the defect, and British firms will always step into the breach and do the thing that is right when the defect is a manufacturing fault.

Size of cell is much more important than at first is apparent. It is essential that correct cells are used in a battery in relation to discharge, otherwise distress occurs and internally the cell is called upon to deal

with products of combustion which it is incapable of doing, consequently an all-round lowering of E.M.F. and of general efficiency results.

#### Voltage Drop

The dimensions of the sac govern the general depolarising ability of the cell, and as E.M.F. is directly proportional to depolarisation, it naturally follows that unless the sac can deal

with occluded gases in an expeditious manner an increase of internal resistance is a natural sequence, with a consequent drop in overall voltage.

Depolarisation is much more complicated than at first is apparent, as factors governing its efficiency are influenced widely by the physical properties of the oxidising agent used, i.e. manganese dioxide. It has been found that the manganese dioxide mined in different parts of the world differs greatly in behaviour.

#### Manganese Dioxide

American manufacturers favour a manganese from the Montana deposits, the available dioxide content of which ranges from 70-74 per cent. This material functions in a perfect way, and in some cases much better than a mineral showing an analysis in the range of 86-88 per cent. Through the relatively inferior qualities of the average manganese available on the European markets, it is the practice of manufacturers to obtain an ore containing as high a dioxide as possible.

This reason will be apparent to the reader when it is explained that the greater the quantity of oxygen added via the dioxide content, the greater the quantity of harmful hydrogen that it will be able to neutralise, thus assisting in decreasing

*(Continued on page 297)*

#### MECHANICAL MIXERS STIRRING THE ELECTROLYTE

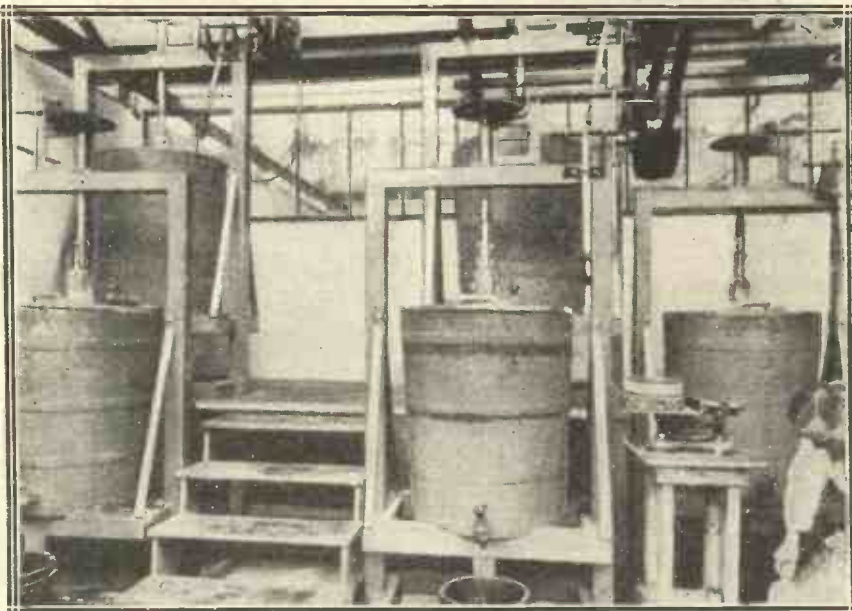

These are the large vats in which the electrolyte is mixed before being put into the cells. The mixing process is all done by machinery, and the driving mechanism can be seen above the vats. Great accuracy and care are necessary in the mixing stage.

# How To Make Your

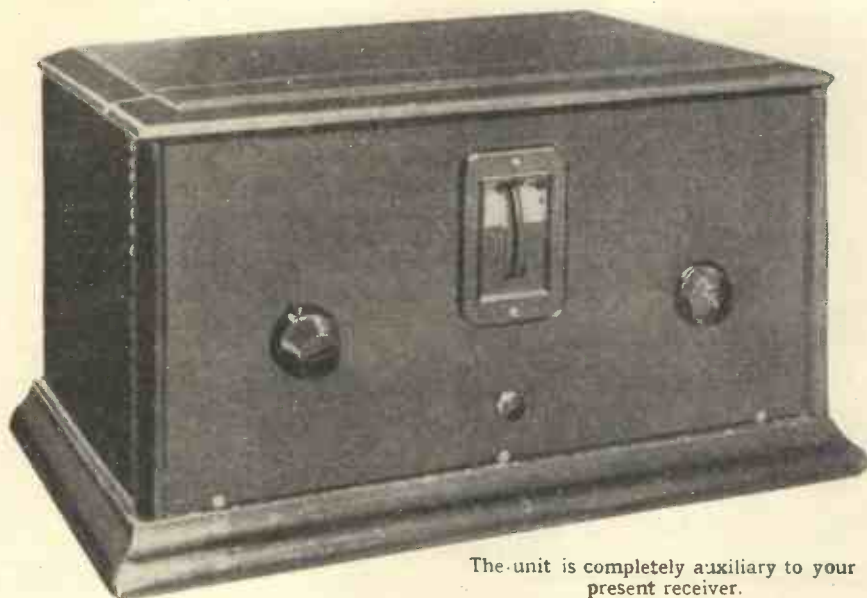

The unit is completely auxiliary to your present receiver.

There must be many constructors who realise the great advantages of using an Eckersley Tuner, but are unable to do so because they find it beyond their means or inclination to build an entirely new set or modify their existing one. But here is a solution to the problem—an adaptor which is immediately applicable to an existing outfit.

Thus take the instance of the man who has a three-valve receiver which, owing to his proximity to the local station, finds that it is not really selective enough to enable him to cut out the offending local and receive distant programmes.

**T**HE Eckersley Tuner needs no introduction to most of our readers, but the idea of building a complete receiver to test the merits of that tuner may not appeal to many of them. It is not everyone, however much he may be interested in radio, who can afford to scrap his set or to buy the complete kit of parts for a new one in order to be the proud possessor of the latest thing in wireless tuners.

For it is the latest, and as such it is worth close attention. We have therefore designed a special unit for those who wish to try out the tuner without upsetting their normal receiver arrangement.

But before we go on to the discussion of the Eckersley Adaptor, as it is called, we would like to give those new readers of ours, and those to whom the tuner is not familiar, a rough outline of the system, and how it operates and what it is supposed to do.

## What It Is

In the first place we must make it clear that the Eckersley Tuner is not a band-pass unit in the usually accepted sense of the term, nor is it a special sort of freak tuner that is designed to bring more power to your set and enable you to get more stations.

It is intended for the man who wants more *selectivity*, but does not want to go to the full extent of band-pass tuning and its usual accompaniment of some loss of sensitivity.

The facts of the matter are these. The band-pass arrangement as we normally know it is an excellent scheme, but it does, in the case of sets using no high-frequency stages, cause a rather unwelcome loss of sensitivity.

Do not run away with the idea that we are decrying the various band-pass arrangements that are on the market. On the contrary, we fully appreciate the advantages that they provide. But it is necessary to show exactly where the Eckersley Tuner falls into the scheme of things.

The band-pass tuner is an excellent thing, otherwise we should not have used it in the three-valve set that is described on other pages of this issue. But it is not really suitable in many cases where simple sets are concerned.

## Where It Scores

What is the best thing he can do short of redesigning his set and adding a tuned high-frequency stage?

It is a difficult question to answer. If he uses band-pass tuning he will probably lose such a lot of sensitivity that he will greatly reduce his bag of foreign programmes, and most of the usual devices for sharpening the tuning of wireless receivers will have a similar effect.

"Oh," you will say, "the Eckersley Tuner will probably suffer from the same complaint."

If you mean that it will somewhat reduce your strength of reception the answer is yes. But if you infer that it will cause you to cut down your sensitivity so badly that you will lose

## YOU NEED THESE COMPONENTS

- |   |  |
|---|--|
| <b>PANEL</b><br>14 in. × 7 in. (Permeol, Peto-Scott, Becol, Ready Radio, Wearite, Goltone).   | Formo, Telsen, Graham Farish, Sovereign, Ferranti, Watmel, Goltone, Lissen). |
| <b>CABINET</b><br>Panel space 14 in. × 7 in., baseboard 10 in. deep (Gilbert, Peto-Scott, Ready Radio, Camco, Pickett, Osborn).   |  |
| <b>VARIABLE CONDENSERS</b><br>2 .0005-mfd. double thumb control (Cyldon type Synchratune Junior, J.B., Polar).<br>1 .0003-mfd. solid-dielectric with shorting position (Ready Radio).<br>1 .0001-.00015-mfd. max. differential reaction condenser (Telsen, Ready Radio, Ferranti, J.B., Lotus, Cyldon, Lissen, Magnum, Formo, Wavemaster, Graham Farish). |  |
| <b>VALVE HOLDER</b><br>1 4-pin (Lotus V.H.K., Telsen, Wearite, W.B., Bulgin, Graham Farish, Lissen, Clifx, Igranic, Magnum).  |  |
| <b>FIXED CONDENSER</b><br>1 .0003-mfd. (Dubliet type 670, T.C.C.)   |  |
| <b>H.F. CHOKE</b><br>1 (Lewcos M.C., Ready Radio, Telsen, R.I., Sovereign, Varley, Peto-Scott, Lissen, Climax, Wearite).  |  |
| <b>RESISTANCE</b><br>1 2-meg. (Graham Farish "Megite," Loewe, Igranic, Dubliet, or (with holder) Telsen, Ready Radio, Lissen, Ferranti, Watmel, Varley).  |  |
| <b>SWITCH</b><br>1 3-point on-off (Telsen).   |  |
| <b>COIL</b><br>1 "Eckersley."   |  |
| <b>MISCELLANEOUS</b><br>1 Terminal block (Sovereign, Belling & Lee).<br>2 Terminals (Eclax, Igranic, Belling & Lee, Bulgin, Clifx).<br>1 Four-pin valve adaptor plug (Lissen).<br>Wire (Glazite or Lacolite, Quickwyre, Jiblinx). Flex, screws, etc.  |  |



# Set Selective

## AN ECKERSLEY-TUNER UNIT FOR IMMEDIATE TRANSFORMATION

most of your foreign programmes, the answer is no.

The Eckersley Tuner is unique in that it enables a degree of selectivity to be obtained that is almost equal to that of a band-pass system, and yet the loss of sensitivity is remarkably small.

You cannot have anything in this world for nothing—not that is worth having, at any rate. And radio is certainly no exception. You have two

sufficient selectivity to enable them to cut out their local stations and get a fair bag of foreigners, but they are prepared to give up some of the ease of tuning that has been a feature of their flat, unselective set, and to go without some of the distant stations.

### Simply Connected

You cannot have it both ways: either you have to lose volume and gain selectivity, or you must lose the

The Eckersley Adaptor is a particularly simple unit for applying the tuner to any type of receiver. All you have to do after building the unit, a particularly easy job, is to take out the detector valve of your set and insert the adaptor plug of the unit in the detector socket, placing the detector valve in the valve holder in the Eckersley Adaptor.

Simple, is it not? And yet there is nothing difficult in the construction

### Can Be at Once Connected to Any Receiver

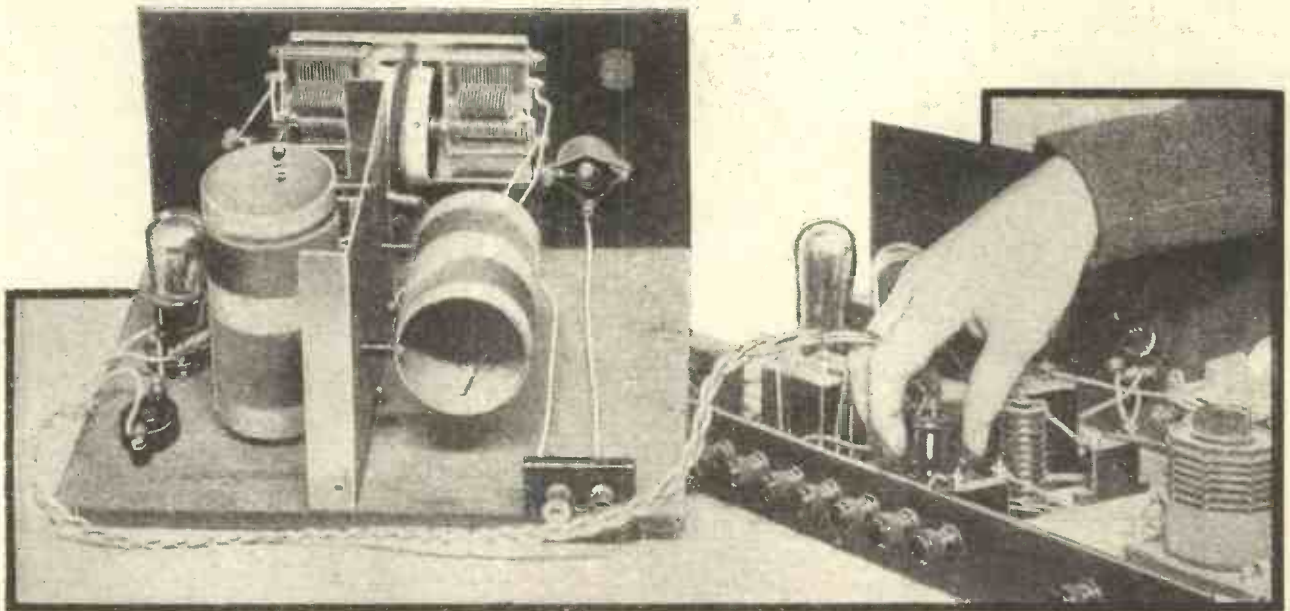

You merely "plug in" and place the detector valve in the Eckersley Unit. No alterations have to be made to the internal wiring of the receiver.

alternative states of affairs—the full measure of sensitivity and the full measure of selectivity. As a compromise between the two we can have a bit of each.

### A Good Balance

The problem is, however, how much of either of the two ideals we shall sacrifice? Each by itself is wholly desirable, but each is the antithesis of the other. We have to balance them together, therefore, and find a compromise that will best suit our particular requirements.

It is here that the Eckersley Tuner comes into its own. Most people want

latter to gain the former. The Eckersley Tuner is the best compromise between the two alternatives that we know.

It does not use a gang tuning scheme, with the consequent advantage that there is no trimming to be done. It can be added to any set, especially if it be built in the form of a simple unit such as is to be described hereunder.

But before we go on to describe that unit let us once again emphasise the fact that the Eckersley Tuner is not a station boosting-idea, but a simple means of increasing selectivity with the minimum loss of sensitivity.

of the adaptor, nor is there much in the way of components in it.

It consists of an Eckersley Tuner, a double-drum-drive condenser (though two single ones could be used instead), a valve holder, grid condenser, grid leak, H.F. choke, two terminals, a couple of solid-dielectric condensers, switch, and a valve plug.

### The Filament Leads

The construction is so simple that there is no need to go fully into it. The diagrams and photographs show exactly what the adaptor is and how it is constructed.

There is one small precaution that

# You Couldn't Call It Complicated!

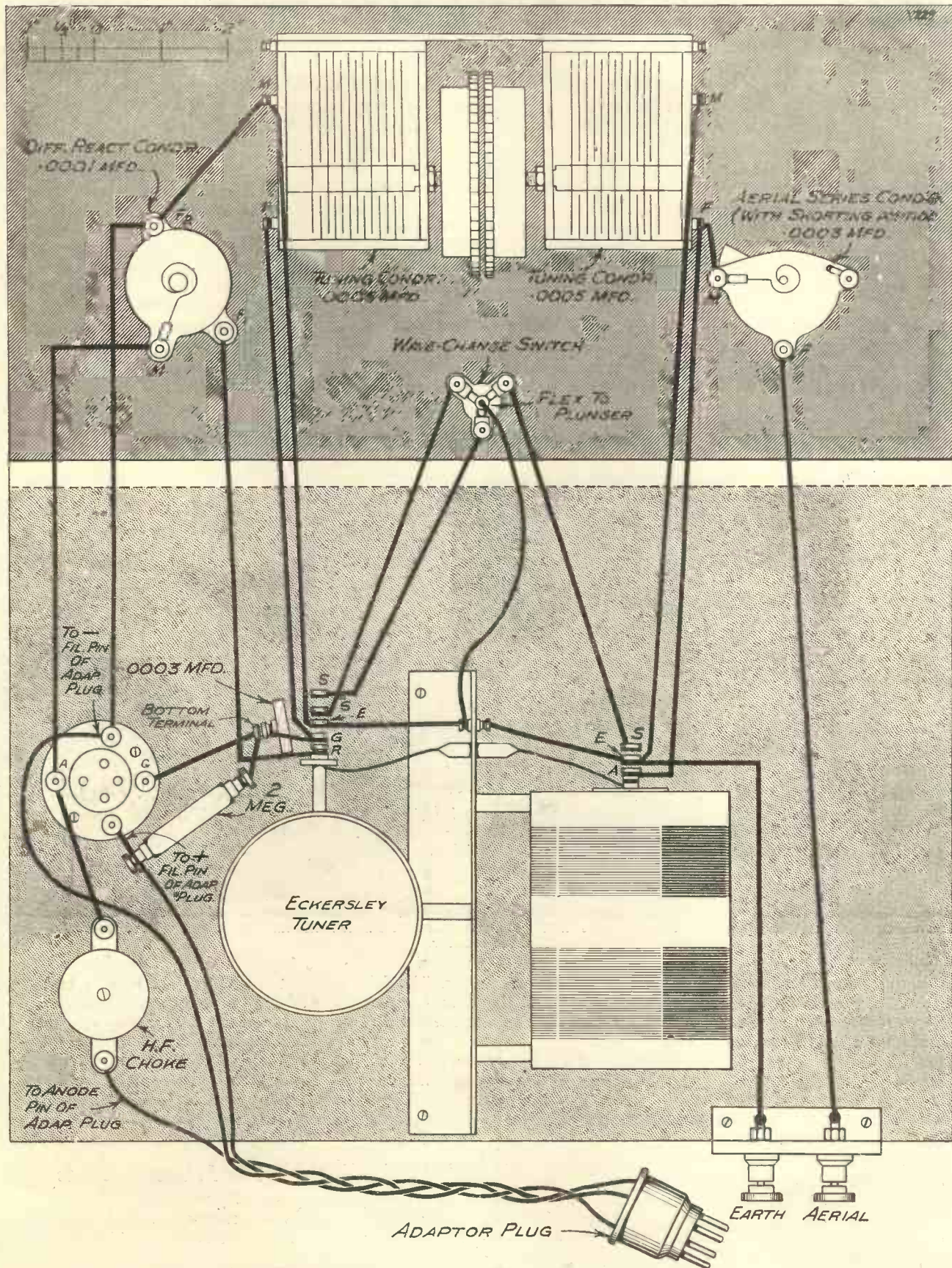

Note the centralised wave-changing by means of a simple push-pull switch, and the sparsity of parts used in this unit.

## Super-Selectivity with Simple Apparatus

should be taken, and that concerns the actual connections of the adaptor plug filament leads. If you look at the diagrams you will see that the unit has an "anode" and two filament leads going to the plug pins of the adaptor plug.

When the plug is inserted in the detector socket of the set with which the adaptor is to be used these plug pins make connection with the anode circuit of the detector in the set, and with the filament circuit of it.

The point is this. The filament lead that comes from the earth circuit of the adaptor should be connected via the plug to the filament circuit in the set that also goes to earth, this time in the set.

This ensures that the correct side of the filament is connected to earth.

### The Controls

The method of using the adaptor we have already outlined, the aerial and earth being removed from the set and transferred to the terminals on the adaptor.

The reaction is controlled by means of the condenser on the adaptor, the reaction control of the set being put at zero. The tuning on the set itself is neglected, as the pre-detector part of the circuit is out of action when the adaptor is in use.

The series aerial condenser on the left of the tuning unit on the adaptor panel is of the self-shorting variety. At the minimum position the moving and fixed vanes come into contact by reason of a pin that passes through the condenser, making contact with the fixed vanes.

This enables the condenser to be shorted out when the unit is to be used on the long waves. And, talking about the long waves, there is one point that we should bring to your notice.

### On Long Waves

The Eckersley Tuner was designed by Capt. Eckersley for use on the average aerial possessed by the majority of home constructors. If it is used on a very short aerial, such as the indoor variety, you may find a little difficulty in properly tuning in stations above 1,700 metres. Should such an event occur the trouble is easily remedied by connecting a .0001-mfd. fixed condenser across the long-wave winding of the aerial section of the tuner. This will in no way affect the tuning of the medium wave-band.

The tuning is very easy provided it is done systematically. The left-hand tuning drum will be found to be quite flat compared with the right-hand drum. This latter will not vary in reading with alterations in the series aerial condenser, as will the left-hand drum.

### Note the Readings

Consequently it is of advantage to calibrate the right-hand drum readings so that once a station has been found it can always be found again regardless of the position of the series aerial condenser. This latter is used for the purpose of adjusting the selectivity on the medium wave-band, but on the long waves it is set at minimum, at which setting it is short-circuited.

To get the real hang of the tuning it is best to practice on the local stations for some time, as it will be found to be a little out of the ordinary, though it cannot be called difficult. Reaction will enable more distant stations to be found easily, as a

feature of this tuner is that any adjustment of the aerial condenser can be made without in the least upsetting the adjustment of the other one. Thus a distant station can be found by its carrier, and then can be practically resolved by means of the right-hand condenser, after which the left-hand condenser can be adjusted to bring the station in at maximum volume, no further alteration being necessary to the right-hand one.

### One Filament Switch

It is difficult to explain in words exactly how a unit of this description should be tuned, but a little practise will soon enable you to get the hang of the Eckersley Adaptor, when you will find you have greatly improved selectivity without any really serious loss of sensitivity.

We must add that the filament control of the Eckersley Adaptor is carried out solely by the filament switch of the set to which it is attached; it needs no switch of its own.

YOU WILL REMOVE THAT "SWAMPING"

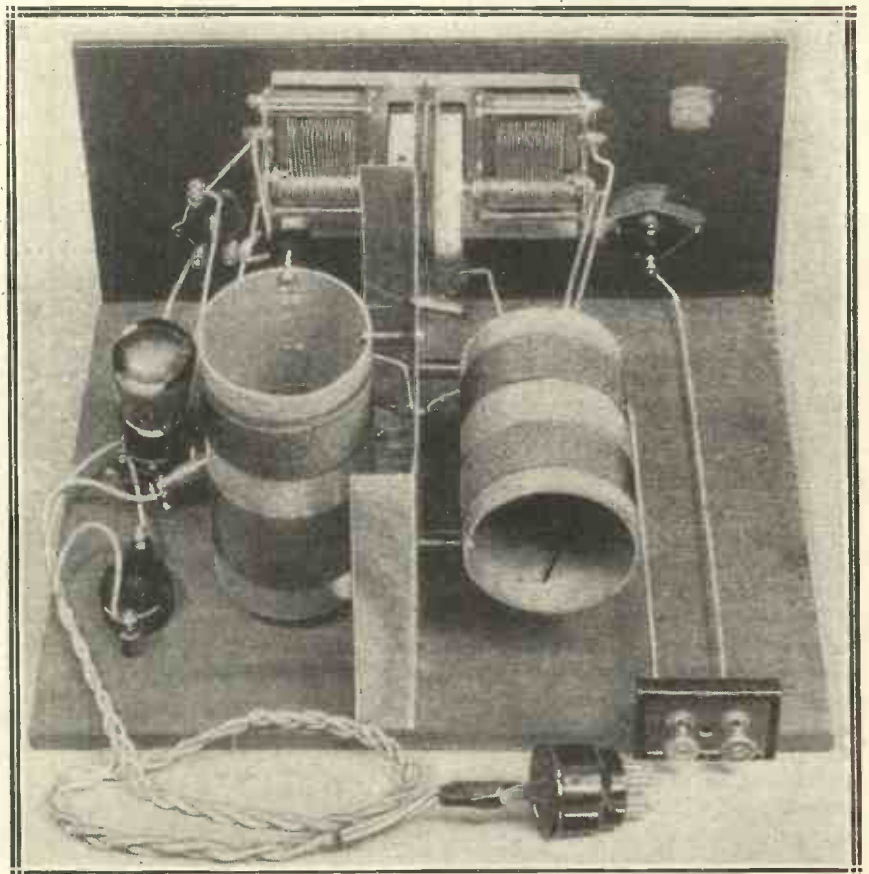

The local stations are unable to smash through any tuning adjustment on an Eckersley Tuner—they are marshalled into their places, although no loss of power is occasioned.

**STRAIGHTFORWARD CIRCUIT ARRANGEMENT**

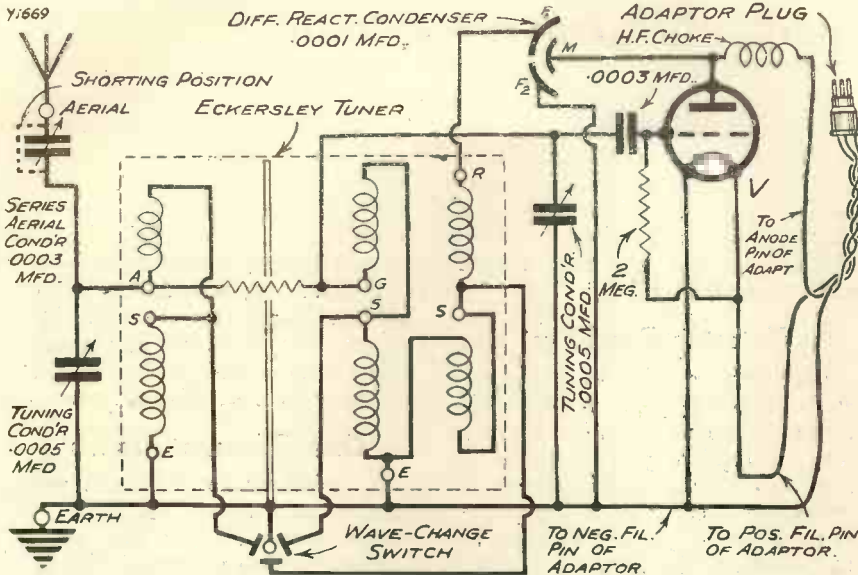

As you can see, the unit is essentially a complete detector circuit of an efficient character, employing the famous Eckersley Tuner.

And now there are one or two points concerning the use of this type of tuner that we should like to discuss. From correspondence from readers all over the country it appears that there is a wish for some means of adjusting the sensitivity of the unit other than by the series selectivity condenser.

A case in point is the letter from a reader in the south of England. This reader wants to use the Eckersley coil, but he wants a cross between the selectivity provided by this coil and that obtained from an ordinarily selective tuning system.

He states: "I do not require quite the selectivity provided by the Eckersley Tuner, but should like a little more than can be obtained with the average tuner. My main trouble here is not the interference between two locals, but a certain amount of noise from shipping, and difficulty in getting some of the long-wave and short-wave foreigners clear of each other."

**Coupling Resistance**

The Eckersley Tuner was designed by Capt. Eckersley to carry out a very difficult purpose—that of providing good selectivity at close distances from the local station without the loss of sensitivity that is usually associated with sharply-tuned circuits.

The factor that controls the selectivity of the tuner as a whole is the resistance joining the high potential ends of the coils. This also, of course, has a certain effect on the sensitivity of the unit, and obviously what suits the man who is close up against the local may not suit him who is not within fifty miles of a transmitter.

You may say that the latter need not go in for the Eckersley Tuner, but if he wants selectivity he must use something of that sort, and it is not only the listener near a station that requires a sharply-tuned set.

**Adjusting Selectivity**

There is a way, and a simple way at that, of controlling the selectivity of the tuner, though that control is not of a continuous variety. With a specially designed non-inductive resistance it could be made so, but that would increase the cost of the com-

ponent; and, really, there is no need for frills of that sort.

All that has to be done by the experimentally-minded constructor is to remove the small leak type of resistance joining the two coils and substitute another of a different value.

This resistance should be of the same non-inductive leak type, and may be anything in value from 100,000 ohms (which you have in the unit already) to 25,000 ohms or so.

**A Favourable Point**

The lower the value the less will be the selectivity, and it will be found that the strength of reception increases as the selectivity decreases. This, of course, is a quite normal state of affairs, but it means that the spread of the local station, if you are at all near, will become very great if anything like the low value is employed.

The fact that the selectivity can thus be easily adjusted is a big point in the favour of the Eckersley coil method of getting selectivity when compared with the immovability of the band-pass unit. It is a feature that should be borne in mind by every constructor, for it enables him to suit his coil exactly to his own requirements. And that ensures that he will get the best results from his Eckersley coil.

We have been discussing the resistance between the two sections of the Eckersley coil, showing how it controls the selectivity of the unit, but we have said nothing concerning this resistance when it is not functioning properly.

**RELIEVED OF ALL RESPONSIBILITY**

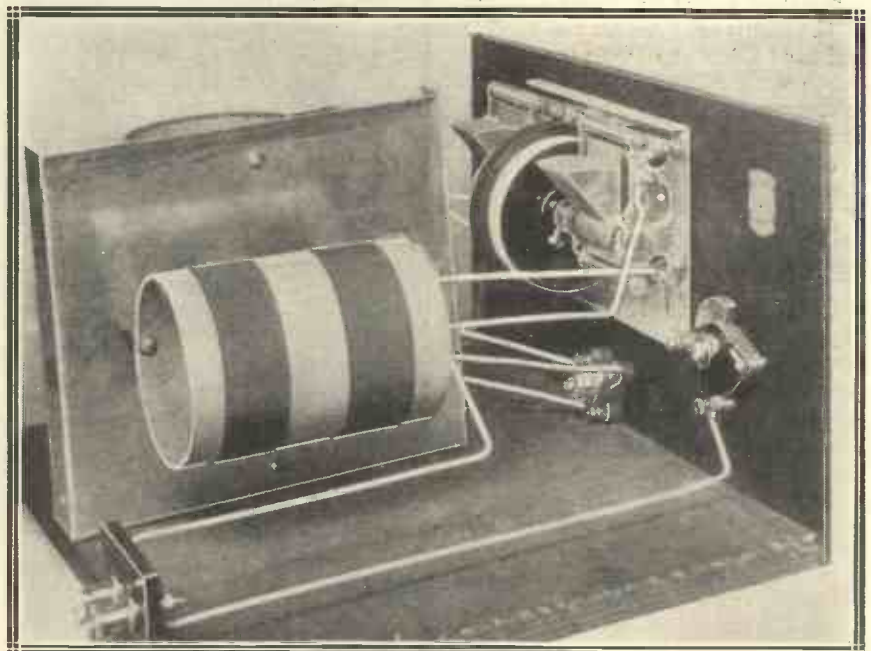

The unit takes over all tuning, reaction and detector tasks from the set with which it is used, and the tuning controls on this latter do not have to be touched when the unit is in action.

## Your Key to Keener Station Separation

Such an occasion is rare, but there have been instances brought to our notice of resistances that have broken during transport, and of others that are of wrong value, due to faults in their manufacture.

In the first case, the effect is that of excessive selectivity with consequent loss of sensitivity. With a broken resistance there is very little coupling between the two coils, and naturally the tuning is extremely sharp, and the strength of reception not what it should be.

In such a case it is usually very difficult to find even the local station, and the possibility of picking up

value it is just as easy to spot the trouble. In the case of a resistance that is too low the selectivity will be of a poor order, although the strength

the remedy in each case is obvious. But it must be said in fairness to the various manufacturers of the Eckersley coil that very few instances of

### UNIFIED TUNING FOR EASIER OPERATION

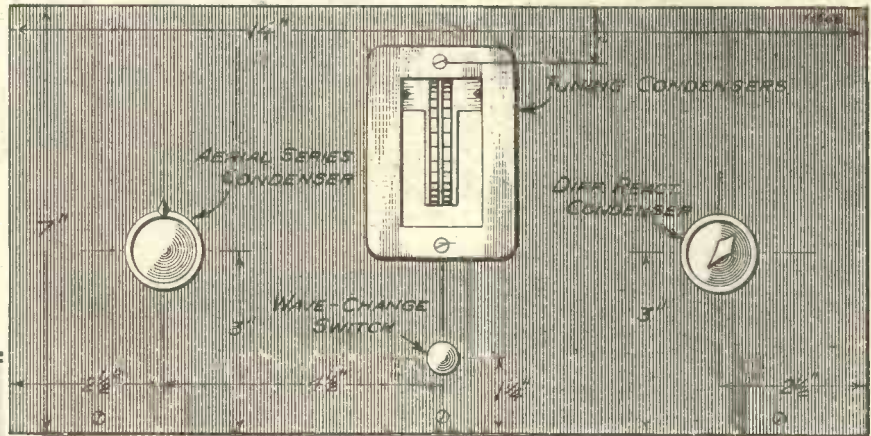

PANEL LAYOUT.

The dual-drum condenser makes station-searching easy, providing the control is handled systematically, as explained in the article.

### A MATTER OF MOMENTS

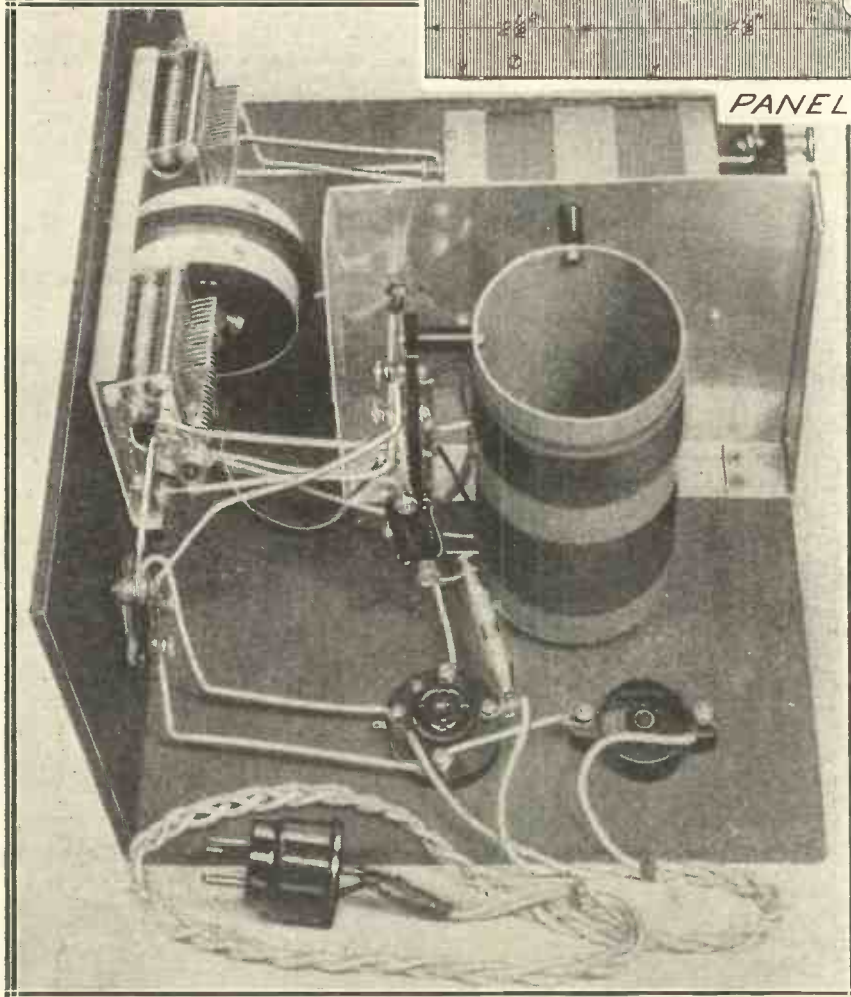

You can bring the unit into action or revert back to the original condition of reception again in a matter of moments.

faulty coils come to our notice, and that those that we do hear of are usually caused by some rough handling of the coil either by the owner or during its passage from the factory to the "consumer."

The Eckersley coil is a pretty robust piece of work, and there is little to go wrong with it.

In the form in which the coil is made available by the Eckersley Adaptor it is peculiarly suitable and convenient, as it enables the owner of any detector and one-or-two-L.F. stage set to use the coil without the slightest alteration of his receiver.

### Regarding H.F. Sets

The adaptor can also be employed in sets having an H.F. stage, if desired, though in such a case the advantages of the coil would be largely lost, owing to the fact that the H.F. stage would be inoperative, the unit being plugged into the detector socket as before, and thereby a great deal of the sensitivity of the receiver would be lost.

It may be asked whether the Eckersley coil can be applied to H.F. sets, so that the use of the S.G. valve plus the advantages of the coil may be obtained. This certainly can be done, but not with the unit that we have just described.

foreign programmes is rather remote. The remedy is, of course, obvious—to replace the faulty resistance with a good one.

of reception will probably be pretty good.

If, on the other hand, the resistance is too high, then the opposite combination of effects is noticed. Again

Where the resistance is of wrong



# ROUND *the* TURNTABLE

By "TONE ARM."

A Wonderful Exhibit—What is Your Favourite Record?—The B.T.-H. A.C. Gramophone Motor.

**H**AVE you ever been to the Science Museum at South Kensington? Those of you who live in the vicinity of the Metropolis, I mean. If not, you have missed two of the most interesting radio exhibits that have been staged in this country.

### Have You Seen It?

I refer, of course, to the standard B.B.C. receiver, and to the latest arrival—the H.M.V. nine-valve super-heterodyne automatic record-changing radio-gramophone.

This is a fascinating sight, and a lesson in set design. It is mounted in a specially constructed glass case, placed at an angle with the back removed.

It is the latest thing in "gramophones," of which there are examples of acoustic and electric models ranging from 1896. Also in the new building is the H.M.V. concert model reproducer No. 600, which provides music every afternoon.

By the way, in case you do not know, the girl who has been announcing for the H.M.V. Sunday concerts at Radio-Paris is a Miss Shipway, who is a British woman living in Paris. She is social secretary to the song writer, Mr. Cole Porter.

### Volume Controls

I am going to recommend something that the theorists will rise up in their wrath and condemn. *But it works*, and that, say I, is the main thing. This piece of radio heresy is nothing more nor less than a 25,000-ohm volume control for pick-up work. It is a great help in a mains set that is harbouring a nasty residual hum when used as a gramophone.

I can hear those technical boys screaming: "What about the high notes?" But the proof of the pudding is in the eating, and though technically such a control might be condemnable, it is certainly a great help in removing that last trace of hum. And it does not really upset the high-note response on the majority of pick-ups. You try it if you are troubled with mains hum.

What is your favourite record? Just now the taste of the record-

buying public seems to be split between such records as "Rhymes," the pseudo-comic and thinly disguised limerick disc, and such recordings as those of Noel Coward's "Cavalcade."

### "He Was Right!"

Christopher Stone, the B.B.C. gramophone "Star," predicted that the second of the H.M.V. "Cavalcade" records, a descriptive disc in which Henry Oscar is the narrator, would be a real best-seller.

He was right, for the record has headed the Plum label sales since it was issued some weeks ago.

"Cavalcade" (No. C2330) took a long time to prepare. Nearly two days were spent on rehearsals, and many records were made and submitted to a committee of critics before the "all set" was given on the final recording.

Eight separate microphones were used, and the artistes included an orchestra and a band, besides a chorus, organ and eight soloists.

### A Wonderful Effort

Cabled permission was obtained from Gershwin in America for extracts of his "Rhapsody in Blue" to be included in the scene depicting the modern age, and over twelve different tunes were played or sung on this single record. And all for a few shillings!

### THIRTY MINUTES' CONTINUOUS PROGRAMME!



Listening to the H.M.V. automatic record-changing radio-gram, Model 522, which will provide more than half an hour's continuous gramophone programme.

I have just received for test one of the latest B. T. H. A. C. gramophone motors, known as the Golden Disc type. This is a truly excellent job as far as I can see at present, but I shall be able to give more details next month.

### "Hum-Proof"

The motor contains special condensers to prevent interference, and the motor is of slow-running type so that the risk of hum and vibration are very slight. The retail price of the motor is 75s., at which figure it appears to be a very attractive proposition.

# THE WORLD'S PROGRAMMES HOW, WHEN AND WHERE TO HEAR THOSE FOREIGNERS



A UNIVERSITY STATION. Yale University Radio Club has fitted up this gear for communicating with stations in distant countries, and it was recently successful in picking up Australian broadcasting.

### CONTENTS OF THIS SPECIAL SUPPLEMENT

- |                                       |                                     |
|---------------------------------------|-------------------------------------|
| Radio Spotlights                      | Station Alterations                 |
| Getting the Americans                 | How, When and Where                 |
| Listening to the Long-Wavers          | The Coasts of Canada                |
| Station Information                   | What the Distant Stations are Doing |
| Yugo-Slavia's Big Noise               | On the Medium Wave-lengths          |
| A Visit to Ljubljana                  | Recent Radio Research               |
| The British Empire Short-Wave Service | German Technique                    |
|                                       | Heard in the Interval               |

# RADIO SPOTLIGHTS

**POZNAN.** A deep-toned "gong" heard from this station (just below Brussels No. 2) is really the anvil interval signal from Katowice relayed by Poznan.

**MADRID.** The chimes at 7 p.m. and 10 p.m. (on 424.3 metres) are relayed from the Home Office building.

**NORTH REGIONAL.** This station has been picked up regularly at Cawnpore (India) on a five-valver.

**CANBERRA,** the Federal capital of Australia, is to continue with its small Class B station, though more ambitious projects have been mooted.

**BARI,** the Italian station which is to be opened this year, will complete the reorganisation of the Italian broadcasting system that was begun when the Rome station was inaugurated.

**WARSAW.** Admirers of Chopin should listen for the Saturday evening recitals, at 9.10 p.m., on 1,411 metres.

**RADIO PARIS.** Measurements in the London area indicate that the power receivable there from the new Radio-Paris transmitter is about double that previously recorded.

**W 4 Z M,** the American amateur station, claims to be the world's "baby," its owner and operator being only ten years of age.

**W 8 A R J,** another American station, claims to be the "Methuselah" of radio, because it is consistently operated by its owner, who is 80 years old.

**WESTERN REGIONAL.** The work at Watchet, Somerset, is now well under way.

**NYON** (Switzerland) is the site of the new League of Nations station. It is to be called "Radio-Nations."

**LANGENBERG'S** transmitter, recently taken into use, has a power of 60 kw., as compared with 17 kw. for the old station.

**ATHLONE.** The projected 100-kw. transmitter is said to be attracting the attention of many advertisers, as it will

## News items for the long-distance man.

be heard easily in Great Britain

**DUBLIN.** The 413-metre wave-length used by Dublin will be employed by the new Athlone station when it is built—possibly before the end of the year.

**BUDAPEST** is considering a novel form of entirely automatic distant control for its new high-power station, which would then need only periodical attention by visiting engineers.

**BRADFORD** claims a record number of wireless licence

**TRISTAN DA CUNHA,** the lonely Pacific island, is one of the best places in the world for radio reception.

**W M A Y,** one of America's "church stations," has had its licence suspended for using an unauthorised transmitter and phantom call letters.

**MOLIERES** is the actual site of the new "Poste Parisien" station. It is in the Chevreuse Valley.

"**POSTE PARISIEN**" uses 600-ft. masts for its new station at Molieres, its

## "KALUNDBORG-COPENHAGEN"

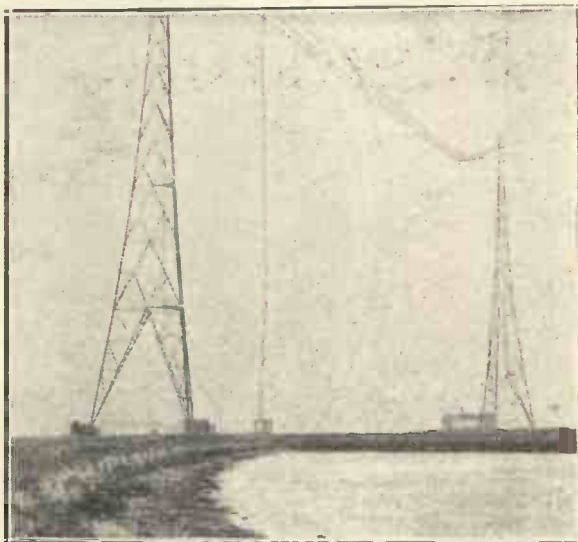

Perhaps some of the punch with which Kalundborg comes over on 1,153 metres is due to its fine position and ever-damp "earth," caused by its seaside situation.

increases in twelve months, with a percentage increase of 33 1/2.

**HEILSBURG** will probably be increasing its power by 25 per cent shortly. It is capable of going up to 150 kw.

**ANKARA,** the long-wave Turkish station (1,538 metres) usually closes down at 7.30 p.m., which is 9.30 p.m. in Turkey. The "Good-night" is given in French, German and Turkish.

**LWÓW** and other Polish stations now precede all official announcements by the roll of a drum.

power being in the neighbourhood of 30 kw.

**PARIS.** The P.T.T. station is considering the adoption of a cock-crow as a call-sign.

**P M Y.** The New Dutch East Indian transmitter, P M Y, was recently leased to a firm of advertising agents, the money so raised being devoted to relieving unemployment.

**HARTFORD, CONN.** This station uses three notes played on a xylophone as an interval signal.

**HUIZEN,** which is now relaying the Hilversum programmes on 1,875 metres, will change over to its own studio again on April 1st.

**BRNO.** The name of this station (which works on 342 metres) sounds like "Radio Birno." It comes in just above the Brussels No. 2 programme.

**RADIO VALENCIA,** which shares the 267.6-metre wave-length with Oviedo, has recently been "wobbling" from its allotted frequency.

**RADIO NORMANDIE** sometimes allows its mechanical "nightingale" to sing for two minutes or more without a break.

**ALBERTA** hopes that its "University of the Air," at present using a 5-kw. station, will eventually have a powerful equipment for this successful educative venture.

**PRAGUE** makes some of its announcements in Czech, German, French and English (488.6 metres).

**RADIO-PARIS** usually puts out its best orchestral concerts at 9.30 a.m. on Saturday and 5.30 p.m. on Sunday.

**VIENNA** is giving prizes totalling about £600 to singers and violinists under 13 competing in Vienna Festival Week. (Particulars from Vienna Festival Committee, Messelpalast, Vienna. Closing date, March 31st.)

**RADIO SCHAEERBEEK** recently organised a parade of dissatisfied radio enthusiasts through the streets of Brussels.

**THE VATICAN.** Experiments in picture transmission have recently been made under the Bein (French) system.

**STOCKHOLM.** The air with which this station closes is that of the National Anthem, "Du Gamla du Fria."





# GETTING THE AMERICANS ON THE MEDIUM WAVES

If you have never listened to American broadcasting coming across the Atlantic direct to your aerial, you should read this interesting article which tells you about one of the greatest thrills of radio.

Now that signs of spring are everywhere in the air our last chances this season of receiving the American stations direct across the Atlantic on medium wave-lengths will soon be over.

It is still often supposed that the only way in which America can be picked up is by using special short-wave coils or by extraordinary receivers of some kind. But this is not so.

## Super Sets Unnecessary

Provided one is willing to sit up till after midnight, the owner of the average long-distance set of the two-valve or three-valve type stands quite a chance of hearing the U.S.A. stations, over 3,000 miles away. Plenty of quite straightforward detector-and-low-frequency sets have done it this year.

For the benefit of those who would like to experience this supreme radio thrill, here are some hints by one who has been successful on many occasions.

First of all, clear your mind of all suspicion that there is some "catch" in it—you don't need a super-hyper receiver, nor different coils, nor a phenomenally good aerial. But you do need good conditions and—perhaps—patience.

## Choose a Good Night

The procedure is as follows: Choose a good night when distant European stations have been coming in well, and when atmospheric conditions have not been very troublesome. And prepare to sit up till, say, 2 a.m.

After the B.B.C. stations have closed, take a "run round" the dials to see what you can get—probably only two or three European programmes, and perhaps none of these specially loud or promising.

But don't be discouraged. Work up and down the dials, investigating any new carriers which may appear, and make careful note of the dial-readings.

If nothing really promising has appeared by 1 a.m., perhaps the best thing you can do is to call it an unlucky night and go to bed,

reserving your energies for another try later on. But if you have heard one, or perhaps several, weak carrier-waves, don't go to bed. Stick it, and watch them as closely as you can.

## Easily Identified

Even if it is weak when first received you may find one of them gets quite strong after a time—as strong as the German and French stations, perhaps. And the Americans all announce clearly and frequently—so hang on and hope.

etc.)—the Z always being pronounced there as "Zee."

Here are some of the "possible" stations, with their wave-lengths:

Metres	Station	Call-letters
256	Philadelphia	WCAU
273	Atlantic City, N.J.	WPG
275	St. Louis, Mo.	KMOX
283	Hartford, Conn.	WTIC
303	Springfield, Mass.	WBZ
306	Pittsburgh	KDKA
349	New York	WABC
379	Schenectady	WGY
394	New York	WJZ
428	Cincinnati	WLW
454	New York	WEAF

The above are only representatives—there are plenty more in between, so no promising carrier-wave should be overlooked.

## BUDDING EXPLORERS LEARN ALL ABOUT RADIO



Harvard University has inaugurated an Institute of Geographical Exploration—the only one in the world for the academic training of would-be explorers. Among the subjects taught are meteorology, navigation, astronomy, photography and, of course, radio transmission and reception. The great success of the radio link in recent Polar expeditions has emphasised the importance of this factor, and Weld Arnold (right), chief of staff, found it invaluable on his own important explorations in South America.

Keep a pencil and paper on hand, and put down everything you hear. Call-signs are frequently used. And don't forget that there is no "Z" in America, as what we call "Zed" they always call "Zee."

So in a call like: "This is Springfield, WBZ," the letters are pronounced "WB Zee," and sound to English ears like "This is Springfield, WBC (or, WBB, or WBC,

As some of the above correspond almost exactly with favourite British station wave-lengths, you may already know exactly where to look.

The best plan, however, is to search systematically, investigating every promising carrier-wave. And presently—if you have chosen a lucky night!—you will get the thrill of your life—a 3,000-odd-miles programme, as clear as a bell.

THE favourite old question, "Are Long Waves Worth While?" has not been raised so often during the past few months, for the long-wavers have been giving a spectacular account of themselves. On this wave-band you can now begin the day by shaving to music from Radio-Paris, and carry on with interesting programmes almost every minute until bed-time.

**Early Programmes**

No doubt there is plenty of activity before the 8 a.m. time-signal from Paris for those who switch on early enough to hear it. But most of us will not be interested in what goes on before breakfast.

It so happens that most of the long-wavers lie far east of England, with local times one, two or—in the case of Moscow—three hours ahead of Greenwich, which accounts for the apparently early hours they keep.

\* \* \*

March will probably see some slight seasonal fall-off in the strength and reliability of the stations working above 1,000 metres, and few will be inclined to grumble if this proves to be the case, for during the past winter they have given us a wonderful run for our money.

**At the Top**

Right at the top of the dial, Huizen has been excellent on 1,875 metres. The snag about this station is that for six months of the year (January to March and July to September) it is connected to the Hilversum studio, and all announcements, etc., come from there. So at the end of March don't be surprised when Huizen performs his quick-change act.

\* \* \*

Radio-Paris is now much more

**LISTENING TO THE LONG-WAVERS**  
Some notes on recent reception conditions on the wave-band above one thousand metres.

consistent than was the case a month or so ago, and presumably the old transmitter is not being used so frequently as a stand-by. Consequent upon his increase in power, he has tended to overshadow Konigs-wusterhausen, on 1,635 metres, but the orchestral concerts from this latter station are usually well worth trying for on Sunday mornings round about noon.

\* \* \*

Farther down the dial, Eiffel Tower

**FAVOURITE VOICES OF VIENNA**



This is a recent scene in the main Vienna studio, with Franz Lehár wielding the baton. Vienna has an experimental station working on the long waves, just below Motala and Moscow Trades Union. The wave-length is 1,237 metres.

has been making himself conspicuous by long counting tests—"un, deux, trois," etc., *ad nauseum*—but the musical items have been excellent in strength and quality. On almost the same dial reading, Warsaw, 1,411 metres, stepped into the breach when Eiffel Tower was silent—in fact, they have too often occupied it together!—and the Polish programmes have maintained a very high standard.

On 1,200 metres is Reykjavik, Iceland. As stated last month, this station has been asking for reception reports from English listeners, giving details of the set employed and conditions—preferably over several days' reception.

Reykjavik, by the way, has been suffering from heterodyning and may be somewhat off its wave-length, the estimated position at the time of writing appearing to be nearer 1,170 than 1,200 metres.

**Heterodyning Difficulties**

Although interference has not been bad on the long waves, there have been some difficulties with heterodyning, apparently due to the long-distance telegraphic transmissions which are carried on in great numbers over this wave-band. The Brussels checking station also attributes some

of the trouble to the long-wave Russians, eight or nine of which work on wave-lengths above 750 metres.

\* \* \*

As Russia has refused to cooperate with the other European countries in observing the Prague Plan of wave-length separation, there is little or no check on the interference which these stations may cause to other parts of Europe.

**The Outlook**

In view of the high power which will eventually be employed by

these Russian transmitters the outlook is a serious one for countries whose borders are close to those of the Soviet Republics'.

It is an open secret that Warsaw's high power was a direct result of the Russian situation, and there are almost certain to be other powerful transmitters arising in South-East Europe to counteract the propaganda which is the avowed object of many Soviet programmes.

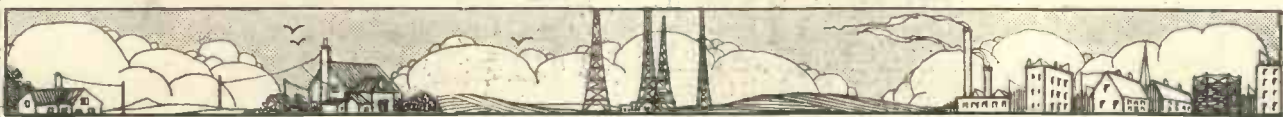

# STATION INFORMATION

Condensed notes and news from broadcasting centres in various parts of the world.



**CARACAS.** This Venezuelan station has recently been working with the U.S.A. on test schedules.

**AMSTERDAM** has been sending out experimental transmissions on 80 metres.

**SAN SEBASTIAN,** the Spaniard on 453.2 metres, now closes down with the "Song of Riego."

**NAPLES** uses a bell as a preliminary signal. This station is almost exactly 1,000 miles from London.

**VIENNA** was unable to broadcast its famous bell in St. Stephen's Cathedral because its tower is not considered safe if the bell is rung.

**TURIN** is shortly to instal crystal-control of its wave-length. This was the station that for long was Europe's worst wave-length grabber, working on 296.2 metres instead of the 273.7 metres allotted to it.

**ALGIERS** has been running a series of talks in the English language on Tuesdays at 9.45 p.m.

**MILAN** listeners are expecting their new station to begin regular testing soon. Its power will be 75 kw.

**FE CAMP.** The chimes at 21.00 are from the old Benedictine monastery at Fecamp.

**BUDAPEST.** Four relay stations will work in conjunction with the projected high-power station at Budapest.

**WASHINGTON.** The Bureau of Standards station (W W V) will transmit calibration signals of great accuracy every Tuesday afternoon and evening during March, on about 60 metres. Time: 14.00-16.00 and 20.00-22.00, E.S.T. The exact frequency is announced at intervals.

**BUREAU OF STANDARDS.** Comments on the reception of the above, fading noticed, etc., will be welcomed by the Bureau of Standards, Washington, D.C.

**REALTOR.** A site at Realtor, near Marseilles, has been

at Woodhouse Lane will be ready during March.

**BELGRADE.** As announced from this station on 430.4 metres, its name sounds like Radio-Beograd.

**GRENOBLE** is to have a 20-kw. station under the new Ferrie Plan for French broadcasting.

**NICE.** The projected Nice transmitter is to be of sufficient power to serve the island of Corsica as well as the mainland.

**MONTPELLIER.** It is proposed that the Montpellier wave-length (286 metres)

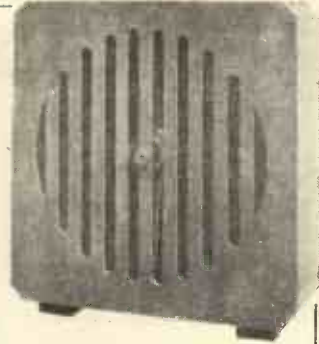

receiving valves in the transmitter, which cost only £5

**FLORENCE** had its aerial blown down in a gale recently, but a temporary one was quickly installed.

**PONTOISE,** the Paris short-waver, recently opened a studio in the Boulevard Haussmann.

**BRUSSELS.** An extension of the hours of working of the Brussels No. 1 and No. 2 stations is under consideration.

**WARSAW** usually transmits a concert by the Warsaw Philharmonic Orchestra on Sunday mornings, commencing about 11.15.

**W 9 G V,** the well-known American amateur station, is to carry out tests on March 11th, 12th and 13th on 20 and 40 metres. There will be a four hours' continuous transmission, a listening break of two hours, and a further four-hour transmission. The first transmission on March 11th will begin at 05.00. That on March 12th at 09.00, and on the following day at 07.00. (All G.M.T.)

**G 5 B Y** and **G 6 P F,** two well-known British amateurs, were among the four successful competitors who attained an accuracy of 99.99 per cent or more in the A.R.R.L. Frequency Measuring Contest.

**BRUSSELS'** schools are now given educational broadcasts on Mondays from 2 to 3 p.m.

## THREE OF THE BOYS!

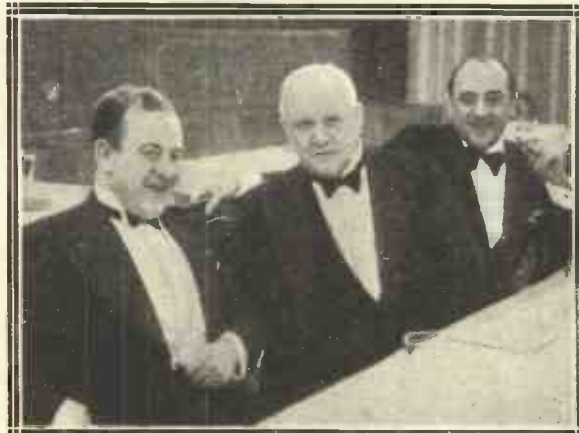

Lovers of light music will be interested in this trio—Jack Hylton, Franz Lehar and Herbert Maritschka (left to right).

ceded to the P.T.T. for a new broadcasting station.

**LIMOGES** (France), now allotted 293 metres, is to be one of France's new Regional stations.

**LEEDS** expects that the enlarged studio accommodation

should be used by the new Nice station when this is completed.

**WARREN** (Ohio) claims a record two-valve feat for amateur station W 8 A P M, which established two-way contact with 43 different countries, using two ordinary

"M.W." IS BRITAIN'S LEADING RADIO MAGAZINE



ORDER NOW THE APRIL NUMBER 1/- ON SALE APRIL 1st.

# ON 575 METRES

**YUGO-  
SLAVIA'S**  
"BIG  
NOISE"  
at  
**LJUBLJANA**

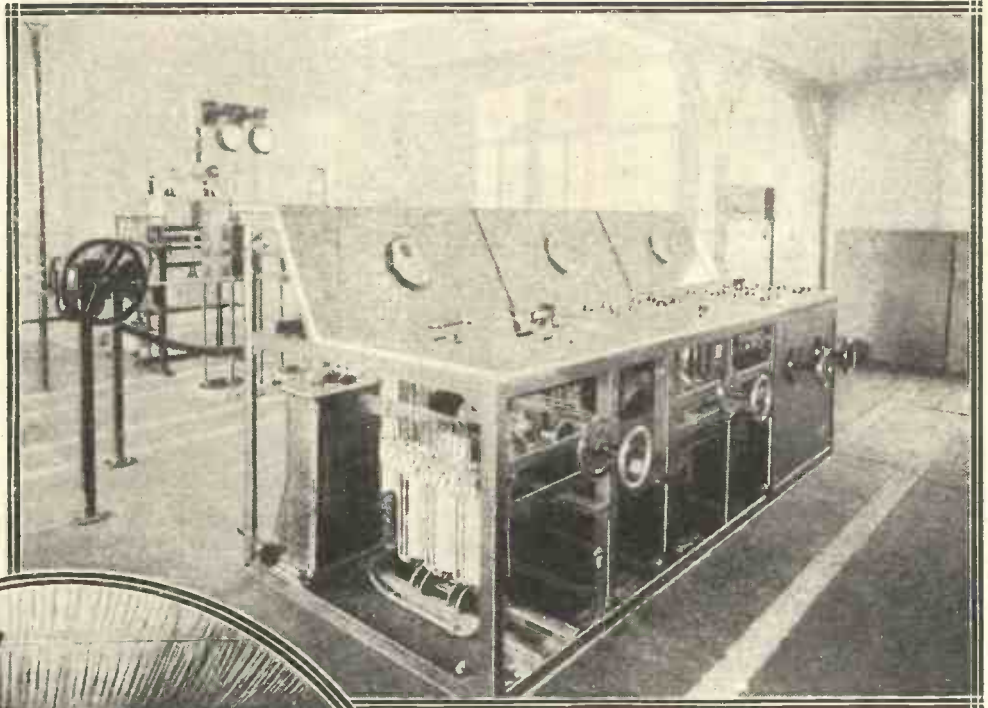

This is a general view of the Ljubljana transmitter, which was installed by the Telefunken radio manufacturing concern of Germany. The power (2.5 kw.) is not at all high, but the station is often heard clearly in this country.

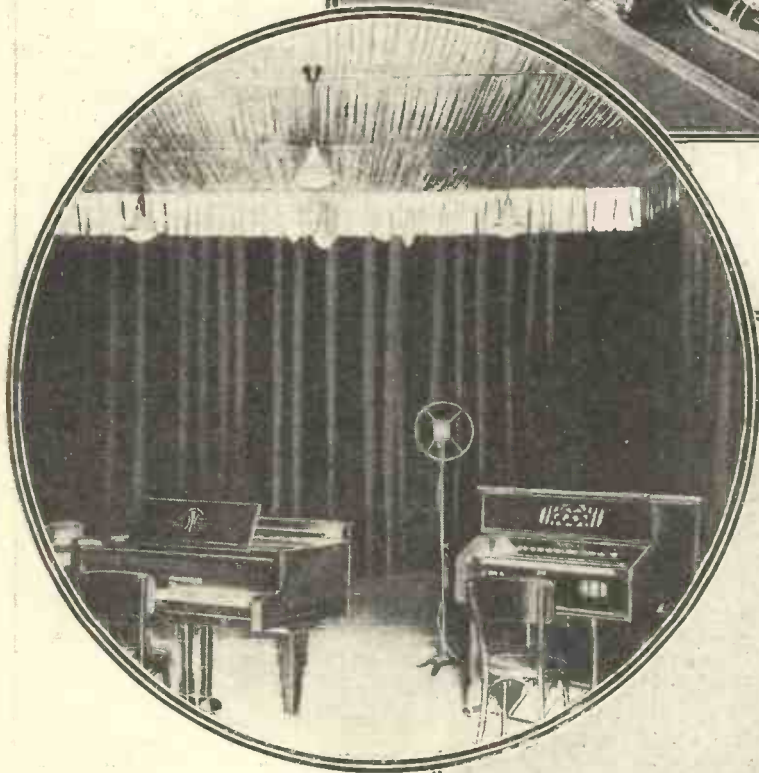

Above is a scene in the Ljubljana studio, which, it will be seen, is arranged on conventional lines with heavy drapings which can be moved when it is desired to alter the room's acoustic properties. To the right is a general view of the station, which is rather picturesquely situated in open country.

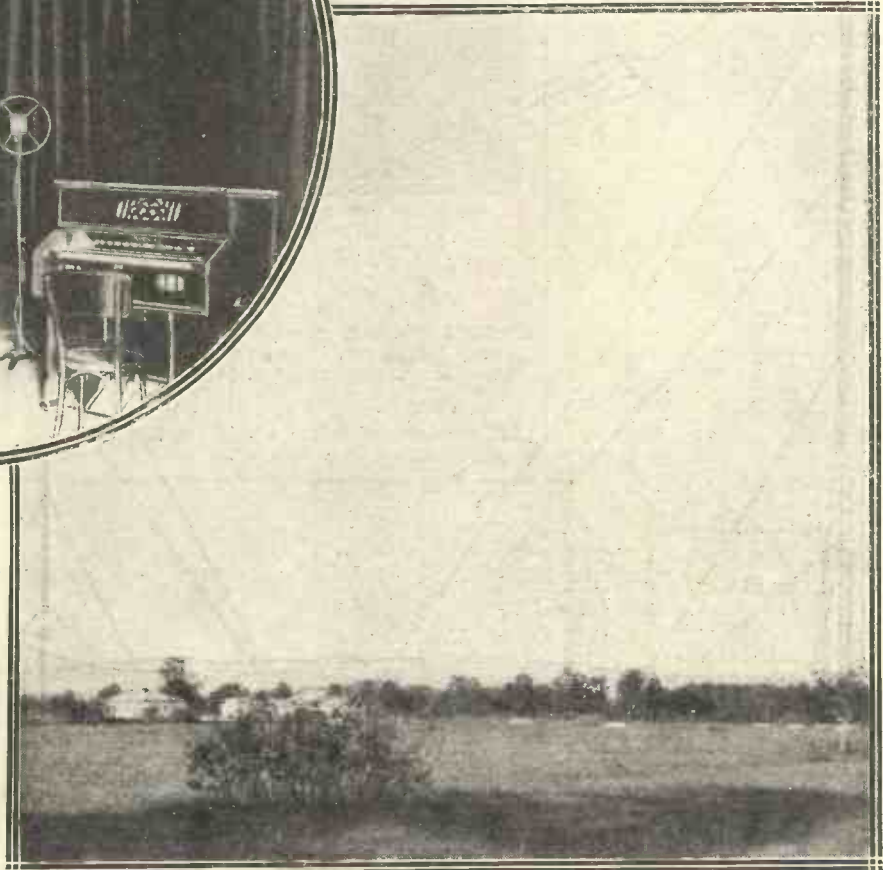

# A VISIT TO LJUBLJANA



At the Klagenfurt relay station I managed to get an introduction to a broadcasting official at Belgrade. He had authority for me to see any station, and it was therefore a toss-up between visiting Zagreb or Ljubljana. There were only three days for this trip, and Ljubljana won: being nearer to the Austrian border!

Before going further, and in order that you may be able to read this account of a visit, Ljubljana is pronounced as though the "js" were "y's." Say it as quickly as possible with the accent at the beginning, and that will be true Yugo-Slavian!

The first impression that the station gives, as one comes up to it from the broad main road, is that it is a dairy farm! I am not factious, for on the occasion of my visit cattle were wandering around the bases of the aerial masts and the white-painted wooden buildings housing the Ljubljana transmitter looked like a typical Yugo-Slavian farm.

### First Impressions

The effect is heightened by the water reservoir tower on top of one of the heights. But the tall ladder-formation aerial masts destroyed the illusion.

We went along to look at the bases of these before going into the station, and I was rather surprised to find that although these are of the straight pillar variety, with parallel sides all the way up, they are supported on quite slender insulated blocks at the bottom and have sturdy guy wires to keep the masts upright.

The chain of insulators in each of these wires is about the height of the average man, and they have to be included because otherwise the wires would pick up some of the aerial current and make the station difficult to hear in one direction, according to the guy wire taking most current.

### Some Earthing!

This an engineer explained to me, and then we walked along to the transmitter huts where two white posts, some eighteen inches in diameter and fifteen feet high, carry another train of insulators to which the lead-in is anchored. The lead-in goes through one of the windows.

The glass has been taken out and a big porcelain mounting fitted in place. Just outside was a long iron lever running up to the lead-in anchorage point, and when I went up to touch it the engineer hurriedly grabbed my arm.

"That's the earthing switch," he explained.

The arm is moved over every night so that the static electricity picked up by the tall aerial is discharged straight through to earth.

This station on 575 metres uses one of the highest wave-lengths on the medium wave-band, and is interestingly described by our Special Correspondent.

The real danger is not from lightning, but from static charges which would spoil the insulators if there was no direct path. More technical explanations followed, and more rapid translations.

### Volts Galore

After this little technical discussion we went inside the building, through the water-pump room to the main control room.

The station inside is unlike any that I have seen before. The valves and coils are not grouped up in separate panels, but are just stood around where most convenient.

Each big water-cooled valve, for example, stands on rows and rows of white porcelain insulators around which are curled the tubes carrying the cooling water.

These tubes end in taps and metal pipes which run down to the ground, and finally disappear in wooden troughs let in to the floor. Each

valve stands on a ring of insulators in this way and there is no protection at all for the unfortunate operator, who could easily grab hold of a 10,000-volt positive wire if he felt suicidally minded!

The power condensers are open in just the same way—at least, so far as the terminals are concerned. The terminals are supported on 6-in. porcelain insulators and each condenser is in a corrugated steel box filled with oil.

### Where Care is Needed

A little pipe at the top enables the old oil to be syphoned off and new oil put in. The condensers run a trifle warm, but even so that oil lasts almost indefinitely, and only an occasional topping up is necessary.

There is one advantage of this quaint method of station construction. The most important leads can be kept very short.

In fact, while walking across to

the control panel I very nearly made the friendly acquaintance of an anode lead (bristling with some 8,000 volts) which ran direct from the power transformer to the anode of the water-cooled valve in the final power stage. Copper tubes are used in place of cable for these connections. I'm glad I ducked!

The air-cooled valves are supported in just the same way. In some of the modulating stages each valve is on a separate insulated pillar with the coils and speech transformers as close to it as possible.

### Quaint H.F.'s

The tuning coils of the early H.F. stages are quaint objects. They are not wound on ebonite rods, but on huge ebonite formers, nearly a yard in diameter and about 2 ft. deep. Standing high above this miscellaneous collection of valves, coils, and what-nots is the aerial gnometer.

This is on a metal pillar some 10 ft. above the floor so that no matter where the control man stands he can see how much "juice" is going out into the aerial system.

While the plant is in action the engineer-in-charge wanders around at that end of the hall where the main control desk is.

All the tuning is done by the remote-control handles on the individual tuning coils standing out in the room. There are the usual red flashlights in the relay circuits so that the man can see that he switches on and off in the right order.

In the next room are the centrifugal pumps for the valve water. There are two, standing on store blocks and sucking the water from a big tank at the side.

### Hours of Working

We walked through this room, and in a room adjoining is the amplifier board which deals with the signals as they come in on the telephone line from the studio.

"What time do you start?" I asked the control man.

"There's an early morning programme from the studio at eight o'clock," he replied. "There are gaps in the morning programme, but from lunch-time onwards we transmit frequently. All the programmes come from the studio, even when it is gramophone music.

"To-day's programme, for instance, started with a news bulletin at eight, gramophone music at intervals during the day (that is what is on at the moment), a military band concert at seven in the evening, news at nine o'clock, and light music from nine-fifteen till the close of the day's programme at—to-day—eleven-thirty."

I thanked him, packed my case with hurriedly-written notes, and dodged the aforementioned 8,000-volt anode lead as I went out!

## USING A FRAME AERIAL

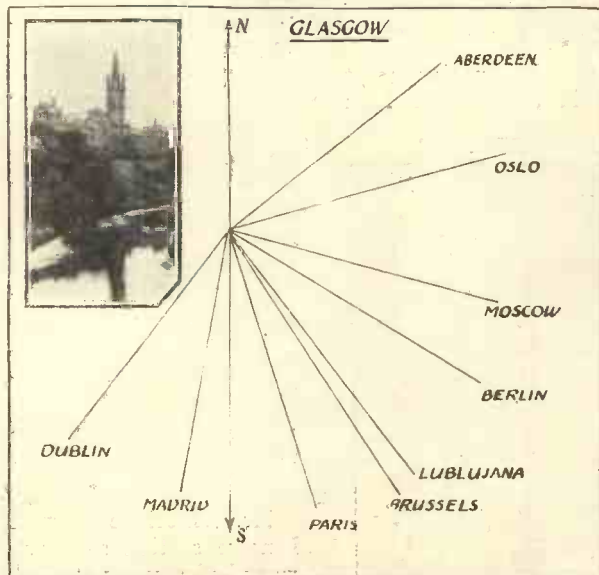

For best strength a frame should be "lined up" with the station to be received, and these radial lines show how a listener living in the Glasgow district should align his frame aerial for some popular "Continental."

## THE BRITISH EMPIRE SHORT-WAVE SERVICE

Some details of the recent improvements effected in the hours of working from Chelmsford 5 S W, and of the new station now being constructed at Daventry to provide overseas Britons with a reliable link with home.

THE recent announcement that the B.B.C. intends to press on with the development of an Empire short-wave station at Daventry, worthy of the important service it will have to perform as a link between distant lands and the Mother Country, resulted in general gratification. And when shortly afterwards the B.B.C. stated that arrangements with Reuter's now make it possible to meet the wish, so expressed by correspondents in the overseas Empire, that news should be provided on short waves, it became evident that the British Empire station would be really worth listening to in future.

### The Chelmsford Station

The present B.B.C. short-waver (G 5 S W, Chelmsford), working on 25.53 metres, has been excellently received all over the world, but it has suffered from two major disabilities. In the first place, news, the very subject in which the distant settler was most interested, was banned; and, secondly, the station closed down on Saturday and Sunday, the very two days on which the majority of its far-flung audience could have listened with the greatest convenience!

The first and most serious drawback—absence of news—has been removed entirely. Empire news bulletins are now being given from G 5 S W every day at 12.30 p.m. (Saturdays, 12.45 p.m.), 6.15 p.m., and midnight.

The three times have been chosen to suit, as far as possible, the needs of the short-wave listeners in the Far East and Australia, in Africa and farther India, etc., and in Canada and the West Indies, respectively.

In regard to the silent week-ends, another great improvement has been made, in that it has been

"WHEN THE DAY IS OVER . . ."



German country-folk enjoying the music from Munich when their day's work is over.

## IN THE HEART OF AFRICA



A British outpost in the heart of Africa. The many isolated Britons who live in these out-of-the-way places are keenly awaiting the opening of the new Empire station at Daventry.

decided that the station will now be closed on Sunday only, instead of as heretofore on Saturday and Sunday. The arrangement has been made in agreement with Marconi's Wireless Telegraph Co., Ltd. (who own and experimentally operate G 5 S W at their Chelmsford works), and the great satisfaction in these improvements will not be confined to the distant places which are most intimately concerned, but will be shared by all at home.

In a recent address to the Royal Empire Society, Mr. Noel Ashbridge, Chief Engineer of the B.B.C., explained that Chelmsford had not been able to give a satisfactory service over the whole of the territory which should normally be covered because it had worked on only one wave-length. This was insufficient to give the desired reliability and range.

### Directional Effects

Since Chelmsford started the question of planning an Empire broadcasting station had been explored along the lines of making use of directional effects, and for this purpose the Empire would be divided into zones. Starting on this basis, the technical equipment would be designed to give the best possible reception facilities for each of these zones, particular stress being laid upon good reception between 6 p.m. and midnight, local times.

The aerial arrangements at the new Daventry station will be such as to admit of modification in order to allow advantage to be taken of experience as the service develops.

Mr. Ashbridge affirmed that the contract for the Empire station at Daventry had been placed and work had already started; but some months of careful testing would be necessary on completion of the station before it was possible to settle down to a fixed routine method of working.

# STATION



# ALTERATIONS

**New Sofia Station—Albania, Too—Quick Work at Frankfurt.**

**Heilsberg's Physical Jerks—Oslo's Chirp—"Radio Nord Italia."**

**VATICAN.** The Pope's station at the Vatican uses a clock-tick signal, on 50-26 metres.

are now causing considerable interest in this subject.

someone who could take an important

days, Heilsberg usually starts a "physical jerks" programme at 5.30 a.m.

**RADIO NORMANDIE,** allotted 219.9 metres, has recently been working on 223 metres instead.

**MADAGASCAR** is expected to begin a regular broadcasting service next month.

broadcast operating part in 2½ hours time—the singer engaged being ill, and all known substitutes having failed! A completely unknown singer stepped into the breach and had scored a great success within three hours.

**VIENNA** gives an English lesson on Mondays, usually just after 6 p.m.

**MOSCOW** is usually to be heard in the small hours, as it starts up early in the morning and its time is three hours in advance of G.M.T.

**COLOGNE.** One of the pleasant-voiced announcers from this station, Herr Oetters-

**OSLO.** The time signal at 7 p.m. on 1,083 metres consists of 25 preliminary notes, a pause of five seconds, and a final "chirp" at exactly 7 o'clock.

## VIENNA'S WANDERING MIKE

**WARSAW** usually commences the day's programme at 9.15 a.m.

**BERLIN.** The three suspects arrested in connection with the Communistic interruption of President Hindenburg's recent broadcast speech have been freed, for lack of evidence.



Viennese listeners are very keen on outside broadcasts, which can often be tuned in on 517 metres from the Vienna station. Here a little girl is "telling the world" about a Children's Party being held in the People's Garden at Vienna.

**COPENHAGEN.** The tuneful interval signal from this station and Kalundborg is a motif from a Danish folksong written in 1300.

**OSLO.** The popular weekly symphony concert, formerly transmitted at 7 p.m. on Fridays, is to be given in future on Tuesdays.

**KONIGSWUSTERHAUSEN** will in future relay the Nauen time-signal at noon as well as the midnight rhythmic time signal. The other German stations are introducing a new system of time signals.

**LUXEMBOURG.** The latest information about this much-talked-of station now under construction indicates that its power will be 200 kw.

**DRUMMONDVILLE.** A new 4-kw. short-waver is on the air from Drummondville, Quebec, on 49.96 metres, relaying Montreal, CFCF Call-sign, VE9DR. (Reports on reception will be welcomed by the Canadian Marconi Co., 211, St. Sacramento, Montreal.)

**SOFIA.** The projected Bulgarian station is to have a power of 15 kw.

hagen, is a well-known actor who scored a great success as Stanhope in the German version of "Journey's End."

**FLORENCE** is shortly to have land-line facilities for linking this station with the "Nord-Italia" group—Milan, Trieste, Genoa, and Turin.

**MONTREAL, CKAC,** has inaugurated a regular series of television broadcasts.

**FRANKFURT.** A broadcast appeal was recently made for

**HEILSBERG.** Except on Sun-

**ALBANIA** is hankering after a broadcasting station of its own, and plans have been submitted.

**COPENHAGEN.** Heterodyning complaints are said to be due to Lisbon, CT1AA, working on Copenhagen's wave, 281 metres.

**"RADIO NORD ITALIA."** This is not a new station, but is an announcement indicating S.B. from Turin, Milan, Genoa, and Trieste.

**PARIS.** The television broadcasts from the P.T.T. station



**NOTE.—All times given above are G.M.T.**

# HOW, WHEN AND WHERE

If you are out for an across-the-world programme it is important to hit the happy moment when reception is at its best from the country concerned. And here are some really practical hints by an expert of world-wide repute.

**I** DON'T know whether the rather old-fashioned game with the above title is still played at Christmas parties. But even if the game has faded away, its title is useful! And in this particular case it applies very appropriately to the subject of short-wave listening.

Strangely enough, it is not so often the "how" that causes disappointments as the "when" and the "where." One can possess an excellent short-wave set and listen on it for two hours a day without hearing a single thing, unless one knows a little about the subject.

## Three Considerations

One of the peculiar properties of the wavelengths below 50 metres is that at a given time of day not only will stations in certain parts of the world be inaudible, but stations using certain wavelengths will also have disappeared. These facts being proved, just think of the complications that arise. Suppose you sit down at 2 p.m. and try to hear Australia.

We have to consider: (1) Is there an Australian station transmitting at that time (obviously)? (2) Is he on such a wave-length that we could expect to hear him in this country? (3) Is that the right time of day for Australian signals to reach us, even if the wavelength is correct?

This all sounds pretty bad, but, fortunately for the short-wave amateur, seven or eight years of short-wave work have been sufficient to enable us to learn quite enough to make up little tables that answer these questions for us.

## Daylight Waves

I do not propose to go into great detail, but the few following facts should help any of my readers who are in difficulties. First of all, remember this—that you have the

greatest chance of receiving long-distance signals *during the hours of daylight* if you choose a wave below 30 metres. This does not imply that you won't hear them right up to 50 metres, but the waves below 30 are more "daylight waves" than the others.

Conversely, if you want to hear them after dark you will be best advised to choose a higher wave.

## Concerning Direction

Next the question of direction comes in. Remembering the direction in which the earth moves round the sun, you will realise that the zone of daylight moves round the earth from east to west. Thus when twilight has reached us in England, Asia is in darkness and the American continent is in daylight.

From this it follows that the "daylight waves"—30 metres and below—are going to be most effective in the late afternoons and evenings for Western signals—America. In the early afternoons they are going to be best for Asia and the Far East. Generally speaking, reception on these waves is always best when

## PLENTY OF POWER



A view at Liblice, near Prague, of the new station now working on 488.6 metres. Its power, 120 kw., is equalled only by the giant Warsaw station on 1,411 metres.

either the receiving or the transmitting end is getting near the conclusion of its allowance of daylight.

## GOOD STATIONS TO LISTEN FOR

- Nairobi, on 49.5 metres, between 6 p.m. and 8 p.m.
- W 2 X A D, Schenectady, on 19.56 metres, between 6 p.m. and 7 p.m.
- W 2 X A F, Schenectady, on 31.48 metres, between 10 p.m. and the small hours.
- W 9 X A A, W 3 X A L, W 8 X A L, W 3 X L, all between 46 and 50 metres, between 11 p.m. and the small hours.
- Rabat, Morocco, on 23.8 metres, practically any time of day.
- Moscow, on 50 metres, from 8 p.m. onwards.

On 20 metres we hear amateur signals from Japan and the East Indies at 3 p.m. and after—just the time when the folk at the other end are thinking of bed.

At certain seasons of the year the same applies to America—they can hear us best when it is approaching 11 p.m. over here. But in the winter they seem to get us best during the afternoons and early evenings—when it is still morning in the States!

Don't let all these complications frighten you! It can all be summed up by a few words in "M.W." about four times a year as the different seasons approach.

## Times to Listen

To conclude, I will give a rough idea of the "best times" and "best waves" for the Spring season in this country.

- Below 30 metres* (all times in G.M.T.).
  - North America—12.00 to 22.00.
  - South America—21.00 to midnight.
  - South Africa—16.00 to 20.00.
  - Asia—13.00 to 18.00.
  - Australia and New Zealand—07.00 to 09.00 and 13.00 to 16.00 (two separate times because their signals can come round the world either way).
- Above 30 metres.*
  - North America—21.00 to 08.00.
  - South America—21.00 to 04.00.
  - South Africa—17.00 to 20.00.
  - Asia—13.00 to 17.00.
  - Australia and New Zealand—07.00 and 19.00 to 23.00.

Of course, these figures are intended only as a rough guide, but they will be found fairly reliable until about the end of May or the middle of June.

W. L. S.





# THE COASTS OF CANADA

Some details of the chain of radio stations that aid navigators in the difficult waters of the Dominion.

By JAMES MONTAGNES.

**Y**OU are listening to a fine concert over your radio, comfortably seated in an armchair, the lights turned low. Suddenly the music stops. You start to get up, to see if perhaps something has happened to your receiver.

### An S.O.S. Call

Half-way out of your chair you stop. The announcer starts talking, and you are prepared to hear of a studio breakdown. You make yourself comfortable once more, and while doing that the announcer states that the station will have to shut down because a ship is in distress, an S O S has been reported and the government radio station has ordered the broadcasting station to stop broadcasting till the ship is rescued.

Your mind flashes to a storm-battered steamer, many passengers on board, men, women and children clambering into lifeboats, heavy seas capsizing the boats, men shouting orders, coloured rockets flashing

thirty-two are administered directly by the Department of Marine and Fisheries.

The primary aim of these stations, to use the words of C. P. Edwards, Director of Radio Service, as stated in his annual report, is "to provide facilities whereby any ship within 500 miles of the Canadian coast can establish instant touch with the shore. Constant watch, 24 hours a day, 365 days a year, is maintained at practically all the stations."

Every station is open to give service for safety of life at sea. That is their big work. To make the calls for assistance as few as possible several services are provided by certain stations. These services are advertised and well known to mariners, who make the best use of them.

### Weather Information

Twice daily, at advertised hours, eight stations on the Atlantic coast, seven on the Great Lakes, and one on the West coast, broad-

## ON THE SHORES OF HUDSON BAY

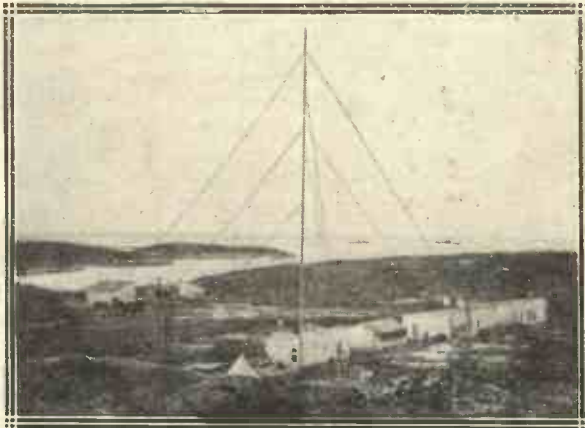

This is Nottingham Island, in the Hudson Straits, at the entrance to Hudson Bay. The station provides bearings for ships by radio, and is in touch with Ottawa daily.

in the air to direct neighbouring ships. You already see in your mind the story you will read the next day in your newspaper. Dimly you recall that there is a radio operator on that ship sending out S O S signals.

### Saving Lives

And a few minutes later you probably tune around the dial to find some other station on the air which is not near enough to the coast to be ordered to stop broadcasting. Your entertainment goes on, while the air is flooded with signals which flash back and forth between steamers and coastal radio stations working to save that ship and its human cargo.

There are fifty-four coastal radio stations in use by the Canadian Government to lend aid to navigators. Of these, thirty are situated on the Atlantic coast, where shipping is heaviest, eight on the Great Lakes, twelve on the Pacific coast, and four in the Hudson Straits and Hudson Bay. Twenty-two of these, comprising stations on the East coast and Great Lakes, are operated for the Government by the Canadian Marconi Company, while the other

cast information covering weather forecasts, position and nature of dangers to navigation, etc. Hurricane warnings are broadcast immediately on their receipt at the coastal stations, while in the spring-time a special patrol covers the Cabot Straits and gives the coastal stations reports on the ice conditions for broadcast purposes.

It is hard to realise to-day that there was a time not very long ago when the mariner had no such simple utility as radio to rely on, not only for the safety of his crew and passengers, but also for aids to navigation. The compass was practically the only means whereby he could obtain direction; the stars, sun and moon not being visible in cloudy weather.

To-day if he is at all in doubt he need but turn to one of the eight direction-finding stations with which the Atlantic and Pacific coasts are equipped.

### Radio Beacons

There are also seventeen radio beacons situated on the Atlantic coast and the Great Lakes on lightships and lighthouses, whose automatic signals are decoded by

the wireless operator in case of fog. They help the mariner steer clear of rocks.

These machines are operated automatically, sending out a coded signal at intervals of a half minute and a minute. Just as a fog horn is used aboard a ship, so these serve as fog horns to a wireless operator.

They are put into operation by the lighthouse keeper whenever a fog or storm arises. Similar apparatus has been prepared by

on some forty tugs and several camps. These stations operate on 199 metres.

The various radio services for mariners have such wavelengths as not to interfere with broadcasting programmes. Before the days of broadcasting, 300, 450 and 600 metres were utilised for ship radio traffic. To-day, at the instigation of the Canadian Government, all ships on the Great Lakes and all American and Canadian, as

## LAKE SUPERIOR'S RADIO BEACON



A view of the lighthouse on Michipicoten Island—one of the seventeen automatic radio beacons in Canadian waters.

the Canadian Government for Australia and is in use in the Antipodes.

### System of Stations

British Columbia waterways are numerous and much used. The shipping from canneries and lumber camps located on the rivers and lakes of the province has built up a big mercantile business for British Columbia and Oregon. Its intended shore line and its rugged construction has made telephone and telegraph connections impossible for most lumber and fishing as well as mining camps.

The result has been that the camps have many times had to wait several months for new supplies and the tugs which tow the lumber have been travelling thousands of miles uselessly.

The thing that did away with all this consists of a system of radio telephone stations placed on Vancouver Island, in Vancouver and

well as most foreign ships coming within several hundred miles of the Atlantic coast, automatically change their wavelengths for communication with ship and shore to 715 metres, a channel far above broadcasting wavelengths.

The Dominion Radio Branch suggested this step to Washington, and this has done materially to do away with interference formerly experienced by broadcast listeners.

### For Your Safety

Of the people who travel aboard ships for pleasure and business, few realise that there is a radio operator on board, who besides supplying them with a news bulletin every day on ocean liners, is responsible for their safety. The next time you are near the wireless cabin of a steamer, remember that inside sits a young man who is there to stick to his job till you are safely taken care of in case of distress.

## WHERE THE OPERATORS WORK

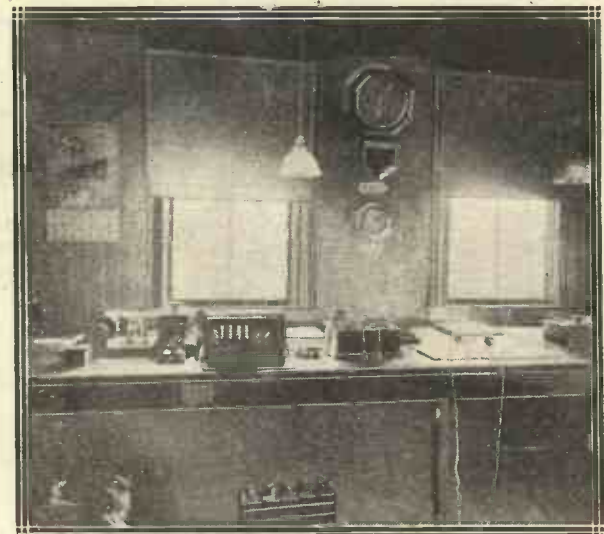

This picture was taken at St. John, N.B., and is typical of the receiving tables in Government radio stations along the Atlantic coast.



# WHAT THE DISTANT STATIONS ARE DOING

More notes from the log of a successful long-distance listener.

**T**HERE is no doubt about it, DX enthusiasts are "in hay." If anything, the reception of American stations on the medium waves has improved, whilst the short waves are once again like their old selves.

On the medium, or "regular," wave-band, as our American friends term it, there is very little to choose in volume between the European high-powered stations. Rather more interesting is the fact that many of the low-powered stations are coming in with almost as much volume as the higher-powered stations.

### Sponsored Programmes

Sponsored or advertising programmes are on the increase, and it certainly appears that European stations are getting Anglicised. Swinging around the dials on a Sunday evening one finds English-speaking announcers from Radio Paris, Rome, Radio Toulouse, and Radio Normandie, besides the special transmissions put over by Moscow for British listeners.

When the babel of European stations is beginning to die down, American broadcasters can be heard coming from the other side of the Atlantic. As the night grows on so do these signals increase in volume until they appear to be within a hundred or so miles from you instead of several thousands of miles.

Enthusiasts "fishing" for these transmissions will find the following points worth remembering. It is, for instance, useless to expect to hear the calls of an American station at any other time than the hour, or each fifteen minutes after it.

### Regular Announcements

This rule of announcing every fifteen minutes is both an advantage and a disadvantage. An advantage because it does not keep the "fan" "keyed up" expecting the call after every item, and a disadvantage because, as all the stations announce at one and the same time, one cannot hear more than one call at a time, and the result is that it takes a considerable time to catch the calls of many stations.

Listeners will also observe that certain American stations employ a bell-like arrangement to attract attention before announcing their call letters, whilst others do not. It is stations belonging to the N.B.C. (National Broadcasting Company) chain that appear to be the chief users of this bell-like arrangement (called in America, "Session chimes"), though there are stations not connected with any chain who employ them.

The C.B.S. (Columbia Broadcasting System) as a rule does not employ "Session chimes," and consequently the listener has no warning as to when to "prick up his ears" for the call. This is an obvious disadvantage.

I have found that, except for one or two occasions, American stations have come in at good strength whenever I have attempted reception.

### Plenty of Punch

WTIC, Hartford (253 metres), and WABC, New York (349 metres), are certainly my best received American stations. However, LR3, Buenos Aires, sometimes equals them in volume. This station is, by the way, the only South American station I can now receive on the medium waves.

That wonderful little 1-kw. station, WNAC, at Boston, has

been giving a good strong signal. This station, though of comparatively small power, is a wonder at getting across.

Last year it and WIOD, Miami, could be received quite clearly when WTIC and other powerful stations were putting across poor signals. I can only conclude that this is due to their using a shorter wave-length.

WCAU, Philadelphia; WPG, Atlantic City; WBZ-WBZA, Springfield-Boston (those two stations are bothersome!); KMOX, St. Louis; WBBM, Chicago, and many unidentified stations have been received at good strength.

these stations do not work simultaneously. If they did Toronto listeners would not have a very enviable time of it!

Montreal is also well supplied with 5-kw. stations, for it has CNRM, CKAC and CHYC. All three stations work on 411 metres. Winnipeg has two 5-kw. stations. These are CKY and CNRW, and both work on 384 metres.

More and more Canadian stations are relaying their programmes on the short waves. This is only natural as the stations have such large "service" areas to cover, and the short waves offer an alternative to higher power.

## COPENHAGEN CALLING



Copenhagen, like London, has recently treated itself to a new broadcasting headquarters—the handsome building shown above. Programmes from here are relayed on 31.51 metres by the Skamlebaek station.

I have received several reports of the reception of Canada on medium waves, but have not been fortunate enough to receive any Canadian station this year.

One of the most interesting Canadian stations is the 10-kw. Calgary station, CFCN. This station operates on a wave-length of 387.5 metres, and has recently been heard in England.

### A Few Canadian Stations

Toronto has a battery of 5-kw. stations. They are CJSC, CJCJ, CFRE, CNRX, CKGW and CPROY. The first four work on 435 metres, and the remainder on 384 metres. Needless to say, all

A new arrival is VE-9DR, Drummondville, which relays CFCF, Montreal, on 49.43 metres (sharing that wave-length with HRB). This station employs a power of 4-kw., and is certainly the best received Canadian station in Europe.

Unfortunately, it has not yet any regular schedule. This, I presume, will come when the experimentation that is a necessity when a new station first comes on the air is concluded.

Other Canadian short-wave stations are CKS, Calgary, which operates twice weekly on 39.74 metres; VE-9CL, Winnipeg, on 48.8 metres; VE-9CS, Vancouver, on 49.43 metres; and VE-9GW,

Bowmanville, on 25 and 49.96 metres.

VE-9GW employs a power of 28 watts on its shorter wave-length, but uses 200 watts on its 49.43-metre wave. The more powerful of the two transmitters is newly constructed, and has only been in operation for a short time.

The 28-watt transmitter was formerly employed on 49.43 metres prior to the advent of the more powerful transmitter. It was then altered so as to work on the lower wave.

I wonder how many listeners have noticed the cheerful, snappy little tunes that the Moscow station puts over?

### The Moscow Method!

The announcer, after the style of American broadcast announcers, gives a description of what the tune is meant to depict. The following "thrilling" programme was broadcast from Moscow not long ago: "The Craze," a song depicting revolutionary soldiers being shot. This was followed by "The Crazy Sea" (depicting a revolutionary sailor being shot); "The Old" (depicting the horrors of the workers in Russia before the revolution); "The Siberian Railway" (depicting Russian soldiers being driven to the slaughter of the Japanese); and, to conclude this remarkable programme, "The Ten-Mile Post," which depicted the place where shot revolutionary workers were buried.

From which it would appear that the present-day Russian composers are rather hard up for themes!

## "LANDMARKS" for Listeners

A list that is of permanent interest to the short-wave enthusiast.

To help to determine the wave-lengths covered by various short-wave coil combinations it is often useful to know the positions of the world's chief telegraphic short-wavers. Many of them work very long hours, and are thus often of use in identifying unfamiliar transmissions.

A knowledge of the Morse code is, of course, necessary to pick up the call letters, but often only the firmest acquaintance with Morse will do. This is because of the fact that certain stations repeat the call frequently, or for long periods, and this constant repetition permits even the unskilled to catch the call letters.

Here are some of the more famous and powerful of the world's radio "landmarks" with their wave-lengths and calls.

M. Call.	Station.
44.61 WQO	New York
43.7 EAJ	Madrid
42.6 WSL	New York
40.54 WEM	New York
39.1 WML	New York
38.34 SUY	Cairo
37.7 GLM	Dorchester
37.47 GLWGLY	Dorchester
34.5 HBC	Berne
34.01 GBJ	Bodmin
33.85 LSD	Buenos Aires
31.5 WKI	New York
30.7 EAM	Madrid
28.2 PLR	Java
27.45 GLQ	Ongar
26.1 WSL	New York
25.18 SUW	Cairo
24.7 JNI	Japan
22.33 WKD	New York
21.70 SUZ	Cairo
21.53 WIK	New York
18.8 CUS	Lisbon
17.2 LSB	Buenos Aires
16.8 PLF	Java
16.71 JNA	Japan
15.88 WKM	New York
15.35 LSF	Buenos Aires
14.95 DGX	Berlin
14.7 LSE	Buenos Aires
14.4 PPX	Rio de Janeiro
14.13 WQA	New York

## ON THE MEDIUM WAVELENGTHS

Reception notes and news of the various important European stations, with some details of forthcoming improvements that are being arranged.

It was being said twelve months ago that the 1931-32 season would be a memorable one for listeners. Never was there a truer prophecy!

The many new high-power stations have certainly provided us with plenty of variety, but in addition there have been the remarkably good reception conditions which alone would have made this a gala season. All Europe seems to be broadcasting "just over the garden wall," so to speak!

What is more remarkable is that many a surprised set-owner, fishing round after midnight for the late-to-bed Europeans, has landed programmes direct from the U.S.A.! But apart from such cases, Europe itself has provided plenty of interest.

### Bristling with Programmes

Instead of picking out a few stations worthy of special mention, it may certainly be said that the medium wave-band simply bristles with easily received programmes from France, Holland, Belgium, Germany and Italy. Spain is getting over in fine style, and Poland, Czechoslovakia, Norway, Sweden, Austria and Switzerland are all easy to listen to.

Plenty of other countries are represented on many quite simple sets of straightforward design, including Russia. The Moscow long-wave and short-wave transmissions have for long been familiar to searchers of those

### FOR TRANSMISSION ON 574.7 METRES

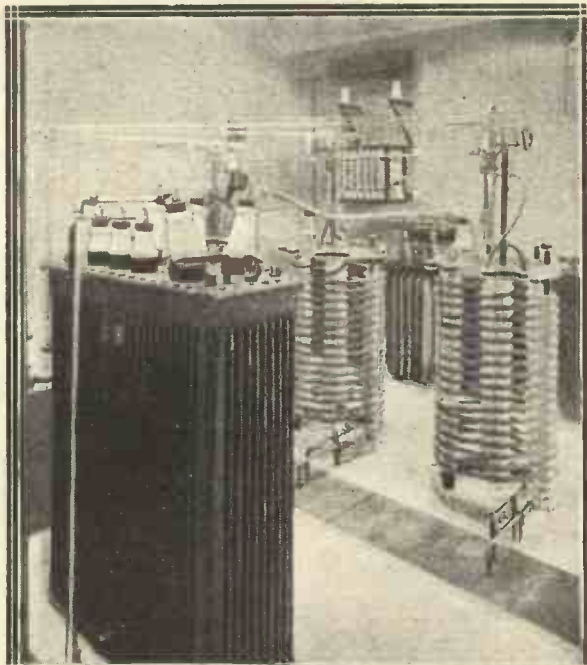

The big coils to the right are those that carry the Ljubljana programmes out to the aerial of this famous Yugo-Slavian station. Ljubljana uses a "cuckoo" as an interval signal.

### LECTURING TO ALL AMERICA



He is Dr. Lion Feuchtwanger, the great German writer, lecturing on historical romance via a microphone that was linked with seventy-six American broadcasting stations.

wave-bands, but now easily-heard Soviet broadcasts are invading "ordinary" waves as well.

### Going Up to 300 Kilowatts

For some reason the Moscow-Stalin station, which has insinuated itself on to 424.3 metres, has not been so loud in my own area as reports from other districts would lead one to expect. This is the station which is supposed to be changing its power some time during this year to something like 300 kw.

Already, when it is working on about one-third of that, it has made itself a confounded nuisance to the Berlin listeners, using 419.5 metres. Apparently the Germans have registered an official protest against this, but it remains to be seen whether it will have the desired effect, and British listeners can congratulate themselves that no such powerful Russian is threatening their own favourite station.

This is an opportune moment to remind long-distance enthusiasts what the forthcoming months have in store of special radio interest. Here are some of the important "high-spots" worth noting.

### More Power for Many Stations

Budapest is to install a new 100-kw. transmitter to replace the present station—Vienna ditto—in themselves these two constitute a revolution at the top of the tuning dial!

Germany plans to ginger-up Munich, Berlin, Leipzig, Hamburg, Breslau and Frankfurt. Considering the punch with which most of these stations come over already, we need have no fears of not hearing Germany!

France has a whole big new Regional Scheme—the Ferrie Plan. It may take some time to materialise, but when it gets going we shall certainly know all about France!

Closer in there is Dublin—at present a humble 1.2-kw. station, but with designs on establishing a 100-kw. at Athlone—twice as powerful as our Regionals! And a similar super-powered station is going up in Luxembourg.

# RECENT RADIO RESEARCH

Some Photographs from Berlin.

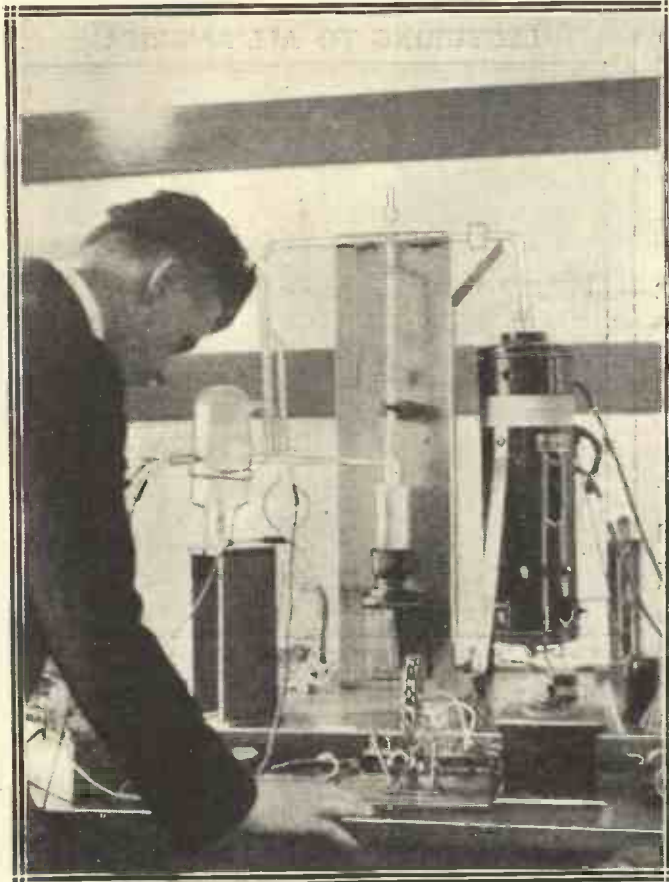

(Above) The pump used for investigating quartz vibrations in a vacuum. Below is a specially interesting picture of an ultra-short-wave transmitter working on 3 metres!

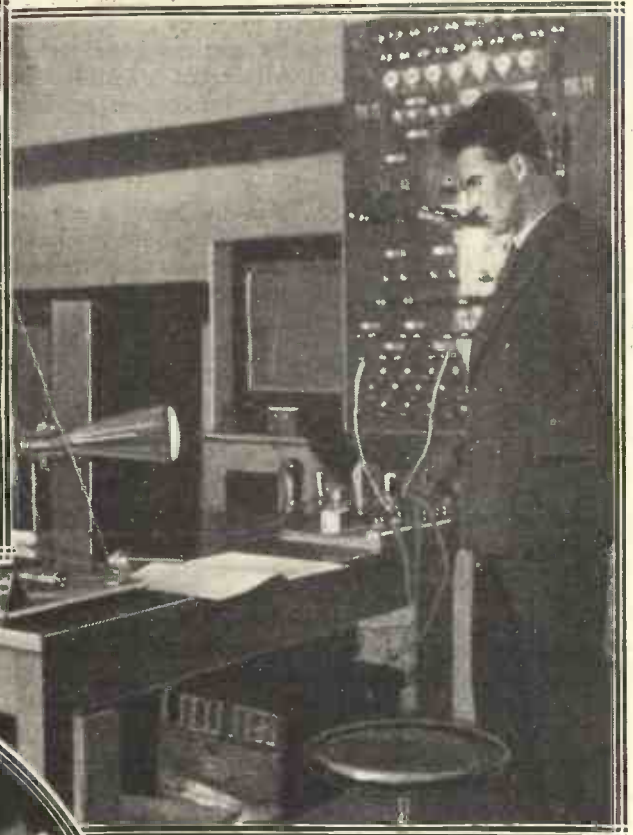

Above we have a cathode-ray tube in action, and in the lower picture is a huge induction coil for generating high voltages for insulation tests.

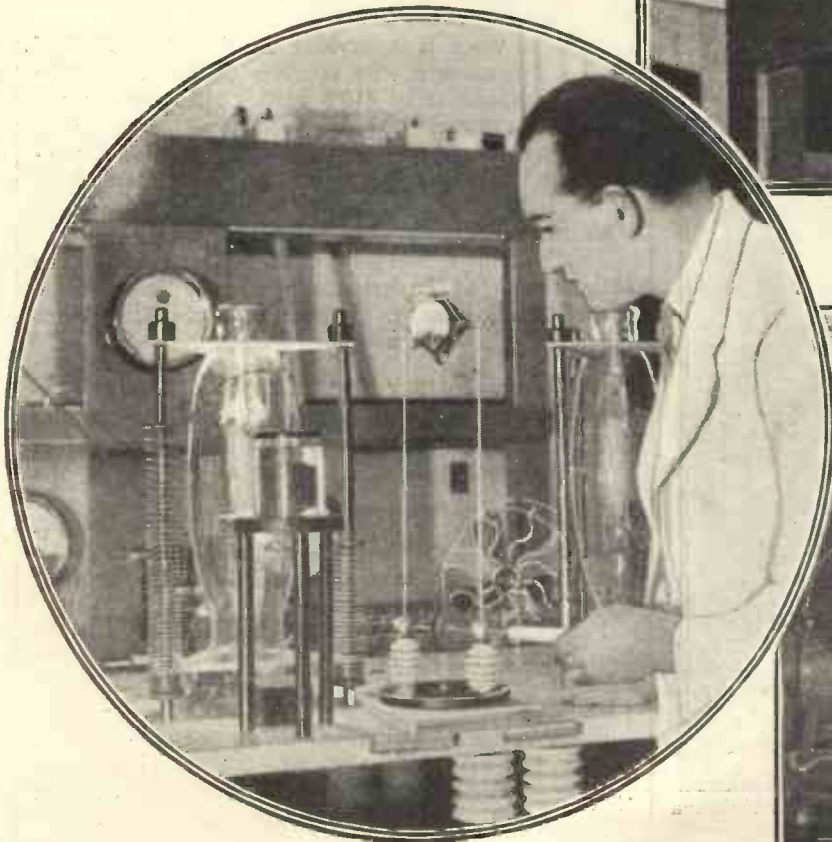

Note the little condenser that is being adjusted by the engineer:

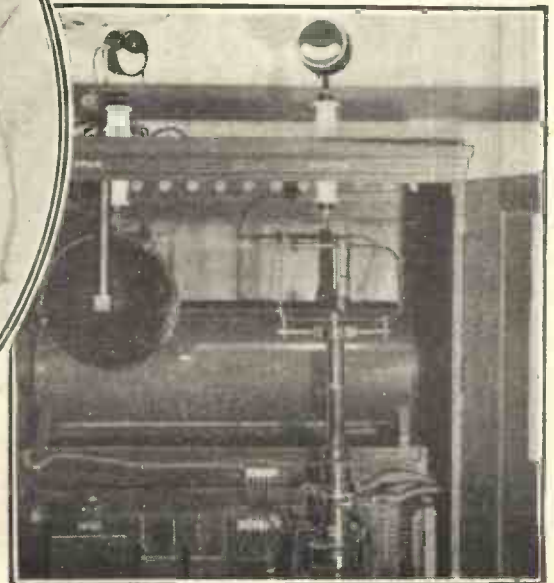

An exclusive interview with Mr. Schäffer, the Chief Engineer of the Reichs - Rundfunk - Gesellschaft, Berlin. By our Special Correspondent.

# GERMAN TECHNIQUE

Our heading photograph shows a German radio engineer at work inside an electrical "cage," so screened that no interference from outside can reach the instruments.

**M**R. SCHÄFFER. Do you know him? A tall, spare man with a slight stoop, who in many ways resembles an eagle. He swoops down on one from one end of the room and fires off a theory, and one can only jot it down before he starts off with something quite different but equally startling.

To begin with, as I sat in a comfortable arm-chair and looked round I made rather a ghastly blunder. I asked if the Halske-Reisz microphone lying on his desk was connected up to a special recording apparatus which could be switched on at will with pressure on some hidden button.

### A New "Microphone"

But Mr. Schäffer laughed, picked it up, opened the Reisz microphone, and offered me a cigarette from its interior. A nice kind of microphone that!

German radio technique is largely based on the excellent work Mr. Schäffer and his assistants have done in generally "going for" acoustics and getting them on to a mathematical basis. On the way there, so to say, he has made gramophone records clearer, better and more natural; and as the gramophone companies are allowed free access to any new development the R.R.G. makes, the general public profits in both ways—via the broadcasting station, and via any gramophone records it buys.

Talking of things in general, Mr. Schäffer pointed out that the present excellence of gramophone records was largely due to the advent of broadcasting and the research work done in connection with the development of its technique.

### Useful Interchange

Mr. Schäffer is a permanent member of the German delegation at all meetings of the International Broadcasting Union, and it is here that he met Mr. Ashbridge and his colleague, Captain Hayes. He greatly appreciates meeting his British colleagues, and told me that it is mainly due to these periodical personal meetings and reciprocal visits to each other's country and laboratories that British and German broadcasting technique were profiting largely from each other's separate experiences and research.

I asked Mr. Schäffer what was the exact difference between British and German studio technique. He answered that with every day that passed the differences were less and less, but that one fundamental difference remained. In Germany one laid greater stress on the effect of sound in space, whereas in Britain one stressed the clarity of the sound.

### The Difference

As these two factors do not depend on absolute measurements, but on the ear of individual observers, they probably will remain different, as they are dependent upon individuals living in different countries and atmospheres, but that from the point of view of the technician a compromise between the two would be the ideal.

Speaking of acoustics, Mr. Schäffer spoke of a very interesting experiment which still remains to be made: Why not substitute

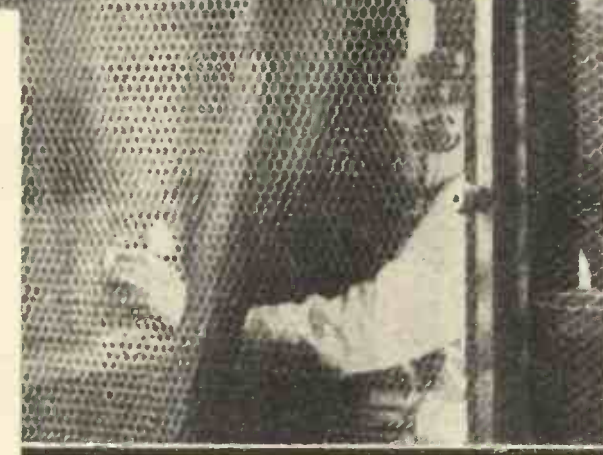

mathematical curves for a musical score?

A mathematical curve would show the exact value of every note, and not in a slap-dash and inaccurate way that our present scoring does. Of course, these curves could only be played on electrical instruments. But it will be only by using these that it will be possible to use the possibilities of the present-day electrical music-instruments to the full.

### Much More Definite

Of course, artistic licence would be a thing of the past, as the composer could fix exactly what sound he wanted in the exact way he wants it and no great conductor would be able to give an in-

dividual reading. Now put that in your pipes and smoke it!

Acoustics are not what they used to be ten years ago, Mr. Schäffer said. Formerly one guessed, nowadays one can get a room down to mathematical formulae.

### That "Timbre"

There is one exception, the "timbre" of a room or hall—or as Dr. Flesch, the Berlin programme director, once termed it, the "sex-appeal" of a room or hall—cannot yet be mathematically determined in advance. As a practical demonstration of his theories, Mr. Schäffer took me over to the test studio and let me listen to two records made of an orchestra playing in the giant Berlin studio.

## STUDYING RECORD REPRODUCTION



Some of the gramophone recording apparatus used for rehearsals, etc., in a Berlin control-room.

It is the largest in the world, and built according to mathematical formulae. It is not finished yet, it still lacks all stucco and decoration, but even when quite empty it sounded good, and when I heard the second record, with a body of listeners to help dampen some of the echo, it was simply wonderful. All the opera houses in the world will envy the German main studio once it is completed.

### "Killing Two Birds—"

By the way, hereby hangs a story. When the experiment was made they wanted to have as many people as possible in the hall, and also as much absorbent material as possible, so they wrote on the invitation that the heating would not be on. Actually it was on, but the people only discovered that later, and so they all came in in their outdoor clothes and later laid these next to them, and so Mr. Schäffer had killed two birds with one stone, for he had the people and the extra absorbent material in the form of heavy coats and hats.

### American Relays

A very special form of radio entertainment is the fashion in Germany at the moment—frequent relays from America. Now this is quite all right, but, after all, there is a difference of six hours between Eastern Standard Time and C.E.T.

Mr. Schäffer does not mind little things like that. He sends a cable or a message over to the man who is to speak in America giving the best transmission time, when it will come over best, and when it suits everybody concerned, except the listener.

The man speaks in New York, his usual weekly talk on what is happening in America, and this is recorded in the R.R.G.'s laboratories. Then in the evening when everybody can listen in the records are played to the public.

### Any Item

And the quality? As good as the original. And in this manner the German stations can "pot" any item they like and serve it up hot and fresh at any time they like.

I left Mr. Schäffer with the feeling that if one let him go at cooking, and if he wanted to do it, he would reduce that art to a series of mathematical formulae and so simplify the whole affair that a penny in the slot would do it all from the raw beef to the complete dinner.

## ITEMS OF INTEREST

**PALERMO** has been heterodyning Sundsvall on 542 metres, though officially Italy is not entitled to this wave-length.

**THE LIZARD.** The direction-finding station at the Lizard has been closed owing to insufficient patronage by passing vessels.

**ROME** employs three announcers—two ladies and one "mere male."

Some of the interesting identification signals that are used by famous European stations.



The photographs show (left) the Polish bugler whose call is relayed from Poznan, and (right) a typical set of chimes for broadcasting.

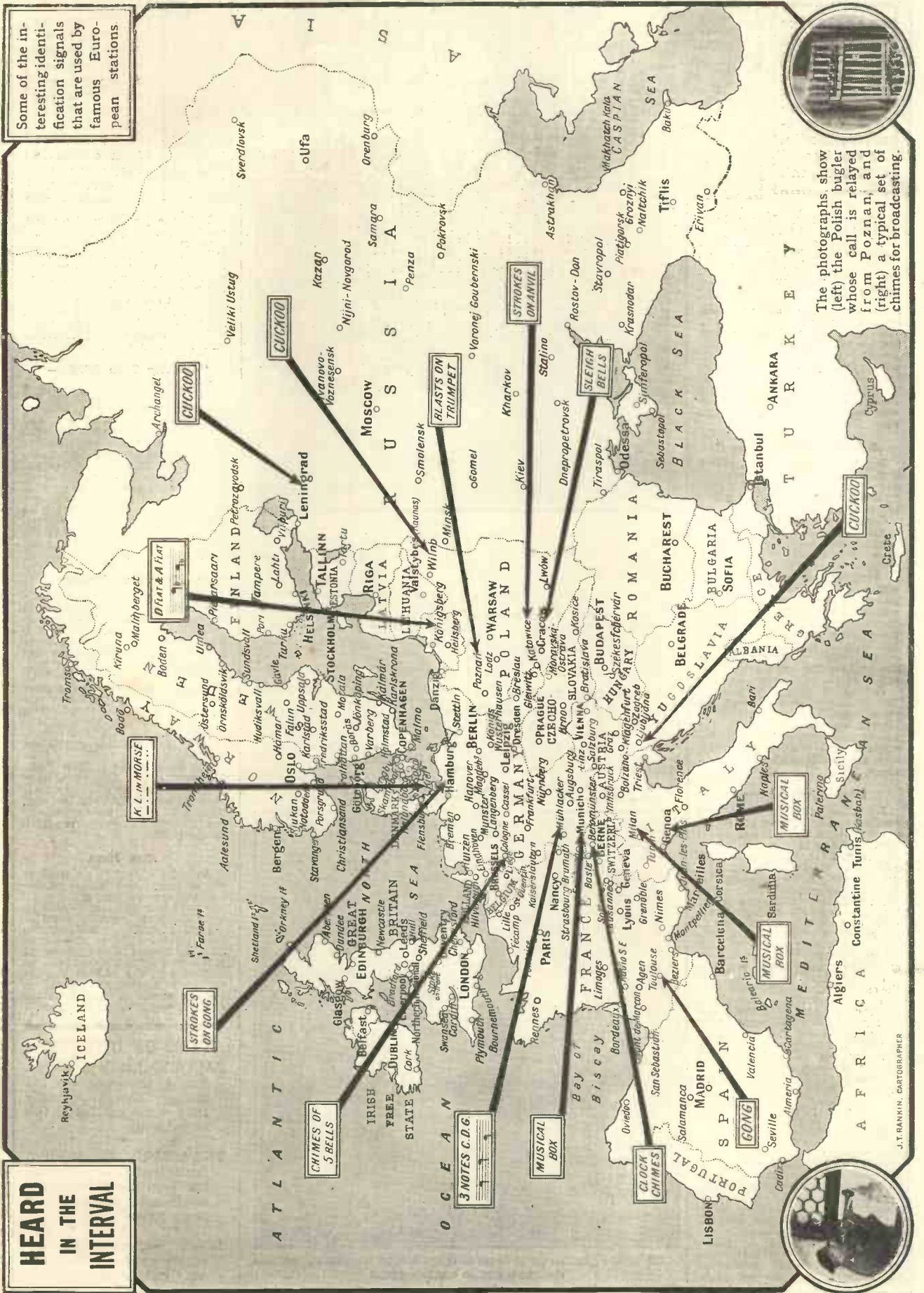

J.T. RANKIN, CARTOGRAPHER

# PICKING YOUR VALVES

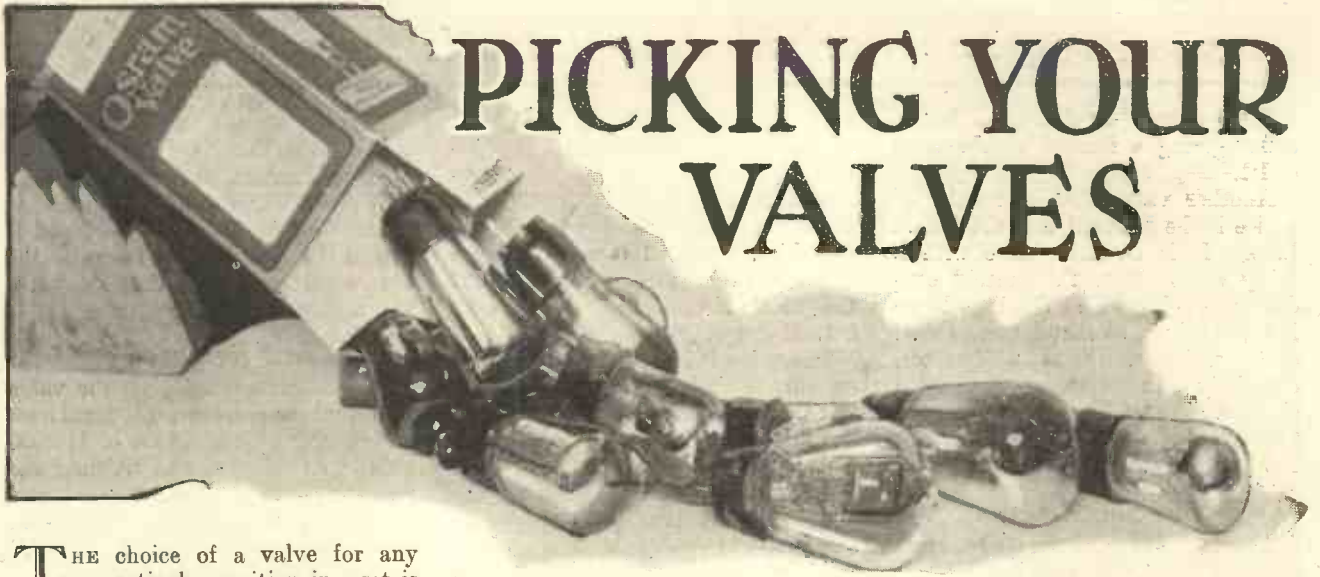

**T**HE choice of a valve for any particular position in a set is becoming a more and more complicated task. Not that it is difficult to find a suitable type, but it is not easy to choose a particular make of that type. What happens is this.

You decide that you need, say, a screened-grid valve. That is easy, isn't it?

## Searching the Lists!

The next thing is to decide what particular S.G. valve will be best in the set you are going to use. That is where the trouble starts. You look up the various lists—if you have them—or ask a friend if you have not.

## PLENTY OF PUNCH



Two of the latest L.F. valves. The one on the left is the Marconi L2/B, an excellent intermediate L.F. amplifier, and the other is the famous Mazda Pen.220.

The result is more chaos, for you find that the valves are all much of a muchness.

They are, too. It does not matter in the average set whether you use

*The numbers of new valves that have recently appeared on the market have made it more difficult than ever to choose the right ones for any particular set. Standardisation of British valves is long overdue, as will be realised from the following article in which some of the latest types are described.*

By K. D. ROGERS.

a B.B.B. S.210 or a C.C.C. S.220. The characteristics are much the same you will find, and the results will be indistinguishable in their difference.

The chaos in the valve world we have pointed out many times before, and though this article is to deal with even more types of valves that have recently appeared on the market, we would like once more to draw attention to the terribly tangled state of affairs.

There is, however, a faint light on the horizon, and rumours have it that the position is likely to change in the future. Not the near future, we are afraid, but there is a distinct possibility that in twelve months or so an attempt to standardise British valves will be made.

## An Interesting Rumour

Details are not forthcoming, for, indeed, it is only a well-founded rumour at present, but if it does come off it will be a great day for home-Constructor and manufacturer alike.

There are far too many valves on the market, and if the valve makers would only get together and list a series of, say, five different types (as distinct from classes, with their many types) of valves, the life of the radio enthusiast would be very much easier. Perhaps they will; we shall see.

But let us describe some of the new valves that have been added to the lists during the last few months.

One of these is the Mazda S.215a, which has been introduced with the S.215b to form a fine pair of S.G.

valves having even better characteristics than the well-known S.215.

## Filling the Gaps!

This latter valve is an old-timer, but the new ones are not to supersede it; they are to fill in the gaps made by set designs having coils of more efficient character than was the rule in the days when the S.215 was introduced.

## THE LATEST IN "S.G.'s"



Following close on the heels of the A.C. variable-mu S.G. valve comes the Cossor battery V.S.G., of which two examples can be seen above.

At the time of writing only one of the two new valves is available for public use—the S.215a. The characteristics are as follow: Impedance,

## The Variable-Mu Valve is Here

727,000 ohms; amplification factor, 800; giving a mutual conductance of 1.1.

Another valve that is worthy of notice is the Marconi and the Osram L.2b. It is an L.F. valve with a fairly steep slope, the mutual conductance being 1.55. The impedance is 10,000 ohms, so that it can be used quite satisfactorily as a detector, especially in transformer-coupled circuits. The grid swing is useful, the valve taking a bias of - 6 volts at 150 volts H.T.

### For Small Sets

Another valve from the same stable is the P.T.2. This is a pentode having characteristics very like the Mazda Pen.220. In other words, it is designed for the output stages of small sets, and would be useful in such a receiver as the "M.W." "Cabinet" Two, described elsewhere in this issue.

The valve is designed to take the same voltage on its screening grid as

current at the maximum H.T., with a screen current of 1.9, the valve provides an undistorted output of remarkable size. It is particularly useful in small receivers such as portables, for at 100 volts quite a valuable output can be obtained, and the total H.T. dissipation is only 3.9 milliamps.

The valve is intended to work with an output choke or transformer, for it is suggested that the loud speaker be shunted by a 20,000-ohm resistance.

A most interesting valve is the Cossor battery variable-mu, the 220V.S.G. It is a special type of screened-grid valve whose characteristics are such that as the negative bias is increased the mutual conductance, and therefore the amplification, of the valve decreases.

### The "Variable-Mu"

Under normal bias conditions the valve operates like an ordinary S.G. valve, but at the same time it allows

Also the use of a variable-mu valve should stop that bugbear known as cross-modulation, for the characteristic of the valve should be such that there is no anode-bend point, and it should be possible to increase the bias without any risk that the valve will rectify.

### Just Released

The characteristics give the valve a mutual conductance at maximum of 1.6, with an impedance of 110,000 ohms. At the time of writing, the valve has only just been released, and it is hoped that a special variable-mu receiver will be available for "M.W." readers in the very near future.

New valves have also been brought out by many of the other valve concerns, including Eta and Tunggram, the latter having also revised their prices.

Fresh valves are always welcome if they mean, as the above do, better results, but one wishes that their arrival was also the signal for the departure of many of the old ones. As things go on the choice of a valve becomes more and more difficult, and those who care to depart from the specifications given in the technical press and by the set manufacturers are liable to find themselves in deep water.

### Another D.C. "Tube"

So far we have said nothing about the latest mains valve, the D.S.b, a Marconi and Osram addition to the range of .25 D.C. valves. It has a mutual conductance of something like 3, having an impedance of round about 300,000 ohms, and an amplification factor of 1,000. It is similar, therefore, to the A.C. valve known as the M.S.4V. So far it is not on the market, but it is expected to be available in a few weeks.

## PREVENTING EAVESDROPPING ON THE ETHER



An apparatus for use in telephone work which prevents anyone but the parties at both ends from understanding the conversation, thus eliminating "wire-tapping," was demonstrated by Sergius P. Grace, of the Bell Telephone Laboratories of New York. The device succeeds in "scrambling" a conversation so that high notes turn into low notes, and low ones into high ones, producing a strange jargon when words are spoken. When "unscrambled" these same words resume their original sounds automatically. The apparatus is being used with practical value and is assuring secrecy in transatlantic telephone conversation.

it has on the anode, the maximum voltage being 150. Either four- or five-pin models can be obtained, the standard fitting being of the five-pin variety.

Taking only 6.5 milliamps anode

of the use of a volume control that does not affect tuning, and does not upset the operating characteristics of the valve. All it does is to decrease the amount of amplification obtained—exactly what is required.

### THOSE FOREIGNERS!

"Modern Wireless" is an invaluable aid to long-distance listening, containing as it does every month a long illustrated supplement dealing with

### THE WORLD'S PROGRAMMES

This unique feature keeps you in touch with innovations and improvements abroad. It is of the utmost value in identifying foreigners and suggesting the best times to listen. You will find this valuable supplement every month in

### "MODERN WIRELESS"



# The NEW NEWS ARRANGEMENTS

Our Special Correspondent, in a visit to Broadcasting House, explains how there is every possibility of there being a better news service when the new London headquarters is in full swing.

"THERE will be no actual increase in broadcasting sessions of news bulletins, weather forecasts, stock market reports, and other items which make up the news service," said the B.B.C. News Editor when I interviewed him recently.

"The new news arrangements will, we hope, make the news service more essential than it is even at present," he continued.

## Last-Minute Items

Knowing that many listeners are now dissatisfied with the sort of news that we have broadcast, and wondering how the B.B.C. intends to overcome the difficulties which at present hedge in broadcast news, I asked to be shown the new news arrangements, so that I could compare them with those which obtain at Savoy Hill.

"Although listeners seem to think that we have the whole day in which to prepare the news bulletins for the early evening and late night broadcasts," explained another news official, when I started to investigate matters, "the real trouble we are up against is in getting very late news items condensed and ready for broadcasting a few minutes before the microphone is due to be switched on.

"At Savoy Hill the news is usually read from Studios



Taking telegraphed messages off the tape machine.

5 or 6, and the News Editor's room and the room housing the tape machines are on a different floor.

## Whispered Corrections!

"All during the day news arrives from the four leading London agencies, and a trained staff picks out the items for broadcasting and writes them in the B.B.C. official style. Very often some important news 'breaks' about ten minutes before, say, the 9 o'clock bulletin, and just as the announcer is going down with his typewritten sheets to the news studio one of the news men in the tape-machine room is receiving some urgent information.

"The trouble is to get the news in, and in the proper sequence.

"It is an invariable Savoy Hill rule that one of the news officials always accompanies the announcer when he goes down to read the news, and when the late items come along they are handed direct to the news official in the studio, who 'subs' them and pushes them under the announcer's nose at an opportune moment.

## A Better Method

"It is rather a makeshift method, but there is no other way out of the difficulty.

"Now, in Broadcasting House we shall have a much more efficient arrangement.

## A CORNER OF THE NEWS ROOM

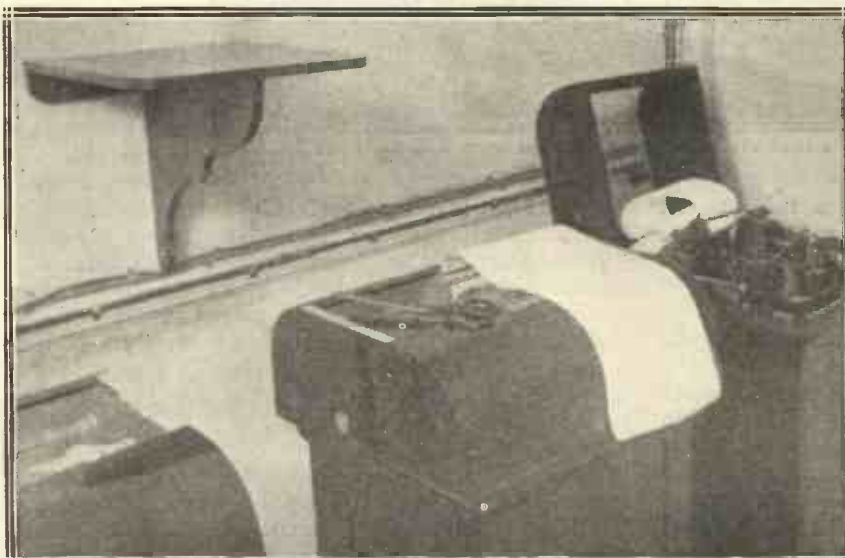

This wonderful "teletype" automatically prints the news. It translates the Morse messages, which arrive in the form of "dots and dashes," into ordinary typewritten communications.

"The News Editor's room, the 'subs' room, the tape-machine room, and the two news studios are all on the fourth floor. This is not according to the first plan which was made out for Broadcasting House, which showed a sort of emergency staircase running from the news studios up to the floor where the officers of the news department were intended to be.

"In the new scheme we have all departments on

## Making it Easy for the Announcer

the fourth floor, and this is the first step towards getting a more efficient news service. There will be no time-lag between the tape machines which represent the outer world of news and the studios.

### A New Annexe

"I expect everybody knows by now that we are having two news studios with one triangular-shaped annexe adjoining both, and that there are windows in this through which late news can be passed. What is, perhaps, not so generally known is the way in which we shall be able to make use of this annexe.

"Every time a news bulletin is broadcast a man from the News Department will go down and sit

start reading the bulletin, as the microphone is faded in.

"If any late items arrive while he is actually reading the bulletin, the news man in the annexe will be able to take them down over the telephone, 'sub' them, find out the pronunciation of difficult words, and then slip the additional sheet through the double window into the studio."

### News Input

I asked if there will be any special improvement in the way in which news comes into Broadcasting House, and I was told that practically the same gear will be installed, the equipment of the Savoy Hill tape-machine room being transferred to Broadcasting House.

paper. The inside of each machine is very much the same as that of a typewriter. There are hammers which are pulled down magnetically on to the strip.

"The dots and dashes come in on the cables, move, extremely rapidly, a light armature pivoting on knife edges. This armature works a relay which brings down the appropriate hammer. No code is used, but, of course, nobody listening-in by eavesdropping on the lines could hear the news. All they would get would be a low intermittent buzzing, not even resembling Morse code.

"The system of news broadcasting and recording at Savoy Hill will be as follows: News received on tape machines; items selected by the 'subs'; news typed out on special foolscap sheets. The broadcasts made by the announcer; sheets for each bulletin put together and filed for a fortnight, and card indexes then made of each item and kept in a fireproofed file, so that if there is any discussion about one of our broadcasts the actual manuscript can be turned up at a moment's notice."

"HERE IS THE SECOND GENERAL NEWS!"



An announcer ready to read the weather forecast and news bulletin to the listening public.

at a sort of desk in this annexe. Here he will have a few reference books and a pronouncing dictionary.

### Checking Pronunciations

"In the few minutes before the bulletin is given the announcer will be able to check up the pronunciations of all foreign words. We have a system whereby words that are difficult to pronounce are underlined in red on the announcer's manuscript.

"Then, having made himself word perfect, the announcer will go into one of the studios, 'buzz' up to the control room on the sixth floor and

"We have four tape machines in Broadcasting House," said the official.

"Lead-covered cables come into the basement of Broadcasting House from the special lines owned by the four agencies—Reuter's, Press Association, Exchange Telegraph and Central News. These four agencies supply the news to all the daily papers, and we have at Broadcasting House exactly the same gear which is responsible for the news getting in your 'daily.'

"These machines work automatically. There is just one connection to the mains point. They type the news items direct on to narrow rolls of

### 'Phoning the Depressions

"What about weather forecasts and Parliamentary reports?" I enquired.

"Weather forecasts will still come to us on printed sheets from the Meteorological Office in Kingsway. Occasionally they have to be 'phoned through, as, for instance, when we are on British Summer Time and the weather forecast officials are still working according to Greenwich Mean Time. That gives us an hour less in which to prepare our weather forecasts for the microphone, and by special arrangement with the Meteorological Office the bulletins are 'phoned through to us.

"Strangely enough, special Parliamentary reports are the only news items which we do not receive on the tapes. We have, of course, an understanding with all four agencies that we shall not collect news on our own. A Reuter's Parliamentary reporter acts for us in the House, though, and he 'phones his bulletins through to us on a private line.

When Broadcasting House has been "on the air" for a few months we shall know whether the news arrangements will make as good an improvement in the broadcasts as is now anticipated.

# DO CONSTRUCTORS SCORE ?



*Some further very readable letters dealing with this interesting subject.*

Sir,—I have been making sets for the past nine years, and I have also owned two—a £70 super-het and a straight eight. Both the commercial sets I found disappointing—very largely because the circuit is so packed and concealed that it's almost a day's work to change a faulty L.F. transformer.

## **Unmarked Components**

I am a woman constructor, and have hooked-up dozens of sets of all kinds, and taken in "M.W." for years.

Commercial sets, for obvious reasons, rarely mark the values for the various components, and unless one purchases expensive instruments one can only guess at values when one comes to dismantle the set for reconstruction. Now, as a home constructor, I have at hand all values of condensers, transformers, chokes, etc., and find that I usually only have to buy new coils, as I haven't time to make them, though I have in the past cut down variable condensers. May I finally remind "M.W." that eight years ago I submitted an article, "Solderless Sets," that was not accepted, presumably because solder in 1924 was considered indispensable!

I had an article in the Christmas number of either "M.W." or "The Wireless Constructor" in 1924.

Yours truly,

Mrs. B. LA BOOKER.

N.6.

## **The Two Publics**

Sir,—With reference to the article under the above heading in your January issue, I have pleasure in

writing to express my complete agreement with your view that the advantages are very largely on the side of the constructor, as compared with the purchaser of the complete set.

One should not lose sight of the fact, however, that there are two distinct sections of the community interested in radio; the one being the mechanically and electrically minded individual who, with the aid of good designs and clear instructions issued by the Press, and by certain manufacturers of repute, can build

## **SAFETY ON THE SEA**

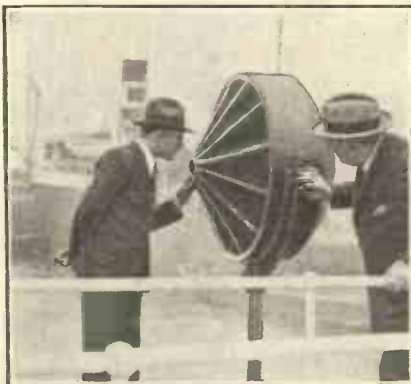

A sound indicator for enabling snips easily to locate their positions in fog, adapted by the Assistant Harbour Master of the Port of London (left).

almost any set that is put out; and, on the other hand, one has the "maiden aunt" type of individual, who neither wishes to assimilate the necessary information to build a set, nor in most cases is capable of doing so in any event.

For the former class of individual, the constructional sets—that is to say, the sets that he builds himself—are

undoubtedly the best proposition; whilst in the latter case it is, of course, out of the question, unless this be built for the party in question by a person having some knowledge of this matter.

I think it should be made clear that the advantage is on the side of the manufacturer as regards cost, due to the fact that the manufacturer invariably uses apparatus which, whilst perhaps good enough for the job, is definitely very different from corresponding apparatus sold as separate first-rate components.

## **Transit Risks**

The manufacturer having complete control of his production, it is unnecessary for him to completely shroud or enclose his various components, which are, therefore, in general, of the skeleton type, which it will be quite impossible to sell satisfactorily to the general public; for they would not be received by them in good condition, or, even if they were, the possibility of damage in transit, and in stock, and in the mere handling, would render the chances of satisfactory results rather remote.

It follows, therefore, that the constructor's set may cost more than what is apparently the corresponding factory set; but the position actually is that the competition in the set market to-day is so very great that no manufacturer can afford to put in the very highest class of product, because if he does the price of his set is so much above that of his competitors that, whilst the few discriminating purchasers appreciate its high qualities, the thousands who do not appreciate the difference between poor and good reproduction are enticed by the low price.

## **Costs and Quality**

If one wants any proof of these contentions, consider how very few commercial receivers there are which, to the trained eye at any rate, are fit to look at inside as well as out.

It will be seen, therefore, that

*(Continued on page 296)*

*An Original and Very Efficient Layout*

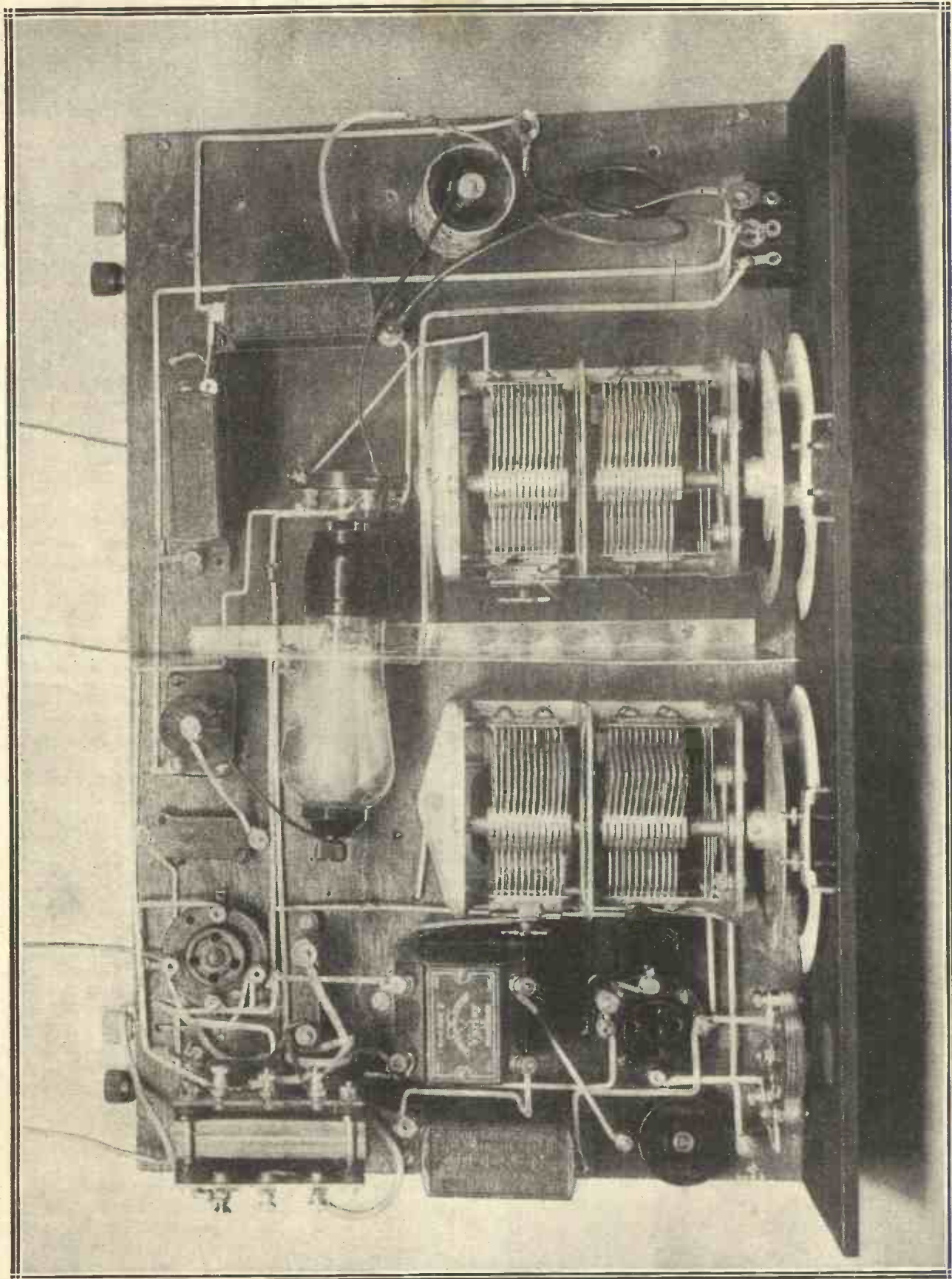

# THE "BI-BAND" THREE

*A Highly-Selective and Easily-Handled Double-Band-Pass Set.*



*Here is a break-away in set design for the man who wants unusually good quality and distance from his three valves, with a logical application of the band-passing method for obtaining super-selectivity. The "Bi-Band" Three has so many distinctive touches that even if you are not contemplating the building of a three-valve set, you will find the article and the illustrations which follow of unusual interest.*

**T**HERE are three ways of achieving sufficient selectivity and sensitivity in a broadcast receiver to deal adequately with present-day radio conditions. The first is the use of something like the Eckersley tuner, the second is to go still further with the matter and employ band-pass tuning, while the last is to use a super-het circuit.

The Eckersley tuner is probably the simplest of the three arrangements, for it does not entail the use of gang condensers, and the necessary trimming that they mean.

### Super-Selectivity

The super-het is more difficult to build and to get going satisfactorily, especially if good quality from the local stations is to be expected.

This type of circuit and the Eckersley coil represent at once the

most difficult and the easiest, and the two extremes of what may be called really adequate selectivity.

By this we mean that in very many cases the super-het is not required, interference being not serious enough to call for the extreme type of selectivity developed by that circuit, and the other type may very well be used in its stead.

In cases where the conditions are very bad the super may be needed, especially if the owner of the set does not mind having several valves.

But what happens in the event of a man requiring a set with a selectivity that comes somewhere between the two? Obviously he will have to use the third of the schemes that we have—he will have to use the band-pass type of set.

And it is about this class of receiver that we want to write this article.

The band-pass set can take many forms; it can be of the straight two- or three-valver having a detector and one or two L.F. stages; it can be of the H.F. variety with one band-pass tuning circuit; or it can be of a more ambitious design and include two or more stages of band-passing.

### The Usual Scheme

Usually the set having an H.F. stage and the one band-pass unit is the type that is built by the home-constructor. It is easy to construct and it is not particularly expensive. It gives quite sufficient selectivity for most purposes, and can be either of the single-dial tuning type or have a double-gang condenser and a separate tuning control for the one side of the band-pass coil or for the intervalve coupling.

## COLLECT THESE PARTS AND BUILD A FIRST-CLASS RECEIVER

- PANEL**  
16 in. x 8 in. (Permeol, Becol, Peto-Scott, Ready Radio, Wearite, Goltone).
- CABINET**  
Panel space, 16 in. x 8 in.; baseboard, 10 in. deep (Peto-Scott, "Morco," Cameo, Ready Radio, Pickett, Gilbert, Osborn).
- VARIABLE CONDENSERS**  
2 .0005-mfd. double-gauged (Polar Uniknob).
- SOLID-DIELECTRIC CONDENSER.**  
1 .0001-.00015-mfd. differential reaction (Telsen, Ready Radio, Lotus, Igranic, Polar, J.B.).
- SWITCHES**  
1 3-point on-off (Ready Radio push-pull, Telsen, Wearite, Peto-Scott, Goltone, Bulgin, Lissen, Magnum).
- RESISTANCES**  
1 50,000-ohm wire-wound volume control (Clarostat, Sovereign, Magnum, Wearite, Colvern).  
1 100,000-ohm Spaghetti (Telsen, Bulgin, Lewcos, Sovereign, Peto-Scott, Ready Radio, Igranic, Varley, Magnum, Tunewell).

- 2 25,000-ohm Spaghetti (Telsen, etc.).
- 1 10,000-ohm Spaghetti (Bulgin, etc.).
- 1 2-megohm grid leak (Graham Farish Ohmite, Dubilier, Loewe, Igranic, or (with holder) Telsen, Ready Radio, Ferranti, Watmel, Varley).
- VALVE HOLDERS**  
1 Horizontal 4-pin (W.B.).  
2 4-pin (Graham Farish, Telsen, Lotus, Wearite, Bulgin, Clix, W.B., Igranic).
- FIXED CONDENSERS**  
1 .0003-mfd. (Formo Mika-Densor, T.C.C., Dubilier, Telsen, Igranic, Ready Radio, Lissen, Graham Farish, Goltone, Sovereign).  
1 .0001-mfd. (Dubilier type 670, etc.).  
1 .01-mfd. (T.C.C., Dubilier, Telsen, Lissen, Ready Radio, Ferranti, Graham Farish, Watmel, Sovereign).  
2 1-mfd. (Telsen, T.C.C., Dubilier, Sovereign, Ferranti, Helsby, Hydra, Igranic, Lissen, Peto-Scott).  
3 2-mfd. (Telsen, etc.).
- CHOKES**  
1 H.F. (Ready Radio, Telsen, Wearite, Peto-Scott, Tunewell, Sovereign, Graham Farish, Lewcos, R.I., Lotus, Varley, Atlas).

- 1 H.F. (Lewcos type M.C., etc.).
- 1 Pentode output choke (R.I. Pentamite, Tunewell).
- L.F. TRANSFORMER**  
1 Small L.F. (Varley, Nicore II, Igranic Midget, Ferranti A.F.S, R.I. Hypermite, Climax-Mu-Max, Lotus, Graham Farish Snap).
- COILS**  
1 British General Band-Pass, aerial model.  
1 British General Band-Pass, anode model.
- SCREENS**  
1 8 1/2 x 4 1/2 in. (Peto-Scott, Ready Radio).  
1 5 1/2 x 2 1/2 in. (Peto-Scott, etc.).
- MISCELLANEOUS**  
2 Terminal strips (Sovereign).  
4 Indicating terminals (Belling & Lee type R, Bulgin, Belex, Igranic, Clix).  
6 Wander plugs (Clix, etc.).  
2 Spade terminals (Belling & Lee, etc.).  
Wire (Glazite, Lacoline, Quickwyre, Jiffilix).  
Grid-bias clips (Bulgin). One for large G.B. and one for S.G. bias.  
Flex, screws, copper foil, etc.

Whichever method of tuning is employed the results as regards selectivity are about the same. The tuning is sharp, and in all medium cases where band-pass tuning is required it is perfectly satisfactory.

There are cases where a still further degree of selectivity, though it may be only a small one, is required—cases where a little bit more separation between stations is needed without any complication in handling. These are catered for in the double band-pass set described here.

### Two Separate Filters

This set not only has a band-pass aerial circuit, but also, after the screened-grid valve, a further band-pass unit of similar type to the aerial. This means that we have a double chance of getting proper selectivity, because the two units are designed to have a 10-kilocycle band width.

Thus before the screened-grid valve a large degree, though not perfect, of selectivity is obtained, and after the H.F. stage the selectivity is improved by the second band-pass coil unit.

This double selectivity scheme does not, of course, have the deleterious effect that an ordinary two-stage, sharply tuned set would have, because of the fairly straight skirts of the resonance curve of the units. The ordinary double tuned stage would result in a sharp peak that would cause a serious loss of the side-bands, and consequent loss of high-note reproduction. We are, of course, assuming that the circuits in each case are providing about the same degree of selectivity. That is, that the station separation in the two cases is the same.

### An Ideal Method

It is easily seen, then, that the double band-pass method of obtaining selectivity is ideal, for it enables the tuning curves of the receiver to be beautifully straight-sided, and thus allows a full measure of high notes to be reproduced.

The fact that a double band-pass tuning arrangement is employed does not make the set any more difficult to handle than a one-stage B.P. receiver, for the two units are tuned by two double-gang condensers which have, in addition to the ordinary pre-set trimmers, variable trimming vanes that can be used during the process of tuning-in the set to make sure that the station is properly tuned in. This makes it possible to get the very utmost out of the set, especially as the band-pass units provide very sharp cut-off of the frequency band.

Owing to the space taken up by the two units, which obviously cannot be cramped in design if full efficiency is to be obtained, an "upstairs" and "downstairs" method of construction has been adopted.

grid-bias by-passing condenser, and the three-point on-off switch.

Above, of course, are the tuning condensers, the valve holders, and all the rest of the set. The result of the splitting up of the receiver components

## COMBINING AN S.G., DET. AND PENTODE

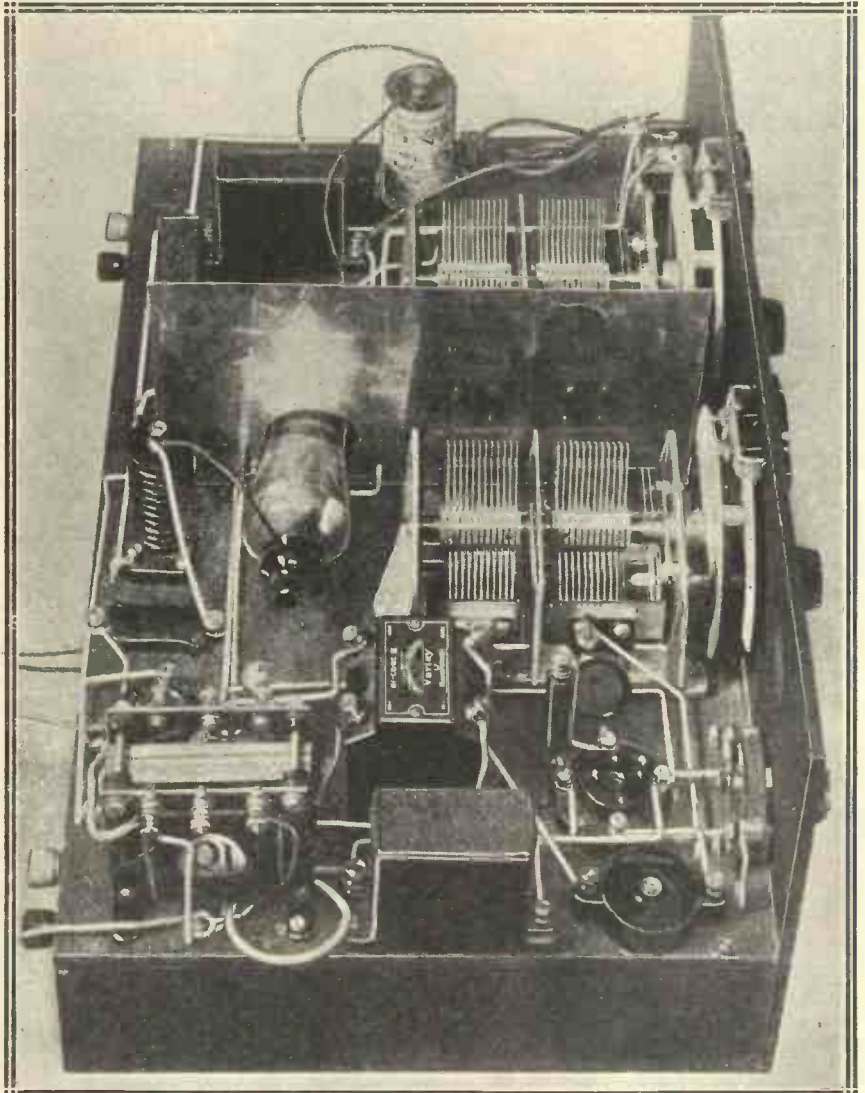

The "Bi-Band" is quite unlike any other three-valver in appearance, and its superior performance was very marked when the original model was tested in the "M.W." Research Department. Not only do the foreign stations "roll in" with easy separation of adjacent programmes, but the quality is particularly good and there is a magnificent reserve of power even on very distant stations.

The panel is of standard size, measuring 16 in. by 8 in., a baseboard having a depth of 12 in. being used. This is mounted part way up the panel so that some of the components can be mounted underneath. This saves a great deal of space, and keeps the area of the baseboard down to a minimum.

The main parts to be mounted "downstairs" are the tuners themselves, this being particularly valuable, as the tuning condensers which tune the coils can be mounted directly above them. Also below are the main grid-bias battery, and the H.F.

is that a particularly efficient layout can be arranged, and at the same time the wiring can be kept simple to carry out.

### Controlling the Volume

Before we go further into the constructional details of the set we must mention one more interesting feature that is worth noting. We refer to the volume control.

This is a 50,000-ohm potentiometer, and controls not only the voltage applied to the anode of the screened-grid valve, but also the voltage supplied to the screening grid. In this

## Band-Pass Tuning Before and After the S.G. Valve!

way the valve is kept at the correct operating condition for a far greater variation of voltage control than is the case when the voltage of the screen grid only is varied.

### Preserving Quality

It is a small point, perhaps, but it is an important one, and makes for good quality reception of the most important part of the set's duties—the reception of the local station.

It is easy enough to build a simple receiver that will give good results on distant programmes, but it is a different thing to make a set that with simple control will give not only good results on distance, but will

After this the layout of the base-board, top and bottom, can be carried out. This is easily done from the diagrams, but there are one or two points that need attention. The first is the fixing of the double-gang condensers. This must be done with short screws, for the underneath of the baseboard is covered with foil, and the screws must not protrude through the board and make contact with the foil. If this does occur, the moving vanes will be connected to the earth circuit, and this will have the result of short-circuiting the fixed condensers in the band-pass units.

The screws anchoring the spaghetti resistances should also be on the short

plates supplied by the manufacturers.

The actual cutting being done by means of a fretsaw, if you have one, or by drilling a number of small holes round the circumference, and filing out after the piece of ebonite has been knocked away.

### Points to Watch

Care must be taken in the mounting of the condensers that the spindles are not strained, otherwise the action of the drive will be seriously impaired, and it is far easier to mount the condensers out of true than you might imagine.

Owing to the depth of the coil units, which are mounted underneath

## An Entirely New Circuit For Meeting Modern Conditions

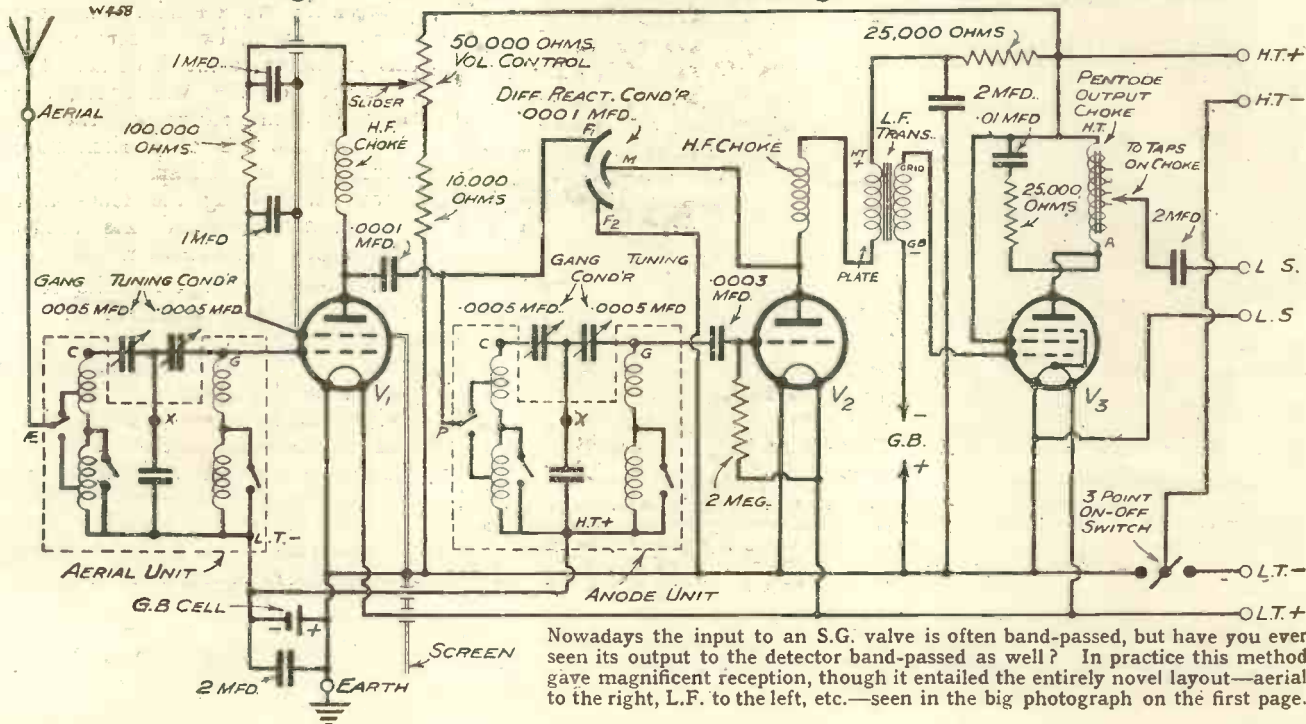

Nowadays the input to an S.G. valve is often band-passed, but have you ever seen its output to the detector band-passed as well? In practice this method gave magnificent reception, though it entailed the entirely novel layout—to the right, L.F. to the left, etc.—seen in the big photograph on the first page.

provide really decent quality on the local. This however, is achieved in the "Bi-Band" Three with the volume control that we have described.

The ideal scheme, of course, would be the variable-mu valve, but at the time of designing the set the battery type of variable-mu valve was not available to the general public, though experiments with this class of S.G. had been carried out in the "M.W." Research Department.

Returning to the construction of the set, the first thing to do is to mark out and drill the panel in accordance with the panel-drilling diagram.

side, for here again it is essential not to make contact with the foil, although in one case such an occurrence would not upset things.

The two screens are made from a couple of standard screens, and are cut to 4½ in. and 2½ in. in height respectively for the top and bottom screens. The length of the screens is 8½ in. and 5½ in.

### Drilling the Panel

The drilling of the panel, and the cutting out of the holes for the escutcheons of the Uniknob condensers can be tackled with the aid of the tem

the baseboard, care must be taken in the drilling of the panel, otherwise there is a danger of not getting the escutcheons in; they come very close to the top of the panel in any case.

### The Valve Hole

Another point to watch in the building of the set is the placing of the valve hole in the top screen. This screen, as you have just read, is made from a standard screen, and it is important that the valve hole be the correct size for the valve that you are going to use.

## WHERE ARE THE TUNING COILS?

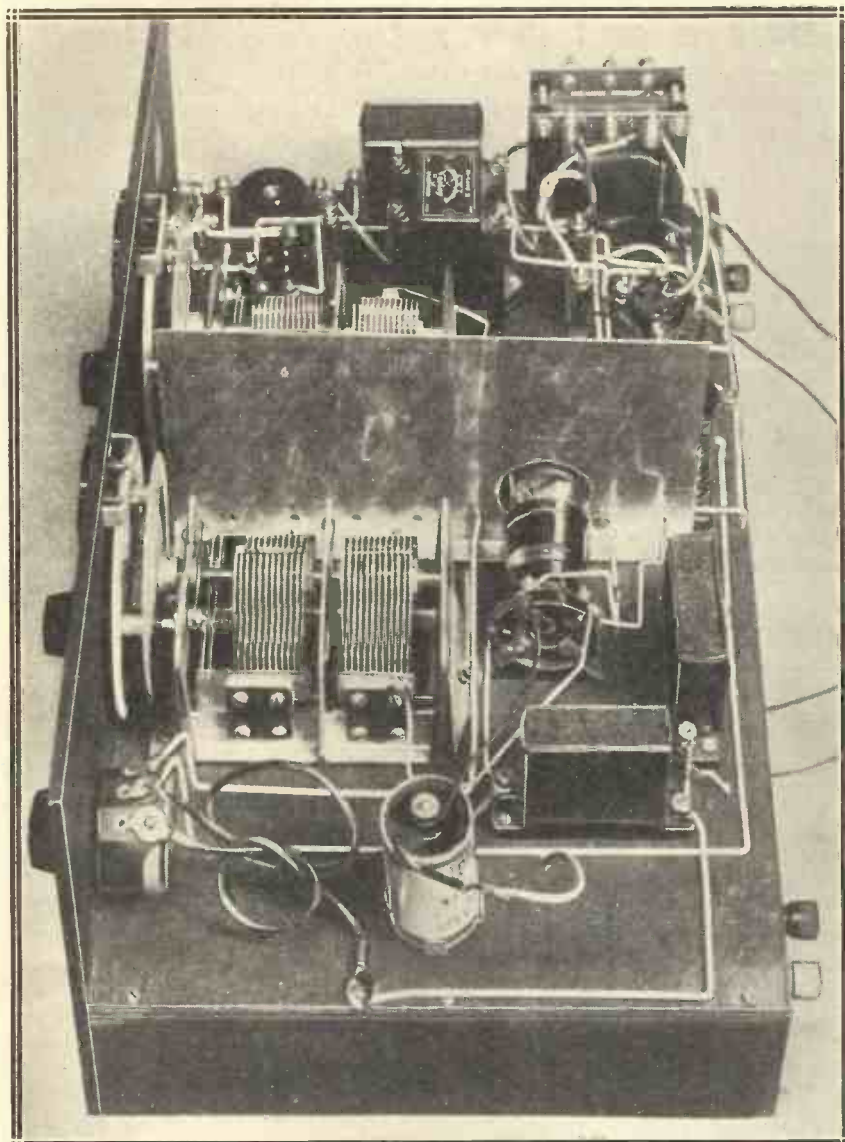

Looking down on the set you can't see a single tuning coil, and even the big photograph on a preceding page shows nothing of the kind! But actually they are efficiently placed, very near their condensers, a hint of their whereabouts being given by the raised baseboard shown clearly in the foreground.

Unfortunately the various valves on the market are of varying diameter and this makes it impossible to standardise any particular diameter of hole.

It has to be cut to fit the valve you are going to use, and of such a size that it fits snugly round the valve at the place where the skirt of the screening grid runs out towards the glass bulb.

### "S.G." Holder Position

Naturally this requirement will also affect the exact position of the screened-grid valve holder in relation to the screen, for obviously this has to be so adjusted that the valve protrudes through the screen by the correct amount to get the screening-grid skirt in line with the screen.

Many cases of instability come to our notice simply because this simple precaution is not carried out. The outside screen is really a continuation of the screen inside the valve, and by not getting it in its proper place you somewhat counteract the effect of the design of the valve.

In the particular set which we have under consideration the hole in the screen dividing the two tuning circuits comes with its centre about  $2\frac{1}{4}$  in. in from the back of the screen, and a distance of  $1\frac{3}{8}$  in. up from the baseboard.

This latter distance, however, must be checked up in each individual case, as it will depend upon the valve holder used for the S.G. valve.

The H.F. choke in the anode circuit of the screened-grid valve

should be mounted so that a short lead from the anode terminal to the choke is obtained, the coupling condenser associated with the choke being fixed close to it on the baseboard.

### Short Wiring

From this condenser a lead has to run through the baseboard to the anode unit of the band-pass coils.

The screen under the baseboard is not critical in its size, but it should adequately shield the wires from the two band-pass units where they run parallel to each other. We refer to the leads from the terminals marked C.X.G. on the aerial coil, and those marked P. and H.T. on the anode unit.

These leads are in the grid and anode circuits of the screened-grid valve, and interaction between them might cause trouble.

A certain amount of screening between the two coil units themselves is also provided by the screen, but this is not so essential, because the units are not only well apart, but the coils themselves are so arranged that the two sets of medium-wave inductances are well apart; the two nearest coils being the long- and medium-wave coils, and these are at right angles to one another.

In mounting the coil units care must be taken that the foil on the underside of the baseboard does not touch the switch contacts of the band-pass units. The best way to guard against this is to cut pieces of thin card the exact size of the coil units, and place these under them before screwing the units in position.

No external coupling capacity for the band-pass coils is required, as the condensers are included in the units themselves.

### Importance of Layout

Coming to the L.F. side of the set, care must be taken that the layout is carried out as closely as possible in accordance with that of the original set.

If this is seriously altered you may get trouble from L.F. feedback. The detector valve holder should be close up against the reaction condenser, and its H.F. choke must lie close alongside. This will keep the grid lead to the detector short, as the connection to the valve is made via a .0003-mfd. grid condenser from the fixed vanes of one section of the second gang condenser.

This, in turn, of course, is connected to the top of the grid winding of the



## Something Completely New in Three-Valve Technique

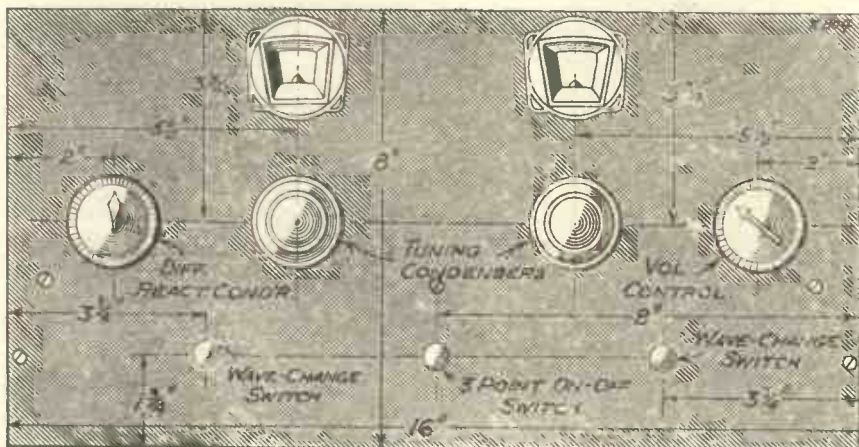

The "Bi-Band" Three is an easy set to handle, despite its extremely long range. The two main tuning condensers each have a "trimming" knob in front of the main control, so this can be operated as a final adjustment on very distant stations. All the dimensions for drilling are given above.

band-pass coil, which lies directly below the condenser. In this way the leads at H.F. potential are kept beautifully short, a fact that does a great deal towards making the design really stable, although it is very sensitive.

The anode leads from the detector are also kept as short as possible, the transformer being placed close to the valve and at right angles to the pentode output choke.

This is also important because we do not want any chance of feedback from the output to the previous stage, and the high magnification obtained from a pentode always makes such a phenomenon a possibility.

### Spaghetti Resistances

It will be noticed that several spaghetti resistances are used in the set. These must be handled with care, as though this type of resistance is quite satisfactory it is not so robust as many people seem to think.

Properly handled a spaghetti will do its work well, but it is a little too much to expect them to stand up to some of the horrible twists and bendings that some constructors subject them to.

The wire of which they are made is necessarily thin, and it cannot be expected that it will stand up to fierce kinking in the attempt to make it go round a right-angled corner. The spaghetti resistance should be bent as little as possible; it is meant to stand the strain of gradual curving, and if treated gently it will not often let you down.

Soldering the tags of spaghetti wires is not a particularly wise thing

to do, as it is easy to ruin the contact between the wire and the tag if the iron is clumsily applied.

A word about the resistances used in the H.T. supply circuit of the S.G. valve. The spaghetti in the potentiometer lead has a resistance of 10,000 ohms and this value was chosen as being a suitable economy value.

### Increased Economy

The purpose of this resistance is twofold. In the first place it limits the current drain on the H.T. battery, apart from that due to the valve, and in the second it helps to make the

voltage control of the S.G. valve smoother, by limiting the amount of drop that is obtained when the potentiometer slider is moved down the resistance.

If the resistance in series with the potentiometer were increased it would result in greater economy, but it would not allow the volume to be reduced sufficiently to give proper control on the local station, when that station was very close.

The screening-grid potential is automatically controlled by the same potentiometer as the anode, the extra drop in voltage required by the screening grid over the anode being obtained by the series resistance of 100,000 ohms between the slider of the potentiometer and the screen grid of the valve.

### Combined Control

This gives a not strictly accurate, but quite near enough, ratio between the screen-grid voltage and that on the anode, and enables the one volume control to operate both voltages.

As the set is described there is no provision for a gramophone pick-up, because it is felt that such an extra would have only a limited appeal, as the use of one L.F. plus a pentode stage is not really enough to cover all types of pick-ups. With a sensitive instrument, such as the Marconiphone, B.T.-H., H.M.V., and so on, the two valves might be sufficient,

### THE COILS ARE IN "THE CELLAR"!

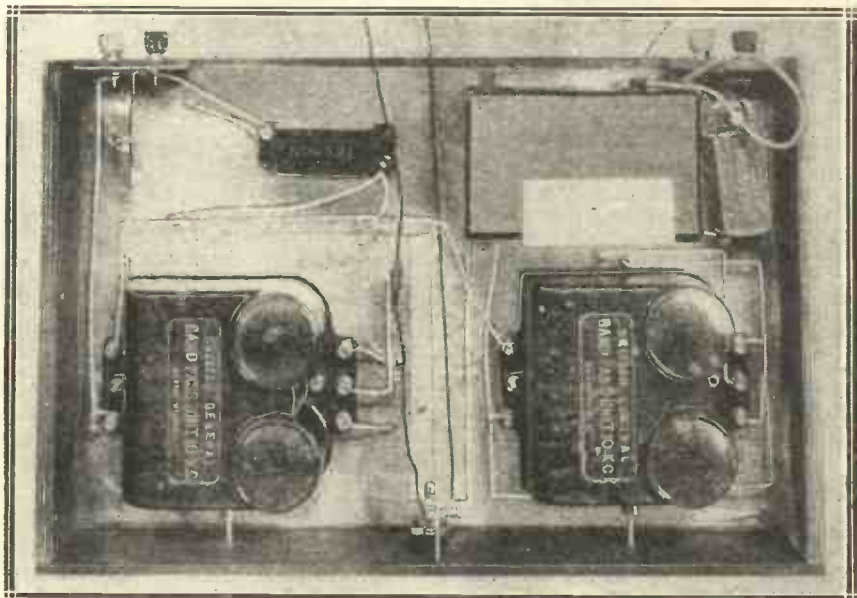

This is a "worm's-eye view" showing how the coil units are placed underneath the raised baseboard and below their respective tuning condensers. Note the neat screen between them, and the clip (top, right) holding the bias battery.

# So Novel That Layout Had To Be Reversed!

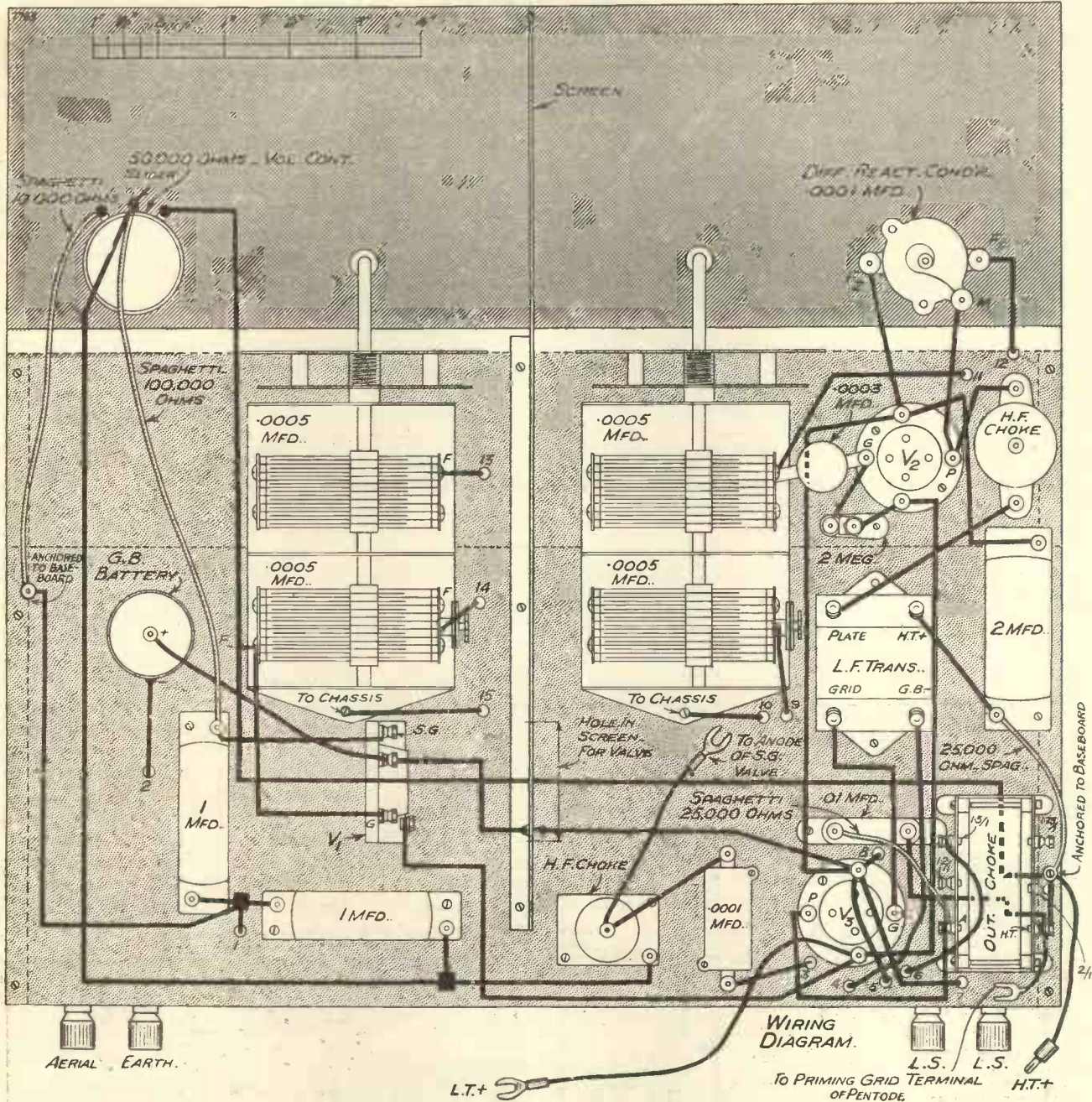

All the L.F. components, which are usually placed on the right of a set, looking at it from the front, are situated on the left of the baseboard in this receiver. Note that for the points marked "anchored to baseboard" short fixing screws should be used, or otherwise they will make contact with the foil fixed underneath the baseboard. Use short screws also for the condenser assembly (marked "To Chassis," holes 10 and 15), as on no account must contact be made with the foil.

but not very much margin of safety would be left.

A pick-up can easily be added, however, by breaking the detector grid lead and fitting a switch on the panel in some convenient place.

A couple of sockets near the switch would allow the pick-up to be "plugged in" at will. The connections to such a switch and sockets would be quite easy, as the following will show.

The lead from the grid condenser to the grid of the detector valve is

broken and the grid leak is taken off the grid terminal and joined to the now free end of the grid condenser.

### Fitting a Pick-Up

This point is then taken to one of the outside contacts of the change-over switch. The centre of the switch is joined to the grid of the valve, and the remaining side of the switch is joined to one of the pick-up sockets that are to be placed in the panel.

The other socket is connected to a grid-bias negative plug, and this

finishes the alteration. The pick-up will have to be volume-controlled externally, by means of a 250,000- or 500,000-ohm potentiometer, as no L.F. control is fitted in the set.

This control would modify the external connections of the pick-up slightly. These would then be as follow: The one side of the volume control would go to the one side of the pick-up, and the other side of the potentiometer would be connected to both the pick-up and one of the sockets on the panel—

## H.F. and Detector Grids are Fed from Band-Pass Circuits

the one that goes to the grid-bias plug.

There is a lead remaining. That is the connection from the slider of the volume control, which is taken to the remaining socket on the panel.

### Quick Change-Over

Then when the pick-up switch is placed in one direction, the grid of the detector valve is placed in contact with the grid condenser (and radio is received), and when in the other position the grid of the detector is transferred to the slider of the pick-up volume control, and the set is ready for gramophone reproduction.

In the actual layout and wiring there is nothing difficult, and if the diagrams are followed carefully the constructor should strike no snags. But the wiring must be made as closely to that shown as possible, but the set is by no means tricky either to build or to operate.

To strengthen the mounting of the panel two battens are used, one on either side of the baseboard. These can be conveniently fitted after the wiring has been done, and then they will not in any way hinder the wiring process; it is sometimes awkward to carry out wiring when there are two  $\frac{3}{8}$ -in. battens running down the sides of the baseboard.

Only one H.T. lead is employed in the "Bi-Band" Three, so that there is an equal drain on all the cells of the H.T. battery, while the decoupling in the set allows it to be used with a mains unit.

The average pentode valve operates quite satisfactorily without any voltage-dropping device in the priming grid circuit to adjust for the loss of voltage in the anode circuit, due to the resistance of the pentode output choke. Consequently no priming grid resistance is included in this receiver.

When the construction has been completed the batteries should be connected up, the valves inserted in their sockets, and the aerial and earth joined up.

It will depend upon the loud speaker what value of anode impedance equaliser resistance is used across the output choke, but the average value is the one given in the diagrams and used in the original set—15,000 ohms, with a .01-mfd. fixed condenser.

### Suitable Valves

The valves can be left very much to the reader's choice, but it is recommended that a fairly high magnification screened-grid valve be used, and an efficient detector and a really good pentode.

The three valves used in the original set are the Osram (or Marconi) S.22, the Mazda H.L.2, and the Mullard P.M.22. Alternative makes are given in the list of accessories.

## Some Outstanding Points In An Outstanding Design

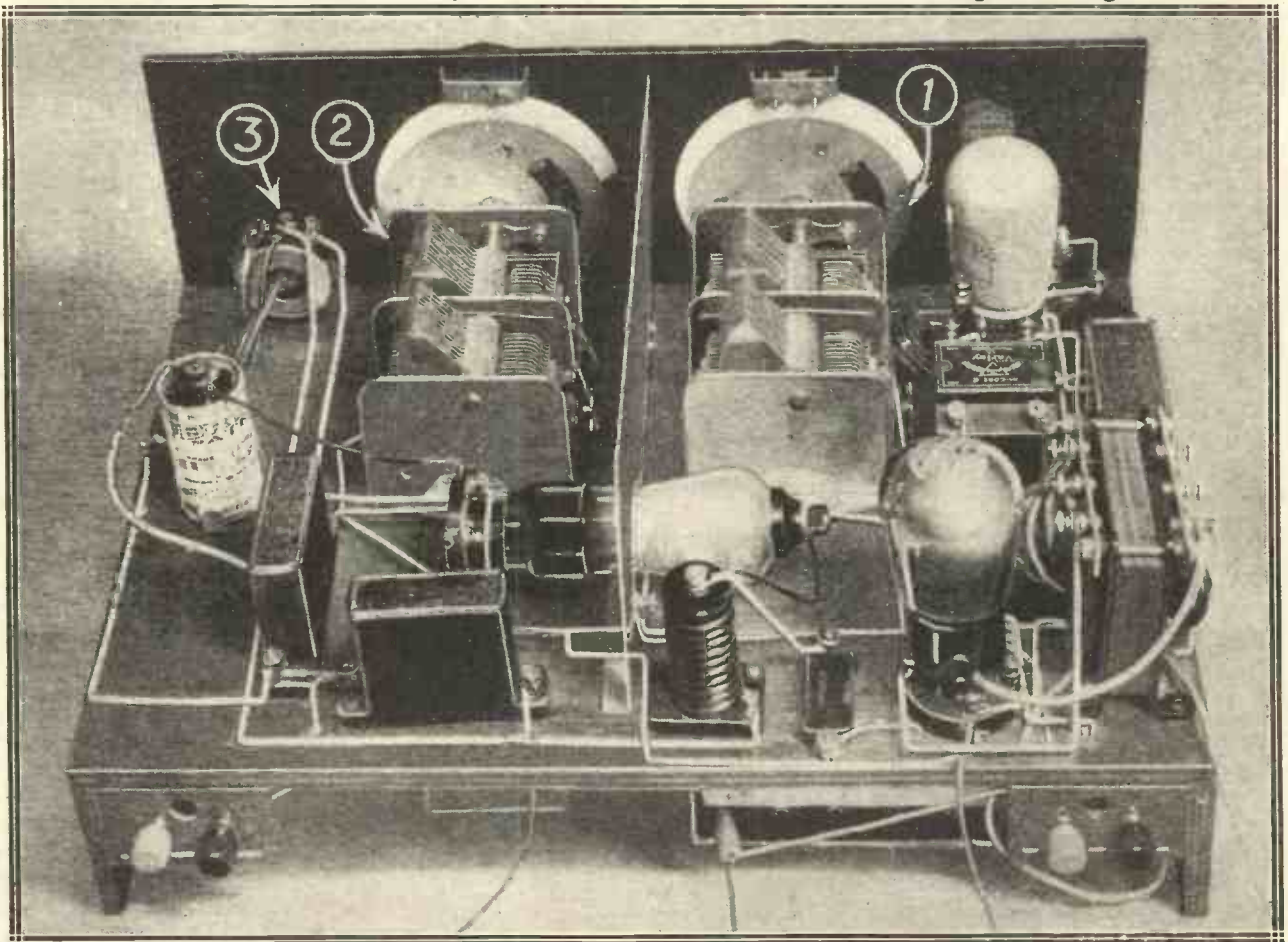

Here is the complete set with valves and grid batteries in place. (1) and (2) indicate the aerial and H.F. band-pass condensers, while (3) is the volume control. Note how the main grid-bias battery is stowed under the baseboard below the pentode valve holder.

## Easy Wiring Underneath the Baseboard

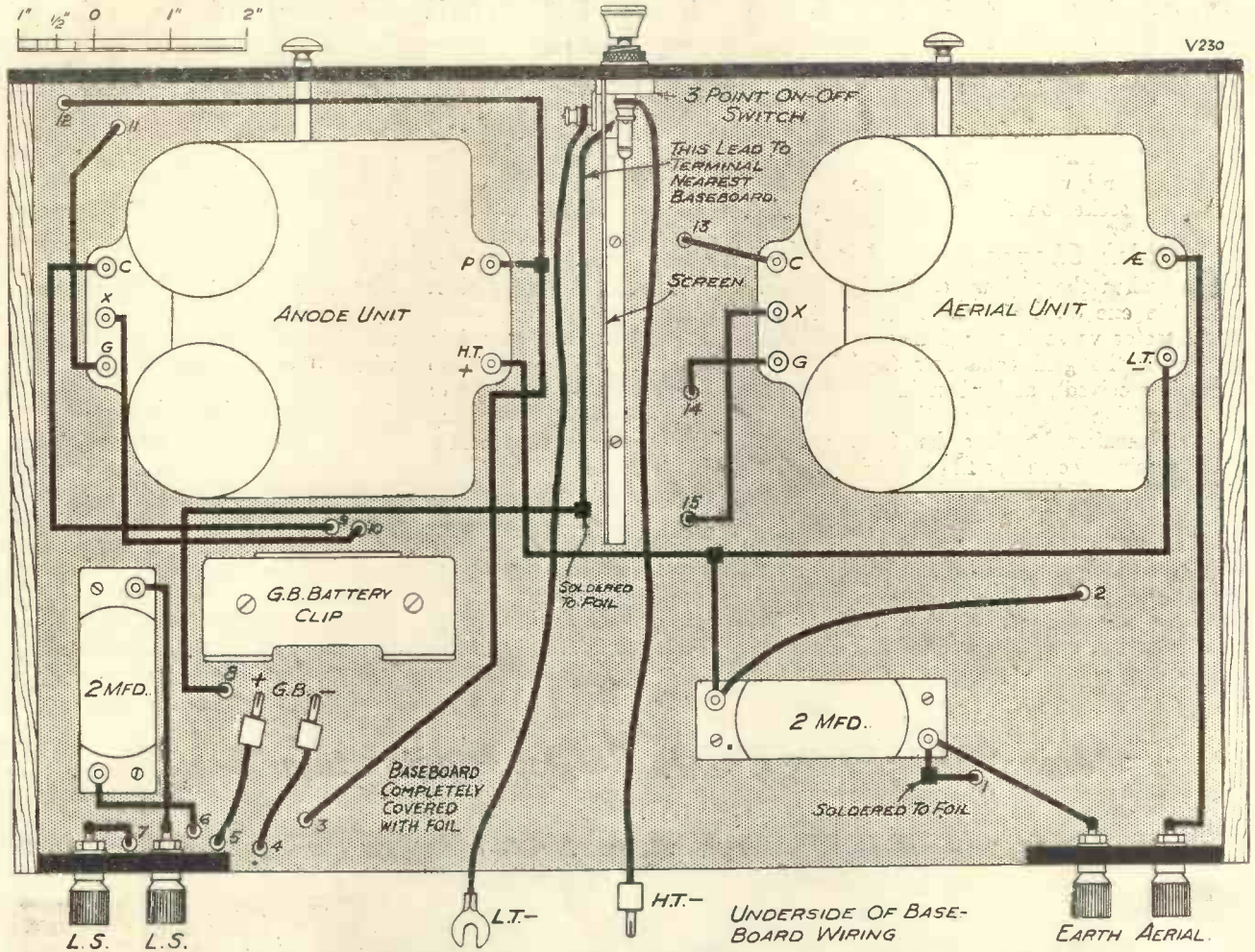

It will be seen that when wires go through the baseboard they pass through numbered holes, these numbers corresponding with those on the main wiring diagram on a preceding page. Thus the wiring is very easy to carry out, and a surprisingly simple layout effect is obtained.

The method of balancing the ganged condensers is easy. First tune in the "local" so that the reception is not too loud, and then screw up the two little wheels on the back sections of the condensers to about two-thirds their total capacity.

This should then so alter the ganging of the condensers that the trimmers

that are controlled by the small knobs on the panel have to be in the centre position when the station is in tune.

To check this a more distant station must be tuned in and further adjustments made until the desired result is obtained.

The tuning is, of course, very sharp, and in a few degrees it is possible to

find and lose a station, but it is never so critical that it is impossible to tune in even a fairly weak transmission.

Finally, a few words about the pentode output choke. The tappings on it are for the purpose of enabling you to match the output valve with the speaker that is to be used with the set.

### RECOMMENDED ACCESSORIES

**LOUD SPEAKERS.**—(Celestion, Amplion, W.B., B.T.-H., Marconiphone, Epoch, H.M.V., Graham Farish, Blue Spot, R. & A.).

**VALVES.**—1 S.G. (Marconi S.22, Osram, Mazda, Mullard, Six-Sixty, Cossor, Tungram, Eta).

1 Det. (Mazda H.L.2, Marconi, Osram, Mullard, Cossor, Six-Sixty, Eta, Tungram).

1 Pentode (Mullard P.M.22, Marconi P.T.240, Osram P.T.240, Mazda Pen.230, Cossor 230P.T., Six-Sixty 230P.P., Tungram).

**BATTERIES.**—H.T., 120-150 volts (Pertrix, Ever Ready, Drydex,

Lissen, Ediswan, Columbia, Magnet).

G.B., 1½-volt cell for S.G. (Pertrix, etc.); 16½-18 volt (wide type with double row of sockets, or two 9-volt batteries side by side) (Pertrix, etc.).

**ACCUMULATOR.**—2-volt (Exide, Ever Ready, Pertrix, Ediswan, G.E.C., Lissen).

**MAINS UNITS.**—To supply 20 milliamps. at 120 volts (Regentone, Ekco, Tannoy, Formo, Heayberd, Lotus, R.I., Atlas, Tunewell). State voltage and type of mains when ordering.

### Matching the Speaker

This can be done quite well aurally, and the process is to alter the position of the tap from the output condenser until the best quality and volume are obtained. The leads from the anode of the valve and from the H.T. battery are left at the two ends of the choke marked "anode" and "H.T." respectively.

One word about the grid bias for the pentode valve. There is not room for the ordinary straight 16½-volt battery, so it is suggested that one of the fatter double-row batteries be used.

# MY BROADCASTING DIARY



*Our own Broadcasting Correspondent records the progress of the British Broadcasting Corporation, and frankly comments on the policies in force at B.B.C. Headquarters.*

## **Wireless Exchanges and the B.B.C.**

**A**LTHOUGH deprived of Post Office co-operation or encouragement, the B.B.C. has managed to make agreements with the two chief companies engaged in wireless exchanges throughout the country. I understand that one result is that the B.B.C. will have a say in the choice of programmes for the wireless exchanges covered by these two companies.

It is easy to understand why the B.B.C. should desire this. For one thing, they are naturally anxious to curtail the amount of foreign sponsored programmes which is mixed with B.B.C. material for the subscribers of wireless exchanges.

They are also anxious—and this is perhaps not so admissible—to impose their idea of Sunday programmes on the exchanges. No doubt it is of advantage to all concerned that there should be reasonable co-operation. But if the B.B.C. tries to stop or severely restrict the inclusion of Continental programmes on Sunday there will be a serious public protest.

Another interesting point which I have heard discussed in this connection is the idea that the B.B.C. should take full responsibility for programme mixing.

## **The Sheffield Studio**

The B.B.C. has done wisely in meeting the wishes of Sheffield. Prolonged negotiations have resulted in the B.B.C. deciding to maintain a studio in Sheffield, so that although there will be no transmission from there, local material can be collected on the spot and important Sheffield people will no longer have to travel to Leeds or Manchester before they can broadcast.

Presumably, the B.B.C. is prepared to face and accept similar demands as and when they are made by other large centres of population which are not now equipped with studio accommodation of this kind. It is not clear whether this is an isolated move or part of a general change in policy involving more devolution and more definite encouragement of the regions.

## **Henry Hall's Auditions**

Henry Hall is not having an easy time filling his new B.B.C. Dance Orchestra with first-class British material, to which he is committed. There were, I believe, no less than fifty auditions before the first eligible candidate was selected.

The search continues.

Meanwhile, relations between Mr. Henry Hall and Mr. Jack Payne, his predecessor, are all that could be desired. As to the problem of a possible attempt on the part of Mr. Hall to suppress song-plugging by outside dance bands, the very suggestion has created a panic in certain quarters, and strenuous efforts are being made to kill the scheme before it is taken seriously.

## **Television**

The lengthy negotiations started by the B.B.C. last November seem to be approaching their end. And there is a prospect for a firm arrangement with the Baird Com-

## **THE KING'S MICROPHONE**

This beautiful gold and silver microphone was made specially for His Majesty the King. It replaces the original one which had been in use for years.

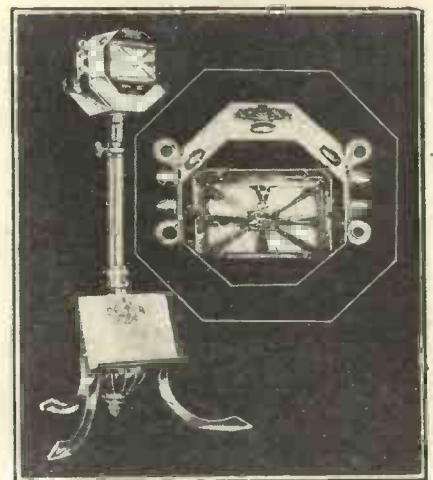

pany. Roughly it is this: The B.B.C. takes over the programme work and reorganises the transmission. Instead of the five half-hours in the mornings during the week and the special feature programme every Saturday or Monday, as at present, the hours of transmission will be reduced, the morning transmissions disappearing.

There will be a new series of half-hour transmissions at 11 p.m. on four nights of the week, vision on 261 metres and sound on 399 metres. The B.B.C. is to make it clear that there will be no exclusive arrangement with the Baird Company, or any restraint on transmitting television by any other process, at any time.

But in view of the fact that the Baird Company would undertake to make clear the possibly temporary character of the B.B.C. transmissions by its process whenever a

## Latest News Items for the Listener

receiving set is sold or hired, the B.B.C. for its part would promise not to throw out Baird television entirely for two years, thereafter giving six months' notice of termination if another system is to be preferred or if the whole experiment is to be abandoned.

Thus, at long last, there is at least the appearance of a reasonable and straightforward arrangement, fair alike to the B.B.C., the Baird Company, and, what is most important, to the general public, or that part of it interested in television.

### AT WORK ON HIS SCULPTURES



Mr. Eric Gill, the eminent sculptor, finishing off his work at Broadcasting House. He used to start work soon after day-break, and seldom finished until dusk.

### That Black List

There has been an unnecessary amount of heart-burning about the alleged black list of artistes by the B.B.C. Explanations so far given are off the point. The facts are simply as follow :

The B.B.C. has so long a list of competent artistes that it has had to suspend auditions for a period of six months, which may be extended. Even with this restriction there are on the books no less than two thousand artistes who have reached the qualification standard for microphone work and have not yet had a chance of an engagement.

There are, of course, several hundred artistes in more or less regular work. The principal members of the Music Department meet fortnightly, and with regard to artistes review the position on the very careful reports of those responsible for auditions.

It follows that in the interests of broadcasting there should be a constant effort to improve standards, and at the same time to provide every available opportunity for new talent to express itself. This means, of course, a continuous revision.

Marginal cases are recurrent ; in such a large list it is inevitable that here and there there should be a falling off in standard, even with artistes of established reputation. When this falling off becomes at all chronic it is only fair to lay off and replace.

Thus what happens is a revision of the eligibility list from week to week ; in cases of doubt a Blattnerphone record is taken in order that the opinion of the expert may be tested and either rejected or confirmed.

### Truce with Sir Thomas Beecham

Lady Snowden's part in bringing about a suspension of hostilities between Sir Thomas Beecham and the B.B.C. has not been adequately recognised. True, an important motive was the desire on the part of Sir Thomas to enable Delius to hear a special concert of his work.

But certainly an equivalent factor was the influence on Sir Thomas' attitude exercised by Lady Snowden's conversations with him on the subject of securing united action in the cause of opera.

Although I have been careful to describe the present position as more of a truce than a peace, I believe that it has the elements of endurance, largely because of the new degree of personal understanding between Sir Thomas and Lady Snowden.

From the point of view of broadcasting, this has much more significance than is involved in the purely personal considerations. A permanent peace between the B.B.C. and Sir Thomas Beecham would vastly enrich the musical programmes and would also make permanent opera a practical possibility.

### The Danger of Faddism

I am sorry to see that the B.B.C. has let itself in for another manifestation of faddism. I have observed and commented on the danger of the uncontrolled activities of such portentous bodies as the Central Council for Broadcast Adult Education, which in its main attributes of unchallengeable respectability, enviable distinction ecclesiastically, politically, æsthetically and intellectually, and intense attitude of high endeavour, is singularly ill qualified to determine beyond very narrow limits the material or the presentation of acceptable broadcasting.

It seems to me that this body has performed a notable and indeed an essential function in helping frame the character of the B.B.C. But it must be kept in check for its own good as well as for the good of the listening public. A family return episode is superlatively ridiculous unless handled by Jack Watt or Philip Ridgeway.



# A RADIO RECKONER

By  
**W. A. BARCLAY**  
M.A.



Here is a further part of a most useful and fascinating series of articles which will save you a great deal of time and trouble. This month two alignment charts are given which deal with Resistance, Reactance and Impedance.

So far in this series we have been considering the elementary properties of the simplest types of wireless circuits. We have seen that the various different kinds of currents which are met with in a radio receiver respond differently to the various components which are used in the set.

frequency currents, but choking back those of the higher frequencies. In previous issues we have shown how the precise amount of reactance which is set up by coils and condensers at the different frequencies may be simply ascertained without any calculation by making use of the new principle of alignment.

ments it has been shown that the amount of reactance in an A.C. circuit may be controlled by suitable adjustment of a variable condenser, so that at certain values of capacity the circuit may offer a maximum or minimum response to the alternating current impulses passing through it.

## PLAIN RESISTANCE

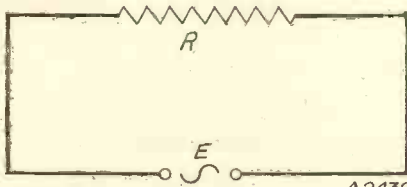

FIG. 1. A.2439

In a plain resistive A.C. circuit Ohm's law can be applied in the same way as for D.C. circuits. The frequency does not enter into the calculations, as there is no capacity or inductive reactance. The only quantity with which we have to deal is plain resistance.

For instance, a "three-noughts-three," or .0003-mfd. condenser, offers comparatively little reactance to H.F. currents of medium wave-length. Such a condenser will, however, oppose currents of audio or speech frequencies to a much greater degree, while, of course, it stops altogether the passage of currents of zero frequency; that is, direct currents:

## An Opposite Effect

An inductance coil, on the other hand, acts in precisely the opposite manner, allowing the passage of low-

## Peculiar to A.C.

It was pointed out in the issue of July, 1931, that although reactance is measured in ohms, it is of quite a different nature from resistance. This distinction is often apt to be confusing to the beginner. It will be helpful to remember that resistance, or opposition to current flow by the nature of the conducting material, is met with by both direct and alternating types of current.

Reactance, on the other hand, only arises where alternating currents are concerned. In more recent instal-

## REACTANCE

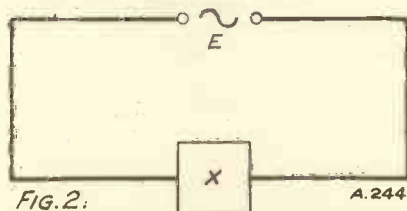

FIG. 2. A.2441

If a coil or condenser is introduced into an A.C. circuit, Ohm's law as used for D.C. circuits is of very little use. The opposition offered to current flow at once becomes dependent on the frequency of the supply. This opposition is called reactance, and is measured in ohms.

## IMPEDANCE

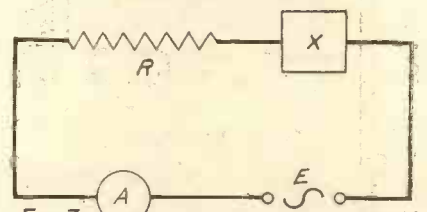

FIG. 3. A.2440

Reactive and resistive ohms are quite different, and cannot be added together directly. But in a circuit containing both these components their combined effect, which is called impedance, can be found from a fairly straightforward formula; or, better still, from the accompanying alignment charts.

In other words, the circuit is then "tuned" or "resonant" to the frequency of these impulses.

## Cannot be Added

Throughout this study we have been careful to insist that an ohm of reactance is quite a different thing from an ohm of resistance, and the two can no more be added together than can, say, an orange and a kangaroo. It might, of course, be held possible to add an orange to a kangaroo, but the reverse process is not conceivable, and, in any case, the

point is that the answer does not make *two* of anything. When all is said, the result of our addition is still simply an orange and a kangaroo.

So with resistive and reactive ohms. You can't add them—at least, not directly. They are two different kinds of things. Nevertheless, there is a method by which radio workers find it convenient to describe the total

fore devote a little space to inquiring somewhat more closely into its meaning.

### Ohm's Law Again

Let us begin by considering once more the application of Ohm's law to very simple circuits containing resistance or reactance only. In Fig. 1 is shown a resistance of R ohms,

amperes. Let us now consider the similar circuit of Fig. 2, in which a coil or condenser has been substituted for the resistance.

Let us suppose that at the frequency f cycles of the supply E.M.F., this component offers a reactance of X reactive ohms. Then it will be similarly found that the amplitude of the resulting current will be I<sup>1</sup> amperes, where

$$I^1 = \frac{E}{X}$$

Suppose, however, that we have to deal with a series circuit such as that of Fig. 3, consisting of a resistance of R ohms in series with a reactance of X reactive ohms. Let us again apply the same E.M.F. E volts at the same frequency f cycles across the whole combination.

### "A False Estimate"

Then, of course, a certain amount of alternating current will flow in the circuit, the amplitude of which we may call I<sup>11</sup>. Our problem is now to find out how big this current amplitude I<sup>11</sup> is. The temptation is very strong to add together the R resistive ohms and the X reactive ohms, and to call the result the total opposition of the circuit.

Nevertheless, to do so would be wrong, as already mentioned, and if we did so we should arrive at a false estimate of the amount of current passing. This may easily be shown by means of a thermo-junction or other current-measuring instrument inserted in the circuit, as shown at A in Fig. 3. This provides us with the amount of I<sup>11</sup>, and in general this will be quite different from the quotient  $\frac{E}{R + X}$ , which would be its value if R + X measured the total opposition in the circuit.

### Impedance in Ohms

Common sense, however, tells us that the circuit of Fig. 3, as a whole, does oppose a certain "impedance" to the applied voltage E. It is usual to denote impedance by the symbol Z, and to measure it, also, in ohms. Then, if Z ohms be the impedance of the resistance R in series with the reactance X of Fig. 3, we may write  $I^{11} = \frac{E}{Z}$ , where I<sup>11</sup> is the amplitude of the current flowing.

There is, then, a quantity Z which stands for the "impedance" of the circuit as a whole, and this, when it is known, may be used to relate the amplitudes of the alternating currents and voltages in the

### COMBINING RESISTANCE AND REACTANCE

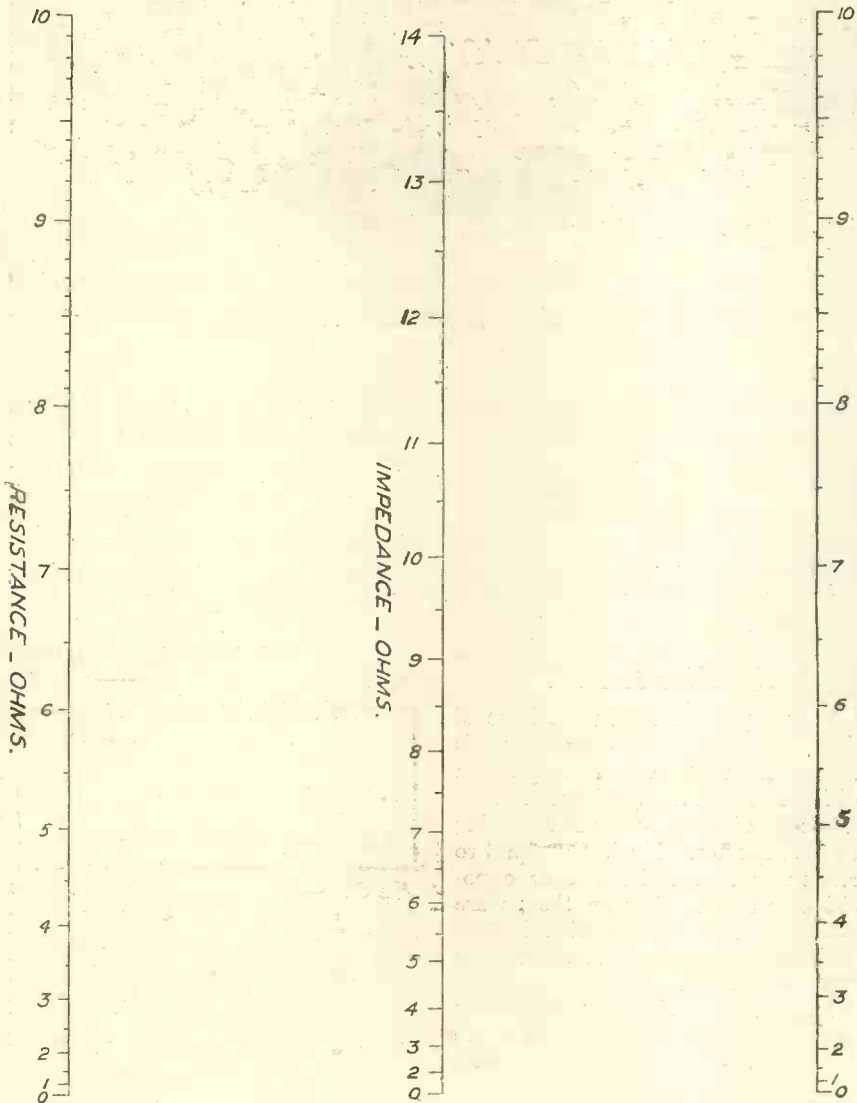

Fig. 4. This and the other alignment charts have been evolved for the benefit of readers who dislike or are unable to tackle complicated calculations. The main purpose of this one is for finding the effective impedance in a circuit, when the values of resistance and reactance are fairly near one another.

opposition which a circuit may offer to alternating currents without directly specifying the resistance and reactance of which this opposition is composed.

### Very Important

To this *total* or *complete* opposition is given the name "Impedance," a term which is of the highest importance in radio work. We may there-

fore across which an alternating E.M.F. of frequency f cycles and amplitude E volts is continually maintained.

Then it is well known that the amplitude I of the resulting alternating current which will flow through the resistance will be given by the

formula  $I = \frac{E}{R}$ , where, of course, E is in volts, R in ohms, and I in



## You Can Forget Those Tiresome Formulae!

circuit. Obviously, the value of  $Z$  will depend on the values of  $R$  and  $X$  which go to compose it. As we have seen, the value of  $Z$  is not the sum of  $R$  and  $X$ .

### The True Relation

What, then, is it? The true relation between  $Z$ ,  $R$  and  $X$  is a little more complicated; it can be expressed by the formula:

$$Z^2 = R^2 + X^2;$$

or it may also be written:

$$Z = \sqrt{R^2 + X^2}$$

It thus appears that if we know the values of  $R$  and  $X$  shown in

Fig. 3, the value of the impedance  $Z$  of the circuit as a whole may be found. Knowing  $Z$ , the alternating current flowing in the circuit for a given voltage across it may be predicted by Ohm's law.

For, of course, the amount of this current in amperes will be given by the quotient  $\frac{E}{Z}$ ; that is to say, by

$$\frac{E}{\sqrt{R^2 + X^2}}$$

For those readers who dislike mathematics, and also for those who understand the formulæ but do not

wish to be bothered with the arithmetic necessary in working out actual examples, the two alignment charts given in Figs. 4 and 5 have been prepared.

These charts are designed to give numerical values of impedance at sight when the values of  $R$  and  $X$  which compose the series circuit of Fig. 3 are given. The method of using these charts is by now well known to readers of MODERN WIRELESS. An index or reading line placed in any position across the charts meets all three scales in corresponding values.

Thus, on Fig. 4, a line placed between  $R = 3$  ohms and  $X = 4$  ohms on the two outer scales gives immediately  $Z = 5$  ohms. This is so because, of course, the formula  $R^2 + X^2$  gives, in this case,  $9 + 16 = 25$ .

### COMPLICATED CALCULATIONS ARE UNNECESSARY

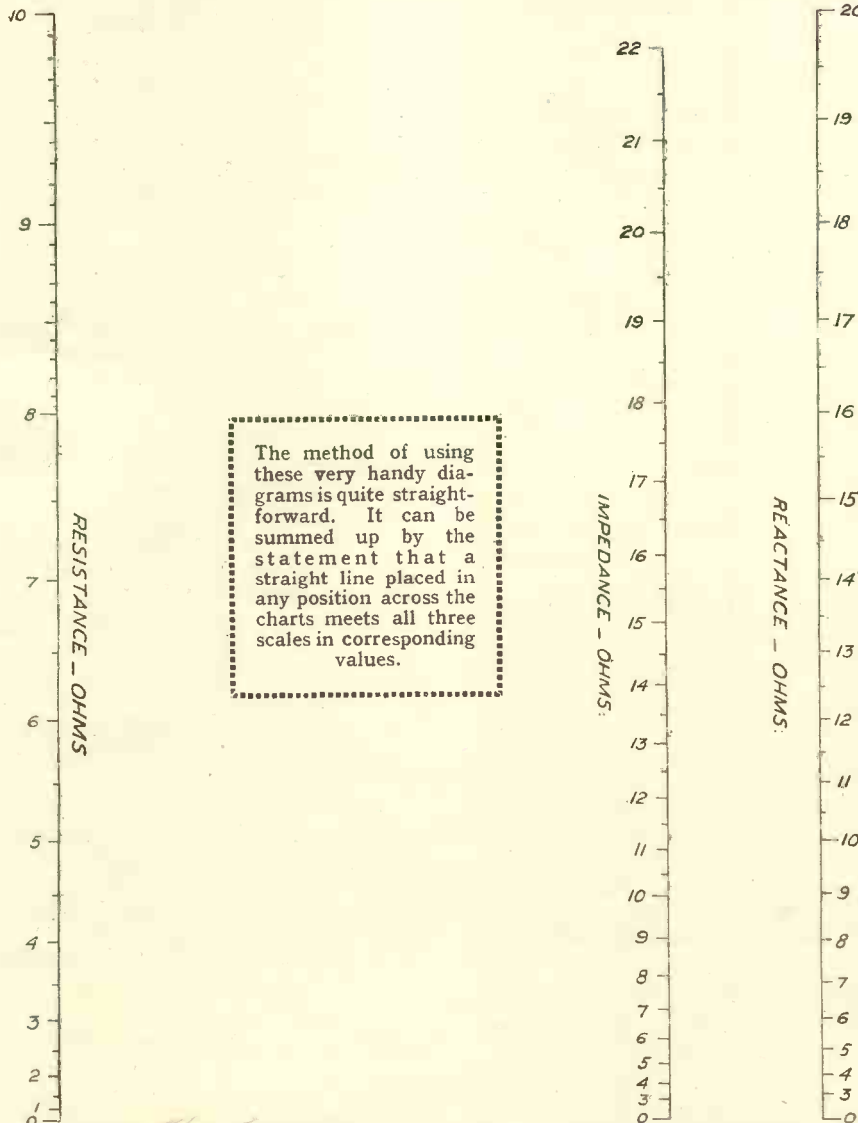

The method of using these very handy diagrams is quite straightforward. It can be summed up by the statement that a straight line placed in any position across the charts meets all three scales in corresponding values.

### HAVE YOU ENOUGH H.T.?

There are many advantages in using the highest possible H.T. that is permissible for your power valve, and it is important that its grid bias should be correspondingly high.

When fitting a decoupling device to a set troubled with L.F. instability, don't forget that the insertion of the resistance in series with the plate supply of one of the valves means that it will, in future, require more H.T. to get an equivalent voltage on the plate.

The chart of Fig. 5 is intended for use in cases where the reactance is somewhat greater than the resistance value. When dealing with large amounts of resistance and reactance the three scales of each chart may all be multiplied by a common factor such as 100 or 1,000.

For example, suppose we wish to know the impedance of an inductive loudspeaker whose reactance at a certain frequency is 1,200 reactive ohms, while its resistance is 500 ohms. Here the scales on Fig. 5 should all be multiplied by the factor 100. Thus by joining the point  $R = 5 \times 100$  to the point  $X = 12 \times 100$  on the two outer scales, we read for the required impedance the value  $Z = 13 \times 100$ , or 1,300 ohms, on the centre scale.

Fig. 5. This diagram is similar to Fig. 4 except that it is intended for cases where the reactance is somewhat higher than the resistance. Readers will no doubt notice that the scales in both these charts do not read up to very high values. This is no detriment to their usefulness, however, for by multiplying all three scales by the same figure their range can be extended to any desired degree.

# QUESTIONS ANSWERED

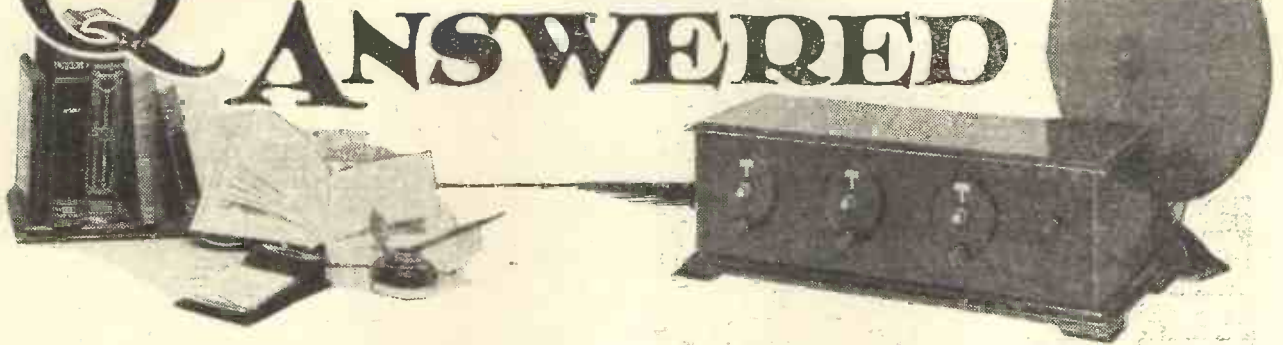

## L.F. Instability

J. H. T. (Yarmouth).—"My set developed a high-pitched whistle a week or so ago, and reception became distorted. Having had my H.T. battery for some months, I suspected that this might be running down. When tested by a wireless dealer the battery gave a reading of 70 volts; the voltage, when new, being 100. I therefore purchased a number of flashlamp units and placed them in series with the old battery to make up the voltage. In spite of this, I still get the whistle. Why is this?"

The reason you still get the whistle, J. H. T., is because you have retained the old battery, whose internal resistance has risen sufficiently to produce instability in your L.F. amplifier.

When the voltage of a battery drops its internal resistance rises, with the result that its resistance may increase to a point where instability occurs, as in your case.

Connecting an additional battery in series to counteract for the drop in voltage has no effect on the internal resistance of the old battery, which remains the same.

The remedy is to replace the old battery with a new one and then your trouble will cease.

## A Super-Het. Query

M. C. (Wimbledon).—"I have been experimenting with resistance-capacity coupling on the L.F. side of my super-het, and I find it impossible to operate the set without terrific distortion. I had no trouble with transformer L.F. coupling, and my idea in using R.C. coupling was solely to obtain better reproduction. Is there any reason why R.C. coupling should not be effective?"

Yes, there is a reason, and it is this: A super-het amplifies the received signals on a long wave-length—a wave-length long enough for resistance coupling to act as a fairly efficient H.F. amplifier.

In consequence, if any high-frequency currents in the anode circuit of the second detector should get into the grid circuit of the first R.C. stage these will be amplified and will interfere with the functioning of the L.F. side.

## TECHNICAL QUERIES DEPARTMENT

Are you in trouble with your set?

The MODERN WIRELESS Technical Queries Department is in a position to give an unrivalled service. The aim of the department is to furnish really helpful advice in connection with any radio problem, theoretical or practical.

Full details, including the revised scale of charges, can be obtained direct from the Technical Queries Department, MODERN WIRELESS, Fleetway House, Farringdon Street, London, E.C.4.

A postcard will do. On receipt of this all the necessary literature will be sent to you, free and post free, immediately. This application will place you under no obligation whatever. Every reader of MODERN WIRELESS should have these details by him. An application form is included which will enable you to ask your questions so that we can deal with them expeditiously and with the minimum of delay. Having this form you will know exactly what information we require to have before us in order to solve your problem.

London readers, please note: Inquiries should not be made in person at Fleetway House or Tallis House.

Very careful filtering is necessary in order to prevent this trouble, and, generally speaking, it is much safer to use transformer coupling. In any case, there is no reason at all why a transformer stage should not give excellent quality provided the transformer itself is a good one.

## What Type of Aerial?

N. K. C. (Peckham).—"Will you please say whether the "Eckersley" tuner is suitable for use with a frame aerial, since I have no facilities for erecting one of the outdoor type."

No, the "Eckersley" tuner is not intended for use with frame aeriels. On the other hand, it will work in conjunction with an indoor aerial such as a length of wire round the picture rail or across the room.

There is, however, little advantage in employing a selective tuner of this type with such a poor aerial system, because the range would be very restricted and the selective properties of the device wasted. In your case we would suggest an indoor aerial in preference to a frame, together with a straight three- or four-valve receiver, employing a stage of screened-grid high-frequency amplification.

The H.F. stage will partly compensate for your aerial difficulty, and with four valves you should be able to receive a number of stations at good strength on the speaker.

## Detector Overloading

N. S. (Watford).—"My set is a four, comprising one S.G., a det., and two L.F. stages. When I tune in to the London Regional or National transmissions I get poor quality, in spite of the fact that I cut down the input to the two L.F. valves with the volume control. The reproduction is most unpleasant, and is characterised by a high-pitched 'hiss.'"

This sounds very much like detector overloading, N. S. You are quite close to the Brookmans Park transmitters, and the H.F. stage is unnecessary for the reception of these powerful transmissions.

Detector overloading usually takes the form of a hiss, and can often be recognised by this simple experiment. First of all, tune in fully to one or other of the local transmissions, and then readjust the detector tuning condenser so that the detector grid circuit is slightly off tune.

You will probably observe a marked improvement in quality accompanied by a step-up in volume.

This should occur both above and below the wave-length of the local.

Your best plan is to equip the set with a volume control on the H.F. side, so that you can regulate the input to the S.G. valve.

# The "Modern Wireless"

## "Cabinet"

### Two

(MODEL "A")

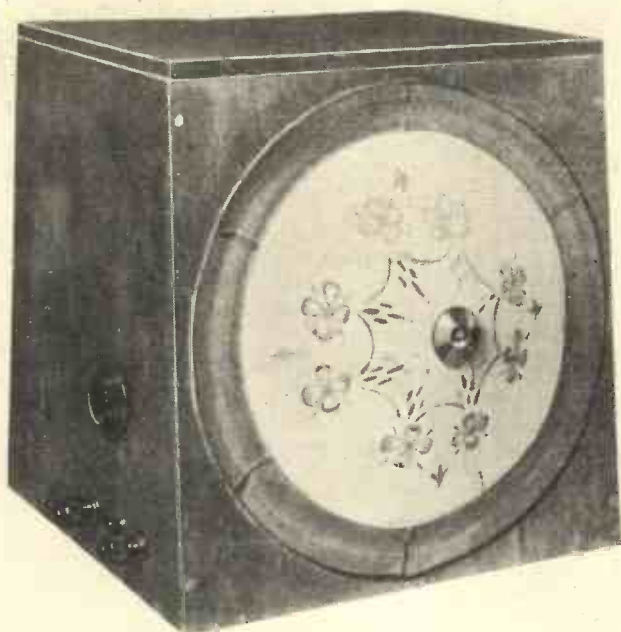

Here is an up-to-the-minute two-valver built into console form with a loud speaker included. Space is provided for the batteries, and the only external wires are the aerial and earth leads. We feel sure you will be delighted with its performance, and as for appearance—well, it speaks for itself!

Designed and Described by the "M.W." Technical Staff.

**H**ERE is a set that is "different." For not only has it been built as compactly as possible, and completely self-contained, but it has been constructed backwards!

This may seem an absurd statement to make, but it is the literal truth. The usual way of building a wireless receiver is to fix a certain circuit design and then to go ahead and, as far as possible, adapt that design to suit some layout that you have in mind.

#### All In the Cabinet

It is the circuit that matters, for upon this depends the usefulness of the receiver. But in the case of the receiver under discussion the form of the set was not made to fit the circuit, but the latter was made to

fit the cabinet. This, in turn, was made to fit the loud speaker.

The beginning of the receiver was the conception of a simple set that could be poked away in some convenient corner, where it would be ready to provide programmes from either of the local stations or 5 X X.

The circuit required for this is the simple two-valver using a pentode output and having an easily tuned circuit. This, then, was decided upon, and then the next thing to find was a suitable, inexpensive loud speaker.

At this point the order of the design of the set was turned topsy-turvy, for when the speaker was decided it was realised that the set would have to be built round the loud-speaker. In fact, the speaker is a part of the cabinet of the set.

So we started with a two-valve circuit and a loud speaker, and the final design is due to the latter, not the former.

As will be seen from the photographs, the loud speaker forms the front of the receiver, being mounted on the sloping front of a home-made cabinet. (The speaker, it must be remarked, is supplied by the makers already mounted on a square piece of plywood that acts admirably as the front of the cabinet).

#### No Panel Needed

With this loud speaker unit and its mounting as a basis, we proceeded to build an easily-constructed but attractive little cabinet which should comfortably house not only the set, but also the batteries. Thus the

### ALL THE PARTS YOU REQUIRE ARE INCLUDED IN THIS LIST

#### CABINET

See text.

#### VARIABLE CONDENSERS

- 1 .0005-mfd. solid dielectric (Telsen, Ready Radio).
- 1 .00015 or .0001-mfd. differential reaction condenser (Telsen, Ready Radio, Polar, J.B., Cyldon, Igranic, Lotus, Graham Farish, Formo).
- 1 .001-mfd. compression type (Formo R.I., Lewcos, Sovereign, Goltone, Telsen).

#### FIXED CONDENSERS

- 1 .0003-mfd. (Dubilier type 670, T.C.C., Telsen, Ready Radio, Ferranti, Lissen, Graham Farish, Goltone, Igranic, Watmel).
- 1 2-mfd. (T.C.C., Telsen, Dubilier, Hydra, Holsby, Ferranti, Lissen, Igranic, Goltone, Sovereign).

#### SWITCHES

- 1 On-off push-pull (Ready Radio, Telsen,

Bulgin, Graham Farish, Wearite, Colvern, Lissen, Igranic, Peto-Scott, Goltone).

- 1 Three-pole wave-change (Telsen, Ready Radio, Lissen, Wearite, Peto-Scott, Graham Farish, Goltone, Colvern, etc.).

#### VALVE HOLDERS

- 1 Four-pin type (Telsen, Graham Farish, Wearite, Bulgin, Lotus, Igranic, Clix, W.B., Formo).
- 1 Five-pin type (Telsen, etc.).

#### CHOKES

- 1 H.F. (Ready Radio, Telsen, Wearite, Varley, Peto-Scott, Dubilier, Lewcos, Lotus, Climax, Graham Farish, Lissen, Sovereign, Atlas, Tunewell, R.I.).
- 1 Pentode output (Varley Nichoke, R.I. Pentamite, Tunewell).

#### TRANSFORMER

- 1 L.F. medium ratio (R.I. Dux, Telsen, Lewcos, Varley, Sovereign, Formo, Igranic, Ferranti, Graham Farish).

#### RESISTANCE

- 1 2-meg. grid leak with tag ends, or with holder if other type is used (Igranic, Dubilier, Loewe, Graham Farish, Telsen, Varley, Ready Radio, Sovereign).

#### COILS

- 1 P.J.3 (Ferranti, Wearite, R.I., Sovereign, Peto-Scott, Ready Radio, Goltone, Melbourne Radio, Formo).
- 1 P.V.2 (Sovereign, etc.).
- 1 Coil quoit (Peto-Scott, Sovereign, Ready Radio, Melbourne Radio, Wearite).
- 2 ozs. of No. 30 D.S.C.

#### MISCELLANEOUS

- 1 G.B. battery clip (Bulgin, Burton).
- 1 Crocodile clip (Goltone, Bulgin).
- Glazite, Lacoline, Quickwyc, Jiffilix, two terminals.
- Flex., screws, battery plugs, etc.

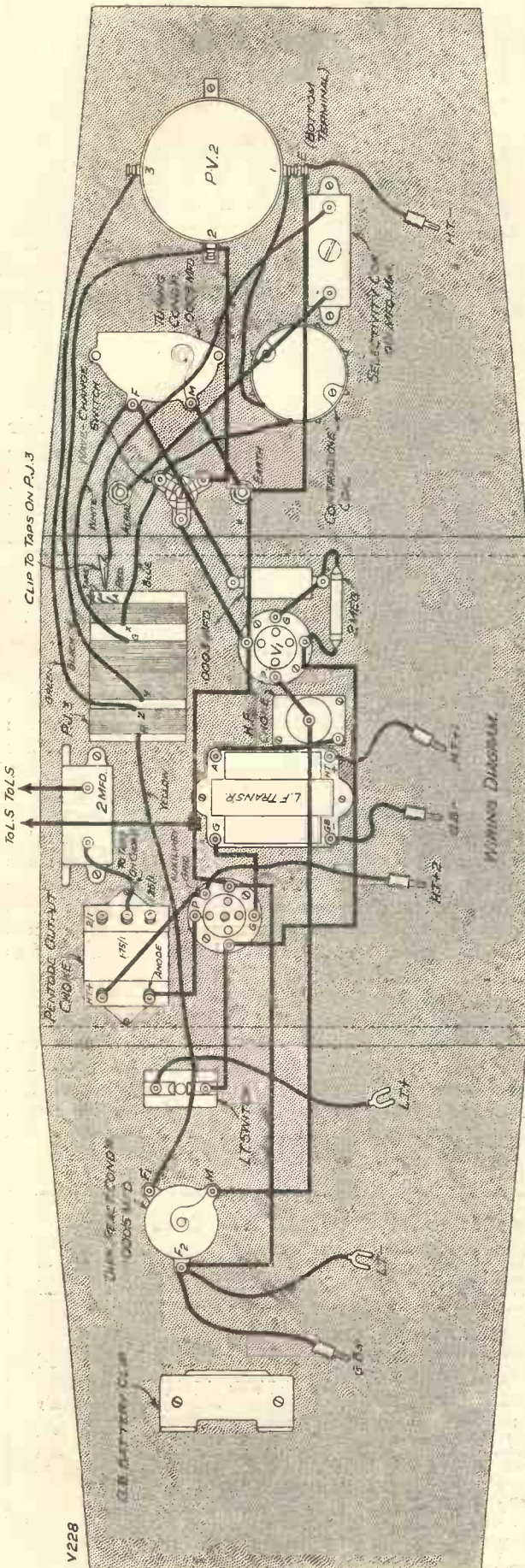

In this diagram the base and the two sides of the cabinet are "spread out" so that the wiring appears flat. The viewpoint is taken from the back of the receiver. There are two or three points about the construction that should be explained here. The first is that the P.V. coil must be mounted above the half-way line so that there is plenty of clearance to get at the adjusting screw of the loud speaker. (If the P.V. coil is mounted too low there is a possibility of its protruding too far and so getting into the way of the adjusting screw.) Note the inclusion of the coil quoit with its 60-turn winding of 26 gauge wire. This is essential for the prevention of break-through of medium-wave stations when the set is tuned to the long waves. The tapping clip on the compression condenser is for the purpose of varying the selectivity of the set by means of the taps on the P.J.3 coil, a rough variation being obtained by this method and the final exact control being brought about by the adjustment of the compression condenser itself. It should also be noted that the loud-speaker leads go direct to the L.T. negative circuit and the output condenser, and not to loud-speaker terminals as is the case in the ordinary set. Reverting to the question of selectivity adjustment it should be remarked that the best results are obtained with most of the control done on the taps of the coil, the condenser being kept as nearly at the maximum setting as possible. This is because the compression condenser is also effective on the long waves, where any decrease in its value has a deleterious effect upon strength. Therefore it is best to keep this control at full value if possible, unless the selectivity on the long waves requires adjustment. In this event all the adjustment must be carried out by means of the condenser, the taps on the coil not materially affecting the selectivity on the long waves.

receiver is completely self-contained, except for the aerial and earth.

No panel is used for this set, the tuning controls being mounted on the sides of the cabinet itself. The result is a very compact little set which is yet always ready to supply entertainment, and which can be handled with the greatest of ease.

**For the Local Station**

The receiver's circuit consists of the bare essentials for successful radio reception of the local stations, with adequate selectivity for the separation of such stations as the two Brookmans Park transmitters at reasonable distances.

Besides this the set is capable, when carefully tuned, of picking up one or two of the more powerful Continental stations on the medium wave-band. On the long waves, 5 X X can be received at quite good strength.

The set is not designed as a DX receiver, being intended as a simple, compact local station set. The parts are not many, and the cost is very small.

The circuit makes use of the well-known P.V. and P.J. coils, and has variable selectivity, so that the constructor can adjust it to suit the requirements of his own particular conditions.

**Small Battery Requirements**

A pentode valve of particularly efficient type is used, the Mazda Pen. 220 being capable of delivering up to 400 or more milliwatts of undistorted output, while at an anode potential of 120 volts it requires only 5 milliamps. from the H.T. battery.

At 100 volts the consumption is still less, of course, and yet the output is sufficient for most ordinary purposes. Thus for the operation of this model an ordinary capacity H.T. battery is all that is required, with consequent saving of space and cost.

This battery, and a small portable accumulator and a grid-bias battery of 4½ volts, constitute the whole of the power requirements of the set.

The first step towards construction after the parts have been collected is the cutting of the sides of the cabinet. These are made out of plywood of the same thickness (3/32 in.) as that on which the speaker is mounted.

Separate diagrams are given of the various sides and, provided care is taken in the cutting of the wood, absolutely no trouble should be experienced in the assembling of the pieces. It is essential, however,

## Economical in Both Construction and Maintenance

that the pieces be cut exactly to size, otherwise no end of bother will be experienced in getting the pieces to fit together.

The front is cut ready for you, and all that remains to do to this is to chamfer the top edge slightly so that it will fit flush with the front of the top of the cabinet.

### FOR YOUR GUIDANCE

Y1667

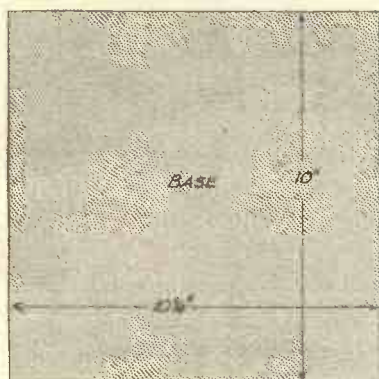
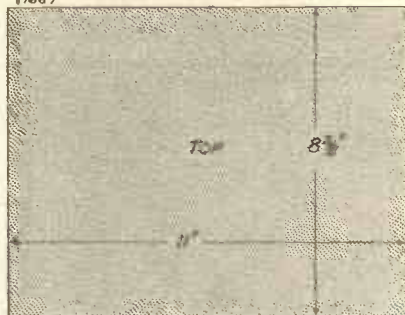

All the necessary dimensions for cutting out the top and bottom of the cabinet are given in these two drawings. For the sides see other diagrams.

This chamfering is necessary because the front of the cabinet is sloping at an angle of about 80 degrees. The sides are tapered towards the top, while the back also slopes inward. This latter could be made vertical, if desired, by altering the dimensions of the sides, and it is conceivable that in some cases, where it is desired to place the set up against a wall, the vertical back might be more convenient. From the side the sloping back gives a more pleasing appearance.

### Starting Construction

The back also should be chamfered if it is to be of the sloping variety, the angle being kept the same as in the case of the front. There is no need to plane the sides, which are vertical.

Having cut the sides and tried them together, making sure that they will fit, the construction of the receiver proper can be proceeded with.

### Mounting the Controls

To do this the cabinet is built up with the exception of top, back and front. The various components are mounted on the two sides and the base, the tuning condenser being situated on the right-hand side, looking at the set from the back, and the reaction control on the opposite side.

Below the tuning condenser, which is of the solid-dielectric variety, is the wave-change switch, a three-pole switch of the usual push-pull type.

Below the tuning condenser and on either side of the wave-change switch are the aerial and earth terminals.

On the other side of the set, below the reaction condenser, is the on-off switch. This completes the controls, which are all conveniently situated so that everything is to hand.

We have said that the coils consist of P.V. and P.J. coils. These are arranged so that the P.J. coil is used for the medium wave-bands and the P.V. (and Contradyne) in series with it for the long waves.

### The Coils

Also, in contrast to our usual procedure, the type of coil used for the medium wave-band is the P.J.3, not the P.J.1, as is usually the case. This is done for the very definite reason that as this is intended as a local station set there is no need for such a high degree of selectivity as

### HOW THE GRID-BIAS BATTERY IS FIXED

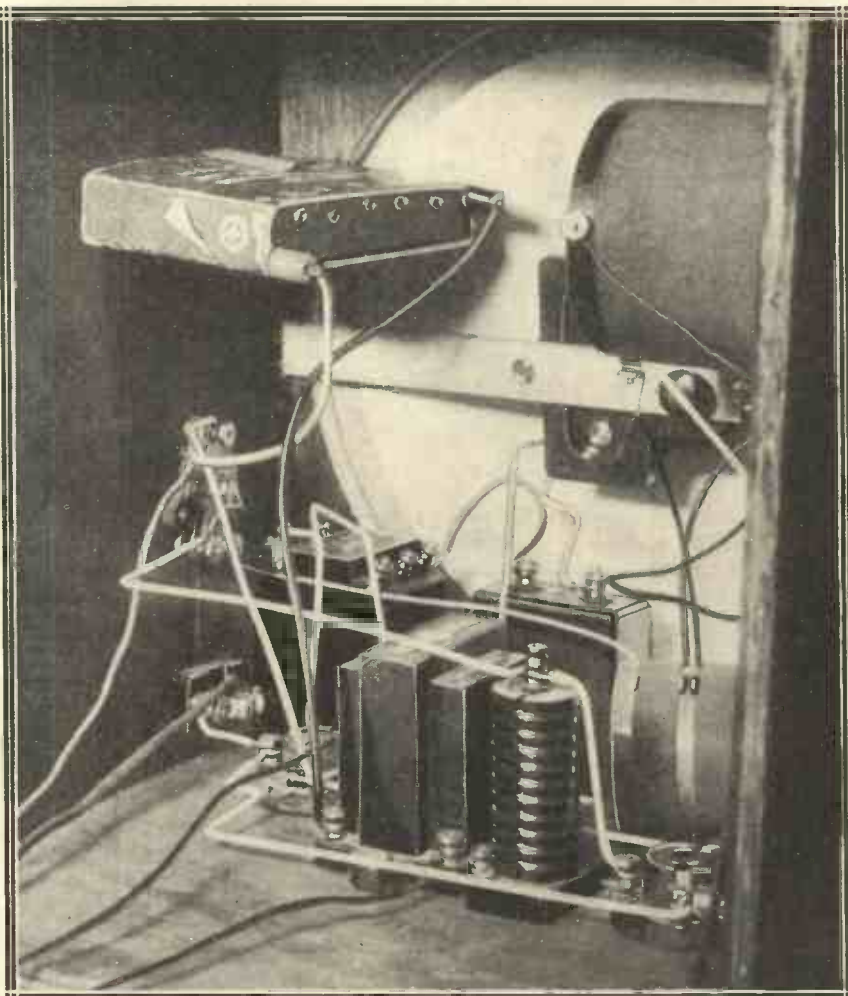

A close-up of the inside of the set, showing some of the wiring and the method of mounting the grid-bias battery by means of a clip fixed to the side of the cabinet. The whole constructional work is exceedingly simple, and the components required are remarkably few in number, as can be seen.

# Selectivity and Power with Pleasing Quality

in the case of a set which is required for the reception of distant programmes.

The P.J.1 coil has a primary winding of only 9 turns, which are tapped at 4 and 6 turns. This enables very sharp tuning to be obtained. The P.J.3, on the other hand, has 30 turns of primary winding, tapped at 10 and 20 turns.

Obviously this provides greater signal strength, but less selectivity, and for a local station set, with the addition of a series aerial condenser, the large primary is more satisfactory.

## On Long Waves

Incidentally, it gives a greater chance of picking up foreigners than does the smaller coil, provided that the local does not interfere. On actual test, apart from theoretical considerations, the P.J.3 coil gives very much better local results than its smaller brother when used as a plain coil, without the assistance of any tuned aerial circuit such as is provided by a selector coil.

On the long waves the P.V. coil comes into operation in series with the P.J.3, the three-point switch controlling the wave-length range by shorting out the aerial and the grid windings of the long-wave coils.

## NO STUNTS!

x803

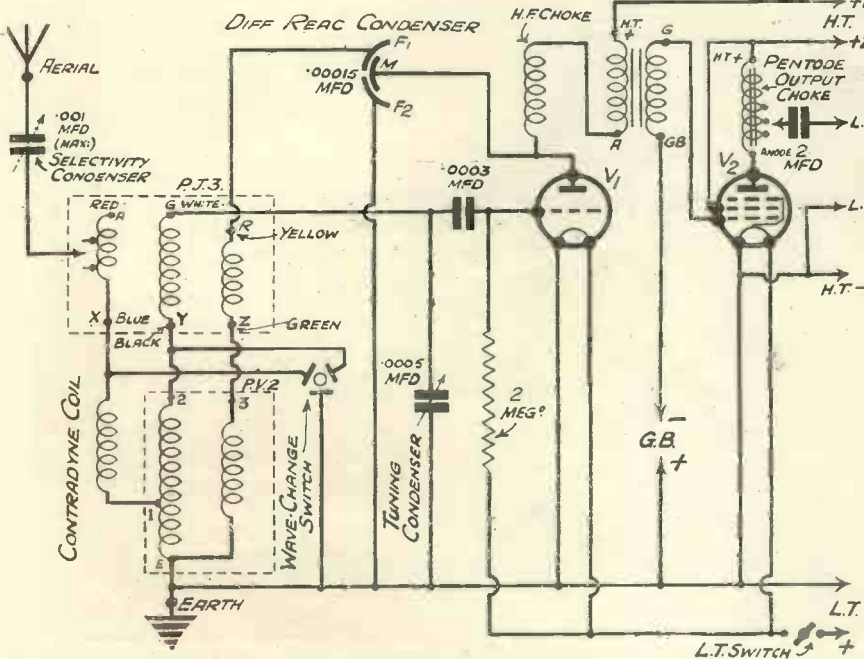

A straight two-valver using a pentode in the last stage. The circuit is highly efficient and employs that well-tried coil combination, a P.J.3 and P.V.2. The latter operates on long waves, and the former on the medium band

## EASILY FITTED LOUD SPEAKER

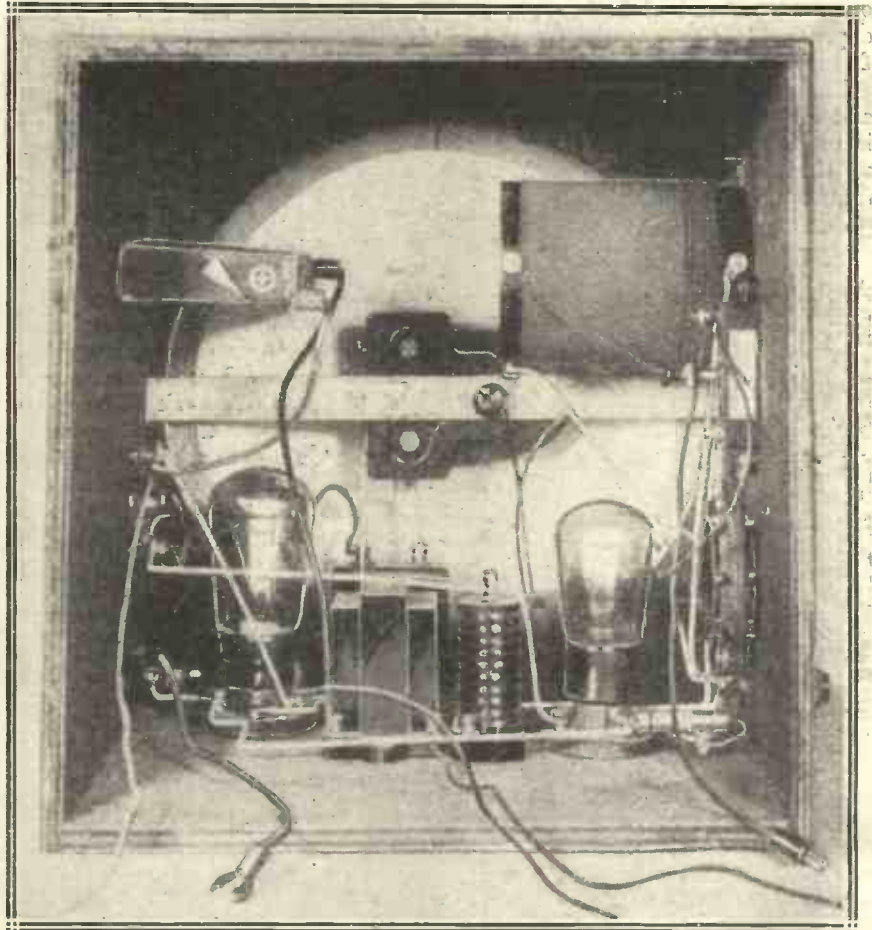

The speaker unit is mounted on a cross-bar which extends from one side of the cabinet to the other.

The wiring of the set is quite easy, but the layout must be followed carefully if you are to have room for the batteries at the back of the loud speaker.

Regarding the loud speaker and its mounting it must be mentioned that the side pieces of the cabinet have to be slotted (as shown in the diagrams), in order that the aluminium bar upon which the speaker unit is mounted may be given clearance.

## Alternative Components

The unit itself does not project back far into the set, so that no trouble will be experienced due to the unit fouling any of the components, though care must be taken that the valve holders are placed clear of any such obstruction.

Special care must also be taken in the layout of the components if the original list is departed from in favour of some alternatives. Specially is this the case where the pentode

## MAKING THE MOST OF LIMITED SPACE

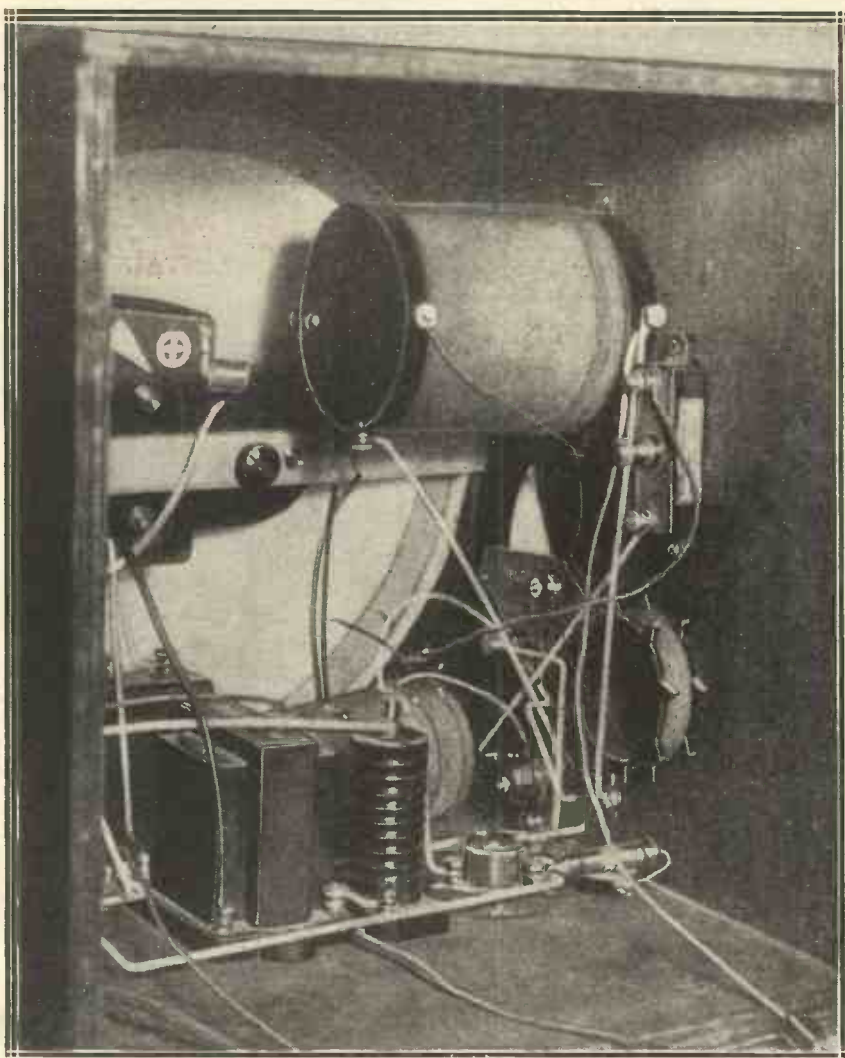

In a compact design such as this every advantage has to be taken of the available space. Many of the components are therefore mounted on the sides of the cabinet, and this photograph shows those fixed to the left-hand side. They include the P.V.2 coil at the top, '0005-mfd. solid-dielectric tuning condenser, selectivity condenser, contradyne coil (on quoit), and the three-point wave-change switch just visible at the bottom.

output choke is concerned. The model used in the original set is small, and is ideally suited for the particular valve used. If, however, a different choke is employed it may be necessary to rearrange the layout somewhat in order to allow more room for the choke.

### The Output Choke

Also, it must be remembered that if a different valve from that specified for the output position is employed it is more than likely that a different choke will be necessary, because the one used will not deal satisfactorily with anode currents of more than 10 milliamps., and most pentodes require more than that.

It is because of its very low anode current that the Pen.220 was chosen, and for its size it does give remarkable results.

We have briefly discussed the

making of the set, and, as you will have seen, it is quite easy. Now let us get on to the operation.

The aerial and earth are joined on to the two terminals on the left of the receiver, and the loud-speaker leads are connected to the output choke as follows: The ends of the choke go to the anode of the pentode and the H.T.+2 respectively, while the two leads of the speaker are connected, one to the filament negative circuit of the set, and the other via the condenser to the tapped output choke.

When the set is in operation the position of the tapped lead is altered until the best quality and strength of reception are obtained. Some readers may like to try fitting a resistance in series with an '01-mfd. condenser across the choke. Increasing the resistance will make the reproduction sound higher-pitched (it will enable more of the high notes to be repro-

duced), while decreasing the resistance will have the opposite effect—it will make the result "rounder."

### Side-Terminal Pentodes

A five-pin valve holder is shown in the original design for the output valve, but if a different pentode (bearing in mind the foregoing remarks about larger pentodes) is used, a four-pin holder can be employed if the valve has a side terminal. Similarly a four-pin pentode can be used with the five-pin valve holder by connecting the side terminal on the valve to the centre socket terminal of the valve holder.

About 60 volts on the detector and the full voltage of the battery on the last valve should be used, the tuning being done with the solid-dielectric condenser on the left side of the set. Reaction is controlled by the knob on the right.

First of all tune in your most powerful station. Then tune in the next most powerful on the same band—the series aerial compression condenser is screwed in all the time. If the two stations do not interfere with each other there is no need to alter the setting of this condenser, unless you need more selectivity for some reason or other.

### Setting the Selectivity

If, however, they interfere, the compression condenser and the taps on the P.J.3 coil must be varied until the selectivity is better. We have said nothing before about the taps on the P.J.3 coil, and are assuming that the crocodile clip from the aerial terminal is placed on the end of the coil (on 30).

With the compression condenser full in, try the tuning and see if the stations interfere. If they do, try the clip on the P.J.3 on the first tap, and if necessary the second tap. If the stations still interfere recourse must be had to the compression condenser, and this must be unscrewed till the stations are heard separately.

It may seem a difficult thing to adjust, but really it is quite easy, for all you have to do is to balance the effects of the condenser with those of the taps on the coil.

### Coil or Condenser?

You will probably say that surely it does not matter whether the selectivity is obtained with the coil or the condenser, the result is the same. This is more or less correct on the medium waves, but on the long waves

## An Ideal Set for Local Station Reception

we want as little of the condenser-gotten selectivity as possible.

This is because the condenser will cut down the strength on the long waves, and the nearer we can have it to fully screwed down the better.

### "The Rest is Easy"

Having got the selectivity part of the set in order, the rest is easy. All that has to be done is to get the hang of the tuning and reaction controls, and there you are.

A final word about the appearance of the set. To leave the loud speaker

### THE TWO SIDES

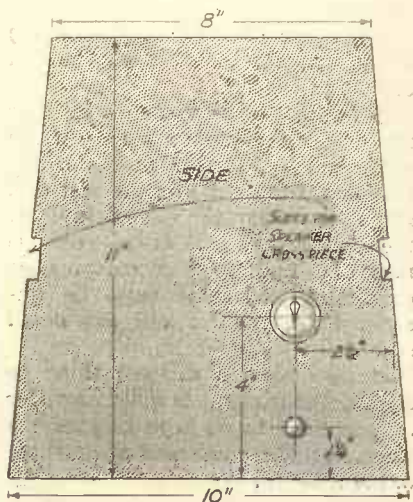
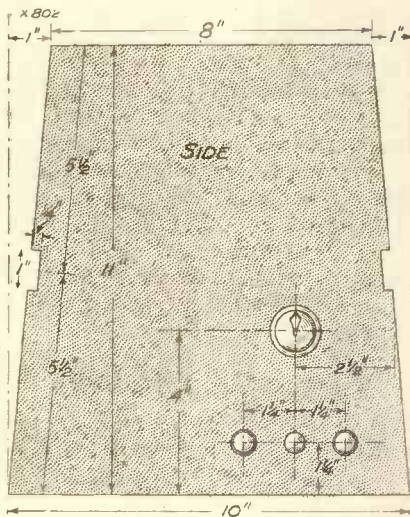

Here are all the measurements you will require for cutting out the sides of the cabinet. The top drawing represents the left-hand upright, carrying the tuning condenser, wave-change switch, and aerial and earth terminals. The bottom one is the right-hand side, which has the reaction condenser and "on-off" switch mounted on it.

as sent out by manufacturer means a rather plain front to the receiver. It is better to paint the cone with some picturesque design, and so press it into service not only as a reproducer of programmes, but also as part of the artistic design of the set.

### SUGGESTED ACCESSORIES

**Loud Speaker.** (Ormond Loud-Speaker Board-Chassis Assembly).

**Valves.** 1 Detector (Marconi H.L.2, or similar type of Mazda, Cossor, Osram, Six-Sixty, Tungram, Eta, Mullard, Dario, Lissen, etc.).

1 Pentode (Mazda Pen.220, Marconi or Osram P.T.2).

**Batteries.** 1 H.T., 120 volts ordinary capacity (Pertrix, Ever Ready, Magnet, Lissen, Drydex, Ediswan).  
1 G.B., 9 volts (Ever Ready, etc.).

**Accumulator.** 1 2-volt small or portable type (Exide, Ever Ready, Pertrix, Lissen, G.E.C.).

**Mains Unit.** Small type of mains unit to give 120 volts at 10 or more milliamps. can be used in place of the H.T. battery if desired (R.I., Regentone, Formo, Tannoy, Heayberd, Lotus, Tunewell, Ekco, Atlas).

Such painting carried out in water-colours in no way upsets the operation of the speaker, but it does give the set a much more pleasing appearance, as can be seen from the photograph of the original receiver.

### Adjusting Tone

There is one point about the operation of the "Cabinet" Two that perhaps we ought to mention, though it does not strictly come into the true operating details.

Rather does it concern a method of tone adjustment which you may find useful when you have got the set working.

The method entails two small extra components—a resistance and a fixed condenser. The former will have a value dependent on the tone required from the speaker, but the latter may be fixed at .01 mfd.

### High-Note Control

These two components are joined one to the other, leaving one of the terminals of the condenser free, and one end of the resistance. These are then joined across the output choke, the free end of the resistance, say, going to the terminal on the choke that goes to H.T., and the terminal on the con-

denser being connected to the plate terminal of the choke.

The result of connecting this little gadget across the output filter is to cause attenuation of the high notes. This enables the tendency of the pen-

### SELF-CONTAINED



With the exception of aerial and earth the set is entirely self-contained, and the dimensions have been cut down to the minimum permissible. There is, however, ample room for quite a "hefty" H.T. battery.

tode to over-emphasise the high notes to be checked, and the amount of attenuation so caused is controlled either by increasing the value of the condenser or, more conveniently, by reducing the value of the resistance.

Of course, the same effect, up to a point, could be obtained by choosing the right value of condenser, and using that alone; but that would introduce an undesirable tuning effect on the choke which the series resistance prevents, unless its value is reduced too much.

Control, or rather adjustment, is carried out by altering the value of the resistance until the balance of high notes to the rest of the musical scale is to the liking of the listener. Reducing the resistance below about 10,000 ohms usually has the effect of "smudging" the reproduction, and the best value lies between 30,000 and that figure.

Another method of reducing the high notes is by the time-honoured fixed condenser across the loud speaker. This is not so good, as it does in effect cause a resonant point in the speaker response, due to a tuned effect of the winding.

But with this set it is not likely that a tone filter will be necessary, and so it was not included in the design. It is, however, a useful thing to know, and the desired results can be obtained very easily.



# AT YOUR SERVICE



by  
**OUR TRADE  
COMMISSIONER**

### Wireless for the Blind

**W**e hear that further orders have been placed with Messrs. Burne-Jones & Co., Ltd., for receiving sets for the use of the blind.

This firm has already manufactured 16,000 sets, ranging from crystal sets to three-valvers, for this purpose, and, in addition to making them, distributes them complete with equipment and instructions throughout the United Kingdom.

### Watmel Circuit Sheets

Some very useful assistance for the radio dealer has been devised by Watmel Wireless Co., Ltd. This takes the form of some circuit sheets on which the theoretical diagrams and layouts of a number of typical circuits are given. These cover all sorts of receivers, from simple three-valve sets to more ambitious mains-driven super-hets.

### A Useful Publication

We have received a copy of the Broadcaster Radio and Gramophone Trade Annual, 1932. It covers requirements in a way never attempted before, containing the first "Who's Who," in which you can read how prominent personalities entered the Trade, what they are doing and what their recreations are.

The servicing of sets is described in a new way, understandable by the least technical, in a fully illustrated section of the book. At 5s. to non-subscribers and 2s. 6d. to subscribers the annual is an investment to attract everybody.

### A "Run" on Components!

With popular sets like the "S.T.300" and the "Cosmic" Three it is only natural that there should be a big demand for components. In the case of one set recently there was such a "run" that the stocks of three different components were sold out

*Here is some varied news of the trade that should interest all readers, whether or not they are connected with the radio industry. Manufacturers, dealers, home constructors and general readers are invited to send items of interest to be included under this heading.*

in a few days! Luckily for constructors, the firms concerned were able, by means of their tremendous resources, to put the matter right again in a remarkably short space of time. As a matter of fact, it was just about forty-eight hours!

### The Ferranti Band-Pass Set

Messrs. Ferranti, Ltd., the noted northern transformer makers, have just placed on the market a three-valve battery and mains-driven band-pass receiver having many interesting features. A special gang condenser

and a totally screened detector unit are two of the innovations included in the set, which is obtainable with a construction chart for home building at a very reasonable figure.

Also, we understand that the H.F. screened and band-pass unit is to be available to the constructor separately, so that he can include it in sets he already possesses if he so desires.

### Olympia in August

Our readers have probably heard that the Wireless Exhibition is to be held in August this year. The 19th has been chosen as the opening date. Last year all records for attendance were broken, and it is hoped that this year, even if the public do not support the Show as well as formerly (for the date may have an adverse effect upon the attendance), the earlier date will enable manufacturers to get into production in good time for the radio "season."

## THE GRAMOPHONE IN BUSINESS



Mr. Richard Haigh, English branch manager of The Gramophone Co., Ltd., addressing the Publicity Club, of London, at their "Gramophone in Business" meeting recently held at the Piccadilly Hotel.

## Items of News From Our Trade Note-Book

Here are some interesting figures of recent Shows. In 1929, 140,627 people invaded Olympia during the Wireless Exhibition (an increase of over 17,000 on the previous year); in 1930 the figures were 161,128, and last year they had risen to 198,070.

### Making Your Set Safer

For forty years, so 'tis said, no improvements have been made in that often badly treated adjunct to radio—flexible cord. Now Messrs. Ward & Goldstone have made it much safer and capable of withstanding much harder wear.

The new cord consists of two rubber-covered leads, instead of the usual cotton-covered type, and the whole is again protected by the braid. The new wire does not tend to hold moisture, and is priced at about the same as the ordinary flex.

### A Handsome Cabinet

One of the most pleasing radio-gram cabinets that we have yet seen is the Grand "De-Luxe" made by Pickett Bros. It can be obtained in various finishes, and is well worth the attention of dealer and set builder alike.

### From D.C. to A.C.

Listeners in areas that are served by D.C. mains are often dubious about installing sets owing to the possibility that in the near future their supply will be changed to A.C.

We are assured, however, that

### HAVE YOU A GOOD RECORDING VOICE?



Mr. Cateret Maule (left), who won a contest held at the Film Artistes' Guild to discover a good recording voice by means of the FAV Recorder.

intending purchasers of Marconiphone radio and radio-gram receivers have no such hesitation, since arrangements have been made for the conversion of D.C. Marconiphone instruments to A.C. as and when occasion arises.

The latest model to be brought into the scheme is the popular Radio-gram Three—Model "330." This instrument can be converted from D.C. to A.C. for a total cost of £10 18s. 3d., this figure including new A.C. valves of the appropriate types.

Those who want their Marconiphone receivers thus converted should get into touch with their Marconiphone appointed dealer by whom the set was originally supplied.

### Prosperity in the Midlands

It is refreshing these days to hear official cheers with regard to successful trade. But we have just received a letter from the well-known firm of cabinet makers known as Radiocabinets Ltd., of Walsall, saying that they are doing a roaring trade.

In the three years that they have been established tremendous strides have been made, and still more machinery is being laid down to cope with the work.

All types of wireless cabinets are made, and the firm is probably the largest in the district, for it makes a vast quantity of cabinets for kit sets, as well as for many big radio firms.

### A New British M.C. Speaker

We have received a leaflet describing the new Motor moving-coil loud speaker, which sells together with the necessary transformer for the modest price of 70s.

for ordinary power valve operation (the transformer being tapped for three ratios), and the other for use with a pentode output valve. The cone diameter is 8 in., and the im-

### SOME SET!



This giant set comprises 50 valves and supplies the residents of the 1,000 rooms in a large block of flats in West London. The valves are, of course, operating as L.F. amplifiers in parallel, and are not being used as cascade amplifiers!

pedance of the speech coil is 10 ohms, its D.C. resistance being half that figure.

### New Mains Valves

I believe the "M.W." Research Department is carrying out some special experiments with some new full-voltage D.C. mains valves. But they do not let much in the way of information slip out.

However, I have managed to extract the name of the valves, and their agent in Britain, in case my trade friends would like to get further details.

The valves are made by the well-known Continental firm of Ostar-Ganz, and they are being introduced into this country by Mr. E. Forbat, of Ilona House, Farham, Surrey.

No dropping resistance is required with these valves, as they are designed to take the full voltage of the D.C. mains across their heaters. But no doubt you will be reading more concerning them when the Research Department have finished with them. They are certainly a new departure, and should have a successful future before them.



*Our Special Correspondent interviews Henry Hall, who is now forming a new dance band to succeed Jack Payne and his merry men at the B.B.C.*

# The New B.B.C. Dance Band

**J**ACK PAYNE has his idea of entertainment; I have mine." So said Mr. Henry Hall, in outlining to me the change of policy he intends to introduce into British radio dance music. I found Henry Hall, Jack Payne's successor as B.B.C. Director of Dance Music, wading through shoals of applications for positions in the new band, which were flooding into Mr. Hall's headquarters at the Midland Hotel, Manchester, at such a pace that a staff of clerks had been engaged to deal with them.

## Over Seven Hundred!

Over seven hundred letters and telegrams asking for jobs reached Mr. Hall within a week of his B.B.C. appointment being announced. They come from all over the country and abroad.

When Jack Payne leaves the B.B.C. he will take the present B.B.C. Dance Band with him. Henry Hall will take possession of the Savoy Hill microphone with an entirely new band.

"It will be all-British," he told me. "There will be fifteen or sixteen men in the band, so I'm afraid hundreds of applicants are going to be disappointed."

## A Romantic Rise

"I am out to buy the best talent, and the band will be built on the lines of an orchestra. In composition it will be similar to Jack Payne's band, but there will be a change of style."

The story of how this young man of 32 years has obtained the most coveted position in the world of dance music is a romance, and at the same time it throws light on the policy he intends to carry out at the B.B.C.

He was born in London and educated for the Civil Service, but

the War upset that plan. After leaving the Army he studied music. He was trained on classical lines and it was as a "straight" pianist that he obtained his first job with the Midland Hotels.

## Lucky Thirteen

"That was in the band here at the Midland Hotel, Manchester," Mr. Hall told me. "Some people have pointed out to me that my arrangement with the B.B.C. provides that I shall give my first broadcast on March *thirteenth*; but I reply that the date I started as pianist here was September 13th, 1922, which was also a Friday!"

This was certainly no evil omen

## HENRY HALL



The popular leader of the Gleneagles Dance Band, who now becomes B.B.C. Director of Dance Music in succession to Jack Payne.

for Henry Hall. By 1925 he had become Director of Music to L.M.S. Hotels, and to-day he controls their fourteen bands in various parts of the country.

In 1926 he formed the Gleneagles Hotel Dance Band, the first provincial dance band to be broadcast. He has sedulously pursued a policy in which melody and rhythm count far more than stunting or jazz.

## A Surprise for Jack

The Gleneagles Band is actually the smallest dance band (six players) on the radio, and it won such popularity that Henry Hall has now been singled out as successor to Jack Payne.

I am able to reveal that while many leading London dance band conductors were angling for this job, Henry Hall did not even apply for it.

He was summoned from Manchester to London by telegram, the contracts were drawn up and signed, and even Jack Payne did not know who was his successor until he was asked to go to a room at Savoy Hill, where a B.B.C. official said: "Mr. Payne, this is Mr. Hall, your successor."

Jack Payne and Henry Hall shook hands, and Jack said: "Congratulations! The best man has got the job."

## "Vocals" to Continue

A B.B.C. committee had been considering this important appointment for some time. Obviously Henry Hall's individualistic methods attracted their attention.

"With the Gleneagles Band," he said to me, "we have kept off well-worn tunes as far as possible and we have had no vocal numbers. In the new B.B.C. band I shall have vocal

*(Continued on page 298).*

# Trouble Tracking

On this page the Chief of the "M.W." Query Dept. discusses, month by month, some of those common difficulties and troubles which can be so perplexing. This month he deals with The "Eckersley" Tuner.



I WANT to say a few words concerning possible faults in sets employing the "Eckersley" Tuner. Now this, if properly treated, is capable of giving very fine results. The selectivity is high and the signal strength much better than other devices giving equal selectivity.

The coils have been deliberately made large because there is nothing to approach a single-layer winding of substantial gauge wire on a decent-sized former.

## Shorting that Condenser

Its bulk, unfortunately, renders it difficult to use the tuner in an H.F. amplifier, mainly owing to interaction risks; but, then, it wasn't intended for circuits other than the detector-L.F. type.

When the tuner is employed on the long waves it is essential to short out the series aerial condenser, i.e. the aerial inductance should be directly in series with the aerial.

Those who have .0003-mfd. solid-dielectric variable condensers should make sure that these are equipped with a "shorting" pin or strip which automatically cuts the condenser out of circuit when the moving vanes are rotated to their extreme position (until they rest against the stop).

## A Simple Test

Should any trouble be experienced on the long waves, such as failure to cover the wave-range properly or weak reception, the shorting contact should be immediately examined and the listener should assure himself that this portion of the set is functioning correctly.

(A simple test is to connect a piece of copper wire between the moving and fixed vanes terminals, or, alternatively, from the aerial terminal on the set direct to "A" on the tuner.)

The standard long-wave aerial winding is designed to suit the average

broadcast aerial. Some aerials are unusually short and cannot be classed as "average."

For example, small indoor aerials, or those very short aerials of the outdoor variety which some unfortunate listeners are compelled to put up with owing to space restrictions.

I know of one at the moment—a single wire about 15 ft. high and 30 ft. in length. Less than one-third the length of the standard P.M.G. arrange-

waves, troubles can be easily overcome by joining a .0002-mfd. fixed condenser across the long-wave aerial winding, between S. and E.

## The Coupling Resistance

So if you happen to have a bad aerial which you can't improve upon, don't grumble because you are unable to bring in half the stations of the world on the loud speaker. This type of aerial needs an H.F. stage

## WATCH THIS POINT ON LONG WAVES

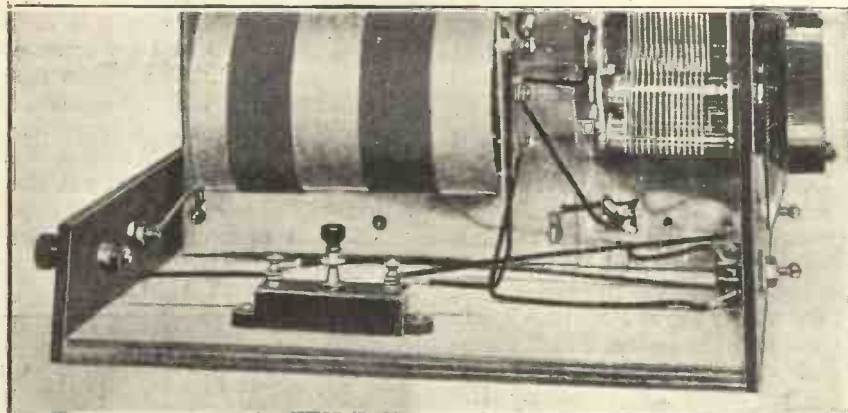

In all sets employing the "Eckersley" Tuner it is essential to "short" out the series aerial condenser when the set is operated on the long waves. This point should be checked up in cases of weak reception on the long wave-band.

ment, and the poor owner can't erect anything better.

Now this kind of aerial doesn't give the receiver a chance. It cuts down the range of reception, because you must remember that a detector and L.F. set has no pre-detector amplifier such as a screened-grid valve, and therefore has to rely largely on the "pick-up" properties of the aerial system for its volume.

## Aerial Compensation

Secondly, an abnormally short aerial reduces the wave range covered by the aerial coil—the aerial series condenser compensates for this on the medium wave-band. On long

to counterbalance its deficiencies.

Then there is the coupling resistance. The whole of the coupling between the two coils—with the exception of a very small magnetic interlinkage due to the "jump over" around the screen—depends upon this resistance.

Its value should be 100,000 ohms. If you increase the value the volume decreases and vice versa. In addition, decreasing the value also reduces the selectivity.

If you find that signals are very weak indeed, inspect the resistance connections between "A" and "G" and make quite sure that they are properly joined to the terminals.

# READY RADIO

★ ★ ★

# COSMIC STAR

★ ★ ★

# RADIO-GRAM

The "Cosmic" Star covers all wavelengths with maximum efficiency on each waveband. Not only can you tune in British and Continental Stations on the medium and high wavelengths, but at the flick of a switch you can go down to the ultra-short wavelengths as used by stations in all parts of the World. Single-knob tuning—no coil changing—everything designed to make reception easy. Wonderfully sensitive and selective—delightful quality. Until you build the ALL-WAVE "Cosmic" Star you are missing half the thrills of radio.

*\*As described in "P.W." Feb. 20th, and subsequent issues.*

**KIT "A"** Complete Kit of Components together with panel (ready cut and drilled), baseboard, Jifflix for easy non-soldering wiring, and free blueprint. **89'6**

or  
**10'3** down and 9 monthly payments of **10'3**

**KIT "B"** Complete Kit of Components, as Kit "A" together with specified Mullard valves and free blueprint. **£5:17:0**

or  
11/- down and 11 monthly payments of 11/-

This beautiful Walnut Radio-Gram Cabinet illustrated has been specially designed for the "Cosmic" Star. Price £3:7:6

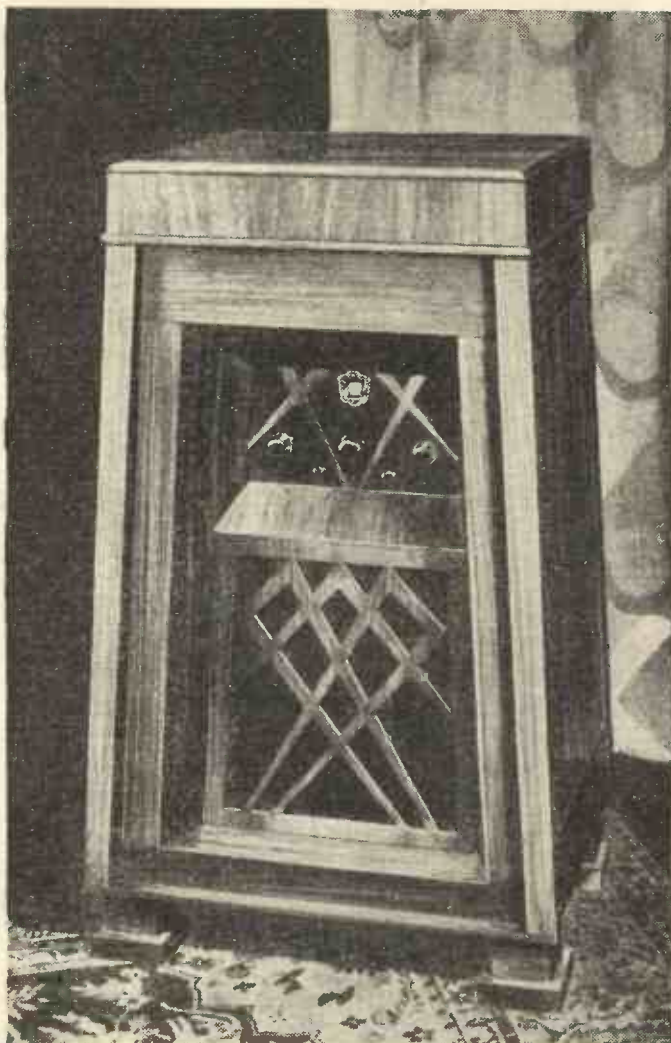

## Full-Size Blue Print of the "Cosmic" Star FREE

Send four 1½d. stamps for a copy of Kendall's Book entitled "10 Hows for Modern Radio Constructors" and we will include a "Cosmic" Star blueprint free.

# READY RADIO

COUPON

To: Ready Radio Ltd., Eastnor House, Blackheath, S.E.3

I enclose four 1½d. stamps. Please send me a copy of Mr. Kendall's book, price 6d., and free full-size blueprint of "Cosmic" Star.

NAME .....

ADDRESS .....

M.W.3.32.

Write to Ready Radio for details of Kits and Prices of the Eckersley Adaptor, the "Bi-Band" Three, etc.

TO INLAND CUSTOMERS.—Your goods are despatched post free or carriage paid.

garding the value of your order, a deposit of one-third of the approximate value will be accepted and the balance collected by our Agent upon delivery of the goods. All goods are very carefully packed for export and insured, all charges forward.

TO OVERSEAS CUSTOMERS.—Everything Radio can be supplied against cash. In case of doubt re-

By the  
*Technical*  
*Editor*

# On the



### R.I.'s New Choke

**T**HE ordinary L.F. choke ceases to offer a high impedance to currents above a certain frequency, because as the frequency rises so does the self-capacity of the component tend more and more to offset the "choking" effect.

For this reason it is often necessary in mains units and sets to supplement ordinary L.F. chokes with special H.F. chokes in order to achieve freedom from hum.

### AN EFFICIENT CHOKE



Unlike ordinary smoothing and output chokes, the R.I. "Dux" is also able to impede H.F. irregularities.

The new R.I. Dux L.F. choke (Audirad system) renders such complication unnecessary, for it is so designed that it is able to "choke" at high as well as low frequencies.

And yet its retail price is only 8s. 9d., and that would be very reasonable for any 25-henry choke able to carry 50 milliamperes. But as it has the

further quality of being able to offer a high impedance to high frequencies, it would appear as though it has no competition on technical grounds.

And it would seem almost inevitable that it will command enormous sales. For normal smoothing duties in mains units and sets its wide use is a foregone conclusion, for constructors and set makers cannot overlook its abnormally insistent claims to consideration.

But what about its application as an output choke? Well, here, too, it has advantages over the choke of ordinary qualities in that it can contribute much more towards decoupling effects. If any H.F. is getting through to the L.F. stages the "Dux Audirad" will raise a barrier against it and prevent a "feeding back" through the H.T. battery or mains unit and a consequent instability.

The "Dux Audirad" is such a new departure, we have never before had an L.F. choke that was not frankly limited to the choking of only L.F., that constructors could be forgiven for being somewhat sceptical of its claims even though it is an R.I. product, especially as it is rather smaller in dimensions than the average run of chokes.

However, we can assure them that it really does what is claimed for it, as our careful tests prove. In fact, it is more efficient purely as an H.F. choke than some components of this nature we have examined in the past!

And regarded as an L.F. choke for universal application, it is right up to R.I. standard, from which it will be gathered that no sacrifices at all have been made to achieve the additional qualities.

We congratulate Radio Instru-

ments, Ltd., on the production of such a vitally useful device at such a low price; many firms would have been tempted to issue the component at a much higher figure.

### A Ready Radio Component

The "Readirad" L.F. volume control is, in our opinion, an excellent production and one of the best pieces of work Messrs. Ready Radio, Ltd., have to their credit.

From the operating point of view, volume controls generally tend to group themselves into three classes. There is first that blatantly wire-wound type—every time you turn the knob of one of these you feel the contact rasping over wire, and you have

### AN ATTRACTIVE ACTION

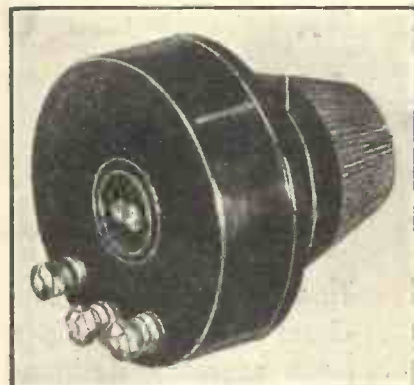

The "Readirad" L.F. volume control has a very satisfactory action.

an uneasy feeling that shreds of metal are torn off at each rotation and wonder how long the thing will last.

Secondly, there is that uncannily velvety type which is so smooth in its operation that a growing suspicion develops in your mind that the contact is maintaining only a featherweight pressure on a resistance element, and that it will come right off in due course.

The third class is a mixture of the two. The knob moves in jerks, first so freely that it feels as though the knob is loose on the spindle, and then so stiffly that you begin to wonder if something is "digging in."

The "Readirad" is none of these. It has a perfectly smooth and even action, but the moving contact rides

# Test Bench

This month we impartially describe R.I., Ready Radio, Bulgin, Ekco, Ferranti and Goltone products.

over a series of metal contacts and there is a satisfying feeling that there is "bite" without wear, and that the resistance element itself is not subjected to friction.

Electrically, too, the "Readirad" volume control is perfectly O.K. It is rated at 500,000 ohms, and our sample is 500,000 ohms. By the way, it is curious that some makers should

## USEFUL CONSTRUCTOR ITEMS



The Bulgin improved potential divider, and "Quickwyre."

think that a volume-control resistance value is quite arbitrary; they apparently do, for sometimes you may or may not find yourself within 30 or 40 per cent of the specification, as readers will have noted in these pages in the past.

## New Bulgin Productions

Of the resourcefulness and ingenuity of Messrs. Bulgin there is no end! Their newest contribution to easier set-building is "Quickwyre," and, when they hear about it, tens of thousands of constructors are going to raise their pliers in salute.

"Quickwyre" is available in either red or black at 6d. per 10-ft. coil. It is an 18-gauge tinned-copper wire, efficiently insulated with a flexible, braided covering.

When "Quickwyre" is snipped off in lead-lengths the insulation can at once be pushed back with the fingers to reveal the brightly polished metal. And, subsequently to soldering or making a screwed joint, the covering can be slipped up the wire again to give a neat, frayless finish.

The Bulgin 20,000-ohm potential divider has recently been improved.

It is able to carry 30 milliamperes, and is divided into 11 equal sections, connections to which are made via neat terminals.

There are mounting feet by means of which the component can be fixed either with the terminal panel horizontal or vertical, and the stout metal casing provides for adequate ventilation.

An important feature is that the divider can be mounted directly on a metal baseboard or panel, in which case the casing is then efficiently earthed through such.

It is a compact and very well-made component, and we can thoroughly recommend it to the attention of mains enthusiasts.

## An Ekco Mains Unit

When the first reports of Messrs. E. K. Cole's fire came through it seemed that a real calamity had occurred. If there is to be catastrophe in radio our Southend friends ought to be among the last to be affected if providence is just. However, it subsequently emerged that there had been exaggeration and that the fire, annoying though it must have been, did not consume material or buildings vital to the continuance of manufacture.

Therefore, there should be no interruption in the supply of the Ekco



The Ekco K.25 mains unit for H.T. and L.T. trickle-charging.

K.25, for which we predict continually heavy demands. It is an A.C. unit giving 25 milliamperes H.T. (50/80 and 120/150 volts, both tapings having intermediate positions), and L.T. trickle-charging at  $\frac{1}{2}$  ampere for 2-, 4-, or 6-volt accumulators. The price is £5 7s. 6d.

A very useful unit indeed. It employs a metal rectifier and the running cost is extremely low.

Its construction is distinctive and sound. The stout protective metal casing is definitely artistic in appearance, and the output points and voltage varying controls are neatly and accessibly grouped in a central position on the top.

On test this Ekco K.25 gave really good results.

A.C. mains users are fortunate in having such apparatus available for their use.

## Two Ferranti Mains Units

Ferranti mains units are sound engineering productions and can bear expert interior inspection. But for some time they were available in only the "heavier" types. Now, however, there are some "popular" models enabling radio enthusiasts

(Continued on page 299.)

## TWO INEXPENSIVE FERRANTI MAINS UNITS

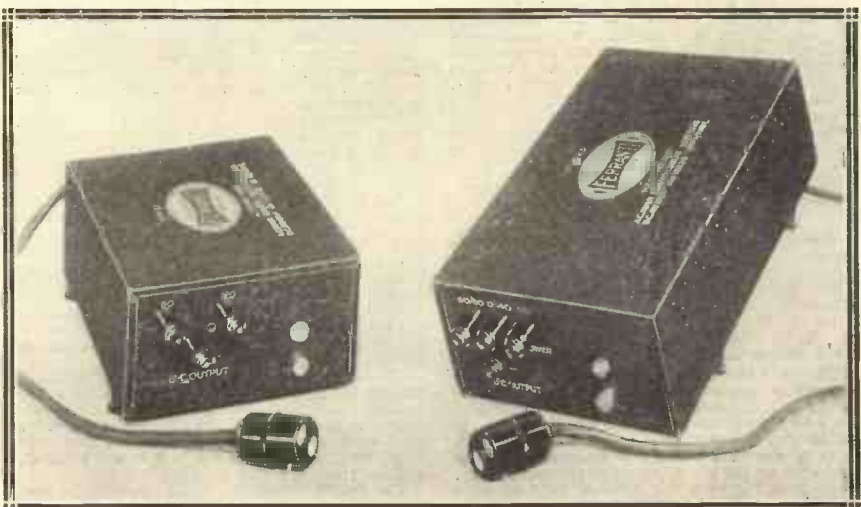

Ferranti H.T. units for A.C. mains. On the left is E.2 and on the right is E.3.



**BROADCAST**

**W**E are taking just a few of the many Broadcast records that have been released during the last few weeks for our review. As usual, they are perfectly dependable, both from the point of view of good selection and from that of excellence in recording.

One of the best of the dance tunes is that provided on 3145 by the Harvard Dance Club Aces. It is called *I Don't Know Why*, and is coupled on the other side by *Three Little Times*. The former is a great favourite among dance-band fans, but the orchestration and tempo of the other number is equally fine for dancing purposes, while the melody, though not quite so haunting, is above the usual.

The recording of these two numbers leaves little to be desired; in fact, one can always rely on the Super Twelve records (of which this is one) to be well produced.

Another Super that we should like to bring before your notice is the Wirrlitzer organ solo of Mendelssohn's *On Wings of Song*, which is paired with *Serenata No. 1*, by Toselli. The organ is that at Madame Tussaud's Cinema, and is played by Edward O'Henry.

In the latter item both the high notes and the pedals are very well brought out, some very deep notes of the latter being well reproduced. The composition does not give the organist much opportunity to let the organ show its paces, the other side being little better in that respect. Both, however, are pleasant records that you should certainly hear. (3147.)

Bob and Alf Pearson are not particularly good in *Old Scottish Songs* (3146), and they would do better, in our opinion, to keep to the syncopated numbers with which they made their recording debut.

In the Consulting Room, on a "Ten," is quite a happy little disc, though we have a suspicion that Mr. Blew is our old friend Tommy Handley. The repartee is not exactly brilliant, but the record is worth hearing if you are a follower of that popular broadcast comedian.

We may be wrong, of course, but with the assistance of the second side, *Looking Over a Flat*, we feel that there is practically no doubt as to the identity of Mr. Blew. The latter side is better than the other. (804.)

A popular disc will be *Ay, Ay, Ay*, Freire's well-known composition that used to be a favourite of Sandler and his Orchestra in the Eastbourne days. In this case it is sung and played by the Waikiki Serenaders, who make good use of the violin and guitar. (807.)

The reverse side has a typical Hawaiian melody, *Aloha Oe*, played very effectively by the same combination. The singing is of the usual "sob" variety, but it is effective.

Harry Roy and his R. K. Oilians are excellent on 809, another "Ten," on which are *Consolation* and *Oh, Mo'nah*. The vocal choruses are not particularly well sung, but the playing of the orchestra, though straight, is very good, and the disc forms a useful addition to the collection of dance records.

The second side is notable for its vigorous banjo accompaniment. This really does come out very well indeed. The theme is, as the title suggests, a Negro one, and the band certainly let themselves go.

**COLUMBIA**

Among the varied assortment sent to us this month by Columbia there are two widely different twelve-inch records: an organ solo by Edouard Connetta, and a couple of monologues by Stanley Holloway.

Let us deal with the organ items first. These are Mendelssohn's *Wedding March* and *Sonata No. 6 Allegro Molto*, by the same composer.

There is a vast difference between the two in the amount of pedal work that is done. On the former one is bound to admire the brilliance of the reed pipes of the organ, while in the latter the pedals and the great organ command attention. It is, of course, a brilliant composition, and one that calls for the use of plenty of the great organ, while from the recording point of view accurate volume controlling is essential if the disc is to be properly modulated.

As Columbia have made the record there is very little to find fault with. The echo effect that is strikingly heard in the two short rests towards the end of the *Serenade* gives a realism to the record that is of a very high degree. The number is D.X.320.

Stanley Holloway's two Old Sam monologues, on D.X.321, are very good, though we do not think they are so amusing as the earlier ones, especially "Pick Up Tha' Musket," and its accompanying item. The two under review here are *Beat the Retreat on Thy Drum* and *One Each Apiece All Round*.

The former is the better of the two, but the humour is more engineered, if we may use the expression, than in the two to which we refer above. The dragging in of Josephine rather weakens the story in our opinion, though the climax is unexpected, and for that reason is good.

Of the ten-inchers we commend to your special notice Heddie Nash singing *Bonnie Mary of Argyll*. The recording is perfect, for not only do all the inflexions and the fine timbre of Nash's tenor voice come through perfectly, but the piano accompaniment is superbly recorded. The piano is a difficult instrument to "fix," and very often a tinny wavering is introduced that completely ruins the reproduction.

A brief selection from some of the records released during the month.

On the reverse side of the record is *The Bloom* is on the *Rye*, another Scottish song that is perfectly rendered by the same vocalist. If you like ballad singing you should certainly not miss this disc. (D.B.720.)

A vocal record of a very different type is that by Florence Oldham on D.B.724. Here we have a couple of light items of the dance type—*If They Ever Had an Income Tax* on *Love and Hang Out the Stars in Indiana*. Both are very artistically sung with an excellently played piano accompaniment. The result is a couple of very tuneful recordings that will find their way into a great many gramophones' libraries.

Billy Mayerl, in *Mignonette* and *Honeysuckle*, on D.B.723, is himself. You can never mistake his playing, and it is a pity that in this disc the quality is not all it might be. The piano sounds a bit thin on the upper register, otherwise the recording is O.K.

**H.M.V.**

Of the selection sent us by The Gramophone Co. the outstanding record is undoubtedly the red label recording of *Walters' Prize Song* from "The Mastersingers." It is an excellent piece of recording, and the power of Richard Crook's voice is well portrayed.

The accompaniment is a little too powerful, almost completely drowning the singer at times. We know that this is in accordance with operatic tradition, but it sounds worse on a record than it does on the stage.

The other side of the record is better from this point of view, for the orchestral part of *In Distant Lands* ("Lohengrin") is not so vigorous. The difficult narrative, too, suits Richard Crooks better than the former aria. (D.B.1598.)

Accompanying this in the red label series is a record by the Chicago Symphony Orchestra on D.B.1557. The two items are operatic, one being *Prelude to Act 3* of "Lohengrin," and the other the *Grand March* from "Tannhauser." Both are excellent.

The effect is that of really virile composition, and the full richness of the works is retained in the perfect recording. The attack and bite of the strings is excellent; perhaps the shrillness is a bit over-emphasised sometimes. But that is a good fault, for the balance of the bass is well retained, and the result is a very fine, brilliant record.

The *Bolero*, from Moszkowski's *Spanish Dances*, played by the New Light Symphony Orchestra, will find a home on the shelves of many radio-

gram enthusiasts who like clean-cut, light orchestral recordings.

The actual composition is not an outstanding one, but the interpretation is good, and the clarity of the recording is equally fine. The reverse side holds *Spanish Dance in G Major*, by the same composer. It is not so lively, but makes a good companion, at the same time contrasting with the abandon of the former piece. (B.4046.)

*Erinalia* is a somewhat dull pot-pourri of Irish airs, played by the New Mayfair Dance Orchestra in waltz time. The airs themselves are beautiful examples of National composition, and somehow it seems to rob them of 50 per cent of their charm to hash them up as a collective Irish waltz number. (B.6094.)

The recently staged London success, *Bow Bells*, is perpetuated in a selection disc by the New Mayfair Orchestra on C.2342. It is an excellent piece of recording, and begins and ends with that star item of the show (from a musical point of view), "Mona Lisa."

Other excerpts it introduces are "Builder of Dreams," "Watching the Hours Pass By," and "Break Down and Weep." We wonder why "You're Blasé," a particularly haunting and tricky item, was not given more "space." However, we cannot have everything.

Paul Robeson is always a winner (when they don't trammel him up with a dance band), and his *That's Why Darkies Were Born* is a fine record. Like so many of the Negro spiritual kind of record, this is extremely simple, but it is telling, and Paul's fine bass voice comes through with a fullness that speaks much for the recording. (B.4058.)

Another fine disc is the *Cuban Love Song*, by Lawrence Tibbett, who is the hero in the talkie of that name. It is sung perfectly, and from the record one can at once realise wherein Tibbett's attraction to picturegoers lies. Apart from his acting the film is worth a visit just to hear his voice.

On the other side is another item from the same film, *Tramps at Sea*. (D.A.1251.)

Lighter stuff, but none the less attractive, is provided by Sylvia Froos on B.4053, which contains *A Faded Summer Love* and *You Didn't Know the Music*. Both are of that tuneful sentimental type that make dance hits, and they are sung with perfect artistry. The orchestral accompaniment, too, is well worth mentioning.

*Mona Lisa* and *You're Blasé* are two good dance numbers on B.6125. They are from the show "Bow Bells," and are played by Ambrose and his Orchestra.

One Little Quarrel is a popular number. H.M.V. have recorded it on B.6118 by the New Mayfair Orchestra.

**ZONOPHONE**

We were unable to review the Zonophone records last month as they did not arrive in time to be included.

Among them is a wide variety, from sacred recordings to light orchestral and dance numbers. Master Graham Payne, the boy soprano, is worth hearing on 6033, whereon are recorded *Cast Thy Burden* (Hamblen) and *Nearer, My God To Thee* (Carey).

Zonophone are always to be commended on their organ recordings, and the accompaniment of the former leaves nothing to be desired. The setting of *Cast Thy Burden* is not a particularly tuneful one, but it serves to show up the wonderful consistency of the soloist's voice. His high notes specially are worth mention, for they are far clearer and stronger than is the case with most boy sopranos. In fact, one wonders sometimes if it is a boy, and not a lady, singing.

We like the well-known Carey setting of *Nearer, My God better than the other item, but it is a pity that the soloist insists on breaking the syllables of the word "heaven,"* as it seriously upsets the scanning of the bymn. We should like to hear more of Master Payne.

Changing abruptly, we come to *Looking For You and What's Gonna Happen To Me?* by Jack and Jill. This is the usual duo record, but it has the advantage of perfect recording plus really excellent diction on the part of the artists.

Both have pleasing voices, while the balance of the orchestral accompaniment is well adjusted. (6029.)

Les Allen is a new one to us, but his record, *Hold My Hand and To The Ends of the Earth*, are good in their way. The style is rather nasal, the singer being a baritone who specialises in light semi-syncopated stuff. The interlude by the orchestra in the middle of each is of the stereotyped kind, but the record is quite pleasing.

A little snappy syncopation in the second item would improve the number, for the theme of the music is simply asking for one or two "hot" breaks. But the orchestra lets the opportunity pass, and instead tries to instil some extra sentiment into the record by some "sob" violin playing. It is a pity, for it lets the record stay in the usual rut. (6025.)

*Carry-On and Resolutions for 1932*, by the Orpheus Dance Band, are good numbers. The orchestration is of the straight variety, but the enthusiasm of the band carries them through both numbers. This band is an excellent contrast to the Rhythmic Eight. (6037.)



# OPERATING THE D.C. "SUPER-QUAD"



*Here are some practical details concerning the super-het. described last month.*

By K. D. ROGERS.

**L**AST month we published an article describing the construction of a six-valve D.C. super-het., finishing off the article at the point where the set was ready for its first test.

With the valves in position, the aerial and earth on, but the set not in its cabinet, we switch on and set about the task of trimming the gang Extenser.

## Small Adjustments

We are assuming that the polarity of the mains with regard to the H.T. unit and the valves has been decided, and that the set has been placed on a convenient table so that you can easily get at the various controls. This is essential if the set is to be properly adjusted, for with a mains receiver one cannot afford to go fiddling around awkward corners and risking shocks in an endeavour to put everything shipshape.

The D.C. "Super-Quad" is a "he-man's" set, and so it is a job not to be tackled lightly. As a constructional task you have seen that, while not exactly dead simple, it is by no means out of the scope of the fairly experienced constructor, and if you can build it you can certainly do the small adjustments that it requires.

There are five trimmers that have to be set—two for the long waves and three for the medium band. But before the trimmers are set it is possible to tune in stations, so that you need have no fear that until the condensers are in order it will be impossible to do anything with the set.

## Setting the Ganging

The tuning of the band-pass circuits is accurate enough for quite a number of stations to be received before any of the trimmers are touched. So the procedure is as follows:

Adjust each of the three trimmers mounted on the Extenser to about the middle point of their adjustment, and then, using the medium wave-band, tune in as weak a station as you can.

The next step is to vary the trimmers by means of a long, thin screwdriver (with insulated shaft) until the maximum strength is obtained.

When you have got to that point tune in a still weaker transmission, and repeat the process.

Next, the long-wave side of the Extenser is used, and the same procedure is gone through, adjustment of the long-wave trimmers being carried out. These are the trimmers situated on the baseboard, and there are only two of them.

## The Output

We can turn our attention now to the output side of the set, and see about the impedance equaliser that is connected across the output choke.

In the diagrams this is shown as consisting of a 15,000-ohm resistance and a .01-mfd. condenser.

That is the value that suits most loud speakers and most pentodes, but it may not be correct for your particular set of circumstances. It must not be forgotten that the output choke is tapped, and that the adjustment available by these taps enables the speaker and pentode to be somewhat matched.

## Tone Alterations

In certain circumstances it may not be necessary to use a resistance and condenser across the choke, and in others it may mean that the resistance need not be of such a low value. The lower the value of the resistance, or the higher the value of the condenser, the more are the high audio-frequencies attenuated, and the less harsh does the reception sound.

This is not meant to infer that the reproduction normally sounds harsh, but the pentode valve is usually

## TRIMMING THE TRIPLE-GANG EXTENSER

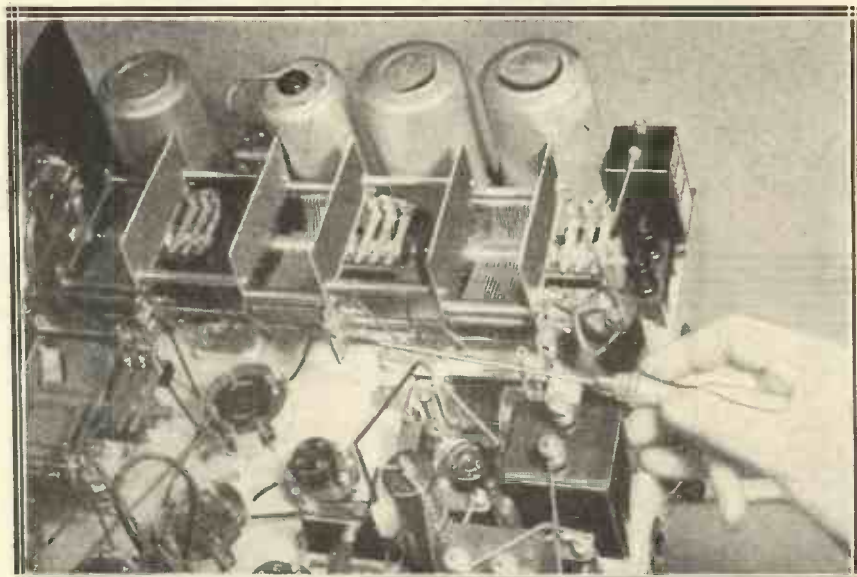

The trimmers for the medium waves are situated on the side of the Extenser and must be adjusted by means of a long screwdriver. In this photo the valves have been removed so that the trimmers can be better seen.

# NEARER CLEARER

## MORE LIVELY THAN BEFORE

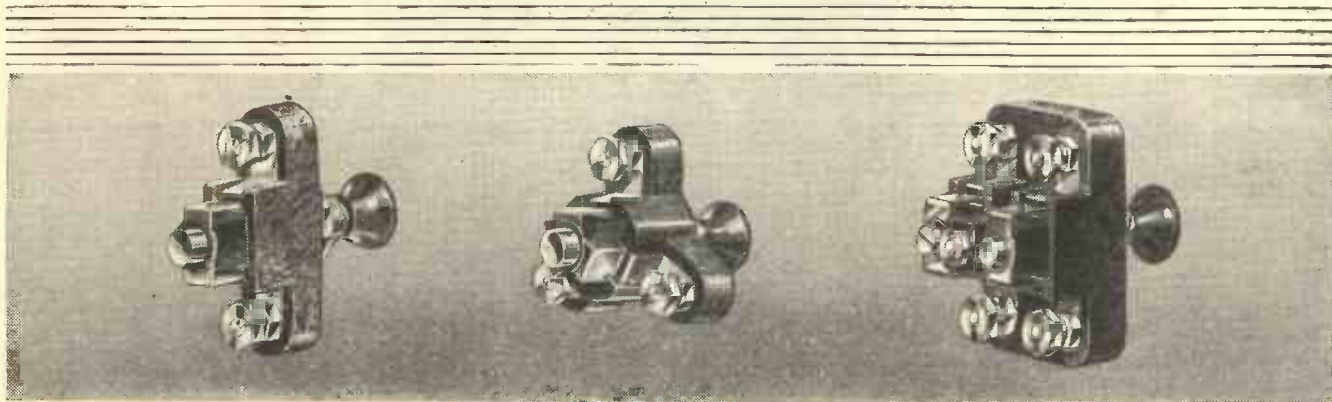

“CHANGING over to Telsen is like taking the wool out of your ears”—that is the verdict of an enthusiastic Telsen constructor which inspired the illustration on the opposite page. Telsen Components in your set give you a realism which is astonishing—they enable you to sit back and **hear**, without straining forward to listen—they bring every item on the programme ‘neater, clearer, more lively than before.’

- DUAL RANGE AERIAL COIL 7/6
- H.F. TRANSFORMER & AERIAL COIL 5/6
- LOGARITHMIC VARIABLE CONDENSER in capacities .0005, .00035, .00025 4/6
- BAKELITE DIELECTRIC DIFFERENTIAL, REACTION AND TUNING CONDENSERS in all capacities. From 2/-
- PRE-SET CONDENSERS ... 1/6
- MANSBRIDGE TYPE CONDENSERS From 1/6
- FIXED CONDENSERS (Prov. Pat. No. 20287/30) 6d.
- PUSH-PULL SWITCHES (Prov. Pat. No. 14125/31)
  - Two-point .. .. . Price 1/-
  - Three-point .. .. . Price 1/3
  - Four-point (2 pole) .. .. . Price 1/6

# TELSEN

100% BRITISH  
RADIO COMPONENTS

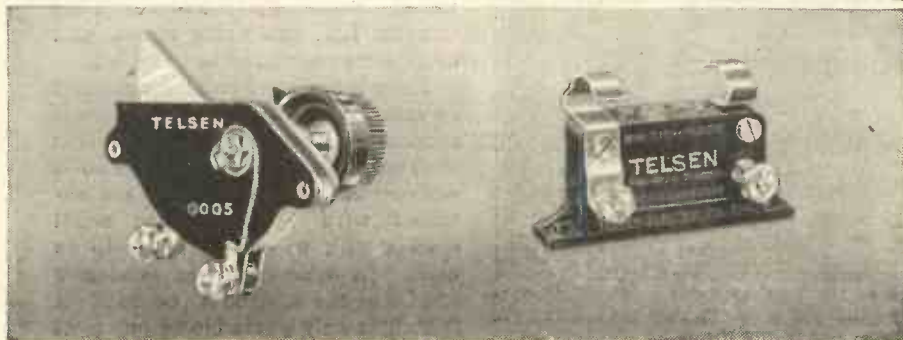
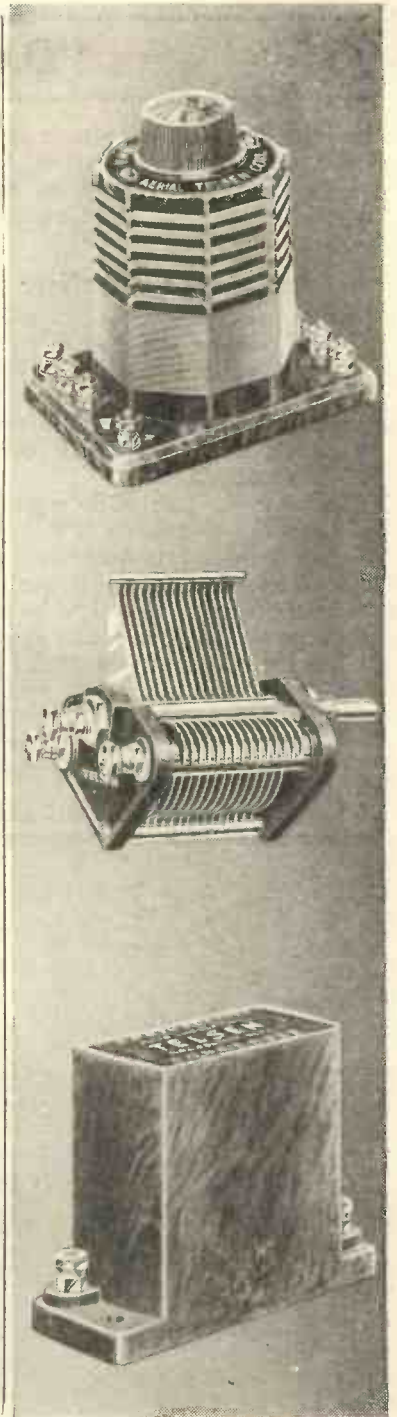

Advt. of The Telsen Electric Co., Ltd., Aston, Birmingham.

## "D.C." Mains That Are Not D.C.

inclined to cause a certain over-emphasis of the high notes, and this, unless it is counteracted to some degree, means unbalanced reproduction.

### Impedance Equaliser

In the case of a super-het. a little extra high-note response is useful; for this type of set, although band-pass, tends to reduce the upper frequencies in practice, and for this very reason the use of a pentode output valve is valuable.

So what we have to do regarding the impedance equaliser is to adjust the value of the resistance till the reproduction sounds right for the particular speaker that is to be used with the set. A boomy cone speaker will not require nearly so much high-note attenuation as will a brilliant type of moving-coil loud-speaker.

We would suggest that values of between 10,000 and 30,000 ohms be

tried for the resistance, the value of the condenser being left as at present. If, however, you try the 15,000-ohm resistance and find that the reproduction is too "mellow," it would be sheer waste of money to get a resistance of a lower value. Similarly, if the reproduction is too high-pitched—an unlikely event—then a resistance of a higher value would be useless.

### Output Choke Taps

Before altering the impedance equaliser, however, the pentode output choke should be adjusted. This is carried out by altering the tap that goes to the speaker. Two of the leads going to the choke remain "put," namely, those that come from the H.T. and from the anode of the valve. The third, however, that which is taken from the loud-speaker via the 4-mfd. fixed condenser, is tried first on one tap and then another until the best position is found.

Probably this will be about two taps away from the H.T. end of the choke, but you will have to check this up on your own loud speaker, remembering to switch off the set every time you want to alter the tap. If you fail to do this you run the risk of getting quite a nasty, though not dangerous, shock.

By the way, a limited control of sensitivity can be obtained by adjusting the variable bias resistance of the "mixer" valve. This resistance is the potentiometer that has its spindle protruding through the baseboard, and has a slot in the spindle so that easy adjustment can be carried out with a screwdriver.

### The Mains Side

The tuning of the set is critical on the right-hand Extenser, which is the one controlling the oscillator, but it is not at all critical on the aerial control.

And now a few words about the mains side of the outfit. As far as possible we have made the D.C. "Super-Quad" completely free from hum and mains noises generally. But it is impossible to cater for every contingency that may arise.

For instance, the set may be used on so-called D.C. mains that are really a rectified A.C. supply. We refer to mercury arc rectified mains. Here all ordinary smoothing is inadequate, and special measures have to be taken.

### Smooth H.T. and L.T.

Obviously it would be unfair to cater for the worst mains in every set, and so make all those constructors that have good electricity supplies use a lot (to them) of unwanted apparatus. And so in the case of the set under discussion we have done all that is necessary to provide a smooth H.T. and L.T. supply in all normal cases; if the set is used on exceptionally bad mains, then external smoothing in the form of L.T. smoothing chokes and condensers may have to be added.

There is one more point which must be mentioned, and that is the pre-set condenser in the aerial lead. This is situated under the baseboard, and is set so that the best results are obtained with the particular aerial system with which the set is to be used. In most cases the condenser can be at the minimum position; in fact, it is only advisable to put it at maximum for the smallest aerials.

### AFTER THOSE LONG-WAVE PROGRAMMES

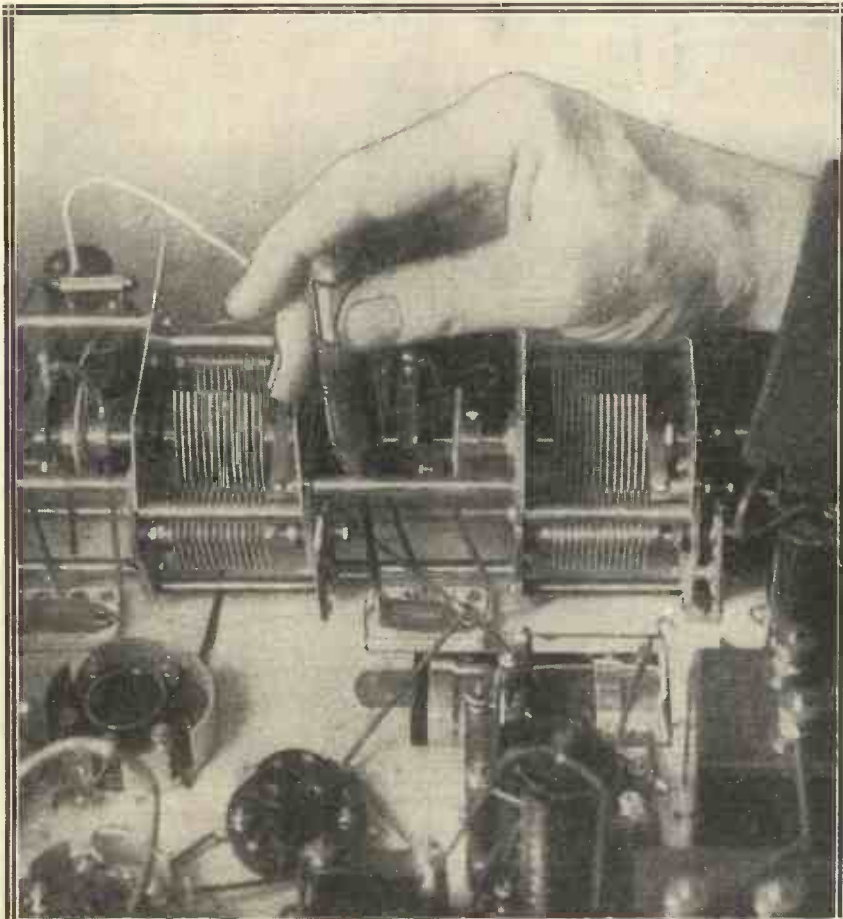

The long-wave trimming condensers are placed on the baseboard and adjusted independently of the medium-wave trimmers, but they should be adjusted after the others have been done, as any alteration in the medium-wave side would throw out the long-wave trimming.

# ... ON THE ... SHORT WAVES

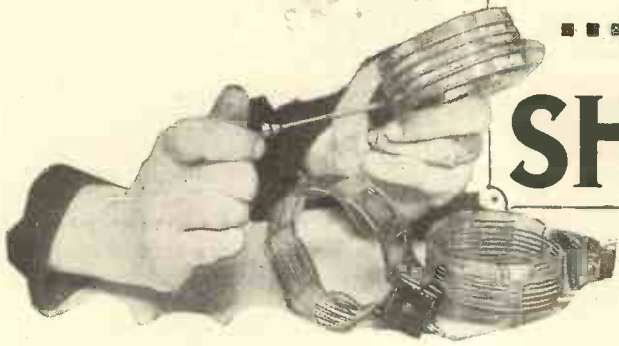

By W.L.S.

*Who discusses recent ether conditions, and advances some interesting arguments for and against single-valve short-wavers.*

**B**EFORE we start the real business, let me clear up a misapprehension that seems to have arisen out of the January issue of "M.W." Numerous eagle-eyed readers have written to me, politely (sometimes!) pointing out to me that I have been contradicting myself.

"Here is this W. L. S.," they say, "designing sets for 'M.W.' without a pennyworth of screening in them, and then writing, further on in the same issue, to say that he always finds screened sets more efficient!"

### "A Nasty Mess!"

At first sight it may appear that I am in "a nasty mess," as one gentleman kindly suggests. But no! I was fully aware of the two remarks, although I did not realise that they would appear in the same issue. Let me explain.

A set built completely in a metal box is almost certain to give better results than an "open" set, *unless* the "open" set is very carefully designed. This is another way of saying that poor or indifferent layout in a set will be compensated for, to a great extent, by using very complete screening and enclosing the whole thing.

The two-valver that I described in the January issue was the result of a large amount of experimenting with different layouts, and I really felt assured, by the time I had finished, that the general design of the set was good enough for me to assume that it would not be improved by screening. This was done for the benefit of those who still think that the building of a set in an aluminium box entails a terrible amount of trouble and hard work.

### The "Ironclad" Variety

For those who like to build a set in a hurry, without spending very much time or thought on the layout and circuit arrangement, I would still say every time: "Make one of the Ironclad variety!"

Nothing of great importance has happened between the beginning of 1932 and the day on which I write these notes. Reception conditions in January might well be described as "average." No other word conveys the mediocrity of that month as regards long-distance work.

February will probably have turned out to be a good month, and I hope that by the time you read these pages everything in the world is coming in well. March, April and May very seldom let us down, and these three months are coming to be regarded as "the DX season" as a matter of course.

While we are on the subject, I may as well mention a few novelties in the way of stations to listen for this month. In most cases I have already heard them myself; in every case I know them to be on the air.

One of the most interesting is the short-wave transmitter of the U.S. Airship "Akron," which works with the call W 10 X A O, on 49 and 62.5 metres.

The new station at Maracao, Venezuela (Y V Q), apparently works on three separate wave-lengths—16.35, 25.7 and 32.8 metres. I have not yet heard him on the last of these, but on the other two he is always good

### Have You Heard Them?

Yet another new country is furnished by Bermuda, with a commercial 'phone which works with some of the Americans. The call is V R T and the wave-lengths 29.8 metres and 60 metres.

There is also a new 'phone circuit between the United States and Hawaii; the stations at the far end appear to be K K P on 18.7 metres and K K H on about 40 metres.

### AN ELECTRICAL DISCOVERY!

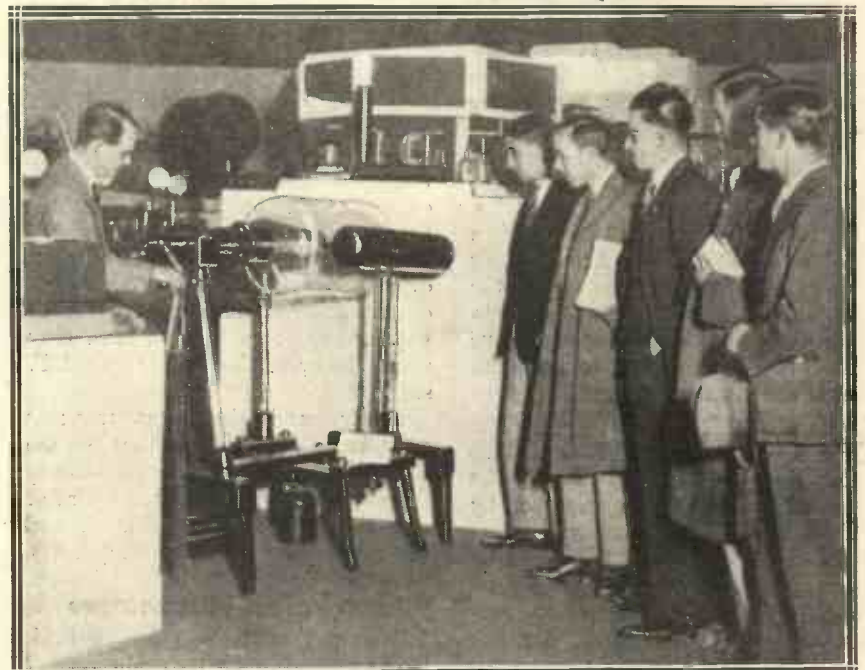

A party of students inspecting the frictional electrical machine invented by Nairn in 1803. The device was found under the site of the Royal Institution Theatre during recent reconstructional work. It must have been dusty!

## Round the Antipodes After Sunrise

One of the best stations from the Far East is now Radio Saigon, on 25.4 metres. He is better here than on the other wave of 49 metres, provided that you can catch him early enough in the day. Naturally the "fade-out" commences earlier on the shorter wave.

### How Many Countries?

Unless it has already occurred to you, you will probably be quite thrilled when you total up the number of countries from which you can hear telephony on the short waves. You will probably find at least thirty. Naturally, if you include the amateurs

One reader, in the space of two hours after sunrise, logged signals from Australia, New Zealand, several parts of U.S.A., including California, Cuba, Brazil and Porto Rico.

### The Best Set

All this was between 41.2 and 42.8 metres! And now to dive into the "Technical Section" for a while. The favourite topic this month seems to be the arguments for and against the single-valve receiver, as compared with representatives of the "heavy brigade" such as O-V-2's, S.G.-V-1's, and the like.

I will state the case from both

tion on one valve only I am bound to say that I like it very much. I don't think the "weak signal" argument holds water very much, for this reason.

When I used two valves or more I always used to have a volume control "on board." I invariably found that when the local noise level was high (as it generally is with me) I could read weak signals much more easily by reducing the volume control.

### Background Noise

Eventually I found that the level to which I was reducing signals on that set was just about equal to the strength at which I could receive them on one valve *without* a volume control. The only difference was that with the L.F. cut completely out the background was still quieter than before.

The state of affairs I find with one valve is this—all over the short waves the characteristic background "hissing noise" is clearly audible on headphones at R2 or R3. Therefore, it follows that anything in the way of a signal that is stronger than that is *easily* heard. So far, so good.

But take the case of a signal *weaker* than the background. One can't decipher it on one valve; but, then, could one on any set? Would not the proportion of signal to background be even worse if one added more valves? Personally, I am convinced that it would, as I find that when I can just copy a signal on one valve I often lose it completely if I switch in a second valve.

### Short-Wave Broadcasting

But I will admit this—that a single-valver is not very suitable for logging the ordinary short-wave broadcast. The stronger stations are always well clear of the background, and not-mags. may be used on them with advantage. Paradoxically, it is on the really weak signals that the single-valver gains most.

If you feel terribly strongly on this subject, please let me hear your arguments, it will be good for all concerned.

My present preference is for a single-valver for amateur DX signals, and an O-V-2 or S.G.-V-2 for "local" broadcast, by which I mean Schenectady, Sydney, Nairobi, and so on, and not the little stations one seldom hears.

ILLUSTRATED BY THE B.B.C.

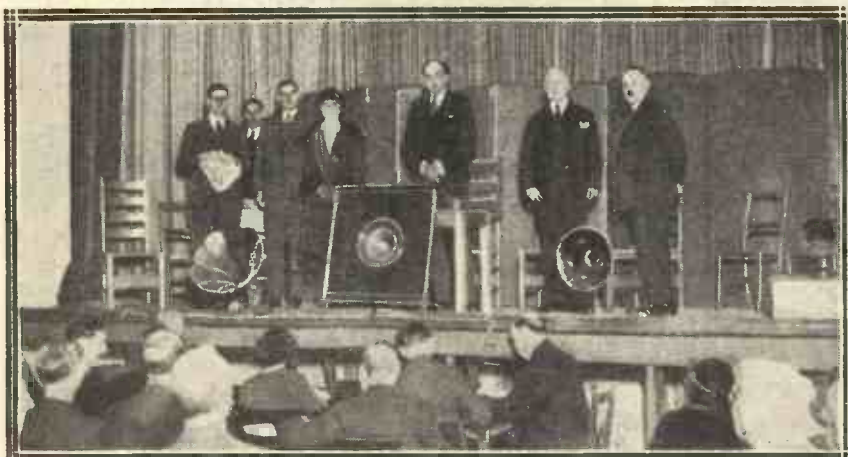

Prominent B.B.C. officials at a London demonstration of good and bad radio reception. In the centre is Sir John Reith.

you will be able to get somewhere near the hundred mark with a little patience and perseverance!

My own "bag"—referring to amateur work only—is 115 countries. This total is very much higher than that obtainable from broadcasting stations only, chiefly because all the little out-of-the-way places that know no broadcasting have one or two active amateurs who know how to make the best of a few watts!

### Early Morning DX

Some of the logs sent in for the recent Reception Competition run by "P.W." showed how many obscure parts of the earth may be logged by keeping a close watch for several hours, even if conditions are not particularly good. The most striking fact shown by analysing the entries is the extraordinary way in which DX signals from all parts commence to rush in immediately after sunrise.

points of view as clearly as I can. First, the case against the single-valver. It may be argued that really weak signals will require such concentration on the part of the listener that they may be missed altogether. Next it may be said that, even allowing the advantage of a quiet background, telephony signals will be harder to tune in than they would be with the help of an L.F. stage.

Lastly, and the most frequent criticism of all, it is said that the use of one valve only is an admission of defeat and a sign that the operator is afraid of S.G. amplification and various other modern developments.

### One-Valver Advantages

"Why, I used one valve in 1924. Do you mean to say that you haven't advanced beyond that *yet*?" and so on.

Well, after some weeks of recep-

# A 29 Gn. Radio-Gramophone

... made by His Master's Voice

IF YOU  
KNOW LITTLE  
OF RADIO  
READ WHAT  
THE EXPERTS  
SAY

"The quality of reproduction of both broadcasting and gramophone records is of the high standard one expects from H.M.V. products. A full round bass is balanced by crispness in the upper register without over-emphasis of sibilants or objectionable needle scratch. It goes without saying that the quality of material and standard of workmanship in the chassis is irreproachable, while the finish of the cabinet work is of the customary H.M.V. excellence."—*Wireless World.*

"An unusual type of set is the H.M.V. model 501 three valve table radio-gramophone. Included in the table cabinet is a three valve all mains set, a moving coil loudspeaker, gramophone pick-up and electric motor. The price is 29 Guineas, a figure that should appeal to many set-buyers wanting radio-gramophone reproduction without the expense usually associated with radio-gramophones."—*Wireless Magazine.*

"Tests soon proved the excellence of the Model 501 radio-gramophone under working conditions. All the laboratory staff agreed with me that the quality of reproduction is outstandingly good. This applies to the loud and soft settings of the volume control. On the radio side it was evident that selectivity, even with a fairly long aerial, is above the average. I found the wave-length calibrations quite accurate enough to locate distant stations, of which a large number have been logged."—*Amateur Wireless.*

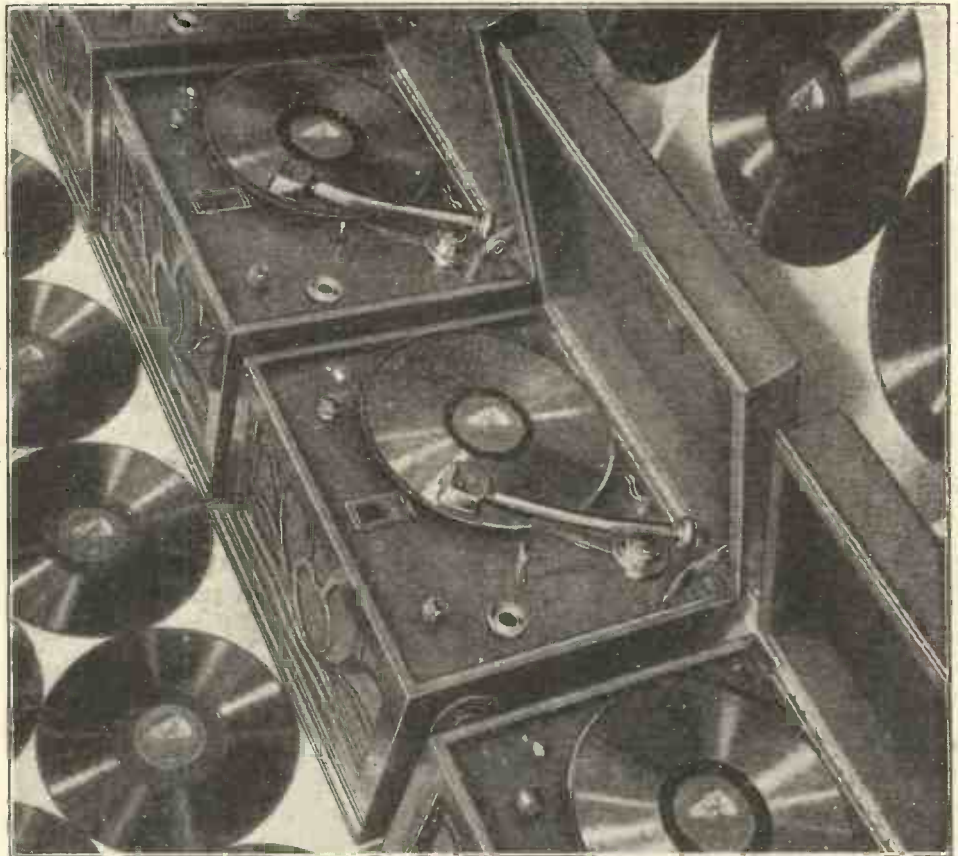

Model 501

*If you are an expert . . .*

## HERE IS THE TECHNICAL SPECIFICATION

**VOLTAGE RANGE.** A.C. Model—100-130 volts, 200-260 volts, 50-60 cycles. D.C. Model—200-250 volts.

**CONSUMPTION FROM MAINS.** A.C. Model—60 watts. D.C. Model—90 watts.

**CIRCUIT.** 3 valves, Screen grid H.F. valve MS4B or DSB.25 with band pass input filter; power grid detector MHL4 or DH.25; super power pentode output valve MPT4 or DPT.25; U10 Full-wave valve rectifier in A.C. Model.

**CONTROLS.** (1) Combined wave-range, gramophone and on and off switch on motorboard; (2) 3 ganged condenser tuning control. Illuminated dial calibrated in wavelengths on motorboard; (3) Combined reaction and volume control at right side of cabinet; (4) Aerial trimming condenser at left side of cabinet for fine tuning of remote stations.

**GENERAL.** Slow-speed Electric turntable motor. Permanent Magnet Moving Coil loudspeaker. Walnut table type cabinet. Felt lined lid.

Model 501. **29 Guineas or £3 - 0 - 11**  
**down** and 12 monthly payments of £2 - 9 - 1.

Ask your dealer for fully illustrated brochure



The Gramophone Co., Ltd.  
London, W.1

# His Master's Voice

**P**OWER valves or output valves are specially designed to transfer the signals from the wireless set to the loud speaker, amplifying them in the process. The points we wish to deal with in this article

are the ensuring that the signals impressed on the grid are faithfully reproduced in the plate circuit and amplified, and that the valve works at its maximum efficiency. For our purpose we shall consider the valve as the power station or generator of power signals. The variation in the plate current should be in accordance with the variation of grid voltage.

Suppose we have a battery of 50 volts whose internal resistance is 10 ohms, and, further, let us suppose the battery is connected across a resistance of variable value, as shown in Fig. 1. We now wish to obtain the

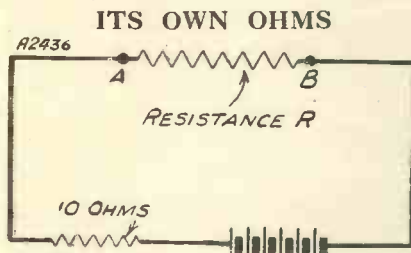

**FIG. 1.** The resistance of the H.T. battery has to be regarded as a series resistance in the circuit.

maximum power, in the resistance, from the battery. How will this be done? At first glance we might say short-circuit the battery, when the current will be a maximum. But if we do so we reduce the voltage to a very small value, and as the power in a circuit is given by the product  $V \times C$ , where  $V$  is the applied voltage and  $C$  is the current, then we have defeated our purpose. Actually, for all batteries there is an optimum, or best, value of resistance which must be connected across the battery to give the most power.

**The Optimum Value**

Let us see how this can be obtained, and in doing so we shall use the example given in Fig. 1. In the figure we see that the battery is connected across the two resistances. One the battery resistance and the other the resistance in which we are particularly interested. As was previously stated, the power in  $R$  is the applied voltage—that is, the voltage measured from  $A$  to  $B$  multiplied by the current.

**POWER VALVE PROBLEMS**

*Useful information for users of power valves.*

By G. LENNIE, B.Sc.

Actually, the voltage applied to the terminals of  $R$  will not be 50 volts, because part of the 50 volts is used in overcoming the battery's own internal resistance. Thus when a certain current flows there will be a drop in voltage across the battery's own 10 ohms, and according to the current variation this voltage drop will vary. It may be interesting to note that when we consider a battery circuit as that shown, with its internal resistance assumed to be for the time being an external one, then we speak of the 50 volts as being the electromotive force of the battery, and the E.M.F. is always given a value in volts.

For a preliminary trial let  $R$  have a value of 4 ohms, then the power in the circuit is found as follows:

- Let  $r$  = internal resistance of battery in ohms
- $R$  = external resistance in ohms
- $E$  = E.M.F. of battery in volts
- $C$  = current in amperes
- $V$  = voltage, across  $R$ , in volts
- $P$  = power in the resistance in watts,

then  $C = E / R + r$   
 $= 50 / 4 + 10 = 3.57$  amps.,

and  $V = C \times R$   
 $= 3.57 \times 4 = 14.28$  volts,

then  $P = V \times C$   
 $= 14.28 \times 3.57 = 50.98$  watts.

In a table is shown various values for  $R$ , with column headed  $C$  giving the corresponding current values, that headed  $V$  giving voltage across  $R$ , and that headed  $P$  giving the watts in  $R$ . Thus we see that for our assumed conditions a resistance of 10 ohms connected across the battery will give us maximum power in the resistance.

These conditions we can apply to our valve, where the internal resistance of the battery is equivalent to the resistance of the valve and the external resistance  $R$  is equivalent to the loud-speaker circuit.

**Equal Resistances**

We notice one important item in the case of our battery system, and that is for maximum power the external

resistance  $R$  has the same value as the internal resistance of the battery.

Applying this interesting result to our valve, we can say that for maximum power output the resistance in the plate circuit outside

the valve shall equal the internal anode resistance of the valve. Unfortunately, the valve, when thus loaded, will distort. A compromise has therefore to be made.

**For Undistorted Output**

We compromise by making the anode load impedance approximately twice the value of the anode resistance of the valve. This has been found a good general value which permits the valve to operate at almost maximum power, and at the same time does not produce distortion.

R Ohms.	C Amps.	V Volts.	P Watts.
4	3.57	14.28	51.0
6	3.13	18.78	58.8
8	2.78	22.24	61.8
10	2.5	25.00	62.5
12	2.27	27.24	61.8
14	2.08	29.12	60.6
16	1.92	30.72	59.0

**A RESISTANCE RULE**  
*Details of a neat and useful little component fitting.*

**I**F your experimental work involves much usage of potentiometers, sliding resistances and the like, you will find this notion very useful for those of the straight type.

A penny ruler is cut to size and screwed to the end-pieces of the resistance coil. To some convenient spot on the slider is fixed a small pointer.

Such an article may very readily be made from a strip of metal cut from a cigarette tin. Even a piece of copper foil, suitably shaped, will suffice, although it is better to have something more rigid to act as a pointer.

**For Making Comparisons**

With this gadget fixed up to your resistance or potentiometer you are provided with a very useful device for ascertaining roughly the setting of the resistance slider. By means of it you can obtain for comparison purposes an idea of how much resistance has been included in a circuit.





# IN PASSING

## How Doctor Thunk Deceived His Rival

LAST month, as you will doubtless recall, I told of my resumed relations with Doctor Thunk, and of his idea of transmitting radio signals to *Alpha Thunkii*, his beastly private star. All he required me for was to construct a small transmitter, self-contained, working on a wavelength of 0.001 metre and automatically sending certain groups of dashes.

### ABOUT THE LICENCE



"The formality is adjusted," he remarked.

It cost me much trouble to make him understand that he must procure a licence for his experiment, because he needed no licence for discovering *Alpha Thunkii* in 1876, when England was a free country, or for gazing at *Alpha* through his telescopes.

### Such is the Law

"Do I understand you to say, Mr. Jones, that I am bound to pay certain monies to ask the permission of one of these Post Office clerks before I may legally create electromagnetic waves?" said he.

"Baby, you said it," I replied. "Such is the law."

So, I'm hanged if he didn't take an old horse-cab round to Sir Septimus

Wonk's place—Wonk being one of those frightfully financial fellows at the Treasury—and came back in half an hour, beaming like a lovesick cassowary.

### A Posh Job

"The formality is adjusted," he remarked, putting his baggy umbrella into the corner by the empty milk bottles and small telescopes. "My friend, Sir Septimus, observed that he 'has the Post Office in his pocket!' What extraordinary language! He said, moreover, that they 'eat out of his hand!' Disgusting! However, there is no legal obstacle now, and you had better be off and make the—er—machine." A cheerful old bird, I *must* say. One of these days I expect that I shall tell him not to be quite so fresh.

That miniature transmitter was a posh job, though I say it myself and can't prove it! It cost old Thunk forty guineas, including the special fasteners which he ordered, a complicated arrangement of springs and levers and clips, of which I will write more later. Remember, once set in action, this set would automatically send *dash dash* (space), *dash dash* (longer space), *dash, dash, dash, dash*; this was supposed, according to Thunk, to tell the inhabitants of *Alpha* that two plus two equals four!

### The Day Arrives

According to instructions, I met Thunk in Bobb's Acre, near Hitchin, taking the set with me. He was on the scene, buzzing about furiously, when I arrived in my humble two-seater, and came trotting up with his

tongue fairly dangling out, as excited as a kid who wants to know whether papa has brought home the fireworks.

"Well! Well! Have you got it? H'm! It's here! In the back? H'm! Where are those special fasteners? Hurry up! The wind is ideal."

### Memories of Ethel

"Wadyer mean—wind?" I asked, as I crawled out of the old bus. "You asked for a radio transmitter, not a blinking glider. Ah! There's the very tree!"

### THE SAME SPOT!



"—I wooed Ethel Pumbrook and lost."

"What do you mean, young man?" he shrilled. "I asked for a transmitter, not a bird's-nest." A fair retort.

"Bobb's Acre has a great place in my heart," I answered. "It is 'way up' in my love life." He looked at me through his pince-nez as though I were a mere satellite of *Alpha*. "Yes," I continued, "under that very tree yonder, to the N.N.E. of that cow with the charming black spot on left hip, I wooed Ethel Pumbrook and lost out because I

## He Thought it Came from Mars!

didn't see eye to eye with her on the subject of coal-fires *versus* gas 'uns."

For a few moments he was incapable of speech. He just swallowed and champed the top and bottom dentures together. So I continued.

"Yes, I went out from her presence, into the night, with nothing but the scent of her hair, and two hairpins which had become lodged in the collar of my coat, and which fell out on to the floor of my room, unnoticed by me, but on the strength of which my landlady gave me the push. Ethel eventually married the village glazier, and every year I send her an anonymous lump of putty for remembrance. How that cow—er—tree brings it all back. My heart is in the glass shop there with Ethel and I must pause till it comes back to me."

### A Kite for Height

"Tut! Never mind your heart! Give us the transmitter and let us proceed, methodically, to the next stage," replied the old fossil. "Hearts are no good except for the circulation."

So I buried my ancient sorrows for the sake of this attractive old fathead, and pulled my radio set out of the "dicky." It was no more than a foot cubed, and as light as aluminium could make it. The Doctor hastened me over to his camp, and the first thing which I set eyes on there was a monster kite.

"Come," I remonstrated, "this kite idea is too ripe; positively Cheddar! Marconi did it in 1901."

"Quite so, quite so!" he replied, with a chuckle. "At my suggestion! Now let us proceed."

### Balloon in Reserve

He had a small windlass already rigged up. "Fifteen miles of the strongest cord known to the rope trade," remarked Thunk, lugging the kite along, looking as he did so like an old blackbeetle busy getting a bit of something good home to the hole behind the scullery door.

Next he got down to some fancy work with the patent fasteners, a medley of pulleys, levers and spring clips, and somehow or other he secured the radio set to the back of the kite.

"What's the tearing hurry?" I asked.

"The first signal *must* begin at 11.23½," he answered. "Goodness!

I forgot!" He slithered across to the dump of stuff which he had brought, and came back fiddling with a slide-rule.

"I meant to check that," he muttered. "Wass the square-root of 36? Mm! Mm! Er—five—er—point 99—Oh, let's call it 6!"

### "MAXIMUM OUTPUT!"

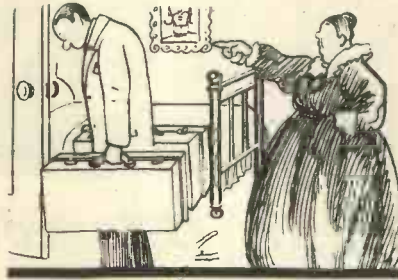

"Two hairpins—on the strength of which my landlady gave me the push."

"Bravo!" I cheered. "Don't let's bother about decimals; take a global figure. Think big!" But he had his head under the kite, and didn't hear me.

"Hey," I cried presently, "you've left a lot of fasteners on the side of the set. What are *they* for?"

"Boys will be boys," he piped. "Wait and teacher will show Johnny." And to my amazement he produced a balloon and a cylinder of gas, and began the process of inflation.

"Going up?" I asked

### THE LOST CORD



The windlass flew round at a hundred revs. per minute and the cord ran out.

"Not me! *Alpha* wouldn't like me to compete with him! This is going up with the kite. My dear young fellow, doubtless you are aware that at a certain altitude the kite will begin to fail us; this will be indicated to us by a persistent sagging or lack of tension on our cord. Ahem! When we reach that point we shall pull the second cord and the mechanism of the fasteners will separate the

kite from the transmitter, which will then continue to rise by means of my little balloon.

"But, darn it," I said, "the balloon will go barging all over Europe, being freed from the line."

"Oh, no, Jones Minor! It will be very tightly fastened to the second line—you observe that the line on the windlass is double—which we shall have fast here."

### That Final Kick

"Well, anyway, the blinking balloon won't last long in the rarefied atmosphere, and down she'll come, or dodder about up there by herself."

"Tut, tut," he said impatiently, "I am not so ignorant as my critics pretend. That balloon contains a new gas, which grows lighter as it becomes colder."

"So it may. But she'll bust all the same."

"Eggs—akly! And even that is intended, young sir. For the explosion will serve to accelerate the transmitter in its upward path, and I calculate that it will eventually be sending out its message at a height of 160 miles."

"And then fall?"

"Then fall."

"Forty guineas' worth, eh?"

"Less 2½ for cash, I understood you to say."

"All right, it's a minute past eleven. Shove on the other cord and let us prepare to destroy the finest portable transmitting set in the world."

### The Set Sets Out

The wind was beautifully strong, and free from gusts. I expect that old Thunk worked it out on his slide-rule. He manned the windlass, while I and a casual cowherd prepared to heave the kite, etc., into the blue. At the stroke of 11.23 a.m. Thunk screeched: "Switch on the transmitter," and this I did, the cow-feller and I then shoving the entire collection towards *Alpha*. They rose perfectly, and old Thunk worked the windlass like a mad mangle-woman.

It was not long before the kite, balloon and set had disappeared from sight, and I sat down in my car and filled a pipe. Thunk, grinning like an ape, paid out mile after mile of cords, but he had to hold his hat on with one hand, so strong was the

(Continued on page 300.)

# For Quality Reproduction

For sheer quality of reproduction the R. & A. Reproducers are without a rival, and at the price are unequalled value. Ask your dealer to demonstrate, and refuse a substitute. If out of stock, he can obtain at short notice. Descriptive literature sent post free on application.

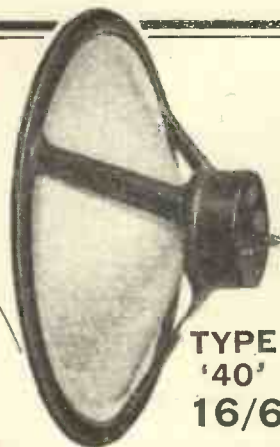

TYPE  
'40'  
16/6

**R & A**

BRITISH MADE

# Reproducers

## R. & A. TYPE '40.'

Chosen by Mr. G. P. Kendall for use with the "Meteor" III, and described by him as the "best value-for-money reproducer I can find." Will satisfy your most critical demands.

## R. & A. '100' Permanent Magnet Moving-Coil Reproducer.

"Wireless Trader" states:—  
"Tone will appeal to a wide public... really excellent value... plenty of bass and no shrillness... reproduction very good."

Let expert opinion guide you, and let your choice be R. & A.

R & A  
'100'  
45/-

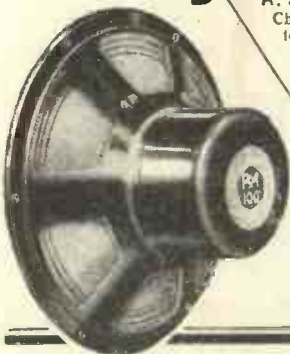

REPRODUCERS & AMPLIFIERS LTD., FREDERICK ST., WOLVERHAMPTON.

# —Specially built to

CAPT. P. P. ECKERSLEY'S  
SPECIFICATION...

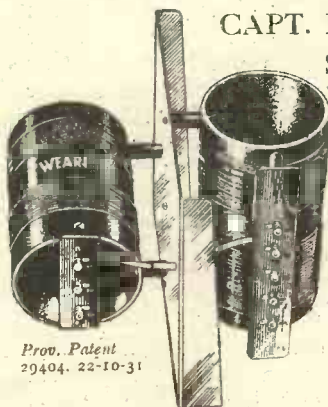

Prov. Patent  
29494. 22-10-31

When the name "Wearite" appears on any coil it is an assurance that that coil possesses characteristics identical with the original. When you buy your tuner for any one of the "Eckersley" Sets insist on "Wearite" and know that your tuning circuits will function exactly as in the designer's own receiver.

PRICE - 15/6 complete

—AND THE BEST OF SETS NEED  
A PERFECT EARTH



HERE IS THE WEARITE EARTH TUBE  
No Spanner, No Screwdriver - - - PRICE 3/6

If you have any difficulty in obtaining Wearite components, send to us direct—giving name of your usual dealer. We will post your requirement by return C.O.D.

# WEARITE COMPONENTS

WRIGHT & WEAIRE, LTD.,  
740, High Road, Tottenham, N. 17.

Phone: Tottenham 3847/8/9.

9876

# ALL YOUR RADIO RESISTANCE REQUIREMENTS COVERED BY....

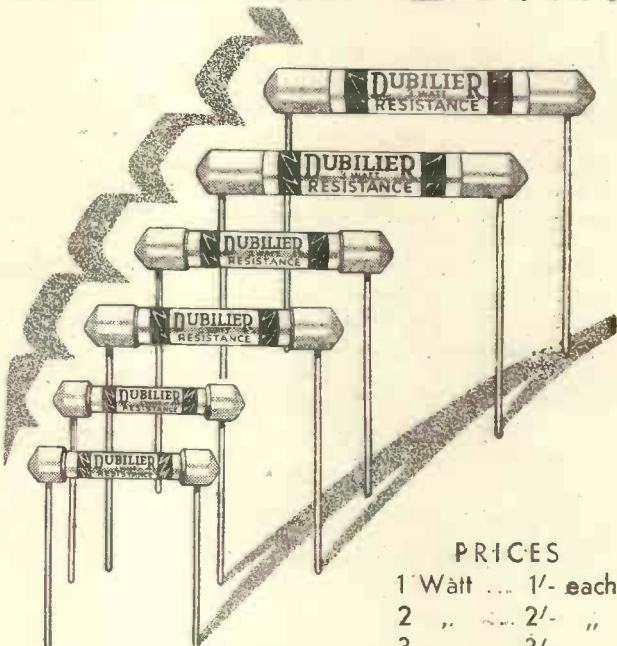

## PRICES

1 Watt ... 1/- each  
2 " ... 2/- "  
3 " ... 3/- "

# ... DUBILIER METALLIZED RESISTANCES

These Dubilier resistances are made under a patented process in One, Two and Three watt types and are available in values to suit every requirement.

They are suitable for voltage dropping, decoupling and providing automatic grid bias voltages, and wherever a reliable resistance is required.

They can be mounted in clips. Connecting leads are fitted in addition.

# DUBILIER CONDENSER CO. (1925) LTD.

Ducon Works,

Victoria Rd., N. Acton, London, W.3

p.1.

# HEADPHONE RECEPTION ON MULTI-VALVERS

Many occasions arise when the owner of a loud-speaker set would like to be able to switch over to 'phones and turn out one valve, so here are details of a simple way in which it may be accomplished.

By L. M. KING BREWSTER.

It is very rarely in modern radio receivers that provision is made for headphone as well as loud-speaker reception. The writer believes that there must be many people who would like for various reasons to be able to use 'phones if it were not for the apparent difficulty of suitably adapting their sets.

To use 'phones on a receiver designed for loud-speaker reception it is essential to provide for the switching out of at least one low-frequency valve if the volume is not to be overpowering. When the full number of valves are in use, even if an efficient volume control is incorporated, the valve noise will be loud enough to make listening unpleasant.

## A Filter Advisable

When mains are used to supply current to the receiver it is advisable to provide some type of filter to isolate the 'phones from the high-tension circuit and so avoid the possibility of shock. Even when this is provided between the output valve and the loud speaker, the switching to cut out one or more valves and at the

## SAVES YOUR BATTERIES

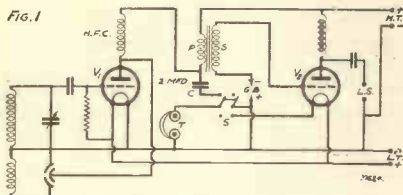

Apart from its convenience, the scheme provides a very definite saving in battery power, both L.T. and H.T.

same time connect through the filter to the appropriate point in the circuit becomes extremely complicated.

If the gain in the amplifier is high, the stray capacity through the switch and extra leads may be sufficient to give rise to instability and distortion.

If a pentode valve is used and a filter output system incorporated, it is probable that some form of tone-correction will be included in the filter.

This, of course, would completely upset if it were switched in after an ordinary valve.

The systems shown in Figs. 1 and 2 overcome all these difficulties and have the added advantages of cheapness and simplicity. It has been used by the writer with every satisfaction.

## Negligible Losses

Provided a good quality switch is used for *s*, the extra capacity between plate and filament of the associated valves will be negligible.

Fig. 1 shows the connections to adapt a battery-operated receiver. The transformer primary P acts as an L.F. choke, while the condenser C feeds the 'phones as in an ordinary choke filter.

If resistance-capacity coupling is used, the side of the condenser C shown connected to the transformer primary in Fig. 1 should be taken to the end of the anode resistance joined to the plate of the preceding valve. The anode resistance then acts in a similar manner to a choke. (The grid condenser, grid leak and grid-bias battery in series across the condenser C and the 'phones may be ignored.)

Fig. 2 shows the connections for a mains-driven receiver. Directly-heated valves are shown. If indirectly-heated A.C. valves are used the connections *a* and *b* should be taken to the centre-tap on the filament winding of the mains transformer.

## Self-Adjusting

Provided a good quality transformer is used the alteration in the load on the filament winding caused by the switching out of *V*<sub>2</sub> will mean only a negligible difference in the voltage on the heaters of the remaining valves. Present-day A.C. valves are so efficient that it is unlikely more than one L.F. stage will be included in the receiver, but even so it is not recommended to attempt cutting out more than one of these valves.

The purpose of the resistance R is to pass a current equal to the total anode current taken by the valve switched out. The value of the anode current may be found by reference to the maker's instruction sheet.

## Using a Pentode

With a pentode valve it will be necessary to add the current taken by the screen to that taken by the anode. The value of R in ohms may now be calculated by the formula

$$R = \frac{E}{i} \times 1,000, \text{ when } E = \text{the H.T.}$$

voltage used and *i* the total current in milliamperes taken by the valves switched out. Suppose it is required to find R when the H.T. voltage = 150, and the current taken is 20 milliamperes. By applying the formula we get  $R = \frac{150}{20} \times 1,000 = 7,500$  ohms

If a resistance of this value is not obtainable, two 15,000 ohm resistances

## FOR A MAINS SET

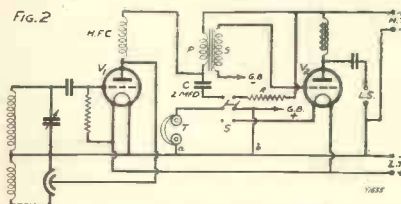

A special resistance keeps the H.T. voltage the same when the output valve is turned out.

connected in parallel may be used, or alternatively two or more resistances totalling 7,500 ohms and connected in series. The value to within a few dozen ohms is not important, but should be higher rather than lower than the calculated value.

Care should be taken to choose a resistance capable of carrying the necessary current without overheating, and the condenser C must have a sufficiently high working voltage to withstand the H.T. voltage used.

## On D.C. Supplies

When current is supplied from D.C. mains on which the positive main is earthed, a condenser equal in value to C should be inserted in the lead shown in Fig. 2 from 'phones to L.T.—. If the filaments of the valves were connected in series, as would probably be the case if they were fed from D.C. mains, it would be necessary to use an additional resistance to pass a current equal to that passed by the valves disconnected.



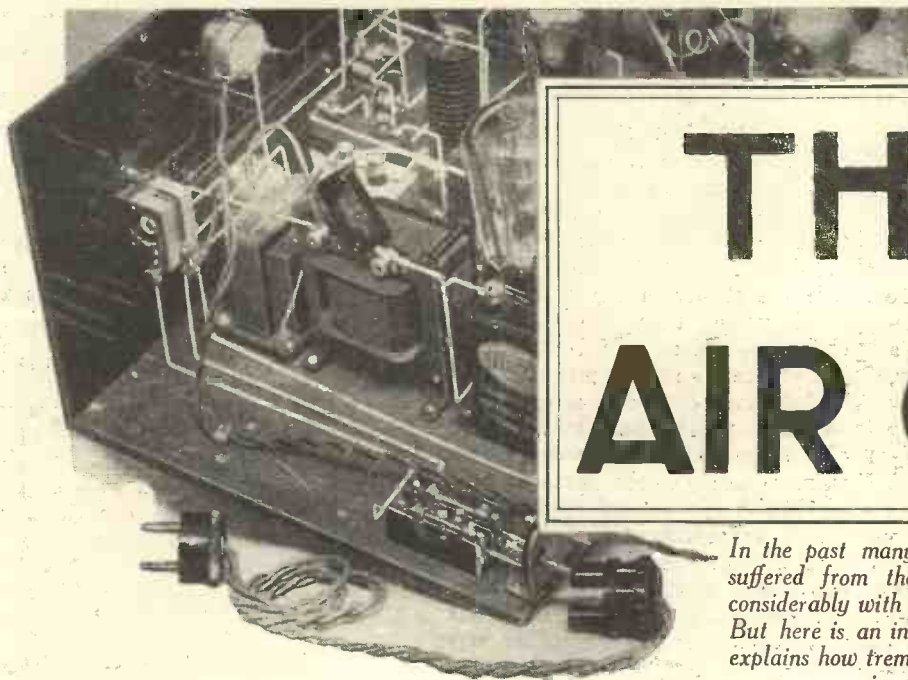

# THAT AIR GAP

In the past many iron-cored chokes and transformers suffered from the defect that their inductance varied considerably with different values of magnetising current. But here is an instructive and interesting account which explains how tremendous improvements have been made in present-day productions.

By Dr. J. H. T. ROBERTS, F.Inst.P.

WITH an iron-core instrument, such as a choke or transformer, the inductance is not constant, but varies with the magnetising current flowing in the windings. To take the case of the choke in particular, the greater the steady current in the choke (assuming

### CONSTANT INDUCTANCE

A2422



STEADY MAGNETISING CURRENT.

The curve of a commercial choke with broken core, or air gap, showing how the inductance is practically independent of the current.

this is of the ordinary type) the less the inductance will be.

In fact, the curve showing the relation between the inductance and the magnetising current may be a steeply falling curve which ultimately becomes more or less parallel to the horizontal axis, in which case the inductance becomes fairly uniform, although of a low value. These effects are due to the influence of the magnetising current upon the permeability of the iron of the core.

### Effect of Steady Current

Now let us consider for a moment what is the practical effect of the change in current through the choke.

In the majority of radio circuits a low-frequency choke will be carrying not only fluctuating or signal current, but also a certain steady current.

We do not need to worry very much in this connection about the fluctuating current; it is the steady current which concerns us. This steady current will act as a magnetising current, and will have the effect of reducing the inductance of the choke.

### Rating of Chokes

This is so well known, in fact, that many commercial chokes on the market are rated for inductance between limits, the first figure giving the maximum or theoretical inductance of the choke for very small steady currents, and the lower figure giving the inductance value when the choke is carrying the largest steady current reasonably likely to be met with in practice, say, for example, 50 milliamps.

It is quite bad enough to have the inductance value of the choke fall to a low value under the conditions in which the choke is actually used, but the position is made worse by the fact that not only does the inductance value fall, but it also varies with changes in steady current.

This variability will, of course, be greater on some parts of the curve than on others; that is, the degree of the variability will depend upon the actual value of the magnetising current in relation to the constants of the instrument.

Now, if we could find some means of preventing this variation of the inductance with magnetising current, and also of keeping the actual inductance to a higher value at the working part of the curve, it would obviously be a very great advantage.

If we cut a piece out of the core of the choke, so as to leave an air gap in the magnetic circuit, we should expect the inductance to be seriously reduced. It hardly seems the right way to attack the problem; in fact,

### EFFECT OF CURRENT

A2423

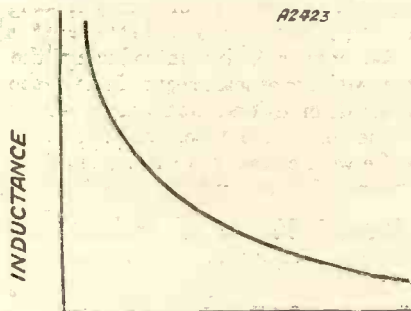

STEADY MAGNETISING CURRENT

An interesting diagram which demonstrates how the inductance of a choke with an unbroken core falls with increasing current.

you would imagine that we were going to make the choke definitely worse by cutting a gap in the core.

You will perhaps be surprised, therefore, to learn that this method is actually adopted in some chokes in order to improve the "curve" of the choke and to get over the very

# Constant Inductance Over a Large Range of Currents

difficulties which we have been considering above.

If we examine the performance curves of different types of choke we shall, however, soon see the reason for this apparent paradox. The curve showing the relationship between the magnetic intensity and the permeability will rise to a maximum at a certain value of magnetic intensity, and then, as the magnetic intensity goes on increasing, the permeability will fall rapidly.

## Maximum Permeability

Now, if we could arrange to work at or about a magnetic intensity corresponding to the maximum permeability, we should expect to get the best results. It is, therefore, necessary in order to do this that we should find some means of reducing the magnetic intensity so as to work at or about this particular point, and at the same time find, if possible, some method which will prevent serious variations in the inductance value with increase in the steady current.

The curious thing is that when we examine the inductance curve of the choke with the gap and compare it with the corresponding curve of the continuous-core choke, we find that whereas the latter falls rapidly for increases in the magnetising current (as already mentioned), the curve for the gap choke shows a remarkably steady value of inductance with increasing values of magnetising current.

So you see, by introducing the gap we have at least secured one of the desired conditions, namely, the steady value of inductance, varying very little with changes in the value of the magnetising current.

## Actual Value of Inductance

A thought which occurs to your mind now is this: Yes, but although we have got a nice straight inductance curve, is not the actual inductance value with the gap choke (for any particular value of steady current) much below the corresponding inductance value with the continuous-core choke?

The answer to this question brings us to what is really the most interesting point about the gap choke. The

answer is, in fact, that whether the gap choke gives a greater or less actual inductance value than the continuous core choke depends entirely on the *actual value* of the magnetising or steady current.

If the steady current has a very small value, then the continuous choke will give a *higher* value of inductance than the gap choke. But if the steady current is raised—if, in fact, it is brought more into the region of practical politics, so to speak; that is, more nearly to the values actually met with in practice—then the inductance of the gap choke is actually greater than that of the continuous choke.

Perhaps it is more correct to put this last statement the other way

A "BROKEN" CORE  
R2424 LAMINATIONS

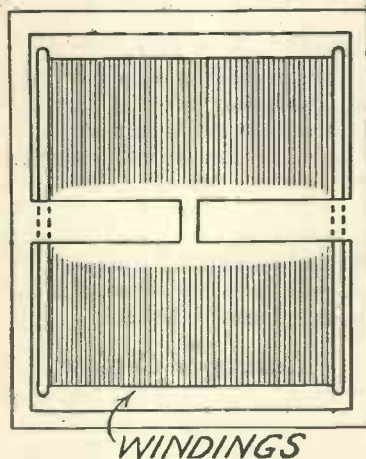

The method of providing an air gap in an iron core can readily be seen from the above diagram. In actual practice the gap is only the smallest fraction of an inch, but it has been somewhat exaggerated here for illustration purposes.

round and to say that at practical values of the steady current the inductance of the continuous choke (which you will bear in mind is falling very rapidly with increases in steady current) falls *below* the inductance value of the gap choke (which you will remember is remaining fairly uniform with increasing values of steady current).

So you see, the continuous choke has the advantage at very small values of steady current, but owing to the fact that the continuous choke has a falling curve, and the

gap choke has a flat curve, the gap choke comes into its own and, indeed, gains the advantage more and more as the steady current is increased.

A simple way in which to visualise what is done here is to think of the case of a loud speaker which has a resonance point in the low frequencies. If we could work actually at the resonance point, the loud speaker would show a sensitivity much above the normal.

But what we want is a fairly uniform response, and so if we work at frequencies which are considerably above the resonance frequency we are working on a fairly flat part of the curve and, notwithstanding that the actual sensitivity is below the resonance maximum, we nevertheless get something which is much more suited to our purpose.

## Importance of Design

Of course, it goes without saying that the mere introduction of an air gap into the core of the choke is not in itself sufficient to give you the important advantages set out above. In fact, if you simply took an ordinary choke and introduced a gap into the core it is more than likely that the efficiency and usefulness of the choke would be seriously impaired.

The air gap in the core must be taken in conjunction with the various other factors in the design of the choke, and when using a gap core the choke itself has to be designed in all respects to correspond. It has, indeed, taken a considerable time and a good deal of research work to arrive at a design which will give these results with the open core.

It seems rather curious, as I said earlier on in this article, that we should be able to make use of something which in the ordinary way would be regarded as a drawback and apply this for the very purpose of increasing efficiency. But when you look into the reasons you see that by clever design of the choke the air gap is used for the purpose of giving you a flat horizontal curve for the relationship between inductance and magnetising current and enables you to get away from the disadvantages of the corresponding current-inductance curve of the continuous-core choke.



# IGRANIC

## Permanent Magnet Moving Coil Speaker



### Amazing Tone-Purity

The extraordinary purity of tone, combined with brilliant clear-cut reproduction of voice and music, will satisfy the most critical ear.

Size of Cone 10" dia. Supplied complete with Dual Input Transformer.

May we arrange a demonstration for you?

**PRICE 67/6**

Write for a copy of our leaflet No. J. 1169.

**IGRANIC ELECTRIC CO., LTD.,**  
149 Queen Victoria St., London

## MODERN WIRELESS

### Advertisement Rates

SINGLE Insertion - - -	£45 0 0
per page and pro rata	
6 CONSECUTIVE Insertions	42 10 0
per page and pro rata	
12 CONSECUTIVE Insertions	40 0 0
per page and pro rata	
ONE INCH single col. (2½ in. wide)	1 15 0
Minimum Space, half-an-inch	17 6

All communications respecting advertising must be made to

**JOHN H. LILE, Ltd., 4, Ludgate Circus, London, E.C.4**

and NOT to Editorial or Publishing Offices.

### BUILD YOUR RADIO-GRAM IN A CAMCO CABINET!

This is the Camco "Waverley" Radio-Gram Cabinet. It is beautifully finished in Oak and Mahogany, and is made in two models—Junior and Senior. Full provision is made for an electric or clockwork gramophone motor. From £5.10. Write for FREE copy of the 24-page Camco Radio Cabinet Catalogue.

**CARRINGTON-MFG. CO., LTD.**  
Showrooms:  
24, Hatton Garden,  
London, E.C.1.  
Phone: HOLborn 8202.  
Works: S. Eroyton.

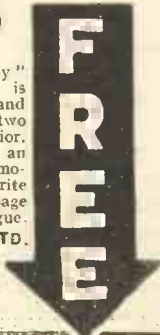

NAME.....

ADDRESS.....

M W 11

# TWO ideal CHOKES-



The **LEWCOS**<sup>REGD.</sup>  
SUPER  
H.F. CHOKE  
PRICE 6/-

AND

The **LEWCOS**<sup>REGD.</sup>  
H.F. CHOKE  
(TYPE M.C.) PRICE 2/6

ACTUAL SIZE

LEWCOS Coils are being continually specified by designers of famous Receivers, because the fine materials used in their manufacture have made them supreme.

The LEWCOS Super H.F. Choke has been especially devised to eliminate the risk of additional self-capacity in the wiring of the Receiver, while the LEWCOS H.F. Choke (type M.C.) is designed for sets where space is of paramount importance.

are specified for the **"BI-BAND 3"**

DESCRIBED IN THIS ISSUE



**LEWCOS RADIO PRODUCTS FOR BETTER RECEPTION**  
THE LONDON ELECTRIC WIRE COMPANY AND SMITHS LIMITED  
CHURCH ROAD LEYTON LONDON, E.10.



# THOSE MAINS SETS

*The advantages of using a separate "power pack" explained*

*By G. V. DOWDING, Associate I.E.E.*

SEVERAL readers have written to us asking why we do not produce more "all-in" mains sets instead of, as is our general practice, leaving the H.T. and heater supplies to external mains units.

I should have thought the reasons were rather obvious, and, anyway, we have included them in the descriptions of various receivers. However, it seems we have not been sufficiently explicit.

In the first place I must make it clear that the external unit method has not been adopted because we think "M.W." constructors are not capable of building up "all-in" gear. Far from it. We know we number among our readers numerous enthusiasts who are able to tackle practically anything.

There are two reasons for the practice. The one is a matter of economics and the other of expediency.

## Attaining Perfection

Our past experience has shown very clearly that whatever else changes as with the progress of radio technique, the mains unit for alternating current mains has for some time reached a stage of development where further progress can only be in more or less minor detail.

And it is very easy to see why this should be. We have got so used to a general progress in radio that we are apt at times to forget that in some of its departments radio has virtually reached perfection.

To take some extremely simple examples, it is difficult to visualise any further progress in the design of switches, volume controls, terminals, valve holders or condensers, as individual elements, isn't it? Nor is there any apparent need for further progress, as these items do all that

they are asked to do in an efficient manner; although, remembering our volume controls and condensers of some years ago, we can say with feeling that it was not always thus!

And what about the A.C. mains unit? This has the job of ironing the "wrinkles" out of rectified current for H.T. purposes, and, perhaps, of stepping down the voltage to a pressure suitable for cathode heating.

## For the Future

Modern mains units do this so well that there is no reason why they should not still be on active service

### MAINS UNIT TIPS

1. Always make sure, before buying it, that the unit was designed in strict accordance with I.E.E. recommendations.
2. Choose a type capable of providing more current than your present set needs.
3. Do not forget the advantages of having at least one variable H.T. plus output.
4. A limited number of H.T. plus tapplings is no virtue, for some sets require three or even four.

ten years hence, and unchallengingly adequate at that, whatever developments there may be in the general technique of radio reception.

You see the point? We cannot, in our most optimistic moods, give any one particular radio set a "front rank" life of anything approaching the above period.

Now the mains rectifying and smoothing parts of a mains set form a very large section of it, both from a dimensional and a financial point of view. So if this can be kept apart

in one self-contained unit it can be handed down from set to set.

But, you might quite well say, if the rectifying and smoothing components were included in the set they could be dismantled and used again. Quite so, but what about all the special screening needed to separate these parts from the rest of the set if compactness is to be achieved, and the undesirability of having all the mains wiring "on board" when you wish to "service" the set?

And then, again, there is the "safety" question. A properly designed and constructed mains unit is a very safe proposition. The "raw" mains, with their potentialities of almost unlimited power (up to the capacity of your mains fuses) and almost unlimited shock, are fed straight into the iron-clad mains unit.

## The Safety Question

The output is now probably limited to the proportions of (1) a moderately large dry H.T. battery; (2) a four-volt accumulator.

And you will not have the local power station virtually poking its tentacles into the innards of the set ready to release its full power (again up to the limits of the mains fuses) across groping fingers or a carelessly employed screw-driver.

It has been said that we quote a different model of mains unit for nearly every mains set. But this does not imply that each set demands one very special unit. All that is necessary is that the unit should be able to fulfil the set's demands.

If we have rung the changes on types and makes, that was more in order to show the versatility of the good unit, although it seems that we have given quite the wrong impression!





# MORE SELECTIVITY

Ever since radio first began the call has been for more and more selectivity, and now the problem has been tackled from an entirely new angle. Here is the scheme described by

**CARDEN SHEILS**

At the present time an interesting struggle is taking place between the straight circuit and the super-het. receiver for the "blue ribbon" of selectivity.

The original merits of the straight circuit have been enhanced by the introduction of new valves of enormous amplifying powers, as well as by the use of circuits designed to give "constant coupling"—and therefore a uniform degree of amplification—over the whole tuning range. In addition we have developed a method of

### VALVES IN "PUSH-PULL"

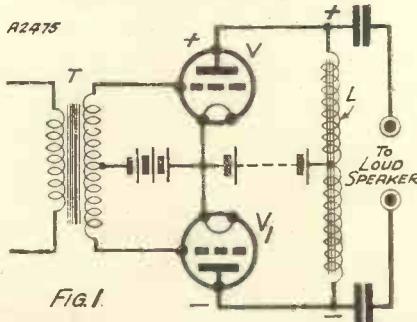

Fig. 1. This is the circuit of an L.F. amplifier using two valves in "push-pull." It was patented as far back as 1915, and was the forerunner of many other circuits, including the arrangement here described, using two valves in a similar manner.

pre-selection by inserting a band-pass or filter input between the aerial and the first valve stage.

The high-water mark of performance on the lines of the super-het. is probably seen in the Stenode Radiostat, where the high-frequency circuits are so "razor-edged" in their tuning that special tone-compensators have

to be used on the low-frequency side in order to restore quality.

### Separated Carrier

As both systems appear, for the time being, to have reached the limit of what can reasonably be expected from them, one naturally begins to look around for other possible solutions to the problem of selectivity.

One very promising suggestion which has recently been made is to separate the carrier-wave from the side-bands, to amplify both separately, and then to re-combine them in a special form of rectifier, so that only the signals appertaining to the selected carrier-wave are reproduced, all other disturbing signals being automatically cancelled out.

Since the rectified output from a detector valve is proportional to the product of the side-band components and the carrier-wave, signal strength can be increased just as effectively by amplifying the carrier-wave separately and then re-combining it with the side-bands, as if both the carrier and side-bands were amplified together, as is the usual practice.

Since the action of this circuit depends upon the use of a special "push-pull" rectifier, it will be helpful first to consider how push-pull combinations work.

### The Ordinary Scheme

In the ordinary type of low-frequency push-pull amplifier, as shown in Fig. 1, the input is applied across a L.F. transformer T to the grids in phase-opposition, so that as the plate current of one valve rises that of the

other falls. Since, however, the high-tension supply is taken to the midpoint of the output choke or transformer, the combined effect of the rising and falling plate currents is equivalent to a single "sweep" of current flowing from one end of the coil to the other.

### Continuous Voltage Fall

This will be made clearer if one takes a snapshot of the conditions at a particular moment. If the current through the valve V is then falling, its plate voltage must be increasing, and the upper end of the coil L will for the moment also become more positive. At the same instant the current through the valve V1 is increasing, so that its plate voltage is falling together with the voltage of the lower end of the coil L. There is consequently a continuous fall in voltage along the whole of the coil L, corresponding to the momentary signal voltage applied to the grids.

### A NOVEL CIRCUIT

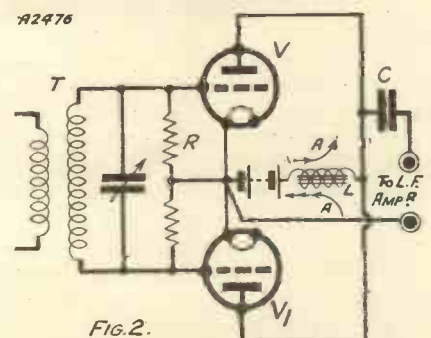

Fig. 2.

Another circuit using two valves in "push-pull," showing how this system can be applied to detection.

## Launching Out On a New Line of Attack

On the other hand, if the input voltages instead of being applied to the two grids in push-pull were applied in parallel, i.e. so that both grids were thrown either positive or negative at the same time, then the conditions in the output circuit would be very different. The rising current in one valve is then opposed to a corresponding rise of current in the other valve, with the result that the two pulses of current mutually cancel each other, and no energy flows through the coil.

### Push-Pull Detectors

A push-pull arrangement of two valves can be used for detecting signals, and, in fact, such an arrangement is free from many of the defects

are cancelled out; whilst those applied to the grids, in phase, are added together. For instance, consider the incoming H.F. signals as applied to the coil T. The high-frequency oscillations reach the two grids in phase-opposition, so that they disappear in the plate circuit as shown by the arrows marked A in Fig. 2. This at once prevents any transfer of H.F. energy into the low-frequency currents and so avoids undesirable feedback.

On the other hand, the low-frequency components set up by grid rectification now occur effectively in phase, so that they add together in the output. The reason is that the coil T has no iron core, and therefore offers little impedance to low-fre-

quency variations. After being separately amplified the outputs from these two circuits are combined through a coil E in the special push-pull rectifier V, V<sub>1</sub>.

### Cancelling Out

If the signals passing through the channel A were applied to an ordinary single-valve rectifier, then all the stations would be reproduced together and would overlap. Even by applying them to the circuit shown, all the signals would in the ordinary way cancel each other out across the coil L, because the low-frequency components are applied "in phase" to an input coil T of the high-frequency type shown in Fig. 2; whereas the output coil L is arranged as in Fig. 1.

But as a result of adding, through the coupling coil E, the carrier-wave of the particular station desired (separately amplified through the channel B and back-coupled valve V<sub>2</sub>), that station is alone reproduced—at a strength dependent upon the strength of the amplified carrier. It will be noticed that the latter is applied through the coil E to a centre-point tapping in the input coil T, and therefore reaches the grids "in phase," whilst interfering signals from the channel A are applied in push-pull across the coil T.

Any disturbing signals that may be present in the broadly-tuned channel A are therefore either completely cancelled out in the output circuit L, or, if they react at all with the amplified carrier, only produce inaudible beat-frequencies, which are rejected by the L.F. amplifier and do not reappear in the loud speaker.

### Avoids Distortion

The circuit arrangement is by no means so complicated as it may appear at first sight. In fact, there is only one sharply tuned circuit, namely, that marked C associated with the back-coupled valve V<sub>2</sub>. The circuits in the channel A, which may consist of one or two stages of H.F., are all flatly tuned, so that ganging is easily carried out.

Finally, since the amplitude of the separately amplified carrier is always large relatively to that of the side-bands, the percentage modulation of the signal, as applied to the push-pull combination V, V<sub>1</sub>, is never such as to give rise to detector distortion,

NOT SO COMPLICATED AS IT LOOKS

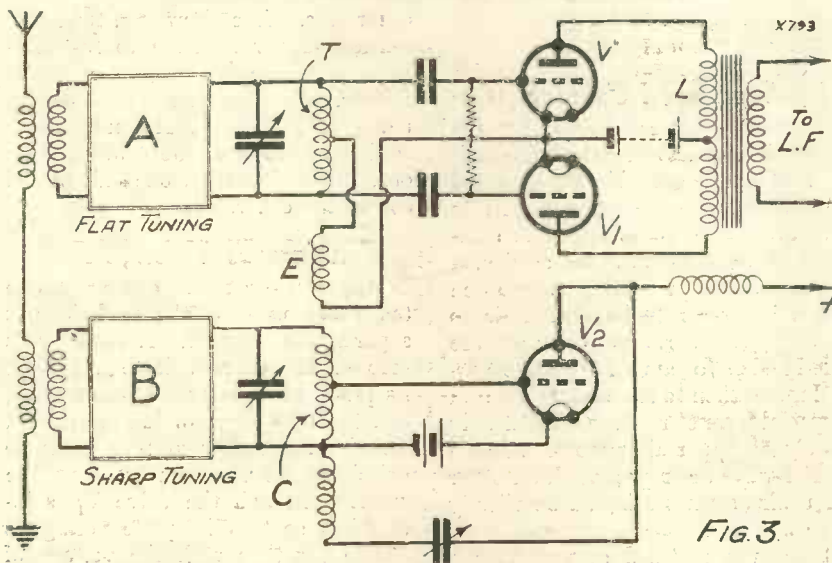

This novel circuit is a very selective arrangement, and although at first sight it looks rather complicated, it is really quite straightforward. It comprises two channels, A and B. The tuning of A is very flat so as to embrace all the side-bands, and the lower one, B, is tuned sharply to the carrier-wave. The carrier is then fed back to the circuit A via the coil E, and although the tuning circuit A is very flat, the only "signal" which is passed on by the "push-pull" detectors is the one to which circuit B is tuned.

of the single valve, whether used with a grid leak or as an anode-bend detector.

For this purpose the circuit of Fig. 1 is somewhat modified. In the first place, as shown in Fig. 2, the input transformer T is now of the high-frequency type; and, in the second place, the high tension is no longer taken to the mid-point of the output coil L, but to one end of it, the plates of both valves being connected together and to a coupling condenser C for the output.

Under these conditions signals applied in phase-opposition to the grids

quency variations. It only acts as a choke to radio-frequency currents. So far as L.F. variations are concerned the two grids are, in effect, connected together by an open conductor.

### Highly Selective

We are now in a position to consider the highly selective circuit shown in Fig. 3. The aerial is coupled to two separate inputs, A, B. The circuit A is broadly tuned to pass a wide band of frequencies, whilst the circuit B is very sharply tuned to the carrier-wave of the particular station

The only coils  
recommended  
for your  
"BI-BAND" 3

*(Described in this issue)*

# BRITISH GENERAL

## BAND-PASS 10-K.C. TUNING UNITS

*(Aerial and Anode Models)*

For definite separation of home and foreign stations and the complete elimination of interference you must have Band-Pass Tuning, such as is given in the circuit described in this issue—in which British General units are specified.

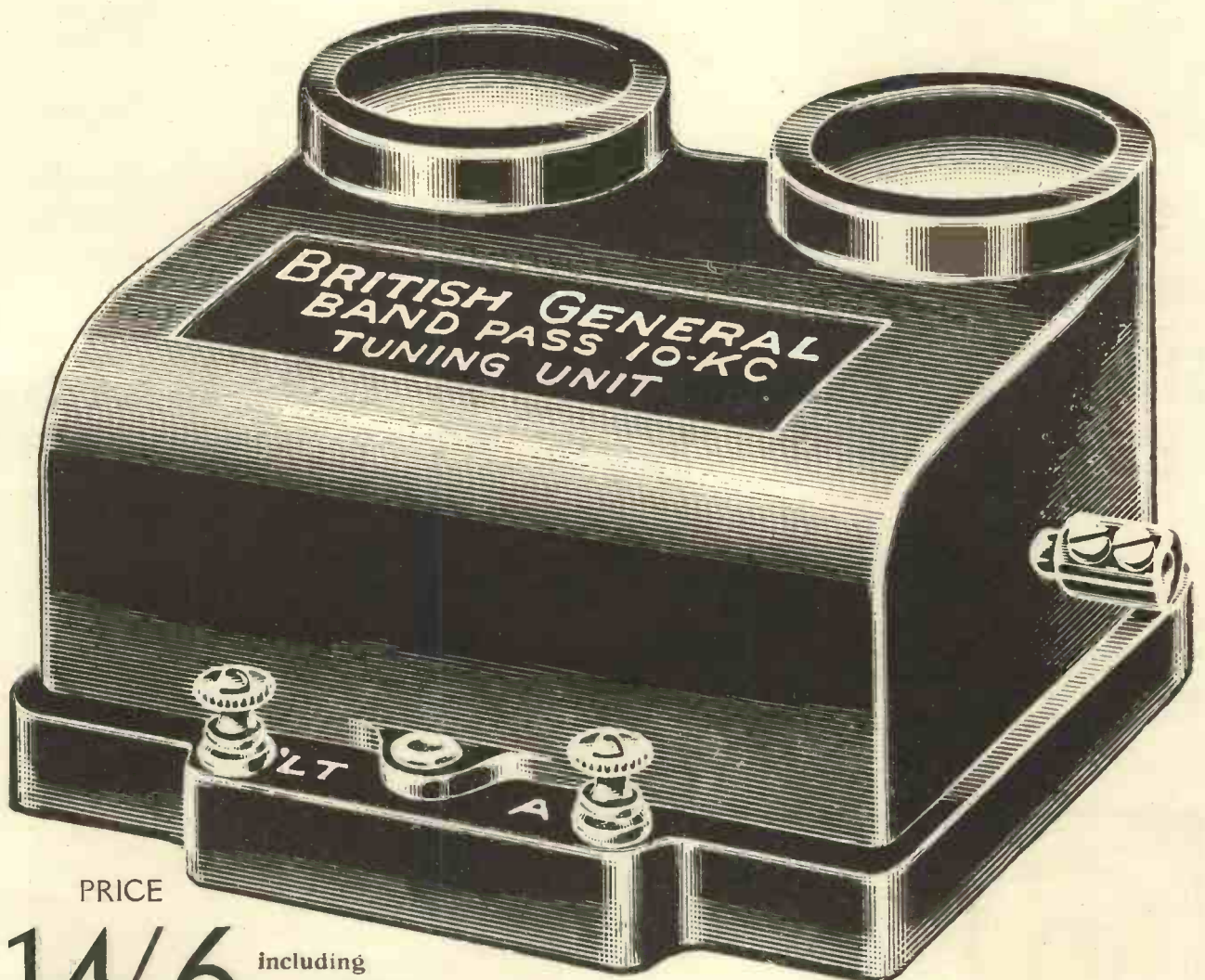

PRICE

**14/6**

EACH

including  
non-inductive  
coupling condensers

*From all dealers or direct from the manufacturers.*

**BRITISH GENERAL MANUFACTURING CO., LTD.**  
**BROCKLEY WORKS, LONDON, S.E.4.**

# RADIO NOTES and NEWS of the MONTH

By G. B.

## Sir Thomas Beecham

READERS will welcome the news that the B.B.C. and Sir Thomas Beecham have at last come to an amicable agreement. Negotiations have been going on for some time past, and I am pleased to say that, as a result, Sir Thomas has promised to conduct in April a studio broadcast performance of Delius' opera, "A Village Romeo and Juliet." Delius is probably one of the greatest living composers. He was seventy a couple of weeks or so ago.

I understand that Sir Thomas and the B.B.C. are now on excellent terms with each other.

## Over a Million Sets!

It is reported that nearly 73,000 sets were purchased in October, 1931, compared with about 36,800 for the

same month in 1930. In 1930 the total number sold by British manufacturers was 649,100, but it is expected that last year's total will be well over a million.

Another interesting point is that by the end of October last year nearly 200,000 people were directly employed in making wireless sets and components.

## A Communal Aerial

Sunlight House, Manchester, is one of the tallest buildings in the city, and it has been arranged that tenants are to have the joint use of an aerial on the top of the building. As the masts will be 35 ft. above the building, the aerial will be roughly 225 ft. above street level.

As the set will be on the top storey, and the lead-in will make contact somewhere down in the basement, it will be interesting to hear what sort of results are obtained.

## French Regional Scheme

Ten new high-power wireless stations are to be built in France, and they should be easily heard all over Europe and a large part of Africa. The first station in the scheme is already being erected, and will be on the air in about six weeks time. It is understood that these new stations will form part of a French Regional Plan.

Each station will have a power between 60 and 80 kilowatts. The whole business of the French Regional broadcasting scheme is now under the control of a French Wireless Broadcasting Commission, and the French Government intends to introduce a bill which will tax listeners, constructors and dealers in such a way as to provide ample funds for a French broadcasting system.

## Captain Eckersley Consulted

Readers will be interested to know that some four years ago Captain Eckersley, our Chief Radio Consultant, was consulted by the French

(Continued on page 292.)

# BUILT FOR BEST RESULTS

Practically every modern circuit uses gang tuning; but results depend entirely on the accuracy and construction of the gang condenser used.

That is why the new J.B. "R" Type Gangs are being specified in so many leading circuits. They are precision instruments, built for best results.

## J.B. "R" TYPE GANGS

Thoroughly shielded. Neat pressed aluminium clip-on dust-proof covers.

Very easily fitted—only round panel holes to cut. .0001 Trimmers (for adjustment once only) in each stage.

Complete with Vernier Disc Drive and Bakelite Panel Plate.

Write for complete catalogue.

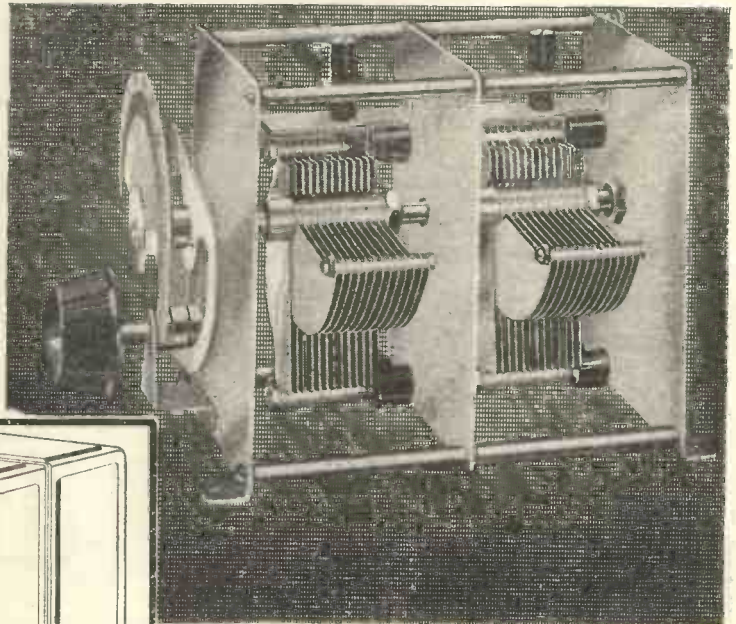

J.B. "R" 2-Gang With Covers Removed.

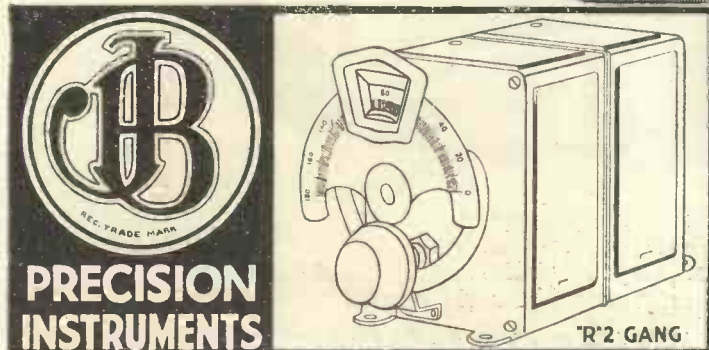

- |                                 |      |
|---------------------------------|------|
| Type R2 (2-gang) as illustrated | 21/- |
| Type R3 (3-gang)                | 29/6 |
| Type R4 (4-gang)                | 37/- |

(Capacity .0005)

Advertisement of Jackson Brothers, 72, St. Thomas' Street, London, S.E.1

Telephone: Hop 1837.

**KIT-BITS** SELECTED COMPONENTS  
CASH or C.O.D.

FOR THIS MONTH'S "MODERN WIRELESS" SETS.

You pay the postman—We pay all Post Charges on orders over 10/-

<b>"BI-BAND" THREE</b>		<b>ECKERSLEY ADAPTOR</b>	
2 Polar Uniknob 0005-mfd. Double-ganged Condensers	£2 2 0	2 GYLDON Junior Synchratone double-drum-drive Condensers (0005 mfd.)	£1 10 0
British General Band- Pass Coil (Aerial model)	14 6	1 Eckersley Coil	15 6
British General Band- Pass Coil (Anode model)	14 6	<b>"M.W." CABINET TWO (Model "A")</b>	
		1 Telsen 0005-mfd. Solid-dielectric and 1 Telsen 0001-mfd. Differential Reaction Condensers	4/6
		Set of 1 P.J.3 and 1 P.V.2 Coils and Ready wound Coil Quoit	6/9

BUY RADIO BY POST—IT'S QUICKER.

**PETO-SCOTT CO. LTD.** 77, CITY ROAD, LONDON, E.C.1  
Telephone: Clerkenwell 9406-7-8

**SCREEN YOUR H.F. LEADS**

With "GOLSTONE"  
AIR-SPACED FLEX-  
IBLE METALLIC  
SCREENED TUBING.

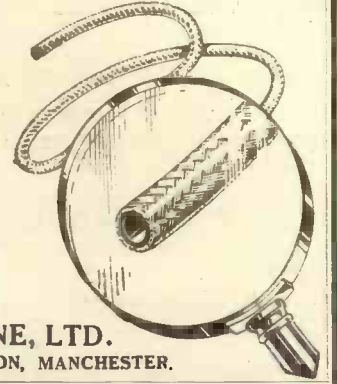

Prevents self-oscillation.  
Low self capacity.  
Minimum dielectric loss.

Size of Tubing: 2 m/m Bore (0.080 ins.)  
to take all Standard Single Panel con-  
necting wires. Supplied in one yard  
lengths. RHS/9 (per yard) 9d.  
From all first-class Radio Stores  
Catalogue on request.

**WARD & GOLDSTONE, LTD.**  
(Dept. "M.W.") PENDLETON, MANCHESTER.

# A New Super Paper of the Films

AND a vastly different one. A paper for those who regard the photoplay as a legitimate and vigorous art-form. Equally a paper for the romance-loving film-star fan.

It is printed entirely, from cover to cover, in photogravure. There are special pages in COLOURED Photogravure. It is, in fact, a triumph of photogravure.

There is all the news of the stars and of forthcoming films. There are criticisms of current issues, personal paragraphs and competitions.

There are exclusive photographs and studio gossip.

There are . . . But we can't mention them *all*.

Sufficient to say that FILM PICTORIAL is a Super Paper of the Films. Now be quick and get a copy.

# Film Pictorial

Newsvendors have it on Thursdays

2d.

**RADIO NOTES AND NEWS OF THE MONTH**

—continued from page 290

Government in connection with a Regional broadcasting plan for France. The present plan is an outcome of those conversations.

An official of the B.B.C. stated the other day, apropos of this new French scheme, that no serious interference from the new stations in France is anticipated. If it should arise, explained the official, when the new stations are built and on the air, the matter will be dealt with through the International Broadcasting Union. If this is the case, then it's a poor look-out for listeners, for the International Broadcasting Union has not been too conspicuously successful in clearing up these problems in the past.

**Please Don't Do It!**

It is reported that several holders of wireless licences have had their licences withdrawn for allowing their sets to oscillate. It appears that Captain Eckersley's early broadcasting days' advice of "Please Don't" is still widely ignored.

When a complaint of interference by oscillation is received at the G.P.O. the matter is immediately investigated, and when the offending set is located the officials warn the set owner and tell him not to do it again. If the offence is repeated, the set owner's licence is cancelled.

**More High Power**

There is a likelihood that a high-power wireless station will be built shortly in the Irish Free State for the purpose of serving Irish and British listeners with sponsored programmes. In other words, a station conducted on much the same lines as Radio-Paris.

Such a station would undoubtedly be capable of reaching a good many listeners in this country. Already the broadcasting station at Cork is putting sponsored programmes on the air—but Cork is by no means an easily received station on the average set in Great Britain.

**"We Shall See"**

Ireland, in fact, seems to be keen on brightening British listeners' radio Sundays. Well, we shall see! But it still remains a fact that the B.B.C. will have nothing to do with sponsored programmes.

**Only a Rumour**

There was a report in the Press the other day that the B.B.C. had had a week-end conference and had decided to appoint a Sunday Director of Broadcasting Programmes—and that, in fact, a real move was to be made in the direction of lightening Sunday programmes in general. On inquiry at the B.B.C. I find that no such conference was held, and that there are no plans being made for altering the present Sunday programme policy. Which is a distinct pity!

**The B.B.C. Inquisition**

Have you had an Inquisition Form yet from the B.B.C.? Of course, you won't get one unless you write in for it, but when you do you will probably find it more of a job to fill in than half a dozen income-tax forms. For instance, the householder will be expected to answer how much the servant gets, how this wage compared with the home of the wife's parents, and whether the husband makes any allowance to the wife, etc., etc.

So far, it is reported that about 40,000 forms have been sent out at the request of listeners. Considering the publicity the scheme has, it looks as though it's going to be a

(Continued on page 291.)

**FORMO** Triple Wave **THREE** Kit

Tune in to the world's ultra short-wave stations in addition to the host of medium- and long-wave broadcasts—by the simple turn of a neat panel switch.

The efficiency of the Kit is assured by the use of the

**FAMOUS MAZDA VALVES**

numbers P220, L2, and HL2.

Prov. Pat.



PRICE (without Valves)

**KIT COMPLETE £35.0**

AN AMAZINGLY SIMPLE SET TO BUILD AND HANDLE WONDERFUL RANGE & SELECTIVITY

Ask your dealer to demonstrate.

FREE BOOKLET with complete wiring diagram on request. **ARTHUR PREEN & CO., LTD.,** Golden Square, Piccadilly Circus, London, W.1



**MAGNUM WIRE-WOUND VOLUME CONTROL**

FOR THE "BI-BAND" THREE. 50,000 ohms - - 7/6

**MAGNUM SPAGHETTI RESISTANCES**

Owing to a special process, Magnum Spaghetts are absolutely dependable.

FOR THE "BI-BAND" THREE.

- 1 10,000 ohms - - 1/-
- 2 25,000 ohms - - 3/-
- 1 100,000 ohms - - 1/6

A comprehensive range of lists, including a booklet on the "Stenode" and a list of leading short-wave stations—Free on request.

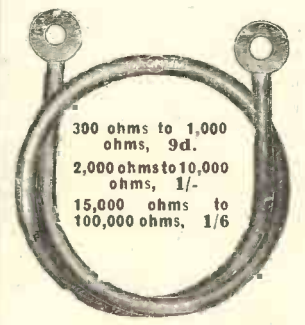

300 ohms to 1,000 ohms, 9d.  
2,000 ohms to 10,000 ohms, 1/-  
15,000 ohms to 100,000 ohms, 1/6

**THE "MAGNADER SER"**

A solid dielectric variable condenser. Recommended for "Cosmic 3."  
'0075, complete with knob - - 3/-  
'005, '0003, '0002, complete with knob 2/6 each.

**BURNE-JONES & CO. LTD.**

"MAGNUM" HOUSE, 296, BOROUGH HIGH ST., LONDON, S.E.1. Telephone: Hop 6257 & 6258. Scottish Agent: Mr. Ross Wallace, 54, Gordon Street, Glasgow, C.1.



# LOUDSPEAKER DIFFERENCES

*There are many types of reproduction obtainable from loudspeakers, and in this article our contributor endeavours to classify them, explaining their peculiarities and their effects upon the human ear.*

By L. H. THOMAS.

**I**F it were possible to divide up the growth of radio into the proverbial seven ages, one of them would certainly be called "The Age of Quality." We are living in it at the present time.

We might all be said to have become "quality-conscious." And this makes it all the more annoying to discover that, however we may search, we are quite incapable of recognising "quality" when we have found it!

## *The Personal Equation*

It is most exasperating, but none the less a fact, that we all have our own ideas of what perfect reproduction should sound like. There is, and can be, no absolute standard by which it can be judged.

I would not go so far as to say that the average listener is sufficiently complacent to imagine that his own set and loud speaker deliver that perfect reproduction that we all aim at; he does, nevertheless, show a distinct tendency to judge all other sets by his own.

One of the acknowledged experts in gramophone reproduction was talking to me on this deep subject a few days ago, and he, too, was appalled at the thought of what some people will put up with, in the belief that it is "quite good." More than this, they become so thoroughly accustomed to it that when they hear a receiver that is far superior they do not like it!

## *A Painful Subject*

Let me enlarge upon the characteristics that are desirable for good reproduction. Perfect reproduction we will talk of no more—it is a painful subject!

Standing out above all other requirements is this: there shall be no violent peaks at any point in the frequency range, from about 100 to

5,000 cycles. One can become "drugged," even to a peak!

Listen, for instance, to certain cheap receivers still being used with small horn-type speakers. Speech sounds metallic and almost unintelligible to those of us who consider ourselves educated up to moving-coil

## AN "OUTSIZE" SPEAKER!

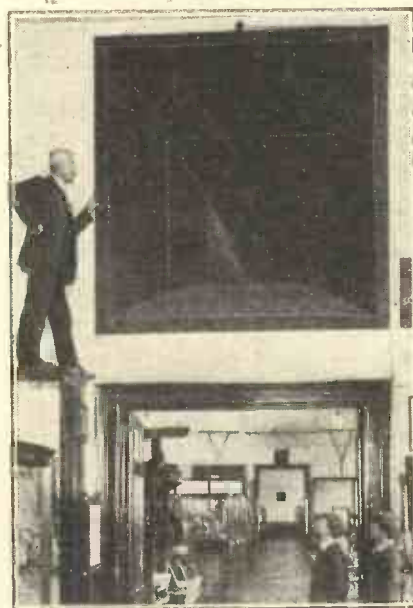

In an endeavour to establish a standard of reproduction by which listeners can judge the efficiency of their own broadcast receivers, the South Kensington Science Museum has installed this gigantic loud speaker. It has a straight logarithmic horn 27 ft. long and 7 ft. square at the mouth. Used in conjunction with a specially designed receiver at the Museum, it is capable of giving very nearly perfect reproduction.

quality. Yet the owner is perfectly satisfied, and after we have proudly demonstrated our gear to him he will often express the opinion that speech sounds "papery."

Generally speaking, strong peaks produce the following effects: Below

about 200 cycles, a peak of any size will tend to give the well-known "woofy" effect. Speech becomes deep with an objectionable boom, and certain notes in musical performances predominate most unpleasantly.

A peak more in the centre of the scale, in the region of 1,000 cycles, gives an even more undesirable effect. Music is completely unbalanced by the constant recurrence of notes in the region of the peak, which tend to "hang on."

## *When Speech is Nasal*

Speech becomes nasal, and, while quite understandable, is by no means a true record of the voice being broadcast.

Higher than this, and anywhere between 1,000 and 3,000 cycles, a peak of serious magnitude gives the well-known "shrill" effect, often put down to good reproduction of "top." Most bad sets and loud speakers exhibit this peak and the 200-cycle peak. They give a casual listener the impression of good bass and good "top," while in reality neither is present to any appreciable extent.

At the extreme top of the scale, for instance between 5,000 and 6,000 cycles, a severe rise in the curve will not do much more than exaggerate the hiss of background, or, in the case of gramophone work, the needle-scratch.

## *Peaks and Troughs*

Now, it seems to be a characteristic of the human ear and brain that when one has become accustomed to a peak in any part of the scale one likes it. Accordingly, on hearing a set or a loud speaker that is, in reality, superior on account of the absence of the said peak, one imagines a deficiency. The straight line now present strikes one as a trough.

(Continued on page 295.)

**RADIO NOTES AND NEWS OF THE MONTH**  
—continued from page 292

flop, for out of the millions of listeners in this country 40,000 is an extremely small proportion.

**The R.M.A. President**

At the Annual General Meeting of the Radio Manufacturers Association. Mr. Leslie McMichael, A.M.I.E.E., was elected Chairman. Mr. McMichael was educated at the Quaker School at Ackworth, Yorks, and was one of the first radio experimenters in the country.

Some years before the war he founded the London Wireless Club, which is now known as the Radio Society of Great Britain, of which Mr. McMichael is vice-president.

**More Listeners**

The total number of wireless licences in force on January 30th, 1932, showed an increase of 143,000 over the previous month. B.B.C. officials seem to think that this large increase is due to the number of new listeners attracted to broadcasting during and just after Christmas.

**That New Band**

Henry Hall, the B.B.C.'s new dance band chief, is running his orchestra on a completely new system. It differs entirely from that of Jack Payne's. By the way, although Mr. Hall will be director of the band, the band itself will be the property of the B.B.C.

**"The First Commandment"**

Under this title Messrs. Hutchinson, the famous publishers, have issued a vivid novel, at 7s. 6d., of the newspaper world, and, of all people, the author is Mr. John Scott-Taggart!

We have been so accustomed to think of "S.-T." as a radio inventor of international repute and an authority on patents that we were frankly astonished to receive a review copy of his novel. Happily, story-telling is for him only a relaxation from the serious business of radio, but our surprise turned to admiration as we read this absorbing novel of a ruthless newspaper magnate.

This is a swift-moving tale of love and of conflict in Fleet Street and in the industrial world. A fight for control of a great newspaper, a General Strike, a murder trial, and an interweaving of human passion and

jealousy make this an intensely readable novel.

**Only His Hobby!**

Mr. Scott-Taggart bids fair to be as successful at his hobby as at his professional work, and we can recommend readers to purchase, or put on their library lists (or those of their wives!), "The First Commandment" with the certainty that they will find it difficult to tear themselves away from it once they have started.

(Readers should get the title right, as a novel having a very similar title has simultaneously been published.—E.D.)

**THE "STAR-POWER" THREE**  
*An enthusiastic appreciation from a South African reader.*

Sir,—Over a year ago you published details of the "Star-Power" Three. As this design appeared to be exactly what is mostly in demand here, where A.C. current at 240 volts is standard and battery sets at a discount on account of difficulty with dry batteries, I made it up a few months ago and I am glad to be able to say that it has quite come up to all expectations and is giving excellent service.

Not only does it bring in the local station with power to spare and with perfect quality, but with the aid of a Brookmans Rejector I can cut out Cape Town (only a mile distant) when in full blast, and get J.B., which is some 900 miles away, at quite pleasant L.S. strength even on a moving-coil speaker.

**No Long Waves Out There**

There is one departure I had to make from your design, perforce, and that is in the matter of coils. When I made the set up "M.W." dual-range coils were not obtainable here, nor the materials for making them, and as in any case dual-range coils are really of little use in this part of the globe, I experimented with various arrangements of one, two and three coils.

I have recently sold the set to a friend who was wanting me to make him up one, and I am now looking forward to your A.C. version of the "Super-Quad," which appeared in the November issue.

Yours faithfully,  
W. D. C. J.

Woodstock, Cape.

**NO MORE GUESSING!**

TYPE 'B' 6d

TYPE 'R' 3d

BELLING-LEE TERMINAL MOUNT. Takes two terminals and mounts them anywhere, vertically or horizontally. Particularly suitable for use with Belling-Lee Terminal Type "B." Price 8d.

**BELLING-LEE FOR EVERY RADIO CONNECTION**

Advt. of Belling & Lee, Ltd., Queensway, Ponders End, Mdx.



## Loud-Speaker Differences—continued from 293.

I realise fully that the problem is not one of radio matters at all; it is all bound up with human nature and physical deficiencies. We can, however, educate ourselves not to become too self-satisfied with our own reproduction until we have compared it with others.

Listening on friends' sets recently for this purpose, I have found the following "types" of reproduction. The first, which we may call "a," has the 2,000- or 3,000-cycle peak, but nothing seriously wrong elsewhere.

It has the effect of making our "golden-voiced announcers" sound distinctly Massachusetts, and of

One can always recognise this type of reproduction—at least, I can myself after careful training—by the effortless understanding of speech. Music is a more difficult test, but the peculiar, refreshing quality of the speech gives it away immediately.

### Faking the Flute

These four broad divisions embrace the majority of sets heard to-day. But about 95 per cent of them will not be accurately described by "a," "b," "c," or "d"—they will fall somewhere in between. Perhaps I may be able to help in classifying them and pointing out possible sources of trouble.

You can see, I hope, that if we have a flute and a violin both playing a single note of, say, 500 cycles, we have two different sets of conditions. The flute will hardly be affected in tone if we cut off everything above 500 cycles. The violin, however, has the 500-cycle "base," accompanied by smaller outputs at, perhaps, 1,000, 1,500, 2,000, 3,000 cycles, and in the most unexpected places. Just imagine what can happen now.

### A Violin Surprise

If we cut off everything above 500, that violin is going to sound like a flute! On the other hand, if we have a peak in our curve such that any

## A Row of Loud Speakers That Speak for Themselves!

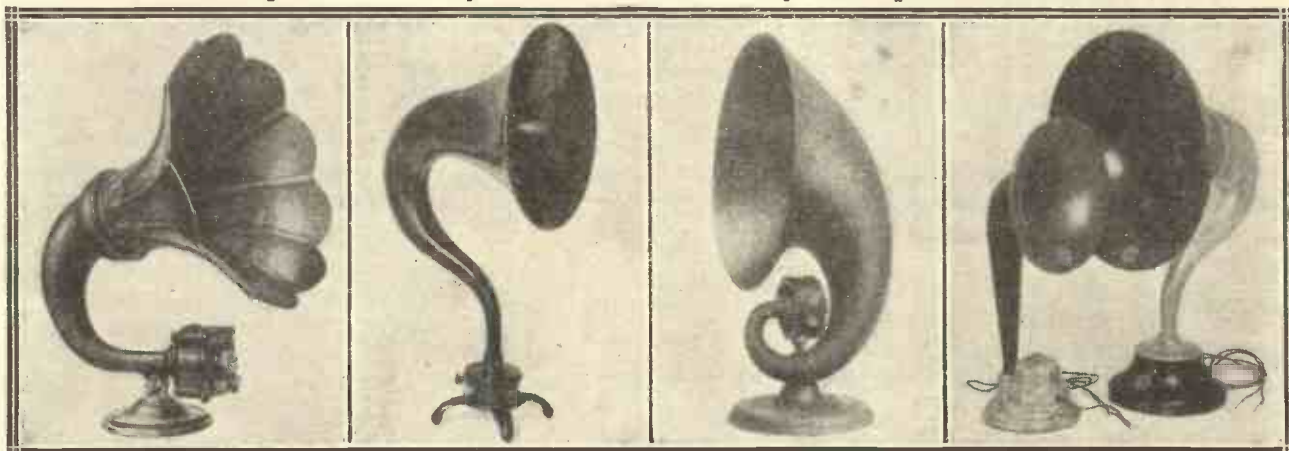

All these loud speakers date back to earlier days of broadcasting, and in their time were claimed to give the last word in radio reproduction. The model on the extreme left is an Amplion "Dragon," of which there are still many in use to-day; next to it is a Orphean, then a Ferranti, and, last of all, two B.T.-H. models.

strengthening the strings and brass in orchestral items at the expense of the remainder.

Type "b" has the 200-cycle peak and is invariably associated with cheap American sets. (A friend of mine, with uncalled-for levity, styles this type the "I fall down and go boom" quality.) Music, on the whole, is pleasing, if a little heavy, but speech is extremely bad, and at times unintelligible, except to the owner of the set, who has to act as interpreter.

### Crisp, Clean Speech

Type "c" has peaks all over the scale, so frequent as to make the overall effect quite good until one hears a chromatic passage.

Type "d," all too rare, has no serious peaks at all, except perhaps the 5,000-cycle variety, which can be conveniently filtered out.

First of all, why is it that a peak, so small as to be seen only in the form of a gentle hump in the curve, can cause all this trouble? Briefly, it can all be put down to our old friends the harmonics.

It is harmonics, in number, strength, and position in the scale, that make orchestral work possible. Without them all instruments would sound almost alike.

Probably the instrument that gives the nearest approach to a pure tone is a flute. A flute stop on the organ is sometimes said to be even nearer.

I have seen an interesting experiment, done by a firm of organ-builders, who convert a flute tone into a violin tone "while you wait," by adding the required harmonics one by one. It is uncanny, but most instructive.

of those harmonics fall within it, we stand a chance of making the violin sound like some other instrument! And then, if it shifts up the scale, the harmonic may likewise shift out of our peak, and it will sound like a violin again.

### The Harmonics

If all this can happen in the one simple case, imagine the complications arising when we try to reproduce an orchestra of 80 performers. Each instrument is identified by its little families of harmonics, all carefully chosen for their characteristics. And some of the families are most complex. Perhaps you are beginning to see why the flat curve is so desirable.

Our old friend, the cheap American receiver, for instance, will excel in converting violins into flutes, because

(Continued on page 298).



**200 v. at 40-50 m.a.**

The output of the Heayberd "M.W.1" Mains Unit—specially designed for the "Eckersley A.C. Three" and other modern receivers. The Mains Unit with the L.T. earth terminal. Three H.T. tappings: 60/80v. Var S.G., 180v. and 200v. fixed. L.T. 4v. 5 amps. for A.C. valves. Westinghouse rectification. Neat steel case. Ready to switch on **127/6**

GUARANTEED 3 YEARS

Send this Ad. now with 3d. stamps or informative lists with diagrams.

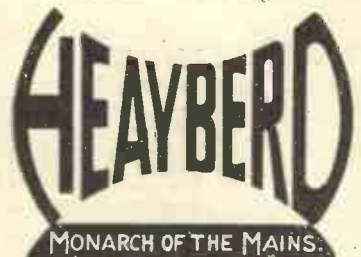

10, FINSBURY STREET, LONDON, E.C.2.  
(One minute from Moorgate Und. Stn.)

**DO CONSTRUCTORS SCORE?**

—continued from page 241

although from the cost point of view the advantage is with the manufacturer, yet from the point of view of the builder of sets, owing to his being able to use his discretion as to the components he shall employ, he is able to use better parts than the average manufacturer can afford, with the result that, from the reproduction point of view at any rate, the home-constructed receiver stands a far better chance than does the completely manufactured article. This is not to say that if a constructor uses parts sufficiently cheap to enable him to compete with the manufacturer in price that he will get as good a result—in fact, in general, it will be far from it; but there is no doubt that if the constructor uses the best parts he can get, the results from a reproduction point of view will be better than those of the completely finished set that he can buy.

**Comparative Skill**

On the other hand, from the point of view of actual production, the manufacturer, by reason of his wide facilities, especially as regards press tools and the like, can produce sets which when they are produced look very neat and handsome, and are generally more compact than the corresponding constructor's type of receiver. As regards the question of skill mentioned in the article in question, this is also probably greater in the case of the people who build manufacturers' sets. Not all-round skill, but the individual employees each have a very high degree of skill in connection with the fitting or assembly of some particular item; a degree of skill which is unlikely to be approached by the constructor unless he does nothing else but construct sets day in, day out, and year in, year out—which would be a very unusual circumstance.

**Getting High Efficiency**

Because the manufacturer has to supply his sets to people who know little or nothing about them, these sets have to be, as far as possible, fool-proof, and, therefore, it is necessary to work to much wider limits. For example, a constructor may build his set so as to operate his various valves at a very high efficiency, because if his receiver gets unstable he can immediately take such steps

as may be necessary to rectify it; whereas in the case of a completely manufactured set such a position is obviously not allowable, so that the degree of amplification which can be obtained, especially in the case of screened-grid valves, is usually far less than may be had experimentally by the careful constructor.

**In the Dark**

Another point where the constructor scores is that with the advancement of knowledge of radio—and radio is such a new science that fresh developments are taking place almost daily—he can immediately take steps to modify or alter his sets to the up-to-date condition. A typical example of this is the many thousands of receivers in use of the constructional screened-grid three type, which may readily be converted to the band-pass method, and so produce higher selectivity and at the same time maintain the quality of reproduction. The corresponding position of the purchaser of the complete set is that his receiver is obsolete, and he must wait until such time as he can afford to get rid of it on some unsuspecting individual to enable him to purchase the latest model.

A final advantage that I would mention is as regards service. The constructor, having built his receiver, knows all its parts in detail, and if anything goes wrong with it he can set to and remedy it; whereas the purchaser of the complete set, even if provided with diagram of it, is, as a rule, completely in the dark as what to do.

**A Final Point**

There is the final and generally quite important point in connection with the home-constructed radio set, namely, that one has the great satisfaction of having built it himself. The time may come, of course, when the completely manufactured radio receiver will be so good and so cheap that the question of building one's own set will not arise; but the writer feels that the time referred to is a long way hence, and the fact that such construction has reached a low ebb in the United States is nothing to go by, as not only are the Americans in general less given to the construction of receivers and models of any kind whatever than are the inhabitants of these islands, but, also, owing to the nature of the industry in America, no special encouragement has been given to the private constructor there.

Yours faithfully,

J. BAGGS.

Manchester.

**CLIX**  
Improves any set

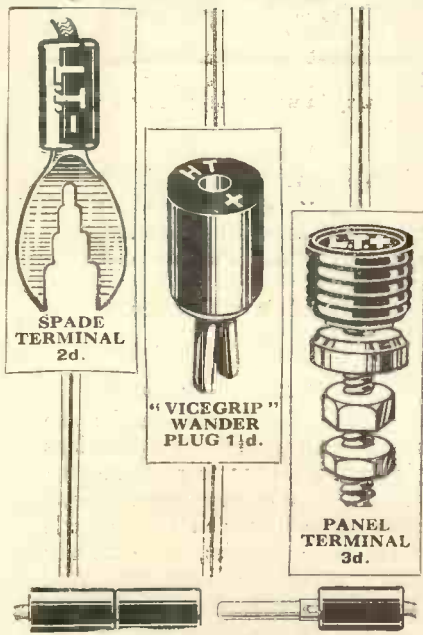

CLIX CONNECTOR 4 1/2d.

From all Dealers. Folder "M" on request.

**Cheapest PERFECT Contact**

Lectro Linx, Ltd., 254, Vauxhall Bridge Road, S.W.1.

**HOW H.T. BATTERIES ARE MADE**  
—continued from page 213

the internal resistance of the battery during discharge, and, more important still, maintaining a higher voltage during prolonged working periods than would otherwise be the case were an inferior quality selected.

All this sounds extremely complicated, but it is through this that the manufacturer finds it necessary to state that his battery is only good for a discharge of so many milliamperes. He has no axe to grind by virtue of this, and knowing the capabilities of his product the reader should adhere to instructions given, and by so doing will create an understanding and invariably give the deserving maker credit for his product.

It is assumed that the battery under discussion is of British manufacture and also that a reasonable price has been paid for it. Batteries of quality contain high-grade materials which are costly when compared with the inferior variety which enter into the making of very cheap batteries.

**Grid Bias and Efficiency**

Both as regards quality and economy the importance of correct adjustment of the grid-bias battery cannot be over-emphasised. Even in more advanced circles and amongst amateurs who should know better, the application of this correction current is sadly neglected.

Irrespective of the cost or quality of the components and valves, a set carelessly constructed and from cheap parts and valves very often gives reception of much better and more pleasing tone than in the case of a more expensively equipped outfit where grid bias has been neglected. In the case of the cheap set, the valves and batteries are functioning in the manner that their respective makers intended them to work.

**Using a Meter**

The adjustment is best carried out by means of a milliammeter, which is inserted into the H.T. leads from the battery to the set. But very few amateurs are in possession of such a meter, as, firstly, the meter of quality is expensive, and, secondly, the fact that so little use is made of a milliammeter that the reader questions whether its purchase is worth while. The valve manufacturers nearly all supply a graph for showing the

(Continued on page 298.)

**SHOCKPROOF DESIGN.**

**FINGER RECESSES FOR CHANGING FUSES.**

**BAKELITE SEPARATING BRIDGE PIECE.**

**HIGH QUALITY BAKELITE MOULDING.**

**LARGE STOCKS AVAILABLE.**

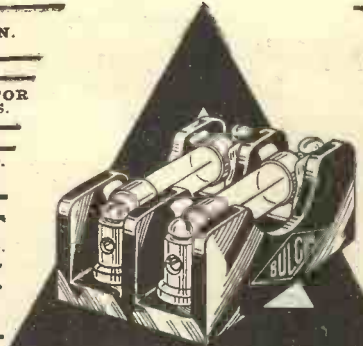

**REGD. DESIGN No. 750293**

**GLASS-ENCLOSED FUSIBLE ELEMENT.**

**PRECISION-TURNED END CAPS.**

**INSTANTANEOUS FUSING.**

**AN ORIGINAL PRODUCTION.**

**FUSEHOLDERS & FUSES**

**FOR EVERY MAINS RECEIVER**

**WHY RISK "BLOWING" YOUR HOUSE FUSES?**

Be on the safe side and incorporate a BULGIN TWIN FUSEHOLDER in between your mains and set. Thus fitted, in the event of accidental short-circuit, there is no risk of putting the house in darkness.

**NEW TYPE 6d.**  
60 & 150 M.A.

**TWIN ENCLOSED FUSEHOLDER 2/6**  
As shown above, Price  
**WITH INSULATED COVER 2/9**  
Complete with Fuses. Price

**FROM 150 M.A. TO 3 AMPS. 6d.**

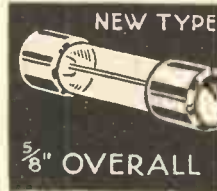

Send 2d. postage for 75-pp. Illustrated Catalogue and Manual.

**A. F. BULGIN & CO., LTD.**  
ABBAY ROAD, BARKING, ESSEX.

Telephones: Grangewood 3266 & 3267.  
London Showrooms: 9, 10, 11, Cursitor Street, Chancery Lane, E.C.4.  
Telephone: Holborn 2072.

**SOLVE ALL H.T. TROUBLES**

WET BATTERIES

**TAYLEX**

SELF GENERATING

Per doz.	No. 1.	No. 2.
	s.d.	s.d.
Jars (waxed)	1 3	1 6
Sacs	1 2	1 9
Zincs	10	11
Rubber Bands (24)	4	4
Terminals	8	10

Trade supplied.

**LONG LIFE : SILENT : ECONOMICAL**  
Sample doz. (18 volts), complete with bands and electrolyte. No. 1, 4/1; No. 2, 5/-; post 9d.; terminals extra. No. 5, with terminals, 7/6(10,000 milliamps) sample unit 6d. Orders 10/- carr. paid. New illustrated catalogue post free.  
**FREE** Bargain List of Receivers, Amplifiers and Components.  
M. TAYLOR, 57, Studley Road, Stockwell, London.

**PICKETTS PIANO-TONE CABINET YOUR RADIO-GRAM**



**USED BY "B.B.C." Famous Engineers, & "Leading Experts."**

The sort that people desire to possess and keep. Sound construction—graceful design—plano finish.

**PIANO TONE** Baffle and Tone Chamber improves your Speaker—yields an amazing body of tone—without distortion.

Sent ON APPROVAL—direct from the makers. 63/- up to £15. Cash or deferred.  
PHOTOGRAPHS and List Free—from sole makers:—**PICKETTS, Piano-Tone Cabinets (M.W.) Works, Albion Road, Bexleyheath.**

**The Daily Telegraph**  
**SECOND CROSSWORD PUZZLE BOOK**  
Price 2/6

**For Crossword Enthusiasts**

50 Puzzles are reproduced in the Daily Telegraph Crossword Puzzle Book. Neither too hard nor too easy, they possess that leavening of wit and humour that has brought a world-wide reputation to the Daily Telegraph Crossword.

At all Newsagents - 2/6

or they can be sent to any address for 2/10 each (post paid), by the Publisher of the

**Daily Telegraph**  
FLEET ST., LONDON, E.C.4.

Make **The DAILY SKETCH** YOUR Picture Paper.

**LOUD-SPEAKER DIFFERENCES**

—continued from page 295

not only is there more output low down than there ought to be, but there is not enough at the top end! As a complete violin-filter it is hard to beat.

Incidentally, if you have ever heard violin solos on the "talkies" you will probably begin to agree with me.

The problem now is to find out the cause of the existence of the peaks. My remarks here must be quite general, but they may possibly help a few sufferers to put matters right.

**Selecting a Speaker**

The "b" type of reproduction with the 200-cycle peak and deficient top, is generally the result of combining a selective set with a poor loud speaker. The speaker provides the peak, and the side-band-cutting properties of the set remove the "top."

Much may be done to this type of set simply by choosing a speaker that peaks at the top end of the scale. Instead of merely producing a boom the speaker will now help to compensate for the deficiencies of the set.

Type "a" reproduction, with the higher peak, generally has as its cause one or more L.F. transformers of doubtful quality, unless a peak is entirely due to the loud speaker.

**Some Final Advice**

The latter may be tested on another set to confirm this. Should the transformers be suspected, changing over to a reputable make will almost certainly be well repaid.

Type "c" is, generally speaking, beyond hope. The best thing to do in such a severe case is to start from the beginning and build another set.

One final piece of advice for London listeners is this: Go and listen to the Science Museum receiver. The combined output of all the gear employed there is probably as near to a straight line as anything that has yet been obtained.

Though the reproduction will probably not, for reasons already outlined, strike you as perfect, you will have to admit that it is pleasing. And if you have sufficient faith to be convinced that, even if you like *your* set better, the big one must certainly have it beaten, then this article will have gone far towards achieving its object.

**HOW H.T. BATTERIES ARE MADE**

—continued from page 297

grid-bias values in conjunction with definite H.T. voltages. By careful perusal of such a diagram and trusting to the ear an average working arrangement can be arrived at.

It is as well to mention that the greater the grid-bias value applied to the valve, consistent with quality, the lower will be the plate current consumed by the valves, and thereby a more economical working is generally obtained from the battery. It is therefore desirous to use as high a voltage as will give a pure, undistorted volume of reasonable amount, and it should be increased until the ear discerns a decrease in volume or distortion on loud passages.

From the above one should be able to arrive at a point where the H.T. battery will not be distressed more than is absolutely necessary. Remember that it is very bad both for valves and batteries to remove the grid-bias plugs whilst the set is working, as by so doing the plate current of the valves immediately jumps to an alarming figure which is totally out of all proportion to that at which the battery designer intended his product to work; further, the emission of the valve will suffer in consequence.

No current in terms of milliamperes actually leaves the G.B. battery, the application being one of voltage at just a few microamperes. Nevertheless the battery ages and after a time ceases to function.

Periodically it should be changed, and a useful rule to remember is, say, every six or eight months. After all, what is an expenditure of a shilling compared with the cost of a good power valve and H.T. batteries?

**Shelf Life and Performance**

It is very seldom that the consumer appreciates the value of a fresh battery. Manufacturers have done all things possible to prevent the ageing of the battery whilst it remains in the dealer's hands, but nevertheless the battery definitely deteriorates while lying idle in the dealer's store.

Chemicals are added to the electrolyte, the function of which is such that, during the working, water is formed to make up for deficiency due to drying. However, this only happens during discharge and cannot take place during inactivity.

Further, the manufacturers' hands

are tied, inasmuch as that when water is added in excess harmful inert and insoluble deposits are formed on the zinc and sac. These oxy-salts, as they are called, will tend to force the active paste out of the cell, and when the cell is designed without allowance being made for this expansion a bursting of the cell is consequent, with the internal short-circuiting of the battery as a natural result.

**Keep Dry and Cool**

Compensation for this is to buy a battery from a dealer whose sales are lively, thus ensuring that the manufacturers deliver at very frequent intervals. In this manner you can be sure of obtaining a battery the age of which is approximately three to four weeks only.

The position that the battery occupies is also of no mean importance. Storage and working conditions are similar, and a cool, dry place will considerably assist the battery in delivery of its best.

Quality of reception depends to a large extent on the efficiency of the wander plugs. These should be kept clean and the split portion of the plug should be opened out until it is a close snug fit in the socket.

**THE NEW B.B.C. DANCE BAND**

—continued from page 265

numbers, but melody and rhythm will count first.

I suggested that the comedy "stunts" of Jack Payne's Band have been popular. Mr. Hall's response was: "We shall introduce novelties, of course. But the dance music will not be sacrificed."

And so this tall, pleasant young man takes up the baton laid down by the famous Jack Payne. Most radio listeners have heard him speak, for he has always done the announcing for the Gleneagles Band.

**Full of Enthusiasm**

He has a quiet manner, but in conversation he breaks out eagerly into the topic which has captured his enthusiasm—radio dance music. Like his predecessor, he is good-looking; unlike him, he wears horn-rimmed spectacles. His otherwise young appearance is countered by greying hair, and to me he seems to be a rather unusual mixture of idealist, showman, musician, and business man.

**WHAT RADIO MIGHT DO FOR BRITISH TRADE**  
—continued from page 206

as the erection and running of a radio station for trade advertising purposes.

British motors, with which I am acquainted very well, even if I have not intimately studied other trades, are still recognised by engineers the world over as the best things of their kind on earth. That fact would be self-evident, anyway, by reason of the fact that we hold most of the motor records that exist.

**A Royal Example**

But although engineers know it, the man-in-the-street in Germany, Italy, France and America doesn't know it; and radio is in a unique position to tell him. The Prince of Wales himself has made many journeys for

**ON THE TEST BENCH**  
—continued from page 269

with shallower pockets to enjoy the benefits of the resources of the great Hollinwood factory.

For example, there are two H.T. units cataloguing as E.2 and E.3, which retail at £3 10s. 6d. and £4 16s. respectively. The first, E.2, has a maximum output of 120 volts at 15 m.a., while E.3 is suitable for larger sets, as it gives 25 milliamperes at 150 volts.

We have had an opportunity of testing both these units, and are able to say that within the limitations of their current outputs they are first-class accessories. "What's in a name?" asked the immortal bard. The modern answer is—quite a lot when it comes to the manufacturer's label on radio goods.

Constructors cannot go far wrong if they confine their purchases to the products of old-established and well-known firms. The law of the survival of the fittest has many an apt illustration in the history of the radio trade, and those who are "still going strong" are fairly certain to be manufacturing apparatus, such as the above-mentioned Ferranti units, which is sound technically and reasonably priced.

**Goltone "Akros" Flexible Cord**

The ordinary flexible cord, such as is used for mains units and loud speakers, comprises two leads, each of circular cross-section. And the general practice is to pad out an enveloping braided covering with cotton filling in order to get an ice, round shape.

This cotton filling is an undesirable expedient, inasmuch as it tends to hold damp and easily flames up and burns when dry. And yet in all these past years of active electrical development no one has hit upon the entirely practical and most efficient way of eliminating this padding which we find in "Akros"—the latest product of Messrs. Ward and Goldstone.

Instead of the two rubber-covered leads being of circular cross-section, they are semi-circular, so that when they lie together a circle is formed, and the outer braided covering lies on it snugly and evenly and without requiring any filling whatever.

So simple; why did nobody think of that before? How often have we felt like saying that in the past? But, as a general rule, all great ideas are essentially simple, and "Akros" is no exception to the rule!

**NEXT MONTH**  
THE FIRST ECKERSLEY "S.G." SET WITH (also for the first time) A BATTERY "VARIABLE-MU" VALVE.  
**"MODERN WIRELESS"**  
FOR APRIL  
On Sale April 1st. Price 1/-

the special purpose of interesting foreigners in our trade abroad; and where the Prince leads, surely the B.B.C. might follow.

Already foreign nations are using radio for various advertising purposes, although we in this country, with our good old Conservatism, are still shocked at the thought of doing so.

**Get a Move On!**

It lies with us now to decide whether we will persist in our shocked attitude till the foreigner develops radio to the full and takes away further vast portions of our trade, gives us more unemployed and less national income, or whether, by getting a move on while there is still time, we will increase our nation's prosperity beyond the doubters' wildest dreams by thoroughly and capably developing the powers which radio offers to display our national shop-window before a waiting world.

**SQUARE PEAK**

Regd. Trade Mark.

Varley "Square Peak," Britain's unbeatable band-pass coils, give band-pass tuning at its best!

Secure the wonderful improvements of "Square Peak" Band-Pass tuning! The new FREE "Square Peak" circuit brochure shows you how to build modern band-pass receivers—S.C. sets, simple Detector Sets and Super-Hets!

Fill in the coupon below and post it to-day!



To Messrs. VARLEY, Kingsway House, 103, Kingsway, London, W.C.2.

Please send me, free and post free, the "Square Peak" circuit brochure entitled MODERN "SQUARE PEAK" BAND-PASS CIRCUITS FOR EVERY REQUIREMENT.

DATE.....  
NAME.....  
ADDRESS.....  
M. IV.

The ACME of CRAFTSMANSHIP  
High-Grade RADIO-GRAMOPHONE CABINET  
of exclusive modern design, hand-made and polished, on Queen Anne legs.  
Figured Oak, £4.12.6.  
Figured Walnut or Mahogany, £5.10.0.  
Carriage paid.  
Illus. Catalogue Free.  
Cabinets made to order a speciality.  
**GILBERT**  
Cabinet Maker,  
**SWINDON**  
Estimates Free. Estd. 1866.

**MIRROR LIKE**  
**PERMANENT PERMOL**  
Specified for "BI-BAND 3."  
Use PERMOL the modern Ebonite guaranteed never to spoil your set by discolouring. Black Mahogany or Walnut finishes, perfect mirror polish, highest insulation, easy to cut and drill and costing only 4/6 for 7" x 18" panel.  
Ask your dealer or write to us for list. Any panel size cut. Cash or C.O.D. by return.  
**BRITISH HARD RUBBER CO., LTD.,**  
POWERS END MIDDLESEX.

**IN PASSING**

—continued from page 280

breeze. After a long time he yelled : "The sag, the sag," and at his urgent request I gave a mighty heave on the green cord ; the white cord then sagged more—that was the kite getting off the bus—and the green cord pulled like the deuce and all.

**"Good-bye to All That"**

Suddenly a mighty gust of wind swept across the field, and Think, feeling his glasses going, involuntarily let go the windlass and grabbed at them. Thereafter the windlass flew round at a hundred revs. per

**FOR EASIER OILING**

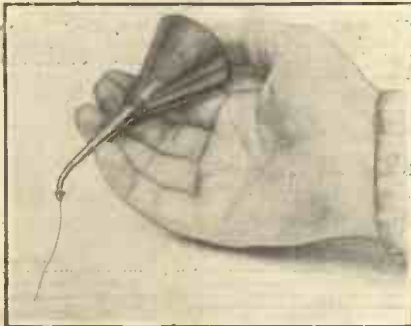

It often happens that the nozzle of an oil-can is too "fat," or it may be too short, to get to the mechanism we wish to oil. A very useful tip is to insert a length of wire in the nozzle. The oil will then run down the wire, and the lubricant can very easily be directed to where it is required.

minute, the cord whizzed out and up, and before we could bring a chunk of the fence to bear on the handle, to stop it, the cord ran out, snapped and ascended to the heavens like a lark.

"Good-bye, all," I said, and led Think to my car. The old bird chuckled all the way home, shoving his bushy eyebrows up and down, and rubbing his hands together as though washing them with invisible soap—like you get on French railways!

**NEXT MONTH**

**A COMPLETE SURVEY OF MODERN VALVES**

**ON SALE**

April 1st. Price 1/-

A week later the old rascal gave me a cheque for £100, and told me to keep the change. Do you know what had happened? No? Well—he had found out that by a clerical error in his slide-rule he had come a cropper over *Alpha Thinkii*—who had really vanished through a collision in 1263 (June 14th ; 16.05 G.M.T.). However, he had kidded Professor Bonk, of a rival College, that he had communicated with Mars, and had bet him that Mars would send *dash dash* (interval), *dash dash* (longer interval), *dash dash dash dash*, at 11. 23½ on a certain date. Bonk was all ready to test this. And I understand that my little set delivered the goods. Signals from 160 miles up *might* be from Mars, but

they couldn't be determined by D.F. as emanating from any point on the earth, and I never gave the secret away till now. The only snag is that Think, bereft of *Alpha*, is mad about Mars. But I'll be hanged if I co-operate with him in *that*!

**FIRST AID AND FITNESS FOR EVERYONE**

LORD NORTHCLIFFE once said there were two things in which everybody was interested—the first was their health and the second was the weather. What is the universal greeting when we meet a friend. "Hallo! How're you?"

You notice that the first thing is an inquiry as to our health, which is and must always be our foremost concern. When we are well we don't worry about our health; we often neglect it. We have plenty of other worries to keep us busy, especially in these times.

But let something go wrong with our health, or with that of the people at home—especially the children—and everything else takes a back place at once! It must be a great thing for those people whose fathers happen to be doctors, or who have a doctor in the family. They don't have to worry about health, they always have someone at hand to keep an eye on them, and to give timely advice or help. They are very much to be envied!

But wait. Why shouldn't you know something of the human body and its needs in sickness and in health? No need for you to be worried to death about some minor ailment of the children, or to make some serious mistake in case of emergency or accident. Call the medical man in case of need, by all means, but why not gain an intelligent understanding of the main facts of health—how to get well, how to keep well, and how to set about avoiding trouble?

The publication of the "Concise Home Doctor" will dispel the clouds of ignorance surrounding so many aspects of disease and hygiene and will help to bring security and happiness to many a home. It is to be published in 52 sixpenny weekly parts and is in truth an Encyclopaedia of Good Health, written by a wide circle of eminent physicians, surgeons and specialists.

The "Home Doctor" is based upon the sound principle that "Prevention is Better than Cure." It is a book to make and keep you fit. It tells you what to do in an emergency, before the physician comes; how to spot children's ailments; all about home nursing; sex and sex hygiene; diet; simple remedies; mothercraft; first-aid; health exercises; anatomy; beauty culture; health problems at all ages, and a thousand-and-one of the very things you have always wanted to know but could never find.

The First Part of the "Concise Home Doctor" was published on Tuesday, February 16th, price 6d. In addition to many photographs and articles, it contains particulars of an ingenious "self-binding case" which is available to subscribers at a very reasonable price. This binding case enables the purchaser to bind each Weekly Part of the "Home Doctor" immediately it is received.

**INDEX TO ADVERTISERS**

	PAGE
Belling & Lee, Ltd.	294
British Blue Spot Co., Ltd.	Cover ii
British General Mfg. Co., Ltd.	289
British Hard Rubber Co., Ltd.	299
British Insulated Cables, Ltd.	Cover ii
Bulgin, A. F., & Co., Ltd.	297
Burne-Jones & Co., Ltd.	292
Carrington Mfg. Co., Ltd.	285
Cossor, A. C., Ltd.	202
"Concise Home Doctor"	Cover iii
Dubilier Condenser Co. (1925), Ltd.	281

	PAGE
"Daily Telegraph"	297
Edison Swan Electric Co., Ltd.	Cover iv
Forno Co.	292
"Film Pictorial"	291
Gilbert, J. C. (Cabinets)	299
Gramophone Co., Ltd.	277
Heayberd, F. C., & Co.	296
Igranic Electric Co., Ltd.	285
Jackson Bros.	290
Lectro Linx, Ltd.	296
London Electric Wire Co. & Smiths, Ltd.	285

	PAGE
Peto-Scott Co., Ltd.	291
Pickett's Cabinet Works	297
Ready Radio, Ltd.	267
Reproducers & Amplifiers, Ltd.	281
Taylor, M.	297
Telsen Electric Co., Ltd.	272, 273
Varley Products	299
Ward & Goldstone, Ltd.	291
Wingrove & Rogers, Ltd.	201
Wright & Weaire, Ltd.	281

All communications concerning advertising in "Modern Wireless" must be made to John H. Lile, Ltd., 4, Ludgate Circus, London, E.C.4. Telephone: City 7261. FOR ADVT. RATES SEE PAGE 285.

# This Might Happen in YOUR Home— WHAT WOULD YOU DO?

A broken arm or leg—a bad cut or food poisoning—would you know what to do? Do you know the elements of first aid and home nursing? You *should* know. Every day lives and limbs are saved by someone who can act quickly and do the right thing at the right time. THE CONCISE HOME DOCTOR is

## A BOOK TO MAKE AND KEEP YOU FIT

written by leading Physicians, General Practitioners and eminent Specialists, FULLY ILLUSTRATED, and published in 52 weekly parts. It will tell you what every man and woman should know of the human body and its needs. It will dispel the all too prevalent evils of ignorance shrouding sex education and sex hygiene. It will deal with maternity, child psychology and beauty culture. It will help those who keep fit through daily exercises and diet. It will show you how to keep cats, dogs and birds in good health.

**PREVENTION IS BETTER THAN CURE.** The HOME DOCTOR will be your shield against suffering and your *instant* consultant in cases of sudden accident. Its total cost (binding included) is just one half a fee for *one consultation* to one Harley Street Specialist, yet more than a score of eminent medical men give you the benefit of their knowledge and advice in its pages.



# THE CONCISE HOME DOCTOR

Complete in 52 Sixpenny Weekly Parts

## Binds into ONE Large Page VOLUME

An ingenious "Self-binding" case is available to all subscribers to THE CONCISE HOME DOCTOR at a very low price. The complete work, by this means, can be built up week by week, each part being bound in it by the subscriber, as it is published. Full particulars of this special offer will be found in the early parts.

The HOME DOCTOR will deal with—

Simple Remedies; Dietetics; Mothercraft; Sex Education; Home Nursing; Care of Animals; Domestic Hygiene; First Aid; Health Exercises; Sex Hygiene; Anatomy; Beauty Culture; Health Problems at all Ages.

First 3 PARTS  
Now on Sale

Buy them To-day

6<sup>D.</sup>  
Each



At all Newsagents and Bookstalls.

ONE OF THE MANY

KITS WHICH GIVE

BETTER RESULTS

USING

THE AMAZING

**MAZDA**  
THE  
BRITISH  
VALVES

EDISWAN RADIO

TELSEN specify Mazda valves for the best results in their Kit sets, because Telsen engineers know and appreciate Mazda supremacy.

No matter what set you already have or are building, Mazda valves will give you a definitely improved performance—more volume, better quality, greater selectivity.

Mazda valves are 100% British made and designed by British engineers.

All good radio dealers sell them and will be pleased to help you choose the correct Mazda types for your set.

THE EDISON SWAN ELECTRIC CO. LTD.



155 CHARING CROSS RD., LONDON, W.C.2