

THE PERFECT RECEIVER—BY CAPT. P. P. ECKERSLEY

MODERN WIRELESS

1 1/2
MONTHLY

Vol. XII. No. 31.

The Leading
Radio Magazine.

JULY, 1929.

4 SETS TO CHOOSE FROM



1



2



3

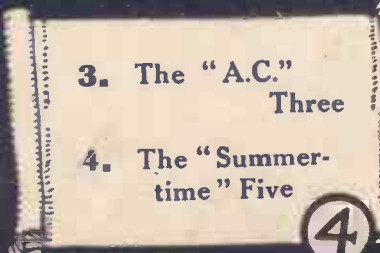

4

1. The M.W. "Hercules"
2. The "Hylo" Two-Valver

3. The "A.C." Three

4. The "Summer-time" Five



LOWEST CONSUMPTION-HIGHEST EFFICIENCY

Enormous H.F. amplification without the use of any external neutralising is the outstanding advantage of the new Mullard P.M. Screened Grid valve. So great is this amplification factor—actually from 60 to as much as 80 per H.F. stage—that one Mullard Screened Grid Valve may advantageously be employed where two H.F. stages are now necessary. Moreover, reaction can often be dispensed with entirely, thus simplifying receiver design and greatly improving quality.

The screened grid is additional to the usual filament, grid and anode, and is situated between the grid and the anode, effectively screening one from the other and reducing capacity feed back to a minimum. The connection to the screen is through the normal anode pin, the anode being connected to a terminal on the top of the valve. Thus the Mullard Screened Grid Valve can be plugged into any standard type of valve-holder.

**PERFECTED
SCREENED
GRID VALVES
BY
MULLARD
—GET DOUBLE
THE DISTANCE!**

- ¶ The lowest possible anode and filament consumption is achieved by the skilful design and construction of the new improved Mullard Screened Grid valve.
- ¶ The 4 volt (P.M. 14) takes a filament current of only 0.075 amp, while the 2 volt valve (P.M. 12) requires no more than 0.15 amp. This is due to months of laboratory research, testing and counter-testing and to the remarkable efficiency of the wonderful Mullard P.M. filament.

Mullard

THE · MASTER · VALVE

Advert. The Mullard Wireless Service Co., Ltd., Mullard House, Charing Crps Road, London, W.C.2.

CONTENTS

VOL. XII. No. 31. MODERN WIRELESS. JULY, 1929.

	Page		Page
Editorial	3	What Do You Want to Hear?	40
The Perfect Receiver	4	The "Summertime 5"	42
Why Mr. Dunstan left the B.E.C.	6	On the Short Waves	48
Characteristic Curves	7	How Many Stages?	50
Freak Microphones	9	Valve Reflections	53
The Ballan Beam	11	Questions Answered	55
The "A.C." Three	14	The M.W. "Hercules"	56
Shall We Copy Uncle Sam?	19	Radio Research	60
Grid-Bias Adjustments	21	Which Condensers Matter Most?	61
The Mystery of Radio Waves	22	Out with the "Traveller's" Two	63
What Readers Think	24	Switch Tuning	65
Concealed Condensers	25	The Versatile Voxhaus	67
Mind Your Wiring	27	Radio on Aeroplanes	70
The "Hyló" Two-Valver	28	In Our Test Room	71
My Broadcasting Diary	33	In Passing	74
"My Wavemeter"	35	Radio Abroad	76
The New Wave-Lengths	39	Radio Notes and News	88

SPECIAL SUPPLEMENT, "RADIO AND THE GRAMOPHONE," PAGES 78-87.

As some of the arrangements and specialities described in this Journal may be the subject of Letters Patent the amateur and trader would be well advised to obtain permission of the patentee to use the patents before doing so.

Edited by NORMAN EDWARDS.

Technical Editor: G. V. DOWDING, Grad.I.E.E.

Scientific Adviser: J. H. T. ROBERTS, D.Sc., F.Inst.P.

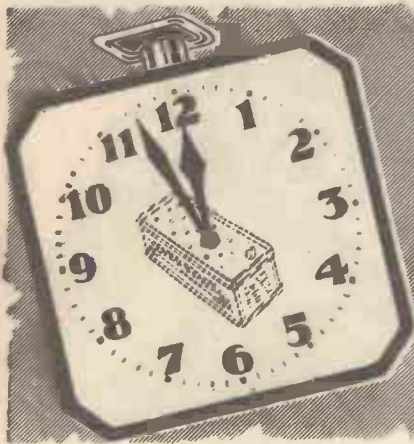

TIME
will prove
the wisdom
of your
choice

THE
"POPULAR PORTABLE"
H.T. DRY BATTERIES
(In Brown Containers.)
For Portable Sets.

PORTABLE 1 63 volts 8/6
PORTABLE 2 99 volts 13/6
PORTABLE 3 108 volts 15/

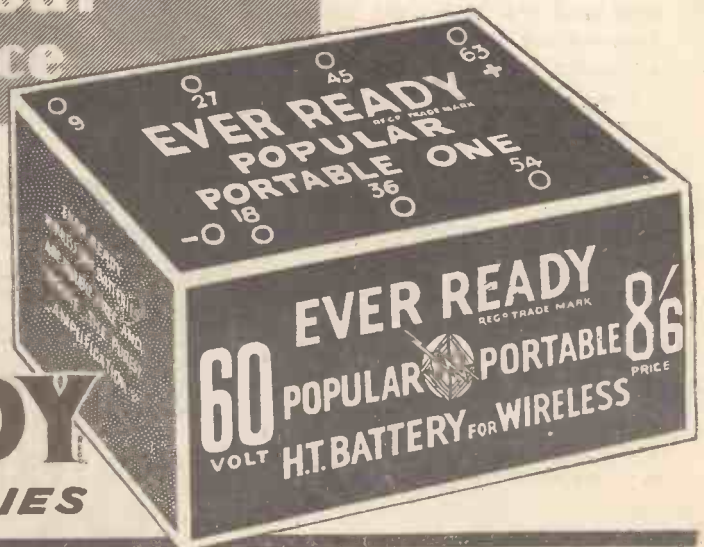

For Perfect Reception
and long life—buy

EVER READY
BRITAIN'S BEST BATTERIES



Interlocked construction makes Cossor the strongest and most dependable Screened Grid Valves ever produced. Even the hardest blow cannot disturb the perfect alignment of their electrodes. These wonderful new Cossor Screened Grid Valves are shock-proof, noise-proof, and break-proof. Every Wireless Dealer sells them.

Made in 3 types for use with 2, 4 and 6-volt Accumulators.

Technical Data.

Filament-Amps. .1. Max. Anode Volts 150, Impedance 200,000, Amplification Factor 200, Grid Bias 1.5 volts at max. anode Volts. Price **22/6** (either type)

A. C. Cossor, Ltd., Highbury Grove, London, N.5.

Cossor

Screened Grid

BRITAIN'S FINEST S.G. VALVE





This Month's Sets—Captain Eckersley's Resignation—The Future of the B.B.C.

THE "Four Sets for All" which we fully describe in this issue of MODERN WIRELESS include the M.W. "Hercules," the "Hylo" Two-valver, the "A.C." Three, and the "Summertime" 5.

The first of these sets is a powerful one-valver which, on test, has given extremely good results, and we recommend it as a set very suitable for long-distance telephone work. It is a product of the MODERN WIRELESS Research Department, and our readers know by experience that sets from that department have to pass a very high standard before they are allowed to be described in our Editorial pages. So little more need be said about this set here, as full details will be found on another page.

The "Hylo" Two-valver has been designed and is described by L. H. Thomas. It is a set with which you can tune-in stations on practically all wave-lengths, from the wave-length of Schenectady to that of 5 X X. The design is strikingly simple, and a glance at the diagrams and photographs on another page will show that it also possesses the merits of easy construction and inexpensiveness.

The "A.C." Three is another set designed and described by the MODERN WIRELESS Research Department. This is a mains receiver, and can be used with ordinary L.T. and H.T. batteries. Nevertheless, the filament circuits are arranged for mains valves, if any constructor wishes to use them. The H.T. can be derived from a separate mains unit, if it is desired to eliminate all batteries. The "A.C." Three is undoubtedly a very fine set, with a universal appeal, and we regard it as one of the Research Department's best efforts from the point of view of simplicity of design and real effectiveness.

The "Summertime" 5 is, of course, a powerful multi-valver which has been specially designed and described by C. P. Allinson, A.M.I.E.E., A.M.I.R.E., and may be described succinctly as "a real loud-speaker distance-getter."

Capt. Eckersley's Resignation

THE resignation of Captain P. P. Eckersley from the post of Chief Engineer of the B.B.C. must have come as a considerable surprise to many thousands of amateurs and listeners in this country,

but to those in touch with Savoy Hill politics his decision was not perhaps such a very great surprise. It has been known for some time past that Captain Eckersley was desirous of exercising his talents in a less restricted atmosphere.

British broadcasting has been developed under his technical guidance during the last six years, and it has now reached a very high point of perfection. The Regional Scheme is clearly worked out on paper, just as an architect would work out the plans for a new building, and it now merely remains for the bricks and mortar to be utilised.

Furthermore, Captain Eckersley, it must be pointed out, will still be retained by the B.B.C. in the capacity of consultant, and so his services will not be entirely lost to the Corporation.

We feel sure all our readers will join with us in wishing Captain Eckersley every possible success and happiness in his new spheres of activity. One thing we may announce, and that is that Captain Eckersley will continue to write technical articles, many of which we have already arranged to be published in this journal.

At the moment of writing we are given to understand that his successor has not been appointed, but that applications for the post will be invited in due course.

The Future of the B.B.C.

A GOOD many questions have been asked lately as to the future of British broadcasting under the new Government—whether any radical changes will be made, and whether there is any chance of a competitive system of broadcasting being introduced into this country. From many of our correspondents and friends closely in touch with Government and B.B.C. headquarters, we understand that no radical changes in the policy of broadcasting in this country are contemplated, but some very interesting developments in connection with the official control of broadcasting are likely to take place in the near future.

There have been rumours again that Sir John Reith contemplates leaving the B.B.C. at the end of the year, but so far we have not been able to substantiate or contradict those rumours. They are still, so to speak, in the air.



I WONDER how many people dream of the perfect receiver, and if they gave their dream what then would their dream have told them about "perfect" reception. So many people just buy or make a receiver, are content with what comes through, leave the thing alone and say, "Oh, that's wireless!" . . . they do not dream of the perfect receiver.

"Perfect" Quality

Others never leave their receiver alone—they dream always of the perfect receiver . . . to their friends the dreams are nightmares. Some discriminate and choose their receivers in terms of performance, price and suitability for their tastes—they are content to know that they've got the best in the circumstances, but they hope for better things one day.

But what is the specification that would represent perfection to the last and most common type of person?

In Britain, at any rate, most people would make their first condition that the quality should be "perfect"—that lovely word!

Secondly, they would ask that the set should be able to pick up foreign programmes.

Thirdly, they would ask for fool-proofness, and would ask particularly that there should be no batteries to renew or charge.

Reality is Useless

Fourthly, they would ask that the set should be portable, and probably, lastly, that it should have a single-handle control calibrated so they could turn it in a flash from Iceland to America and back to London.

Having raised your hopes, let me dash them at once by saying that no such set exists, nor, in my opinion, can exist for some time to come at any rate.

Capt. P. P. Eckersley, M.I.E.E.,

Tells "M.W." Readers of

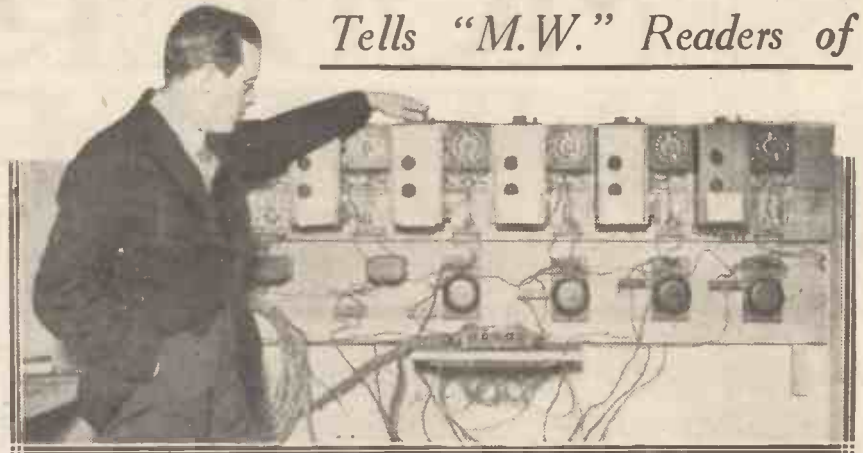

What stands in the way then? Let us take the points one by one. Firstly, quality. What is meant by perfect quality? It cannot be a question of producing reality, because a symphony orchestra in one's living-room would be a painful business. I was much amused apropos in a conversation between a practical man and an artist.

A Question of Art

The practical man was discussing art and the artist was listening. The practical man said that at any rate when he saw a picture, or a piece of sculpture, it pleased him the more as it more nearly resembled what it meant to portray. The artist hailed the practical man as a "new revolutionary," saying that this was an entirely new principle in art, and that no artist acclaimed by posterity as "great" had ever based his work on the principles posed as fundamental to the practical man's appreciation. And thinking over it, that is so true.

Pictures are, in any case, flat; statues seldom life-size, posed frequently in positions no practical people would normally adopt. Look at the best posters and ask yourself—is that reality? Indeed, no! And the practical man was indeed an unconscious revolutionary—of course, John Collier, and all that, but remember his paintings are flat.

The loud speaker—"to return to our muttuns"—is a point source of sound; in general, it cannot reproduce every frequency equally, it sets up standing waves not present in the original; it has a polar diagram different for every frequency; it can, in fact, do no more than paint a picture and give us perhaps sometimes more than, usually less than, the original.

Detail and "Attack"

Some of these daubs, though, take some appreciating, and I am not arguing that one of these unlovely braying things represent the higher forms of art if only we could appreciate them—they do so seem to do things

One of the essentials for superlative quality is plenty of anode power, and that is why the mains-H.T. set is likely to achieve still greater popularity.



The Perfect Receiver

at one, too, which makes them more unpleasant. If the loud speaker is to be good it must pick out the realities, give us detail and attack in music and enable us to feel something of a speaker's personality—the loud-speaker's business is to leave out non-essentials—it cannot put in that which does not exist.

Must Have the "Essentials"

Don't say I have said nothing about perfect quality—I seem to have defined it when I insist that a good quality speaker gives the *essentials* of the sounds it transmits. We may then capture the spirit of the thing transmitted. The Chrysler advertisement tries to give the spirit of a swiftly moving car; it leaves out the

am not allowed to name, and see his choice inevitably fall on the one that gives better attack, but a much poorer response curve.

But we have some way to go to make the practical loud speaker which escapes slavery to a response characteristic and yet gives a wide view of the transmitted spectrum. I should say that in the end we must eliminate resonance in any part of the movement, and yet we must be able to transmit the lower frequencies as pure tone. The first and foremost essential seems to eliminate resonance,

The author in characteristic pose.



In this distinctive and downright article the B.B.C.'s popular Chief Engineer outlines the set of his dreams.

And here he not only surveys the technical possibilities of reception, but writes refreshingly of our loud speakers, our announcers, our foreign programmes—and ourselves!

non-essentials; a photograph of the same car may capture the attention far less.

A loud speaker may, from a technician's point of view, be nearly perfect in that its frequency response characteristic between certain values lies along the office ruler. The musician may regret it as a loud speaker, however, because, for example, it loses the essential qualities of detail and attack in some hidden resonance.

The Musician's Opinion

This is where technical men frequently make mistakes, being blinded by the rules and not intelligent enough to see that the rules they have learnt may not be all the rules to be learnt. On this very point ask a musician to compare two loud speakers which I

which is a way of saying that we must not invite the musician's contempt by masking detail and attack. Good luck to the inventor who first solves this problem. May it be me!

The most perfect loud speaker requires the most perfect set to work it. Such a reproducer will welcome plenty of watts; it will never make us hunch our shoulders against the high-note sopranos, nor flinch from the orchestra's more combined enthusiasms. I am no worshipper of quantity, but it is true that one can stand more and more of it as the quality becomes more and more true, (for "true" see definition above!).

So that the low-frequency valves must be capable of giving the loud speaker undistorted power, and the detector must supply the low-fre-

quency valves with a true copy of what it receives from the H.F., and the H.F. must not go and spoil things from the beginning by tricky little instabilities. The design of straight-line detectors and stable H.F. circuits is so well known by now that it is outside the scope of the present article to do more than to hope that it may be more widely known.

Plenty of Power

But the general reader may agree with me when I say that designers still seem to be afraid of pouring good honest power into the last stage. Householders cheerfully burn lights at 4d. a unit. What's wrong with a few more watts at 1d. or so? It makes all the difference to a wireless

(Continued on page 94.)

WHY MR. DUNSTAN LEFT THE B.B.C.

The true story of the unfortunate "incident" which occurred at Savoy Hill on the night when the polls of the General Election were declared.

ALTHOUGH this issue will be on sale a month after the General Election, listeners will not forget in a hurry the very interesting little debacle which occurred in the B.B.C. studio on the night when the polls were declared—when Mr. Eric Dunstan, one of the B.B.C.'s chief announcers, had "words" with Sir John Reith and eventually resigned.

How it Occurred

From an authoritative source we understand that Sir John Reith, as is his custom on important occasions, decided that he would broadcast the election results as they came in until about 1.30 a.m., and consequently took over the duties of Mr. Eric Dunstan. Subsequently, Mr. Dunstan stated, several telephone calls were received from listeners complaining that the new announcer (Sir John Reith) was not announcing clearly; furthermore, he was talking too swiftly. Mr. Dunstan reported this to Sir John Reith and, according to the "Daily Telegraph," Sir John answered:

"I will not read any slower. I am going on announcing."

Mr. Dunstan said: "I was, not unnaturally, exceedingly angry that my attempts to improve matters under very difficult circumstances were treated in this way, and I left the building, not with any idea of resigning, but as a protest against the arbitrary interference with announcers in the performance of their not very easy duty on a critical occasion.

No Particular Quarrel

"I went on to a party given for the hearing of election results, and talked, perhaps, indiscreetly of my dispute, with the result that my resignation was prematurely recorded in the Press. This I regret, but if my resignation has the effect of ensuring that in future people without any experience or qualification for announcing do not interfere on such important occasions, when nerves are taut and the one thing necessary is a cool head and freedom of action, I do not regret it."

Of course, that is putting it rather strongly, for Mr. Dunstan must

realise that Sir John Reith is generally accepted as a very fine broadcaster, and his experience is probably greater than Mr. Dunstan's in this particular field.

According to a correspondent of ours who was present in the studio, there was no particular quarrel or scene. Mr. Dunstan made his outburst of protest, and Sir John asked him if his nerves were upset and suggested that he might knock off duty until he recovered himself.

A Premature Report

Unfortunately, Mr. Dunstan did not recover quickly, with the result that he went on to a party at Mr. Selfridge's, where he related what had occurred and, of course, there being journalists present, the story



Mr. Eric Dunstan.

appeared in the Press, prematurely announcing Mr. Dunstan's resignation. Mr. Dunstan did not really mean to resign; but probably in the heat of the moment threatened to do so. The B.B.C., however, accepted his resignation.

Mr. Dunstan has had a varied career. He was a Captain of the Buffs, and has been Vice-Consul at Seville, on the staff of the Embassy at Madrid, and Private Secretary to Mr. Gordon

Selfridge. He has also been Assistant to Vice-Admiral Sir Reginald Hall, and was at one time Aide-de-Camp for the Governor of the Fiji Islands.

Re-appointed at Savoy Hill

After that he took up broadcasting, and was eventually sent out to be General Manager of the Indian broadcasting station, thanks to the influence used on his behalf by Sir John Reith. But in India he fell out with the Indian authorities, and eventually came home. On his return, Sir John was good enough to re-appoint him announcer at B.B.C. headquarters, but Mr. Dunstan, evidently holding very strong opinions as to the high and important duties of announcing, apparently resented Sir John's action on the night of the election, and has now severed his connection with the B.B.C.

We hope such incidents will not be repeated, for they certainly are not conducive to the enhancement of the dignity of the B.B.C., and, further, as a Civil Service department, "words" between a subordinate and his chief are a little out of place, especially near such a sensitive fellow as "Mike."

ITEMS OF INTEREST

One of the causes of hand-capacity effects, especially in short-wave sets, is a long earth lead.

* * *

When tapping an aerial on to a coil it is usually the "low" tap which gives greatest selectivity, but this is generally accompanied by a reduction in signal strength.

* * *

One of the most important adjustments on a single- or two-valve set used for long-distance work is the H.T. voltage on the detector.

* * *

For successful long-distance reception it is essential to be able to get a gradual adjustment of reaction without perceptible overlap.

CHARACTERISTIC CURVES



Why do valves have curves? And what good are these peculiar graphs to the average listener? An interesting article by **FREDERICK LEWIS**.

ONE often hears a remark something like this about a particular valve that is under discussion: "It's quite a good curve," or else, "I don't think much of the curve," and it may be of interest to readers of **MODERN WIRELESS** to know exactly what is meant by this type of remark.

order that it should do that job it must have what we term 'certain characteristics.' In other words, it must have certain qualities.

Definite Qualities

If you were choosing a motor-car or a motor-cycle you would want it to have a certain power, some particular maximum speed, definite types of gears, and so on and so forth. In other words, you would want that motor-cycle or motor-car to have some definite characteristics which would make it suitable for use in the way you want to use it.

It is just the same with valves. The design of a valve does not end with putting in a plate and a grid and a filament which will take a certain voltage and certain amperage. Other definite qualities are required before the valve is of any use to the general public.

Those qualities consist mainly of its amplifying powers and impedance, or A.C. resistance. Impedance is a thing which, for many reasons, we would be far better without. Magnification factor, or, in other words, the power of the valve to amplify signals, is a thing that we want very badly indeed, but unfortunately the two are inextricably interconnected.

A Typical Example

Let us study the curve of a well-known valve and see exactly what that curve tells us, and of what use it is to the average set owner. This valve is a well-known L.F. valve,

having an impedance of 13,000 ohms and a magnification factor of 15. It is not now on the market, but its countertype is, and we will compare it with that in a moment or two.

In the first place, when you look at a curve you must not be led away by the visual "steepness" of slope.

"Steepness" of "Slope"

The "steeper" the slope of a curve would denote the greater the amplification powers if all curves were drawn to the same scale. As they are not, we must remember that the slope of the curve will only give a rough idea of the characteristic of the valve

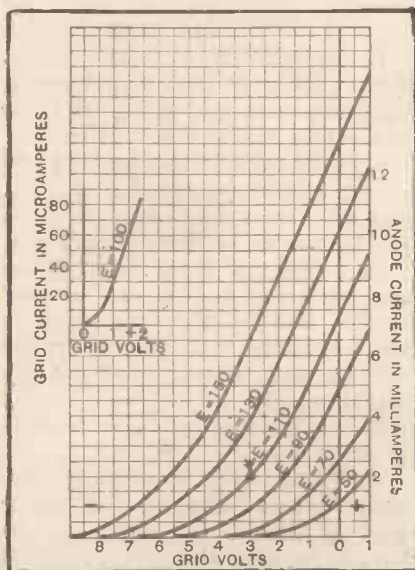

(Fig. 2.) The new D.E.L. 610 gives curves as above.

Why do valves have curves? And why should the makers trouble to map out the curves and publish them for the benefit of valve users?

Well, the reason is that when we buy a valve we buy it for some special purpose. We want it to do a particular job in a receiver, and in

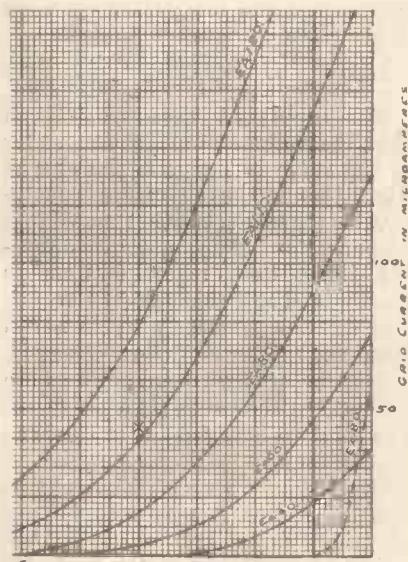

(Fig. 1.) The old D.E.L. 610 valve curves were like these.

It is the "Slope" that Counts

The "slope" of the valve is what really concerns us, i.e. the $\frac{M}{I}$ factor.

Obviously, if we have two valve curves drawn to the same scale, and one has a very much steeper slope than the other, it would mean that for a given voltage variation (shown statically along the bottom line) in grid volts, a much greater change of plate current (along the vertical) would occur in the case of the valve with the steeper slope than in the case of the valve whose slope was not so steep.

Now consider the case of the valve whose curve is shown in Fig. 1. Here we see that at 110 volts H.T. a grid swing—that is, a change of grid volts—from zero to minus 3 will give a change in plate current (along the vertical line) between $3\frac{3}{4}$ milliamps. and 1 milliamp. In other words, it will give us a change of $2\frac{3}{4}$ milliamps. at that particular applied H.T. voltage.

Now take the case of a valve which has a slope—or a magnification factor-impedance ratio—of nearly twice as much. Here we see (Fig 2) that at the same H.T. voltage, the same grid potential variation will give us a plate current change of from nearly $6\frac{1}{2}$ milliamps. to just under 2 milliamps. That is a change of well over 4 milliamps. for the same change of grid voltage.

Obviously, then, this valve is going to give us far greater amplification than the one depicted in Fig. 1, because for any given voltage variation on the grid far greater variation of the plate current is obtained.

"Slope" Most Important

This does not necessarily mean that the voltage amplification factor of the valve is higher in the case of Fig. 2 than in the case of Fig. 1 (actually it is the same), but that the voltage amplification factor-impedance ratio—the thing that really matters—is greater, and so we should get a greater amplification per stage with No. 2 than from No. 1.

This factor is what is known as the "slope" of the valve. It is the factor you want to look out for in choosing a valve for any particular purpose. A valve may have a very high *amplification factor*, but it may also have a very high *impedance*, and it is then ten to one that you will not be able to get so much out of the valve as you would if you used one with the

same magnification factor and a lower impedance.

Let us take an example. Suppose we had a valve with a magnification factor of 20 and an impedance of 40,000 ohms, and tried this up against a valve with a magnification factor of 20 and an impedance of 10,000 ohms, we should get far greater amplification per stage from the valve with the 10,000-ohm impedance than from the valve with the 40,000 ohms. This case is, of course, exaggerated, but it serves to show the point which we want to stress.

The "Grid Swing"

When looking for a valve, therefore, do not look for one with a high amplification *only*. It must have a steep *slope* if you are out for really big amplification per stage.



The curve of the S.G. valve is a peculiar one, and the valve operates best on the top, flat portion.

The main other thing to look out for is what is known as the grid swing—that is, the capability of the valve to deal with strong signals—and can roughly be denoted by the number of volts between the zero line of the graph and the voltage figure along the bottom line which comes below the *beginning* of the curving portion of the characteristic curve at any particular H.T. voltage.

I have marked this point X on Fig. 1, and Y on Fig. 2, for the H.T. voltage which we discussed just now (110 volts), and one has to take into consideration the grid swing as well as the "slope" when choosing a valve. It's no good having a steep

slope if the valve will overload at the slightest suspicion of a strong signal.

You will find that a valve with a small grid swing usually has a steeper slope—in other words, greater amplifying powers—than a valve with a long grid swing, and one has to balance between these two.

If a valve is to go in the last stages of a receiver, then it is likely to have to handle quite a large input, and one must sacrifice slope or magnification powers to some extent for grid swing, so that it may deal with the amount of input required.

You see, we have got to get our signal input voltage variations to fall between two points on the graph—the zero and that figure which comes under the beginning of the curving portion of the characteristic. As a matter of fact, one cannot actually swing quite the full length of that without distortion, so to be quite safe it is best to knock off half a volt from the reading obtained between 0 and whatever figure comes directly under the beginning of the curve. The reason for this we cannot go into now, but as we near the two limits of this voltage swing, distortion begins to occur.

A Valuable Guide

In the two cases given here we find that at 110 volts H.T. we get practically the same grid swing with the two valves, but as Fig. 2 valve gives far greater amplification for that grid swing, it is obviously the better valve, and will give a signal strength much greater than that obtained from Fig. 1.

Of course, all these valve curves are what are known as "static" curves—that is, they are taken in the laboratory with definite applied voltages and currents, and not the actual rapidly varying and uneven A.C. voltages that are encountered in practical use.

Unfortunately it is, so far, impossible to take a "dynamic" or "under working conditions" curve, so we have to judge by the static curve and try and visualise how the valve will act when actually in the set.

The "static" curve is quite good enough as a guide, and if we study these and then compare our *results* with our previous opinions derived from the curves, we shall soon find that we can judge any valve fairly accurately by just spending a few minutes examining its characteristic curves.



FREAK MICROPHONES

THE average broadcasting microphone used nowadays is so satisfactory an instrument to all intents and purposes that many of us are apt to lose sight of the fact that such an important instrument has, in the past, had many variants, the majority of which have been put forward in the hope that they would be in the nature of an improvement in the efficiency of the now standardised pattern of "mike."

The majority of these microphones, however, seem to have failed to "catch on," if one may use that

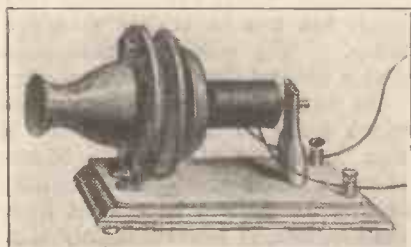

Fig. 1 Bell's first transmitting microphone.

word, applying it to scientific devices, though there is no doubting the fact that a number of them have been extraordinarily efficient when carefully used.

Scientific Curiosities

On the other hand, many of the microphone instruments which have been invented from time to time have been nothing more nor less than freaks and curiosities of the scientific world, and, as such, they have generally been allowed to die a natural death.

Probably, however, the most interesting of these microphone curiosi-

 * An interesting chat about some *
 * unusual microphones that have *
 * done useful service in the past. *
 * From a Correspondent. *
 * *****

ties is the first transmitting microphone ever made, a picture of which you see at Fig. 1. This is Professor Graham Bell's first sound transmitter, which he exhibited at the Philadelphia Exhibition in America during the summer of 1876. It is, therefore, the parent instrument of all electrical speech transmitters, and, as such, deserves an honourable place in the annals of the microphone.

Bell's transmitter operated in virtue of a diaphragm being set into vibration in the vicinity of a magnet, whereby electrical currents were derived, these being conducted to the receiving end of the telephonic installation.

Diaphragm Disadvantages

After this, of course, came the now very familiar carbon granule microphone, from which type of instrument most of the more usual broadcasting microphones have been evolved.

The great trouble about the present-day microphone, however, is that it possesses a diaphragm. Now, it may appear strange to the reader, but it is certainly a fact, that if a satisfactory microphone without a diaphragm could be invented, such an instrument would function more efficiently than the present-day microphones.

For one thing, the diaphragm of a microphone, being a solid body, possesses inertia. That is to say, it tends at all times to resist the forces

which impel it to move, and which also impel it to stop moving.

Then, again, a microphone diaphragm may not always vibrate as a whole. Different parts of it may tend to vibrate at different frequencies at the same time.

Still further, a microphone cannot transcribe very faithfully delicate nuances or shades of sound, the reason being, of course, that these subtle tone-variations do not create sufficient variation in sound energy to enable the relatively heavy microphone diaphragm to respond to them.

The Kathodophon

In consequence of these facts, and of many others, long has been the search for a diaphragm-less microphone, an instrument which would pick up and transmit everything which an ordinary microphone will



Fig. 2. The "Kathodophon"—a diaphragmless microphone of German origin.

do, but which, owing to the absence of a diaphragm, would carry out its function with greater accuracy and fidelity.

A very large number of microphones without diaphragms have been constructed and experimented with, but only relatively few of them have been sufficiently good to enable them to arrive at the practical "trying-out" stage in the broadcasting studio.

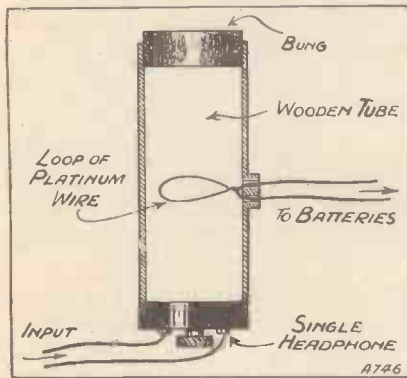

Fig. 3. The Tucker microphone operates on a novel principle.

Perhaps, of these diaphragm-less microphones the best known is the "Kathodophon," an instrument which a year or two ago attained to some degree of prominence in Germany. The Kathodophon, an illustration of which is given at Fig. 2, comprised essentially an instrument in which, by means of an electrically-heated cathode element, the air between two conductors became ionised, and therefore conducting in property.

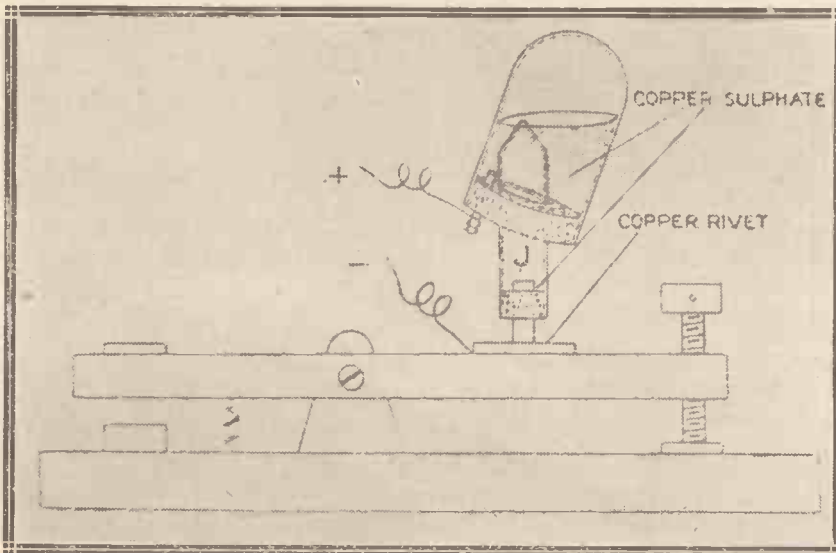

Fig. 4. Use is made of surface tension effects as shown in this example.

When sound waves are allowed to impinge upon this layer of conductable air, they alter its state of ionisation, and therefore the current which

passes across it varies in sympathy with the pulsations of the impinging sound waves.

The Kathodophon was tried out in various German studios, and it even found a use in the production of speaking films. One observes now, however, that the German studios have gone back to the use of the ordinary microphone, so therefore the Kathodophon must not have been as satisfactory as at first sight it appeared to be.

Utilising Glow Discharge

A diaphragm-less microphone working upon a slightly different principle is the "Glow Discharge" microphone, invented by Dr. Phillips Thomas, of America. This microphone, shown at Fig. 5, contained a small gap between two conductors across which a high-tension electrical discharge passed.

Sound waves proceeding into the microphone influenced the rate of the discharge owing to the fact that they varied the resistance of the intervening air. Thus current pulsations were set up in the microphone circuit. Instruments of this type were experimented with in American broadcasting stations and they were fairly successful.

A very curious microphone freak, which, if I remember rightly, did not reach any stage beyond that of a working model, is the "Meniscus Microphone," illustrated at Fig. 4. This instrument, invented during the early days of broadcasting, comprised essentially a very fine orifice which

mounting the apparatus upon a tilting table. Under these conditions, the instrument attained a state of microphonic sensitivity, and it would transmit sound impulses from a special type of sounding board to which it was attached, the resistance offered at the surface of the liquid being varied by the received sound waves.

Still, however, this was going one worse than a microphone with a diaphragm, because in the meniscus microphone the sounding board took



Fig. 5. One of the best known "glow discharge" instruments.

the place of the ordinary microphone diaphragm, and it was naturally very much less free to vibrate than the latter. The meniscus microphone died a natural death accordingly.

An interesting type of instrument which seems to have possibilities is that known as the Tucker Microphone, a sketch of which will be seen at Fig. 3. As will be evident from the diagram, it consists mainly of a vertical wooden resonator in the middle of which was placed a heated platinum wire.

The "Tucker" Type

Speech waves from a receiving headphone were passed up the resonator. These set up vibrating currents of air, very slight in extent, but nevertheless sufficient to cool the platinum wire and to vary its resistance. Varying currents were thus set up in the platinum wire, and these were led away to a microphone transformer, and dealt with in the usual way.

The Tucker microphone is said to give very good results, but, up to now, it has only been used experimentally for radio reception.

THE BALLAN BEAM



A full description of one of the most successful Beam stations—that erected some fifty miles north-west of Melbourne. It has been in operation for some three years, and carries out regular traffic with Great Britain and Canada.

By a Special Correspondent.

HAD you, a year or two ago, been asked to name the locality of Ballan, or even to cite the country in which it is, it is doubtful, unless you happen to be a geographical expert, whether you would have been able to make even a guess. For, at that time, Ballan was a little rural spot "down under" in Australia, quite "off the map."

As a radio enthusiast, however, you are now, of course, aware of the long-distance transmitting station operating on the beam system which has been erected at Ballan. So it is, therefore, that the progress of radio brings fame and popularity, as well as other more practical advantages, to previously almost unknown regions of the world.

The very successful Australian beam station at Ballan, near Ballarat, Victoria, some fifty miles north-west of Melbourne, has been in practical commercial operation for three years, and its transmissions to England have

seidom failed. The station works its English transmissions in conjunction with its companion English beam stations at Grimsby and Skegness. Furthermore, by means of a separate aerial system, the Ballan beam station also runs a regular service with Montreal, Canada.

Separate Receiving Station

It should be borne in mind that the beam station at Ballan is a transmitting one, pure and simple. It does not receive signals, this work being undertaken by a sister station erected at Rockbank, near Sydenham, about fifteen miles from Melbourne.

The Ballan beam station is interesting, however, on account of its constituting the first station to institute a regular service of radio communications with England at anything like an economic rate. Owing to the transmissions being conducted on the beam principle, the

THE "INS" AND "OUTS" OF THE BALLAN STATION

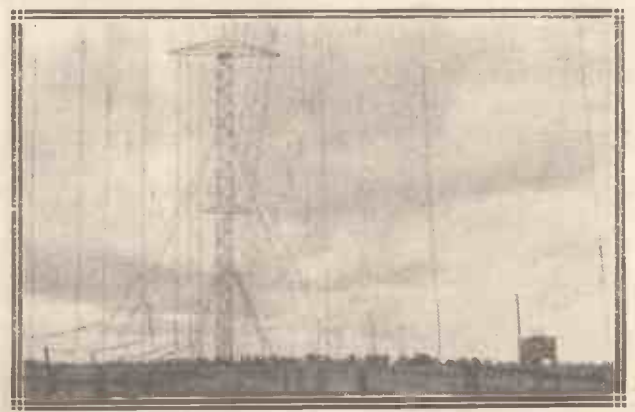

Left) The central radio office at Melbourne, whence communication with Great Britain is carried out via Ballan.
 (Right) The aerial and reflector systems for transmissions to England.

power used by the station is only 20 kw., as against approximately 1,000 kw. which would be required were the normal long-wave method of communication employed. This factor, coupled with the much greater freedom from atmospheric effects which is inherent in the beam method of transmission, has made the Australian beam service the success which it is at present.

Three interesting views of the aerial system employed at Ballan are presented in these pages. The aerial masts are some 260 ft. in height, and for the English transmissions three only of them are used. The aerial wires themselves are normally insulated, but it is interesting to note the large number of ground levers which are employed for the purpose of keeping the aerial support wires in a taut condition.

The Secret of Success

Very early in his experiments upon the beam system of transmission, Senatore Marconi made the discovery that the position of the sun in the heavens exerted a strong effect upon the transmission of beam signals, the latter sometimes travelling between England and Australia in a westwardly direction, and, at other times, in an easterly direction. In the morning, particularly, signals passing between Australia and England tend to travel across the Pacific and Atlantic Oceans, whilst during the evening they travel across Asia and Europe.

In consequence of these facts, the aerial system for the English transmissions at Ballan is constructed in order that the outgoing waves may be concentrated either in a westwardly or in an easterly direction at the will of the transmitting operator, and it is partly due to this fact that the efficiency of the station's service is always maintained at a high pitch.

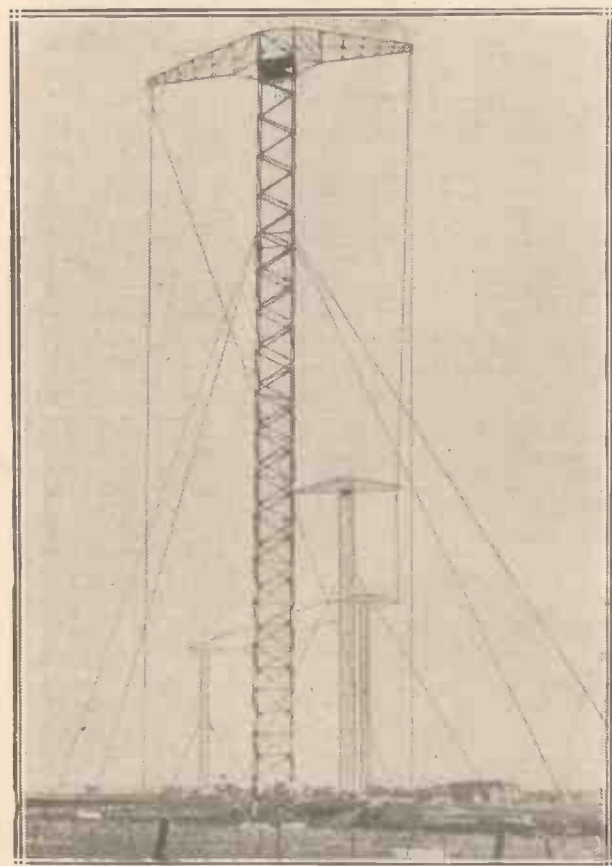

In the foreground are the "English" aerials, while behind can be seen the "Canadian" system.

The aerial feeder system of the station is of much interest. Much attention has been paid to the construction of this system which is responsible for conveying the high-frequency current from the transmitting house of the station to the aerial wires.

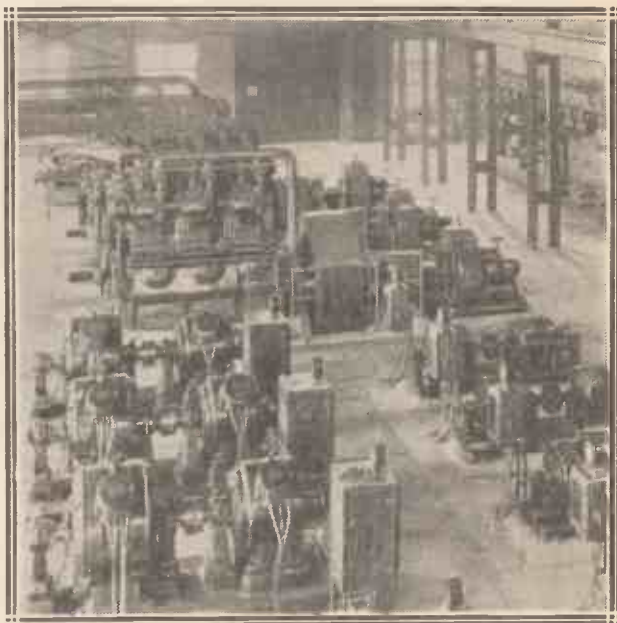

The power house at Ballan, in which are the main dynamos—oil-engine driven—and the alternators, filament current generators and main switchboard.

It is necessary for the feed wires of the aerial to be air-insulated in order to avoid losses. For this reason, the feeder tubes comprise two concentric copper pipes, the outer one being earthed and carried on iron supports. The aerial leads are run through the centre of the feeder tubes and are supported in position by high-efficiency porcelain spacing-insulators. Such an arrangement enables the entire feeder system of the aerials to be electrically and mechanically efficient, and to be free from break-downs.

In the centre of the feeder system is placed a small elevated structure. This is known as an "aerial coupling box," and it contains two coils wound on porcelain insulators. It forms a means of conveniently splitting up the aerial feeder wires and so supplying the required amount of current to any particular aerial wire. The operation of the box is, of course, on the well-known auto-transformer principle.

Oil-Cooled Valves

For some time past the station has transmitted on a 26-metre wave-length, although this value of wave is not yet entirely standardised. However, for a wave of this length the transmitting aerial contains 32 separate wires, and the necessary beam reflecting system comprises an arrangement of some 64 wires.

As will be seen from the photographs of the station (which, it may be stated, were taken previous to the serious fire which recently occurred there) the transmitting gear is fairly conventional in type. The station power-house has been constructed on a well-thought-out plan. Its primary power is derived from oil engines of the heavy type which are coupled directly on to compound-wound dynamos delivering some 500 volts each. Added to these, the power house contains its necessary complement of

One-Hundred-and-Fifty Words a Minute!

auxiliary generators, alternators, and transformers for the purpose of supplying current to the various circuits of the transmitter. A small emergency generating set is also maintained.

As mentioned before, the transmitting gear of the station has little out-of-the-way interest. In the oscillating unit, Marconi oil-cooled valves are employed. An H.T. direct-current supply for the anodes of the valves is employed at from 8,000 to 10,000 volts, and there is also a grid-bias voltage used of about 300 volts.

Tuning is effected in the customary manner by means of widely spaced coils, and the high-frequency circuits of the transmitter are arranged so that they can be altered for working on longer or shorter waves as quickly as possible.

How Signals are Sent

The transmitter is provided with a quick-working relay in order that it can be operated from the central offices at Melbourne.

A picture of a portion of the Central Radio offices in Melbourne is given, from which will be seen some of the high-speed operating gear in use. Signals transmitted to London have their origin at the table situated under the clock in the photograph. From here, high-speed messages pass out to the Ballan beam transmitter which they

operate. They are received in England at the Skegness station and automatically passed on to the London offices. Thus an unbroken communication between Melbourne and London is effected.

High-Speed Operation

As a matter of final interest, it may be mentioned that the average speed of working of the Australian beam transmitter is nearly 150 five-letter words per minute during busy periods. Of course, the communication is a simultaneous two-way one, and an equal speed of reception is maintained. The messages are typed by means of a typewriter which punches a series of holes in a ribbon, the latter being then passed at high speed through a transmitting device which controls the output of waves from the Ballan station in accordance with the holes made in the paper ribbon.

What future developments we may expect from the beam stations it is difficult to conjecture. It seems feasible and not asking too much to expect that telephony will follow in due course using some system of double working so that the Morse messages may still come through unimpeded.

Pictures have already been "beamed" across the Atlantic, and so it seems likely that great things will yet be done and that Ballan will add further to its laurels.

THE MAIN RECTIFIER UNIT AT BALLAN

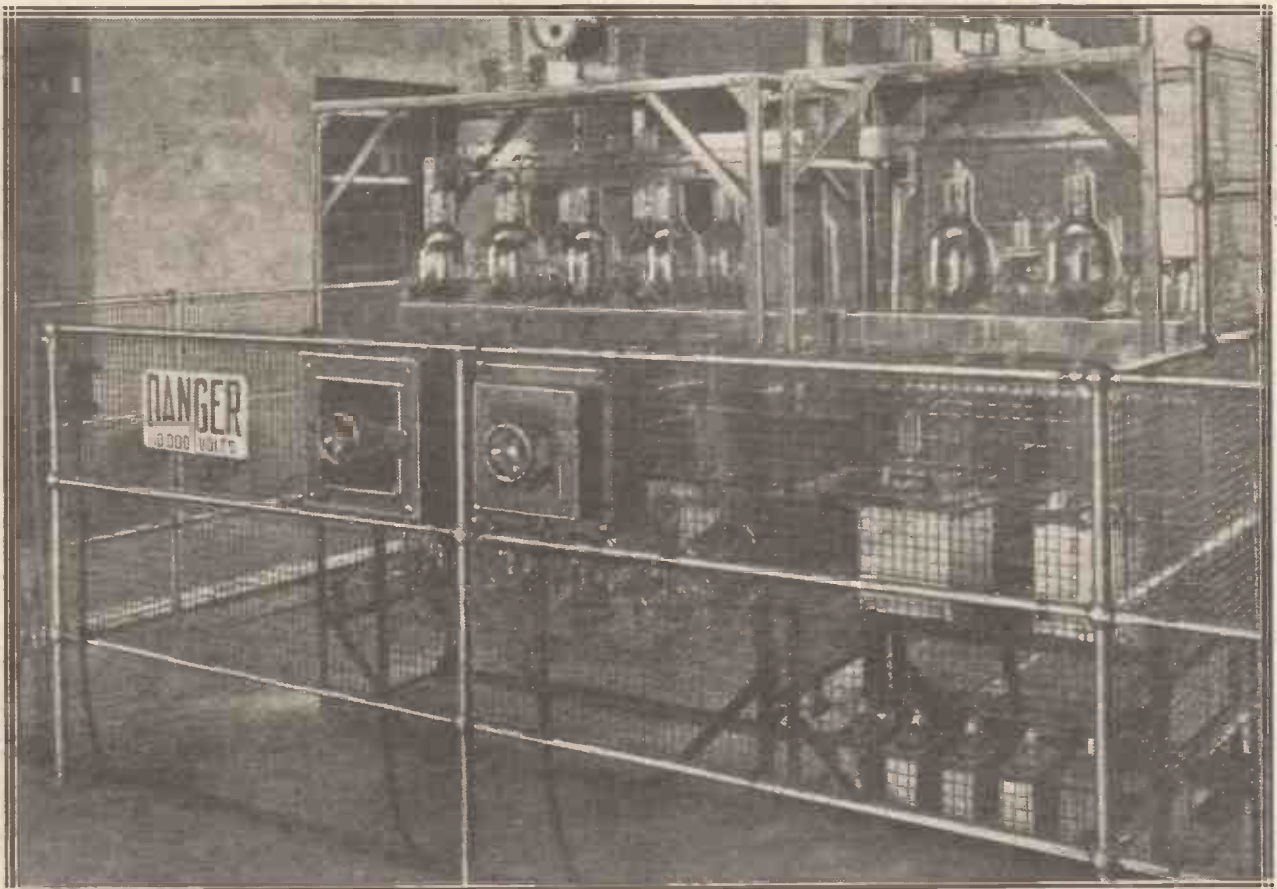

This illustration shows some of the rectifier valves which have to deal with the plate current for the Beam transmitter. Some idea of the voltages concerned can be gained from the notice on the left of the picture.

The

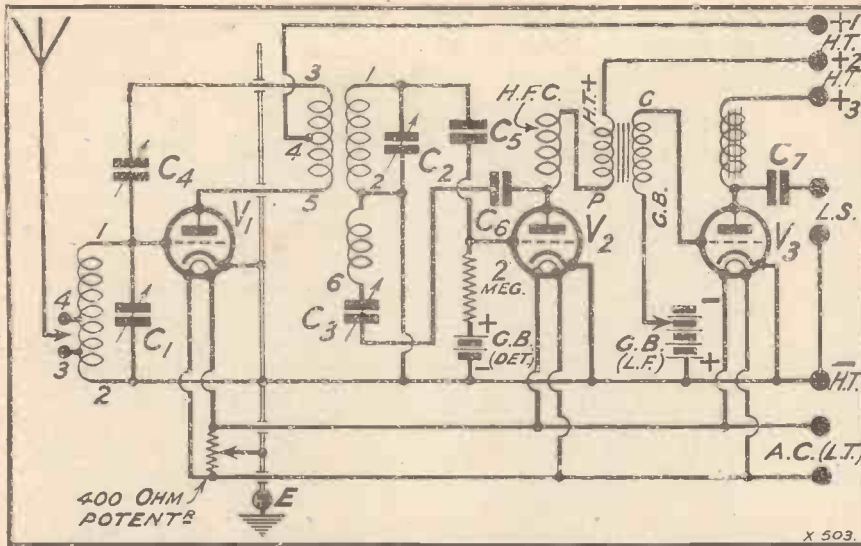

The circuit is straightforward, and there are no unnecessary complications.

WE have recently been thinking over the problem of the all-mains set in a rather critical frame of mind, and we came to the conclusion that most of the previous designs for the home-constructor suffer from the same defect: they are apt to be exceedingly bulky and heavy when they incorporate a fair number of valves.

Built-In Power Units

This applies more particularly to the sets designed for A.C. mains, and the reason is not far to seek, for it is obviously to be found in the fact that in most cases the H.T. and L.T. (i.e. low-voltage A.C.) supply circuits have been built in. The result is usually a decidedly unwieldy receiver which certainly looks rather alarming as a constructional job.

This drawback alone was sufficient to make us consider seriously whether this was really the best way to arrange an all-mains set, but it is not the only one inherent in this type of assembly. There is another

which is quite a grave one from the point of view of the intending constructor, and probably helps to explain why many people hold back from such sets, despite their well-known advantages.

This second point is simply that to make such a set involves constructing a complete built-in mains H.T. supply circuit, and there are two objections to this proceeding. First of all, many prospective constructors already possess a perfectly satisfactory separate mains H.T. unit which they naturally wish to use with any future set they may build.

Reducing Re-building

Secondly, if you build a mains set of the "all-in" type there is always the feeling that when you later decide to make something else (as everyone expects to do sooner or later!), there will be the whole H.T. circuit to pull to pieces and re-build, as well as the receiver portion proper. The extra expense and work is obvious, and it was this consideration which decided us to see whether some simpler and less costly way of arranging an all-mains receiving equipment could not be devised.

Now, we do not wish to insinuate that the all-in type of mains set is a

mistake. Far from it, this is a most useful and convenient type of set in many ways. The point is that it does not suit everyone, and we have endeavoured to devise a scheme which will satisfy the needs of those to whom its particular drawbacks have hitherto been a bar.

Our suggested solution of the problem is almost ludicrously simple, as you will probably have discovered if you have had a look at the photos illustrating this article. "Silly simple" as it may appear, we think you will agree on thinking the matter over that it is a perfectly logical way of tackling the question.

The idea is this: build the set very much like any ordinary battery-supplied type, with the usual row of H.T. and L.T. terminals, and just use a separate mains H.T. unit!

A Simple Solution

The only special provision in the set itself is really in the equivalent of the L.T. circuit. Instead of using ordinary valve sockets, one fits the special holders required for A.C. valves, and the "heater" terminals of these are wired up with twisted flex and connected to the L.T. terminals. Instead of connecting to these terminals the usual L.T. battery, we join up the secondary of a small step-down power transformer and supply them with alternating current at 4 volts. This transformer need not cost more than about 12s. 6d., and replaces the L.T. battery. The current consumption from the mains is extremely small.

For the H.T. supply any good standard unit can be used, while the constructor who does not possess one can even run the set from an H.T. battery at first and build a mains unit at his leisure. Meanwhile, he has the



Here is the complete equipment of the "A.C." Three, using the mains for both L.T. and H.T.

"A.C." Three

A complete solution to your question of "How use the A.C. mains for L.T. and H.T." Here is the simplest and most effective mains set yet placed before set constructors. You can use this fine set with ordinary H.T. or with an H.T. eliminator, or you can use an H.T. battery eliminator and ordinary L.T. with battery valves if you so desire.

Designed and described by the "M.W." Research and Construction Dept.

a pentode and perhaps even a screened-grid H.F. valve. Actually, it was not far short of a normal four-valver, and brought in a most excellent string

plate building it as a really sensitive long-range set, capable, too, of giving excellent quality on the local station, may rest assured that if he does so

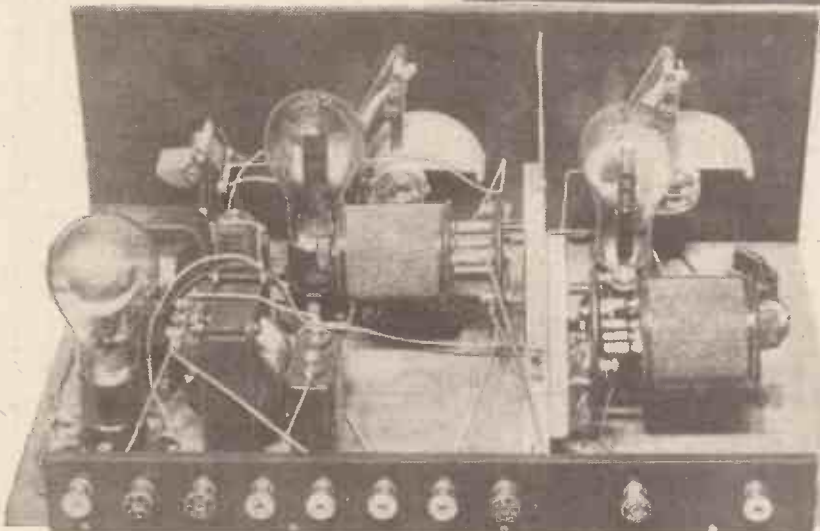

The construction of this "A.C." set is as simple as any ordinary battery operated receiver, while its power and selectivity are well above the average.

advantage of having got rid of the L.T. battery, no small step in itself. Then, later, he will obtain true all-mains working when he adds the H.T. unit.

High Efficiency

Apart from the convenience of having no batteries except for grid bias, it should not be forgotten that a set using the special A.C. valves (indirectly heated type) is also extremely attractive from the point of view of performance. These valves possess extraordinarily good characteristics, and enable one to obtain very fine results indeed with a receiver of quite moderate size.

The one we are about to describe, for example, put up a show on test which would be very difficult to equal with battery valves unless one used

of stations at genuine loud-speaker strength. We do not consider it a fair guide to print the long list of stations obtained by a skilled operator with the aid of an accurate wave-meter, but anyone who may contem-

he will have an instrument of which he may well be proud.

A Simplified Design

The design which we have chosen to form our first example of this simplified type of all-mains receiver has been made (intentionally) very plain and straightforward, since we wished particularly to make its advantages available to the constructor who can afford only a moderate outlay and does not wish to tackle a very elaborate affair.

The H.F. side is modelled upon the arrangement of the three-valve "Solodyne" receivers published in "M.W." last summer, which proved exceptionally efficient. The key to its success, of course, lies in the method of screening and coil-mounting. This scheme provides exceedingly good separation of the plate and grid circuits of the H.F. valve, yet has only a trifling effect upon the

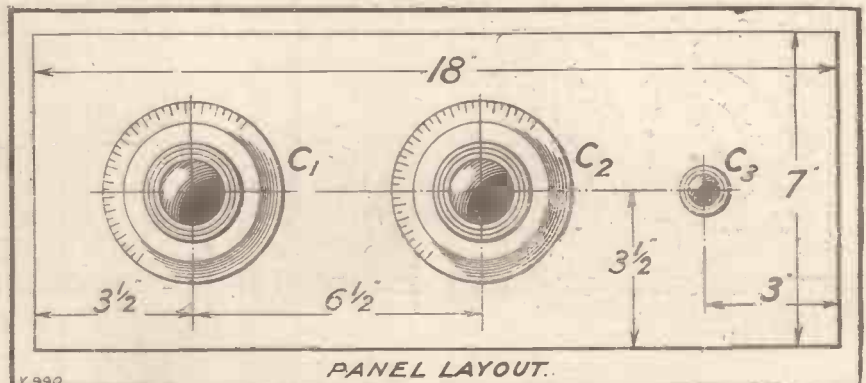

PANEL LAYOUT.

efficiency of the coils, and permits very effective operation of the H.F. stage as a whole.

An examination of the photos will show you the essence of the idea. A single vertical screen of the standard "M.W." type is used, and the coils (cylindrical ones) are mounted on the sides of this in suitable positions. The six-pin bases of the ordinary type are each mounted on a block of wood about 3 inches square and $\frac{3}{8}$ inch thick, which are in turn screwed to the screen, and the result is to cut off just that portion of the coil fields which would otherwise stray and interact. The remainder of the field is not interfered with, and so the efficiency of the coils is practically unaffected. This is an important

point, and has much to do with the excellent results the set gives.

Types of Coils

The coils used, as you will have gathered, are of the 6-pin standard type, which many constructors will already possess. They happen to suit this circuit particularly well, since the "split primary" method of neutralising goes very nicely with the valves for which the set was designed (Cosmos indirectly heated type). One is a "split-primary aerial coil" and the other a "split-primary H.F. transformer," and you will require one of each for the lower wave-band, and one of each for the upper. The flex lead from the aerial terminal, you will observe, can be connected to

either No. 3 or No. 4 on the aerial coil socket, and this gives different degrees of selectivity in the usual manner.

The detector and L.F. portion of the set is of a quite standard nature, with leaky-grid rectification, "Reinartz" reaction, and transformer coupling to the last valve. There is nothing to delay us here, and we can go on to one or two constructional points requiring explanation. First of all, about those coil mountings. The blocks of wood on which the coil bases are fixed are attached to the screen by drilling two or three holes in the latter and passing wood screws through them into the blocks.

In the wiring operation do not

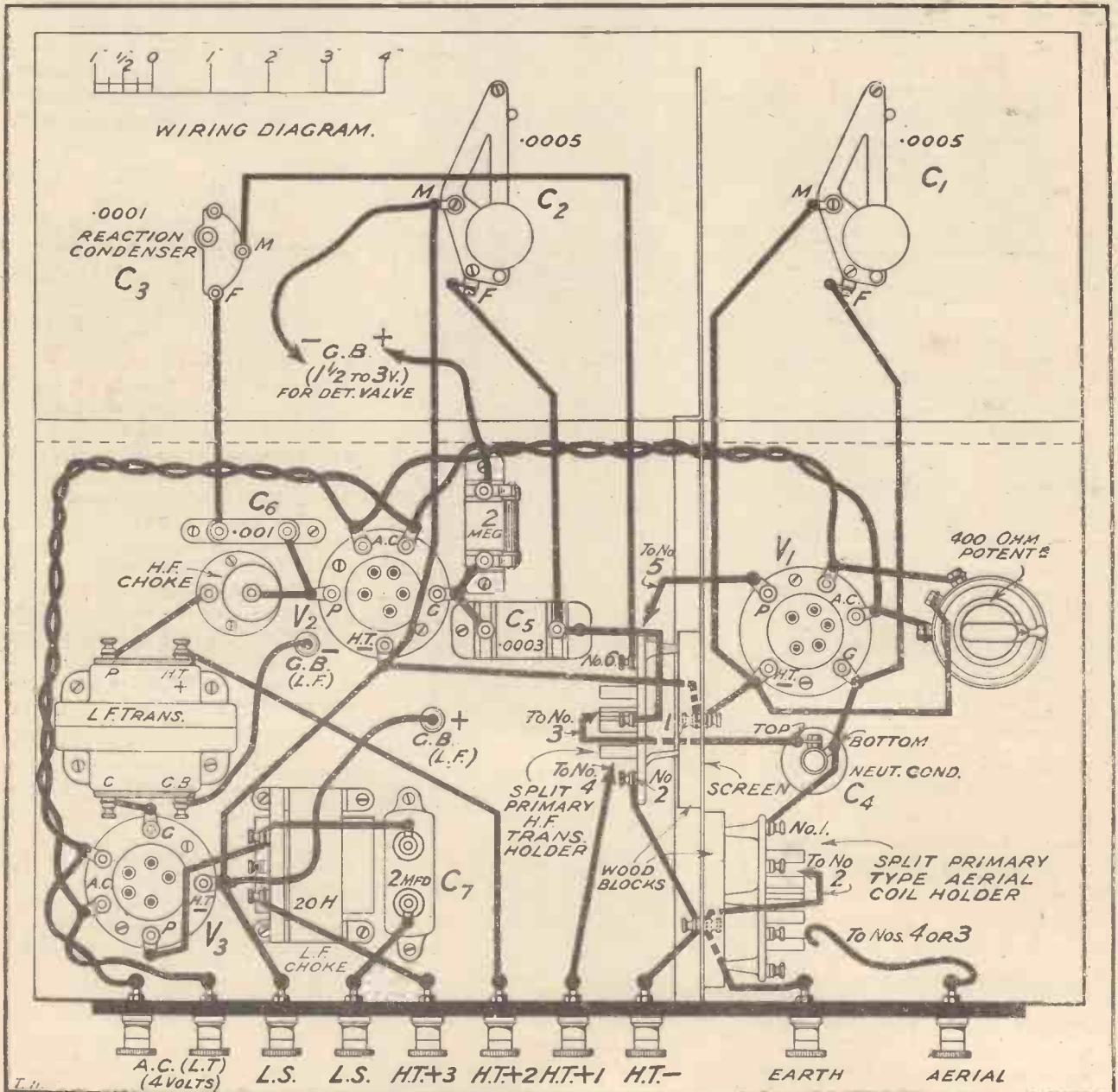

A New "All Mains" Scheme

forget to use twisted flex for the A.C. supply to the valves, to avoid induction effects into the rest of the wiring. This is most important. Another wiring point to note is that it was not possible to show all the connections to the coil bases quite clearly on the wiring diagram, so we adopted a scheme which we think you will find quite easy to follow.

COMPONENTS REQUIRED.

- 1 Panel, 18 in. × 7 in. (Resiston, Kay Ray, Becol, Trelleborg, Ripault, etc.).
 - 1 Cabinet, with baseboard 10 in. deep (Artercraft, Pickett, Raymond, Gilbert, Camco, Lock, etc.).
 - 2 .0005-mfd. variable condensers (J.B. Igranic, Lissen, Gecophone, Ormond, Lotus, Utility, Colvern, Bowyer-Lowe, Pye, Dubilier, Raymond, Burton, Cyldon, etc.).
 - 1 .0001 or .00015-mfd. reaction condenser (Burton, Raymond, Dubilier, Lissen, Ormond, Utility, Bowyer-Lowe, Cyldon, Peto-Scott, J.B., etc.).
 - 3 Special A.C. valve holders (Cosmos).
 - 2 6-pin bases (Magnum, Lewcos, Bowyer-Lowe, Raymond, etc.).
 - 1 Standard "M.W." screen, 10 in. × 6 in. (Magnum, Ready Radio, Paroussi, Wearite, etc.).
 - 1 200- or 400-ohm baseboard potentiometer (Igranic, Lissen, etc.).
 - 1 Neutralising condenser (Gambrell, J.B., Bowyer-Lowe, Magnum, Peto-Scott, etc.).
 - 1 Low-ratio L.F. transformer (Lissen, Brown, R.I., Ferranti, Cossor, Philips, Igranic, Mullard, Marconiphone, etc.).
 - 1 Output filter choke (Magnum, R.I., Wearite, Ferranti, etc.).
 - 1 H.F. choke (Wearite, Varley, Lewcos, Lissen, Climax, Dubilier, Igranic, Magnum, R.I., Bowyer-Lowe, Colvern, etc.).
 - 1 2-meg. grid leak and holder (Igranic, Dubilier, Lissen, Mullard, Pye, Ediswan, etc.).
 - 1 2-mfd. condenser (Dubilier, Lissen, T.C.C., Ferranti, Mullard, Hydra, etc.).
 - 1 .0003-mfd. fixed condenser (Dubilier, Lissen, Mullard, Clarke, Goltone, Igranic, T.C.C., etc.).
 - 1 .001-mfd. fixed condenser (T.C.C., etc.).
 - 1 Terminal strip, 16 in. × 2 in. × ½ in.
 - 10 Terminals (Ealex, Belling & Lee, Igranic, Burton, etc.).
 - 1 A.C. transformer of correct rating for your mains to give about 5 amps. at 4 volts (Heayberd). (See text.)
- Wire, flex, G.B. plugs, screws, etc.

The leads going to the bases are numbered where necessary to indicate the numbers of the terminals on the sockets to which they go. These terminals are clearly numbered on standard bases, and with this key you should not experience any difficulty.

Now about the small step-down transformer which supplies the low-voltage alternating current for the "heaters" of the valves. You will quite likely find that the secondary of this has three terminals, and the middle one is a centre-tap on the winding. This is not used in the present receiver, in which a potentiometer on the baseboard is employed to locate a neutral point on the heater circuit, which point is wired to the "earth" circuit to remove any noticeable hum (with a well-smoothed H.T. supply there should be practically none).

L.T. Connections

The two outer terminals are wired to the "L.T." terminals of the receiver, preferably with twisted flex, while the primary terminals are connected to the mains, either through

place the transformer inside the set itself, and we have taken care to arrange the layout so that there shall be a suitable space on the back of the cabinet just to the right of the inter-valve screen.

Try the transformer here, by all means; connect its metal case to earth with a lead secured under one of its fixing screws (scrape the metal foot of the transformer bare to get good contact), and see whether you get a serious hum. If you do the transformer should be enclosed in a box for safety's sake, and placed at a little distance, say, alongside the H.T. unit. Very likely, however, it will be quite satisfactory inside the set cabinet.

Now there is the question of the H.T. supply. Any good well-smoothed unit will serve our purpose, such as the "Avac" unit described in "M.W." for April, 1928.

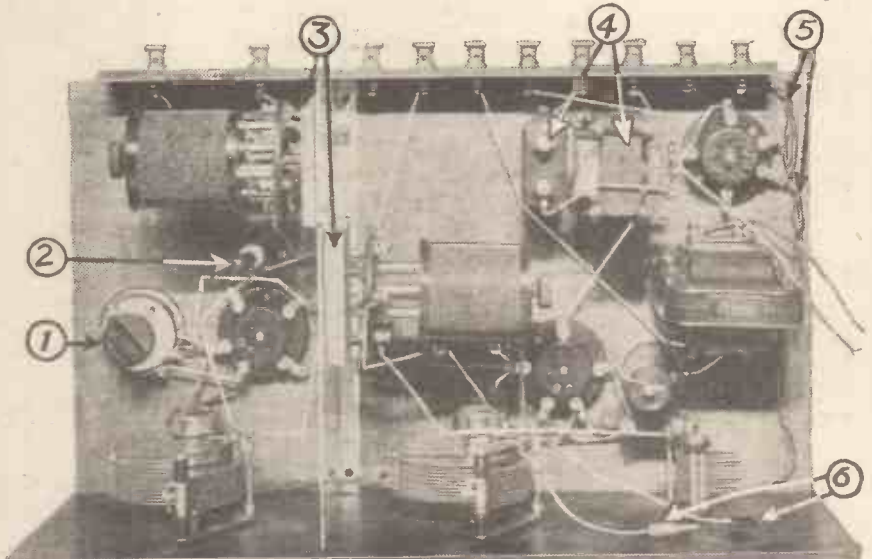

The numbers indicate: (1) the 400-ohm potentiometer; (2) the neut. condenser; (3 and 4) blocks of wood for mounting coil-holders; (5) the L.T. flexible leads; (6) the grid-bias plugs for the detector valve.

a flex lead and a lamp adaptor, or in any other convenient fashion. For example, the flex lead could be inserted in the same plug or adaptor used for connecting the H.T. unit to the mains, so simplifying the connections a little.

The placing of the L.T. transformer is a matter which is very much for the builder to decide according to his own circumstances. It is usually best to arrange it a little way from the set, to avoid induction effects which might introduce hum, but this is by no means always necessary. On many mains it is quite practicable to

If you do not possess a suitable one, note that we propose to describe one in an early issue which will provide the necessary 4-volt low-tension A.C. supply as well as the H.T., so if you intend to wait for this do not buy a step-down transformer just yet. The voltages required, by the by, are as follow: H.F. valve, about 100 volts; detector, 30 to 70 volts; L.F., 120 to 180 volts.

Valve Types

The valves used in this set are the Cosmos indirectly heated ones, the types being two A.C./G.'s (H.F. and

detector), and one A.C./R. (power). The grid bias for the third valve should be from 9 to 12 volts, according to the H.T. applied (see data slip with valve).

A small separate G.B. battery is also required, to apply $1\frac{1}{2}$ or 3 volts positive bias to the detector by means of the plugs provided.

The New A.C. Valve Holders

The valve holders, by the way, used in the original set were the ones at present employed for this type, but it is understood that a new standardised form will be introduced shortly. You will not have any difficulty in making the necessary slight revision in the wiring to suit the new fitting if it should be introduced before you decide to build the set, however.

Operating the set is practically as simple as with any ordinary three-valver of the H.F., detector and L.F. type, and the only special point concerns the setting of the potentiometer. This is not at all critical, and so will be found quite simple. All that you do is to switch the set on, wait a few moments for the valves to heat up, and then turn the potentiometer to the setting giving the minimum amount of hum (silence, for all practical purposes).

How to Neutralise

The other preliminary adjustment is that of neutralising, for which we advise our standard "reaction demands" method, according to the method described below.

Set the reaction control at minimum, and likewise the neutralising condenser. Now, on setting the tuning condensers so that the two tuned

circuits are in step with each other, it will probably be found that the set is oscillating. You will probably find that the set will only oscillate under the above conditions when the two circuits are in tune with each other,

oscillation ceases. Slightly readjust the tuning condensers again to make sure that the set is completely stable once more. Proceed in this way until it is found that the correct adjustment of the neutrodyne condenser has been

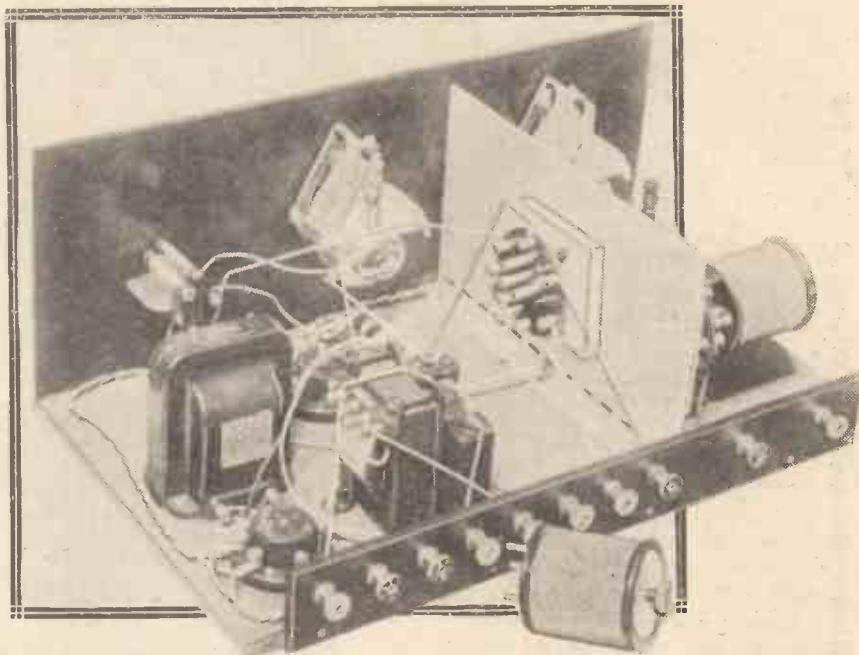

Here you can see very clearly the detector and L.F. end of the set. The H.F. transformer has been removed from its socket. Note the stout flex lead L.T. wiring.

and this can be used as an indication. It is convenient to perform the operation at some point near the middle of the tuning range. Now, increase the capacity of the neutralising condenser.

Test at intervals for oscillation as this is done, and you will presently find that the set has ceased to oscillate and will not recommence even when the tuning dials are slightly readjusted. Now increase the reaction a little, until the set once more oscillates, and again increase the neutralising condenser setting until

over-shot. Once this point has been passed it will be observed that further increases of the neutrodyne condenser setting no longer stop oscillation, but cause it to become stronger, and so you can quickly locate the right adjustment.

By the way, if you find that the set does not oscillate with the reaction and neutralising condensers at minimum, first increase reaction gradually until it just does so.

Now for some miscellaneous points about the actual use of the set. Tuning on the left-hand dial is not at all critical when the set is exactly neutralised, hence searching is particularly easy. As the circuit stands, the overall selectivity is good.

Greater Selectivity

It may be improved slightly, however, if a specially high standard is needed, by using a little negative grid bias on the first valve. To make this addition, just break the lead between No. 2 terminal of the aerial coil socket and the screen, and insert between these points a single small dry cell, with the negative towards the coil base terminal. (It is just as well to connect a fixed condenser of .001 mfd. upwards across in parallel with this cell, i.e. between No. 2 terminal and the screen.)

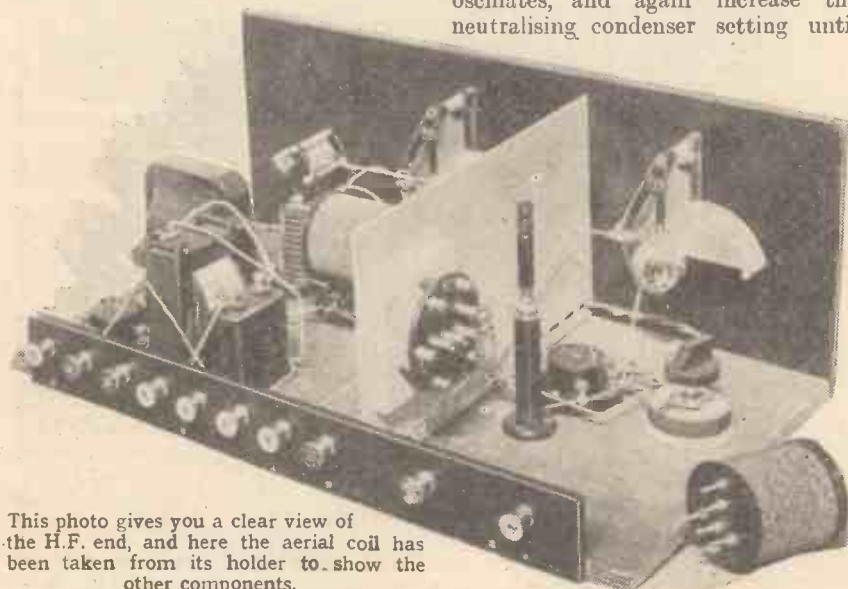

This photo gives you a clear view of the H.F. end, and here the aerial coil has been taken from its holder to show the other components.



A RECENT PHOTOGRAPH OF MR. CORBETT-SMITH.

*For the wine was old an' the night was cold,
An' the best we may go wrong!*

THE casual, remembered lines from a Kipling "Barrack Room Ballad" jingled through my head.

It is odd how some trifling, everyday fact of the moment will often evoke the queerest literary association; and you may well ask what imaginable link there is between "The Shut-Eye Sentry" and a bludgeon attack upon British broadcasting in the pages of a very serious monthly sociological review.

The B.B.C. programmes are so "mediocre" and inadequate, the financial basis is so preposterous, that we should forthwith adopt the American model and hand over our radio entertainment to national commercial advertisers for production upon a competitive basis.

Relevant Evidence Ignored

Such, in brief, is the argument of Mr. N. Bantock Reynolds, set forth with a wealth of detail and statistics in "The Realist." And Mr. Reynolds, like Mr. Kipling's Indian Army officer of the ballad, seems to me to be one of "the best" who, for the moment, has "gone wrong."

Now, those readers of MODERN WIRELESS who honour me with their attention when, as now, the Editor allows me the privilege of a chat will need no reminder that I am no partisan of the B.B.C. Indeed, I am probably their sternest critic, and "bite my thumb" at them whenever occasion may warrant. I am vastly unpopular with that august body in consequence.

But here, surely, is an occasion for crying "Fair play!" and I decline to emulate Mr. Kipling's sentry and play shut-eye. Suppose, then, that we consider for a moment Mr. Reynolds' argument.

SHALL WE COPY UNCLE SAM?

This alternative to the B.B.C. is often put forward by many of the critics of British broadcasting as at present organised. But would American methods be acceptable, or even practical, in this country?

By A. CORBETT-SMITH.

"The devil can cite Scripture for his purpose," cried Shakespeare's Antonio. If Mr. Reynolds is an American citizen, I shall venture the suggestion that he is playing the part of the fox who had his tail cut off in a trap, and who tried to persuade all his fellows that tail-bobbing was the height of fashion and comfort.

If he is a British citizen, then I shall suggest that, while his statistics are accurate, his second premise—that of the programmes—is unsound. He has ignored that mass of relevant evidence, easily obtainable, which could not fail to present to his mind a picture almost precisely the opposite of that which he has painted for us. Mr. Reynolds gives us, in short, a lop-sided and strongly prejudiced argument. His conclusion fails.

Entertainment for Nothing!

The one and only point at issue, the only one for which Mr. and Mrs. John Citizen care a rap, is the programme quality and its value against the fee paid. It is quite reasonable to suggest that, upon the finance figures, that

HENRY'S ETHER SHAKER



The Ford Motor Co. operate this picturesquely situated station at Michigan, U.S.A.

fee might be halved; but Mr. Reynolds contends that by adopting the American method we should secure a vastly better entertainment for nothing, once our set were installed:

Now there, I suggest, is false psychology to start with. We may, in a sense, enjoy getting something for nothing, but who values it when won? I am sure, for example, that we are all enjoying our holiday this year infinitely more for having earned it, or for having saved the shillings. We have won self-respect.

So with radio. Besides, payment, even at ½d. per day, allows us our immemorial privilege of "grousing." You will remember the incident of the man who was given a free theatre seat, and who went out after the first act and paid for it, in order to return and hiss the play. In America they have to take what they can get and be thankful.

PRESS PROGRAMMES

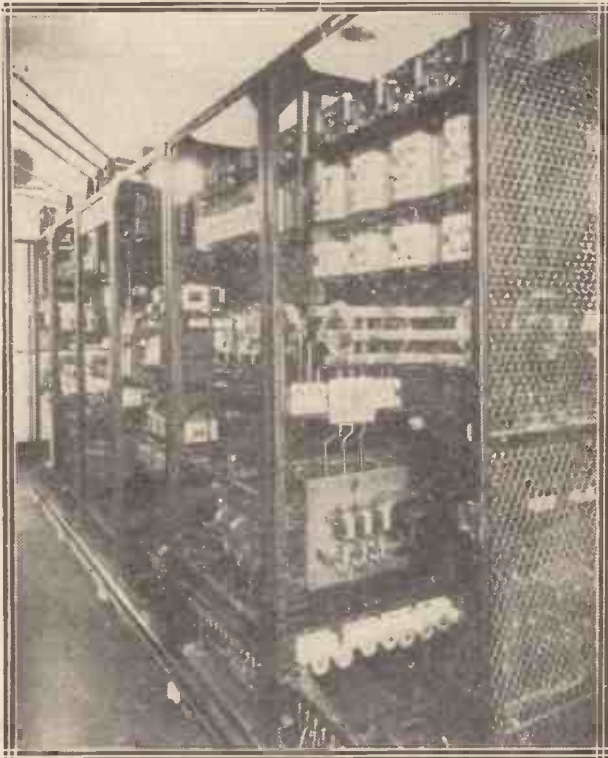

The Detroit Free Press newspaper shares this broadcasting plant with a firm of radio manufacturers. The paper uses the call W C X, and the radio people W J R. The studio is in Detroit, and the power used is 5 kw.

By the American system, through 700 radio stations (there are 44 in New York State alone), the great national advertisers provide, I believe, no more than about 20 per cent. of the day's programmes. That percentage is necessarily covered by the best artists obtainable—according to American tastes.

That "Medley Population"

The rest of the programme time is devoted, in the main, to a species of so-called entertainment, strongly advertisement, of a character which, I am convinced, our people would not tolerate for a couple of days.

To compare American with British radio entertainment is like trying to compare "Comic Snips" or "Snappy Chippets" with the plays of Shakespeare.

America is a vast, self-contained continent with a

population nearly three times the size of our own. Two-thirds of that population is composed of Germans, French, Austrians, Italians, Russian Jews, Poles, Portuguese, Hungarians, Scandinavians, Turks, Armenians, Greeks, Dutch, Chinese, and eleven million Negroes. There are millions of folk there who cannot understand a word of English.

We may presume that those 700 stations deliberately cater for that medley population. Mr. Reynolds would have us adopt the same method for a tiny, crowded island, homogeneous in race, culture and interests, the whole of which is practically within crystal-set range of a central S.B. radiating station.

Here is Direct Comparison

If we, as I suggest, could not tolerate American system programmes, so British programmes are completely beyond the American folk. Apart from the fact that Americans would never allow themselves the time to listen to them, we must reckon in the low mentality of the big majority.

The mentality of the American "hicks" of the great Middle West is well-known. It is sufficiently evidenced by the very low standard of cinema films offered to them, and to America at large, and which the "movie" magnates fondly imagined were good enough for the British market.

Just twelve months ago America thought fit to cable to us the big head-line news that one or two leading radio stations there were going to transmit, by way of experiment, a short series of symphony concerts by a first-class orchestra. Also that they were seriously considering the radio production of Gounod's "Faust."

Just six years ago a single small British provincial station was pouring out a weekly symphony concert, grand opera, regular series in noble literature and poetry, all the plays of Shakespeare in historical sequence, other famous plays of all kinds, travel pictures, chamber music, and I know not how many other important features.

"Ponder these Facts"

To-day, in our radio, we may be getting too much "education"; the guiding spirit of humanity and of the human touch may be signally lacking. But let anyone consider, without prejudice, the programme detail in any single week's issue of the "Radio Times," its astonishing variety, the meticulous care of arrangement and timing, the average high standard of performance, the valuable continuity, the big ideals suggested—let anyone, I say, ponder these facts and then declare whether he would sacrifice them for the casual hours of competitive commercial advertisers, each bent upon securing for himself the maximum publicity for his tin-tacks, mustard, or lingerie.

Come, Mr. Reynolds, surely you are not serious. Shall we, at least, give you the benefit of the doubt?

And if, as I suggest, your psychology is at fault, and that your logical syllogism is unsound, are you even confident over your economic facts?

Bearing in mind the general character of our national trade as that of a dependent island, do you feel assured that a sufficient number of advertisers, with the necessary funds at disposal for those super-programmes, would be forthcoming to maintain the entertainment even for twelve months?

(Copyright in the U.S.A.)



GRID-BIAS ADJUSTMENTS

The grid-bias battery is generally the smallest battery used in a radio receiver, but it does work of the utmost importance, and therefore should be carefully adjusted and kept in good order.

By H. A. R. BAXTER.

You build or buy a new set. You plug-in the valves, tie up the batteries, adjust the H.T. and G.B., and that is that. Every now and then you have the L.T. accumulator charged and every more-widely-spaced "now and then" you renew the H.T. In the interim you do a lot of knob twisting, get many stations and enjoy hundreds of programmes.

Meanwhile that little G.B. battery sits on the baseboard as modestly as a fixed condenser. In a way it is a pity that the G.B. battery does not have to deliver a current and thereby run down fairly quickly. As it is the G.B. battery merely deteriorates.

Save Your H.T.

I expect if a voltmeter census of grid-bias batteries were taken you'd find that over fifty per cent of those in use were hopelessly exhausted. Now this is all wrong, not merely from the point of view of the quality of reproduction, which must suffer when the G.B. battery runs down below the figure needed for proper biasing, but because the H.T. may be wasting away.

In the case of a power valve, and it is here that G.B. is always used, the amount of G.B. (in volts) determines the H.T. current that shall flow, given a certain definite H.T. voltage.

Quality no Real Guide

A power valve connected to 120 or more volts H.T. may need 10 volts grid bias according "to the book." Perhaps at this there will be 10 milliamperes current drain on the H.T. battery. But generally you can with no ill-effect give a valve more grid bias than the makers specify, so that if you are a careful amateur that valve will perhaps have 12 volts bias and be "using" only 8 or less milliamps H.T.

Should the G.B. battery have depreciated so much that the 12-volt tapping is providing a potential difference of only two or three volts, then the H.T. consumption may have risen to 20 or more milliamps. Enough to run down a large dry battery very quickly indeed.

And large dry batteries are expensive—they cost many more tens of shillings than the wee battery that supplies that regulating G.B.

Don't jump in here and say that quality will have gone "phut" and plainly indicate that things are not as they should be. Only a milliammeter will clearly show this.



Tucked away on the baseboard, the grid-bias battery is often likely to be somewhat neglected.

You see that G.B. battery will have run down very gradually, and you may have become slowly acclimated to the distortion. And this at its worst might be by no means as bad as the valve curve, etc., will make out. It is surprising what fairly good results you can get under such conditions.

Use a Milliammeter

The voltage of a G.B. battery will drop quite a bit before it has outlived its usefulness, but if you would save your H.T. and retain the perfect quality that was initially yours, then you will, every week or so, check up the G.B. battery's voltage and the plug adjustments for the various valves to which it may be connected.

A milliammeter provides an excellent check on the state of the G.B. as well as on the general efficiency of the set. It need not be a precision instrument, a cheap one reading up to 25 or so milliamps is all you want.

It should be connected in series with the H.T. battery minus lead and thus registers the total current flow from the H.T. battery.

Early Indication of Trouble

If the needle kicks about while the set is in operation then there is a faulty G.B. adjustment or the serious overloading of a valve. If the reading rises a lot, then either the H.T. battery is giving many more volts or the G.B. battery is running down. Of course, the latter will no doubt be the case.

A milliammeter also gives you an indication of the state of the L.T. battery. If the reading starts to fall seriously, then the L.T. needs immediate attention. Finally, don't forget to have the milliammeter in a position where it can easily be seen.

The Mystery of Radio Waves

It is universally known that light waves all travel at the same rate whatever their wave-length; and they probably do this not only in free space, but even inside transparent matter so long as the atoms do not contain accessible electric charges. Hence, light of all colours travels at the same rate simultaneously from the source. If it were not so, a flashing light would give you an initial blue first and a final red after, or vice versa. Whereas, in fact, all the waves travel together.

The Space Between the Atoms

The same is true of sound. Else when we listened to a band at a distance we should get the treble notes before the bass notes, or vice versa, and the music would be confused. This was pointed out by Sir Isaac Newton himself. The velocity is not by any means the same in dense substances as in air.

For instance, in water sound-waves travel four times as quickly as in air, and even quicker still in wood, such as deal. But whatever their speed may be, all wave-lengths travel at the same rate, so that there is no separa-

 * A fascinating and instructive article, the first of an exclusive *
 * series, by the most popular of all scientific writers and broadcasters. *
 * Sir Oliver deals with the subject in an entirely new way and throws *
 * a fresh light on etheric wave motion. *
 * (1) ON WAVES IN GENERAL. *

tion, or what is called dispersion, in the case of sound; at least, so far as I know, none has ever been observed.

But in the case of light this is not quite true. In a dense substance like water or glass all light travels slower, but the short waves which produce the sensation of blue when they enter the eye are a trifle more retarded than the long waves which produce the sensation of red. Hence, in a dense medium there is some dispersion; and Newton discovered it by passing light through a block of dense material whose facets of entrance and exit were not parallel, in other words, through a glass prism.

The bending of the light depends on the retardation of speed, and since waves of different length have slightly different speeds, their bending is slightly different. They are sorted out by the prism into a spectrum, which is the beginning of spectrum analysis.



“ . . . and when the big Atlantic rollers reach shore they hurl themselves on the beach . . . ”

By Sir Oliver Lodge, F.R.S.

All that is familiar knowledge, though if we proceed to ask *why* light is retarded when passing through a dense substance, and why waves are retarded differently and therefore refracted differently, the question becomes more difficult to answer.

I will not attempt it here, save to say that it is by reason of some interaction between ether and matter, something dependent on the atomic constitution of matter, which can be expressed incompletely and unsatisfactorily, without going into full details by saying that the presence of matter modifies or virtually loads the ether, so that effectively it transmits light slower.

It must never be thought that matter transmits light. Transmission is wholly an affair of the space between the atoms. It is the ether that conveys light always, but it does not transmit it so easily and quickly in the interior of matter as it does in the freedom of empty space.

Sound is Transmitted by Matter

Thus light is in many respects more complicated than sound. Sound is really transmitted by matter; and whether it is conveyed fast or slow, the pitch or rate of vibration is not affected, so that we can hear music through wood or any other material just as well as through air.

Looking through glass, on the other hand, even through an uncorrected telescope, we see everything with a coloured fringe. White light does not remain altogether white; it is partly sorted out into its constituents.

Still, it is roughly true that waves of all length travel at the same rate. Even our long wireless waves are believed to travel at the same rate as the minute waves, less than $1/1,000$ th in. in length, which affect the eye and which we commonly call light. But in this respect the waves of light and of sound differ from nearly all other waves.

The Law of Speed

Waves on the surface of the sea, for instance, travel by no means all at the same speed. If one wave were four times as long as the other from crest to crest it would travel at double the speed. The velocity of big waves varies directly as the square-root of the wave-length; so that big Atlantic rollers travel at a great speed, much faster than a ship; they overtake it and pass under it, and when they reach shore they hurl themselves on the beach with some residual fraction of that speed, though really big waves can hardly travel except in deep water.

There is another class of wave on the surface of water which we see as crispations of the surface, and which are properly called ripples. We can produce them by throwing a stone into a pond, we see them spreading from a rising fish; or we can produce them by blowing on the surface of a teacup. These travel very much slower.

If the wave-length is two-thirds of an inch they travel at the slowest possible rate—namely, at 9 in. a second, in the case of water. For if they are still shorter than that they begin to travel quicker, so that the smallest ripples, such as could be generated by a tuning fork, may

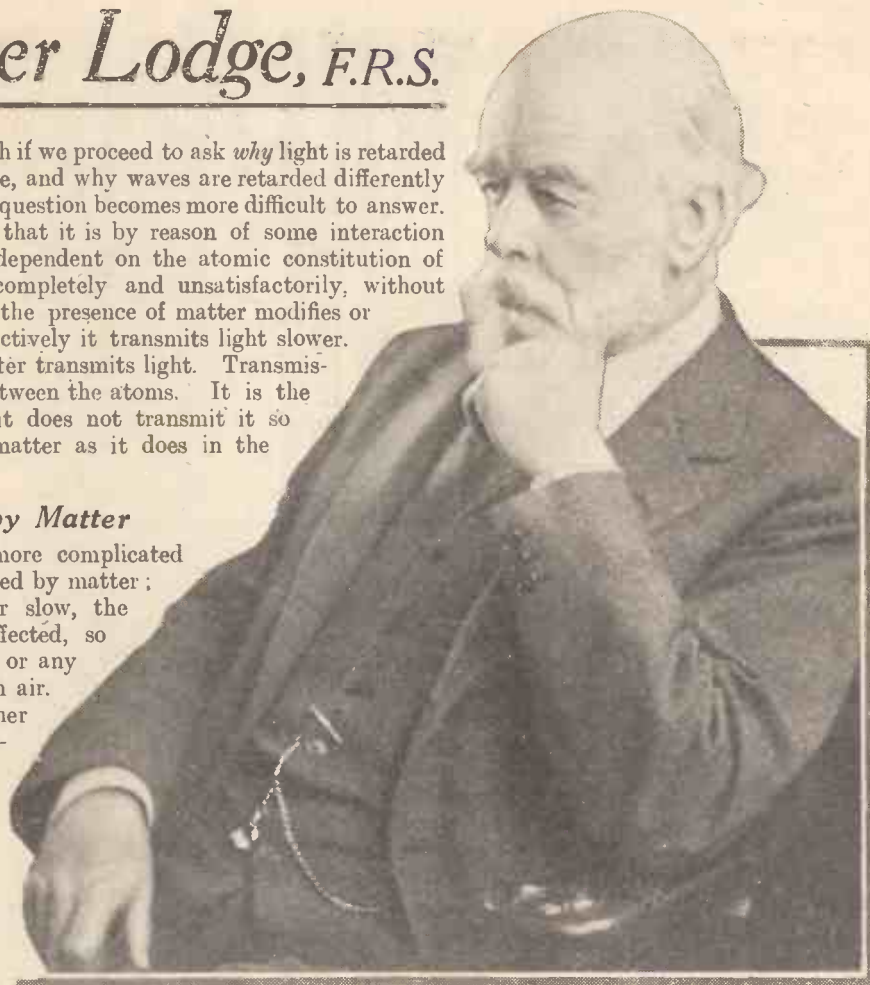

travel as fast as the longest waves. The law of speed for ripples and waves on water is therefore different, the reason being that the controlling forces are different. Big waves are governed by gravitation. Weight is the restoring force which brings them down when they have been heaved up.

Ripples are governed by surface tension. The skin of water is like an elastic membrane, so that ripples are akin to the tremors of a stretched membrane which is struck or jarred. Their speed is inversely as the square root of the wave-length, so that the shorter they are the quicker they travel; the membrane is, as it were, stiffer for the steeply inclined slopes of minute ripples; they are subject to a strong restoring force, because of the excessive curvature of the surface-crispations.

Waves and Ripples on Water

The disturbance which travels at the slowest possible rate is neither a wave nor a ripple, but a half-way house, subject equally to the control of gravitation and the control of surface tension.

If we plotted the speed of water waves as a curve it would be like a U, with one leg stretching up towards infinity in the direction of long waves, the other leg stretching up towards infinity in the direction of short waves; the bend of the U—i.e. its lowest point—representing the velocity of the half-way ripple-wave, which belongs neither to one leg nor the other, but shares equally with both. Its wave-length is 0.68 in., on the surface of water.



WHAT READERS THINK

The Really "Wide-Range" Two—Our Short-Waver

The Really "Wide-Range" Two

SIR,—Although I have not noticed any reports on the "Wide-Range" Two, which was published in MODERN WIRELESS of May, 1928, I feel, in justice to the designer, that I must write a few words of praise. Made up mainly of "junk," on my second attempt, with badly paired coils, I heard W G Y (Schenectady) without previous experience of long-distance work.

Besides 2 L O on the L.S., at great volume, I get 5 G B and unidentified foreigners, all direct on the speaker. On the long waves, 5 X X, Radio-Paris and Hilversum are obtained on Sunday in daylight.

I am fully satisfied that made up to specification this set will give the surprising results which your designer claims for it. I have had three-, four-, and five-valvers, but didn't think that this humble "two" could do so much, and that within three miles of 2 L O.

Yours truly,
"DURNOVARIAN."

Chiswick, W.4.

Our Short-Waver

SIR,—There appears to be a certain amount of controversy regarding the Colonies assisting in the maintenance of radio station 5 S W, as it is represented that this station is mainly for Empire reception. I am a Colonial residing in Jamaica, B. W. I. (quite a large and loyal outpost of the Empire), and a great number of the residents of this island and its neighbours are very keen radio listeners, especially on the short waves—the long waves being very much interfered with by statics.

At present the short-wave programmes coming to us are mainly from New York (2 X A D and 2 X A F) and Pittsburg (W 8 X K), these programmes starting about 5 p.m. and ending about midnight (local time).

I believe station 5 S W (Chelmsford)

listeners, who, after all, are interested in what is going on at home.

As the sun never sets upon the Empire, and all parts want to be served, it would seem advisable for 5 S W to arrange the hours of their programmes to suit different parts of the Empire, such as East on Monday, Wednesday, Friday, and West on Tuesday, Thursday and Saturday, with Sunday a day for all, everybody having plenty of time to spare for either day or night reception. 5 S W closes down at present on Saturdays and Sundays, and these are the only two days on which the listeners here are able to tune in during the day-time.

Under the present conditions it is hardly reasonable to expect the Colonies to assist in the maintenance of station 5 S W. Countries such as Holland and Germany, with their thoughts on their overseas population, broadcast to suit the hours of reception where they want to be heard; and I have heard them sending a South American broadcast as late as midnight, which means 6 a.m. at the station. Surely England, with so many millions to serve, could do likewise with a little careful planning.

I am,
Yours faithfully,
R. MILLERSTAN.

ISOLATORS AS WELL AS INSULATORS

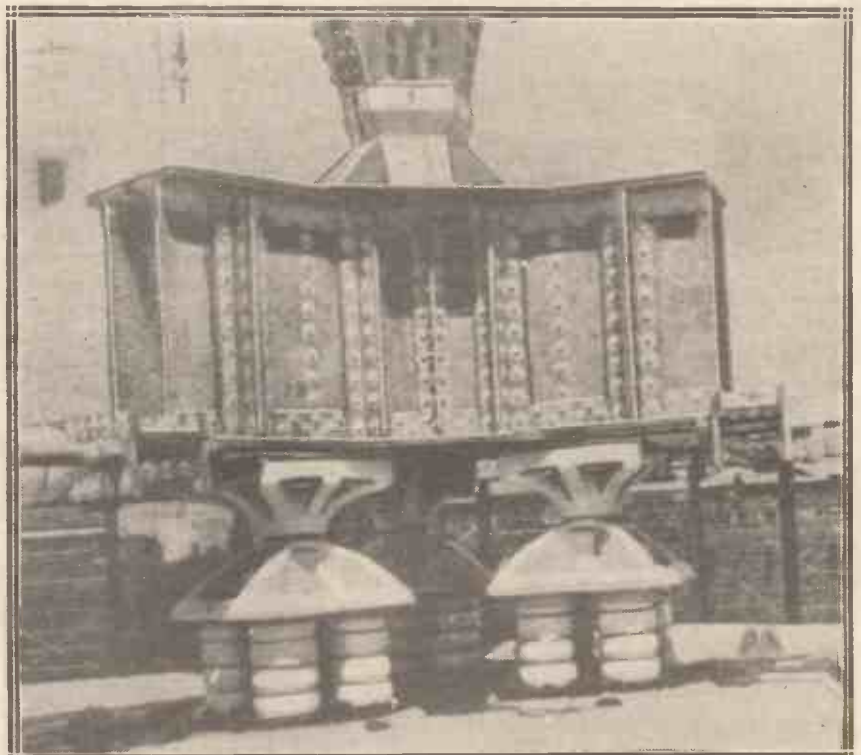

When they built the radio station at Magoya (Japan) they had to adopt special measures to protect the masts against earthquake shocks. The photo shows a system of "isolators" at the foot of one of the great masts.

Concealed Condensers

Besides the ordinary condensers every set has concealed capacities. This article tells how they interfere with the working of the receiver.

By P. R. BIRD.



EVERY wireless set contains a condenser of some kind or other, and most valve sets contain several quite different types of condensers. There is nearly always a variable condenser for tuning, a grid condenser, and several other fixed condensers for various purposes. In addition—generally unsuspected and unwanted—are the *concealed* condensers.

Before getting on the track of trouble due to concealed condensers we must recall how fundamentally simple is the construction of any condenser. In essentials a condenser is simply two conductive surfaces in very close proximity but separated by an insulator (generally air or mica). The provision of terminals, the enclosure in a small insulated flat case (in the case of fixed condensers) and the arrangement of the metal surface as a number of shaped plates (as in the variable condenser) are merely conveniences. Underneath all these variations in form the condenser remains fundamentally nothing more than an insulator separating two adjacent metal surfaces.

A Favourite Insulator

It has already been mentioned that a favourite insulator for condensers is air. This, of course, is present in every receiver, and as the only other requirements to make the condenser are the two separated metal surfaces, it becomes obvious that every wire, every screen, and every connection can become part of a simple condenser merely by placing another wire or metal surface very near to it.

The closer the two surfaces are together and the larger the area of the surfaces, the greater will be this condenser effect; but even small capacities can be very important in

wireless work, and this is one of the reasons why so much stress is laid upon correct spacing and careful wiring.

Very small capacities, such as are accidentally formed by placing wires too close to one another, or by leading a wire too close to a screen, are chiefly of importance at the *high-frequency* end of a receiver. Here they can play many disconcerting tricks, as a glance at the diagram on the next page will show.

The diagram shows the connections of a straight four-valve set, comprising high-frequency amplifier, detector, and two low-frequency stages. The high-frequency portion of the circuit

is the left-hand half of the diagram. On the extreme left is the aerial circuit, the lead-in from the aerial being connected either to A_1 or to A_2 . In the latter case the high-frequency currents in the aerial will flow straight through the coil L_1 to earth, but if the aerial is connected to A_1 they will cross the small fixed condenser on their journey. It is important to remember that they can, and do, pass such a condenser practically without loss.

Aerial Leakage

Let us suppose that we have another small fixed condenser, one side of which is connected to earth. If we take its remaining side and join it to the aerial lead before this reaches A_1 or A_2 , the currents flowing in the aerial have an alternative

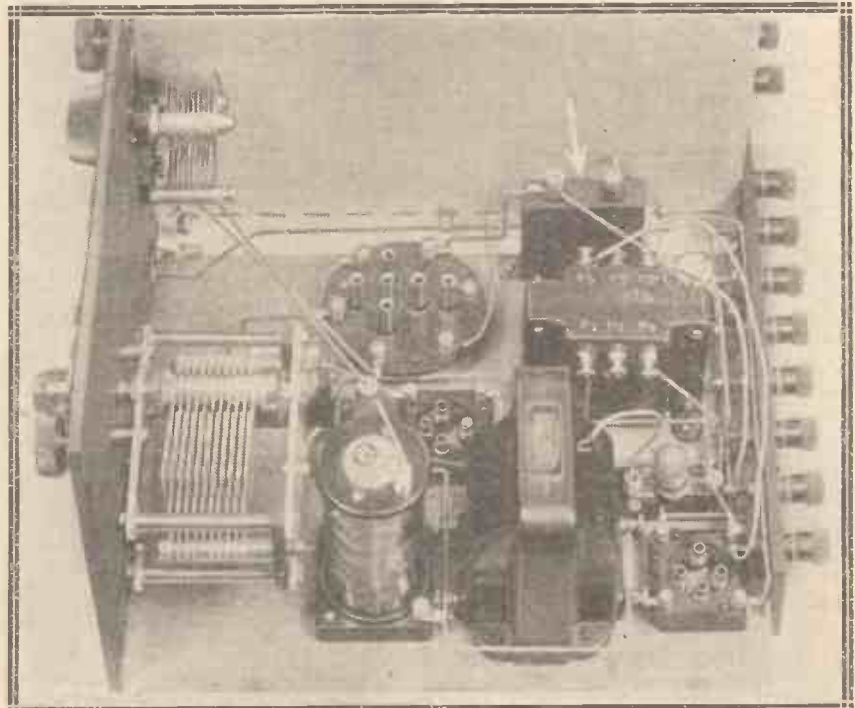

Condensers, like that indicated by the arrow, are often used to bypass energy across certain parts of the circuit. But very often some of the set's required energy is lost because careless wiring gives rise to unsuspected condenser effects.

Why Spacing Affects Results

path offered to them. They can now flow down the aerial lead and over the new condenser to earth, or down the aerial lead and along the old path to L_1 and earth.

How much of the current will take one path and how much the other will depend upon several factors, an important one being the size of the condenser which is added. But obviously any current which flows across the new condenser will not need to flow through the coil L_1 .

Serious Energy Losses

As this coil, coupled to L_2 , is acting as the input to the whole receiver, it will be seen that any current flowing over the extra condenser connected to the aerial will be diverted from the set. The importance of this lies in the fact that if the aerial lead-in

close to one another, so that they fulfil the conditions already referred to and behave themselves (amongst their other varied activities) as condensers.

In every valve the presence of the grid near to the filament means that there exists in effect a grid-filament condenser, and similarly the proximity of the plate means that a condenser effect will take place across the space between grid and plate. These are good instances of what I have called "concealed capacities," for although they are plainly visible to every eye the concealed condenser effects were not successfully combated until quite recently.

What made the tiny condenser between the plate and the grid of the valve such a nuisance was the fact that no sooner did the valve start to

capacity of the valve in the circuit in which it is placed. The action is readily understood from the diagram if we imagine high-frequency impulses on the grid of the valve V_1 , causing corresponding currents to flow along the H.T. positive lead to the point 4 on the H.F. transformer, emerging via the point 5 to the plate of the valve.

How it Operates

Here these amplified impulses would cross from the plate of the valve to the grid by means of the concealed-condenser effect, thus causing instability, unless they were ingeniously cancelled out by the neutralising condenser C_5 . For in this modern circuit, as each surge of current flows from 4 to 5 and through to the plate, an equal but opposite surge flows from

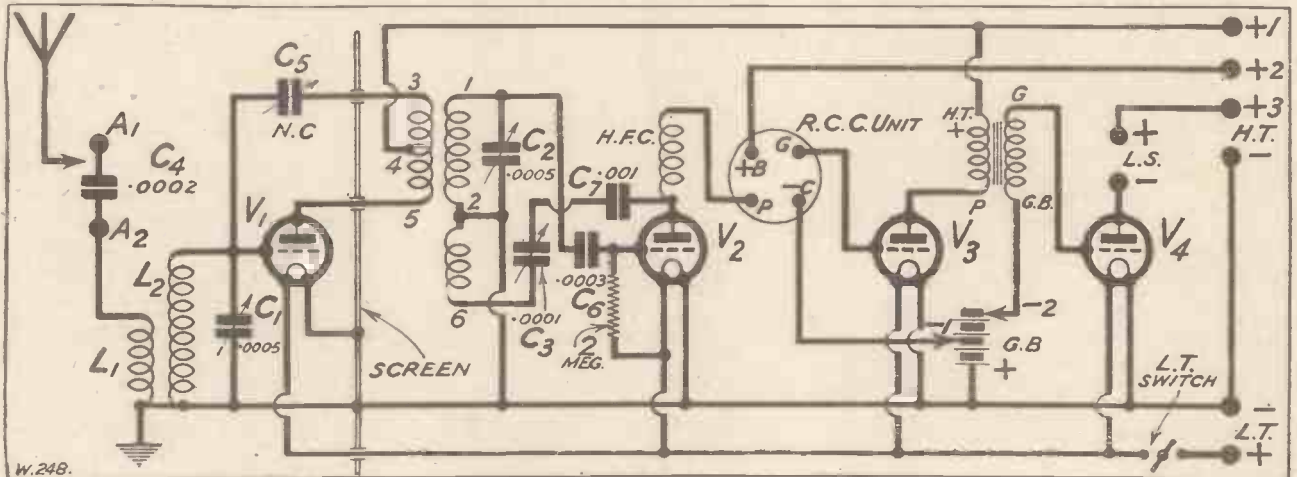

or its associated wires are not well spaced from earth, they actually form a concealed condenser of this kind, and so rob the receiver of some of the energy which should pass into it via L_1 .

It might be imagined that the capacity formed by the accidental proximity of two small pieces of metal would be insufficient to produce any marked effect in a receiving set. Yet small condensers have before now baffled the whole of the wireless industry for years. A good case in point is the small condenser which is formed quite accidentally inside an ordinary valve.

As everybody knows nowadays, the average valve has three electrodes—one a short length of wire called the filament, another a fine mesh of wire called a grid, and the other a small plate or anode. These are all insulated, but must of necessity be placed

amplify than this condenser-effect upset its working and made it oscillate. The energy in the grid circuit was duly duplicated, and amplified in the plate circuit, but then these two, connected by the concealed condenser, always interacted. Some of the energy in the plate circuit was conveyed by this means back to the grid, where, owing to the valve's action, it released more energy in the plate circuit, which resulted in still more energy entering the grid. The result was oscillation, bad language, and an inability to make the high-frequency valve amplify properly.

The Neutralising Condenser

In a modern circuit such as the one shown in the diagram this trouble is overcome by means of a neutralising condenser (N.C.). This is a very small condenser which is adjusted so as to be equal to the grid-plate

4 to 3, and then via the neutralising condenser to the grid. And thus these two impulses, arriving simultaneously, and being equal in strength and opposite in phase, cancel each other out, so far as the valve is concerned. They do not now upset the working of the valve, so that it remains stable whilst it is amplifying, and carries out its functions successfully in a way that seemed impossible before the concealed capacity was successfully combated.

The proximity of two wires may cause either loss of signal strength, or lead to a shunting effect, or to instability, owing to the feed-back from one circuit to another.

So easily do high-frequency currents pass through small air gaps, that the only safe rule is to leave really wide spacing around all such wiring, and thus avoid any possibility of loss through concealed condensers.



MIND YOUR WIRING

Untidy connections or neat wiring—either can cause trouble. But there is no reason why a neatly arranged receiving installation should not be efficient providing certain very important rules are observed.

By D. GLOVER.

THE righteous would say that neatness, being a virtue, must always be rewarded, but this doesn't apply to radio in an unqualified sense. The neatest and prettiest radio receiving outfit in the world could quite conceivably be the least efficient.

At one time the cry of the wireless fan was: "Efficiency before appearance." And the one result of following out this dictum was that two- and three-valve sets were spread out on baseboards of billiard-table size.

"Right-Angle" Leads

But as we began to learn something about wireless so we discovered that wide spacing and other such practices were not always at all beneficial. I wouldn't say that they were harmful, but we learnt how to compact our sets without much loss.

Overcrowding is still a tragic error in certain instances, and packing big circuits into small boxes needs scientific planning.

A great point has been made of taking the connecting wires in a receiver as straight as possible from point to point. Generally speaking there is everything to be gained by doing this. Nevertheless, no harm is likely to eventuate if a tiny bit of right-angle bending is done here and there for the sake of appearances, more particularly on the L.F. side. Indeed, quite a lot of this can be done at the L.F. end of the set without jeopardising the performance of the instrument one little bit.

Important Wires

All this is providing you are working fairly closely to some particular design of receiver. One of the primary objects of a set designer of standing is to arrange his layouts so that there is no necessity for

connecting leads that really matter to wander around areas that do not concern them.

Some leads must be treated much more carefully than this. For instance, leads joining the grid terminals of valve holders to other points must be as short and as direct in their travelling as possible. On the other hand, a little wandering on the part of an L.T. or earth lead may not matter the proverbial two hoots.

So far I have been dealing with the making of tidy internal set wiring, but I must interpolate a word or two about untidy wiring. There is no excuse for this, that even the "culprit" will know, but let me indicate some possible ill-effects. After having these brought to his notice he may, or may not, determine to rewire his set!

Careless wiring may lead to H.T. short-circuits burning out valve filaments. The direct cause could be a faulty connection or join, resulting



In some cases leads can be bunched tidily together, but indiscriminately done this might lead to trouble.

in a lead coming loose or two adjacent leads coming into contact with each other.

The L.T. battery can quite easily be shorted, and this may result in red-hot leads, fire, and so on. Resistances and other components can be burnt out by short-circuits. The least that can happen is that the set might pack up in the middle of a nice programme.

The Battery Connections

The external leads to a set are often straggling, sorry things, with kinks in their middles and whiskers frayed into their ends. That is all wrong. They should be stout, tidy cables, frequently renewed.

Non-corrodable terminals can be bought for a few pence for the accumulator leads.

These external leads are of very great importance, more particularly those which join the batteries to the set. Faulty insulation, a loose end wriggling about, a "whisker" shorting across a pair of terminals, and damage to the batteries or even valve burn-outs might result.

Special Caution Necessary

Having put in some nice new cables of ample gauge and well insulated, do not proceed to bunch them together indiscriminately. You may achieve tidiness at the cost of good results.

The aerial, earth and loud-speaker leads must be well separated, each taking their quickest routes—more particularly the aerial lead. You can group the L.T., grid bias, H.T. negative and earth leads, but it is as well to keep the H.T. positive out of the way of this bunch.

If you are using a mains unit of any kind very special attention indeed should be paid to all the wiring to and in the set.

The Two-



THE two-valver described in this article was built almost entirely with the idea of using it for short-wave work. With the idea in view, however, that it would be more popular if it were easily adaptable for broadcast reception, one or two details were so arranged that it would make a useful "all-wave" receiver for those who do not wish to indulge in the luxury of a separate short-waver.

Plug-in Coils Employed

Incidentally, a rather novel scheme of reaction control is incorporated, which I evolved in connection with my own short-waver, and which, fortunately, has since proved exceptionally efficient on the broadcast wave-lengths as well.

The set consists of a detector and note-magnifier, transformer-coupled, with a choke-filter output circuit. Plug-in coils are used, so that the only limits to the wave-length range of the set are the sizes and number of coils in the possession of the user.

Actually, the limits between which the set has been used are about 15 metres and 3,000 metres; at the lower limit it works perfectly and oscillates strongly, so that there is every reason to suppose that it would be quite useful even down to 10 metres, although a smaller tuning condenser would be necessary here for comfortable working.

Easy to Build

As will be seen from the photographs, the layout is quite simple, and the wiring is reasonably short and direct. Most wires have been

taken by the most direct route to their appropriate points, at the expense of appearance, no doubt, but with what is probably an appreciable gain in efficiency when the ultra-short waves are concerned.

Fig. 1 shows the theoretical circuit, which may now be examined in detail.

Starting with the aerial, we have a capacity-coupled arrangement, using a type "F" Formodensor, which gives a minimum capacity of .0000075 and a maximum of .0001. The smallest figure is, of course, much smaller than we ever need use for short-wave work, and the best adjustment depends largely upon the particular aerial with which the receiver is operated.

The .0001 maximum is, in my opinion, usually high enough for the broadcast band, and gives a respectable degree of selectivity.

The tuning condenser, it will be noticed, has a capacity of .0003. In this I have departed from my usual custom of using a very small condenser, or reducing the effective capacity by some artificial means, such as a series fixed condenser, since I realised that a .0003 with a good slow-motion dial with a high reduction ratio would be quite easy to handle, and would be an advantage for the "short-wave broadcast listener" in that it covered a fairly wide band of wave-lengths.

This is certainly not the plan I would adopt in an "all-short-wave" receiver designed to receive amateur "DX" signals and to cover a narrow band.

Tuning Made Simpler

As, however, we have one batch of broadcast stations round about 31 metres and another in the region of 25 metres, it is distinctly an advantage to be able to receive them both with one coil, where it can be done without loss of efficiency.

Otherwise, of course, a condenser of .0001 or .00005 might be used with advantage. The grid condenser and leak have the standard values of .0001 and 2 or 3 megohms. Series-feed is used for the H.T. on the

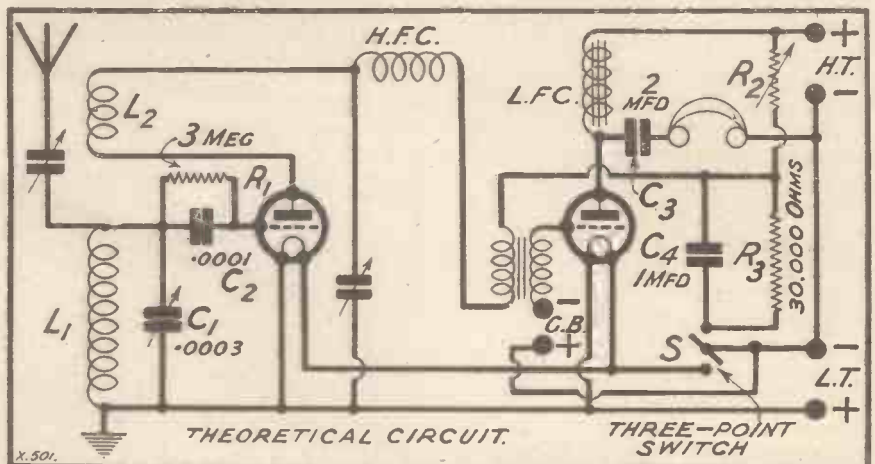

A novel form of reaction control is a special feature of this receiver. This is to be seen in the variable resistance R_2 and the fixed resistance R_3 , which give a kind of potentiometer control of H.T.

"Hylo" Valver

By
L. H. Thomas

* Using plug-in coils and the simplest of components, this receiver will cover all broadcast frequencies. From way above 5XX to right down below Schenectady, and other short-wave stations, no wave-length is outside the grasp of the builder of this "big" little set. *

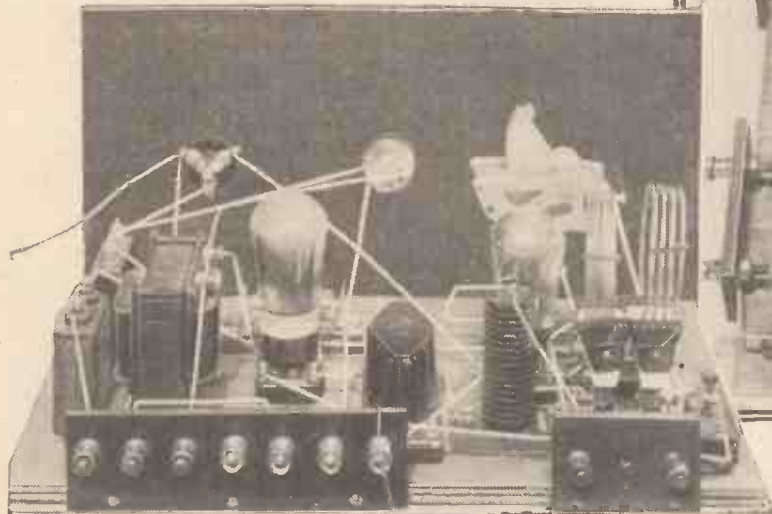
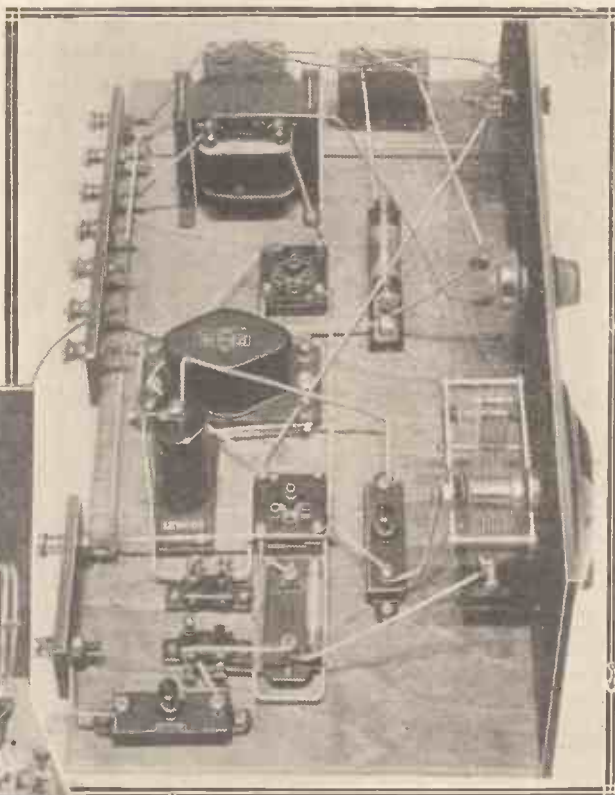

Two photos which clearly illustrate the "make-up" of the receiver. Note the wide spacing of the components and the way the leads run directly from point to point. Such things as these are essential in a set designed to tune down to the short waves. You will see the "variable-fixed" condensers in both photos. One of these components is placed in series in the aerial.

detector, and we may now discuss the reaction control in detail.

Actually, it consists of a means of varying the detector plate voltage. Instead, however, of using the usual "series-resistance" method, which usually gives a control far too critical for my liking, I have arranged a potentiometer (in effect) across the entire H.T. battery, the detector H.T. + terminal being taken to what would normally be the slider.

Fixed Reaction Condenser

The potentiometer consists of one variable resistance (a "Claro-stat") and one fixed resistance, with a value of 30,000 ohms. These are connected in series across the H.T. battery, and the detector H.T. is fed from the common point of the two. The fixed resistance is by-passed to negative H.T. by a large fixed condenser.

Thus, tracing the wiring from the detector plate, we have the reaction coil, an H.F. choke (not strictly necessary unless a transformer incorporating a fixed condenser is used), the transformer primary, and the "Claro-stat," the far end of which is connected to the only H.T. + terminal.

A Formodensor (type "J") is connected from the common point of the H.F. choke and the reaction coil to earth.

This, of course, takes the place of what would normally be the reaction condenser in a "throttle-control" scheme, but as this "potentiometer" control appears to be so much nicer to handle in many ways than the other, we have, in effect, shelved the reaction condenser (or rather, put it on the baseboard out of the way) and fallen back upon

another means for managing the actual control.

The Formodensor is set at the most suitable value and "forgotten." More will be said about this later.

The L.F. End

The L.F. end of the set is perfectly straight, an output filter being used on account of its beneficial effect on the shorter waves. Its use appears to act to a great extent as a guard against "threshold howl" and it also stops the terrible effect noticed in some short-wavers of "hand-capacity" gone astray and running up the 'phone leads! With one side of the 'phones actually connected to earth, we appear to be fairly safe.

A three-point switch is used for the L.T. This is employed on account of the "potentiometer" across the H.T. battery, which, unless disconnected

when the switch was switched off, would make a constant drain upon the battery.

Thus the three-point switch, as arranged, disconnects the L.T. from H.T.—, and also the bottom of the fixed resistance from the same point, all three being connected together when the set is switched on.

Actually the resistance range of the Clarostat (the "Volume Control" type, by the way) is something of the order of 100 ohms or less to .5 megohm, so that the extra drain on the H.T. will be quite negligible when the set is operating.

Operating the Set

Even with the Clarostat "all out" we still have the 30,000 ohms fixed resistance in circuit, so that if a 120-volt battery is used the maximum drain will be 4 m/a. Naturally, this figure will never be reached in practice, because we set the Clarostat so that it is operating about half-way over its travel. The setting of the reaction control has little or no effect upon the tuning—a very strong point in its favour.

Now as regards the operation of the receiver. When the wiring has been suitably checked, connect up batteries, aerial, earth, etc., and insert valves. Here you may largely use your own discretion. The types with which I have been using the set are simply "general purpose" and "power."

Practically any of the "HL" or "DEL" types is suitable as detector, even a "DEH" serving perfectly

across the appropriate terminals will meet the needs of the set.

Insert a six-turn coil in L_1 socket and either another six or a nine in L_2 (reaction). With these two coils the 30-metre band is covered.

Smooth Reaction

Turn the Clarostat as far as it will go in a clockwise direction. This brings it to the "all-in" position, i.e. the position of maximum resist-

however, that by adjusting the value of the Formodensor in the "throttle-control" position we may so arrange things that the detector has just the most favourable value of H.T. when it is just at the point of oscillation.

Also, if there should be any tendency to "threshold howl" (meaning, of course, a "hoot" or "howl" just as the set goes in and out of oscillation), it may be dispelled by using less capacity and more H.T.

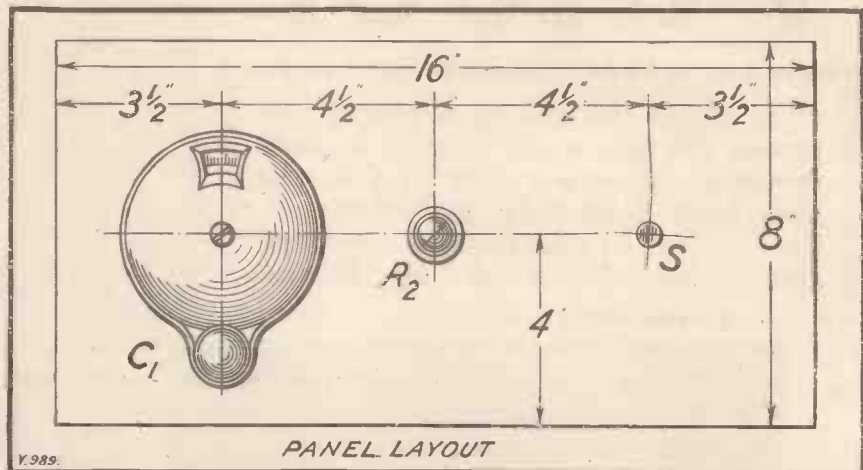

ance. Note that a left-hand thread is used, the direction of rotation being opposite to that employed in most components. Set both the Formodensors to some point at about the middle of the available travel.

With the tuning condenser at maximum, turn the Clarostat in an anti-clockwise direction until the set is heard to go into oscillation. It should normally do this quite

The actual final adjustments, however, are best left to the discretion of the reader.

Regarding the aerial circuit Formodensor, the best position must be chosen by experiment. In some cases it may be possible to work with it "all in"; generally it will be midway between the two extreme positions.

The receiver has been used chiefly for short-wave work, and the usual broadcast stations have all been logged at quite the normal strengths for a good two-valver; more than this one cannot say. W2XO on 21.96 metres is the loudest transatlantic station, but W2XAF on 31 runs him fairly close.

PCJ and the Copenhagen station in the neighbourhood of 32 metres are practically overpowering on headphones on a good night. Scores of amateurs all over the world have also been logged on the 20-metre band. A four-turn coil covers this latter band, with another four or a six as reaction.

Broadcast Reception

For broadcast reception the set behaves quite normally. A 60-turn coil for L_1 and a 35 or 50 for L_2 seem quite satisfactory for the broadcast band, although in view of the '0003 tuning condenser it is probably necessary in some cases to change coils to receive either the very lowest or the very highest stations.

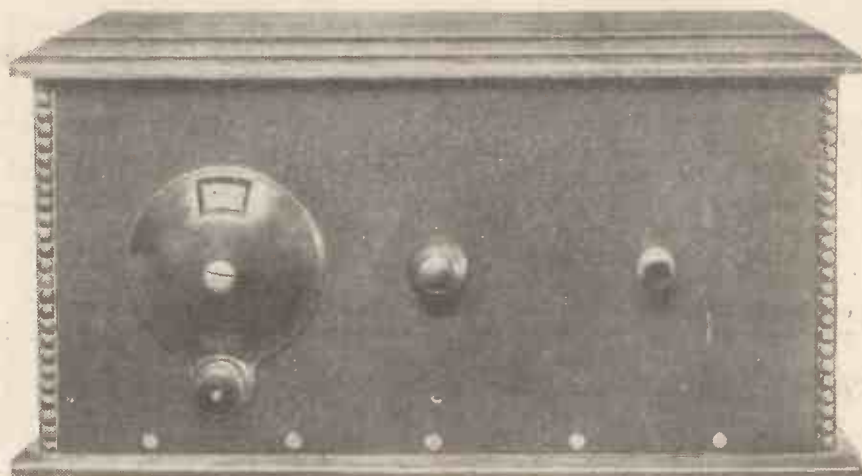

Two controls to tune-in the Antipodes! One condenser dial and the reaction adjustment are all there are to handle.

well. For the note-magnifier I have used several different types of power valve, including a Pentode.

Only one H.T. terminal is in use, of course, so that one 100-volt or 120-volt battery connected directly

smoothly, and a gentle "hiss" will probably be heard just on the oscillation point.

If this all goes off as expected, no further adjustments should be necessary. The beauty of the method is,

Covers Short, Medium and Long Waves

Should the set, when tested on these waves, oscillate so strongly that it is necessary to work with the detector H.T. at a very low value to prevent oscillation, simply reduce the capacity of the "reaction" Formodensor. The aerial condenser should, of course, be "all in." When the set is working on much longer wave-lengths, it is best cut out of circuit completely.

Curing "Threshold Howl"

Should any trouble happen to arise with "threshold howl," although it is rather unlikely, one or more of the following cures may be tried:

LIST OF COMPONENTS.

- 1 Ebonite panel, 16 in. × 8 in. × ½ in. (Becol, Resiston, "Kay Ray," Ripault, Trelleborg, Red Seal, etc.)
- 1 Baseboard, 16 in. × 9 in. deep (and cabinet if desired).
- 2 Non-microphonic valve holders (Bowyer-Lowe, Lotus, Igranic, W.B., Pye, Marconiphone, B.T.H., Formo, Burne-Jones, Benjamin, etc.)
- 1 Type F and one Type J Formodensors (Arthur Preen & Co.).
- 1 L.F. transformer (Mullard, Lissen, R.I., Igranic, Ferranti, Phillips, Cossor, Brown, Marconiphone, etc.)
- 1 Output filter choke (Wearite, R.I., Ferranti, Burne-Jones, etc. Any good choke of round about 20 henries).
- 1 .0003 variable condenser (Lotus, Lissen, J.B., Igranic, Cyldon, Dubilier, Ormond, Utility, Formo, Burton, Colvern, etc.)
- 1 Slow-motion dial (if condenser not of slow-motion type). (Lissen, Utility, Brownie, Igranic, Lotus, etc.)
- 1 H.F. choke (Lewcos, or other good make suitable for high and low waves).
- 1 30,000-ohm wire-wound resistance (Ferranti, Varley, Igranic, Lissen, Dubilier, Mullard, etc.)
- 1 Volume-control Clarostat (Holzman, Claude Lyons, etc.)
- 1 2-mfd. Mansbridge condenser (Dubilier, T.C.C., Lissen, Mullard, Ferranti, Hydra, etc.)
- 1 1-mfd. Mansbridge condenser (T.C.C., Mullard, Lissen, Ferranti, Hydra, Dubilier, etc.)
- 1 .0001 fixed condenser and 2- or 3-megohm leak (Dubilier, Clarke, Lissen, T.C.C., Mullard, Goltone, Pye, Ediswan, etc.)
- 1 Three-spring switch, wave-change type (Pioneer, Bulgin, Wearite, etc.)
- 2 Baseboard-mounting single-coil holders.
- 1 Six- or seven-terminal strip.
- 1 Two-terminal strip.

(a) Different value grid leak for detector.

(b) 1- or 2-megohm leak across transformer secondary.

(c) 2- or 4-mfd. condenser across H.T.

(d) Lower filament voltage for detector.

Normally one of the most effective cures is the insertion of an "anti-motor-boating" device in the detector H.T. lead. The beauty of the particular form of reaction control used in this set is, of course, that this is always present.

True, the by-pass condenser of 1 mfd. is rather on the small side, but it appears to be sufficiently large.

Should trouble arise the connection of a larger condenser in this position should put an end to it at once.

The above are not cures for *expected* troubles, but merely suggestions to save a letter to the Query Department should unforeseen circumstances arise.

And now for a few words on the subject of short-wavers, chiefly for

and to hold it. Do not confuse this with selectivity, since the two are absolutely separate.

A very inselctive set can have critical tuning if the condenser is too large, and a most selective receiver may be the easiest thing in the world to handle as far as the tuning is concerned.

No Congestion

Short-wavers do not need to be tremendously selective, since, although there are a huge number of stations working between, say, 20 and 22 metres, there is so much "accommodation" between these two wave-lengths (speaking in terms of frequency) that the stations do not need to be crowded together, and therefore there is no real congestion. Thus although your tuning condenser may only cover a range of two or three metres, it will tune in a great number of stations, which will be

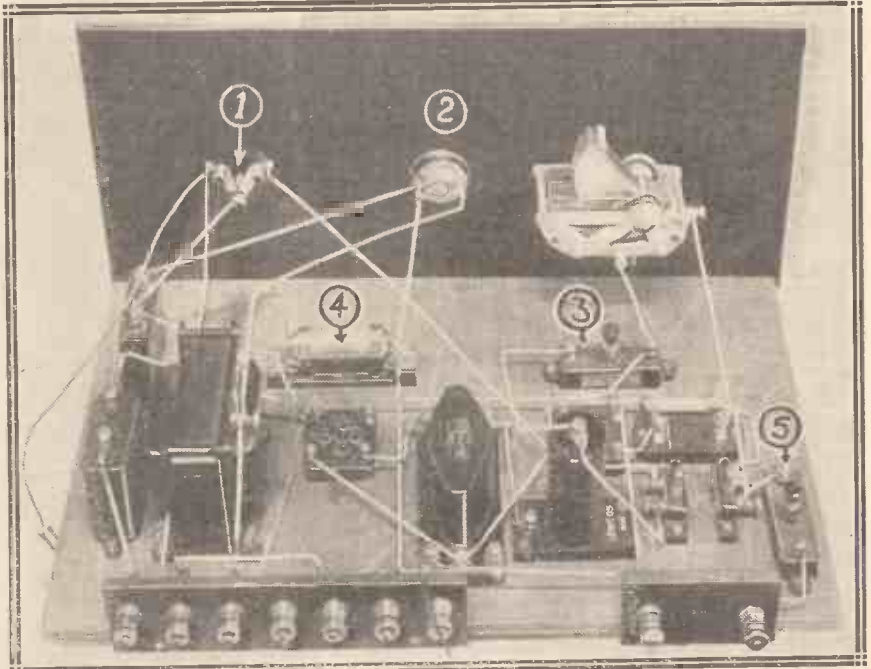

A photo that will help you when arranging the components in position. (1) The three-point on-off switch; (2) the Clarostat; (3) the Formodensor with which the initial reaction adjustment is made (Type J); (4) the 30,000-ohm fixed resistance; (5) the Formodensor in series with the aerial (Type F).

the benefit of those readers who have had no experience of this fascinating branch of radio.

Sharpness of Tuning

If you are using this set for that purpose, the first thing that will strike you is the extreme sharpness of tuning, and the apparent skill necessary to tune-in a station accurately,

comparatively close together on the dial, although one given station will not occupy anything like the space that it would require on the medium broadcast wave-length.

On my own short-waver, on which one sweep of the condenser tunes only from 20.6 to 21.4 metres (roughly the 20-metre amateur band), I often receive three or four different

stations between, say, 90 and 92 degrees on the dial.

No good short-waver should be unnecessarily difficult to operate; hence the obvious necessity for avoiding all troubles such as hand-capacity effects, "threshold howl," etc. Hand-capacity effects should not be present in this particular set; they were certainly not noticeable at all on the original.

Hand-capacity effects are not so hard to dispose of on a short-waver that one need resort to "broom-handles" and the like to be rid of

them. Sensible planning of a receiver will always result in absence of these undesirable effects, without the necessity of taking such "cowardly" precautions; I always regard them in this way, since it is obviously not going to the root of things to use the "broom-handle" method.

Regarding the Aerial

Arranging for both sets of moving vanes, or, at any rate, both the actual connections to the controls (as in the case of this receiver), to be at earth potential, is the most important point.

Length of the earth lead and general care of the wiring of the set all mount up in their effects.

Although many readers query the most suitable length of aerial for short waves, this does not appear to be at all important; there is little to choose between a large aerial used with a very small coupling condenser and a small aerial with a larger condenser.

At all events, a short earth is more important than most considerations connected with the aerial, and the set and lead-in should be planned accordingly.

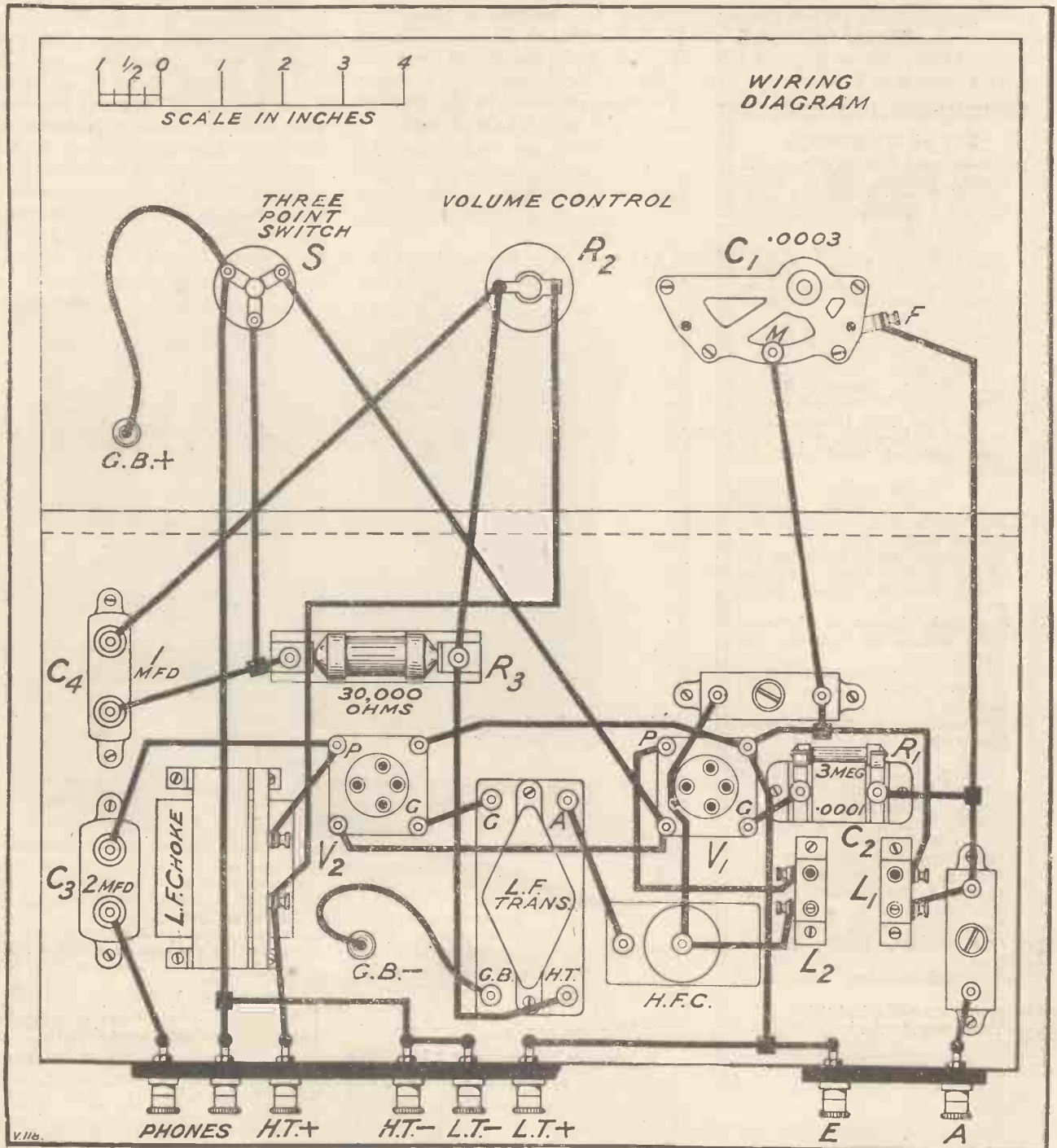

MY BROADCASTING DIARY



Under this heading month by month our Broadcasting Correspondent will record the news of the progress of the British Broadcasting Corporation, and will comment on the policies in force at B.B.C. headquarters.

The Dunstan Affair

I WAS particularly interested in the Dunstan affair, not only because I had known Mr. Dunstan for some years, but also because it was of a type of trouble which I fully expected to see break out at Savoy Hill.

The very keenness of all concerned with broadcasting, and the smoothness of organisation of the B.B.C., leave very little to chance, but impart to the specialist a jealousy in his own work. Mr. Dunstan had been a friend of Sir John's.

It was the personal interest and influence of the Director-General that secured Mr. Dunstan the job of General Manager of the Indian Broadcasting Company, and the same factors intervened to get him back on the announcing staff at Savoy Hill after he had broken with the B.B.C. But Mr. Dunstan was clearly not as happy during his second tenure at Savoy Hill.

He sought elbow-room and was irritated by the various rules and regulations drafted for the guidance of announcers. One had felt that he would get away from the B.B.C. as soon as opportunity permitted. No doubt Mr. Dunstan meant to make his going of some advantage to the other announcers, but he went about matters in a wrong way, which seemed curious in one who knew Sir John so well.

To use the Press, in the first instance, was to foredoom the effort. As all students of broadcasting know, Sir John has always taken the microphone on big public occasions, and usually to the satisfaction of the public, which is all that matters, anyway.

Provincial Demobilisation

Blytheswood Square, the Glasgow headquarters of the B.B.C., is probably one of the gloomiest and most dejected spots in the United Kingdom. For the axe has fallen, and all but one or two members of the staff will be unemployed in September.

I gather Edinburgh will follow Dundee into broadcasting oblivion, and that Aberdeen alone will remain as a transmitter on an exclusive wave. The whole of Scotland is a seething mass of discontent with the B.B.C., not because

of this demobilisation, but because of the delay in starting the regional transmitters.

Malcontents in England lament that the B.B.C. is dominated by a Scotsman in the interests of Scots; malcontents north of the Tweed are much more bitter about the alleged neglect of Scottish interests. Meanwhile Mr. D. C. Thomson struggles on, and really makes a creditable showing in the face of terrific odds.

Once Scotland has been demobilised, the process will be extended (a little more gingerly, I imagine) to Wales and the North of England. Altogether the lot of the average member of the B.B.C. now is hardly enviable.

Pay is notoriously low; there are no contracts, no pensions, and no security, and the work is steadily contracting. Nor does there appear to be any limit to which this contraction may go. One of the Governors is credited with the view that only the engineering staff should be retained after this year.

HUIZEN OF HOLLAND

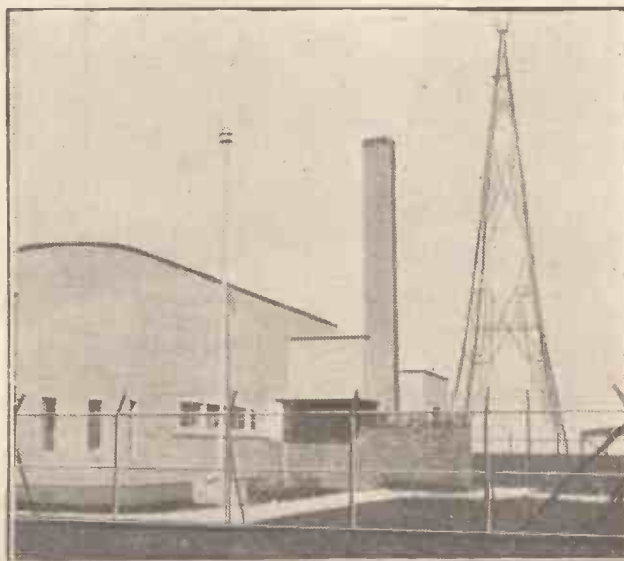

This is the Huizen broadcasting station. Normally it operates with a power of 6.5 kw. on 337 metres, although it changes over to a long wave-length at 5.40 p.m.

All the Latest News for Listeners

Programmes would be picked up outside, publications sold out, and administrative machinery abandoned. Despite these tendencies, I believe that there will be an early reversal of policy, and that the Regional centres will be restored to more than their old independence and prestige.

The Governors and the Staff

A B.B.C. programme man astonished me the other day with the statement that he had never met or seen a single member of the Board of Governors, although he had very pleasant personal relations with members of the Board of the old B.B.C. He added that this attitude of Olympian aloofness on the part of the Governors is strongly resented.

People in Savoy Hill cannot understand how the Governors reconcile their consciences to cutting themselves off from the work for which they, and they alone, are responsible. Mrs. Philip Snowden alone, among the rulers of the B.B.C., seems keen and interested. But her colleagues hold her back from contaminating touch with reality. Somehow I hardly see her being held back for long from anything on which she sets her mind.

Programme Finance: A Strange Silence

I see in a B.B.C. journal that during 1928 the Treasury collared no less than £270,000 of listeners' money—this, mark you, quite apart from the generous £150,000, or so, which the Post Office is understood to have absorbed to

A FINNISH STATION

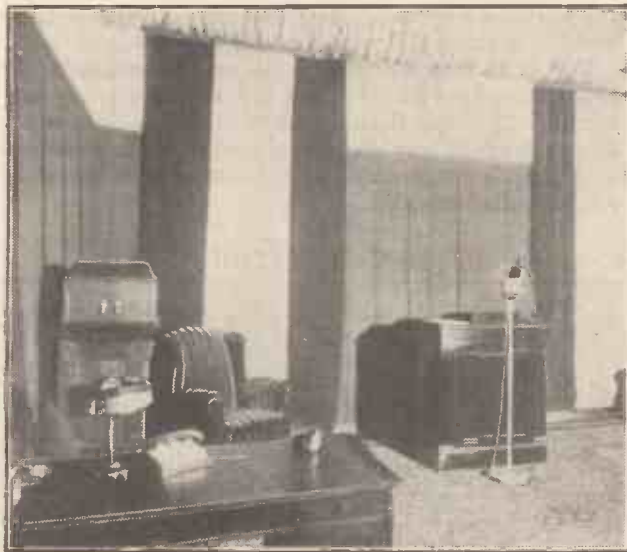

This is the main studio at Lahti broadcasting station.

cover the cost of collection, and incidentally to help pay for pensions for postmen! Of course, these percentages were agreed by Parliament when Sir William Mitchell-Thomson introduced the constitution of the B.B.C. in 1926.

But, so far as I know, nobody has yet spotted the curious omission of the B.B.C. to take advantage of the direct invitation of the P.M.G. to make a scream about the distribution of licence revenue after 1928. The Government which founded the B.B.C. practically promised to give it a larger share of the licence revenue if application

were made at the beginning of 1929. I have been to Savoy Hill about this curious position and can get no statement at all, not even an indication of whether the B.B.C. thinks it is getting enough money now and is, therefore, not caring about the Treasury raids year by year.

One with the business acumen and foresight of Sir John Reith obviously has not been caught napping, and must have some good reason for this apparently inexplicable attitude. It would only do good if the B.B.C. would take its listening public a little more into confidence on the broad issues of finance. Individual salaries don't matter; but when over a quarter of million a year is being diverted without protest to purposes other than that intended by subscribers, the public interest demands an exposition of policy.

The Beecham Problem

It looks rather as if the Gramophone Company alliance with Mr. Lionel Powell and the London Symphony Orchestra has got in ahead with its permanent orchestra scheme. Anyway, the fact is that the best instrumentalists have been booked for exclusive contracts with a permanent orchestra with which the B.B.C. has no concern.

This is the only conclusion that one can reach in the face of the stubborn silence of the B.B.C. Meanwhile I have heard of some tentative arrangements made by Savoy Hill for a slight augmentation of its existing symphony orchestra.

So I suppose the whole fine project of the B.B.C. sponsoring the world's finest orchestra will peter out. But musical friends tell me that they are not sorry. They believe Sir Thomas Beecham will come to terms with the L.S.O. group, and that then the B.B.C. will be forced to do business with the competitive orchestra. If this course is pursued, ultimately the B.B.C. will be the medium through which the new L.S.O. will attain merited fame. Apparently music lovers have much more faith in Lionel Powell and the L.S.O. than in the B.B.C. when it comes to a task such as this.

Meanwhile the expected explosion between Sir Thomas Beecham and the B.B.C. has not taken place. On the contrary, Mr. R. H. Eckersley, the B.B.C. programme chief, is seen about with Sir Thomas a great deal; they are indeed believed to have become almost inseparable personal friends since the permanent orchestra negotiations started some eighteen months ago. Even if music is to benefit by this turn of events, it is an uncomfortable reflection that the B.B.C. appeared unable to carry through its own conception in the face of opposition. This doesn't sound like the result of a job handled by Sir John Reith.

Regional Programmes

I am told that the following scheme of programmes has been decided on under the Regional Scheme: with twin-wave transmitters at London, Cardiff, Glasgow and Manchester, and single-wavers at Belfast and Aberdeen, a main "universal" programme originating in London and transmitted simultaneously by one of each "twin," together with Aberdeen, Belfast, as well as relays operating on the national common (288.5 metres). The other of each of the "twins" will put on a contrast, mostly from London, but occasionally from a provincial centre.

"MY WAVE METER"

BY G.P. KENDALL B.Sc.

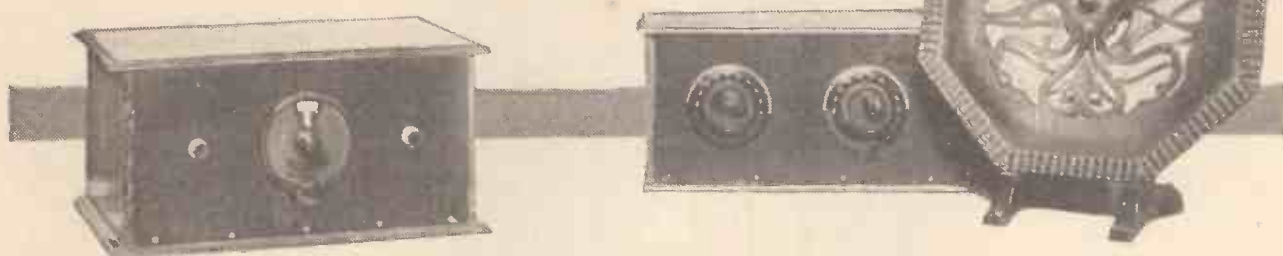

An interesting description of a heterodyne wave-meter which the author has recently designed for his own use. Entirely mains driven, it requires no batteries whatever, and so is always ready at a moment's notice. It works on both medium and long waves, with switching change-over, a "Titan" coil unit being employed.

THE more congested things become in the ether o' nights, the more essential it is that one should have a good, convenient, and reasonably accurate wave-meter always handy if you do much experimental work, testing new and uncalibrated receivers, and so on. Now, this latter is work of which I do a great deal, since every set turned out by the "M.W." and "P.W." Research Department, if it be anything more than a purely local receiver, undergoes its final tests at my home on a special inefficient aerial I keep for the purpose.

An Aid to Rapid Searching

Wave-meters are obviously very helpful here, for such work would be extremely slow and laborious without the aid of a rapid means of identifying stations in the course of searching. The requirements in a wave-meter for such a purpose are chiefly a reasonable degree of accuracy,

a definite and rapid indication of resonance, constancy of calibration, and, of course, wave-change switching so that the instrument can be used on either the ordinary broadcast band or the longer waves without coil changing. Above all, the instrument must always be ready for use, without the necessity for connecting up any batteries externally, or otherwise messing about with it.

These requirements, of course, are

really only those of the ordinary experimenter somewhat intensified, and it has occurred to me that readers of MODERN WIRELESS may be interested to see what happened when I recently decided that it was time that I designed myself a new wave-meter.

Heterodyne Advantages

The earlier requirements in the list which I have just given are comparatively easy to obtain, for the ordinary type of heterodyne wave-meter complies with them quite well. It gives quite as high a degree of accuracy as the average user needs, provided that certain simple precautions are taken, with very definite indications of resonance, and it is not a very difficult matter to incorporate the desired wave-change switching by using one of the circuits which have been developed for use in ordinary receivers. Constancy of calibration,

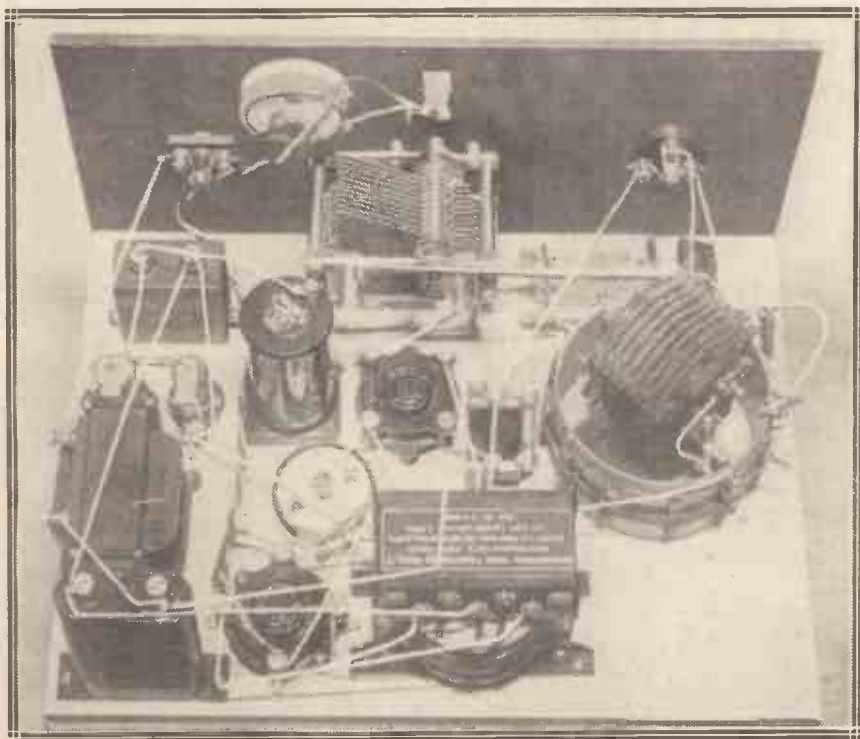

The dial illuminator seen immediately above the variable condenser is run from one of the transformer windings, the voltage being adjusted to suit the particular bulb by means of the rheostat beside the illuminator. The illumination of the dial serves as a reminder that the wave-meter is switched on.

too, it will also give, with just reasonable attention to the obvious details of occasional checking of batteries, and so on.

It is when we come to the final requirement—namely, that the wave-meter shall always be ready for work—that we come up against the real difficulty from my point of view, and I believe from that of most users of wave-meters. The usual procedure, of course, is to run our little heterodyne oscillating circuit from a small 2-volt accumulator for the low-tension and, say, a 16- or 18-volt grid-bias strip for the H.T. supply. I have made and used many wave-meters of this type, and I have found that when each was new everything was fine and the meter was used with much satisfaction.

A Common Experience?

After a while, however, things began to happen. Now, the reason for that may be that I am lazier than most people; but, somehow, I do not think so, and that is not because of a specially good opinion of myself, but simply because when I have mentioned my difficulties to various friends who do similar work, they have mostly looked rather sheepish and said very little, and left me with the very strong suspicion that they have had quite similar bothers themselves.

Now this is what usually happens in my case, and, as I so strongly suspect, in many others: after a

back as soon as finished with. Well, of course, you know what is likely to come of that. Next time that the wave-meter is wanted it contains no

decidedly difficult to keep an accumulator in good condition when working so lightly.

The last small accumulator I used

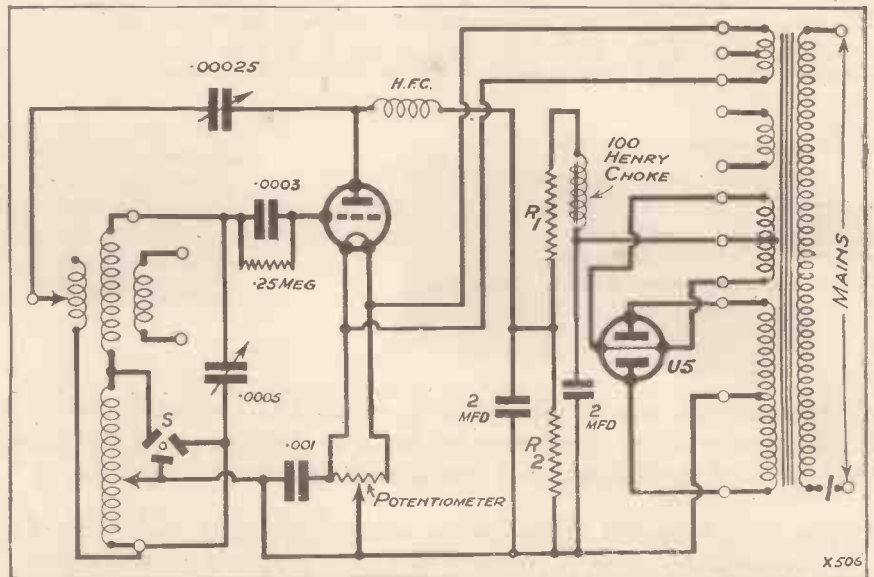

The complete circuit of the wave-meter with the dial illuminator circuit omitted for the sake of clarity.

battery, and there is some waste of time and temper before it is found.

The Accumulators

The same thing does not happen with the little 2-volt accumulator providing the low-tension current, but this is subject to problems of its own. In the first place, it is shut away inside the wave-meter cabinet, and one is therefore apt to forget

for this purpose was usable for just about six months, at the end of which period it was hopelessly sulphated and would not even give the tenth of an ampere required by the filament of the wave-meter valve.

Altogether, experience has convinced me that batteries are an even bigger nuisance in a wave-meter than they are in an ordinary receiving set, and lead to the instrument being out of commission for considerable periods at a time, besides introducing a risk of error in calibration due to unsuspected falls of voltage.

A Logical Solution

Accordingly, I decided that my new wave-meter should be entirely mains-operated, fantastic as the idea may seem at first sight. Think it over and you will see that it is really just as logical as designing an all-mains receiver.

Just as in the case of the receiver, it puts up the cost of the instrument, although considerably less in the case of the wave-meter. Where the instrument receives really serious use, however, the reader can rest assured that this is indeed a very worth-while expenditure, my experience of the new instrument being a delightful change after the annoyances experienced with its predecessors.

The new instrument is rather interesting in itself, and it is very likely that readers of MODERN WIRELESS would like to see a general



The wave-meter presents a very neat outward appearance. The switch on the left is for wave-changing, while that on the right was later wired in to act as an on-and-off control. Panel dimensions are 14 in. x 7 in. and cabinet depth 10 in.

while I find myself in need of a grid-bias battery for some other purpose, and the first one which comes handy is that in the wave-meter, which is accordingly removed with all sorts of good resolutions about putting it

about giving it a refreshing charge at suitable intervals to keep it in good health. Then, again, it receives practically no use, since the current taken from it is only very small and for very short periods, and it is

Always Ready For Use!

description of the methods employed in arranging it, with the aid of which they would be able to design something similar to suit their own needs, if they so desire.

Wave-Change Arrangements

I do not think it would be desirable to describe in great detail the final design which I produced for myself, because I do not suppose readers would care to duplicate it exactly, but will prefer to produce something with similar features to suit their own requirements and ideas. Instead, I will go into the various considerations underlying each particular detail of the instrument, and with the aid of these notes I think you will have no difficulty in designing for yourself the type of instrument that you require.

The wave-meter proper consists of the usual oscillating valve with its associated tuning and reaction circuits for the medium and long waves, and these are quite ordinary. It consists of a Reinartz type of circuit, arranged with one of our standard "Titan" wave-change coils, but there is one little point here calling for explanation, since the matter of reaction adjustment is not quite so simple as it looks.

The point is this: it is not difficult to adjust a Reinartz circuit so that it will oscillate suitably over any one particular wave-band, the method being to set the reaction condenser so that the circuit is only just oscillating at the top of the tuning range, but when it comes to two wave-bands with wave-change switching there is apt to be a little difficulty in getting a reaction adjustment which suits both ranges.

Uniform Reaction

For example, if the circuit oscillates much more easily on one wave-range, one has to use enough reaction capacity to secure oscillation over the whole of the other range, and this is very often enough to make the valve go into an audible "squeal" at the bottom end of the first range, on which it oscillates most easily.

What is wanted, then, is a means of adjusting the size of the reaction windings on the two wave-bands so that practically the same setting of the reaction condenser is required for both tuning ranges. This I found it possible to do with a "Titan" coil, by employing what is normally

the aerial primary winding for reaction on the lower waves and the usual scheme of an adjustable filament tap on the long waves, that is, on the loading coil. Then, by using a comparatively small number of turns on the lower wave-range and a large one for the upper, an almost identical setting of reaction condenser was required in each case, and when the wave-meter was finally adjusted I succeeded in obtaining good oscillation over the whole of both wave-bands with no squealing on either.

Reaction Condenser Mounting

To make it easier to obtain this desirable state of affairs I used a

I used is particularly convenient, since it is specially arranged for baseboard mounting in the position which you will see from the photograph. Other types could, of course, be used with suitable modification of the method of mounting.

The reaction adjustment is the most important one to be made in this wave-meter, and since it is something which you must most decidedly get exactly right, I may as well at this point describe how I did it in my own instrument. First of all, we must have some method of discovering whether the circuit is oscillating properly at any given point on the tuning range, and you have here a choice of two methods. First of all,

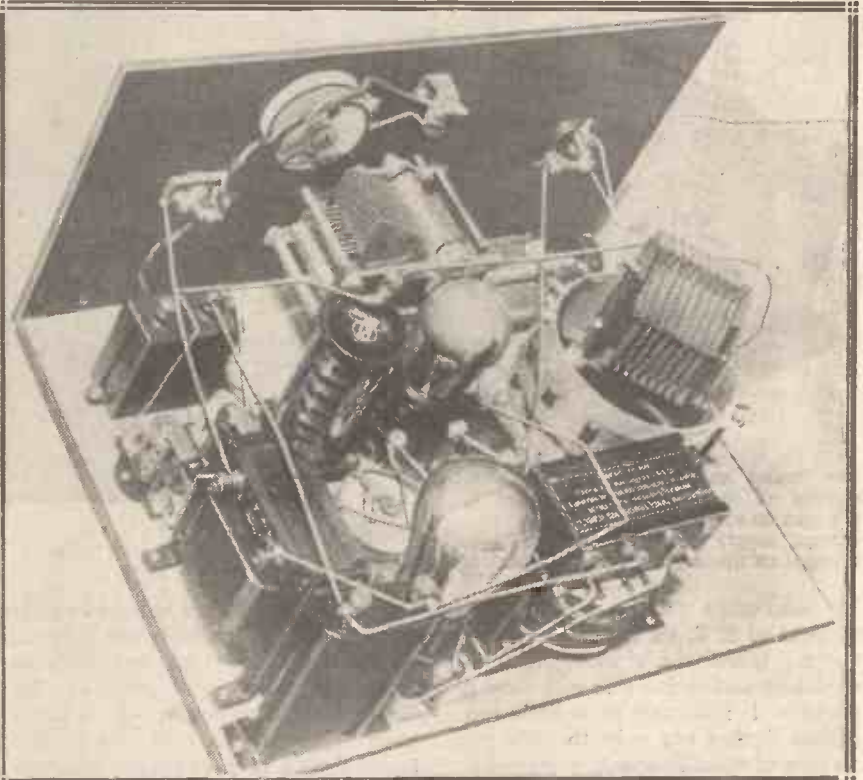

The switch seen on the left of the tuning condenser was later wired into the mains circuit. The connection seen here was a temporary one. Note the two wire-wound resistances which act as a potential divider.

fairly large reaction condenser, the one actually incorporated having a maximum capacity of .00025 mfd. Since perfect constancy of setting was evidently required in this condenser, I chose one of the ordinary moving vane type, in preference to the compression type, and to protect it from possible upsetting of its adjustment I mounted it inside the wave-meter upon the baseboard. For this purpose the "J.B." component which

you can break into the anode circuit of the valve and insert a pair of telephones. Then, by touching the grid side of the tuned circuit, you can note whether you get the usual loud clicks which indicate oscillation.

A Better Method

I did not advise this method if another can be used, since in the preliminary adjustments of an oscillating circuit it is very apt to go into a

squeal at various points, and this is decidedly unpleasant if the headphones happen to be placed tightly over your ears. What I did was to use a milliammeter connected in the anode circuit, which showed by a sudden drop in the reading when oscillation commenced. The best way to break into the anode circuit, by the way, is to remove the lead from the H.F. choke on the other side from the anode of the valve. This is the lead which connects the H.F. choke to the H.T. circuit, and if you insert a milliammeter here you will find that when the circuit is not oscillating you will get a reading of perhaps

reading, which shows you that the circuit has gone into oscillation.

Set the reaction condenser so that this condition is only just obtained, and then turn the tuning condenser slowly downwards to minimum. You will find that the milliammeter will tend to fall gradually as you do so, thus showing that the valve is going into stronger and stronger oscillation.

Stopping a Squeal

If it should break into an audible squeal this will also be indicated on the meter by a sudden drop to perhaps a quarter of a milliamp or some such low reading.

lower wave-band. If you should find that a considerably larger reaction setting is needed for the long waves, transfer the filament tap to the 80-turn point and try again. By juggling with the filament tap and with the low-wave reaction tapping (the tapping clip on the primary winding) you will soon find a combination which gives almost exactly the same reaction setting for long and short waves, and that concludes the reaction adjustment. An important point, by the way, to obtain suitable oscillation over the whole of the tuning range without squealing is the use of a low-resistance grid leak, that employed in my own instrument being only a quarter of a megohm.

Current Supply

The current supply arrangements are quite simple and straightforward, as we shall see if we start at the power transformer and follow through the various circuits in outline. First of all, the oscillator valve is of the new "Point 8" directly heated A.C. type, and the filament of this is run from a small winding on the transformer, which gives it the necessary current at .8 of a volt.

This winding on the particular transformer which I used (a Marconi-phone type L) is provided with a centre-tap for connection to H.T.—, but instead I preferred to use a potentiometer connected across the filament, since it appeared to me that it might be desirable to introduce a certain amount of hum into the radiation of the meter, for some purposes, which could easily be got by moving the potentiometer slider along to one end. This is a minor point, however, and not likely to interest the general user.

Voltage Adjustment

The transformer also incorporates a suitable winding for providing filament current for a U.5 type of rectifying valve, and a high-tension winding giving something round about 140 or 150 volts after rectification. A U.5 valve is accordingly provided with the usual connections, and a very simple smoothing circuit consisting of two 2-mfd. condensers and a single 100-henry Wearite choke.

Since, of course, 150 volts would be far too much on an oscillator valve in a wave-meter, provision must be made to obtain a relatively low voltage, say 40 or 50 volts, and the device incorporated is a very simple form of potential divider, actually a

(Continued on page 94.)

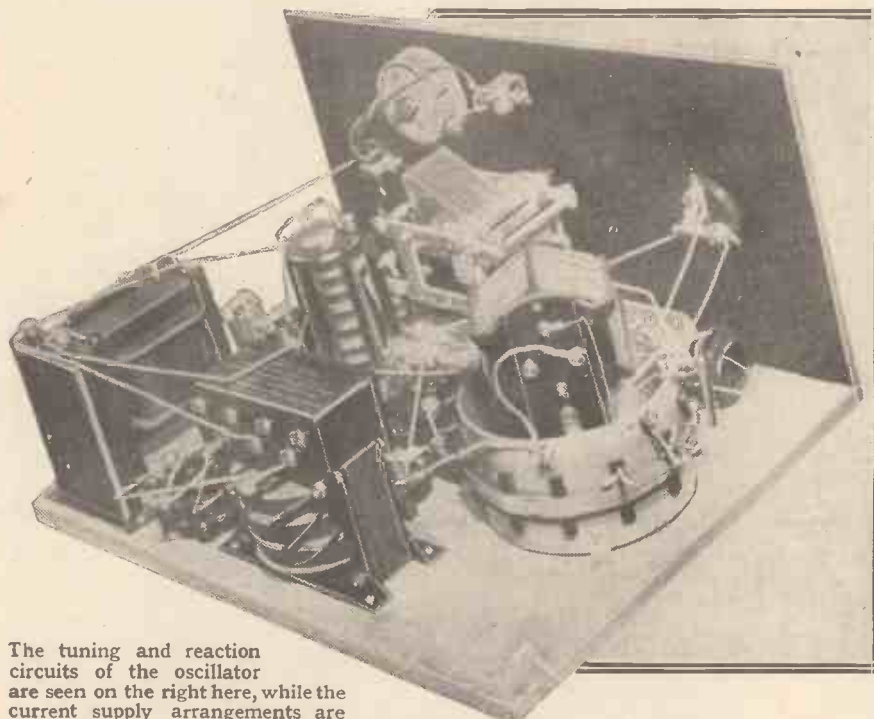

The tuning and reaction circuits of the oscillator are seen on the right here, while the current supply arrangements are grouped on the left and across the back of the baseboard.

1½ milliamps with a moderate amount of H.T. on the H.F. type of valve. When the circuit goes into moderate oscillation this will drop to perhaps 1 milliamp or a little less. (These figures are only to give you an idea of what happens, of course.)

Oscillation Indications

Commence operations with the tuning condenser set to maximum and the wave-change switch pulled out, that is to say, working on the lower wave-range. Place the aerial tapping clip, which now governs the size of reaction winding, on the 12-turn tapping point on the primary winding. Now start with the reaction condenser set to minimum, and gradually increase it. As you do so you can note if the milliammeter gives a kick downwards to a lower

With a suitable low value of anode voltage this will probably not happen, and you will see that just suitable oscillation is maintained over the whole scale, a check being to place your finger on the grid side of the tuned circuit, noting that the milliammeter returns to the normal non-oscillating reading as soon as you do so.

Now switch over to the long-wave setting, and repeat the process. Try the filament tap first of all on the 60-turn point on the loading coil, and you will quite likely find that the same setting of the reaction condenser will do also for the long waves.

Final Adjustment

If necessary, a very slight increase of capacity may be made, and it is not likely to cause any trouble on the

SOME of our readers may have seen in the press the details of the new Prague Plan wave-length scheme. The new British wave-lengths are set out in the table with this article,

THE NEW WAVE-LENGTHS

An impartial survey of the Prague Plan, and an explanation of what it is and how it is going to affect us.

From a Special Correspondent.

Plan," and it will be seen from the table that the changes involved are not particularly serious from the British listener's point of view. Of course, it means a certain amount of sacrifice, but it

and a cursory examination of the new allocations is instructive.

As Captain Eckersley has pointed out, this Prague Plan is a sort of "Wireless Locarno," and is the culmination of the four years' work of the Unione Internationale de Radiophonie. As long ago as 1924 it was generally realised that agreement and co-operation between nations was absolutely necessary if broadcasting technique were to progress, and it was further realised that if mutual interference between stations in different countries was to be ended, it was essential that each station should keep exactly upon some specific wave-length.

A Serious Problem

Further, it was essential that the countries should agree to a definite plan as to the sharing of wave-lengths available.

The trouble before has been to get all nations to agree to one specific plan, and, even when they have agreed, see that adequate steps were taken by the various broadcasting concerns to keep to the specific wave-lengths allotted to them. One of the big troubles, of course, was the scarcity of available wave-lengths, for, in reality, there are only about 100 waves available for all Europe, and when Germany started to come into the broadcasting field and other Continental stations sprang up the problem became more and more serious.

The Brussels Plan

The Brussels Plan was formed and put into operation, but proved ineffective. Now it looks as though the Prague Plan will be the final word on the subject for some years to come, for of all the plans yet agreed upon it seems to be the most likely one for efficient operation.

Attempts were made in 1926 with a Plan de Geneve, and again in 1928 with the Brussels Plan, to solve the wave-length problem, but neither of these agreements was official, in the sense that they were not backed up by the individual governments

concerned. They were more or less like friendly agreements between stations to keep to certain wave-lengths; but the plans had informality and flexibility and, of course, in essence lacked real discipline.

The British Delegation

Eventually, the Czecho-Slovakian Government put forward the suggestion that it would be a good idea to hold a Government Conference finally to discuss and settle up the broadcasting wave-length question. All European Governments agreed, and so, on April 4th, the Prague Conference opened. Every Government interested was represented at Prague.

The Unione Internationale de Radiophonie sent a delegation, headed by Admiral Carpendale of the B.B.C. as President of the Union, which included M. Raymond Braillard, the President of the Union's Technical Committee. The British Delegation consisted of Mr. F. W. Phillips, Assistant Secretary of the General Post Office, and Colonel Lee, Assistant Chief Engineer of the Post Office. This delegation also received the advice and assistance of two B.B.C. engineers accustomed to foreign work.

The result of the Conference's deliberations was the ratification of a new plan, called "The Prague

also meant sacrifice for Germany and Sweden, countries all favourably placed, as Captain Eckersley points out, because of their early start in the broadcasting field.

But the advantages are important, for the plan shows that complete agreement has at last been reached, and the whole business has been settled, signed and sealed with the official seal of the governments concerned.

Captain Eckersley is confident that local listeners may now look forward to an era of uninterrupted listening, and distant listeners to an ever-increasing stability. We, in this country, are now free to develop the Regional Scheme and, luckily, with the full knowledge of the wave-length facilities, etc., available.

Russia has joined in and is in perfect accord with the rest of the European stations. So there is no reason now why the plan should not work satisfactorily with all broadcasting concerns amicably disposed to each other.

Our Ten Waves

Britain retains, of course, the ten exclusive wave-lengths, and when the Plan de Prague comes into force on June 30th, British stations will alter their wave-lengths according to the plan shown herewith. Captain

(Continued on page 95.)

Station.	Present Wave (Brussels Plan)		June 30th (Prague Plan)		On Opening of Brookman's Park for Second Programme (Provisional Reallocation)	
	Frequency	Metres	Frequency	Metres	Frequency	Metres (approx.)
Daventry 5 X X ..	192	1562.5	193	1553	193	1553
Manchester ..	793	378.3	626	479.5	626	479.5
Daventry 5 G B ..	622	482.3	752	399	752	399
Glasgow ..	748	401.1	797	377	797	377
London (1) ..	838	358	842	356	842	356
London (2) ..	—	—	—	—	1145	261
Cardiff ..	928	323.2	968	310	968	310
Aberdeen ..	964	311.2	995	301	995	301
Bradford ..	1020	294.1	1040	288.5	1040	288.5
Bournemouth						
Dundee						
Edinburgh						
Hull						
Liverpool						
Plymouth	1040	288.5	1040	288.5	1040	288.5
Sheffield						
Stoke						
Swansea						
Newcastle ..	1230	243.9	1148	261	1040	288.5
Belfast ..	991	302.7	1238	242	1238	242
*Leeds ..	1160	258.6	1500	200	1500	200

* 1500 kh. (200 metres) is not a British exclusive wave under the Prague Plan, but special arrangements have been made for its use by the Leeds transmitter.

What



"We all like to listen to the people of whom we've heard."

ACCORDING to Oscar Wilde, talk must be spontaneous, but it is obviously difficult to be spontaneous for an average of 13·8 per cent of the B.B.C.'s yearly total of programme time. To a great extent we have lost the art of conversation, and substituted monologues. Probably that is why we are the most bored set of people inhabiting the earth. We bore ourselves and we bore all the foreigners, with whom we try to get equal by calling dagos.

Here is an instance. What could be more boring than to know exactly what you are going to eat at every meal for six months ahead?

The Surprise Element

I suppose the same applies to mental food. In the early autumn of 1928, certain talks were suggested to the B.B.C., and they replied, regretfully, that they would have no available space for a year. What would happen if one said to one's cook: "I want ginger snaps for tea to-day," and she answered, "A splendid idea. I'll have them ready by next Christmas!"

Of course, the groundwork of all programmes—and all meals—must be arranged in advance, especially when the chef is catering for over 3,000,000 guests, but room could be

left for those unexpected special dishes—*plats du jour*—which make the success of any banquet.

"What's in a name?" asks the poet, but, alas, there is all the glamour of adventure, of achievement, of romance in the names we know.

Sometimes, of course, a world-famous personality has not got a voice to match, but with this exception a familiar name has the same illogical value in the air as it has in print or in any other place-of-the-earth—earthy!

We all like to listen to the people of whom we've heard, because they represent to us something outside the humdrum monotony of our daily lives. For the same reason most of us want to hear about strange places and strange peoples.

Stirring the Imagination

Travel lectures are always thronged because the sense of adventure is deep-rooted in the average British heart. Why shouldn't we "travel" on the wireless and, without leaving our own armchairs, taste the excitement of pioneers? Eugène Wright and a dozen others who have ventured into lands of mystery and magic could make our flesh creep and widen our commonplace horizon with tales of jungle or desert.

I doubt if it is feasible to deal exhaustively with the development, religious or philosophical, national, historical, political, artistic, social or industrial, of any one country in the limited time at the disposal of lecturers, let alone with all such phases,



Miss Rosita Forbes.

Do You Want To Hear?

as the B.B.C. are going to attempt in their survey of Chinese civilisation.

But it should be possible to familiarise listeners-in with the conditions of life in foreign countries so that the Englishman may lose that self-conscious insularity which blights his holidays abroad.

"The world is as wide as your imagination," announced an Arab philosopher, and could there be any better medium for rousing popular imagination than the power controlled, but perhaps not yet fully comprehended, by the B.B.C. directors of talks?

Diverse Opinions

Before I began to write this commentary I submitted the B.B.C. programme of talks and lectures to an average lunch party. "What's wrong with it?" I asked. A babel of criticism arose. "It leaves nothing to the imagination." "It's too ambitious." "A monument to the commonplace." "Give me something unexpected." "I hate having the dinner menu presented at breakfast." "Too many subjects—soon there'll be nothing left to talk about," and so on.

"Well, let's each say what sort of talk we'd like to hear on the wireless," suggested my hostess; and two young women of approximately the same age announced simultaneously, "I want to be instructed, not amused," and "I want to be amused, not instructed."

Some interesting suggestions for brightening the talks' features in the B.B.C. programmes are given in this article by a noted woman explorer.

By ROSITA FORBES.

A thrilling short story was the verdict of a hunting maiden who rarely opens a book, and a fisherman retorted with: "No, a really thrilling play, specially written for broadcasting, with all those sudden sort of noises that make the prickles stand up on your spine."

Some More Suggestions

"I like the criticisms of books, plays and films. It saves one such a lot of trouble," said a busy woman; but the best suggestions came from men.

"The news bulletin is all very well for tabloid information," remarked a soldier, "but why can't we have real news, compressed,

of course, but with some sort of colour behind it. I'd like to hear Garvin discussing world affairs—it would save one having to read 'The Times' leaders, which are always too long."

"People who make the news ought to talk about it," elaborated a merchant.

"But the people who do things are often incapable of describing them." I interpolated.

The men, however, were more or less united. "I'd like to hear accounts

(Continued on page 96.)



B.B.C. engineers arranging a synthetic trip to the jungle via the microphone and a broadcasting programme.

The "Summertime" 5

Now that the evenings are longer, and conditions for distant reception are bad, one often begins to feel that a set with a little more pep and punch is required to bring in the distant stations.

In designing the "Summertime" 5 I have, therefore, used two stages of H.F. amplification in order to give it the desired "reach." And so great havé I found the amplification to be that, I have used one stage only of L.F., and this has had to be push-pull in order to handle the signal without distortion.

Special Screening System

As you will have guessed from the above remarks, I am using S.G. valves for the two H.F. stages. By doing this not only do you get the required range, but also, an important point, you get a reasonable degree of selectivity, which, as you have no doubt already found in your own experiments, is one of the qualities lacking with most S.G. H.F. circuits.

Our object is to get stability on the one hand; and on the other, the majority of experimenters like to have some form of reaction control on the receiver. The simplest thing to do, therefore, is to combine the two.

This makes the construction of the set far less critical, and certainly simplifies its design. Don't think, however, that this is sufficient reason

One of the drawbacks to using complete screening is the difficulty in making the connections to valves inside the screen, so I have worked out a special system of screening, and designed a new type of screen, that considerably simplifies the construction and wiring of the receiver.

The control of stability, which is also the reaction control, is smooth and easily adjusted, and also gives a

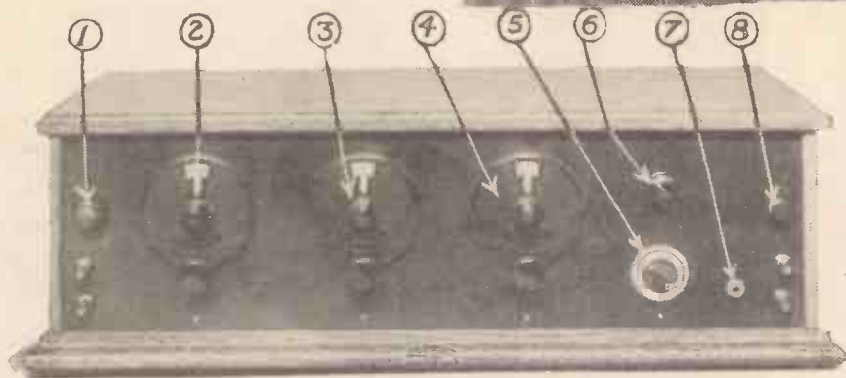
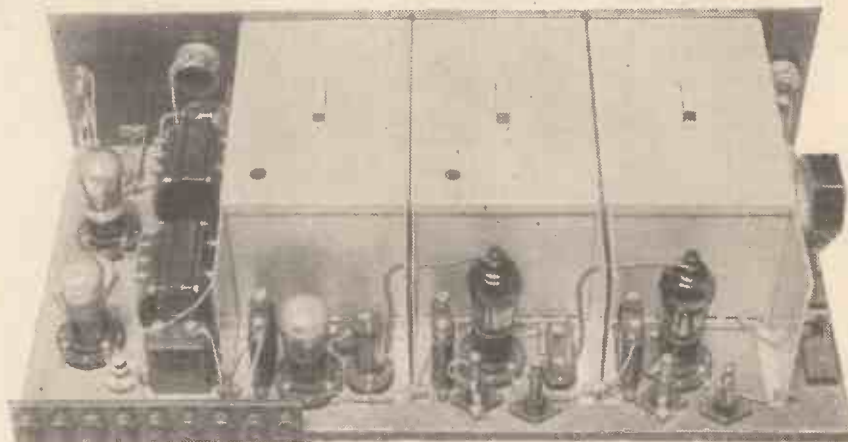

Here are the main controls. (1) High-frequency volume control; (2) aerial tuning; (3) first H.F. tuning; (4) second H.F. tuning; (5) voltage control for screening grids; (6) H.F. filament control; (7) jack for plugging-in gramophone pick-up; (8) on-off switch.

The upper photograph shows the completeness and essential simplicity of the screening arrangements.

With two stages, however, a very satisfactory degree of selectivity is obtained, yet the tuning does not become so sharp as to make the set difficult to handle, or sharp enough to spoil quality by cutting off sidebands.

Naturally, it has been found somewhat difficult to get complete stability under all conditions, and I have tackled the question from a more direct angle than is usually done

to neglect all precautions as regards preventing unwanted coupling between the H.F. stages, it is still desirable to take these precautions so as to obtain the maximum efficiency from the receiver, and it is still essential to use complete screening in order to isolate each H.F. stage from its neighbour, and the more carefully this screening is designed and carried out the better the results we shall get.

certain degree of control over volume. On very powerful transmissions, however, some other form of volume control is desirable, and has, therefore, been included. It has been put in at the aerial end of the set so that the detector valve shall not be overloaded, and its adjustment is simple. Also a filament resistance controlling the two H.F. valves is incorporated. This gives a rough control, the fine control being obtained by other means.

A Very Effective Set

To prevent coupling through this common resistance in the filament leads this resistance is shunted with a 2-mfd. condenser C_{17} , and this, you should note, has quite a definite effect on the stability of the H.F. amplifier.

The results given by this set are all that can be desired. Stations from all over Europe can be tuned in on the loud speaker, while the programmes from the more powerful transmissions, such as Budapest, Milan, Vienna, Brussels, Langenberg, Munich, Frankfurt, Radio Toulouse, Berne, Rome, etc., come in with wonderful volume. On the long waves, too, the efficiency of the receiver is surprising, and the

 * This powerful set, with its two high-frequency stages, *
 * will pull in the loud-speaker programmes from all *
 * over Europe. *
 *
 * Designed and described by *
 * C. P. ALLINSON, A.M.I.R.E., A.M.I.E.E. *



various continental concerts from Hilversum, Motala, Berlin, Huizen, Radio Paris, etc., come in with exceptional strength.

The theoretical circuit diagram is shown in Fig. 1, and first of all I will deal with the general principles of the circuit.

A wave-trap, $L_1 C_1$, has been incorporated so as to enable interference from a powerful nearby station to be cut out. Even with two stages of H.F., if you live very close to a transmitter a trap is needed, and the simple one included enables jamming from this source to be cut out.

The aerial is loose-coupled to the first valve, the aperiodic aerial winding L_2 being provided with two taps for the upper and lower halves of the broadcast wave-band. A variable resistance R_6 connected across the aerial and earth connections gives control over the H.F. input to the set, so that the overpowering transmissions may be reduced to a suitable value.

Using a Frame Aerial

You will notice in the theoretical circuit and in the wiring diagram that the first H.F. grid circuit has a

couple of terminals connected to it marked T_1 and T_2 . These are to enable a frame aerial to be used, if desired.

By removing the aerial coupler and connecting the frame to these terminals numerous transmissions can be tuned in without either aerial or earth, and the H.F. amplification given is great enough to enable a considerable number of stations to be tuned in. For the long waves the frame may be loaded up with a plug-in coil, or else a special long-short frame may be used such as that recently designed by Mr. Colle, and described in "M.W."

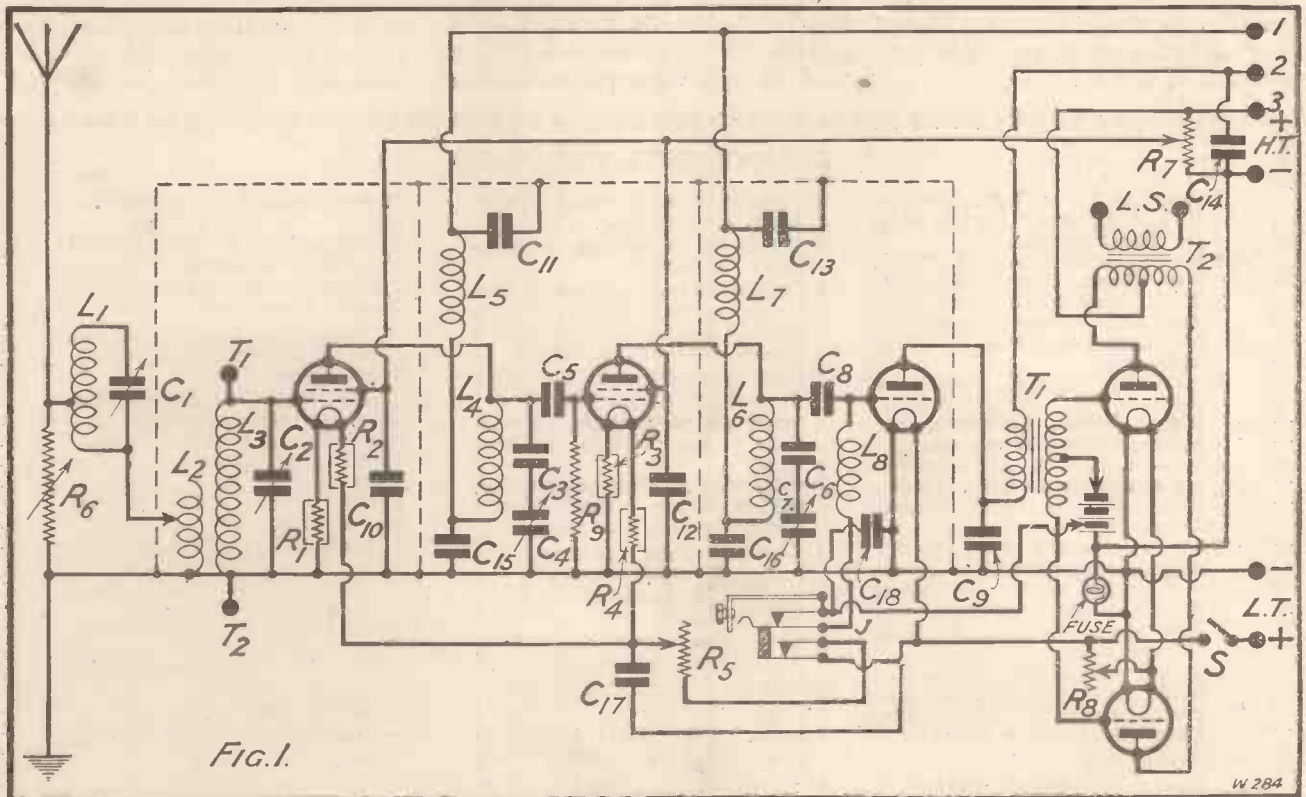

FIG. 1.

W 284

It is advisable to mount the frame well towards the front of the set, for otherwise it may interact with the H.F. valves at the back, and so introduce instability. This point should, therefore, be noted when carrying out the installation of a frame aerial for use with this set.

A special form of series tuned anode has been used for the inter-valve coupling. H.F. chokes L_5 and L_7 are incorporated in such a manner

Both H.F. valves are provided with separate filament resistances, R_1 and R_4 , of the fixed type so that any voltage valve may be used, even with a battery of higher voltage, and since one of these is placed in the negative lead in each case the desired amount of grid bias can be applied without the need for special batteries, for these run down in time notwithstanding the fact that no current is being taken from them.

give amazingly pure reproduction without loss of the low notes.

No reaction is provided in the plate circuit of the detector, but the usual small shunting condenser C_9 prevents H.F. from getting through into the L.F. side of the set.

The screen potential of the two H.F. valves is adjustable from the front of the set by means of a potentiometer R_7 , and it is this adjustment that provides the stability and reaction control. By making the screening grid slightly more positive or negative than is usually indicated, any tendency to self-oscillation can be suppressed, and, at the same time, since the potential of the screening grid affects the amplification of the valve a measure of volume control is afforded.

An Important Alteration

The adjustment is obtained by means of a potentiometer, an arrangement that I have found to be far more satisfactory than the use of a series resistance. It should be noted, however, that when the set is worked off dry batteries or an H.T. accumulator a slightly different way of incorporating this potentiometer should be used. At present it is connected permanently across H.T.+ and H.T.-, and this is all right where the set is used with an H.T. eliminator, and this set is, of course, one that should really be worked from one. With batteries this would result in a small current being passed even when the set was switched off, about 2-3 milliamps, depending on the H.T.

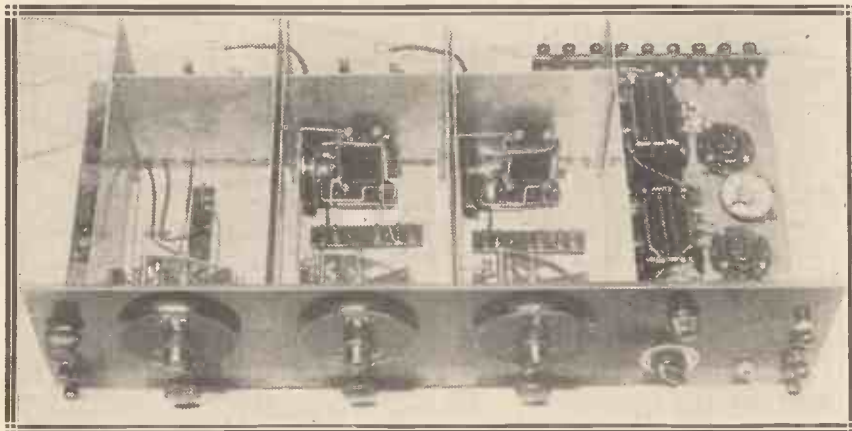

Here the lids of the screening boxes have been removed to show the coil holders and associated apparatus.

as to introduce no extra damping into the circuit, and the spindles of the tuning condensers are all at earth potential. Precautions have been taken against any possibility of a short-circuit in these condensers, resulting in the H.T. supply being shorted, by the use of fixed condensers shown at C_3 and C_6 .

The output from the H.F. side of the set is very great. So great indeed that I have considered it essential to use anode-bend rectification. By using a medium impedance valve, with plenty of H.T. and sufficient bias, it will handle a really "hefty" input, and though transformer coupling is used the right valve will nevertheless

COMPONENTS REQUIRED

- 1 Panel, 26 in. x 7 in. (Resiston, Becol, "Kay-Ray," Ripault, Ebonart, Trelleborg, etc.).
- 1 Cabinet, with baseboard 12 in. deep (Lock, Camco, Raymond, Bond, Pickett, Gilbert, Artercraft, etc.).
- 3 Aluminium screening boxes, type S5 (Burne-Jones, Paroussi, Ready Radio, etc.).
- 3 .0003-mfd. variable condensers (Lissen, J.B., Lotus, Dubilier, Utility, Burton, Gecophone, Pye, Igranic, Ormond, Formo, etc.).
- 3 Slow-motion dials (if condensers not of slow-motion type). (Igranic, Utility, Brownie, Lotus, Ormond, Lissen, etc.).
- 1 Set of long- and broadcast-wave coils and bases (Wearite, Paroussi).
- 2 H.F. chokes for the H.F. anodes (Igranic, or other good make).
- 1 H.F. choke for detector circuit (Wearite, etc.).
- 5 Sprung valve holders (Lotus, Benjamin, W.B., Igranic, Marconiphone, Precision, Pye, B.T.H., Formo, Bowyer-Lowe, Burne-Jones, Ashley, etc.).
- 1 Clarostat volume control (Claude Lyons, Holzman, etc.).
- 1 50,000-ohm heavy-duty potentiometer (Rothermel).
- 1 Compression type semi-variable condenser capacity about .0001 to .0005 (Variodenser, obtainable from Messrs. Rothermel, in original).
- 4 Fixed resistors and vertical holders (see text for values). (Dubilier.)
- 1 2-meg. grid leak (Lissen, Ediswan, Igranic, Pye, Mullard, Dubilier, etc.).
- 2 .0003-mfd. fixed condensers (Dubilier, Goltone, Lissen, Mullard, Igranic, Clarke, Magnum, T.C.C., etc.).
- 1 .0003-mfd. fixed condenser, preferably of the edge-wise mounting type (Dubilier, Lissen, Clarke, T.C.C., Igranic, Magnum, etc.).
- 2 .004-mfd. fixed condensers (Dubilier, or other good make as above).
- 2 .01-mfd. fixed condensers (T.C.C., etc.).
- 2 1-mfd. and two 2-mfd. Mansbridge type condensers (T.C.C., Lissen, Ferranti, Mullard, Hydra, Dubilier, etc.).
- 1 A.F.5C. and one O.P.3C. push-pull transformers (Ferranti).
- 1 Baseboard filament resistance (Igranic, Lissen, etc.).
- 1 30-ohm panel-mounting filament resistance (see text) (Lissen, Igranic, Precision, etc.).
- 1 Double-circuit double-filament jack and plug for pick-up (Igranic, Lotus, Ashley, Ormond, Bowyer-Lowe, etc.).
- 1 On-off switch (Benjamin, Lissen, Lotus, Wearite, Igranic, Magnum, Bulgin, Ready Radio, Burton, Pioneer, etc.).
- 15 Terminals as marked (Igranic, Eelex, Burton, Belling and Lee, etc.).
- 1 H.T. fuse (Magnum, Bulgin, Ready Radio, etc.).
- 1 Single coil holder (Lissen, Lotus, Magnum, Igranic, etc.).
- 2 Sockets and 1 plug (Clix, Eelex, Burton, etc.).
- Ebonite strip for terminals, etc.
- Wire, flex, screws, 4 B.A. rod and nuts, washers, etc.

Reaction Control is Smooth and Easy

voltage, and the following alteration should be made: Use a special L.T., H.T. switch for the on-off switch, and instead of connecting the H.T.— and G.B.+ terminals direct to L.T.—, bring them to the H.T. contacts on the switch. By this means, the potentiometer circuit will be broken at the same time as the L.T. circuit, and thus no load will be imposed on the H.T. battery when the set is not working.

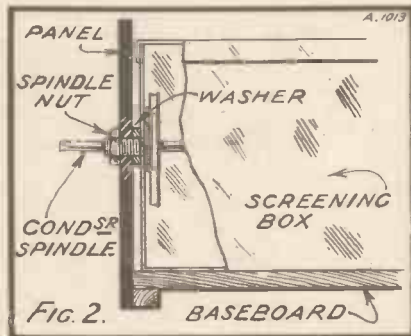

I have also connected a jack in the detector circuit so that if desired a gramophone pick-up may be plugged in. By slightly altering the bias on the detector valve, it takes two seconds to do this, it becomes an amplifier, and when using a pick-up of the more sensitive type ample

volume will be obtained for all ordinary requirements. I have used a filament control jack, so that plugging in the pick-up also switches off the H.F. valves, so that the change-over from radio to gramophone can be made as rapidly as possible.

New Type of Box

To turn to the photographs of the set you will see how the screening has been carried out, an entirely new type of box having been designed. Only the coils, condenser, H.F. chokes, and certain other components which are conveniently carried inside the boxes are completely screened. The valves are located inside small bays at the back of each screen. This gives the required electro-static screening, but allows the valves to be got at with ease, and all connections made to them and their filament resistances without the slightest difficulty. The screening boxes actually used are a little higher than the final design, but this does not affect the construction of the set in any way.

The general appearance of the set will be seen to conform to the most modern practice, and every detail conducive to efficiency and ease of construction has been carefully considered.

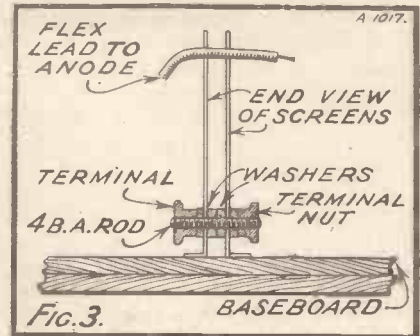

With only one or two exceptions the components have been chosen to be fitted with terminals so that connections can be made without soldering. I have wired the set myself in this manner, so as to show how easy it is. Ordinary lighting flex has been used, and by raising the baseboard $\frac{1}{4}$ in. all battery leads can be taken underneath it, thus leaving only high-frequency and low-frequency leads to be taken above.

Neat Appearance

The views of the set from behind the panel show what a neat appearance this gives the set, and if you examine them carefully the simplicity of the set will be apparent.

Looking at the set from the back, the wave-trap coil and condenser, of

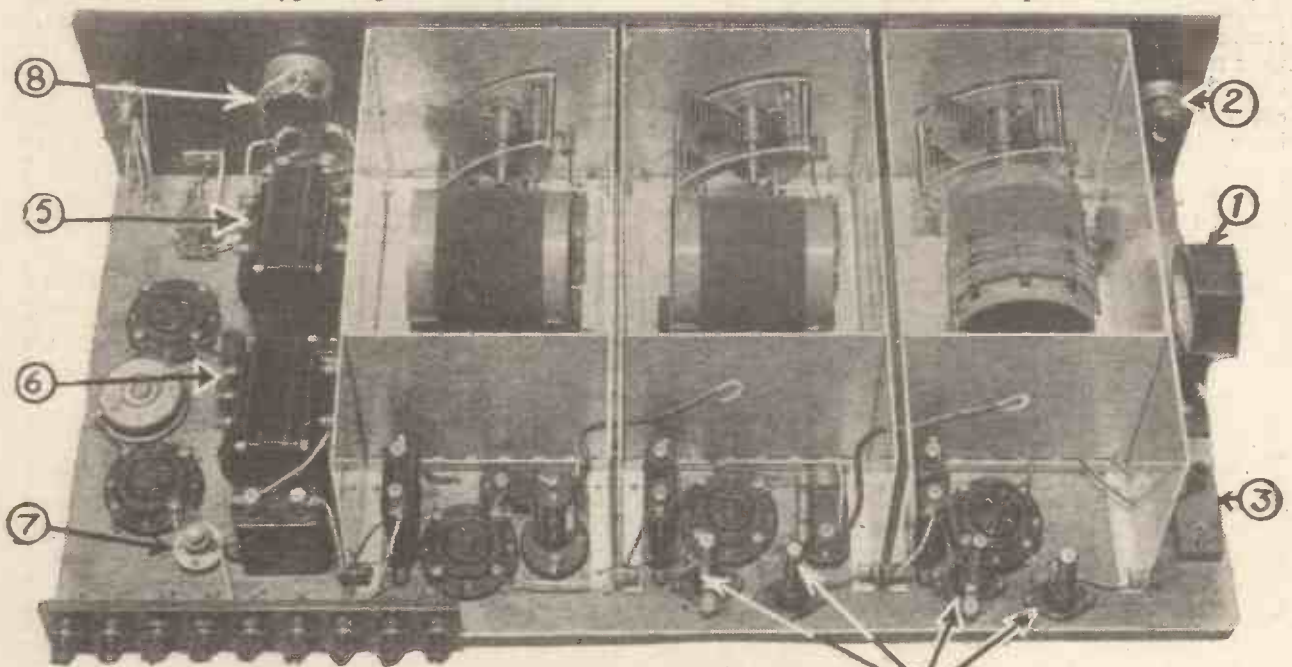

This general back-of-panel view shows all the main components. (1) The wave-trap coil (L_1); (2) the resistance for control of input; (3) terminal board carrying T_1 and T_2 , for connection of frame aerial if required; (4) resistors for H.F. valves; (5) the push-pull output transformer; (6) push-pull input transformer; (7) fuse; (8) H.T. voltage control for screens of H.F. valves.

the baseboard mounting type, will be seen on the left. In the first bay is the first H.F. valve with its two filament resistances, and the screening-grid shunting condenser. Then in the second bay is the next H.F. valve, and lastly the detector valve.

On the extreme right are the two push-pull transformers and the two valves, while the battery terminal panel is fixed as usual to the back edge of the baseboard.

A flash-lamp is connected between the H.T.— and G.B.+ terminal and L.T.—. By this means double protection is afforded the valves, both from the H.T. battery and the grid bias.

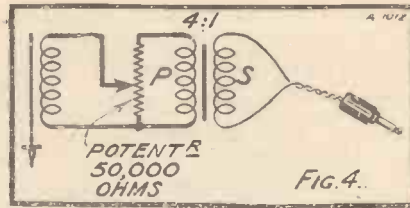

and ample room is left inside for the components to be laid out without crowding.

The constructional work called for is quite easy, and although one or two points have to be watched, they do not involve any real difficulty.

First of all, drill the panel according to the panel layout in Fig. 1. If you

drawn to scale and shows you just where they should go. Mark them from the front of the panel for drilling the holes for the condenser spindles, and drill the holes for them.

Now place the three condensers in position and temporarily fix the boxes to the baseboard at the back. Now place the rest of the components into position, including the L.F. side of the set, and fix them all to the baseboard.

The L.F. Wiring

Now remove the condensers and the screens and drill holes through the baseboard where the various leads

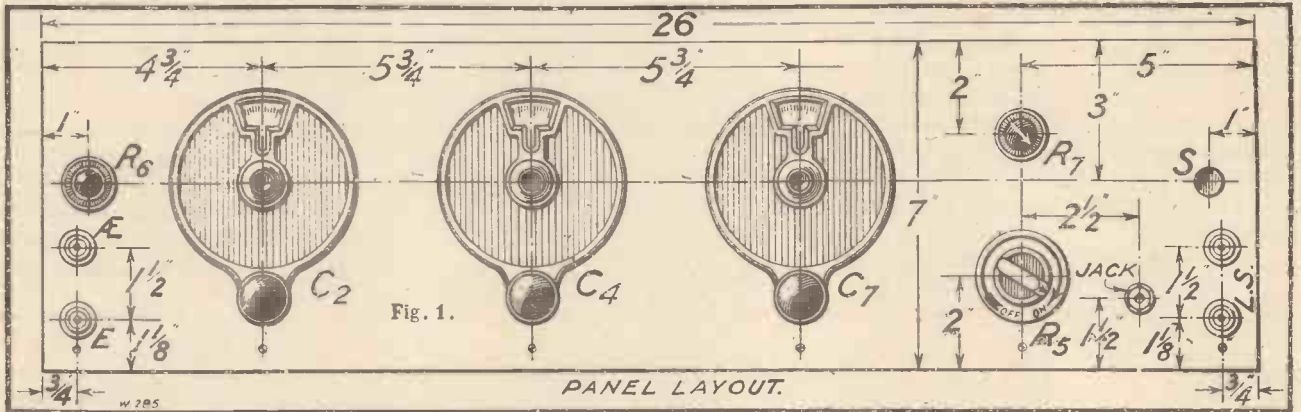

When using big valves with 30 to 40 volts negative it is just as well to make sure that no harm comes from this source, as well as the H.T. supply.

The screening box lids have small handles on them which facilitates their removal for wave-length change, and, as you will see, have small slots cut in them where it is required to bring the leads out from the components inside.

These boxes have been made large enough to enable most makes of tuning condenser to be accommodated,

are using slow-motion dials which are anchored by a small stud at the bottom, drill a hole for this at the same time, and countersink on the back of the panel with a 1/4-in. drill so as to allow the nut to be sunk in nearly flush with the surface of the panel.

Fixing the Boxes

Fix the wooden strips 1/4 in. by 3/4 in. to the underside of the baseboard at back and front edges, and then mount the panel to it. Put the three screening boxes into their correct positions; the wiring diagram is

go through, fix the terminal panel in position and carry out as much of the wiring as is possible. You may find it easier to finish some of the L.F. wiring with the panel off, and it will certainly enable you to drill the holes near the front edge of the baseboard where the leads come through for the battery switch, potentiometer, etc., with greater ease if this is done.

After you have finished the leads which need the panel off to get at, re-fix the panel into position and get on with the rest of the wiring as far as possible.

Next prepare the baseboards which go inside the screens; these are 5 in. by 7 1/2 in., and about 1/2 in. thick three-ply wood being used. Mount the various fixed condenser coil mounts, H.F. chokes, etc., that are placed on them, and do as much of the wiring-up before you put them into the boxes.

When these are prepared, put them inside the boxes and then drill a couple of holes through each baseboard and the bottom of the box at convenient positions for long screws to go through, and fix them into position on to the baseboard proper.

Now put the boxes into position and fix the tuning condensers firmly into place. Note that you will have to

SUMMARY OF WIRING-UP THE "SUMMERTIME" 5.

All components fixed to baseboard. Panel off.

Connect all leads to terminal strip, leaving loose those that go on panel.

Complete L.F. amplifier. L.T.+ to switch, all L.T.+ leads from switch to valves.

Anode V_2 to C_9 and anode terminal of T_1 . C_9 to L.T.—, H.T.+ of T_1 to H.T.+2 terminal and C_{14} .

Fix panel in position.

Grid V_3 to C_8 and L_8 . (Other side L_8 to jack. Jack to G.B.—1. (For connections of jack see Fig. 7.)

Anode terminal of V_2 holder (i.e., screening grid) to C_{12} and slider R_7 .

Grid of V_2 to C_5 and R_6 . R_6 to L.T.— side of R_3 . Other side R_3 to V_2 and R_4 also to V_2 . Other side R_4 to R_5 and C_{17} .

V_1 anode terminal of holder to C_{10} and slider R_7 . One side R_2 to R_3 and C_{17} . Other side R_2 to filament + V_1 . F_1 — V_1 to one side R_1 .

One side R_1 to H.T.+3 terminal.

Other side R_1 to L.T.—.

Two leads from H.T.+1 to positions where they will enter screens, and leave loose.

Fix boxes into position, having drilled 1st box for frame aerial terminals and fixed these, one in contact with box, other insulated.

Wire baseboards, insert and complete rest of wiring as is convenient.

UNDER-BASEBOARD WIRING.

0—1, 2—35, 3—39, 4—36, 5—38, 6—11, 7—42, 8—47, 9—12, 10—56, 13—48, 14—17, 15—37, 16—30, 18—21, 19—29, 24—45, 22—50, 23—25, 20—26, 27—31, 28—52, 32—46 (twin flex), 33—53, 34—43, 40—53, 41—51, 44—48, 49—54.

These are not in the order in which the wiring should be done, but show according to the numbered circles in the wiring diagram where the ends of any lead come through the baseboard. Thus the lead from the anode terminal of V_1 goes through the baseboard at 3 and then comes through again at 39, where it goes to the slider of R_7 , and so on. I think this chart makes the under-baseboard wiring much clearer than any other method would.

Surprising Efficiency on Long Waves

put a washer between the screening box and the panel to prevent the box from being pulled out of shape and to allow the lid to be freely removed and replaced. The small sketch in Fig. 2 shows the necessity for, and the function of, this washer.

Now bond the screening boxes together with 4 B.A. screws or 4 B.A. rod and nuts. Here again washers will be required to keep the correct spacing between the screens, the rough drawing in Fig. 3 showing the manner of bonding the boxes, for these form part of the common L.T. — circuit. Soldering tags may be fixed under the nuts or else washers provided so that connections can be made to the screens.

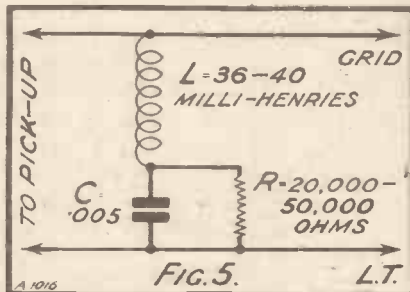

After this complete the rest of the wiring, taking care to slip a length of Systoflex over wires where they go through the screens, just as a precaution against any possibility of a short-circuit, and also to help reduce the capacity of that lead to earth.

Use Heavy Wire

Lastly, insert the H.F. valves into position and mark a point on the side screen opposite the anode terminal, and put a $\frac{3}{16}$ -in. drill right through both screens (also in Fig. 3). Use fairly heavy insulated wire for this lead. I have used high-tension cable (5 m.m.), and these two leads should then finish off the wiring.

It is advisable to use heavy wire for these two leads, because it is by no means a difficult matter for a slack lead to drop against the earthed metal of the boxes when a valve is removed and an H.T. short to occur. I know, of course, and so do you, that the set should always be switched off before doing anything of this nature, but I am afraid we do not always do it.

Now here are a few points to watch about the wiring. Mark the next few paragraphs with a blue pencil when you come to them, so that you do not

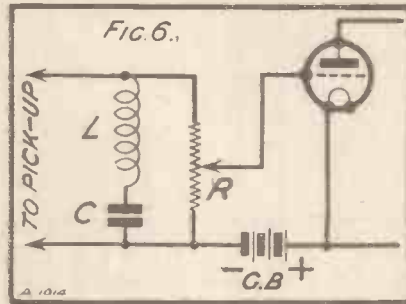

overlook them when building the set.

I have used ordinary rubber-covered lighting flex throughout for wiring, except in the case of two or three leads which should be stiff and rigid. This flex, as you know, is covered with braided thread covering, and in order to distinguish between low- and high-tension leads this should be left on in one case, and removed in the other.

Some Wiring Hints

Since some of the H.T. and L.T. leads cross under the baseboard, I have taken the added precaution of slipping a short length of Systoflex over one of the leads at the point where they cross.

If you use a different method of wiring, be sure that no possibility of a short-circuit can take place under the baseboard as well as elsewhere in the set.

When wiring the two H.F. stages use separate leads for the filament leads, screen-grid leads and H.T. positive leads. Don't use a common

lead with branches from it to various points.

Although the coupling introduced by using a common lead may not be very great, when using two S.G. valves for H.F. amplification it can make a considerable difference to the performance of the set, since the coupling may be great compared with the small amount of coupling left within the valve. Where flex has to be soldered, clean it very carefully beforehand, make it up into a pigtail, and then solder it into position last of all. The numbers in the table give you the details of the under-baseboard wiring, while the full details of the

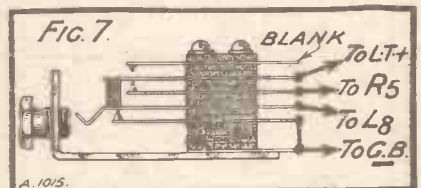

connection to the jack are shown in Fig. 7 so as to make it clear.

After the wiring is finished check it over carefully, mistakes with S.G. valves at 22s. 6d. a time are costly.

Everything being O.K., we are now ready to test out on the aerial. What coils and valves then are we to use?

For the aerial coupler L_1 and L_2 a 75-turn coil on a 3-in. former is needed for L_2 , and a 12- or 14-turn coil with a tap at 6 or 7 turns does for L_1 . Both H.F. coils are 75-turn coils,

(Continued on page 98.)

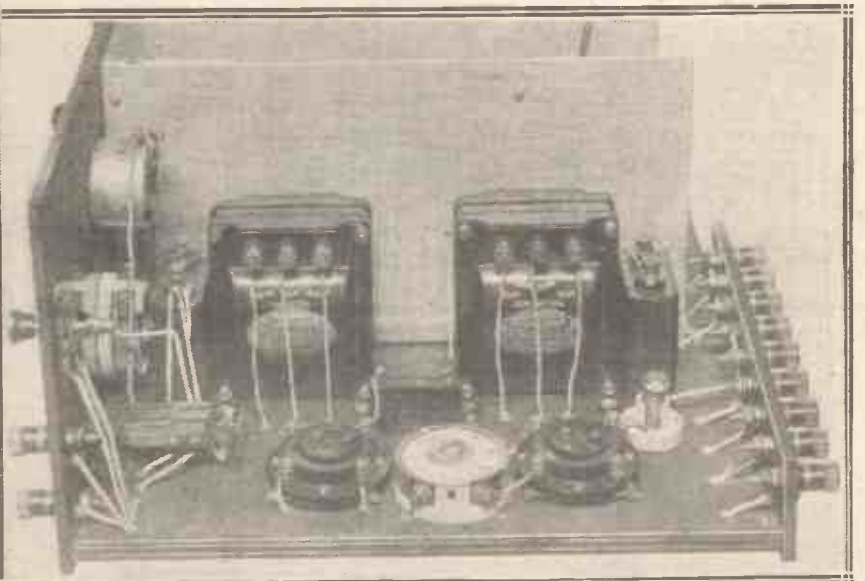

Here is the low-frequency end of the set, showing how the neat method of sub-baseboard wiring simplifies the construction.

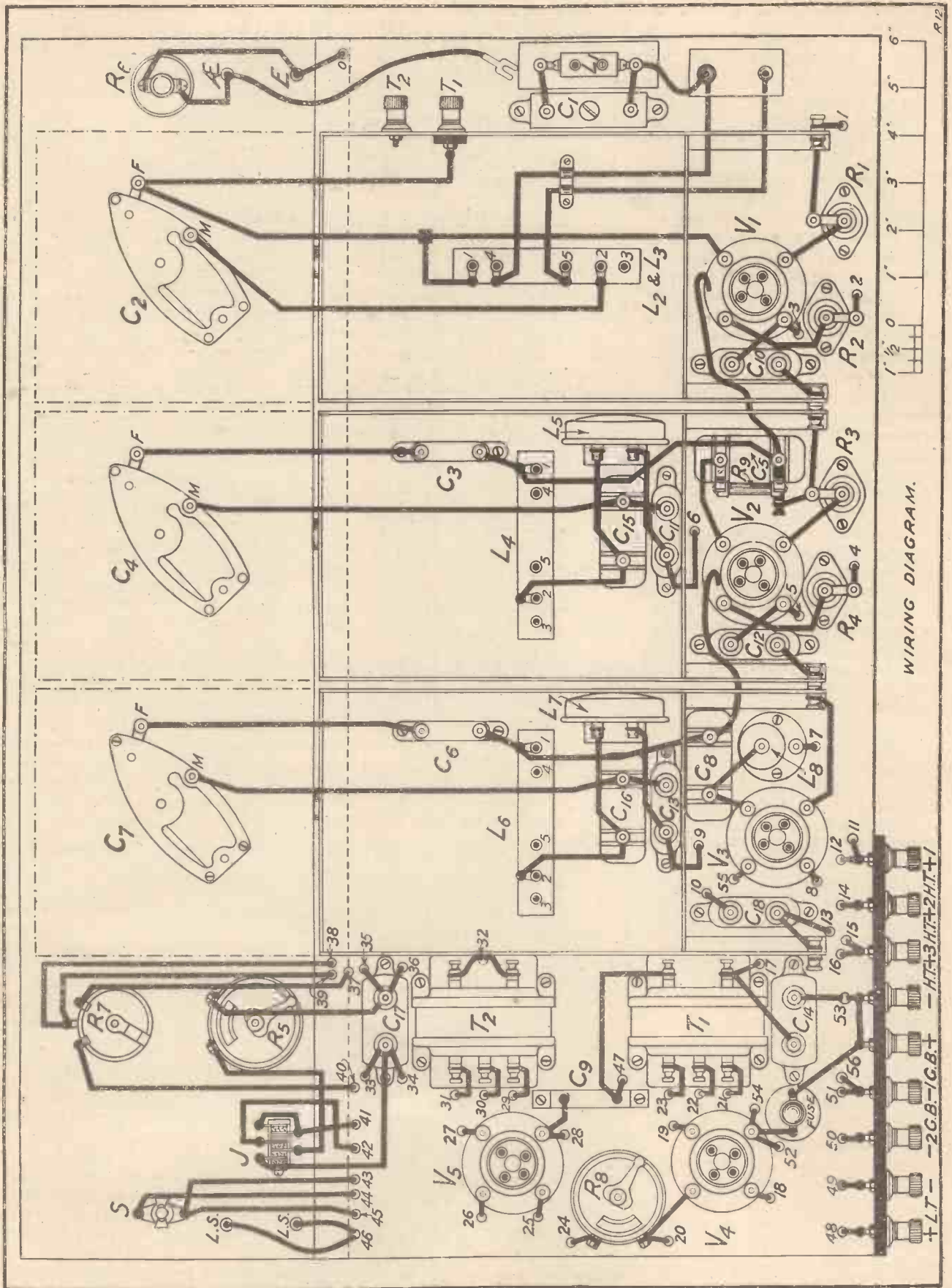

ON THE SHORT WAVES

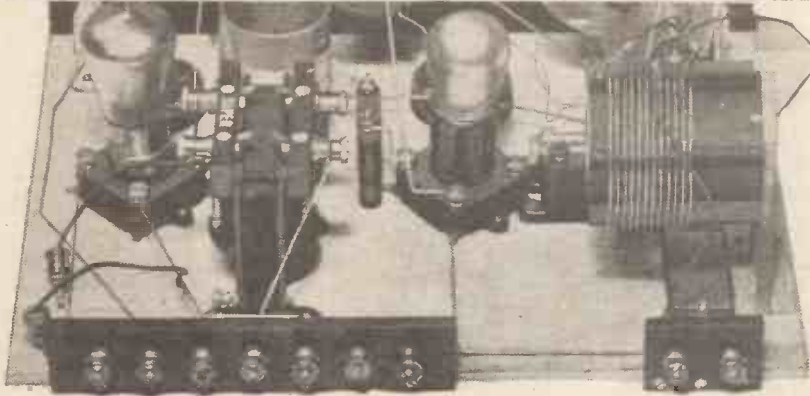

Notes of Interest on Short-Wave Receivers and Reception.

By W. L. S.

THE month of July naturally marks a distinct waning of interest in short-wave work on the part of "the ordinary listener," but probably no more than is the case with other branches of radio. In fact, short waves during the summer are usually rather fascinating, and certainly one is not bothered by the awful atmospheric conditions that make life unbearable for those who sit up late to listen for America on the broadcast wave-lengths!

It is remarkable just how short-wave development has changed everything round; seven years ago, he was indeed a hero who had received the States (even on long-wave Morse!), but now, I am afraid, he who has *not* is looked upon as rather a dud.

Certainly it is remarkably easy on any average night to log two or three American stations on any moderately good short-waver, and the beauty of it all is that the best short-waver is nearly always the simplest, and complications are not rewarded.

Simplicity is Surest

There is a certain class of listener (and constructor, also) who delights in turning out sets that are masterpieces as far as workmanship, and sometimes ingenuity, are concerned, but really and truly have a network of quite unnecessary complications introduced. This type is most unpopular on short waves, for various reasons! In fact, I believe the results obtained vary in inverse proportion to the "gadgets" in the set.

I have just been handling a wonderful little detector and pentode set made by

a friend of mine, and I can honestly say that it ranks with the very best short-wavers I have ever used or heard. And yet when it comes to the point and one examines it, there is nothing original or "pretty" about it except that it is a straight, "honest-to-goodness" kind of set with a very neat, compact layout, reasonably good components, and short wiring.

Incidentally, I am very fond of the pentode for short waves, since I have been using one for some little time myself, and I am convinced that the background one obtains is nothing like proportional to the extra amplification on signals.

I have made a three-valver comprising a screened-grid stage, detector and pentode, principally for use with a loud speaker on distant broadcasting, and hope to report results very soon.

The short-wave adaptor does not seem to be meeting with much approval in this country for some reason or other. By this I mean the small, compact short-wave detector, complete with tuning circuits, etc., which "plugs in" the existing detector socket on any set, simply utilising the note-magnifiers.

This scheme has much to recommend it, and is a great convenience for the reader who has a really good broadcast receiver that he does not want to "maul about" to make it suitable for short waves, and cannot afford to run two separate sets.

A Useful Scheme

The chief snag one encounters in the construction of an "all-wave" set is, of course, the question of condenser values. 0003 for the condenser across the first grid circuit (whether H.F. is used or not) is usually too small for the broadcast wave-lengths, but is always too large for the ultra-short waves, and we have to resort to a fixed condenser in series with the variable to render the set an efficient "all-wave" receiver.

The use of a short-wave unit, with its self-contained coil and small condenser, naturally surmounts this obstacle completely, and is from every point of view a very useful scheme.

A GERMAN SHORT-WAVE STATION

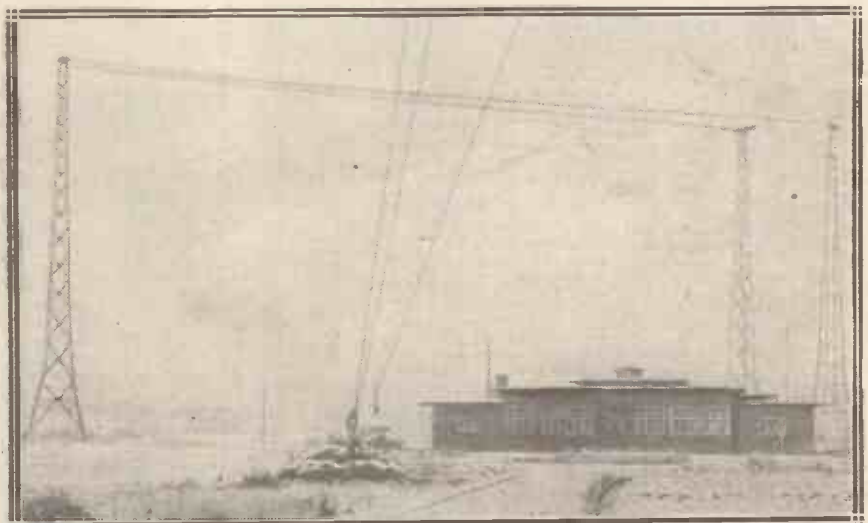

This is the Nauen short-wave station, which uses the code letters A G C and transmits on a 17.20-metre wave-length.

By G. V. DOWDING, Grad.I.E.E.

How

SOMEbody says he has received Vienna at full loud-speaker strength, and in the daytime at that. What is the very first question one of his bored (or interested) friends asks? Why, "How many valves?" of course! That is as inevitable a question as the "How much did it weigh?" query which, in piscatorial circles, always follows the announcement of the hooking of a fine trout or salmon.

But surely such a question is foolish. Would not the inquiry be much more to the point if it dealt with the circuit? Supposing the answer were to the effect that five valves were used on that auspicious occasion; that doesn't tell you much, because three of them might have been H.F. valves, or, on the other hand, three or even four might have been L.F. valves.

A Difficult Proposition

In these days especially, when screened-grid, pentode, old "point-sixes," and "R" types almost rub shoulders, as it were, the powers of a set can no longer be judged by the illumination it provides.

Indeed, radio has become a very complex business, and the choosing of a circuit or set is as difficult as can be.

I find it fairly hard to choose a household set, so goodness knows

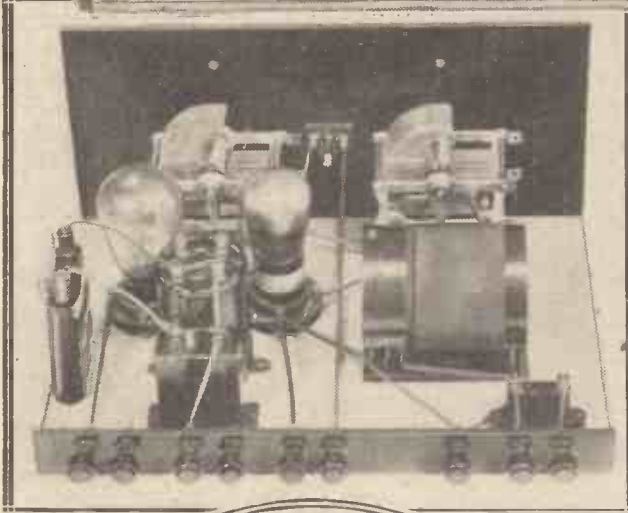
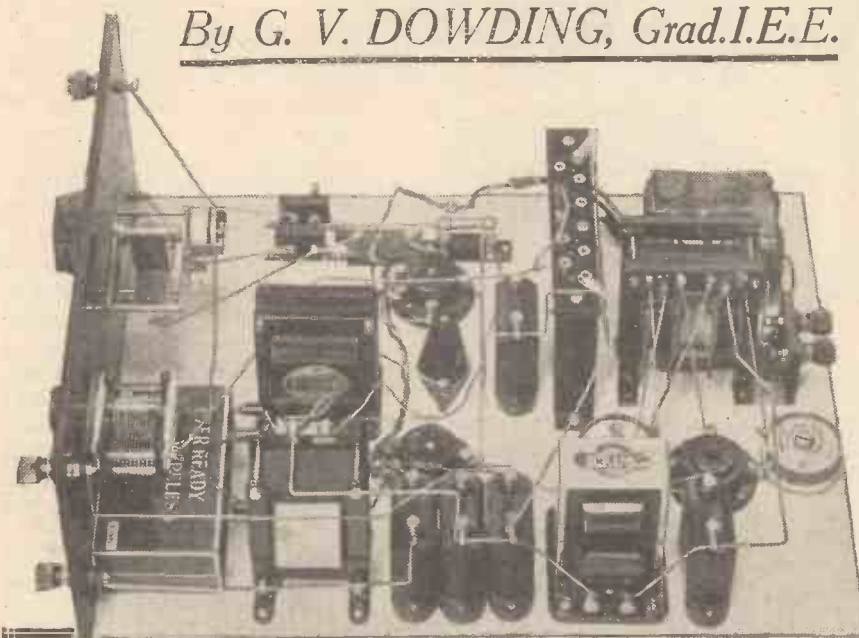

✱

The top two photos of this group illustrate two-valve sets of somewhat varying degrees of complexity. They are both Det.-L.F. transformer-coupled receivers. The one uses plug-in coils, and is an "all from the A.C. mains" set (the "Electric" Two), while the other is a battery-operated outfit. Two of the author's three-valve designs are illustrated in this group—the "Constant" Three (an H.F.-Det.-L.F. one control) and the "Pure Power," (a Det.-2 L.F.).

✱

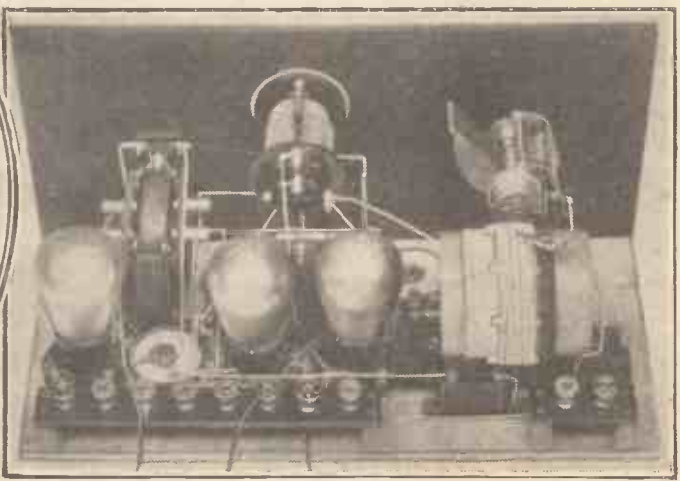
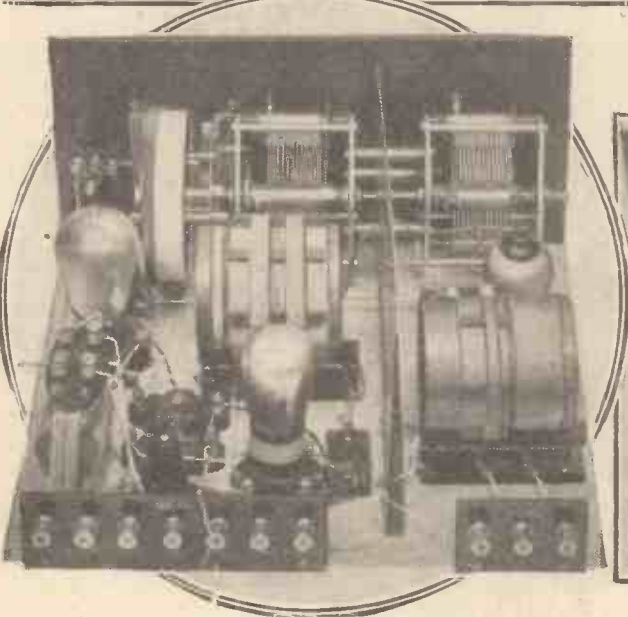

Many Stages?

 * An article of unusual interest *
 * written especially for the guid- *
 * ance of buyers and builders of *
 * valve sets. Practical advice on *
 * such all-important questions as *
 * the choice of H.F. valve types, *
 * Pentode v. ordinary L.F. stages *
 * and such-like are given, together *
 * with other invaluable informa- *
 * tion relative to the perplexing *
 * problems encountered by *
 * amateurs. *

At this very moment of writing I could compile a list of 500 different sorts of sets, each one having some

distinctive feature. And out of that 500 you could not possibly pick out one set which would satisfy everybody,

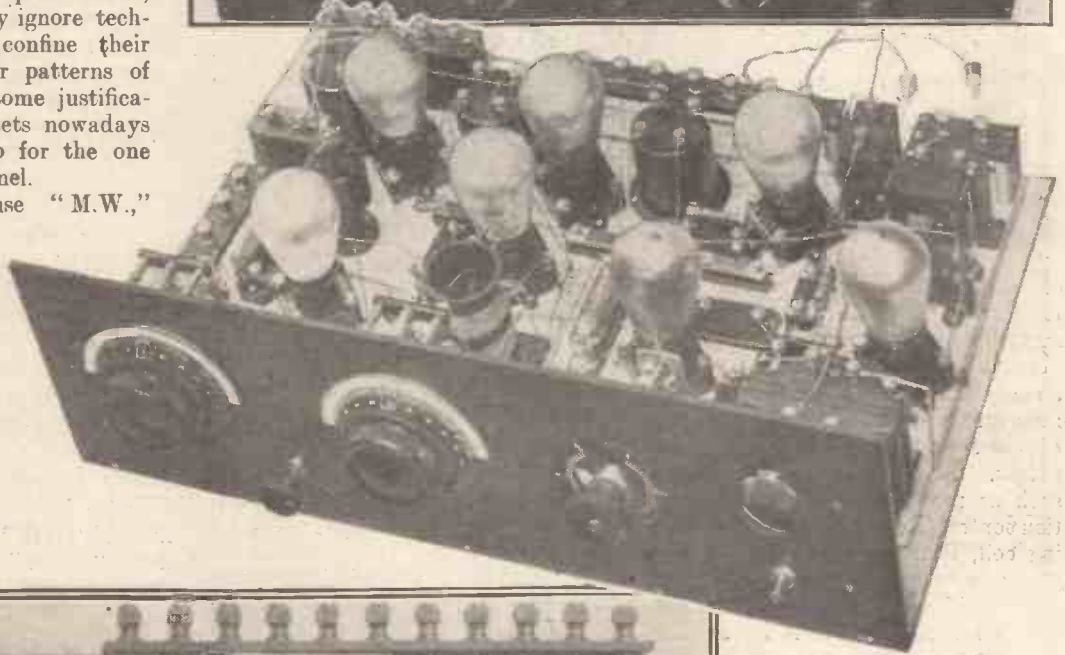

what a knotty problem it must be to some people. No doubt many take the advice of expert friends, while others probably ignore technical aspects and confine their choices to particular patterns of sets, thinking (with some justification) that all radio sets nowadays are good, so let's go for the one with the prettiest panel.

You might accuse "M.W.," "P.W.," and all the rest of the radio press of making confusion more confounded by emitting a steady stream of new designs. But we can't hold back new designs; that way lies stagnation, retrogression, decay, and whatnot.

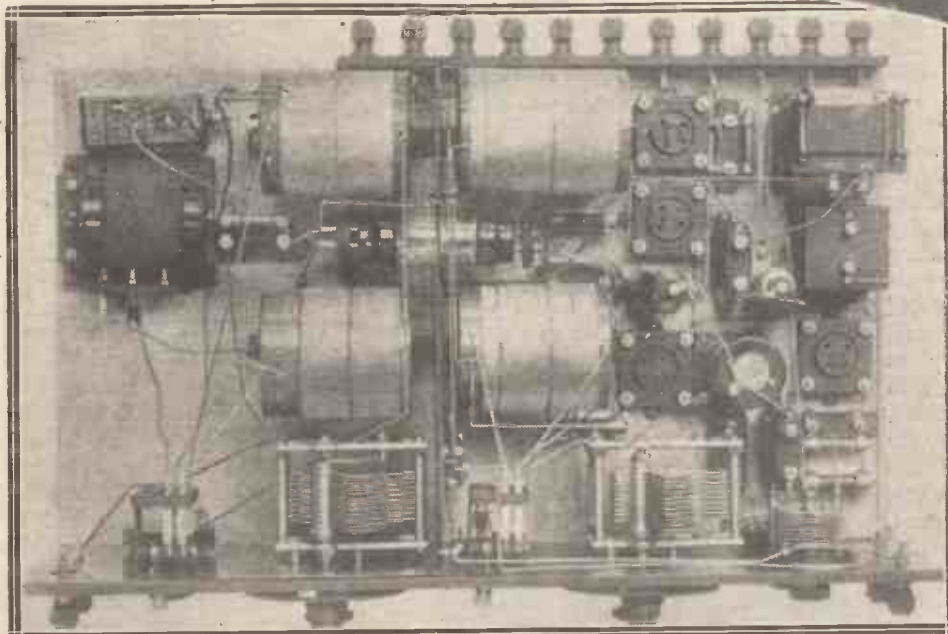

* * *
 The fewest stages are represented in this group by the set to the left. This is the "Twin-Wave" Four (two valves paralleled). At the top you see a five-stage set, and the remarkable difference between the designs of this pair of receivers is very evident. Wave-change contributes to the complexity of the four-valver, and this also employs an S.G. valve. The other set is a seven-valve super-heterodyne receiver (the "Mercury"), a type of multi-valver which seems to be rather a back-number these days. Of the seven stages there are 2 detectors, 3 H.F. and 2 L.F.
 * * *

You see, we don't manufacture little differences merely for the sake of producing a large number of designs. There is a lot of variation to be seen in the following list of three-valvers. A det., 2 L.F., resis. trans.; an H.F., det., L.F., split-primary neut., L.F. trans.; an S.G., det., L.F.; S.G., det., pentode; det., 2 L.F., trans., trans

A Multitude of Varieties

You can double this list by making wave-change an alternative in each case. With four valves the list is three or four times as long. And all these are broad types of circuits. There is still the variations of choke-capacity outputs, layout designs, coil designs, the inclusion or exclusion

Twenty-five shillings is a lot of money for a valve, more than many feel they can pay. And in any case, there are disadvantages accompanying the use of these special valves which further discount their attractive powers.

The pentode is easily dealt with. This needs a high H.T. voltage, takes a moderately high H.T. current and, even so, cannot handle the input that is "money-for-jam" for an ordinary super-power valve. On the other hand, it gives the magnification of two ordinary L.F. valves. You save a valve and an L.F. transformer or R.C. coupler, but you must use a special output transformer (for good results), and you must pay a good bit for the one valve (25s.).

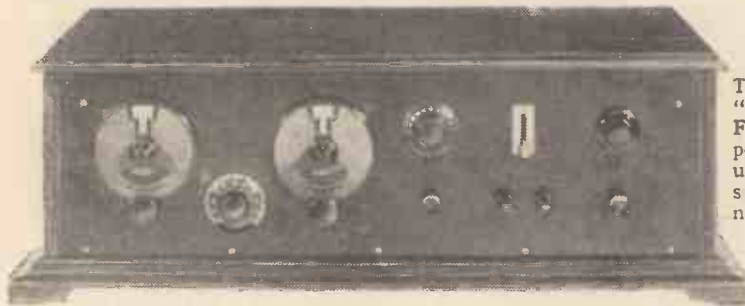

*
The "M.W."
"Orchestral"
Five, a
powerful set
using two
stages of
neutralised
H.F.
*

of refinements, such as volume controls or gramophone adaptors, mains smoothing circuits, etc.

In the three-valve class alone you already have some 40 distinct arrangements indicated, and each one of these may be variable to some extent. Bring in circuit variations, such as methods of detection, reaction control (Reinartz, throttle, swinging coil, Schnell, etc.) and your list grows to enormous dimensions.

You will not need me to point out that all these variations have their individual advantages and disadvantages, and that it is for the individual set buyer or builder to make up his mind as to the compromises he must make. And cost is, of course, one of the most potent factors. One man is fortunately able to indulge in luxuries, another cannot.

Undoubtedly, the S.G. valve and the pentode have caused a great deal of puzzlement, more especially as designs are still brought forward which do not include these innovations. In my opinion, the S.G. and pentode will never in their present forms replace ordinary types of valves. There will be improvements, and, what is even more important, lowering of prices, and when these eventuate we may see the three-electrode H.F. and L.F. valves disappear.

The Screened-Grid Valve

So you see the pentode v. ordinary L.F. issue is not as straightforward as it should be. Examined in the hard, cold light of dawn, as it were, the pentode stands to lose a little of its romance; but, whatever the anti-pentode school says, it still has the solid advantage of great magnification.

I do not use a pentode in my own household set, and I doubt if I ever will unless it is given a few more attractions. But, then, I do not subscribe to the limitation of valves treaty that is, perforce, the doctrine of many amateurs.

On the other hand, I do not use seven or eight valves with parallel L.F. arrangements. There is a happy medium in everything!

The screened-grid valve is, in my opinion, a much more useful valve than the pentode. You can get as much or vastly more amplification with ordinary valves on the L.F. side by using two or three valves as you can with a pentode without the slightest trouble. You don't add to the tuning intricacies of the set by adding L.F. valves.

On the H.F. side every extra valve generally means so much additional tendency to instability and difficulty in tuning. The S.G.

valve gives you greater amplification, and is stable in operation by virtue of its capacity-eliminating construction and operation.

But although one S.G. valve may give you one and a half times the effective amplification of one ordinary valve (I think one and a half is nearer correct than the popular two), don't forget that you lose a valuable tuned circuit by replacing two ordinary valves for one S.G. You get the magnification without the selectivity to make the best use of it.

Where S.G.'s Score

Incidentally, you get a trifle more background, or mush, accompanying your music or speech.

Here again cost comes well to the fore, as the S.G. costs twice as much as an ordinary valve and consumes two or more times the H.T. current. Further, it necessitates a high H.T. voltage.

The S.G. comes definitely into its own where immense sensitivity is required. Two stages of S.G. H.F. give you "super-het" results with surprising stability. Of course, they are somewhat "noisy," but you expect noise with enormous magnification.

A point well worth bearing in mind is that the pleasant reception of distant stations depends upon the normal ratio of static or mush to the music. You might have heard a station on a three-valve set, not loudly but just sufficiently powerfully to hear all his speech. On a five-valve set you might collect so much "mush" with that station that you would never care to listen to it.

H.F. for the Local!

Great H.F. magnification is quite unnecessary for the local station, 5 G B or 5 X X, but for these your L.F. stages must be right up to scratch in order to make the best of the very excellent B.B.C. transmissions.

And if your ideas are "quality first," then you are going to pay a lot of attention to the L.F. side and not trouble very much about the very distant stations.

But even if you were out for only the local station and the Daventrys, you would have a stage of neutralised H.F. in order to be able to feed the detector with ample energy without using any reaction, and in order to give you a respectable sharpness of tuning.

VALVE REFLECTIONS

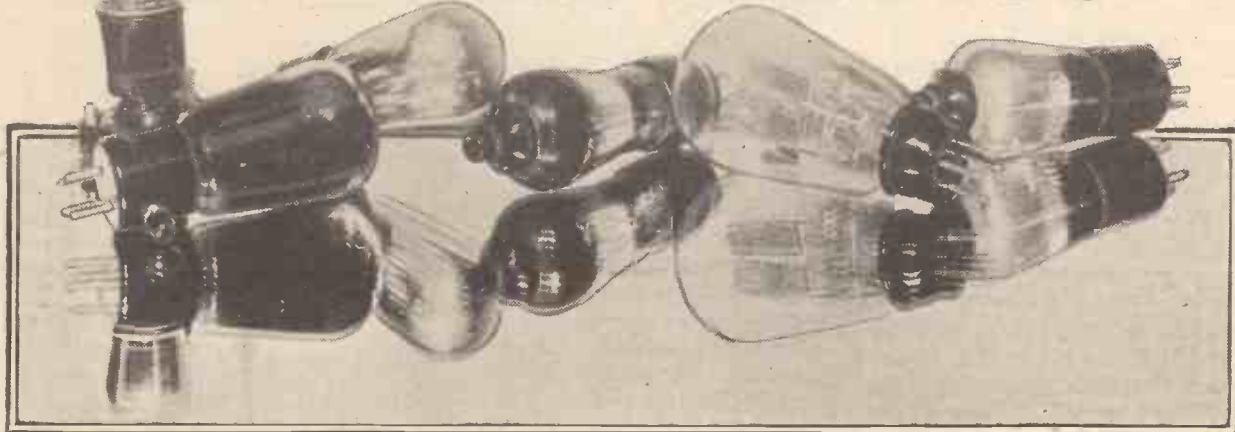

Use and Treatment of Valves—The Pentode—New Cossor Valves.

By KEITH D. ROGERS

THE valve is a very delicate piece of electrical "mechanism" and can truly be said to be the "heart" of a wireless receiver. As such it deserves to be treated with every care and respect, and with all due consideration for its well-being.

If treated properly, it will fully repay any attention that has been given to it, and will give its owner long and useful service. If badly

more than 80 volts high-tension. In the same way, it is no good getting a screened-grid valve if we are not going to screen it at all—if we are just going to plug it into a set with no thought as to the circuit in which it is to be employed. Further, a pentode valve should not be expected to give its best results unless employed with a proper output circuit, and so on and so forth.

then it is best to increase the grid bias or decrease the H.T. in order to bring the plate current roughly into line with the maker's figures.

The Filament Current

On no account should the L.T. be cut down in order to reduce the plate current. The voltage across the valve should be that recommended by the makers and should be neither more nor less, except perhaps in the case of high-frequency valves, where the low-tension can be cut down a little to reduce the volume.

It is quite easy to overrun a valve because of too little grid bias. I have



*
The latest additions to the ranks of the A.C. indirectly-heated cathode valves are a complete series of "M" Cossor valves. They have the new 5-pin base and include S.G., R.C., H.F., L.F., Power, and Super-power (or X-tra power as Cossor's designate the last valve). (See following page.)
*

treated, however, it will give unsatisfactory results and its useful life may be shortened by a very large extent.

Use it Properly

The first thing to do when buying a valve is to make sure that we are able to use it properly. It is not much good getting a large super-power valve, for example, if we cannot give it

* * *
Assuming we have chosen our circuit and our valve to suit, as nearly as possible, we should examine the valve carefully before plugging it into the socket to make sure that its pins will make good contact with the socket.

We will assume that the valve holder is above reproach, and so it just remains to make sure that the valve pins themselves will make good contact with the valve-holder sockets.

Adjusting Voltages

To do this we open the pins out with a knife, seeing that they are perfectly clean before the valve is plugged in. Then we carefully read the maker's instructions as to H.T., grid bias, etc., put the grid bias into the right value first, then put on the H.T. and, finally, switch on the filament.

If we have a milliammeter in circuit all the better, as this will assist in making sure that the correct grid bias and H.T. are employed, and we can check up the plate current with the maker's chart to correspond.

If it is slightly under, it does not matter, but if it is much over this figure



Make sure that the valve pins are clean before using the valve.

come across several cases where the valves in the L.F. stages of a set have been completely ruined because the grid-bias positive plug has fallen out of its socket in the battery.

Watch your Grid Bias!

Make sure then that all grid-bias plugs fit really tightly, and that there is no possibility of their coming out; for should they do so, then the grid or grids of any or all the L.F. valves will be left absolutely free, and this means that the emission of the valve or valves will go up and in a fairly short time the "end" will come.

The Pentode Problem

The coming of the pentode valve has put quite a large number of constructors in rather a quandary. It is difficult sometimes to decide whether the use of a pentode in the last stage of any particular receiver will be really worth while, and unfortunately there is no golden rule.

The pentode valve is exceedingly useful in many sets, and, as most people know, is capable of providing tremendous magnification; but it has to be used carefully if it is to give good results, and one of the essentials for perfect reproduction with a pentode valve is that its output circuit shall be suitable for the pentode valve and the loud speaker with which it is to be used.

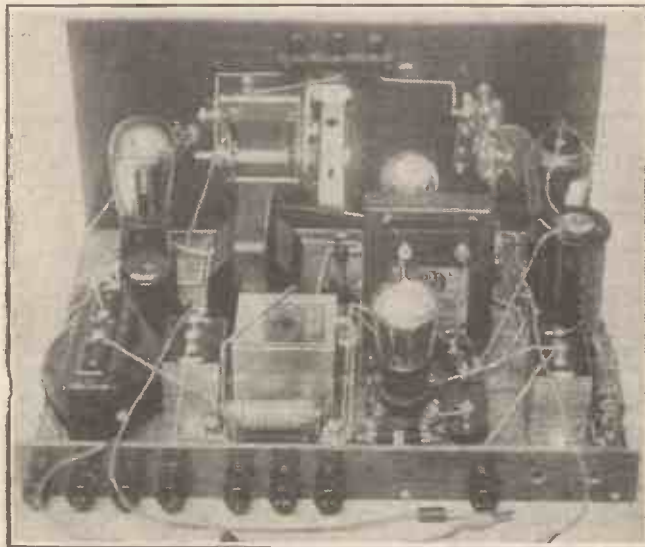

A case where a pentode would be rather overloaded. A super-power valve is needed in the last stage here.

To use a loud speaker direct in the plate circuit of a pentode valve is to court bad reproduction, and in a great number of cases the use of the pentode valve in this manner has been the cause of its failure to give anything like satisfactory results. Many a pentode has been laid aside because the user has not treated it in the proper

way, and has been dissatisfied with the results he has obtained.

In the case of short-wave 'phone reception it is not necessary to have an output transformer for the pentode, and in a detector and pentode circuit this valve can give excellent results on short waves—results which will be superior to those obtained with an ordinary detector and two low-frequency valves over the same wavelengths.

By using a pentode on short waves one can obtain a clearness of background that it seems so difficult to get in any other way, but when it comes to the broadcasting wavelengths and loud-speaker reproduction, it is certainly advisable to use a pentode transformer in circuit between the pentode valve and the loud speaker.

Loss of Bass

Especially is this the case if the loud speaker is inclined to be lacking in bass, for the use of a pentode valve without the transformer will only accentuate that lack of bass, and increase the high notes so that in

many cases the reproduction will become very unreal.

A high-pitched loud speaker can be worse than an over-boomy one; and, if the loud speaker is inclined to be high-pitched, then one has to go carefully about the job if a pentode is contemplated.

If you have a boomy loud speaker, however, the use of a pentode may very probably improve the results by a very

great deal. Two pentodes in push-pull can give extremely good reproduction, and a detector valve followed by an ordinary L.F. and then two push-pull pentodes will give tremendous amplification with quite good purity.

By the way, if you do try a pentode, do not forget the fuse in series with the

priming grid H.T. lead, by way of a precaution in case you apply too much H.T. and cause a flash-over inside the valve. If this occurs you are liable to lose the whole of the valves in your set besides the pentode.

The ordinary H.T. negative to L.T. negative fuse in the set should be used in the same way as usual.

*
One of the most popular pentodes on the British market is the Six-Sixty 2-volter shown here. It is capable of surprising amplification and forms a very useful output valve for a two- or three-valve receiver.



New Cossor Additions

The Cossor Valve Co. have recently added to their range of valves by the addition of some new super-power valves, or, as the makers call them, X-tra power valves.

These are the 230XP, 415XP, and the 610XP, and their characteristics are as follow: The 230XP has an impedance of 2,000 ohms, with an amplification factor of 4, taking about 30 m/a at 150 volts H.T.

The 415XP has exactly similar characteristics except that it takes 15 amp. at 4 volts for its filament, while the other takes 3 amp. at 2 volts—the filament wattage is the same in all three valves.

The 610XP has the same impedance, but an amplification factor of 5, while it takes only 26 m/a at 150 volts H.T. and the correct bias.

More Mains Valves

In addition to these a complete series of mains valves with indirectly heated cathodes are being brought out. These are fitted with the new type of base, having five pins, so are not suitable for the older valve holders we have been using for mains valves. Special holders are, however, being made by a number of firms, so no difficulty should be encountered on this score.

QUESTIONS ANSWERED



Wave-Length and Frequency

E. E. H. (Blackheath).—"What is the formula required for working out the frequency of a station transmitting on a given wave-length, and what is the difference between a kilohertz and a kilocycle?"

The frequency in k.c. of a station can be obtained by dividing the wave-length in metres into 300,000, and vice versa the wave-length can be determined by dividing the frequency in kilocycles into this figure.

With regard to the second part of your query, when talking about the frequency of a station it is necessary to express the figures as so many kilocycles *per second*. The word kilohertz is merely another way of saying kilocycles *per second*, and it means exactly the same thing and it saves the use of two words.

Testing Components

A. W. B. (Chelmsford) wishes to know of a simple method of testing out his components for faults.

Well, A. W. B., it is not easy for the average constructor to make accurate tests for himself. Such work really requires special instruments, and, naturally, the listener does not want to spend money on apparatus that he may not often use.

Usually, however, valuable information can be obtained with a pair of 'phones or a loud speaker and a small dry cell, and it is frequently possible to find a break in a winding or some other fault by this method.

One of the tags of the 'phones should be connected to one terminal of the dry cell, and two flex leads should be connected, one to the remaining 'phone tag and the other to the remaining terminal of the dry cell (a flash-lamp battery is quite satisfactory).

These two flex leads, if now touched lightly together, will produce a strong double click in the 'phones; one click when they make contact with each other, and another when they are separate again. They may thus be used for testing for continuity in leads, etc., since the loud double click is ample evidence that everything is satisfactory.

A fault in the coil holder, for instance, such as a break between the terminal and the plug or socket to which it is connected, may now easily

THE TECHNICAL QUERIES DEPARTMENT

Are you in trouble with your set?

The MODERN WIRELESS Technical Queries Department is now in a position to give an unrivalled service. The aim of the department is to furnish really helpful advice in connection with any radio problem, theoretical or practical.

Full details, including the revised and, in cases, considerably reduced scale of charges, can be obtained direct from the Technical Queries Department, MODERN WIRELESS, Fleetway House, Farringdon Street, London, E.C.4.

A postcard will do: on receipt of this all the necessary literature will be sent to you, free and post free, immediately. This application will place you under no obligation whatever. Every reader of MODERN WIRELESS should have these details by him. An application form is included which will enable you to ask your questions so that we can deal with them expeditiously and with the minimum of delay. Having this form you will know exactly what information we require to have before us in order to solve your problems.

London readers please note: Inquiries should not be made in person at Fleetway House or Tallis House.

be detected, since if one flex lead is connected to the terminal and the other to the side of the holder to which the terminal should make connection, absence of the double click is positive evidence that the component is faulty.

On the other hand, if one of the flex leads is connected to the socket of the coil holder and the other to the plug, if a double click is heard there is a short-circuit across the holder.

Similar tests may be made with valve holders, both for testing for a connection between each terminal and its socket, and for testing for short-circuits between the sockets.

Variable condensers may also be tested by this method, a short-circuit between the plates giving rise to the usual double click, which should not be present in the usual way.

It is, of course, essential to see that all leads are removed from the components under test and also that no coils are in position in the coil-sockets when these are tested.

Back Numbers

L. W. (Birkenhead).—"Where can I obtain back numbers of MODERN WIRELESS?"

Back numbers of this journal can be obtained from The Amalgamated Press, Ltd., Back Number Dept., Bear Alley, Farringdon Street, London, E.C.4. When ordering, always send sufficient cash to cover the cost of postage and packing. The postages on the 1s. and 1s. 6d. issues are 3d. and 4d. respectively.

Continual Howling

G. M. (Richmond) has a set which has started to howl continuously after eight weeks' use, although previously it was working perfectly satisfactorily. The circuit consists of a detector and two transformer-coupled stages.

In the majority of cases a howl of this type is due to L.F. oscillation.

When the set has been working quite satisfactorily previously, the most probable cause of the trouble is a partly run-down H.T. battery.

Very frequently H.T. batteries with small cells are employed. These cells have not a sufficiently large capacity to supply two ordinary valves and one of the power type.

In consequence the internal resistance quickly rises, the voltage drops, and a coupling effect is produced. This in turn causes low-frequency oscillation and howling. The remedy is to use batteries of the double- or triple-capacity type.

Transformer Marking

J. S. (Birmingham) has an L.F. transformer marked I.P., O.P., I.S., and O.S. He is constructing a receiver from a blueprint, in which the transformer terminals are marked H.T., P., G., and G.B. He asks which of the terminals on his transformer correspond to this marking.

The answer to this question, J. S., is as follows: I.P. corresponds to H.T., O.P. to P., I.S. to G.B., and O.S. to G.

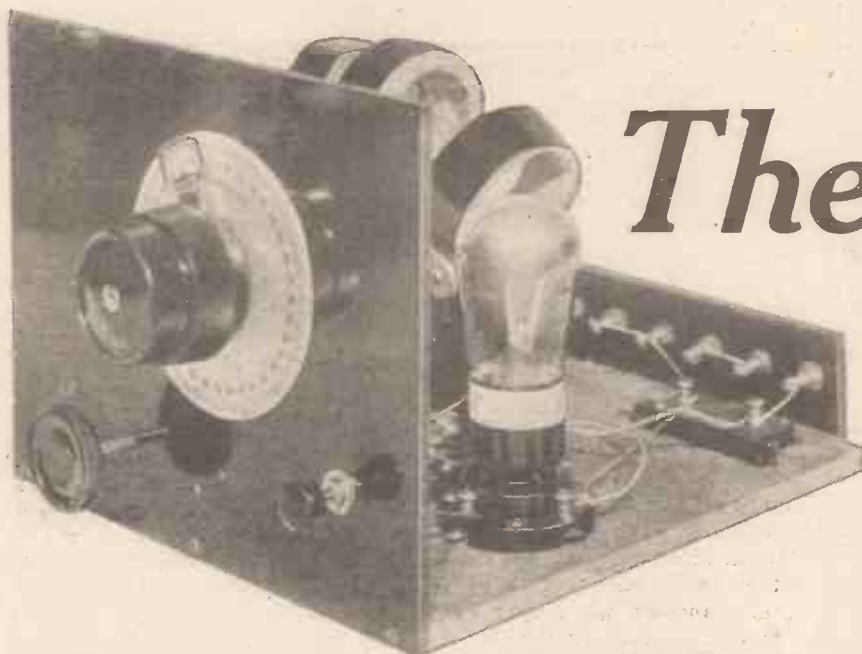

The M.W.

The reaction control is most accessibly placed and projects well clear of the panel. The fine tuning control is an advantage and enables many stations to be tuned-in.

IN these days of capacity-controlled reaction receivers one is rather apt to forget that there are other methods of producing the necessary build-up and reaction amplification.

COMPONENTS REQUIRED.

- 1 Panel, size 9 in. x 7 in. x $\frac{3}{8}$ in. or $\frac{1}{2}$ in. (Becol, Ripault, "Kay Ray," Resiston, etc.).
 - 1 Cabinet to suit and baseboard 9 in. deep ("Raymond," Lock, Gilbert, Bond, Artercraft, Camco, etc.).
 - 1 Two-coil holder with slow motion gearing (Lotus, Raymond, etc.).
 - 1 Baseboard-mounting single-coil holder (Lotus, or similar narrow type).
 - 1 .001 fixed condenser (Lissen, T.C.C., Mullard, Clarke, Igranic, Goltone, Dubilier, Magnum, etc.).
 - 1 .0003 fixed condenser with clips (Dubilier, Mullard, Igranic, T.C.C., Goltone, Magnum, Clarke, etc.).
 - 1 4-meg. grid leak (Dubilier, Igranic, Mullard, Lissen, Pye, Ediswan, etc.).
 - 1 Valve holder (sprung type). (W.B., Bowyer-Lowe, Lotus, Igranic, Benjamin, Magnum, B.T.H., Wearite, Precision, Formo, Burton, Marconi-phone, etc.).
 - 1 L.T. "on-off" switch (Benjamin, Lissen, Burton, Bulgin, Lotus, Igranic, Wearite, Magnum, etc.).
 - 1 .0005-mfd. variable condenser (Lissen, Lotus, J.B., Igranic, Utility, Dubilier, Ormond, Cydon, Raymond, Pye, Gecophone, Formo, Colvern, Bowyer-Lowe, etc.).
 - 1 Slow-motion dial if condenser is not of slow-motion type (Utility, Igranic, Ormond, Lotus, J.B., Brownie, etc.).
 - 8 Terminals.
 - 1 Terminal strip 7 in. x 2 in. x $\frac{1}{4}$ in. or $\frac{3}{16}$ in.
- Quantity tinned copper wire, Systoflex, etc.

A few years ago magnetic reaction was practically universal. Then the well-known American experimenter, Reinartz, popularised a scheme whereby one employed a fixed reaction winding and a variable condenser instead of a swinging coil and a fixed by-pass condenser.

The Reinartz method achieved its popularity chiefly because of smooth control and also its advantages on the very short waves. It was possible to vary the degree of reaction without making very much difference to the tuning adjustment. Adaptations of the Reinartz scheme are now widely used in modern receivers.

Rival Claims

There are also other well-tried arrangements, such as throttle-control, Hartley reaction, etc. All of these schemes are distinctly good, and have their advantages, perhaps in particular in the design of sets which incorporate high-frequency amplification.

The reader will no doubt ask why magnetic reaction did not maintain its popularity in the face of competition from the various schemes employing capacity control.

Well, the chief drawback was the difficulty in obtaining a coil holder with a sufficiently delicate adjustment. Another "snag" was the amount of space taken up by the coils and coil-holder, since it must be borne in mind that one of the coils has to swing through perhaps a right-angle.

The modern two-coil holder, how-

ever, is a very different proposition. It is now possible to obtain one with vernier control, thus the reaction control can be made as fine as one can wish. In a set which employs a straightforward detector valve, space is not an important consideration, because there are no other coils to arrange for and the layout is not critical.

Now with magnetic reaction it is generally admitted by competent authorities that the volume obtainable is greater than with any form of capacity control.

Greater Sensitivity

That is to say, a set with "flip-flop" reaction is capable of giving louder signals than one with, say, "Reinartz" reaction. This, of course, is a great advantage in cases where one has only a single valve with which to get the results. Exactly why this increase in volume should occur it is difficult to explain. The fact that the H.F. currents have a free path back to the filament via the by-pass condenser (C_3 in this set) has probably considerable bearing upon the question. Another advantage is the simplicity of construction and cheapness of this type of set.

The "M.W." Research Dept. had these points in mind in designing the "Hercules" receiver.

The circuit arrangement is perfectly straightforward. Plug-in coils are used throughout. The aerial coil is of the "aperiodic" type, i.e. no tuning condenser is employed, and

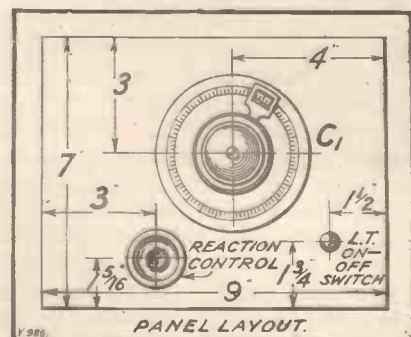

The panel drilling is a very simple affair in the case of this little set.

THE RESEARCH DEPARTMENT PRESENTS

“Hercules”

 * Have you tried “Flip-Flop” reaction? This powerful little *
 * one-valve set owes its extra punch to the fact that in it condenser- *
 * controlled reaction has been abandoned in favour of the older *
 * “two-coil” system of variable *
 * magnetic coupling. *

this is coupled to a tuned grid coil, the degree of selectivity being adjusted by varying the size of the aerial coil. Then in the movable coil socket is placed the reaction coil, which can, of course, be moved nearer to, or farther away from, the grid coil.

You will note that the aerial coil socket is placed up against the socket

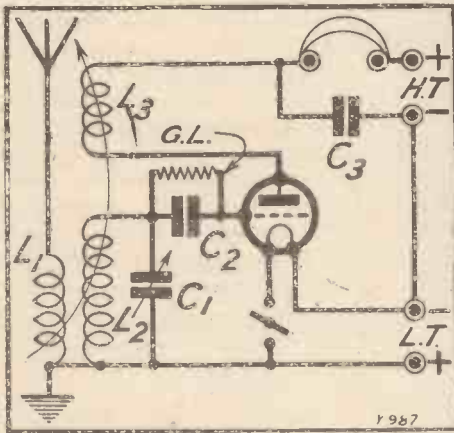

A perfectly straightforward circuit, but one capable of giving most excellent results.

for the grid coil. When you are building the set you must take care to arrange matters so that the centres of the aerial and grid coils are coincident. Thus the height of the L₁ coil holder should be adjusted according to the type of two-coil holder employed.

Making a Start

This is the chief point to watch in copying the design. Now the constructional work is easy. The panel consists of a piece of 9 in. by 7 in. ebonite and the tuning condenser is mounted on the horizontal centre line, 4 in. from the left-hand end, looking at the back of panel. This dimension should be marked off with a scribe and steel rule and a $\frac{3}{8}$ -in.

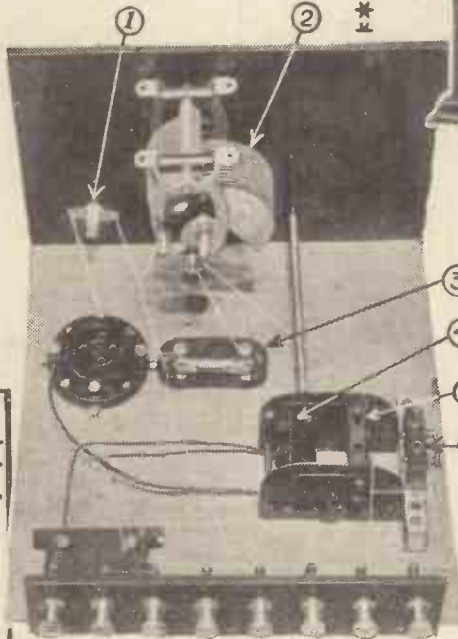

And the baseboard layout is clearly not at all complex. The numbers indicate: (1) The on-off switch, (2) the tuning condenser, (3) the grid leak and condenser, (4) the reaction coil holder, (5) the grid coil holder, (6) the aerial coil holder.

hole drilled for the condenser spindle.

A large drill such as this is best handled in a carpenter's brace, and it is as well to run a $\frac{1}{16}$ -in. pilot drill through first.

Care Needed Here

Then you should drill the hole for the L.T. “on-off” switch and reaction control spindle. The height of the hole for the spindle of the two-coil holder will depend upon the type of component used. Different makes vary, and if you do not choose one of those specified in the list of components it will be advisable to check up the dimensions. This can be done by placing the two-coil holder on the baseboard and measuring the height from the baseboard to the centre of the spindle. To this measurement should be added the thick-



As neat and effective a one-valver as you could make.

ness of the baseboard. Make the hole a little larger than the actual diameter of the spindle, otherwise you will not be able to rotate the reaction-control knob easily.

Fixing the Panel

Secure the panel to the baseboard with three or four wood screws, and make a good firm job of it. Then you can commence to lay out the components. You will note that there are five altogether.

These are the valve holder, grid condenser, two-coil holder, the .001-mfd. fixed condenser, and the single coil-holder for the aerial coil.

There is also the terminal strip along the back of the baseboard. As stated previously, the two-coil holder must be mounted so that there is plenty of space to permit the reaction coil to be moved through an arc of, say, 60 degrees.

Next we come to the wiring up. No. 16 gauge tinned copper and Systoflex are convenient. Alternatively you can use Glazite or one of the other proprietary insulated wires. Remember that you will need two lengths of flexible for the moving-coil holder L₃.

Take care in making the connections to the coil sockets. See that the wires make good electrical contact with the small terminal screws.

When you have completed the wiring you will be ready to commence the preliminary tests. Connect a pair of high-resistance 'phones to the terminals on the strip marked “Phones” + and -. Join up your

aerial, earth, L.T. and H.T. batteries.

Valve to Use

In the valve holder you should insert a valve of the "H.F." type. Such valves are those which have an impedance of between 15,000 and 25,000 ohms, and an amplification factor of 15-20. As a matter of fact, practically any valve will give results in this receiver, but the "H.F." types usually give better reaction control and louder signals.

Sometimes, however, especially where the available H.T. voltage is limited to 60 volts or less, a valve of the L.F. type will be found to be very satisfactory. Of course, an L.F. valve takes more H.T. current and this should be taken into consideration if economy is a vital factor.

In the aerial socket L_1 you will need a No. 25 or 35 plug-in coil, and in L_2 a No. 60. It is difficult to say definitely what size reaction coil is likely to give the best results. Usually

a No. 35 or 50, probably the latter, will be the most satisfactory. These are the sizes for the medium wave-band of 250-550 metres. For 5 X X and the other long-wave stations you will require a No. 100 in L_1 , a No. 200 in L_2 , and a No. 100 or 150 in L_3 .

If selectivity is not important it is quite possible that a No. 150 in the aerial socket L_1 will give louder signals. On the other hand, if selectivity is very important, then a No. 75 in L_1 is advisable, although, it should be remembered, the volume will suffer somewhat.

Operating the Set

To operate the set, switch on the valve by means of the L.T. "on-off" switch, and insert the H.T. + wander plug in the 60-volt tapping on the H.T. battery.

Rotate the tuning condenser dial, keeping the reaction coil well away from the secondary coil L_2 . When you hear signals from your local station, move the reaction coil nearer to the secondary coil by rotating the reaction-control knob. Note whether the volume increases when these two coils are brought more closely together.

If it does not, try reversing the two flexible leads which go to the coil holder. When you find which way round produces an increase in volume, you should then adjust the position of the reaction coil for maximum signal strength.

Possibly you will find that with your particular H.T. voltage and reaction coil the set tends to go into oscillation with rather a "plop" when the reaction coil is brought near the secondary coil. If so you must first of all try decreasing the value of H.T., noting with each re-adjustment whether any improvement takes place. If no adjustment produces the necessary smooth control, then the only alternative is to try a size smaller reaction coil, increasing the value of H.T. unless adequate reaction is obtained over the whole wave-band.

The Grid Leak

If you find that you are getting insufficient selectivity, always try a size smaller aerial coil. On the other hand, if you require more volume, try a larger aerial coil. In addition, it is interesting to note that in a receiver of this type, reaction control is frequently improved by the use of a grid leak of 4 or even 5 megohms, although the set will function quite satisfactorily with one of the more usual value of 2 megohms.

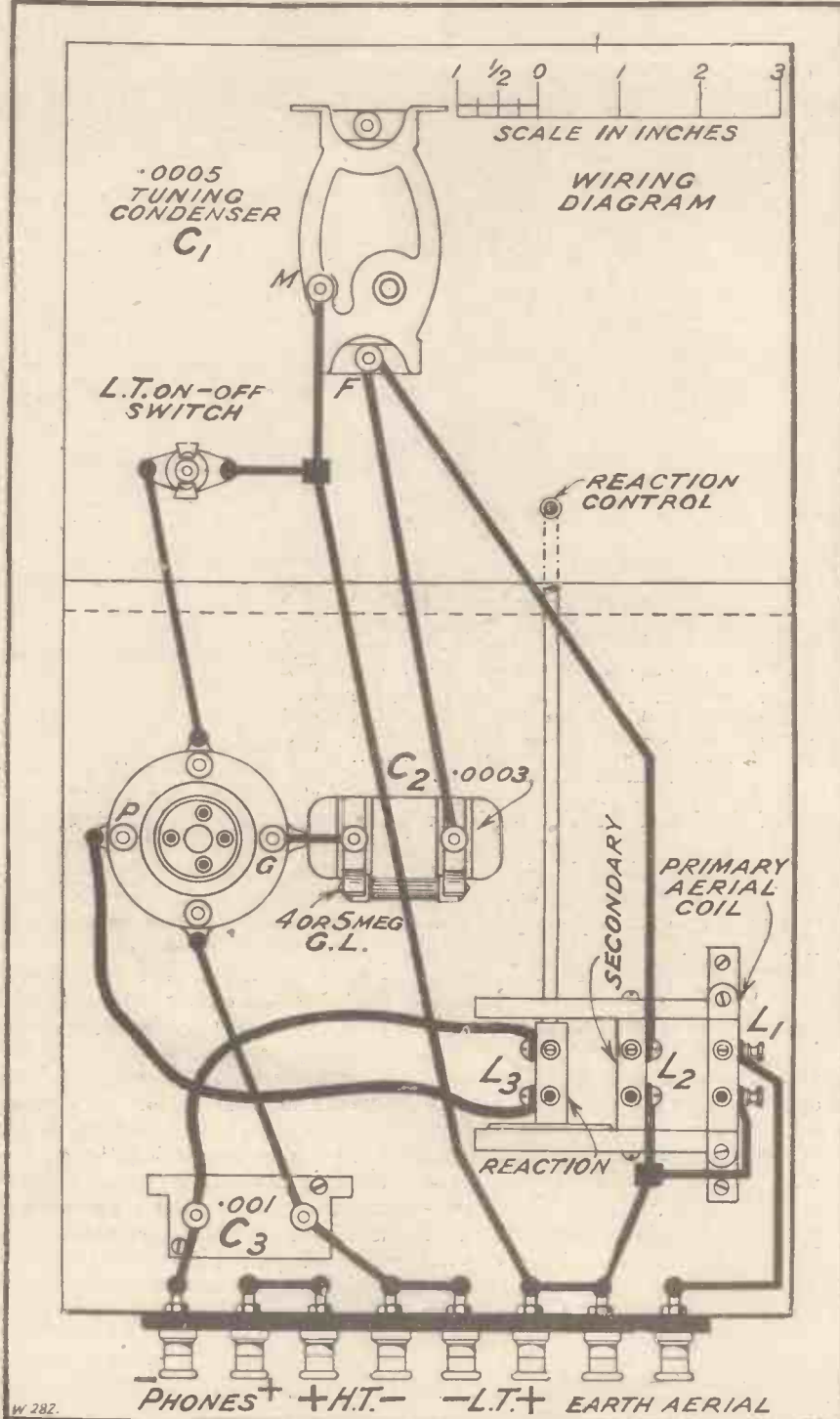

W 282.

This Set Gives You Louder Signals

It may be helpful if we enlarge somewhat upon certain of the points already dealt with previously. For example, there is the case of the aerial coil, which you will note is mounted on a small block of wood. You can see this quite clearly in the photograph on this page.

Compensating Adjustments

Now the height of this wooden block should be sufficient to bring the top of the aerial coil socket on a level with the top of the fixed coil socket of the two-coil holder. Thus the coupling between the aerial and secondary coils will be sufficiently "tight" to ensure maximum results.

If the position of the aerial and secondary coils is not adjusted correctly, then the coupling will be too loose, and signal strength may fall off unless a large coil is employed.

When you are operating the set, you will find that a slight alteration of the moving coil will produce a small variation in the tuning.

You will be able to compensate for this by readjusting the tuning condenser, and after some practice you will discover that you can make the small compensating adjustments of the tuning condenser quite instinctively.

This is really where the art of tuning comes in. The absolute beginner does not obtain the best results from a set simply and solely because he has not acquired the necessary skill in operating. It is these small adjustments that make all the difference between receiving and not receiving a distant station.

The procedure, therefore, is to bring the reaction coil closer to the secondary, at the same time readjusting the tuning condenser dial until the maximum volume is obtained. This alteration in tuning will not be large, and a slow-motion dial or other device attached to the tuning condenser is very useful.

The Aerial Coil

On the preceding page we said that a large-size aerial-coil is the best from the point of view of volume, but it should be remembered that with a large coil the tuning will be very flat.

If you are near a main station it will pay you to use a small coil in the aerial socket. The same thing applies

to 5 X X. A No. 150 coil in the aerial is undoubtedly the best for volume, but there is a danger of the local station breaking through unless a smaller coil is employed. If you wish to receive Hilversum, or any stations round about 1,000 metres, you will need a No. 75 aerial coil, but the No. 200 coil in the secondary socket need not be changed.

It is also probable that a size smaller reaction coil will be necessary, but this is a matter for practical experiment.

With a single-valve set it is advisable to erect the best possible aerial. An indoor aerial will reduce your range considerably and the set will not give satisfactory results with a frame. The type of aerial which usually gives good results is one with a horizontal span of 60-80 ft. and a height of 20 ft. or more. There is practically no advantage in using more than one wire unless the span is very short. In addition, a really good earth makes a vast difference to signal strength.

Now it is possible to ensure a

good, reliable earth system by taking a length of stout copper wire by the most direct route to the main water supply. The connection should be made at the point just above where the pipe enters the ground.

The procedure is to clean the lead pipe for two or three inches along its length until it is perfectly bright, and then to use one of the special earthing clips that are sold for the purpose. The clip is clamped tightly to the pipe, and the earthing wire is joined to the terminal on the clip. The chief point to remember is that all the connections must be clean.

An Alternative Method

Another satisfactory scheme is to bury a zinc or copper plate 3 ft. or 4 ft. in the ground, and to solder to this plate a length of stout copper wire. The plate should be about 3 ft. square, and the soldered joint should be painted over in order to prevent any corrosive effects of the soil. A convenient wire to use for the earth lead is ordinary 7/22 gauge stranded aerial wire.

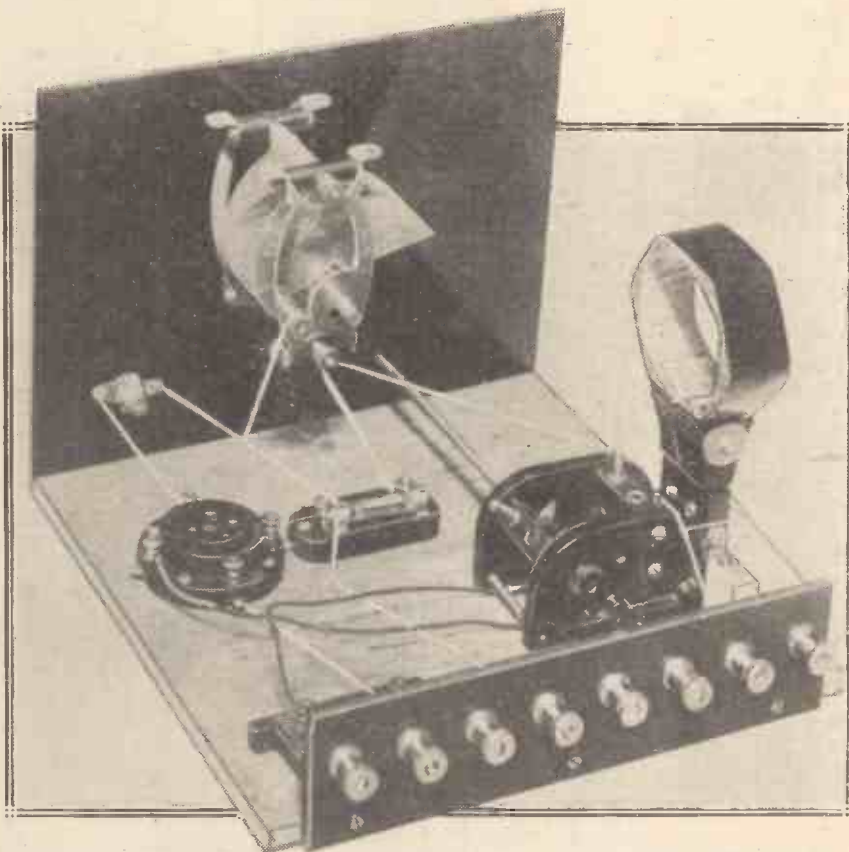

The terminals reading from left to right are: 'Phones minus, 'phones plus, H.T. plus, H.T. minus, L.T. minus, L.T. plus, earth and aerial.

RADIO RESEARCH

If you want to undertake radio research work properly you will have to have a large number of instruments and heaps of time and patience, but as wireless is a comparatively young science the rewards may be great.

By "EXPERIMENTER"

"I WISH I had the time to take up research work," a wireless enthusiast friend said to me the other day. "Later on I am just going to 'make' time, I am tired of just pottering about."

I wondered at the time if he realised just what wireless research work involves, and in case there are others contemplating it here is a little information on the subject.

Now the average amateur who does a little experimental work is accustomed to hooking something up over the week-end and getting results of some kind or another. The research worker must be prepared to spend weeks designing and constructing a piece of apparatus to be rewarded with entirely negative results. He must be prepared to waste days of his time; more days, and yet more days before he obtains even the faintest of indications that he is working on the right lines.

He must be able to sit down and spend weeks of his time in theoretical calculations, in analysis of the constants of the circuit he is working on, and checking up the theory against practice.

Perseverance

It is easy for him to apply fundamental principles incorrectly to the particular problem under review, so that all his work has to be scrapped and begun again from a different angle.

He must be persevering, for he will come up against apparently insuperable difficulties. After exploring all known methods he must devise new

ones, and if they fail he will have to begin all over again.

He must have the widest possible practical and technical experience. Theory alone will not be of much use, for he must know how to apply it and when. Theory alone can be misleading, especially in such a complex subject as wireless, unless guided by the technical knowledge acquired as the result of lengthy experience of every side of wireless practice.

The Equipment Required

To take an example: in high-frequency work we are dealing with tuned circuits to a very large extent. The behaviour of any particular combination of inductance and capacity is easily determined at the resonant frequency, but in some cases the important point is its behaviour when "off tune." Not always so easily determined, while if the wrong point of view is taken the edifice built up on the original premises falls to the ground.

What about equipment?

Here is the great stumbling block to many: The research worker must be prepared to spend considerable sums of money on apparatus, and even if he can make some of it himself, it must be checked against standards. Checking, for which fees of varying magnitude are payable.

Here are some of the instruments he must have: megger, bridge, resistance box, capacity bridge, inductance bridge, standard capacities and inductances, ammeters, milliammeters in several ranges, a micro-ammeter, voltmeter of several ranges, the above instruments for A.C. work as well as D.C., H.F. resistance bridge, Moullin voltmeter, various D.C. and A.C. supplies, high-frequency and low-frequency oscillators covering various frequency ranges, apparatus for measuring amplifier gain, plotting loud-speaker characteristics, etc., etc.

Besides the electrical equipment, there must be an efficient workshop equipment. A small lathe and a

drilling machine will be needed. Drills, reamers, taps, dies, marking-out instruments, such as dividers, squares, protractors, scribers, punches, etc., will be needed.

Rewards

Ample room to carry out the work will also be wanted.

So if you are hankering to take up research work, bear well in mind what the demands made upon your time, purse and abilities will be. Also your rewards may be great.

THE AMATEUR OF TO-DAY—

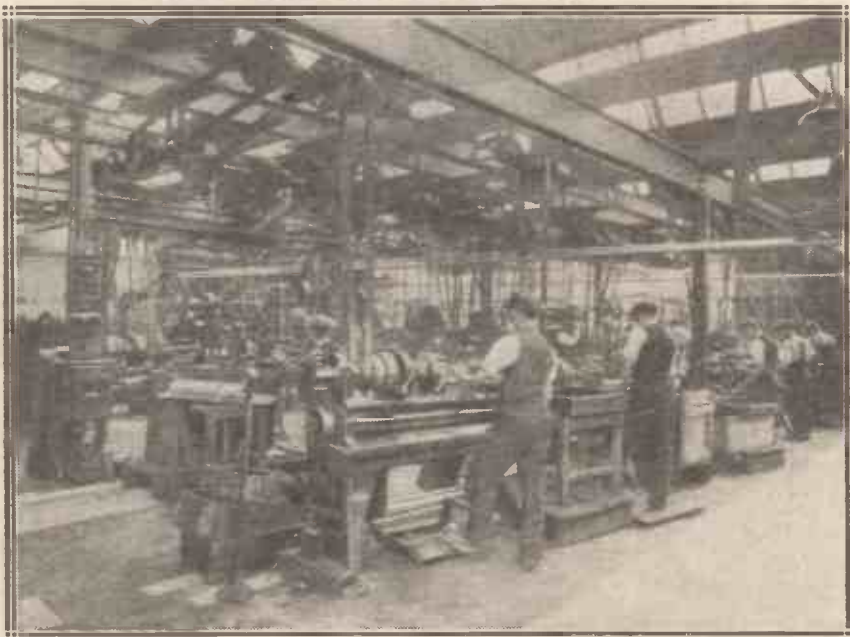

A corner of one of the machine shops in a modern radio factory where wireless parts are scientifically placed in mass production. The outcome of an experimenter's research might necessitate the total modification of such a plant. (Benjamin Electric.)

WHICH CONDENSERS MATTER MOST?

Some condensers must be of exact specified value or they will not do their work, but those used for some purposes can be of almost any value without causing trouble. This article tells you how to differentiate between these two classes.

By C. E. FIELD, B.Sc.



LET us take first the aerial and high-frequency valve circuit of a modern receiver, which might be as shown in Fig. 1, where a neutralised H.F. valve is shown coupled by a tuned transformer to an anode-bend detector.

Dealing first with the tuning condenser marked C_1 (.0005), this may be

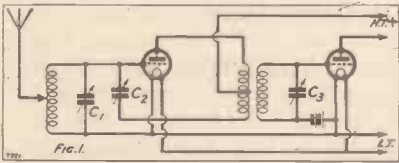

Here a neutralised H.F. valve is shown coupled by a tuned transformer to an anode-bend detector.

classified as *unimportant*. This does not mean that it performs an unimportant function, but that although it is specified as having a value of .0005 mfd., if the constructor happens to have any variable condenser in his store, whether the capacity be .00025 mfd. or .001 mfd., it will in general be quite suitable, although not necessarily quite as convenient from an operating point of view as the one specified.

The Neutrodyne Condenser

When we come to the neutrodyne condenser C_2 , however, we have little latitude as to the capacity value, which should be variable from a maximum value of about .00005 mfd. to as small a minimum as possible. On the other hand, the construction of the condenser, if undertaken by the set builder himself, lends itself to the exercise of ingenuity and originality, the chief requirements being a very smooth and fine adjustment with a minimum of hand

capacity, and a good insulation resistance between the terminals, for often this condenser may be subjected to the voltage of the high-tension battery.

With regard to the tuning condenser C_3 , across the secondary of the high-frequency transformer, the same remarks apply as in the case of the aerial tuning condenser, except that in this case it is advisable not to exceed a maximum value of .0005 mfd.; .0003 mfd. being a very usual figure.

In Fig. 2 is shown the plate circuit of an anode-bend detector valve which might well follow the high-frequency circuit shown in Fig. 1.

H.F. Filters

The first condenser in the circuit, C_5 , is connected in parallel with the anode resistance, and although by no means essential to the operation of the receiver, is extremely important when it comes to the question of finding a suitable component. This condenser, along with the high-frequency choke, H.F.C., forms a "high-frequency filter," which drains off, or filters, all the radio-frequency oscillations coming out of the detector, and so reduces the input with which the following valve is called upon to deal, as well as reducing un-

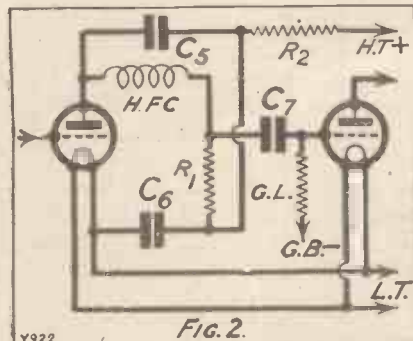

The plate circuit of an anode-bend detector valve which might well follow the H.F. circuit shown in Fig. 1.

wanted coupling between the low- and the high-frequency portions of the circuit.

Now, since this condenser is for the purpose of carrying away high-frequency currents, unless we are careful it will also carry away our highest-frequency voice currents—in other words, it will weaken our top notes. The larger the condenser, and the higher the resistance R_1 , the more serious will this effect be.

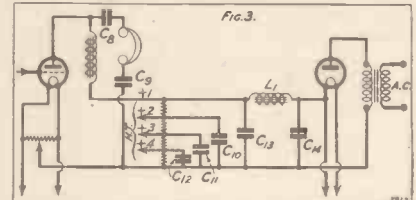

A power valve coupled by a choke and condenser circuit to a loud speaker and deriving its H.T. supply from a smoothing circuit.

For use with an anode resistance of the order of half-a-megohm, a capacity value of .0001 mfd. is suitable, but when a low resistance of, say, 50,000 ohms is employed, the condenser capacity may be increased to .00025 mfd., although nothing would be gained by doing this. Except for use in conjunction with low values of anode resistance, therefore, a capacity of .0001 mfd. should not be exceeded, and if the only available condenser has a much larger capacity, it should be omitted entirely. In any case, its use is not to be recommended with anode resistances of more than half-a-megohm.

Anti-Motor-boating

Connected between the bottom end of the resistance R_1 and the valve filament is another condenser C_6 , which readers will probably recognise as forming, with the additional resistance R_2 , an anti-coupling device for the prevention of low-frequency oscillation. The only stipulation

Choosing Your Condenser Values

that we need make for this condenser is that it should have a capacity of 1 microfarad or more—the bigger the better. The normal type of component used for reservoir and by-pass purposes is quite suitable.

C_7 , on the other hand, requires careful choice. It serves to couple the output from the detector to the grid of the following valve, at the same time insulating the latter from the positive voltage of the high-tension battery. Two important requirements must be met by this condenser.

Firstly, the capacity should be as large as possible if low notes are to be faithfully reproduced.

If very high values of coupling resistance and grid leak are employed (say, $\frac{1}{2}$ and 5 megohms respectively)

it should be of the mica dielectric type, and not a tinfoil or Mansbridge condenser. On account of the cost of mica condensers it is therefore kept to as low a capacity value as the requirements of low-note reproduction permit. If any leakage occurs in the condenser, voltage from the high-tension battery finds its way through to the succeeding grid, and the following example will serve to show the importance of the high insulation resistance.

Increasing Insulation

If the voltage on the plate of the first valve in Fig. 2 is 150, the grid leak 5 megohms, and the insulation resistance of the condenser C_7 is 100 megohms (one hundred million

Now we come to output circuits and battery eliminators.

Fig. 3 shows a power valve coupled by a choke-and-condenser circuit to a loud speaker, and deriving its H.T. supply from a smoothing circuit.

For Choke Outputs

The condensers C_8 and C_9 are, in a sense, performing a similar duty to that of the one last discussed, in that they are required to pass voice currents and block steady high-tension voltage. The capacity in this case, however, needs to be much larger, because the resistance effect offered to voice currents must be small compared with that offered by the loud speaker, which may be equivalent to a resistance of only one or two thousand ohms.

Consequently, ordinary tinfoil or Mansbridge type condensers, of one or two (or more) microfarads capacity, may be employed.

The condensers C_{10} , C_{11} , and C_{12} which are connected across various portions of the output of the smoothing circuit are in a similar category, 1- or 2-microfarad units being generally adopted.

Finally, the smoothing condensers C_{13} and C_{14} are very important, and "any old condenser" will not do for use here. The reason is that although we are apt to think that this is, say, a 250-volt circuit (if the mains voltage is 250), when we switch the mains or the set on or off a voltage of more than twice that value is easily obtained.

The Working Voltage

This is brought about by the fact that the presence of the choke coil L gives to the electric current a property similar to that of momentum, which makes it try to force its way through any barrier, such as a condenser, which tries to stop it, in just the same way that a stone thrown at a pane of glass will break through by reason of the momentum imparted to it in the act of throwing.

These condensers should therefore be of a type made specially for the purpose, and the purchaser should specify that they are required to withstand a *working* voltage (not the same thing as a maximum voltage) of at least half as high again as the normal voltage of the circuit in which they are to be used.

AT THE L.F. END

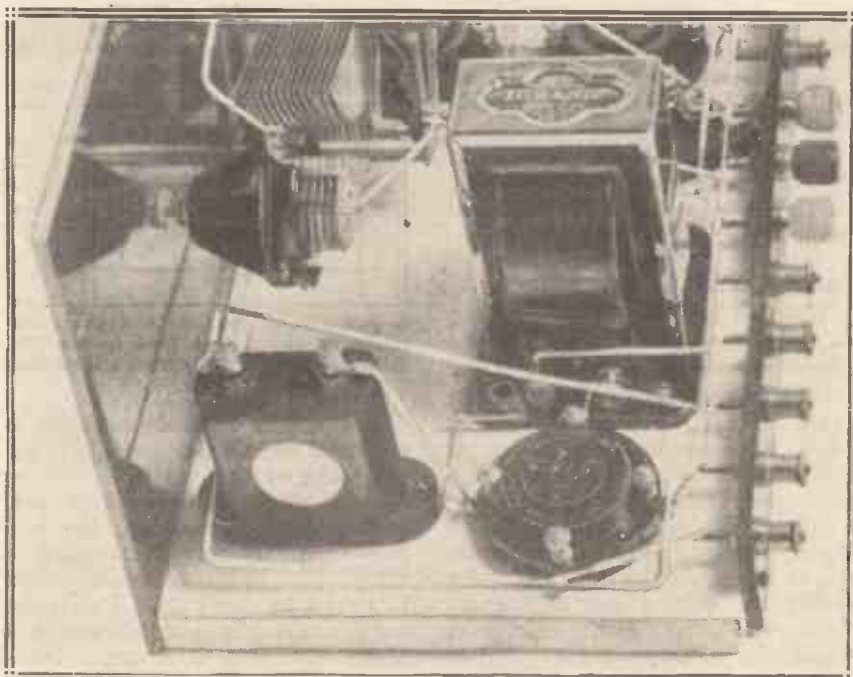

The output end of a multi-valve set of quite a straightforward nature, showing a by-pass condenser which is connected across the maximum H.T. plus tapping and H.T. minus. (It is actually taken to an L.T. terminal on the valve holder, but the result is as stated.)

the capacity of C_7 may be as low as .005 microfarad, although .01 mfd. would be a better value. Normally, however, when somewhat lower resistance values are used, .05 mfd. may be taken as a good value.

Now, why do we not suggest perhaps 5 instead .05 microfarads? The reason is this.

It is absolutely necessary that the insulation resistance of that condenser shall be as high as possible, and it is thus almost essential that

ohms), the leakage will be sufficient to make the following valve grid about 7 volts more positive than it ought to be, with consequent disastrous effect upon the quality of reproduction, and a shortening of the life of the high-tension battery. If only large-capacity paper condensers are available for use in this position, it is quite a good plan to connect two or more *in series*, thus reducing the capacity but increasing the insulation resistance.

OUT WITH THE "TRAVELLER'S" TWO

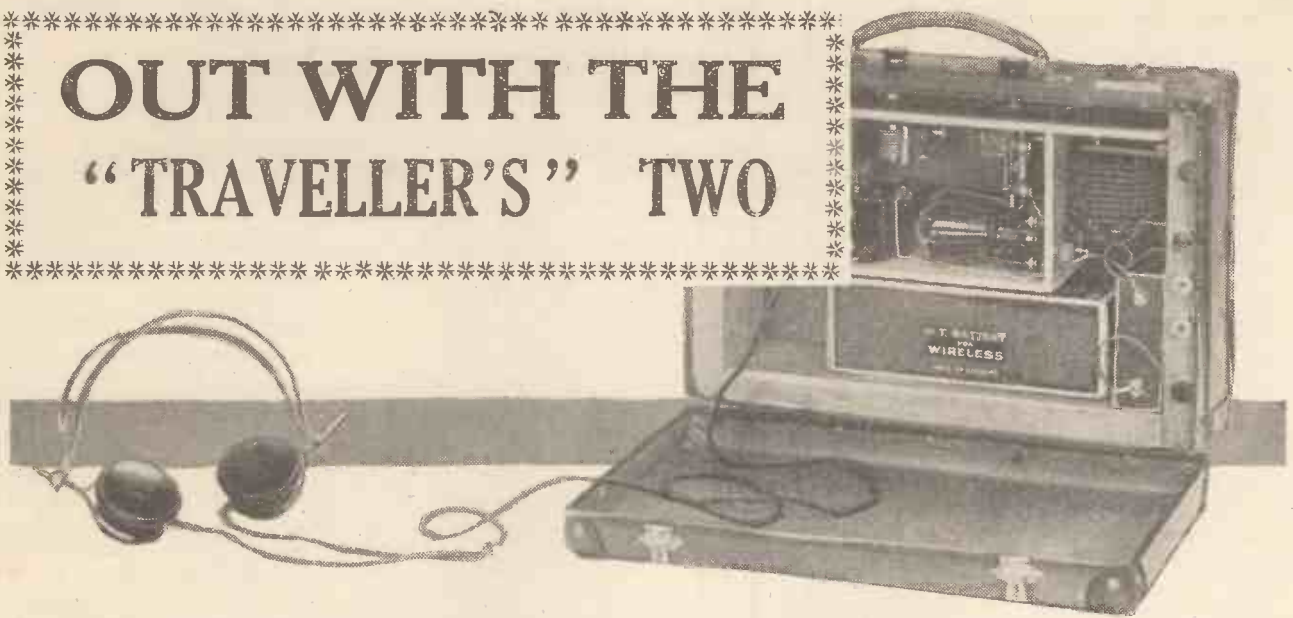

An interesting account of some tests carried out with the neat little portable set described in our June issue.

By J. ENGLISH.

RECENTLY I have been carrying out quite a number of tests with the "Traveller's" Two, a small lightweight portable described in the last issue of MODERN WIRELESS. Some interesting results were obtained, as the receiver was used in different places under very varying conditions, both adverse and favourable.

It is possible that an account of some of these tests may be of interest to those who have made up the set, or intend doing so, as it will help them to form an idea of the manifold possibilities of a portable of this description. I also propose to add a few notes on operation, which considerations of space prevented me from including in the original article on this set.

Completely Self-Contained

For the benefit of any who may have missed the constructional article referred to above I will commence with a very brief description of the two-valve portable used in these tests. As you will see from the accompanying photograph, it is completely self-contained in a small suitcase, and weighs about 10 lb.

The two control knobs are situated near the handle so that it is very hard to see that it is a wireless set at all. Inside there is a frame aerial for medium-wave reception, a standard "M.W." loading coil being brought into circuit for long-wave reception, for which the receiver is intended to be used with a small

external aerial. A dry battery is used to supply the filament current, and, as the filaments are wired in series, this battery has quite a long life.

First of all, a few tests were carried out in the heart of the city of London, where conditions approximate to those of any confined space in a town or city near to a broadcasting station. Under these conditions one appreciates the handiness of a frame-aerial receiver, as it can be switched

on in a few seconds wherever you wish to use it.

Tests in London

The "Traveller's" Two was used in several office buildings, and although strong, clear signals were heard from 2 L O, with somewhat less strength from 5 G B, reception was not so loud as that obtained twelve miles away on the outskirts of the suburbs.

This decrease in signal strength

READY FOR ACTION



The "Traveller's" Two with everything on board. Owing to its lightness it can be carried everywhere with the utmost ease.

with the receiver much closer to the transmitter is rather paradoxical and not perhaps what you yourself would expect to happen. The effect is entirely due to the screening and absorption of the ether waves caused by the multitude of buildings, many of which contain great quantities of steel-work.

Varied Results

In the basement of a modern building in the City area it is really amazing that anything can be heard at all, but even here 5 G B makes himself heard quite well on the 'phones. On the top of a tall building signal strength improved perceptibly owing to the reduction of screening, but even then volume was not all what one would expect so near to the transmitter.

Reception was also carried out on omnibus and tram in the London area, and in each case 2 L O came through loud enough to overcome the noise of the vehicle and the surrounding traffic.

On the tram, of course, there was some slight interference due to the electrical gear, but on the bus I could observe no trace of interference from the magnetos.

Have you ever listened-in in the train while on the way home from the office? This is quite a useful way of breaking the monotony of the journey, but no matter how inconspicuous your portable may be, it requires a good deal of nerve to don the 'phones in a crowded carriage!

No doubt in the future it will be quite a common occurrence to listen to the news-bulletin on the evening train, but at present when I want to test a portable on the train I travel before the rush hour, and select an empty carriage!

On a train journey to the outskirts of London, some twelve miles in all, very clear reception of 2 L O was obtained on the "Traveller's" Two, volume being sufficient to drown external noises, using, of course, the built-in frame aerial.

Long Ranges Covered

Slight fading was noticeable when the train passed through tunnels, but it required a long, deep tunnel or a tunnel with a steel girder roof to produce a marked decrease in signal strength.

Out in the country the frame aerial brings in 2 L O at very satisfying strength, even twenty miles away from the transmitter, and on occasions I have added novelty to a cross-

country ramble by wearing the 'phones while walking!

Provided the frame aerial is kept pointing in the general direction of the transmitter, the movement of walking produces no change in signal strength.

A trial run by car was undertaken to get some idea of the maximum range of reception from 2 L O on the frame aerial alone. It is not easy to say definitely how far from London you would have to go before signals became too weak for comfortable listening, as much depends upon local conditions and the amount of external noise.

However, 30 miles almost due north of 2 L O volume was still ample for comfortable 'phone reception; and here 5 G B was beginning to come in slightly stronger than 2 L O. In view of these results I consider that good 'phone reception should be possible within a radius of 35 to 40 miles from

A LIGHT-WEIGHT!



An airship's transmitter, claimed to have a long range, which weighs only about 4 lb. It is the design of an American coastguard.

2 L O, 75 to 80 miles from 5 G B, and perhaps 15 to 20 miles from other stations rated at 1 kilowatt.

The results obtained with the "Traveller's" Two are somewhat amazing when you realise that a coil of wire barely 14 in. square, some 30 miles from the transmitter, can pick up only an infinitesimal amount of the energy radiated, and that this is sufficient to give strong, clear reception on the 'phones.

Using as a temporary aerial some 20 ft. of wire suspended from a tree, and a ground spike as an earth connection, greater ranges are possible. On high ground some 12 miles north of London, the little-two-valver provided a good volume of sound on a

small portable loud speaker from 2 L O and 5 X X.

Close to this spot there is a stretch of water much used for boating. Here I embarked, with a willing friend to do the hard work of rowing, just to see whether reception varied much on the water. No difference was observable on the frame aerial, 2 L O and 5 G B both coming in loud and clear.

5XX Very Loud

A rough temporary aerial was next run up by attaching a piece of wire to a mast formed of two thin canes bound together. The whole aerial was not much more than 10 ft. long being about 8 ft. above water level at the mast end.

This makeshift aerial system proved quite sufficient for loud reception of 5 X X, too loud for 'phone reception, while Radio-Paris and two unidentified foreigners were quite readable, this being in full daylight.

For an "earth" connection a few feet of D.C.C. wire were dropped overboard, weighted at the end with the earth spike. There seemed to be no difference in results if the wire just floated near the surface of the water, so that it is only necessary to throw a length of wire overboard, not worrying how far it sinks, in order to obtain a good "earth" contact.

With such a short aerial as used here it was necessary to connect the aerial wire to the A₁ terminal, thus giving a tighter coupling on the long waves, while retaining ample selectivity.

Using a "Fence Aerial"

One of the most efficient makeshift aerials that I have ever used was a wire fence. This was situated alongside a railway line out in the country some ten miles from London, and ran almost due north and south. It was formed of six very thick galvanised-iron wires supported every few feet on old sleepers, so that the insulation of each wire was pretty good.

Connection was made to the top wire, which was some 4 ft. above ground level, by a few feet of No. 22 wire twisted tightly round a section scraped clean. On switching on, 2 L O, 5 G B and 5 X X came in at amazing strength, especially 5 X X, which was so loud on the 'phones that a passing train could barely be heard!

No earth connection was used, as this broadened tuning too much without increasing signal strength. Of course, there was an "earth" connection.

SWITCH TUNING



With the present arrangement of broadcasting stations and the probable start of the first regional station in a few months' time the problem of providing wave-change switching on broadcast receivers is becoming more and more acute. Some ingenious methods are discussed below in this interesting article.

By **CARDEN SHEILS.**

ONE of the earliest approximations to "switch" tuning is to be found in certain well-known crystal sets, where a tapped coil is connected in the aerial circuit and theappings are brought out to contacts arranged over an arc of a circle. A radial arm, moving over the contacts, is connected to earth, the crystal and 'phones being inserted between the aerial and earth.

Suiting Different Aerials

If theappings are so arranged that each position of the radial arm corresponds to the wave-length of a particular station, each contact could be so labelled, and the set would then in theory be switch-tuned. This would be of little use, however, in practice, since a crystal set has too limited a range and too flat

tuning to bring in a number of separate stations without overlap. Further, even if theappings were correctly adjusted for a particular aerial, the settings would be incorrect when used with a different aerial.

These defects have been overcome in various ingenious ways. For instance, as shown in Fig. 1, a separate aerial input circuit, 1, 2, 3, is used for each wave-length desired, and each tuned circuit is rendered sensitive by a corresponding reaction coil, R_1, R_2, R_3 . One side of each input circuit is taken to a row of contacts swept over by a radial arm S , which is connected to the aerial A through a condenser C , and to the grid of the valve V through the usual grid leak and condenser.

The reaction coils R_1, R_2, R_3 are connected to a similar row of contacts

which is swept over by a second radial arm S_1 in series with the plate of the detector valve.

The two arms S, S_1 , are linked together and form the station-selective switch. It will be seen that in each position of the switch, one input circuit and one reaction coil is operative, the other tuned components being disconnected.

Push-Button Selection

A somewhat different arrangement is shown in Fig. 2. Here a number of separate push-buttons P_1, P_2 , each labelled with its particular station, are employed instead of the radial switch. No reaction is used, but the working range is increased by means of one or more stages of resistance-capacity amplification V_1, V_2 , inserted in front of the detector valve V_3 .

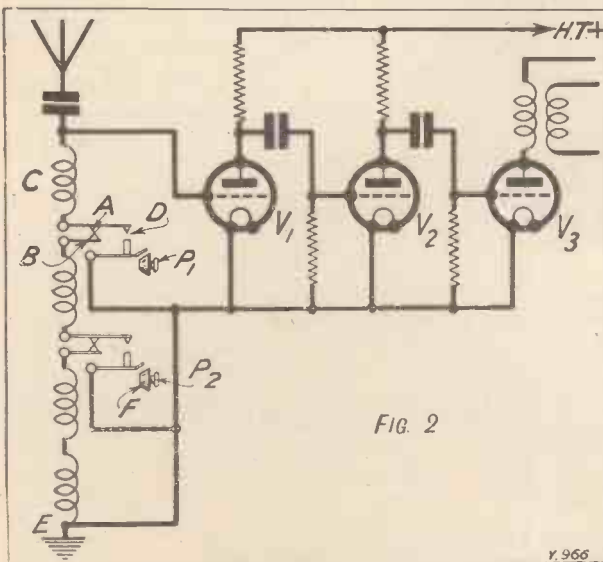

On the left is a simple method of button-switch wave changing, while below is another system showing how H.F. circuits can be changed over by means of a special switch.

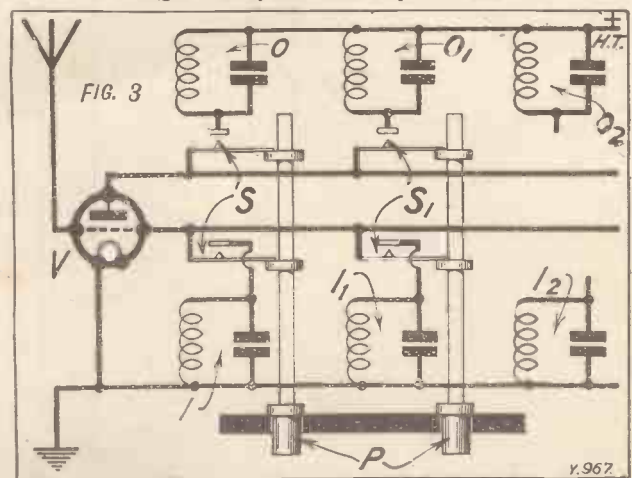

Two examples of switch-tuned circuits—they are discussed in the accompanying article.

Wave-Switching that is Simple and Selective

The aerial tuning coil is divided into a number of different sections, and at the junction points the adjacent ends are taken to spring contacts A, B, which are normally pressed together so as to render the sections continuous.

When a button P_1 is pressed, the corresponding contacts A, B are separated, and the upper active section C of the coil is connected to earth E at the additional contact D. At the same time, the lower inoperative sections of the coil are disconnected from the circuit, thereby avoiding "dead-end" effects.

When Ingenuity is Needed

Each push-button is provided with a conical boss F, which presses on the bevelled extremity of a resilient arm to operate the contacts A, B, and D. When any button has been depressed, it is held down by a spring catch which snaps in behind the boss F.

In order to bring in a reasonable selection of distant stations at good strength and quality of reproduction, one or more tuned high-frequency amplifiers must be employed. In these circumstances, in addition to the tuned input to the first valve, it is necessary to control the tuned interval-couplings of the high-frequency stages.

To apply the method of switch tuning to large sets calls for considerable skill and ingenuity. One arrangement of this kind is shown in Fig. 3. A number of separate circuits I, I_1, I_2 , each tuned to a separate station, are arranged as alternative input circuits to a high-frequency amplifier V, a second similar series of tuned circuits O, O_1, O_2 serving as the corresponding tuned-anode circuits to the same valve.

Seen at the Exhibition

Switches S, S_1 connect (a) the grid to any selected one of the input circuits, and (b) the plate and any one of the tuned output circuits. The particular input and output circuits corresponding to a desired programme are selected by means of a series of push-buttons P, which operate each pair of circuits simultaneously.

One of the most interesting exhibits at the last Radio Exhibition in Olympia was a switch-tuned set comprising two stages of high-frequency amplification. This, with a tuned input, involves the automatic setting of three separate

tuned circuits at each operation. Station selection is effected by means of five two-position switches. One is central on the panel and determines whether long- or short-wave programmes are to be received. The other four are symmetrically placed round the first, and serve to select any one of eight transmitting stations—four on the long- and four on the short-wave ranges.

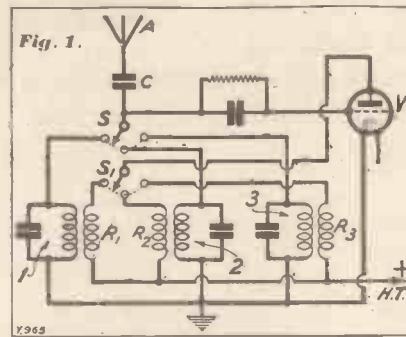
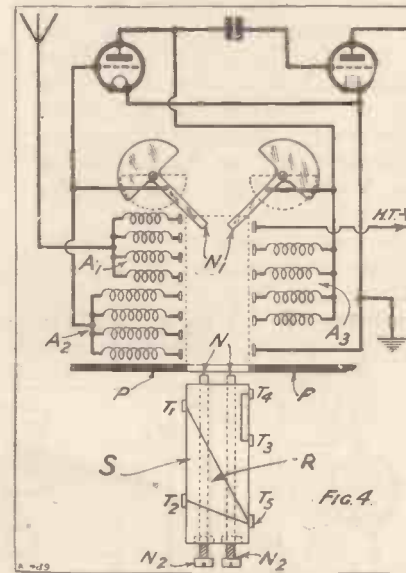

Fig. 1 gives a method of switching which is extremely useful for a detector circuit, and obviates the need for tuning. Fig. 4 is a more elaborate circuit showing how a number of stations can be "fixed" and selected by means of a series of plugs, one for each station.



From the operator's point of view, the selection is simplicity itself. He first throws the central switch according as he wants to receive a long- or short-wave station, and then throws one of the labelled switches to select the particular station required in that range.

The manner in which the switches control the tuning is too intricate for more than a brief description. When

the central switch is thrown over for long waves, it puts a long-wave coil in series with the short-wave aerial coil. As there are three stages of interval-coupling, there must also be three long-wave coils and three short-wave coils associated with each valve, and the central switch cuts these in or out simultaneously.

A Final Example

For each different setting a different fixed condenser is thrown into circuit across each of the coils. Since separate condensers must be provided for each of the three tuning stages, no less than twenty-four condensers are included in the set. The condensers are neatly mounted in pairs to rock on pivots and are operated by the station control switches, which select one or other of each pair, all the pairs being linked together to move in unison.

A final example of switch control is shown in Fig. 4. Here the panel P of the set is provided with a recess or socket into which any one of a series of station-selecting plugs S may be inserted. These plugs are provided with side contact members $T_1..T_5$, which engage with corresponding contacts inside the socket.

For instance, when the plug S is inserted and pressed home, contact T selects one of the aerial coils A_1 , contact T_2 selects one of the grid coils A_2 , and contact T_4 selects one of the anode coils A_3 . The contact T_4 meanwhile connects with H.T.+, and contact T_5 with earth.

Quite Automatic

Two pins N, projecting through the inner end of the plug, engage arms N_1 secured to variable condensers in the grid and plate circuits respectively. When the plug is pressed home these pins automatically adjust the condensers to such a position that in combination with the selected coils both grid and anode circuits are correctly tuned to the desired station.

The pins are screw-threaded at their outer ends N_2 , and work through nuts in the plug, so as to allow of an initial adjustment.

A separate plug S is used for each station. For each station the plug contacts $T_1..T_3$ are differently spaced, whilst the extent to which the pins N project through the plug varies.

VIEWED from the outside, no one would ever expect the Berlin broadcasting station, Voxhaus, to possess so agreeable a charm of arrangement within. The building is typically continental in style, and the front portion of it on the ground floor is let off into offices and shops.

Behind such a suave frontage, however, is a veritable whirl of broadcasting activity. The building, situated within easy walking distance of the much renowned Unter den Linden, constitutes, indeed, Berlin's Savoy Hill, and it is, I think, admitted by most people that the Voxhaus broadcasters take the place of honour.

Have You Heard It?

Nearly every valve-set possessor in England will, of course, have listened in to the strains of music coming across the water from the German Voxhaus (or, literally, "House of Voices") station in Berlin. The station normally transmits on a wave-length of 484 metres, corresponding to some 620 kilocycles frequency. It has a power of 4 kw., sufficient to enable it to be heard in almost any region of England in comfort by means of any multi-valver of even moderate efficiency.

The Berlin station transmits much good music, and, although some portions of the musical programmes have been criticised on account of their tendency to heaviness, the lighter music emanating from the Voxhaus station's tuneful orchestra, has a charm of its own.

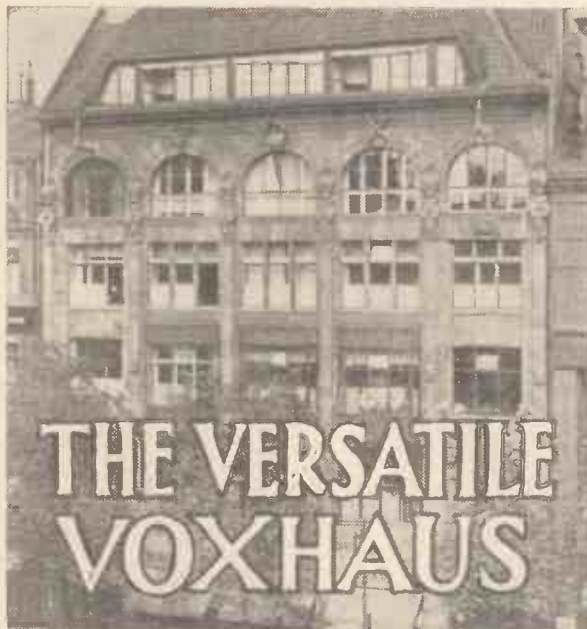

Germany's Leading Station.

The Berlin Voxhaus specialises in three things, to wit, orchestral concerts, radio plays, and outside broadcasts, particularly those of a somewhat novel nature. Radio talks there are, of course, in the Germany broadcasting economy, but the majority of these are made to take up a rôle of secondary importance only.

Very Varied Staff

Like our own B.B.C., the Berlin broadcasting concern employs its "specialists." The Berliners, however, have the advantage of their "specialists" being less hampered by official formalities than our own B.B.C. experts are. The permanent station staff is a fairly large one, and is highly versatile.

Informal meetings of the chief members of the staff take place every day, generally in the mornings, whereby minor details respecting the station's operations are worked out, and future plans examined and deliberated upon.

Perhaps the most enthusiastic department of the Voxhaus station's varied staff is the one which is responsible for the selection and production of what are termed Senderspiel, or radio plays. Now, whilst the average German Senderspiel is generally a comical or light-hearted affair, its production by the station authorities is a very serious matter indeed.

In selecting a play for radio presentation, a special committee appointed by the station authorities meet and discuss the possibilities of the play very thoroughly. If the play has novel features, so much the better for it, for the

HOW BERLIN BRIGHTENS BROADCASTING

In this article our Special Correspondent shows how Germany's leading broadcaster sets to work to provide programmes for its listeners.



Above we see a radio drama being acted in the street outside the Voxhaus station. The microphone is next to the camera and is out of the picture.

Achtung! Achtung! Hier Berlin

more novelties which can be got into it, the better. The details of the play's presentation, then, are thrashed out, and a suitable radio cast is selected. Usually, the radio players are selected only from a body of men and women who have had the maximum amount of experience in the art of radio drama. The play is then passed over to a "technical producer," and its final presentation in front of the microphone takes place in due course.

The Portable "Mike"

The Voxhaus studios, of which there are two or three, are well equipped for the production of "effects." In fact, the station runs a special department almost solely for the working of these "off" noises, and for the devising of further and still more effective, means for their production.

Again, several of the "effects" included in the German radio plays are derived from scenes in real life, and for this purpose a portable microphone outfit is maintained by the station engineers.

The identification of the Berlin station is not difficult for the listener in this country. The station is on the air at various periods of the day, and almost continuously from 5.30 p.m. until late evening, and sometimes until well after midnight. Before giving notice of any important item, the announcer generally issues the exhortation: "Achtung! Achtung! Hier Berlin!" after which he begins with "Mein esehr verehrten Damen und Herren," corresponding, of course, to our more formal "Ladies and Gentlemen."

Interim Identification Signals

Between items, the voice of the Berlin announcer is frequently heard intimating that "Wir machen eine Pause von . . . Minuten," which, being interpreted, is to the fact that there will be an interval of so many minutes' duration. An interval signal used at the Berlin station at times takes the form of a metronome ticking about thirty beats in ten seconds. However, other stations use this method of interval marking, and so its reception cannot be accepted as conclusive evidence of the station's identification.



*** Above we see a comedy broadcast in progress. Note the microphone, which has been specially adorned to create "atmosphere." Below, the final rehearsal of a radio play is in progress. On the extreme left we have the "effects" man, the announcer is seen seated, while the control engineer is seen at the window on the right.

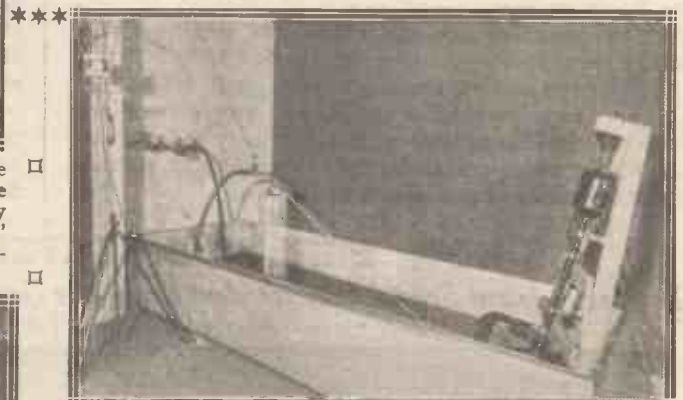

□ The water machine (left) for imitating the sound of rain, etc., is seen above, together with (right) the apparatus for imitating the sounds of ships, motor-boats, turbines, etc. Below are the Committee of Management of the Voxhaus station, who are responsible for the excellence of the transmissions, and for the fare provided.



SOME ASPECTS OF THE DAY'S WORK AT THE VOXHAUS STATION

SILENT POWER

FROM BIG CELLS



MADE IN ENGLAND

PRICES :

60-volt (reads 66) ..	7/11
100-volt (reads 108) ..	12/11
36-volt ..	4/6
60 (super power) ..	13/6
9 volt Grid Bias ..	1/6
4½ volt Pocket Battery (4/6 a doz.),	each 5d.
Single Cell Torch Battery ..	4½d.

The power of a Lissen Battery flows steadily, smoothly. The big cells are packed with energy. The secret process keeps it pure and sustained. The quality lasts throughout the longest programme—there is never a sign of ripple in the current, never a trace of hum.

Hear how well your own loudspeaker will reproduce a heavy orchestral item when you have the power of a Lissen Secret Process Battery flowing through your set—test it on opera, vaudeville, speech, song or sports event. Hear how natural and true everything sounds.

Obtainable at every good radio dealer's—ask for Lissen New Process Battery and be sure to take no other.

LISSEN LIMITED, 20-24, Friars Lane, Richmond, Surrey.

Managing Director : THOS. N. COLE.

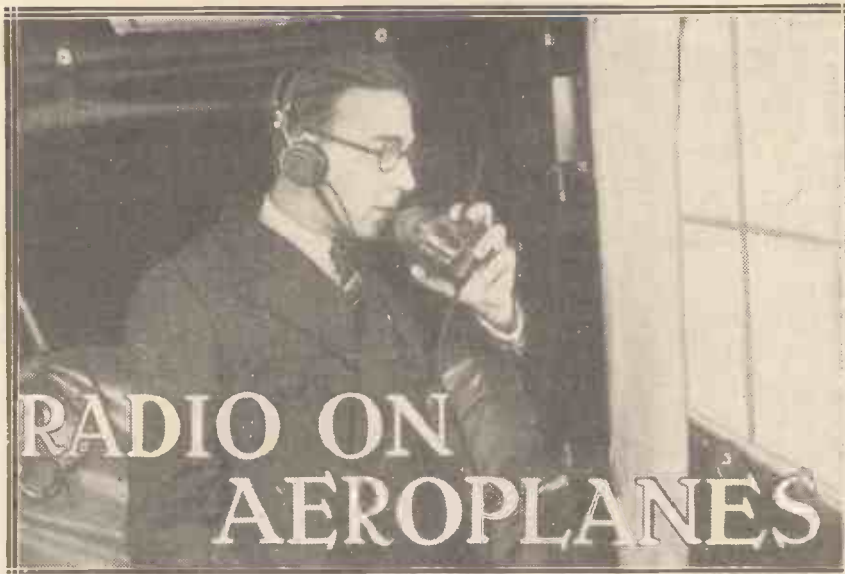

THE requirements for a radio receiver for aircraft are exceedingly rigorous. The apparatus, employing only a small vertical antenna, must be highly sensitive to receive signals at distances of from 100 to 200 miles from 2-kilowatt ground stations; it must provide sufficient output level to make the signals audible over the tremendous noise of engine, propeller, and wind, which is experienced in most present-day 'planes; and it must, of course, be simple and dependable in operation. Compactness and lightness are additional requirements that can never be overlooked.

Silent Operation

All these requirements have been adequately met in the development of a new receiver by the Bell Telephone Laboratories of America.

Throughout the receiver, valves of the recently developed unipotential-

The description of a new aeroplane receiver of American origin which is claimed to possess exceptional advantages.

By F. M. RYAN.

cathode type have been employed. The cathode of these tubes, is not heated directly by the passage of a current, but indirectly by conduction and radiation from an auxiliary filament. By this arrangement the possible introduction of noise from the filament supply is entirely eliminated. Only four valves are used altogether. Three are of the shielded grid type, two being employed in the receiver as radio-frequency amplifiers, and the third as a detector.

There are three tuned circuits, one for the aerial, and one for the output circuit of each of the stages of radio-frequency amplification. A special

gang condenser is employed for simultaneously tuning these three circuits. In this way uni-control is provided with unusually compact and light equipment. The amplification of the receiver is controlled by a potentiometer which varies the shield potential of the two radio-frequency amplifier valves. The only other control is a switch for turning the receiver on and off.

The receiver is mounted in a duralumin box about 12 in. long by 8 in. high and a little over 4 in. deep. Complete with valves it weighs less than 13 lb. The receiver is of high sensitivity; an aerial input of 10 microvolts is sufficient to enable it to deliver an audio-frequency output of 6 milliwatts. It is, however, capable of delivering output levels of as great as 60 milliwatts when required and, owing to the unusual detector characteristic, only 20 microvolts aerial input is required for this greater output.

Wind-driven Generator

Both filament and plate supplies are obtained from a small wind-driven generator with a stream-lined casing, having a diameter of only a little over 3 in. Complete with propeller it weighs less than 7 lb. This generator, driven at 6,500 r.p.m. by a Deslauriers constant-speed propeller, is provided with a double winding, and supplies direct current at voltages of 9 and 220 for the filament and plate circuits. A filter for smoothing out the plate supply is included in the radio receiver.

The employment of this generator ensures a dependable power supply at all times with a minimum amount of maintenance, and avoids entirely the use of dry batteries requiring frequent replacements.

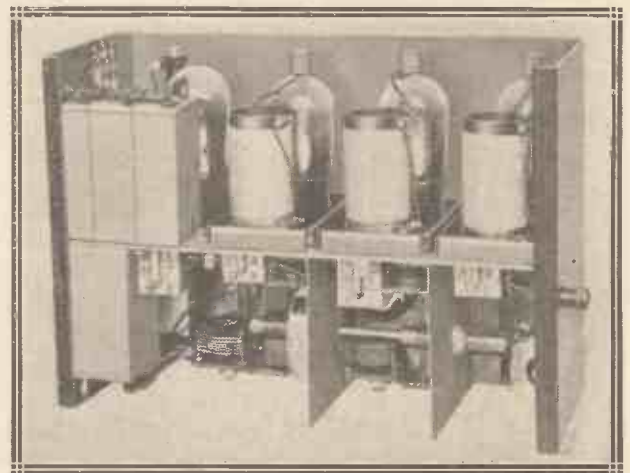
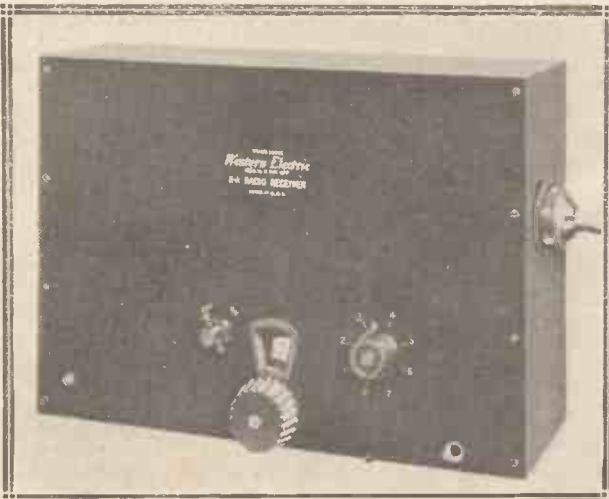

Two views of the new American aeroplane receiver. On the left it is shown complete in its case, while its "works" are on view in the photo to the right. Note the indirectly heated cathode valves employed.



New Amplion Loud Speaker—Ferranti H.T. Unit—New Dubilier Component—Hammarlund Short-Wave Coils—Wates Volt-Amp. Meter.

New Amplion Loud Speaker

THE Graham Amplion people are going to make themselves even more popular than ever with their new Guinea Cone. Twenty-one shillings is a very low price for any loud speaker, and when it bears the well-known name Amplion it becomes decidedly so. It is circular in shape and is provided with a cord for hanging on the wall. It should also be suitable for inclusion in portable sets.

It has a moulded rim of brightly polished material and the cone is also artistically coloured to match. The unit is adjustable.

There is nothing slipshod in the construction of this Amplion speaker despite its price, and even the appearance of its reverse side is completely satisfactory. As to its performance, this is definitely of a high class. We have heard loud speakers priced at four guineas or more which do not come up to this Amplion cone in point of reproduction. Readers should make a point of hearing one when

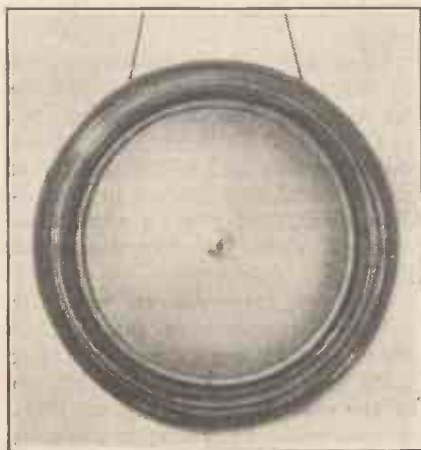

The Amplion Guinea Cone.

next they visit their local radio shop.

The Cossor Wireless Book

This is an excellently made-up book of 64 pages, brightly illustrated with appropriate diagrams and

Manufacturers and Traders are invited to submit for test purposes radio sets, components and accessories to the "Modern Wireless" Test Room at Tallis House, Tallis Street, London, E.C.4. Under the personal supervision of the Technical Editor all tests and examinations are carried out with the strictest impartiality. Readers can accept the Test Room reports published monthly under the above heading as reliable guides as to the merits and demerits of the various modern productions of the radio industry.

photographs. Most of the articles deal with the modernising of the original Melody Maker and operating and other details concerning this receiver. But many of the articles are of general interest and very well are they written. Owners, or potential owners, of Melody Makers should certainly endeavour to secure copies, while many other amateurs who do will no doubt become Melody Maker enthusiasts.

The Ferranti H.T. Unit

The Ferranti H.T. supply unit, type D.E.M.1, for 200- to 250-volt 40- to 100-cycle supplies, weighs 25 lb., and is priced at £13 10s. Its maximum output is 100 milliamps at 200 volts. It is built into a fire-proof safety box fitted with two flexible cables for connection respectively to the supply mains and the receiver. A Westinghouse full-wave permanent

metal rectifier and readily replaceable fuses are fitted in this unit. There are five H.T. positives.

It is completely modern in design and construction and conforms with the I.E.E. recommendations.

The feature of the safety box in which it is built is that the unit is automatically disconnected when the lid is raised. And upon opening the unit in this way all the interchangeable resistances which make this accessory almost completely universal are revealed.

The Ferranti system of shunt-feed is incorporated, so that there is no need to include any such system in the set with which the unit is used.

Hum, motor-boating, instability, and other such things which seem inherent in some H.T. units are quite strangers to this Ferranti production,



The Ferranti H.T. Unit.

which supplies steady, quiet H.T. with the facility of an accumulator.

It is undoubtedly a magnificent instrument and one that we can thoroughly recommend as a reliable, safe and certain deriver of H.T. from the A.C. mains.

New Dubilier Component

The Dubilier K.C. drum-control triple condenser, in combinations of .0003 mfd. and .0005 mfd. capacities, is priced at £2; rather a large sum for one component. Actually, of course, it is really three components, or more if, as is often the case, dials are reckoned as additional equipment.

This Dubilier gang arrangement strikes us as being a sound engineering job. The three condensers are neatly massed on robust aluminium framework and the six terminals are accessibly positioned at the back.

The framework is so arranged that it can be screwed to the baseboard, the panel fitting being a good bit easier than is usually the case with drum-controlled condensers.

The drums are grouped together and can be operated either simultaneously or independently, so that both "trimming" and one-control tuning are available. There is no gearing, but the drums are large and there is no difficulty in obtaining close settings.

Compactness, as we have already indicated, is a feature of this assembly. The maximum height is 5 in., and the projection behind the panel $4\frac{5}{16}$ in. The overall width is 14 in.

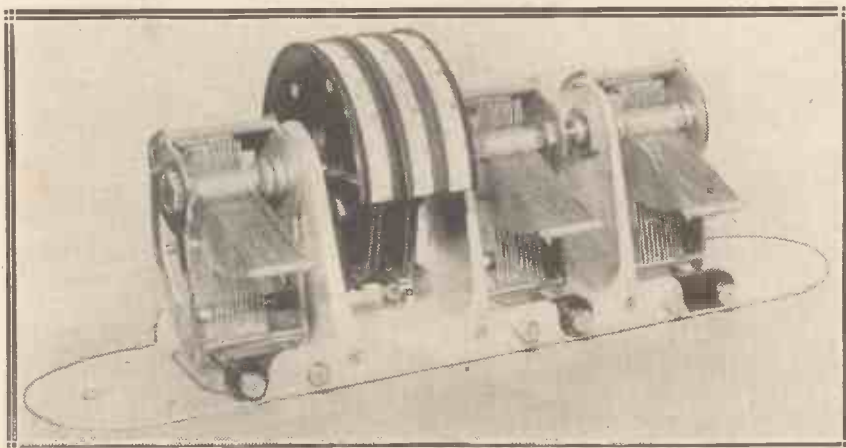

This view of the Dubilier drum-control triple condenser shows the terminals which are accessibly placed at the back.

You have to cut a hole in the panel $3\frac{1}{8}$ by 2 in. wide to enable the drums to project through, but only two screws are required for the neat panel shield. The drum markings and indicators are both such that you can obtain microscopic calibrations.

The movements of the three units are comfortably smooth. The Dubilier K.C. drum-control condenser adds both to the appearance and the easy control of a set, and it constitutes a

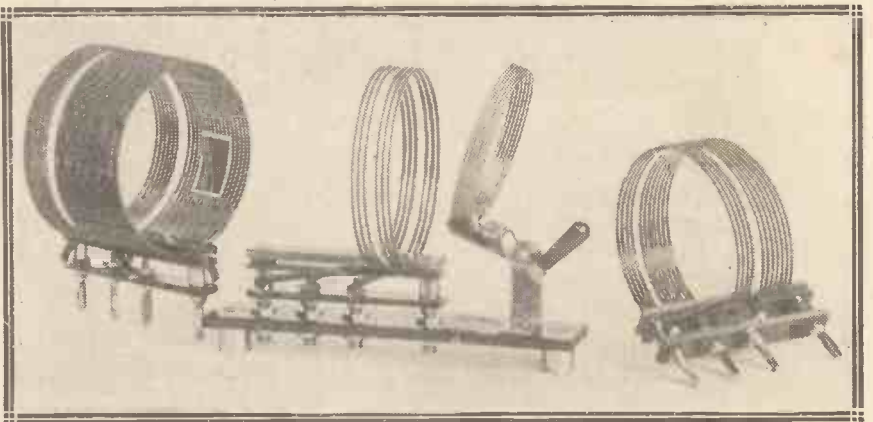

The set of Hammarlund short-wave coils and the holder.

great improvement over the employment of three separate dialled condensers.

Drum condensers are slightly harder to mount than the ordinary type, but there has been so much simplification in set building in other directions that this does not constitute a setback. We hope some day we shall be able to standardise positions for drum controls, thus enabling panels to be sold in standard sizes already cut for these fitments.

Hammarlund Short-Wave Coils

The Rothermel Corporation, Ltd., recently sent us a set of their new

coil which is operated by a small lever. The movement is excellent.

The coils are mounted on bases having four plugs, and these slip into the sockets with perfect compromises

between smoothness and firmness. In fact, the whole of the construction of these coils is American radio at its best. The coils themselves are space-wound on a special former material which is claimed to have exceptionally low losses.

We have very carefully tested these coils and find they have a high order of efficiency. Coils are all-important with a short-wave receiver, and although 48s. 6d. might seem a high price, it tends to shrink in one's estimation when placed against the careful construction and general merit of these components.

Wates Volt-Amp. Meter

The Standard Wet Battery Company are supplying instructions with their Wates Volt-Amp. meter for the accurate measurement of H.T. eliminator voltages using that instrument. This meter sells at 8s. 6d., and with it you can carry out with sufficient accuracy for all ordinary purposes measurements of voltages between 0 and 6 and 0 and 150, and milliamps to 30.

Thus it is just the meter required by the ordinary amateur or listener for checking the conditions of his H.T. and L.T. batteries. It is of the watch pattern and is contained in a strong metal case finished in crystalline black, and has an aluminium dial with nickel-plated terminals and fittings.

The two terminals are used for measuring current in milliamps, while there are the usual two small flex leads and the spike on the bottom of the case for the voltage readings. A nice velvet-lined case is available for this meter at 2s. 6d.

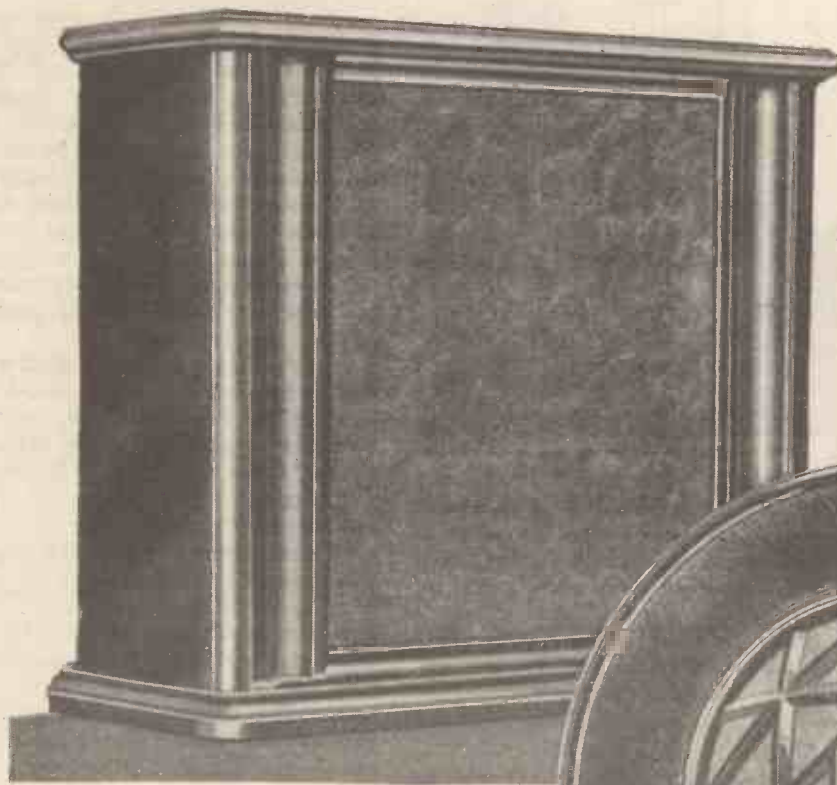

BLUE SPOT

49

PRICE - 42/-

(This speaker, illustrated on the left, is driven by the Blue Spot 66Z unit.)



Attractive Efficiency

There is a Blue Spot speaker to suit each individual taste, but fidelity of reproduction characterises them all.

Here are two of the most popular models, each a masterpiece in its own class.

BLUE SPOT

101

PRICE - 73/6

(Driven by the famous Blue Spot 66K unit.)

F. A. HUGHES & CO., LIMITED, 204-6 Great Portland Street, London, W.1

Distributors for Northern England, Scotland and North Wales: **H. C. RAWSON (SHEFFIELD & LONDON) LTD.**
100 LONDON ROAD, SHEFFIELD; 183 PRINCESS STREET, MANCHESTER.



THE questing spade oft times turns up the forgotten, long-buried kitten or the useless half-brick; anything but the potato. It may be taken as certain that Columbus was not actually looking for America; he was not of the emigrating type, and I doubt whether he ever sold a banana or a slab of

Mainspring: The Hop." It was only when I promised to return to Faversham that Ferdie would consent to turn his lean, inquiring nose along the holy road to Canterbury. He stopped twice on that road to ask cottagers whether they thought that radio gave the hop a slight extra zip. They thought, unanimously, that 'ops weren't wot they was afore the war.



"'Ops weren't wot they was."

ice-cream in his life. But he found America—though Americans would love to prove that it was found by Byrd. Fleming, looking for the snag in an electric lamp, found the valve.

Therefore, brethren, when recently I fled deep into Kent, seeking solace from the slings and arrows of a life on the radio wave, I was not greatly surprised to find that I made a number of discoveries not on the official programme. For instance, there was that waitress at Faversham. She was a (Pass along, Don Juan.—Ed. "M.W."). Bless me, I was only going to say that she was a keen listener-in. Can't I say that?

A Tough Job

All right, then, let's get on to Canterbury. I had a tough job getting Ferdie, my holiday mate, to leave Faversham. There's a brewery there, and he said that he wanted to study it up for an article entitled, "Britain's

Before I go any farther I wish to say that the Thomas à Becket story is about the thinnest I have heard since my kid son explained how the stone turned—absolutely turned—in the air and made for the greenhouse. You enter Canterbury Cathedral. You have, maybe, just lunched and are feeling fairly trim and blood-some; I thank ye. Before the guide has had you for five minutes he kneads you into a sort of oozy, medieval, moss-grown state, and gradually piles on the agony so that by the time you are prepared for the great Becket scene you would not be surprised to see the blood still damp, and to hear the clang of the retreating Norman knights as they bang their armour and things against the pillars.

Quite a Wash-out

But nothing is here for tears, brethren; nary tear shall ye shed. It's a wash-out, and I want to give a B.B.C. "talk" about it, relayed by 5 S.W. Everything which environed the alleged murder, except a few miserable little stone arches, has disappeared. They show you a brick in the floor and tell you that there the body was found; but it isn't even the original brick, and I doubt whether the original site hasn't shifted several times in the past six

centuries. The altar steps whereon the horrid *fracas* occurred are not in Canterbury, and nobody knows where they are, not even Mr. Stobart.

Finally, they haven't even got Becket in a box. Stephen Langton they have, and most of Edward the Black Prince, but Thos. à Becket has absconded from the place to which he owes his fame. You leave the Cathedral and ask a Canterbury man about this Becket affair, and he looks at you with the same nasty kind of glance with which a Wigan man favours you if you ask him where the pier is. Yes! It's a pretty tenuous yarn!

Ferdy's theory is that Becket was really a man called Watkins, an ardent sampler of Faversham ale, who's invariable command to the tapster of the "Cross Keys" was, "Thomas, a bucket!" This fellow, on the eve of New Year's Day, having mellowed himself unusually well, wandered into the Cathedral, slipped on a piece of tripe, and broke his constitution. The charwomen dragged him out, went through his pockets, and left him for dead. Which he was. The citizens, on seeing him cumber the road, merely growled about the Urban District Council, and in course of time poor Watkins disintegrated and blew by instalments into the Stour.

My Great Discovery

But Ferdy has a plebeian mind. My version is just as good as his, and much more refaned. All this, mark you, is only a prelude to my great discovery of how England became great, but as that is a technical matter, demanding all your powers of concentration, you've got to have some more Becket first.



"Thomas, a bucket!"

Thomas Beckett was Chief Engineer and Lord Chancellor of the Canterbury Station, and had lent his wave-meter to the local monks in return for a recipe for Brown Ale. As a result Canterbury's wave used to wobble like a hop-pole in a nor'easter. Now, Henry the Second, announced by K D K A as "Judge

Sensational Evidence of Ancient Broadcasting Discovered

Henry K. Seck, of London, England," went for his holidays to France, taking with him eight ox-wains of gold, fifty sumpter-mule loads of oysters, and his favourite portable.

Henry was very keen on tilting and used to bet freely. Accordingly he used to tune-in to Radio Paris every day to hear the name of the 3.30 winner. But that darned Canterbury jammed him every time. He tried sending knights by forced gallops to Paris and back, but their expenses' bills ("Worshipping at ye Folies Bergere") soon ran through his winnings, and in a fit of rage he exclaimed, "Is there no one with the nerve to nail that Canterbury crow to a barn door?"

Foundations of Chamber Music

There apparently was no one. So then he cried: "Is there not one of ye, who eat my bread, has the stomach to tick-off that black limb of Satan?" No one!

"Doggone my cats," exclaimed the infuriated mon-arch. "Have I no knight who dares refer that Fiend of the Pit to the reg-u-la-tions of the Lon-don Con-fer-ence?"

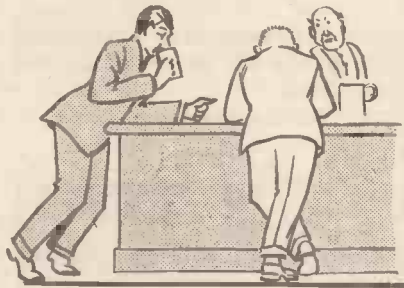

Dropping sadly into little inns.

There were four knights who thought that they might do that without giving offence. So they drew on the cashier for first-class passages per "Golden Arrow," made their way to Canterbury and sent Chancellor Beckett a strongly-worded memorandum.

Mr. Beckett hanged three of them, but when the fourth exclaimed, "Dash it all, man, this is most uncalled for," he replied, "Well, if you put it like that, I resign." And he did, married a hosier's daughter and never smiled again, though he went on a crusade and came back with a parrot which whistled like a kite, thus laying the Foundations of Chamber Music.

Well, that's my version, and you can take it or leave it. Meanwhile, I will proceed to the technical part of the pilgrimage.

As I said, I absconded into Kent in the hope of avoiding for a few days everything relating to my profession, radio; every form of signalling, except the glad eye, was to be banished. And right condignly did I fail. The aerials stretched, tail to tail, all the way from Cannon Street to Faversham.

A Cheerful Companion!

Then, during our walks, Ferdie kept breaking out into circuits, and once, on the river at Fordwich, he explained amperes to a cow who was looking over the bank and who, he said, reminded him of his Aunt Charlotte. When I asked why he had to tell Lottie about amperes, he said it was because he always did. A cheerful companion!

Everywhere we went we encountered beacons, cressets, semaphores, telegraph wires, bells, gongs, and other means of communication. Only tomtoms and ocean cables were missing from the list, and so we took to drink, dropping sadly into solitary little inns and watching ninety-year-old images playing at darts. Ferdie found one ancient who, he alleged, enquired whether Gordon had been relieved yet. One hot afternoon in the "Huntsman"—no, the "Man of Kent"—when the ubiquitous loud speaker began its nasal snarl, I said to Ferdie:

"I reckon that our ancestors had some system of communication the secret of which is lost."

"Why. Watjermean?"

"Look at King Harold. Right up north, he was, sloshing ole man Tostig, and yet he got the news of Williams' landing in time to march south and meet the invader before said invader had got off the shingle and on to the Esplanade. Something rummy, that!"

Remarkably Accurate "Guesses"

"Pooh! He guessed that Bill was due over and took a chance on it. Come and look at the ferrets outside."

"But," I persisted, "English history is full of these remarkably accurate guesses."

"I dessay. They've got a monkey, too. Let's ask it to say a few words into the microphone."

I sighed as Ferdie and his can of "Kent's Best" went slowly out. The westering sun, having been hard at it all day, bringing along the cherries and hops, shot its warm rays upon two red-brick chimneys and transmuted them to gold, the ruddy gold of the ripened apple. I asked the host to what building they belonged and he said:

"Duck."

Through the opposite window I could see the roof of the "Pied Spaniel." A girl at top-most window



A perfect system of communication.

was shaking a duster; she might have been flag-wagging. Seized with a theory I hurled the host a coin and hastened to the "Duck." Yes, the theory held. I could see the "Green Lion" from the door of the "Duck." Back I went and entered the "Pied Spaniel." Eureka! From the window of the snuggery I could see the attic window of the "Stone Hen."

A Perfect Chain

Here, then, I had the secret of England's greatness. *No inn is out of sight of the next.* It follows, therefore, that from every inn you can see two more. This, from Lands End to the northern border! A perfect chain, a perfect system of communication! Whilst the invader broke down the watch-towers and beacons, he left the inns immune from violence, thus cherishing his own undoing. "If the male population is in the inn," he thought, "they are innocuous." He backed a non-starter, for even as he thought, the news was flashing the length and breadth of England, and then—

"William the Goatfaced marched from York and fell unexpectedly upon Harald the Hobo and slew Harald's army like one o'clock." And Harald never had time to wonder how the dickens William knew.

So much for ancient broadcasting,



RADIO ABROAD

Notes and News of Wireless in Other Lands.
By Our Special Correspondents.

Safety First

IN the United States the Federal Radio Commission has allotted five short-wave channels especially for use in connection with railway trains. As I reported in this column some months ago, many successful tests have been made with radio short-wave communication between the guard and the driver on very long freight trains.

Cases have occurred where long trains of this type have separated into two parts, and whereas this would mean the severing of the ordinary means of communication, the radio link still remains available and in this way what might have been serious accidents have been averted.

Brazil

The Brazilian Government, according to orders issued by the Minister of Communications, has made it compulsory for every vessel leaving a Brazilian port to be equipped with a radio set in proper working order. Unless this condition is complied with the clearing of the vessel will be refused.

Private Broadcasting

A curious local broadcasting arrangement has arisen in the Swiss Canton Ticina. A company called the Unione Radiofonie Intercantonale has been formed at Bellinzona for the purpose of setting up and maintaining a small broadcasting service for the Canton.

Apparently the local population principally speak and understand the Italian language, and consequently the broadcast which they at present receive is in the main unintelligible. By means of this new local broadcast-

ing station they will have a broadcast service more adapted to their own needs.

Who Started It?

A gentleman of the name of Mynheer H. S. a Steringa Idzerda, of The Hague, claims to be the first person ever to have broadcast publicly. He bases his claims upon the fact that he began public demonstrations in Utrecht, in 1919, at the third Dutch Trade Fair.

The selection which was broadcast on that occasion was a flute solo, the power in the aerial being 5 watts. This transmission was heard at a distance of over 100 miles. Incidentally, the claim of being the pioneer

in the matter of broadcasting has generally been made by K D K A, Pittsburg, U.S.A.

Listening to Listeners

An arrangement is being made in France, with regard to the preparation of broadcast programmes, which certainly appears to have merits. A Broadcast Council is to be established, consisting of representatives of artists, writers, journalists, scientists and (last but not least) listeners. The idea of giving the listeners a chance of being *listened to*, although perfectly obvious, is one which does not seem to have occurred to those responsible for broadcasting in this country!

According to a new Broadcast Bill which will be passed in next Parliamentary Session, the annual receiving licence in France will be about the equivalent of 3s. for crystal sets and 9s. for valve sets, but a separate tax will also be levied on each valve manufactured and sold.

Dual Stations

Government Broadcasting Stations will be governed by a National Bureau, whilst private stations will still be allowed to operate under their present ownership and special concessions will be granted. In this way broadcasting will be partly in the hands of the Government and partly in those of private enterprise, and it is believed that the best interests both of the broadcasting services and of the public will be served by this arrangement.

(Continued on page 100.)

A WELL-KNOWN RELAY STATION

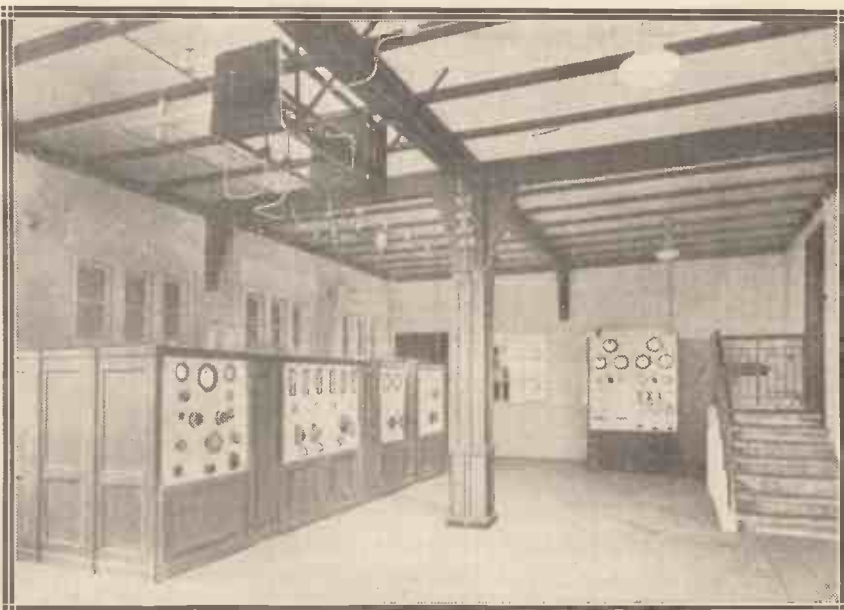

The neatly arranged transmitting apparatus at the Danzig broadcasting station. Danzig relays Konigsberg and uses a power of 0.7 kw. and a wave-length of 456.3 metres.

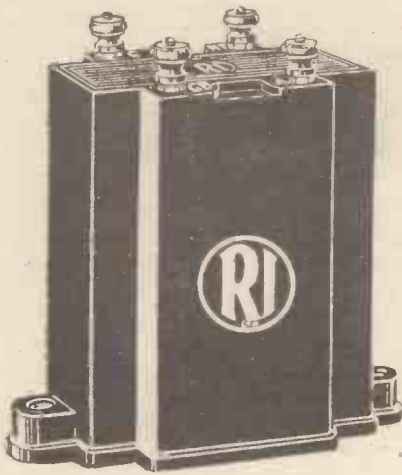

*The Set
Manufacturers
are fitting*

THE HYPERMU L.F. INTERVALVE TRANSFORMER

because it adds loud speaker volume and improves the tone out of all comparison to that obtained with other transformers.

Its iron shroud, inside the handsome Bakelite case, affords a perfect screen which will be found invaluable on Mains operated sets, where magnetic leakage must be avoided.

For gramophone reproduction it outclasses every other form of L.F. Amplification.

Meanwhile write for the New R.I. Catalogue and "Hypermu" Brochure which shows the practically perfect curve.

"HYPERMU" L.F. Intervalve Transformer. Gives the greatest and most uniform amplification of any commercial intervalve transformer. Weight, 14 ounces. Size, 3" x 1½" x 3". A midget in size, 21/- a giant in performance.

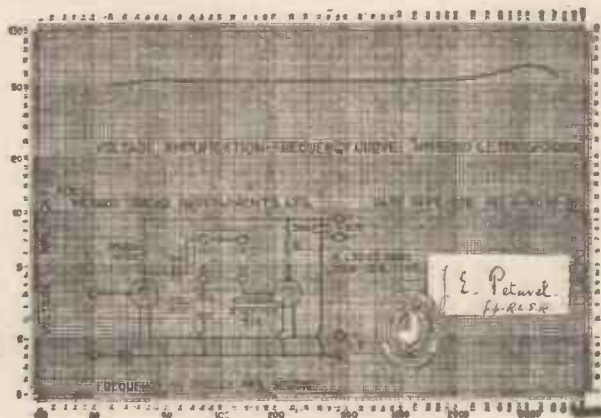

Specialists in Sound Reproduction

RADIO INSTRUMENTS LTD.,
12, HYDE ST., NEW OXFORD ST., LONDON, W.C.1



Radio and the Gramophone

In this section of MODERN WIRELESS each month will be discussed both technical and other data of interest to the set owner who is also interested in gramophones.

Besides articles of a practical nature, a brief survey and critique of the latest gramophone records is included, making the section of vital interest to all music-lovers.

Conducted by **KEITH D. ROGERS.**

CONTENTS

	Page		Page
Reducing Resonance	2	Round the Turntable	6
<p>The problem of designing a sound-box or pick-up so that it will faithfully follow the intricate variations on the record surface is not an easy one to solve. This article deals with some of the methods employed.</p>		<p>A page of odds and ends of interest to radio and gramophone enthusiasts.</p>	
A Polarised Pick-Up	4	Replies to Readers	7
<p>Details of an interesting and novel instrument that has given excellent results, and is not unduly difficult to construct.</p>		<p>A representative selection of questions and answers covering radio-gram reproduction from readers of "Modern Wireless," published for the benefit of other readers.</p>	
Surface Noise	5	Recent Record Releases	8
<p>Every record causes a certain amount of scratch noise due to the use of an abrasive compound in the record placed there to "grind in" the needle point quickly. But too much surface noise is objectionable. Here is one way of reducing it.</p>		<p>Our regular review of some of the records published during the month, written from the point of view of their suitability or otherwise for electrical reproduction in the home.</p>	

Preparing for the Autumn

ALTHOUGH we are now only in midsummer it is clear that great strides are being made amongst the commercial firms with the production of radio-gram apparatus for next season. The Gramophone Company has been experimenting for some time with radio-gram sets and the Columbia Graphophone Company is, we hear, bringing out a very fine electrical reproducer.

Other electrical reproducers are also about to be placed on the market, while we have just had news of a new pick-up which is quite unlike any other pick-up yet produced, and this also should very shortly appear on the market.

A Novel Pick-Up

A novel pick-up is also described in this number of MODERN WIRELESS by Mr. G. V. Colle, of the "M.W." Research Department, and radio-gram enthusiasts who are of a mechanical turn of mind will find it well worth their while to construct this. It is capable of exceedingly good results and operates on quite a novel principle.

Other articles discuss the question of surface noise on records and the design of pick-ups in general, while our regular Replies to Readers and the Record Review pages form a portion of this supplement.

Response Curves

With regard to the design of pick-ups, one of our contributors mentioned last month that pick-up manufacturers should provide the public with response curves of their instruments. Since then we have been shown the response curve of one of the well-known pick-ups, and we hope that other manufacturers will follow suit and provide such curves with their pick-ups.

In their particular section of the industry, these curves are just as important as those which are supplied with all the leading L.F. transformers, and the pick-up curves would be of value not only to experimenters but to all interested in electrical reproduction.

Reducing Resonance

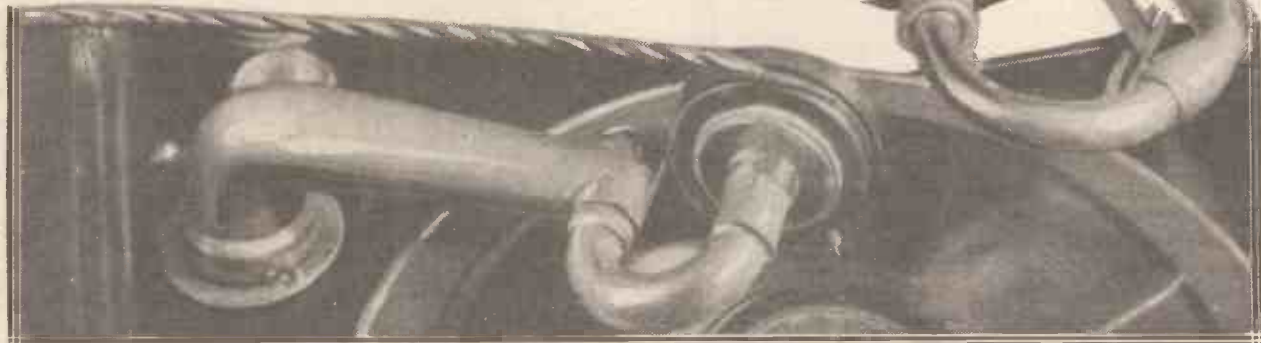

If you will examine a gramophone pick-up you will notice that it consists primarily of a permanent magnetic system around which are coils of wire, and between the poles of which is assembled a steel armature ending in a needle chuck.

The whole idea of a pick-up, of course, is that the vibrations of this

One of the main troubles in pick-up design is the tendency of the needle and armature to resonate at certain frequencies, thus causing "peaks" in the response curve and distorted reproduction. The subject of pick-up resonance and the means taken for its reduction are discussed in this article.

By L. ROBINS.

respond to it if it were in the record, but we do get a large number of the notes in the piano, and the ear does not really notice the absence of many of the missing notes, for the senses fill in many gaps due to cut-off in the recording, or pick-up, or amplifier, so that the whole result is pleasing.

An Inherent Fault

In order that the pick-up shall respond to a large number of frequencies, it is obvious that the armature which holds the needle has to be very carefully suspended and carefully balanced.

Unfortunately, however, every mechanical device has what is known as a resonance period of its own. That is, if you give it a certain

The amount of distance traversed, or, one might say, the violence of vibration of the armature (caused, of course, by the needle on the record), determines the strength of the impulses, while the rate of vibration determines the frequency or pitch of the note—in other words, the note itself.

Wide Range of Frequencies

So for a high note we have the armature vibrating at a very rapid rate, and for deep low notes—such as one gets from the organ—at a much slower rate, say about 70 times per second.

Now in order that a pick-up shall respond to all the notes of a piano scale (or as many as possible), as well as the harmonics of those notes, it would have to be capable of vibrating accurately the impulses of something above 8,000 per second and down below 26.

This is assuming, of course, that all the fundamentals of these notes are recorded in the record—as a matter of fact they are not, and one cannot hope to get out of an ordinary record the lowest note of the piano, nor would the pick-up as we know it

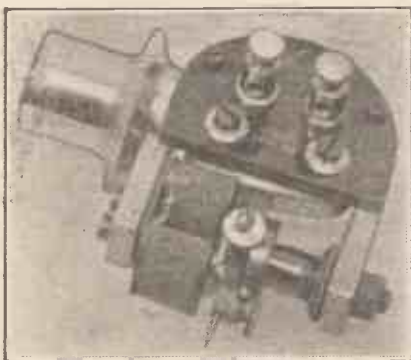

A well-known and popular rubber-damped pick-up—the Woodroffe.

armature in the fixed magnetic field between the magnet poles cause variations in the strength of this field, which in turn will vary the magnetic flux passing through the coils of wire round the magnet.

How it Works

This variation of flux will give rise to tiny voltages in the coils round the magnet, and these are conveyed to the grid and filament of a valve amplifier, where they are amplified and finally passed on to the loud speaker.



A moving-coil speaker greatly assists in obtaining realistic reproduction.

Mechanical Resonance Must Be Avoided

vibration which is anything near its own "natural" frequency, as it is called, it will tend to vibrate on its own, and go on vibrating after the impulses which are applied have ceased.

Notes Over-Emphasised

For instance, suppose we had a pick-up whose armature had a natural vibration at 256 cycles, that is the same period as the middle C of the piano. Then suppose that we passed it over a record which had a note C recorded. The pick-up would immediately vibrate to C, but owing to its natural frequency being of that order it would tend to vibrate far more violently than would be necessary or called-for by the variations of the record, and this C would be brought out of the loud speaker at a greater strength than was really intended, owing to the extra strength of vibration which would not be present when other notes were being dealt with.

Furthermore, when the C has ceased on the record the pick-up would still tend to go on and continue

pick-up armature is recorded on the record.

Take the case of the C an octave higher. This would produce vibrations of that C an octave higher by sheer mechanical force due to the groove, but also, owing to the resonance of the pick-up armature, the middle C would tend to come out too, and so we would get unfaithful reproduction.

In order to overcome this tendency the ordinary pick-up is damped by means of rubber, which tends to wipe out the natural vibration, but which is resilient enough in itself to allow the record groove to "wobble" the needle and armature at the right frequency and in faithful accordance with the needle track. The damping has to be very carefully carried out or the pick-up becomes insensitive.

The damping should only affect the resonance of the armature and should allow the vibrations of the needle track to have completely free play. If the play is not free enough, then the pick-up will not respond properly to the high notes and there will be a lack of brilliance, and if the

to jump about, due to its own resonance. In time this will knock off the corners or "peaks" of the more delicate variations in the record, and will cause rapid record wear and very poor reproduction.

A Difficult Problem

Unfortunately, it is not an easy matter to damp out a tendency to vibrate on a certain frequency and still allow complete freedom of "applied" vibrations. A more elaborate scheme than the rubber on the pick-up is applied by the Gramophone Company in one of the H.M.V. electrical reproducers. In this the pick-up is of a small type, with the armature completely enclosed and immersed in oil, so that the damping is carried out systematically by the oil and the pick-up is moderately free to move. Its natural vibration due to the period of the armature itself is thus damped out very quickly.

The Oliver Pell pick-up has another method of suspension in which the armature is given two natural periods of vibration, one above audibility and one down in the very deep notes; thus between, in the middle scale, the pick-up has less tendency to vibrate and the needle is free to move as directed by the record. Damping is very light, and very little energy applied to the needle by the record is necessary to cause vibration of the needle.

Magnetic Damping

There is shortly coming on the market also, I believe, a pick-up employing magnetic damping, which should be the most satisfactory if accurately applied. On test of the early models this pick-up certainly gave excellent results and amazingly faithful reproduction of the musical scale from low notes right up to the very high frequencies.

A little thought will show how tremendously important is the damping of a pick-up, as well as the method of suspension of the armature,

Whether or not "canned music" can ever reach the reproductive quality of broadcasting, or approximate to the real thing, remains to be seen. Broadcasting and the gramophone will continue to advance as they have done during the last few years, and it is quite likely that it will become almost impossible to tell which is which, or to distinguish either from the actual thing.

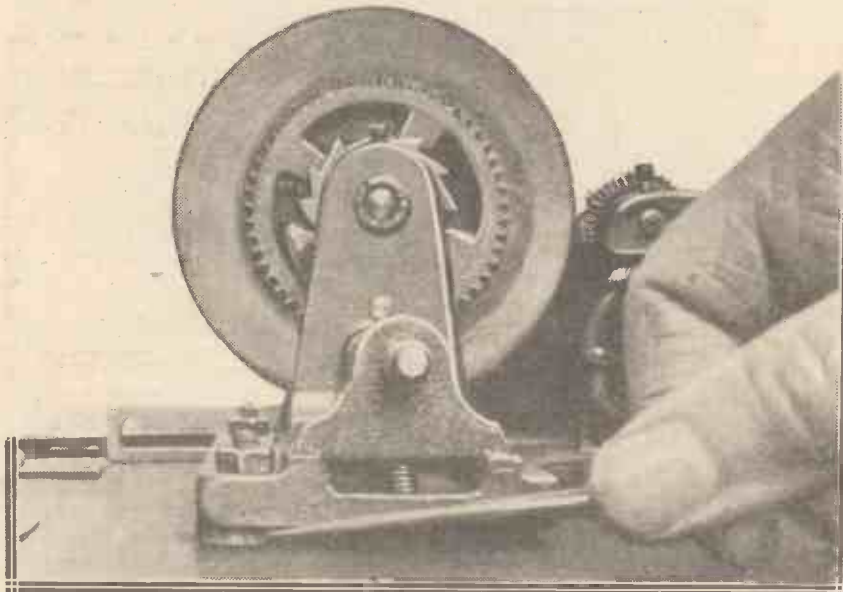

A badly mounted gramophone motor will cause a lot of trouble. It should be even on the underside of the platform, and packing washers should be inserted if necessary under the framework to make sure that evenness is obtained.

it, so that not only do we get what might be called a peak in pick-up reproduction at that point, but we also get the tendency to carry on when a note with a frequency similar to the natural frequency of the

armature is too free, not damped enough, then the pick-up will chatter violently and cause undue record wear, owing to the fact that the needle no longer follows accurately the track of the record, but begins



SAY
'T
'C
'C'

WHEN you think of Condensers, think of T.C.C.—and you won't go wrong. For, because T.C.C. have made nothing but Condensers for over 22 years, the letters T.C.C. on a Condenser are recognised throughout the World as the undisputed hall-mark of accuracy and dependability.

Remember, there is a T.C.C. Condenser for every purpose. Here is an illustration of the Electrolytic Type. All Wireless Dealers stock it—capacity, 2000 mfd. Price 15/-. Double Type: (capacity 4000 mfd.) Price 27/6

WHENEVER

YOU WANT

CONDENSERS

Advt. Telegraph Condenser Co., Ltd., Wales Farm Rd., N. Acton, London, W.3.

(CA) 9226

If you're going to build a set,
don't forget the

"BESTWAY"

WIRELESS BOOKS

**"BESTWAY"
No. 328**

Contains Full Details of
A Wave-Change One-
Valver
The "Bestway" Wave-
Change Three
A Two-Valve Amplifier
The "Home-Circle" Four

**"BESTWAY"
No. 329**

Contains Full Details of
A "Regional" Crystal Set
An All-Wave Two-Valver
A One-Valve Amplifier
The S.G. and Pentode
Three

PRICE 6d. EACH

ON SALE EVERYWHERE



**IMPOSSIBLE TO BURN
OUT VALVES**

This new Belling-Lee product is the first on the market which has both plug and socket completely insulated. SAFETY—high and low voltage plugs are not interchangeable, so that valves cannot be burnt out. CONVENIENCE—no tools required, unique loading device by which both fray and copper are gripped, plug and socket both engraved. FINISH—a feature of every BELLING-LEE product all over the world.

PRICE 9d.

Prov. Pat. (Panel portion 3d. each; flex portion 6d. each.)

BELLING-LEE

Advertisement of Belling & Lee, Ltd., Queensway Works, Ponders End, Mdx.



**THIS CABINET IS SPECIFIED
AND USED BY MR. G. V. COLLE**

for the
"M.W."

PORTABLE 5.

Price complete - 45/-

Carrington Mfg. Co., Ltd., Camco Works,
Sanderstead Road - South Croydon
Telephone: Croydon 0623 (2 lines).

A POLARISED PICK-UP

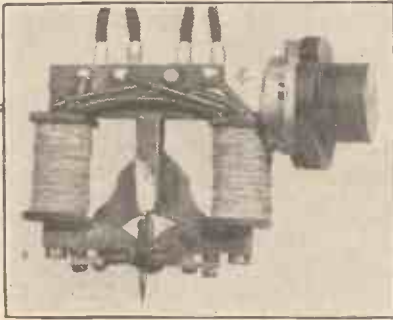

Some details of an interesting experimental pick-up which operates on a novel principle.

By G. V. COLLE.

WHILE recently attempting to depart from the conventional permanent-magnet type of pick-up, the writer came across one design operating on the polarised principle and possessing many novel features. The pick-up, which gave an output about 80 per cent of that of certain £3 3s. and £4 4s. makes now on the market, was designed by Mr. Allen Douglas, who is well known in radio and electrical circles, and who is now connected with the gramophone industry.

obtained was very poor, even with the magnets nearly saturated.

On the other hand, reversing the magnetic windings for the polarising current to cause equal attraction of the reed resulted in a much larger volume output. The conclusion was that the latter was the correct procedure, as it assisted the needle to get a "grip" on the walls of the sound channels on the record.

This, by the way, is not magnetic damping, but, in the absence of other definitions, electro-magnetic "reaction."

Practical Details

The "speech" windings are joined to the input of the amplifier and the magnet windings to a polarising battery of 4 to 6 volts, delivering 100 to 150 m/a current.

The framework consists of pieces of 1/4-in. square soft iron, made non-magnetic by placing in an ordinary open grate fire for from eight to twelve hours, the iron becoming cherry red and being allowed to cool down with the ashes until cold.

Steel screws are used for holding the square iron pieces together; the bottom two, constituting the pole faces, are slotted so as to allow the gap to be adjusted to within fine limits.

A shaped brass bracket holds the pole pieces in position in relation to each other and to the central neutral iron pole, which also serves to support the reed, the latter being riveted to a strip of stalloy iron and inserted in a slot in the neutral pole, after which it is soldered.

Regarding the reed, this is drilled to take a loud steel needle for practically its full length, and is filed to a square shape except for one part where the milled-head screw is attached to hold the needle.

The reed is filed from a lump of soft iron (or mild steel) and is made cherry red for some hours, like the iron for the magnet system.

Referring to the photographs, it will be observed that rubber buffers are fitted to the reed, and these are held in position by two strips of brass, which in turn are attached to the pole-pieces by round-head brass screws tapped into the poles.

Bobbins for the windings are constructed from solid ebonite rod, as end-cheeks attached to sleeves proved very unsatisfactory. The ebonite rod is drilled and filed square to fit the 1/4-in. square iron pieces, after which it is filed externally so that the wall thickness (part on which windings go) is approximately 1/8 in.

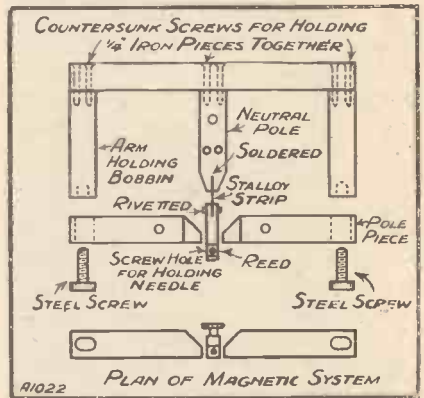

The essential parts of the pick-up.

"Speech" windings, which are wound on first, consist of 2,500 turns of No 47 enamelled copper wire on each bobbin, the wire being soldered to lengths of No. 26 D.C.C. for wiring purposes outside. The windings are covered over with a layer of paper and all odd corners filled up with silk or cotton thread, wound on.

The Polarising Winding

Polarising windings consist of 650 turns of No. 34 D.S.C. wire on each bobbin, wound in the direction indicated in the sketches accompanying this article. It is a good plan to bring all leads out at the top ends of

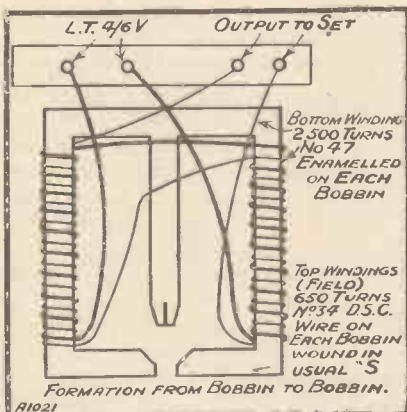

The diagram shows how the magnet windings are connected.

The vibrations of the metal reed cause variations in magnetism of electro magnets which affect the "speech" windings on the bobbins of the pick-ups.

It was understood from the particulars supplied that the reed was damped magnetically, that is, it was held exactly between the pole faces by repulsion from the poles, though the opposite occurred.

Interesting Results

In either instance, the result was rather interesting, because in one case, assuming repulsion were the correct method of damping, the volume

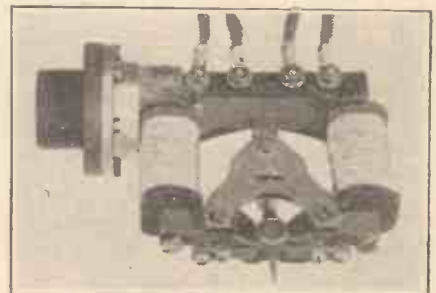

The polarised pick-up ready for use.

of the bobbins. The ebonite strip is attached to the top iron piece by two countersunk brass screws, and the whole framework is supported by an aluminium disc-arm, which in turn is screwed to an ebonite flange, as shown.

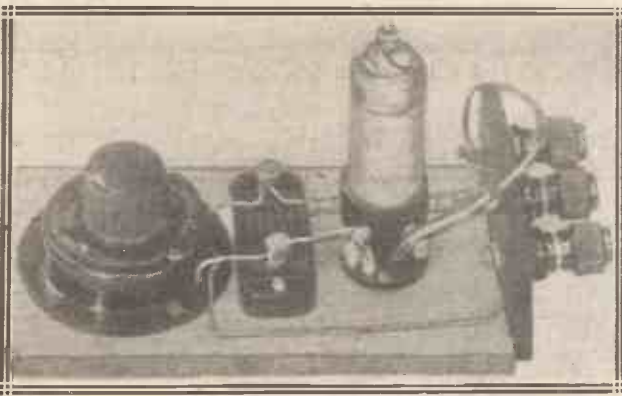

Surface Noise

Some details of a simple scratch filter which forms an interesting accessory to the radio-gram receiver.

By G. W. EVANS.

A GREAT deal has been said from time to time concerning the "scratch" problem in connection with radio-gram amplifiers and the electrical reproduction of records. The electrical reproduction of a gramophone record is often supposed by many people to eliminate the surface noise entirely, and to bring out the music recorded on the disc free from any extraneous noise altogether.

Such would be the ideal state of affairs, but unfortunately it is not the actual state of things. A little consideration will show that if the pick-up is to be at all sensitive to high musical frequencies, then the scratch, which after all is a vibration at a very high frequency, is almost bound to come out through the loud speaker in its due proportion.

Loss of High Frequencies

It is to the higher frequencies and their harmonics that we owe a great deal of the brilliance of the music, and one has to be careful if one undertakes the cutting out of scratch or surface noise that one does not upset the balance of these higher frequencies.

Unfortunately, it seems to be impossible to design any but the most complicated piece of apparatus which will reduce the surface noise and leave most of the higher frequencies, and however complicated the apparatus is a certain amount of the higher frequencies do suffer in the process of scratch filtering.

In order to cut out needle scratch we have to cut down the frequencies above about five thousand per second. A sharp cut-off, of course, would not do, as this would cut out many of the notes in the piano scale, let alone some of the higher harmonics, but a "falling off" from about three or four thousand is sometimes useful in reducing surface noise so that it is not noticeable even when soft passages are being played.

But one must be prepared in so doing to sacrifice some of the brightness and volume of the reproduction, and it really rests with the individual as to whether scratchless music or music with a certain amount of scratch is preferable.

For those who would like to make up a simple scratch filter which is quite of the common type and by no means new, the little experimental "gadget" described here may be of use. It consists essentially of an ordinary volume control and a simple filter which is made somewhat variable by the use of a tapped wire-wound resistance.

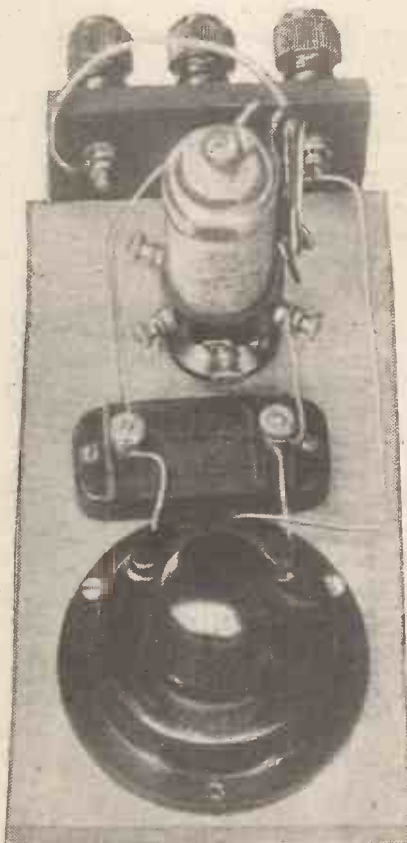

The experimental filter made by the author, and used on "quiet" records when the surface noise is too noticeable.

The ordinary volume control of 500,000 ohms provides an adjustment of signal strength, while the tapped resistance provides an adjustment of filtering.

A Neat Arrangement

In the gadget described here, for average record work the tapping on the resistance is placed so that 25,000 ohms are in series with the input and output of the unit, or, in other words 25,000 ohms are in series with the pick-up and the top of the volume control. This 25,000 ohms is bypassed with a .003-mfd. fixed condenser to earth, while the volume control is placed potentiometer fashion right across the output from the filter unit so that the slider of the volume control goes to the grid of the first L.F. valve.

The whole outfit is mounted on a piece of board $3\frac{1}{2}$ in. wide by $6\frac{1}{2}$ in. long, with three terminals at one end for connection between the pick-up and the set. The centre terminal is a common terminal and is connected both to one end of the pick-up and to the L.T.— or grid-bias lead from the set. The slider of the volume control then goes to one output terminal and thence to the grid of the valve, and the tapping on the variable fixed resistance goes to the input terminal and thence to the remaining side of the pick-up.

When it is Useful

The writer prefers not to use a scratch filter with the majority of dance records, as some of the brightness of the dance bands seems to be lost when this is in operation, but for other records, especially where soft organ or piano music is being played, or violin solos, where a certain amount of brilliance can be sacrificed for quietness of background, the 25,000-ohm tapping is extremely good. For speech records and others where the scratch is serious, then 50,000 or 75,000 ohms are tapped in by means of the clip.

One input terminal from the

(Continued on page 84.)



A page of odds and ends by "Tone-Arm."

Transformer or Resistance

SOME of you who prefer transformer coupling to resistance coupling may be glad to know that I have recently had a test with the new R.I. transformer using the shunt-feed scheme recommended by the makers. This consists of a 30,000-ohm resistance in the valve plate circuit, the transformer being fed through a 1-mfd. condenser, and the quality with this arrangement certainly leaves nothing to be desired.

For radio-gram receivers this little transformer should be of utmost service and should enable one to get the purity required without having to go to resistance coupling and the troubles which accompany it. Care should be taken, however, with this transformer that the circuit advised by the makers—a rather peculiar method of connecting up—is employed, otherwise the straight-line characteristic of the transformer (or, rather, of the whole stage) will not be maintained.

Reducing Record Wear

It seems a very common practice among gramophone users to turn the needle half-way round after using it on one side of the record, so as to be able to play the other side of the record, or a new record, with the same needle. This, of course, is bad for the record, for the needle is really chisel-shaped after one run through the record, and if you turn it round you are liable to cut it into the grooves of the record in a very serious manner.

It is absolutely essential for long record life to use one needle for one side only. The advice given by the gramophone companies on the boxes of needles to that effect is not merely a stunt to sell more needles. It is a really genuine piece of good advice and should be adhered to in every case.

The pentode valve is often very useful in raising the reproduction characteristic of a moving-coil loud speaker. If the moving-coil speaker is a little too prominent on the bass and lacks brilliancy on the high notes, then the pentode valve, used with a suitable output transformer, will often alter the reproduction characteristic of the loud speaker, and give it more brilliance in the treble without apparently decreasing the bass.

Not Always Suitable

The pentode valve, however, is not suitable for use with all speakers, and I have tried it with varying results. One loud speaker that I used simply would not take a pentode valve, because it already had a peak in the upper register, which, while not being noticeable when listening with an ordinary low-impedance valve, became rather unpleasant when using a valve with an impedance of over 5,000 ohms, and exceedingly prominent when a pentode was employed.

Another speaker, however, of the

moving-coil type, which was rather lacking in brilliance on the top notes was greatly improved by the pentode valve, which in this case proved itself to be very valuable indeed.

SURFACE NOISE
 —continued from page 83

pick-up goes to a tapping on the resistance. A fixed point, i.e. 75,000 ohms or so, on the resistance goes to one end of the volume control, and to one side of the .003-mfd. fixed condenser.

The other side of the volume control and the other side of the .003 fixed condenser are joined together and go to the centre terminal. The remaining connection consists in taking the slider of the potentiometer volume control to the remaining output terminal, which is connected to the grid of the valve.

Thus there is nothing difficult in the whole apparatus, and readers who make it up will find it an interesting little gadget.

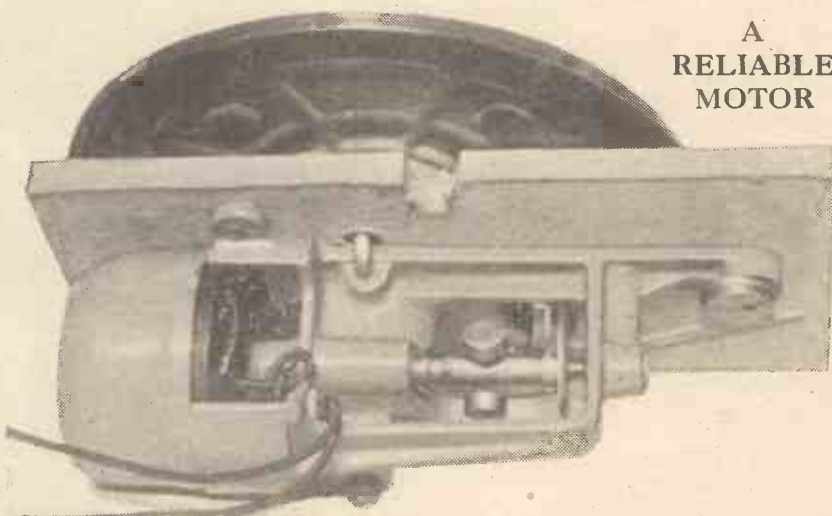

A RELIABLE MOTOR

The New Igranic Phonomotor—an induction type of A.C. motor for gramophones and pick-up work. A report upon it will be given in next month's "Modern Wireless."

FERRANTI AMPLIFICATION CURVES

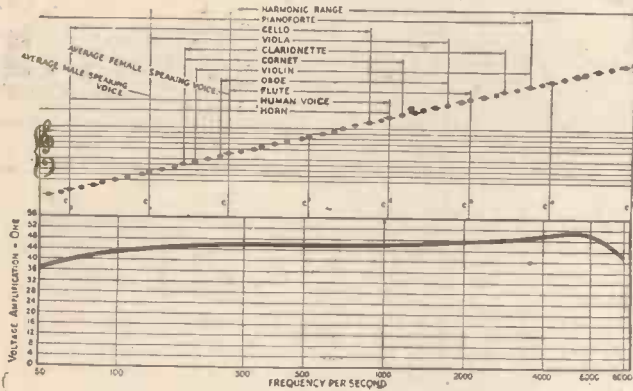

Because you may not have examined a Ferranti curve for some time, and so that you may not be misled, we publish below the guaranteed curve of the AF3.

This curve indicates an unusually good performance, which has been the envy of the whole Radio world for six years.

The Cut-off at 50 cycles is approximately 22% when used under normal conditions.

TYPE AF3 . . . 25/-

FERRANTI LTD.

HOLLINWOOD

LANCASHIRE

INVALUABLE TO EVERY AMATEUR & CONSTRUCTOR "POPULAR WIRELESS" BLUE PRINTS of Tested Circuits

The following is a list of the "P.W." 6d. Blue Prints for Constructors in stock, showing the different circuits available.

P.W. BLUE PRINT Number.

1. DETECTOR VALVE WITH REACTION.
2. OUT OF PRINT.
3. 1-VALVE L.F. AMPLIFIER.
4. CRYSTAL DETECTOR WITH L.F. AMPLIFIER.
5. H.F. (Tuned Anode) AND CRYSTAL WITH REACTION.
6. H.F. & CRYSTAL (Transformer Coupled, without Reaction).
7. 1-VALVE REFLEX AND CRYSTAL DETECTOR (Tuned Anode).
8. 1-VALVE REFLEX AND CRYSTAL DETECTOR (Employing H.F. Transformer, without Reaction).
9. H.F. AND DETECTOR (Tuned Anode Coupling, with Reaction on Anode).
10. H.F. & DETECTOR (Transformer Coupled with Reaction).
11. OUT OF PRINT.
12. OUT OF PRINT.
13. 2-VALVE REFLEX (Employing Valve Detector).
14. OUT OF PRINT.
15. OUT OF PRINT.
16. H.F. (Tuned Anode), CRYSTAL DETECTOR AND L.F. (With Switch for Last Valve).
17. CRYSTAL DETECTOR WITH TWO L.F. AMPLIFIERS (With Switching).
18. 1-VALVE REFLEX AND CRYSTAL DETECTOR, with 1-VALVE L.F. AMPLIFIER, Controlled by Switch.
19. OUT OF PRINT.
20. OUT OF PRINT.
21. THE 2-VALVE LODGE "N."
22. "THE GUARANTEED REFLEX."
23. THE 1-VALVE "CHITOS."
24. THE "SPANSACE THREE." Three-Valve Receiver employing 1 Neutralised H.F. Valve, Detector with Non-radiating Reaction Control and 1 L.F. Valve.

P.W. BLUE PRINT Number.

25. OUT OF PRINT.
26. A "STRAIGHT" 4-VALVER (H.F. Det., and 2 L.F. with Switching).
27. OUT OF PRINT.
28. A "MODERN WIRELESS" 5-VALVER (H.F., Det., and 3 L.F.).
29. AN H.T. UNIT FOR DIRECT-CURRENT MAINS.
30. A REINARTZ ONE-VALVER.
31. OUT OF PRINT.
32. THE "CUBE SCREEN" THREE (H.F., Det., and L.F.).
33. A "KNIFE EDGE" CRYSTAL SET.
34. AN H.F. AND DETECTOR TWO-VALVER.
35. THE "UNIVERSAL THREE" (Det. and 2 L.F. stages resistance-coupled).
36. THE "SPANSACE FOUR" (H.F., Det. and 2 L.F.).
37. THE "LONG SHORT" CRYSTAL SET.
38. A TWO-VALVE L.F. AMPLIFIER.
39. THE "SYDNEY" TWO.
40. THE "SUPER SCREEN" THREE.
41. THIS YEAR'S "CHITOS" ONE-VALVER.
42. THE "Q AND A" THREE. A simple set (Det. and 2 L.F.).
43. THE "INEXPENSIVE FOUR."
44. THE "ECONOMY FIVE." For long-range loud-speaker work.
45. A SIMPLE A.C. H.T. UNIT.
46. THE "REGIONAL" THREE.
47. THE "WAVE-CHANGE" ONE.
48. THE "REGIONAL" CRYSTAL SET.
49. OUT OF PRINT.
50. THE "ANY MAINS" TWO.
51. OUT OF PRINT.
52. THE "BANDMASTER."

ALL "POPULAR WIRELESS" BLUE PRINTS 6d. EACH

All orders for these Blue Prints should be sent direct to the "Popular Wireless," Queries Department, Fleetway House, Farringdon Street, London. E.C.4, enclosing a stamped addressed envelope and a postal order for 6d. for each Blue Print ordered.



REPLIES TO READERS

Valves for Pick-up Work

J. W. H. (London) writes to ask whether he ought to change his valves, as he wants to use his set for gramophone reproduction as well as radio. At the present moment he has two resistance valves, an ordinary power and a super-power valve "in stock." The set is of the detector and two resistance-coupled type.

We should certainly recommend the use of an H.F. valve for the first stage, that is where the detector is at the moment, and also, J. W. H., either an H.F. or a slightly lower impedance valve for the second stage. The S.P. valve should be quite all right for gramophone reproduction, but we are afraid that resistance-coupling valves are liable to be very seriously overloaded when a pick-up is in operation. We would therefore recommend an H.F. valve of the 20,000-ohm type for the detector, followed by a general-purpose valve of about 8,000 to 13,000 ohms, and then your super-power valve.

You can, if you like, use a resistance valve in the first stage, followed by an H.F., but we think it is more than likely that the pick-up will overload the R.C. valve, which will merely magnify the overloading and pass it on to the following stages. Your best plan is certainly to change the valves.

The Output Stage

A. M. (Guildford).—"I have a two-valve set consisting of a detector and one transformer-coupled low-frequency stage, and I should very much like to use a pick-up for gramophone reproduction. Would it be suitable on this set, or should I have to use another valve? What sort of loud speaker would be best for the purpose?"

As regards your set, it would probably be best to employ either a pentode with its proper output trans-

former for the L.F. side, or else to add a resistance-coupled L.F. stage for use with an ordinary super-power valve for the output.

With a sensitive pick-up you would probably get quite loud results with your present arrangement, but there is not a sufficiently large margin of safety in order to allow a volume control, with only detector and L.F., in order to get really satisfactory reproduction.

We would strongly advise the addition of another L.F. stage, or else the use of a pentode, and then the pick-up

.....
 ♦♦♦♦♦ A selection of readers' queries ♦♦♦♦♦
 ♦♦♦♦♦ upon subjects relating to electrical ♦♦♦♦♦
 ♦♦♦♦♦ gramophone reproduction. Let- ♦♦♦♦♦
 ♦♦♦♦♦ ters containing gramophone ♦♦♦♦♦
 ♦♦♦♦♦ queries should be addressed in ♦♦♦♦♦
 ♦♦♦♦♦ the same way as those concerning ♦♦♦♦♦
 ♦♦♦♦♦ other branches of radio. Such ♦♦♦♦♦
 ♦♦♦♦♦ queries come under the general ♦♦♦♦♦
 ♦♦♦♦♦ query rules as laid out elsewhere ♦♦♦♦♦
 ♦♦♦♦♦ in this issue and should be ad- ♦♦♦♦♦
 ♦♦♦♦♦ dressed to the Query Dept., ♦♦♦♦♦
 ♦♦♦♦♦ "Modern Wireless," Fleetway ♦♦♦♦♦
 ♦♦♦♦♦ House, Farringdon Street, London, ♦♦♦♦♦
 ♦♦♦♦♦ E.C.4. ♦♦♦♦♦
 ♦♦♦♦♦

can be suitably controlled by a 500,000-ohm potentiometer volume control between the pick-up and the grid of the first valve.

As regards your loud speaker, this is rather a difficult question to answer, but we think that any good cone type would be quite suitable, and, of course, the moving-coil type would be all right provided you used fairly large valves and at least 150 volts H.T.

Constant Chatter

L. R. (Radlett) writes to say that his pick-up has been gradually getting more inclined to chatter, and the results have become increasingly distorted during the last few months. He queries whether the damping has gone wrong at any point

.... "The pick-up is of the usual rubber-damped variety, and alteration in adjustment makes little difference to the chatter. Certain variations in damping can be obtained, but whatever adjustment is used the pick-up seems to be very unsatisfactory."

Probably the damping material—rubber—no longer has the resilience that it had when the pick-up was bought. If possible, "L.R.", dismantle the pick-up and cut fresh pieces of rubber to take the place of the old pieces. A fairly close-grained Sorbo rubber is very useful for this purpose, but if there is any difficulty about it we would advise you to send the pick-up back to the makers and ask them to readjust the damping and insert new rubber.

Controlling Volume

S. T. C. (Leamington).—"When using a pick-up, is it right to have the first valve of as high a magnification factor as possible, so as to have the volume control on the pick-up right "down," or is it better to have one which will carry the grid swing of the pick-up without any volume control at all?"

In our opinion the compromise between two such valves is the ideal. If you have a valve with a very high magnification factor and have the volume control "down" a very long way, then you are liable to lose brilliance.

On the other hand, if you use a valve which will carry the grid swing applied to it from the pick-up when the latter is dealing with very heavy passages, then you will have nothing left in the way of amplification for weak passages.

We think it would be advisable to use a valve of moderate amplification and a volume control, so that the pick-up has to be controlled on very loud passages, but can be fairly "open" on medium on most recording.

RECENT RECORD RELEASES

Our monthly review of gramophone records.



Broadcast Records

THE Vocalion Gramophone Co. are always up to date, so one is not surprised to find that among the very earliest releases during the last month were three items from the famous talkie film, "Broadway Melody," namely, *The Wedding of the Painted Doll*, *Broadway Melody* and *You Were Meant For Me* (394), played on the Broadcast 1s. 3d. record by Bidgood's Symphonic Dance Band.

Items from *The New Moon* (now at Drury Lane) are also included in the Broadcast list, being played by the Hawaiian Melody Makers; *Softly As In a Morning Sunrise*, on 406, the other side of which has *Flower of Love*, by the same band.

Other good dance tunes in the small Broadcast records are *Rag-a-Muffin*, introducing a piano novelty duet by Bidgood's Broadcasters, on 398, and *It's a Million to One You're Far From Home*, by the same band, on the other side.

Marie, a waltz by the same band, and *I Am Thirsty For Kisses, Hungry For Love*, on 397, is another good disc. In addition, Jack Malcom gives us *Like the Big Pots Do*, on 400, and Mabel Marks provides a very good rendering of *I Must Have That Man*, with a dance accompaniment, on 399.

Broadcast "Twelves"

Amongst the Broadcast "Twelves" we must mention the selection by Bidgood's Symphonic Dance Band, on 5069, of *The New Moon*, with vocal items; while among the more serious items we have *Angels Guard Thee*, sung by Francesco Vada, tenor, on 5077, with the orchestra and organ accompaniment from the Stoll Picture House.

Maurice Cole gives us another item in *Ballad in G minor*, by Chopin (Parts 1 and 2), on 5076. All these records are worth hearing and form excellent entertainment.

H. M. V.

The *pièce de résistance* of the H.M.V. releases this month is, of course, the *Casta Diva*, from Norma, sung by that remarkable prima donna Rosa Ponselle, and accompanied by the Metropolitan Opera House chorus and orchestra. This is recorded in Italian on D.B. 1280, and to lovers of opera and really fine singing is well worth the 8s. 6d. asked for it. It will be remembered that only a few weeks ago Rosa Ponselle had an astounding reception at the Covent Garden Opera House, so that the Gramophone Company has lost no time in recording her voice for the benefit of posterity.

Another 8s. 6d. record consists of *One Fine Day* and *In These Soft Silks and Satins*, from Puccini's operas "Madame Butterfly" and "Manon Lescaut," sung by Dusolina Gianmini, soprano, and accompanied by the Berlin State Opera Orchestra.

This is recorded on D.B. 1264. Her voice is distinctly harder than that of Rosa Ponselle, but here again we have a remarkably fine record with some very vigorous singing.

Among the lighter items must be mentioned *Morning, Noon and Night in Vienna*, by Schubert, played by the Vienna Philharmonic Orchestra on C.1667, and a fine organ record, *Bourrée*, played by G. E. Cunningham on the organ of St. Margaret's, Westminster, together with Gigout's *Scherzo*, on C.1650.

All the foregoing are twelve-inch records, but among the ten-inch

plum labels must be mentioned Peter Dawson's *'Till the Sands of the Desert Grow Cold*, and *Rolling Down to Rio*, on B.3023; and an excellent dance piano record *She's Funny That Way*, with *Wake Up and Dream Medley*, by Carl Gibbons, on B.3031. For piano reproduction this record is exceedingly fine.

Parlophone

Among the latest Parlophone dance hits, which seem to be of outstanding interest this month, are a wide variety of numbers played by various dance combinations.

Naturally, the famous "Broadway Melody" talkie hit, *The Wedding of the Painted Doll*, is one of the foremost items. This is played by Sam Lanin's Famous Players, on R367, and is exceedingly attractive. The reverse side contains *The Toymaker's Dream*, another foxtrot by the same combination.

The Caroline Club Orchestra gives us two waltzes, *Forever* and *Carolina Moon*, the latter being a very tuneful piece of music (R368).

Finally, we must mention the Big Chocolate Dandies in *Cherry*, a foxtrot on R365, and the Little Chocolate Dandies in *Four or Five Times*, a slow foxtrot, on the other side, with really "hot" orchestration.

Naughton and Gold, the well-known comedians, provide us with *Strikes* and *Laugh Mixture* (R361), which will appeal to a large number of "fans." *Ten Little Miles From Home* and *I'll Never Ask For More* provide Bob Fisher with excellent material when he sings with the accompaniment of Archie Rosebery's Kit-Cat Band on R366. All these records are excellent for average pick-up work and should be heard by all radio-gram listeners.

Zonophone

The Zonophone Company have a very interesting novelty record this month by the Happiness Boys in *Twisting the Dials*, in two parts, on A.362. This is an impression of an American listener tuning-in his set and bringing in station after station, together with the usual accompaniment of squeals and growls. This should certainly be heard by all radio DX enthusiasts.

The Zonophone Salon Orchestra gives two very fine renderings of *I Kiss Your Hand Madame*, and an old favourite, *Love Sends a Little Gift of Roses*, recorded on 5319. Exceedingly fine reproduction with a pick-up.

RADIO NOTES AND NEWS OF THE MONTH

A feature in which our Contributor brings to your notice some of the more interesting and important Radio news items.

Conducted by "G. B."

The Pope's Station

It is reported in the Press that the Pope is having a wireless station built which will be one of the most powerful in the world. The curious part about the announcement is that it is stated that when the Papal station is working all other stations will be silenced. Does this mean that the Pope's station is going to jam all stations? The station, by the way, will be sending out ecclesiastical information in various languages, concerts by the Sistene Choir, and ceremonies at St. Peter's.

Russia Follows British Election

It appears that the Soviet Government followed the British Election with the greatest of interest, the details being broadcast by wireless

throughout the U.S.S.R. as the results of the polls became known.

A New Radio Game?

Probably by the time this issue is on sale the Brentford Radio Society will have staged its hunt by wireless. The idea was that a member of the Radio Society should erect a wireless set and start oscillating, while other members of the party set out by motors in a search for their quarry. This seems a new sort of game, and one well worth playing, providing the oscillations set up are not sufficiently serious to cause widespread interference.

Twenty Million Listeners

It is estimated that during the Election the B.B.C. broadcast election news and election speeches to a constituency of 20,000,000 listeners. This

works out that roughly the B.B.C. broadcasting penetrates to one in every three houses in the country. In 1924, during the Election, the audience was far less; then, roughly, only one house in every six or seven had a wireless set, and the estimated broadcasting constituency was barely 6,000,000.

The Best Political Broadcast?

It seems to be the consensus of opinion that the outstanding success of all the pre-Dissolution broadcast addresses was that of Mr. Lloyd George's from Plymouth. But this, of course, is judged not so much on the political excellence of Mr. Lloyd George's speech as on its entertainment value. Of the studio addresses, it seems to be the opinion that Mr. Winston Churchill carried off the laurels.

Short-Wave Peculiarities

Radio experts have always been rather puzzled by the curious results obtained when working with waves less than 100 metres in length. But recently some explanations of a very interesting character of some of the results obtained in recent experiments
(Continued on page 90.)

MAGNUM "TRANSPORTABLE" FIVE



A high-grade instrument of amazing efficiency. Entirely self-contained. Cabinet of polished Mahogany.

Price **18 Guineas.**

Full particulars of The "Summertime" Five and all apparatus described in "Modern Wireless" on application.

Dutch representatives:
Messrs. A.B.C. RADIO,
Singel 400.
AMSTERDAM.

THE "MAGNAFILTER"

Make your set super-selective to meet the new wave-length scheme



As a result of the regional scheme very few sets are capable of eliminating interference between 2 LO and 5 GB, separated by only 45 metres.

The "Magnafilter" solves this problem cheaply and efficiently and without alteration to your set. It is simply connected between the Aerial and Receiver, and when once adjusted needs no further attention. 2 LO and 5 GB can be readily tuned in without interference by merely turning the tuning dials of your receiver.

Careful design and workmanship have reduced the losses incidental to this type of wave filter to an absolute minimum, and it can therefore be utilised without affecting the general reception of other stations.

Price **12/6**

If unable to obtain from your local dealer, a "Magnafilter" will be sent post free on 7 days' approval against cash.

BURNE-JONES & CO., LTD.,
MAGNUM HOUSE

Telephone: Hop 6257.

296, BOROUGH HIGH STREET, LONDON, S.E.1.

MAGNUM "SUITCASE" FIVE



The ideal Portable for outdoor use. This cabinet is covered with Blue Leatherette.

Price **18 Guineas.**

Send for catalogues and lists including particulars of The Magnagram, the latest development in all Electric Radio-Gram reproducers.

Magnum products are on view at:—

The Service Co., Ltd.,
273/4, High Holborn,
W.C.1.

**BIG PRICE
REDUCTION!**



**- FROM
£4.10s.
TO
£3.10s.**

One of the most popular Brown Loud Speakers, the Mascot is providing true Radio reproduction in thousands of homes. Now is your opportunity to buy one of these famous Instruments for the amazingly low price of £3.10s.

**Brown
MASCOT
Loud Speaker**

Advt. S. G. Brown, Ltd., Western Avenue, North Acton, W.3. (A) 9200.

**CAN YOU AFFORD TO MISS
POPULAR WIRELESS**

?

Out Every Thursday, full of good radio fare and containing all the latest wireless news, inventions and developments — "P.W." constitutes

A RADIO INVESTMENT

saving you its cost many times over.

But be sure to get

POPULAR WIRELESS

Every Thursday - - Threepence

IGRANIC



SMALL BUT MIGHTY

Igranic proved that bulk was not essential to purity and amplification in an L.F. Transformer. Others followed but the Igranic "J" Type still stands supreme as the small low-priced transformer with the long, straight curve.

For your portable, where space is restricted and weight must be kept down, use the Igranic "J" Type Transformer. Use it in your domestic receiver, too, and enjoy truly magnificent magnification. Ratios of 3-1 and 6-1. Price 17/6 each.



Igranic
Q.M.B. Switch.
Solid construction,
certain action.
Price 2/6



Igranic
H.F. Choke.
Small in size,
high in efficiency.
Price 5/-

Write direct to Dept.
J89t if your dealer
cannot supply you.



Works BEDFORD

RADIO NOTES AND NEWS OF THE MONTH
 —continued from page 88

on short-wave transmission were read by Mr. T. L. Eckersley to the Institution of Electrical Engineers.

The paper points out that the main interest in short-wave transmission, both from the practical and theoretical points of view, lies in echo and scattering effects; and Mr. Eckersley classes both these results together, as ultimately the two effects merge into one.

Interesting Experiments

Mr. Eckersley holds the opinion that there is a conducting layer consisting of a complex structure of scattering clouds, the scattering being more marked in the lower levels of the layer.

Experiments recently carried out near Chelmsford indicated that local signals from Ongar could be balanced almost perfectly by means of a special receiver; but on the other hand, signals from Bodmin, Grimsby, the Dutch stations and a Berlin station at night-time could not be balanced by any adjustment of the circuit.

The "Skip" Distance

The above stations are within the "skip" distance, while long-distance stations such as Canada, Australia, India, South Africa, Java, etc., give results which are intermediate between those obtained from near stations and more distant stations lying within the "skip" distance.

If you want to
KEEP IN TOUCH

with week-by-week radio developments, you must

READ

POPULAR WIRELESS

"BRITAIN'S BEST."

Price 3d. :: :: Every Thursday.

Reflected Rays

—Mr. Eckersley is of the opinion that the direct rays from the Beam stations are so weak that their effects can be neglected, while the rays received at Chelmsford are those scattered back from the regions where the main transmitting Beam penetrates into the scattering region of the conducting layer.

Varying Height

Mr. Eckersley now estimates the effective height of the daylight conducting layer at about 48 miles in summer and at 60 miles in winter. The scattering of short waves bears some resemblance to that of a searchlight directed from the clouds. And if the searchlight itself is hidden from view, the point of intersection of the searchlight beam and the scattering clouds appears to be the source.

Synthetic "Daylight" at Broadcasting House

The studios at Broadcasting House, the B.B.C.'s new headquarters which will eventually be built in Portland Place, will have windows which will not be windows. The rooms and studios will be built in the ordinary way, and windows will be built into the walls. They will be quite genuine ones, with iron frames and frosted glass, but they will look out on to nothing.

The daylight effect will be obtained by the use of electric lights in a special way, and when the windows are open one will be able to look out on to an expanse of white sheeting. This is the first time the B.B.C. has adopted synthetic daylight!

(Continued on page 92.)

The Secret of successful reception

LEWCOS

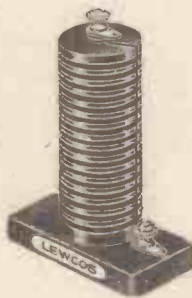

H.F. CHOKE

Reduction in price of

GLAZITE
BRITISH MADE

OLD PRICE :
 10d. per 10 ft. coil.
 NEW PRICE :
 8d. per 10 ft. coil.

SIX-PIN



COIL

The finest quality materials and the high-class workmanship used in the manufacture of the LEWCOS H.F. CHOKE make it supreme. Its extraordinary efficiency may be gathered from the following test report. Charts showing its performance and leaflets will be sent on application.

WAVELENGTH (metres)	IMPEDANCE (ohms)
200	12,000
300	21,800
500	45,500
1,600	214,000

"Self-resonance well above 3,500 metres and in circuit will probably approach 5,000 metres." These figures "definitely establish the Lewcos choke in the front rank of its class."

Lewcos Six-Pin Coils and Transformers can be used with or without screens according to circuit arrangements, but in either case the resistance to the high-frequency currents of radio and their self-capacity are very much lower than any other coils of a similar type, which accounts for the exceptional and proved efficiency of these coils.

Full particulars on application.

THE LONDON ELECTRIC WIRE COMPANY AND SMITHS LIMITED
 CHURCH ROAD, LEYTON, LONDON, E.10. Trade Counter and Cable Sales : 7, Playhouse Yard, Golden Lane, E.C.1



TOROID H.F. TRANSFORMERS

A complete range of models, covering a wavelength band of from 22½ to 2,000 metres.

From **10/6** to **15/-**





NEUTRALISING CONDENSER

For baseboard mounting, Maximum capacity, 50 micro-microfarads.

3/6

MINICAP D.P.D.T. SWITCH 5/6

If unobtainable from your dealer, write direct to us, giving his name and address.



DUCON AERIAL 5/-

For use on electric mains. Absolutely safe.

DUBILIER

RADIO PRODUCTS

Dubilier Condenser Co. (1925), Ltd., Ducan Works, Victoria Road, N. Acton, London, W.3. © 240/S

The New W.B. VALVE HOLDER

5-PIN For A.C. Valves

The most scientifically designed 5-Pin Valve Holder on the market. Fitted with patent expanding leg sockets suitable either for resilient or solid valve legs. Already this new W.B. Valve Holder is in use in the laboratories of the leading Valve Manufacturers in this country.

Ask your Dealer to show you one to-day.

Price **1/6**

WHITELEY BONEHAM & CO., LTD., Nottingham Rd., Mansfield, Notts.

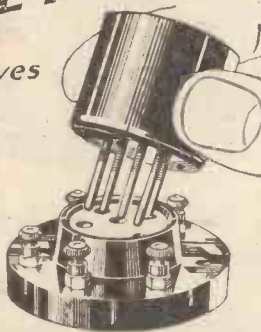

PAREX

SCREENS



COILS

"SUMMERTIME" FIVE

3 Aluminium Boxes ..	7/6	each
3 Short-Wave Coils ..	12/6	"
3 Long-Wave ..	17/6	"
3 Five-Pin Bases ..	1/-	"
H.F. Chokes ..	3/6	"

"A.C." THREE

STANDARD SCREEN (10" x 6")	
Alum. 2/-	Copper 4/-

MY WAVEMETER TITAN COIL 15/-

"A.C." THREE STANDARD SCREEN (10" x 6") Alum. 2/- Copper 4/-

E. PAROUSSI 10, Featherstone Bldgs., High Holborn, W.C.1

Phone: Chancery 7010.

Magnetic Power!

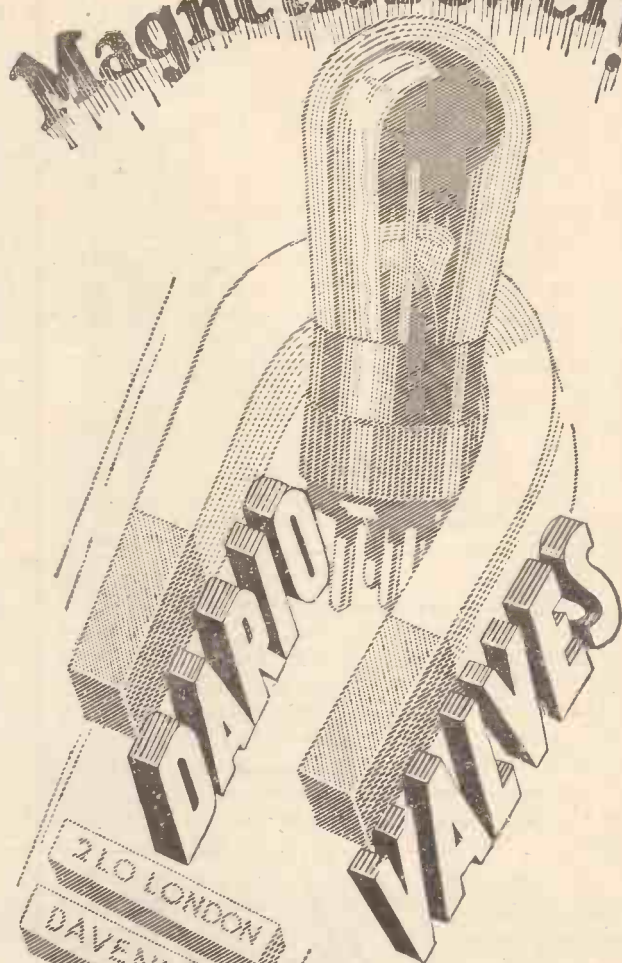

- 2 LO LONDON
- DAVENTRY
- RADIO PARIS
- BARCELONA
- BERLIN
- BUDAPEST
- MILAN
- AMERICA
- MELBOURNE

Magnetic Dario Valves. Stations you heard faintly, now heard at full loud speaker strength. No radio enthusiast should be without Dario.

Dario prices are little short of marvellous. They are due to one of the biggest and most modern Valve outputs in the world.

5/6	TWO VOLTS
General Purpose, .05 amp. ...	5/6
R.C.C., .06 amp. ...	5/6
Super Power, .18 amp. 7/6	
Super H.F. & R.C.C., .18 amp. ...	7/6
Pentodion, .3 amp. ...	21/-

WRITE FOR DARIO FOLDER!

7/6	FOUR VOLTS
General Purpose, .05 amp. ...	5/6
R.C.C., .07 amp. ...	5/6
Super Power, .1 amp. 7/6	
Super H.F. & R.C.C., .1 amp. ...	7/6
Pentodion, .15 amp. ...	21/-

From your dealer or direct:

IMPEX ELECTRICAL LTD.,
DEPT. H, 538, HIGH RD., LEYTONSTONE, LONDON, E.11.

RADIO NOTES AND NEWS OF THE MONTH
—continued from page 90

Television on the Regionals ?

A Special Correspondent writing in the "Observer" recently pointed out that the romantic possibilities of television have been its worst enemy, and that television is now in some disrepute because of the propagation of sensational stories when the art was in the tightest of swaddling bands. However, as the writer points out, within a short time now the public is likely to have an opportunity of judging how far television has advanced from the purely experimental stage, for the B.B.C. is to give television a chance when the first of the Regional stations is ready.

Regional Developments

The writer in the "Observer" goes on to point out that, whilst Mr. Baird has been concentrating on certain specific television problems, Dr. Mihaly, the Hungarian, has devised and developed a method of transmitting cinematograph films to any distance by wire or wireless. The

cinematograph films stand still for a fraction of a second before the projector, and Dr. Mihaly has taken advantage of this. He has speeded up still-picture transmission, and, although this is not true television—since the scene cannot be broadcast whilst it is actually happening—there is only quite a small step to be gone between the possibility of transmitting a film and transmitting a scene, as taken in by the lens of a cinematograph camera.

"Heartbreak House"

It was stated in a newspaper recently that one of the reasons why Mr. R. E. Jeffrey, the late Dramatic Producer of the B.B.C., resigned his position and joined the Talkies was because the hand of officialdom began to rest too heavily on his department—that it strangled initiative, in fact.

Another reason put forward is that the Talkies know how to pay for experts, and that the B.B.C. scale of salaries is not so attractive as it might be.

Whatever the reason, it is certainly becoming more and more alarming to find some of the B.B.C.'s best men resigning and taking up other posts. There must be some reason for the

B.B.C. earning the unfortunate title of "Heartbreak House."

Scottish School Schedule

The syllabus of broadcast transmissions for schools for the Scottish stations of the B.B.C. during the summer time was recently issued, and contains talks by Professor J. Arthur Thomson on Monday afternoons. On Tuesdays one of the new speakers, Dr. George Pratt Insh, will give a broadcast course on Scotland in the Eighteenth Century; the French courses by M. and Mme. Oberlin will also be given on Tuesdays. On Wednesdays and Thursdays the Poetry and Music Courses by Mr. Burnett and Mr. MacLeod will be continued, and on Fridays another new speaker, Mr. W. King Gillies, will give a series of talks on "Our Roman Heritage."

A New "DX" Find

The new station at Bratislava (277.8 m.), in Czecho-Slovakia, which has just been built by the Marconi Company, will probably prove a fine station for British listeners to pick up. Tests have recently been made, and these were heard in all parts of the British Isles, and critics agreed that speech and music were excellent.



TUNE IN ON THE WORLD WITH THE NEW AERO SHORT WAVE CONVERTER

The 1929 Rothermel Aero S.W. Converter is an entirely new and original adaptation of the wonders of radio. Heretofore short waves were appreciated only by the "fans." Now they can be enjoyed by every radio set owner with the use of the new Aero Short Wave Converter. This is a compact factory-built, shielded and filtered converter equipped with special short wave coils and special plug ready to plug into the detector socket of any standard battery-operated radio set.

The converter operates perfectly without motor-boating, by an auxiliary filter system control, an exclusive Aero feature that entirely eliminates most of the troubles experienced with short wave sets.

No change of wiring is required. Just plug your detector valve into the Aero Converter and then place the converter socket in your detector valve holder.

This amazing new unit now makes it possible to reach round the world on short waves between 16.5 and 89.5 metres.

The converter is housed in a beautifully finished golden-brown shielded metal cabinet measuring only 9 x 5 1/4 x 2 1/2 inches.

PRICE £5 17s. 6d.

(Marconi Royalties extra.)

Write for special Leaflet and list of the World's Short Wave Stations.

THE ROTHERMEL CORPORATION

LTD.

24/26, Maddox Street, W.1.

Telephone: MAYFAIR 0578/9.

The Trade Mark on our components is your guarantee. All our components are the outcome of careful design, skilled labour and British made throughout. With this guarantee you are safe in using

WEARITE COMPONENTS

"SUMMERTIME" FIVE

LOW-WAVE COILS (3 to set)	Each	13/9
HIGH-WAVE COILS (3 to set), Litz Wire	"	18/9
BASES	Per Set of 3	3/9

FIVE-VALVE PORTABLE

BATTERY SWITCH, G22, with terminals..	1/-
H.F. CHOKE	6/6

"AUTO-TUNE" ONE

"TITAN" COIL	15/-
WAVE-CHANGE SWITCH	1/6

DUAL-RANGE TUNER as USED IN FERRANTI CIRCUITS

LOW-RANGE, 190-500 metres }	15/-
HIGH-RANGE, 950-1900 .. }	

WRITE FOR LISTS.

WRIGHT & WEAIRE, LTD.,
740, HIGH ROAD, TOTTENHAM, N.17.

Telephone: TOTTENHAM 3847-3848.

TELSEN

TRANSFORMERS



12/6

**BRITISH
MADE**

The **RADIOGRAND**, as shown above, is a component of outstanding merit and remarkable value. Used by all the high-class set manufacturers and sold everywhere. **TELSEN ELECTRIC CO., LTD.** Head Offices: **ASTON ROAD, BIRMINGHAM.**

REDUCED
FROM
£6 TO
£3. 3s.!



The H.Q.

ONE of the most famous of the **Brown** Loud Speakers, the **H.Q.** incorporates the base of the original **H.1.**—the model on which **Brown** reputation was built. Users have always marvelled at the realistic reproduction of the **H.Q.** They marvel still more that such a superb instrument should be

Brown

Advt. S. G. Brown, Ltd., Western Avenue, N. Acton, W.3.

9200

NORTHAMPTON POLYTECHNIC INSTITUTE
ST. JOHN STREET, LONDON, E.C.1

FULL-TIME COURSES IN ENGINEERING

are provided as follows:

**MECHANICAL, CIVIL,
AERONAUTICAL, ELECTRICAL,
& ELECTRICAL COMMUNICATION.**

Students are able to qualify for the Polytechnic Diploma, and (if Matriculated) the Engineering Degree of London University. For Prospectus, giving Particulars as to Fees, etc., apply to **The PRINCIPAL.**

FOR BEST RESULTS GOLSTONE "TITAN" COIL UNIT

Approved by **POPULAR WIRELESS.**
A super-efficient and High-grade Unit for "TITAN" Circuits. List No. T.C./15. **EACH 15/-**
From all first-class Radio Stores. Refuse Substitutes. If any difficulty write direct.
Interesting Radio Catalogue **FREE** on request.

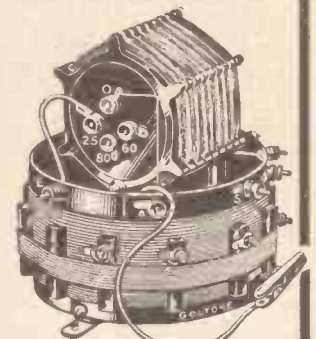

Ward & Goldstone
PENDLETON. MANCHESTER

London Depot: 5 & 6, Eden St., Hampstead Rd., N.W.1. Phone: Museum 4032/3.

THE 100% Broadcast Receiver

BUILD and OPERATE in ONE EVENING

FORMO Screened Grid



BRITISH Components Throughout
Send for Catalogue.

FAMOUS FORMO COMPONENTS as used in this Set and in ALL NOTABLE PUBLISHED CIRCUITS

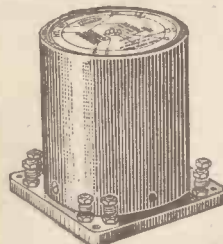

TRANSFORMER-OUTPUT FILTER CHOKE 25/-

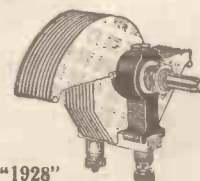

"1928"
LOG CONDENSER 5/-
'0005 '00035 '00025



COILS SG 1 & 2
10/6 each



FORMO-DENSOR 2-
In four variable capacities.

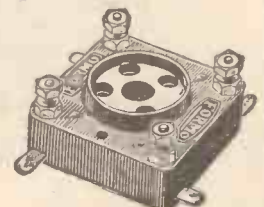

VALVE HOLDER 13

THE FORMO CO., CROWN WORKS, CRICKLEWOOD LANE, LONDON, N.W.2.

The new Lotus Transformer gives you an unexcelled performance—

and costs only **12/6**



Your set will leap into life when you fit the new Lotus Transformer. For purity, tone and good amplification this transformer is absolutely un-equalled at the price and gives as good a performance as you will get from a transformer at a higher figure.

Made with all the care, accuracy and handsome finish typical of every Lotus component, this is the transformer you must get for your next set.

*** OTHER LOTUS COMPONENTS**

NEW Lotus Drum Dials from 29/6;
 Lotus Flat Vernier Dials, 4/9;
 Lotus Valve Holders, 1/3; Lotus Variable Condensers, from 5/-;
 Lotus Remote Controls, Jacks, Switches, Plugs, etc.

Write for free literature.

From all Radio Dealers.

LOTUS COMPONENTS

Garnett, Whiteley & Co. Ltd., Liverpool.

Causton

"MY WAVEMETER"

—continued from page 38

couple of wire-wound resistances of suitable value placed in series, and with a lead taken from their junction point which gives the necessary fairly low voltage. The resistances used were actually of the Igranite wire-wound type, the one marked R_1 being of 50,000 ohms, and the one R_2 of 20,000 ohms, the voltage drop across these being such as to give quite a suitable voltage for the valve. Actually, this voltage is not at all critical, and any values round about those mentioned will serve quite well.

As a matter of fact, quite different pairs of values could be used, provided that the ratio is somewhere about the same, and that their total resistance is not less than, perhaps, 15,000 ohms. The ones I used were simply those I happened to have at hand. Note, by the way, that to economise in Mansbridge condensers I placed the second smoothing condenser on the valve side of the potential divider device, where it also acts as a bypass.

Simple Smoothing

That completes the current supply circuits, and you will see that they are very simple indeed, much simpler, in fact, than those we should need with actual receiving circuits. The reason, of course, is that no great amount of smoothing is needed, since a small amount of hum will not affect the performance of the wave-meter in the least.

Now, there are one or two small details about the arrangement of the meter which I should like to mention, and then I will leave you to consider whether it would be worth your while to make a similar rather elaborate instrument for your own purposes. In the first place there is the problem of how to indicate when the meter is switched on, since when you have had a certain amount of experience of these things you will realise that an instrument used in this way is very apt to be left switched on after use; one of the reasons, incidentally, why the battery type is liable to give trouble.

After thinking the question over a little, I hit upon a scheme which turned out to be quite successful, and that was to fit a dial illuminator for the Igranite "Indigraph" dial which I have employed. This dial illuminator consists of a small flash-

lamp bulb fitted in a special holder behind a hole in the panel, and I have connected it across the same transformer winding which supplies the current for the filament of the U.5 rectifier valve, with an ordinary filament rheostat (30 ohms) in series to give the necessary adjustment to suit different flashlamp bulbs. Thus the dial is illuminated as soon as the meter is switched on, and you will find it is automatically turned off when one has finished.

This device, by the way, is not shown in the circuit diagram, since it would make it look rather more complicated than necessary, but you will see easily how to wire it up. With the particular transformer chosen, by the way, you can also quite well run this dial illuminator off the 4-volt winding which is provided for use with indirectly heated A.C. valves, this winding not being employed otherwise.

Another point concerns the method of switching the wave-meter on and off. At first I used the plug adaptor to the mains for the purpose, but this proved rather a nuisance, not being too accessible. Accordingly, the switch on the right-hand side of the panel, originally intended for another purpose, was wired into the mains supply circuit, twisted flex being used for the purpose, and this has proved of great convenience. The other switch on the left-hand side of the panel, of course, is the wave-change switch, this being pushed in for long-wave operation and pulled out for medium.

THE PERFECT RECEIVER

—continued from page 5

set. We design all our circuits for transmission with a good sound factor of safety—reception only becomes better as such conditions are approached. Of course, stringent limits are set in battery sets; one cannot hope for improvement unless the mains are used directly or indirectly to keep good stout batteries well "up."

Thus my perfect set is growing; it is equipped with a non-resonant loud speaker giving a wide frequency response and plenty of factor for safety. We must, before leaving the quality side, specify a separate volume control, separate from the set, which one can keep by one's side as one sits listening.

(Continued on page 95.)

THE PERFECT RECEIVER

—continued from page 94

If we have a large volume for the asking, we must not be greedy because even our Mr. Hibberd sounds unpleasant, if his voice (quiet and cultured in the studio) is magnified to ten times its natural size—this is just a fact and has nothing to do with any question of artistic distortions; the loud speaker should do its best to leave out the non-essentials—if it puts in exaggerated volume it cannot be said to be doing its job.

Long-Wave Reception

The volume control should be adjusted so that for singing, piano and talking the amount of sound transmitted should be about the same as that in the original. For symphony concerts, opera, and so on, one cannot expect the same volume as in the original—nor should we want it in a small room; for Talkies and such like it is quite a different matter.

Now that we have more long-wave and high-power stations on the Continent, certain other European stations are worth while receiving, and the "perfect" set should be sensitive enough on the long-wave side to get Kalundborg, Zeesen, Paris, Hilversum, Motala, etc., depending upon where in England the receiver is installed.

I cannot agree that, except in exceptional cases, the medium-wave stations are worth while; they fade too badly for general reception. There is no reason why a one-handled control should not tune-in a distant station, but I would ask that rectified current should certainly be indicated in some way, and always, in fairness to the low-frequency circuits, brought to the same value. I loathe adjustable reaction, particularly for long-wave reception, and would hope for sufficient sensitivity, adjustable by resistance in the H.F. circuits somewhere.

Popularity of the Portable

Now, and lastly, as to this portability. I agree that a portable set is fascinating, convenient and rather romantic, but it is, of course, at present impossible to embody all the ideals I have set out above and have the other conveniences as well; the buyer must make the choice—a choice between two definite things it seems to me. The popularity of the portable set is growing daily.

THE NEW WAVE-LENGTHS

—continued from page 39

Eckersley states that the reason for changing 5 G B is in order to keep it away from the close proximity to Langenberg, while Manchester takes the longest medium wave so that it may have the most favourable chance of providing good service in the most populous part of Great Britain.

Glasgow drops below 5 G B, in order to take up a suitable wave for mountainous districts, while London and Cardiff have only very minor alterations. Leeds goes on to a wave-length of 200 metres, which is perhaps the most revolutionary change of the lot, but it seems to be the opinion of Captain Eckersley that this station's wave is essentially suitable for purely local service.

First Regional Programme

Newcastle goes up to 261 metres, but, later on, it will join other B.B.C. stations working on the national common wave-length of 288.5 metres. Captain Eckersley states that he hopes the London station for double-wave working will open towards the end of the year. To begin with it will act as a single-wave station, but, later on, will gradually adopt twin-wave working. This will necessitate a second wave-length for the London station, and consequently, in the plan, our readers will see that provisional re-allocation is allowed for under the heading of: "Opening of Brookman's Park second programme."

There may be further changes, but not necessarily in wave-lengths; rather in wave-lengths being used by various stations as the Regional Scheme reaches maturity. These changes will be announced from time to time, as old stations close down and new ones open up. But it seems fairly obvious that there is little change for a long time to come likely to be made in the wave-lengths of Daventry 5 X X and 5 G B, Manchester, Glasgow, London and Cardiff stations.

Critics of the new plan have pointed out, however, that the separation between 5 G B and 2 L O, when the new wave-lengths are adopted, will be perilously small, and that many listeners will need extremely selective sets in order to cut out 2 L O when 5 G B is being received, and vice versa.

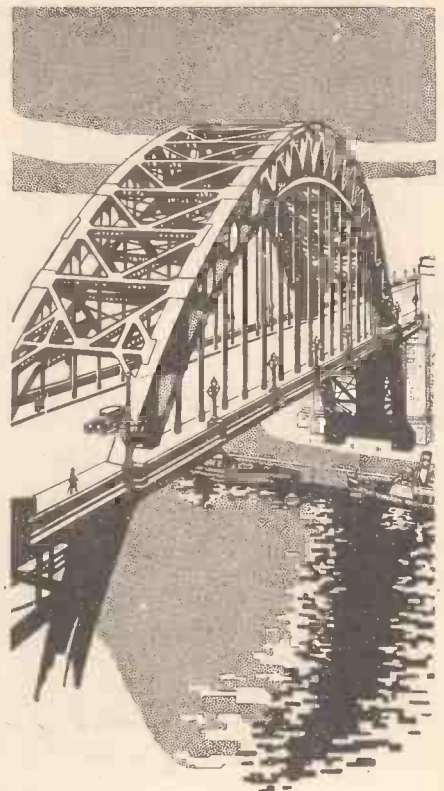

ENGINEERING PRECISION

Bestriding the Tyne like a Colossus, this inspiring new bridge leaps the great waterway in one span, a perfect example to Newcastle—and, indeed, the world—of the skill and precision to be found in twentieth-century engineering.

No less worthy examples of craftsmanship are to be found in the products of J.B. Infinite care and accuracy, and a flair for turning a good design into a perfect one, have raised J.B. precision instruments to an unassailable position of good repute.

Engineering precision is a feature of all J.B. wireless instruments. This J.B. S.L.F.-Condenser (Plain Type) is made as if lives depended on its accuracy. And that is how a condenser should be made. The S.L.F. has the same mechanical and electrical features as the Logarithmic type, except that the Vane form is our very popular True Tuning S.L.F. Remember that True Tuning S.L.F. means selectivity with ease of tuning.

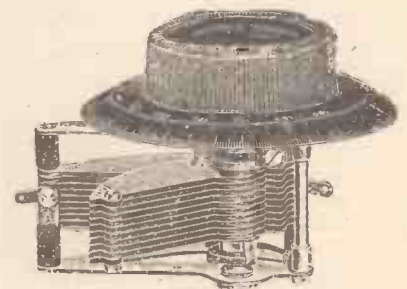

PRICES
Complete with 4-in. Bakelite Dial:

0005	11/6
00035	10/6
00025	10/-
00015	10/-



PRECISION INSTRUMENTS

Advt. of Jackson Brothers, 72, St. Thomas' Street, London, S.E.1. Telephone: Hop 1837.

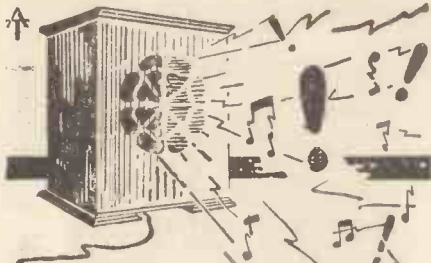

Don't blame the B.B.C

—look to your connections
FAULTY joints are often the cause of crackling and strange noises that mar your programme. Avoid this unpleasantness by using Eelex Treble Duty Terminals in conjunction with Eelex Spades, Pins, and Eye connections. There is no need for messy bother of soldering if you employ Eelex components in your set.



TREBLE DUTY TERMINALS

Forty indicating tops and 6 colours.

(T2LC) 4½d. each.

With plain top only (T2LN) 3d. each.

Write for Booklet S.70.

J. J. EASTICK & SONS, Eelex House, Bunhill Row, Chiswell St., London, E.C.1.
 Phone: Clerkenwell 3282-34.



A Bureau for Your Wireless!

ADAPTABLE TO ALL SETS!

Nothing to touch! The snug way these untidy, dusty parts, trailing wires and batteries are compactly enclosed will delight you. As a beautiful piece of furniture, the "RADIOLA" will add pride to the home because it is modern and stylish. Already over 3,000 delighted users. Highly recommended by the Radio Press and leading experts. "Radiola" de luxe, from £5:5 to £11:11. "Popular" Oak Model, from £3:15. Cash or Easy Payments.

A stately British-made Cabinet, trade-marked and guaranteed, sent on APPROVAL. (If you wish to part with it we will willingly refund FULL MONEY and pay return carriage too!)

Full particulars, Booklet and Photographs FREE (they will interest you!) from the actual makers:

PICKETT'S, WIRELESS FURNITURE MAKERS.

"M.W." WORKS, BEXLEY HEATH, KENT
 Established since the beginning of Broadcasting

Make **The DAILY SKETCH** YOUR Picture Paper

For the Best in Radio

WILL DAY LTD

(THE BEST IN THE WEST)
 10 LISSE STREET, LITTLESTON SQUARE, LONDON, W.C.2
 Telephone: Coleridge 4999-5000. Telegrams: Willday, Willday, London.
 OPEN TILL 7 P.M.
 WRITE FOR OUR CATALOGUE
 POSTAGE & FEE IN CASH

WHEN REPLYING TO ADVERTISEMENTS PLEASE MENTION "MODERN WIRELESS"

WHAT DO YOU WANT TO HEAR?

—continued from page 41

of contemporary events by witnesses capable of describing what they've seen. Foch's funeral should have been immortalised on the wireless, and the Papal ceremony in St. Peter's by H. V. Morton."

One American was present at this impromptu conference, and, at this point, he made a speech: "You folks want to cut out half this junk and leave room for the things that are sure going to happen. There's hardly a name here that cuts ice. It's all canned stuff. Why, in the States we reckon to get every new personality red-hot on the wire. When somebody's made a hit, I guess we want to hear how they size up and what they've got to say about it."

It was impossible to stem the vivid flow, but several facts emerged from

and what the young are thinking—though it would perhaps be more interesting and more profitable to substitute, in some such fashion as I suggest, what they are doing—but these are lessons.

Let us have something to stimulate our imagination as well as our house-craft and our technique, and let it be in the nature of a surprise. It is always the unexpected which attracts, and the blank spaces on a wireless programme would be so many question-marks, heralding adventure.

Is It Resistance?

By G. YOUNG.

WHEN you are testing your set do you ever touch this terminal and that terminal, noting the curious increases and decreases of signal strength that follow? Most people do, I am sure, but do they

AN EXCELLENT CIRCULATION MEANS GOOD HEALTH
 GOOD HEALTH IS ESSENTIAL FOR PROSPERITY
 AND PROSPERITY MEANS CONFIDENCE AND POPULARITY

That is why

"POPULAR WIRELESS"

reigns supreme as the Leading Wireless Journal, standing far above all competitors, because it has the best circulation and the complete confidence of its readers and advertisers.

Compare "P.W." with any other Wireless Paper and you will realise the superiority of

"POPULAR WIRELESS"

EVERY THURSDAY - Price 3d.

it. The American was quite sure that his country got what it wanted and that we didn't. According to him, writers ought to talk about their own books, instead of critics about other people's! Rebecca West, Clare Sheridan, H. G. Wells, Van Druten, Sheriff, dozens of others, all the people who are doing things, ought to debate for our benefit.

Stimulate Imagination

Probably he is right. The general public flocks in its thousands to see anybody in the limelight do anything, however commonplace. It probably wants to hear them just as much as to see them. I confess it would give me pleasure to listen to Dyot on the subject of his recent South American adventures, or, with the Conor O'Briens, beat round the Horn in the smallest sailing-craft that has ever braved its storms.

Of course, we must have pullet-breeding and cooking, and economics

know exactly why these variations in volume happen? Perhaps they put it all down to "capacity" and leave it at that. Capacity may play a part, and a very big part, but this is not always the only factor that is at the bottom of it.

Before I go any farther, however, I must point out that the touching of terminals while a set is in operation is not a business light-heartedly to be indulged in. If you happen to be using a mains unit you may receive a "packet" which will make your fingers tingle and cure you of ever again wanting to touch the "innards" of your set. An ordinary common or garden H.T. battery is capable of giving you a nice little tingling.

And it is not necessary for you to complete a very obvious circuit by holding something else belonging to the receiver or its accessories in the other hand. The completion of the circuit is possible through your body

(Continued on page 97.)

IS IT RESISTANCE?

—continued from page 96

to the ground via the floor on which you are standing and to the earth and so back to the source of supply. Leather boots, carpets and other floor covering should provide ample insulation. *Should*, but do not always do so!

But the man who knows his set and its circuit also knows exactly what he can touch without hurting himself. Of course, there are enthusiasts who think nothing of 150 volts and who can hold on to the two ends of as much as 200 and seemingly enjoy the thrill.

A Human Aerial

Have you ever heard or personally experienced a case of a set bringing in stations heaps louder when someone holds his finger on to a certain terminal or other point? This may well be a capacity effect, but it is not likely to be one which merely alters the tuning of one of the circuits. Otherwise why should not the volume be attainable by legitimate means, by tuning properly in the first instance?

No, one of two other things are more likely to be the cause. One is that the body of the person to whom the revivifying finger belongs is acting as an aerial and collecting more energy from the all-pervading ether. The human body, as with all other bodies that are more or less conductive to electricity, can function quite well as a radio antenna.

And it is a curious fact that some people's bodies act far more efficiently than others in this respect. It is said that the electrical resistance of one's body alters with the state of one's health. Certain it is that I have known a big man to possess aerial powers inferior to those of a little man; I have carried out quite a few experiments.

Feed-Back Caused

The other possible or probable cause is that additional feed-back or reaction effects result when the body is brought into circuit. The fields of H.F. currents are widespread and potent, and where there may happen to be inadequate screening or stabilisation such ancillary regeneration is very possible.

When you place your fingers across two points and bridge them by this means you are bringing resistance into play. If you use two fingers of

one hand the value of the resistance may be as comparatively low as one hundred or even fifty thousand ohms. If you use fingers of different hands then the value may be in megohms. But, as I have said before, much depends upon the individual and the dampness of his hands.

Interpreting the Results

This bridging of two points generally results in either a decrease of volume or in nothing. But in some instances loud squeals result, while in a very few cases the results may be improved either in point of quality or quantity, or even in both. The skilled radio engineer knows how to interpret the effects of this fingering business and, indeed, frequently resorts to it in order to test circuits.

Of course, at best it is only a rough-and-ready way of testing anything, and it would be an impetuous technician who drew momentous conclusions from things like that. Anyway, he would not know exactly the resistance of his frame, for this varies from hour to hour as well as with different individuals. Also capacity has to be taken into consideration whether you like it or not.

It is certainly interesting endeavouring to trace the reason for something caused by a finger bridging, although it becomes easier if you remember that it is mostly resistance that is the factor in evidence. Visualise the two points joined together by an ordinary wire-wound resistance wound so that instead of assuming anti-capacity qualities it has a fair amount of self-capacity.

A Simple Test

If you touch a point with one finger and there is a loud squealing this will probably be a point connected to the grid of a valve (no doubt in one of the L.F. stages) and L.F. feed-back is being caused. But when two points are bridged then they are connected together by a resistance element and direct coupling can result.

You can prove how readily your body acts as a conductor in a very simple way; no doubt many of you will already have done so. If you disconnect one lead of your loud speaker, hold it, the lead, in one hand and touch the disengaged terminal on the set with the other, you will still be able to hear something. You yourself are completing the circuit. If you are not using in, or attached to, your set a loud-speaker bypass or shunt arrangement you may hear only the veriest whisper, as the

(Continued on page 98.)

THERE MUST BE A REASON

Why the tens of thousands who listen in praise Celestion.

INCOMPARABLY SUPERIOR

CELESTION

The Very Soul of Music

LOUD-SPEAKERS

The only sure proof of our Statement is to hear Celestion yourself. You can do so without obligation, at any good Wireless Dealers, or at our Showrooms. Models range from £5.10.0 in oak or mahogany. British throughout. Made under Licence.

The new Celestion Booklet is free and gives you briefly and interestingly all particulars. Mail the coupon below for your copy now!

**CELESTION, LTD. (DEPT. H)
KINGSTON - ON - THAMES.**

Visit our Showrooms:
**106, VICTORIA STREET,
LONDON, S.W.1**



Model C.10. Price £5 - 10 - 0

WHEN A BETTER LOUD SPEAKER IS MADE—CELESTION WILL MAKE IT.

Please send me a copy of the New Celestion Booklet! Post to Celestion, Ltd. (Dept. H), Kingston-on-Thames.

NAME.....

ADDRESS.....

WORTH THEIR WEIGHT IN GOLD

HEAYBERD Power TRANSFORMERS

Over 50 types available from stock for all methods of rectification.

The following for H.T. Eliminators—

200v 20ma, 4v 12/6	500v 100ma, 5v 32/6
400v 20ma, 4v 17/6	440v 120ma, 7.5v 32/6
300v 20ma, 5v 17/6	750v 60ma, 5v 40/-
440v 30ma, 4v 20/-	800v 120ma, 8v 55/-
400v 50ma, 5v 25/-	1000v 120ma, 8v 60/-
500v 50ma, 5v 28/-	2000v 120ma, — 85/-
440v 30ma, 4v and 4 volts 5 amps 28/6	

The following for Westinghouse Rectifiers—

230v 160ma 17/6	12v 1.5 amps 15/-
8.5v 1.5 amps 12/6	12v 3.2 amps 20/-
230v 160ma, 12v 1.5 amps 45v 10ma 32/6	

The following for A.C. Valves, etc.—

4 volts 3 amps 8/4	2 volts 3.5 amps 10/-
4 volts 5 amps 12/6	7.5 volts 3 amps 12/6
5 volts 3 amps 12/6	6 volts 3.5 amps 12/6

The following Power Chokes—

50 henrys 25ma 12/6	50 henrys 100ma 20/-
100 " 25ma 17/6	100 " 100ma 25/-
30 " 50ma 12/6	17 " 100ma 15/-

A Heayberd Transformer is specified for The "A.C." Three.

Details with diagrams free on request.

F.C. HEAYBERD & CO
10, FINSBURY ST EC2
One Minute From Moorgate Station.

The Picture Paper with the MOST News

.. SUNDAY GRAPHIC ..

CLIX - LOX

Adjustable Wander Plug.

Approved and used by well-known designers and constructors throughout Great Britain.

Clix-Lox is the perfect wander plug. It will fit snugly into the socket of any H.T. battery and remain there until withdrawn. The patent Clix method of wiring gives a safe and sure connection. You get no trouble, no bad contacts and no noises by using Clix-Lox.

Write for New Clix Catalogue (M)

LECTRO LINX, Ltd.,

254, Vauxhall Bridge Road, S.W.1.

2¹/₂ each.

Advertisements

As far as possible all advertisements appearing in "Modern Wireless" are subject to careful scrutiny before publication, but should any reader experience delay or difficulty in getting orders fulfilled, or should the goods supplied not be as advertised, information should be sent to the Advertisement Manager, "Modern Wireless," 4, Ludgate Circus, London, E.C.4.

IS IT RESISTANCE?

—continued from page 97

additional resistance brought in will drop the voltage on the plate of the last valve to a very low figure indeed. Where there is a shunt the valve carries on as normally, the only difference being that the L.F. impulses have to travel a path of high resistance in addition to passing through the loud speaker.

A Peculiar Case

I was talking about this terminal-touching stunt, which is fraught with amusing possibilities, to a friend of mine not so long ago. And it appeared that he was well versed in the art. Indeed, it appeared that he had a set which packed right up when you lightly touched the terminal of a fixed condenser. This I could believe so long as it was a finger-touch, but when he went on to say that you could get the same effect when the point was touched with an object made of an insulating material, such as a vulcanite pencil case or a piece of rubber erasing material, I developed pronounced scepticism.

Came a demonstration and mutual mystification. Surely enough the set stopped working directly you touched that terminal with anything—a piece of paper, matchstick, finger; any object fashioned with any material, in fact.

Bad Internal Contact

But every effect has its well-defined cause, and radio is no exception. After ceasing to be misled into thinking that here was something quite new, we got down to hard brass tacks and eventually found that a prosaic loose connection in the interior of the component was the cause of the phenomenon. The terminal was ever so slightly loose in its seating, but as the contact to the foils constituting the plates was a pressure one, a tiny pressure was enough to make the connection very faulty.

READ

POPULAR WIRELESS

THE PAPER THAT MADE

WIRELESS POPULAR

THE "SUMMERTIME 5"

—continued from page 47

the set then covering the 240-560-metre band. (Remember that the tuning condensers are only .0003.)

For the long waves, one 250 coil with two tappings and two plain 250-turn coils are required. As to valves, any S.G. valves will do for the two H.F. stages. If you are going to use 2-volt valves with a 4- or 6-volt battery, or 4-volt valves with a 6-volt accumulator, be sure that you have the correct filament resistances, proportioning them so that about $\frac{3}{4}$ -volt negative is applied to the grid. This negative potential can still be obtained with the 6-volt valve when using a 6-volt battery, for a resistance of 7.5 ohms in the negative lead will give the desired bias without affecting the performance of the valve.

The Detector Stage

If you have a couple of old S.625 valves you would like to use this can be done quite easily by fixing a couple of valve legs over the pins at the top of the valve, providing one with a terminal to connect the anode lead to, and the other with a flex lead finished with a spring clip which is connected to the anode terminal of the valve holder. You will find that these valves will give you quite excellent results, though perhaps not quite so good as the newer S.G. valves.

For the detector I advise you to use one of the Mullard D series, the P.M.2D.X., P.M.4D.X., or the P.M.6D., these being in the 2-, 4- and 6-volt classes respectively. Quite good results can be obtained with a small power valve or even a medium-impedance valve, but you won't get the same signal strength from them, on account of their lower amplification factors.

I can strongly recommend the above valve, not only on that account, but also the fact that its low impedance when actually working as an anode-bend detector results in excellent quality being obtained with transformer coupling. Care must be taken, in any case, to see that the valve is correctly biased, since too little bias will result in poor rectification, and too heavy a current flowing through the transformer primary and resulting loss in the lower register owing to the drop in inductance.

The two L.F. valves should preferably be fairly large valves, such as the

(Continued on page 99.)

THE "SUMMERTIME 5"

—continued from page 98

P.M.256, P.625 or A, or a similar valve. It may appear that since only one stage of L.F. amplification is in use, that these valves are unduly large and that a smaller valve would handle the signal, especially as push-pull amplification is used.

Amplification Per Stage

All this is true enough providing that one is completely out of range of any of the powerful stations, and that reception is never above fairly average strength, but any decent signal will overload the set if small valves are used.

Consider the following figures for a moment. We can assume that the amplification given by the H.F. stage is in the neighbourhood of 1,000, which means that it will be easy for a strong, even though distant, station to be amplified sufficiently to develop an H.F. voltage of about 20 volts across the detector tuned circuit. As we are rectifying, we take half of this, ten volts, and, assuming the modulation to be 30 per cent. we have an audio-frequency signal of 3 volts.

Actual amplification given by the rectifier valve will be about 12, and a 3-1 step-up for the L.F. transformer gives a total L.F. signal of 108 volts. Divide by two, since push-pull is being used, and this gives 54 volts on the grid of each valve, which can just be handled with plenty of H.T. and G.B. on a big valve.

I don't suppose you will have such a big signal to handle except on the local and regional stations and the high-power station, but as these are the three transmissions you probably listen to most, you want the set to be able to handle them without distortion.

Matched Valves

If you can get hold of two exactly matched valves, you can, of course, work them both on the bottom bend. You have probably read how the curvatures of the two characteristics cancel each other out owing to the fact that the valves are being used in push-pull, but the valves must be matched very exactly indeed for this arrangement to be successfully used. So perhaps it will be better to use the large valves when it is desired to deal with a strong signal.

For normal use I think, however, that a valve such as the P.M.6 or the P.625 will be found quite satisfactory,

or an equivalent valve in the other voltage ranges, though I myself am using valves of the P.X.650 or L.S.5A types.

Operating Voltages

Now as regards operating voltages, for the best results you should use 120-150 volts on the H.F. valves, the screening-grid potential being controlled to give stability. Detector needs about 120 to 150 volts, and the L.F. valves from 120 to 180 volts or more, depending on what is available, and the rating of your valves.

Lower voltages can, of course, be used with excellent results, but I recommend the values given above for maximum efficiency. The bias for the detector will be 10 to 12 volts negative at 120 to 150 volts H.T., and for the L.F. valves it will depend on the actual voltage used and the valve employed.

In installing the set take care to keep the aerial and loud-speaker leads away from the back of the set. Should it be essential, however, that one of these pass behind the receiver, then it will be necessary to fix a vertical metal screen, connected to earth, along the back edge of baseboard to prevent interaction between such leads and the H.F. valves.

Having settled these points we can insert the valves, connect up L.T., H.T. and G.B. The coils are in, so connect aerial, earth and loud speaker, short out the wave-trap coil, and go for the local station, the volume control being set at about half-way in.

Preliminary Adjustments

If on bringing the three circuits into tune the H.F. side of the set begins to oscillate, turn the controlling knob one way or the other till the set is stabilised.

Tune-in the local and cut down the volume by means of the input resistance R, the knob for which is at the far left-hand end of the panel, till it is the correct value. Adjust the detector bias to give maximum signal strength and the greatest purity of tone, and adjust the L.F. grid bias.

Adjust all three dials carefully on this station and note their relation to each other. You will find that the dials will stay together quite accurately, the greatest diverger will, of course, be the aerial tuning condenser, or the first dial on the left.

To search for a distant transmission, switch the wave-trap into circuit and adjust the condenser till the local station is reduced to a minimum (note the adjustment is fairly sharp),

(Continued on page 100.)

The Magazine for those Who Love Their Homes

TOWN AND COUNTRY HOMES will solve all your home difficulties. If you want a new house, this sumptuous monthly magazine will help you with its sketches and plans by well-known architects. If you want to re-design your garden, to re-decorate your present house, to instal central heating, to add a touch of the ultra modern or the antique to one of your rooms, you should read TOWN AND COUNTRY HOMES.

The pages printed in rich photogravure add to the beauty of this famous magazine.

Buy it regularly.

TOWN & COUNTRY HOMES

Published Monthly

1/-

THE "SUMMERTIME" 5

—continued from page 99

increase the volume by turning the input control in the requisite direction.

Turn the volume or reaction control in the same direction till the set is just nicely off the oscillating point, and then turn the three dials slowly in step, a degree at a time, and you will find the Continental transmissions coming in at tremendous strength all over the dial.

The coil for the wave-trap is a 50 X, and care should be taken to see that it is correctly connected.

To change over to the long waves you merely replace three coils.

Using a Pick-Up

And, lastly, if you want to use the set with a gramophone pick-up all you have to do is to plug it into the jack provided, reducing the grid bias on the detector valve to about one-third of its value.

It is important to make sure that your pick-up is suitable for use with only two stages, or it may be found necessary to connect a step-up transformer between the pick-up and the set. I am myself doing this by using the arrangement shown in Fig. 4; I get all the volume I want with only two stages of amplification.

Then there is the question of a scratch filter. I am not altogether in favour of using any arrangement of this description as I find that it tends to reduce the higher frequencies, but the best filter I have so far used is based on the circuit shown in Fig. 5.

The complete circuit of filter and volume control would be as in Fig. 6, in which the resistance R of the filter is combined with the volume control.

THE "LOTUS" PORTABLE

FOUR or five months ago Messrs. Garnett, Whiteley & Co., Ltd., redesigned their famous "Lotus" portable and transportable sets, and made them four-valvers of astonishing power.

Each now uses two screened-grid H.F. stages, and a Pentone valve figures in the last position. The transportable is obtainable in oak at 23½ guineas, and mahogany or walnut at 24 guineas, including Marconi royalties.

The portable model is of suitcase design, and a very neat affair it is, too. At 23½ guineas (including royalties) it is very attractive. The loud speaker (of ample dimensions) is contained in the lid, and the controls and batteries are accessibly positioned in the body of the case.

The "Lotus" Portable is a wonderfully economical receiver in point of L.T. and H.T. The filament consumption is only 0.3 amp. at 4 volts, and the H.T. drain is 11 milliampères. When you remember that there are two S.G.'s and a Pentone, this H.T. consumption is very modest.

Good Distance-Getter

As would only be expected, the "Lotus" Portable is a good distance-getter. Yet the makers are quite modest in regard to its capabilities. They claim a daylight range in the case of an ordinary B.B.C. station of 100 miles, and 200 to 500 in the case of 5 X X and 5 G B. In many instances these ranges are, of course, considerably exceeded.

But a station at good loud-speaker strength anywhere in Europe is a certainty on this portable.

RADIO ABROAD

—continued from page 76

Five Years of Broadcasting

An interesting review has just been published by W L S, Chicago, of its work during the five years that it has been "on the air." Many interesting points arise from the review. Amongst others it is noted that over 1,000,000 letters have been received from listeners during that time, and over 4,000 artists, speakers and others have been before the microphone.

One Orchestra Replaces Three

A very simple arrangement, which is not only economic but has other important advantages as well, has been adopted in New York by three of the leading hotels which are under the same management. Instead of having three separate orchestras, only one orchestra is employed, and for that reason the management is able to pay for a much larger and better orchestra than if three were employed. At the principal times of the day—lunch-time, in the afternoon, and at dinner-hour in the evening—the music of the orchestra is broadcast to all three hotels.

Liege Again

Radio Wallonie (Liège), the transmissions from which have recently been suspended, is now again on the air and broadcasts on Sundays, Tuesdays and Thursdays between 9.10 and 11.40. p.m. (British Summer Time) on a wave-length of 280 metres.

INDEX TO ADVERTISERS

	PAGE
Belling & Lee, Ltd.	81
Brown, S. G., Ltd.	89, 93
Burne-Jones & Co., Ltd.	88
Best Way Wireless Books	81
Carrington Manfg. Co., Ltd.	81
Celestion, Ltd.	97
Cossor, A. C., Ltd.	2
Day, Will, Ltd.	96
Dubilier Condenser Co. (1925), Ltd.	91
Eastick, J. J., & Sons	96
Ever-Ready Batteries	1
Ferranti, Ltd.	85

	PAGE
Forno Company, The	93
Garnett, Whiteley & Co., Ltd.	94
Heyberd, F. C., & Co.	98
Hughes, F. A., & Co., Ltd.	73
Igranic Electric Co., Ltd.	89
Impex Electrical, Ltd.	91
Jackson Bros.	95
Lectro Linx, Ltd.	98
London Elec. Wire Co. & Smiths, Ltd.	90
Lissen, Ltd.	69
Metro-Vick Supplies	Cover iii
Mullard Wireless Service Co., Ltd.	Cover ii
Northampton Polytechnic Institute	93
Paroussi, E.	91

	PAGE
Pickett's Cabinet Works	96
"Popular Wireless"	85, 89
Radio Instruments, Ltd.	77
Rothermel Corpn., Ltd.	92
Telegraph Condenser Co., Ltd.	81
Telsen Electric Co., Ltd.	93
"Town and Country Homes"	99
Varley Products	Cover iv
Ward & Goldstone, Ltd.	93
Whiteley Boncham & Co., Ltd.	91
Wright & Weaire, Ltd.	92

All communications concerning advertising in "Modern Wireless" must be made to John H. Lile, Ltd., 4, Ludgate Circus, London, E.C.4. Telephone: City 7261.



The Met-Vick
Model "B"
Eliminator.
H.T., G.B. & L.T.
£8 : 0 : 0

Feed your set from the electric light supply

Do away with the periodical charging of accumulators, and the renewing of dry batteries, by substituting Met-Vick All-Electric valves for your existing valves and coupling the Met-Vick Model "B" Eliminator shown above to your set.

Connected to a lamp socket or wall plug the Met-Vick Model "B" will supply you with unvarying current for H.T., L.T., and G.B. It is remarkably compact, and of regular shape, and can be easily included in existing cabinets in place of batteries.

The Met-Vick Model "B" is also available for H.T. and G.B. only.

Ask your dealer for Section "C" of Radio Catalogue which fully describes all the eliminators shown here.

MET-VICK ELIMINATORS

METRO-VICK SUPPLIES
(Prop. Associated Electrical Industries Ltd.)
155, Charing Cross Road
LONDON, W.C.2

H.T. & G.B. MODEL
A.C. TYPE 40-100
PERIODS

H.T. & G.B. MODEL A.C. TYPE 25
PERIODS

MODEL "B" H.T. & G.B. A.C. TYPE
40-100 PERIODS

MODEL "B"
H.T. & G.B. MODEL D.C. TYPE

L.T. MODEL
A.C. TYPE
40-100 PERIODS

SPECIAL 25 CYCLE L.T.
A.C. TYPE FOR
A.C. VALVES

H.T.
& G.B.
MODEL D.C. TYPE
100-250 VOLTS

L.T. MODEL D.C. TYPE

13th. JULY



Look out for the first of the new VARLEY components, particulars of which will be advertised during the week ending 13th July.

INSIST on seeing this mark on components, sets and accessories—it's your guarantee of efficiency, reliability and up-to-date radio.

Advertisement of Oliver Pell Control Ltd., Kingsway House, 103, Kingsway, London, W.C.2. Telephone: Holborn 5303