

MODERN WIRELESS



November

1/-

Vol. III. No. 6.

Edited by JOHN SCOTT-TAGGART, F.Inst.P., A.M.I.E.E.

November, 1924.

A Transatlantic 4 Valve Receiver BY PERCY W. HARRIS

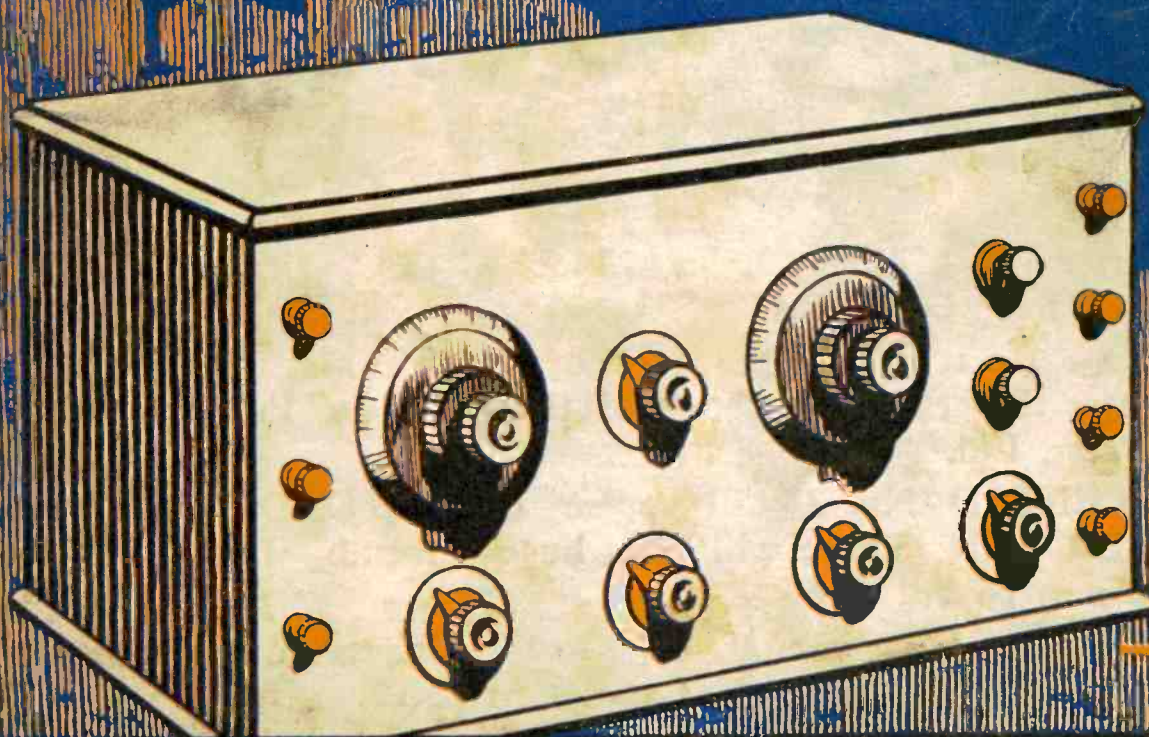

Vol. III.

No. 6

THE T.A.T. SYSTEM; A NEW METHOD OF HIGH-FREQUENCY AMPLIFICATION. *By John Scott-Taggart, F.Inst.P., A.M.I.E.E.*

A LONG RANGE NEUTRODYNE RECEIVER. *By John Underdown.*

MORE ABOUT THE RESISTOFLEX. *By John Scott-Taggart, F.Inst.P., A.M.I.E.E.*

A SELF-CONTAINED SINGLE-VALVE SET. *By Walter Stevens.*

LATEST CONTINENTAL PROGRAMMES.

PRACTICAL HINTS.

TRUBLE CORNER.

NEUTRODYNE NOTES.

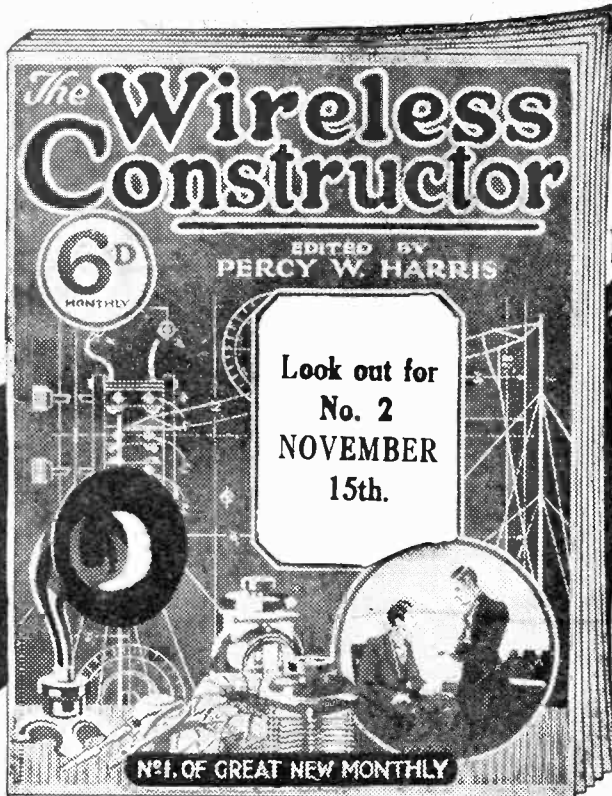

THE
**Wireless
 Constructor**

6d. Monthly.

Edited by
PERCY W. HARRIS.

PLEASE TELL ALL YOUR FRIENDS ABOUT IT.

250,000!

A Quarter of a Million Copies of No. 1 of the "Wireless Constructor" have been sold.

This huge total is a record for any British Magazine and illustrates the great confidence of the Wireless Public in Radio Press, Ltd.

A **SPLENDID** No. 2 will appear on **SATURDAY, NOVEMBER 15th.** There will be a huge demand. Look out for the new cover!

Subscription, **8/-** per annum, to go to the Printers direct (Odhams Press Ltd., Long Acre, London, W.C. 2).

Published by Radio Press, Ltd., Bush House, Strand, London, W.C. 2.

J.W. Gray. VA 1925
J.W. Gray VA 25.

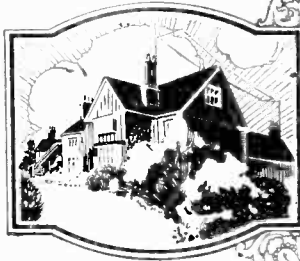

Editor:
 JOHN SCOTT-TAGGART,
 F.Inst.P.

Assistant Editor:
 PERCY W. HARRIS.

Staff Editors:
 E. H. CHAPMAN,
 M.A., D.Sc.
 A. D. COWPER, M.Sc.
 G. P. KENDALL, B.Sc.
 R. W. HALLOWS, M.A.
 S. G. RATTEE, M.I.R.E.

RADIO PRESS, LTD.,
 "Publishers of "Wireless Weekly" and "The
 Wireless Constructor,"
 Bush House, Strand, W.C.2.
 Telephone.—City 9911.

Contents

	PAGE
The "Transatlantic Four" Receiver	603
BY PERCY W. HARRIS.	
In Passing	608
The T.A.T. System of High-Frequency Amplifica- tion	612
BY JOHN SCOTT-TAGGART, F.Inst.P., A.M.I.E.E.	
A Double-Circuit Neutrodyne Receiver	620
BY JOHN UNDERDOWN.	
Wireless Telephony and the League of Nations ...	629
BY CAPTAIN L. F. PLUGGE, B.Sc., F.R.Ae.S., F.R.Met.S.	
A Self-Contained Single Valve Receiver	634
BY WALTER STEVENS.	
Wireless Without Worry	645
BY "FRANCIS."	
A Short and Long Wave Crystal Set	649
BY W. H. FULLER.	
Notes on the Dual Receiver with Neutrodyne Control	661
BY A. D. COWPER, M.Sc.	
More Resistoflex Circuits	665
BY JOHN SCOTT-TAGGART, F.Inst.P., A.M.I.E.E.	
The Three Valve Dual Receiver	671
Regular Programmes from Continental Broadcast- ing Stations	673
BY CAPTAIN L. F. PLUGGE, B.Sc., F.R.Ae.S., F.R.Met.S.	
Trouble Corner	686
Tested by Ourselves	692

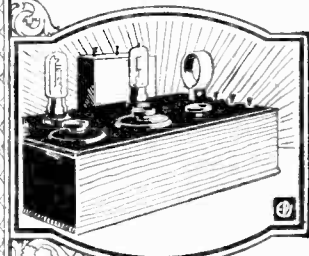

Scientific Adviser:
 Prof. G. W. O. HOWE,
 D.Sc., M.I.E.E.

Advisory Editors:
 Prof. R. WHIDDINGTON,
 M.A., D.Sc.
 Prof. C. L. FORTESQUE,
 M.A., M.I.E.E.

Advertisement Managers:
 BARCLAYS
 ADVERTISING LTD.,
 Bush House, Strand, W.C.2.
 Tel.—City 9911.

*All correspondence relating to contributions is to be
 addressed to the Editor of "Modern Wireless."*

*Nothing contained herein is to be regarded as permission
 or encouragement to infringe any patent rights.*

PROTECT your LIFE and PROPERTY from DAMAGE by LIGHTNING.

It is a fool's paradise where the aerial is earthed *inside* the house. We need not emphasise the invitation to danger. Nor need we *prove* just why you are completely protected by means of the SUCCESS EARTHAREL LEAD-IN SWITCH. A glance at the illustration will show you that the design of the SUCCESS EARTHAREL earths the aerial *OUTSIDE* the house. This will protect your set from damage.

The switch is connected either to aerial or earth by turning the knob fixed inside the house. THE SUCCESS EARTHAREL is weatherproof—their switching arrangements are protected by a metal cap.

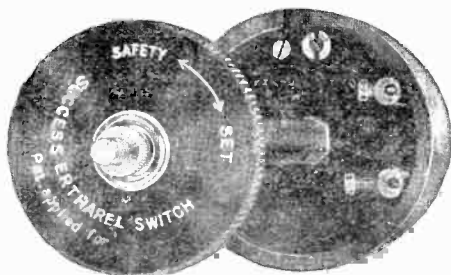

The SUCCESS EARTHAREL supersedes the old type lead-in-tube and forms as necessary a part of your wireless set as your aerial. Your dealer supplies.

PRICE 6/6 EACH.

PROTECTS your SET from LIGHTNING

OUTSIDE HOUSE.

TRUE AERIAL

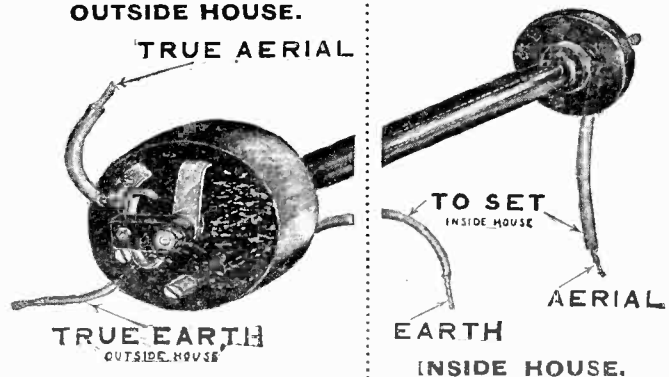

**TRUE EARTH
 OUTSIDE HOUSE**

**TO SET
 INSIDE HOUSE**

**EARTH
 INSIDE HOUSE.**

—for power and for volume

For reason of current economy L.F. stages may be reduced by the employment of power valves. The very high voltage passing through the primary of a transformer behind a power valve will break down the insulation of the primary; a common fault of ill-designed transformers.

The successful employment of Power Valves renders the choice of L.F. transformers a very serious consideration which is simply overcome by fitting the SUPER-SUCCESS (All Black) Transformer.

PRICE 21/-

Advertisement of Beard & Fitch Ltd., London, E.C. 1.

*Right the
wrong's of your
Valve System*

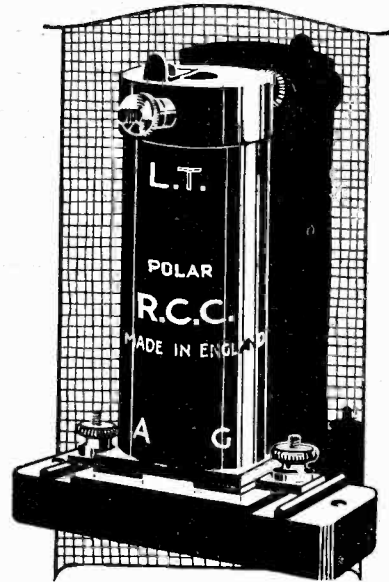

**POLAR RESISTANCE
CAPACITY COUPLING UNIT**

The greatest victory over distortion has been won by the abolition of the iron-core transformer in valve-coupling—and by its replacement with the Polar Resistance Capacity Coupling Unit.

Because of the inductive effects, the self capacity effects and the eddy-currents in iron, the transformer system of coupling will always create distortions and differences in electrical vibrations according to variations in frequencies.

By the use of the Polar Resistance Capacity Coupling Unit such vibrations are handed from valve to valve with all frequencies treated evenly.

Thus the Unit is designed to act in place of the transformer, and at the same time to give such purity of reception as has never before been found possible.

PRICE 15/-

Fully-Descriptive Leaflet on Request.



**The NEW
POLAR
RHEOSTAT.**

By means of an ingenious device this rheostat makes provision for a movable bobbin, which can be interchanged according to the resistance required as determined by the type of valves used.

PRICE COMPLETE 5/6

Illustrated Leaflet on Request.

These Polar Products are obtainable from all Polar Stockists throughout the Country, or may be purchased direct where no authorised dealer exists. Every purchaser is protected by the Polar Guarantee of quality and perfection.



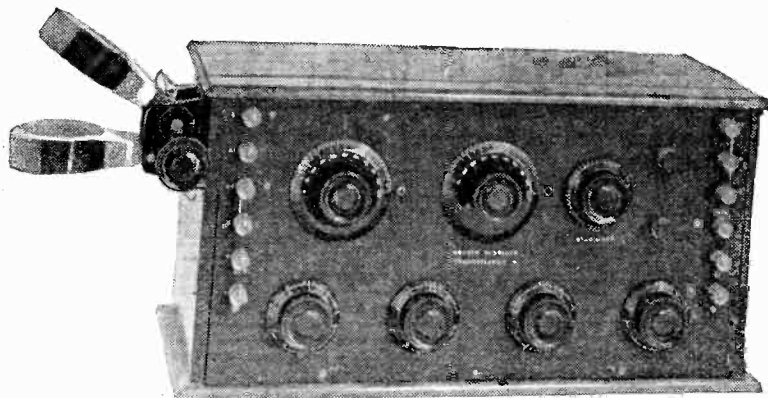

The "Transatlantic Four" with coils in place.

THIS month I am giving the third of a series of designs for wireless receiving instruments, to which I have given the name "Transatlantic." The first of these, using low-capacity valves of the V.24 and QX type, appeared last November, just a year ago, and was followed in December by a suitable note-magnifying unit. The second Transatlantic design, that is, the "Transatlantic Five," appeared in our issue for June, and contained in one cabinet the two stages of high-frequency, a detector, and two resistance-coupled note magnifiers. The feature of this second receiver was the use of four-pin valves in low-capacity sockets. The present receiver is, perhaps, the most compact of the three, and by using two stages of high frequency, a detector and one transformer coupled note magnifier, is economical in valves. Furthermore, the valves and plug-in transformers are contained within the cabinet, the panel itself being reserved for terminals and controls only. This makes for compactness and a neat appearance.

Special Features

The special feature of all three instruments is the use of two stages of high-frequency tuned by a double condenser, the transformers and condensers being matched for simultaneous tuning.

The use of two stages of high-frequency tuned in this way gives to the set a remarkable sensitivity, so that without using the note-magnifying valve there is no difficulty whatever on any reasonable aerial in receiving all of the British Broadcasting stations, a number of those on the Continent, and at suitable times during the night, signals from several of the American Broadcasting stations, in the phones. The first Transatlantic

receiver had but three valves, *i.e.*, there were no note-magnifying stages attached, these being reserved for a separate cabinet. The second design, as above explained, included two resistance-coupled note-magnifiers. The present receiver has but one stage of low-frequency amplification, but owing to the fact that this is transformer-coupled very high amplification is obtained. The strength of signals from the detector valve being in most cases sufficient to work a loud-speaker with only one stage of note-magnification, the signal strength is only slightly less than that obtained with the Transatlantic V, while the compactness and convenience of the design will doubtless appeal to many who wish for a good long-range receiver.

A Detailed Examination

Coming to the detailed examination of the instrument, there are

The "Transatlantic Four" Receiver

A New Modification of a Popular Design.

By PERCY W. HARRIS,
Assistant Editor.

In this receiver the valves and transformers are totally enclosed.

six terminals at each end of the panel, the upper four on the left being concerned with the aerial tuning. When the aerial is connected to the topmost terminal, and the link between A_2 and E is closed, we have a constant aerial tuning condenser of $.0001 \mu F$ in circuit with a $.0005 \mu F$ variable condenser in shunt across the tuning inductance, which is plugged into the two-coil holder.

Aerial Tuning Changes

With the aerial transferred to A_1 we cut out the constant aerial tuning condenser and use the set with capacity in parallel across the tuning coil. With the link open and the aerial connected to A_2 the variable condenser is now placed in series with the inductance coil for short waves. The remaining two terminals at the bottom left-hand side of the panel are for the low-tension leads. On the right we have three separate positive high-tension terminals, and the common

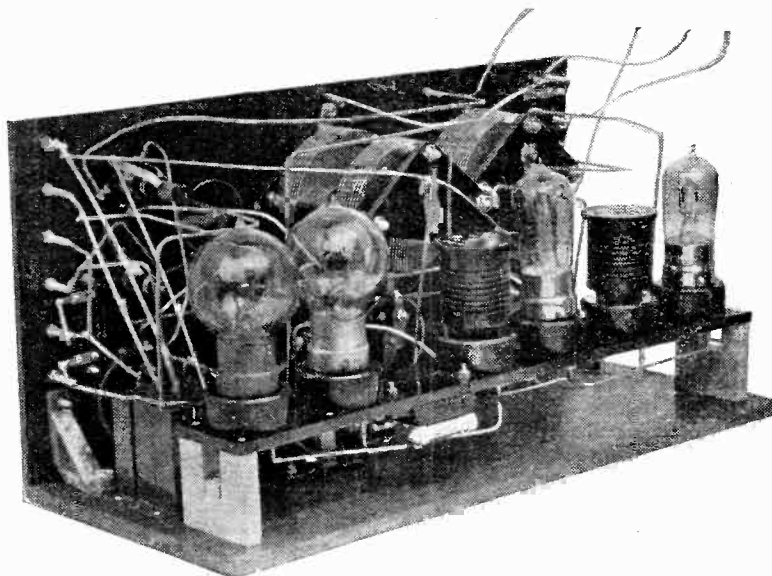

When the panel is withdrawn, the valves and H.F. transformers can be seen mounted to the rear.

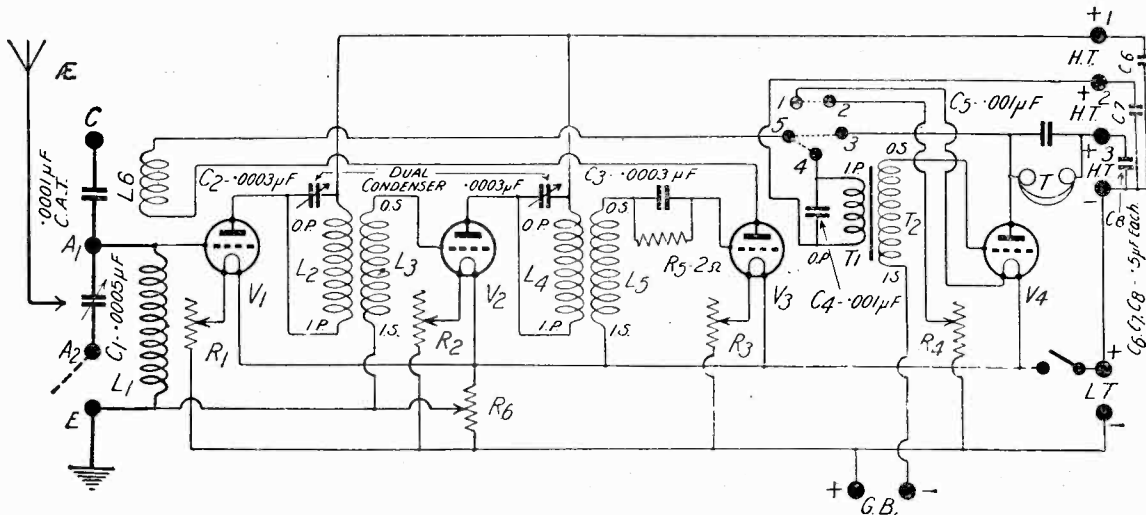

Fig. 1.—The complete theoretical diagram, showing switching arrangements.

negative, enabling us to apply different voltages to the two high-frequency valves, the detector and the note-magnifiers. Within the cabinet connections are provided for joining up a grid bias battery, so that with a suitable adjustment of the plate voltage and grid voltage, a power valve can be used efficiently. The lower two right-hand terminals are for the telephones or loud-speaker.

The two dials control the aerial tuning condenser (whether in series or parallel) and the double condenser which tunes the two primaries of the high-frequency transformer. To the right of this tuning condenser is the control knob of the "stabiliser" (or potentiometer, as it is often called). Still further to the right are two push-pull switches, the upper one serving to cut in or out the last valve (extinguishing the filament or lighting it as required), while the lower one is a simple on-and-off switch for the accumulator. At the bottom of the panel are situated four filament resistances of the dual type, so that either bright or dull emitter valves can be used.

A Useful Arrangement

Withdrawn from the cabinet, the inner constructional details can be clearly seen. By adopting this arrangement it has been found possible to arrange the valves and high-frequency transformers in a straight line, while it has been possible to separate the high-frequency transformers from one another by a slightly greater distance than in previous models. The use of special low-capacity valve holders for both valves and transformers removes some of the difficulties attendant upon the use of four-pin valves in such a circuit.

In designing the instrument space has been allowed for the round bulb valves if these are used. The disc type of plug-in transformer can be used in place of the barrel type if desired, as there is room for either pattern.

Here is a list of the components used. The names of the actual makes adopted in the present set have been given, but it must not be imagined that other makes of equal quality cannot be used just as well.

Components

One cabinet of polished wood to take a panel, 16 in. by 8 in. by 1/4 in. The box must have an internal depth of not less than 8 in. and should be fitted with a sliding base so that it can be withdrawn from the cabinet with the panel attached. The actual cabinet used

is of the same dimensions as that in my "All-Concert-de-Luxe" receiver, and is already available on the market in a number of makes.

One panel of above dimensions in guaranteed ebonite. The actual panel is a "Pilot." Other makes I can recommend from personal experience are "Radion," "Bowyer-Lowe" and "Paragon." (All of these are free from surface leakage).

One strip of similar ebonite, 16 in. by 2 in. by 1/4 in.

Two brackets to hold panel vertically on the base board. (I have used stair-rod eyes.)

Twelve terminals.

Two Clix plugs.

Four filament resistances (dual type if it is desired to use both bright and dull emitters.) Those used are made by McMichael.

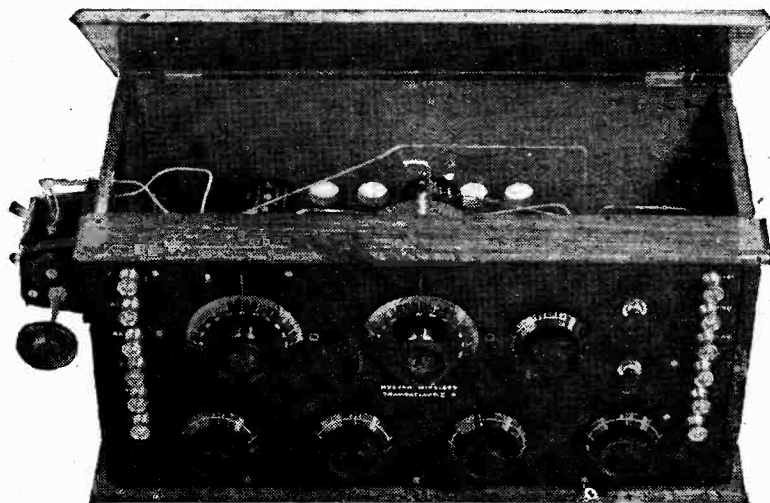

Valves and transformers are easily changed by lifting the lid. The holes in the rear of the cabinet are not necessary in this instrument.

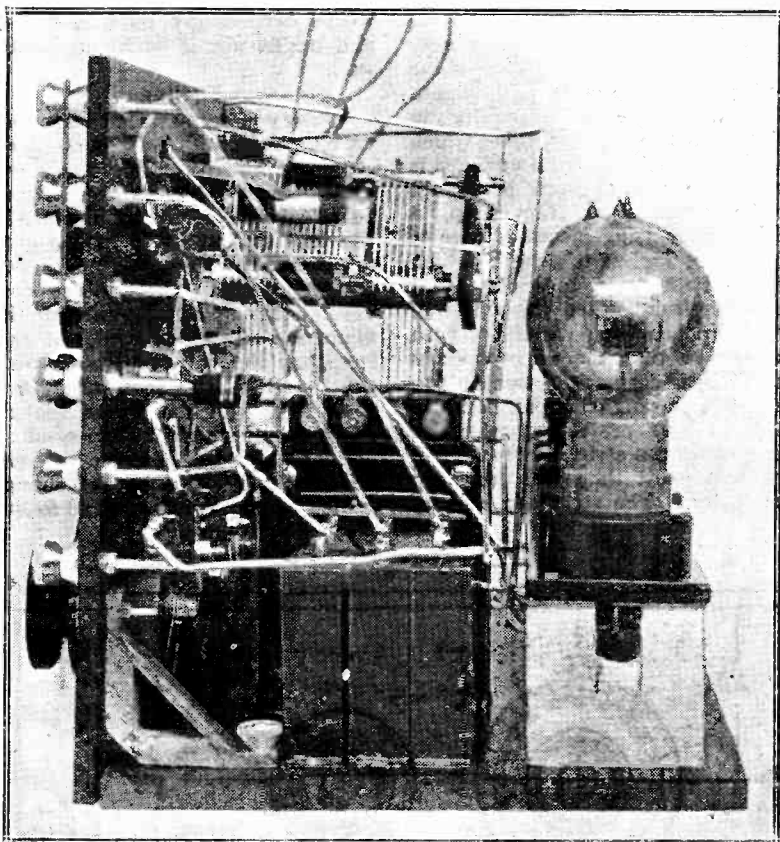

End view of the instrument withdrawn from cabinet.

Similar dual resistances made by Burndept, Ltd., have been illustrated in previous designs of mine.)

One potentiometer (McMichael).

One square law variable condenser .0005 μ F.

One square law double condenser .0003 μ F.

There are now a number of square law condensers on the market. Those shown are Bowyer-Lowe. So far as the double condenser is concerned, it is essential that this shall be well matched, which some of the cheap double condensers are *not*.

Three .5 μ F fixed condensers (Mansbridge).

One fixed condenser .0001 μ F.

Two fixed condensers .001 μ F.

One fixed condenser .0003 μ F with clips and grid leak of two megohms. (All above fixed condensers are Dubilier.)

One good make intervalve transformer. (That shown is the new type of Igranac—5-1 ratio.)

One five point push-pull switch (Lissen).

One on-and-off switch (Lissen). (This has three contacts. Use only two.)

One two-coil holder. (I have used a new design by Peto-Scott which is particularly suitable for the present instrument.

Six anti-capacity valve sockets (H.T.C., Type A.)

One or more pairs plug-in transformers to cover the wavelength ranges desired. (These must be properly matched. I have used McMichael, Bowyer-Lowe, and Gent quite successfully in the present instrument.)

Plug-in coils for various wavelength ranges as explained at the end of the article.

Square section wire for wiring, screws, etc.

A number of advertisers are now specialising in complete sets of parts for the various receivers described in this book. This may save some colonial and foreign

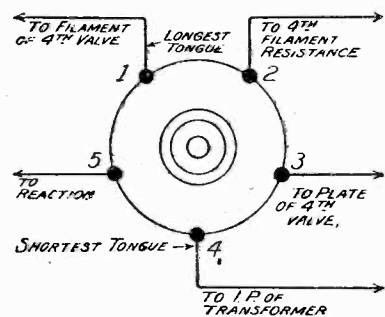

Fig. 2.—Details of push-pull switch wiring, viewed from back of panel.

readers the trouble of sending a number of small orders to different firms.

Constructional Work

The best way to start work is to lay out the front panel carefully from the diagram given (of which a blue print full size is available at the usual price of 1s. 6d., post free from the publishers). Notice that the panel is attached to the baseboard by screws along its bottom edge and also by the two brackets referred to in the list of components. Allowance should be made for the thickness of the baseboard when you are preparing to attach the brackets to the ebonite. The two Lissen push-pull switches are of the "one-hole-mounting" type and the five points type should be arranged so that the screw to which no blade is attached (this makes contact with the central spindle) is in the position marked in the separate switch diagram.

Making Out the Strip

The next step is to mark off the ebonite strip which carries the valve sockets. This is fairly easy, as the H.T.C. people supply a template with their valve sockets to facilitate marking out. Notice, too, that the .0003 μ F condenser and grid leak are mounted on the *under* side of this strip, to facilitate wiring. You will also need two small pieces of wood as supports of the ends of the strip. I have not given the dimensions of these or included them in the list of component parts, as they can easily be cut from any odd pieces of wood which may be convenient. They should support the strip well above the baseboard. The baseboard itself carries, as you will see, the intervalve transformer and one of the .001 μ F fixed condensers. The space at the aerial end of the baseboard can be utilised for the grid bias battery, which can lie on its side and be connected by the Clix terminals. Unless you are using a very high voltage on the last valve, you will probably get very good results by connecting the two Clix together, thus avoiding the use of the grid bias battery.

A Hint

It is well to mount your variable condensers and other components on the panel before you fix the transformer in place, as, owing to the different sizes of various makes of components, the position of the transformer you use may be slightly different from that of mine. The same remark applies to the three .5 μ F fixed condensers. These are used so that each H.T. tapping may be shunted by a large fixed condenser.

Wiring Up

The ebonite panel should now be taken, laid face downwards, and the wiring commenced. You will see that a good deal of wiring can be done on this before it is mounted on the base board. Before commencing to wire up, you should file the tops of all the screws that have to be soldered, being careful, of course, to remove the brass filings from the panel with a brush before proceeding. There is no special point of difficulty in wiring up this panel, but it should be explained that there are two screws which merely serve the purpose of securing the stiff wire in position so that it will not flop about. One of these screws happens to be the screw which holds the

When the back of panel wiring has been carried out this panel may be laid aside, and the wiring of the under side of the valve strip begun. You will have no difficulty in wiring up those connections which join one another on the under side of this panel. Where leads are taken away from the strip, I recommend using pieces of wire of about six inches in length which should be allowed to stick out at right angles. When the whole of the strip has been wired up, turn it over so that the valve sockets are in their correct position on top and, with a pair of pliers, bend up each of the projecting wires so that when the strip is attached to the baseboard they will stick up vertically. The strip can now be

works exceedingly well as shown, and might not if wired any other way.

Testing

When you are satisfied with your wiring, turn all the filament resistances to the "off" position, connect up the low-tension battery only, take a valve and place it in the first socket, push the on-and-off switch to the "on" position, and try to see whether the first valve lights up when you turn the filament resistance round. If this is so, try the valve in the second, third and fourth sockets. When the valve is in the fourth socket, the filament should be switched on and off, not only by the on-and-off switch, but also by the change switch which switches in the fourth

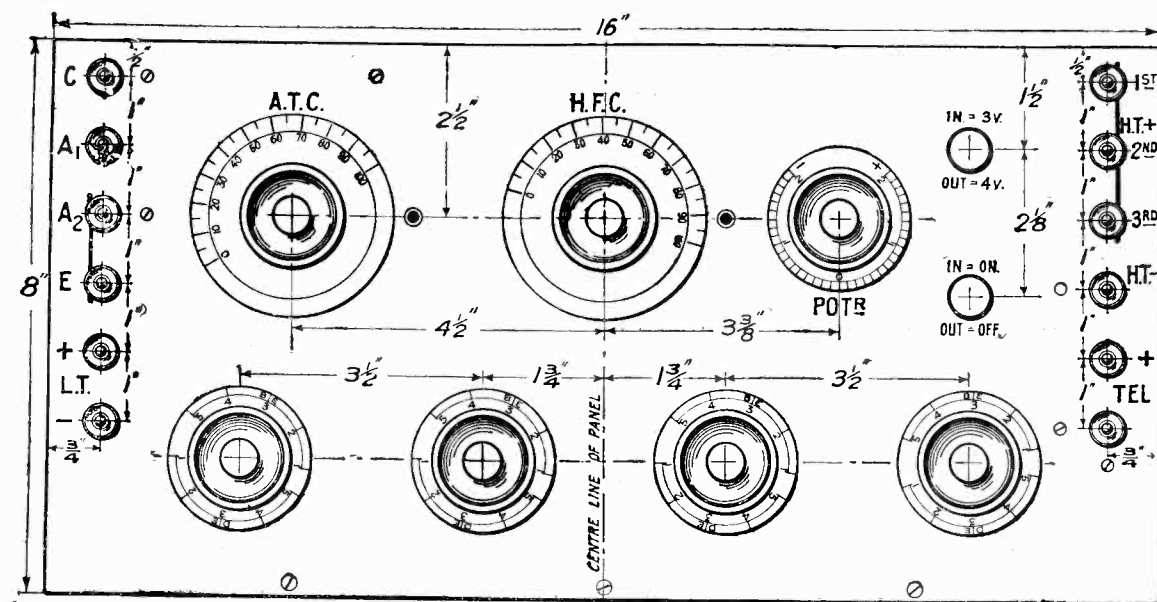

Fig. 3.—Drilling diagram of front of panel. (Blue print 72 A.)

constant aerial tuning condenser, and it should be noted that the long wire which comes to this screw is *not* connected to the condenser itself. It is simply soldered to this screw to hold it in place and to provide a firm lead from which the flexible lead of the coil-holder may be taken. Another such screw will also be seen on the panel to the left of this.

Four flexible leads are soldered to the points shown; these flexible leads are simply single strands of electric lighting flex from which the silk or cotton has been removed revealing the rubber. Four holes should be drilled in the side of the cabinet, so that these wires can subsequently be pushed through and attached to the coil-holder,

attached to its supports and fastened to the baseboard in its correct position.

A Wiring Tip

With these vertical wires sticking upwards, examine your wiring chart carefully and shape connecting wires from the various points. In some cases you will be able to bend the vertical wires to join up the positions you want. In others you will have to cut them off short. The wiring up is a little intricate, but if you carefully examine your diagram and make a point of marking off these wires which you have already connected the work will become easier as you proceed. I do not advise any departure from the wiring indicated, as the set

valve and at the same time lights the filament. If all of these arrangements work satisfactorily push the receiver into its place, thread the flexible leads through the side of the cabinet and fasten them to the coil-holder, which should already be in position.

Valve Hints

Place valves and transformers in position. So far as the valves are concerned the first two should be of the same make and should be suitable for high-frequency amplification while the detector and note-magnifying valves can be any of the general purpose types, or, in the last socket, one of the new dull emitting power valves, such as the B.4, D.E.5, etc., may be used with

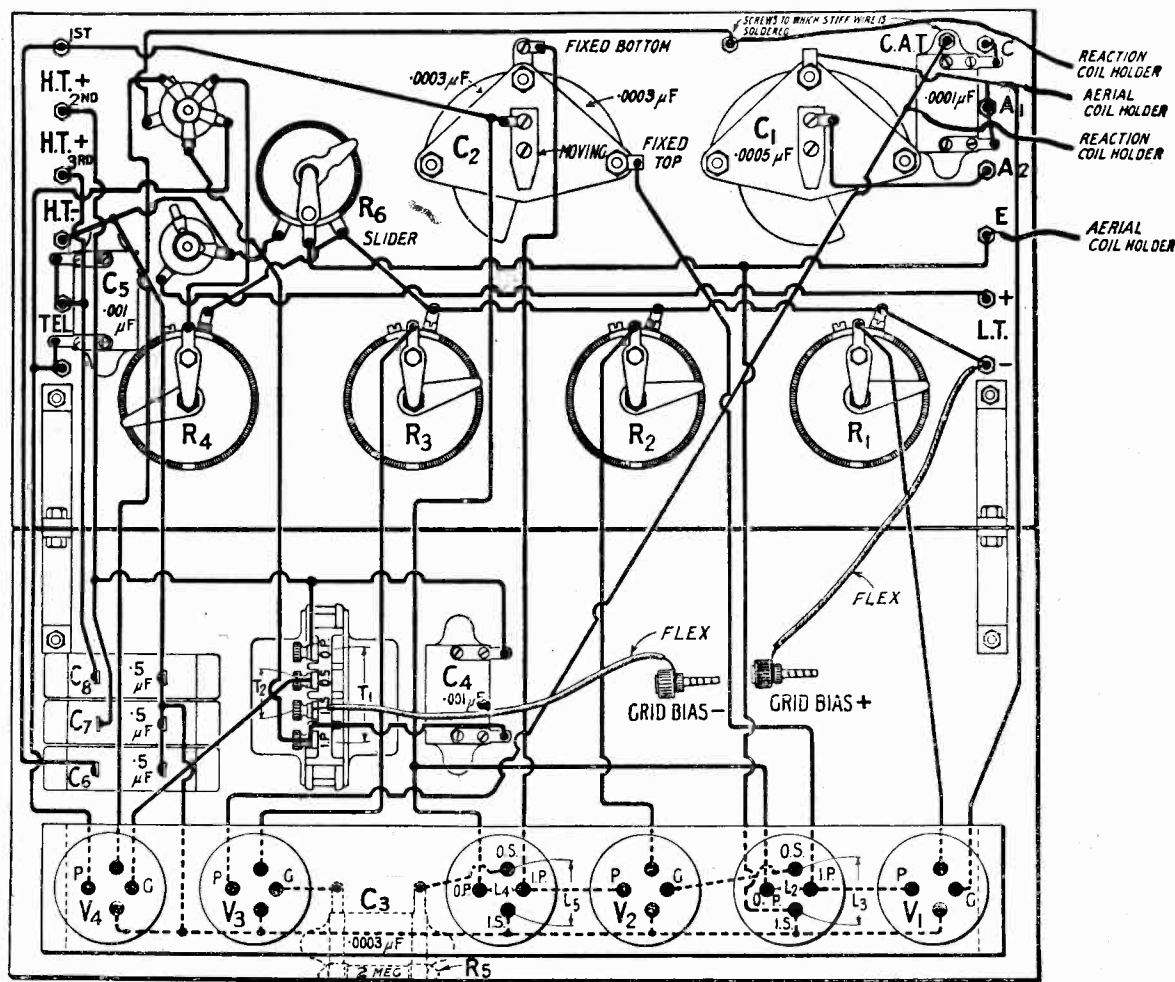

Fig. 4.—Wiring diagram showing front of panel and base as if in one plane. (Blueprint No. 72 B).

advantage. For these tests the two grid bias wires with their Clix terminals can be connected together. Now connect up the high tension battery, and for the time being join together H.T. 1, 2, and 3 by a piece of wire, as for the preliminary test you will not need separate high-tension. A pair of telephones should now be joined up, and about 60 volts of the high-tension battery used. On the left-hand side the aerial should be connected to A₁, A₂ and E should be joined together and the earth wire taken from E. Be particularly careful to see that you have your H.T. and L.T. leads connected the right way round.

Coils Needed

If you have an average-size aerial I suggest you plug into the fixed socket of the coil-holder a No. 25 coil, or if you are near one of the longer wavelength Broadcasting stations, a 35 or a 50. For Radiola and Chelmsford 150 in aerial and 100 in reaction will suit.

Plug-in transformers can be obtained for all wavelength bands. In the reaction socket plug a 25 or 35 coil, this coil being kept at right angles to the aerial coil. Push the change switch into the position which will give three valves only and adjust your two condensers until you hear the local station. For these experiments the "stabiliser" or potentiometer knob can be turned as far as it will go to the right. When you have tuned in your station, turn the stabiliser knob and see whether you can bring the set up to oscillation point. If you are only five or ten miles from a broadcasting station you will not get any increase of strength in this way, but if you are at a greater distance you will probably find that turning the potentiometer knob to the left increases signal strength gradually until you reach oscillation point. Now with the set well below oscillation point slowly move the reaction against the aerial coil. If this movement increases the strength of signals and makes the

set oscillate, all is well. If it reduces it or no oscillation is obtainable when this coil is moved close to the aerial coil, then reverse the connections to the reaction coil. In practically all cases the reaction coil should be kept at right angles, as only on very bad aerials or in difficult positions is reaction necessary on the broadcast wavelengths, as full control of the reaction is obtainable with a potentiometer. You can now try switching in the fourth valve, which should greatly increase signal strength.

If the set has been made correctly and all components are good, you should now have a most interesting time searching for the other stations. So far as results are concerned, I do not think there is much point in tabulating them, as I have not the slightest difficulty in picking up every one of the British Broadcasting stations, most of them being audible on the loud-speaker

(Continued on page 681.)



MANY plays have been broadcast, but none of them seems to me to have the pep that is needed to get not merely across the footlights but across the ether. Somehow all of them seem to lack vim, zip and driving force. None of them so far has moved me to tears; in fact, I cannot even remember writhing in my chair with suppressed emotion, running fevered hands through my hair, tearing off my collar, gnashing my teeth, or giving other signs that my deepest feelings were being stirred. Some time ago the B.B.C. advertised for plays suitable for broadcasting. I feel, somehow, that none of those submitted will quite come up to the standard, and in order that the Company shall not be disappointed I am presenting them free of charge with a thrilling drama of love and hate which you will find below. You will, I think, agree that it has the right atmosphere, and that if it were broadcast it would make even the most hardened loudspeaker choke a little. And now without further delay let me ring up the curtain.

The Play Begins

**RUN TO EARTH,
OR THE FOILER FOILED.**

Dramatis Personæ.

- PROFESSOR FORBIE.** A wireless experimenter.
 - PHONIA.** His daughter.
 - YUPUSHOFF.** His valet.
 - ANGELO.** A young inventor in love with Phonia.
 - PROFESSOR M. A. BLOWSKI.** An expert witness.
 - SERGIUS NASTIKOFF.** A villain.
 - GENERAL CHUCKERSLEY.** Chief Engineer of the Electronian Broadcasting Company.
 - ARTHABUROWSKI.** Director of Programmes.
 - BARON PUSHEMOFF.** Chief Justice of Electronia.
 - E.B.C.** Inspectors, Listeners-in, Counsel, Jurymen, etc.
- Scene:—The Village of Czrwkxzy in the Wilds of Electronia.*

**Act I.
Scene I.**

Professor Forbie's Study

(A spacious apartment, though nearly all the available space is occupied by receiving sets, accumulators, condensers, high tension batteries, coils of wire and loudspeakers. The Professor is seated at the table with the phones on his head, tuning in. As the curtain rises he leaps from his chair, tears off the phones, flings them on to the floor, dances on them, hits his pet corn a nasty one

Borne o'er the Atlantic's never resting waves.
But have I heard it? Well, as man to man
No toot from flute, no boom from big bassoon
Has come to glad these straining ears of mine.
All I have heard is squeaks and yells and howls,
Like those of some lost soul in torment dire.
Squeak, squeak they go, now up, now down the scale

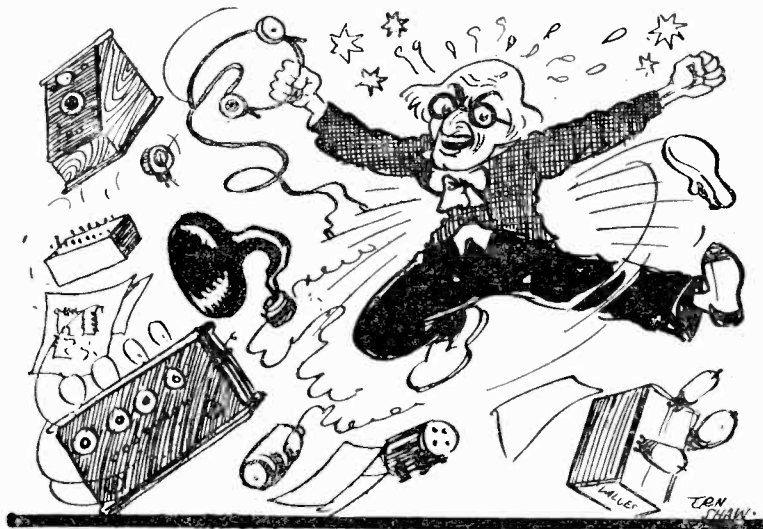

and subsides into a chair. After a moment he gets up and advances to the front of the stage.)

PROF. :
These oscillations whizzing in the air
Make so much noise that both mine ears are deaf.
Observe the clock; the hands mark half-past three
A.m., and here I've sat since kindly dusk
Began to draw her mantle o'er the land.
And all the time I've fiddled with controls,
Striving to hear the strains of music sweet

With ne'er a moment's peace for listeners-in.
This was a joyous village once, but now
There lurks a villain in our midst whose hands
Are ever twiddling knobs, now this, now that.
And worse than that, there is a troubler who,
Using a spark set perfectly un-tuned,
Is audible on any wave you like.
Dot, dash I hear, and then a pause, dash, dash.
A pair of dots, a pause, then dashes three,

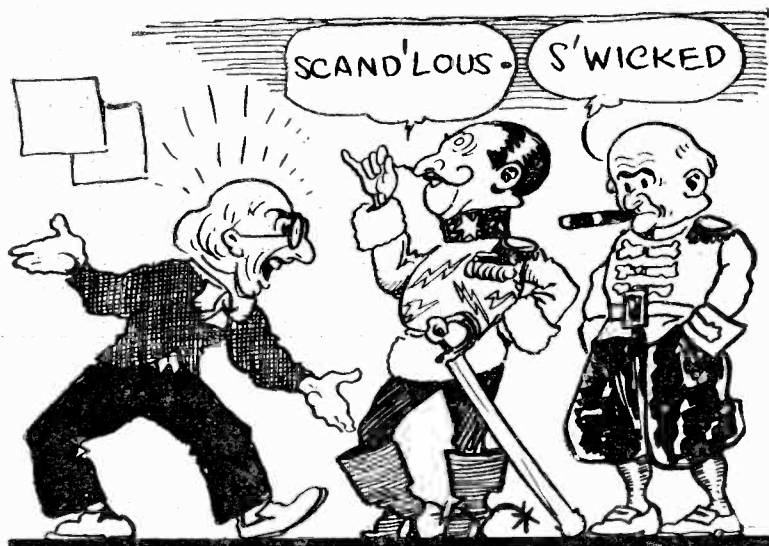

Dash, dot, dash, pause, then dash,
dash, dash, and then
Come two more dashes ere he
switches o'er.
"Am I O.K. old man?" he
buzzes out.
O.K., I ask you! If I could but
find
This welkin-rending ether hog,
I'd put
The lid on his performances. Ah
me!
I hope that he may burn out all
his valves,
Mistaking H.T. plus for L.T. neg.
May his condensers leak, his
batteries
Buckle their plates or burst their
waxen tops.
May housemaids filled with tidy-
ing zeal lay waste
His wireless den; may all his
leads come loose;
May his transformers go up in
blue flames,
His coils go cranky; and may
circuits short
Be with him always bringing
black despair.
And may his aerial fall about his
ears,
His earth dry up, and horrid
hidden faults
Develop in his gear day in day
out.
I'll stand no more of it; I'll hunt
him down;
I'll loose the dogs of war and we
shall see.

(Rises and rings bell. Enter
Yupushoff.)

Yu.: You rung, sir?

PROF.: Of course I did. Did
you think it was an atmospheric?
Don't ask silly questions. Go to
the telephone, dolt, and get me the
Electronian Broadcasting Company.

(Exit Yupushoff. Professor Forbie
sinks into a chair and closes his eyes.
Re-enter Yupushoff.)

Yu.: Number engaged, sir.

PROF.: Away! Don't talk to me
about numbers engaged. Get me
the E.B.C., and quick about it.

(Exit Yupushoff hastily. The
Professor sits drumming with his
fingers on the table. Some time
elapses. Re-enter Yupushoff with
telephone which he plugs in and
hands to the Professor.)

PROF.: Hullo, is that the E.B.C.?
Speak up, can't hear. You're not?
Then why couldn't you say so at
once. (Rattles telephone and has
altercation with exchange.) I'll get
you the sack. I'll . . . Oh is
that the E.B.C.? Professor Forbie
speaking. I wish to lodge a com-
plaint about interference and illegal
transmission. No, no, I did not
say unequal emission. Illegal
transmission. Very serious case.
Goes on continually. Cannot hear
myself think. What's that? You
will send down in the morning?
Good. One can always rely upon
the E.B.C. to act promptly.
(Hangs up telephone receiver. Rises
yawns and puts on a ferocious
expression.) And now my inter-
fering friend, we'll see.

SCENE II.

The Same, the Next Afternoon

(Professor Forbie is sitting at his
desk. The door opens. Enter
Yupushoff.)

Yu.: General Chuckersley and
Arthaburovski, sir.

(Enter General Chuckersley in the
full-dress uniform of Chief Engineer
of the E.B.C. White tunic trimmed
with fur and slashed with zig-zag
lines of blue, scarlet breeches and

patent leather top boots. Gilt spurs
worn upside down. Sword with
diamond studded hilt. He is accom-
panied by Arthaburovski wearing
the more modest undress uniform
of Director of Programmes. Green
tunic with buff facings, purple
velvet plus fours, silk stockings and
buckle shoes.)

PROF.: Welcome, gentlemen,
welcome. I knew that you would
not desert me in my hour of need.

GEN.: Professor, it is the proud
boast of the E.B.C. that when a
cry for help such as yours is
received we attend to it instant-
ly. Tell me all about it. Lay bare
your wounded heart and you shall
hear how our mighty organisation
will bring all its forces to bear.

ARTH.: I would like to second
those remarks. I cannot have my
programmes interfered with, and
if there is a criminal in your dis-
trict, then we will hunt him down
and hang him from the highest
aerial.

PROF.: I will tell you everything
about this terrible business. You
will excuse me if I seem a little
overwrought, for in me you see a
strong man brought to the verge
of madness.

(Both make sympathetic noises.
The Professor tells his tale. They
listen eagerly, interjecting every now
and then in chorus 'scandalous,'
'unthinkable,' 'disgraceful,' 'not
to be borne'.)

GEN.: Professor, we thank you.
This is indeed a dreadful case. We
will mobilise at once the sleuth
hounds of the E.B.C., and it will
not be long before you see the
offender in the chains which he so
richly deserves.

PROF.: I thank you. Your hands
upon it. (They all shake hands.
The curtain descends slowly whilst
they are doing so.)

Act II.

The Next Day, Angelo's Study

(This is rather like the Professor's,
only it is smaller, and it is even more
cluttered up. Besides wireless sets,
Angelo has hundreds of other gadgets,
for he is an all-round inventor. He
is sitting at a table fiddling with
something as the curtain rises.)

AN.: At last I have it. For
many weary weeks I have worked
and puzzled and puzzled and
worked over my patent corkscrew,
and now it is perfect. Think what
it means to me. When I first
sought the hand of the beautiful
Phonia, I was but a poor lad and
the Professor would not believe
that I had any prospects. But
now I am sure of selling my cork-
screw to the great Novelty Syndi-

cate and my future is assured. Let me just try it once more to see how perfectly it works. *(He whacks a cork hard into a bottle, inserts his patent corkscrew and heaves. The neck of the bottle breaks). Tut, tut. I suppose I was careless. Let's try again. (A thunderous knocking on the door.)*

VOICE WITHOUT: Open in the name of the E.B.C.

(Angelo, still clutching his corkscrew, opens the door. Enter phalanx of E.B.C. Inspectors with drawn swords.)

FIRST INSP.: Angelo, you are suspected of causing interference in the ether.

AN.: Please, sir, it wasn't me.

SEC. INSP.: See, we have him red-handed! At this very moment he is holding an ingenious tapping key.

CHORUS OF INSP.: We have the villain! Away with him. *(Enter Phonia.)*

PHON.: Angelo, what is this? You arrested for interfering? Oh, it cannot be. Tell me that you are guiltless.

AN.: Phonia, I swear to you that I am innocent. Never was a man more unjustly charged.

FIRST INSP.: That's what they all say. Come along quietly now and remember that anything you say will be taken down and used as evidence against you.

(Phonia flings her arms round Angelo's neck.)

PHON.: You shall not take him.

SEC. INSP.: Break away there.

(The Inspectors close round Angelo, who is led away still protesting his innocence. Phonia sinks half-fainting into a chair.)

PHON. *(recovered)*: There is foul play here. But Phonia Forbie will show the world that the women of Electronia can foil villains as successfully as those of Los Angeles. My Angelo shall not die. I will prove his innocence to the hilt!

(Curtain.)

Act III.

The Village Green of Czrwkzy.

An open air court has been rigged up, with a seat for the judge upon the dais, jury box, witness box and so on. In the centre of the court is an iron cage awaiting the prisoner. Crowds of villagers whose flattened ears prove that all are listeners-in gather round. A funeral march is being played by the 220 Military Band. Baron Pushemoff enters and takes his seat. Fanfare of trumpets. The jury enter and are sworn. Counsel and witnesses take their places in the court.

BARON PUSH.: Bring in the prisoner.

(Angelo, loaded with chains and looking very pale, is brought in and thrust into the cage.)

BARON PUSH.: Let the trial begin. Prisoner in the cage, are you guilty or not guilty of this dreadful charge brought against you?

AN. *(firmly)*: Not guilty.

BARON PUSH.: Call the first Inspector.

FIRST INSPECTOR *(all in one breath)*: On Thursday, the 21st instant, at 4 o'clock in the afternoon, acting on instructions received, I took a search party to the prisoner's house, where having gained admittance we found him with an ingenious tapping key actually in his hands.

BARON PUSH.: H'm, h'm. *(To Angelo)*: Well, what have you got to say to that?

AN.: It was not a tapping key at all. It was my new patent corkscrew.

BARON PUSH.: Well, even a corkscrew is useful for tapping.

(Laughter in court. It is instantly suppressed by the guards, who poleaxe three peasants.)

BARON PUSH.: Call Professor Blowski.

(Professor Blowski enters the witness box and is handed the corkscrew.)

BARON PUSH.: You are an inventor, I believe.

PROF. BLOW *(modestly)*: Er-yes. In fact, I have just been thinking out a little idea for installing a ventilating system in judges' wigs. Perhaps your lordship remembers the little pressure gauge attachment which I designed for babies' feeding bottles?

BARON PUSH.: Quite so, Professor, quite so. Now tell me what is the instrument which has been handed to you?

PROF. BLOW. *(after examining the corkscrew carefully)*: This is quite obviously a novel and rather ingenious tyre lever. I could improve upon it a little by . . .

BARON PUSH.: Yes, yes, but I am informed that it is a tapping key. Look at it again, Professor.

PROF. BLOW.: Why, now you come to mention it, it is of course a tapping key. If your lordship will allow me I will explain how it could be improved in a very simple way.

BARON PUSH.: That will do, thank you, Professor. I am sure the court is greatly obliged to you for the clear way in which you have delivered your expert evidence. *(To the jury)*: Gentlemen of the jury, you have heard the charge brought against the prisoner and you have heard his defence. You have heard also the very definite statement by Professor Blowski, the leading expert in everything. It is for you to decide whether the prisoner is or is not guilty of the heinous crime of causing interference in the ether by transmitting illegally. It is not for me to bias your judgment in any way. I will merely say that when a man is caught red-handed by inspectors of the E.B.C. in the possession of what is undoubtedly a tapping key, it does look, if I may say so, very black, very black indeed. You will now consider your verdict.

(The jury leaves the box and is making for the Dog and Duck on the far side of the village green when it is gently shepherded away by the





guardians. The judge closes his eyes in deep thought. There is a buzz of conversation in court, which is kept within limits by the guardians with their poleaxes. The 220 Military Band continues to play mournful music. Some time elapses. The jury return, filing slowly into the box.)

CLERK OF THE COURT: Gentlemen of the jury, have you considered your verdict?

FOREMAN: We have.

CLERK: How say you? Do you find the prisoner in the cage guilty or not guilty?

FOREMAN: Guilty on all counts.

(The clerk gently prods the judge in the ribs. The judge hastily stifles a yawn and the clerk whispers into his ear.)

BARON PUSH: Prisoner in the cage, you have been found guilty after a fair trial by your fellows. The sentence of the court is that you be hanged forthwith from the highest aerial in the neighbourhood. The Court of Justice will now close down. Good-day, everybody, good-day.

(The guardians open the cage and are about to lead Angelo off to the place of execution, when a scream is heard from the back of the crowd and Phonia is seen pushing her way through and waving something wildly.)

PHON.: Stay, stay! Injustice has been done! You cannot hang him! He is innocent! I have clear proof here.

(She rushes to the judge's seat and slaps an undoubted tapping key on to the desk before him.)

BARON PUSH: Well, young lady, what's this?

PHON.: See, see! I knew that Angelo was innocent, but I could not find the proof until the last moment. As I waited upon the edge of the crowd Sergius Nastikoff was in front of me and I saw this knob protruding from his coat tail pocket. It is he, not Angelo, who is the guilty one.

BARON PUSH: Let Sergius Nastikoff be placed in the cage.

(They do so. The case is heard. Sergius is found guilty by the jury without their leaving the box. Angelo is brought forward again and honourably acquitted without a stain upon his character.)

BARON PUSH: And I would like to say, young man, that I am distinctly taken with this patent corkscrew of yours, which I propose shortly to test. As President of the Electronia Novelty Syndicate, I think that I can promise you one million likars for your great invention.

(Phonia flings her arms round Angelo. Sergius is led off to the chosen aerial. Angelo and Phonia advance to the centre of the stage, whilst the crowd forms a semi-circle round them. The 220 Light Orchestra strikes up the Wedding March.)

AN.: Saved! By a woman's wit, the foul villain is run to earth!

(Curtain.)

THE LISTENER-IN.

A Reader's Results with "Tri-Coil" Sets.

To the Editor of MODERN WIRELESS.

Sir,—I have been experimenting for the past fortnight with the "All Britain" receiver with tri-coil tuning, as described in the September issue of MODERN WIRELESS, and the tri-coil "Puriflex" (Fig. 18) in the article on the tri-coil system of tuning on page 350 of the same issue.

I used only the materials I had in my junk box, so many of the values were altered to suit what I had. I used three-ply wood highly polished for the "All-Britain" panel.

I am pleased to report that I have obtained the following results with the "All Britain":—

(a) Better tone in the loud-speaker and purer reception than I have obtained before (and I have tried out nearly all the circuits in "More Practical Wireless Circuits," embodying any unusual methods as well as a great number of other circuits.)

(b) Absolute selectivity although only two circuits to tune. This is a strong point, as many experimenters can testify.

(c) Great ease of tuning in either C.A.T. or series or parallel. One can turn the second condenser immediately to the figure representing the station required and then bring the aerial condenser up to it.

(d) With a B.T.H. power valve on L.F. it will give loud results on an Amplion loud-speaker sufficient for a small hall from Cardiff or Bournemouth, whilst with the addition of another power valve amplifier (single valve) and an ordinary type of valve on the first L.F. it will give thoroughly good loud-speaker results on distant stations.

Regarding the tri-coil "Puriflex"—

(a) This has the same selectivity as the "All Britain." With a single-valve power amplifier added, I have received Manchester and London on loud-speaker whilst Cardiff and Bournemouth were working, without hearing the other stations. Loud-speaker strength on Cardiff without any extra amplifier, also on Bournemouth. I consider this good for resistance coupling.—Yours truly,

R. H. CARTER,
Secretary of the Somerton and
District Radio Society.
Somerton, Somerset.

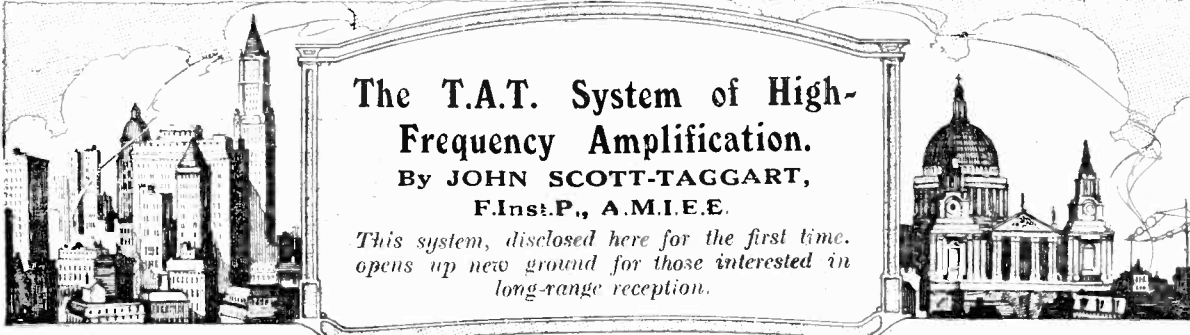

The T.A.T. System of High-Frequency Amplification.

By JOHN SCOTT-TAGGART,
F.Inst.P., A.M.I.E.E.

*This system, disclosed here for the first time,
opens up new ground for those interested in
long-range reception.*

This article forms a part of the series on "Multi-Stage High Frequency Amplification."

Introduction

IN my series of articles on multi-stage high-frequency amplification I have gone into the subject more thoroughly, probably, than has been done before, and it is hoped that full emphasis has been laid on the fact that self-oscillation in high-frequency amplifiers is due to inductive or capacitive coupling of an unintentional nature, and that of the two the inductive coupling is the easier to overcome. Toroidal coils may be used, or the coils may be shielded from each other by enclosing them in metal cases.

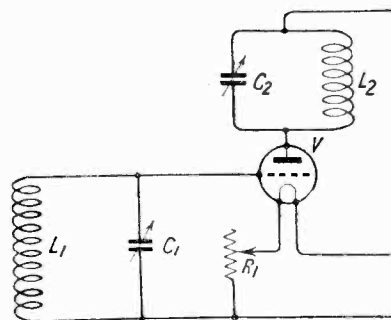
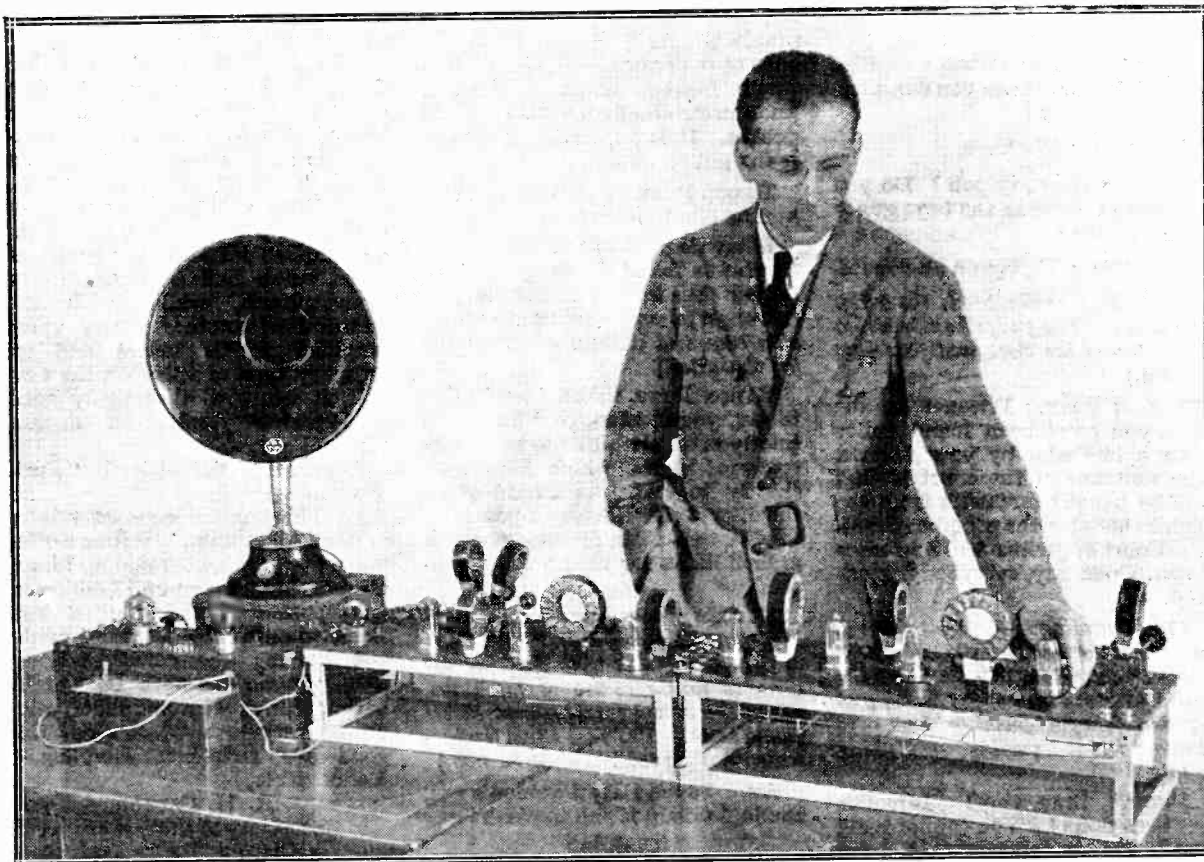

Fig 1.—Tuned anode and grid circuits have an inherent tendency towards self-oscillation

I have also emphasised the fact that a high-frequency transformer with so-called aperiodic primary and tuned secondary very strongly resembles a tuned anode circuit in its operation, and that the method of coupling may be replaced by a tuned anode circuit, the only important difference being that as the coupling between the primary and secondary of the high-frequency transformer is loosened, so does the arrangement differ more and more from the ordinary tuned anode circuit. The result, of course, is that as the coupling is loosened, the aperiodic anode coil begins to act more as such, and self-oscillation



The Author experimenting with a 10-valve set, using 7 stages of T.A.T. high-frequency amplification.

tendency decreases. This, of course, is very valuable when desiring to stabilise a high-frequency amplifier, but no enterprising manufacturer has seen the enormous market for a high-frequency transformer of small dimensions with variable coupling between the windings. Until somebody else besides myself wakens up to this fact, those who desire a variable coupling will use ordinary inductance coils which are much too big for multi-stage work, owing to their big inductive coupling effect between each other, not to mention the big capacity coupling which also increases with the size of the coil.

However, to return to the immediate subject under discussion. I was anxious to lead up to the particular method of high-frequency amplification which I am about to describe, and those readers of MODERN WIRELESS who have studied my articles on this subject during the last few issues will, I hope, fully appreciate the technical

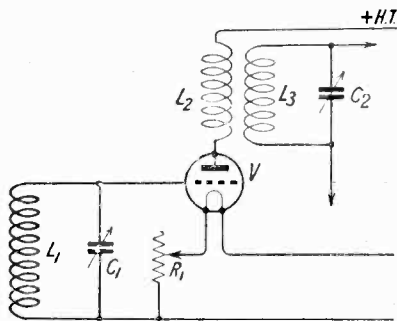

Fig. 3.—A tuned transformer stage is really equivalent to the Fig. 1 circuit.

arrangements described below under the description of the T.A.T. system.

I pointed out that self-oscillation in practically every case was simply due to the fact that in the grid circuit and in the anode circuit were two tuned oscillation circuits, and that when these two circuits were tuned to the same wavelength self-oscillation was highly probable.

Let me summarise some results by Figs. 1, 2 and 3 in this article. Fig. 1 shows a tuned grid circuit $L_1 C_1$ and a tuned anode circuit $L_2 C_2$. When these two circuits are tuned to the same wavelength, the valve will readily oscillate on the slightest provocation, *i.e.*, when there is the slightest magnetic coupling between L_2 and L_1 or the slightest capacitive coupling between the two circuits. This capacitive coupling may take effect due to the capacity between L_2 and L_1 or the capacity inside the valve between grid and anode. However it takes place, the fact

remains that this circuit oscillates very readily, and especially so if the condensers C_1 and C_2 are kept at low values, which, of course, is desirable if maximum build-up is required.

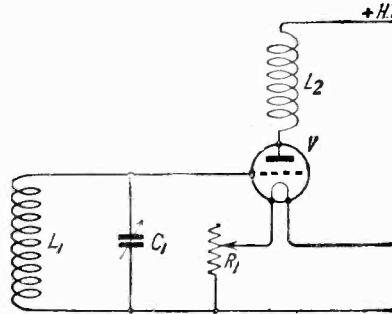

Fig. 2.—An aperiodic H.F. stage which normally will not oscillate.

In Fig. 2, however, an aperiodic anode coil L_2 will prevent the valve oscillating, except in one special circumstance, and this should be very carefully noted, because this circumstance often occurs when working a wireless receiver and produces what, to the beginner, are unexpected results. The coil L_2 is not really aperiodic, but is shunted by a capacity which is really a composite capacity formed of the self-capacity of the coil, the capacity across anode and filament of the valve, etc., etc. If the circuit $L_1 C_1$ happens to be just tuned to what we may call the natural wavelength of the coil L_2 and its associated capacities, then the valve will oscillate readily. This effect is noticed on an ordinary reaction receiver if too large a reaction coil is employed. A No. 100 or a No. 150 reaction coil, for example, will make what would otherwise be a stable broadcast receiver oscillate on the broadcast wavelength. Consequently we should use a smaller reaction coil for such work.

Provided the coil does not re-

sonate at the same wavelength as the circuit $L_1 C_1$, then self-oscillation will not be experienced with the Fig. 2 circuit.

Now, as regards Fig. 3, it might be thought that because L_2 is untuned the valve V will not oscillate. If, however, we connect up this circuit and tune the circuit $L_3 C_2$ to the same wavelength as $L_1 C_1$, the chances are that, provided C_1 and C_2 are kept low, the valve V will burst into oscillation. If the transformer $L_2 L_3$ is of the aperiodic type, no condenser C_2 being employed, then self-oscillation will not take place. But aperiodic transformers of this kind are not much use for broadcast purposes, although they are frequently employed for long wave reception. In those circuits where they are sometimes used it will be found that the transformers approximately resonate to the wavelength to be received, in which case we are not really dealing with an aperiodic transformer, but a more or less tuned one, the tuning, however, being fixed for approximately a certain wavelength by using suitably sized coils.

Reason for Oscillation

The moment we tune one of the windings, however, we have both a tuned grid and a tuned anode circuit. If the condenser C_2 were connected across L_2 the valve would oscillate, as the arrangement would be very similar to Fig. 1. It is not, however, so obvious that if the secondary L_3 is tuned a similar effect will be obtained. As I have previously explained in these articles, however, the arrangement $L_2 L_3 C_2$, if L_2 and L_3 are fairly tightly coupled, acts in much the same way as a single tuned anode circuit, and consequently self-oscillation is very likely to occur. The only way of stopping that is by having a very loose coupling between L_2 and L_3 , and then, of course, we lose in signal strength if the

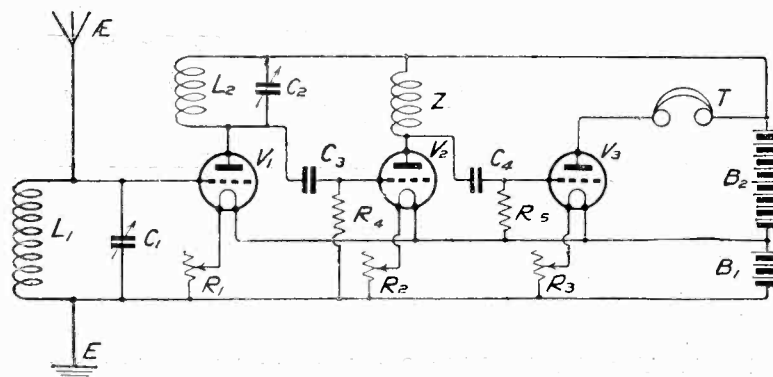

Fig. 4.—An interesting circuit of a commercial receiver.

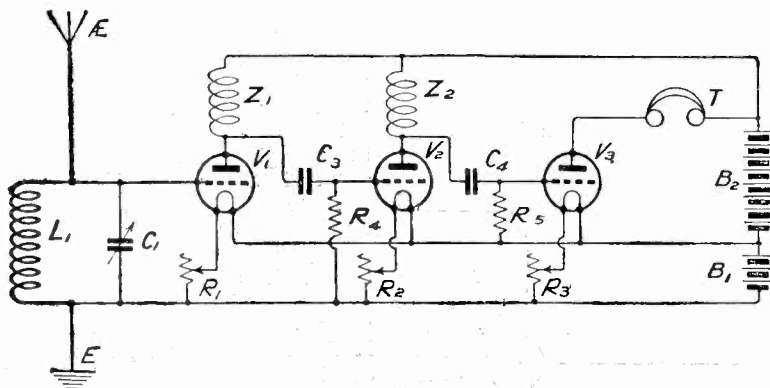

Fig. 5.—Two choke coils do not allow a full degree of amplification.

oscillations in $L_2 C_2$ are applied to a valve detector or another amplifying valve.

The T.A.T. System

The T.A.T. system which I have developed is really a compromise between aperiodic high-frequency amplification and the method using tuned circuits. Aperiodic methods are, of course, well known, and consist of using a choke coil (air or iron-core), aperiodic transformers, or resistances. All these methods have been used in the past, the latter method being particularly suitable for high-frequency amplification of waves over 1,000 metres in length. Choke coupling has been effectively used for short wavelength work because the impedance of a choke coil increases with the frequency. Transformer coupling has been used, but only on much longer wavelengths, and is generally a poor method of passing on the high-frequency currents.

Tuned methods include tuned anodes and tuned transformers in which either the primary or secondary is tuned and sometimes both.

These are the common methods which have been hitherto used.

A method of interest in connection with this article is that illustrated in Fig. 4, which has been used by the Western Electric Company in one of their commercial sets. This circuit uses two stages

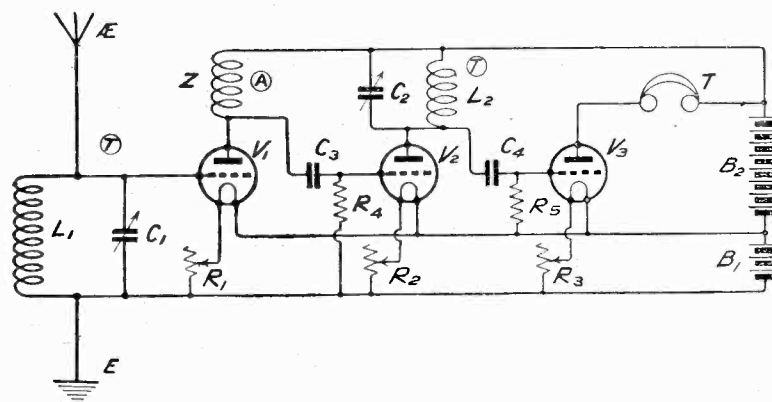

Fig. 6.—Illustrates the T.A.T. system of multi-stage H.F. amplification.

of high-frequency amplification, the first being a tuned anode (in the actual set the whole of the anode inductance is not included in the direct anode circuit) and the second

anode circuit includes a choke coil Z . This choke coil is an air-core coil, and it will be seen that two tuned anode circuits are thereby avoided.

This circuit, however, is not by any means an infallible one as ordinarily arranged, and stabilising methods are required. In such a circuit, however, the second valve will not tend to oscillate, because the anode circuit of this valve is untuned, although the grid circuit $L_2 C_2$ is tuned. I would like to make it quite clear that the circuit $L_2 C_2$ is not only the anode circuit of the first valve, but is actually the grid circuit of the second, the top end of the circuit $L_2 C_2$ being connected to the positive terminal of the high-tension battery, which terminal, however, is at the same high-frequency potential as the filament of the second valve. If the first valve is taken out of its socket it will, perhaps, be a little clearer

that the circuit $L_2 C_2$ is really the grid circuit of the second valve, and that if the first valve is taken out of its socket there is no fear of the second valve oscillating because the circuit $L_2 C_2$ and the choke coil Z do not combine to produce an unstable arrangement the arrangement produced is simply similar to that of Fig. 2.

If, however, we replace the valve in its socket, and look at the circuit $L_1 C_1$ and the circuit $L_2 C_2$, we will see that both the grid and anode circuits of the first valve are tuned, a most dangerous combination. If the second valve were switched out, the first valve would still tend to oscillate, for the reasons given, and so the arrangement of Fig. 4 is no important step towards overcoming self-oscillation in multi-stage high frequency amplifiers, however practical an arrangement the makers may have made it in their own particular set.

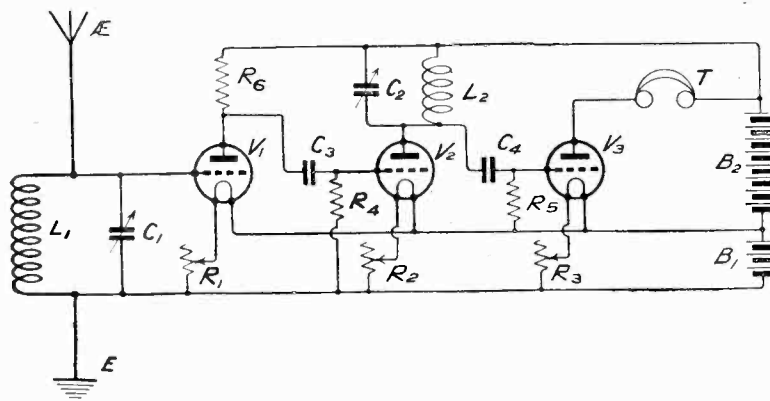

Fig. 7.—The circuit of Fig. 6, using a resistance in place of the choke coil Z .

Fig. 5, of course, is much more stable because two aperiodic choke coils Z_1 and Z_2 are now employed, but this circuit is not so efficient as Fig. 4, although more stable. The reason, of course, is that with choke coils no resonating effect is obtained on the desired wavelength, and consequently signal strength and selectivity suffer. The Fig. 4 arrangement, of course, is much better than a single valve using tuned anode coupling, but is not as good as two tuned anodes if such circuit could be made stable. It is therefore a compromise, and the second valve does not give as great an amplification effect as the first.

In Fig. 5 neither first nor second valve gives a full degree of high-frequency amplification.

The Principle

It was by studying the principles involved in these multi-stage high-frequency circuits that I came to the conclusion that a solution of the problem would be to alternate tuned circuits with aperiodic circuits and so prevent any two tuned circuits coming next to each other. This arrangement I have called, for convenience, the T.A.T. system, the letters indicating "tuned, aperiodic,

aerial circuit, is $L_1 C_1$ (the aerial capacity being regarded as in parallel with C_1). The anode circuit of this valve contains a choke coil Z , preferably of the air-core

type. The high-frequency amplified currents result in varying E.M.F.'s produced across Z , and these are communicated to the grid of the second valve. This valve amplifies the high-frequency oscillations which now appear in the tuned anode circuit $L_2 C_2$, and the oscillating potentials across this circuit are communicated to the grid of the third valve which acts as a detector. In this circuit, using two stages of high-frequency amplification, there is not the slightest tendency for V_1 or V_3 to oscillate.

The valve V_1 will not oscillate because the choke coil Z , not being resonant to the incoming frequency, will not assist the first valve to oscillate. In other words, the first valve circuit is similar to the basic arrangement of Fig. 2. Exactly the same position with the reverse circuit arises in the second valve

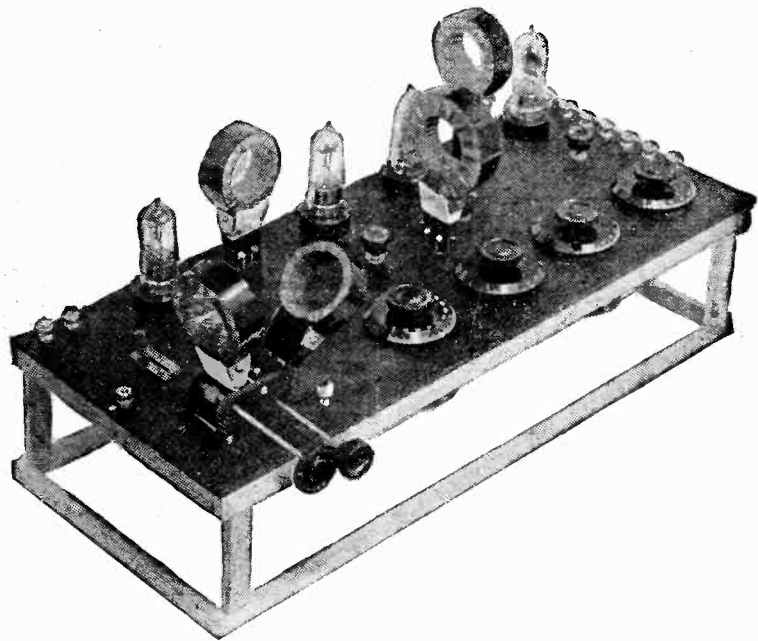

An H.F. amplifier, utilising the T.A.T. system. Two of the condensers shown are verniers.

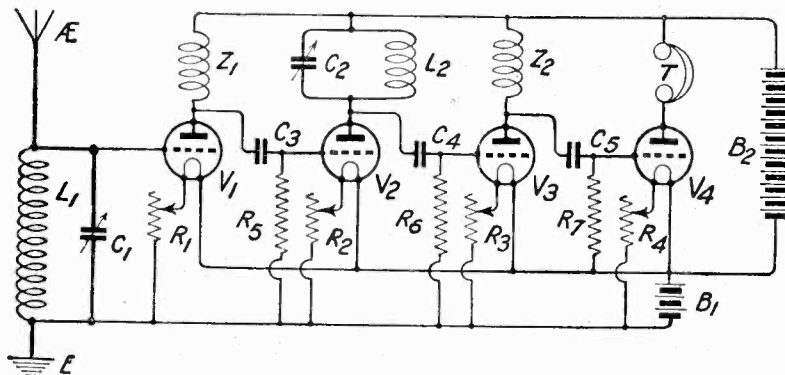

Fig. 8.—Using the T.A.T. system, only one H.F. control is needed for three H.F. valves.

tuned." This implies that the different circuits in the high-frequency amplifier are alternately tuned and aperiodic. If, for example, the first grid circuit is tuned, the anode circuit of that valve will be aperiodic. The next anode circuit will be tuned and the next one aperiodic, and so on, so that a considerable number of stages of high-frequency amplification are possible without it ever happening that both the grid and anode circuit of the same valve are tuned to the same wavelength.

An example of a simple three-valve T.A.T. circuit is shown in Fig. 6. The grid circuit of the first valve, which comprises also the

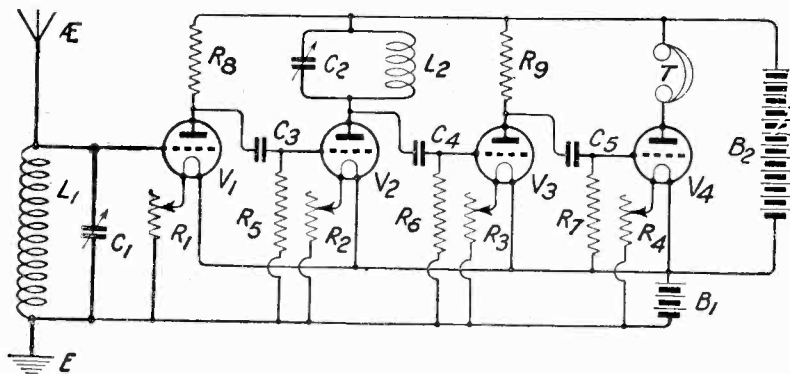

Fig. 9.—The circuit of Fig. 8, using resistance coupling.

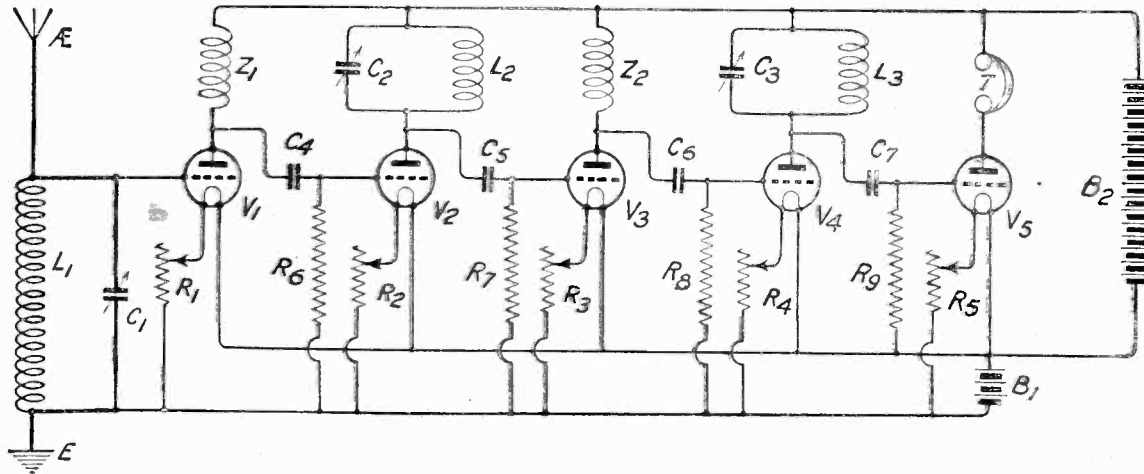

Fig. 10.—A five-valve circuit recommended by the Author.

If we put our hand over the aerial and grid circuit of the first valve, we will see that the choke coil Z is now the grid circuit of the second valve, and this valve will not oscillate because, although the anode circuit is tuned, the grid circuit is, to all intent and purposes, aperiodic, or, at any rate, not naturally tuned to the same wavelength as the anode circuit. This circuit, of course, is radically different from Fig. 4, because in this latter figure the first valve will tend to oscillate although the second will not. In Fig. 6 neither valve will oscillate because we do not have two tuned circuits in either case. In one case the grid circuit is tuned and the anode circuit is aperiodic, while in the case of the second valve the grid circuit is aperiodic and the anode circuit is tuned. The letters T.A.T., indicating tuned, aperiodic and tuned, are shown in circles attached to the three principal high-frequency circuits of Fig. 6. The second valve acts as a first rate high-frequency amplifier, giving

good selectivity, while the first valve does not give selectivity and does not give as good high-frequency amplification as the second. In other words, we have one good high-frequency amplifier and one medium one, but, on the other hand, we have perfect stability, and since we can have half a dozen or more high-frequency valves arranged in the Fig. 6 style, it will be readily seen that a big total step-up effect is obtainable.

Resistance Coupling

Although a choke coil has been shown in Fig. 6, this may be replaced, as shown in Fig. 7, by a high resistance R_s of the order of 50,000 to 100,000 ohms.

The first valve now acts as a high-frequency resistance amplifier. This method of amplification is, as stated above, particularly useful above 1,000 metres, although it is interesting to note that Captain Eckersley used resistance amplification on 369 metres for the King's wireless set. Although some am-

plification is obtainable on these shorter wavelengths, yet I think it is fairly obvious that the Fig. 6 arrangement is most suitable for the shorter wavelengths, while Fig. 7 is more suitable for wavelengths above 1,000 metres. In both cases, however, the principle is the same; tuned circuits are separated by an aperiodic circuit.

This separation, of course, is the essential feature of these circuits. A mere combination of one method of high-frequency coupling with another is, in itself, no remarkable invention. The arrangement of Fig. 4, for example, while possibly a practical circuit, misses the whole point, and misses the whole advantage of the T.A.T. arrangement. The choke coil Z in Fig. 4 might be replaced by a resistance, but, nevertheless, the stability of Fig. 7 will be missing.

An Analogy

The T.A.T. type of circuit may be conveniently compared to a man slightly lame in one leg climbing

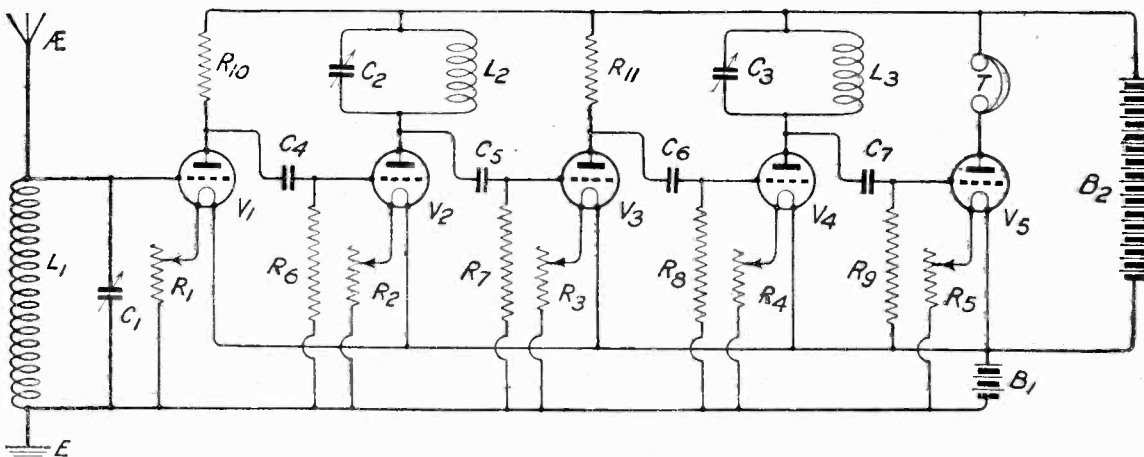

Fig. 11.—Resistances may be used in the Fig. 10 circuit for wavelengths above 1,000 metres.

up a hill. He gets higher and higher, one leg doing a full amount of work, with the lame leg doing a less amount but still helping him up.

So, in the same way, in T.A.T. circuits the aperiodic coupling does not give as big an amplification as the tuned anode coupling, but, on the other hand, it serves as an excellent means of separating two antagonistic circuits which, if placed together in the same valve, would cause self-oscillation. Not

in which a second choke coil Z_2 is used to couple the third valve to the last valve which acts as a detector.

In this circuit, although there are three stages of high-frequency amplification, there is only one knob, C_2 , to turn, and the circuit is as easy to use as an ordinary two-valve tuned anode receiver using one stage of high-frequency amplification only.

Fig. 9 shows the equivalent of Fig. 8 using resistances R_8 and R_9

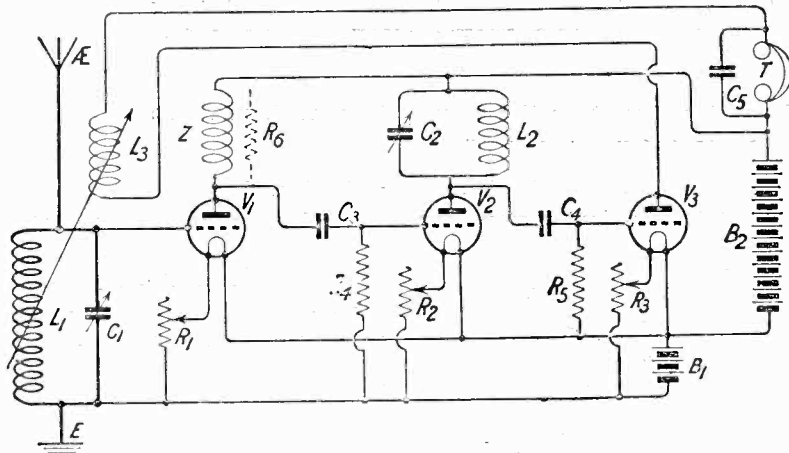

Fig. 12.—A T.A.T. circuit with reaction on to the aerial.

only does the aperiodic circuit carry out these specific functions, but it also helps by giving a material degree of high-frequency amplification.

Naturally the use of these circuits halves the number of circuits to tune, and halves the number of knobs to turn. This alone will prove an inestimable boon to anyone having experience of multi-stage high-frequency amplifiers. This fact, combined with extraordinary stability, will result in much attention being given to these circuits.

Four-Valve Circuits

I have successfully used several stages of high-frequency amplification without the slightest tendency towards self-oscillation, and with such a circuit, of course, at my distance from 2LO (about 9 miles), the idea of using an aerial or earth would be absurd. Loud-speaker results can be obtained with ease, the only trouble being that the selectivity is rather high, and, of course, very high if reaction is used. It was, of course, found necessary to employ reaction because the circuits are ordinarily so very stable, due to the absence of inherent reaction effects.

Fig. 8 shows a four-valve circuit

for coupling valves. It will be seen in this four-valve circuit that the first valve has a tuned grid circuit and an aperiodic anode circuit, the second valve has an aperiodic grid circuit and a tuned anode circuit, the third valve has a tuned grid circuit and an aperiodic anode circuit and the fourth valve simply an aperiodic grid circuit. This, of course, applies also to Fig. 8 and my T.A.T. rule of preventing any valve having both a tuned grid and a tuned anode circuit, or virtually tuned anode circuit, is avoided.

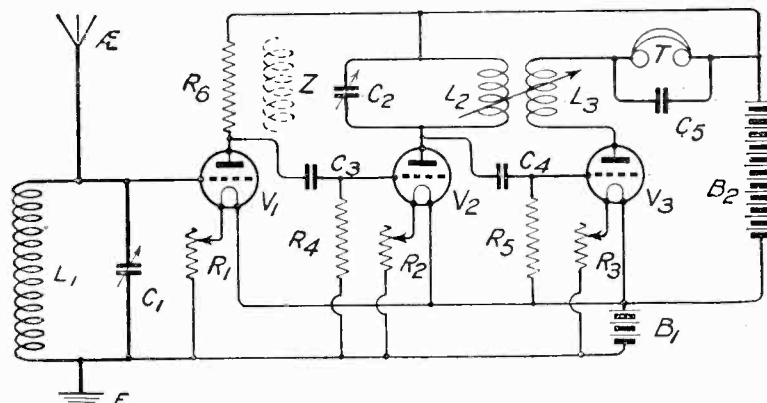

Fig. 13.—An alternative method of obtaining reaction.

Five-Valve Circuits

Fig. 10 is a five-valve receiver which may be recommended; it embodies the principles of the T.A.T. system, two choke coils Z_1 and Z_2 being employed, and two tuned anode circuits $L_2 C_2$ and $L_3 C_3$. Here we have four stages of high-frequency amplification with only three controls, as against three controls on the usual two-valve high-frequency amplification circuit. In the Fig. 10 arrangement we have two valves doing their best and two valves doing medium work.

Fig. 11 shows the equivalent of Fig. 10 using resistances R_{10} and R_{11} for coupling purposes.

It is to be noticed in all these circuits that the resistances may be used for receiving, say, 5XX, while the chokes may be used for receiving the shorter broadcast wavelengths.

Adding Reaction

Reaction may be applied to any of these circuits in many different ways. A usual method will be to apply the reaction from the detector valve to the grid circuit of the first valve, and Fig. 12 shows how this may be accomplished in a simple three-valve set. It will be seen that the reaction coil L_3 is coupled to the grid coil L_1 , and this reaction effect is communicated, of course, not only to the aerial circuit but also to the tuned anode circuit $L_2 C_2$, any adjustment of the coupling between L_3 and L_1 being accompanied by a retuning on C_1 and C_2 . This circuit is the best one for the beginner to try. The size of the choke coil Z will depend, of course, on the wavelength about to be received, and may also depend upon the capacity of the first valve. Generally, however, a No. 200 or 250 coil will be found useful for this purpose when receiving the ordinary broadcasting stations on the 300 to 500 metre waveband. The choke coil Z may be replaced by a resist-

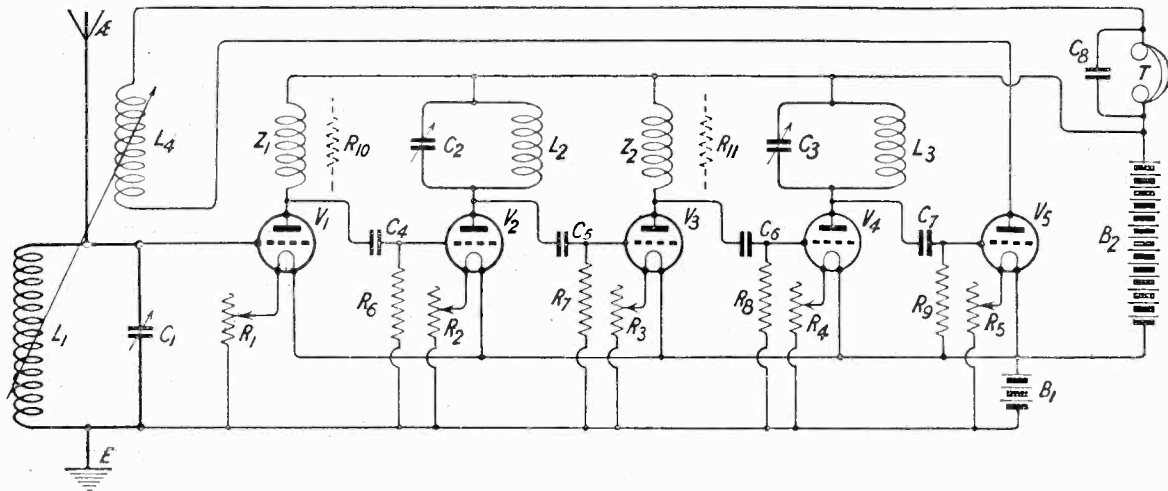

Fig. 14.—An excellent five-valve circuit on the new system, with reaction on to the aerial circuit.

ance R_6 when wavelengths of over 1,000 metres are to be received—*e.g.*, when 5XX is to be heard. The resistance R_6 is shown in dotted lines to indicate that it may replace the choke coil Z in the circuit. The value of the resistance R_6 may conveniently be 100,000 ohms, although as low a value as 50,000 ohms may be employed.

Fig. 13 shows a modified arrangement in which reaction is introduced, not from end to end, but from the last valve to the last tuned anode circuit $L_2 C_2$. A resistance R_6 is shown connected in the anode circuit of the first valve, but for short wavelengths the choke coil Z shown in dotted lines may replace R_6 .

Fig. 14 shows a five-valve receiver in which reaction from the last valve to the first is obtained.

Adding L.F. Amplification

Any of these circuits may have added to them one or more stages of low-frequency amplification for working a loud-speaker. In this case the telephones are replaced by the primary of a step-up intervalve transformer, the secondary of which is connected across grid and filament of another valve fed off the same filament accumulator. The anode circuit of this low-frequency valve contains the loud-speaker, one side of the loud-speaker being connected to the anode of the valve and the other side being connected to the positive of the same high-tension battery used in the circuit chosen.

The ordinary general rules apply, and it is not thought necessary in this article to give examples of circuits using the T.A.T. system combined with low-frequency am-

plification. One or two such circuits may be given in the next issue of MODERN WIRELESS for the benefit of beginners.

Concluding Notes

I would very much like experimenters who try any of these circuits to write and let us know the results. The subject of long-distance communication which is so bound up with multi-stage high-frequency amplification is so fascinating that it is hoped that many readers of MODERN WIRELESS will try out these arrangements, Figs. 12 and 13 being in particular recommended as a start.

The photographs give some indication of successful sets using circuits of this kind, and a successful set using this method of coupling may be described in the next issue of MODERN WIRELESS, the Christmas Double Number.

A Reader's Three-Valve Dual Receiver.

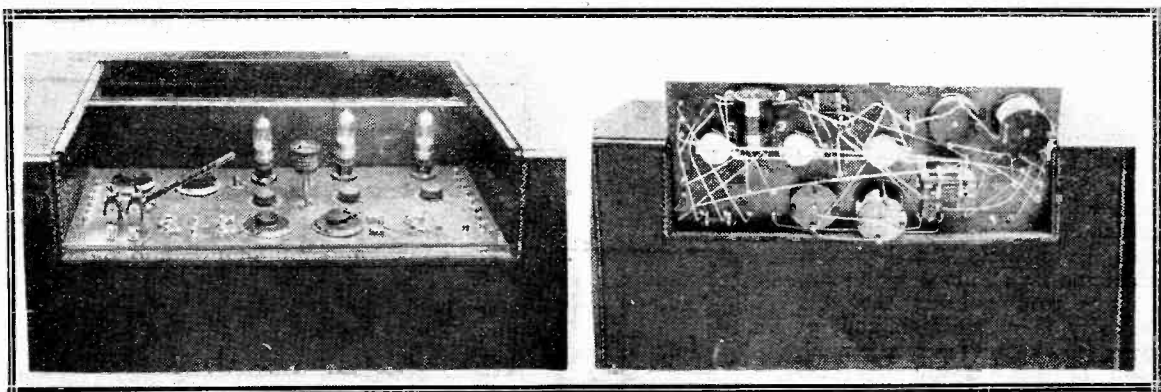

The above photographs are of a Three-Valve Dual Receiver constructed by Mr. Hankin, of Walthamstow. On page 618 are photographs of the handsome cabinet and loud-speaker, and his letter is published on page 671.



The only resident of Little Puddleton who hasn't got a wireless!

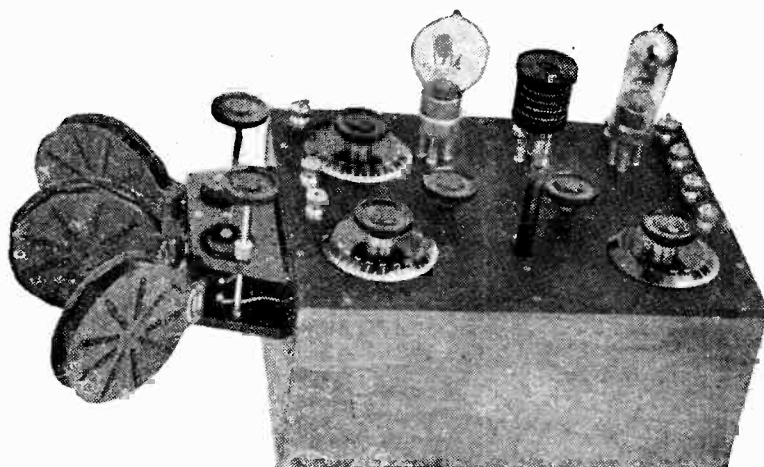

Fig. 1.—Compactness is the dominant note of the receiver.

A Double-Circuit Neutrodyne Receiver.

By John Underdown

A practical receiver combining sensitiveness with selectivity, which will appeal to those who wish for distance.

LONG-distance reception has always held a great fascination for the author, and the present set is designed for this specific purpose. Many receivers fail, not on account of their inability to receive distant signals, but in their complete lack of selectivity. A local station will oftentimes completely swamp the desired signal, making it impossible to do any real long distance work. Thus, in the majority of cases, it is first necessary to be able to get rid of the local station. The judicious use of reaction in this case will help considerably, but is seldom really adequate for complete elimination of the undesired station. A coupled circuit at once suggests itself, but this, with a tuned anode high-frequency valve, unless some form of stabilising is incorporated, is unmanageable. Potentiometer control is usually adopted and stability obtained at the expense of some efficiency, grid current being used to introduce damping into the high-frequency circuit where for maximum results it should be reduced to a minimum.

Neutrodyne Stabilisation

The so-called neutrodyne method of stabilising a high-frequency valve strikes at the root of the trouble and neutralises the internal grid to plate capacity of the valve and also the magnetic couplings which cause instability, allowing the valve to work under the best conditions for efficient amplification without distortion. This principle is used in the present set and allows full advantage to be taken of loose coupling to obtain maximum selectivity.

The particular circuit used is due to Mr. A. D. Cowper, and is the most effective that the writer

has ever experimented with. The action is quite easy to follow, and is given below; it is always much more satisfactory to know what underlies the actual tuning operations, as only by so doing is it possible to get the best results out of a set.

The Action Explained

Referring to the theoretical circuit, $L_2 C_2$ forms the tuned grid circuit of a high-frequency amplifying

valve. Energy from the plate circuit is handed back to the grid circuit, and this is always sufficient in a well designed set to overcome any losses due to resistance, etc., so that continuous oscillations are generated.

Maximum Amplification

The condition for maximum amplification is attained just before continuous oscillations commence, so that obviously, if we can arrange

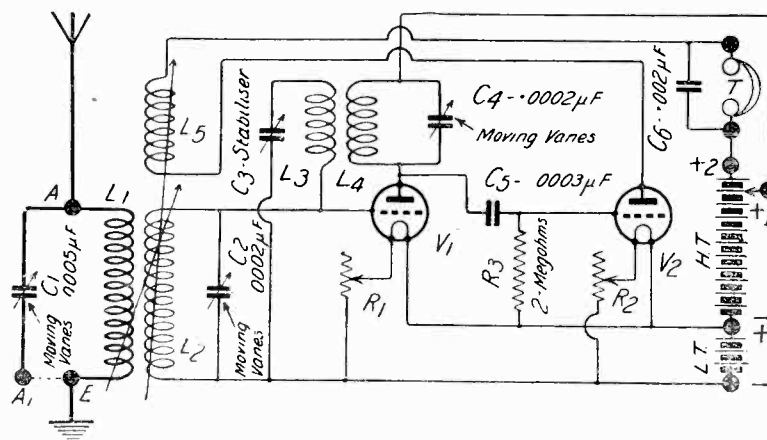

Fig. 2.—The theoretical circuit of the receiver. $L_3 C_3$ is the neutrodyne circuit.

ing valve V_1 , whilst in the plate circuit is another tuned circuit consisting of an inductance L_4 tuned by a condenser C_4 . When the latter or tuned anode circuit is tuned to resonate to the same frequency as $L_2 C_2$, currents introduced into the former will appear in amplified form in $L_1 C_1$ owing to the amplifying action of the valve. Due to the plate to grid internal capacity of the valve and magnetic coupling which exists between leads, part of the magni-

to hand just sufficient energy from grid to plate (this being obtained from the plate circuit) to oppose the former action, we can then tune $L_1 C_1$ to resonance with $L_2 C_2$, so as to impress the maximum voltage fluctuation representing signals on to the grid of the succeeding valve. To do this a reversal of phase is necessary, and this is obtained by closely coupling a coil L_3 to L_4 , one side of which is taken to the grid of V_1 and the other through a small condenser C_3

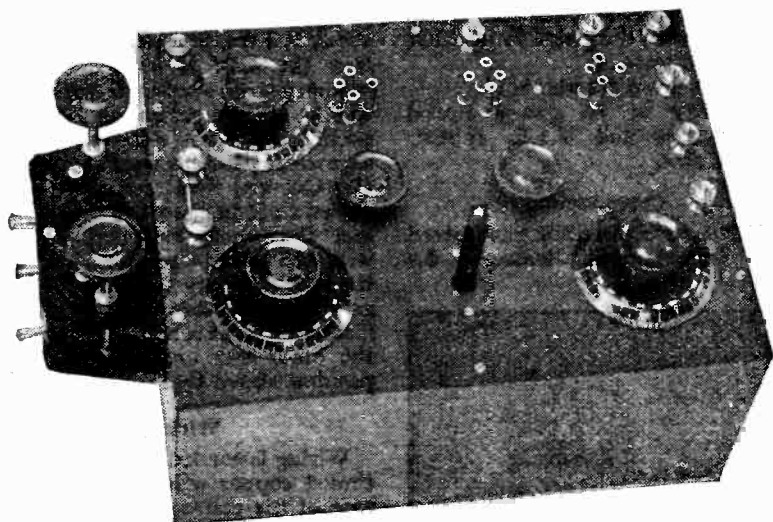

Fig. 3.—The set with coils and valves removed. The stabilising condenser will be seen to the front centre of the panel.

to L.T.—i.e., to a point of high-frequency earth potential. By suitably connecting the leads from L_3 , voltages opposing those set up across the plate to grid capacity in the valve are impressed on to the grid of the valve V_1 , and balance or neutralisation obtained by adjusting the value of the stabilising condenser C_3 .

The Circuit

The set is a two-valve one, consisting of a tuned anode high-frequency valve and a detector.

A coupled circuit is used to obtain selectivity. The aerial circuit L_1 , C_1 may be arranged for either series or parallel working by means of two terminals, A and A_1 . The parallel position is obtained with the aerial connected to A and A_1 joined to E and to earth. With A_1 and E open and the aerial connected to the former series tuning is obtained. C_1 has a value of .0005 μ F. The secondary circuit L_2 , C_2 is variably coupled to the aerial and to the reaction coil L_3 . C_2 is of .0002 μ F, as is C_4 , the tuned

anode condenser. L_4 is the tuned anode coil. C_6 is a by-pass condenser of .002 μ F, connected across the telephones to give smooth reaction control. Rectification is by the leaky grid condenser method, the usual values of .0003 and 2 megohms being adopted and the leak taken to low tension positive. The neutrodyne part of the circuit consists of L_3 , C_3 as previously explained.

General Layout

From the photographs the disposition of the components is clearly seen and calls for little comment. The aerial condenser is in the left-hand corner of the panel and immediately to the front of it is the secondary condenser. That tuning the anode coil is seen to the right of the panel, whilst the handle of the stabilising condenser is seen between those of the anode and secondary condensers. The aerial and earth terminals are on the left and L.T. and 'phones on the right. Separate terminals allowing suitable H.T. potentials to be applied to the valves are at the back of the panel. This allows the H.T. battery to stand at the back and straight through connections to be made if subsequently an L.F. amplifier is added.

Between the two valves, sockets for a high-frequency transformer are located. One winding of this serves as the tuned anode coil and the other as the neutrodyne coil,

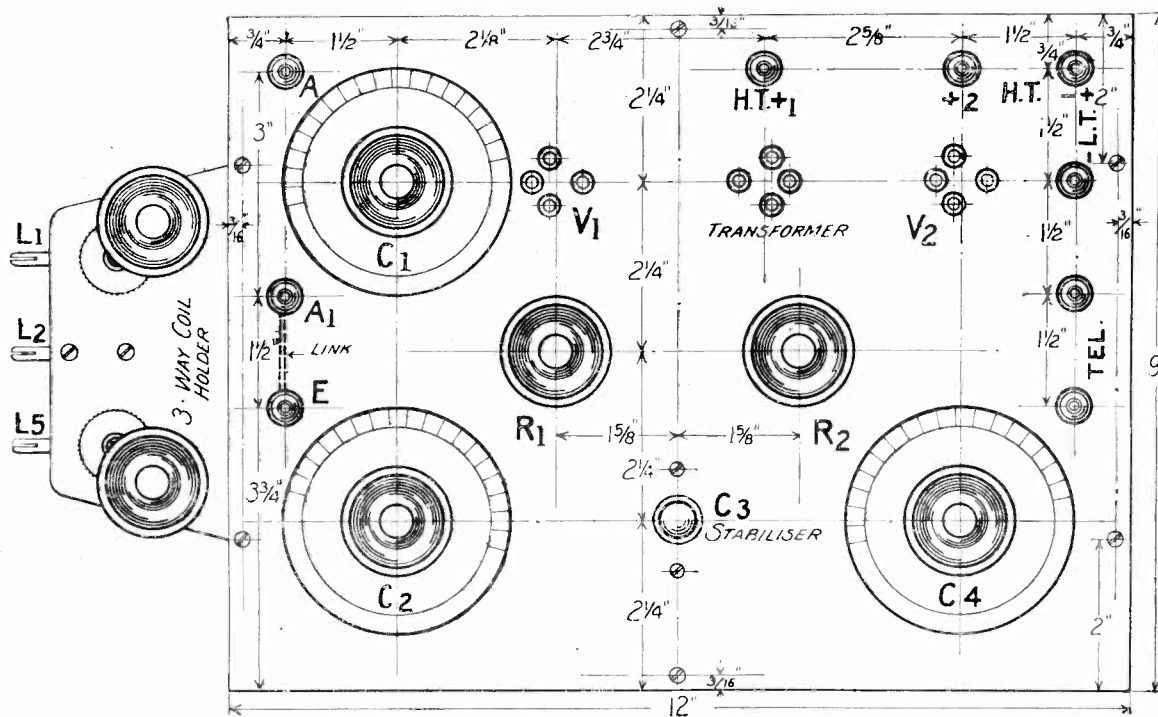

Fig. 4.—The drilling diagram of the set may be used in marking out the panel. Blue print No. 71a.

thus obviating the use of two plug-in coils as with my former design which appeared in *Wireless Weekly* of August 6th and 13th, 1924.

The coil holder is seen on the side of the case and is so arranged that however heavy the coil no tendency to flop will be present. This is a great advantage and economises in panel space. The filament resistances are near the centre of the panel.

Components Required

- 1 Ebonite panel 12 in. by 9 in. by $\frac{3}{4}$ in.
- 3 Square law condensers. One of .0005 μ F and two of .0002 μ F, or .0003 μ F. These were obtained from Bowyer-Lowe & Co., drilling templates being supplied.
- 1 Stabilising condenser. Gambrell Bros., Ltd., supply these. Type for mounting below the panel should be specified.
- 1 3-coil holder. Peto-Scott, Ltd., new Vernier type.
- 1 .0003 grid condenser } Dubilier.
- 1 .002 condenser }
- 1 2 megohm leak }
- 2 6 ohms type filament resistances. Dual types may be substituted here if desired.
- 1 300 to 600 metres H.F. transformer. L. McMichael, Ltd.
- Suitable plug-in coils to cover the above wavelengths. Any good make will do.
- 1 oak tray 12 in. by 9 in. by 5 in. by $\frac{3}{4}$ in.
- The base should be detachable,

as the connections to the coil holder are made with the panel in position and base removed.

9 W.D. type terminals.

Quantity of 16 gauge tinned copper wire and V.I.R. rubber-covered flex.

Construction

If the ebonite is not guaranteed free from surface leakages the

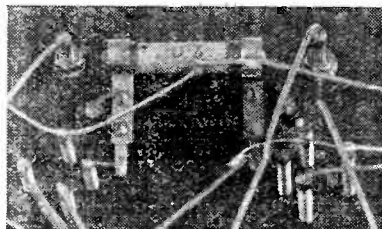

Fig. 5.—Showing how the grid-leak is supported. Note that the right-hand clip connection is broken.

surface should be thoroughly removed with emery paper before drilling is undertaken. The latter may be easily performed after setting out from the drilling diagram given. A scriber or sharp pointed instrument should be used for marking out but on no account use a pencil.

The Leak Connection

No difficulty should be experienced in mounting the com-

ponents and little need be said about it here, except to point out how the leak is connected. An ordinary grid condenser with clips was used, and when mounted in position the leads were soldered as seen in the photograph of the wiring. One clip was then filed through as shown at X in the wiring diagram, and the whole bent up slightly with the leak in position, so that the leak was only connected to the grid side of this condenser, the filament connection supporting the other end and holding it in position above the grid condenser.

Wiring

Wiring is carried out in 16-gauge tinned copper wire, except in the case of the connection to the coil-holder and reaction leads. V.I.R. flex is used here. Reaction leads are twisted together, as shown, to prevent interaction. One is of 16 gauge wire for rigidity, and the other of V.I.R. flex twisted round it.

The connections to the coil-holder are marked clearly, the leads denoted by S going to sockets and those marked P going to plugs. They are of V.I.R. flex and are taken through the side of the case.

Testing the Set

The wiring completed, place the set on test. First connect the accumulator with the valves plugged in and see that this circuit is

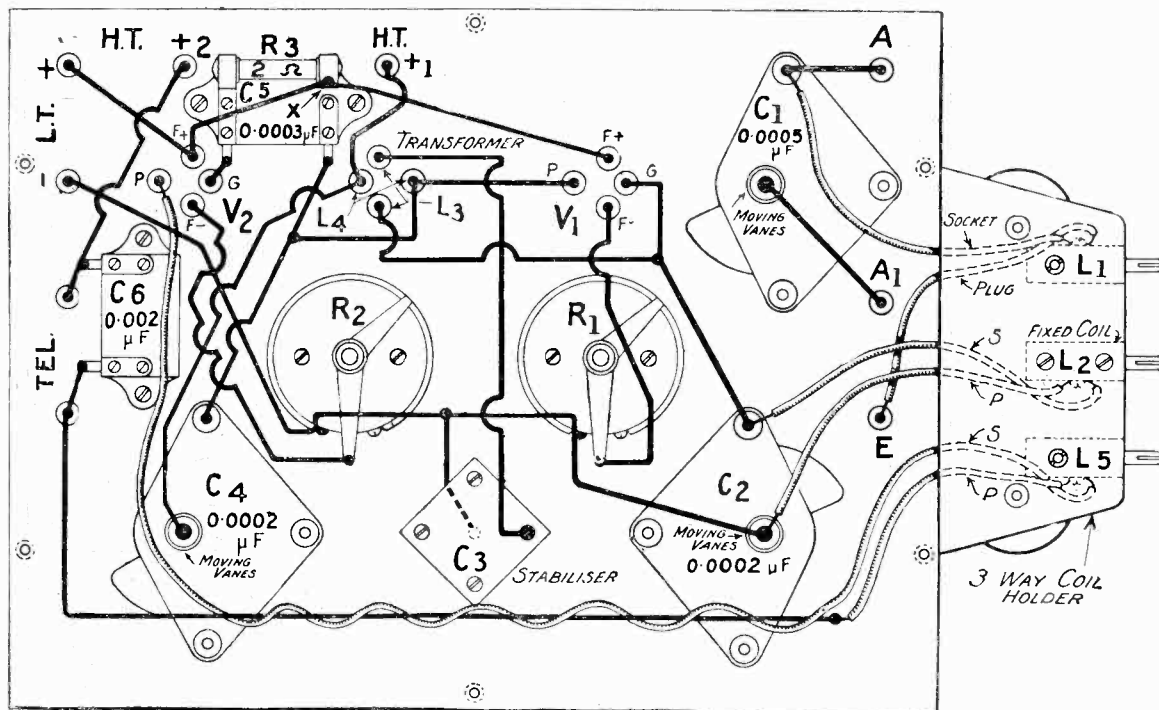
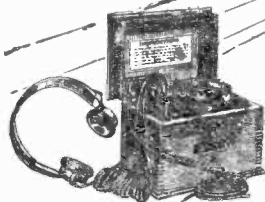
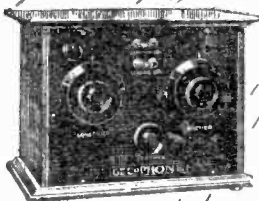

Fig. 6.—Illustrating the wiring. The photograph of Fig. 5 clearly shows the connections at X to the grid condenser C5. (Blue print No. 71 B).

Britain's Best BROADCASTING SETS



GECOPHONE
Crystal Set



GECOPHONE
Single Valve Set

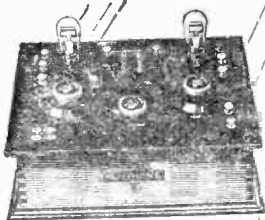

GECOPHONE
Two Valve Set (Det. &
L.F.) Table Model



GECOPHONE
Two Valve Cabinet
Set (H.F. & Det.)

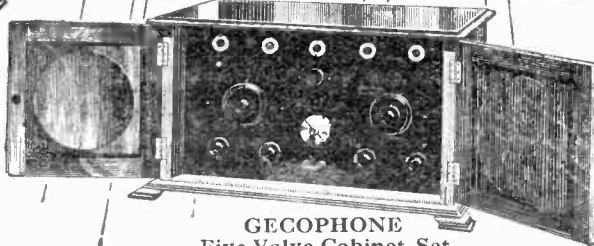

GECOPHONE
Five Valve Cabinet Set

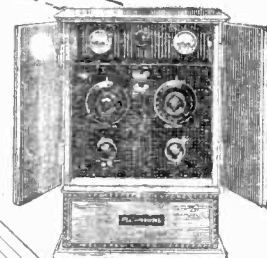

GECOPHONE
Two Valve Cabinet Set
(Det. & L.F.)

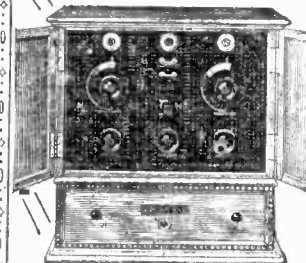

GECOPHONE
Three Valve Cabinet
Set (Det. & 2 L.F.)

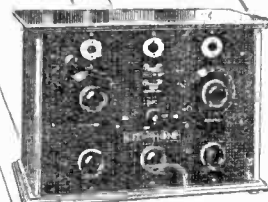

GECOPHONE
Three Valve Table Set
(Det. & 2 L.F.)

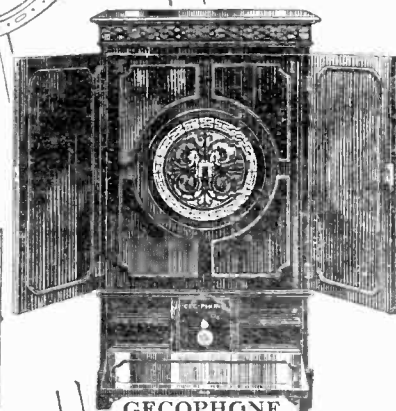

GECOPHONE
Four Valve Cabinet Set de Luxe

1924/5

GECOPHONE

REGISTERED TRADE MARK

MODELS

LET your choice of a Wireless Set be guided by the knowledge and experience of the many thousands of satisfied users of GECOPHONE Sets.

A new range of models has now been introduced, each set embodying all those superlative qualities which have made GECOPHONE famous throughout the World.

The range of GECOPHONE receiving sets now meets every requirement and offers selection to suit the pockets of all sections of the community. Prices from £2 10s. to £120.

Before you make your choice of a Wireless Set ask your dealer to demonstrate the new GECOPHONE models to you. He will gladly do this without obligation.

GECOPHONE Sets are sold by
GECOPHONE SERVICE DEPOTS, Electrical
and Wireless Dealers, Stores, etc.
Ask for price list No. B.C. 3425.

*Advertisement of The General Electric Co., Ltd.
(Manufacturers and Wholesale only),
Magnet House, Kingsway, London, W.C.2*

In replying to advertisers, use COUPON

Brandes

The Name to Know in Radio

To some people

a receiver is merely a piece of mechanism. It has never occurred to them to give it a real chance—to help it become vitally alive. Brandes "Matched Tone" Headphones will exploit the full merit of your Set, bringing it to eager life. The "Table Talker" will make it talk clearly and melodiously. All the liquid tones, the pulsating warmth of a soprano will come to you unspoiled, without any unnatural harshness. It does not matter—the rioting madness of the violin, the immense grandeur of the organ or the intoxicating rhythm of a dance band, they all speak to you—ALIVE with their OWN vigorous cadences. Let Brandes products dispense with dull tonelessness and bring your receiver to vigorous life.

All Brandes products are obtainable from any reputable Dealer and carry our official money-back guarantee enabling you to return them within 10 days if dissatisfied.

Matched Tone
TRADE MARK
RADIO HEADPHONES 25/-

Table-Talker
TRADE MARK 42/-

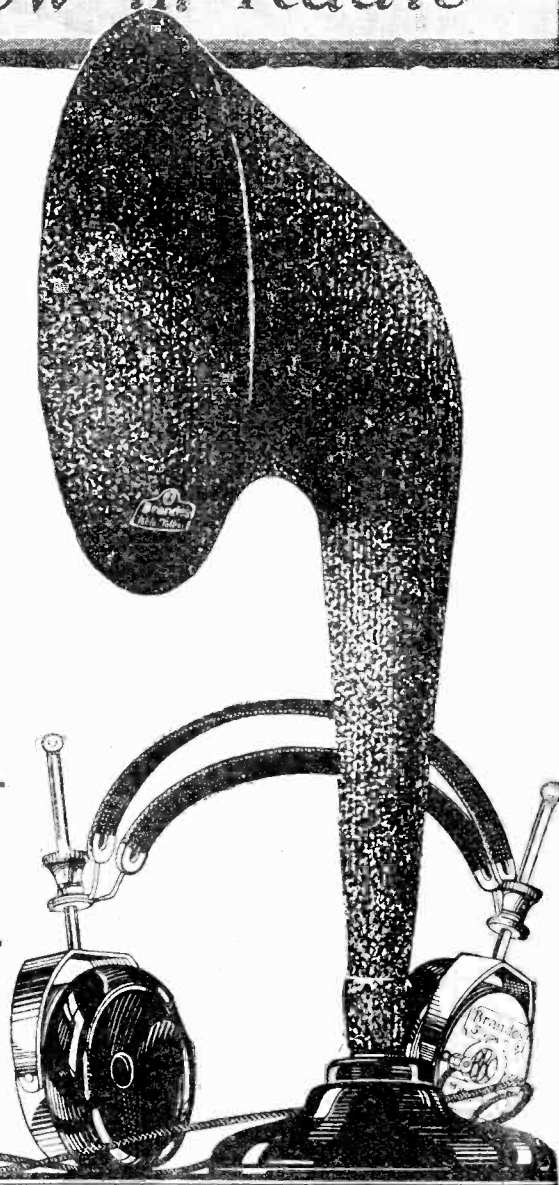

Tune with Brandes "Matched Tone" Radio Headphones. Then Listen with Brandes Table Talker

Brandes Limited, 296, Regent St., W. 1.

WORKS: Slough, Bucks.

satisfactory. I have used most types of general purpose bright emitters here with success. The H.T. may now be connected with the H.F. transformer plugged in. Terminals H.T. + 1 and 2 may be connected together for a start, and usually a value of 60 volts will be found satisfactory.

Neutrodyne Adjustments

The next step is to adjust the neutrodyne circuit. To do this the secondary coil only should be inserted in the socket of the coilholder, and the reaction coil (that is, the coil nearest to the front of the receiver) should be short-circuited by a piece of wire inserted into the socket and twisted round the plug. The secondary coil and H.F. transformer should of course be chosen to cover the wavelength required. For the B.B.C. range I used a 300 to 600 McMichael transformer and a Gambrell "C" coil. Alternatively a 75 or 50 may be used in place of the latter.

Screw the stabiliser condenser out to its minimum position and set the anode condenser C_1 at some intermediate value, say, 40 degs. Now swing the secondary condenser C_2 , tapping the grid socket of the H.F. valve at the same time. Loud ploncks will be heard over a certain number of degrees, say, 20 degs. to 60 degs., denoting that the set is oscillating. Set the secondary condenser at, say, about 45 degs., leaving the anode condenser set as before at 40 degs. and gradually screw in the condenser, tapping to test for oscillation as before. With the anode and

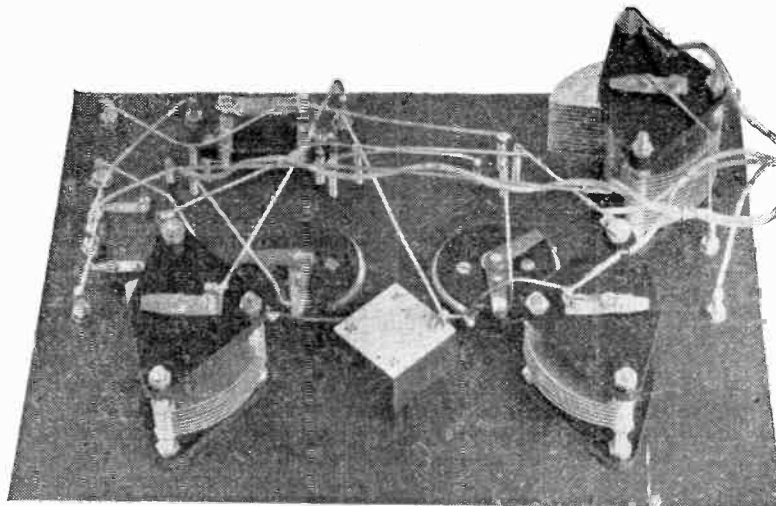

Fig. 7.—Showing the wiring. The leads to the right go through the case to the coilholder.

neutrodyne coils correctly connected a point will be reached where oscillation ceases. Swinging the secondary condenser will now probably cause the set to oscillate only over a very limited number of degrees, and by carefully adjusting the neutrodyne condenser a point will be found where oscillation does not take place, however the condenser C_2 is rotated. The valve capacity is now completely neutralised.

Correct Connections

Should it prove impossible to do this, the neutrodyne coil is wrongly connected and the leads to it should be reversed and the process repeated. Unfortunately

there is a complete lack of standardisation among makers of H.F. transformers, and experiment may be necessary to determine the correct connection. Those given are for the transformer mentioned.

The next step is to test for correct reaction. Insert a small coil in the reaction socket; a 25 or an "a" coil will be found suitable for the 300 to 500 metre band, and if this does not cause the set to oscillate, reverse the leads to it.

Satisfied that all is correct so far, insert the aerial coil and connect the aerial and earth, remembering that in the parallel position A_1 should be joined to E. Now tune on the three condensers and on the position of the coils, when the local station should be easily received. Practise on this station till you are satisfied that you have the feel of the set and are getting the best out of it.

Maximum Selectivity

It is only with practice that one is able to get the best out of this arrangement. The maximum selectivity is obtained with the loosest of coupling between aerial and secondary coils and the reaction coil as tight as possible without using an undue amount of reaction. This means that the two former coils will be as far apart as is consistent with good signal strength, whilst the latter is brought as near to the secondary as possible. Probably at first the handling of the set will seem rather strange, but with practice it becomes very easy and is a pleasure to work.

Test Report

The set was tested in Kent 40 miles S.E. of 2L.O. in a spot which is very good for reception

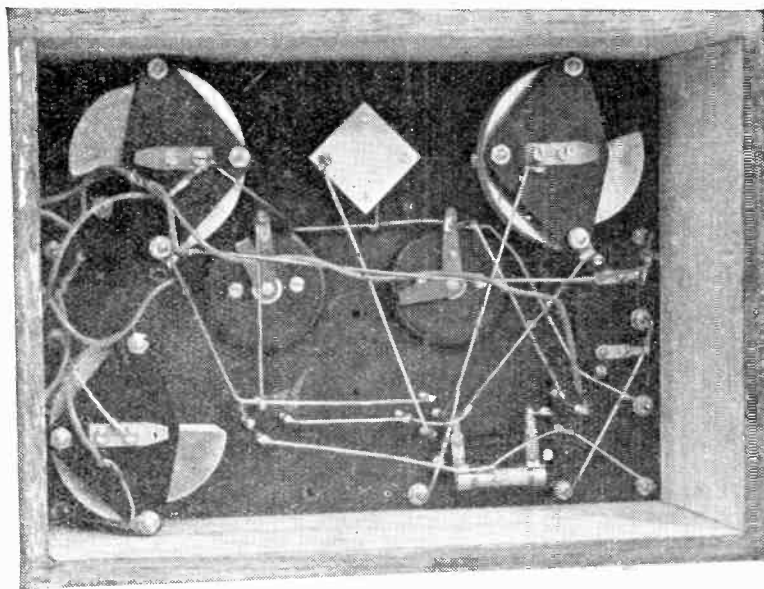

Fig. 8.—The connections to the neutrodyne coil and condenser are clearly seen here.

purposes. London was first tuned in, using an "A" coil in the aerial, a "C" for secondary, with a small "a" for reaction. The McMichael transformer was used, with an "R" valve for the H.F. and an Ora for detector, 60 volts being used on both by joining the H.T. + terminals. 2LO worked a loud-speaker at comfortable volume for a small room. Cardiff was received without a trace of London at excellent 'phone strength, and all the other B.B.C. stations were obtained, as were some of the German, Madrid, and Poste and Telegraphes stations.

On Sunday evening, October 12, or rather early on Monday morning, a station was received at excellent strength, although occasionally fading to a certain extent. A preacher was giving a sermon, his theme being "You can't change human nature." I waited and heard the hymn, "Fight the good fight," until the call sign was announced. This proved to be WGY, Schenectady, New York, which closed down at 9.1 Eastern Standard time. Occasionally signals were so loud as to be heard with the 'phones some inches from the head. After this, WBZ was received,

"Pomp and Circumstance" being the first piece heard. Mr. Harris also received these stations on his 4-valve Transatlantic set, and we were able to compare results. The night was a most exceptional one for reception. Reaction control was delightfully smooth, and one was easily able to hang on the edge so that an atmospheric would send the set into oscillation, but it would come out on its own accord, unlike an ordinary set. With the arrangements used it was possible to work on a very loose coupling, and selectivity was accordingly increased to a surprising degree.

A Further Test

Another test was carried out on the same aerial on the evening of October 18, and much to my surprise signals equal in strength to those usually received on a crystal set were obtained from 2LO with no aerial or earth.

A "C" coil acted as a frame aerial and an "a" as reaction. Signals were of sufficient strength to be quite readable in 'phones. On connecting aerial and earth fair loud speaking was obtained on this station.

5XX, using E, F and D coils as aerial, secondary and reaction coils and a 1,100 to 3,000 McMichael transformer, was received at good loud-speaker strength. (5XX is about 60 miles.)

Radiola was also received on the same coils without a trace of 5XX, and at fair loud-speaker strength, several musical items being thoroughly enjoyed. A few degrees on the secondary and anode condensers and slight re-adjustment of the coupling brought one from Radiola to 5XX. Every word from the latter station could be clearly heard with the loud-speaker in the next room, about 20 ft. away. 5XX was received without aerial and earth at good 'phone strength.

At 10.10 p.m. Eiffel Tower, transmitting the usual weather forecast, was received at excellent 'phone strength. "F," "G" and "B" coils and the 2,500 to 7,000 transformer were used.

On none of these stations was it necessary to readjust the setting of the neutrodyne circuit from the position used for the 300 to 500 metre band of wavelengths.

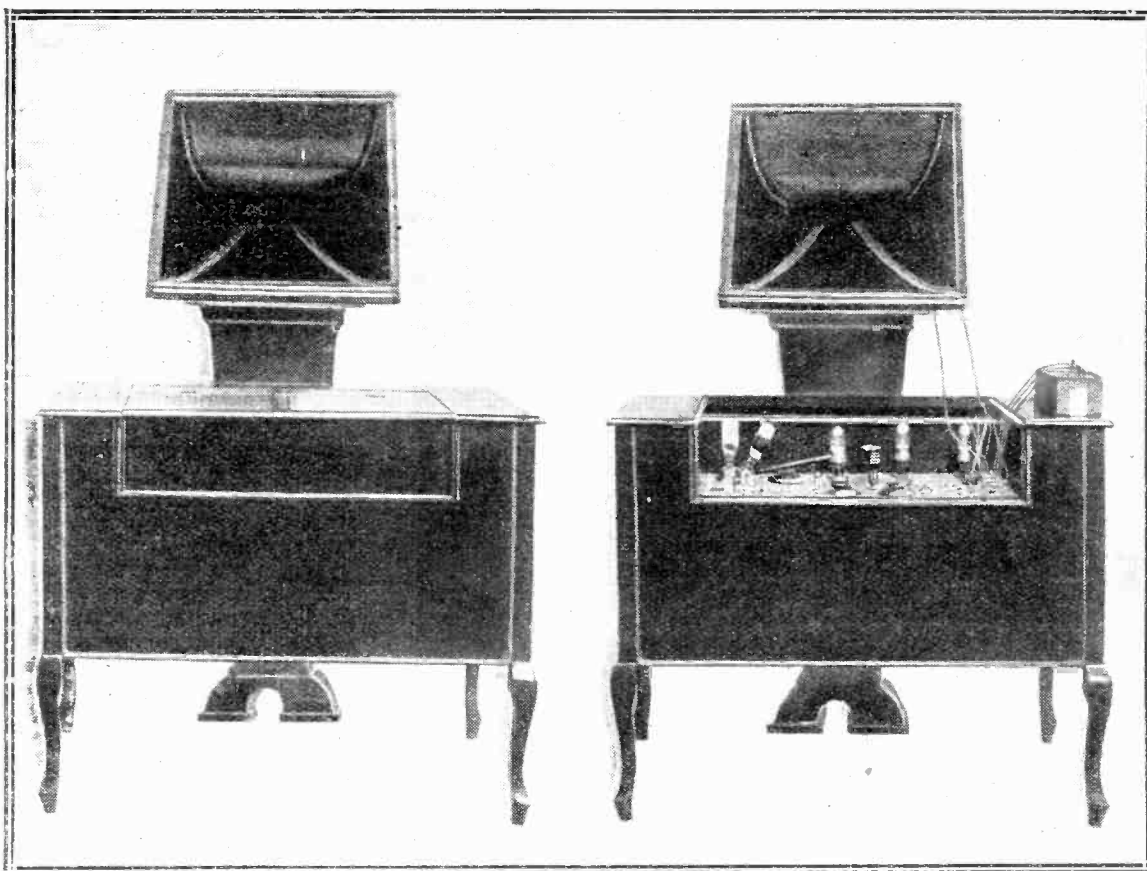

A handsome Three-Valve Dual Receiver constructed by Mr. Hankin.

LISSENIUM.

Get the carrier wave—

And ninety-nine times out of a hundred you've got the signal of an elusive station. With no other rheostat can you duplicate the performance of the LISSESTAT. Its accurate control of a critical electron emission GIVES THE VALVE A CAPACITY TO DETECT AS NO OTHER CONTROL CAN.

SOLD IN THREE MODELS
LISSESTAT (patents pending) gives the most acute tuning possible.

7/6

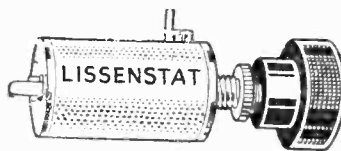

LISSESTAT MINOR (patents pending) provides **LISSESTAT** control at a popular price. Is replacing thousands of inefficient rheostats.

3/6

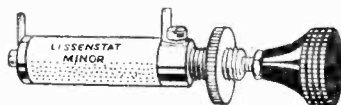

LISSESTAT UNIVERSAL (patents pending) with its feature of protection for dull emitters.

10/6



RECEIVERS
 FITTED
 WITH
 LISSESTAT
 CONTROL
 ARE
 EQUIPPED
 FOR THE
 FINEST
 DETECTION
 POSSIBLE.

Sensitivity—and the significance of the leak.

The leak resistance required in circuit depends upon the strength of signals. It also depends upon whether you want to bring in distant stations or whether you desire undistorted reception of nearer transmissions—it depends, too, upon whether you are using reaction or not, whether you are using a hard or soft valve—what the circuit is, and so on. Under **ALL THESE CONDITIONS, ONLY BY FITTING THE LISSEN VARIABLE GRID LEAK CAN YOU BE SURE OF GETTING THE UTMOST SENSITIVITY.** It covers all the wide range of resistance values required of a grid leak, with minute variation through. **LISSEN ONE-HOLE FIXING, OF COURSE.** 2/6

LISSEN Variable Anode Resistance, same outward appearance as the **LISSEN** Variable Grid Leak, 20,000 to 250,000 ohms. 2/6

DON'T MIX YOUR PARTS—there is a **LISSEN** part for every vital place.
PARTS THAT PULL TOGETHER—when you know that every vital part in your receiver is pulling strongly with each other, you know you have a receiver which is the best you can ever get. With all **LISSEN** Parts you will get results which would never be possible with mixed parts.



SMOOTH OUT YOUR
 LOUD SPEAKER DIS-
 TORTION BY PUTTING
 THE LISSEN VARIABLE
 GRID LEAK ACROSS
 THE SECONDARY OF
 THE LAST TRANSFORM-
 ER, OR ACROSS THE
 LOUD SPEAKER IT-
 SELF—first position is
 best.

LISSEN LIMITED

20-24, WOODGER RD., GOLDHAWK ROAD, SHEPHERDS BUSH, LONDON, W.12.

Telephones: Riverside 3380, 3381, 3382, 1072.

Telegrams: "Lissenium London."

LISSEN PARTS—WELL THOUGHT OUT, THEN WELL MADE.

In replying to advertisers, please use Order Form enclosed.

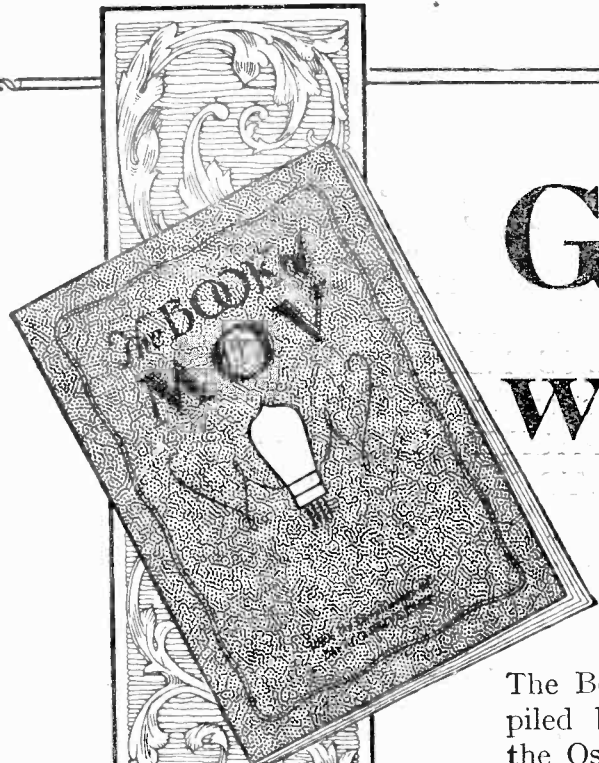

Get this wireless book—free!

The Book of MOV has been written and compiled by radio experts at Marconi House and the Osram Lamp Works. The most interesting and instructive work of its kind ever produced, it is issued gratis by the proprietors of



Sold by Wireless and Electrical Dealers, Stores, etc.

The Book of MOV is a work of reference invaluable alike to the beginner and the experienced experimenter. It should be in the hands of every wireless enthusiast. The voucher below entitles you to a copy.

Fill in and post this Voucher now—

Messrs. The M.O. VALVE Co., Ltd.
 Brook Green, London, W.6.

Please send me, post free, a copy of The Book of MOV.

Name

Address

M.W. No.

Get the Valve in the Purple Box

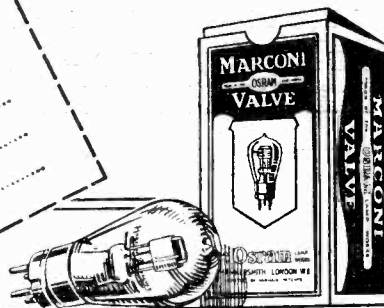

Copies of The Book of MOV may also be had from Wireless and Electrical Dealers, Stores, etc.

Announcement of The M.O. Valve Company, Ltd.

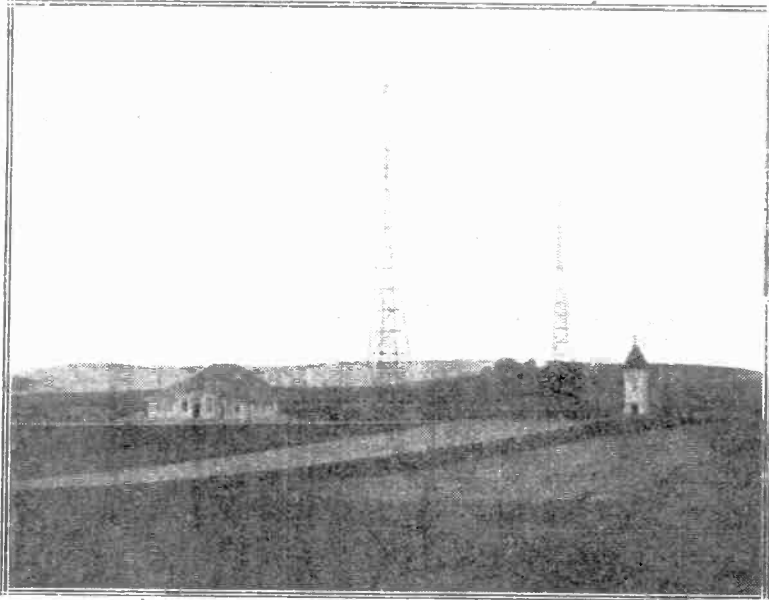

A general view of the Berne station.

Wireless Telephony and the League of Nations

By

**CAPTAIN L. F. PLUGGE,
B.Sc., F.R.Ae.S., F.R.Met.S.**

*An account of the broad-
casting of the speeches at
the recent assembly of
the League of Nations.*

SO many contradictory statements have been made in the Press lately about the transmission of speeches from Geneva, that we feel some details

about this wireless feat might be of interest to our readers.

Certain daily papers stated that Mr. MacDonald's speech at the League of Nations was not trans-

mitted at all, others that it was; but that the power used at Geneva was so small that reception was not possible in this country.

Unfortunately, these statements were incorrect. The speeches and procedure were actually broadcast,

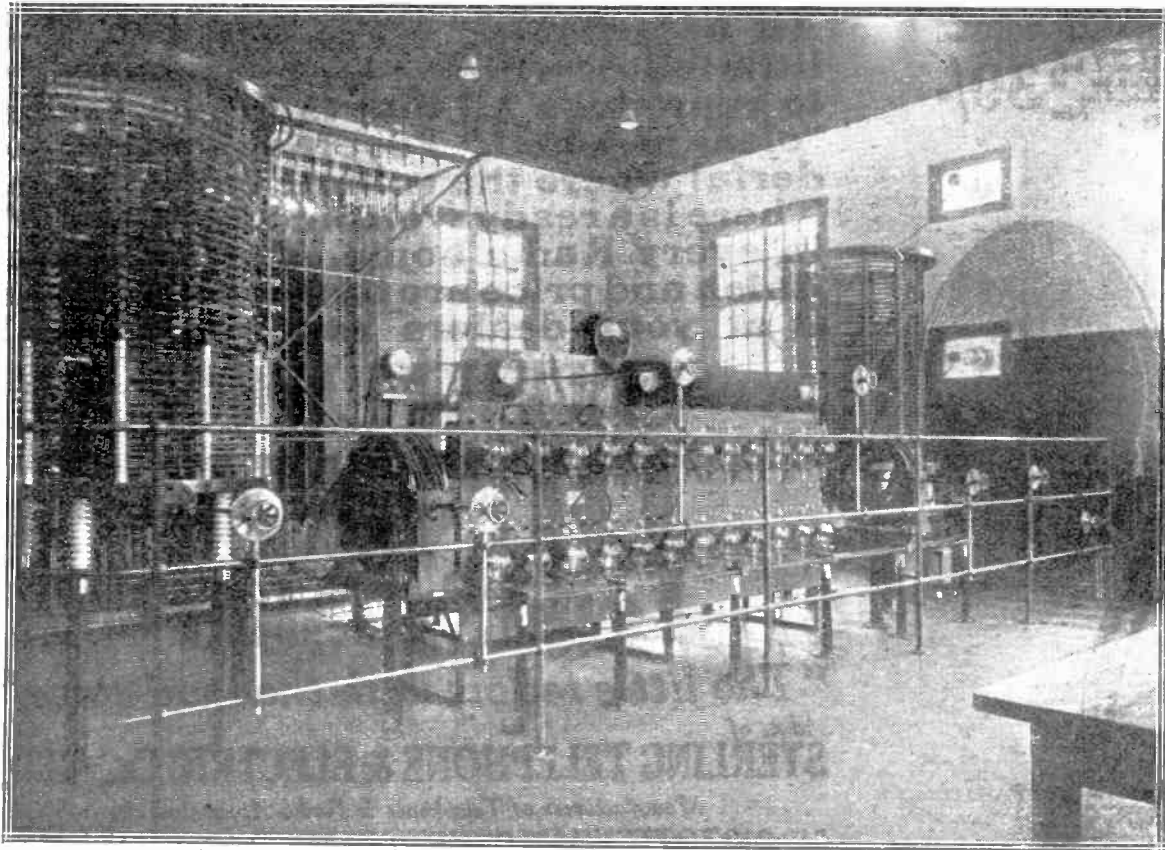

A 25 K.W. Marconi transmitter is used at the Berne station. Although not the station referred to in this article, the station handles, at high speed, messages for the League of Nations when in session, being controlled by land line from Geneva.



*There's always a welcome
for "Dinkie"*

The Sterling "Dinkie" Loud Speaker is supplied in a brown-tinted finish complete with flexible cord. Its dimensions are:—Height, overall, 13 ins., Diameter of Flare, 7 ins., Diameter of Base, 4 ins. Price **30/-**

An entertaining chap, DINKIE—the little fellow with the loud voice! Ready to reproduce all that is broadcast as "clear as a bell." People say it is wonderful where the volume comes from. There is a ready welcome for "Dinkie" in every Radio home. Performance, finish and price are the reasons. Hear it at your dealers and you'll buy!

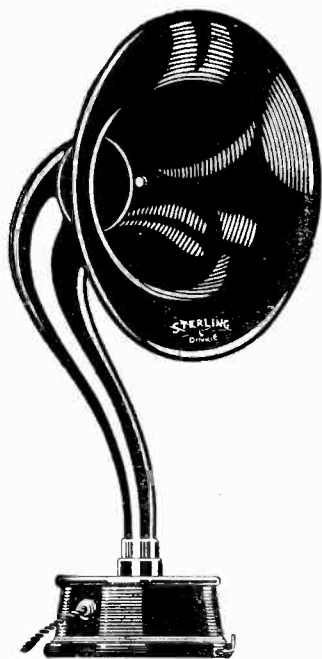

STERLING DINKIE Loud Speaker

"The little fellow with the loud voice"

Advt. of
STERLING TELEPHONE & ELECTRIC Co., LTD.

Manufacturers of Telephones & Radio Apparatus, etc.

210-212 TOTTENHAM COURT RD., LONDON, W.1, ENGLAND.



Ask your dealer for Sterling Leaflet No. 396—it illustrates and describes the wonder of the "Primax."

LUMIERE'S PATENT

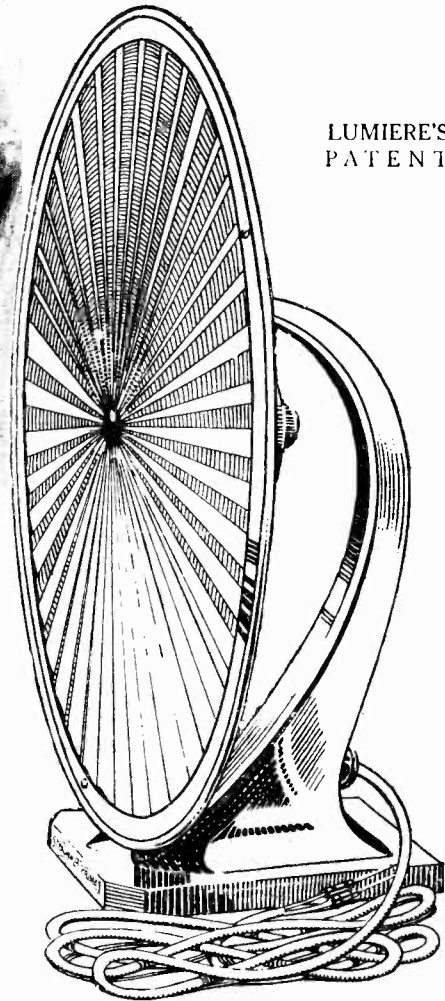

The seventh-heaven!

Music transports us to the realms of romance. Who so hardened whose soul does not respond to the message of a melody! Let the "Primax" be your guide to the seventh-heaven where music reigns. The "Primax" is a wonder Loud Speaker—nothing is comparable to it in perfection of reproduction, evenness of sound distribution, and charm of appearance. It is hornless. Ask your dealer to demonstrate the supreme qualities of the "Primax." After all, hearing is believing!

STERLING PRIMAX LOUD SPEAKER

The Sterling "Primax" Loud Speaker has a pleated white diaphragm mounted in an aluminium frame, supported on a stand of the same light artistic metal. Complete with 12 ft. of flexible cord, 2,000 ohms resistance. PRICE

£7:7:0

STERLING TELEPHONE & ELECTRIC CO., LTD., Manufacturers of Telephones and Radio Apparatus, etc.
TELEPHONE HOUSE, 210-212, TOTTENHAM COURT ROAD, LONDON, W.1 Works: DAGENHAM, ESSEX.

Accuracy

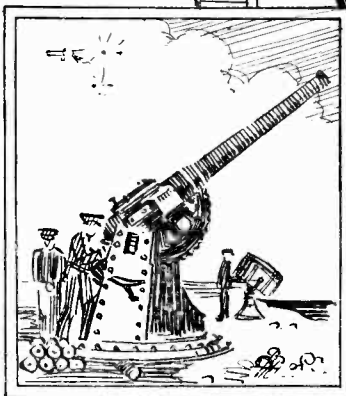
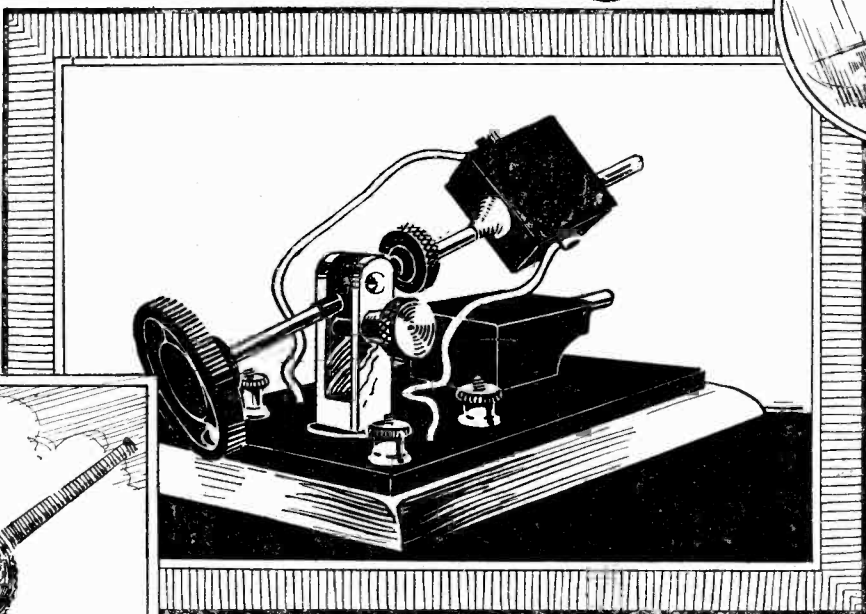
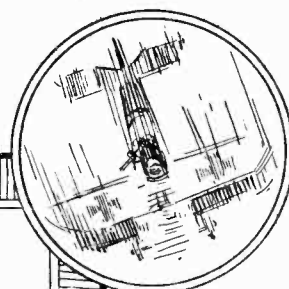

— the object of free movement

Though not so stern in purpose as the movement of the Anti-Aircraft Gun—the movement of the Polar Universal Coil Holder is alike in principle, with the same ultimate object of accurate adjustment. As the gun was specifically designed to follow quickly and precisely the rapid evolutions of the enemy raider through an ever-changing sphere of flight—so is the Polar Universal Coil Holder designed for an equally unlimited range of adjustment of coils.

POLAR UNIVERSAL 2-COIL HOLDER

Provisionally Protected under Patents and Designs Act.

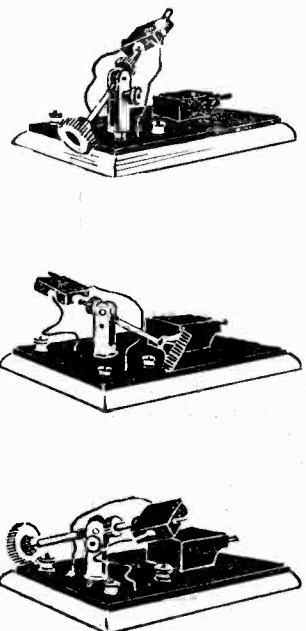

Offers widest possible limits of variation when coupling two or more circuits. The Polar Universal Coil Holder consists of two coil receptors—one fixed and the other displaceable in the same plane, or at right angles to it through a complete sweep of 360 degrees. It also has a forward movement allowing perfect centering of coils. THE MOVING COIL CAN BE COMPLETELY REVERSED. Absolute maximum scope of movement therefore provides the greatest possible advantage in experimental work.

The utmost closeness of coupling can also be obtained. The Holder is made to take the largest size (No. 1,500) of ordinary plug-in coils in both plugs even with these heavy coils, and the adjustment is firm and steady as the spindle can be firmly secured by means of a clamping screw in any position. **There are no rubbing or sliding contacts.** British made of finest materials, and covered by the Polar Guarantee.

Unmounted	10/6
Mounted (as illustrated)	13/-

REC

RADIO-COMMUNICATION

COMPANY, LTD.

34-35 NORFOLK ST. LONDON, W.C.2

Telephone: CENTRAL 4400

Telegrams: RADIOCOMM 237 LONDON

Branches:

NEWCASTLE 25 Colinton St.	GLASGOW 125 Hope Street	CARDIFF 110 High Street	LIVERPOOL 20-21, Market Street	SOUTHAMPTON 25 Queen's Terrace
------------------------------	----------------------------	----------------------------	-----------------------------------	-----------------------------------

Fleet Ad. Co.

and reception was very good in this country. Anyone possessing a set on which they could hear the Ecole Superieur des Postes et Telegraphes could have listened to their Prime Minister delivering his epoch-making speech.

Transmission was not made on 1,100 metres from Geneva, as many listeners may have thought, but was

Superieur was 500 watts, using an aerial of 300 ft., consisting of seven parallel wires.

This transmission was similar to their usual outside broadcast, which begins every evening between 8.15 and 8.45 p.m.

In the "Salle de la Reformation," where the assembly of the League of Nations took place, two

microphones were placed before the principal speakers. There were two distinct circuits, which were installed by the Western Electric Company. One was for the purpose of working loud-speakers in the hall, so that those present could hear distinctly all that was said. The other microphone was for the outside transmission. It led to a four-valve resistance-coupled amplifier, connected to the land line running to Paris.

Microphones of the carbon type were used, similar to those fixed by the B.B.C. in the Savoy Hotel.

The four valves in the amplifier were arranged, three in series and the fourth connected in parallel with the third.

Reports of reception were received from many quarters, and speech was readable in places 1,500 miles from Paris.

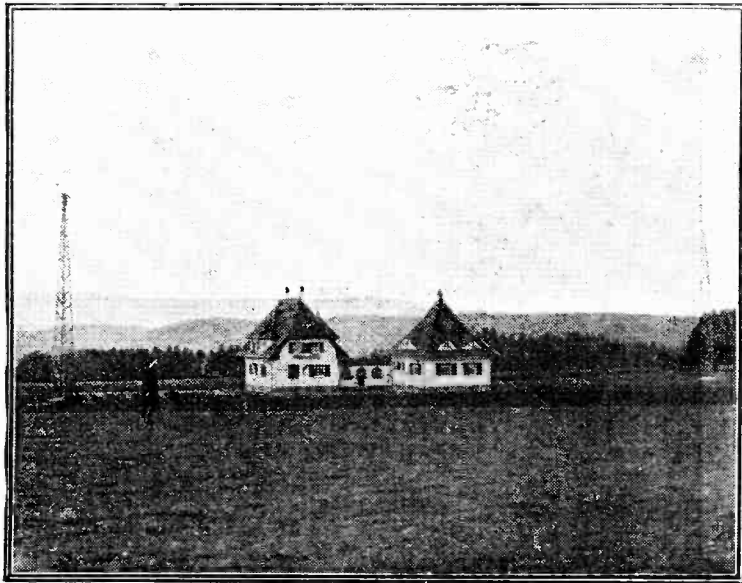

The Marconi receiving station at Munchenbuchsee is connected by land line to the Assembly of the League of Nations at Geneva.

sent out on the aerial of the station of the Ecole Superieur des Postes et Telegraphes on their usual wave length of 450 metres. Speech was carried by land line from Geneva. The land line from Geneva, which runs by way of Annemasse, Bellegard, Boucy, Dijon, Tonnerre and Melun, is the property of the French Ministry of Telegraphes.

I suppose, like many things in broadcasting, in these days of its infancy, the transmission of these speeches had to be arranged in a hurry, and no time was available to inform listeners in this country. It seems strange, however, in these times of high speed and of quick news service that a British Prime Minister was delivering a speech of international interest and importance in a foreign country, that hundreds and thousands of listeners could have heard it in Great Britain, and yet no one knew of it.

I was one of the fortunate who was informed of what was going to take place. I can say that Mr. MacDonald's voice was very clear, as was that of Mr. Cromlyk's, when giving out the French translation.

The power used by the Ecole

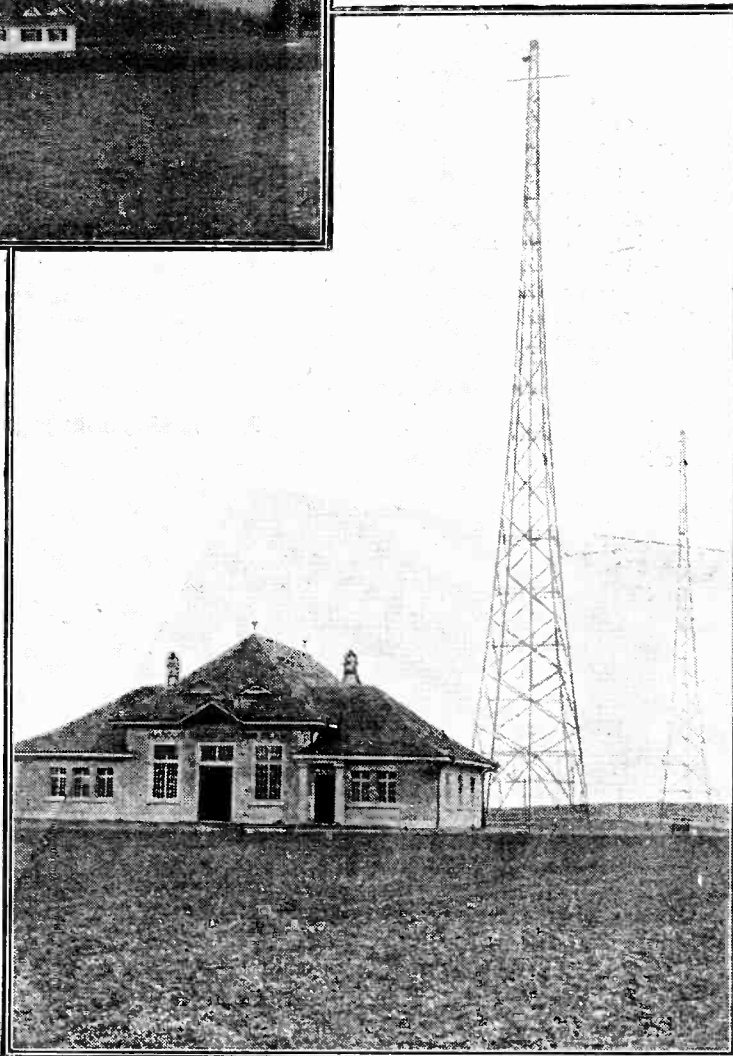

300 feet masts support the aerial at the Berne transmitting station.

A Self-contained Single Valve Receiver

By Walter Stevens.

This set, using a dull emitter valve, will appeal to all who prefer a receiver in which the attendant batteries are enclosed.

THE appearance on the British market of the low-consumption "dull-emitting" valve has caused a considerable amount of re-designing in the average broadcast receiver. The bulky and messy accumulator becomes unnecessary, and a small dry battery takes its place. Whereas the accumulator does not lend itself to inclusion inside the receiver, a small dry battery may be easily housed thus, and since the receiver is almost invariably installed inside the house, it can be made to harmonise more with its attendant surroundings.

In the present receiver, which employs one valve of the dull-

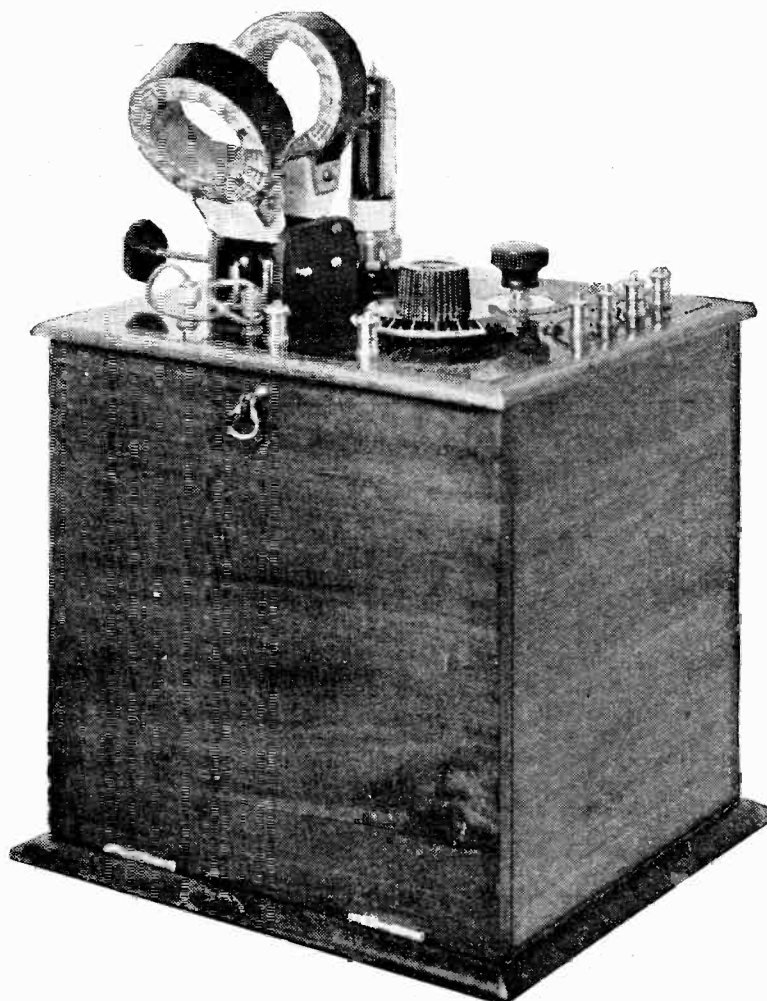

Fig. 1.—A photograph of the finished instrument.

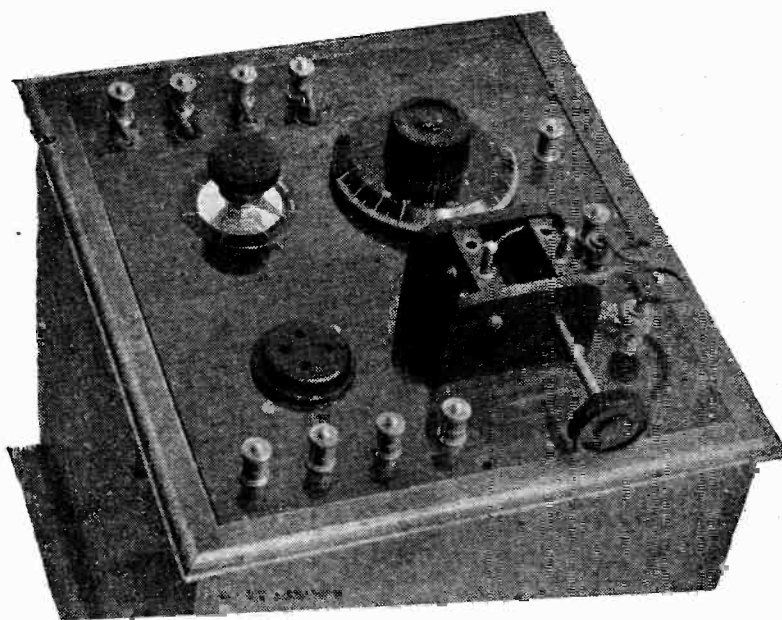
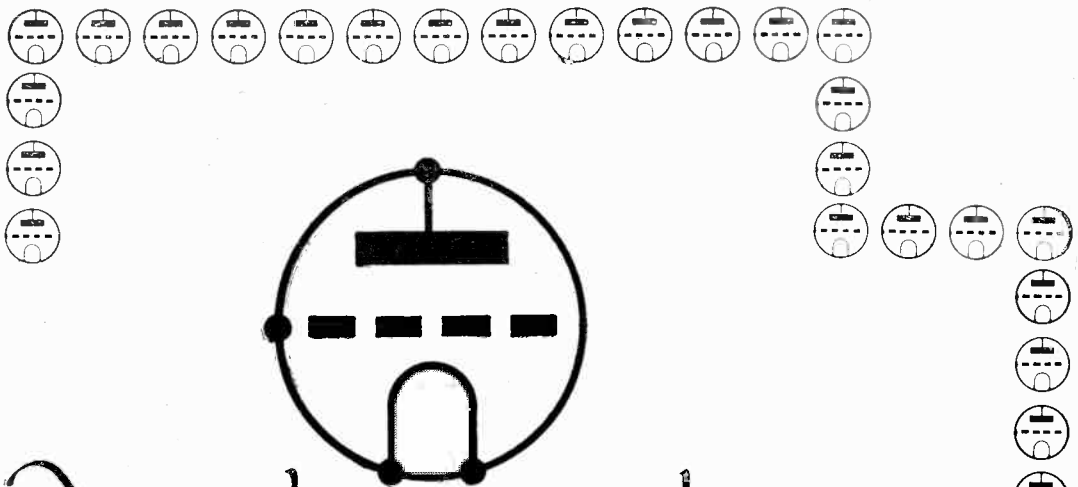

Fig. 2.—The aerial circuit terminals are clearly shown in the front of the photograph.

emitter type, both high-tension and low-tension batteries are housed within the set, which is therefore quite complete in itself, requiring only to be connected to aerial and earth when in use. A photograph of the finished instrument is seen in Fig. 1. The cabinet, it will be observed, is of a larger size than that generally associated with a single-valve receiver. The reason for this becomes obvious upon referring to the photograph in Fig. 5, in which one side of the cabinet is shown open, the high-tension and low-tension batteries being exposed to view.

Terminal Arrangements

In Fig. 1, the terminals on the right of the panel reading from the rear to the front are respectively H.T. +, H.T. -, L.T. +, and L.T. -. A rubber covered lead is taken from each of these terminals, and is connected to its respective battery terminal after passing through a bushed hole in the ebonite panel. The two knobs controlling the



A Symbol with a Story

IT'S a symbol that has become a commonplace . . . you see it in wireless articles . . . two or three times in most wiring diagrams. Everybody knows that it represents a valve. Ever thought how long that symbol took to evolve? The original one didn't look like that; it was just like the picture

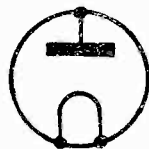

in the corner here. That was 30 years ago. Many

years passed before the broken line was added. It indicated the grid—the *third* electrode which made broadcasting possible.

The original symbol had its beginnings in the Ediswan laboratories, where the world's first valve was made. In every Ediswan Valve you have an accumulated experience dating back to Fleming's momentous discovery.

Ediswan Valves will bring the best out of your wireless set—get some on the way home and enjoy a better programme from to-night onwards. All dealers sell them.

THE EDISON SWAN ELECTRIC CO. LTD.
QUEEN VICTORIA ST., LONDON, E.C.4.

An interesting study of early wireless history may be made at the Science Museum, South Kensington, London, where the complete series of Dr. Fleming's experimental valves can be seen.

EDISWAN

VALVES

162-3

All Your Constructional Difficulties Solved

The greatest wireless disappointment is when, after careful and sometimes difficult constructional work, only moderate results are obtained. This is usually the result of using a collection of wireless parts only semi-efficient in character and quite unsuited to the circuit employed. By building your set with:



you eliminate all these difficulties, and, providing the wiring is carried out correctly, you *know* you will get infinitely superior results, results definitely giving an increased selectivity, a greater range, a purer tone and maximum volume without distortion.

STANDARD ONE-HOLE FIXING ensures absolute simplicity in constructional work.

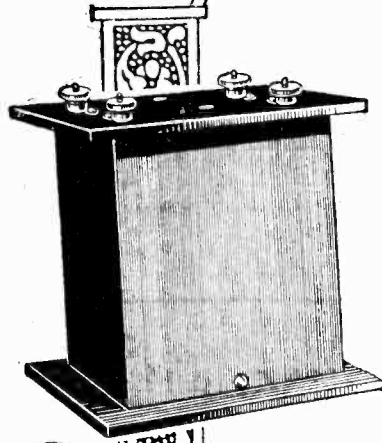

1

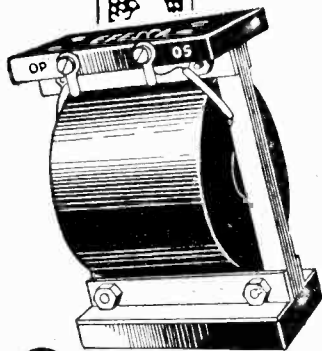

2

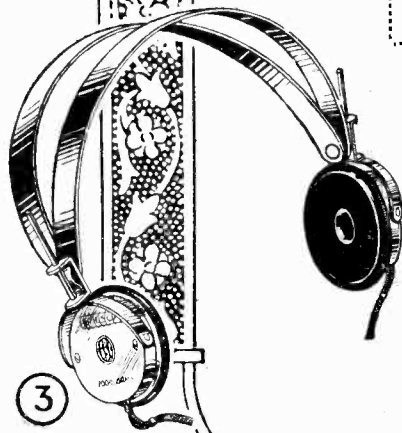

3

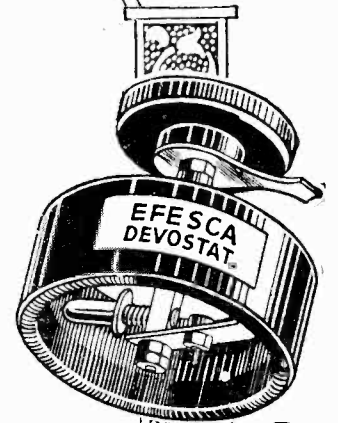

4

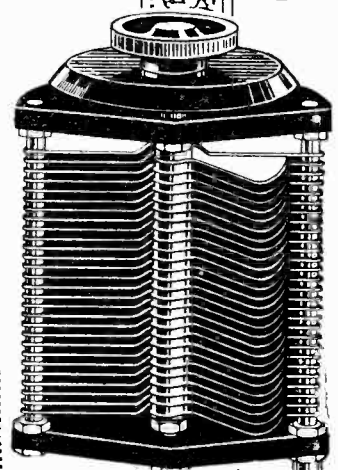

5

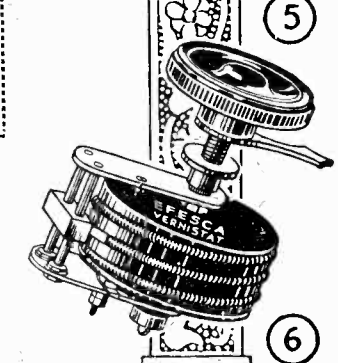

6

The Components Illustrated are:—

- 1.—EFESCA LOW-FREQUENCY TRANSFORMER, TYPE "B." A one-hole fixing transformer of unique design. A special feature is that the windings and laminations are totally enclosed in an insulating compound, thus giving absolute immunity from Atmospheric Humidity. This transformer gives maximum amplification without distortion and is enclosed in metal shroud which eliminates all parasitic noises. Ratio 4—1, 22/6.
- 2.—EFESCA SPEECH AMPLIFYING TRANSFORMER, TYPE "C." This transformer is designed to give the amplification of a power transformer without the loss in purity of reproduction generally experienced with power amplification. The coil is wound in a special manner to neutralise resonant effect, while the laminations of the core are extra-carefully insulated from each other to localise eddy currents and thus prevent distortion. Ratio 2—1, one-hole fixing, 25/-.
- 3.—EFESCA HEADPHONES. Popular priced headphones maintaining the usual Efesca standard of quality. They are exceptionally clear and evenly matched in tone, and produce full volume. The magnets are of cobalt steel ground perfectly true. Diaphragms of Stalloy. Headbands of polished Duralumin. 4,000 ohms, with 6 ft. flexible cord, 21/- . Ditto 120 ohms, 21/-.
- 4.—EFESCA "DEVOSTAT" (Patent applied for). A special designed Rheostat for Dull Emitter Valves consuming .06 amps. The contact carrier rotates concentrically with the resistance former and is fitted with a ball-pointed brush making contact with the resistance wire. A spring plunger maintains the ball at even pressure at every turn of the wire, thereby ensuring fine adjustment, smooth and noiseless contact throughout its action. Resistance 30 ohms. Complete as illustration, 4/6.
- 5.—EFESCA VARIABLE CONDENSER gives a high standard of accuracy. Vanes are spaced with micrometer exactitude, the construction providing smooth action coupled with stability. One-hole fixing. .001 mfd. 12/6, .005 mfd. 8/6, .003 mfd. 7/-, .0005 mfd. 5/6.
- 6.—EFESCA VERNISTAT (Patent applied for). Of unique construction, the Vernistat gives extremely delicate control and is smooth and silent in operation and is specially suited to High Frequency and Detector Valve filament control. Resistance 5 ohms, 6/- each, complete as illustrated.

Our Catalogue No. 522 tells you all about the many unique "Efesca" features—a copy is yours for the asking.

For those not interested in the constructional side there is a wide range of complete Efescaphone sets from the simple crystal set to the multi-valve receiver for loud speaker and long range work.

Sold by all wireless dealers, electricians and ironmongers. Wholesale only from:—

FALK STADELMANN & Co. Ltd.,
Efesca Electrical Works, 83-7, Farringdon Road,
London, E.C.1.

And at Glasgow, Manchester and Birmingham.

filament rheostat and the variable condenser are seen to the left of the battery terminals, while the coil-holder and valve are situated on the left-hand side of the panel. The two terminals at the front edge of the panel are for the telephones.

The aerial circuit terminals are hidden in this photograph by the coil-holder, but may be seen in Fig. 2. Reading from the left they are marked respectively Aerial, A₁, A₂ and E. The usual forms of aerial tuning may be tried by means of these terminals, namely, constant aerial tuning with parallel tuning condenser, parallel tuning without constant aerial tuning, and series tuning without C.A.T.

The Circuit Arrangement

A diagram of the circuit of the receiver is given in Fig. 3. The valve V acts as a detector, reaction

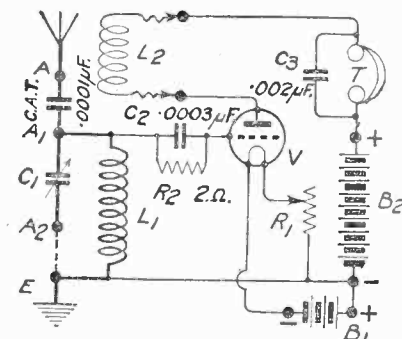

Fig. 3.—The theoretical circuit of the receiver, showing the various aerial terminals.

being obtained by coupling L₁ and L₂. The fixed C.A.T. condenser has a capacity of 0.0001 μF, and is included in the aerial circuit when it is desired to use constant aerial tuning, by joining the aerial

to terminal A. C₁ is the aerial tuning condenser of 0.0005 μF maximum capacity, and L₁ is the aerial tuning coil. The grid condenser C₂ has a capacity of 0.0003 μF, and is shunted by the two megohm leak R₂.

In the plate circuit of the valve are the reaction coil L₂ variably coupled to the aerial coil, and the telephones T shunted by a by-pass condenser C₃ of 0.002 μF, to give smooth reaction control.

The filament rheostat is included in the positive filament lead, since this has been found an advantage with the type of valve it is proposed to use.

Components Required

Manufacturers names are included in the following component list.

While it is not absolutely essential to employ the same makes of components as used in the present

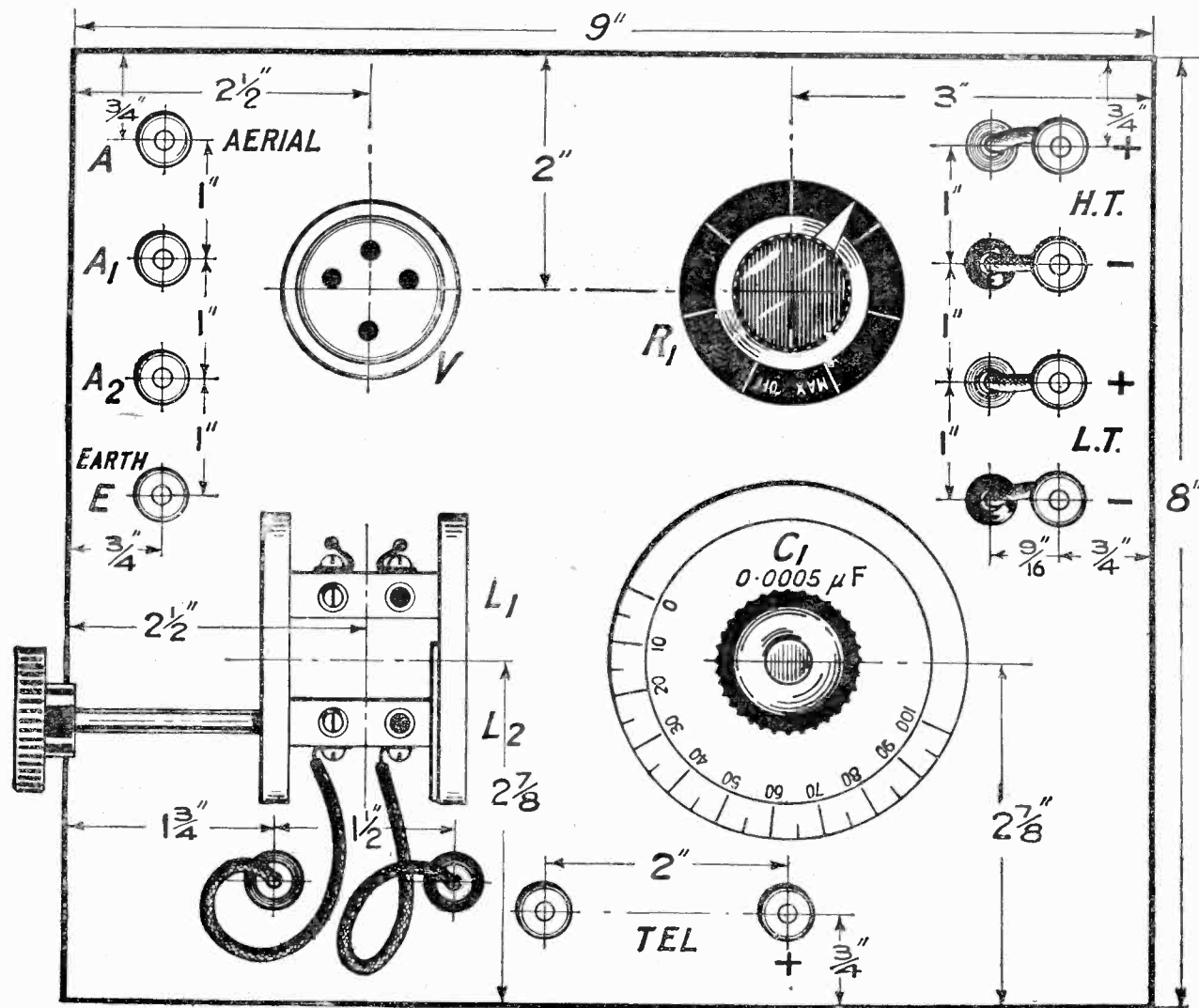

Fig. 4.—The panel may readily be drilled by reference to the above diagram. A full sized blue print No. 70A can be obtained from the Sales Department.

receiver, the values mentioned should be strictly adhered to. The components are:—

- 2 ✓ 1 polished insulating panel guaranteed free from surface leakage, 9 in. x 8 in. x $\frac{1}{8}$ in. That used was brown in colour. (Peter Curtis Ltd.)
- 5 ✓ 1 Polar Junior Vernier 2-coil-holder. (Radio Communication Co., Ltd.)
- ✓ 1 0.0005 μ F variable condenser.
- ✓ 1 30-ohm Peerless Junior Rheostat. (The Bedford Electrical and Radio Co., Ltd.)
- ✓ 1 Valve-holder. (Burndept "Anti-phonic.")
- 2 ✓ 4 Clix panel bushes. (Autoveyors, Ltd.)
- 2 ✓ 4 Clix terminals (Autoveyors Ltd.)
- 10 ✓ Terminals with markings.
- 1 ✓ 0.0003 μ F fixed condenser. (Dubilier.)
- 1 ✓ 0.002 μ F fixed condenser (Dubilier.)
- 1 ✓ 0.0001 μ F fixed condenser. (Dubilier.)
- 1 ✓ 2-megohm grid-leak. (Dubilier.)
- Rubber-covered stranded copper-wire.
- Square-tinned copper for wiring.

Notes on Components

The coil-holder possesses a vernier arrangement which enables a fine control of reaction to be obtained.

Those who have used dull-emitter valves will have experienced the unpleasant microphonic effects inherent in valves of this type. The special springing of the valve-holder used in this receiver will be found to eliminate this trouble.

A valve of the .06 type is employed, a 4½-volt dry battery serving for filament heating. A 30-ohm rheostat is incorporated, the ordinary 4 or 6-ohm resistance being quite useless with this type of valve.

Panel marking has been rendered unnecessary by the use of engraved terminals. The markings, such as Aerial, A₁, LT+, etc., are upon the tops of the terminals, where they are easily seen.

The Panel

The surface of the panel has a pleasing brown colour, and was obtained, as indicated in the component list, from Messrs. Peter Curtis. No difficulty in working this material may be anticipated.

The diagram showing the position of the holes to be drilled is seen in Fig. 4. The saying "Method means quickness," applies aptly to panel drilling, and the best way to set about the work is to mark the position for each hole by means of a tool with a sharp point, and

then drill all holes which are to be of the same size without changing the drill and starting on other points which may be nearer. It is surprising when one thinks of the number of amateurs who drill from one side of the panel to the other, changing the size of drill far more frequently than necessary.

holes in the panel give a poor finish to the set.

From Fig. 6 it will be seen that the wiring of the receiver presents no difficulties. Stiff square section wire is used for making the various connections, and the resulting workmanlike appearance of the back of the panel will be noticed in the

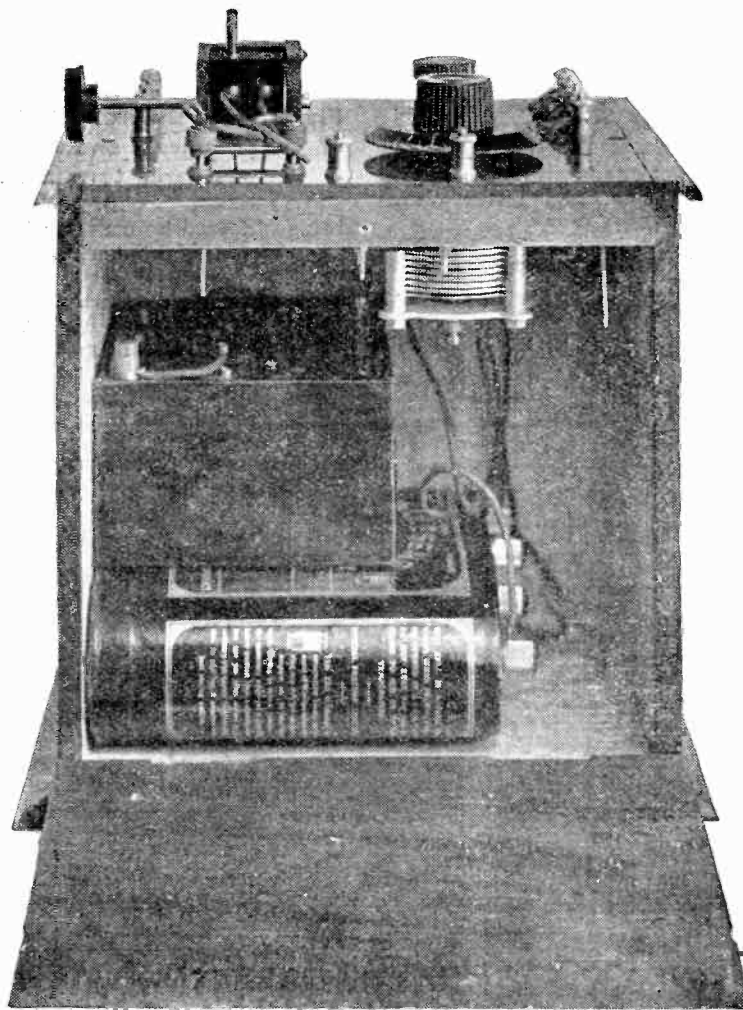

Fig. 5.—A photograph showing how the batteries are housed inside the receiver.

Assembling and Wiring

The smaller components are best mounted first, such as the terminals and valve-holder, as otherwise the panel becomes unnecessarily difficult to handle before the task of assembling is finished. The mounting of the valve-holder becomes clear upon studying Fig. 7, and a hole of an inch and a half diameter requires to be drilled in the panel.

The four Clix panel bushes are mounted by the side of the battery terminals, and included merely for the sake of appearance, since bare

photographs. Fig. 7 will also help to clear up any doubts concerning the wiring.

Two Clix plugs are connected by rubber-covered leads to the screw-head terminals on the reaction-coil socket in order to determine easily the correct direction of winding for obtaining reaction.

The Cabinet

Should the reader desire to purchase this ready-made, many dealers specialise in making cabinets to any size required. The following details will enable the reader to

WHY PAY ?

Why spend good money every week to have your accumulators re-charged when you can do them yourself at home, FREE OF ALL COST?

Why suffer the annoyance of being left with accumulators run down and the trouble of carrying them to a charging station, when you can keep them always fully charged and in perfect condition in your own home?

If you have a Direct Current supply of electricity of any voltage in your house, either for lighting or heating purposes, all you need to charge your own accumulators at home is the

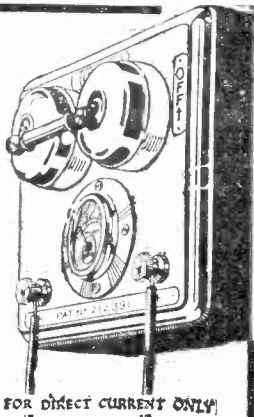

FOR DIRECT CURRENT ONLY

ULINKIN

PATENT No. 212391.

THE D.C. HOME CHARGER

which charges your batteries automatically whenever you have lights, radiators, electric irons or vacuum cleaners in use in any part of your house, without consuming any extra current, and therefore free of cost.

PRICE £2 : 2 : 0 CARR. FREE.

Complete with simple instructions

Send 42/- for a ULINKIN To-day, or write for illustrated booklet and fuller particulars.

Trade Enquiries Invited.

The Gran - Goldman Service
(Dept. M.22), 71, Fleet Street, London, E.C.4

See the ULINKIN at the WHITE CITY EXHIBITION STAND No. 53 November, 15th to 29th.

AUTOMATIC IN ACTION. Requires no attention. Cannot go wrong.

BRANDE'S HEADPHONES.

A combination of all the good points necessary in really good headphones. Excellent receptivity, absolute comfort, exceptional strength, and extreme durability. Ask for the phones in the sealed carton.



List No. 17152

25/-

Per pair.



G.R.C. Low Frequency Transformer.

As used on standard G.R.C. amplifiers, and guarantees maximum amplification without distortion. Correct impedance ratio, minimizing distributed capacity, low core losses, correct shielding and careful impregnation, permits of as many as four stages of amplification being used without howling.

List No. 17175.

Each 15/-

Brown Brothers

THOMSON and BROWN BROTHERS LTD
BROWN BROTHERS (IRELAND) LTD

Wholesale only. Head Offices and Warehouse:
GREAT EASTERN ST.,
LONDON, E.C.2.
118, George St., EDINBURGH, and Branches.

Please order from your local Wireless Dealers

Put the World on your Dial.



The complete absence of inter-electrode capacity simply explains the power of the MYERS to reach across continents. The paralyzing effect of bunched leads in the stem inherent to the ordinary valve is to blind your receiver to the faint signals from stations beyond the seas. But one valve can span and bring in any far distant station with power, with freedom from microphonic noise or distortion. The name MYERS—a password to beyond the seas.

a letter which echoes the enthusiasm for MYERS

If it is power and sensitivity you want remember the MYERS is pre-eminent in this respect. In practice, if you fit MYERS you can save one valve, for they give greater power than any ordinary valve.

"Sirs,—The results obtained with one valve, used as a straight detector with tuned plate, is quite equal (as regards distance) to the use of one H.F. I have therefore cut out H.F. amplification with its attendant troubles.

"Secondly, audio-frequency amplification is really wonderful. With two valves (one detector and one L.F.) here in Tring I can work a large L.S. efficiently, on London; speech is readable in a room 15 ft by 12 ft. with one 'phone earpiece and no trumpet laid anywhere in the room.

F. S. C., F.O., R.A.F., Retired List."

Universal, 12/6
4 volts .6 amp.
Dry Battery, 21/-
2½ volts .25 amp.

Myers

PRACTICALLY UNBREAKABLE

Valves

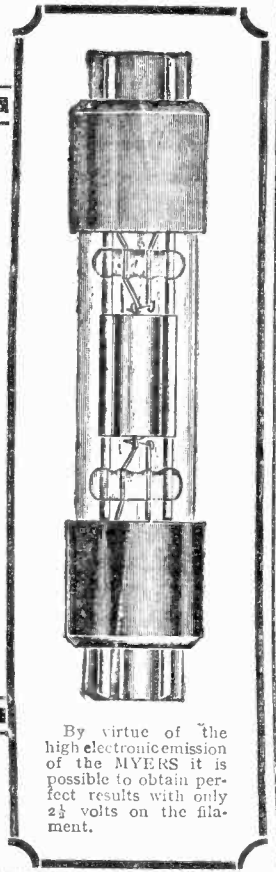

By virtue of the high electronic emission of the MYERS it is possible to obtain perfect results with only 2½ volts on the filament.

LONDON—The Dull Emitter Valve Co., 83, Pelham Street, South Kensington, S.W. (Kensington 3331).
MANCHESTER—R. Davis & Sons, Victoria Bolt and Nut Works, Bilberry Street.
LIVERPOOL—Apex Electrical Supply Co., 59, Old Hall Street.
GLASGOW—Milligan's Wireless Co., 50, Sauchiehall St., Glasgow.
FORKSHIRE—H. Walsworth Sellers, Standard Buildings, Leeds.
SOUTHERN COUNTIES—D.E.D.A., 4, Tennis Road, Hove.

MYERS are obtainable from all dealers or direct from the nearest selling agent.

Advertisement of Cunningham and Morrison, Windsor House, Victoria Street, London, S.W.1.
In replying to advertisers, please use Order Form enclosed.

Barclay Ad. 209

**Variable
Condensers
Type A.**

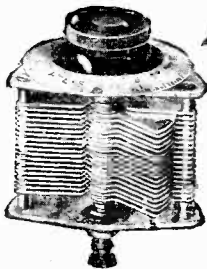

Made in all capacities from .001 mfd. down to Verrier. All vanes are correctly spaced and beautifully balanced; and the top and bottom plates are semi-round in shape, being made of best aluminium.

**L.F. Intervale
Transformers**

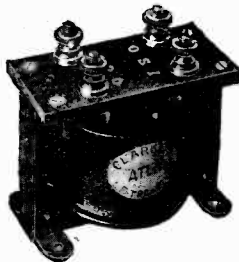

Ratio $\frac{1}{2}$ to 1. Tested for insulation with 500 Volts across the winding, giving a minimum of 100 megohms insulation resistance. Also tested in pairs for transformer "howl."

Give amplification with purity of tone and freedom from all trace of distortion. Twelve months' guarantee against defects due to faulty materials or workmanship.

**Clarke's "Imp"
Crystal Receivers**



Regd. No. 4447.

Stamped "B.B.C." Measures 5in. by 3in. by 3in. high. Fitted with Adjustable Crystal Detector, Crystal Holder, Wave-length Adjuster and four terminals for Phones, Aerial and Earth. Finished in Polished Mahogany with all metal fittings nickel-plated. Can be worked with three or four pairs of Head-phones. Suitable for reception of wave-lengths up to a range of about 25 miles.

CLARKE'S ATLAS

WIRELESS SPECIALITIES

**THE KING
Designed
on Sound**

Self-capacity reduced to an absolute minimum by an arrangement of separators giving greatest air-spacing. Maximum circumferential area is afforded, thus least possible resistance is offered by the special twin wire



**OF COILS
Scientific
Principles**

winding. Wound in true concentric circles, which, combined with other advantages, effects the finest possible tuning. The "Atlas" Plug accommodates itself to any make of coil stand.

**Two-way
Coil Stands**

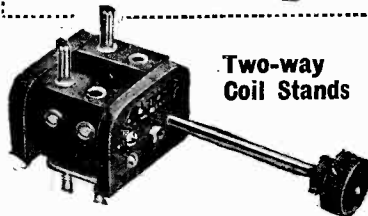

In both horizontal and vertical types. Both types are provided with a neat Tension Adjustment, the Plug Inserts being set at standard centres and all the fittings are nickel-finished. The two and three-way Horizontal Coil Stands can also be supplied with our patented Micrometric Adjustment.

**Clarke's "Atlas" Filament
Control**
Prov. Patent No. 16,427.



Gives an infinite control over the flow of Electrons through the valve, and perfectly adjusts the Valve Filament from dull red to necessary brightness, ensuring longer life to the Valves, as there is no sudden rush of current. Smooth and noiseless. Will carry two amps without overheating. It is impossible for this Resistance to "Pack." One-hole fixing.

Grid Controls

(Var-Grid Leak and Condenser combined)

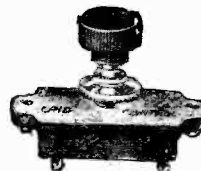

Give uniform adjustment from $\frac{1}{2}$ to 10 megohms. Condenser of finest ruby mica and pure copper foil clamped under pressure; perfectly constant, absolutely noiseless, and impervious to atmosphere. One-hole fixing.

Fixed Condensers



Of thoroughly reliable manufacture, supplied in all values. Bakelite casings and inserts, copper foil and mica dielectric held under pressure by countersunk brass N.P. screws and nuts. Value is kept constant. N.P. soldering tags. Tested to 1,000 volts prior to despatch.

Manufactured only by

**Variable
Condensers
Type B.**

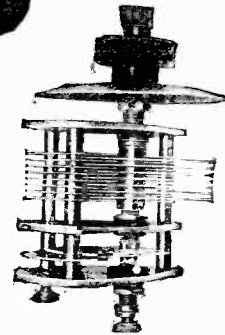

Similar to type "A" but with addition of a Verrier in combination with it. The capacities of these condensers are guaranteed correct. Both A and B condensers are one-hole fixing type.

**"Velvet - Touch"
Rheostats**



6 ohms, affording great assistance in safeguarding valve filaments. Produces just that velvet touch so desirable; no scraping noise as heard in cheaper makes.

**Variometers
"A" Type**

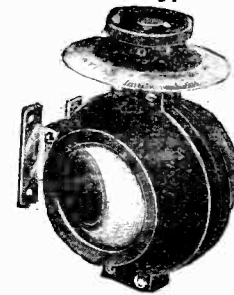

Ball type ebonite rotor swivelling inside an ebonite ball type stator; rotor externally wound, stator internally wound, effecting tight coupling for fine tuning. Ratio 12 to 1. Cover lower W.L.s. of B.B.C. stations. Ebonite knob. Wembley pattern anti-capacity dial, N.P. brackets and fittings, one-hole fixing.

H. CLARKE & CO. (MANCHESTER) LTD. Radio Engineers,
ATLAS WORKS, OLD TRAFFORD, MANCHESTER

Phones: 683 & 793, Trafford Park.

'Grams: "Pirtoid, Manchester."



In replying to advertisers, please use Order Form enclosed

construct the cabinet for himself should he so desire.

The work is carried out in $\frac{3}{8}$ in. finished mahogany, and the required dimensions of the necessary wood are as follows:—

2 sides $9\frac{1}{8}$ in. long, $9\frac{1}{4}$ in. high.

2 sides 8 in. long, $9\frac{1}{4}$ in. high.

Base $9\frac{1}{2}$ in. \times $10\frac{1}{2}$ in.

The cabinet is constructed to a size which allows the upper edge of the ebonite panel to become flush with the top of the cabinet, strips of wood being fixed to the inside of the cabinet $\frac{1}{4}$ inch from the top to act as a support for the panel.

One of the $9\frac{1}{8}$ in. \times $9\frac{1}{4}$ in. sides is hinged and is fitted with a knob, the position of which may be seen in Fig. 1, while in Fig. 5 this side may be seen open, its purpose being to enable the batteries to be easily accessible.

Batteries and Valve

A Hellesen dry battery of $4\frac{1}{2}$ volts has been employed for filament heating. For the sake of quick reference these batteries are given different names, the name of that used in the present instance being "Glate." In any case care should be taken to select a battery of large capacity, otherwise its life will be short.

The high-tension battery was made by the same firm, the name in this case being "Wirin," and has a total voltage of 60.

The valve is one of those known as the .06 ampere type, and any well-known make may be used. This, of course, applies equally well to the batteries, but in no case should cheap ones be substituted, as usually these are very unreliable.

Operating the Receiver

The batteries are inserted in the cabinet (convenient positions are those shown in Fig. 5.) and connections taken from the terminals on the panel through the Clix panel bushes to their respective battery terminals. It is possible that the full 60 volts of the high-tension battery will be required, although the valve is to be used as a detector. Now connect the aerial, earth and telephones to the receiver, and also insert the valve in its socket. This latter should not be done until the rheostat has been turned to the "off" position, and it is advisable to leave the H.T. + terminal disconnected until you are assured that the valve lights correctly.

Constant aerial tuning may be tried first of all by connecting the

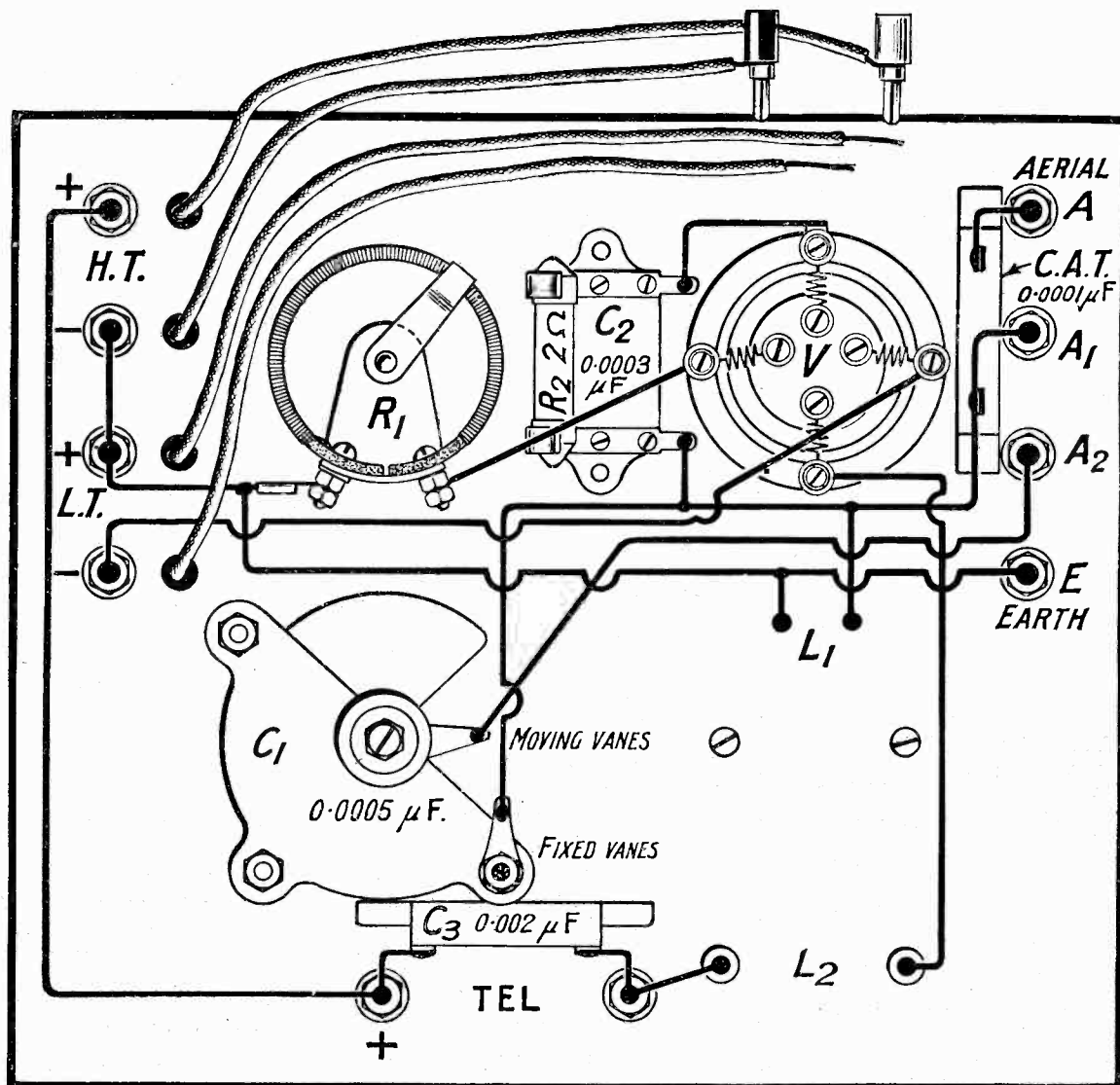

Fig. 6.—The wiring diagram. Full size blue prints are available, No. 70 B.

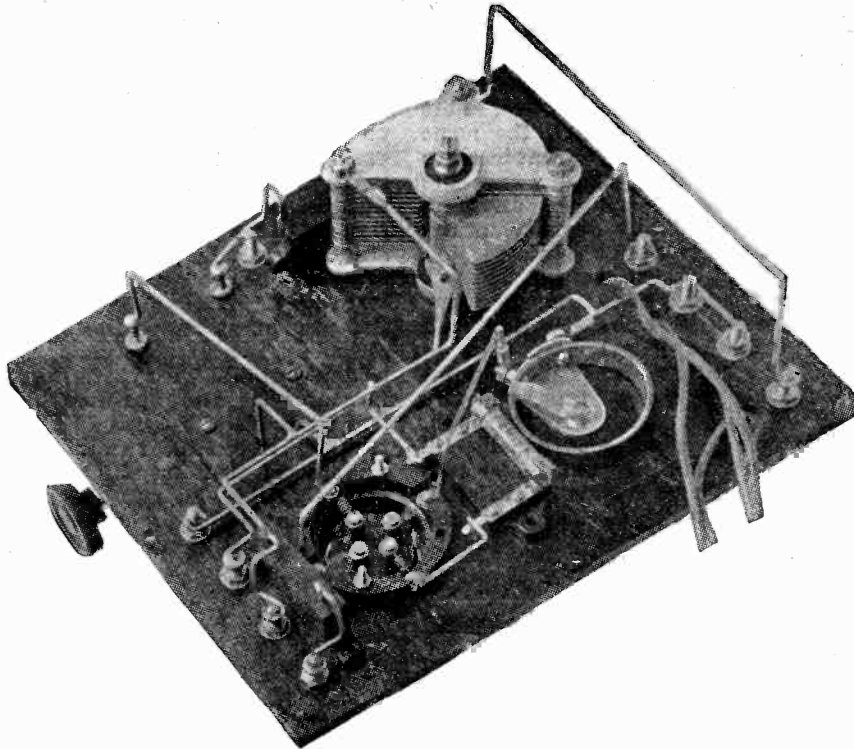

Fig. 7.—The wiring of the receiver can be clearly followed from the photograph.

aerial to A, and E to earth, A₂ and E being joined by a piece of wire. A No. 50 coil is now inserted in the aerial (fixed) socket, and a No. 75 in the reaction coil socket. Switch the valve on, taking care not to burn the filament too brightly. Tuning is carried out by adjustment of the variable condenser. If the station desired is within easy range the coils should be placed as far apart as possible while tuning is carried out, and upon receiving the signals they may be brought slowly towards each other, retuning at the same time on the variable condenser. If signals become weaker instead of stronger, the leads to the reaction coil should be reversed by means of the two Clix plugs and sockets, and the tuning process carried out again.

For best results it is advisable to try varying both the filament temperature and the high-tension supply, and also to try the different forms of tuning.

Series aerial tuning may be used by connecting the aerial to A₂ and earth to E, no link being used in this case. A smaller coil may be tried in the aerial socket with this form of tuning.

Ordinary parallel tuning without constant aerial tuning may be used by connecting the aerial to A₁, earth to E, and A₂ joined to E as with constant aerial tuning.

TEST REPORT.

THE single-valve set described in the foregoing article was tested eight miles east of 2LO. Two aerials were used, one a 75-ft. twin, 45 ft. high, the other a single wire, 60 ft. long, 20 ft. high, badly shielded at one end by the house.

Constant aerial tuning was employed throughout the test, except in the case of 5XX, when ordinary parallel tuning was used.

Comparative Tests.

2LO was the first station received. A No. 50 coil was placed in the aerial socket and a No. 75 coil in the anode socket. The set was first tested on the large aerial and the condenser dial read 18°. On this adjustment 2LO was so loud as to be uncomfortable in the headphones and the loud-speaker was worked with sufficient volume for a small room.

Signal strength on the small aerial was of course not so great, but very good 'phone signals were received. The aerial tuning condenser was in this case set at 19°. The large difference between the two aerials and the small one between condenser readings amply demonstrate the advantage of constant aerial tuning. With this aerial arrangement speech could easily be understood at 15 feet

from the loud-speaker when used in place of the telephones.

Stations Received.

The large aerial was then connected to the set, and the following stations were all received at about equal signal strength, being sufficiently clear to enable the weather forecasts and call signs to be quite easily read:—

- London, 2LO, 18°
- Newcastle, 5NO, 41°
- Birmingham, 5IT, 62°
- Aberdeen, 2BD, 71°

For these stations a No. 50 coil was used for the aerial circuit and a No. 75 for reaction.

- Birmingham, 5IT, 8°
- Aberdeen, 2BD, 11°

These latter readings were obtained with a No. 75 coil in the aerial socket, the reaction remaining unchanged; a slight increase in signal strength was noticed.

On the smaller aerial no other stations except 2LO and 5XX were received, unless undue reaction coupling was used.

5XX was tuned in with a No. 150 coil in the aerial socket and a No. 200 in the reaction socket. The condenser reading was 80° for this station, which comfortably filled a small room on a loud-speaker on the large aerial, and was pleasantly audible on the small one. In the latter case the aerial condenser read 105°. Parallel tuning was employed in both cases.

The valve used during the test was a D.E. 3. H.T. was varied between 20 and 80 volts, as suggested by the manufacturers, best results being obtained with a voltage of about 60.

The whole set, being self-contained, is suitable for placing in the drawing-room, as no unsightly accumulators or other necessary components are outside the set. The receiver is comparatively small and can be placed on a small shelf in a convenient position.

Do not wait a whole month for your next wireless literature.

“The Wireless Constructor”

is published on November 15th.

Place your order at once to avoid disappointment.

**The CURTIS CONSTANT-TUNED
HIGH FREQUENCY
AMPLIFIER
ON CONTROLS
NO CONDENSER**



ABSOLUTELY AUTOMATIC TUNING

IT is quite possible for a signal, practically inaudible on headphones with even one high frequency and detector valves, to become positively deafening when passed through two stages of low frequency amplification, but the reproduction will be far more distorted than if the detector signal strength had been twice as loud, when only somewhat less than half the amount of low frequency amplification would be required to yield the same volume of audibility.

It is axiomatic that the louder the signal strength at the detector valve, the less low frequency amplification required for any given volume of audibility, and correspondingly more natural and tuneful reproduction will result.

YOU CANNOT USE TOO MUCH HIGH FREQUENCY AMPLIFICATION NOR TOO LITTLE LOW FREQUENCY AMPLIFICATION FOR PERFECT REPRODUCTION

BUT the use of more than one stage of high frequency amplification has, hitherto, proved to be commercially impracticable, because of the extreme difficulty in tuning and the need for considerable skill and patience to obtain results which, even at best, would be erratic and unreliable.

Designers and Manufacturers have therefore been compelled to rely on the employment of excessive reaction and low frequency amplification to make up for the weakness of the received signal, with consequent comparative distortion.

The Curt's "Constant Tuned" High Frequency Amplifier is the only automatic high frequency amplifier on this or any other market which, when connected in circuit, guarantees the maximum efficiency of two stages of radio amplification on any wave-lengths between 300 and 3,000 metres, and requires no additional controls, nor more effort, skill or patience in tuning, than is required for the operation of the usual orthodox single stage tuned anode circuit.

THE CURTIS CONSTANT-TUNED HIGH FREQUENCY AMPLIFIER CHANGES THE WHOLE CHARACTER AND QUALITY OF WIRELESS REPRODUCTION AND

WITH its automatic simplicity combined with increased receptivity, selectivity and power, is predestined to make two stages of high frequency amplification a *sine qua non* of every Wireless Receiver for the Experimenter and Home Constructor, or the purchaser who prefers to buy a professionally constructed instrument.

For the greater convenience of the constructor, and so as to conform with existing panel design, the Curtis Constant Tuned High Frequency Amplifier is designed for use and must be connected up in exactly the same way in which an ordinary High Frequency Transformer is used.

The Curtis High Frequency Amplifier may be instantly substituted for any High Frequency Transformer in any existing circuit or instrument where such is used, but the corresponding condenser of such transformer must be turned to zero or any one wire disconnected therefrom.

The Curtis Constant Tuned High Frequency Amplifier guarantees such a reserve of receptivity as to permit the efficient use of a suitably designed wavetraps.

10 DAYS' FREE TRIAL.

So as to give all an immediate opportunity of testing the efficiency of the Curtis Constant Tuned High Frequency Amplifier without cost, we undertake to refund your money in full, if the Amplifier is returned to us, postage paid, within 10 days of your receipt.

Model A, 300 to 800 metres, 15/- postage 6d.
Model B, 800 to 3,000 metres, 17/6, postage 6d.

**PETER CURTIS, LTD.
75, CAMDEN ROAD, N.W.1.**

Telegrams: "Paracurtex."
BIRMINGHAM: 76, Newa Street.
MANCHESTER: 312, Deansgate.

Phone: North 866.
Central 7236.
Central 5095

In Conjunction with THE PARAGON RUBBER MANUFACTURING CO., LTD., HULL

**ANYTHING FROM ANYWHERE
THE DUODYNE III**

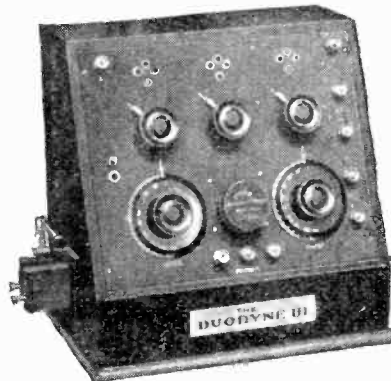

**A GENUINE
LONG
DISTANCE
RECEIVER**

**2 STAGES
HIGH
FREQUENCY
AMPLIFICATION
AUTOMATIC
TUNING.**

IN the Duodyne III the fullest advantage has been taken of the extraordinary virtues of the Curtis Constant-Tuned High Frequency Amplifier. The first valve functions through the Curtis High Frequency Amplifier, the second as an orthodox tuned anode and the last as a rectifier. Guaranteed perfect reception at full power and of extraordinary purity from anywhere in the United Kingdom of any broadcasting station from Aberdeen to Madrid.

In spite of a multiplicity of stations operating on a congested wave band, the Duodyne, used in connection with a Curtis wavetraps, regains that **TRUE FASCINATION OF WIRELESS—LISTENING-IN—AT WHERE YOU WILL!**

PRICE £10

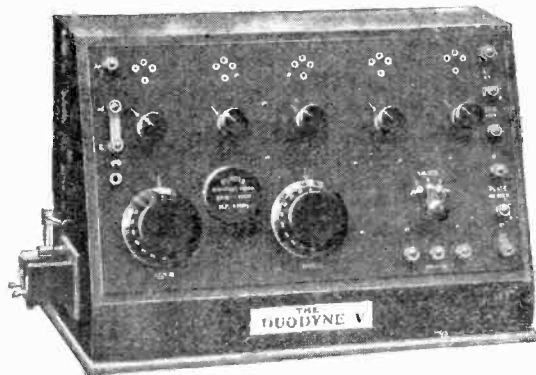

THE DUODYNE V. A truly International Receiver which combines the Duodyne III with a two stage Power Amplifier. Four valves (using one low frequency amplifier only) will be found more than sufficient to operate a Loud Speaker from the most distant stations for drawing room purposes. The last valve will be necessary for Dances, public demonstration or loud-speaker work on the most distant Continental stations.

The exquisite purity of loud-speaker (Amplifier) reproduction with a Duodyne V is a positive revelation and has never yet been equalled by any professional model on this or any other market. Nottingham Relay Station (200 watts) on a Loud-speaker with 2LO (only 11 miles away) cut out is no mean performance for the Duodyne V with a Curtis wavetraps.

PRICE £18 18 0.

WAVETRAPS HAVE FAILED !!

BUT not because of any inefficiency of the wavetraps, but rather because the receivers with which these were used did not have sufficient reserve of power to stand the loss inherent with a wavetraps and yet "fetch in" the more distant stations.

On a conservative basis the Curtis Wavetraps with the Duodyne III will cut out principal station (1 1/2 kw.) at one mile and bring in two other stations; 4 miles and bring in 50 per cent. of the remaining stations; 6 miles and bring in all British Stations at will.

**THE CURTIS WAVETRAPS 35/-
PRACTICALLY ELIMINATES MORSE AND MUSH**

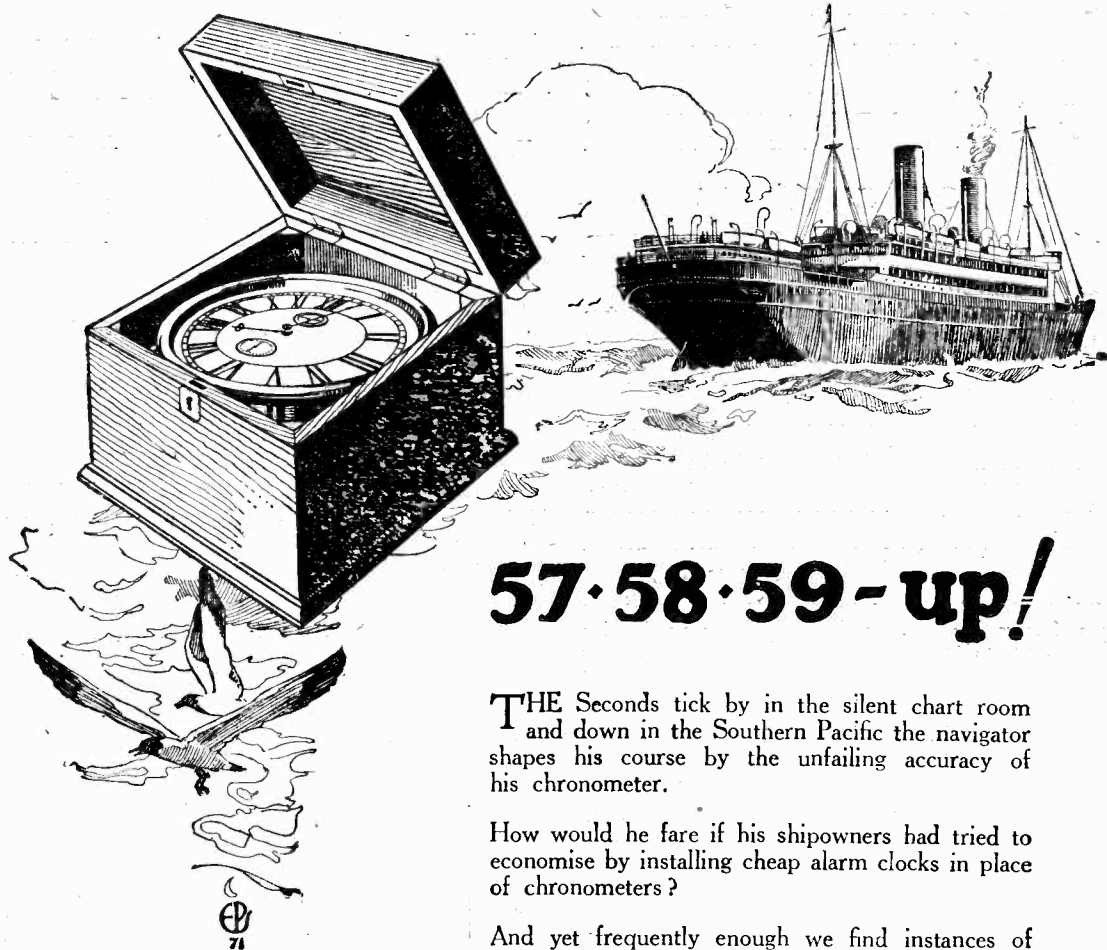

57·58·59 - up!

THE Seconds tick by in the silent chart room and down in the Southern Pacific the navigator shapes his course by the unfailing accuracy of his chronometer.

How would he fare if his shipowners had tried to economise by installing cheap alarm clocks in place of chronometers?

And yet frequently enough we find instances of people getting inferior results from their wireless sets because they have attempted to economise on condensers.

There is no economy in this really, because sooner or later they have to take out the "just as good" and substitute an article of sound manufacture.

We do not say that all cheap condensers are necessarily bad; you may be lucky and get a good one, but if you buy a Dubilier you bet on a certainty you get a good one *every time*.

Naturally if we are to maintain such a high standard our products must be slightly more expensive than those which carry no guarantee, but we are convinced that in the interests of true economy you should specify Dubilier.



*Agents of the Dubilier Condenser Co., Ltd., Deacon Works,
Goldhawk Road, London, W.12.*

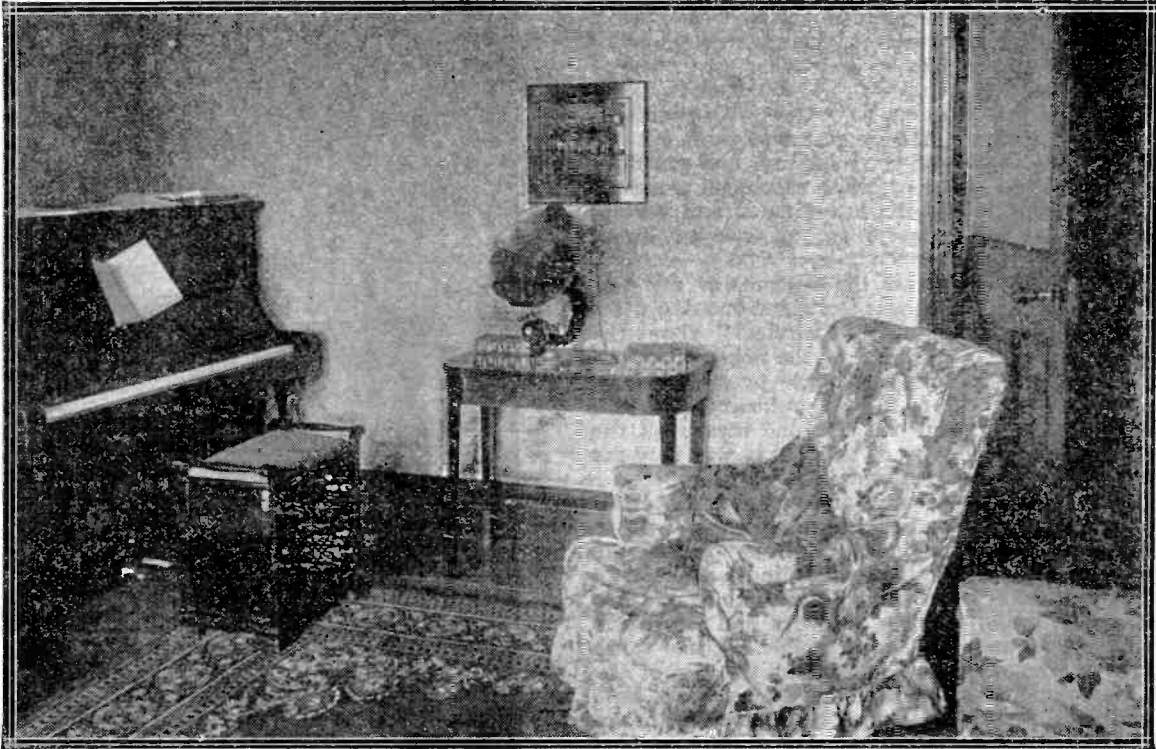

Arranged in this way, the set does not offend the most fastidious.

Wireless Without Worry.

By FRANCIS.

THE wireless enthusiast has an entrancing hobby, but one which, like most hobbies, fails in some of its pleasure if it does not afford interest and entertainment to one's family or intimate friends. For this reason the enthusiast would do well to remember that the reception of telephony without wires has lost its novelty for the layman and is now almost commonplace. Consequently, the entertainment radiated from the various stations of the B.B.C. is alone of permanent interest.

This it will remain, if only care is taken that the speech and music are undistorted and free from extraneous noises. To say "Ah, those are X's," or "That is Morse from Channel shipping," or to blame Leafield, does not compensate listeners for enduring a weird and unpleasant variety of noises, some of which are claimed to be 2LO and some Aberdeen.

The only satisfactory way to make sure of giving entertainment is to receive the programme radiated from your nearest station. Do this, and you can obtain easily sufficient volume to enable you to

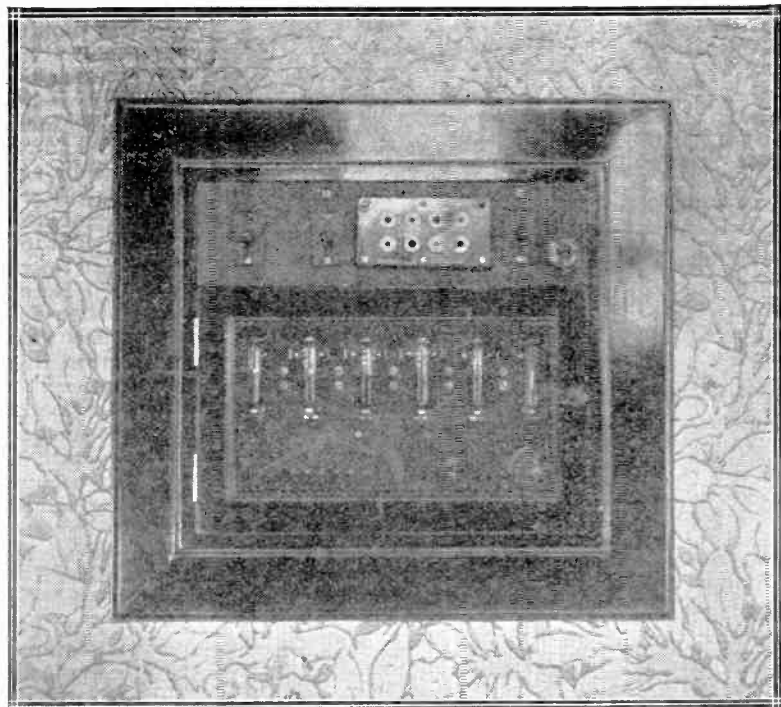

Only this part of the set is visible in the room.

"filter" out noises and interruptions either by re-tuning or other means. Remember that the greater the distance of the station you are receiving, the more noise, atmospherics and other disturbances you are likely to bring in. So, to get clean, pure, undistorted reproduction, be content with your local station. After all, the programmes from all the B.B.C. stations are of good quality, and generally not inferior to those of other provincial places of entertainment, while the latest news and special items of national interest are all relayed direct from London.

These observations are the outcome of my own recent experiences. I was electrified one day when informed that the "mess of wireless" about the rooms had driven my wife to the point where she must have either "a new house or a new husband"! This led to a heart-to-heart talk, with the family ranged on one side and myself on the other. Further enquiry as to what it was they *did* want brought out this information.

They wanted apparatus arranged so that they could switch it on when desired. There was to be little or no "tuning-in"; no one was to come along and tune-in another station in the middle of some interesting item. There were to be no wires about the room, and no batteries and no frame aerial, or, at any rate, none visible. I was to be given a whole room to myself at the top of the house, where I could make as much mess as I liked and produce as many unhuman-like noises

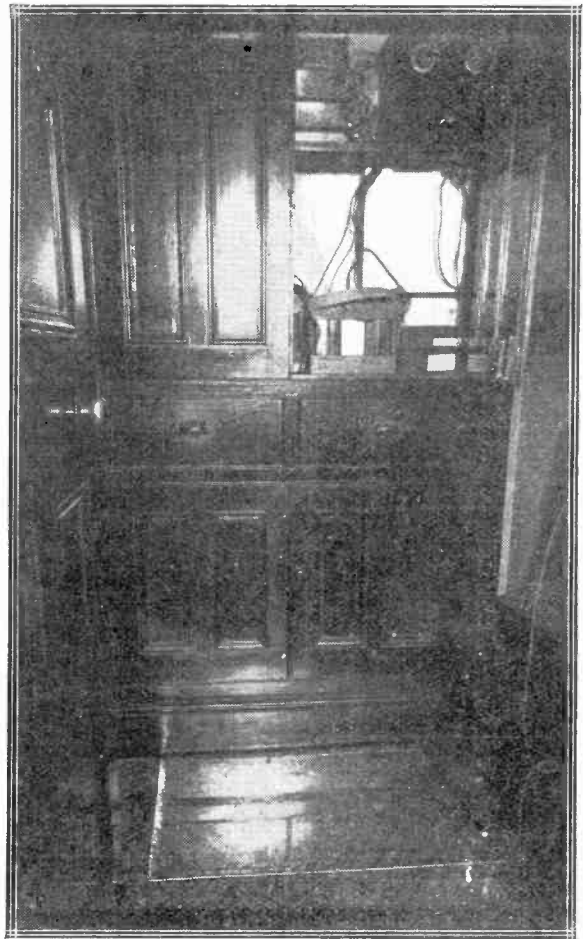

The receiver is housed in the cupboard and the earth plate is normally covered by a mat.

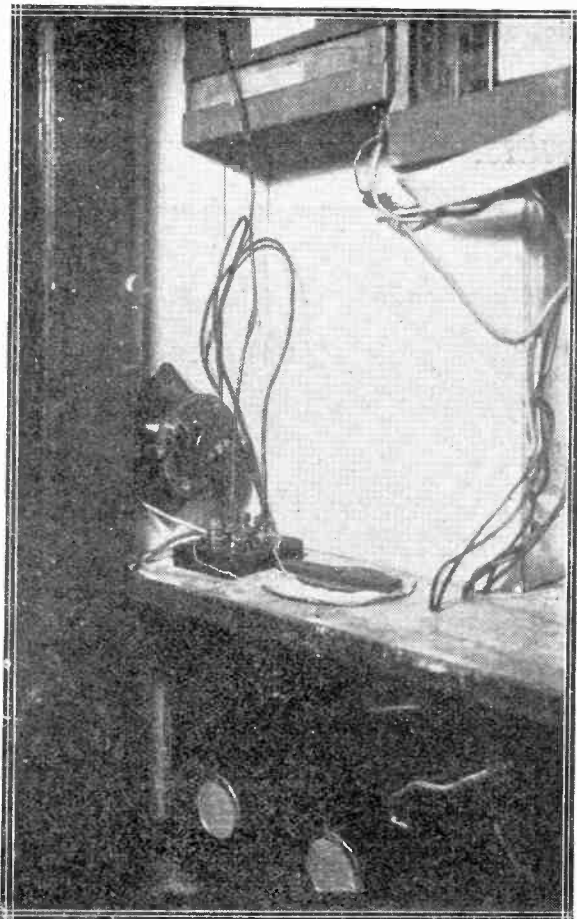

Fixed tuning arrangements are used.

as I pleased. Now, the real object of this article is to show how I managed to satisfy my family and enable them to receive their wireless programme at will and with certainty. The conditions fulfilled may be summarised as follows:—

- (1) Reception from one station only.
- (2) Fixed tuning.
- (3) Switch control.
- (4) No visible aerial, wires, or batteries.
- (5) No additional furniture, or interference with furniture already in room.

One wall of the room selected for this purpose has on its other side a cupboard which opened into another room. In this wall I pierced a hole about 5 ft. from the floor and into the cupboard. Into this hole and flush with the wall was fixed a square box with a back screwed on and an open front. The box was made of a size to just accommodate the receiver decided upon. To cover the edges of the box and joints in the wall a frame was made. Polished mahogany was used to match the room furniture. The width of the framing is $2\frac{1}{2}$ in., and it projects $1\frac{1}{2}$ in. from the wall face. It was fixed by four brass strips, one on each side of the frame. These were screwed to inside edges of the frame and to the inside of the box. Thus there are no visible fixings or nails marring the appearance of the wall. In the front of the frame and flush with its face was fixed a glass-panelled door large enough to enable

—Continued on page 697

GENUINE SERVICE WITHOUT PROFIT

For the benefit of the Home Constructor we have now opened a
CONSTRUCTORS' DEPARTMENT

Any constructor purchasing a complete set of parts either direct from us or through any of Our Agents for any published circuit whatsoever and experiencing any difficulty therewith may send his effort to the Constructor's Department, Peter Curtis, Ltd., together with a postal order to cover the nominal charge of 2/6 per valve holder. For this sum we shall examine the set, rectify any errors and return carriage forward in perfect working order under average conditions on P.M.G. Aerial.

- (a) Care should be taken to pack carefully, as all goods will be returned in same case as received.
- (b) Mention the trader from whom the parts were purchased.
- (c) Unless the charge for passenger carriage is included, the set will be returned carriage forward per goods train.

THE SILVER GHOST PARAGON-CURTIS

CRYSTAL RECEIVER,
With its richly engraved panel and plated fittings mounted on a POLISHED ALUMINIUM casket, combines the exclusive efficiency and elegance of

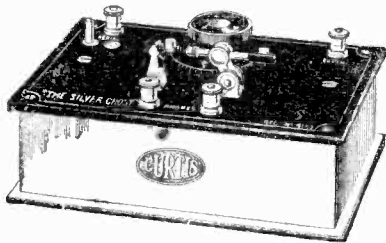

A
Curtis Radio Instrument
PRICE
30/-



GUARANTEED CONSTANT CAPACITY at ALL TEMPERATURES and under ALL conditions.

Made in ONE piece. NO WAX.

.0008 to .006 2/6

One Piece Mica Condenser

The metal plates, mica di-electric and connecting terminals are set in Parafite composition and moulded simultaneously under considerable pressure. The Paragon-Curtis Condenser is practically indestructible; it may be immersed in boiling water for an indefinite period; will stand flame heat, or may be thrown violently against the wall without fear of damage or loss of efficiency.

The STANDARD of CONDENSER EFFICIENCY.

Exquisite Elegance.

Range 25 miles for Local Broadcasting. Range 200 miles on Chelmsford

PARAGON Radio Quality Post Office Specification "The Best Made." EBONITE PANELS

As supplied to the
B. B. C.
(British Broadcasting Co., Ltd.)

TESTED and RECOMMENDED by JOHN SCOTT-TAGGART and "MODERN WIRELESS." Uniform fine grain. Dead Matt Fin. sh. Ground Edges.

STANDARD SIZES.

4 x 4 x 1/8	10 1/2 x 7 x 1/4	4/7
6 1/2 x 5 1/2 x 1/8	12 x 6 x 1/4	4/6
8 x 6 x 1/8	22 x 11 x 1/4	15/3
8 x 6 x 1/4	16 x 9 x 1/4	9/-
10 1/2 x 8 1/2 x 1/4	12 x 11 x 1/4	8/3
12 x 10 x 1/4	18 x 6 x 1/4	6/9
12 x 12 x 1/4	12 x 8 x 1/4	6/-
14 x 12 x 1/4	10 x 8 x 1/4	6/9
16 x 12 x 1/4	7 x 5 x 1/4	2/3
18 x 12 x 1/4	10 x 9 x 1/4	5/8
24 x 10 x 1/4	9 x 5 1/2 x 1/4	3/5
24 x 12 x 1/4	10 x 5 x 1/4	3/3
8 x 5 1/2 x 1/4	12 1/2 x 9 1/2 x 1/4	7/6

SPECIAL PANELS for Sets described in the current issue.

Similar quality and finish, Cut, Edges Ground and despatched same day, 1d. per square inch, postage 6d. extra.

Home constructors may send for any sized panel specified in any of the Radio Press publications. **PARAGON EBONITE PANELS** comply with the requirements of Percy W. Harris, a constructional authority of the highest standing.

STOCKED BY ALL REPUTABLE STORES.

But it must be in Paragon sealed Carton.

EXTRA PRICE FOR DRILLING AND ENGRAVING MODERN WIRELESS PANELS.

To M.W. Specification only.	Delivery from Stock.		
S.T. 100 (2 valves)	7/-	Experimenter's Tuner	9/-
S.T. 100 (3 valves)	5/9	Double Reaction	4/6
Efficient Single Valve	3/6	Crystal Set (Harris)	3/6
Transatlantic	5/-	All Britain	7/-
De Luxe Amplifier	6/-	V2 Portable	5/6
Single Valve All Wave	3/6	3 Valve Dual	8/6

PARAGON POLISHED MAHOGANY EBONITE

Is NOT a Composition, but GUARANTEED POST OFFICE QUALITY EBONITE and is of similar specification to the now universally used PARAGON EBONITE.

PANELS CUT TO SIZE. Squared, edges ground, 1d. per sq. inch.

Local Broadcast on the Loud Speaker.

The reception of local broadcasting needs nothing more pretentious than the **RADIONETTE** (Crystal and Two Note magnifiers). Purity of reproduction is gained by the crystal, which purity we have been careful to retain by the satisfactory choice and disposition of the L.F. Transformers. The **RADIONETTE** Crystal and Two Valves was designed in the earliest days of Broadcasting.

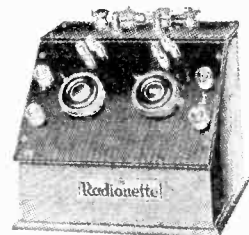

Price £6 0 0

CURTIS FILAMENT RHEOSTAT.

0-40 ohms, single-hole fixing, supercedes all others. Delicate adjustment

in manufacture permits quick and slow action the finest possible degree of filament control. D.E. Valves may be used quite safely with a 6-volt accumulator if controlled by the **CURTIS RHEOSTAT.**

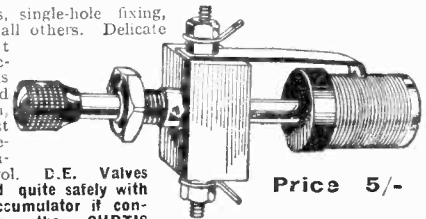

Price 5/-

HAVE AT HAND. Our 16 pp. Catalogue of Raw Materials and accessories. FREE ON REQUEST.

PETER CURTIS, LTD.
75, CAMDEN ROAD, N.W.1.

Telegrams: "Paracurtex." Phone: North 866.
BIRMINGHAM—76, Newall St. Central 7236.
MANCHESTER—312, Deansgate. Central 5095.

In conjunction with
THE PARAGON RUBBER MANUFACTURING Co., Ltd., HULL



BURNDEPT LTD., Aldine House, Bedford Street, Strand, London, W.C.2.

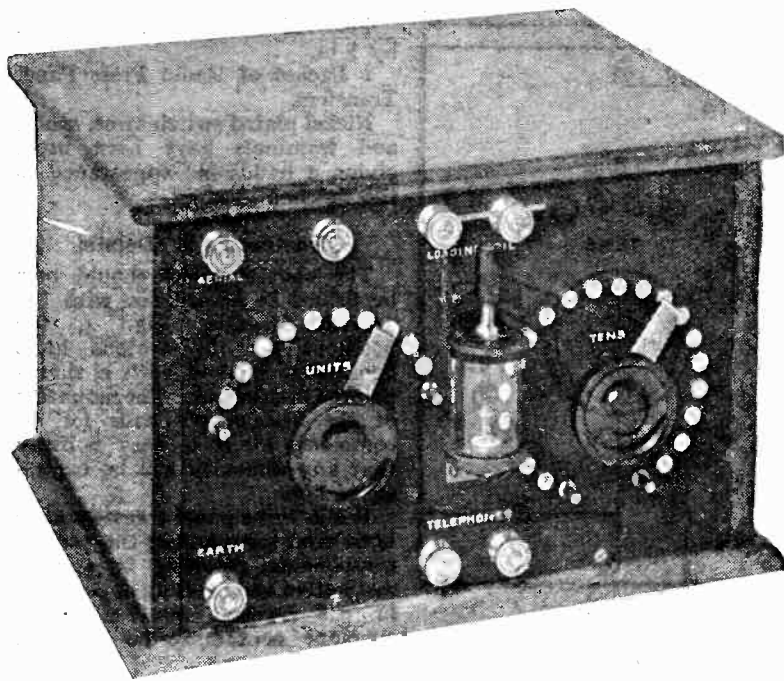

Fig. 1.—The completed set presents a very neat appearance.

A Short and Long Wave Crystal Set

By
W. H. FULLER.

This article contains a description of a crystal set, which, although it may be used on long wavelengths as well as short, is not influenced by dead-end effects on the latter.

A GREAT deal has been written recently on the subject of adding external loading coils to ordinary broadcast receivers in order to tune in the high-power station at Chelmsford. While this may be done quite efficiently, the majority of broadcast listeners object to a receiver which requires these external arrangements, and the present crystal set has been designed to cover the ordinary broadcast band and also 5XX wavelengths without an external and cumbersome loading coil; the whole of the tuning system being permanently housed inside the set. To prevent dead-end effects while working on the lower wavelengths, provision has been made

for cutting out the loading coil by means of two terminals on the front of the panel. The most novel feature of the set, however, is the method in which the two coils have been wound, resulting in compact coils of low self-capacity. The ease with which these coils may be wound is also an important consideration to those whose wish is to make really efficient coils. The well-known tens and units method of tapping the coils has been adopted on account of its simplicity, and the fact that the maximum amount of inductance is always used—an important point where efficiency is concerned. No variable condenser is necessary, thus keeping the cost of the com-

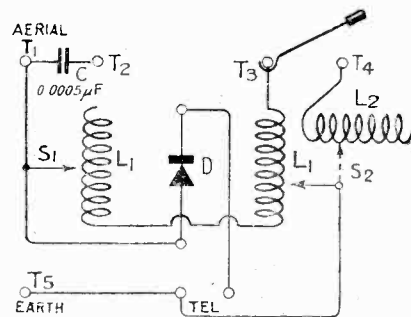

Fig. 2.—The theoretical circuit diagram.

ponents to a low figure. Two rotary type stud switches are used, and the tappings are taken to these. One is entirely concerned with single turn tappings, giving fine tuning, and the other with coarse adjustment by ten turn steps. A fixed condenser of 0.0005 μF capacity has been provided for use on the higher wavelengths, or where the aerial is extra large it may be used in series on the lower wavelengths.

Circuit Diagram

Fig. 2 shows the circuit arrangement of the receiver. T₁ is the aerial terminal, although the aerial may be joined to T₂ as an experiment where the aerial capacity is high. The real object of the latter terminal is to enable the 0.0005 μF condenser C to be placed across L₁ and L₂ on the higher wavelengths. L₁ is shown in two parts; the switch S₁ works over ten turns, and S₂

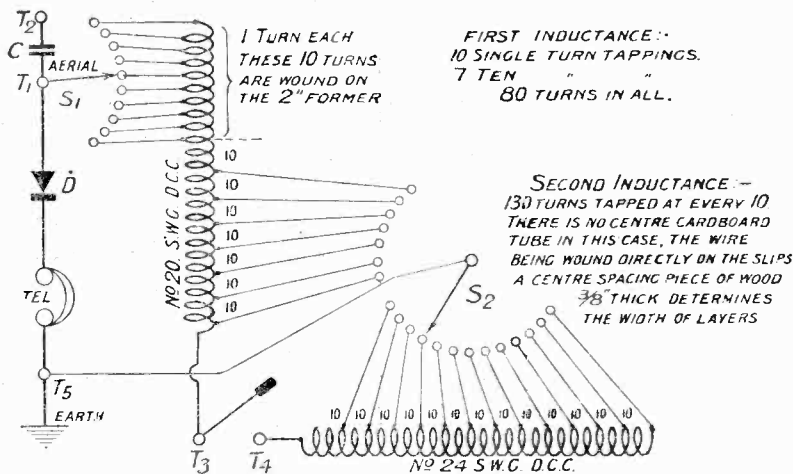

Fig. 3.—This diagram makes clear how the tens and units switches control the amount of inductance used.

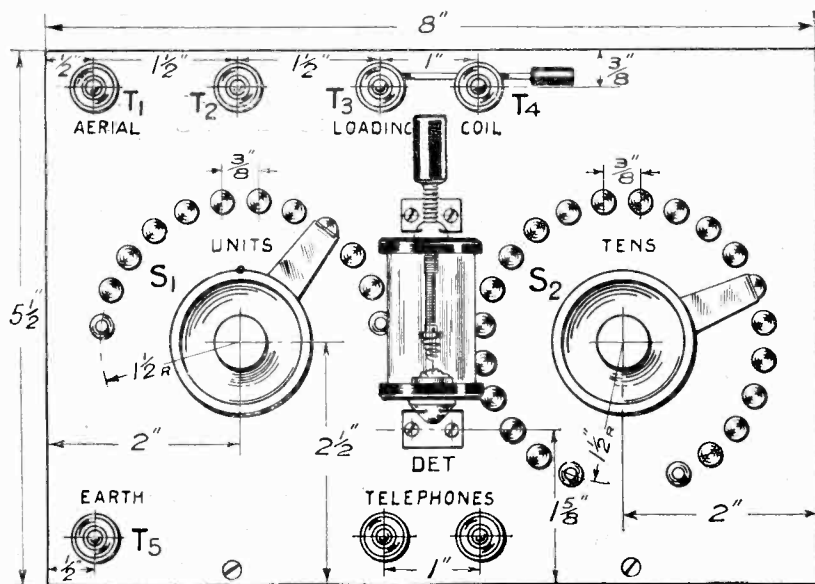

Fig. 4—A drilling diagram of the panel.

works over the remaining seventy turns. The latter switch also controls the amount of L_2 in circuit when the terminals T_3 and T_4 are connected together, thus including the latter coil.

Components Required

The following is a list of components required for the construction of the receiver.

Ebonite panel, 8 ins. by $5\frac{1}{2}$ ins. by $\frac{1}{4}$ in. (Paragon ; Peter Curtis, Ltd.)

Cabinet of suitable size.

1 0.0005 μ F fixed condenser. (Lissen, Ltd.)

- 2 Switch arms.
- 4 Switch stops.
- 30 Contact studs.
- Crystal detector. (Burndept, Ltd.)
- 7 4-B.A. terminals.
- 6 oz. 20 S.W.G. D.C.C. wire.
- 6 oz. 24 S.W.G. D.C.C. wire.
- About 9 ft. tinned square copper wire.
- $\frac{1}{4}$ in. Cardboard tube of 2 in. diameter.
- About 4 ft. of $\frac{3}{8}$ in. by $\frac{3}{8}$ in. wood.
- About 10 ft. $\frac{1}{8}$ in. by $\frac{1}{8}$ in. wood. (Alternatively, thick matches will be suitable.)

Piece of wood 8 ins. by $6\frac{1}{2}$ ins. by $\frac{1}{4}$ in.

1 Packet of Radio Press Panel Transfers.

Nickel plated switch arms, studs, and terminals have been used, giving a handsome appearance to the finished receiver.

Constructional Details

The ebonite panel should now be drilled in accordance with the drilling diagram, Fig. 4, the positions for the various holes being first marked with a sharp-pointed instrument. The mounting of the components calls for no comment, for it is very unlikely that any difficulty will be experienced here.

Radio Press panel transfers have been used for marking the various components, resulting in a very distinctive and pleasing appearance in the finished receiver. An envelope containing 80 different

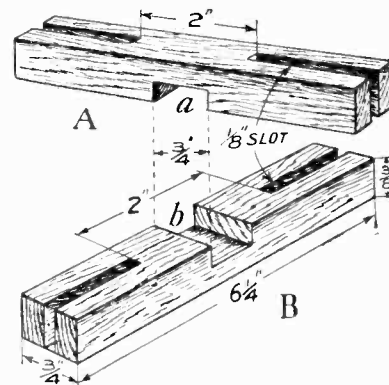

Fig. 5.—The loading coil former is made of wood shaped as above.

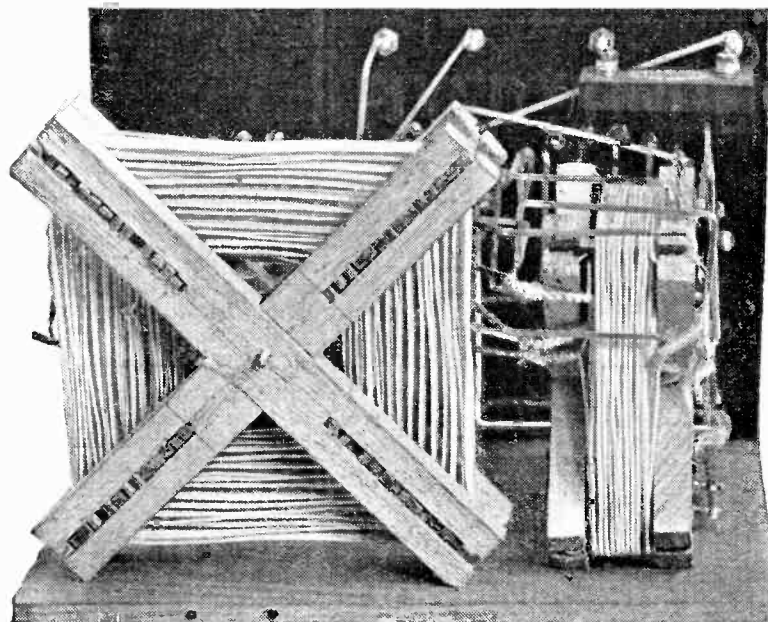

Fig. 6.—The appearance of the finished coils may be seen from this photograph.

labels may be obtained from the Radio Press Sales Department for the modest price of 6d. They are as simple to use as a child's transfer and a good selection is included.

The construction of the coils may now be undertaken, and a good idea of their appearance when finished may be gathered from the photographs showing views of the back of the panel with coils in position.

It will be noticed that the two coils differ in size, the smaller one being used by itself on the lower wavelengths, while the larger is employed in series with the former upon the higher wavelengths. It is a good plan to wind the loading coil first, as despite the fact that it is the larger of the two coils, the necessary tappings require less skill to make than do those of the other coil,

For Detection—Use H.F.

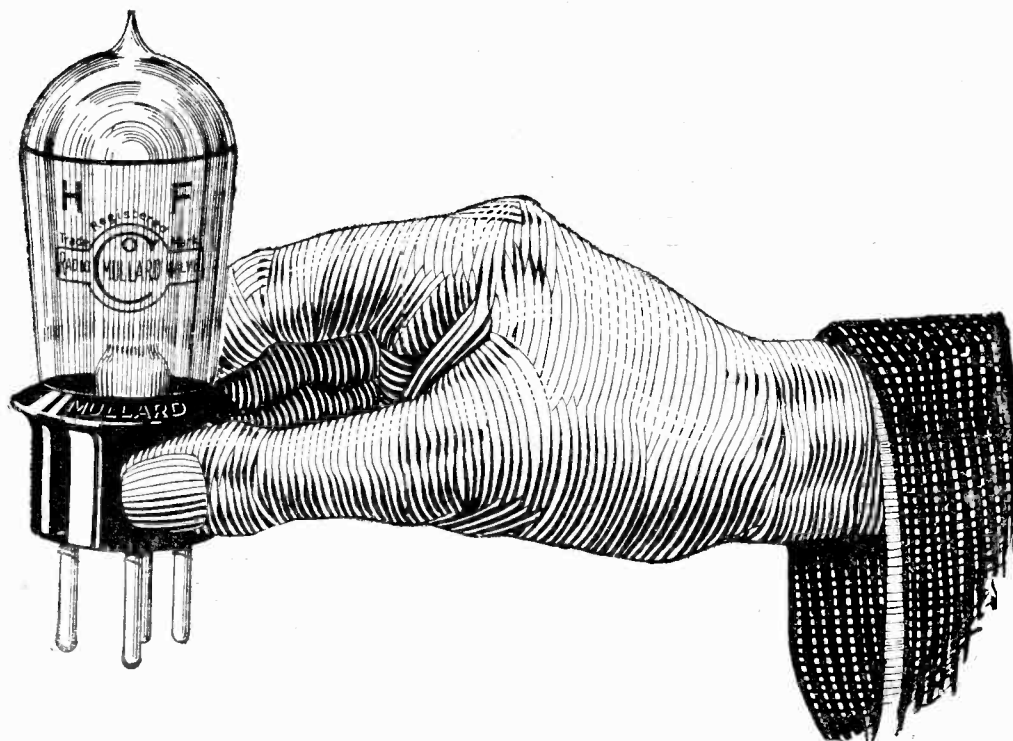

MASTER VALVES have MASTER REASONS

FOR DETECTION—USE MULLARD H.F. VALVES.

Because : MULLARD H.F. VALVES have positive grid current.

Reason : Grid current is essential for the operation of a grid leak detector: without grid current there can be no grid leak rectification.

FOR H.F. AMPLIFICATION—USE MULLARD H.F. VALVES.

Because : MULLARD H.F. VALVES have the correct amount of positive grid current.

Reason : Positive grid current is necessary for stability in H.F. operation.

FOR L.F. AMPLIFICATION—USE MULLARD L.F. VALVES.

Because: MULLARD L.F. VALVES have NO harmless positive grid current.

Reason : Positive grid current damps L.F. amplification and causes distortion.

Stipulate MULLARD H.F. Red Ring Valves for H.F. AMPLIFICATION AND DETECTION—12/6 each.

Stipulate MULLARD L.F. Green Ring Valves for L.F. AMPLIFICATION—12/6 each.

Write for leaflet M8 and take greater care of your valves, by asking your dealer for the Mullard Safety disc, free on request. If he cannot give you this disc send us his name and address and we will send him a supply.

Mullard

THE · MASTER · VALVE

Advt.—The Mullard Radio Valve Co., Ltd. (M.W.), Nightingale Works, Nightingale Lane, Balham, S.W.12.

In replying to Advertisers, please use Order Form enclosed.

Dull Emitters Repaired Quick 10/6

GOOD NEWS! Your "D.E.'s" can now be repaired with 2 volt .25 amp filament, to give results equal to new. Prompt service.

We can do most types except 'WECO-type' and valves having electrodes brought out at opp sides of tube (that is, low capacity valves).

NEW RADION COOL VALVES.

We are now offering three types of dull emitter valves—

- C.1. For H. F. and D.—1.8 to 2 volts .25 amp.
 - C.2. For L.F., 1.8 to 2 volts. 35 amp.
 - C. 3 volt .06 amp., 21/-.
- Anode 20-80. Magnification factor 9.

18/6

RADIONS, LTD., BOLLINGTON, near MACCLESFIELD.

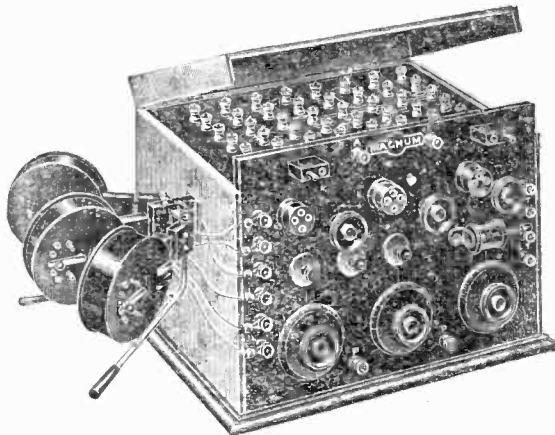

CONSTRUCT THE OMNI for £11 0s. 5d.



CONSTRUCT THE 4-VALVE FAMILY for £3 4s. 5d. (Envelope No. 2.)

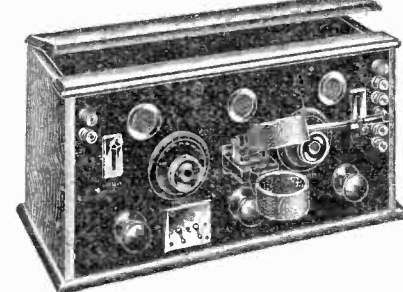

CONSTRUCT THE ALL CONCERT de LUXE for £3 0s. 0d. (Envelope No. 4.)

WARNING — COIL HOLDERS

It has come to our notice that a certain firm are misleading the public by offering for sale under the name of Magnum an inferior imitation of our Coil Holder. In fairness to yourself as well as to us, insist on the genuine Magnum Coil Holder as used by the designers of the Transatlantic V, All Concert de Luxe, Simplicity 3, Puriflex, etc., etc. In future every Coil Holder of our manufacture will bear the name MAGNUM.

Send stamp for Illustrated List and set of leaflets dealing with S.T.100, 4-Valve Family, Simplicity 3, All Concert de Luxe, Transatlantic 5, Puriflex, Omni, 3-Valve Dual, All-Britain, Tri-Coil, and P.L. Harris Crystal Set.

1 lb. Hank No. 16 D.C.C. Wire for P.W. Harris Crystal Set. 3/- post free.

Variable Sq. Law Condenser, .0005, complete, 9/- post free.

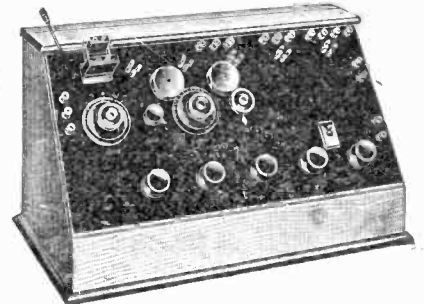

CONSTRUCT THE TRANSATLANTIC V. for £11 13s. 11d.

CONSTRUCT YOUR OWN SET.

THE TRANSATLANTIC 4.
As described in this issue by Mr. Perc. W. Harris.

	£	s.	d.
1 Polished Mahogany Cabinet, as described	1	7	6
1 Ebonite Panel, 16 by 8 by 1/4 in., Drilled and Engraved	0	13	0
1 Var. Sq. Law Condenser, .0003, Bower-Lowe	0	17	0
1 Var. Sq. Law Condenser, Dual, .0003, Bower-Lowe	1	9	0
12 Nickel terminals, complete	0	2	6
1 Lissen Push-Pull On and Off Switch	0	2	9
1 Lissen 5-Point Switch	0	4	0
6 H.T.C. Valve-holders, Type A	0	10	6
2 Dubilier Condensers, .001	0	6	0
1 Mansbridge, .0003 and Grid-leak	0	5	0
3 Dual Rheostats	0	12	0
4 Potentiometer	1	10	0
1 Ignitic L.P. Transformer, new type	1	1	0
1 2-Coil-holder, specially designed for Transatlantic 4	0	9	6
2 H.F. Matched Transformers, 300/600	0	14	0
1 Ebonite Shelf and Wood Supports, Drilled	0	2	6
2 Brackets, Cast Brass	0	1	0
8 yards No. 16 sq. sec. T.C. Wire	0	1	0
2 Chx	0	0	8
1 Grid Cell, No. 126	0	1	9
Assorted Screws, Nuts, etc.	0	0	6
	£13	18	8

Carriage and Packing Free on Retail Orders value £2 and over.

BURNE-JONES & Co., Ltd.
Magnum House, 288, Borough High Street,
LONDON, S.E.1.

Telephone HOP 6257.

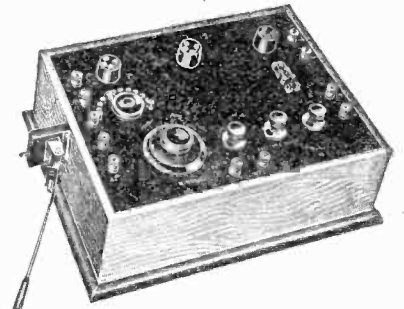

CONSTRUCT THE SIMPLICITY 3-VALVE for £4 13s. 2d. (Envelope No. 3.)

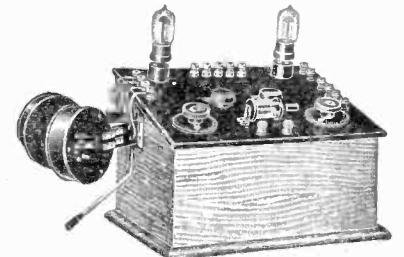

CONSTRUCT THE S.T.100 for £7 4s. 2d. (Envelope No. 1.)

--RADIO PRESS ENVELOPES.

	Post free.
No. 1. S.T.100	1/8
No. 2. 4-Valve Family	2/9
No. 3. Simplicity 3	2/9
No. 4. All Concert de Luxe	2/9
R.P. Hot Pad Transfers	8J.

although it must not be imagined that the construction of either coil presents any great difficulty.

To commence then with the loading coil, the frame is first constructed from a length of the $\frac{3}{4}$ in. by $\frac{3}{4}$ in. wood mentioned in the list of components. 2 ft. 1 in. of this will be required, this length being cut into four $6\frac{1}{2}$ in. lengths. Each piece is now cut as shown in Fig. 5 A and B. The four pieces are utilised to form two crosses, the appearance of each then being as in Fig. 7. The method of fitting two pieces together may be clearly explained by stating that the part marked a in Fig. 5 is simply placed upon the part b. If the trenches are cut $\frac{3}{16}$ in. deep, the two pieces will fit tightly together if made accurately. The slots in each piece can be easily made by using a fret-saw and should be cut out before the cross pieces are joined together.

A small length of $\frac{3}{4}$ in. by

$\frac{3}{4}$ in. wood (say 1 in.) is now prepared, and a hole of $\frac{1}{8}$ in. diameter bored through the centre. The object of this piece of wood is to allow a space of $\frac{1}{8}$ in. between the two crosses when these are joined together to form the sides of the coil former. A hole is bored through each cross in the position indicated by the screw-head in Fig. 7. The two crosses are joined together by means of a wood screw, or nut and bolt of suitable length, this passing through the holes bored in the crosses and the small piece of wood previously mentioned, the latter being placed *between* the crosses to effect the desired $\frac{1}{8}$ in. space.

Winding the Loading Coil.

24 guage wire is used for the winding of this coil. Before commencing, however, a good supply of $\frac{1}{8}$ in. by $\frac{1}{8}$ in. wood should be secured and placed close at hand. A number of strong match-sticks are quite a satisfactory

alternative, if wood of the requisite size is not procurable. A $\frac{1}{8}$ in. square strip about $1\frac{1}{2}$ in. long is inserted at the bottom of each of the four double slots in the former, in such a manner that the strip bridges the gap between the crosses. To one of these the end of the wire is secured, leaving an inch or so free, and winding commenced. It will be found that ten complete turns may be wound in one layer, and a tapping is taken at the tenth turn. The method of doing this is very simple; the wire is merely formed into a loop about two inches long, and the end nearest the coil twisted round a few times to preserve the loop. Winding is continued after inserting another strip of wood in each slot, the wire being taken to the side opposite that on which the tapping was taken, and *over* the next wood strip. This of course brings the eleventh turn over the first turn, and the next turn will come over the second turn, but

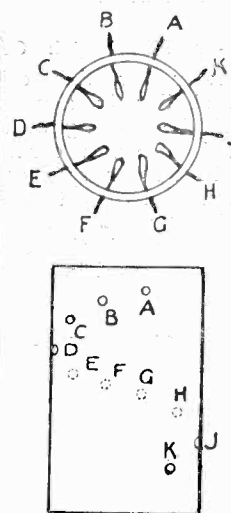
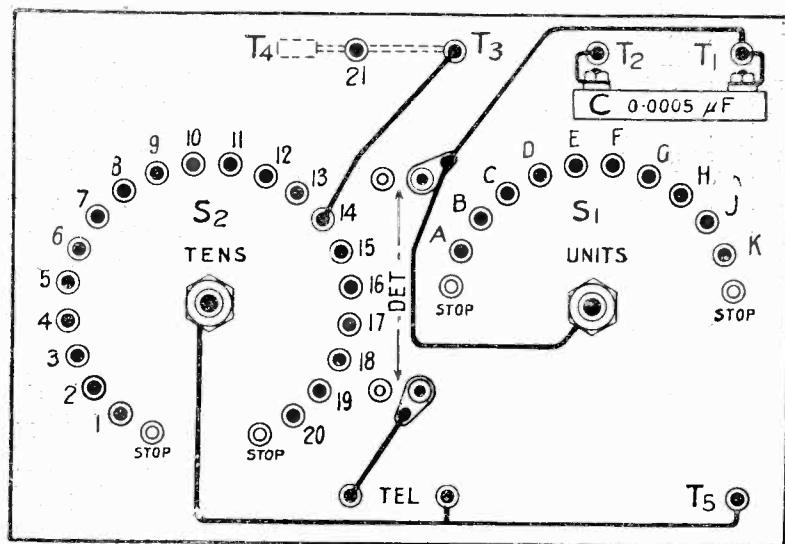

DIAGRAM OF FORMER Showing arrangement of tappings.

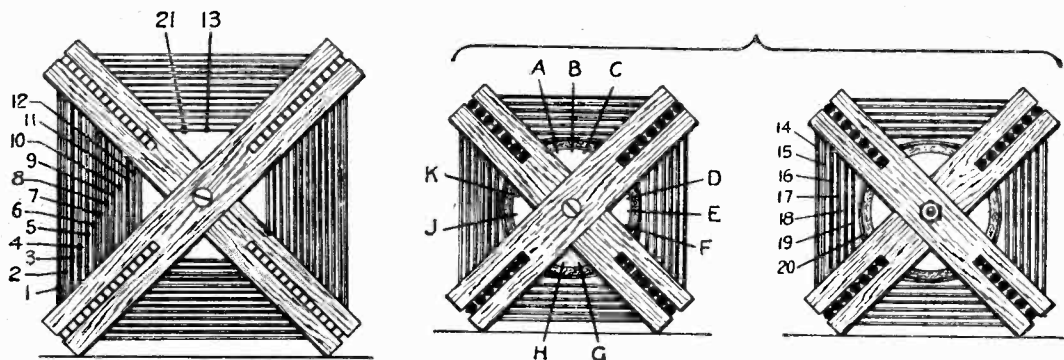

Fig. 7.—Wiring may be conveniently carried out by joining corresponding letters and numbers on the coils and studs. The loading coil is seen on the left and two views of the lower wavelength coil are given, showing the position of the tappings.

separated in each case by about $\frac{1}{8}$ of an inch—the thickness of the wood strips. The coil would be less efficient if the eleventh turn were wound over the tenth, and so on, as this would result in the twentieth turn being over the first turn on reaching the end of the row. This method of winding would increase the self-capacity and is not recommended.

Having wound another ten turns and thus reached a point above the tapping previously made, a second tapping is taken in the same manner as before. Another four wood strips and another layer follow, the tapping for this layer being at the thirtieth turn. The remainder of the coil is wound in an exactly similar manner, the positions of the tappings being approximately as in Fig. 7. From this figure it will be seen that there are thirteen layers in all, the commencement of the winding and the first tapping being on opposite sides of the same row. The numbers are for reference when wiring is commenced.

The Low Wavelength Coil

The former for this coil is somewhat similar in appearance to that of the loading coil. In this case, however, a cardboard tube is utilised for spacing the two crosses, and also to aid in making the "units" tappings. The dimensions of the crosses, which are constructed in a similar

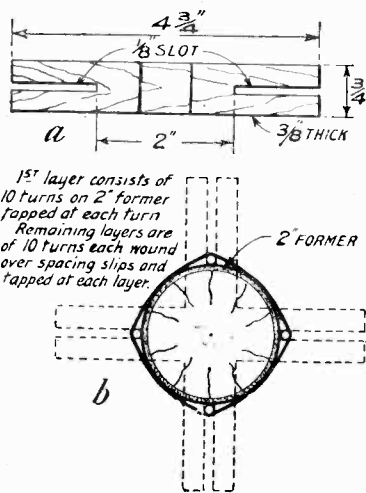

Fig. 8.—Shows the construction of the smaller coil.

manner to those of the loading coil, are seen in Fig. 8. The cardboard tube has a diameter of two inches, and is $\frac{3}{4}$ of an inch long. Ten holes are made in this at intervals of about $\frac{1}{2}$ in. and are illustrated in Fig. 7; this figure, of course, is not drawn to scale.

The first layer, from which the units tappings are taken, is wound on before fixing the tube between the crosses. The end of the 20 gauge wire is secured by means of the first hole in the tube, leaving two or three inches of wire free. One turn is wound, and a loop is then formed, about 3 ins.

in length, this being pushed through the second hole B, and twisted a few times after being brought outside the tube. Another turn is then wound on, and a tapping taken with the aid of the third hole C, and so on, until the tenth turn has been tapped. The relative positions of these tappings, which are lettered from A to K, may be gathered from Fig. 7, in which an end view of the tube is shown.

The crosses are now screwed together with the tube between them, in such a manner that the screw passes through the centre of the tube. On the actual set the spacing of the layers on this coil has been effected by means of $\frac{1}{8}$ in. diameter ebonite rod, but matches or $\frac{1}{8}$ in. square wood may be used with perfect confidence.

Four strips are now inserted, and the eleventh turn wound above the first, as in the case of the coil already constructed. At the twentieth turn, a tapping is taken in a manner exactly similar to that employed in tapping the large coil. In fact, from this point we proceed in exactly the same way as from turn twenty of the loading coil. In this case, however, the coil is completed after winding seven complete layers, including, of course, the first layer, from which the tappings were taken.

Wiring

The wiring diagram is seen in Fig. 7, which, however, does not show the connections from the coils to the studs. The few connections illustrated should be carried out first as it will be hard to get at certain spots on the panel after joining the studs to the coil tappings. This latter should present no difficulty if the constructor is able to solder, for the coil tappings are each given a separate number in the case of the larger coil, while in the case of the small coil, the units tappings are lettered, and the tens tappings numbered. The contact studs are also lettered and numbered, and it is only necessary to join corresponding numbers or letters in the most convenient manner; e.g., tapping 11 on the loading coil goes to stud 11, which will be seen on S₂, and tapping F goes to stud F of S₁.

The coils are prepared for the soldering of their tappings before mounting them on the wooden base mentioned in the component list. It will be found convenient to cut off the ends of the loops

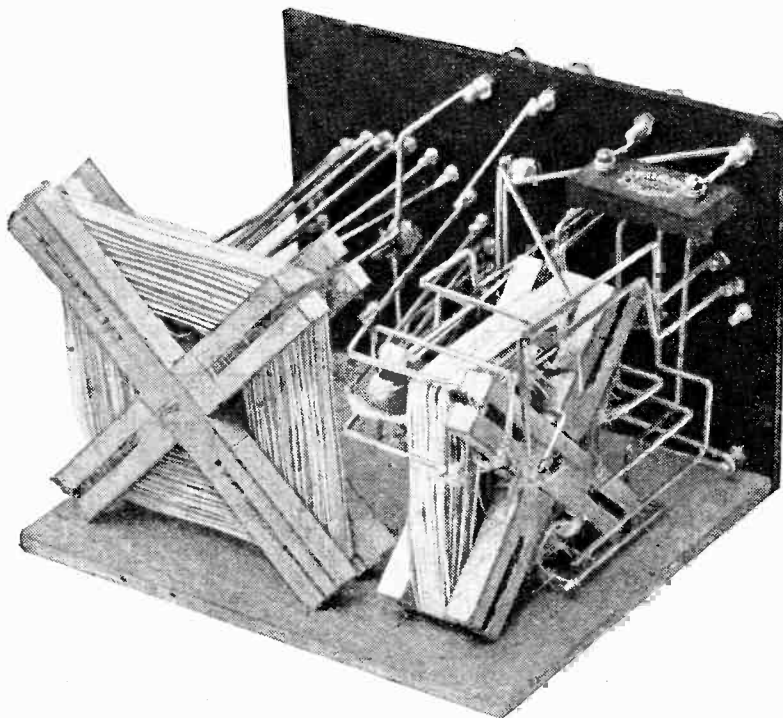
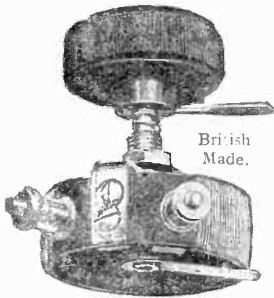

Fig. 9.—A photograph showing the back of the set.

The **SHIPTON** New Type Strip Rheostat & Potentiometer

protects your valves



British Made.

Various devices are available for the protection of valves from accidental short circuit; but fitting is troublesome. When you fit The SHIPTON Rheostat (one hole fixing) your valves are protected, since the SHIPTON 7 ohm model is fitted with a fuse. A spare fuse is contained in every box.

This Rheostat, besides combining a safety fuse, is designed with a special tension spring on the spindle assuring good contact while retaining a silky action, and actually costs no more than the now obsolete rheostat.

THE MOST PERFECT RHEOSTAT YET INTRODUCED

- SHIPTON New Type STRIP RHEOSTAT 7 ohm (with fuse) 3/-
 - SHIPTON New Type STRIP RHEOSTAT 30 ohm 3/-
 - SHIPTON New Type STRIP RHEOSTAT 60 ohm 3/-
 - SHIPTON POTENTIOMETER 600 ohm 4/6
- Packed in neat linenette boxes.

The resistance wire is wound on insulated strip. Noises due to uneven spacing of the wire cannot occur with the SHIPTON. Terminals are standard and connection is a matter of facility.

Three models are available so that whatever valves you may use there is a SHIPTON Rheostat to give you perfect filament control. Ask for it by name. Apply to your local dealer or direct giving your dealer's name and address. Sole agency applications considered for certain territories.

E. SHIPTON & CO., LTD.
37, Tothill Street, Westminster, S.W.1.

Telephone: Victoria 7. Telegrams: "Rentfones, Parl."
Also at 14, King Street, Covent Garden, W.C.

L. & C. 131

"BIG-BEN" LONG RANGE ONE-VALVE SET

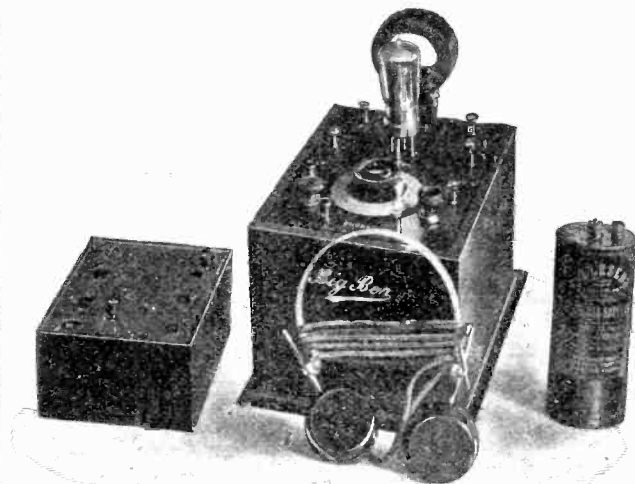

COMPLETE AS SUPPLIED.

This Set will work a Loud-Speaker 10 miles from the Broadcasting Station and has at least a 50 miles range with 'phones.

Supplied complete with B.T.H. Valve (25/-), 1 pair 'Phones, High and Low Tension Batteries, with Marconi Tax paid. Retail Price £7 12s. 6d.

Arrange a demonstration at your local Dealer's. If he cannot supply, instruct him to write to us or write direct to:—

STOCKALL, MARPLES & CO. (1912) Ltd.
6/10, CLERKENWELL ROAD, E.C.1.

Telephone: Clerkenwell 6345 6.

Telegrams: Stockalls, Smiths, London.



Autumn Leaves

Standing at my window the other evening watching a gusty wind whirling the dead leaves round my sundial, I was forced to admit that our short summer was over. All too short it seemed to me; just a few bright days and before we knew where we were autumn had set in with winter unpleasantly close—well, not altogether unpleasantly. I rather look forward to long winter evenings. It's a restful change from being harried by the children to go and play in the garden, as they insist on my doing when it's light till ten.

In the winter they seem perfectly satisfied to sit and listen to the perfect tunes of the Volutone giving them Miss Nobody Special's latest bedtime story or the first part of the evening concert. The Volutone also is powerful enough to enable them to talk without disturbing the concert; in fact, it's proved itself a positive blessing and at a price well in keeping with the Fellows' policy of

Quality Apparatus at Low Cost.

FELLOWS WIRELESS

E.P.S. 531

Advt. of the Fellows Magneto Co., Ltd., Park Royal, London, N.W.10.

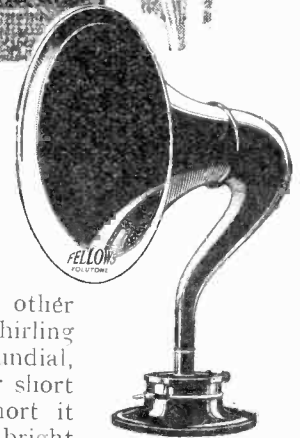

Fellows Volutone.
£4 : 10 : 0
Fellows Junior.
£1 : 10 : 0

In replying to Advertisers, please use Order Form enclosed.

What Mr William Le Queux thinks of the



B.T.H.

B4 Valve

6 VOLTS—0.25 AMPS.

MR. WILLIAM LE QUEUX, the famous novelist, is equally famous in the world of radio technics. He was one of the pioneers of wireless, and has been experimenting for 20 years. His transmitting station 2.A.Z. at Guildford was the first station in the world to broadcast regularly every night.

Mr. William Le Queux, as a result of his Jungfrau experiments, has proved the superiority of the B4 Valve—the first of its kind, and the best

The B.T.H. Type B4 Valve was the first valve taking only 0.25 amperes at 6 volts sold in this country. It is acknowledged as the supreme valve for use as a low frequency power amplifier.

Obtainable from all Electricians & Radio Dealers

TELEGRAMS: "LUVIVE, NICKY, LONDON"
 TELEPHONE: REGENT 8172 (6 LINES)

Sep 8. 1924
 DEVONSHIRE CLUB,
 ST. JAMES'S, S.W.1.

To the British Thomson-Houston Co. Ltd

Sir, It may perhaps interest you to know that during my recent experiments in reception of the B.B.C. stations upon the Jungfrau & other points in the Alps I tested many makes of valves. The ones which gave by far the best all-round results were the B.T.H. B4 - one of which is, I consider, equal to two of any other. I strongly advise every amateur to use them
 William Le Queux

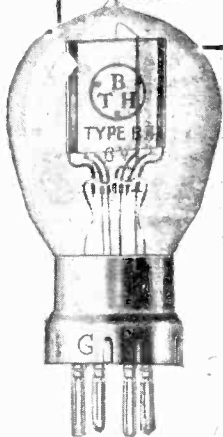

Sir,
It may perhaps interest you to know that during my recent experiments in reception of the B.B.C. stations upon the Jungfrau and other points on the Alps I tested many makes of valves.

The ones which gave by far the best all-round results were the B.T.H. B4 - one of which, I consider, equal to two of any other. I strongly advise every amateur to use them.

(Signed) WILLIAM LE QUEUX

The British Thomson-Houston Co. Ltd.

Works: Coventry.

Offices: Crown House, Aldwych, London, W.C.2

Branches at: Belfast, Birmingham, Bristol, Cardiff, Dublin, Glasgow, Leeds, Liverpool, Manchester, Middlesbrough, Newcastle, Sheffield, Swansea

Price 35/-



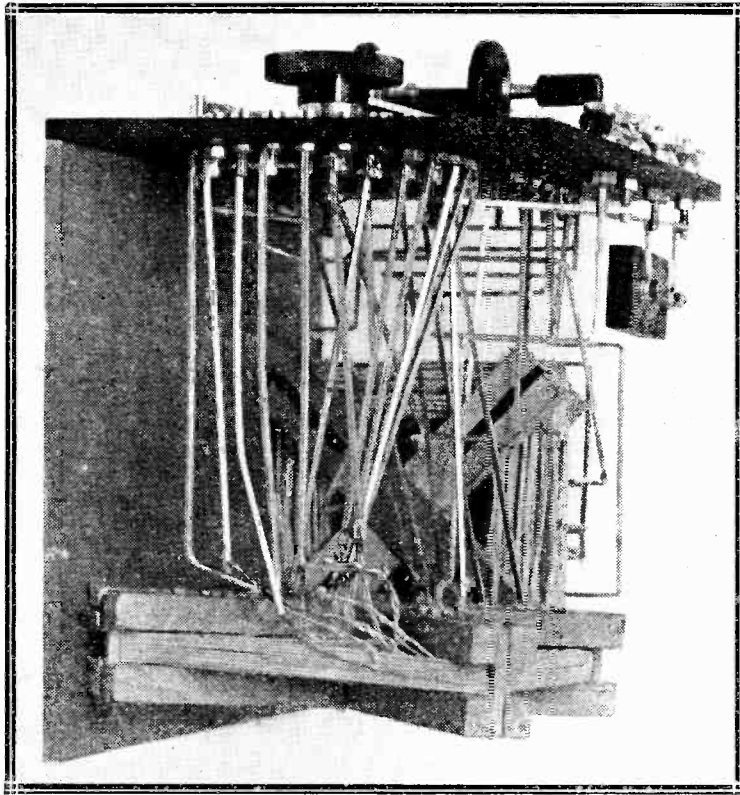

Fig 10.—The connections to the loading coil may be seen from the above photograph.

in order to facilitate the baring and cleaning of the wire. The two ends thus formed are twisted together after being carefully scraped.

The coils are now mounted by means of four wood screws on the 8 ins. by 6½ ins. by ¼ in. wooden baseboard, approximately in the positions shown in photographs of the back of the panel. The wooden board is now joined to the lower end of the ebonite panel by means of two wood screws passing through the panel in the position shown in Fig. 4.

At this stage the tappings of the coils are connected to their respective studs with the aid of ¼ in. square section tinned copper, this wire being chosen chiefly on account of its rigidity. This completes the receiver save for the cabinet, which may be bought or constructed as desired.

Operating the Set

The aerial is joined to T_1 and the earth to T_5 . If it is desired to receive a station working on one of the usual wavelengths, i.e., 350 to 500 metres, the two terminals at the top of the panel, T_3 and T_4 , are left open, and tuning carried out by placing the arm of the switch S_2 on the first stud,

and varying S_1 slowly over all its studs. If this does not bring in the desired signals, the second stud on S_2 should be tried, and

another complete variation of S_1 . This process should be carried on, together with frequent adjustments of the crystal detector, until signals are arriving at maximum strength. It should be noted that when working with the set under these conditions, no signals will be obtained when the arm of S_2 is on any of the studs from 8 to 20, since these are not in circuit.

Aerial Connections

The aerial may be taken to T_2 if a very large aerial is used, and the effect noted after the necessary retuning has been carried out.

The long-wave broadcasting station at Chelmsford is received by connecting the aerial to T_1 , earth to T_5 ; T_3 is joined to T_4 by means of a piece of square section wire, one end of which may be fitted with a small ebonite knob for the sake of appearance.

Searching is carried out in the same way as before, placing S_2 first of all on the twentieth stud this time, then on the nineteenth and so on.

Test Report

THE set was tested east of 2LO in the outer suburbs on a twin aerial 75 ft. long and 45 ft. high. Good results were obtained from both 2LO and 5XX.

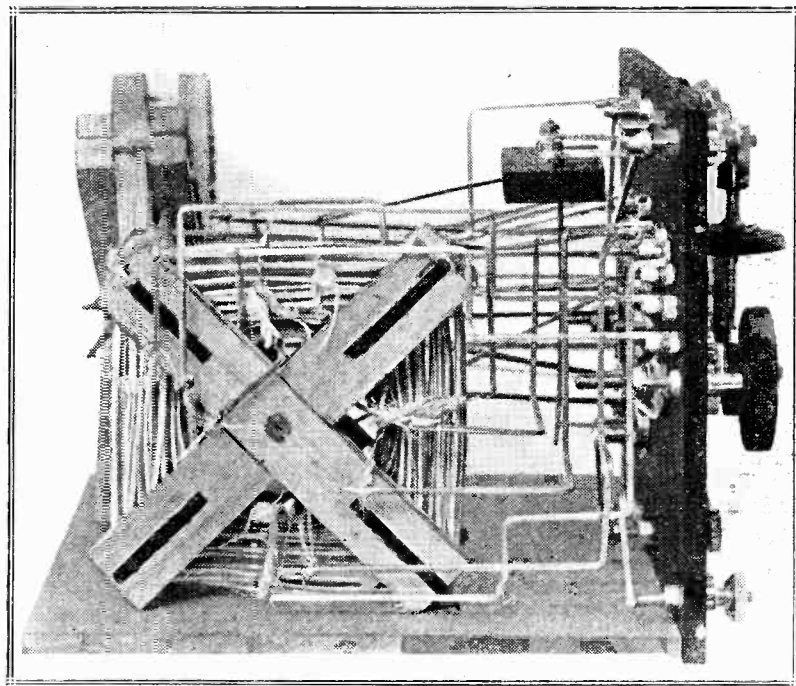

Fig. 11.—A View behind the panel taken from one side.

When receiving 2LO the aerial was connected to the terminal marked aerial, and the earth wire to earth; the link joining the loading coil terminals was taken out. Best results were obtained under these conditions with S_2 on the third stud and S_1 on the second stud. Signal strength was observed to be louder than that obtained from the average crystal set. Upon placing the aerial lead-in upon the terminal T_2 instead of the aerial terminal, rather louder signals were obtained after retuning on S_1 and S_2 . The settings for these were S_1 on the seventh stud and S_2 on stud five. On connecting a loud-speaker to the telephone terminals, speech was audible at a distance of five feet.

Reception of 5XX.

The set was prepared for the reception of 5XX by joining the terminal of the loading coil by means of the link, and taking the aerial to the aerial terminal, and earth lead to earth terminal. Loud signals were received from this station with S_1 on stud six, and S_2 on stud eighteen. When using a loud-speaker, speech was just audible at a distance of 8 ft. It was found that the switch S_1 made little difference to strength of signals from 5XX.

The fixed 0.0005 μ F condenser was placed in parallel with the two coils by joining T_2 to T_3 (earth) and under these conditions maximum strength was obtained by placing S_1 on stud one and S_2 on stud fourteen.

Results on Small Aerial.

On a smaller aerial of comparative inefficiency, 2LO was received at fair strength with the 0.0005 μ F condenser in series; S_1 was placed on its third stud, as also was S_2 .

On the same aerial, 5XX was received with S_2 on stud nineteen, while no stud on S_1 appeared to give better strength than its neighbour. For the latter station, of course, the lead-in was connected to the aerial terminal, and T_3 and T_4 were joined together. On the very small aerials, probably, it will be necessary in most cases to join T_2 to T_3 , thus putting the condenser in parallel with the coils.

It should be noted that all of the foregoing stud numbers bear no reference whatever to those given in the wiring diagram, these latter being merely for the purpose of aiding in wiring up. The stud number in each case is obtained by counting from left to right on the front of the panel.

*The 3 Valve
Dual Receiver.*

To the Editor of MODERN WIRELESS.

Sir,—Enclosed please find a photo of my wireless set. As you will see, it has been altered rather from the original design, which was the 3-valve-dual, as described in the April number of MODERN WIRELESS. I have enclosed the valves, which meant that the H.F. transformer had to be shifted a little. I use a D.P.D.T. switch for 2 or 3-valves. A master resistance—a microstat—is in the L.T. negative lead and is very useful. On the

the telephone terminals. Hence in use, either one or the other of the pairs of terminals has to be shorted. I can detect no difference whatever on either pair of the terminals. Trusting the photo is suitable for publication.—Yours truly, F. C. HOSSSELL.

Teddington.

*A "Tri-Cell"
Reflex Set.*

To the Editor of MODERN WIRELESS.

Sir,—In response to the request for reports on circuits published in your paper, I send the following:

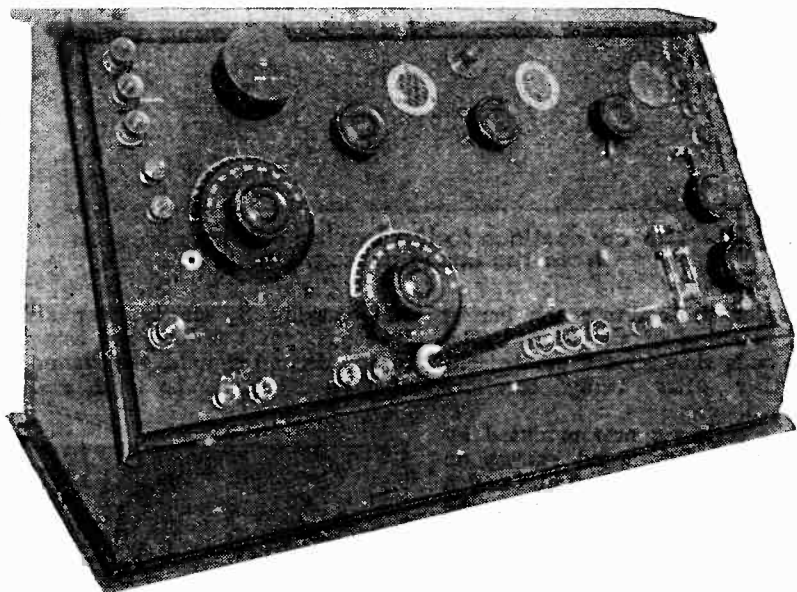

A photograph of the 3 Valve dual constructed by Mr. Hossell.

first 2-valves I can hear, in Exeter, all the B.B.C. main stations and also 2PY and an unknown relay station. All these stations are good 'phone strength, and the third valve would enable me to use a loud-speaker, if I had one. A fine tuning device is shown in the photo, which explains itself, a rubber ring pressing on the edge of the dials. Morse-jamming is always very bad. 5IT and 2BD are never readable owing to morse, which, by the way, is all spark. I do not use the 100,000 ohms resistance across the grid of the first valve and find it is not wanted. The grid bias terminals are along the bottom next to the 'phone terminals. The .004 μ F. condenser is connected across the L.S. terminals and these are joined in series with

I much appreciate the excellent "Tri-cell" reflex by Mr. Percy Harris, in "M.W." of September last.

It took a short time only to construct, and on first test I was able to tune in several B.B.C. stations, including Aberdeen.

Using a Wecco valve and dry batteries 2LO gives loud speaker strength.

On Sunday last, at 7.15 p.m., I heard a concert in German on about 400 metres, probably Munster.

With a frame aerial it works well, and I have to-day listened in Nottingham with frame aerial, with exceptional results.

I use the coils named with outside aerial, but with frame 24 in. side, 10 turns. I use a 20 turn coil for the tuning.—Yours truly, W. J. EASTON.
Acton, W. 3.

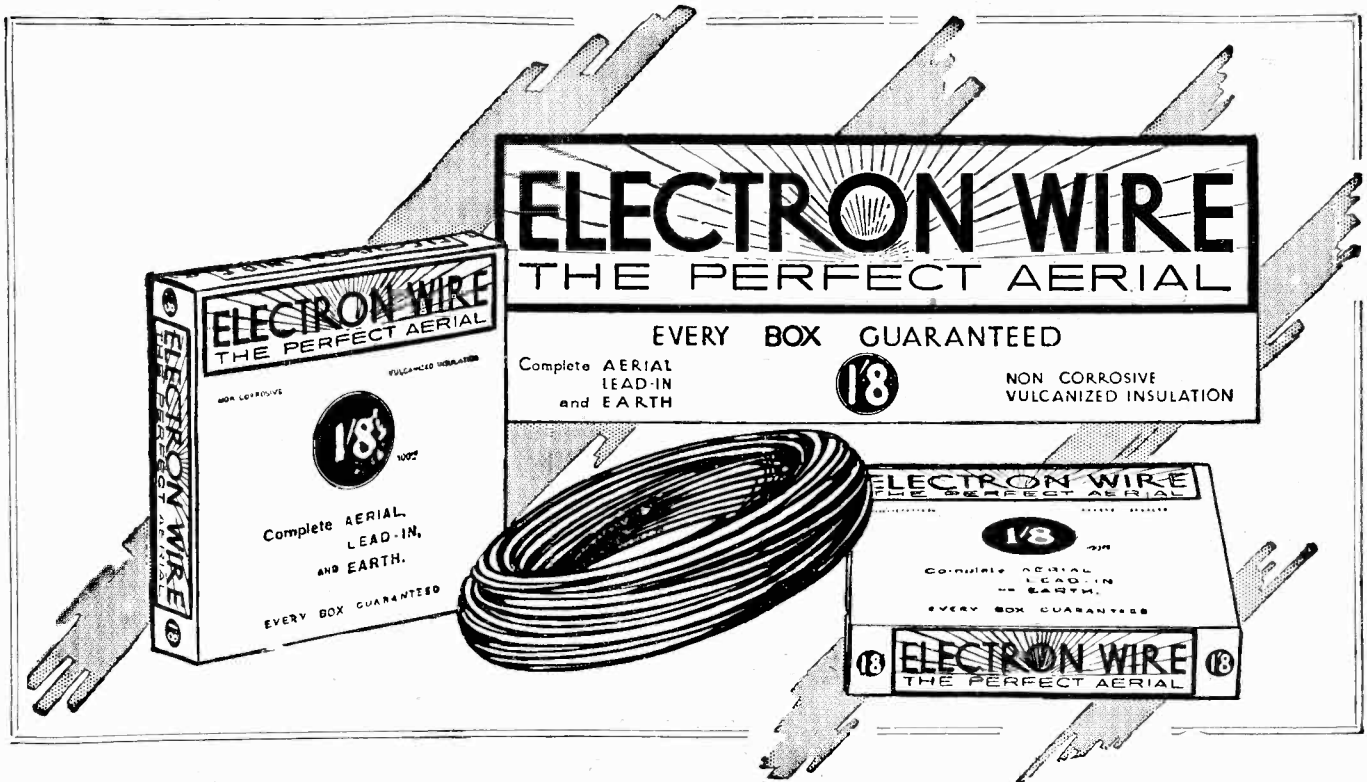

WITHOUT ELECTRON WIRE YOU CANNOT KNOW REAL AERIAL EFFICIENCY

Wireless enthusiasts must be on their guard. There are dealers all over the country who are trying to foist upon the public colourable imitations of the famous "ELECTRON WIRE."

IF "ELECTRON WIRE" IS THE WIRE YOU WANT BE CAREFUL THAT YOU GET IT.

It brings envied results. Multitudes of wireless experts as well as enthusiasts all over the world are using it.

Every day we get shoals of letters telling us of the remarkable reception experts and amateurs are getting with "ELECTRON WIRE."

If you ever find a better aerial get it. A good reception is worth any price you pay.

BUT AVOID DECEPTION. LOOK AT THE NAME AND THE BOX. If it is not our distinctive box refuse it and save disappointment.

Some dealers may even tell you that they cannot get boxes for "Electron Wire," and may try to sell you a wire coiled to look like "Electron Wire." Refuse it.

Ask for and insist upon "Electron Wire" in our distinctive white box printed in blue. Refuse any wire which may look like "Electron Wire," and may even be boxed under a similar name.

TAKE NOTICE OF THIS WARNING!

Buy "Electron Wire" in our distinctive box only, plainly printed in blue on every side with  and the price 1/8. Refuse all others.

Try It—then you will know why it is so popular. Ask your dealer for ELECTRON WIRE. But you must agree to return it if it does not "prove up" to every claim made for it. If your dealer does not sell ELECTRON WIRE yet, he can get it for you, or we will send it direct to you upon receipt of P.O. or cheque. Do not send stamps PLEASE.

The **CHEAPEST AERIAL** and the Best in the World. **1/8** POSTAGE 6d.

Also laid double for extending Phones, Loud Speakers, etc.	Two 150 feet lengths twisted.	Two 250 feet lengths twisted.	Two 500 feet lengths twisted.
	300 ft.	500 ft.	1,000 ft.
	5/-	8/-	15/-

Carriage Paid.

NEW LONDON ELECTRON WORKS, Ltd.

(Members of the B.B.C.)

Telephones: East 1821. East 6043. 99, REGENT'S DOCK, LONDON, E.14. Tel.: "Stannum, London."
'BUSES Nos. 15, 23, 40. 1d. from Aldgate. (Near East Stepney Station, L.N.E.R.)

In replying to advertisers, use COUPON



The Hall Mark of
RADIO PERFECTION

There are definite and convincing reasons why the A.J.S. models will claim the attention of every Radioist. The name alone is complete evidence of reliability in every detail of construction, design, material and finish. On the other hand, every A.J.S. instrument possesses distinguishing characteristics. You owe it to yourself, before deciding on any other make, to get your local dealer to show you the latest A.J.S. improvements.

**The New Model
 A.J.S. Receiver.**

The dominant features of all A.J.S. Receivers are: Efficiency, Selectivity, Power and Clearness of Reception. They are extremely flexible, and function on any wave-lengths from 150 metres to 20,000 metres, and give most successful results on Frame and small Indoor Aerials.

**PRICES.
 Panel Only.**

Two-Valve Panel - £12/-/-
 Three-Valve Panel - £15/17/6
 Four-Valve Panel - £20/5/6

Complete Sets.

Two-Valve Set - £17/10/-
 Three-Valve Set - £22/5/-
 Four-Valve Set - £27/5/-

Complete Sets consist of Panel as illustrated, Valves, Headphones, High and Low-Tension Batteries, Aerial Wire, Insulators, Lead-in Tube.

**The Unitop
 Cabinet Receiver.**

Constructed to contain an A.J.S. Four-Valve Receiver, the Unitop Cabinet combines the maximum of wireless efficiency with the minimum of space. Produced in Mahogany or in Light or Dark Oak, as preferred, the Unitop Cabinet shown is of distinctly handsome appearance. It forms a compact and attractive article of furniture, and may be placed upon any convenient table, while it is sufficiently portable to be carried to any outdoor function.

In Mahogany or in Light or Dark Oak, complete with Four-Valve Receiver and all Accessories, ready for use,

30 Guineas.

**The A.J.S.
 Loud-Speaker.**

The A.J.S. Loud-Speaker is the outcome of lengthy research and experiment, and justly claims to be the last word in Loud-Speaker design. The accurate proportions and smoothly blending curves of its non-resonant horn give to the A.J.S. Loud-Speaker those correct acoustic properties which ensure the true reproduction of the sound waves, while its extreme sensitiveness enables the utmost volume of sound to be produced, with a complete absence of distortion.

Price, with Metal Horn and Electro-Plated Fittings,

£4/15/-

With Oak or Mahogany Horn and Electro-Plated Fittings,

£5/10/-



A. J. STEVENS & CO. (1914) LTD.

WIRELESS BRANCH, WOLVERHAMPTON.

'Phone: 1550 (3 lines). Wireless Call Sign: 5 RI. 'Grams: "Reception, Wolverhampton."

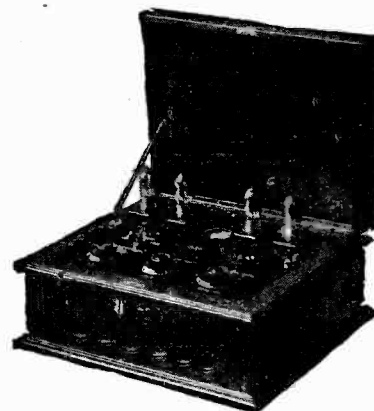
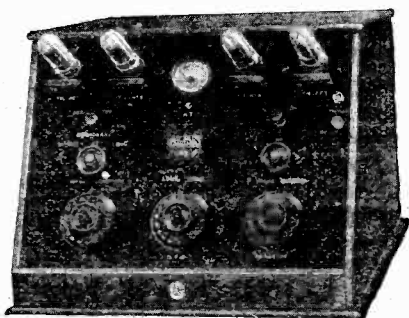



Notes on the Dual Receiver with Neutrodyne Control

By A. D. COWPER, M.Sc., Staff Editor.

These notes will be of interest to readers making the set described in "Modern Wireless," April, 1924, Vol. II, No. 7.

CONSIDERABLE interest appears to have been aroused by the valve-crystal dual circuit, with neutrodyne control of the tuned-anode H.F. stage, described by the writer in the April number of MODERN WIRELESS. From the number of inquiries received from correspondents both in the British Isles and from points in the States (where an account of the dual had appeared in *Radio News*), evidently many amateur constructors have been ambitious enough to attempt this extremely powerful, but at the same time admittedly tricky circuit. Judging from some reports received, others have been successful in duplicating the extremely satisfactory results observed by the author. At the same time, some correspondents have met with trouble on certain points; especially (as was anticipated by the writer) in connection with the extremely small neutrodyning condenser. These notes are an endeavour to clear up some of the points raised.

The Neutrodyne Condenser

Subsequent experiment has shown that the two small condensers in series, one fixed and one a small "vernier" variable, used for the neutrodyne control, can be substituted by a single specially low-minimum two-plate condenser made up with one each of the usual standard "fixed" and "moving" plates, No. 2 or No. 4 B.A. screwed brass rod, knob and pointer, with nuts and spring washer, as illustrated in the diagram. This is mounted on the back of the panel where the "vernier" three-plate condenser originally described was arranged. It will be noted that both fixed and moving plate are trimmed down (with a sharp pair of scissors, subsequently carefully flattening the plates with the help of a domestic flat-iron) so as to give ample clearance in

the minimum position. They are mounted at about $\frac{1}{16}$ in. apart, this distance being adjustable by adjusting the position of the nuts locking the moving plate on its

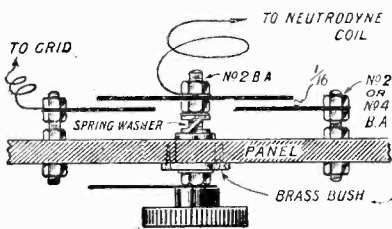
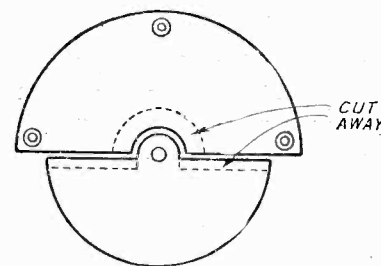

Diagrams of the two plate neutrodyne condenser.

spindle, the spring-washer maintaining the relative position of the plates. There is no need for a scale on this condenser; a plain pointer suffices. Contact is made to the moving plate by an open spiral of, e.g., No. 28 wire, connected to the outer end of the

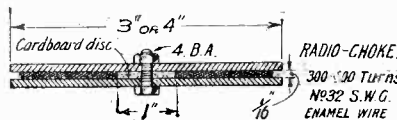

An illustration of a very compact radio-choke.

neutrodyning coil. The fixed plate is connected to the grid.

The dimensions and value of the radio-choke coil interposed between the L.F. transformer "O.S." and the grid are not critical. The simplest possible plain solenoid

coil of No. 32 enamel wire was suggested in the original article. A plug-in coil of about 250 turns can be used instead; or a very compact flat slab coil of No. 32 enamel-insulated wire wound between cheeks of ebonite, fibre, or plain 3-ply wood, 3 to 4 in. diameter and separated by a cardboard disc about $\frac{1}{16}$ in. thick and 1 in. diameter, some 300 to 400 turns of wire being wound in this narrow slot. The resulting coil can be conveniently mounted flat on the side of the frame of the receiver.

The Anode Coil

The anode-coil with its double and two-pile winding, adopted for simplicity and compactness, appears to have given some trouble. Experiment has again demonstrated that the neutrodyning coil, since it does not form a critically-tuned oscillating circuit of its own which may affect the efficiency of reception, can be made in a very much more compact form, regardless of H.F. resistance, by winding it of No. 28 or No. 32 enamel-insulated wire, on the end of the same former on which the anode-coil proper is wound. The anode-coil can also be made single-layer, say 60 turns of No. 20 or No. 22 on a 4-in. tube, the compact fine-wire neutrodyning-coil allowing sufficient room for this. Otherwise the arrangement and connections should be identical with those described in the original article. An even more compact arrangement for both the A.T.L. and anode coil has been adopted by the writer, similar to a form of inductance developed for extreme selectivity, described in a recent number of *Wireless Weekly*. The coils are wound as a succession of single-layer thick slab coils, in slots cut with a hack-saw in a six-rayed star former of 3-ply wood, made up of three sections (as indicated in the diagram) and notched so as to fit together in star form. The slots are spaced at

$\frac{1}{2}$ in. The A.T.I. is wound with No. 20 S.W.G. d.c.c. wire, 20 turns in each of 5 slots, the portion included in the aerial circuit being ten turns of No. 15 in one slot. The anode-coil is of No. 22 d.c.c., 25 turns being wound in 4 slots, the neutrodyne coil being about 50 turns of No. 28 enamel-insulated wire wound all in the next slot, and accordingly in more than one layer thick, as the slot is wider than the diameter of the wire. The neutrodyne coil is, as before, wound in the same direction as the anode-coil and connected up in exactly the same way, the inner end being connected to any point at earth potential for H.F.

The resulting coils are extremely compact, and give the same tuning-range with .0002 μ F tuning condensers as the original ones. In the finished receiver it will be found that freer access is given to the wiring when using these.

No other changes are introduced, the panel being precisely as originally figured. The actual receiver will be available for inspection in the Radio Press Service Department for the customary three weeks after the publication of this note.

Whilst one correspondent has been successful with a perikon type

of crystal rectifier, the writer recommends only the stable carborundum-tinned-iron combination described. It should be clearly understood that no success is to be

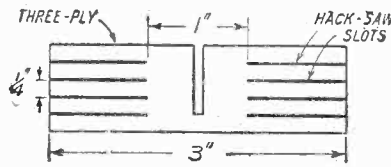
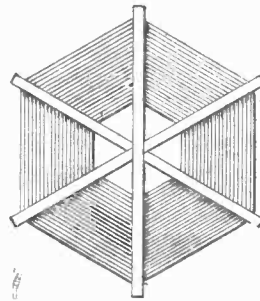

Method of making compact A.T.I. and anode coils.

anticipated with this receiver unless and until satisfactory signals have been obtained with the switch in the "single" position, *i.e.*, plain single-valve reception, using

the tuned-anode as ordinary tuned-plate reaction (and probably not critically tuned to the wave-length, as the neutrodyne may not suffice to hold the circuit down from oscillating with the very liberal Myers 4-volt valve and ample H.T.). Also that on switching to "dual" in general nothing will be heard until the anode is duly tuned, this tuning being quite sharp. Then the neutrodyne control should in one position (maximum) completely or partially silence the receiver, in the other position (minimum) allow violent oscillation, even to the whistling stage, the adjustment for distortionless reception at maximum strength being between these extremes. If this state of affairs is not observed the direction of connection of the neutrodyning coil, etc., should be investigated, and the value of the neutrodyning condenser altered by adjusting the position of the moving plate on its spindle. Too high a minimum may produce persistent howling in all settings of the neutrodyne condenser. The setting of the carborundum crystal is not at all critical in this circuit.

Ample H.T. should be used, *e.g.*, 100-120 volts with a Myers valve.

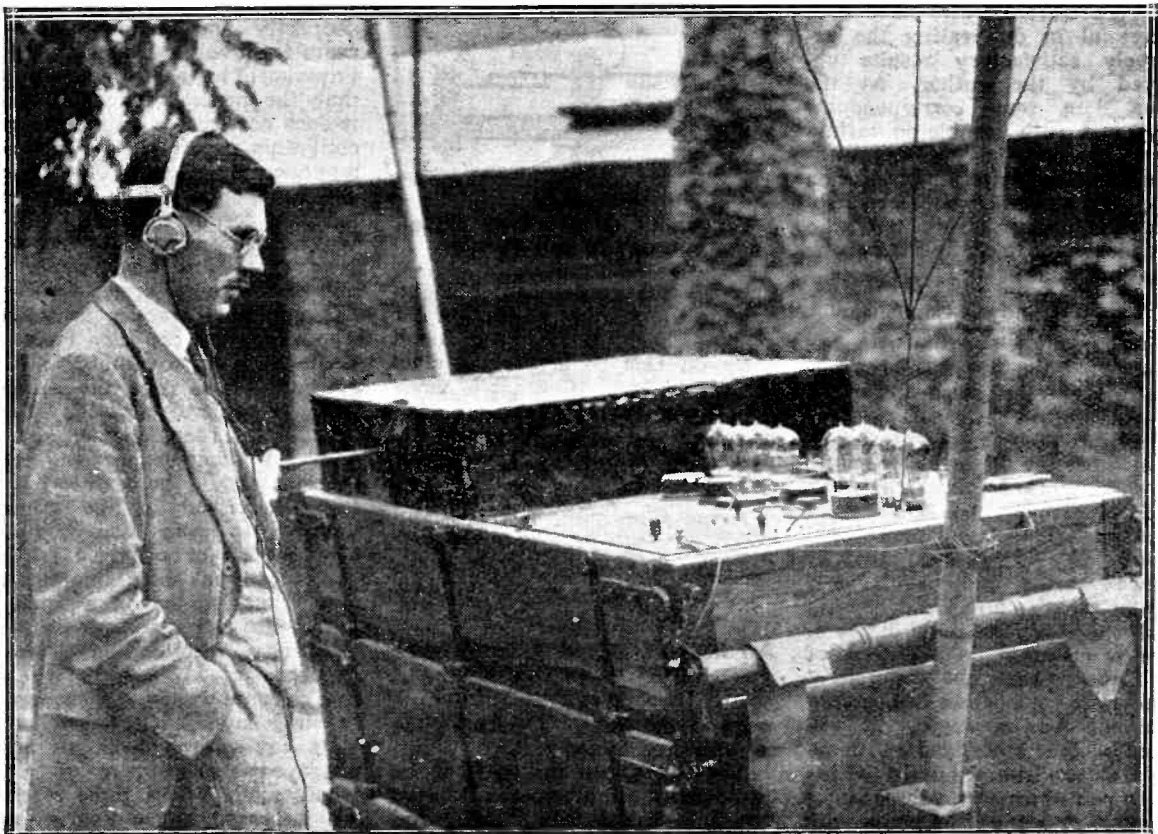

An interesting photograph showing Mr. Kirke, of the B.B.C., tuning the Zoo Perambulator Transmitting Set.

LISSENIUM

Eddy current tuning and the best inductance for it.

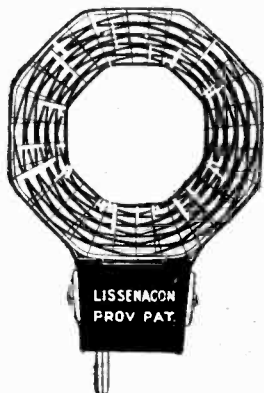

The success of the new LISSEN Crystal Set is largely due to the design of the receiver itself and largely due also to the use of LISSENIUM coils.

These coils have been found to give peculiarly efficient results in conjunction with eddy current tuning.

In the UNIDYNE CIRCUIT also they were the only coils which could be used successfully. **IF YOU EVER WANT COILS WHICH INTENSIFY TUNING—USE LISSENIUM (pronounced LISSEN-AGON) COILS.**

The appropriate LISSENIUM coil for a given wavelength is more responsive to the frequency corresponding to that wave-length than any other make of coil.

LISSENIUM TUNING CHART.

Note the Intermediate coils, 30, 40 and 60.

TABLE I. Wavelength range when used as Primary Coils with Standard P.M.G. Aerial and .001 mfd. condenser in parallel.			TABLE II. Wavelength range when used as Secondary Coils with .001 mfd. condenser in parallel.		
No. of Coil.	Minimum Wave-length.	Maximum Wave-length.	Minimum Wave-length.	Maximum Wave-length.	PRICE.
25	185	350	100	325	4/10
30	235	440	130	425	4/10
35	285	530	160	400	4/10
40	360	675	200	635	4/10
50	480	850	250	800	5/-
60	500	950	295	900	5/4
75	600	1,300	350	1,100	5/4
100	820	1,700	500	1,550	6/6
150	965	2,300	700	2,150	7/7
200	1,885	3,200	925	3,000	8/5
250	2,300	3,800	1,100	3,600	8/9
300	2,500	4,600	1,400	4,300	9/2

The significance of using the same size coil in the new LISSEN CRYSTAL SET as in an anode circuit for the same stations—

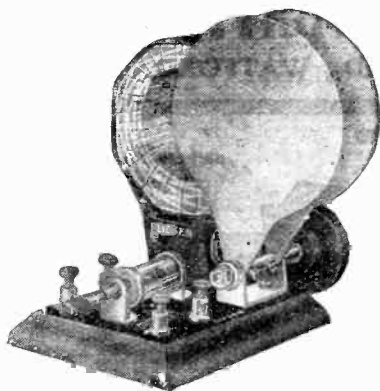

Price of receiver

(includes Crystal) (Patent pending)

Price of No. 50 Lissenagon Coil (covers 300 to 350 metres on this receiver) ...

10/-

Price of No. 60 Lissenagon Coil (covers 350-400 metres on this receiver)...

5/-

Price of No. 75 Lissenagon Coil (covers 400-500 metres on this receiver) ...

5/4

Price of No. 250 Lissenagon Coil for Chelmsford ...

5/4

8/9

If aerial is long, a smaller coil may be used in each case; a No. 40 instead of 50; a No. 50 instead of 60; a No. 60 instead of 75; and a No. 200 instead of 250.

NOTE.—One Lissenagon coil must be ordered with each set—the receiver will not be sold without one Lissenagon coil, because it yields much greater efficiency when these well-known coils are used.

This is the new Crystal Receiver promised in our advertisement of August 6th last—now ready for delivery.

It is well known that a coil used in the anode circuit should have the smallest self-capacity possible. A coil used in this circuit is entirely unconnected with any part of the aerial system, and the stray capacities shunted across it are extremely small compared with the capacities which are shunted across the aerial coil. If, in receiving the same stations, you can use in the aerial circuit the same size coil as you need in the anode circuit, it means that you are able to use on a given wavelength an inductance of a higher value than would otherwise be the case, with consequent extra strength of signals.

In spite of the capacity of the aerial across its terminals, in this new LISSEN crystal set we are able to use the same size coil as would be necessary in an anode circuit to receive the same stations. Consequently a big signal voltage is built up, which is reflected in the strength of signals.

In the new LISSEN CRYSTAL SET a form of tuning is employed which varies the inductance instead of varying the capacity—AND IT DOES SO IN COMBINATION WITH A LISSENIUM COIL, WHICH IS PECULIARLY EFFICIENT WITH THE FORM OF TUNING EMPLOYED.

Tuning is accomplished by moving the metal plate in relation to the inductance, and although the moving plate is entirely unconnected with the electrical circuit, ITS INFLUENCE IS EFFECTIVELY APPLIED THROUGH THE MEDIUM OF THE MAGNETIC FIELD CREATED.

Two coils are needed to receive Chelmsford and another broadcasting station. To change over from one station to the other, take one LISSENIUM coil out and plug the other appropriate one in. One coil on the lower wavelengths covers several broadcasting stations.

LISSEN LIMITED,

20-24, Woodger Rd., Goldhawk Rd., Shepherd's Bush, London, W. 12.

TELEPHONES : 3380, 3381, 3382, 1072 Riverside.

TELEGRAMS : "Lissenium, London."

LISSEN PARTS—WELL THOUGHT OUT, THEN WELL MADE.

In replying to advertisers, please use Order Form enclosed

THE FORMO-DENSOR with INTEGRAL VERNIER

COARSE AND FINE TUNING IN ONE MOVEMENT.

NO MORE BUCKLED VANES.

LOWEST MINIMUM CAPACITY.

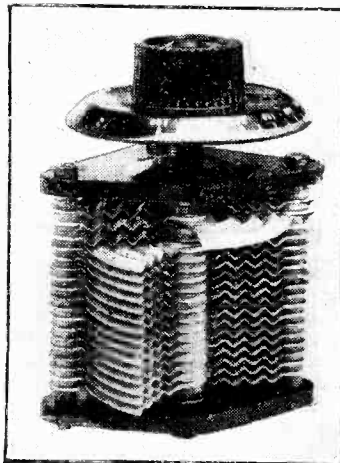

A new addition to the Formo-Densor Series is the **Dual** with **Vernier**, by means of which two stages of H.F. can be simultaneously tuned, without the use of specially matched coils. Patent Pending.

PRICES:
 .001 mfd., approx., 10 s.
 .00075 mfd., 13 -
 .0005 mfd., 9 6
 .0003 mfd., 8 6
 .0002 mfd., 7 6
 Three-plate Vernier, 5 s.
 Dual, plain, 10 6
 Dual with Vernier, 12 s.

"STRAIGHT LINE" TUNING.

SO-CALLED "SQUARE LAW" SUPERSEDED

A special feature of the Formo-Densor is that useless capacity is eliminated to a very high degree, which is rendered possible by its unique construction. This enables the ideal of high inductance and low capacity to be more nearly approached than with the ordinary form of condenser, whether so-called "Square Law" or otherwise, as, with its low self-capacity and low minimum, together with coarse and fine tuning in **one movement**, an equally efficient wave-length curve is obtained, as with any "Square Law" condenser.

THE FAMOUS FORMO COMPONENTS

ARE UNEXCELLED FOR ORIGINALITY
 HIGH QUALITY & FINE PERFORMANCE
 FORMO SHROUDED TRANSFORMERS

ARE MADE IN RATIOS TO SUIT ALL STAGES AND CIRCUITS

They are in use all over the world, and the esteem with which they are regarded and the steadily increasing demand is due to the meticulous care with which they are made and tested, together with their unique design and inherent qualities.

- A. Ratio 1-2.
- B. Ratio 1-3.
- C. Ratio 1-4.
- D. Ratio 1-5.

And Telephone.

The Formo Open type in same ratios at 12/6.

A NEW FORMO LINE THE PORTABLE AERIAL

Which can be erected or taken down in a moment, can be used indoors, out of doors, on the car, on a punt, in fact, anywhere. It can be used as a temporary or permanent aerial, and can be carried in the pocket.

It is the only portable aerial having all the advantages of the orthodox Antenna, and is supplied complete with insulators, hooks, etc., at 7/6.

THE FORMO COMPY. (ARTHUR PREEN & CO., LTD.)
 Contractors to the Admiralty, War Office, India Office, Air Ministry, and Post Office

HEAD OFFICES AND WORKS:

Crown Works, Cricklewood Lane, N.W.2
 Phone: Hampstead 1787.
 Scottish Branch: 22, York Place, Edinburgh

ALL RATIOS 18/-

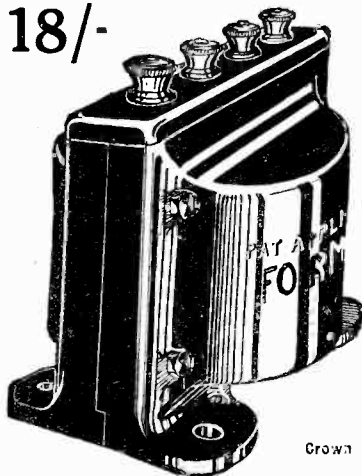

B.B.C.

WIRELESS DRY BATTERIES

For B.B.C. Sets

No. 1 W.

Standard Pocket Lamp Size—1½ volt with patent spiral wire terminals and plug sockets to take Wander Plugs.

Note:—1 doz. = 54 volts.

Used units replaced easily.

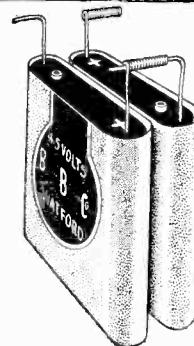

To connect in Series insert straight Terminal in Spiral of next battery. Bend spiral and thus ensure permanent electrical connection without soldering.

BRITISH MADE.

Patent applied for.

Connect as illustrated.

PRICE CARRIAGE PAID, 7/- PER DOZEN, WITH PLUG.

Standard Sizes:

- No. 2 W. Slab. 16½ volts, 3-volt tappings. Size approx. 9 x 1 x 3 ins. Price 3/- each
- No. 4 W. Slab. 36 volts, 3-volt tappings. Size approx. 10 x 1½ x 3 ins. " 6/6 "
- No. 5 W. Block. 60 volts, 3-volt tappings. Size approx. 9½ x 3½ x 3¼ ins. " 12/- "

Prices include Wander Plug. Carriage Paid.

Manufactured by—

Telephone: Watford 617.

The BRITISH BATTERY CO. LTD.
 CLARENDON RD., WATFORD, HERTS

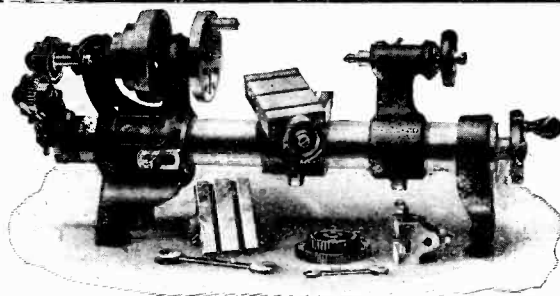

The DRUMMOND 4-in. Multi-purpose Lathe.

Make your own parts!

— half the fun in Wire'less is gone if you buy everything complete

Winding coils, turning up formers, plugs, knobs—a hundred and one jobs, drilling, slotting, boring, screw-cutting—all may be done well and cheaply on the Drummond. A contact stud—or a bush for your car—make it yourself, and pay for the lathe with the money you save.

DRUMMOND Bros. Ltd., REID HILL, GUILDFORD.

— Post this Coupon —

Please send me, post free, lists of your small lathes, with details of deferred payment system. Name Address

(Send in unsealed envelope for ½d.)

More Resistoflex Circuits

By JOHN SCOTT-TAGGART, F.Inst.P., A.M.I.E.E.

Great interest has been evinced in the interesting Resistoflex Circuits given last month, and in this article a further series appear which form an interesting basis for more experiments.

THE fullest details of a successful Resistoflex set are given in Nos. 1 and 2 of our new magazine, the *Wireless Constructor*. The second issue contains a blue print showing the wiring of the complete set, and those who desire to make up a two-valve receiver on these lines cannot do better than follow the instructions given.

On the other hand, there are many who prefer to make up circuits and carry out experiments with them without building up a finished instrument. With this class of wireless public I have the fullest sympathy, as most of my own work has been done in this way, although the finished article is always made up before a circuit is specifically recommended for the average experimenter to build up.

There, are however, many circuits which the more experienced experimenter will want to try out. Such circuits, while not of a character which can be recommended to every class, afford a vast amount of interest, and even if a little more skilled adjustment is required give results which fully justify the extra complications.

Circuits of this kind are possible, using the Resistoflex principle, and one or two are given in this article, and they will afford excellent opportunities for really interesting experimental work.

Basic Resistoflex Circuits.

Before considering these circuits, I would like to repeat, for the benefit of new readers, two of the principal Resistoflex circuits. The first is illustrated in Fig. 1, which differs from Fig. 1 of last month's article on the Resistoflex circuit by a few details. The constant aerial tuning condenser has been omitted because the condenser C_3 across the high resistance R_1 is, in itself, a condenser in series with the aerial capacity, so reducing the effect of the latter capacity. The condenser C_3 has been specified as $.0003 \mu F$, although I would suggest that individual readers

may experiment with different capacities up to $.002 \mu F$. As a matter of fact, $.0003 \mu F$ was used on the actual set being described in the *Wireless Constructor*. If a constant aerial tuning condenser is used, its value should be greater than the $.0001 \mu F$, so that its capacity, when connected in series with C_3 will result in an effective capacity of $.0001 \mu F$. A condenser in the aerial circuit for the purpose of obtaining the constant aerial

I first introduced the use of a constant aerial tuning condenser in the aerial lead, I would explain that the use of this condenser enables greater selectivity to be obtained, and also enables a wider range of wavelength to be covered by the parallel tuning condenser across the aerial inductance. Moreover, a set using this scheme is much more readily reproducible because the same set may be used on all sorts of different aerials

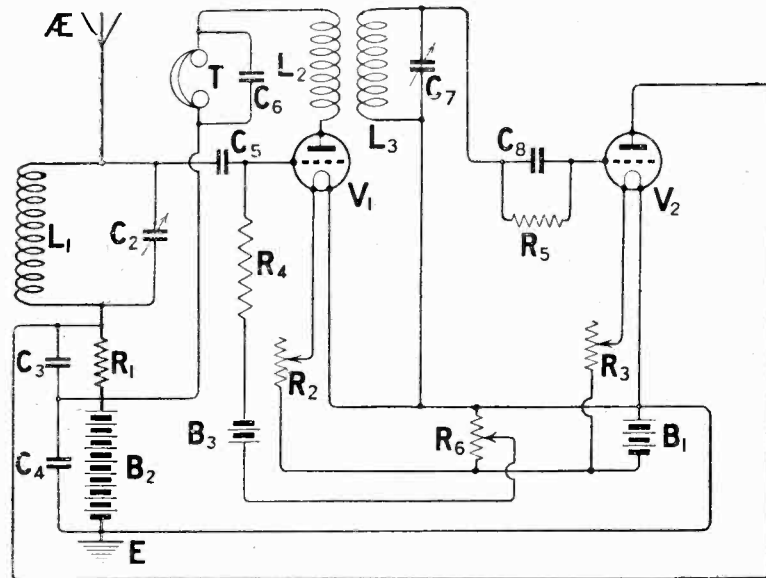

Fig. 1.—The Resistoflex circuit without constant aerial tuning.

tuning effect should consequently have a value of $.0002 \mu F$.

Such a small constant aerial tuning condenser, however, may be omitted altogether, and in the circuits given in this article this omission is made because the condenser C_3 will minimise the effect of the aerial capacity, although this minimisation will not be as effective as the insertion of $.0002 \mu F$ condenser directly in the aerial lead.

As there are many thousand readers of MODERN WIRELESS who were not reading this journal when

with practically no change of tuning and without much change in any reaction adjustment. In other words, all aerials are more or less brought to the same level, as regards their damping effect and their capacity, although, of course, the efficiency of the aerial, its height, length, etc., will continue to affect signal strength.

In Fig. 1 the transformer L_2, L_3 has the secondary tuned, and the transformer may consist of a plug-in type or two coils variably coupled by means of a two-coil

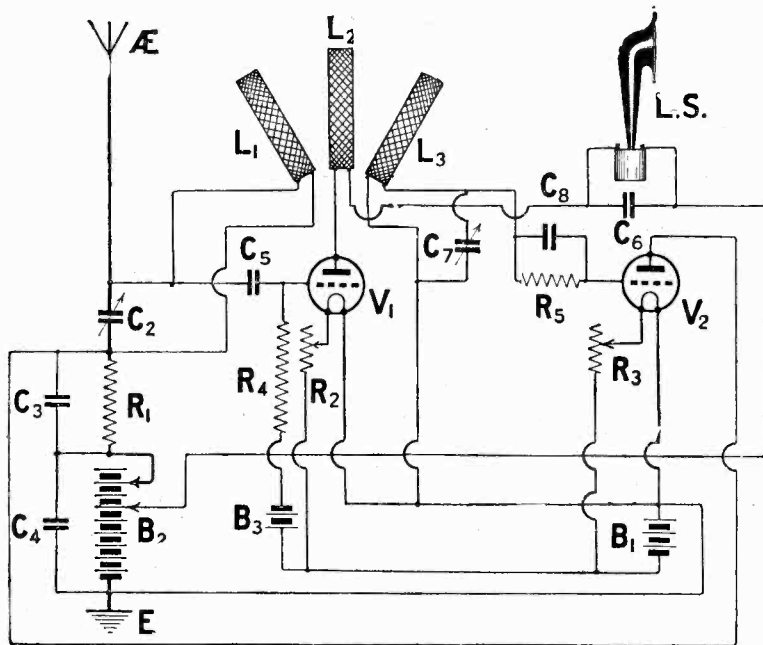

Fig. 2.—A recommended form of tri-coil Resistoflex circuit.

holder. I prefer, myself, the three-coil system of Fig. 2, because a good control of reaction is obtainable by using this method, and greater flexibility is obtained by using the tri-coil system which I introduced in the September issue of MODERN WIRELESS.

Transformer Connections

While speaking of transformers, I might remind readers that there is a great deal in the connecting of the windings. There are four different ways of connecting the leads to a high-frequency transformer, and it is really desirable to try all these connections. The first thing to do, of course, is to have the secondary connected up a certain way and then to try reversing the primary. Then, leaving the primary connected as the last time, try reversing the secondary.

This may sound troublesome, but the fact of the matter is that different high-frequency transformer manufacturers have their own ideas as to the connecting of the windings to the pins, which are made to fit into an ordinary valve socket. It is needless to remind readers that a special anti-capacity valve-holder should be used for a high-frequency transformer; these valve-holders are strongly to be recommended for both valves and transformers, whatever kind of a valve is in use, whether an H.F., detector, or L.F. valve. Several types of these holders are on the market, and preference should unquestionably

be given to these holders for purely technical reasons.

Condenser Values

As regards the condenser C₃ in Fig. 1, it has already been stated that experiments may be carried out to show the effect of different capacities. The condenser C₄ is of the fixed type, and a variation is not necessary, because the sole object of this condenser is to steady the anode voltage and to prevent any high resistance in the anode circuit from producing any peculiar reaction effects. The capacity may conveniently be 2 μF, but in the

case of a good high-tension battery, the condenser may be omitted altogether, although it is really sounder practice to employ such a condenser in all valve circuits, although, of course, you should be sure there is no leakage through the condenser.

The condenser C₆ across the telephones is not critical as regards its value. I have used .0003 μF with success. The battery B₃ is important, but the value of the grid voltage is critical, and in Fig. 1 I have shown the positive terminal of the battery B₃ connected to a potentiometer R₈ connected across the filament accumulator. This potentiometer will enable a careful adjustment of the grid potential of the first valve. This will usually be between 1 volt and 6, according to the type of valve used in V₁ and the voltage of the anode battery B₂. It is impossible to state, in an article, exactly what values to use, but -3 volts on the grid of V₁ will usually be suitable in the case of general purpose valves.

Anode Voltage

Do not make the mistake of using too low an anode voltage for B₂. Remember that the resistance R₁ cuts down the voltage of the detector valve. Personally, I would recommend that 100 volts at least should be used for B₂, and tapplings taken from this battery to the anode of the first valve, and another tapping to the anode of the second valve. The method of taking these tapplings is shown. As a matter of fact, it is desirable, really, to connect a 2-microfarad

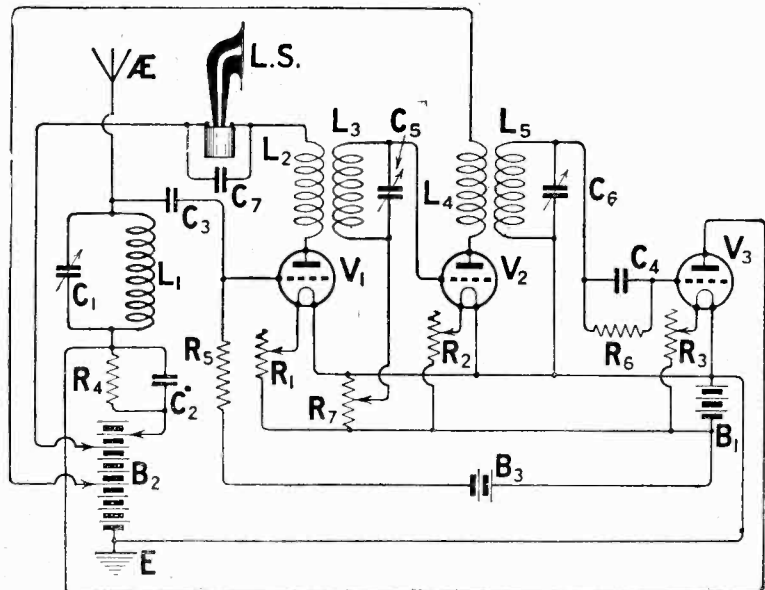

Fig 3.—The principle applied to two stages of H.F., to give one L.F. stage.

T. O. BUSS, Scientific Instrument Maker,

77, CLERKENWELL ROAD, LONDON, E.C.1.

Established 1850.

Exhibition Awards—London 1862. Sydney 1879. Melbourne 1880.

HEADPHONES 17/11

TELEFUNKEN 4,000 ohms
Adjustable diaphragms, most sensitive obtainable with cords, weight 1 ozs. (Double Receiver), post free.
N. & K. HEADPHONES.—4,000 ohms, 12/9; 6,000 ohms, 13/3.

LOUD SPEAKERS.—27/6 Junior Amplion; 42/- Junior de Luxe; 55/- Baby Sterling; N. & K. 21/-.
IGRANIC.—Coils: 25, 5/-; 35, 5/-; 50, 5/2; 75, 5/6; 100, 7/-; 150, 7/10; 200, 8/8; 250, 9/-; 300, 9/5; 400, 10/3; 500, 10/-; 600, 11/-; 750, 11/10; 1,000, 12/8.
VALVES.—Cossor P.1, P.2, 12/6; Mullard Ora, 12/6; Ediswan, 12/6; Marconi R. and R.5, 12/6; Dull Emitter D.E.R., 21/-. Post 6d. each.

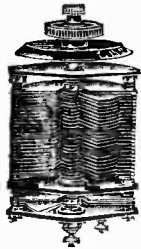

Assembled Complete for Cabinet Mounting. With Ebonite Dial.

Capacity Microf ds.	Price.
.001	7/5
.0005	5/11
.0003	5/2
.0002	4/6
.0001	4/2

With Vernier, 2/- extra or Square Law, 2/- extra Post 6d. set.

FIXED CONDENSERS, .0003, .0005, .002, .003, 10d. and 1/- each. .001, 1/6 each. Post, 3d.
EDISON BELL
.002 to .006 .. 2/-
.001 to .0005 .. 1/3
Grid Leak and Clips 1/3
DUBILIER each
.001 to .006 3/-
.0001 to .0005 2/6

WIRELESS PARTS AND ACCESSORIES.

Aerial Wire, 7/22 bare copper, stranded. Price per 100 ft., 2/6 and 2/4. By Post, 3/6.
Aluminium Vanes, 1 doz., 5d. By Post, 8d.
Basket Coils, 7 in. set, 2/3 set. By Post, 2/7.
Brass Washers, 2, 3, 4 or 5 B.A., dozen, 2d.
" Nuts, 2 B.A., 2 dozen, 3d.
" Nuts, 3, 4 or 5 B.A., 2 dozen, 3d.
" Rod (screwed)—
2 B.A., in 12 in. lengths, each 2d.
3 B.A., in 12 in. lengths, each 2d.
4 B.A., in 12 in. lengths, each 2d.
Contact Studs, 3 in. by 1/4 in., complete with nut and washer, 5d. doz.
Copper Foil Sheets, uniform thickness, 12 in. by 3 in., 3d. each.
Crystal Detector, cup enclosed with glass cover, dust-proof, 3/6. By Post 3/9.
Double Phone Cords, 72 in., 1/11.
E.P.D.T. Switch, 2/6.
Ebonite Coil Plugs, 2 for 1/6.
Empire Tape, 1/2 in., 12 yds., 9d.
Ebonite Dials, with engraved scale 0-180, 1/- each. By Post, 1/6.
Engraved Ivory Scales, 0-180 round ends, 4d. each.
Filament Resistance, 1/8, 2/6 each. By Post, 1/10 and 2/10.
Ircutance Coils Wound Enamel Wire, 12 by 4, 3/- By Post, 5/-.
1 1/2 Insulating Sleeving, 4d. yd. By Post, 4/- doz. vds.
Insulators, Egg, 4 for 11d., 2/6 doz. By Post, 3/6 doz.
Insulators, Reel, 1 1/2 d. each. By Post, 6d. doz. extra.
Knobs, with brass nut (2 B.A.), 3d. each. By Post, 3/6.
Lead-in Tubes, ebonite with brass terminals, 9 in., 1/- By Post, 1/4. 12 in. 1/4. By Post, 1/8.
Lead-in Wire, 10 yds., 1/6.
Nickel Panel Switches, D.P.D.T., 1/5; ditto, S.P.D.T., 1/2.
Porcelain S.P.D.T. Switch, 1/11.
Slider and Plunger, 4d. By Post, 6d.
Slider Knob Plunger and 13 in. rod, 8d. the set. Cannot be sent by Post.
Spacer Washers, Large, 3 doz., 9d. By Post, 1/-.
Spacer Washers, Small, 6 doz. 1/- By Post, 1/4.
Spade Terminals, 4d. doz. Post, 1 1/2.
Switch Arms, with polished knob, bushed 2 B.A. nut laminated blade, spring coil washer, nuts and bush, 1/- and 1/6 each. By Post, 1/3 and 1/9.

Terminals.

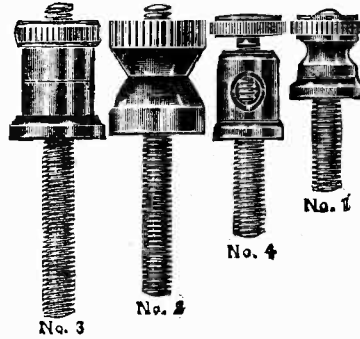

No. 3 Terminals, 2 B.A., with nut and washer, 2/- doz. By Post, 2/6.
No. 2 Terminals, War Office Pattern, with nut and washer, 1/- doz. By Post, 1/6.
No. 4 Terminals, Telephone, with nut and washer, 1/3 doz. By Post, 1/9.
No. 1 Terminals, with nut and washer, 1/- doz. By Post, 1/6.
Terminals (large), aerial and earth, complete with 2 nuts and 2 washers (2 B.A.), 2 for 8d. By Post, 1/-.



USE THE BUSS TRANSFORMER—Ratio 5 to 1. Is thoroughly Tested and is Guaranteed for a period of two years. 18/6 each.

VARIOMETERS

Ebonite 200/650, 4/6.
Spade Tags, doz., 5d.
Twin Flex, 12 yds., 1/11.
Tin Foil, free from lead. Sheets, 17 in. by 11 in., 4d. each.
Valve Legs, with nuts and washers, 1d. each, 9d. doz.
Valve Holders, ebonite, complete with nuts, 1/-.
Valve Pins, split, 7d. doz.
VOLT METERS
0-6, 4/11. Post, 4d.
0-16, 5/6. Post, 4d.

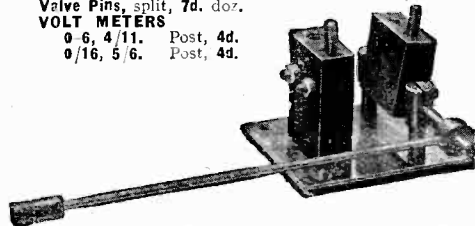

Two-way and Three-way Coil Holders. Best quality ebonite. 2-way, 4/6; 3-way, 5/6.

"EBONITE"

Postage free. Any size cut.

	s. d.		l. s. d.
8 x 1 x 1/2	0 7	12 x 10 x 1/2	0 7 6
4 x 1 x 1/2	1 3	17 x 8 x 1/2	0 8 9
7 x 6 x 1/2	2 8	18 x 18 x 1/2	0 15 9
10 x 6 x 1/2	3 9	36 x 18 x 1/2	1 7 6
17 x 5 x 1/2	5 3		

3/16 in.—25% o.f. above prices. Post free.

Instrument Wires

British Made Copper Wires.

Prices per lb. Other sizes in stock. A charge of 3d. extra is made for reeling off in small quantities. Postage extra.

S.W.G.	Per lb.	per 1,000 yds.	s.c.c.	n.c.c.	s.s.c.	n.s.c.	Enam.
18	140	39	2/9	3/-	4/-	5/-	2/7
20	230	63	3/7	3/6	4/6	6/-	2/8
24	340	95	3/7	4/1	5/6	8/-	3/2
26	530	140	4/4	4/8	6/-	9/-	3/6
28	710	200	5/-	5/6	7/-	10/-	3/10
30	950	262	6/1	7/3	8/-	12/6	4/2
32	1,300	362	7/-	8/3	9/-	13/6	4/4
36	2,000	530	8/8	10/-	12/-	15/6	4/8

D.C.C., I.R.C., Bell Wire, 10 yds., 1/-.
Lead-in Wire Rubber 10 yds. 2/6
Lead-in Wire 10 yds. 1/6
Twin Flex 12 yds. 1/11
Tinned Copper Eq. 16 gauge, 18 ft. 1/-

Wireless Crystals

"Hertzite," Shaw's, 1/-; Buss's, 6d.
Crystal Detectors Mounted on Ebonite. Also in parts unmounted.
1/3. Postage, 6d.



Interval Transformers

"BUSS" TRANSFORMER, 5 to 1, 18/6 ROYAL, 5 to 1, 20/-.
Radio Instruments 25/- Brunet, Shrouded 11/9
Igranic, Shrouded 21/- Silvertown .. 21/-
General Radio .. 14/11 Powquip, Shrouded 18/-
Formo, Open .. 11/9 Formo, Shrouded 18/-
H.F. TRANSFORMER, Plug-in Type, from 4/6. Post 4d. extra.

Celluloid Accumulators

BEST BRITISH MAKE.
4 v. 40 17/6 Post 1/- each;
4 v. 60 21/- " " "
6 v. 60 28/6 " " "
6 v. 80 34/- " " "
6 v. 100 42/- " 2/-
H.T. BATTERIES 30 v. H.T. Batt. 4/6 Post, 1/3
" " 60 v. H.T. Batt. 7/6. " 1/-
Wander Plugs 6d.

Inductance Tubes

Cardboard.
12 x 2 1/2, 4d. Post 2 1/2 d. 12 x 3 1/2, 6d. Post 4d.
12 x 3, 5d. Post 3 1/2 d. 12 x 4, 8d. Post 5 1/2 d.

Dutch Valves Tubular 4/9. Dutch Valves "R" type 5/-

N. & K. LOUD SPEAKER

21/- Post 1/-

Mahogany Boxes

Any size and shape to order. Price on application.

"ELLA"
BATTERY CHARGERS
They work from a lampholder

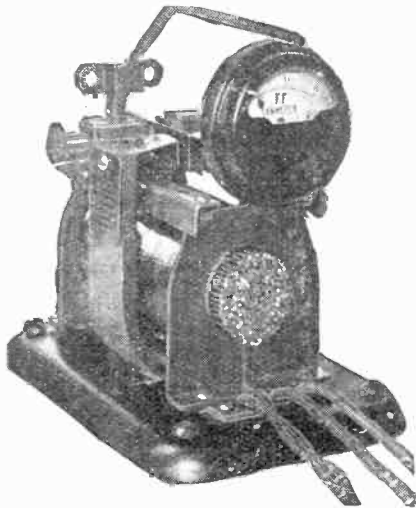

A.C. Model.

Output 5/10 amps. 9 volts. Complete with Pole Indicating Ammeter and all connecting leads and adapter - £6 6 0



AT HOME

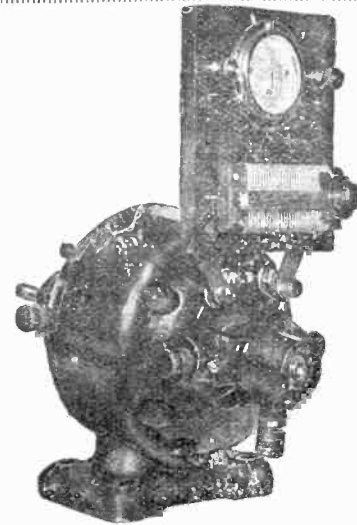

D.C. Model.

Output 5 amps. 9 volts. Machine only £5 12s. 6d. With Switchboard and Pole Indicating Ammeter and Regulating Resistance as illustrated - £6 15 0

There is an "ELLA" Battery Charger for every supply voltage. BATTERIES charged at home have much longer life and give better service than when charged outside. "ELLA" Battery chargers save their cost many times over.

Send for descriptive leaflet. Trade Supplied.

LIONEL ROBINSON & CO. 3a, Staple Inn, London, W.C.2.

'Phone: Holborn 6323 (Two Lines).



*The
Crystal
with
Valve
Power*

NEUTRON

**The World's Greatest Radio Crystal
 Concert Tested and Guaranteed**

Testimony! SARRATT.
 "I have tried several makes of crystal and I must say Neutron is the best. We have only a plain crystal set 21 miles from London, and could hear music quite plainly by laying the phones on the table. It is all you advertised it to be."
W. W.

Stocked by all best Radio Dealers. 1/6

Sole producers,
NEUTRON Ltd. SICILIAN HOUSE, SOUTHAMPTON ROW,
 LONDON, W.C. *Phone, Museum 2677.*
 Insist on NEUTRON in the black and yellow Tin or send crossed P.O. for
 1/6, together with your dealer's name and address, to

Sole distributors:—
V. ZEITLIN & SONS. 144, THEOBALDS ROAD, LONDON,
 W.C.1. *'Phone, Museum 6841 & 3795.*

condenser across each tapping and the earth, instead of across one tapping and the earth as shown. This, however, adds to the expense, and it is really doubtful whether, after all, such a condenser is really worth while.

Potentiometer Control

Instead of using the rather neat method of using a potentiometer (which method, of course, is as old as the hills but rarely used), a variable grid battery may be connected in the position of B_3 with the positive terminal connected in the negative terminal of the filament battery B_1 . The trouble of this arrangement, of course, is that it is not possible to obtain an adjustment of grid potential finer than $1\frac{1}{2}$ volts, and this means a great deal in the case of a general purpose valve working with fairly low anode voltages. It is so easy to weaken signal strength by putting too much negative voltage on the grid, and if you are in any doubt about the question, you would be well advised to use a potentiometer in the manner indicated. This method, of course, prevents the grid battery from becoming run down, and the amount of current taken by the potentiometer itself is negligible compared with the current taken by the valve filaments.

Valves to Use

Fig. 2, of course, is the recommended arrangement described in the *Wireless Constructor*. I would mention here that the first valve may be a D.E.5B, which is a very excellent dull emitter valve when

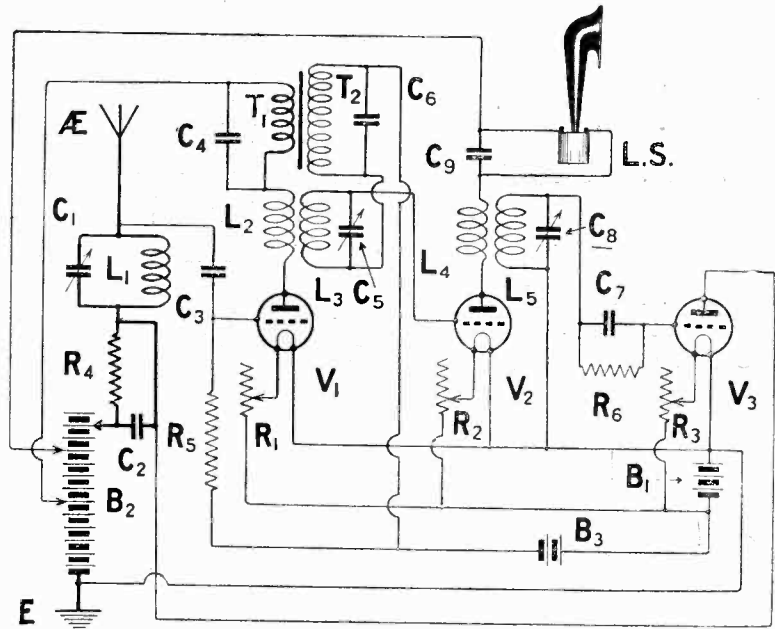

Fig. 4.—This arrangement gives two stages of H.F. and L.F. amplification.

used as the first valve in a circuit of this kind, or, in fact, any circuit which involves resistance amplification. The degree of amplification, with such a valve, is very considerably greater than with the general purpose valves. The capacity between the electrodes, of course, is rather too high, where the valve also has to act as a high-frequency amplifier, as in the case of the Resistoflex, but in this particular type of circuit I have obtained first-rate results with such a valve in the first position. An ordinary valve may be used in the second position. Of course many valves

differ as regards acting as detectors and the second valve should, if possible, be chosen for its detecting qualities. Tappings off the high-tension battery may be arranged as shown.

Double H.F. Circuits

The next four circuits are of great interest because they show two stages of high-frequency amplification, whereby the Resistoflex circuit may be used so as to combine long range with economy of valves. It is possible to apply the principle to two stages of H.F. combined with one, or two, stages of low-frequency amplification, three valves being used in all, the last one being used as a detector.

In Fig. 3 it will be seen that transformer coupling is used to couple the first to the second valve and the second to the third. The third valve acts as a detector, the low-frequency currents passing through the resistance in the combined aerial and grid circuits. These low-frequency potentials are communicated to the grid of the first valve which now also acts as a low-frequency amplifier. The amplified low-frequency currents pass through the loud-speaker L.S. so that in this circuit we have two stages of high-frequency amplification, one detector valve and one stage of low-frequency amplification.

A further development is to obtain an extra stage of low-frequency amplification, and this is shown in Fig. 4. Instead of connecting the loud-speaker in

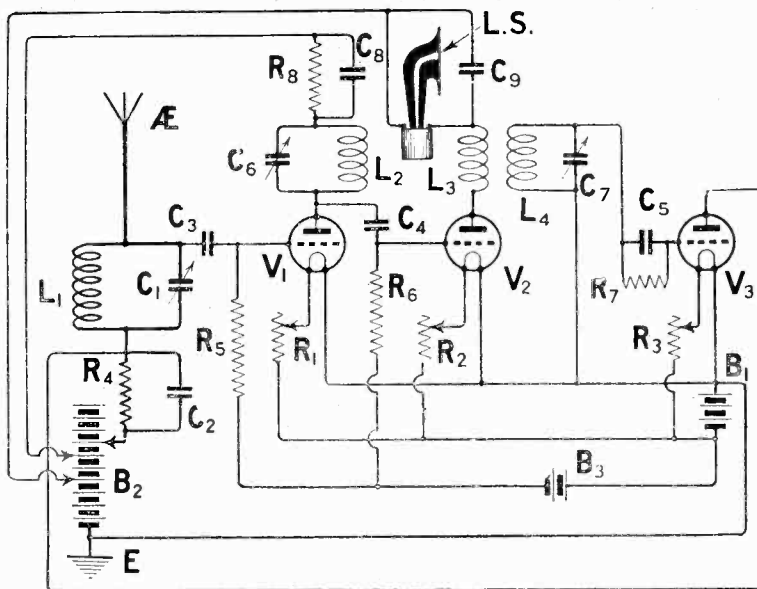
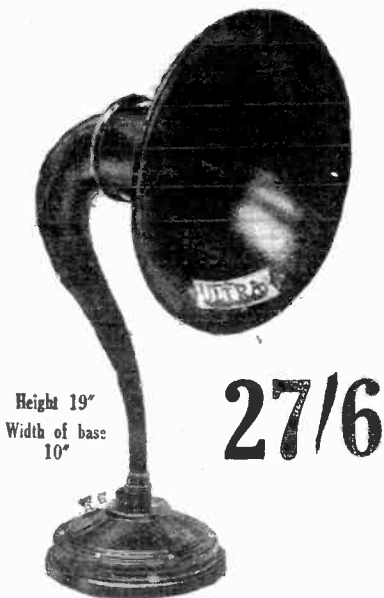

Fig. 5.—A Resistoflex circuit with combined tuned anode and impedance coupling.

ULTRA
REGISTERED TRADE MARK

*New Improved
1925 Model*



Height 19"
Width of base
10"

27/6

The **ULTRA** has earned for itself the reputation as the Premier Loud Speaker. Mellow in tone, of good volume, pleasing in appearance, and faithful in reproduction. Fitted with outside adjustment lever, which has a velvet action, highly polished horn and base. This instrument is perfectly balanced, and requires less current to operate efficiently than any other Loud Speaker.

Ask your dealer for it.

Should you have any difficulty in obtaining same write direct to

Messrs. EDWARD E. ROSEN & CO.
158/160, City Road, London, E.C.
with the name of your Dealer.

the anode circuit of the first valve, we connect the primary of a step-up transformer $T_1 T_2$, the secondary T_2 of which is connected in the grid circuit of the second valve. This second valve provides an extra stage of low-frequency amplification, and the twice amplified low-frequency currents now finally pass through the loud-speaker L.S.

Fig. 5 shows a method of coupling two valves by means of a combined tuned anode circuit and impedance so as to obtain two stages of high-frequency amplification and two of low. It will be seen that the resistance R_3 in the anode circuit of the first valve results

Fig. 6 is a modification of Fig. 5 in that tri-coil coupling is used to improve the sensitivity and selectivity of the circuit by introducing reaction into the anode circuit of the first valve and the grid circuit of the third.

This circuit has great possibilities and opens the field to a very light three-valve set giving two stages of high-frequency amplification and two stages of low.

Conclusion

In conclusion I would impress on readers the importance of a correct adjustment of anode voltage and grid bias, because either of these factors may completely spoil

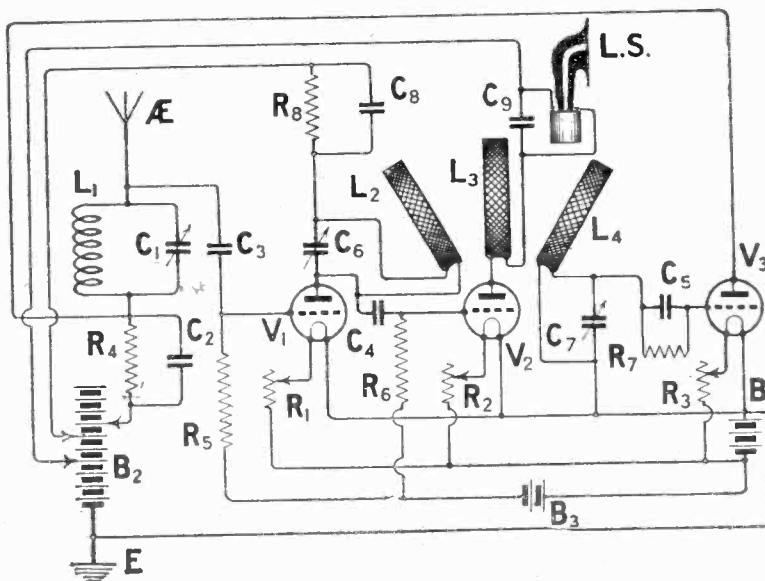

Fig. 6.—The tri-coil system adapted to the Fig. 5 circuit.

in low-frequency potentials being applied to the grid of the second valve, which acts as the second low-frequency amplifier, as well as the second high-frequency amplifier. The high-frequency coupling between the two valves is accomplished by means of a tuned anode circuit $L_2 C_6$.

The high-frequency output of the second valve is communicated to the grid of the third valve by means of the high-frequency transformer $L_3 L_4$, and the anode circuit of the second valve also contains the loud-speaker. The third valve, of course, acts in the ordinary way as a detector, the rectified low-frequency currents being passed through the resistance in the aerial circuit, so enabling the first valve to be used as a low-frequency amplifier as well as a high-frequency amplifier.

the working of the circuit. Experiments may be carried out by varying the different anode resistances, which may vary in value from 50,000 to 100,000 ohms. Experience to date prompts me to suggest the higher values if maximum signal strength is desired, but there is so much opportunity for experiment with these circuits that I would not, at this stage, like to lay down any definite rules.

The gradual tendency to employ special valves also complicates the position for anyone writing particulars of a circuit, because it is obviously impossible to specify details to suit all sorts of different combinations of apparatus. The golden rule, of course, is to have as many elements of the circuit variable so that whatever components are used, efficient results may be obtained.

The Three Valve Dual Receiver
 Photographs of the set referred to in
 this letter appear on pages 618

To the Editor of MODERN WIRELESS.

SIR,—Being a constant reader of your journal MODERN WIRELESS and having built several circuits that have been illustrated in same, I thought I'd write and let you know some of my experiences. Following on from crystal circuits, as we all more or less start with, I built up the 3-valve circuit published in the March edition, Vol. 1. This being my first attempt, I can now look back and see why I was unable to obtain any other station except London at reasonable strength. London, I remember, came in very loud, but Birmingham etc., very weak. Being anything but satisfied, I built the S.T. 100 (which is now well known) circuit when it was published in June, 1923. This set when completed repaid me for my trouble and extra care I had taken. The first time I tuned London in I got the idea into my head that I could get better reception by taking out the 100,000 ohms resistance; it was certainly louder, but again experience tells me now I was sacrificing quality, besides being unable to pick up other stations. Having kept to this circuit for over twelve months, the wrongs revealed themselves. The first thing I did was to put the 100,000 ohms. resistance back in the circuit. This improved the tone immensely, volume came along too, with careful adjustments.

Other B.B.C. Stations

Other B.B.C. stations came in some with surprising strength and clarity. Radiola, Post and Telegraphs, the Hague and two German stations followed. These results were more than gratifying. The next circuit that caught my eye was the 3 valve dual in April issue, Vol. 3. I at once sent for the blue prints of same, as these were a great asset to me; they certainly saved me much time and assured me that the holes are in the exact positions where required, the layout in general being all that can be desired. Having received the blue prints I drilled and tapped all holes for terminals, engraved panel, etc. I fitted the components as advised, wired up (bus-bar wiring 16 gauge). Panel now being completed, although very anxious to put it to the test, I got on with the cabinet; sketched out a design, and being handy with carpenter's tools I set to work. It took me a month to

complete it. I am more than pleased I did the thing thoroughly. As you can see by the photos enclosed, it makes a nice piece of furniture, besides the excellent music and entertainment derived from it. Being all enclosed makes it very convenient, as well as out of the way of dust. Accumulators, H.T. batteries, etc. have a separate division at the back of panel, the grid bias battery I put on the top for convenience sake when in use. The top can be opened on hinges half-way or lifted right away, which enables me to get at my H.T. for plugging different voltages when a change is desired. The loud-speaker horn I constructed myself from mahogany 3 ply, using an amplion attachment. This answers excellently. It is triangular in shape, so can be fitted in the corner of the room if needed. The thing that appealed to me in this circuit was every valve is independently controlled in both high and low tension circuits. I find on test I obtain the best results with 120 volts on the first valve, only 32 volts on the detector valve, and 120 volts on the third valve, using 4½ volts grid bias on both Cossor P1 and P2 valves. All B.B.C. stations come in well. Most excellent London and Chelmsford, very strong and sweet, no distortion whatever.

Continental Stations

Continental stations all seem to come in well. Radiola very strong on loud speaker, can be heard in the next house easily. Madrid I managed to get on Sunday night for the first time, not much volume on loud-speaker, just enough to be heard all over the room. No doubt can be got much stronger with more careful adjustments; on the phones it was plenty strong enough and reception pure. Other stations that I have heard are The Hague, Post and Telegraphs, Petit Parisien, Königswusterhausen, and several more that I do not know. I am more than pleased, especially as my aerial is not very high, and close by a generating station runs parallel with it. Am now looking forward to an enjoyable winter, feeling certain that, under more favourable conditions, stations I have not yet received will come in after London has closed down. For while London is transmitting, I much prefer to enjoy their concert than run the risk of upsetting other people. Thanking you for the valuable information I have gained through your excellent journal, and wishing it every success.—Yours truly,

A. HANKIN.

Walthamstow, E. 17.

Quality RADIO COMPONENTS

Profusely illustrated twelve page CATALOGUE just out. If your dealer cannot give you one send us a card with his name and address to receive it direct FREE and POST FREE.

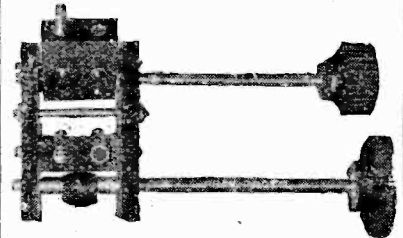

Prov. Protected.

CAM-VERNIER COIL HOLDER

Price 9/6, on base 1/- extra. With Reaction Reverse and Shorting Switch incorporated, 12/6. Postage 4d.

STANDARD COIL SOCKETS

Flash fitting
 1/- each

Postage 2d.

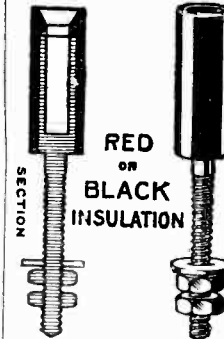
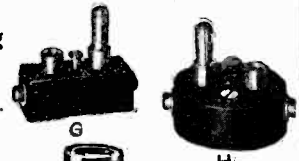

INSULATED VALVE SOCKETS

Set of 4, one red for plate, 1/-, Postage 2d.

PANEL COIL HOLDER

(no base)

Back connections eliminating flex. 2 way 3/6, 3 way 5/6, N.P. 1/- extra.

Post 3d.

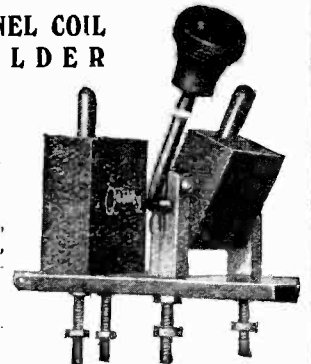

Drilling template with all.

If your dealer has not got them we send post free if you mention his name and address.

GOSWELL ENGINEERING CO., LTD.,

12a, PENTONVILLE RD., LONDON, N.1.
 Liberal Trade Terms. Phone: North 3051.

Two New Envelope Sets.

THOSE readers who have bought Radio Press envelopes and constructed receivers with their aid will have found how extremely easy home construction becomes when every possible detail is fully explained without regard to space. In a periodical certain limits must necessarily be observed, and it is in this respect that the envelope presents its chief advantage by giving just those details which the veriest novice requires.

Two new envelopes are now on sale, and may be obtained from the Radio Press Sales Department and booksellers all over the country, these being envelopes Nos. 8 and 9.

Envelope No. 8 gives full details for the construction of a single-valve reflex receiver, by Herbert K. Simpson. The circuit employed has proved very popular amongst readers, and gives pure signals with excellent volume, being very stable and easy to handle. The only tuning adjustments required

are those of two variable condensers, one tuning the aerial coil which is mounted by itself in a socket on the panel, while the other tunes the secondary winding of a plug-in high-frequency transformer. A crystal detector is used for rectifying, the valve acting in a dual capacity both as a high-frequency and low-frequency amplifier. A rheostat is used which permits the use of either a bright or a dull-emitter valve.

When completed the receiver presents a very neat appearance, and is well worth the trouble taken in making it.

Envelope No. 9 supplies directions for making an efficient single-valve receiver, by the author of envelope No. 8. Despite the large number of single-valve circuits which have made their appearance and perhaps enjoyed a short popularity, the circuit in which the valve acts as a detector with reaction on to the aerial coil, remains one of the most reliable and

efficient of all. This circuit is employed in the receiver described in envelope No. 9. An ordinary two-way coil holder is employed to allow variable coupling between aerial and reaction coils. A variable grid leak is used, and the filament rheostat is of the type allowing the use of either bright or dull-emitter valve.

Each of the two receivers of which brief outlines have been given is very easy to construct, and even with no wireless knowledge at all one could hardly go astray when aided by such explicit instructions as those given in these Radio Press Envelopes.

Radio Press Panel Transfers

After constructing a wireless receiver, the almost inevitable question is asked, "How shall I mark my panel?" The Radio Press, Ltd., have solved this difficulty by introducing a cheap and very effective method. For the very modest sum of 6d. you can now obtain a complete set of 80 different transfers carefully enclosed in a sealed envelope to ensure adequate protection. The transfers are simplicity itself to use, and give any receiver a distinctive and professional appearance. Full instructions for use are given.

An actual SQUARE LAW

The present advocacy of the straight wave-length curve has resulted in the influx of wolves disguised in sheep's clothing. It would appear that by simply re-designing the shape of the moving vanes the wave-length curve has been straightened. But experimenters are warned that a true Square Law Condenser to be efficient both as regards the wavelength and capacity curves must bear obvious signs of SQUARE LAW DESIGN.

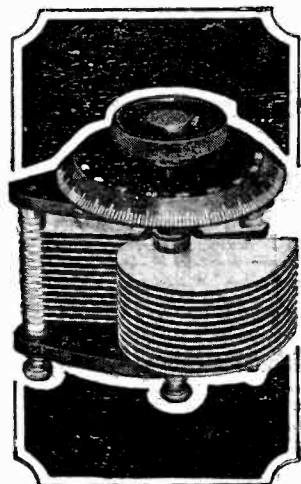

The old type Condenser with vanes cut away is a bad compromise unless precaution is taken that capacity is maintained. Many so-called Square Law, besides giving a very inaccurate straight line, are constitutionally below stated capacity. This combination of error renders accurate and calibrated tuning a frantic pastime.

Do not be induced to pay more or less

in the hope of buying efficiency. Design is a predominant feature in tuning efficiency.

J.B. Condensers contain constructional distinctions which are worthy an instrument double the price. These are well known to all users of J.B. instruments to make a Condenser which yields utmost tuning efficiency throughout a long and useful life.



As an engineering job "J.B." Condensers set a standard among popularly priced instruments. Electrically they are without rival. Designed for definite reasons there are J.B. Models for every tuning purpose. For long-distance reception the J. B. Microdenser, which embodies an ingenious mechanical device for giving a vernier movement to the moving vanes. Then there is the J. B. Super All-Metal with Brass End Plates. Lastly, the J. B. Twin for dual H.F. work with and without the vernier. Be advised and see our Regd. Trade Mark on every Condenser you buy.

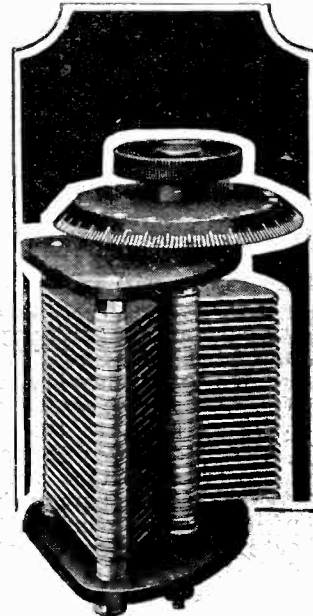

J.B. Condensers are obtainable from all dealers or direct from the manufacturers. Post, one, 6d.; two, 9d.; three, 1/-.

SQUARE LAW	
.001	9/6
.00075	9/-
.0005	8/6
.0003	6/9
.00025	6/9
.0002	5/6
.0001	5/3
Vernier	4/6

JACKSON BROS.
 B. POLAND ST- OXFORD ST. Telephone:-
 LONDON - W.1 GERRARD 7414
 (FIRST FLOOR.)

STANDARD	
.001	8/6
.00075	8/-
.0005	7/-
.0003	5/9
.00025	5/9
.0002	5/-
.0001	4/9
Vernier	4/-

Ref. No. of Transmission.	G.M.T.	Name of Station.	Call Sign and Wave-length.	Locality where situated.	Nature of Transmission.	Closing down time or approx. duration of Transmission.	Approx. Power used.
WEEK DAYS (Contd.)							
	p.m.						
43	3.30	Frankfurt	— 467 m.	Germany	C	Until 5 p.m.	1 Kw.
44	3.30	Konigsberg	— 460 m.	East Prussia	C	One hour	1 Kw.
45	3.30	Voxhaus	— 430 m.	Berlin	C & N	5.30	700 Watts.
46	3.30	Munich	— 485 m.	Bavaria	C	Until 4.30 p.m.	1 Kw.
47	3.30	Leipzig	— 452 m.	Germany	C	Until 5 p.m.	700 Watts.
48	3.35	Eiffel Tower	FL 2600 m.	Paris	N	5 minutes	5 Kw.
49	3.55	Persbureau M.S. Vaz Dias.	PCFF 2135 m.	Amsterdam	N	10 minutes	2 Kw.
50	4.0	Kbel	— 1150 m.	Czecho-Slovakia.	N	10 minutes	1 Kw.
51	4.0	Hamburg	— 392 m.	Germany	L	30 minutes	700 Watts.
52	4.30	Radio-Paris	SFR 1780 m.	Clichy	N C & N	Until 5.45 p.m.	8 Kw.
53	4.30	Eiffel Tower	FL 2600 m.	Paris	N	8 minutes	5 Kw.
54	4.45	Stuttgart	— 437 m.	Wurtemberg	C & W	Until 6 p.m.	1 Kw.
55	5.00	Radio-Belgique	SBR 265 m.	Brussels	C & N	6 p.m.	2.5 Kw.
56	5.55	Lausanne	HB2 850 m.	Switzerland	W & N	10 minutes	500 Watts.
57	6.00	Zurich	— 650 m.	Switzerland	W & N	10 minutes	1.5 Kw.
58	6.15	Kbel	— 1150 m.	Czecho-Slovakia.	C & N	Until 7.15 p.m.	1 Kw.
59	7.00	Eiffel Tower	FL 2600 m.	Paris	W	8 minutes	5 Kw.
60	7.00	Munster	— 407 m.	Westphalia	C & N	Until 8.30 p.m.	1.5 Kw.
61	7.00	Radio-Wien	— 530 m.	Vienna	C	Until 9 p.m.	1 Kw.
62	7.00	Konigsberg	— 460 m.	East Prussia	C & N	Until 8.30 p.m.	1 Kw.
63	7.00	Hamburg	— 392 m.	Germany	C & N	Until 9.50 p.m.	700 Watts.
64	7.00	Stuttgart	— 437 m.	Wurtemberg	C & N	Until 9.30 p.m.	1 Kw.
65	7.15	Zurich	— 650 m.	Switzerland	C & N	9.15 p.m.	1.5 Kw.
66	7.15	Leipzig	— 452 m.	Germany	C & N	8.35 p.m.	700 Watts.
67	7.15	Lausanne	HB2 850 m.	Switzerland	C	8.30 p.m.	400 Watts.
68	7.30	Frankfurt	— 467 m.	Frankfurt	C & N	Between 9 and 10 p.m.	1 Kw.
69	7.30	Stuttgart	— 437 m.	Wurtemberg	C & N	Until 8.30 p.m.	1 Kw.
70	7.30	Breslau	— 415 m.	Silesia	C	Until 10 p.m.	1.5 Kw.
71	7.30	Leipzig	— 452 m.	Germany	C & N	Until 10 p.m.	700 Watts.
72	7.30	Zurich	— 650 m.	Switzerland	C & N	9.15 p.m.	1.5 Kw.
73	7.30	Voxhaus	— 430 & 500 m.	Berlin	C N & W	Until 9.15 p.m.	700 Watts.
74	7.30	Munich	— 485 m.	Bavaria	C & N	8.40 p.m.	1 Kw.
75	8.15	Radio-Belgique	SBR 265 m.	Brussels	N C & N	Until 10.10 p.m.	2.5 Kw.
76	8.30	Ecole. Sup. des Postes et Telegraphes.	FPTT 450 m.	Paris	L N & C	Two or three hours.	500 Watts.
157	8.30	Radio-Paris	SFR 1780 m.	Clichy	N	One half hour.	8 Kw.
	8.30	Radio fornica Italiana	— 4.26 m.	Rome	C & M.	Until 9.45 p.m.	4 Kw.
78	9.00	Radio-Paris	SFR 1780 m.	Clichy	T & C	9.50 p.m.	8 Kw.
79	9.30	Radio-Iberica	— 392 m.	Madrid	C	Until mid-night.	3 Kw.
80	10.00	Eiffel Tower	FL 2600 m.	Paris	T (spark)	5 minutes	—
81	10.10	Eiffel Tower	FL 2600 m.	Paris	W	5 minutes	5 Kw.
82	10.44	Eiffel Tower	FL 2600 m.	Paris	T (spark)	3 minutes	—
83	11.57	Nauen	POZ 3100 m.	Berlin	T (spark)	8 minutes	—
SUNDAYS							
	a.m.						
84	7.00	Frankfurt	— 467 m.	Germany	SC	1 hour	1 Kw.
85	7.55	Hamburg	— 392 m.	Germany	T	5 minutes	700 Watts.
86	8.00	Leipzig	— 452 m.	Germany	SC	1 hour	700 Watts.
87	9.00	Komarow	— 1800 m.	Czecho-Slovakia.	C	1 hour	1 Kw.
88	9.23	Eiffel Tower	FL 2600 m.	Paris	T (spark)	3 minutes	—
89	9.50	Konigswusterhausen.	LP 680 m.	—	C	1 hour	6 Kw.
90	10.00	Eiffel Tower	FL 2600 m.	Paris	T (spark)	5 minutes	—
91	10.00	Kbel	— 1150 m.	Czecho-Slovakia.	SC	1 hour	1 Kw.

Ref. No. of Transmission.	G.M.T.	Name of Station.	Call Sign and Wave-length.	Locality where situated.	Nature of Transmission.	Closing down time or approx. duration of Transmission.	Approx. Power used.
---------------------------	--------	------------------	----------------------------	--------------------------	-------------------------	--	---------------------

SUNDAYS (contd.)

92	10.00	Breslau ..	— 415 m.	Silesia ..	SC ..	1 hour	1.5 Kw.
93	10.00	Radio-Wien ..	— 530 m.	Vienna ..	C ..	2 hours	1 Kw.
94	10.30	Lyons ..	YN 470 m.	Lyons ..	C ..	Until 11 a.m.	500 Watts.
95	10.30	Stuttgart ..	— 437 m.	Wurttemberg ..	C ..	1 hour ..	1 Kw.
96	10.44	Eiffel Tower ..	FL 2600 m.	Paris ..	T (spark)	3 minutes	—
97	10.50	Konigswusterhausen.	LP 2800 m.	Berlin ..	C ..	Until 11.45 a.m.	6 Kw.
98	10.55	Eiffel Tower ..	FL 2600 m.	Paris ..	N ..	5 minutes	5 Kw.
99	11.00	Stockholm ..	— 440 m.	Sweden ..	DS ..	Until 12.15 p.m.	500 Watts.
100	11.10	Zurich ..	— 650 m.	Switzerland ..	C ..	1 hour	1.5 Kw.
101	11.15	Konigsberg ..	— 460 m.	East Prussia ..	T ..	5 minutes	1 Kw.
102	11.57 p.m.	Nauen ..	POZ 2800 m.	Berlin ..	T (spark)	8 minutes	—
103	1.00	Radio-Paris ..	SFR 1780 ..	Clichy ..	C & N	2 p.m.	8 Kw.
104	3.00	Ned. Radio Industrie	PCGG 1070 m.	The Hague ..	C & N	Until 5.20 p.m.	1.3 Kw.
105	3.00	Breslau ..	— 415 m.	Silesia ..	C ..	Until 3.45 p.m.	1.5 Kw.
106	3.00	Stuttgart ..	— 437 m.	Wurttemberg ..	C ..	Until 5 p.m.	1 Kw.
107	3.00	Radio-Wien ..	— 530 m.	Vienna ..	C ..	2 hours	1 Kw.
108	3.00	Frankfurt ..	— 467 m.	Germany ..	C ..	1 hour	1 Kw.
109	3.30	Munich ..	— 485 m.	Bavaria ..	C ..	Until 5 p.m.	1 Kw.
110	4.00	Hamburg ..	— 392 m.	Germany ..	L ..	30 mins.	700 Watts.
111	4.45	Radio-Paris ..	SFR 1780 m.	Clichy ..	C & N	5.45 p.m.	8 Kw.
112	5.00	Radio-Belgique ..	SBR ..	Brussels ..	C ..	6 p.m.	2.5 Kw.
113	6.00	Eiffel Tower ..	FL 2600 m.	Paris ..	N ..	10 mins. ..	5 Kw.
114	6.00	Voxhaus ..	— 430 m.	Berlin ..	Ch ..	30 mins. ..	700 Watts.
115	7.00	Radio-Wien ..	— 530 m.	Vienna ..	C ..	Until 9 p.m.	1 Kw.
116	7.00	Stockholm ..	— 440 m.	Sweden ..	C ..	Until 10 p.m.	500 Watts.
117	7.00	Munster ..	— 407 m.	Westphalia ..	C ..	Until 9.30 p.m.	1.5 Kw.
118	7.00	Voxhaus ..	— 430 & 500 m.	Berlin ..	DS & C ..	Until 9.15 p.m.	700 Watts & 1.5 Kw.
119	7.00	Konigsberg ..	— 460 m.	East Prussia ..	C ..	Until 8.30 p.m.	1 Kw.
120	7.00	Hamburg ..	— 392 m.	Germany ..	C ..	Until 9.45 p.m.	700 Watts.
121	7.00	Eiffel Tower ..	FL 2600 m.	Paris ..	W ..	8 mins.	5 Kw.
122	7.15	Lausanne ..	HB2 850 m.	Switzerland ..	DS ..	Until 8.30 p.m.	500 Watts.
123	7.15	Zurich ..	— 650 m.	Switzerland ..	C & N ..	Until 9.15 p.m.	1.5 Kw.
124	7.15	Leipzig ..	— 452 m.	Germany ..	C & N ..	Until 8.40 p.m.	700 Watts.
125	7.30	Breslau ..	— 415 m.	Silesia ..	C ..	Until 10 p.m.	1.5 Kw.
126	7.30	Stuttgart ..	— 437 m.	Wurttemberg ..	C ..	10.30 p.m.	1 Kw.
127	7.40	Ned. Seintocstellen Fabrick ..	NSF 1050 m.	Hilversum ..	C ..	Until 10.10 p.m.	1 Kw.
128	8.00	Radiofonica Italiana ..	— 426 m.	Rome ..	C & N ..	Until 9.30 p.m.	4 Kw.
128	8.15	Radio-Belgique ..	SBR 265 m.	Brussels ..	NC & N	Until 10.10 p.m.	2.5 Kw.
129	8.30	Radio-Paris ..	SFR 1780 m.	Clichy ..	N ..	Until 9 p.m.	8 Kw.
130	8.30	Ecol. Sup. de Postes et Telegraphes	FPTT 450 m.	Paris ..	C or L	Between 10.30 and midnight.	500 Watts.
131	9.00	Radio-Paris ..	SFR 1780 m.	Clichy ..	D ..	Until 10.45 p.m.	8 Kw.
132	9.30	Petit Parisien ..	— 340 m.	Paris ..	C ..	Until 12.30 a.m.	400 Watts.
133	9.30	Radio-Iberica ..	— 392 m.	Madrid ..	C ..	Until 12.30 a.m.	3 Kw.
134	10.00	Eiffel Tower ..	FL 2600 m.	Paris ..	T (spark)	5 mins. ..	—
135	10.44	Eiffel Tower ..	FL 2600 m.	Paris ..	T (spark)	3 mins. ..	—
136	11.57	Nauen ..	POZ 3100 m.	Berlin ..	T (spark)	8 mins. ..	—

SPECIAL DAYS.

137	P.m. 3.00	Radio-Wien ..	— 530 m.	Vienna ..	Mon. Wed. Fri. C	Until 5 p.m.	1 Kw.
138	4.00	Lausanne ..	HB2 850 m.	Switzerland ..	Wed., Ch	1 hour ..	400 Watts.
139	4.30	Ecole. Sup. des Postes et Telegraphes.	FPTT 450 m.	Paris ..	Thurs., C or L	2 hours	500 Watts.

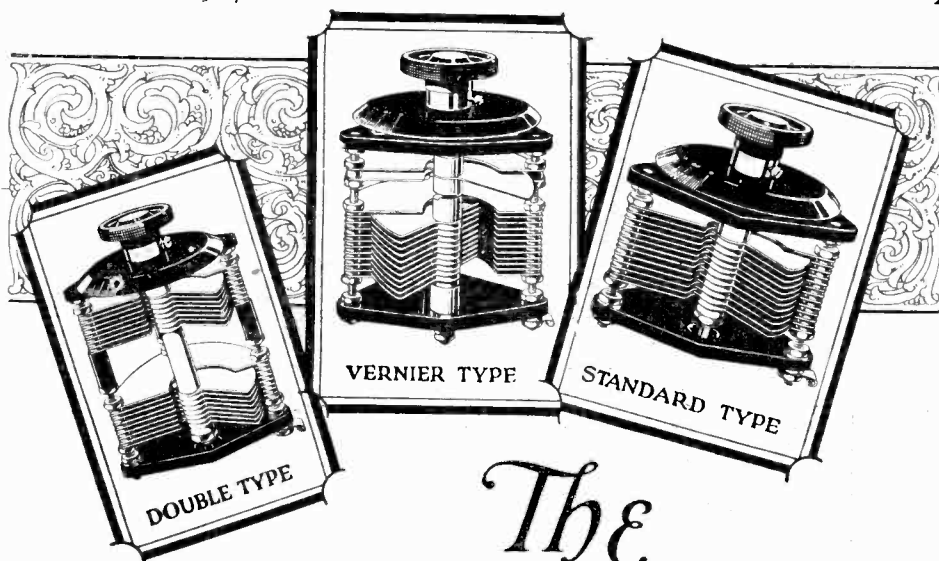

The Decisive Test

You may expect from the Bowyer-Lowe Square Law Condenser a higher standard of condenser performance than is otherwise to be obtained. Read why.

THERE is little difficulty in making a Square Law Condenser. Its principle is well known to Radio Engineers. The real problem is to obtain simplicity of tuning which such a condenser gives without sacrificing other equally important factors in condenser efficiency.

In the Bowyer-Lowe Square Law Condenser this problem has been solved so successfully that the instrument is actually more sensitive, more electrically and mechanically efficient, than a similar size variable condenser of the ordinary kind.

For instance, the capacity ratio of a variable condenser determines its wavelength range. The capacity ratio of the Bowyer-Lowe .0005 μ F ordinary condenser was the highest among instruments of its kind; but the capacity ratio of the .0005 Bowyer-Lowe Square Law Condenser, equal to 150 to 1, is the highest in wireless.

As a result, case after case comes to our notice where users who have installed

these Condensers find that they can cover a given range with fewer coils and obtain reception of a purity and volume which has astonished them. Here are extracts from letters of two of our customers:

"With your new condensers I find that I can tune all B.B.C. Stations on ONE coil instead of three, and obtain clearer and purer reception."

"Since installing your Condensers in the place of others I have been able to receive stations clearer and have picked up long-distance stations more easily, louder and without distortion."

Bowyer-Lowe Square Law Condensers are made on a principle (Patents Pending) which does not involve an increase in the size of the instrument, and reduces all losses to a minimum.

The capacity of every condenser is guaranteed; the high praise of independent critics is the buyer's assurance of their mechanical and electrical excellence.

The Decisive Test of condenser efficiency is performance. Judging on this basis, your choice of a Square Law Condenser will lead you to the Bowyer-Lowe Instrument for selectivity, wavelength range, signal purity and excellence of design.

Bowyer-Lowe Tested Square Law Condensers

All good dealers stock them at prices from 11/6. If unobtainable locally, write direct.

BOWYER-LOWE CO. LTD. LETCHWORTH



How to be sure of your Ebonite

Nothing is more disheartening than to build a splendid set and find when all the work has been done, that metallic ebonite has spoilt your efforts.

Make sure of your ebonite by buying Bowyer-Lowe Panels, which are entirely free from metal. Guaranteed Post Office Grade A, and ready for use without rubbing down.

Prices: Semi-matt surface, 3d. per sq. inch. Hand polished one side and all edges, 1d. per square inch. Drilled and engraved for any Radio Press Set (except OMNI top panel), hand polished one side and all edges, 1 1/2d. per square inch. Thickness 1 inch in all cases. Every sheet is sold under seal and bears on covering and reverse side of panel our Trade Mark. Insist on seeing these proofs of identity before buying.

Bowyer-Lowe NON-METALLIC Radio Panels

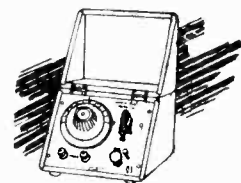

A 'Three-in-One' Testing Device

The Bowyer-Lowe Wavemeter may be used for fine tuning, calibration of coils and transformers; for checking wavelengths, and, by a simple adjustment, as an efficient wavetrap for cutting out an interfering station. To the experimenter it is as useful as his micrometer is to the engineer. The instrument, mounted on ebonite and enclosed in a Mahogany Case, is individually calibrated and supplied with full instructions.

Bowyer-Lowe WAVEMETER

(MARK 1)

£4 - 4 - 0

Write for illustrated brochure.

Bowyer-Lowe Co. Ltd. Letchworth.

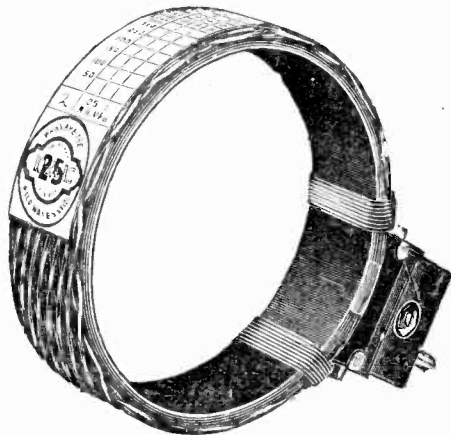

IGRANIC
Concert Coil.

Make a point
of seeing



on

Stands 9 and 14

at the

RADIO EXHIBITION &
WIRELESS CONVENTION

WHITE CITY,
Shepherd's Bush, W.12
Nov. 15 to 29

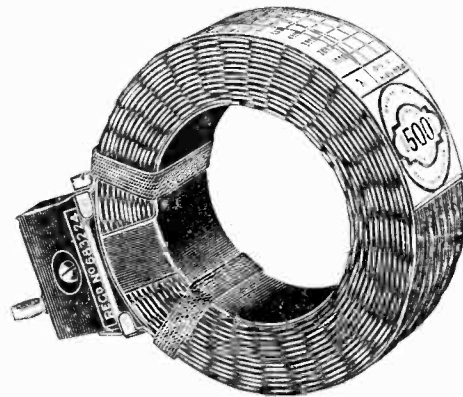

IGRANIC
Plug Mounted Coil.

Honeycomb—the ideal Inductance

Low self-capacity—Small Absorption Factor—Minimum H.F. Resistance—No dead end losses—High self-Induction—these are the qualities of the ideal inductance. They are found to perfection in IGRANIC Honeycomb Duolateral Coils.

Because Igranice Honeycomb coils are so wound that each wire (except where insulated wire comes in contact) is surrounded by an air pocket, *the self-capacity and also the absorption factor is very low.*

Because the surface area of the wire used in the making of Igranice Honeycomb Coils is as large as is compatible with the maintenance of the air pockets, *high-frequency resistance is at its minimum.*

Because Igranice Coils may be obtained in 20 sizes to cover wave-lengths between 100 to 23,000 metres there is a type for the wave-length you use, which will thus ensure *complete absence of dead-end losses.*

Because of these characteristics of Igranice Coils one may transfer to the detector and utilise the maximum of energy and so obtain the highest efficiency.

If you feel that you are not getting the best results—get Igranice Honeycomb Coils and start better reception to-day.

IGRANIC Radio Devices include: Honeycomb Coils, Variometers, Variocouplers, Bi-plug Coil Holders, Tri-plug Coil Holders, Filament Rheostats, Battery Potentiometers, Intervalve Transformers, Vernier Friction Pencils, etc. *They carry a six months' guarantee and are obtainable of all reputable dealers.*

Write for List Z274.

IGRANIC Honeycomb Concert Coil

This coil has been specially developed to provide for the reception of the B.B.C. concerts and the telephony transmitted by experimenters on shorter wave-lengths. For purity of tone, distortionless reproduction, and maximum volume they fill a long-felt want.

Prices: 4/10, 5/- & 5/2 according to wave-length.

IGRANIC Plug Mounted Coil.

Made in twenty sizes for wave-length ranges of 100 to 23,000 metres, each size having a definite wave-length range dependent upon the capacity of the condenser used in association with it.

Prices from 5/- to 15/- each.

IGRANIC Gimbal Mounted Coil

This coil is mounted upon two gimbals, or studs, positioned diametrically opposite, and these form the terminals and the means of fixing to the coil holder. As a result, it is possible to obtain a wide range of precise and accurate adjustments. As in the plug mounted type, it is made in twenty sizes providing the same approximate range of wave-lengths.

Prices from 4/10 to 15/- each.

Birmingham—73-74,
Exchange Buildings.

Bradford—18, Woodview
Terrace.

Cardiff—Western Mail
Chambers.

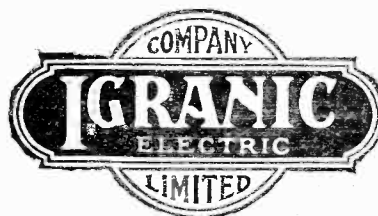

Glasgow—50, Wellington
Street.

Manchester—30, Cross
Street.

Newcastle—90, Pilgrim
Street.

149, Queen Victoria Street, London
Works: Elstow Road, BEDFORD.

Ref. No. of Transmission.	G.M.T.	Name of Station.	Call Sign and Wave-length.	Locality where situated.	Nature of Transmission.	Closing down time or approx. duration of Transmission.	Approx. Power used.
SPECIAL DAYS (contd.)							
140	5.00	Komarow ..	— 1800 m.	Czecho-Slovakia ..	Thurs., C	1 hour	1 Kw.
141	5.15	Zurich	— 650 m.	Switzerland ..	Mon.Wed. Fri., C	Until 5.50 p.m.	1.5 Kw.
142	5.15	Zurich	— 650 m.	Switzerland ..	Thurs. L & Sat. Ch	1 half-hour	1.5 Kw.
143	5.40	Ned. Seintoestellen Fabriek.	NSF 1050 m.	Hilversum ..	Mon., C	Until 6.40 p.m.	1 Kw.
144	6.00	Eiffel Tower ..	FL 2600 m.	Paris	Mon.Wed. Fri. C & N	Until 6.50 p.m.	5 Kw.
145	6.00	Eiffel Tower ..	FL 2600 m.	Paris	Tues., Thurs., Sat., N	10 mins.	5 Kw.
146	6.00	Voxhaus	— 430 m.	Berlin	Wed., Ch	30 mins.	700 Watts.
147	7.00	Svenska	— 470 m.	Stockholm ..	Tues., Thurs., C	Until 10 p.m.	300 Watts.
148	7.00	Stockholm ..	— 440 m.	Sweden	Wed.Fri. Sat. L & C	Until 10 p.m.	500 Watts.
149	7.40	Smith & Hooghoudt	PA5 1050 m.	Amsterdam ..	Wed., C	Until 9.40 p.m.	500 Watts.
150	8.10	Middelraad ..	PCMM 1050 m.	Ymuiden ..	Sat., C	Until 9.40 p.m.	300 Watts.
151	8.40	Ned.RadioIndustrie	PGGG 1070 m.	The Hague ..	Mon., C	Until 10.10 p.m.	1.3 Kw.
152	8.40	Amsterdam ..	PX9 1050 m.	Holland ..	Tues., C	Until 10.40 p.m.	600 Watts.
153	8.40	Ned. Seintoestellen Fabriek.	NSF 1050 m.	Hilversum ..	Fri., C ..	Until 9.40 p.m.	1 Kw.
154	9.00	Le Matin	SFR 1780 m.	Paris	2nd and 4th Sat. of month, C	Until 10.50 p.m.	10 Kw.
155	9.30	Petit Parisien ..	— 340 m.	Paris	Tues., Thurs., C	11.30 p.m.	400 Watts.
156	10.00	Radio-Paris ..	SFR 1780 m.	Clichy	Wed., Fri., D	Until 10.45 p.m.	8 Kw.

The "All Britain" Receiver.

To the Editor of MODERN WIRELESS.

SIR,—The following results on a copy of your "All Britain" Receiver may interest you. The receiver in question was modified by placing the valves *inside* the cabinet, otherwise your design has been copied. I took it away with me on a trip to the Mediterranean coast of Spain just to see what it would do, and started off with a length of electron wire hanging from a height of about 60 ft., thence downwards at a slight angle, the remainder being led down inside a steel ventilator to the room below. With this Bournemouth was read comfortably whilst lying in the port of Valencia, a distance of 700 miles, and as the night wore on most of the other B.B.C. stations were picked up with ease. A temporary aerial was next tried, composed of stranded *steel* wire about 80 ft. long, height 60 ft., down-lead about 40 ft. With this Bournemouth was quite distinct

at 6 p.m., whilst still daylight, from a position just south of Cape St. Vincent (Spain). This is easily 900 miles. By 8 p.m. Glasgow, Manchester and Newcastle were quite comfortable on two pairs of phones in series, distance slightly over 1,000 miles, and, as the atmospheric conditions were so bad later on, the latter part of the programme was received on two valves only. These results were duplicated night after night from all points between Gibraltar and Tarragona, so the results quoted are not occasional "freaks." The atmospheric conditions round this part of the world are against long-distance work, and the stay-at-home enthusiast would hardly credit the terrific din which commences with sunset and continues until the early hours, due to the heat and sultry weather. The crash and roar is appalling, like a constant barrage of machine guns and heavies, until the ear drums become weary of it all. However, on the evening of October 10, I had the opportunity of hooking up to a good four-wire aerial of bronze wire, nearly 80 ft. long; so, after midnight, notwithstanding bad static, I picked up several faint carrier waves, and

eventually heard sufficient to identify them as American. The most distinct was evidently a children's hour by a lady, followed by several announcements and the remark "J. W. F. announcing," a song: "My blue eyed? . . . banjo solo, etc. At 1.25 a.m. G.M.T., another station was tuned in, and during a few seconds' lull in the "artillery display" a gentleman announced "This is WOO, the . . . station in Philadelphia," followed by a song, whistling solo, male voice duet, piano solo, etc. This was heard at Valencia (Spain), and a conservative estimate of the distance from Philadelphia is about 3,700 miles. A few more were heard on October 11 and 12, but the static made it almost impossible to pick out the call letters; but one station was heard very clearly at midnight, G.M.T., reading market reports, one quotation of \$4.20 being pronounced "four dollars *twenny* cents." Considering this would be only 7 p.m. in the U.S., I think the "All Britain" is likely to do some good work later on. Wishing your journal continued success. Yours truly, T. F. S. Malaga, Spain. Oct. 13, 1924.

Can You Locate Faults?

A MODERN valve set is an intricate piece of apparatus capable of giving marvellous results when properly constructed and adjusted. But what if an error has been made in the wiring, or some fault has developed in a vital component?

It would appear at first sight that it is a difficult task for the inexperienced amateur to trace a single fault, as the components of a valve set are numerous, and connections seem puzzling.

In the October 1 issue of *Wireless Weekly*, Mr. R. Roberts gave some valuable practical hints on valve set troubles, and no reader who is pleased with the reliability of the broadcasting programmes can afford to miss these tips for tracing troubles. Some notes on the elimination of distortion are also given in this valuable article.

Part I of an article entitled "A Low-Power Radio Transmitter" also appeared in the October 1 issue, an article which will make a special appeal to the

amateur proficient in reception and to the beginner in radio transmission.

An exceptionally interesting article entitled "One Hundred Metres and Below," by Mr. Percy W. Harris, appeared in the October 8 issue, in which many methods of obtaining good results on these super short waves are discussed.

Nowadays, the experimenter who cannot go below 200 metres on his tuner is looked upon as out of date, and those who are missing the interesting short-wave broadcasting and amateur transmission, should make haste and learn how to receive such stations.

A single-valve receiver for bright or dull emitter valves is described by Mr. Stanley G. Rattee, Member I.R.E., in the October 15 issue. Simplicity in construction, together with ease in operation over all wavelengths, are the outstanding features of this simple receiver.

The Supersonic Heterodyne

Mr. J. Scott-Taggart is writing a series of general and constructional articles on a most fascinating type of receiver—the Supersonic Heterodyne—the first of which appeared in the issue of *Wireless Weekly* for October 22. The operation and design of the

supersonic receiver has never been really tackled in this country, and this article by such an eminent authority on wireless matters will present entirely new ideas to the experimenter.

Capt. Round writes on the design of resistance capacity coupled low frequency amplifiers in the same issue, and all who desire pure, undistorted sound from their receivers should read this extremely interesting article by the research engineer of the Marconi Company.

A unique feature in this issue is the presentation of twelve pages of photogravure reproduction. The remarkable clearness of outline and almost stereoscopic relief of each object combine to afford almost the advantages of having before one the actual object depicted. Radio Press wireless receivers present a most realistic appearance, even rendering a wiring diagram unnecessary in many cases.

Unfortunately the cost of this form of reproduction is high, and it has been decided for the time being to present a free photogravure supplement with every alternate issue of *Wireless Weekly* until it has been ascertained to what extent these are appreciated.

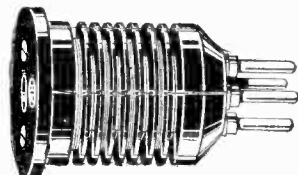

H.F. TRANSFORMERS.

A series of H.F. plug-in transformers in six ranges of wave length. They are made of our highly polished non-loss ebonite. The windings are carried in staggered slots, well protected. For successful H.F. amplification it is essential to use really efficient transformers. Users' opinions confirm that those of M.H. manufacture are the best.

H.F. PLUG-IN TRANSFORMERS

No. 00.	80 to 150 metres	10/-
No. 0.	150 to 300 metres	10/-
No. 1.	300 to 600 metres	10/-
No. 2.	550 to 1,200 metres	10/-
No. 3.	1,100 to 3,000 metres	10/-
No. 4.	2,500 to 7,000 metres	10/-
The Complete Set		55/-

Can be supplied in matched pairs at NO extra charge if requested at time of ordering.

SPECIALITIES

CONDENSERS FOR ALL PURPOSES

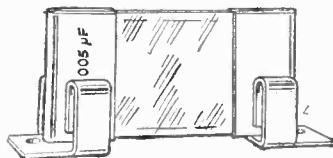

CONDENSERS.

Each supplied with two Clips.

Prices: 0.601 μ F to 0.0001 μ F 1/9 each.
0.01 μ F to 0.002 μ c 2/3 each.

We introduced, and have adopted as our standard, the flat type of fixed condenser which slips into two clips. They are made of high-grade virgin amber mica and tinfoil. Connection is made by their solid metal ends to two spring clips. This type is a distinct advance in the design of the fixed value condenser; its utility and adaptability are at once obvious and appeal to all users.

The Best results can only be secured through buying and building into your set the best components possible. To achieve this end, insist on M.H. components; unimpeachable quality and manufacture throughout.

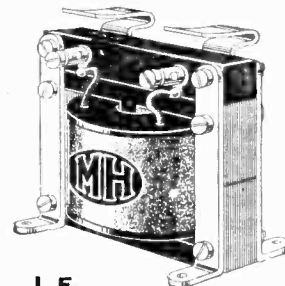

L.F. TRANSFORMERS

A high-grade and efficient Transformer of pleasing design for all intervalve purposes, possessing the best possible electrical characteristics. A fixed condenser is nearly always used with an intervalve transformer; provision is made in this model by the clips at the top to take our standard flat type condenser of suitable value.

21/-

Certain imitations of our Specialities have come to our notice; we therefore expressly advise all customers
TO INSIST UPON HAVING M.H. PRODUCTS.
which guarantee efficiency and reliability.

L.M^cMICHAEL LTD
IN CONJUNCTION WITH B. HESKETH LTD

Wireless Engineers, Radio Corner,
179, STRAND, LONDON, W.C.2

(Continued from page 607.)

at good strength. As a matter of fact the set was not finished until ten minutes past one a.m. one morning, and of course all British Broadcasting stations had closed down long before. Within ten minutes WGY was audible all over the house on the loud speaker, and when this station shut down about 2 o'clock a very slight re-adjustment brought in WBZ of Boston, where a musical programme was in progress. On the next evening I succeeded in receiving all of the British Broadcasting stations at excellent strength, the fourth valve being used only to make use of the loud-speaker. Several German stations, French, and, of course, Madrid, came through well, Madrid being easily of loud-speaker strength. The control of reaction on the stabiliser was very delicate, and, personally, on my own aerial,

desired. If your battery is only a 66 volt you will need another unit joined in series to get the higher voltage for the note-magnifier.

H.T. Tappings

It should be noted that when using only three valves the third H.T. tapping is connected to the detector valve, so that if there is a big difference between the note-magnifier voltage and the detector voltage, the wander plug of H.T.3 should be altered to the detector voltage when cutting out the fourth valve. When a common voltage for detector and note-magnifier is used, no change is, of course, necessary. In any case rapid and frequent switching on and off of the magnifying valve is not recommended. To have arranged a change of voltage at the time of change over would have complicated the switching considerably and in a way I do not

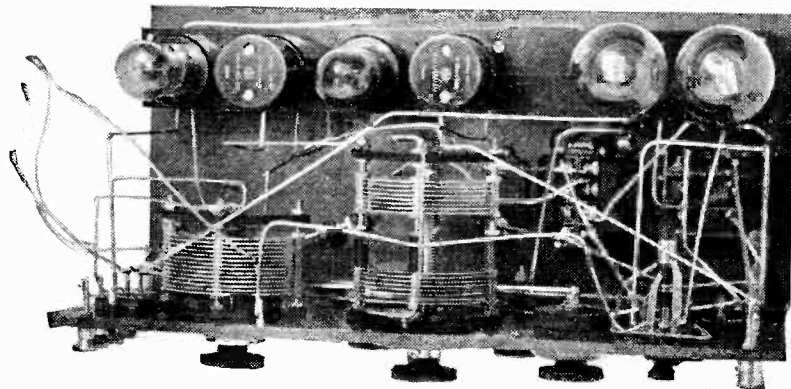

Looking down on the receiver. Notice the double square law condenser for tuning the two H.F. stages

I have not found the need of magnetic reaction, although this is provided for in case some readers have high-resistance aerials. Constant aerial tuning is quite successful in this receiver, and has the advantage of giving a broader range of wavelengths with a given coil.

When you have become quite used to handling a receiver with the common high-tension, you will, of course, want to try the effects of varying the high-tension on the high-frequency, detector and note-magnifying valves, and also of using grid bias. On most high-frequency valves, 40 or 50 volts is ample, and 30 or 40 will generally do for the detector. On the note-magnifying valve I recommend the use of a voltage of about 100 with grid bias to suit the particular valve used. Of course, you only need use one high-tension battery if this reaches 100 volts, separate wander plugs from the H.T. 1, 2 and 3 being plugged in to the values

consider justifiable for the slight advantage gained. It is very easy to switch on the last valve for greater strength and then to vary the wander plug for best results.

It is now possible to buy ready engraved panels for MODERN WIRELESS sets, but if you make up your own panel, I am sure you will be very pleased with the Radio Press panel transfers, which are very easy to apply, and, as to the results, you can see them from the photograph of my own set.

As usual, I shall be very pleased to hear from readers who obtain good results from this set, as it has been designed to meet the requirements of a number of readers who have asked for a Transatlantic design with valves within the cabinet.

Dull emitting valves of the .06 ampere type work quite well in this set, and can be used by those who have difficulty in getting their accumulators charged.

Readers' Result.

To the Editor of MODERN WIRELESS.

SIR,—I think it is my duty to write you a few lines regarding the Panel Card purchased from you, and to tell you the results obtained from the assembled set.

I am more than satisfied, and everybody who has heard it says it is the best and most clear set they have listened to.

Perhaps it will not surprise you to hear that I received a nice concert from America during a period of 1 hour, 10 mins., from 12.20 p.m. on October 5 to 1.30 a.m. on the following day.

Unfortunately morse interference from slips prevented me from hearing any more.

The announcements were very clear, and I distinctly heard the announcer say, "This will complete the concert from the Hotel Brunswick, and we are now switching over to the Opera House, where the opera 'H.M.S. Pinafore' will be broadcast. Springfield, Mass., U.S.A., now closing down."

I have unfortunately not been able to find an American radio programme to verify this.

The three-valve set was made according to your panel card No. 1.

Thanking you for supplying me with such a useful card.

Yours truly,
Lancaster. HARRY TELL.

To the Editor of MODERN WIRELESS.

Sir,—Before leaving Glasgow the parts were obtained for the construction of the "3-Valve Simplicity Receiver."

Having obtained excellent results we thought it only fair that you should be advised of them.

The broadcast concerts from Aberdeen, Glasgow, Bournemouth are received regularly, and on occasions 21.0 and Brussels come in well, this performance being far ahead of the majority of the wireless enthusiasts here, who are using multi-valve sets. Atmospherics and the nearness of SUH are the only drawbacks, harmonics from SUC having been eliminated.

Yours truly,
WIRELESS OPERATOR.
CHIEF OFFICER.
s.s.—Alexandria.

"Reflex Receivers in Theory and Practice."

Owing to the great interest evinced in the Resistoflex articles by Mr. John Scott-Taggart, his usual chapter of "Reflex Receivers in Theory and Practice" has been unavoidably held over this month.

HULLO EVERYBODY!

LISSEN.

Variable Grid Leak 2/6
 Anode Resistance 3/6
 Lissen Dimor .. 3/6
 Lissenstat .. 7/6
 Do. Universal .. 10/6
 2-way Switch .. 2/9
 Series Parallel .. 3/9
 T1 Transformers .. 25/6
 T2, 25/-; T3, 16/6;
 Coils: 25, 4/10; 30, 3/5;
 40, 4/10; 50, 5/-; 60,
 5/4; 75, 5/4; 100, 6/8

POST 3d. each.

DUBILIER.

.001, .002, .003, .004,
 .005, .006, Fixed, 3/-
 .0001, .0002, .0003,
 .0004, .0005 .. 2/6
 Type 577, .01 .. 7/6
 Grid Leaks each 2/6
 Anode Resistance
 50,000, 70,000,
 80,000, 100,000,
 on stand complete 5/6
 Minicap Switch 8/-

POST 3d. each.

IGRANIC.

Coils: 25, 5/-; 35, 5/-;
 50, 5/2; 75, 5/6; 100,
 7/-; 150, 7/10; 200,
 8/8; 250, 9/-; 300,
 9/5; 400, 10/3; 500,
 10/6
 Fil. Rheostat .. 4/8
 Potentiometer .. 7/-
 Vernier Rheostat .. 7/6
 30-ohm Rheostat .. 7/-

POST 3d. each.

**STERLING
 SQUARE LAW
 CONDENSERS.**

with Vernier.
 .001 .. 39/6
 .0005 .. 25/6
 .00025 .. 23/6

EDISON BELL.

.0001 to .0005 Fixed 1/3
 .002 to .008 .. 2/-
 .001 .. 1/3
 .0003 with Grid Leak 2/6
 Variometer .. 10/6
 Twin Detector .. 5/-

POST 2d. each.

**WEST END
 DEPOT FOR**

POLAR; JACKSON
 BROS.; R.I.; BURN-
 DEPT.; GOSWELL
 ENG. CO.; SILVER-
 TOWN; IGRANIC;
 LISSEN; RADIO
 PRESS ENVELOPES;
 DUBILIER; EDISON
 BELL; ETC.

POST FREE OFFER. POST PAGE No. 1. Not Applicable to Foreign Orders.

DELIVERY. Every endeavour is made to despatch goods by return, but sometimes delays occur which are beyond our control and in which cases customers may rest assured that their orders will be executed in the very shortest period. They will therefore realise that it is not possible to have orders cancelled through above causes. All orders over 20/- post free U.K. only.

RHEOSTATS.

Ormond .. 2/-
 Raymond .. 1/6
 Do. with dial .. 2/-
 Extra value do. .. 2/6
 T.C.B. 6 ohms .. 4/-
 Potentiometer T.C.B. .. 5/-
 Burndept Dual .. 7/6

POST 3d. each.

**TRANSFORMERS
 (L.F.)**

Radio Instruments .. 25/-
 Igranic, Shrouded .. 21/-
 Powquip, Shrouded .. 18/-
 Formo, Shrouded .. 18/-
 General Radio 83 .. 14/11
 Brunet, Shrouded .. 13/6
 Formo, Open .. 12/6
 Powquip, 2-1 or 4-1 .. 14/6
 Raymond .. 10/-
 Eureka Concert Grand .. 30/-
 Ditto, 2nd Stage .. 22/6
 Silvertown .. 21/-

**TRANSFORMERS
 (H.F.)**

McMichael, 300/600 .. 7/-
 Ditto 1100/2000 .. 7/-
 Ergno, 250/700 .. 3/11
 Ditto 900/2000 .. 4/6
 Raymond, 300/600 .. 2/9

Others Stocked.

H.T.C.

Special valve holder above
 panel 1/9
 Ditto, for under panel 1/6

POLAR

.001 var. Condenser .. 10/6
 .0005 " " .. 10/5
 .0003 " " .. 10/6
 Micrometer Condenser 5/6
 Cam Vernier 2-way
 Coil Holder .. 11/-

GRID LEAK.

Dubilier .. 2/6
 McMichael .. 1/6
 Edison Bell .. 1/6
POST FREE

WATMEL

Var. Grid Leak .. 2/6
 Anode Resistance .. 3/6

BRETWOOD (New Model)
 Var Grid Leak .. 3/-
 Anode Resistance .. 3/-
POST 2d. EACH

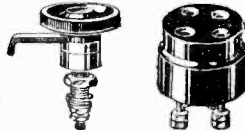

This first-class Ebonite Valve Switch Arm, Holder, cut with 12 Studs, from solid rod, 12 Nuts, 12 hand-turned, 8 Washers. By nuts and washers. Each. 1/3.

**WATES
 MICROSTAT
 FOR D.E. or R.
 VALVES .. 2/9**
 Post Free.



**"ORMOND"
 L.F. TRANSFORMER**
 Post Free.

**"POWQUIP" L.F.
 TRANSFORMERS.**

**BUCKS. (for
 Reflex, etc.) .. 12/6**

MANCHESTER (similar to R.I.) .. 14/11
STANDARD .. 14/11
SHROUDED .. 18/-

**CRYSTAL
 DETECTORS**

Post .. 4d. each
 Enclosed glass. As Sketch. Ebonite Base.

Brass .. 1/-, 1/4, 1/6, 2/-
 Nickel .. 1/6, 2/-
 Ebonite .. 1/6
 Perikon .. 2/3
 (With Zincite and Bornite.)

NOTE!
 OUR WONDERFUL MICRO-
 METER ADJUSTMENT GLASS-
 ENCLOSED DETECTOR. WHY
 PAY MORE? **1/11**
POST 6d. each.

**"BABY" COIL STANDS
 (EBONITE)**

GRAND VALUE
 2-Way, 2/6; by Post, 3/-
 3-Way, 4/3; by Post, 4/9
 Brass Fittings, Knob Type, on Base.

**RHEOSTAT
 (Ebonite Former)**

EUREKA WIRE, KNOB, AND DIAL **1/11**
 By Post, 2/3

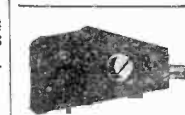

**EDISON BELL
 Shaped Plug**
 1/- By Post, 1/3

Also with Base, 1/3
 By Post 1/6

FINE VARIOMETERS

DOUBLE SILK WOUND, Close Coupling. One Hole Fixing.
4/11 and 5/11
 Post 6d. each.

**EBONITE —
 4/11 and 5/11**
 Post 6d. each.

**DUPLEX WAXLESS
 BASKET COILS**

Min. Self-Capacity Set of 5 **1/8**
 By Post 2/- Set

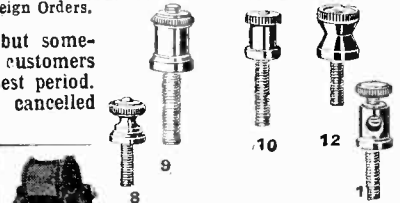

"BUCKS" for Reflex 12/6

EBONITE
 2 for 1/2
 2 for 1/4
 2 for 1/6
 3 Qualities.

BASKET HOLDERS
 2 for 2/-
 2 for 2/8
 2 Qualities.

FORMO SHROUDED 18/-

RAYMOND 10/-
 By post 10/6
FORMO 12/6
 Post Free.



ONE HOLE FIXING 1/3
 By Post 1/8

**PARTS FOR 2-VALVE
 "UNIDYNE" RECEIVING SET**

- THE 4-ELECTRODE VALVE
- Thorge K4 .. each 17/6
 - 6 Terminals .. for 10d.
 - 2 Microstat Filament Resistances each 2/9
 - 1 Variable Grid Leak .. 2/6
 - 1 Single-Pole Double-Throw Switch 1/9 or 2/-
 - 1 .0005 Variable Condenser, with Vernier 7/3
 - 1 Cam Vernier 2-way Coil Holder .. 9/-
 - Panel 5 1/2 in. by 1 1/2 in. by 1 1/2 in., drilled to hold 2 5-Pin Valve Holders .. for 2/-
 - 2 5-Pin Valve Holders .. each 1/6
 - 1 Fixed Condenser, .001 .. 1/2, 2/2 3/3
 - 1 Fixed Condenser, .0002 .. 1/2, 2/2 3/3
 - 1 Shrouded L.F. Transformer .. 20/-
 - 8 yds. No. 13 Gauge Tinned Copper Wire .. 1/2
- Necessary Screws, Nuts, and Washers, Free if above lot purchased. Post extra.

TERMINALS

WITH NUT & WASHER

No. 8 per dozen	1/-
No. 9 ..	1/3
No. 10 ..	1/1
No. 12 ..	1/3
No. 13 ..	1/1

POST FREE
 ALL 4 B.A.

**BATTERIES (H.T.)
 EVER-READY**

60v. - 13/6
180v. - 22/6
 POST FREE

FIBRE STRIP FOR COILS

3 FEET Lengths
1 inch wide.
12 feet 1/-
 Post Free.

**GOSWELL
 ENGINEERING**

Patent Valve Muller 1/6
 2-Way Cam Vernier
 Coil Stand .. 9/-
 3-Way Cam Vernier
 Coil Stand .. 12/6
 3-Way Ordinary .. 7/6
ALL POST FREE.

**RIGHT OPPOSITE
 DALY'S
 GALLERY DOOR**

K. RAYMOND
**27, LISLE STREET,
 LEICESTER SQUARE, W.C.2**

**HOURS
 OF BUSINESS :**
DAILY - 9 to 7.45
SUNDAY - 10 to 1
Phone GERRARD 1637

No responsibility accepted on post orders unless cheques and postal orders are crossed and made payable to the firm. Moneys sent must be registered

TWO PAGES MORE OVERLEAF

ALL OUR CONDENSERS HAVE BEEN TESTED AND RECOMMENDED BY LEADING JOURNALS UNSOLICITED.

BRITISH MADE
SPECIALLY ADAPTED FOR

ALL LEADING CIRCUITS

NEW MODEL

WITH VERNIER
.001 - 9 3
.0005 - 7 3
.0003 - 6 9
With EBONITE DIAL and Two Knobs. Post 6d. Set.

WITHOUT VERNIER
.001 - 6 6
.0005 - 5 3
.0003 - 4 11
.0002 - 4 6
Vernier, .00005 3 9
Complete with knob and dial Post 6d. Set.

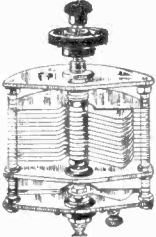

SQUARE LAW

.0005 .. 7 11
.0003 .. 7 6
With Vernier. .0005 .. 10 11
.0003 .. 9 11
Post 6d.
Knob & Dial included.

RAYMOND VARIABLE CONDENSERS

Exclusive Design. Stout Vanes. Extra Insulation. Very Compact. Narrowest Spaces (Pressed Aluminium). Centre Rod cannot bend. Terminal Connections Wonderful for Portables. Capacity Guaranteed. Perfect Efficiency. Handsome Design. Takes up very little space in panel. Nickelled Fittings. Beautifully Made. New one-hole fixing method.

COSTS A TRIFLE MORE, A FEW PENCE ONLY, and is Just what You Want.

NICE DIAL and KNOB included. UNSURPASSED FOR FINE TUNING.

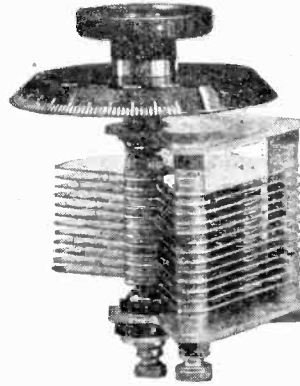

'DE LUXE' MODEL

AS SHOWN WITH DIAL KNOB AND BUSH.

.001 - 7/3
.0005 - 5/11
.0003 - 5/4
.0002 - 4/11
POST 6d. SET.

John Blair, Esq., Rexall Pharmacy, Millom. Your Condensers are a REVELATION to me as a Dealer. Sept., 1924.

C. Walton, Esq., Andover. Tested your Condensers on Me ger and got FIRST PRIZE

9/- TWIN CONDENSER POST FREE.



Composed of two equal units of .00025 or .0003 mid., operated by one Knob and Dial, thereby enabling you to tune two circuits by one turn of the dial. Can be used in series or parallel. Complete as shown with aluminium ends. Knob and dial. For Tuned Anode Circuits.

MANSBRIDGE FIXED CONDENSERS

1 M.F. .. 4/6
2 M.F. .. 5/-
25 .. 4/-
50 .. 4/6
Delivery very slow from makers.

T.C.C. (New.)

Various others Stocked.

"RAYMOND" FIXED CONDENSERS.

Ebonite Base. .001, .0001 to .0005 .. 1/2
.002 to .004 .. 1/3
.006 .. 1/6
.01 and .02 .. 1/9
.05 .. 3/3
POST FREE.

W Kennard, Sig. Telegraphist, H.M.S. Teamington. 2nd July, 1924. The Condensers are splendid, and superior to any I have ever seen. Please find repeat order. W. Hale, Esq., 3, Gaye St., Walsall 30th April, 1924. The last 4 Condensers gave every possible satisfaction—highest quality at extremely low prices. Kindly despatch enclosed further order. E. Shepherd, Esq., 23, Warden Street, Dundee, 12th May, 1924. Everything came to hand in splendid condition, the quality far exceeding my expectations.

The set used by **Miss Evelyn Laye** in her dressing-room at Daly's is made of Raymond parts.

LOUD SPEAKERS

30/- STERLING "DINKIE"
25/- DRAGON FLY AMPLION (Baby New Model.)
55/- BABY STERLING (Brown Floral.)
ALL MODELS OBTAINABLE.

VARIOMETERS

RAYMOND 8/11

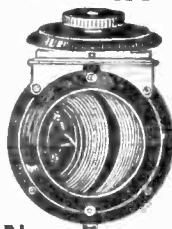

Post 3d. each

FALLON IGRANIC OR EDISON-BELL

Post free 10/-

ENERGO

H.F. Plug-in Transformers Post, 2d. each.
No. 1. 150-450 .. 3/6
No. 2. 250-700 .. 3/11
No. 3. 450-1200 .. 4/3
No. 4. 900-2000 .. 4/6
No. 5. 1600-3030 .. 4/9
No. 6. 2200-5000 .. 4/11

BRUNET (genuine)

4000 ohm Double .. 16/6
4000 ohm Single .. 8/3
2000 ohm Single .. 7/6
POST FREE.

From S. H. COULTER, Esq., 55, Court Road, Barry Dock.

30/9/24. Condenser to hand this a.m. No wonder you are snowed under with orders! IT IS AN EXCELLENT COMPONENT. Please find repeat order.

JACKSON BROS. "J.B." VARIABLE CONDENSERS

	Standard	Super.	Microdenser
.001 ..	8/6	9/6	11/6
.00075 ..	8/-	9/-	11/-
.005 ..	7/-	8/-	10/-
.0003 ..	5/9	6/9	8/9
.00025 ..	5/9	6/9	8/9
.0002 ..	5/-	5/6	8/-
Vernier ..	4/9	5/3	7/9
Vernier ..	4/-	4/6	

Post 3d. set.

SQUARE LAW SHORTLY.

HIGH GRADE EBONITE

POST PRICES	3/16 in.	1/2 in.
6 x 6 ..	1/6	2/-
7 x 5 ..	1/6	2/-
8 x 6 ..	2/-	3/-
9 x 6 ..	2/2	3/3
10 x 8 ..	3/-	4/2
12 x 6 ..	3/2	4/2
12 x 9 ..	4/3	5/6
12 x 12 ..	5/6	7/6
14 x 10 ..	5/6	7/6

Cut to Size, 3/16 in. at 1d. square inch. Post 3d. Foreign Post extra.

CALLERS' PRICES ELSEWHERE.

D.C.C. WIRE POST PRICES

16 D.C.C. 1/2 lb.	- 2/-	20 D.C.C. 1/2 lb.	- 1/3
16 " 1 lb.	- 3/6	22 " 1/2 lb.	- 1/4
18 " 1/2 lb.	- 2/3	24 " 1 lb.	- 1/6
18 " 1 lb.	- 3/9	26 " 1/2 lb.	- 1/8
		28 D.C.C. 1/2 lb.	- 1/10

CALLERS' PRICES ELSEWHERE

FRENCH THOMSON-HOUSTON

4000 ohm 'Phones
100 pairs at 12/11
POST 6d.

SUNDRIES

Post free

Screw Spade Terminals doz. 1/-
Pin Screw Terminals .. doz. 10d.
Spade Tags .. doz. 5d.
Empire Tape, 1/2 in. .. 12 yds 9d.
Insulating Sleeving .. 6 yds. 2/-
Ebonite Knobs, 1 1/2 in. 2 B.A. ... 6d.
Moulded Knobs 1 1/2 in. .. 2 for 8d.
Ditto 1 in. 2 B.A. .. 2 for 8d.
Ebonite ex-handles 6 in. .. 9d.
D.C.C., I.R.C. Bell Wire 10 yds. 1/-
Double 'Phone Cords, 72 in. .. 1/11
Porcelain S.P.D.T. Switch .. 1/11
Ditto D.P.D.T. Switch .. 2/6
Battery Clips .. doz. 10d.
Ebonite Valve Holders 1/3 and 1/4 Lead-in Wire 4 M.M. .. 10 yds. 2/6
Lead-in Wire .. 10 yds. 1/8
Twin Flex .. 12 yds. 1/11
100 ft. 7/22 Aerial Wire with four insulators .. 3/6
Nugravine Titles or Scales .. 8d.
"R.I." Choke Coil .. 10/-
Nickel Panel Switches, D.P.D.T. 1/5
Ditto, S.P.D.T. .. 1/2
Insulating Sleeving 3 yds. .. 1/4
Tinned copper sq., 16 gauge, 15ft. 1/-
Spearpoint Whisker, gold .. 4d.
Gold Whisker .. 4d.
Set of 5 (one gold) .. 6d.
Variometer (250/650) .. 3/3 and 2/6
Ditto Ebonite .. 4/11
Ditto Ball Rotor .. 6/11
Burndept Detector .. 5/6
Screw Wander Plugs .. pair 6d.
Skinderviken Button, Alumin. 5/-
Seven Twist Drills (H.S.) .. 1/11
Taps 0, 2, 4, 6 B.A. .. set 2/-
Sorbo Ear Pads .. pair 1/9
Neutron Crystal .. 1/6
Blue Tungstate .. 1/6
Geosite (G.E.C.) .. 1/3
Tumbler Switches (Ebonite) .. 1/9
Valve Sockets, Plain (nut and washer) doz .. 1/-
Sets of Spanners .. 2/-

RIGHT OPPOSITE DALY'S GALLERY DOOR
Phone: GERRARD 4637.

K. RAYMOND

27, LISLE STREET, LEICESTER SQUARE, W.C.2

No responsibility accepted on post orders unless cheques and postal orders are crossed and made payable to the firm. Moneys sent must be registered

HOURS OF BUSINESS:
DAILY . 9 to 7.45
SUNDAY . 10 to 1

In replying to advertisers, please use Order Form enclosed

POST PAGES CONTINUED

SEE OVERLEAF EXTRA POSTAGE ON FOREIGN ORDERS. SEE OVERLEAF

The CREAM of the WORLD'S HEADPHONES
4,000 ohms.
STERLING 4,000 ohms NEW MODEL ... 25/-
BROWN'S (Featherweight) 25/-
B.T.H. (Wonderful Tone) .. 25/-
BRANDES (Matched Tone) 25/-
GENERAL RADIO .. 20/-

TELEFUNKEN 4,000 ohms HEADPHONES
As light as a Feather .. 17/11

Dr. NESPER HEADPHONES
Genuine Nesper-
phone, 4,000 ohms.
Fitted with adjust-
able diaphragm, de-
tachable receivers,
double leather-
covered head-
springs, long flex-
ible cords, nickel-
plated parts. Very
comfortably fitting
to the head.
LOOK FOR THE TRADE MARK.
4,000 ohms .. 12/6
Post 6d. pair.

GENUINE "N & K" HEADPHONES
Guard against in-
ferior imitations
which are "clever-
ly" got up to de-
ceive. Make sure of
the genuine article,
the original "N &
K," and avoid dis-
satisfaction. See
that the letters
"N & K"—and no
other—are stamped.
4,000 ohms .. 12/11
6,000 ohms .. 13/3
Post 6d. pair.

BEWARE OF "PATTERN" OFFERED CHEAPLY

ACCUMULATORS
MADE BY WELL-KNOWN FIRM FOR ME.
2 v. 40 amps. 9/6. By post 10/6
4 v. 40 amps. 16/6. By post 17/6
4 v. 60 amps. 19/6. By post 20/6
4 v. 80 amps. 23/6. By post 24/6
6 v. 60 amps. 27/6. By post 29/-
6 v. 80 amps. 33/- . By post 34/6
6 v. 105 amps. 38/6. By post 40/6

UNIVERSAL (FRANCO)
Basket Coil Stand, 2-way
POST FREE 5/9
FRANCO, 2-way (plug-in) .. 12/6
Ditto 3-way .. 17/6
The only GEARED COILHOLDER on the market.

CHELMSFORD (5 X X)
D.C.C. Basket Coil, complete with
adapter, specially made to use with
650 variometer, 2/6. By post 2/9
LOADING PLUG and Socket .. 9d.
D.C.C. COIL for 5 X X, 1/6. By post 1/9

BRASS FORMER TO MAKE YOUR OWN COILS
DOUBLE, 23 spokes each side.
POST FREE 3/11

POST PRICE TINNED COPPER
18 Round 1/2 lb. .. 2/6
20 Round, 1/2 lb. .. 2/6
16 Square, 12 ft. .. 10d.
18 Square, 12 ft. .. 9d.

GUIDE FOR CHELMSFORD On 1,600 Metres
Aerial Reaction
Coil No. 150 200
Tuned Anode 250 or 300

"SUCCESS" L.F. TRANSFORMER
21/-

"MURRAY" (Prov. Pat.) VALVE HOLDERS
High finish. Absolutely Safe.
Low Capacity.
EASILY FIXED.
Exceptionally neat appearance
1/3 POST FREE.

RADIO PRESS TRANSFERS 6d.
By Post 8d.

POST PRICES VARIOMETER 250/600 2/6
Ditto with fixing clips 3/-
EBONITE BALL ROTOR 6/11
ALL KINDS STOCKED
at 2/11 3/6 3/9 4/- 4/6
Leave the selection to me and
you won't be disappointed

VALVES
Cossor P.1 and P.2 12/6
Mullard L.F. & H.F. 12/6
Mullard D. ra 21/-
B.T.H. R.4 - - - 12/6
B.T.H. R.5 '06 - - 25/-
Ediswan A.R. - - 12/6
Ediswan A.R.D.E. 21/-
Ediswan A.R. '06 25/-
Marconi R. and R.5 12/6
Marconi D.E.R. - 21/-
Marconi D.E.3 - 25/-
POST FREE

French "R" - - 6/11
Phillips "R" - - 7/6
French '06 - - - 15/11
Post 6d. each

ALL VALVES ON POST SENT AT PURCHASER'S RISK.

MYERS VALVES
UNIVERSAL DULL EMITTER
12/6 21/-
POST FREE

PHILLIPS D.E. VALVES
'04 Type 1'5 to 1'8
each 17/6
Post 6d. each.

THORPE K4 VALVES
(5-pin) for UNIDYNE 17/6
THORPE K 1 .. 10/-
POST FREE
5-Pin Valve-holder - - 1/6

"OOJAH" GRAPHITE
File Rheostat for D.E.
or R Valves .. 4/-

N. & K. LOUD SPEAKER
A LITTLE GEM
21/-
POST 1/-

RADIO PRESS ENVELOPES
No. 1 at 1/6
2, 3, 4 at 2/6

COIL STANDS
Ebonite 2-way with
Extension Handles
Nickel Fittings
3/3
By Post 3/9

Ditto 3-way
4/9
By Post 5/3

CAM-VERNIER (2-way)
POST FREE 7/6

POLAR (2-way)
11/-

GOSWELL
(see elsewhere)

 **"R.I." NEW MODEL**
IN SEALED BOX
Don't Buy Otherwise
Post 25/- Free

NEW LISSEN LINES
5 Point Switch - 4/-
Auxiliary Res. - - 1/3
Lissen Chcke - 10/-
Post Free

RIGHT OPPOSITE
DALY'S
GALLERY DOOR
Phone: GERRARD 4637.

K. RAYMOND
27, LISLE STREET,
LEICESTER SQUARE, W.C.2
*No responsibility accepted on post orders unless cheques and postal orders
are crossed and made payable to the firm. Moneys sent must be registered.*

HOURS OF BUSINESS:
DAILY . 9 to 7.45
SUNDAY . 10 to 1

THIS PAGE IS FOR CALLERS ONLY

ALL POST ORDERS FROM THE OTHER THREE PAGES

Prices subject to alteration without notice. Every endeavour made to keep large stocks; but am not responsible for manufacturers' non-deliveries.

NO POST ORDERS FROM THIS PAGE.

OPEN
WEEKDAYS
9 to 7.45
SUNDAYS
10 to 1

SWITCHES ON

- Porcelain D.P.D.T. .. 1/7 1/2
- Porcelain S.P.D.T. .. 1/3
- Ebonite D.P.D.T. .. 1/8
- Ebonite S.P.D.T. .. 1/3
- Min. Panel D.P.D.T. .. 1/-
- Min. Panel S.P.D.T. .. 10 1/2 d.

BATTERIES 4-5

- Vulco English 4-5 .. 4d.

H.T. BATTERIES.

- Best Made 30 v. .. 4/6
- Best Made 60 v. .. 7/6
- Best Made 66 v. .. 9/-
- Ever-ready 66 v. .. 13/6
- Ever-ready 108 v. .. 22/6
- Siemens' "Q" 15 .. 3/-
- Ever-ready ditto .. 1/9
- B.B.C. 9 volts .. 3/-
- B.B.C. 60 volts .. 9/6
- B.B.C. 36 volts .. 5/6
- B.B.C. 16 volts .. 2/6

RHEOSTATS.

- Small 5 ohms. .. 1/3
- One Hole Fixing .. 1/3
- Ormond .. 1/9
- Ebonite Former .. 1/6
- Ditto and Dial .. 1/10
- Igranite, T.C.B., and all known makes.

CRYSTAL

DETECTORS, &c.

- Enclosed Brass, Large 1/3
- Ditto, Nickel or Brass, Large .. 1/6
- Small Brass .. 9 1/2 d.
- Ebonite, Enclosed .. 1/-
- Mic. Met Type .. 2/8
- Burndep't .. 5/-
- Easi-Fix Cups 1d. & 1 1/2 d.
- Gold Spearpoint .. 3d.
- Neutron Crystal .. 1/6
- Hertzite (Shaw's) 8d. & 1/-
- Midite .. 6d.

VALVES.

- Dutch Detector .. 4/9
- Dutch "R" .. 5/-
- Phillips "R" .. 7/6
- French "Metal" .. 6/11

TOOLS.

- Set of Spanners .. 1/4
- Taps, 0, 2, 4, 6 B.A. set 2/-
- Small Soldering Irons 8 1/2 d.
- 7-Twist (H.S.) Drills.. 1/4

MURRAY VALVE HOLDER (Patent) 1/3

- Legless Valve Holder, Solid Ebonite .. 1/-

EBONITE PARTS.

- Good Coil Plugs from 4 1/2 d.
- Edison Bell Shaped .. 1/-
- Raymond ditto .. 10 1/2 d.
- Basket Adapters .. 8 1/2 d.
- Also at 1/- & 1/3
- 2-way Coil Stands .. 2/6
- With Extens. Handle 2/11
- Also at 3/6, 4/-, 4/6
- 3-way .. 4/3, 4/6, 5/-
- Goswell Cam Vernier 9/-
- Franco " " .. 12/6
- Polar " " .. 11/-
- Etc., etc.
- Coil Plug on Stand .. 1/-
- Ditto, Swivel Movement 1/3
- Coil Plug and Clips .. 6 1/2 d.

BRASS PARTS.

- W.O. or Pillar Terminals 1d.
- Small Pillar .. 4 for 3 1/2 d.
- 'Phone 4 B.A. .. 1d.
- 'Phone 2 B.A., 2 for .. 2 1/2 d.
- Valve Sockets 4 for 3d.
- (Above with Nut Washer)
- Valve Pins and Nuts, 2 a 1d.
- Stop Pins and Nuts 2 a 1d.
- Plug and Socket pr. 1d.
- Spring Washers 4 a 1d.
- Spade Screws .. 1d
- Pin Screws .. 2 for 1 1/2 d.
- Spade Tags .. 5 a 1d
- Spring Pillar Terminals 2 1/2 d.
- Nuts, 2, 4, 5, 6 B.A. doz. 2d.
- Washers (Brass) 12 a 1d.

VARIOMETERS.

- Impregnated Board, Wound D.C.C. and Clips, 200/600 metres 2/6
- Very Good Value, Wound D.C.C. and Knob .. 1/6
- Ebonite D.S. Wound, with Ball Rotor and Knob, 200/700 metres 5/11
- Ebonite, 200/800 .. 3/11
- Raymond Inside Wind-ing .. 8/11

BOXES

- 7 x 5 9 x 6 12 x 9
- 8 x 6 10 x 8 12 x 12

16g D.C.C.
USUALLY IN STOCK.

FIBRE STRIP (For Coils)
3 ft. long, 1 in. wide,
2 1/2 d. per length.

BREAST DRILLS

- 0 to 1/2 chuck
- Cut Bevel and Gear 5/9

SUNDRIES.

- 'Phone Cords (6 feet) 1/5
- Nukraving .. 7 1/2 d.
- Similar Sets (Titles or Scales) .. 8d.
- Good Knobs .. 1 1/2 d.
- Small Knobs, 2014 B.A. 2d.
- Studs, Nuts and Washers doz. 4 1/2 d.
- Switch Arms 8d. to 1/-
- Copper Foil .. 2 1/2 d.
- 18g. Sq. Tin Copper 15 ft. 5d.
- 16g. Sq. Tin Copper 12 feet 5d.
- Round Tin Copper, various Sizes.
- Insulated Staples 5 a 1d.
- Insulated Hooks 4 for 3d.
- Rubber Lead in, 30 feet 1/3
- 7/22 Copper Aerial, 100 ft. 1/10 1/2
- Extra Heavy Aerial 100 ft. 2/- & 2/3
- Good Valve Holders 8d.
- H.T.O. in Stock 1/6, 1/9
- H.F. Transformers, 300/600 2/9
- Empire Tape, 1/2 in., 2 yds. 1d.
- Ditto, 1/2 in., 2 yds. 1 1/2 d.
- 6 in. Ebonite Anticap Handles .. 8d.
- Battery Clips 2 a 1d.
- Skinderviken Buttons (Aluminium) 4/8
- Connecticut Switches 1/4
- 1,000 ohm Bobbins .. 1/3
- 2,000 ohm Bobbins .. 1/8
- Sorbo Rubber Eat Caps pr. 1/4
- Adhesive Tape Roll .. 2 1/2 d.
- Basket Coils .. 1/-
- Waxless ST100 (2) .. 1/-
- Waxless (5) 200/2,000, set 1/8
- Waxed (6), 200/3,600 set 1/8
- Waxed (7), 150/3,600 1/11
- Chelmsford No. 8 Tandeo 1/- 1/6
- Chelmsford, D.C.C. .. 1/3
- 1 Complete with Adapter 2/3 (To use with variometer.)
- Allen var. Gd. Lk. .. 1/3
- Allen Anode Res. .. 1/3
- Scales, 0-180, 2d., 3d., 4d.
- Dial and Knob (Ed. Bell) 1/3
- Dial (Ebonite) .. 10d.
- Brunet Headphones .. 14/6
- Twin Flex .. 4 yds. 6d.
- D.C.C. Bell Wire, 10 yds. 5d. (India rubber covered)
- Sleeving .. yd. 4d.
- Wander Plugs pr. 3d.
- Coloured Plugs each 1 1/2 d. (All screw pattern)
- Electron Aerial .. 1/3
- Polished Boxes, 8 by 6 3/6

SHAW'S HERTZITE.

- BEATS ALL OTHER "ITES." 1/-

Impossible to Advertise
All the Goods Stocked.

'Ware Imitations.
N and K

4,000 ohms .. 12/11

GENUINE STAMPED.

MYERS VALVES.

- UNIVERSAL D.E. 12/6 21/-
- Strong Valve Template 4d.
- Egg Insulators .. 1d.
- Reel ditto .. 1d.
- Thick Rubber Lead-in per yd. 2d., 3d.
- Ribbon Aerial 100 ft. 1/10
- Panels Drilled
- Radio Press Envelopes.
- Raymond Fixed Condensers '001, '0001 to '0005, 10d.
- '002, '003, '004 .. 1/-
- '006 1/3 ; '01 1/9 ; '02 1/9
- Polar Micrometer Condenser .. 5/6

BATTERIES 4-5

- 4d. 4 1/2 5d. 6 1/2
- ALL BEST MAKES.

"FERRANTI" L.F.

- BETTER THAN THE BEST. 17/6

SUNDRIES.

- Tungstelite .. 1/-
- Microstat .. 2/6
- Tumbler Switches (Ebonite) .. 1/4
- Fibre Strip (for Coils) 3 feet 2 1/2 d.
- D.C.C. Wire, per lb. —
- 13 g. .. 9d. 20 g. 9d
- 22 g. .. 10d. 24 g. 1/-
- 26 g. .. 1/1 28 g. 1/3
- 30 g. .. 1/6 Etc., etc.
- Solder .. per stick 2d.
- 2 Color Flex .. yard 2 1/2 d.
- Shellac .. 5d.
- Battery Box .. 4/6 (with clips for 36 v.)
- Nickel Pillar Terminals 2d.
- Nickel Contact Studs 2 for 1 1/2 d.
- Nickel Switch Arm .. 1/- (one hole fixing)
- Loading Coil and plug 8d.
- Gamages Permanite .. 1/-
- Condenser Brushes .. 6d.

SHAW'S HERTZITE.

- BEATS ALL OTHER "ITES." 1/-

Impossible to Advertise
All the Goods Stocked.

'Ware Imitations.
N and K

4,000 ohms .. 12/11

GENUINE STAMPED.

MYERS VALVES.

- UNIVERSAL D.E. 12/6 21/-
- Strong Valve Template 4d.
- Egg Insulators .. 1d.
- Reel ditto .. 1d.
- Thick Rubber Lead-in per yd. 2d., 3d.
- Ribbon Aerial 100 ft. 1/10
- Panels Drilled
- Radio Press Envelopes.
- Raymond Fixed Condensers '001, '0001 to '0005, 10d.
- '002, '003, '004 .. 1/-
- '006 1/3 ; '01 1/9 ; '02 1/9
- Polar Micrometer Condenser .. 5/6

PHILLIPS

- 4 ELECTRODE VALVE 12/6

DUTCH '06

- VALVES 12/6

NO POST ORDERS.

BEST SWITCH ARM.

- 12 Studs 1 1/2 lb. 10 1/2 d.
- 12 Nuts. 10 1/2 d.
- 12 Washers.

CRYSTAL CALLERS DETECTOR. only.

- Glass enclosed. Mi-crometer adjustment. 1/9

BRASS FORMER (DOUBLE) 23 spokes each side. 2/11

Make your own coils
CALLER'S PRICE ONLY.

RAYMOND CRYSTAL SETS

- 7/11, 9 11, 12/11

EBONITE STOCK SIZES

- 3/16 in.
- 6 x 6 .. 1/4
- 7 x 5 .. 1/4
- 8 x 6 .. 1-10
- 9 x 6 .. 2/-
- 10 x 8 .. 3/-
- 12 x 6 .. 4/3
- 12 x 9 .. 5/6
- 12 x 12 .. 5/6
- 14 x 10 .. 5/6

CUT TO SIZE 1d. sq. in.
WE STOCK 1/2 in. EBONITE.

"POPULAR WIRELESS."

FREE TO CALLERS.
(Limited number, of course.)

DR. NESPER (SEE TRADE MARK)

- 4,000 OHM 'PHONES 12/6

(NOT DR. "ANYTHING")

BASKET COILS

- Duplex Waxless (5) .. 1/8
- 1,200/2,000 metres
- Waxless Set of 5 .. 1/11
- 25, 35, 50, 75, 100.
- D.C.C. Chelmsford 1/- 1/3
- Enamelled Do. 1/- 1/2
- Waxed (6) .. 1/8
- 200/3,600
- Ditto (7) .. 1/10
- 150/3,600
- Waxless (2) ST100 .. 1/-
- E ditto (2) U-ityne .. 1/- (For Broadcasting only)
- D.C.C. Coil for Chelmsford, complete with adapter 2/3 (to use with 650 variometer)

RIGHT OPPOSITE DALY'S GALLERY DOOR
Phone: GERRARD 4637.

K. RAYMOND

27, LISLE STREET, LEICESTER SQUARE, W.C.2

No responsibility accepted on post orders unless cheques and postal orders are crossed and made payable to the firm. Moneys sent must be registered.

HOURS OF BUSINESS:
DAILY . 9 to 7.45
SUNDAY . 10 to 1

In replying to Advertisers, please use Order Form enclosed.

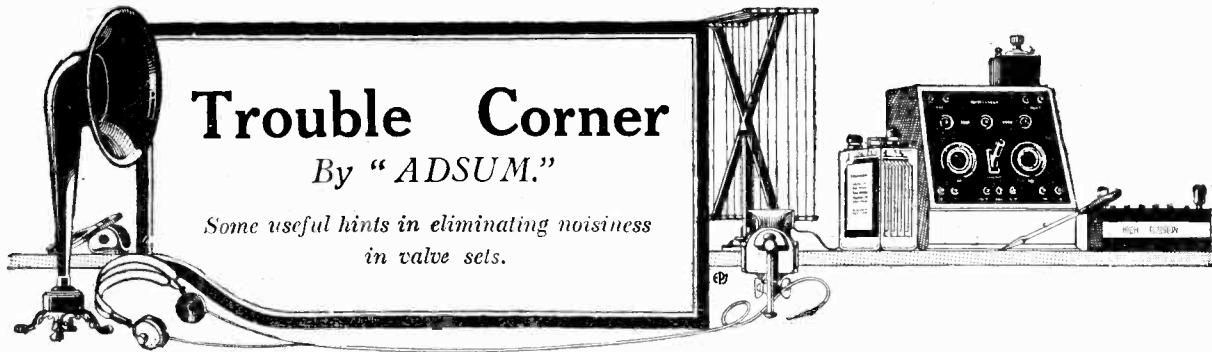

Trouble Corner

By "ADSUM."

Some useful hints in eliminating noisiness in valve sets.

I SUPPOSE that one of the most common troubles to beset the really critical experimenter when he has constructed a new receiving apparatus is the presence of a certain undercurrent of noise. The ideal set would be perfectly silent when no signal was coming in, but absolute silence in headphones or loud-speaker is a condition of perfection that few of us manage to reach. If you disconnect the aerial and earth from the batteries there is a faint but easily discernible noisiness, not unlike the sound of the sea as heard from some considerable distance, and accompanying this intermittent cracklings occur which may be quite loud or very faint indeed. In such conditions nine people out of ten would probably blame the high-tension battery, to whose guilt all symptoms seem to point; but in spite of the evidence it may be entirely blameless. Not long ago I constructed a set which behaved exactly in the way described. I thought that the battery was probably nearing the end of its days, and ascribing noisiness to this cause I did not bother further about the matter. A little later, however, I made up another set containing

two stages of resistance capacity coupled low-frequency amplification—in the first set the low-frequency couplings were by means of transformers. This second set when tried out with the same high-tension battery proved to be

Modern H.T. Batteries

The high-tension battery of today is as a matter of fact a very great advance upon those which were in use even a year or two ago. Then the cells used in plate batteries were identical with those

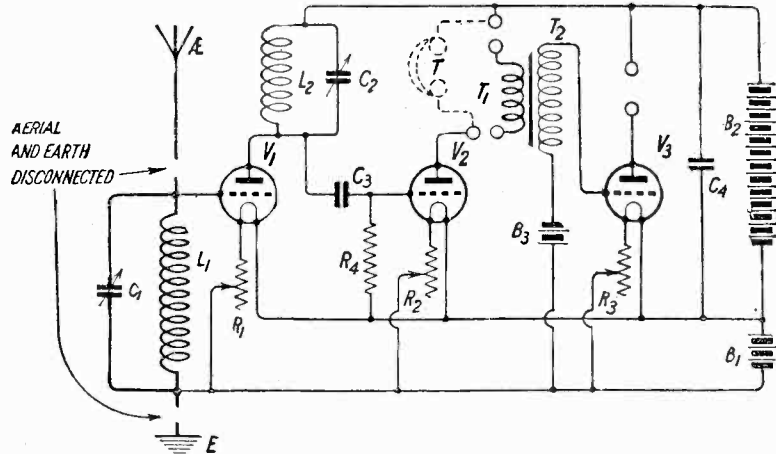

Fig. 1a.—Silence with telephones as above, usually means that the L.F. transformer is the offender.

absolutely noiseless. There was in fact that background of absolute silence which, though we read of it so often, we seldom manage to achieve. Now here is clear proof that the high-tension battery was not to blame.

which form part of pocket flash-lamp refills. They were not specially designed to give a steady current for long periods on end, and as they were frequently overloaded they soon began to develop those current fluctuations which are responsible for cracklings and splutterings. The cells of to-day are much better made, and most makers have tackled the depolariser question with very satisfactory results. The insulation between cells has also been improved and, taking them all round, high-tension batteries are now extremely efficient components of the receiving set. Though as a general rule a battery is not of much use when its E.M.F. has fallen to less than two-thirds of the original reading, I have one in use at the moment which, though it has fallen from 120 volts to rather less than 70, is still perfectly quiet. From other members of the staff of MODERN WIRELESS I learn that they have had similar

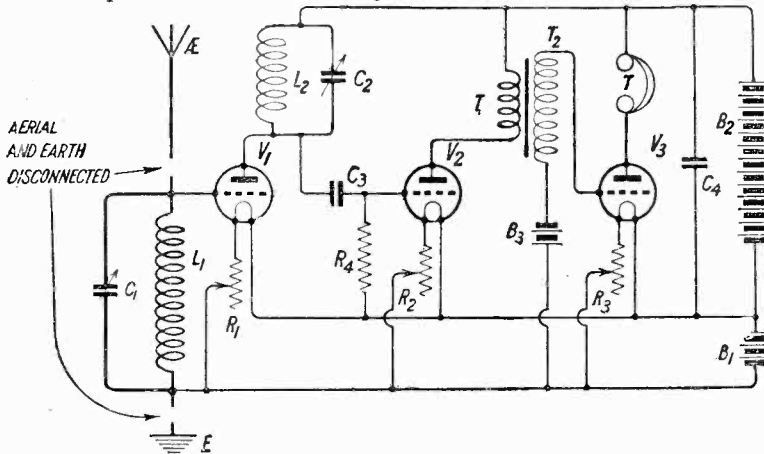

Fig. 1b.—The deductions from Fig. 1a may be confirmed by this connection.



Stella

"the nearest to
PERFECTION"
—says a user.

His letter reads:

"The Loud-speaker re-
ceived is the nearest to
perfection I have ever heard.
On Tuesday I did my best
to make it distort the speaker's
voice and also the music, but
found this impossible. I have
used various other makes, but
can assure you that yours is
the nearest to perfection yet
placed before the public."



**W E M B L E Y
L O U D S P E A K E R**

Portable Miniature, giving
perfect results and
guaranteed at .. **22/6**

Write for Lists of other Stella Loud-speakers at 35/- and 70/-.



STELLA 'PHONES
These noted light-weights are
tested and guaranteed to give
perfect and distortionless re-
ception, with maximum com-
fort. Thousands sold to satis-
fied customers. Equal to any
and cheaper than most other
really good 'phones. **17/6**
Carriage paid, or from local
dealers. Per pair



W E M B L E Y 'PHONES
Identical diaphragms to
"Stella" 'Phones, but lighter
construction, and so made that
only the ear-pieces touch the
head at sides—a boon to lady
listeners, as the hair is not
disarranged. Car-
riage paid, or from
all good dealers. **14/6**
Per pair

Buy at Wembley, or from any good Wireless Dealer. If
unable to obtain from your local store, write direct to:

STELLA WORKS,
31-37, Wybert Street, LONDON, N.W.1.
Telephone: Museum 8330.

The present popularity of Square Law Condensers and the efficient working of the straight wavelength curve require a coil of very low self-capacity. Any high-capacity coil renders more inaccurate the plotting of the wavelength curve on the principles which are now being advocated.

It is easily proved that Square Law Condensers operate nearer the straight line when they are used in conjunction with

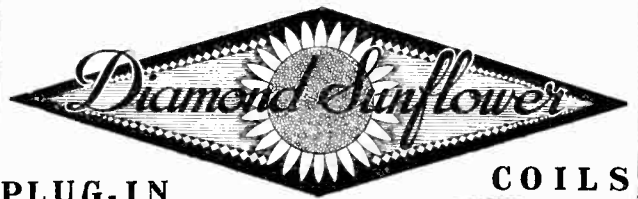

PLUG-IN

This is due to their extremely low self-capacity. Reversion to the old type condenser is only equalled in its inefficiency by coils of high self-capacity with Square Law Condensers.

Low self-capacity, low H.F. resistance, maximum transference of energy and consequently maximum signal strength, sharper tuning and selectivity, follow the fitting of "Diamond Sunflower" Coils, etc., etc. Prices include the plug.

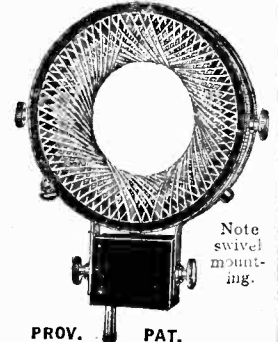

Note swivel mounting.

No. of Coil.	Approx. Wave-length in metres '001 Cond. in Shunt.	Price per Coil.
25	100-293	4/6
*30	142-377	4/8
35	185-465	4/9
*40	215-561	4/11
50	245-658	5/-
*65	310-820	5/3
75	395-1,090	5/6
*85	500-1,350	5/9
100	619-1,495	6/-
*125	671-1,720	6/6
150	720-2,000	7/-
*175	850-2,400	7/3
200	980-2,780	7/6
*225	1,010-3,160	7/9
250	1,240-3,520	8/-

It should be remembered that intermediate sizes are made. This allows for a larger inductance and a lower condenser capacity for any given wavelength—a little consideration which gives better reception. Get "Diamond Sunflower" Coils from your dealer. If not, write or call. Full lists on application.

DIAMOND WIRELESS, LTD. 184a, OXFORD STREET, LONDON, W.1.
Telephone: Museum 1380.
Entrance Gt. Titchfield Street.

Barclays 192

PREVENT OSCILLATION!

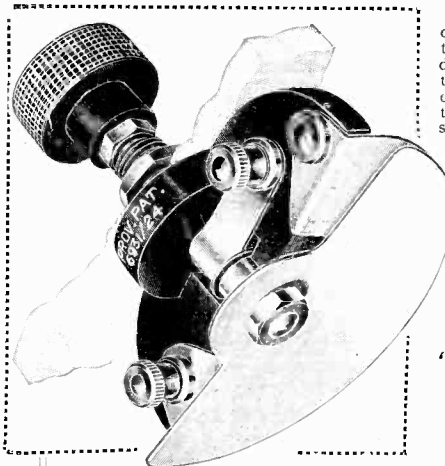

When full use is made of reaction on the aerial the large capacity condenser, swung to a fractional part of a degree, either side, heterodynes the incoming signals. A small condenser of very low maximum does give control; a large condenser cannot.

PRICE
2/6

'Colvern'
Tuning Condenser.

The large capacity condenser is unwieldy. Wavelengths in close proximity cannot be separated. The use of a small maximum condenser, for which purpose the COLVERN is incomparable, is essential for accurate H.F. work. The maximum capacity of the COLVERN is 0.00014, which is ample for the final tuning of any circuit.

Use of the COLVERN results in selectivity, pure reception and freedom from extraneous noise. It is presented as a really convenient, sound and neat unit, suitable for easily attaching to existing sets (one hole fixing). It should be included in all sets in course of construction and most decidedly fitted to existing sets.

If your local dealer does not stock the COLVERN TUNING CONDENSER kindly send his name and address when ordering.

COLLINSON'S PRECISION SCREW CO., LTD.
Macdonald Rd., Walthamstow, London, E.17. Tel.: WAL. 532.

Barclays 208

In replying to advertisers, please use Order Form enclosed

A. MUNDAY, Ltd.,

Electrical and Wireless Engineers,
59, WATLING STREET, E.C.4.

TEL. CITY 2972.

(One door from Queen Victoria St. & Queen St.)

And at 45, EASTCHEAP, E.C.3.

ROYAL 4632.

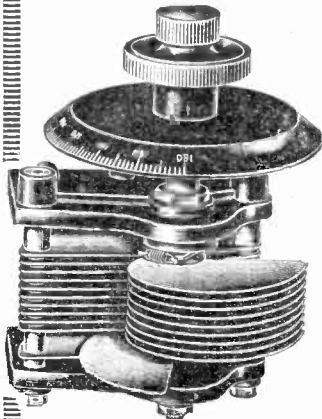

We are Stockists of
STERLING SQUARE-LAW CONDENSERS
BOWYER-LOWE SQUARE-LAW CONDENSERS
POLAR CONDENSERS
ORMOND and FORMO CONDENSERS

Accumulators in Stock charged 6 volt 60 amp., 26/6

ALL MAKES OF EVERYTHING FOR WIRELESS.

ECONOMIC ELECTRIC LTD.



Wound Magnet Bobbins for Head Receivers, wound to 1,000 ohms. Price 1/-.



Cowl Aerial Insulator, of best ebonite, 1/6 pair.



Plug and Socket for Coil Mounting, 1d. pair; 2/9 doz.

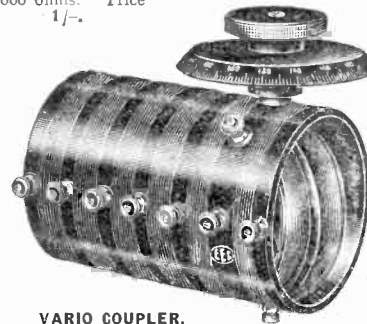

VARIO COUPLER.

Wound on ebonite formers with metal cone bearings and silk-covered windings. Single hole mounting. Wavelength range 275-1,000 metres. Price, 15/-.

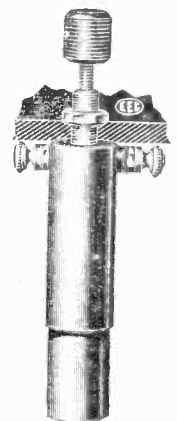

Micro Tubular Vernier Condenser, single-hole mounting. Price 3/6.

40 PAGE RADIO LIST, sent post free on receipt of 4d. in stamps and mention of this advertisement.

ECONOMIC ELECTRIC LTD. | Head Office: 10, FITZROY SQUARE, LONDON, W.1. | Showrooms: 303, EUSTON RD. N.W.1

If Big Ben could hear his chimes!

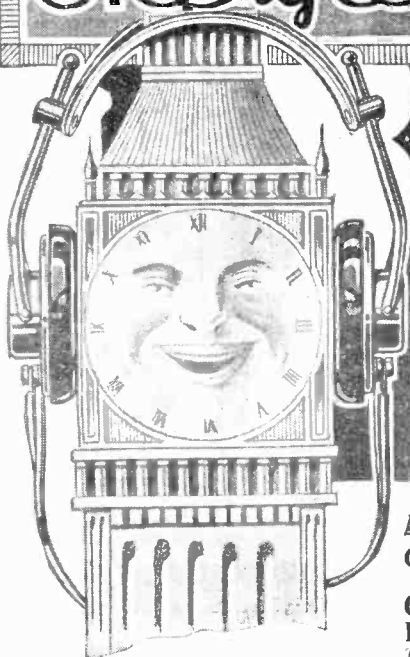

Write for leaflet.

Every Pair Guaranteed

GENERAL RADIO COMPANY, LIMITED,
Radio House, 235, Regent St., London, W.1.
Telephone: Mayfair 7152. Telegrams: "Alenrad, London."

IF Big Ben could hear his chimes reproduced by the new General Radiophones he would indeed be a proud timepiece.

General Radiophones are different. Their ready response to signal intensity of 0000000001 of an ampere is an achievement which places them far above all competitors for efficiency.

A new method of matching the earpieces by means of specially invented visual gauges, and the incorporation of a carefully designed sound box, ensures singular clarity and natural reproduction.

General Radiophones are unrivalled for strength and finish, and they weigh only 7 ozs.

Ask your dealer for a demonstration.

20/- per pair

GENERAL RADIOPHONES



experiences with high-tension batteries of good quality. This being so, the old rule that the high-tension battery should be the first part of the set to be blamed if noisiness occurs may no longer be such a sound one as it used to be. So long as the high-tension battery is of large size, and provided that proper care is taken not to overload it, it will last for a very long time and will give smooth, quiet working throughout its life. You cannot really know what your high-tension battery is being called upon to deliver unless you possess and use a milliammeter, which is an instrument that every wireless experimenter should possess. The most suitable kind is one which reads from 0 to 20 milliamperes. If it is wired into the set so that the whole of the current delivered by the high-tension battery passes through it, it enables you to see at once what you are asking the

in most cases they are the culprits. A pretty good indication can be obtained in the way shown in Figs. 1A and B. If the set is at all noisy disconnect the plate of the rectifier (V₂ in the diagrams) from the primary of the low-frequency transformer and place the telephones in circuit as shown in Fig. 1A. Now listen very carefully to see whether the same kind of noises can be heard. They will of course be much fainter if they are present, since there is now no note magnification, and it may require careful listening to detect them if they were already small in the first instance. To make quite sure that you can recognise the kind of noise replace the telephones for a few moments in their original position as in Fig. 1B. Then reconnect as in Fig. 1A. Should the noises be present when the note magnifier is cut out then they are probably due to the high-

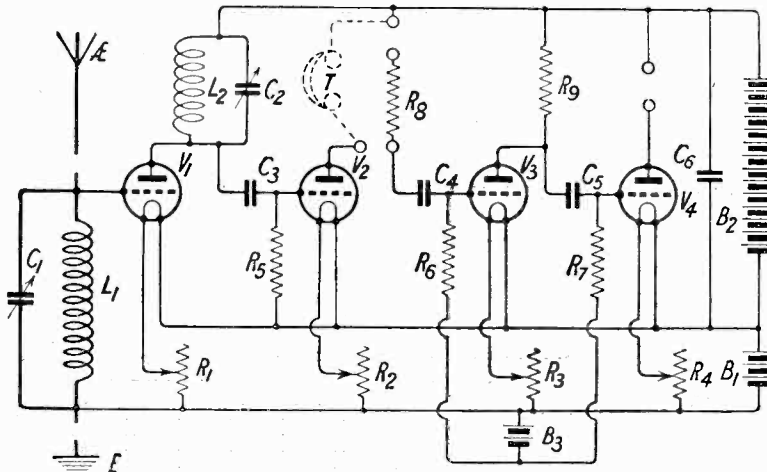

Fig. 2.—Testing for noise due to defective anode resistances.

battery to do. If the load is excessive it should be cut down by applying a proper grid bias to the low-frequency valves. In most sets there is a large waste of high-tension current in the note magnifiers. The amount of grid bias can be increased in many cases without cutting down signal strength and without bringing the working point down to the lower bend of the characteristic curve.

The Transformers

Now if the high-tension battery is not responsible for the under-current of noise which occurs in a receiving set, to what component must we look in order to track it down? The fact that of the two sets referred to above that fitted with resistance capacity coupling was silent whilst the other was noisy shows that the transformers were to blame in this instance, and I believe that

in most cases they are the culprits. A pretty good indication can be obtained in the way shown in Figs. 1A and B. If the set is at all noisy disconnect the plate of the rectifier (V₂ in the diagrams) from the primary of the low-frequency transformer and place the telephones in circuit as shown in Fig. 1A. Now listen very carefully to see whether the same kind of noises can be heard. They will of course be much fainter if they are present, since there is now no note magnification, and it may require careful listening to detect them if they were already small in the first instance. To make quite sure that you can recognise the kind of noise replace the telephones for a few moments in their original position as in Fig. 1B. Then reconnect as in Fig. 1A. Should the noises be present when the note magnifier is cut out then they are probably due to the high-

transformer noise is due in most cases to insufficient insulation between the two sets of windings or between the windings and the core. There is no remedy for this state of affairs but to fit a transformer or transformers of reliable make whose insulation is known to be thoroughly good, or to substitute resistance capacity coupling in place of the transformers.

Anode Resistances

But even resistance capacity amplification can be exceedingly noisy if components of the very best make are not used. Many types of cheap anode resistances are most unstable when in use. Their resistance is continually varying, with the result that current fluctuations and cracklings occur. The best method of testing anode resistances is that shown in Fig. 2, the methods of throwing the note magnifiers temporarily out of circuit being again employed, or the set may be tried with aerial and earth disconnected and the H.F. valve or valves switched off. Where two stages of resistance capacity are employed it may be only one resistance that is seriously at fault. The offender can be discovered by interchanging them. Noises will be at their worst when both stages of note magnification are used and the offender is placed between high-tension *plus* and the plate of the rectifier. It should be noted, by the way, that resistance capacity amplification may give rise to a good deal of trouble where a double circuit tuner is used unless the secondary is earthed. Failure to take this step may lead to the occurrence of actual howling in the note magnifiers.

Transformer Interaction

The whole question of transformer interaction is an exceedingly difficult one. It used to be thought that if low-frequency transformers were placed a good distance apart with their cores at right angles interaction was most unlikely to occur. If it should happen it was held that earthing the cores of both transformers would put an end to the trouble. As a matter of fact experiments made recently have shown that interaction can take place at almost incredible distances, that it still persists even if the cores are at right angles, and that earthing them is by no means a complete cure. It has been found, too, that even metal-cased transformers interact strongly upon one another. I am rather inclined to believe that no set containing two low-frequency transformers can give an absolutely silent background. Recently I have been using the circuit shown in Fig. 3, which gives exceedingly good results. Here V₁ is the high-frequency amplifier with tuned anode coupling, V₂ is the rectifier coupled by means of a low-frequency transformer to the first note magnifier V₃.

Between V_3 and V_4 a resistance capacity coupling is used. If a special valve such as the D.E.5B is used as first note magnifier, and a small power valve as second, the signal strength obtainable falls very little short of that given by two transformer-coupled note magnifiers and the receiving set is wonderfully quiet.

The Telephone Transformer

Though a great deal has been written about noisiness due to interaction between low-frequency intervalve transformers, I do not think that sufficient attention has been paid to the question of the telephone transformer. That interaction does exist between this transformer and the intervalve transformers was brought home to me recently in a rather striking way. The set in use at the time was a five valve receiver with two stages of note magnification. The telephone transformer did not form part of the set, but was attached to the underside of the table upon which it stands, terminals being provided for making the necessary connections. On the occasion in question a strong signal had been tuned in and the second low-frequency valve was accidentally switched off. The

loud-speaker continued to function, though the volume of sound that came from it was quite small. Obviously the telephone transformer was picking up energy from the first intervalve transformer, or in other words very strong interaction was taking place between the two. This was confirmed by removing the telephone transformer from its place beneath the table and placing it close to the loud-speaker a dozen feet away.

Nothing at all now came through, but if the transformer was brought near the set signals at once became audible in the loud-speaker. The moral of this would seem to be that the telephone transformer should never be built into the set if it already contains low-frequency intervalve transformers. It should rather form part of the loud-speaker itself, being placed in a box which can be used as a stand for this instrument.

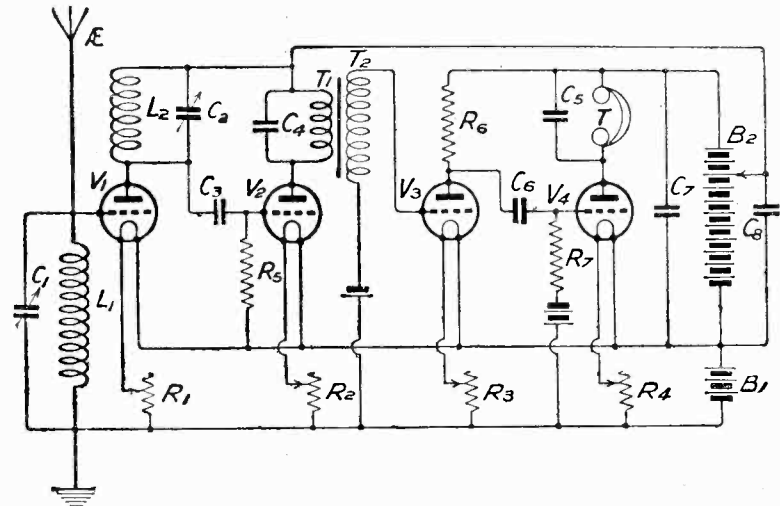
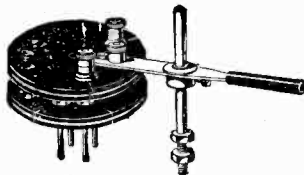

Fig. 3.—A set which the author has found very satisfactory.

The NEW RADIA X REACTION UNIT

is instantly fitted to any panel.



The New H.F. Transformers and Tuned Anode Coils are the result of two years' concentrated experiment and experience on H.F. Valve Couplings. The proportions of primary and secondary provide a definite and effective potential Step-up, which is often talked of but seldom obtained. Tuned with

1,00025 Variable Condenser the marked wave-length range is guaranteed. Post Office quality ebonite with all surfaces machined prevents leakage losses. For best reaction results use Anode Coils above 1,600 metres. H.F. Transformers 95-18c, 3/6 170-330, 3/6 300-500, 3/6 500-900, 4/3 900-1,600, 4/9 1,500-2,600, 5/6 1,600-4,000, 6/6.

Tuned Anode Inductances same range and prices as Transformer. For two or more stages H.F. use Radia X Transformers on first stage up to 500 metres. Tuned Anode Coil over 500. For second and further stages Radia X Semi-Aperiodic Anode Coil untuned. This gives a perfect system which does amplify and doesn't self-oscillate. Prices 9d. each extra up to 900 metres. 1/6 each extra over 900 metres.

Make Your H.F. Valves Efficient.

The New Radia X Reaction Unit (Regd.) achieves a remarkable efficiency: with perfect control can be used on any transformer, but in conjunction with the RADIA X H.F. Transformers or Tuned Anode Coils it makes an average set into a "Super"—without the super's difficulties of control. Probably no other method will enable coupling so close to oscillation point without distortion or reradiation. Height is instantly adjustable. With one-hole fixing, perfect finish and guaranteed uniformity, suitable for 300-1,600 metres, the price is 6/3. Extra coils instantly interchangeable 100-300, 3/3, 1,600-4,000, 3/9.

Tapped Anode Inductance.

Designed as part of our Registered Reactance System, is a most convenient Tuned Anode unit for 180-3,000 metres. It is perfectly made and calibrated, while its neat dead-end switch brings in the sections one at a time. 25/-.

LISTS AND CATALOGUES.—Please send stamp for sectional lists and descriptions of (1) Reactance and H.F. Couplings; (2) Radia X Receiving Sets.

Complete or in parts, or 3d. stamps for full Catalogue including Accessories and Components. Your dealer can supply all Radia X specialities.

RADIA X LIMITED,

40, RADIO HOUSE, PERCY STREET, TOTENHAM COURT RD, LONDON, W.1.

Museum 490.

3 mins. from Tottenham Ct. Rd. or Goodge St. Tube Stations



Barclay Ad. 175

CONSTRUCTORS!

PLEASE NOTE THAT WE CAN SUPPLY FROM STOCK CABINET PANELS, ETC., FOR ALL SETS AS DESCRIBED IN THIS JOURNAL AND IN OTHER RADIO PRESS PUBLICATIONS.

SEND STAMP FOR DESCRIPTIVE LEAFLETS.

EXAMPLES.	Cabinet.	Panel.
FOUR-VALVE FAMILY	18/-	15/6
SIMPLIFIED THREE-VALVE	21/-	12/-
ALL CONCERT-DE-LUXE	26/-	15/-
OMNI CIRCUIT	27/6	24/-
ALL BRITAIN	21/-	15/-

Extra for Carriage and Packing on Post Orders. 1/6 9d. All cabinets are best seasoned walnut, hand-made and polished. Panels are guaranteed electrically, matt non-metallic finish, edges squared, accurately drilled and engraved. Our new 100 page List—an Encyclopedia of Information—sent on receipt of 2d. stamp.

"S. A. CUTTERS,"
15, Red Lion Square, London, W.C.1.
Phone: Chancery 8042.

'TURRET'
Columbian Pine Masts
2,000 IN USE.

Designed by Naval Experts.

27 ft. Turret Two complete	37/6
28 ft. Turret Super Mast	53/6
56 ft. in 3 sections	71/6
42 ft. Telescopic Mast	79/6
45 ft. Super Telescopic	84/6
55 ft. Doubly Telescopic	£5/19/6
58 ft. Super Mast	£5/9/6

Light, neat and efficient. The telescopic sections enable the 42ft. to be erected as a 30ft. and the 48ft. as a 35ft. Mast.

SIMPSON & BLYTHE, 8-9, Sherwood St., Piccadilly, W.1.

Other Causes of Noisiness

There are many other causes of noisiness, some of which may take a good deal of tracking down, unless one can recognize the symptoms and has some idea of what to look for. One that frequently proves baffling is due to the accumulator itself. For some reason a certain amount of chemical action always appears to occur between the container of a celluloid-cased accumulator and the acid solution which forms the electrolyte. This may give rise to excessive gassing during discharge, a phenomenon which is practically absent where cases are made of glass. Even when the battery is standing on open circuit gassing frequently takes place and can be heard if the ear is placed close to it. If gassing is very bad bubbles are apt to form on the plates, setting up a fluctuating internal resistance, with the result that the temperature of the filaments is not quite constant and that crackling noises are heard. A pinch of Hudson's soap, if not a complete remedy in such cases, is certainly a palliative. Dirty or loose connections to the low-tension battery may also be responsible for a good deal of noisiness. Great care

should always be taken to see that the contact surfaces of the terminals of this battery are clean. In some makes of accumulator, connections between individual cells are made by means of lead strips fixed to terminals. Corrosion may take place in time at points where these strips are connected to the terminals, and if this is not attended to a certain amount of unwanted noise will most probably result. Plug and socket connections from the low-tension battery to the set are becoming very popular. That they are most handy there can be no doubt, but care must be taken to see that they fit tightly, otherwise mysterious noises may make their presence felt.

Valves

One of the most mystifying sources of parasitic noises is sometimes to be found in the valves themselves, especially if they are of the kind which work with their filaments heated to a very high temperature. Some filaments begin to be responsible for cracklings as soon as the rheostat is set so that they are brightly illuminated. The only means of discovering whether a valve is noisy in this way is to make use of the process of substitution,

trying other valves in the holder. It should be remembered that it is always bad practice to work valves very brightly.

Gridleaks and Anode Resistances

I referred a little way back to the cracklings due to badly made anode resistances which caused fluctuations in the plate current. Gridleaks may also offend in the same way, and, if they are faulty, noisiness may be extremely bad. The worst of all types of gridleak is that which employs a graphite line made upon mica or ebonite. These almost invariably become troublesome sooner or later in their career. Variable leaks and resistances are very widely used nowadays, and some of them are very badly made. Most of them have a screwed plunger which passes through a collar and compresses carbon pellets contained within a tube. Unless the plunger fits the collar very tightly the leak or resistance will be noisy in certain positions owing to the chance contact made. When buying a variable gridleak or anode resistance, always make sure that there is no play endways or sideways in the plunger; otherwise you are sure to experience trouble from noisiness.

A timely word to the wise on Low Capacity Valve Holders

Low resistance and high capacity in the most vital part of your receiver robs you of selectivity and general efficiency. The obsolete valve-holder increases the capacity and lowers the resistance by reducing the distance between the valve sockets. The H.T.C. Valve Holder designs contacts to be widely spaced. Resistance and capacity is therefore kept down to that of the valve. Essential for the efficient working of plug-in H.F. Transformers.

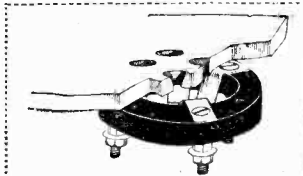

Type C (below panel).
The special advantage of this type is the method of mounting—below panel.
This model is the particular object of imitation. Constructors are advised to be certain that they buy the H.T.C.—look for the template.

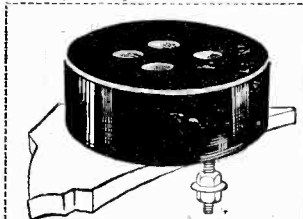

TYPE A (above panel).
This model appeals to those who prefer above-panel mounting. Be sure you get the H.T.C. by looking for the template—it is your guarantee.

We hereby notify the public that they should insist upon getting the H.T.C. Valve-Holder, which is not sold without drilling template bearing the name H.T.C. It is your protection against spurious imitations. BRITISH and FOREIGN Patents are applied for and all steps necessary for the protection of the public, the trade and the patentees will be taken as occasion arises.

High technical opinions on the H.T.C. principle

Mr. John Scott-Taggart, F.Inst.P., A.M.I.E.E.:—"The widely-spaced contacts on certain types of special valve holders are particularly suitable for high-frequency work. The ordinary arrangement where the socket pins are very close together, the nuts and washers being frequently only a matter of 1/16th inch apart, is entirely unsuitable for high-frequency. **OR, IN FACT, FOR ANY OTHER WORK.**"

Mr. Percy W. Harris:—"Four-pin valves can be used in the original Transatlantic design, provided always that low-capacity sockets are used. The ordinary socket will reduce the efficiency of the set considerably, and if it is desired to use four-pin valves, one of the many low-capacity valve sockets now available is strongly recommended."

Type A (above panel) Template Supplied 1/9
Type C (below panel) Template Supplied 1/6

If your local dealer cannot supply write direct to:

H.T.C. ELECTRICAL CO., LTD.
2 & 2a, BOUNDARIES ROAD, BALHAM, S.W.12.
Trade Enquiries Invited. TELEPHONE: Battersea 374

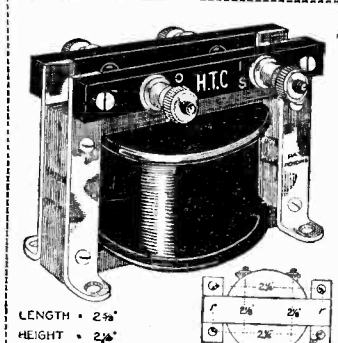

There is no reason why you should incur greater expense than the cost of the H.T.C. with the hope of securing better results. Extraordinary care expended upon their design, and relentless inspection during their construction and of the materials used, preclude any possibility of manufacturing fault. The design of the H.T.C. is such that it operates efficiently in all circuits. They are especially designed to prevent burning out of the primary windings a frequent happening to many makes. **15/-**

In replying to Advertisers, please use Order Form enclosed.



An L.F. Transformer: The U.S. Radio Co.'s "Super."

A SPECIMEN of their "Super" L.F. intervalve transformer has been submitted to us for test by the U.S. Radio Co., Ltd., a South London firm. This is a handsome, well-finished instrument of a familiar type superficially, with large vertical coil and ample iron core. The design has evidently been carefully thought out: the bolts which hold together

the frame and supporting feet do not pass through the laminations of the core, and really comfortably large and accessible terminals, clearly marked, are fitted on two ebonite terminal-strips at the top, soldering tags for more permanent connections being also provided.

The favourable impression given by a first inspection of this instrument was borne out in actual test. Measuring the signal voltage obtained across the 'phones with

a certain uniform test signal, of an audio-frequency controllable between useful limits, the build-up recorded with this transformer compared very favourably with that obtained with other standard patterns under identical conditions: whilst the tone, in reception of broadcast music and speech, with ample H.T. and proper grid-bias in use, was comparable to that of the best of the others. Approximate quantitative comparison with

SIEMENS

DRY CELLS & BATTERIES

suitable for the Filament (L.T.) Circuit of Dull Emitter Valves.

Type of Valve.	Filament Current Amp.	Filament Volts.	Dry Battery To Use.
D.E. 3	.06	2.5 to 3	No. 961 for 1 or 2 valves. No. 960 for 2 or more valves not exceeding 0.3 ampere in total.
B. 5	.06	2.5 to 3	
B. 6	.12	3	
D.F. Ora	.06	2 to 3	
A.R. .06	.06	2.5 to 3	
Wecovalve	.25	1.1	No. 948 or No. 884 sizes, one cell per valve.
Dextraudion	.1	1.0	No. 640 or No. 948 for 1 or 2 valves. No. 884 for 3 or 4 valves.
D.E.V.	.2	3	No. 960 for 1 valve. 3 No. 884 cells connected in series for 2 valves.
D.E.Q.	.2	3	

Prices.		
size No.	E.M.F. volts.	£ s. d.
640	1.5	2 8
948	1.5	6 9
884	1.5	12 0
960	4.5	1 0 0
961	4.5	9 0

OBTAINABLE FROM ALL LEADING DEALERS.

SIEMENS BROTHERS & Co., Ltd., WOOLWICH, LONDON, S.E.18

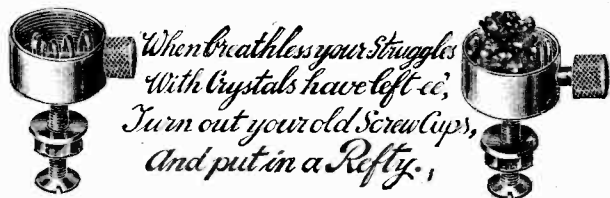

DO YOU RETUNE EVERY EVENING

While it is natural to expect to switch in without the necessity for retuning, experience knows that often elaborate retuning is a preliminary to an evening's broadcast. Think of the effect of an *inconstant* grid leak? one, say, affected by changes of temperature.

Temperature affects the resistance, which in turn controls the flow of electrons back to the filament. An incorrect grid leak resistance, incorrect from temperature affection, may be of too low a value, permitting the grid to become too negative; or, on the other hand the overcharge cannot escape through a resistance too high in value.

Constant in all temperatures is one vital characteristic of an efficient variable grid leak. First adjust resistance best for working conditions—then it's always set—if it's a

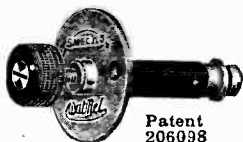

Patent 206098

5 to .5 Megohms . . . 2/6
50,000 to 100,000 Ohms. 3/6

Other Resistances to suit any circuit.

Send P.C. for Descriptive Folder. SEE THE TRADE MARK.



ON EVERY GRID LEAK, BEWARE OF IMITATIONS.

Watmel

the only
CONSTANT VARIABLE GRID LEAK

IMPORTANT NOTICE to intending purchasers

The Watmel Wireless Co. wishes to notify the trade and public that their Variable Grid Leak Patent Application No. 206098 was contested in the Comptroller's Court, and on Appeal in both instances the Patent Grant was upheld and costs awarded.

It is the aim of this Company to protect traders', customers', and also its own interests by securing Patent protection for the novelties in its specialities, as it is these novelties, invented by experts and exhaustively tested, which are the Hall Mark of all Watmel Products.

All goods of our manufacture bear this mark. It is your only guarantee.



THE WATMEL WIRELESS CO.
332a, Goswell Road, London, E.C.1.

Telephone

CLERKENWELL 7990.

100% EFFICIENCY H.T. BATTERY. THE CONSTRUCTOR'S IDEAL.



Amazing value, positively unequalled. See "Apparatus Tested," April issue. Giant Unit Dry Cells, 1 1/2 volts, 1 1/2 in. diam. 300% more capacity. Compare tiny standard cells on photo. Terminated and insulated. Cells, 4/- doz. carriage extra. 60 volt type in polished Oak Case, as reported, 19/5 carriage 1/6. All Cells replaceable. Lists free. Sample Cell 6d. From actual maker only, saving 50% middlemen's profits. Money back guarantee.

Sole Maker: FINCHETT (C.A.), OLD ARNDORRY, OSWESTRY



PRICES:

120 ohms £1.2.6

2000 " £1.4.0

4000 " £1.5.0.

SIEMENS HEADPHONES AND LOUD SPEAKERS



PRICES:

120 ohms £2.10.0

2000 " £2.12.6

4000 " £2.15.0

BRING TO THE TOWN THE MUSIC OF THE COUNTRY AND TO THE COUNTRY THE MUSIC OF THE TOWN.

Obtainable from all Dealers.

SIEMENS BROTHERS & CO, LTD.
WOOLWICH, LONDON, S.E.18.

Also manufacturers of WIRELESS RECEIVING SETS, BATTERIES, &c.

In replying to advertisers, use COUPON

**1d. WISE
£ FOOLISH**

You waste your money

by purchasing inferior components. The disappointing and distorted results laboriously obtained prove this very quickly. You save money in the beginning and in the end by coming to us in the first place and benefiting by our knowledge, our reputation, and our Service. We are

THE LEADING HOUSE IN LONDON FOR FIRST-CLASS APPARATUS AND COMPONENTS
We supply the complete set of components for any of the well-known circuits. Send for particulars and advice.

SPECIMEN LIST OF PARTS RECOMMENDED FOR TRANSATLANTIC

Bowyer Lowe Variable Condensers, .0005	17	0
"Dubilier" fixed condensers, .0003 Dual	£1	9 0 6
Mansbridge fixed condensers, .25	2	3 9 9
" " " " 1. U.F.	3	3 9 9
" " " " 2. U.F.	4	7 8 0
Burndept Dual rheostats	7	7 8 0
Igranite Potentiometers	7	2 6 0
Dubilier 2-grid leaks	1	9 8 0
Bowyer Lowe valve sockets set	1	9 8 0
Burno Jones Magnum 2-coil holder	1	9 8 0
Utility switches, 4-pole D.T.	6	5 6 6
Dubilier 80,000 Anode resistances	2	7 9 0
Connecticut on and off switch	8	0 0 0
McMichael H.F. transformers 300-600	7	8 0 0
" " " " 80-150	1	2 6 0
Igranite coils from	12	5 6 6
Valves: Marconi, Cosmor, and Mullard	£1	2 6 6
Ever-ready 100v. Batteries	£1	3 0 0
Hellesens 99v.	£1	3 0 0

WIRELESS for "CASH" or "EASY" PAYMENTS

THE SERVICE CO. LTD.
(Dept. M.W.) 273-274, HIGH HOLBORN, LONDON, W.C. 1



Complete set of "Tangent" Coils (Nos. 25 to 75) ... 16/-
Complete set of "Tangent" Coils (Nos. 25 to 500) £3:7:0

*Unshrouded efficiency.
Rigid as a Motor Wheel*

"Tangent" Tuning Coils

STOCKED SIZES.			
Coil No.	Min. W/L	Max. W/L	Price.
25	250	390	4/3
35	330	520	4/3
50	430	840	4/3
75	660	1070	4/6
100	840	1430	5/-
150	1100	2030	6/-
200	1610	2720	7/-
250	2009	3520	7/6
300	2400	4250	8/-
400	3300	6450	9/-
500	4500	8750	10/-

Guaranteed not to buckle or crush.
Damping reduced to minimum.
Low distributed capacity.
Electrical efficiency second to none.
Mechanical strength unequalled.

Take no substitute—If difficulty in obtaining—write us.

GENT & CO., LTD—EST. 1872.
Manufacturing Electrical Engineers,
"FARADAY WORKS,"
LEICESTER.

London: 25, Victoria St., S.W.1.
Newcastle/Lyne: Tanbent House, Blackett St.

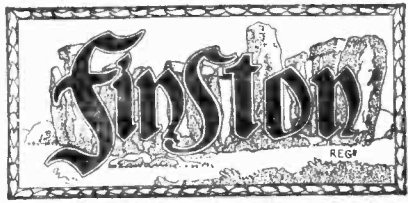

FIXED CONDENSERS

defy the Usage of a Century

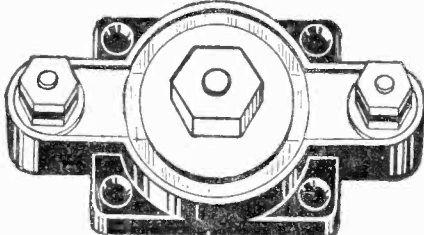

FEATURES.
Reliability of Capacity. Finest grade Mica Dielectric. Highest possible quality Copper Foil. Adapted for Terminal or soldered connections.

CAPACITIES:
'0001 to '001 | '002 to '006
Price 1/3 Each | Price 2/- Each

LIGHTING SUPPLIES CO.,
2, FINSBURY AVENUE, LONDON, E.C.2

BROADCAST MESSAGE TO THE TRADE.

THERE ARE MANY SO-CALLED LIGHTWEIGHTS BUT NONE COMPARE IN WEIGHT, QUALITY, AND PRICE WITH THE—

PRICE: 12/6



Trade only Supplied

The HEADQUARTERS OF ALL WIRELESS ACCESSORIES, AND AT THE RIGHT PRICE & QUALITY. 4,000 ohms

Write for our Illustrated Catalogue, comprising a comprehensive list of all Wireless Accessories.

THE WHOLESALE FITTINGS Co., Ltd.
23, 25 and 27, COMMERCIAL ST., LONDON, E.1.
Phone: London Wall 1191. Telegrams: Calottes, Norton, London.

South London Depot: 65, NEWINGTON BUTTS, LONDON, S.E. 11
Phone: Hop 773.

MANCHESTER: 78-80, High Street.
BRISTOL: 14, North Street, Stokes Croft.

Barclays 153

transformers of known flat characteristics did not bring out any noticeable resonance phenomena.

The ratio is stated to be 5 to 1; measurement of the D.C. resistance of the windings showed that this is not merely the resistance ratio. The insulation resistance appeared to be satisfactory. The present instrument, if the high quality of the specimen submitted is an indication, can be heartily recommended, and indicates the vast strides that have been made recently in the design of really effective transformers for L.F. amplification.

Mullard Safety Discs

Messrs. Mullard Radio Valve Co., Ltd., have drawn our attention to a neat little device, the Mullard Safety Disc, which by guarding against accidental short-circuits whilst inserting valves in their sockets will materially lengthen the average effective life of valves used in experimental work. This is a small disc of coloured felt, adapted to be stuck down on the top of an ordinary solid valve-holder, with four small holes in it corresponding to the valve leg sockets. It is evident that this insulating material effectively safeguards the filament against accidental connection in the high tension battery circuit, as no metallic contact can be established until the legs are properly oriented with reference to the sockets.

"Dualstat" Filament Resistance

A filament resistance, for use with a single bright emitter valve, with a coarse and a fine adjustment incorporated in the single instrument, has been submitted by Messrs. The Northcote Motor Co. In this the resistance spiral is wound on an insulating tube which itself slides within another, and is controlled by the usual spindle and knob. The outer tube is mounted behind the panel by a one-hole-fixing device of the usual pattern. The instrument is about $2\frac{1}{2}$ in. long and $\frac{3}{4}$ in. diameter. Two small terminals are provided on the exterior of the outer tube, the one making connection with some point on the internal resistance spiral by means of a contact-spring. Coarse adjustment of resistance is made by simply withdrawing the knob from the "off" position (*i.e.* right home) to a suitable distance; the fine adjustment is then obtained by rotating the knob, thus enabling an adjustment of a fraction of a single turn of the resistance-wire to be made.

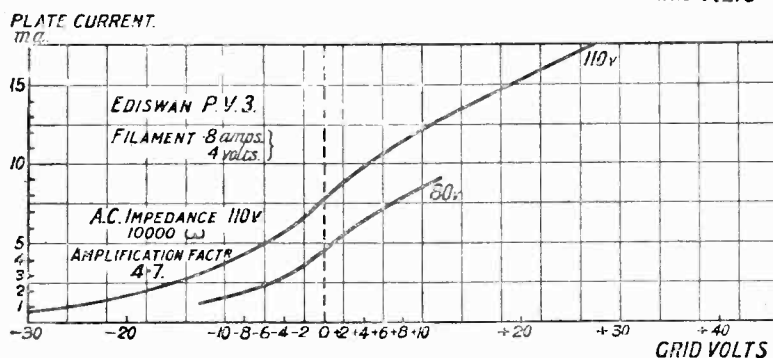
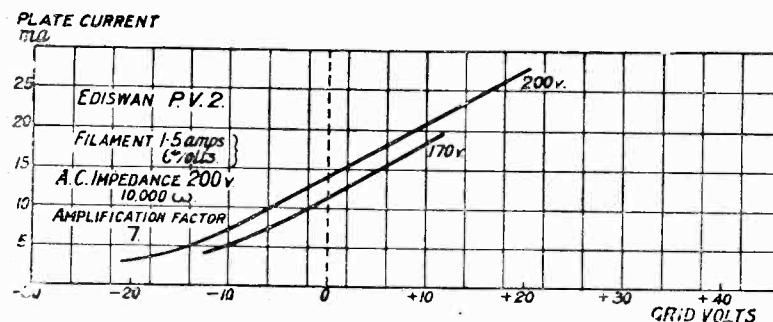
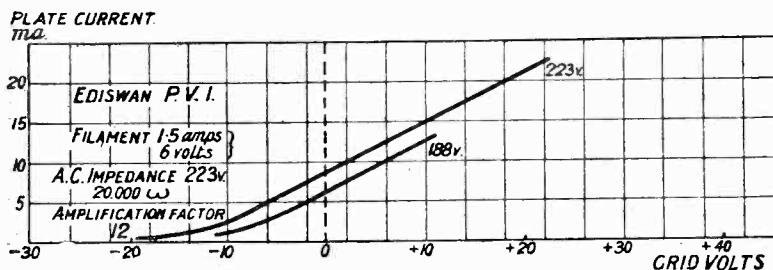

We give above the characteristic curves for the three power valves submitted for test by the Edison Swan Electric Co. A test report on these valves appeared in our last month's issue.

On test the maximum resistance was found to be of the order of one ohm only, which is totally inadequate where a six-volt accumulator is used with any valve that is modest in its requirements as to L.T. supply and voltage. On practical trial it was found easy to obtain a fine adjustment of the detector-valve filament temperature, *e.g.* when using a valve rated at 3.5 volts with a four-volt accumulator.

Owing to its low resistance we cannot recommend this rheostat to our readers. The name also appears rather misleading.

Fixed Condenser Labels

Troubles with the ordinary type of fixed condenser mounted in a wax-filled moulded case, such as the uncertainty as to its nominal capacity on account of the precarious or illegible labelling, is permanently dispelled in a type samples of which have been submitted for our inspection by Messrs. Shermays, Ltd., and which we understand form the subject

of applications for Patents and Registered Designs. In these a small white label with clear black figuring is let in actually in the top of the condenser case, so that it cannot be lost or effaced, and figures are easily read. On the samples submitted the labels were certainly very clear and legible, and afforded no excuse for supplying a .0001 μ F fixed condenser for a .001 μ F, which has been known to occur. The method, we gather, is available for condenser manufacturers.

Cosmos Strip Coils

A set of eight plug-in coils, in which the "Cosmos" strip (composed of a number of wires embedded in prepared paper) is used, has been submitted by Messrs. Metro-Vick Supplies, Ltd., in conjunction with the short-wave coil already reported upon in our columns. The lower numbers are uniform in appearance with the latter, being $3\frac{1}{2}$ in. diameter by $\frac{3}{4}$ in. thick, whilst the higher numbers are $4\frac{1}{2}$ in. diameter with the same thickness. The coils are entirely

CLIMAX RADIO

DOES ALL THE ADVANTAGE OF CRYSTAL PURITY SEEM OUTWEIGHED BY TEDIOUS ADJUSTMENT? THEN START ENJOYING WIRELESS BY GETTING THE CLIMAX SURE-SET DETECTOR.

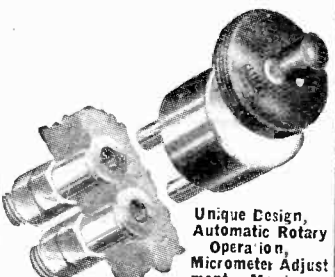

Unique Design, Automatic Rotary Operation, Micrometer Adjustment, Maximum Efficiency,

Setting the crystal is a quick, simple and easy operation, which ensures the whole of the programme being received without annoying interruptions so frequently experienced with ordinary crystal detectors.

GET ONE IMMEDIATELY.

THE CLIMAX SURE-SET DETECTOR finished in highly polished black ebonite, with silver finished metal fittings, complete with Crystal and Cat Whisker, together with Plugs and Sockets for panel mounting.

Price 4/8, postage 3d.

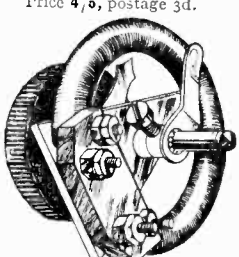

Climax Rheostats can be thrown about the room without sustaining damage and can stand an electrical pressure of 2,000 volts.

"CLIMAX POINTS."

One hole fixing.	Perfect cooling.
Solid rigid coil.	Stands high temperatures and voltages.
Unbreakable bakelite terminal bar.	Large and well spaced terminals.
Steel grub screw fitting.	No lock nuts to work loose.
Riveted brush with perfect brush contact.	Takes any panel up to 3/4" thick.
Bakelite knob with blind brush will not work loose.	

Price

Climax Universal pattern rheostat for bright or dull emitter valves,	
30 ohms - - - - -	4/6
For power valves, 6 ohms - - - - -	3/6
Climax Potentiometer, 300 ohms -	6/-

CLIMAX PATENTS, Ltd.,
182, Church Street, London, W.8.
Phone Park 2023.

Mention "Modern Wireless."

enclosed, and have the usual plug-and-socket fitting. They are labelled with their inductance values in micro-henries, though they are listed under the ordinary numbers 35, 40, 50, 75, 100, 150, 200, and 300, corresponding approximately to those numbers of turns in the usual type of coil.

On trial with .0003 μF aerial-capacity and a variable tuning condenser of .0005 μF (actual) capacity these coils were found to cover the range from 300 to 3,900 metres with ample overlap; and in every case a suitable reaction-coil could be chosen to give steady oscillation at will. The magnetic coupling is not great until the coils are brought quite close; then it suffices for any ordinary purpose, and adjustment of coupling can be conveniently obtained by sliding one coil across the face of the other.

Suitable reaction control was afforded by these coils; thus with a single .06 valve and 50 volts H.T., using Nos. 35 and 75 coils, on an ordinary 70-ft. single-wire aerial (not particularly high, but well situated in a quiet corner of Essex), late at night there came in at comfortable 'phone strength, in addition to the four main B.B.C. stations in their range and Petit Parisien, no fewer than five of the B.B.C. relay stations in turn. 5XX came in on the Nos. 150 and 200 at moderate loud-speaker strength on the single valve (about 35 miles away); Radio-Paris at good 'phone strength, but with severe interference from Chelmsford. 2LO (also at about 35 miles) was audible many feet away from the 'phones. On the Nos. 50 and 75 several foreign stations were read on the single valve, Madrid being, however, badly heterodyned by a German station.

As a secondary, or as tuned-anode coils, the Nos. 50 and 75 covered comfortably the range from 300 to 600 metres with a .00025 μF tuning condenser. We found the tuning sharp, and selectivity accordingly above the average, and have no hesitation in recommending these strip inductance-coils for general use.

Together with the made-up coils, samples were sent us of the paper strip used, with a number of fine copper wires embedded in parallel in its length. This is provided for those who desire to make up their own coils, the strip being wound in spiral form and the wires then joined up in series or parallel in any desired formation. It is thus possible to make up coils of remarkably low H.F. resistance and distributed capacity, whilst the dielectric losses appear to be much less

than one might be tempted to expect with this prepared paper dielectric.

A New Wander-Plug.

A neat type of wander-plug which provides for easy attachment of the connecting wire, and certain electrical connections throughout, has been submitted for our inspection and trial by Messrs. A. H. Hunt, Ltd. The first is made by nipping a bared end of the wire between the conical end of the brass plug fitting and an internal cone in the insulating handle, the wire coming out at the end of the latter; whilst a split end to the lower portion of the plug gives secure electrical contact in the battery connecting-sockets.

Wire-bending Pliers

The present fashion for wirint with stout bare tinned wire, with all angles bent exactly at right angles, has inspired, apparently, the design of a special tool for making those right-angle bends on which the æsthetic appearance of the finished result so largely depend, a bending pliers, a sample of which has been sent us by V. R. Pleasance. This tool is similar to an ordinary pair of small pliers, and is 5 in. long; but instead of the ordinary type of square or wire-cutting jaws, it has jaws formed in V-shape, so that when closed on a wire the latter is forced into a sharp right-angled bend. On trial, both with No. 16 bare wire and with the substantial square wire often used, a sharp bend was readily formed, a little trouble being necessary to ensure that the legs of the bend remained straight during the operation.

Valve Marker

An extremely practical device for the use of the amateur constructor who experiences trouble in marking out the valve-leg holes in his panel is a valve marker submitted for our inspection by V. R. Pleasance.

This tool carries, on the end of a convenient wooden handle, a metal disc from which project four substantial sharp spikes, spaced in the correct manner to correspond to the usual valve-leg spacing. By placing this against the panel and giving a smart blow to the handle, the sharp points mark the panel after the manner of a centre-punch, so that the drilling operation can be taken in hand without centre punching. Practical trial on an experimental panel brought out the convenience and saving of time.

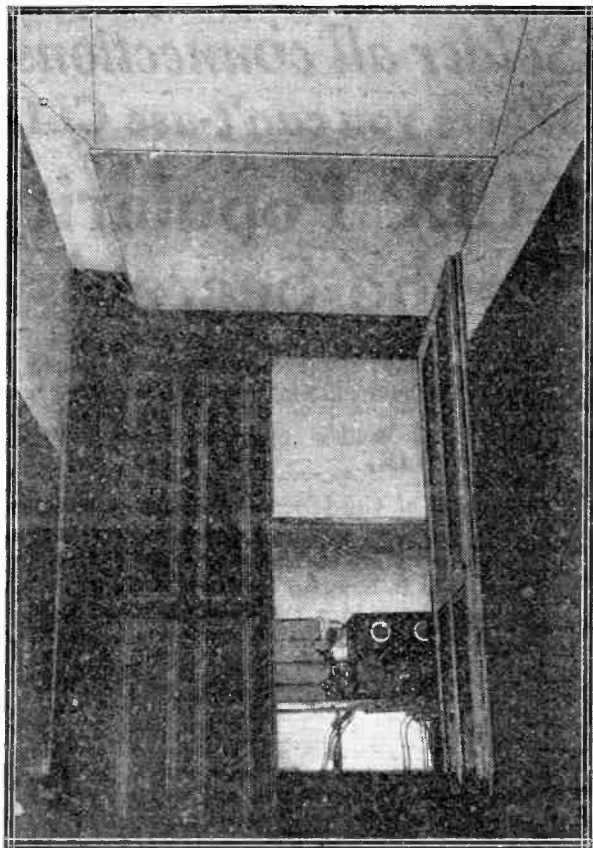

The plate suspended from the ceiling acts as the aerial.

The "All-Wave Receiver"

To the Editor of MODERN WIRELESS.

Sir,—It will no doubt interest you to know the results I have had with your "All-Wave Receiver," as described in your February issue of this year.

I have made it up on an ebonite panel, Paragon, and have mounted it in a sloping mahogany cabinet, its appearance being all that can be desired. There are several small alterations I have made, there being extra H.T. + leads for each valve and a second fixed coil-holder mounted on the panel. I have also added a "vernier" across the anode T.C.

The extra coil-holder enables me to use tuned anode coupling with reaction on the anode, which I find easier to handle than having the aerial and anode coils reacting.

With this circuit I have received all the main British stations except Cardiff on the L.S., a small Claritone, this during the summer

holidays before the wintertime came. Added to this I have had all the French stations, Brussels and Madrid on the L.S. 2ZY, Liverpool and Birmingham are very loud; 5XX comes in fairly well on the L.S., Radiola about the same; Belfast comes in as well as 2LO.

On the 'phones I have had very many amateurs from all parts using two valves, H.F. and Det.

The set is very selective. I am able to get London and Manchester with little interference from the one not wanted, and the terminal arrangement enables many circuits to be tried.

However, the most extraordinary part is the entire absence of distortion, although the transformer is of unknown make purchased eighteen months ago, when I had had little experience. In spite of its performance, I should never risk buying anything but the best again.

I might add that I have enjoyed all the issues of both your excellent papers and am looking forward to the new monthly.

Thanking you for the excellent set.—Yours truly, H. B. TAYLOR.

Knutsford, Cheshire.

(Continued from page 646.)

the valves to be seen and changed when necessary. Above this, and still flush with the frame, is an ebonite panel carrying the control switches, and a distributing block to enable loud-speaker or headphones to be plugged in when required. With the exception of the loud-speaker, which can be in any convenient place, this is the only part of the outfit visible in the room.

On the other side the receiver box projects into the cupboard and the batteries are placed on the shelf immediately below, where they are easily accessible. On the shelf above is placed a two-stage L.F. amplifier with its H.T. batteries.

For the aerial and earth system two tin plates are used each 36 in. by 22 in.; one is suspended from the ceiling from insulated hooks and one is placed on the floor and covered with a mat. The aerial circuit is tuned with a .0005 μ F condenser and an inductance consisting of a basket coil of 70 turns of No. 18 d.c.c. wire. The inductance value was found by trial and the condenser adjustment subsequently fixed with sealing wax. The receiver used is a Marconiphone six-valve H.F. panel, transformer coupled, with no reaction and rather flat tuning. The low-frequency amplifier is a Marconiphone N.B. 2. The volume obtainable is such that signals can be heard loudly and clearly 100 ft. away in the garden when the room door is open. The two first switches are to cut out the L.F. amplifier if desired. The third switch lights the filaments to the L.F. valves, while the Lissenstat knob controls the current supply to the H.F. valves. The photographs clearly show the aerial and earth system, and how the apparatus is disposed. Obviously any form of receiver could be used, and an outside aerial would, of course, simplify the apparatus necessary, but in my case I wanted to free that aerial for other purposes.

The "Tri-Cell" Reflex Receiver

To the Editor of MODERN WIRELESS.

Sir,—I have just finished making a Tri-coil Reflex set as described by Mr. Harris in the September number of MODERN WIRELESS; and as you ask for reports on results obtained, I am writing to say that in my opinion it is the most satisfactory reflex circuit yet evolved. I find it remarkably selective and have no difficulty in tuning in all the B.B.C. stations. I have heard Madrid on it and also a number of other Continental stations which I have not yet identified. Glasgow and Newcastle come in at almost the same strength as London, whilst Chelmsford is too loud for the telephones and has to be tuned down. I am using a "Wecovalve" with two dry cells in parallel.

Thanking you for so excellent a circuit.—Yours truly,

MICHAEL C. W. THOMAS.

Broadstairs.

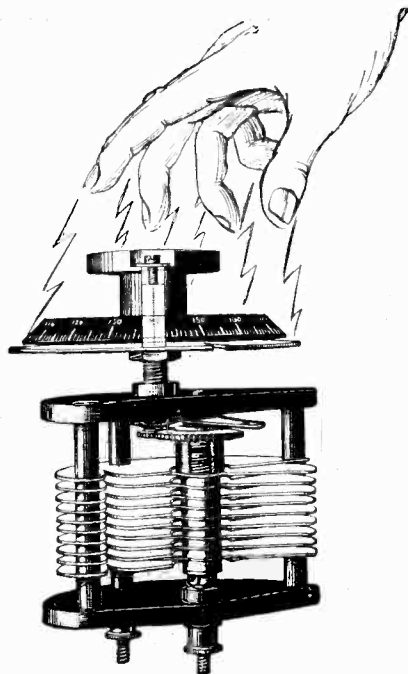

Another Refinement

—added to the “Fulstop” Condenser. The new registered stator vane of the “Fulstop” Condenser reduces the minimum capacity limit to an extremely low point because its shape eliminates all parallel lines as the moving plates rotate. This assists materially the possibilities of fine tuning.

This innovation is another proof that we leave no stone unturned to improve still further what is already the finest variable condenser in the world.

Read what “Modern Wireless” says :

“We can strongly recommend this type of geared condenser for careful tuning and for use in situations where hand capacity effects are troublesome.”—October, 1924.

PRICES :

.001 13/6	.0003 10/3
.0005 11/3	.0002 9/6

Protected throughout the world.

Stocked by most Wireless Dealers, but if you have any difficulty write to :

J. H. NAYLOR, Ltd., THE WIEND, WIGAN.



VARIABLE CONDENSER

Solder all connections! Where you can't-use CLIX CLIX Popularity —the Secret!

You can't have efficiency in Radio **anywhere** unless you have efficient contact **everywhere**.

You can't solder **everywhere**—but you can use CLIX.

By virtue of the tapered plug-socket design CLIX ensures **perfect** contact—an obvious improvement on various forms of split-pin plugs, which, however accurately machined, can only provide a “two-point” contact. Think it out!

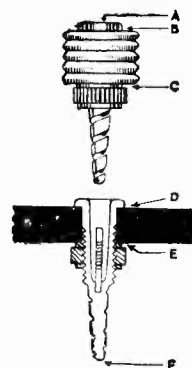

CLIX may be wired at points A, B, C, D, or E. F affords an ideal point for Soldering when permanent connections are required.

Retail Prices —
CLIX with Locknut 3d.
CLIX Insulators (6 colours) 1d. each
CLIX Bushes (6 colours) 1d. pair

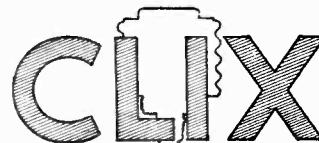

The **Electro-Link** With **159 Uses.**

Obtainable from all Wireless Dealers or direct from the Patentees and Manufacturers :



**Radio Engineers and Contractors,
84, VICTORIA ST., LONDON, S.W.1**

What Others Say

"Amateur Wireless," August 16
 "Simplicity has been the keynote of the C.A.V Loud Speaker—even when the Loud Speaker is reproducing broadcast with sufficient volume to fill a large hall, there is no trace of mechanical noise, the notes being perfectly mellow."

Broadcaster," September, 1924
 "Under the test, and a very severe test, we have given the Loud Speaker, it came out with flying colours. Specially recommended,"

"Popular Wireless," August 2nd
 "The workmanship is solid and sound—no displeasing distortion was noticeable. We can recommend this Loud Speaker to our readers."

"Wireless and Allied Trades Review"
 "Takes its place in the front rank of really good loud speakers and is, if we may suggest anything, a decided advance on many of the instruments we have come across to date."

What more do you want?

WRITE FOR A COPY OF THE C.A.V LOUD SPEAKER FOLDER

C.A. Vandervell & Co., Ltd.
 ACTON VALE, LONDON, W.3



MORE GUARANTEED COMPONENTS



Besides the selection shown in our HALF-PAGE advertisement on Page 680, we introduce to you the following:—

CONDENSERS:

Capacities.	Plain.	Vernier.
0.001 mfd. ...	11/6	17/6
0.0005 " ...	10/6	15/-
0.0003 " ...	8/6	14/-
0.0002 " ...	7/6	12/6
GRID LEAK & CONDENSER, MOUNTED ...	4/-	
GRID LEAK & CLIPS (Anode Resistance) ...	2/-	
REVERSINE COIL HOLDER (2 coil) ...	21/-	
REVERSINE COIL HOLDER (3 coil) ...	39/-	
COIL MOUNTS. For Panel Mounting, with screws and tags ...	1/6	
POTENTIOMETER. Mounted on ebonite base, with Terminals ...	21/-	
POTENTIOMETER. For Panel Mounting ...	9/6	
FILAMENT RESISTANCE ADAPTER (plug-in type) ...	9/-	
PLUGS & SOCKETS in 3-coloured ebonite ...	1/-	
CRYSTAL. Most excellent, long life, sensitive ...	1/6	

L.M. MICHAEL LTD
 IN CONJUNCTION WITH B. HESKETH LTD

WIRELESS ENGINEERS

RADIO CORNER, 179, STRAND, LONDON, W.C.2

Barclays 199

Radio Press Books

— keep them
 for reference
 and get better
 results



C.A. 871.

There's a
Radio Press Book
 for every
 Wireless need

— consult your Book-seller

G.I. 870.

In replying to Advertisers, please use Order Form enclosed.

A SELECTION OF FOUR ITEMS FROM THE "COSMOS" RADIO CATALOGUE AND HANDBOOK D.S. (7117/1 SEPTEMBER 1924)—PRICE 6d.

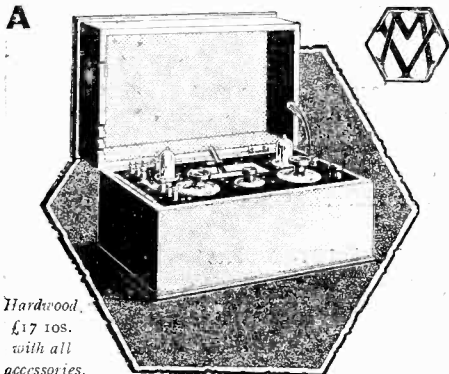

Hardwood.
£17 10s.
with all
accessories.

"COSMOS" UNIVERSAL TWO-VALVE ET.

DESIGNED for reception from both British and Continental Broadcasting Stations on wavelengths from 300 to 3,000 metres. Reaction on to the anode or aerial circuit is changed at will by the movement of one lever—a feature exclusive to "Cosmos" Sets. Illustration shows the receiver in simple hardwood case.

METRO-VICK SUPPLIES, LTD.

(Proprietors: Metropolitan-Vickers Electrical Company, Limited),

4, Central Buildings, Westminster, S.W.1.

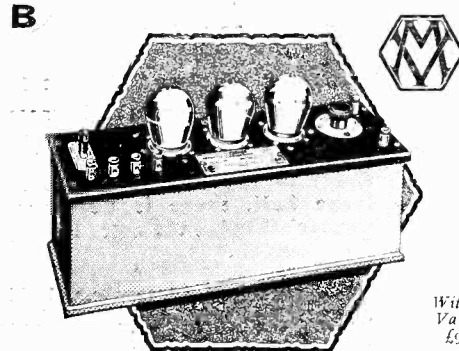

Without
Valves,
£9.

"COSMOS" DISTORTIONLESS NOTE AMPLIFIER

THREE stages of L.F. Amplification, embodying resistance-coupling and giving far better and purer reproduction than is possible with amplifiers using iron-cored transformers. This amplifier is used in standard "Cosmos" Valve Sets, V.S. 6 and V.S. 7.

METRO-VICK SUPPLIES, LTD.

(Proprietors: Metropolitan-Vickers Electrical Company, Limited),

4, Central Buildings, Westminster, S.W.1.

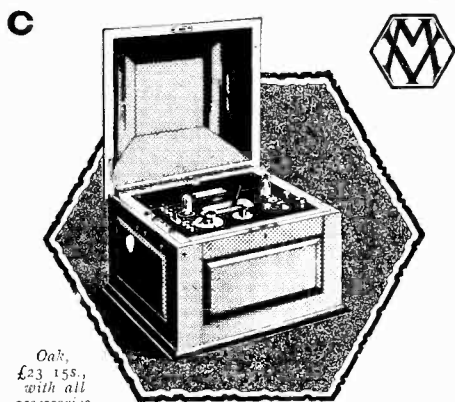

Oak,
£23 15s.,
with all
accessories.

"COSMOS" UNIVERSAL TWO-VALVE CABINET SET.

A HANDSOME Cabinet Set in Oak, embodying the two-valve receiver unit, described above (A). Provision is made in the design of these Cabinets for adding when required, the three-valve note amplifier (B); thus converting the Set into a 5-valve Set for receiving from British and Continental Stations at loud-speaker strength.

METRO-VICK SUPPLIES, LTD.

(Proprietors: Metropolitan-Vickers Electrical Company, Limited),

4, Central Buildings, Westminster, S.W.1.

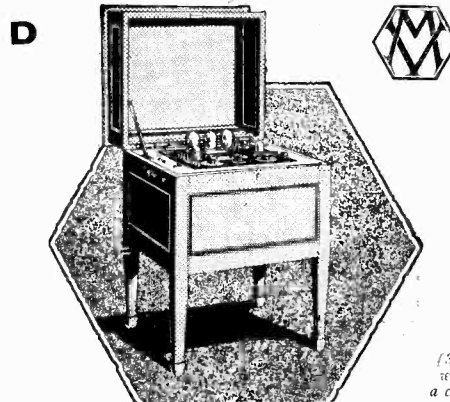

Cabinet,
£37 15s.,
with all
accessories.

"COSMOS" UNIVERSAL FIVE-VALVE SET.

EMBODYING both the two-valve receiver unit (A) and the three-valve note amplifier unit (B); this set comprises one stage of H.F. Detector and four stages of L.F. amplification. It is a very convenient set for armchair listeners, as the height of the table is just right to enable adjustment of controls to be made while sitting in the chair, and it is capable of receiving at L.S. strength both British and Continental Broadcasting.

METRO-VICK SUPPLIES, LTD.

(Proprietors: Metropolitan-Vickers Electrical Company, Limited),

4, Central Buildings, Westminster, S.W.1.

THE "COSMOS" CATALOGUE AND HANDBOOK (D.S. 7117/1) Price 6d. R 269
 OUGHT TO BE IN YOUR POSSESSION. OBTAIN A COPY TO-DAY FROM YOUR DEALER.

Exide



The LONG-LIFE BATTERY

Some Types and Prices

"Exide" Batteries enable you to get the very best results from your set, because they maintain uniform current over a long period of discharge.

Made up in 2-volt, 4-volt, and 6 volt units, there is an "Exide" available for every type of valve.

The prices are low and there is no better battery made.

Use an "Exide" with your set this autumn and secure clearness in reception.

BUILT BY THE LARGEST BATTERY WORKS IN THE BRITISH EMPIRE.

"Exide" Batteries can be obtained from your usual dealer, or the nearest "Exide" Service Station.

Look for this sign

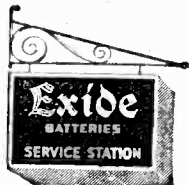

450 Service Agents.

Depots at
Birmingham, Bristol and Manchester.

Manufactured by—

THE Chloride ELECTRICAL STORAGE COMPANY LIMITED.

at CLIFTON JUNCTION, NR. MANCHESTER.

London Depot:

219/229, Shaftesbury Avenue, W.C.2.

C Z TYPE. 4 Volt Sets.				
TYPE.	IGNITION CAPACITY Amp.-Hrs.	ACTUAL CAPACITY Amp.-Hrs.	PRICE Cells Only £ s. d.	PRICE In Crate £ s. d.
2-CZ3	60	30	1 7 0	1 14 0
2-CZ4	80	40	1 12 0	1 19 0
2-CZ5	100	50	1 17 0	2 5 0
2-CZ6	120	60	2 2 0	2 10 0
C Z TYPE. 6 Volt Sets.				
3-CZ3	60	30	2 0 6	2 8 9
3-CZ4	80	40	2 8 0	2 16 6
3-CZ5	100	50	2 15 6	3 4 0
3-CZ6	120	60	3 3 0	3 12 6
C X TYPE. 6 Volt Sets.				
3-CX5	150	75	3 18 6	4 7 9
3-CX6	180	90	4 9 0	4 19 0
3-CX7	210	105	4 19 0	5 9 3
3-CX8	240	120	5 9 0	5 19 6
H Z TYPE. 2 Volt Cell.				
1-HZ2	80	40	0 17 6	1 3 6
1-HZ3	120	60	1 1 0	1 8 0
1-HZ4	160	80	1 4 6	1 12 6
D T G TYPE. 2 Volt Cell.				
TYPE	Intermittent Discharge		PRICE	
DTG	20 amp.-hrs.		5/- per cell	

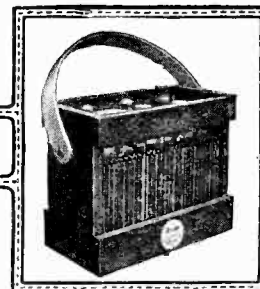

In replying to Advertisers, please use Order Form enclosed.

If you remember



Jones's extraordinarily caustic remarks concerning Loud Speakers, you will be surprised at the calm serenity which reigns throughout his household since the advent of the "Sparta." Judging by his obvious eagerness to display it, he is thoroughly proud of this excellent Speaker. In fact, his persistent desire to make you "listen just a minute" is only equalled by that of the fond parent possessed of a precocious but misguided child nearly able to recite "The Loss of the Royal George." Yet even his severest critics are unanimously

agreed that his claims for sweet, undistorted melody and sustained volume are decidedly upheld by the "Sparta"; whilst the younger generation are thoroughly appreciative of the Savoy Dance music and vote the clarity and purity of reproduction to be first-rate. If you think Loud Speakers must necessarily distort, hear the "Sparta" demonstrated—you will quickly realise why Jones is so enthusiastic. All good dealers stock the "Sparta."



Sparta LOUD SPEAKER

Fuller's United Electric Works, Ltd.,
Woodland Works, Chadwell Heath, Essex
Telephone: 11 Ford 1200 (6 lines).
LONDON DEPOT: 58, HIGH STREET, W.C. 2
Telegrams: "Fuller, Chadwell Heath."
Telephone: Gerrard 5070.

Type A }
120 ohms }
Type HA } £4 15 0
2,000 ohms }
Type HHA }
4,000 ohms }

Type B. The first Loud Speaker to provide for additional control through a 6-position tone selector.

Type "B." .. 120 ohms. £5 15 0

Type "H.B." .. 2,000 ohms. £5 0 0

Type "H.H.B." .. 4,000 ohms. £5 0 0

Send to-day for List 315b describing "Fuller" Components.

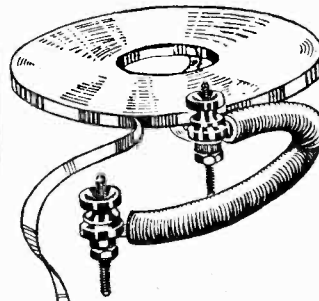

Manufactured under Patent No. 25976/22

DON'T LOSE SIGNAL STRENGTH!

The AMPLIFYTONE AERIAL

is used by experts because they know how much signal strength is lost by the usual wire aerial. HUNDREDS OF TESTIMONIALS.

One User writes:— "I have replaced a 7/22 wire aerial by the Amplifytone I got from you, to my complete satisfaction, both in volume and tone. The improvement is very marked."—D. IRELAND, Glasgow.

The Amplifytone Aerial is made from the highest grade Electrolytic Silicon Bronze (100 feet) 2½ times stronger than copper) in tape form—it won't corrode. Packed in boxes, including patent lead-in clips and insulators. Ask your Dealers, or 6/6 post free from

Beware of Imitations, which only corrode and break. Look for AMPLIFYTONE on the box.

United Manufacturers and Agency, Ltd.,
45, Horseferry Rd., London, S.W.1.

NO MORE CATWHISKERS NO MORE ADJUSTMENTS A Permanent Detector which cannot go wrong NO BATTERIES WANTED EASILY ATTACHED TO ANY SET

Wireless is so recent that progress is bound to be rapid. There are sure to be, from time to time, some really astonishing discoveries all in the direction of simplifying wireless and its application to everyday life.

We must not be surprised at anything which the army of wireless research enthusiasts produce.

Such a discovery is the wonderful New Crystal Valve which abolishes Catwhiskers and other delicate adjustments.

Here is a rectifier which produces good results, however crudely it may be adjusted.

Just a turn of a milled screw and there you are.

The "Hovimo" Crystal Valve must not be confused with the ordinary "Permanent" Detector, neither is it to be compared with the Silicon-bornite and other similar combinations.

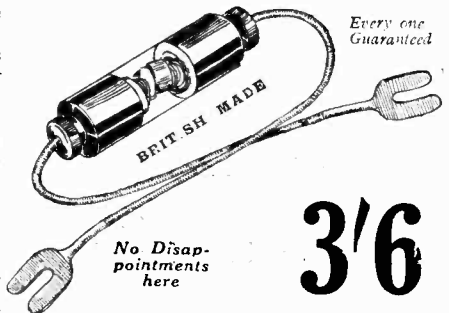

Every one Guaranteed

No Disappointments here

3'6

"HOVIMO" CRYSTAL VALVE

is an entirely new invention. Can be simply adjusted to suit the individual set, and once right, always right. Is equally excellent for crystal sets and for circuits employing crystal rectification, as well as for crystal loud speaker systems. Always producing a remarkably pure tone. Ask your dealer for it, or in case of difficulty write direct to

M. MOLBACK, 27, High Holborn, London, W.C.1

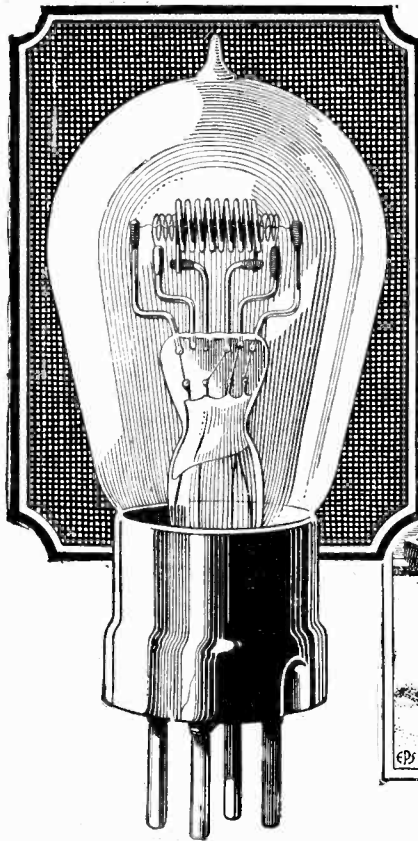

Louden

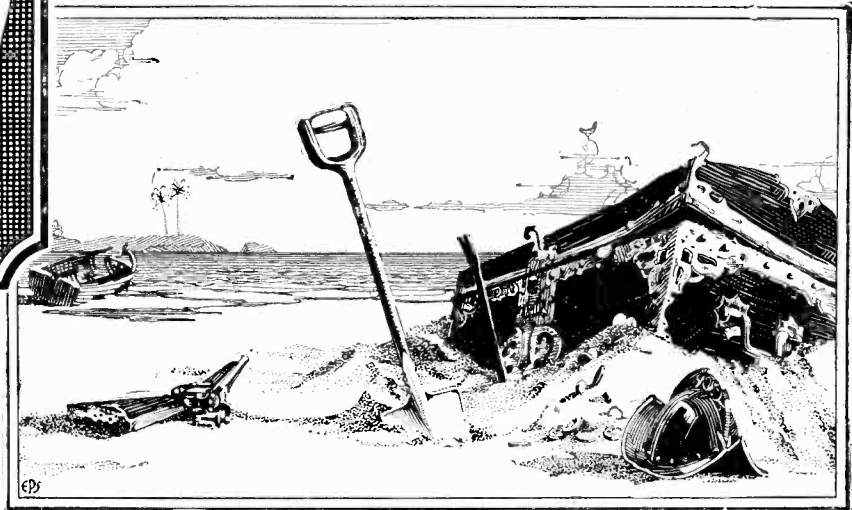

❖ Doubloons !! ❖

10/-

The search for hidden treasure was formerly one of the recognised methods of acquiring wealth.

Unfortunately most of the treasure has now been found, so we have got to fall back on the adage "A penny saved is a penny gained," and amass our treasure by not spending it.

The two chief sources of expense in Wireless are the recharging of accumulators and the replacement of valves. The Louden Valve reduces these to such an extent that, reckoned by the money it saves, it is a fortune in itself. To begin with, the Louden Valve costs only 10/-.

It takes only 0.4 ampere in the filament, enabling your accumulators to last twice as long on one charge as with the ordinary bright filament valve taking 0.75 amp. You have, in fact, very nearly the advantage of a dull emitter valve at a cost of 10/-.

It gives its maximum volume at about 4.9 volts on the filament. Increasing the brilliance of the filament beyond this point causes a slight drop in the volume. Thus there is no temptation to run the valve "all out" and a long life results.

Finally the filament enjoys great length of life because the harmful charges which otherwise would continuously bombard it are forced through the spiral anode out of harm's way.

All these advantages are yours when you buy a 10/- Louden Valve, and this takes no account of the Silver Clear reproduction which alone makes the Louden Valve worth twice what is asked for it.

Buy Louden Valves for your Set to-day and prove the matter for yourself.

**Louden
VALVES**



The Plain Louden for Detecting and Low Frequency Amplifying.

Filament Volts .. 4.8-5
Filament Amps. .. 0.4
Anode Volts .. 40-80

**FELLOWS
WIRELESS**

The Blue Louden for H.F. Amplification.

All Loudens are silver-clear and free from mush. The current consumption is low and the life long.

Louden Valves - Silver Clear

ADVT. OF THE FELLOWS MAGNETO CO., LTD., PARK ROYAL, LONDON, N.W. 10. E.P.S.3.

In replying to Advertisers, please use Order Form enclosed.

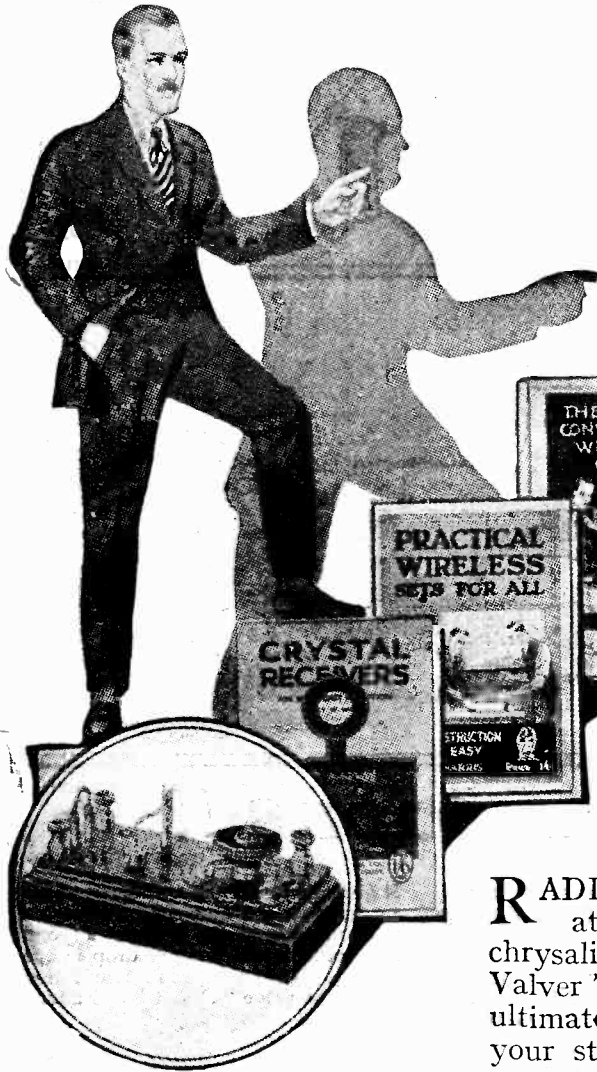

The ideal way
to progressive
wireless
construction.

RADIO is essentially a progressive hobby. Half the attraction lies in the advancement from the chrysalis stage of the Crystal Receiver to a "Five-Valver" or even a full-blown transmitter. Yet your ultimate success depends upon the books which guide your steps along the path of wireless progress. You cannot do better than put your trust in *Wireless Press* publications. With their aid it is a simple matter for you to obtain a complete knowledge of the subject from A to Z.

- "Crystal Receivers for Broadcast Reception." By Percy W. Harris. Price 1/6. Postage 2d.
- "Construction of Amateur Valve Stations." By A. L. M. Douglas. 1/6. Postage 2d.
- "Practical Wireless Sets for All-Home Construction Made Easy." By Percy W. Harris. 1/6. Postage 2d.
- "The Wireless Press Ezi-Wiring Series" :-2/- each. Postage 2d.
 1. A Three-Valve Portable Receiver. By H. S. Pocock.
 2. A Three-Valve Receiver (Cabinet). By F. H. Haynes.
 3. A Two-Valve and Crystal Reflex Receiver. By W. James.
- "The Amateur's Book of Wireless Circuits." By F. H. Haynes. 3/6. Postage 6d.

- "The Home Constructor's Wireless Guide." By W. James. 3/6. Postage 3d.
- "Radio Experimenter's Handbook." Two Parts. 3/6 each. Postage 4d. each.
- "The Wireless Telephone: What It Is and How It Works." By P. R. Coursey. 2/6. Postage 3d.
- "Wireless Telephony: A Simplified Explanation." By R. D. Bangay. 2/6. Postage 3d.
- "The Elementary Principles of Wireless Telephony." By R. D. Bangay. 7/6. Postage 6d.
- "Electrons, Electric Waves and Wireless Telephony." By J. A. Fleming. 7/6. Postage 6d.
- "Wireless Valve Transmitters: The Construction of Small Power Apparatus." By W. James. 9/- Postage 9d.



The *Wireless Press* are the pioneers of authoritative wireless literature, catering for every possible need.

THE WIRELESS PRESS, LIMITED,
12/13, Henrietta St., Strand, London, W.C.2.

In replying to Advertisers, please use Order Form enclosed



Get ALL Wave Lengths with the "G-W" SLIDER on a Two-Slider Coil Inductance. There is no Tuning System so efficient for ALL wave lengths provided you use "G-W" Sliders. They make a BROAD, FIRM contact on ONE wire, and roll smoothly over them without scraping—100 per cent. efficient, 1/- each, from all dealers, or 1/3 post free from

J. & J. LAKER CO., 457, Romford Rd., London, E.7



REPAIRS

TO HEADPHONES
TO LOUD SPEAKERS
TO COILS

Rewound to any Resistance and made equal to new. Price quoted on receipt of instruments. Prompt Delivery.

THE VARLEY MAGNET CO.
(Dept. M), WOOLWICH, S.E.18

Established 28 years.
Phone: Woolwich 888.

STEEL "LAKER" MASTS
STRONG, LIGHT, DURABLE.
BUILT FOR SERVICE.

Best Steel Tubing, 2" dia. in 10' sections. 25' 35/-; 30' 45/-; 35' 52/6; 40' 63/-; 45' 75/-; 50' 95/- Complete with all Accessories. Send Postcard for Catalogue.

J. & J. Laker Co., 457, Romford Rd., London, E.7.

The Sytune MICRO ADJUSTER

Gives the Finest Vernier Control to your Condenser, Variometer, etc.

Post Free. 2/6

"Radiohu" Bus Bar, Flush Panel Valve and Coil Sockets. Ribbon Aerial, Parts supplied for all W.W. and M.W. sets. Send for particulars.

Sparks Radio Supplies 43, Gt. Portland St., London, W.1.

FOR SECURING YOUR AERIALS

and a thousand purposes where great strength and strain is needed. FLEXIBLE STEEL WIRE ROPE, Aeroplane Cable made to Government specification to specified breaking strains. PRICES BELOW COST. Orders of 10/- and over carriage paid, otherwise, please add 1/- for postage.

No.	Dia.	Strain.	100 ft.
0	1/16	5 cwt.	4/6
1	5/32	25 cwt.	10/-
2	3/16	35 cwt.	11/-
	7/32	45 cwt.	12/-
	1/4	70 cwt.	14/-
	11/32	100 cwt.	20/-

Strainers for use with above, right and left-hand threads, 9d. each or 8/6 per dozen. SMITH & ELLIS, Ltd. (Dept. 85), 11, Little Britain, E.C.1. Tel.: City 8994.

Brown

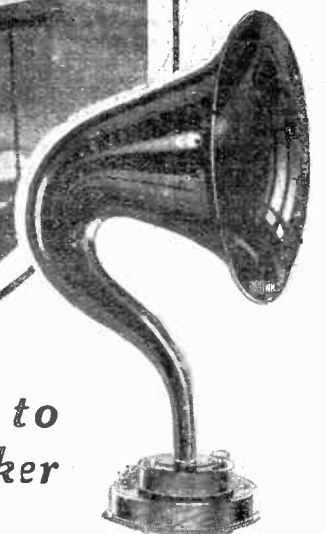

From the tiniest nut to the finished Loud Speaker

THE non-technical visitor to the works of S. G. Brown, Ltd., will be amazed at the large number of processes and the magnitude of the equipment necessary to produce Brown Loud Speakers and Headphones.

To many, a pair of headphones consists merely of a couple of coils in each ear-piece, together with a circular magnet and a diaphragm. But see even the simplest type of Brown headphones—the famous featherweight F. Type—manufactured under ideal conditions and you will appreciate that parts ground to 1/1000 part of an inch must obviously give infinitely better results.

And it is the same with Brown Loud Speakers. Not only has their design—based on the world-famous A. Type Headphones—been proved superior for sensitiveness and tonal purity—but their success is due in no small degree to the wonderful accuracy of the many manufacturing processes. Remember that your Loud Speaker should be an investment—the few shillings necessary to obtain a Brown will be more than repaid to you by the increased enjoyment of hearing really true-to-life reproduction and by the knowledge that you own an Instrument capable of giving you many years of service.

Types and Prices:

H.1.	120 ohms	£5 5 0
	2,000 ohms	£5 8 0
	4,000 ohms	£5 10 0
H.2.	120 ohms	£2 5 0
	2,000 ohms	£2 8 0
	4,000 ohms	£2 10 0
Q.	£15 15 0	in all resistance.

From all Dealers or can be demonstrated at the following Showrooms:
19, Mortimer Street, W.1.
15, Moorfields, Liverpool.
67, High St., Southampton.

S. G. BROWN, LTD. — Victoria Road, N. Acton, W. 3.

Gilbert Ad. 1577.

In replying to Advertisers, please use Order Form enclosed.

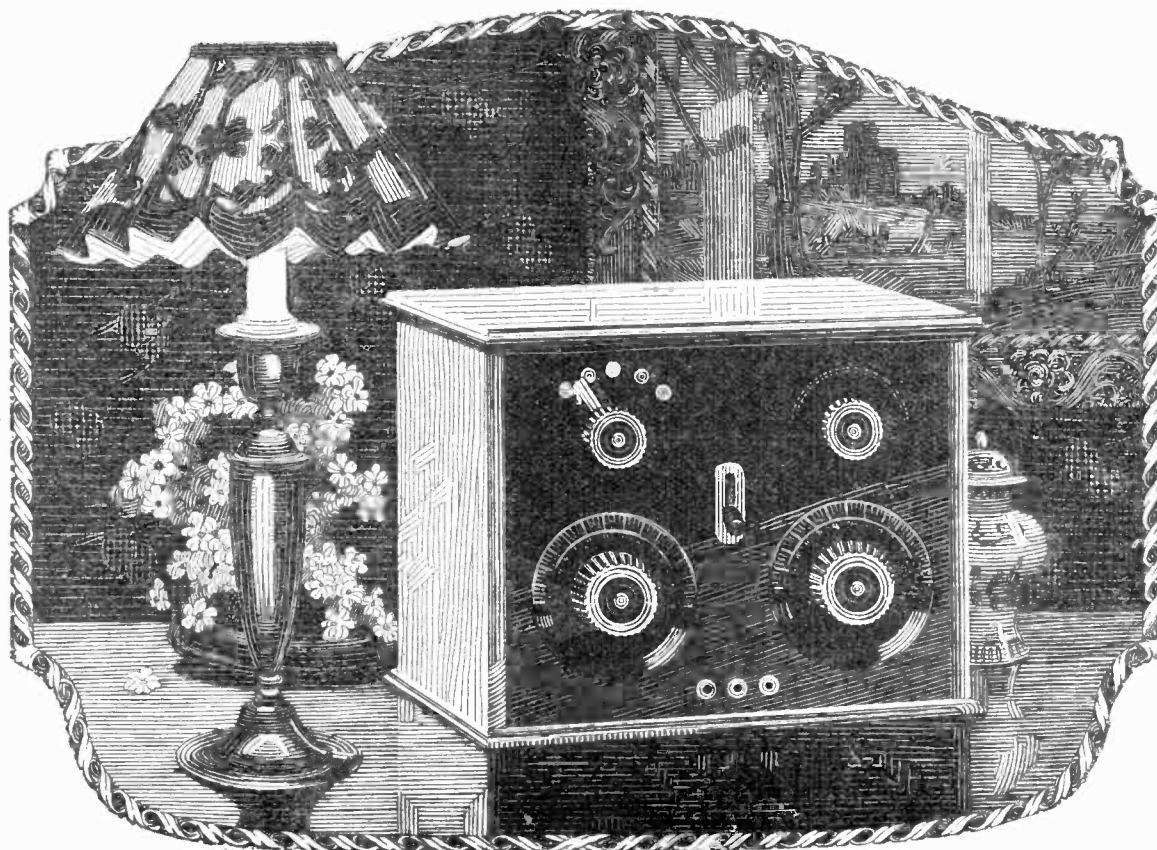

**A cheap Panel—
may be the most expensive
part of your Receiving Set.**

NOT everything masquerading as ebonite is worth using as a panel—in fact, it is difficult to conceive a greater test for any insulation material than to use it in a Wireless Set. The extremely weak impulses received upon your aerial, when conveyed to your Set, so readily leak away that the greatest care must be taken to preserve them if you are going to receive any signals at all. That is why a cheap panel can be easily proved to be a waste of time and money. Radion is the highest grade of insulation in the world, and has been specially developed for wireless use. Its highly-polished surface, which need not be removed before use, enhances the appearance of the finished instrument and prevents the formation of dust.

Radion is sold in black and mahogany—a beautiful colour, very similar to old mahogany—with dials and knobs to match. It is packed in stout envelopes in the convenient sizes shown below. For your next set choose Radion—every panel is stamped—then you can be certain that it will look better and work better.

J Dealers: If you have not yet received particulars of the Radion proposition write to us to-day.

Size	Black	Mahogany	Size	Black	Mahogany	Size	Black	Mahogany
6" x 7"	3/6	4/3	7" x 14"	8/-	10/3	8" x 26"	17/6	21/3
6" x 10 1/2"	5/3	6/6	7" x 18"	10/6	12/9	9" x 14"	10/6	12/9
6" x 14"	7/-	8/6	7" x 21"	12/3	15/-	10" x 12"	10/-	12/-
6" x 21"	10/6	12/9	7" x 24"	14/-	17/3	12" x 14"	13/3	15/-
7" x 9"	5/3	6/6	7" x 26"	15/-	18/6	12" x 21"	19/9	24/3
7" x 10"	5/9	7/3	7" x 30"	17/9	21/6	14" x 18"	19/9	24/3
7" x 12"	7/-	8/6	7" x 48"	28/-	34/6	20" x 24"	39/6	48/-

Special Note:—All 1/8" thick—quite sufficient owing to Radion's tremendous strength.

FROM ALL DEALERS.

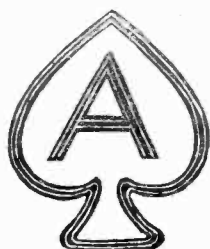
RADION  **FOR PANELS**

AMERICAN HARD RUBBER CO. (BRITAIN), LTD., 13a, Fore Street, London, E.C.2.

Gilbert Ad. 1614

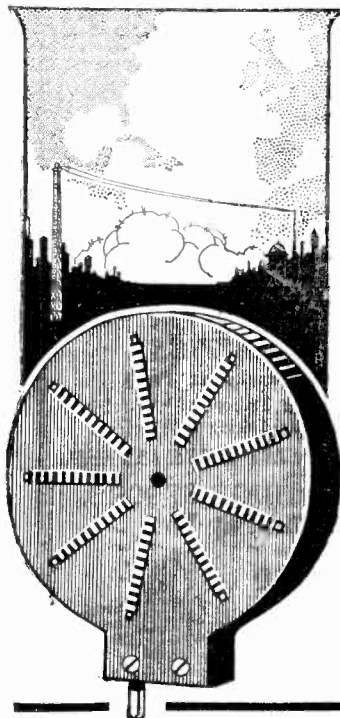

AN APOLOGY.

We tender our sincere apologies to those unfortunate wireless enthusiasts who have been unable to obtain supplies of our "Efficiency" Inductances. The enormous demand which has arisen for these inductances has taxed our manufacturing facilities to the utmost. We have now, however, made arrangements for coping with the rapidly increasing demand and can confidently say that in future no wireless set need be out-of-date through the lack of "Efficiency" Inductances. The term "out-of-date" may sound rather a sweeping statement, but any user of these inductances will tell you that this set is years ahead of those fitted with the old-fashioned type of coil.

FIT "EFFICIENCIES" AND BE UP-TO-DATE.

GAMBRELL BROS., LTD.

76, VICTORIA STREET, LONDON, S.W.1.

Works: MERTON ROAD, SOUTHFIELDS, S.W.18.

Phones: VICTORIA 9938; PUTNEY 3641-2.

West End Agent: J. V. Mulholland, 4, Blenheim St., New Bond St., W.1. Mavfair 2676.

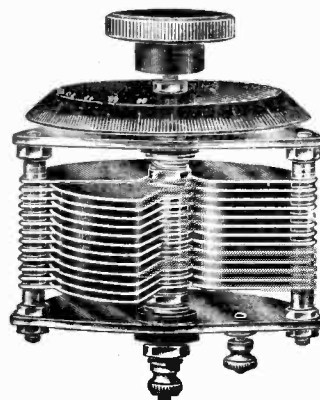

LISTOLEON VARIABLE CONDENSER

The LISTOLEON Variable Condenser is always picked out from its competitors (at whatever price) as being the best in appearance and accuracy.

A Variable Condenser is about the only item in the wireless trade in which appearance is so vitally important. The reason is obvious to the discriminating buyer, because good appearance means accurate and close spacing of the vanes, clean cut stampings and absolutely dead accurate spacing washers.

The LISTOLEON Variable Condenser excels in these features and the nickel-plated finish of all brass parts greatly enhances its good selling points.

An examination of the prices below will show you at a glance that the Listoleon Variable Condenser is beyond competition.

Capacity	.001	..	8/-	With vernier	..	9/6
"	.00075	..	7/-	"	..	8/6
"	.0005	..	6/-	"	..	7/6
"	.0003	..	5/6	"	..	7/-
"	.00025	..	5/-	"	..	6/6
"	.0002	..	5/-			
"	.0001	..	4/8			
"	.00008	..	4/-			

Complete with knob and dial.

RADIOPHONES LTD

SAVOY STREET, STRAND, LONDON, W.C.2

Telephone: Regent 4592.

Telegrams: "Radpholim, Rand, London."

ADVICE TO THE HOME CONSTRUCTOR

WHY BUY EBONITE?

It is expensive and its surface deteriorates under the action of light.

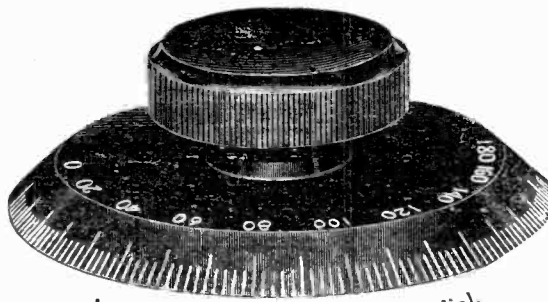

A Moulded TROLITE knob and dial.

DON'T BUY INEFFICIENT SUBSTITUTES FOR EBONITE

They bring untold troubles and are generally of poor appearance.

Ask your dealer for TROLITE

Trolite is backed by a National Physical Laboratory Certificate showing highest insulation resistance and dielectric strength combined with a low-power factor.

TROLITE FOR PANELS AND MOULDED PARTS has the following advantages over EBONITE —

- (1) It is cheaper.
- (2) It does not discolour or lose its surface insulation under the influence of light.
- (3) It can be supplied with a brilliant polish free from surface leakage.
- (4) It is soluble in acetone, and this substance can be used as an adhesive. A joint made with acetone is as strong as the material itself. Trolite components can thus be fixed to a Trolite Panel without screws.
- (5) It can be supplied in various colours and fancy designs.

F. A. HUGHES & CO., LTD.

204-206, Great Portland Street, London, W.1.

ESTABLISHED 1868.

Telephone: Museum 8630-2 (3 lines.)

Telegrams: "Distancing, Wesdo, London."

WHOLESALE ONLY

WHOLESALE ONLY

In replying to advertisers, please use Order Form enclosed.

"UTILITY" VARIABLE SQUARE LAW CONDENSERS

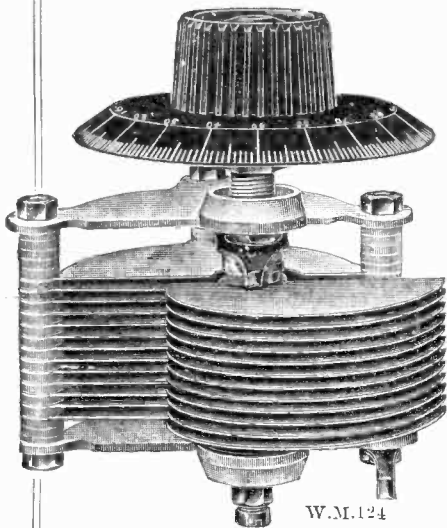

at
same price
as our
ORDINARY

PRICES.

Ref. No	Cap.	Price
WM.123	.001	12/6
WM.144	.00075	11/9
WM.124	.0005	10/6
WM.125	.0003	8/9
WM.145	.0002	7/9

Vernier 2/6 extra.

NO-CAPACITY

The "UTILITY" NO-CAPACITY SWITCH, as used in the constructional articles appearing in this journal. Specially designed by electrical engineers to reduce the electrostatic capacity, this switch has proved to be exceptionally reliable in action and has self-cleaning contacts.

Size	Knob Type	Price
1 Pole Change over.	WM130	13/6
2 "	WM130	24/-
3 "	WM130	35/-
4 "	WM130	46/-
5 "	WM130	57/-
6 "	WM130	68/-

Size	Lever Type	Price
1 Pole Change over.	WM147	14/6
2 "	WM147	25/-
3 "	WM147	36/-
4 "	WM147	47/6
5 "	WM147	510/-
6 "	WM147	610/-

Nickel-plated, sixpence each extra.

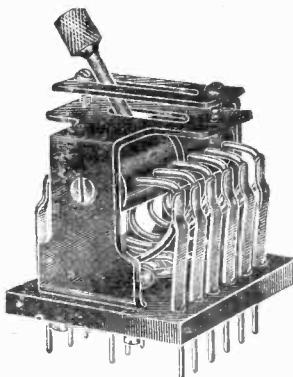

WM. 147.6.

SWITCHES

Manufactured by
WILKINS & WRIGHT LIMITED,
UTILITY Works, Kenyon Street, Birmingham.

WHOLESALE ONLY.

Brandes

WIRELESS DEALERS—Our new 68-page Trade List of Radio Parts now ready, showing Trade and Retail Prices. It is yours for the asking.



Large Stocks of Brandes Phones.
Large Stocks of Igranic Coils.

AUTHORISED FACTORS OF ALL N.A.R.M. SPECIALITIES

Complete Sets, Accessories and Component Parts.
We were one of the very first Wholesale Factors of "Wireless," and our new Catalogue is the very latest thing in Wireless.
THE LARGEST TRADE RADIO LIST EVER ISSUED.

STAGGERING PRICES. HUGE STOCKS.
Get To Know Us—It Will Pay You.

Ask for our "CAPITOL" SPEAKER
(Retail Price £1 : 12 : 6)

Buy from an Established House.
IMPORTANT—Trade only Supplied.

HOBDAY BROS., LTD.

(Dept. D),
21, 23, 25 & 27, Gt. Eastern Street,
LONDON, E.C.2.

'Phone: Clerkenwell 2800 (6 lines).



"Capitol" Speaker

The New 'G.P. RADION The Economical Bright Emitter

THIS Valve has been designed as an all-round receiving valve and is suitable for detection and also for both H.F. and L.F. amplification. While economical from the point of view of current consumption, it compares favourably with most other makes, is free from microphonic noises and has an amplification factor of about 9 to 1.

Anode Voltage	... 30-80 Volts
Filament Voltage	... 3.6-5 Volts.
Normal Filament Current	.48 Amps.
Diameter of Bulb	... 53 m.m.
Overall Length	... 115 m.m.

Standard 4-pin cap.
Orange-tinted bulb.

In case of difficulty send direct.

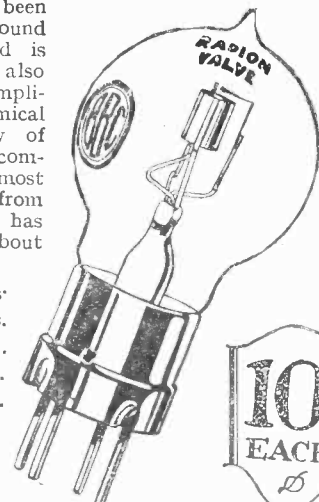

Manufactured only by

RADIONS, LTD.

BOLLINGTON, Nr. Macclesfield.

Telegrams: Radions, Bollington. Telephone: Bollington 71.

"GOLSTONE" (Regd.) WIRELESS RECEIVING SETS British Made.

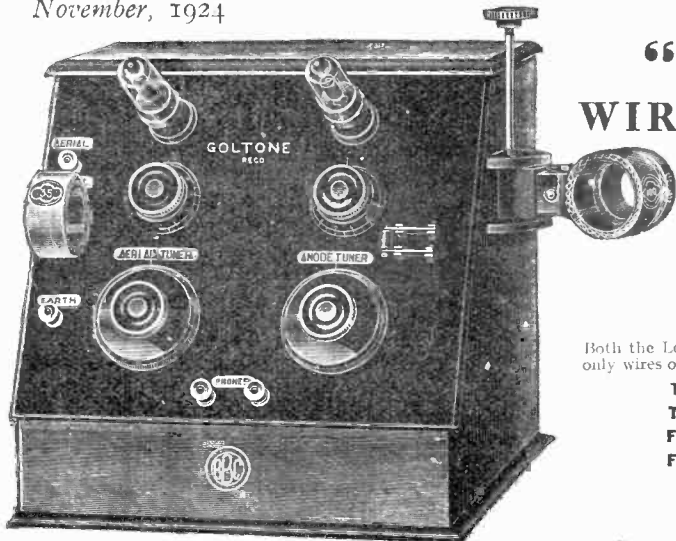

Elegant appearance. Highly selective. Simplicity in Tuning. Designed for receiving on any Wavelength. The Two-Valve Set clearly receives British Broadcasting and Continental Stations, and for Loud-Speaker Reception the Three, Four- and Five-Valve Sets have proved entirely satisfactory in all parts of the Kingdom. Polished Cabinet. Ebonite panel, fitted with Valve Holders, Filament Resistances, Condensers for Tuning Aerial and Anode Circuits, Knife Switch for High and Low Tension Circuits, etc. Provided with Plug-in Coils to receive all the British Broadcasting Stations. Plug-in Coils to receive Paris, Berlin and other high-wave stations are interchangeable and can be supplied.

Both the Low-Tension and High-Tension Batteries can be fitted inside the Cabinet, and the only wires on view are the aerial and earth.

- TWO-VALVE CABINET, £7-10-0.** Marconi Patent Royalties, 25/-
- THREE-VALVE CABINET, £10-10-0.** Marconi Patent Royalties, 37/6
- FOUR-VALVE CABINET, £13-10-0.** Marconi Patent Royalties, 50/-
- FIVE-VALVE CABINET, £18-18-0.** Marconi Patent Royalties, 62/6

See Catalogue for full details, together with particulars and prices of above Sets for "Home Construction."

W. & G. "EASIFIX" RADIO—High and Low Tension Assembly.

CRYSTAL DETECTORS

Improved type dustproof Detectors, mounted on Ebonite Base. Fitted with Glass Dust Shield. Price 1/9 each. Parts only for Panel mounting Price 1/6 each.

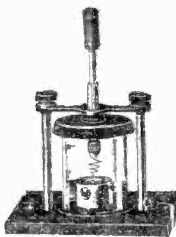

Vertical or horizontal types supplied.



Eliminates all ugly loose wiring and minimises the risk of burning out valves. Each conductor is distinctly coloured and enclosed within an outer braiding. Complete with Wander Plugs. Price 3/- Packed in attractive carton. These lines are stocked by all high class Radio Stores. Write direct if unobtainable.



Large fully illustrated Radio Catalogue, No. R/110, showing a wide range of complete Receiving sets and Radio Components, post free, on request. Enclose Business Card for Trade Terms.

"GOLSTONE" LOW FREQUENCY TRANSFORMER.

Unsurpassed for silence, efficiency and reliability. Provides remarkable amplification with freedom from noise and distortion. Equally suitable with every type of valve. Price 17/6

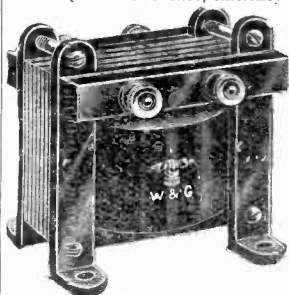

W. H. M., Broughton, Lancs.—I am very pleased with the results from using W. & G. Low Frequency Transformers. I have built many sets with them, and have always found them to be free from distortion though great in volume. They give much better results than any other make I have tried.

The Secret of Success "POWQUIP" OF THE "POWQUIP" TRANSFORMER



EVERY "POWQUIP" TRANSFORMER IS ACTUALLY TESTED ON AERIAL AND IS THE RESULT OF YEARS OF SCIENTIFIC RESEARCH WORK.

The **POWER EQUIPMENT Co., Ltd.**, Kingsbury Works, The Hyde, Hendon, N.W.9.

- LEEDS**—Messrs. Ellison & Hillman, 123, Albion Street.
- LIVERPOOL**—Messrs. "B.N.B." Wireless, 65, Renshaw Street.
- MANCHESTER**—Messrs. Richard Davis & Sons, Bilberry Street.
- BRISTOL**—Messrs. The Sloan Electrical Co., 138, Temple Street.
- BIRMINGHAM**—Messrs. E. A. Wood, Aston Road.
- MALTA**—Messrs. Muscats General Stores, 270, Strada Reale, Valetta.
- AUSTRALIA (New South Wales and Queensland)**—Messrs. Keith Stokes, Montana House, 27-29, King Street, Sydney.



Standard Model.
Price 14/6 each.

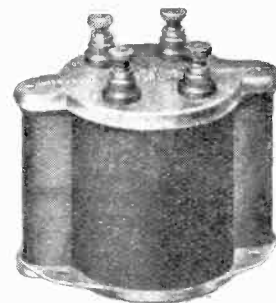

Shrouded Model
Price 18/- each.

In replying to Advertisers, please use Order Form enclosed.



Every step fully explained—

EVEN if a man has never built a Set before—if he has never had the opportunity of examining one closely—if he knows absolutely nothing about Wireless—if he has no friends to advise him—he could still select a suitable design from among those described in "*Wireless Sets for Home Constructors*," and get splendid results from the very beginning.

The complete beginner—if he lived near a Broadcasting station—would probably build one of the Crystal Sets. Even if he wished to start with a Valve Receiver right away, without going through a probationary period

on a Crystal Set, he would find the 2-Valve Broadcast Receiver a wonderfully simple and efficient instrument, costing but little for material. The more advanced experimenter, on the other hand, will appreciate the many exclusive and original features which are incorporated in the 4-Valve Universal Receiver—its sensitiveness and its power.

In any case, we would emphasise that the reader will find every step fully described and explained in the clearest and most interesting manner.



SHOWS HOW TO BUILD:
 Simple Crystal Receivers. A three-valve Regenerative Receiver.
 An inductively coupled Crystal Set. A single-valve Reflex Receiver.
 A two-valve Low Frequency Amplifier. A three-valve Broadcast Receiver.
 A two-valve Broadcast Receiver. A four-valve Universal Receiver.
 Together with information as to the testing and operation of Receiving Sets

Published by Radio Press Ltd., Devereux Court, Strand, W.C.2.
 Post free 2/8.



Wireless Sets for Home Constructors By E. Redpath.

Radio Press Series No 17.

Sole Manufacturers:
PORTABLE UTILITIES
CO., LTD.,
 Fisher St., London, W.C.1.



Scottish Agents:
FULLER, BLACKIE &
RUSSELL, LTD.,
 30, Gordon St., Glasgow.

Dampness—the arch-thief of signal strength.

THE wonderful Eureka Concert Grand was not evolved in a day—nor a week—nor a month—nor, for that matter, in a year. It was the direct outcome of much intensive study of the problem of Low Frequency amplification and the possibility of obtaining "power" results without the necessity of using power valves.

From the first, the radio engineers who designed the Eureka worked on original lines. In fact, apart from the fact that the Eureka has a primary winding and a secondary winding it has little in common with ordinary Transformers. Take its superb insulation, for example. In the Faraday House Test Report (sent free of charge to all interested) it is recorded that the tremendous pressure of 2,000 volts was necessary to break down the insulation between windings and between windings and case.

Concert Grand 30/-

But that is not all. This tremendously high insulation safety factor is permanent. No matter how old your Eureka its insulation will always be perfect because the Transformer is hermetically sealed up after its last test report.

Dampness cannot affect it. Many L.F. Transformers absorb moisture (see Dr. Roberts' article in "Popular Wireless," August 30th) and naturally signal strength is considerably reduced. If your Set is not as loud as it was, say, six months ago it is quite likely that your Transformer is the cause. Discard it and instal a Eureka Concert Grand. You will get greater purity of sound, increased volume, and freedom from trouble. Remember that the Eureka is the only Transformer that can be suspended in water for fourteen days and used immediately without any harmful effects.

Eureka No. 2 22/6

From all Dealers.

Transformer De Luxe



Gilbert Ad. 1589

In replying to Advertisers, please use Order Form enclosed.

THE IDEAL BOOKS FOR THE BEGINNER

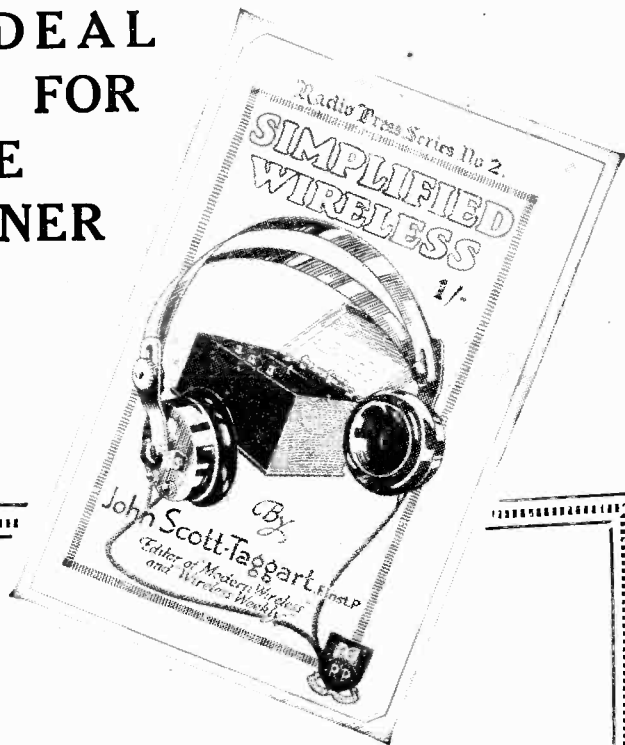
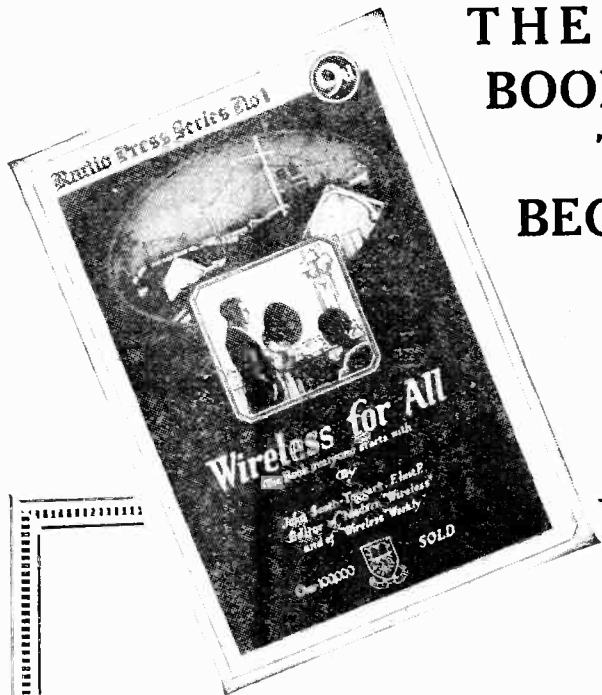

OVER A QUARTER OF A MILLION HAVE BEEN SOLD

of these books which every beginner buys.

"WIRELESS FOR ALL" (9d. net) is No. 1 of the famous Radio Press Series of handbooks. "SIMPLIFIED WIRELESS" (1s. net) is the very popular sequel. Each book, however, is self-contained.

FOR the novice whose knowledge of Wireless is absolutely nil, these are the two books which he will need. Both are from the pen of John Scott-Taggart, F.Inst.P., A.M.I.E.E., a master in the difficult art of explaining technical subjects lucidly and in language everyone can understand. These two books treat the elements of Wireless very thoroughly, and even the more experienced amateur will find them helpful in elucidating any difficult points which may not be absolutely clear to him.

Wireless for All

CONTENTS: Introduction—Morse Code—How to Tell what Station is Working—How Wireless Signals are Actually Sent—Nature of Waves—Light and Wireless Waves Compared—Meaning of Wavelength—How Wireless Waves are Set Up and Detected—How Wireless Stations work at the same time without interfering with each other—Does Weather Affect Wireless—Waves from a Wireless Telephone Station—General Notes on Different Kinds of Waves Received—Some Elementary Instruction in Electricity—How a Wireless Receiver Detects Wireless Waves—The Aerial—The Earth Connection—How a Wireless Set is Tuned to a Certain Wavelength—The Variable Condenser—The Detector—The Crystal Detector—The Complete Wireless Receiving Circuit—Special Tuning Arrangements—The Thermionic Valve—How a Valve Works—How to Start with a Wireless Station—Conclusion—List of Principal Wireless Societies in Great Britain.

9d.

10d. post free.

Published by Radio Press, Ltd., the largest wireless publishers in the world, Bush House, Strand, London, W.C.2.

Simplified Wireless

CONTENTS: Some General Remarks regarding Wireless—Elementary Instruction in Electricity—Sources of Electricity—Effects of a Current of Electricity—Magnetic Effect of an Electric Current—Meaning of Positive and Negative—Electrical Units—How we can vary an Electric Current—Connecting Cells in Series—Connecting Cells in Parallel—Electro Magnetism—The Telephone Receiver—Transformers—Air-core and Iron-core Transformers—Step-up and Step-down Transformers—Inductances—Condensers—Oscillating Circuits—Frequency and Wavelength—The Aerial Circuit of a Wireless Receiver—The Use of a Variable Condenser when Tuning an Aerial Circuit—The Detector Circuit—The Crystal Detector—A Receiver Using a Variable Condenser—Use of a Series Condenser—Loose-coupled Circuits—Notes on the Erection of Aerials—Twin-wire Aerials—The Earth—Frame Aerials—Loud-speakers—How to Make a Simple Broadcast Receiver—Operation of the Receiver—Second Type of Broadcast Receiver—The Variable Inductance—Another Type of Variable Inductance—Some Simple Forms of Crystal Detector—The Telephone Condenser—The Complete Arrangement of the Apparatus—Operation of the Circuit—Use of Lightning Arresters—Some further Safety Hints.

1/-

1/1½ post free.

SQUARE LAW CONDENSERS at the price of Ordinary

Fallon's, in accordance with their usual custom, are giving the public the benefit of the improvements they have effected in their new model Square Law Condensers without increasing the price.

The New Fallon Square Law Condenser, which embodies all the features which have made the Fallon A.11 model world famous, are absolutely the last word in perfect condenser construction.

Extremely handsome appearance, all parts being heavily plated, .008 spacing (the closest possible). In the new model the overall length of the .001 condenser is only 1 1/2 ins. as against 3 1/2 ins. in the old model, and by a new idea in spacing washers, rigidity of construction, never before achieved in any make of condenser, has been obtained.

Features Include:
ONE HOLE FIXING, TAG CONNECTIONS, HEAVY ALUMINUM TOP AND BOTTOM PLATES. Metal to metal adjustable bearings, stout, well-cut aluminium vanes. Complete as illustration.

Reputation. A condenser with the name Fallon imprinted indicates the finest obtainable.

Plates	Price
.001	8/-
.0005	6/-
.0003	5 6
.00025	5/-
.0002	4 6
Vernier .. 5 ..	4/-
Vernier .. 3 ..	3 6

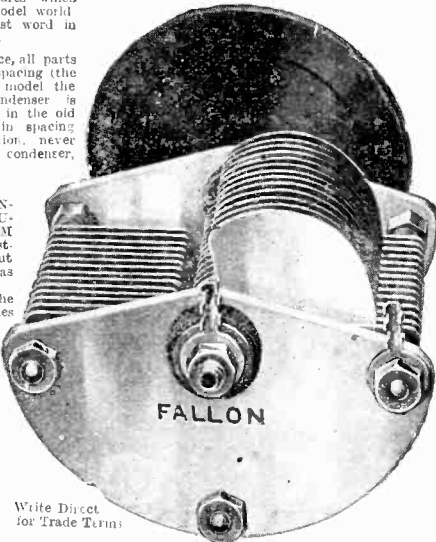

Write Direct for Trade Terms

FALLON CONDENSER CO., LTD.,
The Condenser People. Tottenham 1932:
WHITE RIBBON WORKS, BROAD LANE, TOTTENHAM, N.15.

All Correspondence and Post Orders to above address
City Depot: 143, Farringdon Road, E.C.1. Manchester Depot: 3, King Street West, Deansgate. Glasgow Depot: 120, Wellington St. Barclays Ad. 157.



YOU CAN earn more money

Don't allow hesitation or doubt to keep you back from the bigger pay and the better things that will be yours when you have qualified for them. You CAN—you WILL—earn more money when you know more about your calling.

All the world now agrees that a specialised vocational training is necessary to success. The question for the ambitious man who is desirous of something much better in life than he now enjoys is, How can I obtain the training that will raise me above the crowd? Here's the answer: From the International Correspondence Schools.

This institution originated spare time training by post. It is by far the largest organisation of its kind in the world. It has teaching centres in eleven countries and students in fifty, 1,000 British I.C.S. Instruction Papers—specially prepared for correspondence tuition—are marvels of clearness, accuracy and practical helpfulness.

Make up your mind now that you will find out at once what I.C.S. salary-raising training can do for you. As a first step—

USE THIS COUPON.

INTERNATIONAL CORRESPONDENCE SCHOOLS, LTD.,
94, International Building, Kingsway, London, W.C.2.

Please send me your booklet containing full particulars of the Course of Correspondence Training before which I have marked X. I assume no obligation.

<input type="checkbox"/> Accountancy	<input type="checkbox"/> Commercial Art	<input type="checkbox"/> Shorthand Typewriting
<input type="checkbox"/> Advertising	<input type="checkbox"/> Draughtsmanship	<input type="checkbox"/> Showcard Writing
<input type="checkbox"/> Architecture	<input type="checkbox"/> French and Spanish	<input type="checkbox"/> Textiles
<input type="checkbox"/> Book-keeping	<input type="checkbox"/> Plumbing	<input type="checkbox"/> Wireless Telegraphy
<input type="checkbox"/> Building	<input type="checkbox"/> Salesmanship	<input type="checkbox"/> Woodworking

Engineering, all Branches; state which.....

Professional Exams.; state which.....

The I.C.S. teach wherever the post reaches, and have over 300 Courses of Study. If, therefore, your subject is not in the above list write it here.

Name..... Age.....

Address.....

THE "Royal" LOW-FREQUENCY SUPER TRANSFORMER THE WONDER JOB

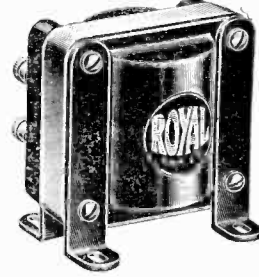

PRICE £1 0 0

1. The self capacity of the secondary winding of the "ROYAL" is 6 micro-micro farads—far and away lower than that of any other Transformer in general use.
2. It is tested to 1,000 volts between windings.
3. The inductive values of both windings are absolutely correct.
4. Hysteresis, leakage losses and capacity are practically nil.
5. It is completely METAL shrouded, thus eliminating any interaction between transformers.
6. Windings completely impregnated—terminal blocks of Cetec, the best dielectric known.
7. Complete absence of resonance peaks—which means that the lower harmonics are rendered in equal truth with the high notes.

DO YOU KNOW ANY TRANSFORMER THAT EQUALS THE ABOVE SPECIFICATION?

AN OFFER.—We shall be pleased for readers of this journal to compare the performance of the "ROYAL" as against any other Transformers which they may have installed in their sets. We are willing to dispatch to you one or two "ROYAL" Transformers on the understanding that if they are returned intact to us within Seven Days, post paid, WE WILL IMMEDIATELY REFUND THE PURCHASE COST. THIS WILL CONVINCe YOU.

SOMETHING NEW. SOMETHING BETTER. TYPE D10 TRIPLE RANGE CONDENSER WITH VERNIER CONTROL

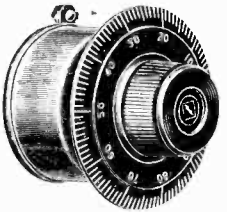

1. Is absolutely immune from stray capacity effect—Your hand will not affect the tuning however fine.
2. Will tune from nil to .001 mf. capacity.
3. By a simple change in the terminal connections either .001, .0005 or .00025 capacities may be used at will, with Vernier control on all capacities.
4. Brings in stations quite unobtainable with Multiple Type Condensers.

Overall Size—
2 1/2 in. by 2 1/4 in. by 2 1/2 in.
PRICE £1 7 6

THE EFFECTIVE RESISTANCE OF THE TYPE D10 IS NIL AND THE WAVE-LENGTH GRAPH IS PRACTICALLY A STRAIGHT LINE.

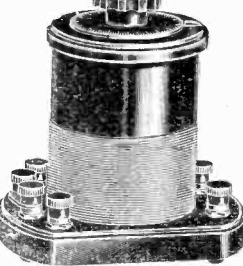

TYPE D5 WAVE FILTER AND WAVE METER UNIT.

A simple and compact unit accessory that will improve the selective power (the ability to cut out interference) of any receiver.

The unit may also be used for a number of other practical and experimental purposes, including the measurement of wave frequencies (wave-lengths) of received signals.

Type D5 Wave Trap or Filter £1 12 6
Type D5 Wave Meter £2 5 0 (Calibrated).

BATTERY SWITCHES.

(Standardised by many leading Manufacturers)
FOR CONVENIENT FILAMENT CONTROL
Single Gang Black 2/0 Double Gang Black 4/6
" " Nickel 2/6 " " Nickel 4/3
Complete in carton with screws.
Write for Complete Illustrated Catalogue.

R. A. ROTHERMEL, Ltd.
Manufacturers' Suppliers of all kinds of Radio and Electrical Instruments
24-6, MADDOX ST., REGENT ST. LONDON, W.1
Phones: MAYFAIR—578, 579. Telegrams—ROTHERMEL, Wesdo, London.

In replying to Advertisers, please use Order Form enclosed.

THREE POPULAR BOOKS

The CONSTRUCTION of CRYSTAL RECEIVERS

By ALAN L. M. DOUGLAS.

This book deals exclusively with crystal receivers for the reception of signals from the ordinary B.B.C. stations and also the high-powered station.

Price 1/6 net (post free 1/8).



HOW TO ERECT YOUR WIRELESS AERIAL

By B. MITTELL, A.M.I.E.E.

To every newcomer and many "old hands" this book will make all the difference between poor and first-rate reception.

Mr. Mittell is a professional radio engineer, and he has had many years' experience of aerial erecting and knows just those points where beginners go wrong. Incidentally, he took a prominent part in the erection of the huge aerials at Northolt and elsewhere. This is a useful volume which should be found on every wireless bookshelf.

Price 1/- net (post free 1/2).

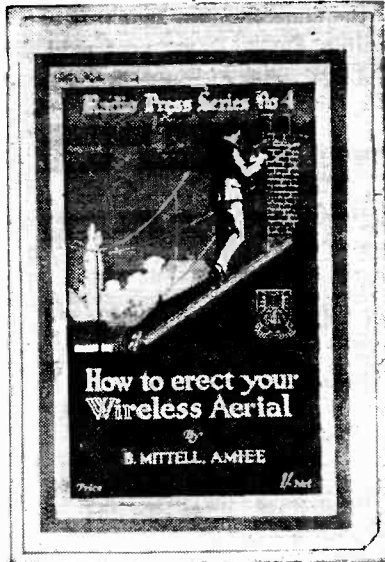

HOW to MAKE your OWN BROADCAST RECEIVER

By JOHN SCOTT-TAGGART, F.Inst.P., A.M.I.E.E.

This book is by the Editor of *Wireless Weekly* and of *Modern Wireless*, and tens of thousands have made their first crystal set from this book, which is a sequel to "Wireless For All" and "Simplified Wireless."

This book contains much valuable data on aerials and how to erect them, and the purchaser can go straight home, make one of the three very simple and cheap sets, erect his aerial, and enjoy the programme from his local station or from the high-powered station.

Price 1/6 net (post free 1/8).

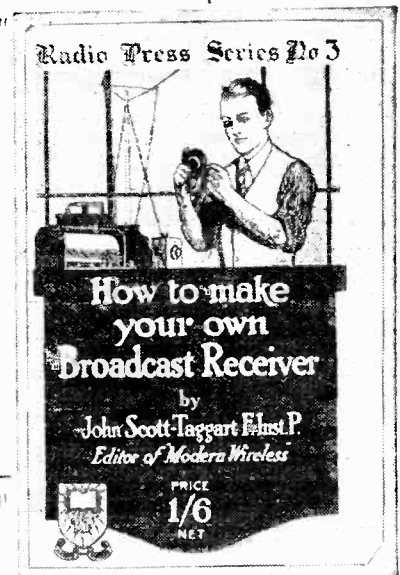

Published by RADIO PRESS, LTD.,
 Bush House,
 Strand, London, W.C. 2.

Barclay 14. 1175

In replying to Advertisers, please use Order Form enclosed.

NEW ACCESSORIES FROM GAMAGES

It offers like these that make Gamages so essentially the Store for the Wireless enthusiast. New, improved apparatus—for the most part EXCLUSIVE TO GAMAGES—all certain to improve results or make things easier for you.

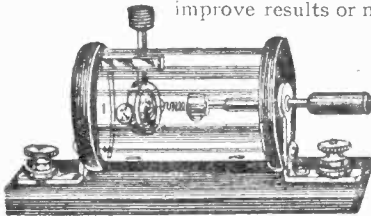

SUPER CRYSTAL DETECTOR
The striking points about this new detector (first of its kind) are the *rotating crystal*, the Silver Cat's Whisker, all brass parts lacquered. New Crystal easily fitted. Complete with Gamages Famous "Permanite Crystal." Price for Table 5/6
Price for Panel Mounting, 4/6
Post 4d. on each type.

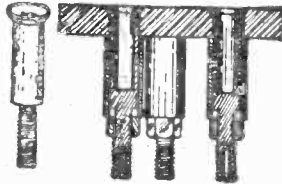

VALVE HOLDERS
Latest type for Flush Mounting. Reduced height makes for compactness, reduced capacity and reduced solid dielectric for efficiency. Flush for protection of velvet. Easy to mount. Brass finish. Price Post per set of 4 ... free.

"MULTIPHONE" CONNECTORS

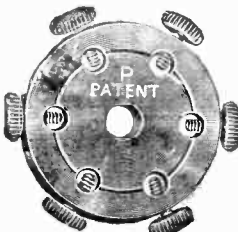
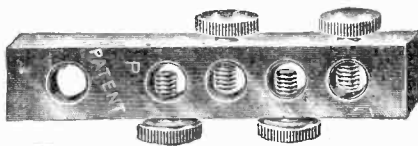

THE "MULTIPHONE" CONNECTORS
For using several pairs of headphones on your set: 4-way round type, as illustrated on left, and 4-way long type as above. Each Post 2d.

"MULTIPHONE" CONNECTORS 6-way round type as above. Post 2d.

THE "GAMAGE" CRYSTAL SET

COMPLETE WITH ALL LATEST Improvements

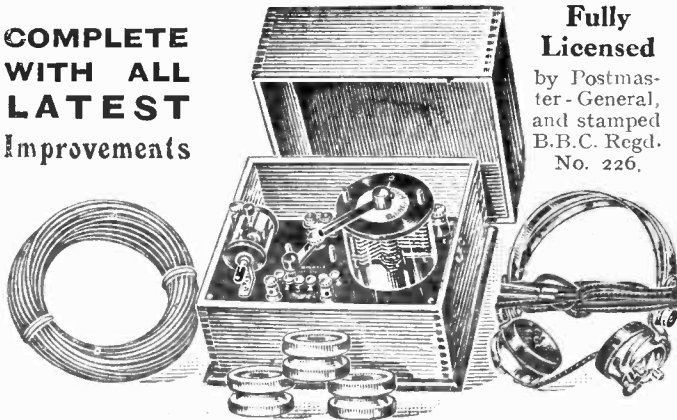

Fully Licensed by Postmaster-General, and stamped B.B.C. Regd. No. 226.

This Broadcast Crystal Receiving Set is undoubtedly the neatest and most efficient of its kind obtainable. The construction throughout is perfect, and every detail has been carefully considered to obtain the best results. The detector fitted is our NEW Super Type with REVOLVING CRYSTAL and Silver Cat's Whisker. Provision is made for adding loading coil to receive the new Chelmsford Station. All Brass Parts are lacquered and all components are the best. Price of Cabinet only, with lid £2:2:6
Ditto, complete with 1 pair of Brown's Sterling, Siemens or Geophone 'phones, Aerial Wire, Insulators and Earth Wire. Post free £3:16:6
Loading Coil for Chelmsford, 6/- extra.

GAMAGES, HOLBORN, LONDON, E.C.1.
Also at **BENEFINKS, CHEAPSIDE, E.C.2.**

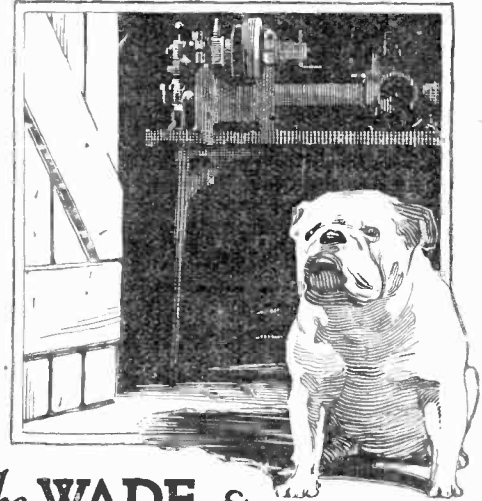

The WADE & the Watchdog

POPULARITY once achieved often becomes a millstone. To be rude to one's enemies is a joy of life, but the tactful avoidance of one's friends is an awkward measure.

An Englishman's home is his castle, but there are times when, satisfied with the friendship of good tools, he wishes it were surrounded by a moat.

Unwanted popularity is often the penalty of a Wade owner. When you get your Wade, keep a watchdog outside your workshop door.

Below is illustrated the Wade No. 2 Lathe. It is back-g geared, self-acting, and screw-cutting. It has 13 change wheels which cut all threads, right or left hand, from 6 to 60 T.P.I., including metric pitches. It takes work up to 4 in. in diameter and 12 in. in length, and is ideal for making wireless parts.

Write to Dept. E.

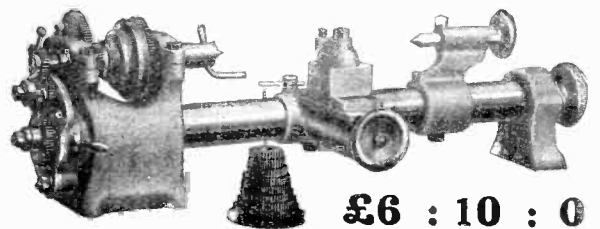

£6 : 10 : 0

C.A.V. Small Tools, Ltd., 181, Queen Victoria St., London, E.C.4.
E.P.S. 7

In replying to advertisers, please use Order Form enclosed

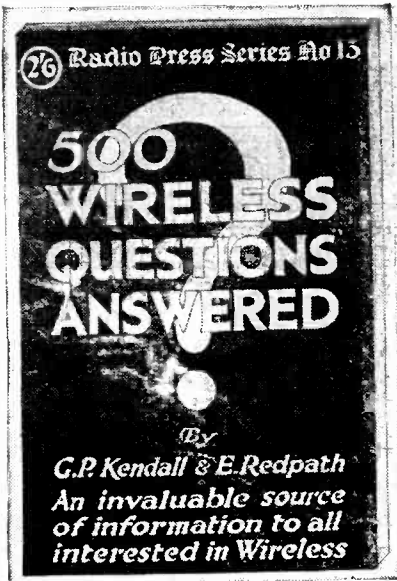

BUY THIS BOOK
AND
Your
Wireless Worries
will Disappear

THIS volume, "500 WIRELESS QUESTIONS ANSWERED" (2/6 net), is a veritable mine of information. Encyclopaedic in its scope, it is written so that the veriest novice can understand.

Every section of wireless is dealt with in a highly competent manner by G. P. Kendall, B.Sc., and E. Redpath, the joint authors, both of whom, by long experience, understand just those difficulties which worry the average experimenter.

There are 500 answers to typical questions on the following subjects :

- | | |
|-----------------------------------|--------------------------------|
| Aerials. | Reaction. |
| Amplifiers. | Secondary batteries. |
| Crystals and crystal sets. | Sounds and signals. |
| Earths. | Telephone receivers. |
| Frame Aerials. | Tuning coils. |
| Gridleaks and condensers. | Tuning condensers. |
| Interference. | Valves. |
| Loud-Speakers. | Wave-lengths. |
| Morse. | Waves. |
| Primary Batteries. | Wire. |
| Ranges. | Miscellaneous-problems. |

Buy a copy to-day from your wireless dealer or bookseller, or send 2/8 to the publishers and get the book by return post.

Published by RADIO PRESS, LTD.,
Bush House, Strand, W.C.2.

Darclay's Ad. 1174

2/6

Silvertown

WIRELESS ACCESSORIES

Quality guaranteed by over 50 years' electrical manufacturing experience

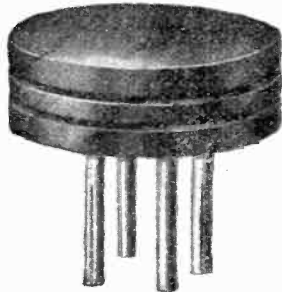

EBONITE TRANSFORMER FORMERS.
No. 3. Complete with metal legs, 1/3 each. Made in other sizes.

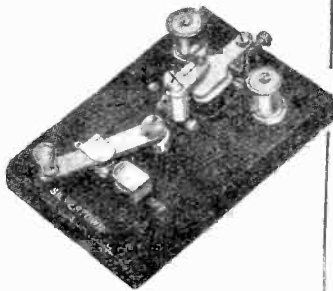

TESTING BUZZERS.
Complete with Switch. Mounted on ebonite base with terminals and shunt or mounted with terminals, shunt and switch. 7/- and 8/- each. Supplied unmounted 3/6 each.

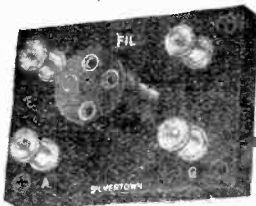

Single Valve Type.
MOUNTED VALVE SOCKETS
Single, double and triple. Suitably engraved for use with valves or for plug-in type high-frequency transformers, 5/6, 9/- and 13/6 each.

106, CANNON ST., LONDON, E.C.4.

BELFAST: 75, Ann Street.
BIRMINGHAM: 15, Martineau Street.
BRISTOL: 4, Victoria Street.
CARDIFF: Pier Head Chambers, Bute Docks.
DUBLIN: 15, St. Andrew Street.
GLASGOW: 15, Royal Exchange Square.
LEEDS: 1, New York Road.

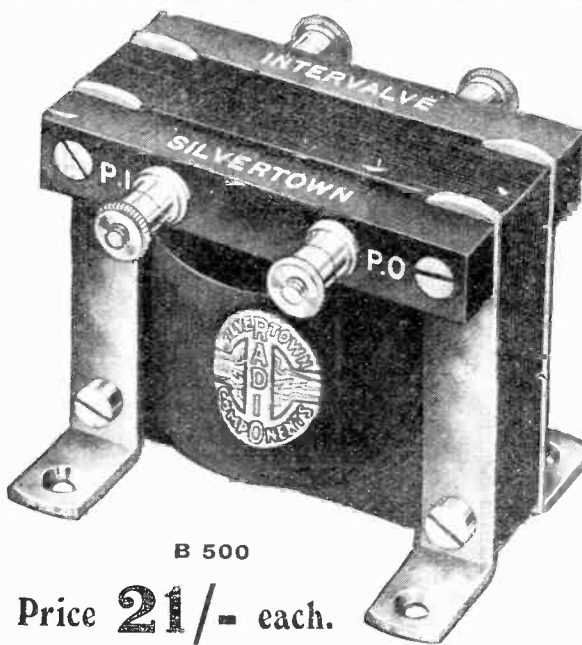

B 500

Price **21/-** each.

Guaranteed for 12 months.

This transformer has been adopted by leading manufacturers of Wireless Receiving Sets and discriminating amateurs in all parts of the world.

High amplification without distortion and complete freedom from internal noises. Correct design, high-class finish. Excellent results have been obtained on tests carried out by the National Physical Laboratory. Copy of the curve can be had on application.

Makers—

THE SILVERTOWN COMPANY,



Works: **Silvertown, London, E.16.**

LIVERPOOL: 54, Castle Street.
LONDON: 100 and 102, Cannon Street.
MANCHESTER: 16, John Dalton Street.
NEWCASTLE-ON-TYNE: 59, Westgate Road.
PORTSMOUTH: 49, High Street.
SHEFFIELD: 88-90, Queen Street.

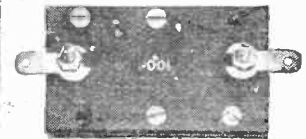

FIXED MICA CONDENSERS
Built up with copper foil and best ruby mica dielectric. High insulation and capacity adjusted to within 5 per cent. Stocked in capacities from 0.0001 to 0.01 mfd. 2/- to 3/6 each.



FILAMENT RHEOSTATS.
With finished and lacquered brass bush for panel mounting. Resistance wire wound on insulating rod, thereby giving perfectly smooth adjustment. 2 or 5 ohms resistance 3/- each. 30 ohms resistance 3/6 each.

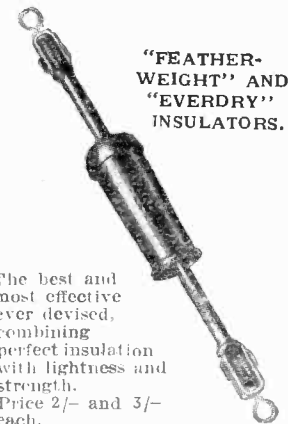

"FEATHER-WEIGHT" AND "EVERDRY" INSULATORS.

The best and most effective ever devised, combining perfect insulation with lightness and strength. Price 2/- and 3/- each.

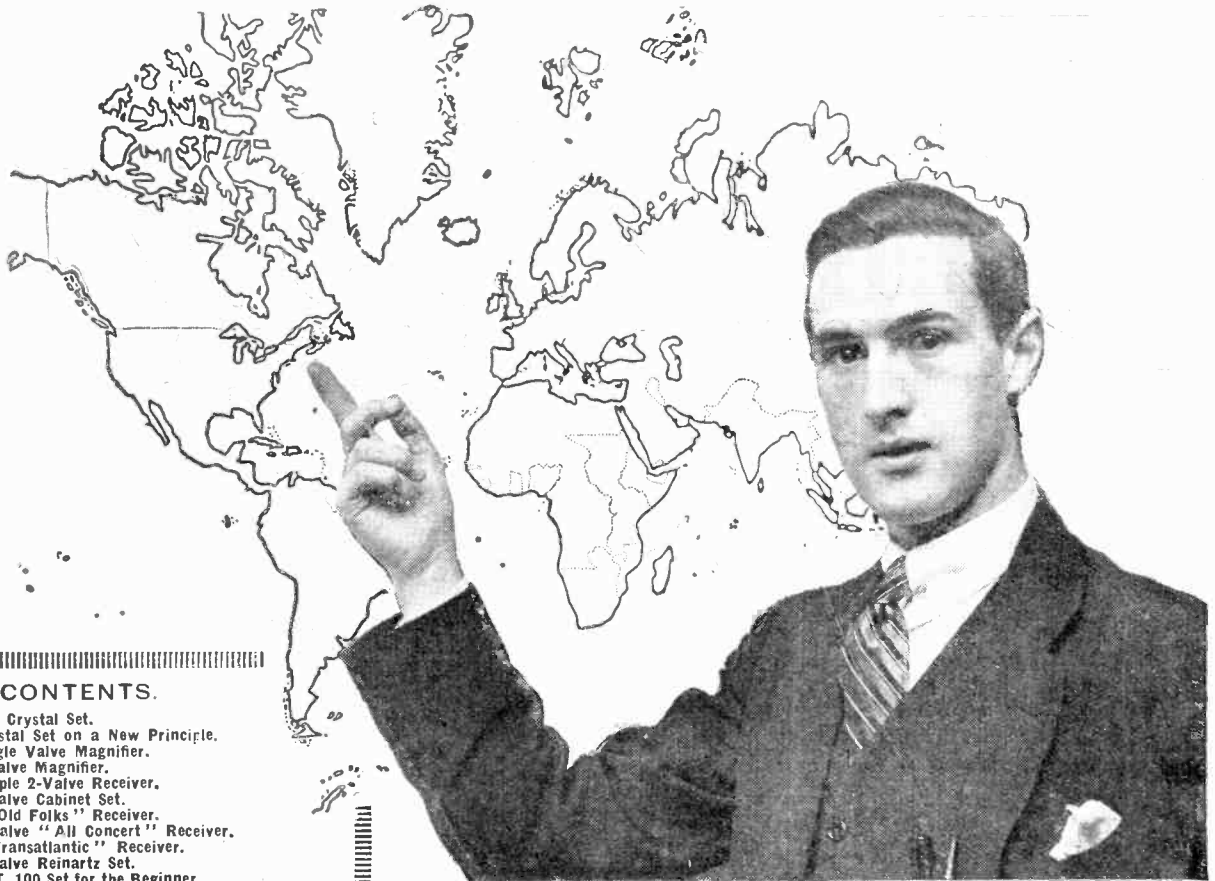

CONTENTS.

- 1 A 2/6 Crystal Set.
- 2 A Crystal Set on a New Principle.
- 3 A Single Valve Magnifier.
- 4 Z 2-Valve Magnifier.
- 5 A Simple 2-Valve Receiver.
- 6 A 2-Valve Cabinet Set.
- 7 An "Old Folks" Receiver.
- 8 A 3-Valve "All Concert" Receiver.
- 9 A "Transatlantic" Receiver.
- 10 A 3-Valve Reinartz Set.
- 11 An S.T. 100 Set for the Beginner.
- 12 Wave Traps in Various Forms.

"I get these stations regularly"

So will you if you buy a copy of

TWELVE TESTED WIRELESS SETS

By **PERCY W. HARRIS**

2/6 net.
Post Free,
2/8



And make one of the fine multi-valve sets such as the "Transatlantic." This is the season for receiving broadcasting from American and Continental stations, and there is no more fascinating or instructive pastime than searching for those elusive stations.

They will, however, not be elusive if you build a set produced by such an experienced designer as Mr. Harris.

Look at the varied contents and you will realise what a bargain such a cheap but reliable book is. Every set is not merely tested by the author but by hundreds, and sometimes thousands, of readers who have bought this book.

Buy it to-day from your wireless dealer or bookseller (2s. 6d. net) or send 2s. 8d. to the publishers:

RADIO PRESS, LTD., Bush House, Strand,
London, W.C.2.

INSULITE

UNBREAKABLE
RADIO PANELS
MATT SURFACE, WHITE OR BLACK,
COST LESS
than any other standard panel.
INSULITE has astounding mechanical strength, yet it is easily cut into perfect radio panels. Resists heat, cold, water, oil, steam, solvents and all weather elements. Highest in dielectric strength. Send 3d. and name and address of your nearest agent for price list and free sample to test.

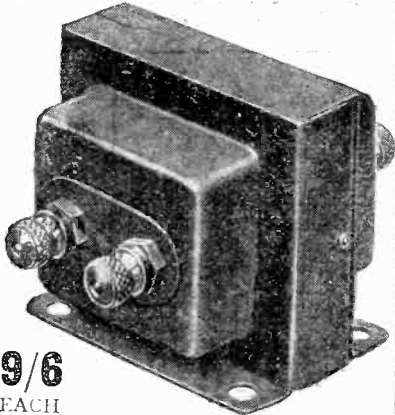

9/6
EACH

CROIX LF TRANSFORMERS

3-1, 4-1, or 5-1. 9/6 each.
50,000 French listeners use them. Don't judge it by the price. TEST IT. CASH REFUNDED IF NOT ENTIRELY SATISFACTORY. Finest value in the world. Super Model, 11/6. Good terms to the Trade.

No Aerial. No Earth Required.
THE ROLLS PORTABLE

A complete 2-valve Receiver in real Hide Attache Case, 14 1/2 in. x 11 in. x 5 in. Weight complete, with everything, only 15 lbs.

Price £14 14s. retail.

THINK. This includes: 2 B.T.H. B5 Valves, 1 pr. Phones, 11.T. and L.T. Batteries and Marconi Royalty. Demonstrations anywhere at any time. **IT'S IT.** Send for Folder.

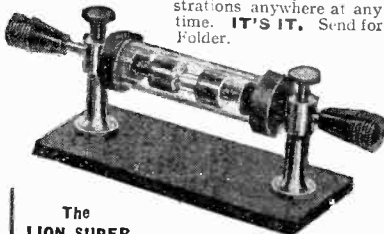

The **LION SUPER PERIKON DETECTOR**

3/- Post Free.

Unique micrometer spring adjustment. A new combination employing neither Zincite, Bormite, nor Copper Pyrite. Specially designed to stand the high voltage in Reiflex Sets.

ONE THOUSAND AGENTS WANTED

Good Terms. Send for our Bargain List: you need it. (We Supply Everything.)

H. LLOYD MARSHALL & CO.
8, Westmoreland Bdgs., E.C. 1.

Special Activation Process
OLDHAM ACCUMULATORS

London Depot:
61, Chapel St., Oxford St., W.1

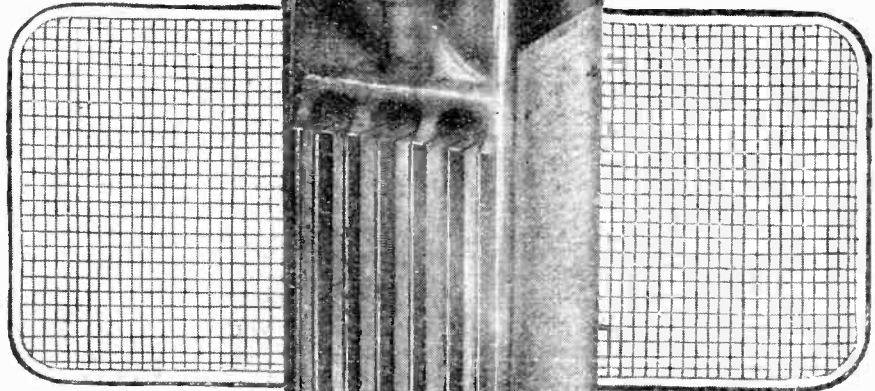

Dealers: Write for full details of the Oldham proposition—you are missing a valuable amount of business if you are not stocking Oldham accumulators.

Hold this new Portable Oldham upside down and the acid cannot spill

At last here is a non-spillable accumulator that can be carried in the pocket without fear of the acid falling out and spoiling the clothes. Just the accumulator for Dull Emitter Valves. Of small size and light weight it is easily the most economical method of lighting Wecos, Wuncells, 1-volt Oras, and two of them in series are absolutely ideal for the '06 amp. type of Valve.

Built from seamless celluloid of the highest grade with substantial terminal knobs, it is a typical Oldham product. Actually it is very similar to the accumulator used in the Oldham Miner's Electric Lamp—the most popular lamp in the country.

and a greater ability to hold the charge when the accumulator is not in use. Remember that it costs only a few pence to charge it—that the charging can be done in a few hours—and that its absolutely constant output is preferable to any type of dry battery. Bearing these points in mind you will realise that the new Oldham Non-spill Accumulator is just the one for your Dull Emitter Valves.

For Dull Emitters

2 volts
10 amp. hrs.
(actual)

12/-

Its plates are manufactured under the same special activation process, which has the property of ensuring a longer life

Oldham & Son Ltd.—Denton, Manchester

Gilbert Ad. 1610.

THE RADIO PRESS ENVELOPE SYSTEM

THE Radio Press Envelope System is generally acknowledged to be the greatest aid to the constructor yet evolved. Each envelope contains working diagrams, exact size blue prints of wiring and of the panel (suitable for drilling), a set of photographs printed on real art paper and in a manner impossible in a book or periodical and showing the set and wiring from every possible angle, a list of components and the full instructions for making each set and using it.

These envelopes are obtainable from all principal wireless dealers and booksellers or direct from the publishers:

RADIO PRESS, LTD., Bush House, Strand, London, W.C.2.

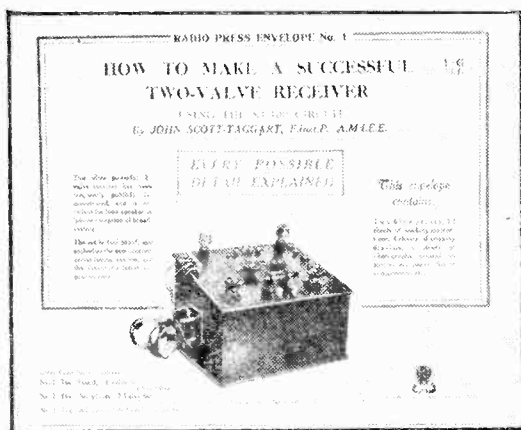

R.P. Envelope No. 1. Price 1s. 6d. (1s. 8d. post free). How to Make an Efficient 2-valve Receiver using the ST. 100 Circuit, By John Scott-Taggart, F.Inst.P., A.M.I.E.E.

A huge number of this ST. 100 envelope has been sold and practically all the tens of thousands of successful ST. 100 sets in the country have been made from this design, which works a loud-speaker with ease up to 30 to 35 miles.

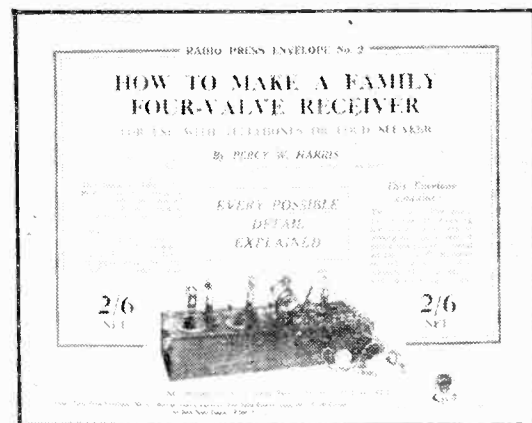

R.P. Envelope No. 2. Price 2s. 6d. (2s. 8d. post free). How to Make a Family 4-Valve Receiver. By Percy W. Harris.

This is the ideal easily-handled set for long range loud-speaker work. For those some distance from a station this set is ideal.

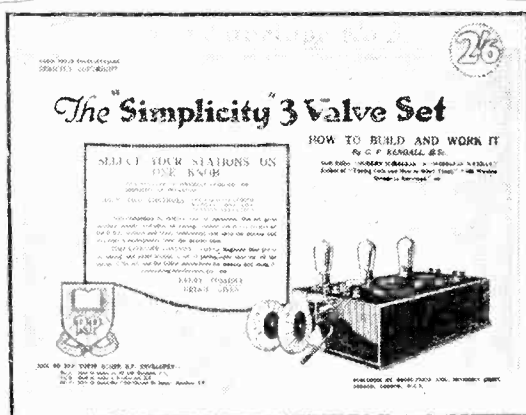

R.P. Envelope No. 3. Price 2s. 6d. (2s. 8d. post free). The "Simplicity" 3-Valve Set. By G. P. Kendall, B.Sc.

Notwithstanding extreme ease of operation this set gives excellent results and will receive all the B.B.C. stations and many Continental ones upon the 'phones and will work a loud-speaker from the nearest ones.



R.P. Envelope No. 4. Price 2s. 6d. (2s. 8d. post free). The "All-Concert de Luxe" Receiver. By Percy W. Harris.

A supremely efficient 3-Valve set with enclosed valves and all the latest technical improvements incorporated.



3 SOUND MEDIA

When compiling your Advertising campaign, do not overlook the claims of the three predominant media in radio: viz., MODERN WIRELESS, WIRELESS WEEKLY and The WIRELESS CONSTRUCTOR. You cannot afford to ignore the responsive public that eagerly and consistently studies the pages of these journals and which constitutes an excellent established market for your goods.

MODERN WIRELESS, WIRELESS WEEKLY and The WIRELESS CONSTRUCTOR readers embrace the huge section ranging from the youthful broadcast receiver experimenter, and the amateur inventor to the highest expert in Wireless, and the greatest confidence is reposed in the practical hints, diagrams and constructional notes repeatedly appearing in the columns of these journals written by men whose names are "household" words in the world of radio. Such a specialised and interested community cannot fail to elicit the maximum response to your appeal.

Write now for advertisement rates and details of forthcoming issues to the Advertisement Managers:—

BARCLAYS ADVERTISING, Ltd.

Advertising Agents, Consultants & Contractors,
BUSH HOUSE, STRAND, LONDON, W.C.2.

Telephone. City 9911 (Extn. 9)

*The Media in
Wireless Journalism*

which, in themselves, constitute an efficient Advertising Campaign for Selling Sets, Components or Accessories.

In replying to Advertisers, please use Order Form enclosed.

Barclays Advt., 1130

BOOK ORDER FORM

Cut out this form and hand it to your newsagent or wireless dealer, or post it to RADIO PRESS, LIMITED Bush House, Strand, London, W.C.2, who will despatch by return post.

PLEASE DO NOT LIMIT YOUR ORDER TO ONE BOOK IF YOU THINK YOU WILL REQUIRE OTHERS.

Please supply a copy of each of the publications against which a tick has been made.

Name.	Author.	Radio Press Series No.	Price.	PRICE PLUS POSTAGE
" WIRELESS FOR ALL."	John Scott Taggart, F.Inst.P., A.M.I.E.E.	1	9d.	11d.
" SIMPLIFIED WIRELESS."	John Scott Taggart, F.Inst.P., A.M.I.E.E.	2	1/-	1/2
" HOW TO MAKE YOUR OWN BROADCAST RECEIVER."	John Scott Taggart, F.Inst.P., A.M.I.E.E.	3	1/6	1/8
" HOW TO ERECT YOUR WIRELESS AERIAL."	B. Mittell, A.M.I.E.E.	4	1/-	1/2
" THE CONSTRUCTION OF WIRELESS RECEIVING APPARATUS."	P. D. Tyers.	5	1/6	1/8
" CONSTRUCTION OF CRYSTAL RECEIVERS."	Alan L. M. Douglas.	6	1/6	1/8
" HOW TO MAKE A ' UNIT ' WIRELESS RECEIVER."	E. Redpath.	7	2/6	2/8
" PICTORIAL WIRELESS CIRCUITS."	Oswald J. Rankin	8	1/6	1/8
" WIRELESS VALVES SIMPLY EXPLAINED."	John Scott Taggart, F.Inst.P., A.M.I.E.E.	9	2/6	2/8
" PRACTICAL WIRELESS VALVE CIRCUITS."	John Scott Taggart, F.Inst.P., A.M.I.E.E.	10	2/6	2/8
" RADIO VALVES AND HOW TO USE THEM."	John Scott Taggart, F.Inst.P., A.M.I.E.E.	12	2/6	2/8
" 500 WIRELESS QUESTIONS ANSWERED."	G. P. Kendall & E. Redpath	13	2/6	2/8
" 12 TESTED WIRELESS SETS."	Percy W. Harris.	14	2/6	2/8
" MORE PRACTICAL VALVE CIRCUITS."	John Scott Taggart, F.Inst.P., A.M.I.E.E.	15	3/6	3/8
" HOME BUILT WIRELESS COMPONENTS."		16	2/6	2/8
" WIRELESS SETS FOR HOME CONSTRUCTORS."	E. Redpath.	17	2/6	2/8
" TUNING COILS AND HOW TO WIND THEM."	G. P. Kendall.	18	1/6	1/8
RADIO PRESS PANEL CARDS.				
Name.	Author.	Panel Card No.	Price plus Postage.	
" HOW TO MAKE THE W.I RECEIVER."	Herbert K. Simpson	1	1/-	1/2
RADIO PRESS ENVELOPES.				
Name.	Author.	Envelope No.	Price plus Postage.	
" HOW TO BUILD AN ST.100 RECEIVER."	John Scott Taggart, F.Inst.P., A.M.I.E.E.	1	1/6	1/9
" HOW TO BUILD A 4-VALVE RECEIVER."	Percy W. Harris.	2	2/6	2/9
✓ " HOW TO BUILD THE ' SIMPLICITY ' 3-VALVE SET."	G. P. Kendall, B.Sc.	3	2/6	2/9
" HOW TO BUILD THE ALL CONCERT DE LUXE RECEIVER."	Percy W. Harris.	4	2/6	2/9
" A SINGLE VALVE REFLEX RECEIVER."	Herbert K. Simpson.	8	1/6	1/9
" AN EFFICIENT SINGLE VALVE RECEIVER."	Herbert K. Simpson.	9	1/6	1/9
SIMPLEX WIRING CHARTS.				
Name.	Author.	Simplex Chart No.	Price plus Postage.	
" FOR 2-VALVE SET."	1	1/-	1/3
" FOR 3-VALVE SET."	2	1/-	1/3
" FOR 4-VALVE SET."	3	1/-	1/3
RADIO PRESS WIRELESS PANEL TRANSFERS				
..	6d.	9d.

CUT HERE

I enclose remittance for (necessary where goods are ordered by post).

NAME

ADDRESS

A real Square Law Condenser at a moderate price

ALTHOUGH every experimenter realises the tremendous advantages of square law Condensers many who would otherwise use them are deterred by the necessarily higher price. The new Peto-Scott square Law Condenser shown here is an attempt to place on the market a really good instrument possessing most of the advantages of higher priced condensers at a figure within the reach of all.

It is substantially made with fine spacing washers and solid ebonite end pieces—both ends of which are brass bushed to prevent

wear. It is affixed to the panel with one hole only—a great convenience to the home constructor.

A special feature is its two-piece dial which is absolutely self-centring. Any dial that must be set on its shaft with some form of set screw cannot be true and develops an unsightly wobble.

Remember that such authorities as Mr. Percy W. Harris and others emphatically state that every Variable Condenser ought to be of the square law type.



Send for our large Illustrated Catalogue.

Forty-eight pages fully illustrated—every possible component described. Should be in the hands of every experimenter for reference purposes. Sent post free together with other literature on receipt of 3d. in stamps.

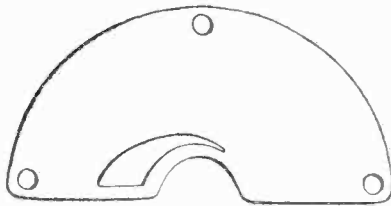

PRICES :

.0001 mfd.	7/-
.0002 mfd.	8/6
.0003 mfd.	10/-
.0005 mfd.	10/6
.001 mfd.	11/6
Dual Condenser for two stages of H.F. Each half		
.0003 mfd.	15/6

Note the novel design of the special Peto-Scott Square Law Plate (registered design No. 707587). Actual tests have proved that the Peto-Scott Square Law Condenser gives absolute straight line reading over the whole of the Dial.

PETO-SCOTT Co. Ltd.

Registered Offices : 77, CITY ROAD, E.C. (For all Mail Orders.)

Branches—
 LONDON - 62, High Holborn, W.C.1,
 and 230, Wood Street, Walthamstow.
 CARD FF - 94, Queen Street.
 LIVERPOOL - 4, Manchester Street.
 PLYMOUTH - Near Derry's Clock,
 Gilbert Ad. 1583

The SUPER Transformer IN QUALITY—EFFICIENCY and TONE SUPER U.S. SUPER

COMPARE IT AGAINST ANY OTHER L.F. ON THE MARKET! NOTE ITS PRICE!! NOTE ITS FINISH!!!

MADE and TESTED BY EXPERTS ONLY

Ratio 5-1 AND IS 5 to 1

U.S. No. 1 14/6 Ratio 5-1

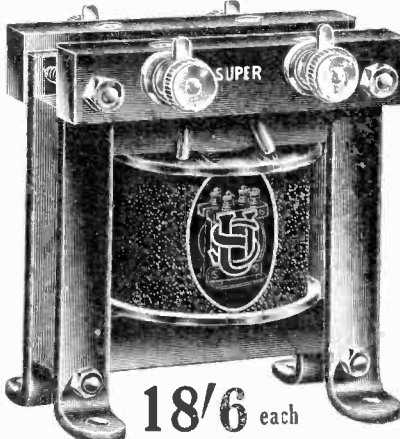

18/6 each

EVERY L.F. BEARING the TRADE MARK of the U.S. RADIO CO., LTD., is Thoroughly Tested and is GUARANTEED FINISHED and DESIGNED LIKE A GUN U.S. No. 2 11/6 Ratio 3 1/2-1

THE SECRET OF THE U.S. SUPER'S SUCCESS They are wound by experienced winders, with the correct amount of the right gauge wire. They are packed with Stalloy iron of sufficient quantity to allow the transformer its maximum amplification. No part of this exceptionally fine instrument is neglected.

IF YOUR DEALER CANNOT SUPPLY YOU, WRITE TO U.S.

U.S. RADIO CO., LTD. Wireless Component Manufacturers, 155, HIGH STREET, LEWISHAM, LONDON, S.E.13. Phone, Lee Green, 2404.

Blame your Transformer—if it isn't a Woodhall

If your Loud Speaker says "Burragurrumph!" don't blame the announcer or the loud-speaker—if the soprano shrieks, don't blame the singer or wireless. Think first of your Transformer.

Cheap Transformers may amplify, but they will not reproduce. "One-to-Five" implies nothing except a doubtful "step-up."

In the "Woodhall No. 1" you have, with only a 1-2:8 ratio, a wonderfully faithful "tone," that is due to correct proportioning of impedance, uniform

amplification, plenty of wire, heavy core, and a unique method of winding.

That method is the use of SILK, simultaneously wound with the wire—a method used in no other Transformer. It is costly, but remarkably efficient.

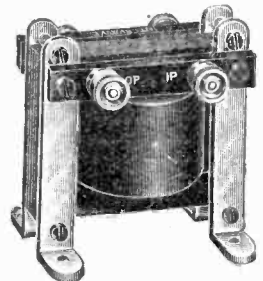

The "Woodhall No. 1" is sold by 23/6 all Wireless Dealers, who can obtain

supplies through their usual Factors. Sole Distributors : PRESSLAND ELECTRIC SUPPLIES, LTD., HAMPTON-ON-THAMES.

The Woodhall-Wireless Manfg. Co., Ltd.

What the Radio Press does for you

Have you ever had any qualms? Qualms, I mean, about the correctness of advice given to you. The opinions of your friends may be safe in some directions, but everyone wants to be sure. Wireless components cost money, ebonite costs money, and time costs money. You cannot afford to rely on advice based on a very limited experience.

If you require really expert medical advice you go to a specialist. Why? Simply because you have confidence in a man who has devoted his life to a special branch of work. He has had hundreds of cases through his hands. He has learnt from each one, quite apart from his own brilliant attainments.

Competence and experience count as much in wireless as in medicine and surgery.

Radio Press, Ltd., are specialists. Unlike general publishers, their efforts are concentrated on maintaining the fullest confidence of the purely wireless public. You must realise that it pays to support people whose whole reputation depends on the accuracy of their articles, the technical supremacy of their sets and circuits.

Just think for a moment. Whom do you regard as the principal wireless writers in this country? What names are household words in every home where there is wireless? Yes, of course, and these people are those who have made the Radio Press by far the largest wireless publishers in the world.

These are their new offices—Bush House, Strand, London, W.C.2—many times the size of their old offices in Devereux Court.

They have succeeded because they have served YOU truly and faithfully. They have succeeded because thinking wireless workers have realised that it pays in the end to support specialists who, moreover, have had the experience gained by coming into contact with half a million readers. No other wireless publishers or general publishers possess the unique advantages of the Radio Press. None has proved so successful. There is a reason.

Think this over and you will realise why the Radio Press, Ltd., have done more than any other concern (except, of course, the B.B.C.) to popularise radio in this Country.

YOU can get that confidence feeling by concentrating on Radio Press publications.

They publish a whole series of handbooks, each of which has the words "Radio Press" on it, and their highly popular periodicals have a joint circulation of 400,000 copies.

They are:—
Wireless Weekly (6d. weekly—every Wednesday. Edited by JOHN SCOTT-TAGGART, F.Inst.P., A.M.I.E.E.

Wireless Constructor (published at 6d. on the 15th of each month). Edited by PERCY W. HARRIS.

Modern Wireless (published at 1/- on or about the first of each month). Edited by JOHN SCOTT-TAGGART, F.Inst.P., A.M.I.E.E.

RADIO PRESS LTD.
BUSH HOUSE, STRAND, W.C.2.



Barclays 1172.



GENUINE LOW TENSION

FOR THE FILAMENT LIGHTING
"The Best in the World"

The Batteries detailed below will be found to cover all the requirements of the different valves.

Price List.				H.T.
Codeword	Volts	Capacity	Price	Batteries
GLORY	1 1/2	28	3/-	Write for
GLOBE	3	12	4/6	L/let 134B
GLARE	1 1/2	56	7/-	
GLINT	3	28	7/-	
GLASS	3	56	14/-	
GLATE	4 1/2	28	10/6	

GENUINE HELLESENS DRY BATTERIES FOR



HELLESEN DRY BATTERIES

OF WIRELESS VALVES
"The Best in the World"

It is far cheaper to use one of the high capacity batteries than a number of the smaller types.

L.T. Price List.			
Batteries	Codeword	Volts	Capacity
Write for	GLOWE	1 1/2	60
L/let 142B	GLOAT	3	60
	GLUPE	4 1/2	60
	GLEAM	1 1/2	130
	GLOAM	3	130
	GLISS	4 1/2	130

A. H. HUNT, Ltd. (Dept. 5) H.A.H. WORKS, Tunstall Rd., Croydon, Surrey. "Keyage, Croydon."

RADIO STOCKS (B. HAINE, Sole and New Proprietor), RADIO HOUSE, NEWMAN STREET, OXFORD ST., LONDON, W.1.

EVERYTHING WIRELESS AT LOWEST PRICES. Send for Free List.

'Phone: MUSEUM 3205.

OXFORD ST., LONDON, W.1.

All goods on 24 hours approval. Send ample postage: surplus refunded.

Accumulators. Best British, 4 Vt. 40 Amp. 17/6, 4 Vt. 60 Amp. 21/0, 4 Vt. 80 Amp. 27/6, 6 Vt. 40 Amp. 25/0, 6 Vt. 60 Amp. 30/0, 6 Vt. 80 Amp. 37/6, 6 Vt. 100 Amp. 45/0.
Aerial Wire. 7/22; Best H.D. Copper, 2/0. Enamelled, 3/6 per 100 feet. Electro, 1/8.
Anode Resistances. Allen, variable, 1/6; Waimel, 3/6; Lissen, 2/6; Dubilier and all makes.
Batteries. Best British H.T. Batteries, 36 volt 7.0, 63 volt 12/6, 100 volt 16/6.
Coils. Basket, waxless, duplex, set Nos. 25, 35, 50, 75 and 100, 2/0; for Chelmsford station, No. 150 1/3, No. 200 1/6. Ditto (extra large air spacings), Nos. 25, 35, 50, 75 and 100, 3/0.
Coil Holders. Radstock quality, solid ebonite, long handles or knobs, two way 2/3, 3/0, 4/0 and 5/0; ditto with Vernier fine adjustment 6/0, 8/6, 10/6. Three way, 3/6, 4/9, 6/9 and 8/6; ditto Vernier, 7/6, 9/6, 12/0. Basket Coil Holders, best, 1/0 and 1/3.
Ebonite Coil Plugs. 6d. each; curved, 1/0 each.
Condensers. (Copper and mica.) Fixed; to .001 9d., to .005 1/0, to .01 1/9, to .1 3/0. Edison Bell Fixed Condensers, to .001 1/3, .002 upwards 2/0; Dubilier to .001 2/6, .002 upwards 3/0.
Crystals. Galite, Hertzite, Talite, Zincite, Midite, 9d. and 1/9; Neutron and Tungstalite 1/6.
Crystal Detectors. Adjustable Enclosed, glass covered, 1/0, 1/6, 1/9, 2/6 and 3/0. Radstock Special Detector, micrometer movements, 3/0. All detectors stocked: Edison twin 5/0, etc.
Crystal Sets from 5/6 to 30/0.
Ebonite. Cut to size 3/6 per lb. Scrap Ebonite 2/0 lb.
Flex. Twin 3d. yard. Bell wire, 12 yards 6d.
Filament Resistances, 1/6, 2/0 and 2/6 with engraved dial. "Microstat" for D.F. 2/6 each. "Radstock" 30 ohm 2/9, Igranic 4/6, Ormond 2/0. All makes in stock.
Frame Aerials. Well-made, fold-up, in carrying case 21/0.

THE QUALITY OF OUR COMPONENTS IS GUARANTEED, AND OUR PRICES ARE THE BEST OBTAINABLE.

FIRST CLASS VARIABLE CONDENSERS.
Best British Make.
Accurate Spacing. Perfect Finish.
Absolutely Best Value Obtainable.

	Ordinary.	Square Law.	With 3 Plate Vernier.
.001	7 3	9 6	18 EXTRA.
.00075	6 6	8 9	
.0005	5 4	7 6	
.0003	5 1	7 6	
.0002	4 5	6 6	
.0001	4 2	—	
.00005	3 1	—	

Postage 6d. one condenser; 3d. each additional instruments.

SPECIAL OFFER OF MANSBRIDGE CONDENSERS.

Octopus Brand. Best Make. New and Guaranteed
SECOND TO NONE
.05 3/6, .1 3/6, .25 3/6, 1mf 4/-, 2mf 4/6

SEND YOUR ORDER WITH CONFIDENCE. IF THE GOODS YOU WANT ARE NOT LISTED ON THIS PAGE, REST ASSURED PRICE AND QUALITY WILL BE THE BEST.

Headphones. "Brandes" 25/0. N. & K. pattern 12/9. "Continental" 12/11. Dr. Nesper's adjustable 12/6.
Insulators. Egg shape 1d., 2 in reel 2 for 1 1/2.
Jack and Plug, 3/0 per pair.
Leading-in Tubes, 12 in. 9d. each, 9 in. 8d., 6 in. 7d., "Simplex" flat lead-in 1/6.
Loud-Speakers. All makes stocked: Special Radio Classic, 20/0.
Sets (Valve). Splendid Selection, open or closed cabinets. From £1 to £30.
Sleeving. (Insulating), 3 feet lengths, 3 for 10d., finest quality.
Switch Arms: first quality 9d., Nickel 1/0, second quality 6d.
Switches. S.P.S.T. 1/0, S.P.D.T. 1/6, D.P.S.T. 1/9, D.P.D.T. 2/0. Panel mounting, S.P.D.T. 1/0, D.P.D.T. 1/6.
Transformers. L.F. "Powquip" 14/6, "Bucks" 11/6, "Radstock" 10/6, Royal 20/0 Best of all. All makes stocked.
Transformers. H.F. Plug-in. Nos. 1, 3/6; 2, 3/11; 3, 4/3; 4, 4/6; 5, 4/9; 6, 5/0.
Terminals. Nickel 2d., Large W.O. & Telephone type 1d. each, Nickel 2d., Small Pillar & W.O. 1d., Nickel 2d., Spade 2 a 1d., Screwed Spade 1 1/2d., Screwed Pins 2d.
Variometers. Double wound 150/550, 2/0, on ebonite 3/0, finest make "Radstock" moulded ebonite ball rotor 6/6. Edison Bell 10/0, Igranic 12/6, G.R.C. 15/0 each, close coupling. All makes stocked.
Valve Holders. Best turned ebonite, with nuts 10d. Radstock Anti-Capacity, legless, 1/0 each, Murrays 1/3; highly recommended.
Valve Legs. With nut and washer plain 1d. each, 9d. doz., nickel 1 1/2d., 1/3 doz., flanged 1 1/2d. each, 1/3 doz., nickel 2d. each, 1/9 doz.
Valves. Tested before dispatch and sent at purchaser's risk. Dutch "R" ideal for detector (hard or soft) 5/6, French R 6/6. All makes stocked.

EVERYTHING WIRELESS AT LOWEST PRICES. Send for Free List.

All goods on 24 hours approval. Send ample postage; surplus refunded.

RADIO STOCKS (B. HAINE, Sole and New Proprietor), RADIO HOUSE, NEWMAN STREET, OXFORD ST., LONDON, W.1.

'Phone: MUSEUM 3205.

A REVOLUTION IN H.T. EFFICIENCY

H.T. Batteries made up of units are recognised as the ideal. The HOVIMO screw connection solves the problem of joining units without soldering.

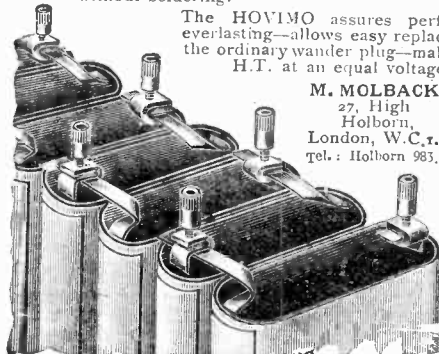

The HOVIMO assures perfect "silent" working—is everlasting—allows easy replacement of units—will take the ordinary wandler plug—makes it possible to keep your H.T. at an equal voltage. Is British made.

M. MOLBACK
27, High Holborn,
London, W.C.1.
Tel.: Holborn 983.

Ask your dealer for them.

1/6

Per Doz. From dealers or direct from me.

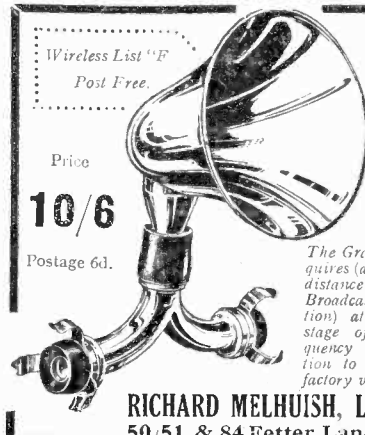

A most efficient device to which ordinary headphones are clipped by simple pressure on the spring clips.

The "Gramophix" Loud-Speaker

The Gramophix requires distance (according to volume) from the listener. Straight Horn (Bell 10 in.) 6/-; Swan-necked Horn (Bell 11 1/2 in.) 15/-; Small Curved Horn (Bell 8 1/2 in.) 7/6; Post 9d. extra.

RICHARD MELHUISH, Ltd., Electrical Engineers and Wireless Experts, 50/51 & 84 Fetter Lane, London, E.C.4 Est. 1828

In replying to Advertisers, please use Order Form enclosed



Published every Wednesday by
Radio Press, Ltd., Bush House,
Strand, London, W.C. 2.
6d. WEEKLY.

Why I read "Wireless Weekly"

1. **BECAUSE**, chiefly, I feel safe. I know that behind this paper is the RADIO PRESS, the largest Wireless Publishing concern in the World, and this is their weekly.
2. **BECAUSE** the Editor is John Scott-Taggart, F.Inst.P., A.M.I.E.E., and the Assistant Editor is Percy W. Harris, and because this is the only paper which contains articles by such other well-known writers as Cowper, Hallows, Kendall, Rattee, Redpath, etc., etc.
3. **BECAUSE** it is beautifully printed on the finest quality paper, and all the photographs come out clearly and not as smudges, as is so often the case. A Photogravure Supplement is now appearing, by the way, in every alternate issue.
4. **BECAUSE** of the regular "Valve Notes" which appear weekly and are written by the Editor. Nothing like these appears anywhere else. WIRELESS WEEKLY appeals to me because I am a valve user, and the paper caters very largely for the valve man.
5. **BECAUSE** I thoroughly enjoy "Jottings By the Way," a very witty weekly feature (now illustrated, by the way).
6. **BECAUSE** new circuits and designs appear regularly and many of them never appear elsewhere. I know that if I miss my WIRELESS WEEKLY I shall miss something new.
7. **BECAUSE** I am pleased to reply WIRELESS WEEKLY when my friends ask me what I read. I know that they know that WIRELESS WEEKLY is a paper in a class by itself. Its price is the highest of the weeklies, and though not a snob, I don't mind my friends knowing that I want the best—and get it.
8. **BECAUSE** it's a "live" paper. It does things. It's the most virile of the RADIO PRESS periodicals. It criticises fearlessly on wireless topics of the day. Its test reports on wireless apparatus are equally fearless. If something new comes along, whether it is oscillating crystals, a new circuit, a new move by the Post Office, every keen wireless man wants to know "what WIRELESS WEEKLY has to say about it"—and they are never disappointed.

PLACE AN ORDER FOR "WIRELESS WEEKLY" WITH YOUR NEWSAGENT TO DAY. A FINE SERIES OF ARTICLES ON SUPERSONIC HETERODYNE RECEPTION HAS JUST COMMENCED.

ORDER FORM

Please deliver reserve WIRELESS WEEKLY (6d. weekly) until further notice.

NAME _____

ADDRESS _____

THREE "BEST SELLERS"

BY JOHN SCOTT-TAGGART, F.INST.P., A.M.I.E.E.
 Editor of "Modern Wireless" and "Wireless Weekly."

No other writer has done more to instruct the Experimenter than the Author of these books, which are read by all who are not mere mechanics. They are not text-books in the ordinary sense, but are helpful guides which presume a negligible amount of knowledge on the part of the reader.





"S.T." Circuits are too well known to need any introduction. This is the latest book of them:—

More Practical Valve Circuits

By JOHN SCOTT-TAGGART, F.Inst.P., A.M.I.E.E.
 Price 3/6 (3/8 post free.)

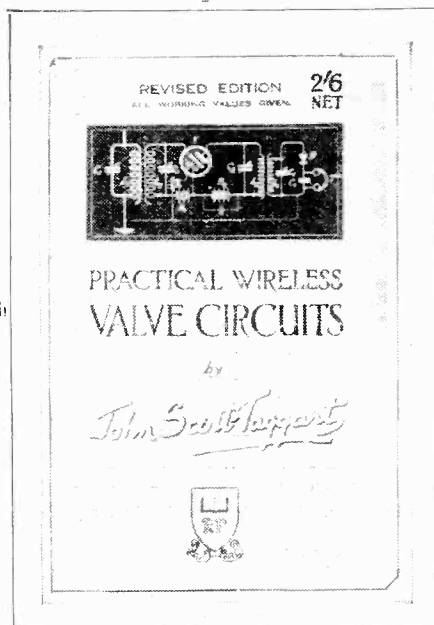
The ST100 circuit is full of dozens of original circuits which you will find nowhere else, as they are copyright. Circuits ST68 to ST151 appear in this extremely useful volume, which has had an enormous sale amongst experimenters.



 All component values are given in the new : editions of :
THESE TWO CIRCUIT BOOKS.



This is the first book of ST circuits and is called **Practical Wireless Valve Circuits**, by John Scott-Taggart, F.Inst.P., A.M.I.E.E. Price 2/6 (post free 2/8). Circuits ST1 to ST67 are published in this book, which is selling as well to-day as when it was published. No experimenter worthy of the name can afford to be without the two ST Circuit Books. They are friends which will never lead you astray. Each circuit in both books is fully described and criticised.

Mr. Scott-Taggart has stated that he regards this as his best book on the Valve from the point of view of the beginner. **Radio Valves and How To Use Them**, by John Scott-Taggart, F.Inst.P., A.M.I.E.E. Price 2/6 (post free 2/8). This book is by far the largest published by Radio Press, Ltd., at 2/6, and is full of very valuable information. The reader is presumed to know only what is contained in our Books, "Wireless For All," and "Simplified Wireless."

3 Additional Models to the AMPLION⁶⁶ Dragon⁹⁹ range

REPRESENTING a most important advance in the production of small and medium size Loud Speakers, the three new AMPLION models illustrated and briefly described will be found of exceptional interest to the Technician, the Wireless Enthusiast and to the Listener-in-desirous of "Better Radio Reproduction."

Although all the advantageous constructional features distinguishing Standard AMPLION models are provided in these designs, the prices are not merely moderate but extraordinarily low, and possible only by manufacture at the hands of specialists upon the most approved lines experience can suggest.

The 'NEW' Dragonfly (An Amplion Baby)

A perfect replica on a reduced scale of the famous "Standard" Dragon model. For a miniature Loud Speaker the "Dragonfly" is outstanding in its efficiency—affording considerable volume, coupled with extreme clarity and "full" tone. The electromagnetic unit incorporating the new "floating" diaphragm, and the non-resonating sound conduit, are exclusive Amplion features.

The 'NEW' JUNIOR

In performance the "New" Junior is actually a "Senior" Loud Speaker, and compares favourably with instruments listed at twice and thrice the figure. All the latest improvements are embodied in the assembly, which reveals an efficiency not previously considered possible in a model so reasonably priced.

The 'NEW' JUNIOR De Luxe

A Loud Speaker of high degree, the "New" Junior-de-Luxe can best be described as an aristocrat of Loud Speakers sold at a decidedly democratic price. Corresponding in proportions to the "New" Junior type, the de luxe edition is provided with a wood trumpet of unique design. In this horn the oak or mahogany panels, as the case may be, are united by a series of metal ribs, affording an assembly of particularly attractive appearance.

The
World's
Standard

AMPLION

Wireless
Loud
Speaker

Obtainable from all Wireless Dealers of repute.

ALFRED GRAHAM & COMPANY,
(E. A. GRAHAM)

St. Andrew's Works, Crofton Park,
LONDON, S.E.4.

Telephone:
Sydenham 2820-1-2
Telegrams:
"Navalhala,
Catgreen, London."

Showrooms:
25-6, Savile Row,
W.1, and 82, High
St., Clapham, S.W.4

The AMPLION "DRAGONFLY."

AR. 101 - 120 ohms.
AR. 102 - 2000 ohms.
Diam. of Trumpet 5½-in.
Over-all Height - 9-in.

Price - 25/-

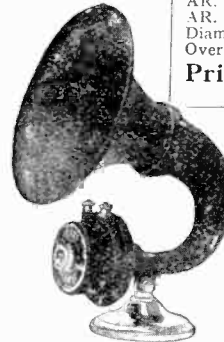

The "NEW" AMPLION JUNIOR.

AR. 110 - 120 ohms.
AR. 111 - 2000 ohms.
Diam. of Trumpet 10-in.
Over-all Height 15½-in.

Price - 50/-



The "NEW" AMPLION Junior-de-Luxe.

AR. 113 - 120 ohms
AR. 114 - 2000 ohms
Diam. of Trumpet 10-in.
Over-all Height 15½-in.

Price - 65/-

Mahogany Horn,
3/6 extra.



YOUR

Wireless Dealer

SELLS

RADIO PRESS BOOKS,

Envelopes, Panel Transfers, etc.,

SEE HIM !

To New Wireless Dealers. Radio Press books, etc., are now being issued to wireless dealers at a flat rate of 25% discount and the distribution is being effected through trade factors and wholesalers. Place all your orders through your usual trade channels.

Lists, prices, and all particulars are obtainable by dealers or factors from
RADIO PRESS LIMITED, BUSH HOUSE, STRAND, LONDON, W.C.2.

A huge business is done in these publications. Why miss it? It will help your ordinary business.

100% efficient—& study the prices!

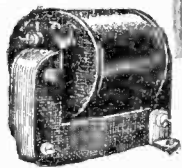

12/6

SUPRA L.F. Transformer.

Results with this instrument are remarkable, owing to its unique construction. Each layer has six insulated sections, and we guarantee this method of winding to give maximum amplification, while distortion is reduced to an absolute negligible minimum. The iron core has 38 laminations and accommodates two angles for fixing to panel.

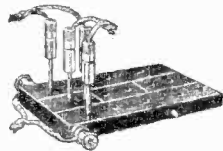

3/6

DOMINOE CONNECTOR AND KWIKPINS.

Labour saving, quick, clean and neat. You can get any combination of series or parallel up to four pairs of headphones in a moment. Nothing can be more simple or more efficient. Also useful for connecting up extra condensers, inductances, etc.

KWIKPINS - 3d. each.

7/6

No. 1. BIJOUPHONE

The only set at anywhere near the price with Variometer Tuning. Enclosed Detector with best quality crystal and point. Moulded ebonite top and base, nickelled fittings. For local station (250/700 metres).



No. 2, 10/- Same exclusive features, but wound for local station and 5XX (Chelmsford),

WARNING.—There are a number of sets similar in appearance, and prospective purchasers are advised to see that the name "WATES" is moulded on top plate and printed on side, otherwise we cannot guarantee satisfaction.

83-5-Y PULL-PUSH SWITCH. 2/6

Useful in a dozen ways. If inserted in filament circuit obviates adjustment of valves every time set is used. Heavily nickelled, one-hole fixing.



WATES BROS., LTD.

12-13-14, Gt. Queen St., Kingsway, W.C.2
 Phone: Gerrard 57516. Grams: Zywateseng, Westcent.
 Works: LONDON, BIRMINGHAM and SOUTHEAD.



CABINETS YOU WANT

PICKETT'S Cabinets—they are good value, from 1/6 each, highly polished. Cabinet Works, Albion Rd., Bexley Heath, S.E.1. Write for Lists M.W.

IT'S THE LEAK THAT DOES IT



The "Bretwood" Grid Leak (Guaranteed) tunes a carrier wave from the silent point up. The "Bretwood" is recognised by highest experts and experimenters as the only variable and reliable Grid Leak.

PRICE 3/-
 Postage 3d

If you are not satisfied within 7 days, money will be refunded.
RADIO IMPROVEMENTS, LTD.
 12-18, London Views, Maple Street, London, W

Barclays 159



HULLO, GIRLS! HULLO, BOYS!

THE BEST CHRISTMAS ANNUALS FOR 1924.

Specially written by the Aunties and Uncles of the B.B.C. Stations.



MAGNIFICENTLY ILLUSTRATED.

3/- each, nett.

ASK YOUR WIRELESS DEALER FOR THEM.

Wireless Dealers who have not already received particulars of Trade Terms should apply at once to:—

COMMERCIAL DISTRIBUTORS, Ltd.
 323, HIGH HOLBORN, LONDON, W.C.2

Telegrams: Burmonta, Holb, London.

Telephone: Holborn 5755.

Your message conveyed to

1,000 people for 8/-

This is the value the pages of "Modern Wireless" give all advertisers participating in its columns.

Could you conceive of a better bargain? Comparing the cost per page £40, half-page £20 and quarter page £10 with the circulation of over 100,000 copies monthly, your advt. appears at the absurdly low rate of 8/- per page, 4/- half page or 2/- per quarter page per 1,000 copies sold. You cannot obtain such cheap, yet excellent means of approaching the right public anywhere else.

Take advantage of this unique bargain immediately by writing to the Advt. Managers for details of the generous discounts also allowed for series contracts in

MODERN WIRELESS

Advt. Managers:

City 9911 (Estn. 9)

BARCLAYS ADVERTISING LTD.
 BUSH HOUSE, STRAND, LONDON, W.C.2

Index to Advertisers

	PAGE		PAGE		PAGE
American Hard Rubber Co., Ltd.	706	Gent & Co.	694	Pressland Elec. Supplies	723
Autoveyors, Ltd.	698	Gil-Ray Radio Co.	727	Radiax, Ltd.	690
Beard & Fitch	601	Goswell Engineering Co.	671	Radio Communication Co., Ltd.	602, 632
Bedford Electrical Co.	727	Graham (A.) & Co.	729	Radio Improvements, Ltd.	731
Bowyer-Lowe Co.	677	Gran-Goldman Service	639	Radio Instruments, Ltd.	Cover iv.
Brandes, Ltd.	624	Helixo, Ltd.	727	Radians, Ltd.	652, 708
British Battery Co., Ltd. (The)	664	Hobday Brothers	708	Radiophones, Ltd.	707
British Thomson-Houston Co.	656	H. T. C. Electrical Co.	691	Radio Stocks	725
Brown Brothers, Ltd.	639	Hughes (F. A.) & Co.	707	Raymond (K.)	CS2, 683, 684, 685
Brown (S. G.), Ltd.	705	Hunt (A. H.), Ltd.	725	Refty Elect. Appliances	693
Burndep't, Ltd.	648	Igranic Electric Co., Ltd.	678	Robinson (Lionel) & Co.	668
Burne-Jones & Co., Ltd.	652	International Correspondence		Rosen (Ed.) & Co.	670
Buss (T. O.)	667	Schools	713	Rothermel (R. A.), Ltd.	713
C.A.V. Small Tools	715	Jackson Bros.	672	"S. A. Cutters"	690
Chloride Elec. Storage Co., Ltd.	701	Laker Co.	705	Service Co.	694
Clarke (H.) & Co. (Manchester,) Ltd.	640	Lighting Supplies Co.	694	Shipton (E.) & Co.	655
Climax Patents	696	Lissen Co.	627, 663	Siemens Brothers & Co., Ltd.	692, 693
Collinson's Precision Screw Co., Ltd.	687	Louden Valves	703	Silvertown Co.	717
Commercial Distributors, Dtd.	731	McMichael (L.), Ltd.	680, 699	Simpson & Blythe	690
Cossor Valve Co.	674	Marconi-Osram Valve Co.	628	Smith & Ellis	705
Cunningham & Morrison	639	Marshall (H. Lloyd)	719	Sparks Radio Co.	705
Curtis (Peter), Ltd.	643, 647	Melhuish (Rd.) & Co.	725	Stella-Works Co.	687
Diamond Wireless, Ltd.	687	Metropolitan-Vickers Electrical Co., Ltd.	700	Sterling Telephone Co., Ltd.	630, 631
Drummond Bros.	664	Molback (M.)	702, 725	Stevens (A. J.) & Co. (1914), Ltd.	660
Dubilier Condenser Co. (1921), Ltd.	644	Mullard Radio Valve Co., Ltd.	651	Stockall, Marples & Co.	655
Economic Electric, Ltd.	688	Munday (A.), Ltd.	725	United Mfrs. & Agencies, Ltd.	702
Edison Swan Electric Co., Ltd.	635	Naylor (J. H.)	698	"U. S." Radio Co.	723
Falk, Stadelmann & Co.	636	Neutron, Ltd.	668	Vandervell (C. A.)	699
Fallon Condenser Co.	713	New London Electron Works	659	Varley Magnet Co.	705
Fellows Magneto Co., Ltd.	655	Nichol (J. O.) & Co.	727	Ward & Goldstone, Ltd.	709
Finchett (C. A.)	693	Oldham Accumulators	719	Wates Bros.	731
Forno Co.	664	Peto-Scott Co.	723	Watmel Wireless Co.	693
Fuller's United Elec. Works, Ltd.	702	Pickett Bros.	731	Wholesale Fittings, Ltd.	694
Gamage, A. W.	715	P. & M., Ltd.	575	Wilkins & Wright, Ltd.	708
Gambrell Bros., Ltd.	707	Portable Utilities Co., Ltd.	711	Wireless Press, Ltd.	704
General Electric Co., Ltd.	623	Power Equipment Co.	709	World's Wireless Stores	727
General Radio Co.	688				

USE THIS COUPON

in writing to advertisers in "Modern Wireless."

CUT HERE

In connection with your announcement in MODERN WIRELESS, please supply me with:

Enclosed please find remittance of.....
(Leave blank if not an order)

If an open envelope is used in applying for catalogues a half-penny stamp will cover postage.

Name.....

Address.....

Date.....

COUPON

Questions and Answers

In future this coupon must be accompanied with 2s. 6d. P.O.

"MODERN WIRELESS" November, 1924

WE HAVE MOVED

to more commodious and better appointed offices at Bush House, Strand, W.C.2, to cope with increasing business resulting from the extreme popularity of:-

MODERN WIRELESS & WIRELESS WEEKLY

Please address all communications respecting these media, in future, to:-

Barclays Advertising, Ltd.,

BUSH HOUSE, STRAND, W.C.2

Telephone: City 9911 Extn. 91.

A REMINDER: Have you yet reserved your space in the January, 1925, issue of:-

The "Wireless Constructor"

on Sale December 15, 1924. A handsome number which you cannot afford to miss. Latest date for instructions and copy, November 15.

December printing order 200,000 to 250,000 copies.

Phone: BARCLAYS, CITY 9911 (Extn. 9.)

12-6
18-0
2-9
1-13-3

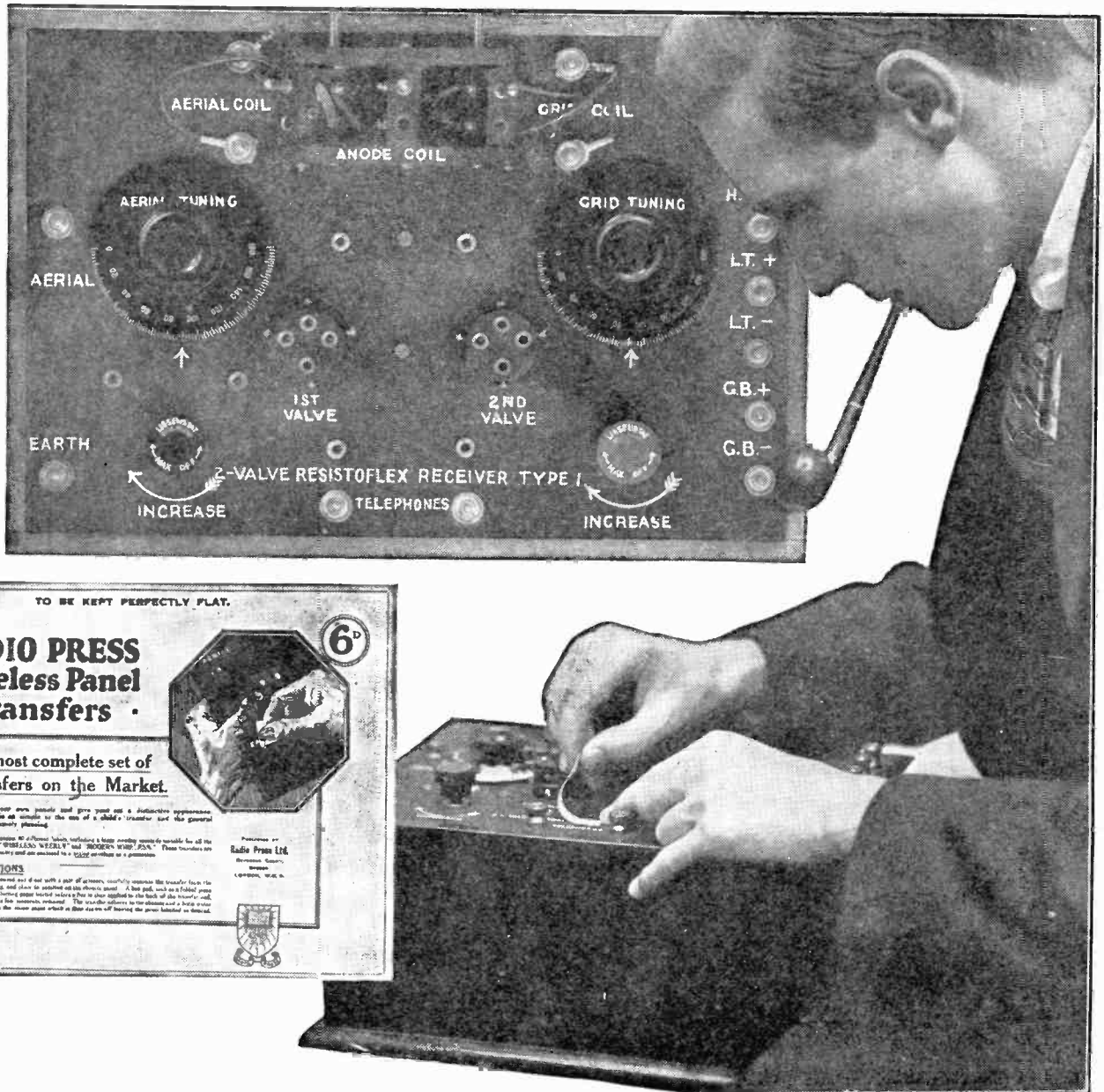

TO BE KEPT PERFECTLY FLAT.

RADIO PRESS
Wireless Panel
Transfers

6^d

The most complete set of
Transfers on the Market.

"Express" your own panels and give your set a distinctive appearance. The process is as simple as the use of a child's transfer and the general effect is permanent, pleasing.

This number contains 80 different labels, including a large variety specially made for all sets described as "RADIO PRESS" and "MODERN WIRELESS". These transfers are of Radio Press quality and are guaranteed to a 100% service as a permanent advertisement.

INSTRUCTIONS
Remove the label from the set and with a pair of scissors, carefully separate the transfer from the set's own backing, and stick to another panel. A hot pad, such as folded piece of thick cloth or heavy paper, should be held to the back of the transfer, and the pressure for a few moments retained. The water soluble ink then dries and a hard bond is set by means of the same paper which is then taken off leaving the panel finished as desired.

Produced by
Radio Press Ltd.
Barnham, Essex,
England.
LONDON, W.C.2.

Give your set "that professional look!"

By using "Radio Press Wireless Panel Transfers" (6d. per large packet of 80 labels), you can give to your set that finished appearance which makes all the difference. Not only are these transfers the cheapest and best but they are officially issued by the Radio Press for their sets. Buy a packet or two from your wireless dealer. They are also obtainable through every bookseller, *but get the title right if you want Radio Press quality.*

8d. post free from **RADIO PRESS, Ltd., Bush House, Strand, London, W.C.2.**

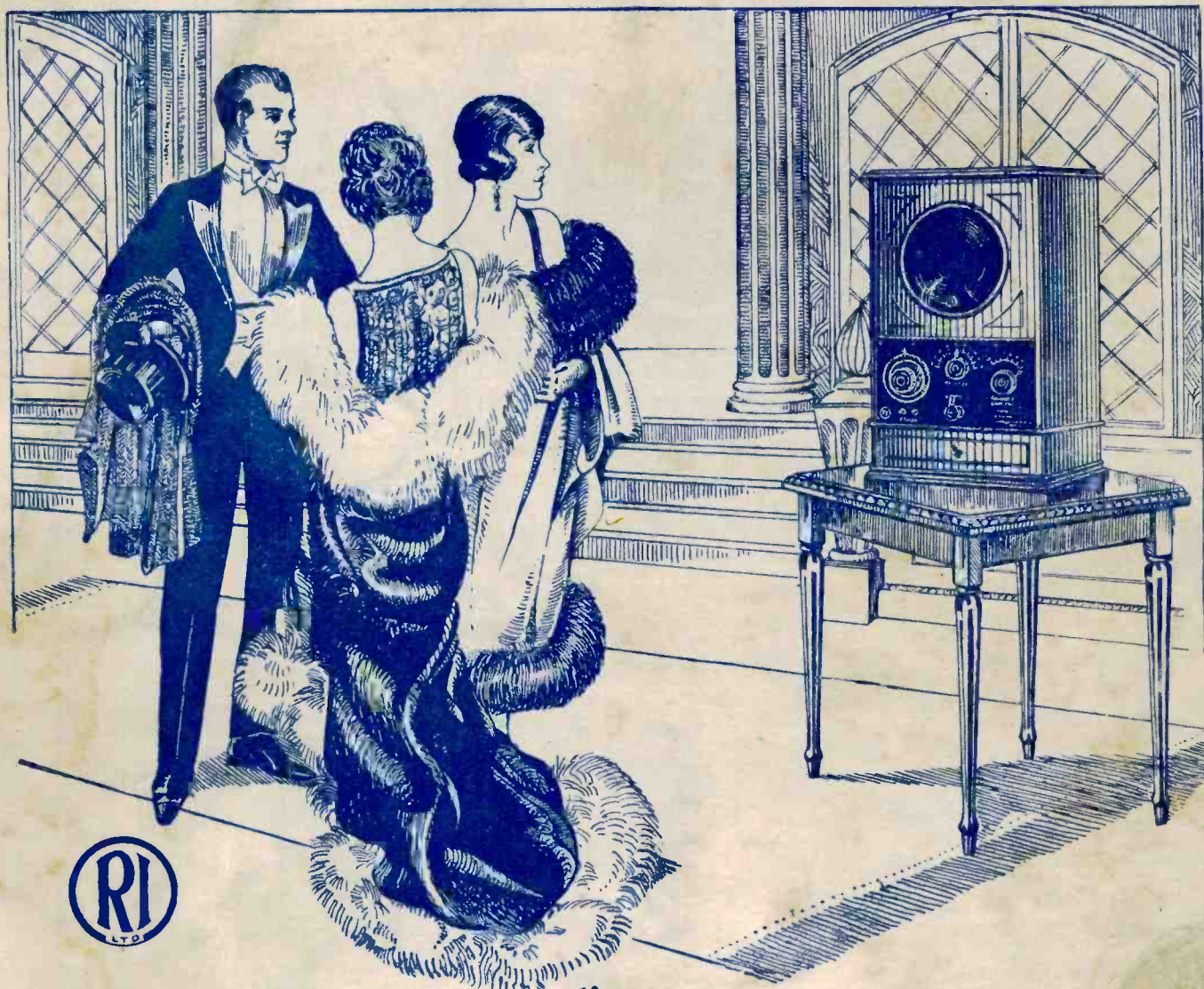

"Le dernier cri"

It hardly seems worth while going to that concert to-night. We can get all the best music from our Lyrianette without the least bother, and it is so much more comfortable to stay at home. I could rave about the wonder of that little Lyrianette—so compact, simple and beautiful, and yet so thoroughly efficient. No bother with accumulators—everything so neatly stowed away inside and no unsightly wires visible. Music comes so clearly from the Lyrianette. It seems futile to go out into the cold nights for entertainment when you can have it amidst your own home comforts.

The RI Lyrianette. 2 valve. Price £22 5s. 0d.

The RI Lyrianette, 3 valve. Price £28 5s. 0d.

Write for the New RI Catalogue.

Telephone: Regent 6214-5-6

Telegrams: "Instradio London"

Radio Instruments Ltd.
12 Hyde Street, Oxford Street W. 1.