



Mullard

R
TRANSISTOR RADIOS
e Historie v/d Radio
Circuitry and Servicing

BIBLIOTHEEK
N.V.H.R.

TRANSISTOR RADIOS

Circuitry and Servicing

BIBLIOTHEEK
N.V.H.R.

TRANSISTOR RADIOS

Circuitry and Servicing



*The issue of the information contained in this publication
does not imply any authority or licence for the utilisation
of any patented feature.*

*Mullard is the trade mark of Mullard Ltd. and is registered
in most of the principal countries in the world.*

© Mullard Limited, August, 1962

Prepared by
TECHNICAL INFORMATION DEPARTMENT
and issued by
MULLARD LTD., MULLARD HOUSE, TORRINGTON PLACE,
LONDON, W.C.1

TP495

(iv)

CONTENTS

Chapter	Page
Introduction	(vii)
1 Semiconductor Materials	1
2 Manufacture of Transistors	8
3 Transistor Action	20
4 Printed Wiring	27
5 Transistor Circuits	33
6 Servicing	52
7 Test Equipment	65
Index	70

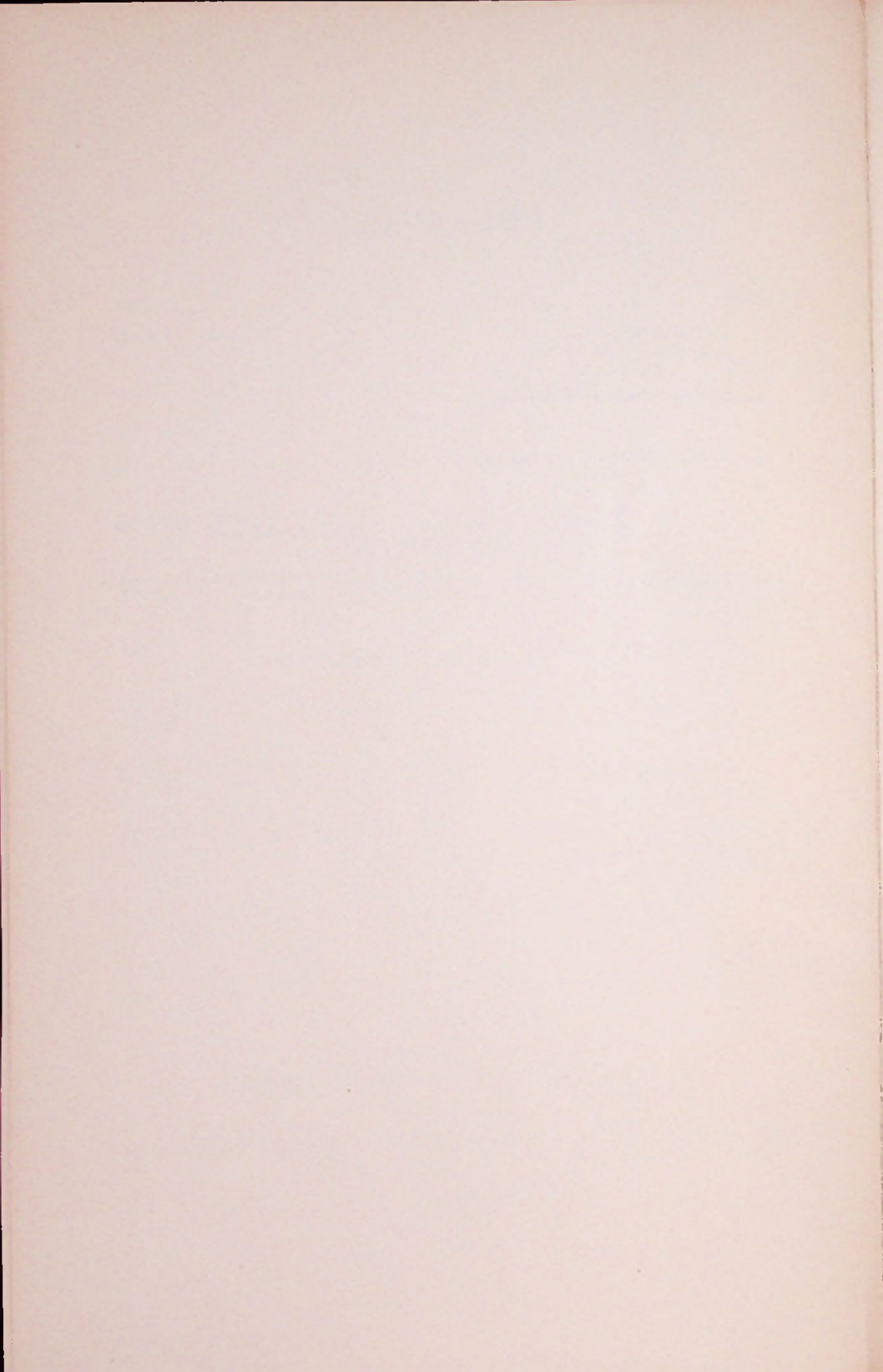

Introduction

The material in the book originally appeared as a series of articles in Mullard OUTLOOK. This series was intended as an introduction to transistor radios for the apprentice service engineer and aroused considerable interest. As a result, it has been decided to reissue the material in book form. The opportunity has been taken to incorporate some new material, and to enlarge the scope of certain topics that had to be briefly treated because of the serial nature of the original. As examples, a section on the manufacture of alloy-diffused transistors has been added and the section on receiver circuits has been considerably enlarged.

The first three chapters are devoted to the transistor—what it is, how it is made and how it works. A chapter on printed wiring follows, as this technique may not be familiar to the reader. The next chapter considers transistor circuits, dealing first with the individual stages of a radio receiver and then with complete receivers. Finally, chapters on the servicing of transistor radios and the test equipment necessary are included.

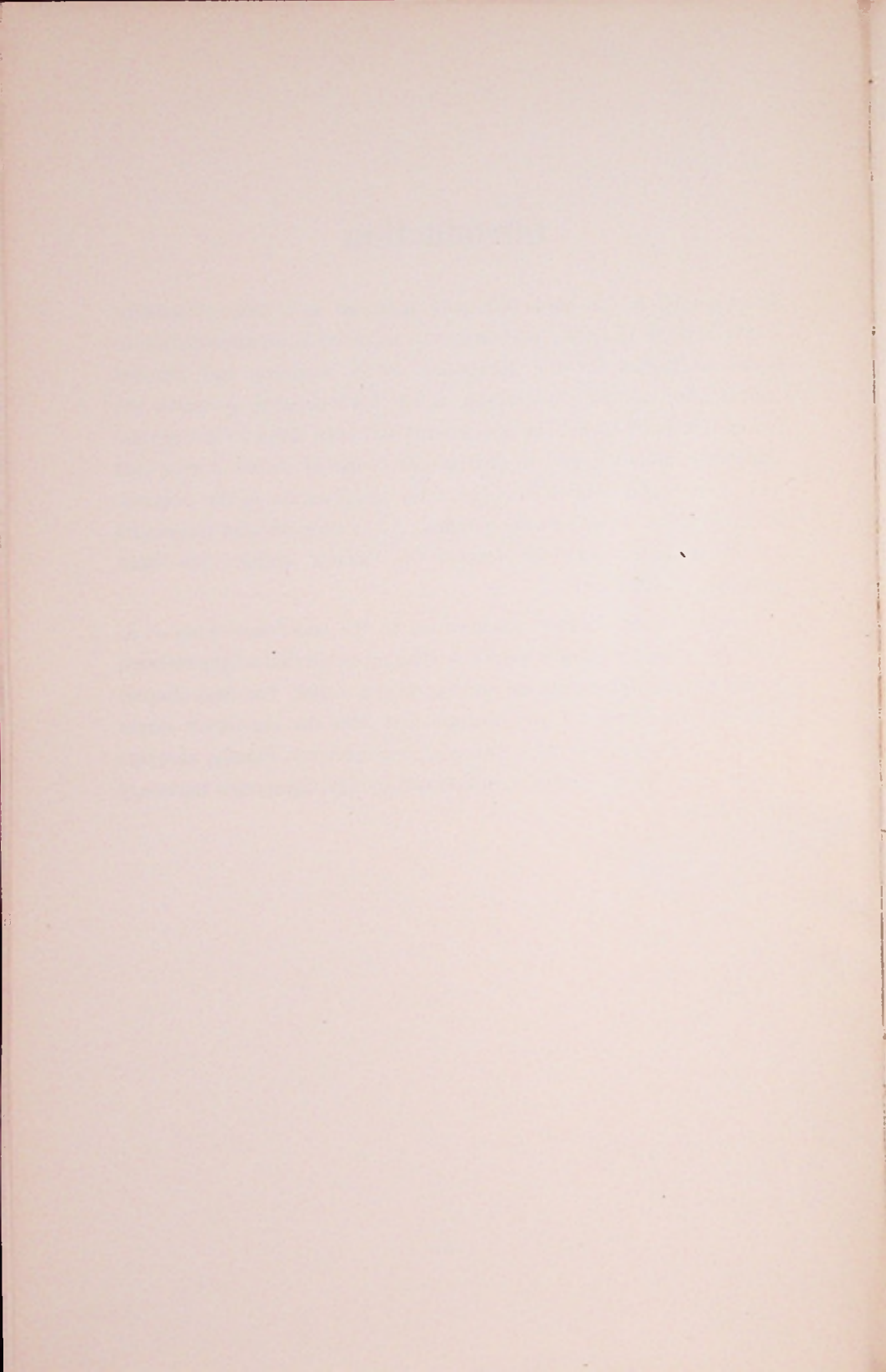

CHAPTER 1

Semiconductor Materials

A transistor consists essentially of a sandwich of three layers of semiconductor material. The actual construction of a junction transistor designed to operate with small signals at audio frequencies is shown in Fig. 1.

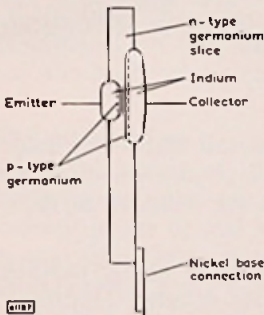

Fig. 1—Cross-section of alloy-junction transistor

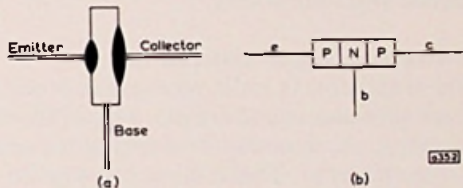

Fig. 2—(a) Simplified cross-section of transistor
(b) Simplified 'block diagram' of transistor

Illustrations of the physical construction of the transistor are not very convenient for discussing its properties. For this purpose much simpler drawings are used, as shown in Fig. 2. In Fig. 2a the cross-section of a transistor is shown, and a simpler diagram which does, however, represent fairly accurately the construction of the working portion of the transistor is given in Fig. 2b. The emitter (e), the base (b) and the collector (c) regions are clearly marked.

For the moment, the emitter can be considered equivalent to the cathode of the thermionic valve — that is, the source of the current that flows through the transistor. The current from the emitter flows across the junction between the emitter and base into the base region. Most of the current flows through the base and out of the collector but a small proportion flows out of the base. The base current is used to control the current flowing in the emitter-to-collector circuit.

Semiconductors

The term 'semiconductor' includes a large number of materials. The most important for transistors are the elements germanium and silicon. Also being investigated at the present time are compounds of two metals, such as indium antimonide, gallium arsenide and indium phosphide. Some sulphides are semiconductors, among the better known being lead and cadmium sulphides which are used in photoconductive cells. Among the oxides there is, for example, cuprous oxide which is used in power rectifiers.

As the name implies, a semiconductor does not conduct as effectively as a conductor such as a metal. If the resistances of three similar pieces of a metal, a semiconductor, and an insulator are measured, the resistance of the semiconductor will be found to lie between the low resistance of the metal and the high resistance of the insulator.

The semiconductor of main interest for transistors in radio receivers at the moment is germanium. It is grey-white and brittle and was discovered in 1886 after its existence had been predicted by Mendeleyeff fifteen years previously.

P-type and N-type Material

The transistors in radio receivers at present are almost exclusively made from germanium and are p-n-p type. The emitter layer consists of p-type material, the base layer of n-type material and the collector layer of p-type material. This is shown in Fig. 2b.

The p-type and n-type materials are formed from highly purified germanium by doping the germanium with specially selected impurities. If the dope - or additive - comes from one group of elements, the result is p-type material, while an additive from another group gives n-type material. The additives producing p-type germanium include indium, gallium, boron and aluminium. Those producing n-type germanium include arsenic and antimony.

Both p-type and n-type semiconductors have a higher electrical conductivity than the pure germanium. In the n-type semiconductor the electric current is carried chiefly by electrons but in the p-type semiconductor the current is carried chiefly by positively charged 'holes'. The n-type semiconductor contains a relatively large number of negative electrons but few positive 'holes'. So 'n' may be considered to stand for negative. The p-type semiconductor contains many positive 'holes' but few electrons. Therefore, 'p' stands for positive.

Besides the p-n-p type of transistor, the n-p-n type may be encountered in some receivers. In this type of transistor, the emitter and collector layers are made from n-type material, and the base layer from p-type material.

Electrons and Holes

Most radio engineers like to regard the electron as a particle, as something small and hard like a miniature billiard ball. A slight refinement of this idea is to think of a miniature snooker ball coloured black to show that it is a negative particle of electricity. This idea of the electron is adequate for most purposes. The hole can also be regarded as a particle. This time the snooker ball would have to be coloured red to show that the hole is positively charged.

A slight difficulty with this idea arises because an electron can fill a hole, and then neither will take any further part in carrying the current. Nevertheless, provided the possibility of this recombination is borne in mind, the idea of the hole as a positive particle is sufficient for an understanding of what happens inside a transistor. It does not, however, answer the question 'A hole in what?' nor is the concept of two miniature snooker balls combining because they are different in colour very satisfying. The hole is, in fact, the vacancy left behind when one of the outer electrons is removed from an atom of a semiconductor, but to understand this idea fully the structure of semiconductors must be considered.

Crystal Structure

All semiconductors are crystalline and their atoms are therefore arranged in a definite pattern. This pattern of atoms in a crystal is known as the crystal lattice. Germanium and silicon have the same crystal structure as diamond, the crystalline form of carbon. The diamond crystal lattice is shown in Fig. 3 in which each atom has the four adjacent atoms equal distances away from it and from each other.

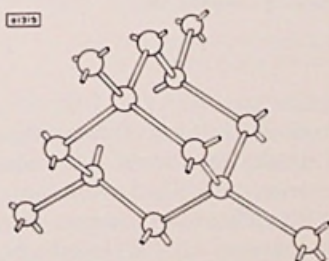

Fig. 3—Diamond crystal lattice

The forces holding the crystal together are contained chiefly in the bonds between each atom and its four neighbours. These are called covalent bonds and are formed by two similar positive nuclei sharing two electrons.

The nucleus of the germanium atom has a positive charge such that the nucleus is normally surrounded by 32 electrons. The chemical

CRYSTAL STRUCTURE

properties and crystal structure of germanium arise from the grouping of the electrons around the nucleus in orbits or 'shells'. The electrons nearest the nucleus form the first shell. Once this is full, other electrons can be held in the second shell. When this is full, electrons go into the third shell, and so on. The number of electrons that can be held in each shell is the same for all elements. The first shell can hold two electrons, the second shell can hold eight, the third 18, and so on. The 32 electrons of germanium are therefore arranged so that there are two in the first shell, eight in the second shell, and 18 in the third shell; the remaining four partially fill the fourth shell. These four electrons in the outer shell are called valence electrons. In the crystal lattice these four valence electrons are shared with the neighbouring atoms so that any two adjacent atoms share two electrons. Fig. 4 shows the covalent bonds in the diamond lattice, the lattice having been flattened for representation in two dimensions.

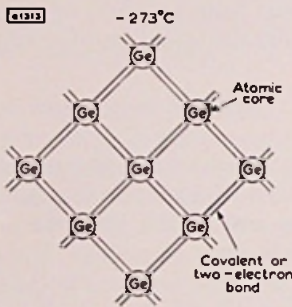

Fig. 4—Germanium lattice at -273°C showing covalent bonds

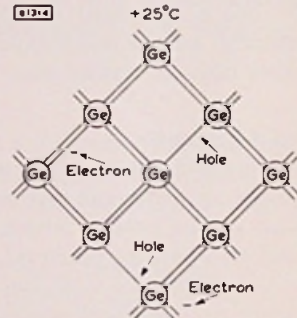

Fig. 5—Germanium lattice at room temperature showing free electrons and holes present

The lattice shown in Fig. 4 is perfect and is never realised in practice. Apart from distortions of the lattice, imperfections arise when (i) an electron breaks free from a covalent bond and so becomes a free charge carrier, and (ii) one of the germanium atoms in the lattice is replaced by an atom of another element (doping). In a perfect crystal at absolute zero (-273°C) all the bonds are complete. When the temperature is raised, some of the electrons in the covalent bonds acquire sufficient thermal energy to break free. This leaves gaps in the bonds, the so-called 'holes'. Fig. 5 shows the lattice with free electrons and holes present.

The numbers of electrons and holes existing in pure germanium must be equal since they are generated as pairs. Suitable additives can be included in the germanium, however, to make the holes much more

CRYSTAL STRUCTURE

numerous than the electrons (p-type germanium), or the electrons more numerous than the holes (n-type germanium). This is the process of doping referred to earlier. The atoms of the additive replace some of the germanium atoms in the lattice.

If the atoms of the additive have five valence electrons, four of these electrons will form covalent bonds with valence electrons from the four surrounding atoms of germanium. The fifth electron from the additive is detached from the additive atom and acts as a mobile negative charge carrier.

Fig. 6 shows an atom of antimony (symbol Sb) in the germanium crystal lattice. Antimony has fifty-one electrons, the first four shells being full leaving five valence atoms in the outer shell. The surplus electron from the outer shell is shown after being detached from the parent antimony atom.

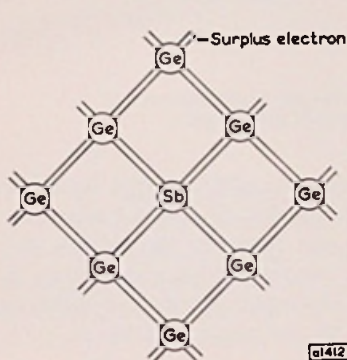

Fig. 6—Germanium lattice with antimony atom showing surplus electron

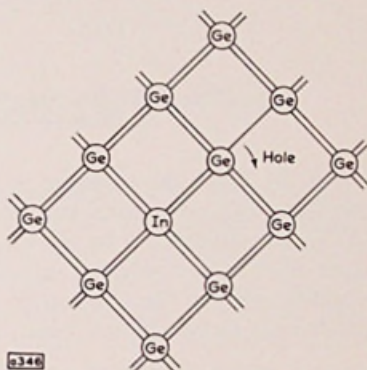

Fig. 7—Germanium lattice with indium atom showing hole

Atoms of additives with three valence electrons can also be substituted in the lattice. The additive atom makes up the complement of four electrons required for the covalent bonds by accepting an electron from a nearby part of the lattice. A vacancy or hole is therefore created. Fig. 7 shows an atom of indium introduced into the germanium lattice. Indium has 49 electrons with three valence electrons in the outer shell. The hole created by the introduction of the indium atom is shown appearing in one of the bonds between two germanium atoms.

Energy Levels

It has already been mentioned that even in highly purified germanium some of the valence electrons receive sufficient energy from thermal

ENERGY LEVELS

agitation to break free from their bonds. A definite amount of energy is required to enable the electron to break free. Smaller amounts of energy have no effect. This situation is described by the diagram given in Fig. 8. All the valence electrons in the crystal have energies lying within a certain band, marked as the valence band. If the electrons are to become conductors of electricity they must receive sufficient energy to jump over the forbidden energy gap into the conduction band. Electrons cannot have energies corresponding to the forbidden gap between the two bands

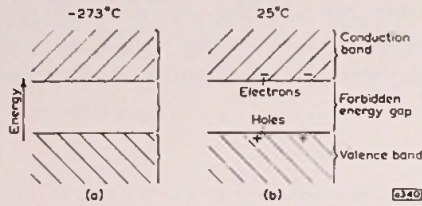

Fig. 8—Energy level diagram for pure germanium:
(a) at -273°C , (b) at room temperature

Fig. 8a shows the situation at absolute zero where all the bonds are complete and no current carriers are available. At room temperature (25°C) the situation is as shown in Fig. 8b. Some of the valence electrons have been converted into current carriers and are shown by the negative signs in the conduction band. An equal number of holes are left behind in the valence band, shown by the positive signs.

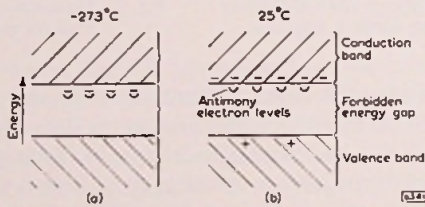

Fig. 9—Energy level diagram for germanium doped with antimony:
(a) at -273°C , (b) at room temperature

Doping the semiconductor with a suitable additive bridges the gap between the two energy bands. Fig. 9 shows the effect of doping germanium with antimony to give n-type semiconductor. The situation at absolute zero is shown in Fig. 9a where it may be seen that the

ENERGY LEVELS

valence electrons of the antimony atoms occupy a position much higher than that of the germanium atoms, not far below the conduction band. Consequently a smaller amount of energy is required to remove the non-bonded electron from the control of the antimony atom. Fig. 9b shows the situation at room temperature. All the antimony atoms have contributed an electron to the conduction band. A few electrons have also been contributed by the germanium atoms with the formation of an equal number of holes in the valence band.

The corresponding energy diagrams for germanium doped with indium to give p-type semiconductor are shown in Fig. 10. At absolute

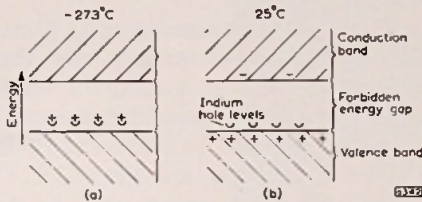

Fig. 10—Energy level diagram for germanium doped with indium: (a) at -273°C , (b) at room temperature

zero (Fig. 10a) the energy level of the vacancies in the bonds is only slightly above the valence band of the germanium valence electrons. At room temperature (Fig. 10b) a germanium valence electron which has a poor chance of receiving sufficient energy to take it into the conduction band, receives sufficient energy to enable it to jump into the vacancy (the 'hole') offered by the indium atom. As before, a few holes are formed by the electrons which have received sufficient energy to jump into the conduction band.

The holes, however generated, can migrate through the lattice in a way similar to that of the electron. The movement of the hole can be described completely by saying that it has the same mass as an electron and a positive charge equal and opposite to that of the electron.

CHAPTER 2

Manufacture of Transistors

At the present time there are two manufacturing processes for transistors. These are the alloy-junction method and the alloy-diffusion method. The alloy-junction method is used for small-signal r.f. and a.f. transistors and medium-power output transistors. Typical Mullard transistors made by this method are the OC44 and OC45 r.f. transistors, the OC70 and OC71 a.f. transistors, and the OC72, OC78 and OC81 a.f. output transistors. Mullard transistors made by the alloy-diffusion method are the AF114, AF115, AF116 and AF117 r.f. transistors. Both methods involve complex techniques, many of which have in the past been confined to the research laboratory. These intricate laboratory processes are now applied to quantity production in the Mullard transistor factories.

Purification of Germanium

The raw material used for both manufacturing processes is germanium. The principal sources of germanium are the copper ores of the Katanga region in the Congo, the zinc ores of S.W. Africa, and the flue dust produced by burning Northumbrian coal. This particular kind of coal contains approximately 0.02% of germanium, equivalent to one ounce in three hundredweights. Burning the coal acts as the first stage in the extraction and the resulting flue dust can contain 1 or 2% by weight of germanium.

The germanium comes to the transistor factory in the form of germanium dioxide, a white powder. This is reduced to metallic germanium by heating the germanium dioxide in an atmosphere of hydrogen for several hours. The germanium is fused into a bar. Chemical analysis would show the resulting germanium to be pure, but for transistor manufacture a degree of purity higher than that of any other manufactured article is required. Traces of impurity have an all-important effect on the conductivity of germanium. Therefore the nature of the impurities and their concentration in the germanium have

PURIFICATION OF GERMANIUM

Bar of germanium reduced from germanium dioxide powder

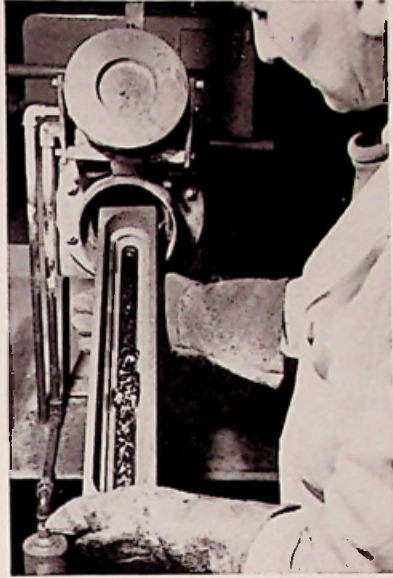

to be rigorously controlled, otherwise the electrical properties will be unpredictable and the germanium unsuitable for transistor manufacture.

The purification is completed by a process known as zone refining. This process is based on the fact that impurities will concentrate more readily in the molten metal rather than in the solid metal. The zone refiner consists of a silica tube surrounded at intervals by r.f. heating

Germanium zone refiner

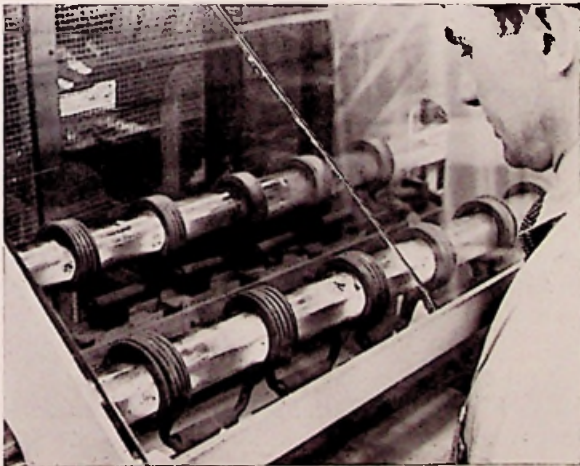

PURIFICATION OF GERMANIUM

coils. The bar of germanium, after being etched in chemicals to remove the scale from the outside is placed in a graphite boat and inserted in the zone refiner. The graphite boat is drawn slowly through the tube. Each r.f. heating coil heats up the graphite boat by induction and so creates a zone of molten germanium. As the bar passes through the coils, the zones travel the length of the bar. The impurities collect in the molten zones and are swept to one end of the bar. The principle of the process is shown in Fig. 1 in which, for the sake of simplicity, only one molten zone is shown.

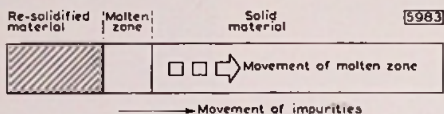

Fig. 1—Principle of zone refining

The purity of the germanium is checked by measuring its resistivity. A small flat surface is ground along the length of the bar. Along this flat the resistivity of the bar is measured, centimetre by centimetre. The measurement is made by means of a probe having four contacts. The two outer contacts apply a known current and the voltage drop between the two inner contacts is measured. The greater the amount of the impurity, the lower the resistance will be between the two contacts. At the end of the bar containing the impurities from the zone refining, the resistance drops considerably. The point at which the resistance becomes too low is marked on the bar, and this end is cut off by a diamond-impregnated wheel and discarded.

The impurities with electrical activity in the refined bar are reduced to one part in ten thousand million, that is 1 part in 10^{10} . In other words, the germanium is 99.999 999 99% pure. This degree of purity was unheard of in metal working before the development of semiconductor devices. The impurity level is outside the range of chemical analysis and can only be tested by electrical methods, such as checking the resistivity of the germanium.

The purification of the germanium eliminates the unwanted impurities. The next stage in the manufacture of the transistor is to introduce the correct amount of the required additive to give p-type or n-type material. As the details of the two manufacturing processes now differ, each will be described separately.

Alloy-Junction Process

The germanium is formed into n-type semiconductor to form the base wafers of p-n-p transistors. The additive used is antimony and

ALLOY-JUNCTION PROCESS

this must be added to the germanium to give a concentration of 1 part of antimony in 10^8 parts of germanium. The process of introducing the additive is called 'levelling'.

When the germanium comes from the zone refiner it is polycrystalline; that is, it consists of many small crystals of different sizes. A sample from the bar will consist of pieces from various crystals. Unwanted imperfections would therefore be present in the sample at the boundaries between the crystals. For consistent electrical properties, therefore, the bar of germanium has to be converted into a single crystal.

The combined process of levelling and recrystallisation is performed in the apparatus shown in Fig. 2. The bar of purified germanium

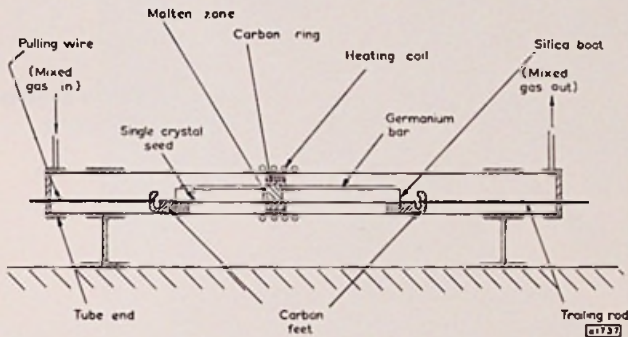

Fig. 2—Levelling table for combined process of growing single crystal of germanium and introducing additive

is placed in a silica boat and a short length of single-crystal germanium, produced during a previous refining and called the seed, is attached to one end of the bar. Between the seed crystal and the bar, small weighed pellets of antimony are placed. The boat is slowly drawn through the heating coil, and a molten zone created which moves down the bar. The germanium resolidifies to form a single crystal of n-type material with the antimony uniformly distributed throughout. The crystal is extremely hard and cannot be scratched with a steel blade. It is usually cut with a diamond. Before the next operation, the bars of monocrystalline n-type germanium are measured for resistivity, again using a four-contact probe.

The n-type germanium is required in the form of small, thin wafers so that the bar of n-type germanium is cut into short lengths which are mounted on a plate and waxed to hold them in position. These lengths are then cut into slices about half a millimetre thick. The cutter works

ALLOY-JUNCTION PROCESS

rather like a miniature version of the familiar bacon slicer but with several diamond-impregnated wheels. The germanium is set at the correct angle for cutting by means of X-rays and the cutting operation is automatic. The slices from the cutter are separated from each other and the wax is dissolved. The faces of the slices are ground (or 'lapped') to remove any parts of the crystal that have been fractured by the cutter. Lapping also reduces the thickness of the slices. After lapping, the resistivity of the slices is measured and they are sorted into groups suitable for the various types of transistor.



Removing slices of germanium crystal after lapping

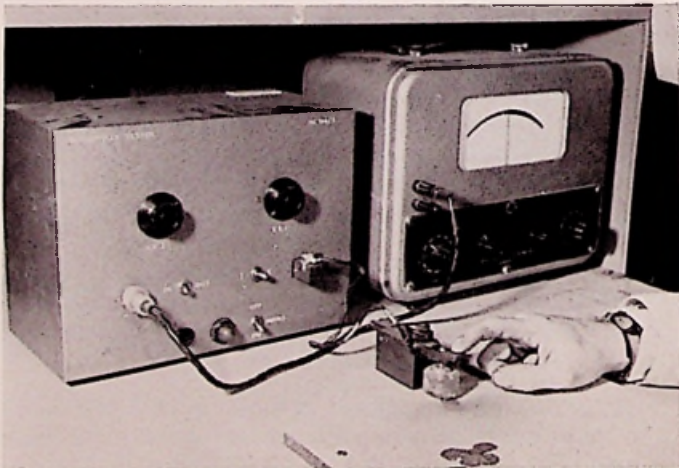

Measuring the resistivity of germanium slices after lapping

ALLOY-JUNCTION PROCESS

The slices are then cut up to form a large number of base wafers. These are circular, square or rectangular, according to the type of transistor. The circular wafers are required for such transistors as the OC44 and OC45 and are 1.45 mm in diameter. These wafers are cut from the slices by an ultrasonic drill fitted with a perforated bit. The

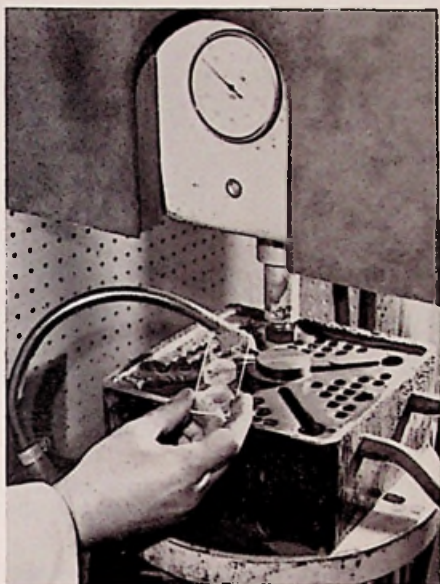

Drilling germanium slices to form circular base wafers

cutting of the square or rectangular wafers is called 'dicing'. The slice passes under diamond cutters which score a set of parallel grooves on it. The slice is turned automatically through 90° at the end of the run and a second set of grooves at right-angles to the first is cut on the return stroke. The resulting criss-cross of grooves, rather like those of a bar of chocolate, allow the slice to be separated into single wafers. A typical size of the wafers, those for the OC81, is 2.4 mm square.

The final reduction in the thickness of the wafers is made by etching. The wafers are placed in a small plastic basket with numerous small holes in the side and bottom, and the basket is agitated in the etching fluid. After the first etch, the wafers are automatically coarse-graded into batches according to their thickness. Each batch is re-etched for a time depending on the average thickness of the batch. After the second etch the wafers are fine-graded. Further corrections to the thickness are not made by etching, but in the subsequent alloying process the temperature

ALLOY-JUNCTION PROCESS

is adjusted to suit the thickness of each fine grade of wafer. The thinnest base wafers are those for the OC44 and OC45 which are only $100\mu\text{m}$ thick, that is a tenth of a millimetre. At this relatively early stage in the manufacturing process the wafers are worth more than their weight in gold.

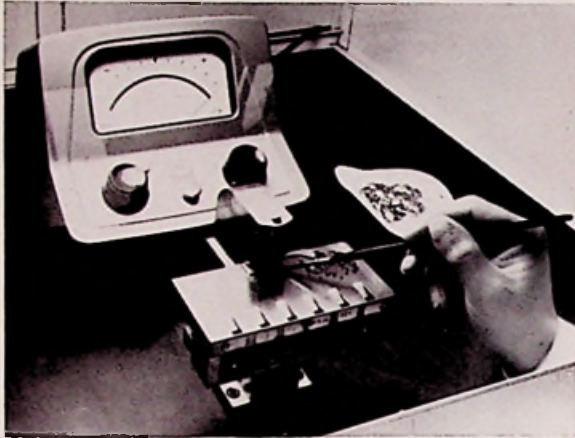

Measuring the thickness of the base wafer prior to alloying.
An electronic method of measurement is used, accurate to $\pm 0.5\mu\text{m}$

To form the p-type semiconductor for the emitter and collector regions, pellets of the p-type additive are fused to each side of the n-type semiconductor wafer. The p-type additive used is indium. Indium wire or strip is cut into portions containing the amount of material required for the pellets. The pellet which forms the collector is three to five times larger than the one used for the emitter.

The process for shaping or 'balling up' the pellets resembles the process used for manufacturing lead shot. The pieces of indium are dropped down a glass tube which is about three feet high and filled with liquid. At the top of the tube, the liquid is sufficiently hot to melt the pieces of indium into droplets. Further down, the liquid is cooler and the drops of indium solidify into spherical pellets.

The alloying of the collector junction is carried out before alloying the emitter junction. The collector pellet, the base wafer and the base connection (previously tinned) are assembled in a jig and carried through an electric furnace whose temperature is higher than the melting point of indium but lower than that of germanium. The molten indium penetrates the germanium to form an alloy which is p-type germanium. This alloy is in intimate contact with the n-type base

ALLOY-JUNCTION PROCESS

wafer. The jigs are removed from the furnace, loaded with the emitter pellets, and passed through the furnace again. The furnace is divided into three temperature zones, the temperatures being controlled to within ± 1 degC on temperatures of approximately 650°C. This close control is



Sorting and inspecting indium pellets for the emitters and collectors

necessary because the depth of alloying and hence the effective thickness of the base depends on the furnace temperature. The section of the transistor shown in Fig. 3 clearly shows the layer of p-type germanium in contact with the base wafer and the pellets of re-solidified indium.

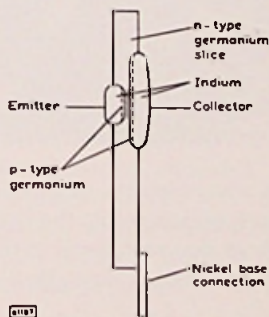

Fig. 3—Cross-section of alloy-junction transistor

The final stages of manufacture are the soldering of the connecting leads to the transistor, and cleaning. The connecting leads pass through a glass foot that will later form part of the envelope of the transistor, and these leads are connected to the emitter and collector pellets and to the base connection by means of jumper wires. The soldering of these jumper wires is a very critical operation. A miniature soldering iron

ALLOY-DIFFUSION PROCESS

would be difficult to handle on such small components and might introduce impurities. Instead, a fine stream of hot gas often serves as the source of heat. In a second method, the heat is provided by discharging a capacitor through the jumper wire. To ensure that the jumper wires are attached accurately to the emitter and collector pellets, the soldering is carried out under a microscope.

After soldering, the flux is washed off by demineralised or de-ionised water and the assembly is etched. The etching removes surface contamination and prevents short-circuits occurring at the emitter and



Attaching connecting leads to the emitter and collector pellets. Microscopes are necessary because of the extremely small size of the components.

collector junctions at the points where the non-alloyed residue in the indium pellets meets the base material. The assembly is given a further wash in demineralised water to remove the chemicals used for etching and then passes through a drying oven.

Alloy-Diffusion Process

The high-frequency performance of a transistor depends on the width of the base layer and the transit time of the charge carriers between the emitter and collector. Variations in the thickness of the base layers will directly affect the high-frequency performance of the transistor. The base width and depth of penetration of the junction of a transistor manufactured by the alloy-junction method are determined by the

temperature and time of alloying and the size of the indium pellet. When alloying the transistor, it is possible for the emitter and collector pellets to melt right through and so short-circuit the base. It is therefore necessary to aim at a mean base thickness large enough to prevent a high rejection rate from this cause. The OC44, which has an average cut-off frequency of 15Mc/s, probably represents the upper frequency limit obtainable with the alloy-junction method of manufacture. Another method of manufacture, the alloy-diffusion method, enables transistors to be manufactured with a base width of only a few micrometres. Short-circuiting of the base is almost entirely eliminated by alloying from one side of the assembly only.

A wafer of p-type germanium is manufactured by the levelling and slicing techniques described in the alloy-junction method. A pre-diffusion process gives a controlled depth of n-type material on the surface of the wafer, as shown in Fig. 4a. Two pellets are placed close

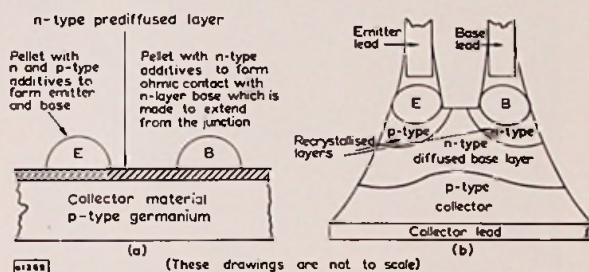

Fig. 4—Alloy-diffused transistor:

- (a) basic components before heating
- (b) Simplified cross-section after diffusion

together on the n-type material. Pellet B, which will eventually form the base connection of the transistor, contains n-type additives only. Pellet E, which will form the emitter, contains p-type and n-type additives. The assembly is heated to the appropriate temperature in an inert atmosphere and the additives in the pellets diffuse into the p-type germanium beyond the depth of the pre-diffusion layer.

The p-type additive in Pellet E diffuses slowly and penetrates a negligible distance only into the wafer. The n-type additives in both pellets diffuse more rapidly and so form a layer of n-type germanium. This diffused n-type layer forms the base of the transistor and its thickness can be limited to less than $5\mu\text{m}$.

While the assembly is cooling, a layer of germanium recrystallises from the pellets as in the alloy-junction method. The recrystallised

ENCAPSULATION AND TESTING

layer beneath Pellet E is predominantly p-type because the p-type additive is more soluble in recrystallised germanium than the n-type additive. This p-type layer forms a p-n junction with the diffused n-type base layer which itself forms an n-p junction with the p-type collector wafer. In this way, a p-n-p transistor is formed. The recrystallised layer beneath Pellet B is n-type and so forms an n-n or non-rectifying junction with the diffused base layer. Pellet B is therefore used to make contact with the base layer. A simplified section of the transistor after diffusion is shown in Fig. 4b.

The concentration of the additives in the base layer is graded between the emitter and collector junctions, as shown in Fig. 5. This gradient

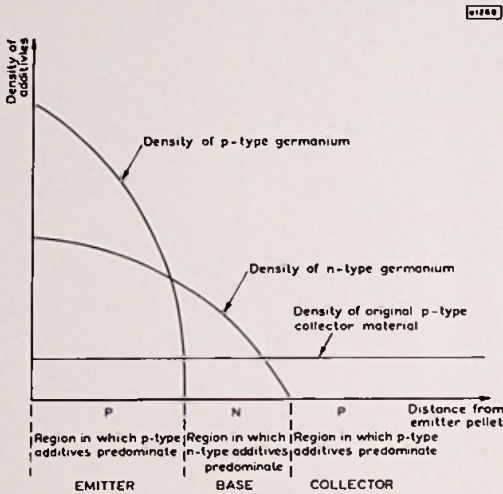

Fig. 5—Concentration of additives in alloy-diffused transistor

produces an accelerating or 'drift' field and it is this drift field that reduces the transit time of the charge carriers and so contributes to the good high-frequency performance of this type of transistor.

After the diffusion process, the transistor is etched and washed, and the connecting leads attached. It is then ready for the final stages of manufacture.

Encapsulation and Testing

Before the transistors made by both processes are encapsulated, they undergo an electrical test. To prevent contamination this is made in a hermetically sealed box containing dry nitrogen gas. The transistors that pass this test are then encapsulated. The glass envelope is filled with a silicone compound to protect the transistor from moisture and

ENCAPSULATION AND TESTING

to help conduct heat away from the semiconductor material, and the glass foot, fitted to the transistor when the connecting leads are soldered, is sealed to this envelope. The seal is made either by electrically generated radiant heat or by a gas flame on a machine which is a smaller version of that used for sealing valves.

Sample transistors are tested for leaks. In the first test, the transistors are submerged in a mixture of methylated spirits and red dye, and any leakage is revealed by the penetration of the dye into the envelope. The second leak test is in effect a tropical test in which sample transistors are subjected to three cycles of high temperature and high humidity over three days. If the envelope is at all leaky, the performance of the transistor will deteriorate markedly and it will be rejected at the electrical test at the end of the cycles.



Final testing of an audio transistor

Finally the envelope is painted or fixed in a metal can and the type number applied. Although the spacing of the leads indicates which is the emitter, base or collector lead, a coloured dot is placed on the case alongside the collector lead for greater ease of identification.

A comprehensive system of quality control is applied throughout the whole manufacturing process. After manufacture, all transistors undergo a series of exhaustive tests. In this way the Mullard engineers ensure that only transistors of the highest quality and reliability reach the consumer.

CHAPTER 3

Transistor Action

In the first chapter it was shown that the operation of a junction transistor depends on the existence of two different types of charge carrier in the semiconductor material. One of these charge carriers is the familiar electron. The other is the positive hole, the hole being the vacancy left when one of the electrons of the outer orbit of the germanium atom migrates to another atom. A hole can be considered to behave in the same way as an electron except that the hole has a positive charge.

Germanium can be made into n-type semiconductor in which there are more electrons than holes, or p-type semiconductor in which there are more holes than electrons. When a voltage is applied across a piece of n-type germanium, the current is carried mainly by the electrons and only a small part by the holes. With p-type germanium, the current is carried mainly by the holes. The charge carrier which conducts more current is called the majority carrier. The other carrier is called the minority carrier. The germanium is made into p-type or n-type by the addition of certain impurities or additives.

Diode Junctions

A single crystal of germanium can be made in which there is a p-type region and an n-type region. A crystal in which there is a fairly abrupt change from p-type germanium to n-type germanium forms a p-n junction which is the basic component of the junction diode and is

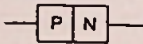

Fig. 1—'Block diagram' of semiconductor diode

shown in Fig. 1. Rectification occurs at the junction of the two regions.

A p-n junction is shown diagrammatically in Fig. 2. The current carriers

DIODE JUNCTIONS

are represented by + signs for the holes and - signs for the electrons.

Holes and electrons tend to diffuse across the junction, holes crossing into the n-type material and electrons into the p-type material. The holes that cross the junction combine with electrons in the n-type material and the electrons that cross combine with the holes in the p-type material. The p-type material is therefore losing holes and acquiring electrons, and so is receiving a negative charge. At the same time the n-type material is losing electrons and acquiring holes, and so is receiving a positive charge. A potential builds up across the junction, the magnitude and polarity of which inhibits further diffusion. This is called the barrier potential. The region in the immediate vicinity of the junction where there are few free current carriers because of the

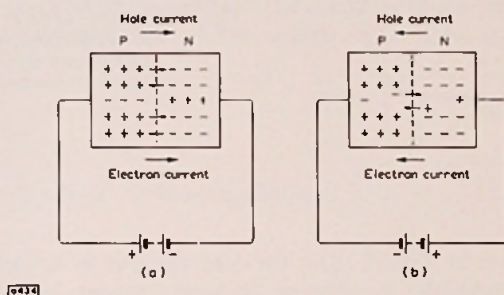

Fig. 2—Current carriers in semiconductor diode:
 (a) with forward bias
 (b) with reverse bias

diffusion process and the formation of the barrier potential is called the depletion layer.

When a bias voltage is applied to the junction, such that the p-type material is made positive with respect to the n-type material, the effect is to reduce the barrier potential. Majority-carrier holes will once more diffuse across the junction into the n-type material. Similarly, the majority-carrier electrons will diffuse into the p-type region. The currents produced by the flow of electrons and the flow of holes are additive, as shown in Fig. 2a, since the electron current is conventionally in the opposite direction from the electron flow. A relatively large current therefore flows across the junction. Fig. 2a also shows that the minority carriers, the relatively few free electrons in the p-type material and the relatively few free holes in the n-type material, also contribute to the current flowing across the junction.

If the applied voltage is reversed so that the p-type material is made

P-N-P TRANSISTOR

negative with respect to the n-type material, minority-carrier electrons from the p-type material flow across the junction into the n-type material and minority-carrier holes from the n-type material flow into the p-type material. As the minority carriers are few in number and only those in the vicinity of the junction are affected, the current flowing is very small. The minority-carrier current is shown in Fig. 2b.

The first case, where the p-type material is made positive with respect to the n-type material, is called forward bias. The second case, where the p-type material is made negative with respect to the n-type material, is reverse bias. The voltage/current characteristic of a junction

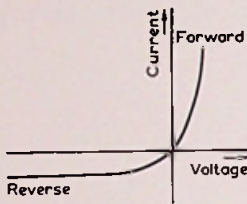

Fig. 3—Voltage/current characteristic for semiconductor diode. The forward current scale is in mA, the reverse current in μA

6435

diode is shown in Fig. 3. The forward current is usually quoted in milliamperes and the reverse or leakage current in microamperes. The applied voltage is only a few volts.

The P-N-P Transistor

The p-n-p junction transistor consists of a crystal of semiconductor material, usually germanium, in which there are two p-n junctions with a common region of n-type material. The base region of n-type material consists of germanium lightly doped with antimony to give electron charge carriers and is very thin, varying from a few micrometres to $100\mu\text{m}$ thick. On either side of the base region are the emitter and collector regions, heavily doped with indium to give positive holes. The transistor can, in fact, be regarded as two diodes back-to-back as is shown in Fig. 4.

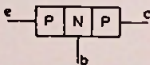

Fig. 4—'Block diagram' of p-n-p transistor

When the transistor is used as an amplifier or oscillator, it is biased as shown in Fig. 5. The emitter-base diode is forward-biased, the n-type base being negative with respect to the p-type emitter. The base-collector

P-N-P TRANSISTOR

diode is reverse-biased, the p-type collector being negative with respect to the n-type base.

The holes in the p-type emitter diffuse into the n-type base region. There is also a current of electrons across the junction from the base to the emitter but this is small since the emitter is more heavily doped than the base. The holes injected into the base diffuse across the base region since it has a negligible electric field across it. Holes that reach the collector depletion layer are attracted into the collector region since it is biased negatively with respect to the base. There is also a minority-carrier current across the collector-base junction of electrons attracted into the base from the collector. Besides the holes injected into the base from the emitter, there are a small number of holes normally present in the base.

Not all the holes in the base reach the collector as a small proportion combine with the electrons of the n-type base (that is, an electron

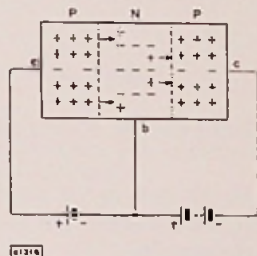

Fig. 5—Current carriers in biased p-n-p transistor

of the base fills the vacancy in the outer electron orbit of a germanium atom and the 'hole' disappears). This process is called recombination and is the cause of the effect called hole or carrier storage. Most of the recombination takes place on the surface of the base around the emitter pellet. Because the base region is so narrow, about 95 to 99% of the current leaving the emitter reaches the collector. The collector current consists chiefly of this hole current across the base but there is also the small minority-carrier current of electrons across the collector-base junction mentioned above, although this makes only a very small contribution to the total collector current.

The base current consists of three parts: the recombination current caused by the recombination of the holes diffusing across the base, the emitter electron current, and the collector reverse or leakage current. The first two parts give a positive current flowing out of the base but the third is in the opposite direction. The recombination current, however, is the greatest part of the base current. The base current is very small in comparison with the emitter and collector currents.

Summarising: a hole current flows from the emitter to the base

AMPLIFICATION WITH A TRANSISTOR

with a small electron current from the base to the emitter. Most of the hole current (95 to 99%) flows across the base and into the collector to form the collector current. The remaining 1 to 5% of the holes combine with electrons in the base. The base current, small in comparison with the emitter and collector currents, consists of the recombination current (the most important part) to which is added the base-to-emitter electron current and from which is subtracted the collector-to-base electron current or leakage current.

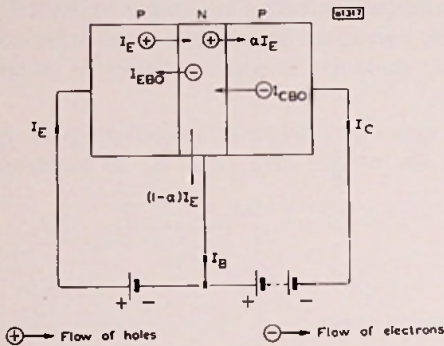

Fig. 6—Currents in p-n-p transistor

The currents in the transistor are shown in Fig. 6. The emitter current I_E , the base current I_B , and the collector current I_C are related by the equation:

$$I_E = I_B + I_C.$$

The emitter and collector currents are related by the equation:

$$\frac{I_C}{I_E} = \alpha,$$

where α has the value 0.95 to 0.98 for a well-made transistor. α will have a value less than unity, since the collector current consists of that part of the emitter current that diffuses across the base region. It will also be seen that the recombination current, the major part of the base current, is equal to $(1-\alpha) I_E$.

The equation $I_E = I_B + I_C$ is not strictly correct since I_C as defined does not include the small collector leakage current, shown as I_{CBO} in Fig. 6. The inaccuracy is small, however.

Amplification with a Transistor

In Fig. 7 the transistor is biased as before (in Fig. 5), with the emitter positive with respect to the base and the collector negative with respect to the base, but an a.c. signal is superimposed on the emitter bias voltage and a load resistor is connected in the collector circuit.

AMPLIFICATION WITH A TRANSISTOR

As the transistor is a three-terminal device, it is possible to connect it into the circuit in three different configurations, each with its own characteristics. These characteristics are tabulated in Chapter 5. In Fig. 7 the transistor is connected in the 'common-base' configuration, the base being common to the input (signal generator) and output (load resistor) circuits.

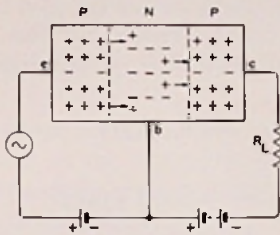

0.130

Fig. 7—Transistor with a.c. signal superimposed on emitter bias voltage and load resistor in collector circuit

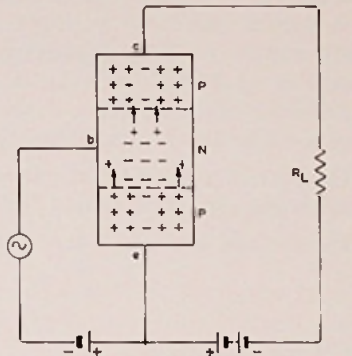

0.131

Fig. 8—Transistor in common-emitter configuration with input signal and load resistor

Since the emitter-base diode is forward-biased, the input impedance of the transistor will be low, being approximately 10 to 50Ω for the common-base configuration, and the hole current across the junction is sensitive to the applied voltage. Changes in the bias voltage across the emitter-base junction (caused by the a.c. signal superimposed on the steady bias voltage) will cause considerable changes in the emitter current and hence in the collector current. The base-collector diode of the transistor is reverse-biased and so the output impedance is high, approximately 0.25 to 2.0MΩ for the common-base configuration. The collector current, which is only slightly less than the emitter current, is therefore flowing through a much higher impedance than is the emitter current, and so a power gain has been achieved. By the choice of a suitable resistance in the collector circuit, an amplified signal can be obtained across the load resistor.

The current gain of the transistor in this configuration, defined as output current/input current, is therefore I_C/I_E , which is the term α in the equation on page 24. Although α is less than unity, the transformation of impedance described above results in the power gain.

The transistor can also be connected into a circuit with the emitter common to the input and output circuits. This is called the 'common-emitter' configuration and is shown in Fig. 8. The bias voltages are

AMPLIFICATION WITH A TRANSISTOR

also shown, the base being negative with respect to the emitter to provide forward bias on the emitter-base junction, and the collector made more negative with respect to the emitter to provide the reverse bias across the base-collector junction.

As in the common-base configuration, the emitter current, and hence the collector current, is varied by changes in the emitter-base bias caused by the a.c. signal. Again there is an impedance transformation, typical values of the input and output impedances being 0.5 to 1.5k Ω and 50 to 200k Ω respectively. This time, the current gain of the transistor is defined as I_C/I_B since the input terminal for this configuration is the base. The current gain, represented by β , can therefore have a value up to approximately 50.

The current gain and impedance transformation ensure a power gain between the input and output circuits.

The relation between α and β can be easily derived since:

$$\alpha = \frac{I_C}{I_E} \quad \text{and} \quad \beta = \frac{I_C}{I_B}.$$

The basic equation:

$$I_E = I_B + I_C$$

can be rewritten as:

$$\frac{I_E}{I_C} = \frac{I_B}{I_C} + 1,$$

that is:

$$\frac{1}{\alpha} = \frac{1}{\beta} + 1.$$

Rearranging this equation gives:

$$\beta = \frac{\alpha}{1-\alpha}.$$

The third configuration is the 'common-collector' configuration, with the input applied between the base and collector, and the output taken from the emitter and collector. The configuration has a high input impedance and low output impedance. It is therefore equivalent to the valve cathode follower circuit, and is sometimes known as an emitter follower. The current gain in this configuration is approximately equal to β , the exact value being $(1+\beta)$.

CHAPTER 4

Printed Wiring

Printed wiring is a technique which may not be familiar but which is extensively used in transistor radios. The term printed wiring is used to describe electrical circuits which take the form of thin copper strips attached to an insulating board instead of the more familiar separate lengths of copper wire. The techniques of servicing printed wiring are somewhat different from those used with conventional wiring, but before considering these techniques it is worthwhile looking at the manufacturing processes.

Manufacture of Printed Wiring

The first stage of the manufacturing process is to arrange the circuit to form a convenient flat component layout. This layout is then drawn and photographed, and transferred to a printing plate. This plate is used to produce an image of the original drawing on a thin layer of copper attached to one face of a laminated insulating board. The image is printed with a special ink called a 'resist'. Sometimes the surface is dusted with a bituminous powder which clings to wet parts of the surface, and the board heated until the bituminous powder fuses. The complete board is then dipped in acid which etches the areas of copper not protected by the resist, leaving a network of copper foil which forms the wiring. The board is washed and dried, the resist dissolved off, and holes drilled or punched in the board for the lead-out wires of the components. The various components are usually fixed to the board by the lead-out wires only, although some larger components may be fixed with clips, and in the case of inter-stage transformers, by the tags on the screening can. After the components have been fitted, the areas of copper where there is no soldered connection are coated with a solder resist. The whole connection side of the board is fluxed and dipped in a bath of solder so that all exposed areas of copper are soldered. The component leads which protrude through the holes in the board are thus firmly connected to the strips of copper

MANUFACTURE OF PRINTED WIRING

foil. A typical printed-wiring board with the components soldered in position is shown in Fig. 1.

There are two important advantages of the printed-wiring technique over conventional wiring. These are a great reduction in the number of dry joints and the possibility of higher production rates. In receivers

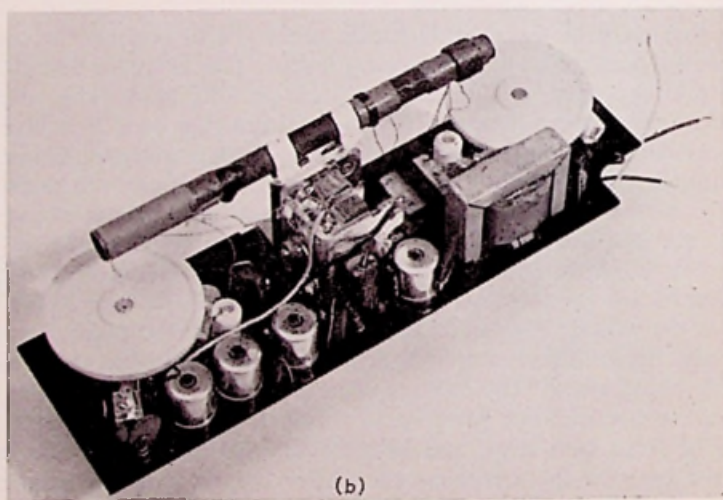
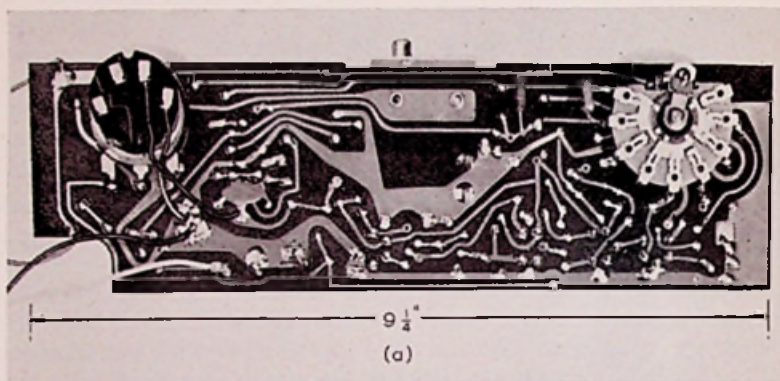

Fig. 1—Printed-wiring board:

(a) showing conductor strips

(b) reverse side showing components in position

manufactured by conventional methods, there is always a risk of dry joints and faulty wiring. With the printed-wiring technique, it is possible to reduce the number of dry joints occurring to about one-tenth of that with conventional wiring. Once a layout has been determined by the printed-wiring board, all further models are identical. All soldered joints are made in one operation and if components are added automatically, high production rates are possible.

Besides the etching technique described above, the printed-wiring board can be made by punching out the copper strips from a sheet of foil and attaching them to the laminated insulating board. This method, however, is slightly more expensive than etching.

Sometimes the wiring is printed onto both sides of the board and the printed technique can be extended to form actual inductors, capacitors and resistors with the foil. In this case the board should be more correctly called a 'printed-circuit' board.

Care of Printed-Wiring Boards

Certain precautions must be taken when handling printed-wiring boards to prevent damage to the board. The 'wiring' on the boards is extremely thin, about 0.003in, and is attached to the board with an adhesive. Bending the board may therefore detach the foil from the board, or more frequently, place a severe strain on the foil and produce hair-line cracks in the foil. These breaks will give rise to intermittent faults. When making connections to the foil, care must be taken to prevent excessive heat from the soldering iron melting the adhesive or damaging components. In general, a 25W soldering iron is sufficient for most purposes and will not damage the printed-wiring board provided that it is applied only long enough to melt the solder. Acid fluxes should never be used on printed wiring, but none of the common cored solders used by service engineers contain acid flux.

Fault Finding

Circuit tracing is somewhat simpler with printed wiring rather than with conventional wiring because of the single-plane layout of the board. Most service sheets include a drawing of the printed-wiring board with the position of the components marked. This helps circuit tracing considerably since the components are usually mounted on the opposite side of the board from the wiring and the board has to be continually turned over. Some manufacturers mark component reference numbers on the foil side of the board to avoid this. Alternatively, if the component numbers are marked on the opposite side of the board from the wiring, the board may be viewed in front of a bright lamp so that the component numbers become visible through the laminate.

COMPONENT REPLACEMENT

When making voltage or resistance measurements, care must be taken to make proper contact with the copper foil as most boards are coated with an insulating material after manufacture. This insulation serves to prevent accidental short-circuiting of the exposed foil to other parts of the circuit. This insulating material must be removed from the measurement points before any connection can be made. Acetone applied with a soft cloth or brush is the usual solvent.

Old printed-wiring boards may be found to be tarnished. If it is necessary to remove the tarnish, this may be done by the very careful use of steel wool. The board should be carefully inspected afterwards to check that no particles of steel wool are left on the board to cause short circuits between lengths of the foil.

The detection of hair-line cracks in the foil when intermittent open circuits are suspected is best done with a magnifying glass and a bright lamp.

Component Replacement

Components should be removed from printed-wiring boards only when absolutely necessary; for example, for the removal of a faulty component or the isolation of a component from the circuit for testing. When removing components, care should be taken to prevent damaging the printed-wiring board by peeling the foil from the board, bending the laminate or dropping solder over other parts of the board.

Small components, such as resistors or capacitors, are best removed by carefully unsoldering the joint between the lead-out wire and the printed-wiring, and pulling the wires through the hole in the board. If the component is to be replaced, the lead-out wires can be cut near the component so that each lead-out wire can be easily pulled away from the foil. If the component is only being removed temporarily for testing, a heat shunt (such as a pair of pliers) should be used to prevent the heat from the iron damaging the component. Excessive heat should not be used as there is then a risk of damaging the printed-wiring board. The bit of the soldering iron should be kept clean. If an oxide layer forms, the soldering operation takes longer and the risk of damaging the component or printed-wiring board through overheating is increased. If the hole through the board becomes blocked with solder, the solder should be remelted and the board gently but sharply tapped to throw the solder clear.

I.F. transformers which are held to the board by soldered tags may be removed by heating the tags and brushing off the solder with a wire brush. A stiff bristle brush can also be used or a sharp-pointed metal rod such as a scribe. Care must be taken to prevent solder being splashed onto other parts of the board. If the board can be removed

from the receiver, the tags can be heated so that the solder melts and by gently but sharply tapping the board against the bench, the solder on the tags will be thrown off. With these methods, some solder will remain on the tags after brushing or tapping and it is necessary to heat the tags while the component is eased from the board.

An alternative method of removing transformers is to heat the tags and ease them a little away from the board. This procedure is repeated until the tags are in line with their fixing holes and the component is then eased away from the board. Great care must be taken not to overheat the board.

Transistors or diodes should be removed only as a last resort. As a transistor or diode can be damaged by excessive heat during soldering or unsoldering, it is important always to use a heat shunt between the component and the soldering iron. A pair of thin-nosed pliers can be used as the heat shunt, or a crocodile clip with strips of brass soldered across the teeth to give a good thermal contact. When replacing transistors in a circuit great care should be taken to connect them in the correct position as incorrect polarity can permanently alter transistor characteristics or even destroy the transistor. Transistor or diode leads should not be bent closer than 1.5mm to the seal and the lengths of the leads on the replacement should not be less than those on the original transistor or diode.

Components should never be removed or replaced in a receiver when the batteries are switched on. If the batteries are connected, surges can be created which may destroy the transistor.

Repair of Boards

Small-scale repairs such as resticking loose foil or bypassing hair-line cracks can be economically carried out but more complicated repairs often justify the replacement of the board. It is then often more economical to fit new components rather than remove them from the old board and resolder onto the new board.

Loose foil can usually be restuck to the board by careful heating and holding the foil to the board until the adhesive has reset. Hair-line cracks can be bypassed with a short length of wire soldered to the foil. The foil must be cleaned before soldering and the heat applied only as long as is necessary. If a long 'jumper' wire is required, this should be insulated to prevent accidental short circuits to other parts of the circuit. The soldered joint can be covered with a clear lacquer for protection. The lacquer replaces the insulating material which will have been melted during soldering.

REPAIR OF BOARDS

The tools required for work on printed-wiring boards, besides the usual screwdriver, cutters and thin-nosed pliers, are: a low-power soldering iron (25W), a small wire brush, a solvent such as acetone for resin coatings and a small brush for applying it, a metal rod approximately $\frac{1}{8}$ inch in diameter with a sharp point, and clear lacquer for coating connections after repairs.

CHAPTER 5

Transistor Circuits

Basic Transistor Configurations

It has been mentioned already that the transistor is a three-electrode device and can therefore be considered in three possible configurations. These are the common-base configuration, the common-emitter configuration and the common-collector configuration. Sometimes the term 'grounded' is used in place of 'common' since the common terminal is usually taken to earth directly or through a decoupling network. The three configurations are shown in Fig. 1, the letters on the diagrams referring to the emitter (e), the base (b), and the collector (c) regions of the transistor.

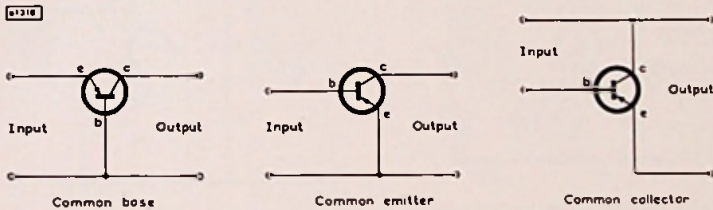

Fig. 1—Basic transistor configurations

Each configuration has special characteristics and the more important are tabulated below:

Characteristic	Configuration		
	Common Base	Common Emitter	Common Collector
Current gain	Less than unity	High	High
Input impedance	Low	Medium	High
Output impedance	High	Medium	Low
Phase shift between input and output voltages	Zero	180°	Zero

The configuration most used for the amplifier stages in transistor radio receiver circuits is the common-emitter configuration.

Bias and Stabilisation

A basic transistor amplifier stage is shown in Fig. 2. This circuit is the basis for many practical amplifier stages as only one battery is required to provide the bias voltages for the transistor, and the designer has most control over the stabilisation.

The bias voltages for the transistor are provided by the voltage drops across resistors R_1 and R_2 . The values of these resistors are chosen so that the current flowing through the potential divider formed by R_1 and R_2 is much larger than the base current of the transistor. In this way, the base potential is held reasonably constant despite variations of the base current. The resistor R_e reduces the effects of transistor spreads and provides stabilisation against temperature changes. Any increase in the emitter current produces a large voltage drop across R_e and the base-emitter voltage is reduced, partly counteracting the original change. A high value of R_e improves the d.c. stabilisation of the circuit, a typical value for the amplifier stage of Fig. 2 being $1k\Omega$. R_e must be decoupled to reduce a.c. feedback.

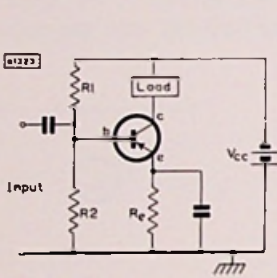

Fig. 2—Basic transistor amplifier stage

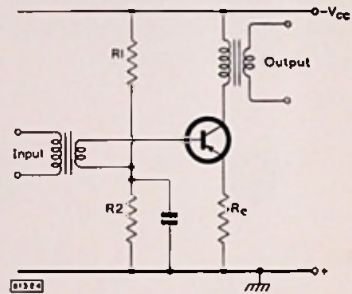

Fig. 3—Transistor class A amplifier stage

It can be seen that if R_e is large and R_1 and R_2 are very small, the circuit becomes effectively the common base configuration with its inherent good stability. If R_e is very small and R_1 and R_2 very large, the circuit becomes effectively the common emitter configuration with its very poor stability. The values of R_e , R_1 and R_2 can therefore be chosen to give the required stability.

Audio Amplifier Stages

Class A Output Stage

Class A operation is used mostly in hybrid and all-transistor car radios where current drain is relatively unimportant. A typical class A amplifier is shown in Fig. 3. In the circuit R_1 and R_2 provide bias as before, R_e improves the stabilisation, and transformer coupling is used for the

input and output signals. The efficiency of a class A amplifier is limited to below 50% and the current drain from the supply is relatively high.

Class A operation is also used to provide drive for class B output stages.

Class B Push-Pull Output Stage

In class B push-pull operation, one transistor conducts while the other is cut off. The method of operation gives a theoretical efficiency of 75% and the average current drain is low. Because of this low current drain, class B operation is favoured for receivers operating from dry batteries.

The basic class B output stage is shown in Fig. 4. The bias and emitter resistors are marked as before. If both transistors are biased exactly to cut-off, a form of distortion occurs which is extremely unpleasant to the listener. This is called 'crossover' distortion and is overcome by applying a slight forward bias to each transistor by means of resistors

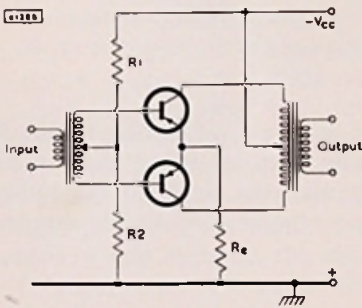

Fig. 4—Transistor class B push-pull output stage

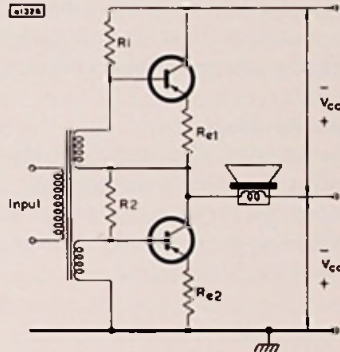

Fig. 5—Transformerless class B output stage

R_1 and R_2 . Resistor R_1 may then have to be adjusted to give the required quiescent current through the two transistors. This can be done by making R_1 adjustable or by selecting it from a number of resistors.

The centre tap of the driver transformer is sometimes connected directly to earth, the bases of the transistors being connected to the negative supply through individual resistors. These resistors, again, may be adjustable or selected to give the correct quiescent current through the transistors.

Fig. 5 shows a transformerless or single-ended class B output stage using a centre-tapped supply. This circuit is favoured in many receivers

DETECTOR STAGE

since it uses only one transformer, a high-impedance speaker providing the required load so that the output transformer is not required. The performance is the same as that of the conventional circuit using an output transformer provided the voltage of each half of the battery is equal to the supply voltage of the conventional circuit.

Another type of push-pull circuit has the output transformer connected in series with the emitter of the transistors. This circuit suffers less from crossover and non-linearity distortion than the conventional circuit with the output transformer in the collector circuit. It is seldom used, however, because of the low gain obtained and the large amount of drive power required.

Heat sinks may be fitted to the output transistors of the audio stage to provide the collector junction with extra cooling and so give a higher dissipation. The sink may be a clip which surrounds the transistor and dissipates heat to the air. Alternatively, the clip may be in contact with the chassis which then acts as a large cooling fin. Transistors dissipating large amounts of power (for example, the class A output stage of a car radio) use a finned heat sink. The transistor and heat sink are mounted on mica and lead washers to give a good thermal contact with the chassis whilst electrically insulating the transistor from it.

Detector Stage

The detector of a transistor receiver is usually a semiconductor diode feeding a potentiometer load. The potentiometer forms the volume control of the receiver which feeds the detected signal to the audio-frequency stages of the receiver. The potentiometer is usually shunted by a $0.01\mu\text{F}$ capacitor.

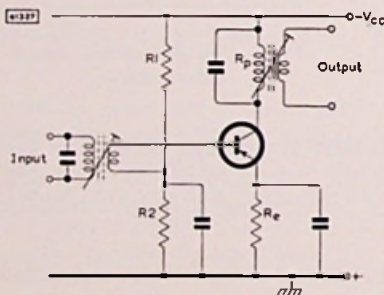

Fig. 6—Basic transistor i.f. stage

I.F. Amplifier Stages

The basic circuit of an i.f. amplifier is shown in Fig. 6. This circuit is similar to the basic audio amplifier stage of Fig. 2, the main difference being that the input and output transformers are tuned to the intermediate frequency, usually 470kc/s .

I.F. AMPLIFIER STAGES

At the frequencies amplified in the i.f. stages, the inherent internal feedback of the transistor becomes very important. This feedback determines the gain which may be safely obtained from a transistor in an i.f. stage, avoiding instability or distortion of the response curve. The internal transistor feedback can be cancelled by 'unilateralisation'.

Fig. 7—Transistor i.f. stage showing unilateralisation components

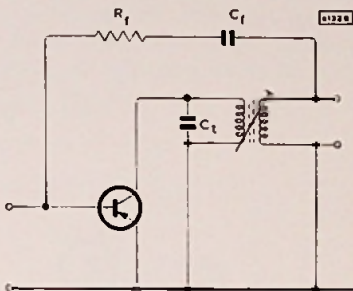

This is shown in Fig. 7 where the internal feedback of the transistor is completely cancelled by the external feedback through the components R_f and C_f . The values of R_f and C_f depend on the internal feedback characteristic of the transistor. In some designs R_f is omitted. C_f then provides what is more correctly called 'neutralisation', since only part of the internal feedback is cancelled. It should be noted that Fig. 7 shows only the a.c. conditions; d.c. supplies are not shown as these are assumed to be short-circuited to a.c. by the decoupling capacitors. Neutralisation is not required with some of the newer types of r.f. transistor (for example, the alloy-diffused types) as the internal feedback capacitance is low. The feedback must still be considered, however, when designing the i.f. stage.

The tuning capacitance required by an untapped i.f. transformer, C_t in Fig. 7, is approximately 3000pF. This value of capacitance, required

Fig. 8—Transistor i.f. stage with tapped transformer

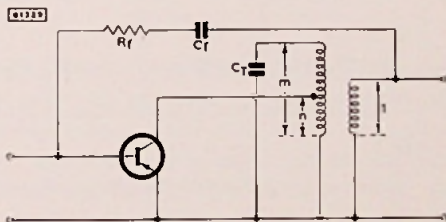

to achieve the desired bandwidth at the correct impedance level, is sometimes inconveniently large and may be reduced by the addition of a tap to the transformer. This is shown in Fig. 8, where the new

I. F. AMPLIFIER STAGES

value of the tuning capacitance C_T is given by: $C_T = (n^2/m^2) C_t$. A turns ratio of 3.16 : 1 reduces the value of the tuning capacitance to approximately 300pF. In practice, values of C_T vary from 100pF to 1000pF.

The complete circuit of a single-stage i.f. amplifier using an OC45 transistor is shown in Fig. 9 and the circuit of a two-stage i.f. amplifier in Fig. 10.

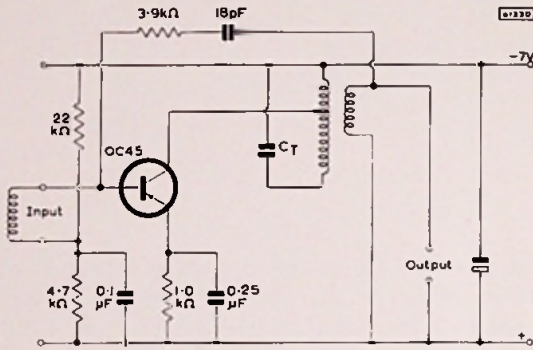

Fig. 9—Single-stage transistor i.f. amplifier

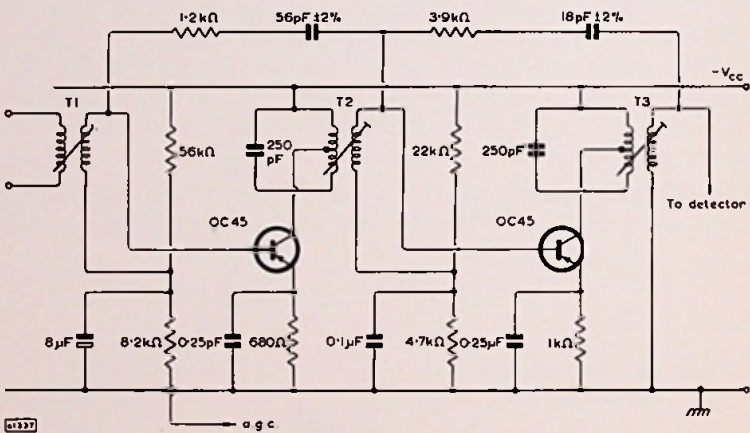

Fig. 10—Two-stage transistor i.f. amplifier

The bandwidth and selectivity of an i.f. amplifier can be considerably improved if both windings of the i.f. transformers are tuned. This type of circuit is shown in Fig. 11. Usually only two double-tuned transformers are used, the final stage or stages being single-tuned, although

A.G.C. CIRCUIT

car radios may differ from this. Unilateralisation requires a phase shift of 180° between the collector current and the base current through the external feedback components. Either the primary or the secondary winding of the i.f. transformer in a single-tuned stage can be used to fulfil this requirement, although connection is usually made to the secondary winding to enable the correct feedback voltage to be obtained without additional taps on the transformer. With a double-tuned transformer, however, there is a phase shift between the primary and secondary windings, and the feedback components must be connected to the primary winding, as shown in Fig. 11.

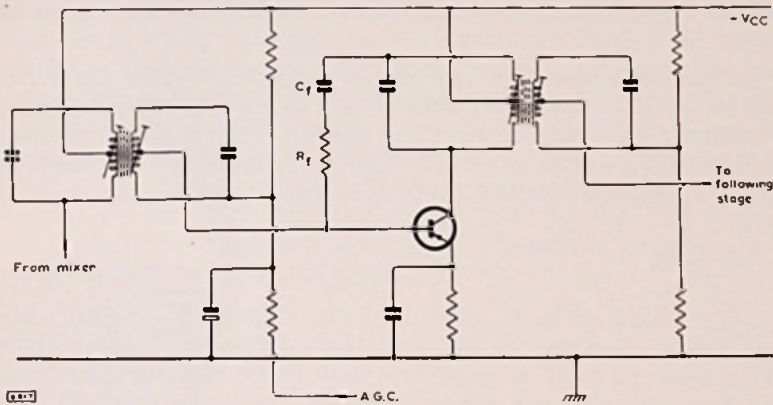

Fig. 11—Double-tuned transistor i.f. amplifier

In some i.f. amplifiers, the transformers are stagger-tuned. Before attempting to align an i.f. stage, the manufacturer's service manual should be consulted to determine how the stage is tuned.

A.G.C. Circuit

The a.g.c. voltage for a transistor portable receiver is derived from the detector, and applied in series with the base-emitter bias voltage of the first i.f. transistor. To eliminate the audio and radio frequency signals from the a.g.c. voltage, the decoupling capacitor of the potential divider feeding the base of the first i.f. transistor is large. A typical value is $8\mu\text{F}$. The a.g.c. control characteristic may be improved by adding a damping diode to the first i.f. transformer. This diode ensures that the a.g.c. action is effective over a larger range of r.f. input voltages than it is in a normal circuit. In transistor car radios, the main a.g.c. voltage is applied to the r.f. amplifier.

MIXER STAGES

Mixer Stages

The frequency changer and mixer stage of a receiver converts, by heterodyne or 'beating' action, the different frequencies of the carrier signal at the aerial to a fixed frequency at the input to the i.f. amplifier. The carrier frequencies vary from 160 to 280kc/s in the long waveband and 540 to 1640kc/s in the medium waveband. The intermediate frequency is usually 470kc/s. The problems of amplification in the i.f. stages are greatly simplified as only a constant, relatively low frequency has to be dealt with. The i.f. frequency is well above the audio-frequency range and this gives rise to the name 'supersonic heterodyne' or 'superhet' which is applied to this type of receiver. The audio frequency information, carried on the r.f. waveform as modulation of the amplitude or frequency, is transferred from the r.f. carrier signal to the i.f. carrier.

Heterodyne action is brought about by injecting signals of different frequencies into a non-linear element such as the base-emitter diode of a transistor. In a radio receiver, one injected signal is the aerial signal and the other is a signal generated within the receiver, the local oscillator signal. The signals combine as shown in Fig. 12 to produce a complex

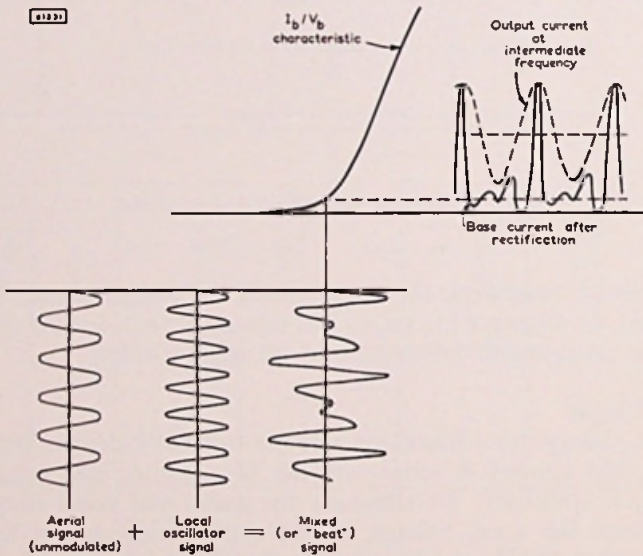

Fig. 12—Diagram showing action of mixer transistor

waveform. When the waveform is applied between the base and emitter of a transistor, part of the waveform is suppressed by the non-linearity of the voltage/current characteristic of the base-emitter diode,

MIXER STAGES

and a current is produced in the base with a component at a frequency equal to the difference between the aerial and local oscillator frequencies. This base current is amplified by normal transistor action to give an output signal in the collector of the transistor.

Components with other frequencies such as the sum of the two injected frequencies are present in the output of the mixer transistor, but the first i.f. transformer which acts as the load to the mixer stage is tuned to the difference frequency, so that it will accept only this frequency and reject all others.

To maintain a constant difference between the aerial and oscillator frequencies, it is obvious that the oscillator frequency will have to change if the aerial frequency is changed; that is, the oscillator tuned circuit must 'track' the aerial tuned circuit. Therefore, if the aerial is tuned to 1500kc/s, the local oscillator must be tuned to 1970kc/s to give a difference frequency of 470kc/s, and if the aerial tuning is changed to 1000kc/s, the oscillator must be tuned to 1470kc/s. It is usual to tune the oscillator to frequencies 470kc/s above the aerial tuning so that signals in the long waveband (with frequencies below 470kc/s) can be accepted. The local oscillator signal applied to the mixer may be derived from a separate oscillator transistor in the receiver, or one transistor may act as both oscillator and mixer.

In a self-oscillating mixer, the input signal from the aerial is applied to the input of the oscillator transistor and so large input signals can bias the transistor to cut-off, thus preventing or 'blocking' the oscillations. Furthermore, as it is necessary to link both the aerial and the oscillator tuned circuits to a self-oscillating mixer, interaction or 'frequency pulling' can occur between the two circuits, with the result that the difference frequency is different from the resonant frequency of the i.f. transformer. Neither of these effects occurs to any great extent when a separate oscillator transistor is used but the extra cost of a separate transistor is an undesirable feature, especially as precautions can be taken in the design of a self-oscillating mixer to prevent blocking or frequency pulling. For these reasons, the self-oscillating type of circuit is most commonly used.

The basic circuit of a self-oscillating mixer is shown in Fig. 13. At the oscillator frequency, the base of the transistor is effectively connected to earth, the aerial tuned circuit having negligible impedance at the oscillator frequency. The input electrode for the oscillator action is therefore the emitter, which is inductively coupled to the collector of the transistor. Both the emitter and collector windings are closely coupled to the oscillator tuned circuit. Positive feedback is applied from output to input through this coupling and oscillations occur at the resonant frequency of the oscillator tuned circuit. The aerial

MIXER STAGES

signal is applied from the aerial tuned circuit to the base of the transistor. Both the aerial and oscillator signals are therefore in series with the base-emitter diode. The component of the heterodyne output signal having the required intermediate frequency is extracted by the i.f. bandpass filter or transformer in the collector circuit.

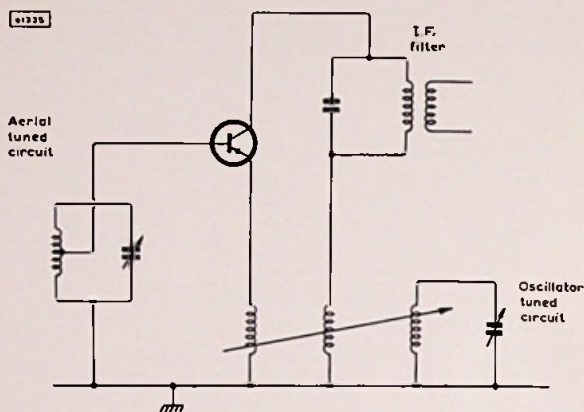

Fig. 13—Basic transistor self-oscillating mixer stage

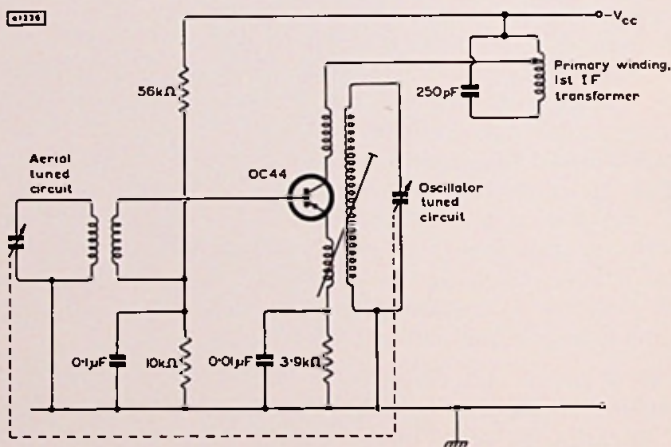

Fig. 14—Transistor self-oscillating mixer stage using OC44

A typical self-oscillating mixer stage using an OC44 is shown in Fig. 14. The circuit is shown for one waveband only, the different wavebands being obtained by switching in other coils in the aerial circuit and other capacitors in the oscillator circuit. The aerial input

is taken to the base of the OC44 and the oscillator feedback from the collector of the OC44 is taken through low-impedance coupling coils to the emitter.

The oscillator tuned circuit is similar to those used in valve receivers since the capacitance reflected from the transistor is very small, approximately only 1pF. To ensure that the oscillation starts easily, the transistor is biased initially for class A operation by the potential divider bias circuit. As the oscillation increases in amplitude, rectification of the oscillation signal occurs at the base-emitter diode. This gives rise to a steady negative voltage across the emitter resistor and bypass capacitor which drives the transistor towards class B conditions. The change in voltage at the emitter stabilises the amplitude of the oscillation, the quiescent emitter current rising slightly (from 0.25 to 0.30mA in the circuit of Fig. 14).

Correct tracking of the aerial and oscillator tuned circuits to maintain the 470kc/s difference in frequencies can be obtained by a conventional padder capacitor or by using a tuning capacitor with specially shaped vanes for the oscillator circuit. The value of the tuning capacitance is not critical but must be sufficient to provide the required frequency coverage.

Stray capacitance can exist between the aerial and oscillator sections of the tuning capacitor and so form a path for unwanted feedback between the two sections. To prevent this feedback and the resulting possibility of spurious oscillations, a screen is usually placed between the two sections. Another source of feedback between the aerial and oscillator sections is through the stray capacitance of the leads to the wave-change switch, so these leads should be short in a well-designed receiver.

Complete Receiver

The individual stages of a transistor radio receiver have been briefly discussed and it is now necessary to see how these stages are combined to form a complete receiver.

Receiver using Alloy-Junction Transistors

The circuit diagram of a typical six-transistor portable receiver is shown in Fig. 15. Three h.f. transistors, one OC44 and two OC45, are used in the mixer and i.f. stages. The detector used is a germanium diode, type OA70. Three l.f. transistors make up the audio stages, an OC71 driving a matched pair of OC72 in a transformerless push-pull output stage.

The aerial used is a Ferroxcube rod which provides adequate selectivity and sensitivity while still being sufficiently small to be used

RECEIVER USING ALLOY-DIFFUSED TRANSISTORS

conveniently in a portable receiver. The long-wave aerial coil is short-circuited to earth during medium-wave reception by section SA1 of the wave-change switch. This is to prevent the coil resonating with its own self-capacitance at a frequency in the medium-wave band and so heavily damping the medium-wave coil.

Low-impedance coils are used to couple the aerial tuned circuit to the base of the OC44 which is used as a self-oscillating mixer. The local oscillations are provided by feedback from the collector to the emitter of the OC44. The oscillator circuit is tuned to a frequency 470kc/s above the aerial signal frequencies, as is usual, and correct tracking of the oscillator circuit is ensured by shaping the vanes of the oscillator section of the tuning capacitor.

The intermediate frequency is extracted from the collector of the OC44 by the first i.f. transformer T3. The two OC45 transistors form the first and second i.f. amplifier stages. Unilateralisation is used in the i.f. stages to ensure stability. The third i.f. transformer T5 is connected to the OA70 diode detector. The audio output is taken to the OC71 driver transistor through the volume control. A d.c. output from the diode detector is fed back to the base of the first i.f. transistor to provide automatic gain control.

The OC71 driver transistor is transformer-coupled to the matched pair of OC72 transistors, biased for class B operation. A single-ended push-pull output stage is used, so that no output transformer is required. Negative feedback is taken from the loudspeaker to the emitter of the OC71 driver transistor.

The battery voltage is chosen as 9V to allow the h.f. transistors to work with a voltage of 6V between the emitter and collector. A further 1V is allowed across the emitter resistors of these transistors to give stabilisation of the working point, and the remaining 2V is allowed for the voltage drop across the decoupling resistor between the audio output stage and the rest of the receiver.

Receiver using Alloy-Diffused Transistors

The circuit of a receiver using alloy-diffused transistors in the r.f. and i.f. stages is shown in Fig. 16. Three AF117 transistors are used for the self-oscillating mixer and i.f. amplifier stages. The detector used is again a germanium diode type OA70 and the audio stages consist of an LFH3 audio package comprising an OC81D driving two OC81 in a push-pull output stage.

As before, a Ferroxcube rod is used for the aerial with the medium- and long-wave coils wound round it. One section of the long-wave coil is short-circuited to earth during medium-wave reception to prevent the coil resonating with its self-capacitance and so damping

the medium-wave coil. The aerial signal is fed to the base of the AF117 self-oscillating mixer and the local oscillations are provided by feedback from the collector to the emitter of the transistor through transformer T1.

Double-tuned transformers T2 and T3 are used in the first two i.f. stages. The i.f. transistors are not neutralised because the low value of feedback capacitance of the AF117 allows a high value of gain to be obtained at 470kc/s without instability occurring. The final i.f. transformer T4 couples the i.f. signal to the OA70 detector diode. The overall gain of the r.f. and i.f. stages is 15dB more than that of the circuit using OC44 and OC45 transistors described previously.

The volume control couples the detected signal to the audio stages. A d.c. voltage from the detector is fed back to the base of the first i.f. transistor to provide automatic gain control. A damping diode type OA79 is used to extend the a.g.c. range and also to clamp the mixer collector voltage. This prevents instability occurring in the mixer when the stage operates with a high collector load impedance with large signals.

The driver transistor is transformer-coupled to the two OC81 transistors forming a conventional push-pull output stage. A low-impedance loudspeaker is used. The battery voltage used is again 9V allowing a line voltage of 7V to be used in the i.f. stages.

Combined A.M./F.M. Receiver

The circuit of a typical a.m./f.m. transistor receiver is shown in Fig.17. This receiver uses nine transistors, all of which are used for f.m. reception and seven for a.m. reception, and has been designed to keep switching to a minimum when changing from a.m. to f.m. reception. The frequency ranges of the receiver are 87 to 101Mc/s on v.h.f., and the medium and long wavebands for a.m. reception.

F.M. Operation

A telescopic 'V' aerial is used for f.m. reception. This is coupled through a wideband transformer L1/L2 to the r.f. amplifier Tr1, an AF114 transistor operating in the common-base configuration. This configuration is used as it gives the highest gain at 100Mc/s. The collector circuit of the r.f. amplifier is tuned by capacitor C7 and is capacitively matched to the input impedance of the self-oscillating mixer stage Tr2, an AF115 in the common-base configuration. The oscillator differs from the type normally used for medium-wave reception. The phase lag between the transistor input and output currents at 100Mc/s in the common-base configuration is approximately 90°. Therefore, when feedback is applied through the feedback capacitor C12 between the collector and the emitter, oscillation occurs.

A.M./F.M. RECEIVER

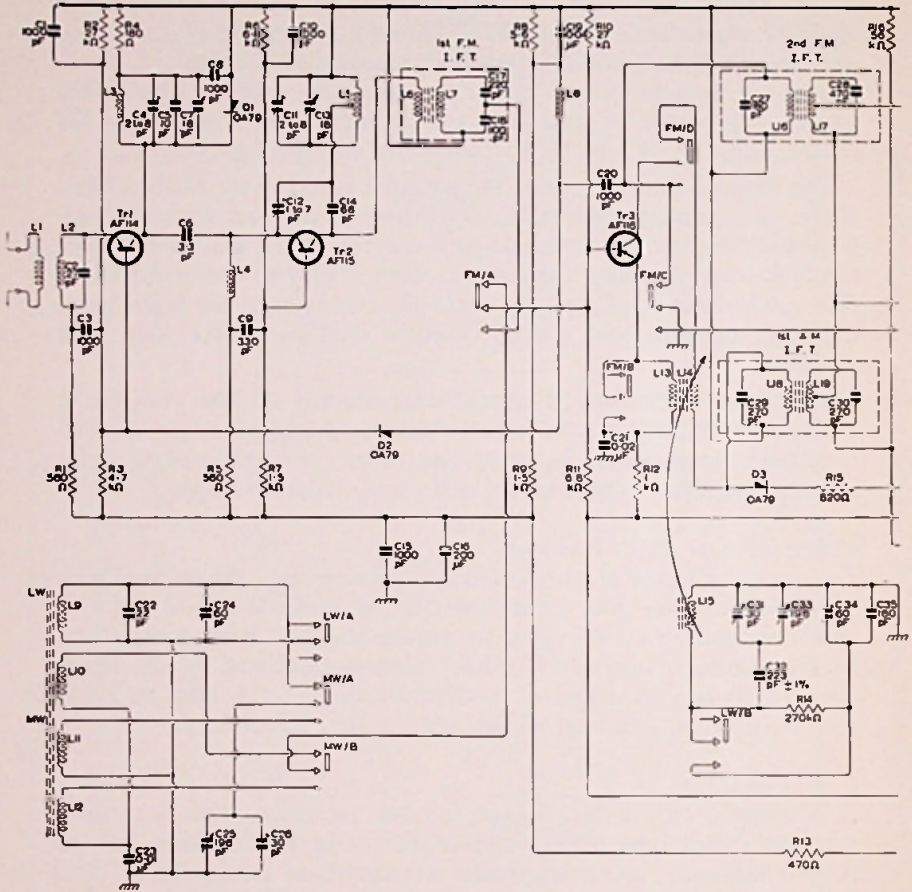
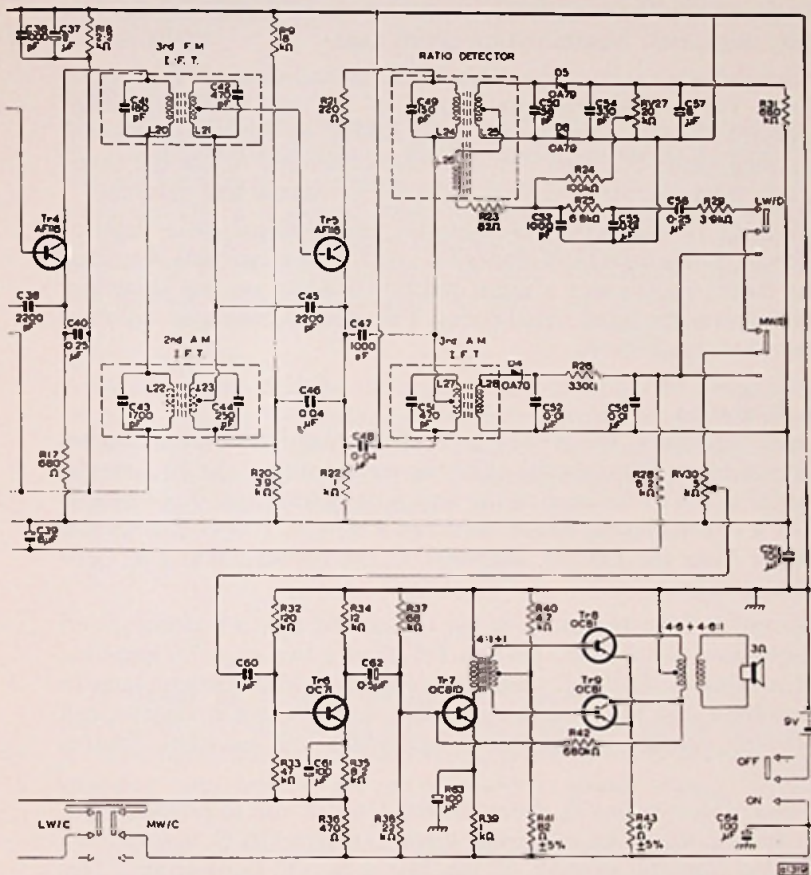

Fig. 17—Nine-transistor a.m./f.m. receiver using

A.M./F.M. RECEIVER



alloy-diffused r.f. and i.f. transistors

A.M./F.M. RECEIVER

The output circuit of the mixer stage is tuned to 10.7Mc/s by the first f.m. i.f. transformer.

Three i.f. stages are used, each with an AF116 transistor in the common-emitter configuration. Double-tuned transformers are used to obtain the best compromise between flatness of the response curve and adjacent channel selectivity. Critically coupled coils are used to simplify alignment. Neutralisation is not used.

A delayed a.g.c. circuit operates from the collector of the first i.f. amplifier Tr3 and controls the current of the AF114 r.f. amplifier. This greatly reduces oscillator detuning caused by large input signals. A damping diode D1, type OA79, is also connected across the tuned circuit in the collector of the r.f. amplifier to reduce this detuning.

The third i.f. amplifier Tr5 feeds the conventional ratio detector circuit which uses two OA79 diodes D5 and D6. Forward bias is applied to the diodes to produce a more constant loading on the secondary tuned circuit as the input signal varies. This ensures good a.m. rejection at low input signal levels.

A.M. Operation

For a.m. operation, the AF114 and AF115 transistors are not used. The signal from the medium- and long-wave coils on the Ferroxcube rod aerial is fed to the base of the first AF116 transistor Tr3 which is used as a self-oscillating mixer. Switches FM/A to FM/D change this transistor from the f.m. i.f. amplifier to the conventional a.m. self-oscillating mixer.

The output from the mixer is fed to the first a.m. i.f. transformer. The remaining two AF116, Tr4 and Tr5, form a two stage i.f. amplifier tuned to 470kc/s. Both i.f. transistors operate in the common-emitter configuration and two double-tuned transformers and a single-tuned transformer provide the necessary bandwidth and adjacent channel selectivity.

A diode D4, type OA70, is used as the detector and to provide a.g.c. to the first i.f. stage. An additional diode D3, type OA79, is connected across the primary winding of the first a.m. i.f. transformer. This prevents the collector voltage of the mixer stage bottoming with large signals and causing spurious oscillation, and provides additional a.g.c. action for the receiver.

Changeover from F.M. to A.M. Reception

Besides the switching of the first f.m. i.f. transistor into the a.m. mixer stage, the only other switching operation is the connection of the relevant detector to the audio stages by switches LW/D and MW/D. Switching the second and third f.m. i.f. transistors is avoided by con-

A.M./F.M. RECEIVER

necting the 10·7Mc/s and 470kc/s i.f. transformers in series. It is, however, necessary to short-circuit the second f.m. i.f. transformer during a.m. operation when it is connected into the collector circuit of the mixer transistor. This is done by switch FM/C and is to prevent the final AF116 transistor Tr5 being overloaded by harmonics of the medium-wave oscillation transmitted through the 10·7Mc/s i.f. transformer chain.

Audio Stages

The audio stages are common to both f.m. and a.m. operation. The relevant detector is switched to the 5k Ω potentiometer RV30 which forms the volume control, and the audio signal is fed to the OC71 a.f. pre-amplifier Tr6. The output from the transistor is capacitively coupled to an LFH3 audio package, consisting of an OC81D transformer-coupled to two OC81 transistors in class B push-pull output. A 3 Ω loudspeaker is used and the audio output power is 500mW.

Power Supplies

A 9V battery is used for the receiver and it should be noted that the negative pole of the battery is earthed. As normal d.c. stabilisation is used for all transistors in the receiver, earthing the negative pole enables the emitter resistors to provide decoupling between stages as well as providing stabilisation.

It should be remembered that the circuits shown in this chapter are typical only and do not refer to particular commercial receivers. In practice, many variants of the circuits described will be found and before checking any receiver, the manufacturer's service manual should be consulted.

Although the three receiver circuits given here have been designed by Mullard engineers, it should be noted that Mullard Limited do not manufacture or market these receivers.

CHAPTER 6

Servicing

The previous chapters have described the transistor and the various types of circuits that may be found in transistor radio receivers. This chapter is concerned with the problems of servicing these receivers. Obviously it cannot be exhaustive, giving a complete list of faults and their causes, but it is hoped that it will give a comprehensive picture of the techniques of servicing and the way in which these techniques can be used to detect various common faults.

Servicing Techniques

The techniques used in servicing transistor radios are in some ways similar to those used for valve receivers. Measurement of the d.c. voltage at various points in the circuit can indicate how a particular stage is operating. The signal path through the receiver can be checked by injecting a signal of appropriate frequency at various points in the receiver, starting from the audio output stage and working towards the aerial. A faulty stage can be located as the first one that does not produce an audio output. Resistance measurements can then be used to locate faulty components or joints.

Although these techniques can be used for transistor receivers, great care must be taken not to exceed the maximum dissipation rating of the transistors. Resistance measurements should be made with an ohmmeter with an output voltage that does not exceed 1.5V, and preferably with the component being tested disconnected from the circuit. If this is not possible, it may be necessary to disconnect the transistors from the circuit. This is best done by unsoldering only the base lead of the transistor as there can then be no doubt about resoldering the lead in the correct position afterwards. If all three transistor leads are removed, there is a possibility of confusing the connections to the transistor when it is replaced, with a risk of permanently damaging the transistor when the receiver is switched on again. A heat shunt such as a pair of pliers should always be used during the soldering operation.

SERVICING TECHNIQUES

It is also important to switch off the receiver before changing components. With the battery connected to the receiver, surges large enough to damage the transistors can be formed when components are connected or removed.

Battery Voltage Check

Run-down batteries can be the cause of many faults, ranging from complete failure of the receiver through failure of the oscillator stage, to low output and high distortion levels. Checking the on-load battery voltage should be the first test to be applied whatever the suspected fault.

The discharge curve for a typical dry battery used in transistor radios is shown in Fig. 1. After an initial drop, the voltage remains reasonably constant for most of the battery life. At the end of the battery

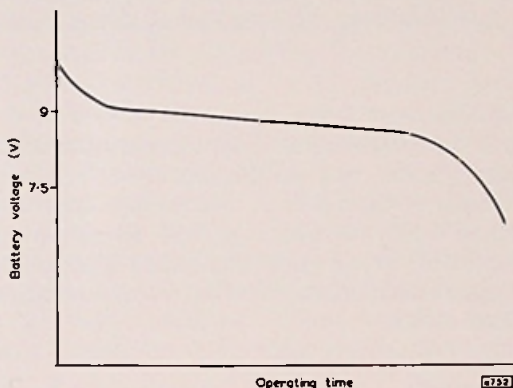

Fig. 1—Typical dry battery discharge curve

life the voltage drops rapidly. The values on the figure are typical for a 9V battery. It will be seen that once the battery voltage has fallen to 7.5V it is necessary to replace the battery as its life is then very limited. Similarly for other batteries, once the voltage on load has fallen by about 20% from the nominal value, the battery should be replaced.

The battery voltage check should always be made after the receiver has been operating for some time. If the check is made immediately after switching on, a weak cell may give a good voltage reading, but after some time on load the voltage of such a cell will drop. If a centre-tapped battery is used in the receiver, the voltage of both halves should be checked as a difference in the voltage of each half can cause distortion. At the same time as the voltage is checked, the battery connections should be examined for correct polarity and for dirt or corrosion.

SERVICING TECHNIQUES

The on/off switch should be checked and also the voltage of the receiver supply line to ensure that there is no fault with the supply to the receiver.

Current Check

A check on the total current drain of the receiver under no-signal conditions can sometimes be useful as it can indicate short circuits and open circuits in the receiver. Should the current drain be greater than the nominal value, there may be a short circuit inside the receiver. If the current is less than the nominal value, there may be an open circuit. It must be remembered, however, that transistors are temperature-sensitive devices and allowance for the effects of temperature must be made in interpreting the current readings. There will be differences in the current drain from day to day depending on the room temperature. For this reason, the current quoted in the manufacturer's service manual has a large tolerance, and the battery drain check is of rather limited use.

H.T. Resistance Check

An alternative to the current check is the measurement of the resistance across the supply leads; that is, the resistance between the supply line and the chassis of the receiver. The voltage from the ohmmeter should not exceed 1.5V. No 'good' or 'bad' resistance values can be given but it is possible to recognise abnormally high resistance values, indicating an open circuit in the receiver, or abnormally low values, indicating a short circuit.

Voltage Measurement

One of the most important tests to be applied, and one of the most revealing, is the measurement of the d.c. voltage across the emitter resistor of each transistor. Care should be taken to connect the voltmeter correctly because the chassis in some receivers is connected to the positive pole of the battery and in others to the negative pole. The manufacturer's service manual should always be consulted before making the measurements. The voltage measured should be within $\pm 20\%$ of the nominal values quoted in the service manual. Should a voltage of a stage be outside this limit, there is a fault in the stage and further voltage measurements should be made within the stage. From the voltages in the service manual it should be possible to locate the fault to within a group of components. The printed-wiring board should be carefully examined for cracks in the foil or for foreign matter causing a short circuit. Soldered joints should be checked for dry joints or open circuits. Individual component values can be measured when the battery is disconnected from the receiver. If it is necessary to remove

a component connected to a transistor from the circuit for testing, the component should be unsoldered at the end remote from the transistor.

Signal Injection

Although the voltage-measurement procedure should enable 'd.c. faults' (such as component failures and open-circuit joints) to be located, it will not show up 'a.c. faults', such as faulty coupling capacitors, or more complex faults such as high distortion levels. These are best discovered by signal injection.

An audio-frequency signal is fed into the audio section of the receiver, starting from the output stage and working towards the detector. The signal is normally fed into the base of the transistor through a 10k Ω resistor to ensure current drive. As a check on overdriving the transistor, an oscilloscope can be connected across the loudspeaker and the output waveform monitored. This will show up any limiting of the waveform caused by overdriving. The oscilloscope is particularly useful for checking distortion, as will be discussed later. If the audio stages operate satisfactorily, an r.f. signal generator should be set to the intermediate frequency modulated with an audio frequency and the i.f. stages of the receiver tested. The lead from the signal generator should be kept short to prevent it affecting the i.f. stages. Finally, the signal generator should be set to a radio frequency modulated with an audio frequency and the r.f. stages tested. In all cases, the faulty stage can be located between the first point that does not produce any increase in the audio frequency output and the last one that did. Measurements around the faulty stage should then locate the fault.

Servicing 'Dead' Receivers

As the name implies, a dead receiver is one that is completely inoperative. This may be caused by a battery that is completely spent or whose voltage is sufficiently low to prevent the oscillator stage working. These faults are only likely to be present if the receiver has been stored for some considerable time and the battery become faulty, as the distortion level usually becomes noticeably high long before the battery voltage has fallen sufficiently to cause these faults. The most likely cause of a dead receiver is a component failure or an open-circuit joint.

The first test to be applied is the checking of the on-load battery voltage. If this is too low, the batteries should be replaced and the receiver rechecked. If battery replacement is not required or does not clear the fault, the supply current should be checked or the resistance between the supply line and the chassis measured. The measurement of the voltages across the emitter resistors, or signal injection will then enable the faulty stage to be located.

Servicing Receivers with Low Sensitivity

Battery Voltage Check

The most obvious cause of low sensitivity is low battery voltage. The first test to be applied, therefore, is to check the on-load battery voltage, the on/off switch and the supply line voltage to ensure that the correct supply voltage is being applied to the receiver.

D.C. Voltage Check

If the battery voltage is satisfactory, the next test is to measure the d.c. voltage across the emitter resistor of each transistor. This test will show whether or not the operating conditions of the transistor are correct. If the transistor is not correctly biased, or is not drawing the correct current, the gain will be affected. If the emitter current of the r.f. stage of the receiver is not correct, the gain of the receiver will be low but if the incorrect current occurs in the i.f. or audio stages, the low gain will be accompanied by a high distortion level. A receiver suffering from incorrect bias of an i.f. or audio transistor is therefore more likely to be discovered through testing for distortion.

The d.c. conditions of the a.g.c. circuit should be examined, especially if the control is derived from a transistor instead of a diode. Incorrect conditions in the a.g.c. circuit will affect the performance of the controlled stages.

If the bias of a transistor is incorrect, measurements should be made on the bias components (the base potential divider and associated components such as transformer windings). Besides the more obvious high-resistance or open-circuit joint, a resistor value which is no longer within the tolerance range, or a leaky bypass capacitor can also cause the fault.

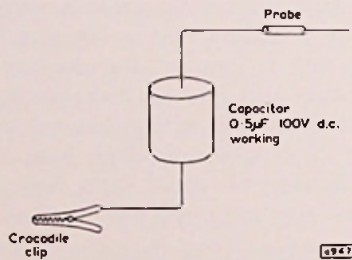

Fig. 2—Method of checking bypass capacitors

Open-Circuit Bypass Capacitor

Low sensitivity can be caused by an open-circuit bypass capacitor in the base or emitter circuit of the transistor. This fault will not affect

the d.c. conditions of the stage and will not therefore be detected by the d.c. voltage check. The bypass capacitors can easily be checked, however, by shunting each capacitor with a $0.5\mu\text{F}$ capacitor. A simple arrangement for the test is shown in Fig. 2. The crocodile clip should be attached to the receiver chassis or earth line and the probe applied to the non-earthed end of the bypass capacitor. In the r.f. and i.f. stages, an open-circuit bypass capacitor will be shown by an increase in volume when it is shunted. In the audio-frequency stages there may not be an increase in the volume but the pitch of the test signal will change.

Measurement of Stage Gain

If the previous tests do not show a fault in the receiver, the gain of each stage should be measured. The method of measurement is an elaboration of the signal-injection technique previously described and, in practice, the measurement of gain would be carried out in conjunction with testing the signal path.

The gain of the audio stages should be measured first. An audio-frequency signal is fed into the base of the transistor through a $10\text{k}\Omega$ resistor (or other value recommended in the receiver service manual) and a $1\mu\text{F}$ isolating capacitor. The loudspeaker should be replaced by a suitable resistance (the value of the resistance being equal to the quoted impedance of the loudspeaker) and a high-impedance voltmeter connected across it. Alternatively, an output-power meter set to the correct impedance can be connected into the circuit in place of the loudspeaker. The input required for an output power of 50mW (or the value of output power given in the service manual) may be determined and the gain of the stage assessed. If the audio-frequency stages are satisfactory, the i.f. and r.f. stages can be checked in a similar manner.

If a stage is discovered in which the gain is not correct, further measurements should be made to check the components of the stage. It is only rarely that a faulty transistor will be found and then the fault is usually the result of some severe overload, caused for example, by connecting the receiver battery incorrectly or changing components with the receiver switched on. There is, however, a chance that there has been a slight but constant overload on the transistor which can cause it to break down in time. This again is most likely to be caused by a faulty bias resistor or printed-wiring defect. Whenever a defective transistor is found, the circuit components around it should be fully checked before introducing a new transistor.

If the stage with low gain contains a tuned circuit, the components of the tuned circuit should be checked. The capacitor may break down

DISTORTION

or become lossy and this will affect the characteristics of the circuit so that the gain will be considerably reduced. Similarly any fault in a coil that affects its inductance value or Q-factor will also affect the characteristics of the tuned circuit and hence the gain, but in general, faults in the i.f. transformer will be shown up by the d.c. checks since the transformer secondary winding forms part of the bias network.

When checking stage gains and signal levels, allowance must be made for the effect of the a.g.c. circuit. It may be necessary in some cases to disconnect the a.g.c. line before making measurements.

A Warning

Do not alter the alignment of the receiver in an attempt to improve the gain. Many receivers are stagger-tuned and although the gain can be improved by 'peaking' the tuning, this will be accompanied by a loss of a response and an increase in distortion. If the alignment of the receiver is suspect, always realign in accordance with the manufacturer's service manual.

Servicing Receivers with Distortion

In general, distortion in a transistor radio is caused by a fault in the audio stages. Before dealing with the methods of finding the cause of the distortion, the types of distortion will be considered. In a transistor push-pull output stage there are two main types of distortion: crossover distortion and distortion from mismatch in the values of gain of the two transistors.

Crossover Distortion

It was explained in the section of Chapter 5 dealing with audio stages that the two transistors of a push-pull output stage have to be given a small forward bias to overcome the crossover distortion. Any change in this bias, therefore, will reintroduce the distortion. Fig. 3a shows the undistorted waveform across the loudspeaker from a transistor push-pull output stage with a sine wave input. As soon as one of the transistors stops conducting, the other starts so that there is a smooth changeover from one to the other. The effect of crossover distortion is shown in Fig. 3b, where it will be seen that the changeover between the two transistors is no longer smooth.

The change in bias of the output stage can be the result of low battery voltage or a change in value of the bias resistors. Both these faults will be detected by the standard tests described previously.

Crossover distortion can also be detected by observing the waveform

DISTORTION

across the loudspeaker of the receiver with an oscilloscope. An audio-frequency sine wave is injected into the base of the driver transistor, the amplitude of the signal being adjusted to give a low value of power output (less than 50mW). If crossover distortion is present, the waveform across the loudspeaker will be as shown in Fig. 3b.

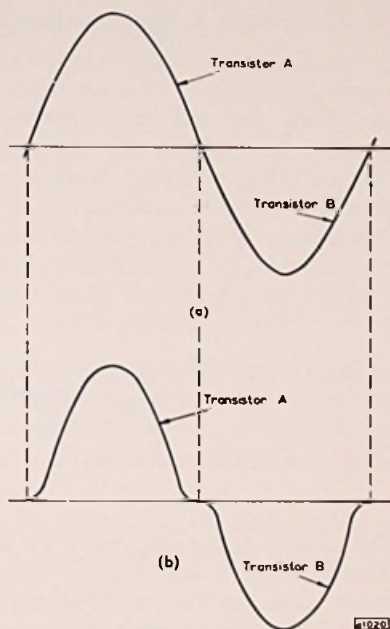

Fig. 3—Diagram illustrating crossover distortion:
(a) undistorted output waveform
(b) waveform showing crossover distortion

Distortion through Mismatch in Gain

If the gains of the two transistors of a push-pull output stage are not similar, the output with a sine wave input will be as shown in Fig. 4. This type of distortion is the result of a faulty transistor or the use of an unmatched pair of transistors in the push-pull stage. Again, this type of distortion can be easily recognised by observing the waveform across the loudspeaker of the receiver when a sine wave input is injected into the base of the driver transistor.

If for some reason one of the transistors of a push-pull stage has to be replaced, both transistors should be replaced with a matched pair to prevent this type of distortion.

DISTORTION

Other Causes of Distortion

If the current through the audio driver transistor is incorrect, distortion will result. This fault can be found by the standard test of checking the voltage across the emitter resistor. Incorrect alignment of the i.f. stages can also cause distortion, giving a narrow bandwidth and therefore poor response. This fault is most likely to be shown by a whistle as the receiver is tuned through a signal, indicating i.f. instability.

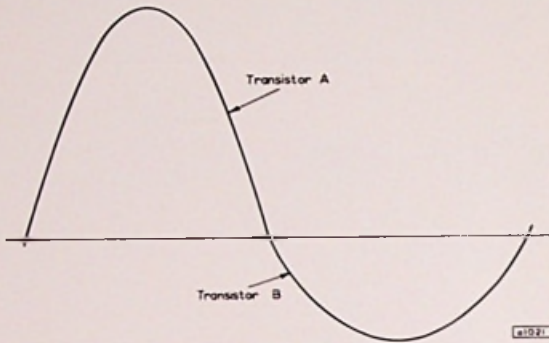

Fig. 4—Waveform showing distortion through mismatch in gain

Distortion can also be caused by the detector if the a.c. loading of the stage is incorrect. This incorrect loading can be caused, for example, by a faulty audio driver stage. Another cause of distortion is the a.g.c. circuit. If this becomes faulty (for example, through failure of the decoupling capacitor), overloading of the audio stages will occur on strong signals with consequent distortion. This fault can be easily recognised as it will occur with strong signals only.

Test Procedure

The standard tests described previously can be used to find the cause of the distortion. The first test is the checking of the battery voltage. This is most important as it is the most likely cause of the distortion. Measurement of the voltage across the emitter resistors of the transistors will show if the bias is correct, and signal injection can then be used, in conjunction with an oscilloscope if required. The audio signal should first be injected into the loudspeaker to check that this is working satisfactorily. In the case of personal receivers with their small loudspeakers, it may be advantageous to disconnect the loudspeaker and feed the output into a power amplifier and larger loudspeaker on the bench so that the distortion can be heard more easily. After the loudspeaker has been checked, the signal should be injected into

the base of the audio driver transistor to check if the cause of the distortion is in the audio stages. An oscilloscope can be connected across the loudspeaker of the receiver to monitor the waveform as described previously. A sine-wave modulated signal of the appropriate frequency can then be used to check the i.f. and r.f. stages.

Servicing Receivers with Instability

In a home-constructed receiver, instability is usually caused by poor layout and faulty positioning of components. In a commercially produced receiver, however, instability only rarely occurs and the most likely cause is faulty decoupling. The faulty decoupling capacitor can be found by bypassing each capacitor in the supply line in turn with a good component. It is necessary, however, to disconnect the original component since if it is leaky and not open-circuit, it may still affect the circuit. The usual precautions when unsoldering should be observed. The a.g.c. line decoupling capacitor should also be checked as i.f. signals in the a.g.c. line can cause instability.

If the i.f. stages of the receiver are neutralised or unilaterised, the neutralising or unilaterising components should be carefully checked. Failure of these components can also cause instability.

Some Other Faults

The previous sections of this chapter have dealt with the major faults of transistor radios. This section will deal with some of the less common faults that can occur.

R.F. Stage Faults

Typical faults associated with a self-oscillating mixer stage are a drop in sensitivity or even loss of signal at one end of the tuning range, and reception of one station all over the range. Similar defects can occur with receivers using separate mixer and oscillator stages but in this case both stages will have to be examined.

In most circuits the oscillator is used to provide part of the working bias for the r.f. transistor. The value of the bias voltage will therefore depend on whether or not the stage is oscillating and this provides a quick check on the state of the oscillator. This bias voltage can be measured in the usual way by measuring the voltage across the emitter resistor of the mixer transistor. The voltage should be measured first with the receiver switched on normally and then with the oscillator coil damped. If the oscillator is working correctly there will be a difference between the two voltage readings. In general, the emitter current (and hence the voltage across the emitter resistor) will be larger when the mixer is oscillating, but some circuits may differ from this.

OTHER FAULTS

A simple method of damping the oscillator coil is to connect a $1\mu\text{F}$ capacitor across the oscillator tuned circuit, taking care to switch off the receiver before connecting or disconnecting the capacitor.

Another possible cause of poor sensitivity over part of the tuning range is a misaligned aerial or oscillator tuning circuit. If this is suspected, the circuit should always be realigned in accordance with the manufacturer's service manual. Poor sensitivity can also be caused by a broken ferrite rod aerial or by a coil that has moved on the aerial rod, and by poor aerial coil connections.

A broken Ferroxcube aerial rod can be repaired with any of the commercially available adhesives that do not require heat treatment. As the physical dimensions of the rod affect its performance, it is important that none of the Ferroxcube material is removed from the mating surfaces by an abrasive. The adhesive should be applied in accordance with the manufacturer's instructions and care should be taken to see that the two parts of the rod are correctly in line.

As with valve receivers, defects associated with loss of tuning range may be caused by short-circuiting of the vanes of the tuning capacitor. The tuning capacitor should be examined for distortion of the vanes or for foreign matter between vanes. This last fault is usually shown by crackling noises during tuning.

Transistor Faults

Under normal operating conditions damage to a transistor rarely occurs and whenever a faulty transistor is found, the circuit around it should be carefully examined for a possible further faulty component. The typical faults associated with a transistor are:

- (i) Short-circuited junction, caused by a high voltage surge; for example, the result of changing components with the receiver switched on.
- (ii) Open-circuited junction, usually caused by a heavy overload.
- (iii) High leakage current, which is usually accompanied by low gain or a high noise level. This defect can be the result of a slight but constant overload that damages the transistor over a period of time, but is usually caused by overheating when the transistor is soldered into the circuit.

A possible transistor fault that may be difficult to locate is a leak in the light-proofing of the transistor. Some transistors have a glass envelope which is painted black and should the paint be chipped, the transistor current will be affected by light shining on it since the currents flowing in a transistor are light-sensitive. This defect can be easily checked by alternately exposing the transistor to a light fed from the

RECAPITULATION

mains and then covering it. There is a leak in the light-proofing if there is a 50c/s hum when the transistor is illuminated. Care should be taken to see that the receiver is not too close to the lamp otherwise hum may be picked up by electromagnetic induction. A leak in the light-proofing of a transistor can be easily cured by a dab of paint.

Recapitulation

The servicing techniques for transistor radios and the ways in which these techniques apply to the major faults that can occur have been considered in this chapter in some detail. It is worthwhile having a brief recapitulation of these tests and faults.

Tests

- (i) Battery on-load voltage check – the fundamental check.
- (ii) Current drain or resistance between 'h.t.' line and earth – limited use but can be useful for 'dead' receivers.
- (iii) D.C. voltage across emitter resistors of each transistor – information about the bias and d.c. conditions of the transistors.
- (iv) Signal injection – for a.c. faults, measurement of stage gain for low sensitivity; use with oscilloscope for distortion.

Faults

The chart overleaf provides a check-list of the common faults and their causes. The list is not exhaustive and should not be regarded as a replacement for the tests given above. The causes are the 'most likely' and indicate what should be looked for while the tests are being carried out.

RECAPITULATION

A Servicing Chart

Symptom	Possible Cause
Receiver operates intermittently	Faulty off/on switch Faulty battery connection Dry joint
Receiver fades after a short period of operation	Battery needs replacing
'Motorboating' (low-frequency instability)	Low battery voltage Defective supply filter Defective audio decoupling capacitor
Heterodyning or howling (i.f. instability)	Defective decoupling capacitor Defective neutralising component Faulty i.f. transistor
Distortion	Low battery voltage Incorrect bias in audio driver or output stages Defective audio coupling capacitor Defective a.g.c. system Faulty transistor in audio output stage
Low sensitivity	Low battery voltage Incorrect bias of r.f. (possibly i.f.) stage Incorrectly aligned i.f. stage Defective base or emitter by-pass capacitor Faulty tuning circuit components Faulty i.f. transformer Faulty r.f., i.f. or audio driver transistor
Low sensitivity at one end of tuning range only	Faulty oscillator or mixer stage

CHAPTER 7

Test Equipment

The test equipment required for the servicing of transistor radios has been mentioned briefly in the previous chapter. In this chapter, the test equipment will be considered in more detail.

Equipment Required

The essential items of test equipment are:

- (i) Voltmeter,
- (ii) Ohmmeter,
- (iii) Audio-frequency signal generator,
- (iv) Intermediate- and radio-frequency signal generator with provision for modulation at audio frequencies.

An oscilloscope and a milliammeter are also useful and an output-power meter may be preferred for some measurements.

Voltmeter

It is essential that the voltmeter does not alter the conditions in the circuit when measurements are being made. The voltmeter should therefore have a resistance of at least $20\,000\Omega/V$. As a glance at the service manual of a receiver will show, the voltages to be measured vary from a fraction of a volt up to 10 or 12V, and occasionally have to be accurate to 0.01V. A suitable voltmeter for transistor radio servicing should therefore have one range with a full-scale deflection of 10 or 15V, and a second range with a full-scale deflection of 1.0V, accurate to 0.01V. A valve voltmeter is very suitable for the measurements if precautions are taken to prevent earth-loop currents damaging the transistors.

Ohmmeter

The voltage at the output terminals of the ohmmeter should not exceed 1.5V otherwise there is a possibility of the transistors and miniature electrolytic capacitors in the receiver under test being damaged. In all cases when resistance measurements are made, the receiver should be switched off. It is helpful if the stage under test can

TEST EQUIPMENT

be isolated from the rest of the receiver as resistance measurements should normally only be made to confirm a defective component. Alternatively, if only one component is suspect this can be isolated from the circuit by unsoldering the connection at one end and then testing with the ohmmeter. However, if components have to be checked while they are still in the circuit there are two methods available to prevent the 'diode elements' of the transistors affecting the measurements.

In the first method the base connection of the transistor or transistors is unsoldered so that the transistor is effectively disconnected from the circuit. The resistance measurements may then be made. The second method uses the voltage of the ohmmeter to 'reverse bias' the diode elements of the transistor so that the transistor does not conduct.

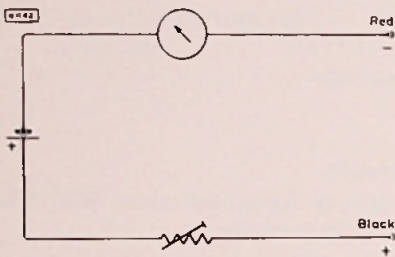

Fig. 1—Circuit of series-connected ohmmeter

The basic circuit of a series-connected ohmmeter is shown in Fig. 1 in which both the colour and the polarity of the output terminals are shown. To provide the reverse bias for a p-n-p transistor, the positive

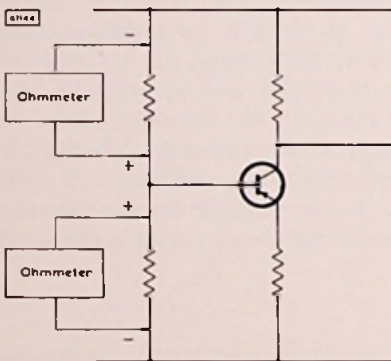

Fig. 2—Method of checking base bias resistors with ohmmeter

ohmmeter terminal (coloured black) is connected to the base (n-type material) and the negative ohmmeter terminal (coloured red) connected to the emitter or collector (p-type material). The connections for measur-

TEST EQUIPMENT

ing the values of the base bias resistors are shown in Fig. 2. If the stage being checked is not isolated from the rest of the circuit, the other stages will appear as a resistance in parallel with that being measured. The measured value of resistance will therefore be lower than the actual resistance.

A.F. Signal Generator

The connection of the a.f. signal generator depends on the output impedance of the generator, and the manufacturer's instructions should always be followed. In general, the signal generator will have an output impedance of approximately 600Ω and this may be fed directly to the top of the volume control of the receiver through a $0.1\mu\text{F}$ capacitor. Alternatively, the signal may be fed to the base of the transistor through a $10\text{k}\Omega$ resistor and $1\mu\text{F}$ isolating capacitor.

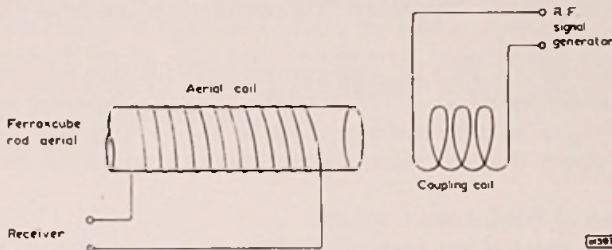

Fig. 3—Method of feeding r.f. testing signal into receiver

R.F. Signal Generator

A low-impedance r.f. generator (output impedance less than 60Ω , say) should be used for checking or aligning the i.f. stages of the receiver. In general, the signal should be fed into the base of the i.f. transistor or mixer transistor through a $0.5\mu\text{F}$ capacitor but the receiver service manual should be consulted for details of the alignment procedure.

When using the r.f. generator to check r.f. faults or for aligning the aerial circuits, the signal is usually fed to the receiver through a loop of three or four turns placed near the aerial coil, as shown in Fig. 3. Again the receiver service manual should be consulted before aligning the aerial circuits as some receivers are partly aligned by injecting an r.f. signal into the base of the oscillator transistor.

Oscilloscope

The use of an oscilloscope for detecting distortion was described in Chapter 6. Another use for an oscilloscope is to check that transistors are not being overdriven when signal injection tests are being made. The oscilloscope should be connected across the loudspeaker in the

usual way and the output waveform monitored. If a transistor is being overdriven, this will be shown by clipping of the output waveform.

Milliammeter

The usual current check is that of the total current drain of the receiver. Other measurements such as that of the emitter current of a transistor can be conveniently measured as a voltage drop across a resistor. The value of the current taken by various receivers varies considerably but a milliammeter with a full-scale deflection of 100mA should be suitable for measuring the current drain of most receivers.

Output-Power Meter

An output-power meter can be used for checking the a.f. output power during sensitivity measurements or alignment of a receiver. The loudspeaker should be replaced by the output-power meter which is switched to the loudspeaker impedance. The meter then indicates the output power directly.

A voltmeter can also be used conveniently for this measurement if an output-power meter is not available. The loudspeaker should be replaced by a resistor corresponding to the loudspeaker impedance and the power level calculated as the voltage drop across the resistor.

Prevention of Earth-Loop Currents

Earth-loop currents are particularly dangerous for transistor receivers. With a valve receiver, the usual effect of earth-loop currents is to cause hum, but transistors can easily be destroyed by these currents because of the small amount of energy required to destroy the junction.

If the chassis of the signal generator (or other item of test gear) is not earthed, the chassis can attain an a.c. potential of 50 to 100V through electrostatic coupling between the primary winding and the core of the mains transformer. This is shown diagrammatically in Fig. 4a.

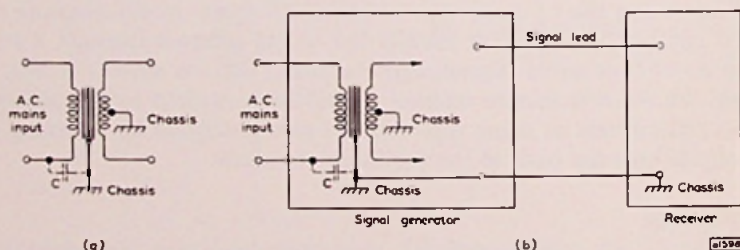

Fig. 4—(a) Diagram showing how unearthed chassis is raised in potential by electrostatic coupling through distributed capacitance C
 (b) showing how potential is transferred to other unearthed chassis

EARTH-LOOP CURRENTS

If a receiver is connected to the output terminals of the signal generator, this electrostatic potential will be transferred to the chassis of the receiver as shown in Fig. 4b. An isolating capacitor in the test leads will not prevent the transfer of the potential since it is an electrostatic effect. If an earthed soldering iron is applied to the base of a transistor, a relatively large current will flow to earth through the transistor and so destroy it.

The formation of this electrostatic potential can be prevented by earthing the chassis of the receiver and test equipment. An isolating capacitor, usually $1\mu\text{F}$, should be connected in the lead between the signal generator and the receiver to prevent direct circulating currents being formed.

A second method by which transistors can be damaged is through the use of an unearthed soldering iron. It is possible for the bit, through the breakdown of the insulation between the element and the bit, to attain a potential of a few volts. When the iron is used on a receiver, the potential of the bit may drive a relatively high current through a transistor and destroy it. This type of defect can be prevented by always using an earthed soldering iron.

INDEX

A.G.C. circuit	39	Forward bias	22
Alloy-diffused transistors:		Frequency changing	40
manufacture	16	Germanium:	
receivers using	45, 47	atom	3
Alloy-junction transistors:		purification	8
manufacture	10	Heat shunt	30, 31, 52
receiver using	43	Heat sink	36
A.M./F.M. receiver	47	Hole	3, 5
Amplification with transistor	24	" current	21
Antimony	5, 11	I.F. stages	36, 45, 47, 50
Audio stages:		Indium	5, 14
class A	34	Instability	60, 61
class B	35	Junction	20
Barrier potential	21	Lapping	12
Bias:		Levelling	11
of diode	21	Low sensitivity in receiver	56, 61
of transistor	22, 34	Majority carrier	21
Crossover distortion	58	Milliammeter	68
Crystal structure	3	Minority carrier	21, 22
Current gain	25	Mismatch in gain of transistor	59
Dead receiver	55	Mixer stages	40, 45, 47
Depletion layer	21	Neutralisation	37, 61
Detector stage	36	N-type semiconductor	2
Dicing	13	Ohmmeter	65
Distortion in receiver	58	Oscillator stage faults	61
Doping	2, 5	Oscilloscope	55, 59, 67
Earth-loop currents:		Output-power meter	57, 68
prevention	69	Printed wiring:	
production	68	manufacture	27
Electron	3	repair	31
" current	21	P-type semiconductor	2
" surplus	5		
" valence	4		
Energy levels	5		
Etching	13, 16, 18, 27		

INDEX

<p>Recombination 23</p> <p> " current .. 23, 24</p> <p>R.F. signal generator 67</p> <p>Reverse bias 22</p> <p> " " with ohmmeter .. 66</p> <p>Servicing techniques 52</p> <p>Signal injection 55, 57, 60</p> <p>Stabilisation of transistor .. 34</p>	<p>Transistor:</p> <p> basic configurations 33</p> <p> faults 62</p> <p>Unilateralisation .. 37, 45, 61</p> <p>Voltmeter 65</p> <p>Zone refining 9</p>
--	--

MULLARD PUBLICATIONS ON TRANSISTORS

There are three other Mullard publications on transistors that may be of interest to readers of this book.

Mullard Reference Manual of Transistor Circuits

This book contains more than 60 designs ranging from circuits for radio and audio equipment to pulse circuits, d.c. amplifiers, converters, and other circuits of interest to users of industrial equipment. The principles of operation of the circuits are explained, and much practical information is included. The Mullard Reference Manual of Transistor Circuits costs 12s. 6d.

Mullard Maintenance Manual

This book contains abridged data for the valves, tubes and semi-conductor devices of interest to the service engineer. The Mullard Maintenance Manual costs 16s.

Both these books are available from radio and television dealers

Mullard Technical Handbook—Vol. 4

This volume of the Mullard Technical Handbook is a loose-leaf publication giving full data for Mullard transistors and other semi-conductor devices. It is available on a subscription basis. Full details may be obtained from Technical Information Department, Mullard House.

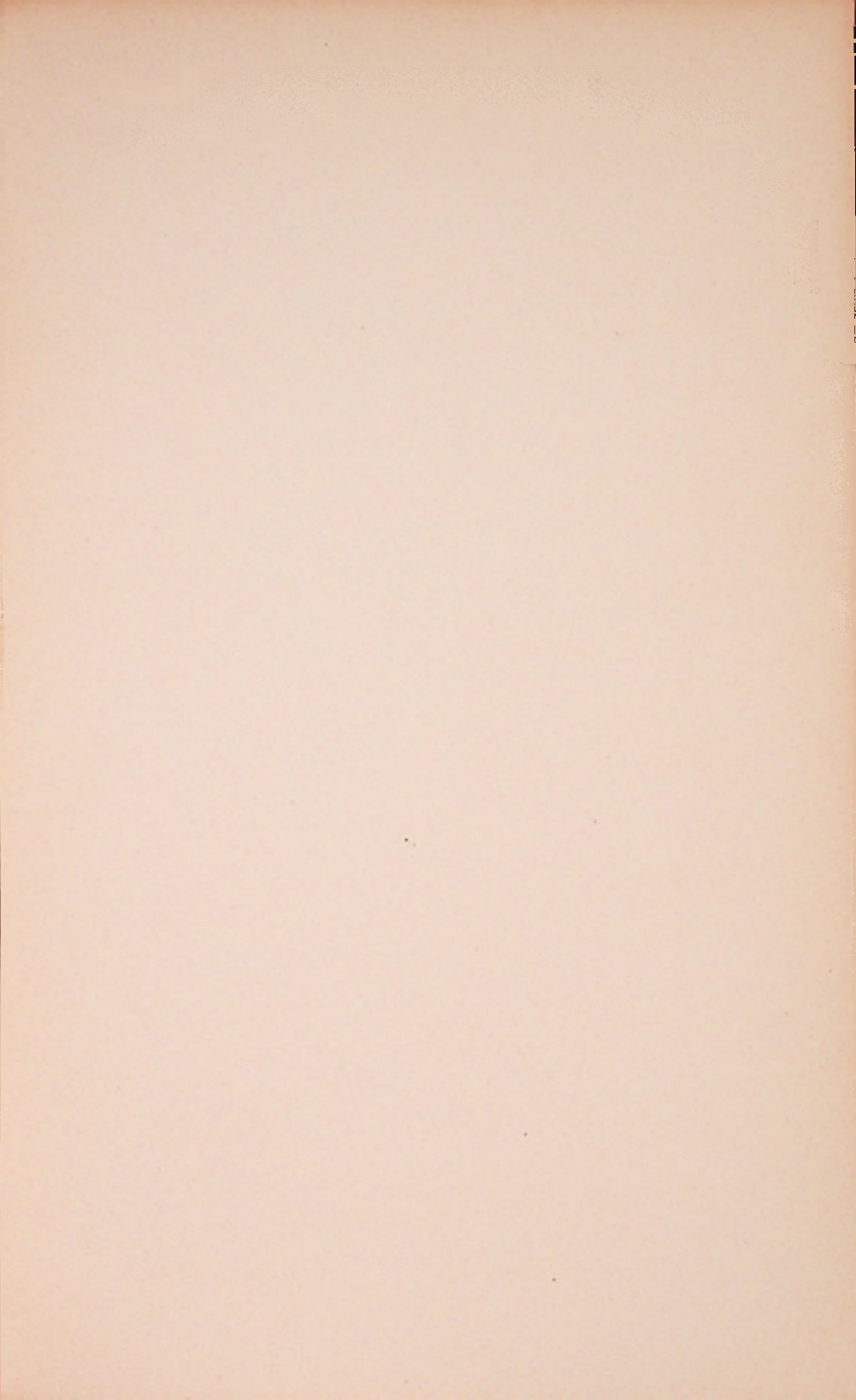



Price **5/-**

N
Bibliotheek Ned. V