

# THE RADIO 1935

J.M. POLLACK

# YEAR BOOK

1/-

**INCLUDING:  
A DAY AT  
BROADCASTING  
HOUSE**

**TELEVISION:  
ITS PRESENT AND  
FUTURE**

**B.B.C. ARTISTES  
ON THE ETHER**

**THE LATEST  
WAVE LENGTHS  
CHART**

**TOGETHER WITH  
A HUNDRED AND  
ONE ITEMS OF  
INTEREST TO  
THE LISTENER**

For the Veins, Arteries and Heart

# Elasto

REGISTERED

**CURES VARICOSE VEINS, BAD LEG, PHLEBITIS, THROMBOSIS, PILES, ECZEMA, RHEUMATISM, AND EVERY VEIN, ARTERY AND HEART WEAKNESS.**

**E**LASTO is something new to curative science; it is based on the knowledge that muscular weakness, varicose veins, bad leg, rheumatism, hardened arteries, heart weakness—to name but a few of the many ailments associated with bad circulation—are *deficiency diseases*; that in all such conditions there is a lack of certain *vital constituents of the blood*. Owing to this lack the body is unable to build up the elastic tissue needed to maintain the vein and artery walls and the membranes in a healthy condition and a state of flabbiness results. Elasto restores to the blood the vital elements which combine with albumin to form elastic tissue and thus enables *Nature* to restore contractility to the relaxed and devitalised fabric of veins, arteries and heart, and so to re-establish normal circulation: *the real basis of sound health*.

Every sufferer should know of this wonderful new biological remedy which quickly brings ease and comfort, and creates within the system a new health force; overcoming relaxed conditions, increasing vitality, and bringing into full activity, *Nature's own laws of healing*. Elasto is prepared in tiny tablets which *dissolve instantly on the tongue, and are absorbed directly into the blood stream, thereby actually restoring the natural power of healing to the blood!*

For the outlay of a few shillings you can now enjoy the tremendous advantages of this Modern Scientific Remedy which has cost thousands of pounds to perfect.

## Read what users of Elasto say:

"No sign of varicose veins now."  
"Elasto put new life into me."  
"Wonderfully active at eighty."  
"My Doctor highly praises Elasto."  
"Now walk long distances with ease."  
"Elasto has cured my bad legs."  
"Worked wonders; legs quite clear."  
"Cured my rheumatism and neuritis."

"Now free from piles."  
"I feel ten years younger."  
"It put me on my feet."  
"Heart quite sound again now."  
"All signs of phlebitis gone."  
"Completely cured my varicose ulcer."  
"I am now free from pain."  
"My skin is as soft as velvet," etc.

## You can get Elasto FREE!

Simply send us your Name and Address, and you will receive by return a FREE SAMPLE of Elasto and a FREE BOOKLET fully explaining how this new wonder remedy CURES THROUGH THE BLOOD. Don't lose another moment, write to-day. Now! while you think of it. This offer is too good to be missed. Don't Long for Relief—Get Elasto and Be Sure Of It.

**THE NEW ERA TREATMENT Co. Ltd. (Dept. 265)  
Cecil House, Holborn Viaduct, London, E.C.**

G. T. SPACKMAN,  
84, SEDCOTE ROAD,  
PONDERS END, MDX.

*The*  
RADIO YEAR-BOOK  
1935



*Broadcasting House, London*

[Photo: A. W. Kerr

*The*  
**RADIO**  
**Year-Book**  
**1935**

*A new and informative Handbook of  
interest and value to every listener*



LONDON  
GEORGE NEWNES LIMITED  
8-11 SOUTHAMPTON STREET, STRAND, W.C.2

## CONTENTS

	PAGE
INTRODUCTORY . . . . .	1
THE B.B.C. YESTERDAY AND TO-MORROW . . . . .	9
A DAY AT BROADCASTING HOUSE. . . . .	12
B.B.C. REGIONS . . . . .	25
THE TIME SIGNAL SERVICE . . . . .	28
BROADCAST MUSIC . . . . .	29
FIRST PERFORMANCES IN 1934 . . . . .	36
WEATHER FORECASTS . . . . .	38
ARTISTES OF THE ETHER . . . . .	39
B.B.C. ADDRESSES . . . . .	88
RULES FOR S.O.S. MESSAGES . . . . .	89
BROADCAST EDUCATION . . . . .	91
MICROPHONE PLAYS . . . . .	98
CONCERNING RADIO DRAMA . . . . .	99
TEN YEARS OF DANCE MUSIC . . . . .	106
SERVICE REUNIONS . . . . .	112
RADIO VARIETY . . . . .	113
BROADCASTING HOUSE: SOME STATISTICS . . . . .	121
HOME AND EMPIRE PROGRAMMES . . . . .	123
WORLD BROADCASTING . . . . .	125
WAVE LENGTHS CHART . . . . .	131
RADIO ORGANISATIONS . . . . .	139
WIRELESS LEGALITIES . . . . .	142
CONCERNING AERIALS AND RECEIVERS . . . . .	146
CONVENTIONAL NOTATIONS IN WIRELESS. . . . .	168
TELEVISION . . . . .	183

# The RADIO YEAR-BOOK, 1935

## INTRODUCTORY

THE first B.B.C. was formed on October 18, 1922, and received its licence on January 18, 1923. It represented a joint effort on the part of three hundred wireless manufacturers and shareholders. Lord Gainford, a former Postmaster-General, was the first Chairman, and the other members of the Board represented the principal wireless manufacturers concerned, that is, the late Mr. Godfrey Isaacs (Marconi Co.), Major Basil Binyon (Radio Communication Co.), Mr. A. McKinstry (Metropolitan Vickers), John Gray (British Thomson-Houston Co.), Sir William Noble (General Electric), Mr. H. M. Pease (Western Electric), and Mr. W. W. Burnham (Burndept). Smaller manufacturers and traders were represented by the late Sir William Bull, M.P., who became Vice-Chairman. Mr. (now Sir) John Reith was the first General Manager, joining the Board as Managing Director in October, 1923.

So rapid was the development of broadcasting that the Government soon appointed a committee of inquiry presided over by Sir Frederick Sykes. This committee, reporting to Parliament in 1923, approved the principles and practice which Mr. Reith had been evolving, and recommended the extension of the licence of the Broadcasting Company until the end of 1936.

In 1925, Mr. Baldwin asked Lord Crawford and Balcarres to preside over another committee of inquiry into broadcasting. The result was recommendations on which the present Broadcasting Corporation was constituted. The Crawford Committee, like its predecessor, the Sykes Committee, approved the principles and the practice that had been established. It felt, however, that broadcasting had become so important to the life of the nation that its con-

stitutional basis should be broadened and the trade ingredient eliminated. Accordingly, the original capital was paid out, and a Corporation established under a Royal Charter. The place of the Board of Directors was taken by a Board of Governors nominated by the Government, with Lord Clarendon as Chairman, Lord Gainford as Vice-Chairman, and Sir Gordon Nairne, Dr. Montague Rendall, and Mrs. Phillip Snowden as Governors, five years being fixed as the term of office. Sir John Reith was designated in the Charter as first Director-General. With Lord Clarendon's appointment to be Governor-General of the Union of South Africa, he was succeeded as Chairman of the B.B.C. by the Rt. Hon. J. H. Whitley, Speaker of the House of Commons. The other members of the first Board of the Corporation, having retired in the ordinary way, were replaced as follows :

Vice-Chairman . Mr. R. C. Norman.  
Governors . . . The Rt. Hon. the Viscount  
                                    Bridgeman, LL.D.  
                                    Mrs. Mary Agnes Hamilton.  
                                    Mr. Harold G. Brown.

The ten years' Licence of the B.B.C. expires on December 31, 1936. Before that time, therefore, the Government of the day will have to make up its mind in what form the B.B.C. is to be continued. This decision is likely to be preceded by some form of public inquiry on the lines of Lord Crawford's Committee of 1925. There is no indication, however, of a desire in any responsible quarter to bring about radical changes in the constitution of the B.B.C.

#### ENGINEERING

The B.B.C. began with the original London Station, 2LO, transmitting from the top of Marconi House, and afterwards from the top of Selfridge's, in Oxford Street. Seven main stations were added in order to reach the other chief centres of population. Then came twelve relay stations, making twenty stations in all. Then, in 1925, the original Daventry 5XX was commissioned as the first high-power long-wave station. With this technical equipment it was possible to provide at least one programme of good signal strength to rather more than 75 per cent. of the population in the United Kingdom and Northern Ireland. In those early days there were more than enough wave-lengths to go round, the Continent of Europe not yet having awakened to the possibilities of broadcasting. But abundance of wave-lengths was not to be permanent.



The B.B.C. began planning to provide alternatives, and as the next step, to place at least two appropriately contrasted programmes within reach of the average listener. In the ordinary way, this would have required twice as many wave-lengths, whereas, in fact, the number of wave-lengths available for broadcasting in this country was about to be reduced. So the B.B.C. conceived a new plan of distribution based on a few high-power twin-wave transmitters in substitution for the comparatively numerous low-power transmitters which had been constructed. The new plan became known as the Regional Scheme. The first instalment was the station for London and the South-East of England at Brookman's Park. Then came Moorside Edge in the Pennines, for Yorkshire and Lancashire. Scotland followed with a new station near Falkirk. West Region was given its twin-wave transmitter at Washford Cross. The high-power transmitter for Northern Ireland is now in process of construction, and it should be ready in the summer of 1935. And now, instead of about three-quarters of the population being able to receive one programme, the B.B.C. can claim an increase to 95 per cent. In addition, rather more than 85 per cent. of the population can now receive at least two programmes on ordinary apparatus.

While still in the middle of the Regional Scheme, the B.B.C. undertook a short-wave Empire Service, constructing special transmitters at Daventry. This has developed rapidly, until now B.B.C. signals are picked up in all parts of the world at times convenient for local listening.

Meanwhile the original high-power long-wave transmitter, which was built at Daventry in 1925, had become obsolete, and a new high-power transmitter was built at Droitwich and opened for service in October 1934. This is the most powerful and efficient transmitter of its kind in the world.

For the past five years the B.B.C. has been transmitting television regularly for the benefit of experimenters, research workers, and amateurs. These transmissions continue twice weekly at 11.0 to 11.45 p.m. on Wednesdays, and 4.30 to 5.15 p.m. on Saturdays, Vision on the London National, and Sound on the Midland Regional.

#### PROGRAMMES

In the early days of the B.B.C. at Magnet House and afterwards at Savoy Hill programmes were contrived with very little material and at short notice. The work was pioneering in the real sense, there being no precedent or experience

available. It was noteworthy, however, that a consciousness of public service and of the importance of high standards pervaded the work from the beginning.

"Personalities" were much more in evidence at the start, and announcers, programme builders, producers, shared with artistes the benefits and penalties of personal publicity. Those were the days of "Uncles" and "Aunts," such as Uncle Arthur (Mr. Arthur Burrows, now Secretary of the Union Internationale de Radiodiffusion), Uncle Caractacus (Captain Cecil Lewis), Uncle Rex (Rex Palmer, afterwards London Station Director and now a high official of the Electrical and Musical Industries), and so on.

With rapid development and a growing sense of responsibility, programme work was departmentalised, specialists being put in charge. Drama, Music, Education, Religion, Children's Hour, etc., were duly stimulated.

The B.B.C., in co-operation with Messrs. George Newnes Ltd., has created a new publishing business—*The Radio Times*, *World-Radio*, and *The Listener* all becoming national journals in their respective fields, and contributing substantially to the success of programmes.

#### SOME PROGRAMME HIGH LIGHTS

- 1923.
- January 8. First broadcast relayed from Royal Opera House, Covent Garden—*The Magic Flute*.
- January 23. First Military Band Concert.
- January 30. First Variety programme.
- February 17. First Broadcast Appeal—The Winter Distress League—by Ian Hay.
- May 1. Opening of Savoy Hill Studios. First of evening talks: Lord Birkenhead.
- 1924.
- January 31. First Adventure by A. J. Alan, "Jermyn Street."
- February 22. First relay of B.B.C. Symphony concert from Central Hall, Westminster.
- April 4. First broadcast by Sir Walford Davies.
- April 13. First Service from St. Martin-in-the-Fields.
- April 23. First broadcast by H.M. the King and H.R.H. Prince of Wales. Opening of the British Empire Exhibition at Wembley.
- May 19. First broadcast of the nightingale.
- July 1. First broadcast after-dinner speech by H.R.H. Prince of Wales at Dominion Day Dinner.

1924.

- October 13. First Election Speech—Mr. Ramsay MacDonald from Glasgow.

1925.

- March 11. First Special Radio Revue—"The 7.30 Revue," from Manchester.
- May 15. First broadcast from an aeroplane. Mr. Alan Cobham teaches Miss Heather Thatcher to fly.
- June 16. First O.B. of Aldershot Command Searchlight Tattoo.
- July 27. Opening of Daventry 5XX.

1926.

- February 16. First broadcast by the London Radio Dance Band.
- March 30. First performance of the opera *Kitesh* (Rimsky-Korsakov), arranged by the B.B.C. at the Royal Opera House, Covent Garden.
- May. General Strike.
- September 20. First O.B. of a Gilbert and Sullivan Opera, *The Mikado*, Act I., from the Princes Theatre.
- December 9. First broadcast of the Ceremony of "The Keys" at the Tower of London.
- December 22. First broadcast of the Nativity Play, *Bethlehem*, from St. Hilary's, Marazion.

1927.

- January 3. First of the Foundations of Music Series.
- January 15. First broadcast description of a Rugby Match, England *v.* Wales, at Twickenham.
- February 24. Command Performance before their Majesties, the King and Queen, at the Victoria Palace.
- March 16. An experiment in Mass Telepathy, conducted by Sir Oliver Lodge and the Society for Psychical Research.
- March 25. First broadcast description of the Grand National. Mr. Meyrick Good.
- April 2. First Running Commentary on the Boat Race. Mr. J. C. Squire and Mr. Oliver Nickalls.
- July 14. Prince of Wales opening the Scottish War Memorial at Edinburgh Castle.
- July 24. Unveiling of the Memorial Arch at the Menin Gate, Ypres, by Field-Marshal Lord Plumer. Speech by H.M. the King of the Belgians.

1927.

- August 21. Daventry Experimental Station, 5GB, broadcast its first programme.
- September 4. Relay from Sydney, Australia.
- September 13. First B.B.C. Promenade Concert relayed from the Queen's Hall.
- October 6. First description of a Boxing Match from the Albert Hall.

1928.

- January 27. First performance of Schonberg's *Gurrelieder*.
- February 2. Ellen Terry Anniversary programme, including a record of her own voice reciting the Mercy speech from *The Merchant of Venice*.
- February 3. Memorial Service for Earl Haig from Westminster Abbey.
- March 28. First performance of a Bernard Shaw play—*The Man of Destiny*.
- May 12, 13. Broadcast of Stravinsky's opera oratorio, *Oedipus Rex*.
- May 20. Celebration of Dame Ethel Smyth's musical jubilee.
- May 28. First of the weekly series of "Bach Cantatas."
- November 19. Centenary Celebrations of Schubert.
- December 12. First Broadcast by H.M. the Queen from Tower Hill.

1929.

- February 28. First National Lecture given by the Poet-Laureate, Robert Bridges.
- April 25, 26. Broadcast of *St. Joan*—Bernard Shaw.
- July 7. Service of Thanksgiving for the recovery of H.M. the King, relayed from Westminster Abbey.
- September 7. Running commentary on the Schneider Trophy Race.
- November 6. *Carnival*, by Compton Mackenzie.
- December 3. Berlin Philharmonic Orchestra, relayed from Queen's Hall.
- December 25. *Scrooge*, adapted and played by Bransby Williams.
- December 31. "The Birth of the Year," including relays of New Year Celebrations from the Continent.

1930.

- January 31. Speech by G. Bernard Shaw, on behalf of the National Theatre, from Kingsway Hall.

1930.

- February 6. A French National programme introduced by H.E. the French Ambassador.
- March 24. National Lecture by Rt. Hon. Lord Hewart of Bury, Lord Chief Justice of England.
- April 8. Conferring of the Freedom of the City of Manchester on Mr. C. P. Scott, Governing Director of *The Manchester Guardian*.
- April 30. Opening of the London-Australia Telephone Service, with conversation between Mr. Ramsay MacDonald and Mr. Scullin.
- June 7. Sir James Barrie from Kirriemuir.
- June 27. Eye-witness account of the Second Test Match at Lords by A. C. Maclaren.
- July 7. Eye-witness account of the Millenary Celebrations of the Icelandic Parliament.
- August 4. Miss Amy Johnson welcomed by the late Lord Thomson, Secretary of State for Air, on her arrival at Croydon.
- September 13. Ridgeway Parade.
- October 27. London Naval Treaty Speeches of Ratification—President Hoover, Mr. Ramsay MacDonald, and the Japanese Prime Minister.
- October 28. Speeches by Mr. G. Bernard Shaw and Professor Einstein, from the Savoy Hotel.
- November 27. Lord Beaverbrook on "Empire Free Trade."

1931.

- January 10. *The Scoop*, a serial detective story. First instalment by Dorothy Sayers.
- February 16. *A Happy Man*, by Chekov, produced by Howard Rose.
- March 14. Prince of Wales opening the British Empire Exhibition at Buenos Aires, relayed from South America.
- April 23. Speeches at the Shakespeare Birthday Celebrations, Stratford-on-Avon, by John Drinkwater, Sir Nigel Playfair, Miss Lilian Braithwaite.
- May 15. *The Forest*, by John Galsworthy, produced by Howard Rose.
- June 16. Mr. W. S. Paley, President of the Columbia Broadcasting System, U.S.A.: "Your Broadcasting and Ours."
- July 13. Mr. H. G. Wells summing up on "Russia."
- September 1. Song Recital by Paul Robeson.

1931.

- October 1. First of a series of Weekly Evening Services from St. Michael's, Chester Square, conducted by the Rev. W. H. Elliott.
- November 21. Yale-Harvard Rugby Football Match from America.
- December 25. Christmas Day Service from York Minster.

1932.

- January 25. Burns Anniversary Programme from Edinburgh.
- March 12. Oration by M. Tardieu at the Funeral of M. Aristide Briand, relayed from Paris.
- March 15. First broadcast by the new B.B.C. Dance Orchestra, directed by Henry Hall.
- May 14. "The End of Savoy Hill," a farewell programme devised by Lance Sieveking.
- June 23. *Midsommer Eve*, a play written for broadcasting, by John Drinkwater.
- August 1. Unveiling by the Prince of Wales of the Somme Memorial at Thiepval.
- October 4. Sir Thomas Horder gives the first of a series of talks on Health.
- November 14. Tenth Birthday of the B.B.C.
- December 25. Christmas Greetings to the Empire, and a Message by H.M. the King.

1933.

- January 28. General Sir Bindon Blood: A Centenary Tribute to the Memory of General Gordon.
- March 22. First performance in England of Hindemith's Oratorio, *The Perpetual*, conducted by Sir Henry Wood.
- April 5. National Lecture by Sir Eric Drummond on "The League of Nations."
- April 17. Oscar Asche in *Chu Chin Chow*, produced by Harry S. Pepper and John Watt.
- June 12. H.M. the King opening the World Economic Conference at the Geological Museum, South Kensington.
- July 14. Fifth performance of Karel Capek's *R.U.R.*, adapted for broadcasting by Cecil Lewis.
- July 30. Act I. of *Die Meistersinger* at the Wagner Festival, Bayreuth.
- August 28. Mr. Hugh Ruttledge: "The Attempt on Mount Everest."
- December 25. "Absent Friends," H.M. the King, and special Empire programme.

## *The B.B.C. Yesterday and To-morrow*

THE big event of 1934 was the opening of the new National transmitter at Droitwich. About the same time new premises were adapted for the studios at Leeds, completing broadcasting arrangements for Lancashire. In October, also, new studios and offices were commissioned in Bristol to enable the West Country wing of the West Region to balance Cardiff. Throughout the year experiments continued in the development of the short-wave Empire service, with the result that in nearly all parts of the world B.B.C. programmes are now received more clearly and consistently than was the case twelve months ago.

The launch of the new Cunard-White Star liner, *Queen Mary*, on September 26, provided an opportunity of which the B.B.C. took full advantage. The programme contained a running commentary by Mr. George Blake, who gave a vivid word-picture of a memorable ceremony. The words of Their Majesties were clearly heard throughout the British Empire and beyond.

The anniversary of England's entry into the World War was marked by an interesting experiment in the reconstruction of history. A programme entitled "Twenty Years Ago" was planned and devised by Dr. Harold Temperley. The purpose was to give an absolutely accurate account of the sequence of events preceding the declaration of war. Fortunately the programme was electrically recorded, because it made such an impression that it was later reproduced at a private meeting of the Historical Association.

The "Scrap-Book" series of programmes, originated and written by Leslie Baily and produced by Charles Brewer, was continued, that of 1910 being particularly successful.

Sir Henry Wood's fortieth season of Promenade Concerts at the Queen's Hall was made the occasion for a brilliant musical festival, thronged by music lovers and listened to all over Europe.

The year 1934 saw the beginning of effective exchange of programmes within the Empire. On Empire Day, May 24, a programme built by the Australian Radio Commission was successfully relayed. It contained vivid cameos of Australian life in characteristic phases. Later, on July 1, Canada's Dominion Day, there was relayed across the Atlantic a programme in which the French-Canadian element was pleasantly and effectively featured.

An important change was made in the organisation of Talks.

Instead of a number of regular series arranged well in advance, more emphasis was placed on topicality and last-minute arrangement. So the series were limited to two or three, and the other talks introduced in accordance with requirements. Experience has more than justified this experiment.

There have also been experiments in the presentation of news. Formerly, the news bulletin consisted of a compact, rather bare, recital of the main facts of the news of the day. Towards the end of 1934 an attempt was made to transform bulletins into something more like a magazine than a catalogue of facts. Explanations, eye-witness accounts, personalities, and so on were injected. It is too early to determine the fate of this experiment. Some listeners object, preferring the old recital of fact.

The increase of staff which was required by the new organisation introduced in 1933 has strengthened the output of the Regions. The result is that British broadcasting is much less dependent on London than it was even a few months ago. Manchester, Birmingham, Cardiff, Edinburgh, and Belfast now possess both the resources and the ability to build programmes eligible for inclusion in the National transmissions. This is an important advance.

The International Broadcasting Union met in London in September 1934, and attempted to consolidate the European distribution of wave-lengths which had come to be known as the Lucerne Plan.

In the late spring, the B.B.C., at the suggestion of the Postmaster-General and with the approval of the Government, attempted to introduce the twenty-four-hour clock system of timing to the British public. The experiment lasted some months, but the response was so negative that the enterprise was abandoned.

On September 29, Christopher Stone said good-bye to his B.B.C. audiences, having decided to throw in his lot with the "sponsored broadcasting" of the Continent.

In October, Sir John Reith, the Director-General of the B.B.C., accepted an invitation from the Government of the Union of South Africa to visit that country to examine the broadcasting situation and to report upon it. As a result, another important contribution was made to the spread of public service broadcasting on the B.B.C. model throughout the world.

The year 1935 opens full of promise of still better broadcasting. The King's Jubilee Celebrations in May are to be marked by a week of special programmes on which the B.B.C. will concentrate the maximum effort. The King's voice will be heard again throughout the world. Dominion Premiers



also will take part in special broadcasts. Musical performances, commemorative of the occasion, are being specially arranged.

The new regional transmitter for the Midlands will be ready for service before the end of February. This will add to the service area, completing the regional scheme in England.

The new high-power transmitter for Northern Ireland should be ready by the end of August.

The practice of exchanging programmes with other countries promises a marked improvement in quality during 1935. Links both by land line and by wireless telephone circuits are being steadily improved. There is good prospect of the effective relaying of more programmes from the Dominions and the United States, as well as from the Continent of Europe.

It is probable that in June the Prime Minister will appoint a special Department Committee to investigate broadcasting and to report upon any changes that should be made in its constitution after 1936.

The number of listeners' licences is likely to increase to 7,500,000 during 1935.

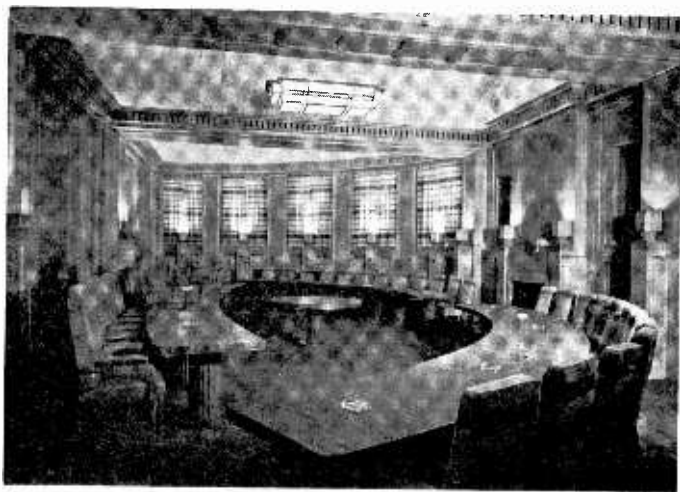

THE COUNCIL CHAMBER, BROADCASTING HOUSE

## *A Day at Broadcasting House*

NOAH'S ark was a contrivance designed to keep all its inhabitants inside. So was Broadcasting House, London, until the B.B.C. headquarters staff were all nicely packed in, and then some one began to push them out.

The process has been going on ever since, with the exodus speeded up every six months or so, until to-day there is nearly as much of Broadcasting House outside the actual building as there is within it.

No one could have foreseen the rapid developments in broadcasting that have made the machine which controls it so gigantic that Broadcasting House was inadequate before it was finished. At least twice as much accommodation in studios and offices as Broadcasting House can offer is required to-day, and there are still no signs that the demands in the future will be anything short of what they have been between one year and the next ever since the B.B.C. was brought into existence.

How is it that the requirements of broadcasting are so truly colossal, and why could not some provision have been made for the gigantic expansion which has so utterly swamped the Big House ?

Let me tell you as briefly as possible.

Some years elapsed between the planning of Broadcasting House and its completion. That was inevitable because, to begin with, no building of its kind had ever been constructed in London. So many preliminary tests and experiments had to be carried out that work was never very rapid, and many modifications had to be introduced into the plans to provide for changing conditions that had given no hint of existence a few months before.

At one time it was even thought that the B.B.C. would not require the whole of its new home, and that it would have to let off part of its ground floor accommodation for shops.

An increase in the number of studios from six or seven at Savoy Hill to a score at Portland Place was going to make every one happy, but the delusion did not last very long.

Television had to be provided for on a scale never anticipated in the Savoy Hill days, and new forms of entertainment demanded space for auditions and rehearsals as well as for their actual presentation for broadcasting. More frequent vaudeville shows, light feature programmes of the musical comedy and revue type, and other entertainments which were

the outcome of trebling the number of producers, all placed a few more straws on the camel's back.

The creation of the Empire service added a big bundle, but that did not matter very much, because it was hopeless to attempt to contend with such rapid expansions which only brought further problems of their own.

Gramophone records needed a proper library, which meant more space. Scores of thousands of records means a whole lot of space.

The recording of programmes—and the Empire service relies extensively on this form of presentation—was another matter that could not be anticipated, and all the time the staff was increasing without previous arrangements having been made to house them.

Finally, there was the wholesale reorganisation of the entire work of the Corporation into two divisions—Administrative, under Admiral Sir Charles Carpendale, and Programmes, under Colonel A. G. C. Dawnay. Each section of the Corporation's activities—Empire, foreign, religion, children's hour, music, outside broadcasts, drama, variety, gramophone programmes, announcers, news, adult, general and schools talks—was given its opposite numbers on both the Programme and Administrative divisions, which brought a corresponding increase to the work of the women typing staff, and to the "accounts" which had general administration departments. The business side of the Corporation's publications department was also separated from the editorial side. Practically everything was duplicated.

Broadcasting House simply burst.

This is the state of affairs at the beginning of 1935, and it is with the knowledge of such a situation that one must describe the use of the various studios both inside and outside Broadcasting House, and how the work is organised and carried out. Broadcasting House consists of eight floors above ground and three below, so that it might be as well to start from the top and work down.

Here, within the central tower, are two studios, 8A and 8B. The control-room is also situated on the top floor.

Studio 8A is one of the brightest, acoustically, of all the studios at Broadcasting House. Originally intended solely for Military Bands, it is in almost continuous use for many and varied purposes. Orchestral concerts are given from it, so are productions of the "Scrap Book" type, performances on large instruments such as the harpsichord, and other shows that require the very best reproduction. Music auditions are held here.

Studio 8B, a much smaller room, was specially constructed

for debates and discussions. Recently it was converted into an engineers' listening and checking room.

Down one floor to Studio 7A, which is now used exclusively for Empire Broadcasting. All the Empire announcements are given here, and so are most of the talks.

Studios 7B and 7C serve the dramatic department for plays and rehearsals. They are the only studios linked by a communicating door, and as their acoustic treatment is entirely different (one being "dead," and the other normal in reverberation), strongly contrasted results are easily obtainable.

Studio 7D is a small effects room, which is used for minor productions, and to relieve pressure on the large effects studio at preliminary rehearsals. It is usually linked with

Studio 7E, which is really a "bank" of six gramophone turntables for effects in plays.

Now down another floor to Studio 6A. A useful studio this for the presentation of plays and performances by small musical combinations up to about a dozen performers. The Gershom Parkington, Leslie Bridgewater, Bernard Crook, and Cedric Sharp quintets and septets would be "housed" in this studio, and "In Town To-night" would be given from it in conjunction with the use of other sixth-floor studios.

Studio 6B is a speech studio, used for plays; so too is 6C, a smaller room which, like Studio 7C, is so panelled and padded as to be absolutely "dead." Studios 7C and 6C have no echo whatsoever. Play murders and other macabre stuff might be done here!

Studio 6D is a large effects studio complete with all the gadgets and contrivances of broadcast make-believe. Thunder noises, wind machines, a water-tank for sea effects, hooters, gongs, bells, a barrel organ, cylinders of compressed air, electrical gear, are all here.

Studio 6E contains another "bank" of gramophone tables, similar to that in 7E.

The fifth floor has no studios—the music library is here, to act as a "sound" buffer between the music, drama, and effects studios I have described, and the quieter type of studio which we are coming to—so down we go two flights of stairs to Studios 4A and 4B. Both are used for the reading of news, gramophone recitals, and "fill-ups." These studios are among the most important in the building, being in continuous use from 10.15 a.m. until midnight. Actually they are the announcers' studio headquarters, 4A for Regional programmes, and 4B for National.

On the third floor is the religious studio, or chapel (3E), and four other studios. The chapel is undoubtedly the most attractive of all the studios in Broadcasting House, with its

representation of the Cross produced by casting a shadow against an illuminated background of blue, fading into white. The daily morning and Sunday studio services are held in this studio.

Studio 3A was formerly known as Henry Hall's studio before he and the B.B.C. Dance Orchestra were moved on to Studio BB. It is now used for Children's Hour programmes, instrumental and vocal recitals, and by small musical combinations. It is also equipped for the broadcasting of talks with gramophone illustrations.

Studio 3B is another talks studio. Visitors to Broadcasting House are always interested in it because it is the one used by the Prince of Wales when he appears before the microphone.

Studio 3C, another talks studio, is also equipped as a listening room as well as for transmission purposes. The majority of talks auditions are listened to here.

Studio 3D is the smallest of all the talks studios, its walls are "decorated" with book-ends so as to present the effect of a small library. Mr. Stanley Baldwin has a preference for this restful studio, which is extensively used by broadcast speakers.

There are no studios on the second—where is the gramophone records library, another "sound" buffer—or on the first and ground floors, so we will use one of the high-speed lifts to the Lower Ground floor, where is the entrance to the Concert Hall.

It is very doubtful whether the B.B.C. is getting all the value originally anticipated from the Concert Hall, which occupies practically the whole of the space through two floors of the Central Tower.

The work of preparing it for a large orchestra is too extensive to make it worth while, but Sections C and E of the B.B.C. Orchestra invariably give their programmes from it. All public chamber concerts are given from this studio, which can seat an audience of about five hundred people. Only when this happens is the gallery brought into use, but many of the seats on the ground floor are movable to provide additional space for the larger orchestras. Occasional productions, such as Geraldo's non-stop programmes, also take place in the Concert Hall, where is also the B.B.C. organ.

Only two other studios in Broadcasting House remain to be described, Studios BA and BB, situated in the sub-basement.

Studio BA was originally intended for all vaudeville entertainments, but since the Corporation took over St. George's Hall, the old home of the Maskelynes, it is used for smaller variety shows, or perhaps to put it in a slightly better way, for shows to which small public audiences are admitted. *Charlot's Hour*, the *White Coons*, the *Kentucky Minstrels*,

programmes by the Café Colette Orchestra, Ambrose's, and other studio dance band entertainments, are given in this studio, which has a gallery (entered from the basement floor above) and seating accommodation for about seventy people. A permanent stage is provided on to which spot-lights are focused from the gallery.

Studio Bb was originally a television studio, until the whole of the Television Department was moved to adjoining premises in 16 Portland Place, after which, up to the beginning of last October, it was used by Henry Hall and the B.B.C. Dance Orchestra. Now it is used for programmes by quintets, two-piano performances, and anything which makes it a sort of general utility studio for musical broadcasts. Many "live," as distinct from recorded, Empire productions take place here.

Apart from the Television Studio in Portland Place and the former Hall of Magic and Mysteries (St. George's Hall), a few dozen paces from Broadcasting House itself, the B.B.C. has studios at Maida Vale and on the Surrey side of Waterloo Bridge. There is also Queen's Hall, which cannot be ruled out as a studio since a whole season of Promenade Concerts and many big Symphony programmes are given from it during the year.

St. George's Hall is not only a studio to which several hundred of the public are admitted to witness the big vaudeville entertainments, but it is the office home of Eric Maschwitz, the Director of Light Entertainment, and of his staff of producers. Almost self-contained in their own suite of offices, and given far more elbow-room than they could ever hope to "cadge" in Broadcasting House, they get on with their work with results that have won unstinted praise from the listening public.

Besides these vaudeville shows, St. George's Hall is used for choral programmes, occasional concerts by the Wireless Military Band, and Section C of the B.B.C. Orchestra, performances of the *Our Miss Gibbs* type, and studio entertainments by "outside" dance bands. It is equipped with an "eight-way mixing unit" and multi-microphone points, which enable the stage, the studio (formerly the old Maskelyne "property" room), and a four-turntable gramophone for effects, to be "mixed" locally, thus providing facilities for extremely complicated musical productions, such as *Wonder Bar*, *Silver Patrol*, *The Gypsy Baron*, etc. St. George's Hall has served the B.B.C. very well. It made possible many developments in light entertainment that would otherwise have been impracticable for a long time.

No. X Studio—it took its number in sequence from the old Savoy lilil studios years ago—is really a converted warehouse

on the Surrey bank of the river Thames, near Waterloo Bridge. Until the opening of the new Maida Vale Studio, it was the largest on the B.B.C. list and was used principally for big orchestral concerts, although at one time some vaudeville shows were given there. The Orchestral Manager had his office on the premises. For a time, from the middle of last October, Henry Hall and the B.B.C. Dance Orchestra rehearsed and gave their programmes from it, including the fortnightly "guest night" programmes, which formerly came from Broadcasting House. It is anticipated that the Dance Orchestra will continue to use this studio until the completion of a new studio specially constructed for dance band requirements at Maida Vale.

Maida Vale, the latest acquisition in studios by the B.B.C., was formerly a skating rink. Here are given the big orchestral shows in a studio so large by comparison with anything the B.B.C. had previously—about 120 feet by 70 feet—that a hundred and twenty musicians seem almost lost in it. Actually a hundred and twenty musicians, and a chorus of three hundred, occupies little over half the floor space. There will be several other studios in the same premises as time goes on, and arrangements to this end include the provision of meals for the staff and artistes such as is now done at Broadcasting House. All technical apparatus for recording programmes, either on steel tape or disc, will be housed in a suite of rooms specially constructed for the purpose at Maida Vale, linked of course by land line with Broadcasting House.

Maida Vale has a physical connection with Broadcasting House through a service of buses running approximately every hour from 9.30 a.m. until 11 p.m.

So much for the impersonal side of broadcasting.

Now let us look at some of the people among the thousand or so who work in the Big House and the other "odds and bits" connected with it.

Excluding the Empire Service Staff, the day's toil at Broadcasting House begins officially at 9.30 a.m. all the year round. It finishes at 5.30 p.m. in the summer and 6 p.m. in the winter, but so far as the public is concerned, Big Ben booms the hour of midnight before the day's broadcasting is brought to a finish.

Office cleaners are hardly out as the staff arrives, and few are late, because a couple of black marks means an inquisition, and what Sir John Reith can do in "keeping time"—he lives at Beaconsfield—other people are not expected to find impossible. Work starts immediately. There is no "warming up" to it.

Many studios are already occupied for rehearsals and audi-

tions before the morning service at 10.15 a.m. starts the day's programmes, which from then go on in an unbroken chain for nearly fourteen hours. Conferences and meetings are soon in full swing, and a never-ending stream of producers, adapters, and engineers of all sorts are busy with a thousand-and-one jobs that may perhaps affect the public within the next few minutes, or more likely not for several weeks ahead.

It is appropriate that we should first see how the announcers work.

In Broadcasting House there are six for British programmes, Mr. A. Stuart Hibberd, the senior announcer, whose voice is known and easily recognisable to millions of listeners, and Messrs. "Freddy" Grisewood, Harman Grisewood (who happen to be cousins), T. A. G. Liddell, R. D. A. Marriott, and L. Marson.

These announcers work in relays. Generally two are on duty during the daytime and four in the evening and at night.

Their work is far less exacting than it once was when they had to prepare their own material.

To-day, there are two presentation assistants, Messrs. Godfrey D. Adams, formerly an announcer, and E. J. King-Bull, who used to devise special programmes when microphone technique was in its more experimental stages.

Each branch and section of the programme department is responsible for writing its own announcements, but the presentation assistants confer to see that everything gets its fair "boost."

They are also responsible, particularly during the evening and at night, for any crisis that may arise, and it is their duty to make decisions on such matters as allowing a programme, say from a provincial station, to overrun its time, or be cut short.

Care is taken not to overburden any one on the microphone and studio staffs with too great a responsibility, and to-day it is no longer the function as it once was of Mr. H. L. Chilman, the House Superintendent, to keep his mind on a hundred items, from receiving distinguished broadcasters to looking after messenger boys.

Studio allocation for all purposes and the duties associated with their suitability and readiness for use, and numerous other incidentals connected with that side of broadcasting, requires a special section, of which Mr. D. Hunter Munro, formerly Assistant Station Director at Aberdeen, is in charge, with a staff that is on duty during all broadcasting hours.

Here again, the work is not permitted to cut across what is known as stage managing, under Mr. E. J. D. Q. Inglis, assisted by Mr. Neil Munro, who look after effects and noises,



It does, however, include responsibility for the administration of the balance and control section, in which there are about a dozen people working directly under Messrs. Paul Askew (Variety and Drama) and L. Stanton Jefferies (Music). Very few programmes are not "balanced" these days, and the work of the "engineers" concerned requires an expert knowledge in the reading of music scores, as it does also of the intricacies of knob-twisting. Much more is asked of the "B. and C." men than is generally understood outside Broadcasting House. They are advisers to producer and conductor alike.

Much of the work already referred to, and the people who do it, comes under the Administration Division of the Corporation, the Controller of which is Sir Charles Cappendale.

On the programme side, controlled by Colonel A. G. C. Dawnay, are the announcers in the presentation section; variety; drama; outside broadcasts; music; and the Children's Hour immediately under Mr. Roger H. Eckersley, the Director of Entertainment; Religion, under the Rev. F. A. Iremonger; and news and adult and general and schools broadcasts under Mr. C. A. Siepmann, the Director of Talks.

Each of these sections provides its own personalities.

In variety, or light entertainment, there is Eric Maschwitz, whose service with the B.B.C. includes a spell in the outside broadcast department, and several years as Editor of *The Radio Times*.

Maschwitz is eminently suited to hold his present position, as indeed he was to occupy his former posts. Few people have turned out more material for the microphone than he did as Holt Marvel, and his name is by no means unknown in the film world. He has probably "lived" broadcasting to a greater extent than most people at the B.B.C.

His staff includes John Sharman, an old vaudeville artiste, and an expert in his job of knowing most people in his profession, and how to produce a good "bill"; Charles H. Brewer, formerly producer at the Midland Regional headquarters at Birmingham, S. Kneale Kelley, Stanford Robinson, John Watt, Denis Freeman, Gordon McConnell, Max Kester, A. W. Hanson, and Brian Michie.

We must not omit Harry S. Pepper, the man who excels in the presentation of Nigger Mistrel shows, or Doris Arnold, with whom he often plays at two pianos. Television under Mr. Eustace F. Robb also comes under the Director of Entertainment, Mr. Roger Eckersley.

Drama is in the charge of Val Gielgud, assisted by Howard Rose, Lance Sieveking, Peter Cresswell, and Lawrence Gilliam.

All are well known, by name at least, to millions of listeners for the sterling work they have been doing for several years.

Gerald Cock, the Director of Outside Broadcasts, takes responsibility for a large share of the programmes. His immediate staff includes Messrs. J. D. M. Snagge, and C. Max Muller, and nominally numerous "O.B." officials attached to the Regions.

Music is a large department, and Dr. Adrian Boult, the head of it, keeps it among the most efficient of the B.B.C. Under him are Aylmer Buesst, B. Walton O'Donnell, K. A. Wright, Stanford Robinson, "Joe" Lewis, Leslie Woodgate, Edward Clark, Julian Herbage, Arnold Perry, Edwin Benbow, and others who build and conduct the various band and orchestral concerts. So, too, are the accompanists, Miss Cecil Dixon, H. Berkeley Mason, and Ernest Lush.

Derek McCulloch looks after the Children's Hour, but his position was shorn of a good deal of its glory when the National programme ceased to contain this daily feature for young people, following the opening of the Droitwich transmitter. The Children's Hour from Broadcasting House is now radiated only from London Regional, Plymouth, and Bournemouth, which places it on the same footing as other Regional Children's Hours. Every Saturday, however, there is a sort of National Children's Hour for the whole country, for which each Region takes responsibility in turn. Something of the intimate appeal of the Children's Hour has disappeared during the last year or so consequent upon the discontinuance of "calling" birthdays, and other efforts to "raise" the standard of the material given.

Religious broadcasts are mainly under the care of the Rev. F. A. Iremonger, the "Chaplain" of Broadcasting House. Mr. Iremonger is also concerned a good deal with the broadcast Charity Appeals.

The Talks Branch, under Mr. C. A. Siepmann, was thoroughly overhauled in the autumn of 1934, and many fresh appointments were made. By amalgamating the old General Talks and Adult Education Departments, a new General Talks Department was formed with Mr. G. N. Pocock in charge. Under him are Mrs. Adams, who holds a part-time post, Miss Wace, and Messrs. F. Greene, J. Salt, and J. Green. It is also intended to appoint new Education Officers for Wales and the Home Counties.

The News Department was also strengthened. This department is immediately under Mr. J. Coatman, whose staff consists of Mr. K. Adam (Home Editor), Mr. R. T. Clark (Foreign News Editor), and Messrs. M. Balkwill, F. D. Walker, and

M. Barkway (Sub-editors). There are also two topical talks assistants (Messrs. J. R. Acherley and R. Murray).

Schools talks remain under the charge of Miss Mary Somerville, who has Mr. F. N. Lloyd Williams as chief assistant, and Miss E. E. Macqueen, and Messrs. V. Alford and G. R. S. Dixon as assistants. There is also a travelling Education Officer.

Another old member of the Talks staff, Mr. Lionel Fielden, was appointed as Special Assistant to Mr. Siepmann. His duties are to provide ideas for the Talks programmes, produce special feature talks, and stimulate and criticise the content and execution of talks throughout the Branch. He is the official responsible for the production of the present type of news bulletins. Attached to him is Mr. R. Suffield, who is known as "Studio Assistant."

An important official of the Programme division is Mr. R. E. L. Wellington, whose work as Presentation Director is never brought to the notice of the public. For a good many years Mr. Wellington has carried out the duties of drafting the programmes in their original or "skeleton" form. This he does several weeks ahead of their actual transmission. Between these times, other people make all the necessary arrangements and fill in the details. It is part of his work to see that each type of programme has a contrasting alternative on another wave-length. Generally he succeeds in arranging one. When he does not, a lot of people notice the omission.

Then there is Mr. L. Bowker Andrews, who looks after the gramophone programmes. With a library of about eighty thousand records, there is plenty to choose from, but it is not quite so simple as all that, otherwise programmes of gramophone records, which form a substantial proportion of the broadcasts, would not be so popular as they are with listeners.

The Empire and Foreign Services, which come immediately under Mr. Cecil G. Graves, the favourite nephew of the late Lord Grey of Fallodon, whose estates he inherited, are also part of Colonel Dawnay's Programme Division. Mr. J. Beresford Clark is the Empire Programme Director, and Mr. Eric Fogg the Music Director. Both these officials were stationed on the North Region for some years before their transfer to Broadcasting House. The Empire Branch has its own producers (Messrs. Cecil Madden and William MacLurg), its own announcers (Messrs. W. M. Shewen, Basil Gray, and E. I. Shankland), and its own News Editor (Mr. J. C. S. Macgregor), who has an assistant, Mr. Robert Bowman, a young Canadian journalist.

Programmes begin at 7.30 a.m. and sometimes earlier, and continue at intervals until 2 a.m. the following day. Staff

duties naturally have no relation to those of other departments, and the "unearthly" hours which the Empire Service demands shall be worked necessitates officials sleeping close at hand. Accommodation has therefore been provided in Portland Place, near Broadcasting House.

The Foreign Service, much smaller than it is important, is in the charge of Miss I. D. Benzie, who assisted Major C. F. Atkinson, the instigator of the department which he also controlled for several years.

Editorial work at Broadcasting House also belongs to the "creative" or Programme Division.

Mr. Gladstone Murray has directed the development of this section of the B.B.C.'s activities for ten years. Mr. Murray's duties with public, political, and other outside interests are as multifarious as they are important. Under him are Mr. J. C. Clarke as "Executive" and in charge of Exhibitions; Mr. M. A. C. Gorham, editor of *The Radio Times*; Mr. E. L. Odhams, editor of *World Radio*; Mr. R. S. Lambert, editor of *The Listener*; Mr. B. B. Chapman, head of the Press Department; Mrs. Lines, photographic department; and staff concerned in the preparation of supplementary publications, together with Information Officers at Birmingham, Manchester, Cardiff, Edinburgh, and Belfast.

All other parts of the vast machinery of broadcasting function through the Administration Division under Sir Charles Carpendale.

There is the Engineering Branch under Mr. Noel Ashbridge, the Chief Engineer, with its two dozen or more departments, sections, and divisions at Broadcasting House, and at other premises in and around London, as well as all the transmitters which are located in two areas, South and North.

Mr. T. L. Lochhead, the Chief Accountant, takes charge of sections dealing with cash, purchase and accounts, financial records and control, premises and standing charges, and costing and audit.

The largest part of the administration work, however, is handled by Mr. B. E. Nicolls, the Director of Internal Administration, who was Station Director at Manchester before his transfer to London eight or nine years ago.

Under him are Mr. G. C. Beadle, the Entertainment Executive official in charge of the executive sides of Empire and Foreign, Religion, Children's Hour, Music, Outside Broadcasts, Drama, and Variety; Mr. R. J. F. Howgill directing the executive parts of programme services—recorded programmes, gramophone, studios, programme compilation, programme finance, and programme correspondence. The Executive side of the Talks Department is taken care of by Mr. J. M. Rose-

Troup; Salaries and the Women's Staff administration comes under the Establishment Officer, Mr. D. H. Clarke; while accommodation and visitors, the House Superintendent, duplicating section, registry and post, catering, and the library give the Assistant Director of Internal Administration, Mr. R. Wade, plenty to think about.

Finally there is the Director of Business Relations, Mr. V. H. Goldsmith, under whom are the Business Relations Manager (Mr. R. Jardine Brown), the Publications Business Manager (Mr. G. H. Dunbar), and the Advertisement Manager (Mr. Ralph Judson).

These are the people who with their efficient colleagues keep Broadcasting House (in the big sense of the word) working smoothly.

And high above them all—controlling, directing, planning, watching, yes and sometimes smiling—sits Sir John Reith himself, the "D.G."

There is also, of course, the Board of Governors, who as public trustees safeguard the fundamental interests of the public and the State in this great service.

## The Leading Wireless Weekly

Every branch of radio is lucidly dealt with and attractively illustrated. No home constructor or wireless enthusiast can afford to be without this remarkable weekly which covers the whole field of radio from A to Z

## **PRACTICAL WIRELESS**

EVERY WEDNESDAY  
THREEPENCE

Obtainable at all Newsagents and Book-sellers, or by post 4d. from George Newnes Ltd., 8-11 Southampton Street, Strand, London, W.C.2

## "I consider the **CHURCH LADS' BRIGADE**

to be the very finest organiza-  
tion for the elder lad."

HIS GRACE THE  
ARCHBISHOP OF YORK.

**Your Support  
is Earnestly asked.**

All communications to:—

The REV. C. M. ARMITAGE,  
M.A., General Headquarters,  
Church Lads' Brigade, Iron-  
monger Lane, London, E.C. 2.



ENTRANCE HALL, BROADCASTING HOUSE

## *B.B.C. Regions*

NO résumé of the work of the B.B.C. would be complete if it omitted to mention the great part which the five Regions carry out in the Midlands, the West, the North, and in Scotland and Northern Ireland.

Each of these Regions has its own Broadcasting House, which works very much on the same lines as Broadcasting House does in London, though, of course, on a smaller scale.

The respective Regional Directors are now regarded as miniature Director-Generals. Gone are the days when they carried the whole of the station's programme arrangements on their broad shoulders. Rather are they now figure-heads, reflecting the glories of Big People elsewhere, representing and upholding the Dignity of Broadcasting—men who really matter.

Which, perhaps, is as it should be to some extent, because fortunately all the Regional Directors are good "mixers." Theirs are not positions which should be swamped with detail work. As Directors it is quite sufficient that they should be asked only to direct.

Without ambiguity, and if only because of his longer service with the B.B.C. during the whole of which time he has been stationed at Birmingham, Mr. Percy Edgar should be mentioned first.

Broadcasting has no more popular and courteous official than the Midland Regional Director, and none has given it more faithful service.

Through good times and bad (and he has experienced his downs as well as ups in broadcasting) he is always on top of the situation. Broadcasting is strong in the Midlands because of his unrelenting and unsparing efforts to give the best always. No family was ever closer united than his staff has always been.

Some day in the future the B.B.C. premises in Birmingham will be more up-to-date than they are at the moment. At present they are more unsuitable for their purpose than they are obsolete, which helps neither Mr. H. J. Dunkerley, the Programme Director, nor Mr. H. Casey, the Regional executive officer.

The West Region through its Director, Mr. E. R. Appleton, will always be remembered for one of the most popular features ever introduced into the programmes—"The Silent Fellowship."

No one envies Mr. Appleton his difficult task of reconciling

the sharply divided interests of Wales and the West Country. How well he does so is evidenced by the large proportion of Welsh broadcasts which non-Welsh-speaking people are willing to tolerate, and how the Welsh interests are satisfied with what they get as distinct from what they claim they should have. Despite his strenuous duties, Mr. Appleton finds time to write books which deserve and receive world-wide fame. His Programme Director is Mr. R. A. Rendall, and executive officer Mr. W. N. Settle.

During the autumn new premises were opened in Bristol to provide a better service of programmes from that centre, and extensive alterations were also carried out at the Regional headquarters offices and studios in Cardiff. The Region has also a Representative at Swansea, where there was once a small relay station.

Mr. E. G. D. Liveing, the North Regional Director, has often said that one must live in the North for a long time to understand and appreciate properly the delightful characteristics of its inhabitants. He ought to know, and that he truly does has been demonstrated over and over again from the distinctive types of programmes which the Region claims to be peculiarly its own. A highly successful tenure of the position of Station Director at Nottingham, where in the early days of broadcasting he built up a gigantic radio circle, was good experience for his appointment as the first Regional Director of the B.B.C. Some two years ago he did temporary duty in London during the absence of Mr. Gladstone Murray in Canada, but the North successfully demanded his return. Mr. E. A. F. Harding is his Programme Director, and Mr. H. M. Fitch his Regional executive officer.

Like the B.B.C. premises at Birmingham, Broadcasting House, Manchester, is by no means suitable for modern requirements. It is certain that something will be done about it in due course. The studios at Leeds, and the North-Eastern headquarters at Newcastle (the latter were brought up-to-date in studios and equipment last October) are of course included in the North Region. Mr. G. P. Fox is the B.B.C. Representative at Leeds, and Mr. E. L. Guildford the Station Director at Newcastle.

Mr. Melville Dinwiddie, the Scottish Regional Director, came to broadcasting from the Church, which may or may not suit the temperament of Scottish people. An admirable man in every respect for the position, he was quick to settle in a new environment, and he brought with him a shrewd understanding of the requirements of listeners. His delightful personality is a valuable asset—a family man with the right instincts of what family entertainment should be. Mr. Moray



McLaren and Mr. J. M. A. Cameron are the Regional Programme Director and executive official respectively, both having had previous experience of broadcasting in London. The Glasgow station (representative, Mr. Andrew Stewart) and Aberdeen offices (representative, Mr. R. M. Kelsall) are also in the Scottish Region.

Broadcasting House, Edinburgh, has been many other things in its history, including a night club and dance hall. Plans are in hand for extensive alterations to modernise the interior of the building.

Northern Ireland, the last provincial area of the B.B.C. to be given regional status, is under the charge of Mr. G. L. Marshall. Before he became Regional Director, Mr. Marshall saw service at several B.B.C. stations and had a long spell at Newcastle—an experienced official who will do much to maintain and further develop the high position the B.B.C. has always held across the Irish Sea. With the opening of the Droitwich transmitter, Belfast comes into the Regional "pool" of programmes, which will increase the scope of Mr. W. J. T. Sutthery, the newly appointed Programme Director, which duties were hitherto carried out jointly with those of Regional executive officer by Mr. W. Mair.

The studio and office accommodation at Belfast were recently brought up-to-date.

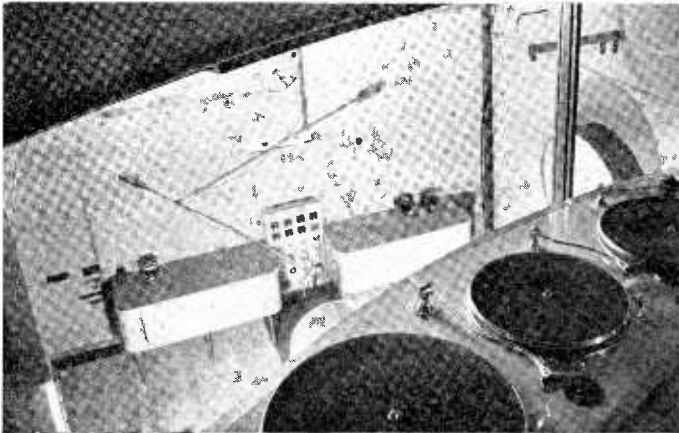

IN THE EFFECTS STUDIOS

## THE TIME SIGNAL SERVICE

Time.	Signals on Droitwich National.	Signals on London Regional.	Notes.
<i>Week-days.</i> 10.15 a.m.	Big Ben	Big Ben	<p>The official broadcasting Time Signal is that which is received from Greenwich Observatory. It consists of six dot seconds, the last dot indicating the point of time to a normal accuracy of one-twentieth of a second. The signal will normally be radiated by all transmitters at the times shown on the accompanying chart. Any signal, however, with the exception of those at 10.30 a.m. and 6.0 p.m., is liable to suppression if superimposition on a current programme is strongly inadvisable on artistic grounds. The signals at 10.30 a.m. and 6.0 p.m. will be suppressed only in exceptional circumstances, and advance notification will be given should such a case arise. Any signal, except those at 9.30 p.m. and 10.0 p.m., which may be suppressed on artistic grounds, will be radiated at the next quarter if that point of time is free from programme matter. The 9.30 p.m. National and the 10.0 p.m. London Regional signals will, if suppressed, be radiated at the next quarter, and superimposed on the Topical Talk, News, or whatever may be going on at the time, unless special advance notification is given.</p> <p>When the News is at 9.40, e.g. during the Promenade Season, the six dot seconds will be radiated at 10.0 p.m. instead of at the beginning of the News.</p> <p>Big Ben will be broadcast in accordance with the chart when possible, and will, in addition, be radiated at the beginning of any programme emanating from London, should the start of the programme coincide with a quarter.</p>
10.30 a.m.	G.T.S.	G.T.S.	
12.0 noon	Big Ben	Big Ben	
2.0 p.m.	G.T.S.	G.T.S.	
5.15 p.m.	Big Ben	Big Ben	
6.0 p.m.	G.T.S.	G.T.S.	
6.30 p.m.	Big Ben	Big Ben	
9.30 p.m.	G.T.S. (When Second News is at 9.30 p.m.)	—	
10.0 p.m.	—	G.T.S. (When Second News is at 10.0 p.m.)	
10.0 p.m.	G.T.S. (When Second News is at 9.40 p.m.)	G.T.S. (When Second News is at 9.40 p.m.)	
11.30 p.m.	G.T.S.	G.T.S.	
12.0 midn.	Big Ben	Big Ben	
<i>Sunday.</i> 10.30 a.m.	G.T.S.	—	
12.30 p.m.	Big Ben	Big Ben	
4.30 p.m.	G.T.S.	G.T.S.	
9.0 p.m.	G.T.S.	G.T.S.	
10.30 p.m.	Big Ben	Big Ben	

# Broadcast Music

By DR. ADRIAN BOULT

SINCE broadcasts to the Empire became part of the B.B.C.'s responsibilities, our transmitters have been in action for some eighteen hours out of every twenty-four. Music is responsible for about 70 per cent. of what is sent out to listeners during all those hours, in round figures, four thousand five hundred hours of broadcast music each year. It is presented to an audience whose numbers can only be guessed, an audience of which we know only two things with any certainty—that no two of its members have exactly similar likes and dislikes, and that no one listener's taste is a constant, unchanging factor.

That must always be the broadcaster's chief difficulty—lack of touch with his public. We think of it as divided roughly into three main classes: (*a*) real music-lovers, who find their recreation in good music of every order, grave or gay; (*b*) those who think of serious music as above their heads, but who enjoy its simpler, more light-hearted, forms; and (*c*) those to whom music makes no appeal at all. There are not many of these last, and fewer still who do not sooner or later join the ranks of (*b*), just as they are steadily enrolling themselves in (*a*). All the available evidence makes it clear that that is the result of broadcasting, and it is to that end that we devote our work: it is no mere casual flood of music that is unloosed upon a listening world.

A year has proved itself to be the most convenient measure on which to plan our scheme of presenting as comprehensive a survey as possible of all that is best in the world's music, old and new, ranging from oratorio and serious opera to musical comedy, folk-song, and dance tunes. Not only the music provided by our own forces within the B.B.C., but a great deal taken from the outside world, is included in the scheme.

Many programmes of the latter order, such as festivals and other events of primary importance in the world of music, are fixed a long way ahead, and as soon as their dates are known, these are noted in a big diary kept by the Programme Branch. From it they are entered weekly on what we call a Programme Sheet, seven weeks ahead of the actual broadcast, further ahead, naturally, in the case of the Empire broadcasts, and then there are added the regular weekly transmissions. Many of these are planned in series, varying, naturally, with the seasons of the year.

The most important of them, from our point of view, are the symphony concerts in the winter months, given in the Queen's Hall, before an audience, and usually broadcast on the National wave-lengths. Their programmes are designed to present a fair proportion of what is accepted as classics, together with a share of newer music which the world looks on as certain to become classical with the passage of time; each season, moreover, the B.B.C. aims at offering to its audiences one or two examples of what the present age is producing. In that last category are included works of which the ordinary concert organisation would have to fight shy, because of its, as yet, limited box-office appeal.

Designed to supplement these symphony concerts, a series continues through a great part of the year on Sunday evenings. Presented, as we have learned by experience, to the largest audience we ever have, the programmes are made up, on the whole, of simpler music than those at the symphony concerts, and include much of the music for which there is no room in that scheme.

The Queen's Hall Promenade Concerts, in which for forty years Sir Henry Wood has done so much to make the best music a thing of delight to the ordinary listener, are all broadcast on one or other of the wave-lengths, National or Regional. Chamber Music is another feature which is planned as a series, year by year, and the public chamber concerts, broadcast from the B.B.C.'s Concert Hall, are supplemented by studio performances of a form of music which is steadily winning more and more adherents.

Definite shares are allotted also to military band programmes, choral and instrumental concerts and recitals, as well as to many programmes of music of the more light-hearted order. The time which remains available after all these have been fitted into place, is laid out to present not only a reasonable balance between the two alternative wave-lengths, but a contrast of such an order that each listener may have a chance of hearing something which appeals to him. Besides those considerations, we have to take into account the activities of the B.B.C. stations throughout the country, and to ensure that they do not overlap our own programmes in London, or others which are taken from sources outside the organisation. These last tend more and more to embrace a large area of the world.

Relays from Continental broadcasting stations, as well as programmes designed for sharing by the listeners of many countries, have been a regular feature of broadcasting for a good many years, and at the London Conference of the International Union of Wireless Transmission held in the beginning

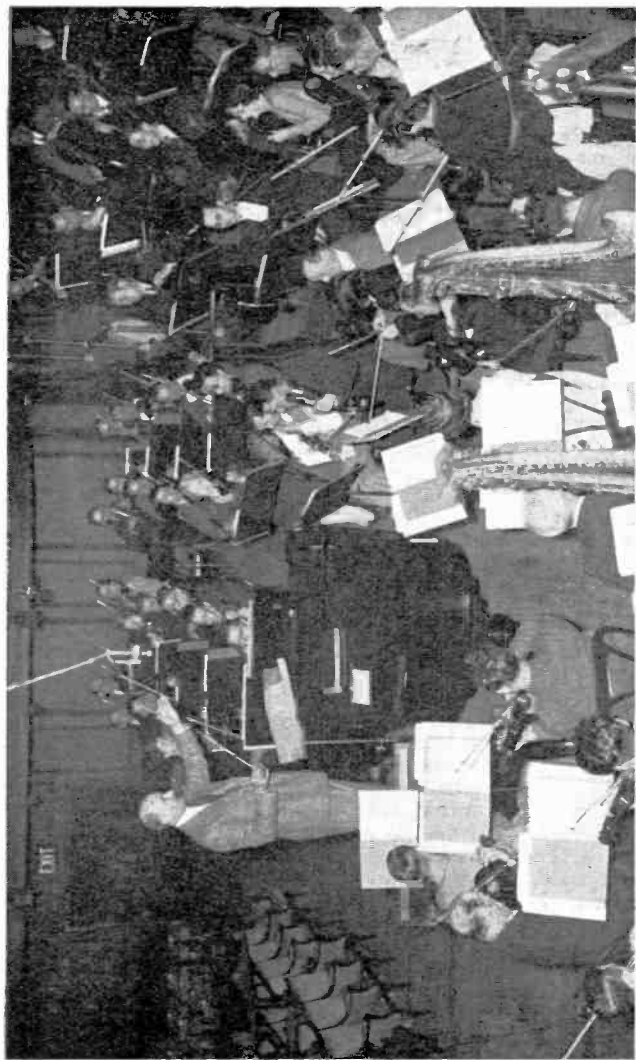

DR. BOULT CONDUCTING THE FULL B.B.C. SYMPHONY ORCHESTRA DURING REHEARSAL AT QUEEN'S HALL

of 1934, that policy was reaffirmed as in every way worthy of extension. The "Outside Broadcasts," as they are called, a term which embraces all programmes not initiated by the B.B.C. itself, whether they happen out of doors or within walls, include operas and concerts from practically all our leading organisations. A twofold object is in view in that form of co-operation. Many British musical activities are being carried on at present only under difficulties, and the financial contribution made by the B.B.C. as a return for the right to broadcast, is naturally welcomed, while listeners, at the same time, have the benefit of hearing concerts which, in most cases, they would be unable to attend in person.

Amateur music-makings are encouraged, too, not only as a stimulus to the singers and players, but with the idea of allowing the public as a whole to realise how high a standard can be reached. Exacting tests, however, have always to be carried out in advance, to ensure, not only that the standard of performance is such as discriminating listeners will approve, but that technical difficulties from such distances are not insuperable. That is true also of all the music of a lighter order which listeners may hear day by day from seaside or summer resort, from picture house or theatre, from restaurant or ballroom.

The programmes for any given week once decided on, the engagement of artistes is the next consideration. To ensure that each task is entrusted to the singer or player best qualified for it, apart from any personal considerations which might influence the selection, that is left in the hands not of any one member of the staff, but of a committee which meets regularly and exchanges opinions without fear or favour. At the same time every care is taken to see that broadcasting engagements are distributed over as wide a range of practising artistes as is consistent with the B.B.C.'s standard, both in order to ensure variety for the listener's benefit, and to give as fair a share as possible of engagements to the many artistes of whom this country may now boast. The B.B.C. tries, moreover, not to miss chances of engaging distinguished foreign artistes who visit England, although no singer or player is ever specially invited to come from abroad except in the rare case when no British performer is available to undertake some particular task.

The great bulk of our programmes, however, is provided by our own regular forces, and most of all by the orchestra. The tasks it has to carry out are obviously at once bigger and more diverse than fall to the lot of any other body of players. On seven days a week, and for many hours of every day, orchestral music of one order or another forms the mainstay

of the programmes, and when two contrasted programmes have to be provided simultaneously, it may mean having the orchestra in two places at once. The B.B.C., accordingly, set itself, some years ago, to form an orchestra which could either play as a whole, or be divided into a number of separate and yet self-contained orchestras, each one with a due proportion of players capable of presenting complete performances of different classes of music.

The full orchestra is made up as follows: first violins, twenty; second violins, sixteen; violas, fourteen; 'cellos, twelve (and at least one 'cellist can take on the viola da gamba parts in such music as the Bach Cantatas); double basses, ten; flutes and piccolos, five; oboes and English horn, five (oboe d'amore and oboe da caccia are also provided for among these); clarinets and bass clarinet, five; bassoons, five; horns, eight; trumpets, five; trombones, six, and tuba, one; harps, two; tympani and percussion, five. It is engaged, as outlined above, at the B.B.C.'s chief orchestral concerts, though it has more than once lent its aid in other undertakings, such as the 1932 Elgar Celebration.

Till now it has been possible only for London listeners to be present at its concerts, but this season it is to make visits to a number of provincial centres where the B.B.C. is represented; the first of these is to Manchester, where the orchestra of 119 players gives a concert in the Free Trade Hall on December 5, presenting music which requires a team of that size for its due performance, and which cannot, as a rule, be presented so adequately by local organisations.

When not engaged in rehearsal or performance as a whole, the orchestra is constantly divided into smaller teams which can play independently of one another. The next team, in point of size, is what is called B., consisting of seventy-nine players; it can be entrusted with symphony concerts which include the classics, Brahms, César Franck, and so forth, as well as big operatic excerpts. While B. is employed, the remaining forty players, known as Orchestra C., can tackle all such music as operettas, musical comedies, or light opera, and a good deal of older music of the serious order.

The orchestra can also be divided into what are known as D. and E., D. consisting of seventy players, dealing adequately with all the music like earlier symphonies, in which the complement of winds is a small one, and E., forty-nine players, fitted for all the programmes which it is convenient to class under the heading "popular orchestral." In that way the B.B.C. can provide on an average six or seven programmes of orchestral music every week, besides the symphony

concerts on Wednesdays and Sundays, programmes which can range over music of many different orders.

It is not only the actual concerts which make such a scheme necessary, but the rehearsals which even the simplest concert always entails. No matter how well-known, no music is ever broadcast without at least one rehearsal, and for the more important concerts five or six are often required; in exceptional cases, where new and difficult music is being prepared, it has sometimes been necessary to rehearse for months in advance. That all these rehearsals complicate the accommodation question must be obvious to the most heedless listener; the allotting of studios, hour by hour, is in itself one of the intricate jig-saw puzzles which have to be solved day by day. Another obvious difficulty is the storage of all the scores and parts required for such constant music-making; that, too, occupies a great deal of space, and demands exact and careful work on the part of the librarian and his staff.

Besides the orchestra whose position is outlined above, there is an independent body called the Theatre Orchestra, whose name sufficiently indicates the scope of its work; listeners to music of a light order know it well. The Wireless Military Band is also independent of the Orchestra, although its members are all orchestral players, and not recruited from the Services. Its programmes, too, form part of the musical scheme, and it presents not merely military band music of the older order, but many arrangements and original pieces which the standard of its work has induced composers to provide for it.

The Wireless Chorus, a body of forty professional singers, available in any number from nine to its full strength, can be called on for all the oratorio, opera, and other choral programmes except those of the biggest order; its nucleus is the Wireless Singers, a team of eight who are full-time members of the B.B.C. staff, like the players in the Orchestra. For bigger choral undertakings the B.B.C. in 1928 formed its own chorus, especially with the view of presenting new music. It consists of 260 amateurs, each of whom has to pledge him- or herself to be a member of another practising choral society, so that there might be no risk of our activities interfering with those of other bodies who are doing good work of their own.

No outline of the ways in which we set about our task of presenting so much varied music would be complete without mentioning a section which works behind the scenes, and the result of whose labours is apparent only in the quality of what the listener hears. It is in the hands of a group of men who are at once trained musicians and, to some extent, wireless engineers. Their duty is to be present at all rehearsals, and to make



themselves familiar with the effects which the conductor or performers wish to produce. They are responsible for placing players or speakers in such a position that the balance of the whole broadcast will be correct, with no one part in the ensemble either too prominent or too far in the background. While broadcasts are being carried out, they listen in rooms specially designed for the purpose, with scores in front of them, and control and adjust the volume in such a way that it reaches the listener as nearly as possible in accordance with the intentions of the composer and performer.

The task of broadcasting music is thus, as a thoughtful listener must long ago have guessed for himself, a constant one, carried on for seven days a week and for many hours of every day. We think of ourselves as servants of the public, and of our task as a service. No light one though it is, it is yet one which is carried out with a constant zest, and there is no one of us that looks upon it but as a privilege. Musicians have never before enjoyed such an opportunity of helping their brothers and sisters throughout the world to share in the infinite delight which music, best of all the arts, can offer.

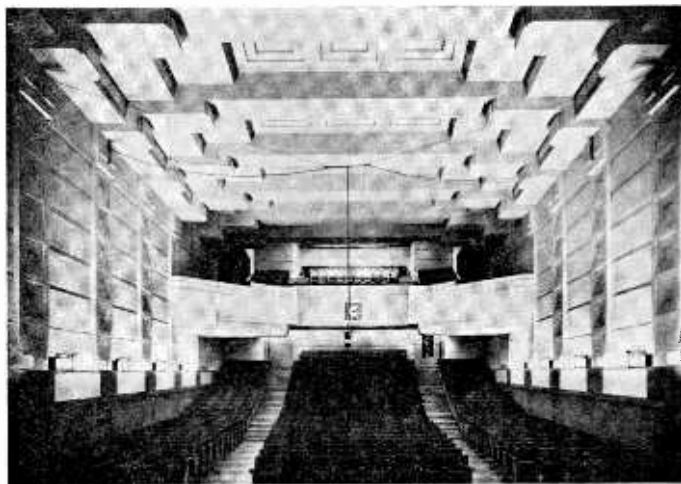

THE CONCERT HALL, BROADCASTING HOUSE

### B.B.C. First Performances in 1934

- AUSTIN, Frederic . . . . . Prelude and Entr'actes 1 and 2 from "Robert Burns."
- BACH—Pick-Mangiagalli . . . . . Two Preludes for Strings.<sup>4</sup>  
 BACH—Respighi . . . . . Prelude and Fugue in D.  
 BANTOCK . . . . . Ballad, "The Sea Rievers."<sup>5</sup>  
 " . . . . . Sapphic Poem for 'Cello and Orchestra.<sup>5</sup>  
 BARTÓK . . . . . Cantata Profana.  
 BERTHOVEN . . . . . Sechs Gesellschafts—Minuette.  
 BELL, W. H. . . . . Symphony in F Minor.  
 BENJAMIN, Arthur . . . . . Violin Concerto.<sup>1</sup>  
 BERG . . . . . "Der Wein."  
 " . . . . . "Wozzeck," Opera in Three Acts.<sup>2</sup>  
 BRIAN, Havergal . . . . . Symphonic Dances from the burlesque opera,  
 "The Tigers."<sup>5</sup>  
 BRIDGE . . . . . Rhapsody for Pianoforte and Orchestra,  
 "Phantasm."  
 BRITTON, Benjamin . . . . . Sinfonietta.  
 BUSCH, Adolph . . . . . Variations on a theme of Mozart.
- CASALS, Enric . . . . . "Sardanas."  
 CONVERSE . . . . . California (Festival Scenes).<sup>2</sup>  
 COOKE, Arnold . . . . . Concert Overture, No. 1.<sup>3</sup>  
 COWELL, Henry . . . . . Sinfonietta.  
 COWEN . . . . . "The Magic Goblet."  
 CREITH, Guirne . . . . . Tone Sketch "Rapunzel."<sup>5</sup>
- DALE . . . . . An English Dance.<sup>1</sup>  
 DELIUS . . . . . Fantastic Dance.  
 van DIEREN . . . . . "Diaphenia."
- FINZI, Gerald . . . . . Introit.<sup>5</sup>  
 FOULDS . . . . . April—England, Impressions of Time and Place.  
 de FRUMERIE . . . . . Suite for Chamber Orchestra.
- GARRETA, Enrique . . . . . "Sardanas."  
 GATTY, Nicholas . . . . . Variations on "Old King Cole."<sup>5</sup>  
 GERMAN, Edward,  
 arr. Arthur Wood . . . . . Cloverly Suite.  
 GIBBS, Armstrong . . . . . "The Love Talker."<sup>3</sup>  
 GRIEG . . . . . New Suite of Incidental Music to "Peer Gynt."
- HADLEY, Patrick . . . . . Symphonic Ballad, "The Trees so High."<sup>3</sup>  
 HANNENHEIM . . . . . Pianoforte Concerto.  
 HINDEMITH . . . . . Trio No. 2.<sup>2</sup>  
 HOLBROOKE . . . . . Poem No. 7, "Queen Mab."  
 " . . . . . Pianoforte Concerto, "L'Orient."  
 " . . . . . "The Viking."<sup>5</sup>

<sup>1</sup> First concert performance.

<sup>2</sup> First performance in England.

<sup>3</sup> First performance in London.

<sup>4</sup> First concert performance in London.

<sup>5</sup> First broadcast performance.

HOLST . . . .	Lyric Movement.
HUMPERDINCK . . . .	Moorish Rhapsody.
IRELAND . . . .	Prelude for Pianoforte and Orchestra.
JACHINO, Carlo . . . .	Pastorale di Natale.
KNIPPER, Lyof . . . .	Suite from " Vantch."
KODÁLY . . . .	Dances of Galanta. <sup>2</sup>
LUCAS, Leighton . . . .	Partita.
MIASKOVSKY . . . .	Symphony No. 7.
MOERAN . . . .	Suite, " Farrago." <sup>4</sup>
MORRIS, R. O. . . .	Symphony in D.
O'NEILL . . . .	Incidental music to " Henry V."
PIZZETTI . . . .	Canti della Stagione alta.
PROKOFIEV . . . .	Symphony No. 3.
" . . . .	Symphonic Suite from " The Gambler."
" . . . .	Concerto No. 5 for Pianoforte and Orchestra. <sup>2</sup>
REDMAN, Reginald . . . .	Introduction and Folk Tune for Strings.
REED, W. H. . . .	Rhapsody for Viola. <sup>5</sup>
SCOTT, Cyril . . . .	Festival Overture.
SINIGAGLIA . . . .	Rondo for Violin and Orchestra.
SPEAIGHT, Joseph . . . .	" Silent Pictures."
SZYMANOWSKI . . . .	Symphonie Concertante.
TAPP, Frank . . . .	" Metropolis."
TAYLOR, Deems . . . .	" Circus Day." <sup>2</sup>
THOMPSON, Randall . . . .	Symphony No. 2.
THOMSON, Virgil . . . .	Capital, Capitals.
TOCH . . . .	Symphony for Pianoforte and Orchestra.
" . . . .	Bunte Suite.
VARÈSE, Edgar . . . .	Octandre for Eight Instruments.
VAUGHAN WILLIAMS . . . .	Fantasia on a theme by Tallis.
" . . . .	Fantasia, " Greensleeves."
" . . . .	" The Running Set." <sup>4</sup>
WEIGL . . . .	Pianoforte Concerto, F Minor.
WEISS, Adolph . . . .	Andante from Kammersymphonie.
WIENER, Jean . . . .	Concerto No. 1 (Franco-American).
WILSON, Stanley . . . .	Two Impressions. <sup>5</sup>
WOOD, Haydn . . . .	Suite, " In an Old Cathedral Town."

<sup>1</sup> First concert performance.

<sup>2</sup> First performance in England.

<sup>3</sup> First performance in London.

<sup>4</sup> First concert performance in London.

<sup>5</sup> First broadcast performance.

## WEATHER FORECASTS

- 10.30 a.m. Droitwich and Regionals (Sundays, Droitwich only). Weather Forecast for Ships. Read twice—first at natural speed, second time at long-hand dictation speed.
- 6.0 p.m. National and Regionals. General Weather Forecast.
- 9.30 p.m. National. General Weather Forecast and Weather Forecast for Ships.
- 10.0 p.m. Regional Programme. General Weather Forecast.

## GALE WARNINGS

Gale Warnings, when received from the Meteorological Office, are broadcast at the following times :

## SUNDAYS :

- 10.30 a.m. With Shipping Forecast. Droitwich National only.
- 12.30 p.m. Droitwich National only.
- 4.30 p.m. Droitwich National only.
- 8.50 p.m. With General News Bulletin.
- 11.0 p.m. With Shipping Forecast. Droitwich National only.

## WEEK-DAYS :

- 10.30 a.m. With Shipping Forecast. Droitwich National and all Regional and local transmitters.
- 1.0 p.m. Droitwich National only.
- 4.45 p.m. Droitwich National only.
- 6.0 p.m. Droitwich National and all Regionals and local transmitters.
- 9.30 p.m. With Second General News Bulletin.
- 11.30 p.m. With Shipping Forecast. Droitwich National only.

Navigational warnings are broadcast with the Shipping Forecast at 9.30 p.m. when received from the Admiralty.

# *Artistes of the Ether*

By A WELL-KNOWN RADIO CRITIC

ONE of the most remarkable facts about broadcasting is that while it has "made" many artistes it has created very few stars. Every day the B.B.C. use an average of fifty named performers (additional to the personnel of the various musical combinations) and in the course of a year at least five thousand different artistes face the microphone. This has been going on for years, but the number of radio stars that has resulted could be counted on the fingers of the two hands.

## **The 100 per cent. Radio Star**

I have a great difficulty in naming more than five performers who are purely radio stars, meaning artistes who had no professional existence before broadcasting. Christopher Stone, of course, is the shining example of radio stardom. Mabel Constanduros was another, but even she has yielded to the lure of the footlights. The 100 per cent. radio star is "A. J. Alan," whose natural gifts as a raconteur the B.B.C. early discovered and have used for years in a most discreet manner and with utmost enjoyment to the listening millions.

There are a considerable number of well-known artistes who owe much of their stage and screen success to their broadcasting. It therefore becomes obvious that constant broadcasting enhances the professional value of the performer enormously. One well-known theatrical agent said to me recently: "Let me put an unknown artiste on the air every week for a year and I'll have no difficulty in booking that artiste as a top-liner at a three-figure weekly salary."

Imagine, therefore, the value to an artiste in broadcasting daily as, for example, the B.B.C. dance orchestra vocalists. Phyllis Robbins and Les Allen were little-known vocalistes—in the professional sense—but after being heard by listeners every day for some months they were able to sign most lucrative contracts for music-hall appearances.

There is a sense, therefore, in which it is true to say that the number of real radio stars is very small. It is equally correct to say that there is no compartmentation of "film stars" and "radio stars" and "concert stars" and "stage stars." The stars of radio are the stars of the other three professions. This is true, even, in the case of the musicians. Dr. Adrian Boult, the most prominent musician on the B.B.C.

staff, was well known on the concert stage before he broadcast, and has since often conducted in public and even taken the B.B.C. Symphony Orchestra on a professional tour.

### Broadcasting Sopranos

Music is, of course, the chief aspect of B.B.C. entertainment. It occupies more hours of air-time than any other category of broadcast. This is because broadcast entertainment is entirely aural and, therefore, vocal and instrumental music find the microphone to be an ideal vehicle for expression.

So far as vocal music is concerned, B.B.C. subscribers could not be better served. I can, at this juncture, refer to a few of the artistes, but only do so after emphasising the explanation that with five thousand artistes about whom I could write those actually referred to are representative of the whole.

The microphone is not too kind to sopranos. The "higher frequencies" (as the technicians term the top notes) challenge the "iron ear" very strenuously. If a soprano is a successful broadcaster her triumph is greater than, say, the successful basso for that reason.

A most talented broadcasting soprano is Olive Groves who, despite her youth, is a microphone veteran. Miss Groves had an unusual upbringing—as her father was the headmaster of a school she was educated at a boys' school. It is unnecessary for me to say that she was not taught singing there!

In fact she did not start as a singer. Miss Groves made her public debut at a parish concert as a pianist and violinist. It was while studying the pianoforte at the Royal Academy of Music that she took up singing and won two scholarships for vocal training. This led, later, to her appearing on the stage at a concert organised by her mother at Cologne for the entertainment of the Army of Occupation, as a singer.

Six years later she was walking in the Strand when a young man stopped her. He reminded her of that concert which, as an officer, he had attended, and, explaining that he had since become an official of the very youthful B.B.C., asked her to broadcast. This she did, in April 1926, and has been broadcasting ever since.

### Wynne Ajello

Even more of a veteran despite the immaturity of her birth certificate, is Wynne Ajello, who preceded Miss Groves to the microphone by six months. On that occasion she sang four coloratura arias with orchestra, and as she had never sung with orchestral accompaniment before, the normal terrors of the microphone were considerably augmented.



OLIVE GROVES

Miss Ajello comes of a musical family but was the first of that family to take up music as a profession. She made her debut as a schoolgirl at the seaside, taking part in a beach singing competition and walking off with the prize. This was a book, *Picturesque Views of the Town*, which she still possesses. When she got past the schoolgirl stage her ambition was to be a dancer, and it was while training for the ballet that she took singing lessons and discovered that she had a voice.

Since that first broadcast in 1925 Miss Ajello has faced the microphone nearly four hundred times. She has been the heroine in scores of broadcast musical shows and various operas, in fact she has played in 150 B.B.C. musical productions.

### Anona Winn

In a different class of sopranos is Anona Winn, who has been broadcasting now for more than six years. Miss Winn is one of the most versatile vocalists to be found in Broadcasting House studios. She is a Melba-trained "straight" singer, with an extensive repertoire of operatic arias; she is one of our best "Blues" singers; she can sing jazz or ballads, play musical comedy or revue.

Miss Winn is Australian-born and was educated there. She matriculated with a view to taking up the law, and was "all set" to be Australia's first Portia when the urge to sing conquered her aspirations to the Bar. So she took up the study of music at the Melbourne Conservatoire, which was under Melba's direction.

Youth, however, insisted on having its fling, so the budding opera star ran away and joined the chorus of a touring show. After being in the chorus of *The Merry Widow*, playing in pantomime and revue, and singing with a concert party, she came to England to appear in *The Blue Mazurka* at Daly's and, later, *Hit the Deck* at the Hippodrome.

Her microphone debut, in June 1928, was in a revue called *Fancy Meeting You*, and since then she has broadcast more than three hundred times including the majority of the popular "Songs from the Shows" series. In addition she has "voice doubled" for several famous film stars in talkies, coached other stars and written songs of which "What More can I Ask" was a big seller.

### Kate Winter

One of the few sopranos who has so completely mastered microphone technique that there is no song or aria, no matter how extensive its range, that she cannot broadcast it with





ANONA WINN

opalescent purity and tonal beauty, is Kate Winter, who attributes her decision to become a professional singer to broadcasting. Miss Winter comes of a musical family. Her father was a very competent amateur singer and choral conductor, her uncle was a singing master, and her cousin, Madame Grace Day Winter, was a well-known contralto.

It was a devious route that Miss Winter took to radio fame. At first she evidenced considerable talents as a pianist and studied the pianoforte, but gave it up because the profession of musical performer was not considered to be as safe as that of school teacher, which she ultimately became.

While teaching school, however, she still studied music, and her cousin persuaded her to take singing lessons. She went to Professor Dan Price for these, and in her spare time taught the pianoforte.

When she got married, Miss Winter found that she had the time to devote more concentrated study to music, and the coming of broadcasting suggested singing as a professional outlet to her musical energies.

Miss Winter made a most successful public debut in a 1927 "Prom" concert, and then important engagements under Sir Henry Wood followed. She has broadcast nearly three hundred times both in solo sessions and in opera and Bach cantatas.

### Esther Coleman

It has always been a matter of interest to me to discover the origins of artistes, and I have been very surprised at the number who are stars in one form of entertainment but began in another. I have already referred to Olive Groves, and Esther Coleman is in the same category. Miss Coleman is probably the most-heard contralto on the air, and yet she was a pianist as a girl and later studied organ. Neither keyboard, however, gave her the opportunities for individual expression that she desired, and so she took up singing, studying at the Guildhall School of Music, clearing the board of Gold and Silver medals, the Challenge Cup and all the other available prizes.

When she first studied public singing Miss Coleman made a speciality of singing modern songs without accompaniment. Then she gave highly successful recitals all over the country of an "Historical Survey of Song" which embraced in its generous ambit the whole gamut of vocal music from the Troubadours of the Middle Ages to the latest classics and employed eight different languages.

Miss Coleman made her microphone debut in 1925 and so is in the "veteran" class. During her ten years of radio work she has had her radio adventures. There was the occasion when she was rehearsing in the Radio-Paris Studio and the engineers made a mistake. They plugged the switch in at the wrong time and the whole of her rehearsal was broadcast.

One other distinction Miss Coleman can claim. She appeared in one of the earliest television programmes, and in proof of her versatility I can reveal that Diana Clare, the dance band crooner, is Esther Coleman the classic contralto.

### Mabel Constanduros

In addition to the "straight" vocalists (dance band singers will be referred to later) women broadcasters are also to be found in other departments of microphone activity. There are, for instance, those who are classed as "entertainers," of whom Mabel Constanduros is the best-known to listeners. Mabel Constanduros is essentially a radio artiste—she has been brought up on the microphone.

London-born, she had stage ambitions which even marriage and motherhood did not quench. So she took up the study of elocution at the Albert Hall School of Speech Training where she was heard, in a school performance, by a professional actor who advised her to demonstrate her gifts of mimicry

to the B.B.C. which was then only two years old. So during the first few weeks of 1925 she went to Savoy Hill for an audition.

The aspirant to microphone honours found herself one of a number of other artistes all waiting, in various stages of nervousness, for an audition. This caused her to lose her nerve entirely. But even so, the light of her genius gleamed and was perceived by the B.B.C. officials. She was engaged to give her first broadcast on March 23, 1925, and most of her broadcasting in those early days was in radio plays.

### The "Buggins Family"

Six months later a chance meeting affected her whole career. During the luncheon interval of a radio rehearsal she found herself sitting at a tea-shop table with Michael Hogan, who was also acting in the play. Their conversation—all "shop" of course—led to the creation of an idea: they would join forces to write for the microphone sketches which they would act themselves.

They decided to enlarge the "Buggins Family" characters which she had already created. Michael was able to double the members of the famous family impersonated, and the "Bugginses" became a national feature. Since then Mabel and Michael have presented the "Family" to listeners nearly three hundred times; they have been recorded for the gramophone, turned into a play, and had a book written about them. On one occasion, when Mabel and Michael contributed the running commentary at a Royal Command Performance, it took the form of the "Buggins Family" at the show.

### Jeanne de Casalis

There are two other female artistes who have invented radio "characters" with which listeners have become very familiar. Jeanne de Casalis created "Mrs. Feather," who is a most amusing commentator. She is that rather garrulous type of middle-class woman who mingles suburban snobbery with newspaper knowledge. "Mrs. Feather" is presented to listeners with all that consummate artistry and flawless diction which characterises Miss de Casalis as a stage actress of West End standing.

Like some of the other artistes to whom I have already referred Miss de Casalis was originally trained for work different from that in which she has made her name. Born in Basuto-land, she went to Paris to study the pianoforte, as her intention was to become a professional pianist. In fact, her first public

appearance was in that capacity with a local show. Unfortunately—or, perhaps, fortunately—she commenced to play the selected piece an octave too high, and her efforts were greeted with an icy silence that caused her to close the piano-lid for ever.

Before she was out of her teens Miss de Casalis appeared at the Casino, Cannes, in a play which she had herself written. From that moment she progressed rapidly to international stardom. It is generally conceded that her best performance was in *Yellow Streak* in London, and it was in that piece that she met Colin Clive (later, of *Journey's End* fame) who is now her husband.

Miss de Casalis declares that the idea of "Mrs. Feather" came to her one morning in her own home. "The telephone bell kept ringing, friends and tradesmen kept calling, and out of the busy-ness of it all, keeping my sense of humour, I visualised a woman in whose adventures thousands of harassed housewife-listeners could see their own domestic experiences."

Sir Oswald Stoll was very interested in "Mrs. Feather," but a monologue was so great a departure from the usual Coliseum policy that he was hesitant of having it performed there. "Mrs. Feather," however, did make her first appearance on the stage and was an immediate success. Brought to the microphone, "Mrs. Feather" became a prime favourite with listeners.

### Hermione Gingold

The other artiste who has given a "character" to broadcast entertainment is Hermione Gingold whose "Mrs. Pull-pleasure" is as distinctive a type as the other two radioddities. Miss Gingold is one of the finest character actresses the microphone has brought to listeners, and versatile enough to include musical comedy in her performances. She is a daughter of the theatre, having first gone on the stage when only ten years old. At that tender age she became a member of Sir Herbert Tree's company at His Majesty's as the page in *The Merry Wives of Windsor*.

Miss Gingold first broadcast in 1927 and has since made about 150 microphone appearances. These have ranged from the part of Madame de Mauban in *Prisoner of Zenda* to a ballet-frocked member of the "Ridgeway Parade" troupe. Her "Mrs. Pullpleasure" sketches have all been in variety programmes.

### Elsie and Doris Waters

These three microphone "characters" are one-woman features—there is one outstanding two-woman feature that

depends on similar characterisation. I refer to Elsie and Doris Waters, whose "Gert and Daisy" are as real to listeners as their radio sets.

"The daughters of Mrs. Waters" are the only girls in a family of six children who used to form themselves into a complete orchestra when young. At that time it was a family rule that all the children must learn the piano and, in addition, could select any other instrument on which they had also to become proficient. Elsie and Doris both studied piano and elocution at the Guildhall School of Music, while



ELSIE AND DORIS WATERS

Elsie (that is the one who plays the piano in the present duo) also studied the violin and was for some time a pupil of Albert Sammons.

The two sisters made their debut at Southwold in the "White Coons" concert party run by Will. C. Pepper, father of Harry S. Pepper the present B.B.C. producer. Arrived at Southwold the two novitiates disliked the stage costumes provided for them and sat up all night making their own. In those days they could not afford to buy outside "material" for their stage work and so said, "We'll have to write our own"—a practice they have continued ever since, so that the greater part of their repertoire consists of their own exclusive numbers.

They made their first microphone appearance in March 1927

after refusing the B.B.C. invitations to broadcast for some time. Since then they have been heard over the air at regular intervals, invariably with acceptance. They have never performed the same act twice over the air, and in the course of their broadcasts have sung 189 different songs of which they wrote 64 themselves, including the popular series of "Wives of Famous Radio Men."

"Gert and Daisy," strangely enough, did not have a radio origin. They are a gramophone invention. The sisters were approached to make records, and attended the studio to make a series. "When we came to our sixth record," Elsie once told me, "we made one side, but did not have a suitable song for the reverse, so we decided to do a talking record if only by way of contrast. At one o'clock in the morning of the day we were due to make the record, we sat down and wrote the patter and the little four-lined song which went with it." And that was the beginning of "Gert and Daisy." They have since appeared all over the country, and when the Princess Royal presented them to the Prince of Wales following their appearance before her at a concert she said, "These are the two ladies who made me laugh so much yesterday." Their next experience of Royalty was in 1934, when they appeared before Their Majesties in the Royal Command Performance.

In the ranks of radio actresses is a considerable number of popular favourites. These include both the musical show and serious drama schools of acting. I select three of the former as representative of a fine body of excellent artistes. Margery Wyn is a blue-eyed, flaxen-haired beauty with a delightful singing and speaking voice. Like so many fine vocalists, she is Northern by birth and training.

Miss Wyn began her professional work in the hardest but finest school—seaside concert party. Her first public appearance was at Westcliffe-on-Sea, and after a season entertaining beach crowds she went into pantomime. A period as principal girl for Alfred Wareing was followed by a season with Francis Laidler as principal boy. Then she went on tour in musical comedy, including *Mr. Cinders* the famous Hippodrome show in which she took Binnie Hale's part.

That brought her into the West End line and she was engaged to play opposite Harry Welchman in a revival of *The Lady of the Rose*, at Daly's, followed by *Nippy* in which she played second lead. After playing the title rôle in *The Quaker Girl* revival, Miss Wyn played opposite Stanley Lupino in *Hold my Hand* at the Gaiety for nearly a year.

Her first broadcast was in 1931 when she was in a Jack

Hulbert radio show. Since then she has sung and acted in dozens of broadcasts, mostly revue and musical comedies. She also made a great hit in the first Radiolympia revue, *Nine Days Wonder*, and her biggest part in 1934 was in the microphone version of *Monsieur Beaucaire*.

### Natalie Hall

Broadcasting has recently brought two bright stars of the stage into radio prominence.

Natalie Hall is an American who brought her extensive trans-Atlantic experience to shine on the British stage and instantly became a B.B.C. recruit. To seal her adoption of this country she married Barrie McKay who was with her in *Ball at the Savoy*, and became a British actress. Even as an actress in her native America she specialised in things British, and made her first appearance on the American stage in the chorus of our Gilbert and Sullivan operas.

Miss Hall is recognised as one of the greatest operetta artistes on either side of the Atlantic. The figure "3" has entered into her life very significantly. She is the third daughter of her family; came to London on June 3, 1933, to accept the third offer to play there; three months later she became engaged; was married on November 30, 1933; received her first offer from the B.B.C. on December 30, 1933; *Ball at the Savoy* closed on January 13, and she broadcast on February 13.

### Adele Dixon

The other stage star to whom I referred is Adele Dixon. Miss Dixon is London-born and first appeared on the stage in *Where the Rainbow Ends* as one of Italia Conti's children. She was only twelve years of age at that time. Although she had never studied elocution, she went to the Royal Academy of Dramatic Art to try for a scholarship. To do this she taught herself by learning the great political speeches of Disraeli and Gladstone so successfully that she won a two-year scholarship.

Soon after leaving the Academy she went to Egypt with Robert Atkins, playing a Shakespearean season. After three months in Cairo and Alexandria she returned to London and for two years played Shakespeare at the Old Vic, including Juliet opposite John Gielgud. This was followed by appearances at the Lyric, Hammersmith, where Julian Wylie saw her and offered her the part of Susie Dean in Priestley's *Good Companions*. This was her first West End starring part, and was followed by *Wild Violets* at Drury Lane. She first broadcast on November 8, 1933.

It is impossible to take even the most cursory survey of radio drama without referring to Barbara Couper, who is a most notable broadcasting actress. One of the most noticeable facts about broadcasters is that the artistes who were discovered by the B.B.C. pioneers in the early Savoy Hill days were so highly suitable to microphonic requirements that they have stood the test of time and are as satisfying now as then. The chief broadcasters of to-day are the broadcasters of ten years ago, as can be seen by the veteranism of most of the artistes to whom I have already referred. This equally applies to Barbara Couper, who this year celebrates her tenth broadcasting birthday.

Since her microphone debut Miss Couper has broadcast in nearly three hundred radio productions. She has also written three radio plays, is part author of the microphone adaptations of *Jane Eyre* and *Wuthering Heights*, and to concrete her association with radio drama she is the wife of Howard Rose, the B.B.C. producer. The background to all her extensive broadcasting is a comprehensive stage experience and a natural aptitude for histrionics.

As a child Barbara Couper set her mind on the stage and wore down the family resistance to the idea by continuous and persistent importunings. At length they capitulated, and so the young aspirant was sent to study under Kate Rorke at the Guildhall School of Music and with Mlle. Alice Gachet at the Royal Academy of Dramatic Art, where she won the special medal for French drama. Soon after this she made her professional debut by appearing in pantomime as Fairy Dewdrop. And then, to gain experience at the other extreme, she became a cabaret singer!

It is experience that counts, and Miss Couper determined to gain all she could, so she followed cabaret work with a spell with a touring company and then acquired repertory experience by a period with a stock company. To all this she added still more variety of work, one interesting effort being to recite "Carillon" at the Queen's Hall with the orchestra. She was also the first to perform Cocteau's dramatic masterpiece, *La Voix Humaine*, a forty-minute effort that brought her into fresh prominence.

### Harriett Cohen

While still in the feminine department of radio artistry I should, at this juncture, introduce the subject of women musicians. Pre-eminent as pianist is Harriett Cohen, whose pianistic performances have brought lustre to radio programmes for several years. Miss Cohen was literally cradled in pianism, and one of her earliest recollections is sitting on



Paderewski's knee in the artiste's room at the Queen's Hall at the age of six. Seven years later she gave her first concert, and the following year was teaching pianoforte—when only fourteen years old!

In the few years that have followed Miss Cohen has established an international reputation, playing in the biggest concert halls of Paris, Berlin, Vienna, Milan, Warsaw, Rome, New York, and Chicago. She is Britain's ambassadress of the pianoforte, and as Bernard Shaw said of her: "There is only one Harriet"!

For six years listeners have enjoyed her expositions of Bach and the modern composers. She has presented the pianoforte works of Vaughan Williams and de Falle in the finest traditions of pianoforte classicism, while Arnold Bax has entrusted the first performance of all his pianoforte works to her. One of her most important broadcasts was the relay to England of her concert with Constant Lambert, at the Bad Homburg Festival.

### Sidonie Goossens

Another woman musician who is a prime favourite with listeners is Sidonie Goossens, the harpist. It is more than eight years now since she first broadcast in a B.B.C. programme, and now that she is the harpist of the B.B.C. Symphony Orchestra, as well as a solo artiste, the number of her microphone appearances has been lost count of. The truth probably is that she has broadcast more than any other woman musician.

Miss Goossens is the bearer of an honoured name in musical circles and comes from a famous musical family. Her grandfather was Aynesley Cook, the operatic singer, her father was Eugene, the Belgian conductor whose baton held sway over the Carl Rosa and British National opera companies; her brother is Eugene, the world-renowned composer and conductor; her other brother is Leon, the best British oboe player; her sister Marie is another harpist; and her husband is Hyam Greenbaum, whose violin work with the Brosa Quartet is well known and who was more recently the conductor to Cochran's *Nymph Errant*.

Miss Goossens is a product of the Royal College and she made her professional debut with *Chu Chin Chow*, since when she has played in all the leading orchestras of this country. She was also in the orchestra during the Grand Opera season and the Russian Ballet; during one Ballet season there were five members of the Goossen family in the orchestra.

At the other end of the orchestra, facing Miss Goossens, is another woman musician whom listeners have heard repeatedly

and whose work they greatly admire. Marie Wilson is the leader of the chief section of the B.B.C. Orchestra, and often leader of the Symphony Orchestra itself. She is yet another instance of the time-confounding virtue of the early broadcasters, because she made her B.B.C. debut in 1925 when she played the Brahms concerto, after which she broadcast from the Manchester, Birmingham, and Cardiff stations before settling down to permanent B.B.C. work at the London studios.

Miss Wilson is the only broadcasting violiniste to be born in Epping Forest, and her father—a well-known violinist at the time—taught her to handle a fiddle almost as soon as she could toddle. Being thus reared on the violin it is not surprising to learn that she made her first public appearance at a concert when she was only five years old. On that remarkable occasion she played "The Blue Bells of Scotland"—with variations!

At the age of fifteen she took up the study of the violin seriously and went to the Royal College, where she won three coveted scholarships, secured her A.R.C.M., and became the Tagore Gold Medallist as the most distinguished pupil of the year. With such a string of successes to her credit she had no difficulty in securing a chair in the Queen's Hall Orchestra, in which she played for three years, leaving it in 1925 to devote her time solely to personal appearances. She is married to Henry Bronkhurst, the pianist.

### Rita Sharpe

To complete this quartette of women musicians there is Rita Sharpe the 'cellist. Miss Sharpe is of the well-known musical family of that name. Her father, G. Frederick Sharpe, is Principal of the Halifax School of Music; her cousin is Cedric Sharpe, professor at the Royal Academy of Music and well-known concert artiste.

Like so many that I have already written about, Rita Sharpe started out to be an artiste on an instrument different from the one on which she has made her reputation. Under the tuition of her distinguished father she studied the piano-forte and became a proficient performer on that instrument. Miss Sharpe, however, is blessed with an original mind and, observing the great number of pianists and the rareness of women 'cellists, she forsook the piano for the 'cello, which she studied in Manchester with Walter Hatton as her maestro. Within a short time she had progressed so well that she was appointed to a vacant professorship at the Huddersfield College of Music.

One day, Albert Sammons, the great violinist, heard her play and advised her to enter for a public scholarship which, despite the fact that it was open to all instruments, and attracted hundreds of competitors, she won. With that impetus she came to London and since her first successful recital in the Wigmore Hall has steadily risen in her profession until she is regarded as one of the finest exponents of 'cello music in the land.

Miss Sharpe is particularly satisfying as a broadcaster. The 'cello is an instrument that suits the peculiar requirements of the microphone, and in the hands of such a sympathetic artiste as Rita Sharpe it provides perfect radio entertainment. She has broadcast nearly one hundred times.

### **B.B.C. Staff Accompanists**

To conclude this section, relating to representative women artistes, I must refer to two interesting trios. The first are the three B.B.C. staff accompanists—Doris Arnold, Cecil Dixon, and Jean Melville. These three young women spend their whole working day on piano stools and much of their nights as well. The listener who hears them providing the pianoforte accompaniment to broadcasting artistes must not conclude that the studio performance is the whole of their work. They are at Broadcasting House every day from well before lunch and often do not finish until supper-time. During the day they are either rehearsing with artistes and producers, or bravely labouring through the accompaniments for microphone aspirants at the daily auditions.

Miss Arnold was born at Wimbledon and took up the study of music at the age of seven. It was as a typist, however, that she joined the B.B.C. and volunteered to play the piano for rehearsals during her lunch hour. She finally forsook one keyboard for the other, and has since been most active with Harry Pepper both as a piano-duettist with him and as the accompanist to his various musical shows.

Miss Dixon, who was born on a sugar plantation in the Fiji Islands, first became a microphone favourite as "Auntie Sophie" of the Children's Hour, in which she also used to fill gaps with pianoforte interludes. She received her musical education at the Royal College of Music and is now a professor there. She was one of the first women to broadcast, having made her broadcast debut in 1922 in the old Marconi House (2LO) studio.

Miss Melville is Australian born, but came to London in 1917 to study at the Royal Academy of Music, which she left to tour this country and the Continent with the Femina.

Quartet. She appeared in the first radio revue, which was presented at the Apollo under the title of *Listening In*, and as pianist to Archie de Bear appeared in all his productions. She first broadcast in 1927, and after a two-year contract with the B.B.C. for songs at the piano she became staff accompanist to the vaudeville producer.

The other trio is a "close harmony" choral combination—the Carlyle Cousins, who made their debut with Ambrose at the Mayfair, broadcasting every Saturday night for six months. They have been busy ever since, touring in musical shows and playing the music halls. At the same time they have constantly appeared at the microphone both in the variety broadcast and in John Watt's "Songs from the Shows." They first broadcast in 1931 and achieved distinction in that year by appearing before the microphone more often than any other act.

### **Predominance of Male Artistes**

It is a remarkable fact that whereas the population of the film studios is predominantly feminine there are more men than women radio artistes. There are two possible reasons for this. One may be that, as I have already stated, men broadcast better than women. The timbre of the male voice is less resonant, less high-pitched, than the female. Another possible explanation is that, as a very large percentage of broadcast entertainment is vaudeville, the demand for comedians is so considerable as to increase the male proportion of artistes. Comedy is not the only department of radio activity in which there is no sex-equality: dance bands and their leaders are exclusively male and, apart from Dame Ethel Smyth, the ranks of orchestral conductors are closed to women.

Men also monopolise the executive positions in the Programme Department of the B.B.C., and as several of them also broadcast listeners are as familiar with them as with their other microphone favourites. There are, for instance, Eric Maschwitz, the Director of Variety, Val Gielgud, the Drama Director, John Watt and Harry Pepper, light-entertainment producers, all of whom are heard broadcasting by listeners in addition to being known on account of their administrative activities.

As music occupies the majority of B.B.C. air-hours, I will deal with some representative male musicians first. Pride of place must be given to Dr. Adrian Boult, the Director of Music and who is, nominally, responsible for all music broadcast by the B.B.C. with the exception of dance-band music. The influence of Dr. Boult on the musical life and status of this

country is inestimable. This fact can be safely stated : under his direction the B.B.C. Symphony Orchestra has brought this country into the forefront of the musical nations of the world.

The ramifications of B.B.C. music are too widespread for the casual observer to be able to chart. There is the B.B.C. Symphony Orchestra of 119 skilled instrumentalists. There are the sectional orchestras, at least one of which broadcasts every night. There is the Theatre Orchestra, which Stanford Robinson has brought to such a fine pitch of musical efficiency. There is the new Variety Orchestra which Kneale Kelley introduced last autumn. There are the various vocal sections—the National Chorus of nearly 200 voices, the Wireless Chorus, and the Revue Chorus, and, more recently, the Vocal Octet.

All the foregoing are attached to the Broadcasting House musical department. In addition there are the Regional musical departments. Each has its own orchestra, male voice choir, and mixed chorus. There is a Musical Director attached to each of the Regional stations, but Dr. Boult is nominally supervisory of them all. Nearly a thousand working musicians are directed by Dr. Boult, and this is a very substantial nucleus of the nation's musical life.

British music, as directed by Dr. Boult, is in safe hands. He came to his present position with the B.B.C. in 1930, and was chiefly responsible for the creation of the present Symphony Orchestra, now regarded as worthy of classification with the four finest combinations in the world. Dr. Boult, who is a Fellow of the Royal College of Music, was educated at Westminster School and Christ Church, Oxford. He finished his musical education at the Leipzig Conservatorium and was appointed to the musical staff of the Royal Opera in 1914. For some years he was the conductor of the Birmingham City Orchestra, which appointment he surrendered to come to the B.B.C.

With such a fine musical background of experience Dr. Boult was perfectly equipped for the work he undertook and which he has brought to such a high state. He was wise enough to gather around him a staff of musicians who are one with him in the ideal for British music which has actuated the B.B.C. policy. His chief assistant is Aylmer Buesst, an Australian-born conductor with a magnificent record of musical successes to his credit.

No member of the conductorial staff has done more to popularise B.B.C. music than Joseph Lewis, and he is never insensible to all he owes Dr. Boult in his career. Mr. Lewis is the oldest inhabitant of the B.B.C. music department, having joined the Corporation six months after it was formed.

Mr. Lewis is a Birmingham product; born there, studied there, and conducted there. He founded several choral societies in the Midlands, and was, for eight years, the assistant conductor to the Birmingham City Orchestra, of which Dr. Boult was, for some considerable time, the chief conductor. Mr. Lewis was appointed musical director of the Birmingham Regional Station in 1923, and in the seven years he spent there broadcast nearly fifteen hundred concerts, including first performances of many British works. He came to the London headquarters of the B.B.C. in 1930 and has done invaluable work in orchestral and choral music.

### Stanford Robinson

On the other side of B.B.C. music—light music—Stanford Robinson stands supreme. As Music Director of the Variety Department he is nominally responsible for all the music of the Light Entertainment Department (excluding dance bands).

Mr. Robinson was born in Halifax of musical parents. His mother was a well-known vocalist and his father, Percy Robinson, was a popular Yorkshire choir leader. Stanford began to master music at the age of five and at seven was a competent accompanist on the piano. Saturday night was music night in the Robinson *ménage*, the whole family presenting complete operas in the parlour.

At the age of fifteen young Robinson was brought to London by his parents and as an outlet for his musical energies he formed an amateur orchestra. This used to rehearse at the Robinson home, Stanford's mother having the task of preparing supper for the performers. A year later Stanford began his professional career by securing a job as a pianist to a cinema. He studied music at the Royal College under Dr. Adrian Boult, and in 1924 joined the B.B.C., taking charge of the Wireless Singers and becoming chorus master.

### Sir Henry Wood

Sir Henry Wood holds a peculiar position in B.B.C. musical affairs. He is not a staff conductor and yet, in the minds of listeners, B.B.C. music would not be the same without him. His first association with the B.B.C. was in 1927 when he conducted the "Prom" concerts—his thirty-third season and the B.B.C.'s first. Since then he has conducted every "Prom" season the B.B.C. has broadcast, and last year (1934) celebrated his fortieth season.

Conducting these concerts is not the whole of his broadcasting activities, however. In the pre-1927 days a "Prom"

concert was just a concert ; he now has carefully to time every work, rehearse the orchestra and artistes with the microphone in mind, give careful consideration to acoustics, balance of the instruments, and various other expert subjects associated with microphone technique. Having regard to the fact that Sir Henry had been a working musician for half a century before he had any experience of the new musical conditions imposed by the microphone, the ease and rapidity with which he has adapted himself to broadcasting requirements is a great testimony to his mental flexibility.

### Sir Dan Godfrey

Although he has now gone into semi-retirement no survey of the year's music would be complete without reference to Sir Dan Godfrey, whose Bournemouth broadcasts have been a source of great delight to listeners for years. For nearly seven years he broadcast a fine concert every Wednesday afternoon which was picked up in places all over the world. After serving Bournemouth and music nobly for forty-one years Sir Dan retired from his position last September, with the well-wishes of all listeners and the gratitude of scores of British composers to whose works he had given prominence.

Sir Dan formed the Bournemouth Municipal Orchestra and conducted them at the debut performance on May 21, 1893, and since then the orchestra has given a high-class weekly symphony concert. Nearly 2000 symphony concerts stand to the credit of Sir Dan, during which he has presented 842 different works of 220 British composers of whom 160 conducted their own works. By broadcasting, many of these British composers have received a world-presentation which otherwise would never have been theirs. Bournemouth, the B.B.C., and British music owe a great debt of gratitude to Sir Dan Godfrey.

There are a number of small musical combinations which are brought into the B.B.C. studios periodically and have established themselves as firm favourites with listeners. Leslie Bridgewater, for instance, has been on the air regularly for some considerable time. Mr. Bridgewater is a product of Worcestershire, and studied at the Birmingham School of Music, becoming quite a well-known professional musician while still in his teens. While in the Army he became the conductor of the South Midland Brigade orchestra, and on demobilisation came to London to study the pianoforte. He founded his broadcasting quintet in 1930 ; it is formed of string players all of whom have appeared, at various times, on the stage of the Queen's Hall as soloists.

Another popular "outside" broadcaster in the same class is Frederick Hartley, whose quintet is regularly on the air. His acquaintance with the B.B.C. microphone is exceptionally extensive. For nine years he has broadcast as solo pianist, accompanist, and syncopated pianist in addition to presenting his quintet, with which he plays the piano. He was, at one time, the staff accompanist at the Dundee station of the B.B.C.

### **The Gershom Parkington Quintet**

But of them all the pre-eminent is the Gershom Parkington Quintet led by the man whose name they bear. Gershom Parkington is the youngest of nine children, all of whom were baptized with Biblical names. Gershom means "a stranger in a strange land," and that has been true because all his life he has been a great traveller; in fact, he once nearly settled down in Russia, being attracted by the timber trade there.

As a young man Mr. Parkington won a Royal College scholarship, and after a period of training he joined the Queen's Hall Orchestra as leading 'cellist. He was also with Sir Thomas Beecham at Covent Garden, and for eight years was Director of Music at Bridlington until his health broke down. That was a blessing in disguise, because the musician went to rest-cure on a Hampshire farm and there conceived the idea of pastoral music. He returned to London, formed his quintet, and introduced it to the B.B.C. in the old 2LO days. Nine years of incessant broadcasting has made him one of the most popular microphone artistes.

During the last few years the B.B.C. have been giving to brass bands and their music the position their advancement is meriting. There is no disposition on the part of the B.B.C. to form a staff brass band, but they have given regular broadcasts to Callender's Band and similar front-rank combinations.

### **The B.B.C. Military Band**

Midway between the brass band and the orchestra is the military band, and the B.B.C. have a fine staff Military Band which Walton O'Donnell conducts. There are thirty-five members of the band, with Charles Leggett, the solo cornetist, as deputy conductor. The band broadcasts three times each week with one previous rehearsal to each broadcast. Every year they play more than a thousand numbers, most of them being in manuscript. When the band was first formed there was a library of fewer than 250 works: there are now nearly three thousand numbers in the band's repertoire.



Walton O'Donnell was born in Madras, where his father was bandmaster of the regimental band, and he is the youngest of three brothers all of whom became army bandmasters. After studying at the Royal Academy of Music for ten years, and passing through Kneller Hall, Walton O'Donnell became Director of Music in the Royal Marines, in which capacity he accompanied the Prince of Wales on his African and South American tours. In recognition of his services he received the M.V.O. at the hands of the King. He joined the B.B.C. in 1927.

### Leslie Woodgate

The chorus master of the B.B.C. is Leslie Woodgate, who is responsible for the National Chorus, the Wireless Chorus, the Revue Chorus, the Male Voice Choir, and the Vocal Octet. This entails an enormous amount of work not merely in conducting but in rehearsal, and also arranging programmes and securing the appropriate music. This, for any young man of only thirty-three, is nothing short of a great achievement.

Mr. Woodgate, who is married to Lena Mason—the violinist in the B.B.C. orchestra—did not commence life as a musician. His first occupation was in the offices of a firm of constructional engineers, which he left to try his luck on the stage. After playing in *The Luck of the Navy* he returned to the more prosaic life of commerce by entering a publisher's office. Thus acquiring a taste for the arts, he became secretary to Roger Quilter the composer.

Later, he studied at the Royal College of Music and is the youngest composer to be given a Carnegie award. He joined the B.B.C. in 1928 and after conducting light orchestral concerts and arranging the music for broadcast shows, he was eventually promoted to his present position as chorus master.

### The "Café Colette" Orchestra

There are two outstanding light orchestras unattached to the B.B.C., but who, by virtue of regular broadcasting, have become prime favourites with the listening public. The first to whom I refer is the Café Colette orchestra. Just over a year ago the B.B.C. completely mystified the whole Continent by broadcasting bright concerts of European music "from the Café Colette," and everybody on both sides of the North Sea were inquiring the whereabouts of a café with such a fine band.

Since then the orchestra has broadcast repeatedly as well as

appeared at all the leading music halls. Walford Hyden, born in Hanley, has broadcast so long and so often that he has lost count of the number of times he has faced the microphone. He has conducted the B.B.C. orchestra, his own Magyar band, and his famous "Café Colette" combination. He made his name and fame before coming to the B.B.C. as Pavlova's conductor on all her chief tours.

### Sydney Baynes

The other popular light orchestra is that which Sydney Baynes leads. Famous as the composer of *Destiny*, a waltz that is destined for immortality, Sydney Baynes has had a long career as conductor and composer. It is the extensive range of his experience that has made him such a sound broadcaster and versatile musician.

Mr. Baynes made his professional debut blowing the organ of a Unitarian Church in Kentish Town, London, which led, after a back-aching year, to another Unitarian Church at Highgate, where he was appointed organist at the princely salary of £10 per annum. This was followed by a similar position in the Crouch Hill Presbyterian Church, where his salary attained £90 and where, in the choir, he found a wife. A period of theatrical orchestral work followed, and theatre-goers became familiar with him conducting the orchestra at the Palace Theatre in Gaby Deslys's days.

### Kneale Kelley and Mark Lubbock

Before leaving this subject of broadcasting orchestras mention must be made of Kneale Kelley and Mark Lubbock. Mr. Kelley joined the B.B.C. in 1923, and for some years was predecessor to Arthur Caterall as leader of the B.B.C. Orchestra. He also performed invaluable service in those early B.B.C. days by breaking down the prejudice of eminent musicians to broadcasting. Mr. Kelley was trained at the Royal College of Music and is a most accomplished violinist.

Mark Lubbock was born in Kent and educated at Eton, leaving in 1917 to join the army. After the war he went on the stage in the chorus of Grossmith shows, abandoning that work to become musical director to a touring company. Then he went to Germany and became Musical Coach and Assistant Conductor at the Orchesterschule, Dresden, returning to England in 1929 when he took up broadcasting. He has collaborated with Denis Freeman in numerous radio musical shows, and as a result of the excellence of his work he was invited in 1932 to join the B.B.C. staff.



STUDIO 8A—MILITARY BANDS AND ORCHESTRAS

### Dance Bands

It is impossible to review B.B.C. programme personalities without devoting considerable attention to its dance band offerings. The first dance band to broadcast in this country was one conducted by Marius B. Winter, and it speaks volumes for his sterling worth when it is recorded that his bands broadcast regularly in this the latest year of British broadcasting to be reviewed. A dance band, conducted by Sidney Firman, was a kind of semi-staff combination in the earliest B.B.C. days, and this was followed by the band led by Jack Payne.

Jack Payne left the B.B.C. staff after four years' consistent and consistently good broadcasting. Many thousands of listeners throughout the country regretted the departure of this fine band, but "Jack Payne and his Boys" still broadcast on frequent occasions.

Early in 1932 Henry Hall and the B.B.C. Dance Orchestra was heard on the air for the first time. Mr. Hall has had a varied experience. He studied at the Guildhall School of Music, but the war intervened. At the termination of hostilities he became a pianist in a dance band. At a later stage he was appointed musical conductor of the L.M.S. hotels, and played in the Gleneagles Hotel, the Adelphi Hotel, Liverpool, and the Midland Hotel, Manchester, before his appointment to the B.B.C. When it is said that he has a fan mail of 35,000 letters a year, some idea is conveyed of the pleasure given to listeners by Mr. Hall and the B.B.C. Dance Orchestra.

Following his return from America in the autumn of 1933 Henry Hall originated the idea of his *Guest Night*, which has been an enormous success. Between March 17, 1934, when the idea was launched, and August 25, 1934, when the first series ended, 120 stars of the films, broadcasting, and the stage had appeared in his *Guest Night* programmes.

Henry Hall and his Band were amazingly successful at Radiolympia in 1933 and 1934.

Many listeners will be interested to know that at one stage in his career Mr. Hall played for the Salvation Army. His experience has thus been varied, but none the less sound and thorough for that. Under his leadership the B.B.C. Dance Orchestra provides dance music which, for its rhythm and tunefulness, can compare with anything that is heard on the air.

Having dealt with the "staff bands" I can now refer to the rather lengthy list of "outside" bands who are regular broadcasters. First on the list I would place Ambrose, whose broadcasts have been a pleasant feature for years. Ambrose is Mayfair—meaning that his style is select, dignified, essentially musical, and primarily for dancing. He is a musician-

violinist and devotes considerable attention to the music his orchestra plays. It is for that reason that his broadcasts are regarded as the best for dancing to.

Bert Ambrose is London-born, but made his name in America where, in addition to leading a select dance band, he also conducted a symphony orchestra of more than a hundred instrumentalists. The famous Luigi of the Embassy Club in London heard his dance band and brought him to London, where he played to Embassy patrons for seven years. He went from there to the Mayfair Hotel, where he stayed for over six years, and is now back at the Embassy again. He has been broadcasting regularly for eight years.

Next in personal preference I place Lew Stone's band. This is also excellent to dance to because it has a fine rhythm section which indicates a steady and pronounced tempo in all the tunes. Lew Stone is a fine musician and an expert in arranging special orchestrations, by which his band is able to present familiar numbers with an entirely fresh interpretation.

Lew Stone has grown up in dance-banding. His first job was playing with a small band in a night club, years ago, for 10s. a night. He became a member of Bert Ralston's band, as pianist, and left them when they went on their South African tour. Then he took up the profession of arranger, and was responsible for some of the orchestral arrangements that made the Ambrose orchestra so popular.

### **Roy Fox's Band**

Roy Fox, arriving here from America, set out to form a band of all the talents, and invited Lew Stone to join him as pianist and arranger. This combination went to the Monseigneur, and broadcast repeatedly until Roy Fox was taken ill and had to be ordered abroad. During his absence Lew Stone took charge, and later, when Roy Fox left the Monseigneur, he remained to control the band.

Roy Fox himself has been broadcasting for nearly five years, ever since he came to this country in fact. American-born, he played the trumpet as a boy and joined a brass band when only fourteen years old. Three years later he made his first venture with a jazz band, and became famous all over the U.S.A. as "the whispering cornetist." After many successes in Hollywood he came here to play at the Café de Paris, and then formed an "all-British band" for the Monseigneur, since when he has played in three Command Performances, broadcast hundreds of times, and turned thousands of listeners into Roy Fox fans.

The prime minister of hot music in this country is Harry

Roy, who has been broadcasting for five years. It is impossible to resist the infectious and yet spontaneous jollity of Harry Roy, which is readily seen when he is on the stage and also is translated by the instruments of his band into brazen joviality when broadcasting. Harry Roy is a master of the "hotcha" style.

London-born and bred, Harry Roy studied the saxophone as a youth and played in several bands. He is still one of the finest saxophonists in this country, and usually provides an interlude in his band performances. His brother, Syd Roy, formed the first hot rhythm band to perform in this country—at the Café de Paris in 1926—and Harry was the sax player. In 1930 Harry formed his own orchestra, known as the "R.K.Olians," which performed on the stage of the Leicester Square Theatre and instantly stamped him as a great showman. He secured the Mayfair contract when Ambrose went to the Embassy, and broadcasts from there regularly.

### **Bertini**

North-Country listeners would not forgive me if I omitted Bertini from this section. For years, now, he has broadcast from the Blackpool Tower Ballroom, and opinion in the North (which may of course be somewhat biased) is that his is an excellent dance band. I certainly know that many social clubs fix their dance night to coincide with Bertini's broadcasts, so that they can dance to his band.

Despite his foreign-sounding name, Bertini is a Cockney, born in the Old Kent Road within sound of Bow Bells. His first name is Bert, hence its italianisation. As a boy he was given a guinea fiddle and joined the class at school, his ambition being to be a professional violinist of the Kreisler class at least. When it came time for him to leave school his father apprenticed him to an ironmonger, but young Bert could not reconcile that business with his ambitions, so, with his fiddle under his arm, left home and trudged east. He spent the night in the Chelmsford Police Station and went on next day to Ipswich, where he got a job in a cinema orchestra. His career has been romantic throughout, and the listeners who stay at home for his broadcasts must number millions.

West End hotels contribute very considerably to the B.B.C. dance band broadcasts. There are three chief hotel bands that are regularly on the air and to a certain extent their styles are not dissimilar. That is understandable: performing as they do primarily for the benefit of the hotel guests, their functions are identical. One advantage that a hotel band has over the studio band is that they are conscious of the inspiration that

the participating audience provides. Listeners indirectly benefit from this, and also from the actual entertainment value that crowd noises possess. It is the absence of "atmosphere" that is such a handicap to the studio band.

### Sydney Kyte of the Piccadilly

Sydney Kyte has been broadcasting from the Piccadilly Hotel every week for nearly three years. He uses a nine-piece band, vocalist, and additional woman crooner. His policy has been : build the band to suit the audience. At the Piccadilly, people come to dine and converse over their dinner. He therefore specialises in a quiet-toned band, and that, incidentally, is ideal for the microphone.

Mr. Kyte shares with Debroy Somers the distinction of having graduated to dance band leadership *via* military band conducting. After studying at the Royal Academy of Music, securing his A.R.A.M. (the only dance band leader in the world with that degree), he joined the 1st Life Guards and became a playing member of the Guards band. After the war he formed a small band for playing at society parties, and eventually became musical director to the Duke of Westminster, which post he still holds. In the early days of broadcasting he was deputy-leader of the Savoy Orpheans and left them to go to the Berkeley as band leader. After a year as musical director at Ciro's he went to the Piccadilly, whence he has been broadcasting regularly.

At the other end of Piccadilly can be found Jack Jackson's band broadcasting from the Dorchester regularly. This is a band, different from Sydney Kyte's in one respect at least : they are more effervescent in their playing, mainly due to the fact that so many Americans are Dorchester guests and expect that sort of thing. They particularly like Jack Jackson himself, because of his brilliant trumpet-playing, and in this they resemble hundreds of thousands of British listeners.

Jack Jackson's father was a famous trumpeter who played in most of the big orchestras in this country and abroad. He gave his son a cornet for a present on his sixth birthday, and when young Jack was a year older he played with the Birdwell Colliery Band when they won third prize in the Belle Vue band contest. At sixteen he left home and got a job in a dance band on the *Samaria*, a Cunard liner. Then followed an adventurous spell which included playing with a band on Yarmouth pier, and touring with a stage show as a member of the orchestra. Returning to London he joined Jack Hylton as trumpeter, played with Jack Payne, and finally settled down on a band of his own.

Only a hundred yards from the Dorchester is the Grosvenor, whence Sid Lipton broadcasts. Mr. Lipton became a proficient pianist and started a career on the concert stage with fine promise. He was involved in an accident which resulted in the loss of part of a finger and incapacitated him for a pianistic career. He turned to dance music as an alternative and joined Ambrose's orchestra, eventually forming his own band and securing the Grosvenor contract, which is one of the band "plums."

Geraldo has specialised in a particular type of dance music. Although his name sounds Spanish, he is not, but his music is. Geraldo is the tango king of the air: his Spanish and Argentine music have been a popular feature of recent broadcasting. He formed a permanent tango band in 1930, and this was established at the Savoy Hotel and has since broadcast repeatedly.

During the past year he has added to his radio popularity by two novel types of broadcasts. His "Dancing Through" series are really non-stop hours during which his band plays 150 dance tunes that have become familiar since the war. When the orchestral broadcast of the "Château de Madrid" mystified listeners as much as the original "Café Colette" show, I revealed in the press that it was Geraldo with a special band playing all-Spanish music.

There are others that would be referred to here if this was intended to be an inclusive survey of all the dance bands. There is Carroll Gibbons for instance, and Howard Jacobs—names that are affectionately familiar to experienced listeners. There are the four Bills—"Bill" (Debroy) Somers, Billy Cotton, Billy Merrin, and Billy Mason, each of whom have broadcast often enough to have created their own particular publics. Also there is Dare Lea, a comparative newcomer, whose successful broadcasts merit some mention here.

### **Jack Hylton : King of Jazz**

One other band must be mentioned—that of Jack Hylton, who is, by general consent, the King of Jazz in this country. I have never yet met any band-leader—and I know them all personally—who has ever hesitated to agree that Jack Hylton "is the daddy of us all." His personal popularity is as high among his rivals as with the listeners. Essentially a stage band, Hylton's does not come on the air so often as the purely dance bands for that reason. When he does it is as a self-contained entertainment, and a "Hylton Hour" is by way of a broadcasting event.

Jack Hylton is a North-Countryman and still retains his



Lancashire accent. At the age of seven his father, who is still alive and proud of his famous son, paid for him to have twelve lessons in singing and pianoforte "to see if t' lad has 'owt in him." Jack had so much "in him" that he was a professional at thirteen—boy vocalist and assistant pianist with a pierrot show at Rhyd—and four years later was conducting revue, pantomime, and opera.

Jack was the dance band pioneer in this country and introduced jazz at the Queen's Hall Roof, going from there to the Grafton Galleries and thence to the Kit-Cat Club. He first appeared in variety in 1924 and has since played before Their Majesties and three Royal Command Performances, as well as other European royalties, Mussolini, and Hitler. Other distinctions he can claim include the honour of being the only jazz band that has ever played in the famous Paris Opera-House, being the first British band to broadcast to America; is a Chevalier of the Legion of Honour.

There are some outstanding dance-band instrumentalists with whom and whose work listeners have become pleasantly familiar. I was amazed when the B.B.C. Dance Orchestra appeared on the stage at the Palladium, to observe the outbursts of applause when the fiddler, the trombonist, and the saxophonist made a solo appearance. I expected the demonstration of enthusiasm for Les Allen, the vocalist, because listeners knew that the young man who stood up to sing must of necessity be the owner of the voice they had heard singing the "vocals" in a hundred broadcasts. But they had, evidently, familiarised themselves with the work of individual instrumentalists also.

The trombonist in question, for instance, is "Bill" Mulraney, a gaunt giant of a fellow whose trombone tone and slide facility have marked him out as one of the greatest exponents of that instrument in the dance-band world. His colleague on the saxophone is Burton Gillis, another six-footer, and familiarly called "Tiny" on that account. He is also the deputy leader of the band.

In trumpet-playing I suppose Nat Gonella is the best known to listeners. During his lengthy service with Lew Stone's outfit he also added to his fame with "hot" singing. Like most other dance-band trumpet-players he commenced in a brass band, and after touring the music halls settled down to dance work.

### Dance Band Vocalists

While on the subject of dance bands it is opportune to refer to their vocalists. Broadcasting has not produced much

in the way of a new art. Its chief discovery has been "crooning," as dance-band vocalism has been called. This is not the place to give my personal views: I am merely recording facts. If it were, I should state that I have a personal distaste for crooning, and give grounds for my arguments against it. The facts are (1) that the microphone has encouraged half-voice singing, and (2) that it has produced a large army of crooners.

It is necessary to make it clear here that every dance-band vocalist is not, by that token, a crooner. A rough-and-ready distinction can be made by applying this test to the vocalist: can he sing in a fair-sized theatre without the amplifying aid of a microphone? If he can, he need not be a "crooner," although, by preferring the half-voice method of tone production and crooning softly into a microphone he may deliberately, and of his own volition, aim to be a crooner. If, however, he must, of necessity, on all occasions (except when singing in a parlour) use a microphone in order to get his tones over, he is unquestionably in the crooner class.

The first recognised crooner was Jack Smith, the well-known American "whispering baritone." He had a fine voice with full-bodied baritonic tones. Deciding to go on the music-hall stage he cast around in his mind for some "stunt" that would give novelty to his work. He hit on the "whispering baritone" idea, and little knew that he was founding a new race of vocalists. Crooning was brought into popularity in this country by Greta Keller, who found it the rage in New York, and in visiting London introduced the art *via* the B.B.C. microphone. Since then it has caught on until a crooner earns as much as the Prime Minister, is more popular, and has a greater personal mail.

So far as this country is concerned, it lost its "King of Crooners" this year when Al Bowlly went to America. Born in South Africa, it was while working in a barber's shop that Al Bowlly discovered his gift for melody singing. He came to London armed with the crooning art and a banjo. At length he managed to "cash in" on the new market that Greta Keller had created, and for some years crooned with the Roy Fox and Lew Stone dance-band outfits.

Outshining him in popularity is Les Allen, who last autumn resigned his position as the official B.B.C. crooner to undertake a music-hall tour. I shall never forget being with him at Radiolympia when the B.B.C. Dance Orchestra made its first public appearance. Whatever storm of applause was given to the band or its leader was a whisper by comparison to the tornado that greeted Les Allen when he rose to sing. That night a special force of police had to be drafted to control the crowd of autograph hunters who besieged the vocalist. His



LES ALLEN

"fan" mail averaged five hundred a week, and during the week following the announcement of his resignation from the B.B.C. he received nearly three thousand letters.

Les Allen is definitely not a crooner. At times he employs the crooning art out of regard either to the sensitivity of the microphone, which prefers softened cadences to full-bodied tones, or to the character of the song he is singing. But long before he faced a microphone Les Allen was earning his living as a vocalist. That was in his native Canada, which he toured with the bands of the 48th Highlanders singing in the biggest concert halls. I heard him at the Palladium sing a song without the microphone, and his voice filled that vast building.

Representative of the women crooners is Phyllis Robbins, who for a time was also crooning with the B.B.C. official dance band. Miss Robbins is a 100 per cent. crooner. Before joining the B.B.C. outfit she was very little known: after

six months of crooning on the air she became a music-hall top-liner with a three-figure weekly salary. All that she needs to put her act over is a microphone, although she also has the potent magnetism of personal charm and stage presence.

Jack Payne's chief vocalist is Billy Scott-Comber, and he also is not merely a crooner. He crooned for Jack Payne during his years as the B.B.C. dance band, but his voice needs no microphonic amplification when he is singing even in the largest music hall in the country. Billy Scott-Comber is a College-trained vocalist and as comfortable singing ballads or operatic arias as jazz tunes.

Dance-band music from the studios comes within the survey of Eric Maschwitz, the Director of Variety, because its official B.B.C. classification is "Light Entertainment," for all of which Mr. Maschwitz is nominally responsible. It is a department of comprehensive scope. The broadcast of an operetta like *Monsieur Beaucaire*, or a variety show or a revue, or a nigger-minstrel troupe are equally "Light Entertainment," and equally under the supervision of Eric Maschwitz, than whom no one has done more to brighten and lighten broadcast programmes.

With such extensive departmental activities it is impossible, in this very cursory survey, to refer to more than a few representative broadcasters who are popular stars of the microphone. In the category of "entertainers" I should place Clapham and Dwyer at the head—for several reasons. They are essentially microphone artistes—it was broadcasting that brought them to the public notice, they have remained faithful to the microphone and, whenever broadcasting, they play to the "invisible audience" rather than the comparative few that happen to be present at the microphone. Another reason why I place them first is because their material is always fresh and always original.

Listeners will not need me to describe a Clapham and Dwyer act. Listeners will, however, require me to identify the two partners. The act is, of course, a conversation between a rather serious and sober-sided man and another who is flippant and has a peculiar mannerism of fumbling and stumbling over his words. The latter is Charles Clapham, and William Dwyer is the other.

Charlie Clapham was born in Birmingham and commenced life as a solicitor's clerk. Unknown to him, a young man in London, named Dwyer, was in a business that was engaged in a law-suit. Clapham had to see Dwyer at the Law Courts to take a statement from him. This done, they went into a near-by café for lunch and waxed confidential. Both confessed to stage aspirations: both admitted they were members



CLAPHAM AND DWYER

of amateur concert parties. That was in 1925, and they joined forces on the spot as a "team." A year later the B.B.C. gave them an audition; a week later they broadcast; a day later they were famous.

Next on my list of representative light entertainers I place Norman Long, the man with a smile, a song, and a piano. The amazing achievement of Norman Long is that listeners not only hear his song and the piano, but also feel conscious of the infection of his smile. To get personality over the microphone like that is the supreme art of the broadcaster and a rare accomplishment.

There is another distinction to Norman Long's credit: he was the first entertainer to broadcast in this country. That was in 1922, in the "debut programme" of the Royal-chartered B.B.C. and in the old Marconi House studio of the 2LO station. It was only fitting that when Savoy Hill took the place of 2LO he should also appear in the first programme broadcast from the new studios. One other "first"—he was chosen for the first Royal Command Performance to be broadcast. That was at the Victoria Palace in 1927, and since then he has appeared before every member of the Royal Family.

Norman Long was Kentish-born and a born musician. He was taught music concurrent with being taught the alphabet, but squandered the first three years of his working life on a stool in an insurance office. It was very irksome to the artistic temperament, but he found relief by playing the piano with a small band during the evenings. This whetted the appetite to such an extent that one fateful day he downed pens and joined a concert party, only to have his new career abruptly interrupted, almost at birth, by the war. He joined in 1914, and served in the infantry and the Air Force until the end. During those four years he gained much valuable stage experience by singing songs at the piano with the soldiers' concert parties.

In the comedian class the B.B.C. is rich in talent. It is not possible to refer to all the excellent fun-makers of the microphone, and so I must select only a few at random as representative of all the others. Tommy Handley, for instance, has been highly popular with listeners ever since he first broadcast ten years ago. His has been a varied broadcasting career which followed stage work that commenced before the war in West-End shows. Listeners all over the world have become familiar with his "Hello, folks" introduction, and he has broadcast hundreds of times both as a solus act, in shows, and in his own productions. He set the seal on his art as a broadcaster by marrying Jean Allistone, the actress, after meeting her at the microphone!

Leonard Henry is another bright comic star of the microphone. After some years of stage work—concert parties, musical comedies, and André Charlot revues—he made his microphone debut in September 1926 and has been a regular broadcaster ever since. Leonard Henry has an infectious style and writes all his own microphone material. In addition to his own clowning he has written numerous shows and revues that have been broadcast, made thousands of “kiddie chums” by his Children’s Hour appearances, and broadcast in the 1932 Royal Command Performance.

There are two comedians who form a school of humour all to themselves. I refer to Gillie Potter and John Tilley, both of whom employ the public address style.

### **The only Stage Humorist to Address the Oxford Union**

Mr. Gillie Potter undoubtedly founded that school, and it has now attracted more than one exponent of that type of humour. Mr. Potter is a stage-humorist rather than a comedian, and his lengthy front-rank experience has made of him a national character. He never employs the “red-nose” methods, but standing quietly on the stage discusses current events in a humorous—as well as “Humorist”—style. It is obvious that this method, being essentially aural and not dependent on stage “business” or visual appeal, is ideal for the microphone medium.

Personal dignity is one of Mr. Potter’s individual traits and this appears also in his work. His is almost a University brand of humour, which possibly accounts for the fact that he was invited to address the Oxford Union, the only stage humorist to be so honoured. It is almost an insult to say that Mr. Potter writes his own material because this is obvious—as if any other person could possibly originate that Harrovian wit!

John Tilley also employs a similar method in entertainment. Some of his mono-sketches have become classics, such as his Chairman’s Address and his Scoutmaster’s Lecture. He aids his vocal wit with a lugubrious expression and a hair-dressing that, in itself, emphasises the Chaplinesque pathos of his voice and manner.

The son of a soccer international player who captained the Scottish Amateur Eleven in two victories over England, his real name is John Mounsey Thomson, and he is Scottish born. He joined the Royal Flying Corps during the war, and when the war was over inherited a legacy of £7000 which he promptly lost in an antique business venture. So he decided to retrace his footsteps and took up a medical career for which his father intended him had not war intervened.



NORMAN LONG



Failing in his examinations, he took various jobs, which included a clerkship in Lloyds Bank, a minor Whitehall position, assistant in a cold-storage company, and a salesman of moth-proof bags. Then he entered Fleet Street and was attached to the advertisement department of a famous financial daily.

John went along to an audition and convulsed the management to the extent that they engaged him on the spot. A few nights later I went to one of his first performances and was so impressed that I gave him his first press notice. This resulted in a broadcast in which his nonsensical style of meandering revealed itself as microphonically ideal.

It was while there that a colleague told him of the new venture at the Windmill Theatre—non-stop variety with opportunities for unknown talent.

There is another comedian who has developed the perfect broadcasting manner—Ronald Frankau, who has solved the "studio audience" problem by ignoring the audience and playing so close to the microphone and in such a low voice that only radio listeners can hear him. I personally believe this to be the right method. After all, a radio artiste is engaged to broadcast to the unseen listeners, not to the handful who comprise the studio audience. While the latter may provide "atmosphere," that is something that a true broadcaster should be able to create in his own mind.

Ronald Frankau first broadcast in 1927 and has faced the microphone on numerous occasions ever since, both with his "Cabaret Kittens" show and as a solus artiste. One of his most popular series of broadcasts have been his burlesque of history and his versions of well-known Shakespearian scenes. He writes all his own material, and as this includes excellent verse it ranks very high in broadcasting value.

He is of a well-known family. His mother, "Frank Danby," was a well-known author; his uncle, "Owen Hall," was the author of *The Geisha* and other familiar musical plays; his aunt, Mrs. Aria, was a famous fashion writer whose *Diary in Truth* was widely read for many years. His brother is Gilbert, the celebrated novelist, and on one occasion the announcer of Ronald Frankau's broadcast said "Gilbert Frankau will now sing," which amused the comedian immoderately as, to use his own words, "Gilbert is so unmusical that he stands when he hears 'Rule Britannia' under the impression that it is 'God Save the King.'"

There are two highly popular radio stars who never broadcast under their own names—one is a comedian and the other a raconteur: "Stainless Stephen" and "A. J. Alan," both of whom have been appearing before the microphone since

early Savoy Hill days. I can disclose the identity of the former ; but, out of respect to his wishes, I refrain from publishing the real name of "A. J. Alan."

### **Stainless Stephen**

"Stainless Stephen" is Sheffield-born and has never lost his Yorkshire accent—nor wants to. As he joined the army in the name of Arthur Clifford, played the music halls as Arthur Clifford, and resides in Sheffield as Arthur Clifford, one is justified in assuming that Arthur Clifford appears on his birth certificate. It was while serving on the Western Front in the York and Lancaster Regiment that a course of Army signalling gave him the idea for the brand of humour that he has since made exclusive. So after the war he took up music-hall work, billing himself as "Arthur Clifford comma Comedian question mark."

Assuming the name of "Stainless Stephen" as being an alliterative tribute to a famous Sheffield product, he made his first broadcast in January 1923 from the Sheffield relay station. He was a great success at once, and since then has broadcast 250 times. He writes his own material, inventing as radio characters "Oscillating Oscar" and "Atmos. P. Herics," which have become members of the microphone population. On one occasion he broadcast a one-man show in which he played eight different characters.

There are quite a number of "teams" who have established for themselves a firm place in the affections of regular listeners. I will briefly refer to one or two who are representative of the whole company. There is, for instance, Claude Hulbert and Enid Trevor, whose usual broadcast is typical of the domestic bickerings that are not exceptional in thousands of suburban homes. Into such a framework these two accomplished artistes build a wealth of humorous and human observations.

Just as the cobbler is badly shod and the butcher a vegetarian, so this bickering couple are very happily married. Mr. Hulbert (brother of Jack) gained his first taste of the stage while acting with the Cambridge Footlights Dramatic Club, for whom he wrote, produced, and acted. He left Cambridge full of stage fever and joined Leslie Henson and Laddie Cliff at the Queen's Theatre. He first came to the microphone in 1928.

His wife, Enid Trevor, married Claude Hulbert ten years ago and together made their first broadcast soon after, as an "argufying" couple. So that the whole of their married life has been peaceful at home and bickersome in front of the microphone. Miss Trevor is a daughter of the late Colonel

Philip Trevor, who was the well-known *Daily Telegraph* sports writer. There is fine stage blood in her veins, she being a descendant of David Garrick, and a niece of Leo Trevor, the playwright, whose *Flag Lieutenant* is still a stage and film success.

Alec McGill and Gwen Vaughan are another much-heard broadcasting couple who employ domestic quarrelling as a background to their humour. Miss Vaughan is Welsh and began her professional career in the chorus of musical comedy. She married Alec McGill, and so started a home-and-away partnership from which listeners have benefited considerably.

Her partner began to earn his living in a shipping office, but being musical gave that up and joined the staff of a local paper as music and dramatic critic. While playing over some new songs for a friend he was "discovered" by the proprietor of a concert party, who immediately engaged him as the pianist. Their act is known to millions as the "Cheerful Chatterers," and they first broadcast more than ten years ago. Alec writes all the material, both the words and the music.

In reviewing the year's broadcasting, reference must be made to a new "team" of entertainers which 1934 produced and which became so intensely popular that microphone longevity is assured them. "The Two Leslies" resulted from Leslie Sarony and Leslie Holmes working together so much in the music-room, writing songs, that they decided to transform the music-room into a broadcasting studio. Their first broadcast together was a session replete with mirthful music and musical mirth. Holmes at the piano joined Sarony in songs, all of which were from the Sarony-Holmes mint.

### The only surviving Army Concert Party

Broadcasting has never produced many full-size concert parties; in fact the microphone never seems to have been kind to that type of entertainment. There was the Ridgway Parade, that had a glorious, if brief, microphone life and is now a very successful music-hall show, and there were the "Lancashire Mummies" and the "Yorkshire Mummies" of the North Regional station programmes. Of all the concert parties that have faced the microphone, however, the "Roosters" are the most famous.

This is a party of six men, four of whom were members of the original party of that name which entertained the troops on the Salonika and Palestine fronts during the war. The name of the party was derived from that of the Commandant of the Summerhill Camp at Salonika—Captain G. Roose, and the "Roosters" are the only surviving Army concert party.

Their first broadcast in 1923 in the informal days of Savoy Hill's first year. On that occasion they had no microphone rehearsal—it was just a case of "carry on," and as they were used to that command their first broadcast was quite a success. So successful, in fact, that their next broadcast was a two-hour show, which was the first of their "Army Reminiscences," which have since become a popular "Rooster" feature. This was written by Percy Merriman, the leader of the party, and who has also been responsible for most of their broadcast material.

### Outstanding Male Singers

Turning now to the subject of male singers, this fact is immediately apparent: broadcasting has brought far more men vocalists to the fore than women. I have already explained the technical reason for the superiority of the male over the female voice for microphone purposes. The remarkable profusion of good male singers makes it impossible, here, to refer to more than a very small section.

In the tenor category there is the outstanding example of Parry Jones, who is in the ten-year class of broadcasters, being among that select gallery of singers who faced the 1924 microphone. Born in the "land of song," he was a well-known South Wales boy vocalist, but, fired by the social conditions of his native land, he set out to be a politician.

Music, however, was irresistible. He deserted politics and went off to Italy, where he studied in Milan under Colli, and also in Germany, returning to England for a spell at the Royal Academy, after which he studied with John Coates, "who taught me more than any one." He has since sung at the Royal Opera, Covent Garden, and all the big British opera companies, and all the important festivals and for all the leading choral and orchestral societies. His list of triumphs would more than fill this page.

The brilliant career of Parry Jones was almost terminated during the war. Returning from a tour of the U.S.A. on the *Lusitania*, the liner was torpedoed. Parry Jones was in the icy Atlantic water for six hours before being picked up. He declares that his strong suit is singing, not sinking!

Frank Titterton, although not such a frequent broadcaster, is quite a well-known microphone tenor. He has a reputation for versatility and, in the beginning of his career, achieved fame by giving a recital in which every type of song—operatic aria, ballad, folk-song, and oratorio—had a place. One of his most notable broadcasts was a studio recital of Sims Reeves's songs with Arthur Fagge, who was Reeves's accompanist, at the piano.

In yet a different class of tenor singing is Jan van der Gucht, who, despite his Dutch-sounding name, is English born—Essex, to be precise. He is particularly happy in light operetta or musical productions of that type. His first broadcast was in 1931, and since then has been in great demand for B.B.C. work, as the calibre of his voice is especially suitable for microphone requirements.

To one other singer will reference be made in this survey of representative tenors. Georges Seversky also broadcast for the first time in 1931, on that occasion as "the singing aviator," on account of the fact that he flew over from the Continent for the occasion. He inherited both qualifications from his father—Seversky, the famous operetta star and amateur aviator of the pre-war pioneering period of aviation. His style of singing is essentially "microphone"—it is not heavy-toned or resonantly vibrant, but low-pitched and has a warmly expressive croon-like quality.

In the baritone class are so many fine singers that I fear to make any selection whatever, because of the risk of omitting singers who deserve mention. To be on the safe side I will refer to the first few whose names come to mind, but that method will, of necessity, overlook many others to whom apology is offered in advance.

George Baker is one of the old Savoyards of Broadcasting—meaning that he first broadcast in the early Savoy Hill days. After more than a decade of radio singing he is as popular as ever. Much of his success is due to his versatility. He has broadcast operatic arias and "Songs from the Shows" with equal facility and musicianship. His "Now we are Six" song cycle was a great favourite with listeners, and his *Beggar's Opera* excerpts were as authoritative as one would expect from a singer who had played that delightful production half-way round the world.

Like so many other singers, George Baker began his career at the keyboard. After a period as a pianist he was appointed to the position of organist at Woodchurch, Cheshire, where he remained for seven years. He gained a scholarship for singing at the Royal College of Music and that ended his pianistic ambitions. Graduating as a professional baritone, George Baker soon made his mark on the concert world, and has sung at all the leading festivals and in all the principal concert halls in the country, as well as playing in musical productions ranging from grand opera to revue.

The name of Herbert Heyner springs to mind on account of his length of B.B.C. service and his extensive concert-stage experience. He is also in the old Savoy Hill brigade, having commenced broadcasting in 1924 and sung constantly ever

since. To his B.B.C. work he has added appearances before Canadian, American, and German microphones. He is a Londoner by birth, and made his professional début at the 1907 "Prom" concerts, since when he has toured the Provinces and undertaken two trans-Atlantic tours.

Foster Richardson is the third baritone for whom I have space to refer. He has not adhered rigidly to what is known as "serious music," but has not hesitated to lend his fine baritonic voice in aiding Tommy Handley's and Bobbie Comber's fun-making. He is a singer of those rousing rollicking baritone ballads, but his chief microphone achievement was in 1932 when he appeared in a broadcast pantomime. To give the illusion of being a twelve-foot giant he sang all his songs and spoke all his dialogue through a big megaphone!

No review of radio's baritones would serve any useful purpose if Stuart Robertson was omitted from the list of representatives. He is a member of that choice band that formed the advance guard who broadcast in the 1924 period of the Savoy Hill era. Since then he has broadcast in almost every type of programme and has gained a very considerable reputation as a Bach soloist.

London-born, of Scottish parents, Stuart Robertson commenced his singing when only eight years of age, and at ten was one of the "Children of H.M. Chapel Royal," remaining there until his voice broke. He studied at the Royal College of Music, and at nineteen was appointed the assistant Vicar Choral at St. Paul's Cathedral, which post he held for nearly seven years. He gave this up in order to accompany Melba on her Australian farewell tour, being the only artiste to go with her, which fact established him as one of the leading young singers in the country. He married Alice Moxon, the broadcasting soprano, in 1927; his sister is Anna Neagle the film star.

### **Broadcasting Violinists**

There is not a great number of broadcasting violinists, and in mentioning two of them I will have referred to the representatives of a small school. In classical violin music Albert Sammons is pre-eminent. While his radio appearances are rare, they are always very important events. He first broadcast in the old Marconi House studio on the occasion of the Duke of York's wedding, and since then he has appeared before the microphone on several occasions, both as a soloist and with other celebrated musicians.

Albert Sandler is probably the most popular broadcasting violinist of light music. He first came to the microphone as a

practically unknown musician when he left the Trocadero Restaurant to take over the leadership of the Grand Hotel, Eastbourne, music. He followed the famous de Groot, and his Sunday night broadcasts gave him an international reputation. After some years at Eastbourne he came to the Park Lane Hotel, whence he has conducted Sunday night concerts for listeners.

It is a strange discovery to find that male instrumental soloists are so few on the air. There is, at least, one pianoforte artiste who should be mentioned, however. Maurice Cole can claim to be one of the first (if not actually the first) pianist to broadcast, as he gave a microphone performance in 1922, from the old 2LO studio in which the microphone was a bundle of bits and pieces, tied together with string and fastened to the top of a soap box.

During the twelve years that have passed he has broadcast from all the B.B.C. stations and also from German studios. He has appeared at "Prom" concerts, some of which have also been broadcast. It was during a B.B.C. engagement that he met Winifred Small, the violinist, married her, and together they have broadcast on many occasions.

So far as male 'cellists are concerned the number is still smaller. Pre-eminent is W. H. Squire, as I have already referred to Gershon Parkington in connection with his famous quintet. Mr. Squire is a recognised 'cello authority, having given his first public performance on that instrument forty-six years ago when he was only seven years old. When the Royal College of Music was opened he was the first elected 'cello scholar, holding a scholarship for six years. He has been principal 'cellist at Covent Garden and Queen's Hall orchestra, as well as composer of many popular ballads, including "In an Old-Fashioned Town" and "When You Come Home."

There is one mandoline player who stands out prominently in listeners' favour. Mario de Pietro came to this country from his native Naples in 1920, and five years later made his first broadcast appearance. A year later he formed his own Tango Band which broadcast very often, and added to its novelty by being the only band to have a woman announcer. She was Joan Revel, and Mario de Pietro was so delighted with her that he married her!

### **The Organ on the Air**

Broadcasting discovered very early that the organ was most suitable to the microphone. Consequently, recitals on church and cinema organs have been a regular feature of B.B.C. programmes. It has been my experience that some

of the cinema organists have a "fan" following that film stars might envy. Of them all I should imagine that Reginald Dixon is the most popular. He broadcasts regularly from the Blackpool Tower, and has made "I Do Like To Be Beside The Seaside" his signature tune.

Reginald Dixon is by way of being a radio veteran, having first broadcast from the Sheffield Relay Station in 1923, on that occasion as a pianist. He is Sheffield born and educated, studying harmony at the Sheffield University and becoming a Sheffield organist when only fifteen years of age. A year later he took up cinema work, becoming the pianist at a small Yorkshire village, and working up to the position of musical director at a large Sheffield cinema.

Harold Ramsay is a cinema-organist—and more. Born in Great Yarmouth, he went to Canada, where he was educated and began his musical career as organist and choirmaster in a fashionable Canadian church. After taking a musical degree at the famous McGill University in Montreal, he went to the Rivoli in New York as solo organist. He came to London in 1932 and quickly secured a place on the air with his organ recitals from the Tooting Granada. In addition to organ broadcasts he has also pleased listeners with his Eight-Piano Symphony and more recently with his Rhythm Symphony Orchestra, while his ballad, "Her Name is Mary," is one of the most broadcast of modern songs.

Two other Reginalds are on the organ list. Reginald New has been broadcasting since 1929, during which time he has given more than five hundred radio recitals. He once achieved distinction by playing three times in one day, and claims to hold the record for organ broadcasts. His first broadcast was from the Beaufort Cinema, and he celebrated his fourth year of broadcasting from the console of the Regal organ at Kingston-on-Thames. Reginald New believes firmly that it is possible to play the great works on the cinema organ as well as music of a lighter type, and this mixture of classes of music makes his broadcasts so enjoyable.

Reginald Foort has been broadcasting organ recitals since 1926, but he broadcast often from 2LO years before as a pianist. Since then he has broadcast from several cinemas, as he has been in great demand to "open" new organs. He is also celebrated as the organist who played the first Wurlitzer organ in Edinburgh; he was the first cinema organist to give a special broadcast to Canada; he is the only British organist to be specially engaged to broadcast from the Hilversum station.

Radio drama has created a very impressive array of microphone actors, the complete list of whom is too lengthy for me



to do more than refer to a representative few. The reason I place Philip Wade first is that he has broadcast more characters than any other radio actor. Philip Wade first started broadcasting in 1925, playing a small part in a Howard Rose production, and was a member of the B.B.C. Repertory Company during 1930, in which year he also made his first effort in radio play-writing. The result was *Boss*, which was ultimately made a North Regional broadcast.

Philip Wade has broadcast in nearly 250 radio productions, usually in character parts. He is the fortunate possessor of a quick-change voice which enables him to impersonate different types of characters. On one occasion he broadcast eight different parts, all of which necessitated different accents and brogues. As a radio playwright he has also achieved considerable success. His *Oranges and Lemons* and *Family Tree* have been broadcast on more than one occasion, while his *The Game*, which was broadcast in August 1933, was also filmed.

Reginald Purdell has been a remarkable success as a radio actor mainly because of his versatility and the perfection of his speaking and singing voice. He is one of the chief assets B.B.C. productions can rely upon. Six years ago he was such a prominent stage and screen artiste that the B.B.C. suddenly inserted him into a Friday night programme as one of those "Surprise Items" that made broadcasting so novel in those days. He gave a surprise to listeners and also to the B.B.C., who immediately perceived that here was the ideal microphone personality. Since that day, he has been a regular B.B.C. star.

Reginald Purdell is a Londoner, born in Battersea, and although he is still a young man, he is a stage veteran. That is because he commenced life as a child-actor. He toured America and Canada with *Tree*, and was all set for a big stage career when war came and interrupted it. After serving throughout the 1914-18 period, he returned to the stage and toured this country and Australia, playing "straight" and in musical comedies. Then he directed the Southend Repertory Theatre, where he produced sixty plays in sixty weeks, and gave that up to come to London, where he appeared in West End productions. He also acted in films, including *Congress Dances*, and is part-author of *Wild Violets*.

I once called Patrick Waddington "The Jack Buchanan of the Air" in print, and the name stuck. It aptly describes him. He is an actor, a singer, a dancer, and a good-looker. That is why he is both a radio and a television star. He first broadcast in 1927, playing a small part in a straight drama, and the beauty of his speaking voice caused him to be in great demand

as a poetry-reader and narrator on the air. It was his work in *That Certain Trio* during the whole of 1930, that established him as a radio singer, and since then he has broadcast in almost every conceivable type of radio production.

Of the more serious school of radio acting is Felix Aylmer, who made his microphone debut in an Armistice Day programme when he reproduced Lord Grey's speech to the House in that memorable Declaration of War announcement. That began a radio career of marked distinction, in the course of which he has played in numerous dramatic productions and been a regular reader of broadcast poetry. In addition, he is the author of *The Pinchbeck Pine*, which he wrote specially as a broadcast play.

### Vernon Bartlett

In no department of activity has the B.B.C. asserted itself with a supreme distinction more than in its Talks, in the progress of which it has brought to the microphone a group of men whose delivery of Talks on different subjects has given them a wide reputation. Vernon Bartlett, for instance, has created a vast public by his commentaries on current foreign affairs.

The secret of his microphone power is in his conversational style, exhaustive knowledge of foreign affairs, and a background of personal experience that ranges from journalism to the League of Nations Secretariat.

Another microphone reviewer of current affairs is Commander Stephen King-Hall, who has made a speciality of addressing children on this subject. He commenced broadcasting a weekly talk on current affairs at home and abroad in the Children's Hour in 1930, and at once gave to the Hour a new and greater popularity. His radio work has not been confined to the Children's Hour, however, as he has broadcast talks on various topics and, three years ago, broadcast a description of the *Empress of Britain* on the occasion of its maiden voyage, and concluded this with a rather sensational feat of conversing with the Captain of the boat, then in the middle of the Atlantic, to which millions were able to eavesdrop.

### Howard Marshall

Howard Marshall is one of the greatest and most popular radio speakers. He has been associated with the B.B.C. for years, his first job being as an Announcer, after which he was transferred to the Talks Department, in which he specialised as a Rugger commentator.

When he left the B.B.C. to join the staff of the *Daily Telegraph* as a special sports writer he imagined that he had finished with broadcasting. But the B.B.C. did not ; they repeatedly call on his services for commentations.

### Sports Commentators

The name that comes quickly to mind in connection with sporting commentaries is George Allison, the B.B.C. soccer expert. It was in 1927 that the B.B.C. introduced broadcast commentaries on Association football, and after a "trial run" the B.B.C. invited George Allison to broadcast the second of the series. That was the Corinthians *versus* Newcastle United game at Crystal Palace on January 29 of that year. Since then he has described more than a hundred soccer matches for the benefit of radio listeners.

His "side kick" in these commentaries is usually Derek McCulloch—"Uncle Mac" and Director of the Children's Hour. Football matches have not been Mr. Allison's only broadcasts ; he has also commentated on the Derby, and there is a classic instance on record when, in order to see properly, Mr. Allison had to be suspended head-downwards from the roof of the stand, his ankles held by an "O.B." engineer !

Another sports commentator is Captain H. B. T. Wakelam, who has broadcast descriptions of rugger, soccer, cricket, tennis, boxing, and the Tidworth Tattoo for the benefit of radio listeners. As he played rugger and hockey for Cambridge he can be regarded as an authority on these subjects at least. It was in 1927 that he first broadcast a running commentary. He has "covered" most of the big rugger matches for the B.B.C. and his commentaries on the Wimbledon tennis finals were made in conjunction with Colonel H. R. Brand, a well-known B.B.C. personality.

### E. M. Stéphan

One of the B.B.C. activities that have contributed richly to the improvement of the British mind is the foreign lessons series. Once or twice each week foreign languages are taught by air, and in this connection the name of E. M. Stéphan is outstanding.

M. Stéphan is a native of Brittany and was educated at the University of Rennes, coming to England twenty years ago, with the intention of qualifying as a teacher of English and returning to France immediately. Instead of which he fell in love with an Englishwoman, married her, and has lived here happily ever since. He is now Senior Lecturer in French at

University College, and has been broadcasting for nearly twelve years.

For more than ten years M. Stéphan has given regular evening French talks to listeners and afternoon lessons to schools for nearly as long. His greatest feat was an impromptu talk for twenty minutes. On that occasion he was at the microphone to introduce Sacha Guitry in a few words. Sacha Guitry, however, did not turn up, so M. Stéphan's "few words" of introduction had to be extended to fill the whole of the time that the missing actor should have spoken!

Two other classes of broadcasters who contribute very considerably to B.B.C. value, but who are often overlooked, should be referred to here. They are the Announcers and the regular preachers of the microphone. Anonymity surrounds most of the Announcers, of whom there are twenty in all, but listeners have come to learn the voices of three of them. Chief is A. Stuart Hibberd, whose "Good-night, Everybody, Good-night" is as well known as Big Ben's tones. Mr. Hibberd became an Announcer on July 14, 1924, and the number of times he has faced a microphone since then is uncountable.

Next in importance to him is Frederick Grisewood, whose announcing genius is based on the elocution training he had when studying to be an actor and singer, in both of which arts he is quite adept. Some time ago he commenced broadcasting a series of dialect stories around a Cotswold character called "Old Bill," which soon became regarded as cameos of broadcast entertainment.

The third broadcaster whose voice is very familiar to listeners is J. D. M. Snagge. He has the advantage of early Irish associations, and is the son of Sir T. Mordaunt Snagge, the well-respected judge. The voice of Johnnie Snagge first became known to listeners when he was assistant to J. C. Clarke at the old Stoke-on-Trent station, but he is best known on account of his running description of the Boat Race which he broadcasts from the bows of a launch that accompanies the rival crews.

### **" Dick Sheppard "**

Known to millions of people he has never seen, and that have never seen him, as " Dick Sheppard," the Very Rev. Hugh Richard Lawrie Sheppard is the much loved " Bishop of Broadcasting." His services have been broadcast for so many years from St. Martin's-in-the-Fields that the Church has become known as " Radio Abbey," and the preacher has made thousands of personal friends among radio listeners. Last year (1934) he invited those friends to a " Party " and had to

take the Royal Albert Hall for two nights to accommodate all who wished to come.

When the Rev. "Dick" resigned from St. Martin's in 1926 on account of failing health, the Rev. Patrick McCormick succeeded him and has become equally famous. He conducts a monthly service which is broadcast from St. Martin's, and is also responsible for most of the morning services which are broadcast from the Broadcasting House chapel-studio. He has made so many friends among radio listeners that when he broadcast a Christmas appeal he received more than £11,500, mostly in small sums.

When the B.B.C. decided to broadcast a Mid-week Service they selected St. Michael's, Chester Square, because Canon W. H. Elliott was the vicar there. They had experience of Canon Elliott years ago when he used to broadcast from Holy Trinity, Folkestone, and this was interrupted by an appointment to the Canterbury Cathedral staff. The first of the Mid-week Services was broadcast on October 1, 1931, as an intercessory service in connection with the "national emergency," and this elicited so much spontaneous appreciation that every Thursday night since Canon Elliott has broadcast a service.

I am afraid that this has been—in fact, must be—a very cursory survey of that vast army of broadcasters who have become familiar voices to millions of listeners. A complete *Who's Who* of radio stars would be a bulky volume. Radio is an ephemeral entertainment; it dies as soon as it is born; we hear it and it is no more. For fourteen hours daily the B.B.C. broadcast radio entertainment; they, therefore, have to bring a wealth of talent to the microphone. Some of this is as ephemeral as the entertainment. They broadcast and are heard no more. I have had to content myself, in this survey, with those artistes whose voices have become familiar to the nation's ears, and in the process have had to omit hundreds of others who are equally popular with listeners for the simple but sufficient reason that there are covers to this book which put the limit on what one can write.

## B.B.C. Addresses

### HEADQUARTERS

<b>HEAD OFFICE AND NATIONAL AND LONDON REGIONAL STUDIOS</b>	} Broadcasting House, London, W.1.	Telegrams: Broad-
		casts, London. Telephone: Welbeck 4468.

### REGIONAL CENTRES

		<i>Telephones</i>
<b>MIDLAND REGION</b>	Broadcasting House, 282 Broad Street, Birmingham.	Birmingham Mid- land 3761.
<b>WEST REGION</b>	Broadcasting House, 39 Park Place, Car- diff.	Cardiff 2514.
<b>NORTH REGION</b>	Broadcasting House, Piccadilly, Man- chester.	Manchester Central 2931
<b>SCOTTISH REGION</b>	Broadcasting House, 5 Queen Street, Edinburgh.	Edinburgh 30111.
<b>BELFAST</b>	Broadcasting House, 31 Linenhall Street, Belfast.	Belfast 5870.

### OTHER B.B.C OFFICES

<b>ABERDEEN</b>	15 Belmont Street.	Aberdeen 2296.
<b>BOURNEMOUTH</b>	72 Holdenhurst Road.	Bournemouth 3460
<b>BRISTOL</b>	23 Whiteladies Road, Clifton.	Bristol 33313.
<b>GLASGOW</b>	282 West George Street.	Glasgow, Douglas 5230.
<b>LEEDS</b>	Broadcasting House, Albrecht Buildings, Woodhouse Lane.	Leeds 28131.
<b>NEWCASTLE</b>	Broadcasting House, 54 New Bridge Street.	Newcastle 20961.
<b>PLYMOUTH</b>	Athenæum Chambers, Athenæum Arcade.	Plymouth 2283.
<b>SWANSEA</b>	Oxford Buildings.	Swansea 3107.

# Rules for S.O.S. and Similar Messages

## 1. FOR RELATIVES OF SICK PERSONS.

The B.B.C. will broadcast messages requesting relatives to go to a sick person only when the Hospital Authority or the Medical Attendant certifies that the patient is *dangerously* ill, and if all other means of communication have failed. In the normal course of events messages will be broadcast only when the full name of the person wanted is available.

*Note.*—When the person sought is known to be on board a ship at sea, a message can only be broadcast if the ship is not equipped with apparatus for the reception of messages by wireless telegraphy. Further, there must be a possibility that the return of the person sought can be hastened by the reception of such a message. This is not considered to be the case where the ship is on its way to a known port. In such cases, inquirers are advised to communicate with the owners or agents of the ship or with the port authorities.

In no case can an S.O.S. be broadcast requesting the attendance of relatives after death has occurred.

## 2. FOR MISSING PERSONS.

Apart from official messages originated by the Police, the B.B.C. does not broadcast messages concerning other missing persons.

## 3. FOR WITNESS OF ACCIDENTS.

Requests for witnesses of accidents are not broadcast except when contained in official messages originated by the Police.

4. No message can be broadcast regarding lost animals or property.

5. There is no charge for broadcasting S.O.S. messages.

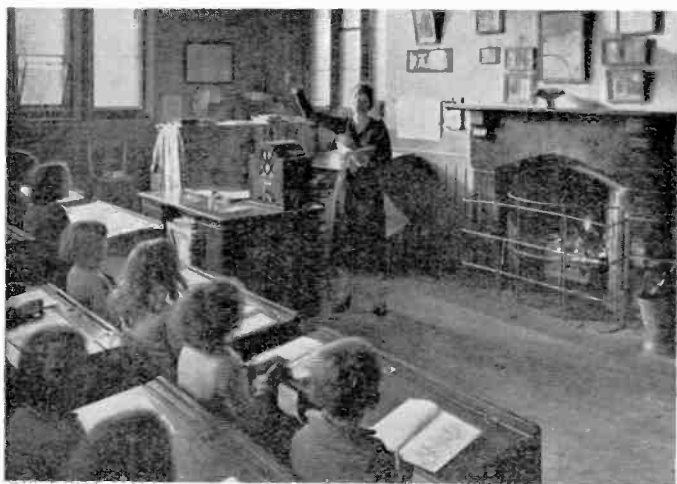

BROADCASTS TO SCHOOLS



A LESSON IN NATURE STUDY



# Broadcast Education

By CHARLES SIEPMANN

**L**ET'S get over the worst as quickly as possible. It is a matter of words. I shall try not to use them more than is necessary, but as they form the subject of this article, they must appear at least once: "education" and "culture." Why do these words provoke such hostile reactions? I suspect that it is partly a question of old associations, and partly a matter of snobbery. Most arm-chair critics of education judge by the standards of their youth, when, if Mr. H. G. Wells's reminiscences are a fair sample of what then took place, things were not well in schools. They forget that education has moved with the times.

Moreover, Englishmen hate being "improved," and it is here that snobbery comes in. Is it not possible that we all slightly resent (for we are all snobs) the implication about education as applied to us—that we are not quite as good as we might be, not quite as *bien élevé* as our friends next door? But whatever the complaints of education as a whole, it is doubtful whether they apply to education where broadcasting is concerned. That, at any rate, is the thesis which needs defence here, and it is best defended by a simple exposition of the facts as they affect developments in 1934.

## Three Aspects of Broadcast Education

There are three aspects of broadcast education. There are the formal courses provided for schools, the formal series in the evening programmes (at 7.30 p.m.) for group listeners, and the general talks which, for all that they are not labelled education, perhaps achieve the aims of education in a fuller and certainly in a more widespread sense than do the formal courses.

Broadcasting as a means of education has this supreme advantage—it cannot afford to be dull; whether in the classroom or in discussion groups or among listeners in their own homes, it has to win its audience by the effectiveness of its technique, by the inherent interest of what it offers, by all the resources available to it and distinctive of it. It has no cane, no means of discipline by which to hold the unwilling interest of its listeners. For the snobs it has the inestimable advantage that it provides education not only without tears but (what is more important) without labels. No one need know that we are seeking education. The winged words are broadcast—all may hear.

Let us look for a moment at these three aspects of the Corporation's work, and note developments. In School Broadcasting there is nothing sensational to report. The loudspeaker is no longer an innovation in the schools. It is more a matter of doing better what has been done before. Year by year the technique of school transmissions is improved. There are still facile critics; sceptical of what broadcasting can do for school children and disdainful of what is in fact done. Yet can any one who has visited the schools, particularly in country districts where pupils are many and teachers are few, deny that, if in nothing else, in the provision of a more ample environment, of a wider range of experience and of acquaintance with able and imaginative minds, broadcasting has a signal contribution to make to education?

It is not a case of doing better what teachers are already doing well. It is a case of making of education something more than the contact between pupils and a single teacher or a group of teachers, of opening the windows of the mind to prospects more varied, more strange and more inspiring than can be provided by any school, however well equipped. It is on such a principle that the courses for broadcasting to schools are selected. To courses already tried by experience fresh ones have been added in 1934. The syllabus of talks to schools now comprises over twenty weekly courses, all carefully graded for special age-ranges, and including two special courses for Welsh schools. Among innovations one full of interest is that on Music and Movement, a course for very young children, in which under the instructions of an unseen teacher young children acquire a sense of movement and of rhythm, responding with extraordinary readiness to the voice and to the piano buried in the sound-proof studios of Broadcasting House.

One interesting point is the appeal that these school courses have, not only for children in the schools, but for their parents and for grown-up listeners at home. If any remnant prejudice against teachers and schools survives, here is at least one means of finally disposing of it. If broadcasting can do little else than break down the unreal division between life and education, it will have done much, and in the common bond between parent and teacher created by their common interest in these talks to schools exists a new and profitable means of getting people to think sensibly about the real inwardness of education.

### **Facts concerning School Broadcasts**

But an ounce of fact is worth a ton of theory, and we shall do well to turn to facts and figures, to measure progress, if

not to judge the inherent validity of this special broadcast service. The year 1934 has realised a spring cleaning among the records and statistical files of the Schools Department. We can now give you firm figures for the schools regularly using broadcast talks. The B.B.C. Schools Register is necessarily incomplete, but it provides the only reliable basic figures for measuring progress. At present there are 2251 elementary and 253 secondary schools regularly listening to one or more broadcast series. The total of schools noted as "interested," and presumably making occasional use of the service, amounts to 340. What can be said of a total of 2849 practising and interested schools? One's appraisal of the significance of such a figure will no doubt vary according to one's temperament. Optimists will marvel at such achievement in so short a span of years, for organised school broadcasting has little more than five years' solid work behind it. Pessimists will complain that the figure is not vastly greater.

But again let's look at facts. It should be remembered that the establishment of school broadcasting has been realised in the face of extraordinary difficulties; first and foremost, the prejudice against a doubtful innovation; second, the fear of teachers that their sphere of interest was being invaded and usurped by an arrogant and powerful institution; third, the financial difficulty of securing funds for the purchase and upkeep of sets. How many listeners realise that the figures quoted above represent the voluntary efforts of several thousand teachers, who until recently have had in many cases little or no support from their Authorities in the way of financial backing? It says much for the pioneering spirit among the teachers of Great Britain that the vast majority of the sets now in use in schools have been purchased on their own initiative, in many cases with money out of their own pockets.

Yet splendid as is this achievement, it is a precarious and unsatisfactory basis for the further and permanent development of the work. Not until Local Authorities have themselves so far endorsed the pioneering zeal of their own teachers as to support them with financial help in the purchase and upkeep of sets can an efficient service be achieved. It is heart-breaking to realise the extent to which the endless ingenuity and labour of the subject committees of the Schools Advisory Council, of the speakers and of the teachers co-operating with them, is jeopardised by inadequate reception in the schools. The economic crisis has added to the difficulties of those whose observation has given them faith in broadcasting as an ancillary means of education, but as we emerge from the crisis it is to be hoped that among Local

Authorities will be found many to whom such facts as the following may prove disquieting. Out of a total of something more than 300 Education Authorities in England and Wales, a bare 59 so much as contribute towards the cost of a set for use in schools; only 79 contribute towards the cost of maintenance; 105 pay for the wireless licence.

Here is a serious problem, and it is encouraging that in 1934 a step forward has been achieved as the result of a circular letter addressed to the directors and secretaries of all Local Education Authorities included in the membership of the Association of Education Committees, urging upon them the importance of considering afresh the whole question of the adequate reception of school broadcasts. It is difficult to overestimate the importance of this work when one considers that school broadcasting provides a training-ground for the listeners of the future. It is here that standards and expectations are formed, and it is not perhaps quixotic to suggest that the standards and the integrity of broadcasting itself may be much influenced by those who year by year pass on from school broadcasting to stake out their claim as adult listeners for an intelligent comprehensive service.

### **Central Council for Broadcast Adult Education**

Now for the second category of formal education. This is again a story of pioneering work, and if, as in school broadcasting, the year 1934 marks a period of consolidation rather than of sensational development, it marks also the end of a phase. It was five years ago that the Central Council for Broadcast Adult Education was established. Its term of service ended in July, and with it the first experimental years in the development of a new educational movement. Wireless discussion groups are something new in history.

When rendering an account of its stewardship, the Central Council drew attention to the steady growth in the movement, and to the significance which attached to it beyond anything which the number of listeners involved seemed to imply. Here, after all, is something remarkable enough—a voluntary movement for self-education, inspired only by the stimulus of a handful of education officers acting as pioneers of a new conception of what broadcasting has to offer. There is little enough, one would suppose, to induce listeners on wintry evenings to leave the comfort of their homes to attend meetings in clubs and institutes and libraries, to listen collectively week by week to series of talks intended to form the basis of discussion.

Yet without any inducement other than the satisfaction to be derived from this seemingly quixotic enterprise

the wireless discussion group movement has grown year by year until it achieved during the winter of 1933-34 a total of 1349 groups. The figures for past years are worth quoting :

In 1928-29	there were	324	groups	organised.
„ 1929-30	„ „	644	„	„
„ 1930-31	„ „	1153	„	„
„ 1931-32	„ „	1107	„	„
„ 1932-33	„ „	1357	„	„
„ 1933-34	„ „	1349	„	„

The figures are enough to prove the vitality of a young and hitherto untried movement, and though it may well be maintained that the personnel of group listeners will never form more than a very small proportion of the total number of listeners, the reports on the quality and the enthusiasm of their work (see a recent pamphlet issued by the Board of Education) justify the belief that here is a movement worth sponsoring and now meriting some more permanent form of organisation.

As the result of months of consultation between the B.B.C. and the Central Council's Executive Committee a plan has now been devised by which the number of area councils served by the Corporation's education officers shall be increased so as to cover the whole country. These area councils have consisted hitherto of representatives of the main interests in adult education in five selected areas. Under the new scheme the old area councils will have their geographical limits extended, and two new councils, one for the Home Counties and one for Wales, will be established, with two new education officers to serve them. Members of the new councils will be nominated by the Corporation. For the time being the extension of areas will involve education officers in more or less intensive work on virgin soil, but after an initial period it is to be expected that the discussion group movement will begin to take root in new ground as in old, and that the movement will tend year by year to become more self-supporting, allowing of the gradual dissipation of the energies of education officers over other aspects of the Corporation's work.

Instead of the old Central Council a new Adult Education Advisory Committee is to be set up, again on a nominated basis, and drawing its membership largely from the area councils themselves. To those who would claim that the services of education officers functioning as field officers of the B.B.C. and as pioneers in a particular sphere of education form no part of the B.B.C.'s work, the answer is, first that the B.B.C. itself recognises no permanent responsibility

and renders these services as a pioneer contribution to a movement which should ultimately achieve its own system of organisation; and secondly that, this apart, it is more than likely that the B.B.C. thereby receives every bit as much as it gives in terms of a knowledge and understanding of the needs of listeners, of their comments and criticisms as represented to these education officers in their daily rounds of town and country districts.

So much for the formal aspects of the Corporation's work in education. But if we can once rid ourselves of the idea that education is by definition a tiresome, busybody's business, it should be possible to conceive of a much wider range of the Corporation's work, especially as regards the spoken word, as education. It does not detract from the value or importance of the formal courses provided for schools and for group listeners to say that theirs is but a part contribution to the sum-total of the B.B.C.'s work for education. Their value is indeed great. They provoke a response among listeners, they breed listeners with standards and expectations, and they are a strong bulwark against that scourge of the modern world—the tap listener, who allows his wireless set to dribble through the day, paying it little heed and satisfied only to have his mind doped by a dull background of miscellaneous sound.

But there are other aspects of the B.B.C.'s work which deserve comment: the service talks providing to special categories of listeners an increasingly wide range of useful information—the talks for gardeners, for farmers, and for women in the home; the new special broadcasts for the Unemployed, a series firmly established for the first time this winter on the basis of tentative experiments earlier in the year. And what of the critics—of films, of books, of the theatre? These, if you will, are on the fringe of education, but the general talks are at least as influential. It is as ridiculous to suggest that education must necessarily lack entertainment as to suppose that entertainment is necessarily entirely frivolous.

The General Talks programme provides a balance between the two. Its range defies definition, but if you consider the controversy, either political or otherwise, that is broadcast week by week, if you consider features like *Mosaics* or the more recent experiment in *Travel* programmes such as that on *Persia*, and if you consider at the same time that these are features listened to not by hundreds nor by thousands, but without question by millions of listeners, it is difficult to escape the conclusion that a vast educational process is at work. Can broadcasting achieve a distinctive

culture of its own? My own answer would be definitely "no." Culture is something finer, more subtle, than anything which can be conveyed by such haphazard processes. But the elements of a new culture are most certainly here, the first prospects of a democratic culture common to all.

It is on this side of education through broadcasting that one can speak with greatest confidence, though without any array of statistics or facts or tables to prove one's case. It is most certain that if there is virtue and education in kindling imagination, in establishing expectations of truth, in bringing to the many contacts and influences hitherto confined to the few, in provoking among listeners a wider range of sympathies and understanding, then broadcasting has a great service to render. Here again the multiplicity of its efforts makes example difficult to cite.

Few people at first blush would admit that the News Service was an educational service, and yet by implication it carries a very definite message. It stands for a rigid adherence to accuracy and truth, to the elimination of bias, to the avoidance of sensationalism. If, as a response to such service, equivalent expectations are inculcated among listeners, something educational has been achieved. It is not, mind you, that the educational, the dogmatic factor is in the forefront of one's mind, but one cannot escape the consequences of what one does, and such factors as these make all broadcasting an educational influence whether one likes it or no. It is on this side that progress is realised increasingly by the very momentum of the years and the gradual habituation of listeners to a service based on a consistent policy.

It is probable that even to-day the sharp distinctions between formal and informal education, as applicable to the various aspects of broadcasting touched on above, are fully evident only to the specialists in the service itself, and as has been already suggested, there is no reason to suppose that in a short time no labels will be left by which to distinguish formal from informal, school talks from adult talks, other than by the adaptation of their subject and their form to the needs of listeners. When we can cease to talk about education as if it did otherwise than add to our enjoyment and to the enrichment of experience, the specialised educational departments of the B.B.C. will have achieved their end.

### *Microphone Plays*

- Meet Mrs. Beeton* (L. du Garde Peach).  
*Quarrel Island* (Norman Edwards).  
*The Family Tree* (Philip Wade).  
*The Magnificent Charlatan* (Cecil Lewis).  
*Bureau de Change, Golden Dragon City* (Lord Dunsany).  
*Pursuit of Adonis* (H. Farjeon and H. Horsnell).  
*Pas Seul* (L. Devine and T. W. Rees).  
*The Lady Sally* (W. Rooke Ley).  
*Old Bannerman* (Eden Phillpotts).  
*Fours into Seven won't go* (Val Gielgud and S. King-Hall).  
*The Little Boy* (E. M. Delafield).

### *Adapted Stage Plays*

- Two Gentlemen of Verona, Antony and Cleopatra, As You Like It, The Merchant of Venice, A Midsummer Night's Dream, Measure for Measure, Cymbeline, Hamlet* (Shakespeare).  
*Ghosts* (Ibsen).  
*Wild Decembers* (Clemence Dane).  
*Emil and the Detectives* (Kästner).  
*Loyalties, The Skin Game* (Galsworthy).  
*The Seagull, Ivanov* (Tchehov).  
*Mr. Pim Passes By* (A. A. Milne).  
*The Calendar* (Edgar Wallace).  
*The Great Adventure* (Arnold Bennett).  
*Beauty and the Jacobins* (Booth Tarkington).

### *Adapted Novels and Stories*

- The Man who Worked Miracles* (H. G. Wells).  
*Lost Horizon* (James Hilton).  
*Wuthering Heights* (Emily Brontë).  
*Trent's Last Case* (E. C. Bentley).  
*Oliver Twist* (Charles Dickens).

### *Famous Trial Series*

- The King's Trvall* (Peter Creswell).  
*The Trial of Simon Lord Lovat* (Whitaker Wilson).  
*The Trial of Richard Hathaway* (George Wright).  
*The Trial of Admiral Byng* (Anthony Ellis).



# Concerning Radio Drama

By VAL GIELGUD

IN writing of broadcast plays it is in the first place vitally important—if I may use the metaphor—to blow away the froth. There is practically no side of broadcasting concerning which so much rubbish has been printed—usually by people who have had quite enough experience of broadcasting to know better. To take a minor example, only the other day a critic concluded a diatribe against certain plays recently broadcast with the magnificent question: “How much has the broadcast play developed *in ten years?*” (my italics). Well, it is true that the broadcast play has now been in existence for just about ten years.

It is not, as I see it, my business here to put forward an elaborate defence of what development there has been, nor would it be appropriate or even good taste to set forth a list of what in my view have been certain quite concrete achievements. I would merely urge that, even under the conditions of modern civilisation—in which speed is everything, and the goal towards which one proceeds is apparently nothing—ten years is not a very long time, and—to take the simplest parallel—not even to the cinema, which hardly sprang to maturity within ten years of that famous sneeze of Mr. Ott’s, which I believe to have been the first human action ever made in a moving picture.

It seems to me that both the critics and the defenders of radio drama take altogether too high a line. For the opposition it may as well be admitted that, axiomatically, drama must suffer from being heard and not seen, and further, that it is not easy for the ordinary person to listen to a radio play for the simple reason that he or she has only been taught to *listen* to music. The broadcast play, therefore, has not only had to adapt itself to lack of visibility in its own make-up, but its practitioners have had in addition to persuade an amorphous and largely apathetic audience (*a*) that such plays are worth listening to at all, and (*b*)—which is much more difficult—that to listen to them with satisfaction or pleasure implies on the part of the audience considerable and consistent effort and mental concentration. Further, those responsible for the policy of broadcasting of plays have not always been perfectly clear in their own minds as to what their objective should be. For this they cannot altogether be blamed, as so far no machinery exists for establishing a really satisfactory record of the reaction of the listening public

to any programme item that is broadcast, nor is it yet apparent how such machinery can satisfactorily be established.

But the broadcast play suffered severely from the fact that in its earliest stages it was regarded simply as another form of entertainment to which the microphone could be brought in the rôle of eavesdropper, so that the listener who could not go to the theatre might get an extremely second-best substitute for theatrical experience.

This quite futile stage fortunately did not last long. It rapidly became apparent that, while to eavesdrop to a concert by means of the microphone is simple, and the result of doing so perfectly intelligible, to apply the same method to a theatrical performance is neither one nor the other. But there are still plenty of people who feel that what they want is the equivalent of eavesdropping to a theatrical performance in the broadcasting of plays, and it is extremely difficult to persuade such people that what they are asking for is both technically impossible and æsthetically ridiculous. To convey drama satisfactorily to a listening audience requires a special technique, in exactly the same way as to convey drama to a seeing audience by means of a camera requires its special technique.

### Early Successes

By about 1928, this realisation was quite clearly established at Savoy Hill, and with the production of such plays as Mr. Cecil Lewis's adaptation of *Lord Jim*, Mr. Sieveking's *First Kaleidoscope*, and Mr. Holt Marvell's adaptation of Compton Mackenzie's *Carnival*, the radio play took what is probably its greatest single stride towards establishing itself as a dramatic medium standing firmly on its own legs.

Unfortunately, technique has too great a fascination of its own. The famous—I am sometimes tempted to describe it as infamous!—contraption of the dramatic control-panel on the one hand made the radio play both simple and fascinating to handle, while on the other it tempted the people who used it to forget what it was for, and to find in it simply a peculiarly fascinating toy. It is, in my view, impossible to emphasise too strongly that however many studios you may wish to use, however many knobs and switches on the dramatic control-panel you may care to operate, the only excuse for all this machinery is to produce the desired end.

The desired end in radio drama is ready intelligibility of speech, of sound, of characterisation, and of plot development. The listening audience should, as I see it, be as indifferent to the ingenuity of the producer—whether, like Mr. Sieveking,



REHEARSAL AT THE B.B.C.



THE DRAMATIC CONTROL PANEL

he "plays his control-panel," or whether, less ambitious, he uses a single studio and a gramophone turntable. Shudder over the tag as you may, the play's the thing. An audience doesn't go to a theatre to admire corrugated iron scenery or a new system of lighting from Germany, although several theatrical producers have come severely to grief by refusing to acknowledge the fact. And the radio play will not be rendered more popular to the ears of the listening public by conducting propaganda designed to prove that the dramatic control-panel is as exciting as the conning tower of H.M.S. *Hood*, or as difficult to play as the mightiest Würlitzer ever designed for the latest superoutrageous cinematograph parthenæum in either of the two hemispheres! The technique of radio dramatic production, in brief, must remain the means, and never be allowed to become an end in itself.

The situation is further complicated by that extremely vexed question, the supply of material. Cheerful, if mildly irresponsible, critics demand at intervals in headlines why the B.B.C. do not find well-established authors of the highest calibre to write their plays for them, and proclaim further with a great air of discovery that it is because the Corporation is too mean to pay their price. For some reason they omit to consider the more elementary facts of the problem. A broadcast play will, as a rule, be produced twice, or—as it is called at Broadcasting House—diagonalised. If it seems to have been reasonably successful, there is a good chance that it will be revived for two more performances within the ensuing nine months.

There are, of course, chances that foreign broadcasting stations will purchase the rights, that film companies may see possibilities in the story, or that in the more remote future further revivals may take place, but it is surely obvious that in the circumstances it is utterly impossible for any broadcasting organisation to offer fees to a well-established author that will tempt him or her from the Tom Tiddler's Grounds of the theatre proper or the cinema, where gold and silver in really large quantities are to be picked up.

### Adaptation of Stage Plays

There are few established authors; there are even fewer good writers, and even these have only a limited number of ideas and also a limited output. The B.B.C. can obviously not compete, say, with Mr. Cochran or Metro-Goldwyn-Mayer for an idea. And if the idea is a really good idea, the betting is that it will appeal just as strongly to Mr. Cochran or Metro-Goldwyn-Mayer as it does to the B.B.C. For this reason,

and also because there is a large proportion of the radio-dramatic listening public who are shut off from the theatre but who nevertheless like to hear broadcast what they can immediately recognise as "plays," a great part of broadcast radio-dramatic material consists of adaptations of work originally made for the theatre.

These adaptations come under two heads. There are the adaptations of classical plays, of which Shakespeare's works are the most celebrated examples. These make first-class broadcasting material, largely because they were written in a form which is particularly easily transferable to the medium of the microphone: they depend for their effect almost entirely upon the power of the spoken word to work upon the imagination of an audience; they were not originally intended to be embellished by elaborations of costumes and scenery and all the other trappings of visibility. That such plays should be kept alive by broadcasting during a period when they do not afford a dividend in the commercial theatre, and are in danger accordingly of falling into oblivion, is one of the minor services that broadcasting has been able to render to the cause of drama as a whole.

The adapted modern stage play is less satisfactory. There are notable exceptions: the work of Ibsen, of Tchekhov, and, to some extent, of Strindberg—very largely because these authors wrote with the subtlest gradations of plot development and characterisation—broadcast most effectively; the same is true of the plays of Galsworthy, because of their strong and simple plots, most of which are clearly related to problems that have not ceased to be contemporary, and arouse therefore vital interest in the minds of those who hear them. The formalised comedies of Oscar Wilde, depending as they do upon verbal neatness and almost machine-like precision of construction, fall into the same category. But the more modern drawing-room or "tea-cup" comedy, knock-about farce of the type which delighted so many audiences for some years at the Aldwych Theatre, the drama of improbable situations unredeemed by good writing, these find in the microphone an interpreter not only unsympathetic, but frequently unmistakably hostile.

### **The Problem of the Audience**

Though this problem of the supply of material is sufficiently complex, it is almost simple when compared with the problem of the audience for whom the radio dramatist and the radio play producer are attempting to cater. None of the rules applicable in general to audiences even begin to apply.

Audiences in theatres are notably susceptible to mass suggestion, and audiences both in theatres and in cinemas have at any rate had to take the amount of trouble involved in getting to a certain place at a certain time and paying for their seats before they approach their entertainment: therefore they expect to be entertained, and frequently find some entertainment where little is rather than admit that they have wasted their time and their money.

Not so the listener. He does not have to go to his entertainment; his entertainment comes to him. The hand outstretched languidly to the switch is practically his only contribution to the performance, and only too often even that contribution is lacking. The radio dramatist is writing, and the radio play producer is producing, for an audience that is simultaneously the largest and the smallest conceivable. It may be numbered in millions, but those millions are split up into listening units composed either of individuals or, at the most, of groups—probably family groups. There is the competition of all the interruptions inseparable from the conduct of domestic life. Callers, babies, pets, telephone, bridge, or the cooking of supper, make alternative and imperious demands.

Besides, "the wireless" has ceased to be a luxury thought of in terms of entertainment into which effort must be put if entertainment is to be got from it; it has joined the bath water and the gas as a necessity, and is related as a rule far more to weather forecasts, news bulletins, and fat stock prices, and the production of dance music as a melodious background to the home than it is to an artistic medium for the provision of entertainment.

The author and producer in a theatre have as a rule a pretty fair idea of the people for whom they are working, but how is it possible to cater satisfactorily for an audience simultaneously in Dunfermline and Dungeness, in Belfast and Bootle, in London and Llandudno? There is no type, class, or occupation that may not be represented in the listening audience, and who therefore have not the right to have their tastes, prejudices, and desires considered. And when there is added to all this the fact that even the most urgent appeals from the would-be provider of entertainment to his audience can only achieve a concrete reply to help to keep him on the right lines from about half of 1 per cent. of those whose demands he wishes to satisfy, it is not surprising if at intervals he abandons all standards other than his own. These may well be mistaken, but they are at least well defined.

The picture, then, appears rather a gloomy one: an artistic medium, admittedly imperfect, hampered by inadequate

material and endeavouring to supply insufficiently defined demands of an almost completely inchoate audience. The ten years so scornfully mentioned by the aforesaid critic do not seem such a very long period in which to put paid to such a considerable account. But there are certain encouraging signs, and the most encouraging of all is the undoubted fact that the audience to the radio play from out the vast body of general listeners is increasing, and showing every sign of being likely to go on increasing.

### Hopeful Signs

If radio drama were still the inferior type of joke that it seemed to be at its inception, it would not be as heartily abused nor as vigorously propagandised as it is. In particular, it is a hopeful sign that it has come to be taken very seriously by actors who are interested in their business. The period during which it was either difficult or impossible to persuade actors to broadcast at all is long past, and, to one radio dramatic producer at least, perhaps the most significant and exciting event of 1934 was the fact that Miss Elisabeth Bergner's first dramatic appearance in England was made, not on the stage, but before the microphone in a performance of Ibsen's *The Wild Duck*.

Accordingly, the level of acting for the microphone in this country is generally acknowledged to be extremely high, and though I am most unwilling to suggest any possibility of complacency *vis-à-vis* production-technique, it appears to be generally acknowledged by foreign broadcasting organisations that as far as radio drama is concerned, the Broadcasting House method, however imperfect, at present leads the world.

In his recently published book, *The Stuff of Radio*, Mr. Sieveking—that vigorous and imaginative, if slightly confusing pioneer—suggests that in the broadcast play “the seeds of death are already latent, owing to the lengthening on the horizon of the shadow of television.” The view may be justified, but I personally cannot look forward to the manipulation of a television control-panel with any satisfaction. Whether the problem of visuality is added to its other problems or not, the broadcast play in one form or another has come to stay. It has never been a rival to the theatre; it is no longer content merely to be a substitute for it. It stands to be appreciated or condemned on its merits. It is the achievement of that standard which is really the result of its first ten years' existence.

# Ten Years of Dance Music

By HENRY HALL

DANCE music, as we know it, is a modern innovation. Not for us the sweet discourse of pipe and tabor, of viol and hautboy, of lute and harp, such as were fashioned when instruments, like the tunes which were played upon them, embodied mankind's tears as well as laughter. A world of dancers sought reaction from the strains and stresses of the Great War. They called for laughter and plenty of it. Away with grief. They needed a new form of dance tune and instrumentation, and they got both.

The birth of this new era was celebrated throughout two continents to the strains of "Alexander's Ragtime Band." One can only speculate vaguely as to what might have been the fate of this new development had not broadcasting burst spontaneously upon the Western World. There could have been nothing more peremptory than the broadcasting medium to urge composers to further flights of fancy. Something was called for that would be still more typical than ragtime of the joy and briskness of living. The answer came in the form of what was termed "jazz" music.

## "Jazz" a Passing Phase

So far as British listeners are concerned, their earliest recollections of this kind of tune will go back eleven years, when the Savoy Orpheans had a broadcasting monopoly; but this lasted only a few months. In August 1924, my Gleneagles Band made its *début* on the air, and the monopoly was broken. In those days there was very little finesse about the work of composition. Tunes were built up very much as I imagine the patchwork quilts of Victorian days were put together. The result would be sometimes a monstrosity, or, on the other hand, something not utterly unpleasant. In either case it was clear that "jazz" was only a passing phase, and orchestrations began to make their appearance, although for a long time they were far from being general.

In those days a full orchestra comprised three saxes, two trumpets, one trombone, a piano, banjo, drums, sousaphone, and possibly a violin, which sometimes was not played. The Savoy Orpheans went so far as to introduce a piano with a double keyboard, one row of keys pitched an octave higher than the other and being brought into requisition as required. This was an immense novelty.



Few dance orchestras in this country approached the size of what I have termed a full orchestra. Combinations consisted mainly of five or six players, and they relied entirely upon commercial orchestrations issued by the music publishers, who, in order to meet the increasing demand for novelty, inserted special "hot" choruses for the benefit of the growing army of small bands who had insufficient man-power to achieve effective results in the playing of "jazz." The advent of Paul Whiteman had in Great Britain, as in America, a tremendous influence on the playing of dance music. He brought with his band first-class orchestrations which were full of rich harmony, and presented something new to the ears of the public. He set in motion that spate of special orchestrations which to-day is the life-blood of every principal dance orchestra in the world.

A dozen bands may play the same tune, but in this year of grace each band will be judged on its own particular interpretation or orchestration of that tune. A peculiar effect of the development of orchestrating has been to bring the genuine musician into his own. A few years ago dance musicians who could fake were earning good salaries, while legitimate musicians were left out in the cold. The new orchestrator required musicians who had "jazz" make-up. He had no use for fakers. Thus, in the course of the evolution, those men who had little knowledge but a good deal of sense were gradually reduced from being highly paid performers until to-day none are left in bands of any note.

### The Search for Novelty

Your dance band musician must even be a soloist if he would earn a big reputation, for the orchestrator is constantly aiming to utilise new instruments and new forms of expression in his search for novelty and sparkle. We have indeed passed out of the stage of orchestrated "jazz," out of the stage of symphonised syncopation. Orchestrators began to think in terms of symphonic music and write in terms of rhythmic melody, obtaining brilliant effects of light and shade in expression and harmony. In order to achieve these effects they brought in wood winds; experimented with different kinds of mutes—hard, metallic, wood, fibre; muffled instruments by directing that they be played in hats; adopted other methods of inducing changes of tone colour in the brass. They took away the cowbells and other paraphernalia which the drummer made all kinds of noises, and they made him the vehicle of straightforward rhythmic sound. But he was by no means an automaton, beating out mere rhythm

with deadly insistence ; he was called upon to play the xylophone, the vibraphone, and the glockenspiel, as well as being responsible for the usual kit of a dance drummer ; as definitely a musician as the pianist, who seems to be regarded by many people as the personification of musicianship in a dance band ; undoubtedly with some justification, for the vogue of the piano solo was prolonged. " Kitten on the Keys," was, I suppose, one of the most famous of dance tunes, and accounted for the long life of the piano solo. It is worthy of record that a number of pianists are to-day leading successful dance orchestras in this and other countries. Leaders and musicians, they have to be in addition showmen and producers. Broadcasting makes that demand upon them. Listeners necessarily began to count when the broadcasting officials decided to devote from 15 to 20 per cent. of programme time to dance music. Whereas formerly a leader had only to study a hundred or so couples on the floor of a ballroom, the microphone gives him an audience running into millions, all of whom are presumably absorbing their impressions of dance music from his performance. The technique of broadcasting and the experience of ten years have shown that dance music broadcasts, both from the practical angle and the angle of their entertainment value, have come to stay.

Very few dance bands, when they are on the air, have much regard for the actual dancers. They are thoroughly conscious of the loudspeaker and the part which it is playing in helping to build up their reputations. Hence, greater attention is paid to-day to the entertainment value of the dance programme than to its intrinsic worth as a mode of expression for the assistance of dancers. In the early days I used to regard it as great fun to broadcast, thinking what a novel thing it was that a microphone should pick up the strains of my band ; but it is no longer a funny business. My band and I have a wholesome respect for the mike, and we have to work very seriously in experimenting with every trick known to us and to the first-class orchestrators who co-operate with us in making dance music for the million.

One important feature of the past ten years' history of dance bands has been the departure to a greater and still greater extent from convention. This applies to the size of bands as well as to other aspects of the work. In recent years the nominal band of ten or eleven has grown into combinations of eighteen, twenty, and twenty-four players. I recall an occasion when the Savoy Orpheans Augmented Symphonic Orchestra numbered twenty-six for a performance at the Queen's Hall.

In some cases effects are sought by the employment of odd



HENRY HALL AND THE B.B.C. DANCE ORCHESTRA

instruments, each band leader carrying his own distinctive ideas and personality into the orchestrations. Sometimes a leader calls for a part for clarinet which is to be played close to the microphone, or for muted brass, also played close to the microphone. Sometimes unaccompanied saxophones, quartets, or quintets are required. My own Gleneagles Band consisted of six players in all—three saxophones, piano, bass, and drums—and no vocalist. Other band leaders have made a special feature of huge brass sections, with as many as three trumpets, three trombones, and five or six saxophones, and it is the fashion to-day to use five saxes, five brass, rhythm section, and two or three violins in the larger bands. The B.B.C. Dance Orchestra consists of fourteen players; but these fourteen handle as many as forty-one instruments in a broadcasting session; in addition to which five are vocalists.

### Every Man a Soloist

Now, all this elaboration of instrumentation calls for close attention to the choice of players. Every man will be a soloist in the really good dance orchestra, which is the most difficult orchestra in the world to build up. Each man will be studied from the viewpoints of stamina and temperament,

will undergo what is virtually a process of psycho-analysis. Why all this painstaking care and consideration? Because, although he will be called upon frequently to act as a soloist, he will be part of a cohesive whole, and exceptional ability in team-work will be demanded of him all the time. Now displaying his individuality, now acting as part of the machine, consistently live in performance, never a creature of moods, always an artiste, he must be something of a paragon of all the musicianly virtues. The orchestrators then get a good idea of the personality and speciality of every man in the band and play up to his ability accordingly.

But this is by no means the end of the story. What of the orchestrator himself? He must be a first-class musician, ready to sacrifice his own personality in the interests and to the advantage of the people who are really in the public eye. He must know the band leader's preference for style, whether he wants the sweet and obvious or peculiar harmony; whether he has a fancy for the unusual; whether he likes solos or whether he begrudges every bar rest allowed to any player. Some leaders will want the racy orchestration, some the sweet, the "hot," or the comedy. The orchestrators then are pandering to the one man who directs the orchestra, who in his turn is pandering to the public taste as he conceives it to be, with the intent of gaining the greatest amount of public approval for himself and his "boys," as he styles them with professional affection.

And equally important as the players is the vocalist. In my opinion, crooners have come to stay. In the restaurant and ballroom they are not important and it is open to question whether people care about dancing to a band that features vocalists; but there seems no doubt that the average person has a predilection for the crooner when the microphone is "live." The advent of the crooner was followed by the appearance of duettists, and that in turn by vocal trios, sometimes drawn from the band and sometimes formed as a separate entity. The next step was the arrival of the feminine crooner, or croonette. She has, of course, physical charm, but greater even than that is her artistry which has its own particular appeal. There are very few bands which have not fallen at some time or other for the little lady who sings so softly and so caressingly into the microphone.

### **More and Better Dance Tunes Wanted**

Another anxious problem for the dance band leader after he has got his players and orchestrators together, is the supply of material upon which they may work. The number

of music publishers catering for dance bands has grown enormously in the past ten years, and the number of songs written for dance band performance is almost beyond count. I receive in my own office approximately 12,000 songs a year. Just think for a moment of the work involved in studying this mass of material in the hope of discovering a possible winner—work that in the main goes for nought ; for even though we broadcast every day, our total library after nearly three years amounts to only 1,800 tunes. Let me hasten to assure you that I am by no means discouraged, nor, I hope, are the composers. I want more tunes, I want good tunes, and I want British tunes, and when my orchestrators and I get the right stuff we will sit up willingly all night putting it into shape.

After ten years of unprecedented popularity we may safely assume that dance music's hold on the public is no mere flash in the pan ; but I do not think that we shall see any revolutionary changes in the near future. Development, it seems to me, will be progress along the lines which present-day tendencies indicate. No band leader, for instance, will be able to stick to one style. There will be constant variety in orchestrations, and close attention will be paid to presentation methods. A good tune will remain a good tune with the passage of the years, even as good tunes of the past, when they are revived, as they often are to-day, are still awarded high marks by the experts. There are, of course, tricks of the trade ; but the best trick of all is to keep a good library. I am confident that the quality of performance will continually improve, and therefore the future will depend upon the maintenance of a high standard of presentation of the right kind of material. We can and do revive the best of the tunes, not only of the past decade, but of twenty or thirty years ago ; but no dance band leaders rely solely upon these classics for their subsistence. Here, then, is a chance for the skilful composer, and he should seize it with both hands. It will pay.

### VISITS TO B.B.C. STUDIOS

VISITS fall into categories : (1) Presence in the studio during a broadcast, usually of a variety programme ; (2) conducted tours round the studios. For either, application should be made to the Director of the B.B.C. Station concerned, but the following points may be of interest :

LONDON. It has been found from experience since the B.B.C. moved into Broadcasting House that, owing to the serious interference caused to transmission or rehearsals taking

place in the various studios, it is impossible to accede to all of the large number of applications for tours round the building. Variety Audiences: lists closed until further notice.

**MANCHESTER.** Audiences are allowed. Applicants should state type of programme and number of party; maximum, 25—evening visits only.

**EDINBURGH.** There is accommodation for an audience at the Edinburgh Studios when the public is admitted.

**CARDIFF.** Conducted parties, but not studio audiences, as accommodation is too limited.

### SERVICE REUNIONS

1. The B.B.C. does not normally broadcast advance notices of meetings, etc., except in cases of great national importance or interest. Certain exceptions are, however, made as regards Service Reunions, primarily with the view to giving assistance in cases where, owing to addresses not being available, it is not possible for those concerned to be communicated with otherwise than by broadcasting. Notices of reunions which are confined to subscribing members of Service or Ex-Service Associations, Regimental, and other Dinner Clubs cannot be broadcast.

2. Subject to time being available, notices are broadcast of the chief annual reunions of the larger formations. Meetings or parades other than the chief annual reunion are excluded, and only one reunion notice can be broadcast for any one unit. These can no longer be repeated from year to year.

3. The smallest units for which notices can be broadcast are those which are normally commanded by a Captain in the Royal Navy, a Lieutenant-Colonel in the Army, or a Wing-Commander in the Royal Air Force. Notices of reunions confined to officers are only broadcast when the number concerned is considerable; e.g. the officers of a Campaign, Corps, or Infantry Division.

4. These notices are read once and cannot be repeated. In no case can the price of tickets or other matter than the date and place of the reunion, and the name and address of the Honorary Secretary, be included in the notice.

5. By the terms of its Constitution the B.B.C. is precluded from receiving payment for the broadcasting of notices.

# *Radio Variety*

By ERIC MASCHWITZ

IN the theatrical world the term "variety" is applied only to music-hall entertainment, which in America is called "vaudeville." At Broadcasting House, however, it is used inclusively, to cover not only vaudeville programmes, but operetta, musical comedy, cabaret, and dance music as well; it is in fact almost synonymous with "light entertainment."

Variety may be called the "bread and butter" of broadcasting—that is to say, it is the section of the programmes which, being "popular" in a high degree, claims the largest audience, and receives the most savage criticism! The great public may forgive a prosy talk on the ground that it is "educational," or an ultra-modern piece of chamber music because it is "clever" or "advanced," but there is one side of broadcasting which it expects to meet its own tastes exactly on every occasion—and that is Variety!

## **A Broadcasting Problem**

No organisation before Broadcasting was ever faced with the problem of pleasing all the people all the time. This, of course, is an impossible task, but how many listeners would admit that? Imagine the task of planning entertainment to please an audience that ranges from duchesses to dairymaids, from clergymen to cotton operatives, from sophisticated West-Enders to simple shepherds, from Cornish miners to Glasgow riveters. The Regional system has somewhat simplified this by adapting entertainment to local tastes, but every locality, however small, contains a thousand diverse types of listeners and none of them will be pleased by everything.

Which form of entertainment comes nearest to pleasing the great majority of listeners? The answer to this question is, I should say, "The simplest!" Popular music—dance melodies, Viennese waltzes, march tunes—simply orchestrated with the melody uppermost; broadly humorous variety acts and sketches; programmes introducing friendly voices and sympathetic personalities, the voices of favourite announcers and compères or of unaffected "ordinary" people such as figure each Saturday in "In Town To-night"; songs and scenes from popular plays and films; tunes from the old music halls, wartime songs or dance music of years ago, which bring back memories, gay or serious; clever instrumental



AN OPERETTA BROADCAST



THE PHILIP RIDGEWAY PARADE





"SOFT LIGHTS AND SWEET MUSIC"



IN A LISTENING ROOM DURING PRODUCTION

solos ; straightforward programmes with a dash of "atmosphere," such as *The Kentucky Minstrels* or the Orchestra of the Café Colette.

Simple programmes have the widest appeal because they are easiest to listen to. It was Filson Young, a brilliant and understanding writer on Broadcasting, who pointed out that listening to radio with concentration for any length of time is a *tiring* job and a strain to the nerves. If you don't believe this, use your eyes the next time you are in a room with one or two people who want to listen attentively to a fairly complicated programme ; they will be straining their ears to catch every sound ; if you strike a match, rustle a newspaper, or even breathe heavily, they will start round and stare at you as reproachfully as if you had let off a cannon !

The average listener expects to find *relaxation* in his entertainment ; his nerves and his body are weary at the end of the day, and to make listening to programmes a mental exercise is merely to irritate him. That is why all future developments in Radio Variety are bound to be in the direction of simplicity—and continuity.

Rapid continuity is essential in good microphone entertainment. A striking opening to a programme will engage a listener's attention. After that, the producer has nothing with which to hold that attention except a thin thread of sound ; if that thread snaps, if there are awkward, ill-timed silences, if the tempo and quality of the programme are allowed to slacken, he loses his listener, and must start all over again at the task of winning and holding his attention.

"Continuity" does not, as some producers seem to imagine, mean express speed (a breathless, over-hasty programme becomes irritating and inaudible), it merely means a sustained appeal that simply will not allow the listener to turn to his newspaper or begin talking. One of the main reasons for the popular success of non-stop music programmes such as those of Geraldo, Sydney Baynes, and Julius Bürger (*e.g. Dancing Through* and *Holiday in Europe*) is undoubtedly the fact that they give the listener no chance *not* to listen.

#### A Thousand Hours of Variety in 1934

In 1934 the Variety Department has been responsible for the supply of more than a thousand hours of light entertainment—and the most notable advance in the year has been in the creation of "programme features." Until late in 1933 there were few established programme hours with familiar titles, which the producer could be sure would send the public expectantly home to listen. There were *Music Halls*, *Songs*

from the Shows, White Coons, and Kentucky Minstrels—but what else?

The listener likes established programmes with which he is familiar. The task of establishing programmes is, however, not an easy one; it demands not only that the programme should be of sound appeal, but that the producer should have the opportunity of repeating his formula at frequent and, if possible, regular intervals. In this respect American broadcasters are on easier ground; there are more broadcasting hours in the U.S.A. and a greater choice of stations, so that regular features if regularly repeated do not crowd out new and experimental ventures.

Before 1933, the amount of programme time allowed to the then equivalent of the present Variety Department was only five hours per week; to-day Variety in its various forms claims twenty-one hours weekly.

So 1934 produced its crop of "features" which will continue to reap popularity in 1935—programmes such as *In Town To-night*, the *Café Colette*, the *Château de Madrid*, *The Old Music Halls*, *Songs from the Films*, *Scrapbook*, *The Air-do-Wells*, *First Time Here*, *Symphony and Rhythm*, *Soft Lights and Sweet Music*, *Best Sellers*, *A Tune a Minute*, *Bands across the Sea*, and Henry Hall's *Guest Night*.

### In Town To-Night

*In Town To-night* is perhaps the most popular, successful, and romantic radio feature ever created in Britain, Europe, or America. The title was invented in October 1933, to cover a half-hour Saturday feature into which could be herded all the "surprise items" that the programme builders were finding embarrassing. The originators of *In Town To-night* were so busy that autumn that beyond titling their effort "A Topical Supplement to the Week's Programmes," they did not have time to decide what form it should take until the day before it made its début—nor to choose a signature tune for it until twenty minutes before the first broadcast. That first *In Town To-night* was certainly the worst of the series (it was really terrible!), but it caught the public fancy and made its signature tune, Eric Coates's now famous "Knightsbridge March," the greatest "best seller" of 1934. Every type of broadcaster, from Mr. Lansbury to a coloured tipster, from film stars to window cleaners, has figured in *In Town To-night*. It is, by the way, the only B.B.C. programme which is broadcast entirely unrehearsed.

The *Café Colette* and its successor, the *Château de Madrid*, have attempted to present "continental" music in the setting

of an imaginary restaurant. The *Cafe Colette* was perhaps the most successful hoax ever practised by the B.B.C.; thousands of listeners wrote and telephoned to Broadcasting House, asking where this famous café could be found; the Paris postal authorities protested to the B.B.C. against the numbers of letters which they had to handle addressed "Café Colette, Paris," while even to this day there are listeners who refuse to believe that the programme is provided by Walford Hyden and a band of British musicians playing in Studio BA! The stylish *Château de Madrid* with its nightingales and plashing fountains has, unfairly, aroused less interest—but you can't play the same trick twice and get away with it!

The success of Willson Disher's "Old Music Hall" programmes is not surprising. The ditties of the old "halls" can always be guaranteed to set audiences singing, whether at home or in the studio. Gay British songs of this type, with outstanding melodies and "home-grown" words, will always have a wider appeal than American jazz which, though it is forced on us as dance music, is not our native music, and in its truly American (or "hot" form) finds very few supporters over here. The real "best sellers" even in dance music are not purely American tunes played in the American way, but simple rhythm-ballads of an almost old-fashioned type.

John Watt's *Songs from the Films*, following the same producer's *Songs from the Shows*, scored another big success for the simple programme-formula. What is the secret of this type of entertainment? Familiar tunes, well sung and played, linked up with an informal, improvised commentary, reminding the listener where the song was first sung, and probably awakening for him a host of private memories. Once having found and established his formula, there seems no reason why Mr. Watt should not continue to ring the changes on it for ever.

"Do you remember——?" Is any phrase more often used than that? We all, it seems, like to remember, to live again in the past. It was by catering for this instinct that Leslie W. A. Baily won success in 1934 for his *Scrapbook* programmes; he had previously attempted similar programmes on a more modest scale from North Regional, but it was not until he brought the item to London that it was developed over the National system in a more ambitious way. By recalling a particular year within the memory of all but children, with the aid of old music, scraps of old plays, newspaper cuttings, reminiscent talks by great and small celebrities, Mr. Baily and his producer, Charles Brewer, have given uncommon pleasure to thousands of people.

In *Soft Lights and Sweet Music*, Austen Croom-Johnson

has created an almost American type of programme (without, of course, the advertisements for Someone-or-Other's liver salts!). The playing of a small but outstanding orchestra, the singing of Elisabeth Welch, the announcements by Sonny Miller, the well-known theme tune, are now familiar in many homes; even listeners who do not care for American syncopation have been won over by Croom-Johnson's subtle and melodious presentation of it. Here is an outstanding example of good programme-presentation and the hold that a "programme of character" may gain.

Another programme that owes some of its inspiration to the U.S.A. is Henry Hall's fortnightly *Guest Night*. The majority of successful transatlantic programmes are of the "party" variety, that is to say, they consist of dance music by a famous orchestra interspersed with brief turns by popular personalities, and it is safe to say that Henry Hall developed his idea as a result of his high-speed visit to the States in the autumn of 1933. *Guest Night* has proved a welcome variation from continuous dance music, and the list of celebrities who have taken part in it must by now run into hundreds. It has the informality and the "surprise" element which are such important ingredients in programme building.

The list of regular features is now, happily, too long for each of them to be recalled and discussed in detail here. Let us hope that many more will be devised and established in 1935. If the Variety Department had a hundred hours to provide each week, instead of only twenty-one, it would be possible to create more of these series-programmes. The usefulness is incalculable, and they rank in popularity with the most popular of individual broadcasters.

I have given considerable space to the question of "programme features" because I believe it to be the most important development of Variety broadcasting in 1934.

### St. George's Hall

Other activities of the year should, however, not be forgotten; the taking over of St. George's Hall as a variety theatre in which for the first time the "studio audience" could be placed in the right relation to microphone and performer; the development of musical comedy adaptations (only five musical comedies were broadcast in the years 1931-33, whereas thirteen were brought to the microphone in 1934); the encouragement of radio-writers, a scheme which produced *Love needs a Waltz*, *Puritan Lullaby*, *Old Words to New Music* (all three by James Dyrenforth and Kenneth Leslie-Smith), *Big Business* (Henrik Ége and Johnny Green),

*Honeymoon in Paris* (Cecil Lewis and Austen Croom-Johnson), *Invitation to the Waltz* (George Posford), and *Charing Cross Road* (Clay Keyes); experimental programmes reproduced from film-track, such as *Picture People*; and, what has been of considerable importance, in that it has added variety to the "variety" programmes, the engagement of more than a hundred stage, film, and music-hall "stars" who had not previously come to the B.B.C. studios.

The future trend of radio variety is a little difficult to prophesy. Startling developments are unlikely, for since clarity and simplicity are the essence of popular microphone entertainment, experiments in "freak" production are not to be encouraged. Much has been learned in 1934 which can be applied during the coming year. Development depends largely upon the supply of material.

### The Question of Material

The question of material is all-important. It falls under two heads—(a) human material, *i.e.* radio personalities; and (b) verbal and musical material.

There is so much entertainment in these days—too much, some might say. Theatre, cinema, radio, and music hall are all competing to discover and exploit new artistes, writers, and composers. The competition is cut-throat, and Broadcasting, which in Britain is organised along non-commercial lines, is at a disadvantage in the struggle, for, having no "box-office," it cannot usually compete in the matter of money; yet at the same time it is the most greedy consumer of material which, once broadcast, can seldom be used a second time.

Experience of over two thousand auditions in the past year has convinced the writer that the rising generation of performers is lacking in original personality; a comedian with a line of his own is rarely to be discovered, while most singers turn out to be "crooners" who not only offer the standard syncopated ditties which the dance bands are already "playing to death," but slavishly imitate the accent and mannerisms of famous American singers. If the "young bloods of Variety" would only take enough trouble to be individual and "different," to work up new songs and material, to strike a line of their own, the task of the B.B.C. Variety Director would be immeasurably lightened!

## BROADCASTING HOUSE: SOME STATISTICS

The height of the building above street level is 112 ft. 9 in.

The depth of the building below street level is 34 ft. 3 in.

The weight of the building is 24,000 tons.

The number of bricks used is 2,630,000.

The cubic capacity of the building is 2,260,161 cub. ft.

The number of doors is 850.

The number of panes of glass in the building is 8000.

The length of corridors is 1 mile.

The weight of earth excavated before building was 43,000 tons.

The average consumption of water per day is approx. 193,000 gallons.

The capacity of the fuel oil storage tanks is 60 tons.

The average oil consumption per day for heating is 2 tons.

The steam-raising capacity of the boilers is 12,000 lb. per hour.

The number of radiators in the building is 840.

The power-consumption of the air-conditioning and ventilating plant is equal to approx. 450 h.p.

The amount of air handled by the ventilating apparatus per hour is approx. 260 tons.

The number of rooms served by the air-conditioning and ventilating plant is 180.

The moisture given off in twelve hours by people in the tower, when it is fully occupied, would weigh 1 ton.

The number of electric lamps in the building is approx. 7000.

The number of thermionic valves is approx. 700.

The average filament heating load is 1800 watts.

The average H.T. load, including local loudspeaker amplifiers, is 1500 watts.

The number of permanent staff engaged in the building is approx. 1000.

The average total electricity consumption daily is 5400 units.

The number of clocks in the building is approx. 115.

Total length of wiring in broadcasting circuits is approx. 150 miles.

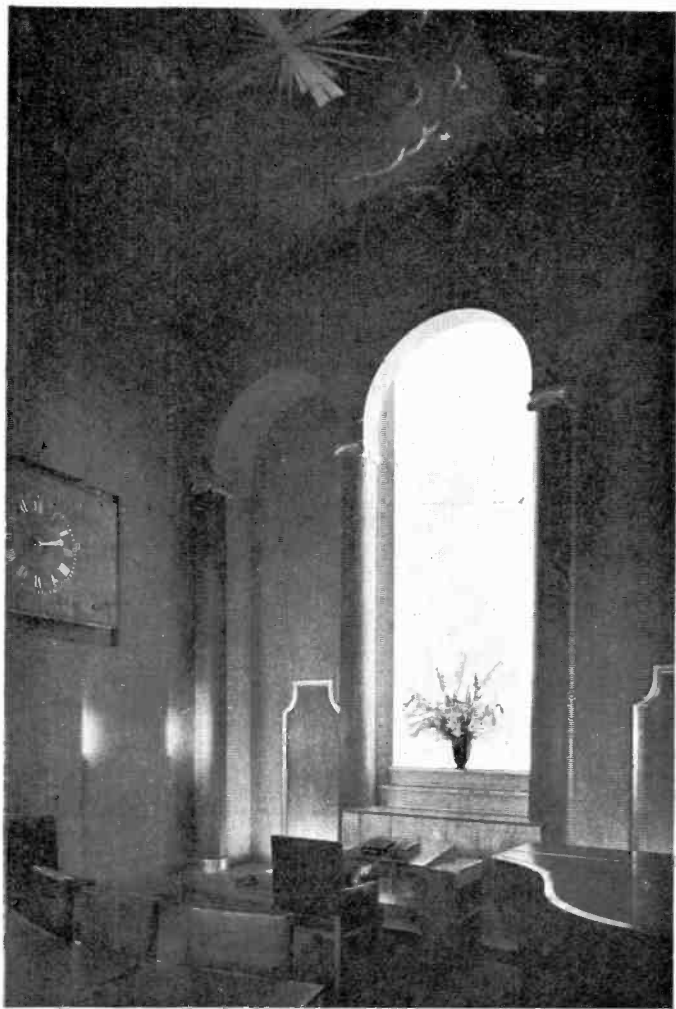

STUDIO 3E—RELIGIOUS SERVICES



## Home and Empire Programmes

FOR purposes of broadcasting the whole of Great Britain is divided into five regions, which are as follows: Scotland, North, Midland, London and West. In addition to these we have the North Irish Region.

The Scottish Region is served by the Westerglen transmitter, which operates on two wave-lengths: 285.7 m. (1050 kcs.) for the National programmes and 373.1 m. (804 kcs.) for the Regional programmes.

The North Region is served by the Moorside Edge transmitter, near Huddersfield, which works on 296.2 m. (1013 kcs.) for National programmes and on 449.1 m. (668 kcs.) for Regional programmes.

The Midland Region has a transmitter of its own at Droitwich working on 1500 m. (200 kcs.) on the National programme and 391.1 m. on the Regional programme.

London is served by the Brookman's Park transmitter (near Potters Bar) which radiates the National programme on 261.1 m. (1149 kcs.) and the Regional programme on 342.1 m. (877 kcs.).

The transmitter of the West Region is at Washford Cross, on the south side of the Bristol Channel, close to Watchet (between Minehead and Bridgwater).

The National programme is common to all the five regions, while each region has a Regional programme of its own. Each transmitter, of course, works on two separate aerials.

The Belfast transmitter works on 267.4 m. (1122 kcs.). These transmitters are supplemented by small local transmitters working with a power of one kilowatt or less. These are: Bournemouth and Plymouth working on 203.5 m. (1474 kcs.), Aberdeen on 233.5 m. (1285 kcs.), and Newcastle on 209.9 m. (1429 kcs.).

The most powerful transmitter of all is the Droitwich transmitter, with 150 kw. in the aerial. Apart from Moscow I., which has a power of 500 kw., Droitwich and Luxemburg come next with 150 kw. and are the most powerful stations in the world. The other four transmitters in the four remaining regions have a power of 50 kw., while Belfast and the smaller stations have a power of 1 kw. with the exception of Plymouth, which works on 0.3 kw.

For the purpose of the Empire service the British Empire has been divided into five zones which are as follows: Zone 1: Australasia; Zone 2: India, Ceylon, Burma, and Malaya; Zones 3 and 4: Africa (a single programme); Zone 5: Canada.

In order to obtain satisfactory reception over such tremendous distances it has been necessary to use short waves for the purpose of Empire transmissions. Owing to the vagaries of short waves, which are affected by all sorts of things, from sun-spots to weather, the strength of the signals varies from time to time in different localities.

The Empire transmitting station is to be found at Daventry and has eight aerial systems. The power used is 20 kw. The wave-lengths are allocated as follows :

Call Sign.	Frequency.	Wave-length.
	Kilocycles.	Metres.
GSA	6,050	49'59
GSB	9,510	31'55
GSC	9,580	31'32
GSD	11,750	25'53
GSE	11,860	25'30
GSF	15,140	19'82
GSG	17,790	16'86
GSH	21,470	13'97

There is, of course, a considerable difference in the time in different parts of the Empire. For this reason Empire programmes are broadcast during the twenty-four hours, but only two wave-lengths are used simultaneously. The wave-lengths used for various zones are changed from time to time, in accordance with the local conditions of reception.

The development of the Empire Broadcasting Service is one of the most important events in the Empire since the inauguration of Broadcasting. It has done more in cementing together the isolated parts of the British Empire than anything else in the past. At last, the home country can keep in touch with its pioneers living miles away from the nearest civilised centre. There are ranches in Canada, farms in Africa, and homesteads in Australia where lonely women, living alone amongst men, are separated from other women by a journey which may take days. To such lonely souls broadcasting is a boon that has completely altered their lives.

## World Broadcasting

THERE are so many stations one can pick up on a super-heterodyne receiver nowadays, that it is essential to know which of these stations are worth listening to. The best programme value both from the point of view of entertainment and quality of reception is, of course, to be obtained from the home stations.

Generally speaking, more distant stations are difficult to receive with consistent volume, as they are subject to "fading" and very often atmospheric and Morse interference play havoc with one's reception. But it is possible to pick up here and there an hour of uninterrupted entertainment and good speech in a foreign language, the latter being a great asset to students of languages. In this respect Broadcasting has revolutionised the study of these languages. A student nowadays is able to listen to the finest French, Italian, Spanish or German spoken by various highly educated people.

On p. 131 *et seq* of this book you will find a comprehensive list of most of the important broadcasting stations throughout the world on all wave-lengths.

The most interesting stations working on long waves are the following: Huizen, in Holland, on 1875 metres with a power of 7 kilowatts; Lahti, in Finland, on 1807 metres with 40 kilowatt power; Moscow L., in U.S.S.R., working on 1724 metres. This latter station has a power of 500 kilowatts and is the most powerful station in the world. From the point of entertainment it is not very good. Sometimes excellent Russian music is transmitted, but most of the time political propoganda in indifferent English is being broadcast.

Next comes Radio Paris, with excellent programmes on 1648 metres and with a power of 75 kw. The weakest station of all the long wave-length stations is Stamboul, in Turkey, working on 1621 metres with a power of 5 kw.

The Deutschlandsender in Germany working on 1571 metres with a power of 60 kw. is heard very well in this country. Next comes our own station, Droitwich, working on 1500 metres and with 150 kw. power. Motala, in Sweden, transmits on 1389 metres with 30 kw. power. Warsaw, in Poland, is very well received in Great Britain on 1389 metres, and excellent programmes are being broadcast from this station from time to time. Its power is 120 kw. Another station with good reception in this country is Luxemburg, on 1304 metres with a power of 150 kw. Unfortunately its programmes are marred by advertisements and its announcers are indifferent. In Denmark we have Kalundborg, on 1261

metres and 75 kw. power. Moscow II. comes in on 1107 metres with 100 kw. and is considerable weaker than Moscow I.

On the medium waves an interesting station is Budapest (Hungary), on 549.5 metres and with 120 kw. power. The music from this station is uniformly good. Another interesting station is Beromunster, in Switzerland, on 539.6 metres with 100 kw. power. Then comes Athlone (I.F.S.), on 531 metres, 60 kw. which sends out interesting Irish programmes.

Vienna (Austria), on 506.8 metres, 120 kw., is justly famous for its music and operas. Brussels I. (Belgium), on 483.9 metres, 15 kw. is always worth listening to. It gives excellent light entertainment. Another excellent station is Prague, in Czechoslovakia, on 470.2 metres with a power of 120 kw., which can be heard very well in this country.

Classical music and whole operas are being broadcast by Rome (Italy), on 420.8 metres with 50 kw. power. The announcing from this station is always first class.

Another important station is Munich, in Germany, working on 405.4 metres with 100 kw. Good classical music is often heard from this station.

A very good station is Milan, in Italy, on 368.6 metres and 50 kw. Next comes Berlin, on 356.7 metres and 100 kw. If you want to listen to typical Parisian light music and gay French songs you should tune in to Poste-Parisien, France, which works on 312.8 metres with a power of 100 kw.

### Short-Wave Broadcasting

Now we come to short-wave broadcasting, which is unknown to the majority of the British public. You will realise that when the whole of the British Empire is receiving continuous programmes from Daventry on short waves and is pleased with these programmes, there is something to be said for short-wave broadcasting. The beauty of it is that you can receive stations which cannot be obtained on any other wave and are thousands of miles away from you. This means that you can receive intelligence of happenings in the most distant parts of the world within a few seconds of the events.

Before we go any further it is necessary to mention here that short-wave broadcasting is not carried on as regularly as broadcasting on other waves. Thus, for instance, you can hear Mozambique, in East Africa, on 84.67 metres (0.15 kw.) on Mondays, Thursdays, and Saturdays, from 6.30 to 8.30 p.m. Quito, in Ecuador, transmits on 73 metres daily, except Tuesdays, between 12.30 and 3 a.m. Their time differs considerably from ours.

Vatican City (Italy) transmits on 50.26 metres daily from 7 to 7.15 p.m. and on Sundays from 10 to 10.30 a.m. On 49.96 metres you can get Montreal, in Canada, daily except Sunday, from 12.30 p.m. to 5 a.m., and on Sundays from 5.30 to 4.15 a.m.

An interesting group of stations is represented by Zeesen (Germany), which like Daventry transmits on a number of wave-lengths. These are as follows: DJC on 49.83 metres, DJA on 31.38 metres, DJD on 25.51 metres, DJB on 19.73 metres, and DJE on 16.89 metres. The groups of letters are the call signs of these stations, so that when you are listening you should know which station it is. This is the quickest way of naming a station. Call signs originated with the commercial and shipping transmitting stations. Similar call signs are given to amateur transmitters to distinguish them one from another.

Another interesting station working on 49.34 metres is Chicago, in U.S.A., which transmits daily from 8 to 9 p.m. There are a number of American stations working on short waves.

Calcutta (India) can be heard daily, except Friday and Saturday, on 49.1 metres between 3.30 and 6 p.m. On Fridays it transmits from 2.30 to 3 p.m. and on Saturdays from 5.45 to 9 p.m.

Johannesburg (South Africa) transmits on 49 metres daily. The League of Nations has its own short wave transmitter which, like Daventry and Zeesen, transmits on a number of wave-lengths. These are as follows: Radio Nations (Switzerland)—HBQ, 40.3 metres; HBP, 38.48 metres; HBL, 31.27 metres. Transmissions take place on Saturdays between 10.30 and 11.15 p.m.

Melbourne (Australia) can be heard on 31.55 metres on Wednesdays from 10 to 11.30 a.m. and on Saturdays from 10 a.m. to 12 noon.

A station that often interferes with Daventry is Jelloy, in Norway, transmitting on 31.45 metres. Mexico City can be heard on 31.25 metres daily from 7 p.m. to 7 a.m., also Buenos Aires, on 28.98 metres from 8 to 9 p.m. A famous station is Eindhoven (PHI), in Holland, which transmits on 25.57 metres. Another famous station is Schenectady (U.S.A.), on 19.56 metres, which transmits daily from 7.30 to 8.30 p.m.

While, given a good superheterodyne receiver, a child can tune in any of the long and medium wave stations, the tuning on short waves is decidedly tricky, being very much sharper than on other waves. The tuning dial has to be provided with slow motion, so that, one fraction of a degree takes some

time to traverse. A slight motion of the dial and the station disappears.

It is necessary to practise a great deal before one becomes an adept at short wave tuning. But there is nothing more exciting than to locate an unknown station on short waves and identify it. The quality of reception is not as good as on the longer waves. Now and again there is a good deal of distortion and round-the-world echoes intervene. On some of the stations one can hear every word doubled for some time. Many of the short wave stations, however, come through very well indeed.

The present-day receivers of the superheterodyne variety are seldom provided with a tuning circuit for short waves as well as long and medium waves. But there are a few sets on the market that cover all the wave-lengths, long, medium, and short. Some of the American receivers are advertised as all-wave receivers, but these in most cases cater for medium and short waves only and do not cover the long waves. Be careful, therefore, to ascertain the meaning of the term "all-wave."

### **Adaptors for Short Waves**

An existing receiver can be converted for use on short waves by a simple and inexpensive addition. There are two types of these adaptors. One of them is generally known as the short wave adaptor. This is provided with a plug that fits into the detector valve socket in your receiver. All you have to do is to connect up the adaptor by placing the plug into the valve-holder of your detector valve after having taken it out. Your wireless dealer will do this for you quite easily without deranging the set. But in this case you are not using on short waves the whole of your valves but only the low frequency side.

A much more satisfactory adaptor is for use externally with your existing receiver. This is the so-called short wave converter, which adds to your set another valve and converts a straight circuit into a superheterodyne one.

The best plan of all is to have a separate short wave receiver, which need not cost a lot of money, for reception on short waves. A number of such short wave receivers are to be found on the market.

Although it may not be apparent at the first glance, listening to wireless programmes is an art in itself. Gone are the times when one used to put on the loudspeaker, say, at seven o'clock in the evening and keep it going till midnight. Life in the meantime had to be carried on in spite of the loud-



CONTROL ROOM, BROADCASTING HOUSE

speaker. This is not the way to listen. The best thing to do is to plan your listening in advance. Treat wireless as you would treat the theatre or the cinema. In the latter case you do not go to places of entertainment every night. You choose the play or the picture that interests you.

Wireless programmes cannot be designed so that every item pleases everybody. It is an impossibility, simply because we are individuals and not a machine-made product, and what pleases one does not please another. But everybody must be catered for some time or other. The programmes on all the stations for this reason are so graded that during the evening everybody is sure to find a few items that will prove of interest to him.

Use the two B.B.C. programme papers, the *Radio Times* for home programmes and *World-Radio* for foreign programmes, and pick out the best items every day, items that are sure to interest you. If every member of the family does this it is quite likely that the set will still have to be used throughout the evening. There is no difficulty in that, provided you do not install your receiver in the living-room. Devote a separate room to listening, so that if you do not like the programme that appeals to other members of the household, you can go into the living-room and read your book or talk.

Most of the trouble is due to the fact that people will talk during a wireless reception, thus spoiling their own conversation which has to be carried out under difficulties, and the enjoyment of the wireless by others.

And, whatever you do, make sure that your wireless equipment is up-to-date. An old-fashioned receiver with an old-fashioned loudspeaker will cut off most of the notes, and you will find that instead of getting a natural reproduction you are getting something which is neither music nor noise.



seventy-three countries and works under the direction of world-famed scientists. Its main work lies at present in research in connection with the propagation of wireless waves. This is divided into four separate problems: (1) Echoes of long delay (problem suggested by Professor E. V. Appleton, F.R.S., and Professor Stormer of Oslo, Norway); (2) Fading (problem suggested by Professor Appleton); (3) Influence of solar spot activity, lunar changes, and weather on propagation of wireless waves (problem suggested by Professor Appleton); (4) The Luxemburg Effect (problem suggested by Dr. Van der Pol of Eindhoven, Holland).

Membership is open to all interested listeners. There is no entrance fee and no annual subscription. The official organ in this country is *World-Radio*. Full particulars from Ralph Stranger, Hon. Secretary, Broadcasting House, Portland Place, London, W. 1.

#### THE TELEVISION SOCIETY

As its name implies, this Society concerns itself entirely with experimental television, and its members are keen television enthusiasts. Regular meetings and discussions take place, and practical work is being carried on by its members. Letters should be addressed to the Secretary, 25 Lisburne Road, Hampstead, N.W.3.

#### THE WIRELESS LEAGUE

This is a League which gives its members personal technical service and insurance of wireless installations. The personal technical service is available to full members only, while insurance benefit is extended to all members. Free advice on all technical matters is also given, and the League registers competent wireless dealers. Full particulars from the Secretary, 12 Grosvenor Crescent, London, S.W.1.

#### THE RADIO ASSOCIATION

This association has existed since the early days of Broadcasting. For a fixed annual subscription the association offers the following service: Set maintenance, insurance, and advice on technical matters. It registers competent wireless dealers throughout the country. Full particulars from the Secretary, 22 Laurence Pountney Lane, London, E.C.

# Wireless Legalities

## THE WIRELESS RECEIVING LICENCE

THE Postmaster-General requires everybody in possession of wireless apparatus, whether in use at the moment or not, to take out a licence at the local Post Office. The price of the licence is 10s. per annum.

The following are the conditions upon which the licence is issued :

1. The licensee shall not allow the station to be used for any purpose other than receiving messages in the premises occupied by the licensee.

2. The station shall not be used in such a manner as to cause interference with the working of other stations. In particular, reaction must not be used to such an extent as to energise any neighbouring aerial.

3. The combined height and length of the external aerial (where one is employed) shall not exceed 100 feet. An aerial which crosses above, or is liable to fall upon or to be blown on to any overhead power line (including electric lighting and tramway wires), must be guarded to the reasonable satisfaction of the owner of the power-line concerned.

4. The licensee shall not divulge or allow to be divulged to any person (other than a duly authorised officer of His Majesty's Government or a competent legal tribunal) or make any use whatsoever of any message received by means of the station other than time signal, musical performances and messages sent for general reception, and messages received from a licensed experimental station in connection with experiments carried out by the licensee.

5. The station and the licence shall be open for inspection at all reasonable times by duly authorised officers of the Post Office who will produce their cards of identity on request.

6. The licence may be cancelled by the Postmaster-General at any time either by specific notice in writing sent by post to the licensee at his address or by means of general notice in the *London Gazette* addressed to all holders of wireless licences, and will be cancelled on breach of any of the foregoing conditions. In the event of cancellation no part of the fee will be returned.

7. The licence is not transferable. Any permanent change of address must be promptly communicated to the Head Postmaster of the district in which the station is situated. The serial number and the date of expiration of the licence

shall be quoted in all cases. Notice of temporary change is not required.

### THE TRANSMITTING LICENCE

1. The applicant shall produce evidence of British nationality and two written references as to character. A certificate of birth should be furnished if possible ; but this will not be insisted on if the referees testify of their own knowledge that the applicant is of British nationality. The referees should be persons of British birth and of standing, not related to the applicant.

In the case of a company, society, or other body, application should be made by one of the principals on behalf of the company, etc. Any permit granted will be issued in his name and he will be personally responsible for the observance of its terms.

2. The installation shall be subject to the approval of the Postmaster-General, and shall be open to inspection at all reasonable times by properly authorised officers of the Post Office, who will produce their cards of identity on request.

3. Secrecy of correspondence shall be observed.

4. Applicants must satisfy the Postmaster-General that they are qualified to conduct experiments of scientific value or public utility. If scientific research is intended they should be certified as competent investigators by a Government department or some recognised scientific body.

5. Each sending station must be under the charge of a person who has satisfied the Postmaster-General, by examination or otherwise, that he has attained :

- (a) a sufficient knowledge of the adjustment and operation of the apparatus which he wishes to work ;
- (b) an operating speed of at least twelve words (Morse) a minute, sending and receiving. This qualification is necessary even when wireless telephony only is used in order that the person in charge of the station may be in a position to act upon instructions in Morse code issued by the Government and commercial stations.

A fee of 5s. will be charged for the examination referred to above, when necessary.

The person in charge of a sending station must also make himself acquainted with the regulations of the International Convention in so far as they relate to the prevention of interference and impose certain duties on all wireless operators. This information is contained in section V. of the Postmaster-

General's *Handbook for Wireless Operators*, which may be obtained through any bookseller or direct from the Stationery Office, price 1s. 3d., postage 1½d.

A licensee not possessing the necessary operating qualifications may be allowed, exceptionally, to employ a qualified operator to work the sending apparatus.

6. Small fees are payable in order to cover the Post Office expenses in connection with the grant of a permit and subsequent inspection, etc., of the station. For each station authorised to use power up to 10 watts the charges, which will cover the use of receiving as well as sending apparatus, will comprise an initial licensing fee of £1, payable in advance (*i.e.* 30s. for the first year and £1 for each succeeding year). Higher fees will be charged for more powerful stations.

7. *Aerials*.—Dimensions allowed are as follows: Combined height and length not to exceed 100 feet.

8. *Portable Stations*.—General conditions same as for fixed stations. Power of portable sending stations will usually be limited to 10 watts. Use will ordinarily be authorised only within a radius of 10 miles of a fixed point.

All inquiries as regards the wave-length to use, etc., should be made to the Secretary, General Post Office, London, E.C.1.

#### ELECTRICITY SUPPLY COMPANIES

1. An authorised electric supply undertaker cannot refuse to allow a consumer to connect wireless or any other form of electrical equipment to the undertaker's system; provided that the consumer is in a position to demand a supply. But the consumer may not use any equipment which is likely to interfere with the supply to other consumers, nor may he increase his maximum load without due notice.

2. Subject as stated in paragraph 1, it is not necessary for the consumer to obtain the consent of the undertaker before installing any particular type of apparatus such as wireless apparatus.

3. When an authorised electricity undertaker wishes to change the system of supply, the undertaker has to obtain the consent of the Electricity Commissioners or in certain cases of the local authority (as for instance the L.C.C. in the London area). The Commissioners and the local authority have power to attach conditions to the consent; the consent is usually given subject to the undertaker replacing any of the consumer's apparatus, which would include wireless equipment, affected by the change.

It is, therefore, the undertaker's responsibility to bear the cost of the necessary alterations to all household apparatus.

including wireless equipment. If the undertaker refuses to make good the change-over of the wireless equipment, or disputes the cost of it, the consumer can take the matter to arbitration in accordance with the conditions of the consent, which usually prescribe this course; and it is understood that it is within the power of the arbitrator to award that the cost of the arbitration shall be borne by the party against whom reward is given.

It is further understood that under the form of consent now issued by the Electricity Commissioners the undertaker is relieved of the responsibility for replacing consumer's apparatus, of whatever kind, installed after notice (six months) of the change-over has been given to the consumer. But it is believed that the responsibility for making good wireless equipment installed, *bona fide*, before notification of the change-over of a supply is given, rests upon the undertaker.

4. The Electricity Commissioners (or the consenting local authority) have power to vary the conditions governing the consent for the change of supply. It is not thought, however, that the Electricity Commissioners will exclude wireless equipment from the household apparatus which requires to be replaced because of the change in the supply, except as stated in paragraph 3.

5. It should be noticed that the foregoing paragraphs state the legal position regarding authorised Electric Supply Undertakers only—that is to say, those undertakers who have undertaken to supply electric current under the provisions of the Electric Supply Acts 1882 to 1926, and to them only. There are a few comparatively unimportant undertakings which have been set up independently of those acts, and over whom the Electricity Commissioners have no control. It must, therefore, be clearly understood that the above-mentioned acts in no way apply to them, and the rights of the consumers in such cases will have to be a matter of bargain between them and the undertaking concern. If a listener requires any enlargement on the above clauses, we would refer him to the Electric Lighting (Clauses) Act of 1899. Section 27 of this Act deals with the necessity for the consumer to install suitable protected wiring, as is used in ordinary houselighting installations.

(Ref., *World-Radio*, 31st August 1928.)

#### INSURANCE POLICIES

It would possibly be advisable for listeners, when contemplating the installation of a mains unit, to inform their fire-insurance companies of the fact, and give them facilities for examining the equipment which has been installed.

# Concerning Aerials and Receivers

By RALPH STRANGER

THE problem that every listener has to face in his installation of a wireless receiver is that of erecting a copper wire high enough for it to feel the influence of passing electromagnetic, *i.e.* wireless waves.

This aerial wire is only a part of the aerial system. This as a whole consists of the aerial wire, the leading-in wire, the tuning circuit of the set, and the earth wire. This arrangement can be seen in Fig. 2.

With such an open outdoor aerial it is the electric field of the wireless waves that is most utilised and when a wave is passing the aerial the electric field establishes itself between the aerial and the earth and oscillates rapidly causing the electrons in the aerial wire to oscillate just as rapidly in the same manner in which they were oscillating in the transmitting aerial wire. The magnetic field affects to some extent the vertical leading-in wire and adds to the effect.

The best wire for an aerial is either enamelled or bare copper 7/22 wire. The enamelling prevents it from being

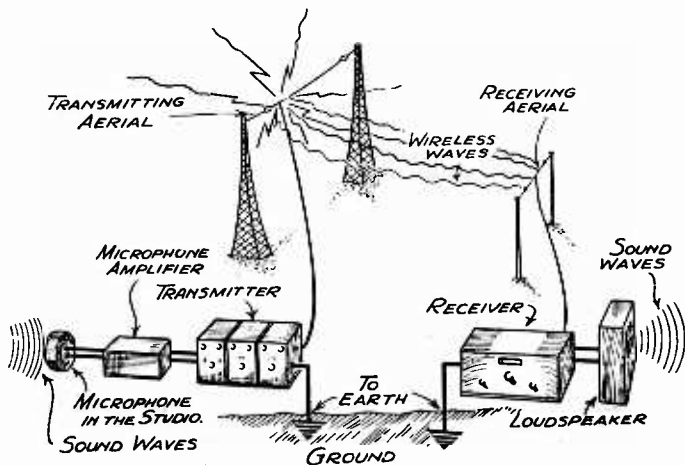

Fig. 1

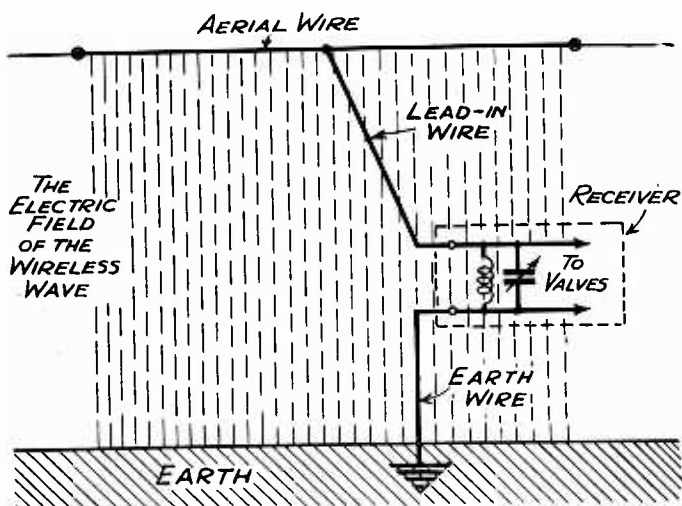

Fig. 2

affected by weather conditions and saves it from corrosion. The 7/22 stands for 7 strands of 22 gauge wire. This will give the best results for reception purposes.

In choosing the site of the receiving aerial it is essential to find a clear space free from trees, buildings, and other obstacles, because if such obstacles are found under the aerial wire they will cause the waves to dissipate their energy in useless work. Similarly, there should be no other aerials running in a direction parallel to the intended run of your aerial. If there is a number of other aerials in the next door gardens run your wire so that it makes an angle with the direction of the nearest aerials. Similarly, your aerial should not run parallel to telephone lines, as otherwise you will get induction and cross talk from them.

A receiving aerial can be supported by two trees or two masts, or a tree and a mast. If trees are used for support you should take care to lop off all the branches that may touch the wire in windy weather.

If masts are used they should be well stayed. A good method of fixing a mast in the ground is shown in Fig. 3. Two thick boards are placed and firmly fixed in the ground,

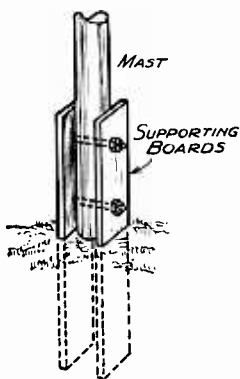

Fig. 3

if it is of this height it should be well and truly stayed.

The aerial wire must be completely isolated from earth. For this purpose insulators are used, and it is better to buy good insulators and thus pay a little more, than run the risk of earthing the aerial, especially in wet weather (water is a good conductor of electricity). The insulators must be of such a shape that there is no chance whatsoever of a film of moisture collecting between the aerial wire and the insulator supporting wire or rope. An insulator is provided with two holes: one for the supporting wire or rope and the other for the aerial wire proper. The correct method of fixing insulators is shown in Fig. 4.

It should be remembered that the Post Office allows only 100 feet of aerial wire to be used, which length includes

the mast being bolted to the boards as shown. In this manner it is possible to lower the mast by withdrawing the lower bolt and swinging it on the upper bolt. A little clearance is given for this purpose between the bottom of the mast and the ground; also clearance is assured behind the mast so that when the mast is lowered its lower portion is free to swing out.

The top of the mast should be provided with a stay collar for the fixing of the staying wires, and, of course, the pulley for the insulator rope. A 50-foot mast is ample, but

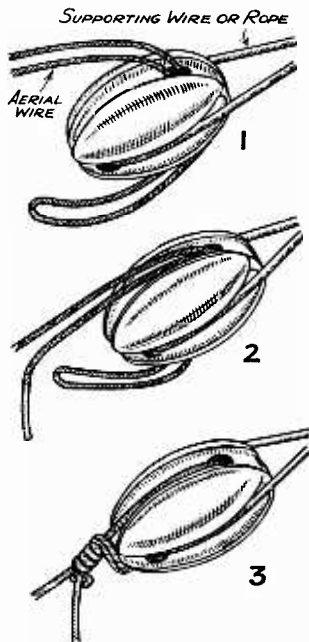

Fig. 4



the leading-in wire. Therefore, you should see that your aerial complies with this regulation.

There are two popular forms of receiving aerials used in this country. One type is the so-called inverted L aerial, the other a T aerial. Both are illustrated in Fig. 5.

In the case of an inverted L aerial it is possible to provide the leading-in wire from the same length of the aerial

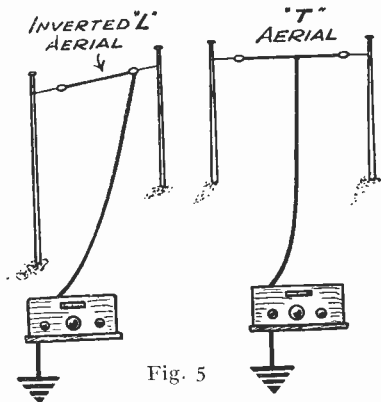

Fig. 5

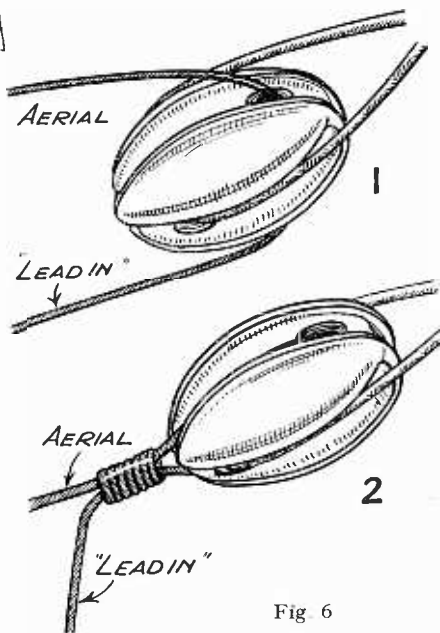

Fig. 6

wire without cutting it, as shown in Fig. 6. It is always desirable to have as few joints (the best method is to have no joints at all) in the aerial wire as possible. But a joint is unavoidable in the case of the T aerial and this joint should be well soldered.

With a height of 50 feet the aerial should not be longer than 40 feet, or even 30 feet. There is one point to consider. If you have a lot of electrical interference in your neighbourhood, such as arises from electric motors and dynamos, electric

tramways, flashing signs, etc., it is mostly your leading-in wire or the vertical portion of the aerial that picks up these interferences. Should you be troubled in this way, you should try one of the screened leading-in wires which are specially designed for the purpose of eliminating such interference. These screened wires do not work equally well on all wave-lengths, nor do they cut out interference altogether, but they help to a very great extent. The best cure for such interference is, of course, at the source.

The best way to bring the leading-in wire inside the house is to use the so-called leading-in insulator, which is illustrated in Fig. 7. This consists of an insulating tube through which is passed a long copper rod with thread at each end. A hole is drilled in the wooden window frame, or if metal frames are used in the metal frame, and the tube is passed through the

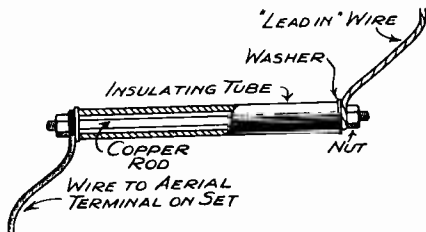

Fig. 7

hole as shown in Fig. 8. If, for some reason, you do not wish to drill large holes in the window framework, then an insulated wire should be used for the leading-in wire (this wire should be well soldered to the aerial wire) which can be accommodated in a hole of small diameter. If even this is undesirable, a wooden board can be used to fit into a slightly open window, so that all draught is eliminated, and all the necessary drilling then can be performed in the wooden board.

The position of the receiver should be so chosen that the wire connecting the leading-in terminal and the aerial terminal of the set is as short as possible. This wire should not trail all round the house, along walls, as this will reduce the efficiency of your reception.

The leading-in wire should go straight to the set. The same applies to the earth wire. It should be thick and short, going straight into the ground in the garden. The earth

wire need not be insulated. Bell wire should not be used either for the purpose of leading-in or earthing.

If you are living in a top flat and it is not convenient to obtain a direct earth, a water pipe can be used for earthing purposes, but you must make sure that the water pipe which you are going to use goes to earth and does not terminate somewhere in the loft. A special fitting can be bought for this purpose. Before you use a water pipe as an earth clean carefully its outer surface so that a good joint can be made with the wire running from the earth terminal of the set.

On no account should gas pipes be used for the purposes of earthing the set. The inside surface of a gas pipe is uneven

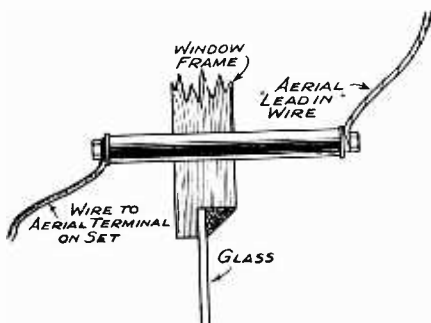

Fig. 8

and the pipe contains an explosive mixture. Should a spark occur inside the pipe during reception you may cause a considerable amount of damage to the property. The whole system of installation is shown in Fig. 8.

There are several methods of obtaining an effective earthing for a set. One method is to get 100 feet of 7/22 copper aerial wire and bury it, all bunched up, in the ground about 3 or 4 feet deep, using one end as the earth wire to reach the set. Another method is to use a clean biscuit-tin with a wire soldered to it, and bury the tin. Some people use metal rods pressed into the ground. Whatever method you choose you should remember that an effective earth should have as much contact surface with the ground as possible. For this reason copper mats rolled into a sort of loose Swiss roll are used for earthing purposes. The various methods of obtaining contact with the ground are shown in Fig. 10. Care should

be taken that the earth is always moist and it is a good plan to empty a few pailfuls of water over the earth during dry weather. During severe cold when the ground freezes, a kettle of hot water will greatly improve reception.

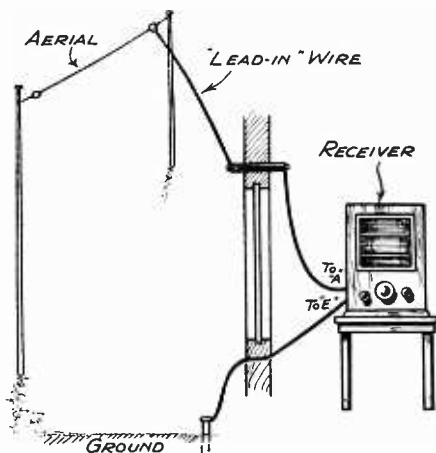

Fig. 9

It is very necessary to have some means of rapid earthing of the set, especially during stormy weather. For this purpose a permanent installation should have a so-called single pole double-throw knife switch. This switch and the method of

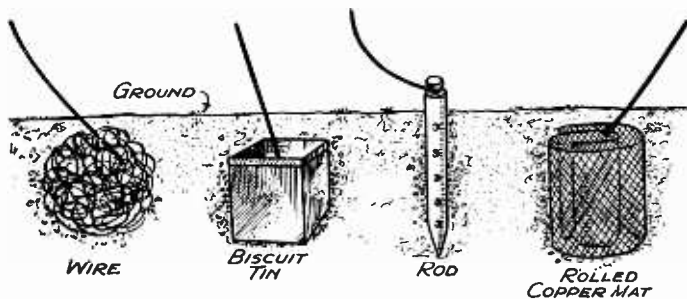

Fig. 10

connection is shown in Fig. 11. This illustration also shows a lightning arrester in position. The purpose of the latter is to deflect all heavy static surges of electrons in the aerial system from the set. Such surges will go through the lightning arrester in preference to anything else, and will thus be conducted safely to earth.

When the blade is in position A the aerial is connected to the aerial terminal of the set, and so reception can be carried out. At the end of reception the blade is shifted into contact B and the aerial is then completely earthed, leaving the set isolated. Such a switch is fixed between the leading-in insulator and the set, as shown in Fig. 12. This represents the final arrangement in a good receiving installation. Although the lightning

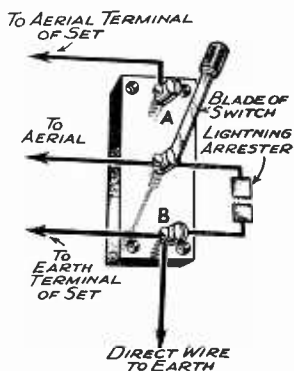

Fig. 11

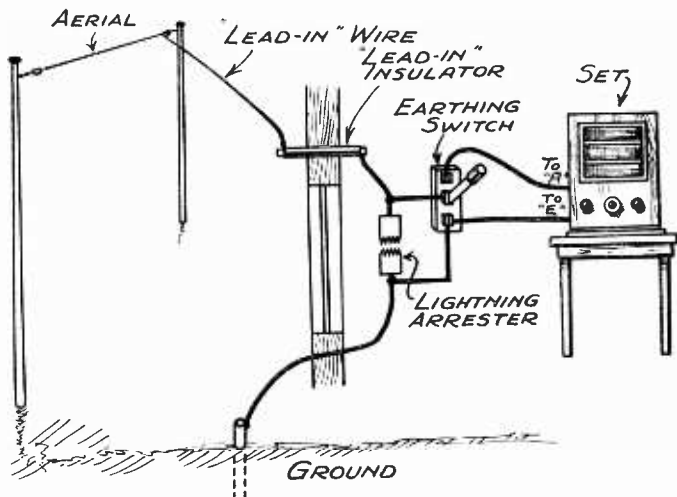

Fig. 12

arrester is placed across the aerial and earth wire it will not affect reception, as it consists of two sets of sharp points placed at a distance from each other in a vacuum.

With such an installation it is necessary to inspect frequently and to clean regularly the contacts of the leading-in insulator which are exposed to the weather outside. Grime will accumulate on the terminal and must be removed. It is a good plan to overhaul it completely and replace corroded wires at least once a year.

There are many listeners who are not in a position, owing to landlord's restrictions, to make use of an outdoor aerial. In this case an indoor aerial becomes necessary. Many of the sets use the electric mains as an aerial, but this method cuts down very considerably the number of stations received and their signal strength, especially when the electric mains form part of an underground system.

A good indoor aerial can be made by carrying 7/22 copper wire, bare or enamelled, across the room, from corner to corner, supported by insulating pins. Bell wire run along the picture rail is not a good arrangement. With a wire well insulated and hung from corner to corner it is surprising what a number of stations can be obtained with a good set.

A good earth should be used with an indoor aerial. If the latter is impossible, there is a method called the counterpoise method which can be used quite effectively inside a flat. A zigzagging wire is used as an aerial and an insulated wire identical in every respect is placed under the carpet or linoleum to provide an earth. The insulation of both wires must be perfect. This system is shown in Fig. 13.

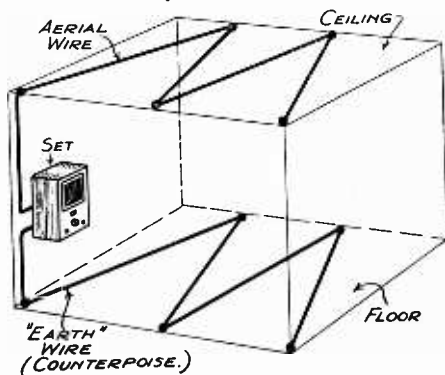

Fig. 13

An alternative to the aerial counterpoise system is the so-called frame aerial which can be used either as a separate unit or it can be incorporated in the receiver as is the case with all portable receivers. Such a frame aerial utilises the magnetic field of the wireless wave and consists of a number of turns of wire wound on a frame. The two ends of the frame aerial wire are connected to the earth and aerial terminals of the set. The frame aerial must, of course, be matched to the set and requires the attention of a skilled radio engineer.

The final advice is this, if you are not a "handy man," and unexperienced in erecting masts, soldering wires, etc., get an expert to do the job for you. It is much cheaper in the long run.

## *Choosing the Right Type of Receiver*

THE modern receiver is a much more efficient instrument than its prototype of even three years ago. And it is much cheaper too. The quality of reproduction, the level of volume, and the generally improved signal makes listening nowadays a great pleasure. Owing to the fact that there are many more stations than there were a few years ago, the superheterodyne type of receiver has become very popular all over the world.

Before you decide on the type of the receiver you wish to purchase, either in order to start listening or to replace an old out-of-date set, you should make up your mind whether you are going to have a radio receiver pure and simple or a radio gramophone. The latter gives, of course, in addition to the radio programmes, electrical reproduction of records which is the only means of repeating at will the music that appeals to you most.

### **Two Classes of Receiver**

Apart from gramophone reproduction, wireless receivers can be divided to-day into two main classes. The so-called straight circuits and superheterodyne receivers. The latter type is very much more selective and is therefore a little more expensive.

If you are satisfied with receiving one or two stations and do not want to listen to foreign stations, a two or three valve

straight circuit receiver will meet your needs, but this should have a band-pass tuner. If in addition you wish to receive most of the foreign stations a superheterodyne receiver is necessary. There are, of course, many varieties in both classes.

From the point of view of supply, wireless receivers can be divided again into two categories—battery and mains receivers. The battery receiver usually needs, for the purpose of feeding its valves, a two-volt accumulator for the filament, and a dry high-tension battery of 120 or more volts. It may also use a small dry grid bias battery. The mains receivers are supplied direct from the electric mains through a suitable equipment, and there are valves called universal valves which can be run directly from any main practically like ordinary electric lamps.

### A.C. and D.C.

Mains receivers are again divided into two classes: A.C. and D.C. A.C. stands for alternating current of a certain frequency which is supplied to the house from a power station generating its power by means of alternators or turbo-alternators, while the D.C. stands for direct current, which is supplied in some districts from power stations generating their power with the help of dynamos.

The valves of a set require direct current. For this reason before the alternating current can be used for the purpose of supplying valves it has to be turned into direct current. The engineers call this process rectification. Thus, you will find that manufacturers specify a certain number of valves in their set, adding, "including rectifier." This means that one of the valves does not constitute part of the amplifying circuit and is merely used in the set for the purpose of turning alternating current obtained from alternating mains into direct current. Some makers do not use a valve for this purpose, but a metal rectifier which performs the same function. The current obtained *via* the rectifying valve is not quite direct, *i.e.* unidirectional, and has to be smoothed out with the help of suitable equipment. The rectifying valve and the smoothing circuit represent a complete unit which can be purchased separately in the form of the so-called battery eliminator, and which can be added to a battery set, thus converting it into a mains receiver.

In the case of direct current mains, although the current itself is of the right kind for the valves, the voltage obtained at the mains may be far in excess of that required and it has to be reduced. This is done with the help of voltage dropping



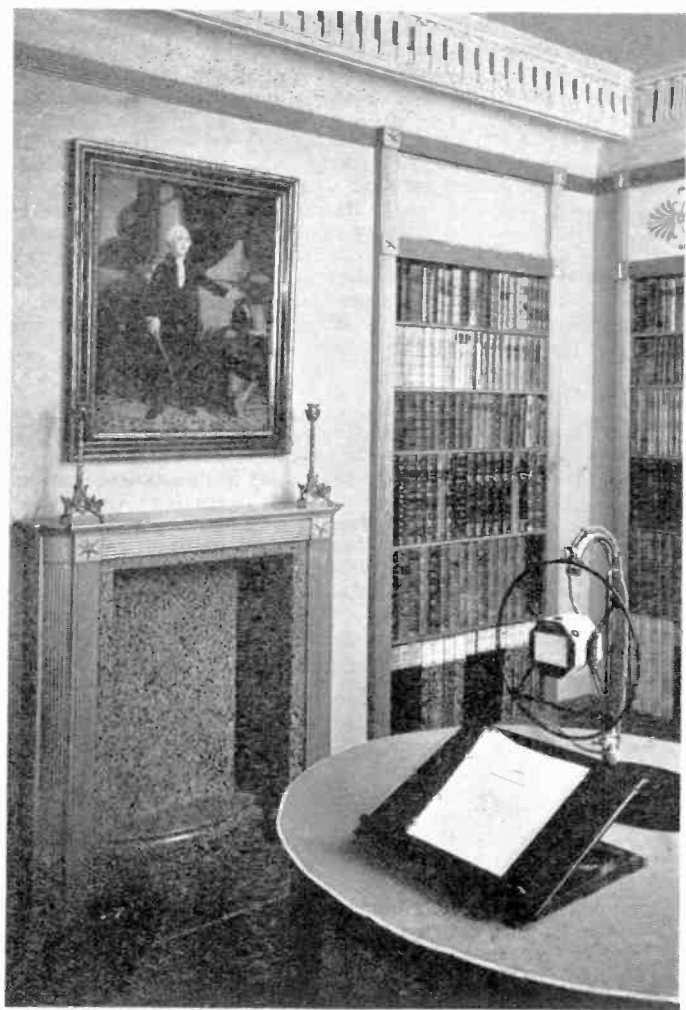

STUDIO 3D: TALKS

resistances. The same thing may happen in the case of alternating current mains where the voltage is dropped with the help of transformers. The equipment in the case of D.C. receivers is a little more costly than in the case of A.C., so that the latter are always cheaper.

The conversion of a given receiver from battery supply to mains supply should be carried out by an expert, as it is exceedingly dangerous to put anything on the mains that is not electrically sound. It is for this reason that the use of home-made battery eliminators is not recommended.

There are other methods of obtaining power for one's receiver. If you happen to live where no facilities for electrical charging are in existence and no electrical mains are available, conditions which prevail in many parts of the British Empire, it is possible to purchase a dynamo which will work in conjunction with a water turbine, a windmill, or a prime mover of some description. Where accumulators are available it is possible to use a rotary convertor which is a combination of an electric motor and a dynamo. The power obtained from the accumulators will drive the motor which will drive the dynamo, and the latter will supply the necessary current. You may be sure that you will not get more power from such a combination than you put into it. You will obtain a little less, as a matter of fact, on account of the losses in the machines, but what you will be able to do is to start with a small voltage and a large current at the accumulator—motor part of the circuit—and get from the dynamo a large voltage and a small current, a voltage that is suitable for the high tension supply of the receiver.

Similarly, if you have alternating mains and wish to obtain a direct current without rectification, you can run an electric motor from the alternating mains and make it drive a dynamo which will give a suitable direct voltage. This process can be reversed with direct mains, and an alternating supply can thus be obtained.

Another way of getting a high tension supply is to use a number of Leclanché primary cells which need not be recharged but will work for a considerable time if the chemicals are periodically renewed.

There is a specially constructed high-tension battery for use in the tropics, called an inert battery. This battery does not deteriorate in long transit, as an ordinary dry battery would, and the cells do not become active till water is added to the chemicals. This is, of course, a great advantage where the battery may be *en route* for several months. In this country, where accumulators can be charged easily, it is usual with battery sets to use accumulators for the low tension

---

# World-Radio

The B.B.C. Foreign Programme Journal—giving Continental programmes for a whole week, arranged hour by hour; and Empire and foreign broadcasting news. The indispensable journal for all who listen to foreign programmes.

PRICE 3d. EVERY FRIDAY EVERYWHERE

---

# The Listener

*The Listener* prints the cream of all B.B.C. talks, illustrates and annotates them, and has, in addition, contributions from the most eminent present-day critics, writers, and scientists.

PRICE 3d. EVERY WEDNESDAY EVERYWHERE

---

# Mr. J. B. Priestley

**writes:**



“In response to your Urgent Appeal for funds, I enclose a cheque for twenty-five pounds. I am certain that when people realise that the Cancer Hospital is in such constant need of money to carry on its great work both as a FREE Hospital and as a centre of Research into the origins of this terrible disease, they will instantly come to your support and your overdraft will vanish like magic. We cannot afford to let you work in the shadow of this enormous financial deficit.

Your Hospital, day and night, by every possible means, is fighting Cancer, and it is unthinkable that we should not come to your assistance and GIVE SOMETHING AT ONCE.”

*Please send a SPECIAL GIFT to the Secretary*

# The Cancer Hospital (FREE)

**FULHAM ROAD - LONDON, S.W.3**

or filaments of the valves and a dry battery for the purpose of high tension.

If your house is equipped with electrical mains you should purchase a mains receiver, as it consumes very little electricity and is highly economical to run, unless you invest in some model de luxe with a large number of valves. Even then I think that the little extra will compensate you for the trouble of recharging accumulators and renewing dry batteries.

Before purchasing a receiver you should ascertain the nature of your electrical supply and tell the wireless dealer what it is. In the case of direct current all that it is necessary to mention is the voltage as stated on the meter. In the case of alternating supply you should ascertain not only the voltage but also the frequency of the supply. You can see what it is from the meter, which will bear a label reading 200 volts, 50 cycles, or some such figures.

One way to choose a receiver is to go to a local dealer or to a manufacturer's showrooms and hear the thing for yourself. At a dealer's you will get a selection of different makes so that you can compare the performance of the various models. Having selected approximately the type that suits your tastes and your pocket, you should ask the dealer to demonstrate the receiver at your residence, and if possible to leave it with you for a few days.

### The Importance of Service

There are several things that you should look for in a modern receiver. In the first place, it must be guaranteed for a definite period of time. You should ascertain carefully what this guarantee means, and what sort of after-sale service is offered.

There have been occasions when a recently purchased set has developed a fault and been taken away. The manufacturer has happened to be busy so that the purchaser, having parted with the money, and with the set, has had to wait for some considerable time. This, of course, is bad service on the part of the manufacturer and the dealer. You should get an undertaking in writing, either from the manufacturer or dealer that, should anything go wrong, the set will be replaced while the faulty model is being repaired.

Having ascertained that there is an efficient after-sale service, you should proceed with the choosing of your set as follows: The set controls should be as few as possible. Four controls is the general rule. One control is used for switching on the set and regulating the volume. Another control is used for changing from one wave-length band to another;

a third control is used for going over from one station to another within the given band of wave-lengths; while there is a fourth control for the purpose of regulating the tone of the instrument. The arrangement and the number of controls differs with each make, but you will soon familiarise yourself with them while you are trying out the sets in the dealer's showroom.

The next point to look for is the tuning scale. The best method of tuning is of course the visual tuning—you must see what you are doing. As a rule the tuning knob controls the movement of a pointer which travels over the figures of wave-lengths or names of stations. The wave-changing switch may bring a different scale under the pointer or the scale may be arranged on each side of the pointer. Another method is the so-called shadow tuning. The dial is as a rule illuminated from inside the set, and it is the scale that moves. There is a fixed thin wire behind the dial and its shadow indicates the tuning-point. Some makers use a column of light or a column of fluid to indicate the precise tuning-point. Study the method of tuning and see how you get on with it.

Handle the set yourself. See that there is no excessive hum and background noise when no programme is coming through. There are sets equipped with so-called noise suppressors which make the background silent during tuning, and this is an advantage. While tuning, observe the distance which the pointer has to travel between each pair of stations, and observe when one becomes silent and another comes in. This distance should not be excessive. It will prove to be much larger on long waves than medium waves. Whatever happens, see that you do not get two stations at once without finally separating them. The smaller this distance of pointer travel between two stations the more selective is the set.

You can obtain too selective a set, as its quality would be bad, but in comparing a number of sets you will soon see what the selectivity of each is by the number of stations you get without any interference within a certain portion of the scale.

### **Automatic Volume Control**

Wireless signals are subject to fading, which manifests itself in that signals vary considerably in strength and are now weak, now strong. This, of course, detracts a lot from the entertainment value of distant stations. Fortunately, modern receivers are fitted with what is known as automatic volume control. The circuit is so arranged and special valves

# DEAF! YOU DON'T NEED EARS TO HEAR BY BONE CONDUCTION

● Described as a Modern miracle, here at last is what the deaf world has long been awaiting—Better Hearing for Church, Conversation, Home, Talkies, Radio, Meetings, Shopping, and street safety! There is no need even to use ears to hear by this method, the very latest invention of bone conduction. "ARDENTE" have worked and experimented on this method over a number of years, and now

## "BONADENTE"

is perfection. Entirely different from all else and combining amplification with amazing true-to-tone results—"BONADENTE" means that there is nothing to be worn in the Ear orifice and is really inconspicuous. It does not matter what is the cause or extent of your deafness, slight or even cases considered hopeless are now benefiting (so-called "Stone deafness"), so that this is the complete answer to your needs whatever you have tried or are using now. Even if the drums are perforated or removed, bone conduction means that you hear by bone-contact—no need to use your ears at all.

## CALL NOW FOR FREE TEST

If unable to call, write for details and "Medical Reports"

FREE TESTS HOME ARRANGED



THE WORLD'S GREATEST HEARING SERVICE

Suite 21,

309 OXFORD STREET, LONDON, W.1

(Look for coloured building and square clock)

Mayfair 1380-1718

Birmingham, Bristol, Cardiff, Exeter,  
Edinburgh, Glasgow, Hull, Leicester,  
Leeds, Liverpool, Manchester, Newcastle.

## Imperial Cancer Research Fund

Patron:

His Most Gracious Majesty The King

FOUNDED in 1902, under the direction of the Royal College of Physicians of London and the Royal College of Surgeons of England as a centre for cancer research, the Imperial Cancer Research Fund is working unceasingly in the cause of suffering humanity. The whole resources are devoted to the systematic investigation of the cancer problem.

Donations and Subscriptions may be sent to the Honorary Treasurer, 8-11 Queen Square, London, W.C.1, or may be paid to the Westminster Bank, Marylebone Branch, 1 Stratford Place, London, W., A/c Imperial Cancer Research Fund.

## A Child's Gratitude

We wish that you could see the condition that some little ones are suffering—and even more that you could see the happiness brought to thousands every year through the help of the National Society for the Prevention of Cruelty to Children. You can earn some little one's gratitude by sending a gift to-day to Wm. J. Elliott, Director.



Victory House, Leicester Sq., London, W.C.2

Chairman: THE VISCOUNT ULLSWATER, G.C.B.

**STUDY  
AT  
HOME**

**YOU CAN HAVE A COLLEGE TRAINING  
IN ALMOST ANY CAREER  
FOR A FEW SHILLINGS MONTHLY.**

**IN YOUR  
SPARE  
TIME**

Founded  
1900



33  
YEARS  
OF  
SUCCESS

**THIS IS THE BENNETT COLLEGE—ALL OF IT**

The Bennett College is not a Rented Room in a well-known street—it is a College, with over thirty years of unbroken success.

The Bennett College Courses for the G.P.O. and C.G.I. examinations have been prepared in close collaboration with P.O. Officials. The Courses combine the knowledge of technical experts and teaching specialists; the tuition is kept constantly in touch with modern progress.

Advantages we have over all other Colleges:

1. All Text-books are supplied FREE.
2. All our Text-books are compiled especially for the examination.
3. The Text-books are sent to the Student immediately he joins the College.
4. A small Monthly Payment brings you exactly the same privileges as if you paid the fees in advance.
5. All lessons are corrected on the College premises and returned the same day as they arrive. This means NO DELAY.

**SPECIAL COURSES PROVIDED FOR :**

P.O. Probationary Inspectors (Open and Limited)  
P.O. Superintendents of Traffic (Open and Limited)  
P.O. Probationary Assistant Engineers (Limited)  
C.G.I. Telephony Examinations (All grades)  
C.G.I. Telegraphy Examinations (All grades) ; B.Sc.  
(Eng.); A.M.I.E.E., etc.

**The Bennett College is the principal Postal Training Centre for P.O. Engineers, and special consideration is given to their requirements.**

**WE GUARANTEE TUITION UNTIL SUCCESSFUL**

**Also ask for our New Book (FREE OF CHARGE)**

**THE HUMAN MACHINE—Secrets of Success**

*Particulars and Advice on Studies, FREE.*

**DEPT. 85 THE BENNETT COLLEGE Ltd., SHEFFIELD**



are so used that when a weak signal reaches the receiving aerial the set gives a strong signal. When a very powerful signal reaches the receiving aerial, the set gives a weaker signal, so that it works approximately at the same volume all the time. You will find that there are variations in signal strength, of course, but they are not so pronounced as in a receiver that is not so fitted.

More valves mean generally a greater range, as they amplify very weak signals that would not be heard with a smaller number of valves.

The last point to look for is that the loudspeaker, which is generally incorporated in the set, is of the mains-energised moving coil type. This is the best loudspeaker you can have nowadays. Cheaper sets have moving coil loudspeakers with permanent magnets which are quite good, but not as good as the energised types.

You should also see that the radio receiver has provision for a gramophone attachment (such a set is provided with pick-up terminals and gramophone switch) if you intend at a later date to use a gramophone in conjunction with your set, which will then serve as an amplifier. Another point that should not be overlooked is the provision of terminals for extra speakers. You may want to extend your set to other rooms.

When trying out a set before purchase, if you yourself are not musical enough, take with you a musical friend, and see that the set does not cut off too many high notes and adequately handles the low notes. Again, comparison in this case between a number of makes is valuable.

An important point to see is that the set is adequately ventilated. In the case of mains receivers with a large number of valves the heat generated after a run of an hour or so may become excessive with a badly ventilated set. This is where the trying out at home comes in.

In conclusion it is necessary to ascertain that the set is made by a reputable firm with large resources behind it, and that the valves used are of good make. There are many listeners saddled with sets that were made by firms which in due course went bankrupt and all service has disappeared.

In carrying out extensions into a number of rooms the best plan is to purchase the special equipment available on the market and use wires which are designed for the purpose. Amateur wiring often produces bad results and makes speech woolly. Such wiring can be extended during warm weather into the garden, but a lot depends on neighbours, as there are many who dislike wireless in the open, and one, of course, must not be selfish and should consider other people. Inci-



PRESS LISTENING HALL

dentally, the acoustics of the garden are not the best from the point of view of reproduction.

There are on the market portable receivers of the battery type, which are portable in that they do not require an aerial and earth and contain all the necessary batteries. But some of them are not portable from the point of view of weight, unless you possess unusual strength! Such a "portable" receiver can be taken about in one's car so that entertainment is available during a picnic.

### Wireless in the Car

There are special car installations, which comprise a set fitted inside a car. The car machinery, especially sparking plugs, generates a good deal of noise and interference, and for this reason the car has to be fitted with suppressors. Special sparking plugs are now available with suppressors incorporated in the plug, but still this does not solve the problem of car interference entirely, and other fittings have to be made, if the set is to move satisfactorily. Firms specialising in this sort of thing will do all the necessary work. I am personally dead against a wireless receiver being used while one is driving, unless it is being used only by passengers with head-telephones. The driver should have nothing to distract his attention. His mind should be concentrated on the traffic. It is a different thing when a car is stationary, and then wireless, of course, is a great boon.

When in doubt as regards the best method of supplying your set, as, for instance, in the case of a contemplated change from batteries to a battery eliminator, it is a good plan to glance through the advertisements of some wireless journal and write to the technical department of the firm that advertises suitable equipment.

When writing, explain your case as fully as possible and you will find that you will be advised correctly. Most of the wireless firms have a very efficient service in this respect.

## *Conventional Notations in Wireless*

IN many mathematical expressions Greek letters are freely used by the mathematicians, and for this reason it is desirable that every serious student of Wireless should make himself familiar with the Greek alphabet.

### THE GREEK ALPHABET

Letter.	Pronunciation.	Notation Use.
α	Alpha.	Angles.
β	Beta.	Angles.
γ	Gamma.	Specific conductance or conductivity.
δ	Delta.	Logarithmic decrement.
ε	Epsilon.	
ζ	Zeta.	
η	Eta.	Efficiency.
θ	Theta.	Angles.
ι	Iota.	
κ	Kappa.	
λ	Lambda.	Wave-length.
μ	Mu.	Valve amplification factor.
ν	Nu.	
ξ	Xi.	
ο	Omicron.	
π	Pi.	Used for 2.141 6.
ρ	Rho.	Specific resistance (resistivity).
σ	Sigma.	Aerial capacity.
τ	Tau.	
υ	Upsilon.	
φ	Phi.	Flux.
ϕ	Phi.	Angles.
χ	Chi.	Unknown quantity.
ψ	Psi.	
ω	Omega.	2π × frequency.
Ω	Omega.	Ohms.

# LIVING TONE

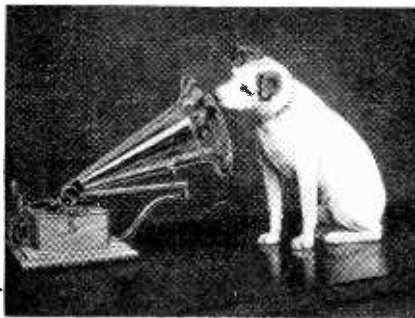

## The story behind the Trade-Mark

In the story of "His Master's Voice" is written the history of the science of sound reproduction itself. For thirty years this famous trade-mark has stood as the symbol of pure, natural tone. And not only tone! Price for price throughout the whole range, "His Master's Voice" instruments are unmatched for their splendid craftsmanship and value. It costs no more to have "His Master's Voice" Radio.

# "HIS MASTER'S VOICE" RADIO

*The Gramophone Company Limited, 98-108 Clerkenwell Road, London, E.C.1*

# CONQUEST OF INFERIORITY COMPLEX

*Wonderful Discoveries of Modern Psychological Research.*  
**MYSTERIES OF MIND MADE CLEAR TO ALL.**

**A**N Inferiory Complex is a disturbance in the subconscious mind which manifests itself in **self-consciousness, lack of confidence, lack of charm—in nervousness and timidity—in causeless fear or worry—in unsociability, depression and a sense of futility—in lack of enterprise—in weakness of will and indecision—in shyness, blushing and other nervous mannerisms—in forgetfulness and lack of concentration.** Its origin lies in experiences and influences during your personality-development which may be entirely forgotten, but their effects remain in the form of a "disturbance centre" in subconsciousness, which sends out powerful negative impulses. You cannot control these impulses—to struggle against them by direct effort only serves to increase

their strength. Remove them altogether and build up in their place a new personality with powerful positive impulses, which will carry you forward to a happier, fuller life—with the power to attract to yourself the things you most desire.

★

Send to-day for Free Book  
**THE BRITISH INSTITUTE OF  
PRACTICAL PSYCHOLOGY  
LTD.**

1 (K.J.) Ludgate Hill, London,  
E.C.4



## DR. BARNARDO'S HOMES :

NATIONAL INCORPORATED ASSOCIATION

Charter :

**"No Destitute Child Ever Refused Admission."**

No voting system.  
No red tape.

**The need of the child is the only consideration.**

On an average 5 children are added to this Family every day, which is the Largest Family in the World.

**The children are rescued from unfavourable surroundings, given a new environment, trained and placed out in life as useful and self-supporting citizens.**

116,500 children admitted. 17,915 children and young people dealt with last year.  
8,500 always being supported.  
1,401 are babies and toddlers under 5.

441 are crippled or afflicted.  
1,146 are under industrial training.  
30,666 have been migrated to the Overseas Dominions.

Will you help Barnardo's in their work for the Nation ?

Please send **2/6** for the Children's Food.

\*.\* Cheques and Orders payable "DR. BARNARDO'S HOMES" and crossed, may be sent to DR. BARNARDO'S HOMES, 297 Barnardo's House, Stepney Causeway, London, E.1.

Letters of the English alphabet are also used for definite notations as follows :

Letters.	Notational Meaning.
A . . . . .	Area, also stands for " amperes."
B . . . . .	Susceptance, also magnetic reluctance.
C . . . . .	Capacity, also stands for " coulombs."
<i>c</i> . . . . .	Velocity of light (186,000 miles per second, or 300,000,000 metres per second).
D . . . . .	Magnetic flux density.
<i>d</i> . . . . .	Distance.
E . . . . .	Electro-motive force.
<i>e</i> . . . . .	Denotes the base of natural logarithms, and stands for 2.7183.
F . . . . .	Magnetic flux (total), also stands for " farads."
<i>f</i> . . . . .	Frequency.
G . . . . .	Conductance.
<i>g</i> . . . . .	Gravity.
H . . . . .	Intensity of magnetic field, also stands for " henries."
<i>h</i> . . . . .	Height.
I . . . . .	Strength of electric current.
<i>i</i> . . . . .	Strength of instantaneous electric current.
J . . . . .	Stands for " joules."
K   . . . . .	Dielectric constant.
<i>k</i>   . . . . .	
L . . . . .	Self-inductance ; inductance.
<i>l</i> . . . . .	Length.
M . . . . .	Mutual inductance, also magneto-motive force.
<i>m</i> . . . . .	Mass, also magnetic pole strength.
N . . . . .	Number of.
<i>n</i> . . . . .	
P . . . . .	Power.
Q   . . . . .	Charge, quantity of electricity.
<i>q</i>   . . . . .	
R   . . . . .	Resistance (electrical).
<i>r</i>   . . . . .	
S . . . . .	Magnetic reluctance.
<i>s</i> . . . . .	Surface ; speed.
T . . . . .	Period or absolute temperature.
<i>t</i> . . . . .	Time ; temperature.
V . . . . .	Voltage ; electric potential ; also stands for " volts."
<i>v</i> . . . . .	Velocity.

W . . . .	Work or energy, also stands for "watts."
w . . . .	Weight.
X . . . .	Electrostatic field strength, also reactance.
x . . . .	Unknown quantity.
Y . . . .	Admittance.
Z . . . .	Impedance.

### PREFIXES USED IN WIRELESS

*Mega-* means a million of.

*Kilo-* means a thousand of.

*Hekto-* means a hundred of.

*Deca-* means ten of.

*Deci-* means a tenth of.

*Centi-* means a hundredth of.

*Milli-* means a thousandth of.

*Micro-* means a millionth of.

*Millimicro-* means a thousand millionth of.

*Micromicro-* means a million millionth of.

#### Examples :

A megohm means a million ohms.

A kilowatt means a thousand watts.

A decimetre means a tenth of a metre.

A centigramme means a hundredth part of a gramme.

A millivolt means a thousandth part of a volt.

A milliampere means a thousandth part of an ampere.

A millihenry means a thousandth part of a henry.

A microvolt means a millionth part of a volt.

A microfarad means a millionth part of a farad.

A microhm means a millionth part of an ohm.

A micromicrofarad means a million millionth part of a farad.

(See the definitions of electrical units in the dictionary.)

### MATHEMATICAL NOTATION OF MULTIPLES AND FRACTIONS OF TENS

100, which is ten times ten, is denoted as  $10^2$ .

1000, which is ten times ten times ten, is denoted as  $10^3$ .

10,000 is denoted as  $10^4$ .

100,000 is denoted as  $10^5$ .

1,000,000 is denoted as  $10^6$ .

And so on. Thus,  $10^{18}$  stands for 1,000,000,000,000,000,000.

Similarly 5,000,000 can be denoted as  $5 \times 10^6$ .



$\frac{1}{10}$  is denoted as 0·1 or as  $10^{-1}$ .

$\frac{1}{100}$  is denoted as 0·01 or as  $\frac{1}{10^2}$  or as  $10^{-2}$ .

$\frac{1}{1000}$  is denoted as 0·001 or as  $\frac{1}{10^3}$  or as  $10^{-3}$ .

Similarly  $\frac{1}{1,000,000}$  is denoted as 0·000001 or as  $\frac{1}{10^6}$  or  $10^{-6}$ .

So that  $10^{-15}$  stands for  $\frac{1}{0\cdot000000000000001}$ .

### THE INTERNATIONAL Q. CODE

- QRA What is the name of your station ?  
 QRB How far are you from me ?  
 QRD Where are you bound, and where are you from ?  
 QRG What is my frequency ?  
 QRH Does my frequency vary ?  
 QRI Is my note good ?  
 QRJ Are my signals weak ?  
 QRK Are my signals good ?  
 QRL Are you busy ?  
 QRM Are you being interfered with ?  
 QRN Are atmospherics troubling you ?  
 QRO Do you want me to increase power ?  
 QRP Do you want me to decrease power ?  
 QRQ Shall I send faster ?  
 QRS Shall I send slower ?  
 QRT Shall I stop sending ?  
 QRU Have you anything for me ?  
 QRV Are you ready ?  
 QRX When will you call me ?  
 QRZ Who is calling me ?  
 QSA What is the strength of my signals ?  
 QSB Do my signals vary in strength ?  
 QSD Are my signals legible ?  
 QSL Please acknowledge reception.  
 QSM Shall I repeat last message ?  
 QSO Can you communicate with " So-and-so " direct ?  
 QSP Please re-transmit to " So-and-so."  
 QTR What is the exact time ?

## SHORT-WAVE REPORTING CODE

## SIGNAL STRENGTH—

- R1 Just audible.
- R2 Audible, but unintelligible.
- R3 Audible, partly intelligible.
- R4 Just intelligible.
- R5 Quiet, but intelligible.
- R6 Moderately loud.
- R7 Normal, good clear reception.
- R8 Strong reception.
- R9 Wipe-out signals.

## FADING—

- F Slight fading.
- FF Fairly deep fading, but no programme lost.
- FFF Complete fade out.
- N No fading.
- SS Very slow fading lasting minutes.
- S Slow fading (one minute or so).
- R Fairly rapid fading (several seconds).
- RR Very rapid fading (one second or so).

## ATMOSPHERICS—

- X Slight static.
- XX Rather bad static disturbances.
- XXX Very strong atmospherics.
- N No atmospherics.

## CODE DESCRIPTION OF TYPE OF SET

- 0-v-0 One-valve receiver.
- 0-v-1 Detector and 1 L.F. stage.
- 1-v-2 H.F. stage, detector, and 2 L.F. stages.
- Sg-v-Pen Screen grid stage, detector, and Pentode.
- Sg-vSg-2 Screen grid, screen grid detector, and 2 L.F. stages.
- Av-2 Short wave plug in adaptor and 2 L.F. stages.
- C-2-v-2 Short wave converter and 2 H.F. stages, detector, and 2 L.F. stages.
- C-SH-6 Converter and superhet receiver (6-valve).  
(See W.R.R.L.)

**A VAC-TRIC GIVES THE GREATEST SUCTION POWER - FOR £6.12.6**

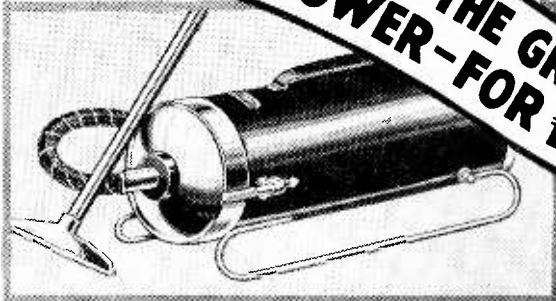
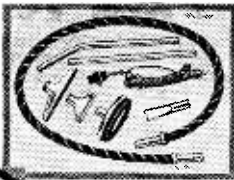

**ACCESSORIES INCLUDE :**

By comparative test, the Vac-Tric has the greatest suction power of any cleaner of its type. Consider, also, the other advantages of the "Popular" Model. Finely finished in heavy nickel plate and leatherette covering, sterling workmanship and complete range of accessories. All British in every respect.

Flexible tubing, Carpet and Upholstery Nozzles, Bookcase Nozzle, Lino Brush, Bent and Straight Tubes, the Vac-Tric Automatic Disinfecting Pad.

**SHAMPOO YOUR CARPETS.**

The Vac-Tric Spraying attachment will shampoo your carpets, spray paint, insecticide, etc. An extra accessory costing only 5/6.



*Vac-Tric Ltd., Cricklewood, London.*

**VAC-TRIC LTD., Waterloo Road, Cricklewood, London, N.W.2.**

*Please send me full particulars of the Vac-Tric "Popular" Model.*

Name.....

Address.....

R. Y. - B.....

# FREE TO AMBITIOUS WRITERS

Valuable Book on Journalism and Story Writing. It Tells of the Prospects for Spare-time Writers and How to Increase Income by Literary Effort at Home. SIMPLY FILL IN COUPON, WHICH IS THE FIRST STEP TO SUCCESS AS A WRITER.

THE free book issued by the Metropolitan College of Journalism, St. Albans, shows the clear way to success in Journalism and Short Story Writing. It tells how lucrative and pleasurable a pastime is that of spare-time writing, and how you may soon begin to earn welcome cash rewards for your contributions. With this authoritative Book in your hands, a vista of financial success as a staff journalist or as a free lance writer and contributor is opened up to you.

As the subject is of such interest to you and the rewards probably so great, surely you will complete the appended coupon and post it without delay.

The book will be accompanied by an offer of an EXPERT FREE CRITICISM of your work. Therefore fill in, and post the coupon NOW.

*My sales to date have amply covered the cost of the Course (Insurance Clerk).*

If you are interested in Play-Writing obtain free particulars of the College intensely practical Postal Course in the subject. Please mark coupon "Play-Writing."

## FREE BOOK COUPON—POST NOW!

Please send me—without charge or obligation—a copy of your Free Book, "Modern Journalism and Story Writing," together with your offer of a Free Criticism of my work.

J10 8

NAME .....

In Capitals)

ADDRESS .....

Radio Year-  
Book, 1935 .....

**METROPOLITAN COLLEGE OF JOURNALISM** Dept. J10.8  
ST. ALBANS

H.R.H. The Prince of Wales  
recently said:

*'I do commend this Institution to the Public for their continued assistance.'*

## The Shaftesbury Homes

and

## 'Arethusa' Training Ship

have recently admitted the

### 30,000th Child

**THIS IS A SPLENDID RECORD OF  
GOOD WORK**

Every child who enters the Society's Homes or the Training Ship 'Arethusa' is fed, clothed and educated, and trained so that he or she becomes not only a useful, but good man or woman.

**FUNDS ARE MOST URGENTLY  
NEEDED NOW**

**1,100 CHILDREN ARE ALWAYS  
BEING MAINTAINED**

164 Shaftesbury Avenue, London, W.C.2

President:

H.R.H. THE PRINCE OF WALES, K.G.

## CHILDREN WHO MAKE HISTORY

Joan and Billy were the first children, we believe, to broadcast a "Good Cause" appeal, and did so on 18th November 1934, on behalf of their School, the Alexandra Orphanage.

The Alexandra Orphanage was the first School to be founded for fatherless boys and girls—as far back as 1758—but it keeps up with the times and gives a splendid home care and efficient training to the 370 children at Maitland Park, Haverstock Hill, N.W.3.

If you would like to help the Orphanage, please send a donation to the Secretary, who will be pleased to send an annual report and full particulars.

ALEXANDRA ORPHANAGE,

Offices: 34-40 Ludgate Hill,  
London, E.C.4.

## INTERNATIONAL MORSE CODE

LETTERS.		FIGURES.	
a	· —	1	· — — — —
b	— · · ·	2	· · — — —
c	— · — ·	3	· · · — —
ch	— — — — —	4	· · · · —
d	— · ·	5	· · · · ·
e	·	6	— · · · ·
f	· · — ·	7	— — · · ·
g	— — ·	8	— — — · ·
h	· · · ·	9	— — — — ·
i	· ·	0	— — — — —
j	· — — — —		
k	— · —		
l	· — · ·		
m	— —		
n	— ·		
o	— — —		
p	· — — ·		
q	— — — · —		
r	· — ·		
s	· · ·		
t	—		
u	· · —		
v	· · · —		
w	· — —		
x	— · · —		
y	— · — —		
z	— — · ·		
		PUNCTUATION.	
		Full-stop	· · · · ·
		Semi-colon	— · · · — ·
		Comma	· — · · · —
		Query (?)	· · — — · ·
		Colon	— — — · · ·
		Exclamation (!)	— — · · — —
		Apostrophe	· — — — — ·
		Hyphen (-)	— · · · —
		Brackets	— · — — — —
		Inverted commas	· — · · · —
		Signal prior to message	— · · · —
		Understood	· · · — ·
		Error (cancel)	· · · · · ·
		End of transmission	· — · — ·
		Ready to receive	— · —
		Wait	· — · ·
		Good-bye	· · · — · —

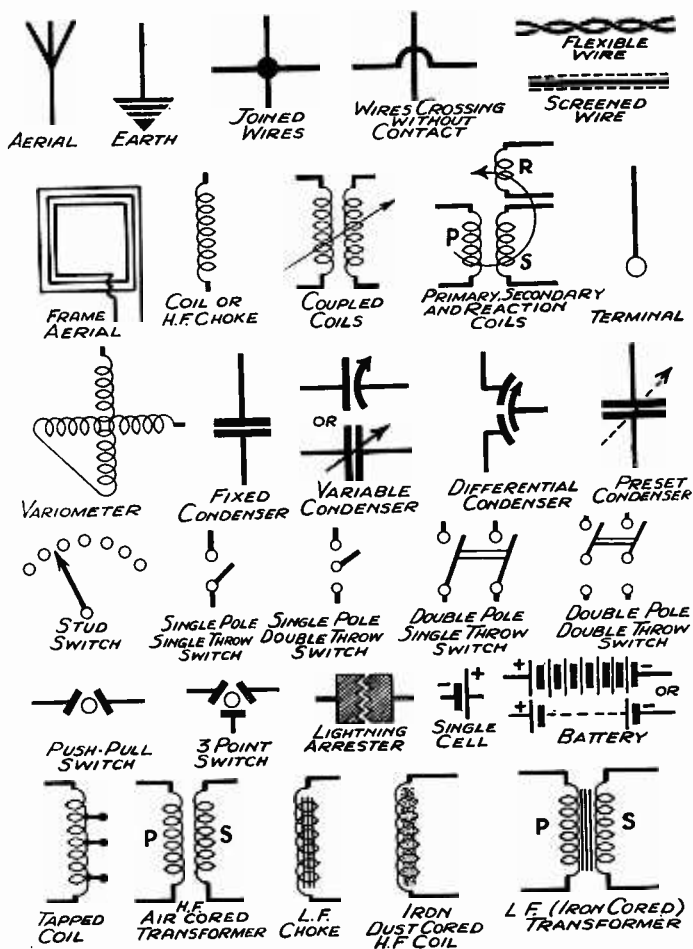

CONVENTIONAL SIGNS USED IN THEORETICAL DIAGRAMS OF WIRELESS CIRCUITS (1)

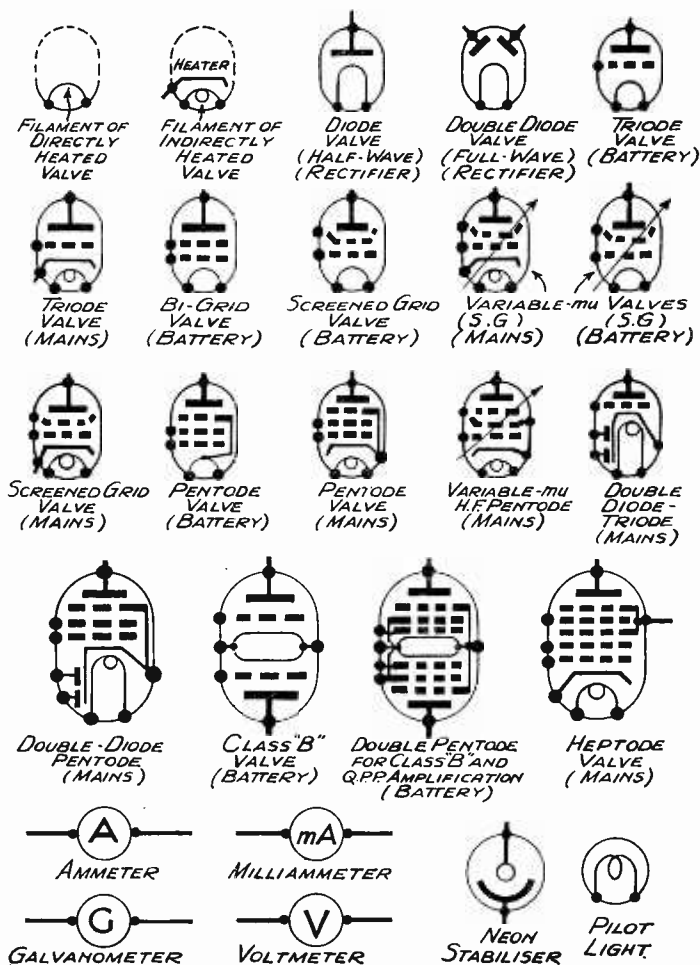

CONVENTIONAL SIGNS USED IN THEORETICAL DIAGRAMS OF WIRELESS CIRCUITS (2)

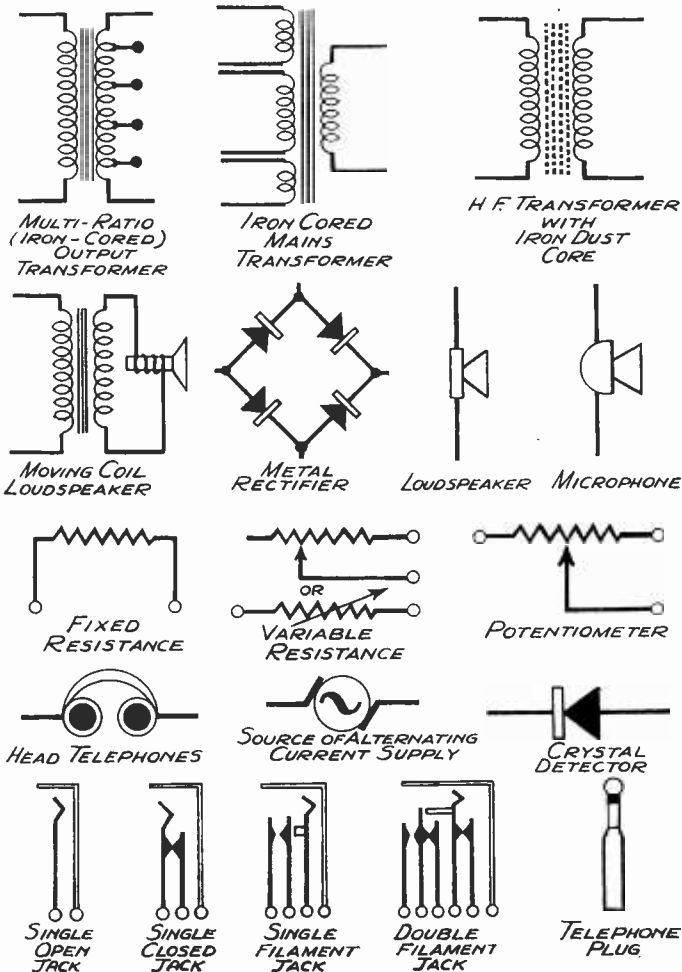

CONVENTIONAL SIGNS USED IN THEORETICAL DIAGRAMS OF WIRELESS CIRCUITS (3)



# "ACID SECRET" OF RHEUMATIC AILMENTS CONQUERED AT LAST!

Over 3,200 British Doctors are already recommending "CURICONES" with success

10,000 Free Home Trial Treatments are available to sufferers from Rheumatoid Arthritis, Rheumatism, Neuritis, Sciatica, Swollen Joints, Rheumatic Gout, and Lumbago. This enables you to prove the benefit to be derived from this wonderful treatment without any cost to yourself.

CROSS-SECTION (highly magnified) of HUMAN VEIN BEFORE taking "Curicones" AFTER taking "Curicones"



Note the "Acid Daggers" and poisons in the blood which cause the fiery agony of Rheumatic Ailments.



"Curicones" rid the system of the razor-edged crystals and poisons which cause swellings and rheumatic pains.

## DON'T GIVE UP HOPE

Cases of Rheumatoid Arthritis, Chronic Rheumatism, Gout, Swollen Joints, excruciating Sciatica and Neuritis, once thought beyond hope, yield to "Curicones." Pain is banished, swelling reduced, stiffness relieved—from within, through the natural agency of the blood-stream. No interference with daily occupations.

Every reader who sends the coupon to Stephen Matthews & Co. Ltd., Mfg. Chemists and Druggists (Dept. B.B.), 19-21 Farringdon Street, London, E.C.4, will receive a test supply of "Curicones" ABSOLUTELY FREE. Also a full and detailed account of the discovery and nature of "Curicones," together with a number of striking tributes to their efficacy from many physicians.

## SEND THIS COUPON

or Postcard will do.

To Stephen Matthews & Co. Ltd., Mfg. Chemists & Druggists (Dept. B.B.), 19-21 Farringdon Street, London, E.C.4.

Please send FREE and post paid a Trial Supply of "CURICONES" with printed particulars of HOW and WHY they conquer Rheumatic and allied ailments.

Name .....

Address .....

Ailment .....

Please write in Block Letters.

# BE A SUCCESSFUL ARTIST

Earn Money with Pen or Pencil in Spare Time

IT is more natural for a man to draw than to read or write. But nowadays most men read and write—yet they fear to draw. Long before man had invented an alphabet, he drew pictures with the burnt end of a stick snatched up from his blazing cave-fire. Drawing is a natural way of expressing what one sees or conceives. Whether by eye-vision or mind-vision, man instinctively "pictures the thing to himself."

Send now a copy of the accompanying sketch (or a specimen of your original work), together with coupon below, and you will receive, without any

charge or obligation, an expert and quite candid criticism of your work. Such advice may enable you to develop a possibly hitherto unsuspected talent. That's the point, "unsuspected talent." By the JOHN HASSALL WAY your natural ability may be utilised for your own great profit, in your spare time, and in your own home.

Learning to draw by the JOHN HASSALL WAY is a fascinating pursuit which always brings pleasure and often profit.

A Handsome BROCHURE containing many illustrations of the work of John Hassall, R.I., and his pupils, will be sent free. This book gives graphic details of the John Hassall Postal Course; what it is, what it has done, and what it can do for you.



Copy this sketch for free criticism

## COUPON—POST NOW!

Please send me—without charge or obligation—a copy of the Illustrated Brochure, "The John Hassall Way," and free criticism of enclosed sketch (my own work).

H15 4.

NAME .....  
(In Capitals)

ADDRESS .....

Radio Year-Book, 1935 .....

Age (if under 21) .....

THE JOHN HASSALL CORRESPONDENCE ART SCHOOL, Dept. H15/4, ST. ALBANS



## ROSS for HEIGHT!

RESULTS SPEAK FOR THEMSELVES

Pupil, age 19½, gains 5 ins. in 6 wks.	Pupil, age 30, gains 2 ins. in 4 wks.
" " 21, " 5 ins. in 5 mths.	" " 40, " 1½ ins. in 6 "
" " 20, " 3½ ins. in 16 dys.	Increased my own height to 6' 3½"

Testimonials from all over the world.

Fee £2, 2s. complete. Convincing Testimony, 2½d. stamp. Mailed privately.

L. MALCOLM ROSS, Height Specialist, Scarborough, England. (P.O. Box 15)

No Appliances  
No Drugs  
No Dieting

ROSS SYSTEM  
NEVER FAILS

## WIRELESS FOR THE MAN-IN-THE-MOON

By COULOMBUS and DECIBEL 2/6 net (by post 2/10)

This book will be read with profit and enjoyment by every wireless enthusiast—beginner or expert.

From all Booksellers, or by post from

GEORGE NEWNES, LTD., 8-11 Southampton St., Strand, London, W.C.2

## "Are You Listening?"

### WHO'S WHO IN BROADCASTING

Edited by SYDNEY A. MOSELEY, is a book all listeners want. It tells you all about your favourite radio stars and other B.B.C. personalities.

Order from a Bookseller, or send P.O. for **3/10** to

**PITMAN, PARKER STREET, KINGSWAY, LONDON, W.C.2**

# Television

**T**ELEVISION means seeing at a distance by wireless. This is the new wonder coming hard on the heels of broadcasting. Another few years will find us seeing at home on a television screen what is happening thousands of miles away. We may be able to watch nightly events taking place in Australia, India, or South Africa. In a few years' time the whole of the Empire may be able not only to hear the King's Christmas Message but see His Majesty delivering it in his study.

The principles on which television works are not hard to understand. In broadcasting we have a microphone and a loudspeaker, apart from the transmitter and the receiving set. The microphone interprets sounds in terms of electrical impulses, while the loudspeaker interprets electrical impulses in terms of sounds.

Once we can interpret anything in terms of electrical impulses we can magnify these impulses, convey them to a transmitter, radiate wireless waves, and induce similar electrical impulses in the receiving aerial.

In the case of an image or a scene, we see that image or scene because rays of light are falling upon objects and are reflected. The reflected rays fall upon the retina of our eye and form an impression of a picture. An object does not reflect all the rays of light that fall upon it in the same way. The surface of an object varies from the point of view of its reflecting properties. For this reason, the image of an object is made up of light spots and shadows with a great number of variations in between these extremes.

## The Photo-Electric Cell

There is a piece of apparatus called the photo-electric cell which varies its resistance to the passage of electric current with the intensity of light falling upon it. If such a cell is kept in the dark it will not let any current go through. With a feeble light it will pass a feeble current. With a very strong light it will pass a very strong current. In this manner we can influence the current passing through a photo-electric cell by varying the intensity of light falling upon it. Thus, in the photo-electric cell we have the means of interpreting variations in light as varying electrical impulses.

Suppose we direct a light upon the face of a man standing in front of such a photo-electric cell. His face will reflect the light

falling upon it, the reflected light will fall upon the photo-electric cell and will produce a certain current through it. This does not help us much as yet. Now, suppose that instead of letting light fall upon the man's face as a whole we take a fine pencil of light and make it traverse rapidly up and down every portion of the face, starting, say, with the edge of the left ear at the top and move the pencil of light up and down, line by line, then we shall find that every portion of the face in turn will send a thin reflected ray upon the photo-electric cell and will cause in it a rapid series of varying-in-strength electrical impulses.

In this manner we can interpret each reflected beam of light falling from a small portion of the man's face upon the photo-electric cell as an electrical impulse, and each shade of light will have a corresponding impulse of its own just as every sound has a corresponding electrical impulse in the microphone. We can scan in this manner with the beam of light a face in as many lines as we like, provided we have the means of moving the beam rapidly and advance it in its up-and-down movement by a small fraction of an inch. This is what is meant by so many lines television system. At the moment the B.B.C. is using a 30-line service, while there are systems that will be shortly available with as many as 180 lines.

It means, therefore, that while the beam of light is exploring rapidly a man's face, the photo-electric cell on receiving a beam of light reflected with varying intensity from each tiny portion of the face will produce a rapid series of varying electrical impulses, each impulse following separately upon another impulse, so that there is a varying current flowing through the cell not unlike the microphone current flowing through the microphone. All we have to do now is to amplify these currents, superimpose their variations upon the carrier current in the transmitting aerial, send out the waves, and have similar currents induced in their correct sequence in the receiving aerial, to be dealt with in the usual way by the receiver.

In this case, of course, we cannot use the loudspeaker, as all we would hear is a series of funny noises. We want now instead of the loudspeaker a device which will interpret electrical currents in the form of light variations. This is very easy, as an ordinary electric lamp will do this for us. For a strong current it will give us a strong light, and for a weak current it will give us a feeble light. Only an ordinary electric lamp does not respond fast enough to such rapid variations and for this reason a special lamp is used—a lamp filled with neon gas and called a neon lamp. This lamp will respond rapidly to every variation and will issue a rapid series of beams varying in intensity of light. All we have to do now is to catch

---

**360** crippled children from all parts of the country are given every chance of becoming physically normal citizens.

**50** crippled boys in the College are being trained to enable them to earn a living.

This is the National work which is being carried on at Lord Mayor Treloar Cripples Hospital and College. The institution is dependent on voluntary support. No matter if you can afford only a little; remember the widow's mite, and the urgent need of the children.

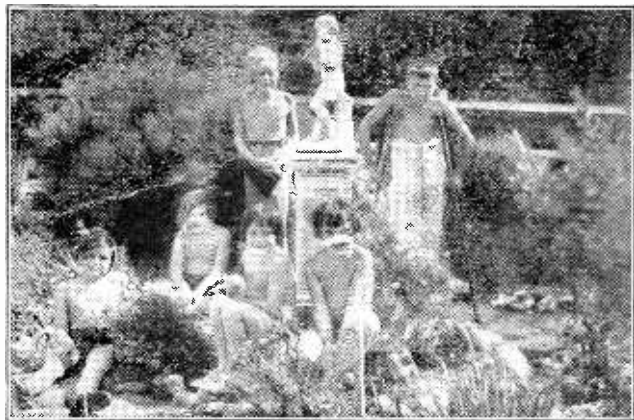

## **LORD MAYOR TRELOAR CRIPPLES HOSPITAL & COLLEGE**

**ALTON and HAYLING ISLAND**

### *TRUSTEES :*

The Rt. Hon. and Rt. Rev. The Lord Bishop of London,  
D.D., K.C.V.O.

Miss Florence Treloar.

The Rt. Hon. The Lord Mayor of London.

Col. The Hon. Frederick Lawson, D.S.O., M.C. (*Chairman*).

T. J. Harrowing, Esq., C.C. (*Treasurer*).

*Secretary* : H. B. Harper, J.P.

*Communications to* : 25 ELY PL., LONDON, E.C.1

---

# FREE TO THOSE WITH AMBITION

## VALUABLE BOOK ON CAREERS



### THIS BOOK FREE

The "Guide to Careers" is not a booklet, but a handsome volume of 132 pages, which includes and deals in a vividly interesting way with:

- (1) The phenomenal growth of the Secretarial and Accountancy professions—the prospects therein.
- (2) The examinations of the several professional Accountancy and Secretarial Societies, the Institute of Cost and Works Accountants, etc.
- (3) Professional Preliminary examinations, Matric., Bar, London University Degrees, etc.
- (4) How to enter for these examinations—subjects—fees—exemptions, etc.
- (5) The best method of study: specialised postal training, taken at home in spare time.
- (6) Practical (non-examination) Courses in all Secretarial, Accountancy, and Commercial Subjects.
- (7) The work of the College—figures showing how its examination successes regularly outnumber those of all other training centres combined.

Also up-to-date  
**CIVIL SERVICE**  
Guide 32pp. Send pc

THOUSANDS of young business men are to-day firmly established in the receipt of big salaries, as a direct result of training received under the expert guidance of the Metropolitan College, St. Albans.

They first realised the urgent need for proficiency in their chosen branch of Commerce, and then were wise enough to discover in the College "Guide to Careers" the one way whereby they could most easily and thoroughly acquire it.

What they have done

YOU also can do.

Specialised Postal Training in Secretarialship, Accountancy, Law and Commerce, taken at home in spare time. Do not delay your own success! Procure now YOUR copy of the "Guide to Careers in Secretaryship, Accountancy, Law and Commerce."

Simply send coupon.

### COUPON — POST NOW!

Please send me—without charge or obligation—a copy of the College 132-page "GUIDE TO CAREERS."

NAME .....  
(In Capitals)

ADDRESS .....

Radio Year  
Book, 1935 .....

# METROPOLITAN COLLEGE

Dept. G15/4, ST. ALBANS

the beam on a screen and move it in precisely the same manner and as rapidly as we moved the scanning beam, and so reassemble the picture. In fact, we repeat the scanning movements at the receiving end in their proper sequence.

If the face is altering its expression or is moving, it does not matter, as in this case the scanning beam is moving fast enough to give us a rapid series of separate pictures of the face, just as in a cinematograph, and owing to the persistence of human vision we shall see a continuous picture of a moving face.

### Methods of Scanning

There are several methods of scanning, but there are three principal methods. In scanning, the problem is to cause a beam of light to travel rapidly up and down, moving a small fraction of an inch forward at a time so that not a portion of the object remains unexplored by the beam.

The British inventor, J. L. Baird, achieved this with the help of a rotating disc carrying spirally placed holes with lenses in them so that when the disc is placed between the source of strong light and the object to be scanned, a beam of light is focused by the lenses on the object. The holes are so placed that when the disc rotates at a certain speed a beam of light moves up and down and gradually advances from one side to the other of the object. At the receiving end a similar disc, run at the same speed, has to be placed between the neon lamp issuing the light and the screen, and the rapidly moving beam reassembles the picture in its correct portions.

Another method of scanning consists of running a drum with a number of mirrors fixed to it so that they cause the reflected beam to move up and down and advance. But such mechanical systems do not facilitate the production of a large number of scanning lines, and this is the reason why the present television system is limited to so few lines and has such an indifferent definition.

There are, however, other methods much faster and more pliable, of which the most successful appears to be the so-called cathode ray oscillograph method. The oscillograph is an evacuated glass tube of a peculiar shape with a large flat end that looks like the top of a large flat mushroom. The tube contains a filament similar to that of a valve, which is heated and emits electrons. The flat end contains a fluorescent screen upon which the electrons are made to fall in the form of a fine beam. Where the beam strikes the screen we get a glowing point. By varying the intensity of the electron beam we can vary the intensity of the glow. Now, such an electron beam can be controlled and deflected with the help of a mag-

netic field. It can be made to travel rapidly in two dimensions, so that it will describe all sorts of figures on the screen with great rapidity.

By using suitable currents in the magnetising coils we can make the electron beam move in the same way as in the case of disc-scanning, only much faster. At the transmitting end it is possible to provide the screen inside the tube with a mosaic of tiny photo-electric cells upon which the image we wish to transmit is thrown. The cathode ray (the electron beam) is then made to scan rapidly this image, and under the influence of the electron ray each tiny cell will emit a current of its own in rapid sequence as soon as the beam strikes it. The stronger illuminated portions of the image thrown upon the mosaic will produce stronger currents from the photo-electric cells lying within these strongly illuminated portions, while the cells lying in the shaded portions will issue weaker current, so that once more we have a rapid sequence of currents corresponding to every shade of illumination.

At the receiving end the electron beam is made to move in exactly the same manner in which it was moving at the transmitting end, and the end of the electron beam falling upon the fluorescent screen will reproduce the same picture as we had at the other end. In this case the electrical impulses are applied directly to the electron beam, now strengthening, now weakening it so that the fluorescence of each point of the screen varies with the intensity of the electron beam and thus the lights and shades of the picture are correctly reproduced.

A tremendous amount of work is going on at the moment in the field of television, and there is a race between a number of commercial houses for supremacy, but the final method of television is not yet settled by the authorities. At the moment of writing a special Commission is sitting for the purpose of determining the best system and the best method of transmission.

It is obvious that in case of television you will want two aerials, one for broadcasting and one for television, if pictures and sound are to be reproduced simultaneously. The pictures alone can be received by adding a television instrument to the existing installation.

If you are interested in the subject you should watch the new developments which are regularly reported in *Practical Television* from month to month.



THE HALL-MARK OF  
INSURANCE SECURITY



*For Prospectus and full particulars  
apply to :—*

**The LONDON & LANCASHIRE INS. CO. LTD.**

7 Chancery Lane, London

Choose your  
programmes  
in advance  
from  
The Radio  
Times

The Official Journal of the British Broadcasting  
Corporation. Every Friday, everywhere, price 2d.