

THE MARCONI REVIEW

October-December, 1938



CONTENTS

THE IMPEDANCE OF A TAPPED RESONANT CIRCUIT	-	PAGE	1
ERRORS IN RADIOGONIOMETERS	- - - -	„	9
AN ORIENTATING PROTRACTOR FOR AERIAL SURVEY PHOTOGRAPHY WITH THE D.F. AUTO PILOT	-	„	16
GRID BIAS FOR CRYSTAL OSCILLATORS	- - -	„	20
HIGH FREQUENCY CONCENTRIC CONDUCTORS	- -	„	22
WIRELESS SERVICES FOR THE NORTH ATLANTIC AIR ROUTES	- - - - -	„	24
PATENT ABSTRACTS	- - - - -	„	35

MARCONI'S WIRELESS TELEGRAPH COMPANY LTD.

Electra House, Victoria Embankment, London, W.C. 2



THE MARCONI REVIEW

No. 71.

October-December, 1938.

Editor: H. M. DOWSETT, M.I.E.E., F.Inst.P.

Assistant Editor: L. E. Q. WALKER, A.R.C.S.

The copyright of all articles appearing in this issue is strictly reserved by Marconi's Wireless Telegraph Company Ltd.

THE IMPEDANCE OF A TAPPED RESONANT CIRCUIT

An expression $\omega^2 \frac{(L_1 + M)^2}{R_T}$ is obtained for the resonant impedance of a tapped parallel tuned circuit, where L_1 is the inductance of the tapped section of the coil, M is the mutual inductance between the two sections, and R_T is the total R.F. resistance of the coil. The overall amplification of an amplifier containing such a tuned circuit in its anode is shown to be $\frac{E_o}{E_g} = g_m \frac{\omega^2(L_1 + M)L_T}{R_T}$ where L_T is the total inductance of the coil.

Confirmation of these expressions is obtained by experiment, but owing to the high impedance of the particular tuned circuit chosen, the expression for the overall amplification requires correction to $\frac{E_o}{E_g} = g_m \frac{R_a}{R_a + \frac{\omega^2(L_1 + M)^2}{R_T}} \cdot \frac{\omega^2(L_1 + M)L_T}{R_T}$.

Introduction.

DURING investigations of the forms of coupling between R.F. amplifier valves an examination of the performance of the tapped parallel tuned circuit produced some interesting results, which, as far as the author is aware, were not previously known.

The problem resolved itself into two parts, that of finding an expression (1) for the impedance at each tapping point, and (2) for the gain of the stage, i.e., the ratio of the output voltage across the whole of the tuned circuit to the input voltage to the grid of the R.F. amplifier valve. The theory and confirmatory experimental results, which follow, are therefore subdivided under these two headings.

Theory.

(1) The resonant impedance between two tapping points of a parallel tuned circuit.

The impedance of the tapped tuned circuit in Fig. 1A is given by the ratio $\frac{E}{I}$, where E is the voltage applied across the tapped portion BC, and I is the current flowing into it. The equivalent circuit is that of Fig. 1B, where it is assumed that the capacitance has no resistance component, and that the total resistance component of the coil is proportionally divided between the two sections.

The Impedance of a Tapped Resonant Circuit.

The relationship between E and I may be derived from the following equations.

From section BC

$$\begin{aligned} E &= [I + I_1] [R_1 + j\omega L_1] + I_1 j\omega M \\ &= I [R_1 + j\omega L_1] + I_1 [R_1 + j\omega (L_1 - M)] \quad \dots \quad \dots \quad (1) \end{aligned}$$

From the complete circuit

$$E + I_1 \left[R_2 + j\omega L_2 + \frac{I}{j\omega C} \right] + [I - I_1] j\omega M = 0 \quad \dots \quad \dots \quad (2A)$$

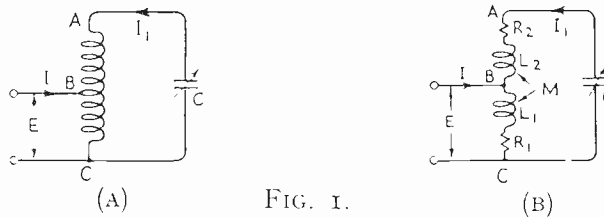

FIG. 1.

thus

$$\begin{aligned} -E &= I_1 \left[R_2 + j\omega (L_2 + M) + \frac{I}{j\omega C} \right] - I j\omega M \\ &= I_1 \left[R_2 + j\omega (L_2 + M + L_1 + M) + \frac{I}{j\omega C} \right] - I_1 j\omega (L_1 + M) + I j\omega M \end{aligned}$$

but $j\omega (L_1 + L_2 + 2M) = j\omega L_T$.

And at resonance

$$\left[j\omega L_T + \frac{I}{j\omega C} \right] = 0.$$

$$\therefore -E = I_1 [R_2 - j\omega (L_1 + M)] - I j\omega M \quad \dots \quad \dots \quad (2B)$$

$$I_1 = \frac{-[E + I j\omega M]}{R_2 - j\omega (L_1 + M)} \quad \dots \quad \dots \quad (3)$$

Replacing I_1 in (1) by expression (3) we get

$$\begin{aligned} E &= I [R_1 + j\omega L_1] - \frac{[E + I j\omega M] [R_1 + j\omega (L_1 + M)]}{R_2 - j\omega (L_1 + M)} \\ &= I [R_2 - j\omega (L_1 + M) + R_1 + j\omega (L_1 + M)] \\ &= I [R_1 + j\omega L_1] [R_2 - j\omega (L_1 + M)] - I j\omega M [R_1 + j\omega (L_1 + M)] \\ E [R_1 + R_2] &= I \left[R_2 [R_1 + j\omega L_1] + \omega^2 (L_1 + M)^2 - R_1 [j\omega (L_1 + 2M)] \right] \\ &= I \left[[R_2 + R_1] [R_1 + j\omega L_1] - [R_1 - j\omega (L_1 + M)]^2 \right] \end{aligned}$$

By noting that $R_1 + R_2 = R_T$ this simplifies to

$$E = I \left[R_T + j\omega L_T - \frac{[R_1 + j\omega (L_1 + M)]^2}{R_T} \right] \quad \dots \quad \dots \quad (4)$$

We can generally assume that

$$R_1 + j\omega L_1 \ll \frac{\omega^2 (L_1 + M)^2}{R_T}$$

The Impedance of a Tapped Resonant Circuit.

so that expression (4) simplifies to

$$E = I \frac{\omega^2(L_T \cdot M)}{R_T}$$

Hence

$$Z_{Bt} = \frac{E}{I} = \frac{\omega^2(L_T \cdot M)^2}{R_T} \dots \dots \dots (5)$$

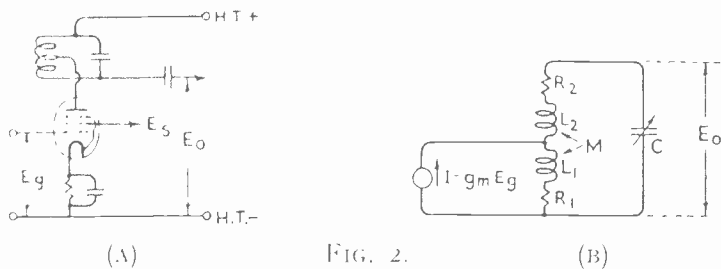

This expression for the impedance at resonance of a tapped tuned circuit is identical with the well known formula for the impedance of the whole circuit except that L_T is replaced by $(L_T \cdot M)$, where L_T is the inductance between the tapping points and M is the mutual inductance between the two parts of the coil.

(2) The overall amplification of an R.F. amplifier using a tapped tuned circuit.

The circuit is shown in Fig. 2A and its equivalent in Fig. 2B. The pentode valve is assumed to have an internal impedance much greater than the tuned circuit resonant impedance and is therefore replaced by a constant current generator represented by $I = g_m E_g$, where g_m is the mutual conductance of the valve and E_g is the input R.F. grid voltage. The output voltage E_o applied to the grid of the next valve is assumed to be that across the complete tuned circuit.

By combining equations (1) and (2B) so as to eliminate E we obtain the following expression

$$I [R_T + j\omega L_T] = I_1 [R_T + j\omega(L_T - M)] = \dots = I_2 [R_2 + j\omega(L_2 + M)] - I_2 j\omega M \dots \dots \dots (6)$$

but $E_o = \frac{I_1}{j\omega C}$
 $\therefore E_o = \frac{I_1 R_T + j\omega(L_T - M)^2}{R_T + j\omega C}$

At resonance

$$\omega L = \frac{1}{\omega C}$$

$$\therefore E_o = \frac{I [R_T + j\omega(L_T - M)] \frac{\omega L_T}{jR_T}}{R_T}$$

$$= \frac{I \omega^2(L_T \cdot M) L_T}{R_T} \dots \dots \dots (7)$$

if $R_T \ll \omega^2(L_T \cdot M) L_T$

The Impedance of a Tapped Resonant Circuit.

The negative sign in (7) is due to the assumption that the positive direction of I_1 is anticlockwise round the circuit.

Replacing I by $g_m E_g$ we get for the overall amplification

$$\frac{E_o}{E_g} = g_m \frac{\omega^2 (L_1 + M) L_T}{R_T}$$

There is therefore a reduction in amplification by connecting a part only of the coil of a tuned circuit in the anode circuit of an ideal pentode. The interesting feature again is that the equivalent impedance is identical with that of the whole tuned circuit except for the replacement of L_1^2 by $(L_1 + M) L_T$.

Experimental Verification.

An unshielded coil having six tapping points was used to check the theoretical investigation. Measurements of the total inductance and the inductance between the ends and each tapping point of the coil were made on the Marconi-Ekco Impedance Bridge (1,000 c.p.s.). The mutual inductance between each section was calculated from the formula

$$L_T = L_1 + L_2 + 2M$$

The coil, tuned by a capacitance of $.000205 \mu F$ was placed in the anode circuit of a Marconi VMP₄G valve as shown by the circuit diagram in Fig. 3.

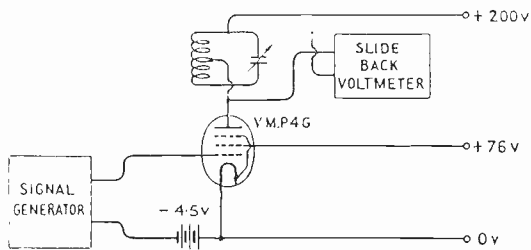

FIG. 3.

A slide back or peak voltmeter, previously calibrated, measured the output voltage. This type of voltmeter was chosen because of its high input impedance. The earth point on the voltmeter was connected to the HT positive and the grid to the anode of the pentode or across the complete coil.

The bias on the VMP₄G valve was adjusted to -4.5 volts for a screen voltage of 76 volts. It was hoped that at these values the impedance of the valve would be high enough to justify the assumption that the valve internal resistance R_a was much greater than the external impedance Z_{BC} .

The grid voltage applied to the pentode was obtained from a Marconi-Ekco Signal Generator and in all the tests a constant peak output voltage of 1.414 volts (i.e., 1 volt R.M.S.) was maintained by varying the input voltage. The peak voltmeter measurements were converted to R.M.S. values since the signal generator was calibrated in R.M.S. values. Results were obtained for constant voltage (1) between anode of the pentode and H.T. positive and (2) across the complete coil. The resonant frequency increased slightly as the tapped portion of the coil was decreased owing to the stray capacitance in the anode lead to the pentode and grid lead to the peak voltmeter. Allowance was made for this in the calculation of the equivalent impedance.

The mutual conductance of the pentode was determined by noting the change in anode current produced by a change in grid voltage from -4.6 to -4.4 volts. A back balanced microammeter was used to facilitate accurate measurements.

The Impedance of a Tapped Resonant Circuit.

The internal resistance of the valve was also measured by the back balanced microammeter, a change of 100 from 250 to 150 volts being made in the anode voltage.

The impedance of the complete tuned circuit was determined by the use of the Marconi-Ekco Circuit Magnification meter. The internal capacitance was set to minimum and the $.000205\mu\text{F}$ tuning capacitance placed in parallel with it. A

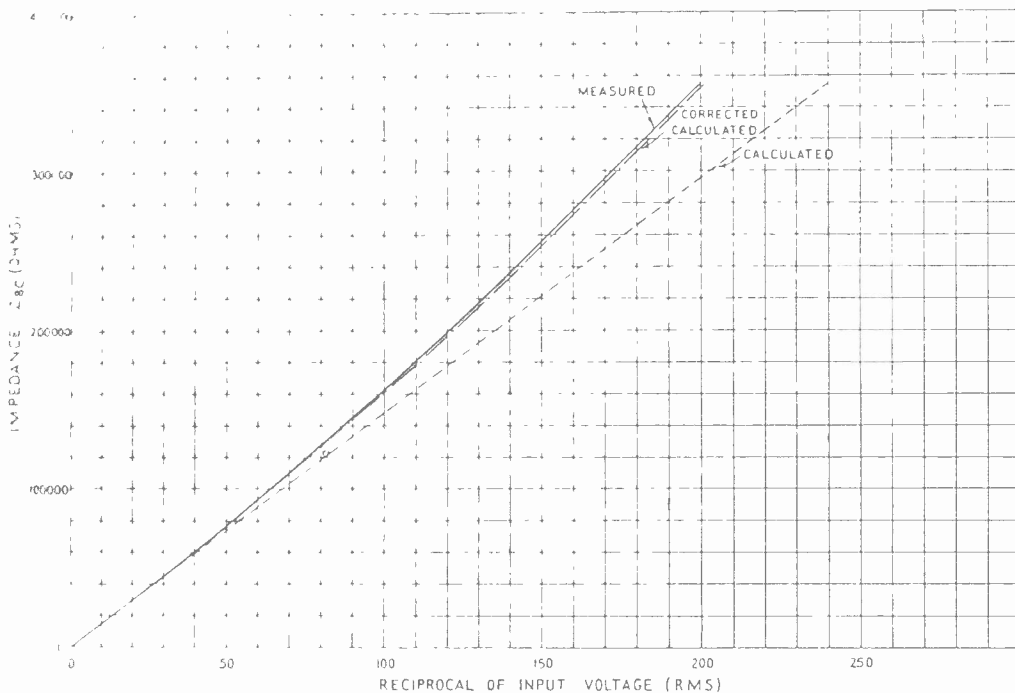

FIG. 4.

slightly lower frequency (384 kc.) was required to tune the circuit than that required when it was connected to the anode of the pentode. It was, however, assumed that the Q value so obtained would be unchanged at the higher resonant frequency.

Results.

(1) Inductance and mutual inductance between tapping points.

Tapping Point.	L_1	L_2	M	$L_1 + M$
0 to 6 (all coil) ..	690 μH	—	—	690 μH
0 to 5	539 ..	54 μH	53 μH	583 ..
0 to 4	385 ..	163 ..	71 ..	456 ..
0 to 3	245 ..	285 ..	80 ..	325 ..
0 to 2	170 ..	375 ..	72.5 ..	242.5 ..
0 to 1	90 ..	470 ..	65 ..	155 ..

The Impedance of a Tapped Resonant Circuit.

The total inductance (L_T) of the coil = 690 μ H.

(2A) Input voltage required to maintain a constant output voltage of 1 volt (R.M.S.) across the tapped portion of the coil.

Tapping Point.	Frequency.	Input Voltage (mV _{R.M.S.})
0 to 6	394 kc.	5 millivolts
0 to 5	399 "	6.55 "
0 to 4	403 "	10 "
0 to 3	407 "	18.5 "
0 to 2	409 "	32.2 "
0 to 1	410 "	78.3 "

(2B) Input voltage required to maintain a constant output voltage of 1 volt (R.M.S.) across the complete coil.

Tapping Point.	Frequency.	Input Voltage (mV _{R.M.S.})
0 to 6	394 kc.	5 millivolts
0 to 5	396 "	5.65 "
0 to 4	398 "	6.9 "
0 to 3	399 "	9.3 "
0 to 2	400 "	12.3 "
0 to 1	400 "	18.8 "

(3) Mutual conductance and anode resistance of the Marconi VMP4G.

$$g_m = 0.675 \text{ mA/volt}$$

$$R_a = 1.82 \text{ M } \Omega$$

(4) Q value and series resistance component of the coil.

$$\text{Measured } Q \text{ value} = 208$$

$$R_T = \frac{\omega L_T}{Q} = 8.2 \text{ ohms}$$

where $L_T = 690 \mu\text{H}$

$$f = 394 \text{ kc.}$$

The impedance of the tapped tuned circuit was calculated from $\frac{\omega^2(L_1+M)^2}{R_T}$ using table (1) and (2A), and it is plotted against the reciprocal of the input voltage in the full line curve of Fig. 4. The dotted line curve on the same figure is the impedance reciprocal input voltage curve obtained by calculating the reciprocal input voltage from:

$$E_{Bc} = g_m E_g \frac{\omega^2(L_1+M)L_T}{R_T}$$

The Impedance of a Tapped Resonant Circuit.

$$(8) \quad \frac{I}{E_g} = \frac{g_m}{E_{BC}} \cdot \frac{\omega^2(L_1 + M)L_T}{R_T} \dots \dots \dots$$

The two curves, which should be identical, diverged as the tapped portion of the coil was increased, and a higher input voltage was required for the measured curve. This suggested that the assumption $R_a \gg Z_{BC}$ was incorrect and the valve anode resistance was therefore measured. Where this assumption is not justified g_m in expression (8) must be replaced by $g_m \cdot \frac{R_a}{R_a + Z_{BC}}$. The dashed line curve in

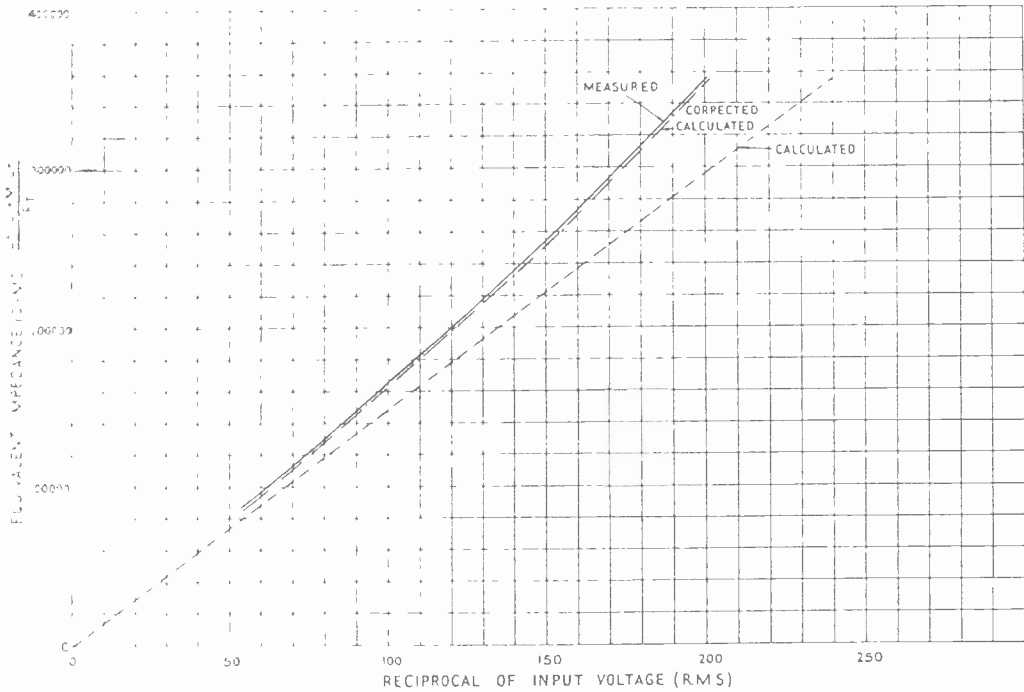

FIG. 5.

Fig. 4 is the calculated curve using this correction and it may be noted that there is very good agreement between it and the measured curve thus confirming the impedance of the tapped parallel tuned circuit as given by $\frac{\omega^2(L_1 + M)L_T}{R_T}$.

The equivalent impedance for experiment 2B $\left(\frac{\omega^2(L_1 + M)L_T}{R_T} \right)$ was calculated from tables (1) and (2B), and it is plotted in Fig. 5 against the reciprocal of the input voltage as the full line curve.

The calculated curve obtained from

$$(9) \quad \frac{I}{E_g} = \frac{g_m}{R_T E_{BC}} \omega^2(L_1 + M)L_T \dots \dots \dots$$

is the dotted line in Fig. 5. The same discrepancy exists as for the previous test.

The Impedance of a Tapped Resonant Circuit.

The corrected calculated curve obtained by replacing g_m in (9) by $g_m \frac{R_a}{R_a + Z_{BC}}$, however, shows good agreement with the measured curve.

Conclusion.

The experimental results confirm the theoretical investigation and show that the resonant impedance of a tapped tuned circuit is given by $\frac{\omega^2(L_1+M)}{R_T}$ and that the overall amplification of an R.F. stage from the grid to the whole tuned circuit is

$$\frac{E_o}{E_g} = g_m \frac{R_a}{R_a + \frac{\omega^2(L_1+M)^2}{R_T}} \cdot \frac{\omega^2(L_1+M)L_T}{R_T}$$

This formula is applicable to triode and multigrid types of valve.

It is of interest to note the effect of using a transformer instead of the tapped circuit. The impedance across the primary of the transformer becomes $R_1 + j\omega L_1 + \frac{\omega^2 M^2}{R_T}$ and the overall amplification is given by

$$\frac{E_o}{E_g} = g_m \cdot \frac{\omega^2 M \cdot L_T}{R_T}$$

Where R_1 and L_1 are the resistance and inductance of the primary coil, M is the mutual inductance between primary and secondary and R_T and L_T are the resistance and inductance of the tuned secondary coil.

K. R. STURLEY.

ERRORS IN RADIOGONIOMETERS

In the early stages of the development of the Bellini Tosi Radiogoniometer, it was found necessary, in order to obtain adequate sensitivity, to tune the two aeri-als of the direction finder and the search coil circuit.

The critical coupling never exceeded a few per cent., owing to the low damping of the aerial circuit. Consequently the search coil only explored the centre of the resultant field produced by the currents flowing in the field coils of the radiogoniometer.

At a later date the so called aperiodic tight coupled radiogoniometer was adopted, and this design improvement greatly simplified the operation of the modern Bellini Tosi direction finder. The need for tuning and phase adjustment in each aerial circuit was eliminated, but in general larger instrumental errors were experienced.

This increase in the maximum error was largely due to the close proximity of the field and search coil windings.

The present note describes a few of the most common errors which are encountered in practice, and indicates methods for measuring their magnitude.

The work has particular application to the carrying out of instrumental accuracy checks at frequencies up to 20 megacycles, but the methods are not restricted only to high frequency measurements.

Greater accuracy is obtainable than by most of the earlier medium frequency methods, especially in the 1.5 to 20 megacycle bands.

Classification of Errors.

IN well designed and constructed radiogoniometers it is usual to expect that the maximum error does not exceed one degree. In special applications considerably greater errors can be tolerated, provided due corrections can be applied, but experience has shown that in general an all-in accuracy of plus or minus one degree will meet most shore D.F. requirements.

Broadly speaking the radiogoniometer is subject to three main sources of instrumental error, namely:—

- (1) Octantal non-uniform coupling error.
- (2) Quadrantal non-uniform coupling error.
- (3) Mechanical inaccuracies causing errors.

Each instrument possessing a peak error of plus or minus one degree will usually possess components coming under one or more of the above generalised headings.

The octantal form of error curve is largely due to the fact that the search coil not only explores the resultant field produced by the two field coils, but also the self fields of individual conductors comprising the two sets of field coils.

Suitable spacings can be designed so that the magnitude of this error is well within the desired margins. In short wave designs unlimited scope does not present itself, and as a rule the octantal error is greater in such cases.

The quadrantal error should not be present as a first order correction in a radiogoniometer. When present it will usually be due to one or more factors such as unequal maximum coupling between search coil and field coils. This may be

due to winding errors, unequal shielding case paths, poor mechanical construction and assembly, or a combination of all three factors. This type of error is usually reduced to a negligible magnitude by making all paths in the field coil system precisely similar, both electrical and mechanical.

The third general form of error is that produced by purely mechanical imperfections in design, assembly or construction. In some cases the combination of mechanical errors may induce a resultant quadrantal error curve, but it is more usual that eccentric scales, spindles or search coil assemblies will produce semi-circular errors possessing quite random minimum and maximum values.

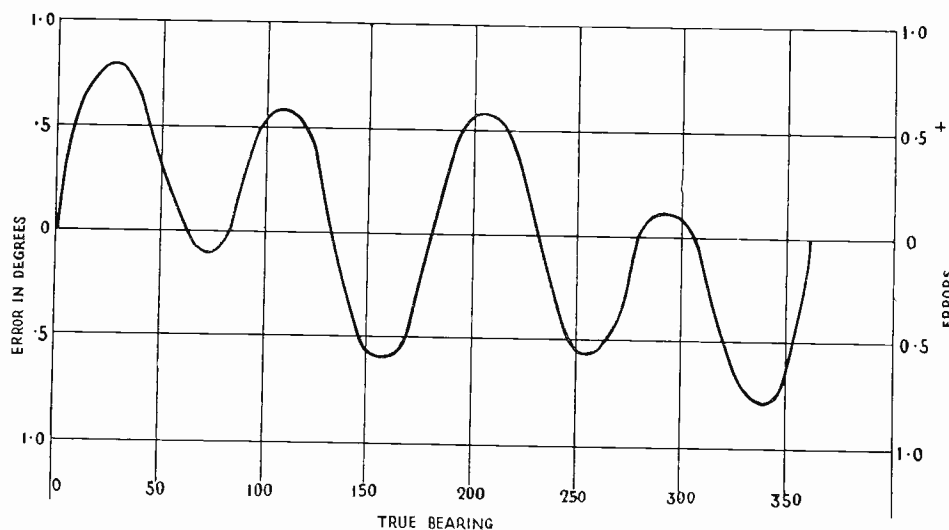

FIG. 1.

The elimination of random mechanical errors should be aimed at by workshop processes and simple mechanical tests, although final measurements of such errors is usually made by electrical means.

The above brief survey is only intended to indicate the main sources of instrumental errors met with in the modern radiogoniometer. Considerable extensions to the three main types of error are actually necessary if a full understanding of the problem is to be obtained.

In Fig. 1 a typical type of overall error curve is plotted relating to a medium frequency Marconi-Adcock instrument. Such curves are measured during normal production testing at the factory and are taken by reference to a standard radiogoniometer operating at signal frequency. This error curve when analysed resolves itself into the following component errors:—

- (1) Octantal coupling error + 0.5 degrees at 22.5 degrees.
- (2) Quadrantal error + 0.25 degrees at 45 degrees.
- (3) Mechanical error (semi-circular) + 0.25 degrees at 90 degrees.

It should be observed that minor errors due to (2) and (3) seriously impair the shape of an otherwise very satisfactory octantal error curve.

Existing Instrumental Accuracy Checking Methods.

The present note largely concerns itself with instrumental laboratory test methods, but it is fully realised that field final tests of the completed installation are essential. Careful factory tests will always reflect themselves in obtaining a satisfactory field performance from an instrumental standpoint. The generally established methods for measuring radiogoniometer error curves are as follows:—

- (A) Measurement of mutual inductance between field coil and search coil at various angular positions of the latter, and constructing a mutual inductance deviation curve. By applying corrections so obtained to the reference goniometer, it is then possible to make a back-to-back check in the manner originally suggested by Mr. G. M. Wright. A sub-standard instrument can be obtained by these means which can be used for checking commercial products. Barfield has also suggested using carefully calibrated attenuators in place of a calibrating mutual inductance for obtaining a pair of mutual inductance curves for a radiogoniometer under test.

The drawback to the above mentioned methods of ascertaining the inherent accuracy of a radiogoniometer is the difficulty of applying them at very high frequencies.

- (B) By the use of a standard radiogoniometer with a very small search coil whose mutual law with angular position is substantially sinusoidal. The design and theory of such a sub-standard very closely resembles that of the Tangent galvanometer; in both cases the exploring device operates in a uniform magnetic field. This method is the simplest and can be relied upon at frequencies of 20 kc. to 20 megacycles, if appropriate steps are taken to eliminate the various stray effects.
- (C) The rotating search coil method whereby the radiogoniometer under test is made to operate as an alternator and the amplitudes of the various harmonics are measured. This method is difficult to apply at high frequencies and has not general application to all cases.
- (D) Field tests whereby the complete station, including aeri-als, are rotated, and bearings taken upon a fixed transmitting source. By discounting site and aerial errors a final overall error curve of the radiogoniometer can be deduced. This method is rather slow and although it has frequently been used, it does not fall within the laboratory test category.

Voltage Ratio Method of Accuracy Checking.

This new method has been successfully applied at frequencies up to 20 megacycles. It consists in applying precisely known and variable voltages to the two field coils of the radiogoniometer, noting the point of zero signals when the search coil is rotated, and comparing the angular position so obtained with that calculated from the voltage ratios.

The method devised by the authors is an extension of Barfield's attenuator scheme, but it does not rely upon measuring the mutual law, is applicable to high

frequencies, and errors due to amplifier gain variations cannot arise, owing to the fact that it is essentially a vector difference method.

A circuit schematic of the device is shown in Fig. 2, and a sketch of constructional details is shown in Fig. 3. A source of well shielded oscillations is connected across a series of resistances (of the order of one ohm each) R_1 , R_2 , R_3 , and the field coils of the radiogoniometer under test N.S. E.W. are connected across appropriate points of the resistance network.

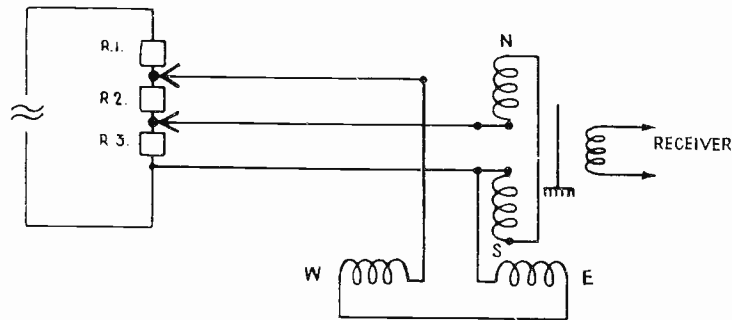

FIG. 2.

Great care with shielding and the precise measurement of resistance values must be taken, also the input impedance of the radiogoniometer must be such that the potentials across R_1 , R_2 and R_3 are not disturbed by the presence of the radiogoniometer.

Accuracy checks upon the resistances have been described by Mr. F. M. Wright in MARCONI REVIEW No. 61, page 30.

SKETCH SHOWING CONSTRUCTION OF CALIBRATING POTENTIOMETER.

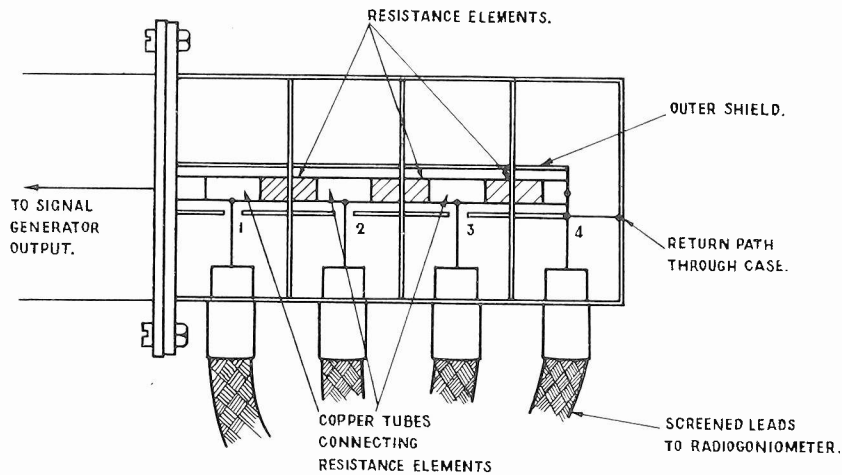

FIG. 3.

The resistance elements consist of concentric shielded graphite resistances and copper tubes, with each element surrounded by a separate shielding compartment,

Errors in Radiogoniometers.

as shown in Fig. 3. Fig. 4 shows the resistance-reactance corrections as a function of frequency for the complete assembly illustrated in Fig. 3.

By applying the corrections of Fig. 4 to the measured direct current ratios of R_1 , R_2 and R_3 , it is possible to construct an error curve for a radiogoniometer either of the low error sub-standard type or of a tight coupled commercial model.

A typical series of voltage ratios showing calculated angular positions from 0° to 90° with corresponding radiogoniometer bearing and error is shown in Table I below and relates to a sub-standard short wave Marconi Adcock direction finder.

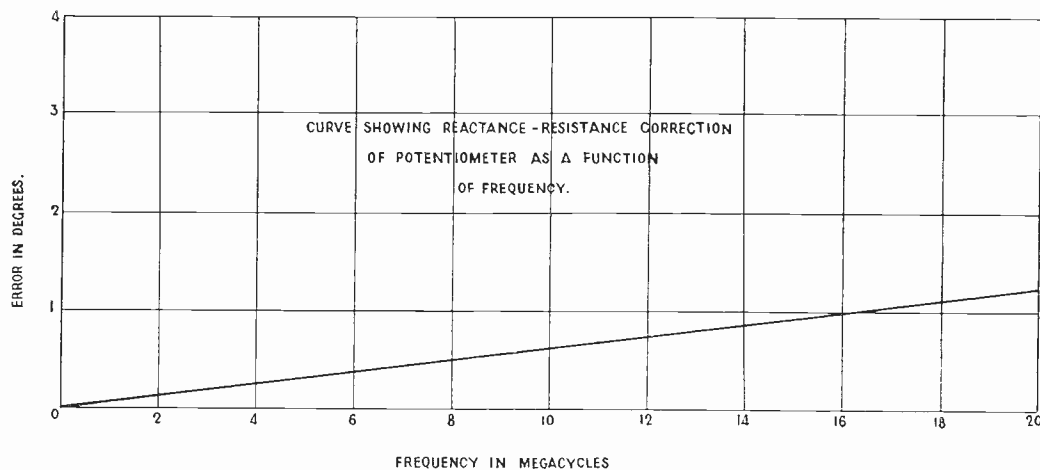

FIG. 4.

The numbers 1, 2, 3 and 4 refer to the tapping points on the potentiometer, as shown on Fig. 3.

Arrangement of Connections.		Calculated Angle.	Measured Angle.	Error.
1.	Zero set by connecting N.S. across 1 & 4	0°	0°	0°
2.	N.S. across 1 : 4 E.W. across 3 : 4	19.5°	18.8°	-0.7°
3.	N.S. „ 2 : 4 E.W. „ 3 : 4	27.7°	27°	-0.7°
4.	N.S. „ 1 : 4 E.W. „ 2 : 4	34°	33.6°	-0.4°
5.	N.S. „ 1 : 4 E.W. „ 1 : 4	45°	45°	0°
6.	N.S. „ 2 : 4 E.W. „ 1 : 4	56°	56.4°	$+0.4^\circ$
7.	N.S. „ 3 : 4 E.W. „ 2 : 4	62.3°	63°	$+0.7^\circ$
8.	N.S. „ 3 : 4 E.W. „ 1 : 4	70.5°	71.5°	$+1.0^\circ$
9.	E.W. „ 1 : 4	90°	90.6°	$+0.6^\circ$

In Fig. 5 is shown a typical series of error curves relating to a standard short wave back-to-back checking radiogoniometer, a defective design of short wave radiogoniometer and a typical commercial short wave Marconi Adcock radiogoniometer.

Errors in Radiogoniometers.

The short wave sub-standard radiogoniometer curve was obtained by the voltage ratio method at 15×10^6 p.p.s., and the other curves plotted by the back to back method from the sub-standard radiogoniometer at the same frequency.

The accuracy so far attainable with the voltage ratio method is superior to the earlier methods, and with steady development should (at least at high frequencies) displace some of the earlier schemes.

The concentric tubular resistance technique seems to be essential to the success of the voltage ratio method at high frequencies, but the use of ordinary resistance elements may be successfully applied to long wave radiogoniometer measurements.

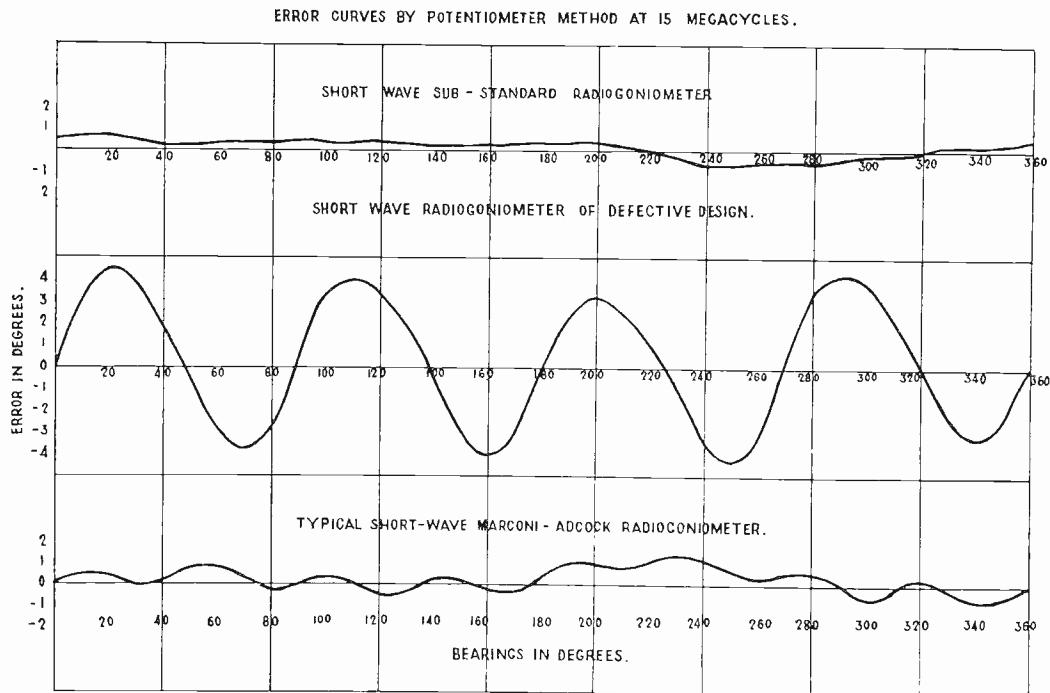

FIG. 5.

Overall Accuracy Checks of Aerials and Radiogoniometer.

The results obtained by the method outlined in the preceding section have been cross checked by an ingenious test suggested by T. L. Eckersley. The scheme consists in accurately erecting a small loop aerial at the centre of the receiving aerial system. This aerial is coupled to a small and symmetrical local oscillator mounted below it so that an efficient directional radiator is ensured.

Fig. 6 shows a sketch of the frame aerial radiator mounted in the centre of a short wave Adcock aerial system. The area of the loop is small compared with that of the receiving aerial, and the arrangement is free from octantal error due to wave spacing of the vertical aerials. It is also free from errors due to non-uniform coupling between the two aerial systems, providing the frame is mounted symmetrically at the centre.

This method represents a large scale back to back test and is useful as a cross check of the instrumental error of the radiogoniometer when connected to the aerials. It also serves to check errors produced by inequalities in aerials and feeders where standing waves occur in the aerial system.

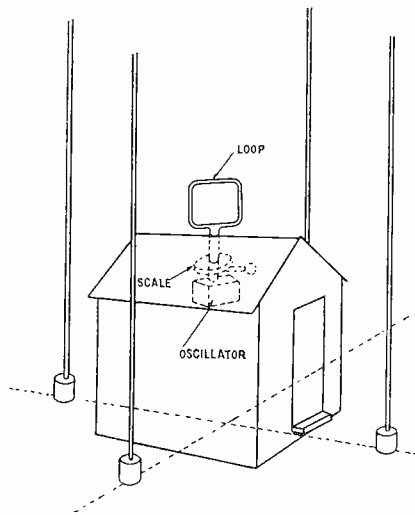

FIG. 6.

This, however, only holds good for certain modes of oscillation of the aerial system, and cannot be relied upon to show up all types of aerial inequalities.

At certain critical frequencies where standing waves occur, a totally different error curve may be produced by the rotating frame method from that obtained by a portable oscillator external to the aerial system and in visual range.

These differences are accounted for by the mode of excitation of the aerial system by the two methods.

It is interesting to note, however, that when an aerial system has been properly equalised, the overall error curve produced by either method very closely approximates to the instrumental error curve of the radiogoniometer as measured by the voltage ratio method previously described.

A careful study of the factors governing the calibration accuracy of a short wave D.F. site has made it clear that the laboratory methods of instrument testing are fully justified.

The work described in the preceding note has resulted in a higher standard of accuracy of the radiogoniometer. Several independent methods of measurement produce agreement to within a small part of a degree at frequencies up to 15 megacycles.

S. B. SMITH.
J. F. HATCH.

AN ORIENTATING PROTRACTOR FOR AERIAL SURVEY PHOTOGRAPHY WITH THE D.F. AUTO PILOT

In the article, describing the Wireless Pilot, published in MARCONI REVIEW NO. 68, a description is given of the use of an Orientator for obtaining the angle of flight when proceeding from a fixed starting point to any other point, using one Wireless Station as the controlling station.

Where the distance from the starting point to the Wireless Station varies a separate Orientator would be required for each starting point.

This condition obtains in the case of Aerial Photographic Survey and the following article deals with a solution of the problem.

THE object of this device is to simplify the calculations necessary for controlling the flight of an aircraft over lines of survey which are defined at each end by landmarks.

Normally the survey of an area would be undertaken by flights along parallel or quasi parallel tracks giving a photographic overlap and for economy adjoining tracks will be flown in alternate directions. The wireless controlled auto-pilot, such as the P.B. deviator, provides within its limits of performance for adherence to a course at any desired angle of flight to the direction of the signal arriving from the wireless radiator chosen for control.

Referring to Fig. 1A the area to be photographed is divided up into a number of parallel strips, of which A B is one. The landmarks being at A and B, we have to determine the angle of flight relative to the direction of the signal arriving from the wireless radiator, for the aeroplane when required to fly from A to B or vice versa. This has to be repeated for each individual strip.

The formula for the angle of flight is—

$$\log_e r/a = \theta_p \cot \phi$$

where ϕ = angle of flight

a = distance of A from Radiator Y

r = " " B " " Y

θ_p = angle in radians subtended by the strip A B at radiator Y.

Hence we require to determine—

the great circle distances of A and B from the radiator ;

and the great circle bearings at A and B of the radiator ;

before proceeding to solve the equation given above.

When 30 or more strips may be photographed in the course of a day's flying it will be realised that the calculations involve a large amount of work, but by the aid of the orientating protractor this work is very much simplified.

One form of the orientating protractor (Fig. 2A and B) is made of transparent material and consists of a protractor covering an angle of, say, 20 degrees subdivided to every $\frac{1}{2}$ degree.

Along the radii a scale is marked proportionally to the logarithm of the distance from the centre. This scale should be adjusted corresponding to that of the map used.

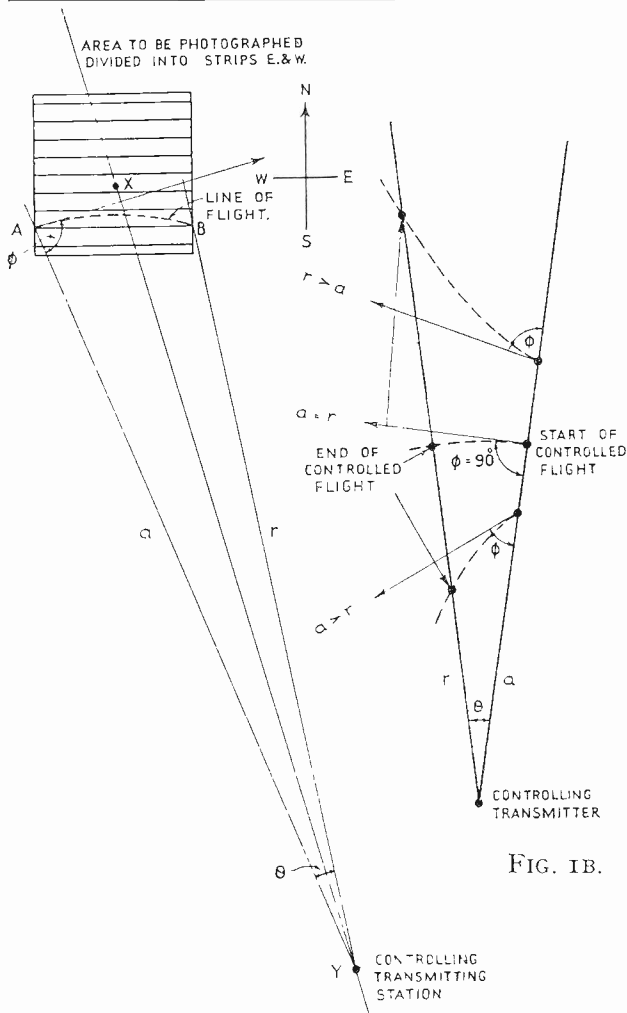

FIG. 1A.

FIG. 1B.

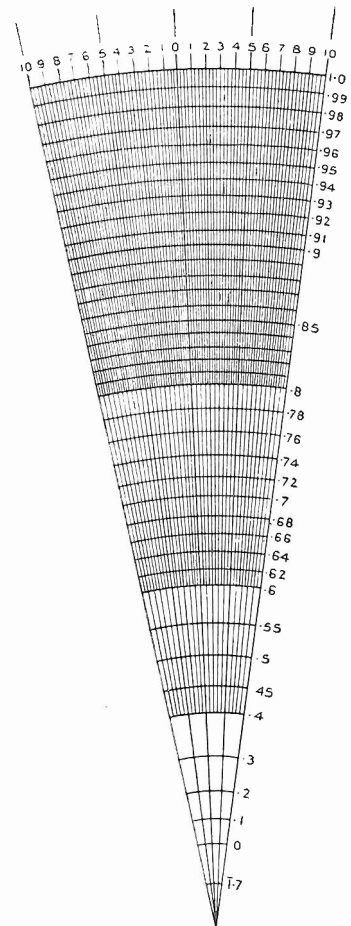

FIG. 2A.

The length of the protractor should be at least equal to the distance of the furthest point on the area to be photographed reduced to the scale of the map; alternatively, it may be made up in sections as required.

Method of Using the Orientating Protractor.

Select any point X (whose co-ordinates of latitude and longitude are known to within the nearest second) in or near the area to be photographed.

Calculate the great circle bearing and distance from this point to the controlling radiator Y.

Determine log (X Y) X scale of map.

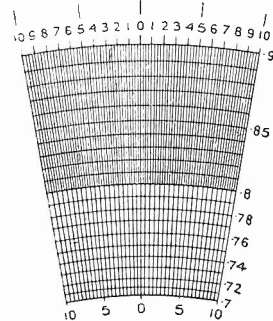

FIG. 2B.

Superimpose the protractor on the map so that the radius through X coincides with the great circle bearing of the radiator Y and the reading on the scale agrees with $\log (X Y) X$ scale of map.

Read off—

- (A) Angle θ degrees subtended by A B at Y.
- (B) The lengths A Y and B Y off scales on the radii by subtraction
A Y — B Y — $\log a/r$.

The tables supplied give values of $\log a/r$ or r/a , whether $a > r$ or $r > a$, for various values of θ and ϕ , from which ϕ can be found.

Fig. 1B shows the sense of the angle of flight ϕ according to whether a is greater than or less than r .

An extract from the set of tables, which are in course of preparation, is shown on page 19.

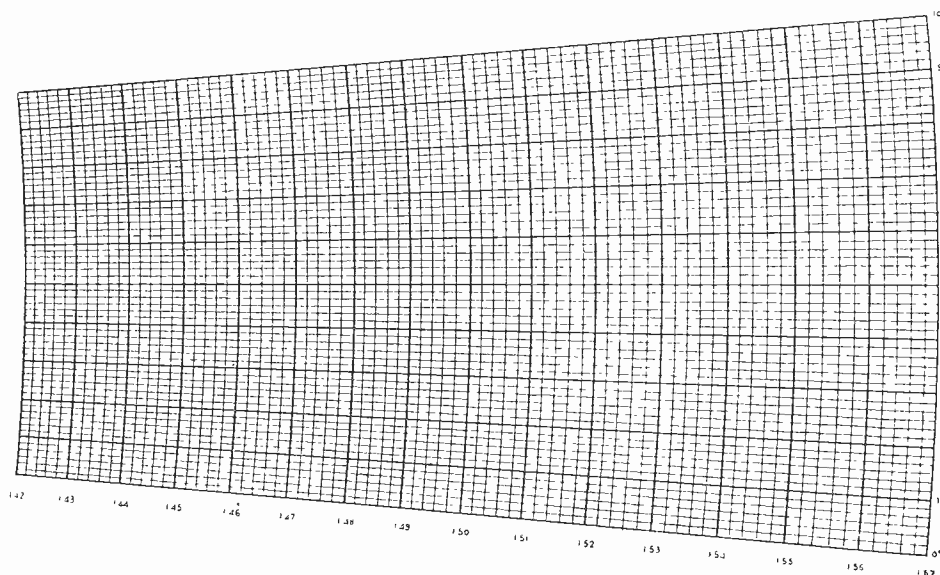

FIG. 3.

Example—

Mark off on Map points X

A and B

Great Circle Bearing of Radiator Y from X 170° E. of N.

“ “ Distance “ Y “ X 318 miles.

Scale of Map used 10 miles to 1 inch.

$\log 31.8 = 1.5024$.

Superimpose on Map Section of protractor as illustrated in Fig. 3, so that a radius coincides with the Great Circle bearing 170° E. of N. of X Y and the scale on the radius at point X = 1.502 read off from protractor.

$\log A Y = 1.505$ (Say)

$\log B Y = 1.495$ “

Angle A Y B = 2° “

$\log A Y - \log B Y = .01$.

LOGARITHMIC RATIO OF DISTANCES.

Angle of Flight	Subtended Angle.					
	1°	2°	3°	4°	5°	
31°01262	.02523	.03785	.05046	.06308
3201213	.02426	.03639	.04852	.06065
3301167	.02335	.03402	.04569	.05736
3401124	.02248	.03371	.04495	.05619
3501083	.02165	.03248	.04330	.05413
3601043	.02087	.03130	.04173	.05216
3701006	.02012	.03018	.04024	.05029
3800970	.01940	.02911	.03881	.04851
3900936	.01872	.02808	.03744	.04680
4000903	.01806	.02710	.03613	.04517
4100872	.01644	.02510	.03388	.04260
4200842	.01684	.02525	.03367	.04209
4300813	.01626	.02439	.03251	.04064
4400785	.01570	.02355	.03140	.03925
4500758	.01516	.02274	.03032	.03790
4600732	.01464	.02196	.02928	.03660
4700707	.01414	.02121	.02827	.03534
4800682	.01365	.02047	.02730	.03412
4900659	.01318	.01977	.02635	.03294
5000636	.01272	.01908	.02544	.03180
5100614	.01228	.01841	.02455	.03069
5200592	.01184	.01777	.02369	.02961
5300571	.01142	.01714	.02285	.02856
5400551	.01101	.01662	.02213	.02764
5500531	.01061	.01592	.02123	.02654
5600511	.01023	.01534	.02045	.02559
5700492	.00984	.01477	.01970	.02462
5800474	.00947	.01421	.01895	.02368
5900455	.00911	.01366	.01822	.02277
6000438	.00875	.01313	.01750	.02188

From the tables under Subtended Angle 2° we find logarithmic Ratio .01023 corresponds to Angle of Flight = 56° and .00984 corresponds to Angle of Flight = 57°.

As A Y is greater than B Y the Angle of Flight relative to the bearing of the transmitter is 56° 35'.

Should B Y be greater than A Y the Angle of Flight then becomes 123° 25'.

M. F. WILLIS.

GRID BIAS FOR CRYSTAL OSCILLATORS

In the following note one of the causes of difficult starting of crystal oscillators is explained, together with its remedy.

IT is not unusual to find that a crystal oscillator will fail to start, although it will maintain oscillation satisfactorily once it has been started by either a mechanical or an electrical impulse; this indicates that the damping on the crystal is greater for extremely small amplitudes of oscillation than for the normal working amplitude. The additional damping is frequently mechanical, particularly with small crystals; for example, it may be due to adhesion of the crystal to the electrode. But the phenomenon of difficult starting may still be present when mechanical damping is absent, if the circuit follows the customary practice of returning the grid leak to cathode or negative filament in indirectly—and directly—heated valves respectively. This was noticed particularly when working on a large ring oscillator, similar to that described by Essen, Proc. Phys. Soc. Vol. 50 (1938), Part 3, p. 413; being supported at nodal points by screws with small tips, the mechanical loss of this type of ring is practically restricted to air damping, so that any discontinuity between starting and operating conditions must be due to electrical causes.

The additional electrical damping at very small amplitudes arises from the characteristic of a grid rectifier, such as is formed by the grid leak of the oscillator valve in conjunction with stray capacities. Fig. 1 shows the grid-current characteristic of a typical indirectly-heated triode (Marconi-Osram MH4), together with the load-line OPQ corresponding to a 1-megohm grid leak. It will be seen that the static (or non-oscillating) operating point P is at about -0.7 volt, and the slope of the grid-current/grid-voltage characteristic at this point (indicated by the dotted line) corresponds to about 156,000 ohms. For a sufficiently small alternating voltage, say less than 0.01 volt peak, the grid-current characteristic can be considered approximately linear about this point; consequently there is little rectification, and the input resistance of the valve is the slope resistance of 156,000 ohms. This is the condition in the face of which oscillation would have to be built up from zero. Now suppose that a signal of the order of 1 volt or more is applied; it is obvious that there will be efficient rectification, and grid-bias voltage will be generated in the usual way, of magnitude nearly equal to the peak value of the input signal. From a consideration of the power dissipated in the grid leak by the rectified current, it can easily be shown that in such conditions the effective input resistance of the valve is approximately half the resistance of its grid leak, or in our example 500,000 ohms. (See, for example, L. B. Turner's book, "Wireless," Cambridge University Press, 1931, p. 160.) Thus the input resistance of the valve is some 3.2 times greater, and damping correspondingly less, for working amplitudes than for the commencement of oscillation.

The remedy for this defect is obviously to provide grid bias just sufficient to avoid grid current under non-oscillating conditions; this will normally require about 1 volt negative to the grid of an indirectly-heated valve, and possibly a little more for a directly-heated valve. A greater value than this is not usually desirable since it tends to reduce the mutual conductance of the valve and hence slightly reduces ease of starting; when grid bias is obtained by means of a cathode resistor,

therefore, the resistance should not have the value employed when the valve is used as an amplifier, but should be specially calculated for this purpose.

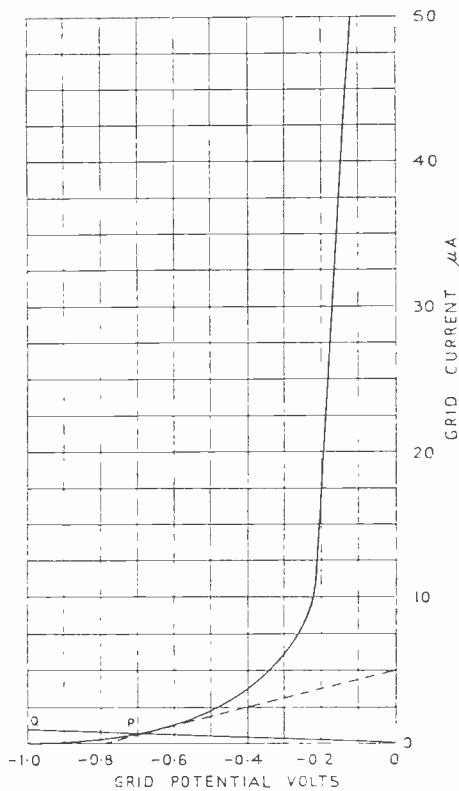

FIG. I.

It should be noted that whatever value of grid bias is employed, there will be a certain amount of grid current under working conditions. Since the shape of a valve characteristic is more or less parabolic, the effective slope (or average value over a cycle) increases with amplitude of oscillation in any valve oscillator of fixed grid bias, so that the amplitude is essentially unstable and tends to grow. It is usually checked by grid current (in the absence of saturation of the cathode emission), either due to the damping effect or due to the negative bias generated when a high resistance grid leak is employed. With normal crystal oscillators it is essential to use a fairly high value of resistance for the grid leak, and the negative bias generated then limits the amplitude of oscillation by reducing the effective mutual conductance of the valve to the value required for stable oscillation.

D. A. BELL.

HIGH FREQUENCY CONCENTRIC CONDUCTORS

The use of high frequency concentric feeders is increasing rapidly and methods relating to their construction are becoming of greater importance. In the following article a novel method of spacing concentric conductors is described which reduces losses and also permits of adjustments being made to the spacing between conductors.

The methods adopted form the subject of a Radio Corporation of America patent No. 13123 of March 11th, 1937.

IN concentric tube feeders it is essential to reduce solid dielectric spacing material between the tubes as far as possible in order to reduce dielectric loss. In addition it is desirable to obtain quite accurate spacing of conductors in the feeder and to be able to alter this spacing easily when the need arises.

The disclosures made in the specification under review have for their object the attainment of the above features. The concentric conductors are rigidly and accurately separated by means of easily adjustable spacing systems employing insulating point-contact rod-like spacing members.

A further object of the invention is to improve the circuit arrangement of concentric conductors in combination with spacing and supporting members.

The essential features of the method to be described are shown in Figs. 1, 2 and 3 applying respectively to a twin conductor the inner tube of which is supported by insulators fixed in the outer conductor; a twin conductor the inner tube of which carries insulators which space it from the outer conductor; and a triple concentric conductor in which both methods shown in Figs. 1 and 2 are used.

Fig. 1A shows a section of the outer conductor provided with three insulator holders, A, B and C. The insulating supports, D, E and F are held in hollow studs,

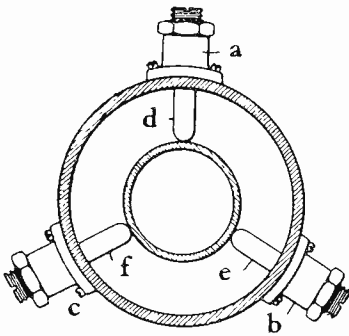

FIG. 1A.

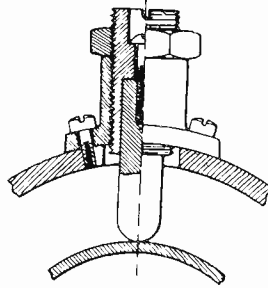

FIG. 1B.

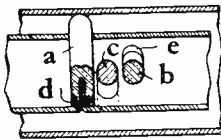

FIG. 2.

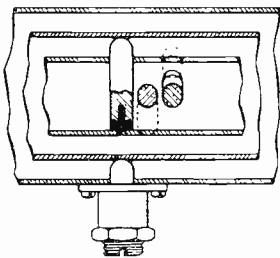
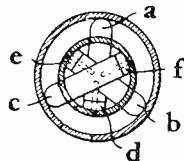

FIG. 3.

which are screwed into the holders, until they support the inner conductor in any desired position. The holders A, B and C may be equi-distantly spaced round the outer conductor and each set of three separated along the outer conductor by a space sufficient to give adequate support to the inner conductor.

Fig. 1B shows a more detailed representation of one of the insulator holders. A lock nut, as shown, can be provided when the conductor is placed in a location which is subject to vibration.

In Fig. 2 an alternative arrangement is shown wherein the inner conductor is provided with apertures located radially 120 degrees apart but not in line with one another longitudinally. Insulating rods A, B and C pass through each of these apertures and are held in place by screws through the opposite side of the conductor.

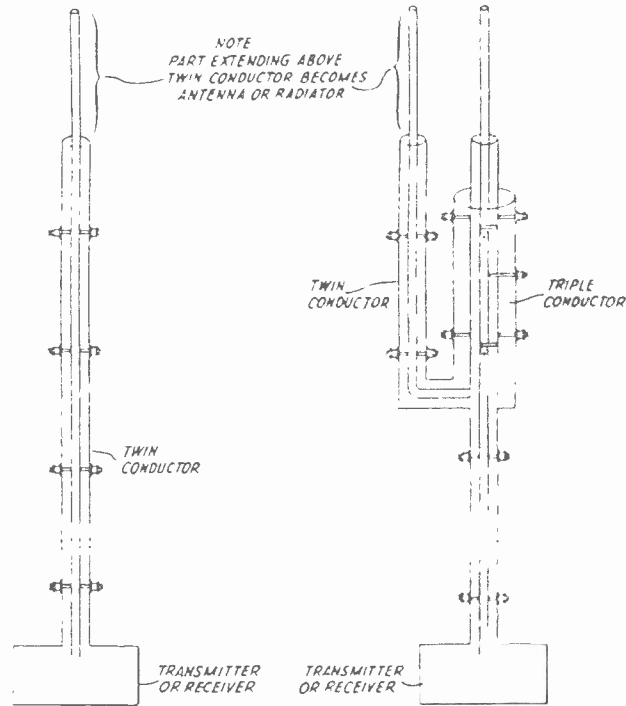

FIG. 4.

FIG. 5.

In order that adjustment may be provided spacers D, E and F are provided, the thickness of which can be altered as desired.

Fig. 3 shows a triple conductor wherein the innermost conductor is spaced from the middle one by means of the method shown in Fig. 2, and the middle one is spaced from the outer one by means of the method shown in Fig. 1.

Fig. 4 illustrates a simple circuit arrangement for coupling an aerial to a transmitter or a receiver using concentric conductors spaced by the method already discussed and Fig. 5 shows a circuit arrangement whereby a twin conductor is combined with a triple conductor for coupling an aerial to a transmitter or receiver.

It will be appreciated that although only two specific circuit arrangements are shown in the figures, many more uses can be found for applying these methods of spacing concentric conductors.

Thus for instance the system may be used in long lines for frequency control when concentric conductors are employed. They may also be used for push-pull coupling arrangements where a twin conductor changes to a triple line terminating in a junction box whence the line proceeds as two twin lines.

Other uses are for such arrangements as cross-coupling filters for television and other systems wherein two wavelengths have to be fed to a common aerial system; the above illustrations only being given as typically representative of many possible applications of the invention.

WIRELESS SERVICES FOR THE NORTH ATLANTIC AIR ROUTES

WITH PARTICULAR REFERENCE TO THE EIRE-NEWFOUNDLAND ROUTE

The provision of reliable and fully adequate wireless facilities for trans-oceanic air services is a relatively new requirement of aviation, in the execution of which a number of problems both theoretical and practical have had to be solved. In this article, the author has attempted to give a brief, but nevertheless comprehensive outline of the work that has been done in this respect, with particular reference to the North Atlantic Air Route.

FOR many years past the establishment of an air connection between the Old World and the New, affording regular, frequent and safe services for passengers, mail and express freight, has been an ideal which has been incapable of realisation. Pioneers such as Alcock and Brown, Col. Lindberg and Kingsford-Smith (to name only a few) have made successful crossings of the North Atlantic in one direction or the other, but many others have lost their lives in attempts to be the first to blaze the trail.

During this period, however, aircraft design has been steadily progressing—the aircraft themselves have become aerodynamically more efficient, aero engines have become very much more reliable as well as being more efficient, as has aircraft equipment for all purposes. Amongst aircraft equipment, the greatest advances of all have, perhaps, been made in radio; not only has the whole technique and art of radio been steadily advancing (in parallel, as it were with the advances made in aerodynamics), but the actual equipment itself has become more efficient, more reliable, and lighter in weight for a given performance than hitherto.

As a result of these dual advances in technique, the establishment of regular air services connecting the Old World with the New is now rapidly reaching the stage of realisation, the regular and trouble-free series of experimental flights which were carried out last summer by flying boats of Imperial Airways and Pan-American Airways bearing eloquent testimony to this fact. The types of aircraft which are at present available for such services, however—where non-stop flights of some 1,800 miles or so in still air, or of distances of the equivalent of perhaps 2,500 miles against prevailing head winds such as are often encountered on the east-to-west crossing of the North Atlantic, are essential—have little if nothing available in the way of pay load after having taken on board sufficient fuel to meet such contingencies as exceptionally strong and persistent head winds, or the necessity for making a detour so as to avoid, for example, an ice-forming area. New types are, however, on the stocks of improved design, which will be capable of carrying a limited—and eventually, doubtless, an economic—pay-load in addition to the necessary crew and fuel. Nevertheless, the climatic conditions experienced on the North Atlantic crossing—particularly in winter—such as fog, ice-forming conditions, etc., are such that the establishment of all-the-year-round services cannot take place until the hazards involved have been more fully assessed and the necessary safeguards made available.

The primary use to which any air route will be put lies in the regular, safe and frequent transport of a limited number of passengers at rates comparable with—

though usually somewhat in excess of—those obtaining in first class surface travel over the same itinerary ; furthermore, first class mail and express freight will also be transported by such a route. When these matters are considered in particular relation to the North Atlantic air route and bearing in mind political, geographical and other considerations, it will be seen that England (i.e. London) is the obvious eastern terminal for the route, while New York is even more obviously the western terminal, the route preferably passing via and serving Canada. Three possible main routes at once present themselves, namely, England-Eire-Newfoundland-Canada-U.S.A. ; England-Portugal-the Azores-Bermuda-U.S.A. ; and England-Faroe Islands-Iceland-Greenland-Canada-U.S.A. While experimental flights over the last named have been made on a number of occasions and a mass of useful data accumulated, and while a regular service is in operation over the Bermuda-New York sector of the second route, attention has perhaps been more particularly focussed on that route passing via Eire and Newfoundland, and for this reason it is felt that a concise description of the inception, and of the present and final stages, of the wireless organisation for this route may be of interest.

Before doing so, however, it is thought that a brief résumé of the wireless requirements to be met on such a service would not be amiss. In the case of the route in question a non-stop crossing of some 1,800 miles or so of open sea is involved ; obviously it is essential that the aircraft should be in continuous communication with either terminal or, preferably, with both during the crossing, as well as with any shipping within range of which it may pass. Equally obviously it is essential that the aircraft should, unless by specific intention, keep as closely as possible to the great circle track so as to make the shortest crossing and avoid unnecessary and possibly dangerously wasteful use of fuel. Navigation of the aircraft, apart from radio aids, will be effected by means of astronomical fixes (whenever weather conditions permit), by positions obtained relative to ships (the positions of which are themselves liable to error), and—perhaps mainly—by dead reckoning. Astronomical fixes will, in all probability, only be obtainable at relatively infrequent intervals, while positions obtained from ships, being dependent upon the presence of such ships in the vicinity, cannot be reckoned upon as a regular source of information. It is, therefore, of the greatest importance that radio aids to navigation be utilised to the full in order that the navigator may check up at frequent intervals on his course as indicated by dead reckoning methods. Furthermore, regular communication between the terminals themselves is of paramount importance, in order that either terminal may relay messages to the aircraft in the event of the other failing to get through and, in order to ensure the rapid transmission of messages concerning the safety and regularity of the service, also of meteorological information.

Hence, the wireless requirements for such a service can be summarised as follows :—

- (A) the provision of continuous communication between the aircraft and either terminal over the whole of the crossing, by night or by day ;
- (B) the provision of navigational assistance to the aircraft, either on request or in accordance with a routine, at any point in the crossing, either by night or by day ; and
- (C) the provision of continuous communication, by night or by day, between the terminals.

Owing to the relatively large distances involved, it will at once be apparent that, to meet these requirements on medium or long wavelengths would require the installation of transmitters of extremely high (and totally uneconomic) power at the terminals ; furthermore, and more important still, it would be quite impossible to envisage the carriage in the aircraft of medium or long wave equipment of sufficient power to ensure regular communication with either terminal over a distance of 1,000 miles or so, as, apart from considerations of cost, the weight and size of such equipment would render it entirely impracticable for the purpose. While the normal communication service, and the D.F. service can be and, in fact, is carried out on medium wavelengths within a limited range of up to some 400-500 miles

from each terminal, these services are necessarily effected on short wavelengths during the major part of the crossing ; due to similar considerations, too, the communication between terminals will have to be carried out entirely on short wavelengths.

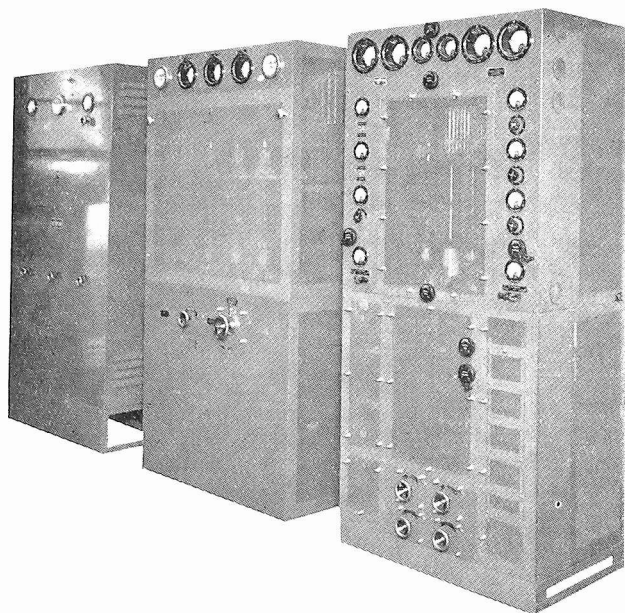

FIG. 1.

American counterpart (Pan-American Airways), the British Air Ministry naturally took the lead from the outset in co-ordinating the efforts of the various authorities concerned and, as soon as it was definitely decided to operate the route via Eire, in co-operating to the fullest extent with those authorities. Early in 1936, therefore, a representative of the Directorate of Signals, Air Ministry, visited the United States and Canada in order to discuss the communication problems involved and agree a common line of attack and, soon after his return, discussions were initiated on similar lines with the Eireann Posts and Telegraphs authorities.

As a result of these discussions, the scheme to be adopted gradually took shape. It was the intention at that time that experimental flights would be made during the autumn of that year (1936) and it was immediately realised that time would not permit of the establishment of the scheme in full, either in Newfoundland or in Eire, and the work was therefore planned in two stages—first, the establishment, at the earliest possible date, of temporary stations at each terminal so as to provide as

comprehensive a service as was possible within the time available and, second, the transformation and expansion of the temporary stations into permanent ones offering the full facilities originally agreed upon, at the earliest possible moment thereafter. Actually, owing to administrative and other delays, and in particular to weather conditions in Newfoundland during the winter season, the temporary station there was not completed until December, the station in Eire being ready, however, some two months or so earlier. No flights took place, however, in 1936 for reasons unconnected with wireless matters, but since then both temporary stations have done yeoman service throughout the whole series of experimental flights which took place last year. Work, however, is now nearing completion on remodelling these stations in order that the full services originally envisaged may be available for the next series of flights, which was due to take place during the present summer but which at present looks like being drastically curtailed owing to the lack of suitable aircraft in time for this year's programme.

The initial planning of the temporary stations, both in Newfoundland and in Eire, was itself a task of some magnitude. Firstly, the temporary facilities which it was the aim of the respective authorities to provide were limited by the practical difficulties in obtaining the necessary apparatus, land and buildings in the time available; secondly, the scheme in each case, had to be drawn up in such a way that its transformation into permanent form at a later date could be effected with the minimum of dislocation of the service and waste of material. As can well be imagined, this latter was a particularly difficult proposition, as it involved the postulation, in full detail, of a complex group of stations to give the full permanent services, under conditions in which many of the factors normally essential to wireless engineers in such a problem were at the time practically unknown. For example, no details of sites were available, weather conditions to be experienced were to a great extent unknown, as were details of available power supplies for the stations; nor had buildings even been envisaged, let alone, in the case of Newfoundland, had the possible sites been cleared of trees, etc., so as to enable buildings and aerial systems to be erected.

Having drawn up on paper, in the fullest possible detail, the permanent organisation proposed, it was next necessary to break it down to a level at which it represented, as far as could be seen at the time, practical politics in so far as its realisation as a temporary organisation could be reasonably anticipated by the proposed date of the flights, in the late autumn of 1936.

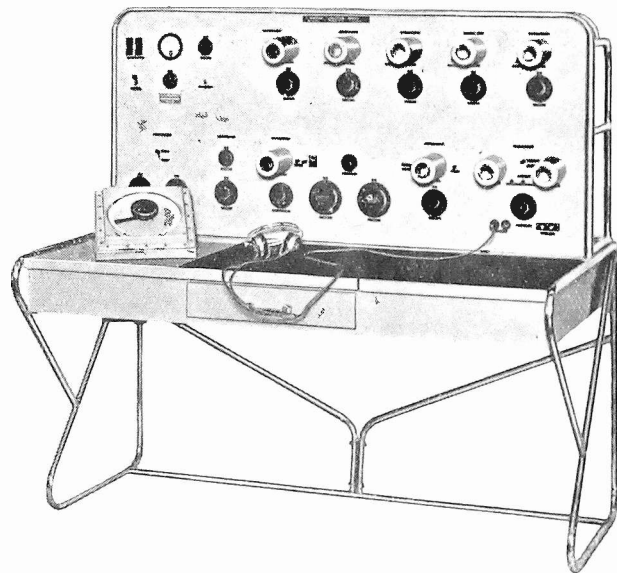

FIG. 2.

Attention was first focussed on the Newfoundland station; a preliminary survey of the country was carried out by the Canadian Marconi Company, as a result of which it was decided by the Air Ministry that the station should be erected at Botwood. By dint of numerous conferences with the Air Ministry it gradually became possible to specify with a reasonable degree of accuracy the apparatus and material which would be required and, in August, 1936, the contract for the station was placed with the Marconi Company, it being understood by everyone concerned, that every possible effort was to be made to have the station in action by October 1st of that year; it was impossible, nevertheless, not to feel certain doubts as to the possibility of being ready by that date owing to the lack of knowledge of local con-

ditions which existed. For example, at first it was not even possible to obtain a reliable large scale map of this distinctly remote district, from which to site the station; then, even when maps became available, the station and, of course, the ultimate permanent station, had to be laid out from the map alone, without any local advice or assistance. Shortly after the contract was placed, however, the Marconi engineer who was to take charge of the work left England for Newfoundland, followed almost immediately by the Air Ministry Signals representative, and the subsequent presence of these two officials on the spot naturally greatly assisted in overcoming the thousand and one engineering difficulties which arose in a job of such a nature.

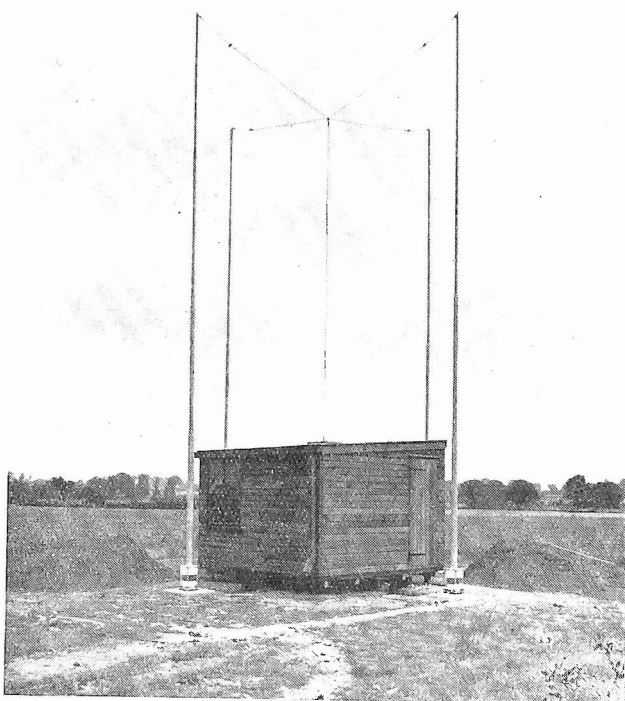

FIG. 3.

stations was given to the Marconi Company by the Eireann Posts and Telegraphs Department; this work was, of course, far easier to handle from an engineering point of view than the Newfoundland station, as for one thing the locality for the sites was covered by large scale maps and was easily accessible for survey and inspection from England, while, for another, the fullest possible co-operation was received from the Eireann Posts and Telegraphs authorities who were, of course, on the spot.

At about this time a contract for the supply of a generally similar group of

Work progressed steadily during the autumn of 1936 with both Newfoundland and Eireann stations, however, and, as stated earlier on, that in Eire was to all intents completed by October of that year, that in Newfoundland being ready, apart from one or two items (the final installation of which was held up by the winter freeze-up until the ground thawed out in the following spring), in December.

Although no flights were made in 1936, it was decided that as soon as the Newfoundland station was in action, a regular communication service should be established between it and the Eireann station, in order that experience could be gained in the operation of the equipment and in the selection of frequencies which would be most free from interference and most suitable for the purpose. An initial

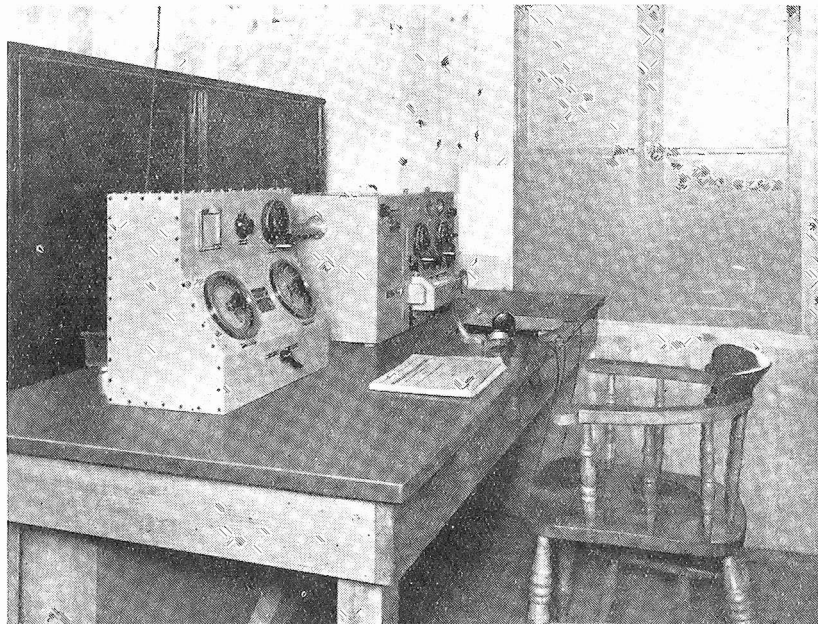

FIG. 4.

programme was therefore arranged with a view to first establishing contact between the stations; communication was immediately established without any hitch whatsoever, and has been continued with the utmost regularity ever since. Quite apart from messages passed in direct relation to the experimental flights of last year, a large volume of traffic has been handled, including meteorological messages and service traffic between the Air Ministry in this country and their representatives in Newfoundland, in respect of technical matters concerning the erection of the permanent station in that country.

A brief description of the apparatus involved at each end may be of interest. At each station a Marconi Type S.W.B8 transmitter (having a waverange of 15-100 metres and an aerial power of 2.5-3.5 kw.) was installed for communication with the other terminal, and for communication with aircraft at ranges in excess of some 400-500 miles or so (see Fig. 1); at each terminal this transmitter operated on

frequencies of 3,082.5, 5,692, 8,240, 11,470 and 17,000 kcs. on four twin-element vertical aerials and one single wire vertical aerial, and worked in conjunction with a Marconi Type Rg.34 short wave superheterodyne receiver having a waverange of 15-200 metres and operating on a simple vertical aerial. A medium wave transmitter was also installed at each terminal for communication with aircraft up to some 400-500 miles, within which range difficulties due to ship and other phenomena were anticipated on short wavelengths. At the Eireann terminal the transmitter comprised a Marconi Type TA.4, having a C.W. aerial rating of 700 watts, while at the Newfoundland terminal a Canadian Marconi Co. transmitter of 1 kw. C.W. aerial rating was employed. In each case the transmitter operated in conjunction with a

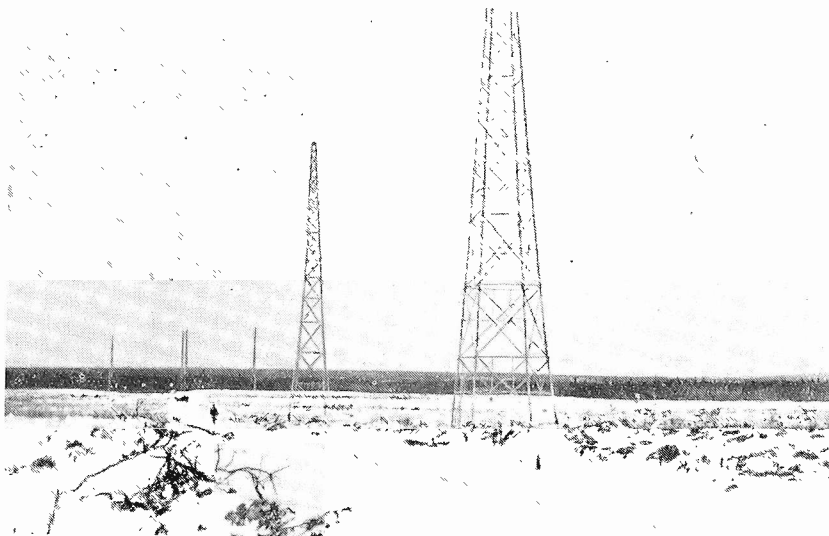

FIG. 5.

Marconi medium wave Type Dfg.10 direction finding receiver working off Bellini-Tosi loops in place of the normal Marconi-Adcock night-error-free aerial systems (see Fig. 2). A frequency of 333 kcs. was employed for this service at both terminals.

In addition to the above, a Type Dfg.12 short wave direction finding receiver operating on Marconi-Adcock night-error-free aerials and having a waverange of 15-200 metres was installed at each terminal in order to provide navigational assistance outside the range of the medium wave direction finder (see Figs. 3 and 4). Finally, several medium and short wave receivers were installed at each terminal for meteorological broadcast reception purposes, and—in the case of the Eireann terminal alone—a short range medium wave station comprising a low power transmitter with direction finding receiver was installed in the proximity of Foyne's Island to assist aircraft in locating the temporary alighting area on the River Shannon, which was several miles away from the site of the main wireless station at Ballygirrean.

As has already been stated, it was fully realised by all concerned from the very outset that, with the limited apparatus available at both terminals, only a limited

service could be hoped for, and that the provision of the full services originally postulated could not be effected until the permanent stations could be brought into being at some later date. The results obtained during the series of experimental flights which took place during the summer of last year, with the temporary stations equipped as described above, greatly exceeded expectation, however, and undoubtedly contributed to a considerable extent towards the successful outcome of the flights. Furthermore, a wealth of useful operational and technical data was obtained during this period, which helped considerably to check up on calculations and proposals already formulated for the permanent stations.

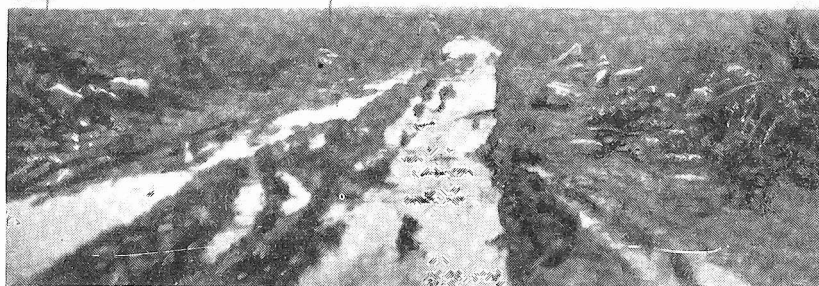

FIG. 6.

Long before these flights had commenced, however, and almost before the temporary stations had been completed, in fact, plans were actively on foot for the transformation of the temporary scheme into a permanent one. This involved, in each case, the supply of additional apparatus and aerial systems for it, so as to give an increased number of communication channels, and the supply of much more comprehensive aerial systems (including directional arrays) for the existing apparatus than time had permitted of in the temporary stations. In the case of the Newfoundland terminal, the situation was greatly complicated by the decision on the part of the authorities concerned to instal the permanent station at the Newfoundland Airport, a distance of some thirty miles or so from Botwood, where the temporary station was already installed, and where plans had already been worked out in great detail for its transmission into permanent form. As a result of this change, the work at the Newfoundland terminal not only involved the augmentation of the temporary station into permanent guise by the addition of extra apparatus and equipment, but its simultaneous removal and re-erection (on a site which at that time was virgin forest) with the minimum interruption to the service.

Some idea of the climatic difficulties which have had to be faced in Newfoundland may be gained by reference to Figs. 5, 6 and 7. Fig. 5 shows the receiving site

(with the aerial system partly installed) in winter, during which time the ground freezes to a depth of up to 4 feet, exceedingly low temperatures being recorded. Fig. 6 shows the site for the remote aerial system for the Type DFG10 receiver during the "thaw," which occurs in the spring, and during which the ground becomes everywhere a veritable quagmire. And finally Fig. 7 shows a portion of the transmitting site, with the aerial feeders in the foreground, in the summer, during which time extremely high temperatures are recorded, forest fires are prevalent, and much inconvenience is suffered from mosquitos and other insects.

In the case of both the Eireann and the Newfoundland stations, the additional apparatus comprises, in the main, 2 kw. short wave 4-channel transmitters of

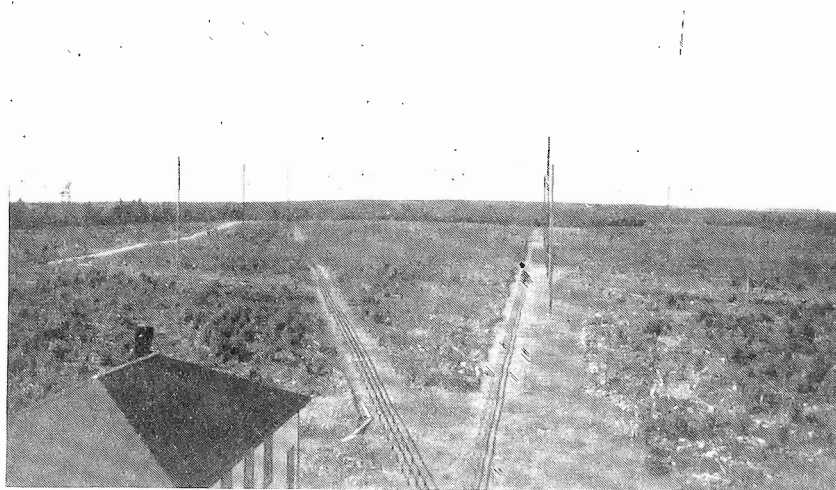

FIG. 7.

Canadian Marconi Co. design and manufacture; these transmitters (of which two are being supplied for Newfoundland and one for Eire) have a waverange of 17-100 metres, operate on twin-element vertical aeriels, and are capable of quick remote selection of any one of four crystal-controlled frequencies. They will be used for communication to aircraft alone, the existing Type SW.B8 transmitters being retained for point to point communication alone, on highly directional aerial arrays. Additional Type Rg.34 receivers have been supplied for use in conjunction with these new transmitters, the existing receivers of this type being retained (but on directional aerial arrays) for use in conjunction with the original type S.W.B8 transmitters. As at present arranged, the frequencies to be employed on the aircraft service will be 3,082.5, 5,672.5, 8,240 and 12,320 kcs. while for point to point services, frequencies of 3,437.5, 5,375, 8,240, 11,470 and 17,000 kcs. will be used; these frequencies are, however, liable to alteration at a somewhat later date as a result of the frequency allocation made at the International Radiocommunication Conference recently held in Cairo.

The existing Type DFG.12 short wave Marconi-Adcock equipment will, of course, be retained, the apparatus being operated, in the case of Newfoundland, off

a new night-error-free aerial system that has been erected at the permanent site near the Airport.

Medium wave communication with the aircraft will be carried out at each terminal by means of the existing transmitter and D.F. receiver, although the latter will now operate off Marconi-Adcock night-error-free aerials erected at some distance from the building housing that and other receivers, and connected thereto by special H.F. feeder (see Fig. 8).

Additional receivers for meteorological broadcast reception are also being supplied for each terminal, while in Newfoundland, three low power stations for communication with aircraft at short ranges (on medium waves) and with one another (on

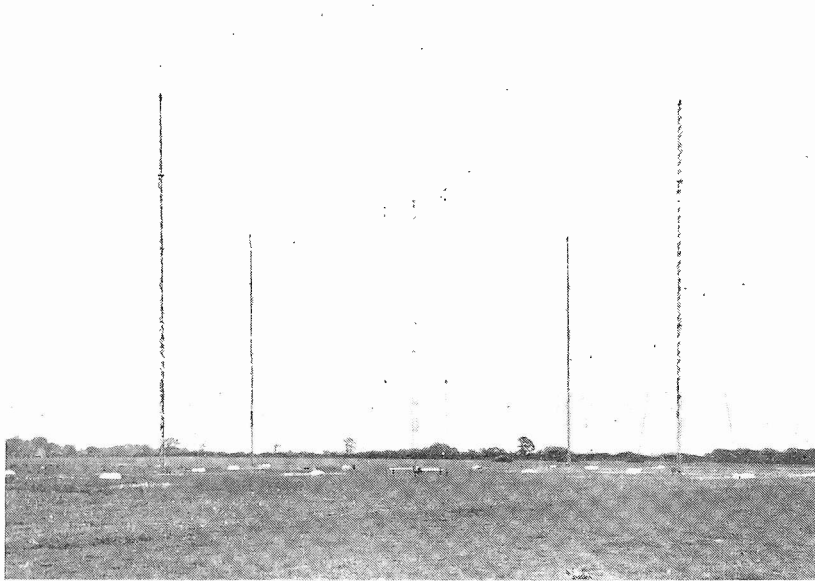

FIG. 8.

intermediate waves) are being supplied for installation at the Airport administrative buildings, at an emergency alighting point on the shores of Gander Lake close to the "Gleneagles" hotel and at Botwood. Each of these stations comprises a Marconi Type TW.12 low power combined medium/intermediate wave transmitter, a Type D.Fg.11 medium wave D.F. receiver and a Type 394E medium/intermediate wave non-directional receiver.

Furthermore, two ultra short wave aerodrome approach beacons of the Marconi-Telefunken type are being supplied for the Newfoundland terminal, so as to give alternative approach paths to the land aerodrome in conditions of poor visibility. In addition, arrangements are in train for the conversion of the Type S.W.B8 transmitter to Type S.W.B10, thereby augmenting its aerial rating from 2.5-3.5 kw. to 10-12 kw. ; provision has been made, in the lay-out of apparatus in the transmitting building at the Eireann terminal, for such an augmentation of power to be effected if found desirable at some later date.

From the above, it will be seen that the plans for the permanent stations in both Newfoundland and Eire are generally similar as regards the apparatus involved and the services to be provided. The main difference lies in the lay-outs adopted, due to differing local conditions and requirements ; in Newfoundland all reception for both air-ground and point-to-point services are concentrated on one site, the transmitters for these services being installed at another site some four miles or so away, while in Eire all aircraft services (both transmission and reception) are concentrated on one site at Ballygirrean, which is some four miles or so away from the site at Clenagh, where all point-to-point services (transmission and reception) are concentrated.

Work on the permanent stations in both Newfoundland and Eire is now rapidly nearing completion and, although in the former case it was considerably delayed due to the winter freeze-up period, it is hoped, in each case, to have the augmented and permanent stations ready for service in time for such experimental flights as may be operated during the late summer of the present year.

It is hoped that the foregoing will have given a broad outline of the problems involved in the establishment of these distinctly special air route stations ; naturally, in an article of this nature, it is not possible to give detailed information as to the types and numbers of aerial systems and arrays employed, the arrangements made for a comprehensive system of remote control for all transmitters, for power supply—both normal and emergency—etc. Nor is it possible to enumerate the technical and engineering difficulties which have arisen and have been overcome in planning, in this country and for execution in the most part in such a remote and unknown locality, a complete scheme in such detail and under conditions where the requirements have to a great extent only become clearly defined as the work proceeded. Suffice it to say that without the whole-hearted and generous co-operation which has been received both from the Air Ministry and from the Eireann Posts and Telegraphs Department—and which the author personally and on behalf of the Marconi Company would like to take this opportunity of publicly acknowledging—the task would have been rendered a thousandfold more difficult and protracted.

C. B. CARR.

PATENT ABSTRACTS

Under this heading abstracts are given of a selection from the most recent inventions originating with the Marconi Co. These abstracts stress the practical application of the devices described.

WAVE FILTERS AND DECOUPLING CIRCUITS.

Application date, November 5th, 1936.

No. 484,487.

Patent issued to Marconi Wireless Telegraph Co., Ltd., and E. E. Zepler.

This specification is concerned primarily with filament decoupling circuits for use at high frequencies on the short wave band. The normal method of decoupling by a series inductance and shunt capacitance loses its efficiency at high frequencies

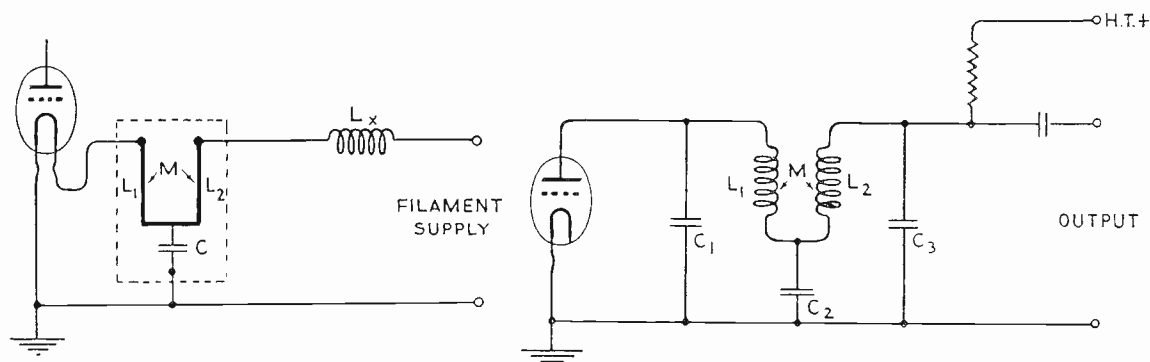

PATENT No. 484,487.

owing to the inductance ($1 \mu\text{H}$ or less) associated with the capacitance leads. This disadvantage is overcome by connecting between the capacitance and filament a second series inductance mutually coupled to the first. By correct adjustment of the mutual coupling a voltage is induced in the second series arm equal to and in phase opposition to that across the capacitance. A suggested form of construction is shown in the Figure. L_x is an external series inductance, which in conjunction with C is the main decoupling filter. The compensating device for high frequencies consists of two leads, L_1 and L_2 joined to the shunt capacitance and suitably disposed to give the necessary mutual inductance. Satisfactory decoupling is thus obtained at high frequencies.

The invention is not limited to filament decoupling circuits but may be applied for rejecting the carrier frequency in the anode circuit of a detector as shown in the second Figure. By suitable choice of L_1 and L_2 in relation to the three capacitances C_1 , C_2 and C_3 which may be all equal in value, and by correct adjustment of the mutual coupling M a very high degree of attenuation may be obtained in the region of the carrier frequency.

MODULATED CARRIER WAVE TRANSMITTERS.

Application date, November 5th, 1936.

No. 484,488.

Patent issued to Marconi Wireless Telegraph Co., Ltd., and O. E. Keall.

This specification provides means whereby modulating signals are automatically controlled in value so as to prevent overloading or underloading of a transmitter.

Modulated signals are received from the transmitter on a local receiver and are applied to a cathode ray tube forming on the fluorescent screw thereof a pattern corresponding to the modulated envelope. A mask of predetermined size is placed just in front of this fluorescent pattern and behind the mask a photocell is placed, whose output is amplified and applied to a gain control circuit operating on the transmitter.

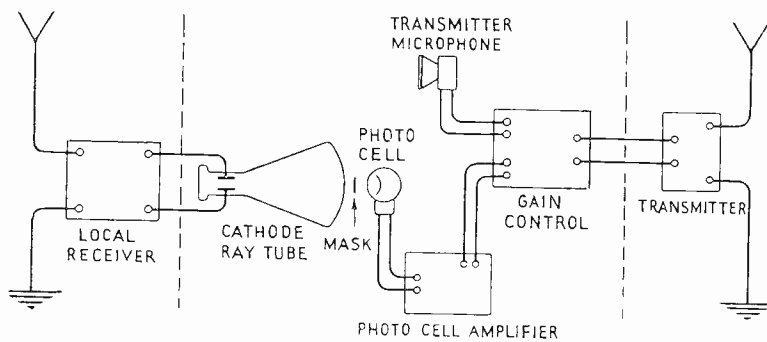

PATENT NO. 484,488.

If the pattern on the tube lies completely behind the mask no light will be received by the photocell and no signals applied to the gain control circuit, but if the modulated signals exceed a predetermined value light from their trace on the cathode ray tube will pass outside the mask, be received by the photocell and apply gain control to the transmitter in such a way that the modulation is reduced. In this way automatic prevention of both over modulation and under modulation (by suitable design of the mask) can readily be obtained.

The operation of the system is easily seen on reference to the schematic diagram of the Figure.

KEYING SYSTEMS.

Application date, November 6th, 1936.

No. 484,588.

Patent issued to Marconi Wireless Telegraph Co., Ltd., and N. H. Clough.

This invention relates to coupling arrangements for absorber keying circuits for transmitters.

Referring to the Figure, a keying valve "a" and an absorber valve "b" are provided, the grid of the absorber valve being controlled by that of the keying valve. The sub-absorber valve may act in any orthodox manner and the control grid is caused to vary in anti-phase with the potential applied to the control grid of the keying valve by applying a source of

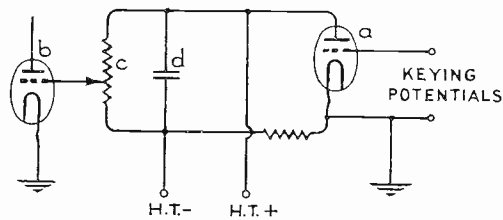

PATENT NO. 484,588.

H.T. potential across two parallel circuits, one circuit consisting of a resistance "c" and capacity "d," and the other consisting of the keying valve "a" and a resistance inserted in the cathode of the valve.

The control grid of the absorber valve "b" is connected to a suitable point on the resistance "c."

When bias on the keying valve "a" is removed, i.e., by keying the impedance of the circuit consisting of this valve and the resistance drops, and current increases in this circuit causing a fall of potential relative to earth of the grid of "b" and vice versa.

MODULATED CARRIER WAVE TRANSMITTERS.

Application date, November 19th, 1936.

No. 485,470.

Patent issued to Marconi Wireless Telegraph Co., Ltd., and N. H. Clough and E. Green.

This discloses improvements in modulated carrier wave transmitters of the floating carrier type.

It is usual in this type of transmitter to rectify the magnified modulating potentials and to apply this rectified power to vary the bias of the main modulator

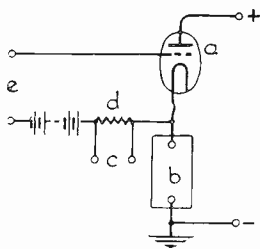

FIG. 1.

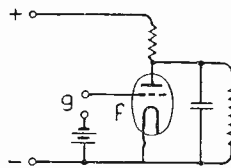

FIG. 2.

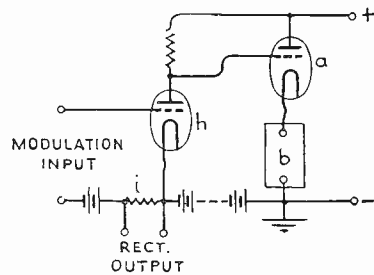

FIG. 3.

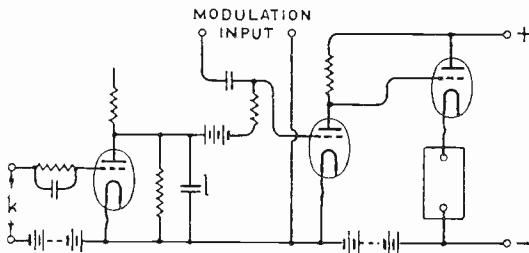

FIG. 4.

PATENT No. 485,470.

in accordance with the rectified modulation envelope. The modulating potentials are usually converted to bi-phase by an iron cored transformer and subsequently rectified by means of a full wave rectifier.

The present invention aims at overcoming difficulties associated with the use of an iron cored transformer and other disadvantages of the system referred to above by

dispensing with the iron cored transformer and rectifying by means of a valve operating as an anode bend rectifier.

The circuits proposed are so arranged that when modulation potentials are applied to the rectifier, this becomes conductive on each positive half-cycle, and the resultant increase of rectified current increases carrier level. In the absence of modulation the current through the rectifier is very small and the bias in the modulator valve stage such that the carrier is set at a low predetermined level.

Normally the floating carrier system applied to a series modulated transmitter consists, Fig. 1, of a modulating stage, "a," and an associated modulated stage, "b," the floating bias for floating carrier action being applied at "c" across a resistance "d" in series with a fixed bias source and a speech input impedance shown at "e." In a proposed arrangement shown in Fig. 2, the rectifier "f" is

fed with H.T. through a resistance, the modulation potentials being applied at "g." The output from the rectifier may be taken from a resistance connected in parallel with a capacity, the resistance taking the place of the resistance "d" in Fig. 1. When modulation potentials are applied to "f," the valve conducts on positive half-cycles and the condenser, which is charged when "f" is non-conducting, is now discharged at a rate which may be made rapid by suitable selection of the valve. When the modulation potentials cease to be applied, the condenser again re-charges at a rate which may be made slow. In the modulator system of Fig. 3, the modulating stage "a" is connected in series with the modulated stage "b" and an input valve "h" is provided, to the grid of which the modulation input is applied. The output of the rectifier, which is not shown in the figure, is applied across the resistance "i." In this arrangement the valve "h" requires an increase of bias on modulation, i.e., the change of voltage developed across "i" when modulation occurs must be in a sense to increase the total bias on "h."

In Fig. 4 is shown what is virtually a combination of Figs. 2 and 3, the left hand part of the figure, showing the anode bend rectifier and the right hand part, the modulating and modulated stages. On the application of modulating potentials at "k," the rectifier valve conducts on positive half-cycles, the rectifier anode potential falls, and the resultant grid bias of the input valve increases and causes an increase of carrier level. The condenser "l" smoothes out changes and introduces a delay in the reduction of carrier level so that the latter does not die down quickly between periods of heavy modulation.

AUTOMATIC GAIN CONTROL.

Application date, December 3rd, 1936.

No. 486,570.

Patent issued to Marconi Wireless Telegraph Co., Ltd., and J. D. Brailsford.

The object of this specification is gain control of an R.F. voltage by the use of two separate amplifier circuits, the outputs of which are connected in phase opposition. It is an extension of Patent No. 469,895, described in the No. 68 (January-

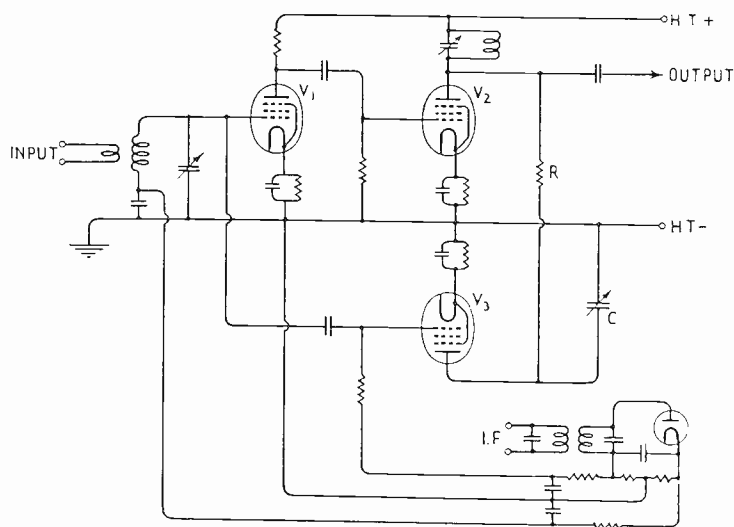

PATENT NO. 486,570.

March, 1938, page 45) number of this journal, and the circuit diagram is shown above. The R.F. input voltage is amplified through the phase changing valve V_1 and output valve V_2 . The other output valve V_3 is supplied directly from the input and its anode is connected to the anode to V_2 by the resistance capacitance combination (RC). This RC circuit neutralises the undesired phase change produced by the stray capacitance in the coupling between V_1 and V_2 . The bias voltages of V_2 and V_3 are initially adjusted to give low gain conditions with however higher amplification from V_3 . The gain of valve V_1 is adjusted not to exceed unity under maximum positive bias. Automatic gain control is obtained by using bias voltages from an A.V.C. diode connected to the I.F. output stage of the receiver. The load resistance of the A.V.C. diode is centre tapped to earth and positive bias for V_1 is obtained from the cathode side of the centre tap and negative bias for V_3 from the other side. As the input signal increases the gains of the two R.F. branches approach each other and thus tend to reduce the output R.F. voltage.

TIME BASE CIRCUITS.

Application date. November 30th, 1936.

No. 486,041.

Patent issued to Marconi Wireless Telegraph Co., Ltd., and D. L. Plaistowe and D. J. Fewings.

This discloses a time base circuit applicable to television receivers, which can either act as a self-generating saw-tooth circuit or as a driven time base.

If desired to act as a self-generating saw-tooth circuit, the switch arm "d" in the figure is connected to "e" and the operation of the device is as follows:—

Current flows from the source of positive potential and charges the two condensers "a" and "b" through the resistance "l," the condensers charging at a rate predetermined by the constant of the charging circuit. From that end of "l," which is connected to "a" down to earth, is placed an electron beam valve consisting of a cathode, an apertured electrode "k," through the aperture of which a beam of electrons is projected, an apertured first anode "g," a second anode "c" and three deflector electrodes, "i," "h" and "j." When there is no charge on the condensers "a" and "b," the electron beam is incident on "g" only, and the internal resistance of the valve between the cathode and "c" is very high. During

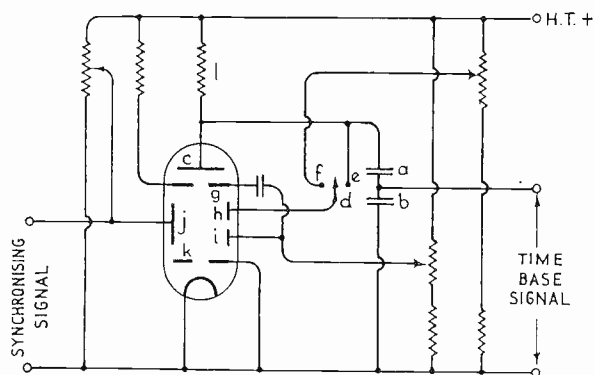

PATENT NO. 486,041.

the charge of the condensers "a" and "b" the beam is not incident on "c" and accordingly there is no load across the charging circuit, but as the potential across the condensers rises the potential applied to "h" also rises. The beam is deflected and when the charging has continued to a predetermined extent the beam passes through the aperture in "g" and strikes "c," thus reducing the impedance of the valve and discharging the condensers.

When this happens the cutting off of the current from "g" causes a positive pulse to be applied to "i" through the condenser connecting "g" and "i" and maintains the beam on "c" until the voltage on "i" has fallen away sufficiently to enable the beam to become once more incident on the first anode "g." When this happens "i" receives negative pulse due to current reappearing in the first anode circuit and the beam is deflected still further back towards its original condition. The operation is then repeated and saw-tooth waves are produced which may be applied to the cathode ray tubes in the normal manner.

The circuit is readily adjustable for different operating conditions, the alteration of the value of the resistance "l" adjusting the charging period, while adjustment of the static potential applied to "j" adjusts the amplitude of the sweep.

In practice the circuit is so arranged that the voltage across condensers "a" and "b" rises almost to a predetermined value just before the synchronising signal, which is applied to "j," produces a small amount of extra deflection needed to cause the electron beam to pass through the aperture in "g," thus synchronising signals of quite small amplitude are sufficient to produce synchronisation.

If the switch "d" is connected to "f," the circuit becomes no longer a self-operating time base circuit but is driven by the incoming strong synchronising signals.

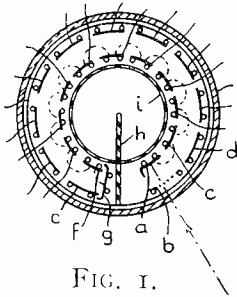

FIG. 1.

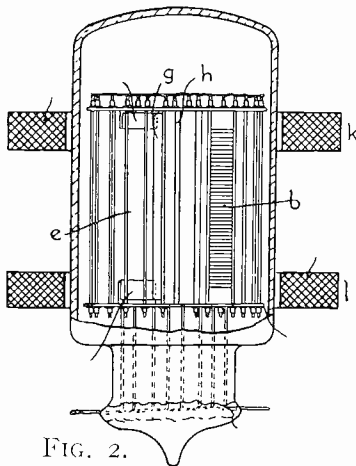

FIG. 2.

PATENT No. 486,888.

ELECTRON MULTIPLIERS.

Application date, December 11th, 1936. No. 486,888.

Patent issued to Marconi Wireless Telegraph Co., Ltd., and G. B. Banks.

This invention relates to electron multiplier systems, and provides for an electron multiplier wherein a ring of cathodes "a" to "f" are disposed at intervals round an imaginary cylinder, at least one of these ("a" in Fig. 1) being capable of primary emission.

The ring of field electrodes ("b" to "e" in Fig. 1) are disposed round the second imaginary cylinder coaxial with the first, each field electrode being opposite one of the cathodes.

An output electrode "g" is provided for collecting electrons from the last of the cathodes and a magnetic field having lines of force running between the cathodes and field electrodes, in a direction parallel to the axis of the two imaginary cylinders, is provided by means of two solenoids "k" and "l."

A central cylinder "i" is shown inside the ring of cathodes and a radial mica partition extends from this cylinder, to separate the output electrode "g" from the primary cathode "a." The field electrodes are provided with increasingly positive potentials in the normal manner and the electron paths are shown in broken lines in Fig. 1 following approximately cycloidal paths from the primary cathode to the

next cathode and so on until the output electrode is reached, electron multiplication, as well known *per se*, occurring at each stage. In Fig. 2 is shown a section of the tube taken at right angles to that shown in Fig. 1, the main advantage of the construction being its extreme compactness and the fact that sensitising is simplified because all the cathodes are equidistant from the end of the envelope, where, in manufacture, the sensitising caesium is admitted.

TUNING SYSTEMS.

Application date, December 11th, 1936.

No. 486,889.

Patent issued to Marconi Wireless Telegraph Co., Ltd., and N. M. Rust and N. Levin.

This patent discloses a method of expanding the broadcast bands of a short wave tuning scale in the region of 17, 19, 25, 31 and 47 metres. A front and side elevation of the scale and its drive are shown. All driving wheels free to move on their shafts are shown in section.

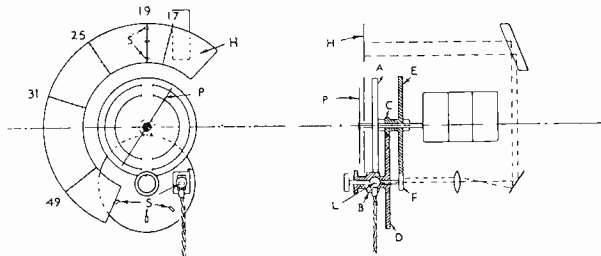

PATENT NO. 486,889.

The toothed wheel A is fixed to the ganged capacitor shaft, but the pinion C and second wheel are loose on this shaft. The pinion C is coupled to D, to which is fixed a second pinion B. Both wheels D and B are free to move on the shaft, at one

end of which is the pinion F coupled to E and at the other end the slow motion knob. The fast motion knob is connected to pinion B and is operated by pressing-in and turning. This action disengages D from C and gives direct drive from B to A. The slow motion drive is through F, E, C, D and B to A. The wheel D has slots S cut into it at points corresponding to the five broadcast bands. Light from the lamp L located in front of D projects an image of the slot on to the scale H by means of the optical system shown. Scale H is attached to the normal pointer P. The movement of the slot image S_i is radially outwards with decreasing frequency and it gives a sufficiently magnified movement of the tuning capacitance to allow of printing of the station names on scale H. The specification points out other possible constructions and gives suggestions to facilitate calibration.

WIRELESS RECEIVING SYSTEM.

Application date, December 31st, 1936.

No. 487,880.

Patent issued to Marconi Wireless Telegraph Co., Ltd., and N. M. Rust.

Automatic frequency correction is often obtained in superheterodyne receivers by the use of two parallel circuits tuned on either side of the intermediate frequency. Detectors, connected across the outputs of these circuits, are coupled to give opposing D.C. voltages. A typical correcting bias voltage-frequency curve is the full line curve in the figure and this voltage is used to control a variable reactance device in parallel with the oscillator resonant circuit. The degree of frequency correction

obtained is dependent on the slope of the control voltage curve on either side of the I.F. and best operation is obtained with the greatest slope.

A method of increasing this slope is described and a suggested form of circuit is given below. Valve V_1 is an I.F. amplifier valve containing two coils L_1 and L_2 in series in its anode circuit. These coils are inductively coupled to the discriminator

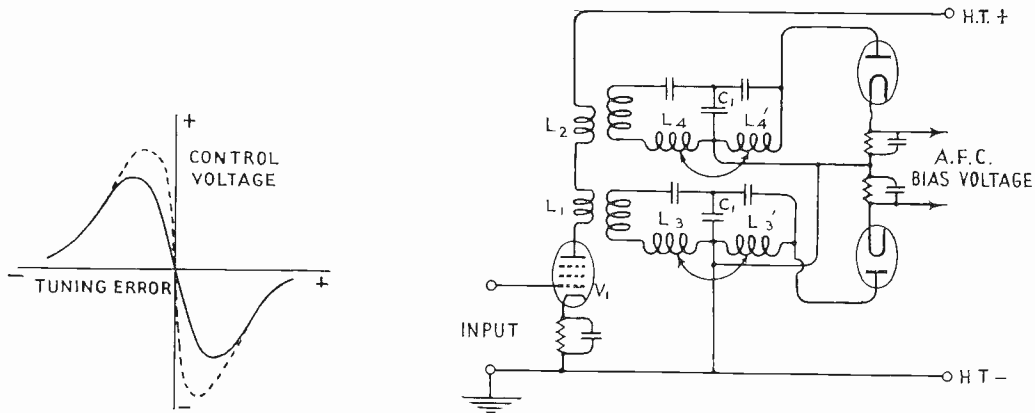

PATENT NO. 487,880.

circuits, which contain the two coils L_3, L_3' and L_4, L_4' . The coils L_3 and L_3' are mutually coupled in opposition and the output voltage for the diodes is taken across L_3' . The mutual inductance coupling forms together with the capacitance C_1 a series circuit resonant at the I.F. The other components of each filter are chosen to give parallel resonance at a frequency an equal amount above and below the I.F. A control voltage-frequency curve similar to the dotted one in the figure is thus obtained. The mutually opposing coils should have a high coupling coefficient and must be electrostatically screened from each other. A method of construction is described in the Specification.

WIRELESS RECEIVING SYSTEM.

Application date, December 31st, 1936.

No. 433,111.

Patent issued to Marconi Wireless Telegraph Co., Ltd., and O. E. Keall.

A valve may be made to act as a reactance if its grid voltage is derived from and is in phase quadrature with the anode voltage. This reactance effect may be varied by varying the gain of the valve and it may be used to control the frequency of an oscillator in an automatic frequency correcting circuit. A disadvantage of this form of control has hitherto been due to the undesirable resistance component introduced in addition to the reactance. A method of eliminating or controlling the resistance component by using a constant impedance phase splitting circuit is described in the specification, and a diagram of connections is given in the figure. The form of phase splitter is well known and constant impedance is obtained when

$R = \sqrt{\frac{L}{C}}$. The capacitance C_1 is a low reactance coupling and the resistance R

has a high value, thus preventing appreciable damping of the oscillator valve (V_1) tuned circuit. The quadrature voltage is obtained from the junction point of L R and C R and the reactance component is reversed by reversing the connections to the transformer T. Automatic variation of reactance magnitude is obtained by

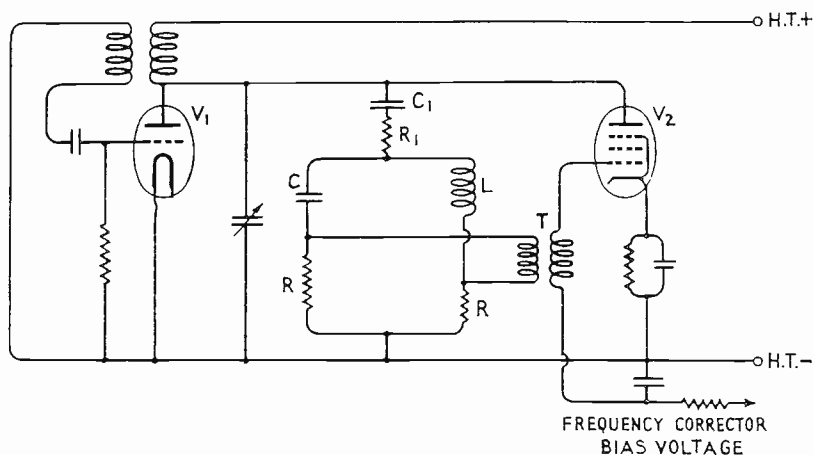

PATENT No. 488,111.

returning the secondary of the transformer to the bias voltage from the frequency discriminator circuits. Values of $R_1 = 50,000$ and $R = 1,000$ ohms are quoted to give $4 \mu\mu\text{F}$ capacitance variation for 9 volts variation of bias. The position of C and R and L and R with respect to earth may be reversed without affecting operation.

The constant impedance condition $R = \sqrt{\frac{L}{C}}$ may be departed from if a variation of resistance as well as reactance is required with changes of bias.

WIRELESS RECEIVING SYSTEMS.

Application date, December 31st, 1936.

No. 488,112.

Patent issued to Marconi Wireless Telegraph Co., Ltd., and O. E. Keall.

Automatic frequency control devices which have an asymmetrical control curve normally suffer from the disadvantage that correction can only be obtained on one side of the correct tuning point. A device is described in this patent which causes reversal of asymmetry so that frequency correction is obtained when the tuning point is approached from the high or the low frequency side. A potentiometer (P in the figure) of value about 2,500 ohms is connected across a source of D.C. voltage (about 2 volts may be used) and the slider S is mechanically coupled to the main tuning capacitor spindle. Connected in series between the slider and one end of the potentiometer is a capacitance C and polarised relay R. A charging current flows through

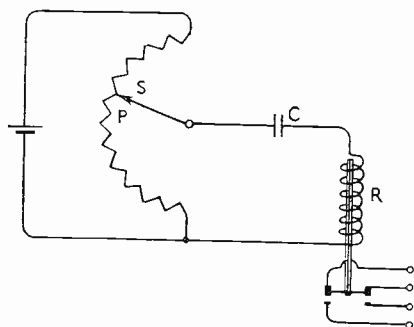

PATENT No. 488,112.

C as the slider is moved upwards and a reverse discharging current when it is moved downwards. The relay is therefore actuated in different directions depending on the direction of motion of the slider, and it is arranged to operate contacts causing setting of the A.F.C. circuit so that correction always occurs on the side of the tuning point which is being approached. The relay action may be improved by replacing R by a resistance connected to the grid of a valve, in the anode circuit of which is the polarised relay.

WIRELESS RECEIVING SYSTEMS.

Application date, December 31st, 1936.

No. 488,260.

Patent issued to Marconi Wireless Telegraph Co., Ltd., and O. E. Keall.

The range of all A.F.C. systems over which accuracy of tuning may be obtained is limited and unless the receiver is tuned within these limits no correction can take place. This invention provides for automatic silencing except when the receiver

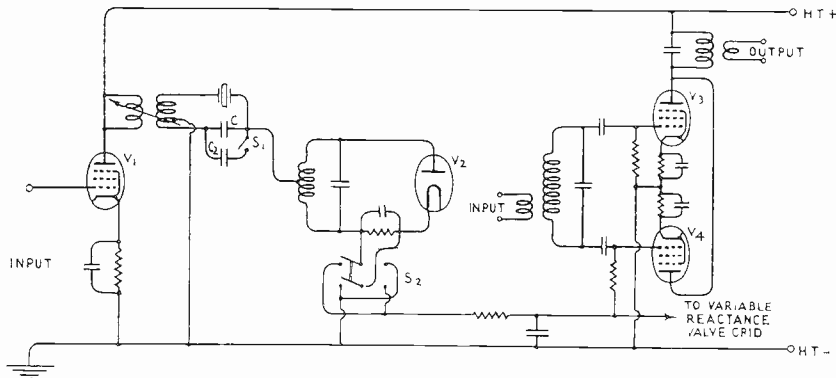

PATENT NO. 488,260.

is tuned within the range of the A.F.C. system. A suitable circuit is shown in the figure. Valve V_1 is an I.F. amplifier valve in the anode of which is a circuit tuned to the I.F. and coupled to a crystal bridge circuit. The output from the crystal bridge is connected to another I.F. tuned circuit which supplies the signal to the diode producing the correcting voltage. The complete circuit gives an asymmetric A.F.C. curve the position of which with respect to the I.F. can be changed by switching capacitance C_2 in parallel with C_1 . The diode correcting voltage is supplied through a double pole switch to the variable reactance valve. Both switches S_1 and S_2 may be operated as described in Patent No. 488,112 so that the asymmetric control characteristic can always occur on the side of the I.F. which is being approached.

Silencing is obtained by using the correcting voltage from the diode to produce out-of-balance of two I.F. amplifier valves (V_3 and V_4) whose anode circuits are in phase opposition. Change of bias on V_4 in either direction disturbs the balance condition and renders the set operative.