

THE MARCONI REVIEW

No. 50.

September-October, 1934.

Editor: H. M. DOWSETT, M.I.E.E., F.Inst.P., M.Inst.R.E.

Assistant Editor: L. E. Q. WALKER, A.R.C.S.

THE NIGHT PERFORMANCE OF THE MARCONI-ADCOCK DIRECTION FINDER TYPE D.F.G.8

Introduction.

Research work is continuously being directed toward the elimination of night errors in direction finders. The present notes record some recent observations in connection with the medium wave Marconi-Adcock system.

DURING the last two years extensive experience has been obtained in the practical operation of a large number of the above equipments: also in connection with development work during the Winter and Spring of 1933/34 a very exhaustive series of night D.F. observations were carried out using the Marconi-Adcock aerial system alongside a coil direction finder.

These experiments were directed towards arriving at a more precise estimate of the relative accuracy of the loop and Marconi-Adcock aerial. An article published in THE MARCONI REVIEW, No. 37, disclosed a series of night error percentages; the method of producing such curves is well known, and does not require further explanation. It might, however, be observed that although in many cases approximately 95 per cent. of the directional observations are accurate to within 3 degrees, it will be found that larger deviations will be noted under adverse conditions. Experience has also shown that extreme care in choice of suitable site both in regard to disturbing sources and in earth conductivity is essential if the installation is to function efficiently as a precise night direction finder.

Under conditions of low field intensity (viz., when the normally polarised direct and reflected rays are 180 degrees out of phase), the receiver noise level must not prevent the taking of bearings, even if incorrect.

During the experimental observations now under discussion, the receivers coupled to the Adcock and loop direction finders were capable of observing bearings on weak signals (mean fields of about one microvolt per metre), so that during periods when a large amount of the horizontally polarised wave is present bearings are still possible on the Adcock aeriels.

The observations were all carried out at the Writtle direction finding station of the Marconi Company and synchronous observations on loop and Adcock aeriels were made by a single skilled D.F. operator.

The station chosen for observation was Kalundborg; the transmitter provides a high field intensity with a mean night field intensity corresponding to five times

The Night Performance of the Marconi-Adcock Direction Finder Type D.F.G.8.

the day value. The waves from this station are also subjected to violent night variations on a loop aerial and the communication represents a typically difficult aircraft to ground requirement.

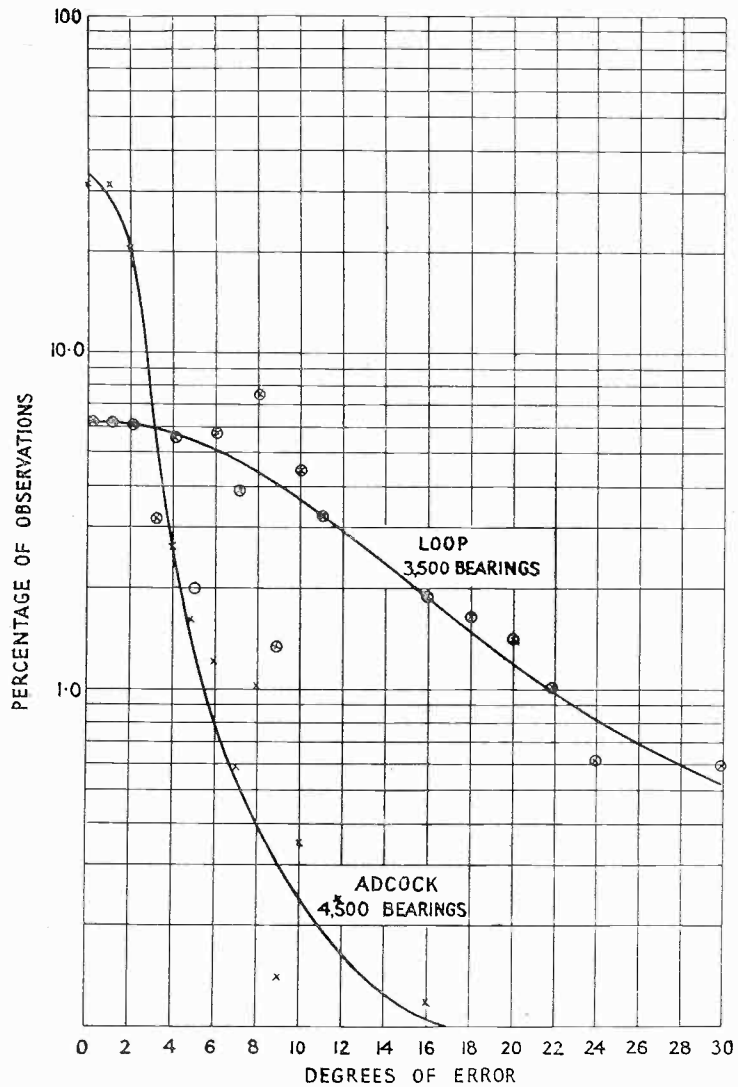

FIG. 1.

The work discussed in these notes covers actual observations during periods of known night error (when using the loop) and in both cases about 160 hours of night direction finding providing :—

4,500 bearings on Marconi-Adcock
 3,500 " " Loop aerial

taken simultaneously or under equal conditions and in the same location.

The Night Performance of the Marconi-Adcock Direction Finder Type D.F.G.S.

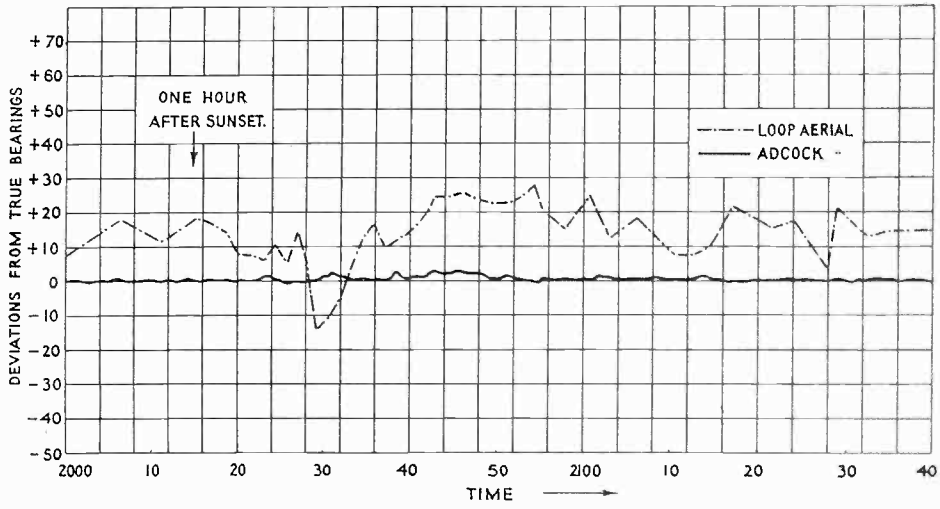

FIG. 2.

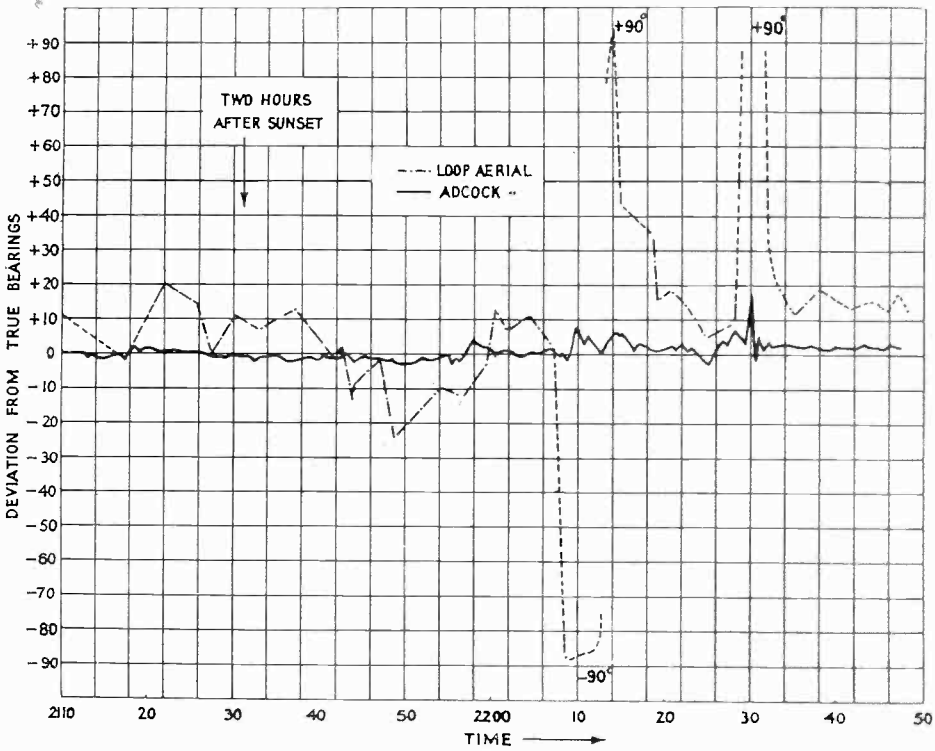

FIG. 3.

The Night Performance of the Marconi-Adcock Direction Finder Type D.F.G.8.

Fig. 1 shows the relative performance of the two systems of direction finding expressed in terms of percentage accuracy, and shows in a simple graphical manner the superiority of the Adcock system over a loop.

An alternative method of expressing the results in probabilities is as follows:—

Marconi-Adcock D.F.		Loop D.F.	
4,500 bearings.		3,500 bearings.	
R.M.S. deviation.	Standard deviation.	R.M.S. deviation.	Standard deviation.
5.02°	2.37°	26°	12.35°

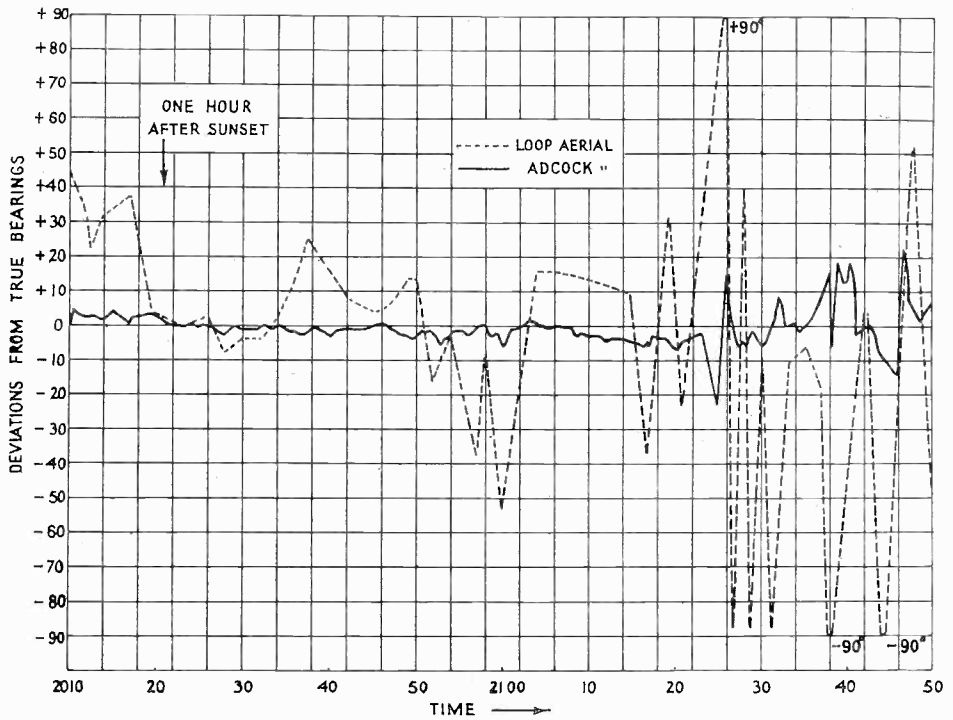

FIG. 4.

Using the theory of probabilities in engineering, it will be seen that the improvement in night D.F. accuracy due to the use of the Marconi-Adcock aerial is approximately five times and under ordinary circumstances the Adcock accuracy will not be worse than 2.37 degrees, and under precisely similar circumstances the loop will not be worse than 12.35 degrees.

Now the probability of an Adcock error not exceeding 2.37 degrees over a long period of time does not imply that on occasions the system will not show errors exceeding this value; this fact is of some importance; it is often assumed that as 95 per cent. of all bearings are correct to within 3 degrees that the system is *night effect free*. A little practical experience will show that the small percentage of D.F. time when poor accuracy is possible does not nullify the great advantages of the system.

A clearer appreciation of these facts will be obtained if the reader closely studies the error curves given in Figs. 2, 3 and 4. These synchronous plots of loop and Adcock results represent typically good, medium, and bad nights from a direction finding point of view, and when presented in a tabular form the curves of Figs. 2, 3 and 4 can be summarised as follows :—

PEAK ERRORS DURING RUN.

Fig. 2.		Fig. 3.		Fig. 4.	
Low night deviation.		Medium night deviation.		Heavy night deviation.	
Loop.	Adcock.	Loop.	Adcock.	Loop.	Adcock.
+30°	+3°	+90°	+15°	+90°	+23°
-14°	-1°	-90°	-5°	-90°	-23°

These figures clearly show the great superiority of the Adcock aerial over the loop, but it will be seen that the Adcock system is not entirely free from night errors. The curves also show that the total time during which serious night errors are present (when using the Adcock aerial) is not a large percentage of the total time occupied in night observations, whereas in the loop case the instrument is almost completely useless.

If the results of all the loop and Adcock observations are expressed in terms of standard deviations, the following figures result :—

Marconi-Adcock D.F. System.		Loop D.F. System.		Notes.
R.M.S. deviations	Standard deviation	R.M.S. deviation	Standard. deviation	Whole period of observation.
5.02°	2.37°	26°	12.35°	
10.7	5.07	42°	20°	Evening characterised by severe night errors.
4.55	2.16	13.7	6.6	Evening with low night effect.

From these notes it should, therefore, be appreciated that although the Marconi-Adcock system of direction finding is far superior to the loop, the user will occasionally have to discount bearings during severe short period night variations, but after experience with the equipment, a skilled operator will obtain an all-round night accuracy approaching that possible when using the equipment during the day.

S. B. SMITH.

AUTOMATIC START-STOP APPARATUS FOR MORSE CIRCUITS

The following note describes apparatus whereby in traffic receivers, recorders may be started and stopped under control of the received signals so as to be operative substantially only during the time signals are being received.

AS a result of the high traffic handling capacity afforded by modern short wave Beam Services, there are frequent periods during which these circuits are clear of traffic. On most circuits the transmission then takes the form of "Reversals," a procedure which facilitates the maintenance of the channel particularly at the radio receiving point where variable conditions are encountered.

The objects of the apparatus to be described are :—

- (A) Automatically to render the recorder circuits inoperative during idle periods, thereby effecting economy in recorder slip and in wear and tear of recorders.
 - (B) Automatically to restart the recorder circuits in accordance with traffic and maintenance requirements.
- (B) must be instantaneous in operation, whereas (A), on account of the possibility of short groups of reversals appearing in traffic, should have a delayed action.

One method of complying with the above conditions is illustrated in the circuit diagram shown in Fig. 1. Three indirectly heated valves (conveniently ML4) and two relays are incorporated in the circuit, the relay upon the left being operated by the signals from the wireless receiver.

It is seen that equal negative potentials are applied alternately to the grids of valves V1 and V2 by the signal-relay tongue. During reversals these grids are maintained sufficiently negative, by the action of resistances R1 R2 and condensers C1 C2, to prevent current flow in the anode circuits ; consequently valve V3 remains conductive, the direction of current through the relay winding in its anode circuit being such as to open contacts P. The circuit associated with XPY (which may, for instance, include an undulator or tape-puller) is thus broken.

During traffic the tongue remains on the Space and Mark contacts for longer periods, and in accordance with the values of the resistances R1 R2 and condensers C1 C2 the voltage on the tongue " T " is chosen so that the valves V1 and V2 respectively conduct as a result of the more complete discharge of condensers C1 and C2. The grid of valve V3 then becomes negative with respect to its cathode, and the valve non-conductive, remaining in this condition during signalling by virtue of condenser C3. It is arranged that, in the absence of current in the anode circuit of valve V3, contacts P close as a result of either a mechanical or an electrical bias.

Automatic Start-Stop Apparatus for Morse Circuits.

The circuit XPY is therefore closed during traffic. The time-constant of $R_3 C_3$ is such that, on the resumption of reversals, valve V_3 continues to be non-conductive for about 20 seconds. By this means, contacts P are not opened for short groups of reversals appearing in traffic. From the above description it is evident that, as contacts P close at the instant of commencement of traffic and reopen at about 20 seconds after the cessation of traffic, the circuit XPY is virtually inoperative except for traffic periods.

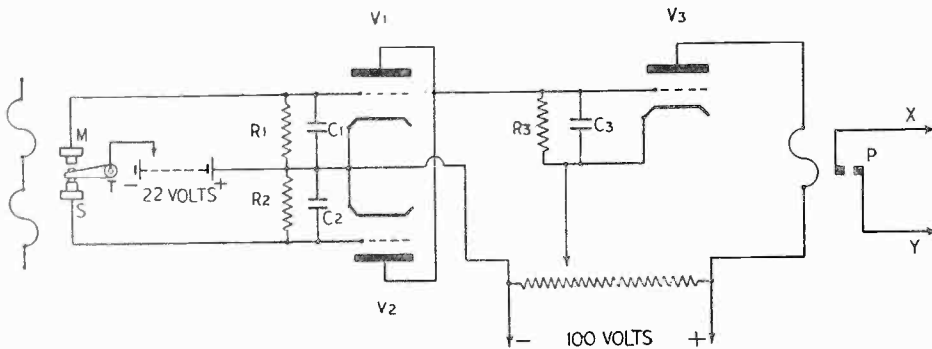

FIG. I.

On account of the large time constant of the resistance-capacity combination $R_3 C_3$, it is not essential that current shall exist in the anode circuits of valves V_1 and V_2 for the major period of Space and Mark. A range of speeds can therefore be covered for any given adjustment of the tapped battery connected to the signal relay tongue, the range limits for each selected voltage being:—

- (1) A MINIMUM speed below which reversals produce current in the anode circuits of valves V_1 and V_2 .
- (2) A MAXIMUM speed above which there is insufficient energy in the anode circuits of valves V_1 and V_2 during signalling to maintain valve V_3 non-conductive.

Suitable values of R_1 and R_2 (with a tapped battery of 22 volts) for high speed working are .25 megohm and C_1 and C_2 .1 microfarad. R_3 and C_3 may be 1 megohm and 10 microfarads respectively.

It will be observed that the arrangement of the circuit is such that, in the event of failure of the 22 or 100 volt supplies, signal relay, or any of the heater elements of the I.H. valves (the heater elements being connected in series), the consequent absence of current in the anode circuit of valve V_3 would restore the circuit XPY to its normal traffic condition. Moreover, should reversals become mutilated by a fading signal or by interference from atmospheric or other sources, the operation of the circuit XPY would indicate to the receiving station staff that the circuit required attention.

A. M. HUMBY.

A SYSTEM FOR SINGLE-SIDEBAND AND CARRIER BROADCAST TRANSMISSION

The progress of broadcast transmission has led to considerable congestion in the allotted band of frequencies, while the national value of such transmissions, particularly in the lower frequency band, has become increasingly recognised. This situation led naturally to the suggestion that the single sideband method of transmission might be applicable to broadcast transmitters, a view encouraged by the success of a similar system in use for Transatlantic telephony. It was early realised that the two cases were not strictly comparable, for, in the broadcast case, fresh receivers could not be expected to replace the large number at present in existence, and skilled operation could not be presumed. As a means of meeting these difficulties, the proposal was made that the carrier be radiated, one sideband alone being suppressed.

The possibilities of this system appeared sufficiently encouraging for a sub-committee of the C.C.I.R. to be appointed to investigate its use and limitations. Meanwhile the Marconi Company considered that such an investigation would not be complete without a study of the production of such signals. Accordingly, a survey of the problem was undertaken and, of the variety of possible means, that selected which called for the minimum development of special apparatus. On this basis an equipment was designed and built and it is with this equipment that the following description is concerned, rather than with the aspects of such transmissions covered by the C.C.I.R. (Lisbon) sub-committee 9, Question 21.

THE implications of a system for single sideband and carrier broadcast transmission can be formulated without much difficulty, for the audio-frequencies to be transmitted are well known to be from 50 cycles per second to 10,000 cycles per second as a minimum, extension of this range in either direction being welcomed for high quality. The carrier frequencies allocated to broadcast transmission are between 150 and 1,500 kilocycles per second, of which, for the reasons mentioned in the introduction, those of lower frequency are more vitally concerned with the present difficulties of congestion. In a system of normal type then, for the figures mentioned, the frequency separation between the carrier and either of the sideband frequencies most nearly approaching it will be 0.033 to 0.0033 per cent., according to the carrier frequency.

For single sideband transmission with carrier, it is therefore necessary to provide a system having considerable suppression of a frequency band whose boundary differs by but 0.066 to 0.0066 per cent. from that of the band to be transmitted uniformly. These figures are such that considerable suppression of the unwanted band is beyond the capability of normal filter design.

In this situation, three courses appear open. Special forms of selective circuit using mechanical or similar resonators may be developed, phase and amplitude balance may be used to eliminate the unwanted band, or the audio-frequency band for transmission may be divided into parts, for which the classical method of successive modulation can be used with normal filters and these parts subsequently recombined.

The considerations from which a choice of method was made were the stability, ease of reproduction and ease of operation of the resulting systems. The question of economy in the final product was held to be a matter of subsequent importance until the commercial prospects could become better known. On the criteria stated, it was thought that the first type of system might eventually be feasible, but that at present the technique and reproduction of such means of frequency selection were too embryonic for use in this case. Again it was believed that the difficulty with the second system would be its operating stability, and, that if means were sought to improve this aspect, a long study would probably result in a system scarcely less elaborate than its competitors. Choice then fell on the third system where the only doubtful points appeared to be the ability to divide and re-unite a signal frequency band. This chosen system has become commonly named the "Split band" system for single sideband and carrier broadcast.

Split Band System.

This system has been broadly outlined as the division of the signal band, successive modulations of the parts and their subsequent recombination. The choice of division of the signal band deserved first consideration, and arose from the natural limitations of commercial modulators and filters. Using the normal type of balanced modulator, the major unwanted products at the output are the even multiples of the carrier frequency and odd multiples of the input frequencies, terms higher than the third being in either case relatively unimportant. This implies the general rule that, for high quality, the oscillator frequency must be at least three times the highest input frequency where the upper sideband is to be selected and four times that input frequency where the lower sideband is taken. The second limitation is not so definite and is determined by the feasible discrimination in filters and permissible carrier leak. It was estimated that for a carrier suppression of 60 dB., the modulator balance could be expected to furnish a carrier some 25 dB. below signal level and that the filter should therefore provide 35 dB., discrimination between the lowest wanted output frequency and that of the carrier. To provide this discrimination a further estimate led to the belief that the lowest input frequency should be at least 3.7 per cent. of the carrier frequency, some margin being allowed for adjustment as experience might indicate.

These two considerations led to the result that for the full broadcast range of input frequencies at least three divisions of the band would be desirable. This complexity did not appear to be justified as a first step, and two divisions only were chosen as allowing an input frequency range of 100 to 8,100 cycles per second on the basis taken for estimate. Experience has since shown that the filter discrimination exceeds the estimate and that lower frequencies can be transmitted with a two division system. From the figures cited, it followed that 100 to 900 cycles per second could be used to modulate a carrier of 2,700 cycles per second if the upper sideband were taken, the frequencies 900 to 8,100 cycles per second modulating a carrier of 24.3 kilocycles. To re-unite the signal band it was clear that the modulation product of the first division should modulate a further carrier of 21.6 kilocycles, i.e., 24.3—2.7 kilocycles—a process falling within the limits estimated as feasible. The elementary system was then the division of the signal band into two parts, two successive modulations by the lower frequency division, a single modulation by the upper division and a recombination of the final upper sidebands of the two divisions. The success of such a system obviously depends on the ability to divide the band without serious degradation and to ensure

It was desired to radiate the carrier frequency as well as the sideband frequencies, so that the production of this carrier frequency next called for consideration. This carrier could be derived from the sum of B_{1O} and C_{1O} frequencies, or either of these derived from the difference of the remaining two. Since modern stations are already equipped with master oscillators of high stability producing allocated frequencies, the choice is reduced to deriving either B_{1O} or C_{1O} . Between these, the deciding factor proved to be ease of derivation and the system adopted can be followed on the figure. To the demodulator D_{1M} are supplied inputs from the master oscillator $M.O.$ and from the oscillator C_{1O} . The difference frequency appearing at the output of D_{1M} is selected by the filter D_{1F} and furnishes the equivalent oscillator B_{1O} . This equivalent oscillator, as already stated, supplies both B_{1M} and D_{2M} .

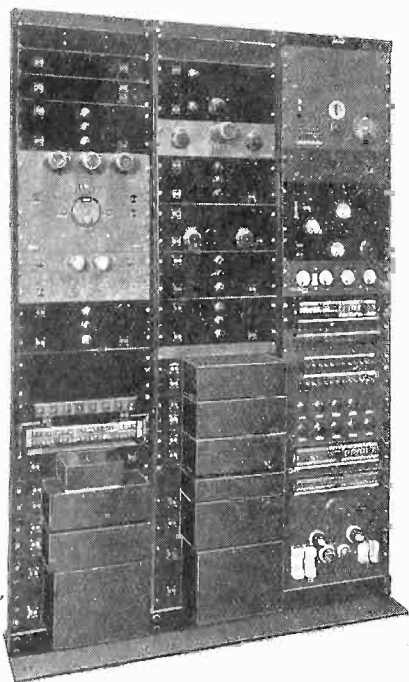

FIG. 2.

The entire oscillator arrangement is therefore automatically correct, since $A_{1O} + A_{2O} = B_{1O}$ and $B_{1O} + C_{1O} = M.O.$ in frequency.

The next matter for arrangement was the insertion of the equivalent carrier frequency in the equipment output and the control of effective modulation. Since the master oscillator might be of any design on a particular station, it was arranged that its output should reach the equipment through an amplifier having two independent outputs—the one for oscillator derivation, the other for transmission. It was undesirable that the latter output should pass back through C_{1F} to C_{1M} , and the signal and carrier outputs were therefore combined in conjugate on a resistance bridge whose fourth arm was formed by the input to an amplifier C_{1A} through an attenuation pad. To provide effective modulation control, a variable attenuator was inserted between this combining bridge and C_{1F} output.

In practice, the rather low output of C_{1A} is amplified and then taken through unbalanced feeder to the transmitter.

The general form of the apparatus is shown by the photograph (Fig. 2), for which the line drawing (Fig. 3) of the layout serves as a key. The appearance of the whole must be ascribed to the inclusion of apparatus existing before this system was designed.

Operation.

The operation of the system is not as difficult as a first impression might suggest. The various modulators naturally require balancing in the usual manner by bias and condenser adjustment, but unbalances only result in distortion terms or unwanted tones of comparatively lower order. This is due to the fact that oscillator

leaks from A1M or B1M result chiefly in final products of the final equivalent carrier frequency, while in other cases the frequency discrimination of the succeeding filters can be sufficiently great to prevent major difficulty.

The adjustment of oscillator frequencies again is not difficult. The master oscillator frequency is presumed correct, so that only A1O and C1O are normally adjusted. Of these, the former is set by the frequency-response of A1M and A2F, the latter by the frequency-response of B1M and B2F.

The alignment of levels is conventional. With no output carrier a prescribed level is established at the volume indicator point on the input, first at a frequency

passing to the "A" chain, then at a frequency using the "B" chain. The resulting outputs are measured at some convenient point, e.g., the equipment output, and made equal by adjustment of the individual chain gain controls on the splitting amplifier. The input is then removed and the carrier supplied, causing a particular output current. This current is then reproduced by a tone input of the previous prescribed level to the equipment in the absence of an output carrier, adjustment for this purpose being possible by the attenuator succeeding C1F. This attenuation is then increased as desired and the output carrier replaced.

DISTRIBUTION	DISTRIBUTION	DISTRIBUTION
C1A	A1O	MASTER OSCILLATOR
M0A		
D1M	VOLUME INDICATOR	DETECTOR
C1M	A1M	INTERMEDIATE AMPLIFIER
	SPLITTING AMPLIFIER	
COMBINING AMPLIFIER	A2M	SUPPLIES AND METERING
B1M	D2M	
	B1F	
MODULATION CONTROL	A2F	
HYBRID AND PADS	A1F	
D1F	A2E	
C1F	D2F	
B2E		
B2F	A3F	

FIG. 3.

since frequencies in this band would suffer attenuations and phase changes altering rapidly with frequency due to filter cut-offs. Theoretically it is obviously possible to obtain uniform r.m.s. output from two chains carrying the same varied frequency if the attenuation and phase shift of each chain be specified. Practically this is too difficult to implement, and the chief influences proved to be the A1F and B1F filters. These filters were designed initially to have an appreciable common transmission region, experience being left to show the resultant orders of disturbance. With this arrangement, considerable fluctuations of system gain appeared around the common frequency band. The next step was to arrange the two paths so that the neighbourhood of the frequency division showed a minimum on either side of a maximum frequency response rather than the converse result. One filter was then modified to bring its cut-off frequency nearer that of the other, and at the same time to provide a total attenuation for the two filters at the frequency of the

maximum response some 3 dB. above that for frequencies well in the transmission range of either filter. This procedure gave a satisfactory result, and the addition of elementary audio-frequency equalisation gave the results of Fig. 4. In view of this performance, the improvement possible by the use of phase correcting networks seemed a doubtful justification for their inclusion.

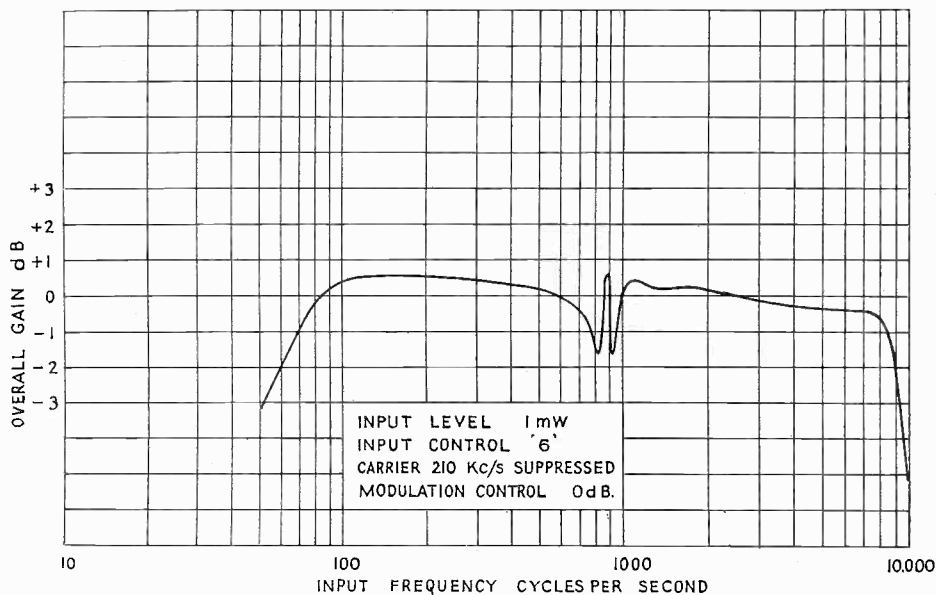

FIG. 4.

Transmitter and Antenna.

The transmitter used for tests followed normal lines, but suffered some changes first for an increase in power radiated and secondly for improved overall frequency response. The arrangement employs an intermediate amplifier on the input equipment racks coupled through a concentric feeder to the transmitter proper. The intermediate amplifier comprises a single valve stage working between 600 and 74 ohms through transducers, while a second transducer terminates the feeder on the 20,000 ohms grid circuit of a class "A" amplifier. The transmitter is completed by one further stage of two valves in parallel, each rated at 500 watts anode dissipation.

The connection of the transmitter to the aerial, a well known problem for long wave broadcast transmissions, is eased by the restricted transmitted band necessary to this system. The aerial dimensions were arranged so that its impedance closely resembled a capacity and a resistance in series, when a simple transducer could be designed around these measured values.

The overall transmitter frequency response is shown on Fig. 5, where the antenna currents are expressed in decibel ratios referred to that for 210 kilocycles per second.

Auxiliary Apparatus.

To complete the description of apparatus, mention must be made of the monitoring and input arrangements. For the first purpose, an anode band detector is coupled grid-to-grid with the intermediate amplifier valve. From this detector, the audio-frequency output passes through pads and a switch to a loudspeaker amplifier. Pads succeeding the detector enable the loudspeaker level to be maintained despite changes in carrier-to-sideband ratio.

The input arrangements are elementary, substitution of the microphone for the gramophone amplifier being by key operation and automatically isolating the loudspeaker.

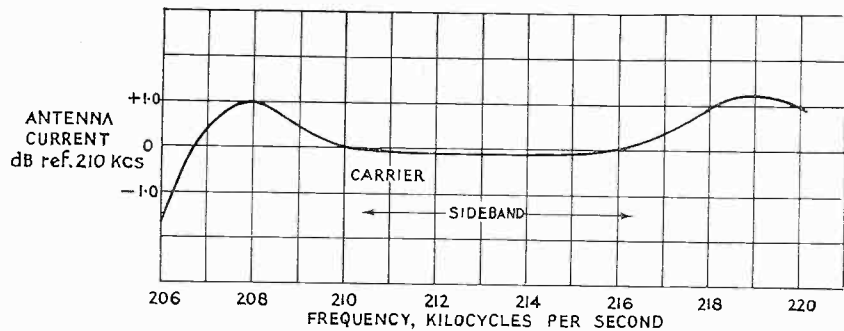

FIG. 5.

Results of Transmissions.

Transmissions were commenced on September 4th, 1934, and were initially subject to interruption while transmitter power was increased. The next period was affected by changes improving transmitter performance and by the use of a new type of gramophone pick-up and record. To weight observations for these changes is well-nigh impossible, so that the following results do not allow for them.

The broadcast announcements stated the purpose of the tests as seeking information on the carrier-sideband proportion necessary for satisfactory reception, and a number of private observations were received. In reply a form was sent to such observers for their use should they care to make further reports.

On quality, the performance as between different carrier sideband ratios was as follows:—

Unity preferred to	5dB., 15%	5dB. preferred to	unity 85%
5dB. „	8dB., 41%	8dB. „	5dB. 59%
8dB. „	10dB., 85%	10dB. „	8dB. 15%

On strength, the statements were almost unanimous in finding the receiver signal diminishing as the ratio increased; but a large proportion of the reports showed difficulty in observing any change in strength between the 5dB. and 8dB. ratios.

Opinions of technical observers were very much alike, whether the observations were made on the monitoring loudspeaker or receiver in finding distortion reduced as the carrier-sideband proportion increased, such improvement becoming imperceptible at 8 to 10dB. There is evidence that the linear type of detector has, as expected, a more distorted output than the square law type. It appears, however, that the difference is not so great as calculations have indicated, and diminishes with increased carrier-sideband ratio.

An interesting result was the observation that under some conditions the bass register was less distorted than the higher notes. This is attributed to the theoretical fact that in some types of detector the differences of the modulating frequencies appear as distortion products, but not the sums.

As a broad generalisation, the results show that on receivers of current types, a carrier sideband energy ratio of 8dB., measured as described, provided satisfactory reception. This ratio corresponds for a single steady tone signal to a carrier-sideband voltage ratio of 1 : 0.398—an interesting comparison with the mean 30—40 per cent. modulation normal in high quality broadcast on present systems.

Note on Relation of Voltage Ratios to Energy Ratios.

In a single sideband and carrier transmission, supposing the carrier voltage to be E_c , and the sideband voltage for a single tone signal to be E_s , unity ratio will occur both for energy and voltage when $E_s = E_c$. A similar two sideband and carrier transmission, however, has a carrier-sideband energy ratio of 1 : 0.5 when the voltage ratio is unity. Hence, for a single tone signal, a transmitter capable of handling a carrier normally modulated 100 per cent. can handle a single sideband and carrier of unity energy ratio.

In the transmission of programmes on multiple tones, the common situation persists that the input voltage is the sum of the individual component voltages while the energy is proportional to the sum of the squares of the individual voltages. So that the empirical values found for the mean indicated modulation that avoids noticeable distortion still hold for single-sideband and carrier transmission. The only change is that with such modulations, the sideband energy content in the single sideband is double that in the two-sideband transmission.

Conclusions.

These tests have given definite information on certain of the problems involved in the use of single sideband and carrier broadcast. A feasible means of producing and transmitting such signals has been found, and has proved reliable in practice. Typical modern receivers can provide satisfactory quality from these transmissions, provided that the carrier-sideband ratio exceeds a figure between 5 and 8 decibels.

Changes in interference remain unexplored, since transmissions during British broadcast hours were not possible. Change of service area in comparison with normal transmission is still problematical, while transmitter problems were not examined to any extent beyond that necessary for the tests.

F. M. G. MURPHY.

AERIAL TERMINATIONS

The following notes are complementary to an article on Aerial Resistance that appeared in the March-April REVIEW. As previously, the notes are intended to cover an outline of the principles involved, principles that are a matter of routine to the radio-physicist but that are, sometimes, not so familiar to those whose main duties lie outside the study of aerial problems. Throughout the notes where aerial heights are mentioned, the electrical and not the physical dimension is assumed—thus for a quarter wave aerial the actual physical dimension will be nearer $1/4.4$. Similarly, for a half wave aerial the dimension will be nearer $1/2.2$.

Aerial Reactance.

AN earthed vertical wire three-quarters of a wavelength in height will function as an open oscillator, if coupled to an appropriately tuned source of excitation, with current and voltage distribution as per full and dotted lines indicated in Fig. 1A.

The reactance due to the distributed inductance and capacity is, of course, balanced for the aerial as a tuned whole, but if we consider the aerial as being developed to its ultimate height in progressive stages from 0λ to $\frac{3}{4}\lambda$, then, if still excited at a frequency corresponding to λ , the reactive component of the terminal impedance will vary with the height of the wire. Taking the earth as our datum and commencing at 0 length of wire, reactance will have a starting value infinitely great and capacitive—since a point possesses infinitely small capacity. For all stages of development up to one quarter wavelength the reactive component will be capacitive, gradually decreasing in value according to the usual cotangent curve; actually the curve is slightly modified because of the gradually increasing resistive load due to radiation. At the quarter wavelength point the reactance component vanishes and we are left with an equivalent resistance of 36.6 ohms; that is, due to radiation the resistive component has progressively increased until for an aerial one quarter wavelength high it reaches the above value.

Beyond the quarter wave point reactance gradually increases again and is inductive: on account of the progressive loading it no longer extends to infinity but, reaching a maximum, curves round and falls back to zero at the half wavelength point. Note that for a half wavelength vertical aerial the load due to radiation has increased to an equivalent resistance of, say, 104 ohms, this latter figure being, by definition, still computed on the current value at the quarter wave point, i.e., at the current loop.*

Continuing through the half wave point until we reach the three-quarters wavelength height, reactance swings back into capacitive value, reaches a maximum and falls again to zero. Thus, tracing the growth of an aerial from 0 height to three-quarters wavelength height, reactance values can be plotted against aerial height and a curve obtained, somewhat as indicated in Fig. 1B. The actual computation of such a curve is not particularly easy, although for the first quarter

* As previously explained, the given figures of 36.6 ohms and 104 ohms are subject to an increase with the higher frequencies and, under such conditions, with variations in ground conductivity; in particular, for short waves the half wave aerial may have a radiation resistance as great as 160 ohms.

wavelength section the approximately cotangential values are fairly obvious: the remaining section might be regarded as a uniformly loaded single wire feeder one-half wavelength long, terminated by a quarter wavelength aerial, that is, by a resistive load of some 36.6 ohms. The subject is discussed a little further in a note at the end of this article.

Termination of Quarter Wave Aerial.

In the foregoing paragraphs we have discussed variations in the reactive component of the terminal impedance, with the object of introducing the subject of

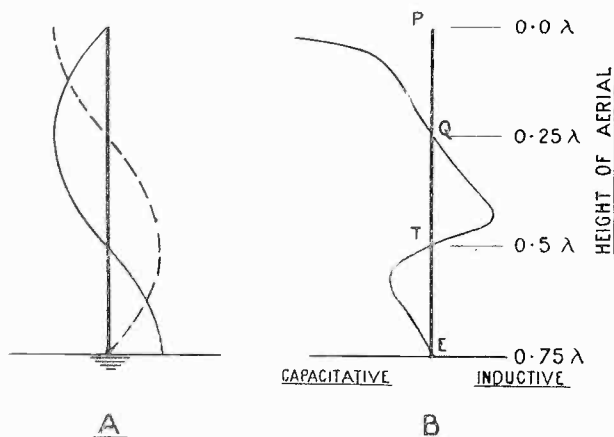

FIG. 1.

aerial terminations. Since the scope of these notes is limited, only two main types of aerial will be considered, namely:—

- (A) The Quarter Wave type, covering dimensions that extend from short aerials to those that are of an electrical length somewhat exceeding the quarter wave, and
- (B) The Half Wave type, extending from the merging point between the two types to some fraction beyond the half wave.

Commencing with the former, it is a fundamental of our knowledge that aerials less than quarter wavelength can be “tuned” to earth with so many turns of inductance, the actual value of inductance depending on the dimensions and frequency of any particular aerial. In other words the value depends upon the aerial’s equivalent length, as a fraction of the quarter wavelength corresponding to some point between P and Q on Fig. 1B: it is thus a problem of neutralising so much natural capacity reactance by so much added inductive reactance. The fact that the turns of inductance also provide the necessary facility for coupling to the transmitter is of importance; when it happens that the aerial can be tuned with so few turns as to be insufficient for the purpose of coupling, then it is necessary to simulate artificially conditions which ensure that a sufficient number of turns are available.*

* There is, of course, the possibility of a capacity coupling, but the capacity must be neutralised with an inductance.

A case in point is the full quarter wave aerial, capable of being tuned by direct contact with earth, that is without any turns of inductance. As mentioned, the equivalent load resistance for a plain, straight aerial of this type is 36.6 ohms, while for flat top quarter wave aerials the load resistance may be considerably less ; thus at most it is of low value and can therefore be simulated by the series arrangement of capacity-inductance termination (see Fig. 2). This artifice ensures a sufficient number of turns of inductance for coupling to the transmitter, either directly or via a feeder termination. The relative values of capacity and inductance for "tune" can, of course, vary widely, but if one takes as an axiom that the current value through the coil should match the current value at the base of the aerial, then the inductance chosen should be approximately equal to the effective inductance of the quarter wavelength aerial. This means, of course, that the associated capacity equals the effective H.F. aerial capacity. One might regard this capacity as artificially added reactance, the object being to introduce turns of inductance.

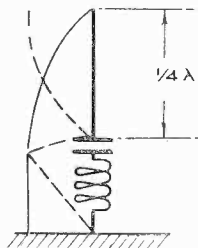

FIG. 2.

is smaller, since it has to effect the dual function of first neutralising the natural inductive reactance, due to the aerial extending beyond quarter wavelength, and then adding sufficient capacity reactance to ensure an adequate coupling coil.

As the aerial height increases we approach an interesting stage, namely, when the resistive component of the terminal impedance increases rapidly and reaches such a value that the acceptance of a capacity-inductive series circuit is unsuitable, i.e., the series circuit must be replaced by a capacity-inductance parallel circuit. As to the precise length of aerial at which it is preferable to change over from series to parallel condenser-inductance, this is largely a matter of choice of component values, but it may be taken as lying between the stages when the electrical length of the aerial is around five-sixteenths wavelength. The bias in choice is usually towards the parallel circuit.

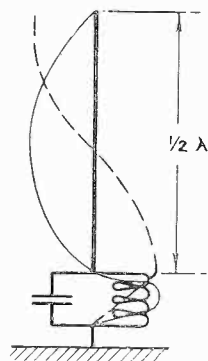

FIG. 3.

Termination of Half Wave Aerial.

From Fig. 1B it will be observed that at the half wave point "T" reactance again vanishes and the resultant impedance is of a purely resistive nature : this resistance is usually referred to as the base or terminal resistance ; it has no longer the comparatively low (radiation resistance) value of 36.6 ohms, measured in terms of current at loop value, but has the comparatively high figure of the order of 3,000 ohms, associated with the voltage loop value. It is obvious, therefore, that to terminate the aerial at this point a circuit of comparatively high resistance should be employed, that is, the parallel inductance-capacity circuit is indicated (see Fig. 3).

In Part I of these notes it was shown that the actual value of the terminal resistance might be computed from a consideration of the H.F. feed current necessary to sustain oscillations in a half wave aerial. Another method follows from the

equation for the equivalent resistance of the parallel capacity-inductance circuit employed to terminate the aerial, that is, provided the inductance value is half the effective total inductance of the half wave aerial.

From a consideration of Fig. 1A it is pretty obvious that apart from radiation such a closed circuit capacity inductance combination can replace the final quarter wavelength section of a three-quarter wavelength aerial. Further consideration will reveal that in this case the closed circuit inductance is just half the effective inductance of the half wave aerial, while the load resistance of the closed circuit is that associated with half wave current at loop value, that is, it is the true radiation resistance of the half wave aerial. Thus if L signifies the total inductance of the half wave aerial and R its true radiation resistance, the terminal resistance R^1 is given by

$$R^1 = \frac{w^2 L^2}{4R} *$$

Apart from the fact that this particular combination of inductance and capacity matches the half wave aerial terminal resistance, it is quite a good one for terminating a half wave aerial, since it ensures sufficient turns for coupling. Moreover, as we have seen, it possesses the considerable advantages that the closed circuit current equals the loop current value of the half wave aerial, while the load resistance is equal to the radiation resistance—neglecting closed circuit ohms. In the writer's opinion the above is the best closed circuit termination; although other combinations are possible, and frequently adopted, none will give these exact current and resistance values, a fact often overlooked by the unwary when calculating radiation resistance from aerial couplings.

Within reasonable limits this closed circuit termination can be modified to suit aerials that are either effectively longer than or shorter than the half wave aerial. Generally speaking, the guiding factors are those usually associated with design problems, namely that voltage and current values are within safe limits for economic insulation and copper, and that the turns are sufficient for coupling purposes.

Finally there is an alternative method, and in the writer's opinion a preferable method, for terminating half wave aerials. The method is simple and consists of extending the lower end of the half wave aerial by means of a "tail" until definite and adequate capacitive reactance is assured, say at one-eighth wavelength of tail, and completing with an earthed coil as indicated in Fig. 4. It might be asked, why not start the coil immediately at the half wave point?—the answer being that, certainly on the higher frequencies, it is difficult to tune satisfactorily, by means of turns of inductance only, from a point that is not definitely capacitive in reaction—such a point, for instance, as the end of a half wave aerial.

The advantages of the system are as follows:—

- (A) Simplicity of tuning, since all that is necessary is to vary coil turns until earth current is a maximum.
- (B) Absence of condenser.
- (C) Ample turns for coupling can be assured. Aerial resistance easily measured, because, for all intents and purposes, it coincides with the coil load resistance.

* See note at end of article.

The drawback to the system, when compared with the closed circuit termination of Fig. 3, is the absence of any harmonic filtering effect, but in the writer's opinion it is definitely preferable to rely on other methods for harmonic attenuation.

If the lower end of the half wave aerial is, say, some 10 feet from the ground, then the tail can be run as a horizontal extension and radiation will be very slight : such as it is it can be still further reduced, while also effecting an economy in space, by the loop principle roughly indicated in Fig. 5.

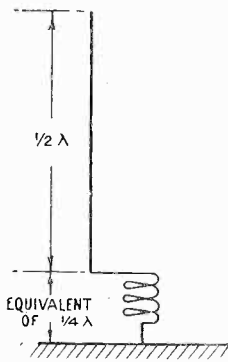

FIG. 4.

ADDITIONAL NOTES.

Note on Aerial Reactance Curve.

Earlier in these notes, when dealing with the shape of a three-quarter wave aerial terminal reactance curve, the lower half wave portion of the aerial was regarded as a uniformly loaded feeder line terminated with a low value resistance, namely 36.6 ohms.

The properties of terminated H.F. feeder lines are dealt with in various textbooks and periodicals (see, for example, an article by E. Green, in *THE MARCONI REVIEW*, No. 17), but when there is also a uniformly distributed load—analogueous to the radiation loading of an aerial—the computation of reactance values becomes more difficult ; it is possible, however, to arrive at a reasonable idea of the effect of this uniform loading by visualising it as corresponding to an increase in the terminal loading. Regarded in this way it is obvious that the effect is to flatten out the reactance curve, and this will be rather more apparent if we consider the final quarter wavelength section of the aerial as if it were terminated by the base of a half wave aerial, that is, with a resistance of the order of 2,000 ohms.

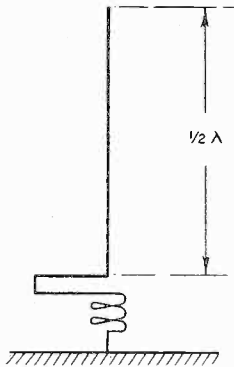

FIG. 5.

Although we have been solely concerned with an aerial whose effective length is but three-quarters wavelength it may be useful, for the purpose of a clearer understanding of the reactance curve, to ignore this limitation and consider the case of an in-phase aerial extended to three or four wavelengths in height. The effect of this will be to increase the radiation resistance of the aerial to something like 600 ohms, that is, to a value that tends to equal the surge impedance of a plain straight wire of the same diameter as the aerial. Under these conditions the lowest section of the aerial may be regarded as a wire terminated with its equivalent surge impedance : from this it is obvious that the reactance curve of the final section tends to flatten out and disappear, since this section of the aerial is simply behaving as a more or less properly terminated feeder.

For the simple case of a high, in phase, short wave aerial, if we compute the equivalent resistance from point to point, moving down the aerial, the equivalent resistance referred to the current loop—radiation resistance—tends to merge into the equivalent resistance referred to the voltage loop, the former increasing and the latter

decreasing: in fact we gradually approach feeder conditions and the radiation resistance tends to become a constant for all points towards the lower end of the aerial. The value approximates to 600 ohms, that is, the surge impedance of a long straight wire, the exact figure depending on the inductance and capacity per centimetre of the wire in question.

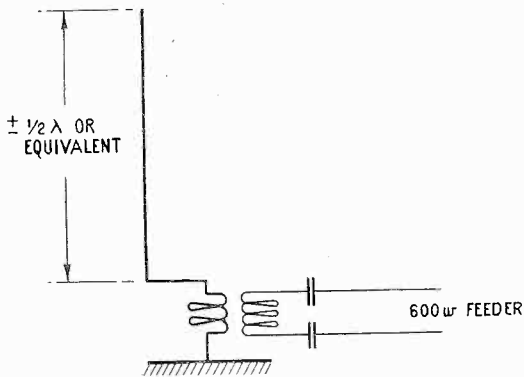

FIG. 6.

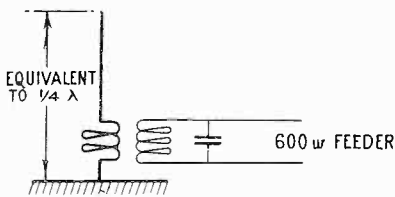

FIG. 7.

If one had a really high aerial to deal with, as is possible in the case of short waves, it becomes pretty clear that the definition of aerial resistance would have to be rather carefully worded, and stated in terms of the current measured in the lower section of the aerial, where it tended to be uniform.

Feeder Line Termination, 600 Ohm Balanced Type.

In order to transform the H.F. load resistance of the aerial coil into the 600 ohms equivalent of the feeder loading, or termination, a certain mutual coupling is necessary as between aerial coil and feeder terminal coil. To arrive at this value the usual method is to adjust the coupling between the two coils by varying the feeder coil turns. The desired condition, which corresponds with maximum transfer of energy from feeder to aerial, will be indicated by uniform current along the feeder.

Whatever value of feeder coil is appropriate, its inductive reactance must be neutralised in order to bring about the effect of a pure resistive load, and, for medium waves, it is possible to neutralise by means of two series condensers, as indicated in Fig. 6. Assuming a half wave aerial, with single termination as depicted, the load resistance in the aerial coupling coil will be pretty close to the aerial radiation resistance, say 100 ohms, so that we require a load resistance transformation of 100/600 ohms.

In the case of the longer waves, where the aerial is the simple tuned type indicated in Fig. 7, the aerial load resistance again coincides with the measured radiation resistance, and may be of the order of 20 ohms; thus the load transformation ratio is 20/600: under these circumstances it is more convenient to terminate the feeder as shown in Fig. 7.

In order that the feeder line be terminated by the equivalent of a resistance of 600 ohms in this latter case, the relationship between the feeder coil inductance, L_f , and the feeder coil loading, R_s , must be such that:—

$$600 = \frac{\omega^2 L_f^2}{R_s}$$

and since R_s is the load thrown into the feeder circuit from the aerial circuit, it follows that the relationship can be secured by adjusting the aerial coupling. It is usual to vary the coupling by varying turns of L_f , thus changing two variables at once. In practice it has been found that the feeder closed circuit current approximately equals the aerial current, thus in a well designed quarter wave aerial feeder termination, the load resistance of the closed circuit coincides approximately with the resistance of the aerial circuit to which it is coupled.

There is an increasing tendency to adopt the feeder termination of Fig. 7 on medium waves, the object being to attenuate harmonics via the fairly large shunt capacity across the feeder.

Terminal Impedance of Half Wave Aerial

The classic equation for the equivalent parallel resistance of a closed circuit is $R_t = \frac{w^2 L^2}{R}$ where R is the circuit series resistance and L its circuit inductance.

Let the circuit be coupled with a half wave aerial, as per Fig. 3, and let its inductance equal half the effective inductance of the aerial (see Fig. 1). Then, since the aerial terminal E.M.F. is acting across equivalent inductances, the closed circuit current equals the aerial loop current and the closed circuit resistance (due to coupling) equals the aerial radiation resistance, ignoring minor losses.

Consider the case of a moderately thin wire half wave aerial for 100 metre wave, for which we can take as fairly accurate approximations the following constants:—

$$\begin{aligned} \text{Physical length} &= 45 \text{ metres} \\ \text{Inductance per metre} &= 2/10^6 \text{ Henries} \\ \text{Effective Inductance of Half Aerial} \end{aligned}$$

$$= \frac{1}{2} \left(45 \cdot \frac{2}{10^6} \cdot \frac{\pi}{2} \right)$$

Substituting this value for L in the above formula we obtain:—

$$R_t = \frac{290,000}{R}$$

and if we assume a radiation resistance of 100 ohms, we obtain a value of 2,900 ohms as the aerial terminal impedance.

It is interesting to observe that if the radiation resistance diminishes, as would be the case for "half wave" aerials with flat tops, the terminal impedance rises. Again, if the distributed inductance diminishes, as would be the case for half wave aerials of multiple wire or cage formation, the terminal impedance diminishes.

N. WELLS.

A DAYLIGHT STROBOSCOPE LAMP

A simple form of stroboscope lamp circuit is described which can be actuated from the ordinary "grid" A.C. mains. The very short and brilliant flash obtained enables stroboscopic methods to be used quantitatively in the examination of the motion of machinery synchronously actuated from the same supply source.

FOR purposes of checking and eliminating "hunts" and slight irregularities of motion in the tape driving mechanism of a Marconi-Stillé Recording and Reproducing equipment, a stroboscope lamp which gave sufficiently brilliant illumination to work in daylight was required. It was also found to be very desirable in order to get clear-cut stroboscopic images for the flash time of the lamp to be of very short duration.

Preliminary experiments were carried out with a neon lamp arrangement which was placed in series with the anode circuit of a valve, the grid circuit of which was energised from a note oscillator, the frequency of which could be varied at will. The sharpness of flash could be controlled to some extent by "backing off" the grid circuit of the valve, but the arrangement did not give a very sharp image, and the brilliance of the flash was not really sufficient for daylight working.

As valuable time was wasted adjusting the frequency of the oscillator to give a stationary image, and as the mechanical arrangements being examined were driven off a synchronous motor from the A.C. mains (grid system), it was decided to aim for an arrangement which could be energised from the mains and would give the required improvements as regards brilliancy and sharpness of flash; the stationary stroboscopic image on the particular rotating part being obtained by dividing the stroboscopic disc or ring into the correct number of parts. The stroboscopic marks used were actually engraved lines filled in black, the disc or ring being of aluminium, the black marks thus standing out clearly against the light aluminium surface.

First attempts were made with a gas-filled relay controlled from the mains, a very similar principle of operation being employed to that described below. With suitable adjustments a very sharp image could be produced, but the light intensity was not enough for daylight operation.

As of the glow discharge tubes the sodium tube produces the most brilliant illumination, it was next decided to try out one of these. The type of tube used being one that was specially developed for television purposes, a cold cathode tube, containing a mixture of neon and sodium vapour, the correct sodium vapour pressure being maintained by an auxiliary heater. First attempts were made using a valve circuit energised from the mains as a control device, but applying the condenser principle described below. This gave a sufficiently brilliant flash, and by careful adjustment could be made to give a very sharp image, but it was found to be somewhat erratic in operation and there were too many interlocking adjustments possible. Simplifications in which the valve was omitted were then tried out. The first results in which raw A.C. was used, gave clear and bright images, but they were found to be double, owing to the fact that because of dissymmetry of the electrodes, the striking and quenching voltages for one half-cycle of the A.C. were not the same as those for the opposite half-cycle.

A Daylight Stroboscope Lamp.

An interesting feature was noticed, in that the two images were of different colour, presumably owing to the fact that the relative proportions of sodium and neon glow were different for opposite A.C. half-cycles.

A copper oxide rectifier was then used to cut out one half-cycle of the A.C., with the result that the double image disappeared. The arrangement was found to be very stable in operation, and the initial adjustments quite simple.

Fig. 1 shows the connections diagrammatically, and the principle of operation will now be described.

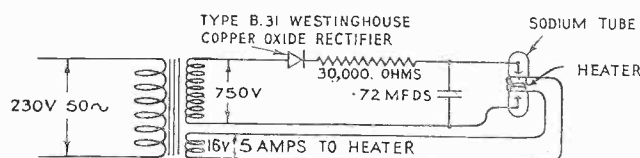

FIG. 1.

It will be seen that the sodium tube is connected directly across a fairly large condenser, which is charged every half-cycle from the transformer through the rectifier and 30,000 ohm resistance. The relative values of the condenser and resistance are adjusted so that the condenser has only time to charge to the striking voltage of the sodium tube once per half-cycle, but there are of course an infinite number of combinations of resistance and condenser which would secure this condition for the given A.C. volts. It is well, however, to keep the condenser as big as possible in order to obtain brilliance of flash. It was confirmed by experiment that the product of condenser value multiplied by resistance value must remain approximately constant to secure the same timing, i.e., doubling the condenser involves halving the resistance and *vice versa*. The cycles of charge and discharge are illustrated by Fig. 2. The very short time of discharge is due to the peculiar volts current characteristic of the tube. From experiments on a sodium tube "blink" circuit, it is estimated that the flash time can be made as short as 10 micro seconds.

The diagram at the top left-hand corner of Fig. 2 illustrates the type of characteristic given by a sodium tube. The striking and working voltages depend to a large extent on the gas pressure and shape of electrodes, heating, etc. To obtain the characteristic it is necessary to use a safeguard resistance to prevent damaging the tube. On increasing the voltage with the potentiometer, no current flows through the tube until the striking voltage is reached, when the tube conducts and the volts across the tube become the working tube volts. An increase of voltage at the potentiometer will only increase the current without altering the tube volts until the safe limit for steady current through the tube is reached. (Short flashes have a very much higher instantaneous value than this steady value.)

Decreasing the potentiometer voltage decreases the current until when the current becomes under a milliamp, the tube volts start to rise until the quenching voltage is reached, when the tube ceases to conduct. The tube can only be made to conduct again by increasing the potentiometer volts to the striking volts. With the tube which was used, the striking volts were 180, the tube volts 60, and the quenching volts 70. It will thus be seen that the resistance of the tube itself is dependent on the current through the tube. The action therefore of applying a

A Daylight Stroboscope Lamp.

charged condenser to the tube (charged to a voltage equal to or higher than the striking voltage of the tube) is to cause a sudden heavy rush of current from the condenser until the condenser volts are reduced to the quenching voltage when the tube ceases to conduct. A study of the characteristic will show that the effective resistance of the tube itself must be very low when the condenser becomes charged

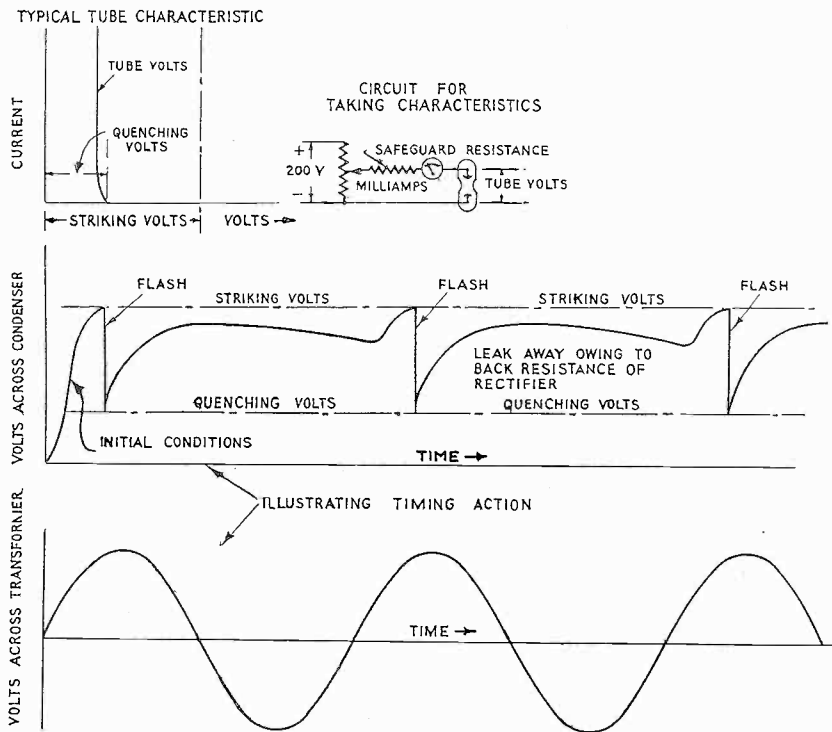

FIG. 2.

to the striking voltage, and in fact the instantaneous current must be largely governed by the condenser resistance, resistance of leads, etc. The result is therefore arrived at that, owing to the very heavy rush of current from the tube, the condenser is very quickly discharged, and the quenching voltage rapidly reached. The flash is therefore a very short flash of high brilliancy.

The bottom curves illustrate the charging and discharging of the condenser, and how, after the initial conditions have steadied down, the flash is automatically timed by the A.C. from the transformer, when the correct values of resistance and capacity have been found to ensure that not more than one flash occurs per A.C. cycle. By increasing the condenser or resistance values it is possible to produce a flash correctly timed every second, third or fourth cycle, etc. The charge law of the condenser is, of course, a function which is derived from the sine function governing the A.C. and an exponential function.

A Daylight Stroboscope Lamp.

To improve the timing a "peak" transformer could be used. As this produces a very peaky wave form, the timed flash could, where requirements are such, be made to take place at the part of the cycle where the rate of change of the A.C. volts is greatest, and its timing would be therefore more accurately defined. So far as our experience has gone this arrangement would not, however, appear to be necessary for ordinary work.

With the above stroboscopic arrangement the definition is so sharp that it is possible to use a vernier stroboscope, which will show clearly wobble in one-hundredths of a cycle (relative to 50 cycles). Alternatively a reading microscope can be used which will give direct measurement, the definition of the observed stroboscope marks remaining sufficiently good to take definite readings with a reading microscope having a magnification of twenty diameters.

N. M. RUST.



MARCONI NEWS AND NOTES

ENGLAND-AUSTRALIA FILM TELEGRAPHED BY MARCONI FACSIMILE SYSTEM.

A FACSIMILE telegraph service by short-wave Beam between England and Australia was opened by Cable and Wireless, Ltd., in conjunction with Amalgamated Wireless (Australasia) Ltd., on October 16th, utilising the latest Marconi system of facsimile telegraphy.

The unequalled efficiency of this means of transmitting photographs, drawings, and facsimiles of all kinds, was demonstrated in a remarkable manner shortly after.

A well-known British film company, whose operators had secured first class news pictures of the arrival in Melbourne on October 23rd of the winners of the England-Australia Air Race, decided to make the bold experiment of having this film, of outstanding topical interest, transmitted by wireless from Australia to England so that it could be circulated without delay to cinemas in this country. Thanks to the efficiency of the recently opened wireless facsimile service, the scheme was entirely successful.

Thus, by modern scientific engineering was accomplished the almost incredible feat of showing in English cinemas the arrival in Australia of aviators who had left English soil only six days before.

The extracts from the telegraphed film shown on the opposite page are reproduced by courtesy of the Gaumont-British Picture Corporation, Ltd., of London, and Cable and Wireless Ltd.

Wireless on the Starting Line.

Marconi wireless apparatus also played an important part in facilitating the arrangements for the start of the England-Australia Air Races at Mildenhall Aerodrome, Suffolk, on Saturday, October 20th.

Owing to the size of the aerodrome, and the comparatively poor visibility at the early hour of the start (6.30 a.m.), rendering it difficult for the officials and newspaper correspondents from all parts of the world to identify readily the different aircraft as they took off, a wireless link was provided between the starting line and the Press enclosure and the Press Office.

Two Marconi portable field transmitters, of a class specially developed for military use on the march, were carried like infantrymen's knapsacks on the backs of two officials of the Royal Aero Club, who were stationed behind the starter for the race. As each machine took off, at intervals of 45 seconds, these officials announced into small hand-microphones the identity of the machine, the time of its start, and any special features of the take-off.

Marconi portable transmitter at Mildenhall Aerodrome at the start of the England-Australia air races. The equipment was entirely self-contained as shown.



These messages were received by a portable receiver installed in the saloon car used by the Marconi Company to demonstrate mobile wireless working to police authorities throughout Great Britain. From this receiver messages were relayed to Marconiphone amplifiers and loudspeakers so that an official announcement of the identity and time of starting of each machine was immediately available. The Press Office at Mildenhall was connected by telephone and telegraph lines direct to London and to the principal news centres of Europe, America, and Australia, so that by means of "flash" messages it was possible to have the official news of each machine's departure circulated throughout the world almost as soon as it was out of sight and earshot of those on the aerodrome at Mildenhall.

New Broadcasting Developments.

IMPORTANT broadcasting developments in many countries are reflected in new orders received by the Marconi Company. Recent advances in broadcasting technique and the ever-increasing popularity throughout the world of this form of entertainment and instruction have necessitated the building of new stations and the reconstruction of older installations in order to meet modern requirements.

An outstanding event in Great Britain has been the opening of the new "national" broadcasting station of the British Broadcasting Corporation at Droitwich. The 150 kilowatt transmitter for this station was constructed by the Marconi Company and its performance has received the unqualified praise of experts and listeners alike. It replaces the old British "national" broadcasting station

5XX, which was built by the Marconi Company at Chelmsford in 1924 and removed to Daventry in 1925.

Another Marconi 150 kilowatt broadcasting transmitter is now under construction for installation at Lahti, Finland, where it will replace the existing 40 kilowatt station.

Both these high-power installations incorporate the Marconi "series modulation" system, which was described in *THE MARCONI REVIEW*, No. 41, and are also notable for their use of the Marconi C.A.T.14 valves, the largest water-cooled valves of their type in existence. These valves operate at 18,000—20,000 volts to the anodes and 32 volts at 460 amperes to the filaments. On telegraphic loads they can be worked with an anode input of 500 kilowatts and are capable of withstanding a continuous anode dissipation of 150 kilowatts. On telephony with an anode input of 150 kilowatts they will deliver an unmodulated carrier energy of 50 kilowatts.

Beromunster, Switzerland, has also joined the ranks of the very high power European broadcasting transmitters, the Marconi Company having received instructions from the Swiss Telegraph Administration to increase the power of the existing Marconi transmitter from 60 to 100 kilowatts. This was effected by replacing the power amplifier by a new stage containing two C.A.T.14 valves. At the same time a number of other modifications were made to bring this station completely up-to-date in its equipment.

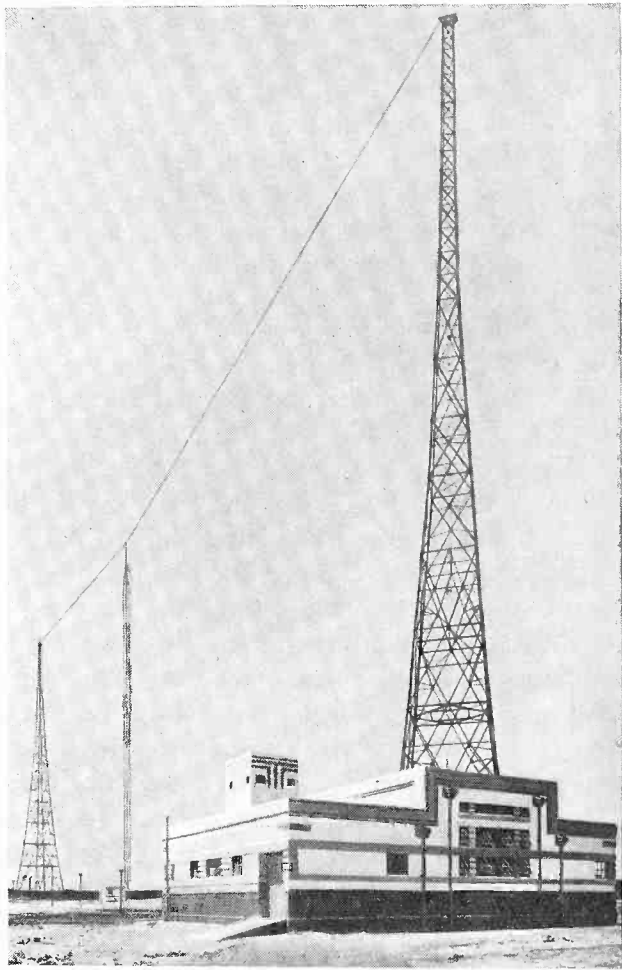

Cape Town Broadcasting Station.

These included the incorporation of the Marconi "floating carrier" system (described in *THE MARCONI REVIEW*, No. 45), "series modulation," and a Marconi high precision crystal drive having a constancy of 5/1,000,000.

The Marconi Company also has in hand contracts for the installation of 150-kilowatt broadcasting stations at Bod (Roumania) and Motala (Sweden).

South Africa, Palestine, and Brazil.

Closely following the successful inauguration of the new Marconi broadcasting station at Cape Town, the African Broadcasting Company decided to install two more identical stations at Grahamstown and Pietermaritzburg. The new transmitters will serve areas of South Africa not adequately served by the existing stations and are thus expected to give further stimulus to broadcasting in the peninsula. Both employ "series modulation."

In Palestine, a new broadcasting service is being inaugurated by the Department of Posts and Telegraphs, which has entrusted the Marconi Company with the task of constructing and installing the first station. The site for the transmitter, of 20 kilowatts unmodulated aerial energy, has been selected about seven miles north of Jerusalem and the working wavelength will be 449.1 metres.

The capital of Brazil is also to have a Marconi broadcasting station in the near future, a 10-kilowatt transmitter of the latest design having been ordered by Radio Tupy Limited, of Rio de Janeiro.

Alternative Programme Service for Egypt.

AN alternative programme system, providing separate simultaneous transmissions for Arabic and European listeners, was inaugurated by the Egyptian State Broadcasting organisation on November 1st.

Since the opening on May 31st this year of the official broadcasting service, which is operated by the Marconi Company on behalf of the Egyptian Government, one of the main problems confronting the responsible officials, both European and Egyptian, has been the fair allocation of programme time to meet the wishes of the two sections of the community. In many respects their tastes and interests relating to art and entertainment differ fundamentally, a fact which has been recognised in the past by the allocation of approximately 70 per cent. of programme time to "Arabic" programmes and 30 per cent. to "European" programmes.

This plan, however, left both communities wanting more programme time, especially at the most popular hours, and following a recent exchange of visits between a member of the London Management of the Marconi Company and the Director-General of Egyptian State Broadcasting it was decided to organise a complete alternative service, for which two new stations will be erected in addition to the existing stations at Cairo and Alexandria. The new stations will not be completed until early next year, but in the meantime the alternative programme service is being inaugurated from two temporary stations.

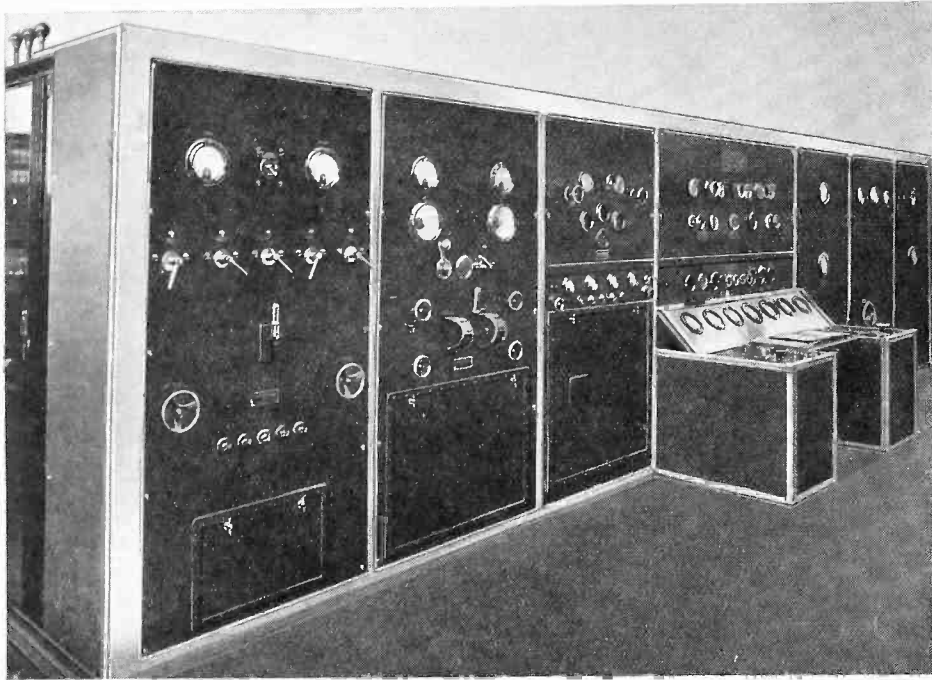

Marconi 10-kilowatt broadcasting transmitter at Cape Town.

Wireless at British Airports.

GREAT progress has been made by the British Air Ministry this year in equipping new civil airports with wireless apparatus. Hull (Hedon), Portsmouth, and Belfast now all have up-to-date aerodrome wireless stations in regular operation, the equipment consisting of Marconi transmitters suitable for either telephone or telegraph operation, and directional receivers enabling navigational aid to be given to aircraft in flight.

The transmitters and receivers are of a type designed for mobile use and can be accommodated, together with all necessary running machinery, switchboards, and batteries, in a motor lorry or trailer. The transmitter has a rated power of 500 watts (to the valve anodes on continuous wave telegraphy), with a waverange of 500 to 1,200 metres, and is known as the Type D.M.ra. It is particularly suitable for aerodrome work as it is arranged for quick wave-changing and remote control, and can therefore be used very conveniently for any of the various classes of services for which a modern aerodrome transmitter must cater. These include telephone and telegraph communication with aircraft in flight, contact with other aerodromes for the exchange of traffic information, and the regular transmission of weather reports.

The Marconi directional receivers for Hull, Portsmouth and Belfast are of a type that have been selected by the Air Ministry after extensive tests. They can be used both for general reception and for direction finding by the Bellini-Tosi system.

Marconi Equipment for Police Autogiro.

THE autogiro in which experimental flights over London have been made by Scotland Yard officers in order to determine the possible value of this class of aircraft for traffic control and other purposes is fitted with Marconi short-wave transmitting and receiving equipment to enable it to maintain two-way communication with the ground.

The wireless apparatus has been specially designed for compactness and light weight. Both the transmitting and receiving panels are fitted beneath the dashboard in the observer's cockpit of the autogiro and the total weight of the equipment, including batteries and all accessories, is 70 lbs.

The transmitter is arranged for continuous wave telegraph working and comprises a master oscillator and magnifier circuit, with a P.625 valve in each stage. The receiver is a straightforward 3-valve instrument, with one screen grid high frequency valve Type S.410, a detector Type L.410 and one low frequency valve, Type L.410.

High tension supply for both the transmitter and receiver is taken from a 240-volt dry battery, the power to the anode of the magnifier being 4-5 watts; the battery is tapped at 120 volts for the receiver. A 6-volt accumulator supplies low tension current to the filaments of the transmitter and receiver valves.

The Marconi Company has previously fitted wireless equipments in the autogiros used by Scotland Yard for traffic control on Derby Day for the past three years, and its efficient operation has contributed materially to the success of this form of traffic control on those occasions, enabling the observers in the air to give immediate information to the police on the ground regarding the state of the roads and any areas where traffic congestion was impending.

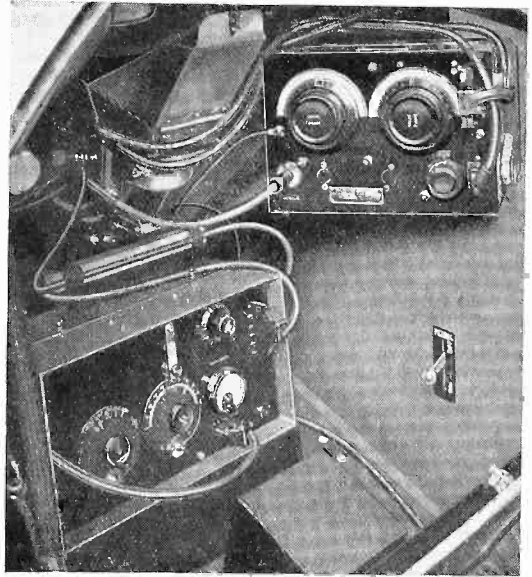

Police autogiro equipment.