

THE MARCONI REVIEW

March-April, 1934



CONTENTS

THE MARCONI SYSTEM OF FACSIMILE TELEGRAPHY -	PAGE	1
AERIAL RESISTANCE AND AERIAL TERMINATION -	„	13
OPTICAL EFFICIENCIES AND DETAIL IN TELEVISION SYSTEMS - - - - -	„	21
MARCONI NEWS AND NOTES—		
NEW BEAM WIRELESS SERVICE OPENED - -	„	29
POZNAN STATION RECONSTRUCTED - - -	„	29
ICELAND CALLING - - - - -	„	29
RADIO-BELGRADE'S NEW HOME - - -	„	30
NEW MARCONI EQUIPMENT FOR IMPERIAL AIRWAYS	„	32
WESTERN AUSTRALIAN AIR SURVEY - - -	„	32

MARCONI'S WIRELESS TELEGRAPH COMPANY LTD.

Electra House, Victoria Embankment, London, W.C. 2

THE MARCONI REVIEW

No. 47.

March-April, 1934.

Editor: H. M. DOWSETT, M.I.E.E., F.Inst.P., M.Inst.R.E.

Assistant Editor: L. E. Q. WALKER, A.R.C.S.

THE MARCONI SYSTEM OF FACSIMILE TELEGRAPHY

Equipment embodying the latest developments in Radio Facsimile Telegraphy has recently been installed in the Central Telegraph Office of Imperial & International Communications, Ltd., at Moorgate Street. The Design of this Apparatus is the outcome of considerable research and development in the field of Facsimile Telegraphy.

The equipment has been designed for the transmission and reception of printed or written matter such as letters, drawings, balance sheets, cheques, and also for reproductions of half-tone subjects, photographs, etc.

The method of message scanning is the same as that used in the Marconi-Wright Apparatus, described in MARCONI REVIEWS Nos. 4 and 5, the subject to be transmitted being wrapped round a cylindrical drum and scanned by an internal rotating optical system.

The main difference is that in the present system the same machine is used for transmission or reception; also, the assembly is self-contained and the various amplifiers, thermostats, etc., are mounted in four 19 in. by 7 ft. 6 in. racks. The earlier design of facsimile equipment was produced as a direct drive system, whereas the new design is driven via a precision gearbox, the amount of hunting experienced in the machine to be described is extremely low and certainly fulfils the specification recommended by the C.C.I.T.

THE equipment conforms with modern telephone practice as regards general layout of panels. These are mounted on 19 in. telephone racks, arranged in two pairs on each side of a bench framework. On this framework is mounted a heavy bedplate which supports the message drum, rotating optical system, also the main and auxiliary driving machines and controls.

The racks on the right hand side of the machine contain the apparatus for controlling the speed of the driving motor and supplying synchronising current for holding the machine in step with the receiver or transmitter at the distant end of the circuit.

The right hand pair of racks (Fig. 1) are known as the Speed Control Racks. The pair on the left are known as the Line Amplifier Racks, and contain amplifiers, measuring and monitoring equipment necessary for the transmission and reception of still pictures. A photograph of the bench framework is shown in Fig. 2.

Speed Control Racks.

The method of maintaining synchronism between the transmitter and receiver in the Marconi System is by the use of synchronous motors supplied with independent sources of alternating current. This current is generated by tuning forks accurately adjusted to the same frequency in manufacture and housed in thermostat chambers so that the frequency of each remains constant over a long period.

The tuning forks used are made of Elinvar steel; this alloy has a very low temperature coefficient both in regard to elasticity and expansion. The forks are cut from the solid and accurately ground to have the same frequency to within very close limits.

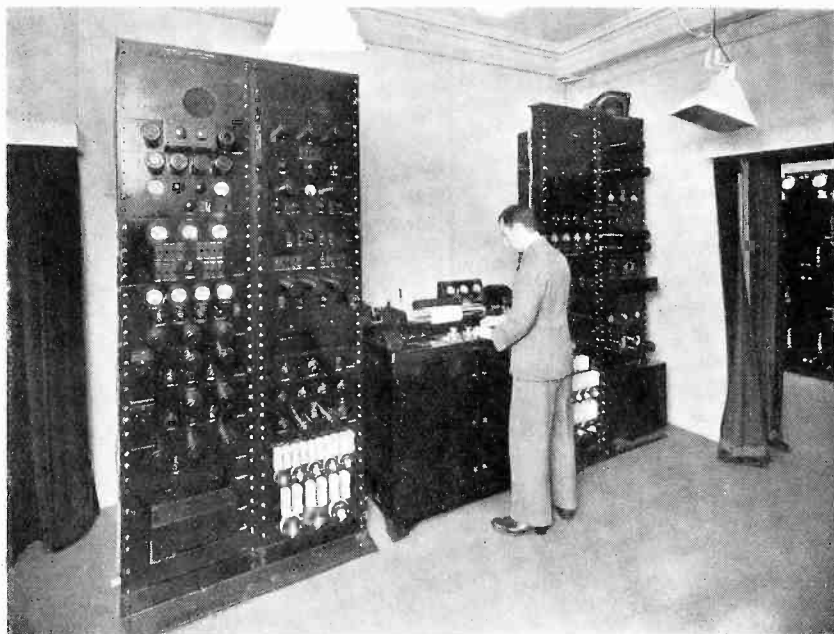

FIG. 1.

The thermostat chamber consists of a lagged copper box mounted inside an outer compartment lined with hair felt and "tentest" board." In the air space between the inner and outer chambers are heating mats for maintaining a temperature of 50° C. approximately. The temperature is regulated by means of mercury contact thermometers; these apply bias to the grid of a valve and cause a relay in the anode circuit to control the heating supply to the chamber.

The tuning forks are kept vibrating by a resistance coupled valve maintaining circuit and generate a fundamental frequency of 300 cycles. A minute adjustment of the tuning fork frequency is available in the maintaining circuit of approximately ± 1 in 20,000. The overall constancy of the Elinvar fork drive is well within commercial requirements of ± 1 part in 100,000. The temperature coefficient of the fork is about 1 part in 160,000 per degree Centigrade.

The output of the fork is amplified and fed into a frequency multiplier panel. This changes the synchronising frequency to 600, 900 or 1,200 cycles; this frequency change is for the purpose of varying the speed of the main driving motor in the same ratio.

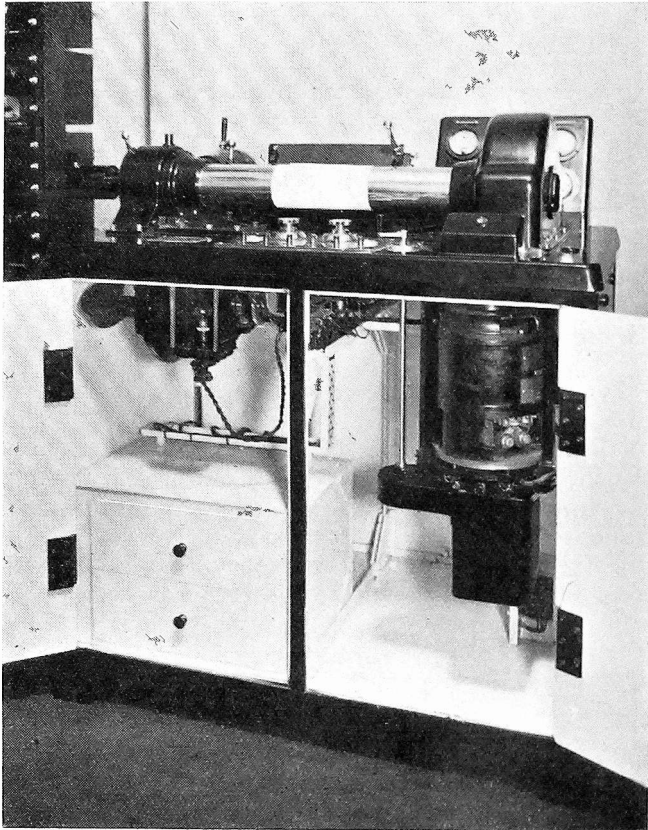

FIG. 2.

A single handwheel control brings about change of speed and synchronises the machine at the correct frequency. An electrical gear-box is thus capable of changing the motor speed over a 4/1 range. Considerable amplification of the synchronising tone is required to produce the necessary torque to hold the driving machine in step. The output stage consists of 3 DA60 valves in parallel operating with 500 volts on the anodes.

An output transformer matches the impedance of the machine synchronising winding with that of the valve circuit, and under these conditions the speed and angular hunting of the machine remains constant to well within the limits recommended by the C.C.I.T.

The speed control racks also contain a circuit for synchronising the chopper motor at a multiple of the fork frequency (1,200 cycles)

in order to ensure a steady carrier for the photo cell amplifier.

The output circuit in this case consists of a single DA60 valve transformer coupled to the chopper motor.

By means of one of the panels known as the synchronising Amplifier it is possible to switch the various synchronising tones either to line for comparison with distant sources, or to operate neon lamps illuminating stroboscopic discs on the shafts of the main and chopper motors for checking local synchronism and hunting. A schematic diagram of the Speed Control Racks is given in Fig. 3.

Line Amplifier Racks.

The Line Amplifier Racks contain the apparatus for converting the varying light intensities picked up by the optical scanning system from the subject under

transmission into pulses of tone for passing over a telephone line to key a wireless transmitter. Also, the signal from a wireless receiving station is converted back into varying light intensities for recording on bromide paper.

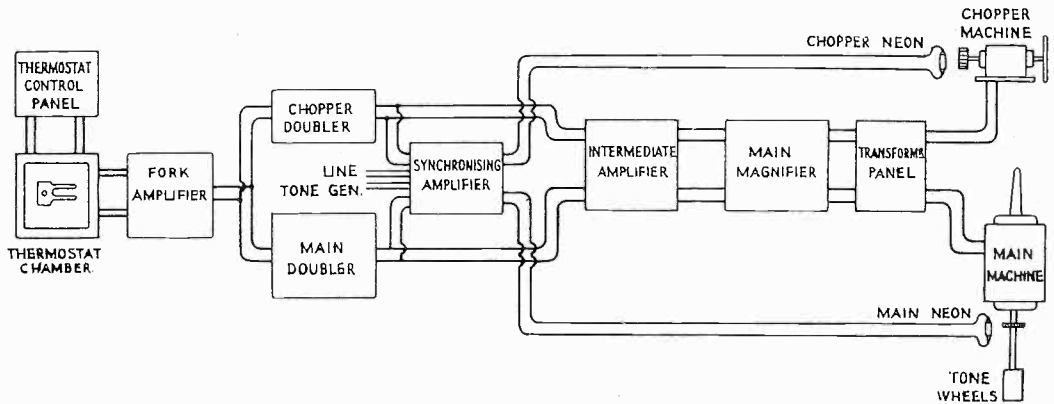

FIG. 3.

Transmitting Circuits.

The light fluctuations from the optical system are fed into a light-tight box containing a caesium photo-cell which in turn is housed in a screened brass unit containing a four stage resistance coupled amplifier (Fig. 4). The path of the light is interrupted by the chopper disc and a carrier frequency is produced before the light strikes the photo cell; in this way a straightforward low frequency amplifier may be used without the necessity of employing D.C. amplification, which has been found to be unstable in a low level circuit of this nature.

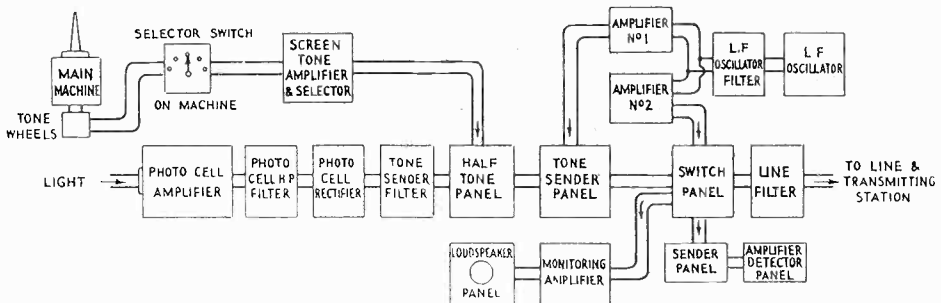

FIG. 4.

The output of the photo-cell amplifier contains the chopper carrier frequency on which is superimposed the picture modulation. This picture modulated tone is then rectified and passed through a low pass filter in order to eliminate the rectified component of the carrier. The resultant, which consists of the picture modulation only, is used to key a tone sender suitable for relaying and operating the distant wireless transmitter. It can be shown that if the output of the photo-cell amplifier were used to key the transmitter directly, a negative result would be obtained at the receiver, since the maximum output from the photo-cell amplifier occurs when the scanning spot is passing a white portion of the subject.

With direct scanning of the subject it is therefore necessary to reverse somewhere in the circuit if positive copies are desired at the receiving end.

The reversal takes place in the Tone Sender Panel and is arranged as shown in Fig. 5.

The output from a local oscillator supplying the line tone is connected to a pair of MH4 valves with the grids connected in push-pull. The rectified output from the photo cell amplifier is connected between the centre point of a high resistance joining the grids and earth so that when the photo-cell output is maximum the bias on the push-pull valves becomes highly negative and the line tone is cut off.

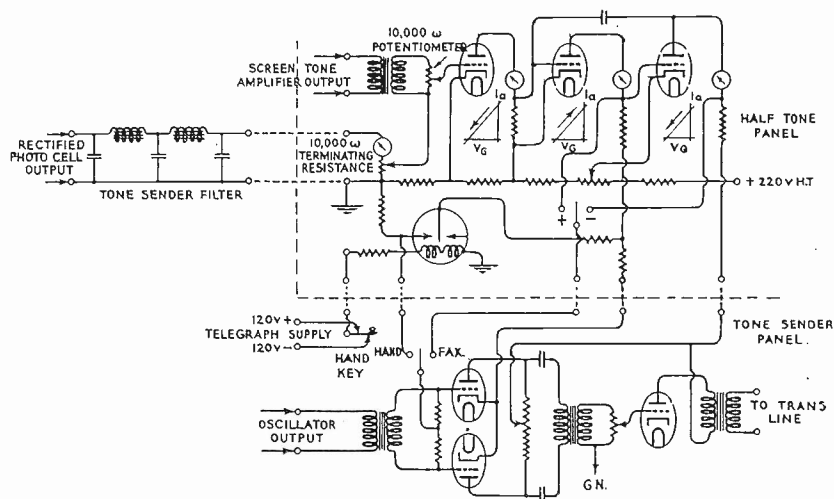

FIG. 5.

The reverse takes place with minimum output from the photo-cell, resulting in full tone to line.

It has been found impracticable to employ amplitude modulation of a transmitter on a long distance radio circuit due to continuous changes in level of the received signal, and for this reason the tone sent to line to key the transmitter must always rise to a constant amplitude in order that full on and off keying is obtained.

This is a simple matter to arrange when scanning black and white subjects, but in the case of half-tones such as photographs, etc., a system of keying known as the constant frequency variable dot system is employed. By this method the various intensities of the subject as recorded by the optical system and photo-cell amplifier are converted into pulses of tone of fixed amplitude but varying duration.

This variable dot length is provided by the Half-Tone Panel which operates in the following manner :—

Mounted on the machine shaft are a series of "lowmoor" iron-toothed wheels with electro-magnetic pick-ups. These miniature alternators are for generating various synchronous screen frequencies which can be selected by a switch on the

machine bedplate. The frequency required is passed through an amplifier and filter circuit and coupled to the grid of the first valve of the Half-Tone Panel.

This panel contains three valves connected as D.C. amplifiers, and the rectified output from the photo-cell is superimposed upon the grid of the first valve in addition to the screen tone (see Fig. 5).

The output from the panel keys the grids of the tone senders in a similar manner to that already described, but the circuit is so arranged that pulses of line tone of varying duration are released with varying output from the optical transmitter.

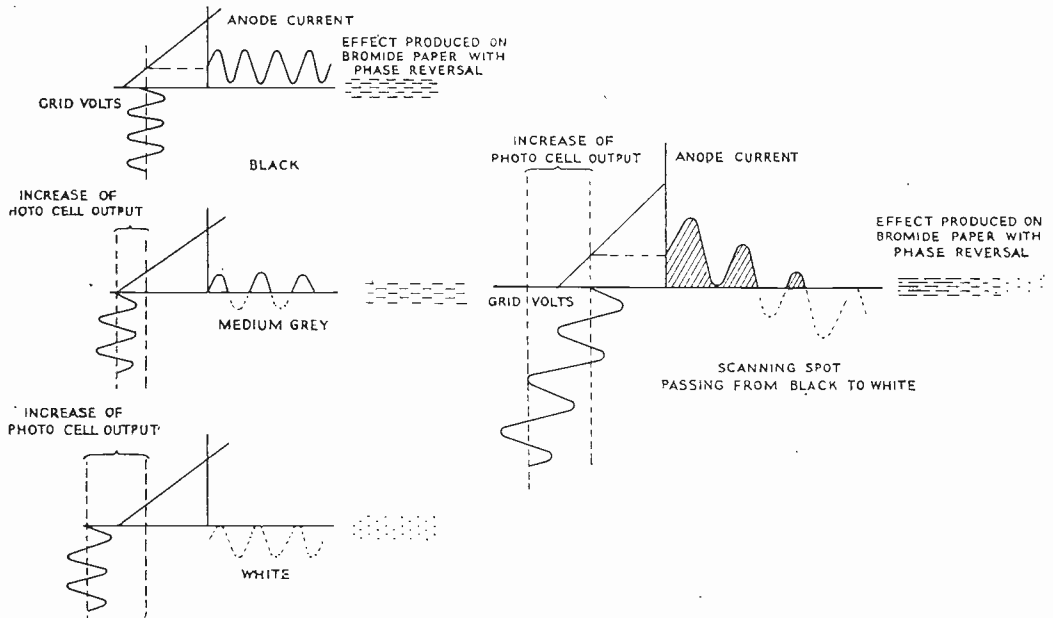

FIG. 6.

The second valve of the Half-Tone Panel acts as a limiter so that the amplitude of the tone released is constant. The third valve acts as a reversing valve and is used when it is desired to transmit negatives.

In addition to the variation in length of pulses transmitted for varying intensities of the subject a reversal of phase of the screen tone takes place every revolution of the optical system in order to produce a press block formation of the screen on the received picture.

The mesh of the screen can be altered by simple switching from one screen tone to another. It is often necessary when radio conditions are poor to use a coarser screen in order to prevent doubling or echo effects from blurring the picture.

The local oscillator used for keying the transmitter provides three tone frequencies of 1,300, 1,600 and 1,900 cycles. This range is provided in order to suit the characteristics of the various lines to the transmitter.

Fig. 6 shows the effect of variations in the output from the photo-cell on the duration of the line tone pulses, and the equivalent effect at the receiver as recorded on bromide paper.

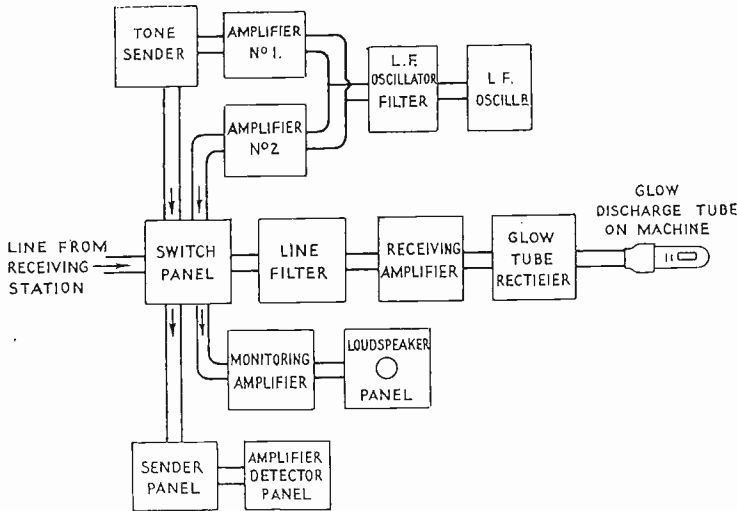

FIG. 7.

Receiving Circuits.

The receiving circuits are shown in Fig. 7. The receiving amplifier for amplifying the incoming line tone from the wireless receiving station consists of three resistance capacity coupled stages with an overall gain of 40 dB. approximately ; the tone passes through a high pass filter before the tone is amplified.

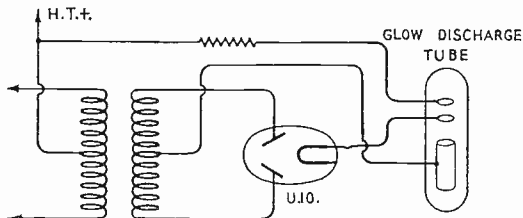

FIG. 8.

Laboratory at Chelmsford, has two main electrodes, the cathode being in the form of a tube and the anode a ring. There is also a third auxiliary electrode to facilitate striking. The tube is filled with a special gas mixture of neon and argon and gives a strong actinic light when a potential of the order of 300 volts is applied to the electrodes.

The recording tube has been found to give very satisfactory results in practice and gives dense blacks on ordinary commercial bromide paper when passing a current of 10 milliamps and at the maximum speed of rotation of the scanning device.

Monitoring and Measuring Apparatus.

A Check Monitoring loudspeaker is provided for aural checking of incoming or outgoing signals together with a separate amplifier for running in leak across

any line. Also, a very comprehensive Meter and Test Panel is supplied for checking L.T. H.T. grid bias voltages and H.T. feeds in all positions by common meters and keys.

A simplified form of Transmission Measuring Set is also included, comprising sender and amplifier-detector circuits for measuring the levels of incoming and outgoing signals. This contains one meter which by suitable switching performs three functions of D.C. and A.C. calibration and level measuring. The range of the instrument is +30 to -40 dB.

Description of Optical Transmitter and Receiver.

The general optical and mechanical functions of the new type machine are very similar to the earlier Marconi-Wright apparatus with the exception that the new type is more compact, and is entirely self-contained, as a combined transmitter and receiver mounted on one baseplate and housed on an all-metal cabinet. By mounting all the various optical, mechanical and electrical components on a very rigid cast iron bedplate, most of the difficulties of aligning separate units has been overcome, and a resulting saving of floor-space, coupled with a neater looking assembly, has been attained.

The design has been so arranged that wherever possible self-contained detachable units with accurate mechanical registers have been made. This allows for easy assembly and accurate alignment in minimum time.

The machine consists in a very rigid cast iron bedplate heavily ribbed on the underside, to which are attached the following unit assemblies. Those mounted on the topside are: An optical rotor made in two separately detachable halves, each half being almost identical and consisting of a gunmetal tube 88 mm. diameter supported by a cast iron pedestal. These tubes are mounted almost central on the baseplate with their common axis coincident with the longitudinal axis of the base. The right hand side tube carries an inner sleeve mounted on ball bearings, and has an optical head mounted at one end and a wormwheel at the other or pedestal end. The left hand tube has no internal fittings and acts as the subject support and protection for the rotating optical parts. When in their correct positions, the tubes are separated by about one-sixteenth of an inch, leaving a slot right round their periphery. Rotating under this slot an optical head (with a fully corrected lens system) can scan the circumference of the tubes through the slot, and allows for complete exploration of suitable sized subjects when wrapped round the tubes. On the left hand side of the left hand rotor pedestal, and abutting the face is a stationary optical head which contains two prisms mounted on a quadrant. The quadrant can be swung by a ball handled lever outside the box. The swinging of the quadrant causes the necessary change in the optical arrangements to be made for either transmission or reception of subjects. Behind the stationary head a special housing carries a glow discharge tube suitably mounted in a plug-in holder and attached to a removable cover. This cover has focussing and aligning arrangements to suitably position the glow tube column, and is held in place by three screws which are also the electrical connections. Immediately behind the rotor tubes and parallel to the optical axis, a special housing carries a high precision leading screw of 5 mm. pitch. This screw is arranged to impart motion through a pair of cylindrical bush nuts to a carriage so mounted that the screw also becomes the track on which the carriage

The Marconi System of Facsimile Telegraphy.

moves. A gripping device with deflector plate is fitted to the carriage, and grips the subject between two rubber covered rollers maintained under tension by springs. A knurled wheel tightens the subject round the drums by rotating the lower roller against a ratchet device. A cranked handle on the left hand end of the leadscrew housing is arranged for winding the carriage back after each run. The screw receives its motion from the optical rotor shaft through chain, dogclutch and spiral gear train. This mechanism is encased in a gearguard and runs in an oil bath. Behind the gearguard at the back of the baseplate an instrument panel with meters and selector switches is fitted and is arranged for checking synchronising current in chopper and main machine windings, and bus bar, chopper and main machine armature, and light source voltage, also for the selection of screen tone frequencies.

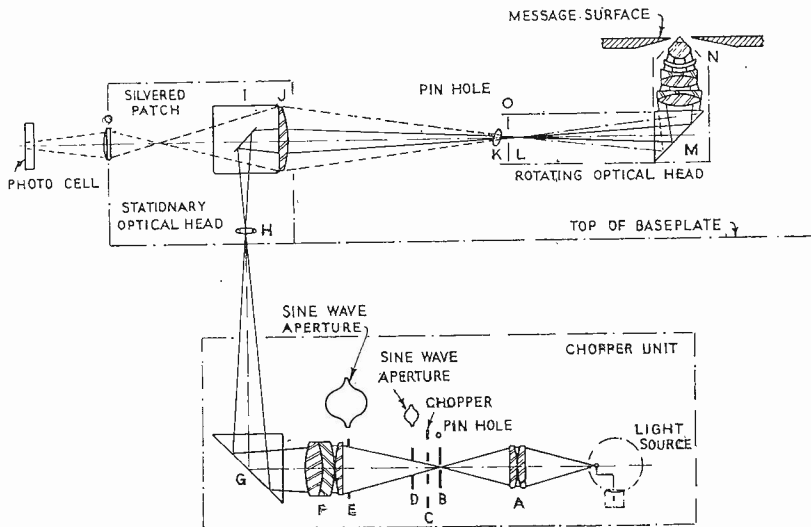

FIG. 9.

In front of the gearguard a small housing carries a neon tube which illuminates the stroboscope disc of the main machine through a hole in the baseplate; a hole in the top of the housing allows for observation of the disc.

Central and in front of the optical rotor tubes a small switch panel is fitted which provides means for switching the light source, main machine and chopper machine, and two central handles working rheostats under the base provide D.C. regulation for the machines.

Underneath and mounted on the baseplate on the right hand side in front, a special cradle carries a synchronous motor alternator. The alternator is provided with accurately ground trunnions co-axial with the shaft and a set of five slip rings. The machine is mounted vertically in the cradle by means of sliding bearing blocks mounted on the trunnions and sliding into horn blocks in the cradle. This leaves the carcase of the machine free to rotate about the armature. Electrical connection is made to the machine windings, etc., through the slip rings and carbon brushes. On the lower trunnion is mounted a gear wheel which engages through a train with a shaft; this shaft protrudes through the baseplate and terminates in a cranked handle

alongside the neon tube housing and gearguard. With this handle it is possible to rotate the motor carcass in either direction with the machine running and synchronised, and this allows for the phasing of the receiving scanning spot with the distant transmitting scanning spot. The lower spindle is extended and has mounted on it five toothed "lowmoor" iron wheels. A structure supported from the lower trunnion block carries five magnetic pick-up devices. These five separate tone generators are used to generate synchronous tone frequencies of 70, 90, 150, 210 and 270 cycles at the lowest synchronous machine speed, and provide the screen tone for half-tone work. The top spindle protrudes through the baseplate and engages the wormwheel on the optical rotor with a seven start worm on a No. 1 Morse taper and an oil trap prevents oil running down the machine shaft. To the left of the main machine unit the Chopper Unit is mounted and consists of a casting on which is mounted a small synchronous motor alternator which carries the chopper disc mounted on a special spider. The disc and spider are totally enclosed in a housing which is made in two halves, and forms the support for optical parts of the unit, it also allows for removal of chopper disc lenses etc., for cleaning without disturbing the motor and lamp box. In front and mounted from the same support as the motor, a light tight box houses a special concentrated filament lamp, suitably mounted so as to have universal adjustment for positioning, aligning, and focussing the filament.

The whole bedplate assembly is mounted on a substantial framework by means of adjustable buttons which allow for levelling and equalisation of weight distribution; it is not bolted to the frame at all.

The frame is covered in with aluminium and arranged so that the back and sides can be completely removed by means of turn buttons, while the two front panels are hinged doors; a compartment in the lower left hand side of the frame fitted with two drawers houses various spares and tools.

Description of Transmitting Optical Arrangements.

Fig. 9 shows the transmitting optical arrangements. "A" is a condenser lens which collects light from a concentrated filament source, and focusses it down to give intense illumination of a pinhole "B." The beam on leaving "B" is interrupted by a chopper disc "C." This disc is $\frac{7}{8}$ in. diameter made from thin sheet "Monel Metal" having 78 radial slots and teeth .15 in. wide at pitch line and can be synchronously run at either 1,000 or 2,000 r.p.m., giving chopped light frequencies of 1,300 or 2,400 cycles. This chopped light is collected by a fully corrected condenser lens "F," after it has passed through the two sine wave apertures "D" and "E" respectively, and emerges as a converging beam, focussed at "H" after passing the right-angled prism "G." After passing the lens "H," the light is projected on to a silvered patch on prism "I."

The diverted beam is collected by the lens "J" on the prism face and focussed down to fully illuminate the pinhole "L" after passing through ghost lens "K" (The pinhole "L" is the one which controls the spot diameter at the scanning surface; for a .25 mm. spot it is .17 in. diameter).

The objective "N" is a fully corrected lens which collects light passing pinhole "L" through prism "M" and focusses it down in this case to .25 mm. intense spot at the scanning surface.

This beam of incident light does not occupy the full light cone of the lenses "J," "K" and "N," and is so arranged that scattered light reflected from the subject being scanned is picked up by the objective "N" and focussed back through prism "M" and pinhole "L," lens "J" collects light passing pinhole "L" and passes it on through the prism "I." The beam emerges from prism "I" with the shadow of the silvered patch in its centre. Lens "O" collects the scattered light beam and focusses it down as a circular spot of about $\frac{5}{16}$ in. diameter on the active surface of the photo-electric cell. The ghost lens "K" is arranged so that the image of the silvered patch reflected back by prism "M" is diverted sufficiently from the optical axis as to fail to be within the field of lens "J," and does not, therefore, get passed on to the photo cell.

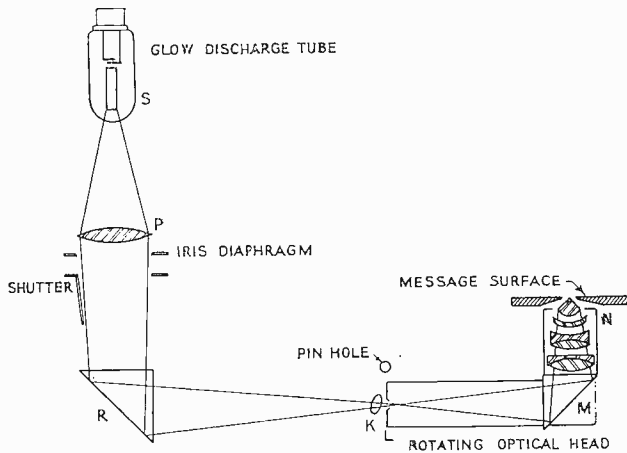

FIG. 10.

When on receive, Fig. 10 shows a schematic section view of optical parts. Lens "P" collects light modulated at picture frequencies from the glow discharge tube "S" and focusses it down through prism "R" to fully illuminate pinhole "L." The objective "N" collects light passing through pinhole "L" and focusses it down to an intense spot at the message surface, and so exposes commercial bromide paper to correspond with the modulation.

The shutter is used when feeding bromide into the machine, and the Iris diaphragm gives control of density of exposure to suit machine speed. This Iris is calibrated in square cms., and it is therefore easy to produce blacks of even density on all four machine speeds by halving or doubling to suit when lowering or raising the speed.

Operation of the Facsimile Machine.

When the equipment is in constant use for the transmission and reception of Facsimile messages, the heating of the thermostat chamber containing the tuning fork is continuously maintained so that on starting up the transmitter and receiver can be synchronised in a short space of time.

The usual procedure is to run up both machines and send a synchronising signal. This can be done by placing a piece of white paper on the transmitting drum and adjusting the transmitting circuits for the normal transmission of a black and white subject. It will be found that the response round the drum is uniform except at the point where the clipper bar holds the paper in position, and a short "pip" is sent to line each time the optical rotor passes this point. This signal is recorded on the receiving drum and is observed as a momentary flick of light occurring once per revolution of the optical receiver. The camcase of the receiving motor is then rotated by the phasing handle on the bedplate until the spot of light coincides with the

The Marconi System of Facsimile Telegraphy.

clipper bar position on the receiver. The machines are then in phase with one another and a test transmission can commence.

By scanning a simple black and white subject with a series of parallel lines drawn at right angles to the direction of scan the exact synchronism of the two machines may be checked. If the receiver is gaining or losing on the transmitter, the lines on the received copy will not be parallel with the edges of the paper and



FIG. 11.

the normal procedure is to run a series of short tests at the beginning of a day's run and adjust the frequency of the tuning fork at the receiver by the adjustment provided until the received copy is squared up. The adjustment then holds over a long period. A cathode ray oscillograph is usually employed for checking keying formation; this has been found more efficient than taking leak circuit photographs.

A reproduction of a half-tone picture transmitted by radio across the Atlantic is shown in Fig. 11. Whilst the grain of the reproduction has, of course, been altered in the printing processes to which it has been subjected, a fair idea of the detail obtainable can be obtained.

J. W. EASTMAN.
J. F. HATCH.

AERIAL RESISTANCE AND AERIAL TERMINATION

These notes are in the nature of a discussion of the term "Radiation Resistance" under summarised headings. No attempt has been made to enter into the mathematics of the subject, though a few simple calculations are included with the object of linking together the various arguments and thus forming a comprehensive picture. The application to medium waves and to short-waves is treated separately, apart from general principles.

The subject of aerial resistance is intimately connected with the nature of aerial radiation, in other words, with the diagram of radiated energy distribution, and in view of the growing recognition of the importance of vertical polar distribution, more particularly for short wave services, an opportunity is taken to reiterate the point of view consistently adopted by the Marconi Company since the inauguration of their short wave Beam Services.

As the subject is allied with that of aerial tuning, or termination, it is hoped to complete the general discussion with a second article dealing with this matter.

Aerial Resistance.

IF A, in Fig. 1, represents a half wave vertical aerial well away from the influence of the earth it will oscillate to a fundamental wave whose dimension is approximately twice the length of A. Current and voltage distribution is sinusoidal, and is represented in the figure by full and dotted lines respectively. Actually, the pure sinusoidal form is slightly modified by the influence of the first harmonic, but this point does not materially affect the general discussion.

Since the wire possesses distributed capacity and inductance, reactance will vary along its length, a point that will be dealt with more particularly in the second part of these notes.

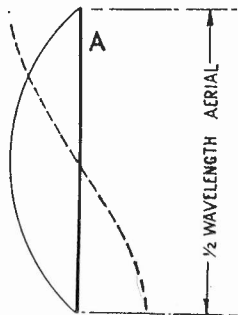

FIG. 1.

It has been shewn that the power radiated by such an aerial is

$$73.2 I^2$$

where I is the R.M.S. current at the centre of the aerial. Obviously the power radiated is equivalent to that absorbed by a resistance of 73.2 ohms passing a current of I amperes. The term "Radiation Resistance" has been applied to this ohmic value, but it cannot be too strongly emphasised that it is purely fictitious and simply defines an equivalent ohmic load resistance at a specified point in the aerial.

Generally speaking, it is not convenient to measure the current of a half wave aerial at its centre and, as matters now stand, the term radiation resistance is often applied, though wrongly, even though the measurement be taken at some other point. Consideration will reveal that in such event the value for R may vary widely from the original centre point value.

Variation of R_r with Point of Measurement.

If we denote the true radiation resistance by R, that is, the resistance equivalent for the centre point of the aerial, then for any other point along the aerial there is

a fictitious resistance value R_p such that $R_p I_p^2 = \text{power radiated}$, where R_p is the R.M.S. current at that particular point. Since $R_p I_p^2 = R \cdot I^2$, and adopting sinusoidal current values, a curve may be drawn to indicate the equivalent resistance for all points along a half wave aerial, and the general conformation of such a curve is indicated by Fig. 2.

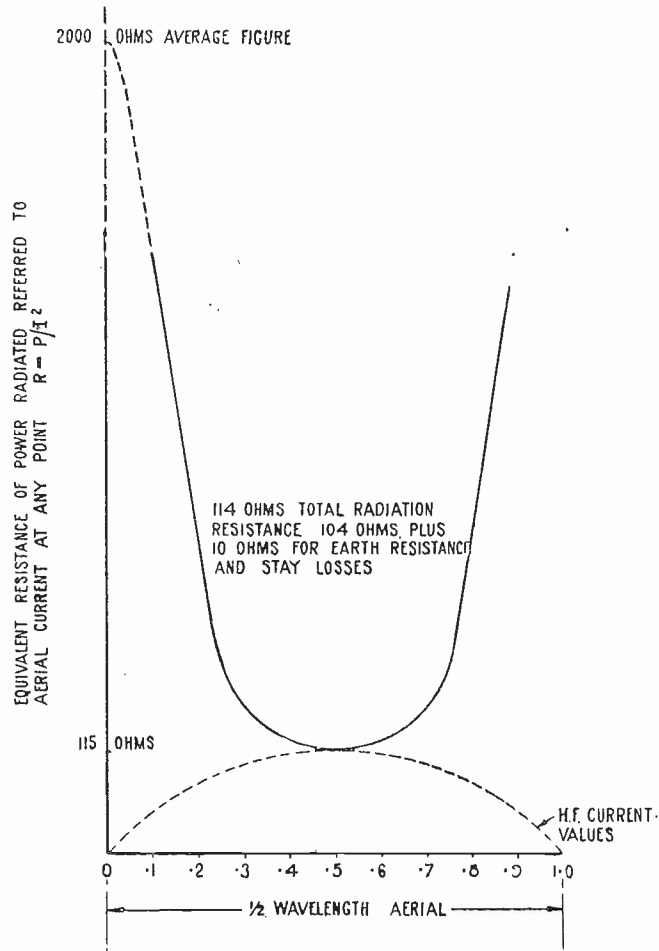

FIG. 2.

It will be noticed that the curve tails off into limiting values towards the ends ; this is because sinusoidal distribution does not hold at the extremities. In the first place there is a residual H.F. feed current entering at the lower end, that is, assuming the aerial is fed at the lower end, and, again, there must be some form of cumulative current effect at the upper or open end of the aerial, which might be regarded as a small concentrated capacity effect.

End Impedance of Half Wave Aerial.

A neat and simple method of determining the base impedance has been suggested by E. Green, who proceeds to find the terminal voltage by equating the electro-magnetic and electro-static values somewhat as follows :—

As a preliminary step the effective capacity and inductance of a half wave aerial is defined thus ; If C_0 represents static capacity per cm. length of aerial, and l the length, then $C_0 l$ represents total static capacity ; but the effective capacity is one quarter of this, because, in the first place, oscillations are due to one half of the aerial charging or discharging with respect to the other half, while, in the second place, the two halves are in series when the system is regarded as a circuit.

In the case of inductance, obviously this equals $L_0 l$, when L_0 is inductance per cm. of length.

The inductance and capacity per centimetre for any size and length of wire is calculable, and the electro-static and the electro-magnetic energy in any half wave aerial can be expressed in terms of these two values.

Knowing that the electro-static energy at any given instant equals the electro-magnetic energy, we may equate them at the instant of maximum value, thus :

$$\frac{L_0 l}{2} I^2 = \frac{l}{2} \left(\frac{C_0}{4} \right) V^2$$

from which it is obvious that

$$V/I = \sqrt{4 L_0 / C_0}, \text{ or } E/I = \sqrt{L_0 C_0}$$

where V is the maximum R.M.S. voltage, that is, the R.M.S. voltage between aerial tips, E is the voltage between one tip and earth, and I is the maximum R.M.S. current that is the max. R.M.S. current at the centre of the aerial.

The values for L_0 and C_0 vary according to wire diameter and length, but we may take a mean figure for the ratio V/I of 1500, which is roughly correct for a 100 metre length of No. 14 wire. Thus $V=1500 I$, and half this figure will give E , the voltage between one tip and earth.

Having found E , we proceed to find the value for the feed current of a base fed half-wave aerial as follows : Assume I to be one ampere, then adopting an R value of 114 ohms, as will be explained later, power radiated is 114 ohms $\times I^2=114$ watts. From this we deduce the base feed current to be Watts/Base Voltage or $114/750=0.152$ amperes. Finally, by dividing the base voltage by the feed current, we derive the base impedance thus, $R \text{ base}=750/0.15=5,000$ ohms.

This is rather a high value, but it must be remembered that it refers to a thin wire half wave aerial, oscillating to 200 metres. It is probable that the effect of the earth on the self capacity of the aerial will decrease the ratio of L_0/C_0 and thus reduce the figure, and it is certain that cage aerial designs, in which the value of C_0 increases while that of L_0 is reduced, will lead to a material modification of this figure, to the extent of reducing it to the order of 1,000 ohms or less.

In the case of half wave T aerials, where the radiation resistance value, referred to point of max. current, is considerably less than 100 ohms, the base impedance rises appreciably and, in fact, may exceed 5,000, ohms if the aerial is formed of a single wire.

In the curve depicted an average value of 2,000 ohms. has been assumed.

Effect of Earth's Proximity.

It has been stated that a half wave aerial vertical removed from the influence of the earth, the power radiated is $73.2 I^2$; when the aerial is brought down close to a perfectly conducting earth the figure becomes $104 I^2$, that is, the radiation resistance has gone up because the aerial and its image are now brought together, and the inter-action between the two throws additional resistance into the radiating aerial. In simple language, the shape of the vertical polar curve for two half wave elements in line but separated is sharper than when the aerials are brought together, i.e. tip to tip. (See Fig. 3.)

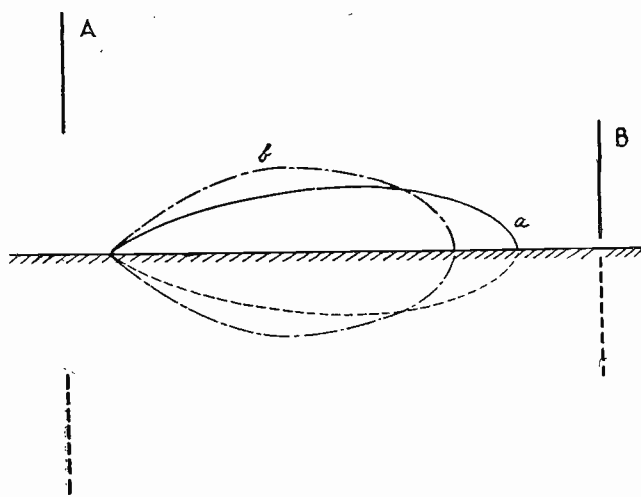

FIG. 3.

In connection with these two polar diagrams, if power is assumed constant the areas will be substantially constant, while the major axes, i.e., the axes in the equatorial plane, work out roughly in the proportion of 10 to 8.5, as between raised and lowered aerials. This is approximately as $\sqrt{104} : \sqrt{73.2}$, that is, directly proportional to the currents in each case, or inversely proportional to the radiation resistances.

In the practical case of partially conducting earth the figure will vary with frequency and also with the nature of the ground, but for medium and long waves 104 ohms appears to remain a fairly accurate indication of the value, though some ten per cent of the power radiated is absorbed as ground losses. It should not be overlooked that the direct earth resistance loss, also losses due to stays, should be added to this figure: the former varies widely, but perhaps 5 ohms is a fair conservative estimate of the average, while 5 to 8 ohms may be added for stay losses. An approximate figure of 114 ohms has been adopted for Fig. 2.

Quarter Wave Aerials.

A figure of 104 ohms has been mentioned as the radiation resistance measured at the centre of the half wave vertical aerial close to earth, that is, of a half wave aerial with an image immediately beneath it. In the case of the quarter wave aerial the image may be regarded as completing the half wave aerial, in which case there is no mutual effect and the power radiated will be half that radiated by a complete half wave aerial in space. (See Fig. 4B.) Thus the radiation resistance referred to maximum current, in this case the earth current, will be 36.6 ohms, i.e., half the resistance of a half wave aerial in free space. The direct earth resistance, and the resistance due to the proximity of stays, should be added to this figure.

An aerial that is less than a quarter wave long is tuned by an earthed coil and it is obvious that the power radiated will diminish as the proportion of open aerial is cut down, hence the radiation resistance will be less, often very appreciably less, than 36.6 ohms.

Thus we may say that, for aerials varying in open length between a half wavelength and a fractional length, the radiation resistance will vary between an upper limit of 104 ohms and a lower limit of 2 ohms, or less.

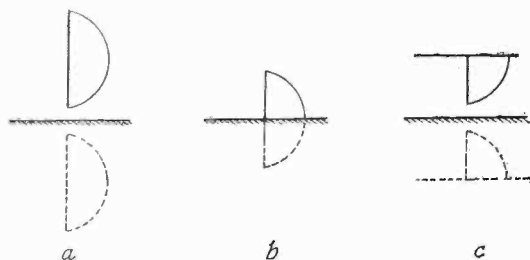

FIG. 4.

Half Wave T Aerials.

To calculate the radiation of plain straight wire aerials is comparatively simple for mathematicians, but the case of half wave T aerials is much more difficult. One type only, the T aerial with equal quarter wave limbs and uniform wire, has been calculated partially and checks up at 32.2 ohms, as against 36.6 for the vertical quarter wave aerial. From this it might appear at first sight that there is no justification for such a form of aerial construction when compared with the true quarter wave aerial, but consideration of the two types shows max. current at the upper end of the vertical member of the T aerial as compared with max. current at the lower end of the quarter wave type; this implies slightly lower angles of radiated energy and less interference, by reflection, with distance broadcast zones. In other words the polar curve of energy distribution in the vertical plane is slightly sharper and better for the half wave T aerial than for the quarter wave aerial.

The half wave T aerial might be regarded as an inverted quarter wave vertical aerial. (See Fig. 4C.) When mast heights permit a greater vertical height than the quarter wavelength, the advantages of the inversion become more marked.

General Discussion—Medium Waves.

We are now in the position to ask: Is the already fictitious term "Radiation Resistance" a fair description of the radiation value of the aerial for medium and long waves? We have seen that it can no longer be loosely employed as a means for comparing two or more of the same type of aerial, still less different types of aerials, since the measurements may be made at different points along the aerial system and lead to different results.

If we are merely concerned with measuring the efficiency of a transmitter, then obviously the point at which the aerial resistance, as such, is to be measured is in that part of the aerial which constitutes the coupling between aerial and transmitter, since it is at this point that energy is transferred from transmitter to aerial and where, so to speak, the responsibility of the former is at an end. It does not

always follow, however, that the resistance measured at such a point is the most accurate indication possible of the effective radiation resistance of the aerial proper.

Were it convenient always to measure radiation resistance at that point in the open, or radiating, portion of an aerial where current is a maximum, and reactance is zero, then the term "Radiation Resistance" would have a more specific meaning. In former days, when the term was first applied, aerials were almost invariably of the earthed quarter wave type, and the point of maximum current was at the earth connection, was non-reactive, and was capable of easy measurement. With modern broadcast aerials, however, aerial lengths may be half wave (straight or inclined), half wave T, and lengths that vary between half and quarter wave, the latter generally in the form of T aerials. In many such cases the actual measurements of the equivalent resistance is made at some point far removed from current maximum, and may bear very little obvious relation to a similar measurement made at a slightly different point: provided, however, that the measurement is made at some point on the open aerial, usually its base, and this point is clearly defined in relation to the form of aerial and wavelength radiated, experienced engineers may form some idea of the radiating properties of the aerial.

Comparison of the Half Wave T Aerial and a Half Wave Vertical Aerial.

It may not be out of place to consider the difference, as to effects at a distance, between a half wave T aerial and a half wave vertical aerial. For similar aerials on a common frequency the field strength at a distance varies as the current in the aerial, but in order to compare the radiation of two different types of aerials at a distance there must be some common factor as a basis. The accepted method is to multiply the height of the radiating portion of the aerial by the average current along that height, and to call this the "metre-amperes"; the field strength at a distance as between any two or more aerials working on the same wavelength will be proportional to the metre-amperes in each case.

If power to aerials is written $I_1^2 10.4$ and $I_2^2 32.2$ for the vertical half wave and T half wave types respectively, then a ratio of I_1 to I_2 may be expressed as 3 : 5 approximately. Again, the average current in each type is $\frac{2}{\pi}$ times the respective R.M.S. max. currents, and the metre amperes may be written $\frac{2}{\pi} \times I_1 \times \frac{\lambda}{2}$ and $\frac{2}{\pi} \times I_2 \times \frac{\lambda}{4}$; these quantities can be expressed as a ratio in the form

$$\frac{2}{\pi} \times 3 \times \frac{\lambda}{2} : \frac{2}{\pi} \times 5 \times \frac{\lambda}{4}$$

which gives an approximate ratio of 1.5 : 1.25 in favour of the vertical half wave aerial.

Again it would seem as if the expense of the high mast system is not warranted, but against this there is the important issue of a low angle radiation, i.e., sharper polar curve, greatly in favour of the vertical half wave aerial.

Effect of Earth's Proximity on Short Wave Vertical Aerials.

Returning to the problem of height of vertical half wave aerial above a conducting earth, it is an interesting fact that the radiation resistance varies only slightly

as the height decreases to within one-half wavelength, as between lower tip and the surface of the earth. Below this height the radiation resistance increases rapidly as we have seen, reaching 104 ohms in the case of medium waves: in the case of the higher frequencies associated with short waves the figure becomes 160 ohms when the lower tip is just above earth, the greater increase being due to the intensive ground absorption and losses, especially in the near vicinity of the aerial.

Although radiation resistance has increased to 160 ohms when the lower tip is very close to earth, the effective radiation leaving at an angle of from 10 to 18 degrees to the earth's surface, and forming the long distance indirect ray, amounts to rather less than one-fifth of the whole. Thus for short waves the radiation equivalent of 73.2 ohms for a vertical half wave aerial, distant one half wave or more above the earth's surface, represents considerably more effective radiation than the equivalent of 160 ohms for the same aerial very close to the ground: the gain in power is probably 6 : 1 representing $2\frac{1}{2}$: 1 in field strength for long distance signals, and this power gain will increase as the height increases beyond the half wave length clearance, becoming perhaps 10 : 1 at the useful limit of height.*

Since it is possible to erect mast heights of from one to three wavelengths for short waves, this fact is of great importance.

Although it must lead to some uncertainty, it is perhaps only fair to record that all experimental proofs do not bear out the value of 160 ohms, probably because of varying ground conditions, though all agree on the intensive ground absorption of the higher frequency waves when the aerial is near to the ground. Messrs. Friis, Feldman and Sharpless give a figure of approx. 100 ohms for R_r when the tip is close to the ground, and 70 ohms when the distance is approximately one quarter wavelength.

The Marconi-Franklin Vertical Uniform Aerial.

It is obvious that in order to obtain efficient low angle radiation from vertical aerials the aerial unit as a whole must be raised well above earth; alternatively the aerial may itself be extended in height, provided that means are adopted to ensure that at any instant radiation shall be of the same sign, or sense, throughout the length of aerial. An extended aerial is definitely preferable to a raised aerial—because of the greater amplification and selectivity that follows as a result of the concentration or sharpening of the vertical polar curve. On the other hand, it is obvious that, in order to gain this advantage, the major axis of the vertical polar curve must be inclined at the correct angle.

As the result of an experience probably exceeding that of any other radio concern the Marconi Company emphatically recommend high vertical aerials where economic factors justify the capital expenditure. No aerial can give greater radiation per unit length than an aerial on which current formation is uniform, and the Company's "Uniform" vertical aerial fulfils this ideal in a manner amply vindicated by comparative tests under traffic conditions covering a period of upwards of four years †

An aerial of this type tends to become a simple uniformly loaded transmission line, with a radiation resistance of 600 ohms referred to any point (except the tip) along the aerial, and, incidentally, coinciding with the surge impedance.

* v. "Radiation from a Short Wave Vertical Aerial," T. L. Eckersley, MARCONI REVIEW, No. 23.

† v. "The Uniform Short Wave Aerial," MARCONI REVIEW, No. 16.

Although the fact is but indirectly connected with the subject of these notes, it is perhaps not out of place to mention that the great advantage of the uniform aerial lies in the feature that, by adjustment between the folded loops forming the aerial, it is possible to vary the tilt of the vertical emission diagram. For all other systems of beam aerial arrays it is necessary, in order to obtain a given tilt, to erect the array to a given height, (*v.* for example, a paper by T. Walmsley read before the I.E.E. on 3rd January, 1934, and also previous papers by T. L. Eckersley)—but in the case of the Uniform type of aerial array it is possible, by virtue of the fact that the component aeriels are in vertical formation, to take advantage of this feature and give the required tilt by careful design of aerial loop proportions, and thus effect an appreciable saving in mast height.

Radiation Resistance of Beam Aerial Elements.

The effect of a reflector behind an aerial is to increase the radiation resistance to a theoretical value of twice the original. On the other hand, the effect of multiplying elements, with half wavelength separation, as in a spaced array, is to reduce

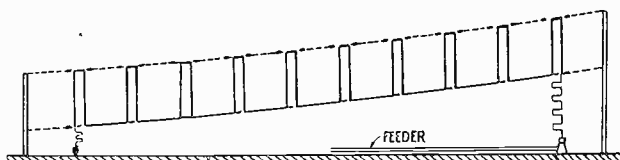

FIG. 5.

the original radiation resistance of each element in the proportion of $2/3$. Thus the final effect on the individual active elements of a beam array is an increase of $2 (2/3) = 1\frac{1}{3}$ times the radiation resistance of the element if treated as a separate aerial.

The Marconi-Franklin Series-Phase Aerial.

Where economic factors do not justify the capital expenditure incurred in the erection of high beam arrays, the logical process is to take advantage of the concentration due to a number of suitably phased radiating elements erected in line, in the direction of propagation. The Marconi-Franklin Series-Phase Aerial is of this type and is constructed with a number of quarter wave loops, spaced quarter of a wavelength apart and run comparatively close to earth, being supported on low masts. One form of this aerial is shown in Fig. 5. It should be noted that the radiating elements are in effect double current loops, therefore, if the radiation power of one limb of the loop is written I^2R then, since I is sensibly similar for both limbs, the power radiated per complete loop is $(2I)^2R$; thus the radiation resistance of each loop is four times that of a simple quarter wave element.

As a whole the aerial can be treated as a feeder loaded at regular intervals, and under the conditions obtaining in the design, this gives an end impedance of approximately 300 ohms, a figure that may be accepted as equivalent to the radiation resistance of a single array.

The Marconi-Franklin Series-Phase design forms one of the most interesting and notable advances in aerial technique that has been developed during the past few years.

In conclusion, the author wishes to acknowledge his indebtedness to Mr. C. E. Rickard, Engineer-in-Chief of the Marconi Company, for many helpful discussions upon a subject of which he has exceptional knowledge.

N. WELLS.

OPTICAL EFFICIENCIES AND DETAIL IN TELEVISION SYSTEMS

The question of the relative efficiencies of the several orthodox methods employed in television systems using mechanical methods of scanning is one that has not perhaps received the attention it deserves.

In addition to optical efficiency, the consideration of which, after all, has much to do with the preliminary choice of a television system, the problem of obtaining data relating to detail required in the final picture to the frequency band necessary for the production of this detail is of importance.

In the following article an attempt is made to discuss these problems and to deduce results which are of use in the initial formulation of the constants of television systems.

ANY attempt to put the operations involved in television on an exact quantitative basis is doomed fundamentally to partial failure. This is partly because of the constants involved, many are by no means clearly defined, and partly because such results must clearly be referred to the perfect television system, or at least to some television system which must give an arbitrary and exact amount of detail which is suitable for some particular purpose. Unfortunately, although it is manifestly possible to postulate such a system in abstract terms, it is just as impossible to reduce these abstract conditions to any exact numerical values.

We have, however, two standards of reference, one natural, and the other artificial. The first is that of the eye, i.e., we can express the detail obtainable in any given television system in terms of the detail observable by the eye. The second standard has been provided by the film industry. The choice of this is permissible as television may primarily be regarded as a method of entertainment and we are accustomed to regard the detail given in the average cinema as possessing sufficiently good entertainment value.

Let us first, then, examine briefly the mechanism by which the eye conveys the impression of the objects viewed to the brain. The eye consists basically of a lens system which projects an image of the object being viewed on to the retina, a light sensitive structure which is excited by the influence of light on it and which causes the sensation of light and colour to be conveyed via the optic nerve to the brain. The retina consists of a number of light sensitive cells and has an effective area of the order of $1\frac{1}{2}$ square inches. In this aperture are approximately 5,000,000 cells. We may imagine that the image is divided into 5,000,000 picture elements and that this number is sufficient to convey the impression of the object to the brain. The process of vision is instantaneous, i.e., the mental impression corresponding to the whole of the image projected on to the retina is conveyed at one time through the many optic nerves and their associated retinal cells.

The ideal system of television would therefore be an electro-mechanical or purely electrical analogy to the optic system, the transmitter or generator of the signals corresponding to the eye, the link between transmitter and receiver to the optic nerve, and the receiver to the brain.

Unfortunately, both electrical and mechanical considerations impose limitations which prevent us from even approaching the detail obtainable in such a system. This brings us to the first salient fact which must be observed in the design of any

television system. It is not a question of what detail would be appreciated so much as of what detail is the minimum acceptable for any particular purpose.

The technique of motion pictures gives us our second standard of reference. The average person has become so accustomed to images of moving objects being presented to him via the cinema screen that he would be quite satisfied if a television system could be practically realised that would give him the same degree of detail. Let us see to what this corresponds in the matter of picture elements. Consider an observer seated 100 feet away from a screen measuring 20 feet across by 15 feet down—a fairly typical case. Now the minimum angle that the eye can resolve is of the order of 1 minute of arc. The angle subtended by the screen at the observer is approximately 11.5° . Hence the number of picture elements needed in a horizontal direction is 11.5×60 or 690. If we want equal resolution in horizontal and vertical directions, the number of vertical picture elements will be $690 \times .75$ or approximately 520. Hence the total number of picture elements needed will be of the order of 360,000.

Finally, if we assume orthodox methods of scanning in either vertical or horizontal directions, and a square picture, we arrive at a number of scan lines per picture, equal to 2,000 in the case of the eye, and to 600 in the case of the cinematograph.

The next procedure is to examine the difficulties associated with the production of a television system employing large numbers of scan lines. These difficulties conveniently fall under two headings.

- (A) Difficulties associated with obtaining the requisite amount of light for analysing the picture at the transmitter end, and more especially for reconstituting or synthesising the picture, element by element, at the receiver end.
- (B) Difficulties associated with the frequencies involved in the production, amplification and transmission of the electrical signals into which the light densities of the picture are changed.

The consideration of (A) involves the determination of the relative optical efficiencies of the various scanning systems employed at both transmitter and receiver, and of (B) the fundamental nature of the television signal. In what follows, therefore, we shall attempt to cover the general principles underlying the design of a television system under these two headings. We shall moreover limit ourselves almost exclusively to those methods of scanning which employ mechanical methods.

Optical Efficiencies of Mechanical Scanning Systems.

At the transmitter, two distinct methods of scanning are available. In the first, known as the direct method, the scene to be televised is uniformly illuminated, and an image of it is projected, one picture element at a time, on to the photo cell, the light densities of the various elements giving rise to the picture signals. The scanning mechanism merely serves to select and pass the light from these elements, in a sequential fashion, on to the photo cell. In the second, or indirect method, the scene is illuminated one picture element at a time by a constant intensity light spot. A certain proportion of the light reflected from the particular element of the scene being scanned is then picked up by the photo cell and gives rise to similar picture signals as were obtained in the direct method. So far then as the actual form of the signal with which we have to deal we need not concern ourselves as to what method

of scanning is employed, but since the current generated in the photo cell bears a very nearly linear relationship to the amount of light incident on it, and since it is obvious that the amount of light available from corresponding picture elements will differ in the two cases, the amplitude of the signals will depend on the type of scanning used.

As far as the receiver is concerned, only one method is possible, assuming that we are only interested in forming the picture on a screen. This will correspond to the indirect method at the transmitter and therefore the results which are obtained for this method at the transmitter can be applied to the receiver system.

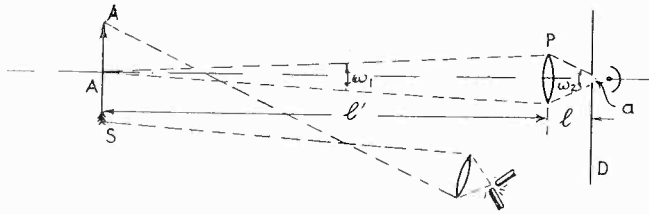

FIG. 1.

We shall first obtain a comparison of the efficiencies of the direct and indirect methods of scanning using an aperture disc. We shall then examine the relative efficiencies of the aperture disc, lens disc and mirror wheel using the direct scan and then the relative efficiencies of the three methods using the indirect principle of scanning.

Efficiency of Aperture Disc Direct Scan.

Let us assume that the intensity of the arc A (v. Fig. 1), whose light is collected by the condenser C and used to illuminate the subject is I. All the light emitted by the arc will not be available but only that proportion collected by C. Let KI lumens be collected by C and thrown upon the subject. Then $\frac{KI}{n}$ will be the number of lumens falling on one picture element of the subject of area A where n is the number of picture elements. Of the light reflected by the picture element $\frac{K'KI}{n} \frac{\omega_1}{2\pi}$ lumens will be collected by the projection lens P, where ω_1 is the solid angle subtended by the projection lens at S, and K' is a constant depending on the reflection coefficient of the picture element.

Now the following relations hold

$$\omega_1 = \frac{\pi r^2}{l'^2} \quad \omega_2 = \frac{\pi r^2}{l^2} \quad \text{and} \quad \frac{l^2}{l'^2} = \frac{a}{A}$$

where r is the radius of the projection lens

- l' is distance between subject and projection lens
- l is distance between projection lens and image and is nearly equal to f, the focal length of the projection lens.
- ω_2 is solid angle subtend by projection lens at disc D.
- a is area of picture element as projected on disc.
- A is area of element on subject.

Hence $\frac{\omega_1}{\omega_2} = \frac{l^2}{l'^2} = \frac{a}{A}$

and $\frac{K'KI\omega_1}{2\pi n} = \frac{K'KIa\omega_2}{2\pi nA}$

$$= \frac{K'KIa}{2\pi nA} \frac{\pi r^2}{l^2}$$

$$= \frac{K'KIa}{2nA} \frac{r^2}{f^2}$$

Hence the overall efficiency η of the system is

$$\eta = \frac{\frac{K'K}{2n} \cdot I \cdot \frac{a}{A} \cdot \frac{r}{(f)^2}}{I} \dots \dots \dots (1)$$

Putting in practical figures, we have

$$K = \frac{1}{3}$$

$$K' = \frac{1}{10}$$

$$n = 2500$$

$$na = (1/10 \text{ foot})^2$$

$$nA = (10 \text{ feet})^2$$

$$\frac{a}{A} = \frac{1}{10000}$$

$$\frac{r^2}{f^2} = \frac{1}{16}$$

$$\therefore \eta = 4 \times 10^{-11}$$

Efficiency of Aperture Disc Indirect Scan.

Here again assume a light source A of intensity I, as illustrated in Fig. 2. Then KI lumens will be collected by the condenser lens C and projected on to the disc D. The aperture in the disc will pass $\frac{I}{n}$ of this, or $\frac{KI}{n}$ lumens. All this will be collected by the Projector lens P and will illuminate the picture element area L on the subject S, and a proportion $\frac{K'KI}{n}$ lumens will be reflected.

Suppose the photo cell to be placed at the focus of the reflector radius R and focal length F. Let ω_1 be the solid angle subtended by the reflector at the subject and let ω_2 be the solid angle subtended by the reflector at the photo cell. Let l and l' be the distances between subject and reflector, and reflector and photo cell respectively. Then $\frac{K'KI}{n} \frac{\omega_1}{2\pi}$ lumens will be received by the reflector and hence by the photo cell.

$$\text{But } \omega_1 = \frac{l^2}{l'^2} \cdot \omega_2 = \frac{a'}{A} \frac{\pi R^2}{F^2}$$

where a' = area of image of picture element at photo cell.
 A = area of picture element on subject.

Hence the amount of light received by the photo cell will be

$$\frac{K'KI}{2n} \frac{a'}{A} \left(\frac{R}{F}\right)^2$$

and the efficiency of the system η_1 will be

$$\eta_1 = \frac{K'K}{2n} \frac{a'}{A} \left(\frac{R}{F}\right)^2$$

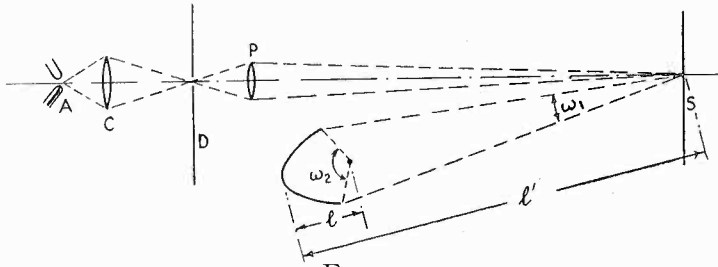

FIG. 2.

Ratio of Efficiencies.

The ratio of the efficiencies of the direct and indirect methods of scanning will be therefore

$$\frac{\eta}{\eta_1} = \frac{a (r/f)^2}{a' (R/F)^2}$$

In actual practice, for a reasonable sized disc and a photo cell of 1 in. square, $\frac{R}{F} = 2$
 $a = a'$. Also $\frac{R}{F} = 2$

$$\therefore \frac{\eta}{\eta_1} = \frac{1}{64}$$

This ratio might in practice be even further reduced by using more reflectors and photo cells. It could be increased only with great difficulty by increasing the size of the disc. If no reflector were used and the photo cell picked up directly from the subject, the actual optical efficiencies would be equal. A great difference, however, would be observed by the subject. In the case of indirect scanning at any one instant, only a very small fraction of the total light is incident upon the subject, but for direct scanning the full intensity of the light source is thrown upon the subject the whole time. That is to say for the same input to the photo cell, in one case the subject would be more or less comfortable, in the other the subject would be in an intolerable position.

Amount of Light received by Photo Cell using an Aperture Disc and Inverse Scan.

We have $L = \frac{K'KI}{2n} \frac{a}{A} \left(\frac{R}{F}\right)^2$

and we may take the candle power to be 15,000 candles. This represents an output of $15,000 \times 4\pi$ lumens. Hence

$$\begin{aligned}
 L &= \frac{15,000}{10 \times 3 \times 2 \times 2500} \times \frac{1}{1,0000} \times 4 \times 4\pi \\
 &= \frac{4 \times 4\pi}{100000} \\
 &= 5 \times 10^{-4} \text{ lumens.}
 \end{aligned}$$

Photo electric current = $i = 5 \times 10^{-3}$ microamps (10 microamps/lumen).

Relative Efficiencies of Aperture Disc, Lens Disc and Mirror Wheel using Direct Scan.

In order to obtain the general relationship of the optical efficiencies resulting from these different methods of scanning, we shall treat each method in greater detail and obtain the light falling on the photo cell in terms of constants which will be different in each case and which are fixed either by necessity or by the fundamental requirements of design. It must be emphasized again, however, that the results will be approximate, and therefore only very general conclusions can be drawn from them.

It will be necessary only to consider the amount of light falling on the photo cell in the three cases assuming a brightness of B candles per unit area of the subject which is supposed uniformly emitting through a hemisphere. For simplicity, and to fix ideas, we shall assume horizontal scanning with n lines. In all cases, D is the diameter of the disc or wheel and we will suppose that the same maximum value of D holds in all three cases, though it will be seen at once that a greater diameter is permissible mechanically for an aperture disc than a lens disc or mirror wheel.

Further, a will always be the size of element in front of the photo cell.

A the size of element on the subject.

H the horizontal dimension of the scene to be scanned.

V the vertical dimension of the scene to be scanned

and finally, $\frac{H}{V} = r$ the picture ratio.

(1) Aperture Disc.

Here h and v are the corresponding dimensions of the picture on the disc. The system is illustrated in Fig. 3.

Amount of light picked up by the lens :

$$= \frac{BA^2}{2\pi} \frac{\pi d^2}{4l'^2}$$

Neglecting losses in the lens system, this is substantially the amount of light incident on the photo cell. Calling this L_p , we have

$$L_p = \frac{BA^2 d^2}{8l'^2}$$

Also $\frac{l'^2}{l^2} = \frac{A^2}{a^2} = \frac{l'^2}{f'^2}$

and $\frac{v}{n} = a = \frac{h}{rn} = \frac{\pi D}{nrn}$

$$\therefore L_p = \frac{B \pi^2 D^2}{8 r^2 n^4} \left(\frac{d}{f'} \right)_a^2$$

The suffix a indicates the aperture disc method.

(2) Lens Disc.

Here c (v. Fig. 4) is the mean distance between two consecutive lenses and is equal to $\frac{\pi D}{n}$

As before :

$$L_p = \frac{BA^2}{8} \frac{d^2}{l'^2}$$

$$A = \frac{V}{n} = \frac{H}{rn}$$

$$\therefore H = Arn$$

$$\text{Also } \frac{H}{c} = \frac{l+l'}{l} \therefore \frac{H-c}{c} = \frac{l'}{l} = \frac{l'-f'}{f'}$$

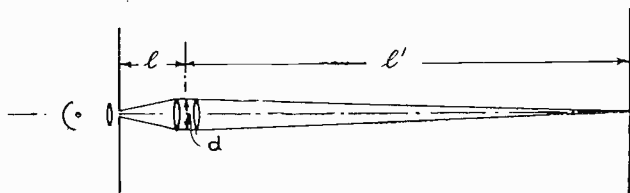

FIG. 3.

$$\therefore \frac{H}{c} = \frac{l'}{f'}$$

$$\therefore l' = f' \frac{H}{c}$$

$$= \frac{Arn^2 f'}{\pi D}$$

$$\therefore L_p = \frac{B \pi^2 D^2}{8r^2 n^4} \left(\frac{d}{f'}\right)_l^2$$

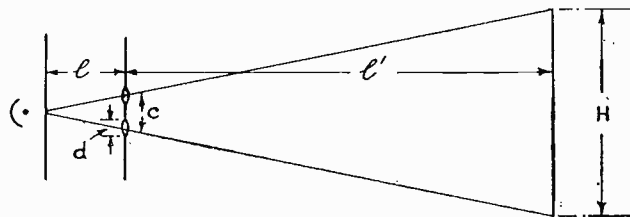

FIG. 4.

The suffix l indicates lens drum scanning.

An interesting point arises out of this analysis which is well worth discussing here owing to a certain prevalence to making the lenses rectangular in shape. Clearly for maximum efficiency, the largest possible diameter of the disc would be chosen, and then the lowest F/ratio would be selected consistent with the maximum permissible distortion. The actual focal length of the lenses would be determined by the number to be placed round the disc. Having arbitrarily selected some focal length and then found that the full permissible diameter cannot be accommodated, it would be preferable to reduce the focal length, so as to retain the maximum aperture rather than cut the lenses.

(3) Mirror Wheel.

Fig. 5 shows briefly the arrangement discussed below.

$$\text{Light picked up by one mirror} = \frac{BA^2}{2\pi} \frac{c}{(l' - d')^2}$$

where c is the area of one mirror.

$$\text{As before, } H = Anr.$$

$$\text{Angle between the beams} = \frac{4\pi}{n}$$

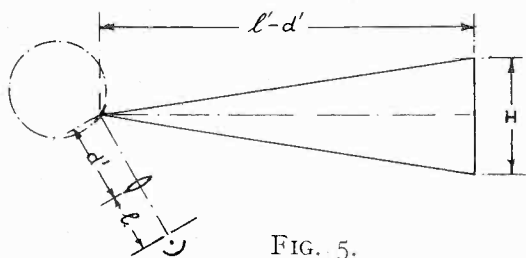

FIG. 5.

$$\text{and } \frac{H}{2(l' - d')} = \tan \frac{2\pi}{n} = \frac{2\pi}{n}$$

$$\therefore H = \frac{4\pi(l' - d')}{n} = Anr$$

$$\therefore \frac{A}{(l' - d')} = \frac{4}{n^2 r}$$

$$\therefore L_p = \frac{K^2 B \pi c}{r^2 n^4}$$

where K is the reflection coefficient of the mirror. Let the dimensions of the mirror be $m \times k$, the latter being the dimension round the drum, so that

$$k = \frac{\pi D}{n} \text{ approx.}$$

$$\therefore C = \frac{m\pi D}{n}$$

$$\therefore L_p = \frac{8 K B m\pi^2 D}{r^2 n^5}$$

This assumes that the lens is large enough to pick up the light from any one mirror in all positions of its traverse. Since the focal length does not enter into the formula for L_p , this is quite feasible. Bringing all these results to a common basis we have that :

$$L_{pa} : L_{pl} : L_{pm} :: \left(\frac{d}{f'}\right)_a^2 : \left(\frac{d}{f'}\right)_l^2 : \frac{64 mK}{nD}$$

Under actual working conditions $(d/f')_a$ can be a good photographic lens used at the largest possible aperture which is about $f/2$.

$$\therefore \left(\frac{d}{f'}\right)_a^2 = \frac{1}{4}$$

In the case of the lens disc, the problem is not so simple. For good achromatic lenses, probably the maximum useful aperture would be $f/6$. Even at this aperture there would be much more distortion than would be permissible in the ordinary way, but remembering the relatively poor quality of the final television image, $f/6$ is a reasonable value producing distortion well within that due to the coarse analysis of the scanning mechanism.

$$\therefore \left(\frac{d}{f'}\right)_l^2 = \frac{1}{36}$$

For the common diameter we can assume 16 in. Although this is at or near the limit for a mirror wheel, or lens disc, it can be exceeded for the aperture disc. For the other values we can take $m = 3$ in. and $K = .75$, so that finally we have

$$L_{pa} : L_{pl} : L_{pm} :: \frac{1}{4} : \frac{1}{36} : \frac{9}{n} = 1 : \frac{1}{9} : \frac{36}{n}$$

This result shows rather strikingly that for values of n greater than 36, the aperture disc is the most efficient method for direct scanning.

For very high values of n , of the order of 300, the lens drum is better than the mirror wheel. But, in practice such values of n are impossible, as the light flux becomes so small as to be far beyond the limit that can be handled by the photo cell and its amplifier.

(To be continued.)

MARCONI NEWS AND NOTES

NEW BEAM WIRELESS SERVICE OPENED.

A NEW Marconi short-wave Beam telegraph service between China and Great Britain was opened on February 3rd, providing for the first time direct regular wireless communication between the two countries.

The Beam installation in China, situated at Chenju, near Shanghai, was formally inaugurated on the day of the opening of service and—according to the Shanghai correspondent of the *London Times*—“greatly impressed distinguished Chinese and British present as an example of the combined complexity and simplicity of modern scientific work.” The corresponding stations in England are the Marconi Beam stations at Dorchester and Somerton, operated by Imperial and International Communications Limited.

Poznan Station Reconstructed.

THE Polish broadcasting station at Poznan has recently been reconstructed and is now working with an unmodulated aerial input of 16 kilowatts, to which the power has been increased from the previous figure of 1.7 kilowatts.

The wavelength allotted to Poznan in accordance with the Lucerne Plan is 345.6 metres, close to London Regional's 342.1 metres (868 and 877 kilocycles respectively) and the transmitter has been fitted with a Marconi crystal drive which regulates the transmitted frequency to a very high degree of accuracy, and thus minimises the possibility of interference. The crystal drive was completely erected, connected up, and ready for operation within four hours of the delivery of its packing cases at Poznan.

The new Marconi system of “series modulation,” which provides a great simplification in transmitter design, and at the same time enhances the fidelity of reproduction, is another special feature of the reconstructed station.

Iceland Calling.

RADIO-TELEPHONE communication between all parts of Iceland and Great Britain is among the services to be provided by new Marconi short-wave transmitting and receiving stations which have just been ordered by the Iceland Posts and Telegraphs Administration for erection near Reykjavik.

In addition, the new stations are to be used for short-wave broadcasting and for transmitting weather bulletins by radio-telegraphy at regular intervals. This wireless meteorological service will supplement the present cable meteorological services to Great Britain, France, Germany, Holland, Norway, Sweden, and the United States of America.

When the installations are completed, Iceland will possess the most up-to-date short-wave stations of their class in the world, incorporating the latest developments of radio technique. The transmitter will be of entirely new design, with a

novel system of low-power keying and tone modulation—the direct outcome of the intensive research recently carried out by Marconi engineers into the problems of television transmission. Tests have shown that this new “television” modulation system gives remarkable fidelity of reproduction in telephone circuits, and is also suitable for continuous wave telegraph operation.

“Privacy” Equipment.

The telephone equipment will also include “privacy” apparatus which will make speech transmitted from the Reykjavik station unintelligible in ordinary receivers by the frequency inversion system. The Marconi Company is also supplying terminal equipment, connecting the radio channel with the land-line telephone system throughout the island, so that calls can be made to and from telephone subscribers not only in Reykjavik, but in all parts of Iceland.

Directional aerials of the Marconi series phase type are to be employed, primarily oriented for the European capitals, for which the various services of the stations are intended. Provision is also being made for the special requirements of short-wave broadcasting, and it is hoped that when this service is in operation Icelandic programmes will be heard regularly by listeners in all parts of Europe and the United States of America.

Radio-Belgrade's New Home.

SOMETHING like a record in the rapid moving of a complete wireless transmitting station was accomplished when the Marconi broadcasting station at Belgrade was dismantled, transported to a new site, re-erected, and tested within five days at the end of February.

The old Radio-Belgrade was situated in the centre of the city, and it was decided for technical reasons—particularly to secure a more efficient aerial system—to move the entire transmitting plant into the country. For this purpose, a site was chosen some time ago at Makis, ten kilometres from Belgrade, where the necessary buildings were erected, together with a new aerial system carried by two 100-metre insulated steel towers (shown in the accompanying photograph).

On Friday evening, February 23rd, the old Radio-Belgrade gave a European concert which was relayed to a number of Continental stations until midnight, when the technical staff immediately began to dismantle the station. By

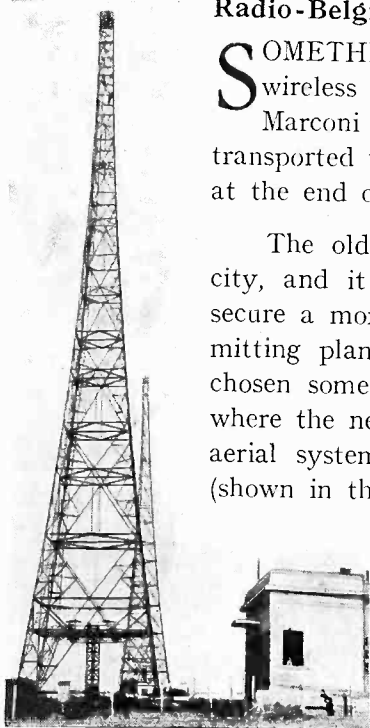

working day and night, the engineers succeeded in re-assembling the station at Makis by nine p.m. on Wednesday, February 28th, when the first test transmissions were made from the new site.

Telegrams and letters from listeners in all parts of Yugo-Slavia and abroad have reported that reception of Radio-Belgrade is now clearer and better than it has ever been since the original station was opened five years ago.

The transmitter which was the subject of this rapid and successful removal is a Marconi Type "Q" of nine kilowatts power.

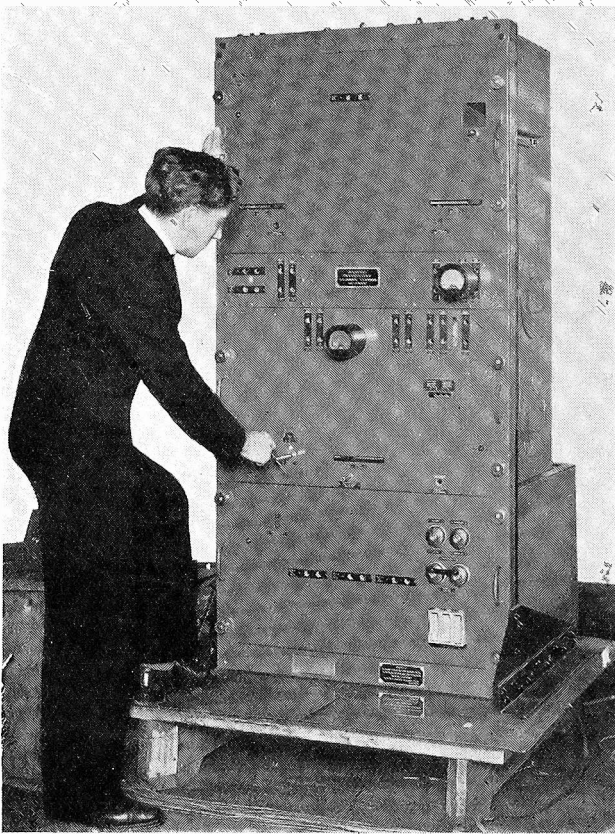

*New Marconi 500-watt tele-
phone-telegraph transmitter,
Type S.8a, specially suitable
for police headquarters or for
commercial stations. The
waveband is 20-80 metres.*

New Marconi Equipment for Imperial Airways.

TWO "Scylla" type aircraft which are now being built for Imperial Airways Limited at Rochester are being fitted with a new type of Marconi wireless equipment known as the A.D.41A/42A.

This new Marconi equipment follows very closely the design of the medium wave portion of the well-known A.D.37A/38A combined medium and short wave set which is installed in the whole of the Imperial Airways fleet of "Atalanta" class aircraft.

It therefore represents the most up-to-date practice in aircraft transmitting and receiving equipment operating on medium waves and, although a new equipment in this form, has behind it the successful experience of the A.D.37A/38A in all parts of the world.

The transmitter and receiver can be installed either as one unit or as two separate units to suit the accommodation available in any type of aircraft.

Western Australian Air Survey.

WIRELESS will play an important part in the air survey of Western Australia which is to be made by the Western Mining Corporation in connection with their mining prospecting operations.

The two aeroplanes to be used for the survey have been fitted with Marconi transmitting and receiving equipment, and a comprehensive service of air-and-ground wireless communication and direction finding will be provided by three mobile Marconi ground stations mounted in motor lorries. By means of this wireless organisation the position of the surveying aeroplanes will be plotted on a chart in the office of the Manager of the Expedition during the entire operations in the air and it will be possible to exchange messages by medium and short waves between any of the ground stations and the aircraft in flight and also with Australian wireless stations outside the survey area. The Manager will thus have direct control over the vital operations of aerial photography, each pilot will be constantly informed of his position—a factor of considerable practical value when working over remote areas—and the geologists will be able to communicate any reports regarding visual reconnaissance direct to headquarters by wireless telephony.

The importance of such a service of constant communication to facilitate the work of the survey is emphasised by the fact that the agreement between the Western Mining Corporation and the Government necessitates that vast mineralised areas in Western Australia will be examined within two years. Without the aid of aircraft, photography, and wireless, a geological survey of this extent, covering many thousands of square miles, would probably occupy some thirty or forty years.