

ELECTRONICS

and Beyond



FEBRUARY 1998 NO. 122 £2.65

<http://www.maplin.co.uk>

The '97-'98
El Niño Event

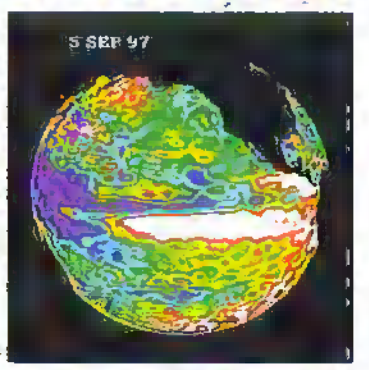

Is it the biggest yet?

Short Range
Personal
Communicators



Which of them
should you use?

Nuts & Bolts



A toolbox for
your computer

Getting Audio
onto CDs



The mechanics
of CD mastering
and MPEG audio

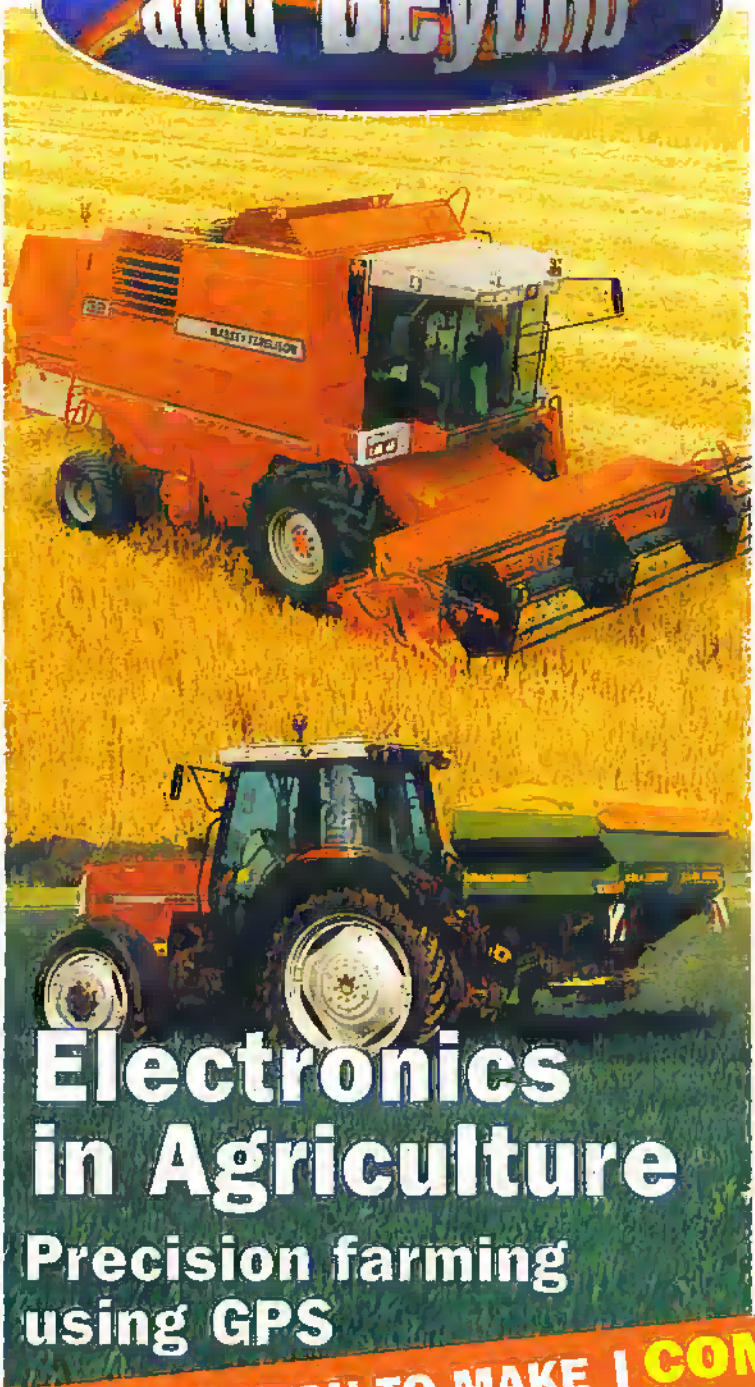

Electronics
in Agriculture
Precision farming
using GPS



PROJECTS FOR YOU TO MAKE
Video Distribution Amplifier
- in a case of its own
Interface BUS Expansion Module
Making your own audio CDs

COMPETITION!

Win a copy of
Nuts & Bolts
Virtual Toolbox
- see inside
for details

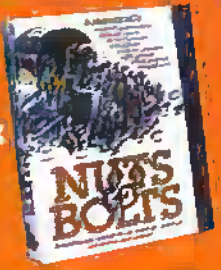

Britain's most widely circulated magazine for electronics!

Do you need

practical help in learning the ins-and- outs of the Microchip PIC Family?

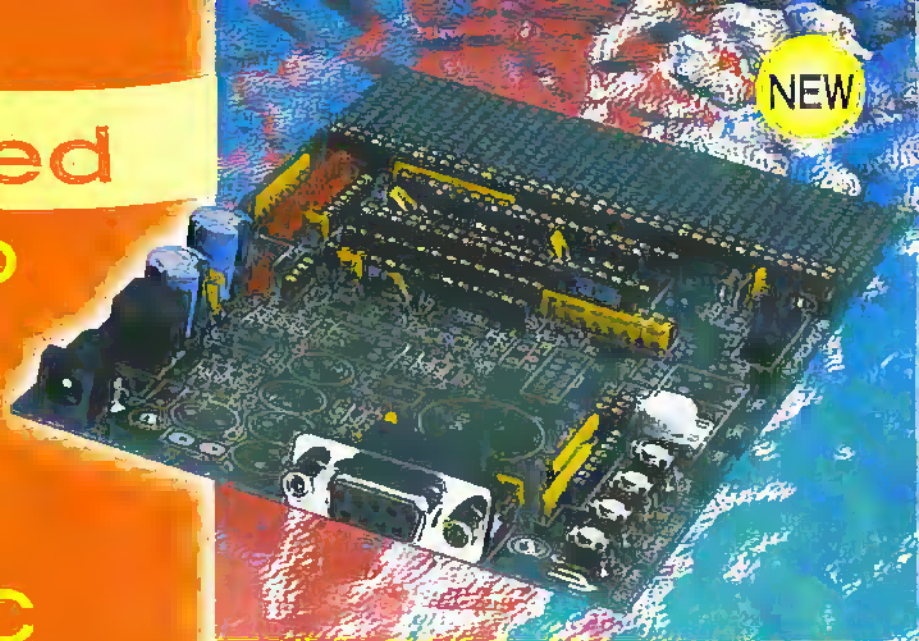

INTRODUCTORY OFFER £99.00

Then take a closer **look** at the Arizona Technologies Tutorial Board and modular training programme:

The Arizona Technologies is a low cost modular tutorial system for getting started with the Microchip PIC. It is based around a versatile demonstration and prototyping PCB and a windows help file software suite. All Microchip software tools are provided and dealt with in great depth. This is very much a learn-as-you-go product, with the basics covered with the main board, and further tutorials available as add-ons, once you are comfortable with the device operation.

ITEM NO	MAPLIN PART NO	DESCRIPTION	PRICE
1	NT62	Main Board	£99.00
2	NT63	Keypad Interface	£29.95
3	NT64	LCD Module Interface	£29.95
4	NT65	Dallas Touch Memory Interface	£24.95
5	NT66	Swept Tone Generator	£24.95
6	NT67	Real Time Clock Application	£19.95
7	NT68	Input Capture/Output Compare	£19.95

The introductory offer of £99.00 includes: Demonstration and prototyping board, diskette of tutorial software, Microchip CD Rom (data, apps notes, editor, assembler and simulator), Product registration and support form, PCB Circuit diagram, Technical Hotline details.

PIC Tutorial Board is supported by the UK Technical Hotline on (44) 1509 611344 or email: tutorial@arizona.co.uk. You can see before you buy by visiting the web page on <http://www.arizona.co.uk/arizona>

Also available to help with the PIC

A tutorial in programming the Microchip PIC (MAPLIN Code: NR74) is the latest in a series of learning aids to make your first steps into the exciting world of the Microchip PIC that much easier. Written by Paul Benford and Gordon MacNee, long standing experts on the PIC and microcontroller based applications, this book is a must for any design engineer getting onto the PIC trail.



**Publishers of Technical
and Educational Books**

ICKNIELD WAY, BALDOCK,
HERTS. SG7 5BB
TEL: 01462 896808 • FAX: 01462 896700
Email: simon@characteru.net

NEW

ORDER YOUR COPY NOW!
MAPLIN PART NUMBER: NR74

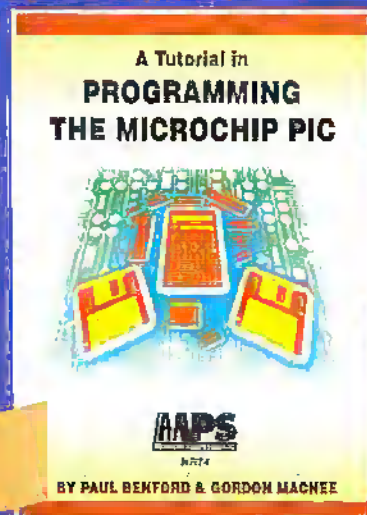

ELECTRONICS

February 1998

and Beyond

Vol. 17 No. 122

Projects

- 26 The AVR Project**
Kevin Kirk continues the story of AVR microcontroller applications.
- 30 IBUS Expansion Modules**
Neil Johnson provides the first in a series of add-on modules for his Interface Bus as featured in our November '97 edition.
- 40 Video Distribution Amplifier Case**
The boys from the Maplin lab have produced a lovely box for your VDA kit.
- 44 Getting Audio onto CDs Part 2**
Martin Pipe outlines the way to install the hardware into your computer. He also looks at the mechanics of CD mastering and MPEG audio.

Features

- 8 Getting on to the Internet Part 2**
This second episode centres around the history of the MODEM and how the latest state of the art MODEMs can be connected to your PC for the Internet. Mark Brighton reports.
- 13 Electronics in Agriculture**
George Pickworth investigates precision farming using the GPS navigation system.
- 18 Gravitational Waves**
Douglas Clarkson goes on the trail for the evidence of gravitational waves.

- 24 The El Niño Effect**
Weather satellites have been closely monitoring the current El Niño effect. It could be the biggest yet as Dr Chris Lavers reports.
- 36 Radio Communication Products**
Harry Watkins reviews some of the hand-held personal communicators on offer for business use and for pleasure.
- 58 Nuts & Bolts Review**
Stephen Waddington reviews the latest Toolkit software for your computer and has three copies to give away in our competition.
- 64 Security Electronic Systems**
Ray Marston looks at Infra-red light beam and PIR movement detector circuits in part 5 of this series.
- 72 CB Radio Abuse**
Chris Perry of the British Citizens' Band Confederation outlines some of the misuses of the CB system.

Regulars

- 2 News Report**
- 6 Back Issues**
- 24 How to Subscribe**
- 38 Comment**
- 52 What's On & Diary Dates**
- 53 Clearance Sale**
- 54 Research News**
- 61 Classified Adverts**
- 70 Air Your Views!**
- 76 @Internet**
- 79 In the Pipeline**
- 80 Technology Watch**



Cover picture: © Copyright 1998 Maplin Electronics PLC. All rights reserved.



8



13



30



44

Editorial

Editor Paul Freeman-Sear *pfs@maplin.com*
Editorial Assistant Lynda Hardy
News Editor Stephen Waddington *sw@maplin.com*
Technical Illustration Set Square Designs

Production

Design Layout Artist Karen Harris
Photography Librarian Mavis Williams
Published by Maplin Electronics plc,
PO, Box 777, Rayleigh, Essex, SS6 8LU.
Tel: (01702) 554155.
Fax: (01702) 554001.
Lithographic Reproduction by
Planographic Studios,
18 Sinder Road, Brook Road Ind. Estate,
Rayleigh, Essex SS6 7UA.
Printed by Millennium Web Offset plc.,
Perlym, Cornwall, TR10 9EP

Management

Manager Paul Freeman-Sear *pfs@maplin.com*
Marketing Services Manager Steve Drake

Subscriptions

Mairteen Harvey
Tel: (01702) 554155 Ext. 311.

Advertising and Circulation

In association with Fox Publishing
135 Greenford Road, Sudbury Hill,
Harrow, Middlesex, HA13YD.
Tel: 0181 869 8410.

UK Newstrade Distribution

Seymour, Windsor House,
1270 London Road, Norbury,
London SW16 4DH.
Tel: +44 (0)181 679 1899.
Fax: +44 (0)181 679 5907.

Copyright 1998 Maplin Electronics PLC.

Copyright: All material is subject to worldwide copyright protection, and reproduction or imitation in whole or part is expressly forbidden. Permission to reproduce printed circuit board layouts commercially or marketing of kits must be sought from the publisher.

Advertisements: Whilst every reasonable precaution is undertaken to protect the interests of readers by ensuring, so far as possible, that advertisements appearing in the current issue of Electronics and Beyond are bona fide, the publisher and staff of the magazine cannot give any undertakings in relation to statements or claims made by advertisers, whether on printed pages or on loose inserts. Readers who have reasonable grounds to believe that they have been misled are advised to contact their local Trading Standards Office.

Editorial: The views of individual contributors/authors are not necessarily those of either the publisher or the editor. Where errors occur, corrections will be published as soon as possible afterwards.

Publisher's Statement: Maplin Electronics PLC. take all reasonable care to prevent piracy, loss or damage of any kind being caused by any matter published in Electronics and Beyond. So far as is permitted by English law, liability of every kind including negligence is excluded as regards any person in respect thereof.

ELECTRONICS

and Beyond

Built-in Obsolescence

Two factors affecting the electronics trade are negative inflation on a variety of products and manufacturing product lifetime. A classic example of the former is the colour TV. In the late 60s a TV would typically cost £350. Thirty years on, a comparable version costs around £250. On the latter, many product lifetimes particularly in the computer/computer peripherals area are now down to around six months. For distributor companies like Maplin these factors represent a real challenge.

From the company point of view, it means you either hold zero stocks and you order/manufacture on demand, something that was taken up by many companies in the UK after a recession (it's called adopting the 'Just-in-time' approach) or the company has to somehow ensure a high turn-over of stock, clearing those lines within months. Both have their own set of risks.

From the customers' point of view it always presents a bit of a challenge knowing when to take the plunge and to buy. The customer has to make a decision about using a technology that will be 'old-hat' in around six months. What is also particularly galling, is that in some cases, the customers' showpiece gadget has dropped to around half of the original price.

Wouldn't it be interesting to see an 'obsolescence time estimate' printed on relevant packaging to give greater consumer choice, but I doubt that will happen somehow.

Congratulations

Yes well done Mr P Stevenson of Peterborough. You have won your request of a Teletest-2 for TVs, VCRs and Home Cinema in our December competition.

Paul Freeman-Sear, Publishing Manager

ELECTRONICS
and Beyond

Nuts & Bolts
A Toolbox for your computer

Getting Audio onto CDs
The mechanics of CD mastering and MPEG audio

Electronics in Agriculture
Precision farming using GPS

Short Range Personal Communicators
Which of them should you use?

COMPETITION!
Win a copy of Nuts & Bolts Virtual Toolbox - 200 inside for details

PROJECTS FOR YOU TO MAKE
Video Distribution Amplifier - in a case of its own
Interface BUS Expansion Module
Making your own audio CDs

The '97-'98 El Niño Event
Is it the biggest yet?

Britain's most widely circulated magazine for electronics!

Britain's Best Magazine for the Electronics Enthusiast

NEWS REPORT



Philips Enters Handheld Computing Market

Philips Semiconductors' Handheld Computing Group has announced three major agreements for the company's TwoChipPIC and TwoChipPIC Plus architectures, which are specifically designed for the handheld personal computer market and provide the essential combination of high performance with low power consumption.

The TwoChipPIC chipset will be embedded in Quantum Micro Systems' QMS-104 computer board while the TwoChipPIC Plus will support the new Microsoft Windows CE 2.0 platform and forms the basis of an alliance between Philips Semiconductors Handheld Computing Group and Epson to provide high-resolution 16-bit colour support for handheld equipment.

For further details, check: www.semiconductors.philips.com.
Contact: Philips Semiconductors, Tel: +31 40 272 20 91.



Samsung Demonstrates Massive TFT-LCD

As the world's first 30in. single glass thin-film-transistor liquid crystal display (TFT-LCD), Samsung Electronics' next-generation TFT-LCD can function as a high-definition multimedia display and large screen wall-hanging TV. Commercial versions of the screen are expected to become available some time next year.

For further details, check: www.samsung.com.

Contact: Samsung, Tel: (0181) 391 8213.

Encoding Chips Enable High-Quality

Leveraging its experience in mixed-signal design, Texas Instruments (TI) has announced two new video encoding and decoding devices. These chips offer high-quality video processing for personal computers (PCs) and other video applications such as set-top boxes, video conferencing and digital television.

Video decoders and encoders allow the digital world of PCs to connect with analogue video devices such as camcorders, VCRs and televisions.

TI's new TVP5010 video decoder and TVP6000 video encoder bring high-quality video to the PC by combining advanced analogue decoding capabilities, such as dual comb filters, with other special features like a flicker filter and overscan compensation, which are used to encode digital video signals.

For further details, check: www.ti.com.

Contact: Texas Instruments, Tel: (01784) 212000.

Intel-Digital Settlement May Signal End of Alpha

As part of a settlement ending a patent infringement lawsuit brought by Digital Equipment Corporation against Intel, Intel is paying Digital \$700 million and royalties but Digital is committing itself to develop computers based on the next-generation of Intel chips and competing directly against Digital's Alpha chips.

Thirty-five computer vendors have already promised to use Intel's new chip when it comes out in 1998, and industry analysts see Digital's commitment to Intel chips as a signal of the end of its own line of Alpha chips.

For further details, check:

www.intel.com; or www.digital.com.

Contact: Intel, Tel: (01734) 403000; or Digital, Tel: (01189) 868711.

Intel Chips in to CDT

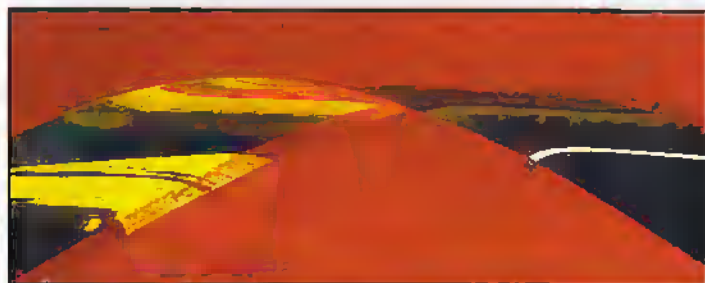

Intel has joined Cambridge Display Technology's (CDT) list of high-profile backers to become an investor in the UK based start-up display company.

Other investors include rock group Genesis, Esther Dyson, president of EDventure Holdings, an emerging information technology commentator, former Acom Computer founding director Hermann Hauser, the Sculley Brothers and Steve Kahng, president of Power Computing Corporation.

Unlike other display technologies, LEP can be manufactured on a single piece of glass or plastic and consequently could have flexible properties. CDT has already demonstrated a single-colour LEP dot matrix display and expects to show more complex applications by then end of 1997.

Since its founders discovered LEP in 1990, CDT has followed a strategy of commercial exploitation through licensing and joint development, with fundamental research focusing on the core LEP technology taking place in the company's Cambridge laboratories. CDT has licensed its patented technology to Innovative Display Technologies, Hoescht, Philips and Uniax, with the latter two expecting to make beta products available as low information content displays for mobile phones in early 1998.

The Intel investment will support CDT's ongoing research and development work led by Cambridge University's Cavendish Professor, Richard Friend. Friend's team is currently developing schemes to allow synthesised polymers, which efficiently emit light in the red, green and blue regions of the visible spectrum, to be used to construct colour graphic displays.

For further details, check:

www.cdtltd.co.uk; or www.intel.com.

Contact: CDT, Tel: (01223) 276351; or Intel, Tel: (01734) 403000.

Microchip Debuts World's Smallest EEPROM Microcontrollers

Microchip Technology has expanded its PICmicro family of 8-pin 8-bit microcontrollers with two new devices. The PIC12CE518 and PIC12CE519 contain 16 bytes of on-board EEPROM data memory, making them the world's smallest EEPROM microcontrollers.

The PIC12CE518 and PIC12CE519 feature 512 words of one-time-programmable (OTP) program memory and 25 bytes of user RAM and 1,024 words of OTP program memory and 41 bytes of user RAM, respectively. With OTP program memory and EEPROM data memory, Microchip delivers a highly flexible microcontroller solution in the space of a mere 0.04 square inches.

For further details, check: www.microchip.com.

Contact: Microchip, Tel: (0118) 921 5800.

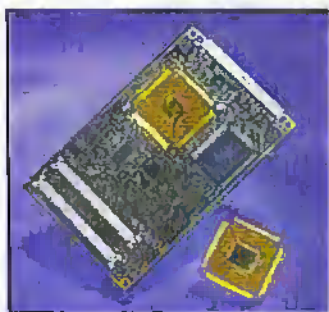

Intel Confirms Latest Pentium Flaw

Intel has confirmed that a flaw in the company's Pentium and Pentium/MMX processors has been discovered. The "FO bug," as the glitch has been dubbed, involves a sequence of illegal opcodes - instructions not normally intended for use with the Intel chips.

Meanwhile a small company called Freedom Fighter says it has developed a fix for the Pentium chip flaw. The FO Fighter software is designed to work with Windows 95 or NT operating systems and detects and deletes the problem-causing code before it causes any damage.

For further details, check: www.intel.com.

Contact: Intel, Tel: (01734) 403000.



Aviation Radio Re-tunes

Civil aviation enthusiasts will have to change their existing equipment in order to listen in to conversations between pilots and air traffic control. New channel spacing, to be phased in throughout Europe in 1999, dictates that the receiver band for civil aircraft changes from the current 25kHz to 8.33kHz.

Contact: Radio Authority, Tel: (0171) 430 2724.

Xerox Develops Diode For Laser Printers

Xerox has developed a semiconductor diode that generates tiny blue laser beams with shorter wavelengths to produce more dots in an image and thus achieve much higher picture resolution than is possible using wavelengths at the infrared end of the spectrum. The technology is expected to be incorporated in commercial laser printer products within the next five years.

For further details, check: www.xerox.com.
Contact: Xerox,
Tel: (01908) 692444.

Apple Mac OS For Intel Machines

Apple is thought to be involved in an effort to develop a version of its Macintosh operating system to run on computers based on Intel processors. Meanwhile interim CEO Steve Jobs says he's not interested in a permanent position at Apple Computer, and is confident that the company will find a successor to former chief executive Gil Amelio before year's end.

For further details, check: www.apple.com.
Contact: Apple,
Tel: (0181) 569 1199.

Yale Grow Chips In Test Tubes

Researchers are working on an alternative method of producing computer chips by growing them in test tubes. The idea is to encourage organic molecules into organising themselves into wires and transistors by zapping them with an electrical current. The result could be superchips with many billions of transistors.

For further details, check: ee.yale.edu.
Contact: Yale University, Tel: +1 203 432 4300.

IBM Calls For Urgent Action On Social Inclusion

NOP Solutions Research undertaken on behalf of IBM and released at the end of November, reveals the urgent need for government action to prevent social exclusion in the information society. Figures show that not only are the less advantaged social groups unlikely to have used current technology such as PCs, the Internet and touch screen terminals, but 61% are also concerned about their ability to use technology in a future where the government deals with the citizen electronically.

For further details, check: www.ibm.com.
Contact: IBM, Tel: (0990) 426426.

Analysts Warn of Bleak Future for ISDN

Research released by analysts Ovum, anticipates a halt in the growth of ISDN lines by 2003. Its report, 'Digital Subscriber Line: the Route to Broadband', predicts that users will migrate to higher bandwidth solutions such as unswitched digital subscriber line technologies (xDSL). In the short term, however, growth in demand for both ISDN and xDSL will be driven by increased user demand for bandwidth and telcos' determination to maximise return on existing copper networks.

According to Kate Hewett, consultant at Ovum and author of the report, "Digital subscriber line technologies can turn a

normal copper pair into a broadband connection. There are over 700 million fixed lines in operation worldwide, the majority of which are copper. This is an enormous potential market. ISDN is only an interim solution. Once true broadband solutions such as ADSL, VDSL and single line HDSL become available, ISDN's growth will filter."

But there are still some market barriers to overcome. "Until recently, the xDSL market has suffered from the lack of a 'killer application' for cost sensitive residential and SOHO users," continues Hewett. "But increased use of the Internet, teleworking and data

networking are rapidly changing this. However uncertainty over pricing and marketing strategies, as well as

the fact that telcos have invested heavily in making their networks ISDN-capable, are causing xDSL deployment to stall," concluded Hewett.

For further details, check: www.ovum.com.
Contact: Ovum,
Tel: (0171) 255 2670.



NEC Launches Windows CE 2.0 Handheld PC

Weighing in at under 1.5 lbs a lightweight mobile companion, optimised for e-mail and document viewing and editing was launched last month by NEC. The MobilePro 700 Handheld PC (H/PC) features an innovative new design that boasts a comfortable, typable keyboard, and a large, backlit screen.

Designed for Microsoft's Windows CE.2.0 operating system, the NEC MobilePro 700 features the familiar Windows interface. Included in Windows

CE 2.0 are: Windows CE Services 2.0 for synchronisation of files with a desktop or notebook; Microsoft Pocket Word and Microsoft Pocket Excel, for maximum productivity on the road; Microsoft Pocket Outlook, for email retrieval and distribution; and Microsoft Pocket Internet Explorer, for Internet Access and web browsing.

For further details, check: www.nec.com.
Contact: NEC,
Tel: (0181) 993 8111.



GPT Seeks Graduates Who Will Make A Difference

Some of the finest young brains in Britain are being recruited to fill 200 vacancies at GPT. Britain's largest telecommunications manufacturer has targeted over 80 of the UK's leading universities in a recruitment drive, timed to attract the very best graduates leaving higher education next year.

Resourcing manager Tony Lewis told Electronics and Beyond, "GPT's objective is to find up to 200 graduates who will make a difference in the challenging and competitive world of telecoms. They will be recruited in the next few months to ensure they start work with us next year and will benefit from industry leading development."

He said the graduate vacancies were in addition to about 100 vacancies at the company for skilled engineers and technicians.

For further details, check: www.gpt.co.uk.
Contact: GPT, Tel: (0800) 174498.

Partnership Unveils Storage First

SanDisk has teamed with Siemens to launch the MultiMediaCard (MMC), the world's smallest solid state storage device. The MMC provides portable data and audio storage to the smallest advanced mobile phones and pagers currently being developed. With support already from leading telecommunications companies, SanDisk expects that the MMC will emerge as the portable storage standard for

mobile phones, pagers and other handheld products. The MMC, which weighs less than two grams and is the size of a penny, was designed to meet the unique requirements of the portable communications and computing markets.

For further details, check: www.sandisk.com; or www.siemens.co.uk.
Contact: Sandisk, Tel: +49 511 875 9185; or Siemens,
Tel: (01344) 396693.



Breakthrough Technology Enables Record-Breaking Hard Drives

IBM has announced the world's highest capacity desktop PC disk drive with new breakthrough technology called Giant Magneto-resistive (GMR) heads. No bigger than the head of a pin, the GMR head is a major advancement over the previous technology called a magneto-resistive head.

Pioneered by IBM Research scientists, GMR heads will be used in IBM's new Deskstar 16GP,



a 16.8-gigabyte drive that holds eight times more information than today's average desktop hard drive. The new drive can hold 8 hours of full-motion video (MPEG-2 quality video) or information that when printed fills more than 16 pick up trucks

For further details, contact:
www.ibm.com/storage.
Contact: IBM,
Tel: (0990) 426426.

Enhanced Video Camera from Panasonic

Panasonic has launched a compact lightweight 3CCD camera which maximises the performance of digital video format to offer superior picture and sound quality. The NVDX100B employs the 3CCD camera system, similar to that used in profession video cameras.

Each of the three CCDs utilises 320,000 pixels to make-up the red, green and blue components of the picture. Adding to this is a double density pixel distribution – a resolution enhancing technology which increases the effective number of pixel elements by approximately 1.5.

For further details, check: www.panasonic.co.uk.
Contact: Panasonic, Tel: (0990) 357357.

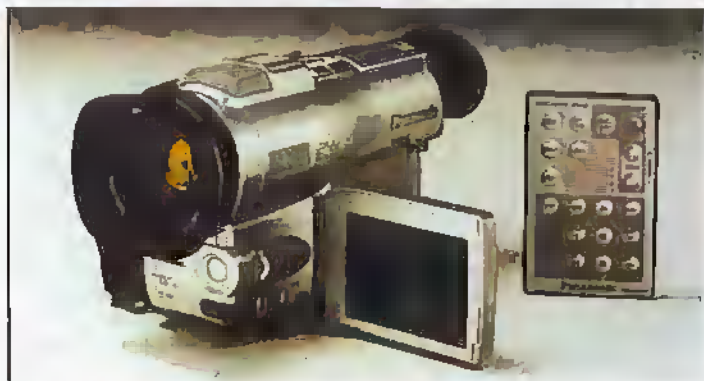

Mountbatten Medal Awarded Jointly to Computing Pioneers



Professor Tom Kilburn and Professor Maurice Wilkes have been jointly awarded the 1997 Mountbatten Medal by the

National Electronics Council (NEC). They received their award from His Royal Highness The Duke of Kent KG at a ceremony held at the IEE in London.

Professor Tom Kilburn led the team at Manchester University which set out to design a universal digital machine and they were the first people to actually run a machine under stored programme control. He set up the Computer Science

Department at the University and later became its first Professor of Computing. The pioneering Manchester machine included the key elements of storage, computation and random access memory.

Professor Maurice Wilkes, working at Cambridge University, was personally responsible for many of the key concepts used in today's computers: micro-programming, random access memory, parallel computing and floating point arithmetic. His work led to the development of the EDSAC machine which started operating in 1949 and was used for the University's first computing service.

For further details, check:
www.iee.org.uk.
Contact: IEE, Tel: (0171) 240 1871.

National Semiconductor and Cyrix Merger Approved

The merger between National and Cyrix Corporation has been approved, taking the semiconductor one step closer to developing the single chip Personal Computer (PC).

"We will offer new integrated processors capable of powering a broad range of PCs and information appliances, bringing information to people anytime, anywhere," said Brian Halla, CEO, National Semiconductor.

For further details, check:
www.national.com;
or www.cyrix.com.
Contact: National Semiconductor,
Tel: (01475) 633733;
or Cyrix, Tel: +1 800 777 9988.



Lucent Reveals Faster Transistor

Researchers at Bell Laboratories, the research and development arm of Lucent Technologies, have fabricated the world's smallest practical transistor that is four times smaller, five times faster and draws 60 to 160 times less power than today's transistors.

While Bell Labs and others have built extremely small transistors before, no one has built a transistor this small with all the components scaled to deliver the kind of performance needed for a practical microchip, the company said. The achievement paves the way for powerful new integrated circuits that pack many billions of transistors on a single silicon chip, as opposed to the millions on today's chips.

"As we celebrate the 50th anniversary of inventing the transistor at Bell Labs, we are ushering in the age of 'nanoelectronics' by developing the technology to produce future generations of microchips," said Mark Pinto, chief technical officer of Lucent Technologies' Microelectronics Group. In microelectronics, chip features are measured in microns, or millionths of a metre; in nanoelectronics, chip features will be measured in nanometers, or billionths of a metre.

The experimental 'nanotransistor' exceeds today's transistors in such key measures as how much current flows through a transistor and how much a transistor boosts a signal. Future chips based on this technology would consume far less energy, a boon for users of portable communications and computing devices.

"This new technology could go a long way toward satisfying consumers' demands for longer battery life, less weight, and additional capabilities in wireless telephones and portable computers," said Pinto. "Cutting power demand could lead to portable multimedia terminals that run for weeks on a single battery and include features such as automated adaptability to wireless standards around the world."

"The nanotransistor puts us way in front of the industry curve," said Pinto. "It is what the semiconductor industry predicts will become state-of-the-art 12 years from now."

For further details, check: www.lucent.com.
Contact: Lucent, Tel: +1 888 584 6366.

PEAK Get rid of those databooks!



DCA50 Component Analyser
An incredibly versatile unit that will identify almost any transistor, MOSFET, diode or LED as well as identify pinouts! It will even measure transistor gain. Just apply the test clips in any order and press the button. Fits in the palm of your hand. Supplied with battery and manual.

DTA30 Transistor Analyser

The user can connect any bipolar transistor to the three test clips in any configuration and the DTA30 will verify device operation and identify all three leads as well as the transistor type (NPN/PNP).

HMA20 MOSFET Analyser

A truly unique instrument that will verify the operation of enhancement mode MOSFETs. Of course, it will identify the three leads and the MOSFET type too.

DCH10 Diode Tester

A simple device that will test and identify the leads of diodes, zeners, LEDs and other semiconductor junctions. It will even illuminate an LED under test regardless of the connected orientation.

All units feature auto power-on and auto power-off and are supplied with a long life battery. If you want to place an order, just send a cheque for the amounts shown, there's no VAT or P+P to add, what you see is what you pay! Goods are normally despatched within 24 hours and are guaranteed for 12 months following receipt of order. For delivery outside the UK please add £5.

Just phone, fax or email for a free information pack.

Peak Electronic Design Limited

70 Nunsfield Road, Buxton. Tel: (01298) 700 12 Web: www.peakelec.co.uk
Derbyshire, SK17 7BW Fax: (01298) 700 46 Email: sales@peakelec.co.uk



DTA30
£26

HMA20
£26

DCH10
£19

SMART CARD INTERROGATION SYSTEM

- Smart Card Reader/Writer (Programming Interface)
- Smart Card Interrogation System, to identify the commands accepted by any valid Smart Card and log them to disk for evaluation.
- Will allow the user to "re send" known commands and monitor the result.
- Passive interface to allow the user to monitor the data flow between Card and host system.
- 244 page Hard Back reference book, covering all aspects of Smart Card design and programming.
- Sample program to read Phone cards
- Data on NEW Visa Smart Cards.



£169.95

SMART CARD EVALUATION PACKAGE

- Smart Card Reader/Writer (Programming Interface)
- Evaluation applications, for use with Smart cards provided in the package. Smart ID Card, Smart Electronic Purse, Smart Loyalty Card.
- 'C' Library & Command descriptions. For you to design your own Smart Card applications using the cards provided.
- Programmers Development Suite. Text Editor, Assembler, Simulator for programming the Cards provided.
- sample smart cards included

£99.95

PIC16x84 & EEPROM READER / WRITER

This high quality versatile unit reads and writes to SMART CARDS, MEMORY CARDS, PAY PHONE & PIC1684 cards. Complete with comprehensive programming information, PHONE CARD data VISA CARD data. Requires a PC running DOS8.2 or higher. Complete with Cables, software.

£79.95

Power supply £8.50

SMART CARDS FROM £1.00 each

- CreditCard: Now you can supply members of your Club or customers with your own Custom Credit Card. Allowing you to read the value of the card and to Credit/Debit the value.
- Dongle Card: Protect your computer with the Dongle card, code can be changed allowing the operator to load their own code. Using a Smartcard Reader you can control access to the computer, controlling unwanted access.
- TimeCard: Ever wanted to be able to track the time you started work, or monitor colleague's movements, with the TimeCard you can.
- CRN1: Embedded PIC16F84 microchip using RB7 pin 13 input output 1024 byte memory and 64 bytes eeprom.
- CRN2: Embedded PIC16F84 microchip using RB7 pin 13 input output 1024 byte memory and 64 bytes eeprom and 16K memory chip.
- CRN202: 2048 bit memory, using I2C Bus serial memory. (The CRN202 is just I2C memory and does not have any protection, ideal for storing data on smart-cards.
- CRN102: 1024 bit eeprom configured as two 512 x 1 bit memory zones. Features secure transport code, two stage personalization, invalid security code lock-up and customer programmable Memory Security Access.
- CRN033: Pin Controlled 256 x 8 bit EPROM with programmable write/erase protection for each of the first 32 bytes.

PIC 12C508/509 DEVELOPMENT SYSTEM

- Fully Integrated System inclusive of connection cable to printer port. Power supply. 2 x PIC16C508 devices & detailed instruction manual. Supplied with integrated editor / assembler. Supports Microchip files. DATA SHEETS & MPASM supplied on disk
- FULL in circuit emulation - displaying all file registers.
- Single step through code, run with or without break.
- Supplied with circuit diagrams and ASM files for:
 - * Digital Volt Meter
 - * Sound Effect Unit (variable sounds)
 - * LCD Interface (16x2 lines)
 - * Keyboard Interface
 - * Stopwatch

£59.95

Pro-PIC PROGRAMMER

Programs all popular PIC devices via ZIF socket 16C52,54,56,57,58,61,62,63,64,65,620,621,622,71,73,74,83,84,564,568, P14000, 12C508,509

& MEMORY DEVICES

24C01,02,16,LC32,LC65

£49.95

- 87C51/2 programmer 39.95
- GAL programmer 49.95
- EPROM programmer 69.95
- EPROM emulator 59.95
- Eeprom Programmer 34.95

CROWNHILL ASSOCIATES LIMITED
THE OLD BAKERY, NEW BARN ROAD
ELY, CAMBS, CB7 4PW
Tel: 01353 666709 Fax: 01353 666710
Email: sales@crowhill.cambs.net

Prices are exclusive of Postage Packing & VAT delivery is by registered mail Cheques and P/O's payable to: Crownhill Associates Limited

We accept VISA MASTERCARD SWITCH

Getting On-Line TO THE INTERNET

PART 2

by Mark Brighton

Hardware and Software requirements

In last month's article, we had a general look at the main types of service providers who can connect you to the Web. This month, we assume that you have not opted to choose the ubiquitous Compuserve / AOL service (these companies have merged to form what may end up as a truly massive single service provider, serving about one third of all Internet subscribers world-wide), but have decided to subscribe to a service provider offering a simple standard Internet connection, using Demon Internet as our example.

We will look at the hardware you will need to connect your PC to the Internet, and the Software package that allows you to browse or "surf" the Net.

Starting points: The Modem

If you already have a Pentium or 486 based PC (older CPU's will also work, but with limitations on what you can do whilst on line in terms of running other programs concurrently at a reasonable speed), you only need to add a device called a modem to it and plug the modem into a convenient phone socket.

A modem is an electronic circuit that sits between the PC and the telephone line and converts the digital data from your computer from a series of logic ones and zeros (normally represented by two voltage levels) that cannot be sent down a phone line, to short bursts of different frequency tones that can. Modems are fully bi-directional and also convert incoming tone data (also called Frequency Shift Keying or FSK) back into serial logic data represented by voltage levels that your PC can deal with.

Internal modems also deal with the conversion of parallel data from your PC's data bus to serial data, and vice versa, whereas external modems plug into a computer where this conversion has already been done. Your PC deals with data in parallel format, 32 or even 64 bits at a time for newer CPU's, and it isn't possible to force data down a standard telephone line at this "width", so it is converted to a serial format and sent, one bit after another, down the phone line. Special marker bits show the start and end of each byte of data. Incoming data has to be rebuilt into parallel words which are then placed onto the data bus to be read by the CPU.

Development of the modem

There is nothing new about the modem. We can trace it's ancestry back to the Radio Teletype (RTTY) machines of the 1930's, where keystrokes were encoded in 5 bit Baudot code, and the resultant serial data modulated an RF carrier which was transmitted, then received, demodulated and converted back to type at the far end. Even today the data transmission rate in bits per second is sometimes (not strictly correctly) referred to as "9600 Baud" or whatever, whereas the older Baud rate actually referred to the number of state changes on the line per second which is not often the same as the number of bits transmitted. The name "modem" is derived from the MODulation and DEModulation functions of the unit.

Punched paper tape allowed messages to be stored for later transmission, or archived. When the need for transmission of computer data between sites developed in the 1950's and 1960's, it was only natural to extend the old Radio Teletype technology to this new modem application, although the original Baudot code was too limiting for computer data transmission. 5 bits of data only allows for 32 individual character codes to be transmitted, with one of those being a figure-shift character that allowed an alternative character set to be used until a letter-shift character switched back to the original set. Use of an 8 bit serial (byte) code allows all numbers between zero and 255 to be transmitted, or a pair of bytes to form a 16 bit word. The ASCII character set was created to represent all keyboard characters without the use of a shift code (actually based on a seven bit code), and later extended by the computer manufacturers to cater for semi-graphic characters and regional variations.

The original RTTY standard was based on mechanical equipment with rotating clutches and camshafts used to serially encode data. Transmission rates were correspondingly slow (the "electric typewriter" teleprinter at the far end had to be able to keep up anyway), at about 45 bits per second (bps), but once computers progressed from teleprinter displays to Video Terminals, or had memory storage for leisurely retrieval of received data, faster transmission was required.

Development of the modem, limited by the restricted bandwidth of the old

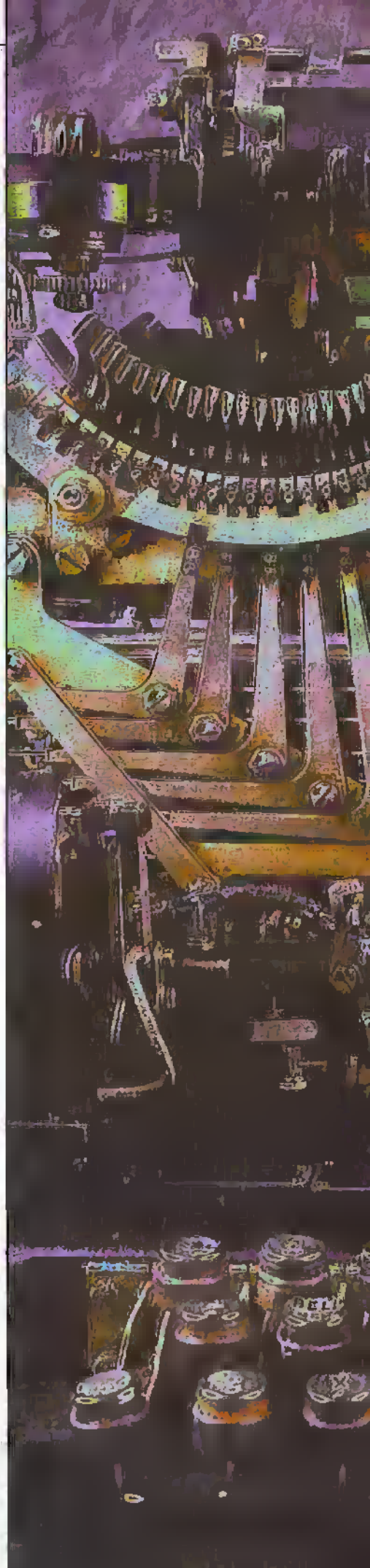

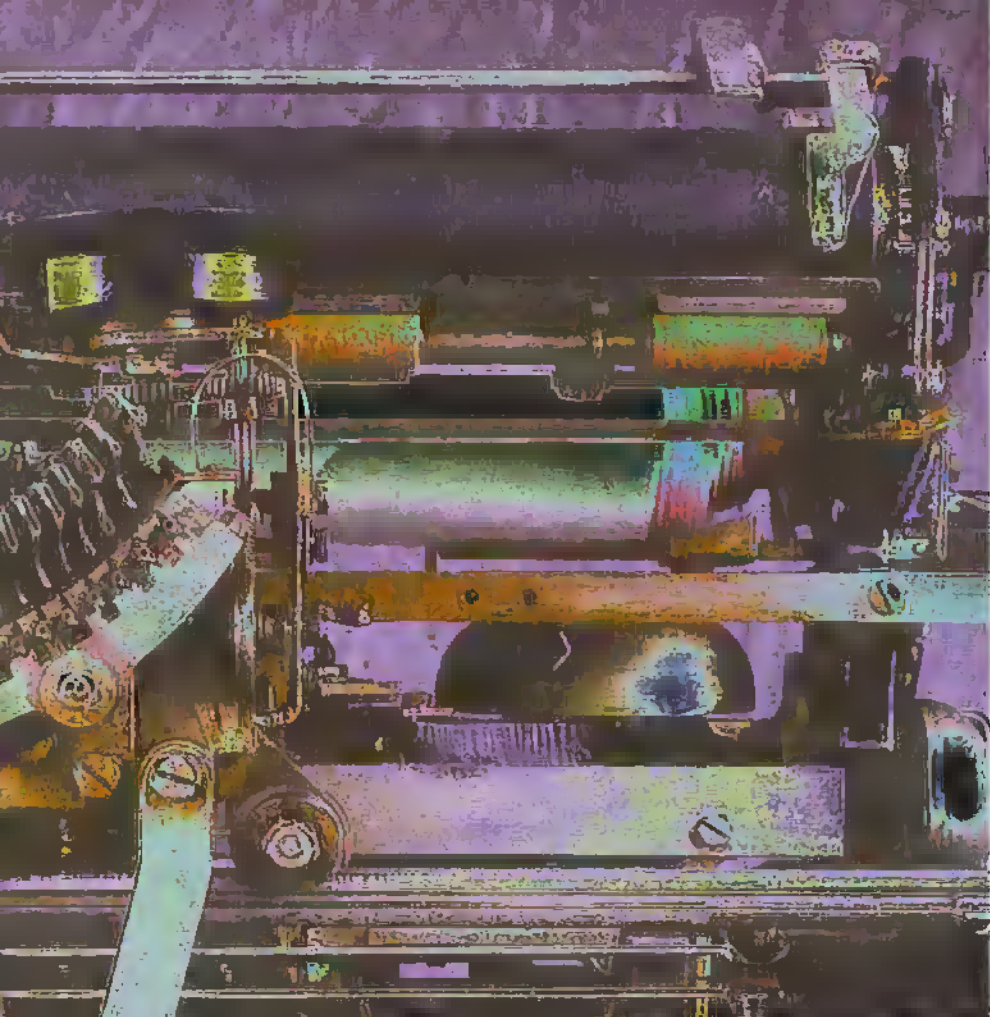

Photo 1. A Teletype 15-type machine of circa 1945 (made in Chicago).

analogue telephone lines, was fairly slow. Indeed, the Maplin Modem kit originally published in this magazine in 1983 (issue 5) only managed 300 bps (about 30 characters or bytes per second) and this was state of the art! Download of a (by today's standards) relatively small data file of, say, 50K could take almost half an hour at this speed, so this would be of little use today. The budding Bulletin Board Services (BBS's) were text based with no fancy graphics (many still are!) and even the revolutionary Prestel Viewdata subscriber service, running at 1200 bps (to you) and 75 bps (from you), was a text based service.

To most people today, the Internet means the World Wide Web, with intensely graphical presentation throughout giving glossy magazine like quality to pages displayed on your machine. This and the requirement for downloading huge data and picture files means the need for fast modems is ever greater, with effective delivery of pages being dependent on the fastest modems available, if you are lucky enough to make a good uncongested connection.

In today's market, there are a number of different types of modems capable of running at various maximum speeds, at a wide range of prices. We will take a closer

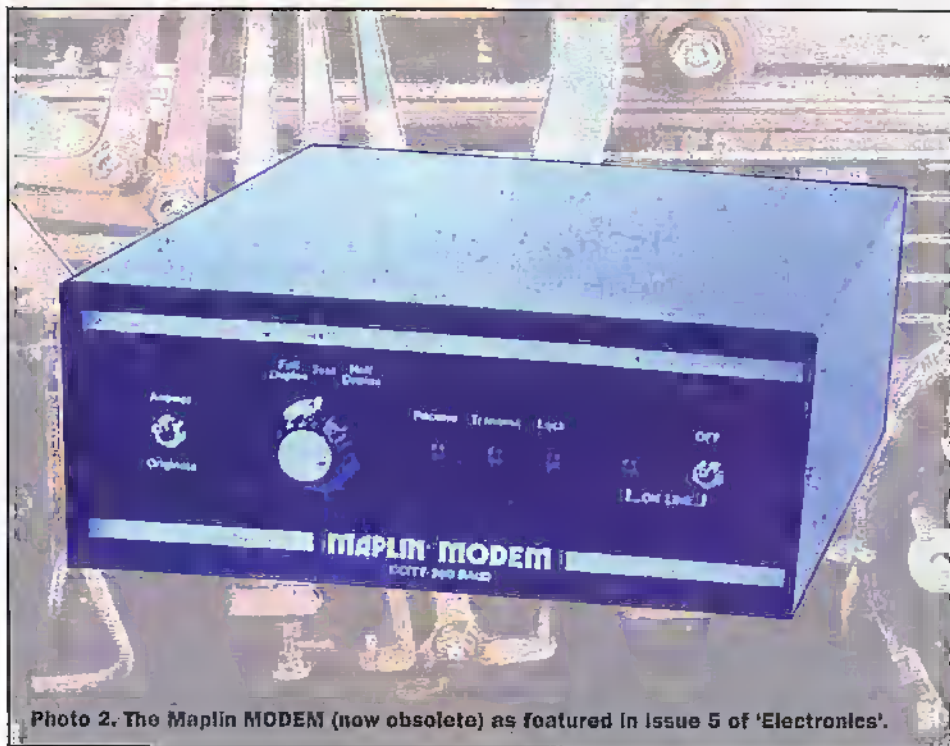

Photo 2. The Maplin MODEM (now obsolete) as featured in Issue 5 of 'Electronics'.

look at some of the types available before choosing a specific modem for our installation example, which we will then cover in depth. The market breaks down in several different ways and we need to consider each of these in turn to make a final choice.

Modem types

Internal or External Modem?

Modems are available as an external type, complete and boxed, or as a plug-in internal card to fit inside your PC. The type you choose is largely a matter of personal preference and confidence level in terms of lifting the lid of your PC.

An external modem is easy to fit. Just plug a serial lead into your Com port; plug the power supply into the modem and you are ready to go. It is also very portable. If you move from place to place and need to connect the modem to several different computers, this may be the right choice for you. Windows 95 will usually detect a new external modem (make sure that the modem is powered before booting Windows 95) and prompt you to install any necessary software or configuration information.

There are a few possible minor disadvantages to an external modem. You will have to find a place to put it and an extra mains socket or mains adaptor to plug it into. It may cost a little more than an internal type. Users of older PC's should ensure that their serial RS232 communications ports are based on the high speed 16550 UART IC and not the older 8250 type, otherwise they won't be able to use the faster speeds. If you do have the older device, a new I/O card is not expensive, but rather defeats the advantage of not having to lift the lid of your PC!

Internal modems disappear inside your PC, with no extra leads or power supply

arrangements required. They plug directly into your PC's ISA bus, doing their own parallel to serial conversion at whatever speed they need, so you don't have to worry about existing serial capability. They are the cheapest option to go for and probably the most practical solution for anyone using a single PC to access the Internet, especially if you are not apprehensive about the prospect of fitting the card into a spare expansion slot inside your machine. If you are unsure about your ability to do that, then just read on! We will take you through that process, step by step.

Approved or Non Approved?

This is an easy subject for us to advise on. All modems in this country legally recognised as fit to connect to the public telephone network are sold with packaging clearly marked with a green approval disk. Those that are not approved should be marked with a red triangle. If it doesn't come with the green disk, you are not legally permitted to connect it to BT, Mercury, etc.

For those of you who need to connect to a private telephone network (and note that a company's phone system may well not qualify as the prohibition covers direct or indirect connection to the public network, with many if not all company systems probably counting as an indirect connection), it is possible to choose a non-approved modem at a greatly reduced cost, but there are non-approved modems and non-approvable modems!

Should you be in a situation where you feel you can choose a non "green disc" modem, look for one with the American FCC approval sticker. Compliance with the American safety standards is a lot better than no compliance at all, especially when you bear in mind the possible consequences

of; a) the live mains being connected to your telephone line via your (faulty) PC, or, b) a lightning strike on the telephone lines crackling through your PC (and whoever may be using it?). Nothing can guarantee total protection against nearby lightning strikes, but a type approved, tested modem will be far more likely to provide a higher level of protection than a non-approved one.

Maximum transmission speed

Modems are sold by their maximum connection speed in bits per second (bps) or Kilobps. This is often abbreviated to a simple number like "a 14.4K modem". In addition to the actual speed, there are many standard names (version number Vxx) or labels that apply to the data transfer speed and protocol. The older standards below 14,400bps are just too slow for any regular Internet use. This includes lower "V" numbers V22, V22bis, and V32. Modems with these specifications are "junk box" boards and should cost very nearly nothing.

The V32bis standard connects at up to 14,400bps (14.4K). This is frustratingly slow for any Net site with significant graphical content and should be avoided unless you are running a pocket money budget or are donating the modem from someone who has upgraded to a newer standard. These were state of the art about three years ago!

The V34 standard connects at up to 28,800bps, twice as fast as the previous standard and is available very cheaply now because it has already been superseded, despite being quite new. This is currently not a bad connection speed for the Net, where maximum connection speed is often limited by overloaded servers in any case. Not exactly future proof though, because Net sites are guaranteed to get more graphical still as maximum modem speeds increase and the Internet infrastructure develops more bandwidth.

V34bis and V42 both provide connection at up to 33,600bps, which is the maximum rate many Internet Service Providers can serve (and some have only fairly recently upgraded to that at time of writing). Prices here were quite high until recently, when the availability of the latest 56.6K modems knocked them off of the top of the technology tree.

There are two new 56Kbps "standards" (the actual "V" standard is not yet finalised). Some of the more recent 33.6K modems may be upgradable to one of the newer standards - at a price. The two competing standards, from Rockwell (K56Flex) and US Robotics (x2) are similar, but not compatible. Only a few ISP's have committed to upgrade to one of these standards at the time of writing, but Demon have stated that they will be upgrading some of their equipment to the K56 standard. They make the point however that only connections using digital telephone equipment will benefit from the full data transmission rate, which will otherwise default to a lower setting on connection

handshaking (an initial data exchange between the ISP server and your PC upon establishment of connection).

The reason that the new 56K modems are able to receive data so much faster than the 33.6K modems (note that they only transmit data at 33.6K, but most of the data transfer is usually from the ISP to your PC, so this is not a problem) is that the data is modulated in a different way. The methods used to encode binary data onto the telephone line have increased in complexity over the years and make for some pretty heavy reading, but suffice to say that 56K modems use a Pulse Amplitude Modulation technique similar to the way an ISDN line works, as opposed to the conventional Quadrature Amplitude Modulation used until now.

QAM is subject to a data rate limit of 35Kbps, because the noise present on a QAM signal, largely introduced by the analogue to digital and digital to analogue conversion processes in the digital telephone network, makes reliable resolution of faster data rates impossible. PAM is based on the direct use of the digital levels generated by the circuitry in a modern digital telephone exchange to represent the data bit patterns as opposed to a modulated analogue signal being converted (with the quantization errors introduced by the use of a finite number of digital steps to represent an infinite number of analogue levels) to digital and back to analogue.

In practice, 128 different analogue levels of amplitude are required in order to transmit a signal at 56Kbps, with the decoder (codec) circuit in the modem resolving those levels with a high degree of precision. Noise on the telephone connection may make it impossible for this number of levels to be resolved, in which case the system uses just 64 different levels, still capable of carrying a 48Kbps data signal. Failing all else, the modem will revert to using one of the older 33.6Kbps or 28.8Kbps standards.

Internet Browser Software

Once you have chosen and fitted a modem, all you need to do is to choose and install suitable browser software. A browser will allow you to view World Wide Web pages, download files, connect to any of the newsgroups and read thousands of messages posted by devotees of any imaginable subject, send and receive E-mail and in short is the universal Internet access program used by most people who 'surf the Net' regularly.

Those of you with more recent versions of Windows 95 will already have a version of Microsoft's own browser program, Internet Explorer. Microsoft has recently updated this browser from version 3 to version 4 (this software is being freely distributed on magazine disks) which integrates the functions of the Internet browser more closely with the desktop and



Photo 3. A typical 56K bps MODEM from LASAT (available from Maplin Electronics soon).

folder concept Windows revolves around. We will look at the different versions more closely next month and see what they do and how they work.

The other main player on the browser front is Netscape Navigator, also recently updated and extended by the release of the broader package called Netscape Communicator. Netscape Navigator and Communicator are both available free of charge for evaluation purposes, after which Netscape ask you to pay for the product if you wish to continue using it. The trial period is limited to 90 days for business and government organisations, but the software is not disabled after that period, Netscape relying on what they call "the honour system" for payment.

These browser packages are also downloadable from the manufacturers web sites, but this is a bit of a chicken and egg situation if you haven't already got a browser to download the software with! It does mean that you can try out all of the available browsers once you have one up and running, if you are prepared for some fairly long download times. For example, Netscape Communicator is about 10

Megabytes long and takes over half an hour to download even at 33.6K. If you buy the PC or Internet magazines for a month or two, you should be able to pick up enough evaluation copies of the different browsers to show you how they work. In practice, you will find very little real difference between the different programs. After all, they are all displaying the same pages albeit with slight font differences.

Just a last word about browser versions this month. Many of the sites you will encounter on the World Wide Web split the content of their site into several small sub screens or windows called "frames", sometimes with separate scroll bars. This makes it easier to navigate a complicated selection of displays, yet may leave a common selection bar and tiling visible as only one frame changes at a time. Netscape Navigator and Microsoft Internet Explorer versions 3 onwards do provide full support for the display of frames, but earlier browsers may not.

Next month we will look at each of the main browser packages a little more closely, and install an internal 56K modem and browser software.

Electronics Principles 5.0

A COMPLETE PC BASED ELECTRONICS COURSE!

If you are looking for an easy and enjoyable way of studying or improving your knowledge of electronics then this is the software for you.

Now includes the PIC16C84 & PIC16C71 hardware and instruction set.

Electronics Principles 5.0 is a significant upgrade of our popular electronics educational software. Now containing even more analogue, digital and microcomputer theory, PLUS over a hundred new mathematics topics to further your understanding of formulae and calculations. Telephone for a comprehensive list or upgrade details.

This software has been developed to teach electronics and is suited to both the complete novice and the more advanced student or hobbyist wanting a quick revision and access to hundreds of electronics formulae. It is extremely easy to use. Just select a topic, which is always presented as a default diagram (no blank screens!) and input your own values. Alternatively, use those from any standard electronics text book to see the results (as frequency response curves, calculations, logic states, voltages and currents etc).

Graphics presentation has been enhanced and speeded up with new menus and indexing which enables a quicker access and more informative description of the extended range of five hundred and sixty electronics and mathematics topics.

The PIC16C84 microcontroller hardware and instruction set has been introduced and brought to life through colourful interactive graphics where you can study the architecture of this device by changing the data values to simulate all of the registers, direct/indirect addressing, program/data memory and input/output port configuration. Along with those analogue to digital functions of the PIC16C71. If you would like to learn more about the principles of these popular microcontrollers then it could not be made easier.

Electronics Principles software is currently used in hundreds of UK and overseas schools and colleges to support City & Guilds, GCSE, A-Level, BTEC and university foundation courses. Also NVQ's and GNVQ's where students are required to have an understanding of electronics principles.

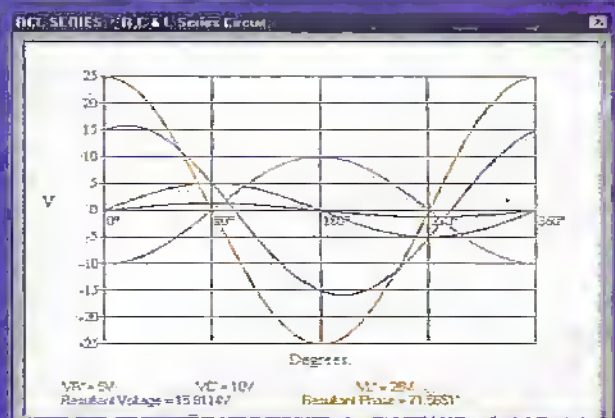

Still only £99.95*

EPT Educational Software, Pump House, Lockram Lane, Witham, Essex, UK, CM8 2BJ
Tel/Fax: 01376 514008. sales@eptsoft.demon.co.uk http://www.eptsoft.demon.co.uk

*UK and EC countries add £2 per order for post & packing. VAT should be added to the total.

Outside Europe £3.50 for air mail postage by return.

Switch, Delta, Visa and Mastercard orders accepted - please give card number and expiry date. Cheques & Postal Orders should be made payable to EPT Educational Software.

Photo 1: Showing a combine harvester at work. The GPS antenna is the stubby antenna on the right front of the cab.



Electronics

IN AGRICULTURE

George Pickworth investigates precision farming using GPS.

Precision farming employs a global positioning system (GPS) to tell mobile agricultural machinery precisely where it is within a field. A convenient starting point for this study is a GPS/computer equipped machine fitted with sensors which continually record data relative to its position as it works its way over a field.

The recorded data is then used as the basis on which to program the computer on other GPS equipped machines so that they automatically perform specified operations at precise co-ordinates within a field.

The whole process was termed by Massey Ferguson as 'The Precision Farming Circle'. Although intended for farmers, all will become clear as we work our way around the circle shown in Figure 1.

Let us start with a combine harvester at the top of the circle; this is fitted with a flow

meter which measures the mass of grain as it is harvested and continually plots this against the position of the harvester (See photo 1).

The Datavision 11TM terminal I installed inside the cab of Massey Ferguson 30/40 Series combine harvesters allows the operator to call-up information regarding the operation of the machine and grain flow through the meter by simply touching the screen.

Farm Office PC

By means of a smart card, (Fieldstar Data Card™) data is transferred from the harvester computer to the farm office computer which then prints out a yield map for the field (see Figure 2)

Smart cards are much better suited to the harsh and dusty agricultural environment than floppy discs.

A typical yield map has 1.0 ton/ha contours but can be varied so as to give the best definition of the range of variations within a field. However, a 1.0ton/ha variation is too small to estimated subjectively by the farmer yet is of great economic significance. Indeed, yield mapping has shown variations to be much greater than had been expected.



Photo 2: Showing the datavision terminal inside the cab of a Massey Ferguson Combine Harvester. Data can be called-up by touching the screen.

Management

The yield map is the basis upon which the various soil types within a particular field are managed. However, it was not simple a matter of using data from the yield maps to program the computer on the fertilizer distributor to apply heavy rates of fertilizer where yields are low and decreasing application rates where yields were high.

Other factors such as soil compaction, poor drainage, or alternatively, shortage of available moisture can effect yield. Indeed, in East Anglia, available moisture is the principal factor limiting crop yields. Nonetheless, variations in yield are usually related to the soil-type and once these have been located and plotted on the yield map the next phase is usually to take soil samples for analyses,

Analysis

Moving on around Figure 1 we come to soil analysis. The relationship between soil types, rate of fertilizer application and crop yields has long been

studied and is well known. So, with reference to the yield map and using an ATV fitted with GPS on which to travel across the field, or even using a held-held GPS receiver, the farmer takes soil samples for analysis. The position from which the sample is taken is accurately plotted by the GPS.

During soil analyses, the physical condition of the soil is also noted. Obvious problems such as poor drainage can then be corrected. Less obvious problems involve digging pits to observe the soil profile. For example, the soil in some parts of the field may be compacted and requires extra deep cultivation. The cultivator is then programmed to treat these specific areas rather than the whole field thereby saving on tractor fuel costs etc.

Crop and plant density

From data obtained during analysis of the soil samples, the optimum fertilizer mixture and application rate for each soil type is prescribed and an

Photo 3. Showing soil samples being taken with the aid of an ATV fitted with GPS (Soyl Ltd).

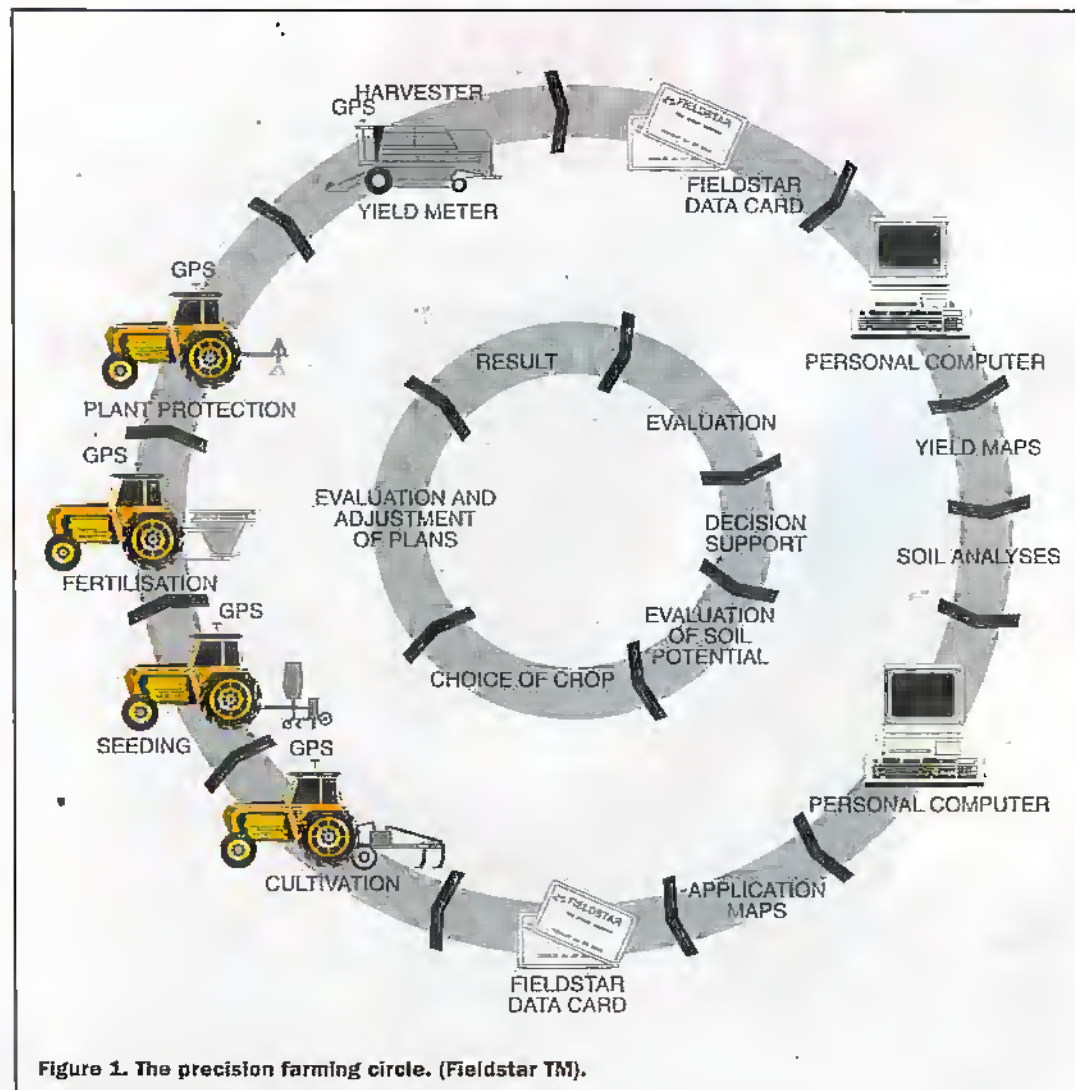

Figure 1. The precision farming circle. (Fieldstar TM).

application program prepared. In my part of East Anglia the target yield for a wheat crop is about 10 tons/hectare.

Paradoxically the most economic return is often obtained when high rates of fertilizer are applied to the better soils. On the other hand, it may be uneconomic to apply heavy rates to poorer soils where lower yields may well be more profitable. By the same token, it may be desirable to reduce plant population density on poor soil and increase it on good soil.

Once the decision has been made with regard to crop and plant density, the seeder computer is programmed to vary the seeding rate accordingly (see Figure 1 Seeding).

Fertilizer

Progressing around the Precision Farming Circle, we come to the application of fertilizer. A decision on fertilizer type and application rates would normally have been made before the crop was planted. As we have seen, this would be based on the yield map and analysis of soil samples.

When the time arrives for fertilizer application, data, as with the cultivator and seeder, is transferred to the fertilizer computer by smart card (Figure 1 Fertilisation)

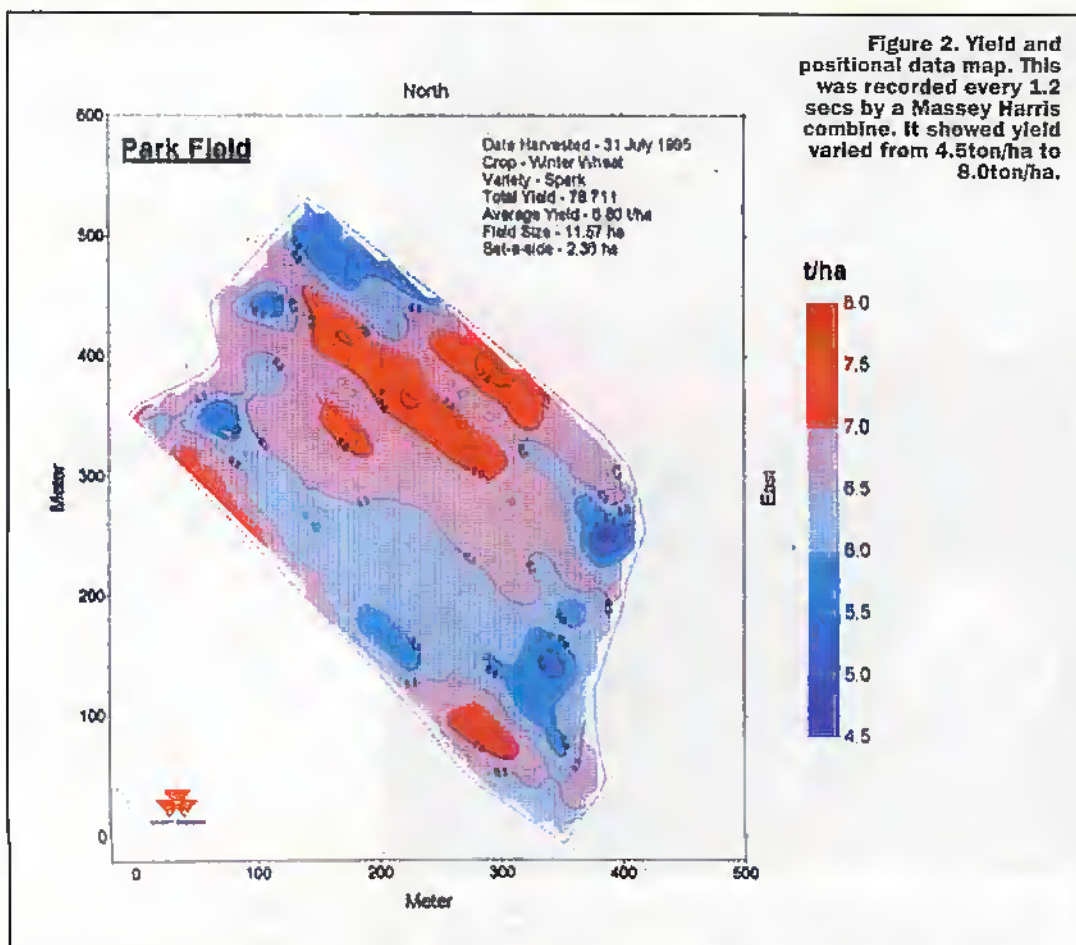

Figure 2. Yield and positional data map. This was recorded every 1.2 secs by a Massey Harris combine. It showed yield varied from 4.5ton/ha to 8.0ton/ha.

Flow Meters

The key to GPS techniques was the development of highly accurate flow meters which constantly monitor the amount of grain taken from the crop as the combine harvester works its way through the field. This of course required that the swath width remains constant at a given figure.

The most accurate, and indeed, the most simple and reliable flow meters employ Americium 241 as a radio active source. They work on the principle that the greater the mass of grain passing between the radiation source and the detector, the greater the absorption and the lower the reading presented by the detector.

Notwithstanding that radiation is minimal, perhaps no more than from a luminous watch, the use of radio active material involves considerable formalities and form filling by the farmer; fees have to be paid to the responsible government agency. Moreover, the container has to be regularly inspected to ensure it has not been removed

Fertilizer distributors are one of the most sophisticated farm machines. Contract type fertilizer distributor are very large and self propelled. They have multiple hoppers, each containing a single plant food, i.e. nitrogen, phosphorus and potassium fertilizers, plus several trace elements.

The computer, in conjunction with linear motors, opens or closes the shutters thereby precisely regulating the flow of fertilizer from individual hoppers to a disc spinning at high speed which spreads it over a swath as the machine advances.

Less sophisticated distributors have two hoppers containing basic plant foods and the machine may either be towed by the tractors or mounted on the tractor.

In some cases a single specific mixture of fertilizer is all that is required and this can be carried in a single hopper; the GPS/computer controls rate of application at different parts of the field.

Plant Protection

We now come to the last operation on our journey around the circle and this concerns pests and diseases. It is difficult to predict problems

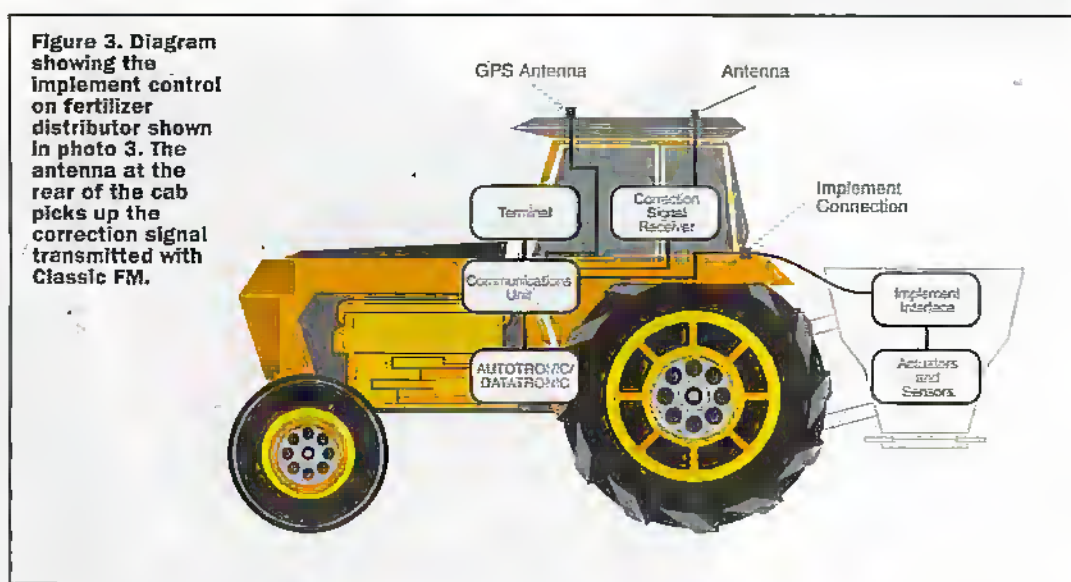

by pests and diseases, but satellite images, which are available to farmers, can give a good indication of the location and intensity of such problems.

The images can be transposed on the yield map and the crop sprayer's computer can then be programmed to apply agrochemicals only where necessary. This is not only cost saving but environmentally friendly.

Now that we have completed our journey around the Precision Farming Circle we will look at some of the equipment in more detail.

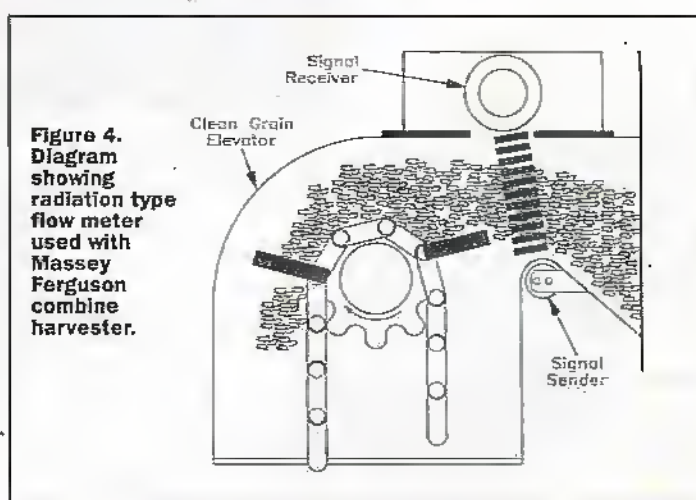

Photo 4a. Showing a single fertilizer hopper mounted on a tractor. Note GPS antenna mounted on top of the cab.



Photo 4b. Showing a pair of fertilizer hoppers mounted on a high tractor fitted with low ground pressure tyres. Note the spinners under each hopper.



from the machine.

If the combine is used on contract work, the fire brigade has to be advised of the exact place at which it is working. Presumably this is a precaution should the combine catch fire and set fire to the standing crop.

It is not surprising therefore that many attempts have been made to develop an alternative type of flow meter. Devices measuring weight or volume have been tried but were not well suited for installation in a combine harvester. However, radiation type flow meters are rugged and its inherent design enables it to fit snugly into the combine without the need for any modification to the machinery.

The great advantage of radiation type flow meters is that they measure mass and this avoids correcting readings to compensate for moisture content and specific density of the grain. No other adjustment or calibration is required once the base setting is established. Accuracy is within $\pm 0.5\%$.

About GPS

Global Positioning was developed for the American military for accurate positioning of personnel. Many readers will

already have a basic understanding of the system, but for completeness, I have included the following notes.

Twenty-four GPS satellites are in polar, equatorial and intermediate orbits around the earth. As they traverse the sky, extremely accurate time signals are transmitted and these are received by the GPS receiver. The received data is instantly processed and the receiver indicates its geographical

position.

However, the satellite signals are intentionally encrypted with randomized positional errors to reduce accuracy with civilian receivers. Remarkably, encryption was switched off during the Gulf War but was re-introduced immediately afterwards.

Studies made by agricultural organizations in Shropshire showed the accuracy of the system with civilian receivers to

be typically 25-100 metres. The more expensive the receiver, the more accurate the position given. However, tall trees and buildings can degrade accuracy.

Uncorrected positional information is far too inaccurate for precision farming. However, enterprising companies soon developed techniques to counter-act both introduced and inherent errors by using a technique known as Differential GPS (DGPS).

Differential GPS requires two receivers; one static, usually on the farm office, whilst the other is installed on the mobile machine. The position of the static receiver is known precisely, so differences in its position as given by the GPS relative to its actual position are caused by introduced and inherent errors.

The static receiver extracts the error signal and this is transmitted to the mobile GPS receiver where it corrects the position given by incoming

satellite signals. Differential GPS are claimed to give an accuracy of one metre.

The use of a static GPS receiver on the farm office is perfectly satisfactory when a machine is working close by but was useless for agricultural contractors operating over a wide area. However, enterprising companies were quick to realize that error signals could be detected by a central

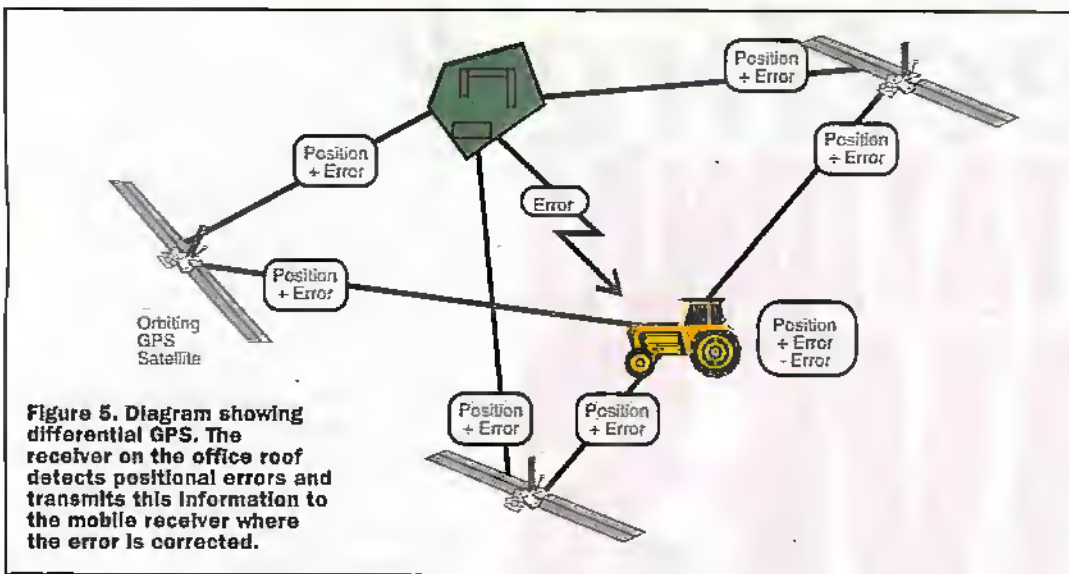

Figure 5. Diagram showing differential GPS. The receiver on the office roof detects positional errors and transmits this information to the mobile receiver where the error is corrected.

station and then be transmitted by broadcasting stations along with normal entertainment programs. Accuracy quoted by some companies is typically within 5.0m but for an extra fee accuracy down to within 2.0m is offered.

Focus Ltd transmits error signals with Classic FM; this service is available to farmers and presumably other users for a fee. This of course requires a special receiver and antenna in addition to the GPS antenna.

There is an equivalent system called GLONASS that was developed by the former Soviet Union but is now under the control of the CIS Space command. It is understood that this service will shortly be available to civilian users.

GLONASS will not only give better coverage for European farmers, but positional errors, inserted with the American system, cannot be applied. This means that farmers will be able to attain the required degree of accuracy with a single receiver instead of the two required with DGPS.

World Wide

Whilst variations in soil types and fertility were most pronounced and occurred more frequently in farming areas, where small fields and hedges had been a traditional feature, they also occurred in other areas of the country where larger fields had long been a typical feature.

Moreover, fertility variations occur in the great grain producing areas of the world; these of course, include North America and Australia and the Ukraine. Obviously, the larger the fields, the more valuable GPS technology becomes.

Other Crops

So far we have looked on at GPS when applied to grain production, but it is of course applicable to all crops that can be mechanically harvested; this of course means that specific types of flow meters had to be developed for different crops. In the UK, candidate crops include oil seed rape, sugar beet, potatoes and peas. Indeed, provided that flow meters can be developed the system could probably be applied to horticultural crops. Overseas, sugar cane is an obvious candidate.

Evolution of Precision Farming

One reason why GPS technology became almost indispensable with modern UK farming was the removal of the hedgerows and the creation of large fields; a practice sometimes referred to as prairie farming.

The hedges of traditional

small fields often demarcated areas of differing soil types, so farmers developed management systems best suited to individual fields. For example, some fields were found to be well suited to wheat, whilst some were well suited to horticultural crops. On the other hand some were best suited to pastures.

Fields were given individual names which occasionally gave a clue to their characteristics. On my father's farm the names of fields included 'Sandyfoot', 'The Flats', 'Stonhill' and 'Wigford'.

Moreover, over generations, a particular kind of management applied to a field often modified its soil type and gave it different characteristics to adjacent fields. In addition, the fertility levels across individual fields had become almost constant. So it was perfectly satisfactory to apply fertilizers at a 'blanket level'.

The hedgerows disappeared as small fields were integrated into larger fields and before the evolution of GPS technology

the farmer had no practical means of locating the original fields and applying optimum management techniques.

Large fields are therefore usually a complex pattern of different soil-types each having its own inherent fertility level. Indeed, many of the variations shown on yield maps corresponds almost exactly to the original fields shown on original farm plans.

So, prior to adoption of GPS technology, it was virtually impossible for farmers to locate, and re locate the various soil-types; it was analogous to plotting positions at sea. The farmer therefore often had no option other than to treat large fields as if they were composed of a single soil-type and apply fertilizer at a 'blanket' rate. This was not only wasteful, but environmentally undesirable.

The adoption of GPS technology to match fertilizer applications to crop intake is not only sound economic practice, but the amount of fertilizer remaining in the soil after harvest is minimized. There is less residue to leach out of the soil during winter months. So contamination of streams and rivers is greatly reduced.

References

- Centre for Precision Farming, Cranfield University
 - Galaxy PrecisionAg Services, Great Yarmouth
 - Soyl Ltd, Hambledon, Hampshire
 - Agco Ltd, Formerly Massey Ferguson, Coventry
 - Focus Ltd
- I also wish to thank Mr. R Woods, farmer of Clopton, Northants for his cooperation and help in preparing this article.

Figure 6a. Sketch plan showing the fertility level of individual field separated by hedges.

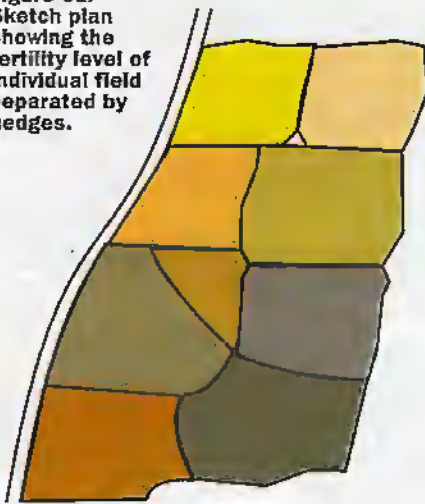
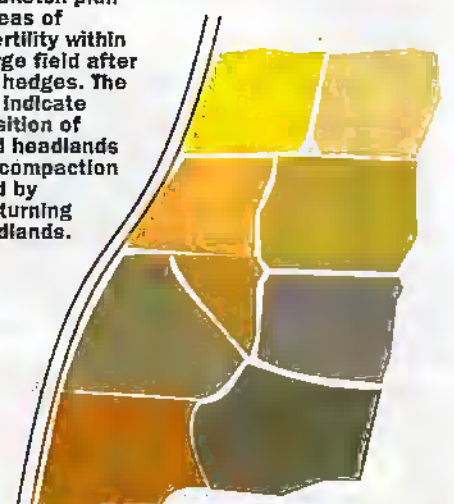

Figure 6b. Sketch plan showing areas of different fertility within a single large field after removal of hedges. The light areas indicate original position of hedges and headlands where soil compaction was caused by machinery turning on the headlands.



Detecting GRAVITATIONAL WAVES

by Douglas Clarkson

The twentieth century has seen a vast expansion in the means to observe the physical universe. Subtle secrets of the universe's cosmic scale have been extracted using the electromagnetic spectrum. From these details, a theory of the Universe has been pieced together. This theory now encompasses features and events which push known physical laws to their limit.

Understanding of the universe also relates to understanding the nature of gravity — as both a static constant parameter that causes dust to coalesce to form young stars and that which causes galaxies to attract each other to a dynamic effect where, for example, during a non uniform supernova explosion, the gravity field of a star distorts as it converts mass into vast quantities of energy.

In accordance with Einstein's General Theory of Relativity, gravity fields perturb a broad range of physical parameters. The frequency of a photon, for example, is affected by the strength of a gravitational field. The relative observation of time is affected and also physical dimensional space is distorted.

The General Theory of Relativity expounded by Einstein promotes the basic idea that 'gravity is no force but an aspect of the geometry of space-time'. Within this context, space is not seen as an absolute nonvariant entity. Instead it is considered to be influenced by the distribution of mass and energy in the Universe. In this sense 'matter tells space how to curve but space tells matter how to move'.

Thus the falling apple that Newton is considered to have observed is more like the path of an object through space-time as distorted by mass.

Within this framework, large masses introduce a strong curvature in space-time. Such effects have been verified in the path of the light of stars in the vicinity of the sun and gravitational lensing effects of light from distant objects deflected by intervening large massive structures.



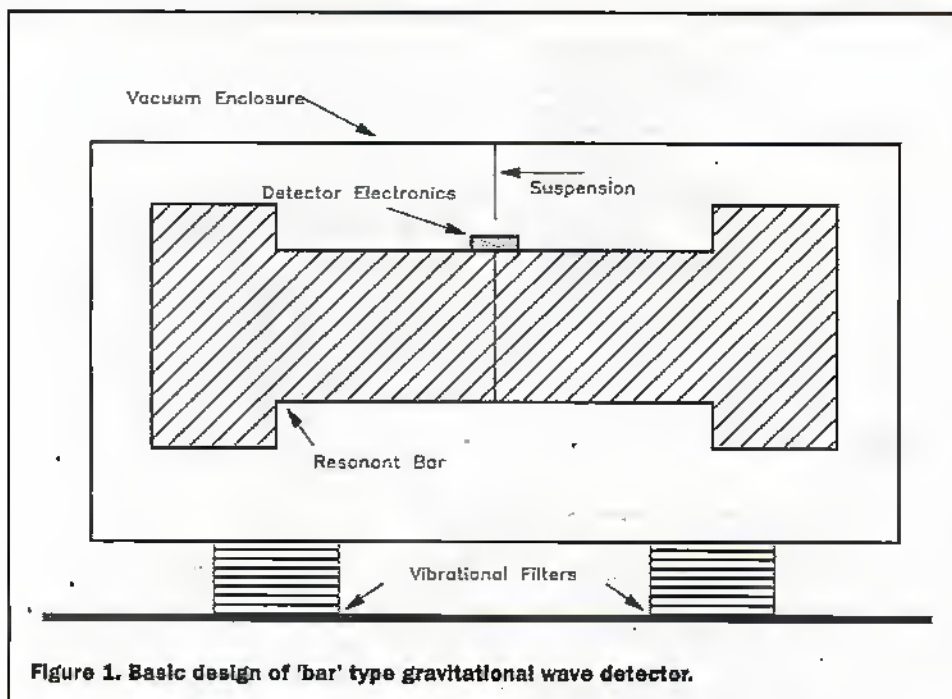

Figure 1. Basic design of 'bar' type gravitational wave detector.

It is often difficult to convey the almost utter impossibility of detecting the distortion of space-time by gravitational waves caused by acceleration of non-uniform masses. The size of the effect is similar to a change equivalent to that of the thickness of a human hair in a distance of 4.5 light years – the distance to the nearest star.

As yet no gravitational waves have ever been detected. As sensitivities move towards detecting a change in length of 10-18m, the race is on to be the first team to catch the first blip of a dying star or the repetitive wobble of ultra dense neutron stars about a centre of mass.

Possible Origins of Gravitational Waves

There has been considerable speculation about the nature of events which may be able to be detected using gravitational wave detectors. Surprisingly the most clearly understood event would appear to be that of coalescence of compact object binary systems, such as that of neutron stars or neutron stars/black holes spiralling together. The nature of the gravitational radiation would be that of a 'chirp' of frequencies around 200Hz as the masses finally rapidly spiral towards each other.

There is speculation that the mutual attraction and coalescence of black holes would radiate a very intense gravitational wave disturbance. Also, gravitational radiation would be released by objects cascading into black holes.

It is likely, however, that just as electromagnetic waves cover a very wide frequency range, so gravitational waves also exist over a broad frequency range. The nature, however of residual low frequency components of gravity fluctuation arising from events on the surface of the earth (tides etc) means that detectors on earth cannot be made sensitive to the frequencies of below around 1Hz. This has stimulated interest in space based detection systems such as the proposed LISA project.

Early Detectors

The passage of a gravitational wave through space distorts space itself. For a distinct physical mass, it is considered that this can impart quanta of vibrational energy to a physical structure. Such gravitational wave effects, however, are extremely weak in their interaction with matter.

In this context, the earliest types of gravitational wave detector were of this design where the modes of vibration of the physical resonator were monitored for 'leaps' that could be attributed to absorption of energy from a gravity wave.

Figure 1 shows the typical configuration of the early bar designs. The system consists essentially of a dumb-bell shape suspended in a vacuum to minimise transfer of energy to the resonator from gas molecules. Ground vibrations are reduced by mounting the structure on a set of mechanical vibration filters such as alternate layers of rubber and lead.

The energy of vibration of the bar is detected by high sensitivity transducers at the centre of the bar – a node of physical vibration but an antinode of strain.

First Findings

An initial series of experiments by Joseph Weber at the University of Maryland using bar detectors in the 1960's stimulated work

in various centres to try to repeat his findings which appeared to indicate that gravitational events were being detected with a much higher frequency than would have been expected.

In an early 'bar' type detector developed at Glasgow University during the 1970's, the system was so sensitive that the piezoelectric sensors could detect changes of energy of $kT/2$ – corresponding to a mode of vibration of the gas molecule. It is now concluded, however, that such systems were not sufficiently sensitive to detect gravitational waves. Only with laser interferometer systems, however, can the required level of sensitivity be achieved.

The Hulse and Taylor Effect

It is quite the pattern of the Nobel Committee for science to award prizes after what seems a long delay. The 1993 Nobel Prize for Physics was awarded to Russel A Hulse and Joseph H Taylor for the discovery of the binary pulsar system PSR B1913+16 in 1974. Pulsars are thought to be formed from the collapsed structures of massive stars at the end phase of the fission cycle. Being composed essentially of nuclear material, they typically would have a mass comparable to our sun but with a diameter of only 10km.

The process of collapse tends to accentuate the rotational speed of such objects – much like an ice skater undertaking a fast spin. Some pulsars can rotate as rapidly as 625 revolutions per second. The binary pulsar system, indicated in Figure 2 as two objects of similar mass orbiting about a centre of mass, discovered by Hulse and Taylor was in fact a pulsar and a companion collapsed star. By measuring with high accuracy the frequency changes in the pulsar's signal, the nature of the orbit of the binary pulsar could be determined. Also, the predicted changes in orbital conditions expected due to loss of energy by emission of gravitational wave energy of the accelerating masses was observed to within 0.3% of expected values.

This was the first observation of systems acting as known points radiating gravitational wave energy. The recognition by the Nobel Committee of this work was a considerable stimulus to physicists in the world community seeking to develop systems to detect such gravitational waves. All of a sudden it was very much in fashion

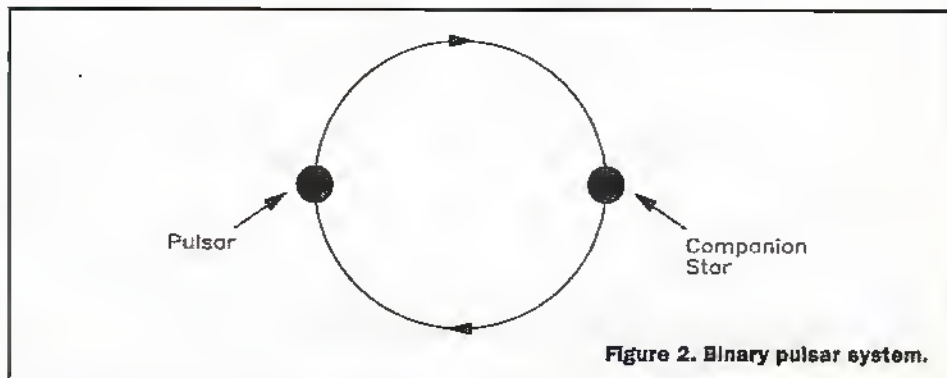
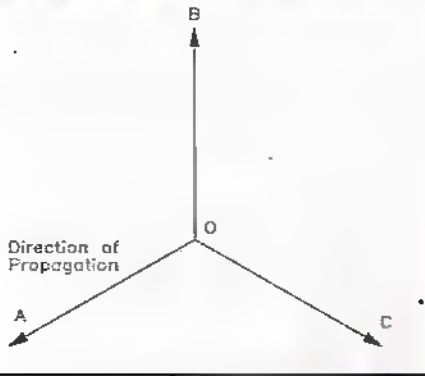

Figure 2. Binary pulsar system.

Figure 3. With direction of propagation of gravitational wave along OA, if an expansion takes place in direction OB then a corresponding compression will take place along OC.



to begin looking for gravitational waves with a new generation of detectors. Various national and international projects, long on the drawing board, received a boost at this period for their funding. It is hoped that when operational they will help the fundamental understanding of the how stellar evolution is proceeding in our sector of the galaxy and also throw new insights into the nature of gravity itself.

Interferometer Detectors

An alternative approach to detecting gravitational waves is to measure the change in separation between two masses. Optical detection systems using laser interferometers, however, detecting the relative change in path length of light along a specified axis allows systems with higher detection sensitivities to be developed.

As a gravitational wave propagates as indicated in Figure 3 along direction OA, if an expansion takes place along axis OB then a corresponding compression takes place along axis OC. For an interferometer design the two effects in combination should

distort the optical equilibrium of the interferometer.

The theory of laser interferometry detectors is outlined in Figure 4 which essentially describes a Michelson interferometer. Light from the laser is split by the beam splitter, so that a portion passes to mirror A and is reflected and a portion is transmitted to mirror C and is reflected. The radiation is combined at a photodiode system (B) in the central mirror optics. If for example the path lengths change relative to each other, eg as a result of the passage of a gravitational wave, then the relative phase of the wave trains combined at the photodiode also changes and there is a change in the detected output level.

Such systems are utilising state of the art optical components in terms of stability of laser parameters, alignment of optics and high reflectivity of mirror systems employed. The availability of ultra high quality mirrors, with loss factors of less than 100 parts per million also allows the intensity of the laser beam required to be reduced to commonly available power levels between 10W and 100W.

The sensitivity of the interferometer

system can be increased significantly if light is made to undergo many numerous traverses within the optical arms of each axis. In the French-Italian VIRGO detector system, a set of 3km arms is equivalent to a single pass 120km arm detector.

The GEO600 Project

The GEO600 project is a collaborative project for a 600 metre length Michelson interferometer detector which is being built near Hanover in Germany. The key participants include groups from Glasgow, Cardiff and Hanover.

The Physics Department at Glasgow University has played a leading role in the UK in developing experimental gravitational wave detectors. As described, early developments were undertaken using bar detectors. Initial laser interferometer work had been undertaken using Fabry Perot cavities with 10 metre arm lengths with a detector sensitivity of 1.5×10^{-18} m. Photo 1 shows the current 10 metre interferometer system at Glasgow configured with more advanced optical systems.

Figure 5 indicates the planned optics for the GEO600 detector. The laser system and mode cleaner results in an ultra stable laser with 'pure' frequency components. The interferometer splits light into two main paths and detects any relative change of dimension in the interferometer arms. While sheer physical size of the detector arms is one of the challenges of such experiments, most effort is being directed towards the optical resonator technology – with advantage being taken of the state of the art developments in high efficiency mirrors and ultra stable laser technology. In the UK, industrial links have been formed with GEC-Marconi and Omnitec in the development and manufacture of high quality mirror systems. One of the spin offs of high efficiency mirror technology relates to the development of laser gyroscopes. One of the key aspects of such detector

Figure 4. Basic principle of laser interferometer: For laser radiation introduced into interferometer system, any change in beam path will introduce changes in recombined light signal at B.

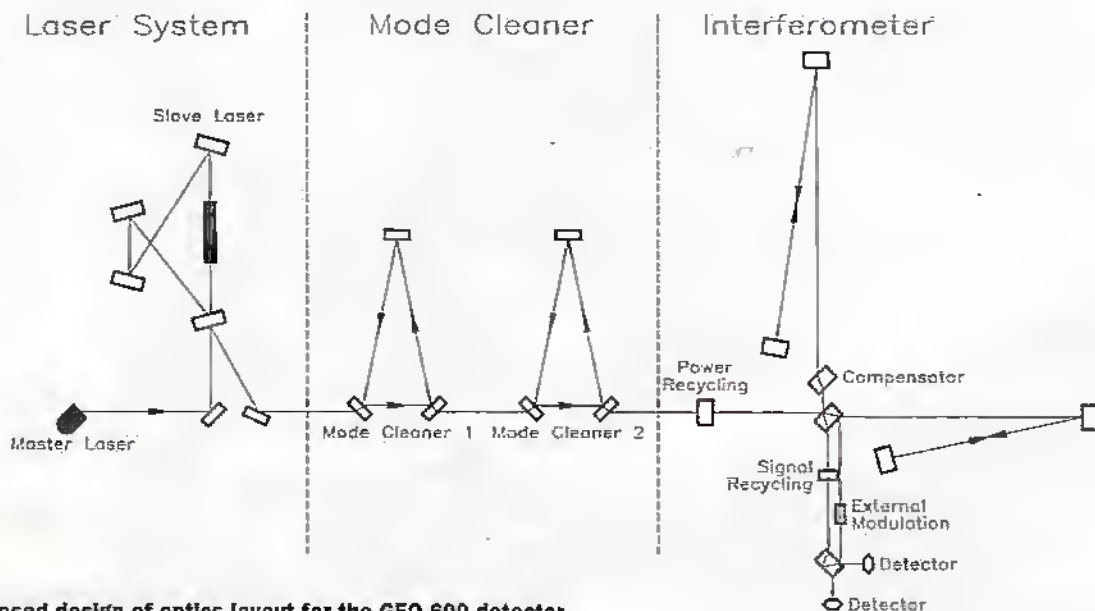
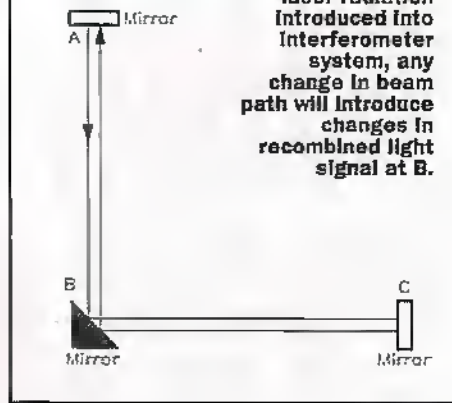

Figure 5. Proposed design of optics layout for the GEO 600 detector (Courtesy GEO600 Project)

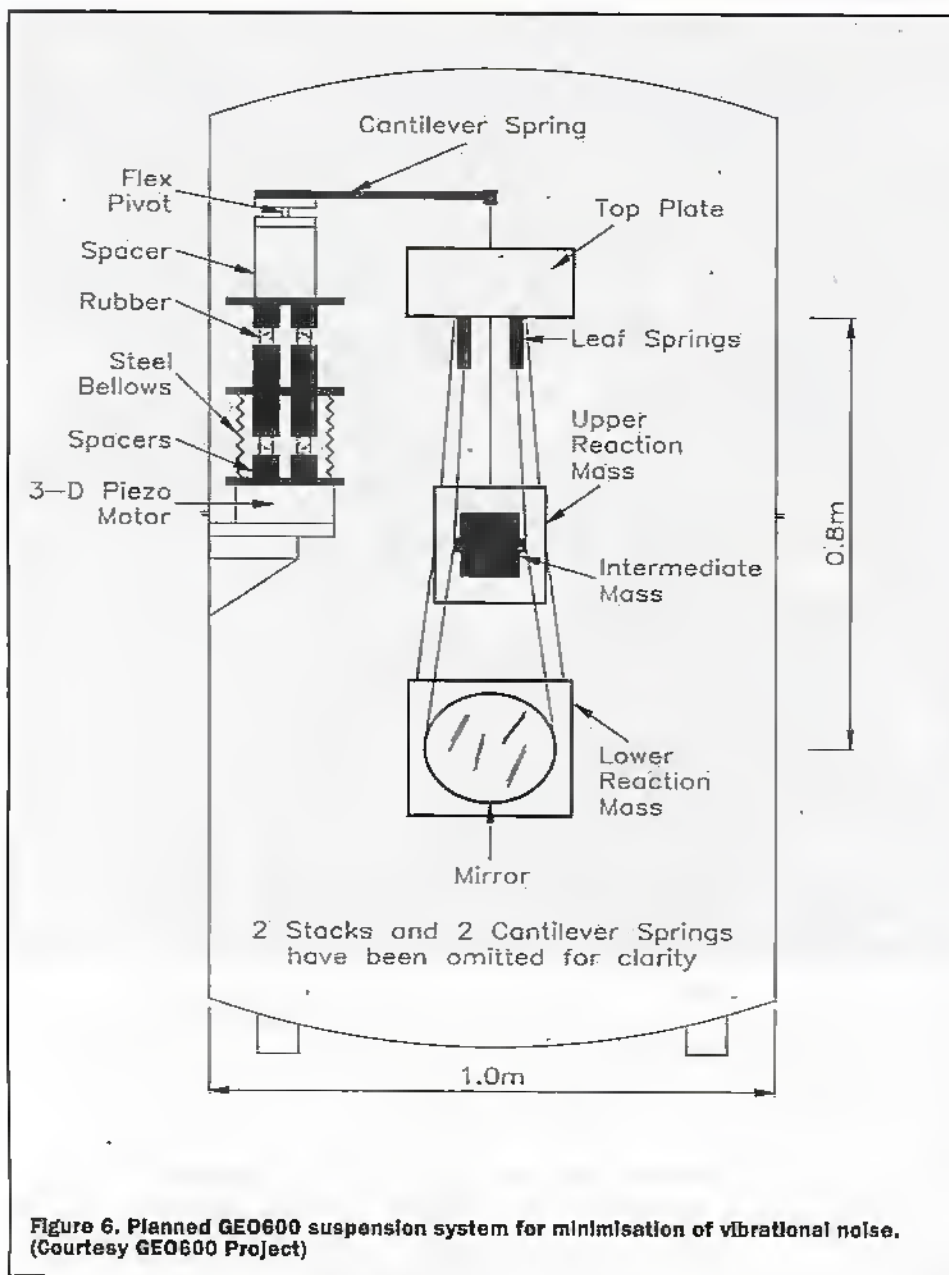

Figure 6. Planned GEO600 suspension system for minimisation of vibrational noise. (Courtesy GEO600 Project)

systems is the requirement for very high quality clean room conditions within the detector systems.

A key design element of the GEO600 system is the suspension system for the optical components. It is essential that mirror elements etc are free from any ground borne vibration as possible in order to optimise the sensitivity of the overall system. Figure 6 indicates the elaborate planned suspension system for minimisation of such vibrational noise.

The timetable for GEO600 is outlined in table 1.

Process	Timescale
First tube	end of 1998 (done)
Second tube	mid 1997 (done)
Central cluster and vacuum	end of 1997
Mode cleaner and optics stacks and suspension	end of 1997
10 W laser	spring 1998
600m cavity	mid 1998
Michelson interferometer	mid 1999
dual recycling	spring 2000
First signal ?	2000 onwards

Table 1. Timescale of Geo 600 project.

LIGO

In the USA, LIGO (Laser Interferometer Gravitational-Wave Observatory) is an ambitious project for detecting gravitational waves. Two separate detectors with 4km interferometer arms are being constructed at Livingston, Louisiana and Hanford, Washington – nearly 2000 miles apart.

The final LIGO sites were selected from a proposal of 19 sites in 17 states. Key factors included the location in seismically and acoustically quiet areas but still within convenient distance for resident and visiting staff.

It is anticipated that the main facilities will be constructed by 1998 and with initial operation of the detectors from 2000 onwards.

LISA

The Laser Interferometer Space Antenna (LISA) mission is currently being evaluated by the European Space Agency to seek to measure low frequency gravitational waves in the spectrum 0.1 Hz to 0.0001 Hz. The observation of such signals is not possible

on the surface of the earth due to the background of local gravitational noise.

The LISA mission is part of a Horizon 2000 ESA proposal and as such is still a long way of for actual implementation. The earliest the mission could possibly be implemented is probably 2008. Although there appears no official NASA – ESA partnership for a joint mission, there is a close degree of co-operation between teams at NASA and ESA over the basic concepts of the mission. A possible recent option has been to utilise only three spacecraft instead of the initially anticipated six craft.

The actual orbit of the series of satellites is itself quite complex to describe but is outlined in figure 7. The satellites are essentially in a sun centred orbit tagging along some twenty degrees behind the earth – approximately at a distance of some 32 million miles. This ensures that the satellites are a sufficient distance away from base line gravity disturbances from the earth. The plane that the satellites occupy is at some 60 degrees to the plane occupied by the earth. The satellites themselves rotate in a circular orbit around a notional central point. The length of each interferometer arm is a staggering 5 million km.

In current ESA proposals it is planned to launch all spacecraft using a single Ariane 5 rocket. More detailed analysis of payload structures, however, is being undertaken in order to achieve this launch requirement. The basic payload of Ariane 5 into Geostationary Transit Orbit is 6800 kg. Allowing for 900 kg of a SPELTRA structural unit, this allows 5900 kg for three composite structures each of which will contain two satellites. Allowing a 900 kg launch mass margin, this further reduces the total mass of the spacecraft to 5000 kg.

The technical development of LISA will depend closely on advances with the technology of the earth based detectors such as GEO600, VIRGO and LIGO. Already, for example, groups involved in the GEO600 mission are also actively engaged in considering specifications for LISA detectors. Initial analysis of the mission requirements and costs indicate that it would be too expensive to proceed with at present but it could have a chance of being pursued as a 7 the Cornerstone mission.

The anticipated threshold sensitivity of the LISA detector system is indicated in Figure 8. It is anticipated that such a system should be able to detect a wide range of low frequency gravitational waves.

The present emphasis is on incorporating state of the art technology in the design specification of LISA in order to introduce greater performance of the satellites and ensure that costs fall to within the budget of a Cornerstone Mission. One key question of the practicality of the mission relates to stabilisation of the proof masses in the satellites to a positional resolution of 10nm. While computational models of such mirror systems can be developed, it may be necessary to fly prototype modules in space to verify the arithmetic.

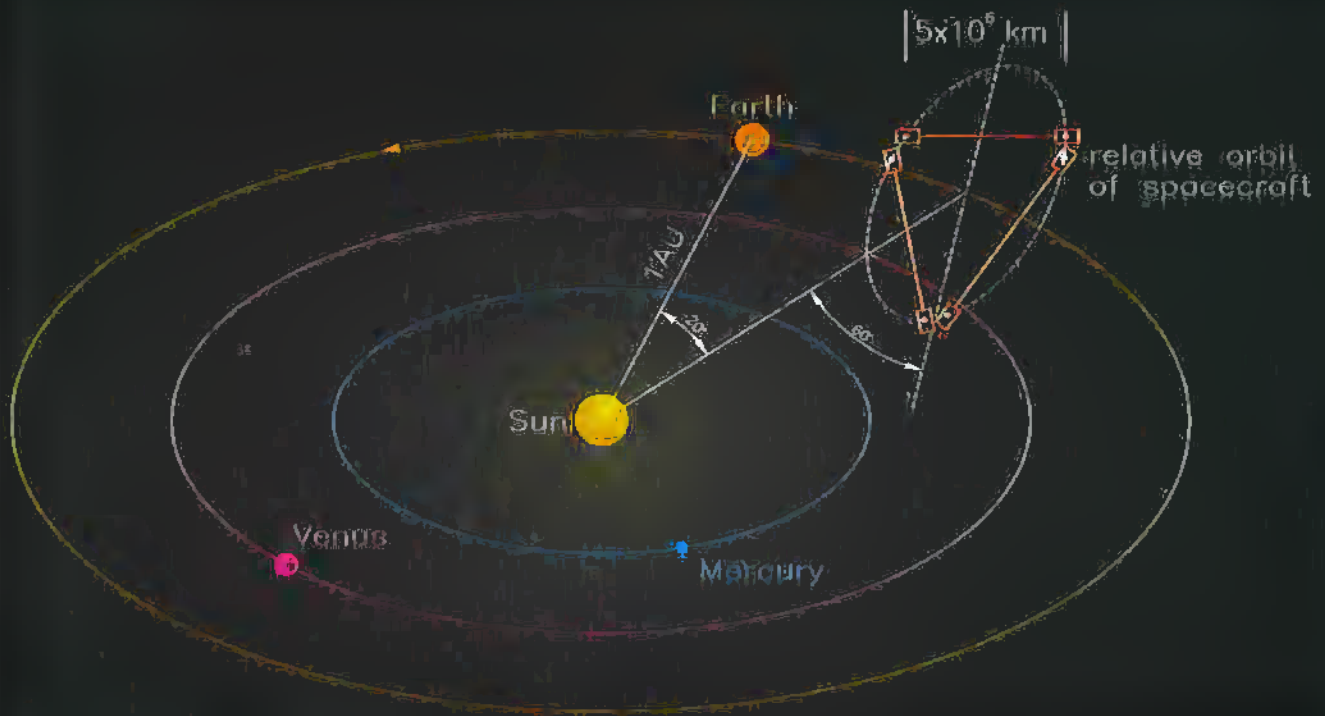

Figure 7. Planned orbit of LISA spacecraft. (Courtesy ESA)

VIRGO

The VIRGO project is Europe's most ambitious gravitational wave detection project. As a joint French Italian project, which is being built near Pisa in Italy, the

structure utilises 3km length interferometer arms.

The main laser system is a Nd:YAG at 1.0611 nm which is injection locked from a 1W laser. The main laser beam will have a power of 25W.

The VIRGO interferometer system is designed for high sensitivity. In seeking to detect gravitational waves there is the basic limitation of the frequency of events which may be able to be detected. Supernova explosions are expected to radiate

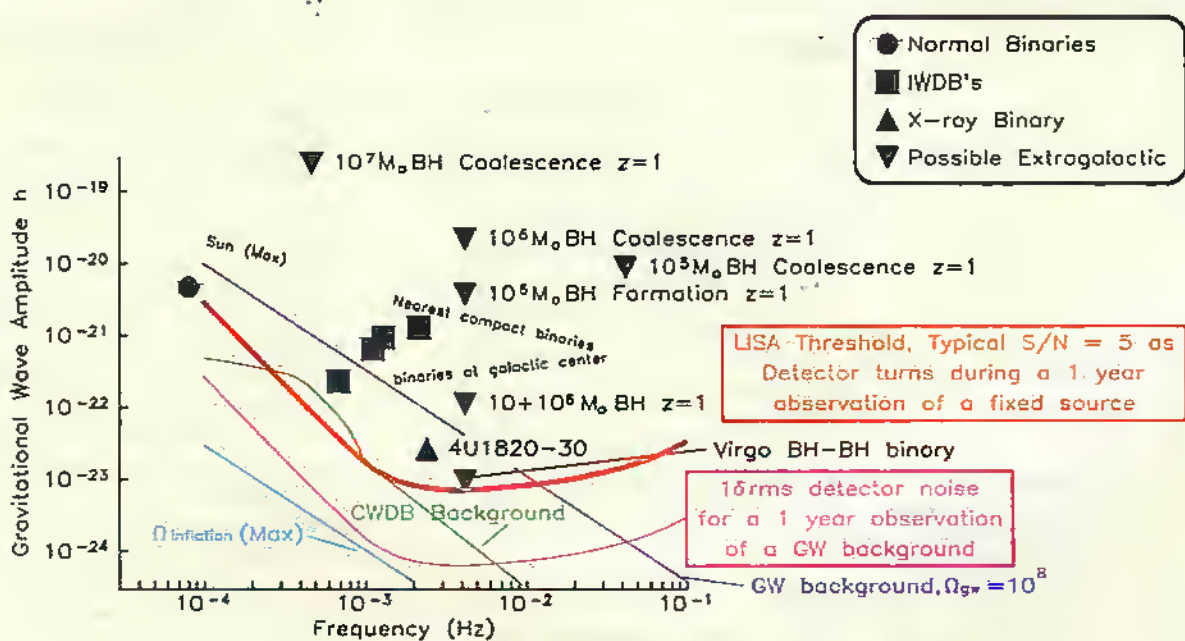

Figure 8. Anticipated threshold sensitivity of the LISA detector system. (Courtesy ESA)

gravitational waves but if the rate of occurrence is low, then only a few events per century may be detected. The VIRGO system is designed to have sufficient sensitivity to detect events originating as far away as the Virgo cluster which contains about 300 large galaxies. The base line sensitivity of the VIRGO system is indicated in Figure 9.

TAMA300

The Japanese experiment in gravitational wave detection is called TAMA300 and is a 300 metre interferometer system located on the Mitaka campus of the National Astronomical Observatory – located in the Tama area of Tokyo. It is anticipated that this system will become operational around 2000. The next development could be the construction of a 3km interferometer.

Co-Incidence Systems

It is quite possible for spurious results in one detector to be generated due to random vibrational events. It takes two detectors to determine co-incidence effects

and three detectors to determine directionality of incoming signal. Thus in the USA the LIGO system has two separate interferometer units some 2000 miles apart to determine basic co-incident events. The propagation delay of gravity waves over the distance of 2000 miles is around 11ms. With modern atomic clocks able to be synchronised over time resolutions of 1 part in 10¹⁵, there is adequate technology available to achieve a high degree of time resolution.

While a series of national and international projects are nearing completion, there is the basic understanding that the quality of observations will be significantly improved by co-ordinating observations.

Systems like VIRGO can have the system sensitivity optimised for a given anticipated frequency of signal. This is essentially undertaken by altering the mode of optical resonance of the detector system. In this way the detector can be made to hunt for a specific class of gravity wave event.

Where several detectors are operational and functioning to verify events by synchronised observing, the diverse systems will require to optimise their sensitivity to a common area.

Summary

Some 80 years after Einstein first announced his General Relativity Theory, scientists are on the verge of detecting gravitational waves as caused by massive disturbances of mass in some distant corner of the Universe. This will in turn provide invaluable insight into many aspects of cosmology which have been previously the subject of speculation. It may also provide that certain insight that could lead towards completing a unified theory of everything.

Further Reading

K.S. Thorne, in *300 Years of Gravitation* edited by S.W. Hawking and W. Israel, Cambridge University Press, 1987.

Further Reading

GEO600 Home page

<http://www.geo600.uni-hannover.de/>
(with links to other experiment(s))

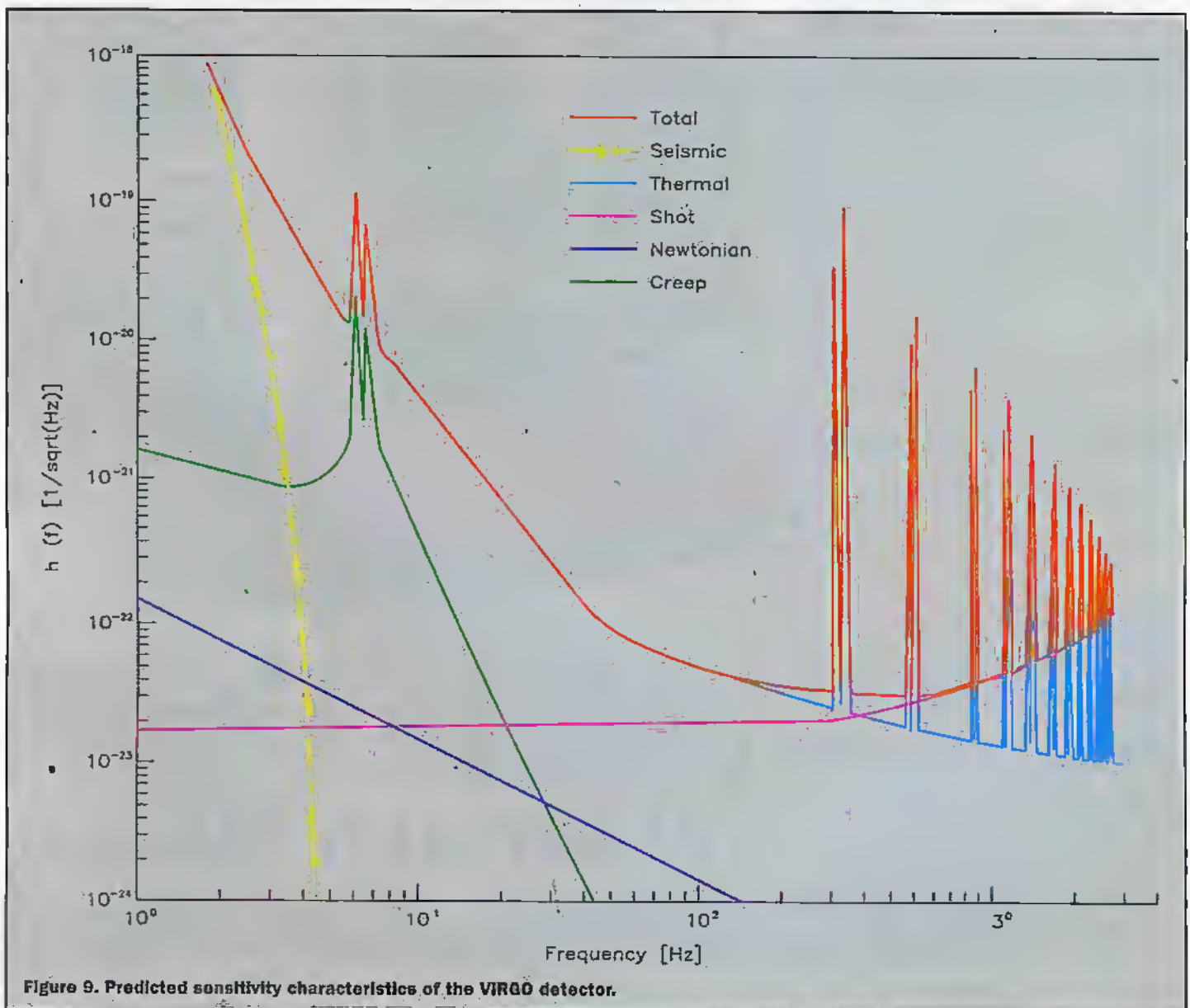

Figure 9. Predicted sensitivity characteristics of the VIRGO detector.

ELECTRONICS and Beyond

HOW TO ORDER

Simply fill in the details and send your completed subscription form to:

Electronics and Beyond Subscriptions
Maplin Electronics PLC, PO. Box 777,
Rayleigh, Essex SS6 8LU

You can pay by cheque or postal order (payable to Maplin Electronics). Or pay by Credit Card using either the coupon opposite or by placing the Order for your Subscription directly by phone to the most appropriate of our Subscription Hotlines below.

PAYMENT BY CHEQUE

I wish to pay by cheque made payable to Maplin Electronics.

Yes, I'd like to subscribe to *Electronics and Beyond*. Please start my subscription with the next issue.

I am an existing subscriber, please extend my subscription.

Please tick the subscription you require.

6 issues UK £14.10

Euro, Europe Airmail and Surface Mail outside Europe £20.00 (or 47 IRCs)

Airmail outside Europe £25.75 (or 60 IRCs)

12 issues UK £28.20

Euro, Europe Airmail and Surface Mail outside Europe £40.00 (or 94 IRCs)

Airmail outside Europe £51.50 (or 120 IRCs)

PAYMENT BY CREDIT CARD

I wish to pay by CREDIT CARD. Please debit my account.

I wish to pay by: MasterCard Visa American Express

Card Number

Expiry Date

____/____

Signature

Date

DELIVERY DETAILS

Mr/Mrs/Ms

Address

Postcode

Daytime Telephone Number

SUBSCRIPTION HOTLINES

UK (01702) 554155 Ext. 331

Overseas +44 1702 554155 Ext. 326

Full details available on request

ARE YOU A FULL-TIME STUDENT OR A HEAD OF TECHNOLOGY IN EDUCATION?

Why not take advantage of our special subscription rates.

Telephone: (01702) 554155 Ext 288

Subscribe now and save **10%** on the normal price



Choose either a 6 issue or 12 issue subscription – both include free delivery so you save yourself time, money and avoid the disappointment of missing your favourite electronics magazine.

LOOK AT THESE SAVINGS!

Normal Cover Price
£2.65

6 Issues Subscription
£14.10 SAVING £1.80

12 Issues Subscription
£28.20 SAVING £3.60

Subscription prices include FREE delivery – No postage charge. Full time students subscription price = 1/3 Cover Price + p4p. (Please supply proof of educational status)

ELECTRONICS

and Beyond

SUBSCRIBERS' SPECIAL OFFERS

SUBSCRIBE TODAY AND QUALIFY FOR THESE AMAZING SAVINGS!

OFFER OPEN FROM 24th DECEMBER 97 to 28th FEBRUARY 98

HEADSET & BOOM MICROPHONE

CATALOGUE PRICE £11.99

SUBSCRIBERS' PRICE £9.99



MICRO CASSETTE RECORDER

CATALOGUE PRICE £34.99

SUBSCRIBERS' PRICE £29.99



STEREO HEADPHONE

CATALOGUE PRICE £44.99

SUBSCRIBERS' PRICE £34.99



AUTOMATIC CD CLEANER

CATALOGUE PRICE £14.99

SUBSCRIBERS' PRICE £9.99



BATTERY OPERATED STEREO MIXER

CATALOGUE PRICE £29.99

SUBSCRIBERS' PRICE £24.99



MULTI-LINK REMOTE CONTROL

CATALOGUE PRICE £49.99

SUBSCRIBERS' PRICE £34.99



As a fully paid-up subscriber you can use the special Subscriber-only order codes and save up to 34.9%

When ordering any of these special offers which apply only for Subscribers and new Subscribers of *Electronics and Beyond*, please quote your Subscribers' Membership number (telephone Customer Services on 01702 554002 if not sure) and the special order code number. All items are subject to availability. Prices include VAT. Catalogue prices refer to the 1997 Maplin Catalogue. Overseas subscribers telephone +44 1702 554000 Ext. 326 for carriage charges. A £2.95 Carriage Charge will apply to all UK orders under £30.00 (MPS Account Holding Customers exempt).

AVR Project

PROGRAMMABLE LOGIC CONTROLLER

In the December issue of *Electronics & Beyond*, the general circuit aspects for the PLC were discussed. This month Kevin Kirk studies the system in a little more detail.

To start off we'll just have a quick tour of the hardware to cover any little queries that may still be hanging around. The inputs, via the Optos, are fairly straightforward. All you need to do is to select a resistor value so that you limit the current to around 10-20mA. To do this you assume that the LED drops around 2 Volts. So if you are driving it with, say, 12 volts then you calculate the resistor value as $12 - 2 / 0.02 = 500$ ohms (let's call it 560 ohms for cash – or the nearest E value). Just ensure that you connect it with the anode to the +ve supply. The outputs, also via the optos, are also fairly easy. Note that we are driving them directly from the output of the AVR. This is one of the neat features of the device, it can drive LEDs directly. This really does simplify this type of circuit as we don't need any driver transistors. One other minor point to note if you are using a monolithic 5 volt regulator and that is be sure to put a capacitor (470nF polyester, 1uF Tantalum or 10uF Aluminium Electrolytic) close to the regulator between the +5 volt output and ground as, without it, the regulator tends to burst into oscillation. Which can swing the output rail up and down by as much as 2 volts p-p which can make life really exciting for both the AVR

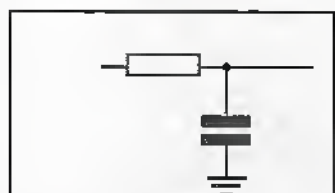
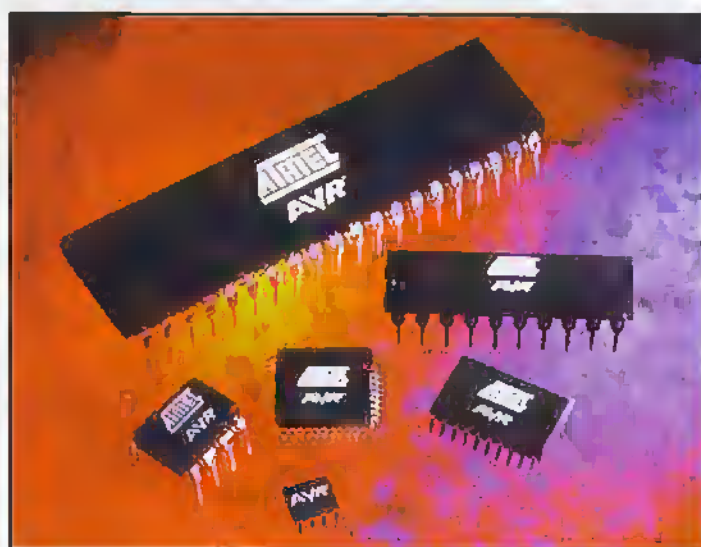

Figure 1. Integrator.



and the serial programmer.

Analogue to Digital conversion was mentioned in the December article, with a cryptic circuit diagram. We'll now expand upon it as it can be a very useful addition to the project. It can be achieved in a number of ways. The first is to use a simple Resistor and Capacitor combination (see

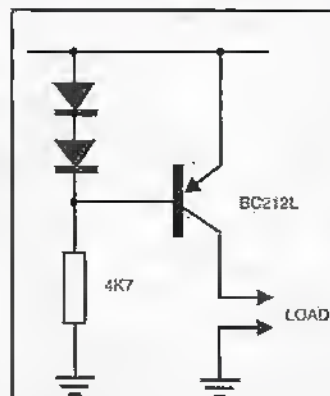

Figure 2. Constant current supply.

Figure 1). This is the simplest in hardware terms but is quite complex software-wise as you have to create a lookup table to deal with the fact that the capacitor has an exponential charge curve. However, by adding a simple bit of hardware we can make this charge slope into a more manageable straight line slope. The bit of hardware in question is a constant current generator. We could create one with a circuit such as that shown in Figure 2. This circuit works by forward biasing the

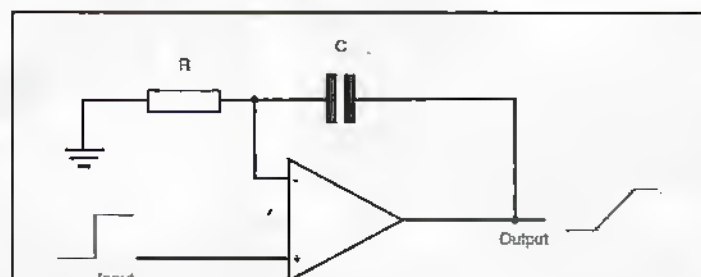

Figure 3. Linear Integrator.

transistor on by a set amount using the two diodes. The other method is to create ourselves a nice linear integrator by using the capacitor as part of the feedback circuit on an opamp (Figure 3). In fact that's what we'll use because it makes the calculations easier.

The actual method we are going to use is the single slope A/D. The operation is fairly easy, all you do is start a capacitor charging and compare the voltage on the capacitor with the unknown input voltage using a comparator. Which, conveniently, we happen to have in the AVR. Meanwhile we run a counter which is stopped, and read, as soon as the charge value exceeds the unknown voltage input value. The value in the counter is now analogous to the input voltage value. So if the input voltage is low then it won't take many counts until the capacitor charge exceeds it, on the other hand if it is high then it will take longer, hence more count values. We'll allow for worst case (high input voltage of up to 2.55 volts) in our calculations.

So much for theory. So how do we do this practically? The hardware is fairly simple. It just needs the integrator tying onto the comparator port and a spare bit, which is used for charging/discharging. Note that this method is not the quickest in the world as it will take the same amount of time to charge as it does to discharge the capacitor so it is effectively half the speed it could be. We could get round that by adding a bit of crude brute force (hopefully leaving out the ignorance) and provide a simple switch across the capacitor to short it out (see Figure 4). This effectively turns the integrator into a buffer and will hold the capacitor at 0 volts when it is not performing a conversion. Its not going to win any prizes for elegance but it works! A word of caution, choose a value of resistor that limits the maximum discharge current to

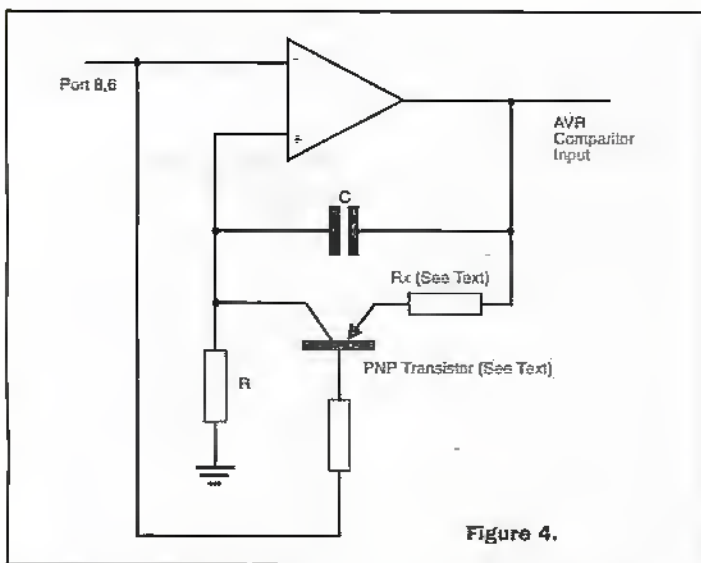

Figure 4.

stay within V_{ce} of the transistor (which should be a low leakage type – a BC212 was used in the prototype). The rule of thumb is the bigger the capacitor the bigger the resistor – big here means a few ohms, incidentally a 1 ohm was used in the prototype which provided a $1\mu s$ discharge time, this is excellent.

We can set up a comparator interrupt to provide background checking then the microcontroller can be beavering away looking after the general I/O while this is going on. The cycle starts with the capacitor discharged which means that PD6 is set to a 0. PD6 is then set to a 1 and the capacitor starts charging at a linear rate. As soon as the trip threshold has been reached (ie when the voltage on the integrator output > the unknown input voltage) a comparator interrupt is generated which can be used to read the counter. PD6 is then set to a 0 again and, after a suitable time to allow the capacitor to discharge, the cycle is ready to start again. The charge rate is determined by the values of C and R and should be selected depending on the resolution of the A/D. If you want an 8 bit A/D then, in theory, you only need to use the counter in 8 bit (no prescaler) mode so the timing would be equivalent to the time it takes the counter to count to full-scale (which is 5 Volts in this case). So using an 8MHz clock we are looking at a theoretical conversion time of $32\mu s$ (I told you the maths would be easy with an 8MHz clock!). The problem is the comparator propagation delay is given as 750ns (worst case) which means that it can take up to 750ns to respond to each incremental input voltage change. So we have to allow for

that in our calculations. The best way of doing this is to use a divide by 8 prescaler on the counter and to change the CR time constant to at least $250\mu s$. Now we effectively allow $1\mu s$ per bit of resolution, which incidentally tends to put a practical upper limit of around 10 bits on this type of convertor, in this application, given the leakage on polyester capacitors. To ensure that we don't run out of headroom on the op-amp (which only has a 5 volt supply and which can't pull right up to the rail) and to keep the maths easier we will limit the input to a Full Scale of 2.55 volts which yields a resolution of 10mV per bit (now isn't that a nice round figure!). We can achieve this by doubling the CR time constant. Which provides a final figure of $500\mu s$. This limits us to a conversion rate of getting on for 2,000 conversions per second for an 8 bit value, which sounds poor but is not the end of the world as most process variables (such as temperature, pressure etc.) don't tend to

change very fast anyway.

Note that we can also put a fairly heavy filter on the voltage input which will provide good series mode rejection so noise spikes etc. will not be a problem. A $1\mu F$ capacitor across the 5V1 zener should do the trick. Finally try to choose an op-amp with a low input bias current and the ability to be able to work down to 0 volts on the output on a single rail supply. An LM358 was used in the prototype and worked quite happily, you could use the other op-amp for amplifying the input voltage. If you find that the op-amp you have chosen doesn't pull low enough then use a split rail supply and put a 100K resistor between the output of the op-amp and the comparator input which will provide protection against injecting negative voltages into the AVR. You should also put a small diode (a 1N4148 will do) with the cathode connected to the output of the op-amp and the anode connected to ground, this will also serve as a voltage clamp and will assist in recovery time if the output were to go negative.

So that's the hardware done, so let's have a play with the software.

The Software

What we could really do with designing is some sort of template so the system can be customised to fit its particular application very easily. Now we have, by putting the A/D in, added another level of complexity to the system as we now have to add the comparator interrupt and a counter interrupt (which will be used to determine whether the input voltage is too high). What this means in practise is that we'll just have to

jump over the interrupt vector at the start. A practical template would be as in Listing 1.

You may have noticed one of the nice features of the AVR is the orthogonal instruction set. Which means that all instructions occupy the same code space irrespective of their function. This allows us to substitute a jump with a nop, which is neat for calculating interrupt vector addresses, which is what it has been used for here.

Ok so that gives us a framework so let's fill it in. We'll start with the interrupt handlers as they will remain the same irrespective of what goes into the main loop. Count is designed to provide over-voltage indication. The idea is that if the integrator reaches just over 2.55 Volts without the comparator tripping then we must be in an overvoltage situation. All we need to do is to set a flag and the main program can pick that up during its regular trawl loop and you can decide on a course of action to take. The AVR provides us with a really nifty uncommitted flag that can be easily written to, called the T flag, which is bit 6 of the status register. So all we need to do is to set this flag and return. You use the bset instruction to do this. The only other instruction you need is to reset the integrator back to a 0 to discharge the capacitor ready for the next A/D. So the full routine is shown in Listing 2.

Right! That was easy. Note the fact that we are clearing the interrupts using the global interrupt disable on bit 7 of the status register. We'll cover this in more detail later on. We are doing this to ensure that we don't trigger an interrupt accidentally when we set up the A/D subsequently.

```

;*****
;Programmable Logic Controller
;Version xxx.x
;Authored by : Yourname
;*****
    rjmp    go          ;Jump over Interrupts to Start.
    nop                    ;Place marker for unused External Interrupts
    rjmp    count       ;Jump to counter interrupt routine
    rjmp    compar      ;Jump to Comparator interrupt routine
;*****
go:                ;main code goes here
    rjmp    go          ;loop to begining - always put at the end
;*****
AD_start:        ;A/D start up routine goes here - see text
    ret                ;return from subroutine
;*****
count:           ;counter interrupt handler goes here
    reti              ;always terminate with a return from interrupt instruction
;*****
compar:         ;comparator interrupt handler goes here
    reti
;*****

```

Listing 1.

So on to the comparator interrupt handler. First of all we should stop the counter and read its value which, as you recall, is the A/D output value in $mV \times 10$. So to stop the clock we need to clear the timer control register which is regarded as I/O by the AVR. So we'll seed a scratchpad register, let's say R15, with 00h and then move this out to the register. We can now read the value from the counter into R15 (waste not - want not!). Also in this routine we want to let the rest of the system know that we've had a valid conversion so we start by resetting the T flag using `bclr 6`. So the final code is shown in Listing 3.

You will see that we've sneaked a sub-routine in just after the main loop. This is purely to set up the Analogue to Digital convertor. Once it is called it sets up the interrupts, the comparator, the counter, the prescaler and the integrator. If you don't want to use the A/D then don't call it! We'll go through it step by step.

First of all the interrupts. For such a baby processor the AVR is rich in interrupts. There are two mechanisms for enabling interrupts. The first is a global interrupt enable bit (bit 7 in the Status Register) which can be used to switch off all interrupts (say in a software loop) so we need to set that before the interrupts will do anything. To do this we'll use `bset 7`, we'll put this at the end so we don't get any spurious interrupts while we're setting things up. Next we have to set up the two interrupts and the associated hardware control bits. The first is the comparator where there are three things we need to set up. The first is to set up the pins that are associated with the comparator as comparator rather than logic inputs. Next we need to enable the interrupt and finally we need to set the comparator up to interrupt on a rising edge (ie as the integrator input on the + terminal passes the unknown input on the - terminal). Fortunately this is all in one control register on bits 7 (enable = 0), bit 3 (interrupt enable = 1) and bits 1 and 0 (rising edge selection = 11). This yields 00001011 in binary which translates into \$0B in hex so we'll use r14 as our transfer register as the control register (ACSR) lives in I/O space. So we'll need to use an out instruction.

The counter setup uses two registers. The first is the prescaler which we agreed should be set to /8 so we'll

need to put 0 1 0 into bits 2, 1 and 0 respectively of the counter control register (TCCR0). This translates into \$02 and we'll use r14 as our transfer register. Finally the interrupt needs to be set which means setting bit 1 in the counter interrupt mask register (TIMSK). Again use r14. So the final code is shown in Listing 4.

That was fun! The A/D will, when this routine is called, perform a single conversion in the background and will store the result in r15, with the t flag reset to a 0 if the conversion didn't overflow (in other words the conversion was valid). If the counter overflowed then the t flag is set and the last valid conversion value will be

left in r15.

Now for the main routine. This is where you put in your input, as it is you who will decide what the function is. First we have to do a little bit of housekeeping by setting up the ports. The ports are true tristate which means that you must instruct the processor as to whether you want them to be inputs or outputs. The design calls for all of port b to be inputs and all of port d to be outputs so this is quite painless. There are two tristate control registers called, logically enough, data direction registers. If a bit is set (ie a 1) then that corresponding port bit is set to an output, conversely resetting (clearing) a

bit will set the port bit to read. So the first four instructions in the main loop are shown in Listing 5.

Writing your own code

This project was chosen because it provides a very flexible tool on which you can practise your code writing skills and which provides an extremely useful tool at the end of it. As previously stated the AVR is a wonderful device to learn on as you get at least 1,000 re-programming lives to perfect your code on. The devices are also low cost. Where else can you get that much fun, and learn a new skill, for just over a fiver?

As you can imagine the AVR is extremely good at digital manipulation so you have a plethora of instructions available for you to provide exactly the control functions you require. If, however, you are a beginner I would suggest you stick primarily to bit manipulation as this only involves having to learn 4 instructions. These are shown in Listing 6.

A skip instructions tests a bit and skips over the next instruction if the condition is met. So, for example, if you wanted to test to see if a button has been pressed on an input (say on bit 1 on port b - 0 = pressed) and loop until it has been then use Listing 7.

Note that the `sbic` instruction reads the pin rather than the port. The architecture of the device allows the user to read the pin itself or the associated port latch. This means that you can read the pin for true inputs and the contents of the port latch if you want to read and modify what you've written before. Believe me this saves a whole lot of grief on some designs. So when you read-in, use the pin designation as shown above and to write-out out port in Listing 8.

Try writing some code to toggle a few bits around. Just to get you started here's a little bit of code that creates a moving light display on bits 0 to 3 on port d. If you use the triac drivers you can make disco lights etc. If you use the transistor opto you can drive a series of LEDs for christmas lights etc. Shown in Listing 9.

If you want to send the lights the other way then first set the carry using `sec` put this immediately after the `lpi`: `ldi r13,$1e` instruction and before the next. Then substitute the

```
count:  bset 6      ;set T Flag.
        cbi  portd,6 ;reset comparator
        cbi  7      ;clear global interrupt
        reti
```

Listing 2.

```
compa:  clr  r15    ;reset r15 to 00
        out  tccr0,r15 ;reset timer control
        register
        in  r15,tcnt0 ;read value from counter
        cbi  portd,6 ;reset comparator
        cbi  7      ;disable all interrupts
        reti
```

Listing 3.

```
AD_start: ldi  r14,$0b
          out  ACSR,r14 ;set up comparator
          ldi  r14,$02
          out  TCCR0,r14 ;set up prescaler for /8
          ldi  r14,$02 ;set bit 1 only
          out  TIMSK,r14 ;set up counter interrupt
          sbi  portd,6 ;enable integrator
          bset 7      ;enable global interrupts
          ret  ;return from sub-routine
          ;Don't use reti
```

Listing 4.

```
go:  ldi  r14,$ff ;use r14 as a temporary
     transfer register
     out  DDRD,r14 ;set up port D data direction
     register
     clr  r14
     out  DDRB,r14 ;set up port B data direction
     register
```

Listing 5.

```
SBI ;Sets a bit in an I/O register (ie makes it
a 1)
CBI ;Clears a bit in an I/O register (ie makes
it a 0)
SBIS ;Skip if bit in I/O register is set (ie it
is a 1)
SBIC ;Skip if bit in I/O register is cleared (ie
it is 0)
```

Listing 6.

```
loop:  sbic pinb,1 ;test port b, bit 1
input and skip if valid
       rjmp loop ;else loop until it has been
```

Listing 7.

```
sbi portd,1 ;set bit 1 on port d
```

Listing 8.

```

go: ldi r14,$ff ;use r14 as a temporary
transfer register
out DDRD,r14 ;set up port D data direction
register
clr r14
out DDRE,r14 ;set up port B data direction
register
lp1: ldi r13,$1e ;set up port with 1 light (bit
0) on, others off
lp2: out portd,r13 ;send it out to the port
ldi r12,$7f ;make this smaller to make
lights go faster
t1: ldi r11,$ff ;timing loop starts
t2: ldi r10,$ff
t3: dec r10
brne t3
dec r11
brne t2
dec r12
brne t1 ;timing loop ends
lsl r13 ;shift lights to the left
sbrc r13,4 ;test to see if bit 4 is
reset (end of sequence detection)
rjmp lp2 ;if not end of sequence then
carry on
rjmp lp1 ;else reset back to the begin-
ning

```

Listing 9.

code as shown in Listing 10.

You could use a switch on one of the inputs to decide which way the lights move. Note the software timing loop which just makes the processor count as a way of slowing it down.

Finally you can use the A/D values by simply comparing the

value with a setpoint and switching on and off a port, say depending on the value. For example if you wanted a simple temperature control you could use one of those wonderful monolithic temperature probes that produce a 10mV/degree output (don't use the absolute

```

ror r13
sbrc sreg,
brcs lp1
rjmp lp2
instead of:
lsl r13 ;shift lights to the left
sbrc r13,4 ;test to see if bit 4 is
reset (end of sequence detection)
rjmp lp2 ;if not end of sequence then
carry on
rjmp lp1 ;else reset back to the begin-
ning

```

Listing 10.

```

loop: cpi r15,$19 ;this value is the set-
point in degrees - $19 = 25 dec
brsh op_off ;same or equal so turn
output off routine
cbi portd,0 ;put output on
rjmp loop ;do it again
op_off: sbi portd,0 ;turn output off
rjmp loop ;do it again

```

Listing 11.

version as they give an output in Kelvin!). The code for this (assuming port d bit 0 is connected to a heater) is shown in Listing 11.

I hope that this proves how easy it is to work with the AVR. Remember if you need to really get to grips from an earlier stage or you need more in-depth tuition then Maplin has a training system available called the AVR Explorer (Order code NR41U at just under £99). There is also a development

system which includes everything you need to get started, including software and programming hardware (Order code NR20W at £65).

Finally here are a couple of web addresses you may find useful:

www.atmel.com for datasheets, info on latest versions of the device
www.kanda-systems.com for development tools, books, C Compilers etc.

Happy programming.

NEED TO DEMONSTRATE EMC COMPLIANCE?

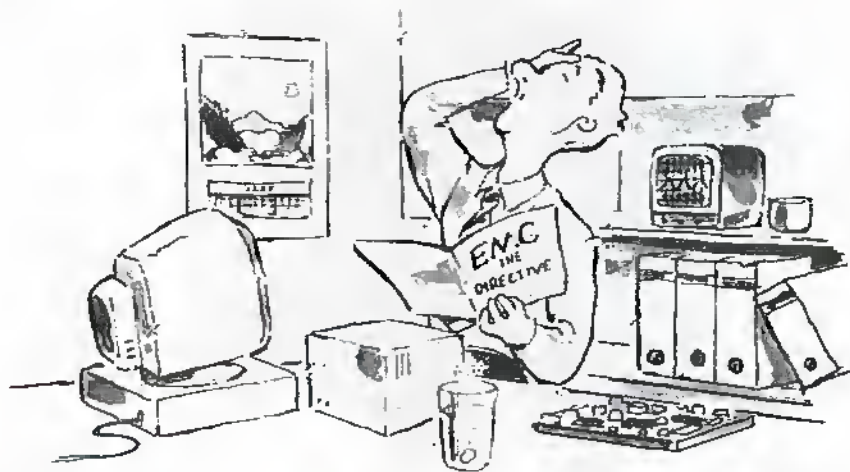

*EMC Testing
from
£85 per hour*

- COMPREHENSIVE EMC AND CLIMATIC TESTING
- IMPARTIAL ADVICE AND PRACTICAL ASSISTANCE
- NO OBLIGATION FREE CONSULTATION

If you don't want to arrange a visit, but would just like a chat then please give us a call and we'll be happy to help.

Telephone 01949 843757

Data and Information Testing Ltd, Technology House, 1 Normanton Lane, Bottesford, Nottingham. NG13 0EL.

IBUS

8 BIT DIGITAL INPUT/OUTPUT MODULE

Design & Development by Neil Johnson

The Interface Bus ("IBUS" for short) is a simple, slow parallel 8 bit expansion bus for the IBM PC and compatibles. It was introduced and described in the November '97 edition of Electronics and Beyond, as the IBUS Printer Port Adaptor, providing an interface between the PC and the IBUS.

This month's project is the first in a family of expansion modules: It has 8 TTL-compatible inputs and 8 TTL-compatible outputs, which can be used for a wide range of simple interfacing applications. A few examples are provided later on.

Guided Tour

The digital input/output module is a simple design, consisting of four sections: IBUS interface, output register, input register and power supply. In keeping with the IBUS philosophy of KISS (Keep It Small and Simple) each section is implemented with only one integrated circuit and the minimum number of glue components (resistors, capacitors etc).

The full circuit diagram is shown in Figure 1. Starting at the top left hand corner is the IBUS interface, consisting of the address decoder and enable gates. The IBUS address (A0-A7) is compared with the board address, selected by SW1 and RP1, by the 8 bit magnitude comparator IC1. If both bit patterns match then pin 19 is pulled low. The enable gates, IC3a-c, control the read and write signals from the IBUS.

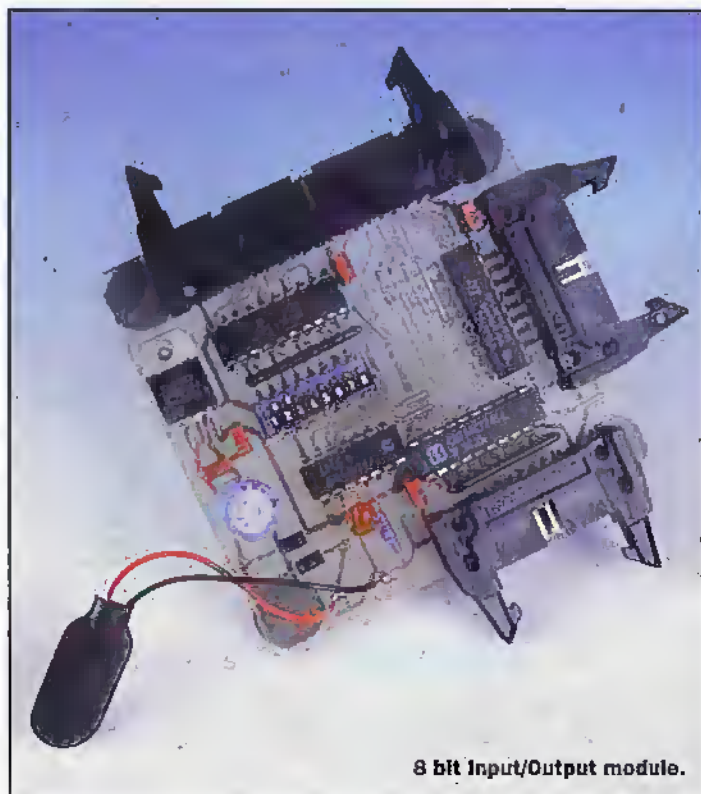

8 bit Input/Output module.

With IC1 pin 19 low both control signals can operate their respective I/O registers. The unused inputs of IC3 are tied to the output of IC3c.

The output register consists of octal transparent latch, IC5. When pin 11 is held high, by both the output of the address

decoder and the write strobe, WR, being low, the latch copies the contents of the IBUS data bus (D0-D7) to its outputs and, via JP2, to the outside world. Then, when the WR strobe returns to its high state, the latch is closed, storing the 8 bits in IC5.

The input register, IC2, is an octal bus transceiver configured for one direction only. The eight data inputs to the transceiver, from connector JP3, are pulled high by RP2. Not only does this ensure all unused inputs are forced into a known high state, but also simplifies interfacing by requiring only the addition of a switch between an input and ground to complete the input circuit.

Normally the output pins of the transceiver are in a high impedance third state (a tri-state output). Only when pin 19 is pulled low, by the gated input of the read strobe, RD, also being low, will the logic levels of the eight inputs be fed onto the IBUS data bus.

The final part of the circuit is the power supply. The input voltage, of greater than 9 volts, passes through reverse protection diode D1. This one component may only cost a few pence, but it can save many embarrassing moments, like stopping C7 exploding in your face, and IC4 going up in smoke.

The supply voltage is then smoothed by C3 and C7 before being reduced to a regulated +5 volts by IC4, a member of the cheap and cheerful 78xx family of voltage regulators.

Second protection diode D2 prevents any reverse voltages from damaging IC4, while R1 and LED1 provide indication of power. The remaining capacitors, C1, 2, 4, 5 and 6, provide local supply rail decoupling.

Construction Site

Assembly of this module is very straightforward, with all components mounting directly on the circuit board. See Figure 2.

Begin with the 9 wire links, resistor R1, the two diodes, the ceramic capacitors and the two resistor packs, RP1 and RP2. If PCB pins are to be used for the power connections these should also be inserted at this time.

The next components to fit are the integrated circuits. If IC sockets are to be used they should be inserted now, together with SW1 and the voltage regulator, IC4. Insert all remaining components, leaving LED1 and C7 to last.

If you have chosen to build the accompanying terminal pod, shown on the right of Figure 2, insert the expansion connector first, followed by the PCB mounting terminal blocks.

Figure 1. Circuit diagram of IBUS 8 bit digital Input/Output Module.

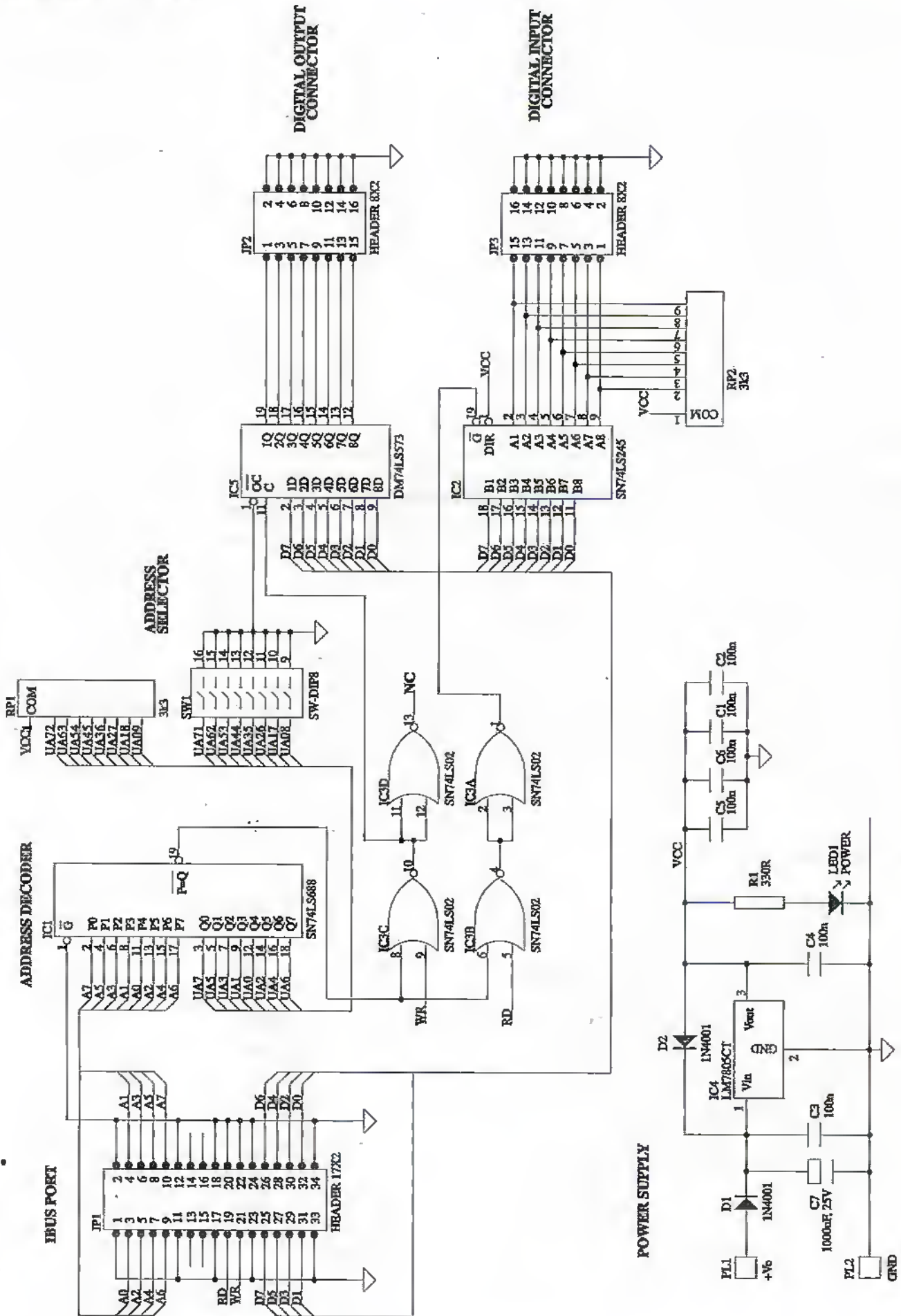

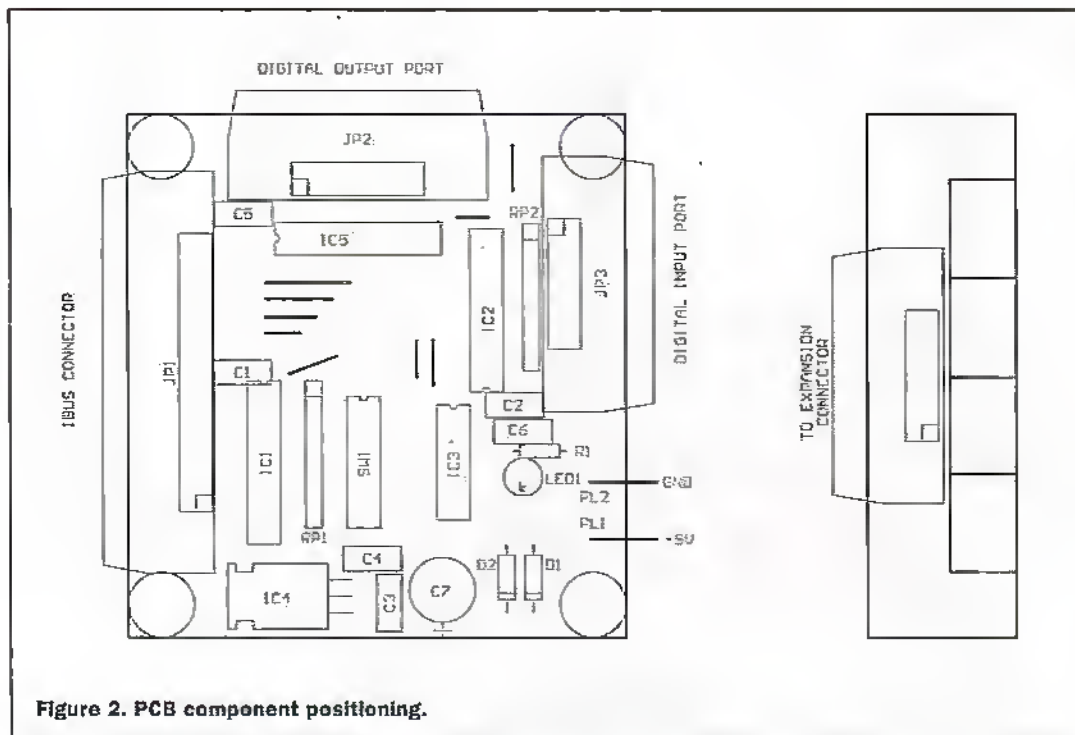

Figure 2. PCB component positioning.

Testing, Testing

The first test of your assembled board is to give it a thorough visual inspection with your eyeball. Check for the correct orientation of the polarized components, in particular IC2 which is upside down. Also check that C7 is the correct way round — if you are wrong a loud bang and yellow confetti will point your error out to you.

Also check for, and remove, solder bridges between the closely spaced pins on the ICs and the connectors JP1, JP2 and JP3.

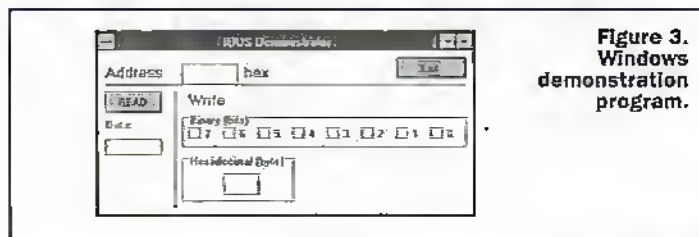

Figure 3. Windows demonstration program.

The next test is to power up the board. Use a bench power supply, or one of those small black multi-voltage mains adaptors, and slowly raise the input voltage from, say, 2 volts to about 9 volts. Using a multimeter check the output of

the voltage regulator, IC4 pin 3, rises up to, but does not exceed, 5 volts.

The final test requires the board to be connected to a PC via a Printer Port Adaptor (PPA), described last month. This should be done with a length of

34 way IDC ribbon cable and matching connectors. The IDC connectors can be crimped onto the cable with careful use of a small bench vice.

With the board connected to the PPA, the PPA connected to a PC, both boards powered up, and the PC running the IBUS software (available from the author — see Parts List) you are ready to send and receive data to and from the digital input/output interface board.

The IBUS address to which the board will respond is set by SW1. With a switch closed in the ON position the corresponding address bit corresponds to a '0', and vice versa. The switches are numbered one higher than the corresponding address bit, so address bit A0 is set by switch 1, address bit A1 by switch 2, and so on. So, for example, if all of SW1 was set to ON the board address would be 00000000, or 00 in hexadecimal. Likewise, if all of SW1 was set to OFF, the board address would be 11111111, or FF hex. Once you have determined the address of your interface board this value can be entered into the address box, see Figure 3.

To read the input register press the "Read" button, to the left of the window. The data read from the input register is then shown, in hex format, in the box below the button. To write a value to the board either enter the hexadecimal value, in the box marked "hex", or click on the individual bit markers above it.

Figure 4. Example input circuits.

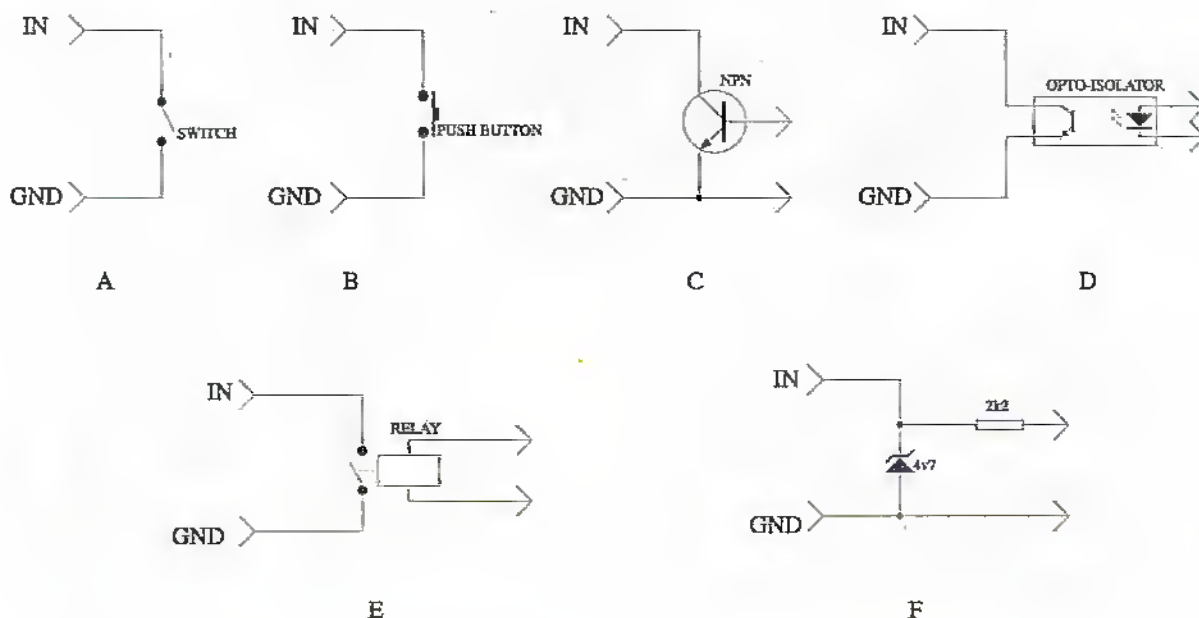

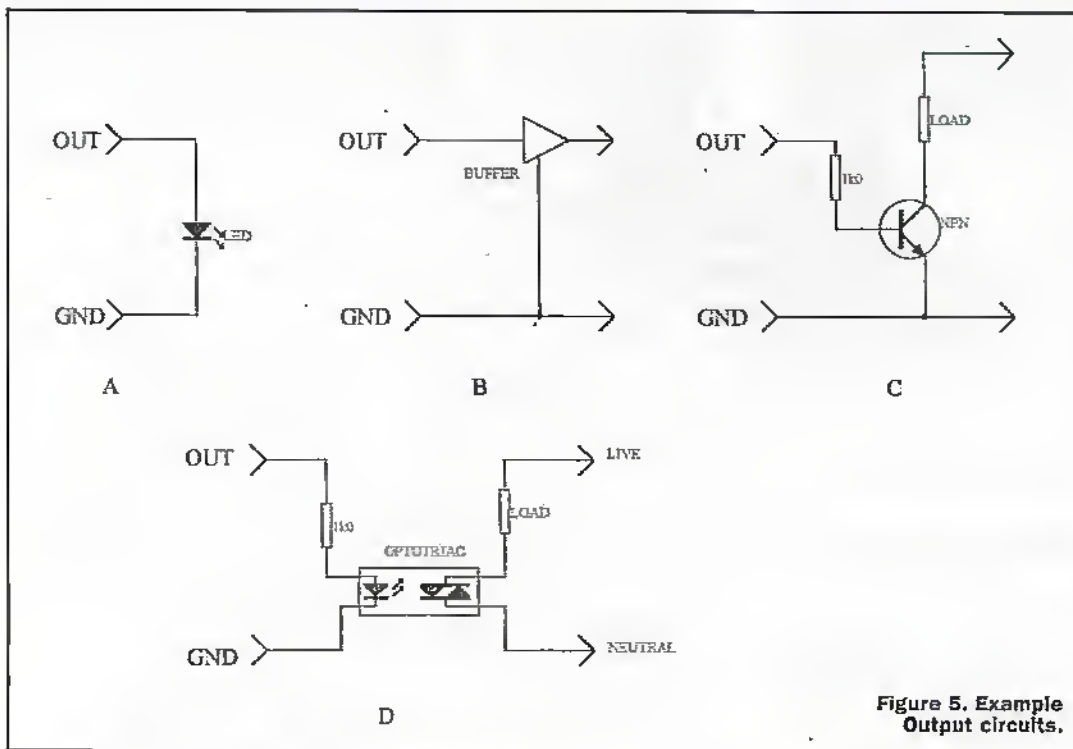

Figure 5. Example Output circuits.

Using a multimeter, or logic probe, and a "bit of wire" (author's note: this is a very useful technical phrase that is worth remembering – it took the author five years and two degrees to get the "bit of wire" just right) you can check that all eight outputs and all eight inputs work correctly. For the inputs remember that they are pulled high, and that external switches pull them low when the circuit is completed.

Cook Book

For those constructors itching to start interfacing, off you go. For the rest of us, here are some example input and output circuits, together with a few ideas for possible applications. Please note that they are presented as ideas only – they have not been tested by the author.

The example input circuits are shown in Figure 4. The first two need no explanation – a switch or push button to pull the input to ground, depending on whether the application requires a latching or momentary action. The switch contacts can be made from virtually anything. Traditional toggle switches and push buttons are readily available. However, with a little imagination, try making a set of contacts out of bits of wire, tin foil, tap water, in fact any reasonably conductive material.

The next two input circuits, C and D, are again very similar. In both circuits the switching action is implemented with a

relay with the coil activated when current flows into the base of the transistor; while in D the base must be illuminated by the associated LED. A variation on D is to use a single opto-transistor, without the LED, which could be used to make a light detector, with applications ranging from position sensor (using a toothed wheel and lamp) to a simple burglar alarm – the intruder turns on the light and BEEP BEEP BEEP!

The fifth input circuit, E, allows a variety of different input voltages (even mains) to be connected to an input simply by selecting a relay with

the correct coil voltage. Finally, circuit F shows an alternative to E, but only suitable for DC voltages. The zener diode limits the maximum input voltage to 4.7 volts, while the resistor limits the input current. The example value given would be suitable for input voltages up to 30 volts. For higher voltages increase the value of the resistor, keeping the zener current to below 100mA for a 500mW zener diode. A typical zener current for this application should be about 10mA. To calculate the value of the resistor, and its rating, use the following equations:

$$R_{value} = (V_{in} - 4.7) / 0.01$$

$$P_{power} = (V_{in} - 4.7)^2 / R_{value}$$

The example output circuits are shown in Figure 5. The first one uses a low current LED connected directly to the output. This makes use of the poor current sourcing of the TTL output stage, which can source about 4mA, enough for the low current LED.

The second circuit, B, places a buffer between the TTL output and any further circuits. If an open-collector buffer was used, then higher voltage circuits could be driven; for example, CMOS circuits running at 15 volts. Circuit C effectively implements an open-collector circuit, complete with load in this case. The transistor should be selected on the type of load that is being switched. For high power loads a Darlington transistor is recommended.

Finally, circuit D shows a simple way of controlling a mains-powered load. For small loads, up to a couple of hundred watts, the circuit shown will be sufficient. However, for higher power loads, up to thousands of watts, it would be better to use a purpose-built logic-controlled "opto-relay" module and an RC snubber network (an R and a C in series) wired in parallel to the triac. This would ensure correct turn-off of the device. Likewise, a high current low valued inductor in series with the load would help to reduce RF interference from the sudden current surges likely during switching.

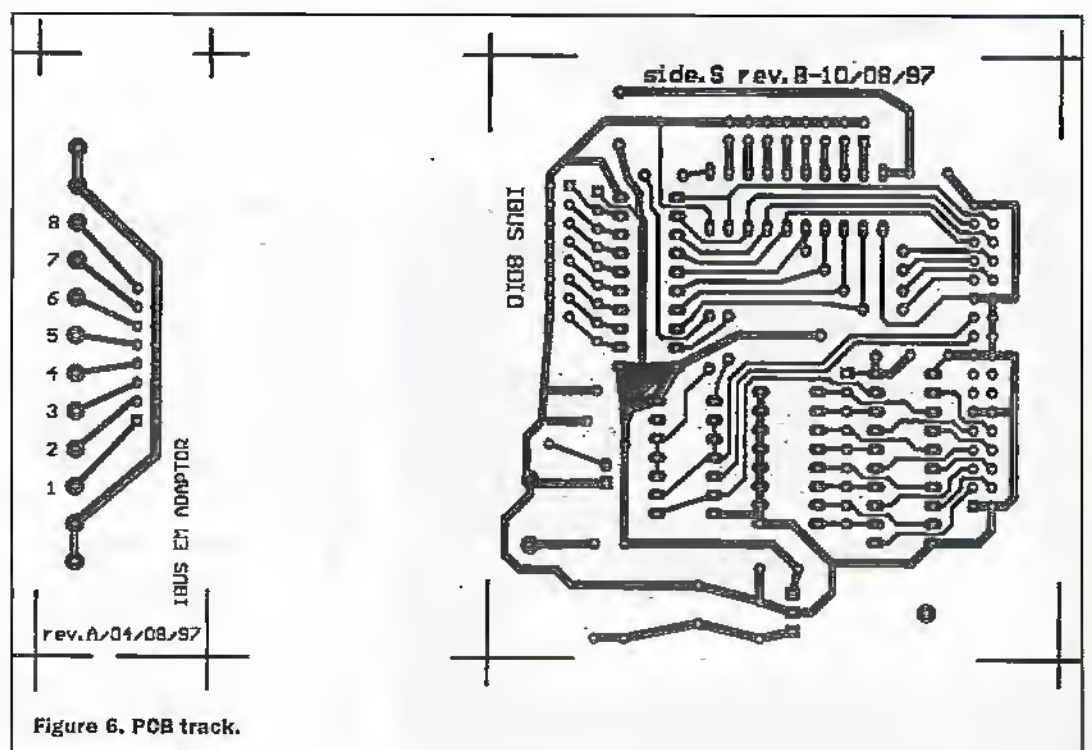

Figure 6. PCB track.

The above circuits should provide a starting point for your interfacing experiments. Below are a few ideas for some simple interfacing projects to get you started.

Model Railways

To modernize your model railway layout connect some small, low current LEDs to the digital outputs, and connect reed-switch train sensors to the digital inputs. With a suitable program you can monitor where your trains are, and set the colour light signals accordingly. By careful placement of the train sensors you can also detect when a train goes past a red light, and then suitably reprimand the driver for failing to obey a stop signal!

Logic Tester

With the addition of a ZIF (Zero Insertion Force) socket and some patch leads a simple logic chip tester can be implemented. Use the eight outputs to provide a sequence of test patterns, and use the eight inputs to monitor the outputs from the chip under test. With a test program running on your PC you will be

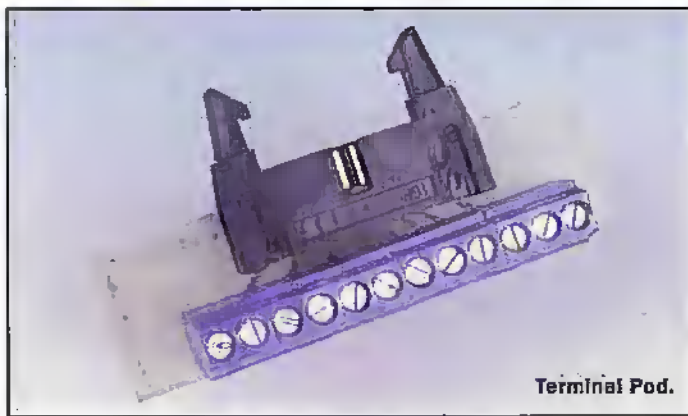

able to test suspect devices with a click of the mouse.

Memory Games

Use the outputs to drive a set of lamps, via drive transistors, and connect a matching set of push switches to the inputs. Then program the computer to play a short sequence of flashing lights. The contestant then has to hit the push switches in the same order as the lights. Get it right and the next sequence is played, a bit faster or a bit longer. Make a mistake and the contestant loses. If you've ever played the game "Simon" you will know exactly how to play, and win, this game.

With enough imagination, and a dash of creativity, anything is possible! If your circuit goes up in smoke, at least you can be sure that the IBUS interface system has kept your expensive PC safe behind its electrical barrier. As the song goes "dust yourself down, brush yourself off, and start all over again..."

Family Tree

This expansion module is the first in a series of modules to be published over the coming months. Future modules include:

- ◆ an 8 channel relay output module,

- ◆ an 8 channel opto-isolated input module,
- ◆ an 8 bit analogue output module, and
- ◆ an 8 bit analogue input module

These modules are intended to form basic building blocks from which more complex systems can be built. For example, an analogue output module and an analogue input module could be used to build a computer-controlled power supply: the analogue output to set the output voltage, and the analogue input to measure the load current for, perhaps, plotting on the computer screen.

For more advanced projects it is probably worth building a custom IBUS interface. The above projects can be used to guide the designer in implementing the IBUS interface for his/her project. Keep watching!

Acknowledgments

The author would like to express his thanks to Cambridge Consultants Ltd, Cambridge, for their continued help in providing development facilities for this project. **CHS:335***

PIC COOKBOOK

VOLUME 1

PIC COOKBOOK

Volume 1

A collection of Working Application Ideas

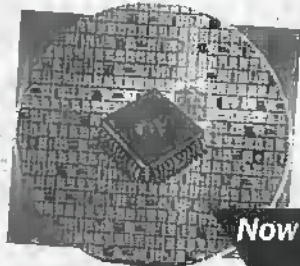

Now Reduced by

£5

MPS
MAPLIN ELECTRONICS

BY NIGEL GARDNER & PETER BIRNIE

MAPLIN ORDER CODE: DT76H PRICE £14.99 (inc VAT)
Available from Maplin Electronics by Mail Order and selected stores

PARTS LIST - EXPANSION MODULE

Resistors - all $\pm 5\%$ 0.25watt unless stated

R1	330R	G330R
RP1, 2	4x7 8 commoned resistors	RA29G

Capacitors

C1-6	100n ceramic	RA49D
C7	1000uF, 25v radial electrolytic	AT52G

Semiconductors

IC1	74LS688	KP49D
IC2	74LS245	YF91Y
IC3	74LS02	YF02C
IC4	LM7805	QL28F
IC5	74LS573	AE29G
D1,2	1N4001	QL73Q
LED1	5mm red LED	WL27E

Miscellaneous

JP1	34 way IDC R/A PCB plug	FA44X
JP2, 3		16 way IDC R/A PCB plug, FA42V
SW1	8 way DIP switch	QY70M

PCB, IC sockets (optional), tinned copper wire for 9 links, 2 veropins for power connections.

Parts List - Terminal Pod

1 off	16 way IDC R/A PCB plug	FA42V
2 off	6 way PCB terminal blocks	KE54J

PCB

The software accompanying this project, supplied on a 3 1/2" disk, is available from the author at the address below. The disk costs £1.0. Postage is £2.50 for the UK, £5 for everywhere else. Please send your order, with cheque or postal order payable to "Neil Johnson", to:

Neil Johnson, IBUS Module, 2 Chapel Field, Daxter Road, NORTHAM, East Sussex, TN31 6PQ, UK.

Photo 1.
Maxon PC-50.



Radio

COMMUNICATION PRODUCTS

PART 2

'Walkie Talkies' Shortrange Business Radio (SRBR) & Personal Communicators

by Harry Watkins

This month I thought that I would take a closer look at ways in which people can keep in touch with each other in a local situation. For example: if you have a factory and you need to keep in contact with others in the building or yard; if you need to keep in contact with a partner who works in their shed at the end of the garden; or any of the many other uses of portable two way radio.

All that was generally available up to now were either cheap 'toys', working on 49MHz or 27MHz frequencies or expensive Private Mobile Radio (PMR). However, 'Walkie Talkies', as these radios are often referred to are often an inexpensive alternative to portable telephones or PMR.

A point of clarification here. We have just discussed two very different types of users that is the professional or business user and the public or private user. During the last few years there have been some relaxation of rules and regulations governing the use of some transmissions. Especially low power devices and some business frequencies. Maxon and Motorola have both produced portable transceivers (transmitter and receiver combined in one unit) which allow users to take full advantage of this new legislation.

I am sure we are all aware of the cost of portable telephones where a monthly rental is charged plus the cost of the calls. With Short Range Business Radio (SRBR) and Personal Communicators the costs are considerably lower.

Maxon Personal Communicators

These items, which are now available again after what seems like too long an absence (due to the rigours of EMC compliance), are

probably the most popular 'Walkie Talkies'. They can be purchased by anybody for any use, there are no restrictions at all whether they are used for business or private use. One good thing about the Maxon range is that after the initial purchase of the radios by the user there is nothing else to pay for - apart from batteries that is. There are two models currently available: the PC-50 (Maplin Code NV62S) priced at £79.95 - see Photo 1; and the 49-SX (Maplin Code JM34M) priced at £59.95 - see Photo 2. Both work in the 49MHz band allocated for this purpose. Their useful operating range is up to about a quarter of a mile (400m) so many applications are covered.

PC-50

The PC-50 is a smart looking pocket size unit measuring (approx.) 15cm (6in) high by 6cm (2.5in) wide and 4cm (1.5in) deep, the aerial supplied is another 15cm long. It requires 3 x AA Alkaline cells, which are not supplied. It weighs (approx.) 230g (8oz) without headset and 360g (13oz) with the headset. It has 5 channels A, B, C, D & E and a built in speaker. So if there is interference on one channel the radio can easily be switched to another channel. Also if there are many users on the same system up to five users could monitor different channels and the controller could speak to one person without disturbing the others.



Photo 2. Maxon 49-SX.

Photo 3.
Motorola S-200.



The PC-50 replaces the old model 49-HD. There are a few changes to warrant the new model number. Firstly the PC-50 can be used in two ways: as a hand-held transceiver or as a hands-free transceiver with the supplied headset. The headset is removable and does not need to be plugged into the unit when it is being used as a hand-held transceiver. Unfortunately there is no user adjustable squelch control on the PC-50, operation is silent but I would still have preferred to see this control available for manual adjustment. There is a call button which when pressed transmits a tone to other listeners' on the same channel.

The PC-50 is supplied with an adjustable Voice Operated Transmit (VOX) headset. This consists of a headband with an earpiece and a boom microphone. As well as a separate control on the radio for Press To Talk (PTT) there is also a control for the VOX. So when the headset is plugged in either the PTT on the radio can be used or in the VOX mode, transmission will automatically take place when the person wearing the headset talks. This is particularly useful in situations when the operators hands are needed for something else. Like food servers in drive-thru restaurants, drivers or roof workers, etc. There is a VOX level adjuster to ensure that the radio only transmits when you want it to. When the headset is plugged in it disengages the built in speaker.

Also supplied with the PC-50 is a belt hook. An LED indicator illuminates when either the CALL or PTT is pressed, this also functions as a battery low indicator. A soft-case is also available (Maplin Code NW16S) and sells for £9.95.

49-SX

The 49-SX is the same as the earlier model previously available, but now compliant with EMC regulations and CE-marked. It is a single channel (A) transceiver. The main unit measures (approx.) 11.5cm (4.5in) wide by 6cm (2.5in) high and 2.5cm (1in) deep and requires two AA Alkaline cells, again not supplied. It can be attached to a belt with clip supplied. The 49-SX is wired to the supplied headset which consists of a headband with an earpiece on one end (detachable for fitting inside motorcycle helmets - velcro is supplied for this purpose, as are full instructions).

The controls are very simple: an on/off/volume control, a VOX/PTT/VOX level control, a Push-to-Talk (PTT) switch and an LED to show transmission is taking place or the battery is running low.

Both of these Maxon units can be used with each other if the PC-50 is switched to channel A.

Short Range Business Radio (SRBR)

The Radiocommunications Agency describe SRBR as "SRBR speech service is a short range, handheld, two-way speech radio service for business use." Therefore it is not intended for private use by the general public, but for business use in places of work such as schools, shops, offices, hotels, building sites, etc. A licence is required (£30.00 for three years), if you buy an SRB radio from Maplin, the licence application form is included with each radio. This is very much cheaper and easier to obtain licence than for PMR. Only one licence is required for any number of radios to be used in connection with the licensee's business. For those interested, SRBR operates within the 450MHz to 470MHz band. SRBR is a relatively new range of business radios being inexpensive to purchase and easy to operate. They are the ideal solution to many professional communications problems. They can be used immediately after purchase. The range of transmission is up to a mile with superb voice clarity. The Motorola models have three channels and five Continuous Tone Coded Squelch System (CTCSS) tones (both user programmable). CTCSS stops the user from receiving unwanted transmissions by encoding a tone on to the signal. Only signals carrying the same tone on the same channel will be received. Motorola SRBR S-200/S-240

Maplin stock two Motorola SRBR transceivers: The S-200 (Maplin Code JV38R) - see Photo 3 - which sells for £198.58 and comes complete with rechargeable nicad battery pack and charger, helical aerial, belt clip and user-guide. And the S-240 (Maplin Code JV37S) - see Photo 4 - which sells for £220.08 and has the same facilities as S-200 but has the addition of VOX operation when used with an optional headset. Both radios are supplied with a Ni-Cd battery pack and charger. The units can also be operated from 6 x AA Alkaline cells, which are not supplied.

Both Motorola transceivers have an accessory connector on the side which can be used with a wide range of external speaker and microphone options, both Motorola and 'third party' accessories are available. Both models are (approx.) 15cm

(6in) high by 6cm (2.5in) wide and 3.5cm (1.5in) deep, the aerial is another 9cm (3.5in) long and each unit weighs 330g (11.5oz) including battery.

There are many original Motorola accessories stocked by Maplin for these transceivers. An extra Ni-Cd pack (Maplin Code MH08J) sells for £24.95 and allows you longer operating time away from base. An extra charger is available, should you need a new one, for use at a different location (Maplin Code MH16S) and sells for £11.95. A fast one hour charger is available - if you cannot wait for the standard overnight charger - (Maplin Code MH12N) and sells for £49.95. A carry case is always worth buying to save your radio getting damaged and dirty (Maplin Code MH15R) and sells for £15.95. A VOX headset for those users who need hands free operation is available (Maplin Code MH28F) and sells for £49.95. A hand-held speaker microphone (Maplin Code MH32K) sells for £59.95, letting the user keep the radio in a pocket or on a belt whilst still being able to use it.

So whatever your needs there is a two-way radio available to suit your purpose and as you has been described can be adapted for virtually any situation. **Reviews**

Photo 4.
Motorola S-240.



- Photo 1. Maxon PC-50
Maplin Order Code NV62S
see page 812 of Maplin Catalogue.
- Photo 2. Maxon 49-SX
Maplin Order Code JM34M
see page 812/3 of Maplin Catalogue.
- Photo 3. Motorola S-200
Maplin Order Code JV38R
see page 815 of Maplin Catalogue.
- Photo 4. Motorola S-240
Maplin Order Code JV37S
see page 815 of Maplin Catalogue.

COMMENT



by Keith Brindley



according to the BBC, elements of the CD-ROM support the National Curriculum Key Stage One — a phrase that should attract much attention from parents or grandparents of pre-school and early years children. Not that the children need to know this, mind you. The games, puzzles and activities on the CD-ROM are attractive in their own right, and any 3 to 6 year old would be convinced they've been given it as a fun thing, and not as an educational tool. Waak, waak — as Pingu would say.

Slightly higher up the educational scale covering all Key Stages of the National



Curriculum, Dorling Kindersley always has several attractive and well-designed CD-ROMs coming off its production line. As a seasonal treat this year, you can buy bundles of CD-ROMs from the range at very attractive prices. The bundle here for example, comprises four: My First Incredible Amazing Dictionary; The Dorling Kindersley Children's Dictionary; My First Amazing World Explorer, and Castle Explorer. While none of these are brand spanking new they do represent extremely good value for money and cover a wide range of interests and educational levels. If you haven't already got them, getting them in a bundle is an ideal purchasing method.

Not famous for its forays into multimedia (although if it continues with CD-ROMs like this one, it soon will be) Lego is well known for its range of building-brick construction kits. Long gone, though, are the days of youngsters merely building houses and cars out of basic cuboid Lego blocks. Today's kids are more likely to be constructing spaceships or trains out of some highly involved kits in the Technics Lego range. In response to the growing use of family computers, and the convergent and technical natures of both kits and computers, Lego has made some recent kits available with CD-ROMs giving construction details along with other activities to integrate the two technologies. The Technics Lego Nautilus submarine kit is one of the first to include a CD-ROM doing so, and is a fine example.

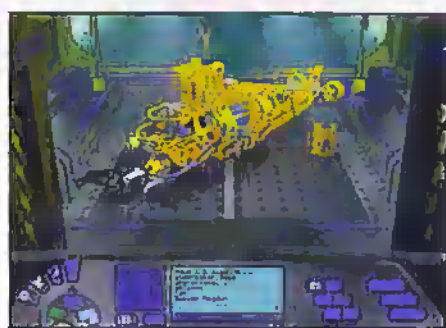

Finally, though not educational in the exact meaning, I couldn't miss out Virtual Springfield. The err... wholesome US town of Springfield is, as lovers of the Simpsons will already know, home to Bart, Lisa, Maggie, Homer and Marge Simpson — America's first family (even more famous than the Clintons). On air for years on satellite television and only the last few months on terrestrial, the Simpsons represent the ultimate in American comedy, with its off-beat humour and pantomime-like quips that please kids and adults alike. Virtual Springfield lets you roam around the town, entering buildings as you choose and interacting with people and objects therein. From the Simpson's house itself (checkout the Homer pin-sticking doll underneath Bart's bed), to the gorge above the town, you can spend many a long hour of mirth. With an all new dialogue read by original cast members, together with seemingly endless 3D multimedia animation, this is one simply not to miss.

All CD-ROMs should be available from any good computer media stockist. The Technics Lego Nautilus submarine kit is available from all good toy stores. I hope you recover rapidly from the Christmas and New Year blues, and I hope these suggestions go no small way to ensuring it. This column will return to normal next month. **BBB**



The opinions expressed by the author are not necessarily those of the publisher or the editor.

OK, so you're bloated with the turkey, goggle-eyed with the TV, dishwasher handed with the washing up, or simply in need of some respite from the kids. Yes, Christmas and New Year is like that, isn't it? A wonderful time of year — bah, humbug! Fortunately, there's relief for all you Scrooge-types here in the form of some wonderful solutions. As you might expect these are all for the computer user, and all by no strange chance are on CD-ROM, so you'll need to check that the computer you aim to run them on is capable of doing that, but most have pretty average minimum multimedia requirements. For PC users, this normally means at least a double-speed CD-ROM drive, a 640 by 480 monitor with 8-bit ie 256 colours, a 16-bit 100% compatible SoundBlaster soundcard, loudspeakers, mouse, and sufficient RAM — which actually varies according to the CD-ROM although is typically 8Mb of free RAM — together with a 486 processor running at least at 66MHz. For Macintosh users this normally means you need a, err... Macintosh, as all multimedia requirements are standard on all recent models.

All CD-ROMs here are available in either Windows or MacOS formats, and most of them are actually hybrid formats meaning they'll play on either computer operating system straight out of the box, although check packaging to make sure before you buy.

First off is one for the litt'uns in your life. Unfortunately it's also got one of the highest system requirements in terms of display needs — 16 bit display corresponding to 64 thousand colours — although it will actually, with lower colour resolution, play on a mere 8-bit, 256 colours display. Pingu is a BBC Multimedia CD-ROM featuring everone's favourite, lovable yet rather naughty, penguin Pingu. Wonderfully designed with its audience of 3 to 6 year olds very carefully in mind, this CD-ROM is a real treat. There are ten activities as well as screen savers (one of which is even an aid to telling the time), with the main aim of teaching young children while they enjoy themselves. Indeed,

EASY-PC Schematic and PCB CAD

From Super Schematics

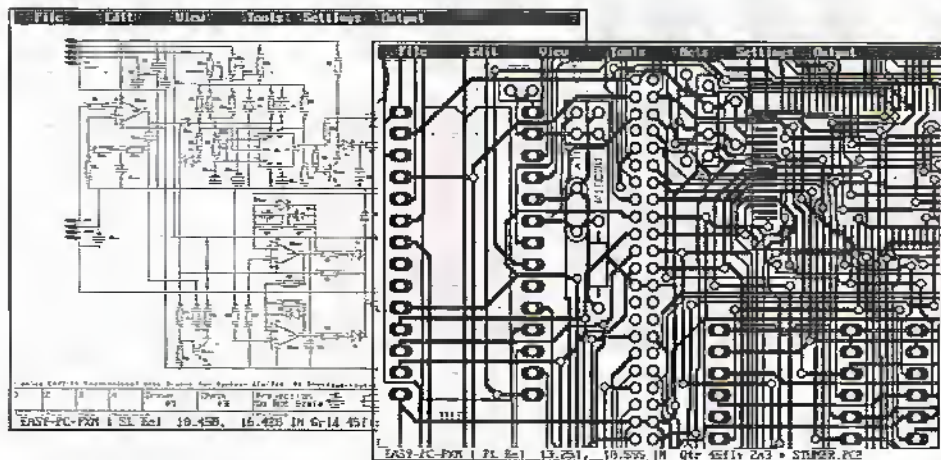

To Perfect PCB's Prices From £75/\$135 Number One Systems

UK/EEC: Ref: MAP, Harding Way, St.Ives, Cambridgeshire, ENGLAND, PE17 4WR. e-mail: sales@numberone.com
Telephone UK: 01480 461778 (7 lines) Fax: 01480 494042 International +44 1480 461778
USA: Ref: MAP, 126 Smith Creek Drive, Los Gatos, CA 95030
Telephone/Fax: (408) 395-0249

Stocked by: Maplin, RS, Farnell, CPC, Mega, Cirkit etc.,etc.

<http://www.numberone.com>



adchipr02

- Runs on:- PC/ 386/ 486 with VGA display
- Links to PULSAR (logic), ANALYSER III (analogue) & LAYAN (electromagnetic) simulators (Pro' versions)
- Design:- Single sided, Double sided and Multi-layer boards.
- Provides full Surface Mount support.
- Standard output includes Dot Matrix / Laser / Ink-jet Printer, Pen Plotter, Photo-plotter and N.C. Drill.
- Optional, powerful, 32 bit, Shape based, Shove Aside, Rip-up and Re-try Autorouters (XM only).

Speaker Design Software - 1997 Upgrade for Windows™



Now with lots of new features including:

- Database of 1,000 popular drivers from over 150 different manufacturers world-wide
 - dBASE IV format
 - New Low Pass Filter options for making sixth order alignments
 - See the effects of extra resistances added in series with voice coil
 - Improved graphs with -3dB (F3) point
 - Save graphs as metafiles or BMPs
 - Microsoft Access™ 2.0 'Jet' database engine
 - Supplied on 4 3.5" HD disks for £35.00 all inclusive - a must for all audio DIYers.
- For details & order coupon write to: Three Crowns Publishing, PO Box 5773, Laindon, Essex SS15 5FJ tel: 0410 225257. E-mail: tcrowns@mc-h.demon.co.uk.

See also <http://www.monitor.co.uk>

PC Windows™ Programs



Hundreds of titles available for shareware prices - if you're using Microsoft Windows™ then you're sure to find something useful among these - includes applications for business, Windows™ tools & utilities, educational, 'miscellaneous' & 'interest' programs & of course games. Also available: Make your own Windows™ help files, Web HTM(L) page translator, disk & backup copiers, measurements converter, label maker, stock control database, working demos of PaintShop Pro™, Drag 'n' Zip™, PagePlus™, etc., astronomy, chemistry - write for latest list to: PO Box 5773, Laindon, Essex SS15 5FJ or send 1 3.5" HD disk for free on-disk catalogue.



Professional 88-108MHz FM Broadcasting Kits

With a Veronica FM kit you will experience stable and predictable results unlike any other kit you may have bought in the past. Our kit range also includes stereo coders, audio compressor/ limiters, antennas, power amps and other broadcasting accessories

Typical Applications

- Hobbyist /DJ
- RSL Broadcasting
- Hospital Radio
- Student Radio
- Local Radio
- Community Radio

We Ship Anywhere In
The World And Prices
Start At £9.95

PLL Transmitter Kits
Licensable In The UK

High Quality Screen
Printed PCBs

Clear Instructions
and Schematics

Ready Built and Tested
Service Available

Contact us for a free brochure including
prices and more detailed information

Tel 01274 883434
Fax 01274 816200

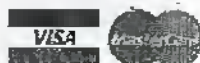

veronica@legend.co.uk <http://www.legend.co.uk/~veronica/>
18 Victoria Street, Queensbury BRADFORD, BD13 1AR, UK

PROJECT

Video DISTRIBUTION AMPLIFIER CASE



The Project Team had already developed the Audio / Video Modulator (AVM) and dressed it in a cool blue case that looks heaps better than the standard black plastic coffins. The case dimensions were chosen to complement the AVM and sprayed in the same colour. A future project, the Time Date Stamp will be appearing in a similar costume. The three units comprise what we have loosely termed 'the Video Stack System'.

What's in the kit?

The kit comprises the case and all the necessary hardware to allow a complete Video Distribution Amplifier (VDA) unit to be constructed, but the VDA, LU79L, must be purchased separately. The case is folded from mild steel and finished in a glossy powder-coat. This paint is a very hard-wearing type designed to cope with knocks, bangs and scrapes.

A 2.5mm standard, and I mean standard not some other vague size, power connector is rear panel mounted. Four hi-quality, 75Ω BNC sockets are rear panel mounted to provide the full output capability of the VDA. A front panel mounted BNC connector provides the input connection.

The VDA pots that control gain and allow for high frequency boost, something you don't find on other units, are front panel mounted. Exactly where they should be! To complement the other units, and help with diagnostics when things don't work, a front panel LED indicates that power is present.

The kit also contains all the internal connecting wires and insulating sleeves in excess length to allow for the slight cutting errors. Just to finish, we even included the same style of feet.

Designed by The Maplin Project Team

Back in March '97, Maplin Electronics released the Video Distribution Amplifier Kit. This kit outperformed the current ready-built units that were similarly priced. It did, however, have one major disadvantage. The constructor had to drill and cut and ream and file and paint and label their own case.

How it works

This is the subject of a separate instruction leaflet, XZ10L, or read the article in the Electronics and Beyond magazine, back issue 108 XD08. Of course, if you buy the case you will almost certainly want the VDA and the instruction leaflet, with the function description, is included in the kit.

Putting it together

This is the easy bit (there isn't a hard bit). Cut screened wires, wire ref. 12, 13, 14, 15 and 16 to the lengths in the wiring schematic Figure 1. The screened lead is the grey lead.

Prepare the ends as shown in Figure 2, preparing the screened leads. Don't worry about being too precise with the dimensions, just try to keep the centre core insulation as short as possible. Twist the wire ends, including the screen ends (there should be one on each lead, not one on each end of every lead) and tin them. Cut ten 20mm lengths of the larger heat-shrink sleeving. Slide one piece over each end of the prepared screened leads. On the cable end where the screen has not been removed, make sure that the sleeve passes over both the centre core and outer screen.

Cut the unscreened leads to

FEATURES

Fully punched and silk-screened case

Matches other units in video range

Provides all parts required except 'amp kit'

Power on indicator

Provides four video outputs

APPLICATIONS

Custom-made case for Video Distribution Amplifier LU79L

Modular unit of 'Video Stack System'

the lengths shown in Figure 1. Trim 6mm from both ends of each unscreened lead. Twist the stripped ends and tin these. Make sure that all the cores are twisted and tinned because any spare ends will cause shorts and may cause serious damage to the DVA.

Make a small hook in the ends of all the leads, including the screens, using a pair of snipe nosed pliers. Pass the hook over the Veropins on the VDA PCB and tighten them gently with the pliers. This stops them slipping when you solder them. It is sensible to proceed one lead at a time, fixing and then soldering each before starting the next lead. The screened leads should stand vertically from the board allowing the sleeving to be passed down over the bared ends and the Veropins. Shrink

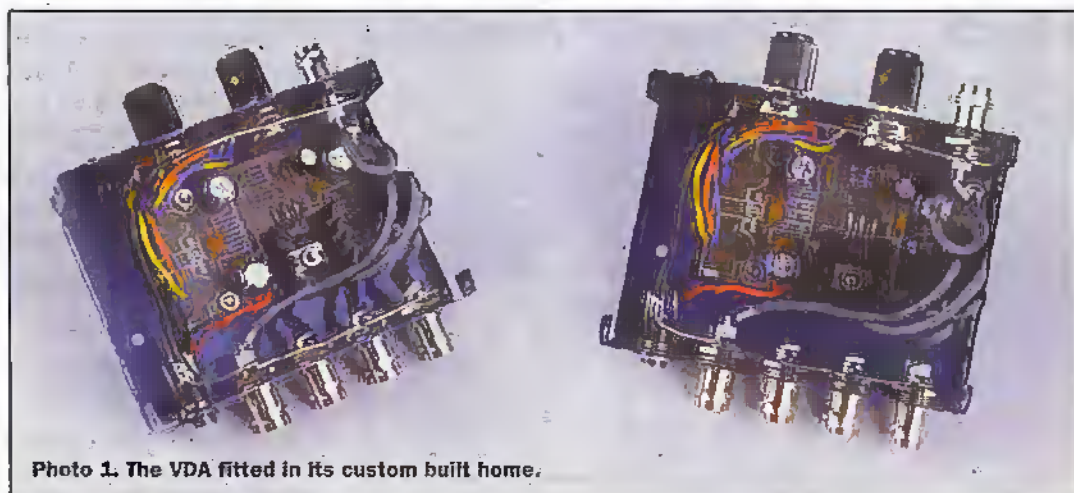
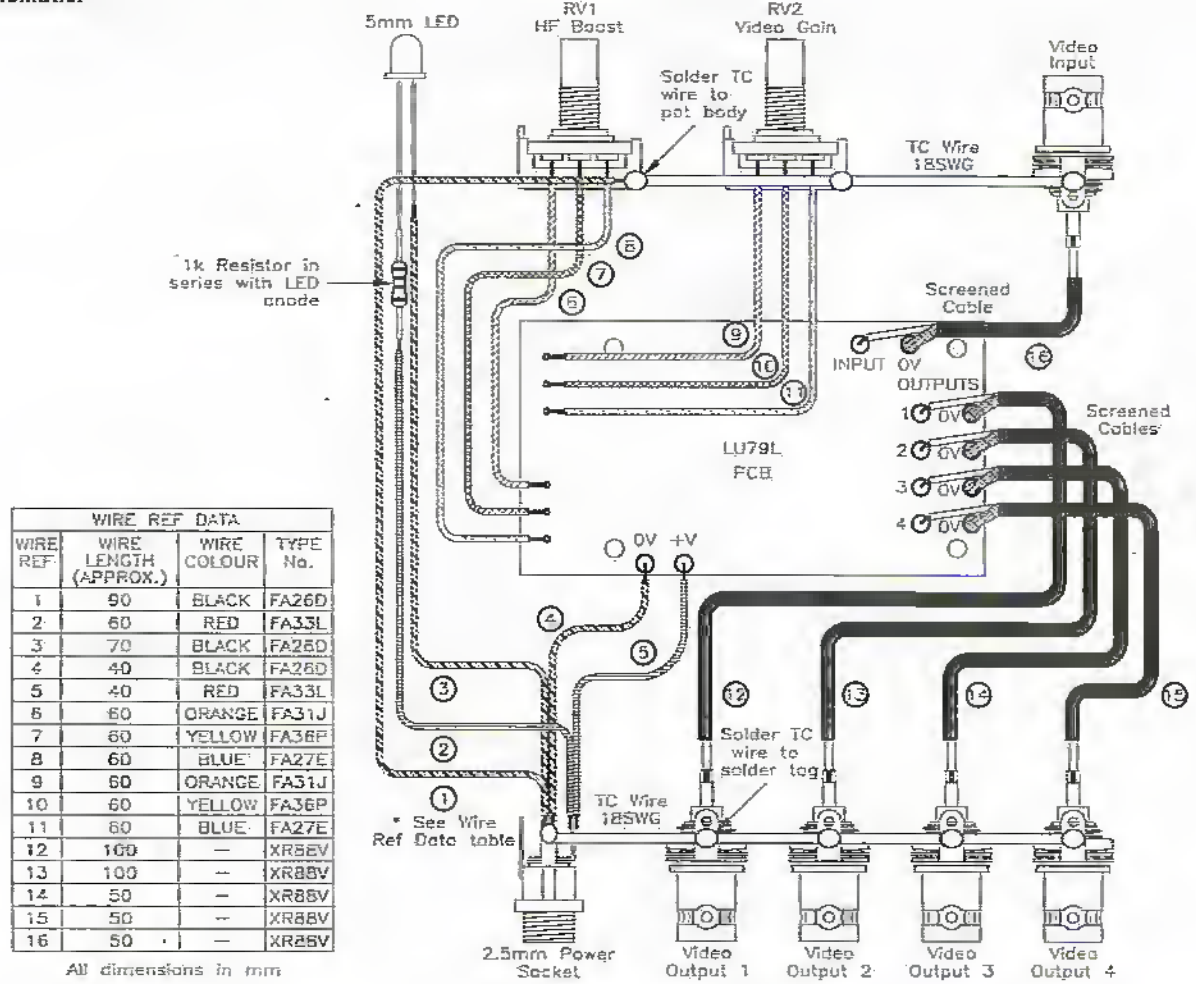

Photo 1. The VDA fitted in its custom built home.

Figure 1.
Wiring schematic.



each sleeve in place.

This is normally done with a hot-air gun but you can use a (very hot) hairdryer instead. If neither of these is available use a soldering iron held close but not touching the sleeving. As a final resort a match or gas-lighter flame held close will do the job but be careful not to burn the board, components, other leads or your fingers.

When all the wires are in place fit the LED clip by pushing it in from the front of the case. Snap the LED into the clip from the back. Note the long leg and bend it near the LED body to identify it later. Now trim the legs to around 10mm. Trim the legs on the resistor to 10mm and solder one end to the long LED leg previously identified. This is easier if both legs are pre-tinned and then held together with the snipe nosed pliers. Solder the red wire to the other end of the resistor and the black wire to the short leg of the LED.

Identify the upper side of the pot bodies by pushing them into the case. The pots have a small lug to stop them turning

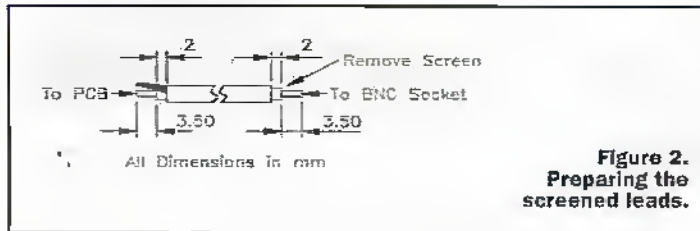

Figure 2.
Preparing the screened leads.

(only the shaft should turn) so they will only fit one way. Remove the pots and file through the plating on the top of each body to allow the 18 ssvg tinned copper wire to be soldered later. Tin the filed area. See Figure 1. Using a hacksaw, cut the shafts of the pot to 8mm measured from the fixing thread. File off any burrs and sharp edges. Fit the two pots as shown in Figure 3 to the front panel. Fit the input BNC as shown in Figure 1 making sure the tag is to the top. Bend the tag inwards so that it is flat when viewed from above.

Fit the power connector and the output BNCs to the rear panel. Again fold the tags so they are flat when viewed from above. Solder a length of tinned copper wire across the tags and to the connector, as shown in Figure 1.

Connect the free ends of the screened leads to the BNCs fitted to the rear panel. Push the sleeves over the connections and shrink them in place.

Slide the length of small-diameter, heatshrink sleeving along the red wire attached to the LED, over the resistor and over the LED leg. Shrink this in place.

Clip both the red and black wires from the LED to the power socket as shown in Figure 1. Clip the red and black wires from the PCB to the power socket as shown in Figure 1. Solder the red leads only to the power socket. Clip wire 1 to the power socket and solder in place with the other black wires.

Solder a length of tinned copper wire from the front panel BNC, across the pots as

shown in Figure 1. Don't forget to solder the wire to the areas on the pot bodies that were tinned earlier.

Fit the PCB in the case the same way round as shown in Figure 1. The hardware assembly schematic, Figure 3, shows how to pass the four screws up through the case base, through the spacers, through the PCB mounting holes and finally secure with the shakeproof washers and nuts. Tighten the nuts hand-tight or the shakeproof washers will cut into the surface of the PCB. Be careful not to move the board excessively as some of the connections already made may break.

Solder the wires from the PCB to the front panel BNC and to the pots.

Screw the rear panel to the case using the black self-tapping screws.

Double check all wires are soldered in the correct places! If you have a meter, check on the lowest range for continuity.

Slide the cover on and screw in place using the remaining self-tapping screws.

Figure 3. Hardware assembly schematic.

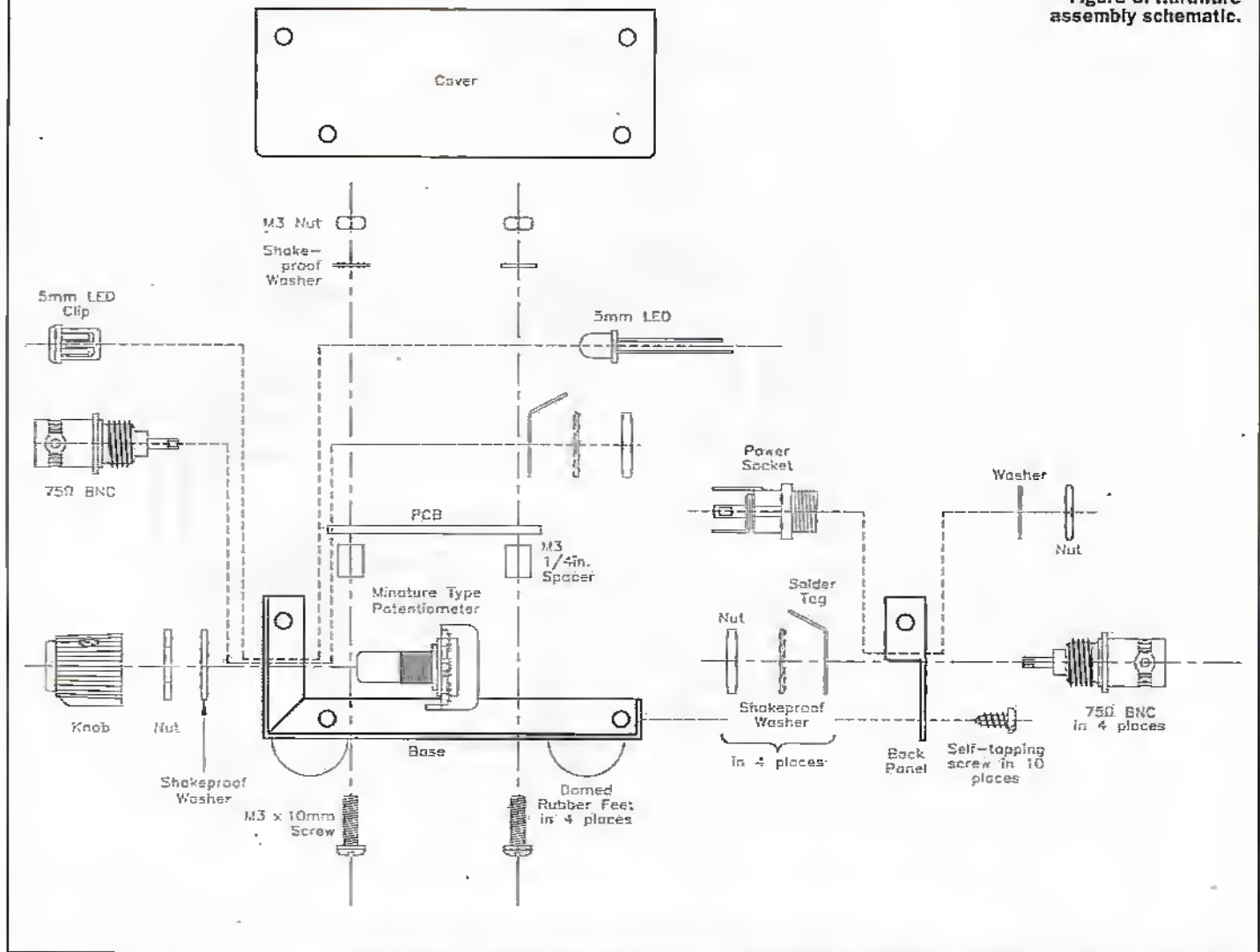

Testing your assembly skills

Connect a regulated 12V supply to the power socket noting that the centre-pin is positive. If all is well the LED will light brightly. If not, remove power and see troubleshooting later.

Connect a video source to the input BNC and a monitor to one of the outputs. Set the gain control and the HF boost fully anti-clockwise. If all is well the monitor will display whatever the video source is transmitting (logical?). If not, advance the gain until the image is clear and stable. Further information on control settings can be found in the VDA Instruction Leaflet.

Test each output in turn to confirm that they all work. It is a good idea to tap and (gently) shake the case while testing to locate any bad joints early.

Finally purchase the other units and sit and admire your new Video Stack System that the Jones certainly haven't got.

PROJECT PARTS LIST

RESISTORS: All 0.6W 1% Metal Film (Unless Stated)

R1 1k 1 M1k

MISCELLANEOUS

5mm Red LED	1	WL27E
75Ω BNC socket	5	FE31J
2.5mm Power Socket P/Mount	1	JK10L
LED clip	1	UK14Q
Heat Shrink CP48	200mm★	BF89W
Heat shrink CP32	30mm★	BF88V
Domed feet	1pk★	BP58N
Blue Pot Knobs	2	FE74R
M3 spacer 1/4"	4★	FG33L
M3 x 10mm Screw	4★	JY22Y
M3 Shakeproof washer	4★	BF44X
M3 Nut	4★	JD61R
Miniature Coax	350mm★	XR88V
18swg Tinned Copper Wire	150mm★	BL12N
16/0.2 wire red	100mm★	FA33L
16/0.2 wire black	200mm★	FA26D
16/0.2 wire blue	120mm★	FA27E
16/0.2 wire orange	120mm★	FA31J
16/0.2 wire yellow	120mm★	FA36P
Video Distribution Amp Case	1	NV74R
Video Distribution Amp Leaflet	1	X253H
Constructor Guide	1	XH79L

The Maplin 'Get-You-Working' service is available for both projects, see Constructors' Guide or current Maplin Catalogue for details.

The above items are available as a kit.

Order as LU82D (Video Distribution Amplifier Case Kit) Price £19.99

Please note: Items in the Parts List marked with a ★ are supplied in 'package' quantities (e.g., packet strip, reel etc.), see current Maplin Catalogue for full ordering information.

Troubleshooting

Thoroughly check all connections (and the VDA if you haven't already done so). If the unit functions on the video but the LED doesn't light then it is probably fitted the wrong way round. This doesn't mean the wires are poking out the front of the case but the connections are the reverse of those required. Unsolder the LED leads and re-solder them the other way round.

If you cannot find the fault, the Maplin 'Get You Working' service is available. See the ordering information at the end of this document.

Using the VDA

Full information on the use of the VDA is available in the VDA Instruction Leaflet. Details of the other kits mentioned can be found in the Maplin Catalogue. Note that at time of going to press the Time Date Stamp Kit is not complete and therefore not published. Full details will be available from the March '98 catalogue.

MONITOR BREAKTHROUGH!

SUN Graphics Display Monitors used by industry worldwide; sold on the strength of their quality and reliability but supported by ultra expensive Spare Stations now PC COMPATIBLE. These second user models are none interlaced have Trinitron F.S. Tubes. Resolution up to 1280 x 1024. Carry a 28 day RTB warranty. The secret lies in the unique graphics accelerator card which accompanies each monitor. Will run games to CAD packages. Your chance to have a Rolls Royce monitor at an affordable price.

MODELS AVAILABLE:

Sony GDM 1962 19" (18" viewable) £400
 Sony GDM 1662 17" (15½" viewable) £300

PRICES INCLUDE VAT - FREE DELIVERY



RFT Marketing Unit 6S, Hudson Road,
 Saxby Road Industrial Estate, Melton Mowbray,
 Leicestershire LE13 1BS.

TEL: 01664 66181

CONTROL & ROBOTICS from Milford Instruments

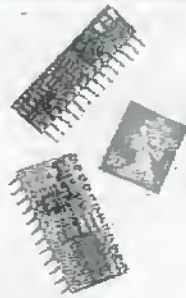

BASIC Stamps-
reprogrammable stamp sized computers
 Easy to use BASIC language

- 8 or 16 Input/Output lines each 20mA capability
- 80 or 500 Program lines
- Re-programmable thousands of times from PC or Mac
- 5-12VDC Supply. Stamps from £25.00 each.

Development Kits including programming software, Stamp, Cable, Project Board and 25+ Application notes from £79.00.

MUSCLE WIRES

Wires that contract approx 5% when heated (eg 250mA current) -120 page Project book and 3 one metre lengths of wire. £40.00



STAMP BUG

Autonomous roving insect using the BASIC Stamp as its "brain". Approx 300mm overall length. KITS FROM £29.00



LYNX ARM

5 Axis robot arm kit; approx size 300mm. Control from any serial comms port or Stamp. Includes software to run from PC. KITS FROM £85.00



All prices exclude VAT and shipping.
 For a full catalogue of the above items and other products, please call or fax Milford Instruments at 01972 683665; Fax 01972 681465.

JAB Electronics

F.M. BROADCAST TRANSMITTERS

Fully Built, Boxed and Tested
 Prices start from as little as £30.00

RSL Professional Transmitters
 V.F.O. High Quality Transmitters
 Limiters / Compressors
 Stereo Encodes

JAB Electronics, 96 Roof of the World
 Boxhill Road, Tadworth
 Surrey KT20 7JR

Tel: 01737 842774

KEVIN JARVIS ELECTRONICS LTD

Stockists of Surplus
 Electronic Components,
 Computer Parts and
 Finished Products

SSE

Solid State Electronics (UK)

Manufacturer of Scanning,
 Ham Radio, Short Wave
 and CB Accessories

**SEND FOR YOUR FREE CATALOGUE
 AND PRICE LISTS NOW!**

PHONE, FAX OR WRITE

Telephone: 01703 325999
Facsimile: 01703 236307
 27M Park Road · Southampton · SO15 3UQ

Philips' CD-RW drive and disc.



Making YOUR OWN CDs

..... PART 2

In the second part of his article on making your own CDs, Martin Pipe examines how to install the hardware, and the mechanics of CD mastering. Plus a look at MPEG audio.

Last month, we discussed the equipment that you will need to make your own audio CDs. The applications are enormous – anything from instant-start radio station jingles to compilations where you choose the tracks. To summarise, the whole concept hinges on a computer peripheral known as a CD burner, plus a special variety of blank disks that are dropping fast in price. CD burners were originally intended for the creation of data disks – until some clever dick put two and two together, and wrote software that allowed personal computers to make audio CDs. You could, for the first time, copy a PC's proprietary digital audio recordings across to a blank CD in the industry-standard Red Book format developed by Sony and Philips – companies that, by the way,

produce CD burners.

Later generations of this software allowed the copying of CDs digitally – in other words, with no perceivable loss of quality. What's more, there's no need to worry about SCMS – a copy-protection system that prevents anything further than a first-generation digital copy from being made. SCMS (Serial Copyright Management System, examined in last month's article) is a fixture on DAT machines, consumer DCC and MiniDisc digital audio equipment, plus the new breed of consumer audio recorder. Although the pirating of music is always an activity to be frowned upon, don't you think that it's an amusing irony that Sony and Philips' not only produce recording equipment able to get around SCMS, but also own record companies likely to be affected?

Soundcard Issues

In most instances, you get the audio – tape, tuner or records (the latter with an appropriate preamplifier, like that discussed last month) into your computer using nothing more exotic than a soundcard, a peripheral to be found in all Macs and the vast majority of PCs. It is worth bearing in mind that some PC soundcards are better than others (the Mac's in-built audio, however, is consistently good). Some of the cheaper ones have a restricted frequency response, and add noticeable distortion – even in their supposedly CD-quality modes. What is particularly interesting is that I have noticed a difference between cards that use the same chipset – and have thus presumably been designed from the same semiconductor manufacturer's application circuit!

Inside all consumer PC

soundcards is an analogue mixer that combines the output from the DAC (for playing digital audio clips in all modes except recording), line input, CD audio (attached to the CD-ROM drive's line output), mic input and integral MIDI synthesiser. Levels are varied from the GUI, via a control panel with virtual sliders. The output then goes to or to the line output and/or in-built amplifier, and to the ADC during recording. Different sets of adjustments are available for both recording and playback; in Windows 95, for example, the recording settings are tucked away under Control Panel/Multimedia/Audio/Recording.

A consumer design based around the use of VCAs, the typical soundcard mixer is hardly audiophile quality – on paper at least. Soundcard mixers, many of which offer the potential for further sonic degradation through the provision of tone controls, loudness compensation, stereo wideners and other such gimmicks, are built down to a price. The same is true of the 16-bit ADC and DACs built into such peripherals. That said, the results can be more than adequate for all but the most discerning of ears. Indeed, I have transcribed some of my old vinyl LPs to CD (using an audiophile turntable and preamplifier) and the results have often bettered the 'official' CD issue. That's not to say you can't get the potential for better, though. There are professional sound cards – more of which later – designed for no compromise capture of audio to hard disk.

A problem that many notice from consumer soundcards is a poor signal-to-noise ratio; indeed, this can spoil classical or uncompressed (i.e. not FM radio) live recordings. There are ways around this. The first trick

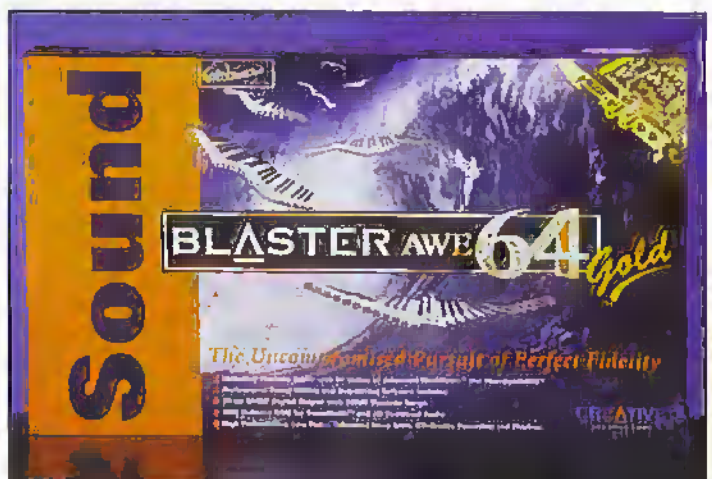

is to ensure that all unwanted inputs (i.e. anything that isn't the line input) are switched off (i.e. muted) or, at the very least, turned right down during recording. The microphone and CD-ROM audio inputs are particularly bad in most cases. Another trick is to try relocating the card in a different expansion slot, preferably one that is as far away as possible from other cards in your system. It is surprising the difference that can be made here; it would appear that some expansion cards chuck out rather more interference than others. Note that the chips on soundcards are normally well-decoupled; noise carried via the power supply is seldom a problem ('scope it and see!'). The ultimate solution would involve enclosing the soundcard in a shielded envelope, and connecting it to ground – thus eliminating the pick-up of stray signals floating around in your computer. It has to be said that there are lots of these!

The old Creative Labs Soundblaster 16 is one of the best consumer-level soundcards ever produced – if you don't count the naff FM synthesiser. In particular, it has a surprisingly high standard of audio and lends itself well to audio CD mastering. Indeed, it was one of the input devices used in the research of this article. Soundblaster 16s can be acquired rather cheaply on the second-hand market; the typical home user tends to chuck these away in favour of inferior models that offer WAVEtable synthesis and thus do games better'. In my junkbox is another Creative Labs Soundblaster 16 SCSI, in which one of the mixer's analogue stereo channel inputs has died. At the moment, I am working on a method of bypassing the mixer (the C11745A) chip, which should yield an even better sound quality. I will hopefully be able to give you a report in the final part of this article. It's down to getting hold of a datasheet for the device – which is available to OEMs – from Creative Labs.

Other Creative Labs soundcards are good for CD mastering; this, plus their excellent level of support, makes them the only serious consumer choice. The physically-impressive AWE32 is essentially nothing more than a Soundblaster 16 with WAVEtable added, and I have discovered that it offers much the same level of performance. Creative



Labs latest top-of-the-line product, the plug-and-play AWE64 (and its up-rated gold derivative, with phono output sockets) goes one better – this is truly an excellent-sounding consumer card. A future card, due for release next year, will incorporate digital mixing (presumably it will have ADCs for each analogue input channel, or a complex multiplexing system) and SP/DIF digital I/O at an affordable price.

Cream of the crop are the Terratec EWS6-EXL – which will be examined next month – and the Turtle Beach Fiji. Both of these specialist 400 soundcards offer coaxial SP/DIF (Sony-Philips Digital Interface) I/O. The Terratec goes one step further by including a Toslink

optical digital input. This, like the coaxial digital connections, is located on a terminal module that occupies a spare half-height 5.25in. drive bay. Thanks to the digital input, you can plug in your DAT, MiniDisc or DCC deck in directly, bypassing the analogue and conversion circuitry at both ends. Ideal if you want to transfer your live recordings to CD with no loss of quality – the DDD label on that CD looks good too, doesn't it?

Although the facility has benefit for our application, it's included primarily for transferring audio across for use by the sampler – another musician-friendly feature included in both cases. Both Terratec and Turtle Beach are capable of working full-duplex at 16-bit – something that really

comes into its own if you're into direct-to-disk multi-track recording (these cards are aimed at musicians). The analogue circuitry is also up to scratch; phenomenally-low figures are quoted for distortion, signal-to-noise ratio and crosstalk are quoted in both cases (conversely, consumer cards seldom quote such figures in their specifications!). The conversion circuitry is superior – the Turtle Beach specifies a 20 bit DAC and ADC, while the Terratec is 18-bit throughout.

If you don't want to spend £400 on a SP/DIF card, there's a much cheaper alternative. The 17 Audio Excel AV310, which employs a single chip (the CMI 8330) for nearly everything, has SP/DIF input and output. Unfortunately, it's designed primarily for use with CD-ROM drives that have a digital output, which is at TTL-level. Proper SP/DIF specifies an transformer-isolated peak-to-peak signal of 0.5V. What's more, the AV310's analogue performance is decidedly ropey; it goes into distortion all too easily. Next month, we'll concentrate further on mastering from digital sources, and examine the AV310's potential still further.

Interfaces and Stuff

Whatever your choice of soundcard, it has one job in life as far as CD mastering is concerned. It has to take the audio input (whether digital or analogue) from the outside world, process it where necessary and store it as a 16-bit, 44.1kHz stereo (i.e. CD-quality) WAV or AIFF file. That brings us onto the next point. Lots of hard disk space will be needed – remember that a complete CD will hold up to 74 minutes of music. In the knowledge that a minute of CD audio consumes just under 9Mb of a CD, you're given some idea of how much space you'll need. Modern ATA-3 (IDE) drives are more than capable of handling real-time transfer of digital audio, and capacious drives (how does 4Gb sound?) are now available for less than £200. If your own PC has a IDE disk suitable for digital audio, it's worth considering a CD burner with the same interface.

My own preference is for SCSI; since I tend to work with digital video, my hard disks are high-performance high-capacity SCSI models. They are



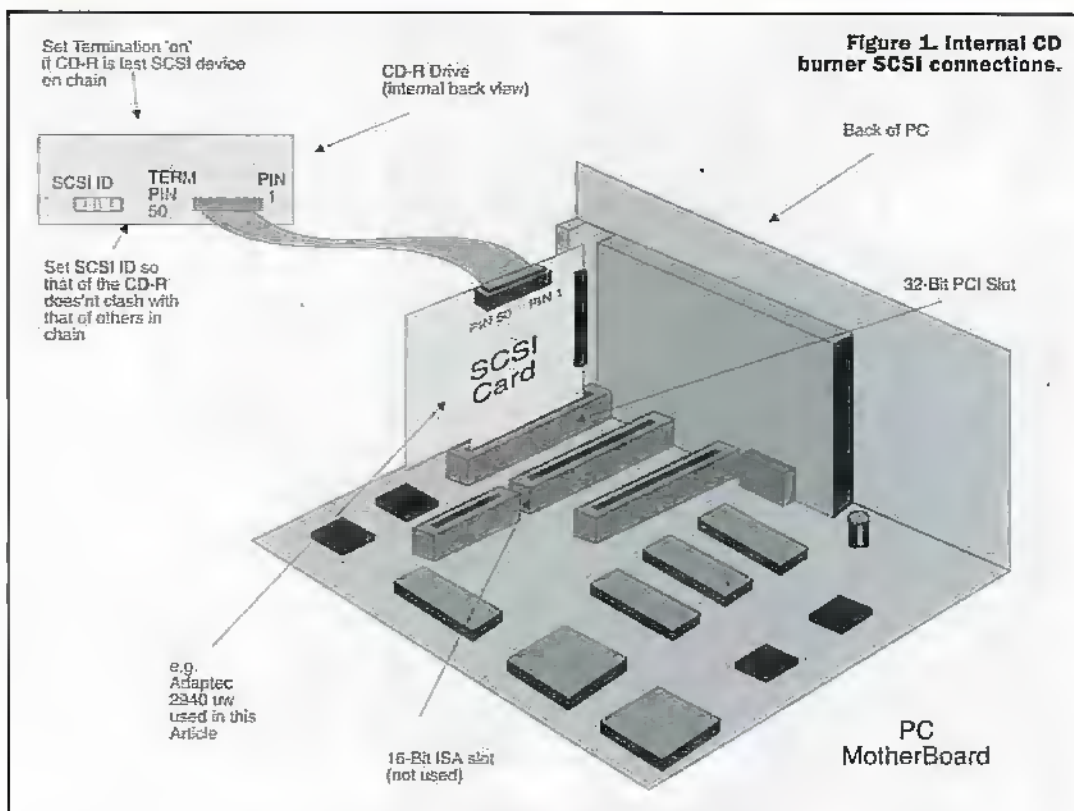

Figure 1. Internal CD burner SCSI connections.

interfaced to the PC by means of an Adaptec 2940UW host adaptor, a bus-mastering PCI card. A decent disk subsystem, capable of sustaining the throughput dictated by the CD burner's writing speed, is essential. During the writing of CDs, the writer must have a steady stream of data. The CD burner has a buffer (typically 1Mb in size), which is designed to compensate for instances where the flow of data is interrupted (by, for example, a thermal recalibration process within the hard disk). The buffer can only go so far; if it empties at any point during writing, then you'll get a buffer under-run error message – and a ruined CD-R. You are best advised to tweak your system for optimum performance (for example, disabling screen savers and enabling bus mastering and 32-bit disk access – if supported).

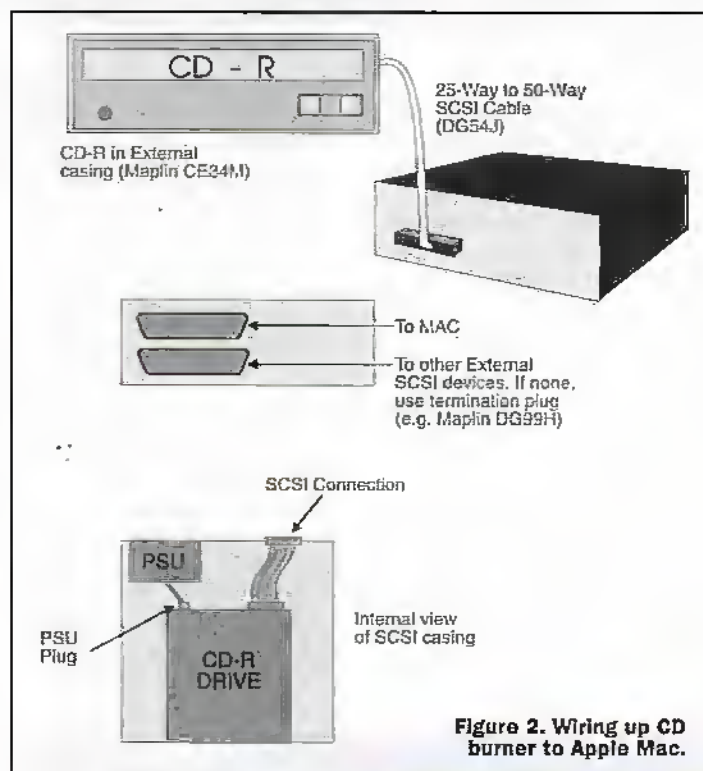

Figure 2. Wiring up CD burner to Apple Mac.

Details of how to install a SCSI CD burner are given in Figures 1 - 3. The basics behind SCSI are straightforward enough; up to seven individually-addressable devices (plus the controller) can be simultaneously daisy-chained with SCSI 1 and SCSI 2. The latest SCSI specifications, Ultra Wide and SCSI 3, will address up to 15 devices (plus the controller). Each device must have a unique address (or 'ID'), which is set via jumpers or DIP switches; the controller resides at ID7. Available SCSI peripherals include, hard disks and CD burners apart, scanners, DAT tape drives (which won't read audio DAT tapes, in case you were wondering!) and SCSI CD-ROM drives (which support digital audio extraction!).

The next issue is that of termination. Each end of the SCSI bus must be terminated by a resistor pack, or reliable operation – essential during the burning of a CD – isn't guaranteed. The SCSI bus is, after all, a series of transmission lines. Failure to terminate them properly could result in reflections, and hence corruption of the datastream. Most recent SCSI host adaptors, such as the Adaptec 2940, support automatic termination. Normally, these cards will terminate themselves if they detect one or more peripherals connected to either the internal or external SCSI buses. If they detect that both internal and external buses are in use, they then switch off their own termination. If this wasn't done, then there would be three sets of terminators in place – one at either end, and one in the middle!

Most PCs have sufficient internal space for a CD burner; as a result, you need only connect it to the internal SCSI 2 bus of the host adaptor via a 50-way ribbon cable (normally supplied with the card), and

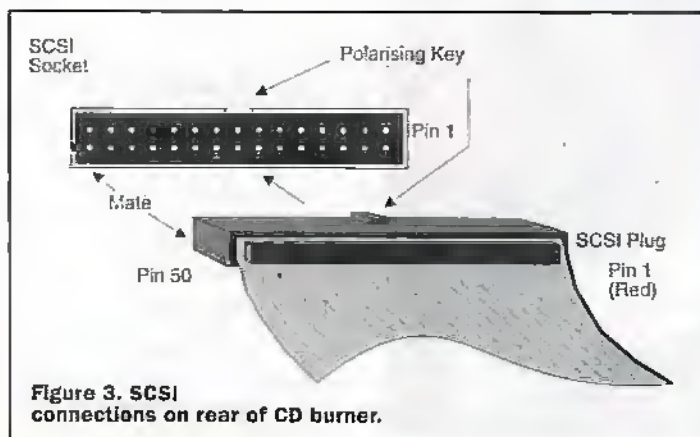
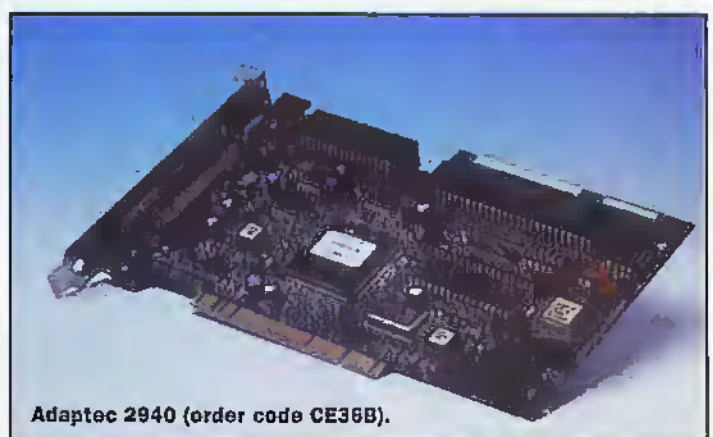

Figure 3. SCSI connections on rear of CD burner.



Adaptec 2940 (order code CE36B).

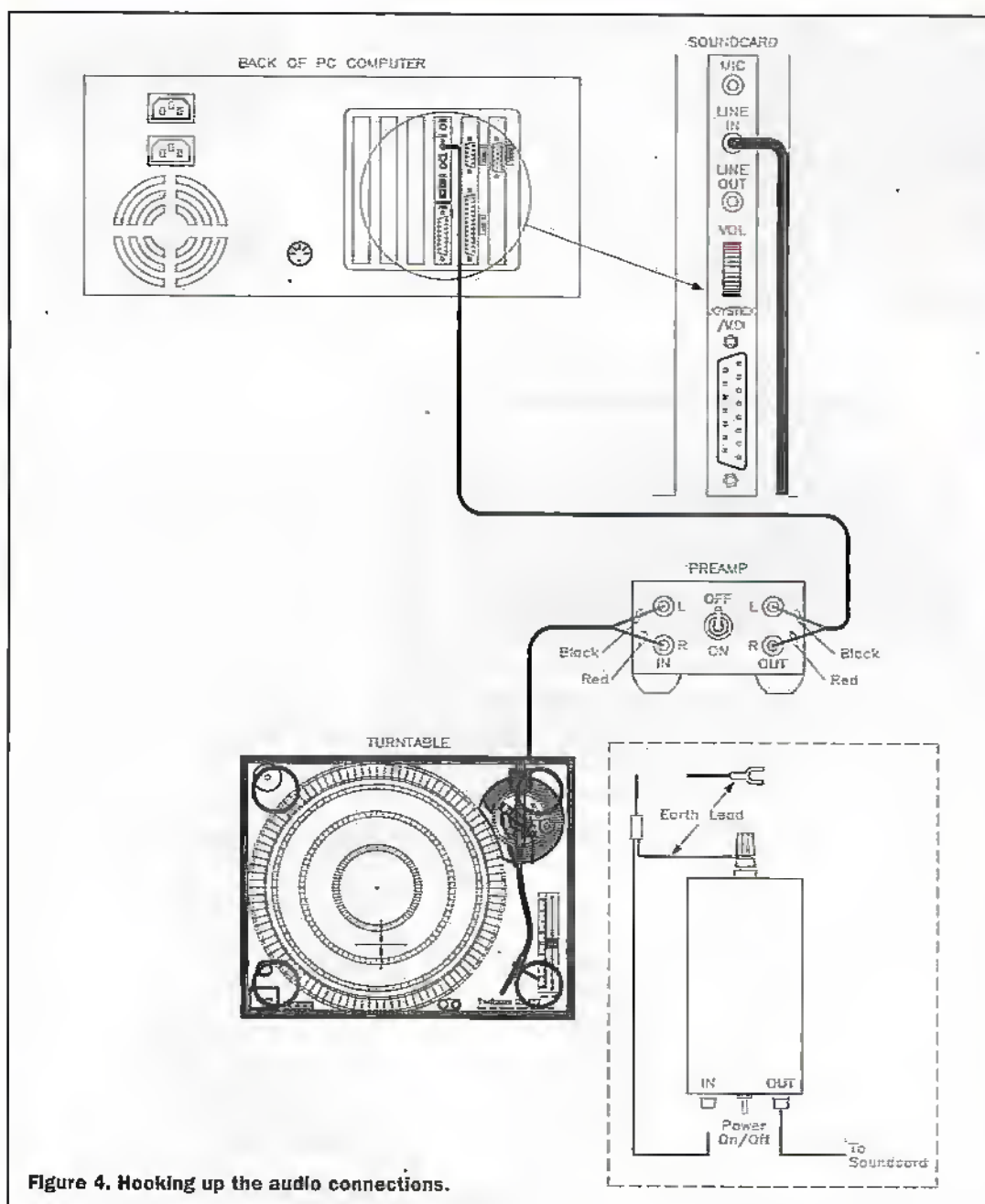

Figure 4. Hooking up the audio connections.

enable the drive's termination. As an alternative, you could build the burner into an external enclosure (such as Maplin's CD3-EM), a box that contains a half-height drive bay, external SCSI connectors and a switch-mode power supply. All Apple Macs have a SCSI interface, but few have the space for an internal CD-R drive; in these cases, external

SCSI enclosures are the only solution. To connect the case to the Mac's external SCSI port, you will need a cable with a 50-way Centronics plug at one end, and a DB25 at the other (Maplin order code DG541)

To connect to a PC, you'll need a different cable that does have a 50-way Centronics at one end. The connector at the other end will depend on your SCSI

host adaptor. If it's a Fast SCSI-2 card, then it will need to be a 50-pin half-pitch plug. If it's an UltraSCSI card, that cable will need a 68-pin half-pitch connector at its other end instead. The respective Maplin order codes are DG63T and DG66W. If the enclosed CD burner is to be the last device in the chain, ensure that the drive's termination is switched

on, or purchase a SCSI-1 termination resistor block (Maplin DG99H) that plugs into the second SCSI port on the back of the enclosure.

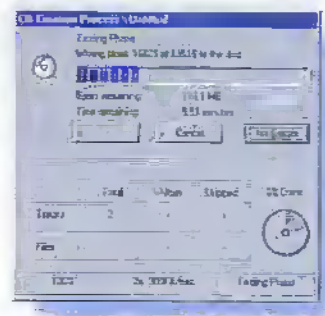

CD mastering software allows you to undertake a 'test run' in order to ensure burning will proceed without errors.

Audio Recording

Windows Sound Recorder will only capture audio for a few tens of seconds – clearly not long enough for music tracks. There are alternatives available, however. Adaptec's Easy CD Creator Deluxe, a commercial Windows 95/NT 4.0 (Mac soon!) CD mastering package that sells for £80 or so, comes with a neat application that goes by the name of Spin Doctor. This includes not only a WAV recorder (with a useful recording level indicator) but also some neat DSP features. It will average out the audio levels of a series of captured songs, avoiding drastic changes in volume when you come to play the final CD. There is also an effective noise reduction filter, for cleaning up scratchy records or hissy tapes. Don't be tempted to use it unless absolutely necessary – it does add distortion (such as sibilance, particularly at the higher settings), and is an off-line process that takes ages to complete. Audio editing programs, such as the popular shareware CoolEdit 96 and Goldwave (available from various sites – check out the various text-string search



External SCSI casing (order code CE34M).



SCSI terminator (order code DG99H).

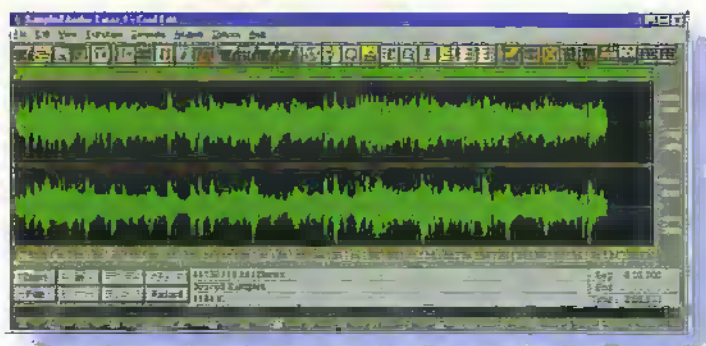

Cool Edit - a flexible shareware program.

engines on the Internet, like <http://www.altavista.digital.com> and <http://www.shareware.com>, can also be used to capture audio, and are particularly handy if the CD mastering software doesn't make provision for capturing analogue audio for transcription to CD – and most don't. The correct recording levels are important, to avoid distortion; I recommend experimenting with clips from songs first, in order to determine the optimum level.

Audio editing programs are capable of a lot more than simple capture, however. You can accurately trim clips (to dispose of vinyl lead-in and lead-out grooves, example), and carry out smooth fades. Other effects include sample rate conversion (if, for some reason, you want to commit a mono 8-bit file to CD, you can), various DSP noise filter trickery and other post-production effects like echoes, channel swapping and panning. Be warned, though – since we could be working with files over 100Mb in length, processing times can be rather long. For example, a trim operation on Goldwave can take nearly 10 minutes, if the time-consuming creation of temporary files is factored in. Those temporary files also consume oodles of hard disk space!

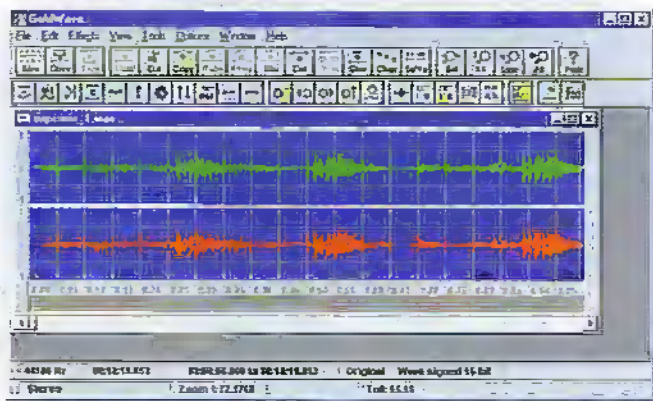

Goldwave, an excellent shareware audio editing program.

The CD mastering software supplied with burners, notably Easy CD Pro (Mac and PC) also makes provision for the copying of audio CDs (or data files, for that matter). An add-on program for Astarte's Toast, CD-Copy, allows the same ends to be achieved on Apple Macs. Typically, the audio tracks are converted into digital audio format and stored on the hard disk; a 'drag and drop' interface allows you to select the desired pieces of music from the original disc. CD-sourced tracks can be combined with other material that you have captured (such as vinyl records) to generate flexible compilations. As an alternative, some programs allow you to copy the entire disk in one go if your CD-

ROM supports digital audio extraction. Interestingly, Adaptec includes one with its SCSI utility suite (EZ-SCSI v4). Effectively, the data is shunted from the CD-ROM straight across to the CD burner across the bus. Multi-speed copying of CDs is possible if your equipment supports it – a high-quality version of the twin tape deck, if you like...

If your mastering software doesn't support extraction of



Shareware MP3 players.

CDD2600, the audio quality of a CD capture may be spoiled by background noise. The reason behind this is jitter. Thankfully, freeware jitter-correction programs can be found on the Internet. Indeed, jitter correction is built into CD Worx (which can be downloaded from <http://www.inote.com/~ryubk/cdx9521z.zip>)

By now, you should have a collection of digital audio files on your hard disk, all of which should be 44.1kHz, 16-bit, stereo. It's now time to make

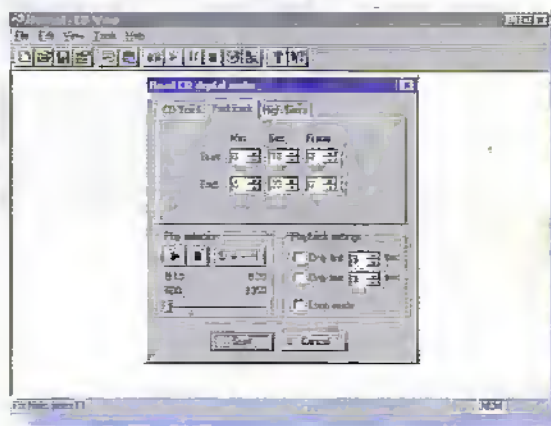

CDWORX allows audio tracks to be extracted from CDs - if your CD-ROM drive is up to it!

audio from CDs digitally, then some shareware and public domain programs can help. Another command-line program for the PC, CD-DA, allows you to specify tracks by number and write them to the hard disk as a .WAV file. The shareware program, which also supports weird and wonderful formats like CD-I (remember that?) is available from many Web sites as da2wav17.zip, as is the simpler CD Grab program (cdgrab.zip). A Windows 95-based shareware alternative is CD Worx. Note that you'll need a CD-ROM drive capable of digital audio extraction – all of the SCSI drives I know of *are*, and some recent IDE/ATAPI models can apparently handle it as well. You could, as an alternative, use the CD burner for extraction; this is certainly true of SCSI models. In some cases, certainly the Philips

your CD, using the mastering software supplied with your drive. Windows 95 programs, like Adaptec's Easy CD Creator, benefit from a wizard that guides you through the process. The first job is to select the type of disc that you want to create. In most cases, this will be an audio CD (i.e. Red Book). As an alternative, you could select 'mixed mode'. This allows you to put both data and music onto the same CD. Audio CD players won't play the first track, which contains the data.

Or rather they will – the track registers on the time-elapsd display – but muting is engaged to prevent what would be a terrible racket from damaging your ears or speakers. The next stage is to add the tracks (and/or files, if it's a data or mixed mode disc) to a playlist that is an essential part of the

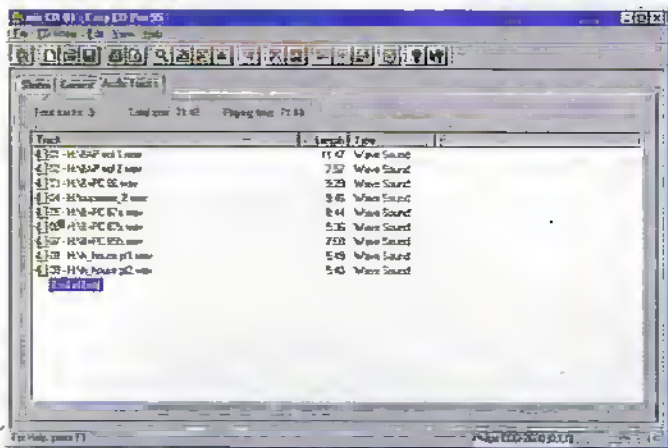

Audio track listing on Easy-CD Pro 95, CD mastering software supplied with the Phillips CDD 2600 - and many other burners.

mastering program. Up to 99 tracks are allowed by the Red Book standard – enough for anybody. It's an easy process, and mastering programs will tell you – typically via a percentage bar – how close you are to filling the CD. I would recommend that you fill the disk in one go where possible – splitting the activity into multiple sessions may cause incompatibilities with audio CD players, although pretty much all CD-ROM drives are able to read so-called multisession discs.

And now it's time to make

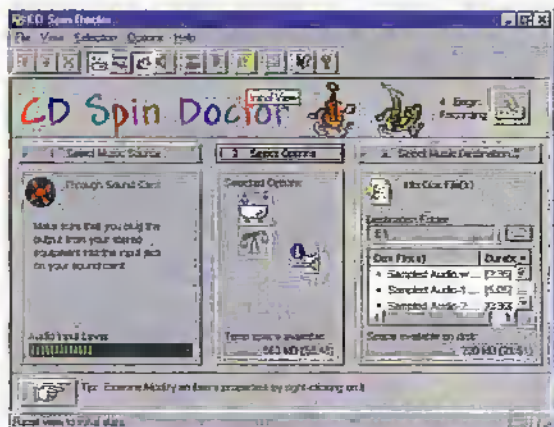

your CD! Various options are available for writing. The first, and most obvious, is the writing speed (1x 2x 4x, depending on your burner's capabilities). Although it's tempting to go as fast as possible – and it's better for the disk too, the writing speeds should be matched to the PC's performance. Test options allow you to empirically determine the fastest practical speed. Another common writing feature built into many CD mastering programs is the oddly-named 'disc-at-once', which dispenses with the two-second gap that CD players automatically place between tracks. Handy for mix-type dance compilations, or classical music.

In the majority of cases, it is also possible to create a disc image – a representation of the audio and/or computer data as it will appear on the CD. This option is useful if you plan to make several copies, or produce a mastering file suitable for mass-duplication by an external agency. Unless the CD is to be a multi-session disc, check the 'close disc' option, which ensures that the CD can be read on all equipment – but not subsequently added to. Discs that are still 'open' can, in my experience, only be read by CD burners. It is also worth pointing out that around 15Mb

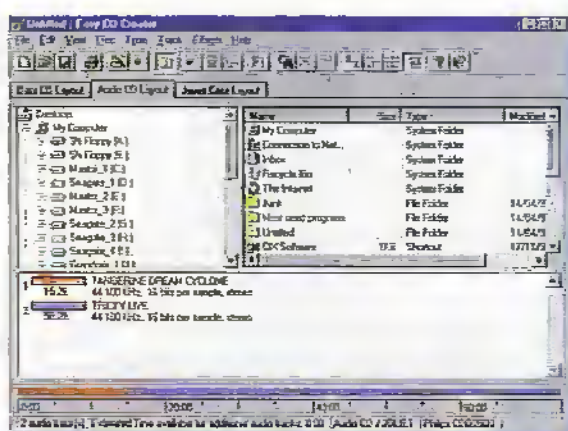

Producing audio CDs with Adaptec's Easy-CD Creator.

Toast - a Mac CD mastering application that can handle the creation of audio discs.



Spinductor, included with Adaptec Easy CD creator.

of the CD's capacity is wasted between each session and the next, so don't use multisession writing unless you have to!

An option particularly recommended, particularly for the first few runs, is the speed test. This takes the form of a simulated write, and is good for assessing whether your system is capable of providing the continuous flow of data needed by the burner. If you get buffer under-runs – which would ruin a disc during actual writing – try

a lower speed. The Adaptec programs are well thought-out in this respect. They will test-write at the highest speed first of all. If successful, writing will automatically proceed. If an error is encountered, then successively-slower runs are tried until no errors are reported, at which point writing at that speed commences. At the end, you should have a disc that is compatible with all of the CD equipment dotted around the home!

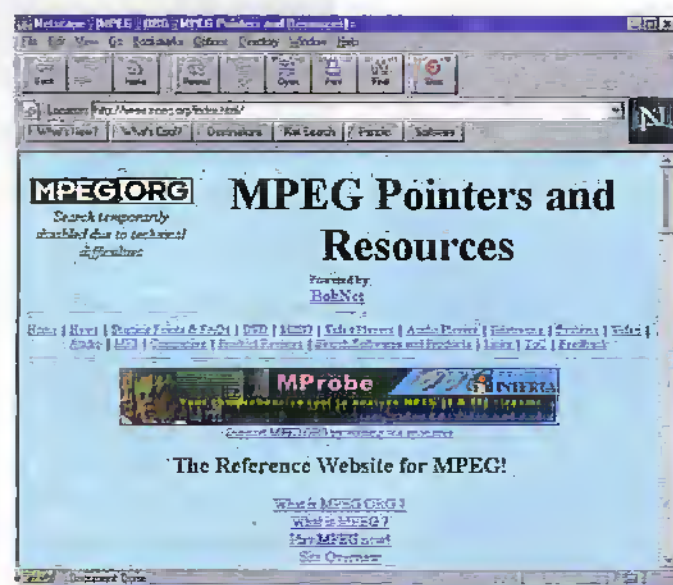

Useful information can be found at: <http://www.mpeg.org>.

MPEG Audio

MPEG audio has aroused significant interest of late, in both political and technological camps. Basically, it allows you to compress an audio file to less than one tenth of its original size with no significant loss of quality. The compressed file requires a special application for playback. MPEG audio was designed for satellite communications and CD-quality broadcast links over ISDN.

However, it is also becoming popular in the world of CD. Games and multimedia developers use MPEG audio to maximise the disk capacity. For the same reason, take-up among owners of CD burners is similarly strong. You can fit several hours of CD-quality music onto a single 650Mb CD-R. MPEG audio CDs could provide background music while you work, or simply be utilised as a great audio archiving medium. The problem is that your computer needs to be powered up on whenever you want to listen to any music that's been recorded in the MPEG audio format; the files are recorded as data (ISO9660 for cross-platform accessibility, Joliet for Windows '95 and NT4 long filenames) and as such can only be read by CD-ROM drives.

MPEG audio has been in the news recently, mainly because it is now seen as a threat to the music industry. Many enthusiasts are illegally uploading copyrighted songs, in MPEG audio format, to FTP servers for download by their friends – and anybody else who finds the servers in question. Theoretically, you could build up an impressive music collection without having to purchase a single CD. Whether you would want to is another matter – the average length of a file is 4Mb; quite a long wait when average Internet access speeds are considered, and a significant phone bill at the end of it! In the States, where local calls (and hence connect charges to ISPs) are free, it's another matter. Some US record companies recognise the potential of MPEG audio distribution, and are selling songs for download – just pop in your credit card details, and half an hour later the music's in your PC.

MPEG audio compression is very similar to the systems employed by Sony's MiniDisc and Philips DCC (the latter does, in fact, employ an early

form of MPEG audio). All of these systems achieve their impressive efficiencies by discarding information that cannot be perceived by the average human ear. Central to their operation is the fact that the ear can only hear sounds above a certain threshold. The level of this threshold is dependent upon the frequency of the signal, and is at its lowest point in the midrange (around 2 to 5kHz). Below and above these frequencies, ears become progressively less sensitive. In addition, some sounds will mask out others close in frequency but lower in amplitude. A system known as perceptual adaptive sub-band coding (PASC) is responsible for the encoding process.

The audio signal is split into 32 sub-bands by filters, each of which has the same fixed bandwidth. Next, the thresholds are determined for each sub-band by examining the amplitude of each sub-band, and the immediately-adjacent ones. Any signals above these thresholds are encoded; the others are discarded. During playback, the audio signal is synthesised out of these encoded spectral components. PASC is used in all variants of MPEG audio encoding. There are currently three of these, which are hierarchically-compatible – Layer 1 (developed for DCC), Level 2 and Level 3. All have the same header information, a similar resilience to errors and can work at a variety of sampling frequencies (32, 44.1, 48kHz).

Layer 1 is capable of working at data rates from 32kbit/sec to 448kbit/sec. The upper limits of Layers 2 and 3 are 384kbit/sec and 320kbit/sec respectively. All three can provide an audio accompaniment to MPEG 1 or video, or used in their own right. The main practical differences concern the levels

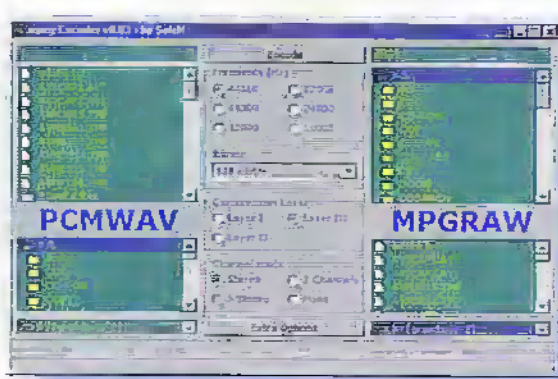

MPEG encoder a shareware for Windows 95.

of compression possible. Layer 1 could typically only manage 4:1 if CD quality was to be obtained, while Level 2 will deliver similar results at between 6:1 and 8:1. Level 3, currently the most popular, delivers the same quality at between 10:1 and 12:1. It is these levels of compression that have got people really excited.

Working with MPEG audio

Although hardware MPEG audio encoders are available, they tend to be rather expensive items designed for the broadcast industry. A much cheaper alternative is to do it via software, and there is much of this lurking around the virtual nooks and crannies of the Internet. The only disadvantage is that encoding tends to be an off-line process. You take your audio signal as a .WAV file (in the case of PCs), and stuff it through the encoder program. Some time later, you'll get an additional file (.Mpx, where x is the layer type; MP3, for example, is Layer 3) that contains the MPEG-encoded audio. The speed of conversion depends wholly on the performance of your system.

The Benc.exe and B3dec.exe MP3 encoder/decoder shareware PC programs, for

example, are available from many web sites in a single archive by the name of B3v261d1.zip. They originate from Fraunhofer-Gesellschaft, commercial German research organisation (<http://www.iis.fhg.de/audio>). This group was closely associated with MP3 development, and is also responsible for the popular Winplay3 MP3 player for Windows. The first program, Benc.exe is the encoder (uncompressed 16-bit .WAV to MP3), while the second is the decoder (MP3 to 16-bit WAV). Because they run under DOS, they're not particularly user-friendly. They will, however, quite happily work in a DOS box under Windows; there is no need to 'shell out'. Somebody has written a Windows 'front

MP3 file that was created from it. The fact is that one is over ten times the size of the other! You can specify the bit rate (and hence compression quality), plus other options. Some of these, such as the ability to handle a range of input file types (Sun workstation audio, for example), are disabled on the unregistered program; if you need them, you'll need the \$250 registration fee! The default options (112kb/s transfer) will suffice for most applications, in which case use is easy:

Benc input.wav output.mp3. It is probably putting both programs into your DOS directory (or making a PATH reference to them) so that they can be run from any drive or directory on your PC.

I found that Benc.exe was capable of converting a 3 minute .WAV file into Layer 3 MPEG in under 20 minutes, using a P133 (now old hat!) with 48Mb of RAM and plenty of SCSI storage. The output was optimised for CD-quality 112kbit/sec transmission; there is no discernable difference between the MP3 file and the original CD-sourced .WAV. The original 3 minute song, by the way, consumed over 31Mb of hard disk space; Layer 3 compression brought it down

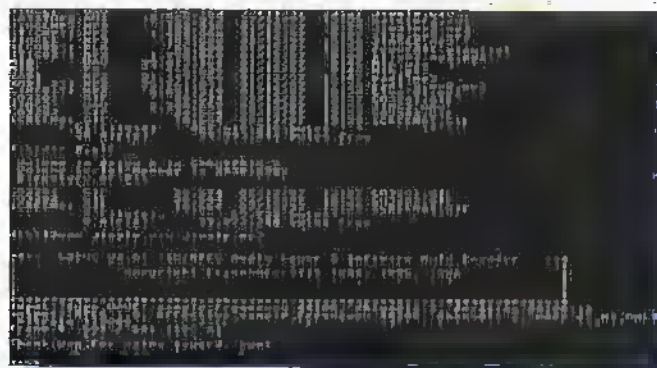

A DOS based WAV-2-MP3 file convertor.



L3DEC converts MP3 audio files into standard Windows WAV format.

end' for these programs, making them somewhat more user-friendly – no more grappling with that awkward command-line syntax! This front end, Visual Encoder, can be found at <http://members.vision.net/~flipino/coders.html>

The encoder is highly-flexible and delivers some highly impressive results. In nearly all cases, you can't tell the difference between a song extracted as a digital audio file directly from the CD, and the

to about two and a half megabytes. This corresponds to a 12.5:1 compression rate; pretty neat, huh? The second program, B3dec, is useful if you want to write a MP3 song to a CD that conforms to Red Book (and hence can be played on any CD hardware). CD mastering software will only produce these from WAV files. With some shops now selling music over the Internet as MP3 files, B3dec is definitely a useful program to have around if you

want to put your purchases on rather more convenient CDs. To create a standard WAV file from a MP3 the following command is used:

```
l3dec input.mp3 output.wav -wav
```

Most of the time, however, you'll use a simple application such as WinPlay, which lives at <http://www.iis.fhg.de/audio/> to play MP3 files that you've written to your hard disk. Such programs look rather like Media Player, although others are rather fancier in their user interface. Interestingly, Media Player will itself handle playback of the older MP2 (but not MP3) files if NetShow (<http://www.microsoft.com/netshow>) has been installed. This is because NetShow handles .asf (active streaming format) files – including MPEG audio – and the appropriate codecs are installed with the software. Other Windows 95 shareware players include the excellent WinAmp (<http://winamp.1h.net>), and MuseArc (from various sites).

Fraunhofer-Gesellschaft also markets, via its Opticom offshoot, a fully-commercial (\$400) MP3 encoding program for Windows 95. It's quicker and considerably more user-friendly than its DOS predecessors, and installs a codec that can be used by other Windows applications (such as digital audio editors). A freeware Windows-based alternative is MPEG Encoder, which at the time of writing can be obtained from its creator's web site (<http://users.bart.nl/~soloh/>). It's rather slow, but provides a lot of options. If you're prepared to accept Level 2 MPEG audio coding, then you might be interested in a shareware plug-in for the aforementioned Cool 96 audio editing program (<http://www.syntrillium.com/cool.htm>).

Players and converters abound for Mac, too. A powerful Layer 3 encoder – which requires a PowerPC – is available for Macromedia's Shockwave (it's a commercial \$300 plug-in for SoundEdit). Further details from the Macromedia web site at http://www.macromedia.com/support/soundedit/how/shock_sound_devtools.html.

A free alternative is the Mpeck Encoder, a PowerPC-native program that supports both Layer 2 and Layer 3 audio. It lives at <http://www.anime.net/~go/mpeckers.html>.

The only 680x0 Mac MP3 program that I could find was

MPEGAud, which is available in both FPU and non-FPU versions. The program, which supports Layer 2 only, can be found at <http://home.ptd.net/~warnergt/MPEGAud1.0.1a2.hqx>.

Mac MP3 players include the PowerPC-only MacAmp (<http://macamp.1h.net/getit.html>) and SoundApp (<http://www-cs-students.stanford.edu/~franke/SoundApp>), which will run on a 680x0 Mac with a FPU.

Windows 3.x programs are also available, although if your machine doesn't haven't sufficient power to run Windows 95, then it probably won't have the juice to run software MPEG (or, for that matter, CD mastering) applications. In the interests of those who still run Windows 3.x on the grounds of compatibility with Windows 95-incompatible (but nevertheless essential) 16-bit programs, here goes: The aforementioned WinPlay (<http://www.iis.fhg.de/audio/>) is also available for Windows 3.x, while encoding can be achieved using DOS (or the DOS window) to run l3enc.exe (covered earlier). The decoder l3dec.exe will also run in this way.

Iomega RecordIt, available for PC and (shortly) Mac platforms, is a commercial MPEG audio recording program currently being given away with 10-packs of Zip disks. You can also purchase it on-line from the US Iomega web site (<http://www.iomega.com/product/prodguide/softguide/index.html>) for \$40. RecordIt compresses audio sufficiently for it to be written without problem by the popular Zip drive – which, although much faster than a

floppy, is still no match for a hard disk – without any problems. RecordIt's core is the i-media compression technology bought in from the QDesign Corporation (<http://www.qdesign.com>). The compression is compliant with MPEG audio, and indeed the files that it produces can be read as Level 2 audio files, and as such converted into WAV by the command-line l3dec.exe program. Such files can also be played back through Media Player, because the relevant codec is installed within Windows.

RecordIt's main advantage over the others we've looked at is its ability to work in *real* time without any extra hardware – apart, of course, from the soundcard. The software offers four grades of compression quality (AM to CD), and an input selector (mic/CD/line). From then on, it's a case of hitting the record button to capture compressed audio to a named file. Another button provides file selection and playback. RecordIt works exceptionally well; comparing CD with a RecordIt recording (made at the highest quality setting) revealed no discernible difference. The hype implies that RecordIt uses MPEG 2 audio. That's not strictly true; the compression system behind the format is Layer 2 audio – a system that could be pressed into service with both MPEG 1 and MPEG 2 video. Because its codec slots into Windows, MP2 files can be used by other Windows applications including Media Player. For example, the MPEG conversion program supplied in Ulead's Media

Studio video editing suite allows conversion back to WAV. MP3 players will also handle the earlier MP2 files, since backwards-compatibility has been written into the standard.

The highest-quality mode (256kbit/sec) is reserved for CD, while the next one (192kbit/sec) down will easily accommodate the output from a hi-fi tuner; you can record broadcasts with your computer using a limited amount of hard disk space. If you like what you hear, it would be possible to expand them into WAV files using the above tools, and create Red Book audio CDs. As an alternative, the MP2 files can be stored on CD-Rs in their own right – there's sufficient space for several concerts, or a whole comedy series.

If anything, RecordIt's 192kbit/sec mode is too good for some of the atrocious-sounding rubbish being poured out of radio stations (Radio One and ILR, especially) which is compressed to the point of unlistenability. But who cares if the squashed dynamics and unpleasant harshness mean hooking in another listener over the noise? DAB gives broadcasters an excuse to deliver the best quality from an uncompressed studio feed, bringing out the best from our hi-fi equipment. Indeed, compression will be a switchable feature restricted to the receivers – notably: those built into car audio. Whether engineers will simply lift the audio downstream of the compressor/limiter in the interests of laziness is another matter.

Rant mode off..

Copyright Warning

With the equipment and procedures outlined in this article, it is possible to make recordings of copyrighted works. If this is the case, such recordings must be made solely for your own use, and then only if you have the original recordings. If you do not own the copyright, or have permission to copy from the copyright owner, you may be violating copyright law and could be subject to payment of damages and other remedies. If you are in any doubt, please contact your legal advisor.

In the final part of this article, we look at mastering CDs from digital sources, making Video CDs and the presentation of your discs.

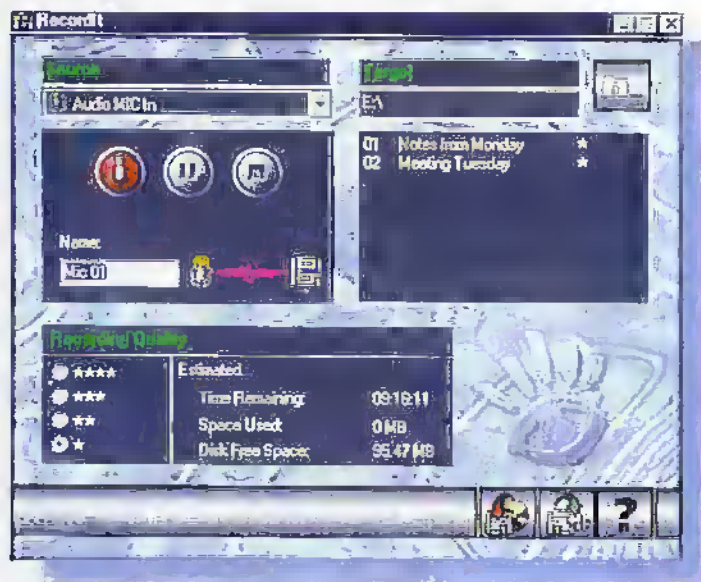

RecordIt from Iomega, is a real time MPEG level 2 audio recorder and player.

Diary Dates

Every possible effort has been made to ensure that information presented here is correct prior to publication. To avoid disappointment due to late changes or amendments, please contact event organisations to confirm details.

January 1998

7 January. From Reel To Real – The Power Generation: Early Eminent Electrical, Engineers Captured On Archive Film, IEE, Savoy Place, London. Tel: (0171) 240 1871.

18 January. Oldham Amateur Radio Club Mobile Rally, Elizabeth Hall, Civic Centre, West Street Oldham, Lancashire. Tel: (01706) 846143.

21 January. Energy Efficient Motors: Saving Money Or Costing The Earth, IEE, Savoy Place, London. Tel: (0171) 240 1871.

22 January. Industrial Manufacturing Business In The 21st Century Seminar, National Motorcycle, Museum, Birmingham. Tel: (0171) 240 1871.

27 January. Tools And Techniques For Dealing With Uncertainty, IEE, Savoy Place, London. Tel: (0171) 240 1871.

28 to 29 January. Business Computer Systems Show, GMEX Centre, Manchester. Tel: (0161) 725 8016.

February 1998

2 February. The Internet And The Law, Manchester Metropolitan University, Manchester. Tel: (0171) 240 1871.

6 February. Personal Communications In The 21st Century, IEE, Savoy Place, London. Tel: (0171) 240 1871.

11 to 12 February. Image Processing and Optic Technology, National Exhibition Centre, Birmingham. Tel: (01822) 614671.

12 February. Self Learning Robots Seminar, IEE, Savoy Place, London. Tel: (0171) 240 1871.

16 February. Serious Low Flying Colloquium, IEE, Savoy Place, London. Tel: (0171) 240 1871.

17 to 19 February. Video Forum, Wembley Exhibition Centre, London. Tel: (01273) 857800.

22 to 25 February. Focus on, National Exhibition Centre, Birmingham. Tel: (0181) 681 2619.

March 1998

3 to 5 March. Integrating CAD/CAM, National Exhibition Centre, Birmingham. Tel: (0171) 388 2430.

4 March. Design Of Digital Cellular Handsets Colloquium, IEE, Savoy Place, London. Tel: (0171) 240 1871.

4 March. Electronic Aids For Motor Vehicles, IEE, Savoy Place, London. Tel: (0171) 240 1871.

11 to 13 March. The Production Show, Business Design Centre, London. Tel: (0171) 505 8340.

12 March. MOBILISING UK plc, London. Tel: (0171) 562 7650.

17 to 19 March. NEPCON Electronics, National Exhibition Centre, Birmingham. Tel: (01892) 544027.

19 to 21 March. Communication Skills Fair, Navotel, London. Tel: (01322) 660070.

24 to 26 March. Energy for Industry, Olympia, London. Tel: (01483) 799141.

27 March. Women In Engineering, Lecture By Veronica Perkins Davis, IEE, Savoy Place, London. Tel: (0171) 240 1871.

Please send details of events for inclusion in "Diary Dates" to: News Editor, Electronics and Beyond, PO, Box 3, Rayleigh, Essex SS6 8LR or e-mail to swaddington@cx.compulink.co.uk.

What's On?



There Will Always Be A Place For A Good Book, Concludes Technology Forum

The prospect of an early night with a lap top and a good CD ROM is still remote according to delegates at a recent IEE Forum to debate 'Electronic Publishing – How will it work?'

Organised by the IEE and held under the aegis of the Engineering Council's 20/20 Vision programme, the Forum sought to identify the social and economic impact of new publishing technology, rather than focus on the technology itself.

Traditional publishing houses, libraries, Universities, engineering societies, government departments and electronic publishers were all represented at the meeting which was held at the IEE and chaired by Professor Sir Geoffrey Allen.

All agreed that, for the foreseeable future, paper-based and electronic information systems will operate in tandem. Information overload, a variety of transfer standards, financial constraints,

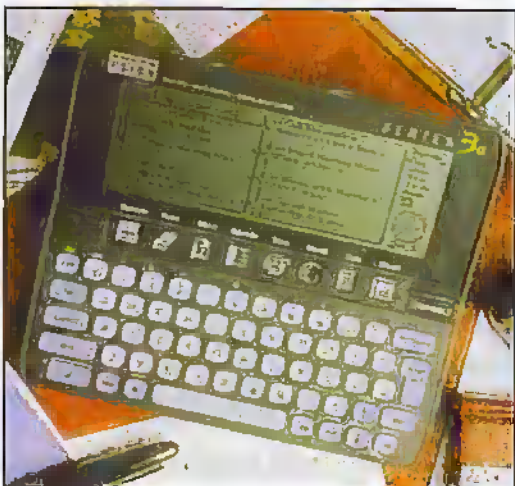

difficulties in information retrieval and the complex issues of copyright all dictate that the paperless society will be some time coming.

Delegates to the Forum agreed, however, that electronic systems will play an increasing role in publications, even if the eventual output medium is print-on-paper.

The transition from print-based to screen-based systems does not guarantee that traditional publishers will be able to make the transfer successfully and indeed it is likely that new information providers will emerge as the publishers of the future.

It was also agreed that traditional libraries, which have provided a high level of service in the past, will continue to do so as long as paper publications are available. The growth in electronic publications offers libraries new opportunities as information intermediaries which, resources permitting, most will embrace willingly.

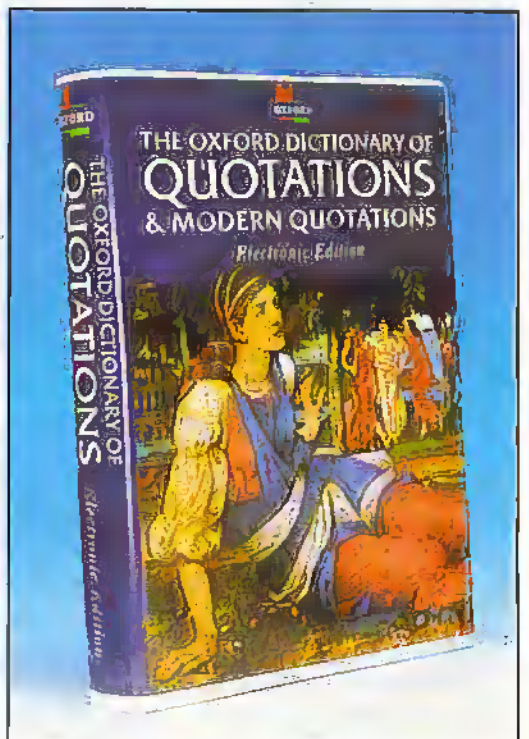

Captains Of Industry' Debate Industry's Future At Computers In Manufacturing

Computers in Manufacturing, this year featured a debate for Captains of Industry – board-level members of manufacturing industry in the UK. The event, which included keynote addresses from two of the UK's leading industrialists as well as the chairman of the Select Committee on Trade and Industry, was attended by some 120 board-level executives from across the UK.

Addresses at the debate – entitled Britain: A Manufacturing Future? – were delivered by Martin O'Neill, MP, chairman of the Select Committee on Trade and Industry; Jurgen Gehrels, UK chief executive of Siemens plc; and Khalil Barsoum, general manager of IBM UK and Ireland.

One of the key messages at the event was that UK industry cannot afford to get left behind in the technology race. "I do not believe that the UK has a future as a low-cost manufacturer," said Gehrels. "We must now play the innovation card. 70 per cent of Siemens' business comes from products introduced in the last five years. Some companies in the UK are still too short-term and don't invest enough in IT."

Barsoum focused on the rate of technological development in the IT industry. Networking in particular will be the key to the future. "Chip power has always been the focus in the past," he said. "But exponential growth in networking bandwidth will be what drives the IT revolution forward. In 1988, a

fibre-optic cable carried 45 million bits per second. In a few years, a similar cable will be able to carry 1 trillion bits per second. And in fifteen years' time, the kind of technology that industry invests in now will be available in Dixons."

According to Martin O'Neill MP the event was particularly useful in that it helped to spread the gospel of IT among manufacturers of all sizes. "The opportunities offered by the IT revolution must be made available and understood by all in business," he said. "Even the biggest manufacturer is dependent upon small companies 'down the road' who supply them. Getting the message across and down to small and medium-sized enterprises is as important as reaching the big companies."



First Building Block In Place Creating National Grid For Learning

David Blunkett, Secretary of State for Education and

Employment has officially launched the Merseyside Education OnLine Network (MEON), the first building block in the Government's National Grid for Learning.

MEON, initiated by The Merseyside Learning Partnership, aims to improve education radically through the application of technology, unlocking fresh potential for learning and achievement. ICL, the IT

systems and services company, was selected by MLP to design, implement and manage the project.

Based on Merseyside, MEON will provide education services to secondary school children, young people and adults. Unlike previous education ventures, MEON is being operated along commercial lines. It has backing from the Single Regeneration Budget (SRB) through the Government Office on Merseyside (GOM), the participating schools and ICL.

David Blunkett, Secretary of State for Education and Employment said, "I am pleased to see innovative schemes like MEON being put into place. I am sure that both teachers and pupils at the schools taking part in this pilot venture will benefit greatly from their access to information technology.

"I intend to see all schools and colleges connected to the information superhighway in the next five years as part of this government's commitment to education. The National Grid for Learning will provide a national focus for harnessing new technologies to raise educational standards so that all schools can benefit in the way that these Merseyside schools are already doing."

MEON extends learning to a wider community, including adults, supporting the concept of 'life-long learning', a process of reskilling several times within a lifetime. This community learning approach is a key pointer to the future nature of education. It progresses ICL's Knowledge Utility Model which comprises: curriculum content; infrastructure; training and professional development of teachers within a managed service environment.

Illustration

JANUARY CLEARANCE SALE

DESCRIPTION	CURRENT PRICE	SALE PRICE	ORDER CODE
ACTION BLASTER	£29.99	£24.99	53361
Digital Camera QV100	£499.99	£399.99	53362
Sportster 33.6 Int	£159.99	£99.99	53363
Sportster 33.6 Ext	£169.99	£139.99	53364
WD 2.1GB Hard Drive	£189.99	£149.99	53365
Cyber PET - Dinosaur	£9.99	£4.99	53366
Auto CD Cleaner	£14.99	£9.99	53367
Learning TV & VCR Remote Control Watch	£49.99	£39.99	53368
CD Player and Car Kit	£64.99	£59.99	53369
Talking Timer			
UT-8845 spl 42651	£14.99	£9.99	53370
Rio Vapouriser			
Book package 62758	£17.99	£14.99	53371
Remote Car alarm	£29.99	£24.99	53372
I/R Halogen Lamp	£15.14	£12.99	53383

DESCRIPTION	CURRENT PRICE	SALE PRICE	ORDER CODE
Security System Kit	£104.99	£99.99	53384
Garmin GPS III	£449.99	£399.99	53385
Garmin GPS II	£149.99	£129.99	53386
White LED 5mm	£4.99	£2.99	53387
SIMM 2 x 32 8Mb EDO	£25.29	£19.99	53388
Car Battery Analyser	£4.99	£3.99	53373
In Car Ioniser	£12.99	£6.99	53374
Fluke 7-600	£69.33	£59.99	53375
Fluke 7-300	£49.35	£39.35	53376
Samsung SF40 Fax	£199.99	£179.99	53377
Oscilloscope OS9100P	£699.00	£599.00	53378
Scope OS-3020	£899.00	£799.00	53379
Scope OS-9100D	£799.00	£649.00	53380
Digital Scope 3040	£1159.00	£999.00	53381
Scope OS-904RD	£599.00	£499.00	53382

MAPLIN
ELECTRONICS GROUP

Call the Maplin order line NOW on (01702) 554000
REGISTER FOR OUR DECEMBER OFFER DETAILS

Offer ends 28 February 1998. Prices are subject to VAT (except books) All orders subject to a postage & packaging charge of £2.95 (inc.VAT) with no p & p charge on orders over £30.00.

There can be no doubt that the arrival of the latest El Niño or Southern Oscillation has already left its chaotic marks in the choking smog of Indonesia and hurricane forcewinds battering the Baja Californian coasts, costing millions of dollars and tragic loss of life. Although President Clinton emphasised the likely effect of El Niño in an October White House news brief, accurate satellite measurements giving strong evidence of the impending consequences of the 1997-1998 El Niño were available as early as May 1997. These were provided by the US/French TOPEX/POSEIDON project.

El Niño is a regularly occurring climatic feature which was first noticed by Peruvian fishermen several hundred years ago around Christmas who named the effect 'the baby boy' Jesus. Scientists refer to the opposing event when warm water is transferred to the Ocean near Indonesia as La Niña or 'the baby girl'. El Niño increases the average ocean surface water temperature, which causes climatic change across the world. The effects of El Niño may be felt as far away as Eastern Africa, where reduced rainfall in the Ethiopian highlands restricts the flow of the Nile river. Warm water increases water vapour over the Pacific and results in heavy rains in the usually dry US Southwest and fires in the drought-stricken rain forests of Malaysia. The situation is currently so bad in Papua New Guinea that Australia and New Zealand are airlifting supplies and water to minimise the suffering, although there is unlikely to be any significant increase in rainfall until January 1998.

Simultaneous ocean measurements taken by two orbiting NASA science instruments between 1996 and February 1997 suggested that another weather-disrupting El Niño condition was developing in the Pacific. Sea-surface height measurements taken by a radar altimeter onboard the joint US-French TOPEX/POSEIDON satellite and wind data collected by the NASA Scatterometer (NSCAT) on Japan's Advanced Earth Observing Satellite (ADEOS) were used together for the first time to diagnose changing

RESEARCH NEWS

by Dr. Chris Lavers

Satellite Monitoring of the Catastrophic 1997-1998 El Niño Event

oceanographic and atmospheric conditions in the tropical Pacific Ocean. Unfortunately the ADEOS satellite was lost unexpectedly in July this year because it experienced some technical difficulties since its orbital insertion in August 1996. Officials at NASDA the Japanese National Space Development Agency say that the satellite's

solar array may have been hit by space debris. The loss of NASA instrumentation for ozone detection and its scatterometer to measure ocean waves and windspeed will hopefully be minimised by the Tropical Rainfall Measuring Mission (TRMM) due for launch from Tanegashima Space Centre in Japan on 31 October. The TRMM is the first Earth-

science satellite dedicated to the study of tropical and subtropical rainfall. It carries microwave and visible/infrared sensors and has the first spaceborne rain radar which will compliment work undertaken by the Rutherford Appleton Laboratory based ironically in Papua New Guinea. Tropical rainfall makes up over two thirds of global rainfall and is the primary distributor of heat through atmospheric circulation.

The El Niño phenomenon is believed to be triggered when steady westward blowing trade winds weaken and may even reverse direction. The change in wind direction allows the large mass of warm water that is normally located near Australia to move eastward along the equator until it reaches the coast of South America. This displaced pool of unusually warm water affects where rain clouds form and, consequently, alters the typical atmospheric jet stream patterns around the globe. The change in the wind strength and direction also impacts global weather patterns. NSCAT observed two episodes of trade

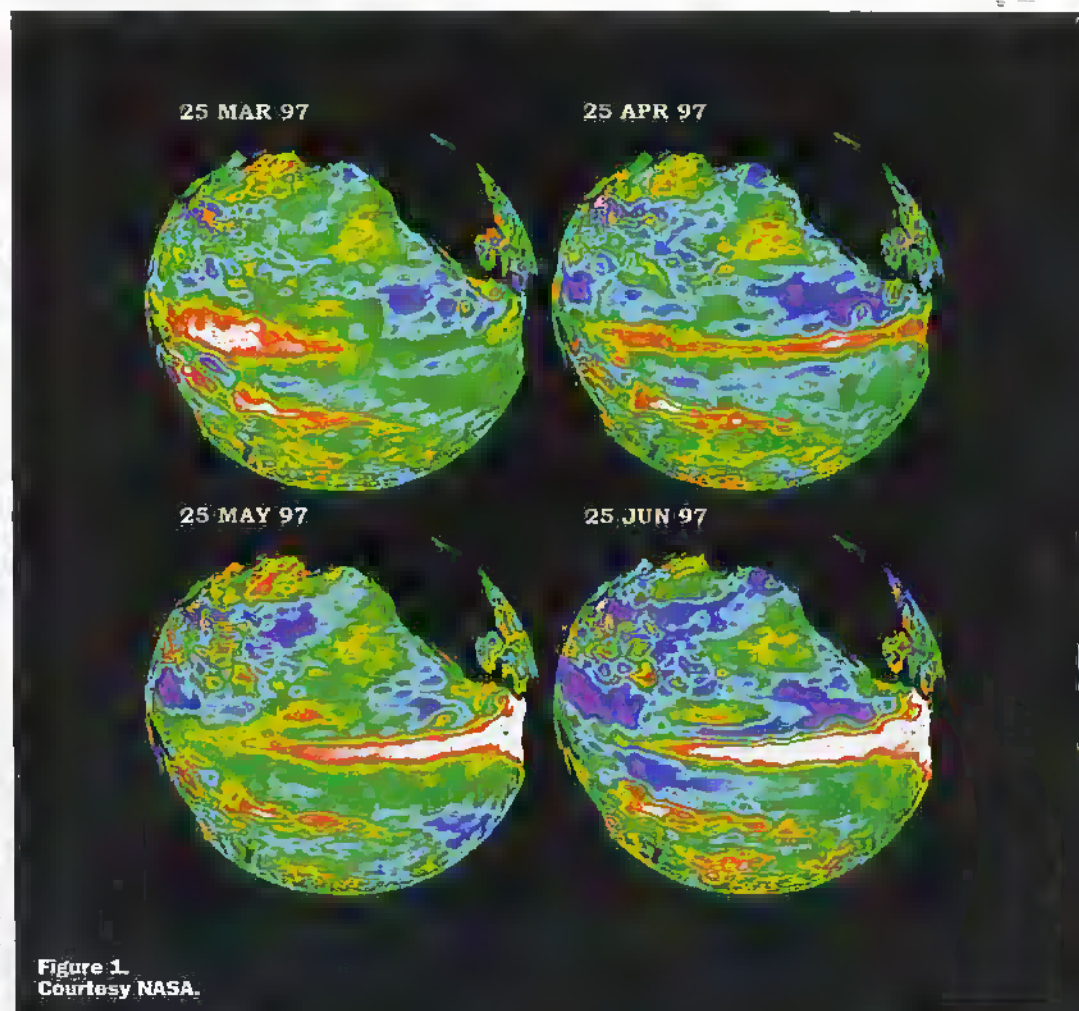

Figure 1. Courtesy NASA.

wind reversal in the western Pacific, one at the end of December 1996 and the other at the end of February 1997. Both generated warm water masses, called Kelvin waves, that travelled across the Pacific and were measured by TOPEX/Poseidon. Dr. Lee-Lueng Fu the TOPEX/Poseidon project scientist at NASA's Jet. Propulsion Laboratory, Pasadena, CA says, "Kelvin waves are often a precursor to a warm state of the tropical Pacific, sometimes leading to an El Niño". Figure 1 shows the effect of changes in the Pacific over several months with the warm water mass as white. "Whether an El Niño event occurs cannot be determined by just examining the satellite data," Fu continued. "A computer model coupling ocean-atmosphere data, like the one used by the National Oceanographic and Atmospheric Administration (NOAA), is a necessary tool to issue scientifically based predictions." For the first time, both TOPEX/POSEIDON and NSCAT provided a near real-time view of global ocean winds and sea levels.

Since the beginning of the instrument's operation in September 1996 NSCAT observed stronger than normal easterly winds in the central and western tropical Pacific, indicated by the higher than normal sea levels and sea surface temperature. This is usually a precursor of subsequent anomalous warming in the east. Kelvin waves moving across the Pacific do not necessarily mean El Niño but studying how seasonal phenomena like the Kelvin waves are related to events like El Niño over several years will help prediction. TOPEX/POSEIDON and NSCAT (while functioning) provided continuous near real-time observations of the critical developments in the Pacific.

The TOPEX/POSEIDON satellite uses an altimeter to bounce radar signals off the ocean's surface to get precise measurements of the distance between the satellite and the sea surface. This data combined with measurements from other instruments pinpoint the satellite's exact location in space. Every 10 days, scientists produce a complete map of global ocean topography; the barely perceptible hills and



valleys found on the sea surface. With detailed knowledge of ocean topography, scientist can then calculate the speed and direction of world-wide ocean currents.

The NASA scatterometer used an array of stick-like antennas that radiated radar pulses in the Ku-band across large areas of the Earth's surface. The manner in which the radar signal bounces off the ocean's surface and any frequency shift it may suffer, allows scientists to calculate both wind speed and direction. At any given time NSCAT's antennas scanned two swaths of ocean, one either side of the satellite's near-polar, sun-synchronous 500-mile orbit. The scatterometer took 190,000 wind measurements per day, mapping more than 90% of the world's ice-free oceans every two days! Both the TOPEX/POSEIDON altimeter and the NASA scatterometer

are radar instruments which were designed to operate continuously, collecting data day or night, regardless of sunlight or weather conditions.

In addition, NOAA has ships such as the KATIMMOANA serving a number of buoys which record sea-surface and wind data averaged over 5 day periods. The primary mission of the NOAA ship KATIMMOANA, shown in the background whilst a buoy is being serviced (Figure 2), is the servicing of the TAO array of moored buoys spanning the equatorial Pacific and the collection of upper air soundings. The TAO moorings are designed to transmit in real-time (via satellite) critical meteorological and oceanographic observations from the equatorial Pacific. These observations are used by scientists and weather forecast offices around the world to study the role of the tropical Pacific in short-term climate variations, such as the Southern

Oscillation, whose effects are felt world-wide. The TAO program is an international program directed by Dr Michael McPhaden and managed by the TAO Project office at NOAA's Pacific Marine Environmental Laboratory. NOAA has placed an upper air Doppler radar for atmospheric profiling measurements along the KATIMMOANA's cruise tracks, in addition to a weather balloon sounding system. Information recorded includes: GPS longitude and latitude, surface water temperature and salinity, air temperature, relative humidity, barometric pressure, wind speed and direction. The latest independent NASA satellite measurements confirm El Niño is back and strong.

New data from Pacific Ocean sea-surface height measurements and atmospheric water vapour information taken from two independent Earth-orbiting satellites collected since April 1997 confirm that a full-blown El Niño condition is established in the Pacific. Five years of global ocean observations made by TOPEX/Poseidon since its launch in August 1992 have tracked three El Niños, with the El Niño beginning in 1997 expected to be one of the largest on record. The recent data shows a large warm water mass with high sea-surface elevations, about six inches above normal, occupying the entire tropical Pacific Ocean east of the international date line. The surface area covered by the warm water mass is about one and a half times the size of the continental United States. This warm water mass travelled eastward from the western Pacific along the equator earlier this spring. Currently, sea-surface height off of the South American coast is 10 inches higher than normal, comparable with the conditions during the so-called 'El Niño of the century' in 1982-83. In addition, recent atmospheric water vapour data collected from NASA's Upper Atmosphere Research Satellite (UARS) show signs of an El Niño condition in the tropical Pacific Ocean. The Microwave Limb Sounder (MLS) experiment on UARS has detected an unusually large build-up of water vapour in the atmosphere at heights of approximately eight miles over the central-eastern tropical Pacific. Not since the last strong

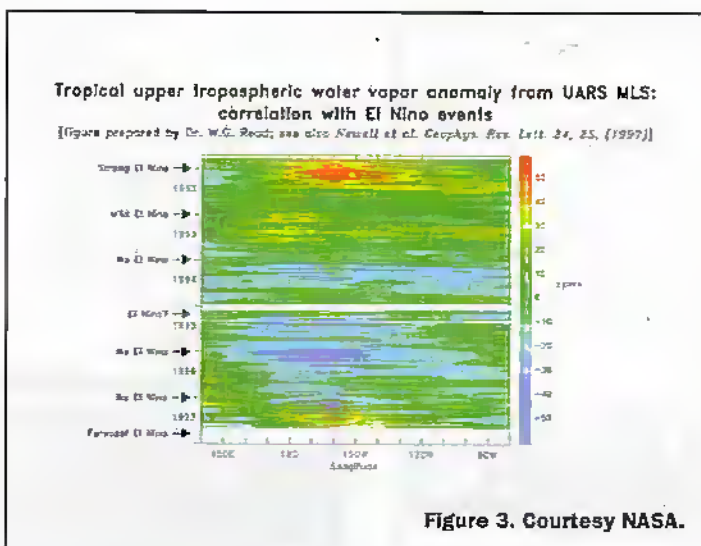

Figure 3. Courtesy NASA.

El Niño in the winter of 1991-92 has there been such a large build-up of water vapour in this part of the atmosphere (Figure 3). Increased water vapour at these heights can be associated with more intense winter-time storm activity bringing tropical moisture from Hawaii to the South-western United States.

In May, the National Oceanographic and Atmospheric Administration (NOAA) issued an advisory statement regarding early indications of El Niño conditions. Subsequent El Niño forecasts supported by NOAA indicated the likelihood of a moderate or strong El Niño in late 1997. The forecast model operated at NOAA's National Centres for Environmental Prediction used data collected by the TOPEX/Poseidon satellite. The added amount of oceanic warm water near the Americas, with a temperature between 21-30°C is about 30 times the volume of water in all the US Great Lakes combined," said Dr. Victor Zlotnicki, a TOPEX/Poseidon investigator at JPL. "The difference

5 SEP 97

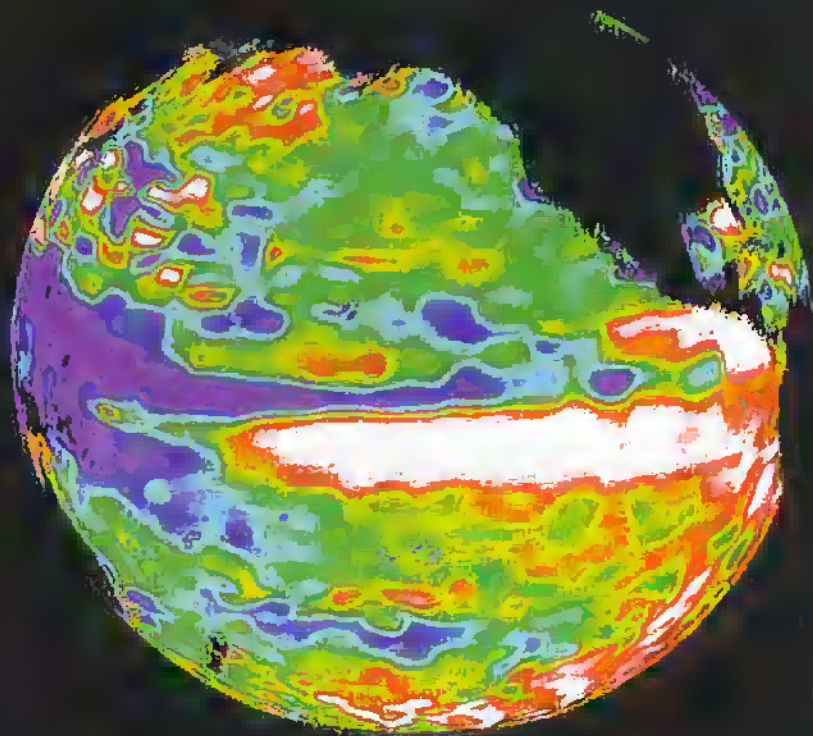

Figure 4. Courtesy NASA.

MAPLIN REWARD!

Turn your project design & development skills into cash: earn up to **£1,000**

Can you answer YES to any of the following?

- ◆ I have a fully designed, developed & working project, and I think that others would be interested in building my design
- ◆ I have proven design and development experience, and I would be interested in undertaking commissioned work
- ◆ I have a flair for writing software for PCs (or PIC chips), and I would be interested in writing software for Maplin projects

If you answered YES -

Write to us or E-mail us with a brief summary of your ideas or electronics/software skills and if we think you've got what it takes to 'join' the Maplin Projects Development Team we'll send you information on what we can offer you in return for your skills. Please mark your letter or make the 'subject' of your E-mail: 'Join the Team'.

Even if you answered NO -

But you've still got a great suggestion for a project that you think would have commercial potential then we'd still like to hear from you! Write to us or E-mail us with details of your suggestion and why you think it would be a popular project. If your project suggestion is completely new and commercially viable we'll send you £20 worth of Maplin Gift Tokens. If your suggestion directly results in us developing and marketing a project from your idea, we'll send you £50 worth of Maplin Gift Tokens. Please mark your letter or make the 'subject' of your E-mail: 'Project Suggestion'.

PMRC Development
Maplin Electronics PLC
274-288 London Road
Hadleigh, Beaufort
Essex S57 2DE
United Kingdom
Email: pmrc@maplin.co.uk



between the current, abnormally high amount of heat in the near-surface waters and the usual amount of heat in the same area is about 93 times the total energy from fossil fuels consumed by the United States in 1995." The latest data recently released for September (Figure 4) shows a strong warming event. The TOPEX/Poseidon satellite developed by NASA and the Centre National d'Etudes Spatiales (CNES) in France provides radar altimetry data which combined with measurements from other instruments makes it possible to pinpoint the satellite's location very accurately in space.

The MIS instrument was designed originally to study atmospheric ozone depletion, but scientists have devised new ways of using the data to study atmospheric water vapour. The UARS satellite is

completing its sixth year of operation after being designed for only a two-year mission, and is conducting an extended mission of longer-term global monitoring. The Jet Propulsion Laboratory, a division of the California Institute of Technology, Pasadena, manages the TOPEX/Poseidon mission and the MIS instrument for NASA's Mission to Planet Earth. The UARS satellite is managed by NASA's Goddard Space Flight Centre in Massachusetts. NASA's Mission to Planet Earth is a long-term science research program designed to study the Earth's land, oceans, air, ice and life as a total system.

The use of satellite data is certainly proving invaluable in enhancing the reliability of short-term global weather prediction, particularly relevant to the latest El Niño which is possibly set to be the largest on record.

The following Internet sites can be accessed for more information:

TOPEX/POSEIDON: <http://podaac.jpl.nasa.gov/topex>
NSCAT: <http://winds.jpl.nasa.gov>
NOAA: <http://rlio.pmel.noaa.gov>

PRICE £299
+ £6 P&P

New TARGET HF3E

PHONE FOR
FREE COLOUR
CATALOGUE

NEW EDITION TO THE TARGET HF3 RANGE OF RECEIVERS
With parallel computer interface and receiver control software including Spectral Display plus serial interface for RTTY, Fax, etc.

- ★ Frequency range 30kHz-30MHz
- ★ USB, LSB, AM
- ★ 1kHz steps with clarify
- ★ Filter bandwidth SSB=2.6kHz wide
AM=6kHz wide
- ★ Power required 12 volts



- ★ Quasi synchronous demodulator
- ★ S0239 antenna connection
- ★ Backlight
- ★ 10 user programmable memories
- ★ Tilt foot for ease of desktop view of display
- ★ UK PSU and wire aerial

TARGET HF3 AND HF3M RECEIVERS

HF3 - £159.95 + £6 P&P

- ★ Fully synthesised employing a phase lock loop VCO to ensure stable and accurate signal reception
- ★ Frequency range 30kHz-30MHz
- ★ CE approved ★ 1kHz steps with clarify
- ★ Audio output 2 watts ★ Headphone socket



HF3M - £209.95 + £6 P&P

- Specifications as HF3
Also includes:-
- ★ Built-in weatherfax interface
 - ★ WEFAX disk and software
 - ★ Interconnections cable to PC (9 pin serial)

Web site:
<http://www.kbnet.co.uk/akd>
E-mail: akd@kbnet.co.uk

2 YEAR GUARANTEE ON ALL MODELS

Tel No:
01438 351710

AKD

UNIT 5
PARSONS GREEN ESTATE
BOULTON ROAD
STEVENAGE, HERTS. SG1 4QG



SERVICE MANUALS & TECHNICAL BOOKS



PRICE

CRASH

We now have 8 Monitor CD-ROM's

On our CD-ROM's

Due to the success of our CD-ROM compilations we can now offer them at a new reduced price of just £24.95 each (plus VAT). Now there is even more reason for you to change to this method of data purchase. Why spend £££'s on individual manuals when you can get dozens on just 1 CD-ROM and save a fortune.

Coming soon - TV Manuals on CD-ROM

DON'T DELAY - ORDER TODAY

Full details on the contents of each CD-ROM shown on our web site and our free PC Disc
All orders plus post/packing £2.94

We have the largest range of Service Information and Technical Data obtainable anywhere.

For Televisions, Video Recorders, Test Equipment, Computer Monitors, Vintage Wireless, Domestic Equipment etc etc.
In fact practically anything electronic.
Originals or Photostats as available.

Also available. Our catalogues on PC Discs detailing Hundreds of Technical Books and Repair Guides. Return coupon for your FREE Discs. The entire index of manuals we have is available on PC disc for just £5.00 inclusive with FREE updates.

MAURITRON TECHNICAL SERVICES (EB)
8 Cherry Tree Road, Chinnor, Oxfordshire, OX9 4QY
Tel:- 01844-351694. Fax:- 01844 352554.

Emil:- sales@mauritrion.co.uk Our catalogue is now on the Web at <http://dialspace.dial.pipex.com/mauritrion/>

Please forward your PC Discs catalogues of CD-ROM'S and Technical Books for which I enclose 4 x 1st Class Stamps.

Please supply Index of manuals on PC Disc for £5.00 inclusive.

NAME _____ *Circle items required*

ADDRESS _____

POSTCODE _____ You may pay by Cheque, PO or
Visa, Access, Delta, Electron, JCB, Mastercard, Eurocard etc

□□□□ □□□□ □□□□ □□□□

EXPIRES _____ SIGNATURE _____



MANCHESTER
METROPOLITAN
UNIVERSITY

Crewe+Alsager Faculty

PIC MICROCONTROLLERS

Beginners Course on 16C84. One day course. Fee: £125, includes lunch, 16C84 chip and Development Board plus software.

Advanced Course on 16C84 and 16C71. One day course including look-up tables, long delays, keypads, 7 segment displays and A-D conversion. Fee: £125 includes lunch and 16C71 reprogrammable Microcontroller chip, with 4 channel A-D.

Complete Teach Yourself Package including PSU, Switch Input Board, Keypad Board, Development Board, 7 Segment Display Board and Buzzer, LED Output Board, Analog Development Board and 115 page course book, plus software. Fee: £145 + £6 p+p + VAT.

Four-day Course - Understanding Microcontrollers
Course Fee: £395, includes lunches and the complete teach yourself package. Accommodation available.

For dates and further details contact Dave Smith,
Crewe+Alsager Faculty,
The Manchester Metropolitan University,
Hassall Road, Alsager, Stoke-on-Trent, ST7 2HL
Tel: 0161 247 5437 Fax: 0161 247 6377
E-mail D.W.Smith@MMU.AC.UK

Virtual Toolbox FOR THE PERSONAL COMPUTER

Cross Atlantic's new suite of PC utilities, Nuts and Bolts, contains just about everything but the kitchen sink. Here Stephen Waddington reviews the new Windows toolkit.

In a perfect world, Windows 3.1 and Windows 95 would be perfect operating systems that had no need of improvement. But this is real life and we all know that Microsoft operating systems crash regularly and require a programmer experienced in machine code to achieve optimum performance. Every operating system what ever its flavour, needs some occasional fine-tuning, just as a car needs a regular service.

The PC utilities market is a crowded one, but a suite of tools called Nuts and Bolts launched in July this year has broken through the pack, offering remarkable performance for its relatively low cost. Developed in the US by New York based Helix



Photo 1. The Nuts and Bolts utilities can be accessed individually, or via a dash board interface.

Software, the application includes more than 30 individual component utilities integrated in a single package as shown in Table 1.

Windows 3.1 and 95

The Nuts and Bolts CD-ROM comes with separate 32- and 16-bit versions for Windows 95 and

3.x. The 16-bit version does not include some advanced utilities, for example the Registry editor used to modify the start-up configuration files, that apply only to Windows 95.

If you're using Windows 95 and are comfortable with its idiosyncrasies, Nuts and Bolts offers a wealth of useful tools. The only drawback is that it's not a good choice for PC novices. The package is highly customisable, and it makes extensive use of wizards to lead you through complex procedures. Inevitably you need a basic level of understanding about a PC architecture.

Although Nuts and Bolts is relatively easy to use, the user interface is confusing at times, especially when using the wizards, because so many of the utilities initially look the same. Each of the Nuts and Bolts component utilities can be used independently as individual utilities, or collectively using the integrated Nuts and Bolts dashboard as shown in Photo 1. And any of the Nuts and Bolts component utilities can be directly linked to each other and use capabilities in other components. For instance, Stronghold the file decoding utility can compress files using the ZIP utility prior to encryption.

The Nuts and Bolts utilities fall into four general categories as shown in Table 2. These cover hard disk cleanup and optimisation, system file and configuration repair, security and management, and error prevention and crash recovery.

What You'll Find in a Pile of Nuts and Bolts

- ◆ Launchpad (Win 3.1 and 95) Launches programs, documents, and folders.
- ◆ Bomb Shelter (Win 3.1 and 95) Protects against overwriting.
- ◆ Cleanup Wizard (Win 3.1 and 95) Finds duplicate, old, and unused files to delete, compress or move.
- ◆ Discover Pro (Win 3.1 and 95) System info with diagnostics and benchmarks.
- ◆ DiskTuner (Win95) Defragments disk space.
- ◆ Image/Restore (Win 3.1 and 95) Saves an 'image' copy of critical disk info.
- ◆ DiskMinder (Win 3.1 and 95) Diagnoses and repairs disk problems.
- ◆ TrashGuard (Win95) Protects deleted files.
- ◆ E2 Setup (Win95) Customises the desktop and startup.
- ◆ WinGauge (Win 3.1 and 95) Graphically tracks system memory, resources, and performance in real time.
- ◆ Rescue Disk (Win 3.1 and 95) Creates a boot disk for disk recovery.
- ◆ Shortcut Wizard (Win95) Locates orphaned shortcuts and repairs or deletes them.
- ◆ Registry Pro (Win95) Manually edit and repair Registry database.
- ◆ Shredder (Win 3.1 and 95) Permanently deletes files and 'security wipes' free disk space.
- ◆ Zip Manager (Win 3.1 and 95) Compresses ZIP files and unzips existing ZIP files.
- ◆ Stronghold (Win 3.1 and 95) Encrypts sensitive files.
- ◆ Registry Wizard (Win95) Troubleshoots the Registry database.

Table 1. Individual component utilities contained within the integrated Nuts and Bolts package.

Nuts and Bolts Benefits

- ◆ **Avoid Crash-Causing Application Conflicts**
Prevent any single crashed application from taking down your entire system. Recover lost drives. Fix damaged files, repair shortcuts, directories, and registry and system settings. Boot up after the worst disasters with your own Nuts and Bolts rescue disk.
- ◆ **Optimise and Customise**
Test all your hardware with the push of a button. Check your Windows Registry for conflict free installation of applications. And keep an eye on your memory, and critical system resources to prevent problems before they occur.
- ◆ **Disk Management**
Dump all those old, unused, duplicate or orphaned files that are cluttering your memory. Delete leftover shortcuts and program groups. Enjoy a lean and mean registry by eliminating useless 'tips' and colour schemes. Defragment your hard drive and organise it so that the programs you use most are at the front of your hard drives for quick access. Optimise and defragment your registry for a faster boot-up.
- ◆ **Data Security and Management**
Encrypt sensitive files for total security. Send self-decrypting e-mail that can't be intercepted. Shred sensitive files so they are absolutely, positively unrecoverable. Create and manage compressed, industry standard ZIP files for quick e-mail and Internet transmission.

Table 2. The four general categories of utility contained within Nuts and Bolts

Clean and Optimise

Nuts and Bolts' Clean and Optimise utilities help users optimise and maximise the performance of key parts of the Windows operating system and ensure that it runs at peak performance.

Disk Tune improves PC performance by rearranging files on the hard disk. With four levels of optimisation, Disk Tune is based on the Helix FastTrax algorithm disk defragmenter, and is up to 500 per cent faster than Windows' Defrag or Norton's Speed Disk.

The primary concern of users when it comes to defragmenting a disk is the speed of the process. Disk Tune has several capabilities that go beyond simple defragmenting. Disk Tune can create custom, optimal hard disk configurations as shown in Photo 2. By default Disk Tune's 'Reorder + Unfragment' option will completely reorganise the hard drive placing recently modified files at the end near the free space as shown in Photo 3.

This reordering as opposed to simple defragmentation provides faster access times to frequently used programs when minimising future fragmentation by moving files that are being modified at the end of the drive. The optimisation process is also highly configurable so that custom configurations are easy to create.

Cleanup Wizard identifies old, duplicate or unneeded files so that they can be deleted, archived using ZIP techniques, shredded or recycled, to free up disk space as shown in Photo 4. Readers should be careful with this utility and check that highlighted files are not being used. Under test we found that the utility identified a number of large active database data files that had not been modified for a while and recommended that they be deleted.

Registry Wizard maintains, troubleshoots and repairs the Windows 95 Registry; the data and configuration file used to set-up the PC at start-up. The Nuts and Bolts Registry Wizard is the only utility on the market that can defragment, condense, sort and optimise the Windows Registry, letting users slim down their Registry and shed wasted disk space. The result is a faster, leaner Windows system. Under test we found that this utility reduced the start-up time for Windows 95 by as much as 60 per cent.

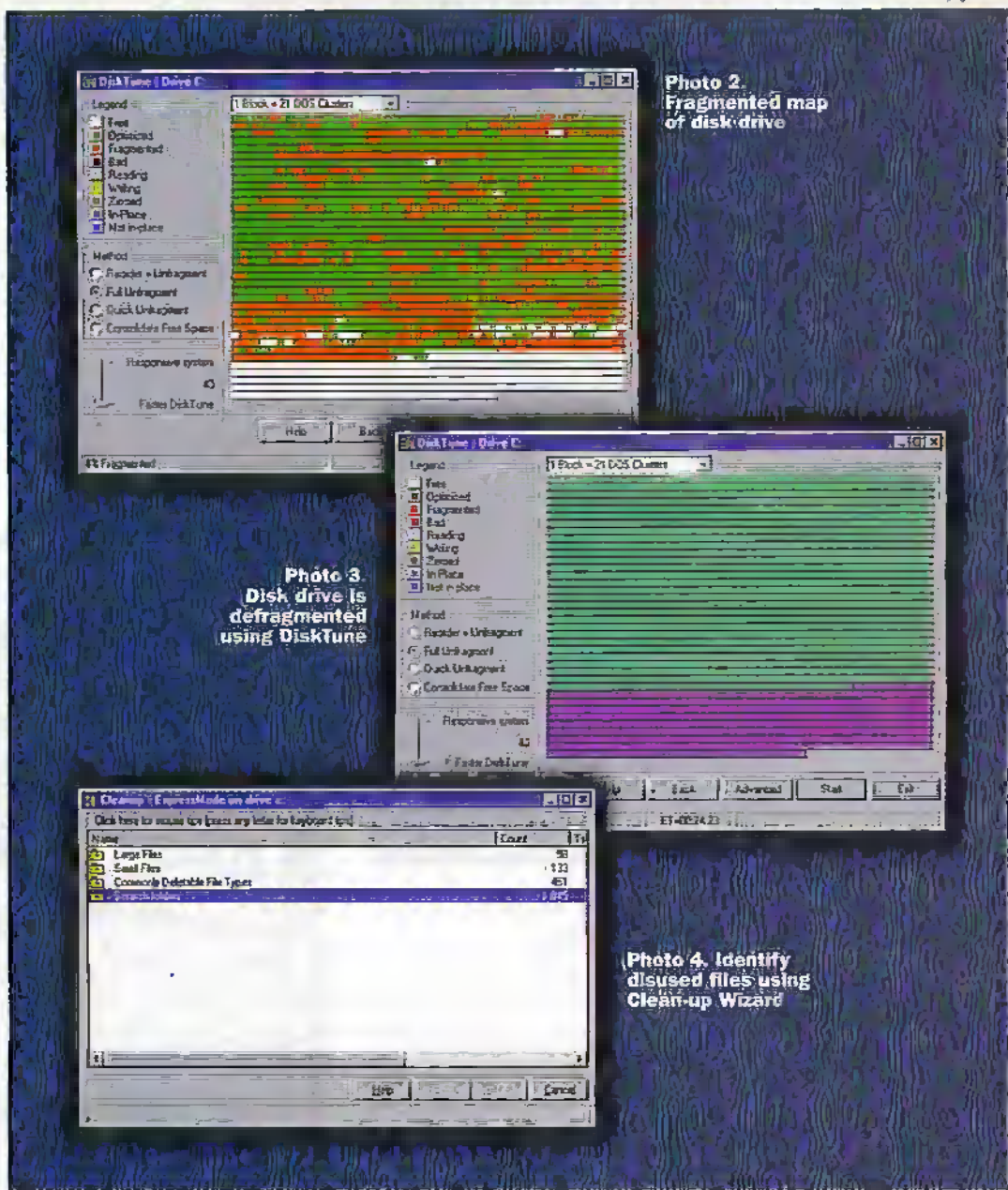

Photo 2. Fragmented map of disk drive

Photo 3. Disk drive is defragmented using DiskTune

Photo 4. Identify disused files using Clean-up Wizard

Repair and Recover

The Nuts and Bolts Repair and Recover utilities provide all the tools needed to diagnose and correct system problems, along with complete Disaster Recovery.

Under test, Disk Minder diagnosed and repaired existing or potential disk problems up to 100 per cent faster and far more accurately than Windows' ScanDisk. Disk Minder finds and corrects even the most serious errors such as lost partitions or damaged boot sectors using 'Guided Artificial Intelligence' technology to correct cross-linked files and size errors for maximum data recovery.

Image and Restore saves critical system and disk data as shown in Photo 5, which can be restored to recover from disaster. The critical disk structures are saved using a new, patent pending technology developed by Helix which can

recover an entire disk even if the partition, boot sector and FAT are completely wiped out.

Rescue Disk can be used to boot up a PC and begin recovery. DOS based versions of Disk Minder, Disk Editor, Image

and Restore, and the DOS rescue disk utility have been specifically coded to fit on a single floppy and use as little memory as possible, using Helix's long experience with Memory Management.

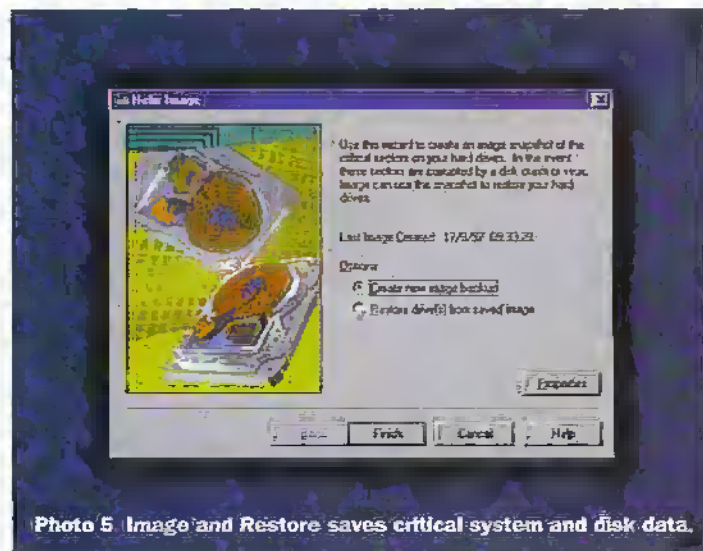

Photo 5. Image and Restore saves critical system and disk data.

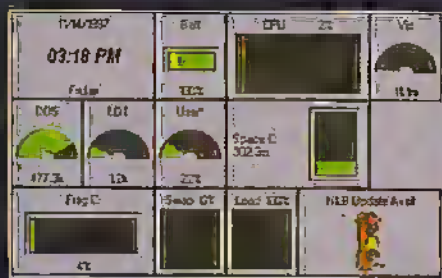

Photo 6. WinGauge tracks system memory, resources, drives and performance.



Photo 7. Discover Pro allows several aspects of a PC system to be examined simultaneously.

Secure and Manage

Nuts and Bolts Secure and Manage utilities let users manage their data more efficiently, with drag and drop encryption, compression and security. Nuts and Bolts also provides easy Windows customisation and quick access to applications via a dockable tool bar.

Stronghold provides crack-proof 40 bit DES encryption of sensitive files. Stronghold includes an easy to use Wizard interface, which lets users create self-decrypting files for e-mailing even to someone who does not have Stronghold.

Shredder completely and securely deletes files. Unlike other security delete tools, the Nuts and Bolts shredder can wipe compressed disks and both long and short file names using either quick erasure or US government-standard 'data declassification' technology.

Zip Manager manages, creates and extracts ZIP archive files. The Nuts and Bolts Zip Manager is fully industry standard ZIP compliant and uses drag and drop, COM, Wizard or Explorer interface styles. The Nuts and Bolts Zip Manager is fully integrated with Nuts and Bolts Clean Up and Stronghold for easy compressed file encryption and unused file archiving.

Prevent and Protect

Nuts and Bolts' Prevent and Protect utilities monitor the user's system and applications, alerting the user to any potential problems before they occur, and preventing program crashes from crashing the whole system.

Bomb Shelter provides full crash protection and chip-level write protection of critical system components. Unlike other crash protection programs, Bomb Shelter not only recovers from crashes, but also actually protects the whole system from misbehaved programs, increasing stability and reliability.

WinGauge as shown in Photo 6 graphically tracks system memory, resources, drives and performance in real-time, alerting users before error conditions arise, so that they can take preventative measures such as cleaning up or optimising their disk or registry, and keep their system optimal.

Trash Guard protects against accidental file deletes by moving all files deleted by programs or drivers (even in DOS) to the Recycle Bin. Trash Guard is integrated into and works in close co-operation with the Windows Recycle Bin.

Discover Pro as shown in Photo 7 includes Windows

native, 32-bit hardware diagnostics and an enhanced MIDI interface that lets users examine several aspects of their system simultaneously. Discover Pro also features a new, easy to read summary interface for novice users, which highlights key information and lets users verify CPU speed, L2 Cache Size, and Video RAM installed at a glance.

Final Word

Inevitably PCs crash. Nuts and Bolts is a neat virtual toolbox that enables users to prevent damage and restore a

machine's original configuration as quickly as possible. But prevention is always better than cure and the virtual toolbox enables users to keep and maintain their system in tiptop condition. The user interface can be confusing, but it's worth working through the sometimes-complex wizards and menus.

Further Information

Check www.crosstlantic.com or www.helixsoftware.com for further information about Nuts and Bolts and PC maintenance.

COMPETITION

Win a Copy of Nuts and Bolts

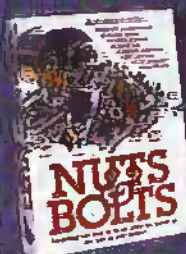

We've got three copies of Nuts and Bolts to give away to readers of *Electronics and Beyond*. All you have to do is answer the following questions correctly to be included in our prize draw on 7 February 1997.

When is Windows 98 expected to be launched?

- (a) 1998
- (b) 1999
- (c) 2000

What are Windows 95 Registry files?

- (a) Data file containing details of database files
- (b) Software application registration data files
- (c) Configuration files used to initialise a PC on start-up

What is the normal file extension used to identify compressed files?

- (a) .doc
- (b) .zip
- (c) .exe

Name:

Address:

Post code:

Send your replies to: The Editor, *Electronics & Beyond*, PO Box 777, Rayleigh, Essex, SS6 8LU.



ELECTRONICS Classified



Computers

IBM Etherlink III board, new, unused £30. Valve amplifiers, modern version of classic Mullard 5-20, mono pair £250, single chassis dual mono £300. 0181 427 1378 (Harrow).

AR88D with documentation and some; spares £40. Heathkit HW-16 CW Transceiver for 80m, 40m, 15m; £20. Phone Eric on 01792 813798 or e-mail lubana@clara.net.

Wanted

Electronic Penfriend. Want a Nigerian penfriend? A talented songwriter, playwright, poet. Interested in electronics. Write to: Ayotunde Raifimi-Lawal, 13 Araoti Street, Yaba, Lagos State, Nigeria.

Service Manual for the Tequipment DM64 oscilloscope. If you can help, please contact me on (01493) 751707. Thanks.

Meter for AVO CT160 Valve Tester or complete scrap unit. Why? Would also consider my movement rewound — do you know where? Pete Shepherd, Tel: (01268) 887402.

BBS Corner

Apple Crackers. FirstClass Client BBS, mainly for AppleMac and PC users. Baud rate 2-4K-bit/s to 28-8K-bit/s, 8 data bits, no parity, 1 stop bit. Tel: (01268) 781318/780724.

Mactel Metro/Iconex. FirstClass Client BBS, AppleMac and PC users. E-mail address on Internet for registered users. Baud rate 2-4K-bit/s to 28-8K-bit/s, 8 data bits, no parity, 1 stop bit. Tel: (0181) 543 8017 (Meim) or (0115) 9455417 (Iconex).

Spider! Amiga BBS. The lighter alternative. Mainly Amiga and some PC files. Fidonet, MercuryNet and Mufonet. Online games. Speeds up to 19200. Tel: (01568) 613520.

Club Corner

ARS (Aberdeen Amateur Radio Society) meets on Friday evenings in the RC Hall, 70 Cairngorm Crescent, Kincorth. For details contact: Martin, (CMOJCN), Tel: (01569) 731177.

The British Amateur Electronics Club (founded in 1966), for all interested in electronics. Four newsletters a year, help for members and more! UK subscription £8 a year (Junior members £4, overseas members £13.50).

Placing an advertisement in this section of *Electronics and Beyond* is your chance to tell the readers of Britain's best magazine for electronics enthusiasts what you want to buy or sell; or tell them about your club's activities — Absolutely Free of Charge! We will publish as many advertisements as we have space for. We will print the first 30 words free, but thereafter the charge is 10p per word for each added advert per reader. Placing an advertisement is easy! Simply write your advertisement clearly in capital letters, on a

postcard or sealed-down envelope. Then send it, with any necessary payment, to: *Electronics Classified*, P.O. Box 777, Rayleigh, Essex SS6 8LU. Advertisements will be published as soon as possible, space allowing. No responsibility is accepted for delayed publication or non-inclusion of advertisements. Readers who have reasonable grounds to believe they have been misled as to the nature of an advertisement are advised to contact the Publisher and their local Trading Standards Office.

For further details send S.A.E. to: The Secretary, Mr. J. F. Davies, 70 Ash Road, Cuddington, Northwich, Cheshire CW8 2PB.

Bury St. Edmunds Amateur Radio Society. Meetings held at Culford School, 7.30pm for 8.00pm on the third Tuesday of each month, unless otherwise stated. Further details from Kevin Waterson, (G1GV), 20 Cadogan Road, Bury St. Edmunds, Suffolk IP33 3QJ. Tel: (01284) 764804.

Crystal Palace and District Radio Society meets on the third Saturday of each month at All Saints Church Parish Rooms, Beulah Hill, London SE19. Details from Wilf Taylor, (G3DSC), Tel: (0181) 699 5732.

Derby and District Amateur Radio Society meets every Wednesday at 7.30pm, at 119 Green Lane, Derby. Further details from: Richard Buckley, (G3VGV), 20 Eden Bank, Ambergate DE56 2GG. Tel: (01773) 852475.

Electronic Organ Constructor's Society. Details of programme magazine and membership from: Don Bray (Hon. Sec.), 34 Eiberton Way, Seaford, Sussex BN25 3QB. Tel: (01323) 894909.

E.U.G. User group for all 8-bit Acorn Micros, since 1991. Still going strong. Programming, news, information, sales. Contact: E.U.G., 25 Bertie Road, Southsea, Hants. PO4 8JX. Tel: (01705) 781168.

The Lincoln Short Wave Club meets every Wednesday night at the City Engineers' Club, Waterside South, Lincoln at 8pm. All welcome. For further details contact Pam, (G4STO) (Secretary). Tel: (01427) 788356.

MERG? 2 first class stamps (or 4 IRCs) to John Weal, 23 Chapel Street, Yaxley, PETER 3LW brings you a substantial introductory pack to the Model Electronic Railway Group — actively applying electronics and computers to the model railway operation.

Preston Amateur Radio Society meets every Thursday evening at The Lonsdale Sports and Social Club, Fulwood Hall Lane, Fulwood, (off Watling Street Road), Preston, Lancashire PR2 4DC. Tel: (01772) 794465. Secretary: Mr Eric Eastwood, (G1WOC), 56 The Mede, Freckleton PR4 1JB, Tel: (01772) 686708.

Science At Your Fingertips. Want to meet friends interested in Science? Send an SAE to: Daniel Gee, S.A.Y.F., 37 South Road, Watchet, Somerset TA23 0HG, or Scott Mason, S.A.Y.F., 58 Park Avenue, Devonport, Plymouth PL1 4BR <http://homepages.enterprise.net/icedragon/says.htm>.

SEEMUG (South East Essex Mac User Group), meet in Southend, every second Monday of each month. For details Tel: Michael Foy (01702) 468062, or e-mail to mac@aikefoy.demon.co.uk.

Southend and District Radio Society meets at the Druid Venture Scout Centre, Southend, Essex every Thursday at 8pm. For further details, contact: P.O. Box 88, Rayleigh, Essex SS6 8NZ.

Sudbury and District Radio Amateurs (SudDRA) meet in Gt. Comard, Sudbury, Suffolk at 8.00pm. New members are very welcome. Refreshments are available. For details please contact Tony, (G8LTY), Tel: (01787) 313212 before 10.00pm.

TESUG (The European Satellite User Group) for all satellite TV enthusiasts! Totally independent. TESUG provides the most up-to-date news available (through its monthly 'Footprint' newsletter, and a teletext service on the pan-European 'Super Channel'). It also provides a wide variety of help and information. Contact: Eric N. Wiltsher, TESUG, P.O. Box 576 Orpington, Kent BR6 9WY.

Thanet Electronics Club. For school age Ham Radio and Electronics enthusiasts, enters its 16th Year. Meetings held every Monday evening from 7.30pm at The Quarterdeck, Zion Place, Margate, Kent. For further details contact: Dr. Ken L. Smith, (G3JIX), Tel: (01304) 812723

Wakefield and District Radio Society meet at 8.00pm on Tuesdays at the Community Centre, Prospect Road, Ossett, West Yorkshire. Contact Bob Finn, (G3WVF), (QTHR), Tel: (0113) 282 5519.

The (Wigan) Douglas Valley Amateur Radio Society meets on the first and third Thursdays of the month from 8.00pm at the Wigan Sea Cadet HQ, Training Ship Sceptre, Brookhouse Terrace, off Warrington Lane, Wigan. Contact: D. Snape, (G4GVG), Tel: (01942) 211397 (Wigan).

Winchester Amateur Radio Club meets on the third Friday of each month. For full programme contact: G4AXO, Tel: (01962) 860807.

Wirral Amateur Radio Society meets at the Ivy Farm, Arrowe Park Road, Birkenhead every Tuesday evening, and formally on the first and third Wednesday of every month. Details: A. Seed, (G3FOO), 31 Withert Avenue, Bebington, Wirral L63 5NE.

Wirral and District Amateur Radio Society meets at the Irbay Cricket Club, Irbay, Wirral. Organises visits, DF hunts, demonstrations and junk sales. For further details, please contact: Paul Robinson, (G0JZP) on (0151) 648 5892.

Please write your classified advert using one word per box below. Adverts of 30 words or under will be printed free of charge, but thereafter the charge is 10p per word. Please include any payment for extra words with your advert.

ELECTRONICS Classified

Name _____
Address _____

Daytime Telephone _____
Return your advert to: *Electronics Classified*, P.O. Box 777, Rayleigh, Essex, SS6 8LU.

WHAT'S IN A NAME

PART 12

Blumlein: The Brunel of Electronics

by Greg Grant

We conclude this series of articles with a look at one of the most gifted electronics engineers of this century.

Someone once remarked of the Cromwellian admiral Robert Blake that it was astonishing that so little was known about so able a man. The same could be said of Alan Dower Blumlein.

I'm reminded of him every time I visit Cornwall, that land beyond England. To get there, you've to cross the river Tamar by a magnificent monument to Victorian engineering panache, on whose archway is stamped 'I.K. Brunel: Engineer.' What a marvellous tribute: it says all there is to say really. Let the man's achievements speak for him. Something similar needs to be done for Blumlein.

Both men had a great deal in common. Brunel for example was only 24 when, in 1829, his first design appeared, a proposal for bridging the river Avon. By contrast, Blumlein was 25 when, in 1928, his first invention appeared. This was the bifilar-wound, Inductive Ratio-Arm Bridge circuit, shown in Figure 1.

Like Brunel too, Blumlein had an excellent grounding in maths and both men carefully analysed their designs and ideas before even attempting construction. When, for example, Blumlein designed a circuit he worked out the impedances, the gains per stage, the pulse widths and/or shapes and the frequency response.

Brunel's approach to his discipline was virtually identical. His second design for the Avon Gorge Bridge – the one that speaks so eloquently on his behalf to this day – was, in the view of the selection committee, the most mathematically accurate of all the designs submitted. And the opposition was formidable, it including designs from the other leading engineers of the day such as Thomas Telford.

From docks and railways, tunnels and cuttings to bridges and cargo ships, Brunel left an indelible mark on the mechanical and civil disciplines within the engineering profession. Blumlein was no less versatile and wide-ranging in his achievements, leaving a lasting mark on the radar and communications disciplines as well as on circuit design generally.

From sound recording and reproduction to antennas and cables, television and

telephony by way of electrical measurement, he left a body of work that astonishes to this day, more than half a century after his death.

Two other aspects of both men's work was firstly startling originality, secondly the ability to pump new life into old ideas and techniques. Brunel's 'Great Western,' for example was the first large steam-powered cargo carrier to operate on the Atlantic route. It was also timber-built, indeed probably the apogee of ship design using wood. Twenty years later his 'Great Eastern' was the first large vessel constructed with a double hull. Its size stunned even the Victorians – who by *no* means thought small – and nothing remotely like it was built for another 40 years!

When, two years after the 'Great Eastern,' Brunel designed the Maidenhead Bridge its major feature was its flat arch, the flattest such brick structure in the world at that time. Yet the principles underlying it and the materials employed had been common practice for centuries.

By contrast, in 1938, Blumlein filed a patent relating to his research into the field produced by a current flowing in a linear, slotted, hollow conductor. This would later – some time later in fact – be recognised as one of the most important pieces of research on antennas carried out in the 1930s. It would lead to the Resonant Slot antenna, long used in the world's VHF Omnidirectional (VOR) equipment for civil air navigation.

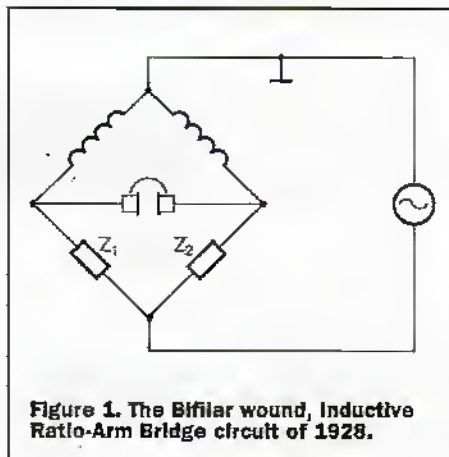

Figure 1. The Bifilar wound, Inductive Ratio-Arm Bridge circuit of 1928.

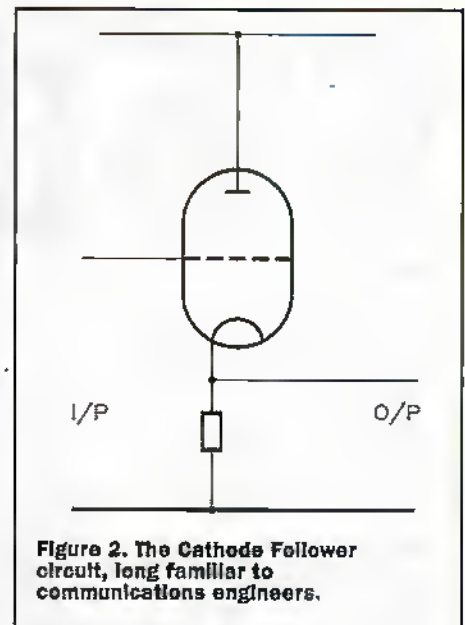

Figure 2. The Cathode Follower circuit, long familiar to communications engineers.

Blumlein Circuits

Four years before this however Blumlein had patented the Cathode Follower circuit, illustrated in Figure 2. Although the valve had been in existence for 20 years, Blumlein could still look at this amplifying device anew and expand its usefulness. Something in fact he'd repeat two years later with his solution to video cable interference: the Long-Tailed pair circuit, illustrated in Figure 3.

Another area in which both men held almost identical views was training and teaching. Brunel had a marvellous facility for describing his designs to both his fellow engineers and to committees of laymen. In his Maidenhead Bridge design for example, the contractor he'd employed became worried at the arch's flat design, feeling that the weight would crush the bricks. Brunel, using geometry and his design drawings, convinced the man that the weight would, in fact, be a lot less than that in another wall he – the contractor – had but recently built!

Blumlein too had the gift of readily conveying an understanding of all that he was up to. His colleagues frequently remarked on his patience at going over a circuit diagram again and again, to ensure they understood what he was getting at. On another level, being full of fresh and original ideas himself, Blumlein gave full credit to others for their ideas and improvements. Consequently, his colleagues gave him their complete trust.

RADAR Contribution

And what ideas he had! Apart from those already touched upon, there was his wartime work on radar, in the course of which he used a timebase generator he'd designed, one far more linear than anything that had been available previously.

Furthermore, this timebase hinged on a valve defect. The American radio engineer John M. Millar was the first man to discover that the gain of a triode valve actually increased the device's input capacitance by a factor determined by the Gain times the Inter-electrode Capacitance. Blumlein made

IR Light-Beam Alarm Basics

Last month's episode of this 'Security Electronics' series explained (amongst other things) the basic operating principles of visible light-beam alarm circuits, and ended by explaining that virtually all modern light-beam security systems in fact operate in the invisible infra-red (rather than visible light) range, and use one or more pulse-driven IR LEDs to generate the transmitter's 'light-beam', and use matching IR photodiodes or phototransistors to detect the beam at the receiver end of the system. The graph of Figure 1 conveys some useful information regarding the spectral response of the human eye and of general-purpose and IR photodiodes and phototransistors.

Thus, the human eye is sensitive to a range of electromagnetic light radiation; it has a peak spectral response to the colour green, which has a wavelength of about 550nm, and has relatively low sensitivity to the colour violet (400nm) at

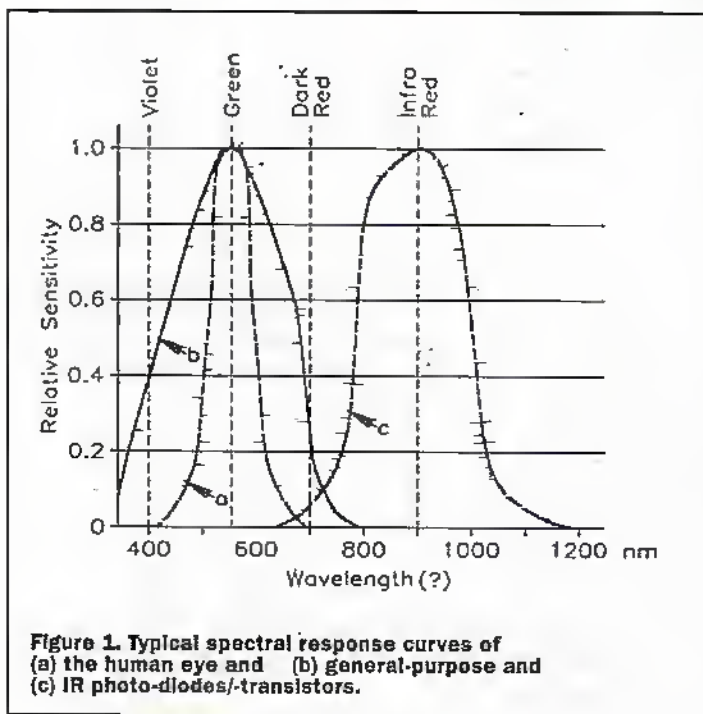

Figure 1. Typical spectral response curves of (a) the human eye and (b) general-purpose and (c) IR photo-diodes/transistors.

one end of the visible-light spectrum and to dark red (700nm) at the other; the human eye is blind to electromagnetic light radiation beyond this narrow spectrum. Optoelectronic semiconductor devices such as photodiodes and phototransistors have spectral responses that are determined by the chemistry of their semiconductor junction material; general-purpose 'light sensitive' types have (as shown in Figure 1) typical spectral

Security ELECTRONIC SYSTEMS & CIRCUITS

PART 5

Ray Marston looks at IR light-beam and PIR movement-detector circuits and systems in this month's episode of the series.

responses that straddle the human visibility spectrum, but IR types operate at a peak wavelength of about 900nm and generate an output spectrum that is well beyond the range of normal human visibility. IR light-beams are thus invisible to human eyes.

A simple IR direct-light-beam intrusion detector or alarm system can be made by connecting an IR light-beam transmitter and IR receiver in the basic way shown in Figure 2. Here, the transmitter feeds a coded pulse-type signal (often a simple squarewave) into an IR LED that has its output focused into a fairly narrow beam (via a moulded-in lens in the LED casing) that is aimed at a matching IR photodetector (phototransistor or photodiode) in the remotely placed receiver. The system action is such that the receiver output is 'off' while the light-beam

reaches the receiver, but turns on and activates an external alarm or other mechanism if the beam is interrupted by a person or other object. This basic type of system can be designed to give a useful detection range of up to 20 metres when used with additional optical focusing lenses, or up to 5 metres without extra lenses.

Note that the simple Figure 2 light-beam alarm system works on a strict line-of-sight principle between the Tx and Rx lenses, and the alarm may thus activate if any object with a diameter greater than the smaller of the two lenses enters the beam's line-of-sight. Thus, a weakness of this simple system is that it can easily be false-triggered by relatively small insects entering the beam or resting on one of the lenses. The improved dual-light-beam system shown in Figure 3 does not suffer from this defect.

The Figure 3 system is basically similar to that already described, but transmits the IR beam via two series-connected LEDs that are spaced about 75mm apart, and receives the beam via two parallel-connected photo-detectors that are also spaced about 75mm apart. Thus, each photodetector can detect the beam from either LED, and the receiver's alarm will thus activate only if both beams are broken simultaneously, and this will normally only occur if a large (greater than 75mm) object is placed within the composite beam. This system is thus virtually immune to false triggering by insects, etc.

Note that, as well as giving excellent false-alarm immunity, the dual-light-beam system also gives (at any given LED drive-current value) double the effective detection range of the simple single-beam system, since it has twice as much effective IR transmitter output power and twice the receiver sensitivity.

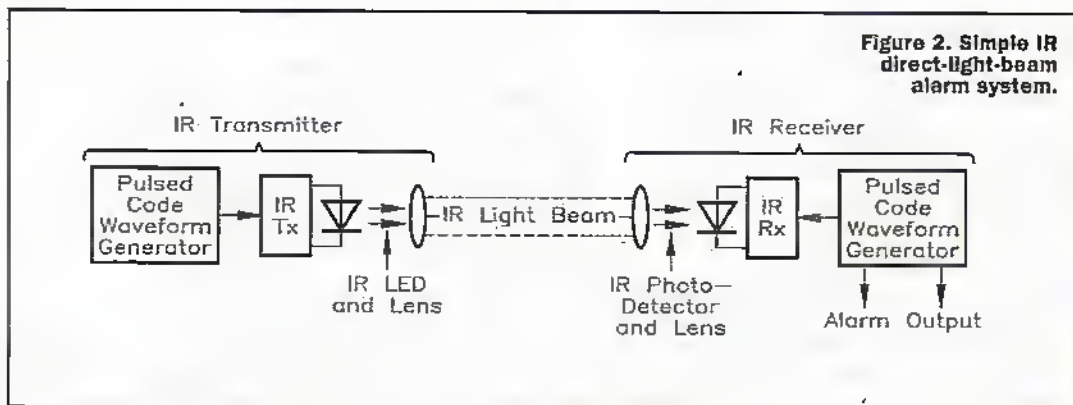

Figure 2. Simple IR direct-light-beam alarm system.

IR System Waveforms

IR light-beam systems are usually used in conditions in which high levels of ambient or background IR radiation (generated by natural or artificial heat sources) already exist. To enable the systems to differentiate against this background radiation and give good effective detection ranges, the transmitter beams are invariably pulse-coded, and the receivers are fitted with matching pulse-code detection circuitry. In practice, the transmitter beams usually use either a continuous-tone or a tone-burst type of pulse-coding, as shown in Figure 4.

IR LEDs and photodetectors are very fast acting devices, and the effective range of an IR beam system is thus determined by the peak currents fed into the transmitting LED (or LEDs), rather than by the mean LED current. Thus, if the waveforms of Figure 4 are used in IR transmitters giving peak LED currents of 100mA, both systems will give the same effective operating range, but the Figure 4(a) continuous-tone transmitter will consume a mean LED current of 50mA, while the tone-burst system of Figure 4(b) will consume a mean current of only 1mA (but will require a more complex circuit design).

The operating parameters of the tone-burst system require careful consideration, since this type of IR intrusion detecting system actually works on a 'sampling' principle and is usually intended to detect the presence of a human intruder. Note that humans moving at normal walking speed take about 200ms to pass any given point, so IR light-beam systems do not need to be switched on continuously to detect a human intruder, but only need to be turned on for brief 'sampling' periods at repetition periods that are far shorter than 200ms (at, say, 50ms); the actual sample period can be very short relative to the repetition period, but must be long relative to the tone frequency period. Thus, a good compromise is to use a 20kHz tone with a burst or 'sample' period of 1ms and a repetition period of 50ms, as shown in the waveform example of Figure 4(b).

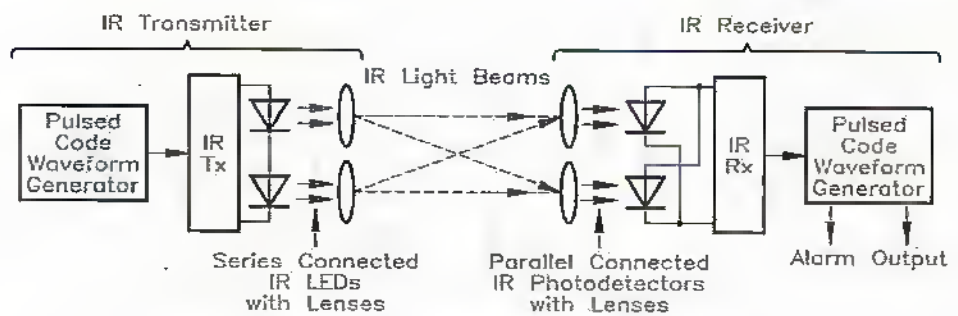

Figure 3. IR dual-light-beam alarm system.

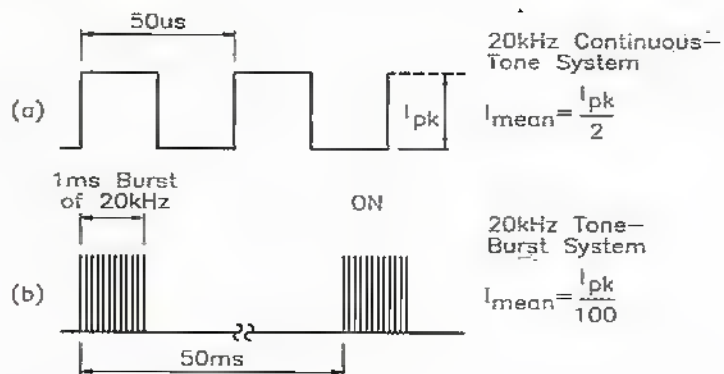

Figure 4. Alternative types of IR light-beam pulse-code waveforms, with typical parameter values.

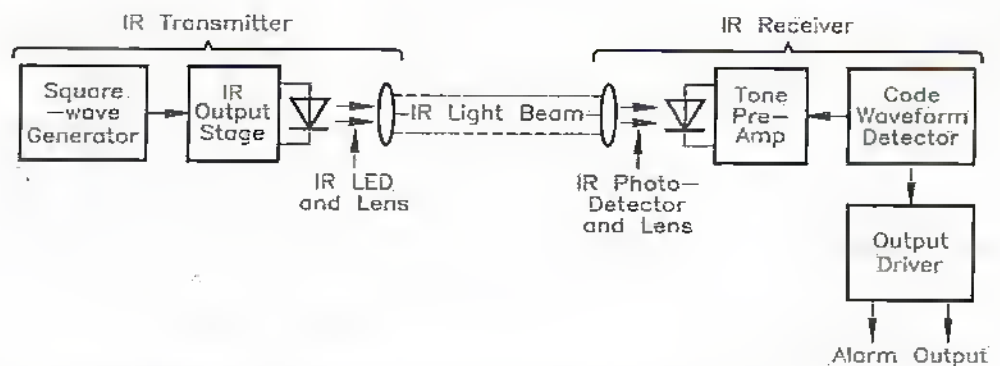

Figure 5. Block diagram of a continuous-tone IR light-beam intruder alarm/detector system.

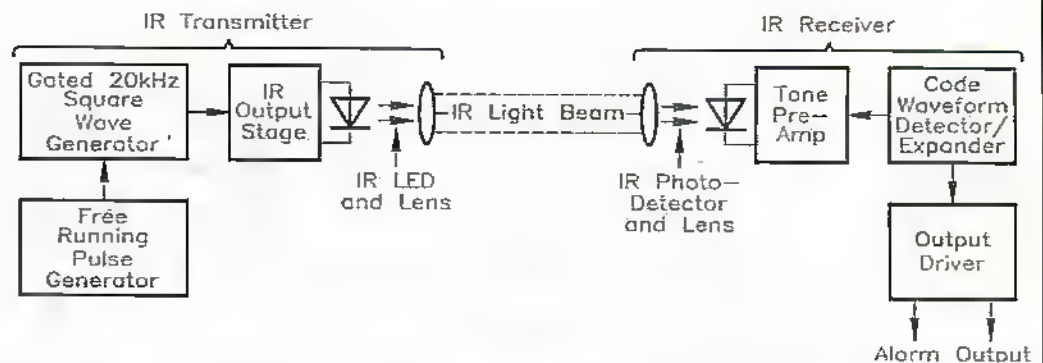

Figure 6. Block diagram of a tone-burst IR light-beam intruder alarm/detector system.

IR System Design

The first step in designing any electronic system is that of devising the system's block diagrams. Figure 5 shows a suitable block diagram of a continuous-tone IR light-beam intrusion alarm/detector system, and Figure 6 shows the block diagram of a tone-burst version of the system. Note that a number of blocks (such as the IR output stage, the tone pre-amp, and the output driver) are common to both systems.

The continuous-tone system (Figure 5) is very simple, with the transmitter comprising nothing more than a squarewave generator driving an IR output stage, and the receiver comprising a matching tone pre-amplifier and code waveform detector, followed by an output driver stage that can activate a device such as a relay or alarm, etc.

The tone-burst system (Figure 6) is rather more complex, with the transmitter comprising a free-running pulse generator (generating 1ms pulses at 50ms intervals) that drives a 20kHz squarewave generator, which in turn drives the IR output stage that generates the final tone-burst IR light beam. In the receiver, the beam signals are picked up and passed through a matching pre-amplifier and then passed on to a code waveform detector/expander block, which ensures that the alarm does not activate during the 'blank' parts of the IR waveform. The output of the expander stage is fed to the output driver.

IR Light-Beam Transmitter Circuits

Figure 7 shows the practical circuit of a simple continuous-tone dual-light-beam IR transmitter. Here, a standard 555 timer IC is wired as an astable multivibrator that generates a non-symmetrical

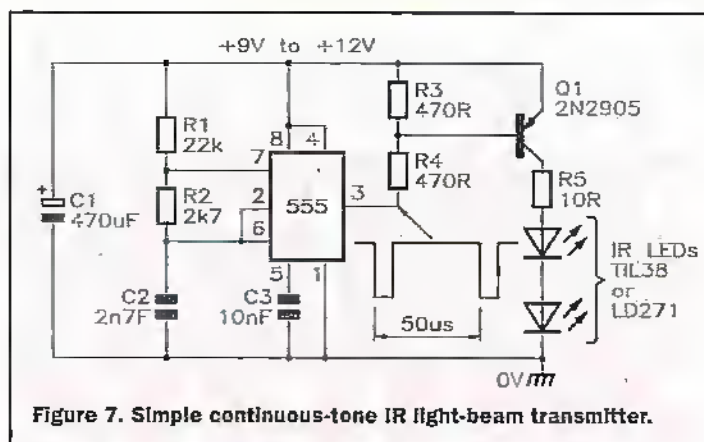

Figure 7. Simple continuous-tone IR light-beam transmitter.

20kHz squarewave output that drives the two series-connected IR LEDs at peak output currents of about 400mA via R4 and Q1 and the low source impedance of storage capacitor C1. The circuit's timing action is such that the ON period of the LEDs is controlled by C2 and R2, and the OFF period by C2 and (R1+R2), i.e., so that the LEDs are ON for only about one eighth of each cycle; the circuit thus consumes a mean current of only about 50mA.

The Figure 7 circuit can use either TIL38 or LD271 (or similar) 'high power' (100mW or greater) IR LEDs. These popular and widely-available LEDs can handle mean currents up to only 100mA or so, but can handle brief repetitive peak currents of up to at least 2.5A. Figure 8 shows the outline and connections of these devices, which have a moulded-in lens that focuses the output into a radiating beam of about 60° width; at the edges of the beam the IR signal strength is half of that at the beam's centre.

Minor weaknesses of the IR output stage (Q1 and R4 to R5) of the Figure 7 circuit are that it has a very low input impedance

(about 300R), that it gives an inverting action (the LEDs are ON when the input is low), and that the LED output current varies with the circuit's supply voltage. Figure 9 shows an alternative universal IR transmitter output stage that suffers from none of these defects. Here, the base drive current of output transistor Q2 is derived from Q1 collector, and the Q1 circuit has an input impedance of about 5k0 (determined mainly by the R1 value). Thus, when the circuit's input is low Q1 is off, so Q2 and the two IR LEDs are also off, but when the input is high Q1 is driven to saturation via R3, thus driving LED1 (a standard red LED) and Q2 and the two IR LEDs on. Under this latter condition about 1.8V is developed across LED1, and about 0.6V less than this (= 1.2V) is thus developed across R4, causing Q2 to act as a constant-current generator that feeds a peak collector current of 1.2V/R4 amps into the two IR LEDs. Thus, this circuit's peak output current can be set by giving R4 an ohms value of 1.2V/I, where I is the desired peak output current in amps.

Figure 8. Outline and connections used by the LD271 and TIL38 IR LEDs.

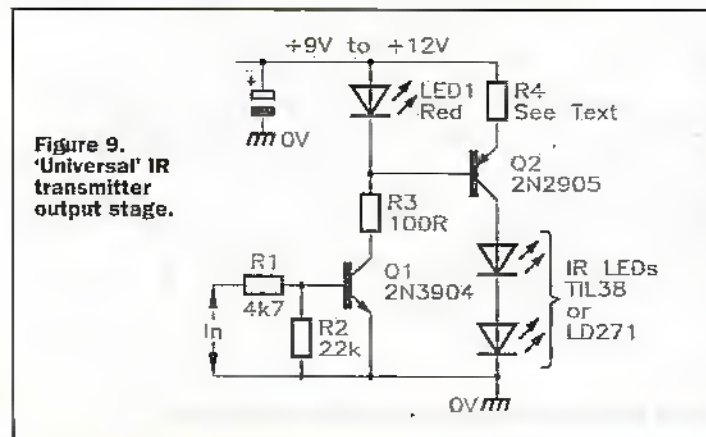
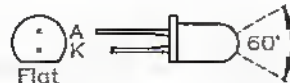

Figure 9. 'Universal' IR transmitter output stage.

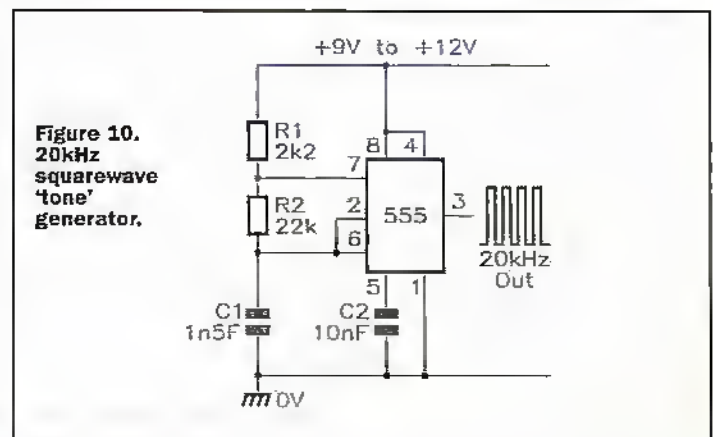

Figure 10. 20kHz squarewave 'tone' generator.

Figure 10 shows a 20kHz squarewave generator (made from a 555 timer IC) that can be used in conjunction with the Figure 9 output circuit to make a continuous-tone IR beam transmitter. In this case the Figure 9 circuit's R4 value should be at least 6R8, to limit the peak IR LED currents to less than 200mA.

Alternatively, Figure 11 shows the circuit of a tone-burst generator that gives 1ms bursts of 20kHz at 50ms intervals and which can be used in conjunction with the Figure 9 output stage to make an IR tone-burst transmitter. Here, the IC1a and IC1b sections of a 4011B CMOS quad 2-input NAND gate IC are wired as a free-running asymmetrical astable multivibrator that produces 1ms and 49ms periods; this waveform is inverted and buffered by IC1c and used to gate a 20kHz 555-type squarewave generator via D2, and this squarewave is then buffered and inverted by the final 4011B stage (IC1c), ready for feeding to the input of the Figure 9 output stage.

Note when using the Figure 11 circuit that R4 in the Figure 9 output stage can be given a value as low as 2R2, to give peak output currents of up to 550mA, but that under this condition the transmitter will consume a mean current of little more than 6mA.

IR Receiver Pre-amp Design

The basic IR input signal to an IR light-beam receiver can be picked-up and converted into a proportional current by either an IR photodiode or an IR phototransistor. If a photodiode is used, it can be connected in series with a load resistor (with a typical value in the range 10k to 100k) and used in either of the reverse-biased configurations shown in Figure 12. The diode's basic action is such that its reverse-biased leakage current is

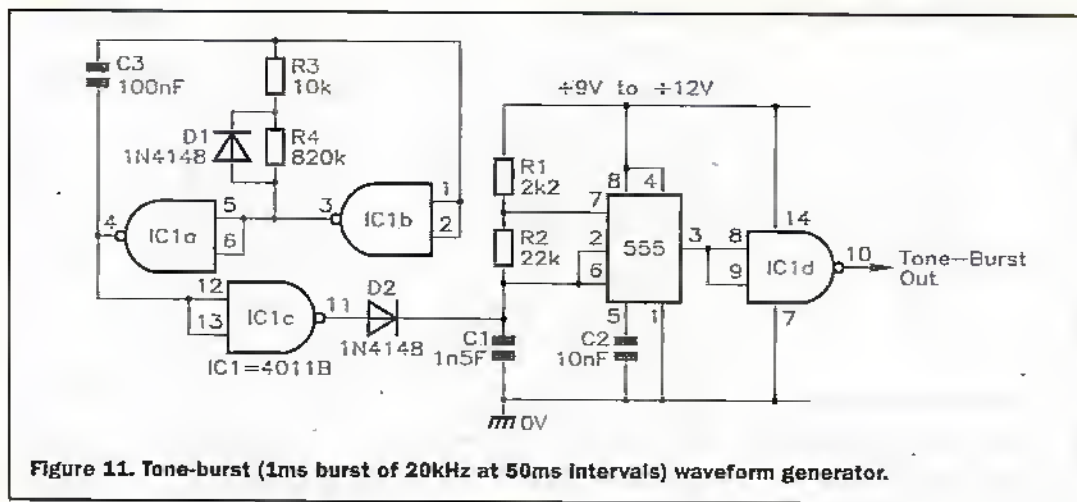

Figure 11. Tone-burst (1ms burst of 20kHz at 50ms intervals) waveform generator.

proportional to the IR light intensity on its junction, being very low under dark conditions and relatively high when brightly illuminated; this current is converted into a proportional output voltage by R1.

An IR phototransistor can be used by connecting it in either of the basic ways shown in Figure 13(a) or (b), in which load resistor R1 has a typical value in the range 1k Ω to 33k Ω . Most phototransistors have only two externally-accessible leads (collector and emitter), but a few are 3-lead types with an accessible base lead; a 3-lead device can be used as a photodiode by connecting it in either of the basic ways already shown, or can be used as a photodiode by wiring it in the way shown in Figure 13(c).

Note that a phototransistor's sensitivity is typically one hundred times greater than that of a photodiode, but its maximum operating frequency (typically a few hundred kHz) is proportionally lower than that of a photodiode (typically tens of MHz). Also note in Figures 12 and 13 that the photosensor exhibits a high sensitivity but a low cut-off frequency if R1 has a high value, and a low sensitivity but high cut-off frequency if R1 has a low value.

Figure 14 shows the practical circuit of an IR light-beam receiver that is designed for use with 20kHz continuous-tone or tone-burst single-beam or dual-beam systems, and used IR photodiodes as signal converters. Here, the two IR diodes are connected in parallel and wired in series with R1, so that the converted IR signal is developed across R1 (note that one of these diodes can be removed if the unit is used with a single-beam IR system). The converted R1 signal is amplified by cascaded op-amps IC1 and IC2, which can provide a maximum signal gain of about x17,680 (= x83 via IC1 and x213 via IC2), but have the gain

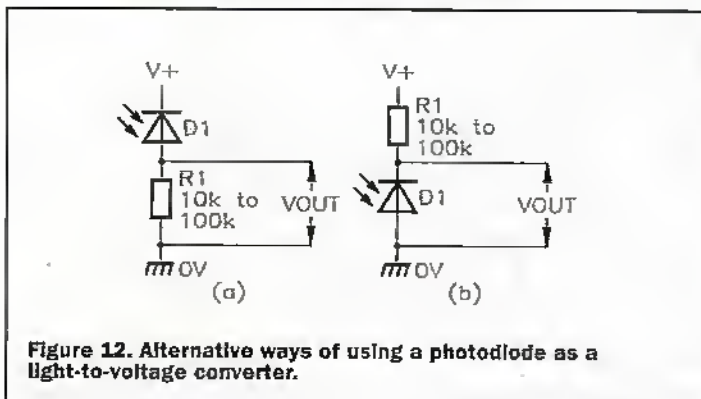

Figure 12. Alternative ways of using a photodiode as a light-to-voltage converter.

made variable via RV1. These two amplifier stages have their frequency responses centred on 20kHz, with third-order low-frequency roll-off provided via C4-C5-C6 and with third-order

high-frequency roll-off provided by C3 and the internal capacitors of the two op-amps.

The Figure 14 receiver pre-amp circuit can be used with a variety of IR detector diode

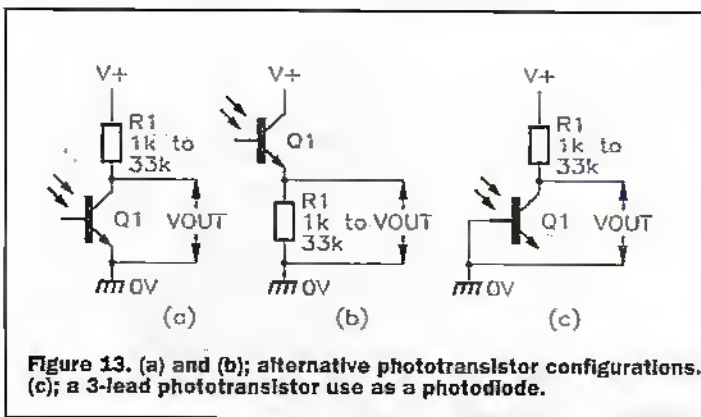

Figure 13. (a) and (b); alternative phototransistor configurations. (c); a 3-lead phototransistor use as a photodiode.

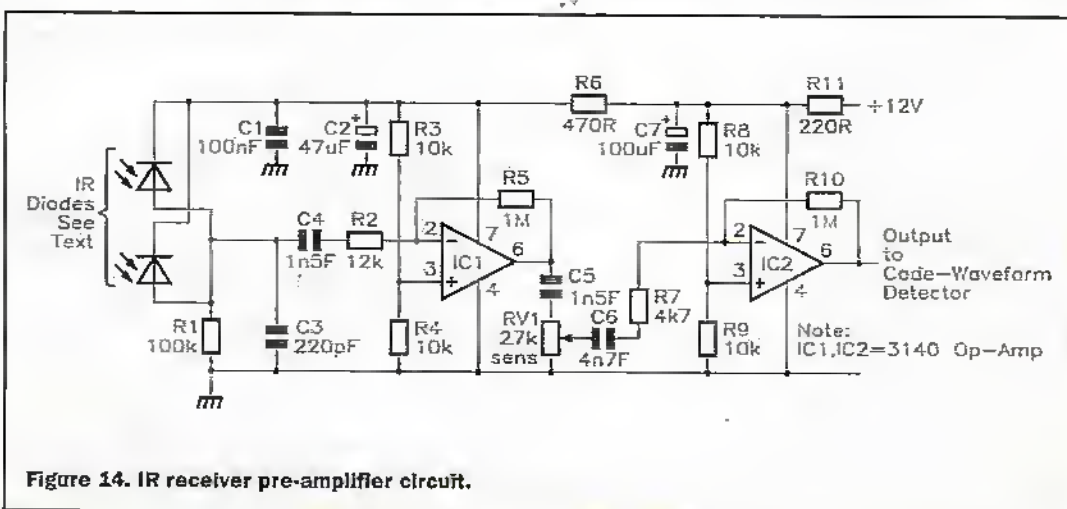

Figure 14. IR receiver pre-amplifier circuit.

types, which ideally should be housed in black (rather than clear) infra-red transmissive mouldings, which greatly reduce unwanted pick-up from visible light sources. Figure 15 shows the case outline and IR-sensitive face positions of three popular IR photodiodes of this type.

The output of the Figure 14 pre-amplifier can be taken from IC2 and fed directly to a suitable code-waveform detector circuit, such as that shown in Figure 16. Note, however, that if the IR Tx-Rx light-beam system is to be used over ranges less than 2 metres or so the pre-amp output can be taken directly from IC1, and all the RV1 and IC2 circuitry can be omitted from the pre-amp design.

A Code Waveform Detector

In the Figure 16 code waveform detector circuit the 20kHz tone waveforms (from the pre-amp output) are converted into dc via D1-D2-C2-R5-C3 and fed (via R6) to the non-inverting input of the 3140 op-amp voltage comparator, which has its inverting input connected to a thermally stable 1V0 DC reference point. The overall circuit action is such that the op-amp output is high (near the positive supply rail voltage) when a 20kHz tone input signal is present, and is low (at near-zero volts) when a tone input signal is absent; if the input signal is derived from a tone-burst system, the output follows the pulse-modulation envelope of the original transmitter signal. The detector output can be made to activate a relay in the absence of a beam signal by using the expander/output driver circuit of Figure 17.

An Expander/Output Driver

The operating theory of the Figure 17 circuit is fairly simple:

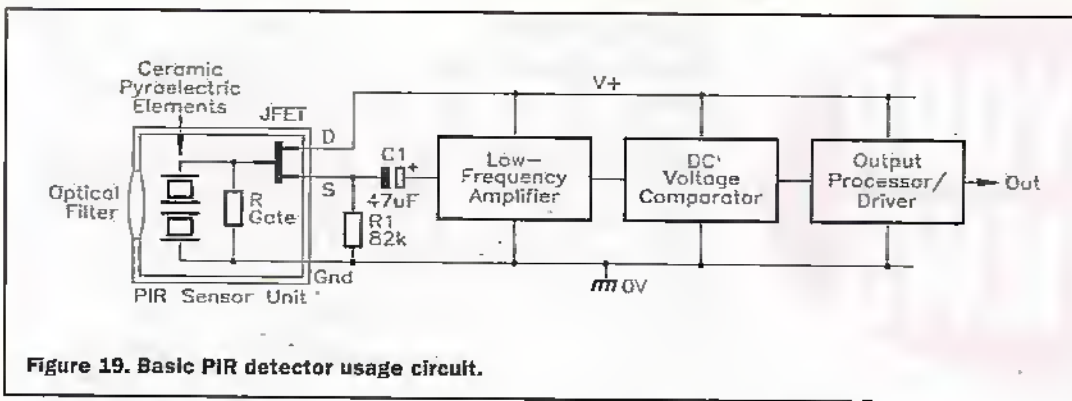

Figure 19. Basic PIR detector usage circuit.

PIR Movement-Detecting Systems

IR light-beam alarms are 'active' IR units that react to an artificially generated source of IR radiation. Passive IR (PIR) alarms, on the other hand, react to naturally generated IR radiation such as the heat-generated IR energy radiated by the human body, and are widely used in modern security systems. Most PIR security systems are designed to activate an alarm or floodlight, or open a door or activate some other mechanism, when a human or other large warm-blooded animal moves about within the sensing range of a PIR detector unit, and use a pyroelectric IR detector of the type shown in Figure 19 as their basic IR-sensing element.

The basic Figure 19 pyroelectric IR detector relies on the fact that some special ceramics generate electrical charges when subjected to thermal variations or uneven heating. Modern pyroelectric IR detectors such as the popular PIS201S and E600STO types incorporate two small opposite-polarity series-connected ceramic elements of this type, with their combined output buffered via a JFET source-follower, and have the IR input signals focused onto the ceramic elements by a simple filtering lens, as shown in the basic PIR detector usage circuit of Figure 19. It is important to note at this point that the detector's final output voltage is proportional to the difference between the output voltages of the two ceramic elements.

The basic action of the Figure 19 PIR detector is such that, when a human body is within the visual field of the pyroelectric elements, part of that body's radiated IR energy falls on the surfaces of the elements and is converted into small but detectable variation in surface temperature and corresponding variation in the output voltage

of each element. If the human body (or other source of IR radiation) is stationary in front of the detector's lens under this condition, the two elements generate identical output voltages and the unit's final 'difference' output is thus zero, but if the body is moving while in front of the lens the two elements generate different output voltages and the unit produces a varying output voltage.

Thus, when the PIR unit is wired as shown in the Figure 19 basic usage circuit, this movement-inspired voltage variation is made externally

available via the buffering JFET and de-blocking capacitor C1 and can, when suitably amplified and filtered, be used to activate an alarm or other mechanism when a human body movement is detected. In practice, pyro-electric IR detectors of the simple type just described have, because of the small size (usually about 20mm²) and simple design of the detector's IR-gathering lens, maximum useful detection ranges of roughly one metre. In modern commercial PIR movement detecting security units, however, this range is

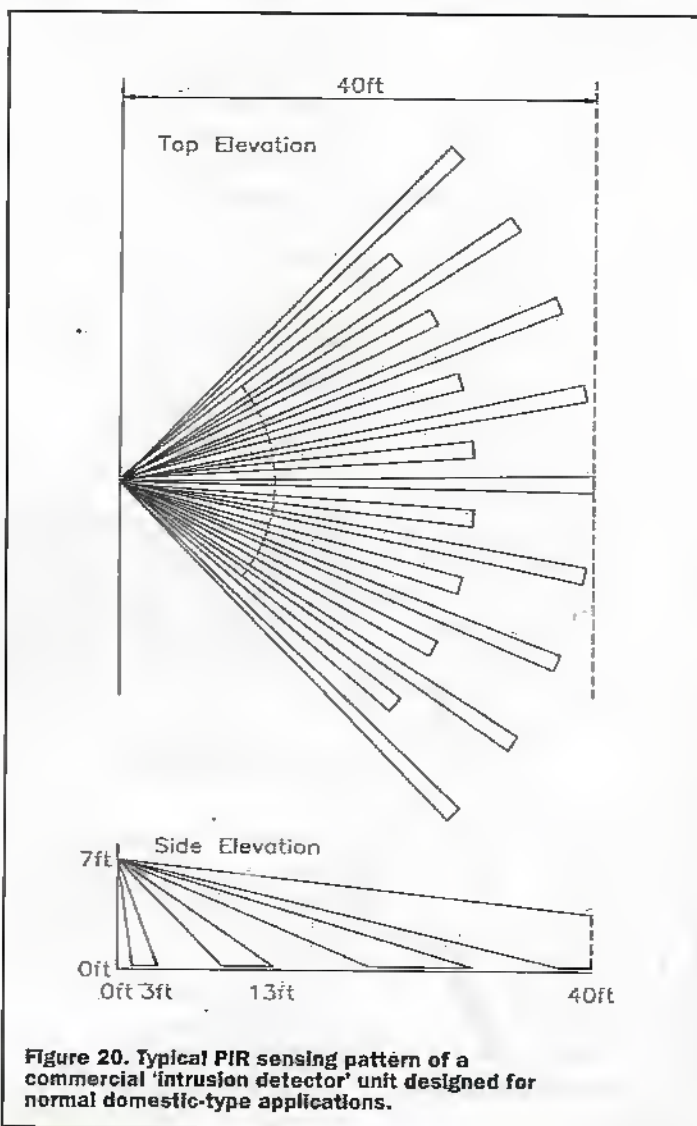

Figure 20. Typical PIR sensing pattern of a commercial 'intrusion detector' unit designed for normal domestic-type applications.

greatly extended (usually to well over ten metres) with the aid of a large (about 2000mm²) multi-faceted external IR-gathering/focusing plastic lens, which splits the visual field into a number of parallel strips and focuses them onto the two sensing areas of the PIR unit.

Figure 20 shows the typical PIR sensing pattern of a commercial 'intrusion detector' unit designed to protect a normal-sized room in domestic-type applications. In this example the unit is mounted on a wall at a height of seven feet and is aimed downwards at a shallow angle, and the multi-faceted plastic lens splits the visual field into a large number of vertical and horizontal segments. Any person moving through a single segment will activate a single trigger signal within the PIR sensor; a person moving through the entire visual field will thus produce numerous triggering signals, but a stationary IR source will produce no signals. Most intrusion detectors of this type incorporate 'event counting' circuitry that will only generate an alarm-activating output if three or more trigger signals are detected within a few seconds, thus minimising the chances of a false alarm due to sudden changes in temperature caused by the auto-activation of time-switched security lights, etc.

The lens-generated PIR sensor pattern shown in Figure 20 is the type that is often used in burglar-alarm systems to protect a single room in a medium-sized house. Alternative (and usually interchangeable) plastic lens types, offering different ranges and coverage patterns for various special types of application, are available at low cost from many commercial PIR-unit suppliers. Amongst the most important of these are the 'pet' type, in which the field's vertical span is restricted to 2.5 to 6.6 feet above ground level to avoid activation by domestic pets while giving good sensitivity to normal humans; and the 'corridor' type, in which the field's horizontal span is restricted to about 20 degrees to give long-distance coverage (typically about 30 metres) of narrow corridors and passageways.

Note that, because high-quality commercial PIR security units of this basic type are widely available at comparatively low cost, it is not practicable (on aesthetic and economic grounds) to try to build similar units on a DIY basis.



E-mail your views and comments to: AYV@maplin.demon.co.uk

Write to: **Electronics and Beyond**, P.O. Box 777, Rayleigh, Essex SS6 8LU

Cheap Cable Core Identifier

Dear Sirs,

The Cheap Cable Core Identifier described by Dr Manning (Circuit Maker—Jan 1998) is an excellent example of a low tech answer to a low tech problem which is almost as good as the high tech solutions on sale.

It's main drawback is that it is subject to possible errors caused by the cable resistance in long cable lengths. This problem could be eliminated by simply connecting a battery across the resistor chain and switching the multimeter to volts. The high input

impedance of a typical multimeter would then mean the cable resistance had no effect on the reading for any cable length (within reason).

If the user is really lazy (like me) then the addition of a variable resistor in series with the battery would enable the voltage across the chain to be "calibrated" to a nice convenient round figure.

Even with this optional enhancement the additional cost to the project is only a few pence with a vast improvement in reliability.

Roly Williams
Roly_W@compuserve.com

Thank you for your comments.

Portable Amp Wanted

Dear Editor,

I hope that you or one of your readers may be able to help. I have been trying to obtain a small battery powered amp and head worn mic system for one of our service users. So far we

have been offered only one system, this was £500 and didn't work at all well. Any ideas on the matter would be gratefully received. I wait in anticipation.

Neil Sharpe
Banff Day Service Social work dept,
Collegiate Road, Banff Aberdeenshire,
Scotland, AB45 1DZ

We can certainly try.

Readability of Maplin Magazine

Dear Sir,

May I desperately ask you to persuade your management that not all your magazine readers are youngsters with brilliant eyesight. Regrettably, as we mature, our sight declines. Maplin magazine is printed in the worst possible typeface. It is not merely small. It is not black on white but grey on sometimes white. The paper is more often off-white or coloured.

Please! Please! Print it in decent black type so that we slightly wrinkled can read it.

George Boyce
Geoboyce@aol.com

Garamond is a normal typeface used by many publishers. I hope the main body of the text is always black on white. We have not had any complains before, but we will keep a close eye on clarity. — Ed.



Digital Alpha Microprocessor

Dear Sir,

It was with a mounting sense of incredulity that I read Stephen Waddington's — otherwise excellent — Information Economy — The Chips Business article in the December issue to find no mention of the Digital Alpha microprocessor.

The Alpha is the fastest microprocessor, bar none and can run Digital's Open VMS, UNIX and Microsoft Operating Systems. Yet Stephen's article makes no mention of the Alpha at all.

Instead he says that "...it is possible within the next ten years, we'll see clock speeds break the 500MHz barrier and extend upwards towards 1GHz".

Stephen! Wake up and smell the MHz. Digital 8000 series systems are already on sale and

incorporates Alpha chips clocking in at 625MHz— check out www.digital.com/semiconductor for further details.

Alan Trevenno
Digital Equipment

Stephen Waddington replies: It's a fair cop. Guilty as charged. I did mention the StrongARM microprocessor, developed jointly between Digital Semiconductor and Advanced RISC Machines in Cambridge. It will be interesting to see what happens to both this device and the Alpha now that Digital has signed over its chip business to Intel. As part of a settlement ending a patent infringement lawsuit brought by Digital Equipment Corporation against Intel, Intel is paying Digital \$700 million and royalties but Digital is committing itself to develop computers based on the next-generation of Intel chips and competing directly against Digital's Alpha chips.

Port, er, Sorter!

Just a quick note regarding Mr. de Wet's letter concerning parallel ports in the December 1997 issue (No.121). As always, it is not as simple as it first seems. There seems to be three types of configuration, viz.: Simple — output only; Bi-ionic — Bi-directional on the control lines but not on the data lines (I think); Bi-directional — as the name suggests, both-way communication on both the control and data lines. I have used the following simple Qbasic programme to determine whether or not the port is Bi-directional:

That's it! When you run it, you will see a stream of numbers running up the screen. If your port is Bi-directional, putting '0's and '1's on D0 to D7 will change the value of the number. If it stays at either 255 or 0, then the port is probably not Bi-directional. But do not worry; replacement cards are available and with care, you should be able to pick one up for a very modest sum. Hope the info. helps.

Bryan Taylor, Ipswich. E-mail: Bryanvt@MSN.com

Thank you for sending in these details, which we hope will solve Mr de Wet's computing snag.

```
'Set port to bi-directional mode (LPT2)
OUT $H27A, 32          'FOR LPT1 USE $H37A
DO
PRINT ;,INP($H278)    'FOR LPT1 USE $H378
IF INKEYS=CHR$(27) THEN END 'ESCAPE ROUTE)
LOOP
```

Sounding Off!

Dear Sir,

LG Jones of Abergavenny refers (Sounding Off! - Electronics and Beyond — November 1997) to the use of 0.775V rms V rms as a reference level, which 'apparently' dates to the early telephony industry'. My understanding is that it was intended to measure output compared to a reference level

of 1 milliwatt. Many telephone circuits have a characteristic impedance of 600 ohms, and, simply, one milliwatt dissipated in 600 ohms represents 0.775V, by Ohm's law.

Michael Clementson
16 Brynderwen Close,
Cyncoed, Cardiff
CF2 6BR

Quite correct - deci-Bell - Alexander Graham Bell inventor of telephone and all that!

Software HINTS & TIPS

by Ruth Hewer

Hello again. This month I have been asked to show some keyboard shortcuts.

I know Windows 95 has a toolbar at the bottom of the screen that shows you which applications you have open on your computer but Windows 3.11 is not so obvious.

If you press and hold down the ALT key and then press the TAB key a box appears on your screen showing which applications are open. By pressing the TAB key you will notice a box moves from each application and the wording at the bottom of the box tells you what each application is. If you let go of the ALT key, Windows will take you to the application that had the box around it.

In all Windows applications if you look on the toolbars you will notice that some of the words have letters which are underscored:

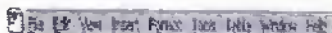

For example, on the Word toolbar above you will notice that the F on the word File is underscored. This means that if you press and hold down the ALT button and press the letter F on your keyboard the following menu will appear:

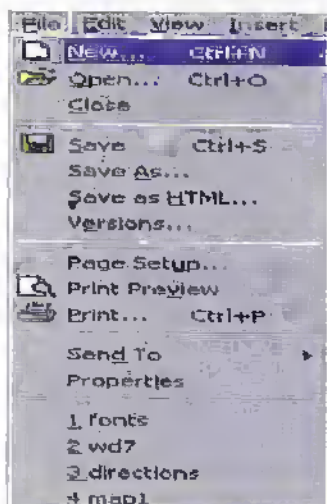

This is the same menu that would appear had you pointed the mouse at the word File and clicked. This works in the same way for all the items on the toolbar. Once I have the menu open I can simply press the letter of the command I wish to

To	Press
Copy text or graphics	CTRL + C
Paste the Clipboard contents	CTRL + V
Cut text or graphics	CTRL + X
Insert a page break	CTRL + ENTER
Go to the beginning of the document	CTRL + HOME
Go to the end of the document	CTRL + END
Apply or remove bold formatting	CTRL + B
Apply or remove italic formatting	CTRL + I
Apply or remove underline formatting	CTRL + U
Print a document	CTRL + P
Save a Document	CTRL + S
Exit Word	ALT + F + X

Basic Word Shortcuts

To	Press
Complete a Cell entry	Enter
Cancel a Cell entry	ESC
Move to the beginning of the line	HOME
Hide Rows	CTRL + 0
Unhide Rows	CTRL + SHIFT + (
Hide Columns	CTRL + 0 (zero)
Unhide Columns	CTRL + SHIFT +)
Apply the general number format	CTRL + SHIFT + ~

Basic Excel Shortcuts

To	Press
View the shortcut menu for the selected item	SHIFT + F10
Display the Start Menu	CTRL + ESC
Rename a selected item in Explorer	F2
Find a folder or File in Explorer	F3
Create a shortcut	CTRL + SHIFT while dragging the file
View item properties	ALT + ENTER

Basic Windows Shortcuts (Windows 95)

use. For example P would print the document for me.

There are a lot of shortcut keys available in Word. I have listed the more common ones below but if you click on the Help button and select Contents and Index and type in the word shortcuts you can print a list of them for your convenience.

To make text bold etc, use the same commands as in the Word table.

The Right Hand Mouse Button

There is also the right hand mouse button (for those people who use the mouse in the standard set-up)

The right mouse button acts as an edit/format menu in Word, unless you are in a table etc. If I were to press my right

hand mouse button now, the following menu would appear:

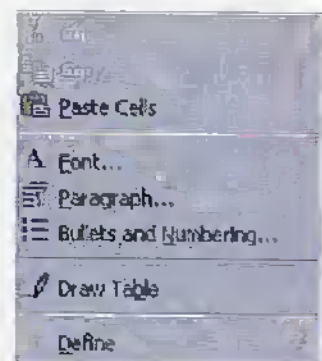

If I had pressed the right mouse button when I was working on my table earlier, the following menu would appear:

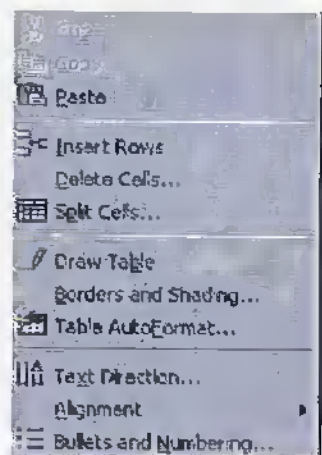

Word is intelligent enough to recognise that whilst working in a table, I may require a table menu.

Now, when I am working in Word or Excel etc, if I want to copy, cut and paste something I can simply highlight it, click on the right mouse button and select Copy, Cut and then go to where I want to paste it. Click on the right mouse button and select paste.

Going back to the keyboard shortcuts, to accomplish the above I would highlight the text, select CTRL + C, CTRL + X, move to where I want to paste it and Press CTRL + V. These shortcuts appear in many pieces of software and are useful to know.

I hope that some of the above will help you make your working life easier. It may appear to take a little longer at first, but as with everything, practice makes perfect. I'm now going to ALT + F, S, ALT + F, X. See you next month.

If you have any queries contact us via Email at: ruth@apl1n.demon.co.uk

Abuse on CB RADIO

What can we do about it?

Chris Perry of the British Citizens' Band Confederation outlines some of the misuses of the CB system and how they can be rectified.

A good indication of how many breakers' have turned off, or turned away from CB radio, is the amount of CB licences that are issued now – as to the amount of licences that were issued ten years ago. Ten years ago the figures were around two hundred and fifty thousand. Today I estimate that there are no more than forty nine thousand.

There are two reasons why I feel that this is the case – firstly breakers' are fed up with the abuse and have just turned off – secondly breakers' feel that they do not receive sufficient response or support from the Radiocommunications Agency in combating abuse for the amount that they pay for their licence.

The vast decrease in the sale of licences, will not go without a knock-on effect. If the sales of licences continue to diminish there will be less money for the RA to spend on 'cleaning up' the frequencies, and if licence sales diminish even further then there is a serious threat of officially losing CB altogether, and those of you who might scoff at this comment, can I remind you of what happened to the 93MHz service!!

What we can do about it ...!

So.....what can we do about it? What can we do to protect our CB usage, and service? I think the first important thing we can do is – **don't stop buying a licence!** Why? Because when Government Officials 'officially' look at any situation they only study facts and figures – they only, '...look at statistics' – they will only look at, '...how many licences are being issued', not, '...how many users' there are out there. I know that for a fact, as I have been a Civil Servant myself for nearly twenty three years. We don't want to lose CB radio altogether – the more revenue that the RA can gather from CB licences, the more money goes into the pot for the service altogether. In short, the more money there is – the more can be done to get rid of the 'abuse-element'. That's why we need to not only

keep buying a licence, but try and increase licensees overall. Secondly, we need to be prepared to do something ourselves to clear up the abuse that is clearly on the increase. We need to be prepared to report all cases of abuse. We need somewhere or someone where we can report abuse to; but where is there? Well, officially there's the RA's Watch-Dog the Radio Investigation Service (RIS), and possibly the Performing Rights' Society (PRS). Last, but by no means least, the British Citizens' Band Confederation (B.C.B.C.)

The RIS

The problem of reporting abuse through the RA/RIS is that it can take a long time to get any action taken against the perpetrator. This is not always down to the Authorities themselves. People write, or phone in, reporting abuse with details that are so scant, they just have no clear or precise information to act upon; hence nothing gets done. Because they are working on a very restrictive budget, they have to make sure that any case of abuse that they act upon, is guaranteed to result in a positive prosecution otherwise they lose money in costs. That money comes out of our licence fees, so let's not waste our money!!

The Performing Rights Society

The Performing Rights Society (PRS) is the organisation which looks after the rights of their members who are normally artists and performers. The officials of the PRS visit Public places such as shopping malls, pubs, clubs etc. and check with the owners/management that the premises are licensed for the playing of music to the Public. In short they protect the copyright of their members. What's all this got to do with CB radio? The PRS also like to take an active part in prosecuting 'pirate' radio stations, irrespective of what frequencies they operate on. So all CB DJ's – or potential DJ's beware.



The biggest single complaint from CB users is that of abuse. Time – after time whether it be at, 'Open Forum' type meetings – or in articles or letters in the Radio Active CB Magazine the matter of abuse will invariably rear its ugly head! And it can be very ugly. Abuse can come in various guises – from that of threats to kill – to that of simple mike keying, and a whole variance of abuse in-between.

Some breakers' respond – some do not. Some breaker's respond by giving as good as they got, and some turn off, but how long is it before you get sick and tired of having a go back, or turning off your rig? How long will it take before you get so fed up that you turn your rig off for good?

This so-called 'hobby' of ours is supposed to be there for our enjoyment. To entertain us – to get some pleasure out of – to relax with. Over the many years of being a CB'er (I started with legalisation in November 1981) I have witnessed a steady increase of abuse in one form or another, and I can fully understand and sympathise with decent CB'ers, over the frustrations and stress that they experience when suffering from this type of unsociable behaviour. For a lot of breakers' there is no longer any enjoyment to be had from CB radio.....How many decent breakers' have turned off for good?

The British Citizens' Band Confederation

The British Citizens' Band Confederation has been set up by CB'ers for CB'ers, and for that reason the organisation is fully aware of the abuse-related problems that are prevalent throughout the country. In fact, top of the list for our 'Aims and Objectives', is that of taking an active role with the RA/RIS, and forge links with the PRS in order to stamp out this anti-social behaviour.

However, this cannot be achieved without assistance from our members'. In order for the B.C.B.C. to achieve a 'cleaning up' of the CB frequencies we need you to tell us where the problems are. We cannot do it otherwise. There are no vast fortunes available to buy expensive 'tracking' equipment, or employ teams to manage such equipment. Even the Radio Society of Great Britain (RSGB) don't operate like that, they have to rely on their membership to bring to the notice of the Society any problem operators; and it is our intention to operate after the same fashion.

What we would like you to do is nothing more than use your CB as normal; but should you experience, or suffer abuse yourself, then log it down on one of the specially prepared B.C.B.C. 'Abuse Forms'. Once a sheet is completed, send it to the B.C.B.C., that's all you have to do. Your anonymity is guaranteed. No one - except for the Regional Manager, and the Director of Regional Services will even see the report in its original format. Any relevant information to be passed on to the Authorities will be sent on a completely different form. Confidentiality to our members' will be paramount.

By using this method of reporting abuse, the offender will not know from where the report originated. In fact, the *first* thing they *will* know about it, is when the Authorities are stood knocking on their door!

So, do you feel that the time has come where you can help out? Can you do it? If so, why not join the B.C.B.C. and have a direct effect on your hobby? An effect not only in the area of abuse, but an effect within CB radio overall. Be a part of the only National Organisation that takes its lead direct from its membership. Let us return to what CB used to be like. Let's return to enjoying CB radio. Let's make a serious start - and then continue to get rid of - the 'bucket-mouths' - the 'music-players' - the 'mike-keyers'. Let's get rid of the other nuisance-value elements that give CB and CB'ers a bad name. That gives decent CB'ers aggravation and headaches. Let's now give **them** something to think about. Let's give them the elbow.....for good!!

All B.C.B.C. Members' will find a specially prepared 'Abuse Form' within their membership pack.

CB Radio Information and Licence Application RA 246 CB Radio Information Sheet is available from Maplin Electronics (Order code NW07H).

This useful and informative 12-page leaflet produced by the Radio Communications Agency is essential reading for anyone who

About The British Citizens' Band Confederation

The British Citizens' Band Confederation (BCBC) has been set up by CB'ers for CB users.



What is the BCBC?

The BCBC was formed in 1997 to encompass the many different needs of CB radio users and present those views with one voice to the Radiocommunications Agency and other European administrations. It is a democratic organisation run by its Membership through elected representatives. Membership is open to individuals, families, clubs, societies and organisations.

What issues will the BCBC be raising?

The needs of CB radio users are varied and widespread. The BCBC membership decides policy and direction. Views of members are sought through questions and written views are encouraged. These views are then formally presented to the Radiocommunications Agency for consultation, and where required the trade supply technical reports.

How will the BCBC help CB radio users?

In addition to regular meetings with the Radiocommunications Agency. The BCBC is also able to offer direct advice to members or seek answers on members' behalf. Members also receive regular information updates.

What makes the BCBC different?

The BCBC is unique for a number of reasons. The BCBC was formed because licensed CB radio users expressed, in a Radiocommunications Agency questionnaire, a desire to have one single representative organisation. To help achieve the best possible results, the BCBC have made provisions for all types of users, including the trade. The BCBC is recognised and endorsed by both the Radiocommunications Agency and the Radio Society of Great Britain (RSGB). Maplin Electronics, along with other individuals and companies, is a Founder Member of the BCBC.

Membership details and an membership application form for the BCBC can be obtained as follows:

- ◆ from Maplin Electronics by ordering NW06G - free of charge when ordering other goods or
- ◆ from all Maplin and Mondo Maplin stores - free of charge or
- ◆ by writing to: The Membership Secretary, BCBC, PO Box 5826, Basildon, Essex, SS16 5FQ

Membership fees are, at time of writing, £6.00 for licensees and £10.00 for non-licensees. Various classes of membership are available, please see membership details. Please note: Maplin Electronics cannot accept membership applications or payment of membership fees, such must be sent direct to the BCBC at the above address.

The BCBC and Maplin Electronics actively encourage all CB radio users to hold a valid CB radio licence, to behave in a responsible and courteous manner and to abide by the terms, provisions and limitations set out in the terms of the CB radio licence.

Whilst every reasonable precaution is undertaken to protect the interests of customers, Maplin Electronics PLC does not accept any liability for any circumstances arising from membership of the BCBC, however occurring; or for any falling on the part of the BCBC in respect of undertakings given. Any payment made to the BCBC is made entirely at the individuals risk. The views expressed by the BCBC are not necessarily those of Maplin Electronics PLC.

is interested in CB Radio. It answers the most frequently asked questions about licensing and what the service is/is not allowed to be used for. The leaflet also lists the channel numbers and frequencies of the UK & CEPT channel allocations. Additionally the leaflet includes the CB Radio Code of Practice, useful points of contact for further information and an application to be added to the Radiocommunications Agency CB mailing list.

Leaflet RA 246 can be obtained as follows:

- ◆ from Maplin Electronics by ordering NW07H - free of charge when ordering other goods or
- ◆ from all Maplin and Mondo Maplin stores - free of charge or
- ◆ from The Library, Radiocommunications Agency, New King's Beam House, 22 Upper Ground, London, SE1 9SA. Tel: 0171 211 0505/0502

RA 240 Application for CB Radio Licence (NW08J)

Anyone wishing to use the CB Radio service legally must have a valid licence. Operating a CB Radio without a licence is contrary to the Wireless Telegraphy Act 1949 and renders the individual liable to prosecution. The licence, at time of writing, costs £15 per year. It covers the license holder for any number of CB Radios and other individuals under the license holders general supervision (see RA 246 for a more detailed explanation). CB Licences can no longer be obtained 'over the counter' at post offices.

Application RA240 can be obtained as follows:

- ◆ from Maplin Electronics by ordering NW08J – free of charge when ordering other goods or
- ◆ from all Maplin and Mondo Maplin stores – free of charge or
- ◆ from the Radio Licensing Centre, Subscription Services Ltd, PO Box 884, Bristol, BS99 5LE. Tel: 0117 925 8333

Please note: Maplin Electronics cannot accept license applications or payment of license fees, such must be sent direct to the Subscription Services at the above address.

Additional Information

For enquiries on CB licensing conditions and policy, please contact:
Citizens' Band Service,
Radiocommunications Agency, New King's
Beam House, 22 Upper Ground, London,
SE1 9SA. Tel: 0171 211 0158/0159/0160.
Email: aswcb@ra.gent.gov.uk
For general enquiries, please contact
the Radiocommunications Agency enquiry
point, Tel: 0171 211 0211
Radiocommunications Agency Web Site:
<http://www.open.gov.uk/radiocom/ratime.htm>

Using the latest technology, this mobile CB transceiver offers a sophisticated array of features. It covers both the 40 UK and 40 CEPT channels. Features include illuminated LCD display, comprehensive scanning, dual watch, key lock, dual function button control, priority channel 9 and 19, display of supply voltage, beep on/off and programmable functions on the microphone.

This 4W mobile measures 150 x 45 x 157mm and is supplied with 12V DC lead, microphone, mounting kit and comprehensive instructions.

The rig is now available from Maplin Electronics. Order Code NV99H Price £129.95.

NV99H - Maycom EM-27 Professional UK & CEPT 80 Channel Mobile CB.



MAPLIN projects

TOP 20 KITS

Position This Month	Position Last Month	Stock Code	Description	Price Inc VAT	Catalogue Page
1	3	LK63	Live Wire Det Kit	£6.99	785
2	4	LP56	Mosfet Amp Kit	£21.99	706
3	9	LP16	TDA7052 Kit	£6.99	703
4	-	LP53	VR Remote Tester	£10.99	787
5	10	LP30	1/300 Timer	£8.99	726
6	8	LP69	L200 Kit	£7.99	762
7	6	LP77	Lights On Reminder	£6.99	716
8	17	LP83	LED Xmas Tree	£15.99	0
9	5	LP28	Beginners AM Radio	£10.99	765
10	11	LK42	Car Batt Monitor	£12.99	714
11	14	LT31	SSM 2017 Pre-Amp	£16.99	709
12	13	LP66	Courtesy Light Extr	£4.99	716
13	-	LP54	LED Xmas Star	£10.99	0
14	16	LM76	LM386 Kit	£4.99	703
15	19	LP03	TDA2822 Stro Pwr Amp	£10.99	703
16	-	LT09	Music Maker	£4.99	739
17	15	LU29	PIC 16C84 Programmer	£19.99	731
18	12	LT34	555 Proto Card	£7.99	729
19	18	LP12	IBM Expansion Kit	£27.99	376
20	-	LT82	Robot Voice Kit	£29.99	710

Over 200 kits available. All kits are supplied with full instructions. The descriptions above are necessarily short; please ensure that you know exactly what the kit is and what it comprises before ordering by referring to the current maplin catalogue. Maplin Projects: Top 20 Kits: based on November 97 sales figures. All items subject to availability. Prices are subject to change. E&OE.

MAPLIN modules

TOP 20

Position This Month	Position Last Month	Stock Code	Description	Price Inc VAT	Catalogue Page
1	1	YU49	Clock Module	£4.69	728
2	8	AM27	418MHz Tx	£13.99	770
3	6	FS13	Counter Module	£9.99	755
4	5	WC20	UHF Modulator 6MHz	£10.99	791
5	13	YT99	Temp Mod Wide Range	£13.99	754
6	4	FE33	Temperature Module	£9.99	753
7	3	FP64	Min/Max Temp Module	£11.99	754
8	9	AM28	418MHz Rx	£25.99	770
9	18	AM11	Expansion Card Assm	£34.99	376
10	2	YU07	Small Temp Mod Ext	£10.99	753
11	7	GW01	DVM Meter Module	£12.99	756
12	11	RJ89	W/Less Clock Module	£24.99	728
13	14	AM03	150W MOSFET Amp Assm	£29.99	706
14	16	LB97	Pre-Amp EQ2S	£12.49	709
15	10	MK68	EM2 MSF Rcvr Module	£16.99	727
16	15	YU05	Small Clock Module	£8.99	728
17	12	NV10	TDGM622-1TimeDateVGM	£49.99	790
18	-	NV08	418MHz AM Tx Module	£9.99	769
19	-	YU00	Dual Disp T Module	£13.99	754
20	-	LP85	RS232-Digitl Conv Assm	£19.99	724

Over 100 modules available. Not all modules are supplied with data/instructions, however full technical data is available on request from Technical Sales. The descriptions above are necessarily short; please ensure that you know exactly what the module is and what it comprises before ordering by referring to the current maplin catalogue. Maplin Modules: Top 20: based on November 97 sales figures. All items subject to availability. Prices are subject to change. E&OE.

projects

New Project Kits from Maplin

AUDIO LEAD CHECKER KIT

- No home or professional studio should be without one!

FEATURES:

- Rapidly and clearly identifies connections on most audio cables
- Will test very long cables
- Clear led readout
- Robust design

IDEAL FOR:

- PA/Sound engineers
- Gigging bands
- Fault diagnosis

Kit includes all components, PCB, fixing hardware, case, front panel label and full instructions.

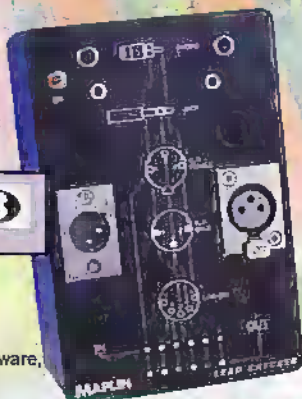

PROJECT RATING 3
Average

AUDIO LEAD CHECKER KIT LU26D £19.99

Construction details: Audio Lead Checker Leaflet XZ20W 80p
Issue 114 / June 1997 Electronics & Beyond XD14Q £2.25

MELODY GENERATOR KIT

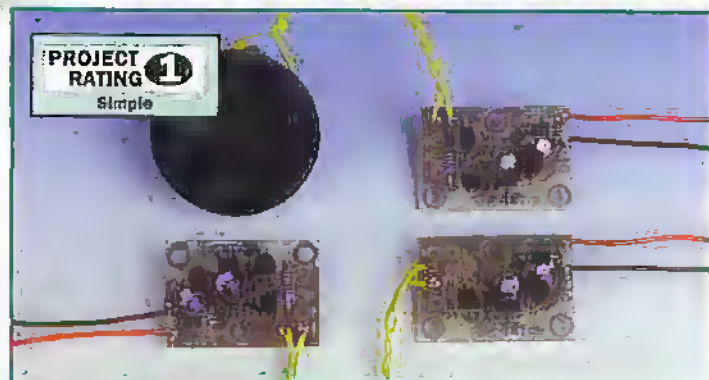

PROJECT RATING 1
Simple

FEATURES

- Ideal beginners project
- Safe, low voltage operation
- Low current giving long battery life
- Directly drives speakers (included) or piezo sounders
- Large range of melodies supported (15 available)

APPLICATIONS

- Children's toys
- Teaching nursery rhymes
- Turn ordinary cards and gifts into novel presents

Kit includes all components; PCB, speaker, connecting wire and full instructions. One or two 1.5V batteries are required (not supplied).

MELODY GENERATOR KIT:

LU64U Happy Birthday	LU65W London Bridge	LU67 Old McDonald
LU68 Greensleeves	LU69 Love Me Tender	LU70 Jingle Bells
LU75 Merry Christmas	LU76 12 Days of Christmas	LU77 You Are My Sunshine
LU80 I Just Called	LU81 Twinkle Twinkle	LU84 I'd Like To Teach
LU90 White Christmas	LU91 Warning Tone	LU92 Wedding March

All at £4.99

Construction details: Melody Generator Leaflet XZ47B 50p
Issue 120 / December 1997 Electronics & beyond XD20W £2.65

These kits are:

- Supplied with high-quality fibre-glass PCBs - pre-tinned, with printed legend and solder resist
 - Supplied with comprehensive instructions and a constructors' guide
 - Covered by the Maplin Get-You-Working Service and 12-month warranty
- Kits do not include tools or test equipment. Kits may require additional components or products, depending on application, please refer to construction details or contact the Maplin Technical Support Helpline (tel: 01702 556001) if in doubt.

PROJECT RATING 1
Simple

NATIONAL LOTTERY PREDICTOR KIT

FEATURES

- Ideal beginners project
- Simple to use - one switch operation
- Automatic switch off saves batteries
- Full source code available

APPLICATIONS

- Use to choose your lottery numbers!
- Excellent introduction to microcontrollers
- Use in other games

Kit includes all components, PCB, fixing hardware and full instructions. Two AA batteries are required (not supplied).



NATIONAL LOTTERY PREDICTOR KIT LU61R £9.99

Construction details: National Lottery Predictor Leaflet XZ46A 50p
Issue 120 / December 1997 Electronics & beyond XD20W £2.65

PAL COLOUR ENCODER KIT

FEATURES

- PAL and NTSC compatible
- TTL compatible inputs
- 64 colour palette
- Composite video and UHF outputs
- Analogue or digital RGB inputs
- Optional S-video output

APPLICATIONS

- Colour bar generation
- RGB to composite and UHF conversion
- Computer displays

Kit includes all components; PCB, Modulator, hardware to connect the Maplin Colour Bar Generator LT50E and full instructions. A +12V DC @ 300mA, regulated supply is required (not supplied).

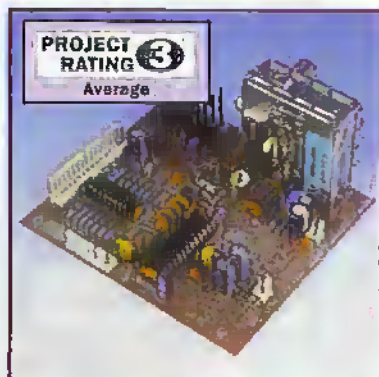

PROJECT RATING 3
Average

PAL COLOUR ENCODER KIT LU74R £24.99

Construction details: PAL Colour Encoder Leaflet XZ41U 80p
Issue 115 / July 1997 Electronics & beyond XD15R

ORDER NOW!

Tel: 01702 554000, Fax: 01702 554001, E-mail: Sales@maplin.co.uk
Or write to Maplin Electronics, P.O. Box 777, Rayleigh, Essex, SS6 8LU
Or Tel: 01702 554002 for details of your nearest Maplin or Mondo store.

Please quote **Priority Reference Code MA044** when ordering.



For orders over £30.00 inc VAT goods are dispatched free of handling charges. A small order charge of £2.95 inc VAT is applied to orders less than £30.00 inc VAT. All items subject to availability. All prices are inclusive of VAT and are subject to change. E&OE.

MAPLIN

Internet Web Site:
<http://www.maplin.co.uk>

Comdex shows the way

At the recent Comdex in Las Vegas, several things pointed the way forward for computer manufacturers. Although they've been saying it between themselves for several years, and valiantly and vainly attempting to get the rest of the world to sit up and listen, the time is finally beginning to look right for convergence of the personal computer with home television technology. Multimedia computers have been around for a while, of course, and the dream of combining a computer in the same box as a television has been dreamt for several years, but actually being able to integrate television successfully within a computer has evaded manufacturers yet.

However, it's beginning to happen. Several computer makers are showing products that can display television pictures right out of the box (yes, that's a pun). Apple, for a while now, in fact, has had television-enabled family Macintoshes at respectable computer prices, and as usual the other computer makers are in a rush to do the same on their Windows boxes. These are still though too expensive for Joe Public to rush out and buy as a replacement for his 12-inch portable that's just blown its last gasket.

Network Computer, and Wintel equivalent NetPC, designs are starting to see the light of day, in a move expected to bring down computer prices though, and it's likely that several versions of these will be available over the coming months. Don't expect them to fall immediately to the sub-£400 retail price level all the hype would have us believe, but they will be cheaper than equivalent full-blown personal computers. With the cheapness on the other hand, will be a considerably lower ability in the early days — and whether they're the right device for the home market (let alone the business sector they're initially intended for) has yet to be established.

AOL Surpasses 10 Million as Network Collapses



In the same week that AOL at www.aol.com, announced it had hit a membership of 10 million, it had e-mail delivery problems, preventing a significant number of its subscribers from sending or receiving messages.

AOL Continues to Build Out Network & System Capacity. As member usage climbs, the Company continues to build out its access network called AOLnet by 25,000 modems monthly. In addition, the service has upgraded over 75 per cent of AOL access

numbers to support the new high-speed 56K modems. "Our number one priority remains serving our members better," said Steve Case, chief executive of AOL. "We've reached 10 million members, and we're gearing up to support millions more. We're committed to ensuring that AOL continues to offer the best online experience possible," added Case.

AOL can be sampled free of charge for 50 hours during your first month. Ring 0800-279-1234 to obtain free AOL Software and information about our new flexible pricing plans. The AOL software is also available to download from the Web.

Microsoft Doubles Share of Browser Market

Over the past nine months, Microsoft at www.microsoft.com, has doubled its share of the Internet browser market to 40 per cent, up from 20 per cent at the end of 1996, according to a Dataquest survey at

www.dataquest.com.

Arch rival Netscape at www.netscape.com, still leads with close to 58 per cent, but that's down from 73 per cent earlier.

If Microsoft's growth in browser share continues, Dataquest projects Internet Explorer to reach parity with Netscape Navigator as early as the second quarter of 1998.

RealNetworks' RealPlayer 5.0 Hits One Million Downloads



Over one million RealPlayer downloads since the beta release in October. This represents a 120 per cent increase over the first two weeks after version 4.0 was released in February. In total, over 26 million players have been downloaded from www.real.com since the company first pioneered the use of streaming audio with RealAudio.

The RealPlayer 5.0, which plays all RealAudio and RealVideo programming on the Web, introduces RealFlash animation synchronised with

RealAudio. RealFlash, incorporating Flash technology from Macromedia, provides compelling animations that can now be delivered in real-time.

RealVideo improvements include full-screen video streaming over high speed connections for Windows 95 and Windows NT users, quality improvements to 28.8 kbps video, and new video formats for users of 56K modems. Other enhancements include near-CD quality voice for 28.8 kbps modems.

Top of the Ladder

The main digital protocol that makes up the Internet, the transport control protocol/Internet protocol (TCP/IP), which allows computers of all types to send and receive digital information of all types over the Internet, looks as though it's nearing the end of its technology. Previously, it had been thought to be infinitely scaleable, such that it could be used with whatever technology is used to make up the transmission media in the Internet. However, the latest advances in the Internet which use, say, satellites for direct-to-home delivery of digital content are stretching TCP/IP to its limit. The problem arises in two ways. First, because the return route from the user to the computer controlling the satellite uplink of data has to be by more conventional modem or ISDN link (the satellite link is from satellite to computer only), the overall connection is highly asynchronous, and TCP/IP finds it difficult to cope in such circumstances. Second, satellite linkages have inherent high latency together with high bandwidth. Again, TCP/IP can't cope well.

It's likely that next-generation derivatives of the current TCP/IP will be more dynamic, to cater for an increasing use of such transmission techniques within the Internet.

Macromedia Announces Web Tool



HTML technology allows developers to switch back and forth between their current HTML source editor and

Dreamweaver without fear of changes to their hand-written HTML. Dreamweaver works in conjunction with any HTML editor to provide a more productive environment and provides complete control over original HTML source code.

Throughout the product's development cycle, the Dreamweaver product engineering team consulted with an advisory group of top Web developers to create a tool targeted towards the real world needs of professional Web site creation. "Professional Web developers are eager for a tool that enables them to easily create high-quality, high-traffic sites while providing maximum authoring flexibility," said Kevin Lynch, Macromedia's vice president, Internet Authoring Tools. "We believe combining the productivity of a visual tool with the control and flexibility of HTML source editing will strongly appeal to the professional."

Dreamweaver from Macromedia at www.macromedia.com, is a new visual Web authoring tool created for Web development professionals. With Dreamweaver, Web professionals can now combine the power and productivity of a visual tool with the control and flexibility of an HTML text editor. Dreamweaver is also the first HTML editor to have in-depth support for Dynamic HTML.

Many Internet professionals have rejected the current generation of visual HTML editors – preferring to stay with text editors – because these tools make significant changes to imported HTML when the page is exported. Thus, hand-written HTML can become nearly unrecognizable after passed through a visual Web page editor. This is one of the key problems Dreamweaver solves.

The Dreamweaver engineering team built the product on a foundation that preserves the quality of original HTML source. The underlying 'Roundtrip

Summarise and Survive

The latest developments in text summarisation software from BT Laboratories (BTL) are now available on trial to customers from BTL's Internet Online Shop at transcend.labs.bt.com.

The experimental text summarisation software known as ProSum, has been developed to cope with the increasing problem of information overload. It is now available either as an on-line service via the Internet, or as a Microsoft Word add-in that can be installed and in use on a PC in under five minutes.

ProSum, short for profile-based summarisation, can summarise text as much or as little as required by the user. Abridgements of the original text can be shown clearly, by either marking up the document or producing a separate executive summary.

A unique feature of ProSum is that users can choose their own key-words to pin-point items of particular interest. The

on-line Internet version can also be used to summarise Web pages.

Chris Dix, manager of BTL's Online Shop, said, "We've developed ProSum to help people cope with the ever-increasing problem of information overload, the sort of information now widely contained in reports, sent via E-mail or captured from the Internet which constantly fills up PC hard discs around the world."

"It can be difficult even to keep up with current information, much less to research and digest the information currently available from databases around the globe. We believe ProSum goes some of the way towards relieving that problem," added Chris.

The on-line service from the BTL Online Shop costs just 25p per summary, using micropayment tokens, which are purchased via secure on-line payment using VISA or Mastercard credit cards.

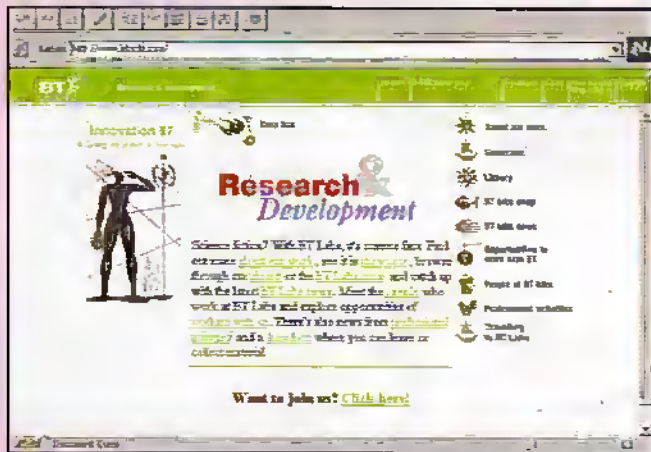

Philips and emWare Join Forces to Offer Embedded Internet Connectivity



Philips at www.philips.com the largest manufacturer and supplier of 80C51 microcontrollers, and emWare at www.emware.com, an embedded Internet software company, today announced a partnership to offer Internet connectivity using Philips' 80C51 microcontrollers and emWare technology.

As a result of the partnership, designers will now be able to create embedded devices that can be connected to the Internet and controlled remotely using a standard Web browser. emWare develops

the first device Web server – which consumes only 1K of memory – specifically designed for microcontroller-based embedded devices.

Customers can network emWare-embedded devices and control them via the Internet, an intranet or lightweight networks such as I2C. I2C is a simple two-wire serial bus commonly used to interconnect ICs on a broad range of consumer electronics products. The I2C is available on over 100 different IC devices supplied by more than 25 semiconductor companies.

Be Makes Complete BeOS Available For Internet Download

NETCOM Triples Customer Web Space

NETCOM at www.netcom.net.uk has tripled the standard amount of Web space available to all its users, from personal dial-up customers to business users.

All packages in the Netstart and Netserve ranges are now available with 10MB as standard. Current business customers will be able to take advantage of this latest offer from NETCOM by upgrading for a nominal fee. All users of NETCOM's

NETCOMplete dial-up service will be upgraded automatically.

At the same time, improved Web statistics offering daily, weekly and monthly site access information and data will be available to all users of NETCOM's packaged Internet business solutions. Existing business users will be able to upgrade to the new increased specification automatically by taking advantage of the new Web space upgrade.



Be has made Release 2.0 of its ground-breaking operating system BeOS, available for download over the Internet.

Developers and users wishing to run the BeOS can now download an unrestricted version of the product free of charge from Be's Web site at www.be.com/products/beos_download.

"BeOS was born on the Web," said Jean-Louis Gassée, President and CEO of Be. "We designed the product to be compact and Internet-friendly. Making the complete BeOS available on the Internet is the next natural step in our

company's, and our product's, evolution."

The download version includes all the components needed to run the BeOS on a wide variety of PowerMacs and compatibles. Although the download is only 9MB in size, this includes the complete core OS, an email client, a Web browser, personal Web server, ftp client and server, telnet client and server, remote access capabilities, command line tools and demonstration applications. The downloadable version of the BeOS has been designed to be simple to install, and includes detailed instructions.

Site Survey

The month's destinations

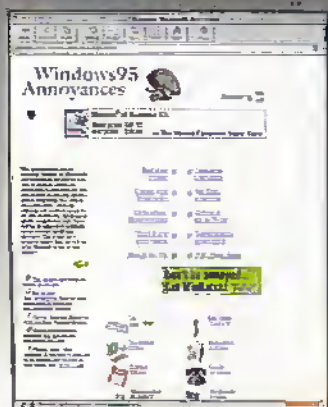

Microsoft's come in for some stick recently at home and abroad for its anti-competitive practices, and several Web sites have sprung up to keep us all updated. One of these, called Windows 95 Annoyances at <http://www.annoyances.org/win95/> takes a long look at Windows 95 and its problems. Doubtless there's only a month or two to go before it changes its name to Windows 98 Annoyances, with a totally new set of grievances, but it's



there in the meantime. Maybe the most encompassing Web site ever about wine, Wine Spectator boasts a searchable database of several thousand wines, so it's worth a detailed browse on <http://www.winespectator.com/> to see if that precocious little Chardonnay you had last Christmas, with its breath-taking afterburn, and its bouquet like a dock's amputee is still available from your local vintners. Always one for decent

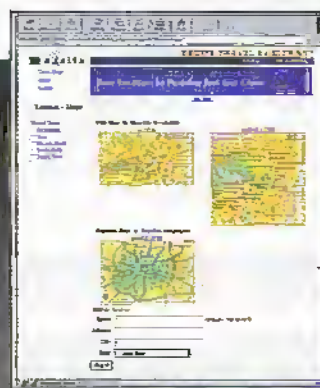

search engines, @Internet has found what must be the ultimate for the traveller. AExcite Travel, on <http://www.city.net> you can find details of over 5000 cities worldwide. Just type in the city you want to find information about and let the search engine rattle out sites and information about the city for you. Maps, tourist information and more are then available at the click of a mouse button in your Web browser window.

ELECTRONICS

and Beyond

in the pipeline

Don't miss another great assortment of entertaining and easy-to-make projects and essential electronics information aimed at the novice constructor.

Issue 123 on sale Friday 6th February

Analogue v Digital

Mike Bedford examines the advantages behind the use of each method for a variety of applications.

Dairy Farming Technology

George Pickworth looks into the latest technological developments around the farmyard.

Fan Failure Alert

Avoid costly overheating damage on your computer by installing this protective project.

PLUS From Infra-red to Ultra-violet and X-rays, Reg Miles examines all forms of image conversion to 'see' the otherwise invisible. There's another Interface BUS module to construct from Neil Johnson.

Douglas Clarkson leaps into outer-space and reveals the mysteries of Neptune.

For model aircraft enthusiasts we have a Model aircraft Speed controller and if you are after an amusing simple light display then we can help out with this simple project.

ELECTRONICS
and Beyond
BRITAIN'S BEST MAGAZINE FOR ELECTRONICS

ADVERTISERS' INDEX

AKD	p57	Forest Electronic Developments	p35	Number One Systems	p39
Bluebird	VFC	JAB Electronics	p43	Peak Electronic Design	p7
Chelmer Value	p35	Kevin Jarvis Electronics Ltd	p43	Right First Time	p43
Crownhill	p7	Manchester University	p57	Technology Education Index	p35
Data Information Technology	p29	Mauritron Technical Services	p57	Three Crowns Publishing	p39
EPT	p12	Milford Instruments	p43	Veronica FM Kits	p39
		NCT Enterprises	p35		

Project Ratings

Projects presented in this issue are rated on a 1 to 5 for ease or difficulty of construction to help you decide whether it is within your construction capabilities before you undertake the project. The ratings are as follows:



1 Simple to build and understand and suitable for absolute beginners. Basic tools required (e.g., soldering iron, wire cutters, pliers, wire strippers, and screwdriver). Test gear not required and no set-up needed.



2 Easy to build, but not suitable for absolute beginners. Some test gear (e.g., multimeter) may be required, and may also need setting up or testing.



3 Average. Some skill in construction or more extensive set-up required.



4 Advanced. Fairly high level of skill in construction, specialised test gear or set-up may be required.



5 Complex. High level of skill in construction, specialised test gear may be required. Construction may involve complex wiring. Recommended for skilled constructors only.

Ordering Information

Kits, components and products stocked at Maplin can be easily obtained in a number of ways.

1 Visit your local Maplin store, where you will find a wide range of electronic products. If you do not know where your nearest store is, telephone (01702) 554002. To avoid disappointment when intending to purchase products from a Maplin store, customers are advised to check availability before leaving any distance. 2 While your order on the form printed in this issue and send it to Maplin Electronics PLC, P.O. Box 777, Rayleigh, Essex, S66 8LU. Payment can be made using Cheque, Postal Order, or Credit Card. 3 Telephone your order, call the Maplin Electronics Credit Card Hotline on (01702) 554000. 4 If you have a personal computer equipped with a MODEM, dial up Maplin's 24-hour on-line database and ordering service. CashTel, CashTel supports 230-, 1200- and 2400-baud MODEMS using CDTT tones. The format is 8 data bits, 1 stop bit, no parity, full duplex with Kermit handshaking. 5 Existing customers with a Maplin customer number can access the system by simply dialling (01702) 552941. If you do not have a customer number, telephone (01702) 554002 and we will happily issue you with one. Payment can be made by credit card. 6 If you have a tone dial (DTMF) telephone or a push tone device, you can access our computer system and place your orders directly onto the Maplin computer 24 hours a day by simply dialling (01702) 556751. You will need a Maplin customer number and a personal identification number (PIN) to access the system. 7 Overseas customers can place orders through Maplin Export, P.O. Box 777, Rayleigh, Essex S66 8LU, England; telephone +44 1702 554000 Ext. 376, 327 or 351; Fax +44 1702 554001. Full details of all the methods of ordering from Maplin can be found in the current Maplin Catalogue.

Internet

You can contact Maplin Electronics via e-mail at enquiry@maplin.co.uk or visit the Maplin web site at <http://www.maplin.co.uk>.

Prices

Prices of products and services available from Maplin shown in this issue, include VAT at 17.5% (except items marked NV which are rated at 0%). Prices are valid until 28th February (terms and conditions excluded). Prices shown do not include mail order postage and handling charges. Please add £2.95 to all UK orders under £30.00. Orders over £30.00 and MPS Account Holding customers are exempt from carriage charges.

Technical Enquiries

If you have a technical enquiry relating to Maplin projects, components and products featured in Electronics and Beyond, the Technical Sales Dept. may be able to help. You can obtain help in several ways: 1 Over the phone, telephone (01702) 556001 between 9.00am and 5.30pm Monday to Friday, except public holidays. 2 By sending a facsimile, Fax (01702) 554001. 3 Or by writing to Technical Sales, Maplin Electronics PLC, P.O. Box 777, Rayleigh, Essex, S66 8LU. Don't forget to include a stamped self-addressed envelope if you want a written reply. Technical Sales are unable to answer enquiries relating to third-party products or components which are not stocked by Maplin.

Maplin 'Get You Working' Service

If you get completely stuck with your project and you are unable to get it working, take advantage of the Maplin 'Get You Working' Service. This service is available for all Maplin kits and projects, with the exception of 'Data Files' projects not based on Maplin ready etched PCBs; projects built with the majority of components not supplied by Maplin; Circuit Maker kits; Mini-Circuits or other similar 'building block' and 'application' kits. To take advantage of the service return the complete kit to: Returns Department, Maplin Electronics PLC, P.O. Box 777, Rayleigh, Essex, S66 8LU. Enclose a cheque or Postal Order for the servicing cost (minimum £17) as indicated in the current Maplin Catalogue. If the fault is due to any error on our part, the project will be replaced free of charge. If the fault is due to any error on your part, you will be charged the standard servicing cost, plus parts.

TECHNOLOGY WATCH



with Martin Pipe

DECT (Digital European Cordless Telephone) is beginning to take off in the UK. As the name suggests, consumers are adopting them as an alternative to the old analogue cordless phones, which adhered to a standard known as CT1. The old standard specified narrowband frequency modulation on carriers in the order of 1.6MHz and 49MHz. One frequency is used for the receive path, the other for transmit. The number of transmit and receive channels allocated for CT1 use are restricted. As a result, there's a fair chance of interference from a neighbour's phone, if you live in a built-up area. Because no scrambling is involved, there's a fair chance that nearby scanner enthusiasts can listen into your calls.

Add to this the limited range, and crackles and hiss, and it becomes clear why the superior alternative is being embraced warmly. At the time of writing, DECT had been adopted by around 30 countries worldwide. It comes as no surprise either to learn that DECT cordless phones, in this case from Hagenuk, are to be found in the latest edition of the Maplin catalogue. Other models are available from Siemens, Dancall and Philips, among others. Some DECT products, such as the upmarket Dancall model, have the ability to be hooked up to a pair of phone lines. These are ideal for small businesses and home office users.

So how is DECT better than CT1? To the consumer, DECT offers a better sound quality, and a much-improved range (up to 300m) between handset and base station. Because the digitised audio is encrypted, there's little chance of electronic eavesdropping. DECT's spectrum is in the region of 1880-1900MHz – in other words, there's 20MHz to play with. DECT specifies a micro-cellular architecture, in which frequencies are dynamically allocated whenever calls are being made or taken, thus eliminating the possibility of clashing with your neighbour's communications. Whereas conventional GSM cellphones specify an RF output of 2W, DECT handsets get by on 250mW.

There's more to DECT than simple cordless telephony. ETSI, the standards body responsible for releasing the original specification back in 1992, is constantly looking at new applications for the communications technology. It helps that DECT is somewhat open – and hence flexible. Indeed, the published specification covers a universal air interface standard that simply describes how a base station communicates with portable terminals. In comparison, the complete network is covered by the GSM cellular specification.

ETSI has also published interworking profiles that describe how DECT can co-exist with other communications networks, such as GSM and ISDN. At least one major telecoms equipment supplier is already trialling systems in which DECT provides a LAN with wireless extensions. Completely cordless LANs, or CLANs, are also envisaged. Wireless videoconferencing has been hinted at too. When used for data applications, up

to half a megabit can be transferred per second by splitting the intelligence over multiple time slots.

DECT, as its full name suggests, is a fully-digital system. Like GSM and PCN cellular phones, is based on TDMA (time division multiple access). In the full specification, a base station can support up to 12 channels over a single 1152kbit/sec carrier. This bandwidth is segmented, using TDMA techniques, into 24 repeating time-slots. Utilising TDD (time division duplex) operation, half of these time slots are utilised for transmission, and the other half for reception. Within the 20MHz allocated to DECT, ten carriers can be accommodated. Up to 120 speech users can thus be handled within a given area.

Any DECT handset (or terminal) can access all of these channels, and the highest quality channel available is selected whenever a connection is required. As with conventional cellphones, the handset is continuously seeking a better radio communications path, and will automatically switch (or hand over) to the base station that is providing the strongest signal.

Handover is totally seamless – indeed, connection to the new channel has to be made before transmission ceases on the original one. Obvious security measures have been taken to ensure that you don't hand over to base stations you shouldn't be connected to, otherwise you could have great fun ringing up your neighbour's phone bill! To achieve this, base stations and handsets are individually addressable (if they weren't, the TDMA system would fall flat on its face...).

A company-wide communications system, which is based around DECT equipment supplied by Ericsson, is currently being trialled by BT. Although the scheme – to be called OnePhone when commercially-

launched – will be aimed at business users, there are significant implications for domestic telecommunications. The trial currently involves 200 employees at 4 different BT locations in Uxbridge, Hemel Hempstead, London and Leeds. OnePhone's main benefit is that it allows people to be reached from the same number.

At each location is a DECT base station, known as a mobility server. All are in constant communication with each other via 2Mbit/sec leased lines. Calls to any of the 200 trial staff are routed through these boxes. Subscribers are given a DECT handset, and with this they can roam to any of the company sites connected to the system; when a subscriber turns up at a particular site, his handset automatically negotiates with the local mobility server. As a result, the OnePhone network now knows where a subscriber's calls should be routed. If the individual is not within range, the call could be diverted to another location, such as an employee's home office, or to voicemail.

Even more interesting is the second phase of the trial, planned for next summer, which will involve special dual-mode handsets that combine DECT and GSM facilities. Current prototypes of this phone look like two handsets glued together, but more elegant models are in development. If an employee is not within range of one of the four mobility servers – let's say, for example, he was travelling between sites or was abroad – a divert to a GSM number would automatically be set up. In the trial, Cellnet – which is closely associated with BT – will provide the GSM service. The OnePhone network will be linked to a GSM exchange using a piece of equipment known as an interworking unit, or IWU.

There is no reason why DECT mobility servers couldn't be set up in other locations. Local telecommunications providers may well set themselves up to market low-cost extended-range cordless phones and high-speed data services. These would appeal to consumers (particularly those who don't need the national coverage of cellular), local businesses and areas with poor cellular coverage. If those local telecommunications companies were to set up roaming agreements with each other, then country-wide coverage would be possible.

Such a scenario isn't far removed from a system, known as Rabbit, that failed in the early 1990s (its operator, Hutchison Telecom, eventually got lucky with the Orange cellular network). Rabbit took the form of a DECT-like digital cordless phone system, known as CT2. The handset would, however, also communicate with telepoints installed in public areas, allowing outgoing calls to be made. Unfortunately, Rabbit wouldn't accept incoming calls, and that proved to be its downfall. DECT isn't affected by this limitation, and indeed you would have the advantage of being contactable via a single number.



Lucy Handley of BT's Mobility Solutions group using a BT OnePhone.

E-mail your comments or suggestions to Martin Pipe at whatnet@cix.compulink.co.uk.

Bargain Basement 'Scopes



AS81C OS-9100P was £699.00 now £599.00

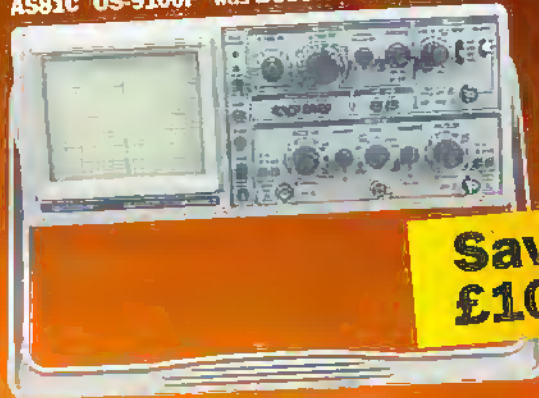

GW03D OS-9020P was £359.00 now £279.00

GW04E OS-9040D was £495.00 now £395.00
DK26D OS-9060D was £685.03 now £595.00



GW05F OS-9100D was £799.00 now £649.00

GW06G OS-904RD was £599.00 now £499.00



GW07H OS-3020 was £1,159.00 now £999.00
JX40T OS-3040 was £1,159.00 now £999.00
JV08J OS-3060 was £1,149.00 now £1,049.00

For details of 'scopes - see Catalogue.
Available now by Mail Order and selected Maplin Stores.

Telephone orders (01702) 554000
Fax (01702) 544001

Prices include VAT. A £2.95 carriage charge will apply to all UK orders under £30.00 (Account Holding Customers exempt). Overseas subscribers telephone +44 1702 554155 Ext. 326 for carriage.

MAPLIN
ELECTRONICS



More
than
18,000 top
quality
products
bound

for the
enthusiast

£3.45

MPS
MAPLIN PROFESSIONAL

PLUS
COMPLETE GUIDE TO ELECTRONICS, COMPUTERS AND MUCH MORE!

01702 554000

MPS
MAPLIN PROFESSIONAL

THE COMPLETE CATALOGUE FOR ELECTRONICS

1997/8

September '97 - February '98
Visit our Web Site
<http://www.maplin.co.uk>

42 Local Stores Nationwide - 8 New
Save £50+ Vouchers Inside
2000+ New Products
Trade Prices
FREE DELIVERY

BRITAIN'S BEST-SELLING ELECTRONICS CATALOGUE

Available from 1st September 1997

The 'must have' tool for DIY enthusiasts, hobbyists and students, amateurs and professionals in the world of electronics.

- Over 25 years experience
- 42 stores nationwide
- Same day despatch
- Order 24 hours a day
- Free technical support on 01702 556001
- Free delivery on orders over £30.00
- Over £50 worth of discount vouchers

Order now on 01702 554000

Available at: WH Smith, John Menzies or your local Maplin Store.

(Add 50p for P&P). Orders outside the UK please send £8.45 or 21 IRCs for Airmail in Europe or surface mail outside Europe. Send £16.00 or 37 IRCs for Airmail outside Europe to:
Maplin MPS, PO Box 777 Rayleigh, Essex, England SS6 8LU.

When ordering please quote priority Code MA047.