

# ELECTRONICS

*The Maplin Magazine*  
Britain's Best Selling Electronics Magazine

## Discover the Secrets of Video Termination

It's Huge! – All About the World's Largest Radio Telescope

Terrific Valve Preamp Tone Control Project

The Heat is on – How to Prevent Thermal Overload

Realistic Model Railway Signal Lights Project

Versatile and Compact Timer Project

Fascinating Facts – How Electricity was Discovered!

Get Rockin' with this Pocket-sized Guitar Headphone Amplifier Project!

ISSN 0957-5456



9 770957 545077



# RETURN TO THE SOUND THAT TIME FORGOT!

IT'S NOT A  
DINOSAUR!

FOR TIMELESS  
QUALITY VALVE  
SOUND - AT AN  
AFFORDABLE  
PRICE!

Complete Kit  
Just £199.50<sup>H18</sup>  
SAVE OVER £20!

"... handles vocals wonderfully, bringing body and texture to images, making them seem fuller and more real than most solid-state amplifiers... The 4-20 brings you the benefits of valves, with few of the drawbacks... the 4-20 delivered plenty of output with low distortion... it offers a good introduction to the realm of valve amplifiers, outperforming many commercial designs."

Nick Lucas, Hi-Fi World, November 1994.

Full details of how to build this superb valve amplifier yourself may be found in the January and February 1994 issues of *Electronics - The Maplin Magazine*.

*Electronics - The Maplin Magazine* January 1994 Issue

*Electronics - The Maplin Magazine* February 1994 Issue

Power Supply Kit Only

Amplifier Kit Only

Complete Monobloc Amplifier Kit [1 x Power Supply Kit + 1 x Amplifier Kit]

Complete Stereo Amplifier Kit [1 x Power Supply Kit + 2 x Amplifier Kit]

Carriage: kits marked **C** add £2.80, kits marked **H** add £6.00. If ordering several kits maximum total carriage is £6.00.

Handling: add £1.50 to each order. Please note: carriage and handling charges apply to Mail Order only - you do not pay carriage or handling if you purchase these kits from Maplin Regional Stores. Export customers please call Maplin Export Department or your nearest distributor.

Photograph shows Stereo Millennium 4-20 Amplifier (LT72P). The Millennium 4-20 Amplifier is not available ready built. The kits listed are rated 4 (Advanced) on the 1 to 5 Maplin Construction Rating Scale.

**Maplin Electronics plc.**, P.O. Box 3, Rayleigh, Essex, SS6 8LR. Tel: (01702) 554161. Fax (01702) 553935.

For details of your nearest Maplin Regional Store Tel: (01702) 552911. Maplin Export Department +44 1702 554155 xtn 326 or 351.

Prices include VAT at 17.5% except items marked *NV* which are rated at 0%.

All items subject to availability. Prices are correct at time of going to press (errors and omissions excluded), but may be subject to change.

(XA73Q)

Price £1.95 *NV*

(XA74P)

Price £1.95 *NV*

(LT44X)

Price £59.99 **C6**

(LT45Y)

Price £79.99 **C6**

(LT71N)

Price £129.50 **H12** Save over £10!

(LT72P)

Price £199.50 **H18** Save over £20!



## PROJECTS FOR YOU TO BUILD!

### GUITAR HEADPHONE AMPLIFIER 4

Practice those screaming guitar solos, anytime day or night, without annoying the neighbours! This essential pocket-sized project for guitarists includes a distortion effect which is fully variable from 'clean', through soft fuzz, to mega overdrive!

### MODEL TRAIN SIGNAL LIGHTS CONTROLLER 20

Add further realism to your model railway layout by building this signal lights controller. Using reed switches to detect train position, it provides fully automatic operation for 2-, 3- or 4-aspect signals. The controller can drive LEDs or filament lamps, and can operate from a wide range of supply voltages.

### NEWTON VALVE PREAMPLIFIER TONE CONTROL MODULE 36

The final part of the Newton Valve Preamplifier project, the Tone Control Module, is presented this month. This module, together with the Power Supply Unit and RIAA Modules published last month, form the basis of a highly versatile, modular Hi-Fi valve preamplifier.

### UNIVERSAL TIMER MODULE 60

This compact start/stop timer module is suitable for a wide range of timing and control applications. An ideal beginners' project!

## FEATURES ESSENTIAL READING!

### HOW TO PREVENT THERMAL OVERLOAD 12

This two part feature deals with power management in semiconductor devices; it explains how to design circuits to operate within safe power dissipation limits, and how to choose the optimum heatsink design.

### LEDs AND THEIR APPLICATIONS 14

This commonly encountered component is often taken for granted. This practical series looks at how LEDs work, how to choose the most appropriate device for the job, what the specifications actually mean, and gives lots of other useful advice. This month, flashing LEDs, multicolour LEDs and multi-segment LED displays are investigated.

### VIDEO TERMINATION – WHEN, WHERE & WHY 28

Professional video engineer Ian Berry takes a practical look at the often misunderstood subject of video termination.

### AN INTRODUCTION TO DIGITAL SIGNAL PROCESSING 33

Jason Sharpe throws aside the secrets of digital signal processing in this fascinating and easy to understand series. BASIC programs are used to enable the reader to conduct 'virtual' experiments on a PC.

### HOW AUDIO DATA COMPRESSION SYSTEMS WORK 47

Getting usable record and playback time from consumer audio formats such as MiniDisc and Digital Compact Cassette involves playing some clever games with our hearing. Andrew Rimmell looks at what's involved and how the technology can be put to use.

### THE HISTORY OF ELECTRONICS 52

Ian Poole tells the story of how electricity was discovered, and put to practical use, in the first part of this fascinating new series.

### FILTERS – HOW AND WHY? 55

Filter circuits are commonly encountered in electronic circuits. John Woodgate, continues this informative series with a look at notch-filters and tuned circuits.

### WHAT ON EARTH IS FUZZY LOGIC? 65

Frank Booty takes a look at what fuzzy logic is, and how it can be used to improve processor based control systems.

### WINDOW ON THE UNIVERSE 68

The Aricebo Observatory is able to reveal secrets hidden in the furthest reaches of the universe, instead of using traditional optical methods, observation is carried out by monitoring radio emissions. In this informative article Douglas Clarkson explains why the work carried out at the world's largest radio telescope is so important.

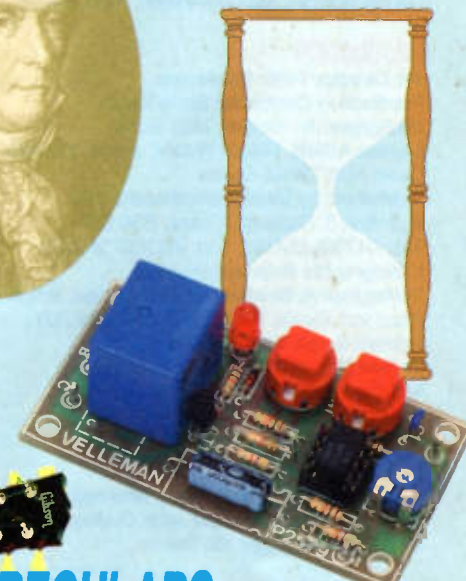
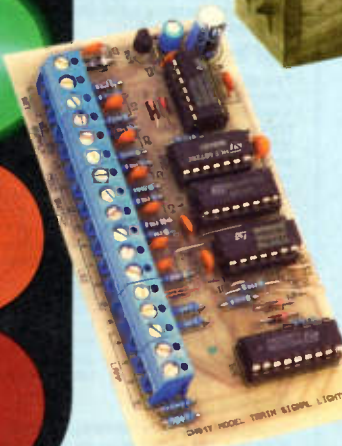

## REGULARS NOT TO BE MISSED!

ABOUT THIS ISSUE...	2	@INTERNET	46	ORDER COUPON	64
TECHNOLOGY WATCH	3	STRAY SIGNALS	51	DIARY DATES	67
NEWS REPORT	9	READERS' ADVERTS	62	NEXT MONTH	72
READERS' LETTERS	11	HOW TO SUBSCRIBE	63	DID YOU MISS?	IBC

# ABOUT THIS ISSUE...

Hello and welcome to this month's issue of *Electronics*! Instead of explaining what is in store this month or giving details about the latest developments in electronics, computer or communications technology, I am delighted to take this opportunity to provide details of one of the most exciting changes to Maplin Electronics since its formation in 1972.

No doubt, many *Electronics* readers will have read in the national newspapers and electronics trade press that Maplin Electronics plc has been acquired by Salfire plc (previously Cannon Street Investments plc), a stock exchange listed company with extensive interests in electronics distribution in the UK and in continental Europe. A number of readers have asked how this acquisition will affect Maplin. In the limited space that is available here, I hope that I can put you all 'in the picture'.

Since 1972 Maplin has grown to be one of the most well-known and respected suppliers of electronic components and products in the UK. In recent years the rate of expansion has dramatically increased, the most dramatic changes have taken place in the past six years:

- The number of Maplin regional stores has reached 34, with more on the way
- Operations centres have expanded with a purpose-built distribution centre in Wombwell, South Yorkshire and new Head Office in Hadleigh, near Rayleigh in Essex
- This magazine made the move from quarterly publication in black and white to monthly publication in full colour
- The publication of the Maplin Catalogue in full colour
- Major upgrades in data processing, networking and communications
- The introduction of state-of-the-art desktop publishing systems
- Opening of overseas offices and a transshipment centre in the Philippines
- Establishment of overseas distributors

- Expansion of Maplin's trade division, MPS Electronics
- ISO 9002 Quality Assurance registration

The success of Maplin's expansion programme has confirmed its ambitions to introduce its products and services to an even wider audience and to continue to improve service to existing customers. It made sense for Maplin to find a like-minded partner so that it could pool its business, people and financial resources to accelerate its expansion plans.

Electronics distribution is already a very important core element of the Salfire group of companies. The other electronics companies in Salfire include Altai – an electronics supplier to wholesale and retailers in the UK and Europe; Dunnet – a European computer retailer; and Network – a component supplier to manufacturers. There is a degree of overlap in the product ranges in these companies and Maplin, but each serves a different customer base.

Within this expanded group, Maplin will continue to operate as a separate company. The quality of service will be enhanced by the acquisition. Maplin will be in an even better buying and shipping position and will have access to a wider product range at keener prices. The absolute scale of operations is important in sustaining the cost of new product development and ensuring compliance with the vast array of product safety and environmental regulations now being imposed by the EEC. However, Maplin will ensure that its traditions of friendliness, quality, service and technical support are maintained for all its customers – no matter how large or small.

I hope that I have achieved my objective of putting you 'in the picture' and that you can see that the acquisition is a positive step in providing you with the best service possible! So until next month, from everyone here at *Electronics*, enjoy this issue!



## Exclusive Subscribers' Club Special Offers



On offer this month, to subscribers only, is a selection of four specially selected items: A powerful Rubber Torch, a CD Laser Cleaner, a Cycle Lamp Set and a dual-purpose Aquarium/Room Thermometer. There's a total saving of £6.00 on these items, based on their normal price. If you are a subscriber, full details of how to order these items are included on the special offer leaflet in this issue – if the leaflet is missing, contact Customer Services, Tel: (01702) 552911. If you are not a subscriber and would like to take advantage of future special offers and other benefits of subscribing, turn to page 63 of this issue to find out more or Tel: (01702) 554161.

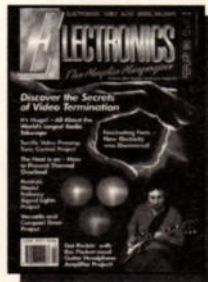

Front Cover Pictures:  
Spark Between Fingers  
© Copyright 1994 Tony Stone Images,  
All Rights Reserved, Used by Permission.  
Other Pictures:  
© Copyright 1994 Maplin Electronics plc.,  
All Rights Reserved.

## EDITORIAL

Editor Robert Ball AMIPRE

Technical Authors Robin Hall FBIS, G4DVJ,

Mike Holmes, Brian Clark, Maurice Hunt

Print Co-ordinators John Craddock,

Len Carpenter

News Editor Stephen Waddington BEng (Hons)

Technical Illustrators Ross Nisbet,

Paul Evans, Nicola Hull, Kevin Kirwan

Project Development Chris Barlow,

Dennis Butcher, Alan Williamson, Nigel Skeels

## PRODUCTION

Art Director Peter Blackmore

Production Controller Steve Drake

Designers Jim Bowler, Matt Buhler

Layout Artists Tracey Walker, Adrian Dutwich,

David Holt, Daniel Drake

Published by Maplin Electronics plc.,

P.O. Box 3, Rayleigh, Essex, SS6 8LR.

Tel: (01702) 554155. Fax: (01702) 553935.

Lithographic Reproduction by

Planographic Studios, 18 Sirdar Road, Brook

Road Ind. Estate, Rayleigh, Essex SS6 7UY.

Printed in the United Kingdom by

St Ives (Caerphilly) Ltd., Caerphilly,

Mid-Glamorgan, CF8 3SU.

## MANAGEMENT

Publications Manager Roy Smith

Development Manager Tony Bricknell

Drawing Office Manager John Dudley

Marketing Manager Vic Sutton

## ADVERTISING

Jackson-Rudd & Associates Ltd.,

2 Luke Street, London, EC21 4NT.

Tel: (0171) 613 0717. Fax: (0171) 613 1108.

Advertisement Manager Eric Richardson.

## UK NEWSTRADE DISTRIBUTION

United Magazine Distribution Ltd.,

16-28 Tabernacle Street, London EC2A 4BN.

Tel: (0171) 638 4666. Fax: (0171) 638 4665

©Copyright 1994 Maplin Electronics plc.

Copyright: All material is subject to worldwide copyright protection, and reproduction or imitation in whole or part is expressly forbidden. Permission to reproduce printed circuit board layouts commercially or marketing of kits must be sought from the publisher.

Advertisements: Whilst every reasonable precaution is undertaken to protect the interests of readers by ensuring, as far as possible, that advertisements appearing in the current issue of *Electronics* are bona fide, the publisher and staff of the magazine cannot give any undertakings in respect of statements or claims made by advertisers, whether on printed page or on loose insert. Readers who have reasonable grounds to believe that they have been misled are advised to contact their local Trading Standards Office.

Editorial: The views of individual contributors/authors are not necessarily those of either the publisher or the editor. Where errors occur corrections will be published as soon as possible afterwards.

Publisher's Statement: Maplin Electronics plc., take all reasonable care to prevent injury, loss or damage of any kind being caused by any matter published in *Electronics*. Save insofar as prohibited by English law, liability of every kind including negligence is disclaimed as regards any person in respect thereof.

## Project Ratings

Projects presented in this issue are rated on a 1 to 5 for ease or difficulty of construction to help you decide whether it is within your construction capabilities before you undertake the project. The ratings are as follows:

- 1 Simple to build and understand and suitable for absolute beginners. Basic tools required (e.g., soldering iron, side cutters, pliers, wire strippers and screwdriver). Test gear not required and no setting-up needed.
- 2 Easy to build, but not suitable for absolute beginners. Some test gear (e.g., multimeter) may be required, and may also need setting-up or testing.
- 3 Average. Some skill in construction or more extensive setting-up required.
- 4 Advanced. Fairly high level of skill in construction, specialised test gear or setting-up may be required.
- 5 Complex. High level of skill in construction, specialised test gear may be required. Construction may involve complex wiring. Recommended for skilled constructors only.

## Ordering Information

Kits, components and products stocked by Maplin can be easily obtained in a number of ways:

Visit your local Maplin store, where you will find a wide range of electronic products.

If you do not know where your nearest store is, Tel: (01702) 552911. To avoid disappointment when intending to purchase products from a Maplin store, customers are advised to check availability before travelling any distance.

Write your order on the form printed in this issue and send it to Maplin Electronics, P.O. Box 3, Rayleigh, Essex, SS6 8LR. Payment can be made using Cheque, Postal Order, or Credit Card.

Telephone your order, call the Maplin Electronics Credit Card Hotline on (01702) 554161.

If you have a personal computer equipped with a MODEM, dial up Maplin's 24-hour on-line database and ordering service, CashTel. CashTel supports 300-, 1200- and 2400-baud MODEMs using CCITT tones. The format is 8 data bits, 1 stop bit, no parity, full duplex with Xon/Xoff handshaking. All existing customers with a Maplin customer number can access the system by simply dialling (01702) 552941. If you do not have a customer number Tel: (01702) 552911 and we will happily issue you with one. Payment can be made by credit card.

If you have a tone dial (DTMF) telephone or a pocket tone dialler, you can access our computer system and place orders directly onto the Maplin computer 24 hours a day by simply dialling (01702) 556751. You will need a

Maplin customer number and a personal identification number (PIN) to access the system. If you do not have a customer number or a PIN number Tel: (01702) 552911 and we will happily issue you with one.

Overseas customers can place orders through Maplin Export, P.O. Box 3, Rayleigh, Essex, SS6 8LR, England; Tel: +44 1702 554155 Ext. 326 or 351; Fax: +44 1702 553935.

Full details of all of the methods of ordering from Maplin can be found in the current Maplin Catalogue.

## Subscriptions

Full details of how to subscribe may be found on the Subscription Coupon in this issue. UK Subscription Rate: £21.98/12 months, £10.98/6 months.

## Prices

Prices of products and services available from Maplin, shown in this issue, include VAT at 17.5% (except items marked NV which are rated at 0%) and are valid between 01 January 1995 and 29th February 1995 errors and omissions excluded. Prices shown do not include mail order postage and handling charges, which are levied at the current rates indicated on the Order Coupon in this issue.

## Technical Enquiries

If you have a technical enquiry relating to Maplin projects, components and products featured in *Electronics*, the Customer Technical Services Department may be able to help. You can obtain help in several ways: over the phone, Tel: (01702) 556001 between 9.00am and 5.30pm Monday to Friday, except public holidays; by sending a facsimile, Fax: (01702) 553935; or by writing to: Customer Technical Services, Maplin Electronics plc., P.O. Box 3, Rayleigh, Essex, SS6 8LR. Don't forget to include a stamped self-addressed envelope if you want a written reply! Customer Technical Services are unable to answer enquiries relating to third-party products or components which are not stocked by Maplin.

## 'Get You Working' Service

If you get completely stuck with your project and you are unable to get it working, take advantage of the Maplin 'Get You Working' Service. This service is available for all Maplin kits and projects with the exception of 'Data Files'; projects not built on Maplin ready etched PCBs; projects built with the majority of components not supplied by Maplin; Circuit Maker ideas; Mini Circuits or other similar 'building block' and 'application' circuits. To take advantage of the service, return the complete kit to: Returns Department, Maplin Electronics plc., P.O. Box 3, Rayleigh, Essex, SS6 8LR. Enclose a cheque or Postal Order based on the price of the kit as shown in the table below (minimum £17). If the fault is due to any error on our part, the project will be repaired free of charge. If the fault is due to any error on your part, you will be charged the standard servicing cost plus parts.

KIT Retail Price	Standard Servicing Cost
up to £24.99	£17.00
£25.00 to £39.99	£24.00
£40.00 to £59.99	£30.00
£60.00 to £79.99	£40.00
£80.00 to £99.99	£50.00
£100.00 to £149.99	£80.00
Over £150.00	£80.00 minimum

## Readers Letters

We very much regret that the editorial team are unable to answer technical queries of any kind, however, we are very pleased to receive your comments about *Electronics* and suggestions for projects, features, series, etc. Due to the sheer volume of letters received, we are unfortunately unable to reply to every letter, however, every letter is read – your time and opinion is greatly appreciated. Letters of particular interest and significance may be published at the Editor's discretion. Any correspondence not intended for publication must be clearly marked as such.

Write to: The Editor, *Electronics* – The Maplin Magazine, P.O. Box 3, Rayleigh, Essex, SS6 8LR, or send an E-mail to AVV@maplin.demon.co.uk

# TECHNOLOGY WATCH!

with Keith Brindley

## A tall (or should that be long) tail . . .

I suffer from repetitive strain injury – RSI. It's not, of course, a properly recognised condition; either medically or legally, but to many thousands of sufferers like myself, it's a real and painful one nevertheless.

As many sufferers will know too, RSI is generally caused by exposure to a constant working routine which aggravates muscles, bones, tendons and so on, to the extent that doing your own work can become quite difficult, and in some cases impossible. Housemaid's knee is one possible form of RSI, in which someone (oh, go on, yes – a housemaid) develops a sore knee from some repetitive action; most probably I suppose kneeling. Tennis elbow, writer's cramp (just joking), boxer's ears (still joking) footballer's brain (I'm not sure if I'm still joking) [you stopped short of the drummer jokes Keith! – Ed.] are all possible examples. In my own case I have a sore wrist. And before any of the cruder of our readers suggest why, I'll state that it's my belief that it's caused by excessive grappling with a rodent. I mean a computer rodent, of course – my computer's mouse.

My pain manifests itself as a nagging on the wristbone, which increases to true pain depending on how much work I do with the mouse. Days when I'm writing, the pain decreases (keyboard activity is obviously not a cause). Days when I'm desktop publishing however, and using the mouse a lot, see a corresponding increase in pain. I could change my career and not use a computer at all, but that's not a truly feasible option, is it? So what is the alternative?

RSI developed in office environments varies. Office workers can have wrists like mine, necks like giraffes, ankles like racehorses and backs like gorillas, but if the environment doesn't suit, RSI will

result. Having a properly designed and adjustable workplace environment helps. An adjustable chair which allows height, back tilt, seat tilt adjustments helps. The tools of my job – keyboard, mouse, monitors, CPU and so on – at easily reached and manageable locations all help. All of these are recommended methods of easing the burden of RSI pain, in the workplace, and I've tried them all with varying levels of success.

But I can safely say that the single most effective thing I've come across recently is due to a relatively recent technological advancement, hence the reason why I'm looking at it here. It's the Wacom ArtPad; an ultra-small graphics tablet which plugs into an IBM-compatible computer's communication port (or an Apple Macintosh's desktop bus) and which effectively takes the place of a mouse, although the two devices live and work happily in parallel alongside each other. The whole pad only measures about 191 × 175mm, and the active area of the pad is just 128 × 96mm.

Graphics tablets have been around for a while (and Wacom has been producing them for most of that time too) so what's new about the ArtPad? Basically its size. The fact you can get at the whole of the pad without moving your arm actually makes the ArtPad easier to use than bigger pads – completely the opposite to what you might expect. You can arrange the pad to effectively represent your monitor (controlling software is provided), such that you position the supplied pen on a particular location on the pad and your cursor moves to a corresponding part of the screen in an absolute manner. Alternatively, the software can be used to move the cursor relatively, in a more mouse-like way. You can arrange that the pen's sideswitch acts as a single

mouse click, a double-click, a control key combination or whatever.

The pen is cordless, so there are no problems getting tied in knots if you have several tricky manoeuvres to perform in rapid succession. The ArtPad itself is pressure sensitive, so it is ideal for use with newer artist or graphics manipulation software, or handwriting recognition applications. To be honest, that's its main purpose in life according to Wacom. But I think differently. Yeah, it's great for artwork and handwriting if that's your scene – but as a manipulation tool for general computer housekeeping tasks – dragging windows or files around the screen, or double-clicking documents and applications – it's even better. And for my RSI, it's sheer bliss. It beats a mouse, pun intended, paws down. In fact, *my* mouse is currently out of work. A redundant rodent.



Wacom's ArtPad is available by itself R.R.P. £159.00 + VAT or bundled with a copy of the art application 'Dabbler' R.R.P. £199.00 + VAT. Contact: LETRASET Tel: 0171 928 3411 or Computers Unlimited Tel: 0181 200 8282. Check it out.

*The opinions expressed by the author are not necessarily those of the publisher or the editor.*

## LIFE WITH MICRO CHIP...

CHIP IS PHONING  
IN SICK AND IS  
SPEAKING TO  
HIS BOSS

...I went for  
a beer and a  
curry and  
got RSI!

What Repetitive  
Strain Injury?

No  
Rather  
Serious  
Indigestion

# GUITAR-HEADPHONE-AMPLIFIER

## SILENCE PLEASE

**KIT AVAILABLE (LT80B)**  
**PRICE £12.99**

An electric guitar produces very little volume if not plugged into an amplifier. One advantage of this is that it is possible to practise without annoying the family or neighbours! The disadvantage, of course, is that it just doesn't sound the same. Especially when aiming for those screaming lead solos! With this in mind, the design is a low-cost, battery-operated amplifier that could drive a pair of headphones and offer a realistic distortion effect. The unit is fitted into a clip-on box with battery compartment (KC25C).



### FEATURES

- \* Extremely low cost
- \* Practise in privacy
- \* Authentic rockin' sounds
- \* Separate volume and distortion controls



Design and Text by  
**Lawrence Saunders**

This had two consequences for the design. One was that the circuit had to use a minimum of components to keep the size down and the other was that the current consumption be kept to a reasonable level to prolong battery life.

## Circuit Description

A block diagram of the unit is shown in Figure 1. The circuit breaks down into two major parts, the input and preamplifier stage, and the power amp. The input is based around a low noise op amp. I chose the TL071 because it is a particular favourite of mine, offering excellent performance for modest cost.

(I happen to know that the dual version, the TL072, is widely used in commercially produced recording-studio mixers costing hundreds of thousands of pounds. If it's good enough for them . . . !)

The power amp, used to drive the headphones, was chosen after much deliberation on the parameters of the various IC amps available. (Well, actually, I just happened to have a TBA820M in my spare's box and it seemed to fit the bill!) It operates

The PCB fitted into the box.

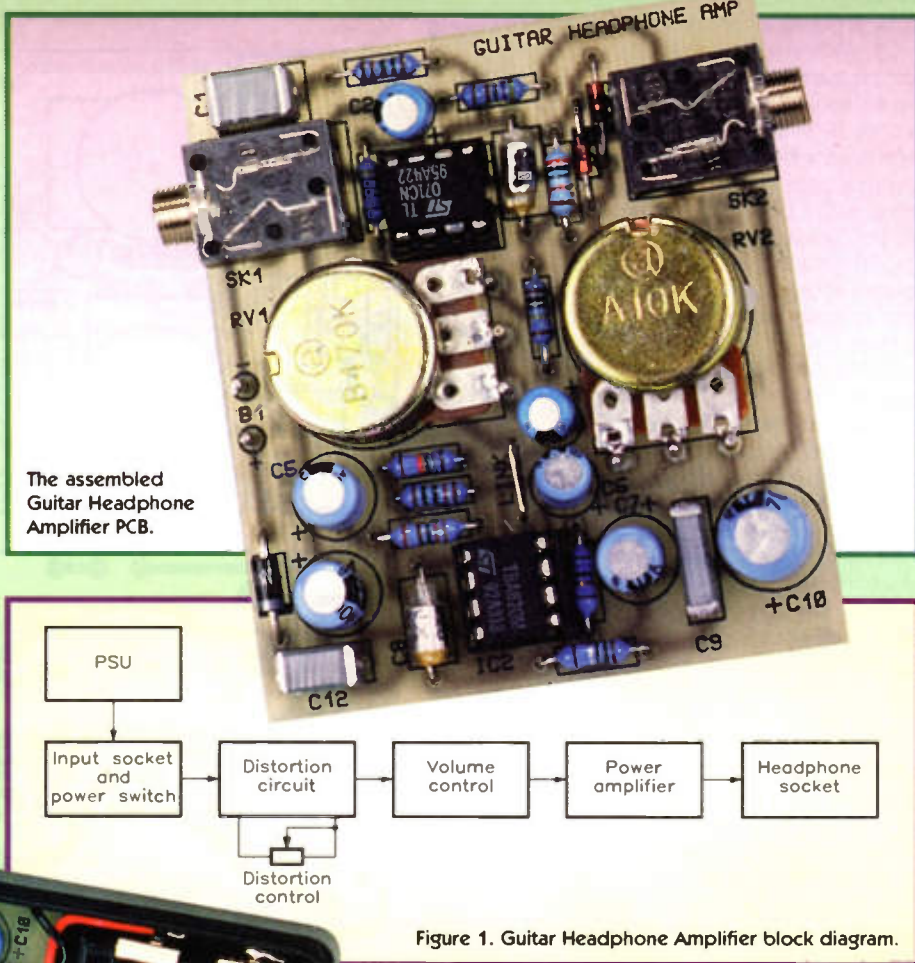
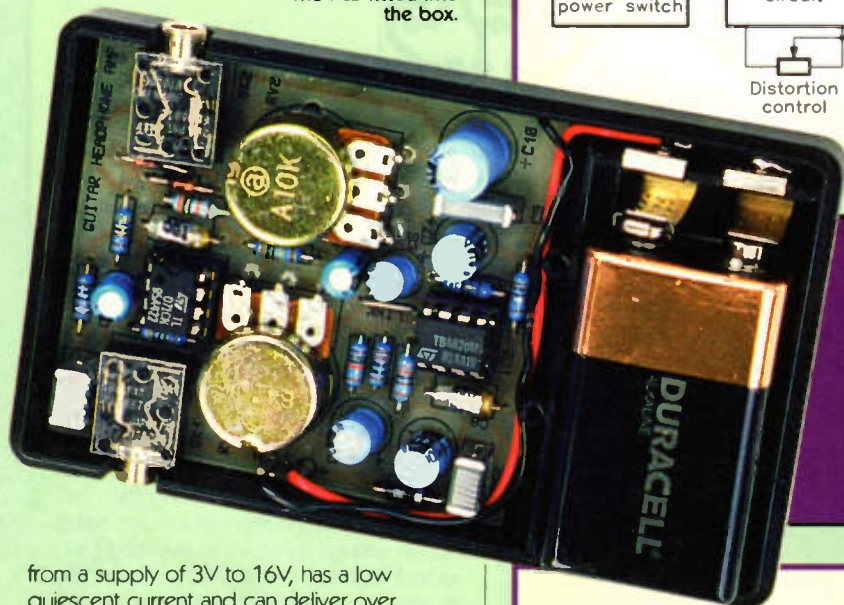

Figure 1. Guitar Headphone Amplifier block diagram.

## Specification

Supply:	9V Nominal
Quiescent current:	9mA
Maximum current:	67mA
Input sensitivity:	<5mV to give full output
Maximum voltage gain:	55dB
Output power:	600mW
PCB dimensions:	63 x 55mm
Dimensions of unit:	103 x 69 x 39mm (inc. knobs)

from a supply of 3V to 16V, has a low quiescent current and can deliver over 1W of power.

Figure 2 shows the complete circuit diagram of the unit. A stereo, PCB mounting, 3.5mm socket is used for the input. The negative supply from the battery is taken through the 'ring' connection of the socket and the negative side of the circuit is connected to the 'earth' connection. This means that when the mono plug is inserted from the guitar it shorts the 'ring' and 'earth' connections, thus connecting the battery negative to the circuit. Therefore, insertion and removal of the input plug also switches the unit on and off.

The signal is taken from the 'tip' connector of the socket and is AC coupled via C1 to the op amp circuit. R1 sets the input impedance to approximately 10k. The value of C1 was chosen so that the cut-off frequency of the high-pass filter it forms with R1 would be below the lowest note available from the guitar. (The figure is given by the following equation:

$$f_0 = \frac{1}{2\pi C_1 R_1}$$

which in this instance gives 33Hz).

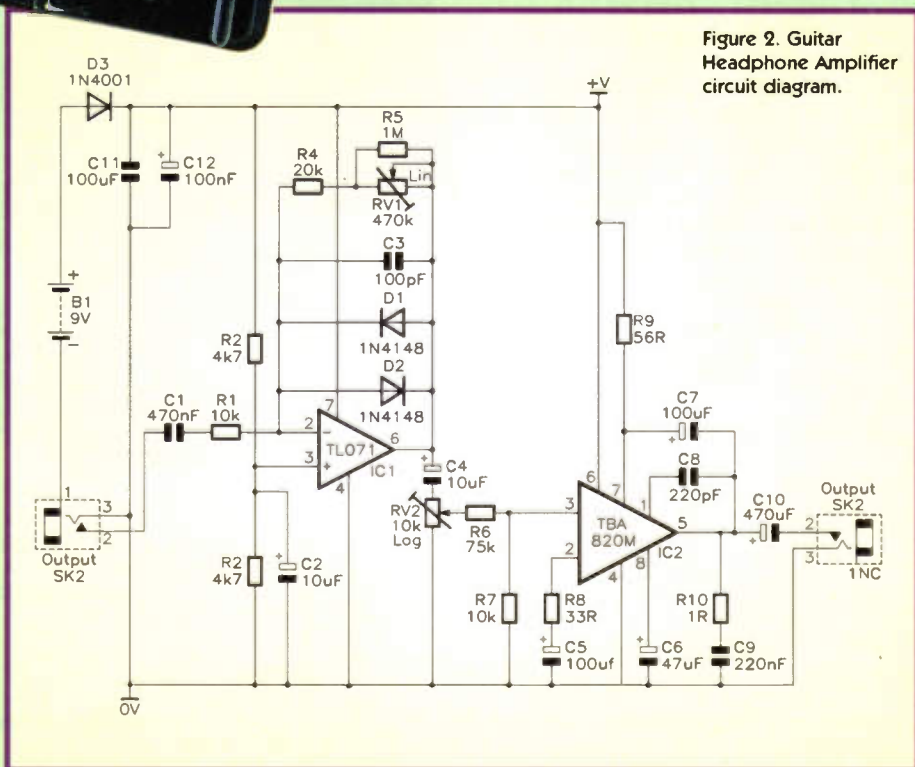

Figure 2. Guitar Headphone Amplifier circuit diagram.

Most common forms of op amp use both a positive and a negative supply with a zero-volt rail used as a reference for the signal. As this circuit is designed to operate from a single 9V PP3 battery, resistors R2 and R3 provide a voltage point to which the non-inverting input is referenced. Ignoring the effect of D1, D2 and C3 for the moment, the gain of the circuit is set by R1 with R4, RV1 and R5. With RV1 at zero, the minimum gain of the circuit is 2. As RV1 is advanced the gain increases and the output signal increases in level.

As the peak voltage output at pin 6 reaches 0.6V then the two diodes are brought into action, D1 conducting on positive half cycles and D2 on negative ones. This has the effect of clipping the top of the signals and introducing high-frequency harmonics. As the gain of the circuit further increases, the more harmonics are produced tending toward square-waves. (A square-wave can be constructed from the sum of all the odd harmonics of a given frequency.) This produces the well-known 'fuzz-box' effect. I thought this sounded too harsh on the prototype, with the harmonics all but swamping the original sound, especially on chords. To 'tame' the circuit a bit, R5 was added to limit the gain and C3 was used to feed back some of the high-frequency components of the distorted signal, thereby reducing the gain at these frequencies. A couple of sums and a bit of trial and error settled the value at 100pF. The actual cut-off frequency varies as RV1 is changed. This leads to a wide range of sound effects being available.

The reason that the gain was set at 2 when RV1 is at zero is so that there is not too much difference in level between the 'clean' signal and the distorted one, as RV1 is advanced.

The signal from pin 6 of the op amp has a significant DC offset so a DC blocking capacitor C4 couples it to the top of RV2. This pot acts as a volume control with the wiper offering the full signal at the top of its travel, and zero signal at the bottom. A logarithmic pot is traditionally used for volume control because of the logarithmic way human hearing works, and who am I to flout tradition?

Anyway, the level of this signal is too large for IC2, the TBA820M device. C6 is connected to pin 8 for ripple rejection and C8 for high-frequency compensation. R9 & C7 are the 'bootstrap' components connected to pin 7 (part of the internal output driver stage), whilst R10 and C9 form a Zobel network. I had to look this bit up because all I did was 'lift' the circuit straight from that hobbyist's bible, the Maplin Catalogue! The only bit I changed was to reduce the value of R8 to increase the gain

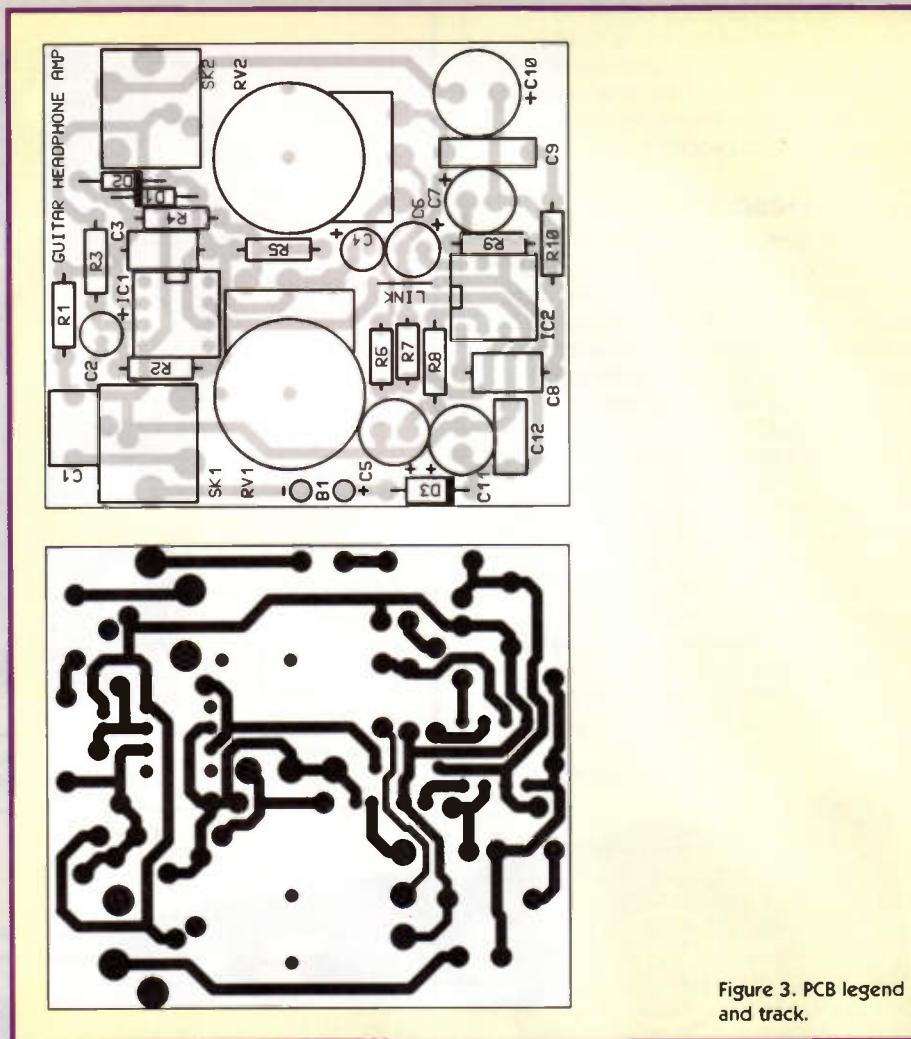

Figure 3. PCB legend and track.



to a suitable level. The output has a DC offset relative to the 0V rail, so C10 is used to block it and couple the signal to the headphone socket.

This socket is also a 3.5mm stereo, PCB mounting type. The socket is wired in such a way that the left and right speakers in the headphones are wired in series. This guarantees that the impedance presented is high enough so as not to overload the output of the TBA820M and so it will drive headphones fitted with either a mono or stereo jack plug.

### Construction

With reference to Figure 3 and the Parts List, start construction with the resistors, using an offcut lead from a resistor for the wire link. Capacitors next, then diodes and IC sockets, remembering to observe the correct polarity for each electrolytic capacitor, the diodes and IC sockets.

Fit SK1 & SK2, and PCB pins for B1+ and B1-.

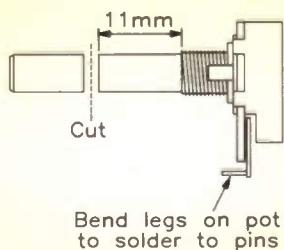

Figure 4a. Modifying the miniature potentiometers for PCB mounting.

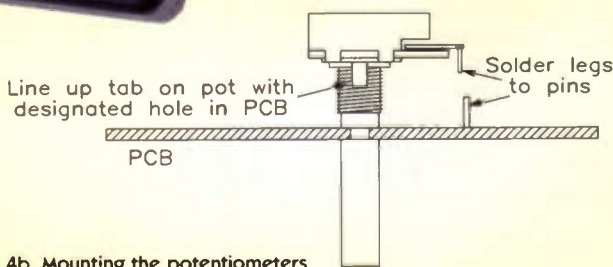

Figure 4b. Mounting the potentiometers into the PCB.



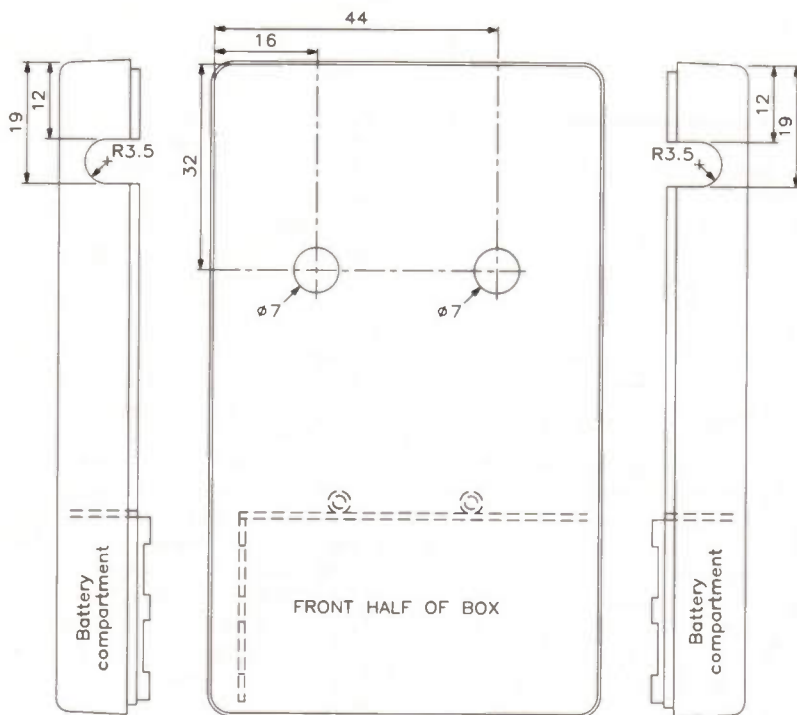

Figure 5. Box drilling and cut-out details.

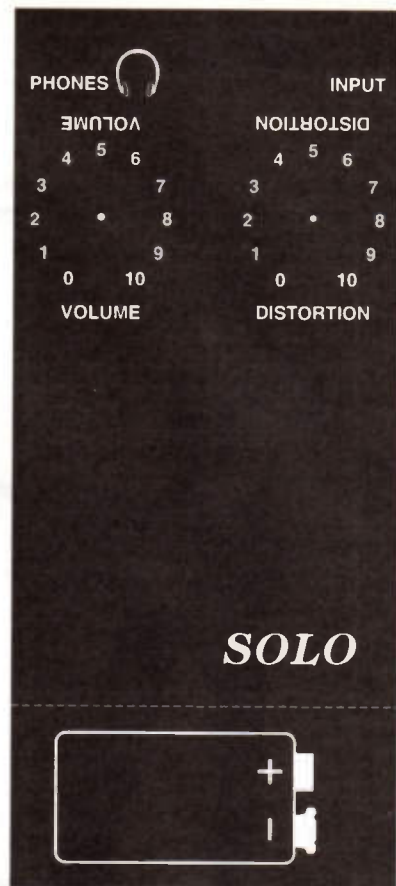

Figure 6. Front panel label design, including battery compartment orientation sticker.

Cut down the shafts of RV1 and RV2 to the lengths shown in Figure 4a. Fit RV1 using the following method: solder three PCB pins in each potentiometer connection point on the PCB, and bend each potentiometer pin at 90° parallel to the shaft, and with the bend occurring at the point where each pin is 'stepped' (Figure 4a). Insert the pot through the PCB from the legend side, so that each pin lies alongside a PCB pin; solder each pin to its matching PCB pin, ensuring that the body of the pot is flush with the PCB. See Figure 4b. Repeat this for RV2. Note: Do NOT fit the washers or nuts to the potentiometers at this stage!

Drill the two holes for the shafts of RV1 & RV2 in the front of the case, referring to Figure 5. Cut off the four PCB mounting pins moulded inside the case, so that they are flush with the raised 'L's' in each corner of the PCB compartment (Figure 5).

Again referring to Figure 5, use a round file to cut slots for SK1 & SK2 in the sides of the case front. The slots do not have to be a perfect fit, but regularly offering the PCB into position will help to produce a neat slot.

Remove and discard the two locking nuts from SK1 & SK2. Strip one end of the red hook-up wire (supplied) back by about 5mm and solder it to the B1+ pin; similarly prepare the length of black hook-up wire and solder it to the B1- pin.

Make a final check of the PCB for dry joints, solder bridges, etc. If you have a multimeter, switch it to read 'ohms' and put the leads across the battery leads. Insert the input plug, a reading of about 9kΩ should be obtained. If a substantially lower reading is obtained, then check again for short circuits.

Trim and stick the front panel label (the

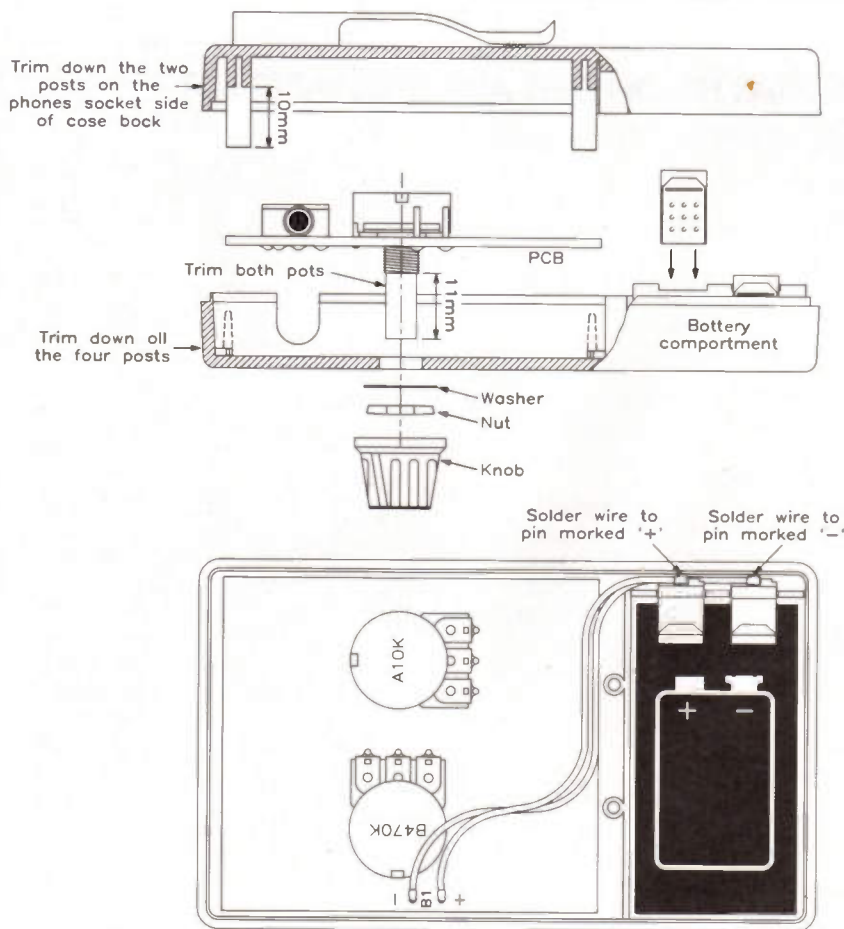
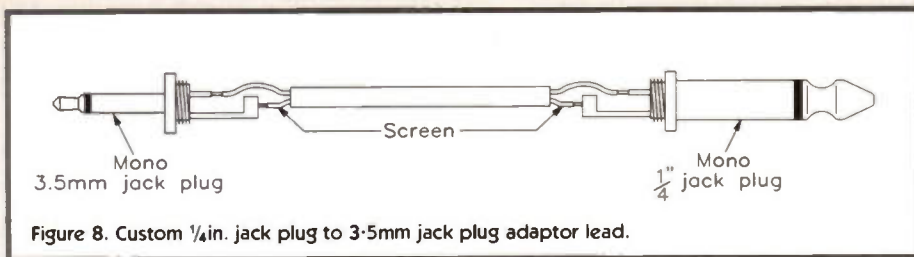

Figure 7. Exploded assembly diagram showing battery connector wiring and battery orientation.



on the knob with the start of the (level indication) on the front panel and carefully tighten the grub screw in the knob to secure it.

## Testing and Using

Insert a PP3 battery, ensuring correct polarity. An alkaline type will give the longest life but you may prefer to use a Ni-Cd.

Putting the input plug in the socket will now switch the unit on. A pair of headphones also needs to be plugged in, personal stereo player type headphones are ideal.

One consequence of using a 3.5mm socket for the input is that either a short custom-made lead has to be used with a 1/4 in. plug on one end and a 3.5mm plug on the other, see Figure 8 (this should not pose a problem to someone who has just built the headphone amplifier!) or of course use a standard 1/4 in. jack-to-jack lead and a 1/4 in. to 3.5mm adaptor (see the optional parts list).

With the volume knob and distortion knob both set to minimum, a slight hiss is all that should be heard. You should always turn the volume control to minimum before switching on, when wearing the headphones, or your might be deafened! Plugging the lead into a guitar, advance the volume whilst strumming. A clear sounding guitar should be apparent. Adjust the level to a comfortable one, and then advance the distortion control. The sound will increase in volume a little and then begin to distort. Gently at first, then more aggressively, right up to heavy metal overdrive! Please note that the guitar's own volume knob needs to be left on full. The general *modus operandi* of the Guitar Headphone Amplifier is illustrated in Figure 9.

Now go away and practise those Eddie Van Halen licks!

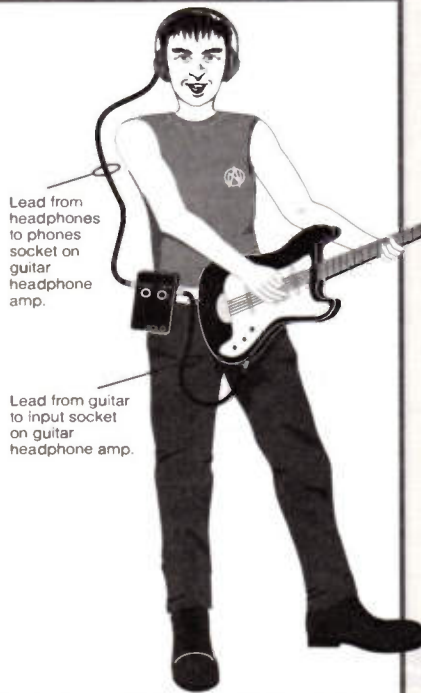

Figure 9. The guitar headphone amplifier in use: guitar cable connects to amplifier unit, headphones plug into unit.

design is illustrated in Figure 6) to the front of the case; the two holes can now be cut out of the label with a sharp craft knife or a scalpel, using the holes in the case as a cutting guide. Note that the label includes a stick-on battery symbol portion; this should be cut away from the main label and attached to the floor of the battery compartment, with the terminal symbols towards the contacts in the case (see also Figure 7).

Screw one pot nut onto each pot shaft and do it up 'finger tight'. Refer to Figure 7 for the following. Offer the assembled PCB into position in the case and assemble the remaining pot washers and nuts into place on the pot shafts; tighten these with a spanner, but do not use excessive force – they should be just too tight to remove with finger pressure only. Be careful not to damage the label.

Trim and solder the battery wires to the 2 battery clips which may then be pushed into their positions in the moulded recesses of the battery compartment, see Figure 7.

Fit the clip to the back of the case (if required) and screw it in position on the front half, ensuring that the wires do not get trapped.

Fit one knob to each of the controls; turn each pot to minimum first, align the white dot

## GUITAR HEADPHONE AMPLIFIER PARTS LIST

RESISTORS: All 0.6W 1% Metal Film (Unless specified)

R1,7	10k	2	(M10K)
R2,3	4k7	2	(M4K7)
R4	20k	1	(M20K)
R5	1M	1	(M1M)
R6	75k	1	(M75K)
R8	33Ω	1	(M33R)
R9	56Ω	1	(M56R)
R10	1Ω	1	(M1R)
RV1	Miniature Linear 470k Potentiometer	1	(JM75S)
RV2	Miniature Logarithmic 10k Potentiometer	1	(JM77J)

### CAPACITORS

C1	470nF Polyester Layer	1	(WW49D)
C2,4	10μF 35V Miniature Electrolytic	2	(JL05F)
C3	100pF Polystyrene	1	(BX28F)
C5,7,11	100μF 16V Miniature Electrolytic	3	(RA55K)
C6	47μF 16V Miniature Electrolytic	1	(YY37S)
C8	220pF Polystyrene	1	(BX30H)
C9	220nF Polyester Layer	1	(WW45Y)
C10	470μF 16V PC Electrolytic	1	(FF15R)
C12	100nF Polyester Layer	1	(WW41U)

### SEMICONDUCTORS

IC1	TL071CN	1	(RA67X)
IC2	TBA820M	1	(WQ63T)
D1,2	1N4148	2	(QL80B)
D3	1N4001	1	(QL73Q)

### MISCELLANEOUS

	8-Pin DIL Socket	2	(BL17T)
	Pocket Clip Case	1	(KC95D)

PCB 3.5mm Stereo Jack Socket	2	(FK20W)
15mm Knob K14 A	2	(FK38R)
M10 Nuts for Miniature Potentiometers	1 Pkt	(FP06G)
1mm PCB Pins	1 Pkt	(FL24B)
Hook-Up Wire Black 10m	1 Pk	(BL00A)
Hook-Up Wire Red 10m	1 Pk	(BL07H)
Front Panel Label	1	(KP76H)
PCB	1	(GJ03D)
Instruction Leaflet	1	(XV14Q)
Constructors' Guide	1	(XH79L)

### OPTIONAL (Not in Kit)

Metal 1/4 in. Jack Plug	1	(HF87U)
Metal 3.5mm Jack Plug	1	(HF81C)
Single Microphone Cable	1m	(XR16S)
Alkaline PP3 Battery	1	(JY49D)
3.5mm to 1/4 in. Jack Adaptor	1	(RW02C)

The Maplin 'Get-You-Working' Service is available for this project, see Constructors' Guide or current Maplin Catalogue for details.

**The above items (excluding Optional) are available as a kit, which offers a saving over buying the parts separately.**

**Order As LT80B (Guitar Headphone Amplifier Kit) Price £12.99**

Please Note: Where 'package' quantities are stated in the Parts List (e.g., packet, strip, reel, etc.), the exact quantity required to build the project will be supplied in the kit.

The following new items (which are included in the kit) are also available separately, but are not shown in the 1995

Maplin Catalogue.

**Front Panel Label Order As KP76H Price £1.99**  
**Guitar Headphone PCB Order As GJ03D Price £2.49**

# NEWS

## Report

### Chip Doubles PCMCIA Slots

Currently in the final stages of development in the laboratories at National Semiconductor, is a standards-based interface circuit that supports two input/output functions on a single PCMCIA Card. Not only that, but both I/O functions may run concurrently with memory, an engineering feat that has challenged designers ever since the time PCMCIA cards were first built in the 1980s. The IC also includes new features to reduce power drain on portable and personal digital assistant (PDA) batteries.

Contact: National Semiconductor, Tel: +49 81 41 103 433.



### Videoconferencing for All

British businessmen and women still waiting for a flight with videoconferencing must be incredibly patient – the technology has been about to take off for at least ten years. Now things could be moving at last, with a new product – eclipse – from Compression Laboratories Inc. (CLI), the company that lays claim to having invented the technology with the introduction of the first commercially viable videoconferencing codecs (codec/decoders that digitise and compress full-motion video and audio) in 1982.

The new system is easy to operate and seems to have all the key requirements that could elevate videoconferencing from a rich company's expensive toy to an essential piece of office equipment.

The functionality of the eclipse 8200 and 8300 models, based on ITU-TSS standards, is comparable to many more costly and complicated systems. For

high-quality audio, the new models feature wide band audio at 3.5 to 7kHz based on the standard ITU-TSS G.728, G.711, G.722. To provide users with viewing control, they include far-end camera control, based on ITU-TSS H.281 and H.224, and operated from a wireless Self-Guide remote control unit. High-resolution graphics, with the choice of two different document cameras, are offered based an Annex D of the H.261 standard.

To make it easier to control videoconferencing networks requiring the participation to multiple sites as part of one conference, the new models also offer the option of Multipoint Chair Control from the remote control unit. Multipoint Chair Control is based on ITU-TSS H.243. The wireless Self-Guide user interface is a key feature as participants can control an entire conference using this simple device, including all video, audio and camera functionality.

Contact: Compression Laboratories Inc., Tel: +408 435 3000.



### Get a Grip on Virtual Reality

The Building Research Establishment (BRE) this month launched a Virtual Reality Forum for the construction and design industry at the National HVAC Show, Olympia.

Virtual Reality, which makes it possible for designers and clients to walk through a proposed building, is already a powerful construction design tool in the Far East,

and to remain competitive it is important for the UK to invest in the technology.

BRE has established the Forum in conjunction with Colt Virtual Reality to promote awareness of VR and its potential in the construction industry. Colt Virtual Reality, which is already developing the technology, will provide technical back-up for the Forum.

Contact: Building Research Establishment, Tel: (01923) 894 040.

### SDH Radio System for Energis

Thorn Communication & Telecontrol Systems (C&TS) has successfully installed and commissioned the first SDH (synchronous digital hierarchy) radio system in the UK for Energis, the telecommunications company belonging to the National Grid Company plc. The turnkey system has been designed to link Energis' new offices in Reading, Berkshire with its national fibre optic network, which is carried over the NGC transmission network power lines.

The system is based on high capacity digital microwave radio relays using the latest generation technology to provide capacity for such services as digitised voice, data, video and control information. The system provides a capacity of up to 155M-bit/s, to meet the latest European and world specifications for SDH networks, uses radio equipment design and has been developed by ABB Nera to meet the requirements of major telecommunications operators into the next century.

Contact: Thorn C&TS, Tel: (0131) 458 3000.



### No Shutdown Software Needed!

Serial Cable Not Connected

V<sub>CC</sub> = 2.7V to 3.6V

Serial Cable Connected

V<sub>CC</sub> = 2.7V to 3.6V

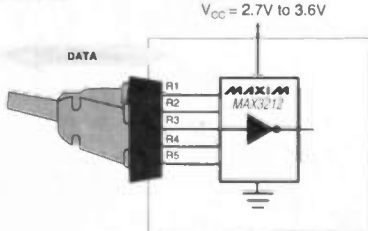
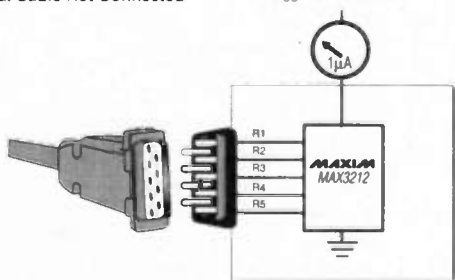

### Auto-shutdown RS-232 IC

Maxim has introduced the MAX3212, an RS-232 IC that uses Maxim's new Auto-shutdown mode. If there is no valid RS-232 level on the receiver inputs, the IC shuts down automatically, reducing the supply current to 1µA, saving over one-thousand times the supply current of similar RS-232 devices. (See left.)

Contact: Maxim, Tel: (01734) 845255.

### Low-Cost V.34 Modem

Data communications company US Robotics has launched a V.34 version of its budget priced Sportster Fax Modem at £299, offering 28,800bps uncompressed data transmission over dial-up lines.

Contact: US Robotics, Tel: (01753) 811180.



### BT to Put on Trial Interactive TV

BT is to start consumer trials of BT Interactive TV (which includes video on demand) in the middle of next year with 2,500 households in Colchester and Ipswich. This follows the success of its technical trials, held in Kesgrave, near Ipswich, with 60 BT employees.

BT Interactive TV brings together the telephone and the television to enable customers to choose a range of services from a menu on an ordinary television

set. The material is then transmitted from a central database over the telephone network to the television, while not affecting the normal telephone line.

BT aims to offer, shopping on demand, a range of educational programmes for homes and schools, movies and television programming, a home banking service, a magazine service and community link (a local information service). Additional services will be introduced during the course of the trial.

Contact: BT, Tel: (0171) 356 5369.

### Square-Pixel Digital Video to NTSC/PAL Encoder

Philips Semiconductors this month released, the SAA187 digital video encoder chip. The device is targeted at PC, workstation motherboard, and add-on board manufacturers incorporating video and processing systems.

The SAA187 is a 5V monolithic CMOS IC that encodes MPEG decompressed data or digital YUV video data into NTSC or PAL Composite Video with an on-

screen display and closed captioning. Its basic encoder function consists of sub-carrier generation and colour modulation, as well as the insertion of synchronisation signals. Luminance and chrominance signals are filtered according to RS-170 and CCIR-624 standards requirements.

Contact Philips Semiconductors, Tel: +31 40 72 20 91.

### PC to Radio Interface

Radio amateurs G0LOV/G4LUE has signed an agreement with Badger boards to sell the company's kits which allow amateur radio enthusiasts to transmit and receive computer data. The kits are used as an interface between a radio and an IBM compatible PC. The modes included are Morse, Slow Scan Television, FAX, Radio Teletype and Amtor.

The kits cost from £19 excluding case, or can be bought ready built at £24 excluding case. Also included in the price are shareware software drivers.

Contact: G0LOV/G4LUE, Tel: (01226) 283021; E-mail: njh@smsltd.demon.co.uk.

### Free Colour Guide to PCMCIA

Portable Add-ons has come up with a solution for virtually every problem the portable computer user may encounter. In the company's free colour PCMCIA

Guide, you can read about all its solutions, products and technology.

All PCMCIA cards share the same dimensions in length and width, and use a 68-pin connector, but they come in a variety of thicknesses. Enhanced facilities provided by the cards include hard disk drives and card readers for using PCMCIA cards on a desktop PC. The cards function with low power consumption and fast data access speed, and, with 'plug and play' capacity, the user can insert, remove and swap cards without the need for special configuration, rebooting or power-down.

PCMCIA slots are implemented by all major PC manufacturers, with virtually all new mobile computers coming equipped with PCMCIA capacity. With future developments promising 32-bit cards with faster performance and 3.3V cards giving even lower power consumption, PCMCIA technology is a development firmly placed in today's market and set to gain much wider popularity in the future.

Contact: Portable Add-ons, Tel: (01483) 440777.



Finally an upgradeable PCB CAD system to suit any budget ...

# Board Capture

## BoardCapture - Schematic Capture

- Direct netlist link to BoardMaker2
- Forward annotation with part values
- Full undo/redo facility (50 operations)
- Single-sheet, multi-paged and hierarchical designs
- Smooth scrolling
- Intelligent wires (automatic junctions)
- Dynamic connectivity information
- Automatic on-line annotation
- Integrated on-the-fly library editor
- Context sensitive editing
- Extensive component-based power control
- Back annotation from BoardMaker2

£395

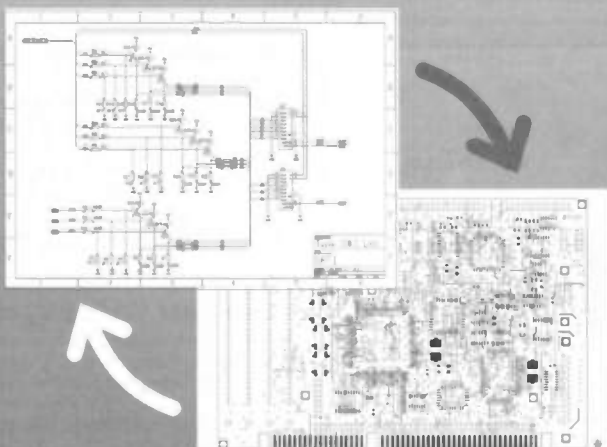

# BoardMaker

## BoardMaker1 - Entry level

- PCB and schematic drafting
- Easy and intuitive to use
- Surface mount support
- 90, 45 and curved track corners
- Ground plane fill
- Copper highlight and clearance checking

£95

## BoardMaker2 - Advanced level

- All the features of BoardMaker1 plus
- Full netlist support - OrCad, Schema, Tango, CadStar
- Full Design Rule Checking - mechanical & electrical
- Top down modification from the schematic
- Component renumber with back annotation
- Report generator - Database ASCII, BOM
- Thermal power plane support with full DRC

£395

# BoardRouter

## BoardRouter - Gridless autorouter

- Simultaneous multi-layer routing
- SMD and analogue support
- Full interrupt, resume, pan and zoom while routing

£200

## Output drivers - Included as standard

- Printers - 9 & 24 pin Dot matrix, HPLaserjet and PostScript
- Penplotters - HP, Graphtec, Roland & Houston
- Photoplotters - All Gerber 3X00 and 4X00
- Excellon NC Drill / Annotated drill drawings (BM2)

Contact Tsien for further information on  
Tel 01354 695959  
Fax 01354 695957

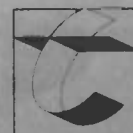

tsien

Tsien (UK) Ltd Aylesby House Wenny Road Chatteris Cambridge PE16 6UT

All trademarks acknowledged

A readers' forum for your views and comments.  
If you would like to contribute, please  
address your replies to:

The Editor, Electronics – The Maplin Magazine,  
P.O. Box 3, Rayleigh, Essex SS6 8LR, or send  
an E-mail to: AYV@maplin.demon.co.uk



Dear Editor,  
Mr M. R. Parry who, in the last issue, said that it took five years to recoup the cost of a fluorescent tube, must be buying cheap tubes and expensive filament bulbs, as well as missing the whole point of fluorescent lighting, which is energy – and cash – saving, overall. In round figures, electricity costs me about 10p per kilowatt-hour – that is, taking into account the standing charge and the VAT, so kindly imposed recently. A fluorescent lamp rated at about 20W produces about the same light as a 100W filament bulb. Either a two-foot fitting with an 18W tube or a 20W filament bulb replacement fluo lamp with built-in ballast costs from £6 to £10 and the tube or economy bulb will last about 8,000 hours compared with filament lamps' 1,000 hours each. I can buy eight 100W bulbs for about £2, but over the 8,000 hours of their lives – about two years of average use – they'll consume 800kWh, costing £80, so the total cost for 8,000 hours of light from filament bulbs is £82.

Because of control gear losses a nominal 20W fluo' will draw a little more power than 20W from the mains. Let's look on the black side and say 25W. Consumption over 8,000 hours is 200kWh, costing £20, total over 8,000h, say £30. So the saving is £50 or more over 8,000h or, allowing that I overestimated gear losses slightly, 50p per week per 100W bulb replaced by a 20W fluorescent lamp. If you bought an 'economy' bulb you then start again. If you bought a 2ft fitting though, just replace the tube, at about £5 for a good quality Thom 'Polylux' or Philips 80 series tube, or if you can tolerate the poor colour rendering from cheaper tubes, about £2 replacement cost, and savings amount to even more.

Above all, cutting power consumption both reduces VAT paid to the government and carbon dioxide pollution. If you pay a bit more for your fluorescent fitting, and buy one with electronic ballast operating the tube at 30kHz or more instead of the 50Hz of the mains, you get even more light for your money – about 20% more. And then you can, if



## STAR LETTER

This month, Mr Dick Oliver, from Essex, wins the Star Letter Award of a Maplin £5 Gift Token for his very interesting letter about saving energy.



it's organised properly, dim the fluorescent lamp. Come on Maplin, now that IC 'hearts' are available for this job, how about a project? On heating controls, wasteful boiler 'cycling' is normally a problem only with the old type of heating system using gravity circulation to heat the hot water cylinder, with hot water temperature controlled by the setting of the boiler

thermostat. In other words, on hot water duty the only control (apart from the clock, if fitted) is the boiler thermostat. Thus, the moment the boiler cools below this setting, it lights up again, even though the hot water tank may be fully charged. The simplest way to stop this (and the cheapest at under £15) is to fit the strap on thermostat on the hot water

cylinder, to stop the boiler firing till the cylinder temperature drops below the set level. Obviously this must be wired to interrupt firing only on hot water duty, not when house heating is required. Experimental adjustment of the height of the thermostat on the cylinder will stop the boiler from firing till there's, say, only one bath left in the cylinder. So there's no need to spend £100 or get involved in complex electronics.

But any system using gravity hot water circulation must be coming to the end of the boiler's life, so consideration should be given to replacing the boiler with a modern condensing boiler – efficiency about 90%, compared with maybe under 70% for the old cast-iron-boiler gravity-hot-water-system, and updating the controls to include pumped hot water and possibly zoned heating. After all, there's little point in heating living rooms during the night or bedrooms during the day. But again think more deeply about the system. Condensing boilers work best with a much lower return water temperature than is permissible with non-condensing boilers, where condensation of the water in flue gasses must not occur lest it causes corrosion. The cost of this with an old non-condensing boiler, is the loss of the latent heat of vaporisation, a worthwhile 542 cal/gm of water.

Thus, in a conventional system, whether pumped or gravity, the hot water circuit is normally 'wired' in parallel with the heating circuits. Though I've never yet come across a heating engineer doing anything different with a condensing boiler, it seems more sensible to me to run the return from the heating radiators through the hot water cylinder coil, with a motorised valve arranged to short-circuit the house-heating circuits when hot water duty alone is required, thus ensuring that the return water to the condensing boiler is at the lowest possible temperature, to give the highest boiler efficiency.

There you are, heating engineers with an interest in electronics and an environmental conscience – you read it first in Electronics!



### Video Box Ideas

Dear Editor,  
When setting up the 'Maplin Video Box' [published in Electronics March 1992/Issue 51 – Ed.] which I recently constructed, I thought some of the preset controls would be useful as variable controls, i.e., Brightness, Contrast, Colour and Wiper, etc. I have made some small modifications which may be of interest to some of your readers.

1. In series with R14, I included a 100k potentiometer which acts as a contrast control (alters video bias).
2. In series with R38, I included a 10k potentiometer to give a brightness control (maximum video level).
3. For adjustable colour I opted for a switched circuit after trying variable potentiometers, and used a 5-way switch and a range of polystyrene capacitors. I used these to replace C16, originally 68pf. The central (normal position) now uses a 100pf instead of the 68pf. The left and right edge potentiometers can be modified to give vertical wipes, fading to black from LH or RH edge of the screen.
4. I replaced R44 with a 100k potentiometer (linear) – this needs to be 100k, I found some were low, i.e. 89k which would not give a full wipe.
5. R45 was replaced with a 47k potentiometer. (Full range was achieved with a resistance of about 32k). I have modified a 47k dual potentiometer and replaced one section with a 100k potentiometer to give a 'curtain effect', but some readers may not be happy modifying it in this way (left and right wipes together).
6. A bypass switch was also included and allows comparison with the direct signal.

7. When trying to alter the gain of the video signal I found that when I put a capacitor (150pF) in parallel with R21 I got an interesting effect. The colour was inverted. This can give inverted black and white (when S3 is used). I have included this as another switched effect (but I haven't worked out how it works!). All potentiometers linear types. Set to centre and set up normal. I hope these tips are of use to your readers.

R. H. McQuade, Lancs.

Thank you for the tips! I am sure that your ideas will provide a useful starting point for other video enthusiasts to experiment with this popular project.

### Index Availability

Dear Editor,  
Please, please, please consider making the Electronics index available on disk. I have five magazine folders with your excellent magazine in, and an index would be most welcome. It takes me ages to search through for information I know is there somewhere. As well as making this information available on the Internet and some BBS, why not add a module to CashTel allowing customers to download the index and upgrades. In fact why not have your own BBS dedicated to electronic information and projects.

Thank you for some very interesting articles, projects etc.  
S. Amor, Cornwall.

Thanks for the feedback on making the index available on disk/Internet/BBS/CashTel, moves are afoot to upgrade CashTel and provide a file download facility – watch this space for further developments. All comments and suggestions are, as always, most welcome.

### Minor Money Worries

Dear Editor,  
I would like to have a groan at Electronics about the price of the magazine. The features are extremely informative and are useful when you need that extra bit of information. However, this might grind to a halt; for me that is. Even though the graphs in Issue 77 say that the under 16s are only 6%, we still exist, I am only 11 years old and the price of Electronics costs a bomb to me. Please, please will you sell the magazine at a reasonable price. If you don't, by the year 2000, you'll be selling them for £15 each!  
Jeremy Harper, London

Whilst I appreciate that pocket-money doesn't grow on trees, and that £2.10 represents a sizeable chunk of your monthly 'income', we cannot realistically reduce the cover price of Electronics. Publishing Electronics obviously costs money – there's the staff wages, production, printing costs, etc., which amount to a very substantial sum – and it's all got to come from somewhere! The cover price of Electronics is kept as low as possible, honestly! The other electronics magazines are dearer, and frequently carry less pages of editorial than Electronics (not to mention the quality of editorial) – so you're getting the very best value for money. The survey, the results of which were published in Electronics May 1994/Issue 77, showed that 90% of respondents felt that Electronics represents value for money. So in answer to your question, we already are selling, and will continue to sell, Electronics at a reasonable price! One way that you can save money is by taking out a subscription (ask the 'pocket-

money providers' for a cash advance or suggest it as a birthday or Christmas present!) a subscription costs less than buying each individual issue and each issue will drop onto your doormat before it is available in the shops. Depending on the method of subscription, you can save up to £5.82, see page 63 for details.

### PI in the Sky

Dear Editor,  
I have been reading J. M. Woodgate's series on filters with great interest. I thought I was getting on fine with the maths involved until the author started using a notation which is totally unknown to me. How big is PIEF? Does it rhyme with knife, beef or Kiev? Maybe it's meant to rhyme with PI F.  
Roly Williams, Strathclyde.

John Woodgate replies:  
Two scaling factors are needed to denormalize a normalized filter, which is one designed for a load or source (or both) impedance of 1Ω and a cut-off frequency or bandwidth of 1/2π Hz. Giving meaningful symbols to these variables is complicated by the fact both impedance and frequency are associated with the Greek letter ω or Ω. In my series on woofers, I called the factors 'the Ω-factor' and 'the W-factor', but I found that even I could not always remember which was which! So, in the Filters series, I changed to Ω-factor' and 2PIEF', thinking that the equation: 2PIEF = 2πf = ω, as well)

would make things clear, and would be in the modern trend towards 'meaningful' symbols rather than Greek letters, especially in programming. Perhaps, I should have written 'TWOPIEF'!

## Factors Setting Limits

The shaded area in Figure 1 shows the acceptable operating region applicable to two terminals of an electronic device across which there is a potential difference  $V$  when the quiescent, or base current is  $I$ . We will assume from now on that the device is a silicon semiconductor, because that is most likely to be met in everyday design work, but the discussion has general applicability. Thus,  $I$  and  $V$  could refer, respectively, to the anode current  $I_A$ , and anode-cathode voltage,  $V_{AK}$ , of a diode, or the collector current,  $I_C$ , and collector-emitter voltage,  $V_{CE}$ , of a bipolar transistor, etc.

The current rating  $I_M$ , voltage rating,  $V_M$ , and power rating,  $P_D$  are specified in manufacturers' data. They are ratings rather than 'characteristics'. A rating refers to a limit, operation beyond which impairs the serviceability of a device. It is set after extensive life tests have been made and an acceptable failure rate has been decided on by the manufacturer.

By comparison, a characteristic is a measurable parameter, e.g. forward voltage drop across a diode at a specified current. To some extent the quoted  $I_M$  is misleading. The current-handling capacity of a PN junction is dependent on junction area and provided power dissipation is properly controlled,  $I$  can normally be increased to any value likely to be required in practice. If it is too large, failure can occur because of the melting of internal connection wires but that is normally at current levels much greater than  $I_M$ . The factor determining the specified  $I_M$  is degradation in characteristics. In the case of a diode intended for rectifier use, the degradation is an excessive anode-cathode voltage drop. For a bipolar transistor used in a linear amplifier the degradation is the fall in the value of common-emitter current gain leading to unacceptable distortion as well as the need for an increased base-drive current.  $V_M$  specified the onset of

# POWER MANAGEMENT IN SEMICONDUCTOR DEVICES

It is well-known that electronic devices can be destroyed if manufacturers' limits on current, voltage and power-dissipation are exceeded. Protection from over-dissipation, which often involves an excessive current flow, requires care at the equipment design stage and is easily overlooked by the unwary.

This two-part article makes a systematic approach to the problem of device power-management.

Part 1 deals with the device itself. It explains how limits on current and voltage involve a consideration of power and clarifies the meaning of power specifications, as listed on manufacturers' data sheets, by reference to industry-standard devices. Part 2 considers devices in-circuit. It presents a novel set of curves that summarises power relationships and discusses their application in the selection of power-limiting resistors in some typical circuit designs.

a breakdown mechanism in a reverse-biased PN junction. Two well-known processes are 'Zener' and 'avalanche' breakdown.

With the Zener effect a high electric field, in vicinity of the junction, caused electrons to be pulled directly from bonds in the device's crystal lattice structure. In the avalanche effect the high field strength causes an exponential increase in the carrier population because of the mechanism known as 'ionisation by collision'. Which effect predominates depends on the impurity doping profile each side of the junction. Normally, the Zener effect has the major influence for  $V$  about 5V or less while at higher voltages the avalanche effect predominates. Both effects occur within the body of the device rather than at the surface, and the breakdown is reversible and non-destructive provided the associated current is limited so power dissipation is controlled. Device characteristic curves tend to become parallel to the  $I$  axis during a voltage breakdown process, thus limiting the voltage swing that the circuit designer can permit if severe distortion is to be avoided.

When a transistor is used as a common-emitter switch to drive an inductive load (e.g., a relay coil), the incorporation of a flywheel diode (D in Figure 2) prevents the collector voltage rising appreciably above  $V_{CC}$  so if  $V_{CC} < V_M$  the device is protected. For a MOS device exceeding the gate-source voltage if a rogue spike appears can cause irreparable damage through fracture of the gate dielectric: that is why gate-protection diodes are incorporated in MOS logic devices.

The graph for  $P_D$  is a rectangular hyperbola, as it refers to the condition  $IV = \text{constant}$  ( $= P_D$ ) and is easily drawn once  $P_D$  is known.  $P_D$  describes the rate at which energy is supplied to the crystal lattice in the form of heat. If  $P_D$  is exceeded for a significant time interval, the associated energy is likely to be excessive, leading to irreversible damage to the crystal structure.  $P_D$  is never exceeded in conservative designs.

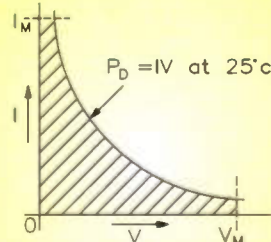

Figure 1. Device operating limits for two terminals of electronic device.

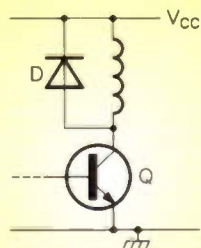

Figure 2. 'Flywheel diode' D prevents excessive collector-emitter voltage when Q is switched off.

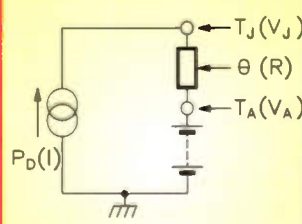

Figure 3. Thermal equivalent circuit with electrical analogues (bracketed).

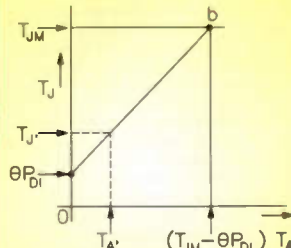

Figure 4. Plot of junction temperature  $T_J$  vs ambient temperature  $T_A$ , for circuits in Figure 3.

## Power Dissipation Explored Further

For most practical applications it is assumed that  $P_D$  is directly proportional to the difference between the junction temperature  $T_J$  and the ambient temperature,  $T_A$ , of the surrounding air.

$$\text{Thus } P_D \propto (T_J - T_A) \quad (1)$$

This is certainly a legitimate assumption for 'low power' devices (<1W say), because heat is transferred away, principally by conduction, so (1) is merely a restatement of a basic law of heat conduction (which applies, also, to the lagging of hot water pipes).

Inserting a constant of proportionality,  $\theta$ , (1) can be rewritten,

$$(T_J - T_A) = \theta P_D \quad (2)$$

This is the thermal equivalent of Ohm's Law (see Figure 3) with temperature replacing voltage and power replacing current flow.  $\theta$  is the thermal resistance and is expressed in degrees C per Watt ( $^{\circ}\text{C}/\text{W}$ ) or degrees C per milliwatt ( $^{\circ}\text{C}/\text{mW}$ ).

$T_J$  has a maximum permissible value,  $T_{JM}$ , that is set by the temperature at which conduction due to thermally generated carriers becomes comparable with that resulting from the impurity doping pattern. This temperature is in the range of  $200^{\circ}\text{C}$  for silicon, hence  $T_{JM}$  is set at that value for military-grade devices supplied in metal or ceramic packages.

However, the softening of the plastic encapsulation of industrial-grade and consumer-grade devices at elevated temperatures necessitates the use of lower values of  $T_{JM}$ . Thus,  $T_{JM}$  might be  $175^{\circ}\text{C}$  for a device used in an industrial control system but only  $125^{\circ}\text{C}$  to  $150^{\circ}\text{C}$  for a device used in domestic equipment. The thermal resistance  $\theta$  is dependent on chip size and mounting, the geometry and thermal conduction properties of the package and the way in which heat is conveyed from the package to the surrounding air.

A graph of  $T_J$  vs  $T_A$ , based on (2), is shown in Figure 4. It is a straight line, with a slope of +1, that cuts the  $T_J$  axis at  $T_J = \theta P_{DI}$ . At any ambient temperature such as at  $T_A$ , the corresponding junction temperature is  $T_J$ . Of particular importance is the  $T_A$  at which  $T_J = T_{JM}$ . From the geometry of the diagram this is at  $T_A = T_{JM} - \theta P_{DI}$ , the point 'b' where the diagonal line cuts limit line  $T_J = T_{JM}$ .

Figure 5 shows a family of diagonal lines of four different values of  $P_D$  including that shown in Figure 3 and  $P_{D0} (=0)$ . The

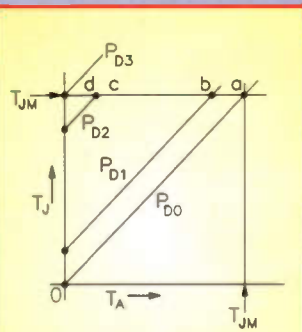

Figure 5. A family of characteristics, based on Figure 4, for four values of  $P_D$ .

intersection points a, b, c, d form the basis of the construction of the 'derating' diagram shown in Figure 6. This is the locus of  $P_D$  as  $T_A$  varies, with  $T_J$  constant at  $T_{JM}$ . The slope of the line section 'ad' is  $(-1/\theta)$ ; the magnitude of this is the 'derating factor', expressed in  $\text{W}/^{\circ}\text{C}$  or  $\text{mW}/^{\circ}\text{C}$ .

There is no reason to assume that the line changes slope at 'room temperature',  $T_A = 25^{\circ}\text{C}$ : no new physical process commences at this temperature. However, data sheets indicate that  $P_D$  is to be assumed constant below  $25^{\circ}\text{C}$ , so the graph there is taken as the horizontal line 'cd', rather than the diagonal 'cd'. This is a matter of convention and reflects a desire on the part of manufacturers to restrict the operating range. Operation down to  $-65^{\circ}\text{C}$  is possible (below that the doped impurities responsible for the controlled conduction mechanisms cease to be fully ionized). Nevertheless, operation over a very wide temperature range can cause mechanical stresses in the component parts of a package due to differing thermal expansion coefficients.

In most applications operation is above  $25^{\circ}\text{C}$ . In fact,  $T_A$  may be well above this if a device is operated in a confined space in an equipment cabinet.

For low-power devices the value of  $\theta$  normally specified, or deduced, is the thermal resistance from junction to ambient,  $\theta_{JA}$ ,  $\theta_{CA}$  which are respectively the junction-case and case-ambient

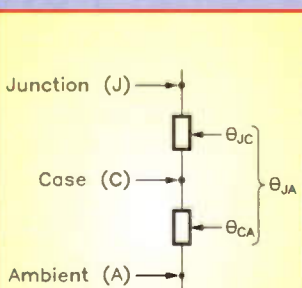

Figure 7. Showing composition of  $\theta_{JA}$  for a low-power device.

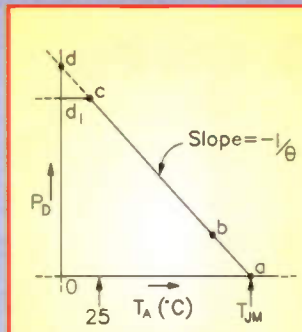

Figure 6. Thermal derating diagram derived from Figure 5 to which letters a, b, c, d correspond.

thermal resistances. For devices operative above 1W,  $P_D$  is usually quoted at a given case temperature,  $T_C$ . From this information,  $\theta_{JC}$  can be calculated. The attachment of a heatsink, with thermal resistance  $\theta_{SA}$  offers a method of operating at a lower  $T_C$  since it provides a shunt path for the transfer of heat to the surroundings. It is desirable, for most efficient heat transfer, to bolt the metal case of the device directly to the sink but this is not always possible because they may be at different circuit potentials. A tried and trusted method of providing the necessary electrical isolation is the use of a mica washer and bushes. The application of a proprietary heatsink compound ensures good thermal contact by eliminating any small air gaps between the washer and metal parts. The resultant thermal resistance junction to heatsink is  $\theta_{CS}$ , which is typically less than  $1^{\circ}\text{C}/\text{W}$ .

In Figure 7,  $(\theta_{CS} + \theta_{SA})$  is much less than the  $\theta_{CA}$  due to the device itself. Hence we can write,  $\theta_{JA} = (\theta_{JC} + \theta_{CS} + \theta_{SA})$ . With heat sinks, radiation and convection play a significant role in heat dispersal so surface area, finish and mounting methods are important considerations. A typical heatsink for high-power applications is 'finned' and made from black extruded aluminium; vertical mounting aids convection cooling. The associated design problem is the choice of such a heatsink to meet a calculated  $\theta_{SA}$

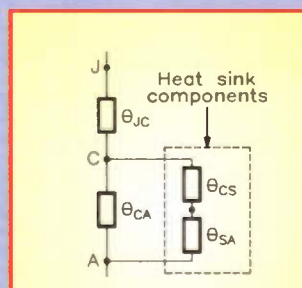

Figure 8. Heatsink components (in dotted rectangle) provide a shunt path from case to ambient.

requirement, from a component supplier's catalogue, and is dealt with below.

The ideal 'infinite heatsink' sometimes referred to in the literature, applies to the theoretical limit case  $(\theta_{CS} + \theta_{SA}) = 0$ . This condition is only approached in practice when a heatsink is cooled by circulating water or blown air. Also see Figure 8.

## Application Examples

We discuss now two examples of industry-standard NPN transistors, one low power (BC107), the other high power (2N3055).

(1) The BC107, in a TO18 package, is listed as follows:

$$P_D(\text{max}) = 300\text{mW at } T_A = 25^{\circ}\text{C}; \\ T_{JM} = 175^{\circ}\text{C}$$

Problem: Determine  $P_D(\text{max})$  at  $T_A = 50^{\circ}\text{C}$ .

Solution: A plot of  $P_D$  vs  $T_A$  is shown in Figure 9. This can be a scale drawing for a graphical determination or a rough sketch for a calculated value. Let  $P_X = P_D(\text{max})$  at  $T_A = 50^{\circ}\text{C}$ . Then using Figure 9,  $P_X = 250\text{mW}$ . Possible graphical reading errors can be eliminated by using the formula:

$$P_X/300 = 125/150 \quad (3)$$

Equation 3 follows from the geometry of similar triangles. Another way to calculate  $P_X$  is from a knowledge of  $\theta_{JA}$ :  $\theta_{JA} = 150/300^{\circ}\text{C}/\text{mW}$ . Hence  $(1/\theta_{JA}) = 2\text{mW}/^{\circ}\text{C}$  and  $P_X = 125^{\circ}\text{C} \times 2\text{mW}/^{\circ}\text{C} = 250\text{mW}$ .

Note that it is possible to obtain more than the 250mW calculated if a small lobed 'slip-on' heatsink is used, but no figure is generally available in component suppliers' catalogues for the  $\theta_{JC}$  of a BC107, so it may not be possible to calculate the improvement. However, the use of such a heatsink does provide some 'insurance' in marginal cases because it helps in lowering  $T_J$ . In fact, for applications where reliability is paramount, e.g. equipment operating in a hazardous environment that makes servicing difficult, working at a  $T_J$  lower than  $175^{\circ}\text{C}$  is preferred since failure rate is related to  $T_J$ . A suggested figure for  $T_{JM}$  is  $150^{\circ}\text{C}$ . For the BC107 in this example that means  $P_X = (150 - 50) \times 2 = 200\text{mW}$ , as  $1/\theta_{JA}$  is unchanged.

(2) The 2N3055, in a TO3 package is specified as follows:

$$P_D(\text{max}) = 115\text{W at } T_C = 25^{\circ}\text{C}; \\ T_{JM} = 200^{\circ}\text{C}$$

Continued on page 19.



## Part Two – Variations on a Similar Theme

By Andrew Chadwick B.A., C.Eng., M.I.E.E.

**F**OLLOWING on from the article on LEDs last month, Part 2 continues with different forms of LEDs, including multicoloured types, bar, 7-segment and flashing.

### OTHER TYPES OF LEDs

If series resistor calculations are too much effort then an LED with an integral resistor may be the answer. The resistor is fitted inside the LED package or body, in the case of a panel mounting LED, and is selected so that the LED may be connected directly to a standard voltage supply of 12V, for example.

Constant current LEDs are even more sophisticated although at a price! They incorporate a regulator chip which maintains the LED current constant despite wide variation in supply voltage. Typically they can be connected directly to a DC or AC supply of between 2V and 20V.

Bi-colour and tricolour LEDs contain two LED chips in one package. In a bi-colour LED the chips are connected in inverse parallel as shown in Figure 9a and so there are two connecting leads. In the tricolour LED the two cathodes are connected together and this common connection and the two anodes are brought out to three leads as shown in Figure 9b.

As implied by their name, bi-colour LEDs are normally used to produce light

of two distinct colours. If a red/green bi-colour LED is connected so that the red LED chip is forward biased, the green LED will obviously be reverse biased, and so only red light will be produced. Reversing the connections will produce green light, although the series resistor may have to be adjusted slightly to match the brightness.

Figure 10 shows the circuit of a neat power-on/overload indicator using a red/green LED. Under normal conditions the op amp output is low and current passes through the green LED chip via series resistor R1 and transistor Q2. On overload the output goes high and the red LED chip is turned on via transistor Q1 and resistor R2.

If an AC supply is applied to a bi-colour LED then each colour will be turned on alternately. The resultant colour will obviously depend on the two basic colours, and also on the mark space ratio of the AC supply. This effect has been used in a circuit for a logic probe, to indicate whether a logic signal was high, low or switching between the two.

The extra connection to a tricolour LED means that even more control is possible. The current through each of the LED chips can be individually controlled to give a range of colours between the two basic LED colours. Alternatively intermediate colours can be produced by pulse-width, modulating the drive to either or both LED chips.

Flashing LEDs are similar to constant current LEDs and require no series resistor. An IC incorporated in the LED flashes it on and off at a fixed rate, as well as limiting the current. However, the voltage range for the flashing LED is more restricted, and a.c. supplies cannot be used. The advantage of a flashing LED is that it attracts attention far more effectively than one that is steadily illuminated. Other variations are a flashing/steady LED and a bi-colour LED with flashing red and continuous green.

LED light bars provide even illumina-

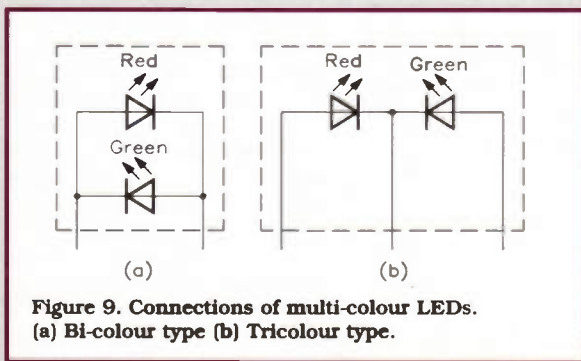

Figure 9. Connections of multi-colour LEDs. (a) Bi-colour type (b) Tricolour type.

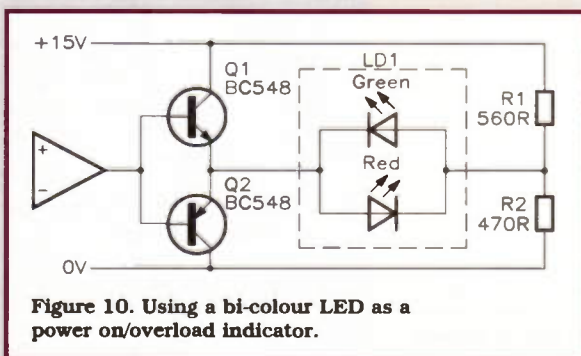

Figure 10. Using a bi-colour LED as a power on/overload indicator.

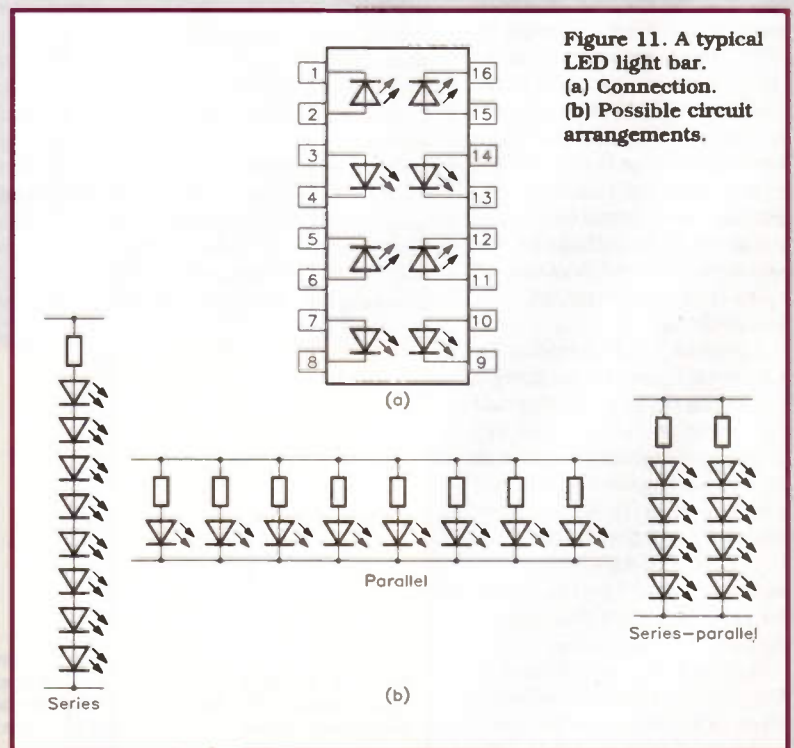

Figure 11. A typical LED light bar. (a) Connection. (b) Possible circuit arrangements.



Colour/ Type	Package D=Diffused	LED Diameter (mm)	Peak Wavelength (nm)	Maximum Power Dissipation (mW)	Maximum Light Output (mcd)	Forward Voltage (V)	Forward Current (mA)	Viewing Angle (deg)	Stock Code
FLASHING LEDs maximum reverse voltage 500mV									
RED	D	3	700	200	3.2*	3.5 to 13**	6 to 70†	60	UK30H
	D	5	700	200	8.0*	3.5 to 13**	6 to 70†	60	QY96E
	D	8	625	200	100.00*	3.5 to 13**	6 to 70†	60	UK38R
	D	10	625	200	100.00*	3.5 to 13**	6 to 70†	60	UK43R
GREEN	D	3	565	200	20.0*	3.5 to 13**	6 to 70†	60	UK31J
	D	5	565	200	32.0*	3.5 to 13**	6 to 70†	60	QY97F
	D	8	565	200	70.0*	3.5 to 13**	6 to 70†	60	UK39N
	D	10	565	200	70.0*	3.5 to 13**	6 to 70†	60	UK44XD
YELLOW	D	3	590	200	20.0*	3.5 to 13**	6 to 70†	60	UK32K
	D	5	590	200	32.0*	3.5 to 13**	6 to 70†	60	UK35Q
	D	8	590	200	70.0*	3.5 to 13**	6 to 70†	60	UK40T
	D	10	590	200	70.0*	3.5 to 13**	6 to 70†	60	UK45Y
MULTI-COLOURED LEDs maximum reverse voltage 5V									
RED/GREEN BI-COLOURED	D	3	625/565	105	40/40**	2.0/2.2	30/25 max	60	UF96E
RED/GREEN TRI-COLOURED	D	3	625/565	105	32/12.5 <sup>x</sup>	2.0/2.2	30/25 max	60	GW62S
RED/GREEN BI-COLOURED	D	5	625/565	105	50/40**	2.0/2.2	30/25 max	60	QY83E
RED/GREEN TRI-COLOURED	D	5	700/565	120/105	90/70**	2.0/2.2	25 max	60	YH75S
RED/GREEN TRI-COLOURED	D	10	625/565	105	90/60**	2.0/2.2	30/25 max	50	UK29G
FLASHING MULTICOLOURED LEDs									
RED FLASHING/CONTINUOUS	D	5	660	200	1.6 <sup>xx</sup>	4.75 to 7	12 typ	-	QY98G
RED FLASHING/ GREEN CONTINUOUS	D	5	630/560	200	6 <sup>xx</sup> /6 <sup>**</sup>	4.75 to 7	12	-	QY99H
Notes: *V <sub>F</sub> = 9V, **V <sub>F(TYP)</sub> = 9V, †I <sub>F(TYP)</sub> = 38mA @ 9V, **I <sub>F</sub> = 20mA, <sup>x</sup> I <sub>F</sub> = 10mA, <sup>xx</sup> V <sub>F</sub> = 5V.									
Please note that the devices above are a selection from an extensive range of optoelectrical products. see the Maplin Catalogue for more details.									
Table 3. Flashing and multicoloured LED selection chart.									

tion over a rectangular area. The smaller versions consist of a single epoxy encapsulated LED in a rectangular plastic case. This gives a very even illumination over the top surface with no light loss from the sides. Larger versions contain eight LEDs in a package with an illuminated area of about 9 × 19mm.

The connections of such a device are shown in Figure 11a, the pins being on a standard 0.3in. DIL arrangement. As both cathode and anode of each diode are accessible they can be connected in series, parallel or series-parallel arrangements as shown in Figure 11b depending on the supply voltage available. The value of the series resistors can easily be calculated using the formulae already given, except that V<sub>F</sub> should be replaced by 8 × V<sub>F</sub> in the series arrangement or 4 × V<sub>F</sub> in the series-parallel circuit.

## SEVEN SEGMENT DISPLAYS

Combining several LEDs in one package is nothing new. One of the first applications of LED technology was the seven-segment display, which consists of seven LEDs arranged in the familiar figure eight pattern shown in Figure 12a. Either the cathodes or anodes of the segments are

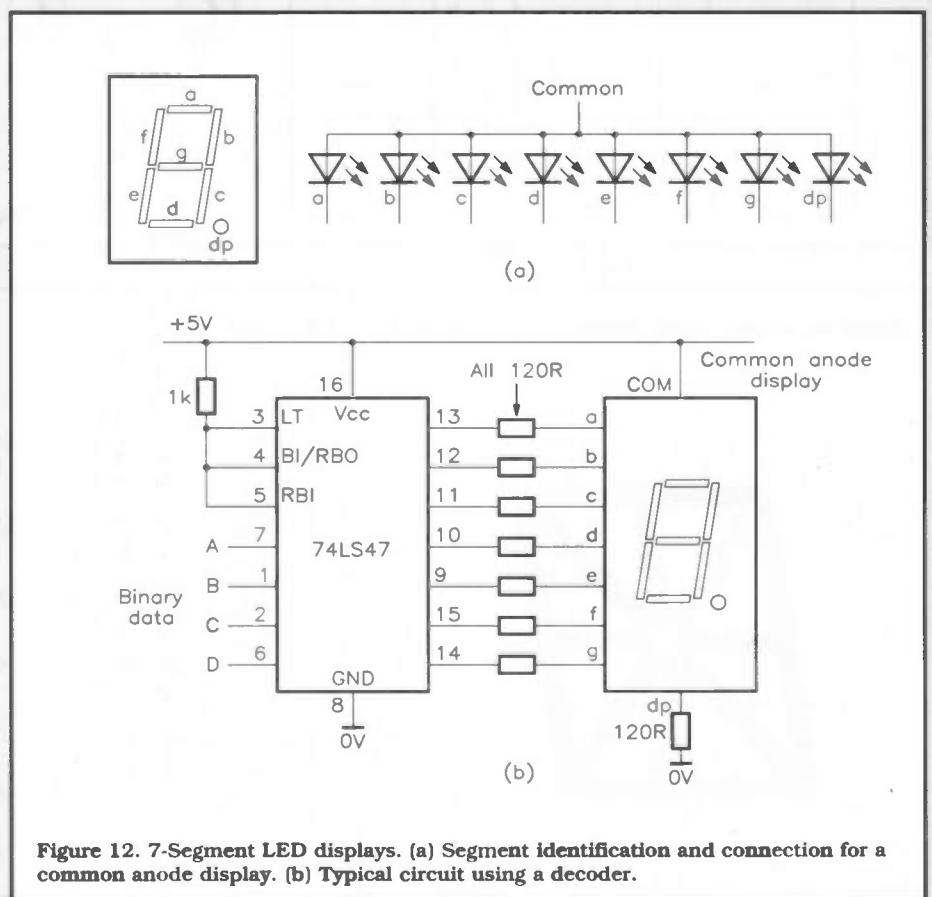

Figure 12. 7-Segment LED displays. (a) Segment identification and connection for a common anode display. (b) Typical circuit using a decoder.

connected together to a common pin, giving common cathode or common anode displays respectively. The remaining electrode of each segment is connected to a separate pin. A decimal point may also be incorporated either on one or both sides.

In the case of a common anode display the common anode pin is connected to the positive side of the supply. An individual segment can be turned on by connecting the appropriate pin to the negative supply via a current limiting resistor. However, the segments are normally controlled by electronic switches in a decoder IC, as shown in Figure 12b. When the binary representations of the numbers 0 to 9 are applied to the decoder inputs, the required segments are turned on to produce a display of the digit. The circuit of Figure 12 uses a 74LS47 TTL decoder which is designed for use with common anode displays.

		Binary input															
		0	1	2	3	4	5	6	7	8	9	10	11	12	13	14	15
Type	A	0	1	2	3	4	5	6	7	8	9	c	∩	∪	ε	ε	
	B	0	1	2	3	4	5	6	7	8	9						
	C	0	1	2	3	4	5	6	7	8	9						
	D	0	1	2	3	4	5	6	7	8	9	L	H	P	R	-	

Figure 12. c) Data on other common decoders.

Data on some of the other decoder ICs that are available is shown in Figure 12c. The pattern of segments differs between decoders, particularly for binary inputs greater than ten.

When more than one digit needs to be driven the technique of multiplexing is

often employed. This reduces the number of connections to the display and also the semiconductor inventory. Figure 13 shows the principle of a four digit multiplexed display. The segments of the digits are connected to each other and to the outputs of a decoder. However, the com-

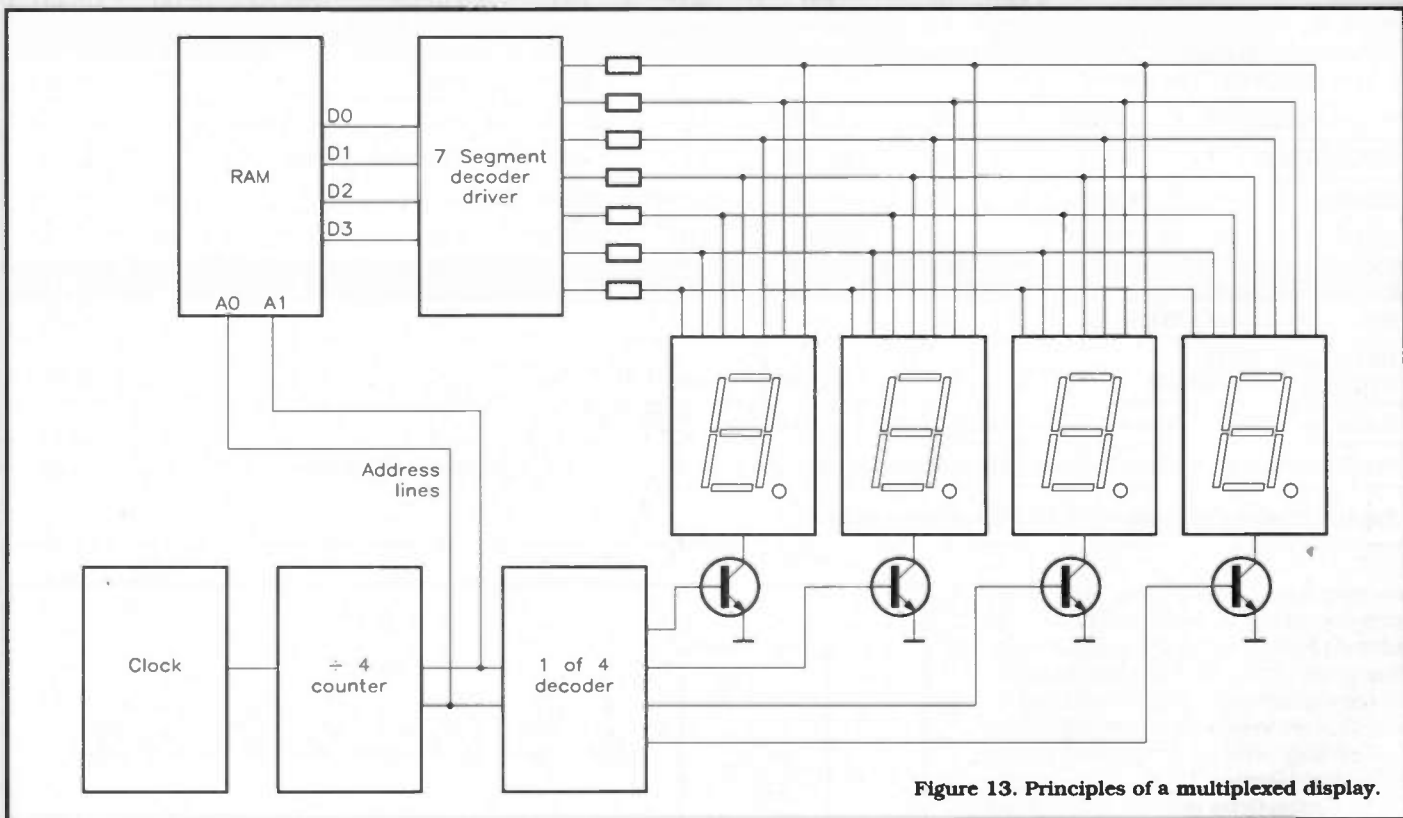
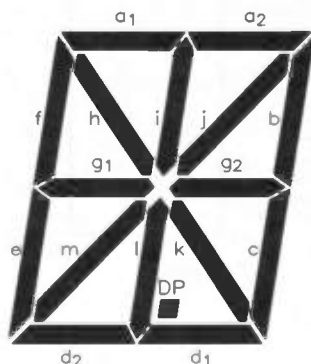
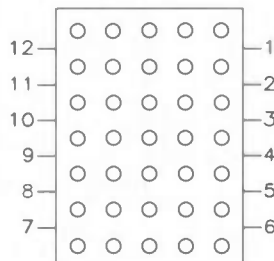

Figure 13. Principles of a multiplexed display.

Figure 14. Alphanumeric displays. (a) Star-burst type. (b) 5 × 7 dot matrix.



(a)



(b)

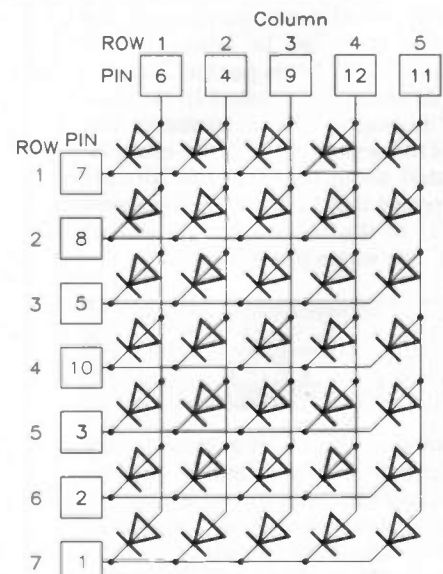

**Figure 15. Serial interfaces for multi-character alphanumeric displays.**

- (a) External column multiplexing.
- (b) Internal multiplexing.

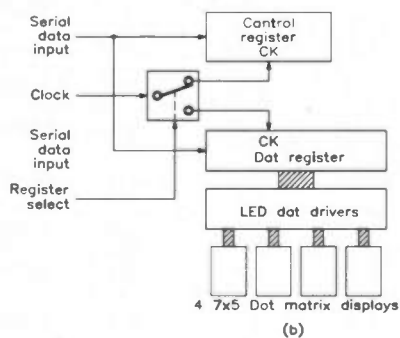
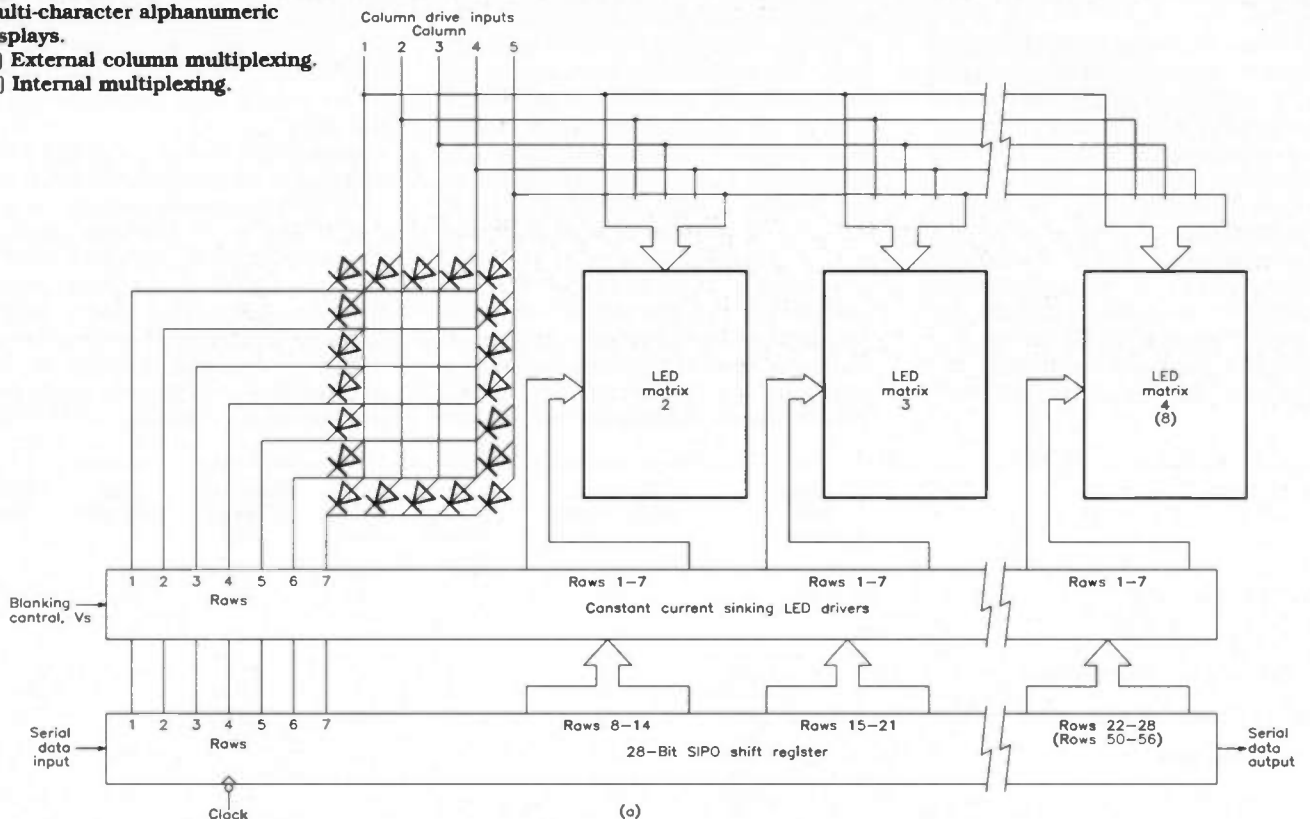

mon cathode pin of each digit is connected to ground via a transistor switch. A counter and decoder controls the transistors so that only one is on at any time.

In order to display a four digit number the binary codes for the four digits are stored in some form of memory. This is shown as RAM in the figure although it could also be a series of latches. The counter output controls the address lines and selects the data for the first digit from the RAM. This data is presented at the decoder inputs and the appropriate segment outputs go high. However, the 1-of-4 decoder ensures that only the first transistor switch is turned on, so that only the selected segments in the first display light up. After one clock period the counter is incremented, the second digit is fed to the decoder and the second transistor turned on. This is repeated for the third and fourth digits before returning to the beginning. Each digit is therefore only on for a quarter of the time, and so to give a comparable brightness to a non-multiplexed display it must be driven with roughly four times the current. Further details are given in Part 3 on pulsed operation. In order to avoid visible flicker the digits must be refreshed rapidly, a

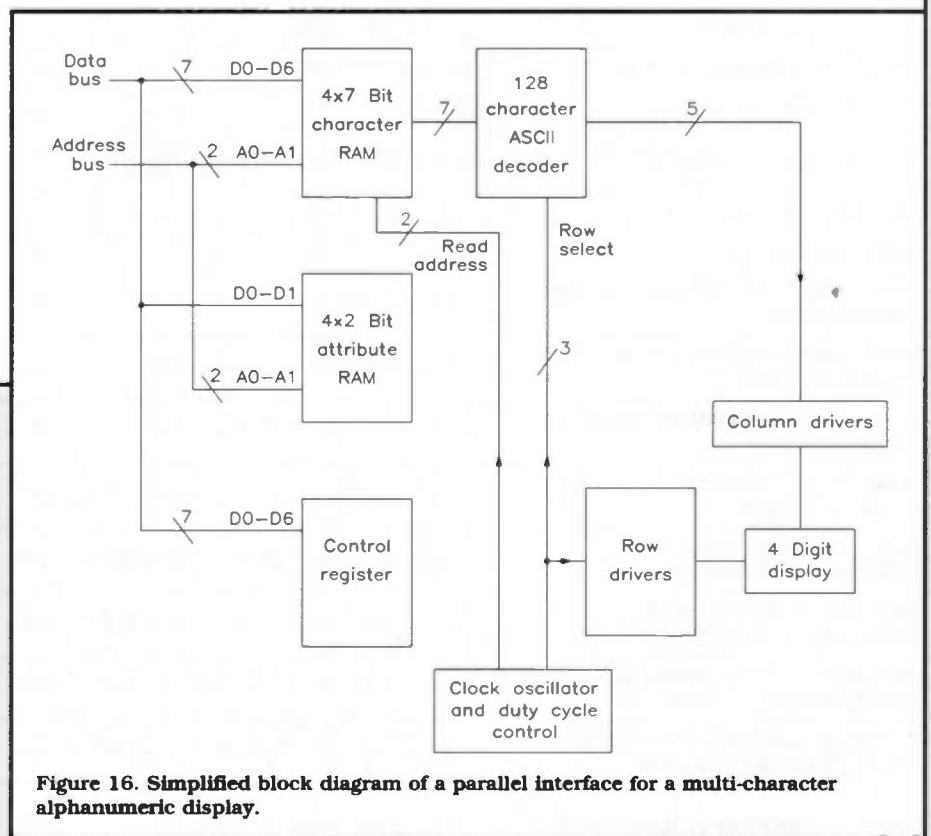

**Figure 16. Simplified block diagram of a parallel interface for a multi-character alphanumeric display.**

reasonable minimum frequency being 100 times a second.

It is apparent from the above that implementing a multiplexed display requires fairly complex hardware, bearing in mind that the details of how the data is loaded into the RAM have been omitted from Figure 13 for clarity. The multiplexing logic is therefore often incorporated within an IC performing another function, such as a counter or A-to-D converter, and all the user needs to provide is the display!

## ALPHANUMERIC DISPLAYS

At one time there was a craze for producing words on a calculator by entering certain numbers and then viewing the display upside down. However, a more practical approach to displaying alphanumeric characters is to use a 'star-burst' display. These normally consist of a number of characters each with 14 segments

connected in common anode or cathode configuration and arranged, as shown in Figure 14a.

The other alternative is the dot-matrix display which consists of a rectangular array of individual LEDs. An array 5 LEDs wide by 7 high is very common and can produce good representations of alphanumeric characters. The LEDs are connected to an XY matrix of row and column connections, see Figure 14b.

Alphanumeric decoders are far less common than the seven segment type and are often incorporated into the display itself. They are usually designed to interface to a microprocessor and accept data in serial form, or as parallel ASCII data.

Two alternative serial interface schemes are shown in Figure 15. In the first, Figure 15a, the serial data is a string of 28 bits controlling the LEDs in the 28 rows. The five column drive inputs are combined and multiplexed externally. Data for all rows in column 1 is shifted in, and column 1 drive input taken high; row data for column 2 is then shifted in, and column 2 drive taken high. This is repeated for the other 3 columns before returning to column 1.

In the second scheme, Figure 15b, the multiplexing is taken care of internally. Serial data is shifted into the dot register, each bit of which determines whether the corresponding LED is to be on or off. This is shown schematically in Figure

15b. An extra row is actually incorporated that does not correspond to any dots, so that for a four character display  $8 \times 5 \times 4 = 160$  bits are needed. Data may also be shifted into a control register to control display brightness and blanking.

A simplified diagram of typical parallel interface is shown in Figure 16. A character is displayed by writing its ASCII code to one of the four locations in the character RAM. Information about the attributes, such as a cursor, for each character are written to the attribute RAM. Writing to the control register controls brightness and blanking. An internal oscillator controls the multiplexing circuitry which reads the ASCII charac-

Colour/Type	Package Size (mm)	Number of Elements	Maximum Forward Current (mA)	Light Output (mcd)	Forward Voltage (V)	End Stackable	Stock Code
RED LED LADDER	25 × 10 × 8	10	30	4*	2*	Yes	BY65V
GREEN LED LADDER	25 × 10 × 8	10	30	3*	2.2*	Yes	YG33L
RED LED BAR + HEADER PCB	68 × 14 × 6.65	10	30	2**	2**	No	YH76H
4 RED/4 GREEN/4 YELLOW LED BAR	57.5 × 7 × 8	12	30	2/4/4*	2.2/2.1/2*	No	FE26D
RED LED ARRAY	14 × 6.13 × 8.6	2	30	1.2*	2*	Yes	YH77J
RED LED ARRAY	21 × 6.13 × 8.6	3	30	1.2*	2*	Yes	YH78K
GREEN LED ARRAY	14 × 6.13 × 8.6	2	30	1.1*	2.2*	Yes	YH79L
GREEN LED ARRAY	21 × 6.13 × 8.6	3	30	1.1*	2.2*	Yes	YH80B
YELLOW LED ARRAY	14 × 6.13 × 8.6	2	30	1.5*	2.1*	Yes	YH81C
YELLOW LED ARRAY	21 × 6.13 × 8.6	3	30	1.5*	2.1*	Yes	YH82D
BI-COLOUR DOT MATRIX	60.3 × 60.3 × 9.2	8 × 8 Red/ 8 × 8 Green	20/20	3.6/1.8**	2/2.2**	Yes	GW63T
RED DOT MATRIX	53 × 38 × 8.5	5 × 7	30	1.5*	2*	Yes	FT61R
RED DOT MATRIX	17.8 × 12.7 × 6.3	5 × 7	30	1.5*	2*	Yes	FE25C
0.3in. RED 7-SEGMENT DISPLAY COM-ANODE	19.3 × 10.16	7 + DP	30	1.3*	2*	Yes	FR36P
0.3in. RED 7-SEGMENT DISPLAY COM-CATHODE	19.3 × 10.16	7 + DP	30	1.3*	2*	Yes	FR38R
0.5in. RED 7-SEGMENT DISPLAY COM-ANODE	19 × 12.8	7 + DP	30	1.3*	2*	Yes	FR39N
0.5in. RED 7-SEGMENT DISPLAY COM-CATHODE	19 × 12.8	7 + DP	30	1.3*	2*	Yes	FR41U
DOUBLE RED 0.56in. DIGIT DISPLAY COM-ANODE	25 × 19 × 8	2 × 7 + 2 × DP	30	1.3*	2*	Yes	BY66W
DOUBLE RED 0.56in. DIGIT DISPLAY COM-CATHODE	25 × 19 × 8	2 × 7 + 2 × DP	30	1.3*	2*	Yes	BY68W
DOUBLE GREEN 0.56in. DIGIT DISPLAY COM-ANODE	25 × 19 × 8	2 × 7 + 2 × DP	30	1.3*	2*	Yes	FA01B
DOUBLE GREEN 0.56in. DIGIT DISPLAY COM-CATHODE	25 × 19 × 8	2 × 7 + 2 × DP	30	1.3*	2*	Yes	FA02C
RED 1in. DISPLAY COM-ANODE	32.9 × 22.4 × 8.5	7 + DP	30	2.4*	4.4* per segment 2.2* for DP	Yes	FA03D
RED 1in. DISPLAY COM-CATHODE	32.9 × 22.4 × 8.5	7 + DP	30	2.4*	4.4* per segment 2.2* for DP	Yes	FA04E
1.8in. BI-COLOUR DISPLAY COM-ANODE	56 × 38 × 11	7 + DP (Red) 7 + DP (Green)	30	30**	6** per segment 2** for DP	Yes	GW64U
4in. RED DISPLAY COM-ANODE	122 × 90 × 15	7 + DP	60 per segment 30 for DP	21*	7.4* per segment 3.7* for DP	Yes	JX86T

Notes: \*I<sub>F</sub> = 20mA, \*\*I<sub>F</sub> = 10mA, maximum reverse voltage 5V.

Table 4. Bar graph and LED array selection chart.

**Figure 17. 10-Element bar graph array.**  
(a) Appearance and connections. (b) Typical circuit.

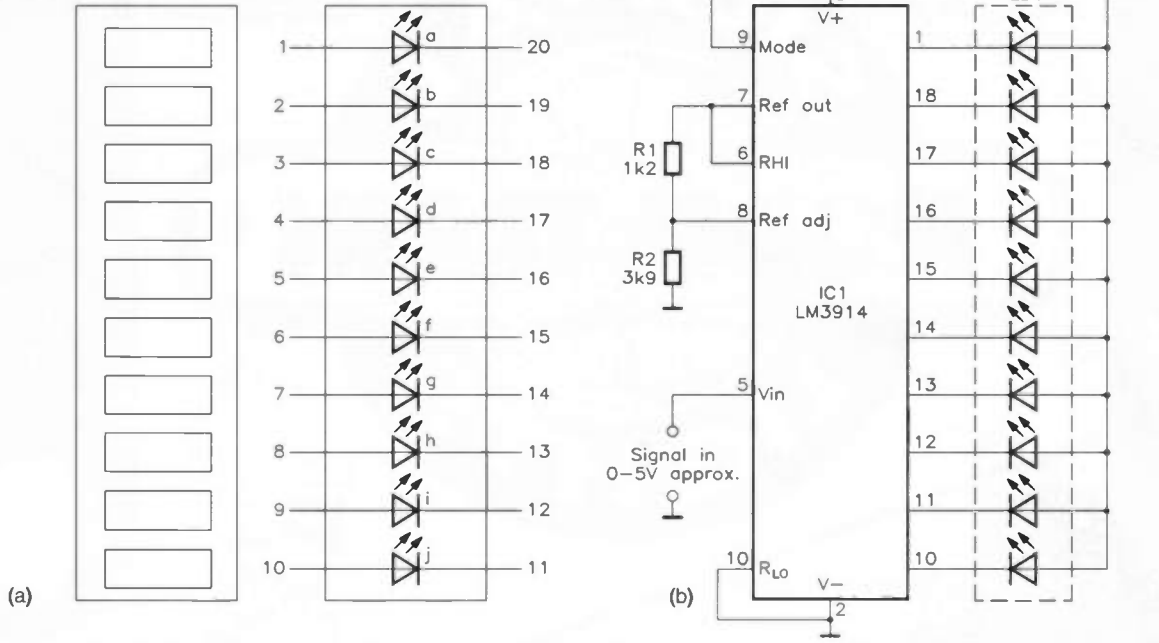

ter codes from the RAM sequentially. The 7-bit code is converted into the appropriate row and column information to control the display drivers by means of a decoder. Obviously with this type of interface the form of the characters is set by the internal decoder, whereas in the serial types it can be determined externally.

## BAR GRAPH DISPLAYS

Another form of LED-based display that has become popular in recent years is the bar graph array. This typically consists of 10 rectangular segments arranged linearly in a single package. Each segment is illuminated by a single LED whose cathode and anode are connected to pins in a 0.3 inch DIL arrangement as shown in Figure 17a. Bar graph arrays are often used to display a voltage in a semi-analogue form, and a number of dedicated ICs are available to achieve this. Figure 17b shows a typical circuit using the popu-

lar LM3914. The analogue signal at pin 5 is connected to ten comparators in the IC, each of which controls one of the segment outputs. The other inputs of the comparators are connected to an internal resistor network which produces a series of ten increasing voltages, derived from an internal reference. When the input exceeds a particular comparator's reference voltage the corresponding segment will be illuminated. Thus a gradually increasing voltage produces a 'bar' of light whose height is proportional to the input voltage. The IC can also produce a position indicator display where a single segment appears to travel along the array as the voltage increases. The current drive to the LEDs is regulated in the IC and so no series resistors are required. The LM3915 is identical to the LM3914 but produces a logarithmic instead of a linear display, while the LM3916 is designed to produce a VU meter response.

Bar graph arrays are also available with segments of different colours. One type has the first three segments green, the

next four yellow and the final three red thus giving an easily visible warning when a voltage is reaching a critical level. They may also be stacked end to end to increase the number of segments.

## NEXT MONTH

The series will conclude next month with Pulsed Operation and Infra-Red LEDs, together with all the associated techniques and principles. In addition, selection guides for the best types of device in applications for remote control, isolation devices and fibre optic communications systems etc.

## REFERENCES

- LAA Warnes - *Electronic Materials*.  
J Wilson, JFB Hawkes - *Optoelectronics*.  
Hewlett Packard - *Optoelectronics Designer's Catalogue*.  
D. W. Tenquist, R. M. Whittle, J. Yarwood - *University Optics*.

## POWER MANAGEMENT - Continued from page 13.

**Problem:** What is the heatsink specification required to obtain 40W at  $T_A=50^\circ\text{C}$ ?

**Solution:** From the specified data,  $\Theta_{JC}=(200-25)/115=1.52^\circ\text{C/W}$  (4)

However, it is required that,  $\Theta_T=(\Theta_{JC}+\Theta_{CS}+\Theta_{SA})$   
 $= (200-50)/40=3.75^\circ\text{C/W}$  (5)

Hence,  $(\Theta_{CS}+\Theta_{SA})=(3.75-1.52)$   
 $=2.23^\circ\text{C/W}$

Assuming  $\Theta_{CS}=1^\circ\text{C/W}$ , (6) gives  $\Theta_{SA}=1.23^\circ\text{C/W}$

This figure is readily achievable in practice. Figure 10 shows the graphical background to (4) and (5). Graph (i), which is for the 2N3055 without a heatsink, is constructed from the device data.

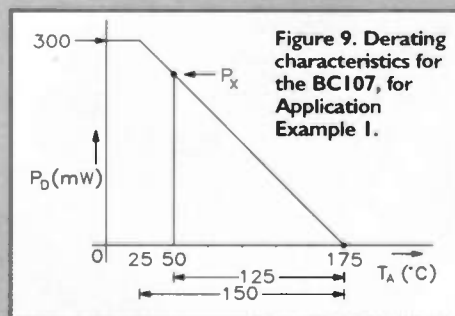

**Figure 9. Derating characteristics for the BCI07, for Application Example 1.**

The numbered horizontal scale refers to  $T_C$  and the slope of the graph for  $T_C > 25^\circ\text{C}$  is  $(-1/\Theta_{JC})$ . Graph (ii) applies when a heatsink is used. The horizontal scale now refers to  $T_A$ . That part of the graph for  $T_A > 25^\circ\text{C}$ , constructed by

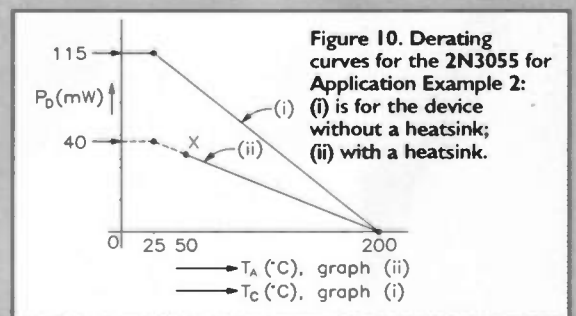

**Figure 10. Derating curves for the 2N3055 for Application Example 2: (i) is for the device without a heatsink; (ii) with a heatsink.**

drawing a straight line through the axis point  $T_A=200^\circ\text{C}$  and the required operating point X ( $P_D=40\text{W}$ ,  $T_A=50^\circ\text{C}$ ), has a slope  $(-1/\Theta_T)$ .

It will be apparent from the calculation above that it is virtually

impossible for a 2N3055 to tolerate 115W.

The reader might be forgiven the impression that there is an element of 'specmanship' in the data sheet specification of high-power transistors.

KIT AVAILABLE  
(LT66W)  
Price £9.99

# SIGNAL LIGHTS

## MODEL TRAIN

**2**  
PROJECT  
RATING

Design by  
Alan Williamson  
Text by Alan Williamson  
and Brian Clark

After innumerable requests from readers and customers for more model train projects, we now present a simple 2, 3 or 4 aspect signal light system for single direction or dual track systems. Different signal aspects may be required for different applications and situations, so the ability to select aspects with a single PCB link is built in.

The assembled  
PCB which  
measures  
110 X 55mm

**Specification**  
Supply voltage: 8 to 15V DC  
(optionally up to 35V DC)  
Supply current: 19 to 34mA  
(with LEDs)

## Two Aspect Signal

A two aspect signal alternates between green and red lights, so that when a train passes over a sensor embedded in the track (which is ideally a reed switch situated beside the signal lights), the green light is replaced by red (see Figure 1). The signal light only changes back to green after the train has passed a second signal, indicating that the train has left the section of track between the two signals. The red signal, by convention, is the lower light, and is at eye level so that the train driver cannot possibly miss the red danger signal.

## Three Aspect Signal

A three aspect signal uses a green, a red and an amber light. When a train passes a green signal, the light is replaced by a red

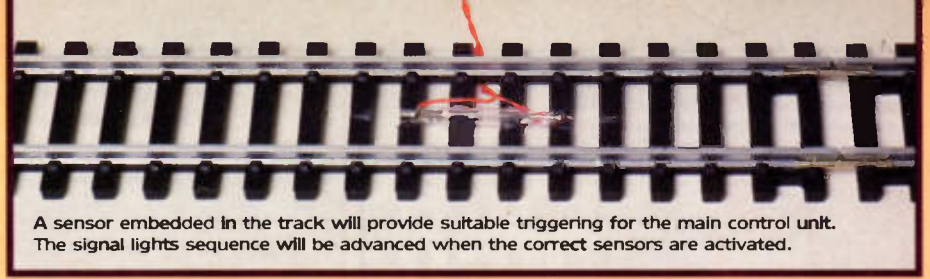

A sensor embedded in the track will provide suitable triggering for the main control unit. The signal lights sequence will be advanced when the correct sensors are activated.

one as before with the two aspect signal, but when the train passes a second signal further along the line, the first signal changes to amber indicating caution, as a train is present in the second section of track ahead. Only when the train passes a third signal does the first signal change back to green, showing that the track is clear at least two sections ahead. As with the two aspect signal the red is at the bot-

tom of the light array, with the amber signal (being the next most critical) just above the red. The green signal appears at the topmost part of the signal light array.

## Four Aspect Signal

The four aspect signal is similar to the three aspect type, except that when a train passes the third signal the first signal

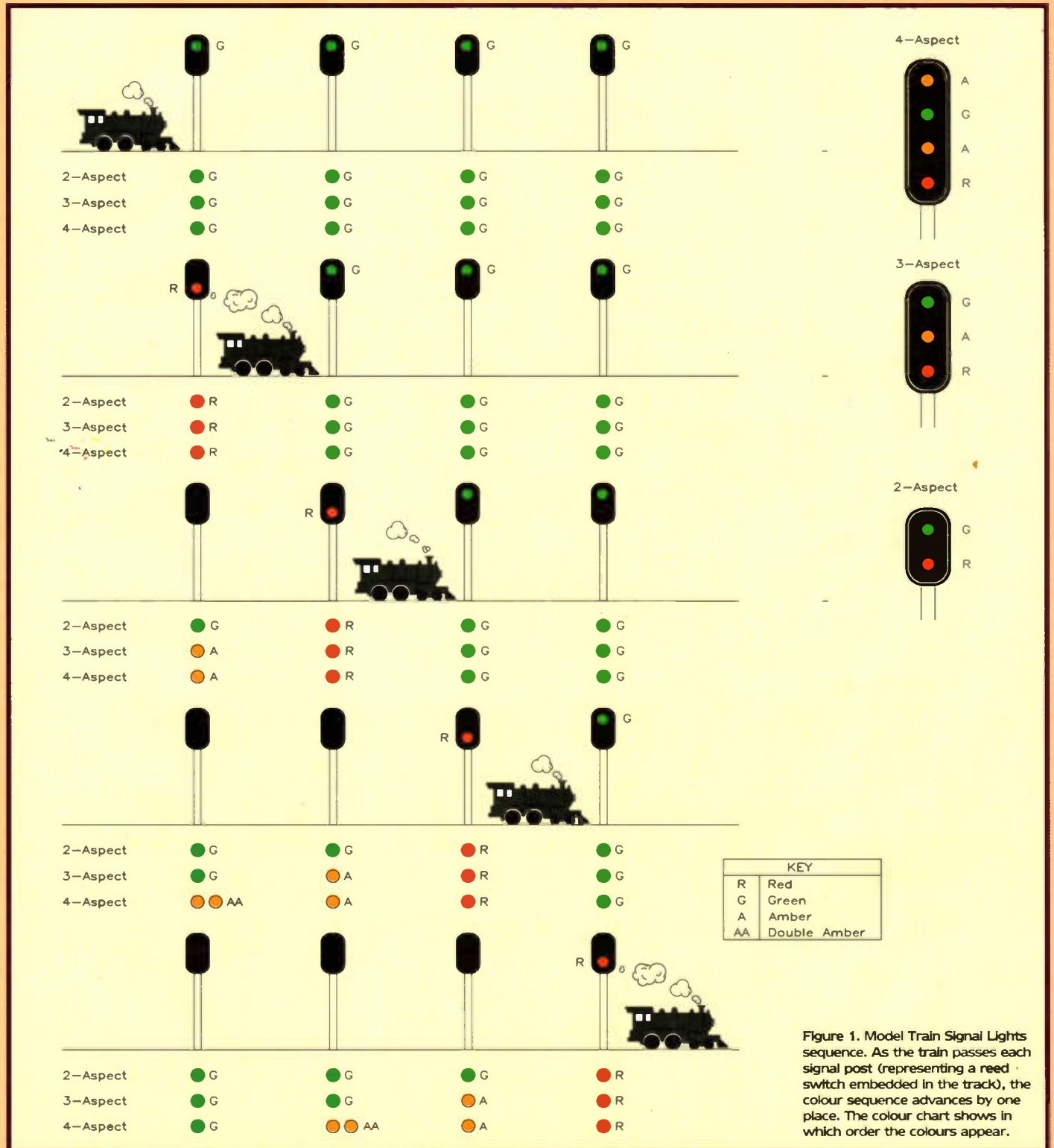

Figure 1. Model Train Signal Lights sequence. As the train passes each signal post (representing a reed switch embedded in the track), the colour sequence advances by one place. The colour chart shows in which order the colours appear.

Figure 2. Circuit diagram. This will be particularly useful when placing the components on the board as the reference designators are also printed as a component overlay mask on the PCB.

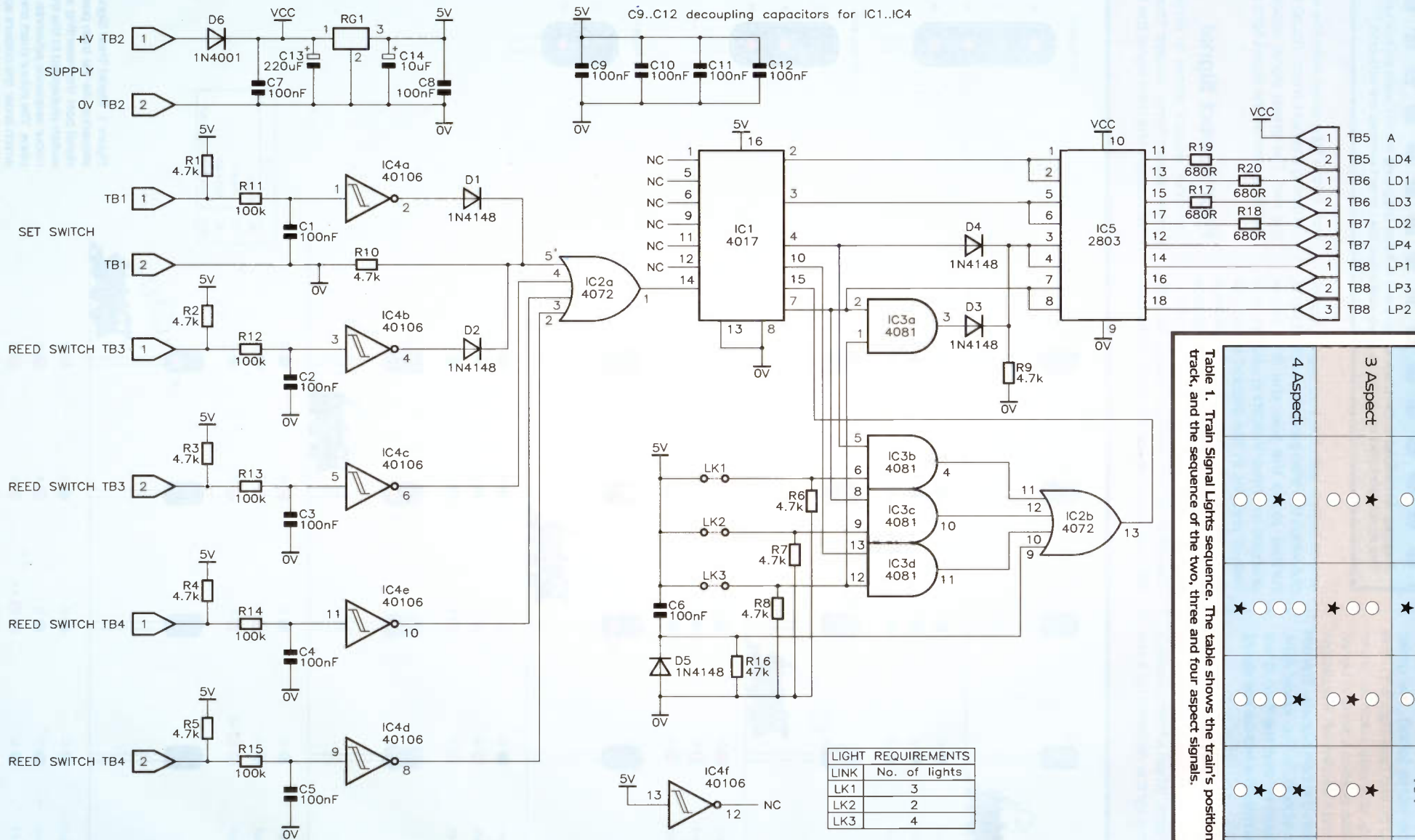

Table 1. Train Signal Lights sequence. The table shows the train's position along the track, and the sequence of the two, three and four aspect signals.

	Initial Sequence	Sensor 1	Sensor 2	Sensor 3	Sensor 4
4 Aspect	○ ○ ★ ○	★ ○ ○ ○	○ ○ ○ ★	○ ★ ○ ★	○ ○ ★ ○
3 Aspect	○ ○ ★	★ ○ ○	○ ★ ○	○ ○ ★	NA
2 Aspect	○ ★	★ ○	○ ★	NA	NA



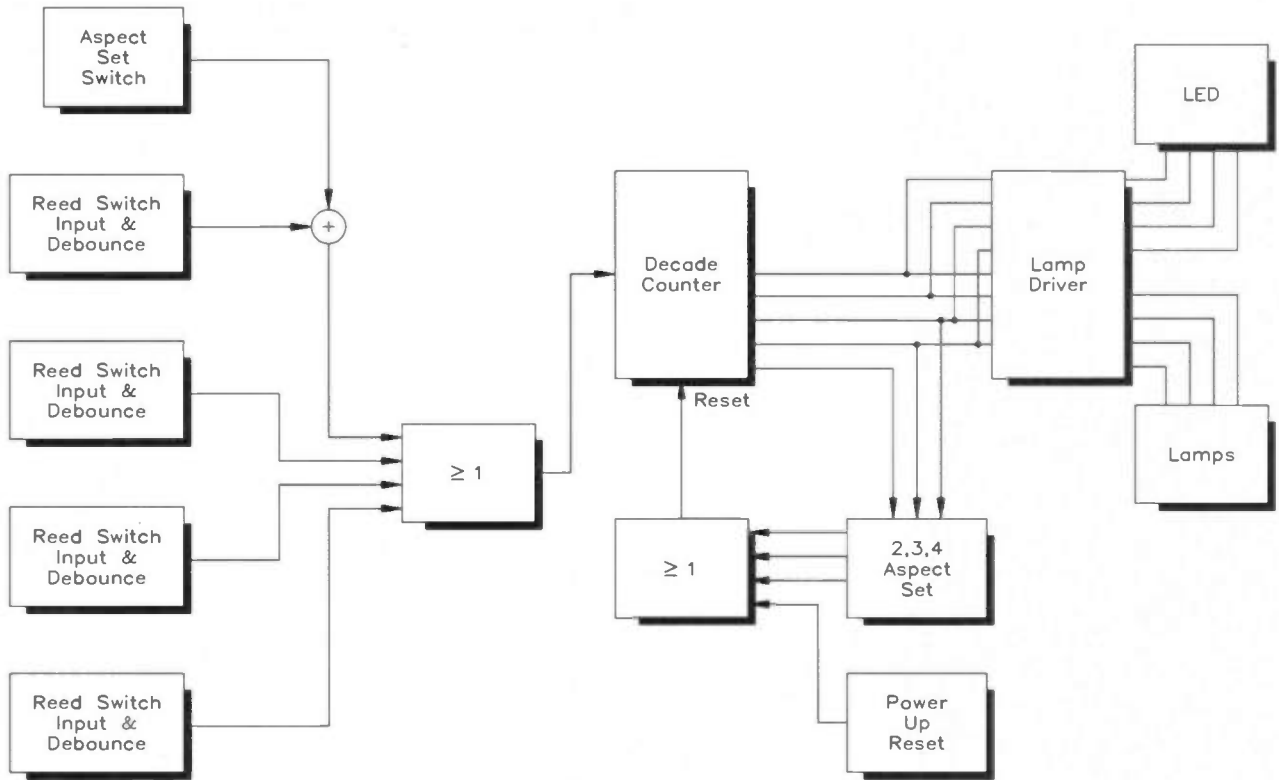

Figure 3. Circuit block diagram. The above block diagram will help when assembling and testing the train signal lights. Should a problem develop, the diagram will provide an overview of operation when fault-finding.

changes to a double amber. The fourth signal passed changes the first signal back to green. This system affords more protection as the driver can instantly see if there is a train within the next three sections of track, and if so, exactly which section it's in. If one of the amber lights fails, showing a single amber, the driver proceeds with more caution, thinking the train to be one section closer than it actually is. If no signal shows then you have problems; is it a green, a single amber or a red! Luckily solid-state LED devices do not wear out that easily.

### Circuit Description

Each of the track sensing reed switches and set inputs are debounced with the aid of IC4 (and associated components), a Schmitt triggered hex inverter (see Figure 2 for a circuit diagram, and Figure 3 for a block diagram). The outputs of the inverters are then ORed together by IC2a, which then clocks the input of the 4017 decade counter.

The set switch input is required to 'clock' the signal light sequence to the appropriate condition after powering up the circuit (as mentioned briefly earlier). In some situations you may require the signal to start at red or amber. The manual switch therefore enables you to step through the signal sequence until the required signal lamp is illuminated. This provides the opportunity to start the signal at red, when a train is going to start off from within the first section of track (after the first track sensor).

The links LK1-3 determine whether the system will be a 2, 3 or 4 aspect signal light. IC3 is a 4081 quad 2-input AND gate package, with 1 input from each of the gates (IC3a,b,c) connected to the third, fourth and fifth outputs of IC1 (pins

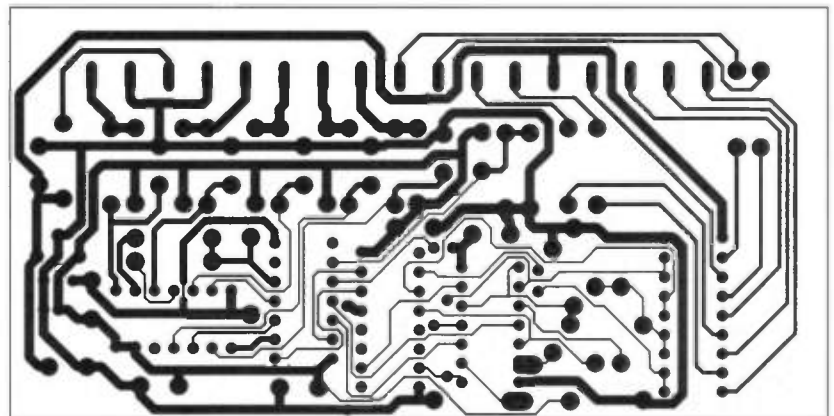
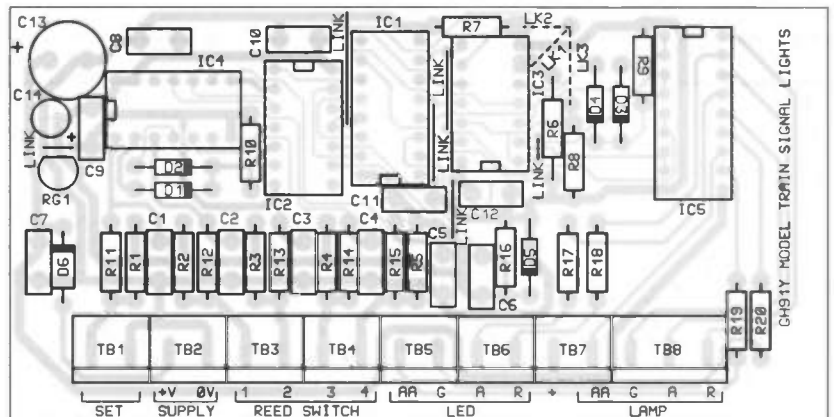

Figure 4a. PCB legend showing references to all the components used. Pay particular attention when placing polarised components like electrolytic capacitors, diodes and ICs. Figure 4b. Should you choose to etch the PCB yourself you will need the track layout. One of the easiest methods is to transfer the positive track layout to a transparent sheet and use it as a mask on photo-sensitised board. Expose the board (with attached mask) to UV light as usual, then develop and etch. A lacquer coating will prevent oxidation.

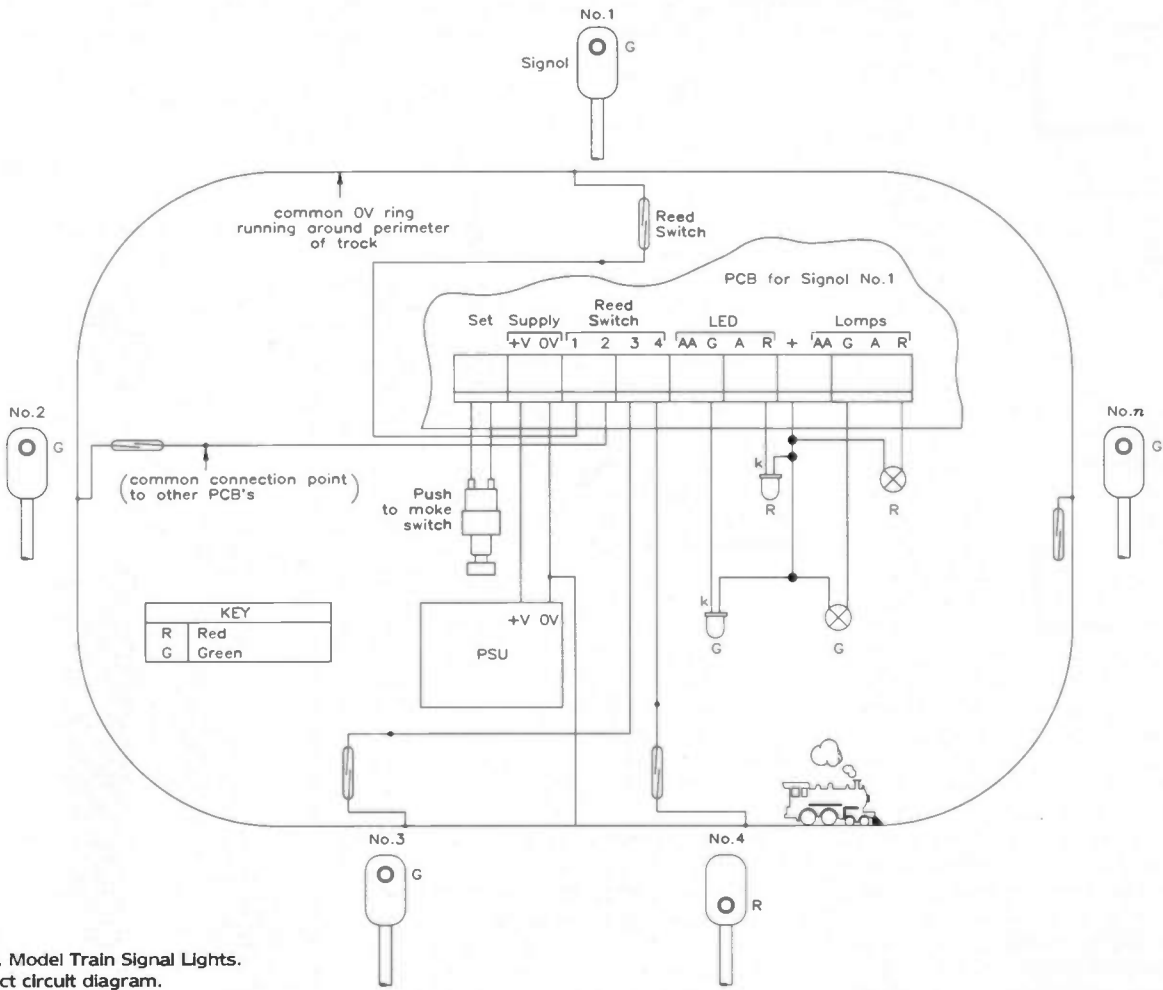

Figure 5a. Model Train Signal Lights. Two aspect circuit diagram.

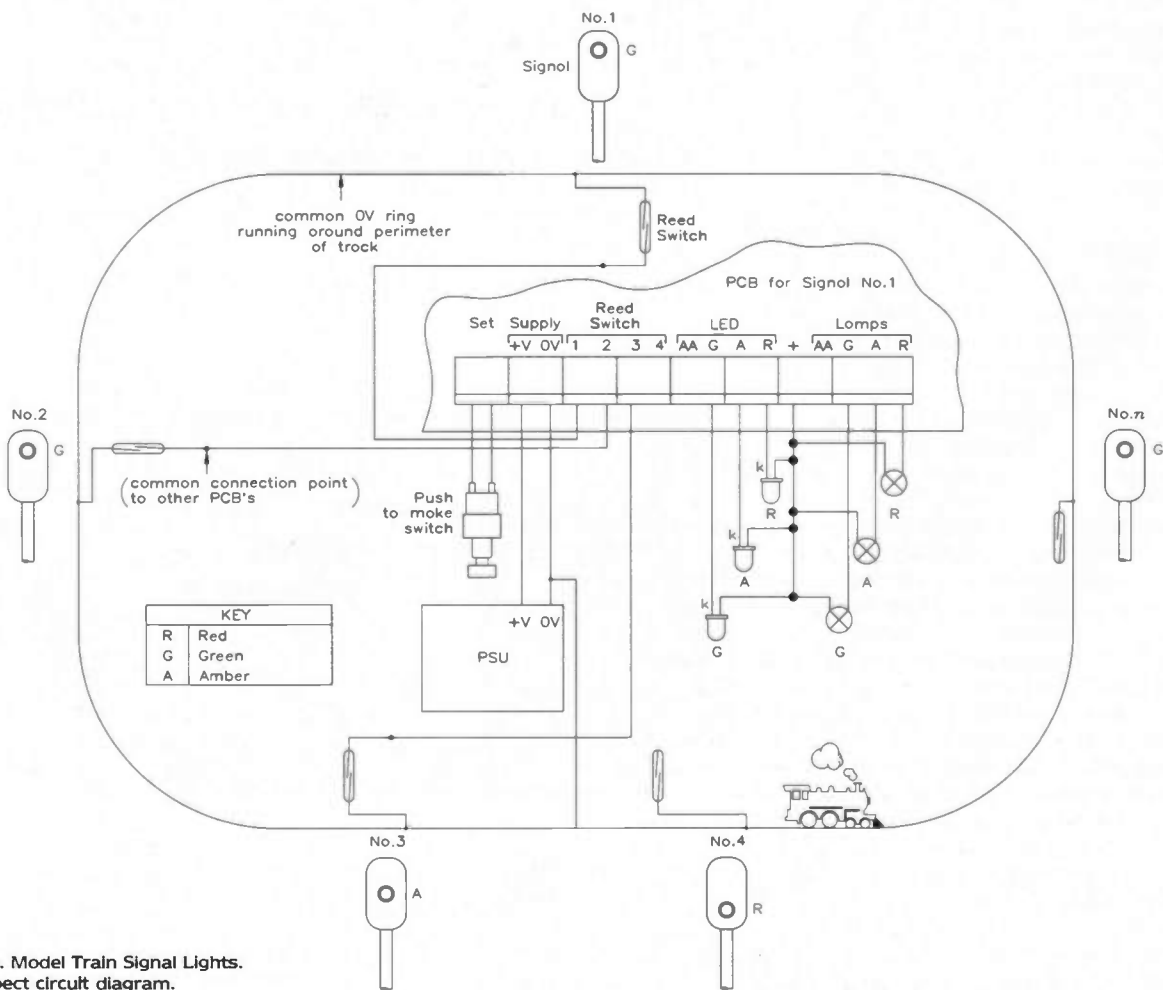

Figure 5b. Model Train Signal Lights. Three aspect circuit diagram.

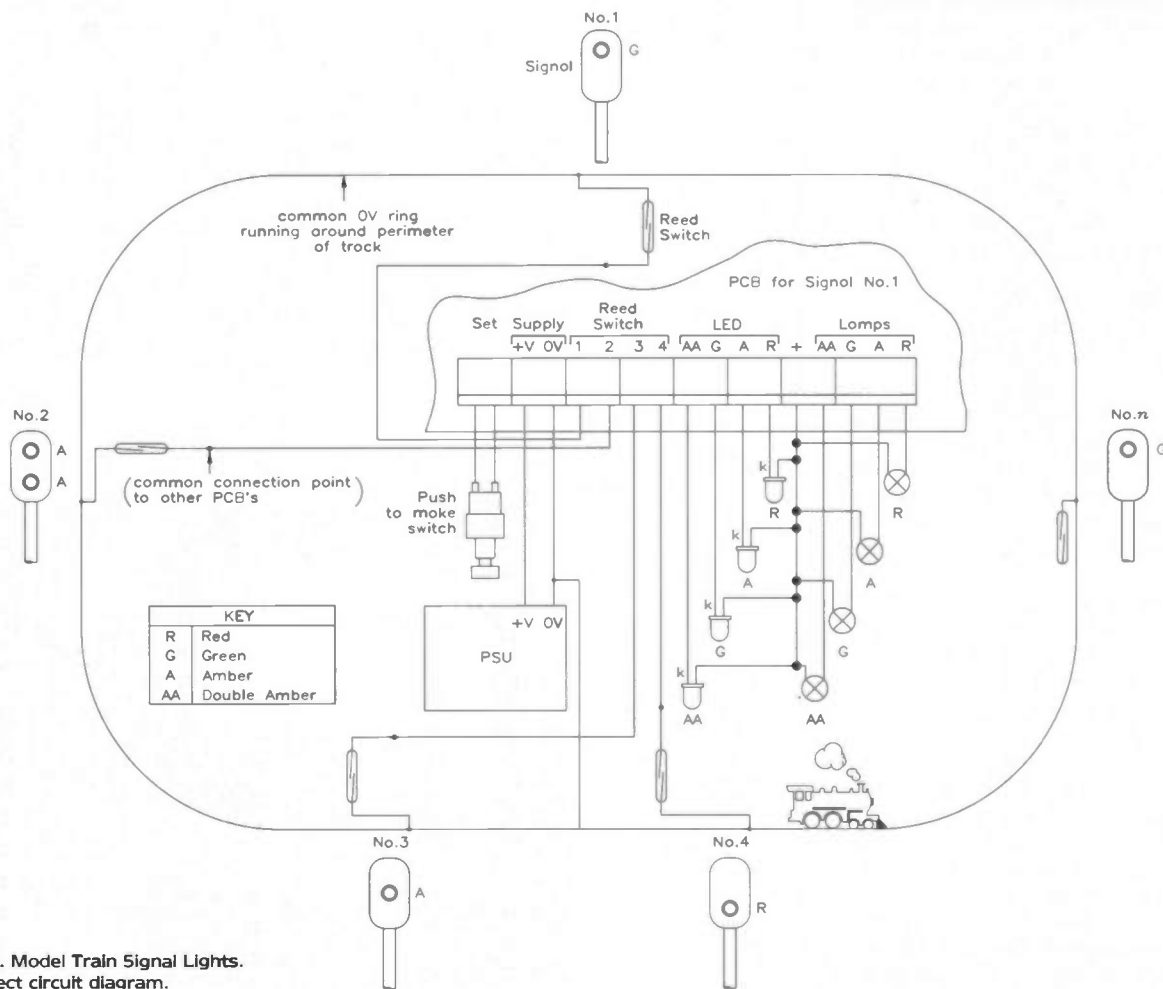

Figure 5c. Model Train Signal Lights. Four aspect circuit diagram.

4,7,10). Fitting one of the links (LK1-3) will cause the associated gate (IC3a,b,c) to become active and reset the 4017 counter (via IC2b) to the first state (green light), after the correct number of input pulses.

From the outputs of IC1, pin 3 is used for the green signal, pin 2 for the red signal, pin 4 the single amber and pin 7 for the double amber signal. IC3d is used only for the four aspect double amber with the diode D3 ORed in parallel with D4 to provide the double amber (in four aspect signals).

The components R16, C6 & D5 provide an automatic reset signal to the counter IC upon powering up the circuit, thus forcing the system to green.

IC5 is an open-collector octal buffer/driver, allowing the use of either LED and/or incandescent signal lights. The outputs marked 'LD' are the LED connections and include a series resistor for current limiting; the (+) terminal is the common anode connection. The outputs marked 'LP' are the incandescent lamp connections. If you are using LEDs that already include series resistors then you may connect them to the 'LP' outputs. Connecting the LEDs of this type to the 'LD' terminals would essentially place two series resistors before the LED and make them too dim. The common lamp and LED feeds are connected to the (+) terminal. Please note that the (+) terminal is connected directly to the unregulated supply and you should therefore choose your incandescent lamps so that they are compatible with the power supply you intend using. Likewise calculation of the series resistors for the LEDs should be adjusted accordingly.

Diode D6 prevents any damage occurring to the circuit from reverse polarity connections. Capacitor C13 provides the main reservoir decoupling and C7 provides decoupling at higher frequencies. RG1 is a 5V regulator which is required where a variable PSU is used (normally between 8 and 24V). Capacitors C8 and C14, at the output of the regulator, provide the same function as C7 and C13. The capacitors C9 to C12 provide local (noise) decoupling for the ICs 1-4.

## Construction

If you have chosen to make your own PCB then your construction begins here. Use Figure 4a as a guide to component placement and Figure 4b for a track mask and drilling drawing. When you have made the PCB you should use a lacquer to prevent the copper from oxidising, particularly if you do not intend to solder it up immediately. With the PCB finished you can now start to assemble!

A two aspect light system requires that the LK1 link be fitted, thus ensuring the light sequence can only alternate between green and red. Fitting link LK2 selects a three aspect system, and link LK3 selects a four aspect system.

## Construction is fairly straightforward:

1. Begin with the smallest components first, working up in size to the largest. Use the component overlay to ensure you place the components in the cor-

rect positions. The ICs should be inserted into their sockets last of all, taking care that all the pins locate in their socket correctly before pushing the IC fully home. Otherwise the pins will either bend over or fall off!

2. Take care to correctly orientate polarised devices such as electrolytic capacitors, diodes, regulator and ICs. Remember once soldered in, ICs and sockets can be difficult to get out again.
3. Thoroughly check your work for misplaced components, solder whiskers, bridges and dry joints. A visual inspection can save hours of fault-finding, and it is best to look at the board while it is at this stage, before it gets boxed.
4. Clean all the flux from the PCB using a suitable solvent. This also loosens any blobs of solder and helps to eliminate the possibility of short circuits.
5. Fit the module into a suitable enclosure, e.g., YU55K. No drilling details are shown, as individual model railway requirements will vary greatly.

## Testing the Circuit

Once all the components on the board have been checked and you are sure they are all correct, connect up the LEDs/lamps and apply a suitable voltage to the supply terminals of the PCB. Depending on the required aspect of the finished system, use the circuit diagrams in Figures 5a to 5c as a guide. It is suggested that a 12V DC power supply be used, so remember to

choose incandescent lamps, etc. accordingly, as their common anode connection will be at power supply potential. If all is well the first LED/lamp should illuminate. If you have followed the colour code for the signals, you should see a green light. If a signal other than green shows, try stepping through the sequence of lights manually using the push switch. If you still have no success try the fault-finding chart located on the next page.

## Circuit Operation

In normal operation, the sensors, which are embedded in the track, will be triggered by the train travelling over them. If reed switches are used, a small magnet may be required to activate each switch. This can be achieved by fixing the magnet to the underside of the train or carriages. As long as the distance between the magnet and the reed switch is small enough to allow correct switching, the control unit takes care of the rest. In some cases the reed switches operate normally due to the close proximity of the magnets in the train's electric motor.

The actual signal lights will be located close to the track so the wires for the lamps can be located either alongside the track, under the track itself, or hidden below 'ground level' if the track has been mounted on board, etc. Cable connections can easily be made with the control unit as the screw connectors allow very easy installation. If you find that the wiring is slightly wrong, maybe a signal lamp is not making a good connection or lamps illuminate in the wrong order, the connections can easily be modified.

The signalling system can easily be modified for more signal posts, by adding another control board for each extra set of signals required, and connecting the sensor inputs to more reed switches. You may be using two signal control boards but require the signalling areas to overlap. This does not present a problem, as there are

### ① Light Backplate Options

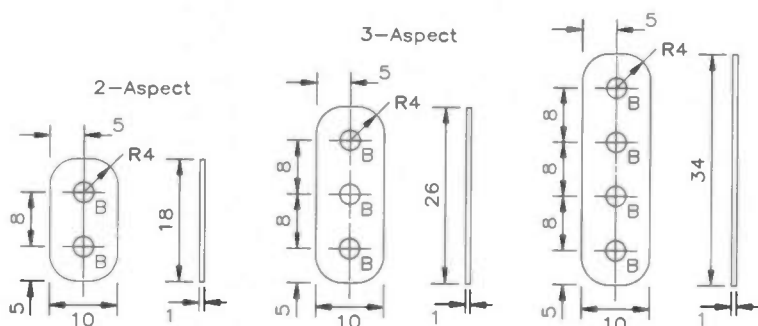

### ② Support

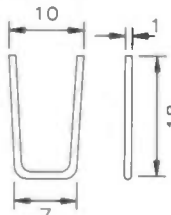

### ③ Pole

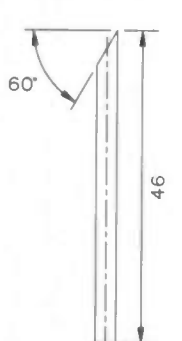

### ④ Ladder

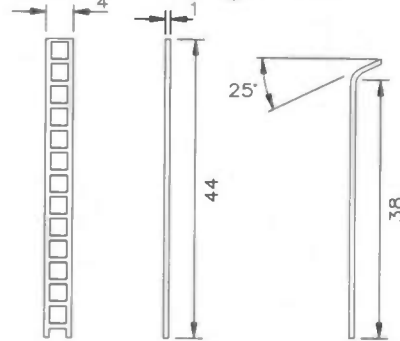

### ⑤ Safety Rail

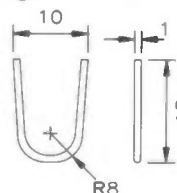

### ⑥ Cover

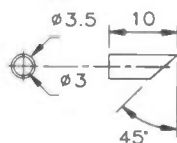

HOLE DATA		
REF	SIZE	No.
A	∅ 1.5	2
B	∅ 3	3

Table based upon 2-aspect signal light

All parts made from brass  
All dimensions in mm ± 0.25

### ⑦ Base Plate

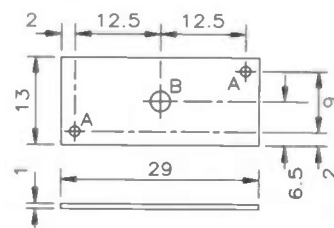

Figure 6a. Exploded diagram of Model Train Signal Lights. This diagram shows just one way in which to construct the train signals. Scaling the design to the correct size with respect to engine and carriage size will add to the element of realism. These signals are based on a design by W. B. D. Ball.



### Exploded View

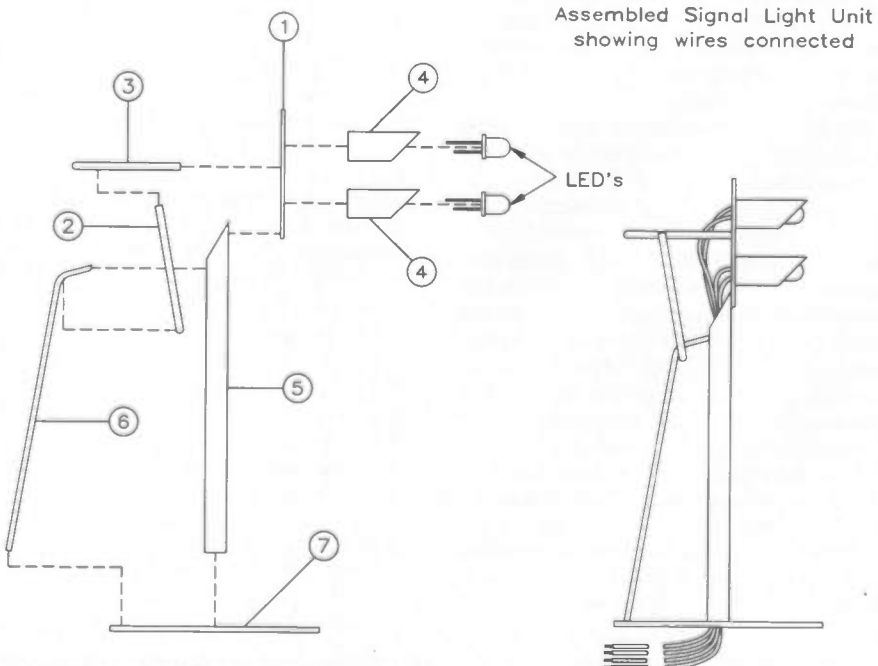

Figure 6b. The finished Model Train Signal Lights.

no reasons why the last two reed switches of one signal array cannot be connected to the first two inputs of the next signalling array. This means that if the train passes

into the third section of track on the first set of signals, then it simultaneously triggers the second set of signals as being in the first section of track. Additional sen-

sors are only then required if you need three or four aspect signalling on the second set of lights, i.e. the second set of signals needs to be more elaborate than a simple two aspect system. The two sets of signals work perfectly in this configuration, with respect to the train's location along each section of track, even though some of the input sensors are shared.

## The Finishing Touches

So now you should have a set of working train signal lights ready for incorporating into your existing model train set up. Figure 6a shows an exploded diagram of how to construct all three models of train lights. Using this as a guide you can adapt the design to your exact requirements, scaling the pattern so that it will be the correct size when compared to your engines and carriages, etc. Figure 6b shows the finished signal lights in all their glory. Happy constructing, and look out for more model trains projects appearing in the near future.

### FAULT-FINDING CHART

No lights at all, when powered up.	<ol style="list-style-type: none"> <li>1. Check that power is getting to the ICs, etc., by testing for 5V on pin 7 of IC2, IC3 and IC4, and pin 8 of IC1.</li> <li>2. Check that the LEDs (if used) are connected the right way round.</li> <li>3. Check the reed switches are not short circuit.</li> <li>4. Check for short circuits on the back of the PCB.</li> </ol>
At least one light works but does not change.	<ol style="list-style-type: none"> <li>1. Check the reed switches are not short circuit.</li> <li>2. Check for solder splashes and shorts on the PCB.</li> </ol>
Does not start on green but otherwise works correctly.	<ol style="list-style-type: none"> <li>1. Check around IC2 and IC3 for short circuits.</li> <li>2. Check D5 is correct and that R16 and C6 are the correct values.</li> </ol>
Sequence changes but is not correct.	The reset circuitry may not be working correctly, so try checking pin 15 of IC1. Reset pulse should occur after last lamp sequence in each signal aspect.

## MODEL TRAIN SIGNAL LIGHTS PARTS LIST

RESISTORS: All 0.6W 1% Metal Film

R1-10	4k7	10	(M4K7)
R11-15	100k	5	(M100K)
R16	47k	1	(M47K)
R17-20	680Ω	4	(M680R)

CAPACITORS

C1-12	100nF 16V Minidisc	12	(YR75S)
C13	220µF 35V PC Electrolytic	1	(JL22Y)
C14	10µF 35V Miniature Electrolytic	1	(JL05F)

SEMICONDUCTORS

D1-5	1N4148	5	(QL80B)
D6	1N4001	1	(QL73Q)
RG1	LM78L05ACZ	1	(QL26D)
IC1	HCF4017BEY	1	(QX09K)
IC2	HCF4072BEY	1	(QX27E)
IC3	HCF4081BEY	1	(QW48C)
IC4	HCF40106BEY	1	(QW64U)
IC5	ULN2803A	1	(QY79L)

MISCELLANEOUS

18-pin DIL Socket	1	(HQ76H)
14-pin DIL Socket	3	(BL18U)
16-pin DIL Socket	1	(BL19V)
Red LED	1	(WL27E)
Green LED	1	(WL28F)

Orange LED	2	(WL29G)
2-way PC Terminal 5mm	7	(FT38R)
3-way PC Terminal 5mm	1	(RK72P)
Miniature Reed Switch	1	(FX70M)
Push Switch	1	(FH59P)
PCB	1	(GH91Y)
Instruction Leaflet	1	(XV13P)
Constructors' Guide	1	(XH79L)

OPTIONAL (Not in Kit)

ABS Box PX4	1	(YU55K)
10-way Ribbon Cable	As Req.	(XR06G)
Magnet Small	1	(FX71N)
Magnet Large	1	(FX72P)

The Maplin 'Get-You-Working' Service is available for this project, see Constructors' Guide or current Maplin Catalogue for details.

The above items (excluding Optional) are available as a kit, which offers a saving over buying the parts separately. Order As **LT66W (Model Train Signal Lights Kit) Price £9.99**

The following new items (which are included in the kit) are also available separately.

Train Signal Lights PCB Order As **GH91Y Price £3.79**

# FOR BARGAINS AND MORE, VISIT YOUR LOCAL STORE

**Belfast** 357-359 Lisburn Road.

**Birmingham** Sutton New Road, Erdington.

**Bradford** 28 Valley Road, Ham Strasse.

**Brighton** 65 London Road.

**Bristol** 302 Gloucester Road, Horfield.

**Cardiff** 29-31 City Road, Roath.

**Chatham** 2 Luton Road.

**Cheetham Hill** 169 Cheetham Hill Road, Cheetham Hill.

**Coventry** 12 Bishop Street.

**Dudley** Unit 7, Sterling Park, Pedmore Road, Brierley Hill.

**Edware** 146-148 Burnt Oak, Broadway.

**Edinburgh** 126 Dalry Road, Dalry.

**Forest Hill** 107-113 Stanstead Road.

**Glasgow** 264-266 Great Western Road.

**Hammersmith** 120-122 King Street.

**Ilford** 302-304 Green Lane.

**Leeds** Carpet World Building, 3 Regent Street.

**Leicester** Office World Building, Burton Street.

**Liverpool** Edge Lane, Fairfield.

**Manchester** 8 Oxford Road.

**Middlesbrough** Unit 1, The Forbes Building, 309-321 Linthorpe Road.

**Milton Keynes** Unit 2, Office World Building, Snowdon Drive, Winterhill.

**Newcastle-upon-Tyne** Unit 4, Allison Court, (The Metro Centre) Gateshead.

**Northampton** 139 St. James Road.

**Nottingham** 86-88 Lower Parliament Street.

**Portsmouth** 98-100 Kingston Road.

**Preston** Unit 1, Corporation Street.

**Reading** 129-131 Oxford Road.

**Sheffield** 413 Langsett Road, Hillsborough.

**Slough** 216-218 Farnham Road.

**Southampton** 46-48 Bevois Valley Road.

**Stockport** 259-261 Wellington Road South.

**Stoke-on-Trent** 39-45 London Road.

**Southend-on-Sea** 282-284 London Road.

RING 01702 552911 FOR FURTHER DETAILS

# MAPLIN STORES NATIONWIDE

# TO TERMINATE OR NOT TO TERMINATE?

by Ian Berry

Many pieces of video equipment have a small switch on the back next to the video input sockets marked 'Term' or '75', what exactly does this do? Come to that, why are there sometimes two sockets instead of one, for the same input?

**T**HE answer to the first question is easy. The switch connects a  $75\Omega$  resistor from the input to ground in the 'Term' or '75' position and leaves it open circuit in the other position (sometimes called 'High', 'Open' or 'Bridge'). Why it is needed is a far more complicated question, requiring a long mathematical treatise on Transmission Line theory. You will probably be pleased to know that this is a layman's guide and hopefully will contain the least amount of mathematics. If you are interested in the various mathematical proofs of all this then the articles beginning in *Electronics* Issue 77, will be useful.

The answer to the 'why' part of the question is all to do with the problem that video signals contain relatively high-frequency components, the highest of which can reach a range of between 5 and 8MHz. At this sort of frequency it becomes necessary to use coaxial cable to move signals around, and the characteristics of this cable begin to affect the signals carried.

One effect of sending RF signals (which a video signal is) down coaxial cable is the occurrence of reflections from the cable ends. In other words, part of the signal sent down the cable bounces back from the far end, comes back up the cable and is reflected again from the input end and so on. Thankfully only small parts of the signal are reflected and after a couple of bounces they are so small as to be insignificant. However, the signals that are reflected interfere with the wanted signal causing cancellations and out of phase additions to the wanted signal, giving the so called 'Ghosting' effect sometimes seen on UHF TV reception.

Over short lengths of cable the reflections appear so close together that they cannot be seen, but in this case the effect is to smear out

the vertical edges of the picture causing a reduction in resolution or picture sharpness.

A Time Domain Reflectometer is a piece of test equipment that actually uses this effect to find the position of a break in a cable which is normally inaccessible, buried underground for example. The equipment sends a very

short pulse into the end of the cable and measures the time required for the first reflection to come back. From this the distance to the break in the cable can be calculated.

Thankfully there is a method by which all these reflections can be eliminated. This is known as 'Terminating the cable in its characteristic impedance'. This rather long mouthful simply means that at either end of the cable the signal must 'see' the same impedance as that possessed by the cable itself. Without going into the mathematical lengths, the net effect of this cable terminating exercise is that all the signal pushed into one end of the cable is absorbed by the load at the other end, and no reflections occur.

At the receiving end of the cable all that is necessary is to ensure that the total impedance between input and ground is the same as the cable impedance. For all video cables this is  $75\Omega$ . This value would be made up of a fixed resistor in parallel with the input impedance of the item in question, the resulting resistance being  $75\Omega$ . In normal practice the input impedance of the item of equipment is made sufficiently high, around 10k is usual, this can be neglected in the calculation, and a fixed resistor of  $75\Omega$  used directly.

This has another benefit which becomes apparent when several items of equipment are to be connected to the same video output. This is where the two input sockets are useful, see Figure 1. The signal is input into one of the sockets and the other used to 'loop' the signal to the next input in line. This is the origin of the word 'loop' found on the terminating switch on some items of equipment. The signal is passed through each pair of input sockets in turn until the last item of equipment in the loop is reached.

Should all the terminating switches be on or off? Consider, if all the switches are off then the cable is not terminated in  $75\Omega$  at all. The dreaded reflections will be present. If all the switches are on then the terminating resis-

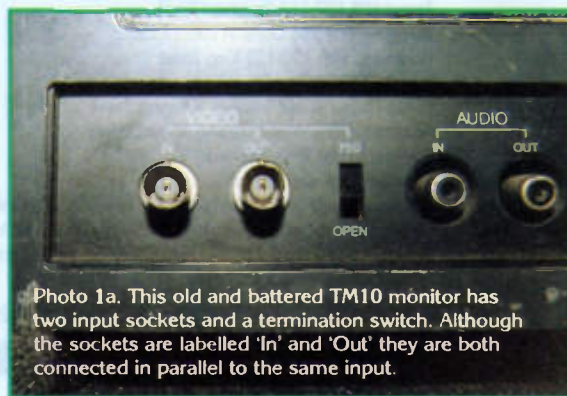
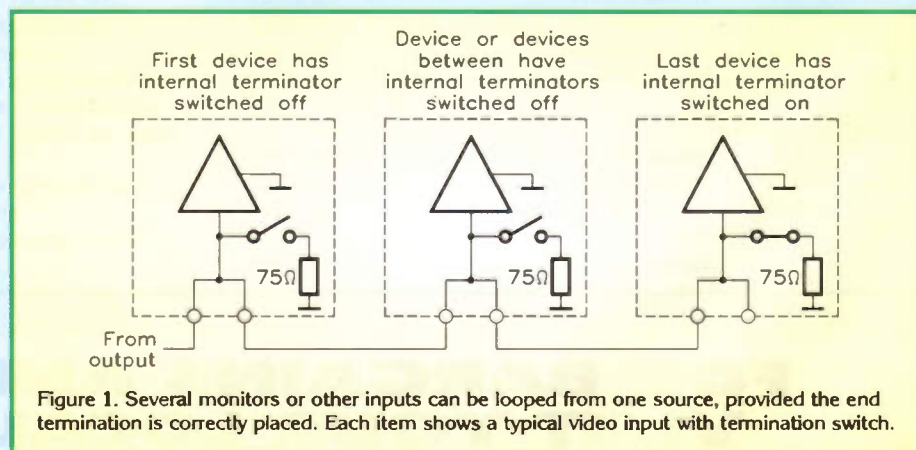

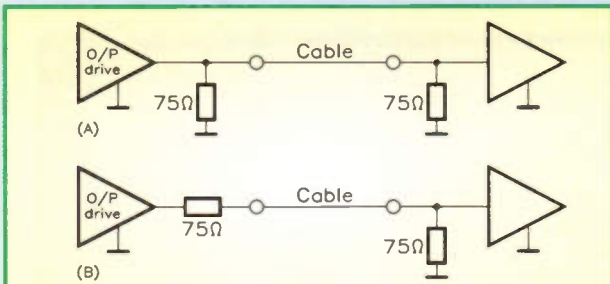

Figure 2. Two methods of matching cable characteristic impedance, using back termination resistors.

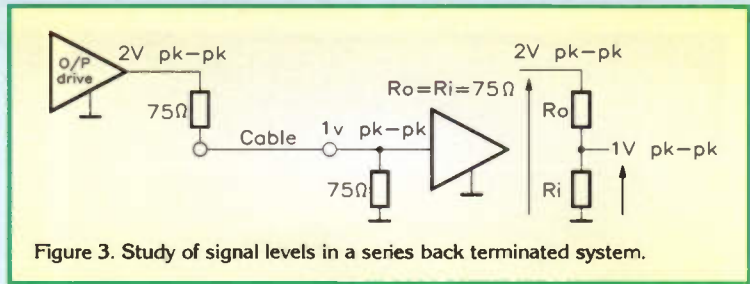

Figure 3. Study of signal levels in a series back terminated system.

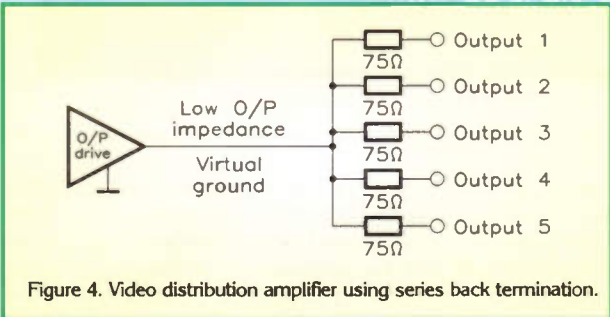

Figure 4. Video distribution amplifier using series back termination.

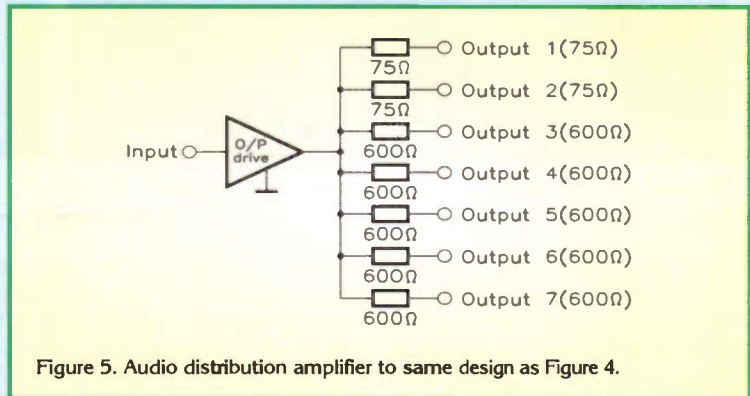

Figure 5. Audio distribution amplifier to same design as Figure 4.

tance will be the product of *all* the resistances in parallel (two terminations gives 37.5Ω, three terminations gives 25Ω and so on). This will have two effects. First the cable will still not be terminated correctly, but this probably will not matter as the second effect will be to reduce

the video level drastically due to the loading effect of the reduced impedance.

Obviously the correct solution is to switch only one termination switch on, but which one? Each loop through a video input is regarded as an extension to the overall cable length thus only the switch at the end of the cable (the last input arrived at) should be in the 'terminate' position, all the others should be in 'loop' or 'bridge'. Figure 1 shows how this should be arranged. Now the cable is correctly terminated at its end, and with the correct resistance, so all will be well.

There will be variations to layouts of input connectors on different items of equipment (Photos 1a and 1b). Some general rules are:

1. If only one socket is provided, and there is no switch, this input is internally terminated and cannot be looped out to another input.
2. If two sockets are provided, and there is no switch, this input must be terminated by a dummy plug with a 75Ω resistor wired inside it, assuming it is not to be looped out to another input.
3. If an input has *two* plugs in it (i.e. looped out to another input) it should not be terminated.
4. If an input has only one plug in it, it *must* be terminated.

There is, as ever, an exception to the above rules of thumb. This concerns certain monitors (both Sony and Panasonic produce examples of these) which have an *automatic* termination. They have two sockets and no termination switch. However, even if only one plug is input (i.e. no loop out to another monitor) the monitor will still be terminated correctly without further action, and if there is a loop output the monitor will not terminate the signal. This works by sensing the level of the input signal. If the input is 1V Pk-to-Pk there is already a termination somewhere in the loop and the monitor remains unterminated. If, however, the sensed input level is 2V Pk-to-Pk, then a termination is required, and the monitor provides one. This can cause problems if this type of monitor is not at the end of a loop and the cable length to the end is quite long, if the last input is not terminated the automatic termination will operate and put in a 75Ω part way down the cable that could lead to reflections again.

There are a couple of further points to bear in mind. Often the two input sockets are labelled 'input' and 'output' (Photo 1a). This can be confusing, as in fact the two sockets are simply wired in parallel, and it does not matter which socket is used as input and

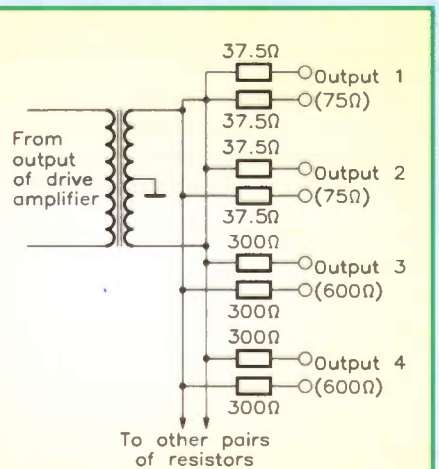
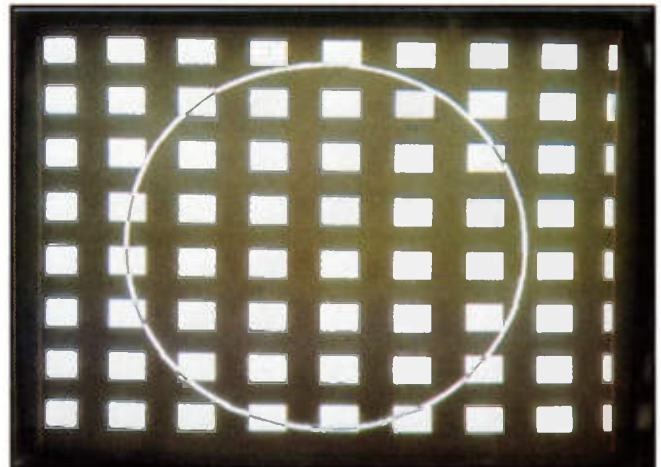
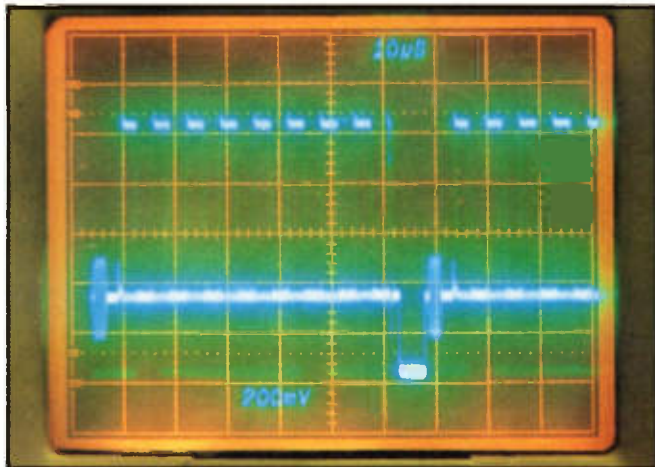
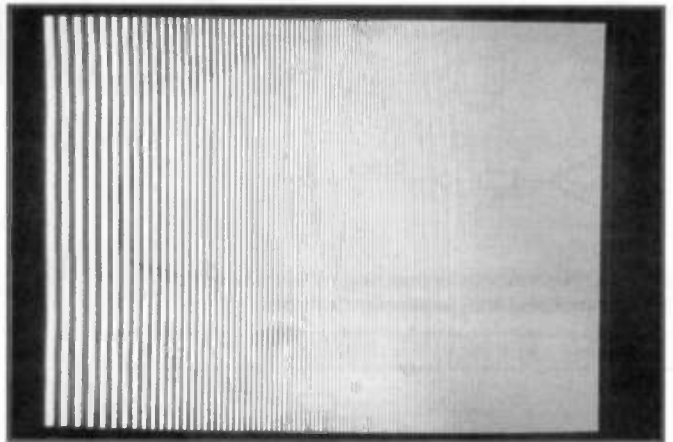
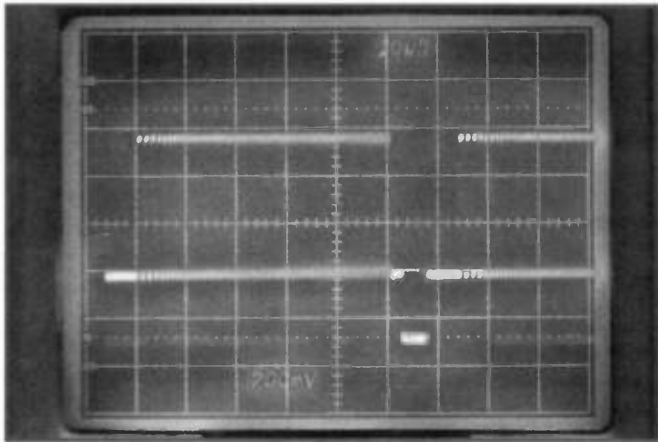

Figure 6. Balanced version of Figure 5. Note resistor values are half the value of output impedance required.



Photos 2 & 3. The undistorted square waveform and how it appears on a monitor screen.



Photos 4 & 5. The undistorted frequency sweep and its picture.

which is used as loop output to another input. It is not possible to go on looping inputs together *ad infinitum*. When several inputs are looped, their input impedances appear in parallel, so reducing the termination impedance. Another effect is caused by the input capacitance to ground. This will add to the terminating impedance, but will also begin to reduce the high frequency content of the signal, not only reducing the colour information but also the fine detail or resolution of the picture. Throughout the article so far the terms 'resistance' and 'impedance' have been used to mean the same thing. At the frequencies used in video transmission, it does need to be borne in mind that 'impedance' is made up of components of resistance, capacitance and inductance, all of which have different effects on the quality of the signal. However, for our purposes in talking about terminations, a simple resistance is all that is required.

So much for the *input* end of the cable. The *output* (or source) end also needs to be terminated. It would appear that a simple resistor to ground would fulfil this criterion. In some cases this is so, but more common by far is the system of back-termination (as this termination of an *output* is known) by means of a virtual earth driver and a series resistor.

How can putting a resistor in *series* with the output terminate the cable? The answer lies in the virtual earth driver. Virtual earth means that to all intents and purposes the output is grounded. This is achieved by making the output impedance as low as possible (some video distribution amplifiers have output

impedances of less than  $1\Omega$ ). Now put in a series resistor of value  $75\Omega$ . Looking back into the output socket the cable 'sees' a resistance of  $75\Omega$  to 'ground'. This fulfils the source end termination requirements. But why a series resistor instead of a parallel resistor to ground? The amplifier has to drive the cable, the input to the next piece of equipment, and the two terminations at each end of the cable. The actual cable and the next input have impedances so high as to be negligible, however, the two terminations constitute the load on the output driver. If the output termination is in parallel, then the driver must operate into two  $75\Omega$  resistors in parallel, or  $37.5\Omega$ . If the output termination is in series, then the driver operates into two  $75\Omega$  resistors in series or  $150\Omega$ . It is much easier to drive the higher value of resistance so this is the configuration normally adopted. Figure 2 shows both methods of back termination.

This method of back termination also has another advantage. The series resistor at the driving end of the cable serves to decouple the not inconsiderable capacitance of the cable from the output of the amplifier. A glance at the specification for URM70 cable (Stock Code XS32K) reveals a capacitance of  $67\text{pF}$  per metre. Thus a  $100\text{m}$  length will have a capacitance to ground of  $67 \times 100$  or  $6700\text{pF}$ . Connecting this directly to an amplifier designed to drive quite high currents at several megahertz will almost certainly cause an overload. (This is a simplification of course, as any coaxial cable has a complex impedance made up of series inductance and parallel capacitance which will change depending on the frequency used.)

The complex impedance characteristic of coaxial cable gives rise to problems when very long cables are used. In general, the higher frequency components of the signal will tend

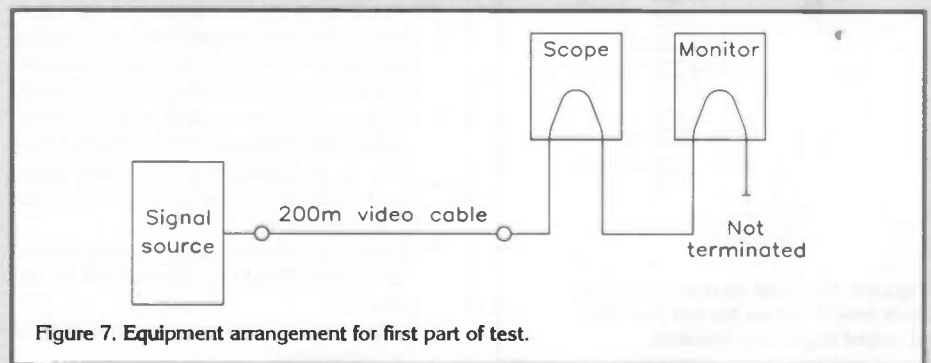
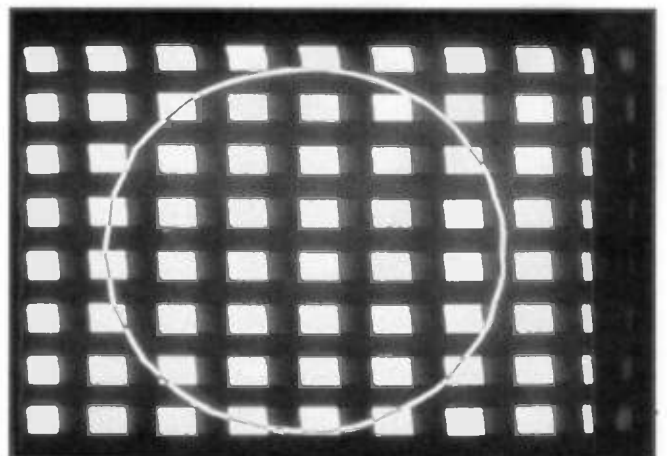
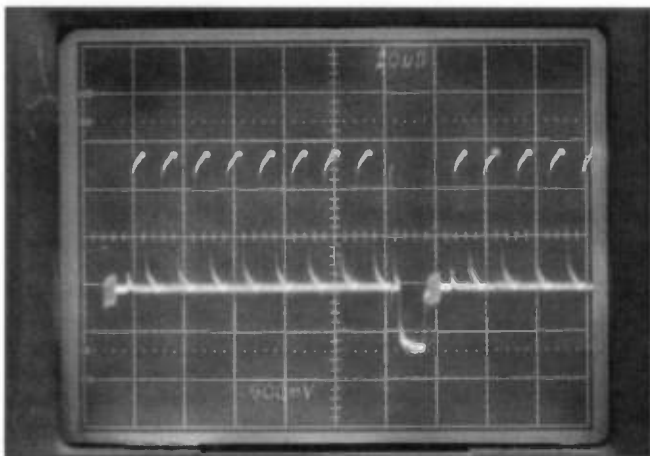
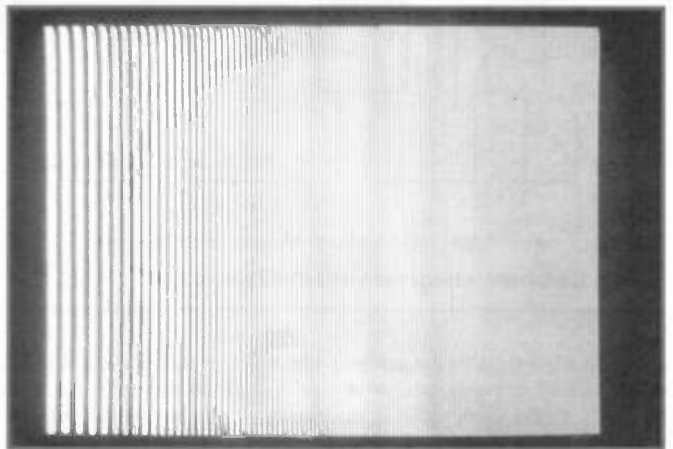
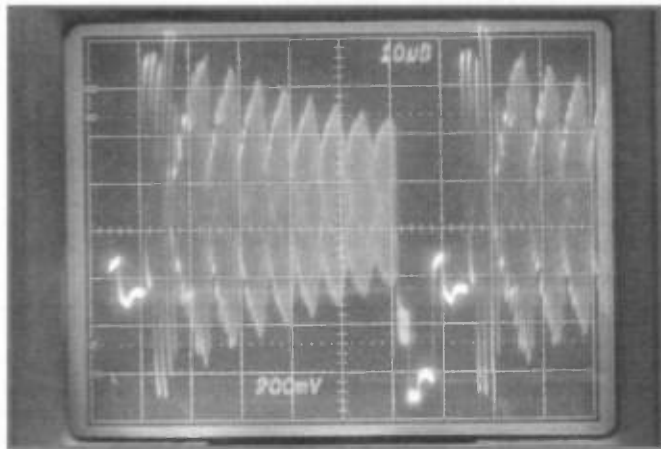

Figure 7. Equipment arrangement for first part of test.



Photos 6 & 7. 200m of cable before the monitor and oscilloscope with no termination.





Photos 8 & 9. As photos 6 & 7, but with a frequency sweep instead of the square pattern.

to fall off first giving loss of colour information and fine picture resolution. On runs of cable over 20 or 30 metres or so an equalising amplifier is required to restore high frequency performance. This normally takes the form of a five or six output distribution amplifier, with a cable equalising section added calibrated in metres. This is only effective up to around 300 to 500 metres of cable, noise being the limiting factor. Above 500 metres the signal is normally modulated onto a carrier and treated as a pure radio signal. The television cameras on motorways, for example, are modulated onto a carrier normally in the HF part of the radio spectrum, and can be sent down cable

lengths of many tens of kilometres without problem. This system allows many camera pictures to share one cable by multiplexing many carrier channels together, the same way as all four TV channels use the same aerial.

One effect of the series method of driving cable is the requirement of the amplifier to provide not 1V Pk-to-Pk at its output but 2V Pk-to-Pk (at least before the series output terminating resistor, see Figure 3). A little thought serves to indicate why this is so. A correctly terminated output and input configuration has two series resistors to ground connected to it, with the input to the next piece of equipment connected to the centre junction. This is in

effect a potential divider network, so that only half the output voltage (the two arms of the potential divider being equal) will appear at the input. This is usually no problem as the driver circuit is designed with this in mind, but if the termination resistor is not correct, then the signal level seen by the next input will also not be correct. No termination will give a double-level input of 2V Pk-to-Pk while a double termination will give a reduced signal level. This is why the signal level changes when the termination switches are turned on and off and, of course, the correct place for the switches is not when the maximum picture level appears on the monitor or whatever.

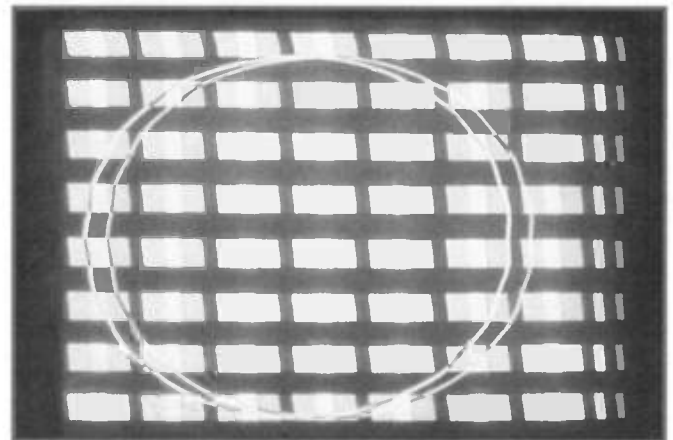
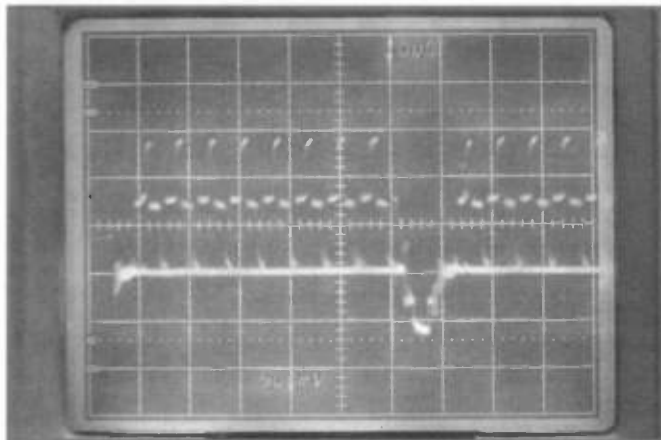

Photos 10 & 11. 200m of cable after the monitor and oscilloscope still with no termination. The reflection can be seen very easily.

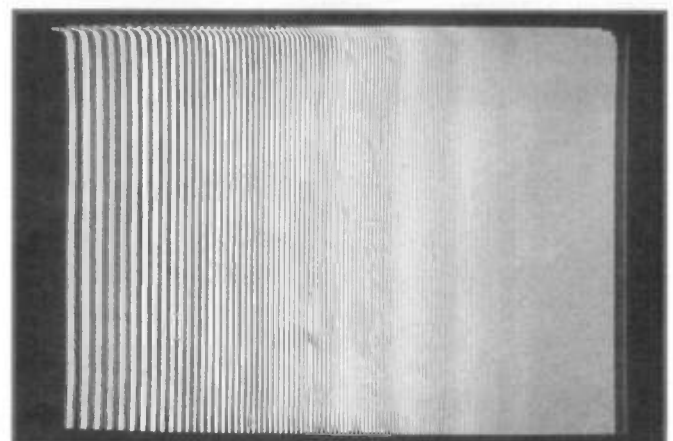
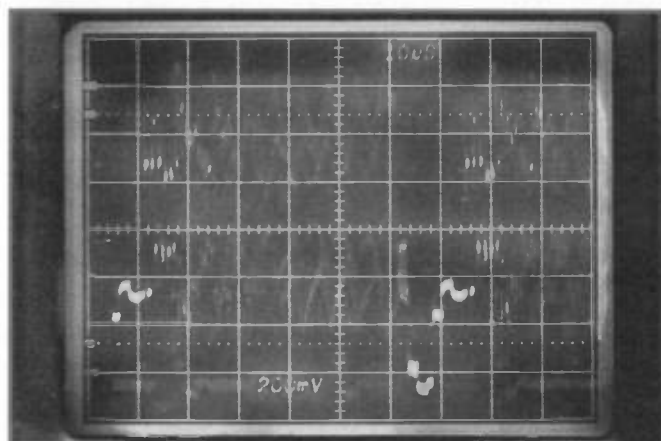

Photos 12 & 13. As photos 10 & 11, but with the frequency sweep.

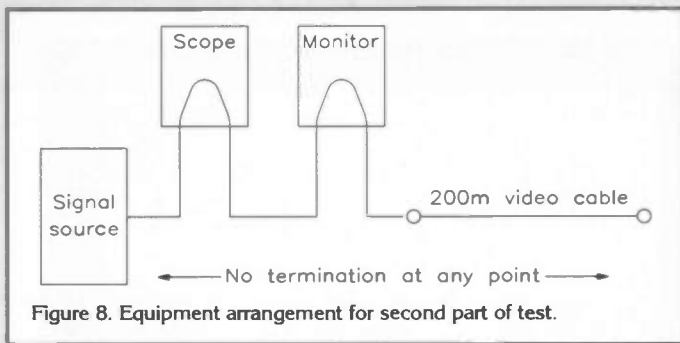

Figure 8. Equipment arrangement for second part of test.

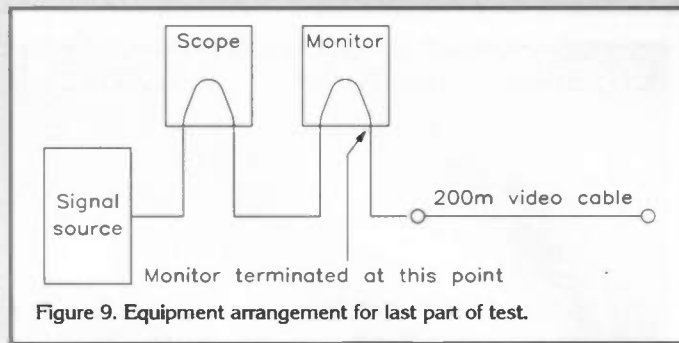

Figure 9. Equipment arrangement for last part of test.

An added advantage to the series method of back termination is only apparent if a cable fault occurs. If the cable goes open circuit there is no problem – just that no video comes out of the end. However, let the cable go short circuit and it is a different story. If the termination is a parallel resistor to ground, a cable short will connect the driver output straight to ground. Some drivers will be able to stand this, but some will not and will tell you so with a tell-tale little cloud of smoke! With a series resistor, all that happens is that the driver output runs into  $75\Omega$  instead of  $150\Omega$ , and this should give no problem at all.

Use is made of this virtual earth and series back-termination arrangement in video distribution amplifiers, where one input is split into several (usually five or six) outputs. In Figure 4, the driver amplifier is designed to maintain its correct output into a much lower termination resistance. All that is required is a higher output current capability. Since the driver

amplifier output is virtually at ground potential, several series resistors can be connected to the output point simultaneously, thus giving several outputs. As the actual amplifier output is effectively grounded (its output impedance is *very* low) the several outputs are isolated from each other and anything happening to one output (shorts or open circuits, reflections from long unterminated cables, etc.) will not affect any other output. The only requirement to be met is that the driver amplifier will operate happily when all its series output resistors are shorted to ground. An appropriate driver amplifier is the EL2099CT (Stock Code AY89W) made by Elantec which will drive up to six  $75\Omega$  loads, with little more extra components than a power supply.

The virtual earth and series output resistor combination is used in many other fields, as it makes it possible to determine output impedance by choice of series resistor. In distribution amplifiers for audio, for example, the same

driver can supply  $600\Omega$  outputs ( $600\Omega$  series resistor) for general-purpose use, and at the same time provide  $75\Omega$  outputs ( $75\Omega$  series resistor) for line driving. Figures 5 and 6 shows how this works for both balanced and unbalanced outputs. A very effective audio distribution amplifier can be implemented by using an audio power amplifier kit of a few watts output, and connecting a fan of resistors to suit your required output impedance to the speaker output terminal. Since an amplifier designed to drive a loudspeaker has a very low output impedance, it can be regarded as a virtual earth. The 8W power amplifier kit (Stock Code LW36P) is eminently suited to this sort of application.

It is perfectly possible to demonstrate the problems raised by lack of terminations. All that is required is a means of generating a test signal, a monitor to look at the pictures on, an oscilloscope to view the waveform produced, and, of course a long length of

*Continued on page 35.*

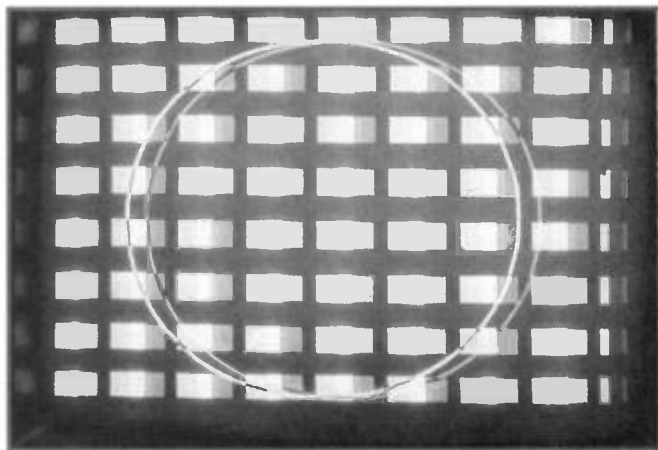
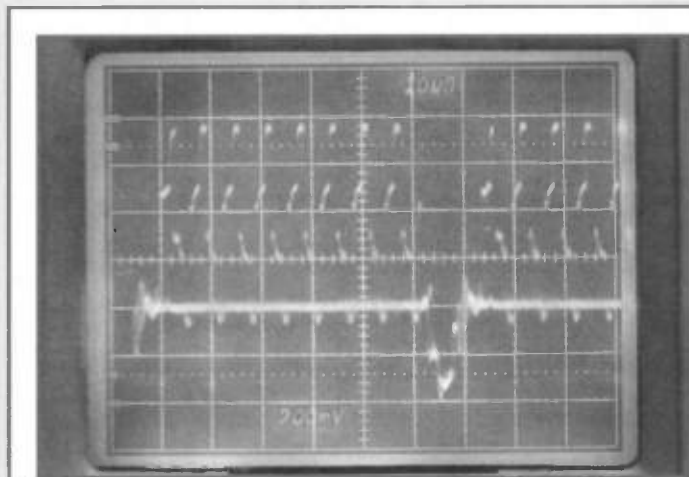

Photos 14 & 15. 200m of cable after the monitor and oscilloscope, but with the monitor terminated in  $75\Omega$ .

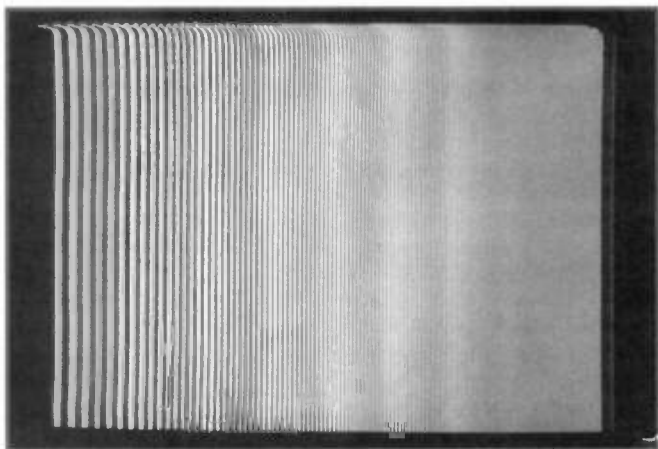
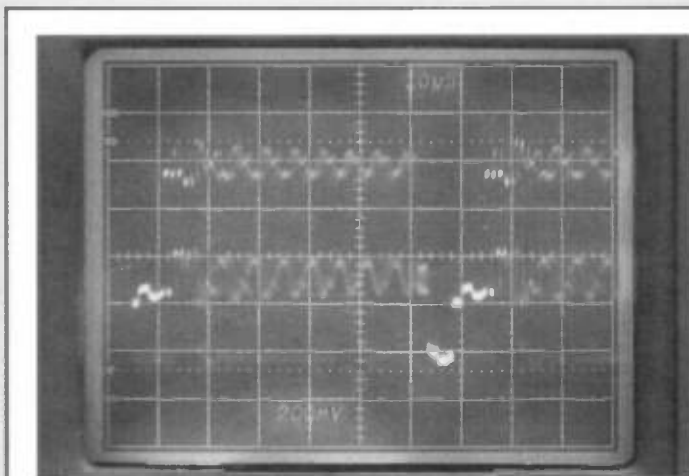

Photos 16 & 17. As photos 14 & 15, but with the frequency sweep.



# DIGITAL SIGNAL PROCESSING

In this concluding part, we see how the pole-zero diagram can be used to design filters.

## Designing Filters

Pole-zero diagrams can be used to design filter responses. Imagine the unit circle as a clock face, with a hand travelling anticlockwise from 3 (0°) to 9 (180°). When the hand is close to a pole, a peak occurs in the frequency response, while zeroes cause dips in the response. Using this information, filters can be designed by placing poles and zeroes appropriately to produce the desired response.

For example, if we require a similar response to Figure 18, we can place a pole where a peak is required, and zeroes either side to lower the response (see Figure 19). Poles have to be placed inside the unit circle for stability; the further inside, the faster the impulse response settles to zero. Two poles and three zeroes are required as they occur in conjugate pairs. Now, the transfer function must be worked out.

The poles are at  $0.6 \pm 0.6i$ , so, from the definition of a pole  $P(z) = 0$ , when  $z = 0.6 \pm 0.6i$ . A pole has been added at zero to balance the equation.

$$Q(z) = z(z - 0.6 + 0.6i)(z - 0.6 - 0.6i) \\ = z^3 - 1.2z^2 + 0.72z$$

$$P(z) = (z - i)(z + i)(z - 1) = (z^2 + 1)(z - 1) \\ = z^3 - z^2 + z - 1$$

Giving

$$H(z) = \frac{P(z)}{Q(z)} = \frac{z^3 - z^2 + z - 1}{z^3 - 1.2z^2 + 0.72z}$$

Notice the powers of  $z$  are positive.  $z^{-1}$  is a one unit delay, so positive powers require future inputs. This filter is non-causal; it runs on inputs that have not occurred yet! To make it causal, the impulse response will be delayed by multiplying by  $z^{-3}$ , giving

$$H(z) = \frac{-z^{-3} + z^{-2} - z^{-1} + 1}{0.72z^{-2} - 1.2z^{-1} + 1}$$

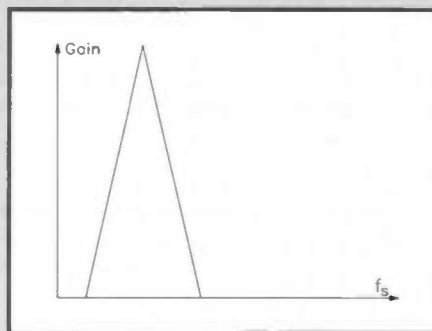

Figure 18. Example frequency response.

This must be rearranged to the form that DSPWB uses. Now,  $H(z) = Y(z)/X(z)$ , so

$$(0.72z^{-2} - 1.2z^{-1} + 1)Y(z) = X(z)(-z^{-3} + z^{-2} - z^{-1} + 1)$$

so

$$Y(z) = X(z)(-z^{-3} + z^{-2} - z^{-1} + 1) + Y(z)(-0.72z^{-2} + 1.2z^{-1})$$

So, the coefficients are:

$$\begin{aligned} p(0) &= +1 & q(1) &= +1.2 \\ p(1) &= -1 & q(2) &= -0.72 \\ p(2) &= +1 & q(3) &= 0 \\ p(3) &= -1 & & \end{aligned}$$

The frequency responses produced by DSPWB, with (a) only the  $p$  values (zeroes only), (b) only the  $q$  values (poles only, and  $p(0)=1$ ), (c) the final filter response, and (d) the responses overlaid on top of each other, are shown in Figure 20.

## Frequency Response

Frequency responses can be found analytically, without using a computer. The procedure is very mathematical, and you may wish to skip this section.

The frequency response can be found from the transfer function,  $H(z)$ , by substituting  $e^{j\omega T}$  for  $z$ , where  $T$  is the sampling frequency ( $=1/f_s$ ) and  $\omega = 2\pi f$ . If we let  $T=1$ , the frequency response will be in the range  $0 < \omega < \pi$ . As  $e^{j\omega}$  is periodic, the frequency response repeats as shown in Figure 21. Now, the frequency response can be obtained by plotting  $|H(e^{j\omega})|$  for various values of  $\omega$ . The phase response is obtained by plotting  $\arg(H(e^{j\omega}))$ .

For example, taking a simple low-pass filter  $H(z) = z^{-1} + 1$ , and substituting  $z = e^{j\omega}$ , giving

$$H(e^{j\omega}) = e^{-j\omega} + 1$$

Expanding  $e^{-j\omega}$ ,

$$H(e^{j\omega}) = 1 + \cos \omega - j \sin \omega$$

so,

$$\begin{aligned} |H(e^{j\omega})| &= \sqrt{(1 + \cos \omega)^2 + \sin^2 \omega} \\ &= \sqrt{2 + 2\cos \omega} \\ &= \left| 2\cos \left( \frac{\omega}{2} \right) \right| \end{aligned}$$

Varying  $\omega$  between 0 and  $\pi$ , we obtain the response in Figure 21.

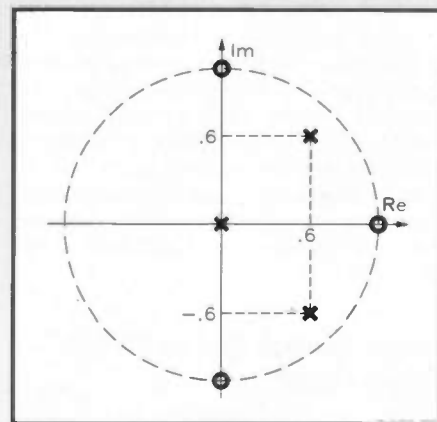

Figure 19. A pole-zero diagram.

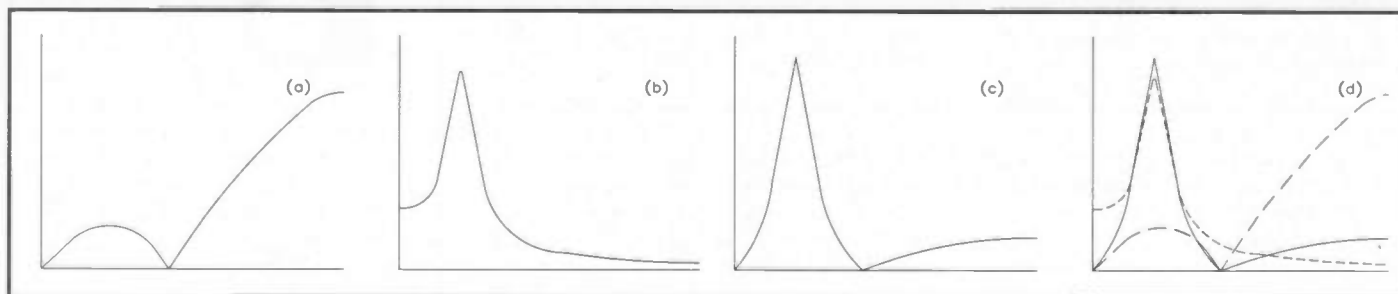

Figure 20. DSPWB frequency responses: (a) only the  $p$  values (zeroes only); (b) only the  $q$  values (poles only, and  $p(0)=1$ ); (c) the final filter response; (d) the responses overlaid on top of each other.

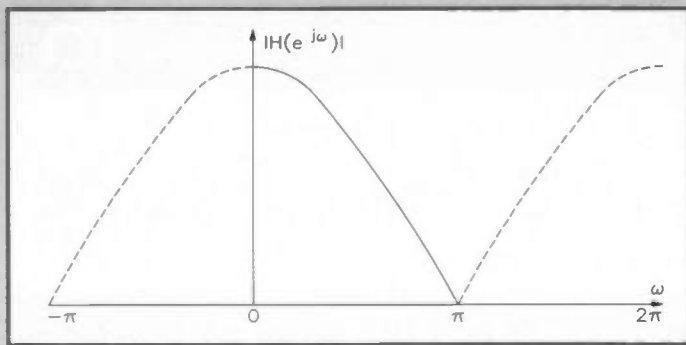

Figure 21. Example frequency response found from the transfer function.

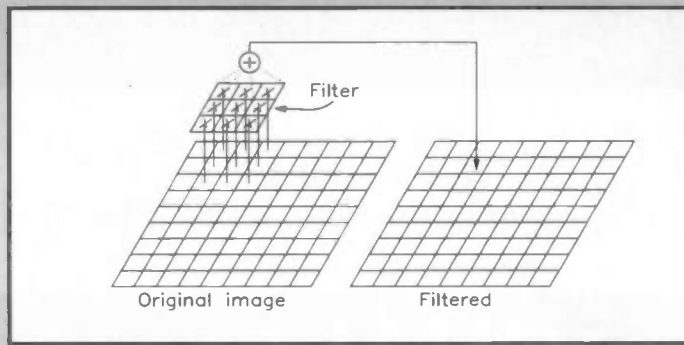

Figure 22. Operation of a 2-D filter.

## Transforming Filters

Low-pass filter designs can be transformed into various other responses. This is done by simply substituting for  $z$ :

Low-pass  $\rightarrow$  High-pass:  $z^{-1} \rightarrow -z^{-1}$

Low-pass  $\rightarrow$  Band-pass:  $z^{-1} \rightarrow -z^{-2}$

Low-pass  $\rightarrow$  Band-stop:  $z^{-1} \rightarrow z^{-2}$

For example, to transform the second-order low-pass filter  $H_{lp}(z) = z^{-2} + 2z^{-1} + 1$  to a band-pass filter, substitute  $-z^{-2}$  for  $z^{-1}$ , giving  $H_{bp}(z) = z^{-4} + 2z^{-2} + 1$ .

## 2-D Filtering Images

The signal being processed does not have to be one-dimensional. Program 3 filters a 2-D image using a  $3 \times 3$  filter. Figure 22 shows the principle using a  $3 \times 3$  filter. The filter, a matrix of numbers, is moved from left to right, one pixel at a time. When the end is reached, the action is repeated on the next line. The centre of the filter is placed on the current pixel, and each pixel under the filter is multiplied by the appropriate number. The results are then summed and stored in the destination pixel.

A selection of filters is shown in Figure 23. The default filter (a) is an edge detection filter; it highlights the edges of the image (see Figure 24). Such feature extraction filters are useful for image recognition and compression. The program allows the filtered image to be filtered again (up to seven times), so the effect can be animated. Pressing a key cycles the screens, and 'Q' quits the program. Change the filter by editing the data lines in the program.

Larger filters can be used, but require much processing; processing an  $80 \times 80$  pixel square with a  $3 \times 3$  filter requires around 58,000 multiplications.

## Every Home Should/Will Have One!

DSP is becoming a serious business, and is used in many applications, from telephones and television to satellite communications. The humble toaster has yet to be affected, but how long will it be before we can specify the precise shade of our toast?

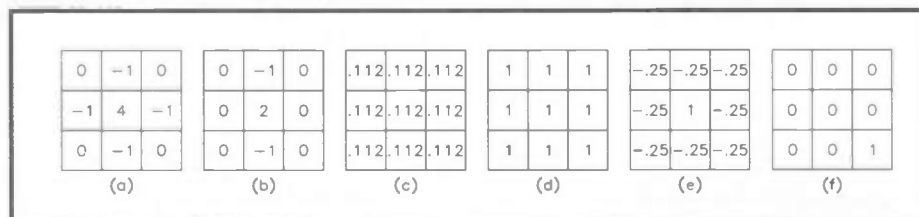

Figure 23. A selection of 2-D filters to try.

```

REM /-----
REM |2D (3x3) Filter Demonstration Program      J.M.Sharpe 1993
REM \-----

CONST XS% = 70, YS% = 70                                'Area to filter
DIM i%(2 TO XS% + 1, 2 TO YS% + 1), f(1 TO 9)
RESTORE: FOR n% = 1 TO 9: READ f(n%): NEXT
REM *****FILTER DATA*****
DATA 0,-1, 0
DATA -1, 4,-1
DATA 0,-1, 0
REM *****
CLS : PRINT " 2D-Filter Demonstration": PRINT "-----"
PRINT : PRINT "Apply filter how many times(1-7)?"
DO : a% = VAL(INKEY$): LOOP UNTIL a% > 0 AND a% < 8
SCREEN 7, , 0, 0                                        'Graphics screen 0
LINE (1, 1)-(XS% + 2, YS% + 2), 2, B                  'Green border
REM *****Draw Graphics To Be Filtered*****
LINE (3, 3)-(XS%, YS%), 1
LINE (10, 10)-(60, 60), 1, BF: LINE (15, 15)-(20, 20), 0, B
CIRCLE (40, 40), 18, 0: PAINT (40, 40), 0
REM *****Main Loop*****
FOR z% = 1 TO a%
  FOR x% = 2 TO XS%: FOR y% = 2 TO YS%                  'Copy Screen Into Array
    i%(x%, y%) = SGN(POINT(x%, y%))                  'i=1 if point set, 0 if black
  NEXT y%, x%
  SCREEN 7, , z%, z%: CLS                              'Switch to next screen
  FOR y% = 3 TO XS%                                    'Apply filter
    FOR x% = 3 TO YS%
      o = i%(x% - 1, y% - 1) * f(1) + i%(x%, y% - 1) * f(2) + i%(x% + 1, y% - 1) * f(3)
      o = o + i%(x% - 1, y%) * f(4) + i%(x%, y%) * f(5) + i%(x% + 1, y%) * f(6)
      o = o + i%(x% - 1, y% + 1) * f(7) + i%(x%, y% + 1) * f(8) + i%(x% + 1, y% + 1) * f(9)
      IF (o) < 1 THEN PSET (x%, y%), 0 ELSE PSET (x%, y%), 11
    NEXT x%
  NEXT y%
  LINE (1, 1)-(XS% + 2, YS% + 2), 2, B                'Draw green border
NEXT z%

n% = 0                                                'Cycle Screens
DO: SCREEN 7, 0, n%: n% = (n% + 1) MOD (a% + 1)
DO: i$ = INKEY$: LOOP WHILE i$ = ""                  'Press key for next screen
LOOP UNTIL LCASE$(i$) = "q"                          'Press Q to exit

```

Program 3.

Powerful DSP systems will become increasingly popular with the advent of multimedia and virtual reality applications.

Processing sound and images in real time requires extremely fast, specialist CPUs. Probably the most popular range is the TMS320 series from Texas Instruments. These

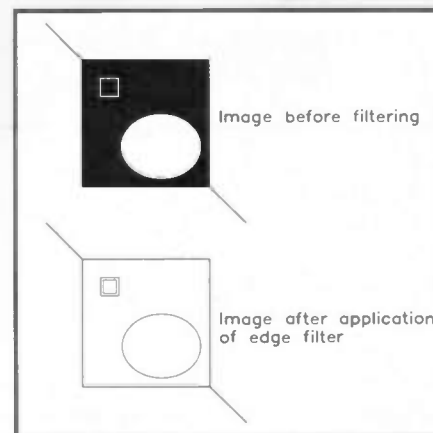

Figure 24. Application of an edge detection filter.

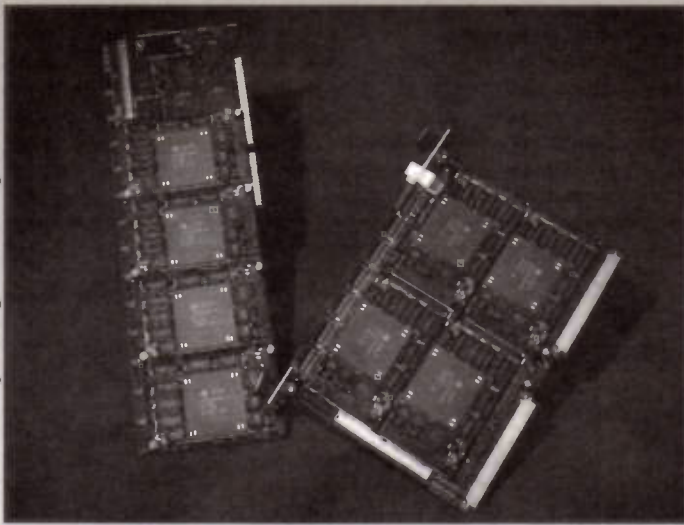

Photo 1. Latest TMS320C40 parallel DSP boards.

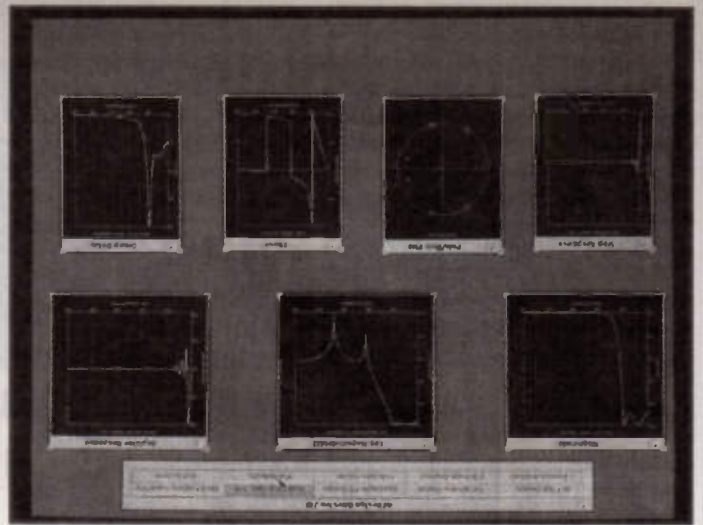

Photo 2. Professional filter design package.

CPUs have specialised hardware, such as floating point units, multipliers, and barrel shifters. A recent addition to the range is the TMS320C40. It has 32-bit address and data buses, 8K-bytes of internal RAM, a 512-byte cache, a 40-bit floating-point ALU, and twelve 40-bit registers. For parallel operation, it also has six 20M-bits/s communication channels, and a 6-channel DMA coprocessor. Photo 1 shows two add-on boards with four such processors. It is capable of around 1GOPS (Giga-byte Operations Per Second), 200MFLOPS (Million Floating-point Operations Per Second), and 100MIPS (Million Instructions Per Second). Such boards cost several thousand pounds.

Photo 2 shows a professional filter design

program, similar to the one presented previously. Code generators are available to automatically turn the design into optimised machine code for various processors, thus saving much hard work and mathematics.

To keep the cost of consumer products low, the specialist DSP functions are performed using hardware. If a product is to sell in volume the circuit can be integrated onto a chip. After the initial development cost, the production cost is low compared with using specialist DS processors.

### And Finally . . .

This series has only scratched the surface of a very large subject. Hopefully, it has introduced some of the concepts involved, and the uses

of DSP. Further reading matter is listed below: [1] is a good introduction to analogue and discrete signals and systems. [2] and [3] are rather complex, and contain much 'post A-level' maths.

### Further Reading

[1] Meade and Dillon, *Signals and Systems (2nd edition)*, Chapman Hall, 1991.

[2] Proakis and Manolakis, *Introduction to Digital Signal Processing*, Maxwell Macmillan, 1989.

[3] Baher H., *Analog and Digital Signal Processing*, John Wiley & Sons, 1990.

Thanks go to Loughborough Sound Images for supplying details of DSP systems and processors. 

### TO TERMINATE OR NOT TO TERMINATE? – Continued from page 32.

cable. In the following examples the cable is 200m of PSF 1/3 (the cream coloured video cable generally regarded as top of the range). 200m may be looked on as bit excessive, but it does tend to make the problems easier to see.

Two test waveforms are used. The first is a checker-board pattern of black and white squares, and a circle (Photos 2 and 3). This will show any sideways movement due to reflections from the end of the cable. The second test waveform is a frequency sweep at TV line rate. At the left of the screen is a frequency of around 100kHz, and this rises to 5MHz at the right of the screen (Photos 4 and 5). This will show problems due to the different cable characteristics at different frequencies.

The tests are divided into three sections.

The first has the 200m of cable between the signal generator and the monitor and oscilloscope (Figure 7). Photos 6 and 7 clearly show how the reflections produced by the lack of termination have severely reduced the resolution and smeared out the vertical edges. Photos 8 and 9 show how additions and cancellations occur at different frequencies.

Next the 200m of cable is placed after the monitor and oscilloscope (Figure 8) but still left unterminated. Photos 10 and 11 show that the problem is now much more severe than in the first case. The first reflection is at approximately the same level as the original, and displaced sideways by a considerable distance. Photos 12 and 13 show that the frequency sweep is still full of additions and cancellations at different frequencies.

Test three is approximately the same as test two except that the monitor is terminated (Figure 9). This is still not correct as the termination is nowhere near the end of the cable. Photos 14 and 15 show that the problem is just as severe as without a termination at all. Photos 16 and 17 indicate that the frequency dependent errors appear to be not quite as bad as for the other cases, but the waveform is still far from perfect.

The use of such a long length of test cable makes the errors much easier to see but the results are the same for shorter lengths of cable, although obviously not so severe.

So in conclusion then the rule is always terminate but only once. If your input has two plugs in, don't terminate, if it has only one plug in, do terminate. 

**Maplin**  
**SALE**

**AT MAPLIN STORES NATIONWIDE\***  
**HURRY! Starts 9a.m. Tuesday 3rd Jan. '95**  
**Choose from a super selection of bargains!**

Computer accessories, Lighting and Torches, Batteries and Chargers, Car Audio and Security, Audio and Musical, Tools and Test Gear, Clocks and Timers, and much, much more.

**SUPER SAVINGS!** **THERE'S A MAPLIN STORE NEAR YOU!**  
**SAVE BEEBEE'S** See page 27 for details.

\*Customers Please Note: This promotion is at Maplin stores ONLY. Sales items are not available by mail order. Promotion ends 28th Feb. '95.

# NEWTON STEREO VALVE PREAMPLIFIER

PART:3

## Tone Control Unit

**KIT AVAILABLE  
(LT77J)  
Price £39.99<sup>A1</sup>**

**Design by Mike Holmes  
and John Mosely  
Text by Mike Holmes**

**T**HERE is currently some heated debate as to whether tone controls *per se* should exist at all. Ideally, what should happen is that the recording (be it record, CD or tape) is accepted as the final version of the mixing and engineering process, since after all this is how the producer and artistes want their finished product to sound. But what if the listener has different ideas?

Speaking for myself, I am something of a 'knob twiddler' (if you'll excuse the expression!), because often my moods change, and the way in which I perceive sound can also change almost from day to day. Consequently I might feel on one occasion there is not enough bass, on another not enough treble, or too much. Then there is the compensation which may be necessary to overcome acoustic deficiencies in the domestic environment – it is one thing to listen to the recording in the studio with all the latest gear, but your own speakers or your room rarely measure up to this level of perfection.

I am, for instance, an advocate of the graphic equaliser (shock, horror, gasp!), if only because it allows cassette recordings to be tailored, for listening in the car or from the personal stereo. Also, I have come across recordings where the engineer's idea of what the tonal response should be is very strange – I'm sure there must have been something wrong with his, or her, hearing!

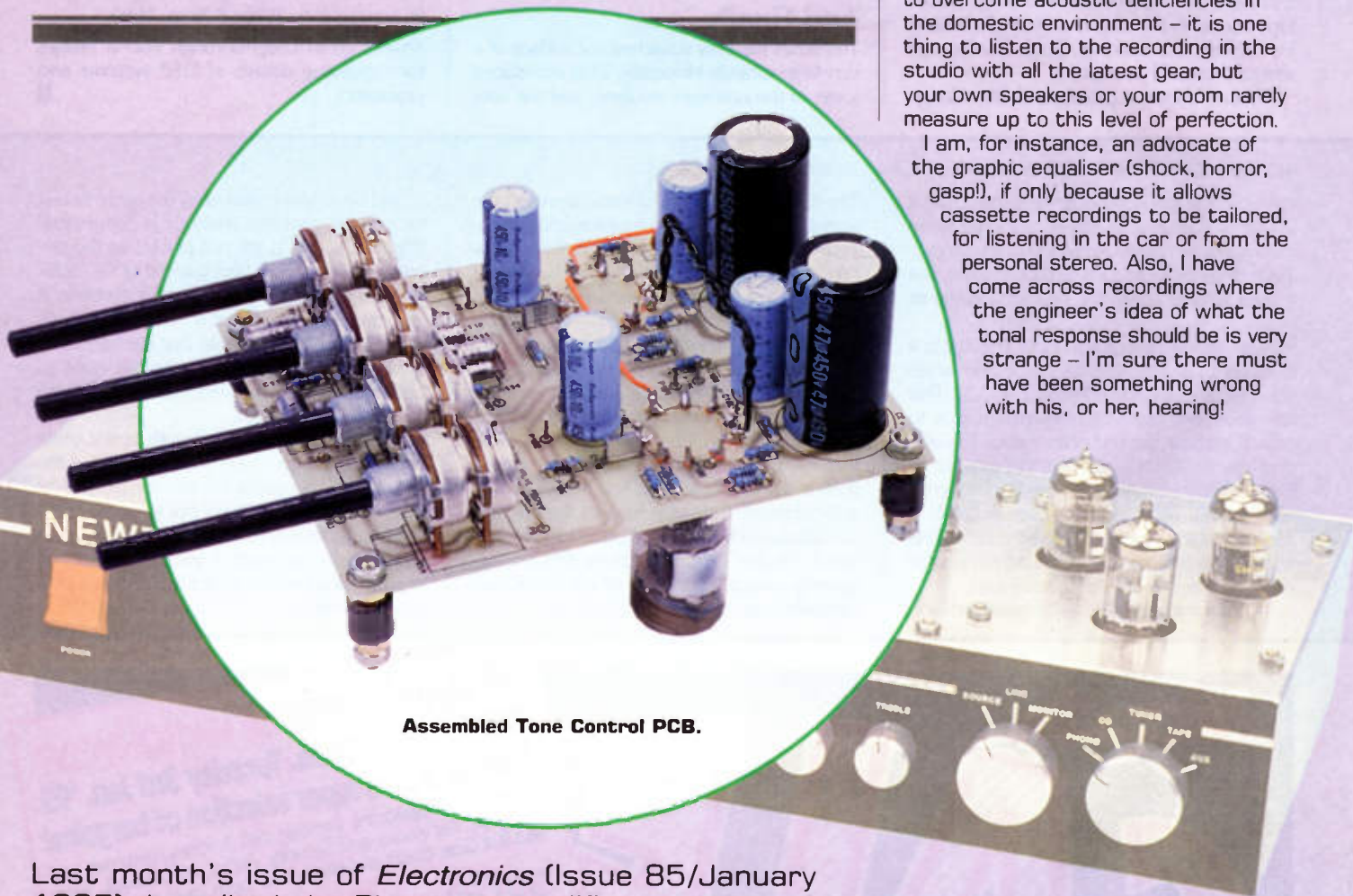

**Assembled Tone Control PCB.**

Last month's issue of *Electronics* (Issue 85/January 1995) described the Phono preamplifier module and the Power Supply Unit for a complete stereo valve preamplifier. This month the remaining Tone Control Module is featured, which completes the system. In addition some practical examples, of how to connect together the modules in various combinations, are included.



# FEATURES

- \* Simple PCB construction
- \* Compact stereo module
- \* Versatile connection options
- \* Passive tone control network
- \* Wide dynamic range
- \* Onboard low-impedance output buffer

## Specification of the complete system

### Phono stage

Input impedance:	51k $\Omega$ + 330pF*
Line output impedance:	1k $\Omega$
Overall gain, phono to line:	48dB @ 1kHz
Line output level:	1 to 2V peak (2.5mV @ 1kHz for 5cm/s)
Signal to noise ratio:	40 to 60dB (depending on cartridge)
RIAA equalisation network type:	Passive optimised

\* Select values to match the requirements of the cartridge used.

### Tone control stage

Line input impedance:	1M $\Omega$
Main output (to power amp) impedance:	<10k $\Omega$
Overall gain:	6dB flat
Frequency response:	20Hz to 20kHz $\pm$ 0.5dB, -2dB @ 100kHz
Output noise:	<200 $\mu$ V peak max.
Signal to noise ratio:	60dB for 100mV input level
Line input signal level:	0dB typical
Max. permissible input level before onset of clipping:	6V Pk-to-Pk
Bass boost and cut:	+16dB and -12dB @ 20Hz max.
Treble boost and cut:	+18dB and -19dB @ 20kHz max.
Balance offset boost:	+3dB max.
Tone control network type:	Passive Baxandall
Power supply:	230 to 240V @ 50Hz or 115 to 120V @ 60Hz
Power consumption:	30W approx.

(Could do with a trip to the doctor for a little de-waxing, perhaps . . .) While we are on the subject, what about listeners with hearing difficulties? Enough of this. Suffice to say that tone controls have their uses, although they must be used intelligently, ideally set flat, but providing the option to 'tweak' the sound slightly if required. The Newton's Tone Control Module not only meets this requirement, but also provides you with another capable line driver to feed the power amplifier(s), freeing the Phono Module's line driver for dedicated 'line out' functions.

A block diagram of the tone module is shown in Figure 1. It comprises a balanced 'Baxandall' style control network which is passive (i.e. not incorporated into the feedback loop of an amplifier), and driven by a first amplifying stage which adds the necessary gain to provide the bass and treble boost ratio. Rather than take the output directly from the network (as is the case with Mullard's 'two-valve' preamplifier), it is buffered by the line driver, which also allows a balance control to be included.

## Circuit Description

The complete circuit diagram of the module is shown in Figure 2. Note that only one channel of a stereo pair is illustrated, although these share common supply components (R1, R2, C1, C2, C3 & C4). The tone control network is recognisable by the familiar Baxandall pattern (C11 to 15, R12 to 15, and VR1 & VR2), and is borrowed more or less complete and unchanged from Mullard's 'two-valve' circuit. However, I have been asked more than once why the potentiometers are logarithmic, and why the components on either side differ in value by a factor of 10:1.

The simple reason is because the network is passive, not 'active'. In the 'active' version, the 'high side' of the

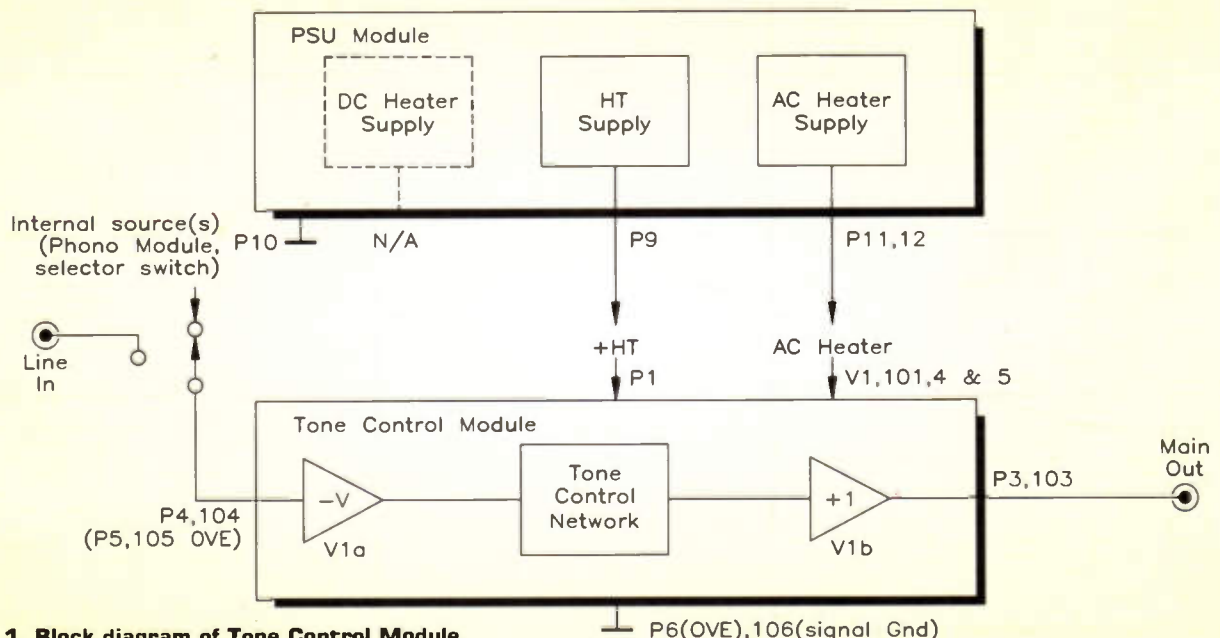

Figure 1. Block diagram of Tone Control Module.

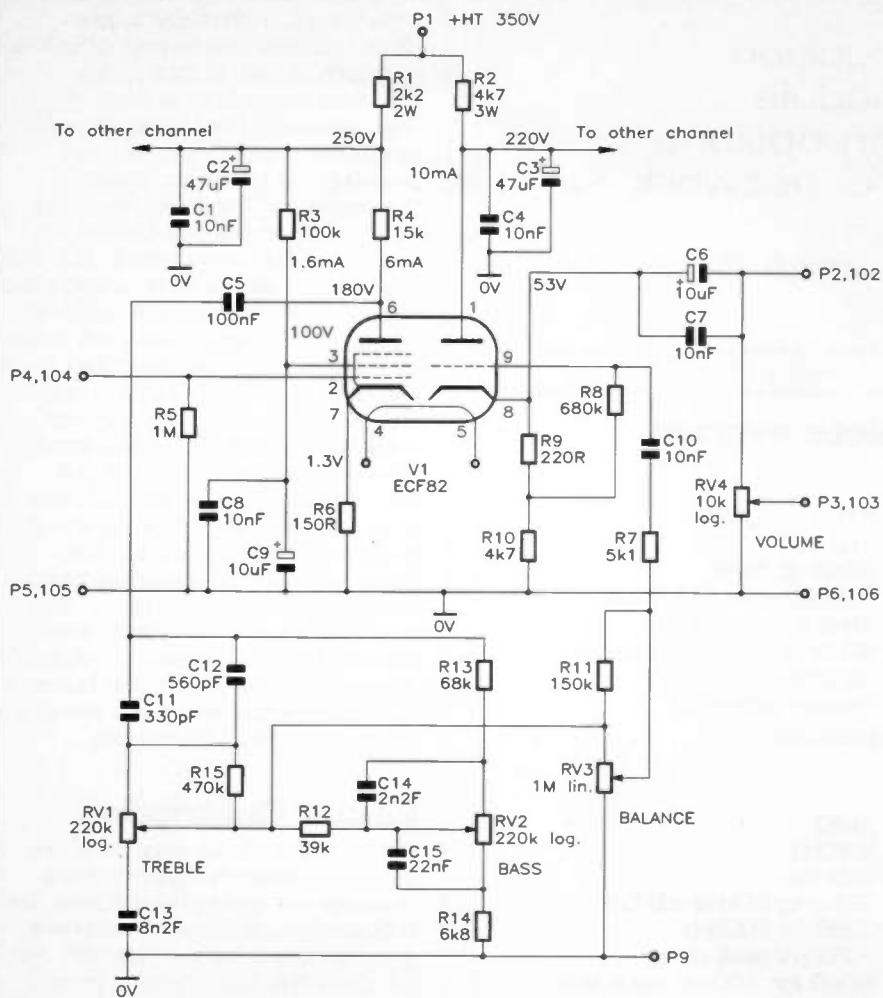

Figure 2. Circuit diagram.

network forms a feedback chain for an amplifier, the 'output' (from the potentiometer 'wipers') being returned to the non-inverting input. The 'lower side' of the network then feeds the amplifier, operating in 'virtual earth' input mode. (The amplifier is typically an op amp, although before this a single inverting transistor stage was common.) The effect of this was that, while all scales in the network were linear (linear pots, etc.), when the position of a control was mechanically changed by a linear degree, the actual gain of the amplifier was altered twofold, either up or down. This twofold, or doubling or halving, effect gives rise to the equivalent logarithmic increase or decrease of signal gain that is necessary to match the logarithmic response of the human ear to 'loudness'.

Consequently, if the active component (the amplifier) is removed, this does not happen. Hence it is necessary for the network itself to provide the logarithmic ratios of change. VR1 & VR2 are logarithmic so that while each is in a mechanically central position, the portion of track on the anticlockwise side of the wiper is one quarter (approximately) the value of the remainder of the track on the other side. Used to tap a proportion of a signal applied across the whole track, rotating the wiper fully clockwise will result in a fourfold increase (12dB) of signal level. Rotating it anticlockwise decreases the signal with similar behaviour. The reactances of the capacitors C11 & C12 and C13 set the maximum and

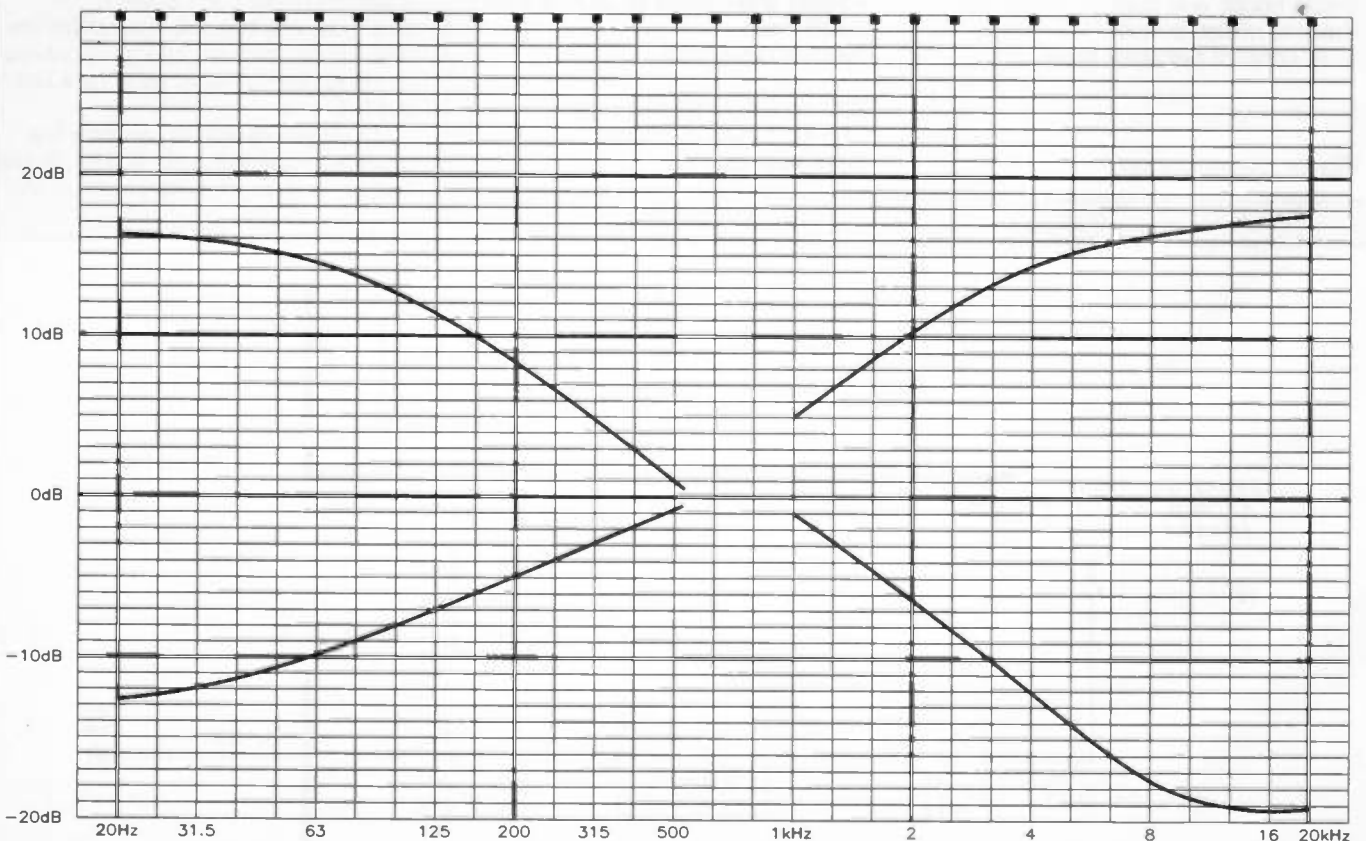

Figure 3. Frequency response of tone control network.



minimum limits for the treble section, R13 & R14 the bass section. Note that C11 & 12 combined equal 820pF, one tenth the value of C13, similarly R13 & R14 are of the same ratio.

The one disadvantage of using logarithmic pots is that the accuracies of their track resistances are less precise than that for linear pots, giving rise to offsets, relative to the mechanical position, and possible mismatching between ganged tracks. Generally the differences are small and can be ignored, however, some comments from 'reviewers' of the prototype suggested that the treble could do with improvement, that is, the control has to be increased slightly from the centre position to make the response truly 'flat'. This is all very subjective and at the mercy of the vagaries of track matching, however, a little treble boost (to recover losses due to the reactive input impedance of the network) is not out of place. R15 provides this by bridging the top half of VR1, shifting the centre point slightly in the opposite direction. If you find that in practice this is not necessary, then it can be removed. (In the Mullard 'two-valve' circuit the network has a 47k $\Omega$  resistor on the other side, presumably to cut the treble.) A graph showing the response of the bass and treble controls at both maximum and minimum settings is shown in Figure 3. In the 'flat' position response is effectively flat over the whole audio band dropping by approximately 2dB at 100kHz. More detailed specifications are listed in Table 1.

The reactive input impedance of the network can be a bit of a problem for the driving valve, becoming a considerable load at high frequencies, where the impedances of all the capacitors are at their lowest. The Mullard circuit employed an EF86 to drive its network, but, as mentioned in Part 1, it was not found ideal, as this valve typically has a high output impedance, and is not well matched to the task. Gain, such as can be provided by a pentode, is required, however, since to achieve the necessary boost levels for both treble and bass, a high signal level has to be put into the network in the first place if only to ensure unity gain throughput in the 'flat' position.

The device that was finally chosen, and which I have had experience with in the past, is the ECF82 triode pentode. The pentode section is employed to drive the network, while the triode section forms the output buffer.

The ECF82 neatly combines a high current, wide band pentode with an even higher current triode in one B9A envelope. These are basically video valves, and the ECF82 was once commonly used in vision amplifiers and other forms of video processing in television broadcast applications. It has even been employed as the front-end for AM receivers, using the pentode as the mixer and the triode

as the local oscillator. It is a very capable device in the AF range and is still used in at least one design of a modern Hi-Fi valve power amplifier.

In the Tone Control Module the pentode, V1a (Figure 2), provides 29dB of flat gain from the line level signal at pin P4, raising it to an amplitude sufficient for the tone controls to work with. An anode load resistor of 15k $\Omega$  (R4) maintains a current of 6mA, while the screen grid current is slightly starved, producing a screen grid voltage of 100V DC compared with the anode's 175V DC. This has the effect of boosting the gain of the valve. Some local negative feedback is provided by cathode resistor R6 not being decoupled to signal ground. The gain of this stage limits line input level at around 3V peak; overload distortion becomes apparent at approximately 4V peak.

Some HF roll-off is apparent at the anode, which can be graphically shown by an oscilloscope while monitoring a squarewave at this point. This is caused by the combined reactive impedances of the capacitors in the network loading the valve in the HF range. However, the 'scope will also show the squarewave shape being recovered at the output of the network, which has absorbed the HF energy, not wasted it.

Both left and right channel pentode stages are supplied with HT via R1 and decoupled by C1 and C2, C1 removing any high-frequency components on the supply line, but each screen grid is decoupled

separately by C8 & 9, and C108 & 109.

The common output of the tone control network goes to the dual ganged balance control, VR3, which has reverse connected tracks to achieve the left/right channel boost/cut action. R11 (and R111) is added to limit the degree of signal boost when one side is increased over the other, which might cause overloading problems for amplifiers further along the chain. It also recovers some of the 6dB loss of the balance control when in the 'centre' position. VR3 is 1M $\Omega$ , providing absolute minimum loading of the tone control network.

At the output of VR3, overall 'flat' gain is 6dB, all due to the gain of V1a. The high output impedance, at this point, is unsuitable for long lengths of screened lead and whatever may be the input impedance of the power amplifier, so a common cathode, non-inverting buffer is added, V1b. Cathode bias is properly derived from a series resistor chain, R9 and R10. The bulk of the voltage drop, which allows a sizeable signal voltage swing, is across R10 and is derived from an anode current of 10mA. This leaves R9 to develop the actual cathode bias of 2V, with the lower end communicated to the signal grid via the grid leak resistor R8. Both the pentode and triode of the ECF82 should have fairly high anode currents to ensure that each is maintained in the linear region of its operating curve.

As with the Phono Module's line driver, the input impedance of the

#### Test conditions:

Volume setting:	Maximum
Bass setting:	Flat
Treble setting:	Flat
Balance setting:	Centre
Input signal level:	0dBm
Input source impedance:	600 $\Omega$ via 1.5m screened lead
HT supply:	320V + 100mV ripple @ 100Hz
Input impedance:	1M $\Omega$
Output impedance:	< 10k $\Omega$
Overall gain:	6dB
Frequency response:	20Hz to 20kHz $\pm$ 0.5dB, -2dB @ 100kHz
Output noise:	< 200 $\mu$ V peak maximum
Signal to noise ratio:	60dB for 100mV input level
Maximum permissible input level before onset of clipping:	6V Pk-to-Pk
Maximum bass boost:	+16dB @ 20Hz
Maximum bass cut:	-12dB @ 20Hz
Maximum treble boost:	+1dB @ 20kHz
Maximum treble cut:	-19dB @ 20kHz
Maximum balance offset extra gain:	+3dB
Minimum balance offset gain:	Zero output
Pentode stage gain:	29dB, constant
Triode stage gain:	0dB
Tone control network type:	Passive Baxandall
Power requirements:	
HT supply:	300 to 350V DC
HT current consumption:	30 to 40mA
Heater supply:	6.3V AC @ 900mA

**Table 1. Tone Control Module specification.**

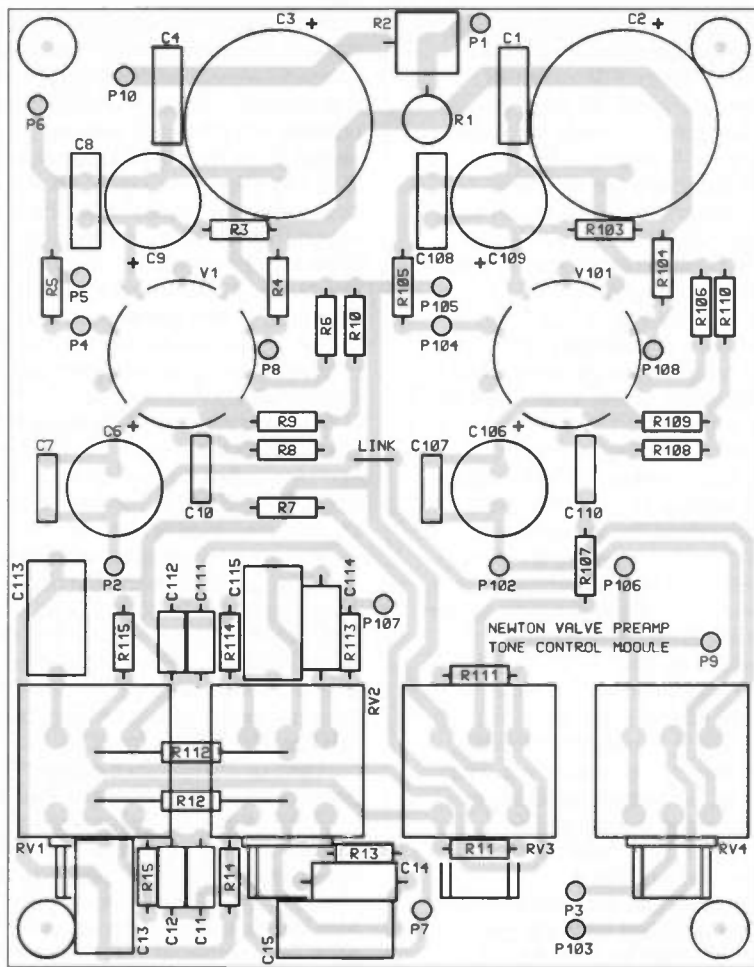

Figure 4. PCB legend.

stage is not determined by the value of R8 alone. The action of the cathode following the signal grid results in an impedance multiplying effect for R8, so that instead of being 680kΩ the actual input impedance is nearer to 10MΩ. The small value of the polycarbonate capacitor, C10, which AC couples the input, is more than ample for this.

AC coupling at the output is via C6, a high voltage electrolytic. Generally electrolytics of this type are not a good choice for an audio signal path, but a high value is necessary to ensure good bass response into a (comparatively) low impedance load. HF performance is assured, however, by C7. Alternatively you might replace these with an equivalent value made up from audio grade polypropylene types, but these are very large and will have to be connected off the board with the space to accommodate them.

R7, in series with C10 and the signal grid, is a 'grid-stopper' (to use the vernacular), and serves to limit the bandwidth of the buffer stage. It should not be omitted, else the triode will go into common grid mode whenever the balance control is reduced to minimum, connecting the input directly to OV. Where's the harm in that, you may ask? None, except that in this condition the triode suddenly becomes a very capable

RF noise generator whose output range extends into the UHF. While this may be very useful in different circumstances, it is not desirable here! This is a form of instability, prevented by R7.

Finally, a stereo ganged logarithmic volume control, VR4, connects across the output. The 10kΩ track is usually of low enough impedance to drive most types of screened lead with no discernible loss in HF performance. Alternatively the buffer output is directly available at P2 (P102). You may use this if the power amplifier has its own volume control, or if you want to mount the preamplifier's volume control somewhere else on the front panel and fitted with a large knob, as some people prefer. In this case VR4, normally mounted on the PCB, is located somewhere else and hard wired to P2, P102 and P106 (the common signal ground). Due to the low impedances here screened lead is not necessary.

If no volume control at all is used (VR4 omitted), you MUST substitute the VR4 positions on the PCB with 10kΩ resistors, to ensure that the output side of C6 is referenced to OV DC at all times. This is so that the buffer does not deliver a hefty pulse down the line to the rest of the system as C6 charges up! One concern here was the danger of inflicting any solid-state circuits

that are connected to the output of the buffer to high-voltage pulses on switching on or off. In practice though the transition is very slow, both at warm-up and switch off, and peak deviations are rarely more than 2 or 3V, PROVIDED VR4 or equivalent resistors are fitted.

## Tone Control Module Construction

Refer to Figure 4 for the PCB legend. The PCB is a simple single-sided glass fibre type, and is strong enough to carry all the components including the valves in their holders. Note that it includes a solder resist layer on the track side, which will also help to minimise current 'creepage' across the surface between points of high potential difference when in use. Once the PCB has been assembled and tested, and is known to operate correctly and be ready for use, you are advised to apply conformal coating to the finished solder joints to augment this protection.

Begin construction by inserting and soldering the 27 PCB pins at P1 to P6, P101 to P106, and also at the two valve holder positions. In each case, insert and solder nine pins from the track side into the outer of the two concentric rings of holes for each valve holder; that with the smaller holes. Next, carefully insert the B9A valve holder into the board from the track side, into the inner ring (larger holes) until it is fully seated flat on the PCB. Each pin of the valve holder is then bound to its corresponding PCB pin with a turn of bared bell wire and soldered to it (don't be sparing with the solder). If the wire insists on slipping off the valve holder pin then bend the pin inward to form a hook. The wire loop must be soldered to both pins. A wire wrapping pen may be useful here if you are in the habit of using one. Attach and solder a pair of opposing pins first and double-check that the valve holder remains true before continuing.

Some 'spare' holes will be left over, P7 to P9. These do not have PCB pins. (Table 2 lists the functions of the various pins and links.)

Next begin installing components by fitting the smallest first, working up to the largest. With the aid of the parts list and circuit of Figure 2, identify, fit and solder all the small resistors. An ohmmeter will aid identification of values if you are unsure of the colour codes. Using an offcut of resistor lead, insert and solder the short wire link at the position on the PCB marked 'LINK'. Then fit and solder all the small polycarbonate capacitors C7, C10, C107, C110. Fit and solder the polystyrene capacitors C11 to C15, and C111 to C115. CAUTION: these components can be damaged by overheating.

Install the ceramic disc capacitors C1, C4, C8 and C108. Fit the 2W

Pin No.	Function	Channel
P1	+HT supply	Common
P2	Buffered output direct	Left
P3	Volume control output	Left
P4	Tone control main input	Left
P5	Input screen OV	Left
P6	Supply OVE from earth bus (PSU)	Common
P101	+HT supply	Common
P102	Buffered output direct	Right
P103	Volume control output	Right
P104	Tone control main input	Right
P105	Input screen OV	Right
P106	Signal OV for outputs and buffer	Common
P7	C5 to tone control network	Left
P8	V1 pin 6 to C5	Left
P107	C105 to tone control network	Right
P108	V101 pin 6 to C105	Right
P9	OVE for potentiometer screening	Common
P10	Buffer HT supply to valve holders	Common
V1 pins 4,5:	6.3V AC heater	Left
V101 pins 4,5:	6.3V AC heater	Right

**Table 2. Tone Control PCB pin designations.**

metal film resistor R1. Note that this stands on end to conserve space on the PCB and to aid cooling in use. Bend one lead to lay flat against the body of the resistor, and insert the component vertically orienting it to the PCB legend. Similarly mount R2, the white ceramic encapsulated 3W wirewound resistor according to

the legend, except that in this case include the ferrite bead, by sliding it over the lower wire that will be inserted completely through the PCB, so that the component is raised off the surface of the board by the thickness of the bead when in place. R2 can get quite hot and the bead, acting as a spacer, protects the PCB.

The lead from the top end of R2 may need to be extended by adding tinned copper wire (twist together and solder) to reach the other PCB hole. Install all the small radial electrolytic capacitors, taking care to orientate them correctly according to the PCB legend. In each case the negative lead is identified by a stripe and (-) symbol on the body. Insert the indicated wire lead into the hole OPPOSITE that marked as (+) on the legend. Insert and solder the four small 47µF 50V capacitors into the PCB, followed by the four 10µF 450V types. Make sure that all the electrolytics are seated fully onto the PCB.

At this stage check the quality of the work before installing C2 and C3, and the potentiometers, which will make it difficult to access smaller components nearby, due to their size. Look for bad solder joints, solder bridges and misplaced components and rectify where necessary. It is still possible to double-check resistor values, as there are hardly any leakage paths to upset ohmmeter readings. Now install C2 and C3.

If you know the exact final length required for each potentiometer control spindle you can cut them back with a junior hacksaw. Otherwise you can leave this operation until the PCB is installed in the chassis, it is not difficult. The nuts and lockwashers are not necessary and can be discarded. Identify one of the 220k logarithmic potentiometers and install it in the RV1 position, and then the other 220k potentiometer in the RV2 position. Note that these physically hide some small components nearby, especially R12 & 112, although there is plenty of space underneath the pots, DO

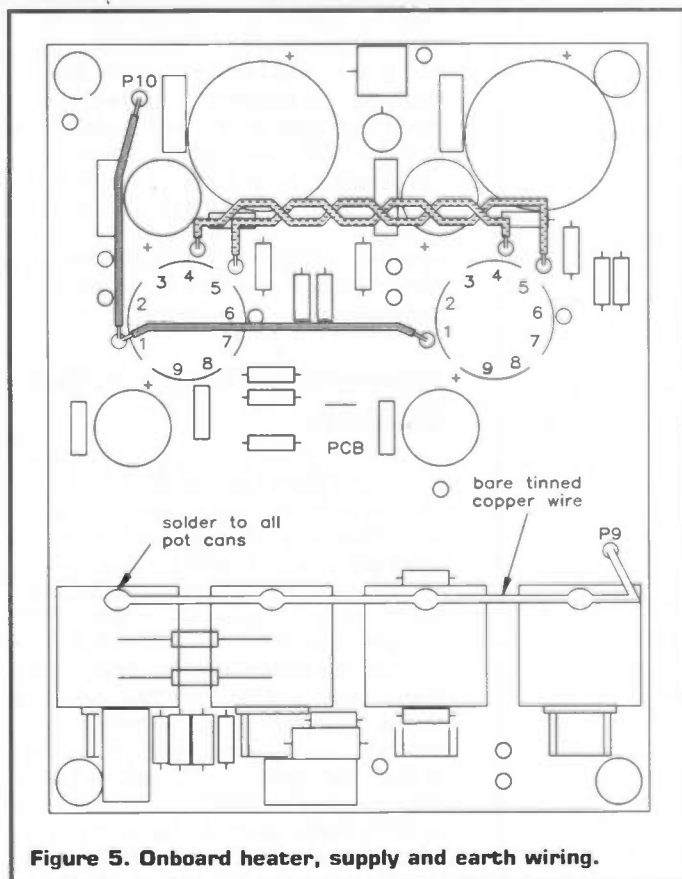

**Figure 5. Onboard heater, supply and earth wiring.**

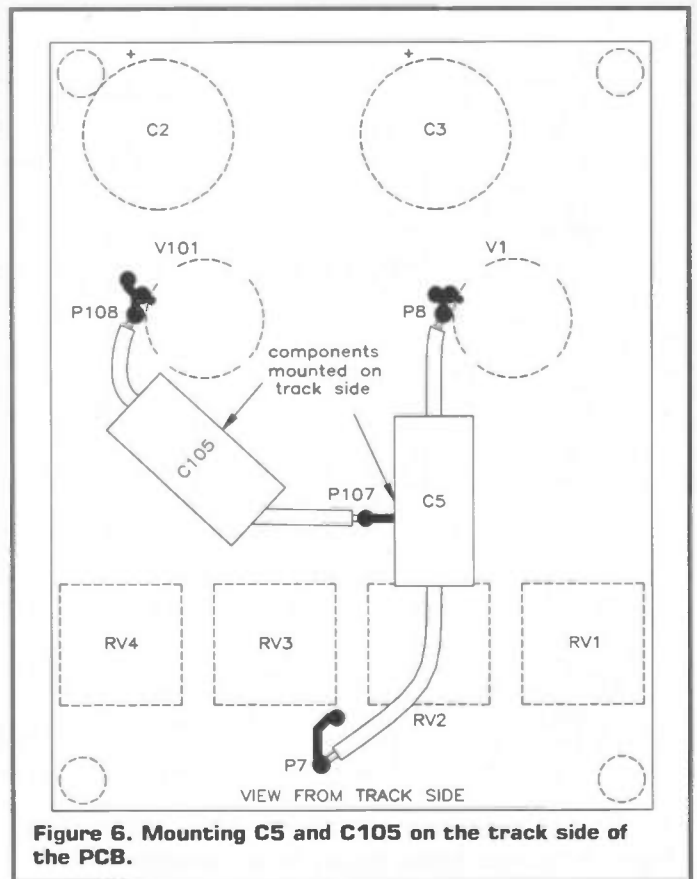

**Figure 6. Mounting C5 and C105 on the track side of the PCB.**

ensure that the pots are seated fully on the board or the shafts will be off-centre and not line up.

Similarly fit the 1M lin. pot at RV3, and the 10k logarithmic pot at RV4. Next it is necessary to connect the metal bodies of all four potentiometers to OV. This is to provide screening of the internal tracks and wipers, which normally occurs if the pots are mounted in earthed metalwork. However, because in this case they are not physically attached to any metalwork, unwanted noise pick-up can result, aggravated by the bodies themselves acting as 'aerials'. Using tinned copper wire or stripped bell wire, join all four cans together with a single length, with a solder joint at top rear of each can, with one end terminated at P9 on the PCB (OV), see Figure 5. This could be awkward to do unless you have a powerful soldering iron (25W minimum), but the screens are normally plated steel and take solder readily.

With two lengths of black bell wire tightly twisted together, join V1 pin 4 to V101 pin 4, and V1 pin 5 to V101 pin 5, wrapping them around the PCB pins, see Figure 5. Pin numbering for all the valves is clockwise as viewed from the component side of the board, and always with pin 9 at the bottom.

**Amplifier chassis prepared for assembly.**

The rings of PCB pins make all valve connections accessible. Using orange bell wire, join together V1 pin 1 to V101 pin 1, allowing some slack to avoid the other valve holder PCB pins. Also connect V1 pin 1 to P10 near C4. This provides HT for the output buffers, see Table 2.

Due to their physical size, it is more convenient, if a little unconventional,

for the large yellow polypropylene capacitors C5 and C105 to be mounted on the track side, as illustrated in Figure 6. The way in which the PCB is mounted in the chassis allows plenty of room. Cover exposed lengths of lead with sleeving stripped from 6A power connection wire or mains cable. C5 connects between P7 and P8, while C105 is between P107 and P108, ON THE TRACK SIDE. The leads are pushed through the holes, bent over and cropped as usual, but soldered on the track side where they enter each hole. See Table 2 for PCB and hole designations.

Finally prepare the four rubber couplings. These will be used as mounting pillars for the PCB. Remove the spring washers from each, replace the nuts and tighten carefully, to avoid splitting the rubber. The final distance will be approximately 17mm. Using the extra M4 nuts provided in the kit, attach each coupling to the PCB mounting holes on the track side. In use the PCB hangs upside down in the chassis, while the two valves will protrude through holes in the chassis top panel. Temporarily set aside the assembled PCB while you prepare the chassis, if you have not already done so.

## Preparing the Amplifier Chassis

An 8 x 6 x 2 1/2 in. chassis is supplied with the Phono Module Kit (LT76H), and instructions for preparing it for both Phono and Tone Control PCBs were given last month. They are repeated here if for some reason you do not have the information handy. You will need Box AC86 (XB68Y). Drilling and cutting details for the chassis for the amplifier section is shown in Figure 7. The removable lid is the bottom of the box, not the top. The 3/8 in. holes in the rear panel are for gold-plated phono sockets (JZ05F, Black and JZ06G, Red), which come with insulating shoulder washers, since the OV side of the sockets must be

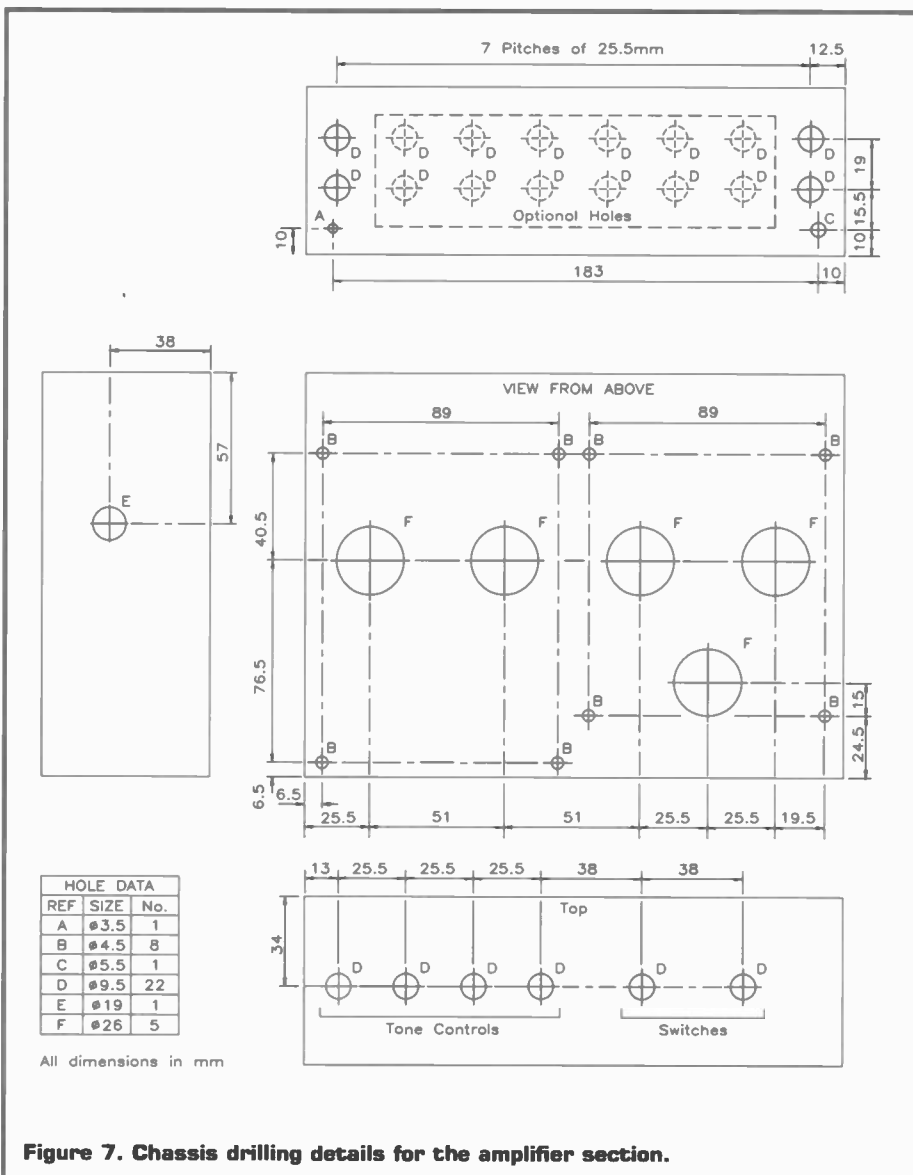

**Figure 7. Chassis drilling details for the amplifier section.**

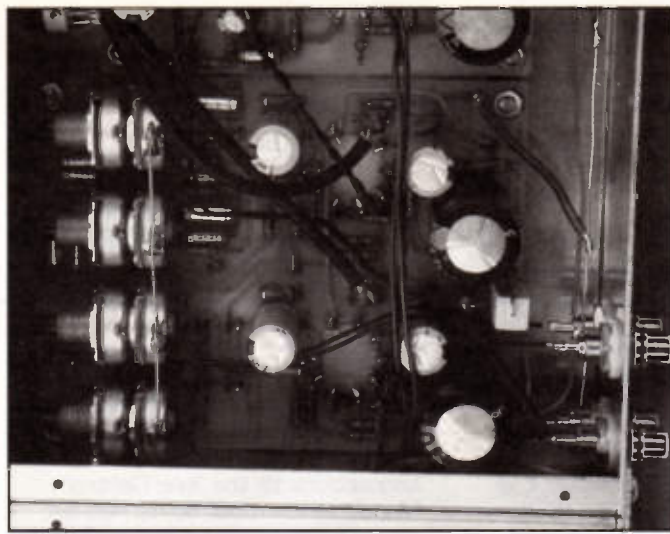

**Tone Control PCB wired up in the chassis.**

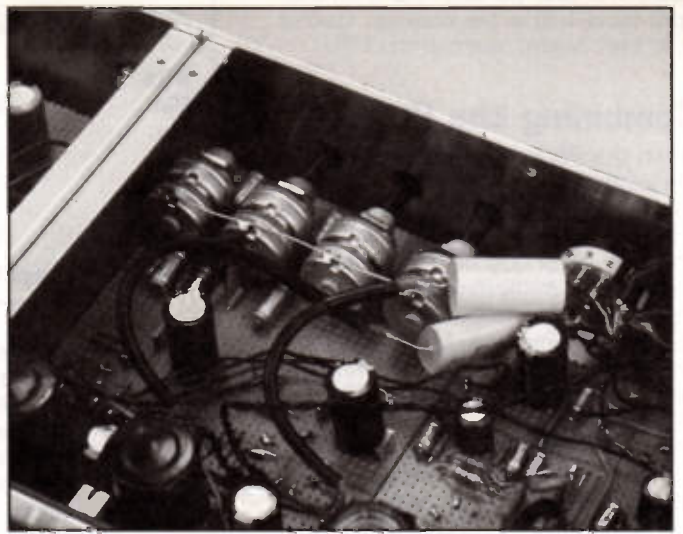

**Prototype Tone Control module in the chassis.**

isolated from the chassis. Alternatively you might use an 8-way phono socket on a paxolin panel (with 4 x M3 fixing holes), for which a rectangular cut-out is required. Up to 8 pairs of single phono sockets can be accommodated on the rear panel, or two sets of 8-way units end-to-end. The rear panel must include an M3 clearance hole for a fixing point for the earth strap from the PSU module. It can also include a earthing terminal post for a record deck, where a separate earth lead ties the deck's chassis to the amplifier earth, letting

the signal screens free for signal earth return only (this is common practice).

The left-hand side panel has a  $\frac{3}{4}$ in. diameter hole whose position corresponds with the grommet on the PSU chassis, allowing the two chassis to be joined end to end.

The number of  $\frac{3}{8}$ in. holes in the front panel depends on whether you are going to include the Phono Module, and assumes that you are also going to use multi-way rotary switches. Note that, for the Tone Control Module to be used, the row of holes

is 34mm from the top of the chassis; this is the exact distance to the Tone Control spindles when the module is mounted in position on its rubber couplings. In this case they are all 1in. apart starting  $\frac{1}{2}$ in. from the left hand side.

If both modules are installed, there is just enough space (in front of the Phono PCB) for two rotary switches in the opposite half of the front panel. The top panel has 1in. diameter holes, preferably made with a round sheet metal punch, to clear the valve envelopes when the PCBs are in

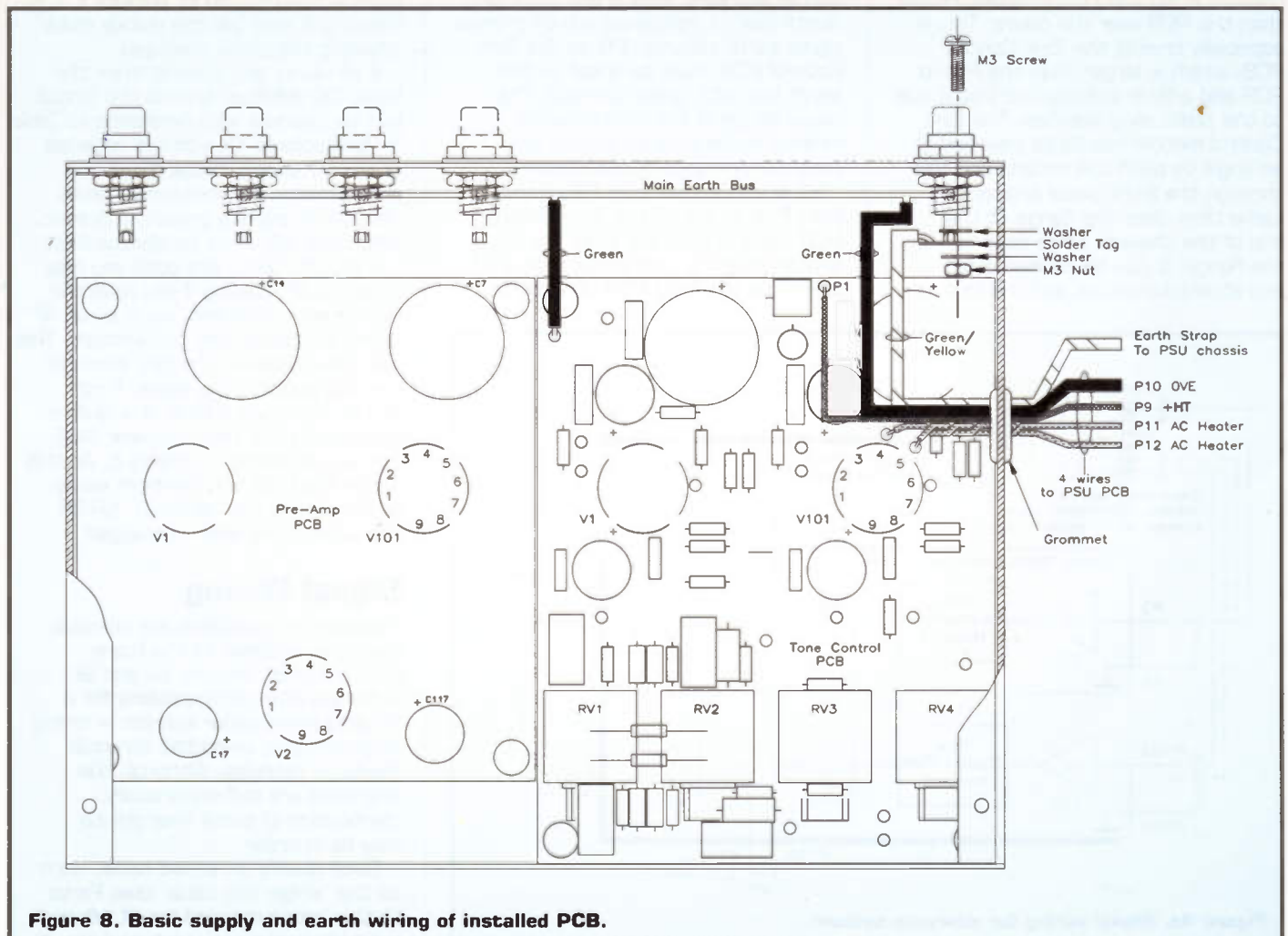

**Figure 8. Basic supply and earth wiring of installed PCB.**

place. The Tone Control PCB is on the right-hand side of the chassis, looking at it from below, nearest the PSU.

## Combining the Chassis

When the PSU and amplifier chassis are joined end to end, the complete assembly becomes 16in. wide which is a typical width for most stereo items. The rear join should be made with a rectangle of aluminium plate 2½in. high x 1in. wide with a hole at each corner for fixing using M4 hardware or pop rivets. Ideally the front should have a covering front panel cut from 16swg aluminium sheet. All frontal holes will be duplicated in this panel. It can be any height you like (the prototype is 4½in. high to fill a gap between two shelves). The separate front panel is rigidly attached to both chassis by M3 hardware in each corner of the front panels of both chassis. The panel can be painted, and the countersunk screws allow a stick on design to be attached, completely hiding the fixings.

## Installing the Tone Control PCB

The four flexible rubber couplings that are used as mounting pillars for the PCB, should, as already described, be fitted onto the PCB first. Experience has indicated that it is much easier to insert the threaded ends of the pillars through the chassis when the PCB is fitted, rather than the PCB over the pillars. This is especially true of the Tone Control PCB, which is larger than the Phono PCB and a little awkward to install due to the protruding spindles. The Tone Control module has to be inserted at an angle to push the control spindles through the front panel and at the same time clear the flange at the end of the chassis. Once clear of the flange, it can be pushed down and straightened up, and the four

HT+ = 320V; junction of R1, C2, R3 & R4 = 250V

V1a Pin No.	Volts	V1b Pin No.	Volts	
7	1.5	8	55	cathode
2	0	9	53	signal grid
3	100	-	-	screen grid
6	175	1	225	anode

Table 3. Voltage test points.

mounting studs pushed through the top panel. Because of this, it is impossible to install or remove the Tone Control Module while the Phono Module is in place, as it is in the way. Since the mountings are flexible, it is a simple matter to 'hook' the studs through the chassis panel with a thin-bladed screwdriver if they do not go first time. Secure all four studs with the four M4 nuts and DO NOT overtighten, or there is a risk of damage to the rubber. Rotary switches are fitted only after the Phono Module is installed.

## Power Supply Wiring

Figure 8 shows the power supply, earth and heater wiring. As described last month, the screen tags of all input and output sockets (EXCEPT 'Phono') are linked together by a length of tinned copper wire, connected at one end to P10 (OV) on the PCB using green 6A power connection wire. This is the common 'earth bus', a reference point for most signal earth returns. P6 on the Tone Control PCB must be linked to the earth bus with green 6A wire. The heavy gauge of the wire ensures minimal resistance to ground for best performance of the system.

HT is connected from P9 on the PSU PCB to P1 on the Tone Control PCB using orange bell wire. The AC heater supply is connected from P11 & P12 on the PSU PCB, directly to

V101 pins 4 & 5, using a tightly twisted pair of black bell wires (see also Table 2). All these connections are via the grommet in the PSU chassis. These are the essential basic connections to the Tone Control Module which must be carried out as described, with no deviations.

## Testing the Tone Control Module

As this point the module can be fired up and initially tested for correct operation. Plug in the two ECFB2 valves and turn the chassis upside down and support it to keep the valves clear of the work surface. Reconnect the Euro mains lead and switch on. In a short time you should be able to establish that the heaters are glowing. If not, perform the complete SIDE procedure and examine the heater supply wiring for errors. WARNING: Never heat valve holder pins with a soldering iron while a valve is still plugged in; remove it first (heating a valve pin too quickly risks cracking the glass envelope).

If all valves are glowing, then the basic DC voltages around the circuit can be checked with reference to Table 3 (Test points). Due to the vagaries of the HT supply, these levels are approximate, but measured values should not deviate greatly, a drastic difference will show an obvious fault.

If the DC tests are good you may go on to AC testing if you have the necessary equipment, such as an AF signal generator and oscilloscope. This will show whether the two identical circuits perform the same, if not, one of them has a fault. If a fault is found carry out the complete SIDE procedure before rectifying it. At this stage the PCB may be more easily disconnected and removed, AFTER the valves have been unplugged!

## Signal Wiring

Various configurations are possible, from the simplest to the more sophisticated. Figures 9a and 9b illustrate two configurations for a finished preamplifier system in wiring diagram form, using the versatile 'Newton' modules. Although the diagrams are self-explanatory, clarification of some finer points may be in order:

Good quality screened cable, such as the 'single mic cable' (see Parts List) is recommended for all left and right channel signal input sockets. It

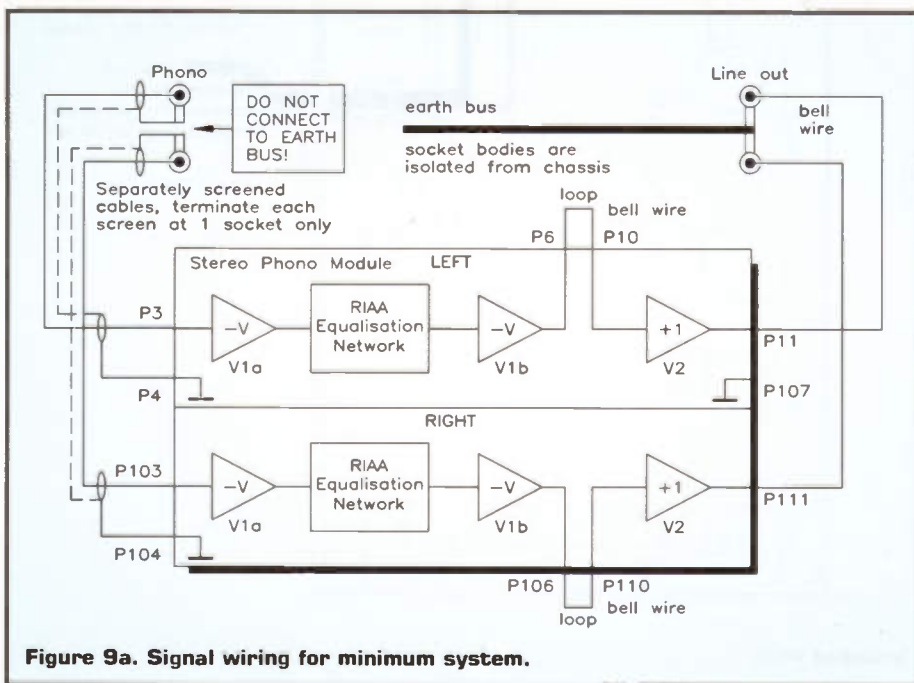

Figure 9a. Signal wiring for minimum system.

may be possible to employ multi-core screened cable, sharing a common outer screen, to make life simpler where many inputs to a selector switch arrangement are desired, but ONLY IF it is known that there is not likely to be two or more signals coming in simultaneously, or crosstalk between the conductors may result. This is because of the high input impedance of both the line drivers (Phono Module) and the Tone Control module.

For each left and right channel 'phono' input, the body of the socket connects to the equivalent input OV pin on the Phono PCB ONLY via the cable screen. The cable becomes merely an extension of the record player's twin signal leads; the socket bodies must not be connected to the earth bus, or linked together. A 'hum-loop' will most definitely be the result in either case.

Where extra line level inputs are desired (Figure 9b), the cable screens are connected to the earth bus ONLY. At the other ends, cut back the screen braid and wrap with insulation tape, so that only the centre

conductors are free to connect to the relevant pins on the selector switch. Signal ground for each PCB is already referenced to the earth bus, so connecting these screens to OV at both ends only causes hum-loops. Similarly, the screened leads linking the selector (or line switch, Figure 9b) moving contacts to the Tone Control input have their screens earthed at the Tone Control PCB only. In practice this makes wiring in the switching area very much easier as only signal paths are involved.

In Figure 9b, 6-way rotary ('wave-change' type) switches are shown. Although you can use alternative switches, this type is, on the whole, very reliable, and probably second only to good quality wafer switches. This switch (FF74R) has 12 fixed contact pins and 2 moving contact pins, organised into 2 x 6-way, with an adjustable stop from 2-way to 6-way. The fixed contacts are numbered on the back, anticlockwise from '1' to '12', while the moving contacts are 'A' and 'C' ('B' and 'D' not used). 'A' connects to '1' to '6', while 'C' simultaneously connects to '7'

to '12', hence if 'A' is set to '2' then 'C' is set to '8', and so on. For wiring up a stereo switching arrangement, it is simple to remember that this layout ensures that each pair of fixed contacts for left and right inputs are exactly diametrically opposite one another.

When the switch is fitted it might be a good idea to introduce a very short squirt of WD40 through one of the four holes in the front of the plastic switch body (after removing the nut and washer). This ensures smooth operation and will keep oxides at bay for a reasonable time.

Line input impedance is about 1M $\Omega$  if the Tone Control Module is included, even when it shares the selector with the line driver input. This is because the line driver has a much higher impedance. In Figure 9b, selector input impedance will rise to nearly 10M $\Omega$  where the 'Line' switch is set to a different function, removing the Tone Control impedance from the selector line. In this example, 'Line out' will always be the signal currently selected from one of the programme inputs (Phono, CD, Tuner, etc.), buffered with an output impedance of 1k $\Omega$ . 'Line out' and 'Line in' allow a 3-head tape recorder with monitoring facility, or a graphic equaliser, to be linked into the system.

Tape monitoring to the line function switch is shown taken from the 'Tape' input sockets via screened lead, in practice it is easier to link across to the relevant pins on the nearby selector switch with bell wire. In fact all connections between both switches and the Phono and line driver PCB can be made with plain bell wire, even though the line impedance can be high, as the connections are very short.

The long-wire connections between the line driver outputs, Tone Control outputs and the output sockets are again bell wire, as the output impedances are low.

## Conclusion

Figures 9a and 9b illustrate the basic configuration; they can be configured in different ways to create a customised preamplifier. My own version (the prototype in the photos) follows the pattern of Figure 9b, but having tape input and monitoring for two recorders, and two unswitched and four switched Euro mains outlets for six other components of the stereo system. John is using a Phono and line driver Module preamp in one system, and a line level only, multi-way switching variation with two pairs of line drivers in another. If you play CDs more often than records, you might consider adding a miniature toggle switch to the rear panel of the PSU chassis, to turn off the phono preamp DC heater and preserve the life of the valves while they are not being used.

I think we all agree that the valve technology resurrection has coincided nicely with the increased availability of compact discs and players, and valves generally make the most of them. They

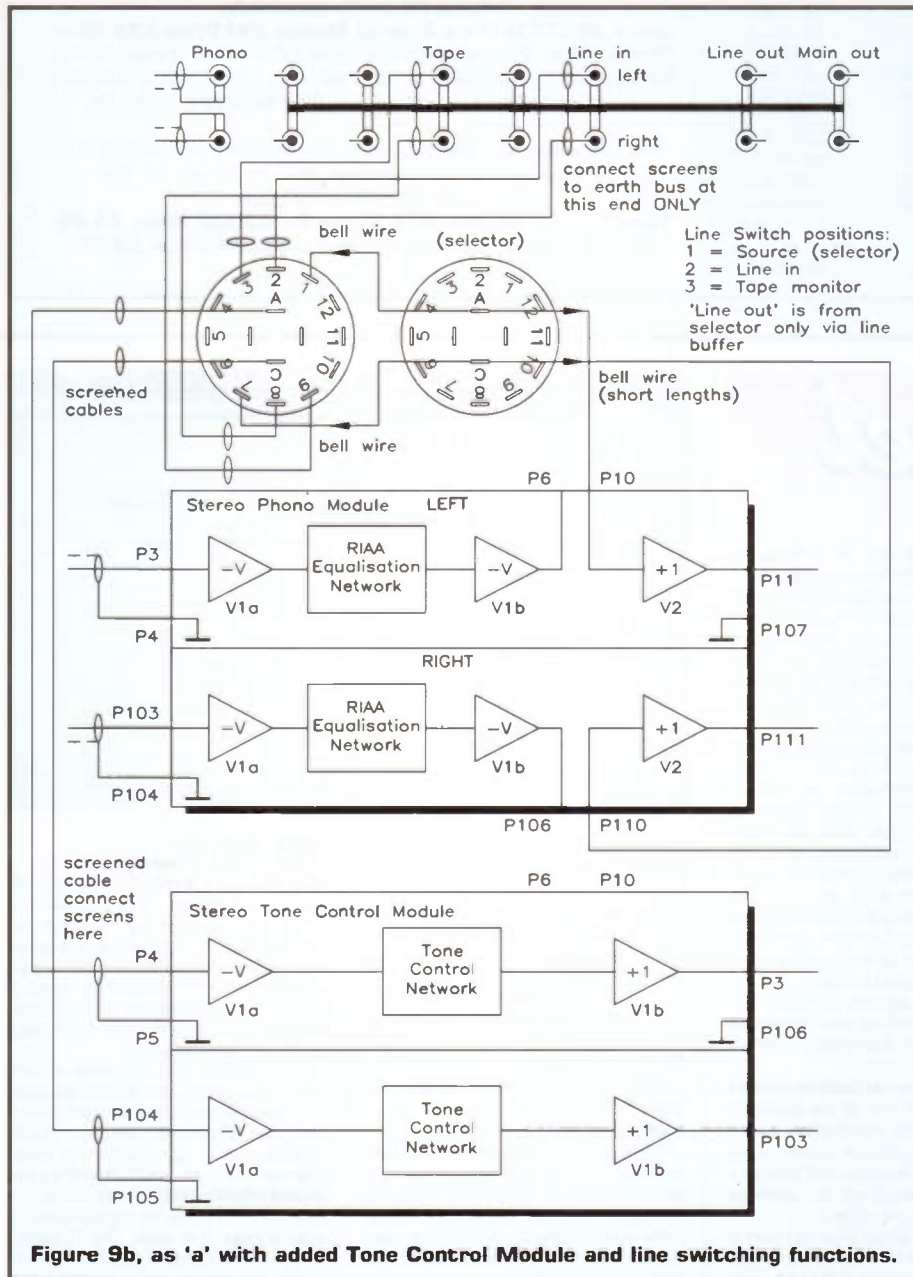

Figure 9b, as 'a' with added Tone Control Module and line switching functions.

are in their element, as it were, given the CD's high output and wide dynamics. This is very interesting, because it just goes to show how much the early valve equipment was compromised not only by some inferior electrical components (by modern standards), but also by the quality of the transducers of the time, all contributing to even less perfect

recordings to be replayed. CDs are an improvement out of all proportion and don't seem to faze the modern valve amplifiers at all, in fact they have given them a new lease of life. An interesting demonstration CD is now available from Maplin (AY00A), which includes test tones, an organ recital, a drum solo and various far-out sound effects, including a jet fighter flypast!

What advantages are offered by the passive RIAA equalisation is still a moot point, though I will admit to hearing at least one extra instrument in a record I played recently. The record is over ten years old, but I've never noticed this detail before! Generally records play really well and it is nice to have an output level on a par with other sources, such as CD. **E**

## NEWTON VALVE PREAMP TONE CONTROL MODULE PARTS LIST

RESISTORS: All 0.6W 1% Metal Film (Unless specified)

R1	2k2 2W 1% Metal Film	1	(D2K2)
R2	4k7 3W Wirewound	1	(W4K7)
R3,103	100k	2	(M100K)
R4,104	15k	2	(M15K)
R5,105	1M	2	(M1M)
R6,106	150Ω	2	(M150R)
R7,107	5k1	2	(M5K1)
R8,108	680k	2	(M680K)
R9,109	220Ω	2	(M220R)
R10,110	4k7	2	(M4K7)
R11,111	150k	2	(M150K)
R12,11	239k	2	(M39K)
R13,11	368k	2	(M68K)
R14,11	46k8	2	(M6K8)
R15,11	5470k	2	(M470K)
RV1	2 Dual Pot Log 220k	2	(FX13P)
RV3	Dual Pot Lin 1M	1	(FW91Y)
RV4	Dual Pot Log 10k	1	(FX09K)

### CAPACITORS

C1,4,8,10B	10nF HV Ceramic	4	(BX15R)
C2,3	47μF 450V PC Electrolytic	2	(JL18U)
C5,105	100nF Polypropylene	2	(FA21X)
C6,9,106,109	10μF 450V PC Electrolytic	4	(JL11M)
C7,10,107,110	10nF Poly Layer	4	(WW29G)
C11,111	330pF 1% Polystyrene	2	(BX51F)
C12,112	560pF 1% Polystyrene	2	(BX54J)
C13,113	8n2F 1% Polystyrene	2	(BX85G)
C14,114	2n2F 1% Polystyrene	2	(BX60Q)
C15,115	22nF 1% Polystyrene	2	(BX87U)

### VALVES

V1,101	ECF82 HF Triode Pentode	2	(ST30H)
--------	-------------------------	---	---------

### MISCELLANEDUS

1mm PCB Pins	1 Pkt	(FL24B)
PCB B9A Valve Base	2	(CR32K)
Rubber Coupling	4	(FB98G)
Ferrite Beads	1 Pkt	(LB62S)
M4 Steel Nut	1 Pkt	(J060Q)
Single Mic Cable	1m	(XR16S)
PCB	1	(GJ00A)
Instruction Leaflet	1	(XV12N)
Constructors' Guide	1	(XH79L)

### OPTIONAL (Not in Kit)

15mm Solid Aly Knob K8A	4	(YR64U)
-------------------------	---	---------

The Maplin 'Get-You-Working' Service is available for this project, see Constructors' Guide or current Maplin Catalogue for details.

**The above items (excluding Optional) are available as a kit, which offers a saving over buying the parts separately.**

**Order As LT77J (Tone Control Module Kit) Price £39.99** Please Note: Where 'package' quantities are stated in the Parts List (e.g. packet, strip, reel, etc.), the exact quantity required to build the project will be supplied in the kit.

The following new items (which are included in the kit) are also available separately but are not shown in the 1995 Maplin Catalogue.

**Tone Control Module PCB Order As GJ00A Price £4.99**  
**ECF82 Triode Pentode Order As ST30H Price £6.99**

# @Internet

Here at Maplin, we can remember back (well, almost) to the dawn of computing let alone the beginnings of the Internet. Back in those days if you didn't know your peek from your poke, or your logic 0 from your hex, you weren't a computer enthusiast at all. Of course, all this was (and still is if you talk to some computer-orientated individuals) just irrelevant jargon. Jargon (to para - somebody else's - phrase) is that which is used by those in the know, to keep those out of the know still out of the know. There is, of course, no need for jargon in any technical specialisation. However, it exists and no more so than in the use of the Internet - but one of the aims of this column is to cut it all down to size.

In your World Wide Web browser you'll have come across the command *Open URL*. It's this command which you use to gain access to sites on the Web (but you can also use it to get to Gopher and FTP sites). The acronym (a useful tool used by jargonisers the world over to further confuse ordinary mortals) *URL* stands for *universal resource locator*. This doesn't mean a lot in English (which is probably why the acronym is used - to hide the jargoniser's poor use of language), but basically it implies a pointer built-in to the browser to a physical computer site, which users can access. We say *implies*, however, because it doesn't necessarily have to be a single site (computers from many

physical positions can be involved). To the user though, that's how it appears.

Once the command *Open URL* is used, you type in the location of the site you want to get to, and away you go into cyberspace (oh alright, you simply connect to it over the 'phone lines - we said we were going to cut jargon down to size, didn't we?). The *URL* is really just an address which your computer enters into the system to get you to where you want to go, much like you address an envelope when you want to post a letter home to Mum. However, unlike the Royal Mail, which still has a little bit of human involvement, and which can get letters to their destinations even if the handwriting's a bit grotty, or the address is a bit wrong, the Internet is rather unforgiving if you get the *URL* even just a trifle incorrect. So be very careful when entering your required location.

Locations can be one of three main forms when entered from your World Wide Web browser. First is the Web location, in the pretty standard form:  
**http://web name.server.location.country** which should get you to the location's home page (which effectively is a contents list of what you can access at the location). Note the points and strokes - their positions (along with the spellings of the other bits) are critical.

If you know the actual page you want to get to, you can enter it at the same time you enter the *URL* at the *Open URL* com-

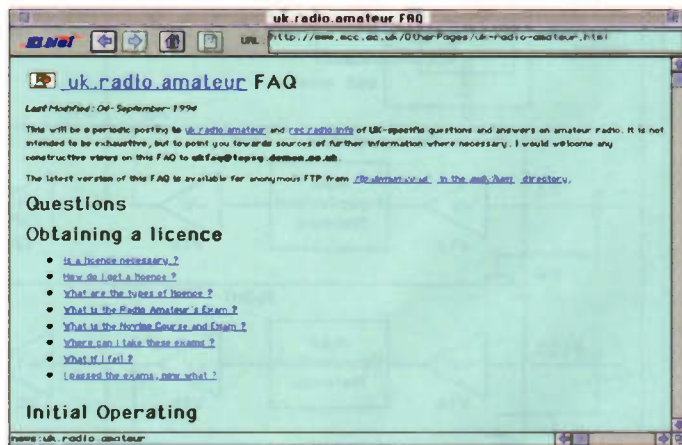

mand, and give its full location in the form:  
**http://web name.server.location.country/folder/filename.html**

which, although it's a bit of a mouthful, gets you straight to where you want to go, rather than having to step through hyperlinks off the home page to get there.

Second, you can get to FTP sites from a World Wide Web browser, by entering the *URL* in the form:  
**ftp://ftp.site.name**

Third, you can go to a gopher site with the form:  
**gopher://gopher.site**

Remember too that any decent Web browser such as Mosaic (as well as many others) can store your favourite locations in a *hotlist*. Choosing from your hotlist is far quicker (and, of course, prevents typing errors) than entering the *URL* by hand each time.

### Site Survey - the month's destination

Way out on the World Wide Web (well, just south of the M62 actually) is Manchester Computing Centre's site, which definitely deserves a mention and a closer look. It's a tidily and well-organised Web location which offers things of interest for technical and non-technical browsers alike (try the MCC home page on <http://www.mcc.ac.uk>).

For instance, radio amateurs should be pleased to see quite a lot of information available with them in mind. Either take the hyperlink *Amateur Radio Information* or go direct via <http://www.mcc.ac.uk/OtherPages/AmateurRadio.html>. From there you can get even more by hyperlinking to related pages and sites. The *Frequently Asked Questions* page is particularly informative to newcomers to amateur radio.



The introduction of the Compact Disc (CD) in 1983 brought to the consumer a new dimension in audio quality, no more tape hiss and no more turntable rumble.

The CD recording system uses a Digital-to-Analogue Converter (DAC) with 16 binary bits, encoded in Pulse Code Modulation (PCM) format, and sampled at a rate of 44.1kHz. Recording studios use 18, 20 or 24 bits sampled at 48kHz. If the digital audio data were to be recorded on to a computer's hard disk, 1 minute of stereo sound would require 10M-bytes of disk space. On CDs extra data is encoded along with the audio data, specifying track numbers, timing information etc. The binary data is read off the CD at a rate of 1.4M-bytes/s, and thus we can see that digital audio, using PCM, requires a large amount of storage space. The PCM DAC process is not discussed in detail here, see, 'Introducing Digital Audio', for a good introduction to sampling and digital audio.

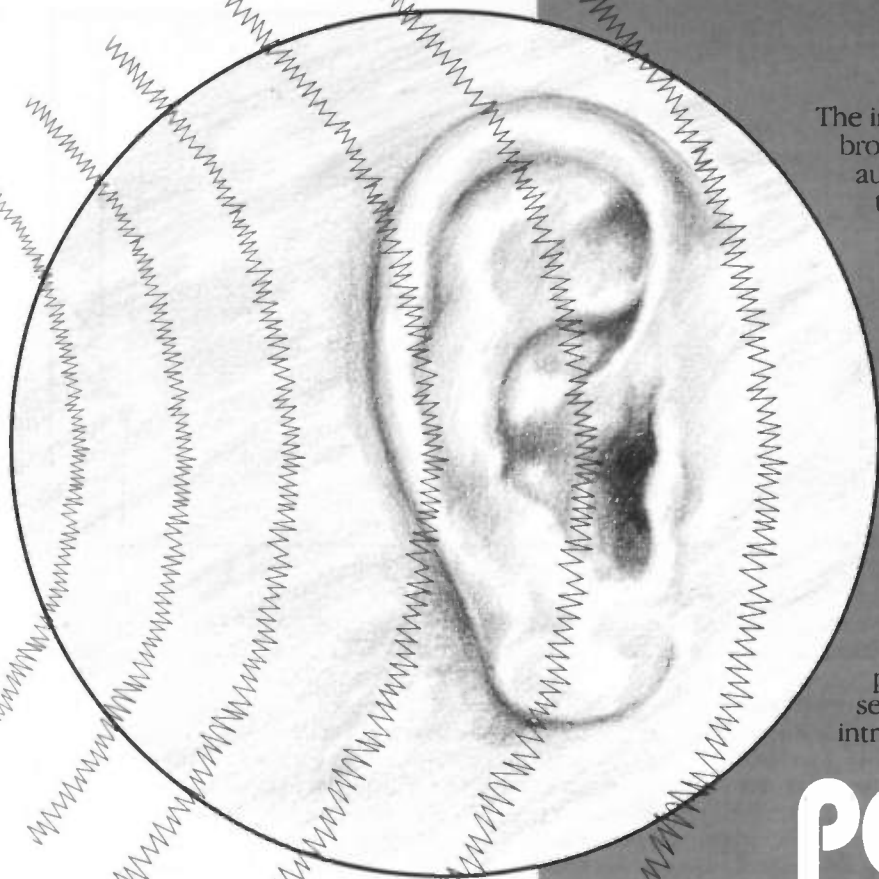

# PERCEPTUAL CODING FOR DIGITAL AUDIO

**Andrew Rimell MSc, BEng**  
**Centre for Audio Research and Engineering, University of Essex**

**T**HERE are many data compression schemes available and these are regularly used in computer systems to make optimal use of the hard disk space. In the last few years a new type of audio data reduction system has been developed. It relies on the fact that the human hearing system is non-linear and that the perceived frequency response is somewhat different from that which would be displayed on a signal analyser

(i.e. a graph of electrical voltage against frequency). This is partly due to masking effects within the hearing system (a mixture of physiological and psychological effects). The masking mechanism is described later, but here we can say that certain tones in an instantaneous snippet of music mask out other tones and so there are parts of the music that are not noticed by the brain.

The perceptual coding techniques dis-

cussed here make use of this effect by only encoding the part of the music (or whatever signal is to be recorded) that is perceived by the brain. Because not all of the music needs to be recorded less digital data is needed, thus using less recording medium.

Later, two sections describe the relevant parts of the human auditory system and where perceptual coding is being used today. Another section summarises the material discussed.

## The Perceptual Model

### The Threshold of Hearing

The absolute threshold of sound is the minimum detectable level of that sound in the absence of any other external sounds and is known as the Minimum Audible Field (MAF) as shown in Figure 1. The standard curves are found by testing a large number of people and finding the average value of detection. It should be emphasised that the standard thresholds are determined using young, healthy listeners with 'normal' hearing.

The psycho-acoustic characteristics of the human auditory system permit signals to be discarded for sounds below the MAF curve. Errors, in the form of distortion and noise, are considered to be inaudible when they are below the MAF curve or if they are masked by the presence of stronger signals.

The audible frequency range of normal hearing, spans a range of between 20Hz and 20kHz. For sounds with frequencies below

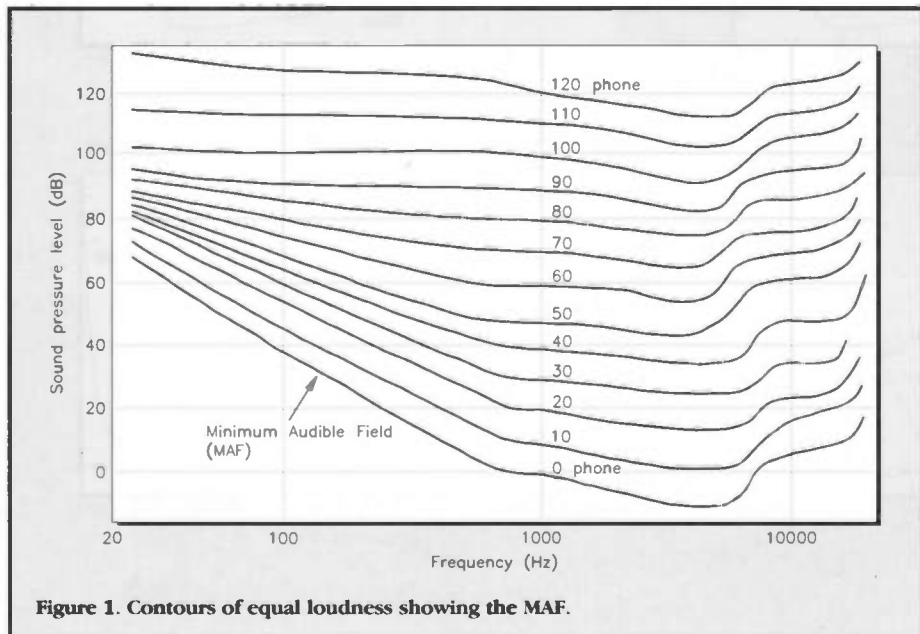

**Figure 1. Contours of equal loudness showing the MAF.**

1kHz or above 5kHz the ears are less sensitive as shown by the standard Fletcher-Munson curves in Figure 1; this shows equal loudness contours for loudness levels from 0 Phon to 120 Phon, where the 0 Phon curve is the MAF.

### Critical Bandwidth

The human auditory system behaves as if it contained a number of overlapping band pass filters, these filters are called 'auditory filters'. The Basilar membrane provides the basis for the auditory filters, each location on the Basilar membrane responds to a limited range of frequencies' so that each different point corresponds to a filter with a different centre frequency. The actual number of filters along the Basilar membrane is thought to be about 11,000, they are approximately spaced linearly up to 100Hz and logarithmically above that. Figure 2 shows the response of the auditory filter at 1kHz.

When trying to detect a signal in a noisy background, the listener is assumed to make use of the filter, within the Basilar membrane, with a centre frequency close to that of the signal. This filter will pass the signal but remove a great deal of the noise. Only the components in the noise which pass through the filter will have any effect in masking the signal.

Increases in noise bandwidth result in more noise passing through the auditory filter, provided that the noise bandwidth is less than the filter bandwidth. However, once the noise bandwidth exceeds the filter bandwidth, further increases in noise bandwidth will not increase the noise passing through the filter. The bandwidth at which the signal threshold ceases to increase is called the 'critical bandwidth'.

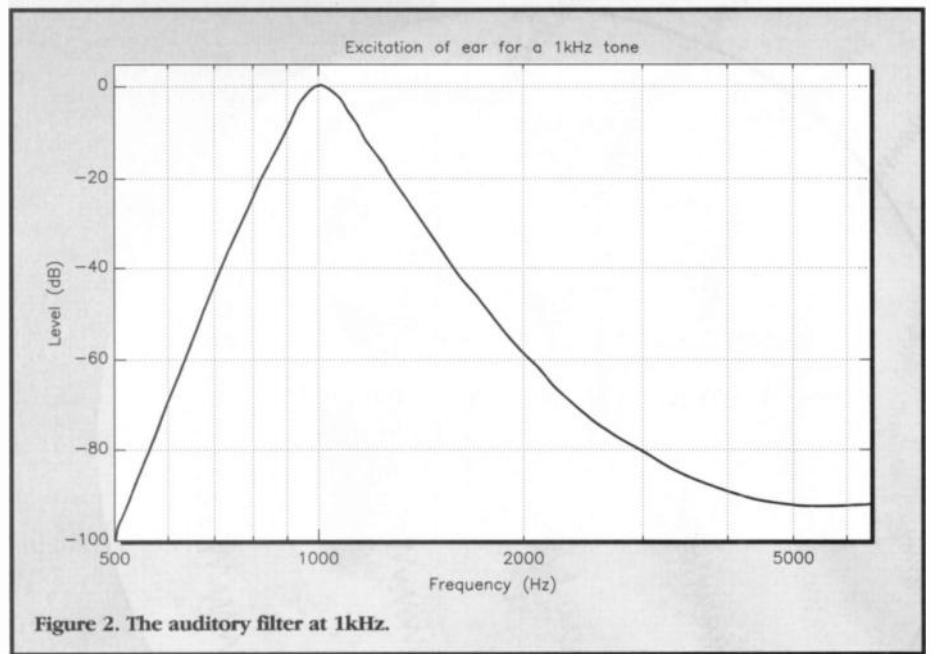

Figure 2. The auditory filter at 1kHz.

### Masking Patterns

Information on the masking effect of signal components is available primarily for single tones or bands of noise, as a result, coder design depends greatly on principles derived from these simple masking experiments. These typically generate masking curves of a single high level component masking the presence of another smaller component, and are quite useful because they can be used to derive an upper bound on the levels of permissible error signals due to the data rate reduction process. Since the masking effect varies significantly depending on whether the large level component or masker is tone-like or noise-like in character, the more demand-

ing the situation of sine-wave masking curves, as shown in Figure 3. The figure represents various hearing thresholds when individuals are subjected to various levels of 100Hz, 500Hz, 4kHz and 8kHz sine-wave maskers.

The most appropriate way to examine masking phenomena is to perform a spectrum analysis based on critical bandwidths, although approximation can be made by using 1/3 octave bands. These spectral analyses of masking are then used as a basis for the design of the coder filter bank structures, and the methods to reduce the bit-rate via word-length reduction.

The first observation from Figure 3 is that masking is generally greatest at the maskers

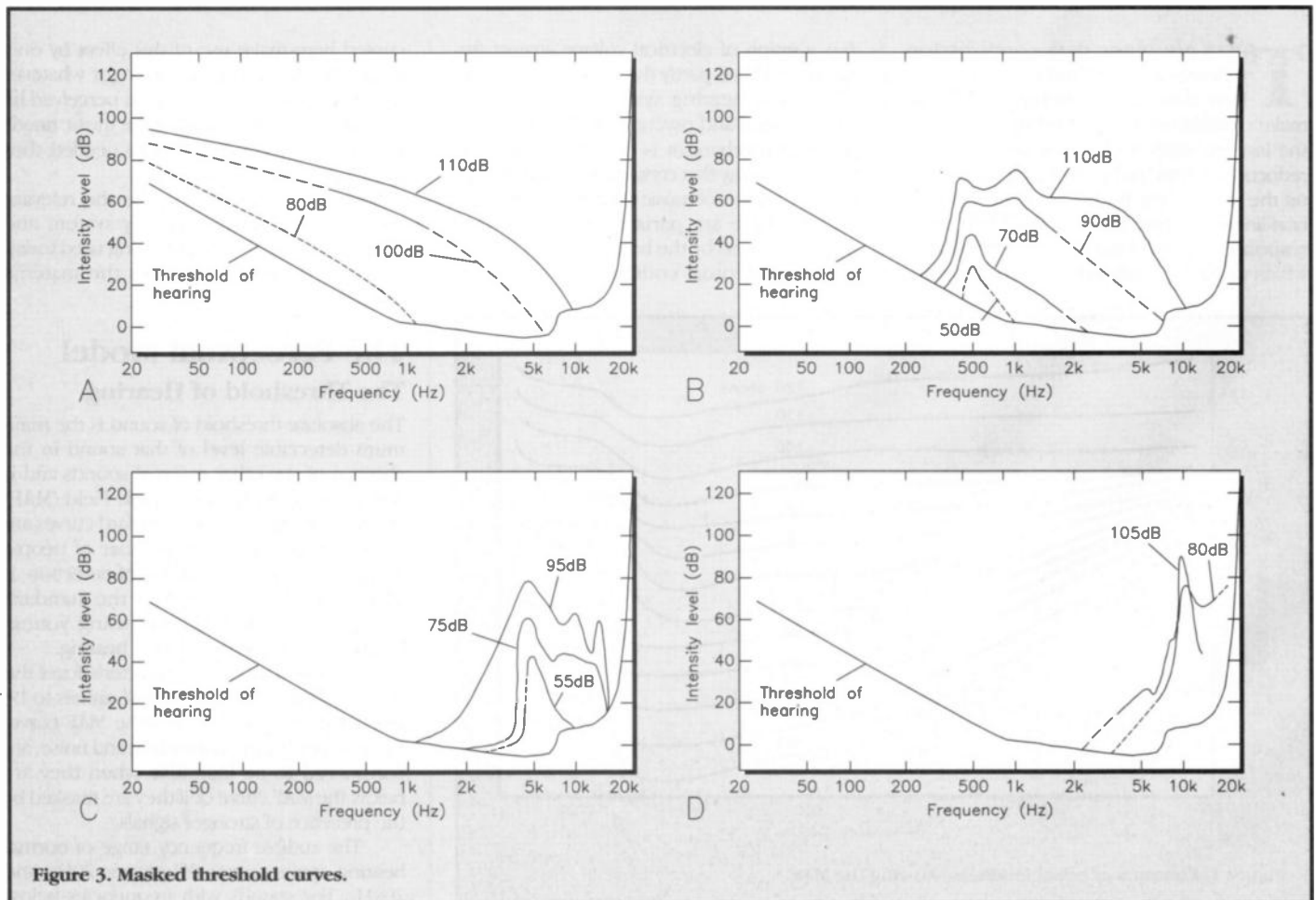

Figure 3. Masked threshold curves.

frequency. This indicates that the coder design should concentrate error energy directly adjacent to the signal frequency. The next property the plots have in common is that the masking effect slowly decreases with increasing frequency separation, if the smaller signal is higher in frequency than the masker. The masking effect for signals at the 70dB acoustic level may extend only a few octaves upward in frequency while higher level situations may produce six upward octaves of significant masking.

Looking at masking signals lower in frequency than the masker shows a very different situation. For these signals, the masking effect falls off much more quickly. This is particularly evident for frequencies between 500Hz and 2kHz when evaluated in a dB per Hz fall off from the masker frequency; in this frequency region the slope can be as steep as 100dB per 350Hz below 500Hz (i.e. 90dB/octave) and drop as deep as 40dB within half an octave.

The differences in the masking characteristics vs. frequency are also very significant. In Figure 3a, the masked threshold falls off only for frequencies above 100Hz. The upward frequency fall-off in masking above 100Hz is rapid on a dB per Hz basis, with a slope that is as much as 100dB per 400Hz. In the case of 100Hz masking curves, it is important to note that a ratio of as much as 100dB may be necessary between the 100Hz masker and a resultant error component, if the error is to be inaudible. This means that any filter bank used by a rate reduction coder is most effective if its ultimate attenuation spans this 100dB range. The masking curves of 100Hz are typical for masking situations for maskers at, or below 200Hz.

The masking curves for 500Hz, depicted in Figure 3b, show a different situation. In this case there is a rapid reduction of downward frequency masking of up to 100dB per 360Hz, while having a much slower reduction at higher frequencies. In addition, high sound levels between 90dB and 110dB cause a very large masking effect at the second harmonic, causing the masking effect to be significantly extended upward in frequency. These 500Hz curves are typical for the masking properties of mid-range signals in the 500Hz to 2kHz region. Although not shown, at 2kHz the slope of the masking curves have only  $\frac{1}{2}$  to  $\frac{1}{3}$

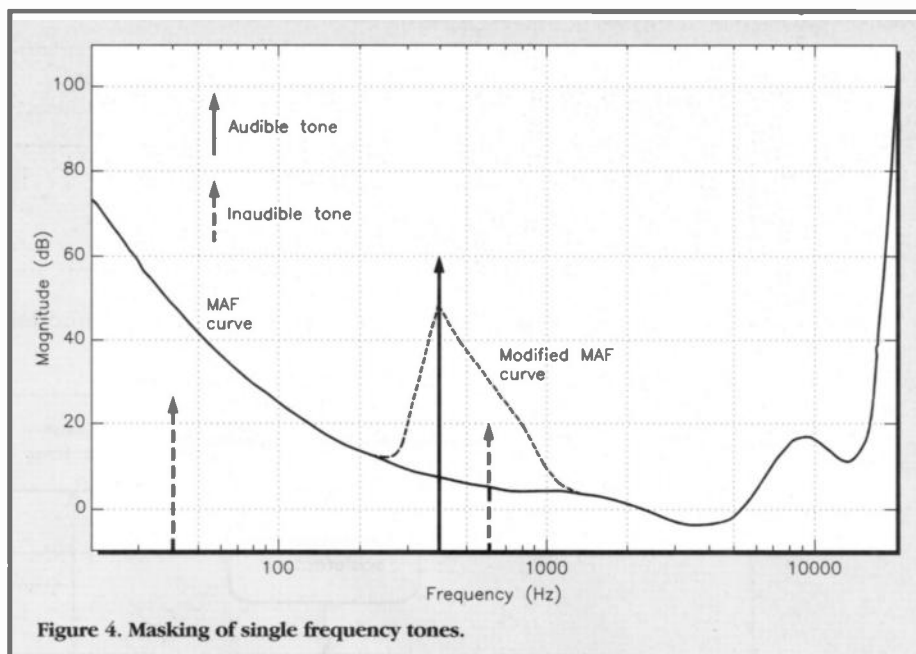

Figure 4. Masking of single frequency tones.

of the slope of masking curves at 500Hz, but the total fall-off has increased to 60dB.

Figures 3c and 3d show masking that is typical for high-frequency signals. Masking for lower frequency error components falls off fast but not as fast as in the case of the mid-range signals. However, the total exceeds 70dB for maskers at 8kHz and above. As in the case of mid-range signals, upward frequency masking reduces slowly with frequency but covers a more extended frequency range.

Figure 4 shows how a large tone of one frequency can mask a smaller tone of similar frequency. The main tone is the solid line at 400Hz and from the figure we can see that the presence of this tone modifies the MAF curve described earlier. Any tone below the MAF curve can be considered to be inaudible. The tone at 600Hz is below the new MAF curve and we can say that the 400Hz tone masks the 600Hz tone because if the 400Hz tone were not there then the 600Hz tone would be audible as it would then be above the original MAF curve. Also shown is a tone at 40Hz and this will always be inaudible as it is below the original MAF curve.

For a description of the physiology of the ear see 'Hearing and Deafness, Part 1 - The

Hearing Process', and for an in depth analysis of the physiology and psychology of the human hearing system see 'An Introduction to the Psychology of Hearing'.

## Applications

In the Spring of 1993 two new products arrived in the shops, one was the Sony MiniDisk (MD) and the other was the Philips Digital Compact Cassette (DCC). Both of these products use perceptual coding to reduce the amount of data required to a manageable amount. The main breakthrough is that it is possible to record digital audio on to both of the systems, and these are the first mass produced consumer products that can do this. Professional users have had Digital Audio Tape (DAT) recorders for a few years now. These record digital audio data in the same PCM format as is used for CD recording, and DAT machines can be used for mastering CDs. Due to problems connected with copyright, it is unlikely that DAT machines will ever be released into the consumer market.

The Sony MD looks like a 3.5in floppy disk. The disk comes in two forms, the prerecorded play only type and the rerecordable type. The prerecorded type is similar to a miniature CD (but inside a hard case) and the player uses an optical laser to read the data. The recordable type uses a mixture of magnetic (just as in a floppy disk) and optical technologies. The MD players available so far have been Walkman types and are a similar size to standard analogue cassette Walkmans, an in-car version is also under development. The perceptual coding system used in the MD is called Adaptive Transform Acoustic Coding (ATRAC) with a data rate of 0.3M-bit/s compared to CDs 1.4M-bit/s. The Philips DCC is a digital tape cassette, similar in size to an analogue cassette, and the tape itself is protected from the environment in a similar way to video cassettes. The DCC machines are generally Hi-Fi sized and a DCC machine can also play analogue cassettes. The perceptual coding system used in the DCC is called Precision Adaptive Sub-band Coding (PASC).

Currently under development is Digital Audio Broadcasting (DAB). This will bring digital stereo radio broadcast signals into the home and car, etc., and is being developed by the BBC in the UK along with other broad-



A typical Digital Compact Cassette system, with record and playback for crisp digital audio.

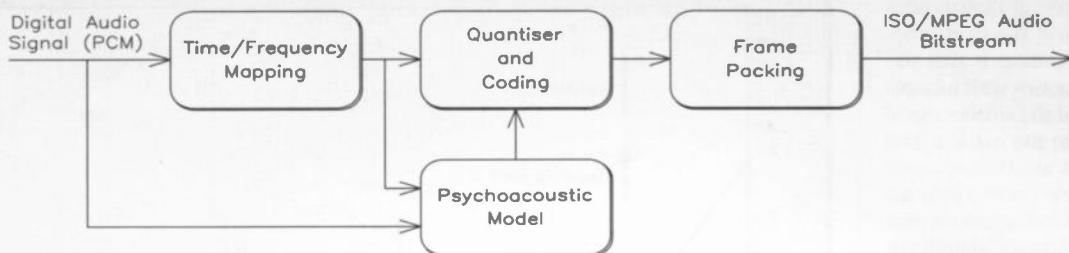

a) The basic structure of the ISO/MPEG audio encoder

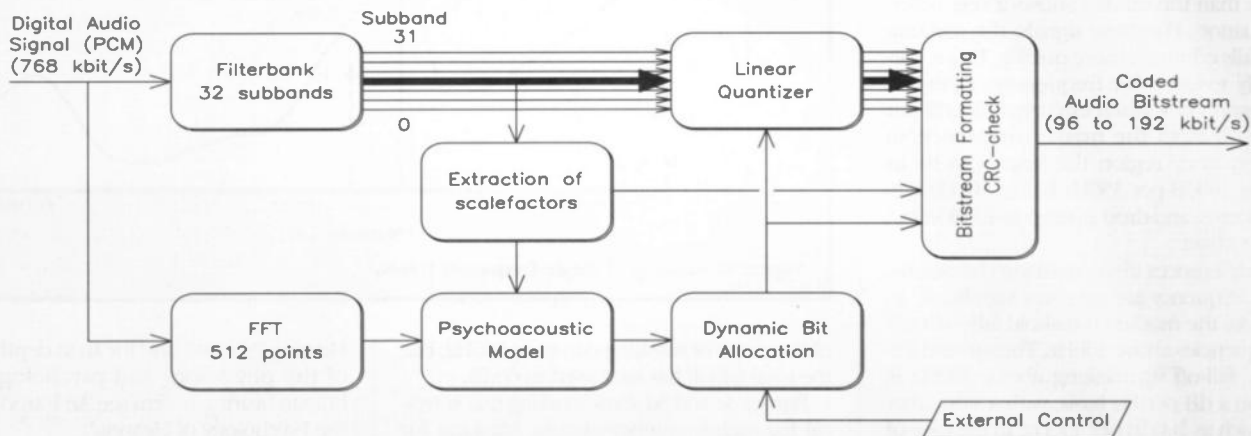

b) Block diagram of the ISO/MPEG audio encoder: Layer I (single channel shown)

Figure 5. Block diagrams showing the ISO/MPEG encoding process.

The MiniDisc format, for recording and playback of digital audio.



casters and manufacturers from most of the central European countries. One of the main problems with broadcasting digital audio over the already overcrowded airwaves is the large amount of frequency bandwidth required. In order to make efficient use of the airwaves it is necessary to use a method of data reduction and again perceptual coding is to be employed. The system used by DAB is called Masking pattern Universal Subband Integrated Coding And Multiplexing (MUSICAM).

A recent arrival is the Compact Disc Interactive system (CDI). With a CDI system it is possible to play virtual reality games, check reference books and watch films to name but a few applications. The CDI uses CDs which are the same size as standard audio CDs but using different coding systems. Because the discs are no larger than an audio CD it is necessary to use data compression/reduction in order to fit moving pic-

tures with a stereo sound track on to the disc. The whole method of data reduction (audio and video) is defined by an international standard (ISO 11172), and is known as the Moving Pictures Expert Group (MPEG) coding standard. The audio data reduction scheme is defined by Part 3 of ISO 11172 [4].

Figure 5 shows block diagrams which describe the whole encoding system. Figure 5a shows the general principle where the psycho-acoustic model is used to determine the number of bits required to encode the signal. Figure 5b shows how the layer I system works (there are three layers as described below). The audio signal is split up into 32 frequency bands and the amount of masking between bands is used to determine the allocation of the digital bits. The FFT block takes the audio data and produces a frequency analysis of the signal which is also used by the psycho-acoustic model. The data out, of the system, can be at a number of rates (96 to 192 bit/s for

layer I and 32 to 192 bit/s for layers II and III) and it is up to the system designer to select the most appropriate rate.

We can see that there are many similar perceptual encoding standards (ATRAC, PASC, MUSICAM and others). These standards are virtually the same except for small technical details and so the MPEG-Audio standard was defined to bring the best parts of each scheme together to generate one standard, in fact the MPEG-Audio standard contains three different psycho-acoustic models (layers), with the designer being free to choose the most appropriate.

## Summary

The CD provides high quality digital audio but there is too much data present for use in other systems. By using a part of the human auditory perception process it is possible to determine which part of the signal is audible and which is not. By only encoding the audible part of the signal it is possible to reduce the amount of digital audio data being recorded. The use of perceptual encoding methods has enabled the development of new digital audio equipment from recording machines to broadcast systems.

## References

1. *Introducing Digital Audio*, I. R. Sinclair, P.C. Publishing 1992.
2. *Hearing and Deafness, Part 1 - The Hearing Process*, R. Ball, *Electronics*, No 42 Feb-Mar 1991.
3. *An Introduction to the Psychology of Hearing*, B. C. J. Moore, Academic Press 1989.
4. ISO 11172-3 Coding of moving pictures and associated audio for digital storage media at up to about 1.5M-bit/s, Audio, 1993.

# Stray Signals

by Point Contact

## THE TRUE ROAD TO RADIO.

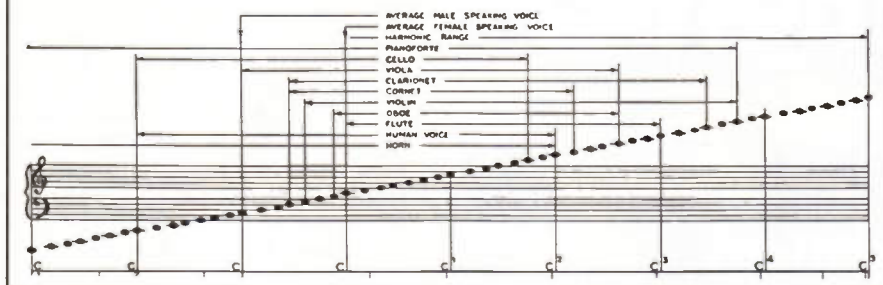

### Words, Words, Words

PC's interest in words was evident from an early age, reinforced over many years by a similar interest on the part of the missus, herself a linguist. It is just as well he doesn't find them a bore (the words, that is, not the years), largely earning his living from writing them, as he does, under a variety of pen names. By and large, people are streets ahead of machines when it comes to words, either the written or spoken variety. Unless it's very bad, one can usually read anybody's 'joined-up writing', whilst machines have trouble even with capitals. And they have even more trouble with the spoken word. Programming a computer to recognise and take in speaker-independent continuous speech is a gargantuan task, and one which hits the limits of the hardware, as well as the programmer. The problem is getting the computer to be versatile enough in recognising the context, as this provides the essential clues to meaning which a human uses without even realising that he is doing so. Thus if on a seaside holiday, the conversation turns to vandalism, you will instantly follow if someone complains that you can always trust hooligans to wreck a nice beach, but a computer might think that they were talking about the problem of how to recognise speech – especially if it had the difficulties of doing just that on its 'mind' at the time!

Mind you, people can have difficulties with the spoken word, too. On one of PC's rare visits to London; on the platform at Earsl Court station, a foreign looking gentleman asked which train he needed for "Bye-swat-AIR", or at least that's what it sounded like to me, even when he repeated it; only slowly did it dawn on me that he wanted to get to Bayswater. And when I was staying with a family once in New Zealand, I was completely mystified when the wife said to her son as we were all about to go out, "Where's your reared hett?" The lad scampered off and came back wearing a red knitted hat, so it was obviously plain as a pikestaff to him. Still, I reckon it will be a good few years yet before machines can

recognise speech – and merely recognising it is still a long, long way from understanding it.

### Mind My Mains – Again

PC's comment last month that an RCCB now resided in the output socket of his standby mains generator prompted a letter from J. H. of Kent. He pointed out that usually the output of such a generator is floating, not connected in any way back to the earth pin of the output socket, which is connected only to the motor generator housing and other metalwork. He went on to say that consequently an RCCB would not work, since any current flowing along one output conductor could only return via the other, but that the test button would still work, giving the user 'a false sense of security'. So the generator winding is floating? – a good point, but then how can the test button possibly work either? And wait a minute, if the output is truly floating, either end could be earthed at will, even via the human body, all the voltage with respect to ground then appearing at the other output terminal. Of course, the generator output won't be completely floating, in the sense that there will be distributed capacitance between the generator winding and the metal work of the generator housing, so rather than speculate on what would or could happen, I decided to take a few measurements. Using a 13A mains lead with bare ends, the L and N leads were shorted together and their capacitance to the E lead measured, result 170pF. The lead was plugged into the output socket (the generator was not running of course!) and a quick test with an ohmmeter showed no connection between the generator winding and E. The capacitance between the winding and the generator's earth terminal/metalwork was then measured, answer – a surprisingly low 1100pF, or barely 1nF discounting the 170pF of the mains lead. Of course, this measurement gave no clue as to whether the effective capacitance was equally divided between the L and N ends of the winding or not – if it were, the output voltage relative to ground at L and N would each equal half the rated output voltage. To check, the generator

was run up to speed and a 'scope used to measure the output voltage at the L and N terminals with respect to the generator output socket's E terminal, which was thus connected via the 'scope to mains earth. Result, generator L conductor, just over 500V Pk-to-Pk, N conductor around 200V Pk-to-Pk, the waveform of the output of the generator (a Kawasaki 1100W model) being surprisingly good. Thus clearly the capacitance from the generator's neutral to its metalwork was a good deal larger than from its live to metalwork. However, the reactance of 1000pF at 50Hz is 3M $\Omega$ , so that whichever end of the winding was connected to case, the current through that connection should be less than 240V divided by 3.2M $\Omega$ , or around 80 $\mu$ A. Nevertheless, with the generator running freestanding (i.e. isolated from mains earth) the RCCB tripped as soon as it was plugged into the generator – a result which leaves me pondering. But still, if used during power cuts (we haven't had one here for months), the generator E will be connected to the house wiring E, which in turn will still be firmly earthed, even though the public electricity supply is temporarily absent. Thus in this application, safety is assured, as long as all your appliances are in good order, with their earth leads properly connected (if not double-insulated).

### Tailpiece

Browsing round a second-hand bookshop recently, PC came away with a largish book, though no thicker than one inch, published in 1931 and entitled *The True Road To Radio*. Though covering all aspects of the then state of the art, it was in fact commercially sponsored. It promoted a well-known make of intervalve transformer, the frontispiece being a sepia photograph of Sebastian Ziani de Ferranti, who had died the previous year. The frequency response of these transformers was very wide, much more so than that of the then common moving iron loudspeakers, and even of the (mains energised) moving coil types which were already then appearing, extending from well below 50Hz and only a dB or so down at 8kHz. The plot of the frequency response on page 176 is surmounted by an indication of the corresponding frequency. This is reproduced here as a handy guide for any budding composer, who needs to avoid asking instruments to play notes beyond their register.

Yours sincerely,

*Point Contact*

The opinions expressed by the author are not necessarily those of the publisher or the editor.

# A BRIEF HISTORY OF ELECTRONICS

## PART 1: The Foundations Laid

by Ian Poole

Electronics is an integral part of our lives nowadays. To prove this it is only necessary to look around our homes. On average every household has three or four radio sets, Hi-Fi systems are also very common, and most households have at least one television set.

**E**LECTRONICS provides far more than just entertainment in our lives, there are very many examples of functional equipment we take for granted. Many of us possess digital watches that give the time far more accurately than any mechanical watches ever could. Another example is the many electronic central heating controllers that are now in use to give the optimum efficiency from any system. The automotive industry is an extensive user of electronics especially now that processor controlled engine management systems are being used more widely. Computers, another branch of electronics, have also affected our lives in a very large way.

It is probably true to say that if electronics did not exist then our lives would be completely different. It is probably the largest change that has occurred to society this century.

The story of how it all started is fascinating. The people who laid the foundations were trying to explain the natural phenomena they had observed. If any of these early pioneers were alive today they would not believe what has been achieved as a result of their work.

### The Very Beginning

Today's highly complicated electronics is founded on some very basic laws. The initial discoveries were made when people observed some of the effects surrounding magnetism and static electricity.

The first discoveries date back to the ancient Greeks and the Chinese who investigated the

properties of lodestone, a magnetic oxide of iron. In fact, the Chinese are often credited with the invention of the magnetic compass. Knowledge of this discovery was spread over many points of the globe as travellers used it for gaining a sense of direction. Eventually it reached Europe, possibly as a result of the Arabs. Here the Greeks, with their well-developed society paid most attention to it.

Another early discovery of major importance was the fact that when a substance called amber was rubbed it attracted light objects to it. This strange phenomenon possibly added extra value to the stone when it was traded.

These were only discoveries of the basic effects and very little was understood about them. It was many hundreds of years before people started to make further progress into understanding a little more.

### First Investigations

One of the first to take further steps was a man named William Gilbert, who was the physician to Queen Elizabeth I. He performed a vast number of experiments on magnetism and electrostatics, discovering electrostatic repulsion and the fact that the earth acts as a gigantic magnet. This was the first time these topics had been detailed in any scientific manner. Then in 1600 he detailed his findings in a large volume called *De Magnete*, written in Latin, the scientific language of the day.

The next major step forward was announced in 1670 by a German named Otto von Guericke. He produced a friction spark generator consisting of a ball of sulphur which could be spun round and rubbed against the hand producing sparks. Although exceedingly basic, this was the first electrical machine.

Once the machine had been demonstrated, it was refined and improved giving larger and more reliable sparks. Other experiments were then performed using the machine, helping to reveal more about the nature of electricity.

### The Leyden Jar

One of the other major inventions of this time was the Leyden jar. This device for storing static electricity was discovered independently by two scientists, in about 1745 by a German, Ewald Georg von Kleist, and a Dutch physicist named Pieter van Musschenbroek, who came upon the same idea when he was working at the University of Leiden. In its early form, the Leyden jar consisted of a cylindrical glass container partially filled with water. The top end was closed with a cork, and a small wire was passed through the cork so that it entered the water. A charge could be applied to this from a friction device. When the source of the static electricity was removed, the jar retained its charge and could produce a shock when anyone touched it.

One major discovery was made by Stephen Gray in the early 1700s. He discovered that charge could be transferred from one body to another if they were connected by certain sub-



Guericke's Sulphur Globe Friction Generator  
c1670. ©Copyright Science Museum.

stances but not others. In doing this he made the distinction between conductors and insulators, although he used different names for them.

## Experiments With Lightning

Others took the study of static electricity in different directions. One famous example was undertaken by Benjamin Franklin. A very talented person, Franklin was a publisher, author, scientist and a diplomat. He is probably best remembered for his part in gaining freedom for the American colonies from Great Britain. However, as a scientist and inventor he was also very successful, inventing a stove and bifocal lenses. In addition to this he took an interest in electricity. He proposed mounting a long pole on top of a tall building to draw charge from the clouds in a thunderstorm, and using a Leyden jar to detect it. This experiment was very successful and he was able to detect that charge was present. Not satisfied with the results from this, Franklin's next experiment used a kite to take a wire right up into the clouds. Doing this he managed to show that clouds were usually negatively charged, although on occasions a positive charge was present.

Franklin was very lucky, and was not injured performing these experiments. Others were not so fortunate. One, a Swede named Professor Richmann was killed in St Petersburg whilst using the experiment to investigate if there were any differences between atmospheric and frictional electricity.

## Non-Static Electricity

Until the latter quarter of the 18th century static electricity was the only form of electricity which had been discovered and studied. As yet 'dynamic electricity' had not been discovered.

The first person to make major strides in this direction, was an Italian named Luigi Galvani. Born in Bologna in northern Italy in 1737, Galvani studied medicine at Bologna University, obtaining his doctorate with a thesis on the formation of bones in 1759. After this he was appointed lecturer in anatomy at the university, where he continued his researches concentrating on a number of topics including the middle ear.

From about 1780 Galvani became more interested in muscle movement. Using a Leyden jar he experimented with muscular stimulation by electrical means. He performed many interesting experiments and in one he managed to produce muscle movement by touching the nerves of a frog with a metal instrument during a thunderstorm. In another he made a frog's muscles twitch by touching a nerve when a static electricity generator was running nearby.

From his experiments, Galvani deduced that there was a new form of 'animal electricity' which activated the muscles. He concluded that this was generated within the animal and was different to the natural electricity generated by friction generators and thunderstorms.

## The First Batteries

Whilst Galvani came to the wrong conclusion, his work was by no means in vain. It was taken up by his friend and contemporary, Alessandro Volta. Born in 1745 in Como in northern Italy, he became a professor at the Royal School of

Como in 1774, moving to the University of Pavia in 1778, a year after he had discovered methane gas.

Volta's main work started in 1794 when he began experimenting with electricity. He found that animal tissue was not needed to produce electric currents. Instead he found that two



Alessandro Volta.  
Institution of Electrical Engineers.  
©Copyright Institution of Electrical Engineers.

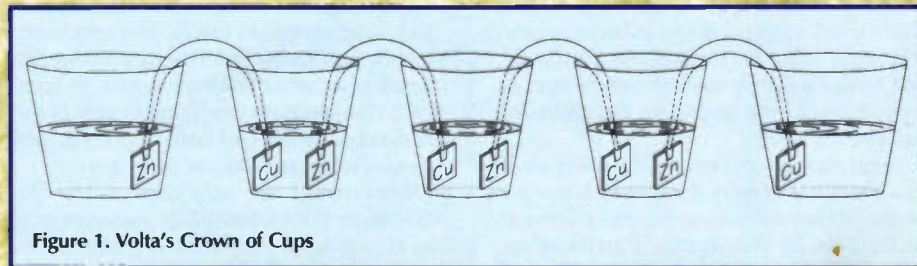
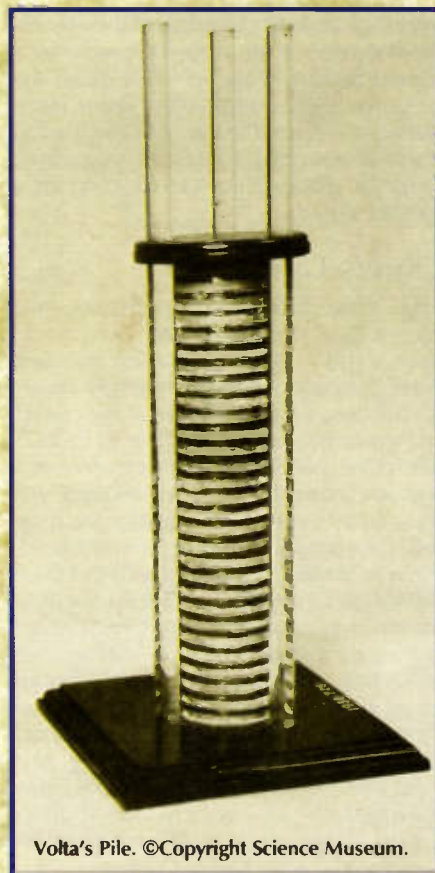

Figure 1. Volta's Crown of Cups



Volta's Pile. ©Copyright Science Museum.

dissimilar metals could be used. After much experimentation, and a number of erroneous conclusions, Volta discovered that zinc and copper gave the best results for his purposes. He demonstrated a number of batteries. In one, called the 'Crown of Cups', he arranged twenty or more cups containing brine with pairs of wires of different metals dipped into the solution. By having a number in series (as shown in Figure 1), he found he was able to multiply the voltage of the single cell many times.

Possibly the most famous of his batteries is known as 'Volta's Pile'. In this he arranged pairs of discs of these metals in a pile, separating each pair by cardboard soaked in brine. By arranging the discs in this manner he was able to produce a large number of individual cells in series. From some piles the voltage was sufficiently high to give a shock similar to that given by a friction static electricity generator.

News of the discovery spread rapidly and it was discussed at many seats of learning. Other scientists repeated the experiments. They, too, noted the continuous current which was given in comparison to the transitory one given when static electricity was stored.

As a result of his work, Volta received many honours. Even Napoleon rewarded him handsomely for his discoveries and he was recognised by many learned societies across Europe. In his later life he even became a senator and received a generous annuity for his contributions to science.

Although Volta produced the first batteries, many other people developed improved versions. Being the first, Volta's battery obviously had some limitations, and many people made their own versions. J. F. Daniell, a professor of chemistry at King's College in London produced a cell which had electrodes of copper and amalgamated zinc. This produced a voltage of 1.08V and had the advantage that it gave a constant current over a long period of time when under load.

Leclanché produced a revolutionary design. His battery used amalgamated zinc as one of the electrodes, and carbon rod in a porous pot containing carbon and manganese dioxide powders as the other. This cell produced a voltage of 1.5V and gradually became the most widely used type, being the forerunner of today's primary cells.

## Magnetism and Electricity

Whilst Volta had made some major discoveries, little was known about the nature of electricity. Many ideas were abounding in the learned societies about electricity. At the time, most thought that magnetism and electricity were two totally different sciences, although it was recognised that there were some similarities. For example, both magnetism and electricity had polarities. However, no one had been able to establish a link, that was, until Oersted discovered it.



André Ampère.

©Copyright Institution of Electrical Engineers.



Georg Ohm.

©Copyright Institution of Electrical Engineers.



Michael Faraday.

©Copyright Science Museum.

Hans Christian Oersted was the oldest son of a Danish chemist. Even in his early years the young boy had a great desire to learn and soon devoted himself to a scientific career. After a number of years in various occupations, he eventually became a professor at Copenhagen University.

Oersted's great discovery came mainly by accident as he was lecturing to his students one day in 1820. He noticed that a magnetic needle was deflected when it was placed near a wire carrying a current. In his first experiments the effect he noticed was very small, and he did not understand its significance. As a result he did not investigate the effect any further for a while.

Fortunately he returned to the effect some months later. However, this time he knew that he would have to increase the effect if he was to be able to investigate it any further. Accordingly he took a much larger battery and he found that the effect was much more visible. He was able to detect that the magnetic needle was deflected only when the current was flowing, and that it was not caused merely by the presence of an electric potential in the vicinity.

Oersted did not content himself by only proving the existence of the effect. He performed a number of experiments from which he learned that the magnetic field ran around the wire. He also discovered a number of other facts which might seem obvious today, but were nevertheless still important in their own right in proving that it was not a new form of magnetism. For example, he found that the fields did not affect non-magnetic materials. He also found that the fields passed through many materials, and in all its ways it was the same as an ordinary magnetic field.

### A Greater Understanding

News of Oersted's discovery spread rapidly throughout Europe. Many people now realised the importance of electricity and a number of practical ideas for its use were postulated. A number of others were able to take up the trail of Oersted's new discoveries.

One of these was André Marie Ampère. He was a brilliant physicist who became professor of physics and chemistry at the University of Bourg at the age of 26 and eight years later he was made professor of mathematics at the Ecole Polytechnique in Paris.

In many ways Ampère was a brilliant scientist, although he was not consistent in his work. When engrossed in a subject he was able to make enormous strides forwards in a short space of time, but often he worked in a very haphazard fashion.

When he heard about Oersted's discovery Ampère immediately set about recreating the experiments and developing the ideas further. Within a week he had put together the first of seven papers in which he outlined the 'Law of Electromagnetism'. In this he mathematically described the magnetic forces which existed as a result of a current flowing in a wire. In addition to this the theory explained many of the phenomena which had been noticed as well as many which had not yet been seen.

Ampère did not only confine his discoveries to the mathematical explanation of the concepts. As part of his experiments he invented a method of determining the amount of current flowing in a wire. To do this he made an instrument based upon the effect of the deflection of the magnetic needle by a current flowing in the wire. He called the instrument a galvanometer after Galvani, and it was even suggested that it could be used to send messages using it as a form of telegraph. However, this idea was not taken up for a number of years.

### Ohm's Law

Although the effects of potential difference and current were well established, no one had been able to determine the link between them. Nowadays every schoolboy knows 'Ohm's Law' which links the voltage, current and resistance in a circuit. However, in 1825 when Ohm performed his first experiments it was only known that if a good conductor was replaced by a poor conductor then the magnetic force around the conductor was reduced.

Georg Simon Ohm was the eldest of three children to survive from the family of a locksmith named Johann Wolfgang Ohm. Georg's father had a keen interest in mathematics which he passed on to his children. Although Georg was a promising student he failed soon after starting at university because the attraction of the social life proved too strong. As a result Ohm turned to teaching before finally obtaining his Ph.D. Despite his degree Ohm's career was never easy, and he continued his teaching at a high school in Cologne.

Here the school was equipped with a good laboratory and Ohm started to investigate the relationship between voltage and current. At this time little was known about the relationship connecting the two quantities beyond the fact that if the voltage across a conductor was reduced then the magnetic effect around it fell. No one had been able to deduce the link between the two. Much of the reason for this was because the methods of measurement for any of these quantities were all very rough and ready. A very far cry from the highly accurate instruments we use today.

Ohm had to measure the change in magnetic force when a good conductor was replaced with an inferior one. To achieve this Ohm had a number of lengths of the same wire. Using the results from his experiments Ohm deduced a relationship and published his findings in 1825. Unfortunately this was not the Ohm's Law we know today. Instead it was a comparatively complicated formula involving a logarithm.

Ohm continued his researches. The failure of his first equation had mainly been caused by the internal resistance of the batteries. Making use of a new type of battery, based on the thermoelectric effect as discovered by Seebeck, Ohm was able to produce a much more constant voltage, across the samples of wire. Now he was able to deduce the relationship as we know it today. This represented a considerable achievement since he produced this relationship using only measured data.

### Faraday's Contributions

One of the most influential characters in the history of electrical and electronic development must be Faraday. In his lifetime he published over 150 papers, a lot even by today's standards. In these he covered a very wide range of topics and described a large number of new effects and laws he had discovered.

Born just outside London of Yorkshire stock, Faraday only received a very rudimentary education. In his later life he found this quite restricting, as he was not able to delve into the depths of mathematics to investigate any new theories. Instead he adopted a more intuitive approach, relying on his genius.

One of Faraday's first discoveries was that of 'electromagnetic induction'. He had been searching for an effect of this nature for many

*Continued on page 59.*





# FILTERS

## Part 5: High-Performance Active Filters

**J. M. Woodgate** B.Sc.(Eng.), C.Eng., M.I.E.E., M.A.E.S., F.Inst.S.C.E.

This month, the concepts and practicalities of designing state-variable filters are examined.

**T**HE form of Sallen and Key active filter that we have looked at previously in this series has quite good performance, and the great advantage is that the circuits are extremely simple. However, if the measured performance of the hardware is not within the specification, it is not a straightforward process to modify the circuit values to correct the errors, because changing the value of any one component alters the response in a complex manner. The errors arise from component tolerances, gain errors and phase-shift in the op amps. For more critical applications, what are known as 'state variable' circuits are used. The term 'state variable' (which may seem ambiguous - in fact, 'state' is an adjective describing 'variable', thus meaning 'a state type of variable', to be carefully distinguished from a 'state which is variable'!) is a bit of mathematical mystification that we can ignore. It offers no help with the electronics to delve into the precise meanings of the term. What it results in, however, is very practical indeed: pole and zero positions and filter *Q* can be varied independently, and by adjusting the value of one component only for each characteristic.

Although the state variable circuits are more complex than the Sallen and Key, this is largely due to the use of three or four op amps for each second-order filter section. If these op amps are bought, for example, as LM324N quad packages (UF26D), they cost only 45p each. Since the state variable circuits are tolerant of op amp deficiencies, there is often no need to use more costly high-performance devices, except perhaps if noise, or large-signal handling at high frequencies, is a critical factor.

### Basic Circuits

For low-pass and band-pass filters, each second-order section requires three op amps, while high-pass and band-reject filters require four, as shown in Figure 50.

Each op amp represents a building block, and it is useful to note the different types. In Figure 50, IC1 forms a low-pass filter by itself, but only a first-order one, with finite pass-band gain due to the presence of R1. IC2 also looks like a low-pass filter, but the absence of a resistor across the capacitor gives it, theoretically, infinite gain at zero frequency (DC), and this circuit is called an integrator. IC3 is simply a unity-gain inverter, while IC4, if included, is an inverting adder, like an audio mixer stage. It is possible to cascade the building blocks in different orders, with subtle advantages, as we shall see later. This four op amp circuit is also known as a 'bi-quad' circuit, because both the numerator and denominator of its transfer function (see Part 1) are quadratic expressions.

### Poles, Again

A certain amount of very tedious algebra leads from the low-pass circuit of Figure 50 to the design equations:

$$R_1 = \frac{1}{(2\alpha C)}$$

and

$$R_2 = R_3 = R_4 = \frac{1}{C \sqrt{(\alpha^2 + \beta^2)}}$$

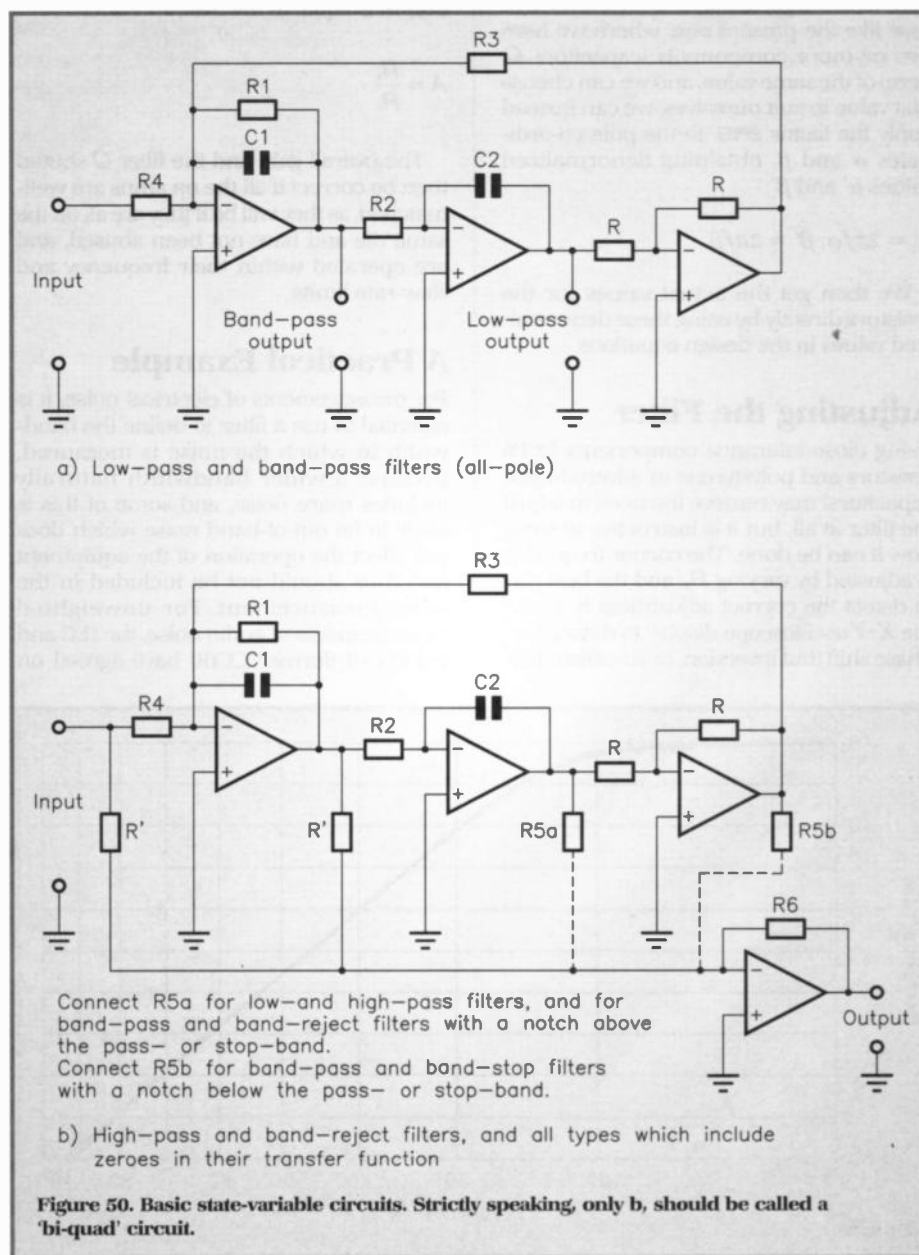

where  $-\alpha \pm j\beta$  are the positions of the poles in the complex plane (see previous Parts of this series) and the other variables are as shown in Figure 50. The value of  $C$  is arbitrary and can be chosen to give convenient resistor values. For a Butterworth filter of any order, the second equation can be much simplified, because for every second order section:

$$\sqrt{(\alpha^2 + \beta^2)} = 1$$

so that

$$R_2 = R_3 = R_4 = \frac{1}{C}$$

In fact, one can go further, and give the filter a pass-band gain  $A$ , greater or less than 1 as you wish, by making:

$$R_4 = \frac{1}{AC}$$

## Denormalized Poles

Up until now, we have always calculated the component values for the normalized filter, whose corner angular frequency is  $\omega = 1$  rad/s, where the response is 3dB down from the value in the pass band. Then we have scaled the values using the denormalization factor  $2\pi f$ . However, in a case like the present one, where we have two or more components (capacitors  $C$ , here) of the same value, and we can choose that value to suit ourselves, we can instead apply the factor  $2\pi f$  to the pole co-ordinates  $\alpha$  and  $\beta$ , obtaining denormalized values  $\alpha'$  and  $\beta'$ :

$$\alpha' = 2\pi f\alpha, \beta' = 2\pi f\beta$$

We then get the actual values for the resistors directly by using these denormalized values in the design equations.

## Adjusting the Filter

Using close-tolerance components ( $\pm 1\%$  resistors and polystyrene or silvered-mica capacitors) may remove the need to adjust the filter at all, but it is instructive to study how it can be done. The corner frequency is adjusted by varying  $R_4$ , and the best way to detect the correct adjustment is to use the  $X$ - $Y$  oscilloscope display to detect zero phase shift (but inversion, or so-called '180°

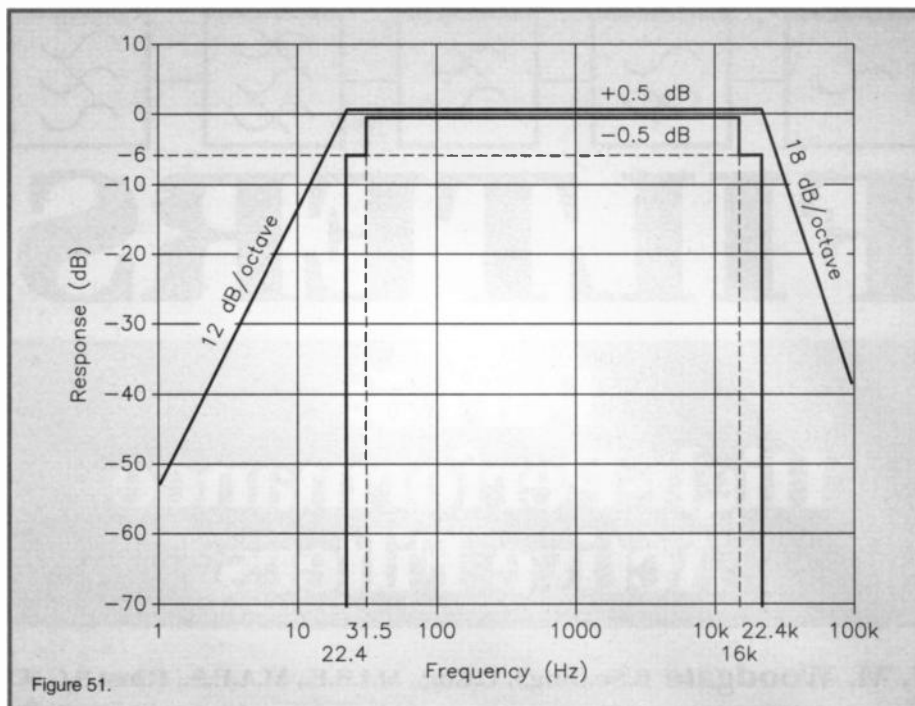

Figure 51.

phase-shift') between the input and the band-pass output at IC1 output pin. The gain can then be adjusted by varying  $R_1$ , so that the gain from input to the band-pass output is equal to the desired value:

$$A = \frac{R_1}{R_2}$$

The overall gain and the filter  $Q$  should then be correct if all the op amps are well-matched, as they will be if they are all on the same die and have not been abused, and are operated within their frequency and slew-rate limits.

## A Practical Example

For measurements of electrical noise, it is essential to use a filter to define the bandwidth in which the noise is measured, because a wider bandwidth naturally includes more noise, and some of this is likely to be out-of-band noise which does not affect the operation of the equipment and thus should not be included in the noise measurement. For unweighted measurements of audio noise, the IEC and the ITU-R (former CCIR) have agreed on

Figure 51. The specification of the IEC/ITU-R noise band limiting filter.

Figure 52. A comparison of theoretical and measured results from the untweaked 22-4kHz low-pass filter.

the filter specification shown as a 'mask' in Figure 51. This is an example of a wide-band band-pass filter, which is best made by cascading a low-pass and a high-pass filter. The low-pass part could, as shown, have a cut-off rate of 18dB/octave, i.e. a third-order filter would just do, but equally it could have a nearly infinite cut-off rate and still meet the specification. A fourth-order filter, having a cut-off rate of 24dB/octave is therefore preferable, and this we can make from two sections of the Figure 50 low-pass type. The response specification is maximally-flat, so we require Butterworth filters at both ends of the pass-band.

To begin, the target filter specification indicates that the  $-3$ dB frequency is 22.4kHz. We now need the pole locations for a fourth-order Butterworth filter, which we can get from a filter design handbook, or by applying de Moivre's theorem in complex numbers, as suggested in Part 4. This tells us that:

$$(\cos x + j \sin x)^m = \cos mx + j \sin mx$$

and enables us to find the  $n$ -th roots of complex numbers (and real numbers as a special case of complex numbers).

The pole locations of the  $n$ -th order Butterworth low-pass (or high-pass) filter are the  $2n$ -th roots of  $-1$ , and  $-1$  can be written as  $\cos \pi + j \sin \pi$ . Substituting this for the right-hand side of de Moivre's equation, for  $n = 4$  (since we need a fourth order filter)  $m = 8$ , and we find that one solution for  $x$  is  $x = 5\pi/8$  radians or  $112.5^\circ$ .  $x$  must be greater than  $\pi/2$ , since the real parts ( $-\alpha$ ) of the pole locations must be negative.  $m x$  is then  $40\pi/8 = 5\pi$ , and the cosine and sine of this are equal to the cosine and sine of  $\pi$ : we have gone two and a half times round a circle and end up halfway round!

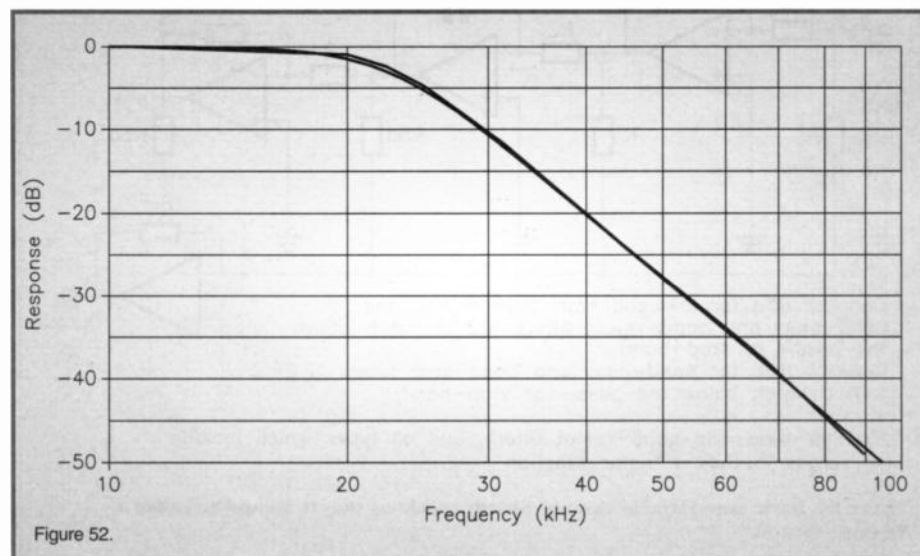

Figure 52.

So, writing the pole locations as  $-\alpha + j\beta$ , as usual, we find that  $\alpha_1 = -\cos 5\pi/8 = 0.383$  and  $\beta_1 = \sin 5\pi/8 = 0.924$ . These are the values we shall use for the second section. However, there are four eighth roots which have negative real parts, and the second pair are given by  $x = 7\pi/8$ , since this gives  $m\pi = 56\pi/8 = 7\pi$ , which is three and a half turns, equivalent again to half a turn or  $\pi$  radians. This value of  $x$  gives (not entirely as a surprise)  $\alpha_2 = 0.924$  and  $\beta_2 = 0.383$ . These values apply to the first section, although to design Butterworth filters we only need  $\alpha$  in any case. It is usual to put the section with lower  $Q$  first, and a larger value of  $\alpha$  means a lower  $Q$ . There are no more distinct root values: if we go any odd number more times round the circle, we land on one or other of the above values of  $x$ . Even numbers are out because they give the roots with positive real parts, which apply to oscillators, not filters.

We now apply the design equations given above, and find the following results:

First section:

Choose  $C = 470\text{pF}$  as a suitable value, remembering that we want to use polystyrene or silvered-mica components of  $\pm 1\%$  tolerance.

Then

$$R_1 = \frac{1}{(2\alpha_1 C)} = 8181\Omega$$

and

$$R_2 = R_3 = R_4 = \frac{1}{(2\pi f C)} = 15117\Omega$$

These are quite close to preferred values, and could equally well be  $20\text{k}\Omega$  15-turn cermet preset pots for fine adjustment. We can also make the arbitrary value  $R = 15\text{k}\Omega$ . With an input signal at  $22.4\text{kHz}$  exactly (No counter? Look at the Academy digital multimeters with built-in counters, GW20W at only £34.99 A1, GW21X at £39.99 A1 and GW86T at £44.99 A1.), we tune  $R_3$  for zero phase shift between the input and the band-pass output, and then tune  $R_1$  to get a gain from input to band-pass output of  $8181/15117 = 0.54$  or  $-5.33\text{dB}$ .

Second section:

We can use  $470\text{pF}$  again for this section, and the calculations with  $\alpha_2 = 0.383$  give  $R_1 = 19751\Omega$  and the other resistors are still  $15,117\Omega$  and can be made up from  $18\text{k}\Omega$  and  $1.8\text{k}\Omega$  in series or be a  $20\text{k}\Omega$  preset with  $4.7\text{k}\Omega$  in series to move the slider away from the end-stop. The gain value for tuning  $R_1$  is  $19751/15117 = 1.31$  or  $2.32\text{dB}$ .

A filter using an LM324, and built on a YR83E 'Euro breadboard', whose stray capacitances could affect accuracy at these frequencies, gave a response  $2.4\text{dB}$  down at  $22.4\text{kHz}$  relative to the response at  $1\text{kHz}$  after tuning, and the comparison of theoretical and measured values is shown in

Figure 53. The complete circuit of the noise band limiting filter based around LM324 sections.

Figure 54. The bi-quad configuration used in the MAX274 and '275 'continuous time' active filter ICs.

Figure 52. The theoretical curve is the plot of the Butterworth polynomial in the form  $10 \log(1 + \Omega^{2n})$ , not a circuit simulation. A closer approach to the correct  $-3\text{dB}$  response at  $22.4\text{kHz}$  could be obtained by tuning  $R_1$  in each section for the correct section  $Q$ , which is  $1/2\alpha$ , by measuring the band-pass bandwidth ( $22400/Q$ ) after each adjustment, which is rather a slow process. The phase shifts in the op amps cause the section  $Q$ s to be higher than they should be, and are responsible for the  $0.6\text{dB}$  error, but they do not damage the response shape significantly. The  $-3\text{dB}$  frequency is actually  $23100\text{Hz}$ , which is well within the mask and represents a not unreasonable  $3\%$  error with  $\pm 1\%$  tolerance components. However, the device slew-rate limitation does cause the maximum input voltage to be limited to only  $470\text{mV}$  before the first stage begins to distort grossly, although the resulting waveform distortion cannot be seen at the filter output because of the filter's own action.

It should be understood that the use of the LM324 in this application is purely to show what can be achieved with this circuit when the op amps are pushed beyond their optimum frequency limit. In a design optimised for performance, a faster device

such as the RC4156 or even LM837 would be preferred. Nevertheless, it is possible to improve the results with the LM324. This can be done by setting  $R_1$  in the first section for  $-5.33\text{dB}$  gain at  $22.4\text{kHz}$  from the input to the low-pass output. Next, measure the overall gain (input to the output of section 2) at a much lower frequency, such as  $1\text{kHz}$ . Then adjust  $R_1$  of the second section so that the overall gain at  $22.4\text{kHz}$  is  $3\text{dB}$  less than at  $1\text{kHz}$ . On the breadboard filter, this gave the following results:

Frequency kHz	Measured response dB	Theoretical response dB
22.4	-3.0 (set)	-3.0
44.8	-24.3	-24.1
89.6	-48.6	-48.2

These values are tabulated rather than plotted in Figure 52 because the resulting curve is indistinguishable from the theoretical. The only way to show them graphically would be to plot the error curve, the difference between the theoretical and actual responses.

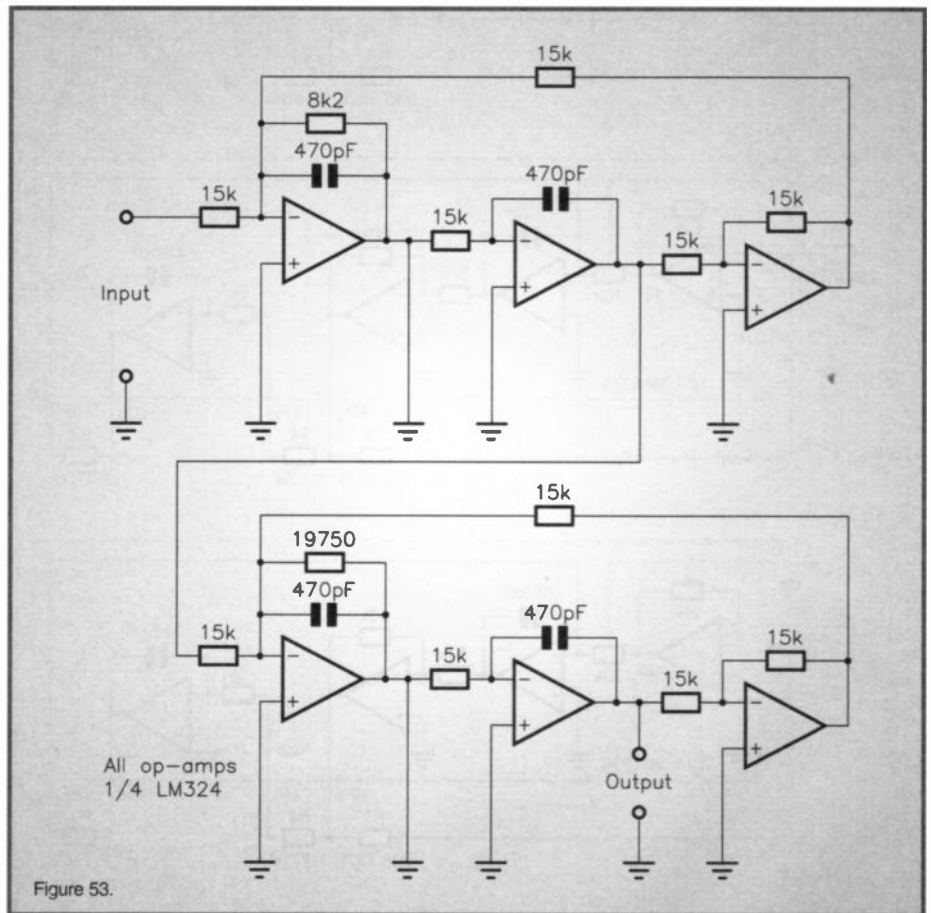

Figure 53.

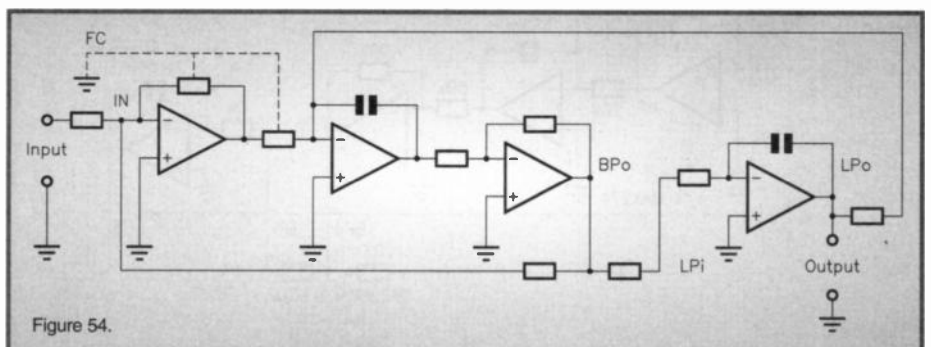

Figure 54.

## High-Pass Filters

We only need two new design equations for high-pass filters, and one that is not really new. We simply need to make  $R_4$  equal to  $R_1$  instead of equal to  $R_2$ , and then make  $R_5 = 2\alpha R$  and  $R_6 = \alpha R$  to give the filter a gain of  $A$  in the pass-band. In these examples, we set  $A = 1$ , so that  $R_6 = R_1$ , and  $f$  is the corner frequency, at which we want the response to be  $-3\text{dB}$ . The noise filter provides the perfect excuse for a fourth-order Butterworth high-pass filter, this time with a corner frequency of  $22.4\text{Hz}$ . We can cheat unmercifully here, by choosing  $C$  to be  $470\text{nF}$ , just 1,000 times larger than for the low-pass filter whose corner frequency is 1,000 times greater. The pole locations and most of the resistor values then come out exactly as for the low-pass filter, except for

$R_4$ , as noted above. If we make the arbitrary resistor value  $R$  equal to  $18\text{k}\Omega$ , then for the first section,  $R_5 = 33.26\text{k}\Omega$ , very close to a preferred value, and  $R_6 = 13.78\text{k}\Omega$  ( $12\text{k}\Omega$  in series with  $1.8\text{k}\Omega$ ) for the second section; of course, it is not easy to obtain  $470\text{nF}$  capacitors with a tolerance of  $\pm 1\%$ , so some measurement, and paralleling of smaller values is likely to be necessary. Alternatively, pairs of  $470\text{nF}$  components of wider tolerance (such as the poly-layer type) can be measured and

matched up and the resistor values calculated from the measured capacitor values. At these low frequencies, polyester capacitors should have sufficiently low losses, and the LM324 is also adequate (unless particularly low noise is essential: for measuring noise in digital equipment, perhaps).

The complete circuit of the filter is shown in Figure 53. It would be possible to make the high-pass filter of the fifth order, so as to fall well inside the upper limit of the mask at low frequencies, and this is left as an exercise for the reader. What are the five tenth roots of  $-1$  which have negative real parts, to begin with?

Figure 55. The sections of the 8th order low-pass filter, implemented with the MAX274 'continuous time' active filter IC, as generated by the manufacturer's design software.

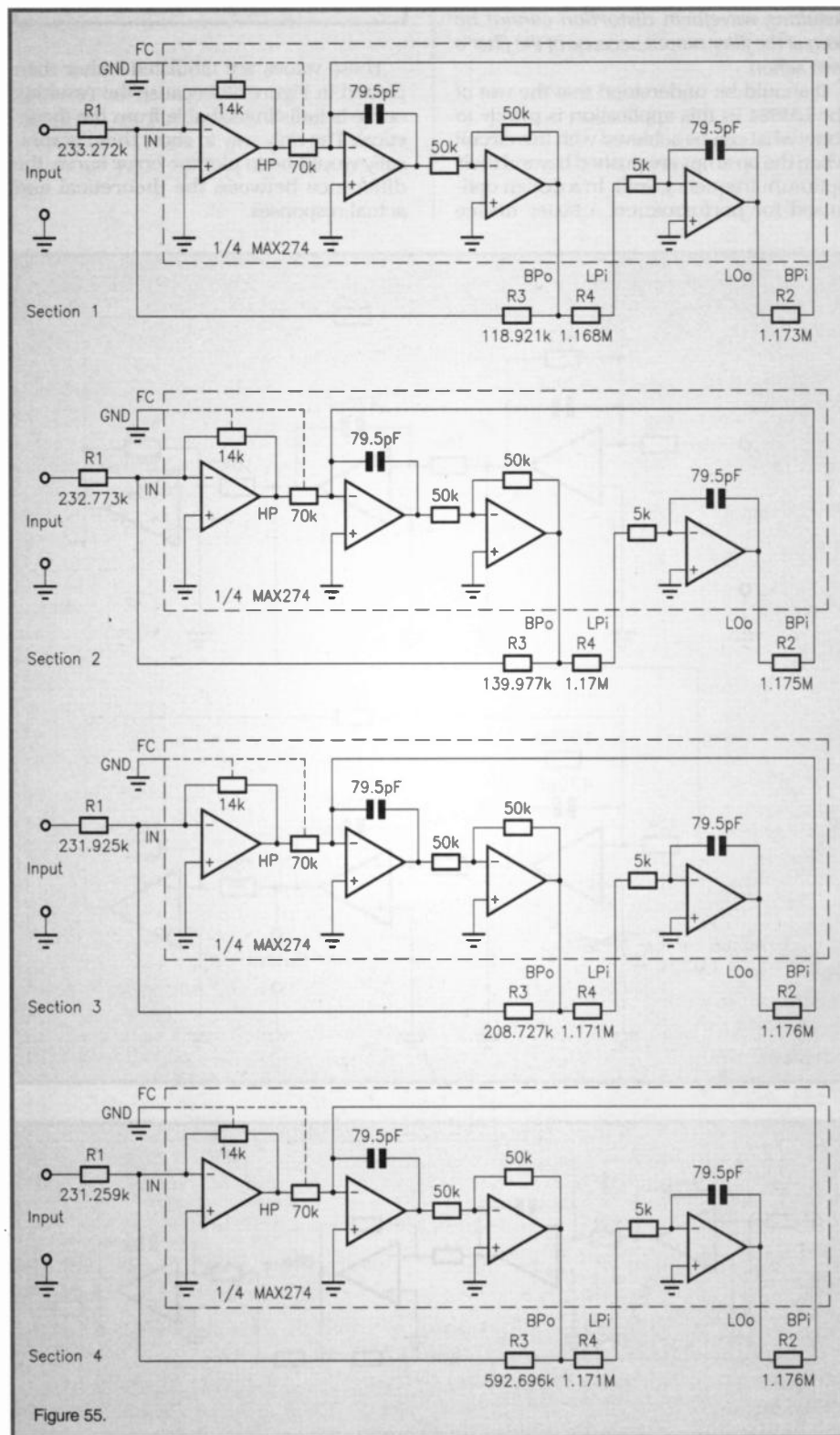

## Odd-Order Filters

These can be made from one or more second-order active sections with an additional  $RC$  passive first-order section to produce the real pole (i.e. one for which  $\beta = 0$ ) possessed by all odd-order filters. For a high-pass Butterworth filter, the real pole may be obtained by coupling the signal into  $R_4$  through a capacitor  $C$ , whose value is:

$$C = \frac{1}{(2\pi f \alpha_0 R_4)}$$

where  $\alpha_0$  is the pole position of the real pole, and is equal to 1 in this case.

Alternatively, a separate  $RC$  network can be provided at the output, and this is the only solution for a low-pass filter. It should be noted that, while the positions of the complex poles are the same for Butterworth low and high-pass filters, the position of the real pole of a high-pass filter is, in general, the reciprocal of the position of the real pole of the low-pass filter with the same corner frequency. For Butterworth filters, the real pole is at  $-1 + j0$ , so the positions of the real poles are still the same for both filters.

## Band-Pass Filters

There are no separate design equations for Butterworth band-pass filters, since the low-pass configuration provides a band-pass output as well. However, the section  $Q$  is likely to be much higher than for a low-pass filter. The  $-3\text{dB}$  bandwidth of a section is equal to  $1/(2\pi R_1 C)$ . It is possible to include a transmission zero in a section by including  $R_{5a}$  and a fourth op amp, as shown in Figure 50.

## Band-Reject Filters

Band-reject filters are made by subtracting the band-pass output signal from the input signal. Since the band-pass output is inverted anyway, this is actually an addition operation, accomplished in the fourth op amp, as shown in Figure 50.

## Special-Purpose Integrated Circuits

A few years ago, attention was focused on switched-capacitor filters, implemented with special-purpose devices such as the MF10CN (QY35Q). I am not going to deal with them in this series, as I have discussed them before, and the MF10, MAX293 (AY41U) and MAX297 (AY42V) have also been featured in Data File articles. In any case, these hybrid digital/analogue devices tend

to have the disadvantages (as well as the advantages) of both techniques. In particular, the EMC Directive is steering designers away from non-essential digital and pulse circuits, because of their potential to emit radiated and conducted disturbances. This has resulted in the appearance of what are called 'continuous time' devices. This is a pseudonym for 'analogue', and shows how fashion and sentiment have even penetrated the supposedly scientific world of electronics. But it is an ill wind . . . semiconductor manufacturer Maxim claims to be doing very well out of the new emphasis on non-digital techniques.

As an example, we shall look at the Maxim MAX274 device, which contains four state-variable sections, and therefore sixteen (!) op amps in a 28-pin narrow DIP package. There is also a two-section version, MAX275, of very similar characteristics. The configuration of the sections is not the same as shown in Figure 50, and is shown in Figure 54. The reason for this is that it allows a larger bandwidth to be achieved, in spite of the small values of the integrated capacitors, dictated by the room available on the die. Normally, stray capacitances would have a large effect, which is why the output of the first op amp (the high-pass output) is not available externally. The device is therefore limited to low-pass and band-pass applications, although a notch can be produced by adding an external op amp. Within that limitation, however, Butterworth, Bessel and Chebyshev filters,

of up to eighth order can be made very easily. The noise level is lower than for typical switched-capacitor filters and there is no need for an anti-alias prefilter or a clock filter (or a clock, for that matter!). Total harmonic distortion is typically less than -89dB (0.0036%).

Clearly, I cannot reproduce the Maxim data sheet here (all 25 pages), but it is extremely comprehensive, with real electrical data, including noise specifications, as well as purple prose and many graphs.

## A Practical Example

A recently-published design for a direct-conversion radio receiver includes a seventh-order elliptical filter with a corner frequency of 1700Hz, implemented with three TL074 quad op amps. This is certainly an application where the fast edges associated with a switched-capacitor filter would be very troublesome. As an alternative, the MAX274 can offer an eighth-order Chebyshev, with nearly as steep cut-off rate, and a notch could be added at, say, 2kHz, to increase the rate still further. However, we will stick to our Butterworths, and an eighth-order Butterworth reduces the response to noise level at well below 5kHz. The necessary design equations for the four external resistors per section, which are all that is required to add to the device, apart from power supplies, of course, a single 5V supply or  $\pm 5V$  at 30mA. Actually, I have used Maxim's plug-ware filter design

program, which will feature in a future part of the series, and the resulting sections are shown in Figure 55. (Plug-ware? That's software offered free or at a very low price to promote the products associated with it.) The performance of the prototype, constructed with Maxim's evaluation kit, was as follows:

Insertion loss (100Hz): -0.78dB. The program predicted -0.59dB. Response at 1698Hz: -3.34dB (untweaked). Why 1698Hz? The Lindos LA101 is a digitally-synthesizing signal generator and the frequency is not infinitely variable.

Noise (22.4Hz to 22.4kHz, of course): -70dB(V)

Maximum input signal level: +10dB(V)  
The typical noise spec. is 120 $\mu$ V in 10kHz bandwidth, which corresponds to:

$$120 \times \sqrt{\frac{22.4}{10}} \mu V$$

in 22.4kHz bandwidth, and this is -75dB(V). Since the prototype was constructed on an open, single-sided PCB with no screening and several long wires, it is not surprising that the measured level was 5dB higher.

## Next Month

Next time we shall look at number of special types of filters: all-pass filters, broad-band delay networks, wide-band audio 90° phase shift networks and the -3db/octave filter. E

## A BRIEF HISTORY OF ELECTRONICS - Continued from page 54.

years believing that it must be possible to link two circuits by a magnetic effect. Finally he made the discovery in 1831. In his experiment he wound what was effectively a transformer and noted that a meter attached to the secondary deflected only when the current in the primary circuit was started or interrupted. The discovery was very important and he presented the results of his work to the Royal Society in late 1831. Unfortunately for him, an American named Henry had been pursuing similar lines of work and had made the same discovery, possibly just before Faraday.

Despite his obvious disappointment Faraday pursued many other lines of research. He discovered the process of electrolysis, giving names including anode, cathode and ions which are still used today. He also investigated various aspects associated with light, proving that the polarisation of light could be affected by a strong magnetic field.

However, it is for his work on electromagnetic theory that Faraday will be chiefly remembered. Not only did he discover electromagnetic induction, but he revealed many of the effects associated with it, opening its use to many others in the future by providing a full understanding of its operation.

## Remembered

These early pioneers provided the cornerstones of today's electronics. Their early discoveries were possibly more momentous than many of the high-tech developments we see today. Fortunately their names are not forgotten. In 1863 the British Association chose the name volt to represent the unit of EMF, ohm to represent the unit of resistance and amp to represent current. These terms were later adopted internationally in 1893 when a conference in Chicago agreed to adopt the names ohm, ampere, coulomb, farad, joule, watt and henry as standard electrical units. This is a fitting memory to those who gave so much to modern-day science.

Many of these breakthroughs concern the observation and discovery of various effects. Next month we will look into some of the first uses of electricity and how these started to lay the foundations of modern-day electronics. E

## PCB and SCHEMATIC C.A.D.

### EASY-PC

**£98**  
+VAT & P+P

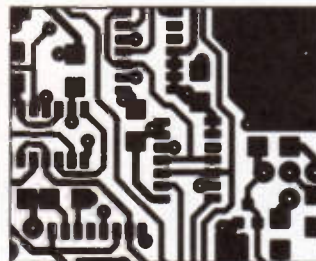
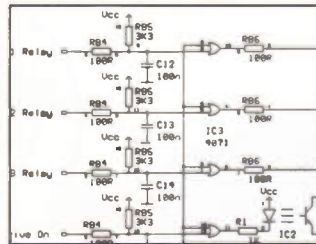

- Runs on PC/XT/AT/286/386 with Hercules CGA, EGA or VGA and many emulations.

- Design Single sided, Double sided and Multilayer boards.

- Use Surface Mount components.

- Standard output includes Dot Matrix / Laser / Inkjet printers, Pen Plotters, Photo-plotters and NC Drill.

- Award winning EASY-PC is in use in over 18,000 installations in 80 Countries World-Wide.

- Superbly Easy to use.

Options - 500 piece Surface Mount library - £48.00  
1000 piece symbol library - £38.00. Gerber import facility - £98.00

For full info' please phone, fax or write to:

**Number One Systems Ltd.**

Ref: MAP, Harding Way, Somersham Road,  
St. Ives, Huntingdon, CAMBS, England, PE17 4WR  
Telephone:- 0480 461778 (7 lines) Fax: 0480 494042  
International:- +44 480 61778 Credit Cards Welcome

BRITISH  
DESIGN  
AWARD  
1989

## APPLICATIONS

- ★ Control timer for dedicated equipment
- ★ Radio/tape recorder sleep controller
- ★ Safety control timer

Text by  
Alan Williamson  
and Robin Hall

## FEATURES

- ★ Push-button Start/Stop
- ★ Adjustable timeout period
- ★ Single pole changeover relay

**KIT  
AVAILABLE  
(VF06G)  
PRICE  
£8.99**

Nowadays there are still many items of electrical and electronic equipment in the home, such as radios, tape recorders and amplifiers that do not have a built-in timer and yet would benefit from one. For example, some bedside clock radios have a sleep control, which after activation allows the radio to play for a predetermined time, and allows the person to drift off to sleep without worrying about switching the radio off. This project would allow the same facility to be applied to devices that do not have one built in.

There are other applications for the Universal Timer, such as switching on equipment that is required to be left unattended, and yet be automatically, and safely switched off.

# Universal Timer

## Circuit Description

The block diagram for the Universal Timer is shown in Figure 1.

The heart of the circuit is the classic 555 timer IC; the pin connections of the IC are shown in Figure 2, and the internal block diagram in Figure 3.

The circuit diagram of the Universal Timer is shown in Figure 4. The power requirement for the Universal Timer is +12V DC with a maximum supply current of 61mA. Capacitor C1, (100nF tantalum) decouples any high-frequency noise on the supply. The circuit is configured as a monostable; R1, RV1 and capacitor C2 set the monostable period. The resistors R2 and R3 are connected to the internal divider chain of IC1; fitting a resistor in the R2 or R3 position will alter the internal 555 comparator's reference voltage (pin 5 nominally  $0.66 V_{CC}$ ) and therefore, in turn will alter the required threshold voltage on C2.

Close-up of assembled  
Universal Timer PCB.

### Mains Warning:

Note that mains voltages should not be directly switched by the relay on the PCB. If it is desired to switch mains, then a suitably rated relay controlled by the relay on the PCB should be used. Alternatively, an off-board relay can be controlled by wiring its coil to the relay coil pads on the PCB.



## Specification of Prototype

Supply voltage: +12V DC  
 Quiescent current: 11mA  
 Operating current: 40 to 61mA  
 Timer period: 2 seconds to 15 minutes  
 Relay contact & PCB rating: 2A @ 50V AC/DC

Resistor R4 is the input pull up resistor (START), and R6 is the reset pull up resistor (STOP).

Pin 3 of IC1 is the output, and transistor T1 is the buffer/driver, used to switch the relay (RY) on and off; the diode D1 is the load dump protection diode for T1, preventing damage from the inductive backlash of the relay when switching off.

R7 is the current limiting resistor for the LED LD1, which is in parallel with the relay and D1 as the 'on' indicator.

## Circuit Operation

Capacitor C2 is normally short circuit to ground by the discharge transistor within IC1; pushing the 'START' button will cause IC1's internal flip-flop to change state, which will switch the output to source, and switch off the discharge transistor, thus allowing C2 to charge up to the 'threshold' voltage. Once the threshold voltage has been reached, the threshold comparator will change state and reset the flip-flop, which in turn switches the output to sink and switch on the discharge transistor, shorting C2 to ground.

The 'STOP' switch when pushed, will reset the flip-flop at any time within the time out period.

## Construction

Construction is straightforward; most of the components are mounted on the legend side, with the exception of the PCB pins, which are mounted from the track side.

Begin with the smallest components first, working up in size to the largest. The resistors R2 and R3 are optional, see 'Setting Up'.

Figure 1. Block diagram of the Universal Timer.

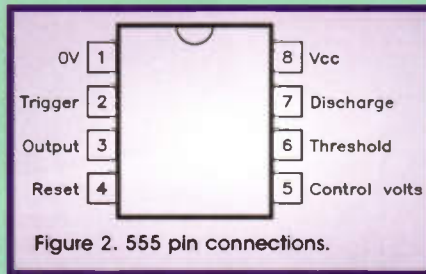
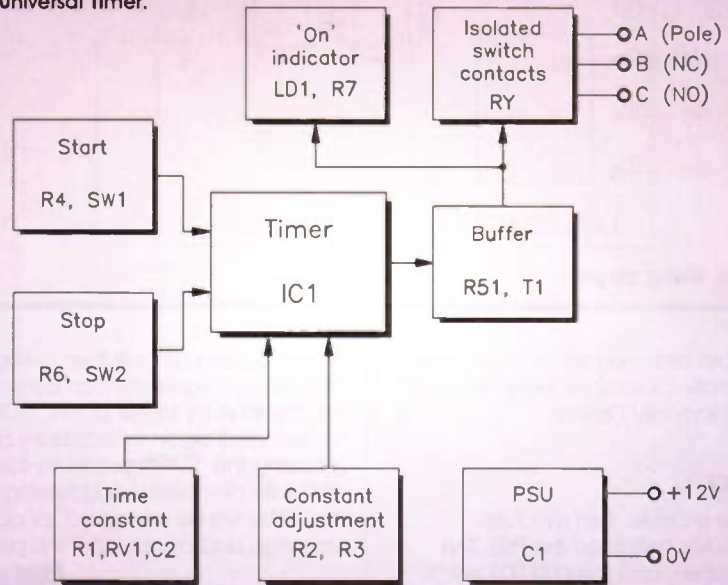

Figure 2. 555 pin connections.

Insert the +V IN and 0V PCB pins from the track side. Be careful to orientate correctly the polarised devices, i.e. electrolytics, transistor, diodes.

Fit the 8-pin DIP IC socket, making sure that the notch on the socket matches the legend on the PCB. The last stage of construction should be to insert the IC into its socket again making sure that the orientation of the notch is correct.

Thoroughly check your work for misplaced components, solder whiskers bridges and dry joints. Finally, clean all the flux off the PCB using a suitable solvent.

## Setting Up

The control voltage of the 555 monostable can be altered to any value between 0.45 and 0.9 V<sub>cc</sub> by fitting a resistor in the R2 or R3 positions; there are two resistors of different values supplied with the kit specifically for this purpose.

As a rule of thumb, the time constant (without R2 or R3 fitted [control voltage 0.66 V<sub>cc</sub>]) will be 1.1RC; with the values supplied, the minimum timeout period is 110ms and the maximum is 4 minutes.

Fitting R2 will halve the timeout period, and fitting R3 will more than double the timeout period. As can be seen, the change in control voltage is not linear; this is because the charging waveform on the timing capacitor C2 is exponential. The mathematics involved in calculating a new constant is a fairly complex affair, experimentation is the only practical answer.

The wiring diagram is shown in Figure 5; connect the PSU between (+) and (-), and the device to be switched to the

Figure 3. Internal block diagram of the 555 timer.

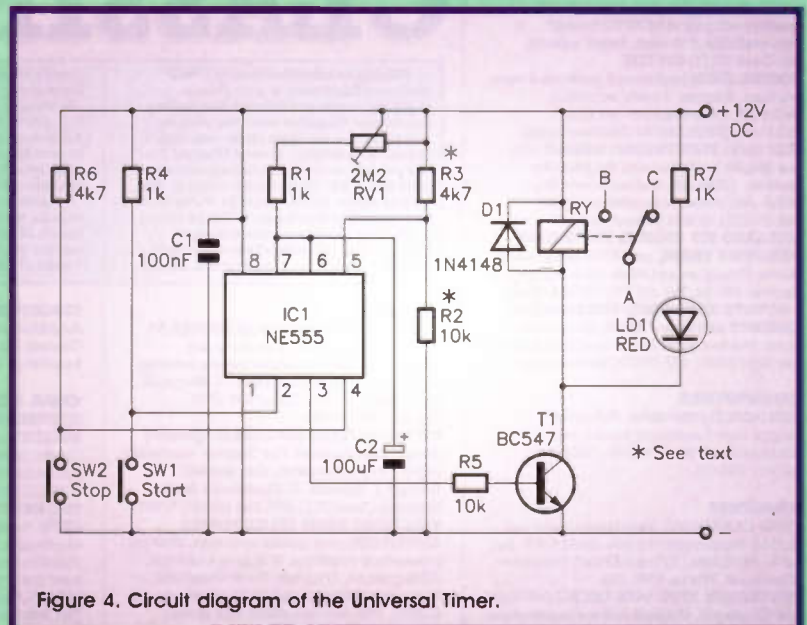
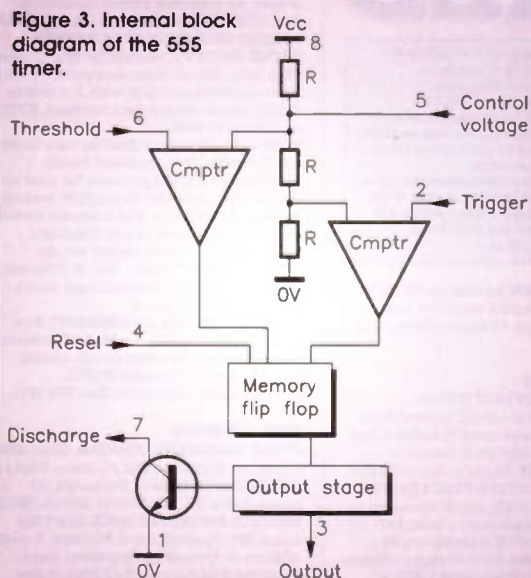
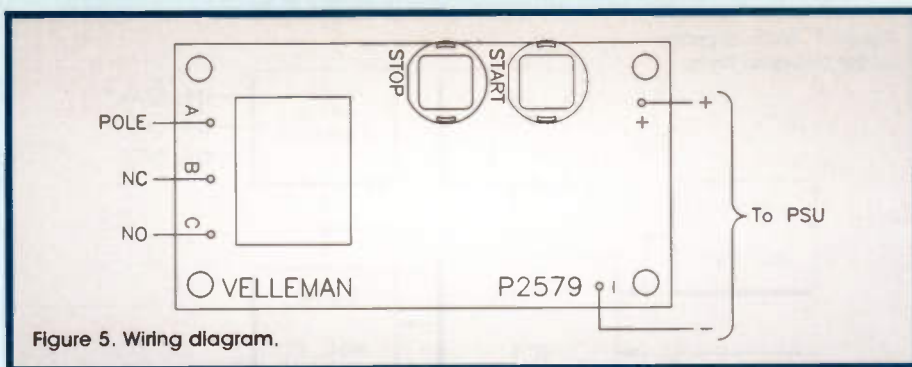

Figure 4. Circuit diagram of the Universal Timer.



relay will de-energise. Normally open (NO) and normally closed (NC) timed modes of operation can be configured from the double-throw relay, see Figure 5.

## Finally

There are many uses and applications for the Universal Timer Module, such as in hobbyist and other areas. Note that mains voltages should not be directly switched by the relay on the PCB. A suitably rated relay should be used off-board and controlled by the relay on the PCB. Alternatively an off-board relay can be controlled by wiring its coil to the relay coil pads on the PCB, i.e. +12V and TR1 collector, note D1 *must* be fitted. All mains wiring must be adequately insulated against accidental contact. Voltage levels on the PCB for the on-board relay contacts should not exceed 50V DC (35V AC).

relay output between either COM and NC (Normally Closed), or between COM and NO (Normally Open).

## Testing

To test the module, turn RV1 fully anticlockwise, switch on the PSU. The relay will close, and the LED LD1 will illuminate. Now turn RV1 to its mid position. The relay will remain closed for about 5 minutes and then release after

this time, and LD1 will then extinguish. The timing sequence can be interrupted at any time by pressing the 'STOP' switch, or restarted again if necessary by pressing the 'START' switch. By turning RV1 fully clockwise and pressing 'START', the relay will be energised for about 15 minutes, and again, after this period, the



## UNIVERSAL TIMER PARTS LIST

RESISTORS: All 5% (Unless specified)

R1	1k	1
R2	10k	1
R3	4k7	1
R4	1k	1
R5	10k	1
R6	4k7	1
R7	1k	1
RV1	2M2 Horizontal Preset	1

### CAPACITORS

C1	100nF Monolithic Ceramic	1
C2	100µF 16V Electrolytic	1

### SEMICONDUCTORS

IC1	NE555/CA555	1
T1	BC547	1
D1	1N4148/1N914	1
LD1	Red 5mm LED	1

### MISCELLANEOUS

SW1, SW2	Push Switch	2
RY	12V DC Relay	1
	8-pin DIL IC Socket	1
	PCB	1
	PCB Pin	5

The Maplin 'Get-You-Working' Service is available for this project, see Constructors' Guide or current Maplin Catalogue for details.

**The above items are available in kit form only. Order As VF06G (Universal Timer) Price £8.99**

Please Note: Some parts, which are specific to this project (e.g., PCB), are not available separately.

## AUDIO

### CIRADE TOROIDAL TRANSFORMERS.

300VA 39-0-39 plus preamp windings. Possibly suit pair of MOSFET boards. Two available, £16 each. Buyer collects. Tel: Dave (0171) 625 7727.

**FOSTEX X-28H** high-speed multi-track tape machine. 8 inputs, 4 track recording, Dolby NR. Only 6 months old £350.

Tel: Dave (0956) 540085 (Medway area).  
**MES 51/53 ELECTRONIC ORGAN** with one Maplin keyboard and the parts for another. Quite old, and not in working order. Any reasonable offer accepted. Tel: (01277) 363615 (Ongar, Essex).

**MULLARD 510 CHASSIS PARTRIDGE PARMKO TRANS**, pair KT66 and preamp valves. Grampian and other valve equipment. Approx. £60 lot. Tel: (01732) 367684 (Kent).  
**5 OCTAVE KEYBOARD/PEDALS/TEAK CABINET** and some DMOT2 Generators, given free to a good home near Manchester. Tel: John (0161) 437 7357 (Cheshire area).

## COMPUTERS

**DRAGON 32**, disk drive. Full set of Dragon User magazines, books, and information. Offers: Tel: Mr. Callender (01295) 253475.

## VARIOUS

**SHED CLEAROUT.** Very cheap, used and unused components for sale. Send S.A.E. for list to: M. Knight, 10 Daniel Road, Mancetter, Atherstone, Warks. CV9 1PA.  
**TEKTRONIX TYPE 545B OSCILLOSCOPE** and CA plug-in. Original makers maintenance manual. £100 o.n.o. Tel: (01279) 793474.

# CLASSIFIED

Placing an advertisement in this section of *Electronics* is your chance to tell the readers of Britain's Best Selling Electronics Magazine what you want to buy or sell, or tell them about your club's activities—Absolutely Free of Charge! We will publish as many advertisements as we have space for. To give a fair share of the limited space, we will print 30 words free, and thereafter the charge is 10p per word. Placing an advertisement is easy! Simply write your advertisement clearly in capital letters, on a post-card or sealed-

down envelope. Then send it, with any necessary payment, to: Classifieds *Electronics—The Maplin Magazine*, P.O. Box 3, Rayleigh, Essex SS6 8LR. Advertisements will be published as soon as possible, space allowing. No responsibility is accepted for delayed publication or non-inclusion of advertisements.

Readers who have reasonable grounds to believe they have been misled as to the nature of an advertisement are advised to contact the Publisher and their local Trading Standards Office.

## WANTED

**AYR TELETEXT ADAPTOR MODEL T1** circuit diagram, service sheet or any information. Even consider buying working unit. Contact: Mike McMahon, 37 Herschell Road, Leigh-on-Sea, Essex SS9 2NH. Tel: (01702) 712746.

**CD 3061 OCTAVE DIVIDER IC** (possibly 'Sanyo' manufacture). For 'Bentley' electronic organ. Any information, also wanted. Contact: J. Runacre, 21 Dundonald Road, Ramsgate, Kent CT11 9PU. Tel: (01843) 586371.  
**VELLEMAN K4000 VALVE POWER AMPLIFIER**, plus quality speakers. Must be in excellent condition. Will give 4-channel, 50Meg scope, Freq-SineWave Generator, Frequency Counter, and DVM, worth around £1,500. Will deliver/collect with straight swap. Tel: (01443) 685228.

**CIRCUIT DIAGRAM** for Luxman SQ1220 Amplifier. Manufacturers unable to help. Contact: Mr. R. Perry, 62 Aspen Green, Erith, Kent DA18 4HX.

## CLUB CORNER

**SOUTHEAST & DISTRICT RADIO SOCIETY** meets at the Druid Venture Scout Centre, Southend, Essex every Thursday at 8pm. For further details, contact: F. Jensen, (G1HQ) P.O. Box 88, Rayleigh, Essex SS6 8NZ.  
**THE BRITISH AMATEUR ELECTRONICS CLUB** (founded in 1966), for all interested in electronics. Four newsletters a year, help for members and more! UK subscription £8 a year (Junior members £4, overseas members £13.50). For further details send S.A.E. to: The Secretary, Mr. J. F. Davies, 70 Ash Road, Cuddington, Northwich, Cheshire CW8 2PB.

## THE LINCOLN SHORT WAVE CLUB

meets every Wednesday night at the City Engineers' Club, Waterside South, Lincoln at 8pm. All welcome. Further details from Pam, (G4STO) (Secretary) Tel: (01427) 788356.  
**WIRRAL AND DISTRICT AMATEUR RADIO SOCIETY** meets at the Irby Cricket Club, Irby, Wirral. Organises visits, DF hunts, demonstrations and junk sales. For further details, please contact: Paul Robinson, (G0JZP) on (0151) 648 5892.

**TESUG** (The European Satellite User Group) for all satellite TV enthusiasts! Totally independent. TESUG provides the most up-to-date news available (through its monthly 'Footprint' newsletter, and a teletext service on the pan-European 'Super Channel'). It also provides a wide variety of help and information. Contact: Eric W. Wiltsher, TESUG, Rio House, Stafford Close, Ashford, Kent TN23 2TT, England.  
**MODEL RAILWAY ENTHUSIAST?** How about joining 'MERG', the Model Electronic Railway Group. For more details contact: Mr. Eric Turner, Treasurer MERG, 38 North Drive, Orpington, Kent BR6 9PQ.

## BBS CORNER

**APPLE CRACKERS.** FirstClass Client BBS, mainly for AppleMac and PC users. Baud rate 2.4K-bit/s to 14.4K-bit/s, 8 data bits, no parity, 1 stop bit. Tel: (01268) 781318/780724.  
**MACTEL METRO/ICONEK.** FirstClass Client BBS, AppleMac and PC users. E-mail address on Internet for registered users. Baud rate 2.4K-bit/s to 14.4K-bit/s, 8 data bits, no parity, 1 stop bit. Tel: (0181) 543 8017 (Metro) or (01602) 455444 (Iconex).



# SUBSCRIBE TO

**\* BRITAIN'S BEST SELLING \*  
ELECTRONICS MAGAZINE!**



**\* 2 FREE ISSUES** if you agree to subscribe by Direct Debit or Continuous Credit Card, saving you £5.82!

**\* FREE DELIVERY TO YOUR DOOR,** and there are no additional carriage charges.

**\* PLUS – News, reviews, readers letters, competitions and lots, lots more besides!**

To subscribe just send a cheque/postal order for £10.98 made payable to Maplin Electronics, P.O. Box 3, Rayleigh, Essex SS6 8LR. **OR** you can take advantage of our offer of two free issues by completing the coupon below and agreeing to pay by Credit Card or Direct Debit. The two free issues offer only applies if you use one of these two methods of payment. Simply fill in the 'Payment by Credit' or 'Payment by Direct Debiting Mandate' and return it to Maplin. Every time, about 1 month before your subscription is due, we will send you a letter giving details of the subscription rate and telling you the date on which we will charge your Credit Card or debit your bank account. If you do not wish to continue your subscription, you have until that date to let us know, and we will then cancel your authority to bill your Credit Card or cancel your mandate. Otherwise, if you do nothing, your subscription will continue. The authority or mandate you give us does not allow us to charge anything other than the Maplin Magazine subscription. The benefit to you is that you no longer need to remember to renew your subscription or send off any more cheques or postal orders. Payment is made automatically.

**\* YES, SAVE MONEY** by taking a subscription, it's cheaper than buying each individual copy.

**\* REGULAR SUBSCRIBERS' SPECIAL OFFERS**  
Super savings on selected products!

**OVERSEAS READERS – SUBSCRIBE NOW!** – Phone Maplin Export: +44 1702 554155 Ext. 326 or 351. Full details on request.  
Subscription rates for 6 issues are: £15.00 (or 37 IRCs) in Eire, Europe and surface mail outside Europe; £22.50 (or 55 IRCs) Air Mail outside Europe.  
Subscription rates for 12 issues are: £30.00 (or 73 IRCs) in Eire, Europe and surface mail outside Europe; £45.00 (or 110 IRCs) Air Mail outside Europe.  
**AFRICAN READERS – SUBSCRIBE NOW!** – Phone Maplin South Africa: +27 24 51 5124.  
Subscription rate for 6 issues is: R114,00; Subscription rate for 12 issues is: R215,00.

## TAKE THE NEXT 2 ISSUES OF THIS MAGAZINE FREE!!

Because we're so certain that now you've seen the Maplin Magazine you'll want to receive it regularly, we're offering to send you the next two issues free of charge with absolutely no obligation to continue. Just fill in the details below and if after receiving two issues you do not wish to continue, just let us know at least one month before the next issue is due and we will cancel your subscription. The two free issues will be yours to keep whatever you decide. If you already have a subscription, fill in the details below and we'll add two issues free of charge to your current subscription. **SEND NO MONEY NOW.** About 2 weeks before the third issue is due, we will charge you £10.98 for the next six issues, unless you have cancelled. This offer is not available to those already paying by Direct Debit or Continuous Credit Card or those who have stopped payment by either method within the last year. **THIS OFFER IS OPEN TO RESIDENTS WITH U.K. ADDRESSES ONLY.**

**PLEASE START MY SUBSCRIPTION WITH ISSUE**  (If left blank subscription will start from next issue.)

EITHER

**★ PLEASE ADD YOUR ADDRESS, SEE BOTTOM RIGHT ★**

**PAYMENT BY CREDIT CARD.** Please charge my Credit Card Account

I authorise you until further notice in writing to debit my CREDIT CARD account by £10.98 and in future, with any amounts which, after notification, MAPLIN ELECTRONICS plc may debit thereto in respect of my subscription to the Maplin Magazine.

Customer Number (if known) .....

Access  Visa  American Express

Account No. \_\_\_\_\_  
Signature \_\_\_\_\_ Date \_\_\_\_\_

OR

**PAYMENT BY DIRECT DEBITTING MANDATE** in favour of Maplin Electronics plc, P.O. Box 3, Rayleigh, Essex SS6 8LR.

Direct Debit payment option is only open to customers with bank accounts in the U.K. including Channel Isles, Isle of Man and N. Ireland.  
Please note: Instructions cannot be accepted to charge Direct Debits to a Deposit or Savings Account.



Bank Sort Code \_\_\_\_\_ Bank Account Number \_\_\_\_\_

Name of account to be debited \_\_\_\_\_

Bank Address \_\_\_\_\_  
\_\_\_\_\_  
\_\_\_\_\_  
\_\_\_\_\_  
\_\_\_\_\_

I authorise you until further notice in writing to charge my account, with you, any amounts which MAPLIN ELECTRONICS plc may debit thereto by Direct Debit in respect of my subscription to the Maplin Magazine.

I will inform the bank in writing if I wish to cancel this instruction.

I understand that if any direct debit is paid which breaks the terms of this instruction, the bank will make a refund.

Signature \_\_\_\_\_ Date \_\_\_\_\_

**Enter your address and Maplin customer number, if known.**

\_\_\_\_\_  
\_\_\_\_\_  
\_\_\_\_\_  
\_\_\_\_\_  
\_\_\_\_\_  
Postcode \_\_\_\_\_

Put this form in an envelope and address it to: Maplin Electronics, Freepost, P.O. Box 3, Rayleigh, Essex, SS6 2BR.



# FUZZY LOGIC IN CONTROL

by Frank Booty

**T**HE concept of fuzzy logic was devised by Professor L. Zadeh in 1965. Steam engine control was demonstrated in 1974 by Professor Mamdani, and cement kiln control by F. L. Smith in 1982. In 1986 there were eighty-six applications with fuzzy logic in Japan. Until recently, Western companies have treated anything 'fuzzy' as a curiosity, while Japanese companies have been adopting the techniques with enthusiasm.

When a person controls a process, perhaps as commonplace as a car engine or as specialised as a chemical plant, they describe their expertise in an apparently imprecise way. In starting a car a person may accelerate the engine a little before engaging the clutch and driving away. The chemical plant operator may reduce process heating slightly if the product temperature is rising slowly. While imprecise, such rules appear to work well in practice.

The description of control in such circumstances is in linguistic terms. Because such terms are imprecise they are sometimes termed fuzzy. In the early days of Artificial Intelligence the term fuzzy logic was coined to describe the mathematical techniques employed to describe and manipulate such descriptions. If fuzzy logic could be applied to the control of machinery and systems, the best of human performance could be achieved quickly and consistently.

## Fuzzy Control

Fuzzy control in early work was applied to difficult industrial problems and showed substantial benefits over both manual control and conventional automatic methods. The best publicised examples are probably those to do with control of cement kilns. Others include heat exchanger control and steam plant control. As an accessible and practical technology, fuzzy control attracted the interest of Japanese research and development groups. Now with a wealth of practical application, Japanese industry is reaping the benefits. Examples include an automatic train control system, applications in consumer products like washing machines, vacuum cleaners; and air-conditioning. The list is extensive.

Fuzzy control is now a well-developed technology with certain clear advantages. Those

advantages are already recognised in Japan, and are increasingly becoming understood in the West. Once the traditional hype surrounding the issue has been stripped away, it's possible to see sound engineering reasons for adopting fuzzy techniques.

Applications of fuzzy control are expected to become more numerous and Western companies are expected to include fuzzy techniques in their products. It will be possible to see applications of control where control has not been judged possible, and where some of the virtues of fuzzy control are most attractive:

There are small consumer goods (toasters and coffee makers where new approaches to control will yield attractive, convenient and versatile products). People-oriented control (train control, control of cars, elevator control). Applications in the 'intelligent building' (heating, ventilation and lighting). Making machines easier to use (washing machines, vending machines where wide choice confuses customers). Healthcare (diagnostic systems which offer the best of human judgement in small and cost-effective packages).

The success of the Japanese developments in fuzzy control has shaken groups into action. Siemens established a fuzzy task force to build a technical base in fuzzy control. The task force was also instructed to create a network both inside Siemens and among its suppliers to collect and disseminate information. US based consumer goods manufacturer Whirlpool while considering much of fuzzy logic to be *glitz* is interested in what fuzzy logic has to offer in improving the function of 'white' goods. Cambridge Consultants in the UK had its work in fuzzy logic spurred on by the need to translate the judgement of an expert helmsman for a ship control application. The resulting fuzzy logic system became the test bed for developing and testing new fuzzy logic systems for closed loop control and supervisory control.

There are clear advantages to fuzzy control. Fuzzy control is knowledge based since it uses the expertise of human operators programmed into the controller. Hitachi demonstrated that fuzzy train control was far better than conventional methods. Among the benefits was a 10% decrease in energy consumption for

the same journeys. Fuzzy control succeeds by emulating a successful human control strategy.

Fuzzy control makes no assumptions about the underlying system and so does not become excessively complicated when for example there is another measurement to handle. It permits rapid development and prototyping. Rockwell Engineers reported an order of magnitude improvement in the time taken to develop an automotive control system compared with a conventional approach. Reduction in memory requirements of 10 to 1 have been recorded where a fuzzy controller was compared with a conventional approach.

## Fuzzy Elements

A simple fuzzy controller consists of three elements: a *rulebase*, a *fuzzifier* which converts measurements into fuzzy variables and a *defuzzifier* which takes the results of reasoning and produces a new control setting. More complex forms of controller may also have predictive abilities and time delay compensation.

The *rulebase* consists of the rules which dictate control actions. In a temperature controller the rules of the form are:

If the temperature is high and increasing then reduce heater setting.

If the temperature is low and increasing then leave heater setting unchanged.

These summarise the control strategy, without undue concern for the inner workings of the heating process.

The *fuzzifier* is the link between the measurements and the rules. Each measurement needs to be converted into a representation which can be used by the rules. When a person describes a temperature as 'high' it is only with a degree of confidence. The higher the temperature the greater the degree of confidence. As the temperature decreases it will be categorised less as 'high' and more as 'OK'. Rules which depend on 'high' temperatures will apply less than rules which depend on 'OK' temperatures.

After the rules have been processed the *defuzzifier* takes the recommended control actions from all the rules that apply, and combine them to give a new control setting.

This example illustrates how, as temperature decreases, the application of control rules changes gradually. Such gradual changes are one of fuzzy control's significant attractions particularly in control systems which involve people, such as with trains and elevators for instance, where smooth operation is essential.

Fuzzy control's credentials make it a likely favourite for control of difficult processes particularly in industrial and consumer products. While a leading contender, it is not the only control method available, and it remains one of several control techniques to be applied on the basis of good engineering judgement. The key factors in choosing fuzzy control are an ill-defined and perhaps time-varying system to be controlled, limited control computer capacity, and the need for a fast proof of concept. The benefits are reduced development

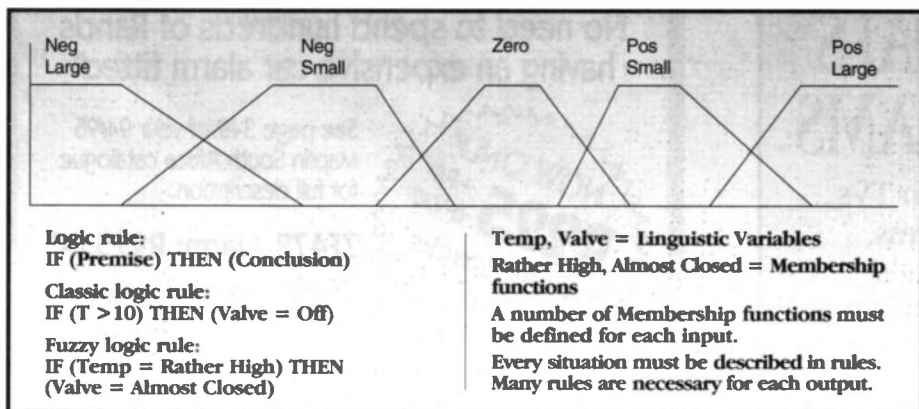

Figure 1. Fuzzy Control.

time, smaller control system size and cost, and substantially lower risk in the development of control systems.

## Fuzzy Control Adoption

There is a basic checklist which is designed to assist in indicating whether it would be worth considering fuzzy control in an application:

- Is there human control expertise that can be applied? It may come from process or machine designers, or from control experts.
- Is the system difficult to characterise? Washing clothes and toasting bread illustrate the difficulty.
- Is the product life-cycle short? Would sequential development of the machine, process and the control system take too long?
- Is any unevenness in control noticeable by people, such as in an elevator, train or tram?
- Is there significant pressure on the cost and complexity of the control system?
- Is a fast proof of concept needed?

If any of these points apply, then fuzzy control should be considered. The more points that apply the more likely it is to be the appropriate technical solution for control.

## Summary

There are clear merits and demerits of fuzzy control. With the merits: fuzzy controls processes, which could only be controlled manually, fuzzy control is easy to understand and unpredictable disturbances can be handled. With demerits: fuzzy is hard to back

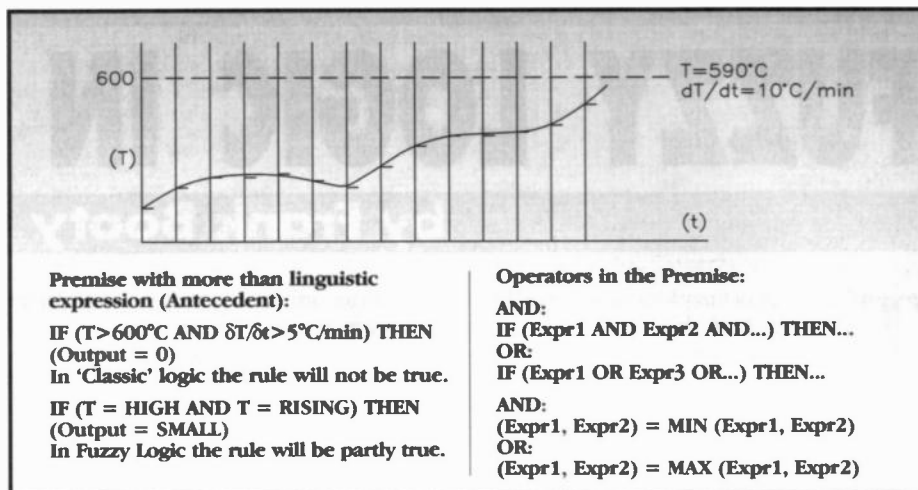

Figure 2. Fuzzy Logic.

up theoretically, and no method to determine rules or *membership* exists.

The future development of fuzzy control is likely to cover the addition of a learning function, methods for determining *membership* function and theoretical analyses for stability.

Applications – fuzzy logic can be used for: modelling of human decision making, performance indication, intelligent warning systems, control optimisation and control algorithms. In process control, fuzzy logic should be used when a mathematical description of the process is not available or difficult to make (nonlinear, time variant); the control strategy cannot be expressed in mathematical formulae; the process can be controlled by in-

tuition and the experience of skilled operators; and many inputs must control one or more outputs.

Fuzzy logic has already been successfully applied to polymerisation control (models can get very complex, reaction is sensitive to impurities, giving time-varying nonlinear behaviour); cement kiln control (complex interaction of controlled variables, difficult to model, process controlled by experience); temperature control of waste incinerator (process characteristics unpredictable, depend on raw materials input); water purification control (addition of chemicals, depending on water quality); distillation column temperature control; and glass melting furnace control.

## TECHNICAL INFORMATION SERVICES

76 Church Street, Larkhall, Lanarks, ML9 1HE  
 Tel: (0698) 883334 Fax: (0698) 884825  
 Technical Help Line (0698) 888343

We have the World's Largest Selection of:

## SERVICE MANUALS CIRCUIT DIAGRAMS

We also have 100s of Titles on TVs, VCRs, Satellites, Midi Systems, Computers, Test Equipment, etc... Please Phone or Send an SAE for FREE QUOTE & CATALOGUE of Publications

## Maplin SOUTH AFRICA

### PROTECT YOUR CAR

### WITH THE BEST VALUE REMOTE CONTROL ALARM

in South Africa

No need to spend hundreds of Rands having an expensive car alarm fitted!

**NOW ONLY R225** +PP & VAT  
 While stocks last!

See page 349 of your 94/95 Maplin South Africa catalogue for full description.

ZF47B Alarm: **R225,00**

ZF48C Spare Remote Transmitter: **R65,00**

Maplin South Africa (Pty) Ltd.  
 P.O. Box 1846, Somerset West, 7129, RSA.  
 Tel: (024) 515 124 Fax: (024) 515 127

## DIARY DATES

Every possible effort has been made to ensure that the information presented here is correct prior to publication. To avoid disappointment due to late changes or amendments please contact event organisations to confirm details.

**17 to 19 January.** Outdoor Event & Live Music Production, Wembley Centre, London. Tel: (01203) 694393.  
**27 January.** Caught in the Net. Arts Theatre, 6-7 Great Newport Street, London WC2. Please phone for details of other dates. Tel: (0171) 836 2132.  
**29 January to 1 February.** European Lightshow Exhibition, Earls Court, London. Tel (01952) 290905.  
**7 to 9 February.** ISDN USER - Integrated Communications Exhibition, Olympia, London. Tel: (01733) 394304.  
**14 to 16 February.** SMARTCARD -

International Smart Card Exhibition and Conference, Olympia, London. Tel: (01733) 394304.

**1 to 2 March.** Electronic Books International, Wembley Centre, London. Tel: (0171) 976 0405.

**7 to 9 March.** Computers in Libraries, Wembley Centre, London. Tel: (0171) 976 0405.

**16 to 19 March.** Computer Shopper Show, NEC, Birmingham. Tel: (0181) 742 2828.

**9 to 11 April.** European Computer Trade Show, Business Design Centre, London. Tel: (0181) 742 2828.

**22 April.** Special International Marconi Day exhibition station at Puckpool Park Wireless Museum, IOW. Tel: (01983) 567665.

**8 May.** Working wartime CW shortwave station to celebrate VE-Day at the

Puckpool Park Wireless Museum, IOW. Tel: (01983) 567665.

**16 to 18 May.** Internet World, Wembley Centre, London. Tel: (0171) 976 0405.

**14 to 15 June.** Government Computing & Information Management, Royal Horticultural Halls, London. Tel: (0171) 587 1551.

**27 to 29 June.** Networks Exhibition, NEC, Birmingham. Tel: (0181) 742 2828.

**2 September.** Wight Wireless Rally at the Arreton Manor Wireless Museum, near Newport, IOW. Tel: (01983) 567665.

**10 September.** Southend & District Radio Society 75th Anniversary Radio and Computer Rally, The Cliffs Pavilion, Southend. Tel: (01702) 353676.

**10 to 13 September.** PLASA - Light and Sound Trade Show, Earls Court, London. Tel: (0171) 244 6433.

**19 to 21 September.** Computers in Manufacturing Exhibition, NEC, Birmingham. Tel: (01932) 564455.

**20 to 21 September.** Electrical Engineering Show, Hinckley Island Hotel, Hinckley. Tel: (01732) 359990.

**4 to 6 October.** Electronic Data Exhibition, ICC, Birmingham. Tel: (0181) 742 2828.

**12 to 13 October.** Electrical Engineering Show, Forte Post House Hotel, Basildon. Tel: (01732) 359990.

**10 to 12 November.** Design & Technology Education Exhibition, NEC, Birmingham. Tel: (01425) 272711.

Please send details of events for inclusion in 'Diary Dates' to: The News Editor, *Electronics - The Maplin Magazine*, P.O. Box 3, Rayleigh, Essex, SS6 8LR.

### Future of Amateur Radio at Science Museum More Secure

The RSGB are trying to ensure that there will be an amateur radio exhibit at the Science Museum in London's Kensington.

Following the announcement in the summer that the GB2SM exhibit was to close, the Society made a number of representations to the Museum. These sought to discover the reasons behind the intended closure and how best to retain a high public profile for amateur radio.

During October RSGB General Manager, Peter Kirby, G0TWW, met with the Science Museum's Director, Sir Neil Cossons, at Kensington. The outcome of this meeting was an agreement that the Museum would enter into discussions with the Society with a view to providing an innovative, state-of-the-

art, hands on exhibit to replace the existing station.

Contact: RSGB, Tel: (01707) 659 015.

### Gates Previews the Technological Future at COMDEX Fall 1994

Microsoft Chairman Bill Gates gave a glimpse of the role technology can play in our lives in ten years time, during his keynote speech at COMDEX Fall 1994. Comdex is a major international computing and electronics exhibition that takes place bi-annually in the USA.

In a dramatic presentation entitled 'Information at Your Fingertips - 2005' Gates transported his audience to the city of Seattle, USA, ten years into the future to illustrate the various types of technological

products that we will see in offices, homes, schools, hospitals and even police cars.

Gates used mobile and voice-activated computers and cellular-video car phones to solve a crime (with the help of two fictional detectives from the Seattle Police Department in 2005) to demonstrate how computing advances in the next decade will dramatically improve access to the information we need.

"By the year 2005, people will use technology to learn, work, shop, socialise and even consult a doctor," said Gates. "Kids at school, parents at the office, police at the scene of a crime - everyone will benefit from the wealth of tools and information available at our fingertips."

During his address, Gates showed how technology will enhance and advance health care when, in one scene, a patient

was rushed to hospital. During the ambulance ride, vital X-rays were up-linked to the hospital, and a team of specialists in different cities consulted with the emergency medical team to diagnose the patient's condition and suggest treatment, even before he was wheeled into the emergency room.

Other parts of the production depicted a teenager using his laptop computer connected to the information highway to do his homework, complete with music, full-screen colour photos and diagrams. His mother, meanwhile, used the family's home PC to select her favourite TV programmes, and watch them when and where she wanted. Nearly all of the characters used wallet PCs that contained electronic money, ID, credit cards and digital photos to complete transactions, or contact other people.

Contact: Microsoft, Tel: (01734) 270 001.

# SEETRAX CAE - RANGER - PCB DESIGN

## Ranger1 £100

- \* Schematic capture linked to PCB
- \* Parts and wiring list entry
- \* Outline (footprint) library editor
- \* Manual board layout
- \* Full design rule checker
- \* Back annotation (linked to schematic)
- \* Power, memory and signal autorouter - £50

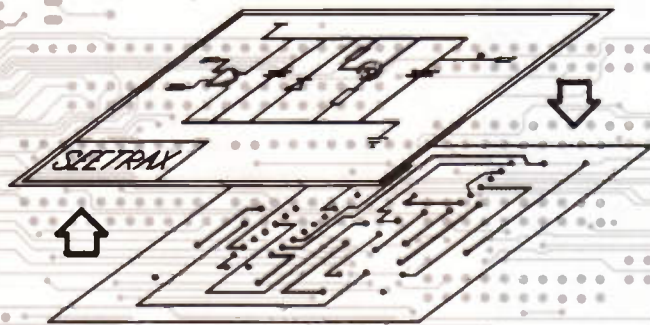

All systems upward compatible. Trade-in deals available.

Call **Seetrax CAE** for further information/demo packs.  
 Tel 0705 591037 Fax 0705 599036

Seetrax CAE, Hinton Daubnay House, Broadway Lane,  
 Lovedean, Hampshire, PO8 0SG

All trademarks acknowledged.

## Ranger2 £599

All the features of Ranger1 plus

- \* Gate & pin swapping (linked to schematic)
- \* Track highlighting
- \* Auto track necking
- \* Copper flood fill
- \* Power planes (heat-relief & anti-pads)
- \* Rip-up & retry autorouter

## Ranger3 £3500

All the features of Ranger2 plus

- \* UNIX or DOS versions
- \* 1 Micron resolution and angles to 1/10th degree
- \* Hierarchical or flat schematic
- \* Unlimited design size
- \* Any-shaped pad
- \* Split power planes
- \* Optional on-line DRC
- \* 100% rip-up & retry, push & shove autorouter

## Outputs to:

- \* 8/9 and 24 pin dot-matrix printers
- \* HP Desk/Laser Jet, Canon BJet, Postscript (R3 only)
- \* HP-GL, Houston Instruments plotters
- \* Gerber photoplotters
- \* NC Drill Excellon, Sieb & Meyer
- \* AutoCAD DXF

# FOCUS ON THE ARECIBO OBSERVATORY

## Facts and Figures

The Arecibo telescope in Puerto Rico is quite different from any other radio telescope in the world. For one thing it is the biggest; at over 1,000 feet in diameter (307 metres) it dwarves other telescopes such as Jodrell Bank (250 feet). The design is certainly different and borrows much from expertise used in the construction of modern suspension bridges. The main dish structure is fixed, and suspended above a natural depression amongst lush tropical vegetation. Three towers, the largest of which is some 365 feet high, suspend a central platform weighing some 600 tons above the giant dish. Each of the support towers is anchored by five  $3\frac{1}{4}$  in. diameter steel bridge cables.

The Arecibo Observatory is part of the National Astronomy and Ionosphere Centre – a national research centre operated by Cornell University under contract with the National Science Foundation.

Completed at a cost of around \$9.3 million in 1963, and with an \$8.8 million upgrading completed in 1974, the cost of replacing the telescope today would be around \$100 million.

The aerial view shown in Photo 1, indicates the scale of the observatory. The actual dish is not solid but consists of almost 40,000 perforated aluminium panels each measuring about  $3 \times 6$  feet. It is possible to adjust each panel independently to maintain a precise spherical shape which varies by less than 0.12 of an inch over its entire surface. The array of aluminium panels are themselves suspended from a complex network of cables.

The upper half of the central platform is a triangular structure, below which hangs a circular track; used to orientate the azimuth arm. This structure, some 328 feet long, consists of two carriage houses below which are mounted feed antennae; by directing these antennae feeds to specific points of the telescope surface, signals from  $20^\circ$  either side of vertical can be selected. Thus, rather than in a conventional telescope where the orientation between the telescope surface and the collecting antennae are fixed, and the telescope moved, the Arecibo system has a fixed detecting surface; but the collecting antennae can be located at specific locations to select signals from a specific direction in space. This gives the ability to steer the telescope's 'line of sight' within  $\pm 20^\circ$  from the vertical. The effective collecting diameter of the telescope is somewhat less than the 1,000 feet of the total cross section for significant azimuth angles.

The Arecibo telescope has a somewhat restricted angle of scan, compared with a

Above left: Photo 2. Picture of the Arecibo telescope after completion of the ground screen round the periphery of the telescope in order to reduce the effect of ground noise.

Left: Photo 1. View of the Arecibo Observatory before the construction of the ground screen. The 1,000 foot diameter telescope, rests in a natural depression in central Puerto Rico.

conventional Radio Telescope, that can be steered to almost all locations in the sky. It would, however, not be possible to construct a steerable dish of the size of Arecibo – it would tend to deform under its own weight.

The high sensitivity of the Arecibo Observatory allows observations to be made of specific cosmic structures in much shorter times than smaller observatories. Where several hours of observing time would be required by other observatories, typically several minutes of data will suffice with the high signal to noise ratio of the Arecibo system.

The highly sensitive feed antennas are held in Liquid Helium or Nitrogen in order to reduce the intrinsic electron noise in the system. The telescope can detect frequencies between 50MHz and 5,000MHz (6m to 6cm wavelengths).

A key characteristic of any radio telescope system is the accuracy of its positioning system. The current positional accuracy of 2.3mm of the point of focus of the telescope is a fundamental limitation of its operation. Increasing use will be made of laser ranging technology to improve this level of precision.

A recent enhancement of the telescope (completed in August 1993) has been the construction of a ground screen around the periphery of the main dish. This 60 foot high fence reduces considerably ground based interference and further improves the signal to noise ratio of the telescope. Photo 2 shows the completed ground screen around the perimeter of the telescope. Figure 1 shows interim results of reduced system temperature noise as a function of zenith angle. The ground screen is effective in reducing interference when sections of the telescope close to the periphery are utilised.

## Windows on the World

Figure 2 shows the nature of transmission through the atmosphere of frequencies in the electromagnetic spectrum. Where photons are relatively energetic, e.g., from ultraviolet and higher energies through the X-rays and gamma radiation, then they tend to interact by ionising molecules along their path, and are absorbed.

Absorption at longer wavelengths tends to take place due to lower energy molecular interactions in the near and infra-red wavelengths. There is a relatively wide radio 'win-

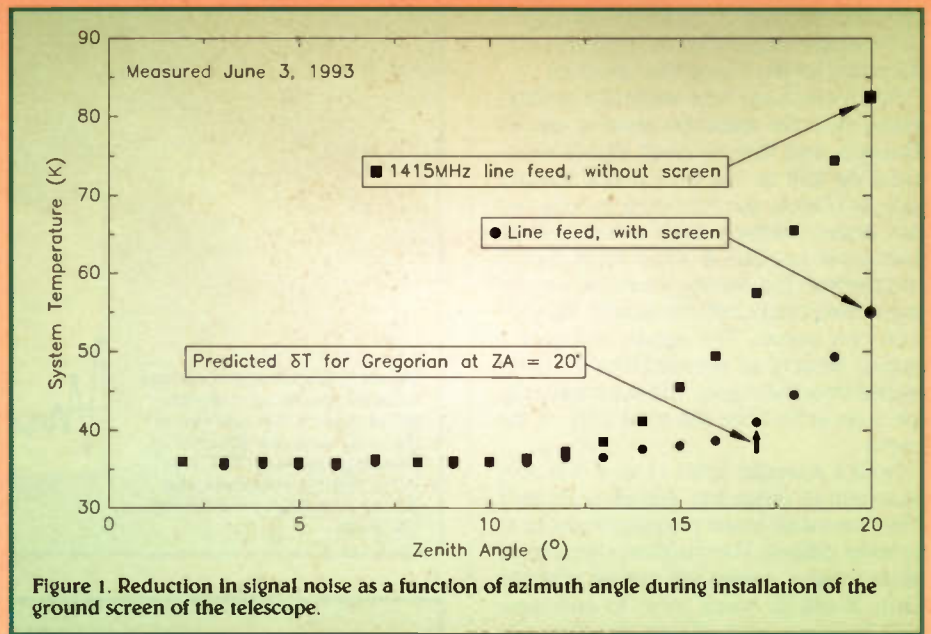

Figure 1. Reduction in signal noise as a function of azimuth angle during installation of the ground screen of the telescope.

dow', however, ranging from about 10MHz to 200GHz which allows telescopes like the one at Arecibo to probe the furthest depths of the Universe. Often radio telescopes can probe regions of the universe within which visible light is absorbed due to clouds of dust, etc.

Problems are increasingly encountered by man-made signal interference, due to a broad range of electronic and communication devices – even in places such as the remote interior of Puerto Rico. This problem is being tackled at Arecibo by the careful monitoring of applications for use of frequency bands likely to be used by the telescope. There is also increasing interference from satellites such as the GLONASS system for global positioning. This system currently has 15 satellites in orbit and will have a full complement of 24. A joint experiment was undertaken during November 1992, to switch off satellites or switch frequencies to clear specific frequencies used to identify molecules species in space.

## The Doppler Effect

The Doppler effect tends to increase the wavelength of radiation from retreating objects, and reduce the wavelength of radiation from objects advancing towards the earth. The situation is analogous to the

change in the tone of a siren in a vehicle as it approaches an observer, passes and then moves away.

Most distant radio sources have red shifts proportional to the relative retreating velocity, i.e. the wavelengths of e.g., natural hydrogen transitions are increased in wavelength. Figure 3 shows the relative overall shift of a spiral galaxy as well as the faster velocity at one side, and a slower velocity at the other. In this way radio telescopes can be used to map out relative velocities of objects throughout the observed universe.

## RADAR Astronomy

One of the more unique features of the Arecibo telescope is its radar facility. A range of powerful transmitters can send out a narrow beam of radiation and the telescope can then detect signals reflected from distant targets. One main transmitter at 430MHz can radiate at powers of 160kW and another at 2,380MHz can radiate at 400kW. A new S-band transmitter capable of being driven at 1MW output at 2,380MHz is part of the current programme of upgrading of the Arecibo systems.

The Arecibo telescope, for example, was able to scan below the cloud layers of Venus to map out the diverse terrain of the planet.

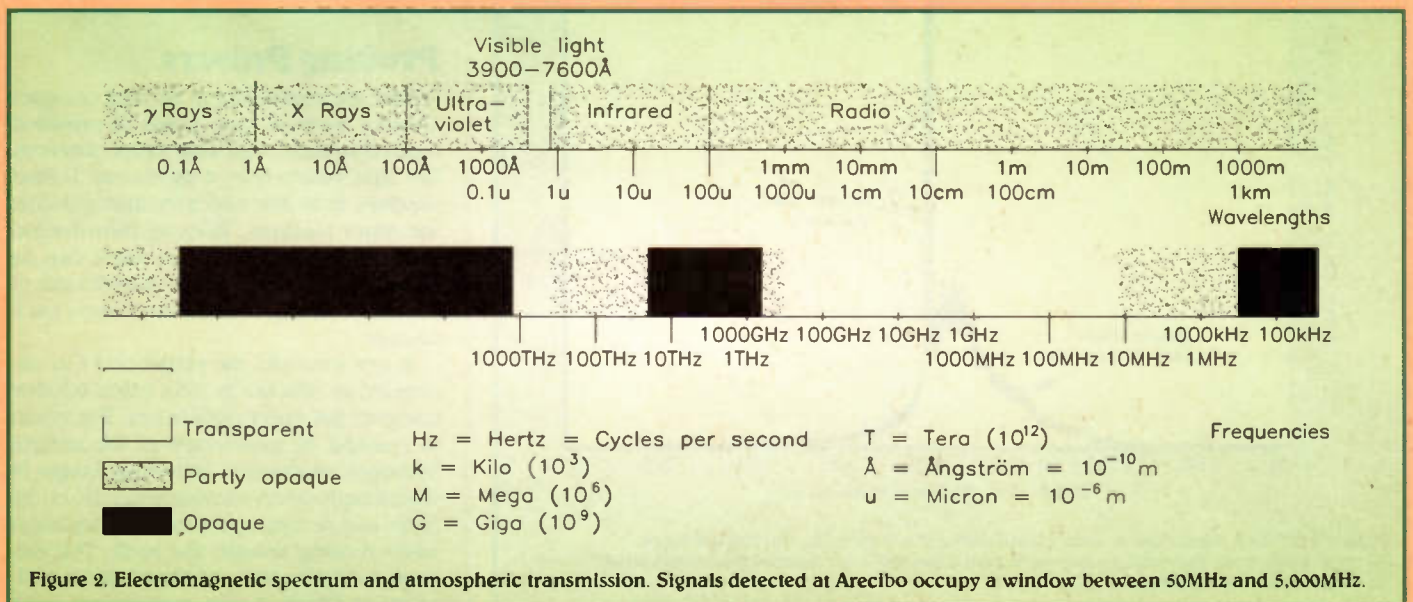

Figure 2. Electromagnetic spectrum and atmospheric transmission. Signals detected at Arecibo occupy a window between 50MHz and 5,000MHz.

Extensive mapping of the surface features of Mars was also undertaken as confirmation of likely sites for the Viking Mars landings.

Figure 4 indicates how waves can be transmitted from the telescope along a specific direction, and then received signals monitored. As well as detecting major features such as planets, the Arecibo telescope can also detect relatively small objects – even man-made satellites at the orbit of Jupiter and beyond. The Arecibo telescope was the first to detect radar reflections from the solid core of a comet. The signals in Figure 5 appear largely as scatter from particles ejected from the comet. The sharp spike signal is an echo from the solid core of the comet.

From a scientific point of view it is very important to 'range find' comets accurately. This allows their future planetary motions to be better defined. There is always the remote chance that a comet will collide with the earth. It will be much better to anticipate such incidents with plenty of warning in order to implement appropriate counter-measures.

Perhaps the more tricky types of planetary intruder are asteroids. These are detected only by reflected light from their surfaces, and have no tail of particles lit up by the sun. The sensitivity of the Arecibo telescope will soon be able to resolve features of 'near' asteroids to about 10m in size.

Photo 3 shows details of the Asteroid Gaspara which is locked into a 'safe' orbit beyond the orbit of Mars. The picture was taken by the Galileo Spacecraft on 28th October 1991, at a close encounter distance of about 10,000 miles. The size of the asteroid is about  $19 \times 12$  km – a typical size of 'small asteroids' in the solar system.

While the Arecibo telescope can provide detailed information about orbit paths of such objects, it is not ideal as a system to keep a watchful eye on such cosmic intruders, because the scanning beam is only two arc minutes wide and it can only be swept slowly about the mean vertical position. The best method of detecting approaching asteroids is by means of wide field camera optics where streaks of light in unexpected

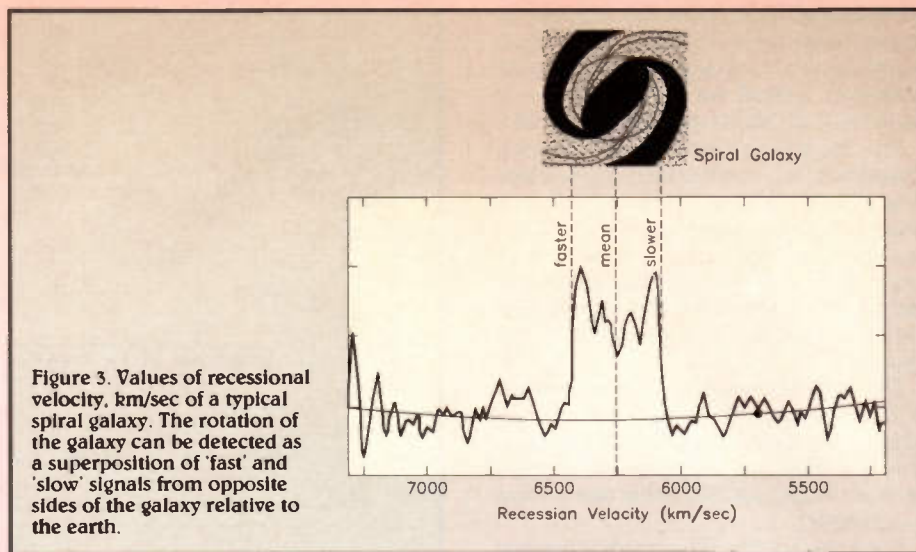

Figure 3. Values of recession velocity, km/sec of a typical spiral galaxy. The rotation of the galaxy can be detected as a superposition of 'fast' and 'slow' signals from opposite sides of the galaxy relative to the earth.

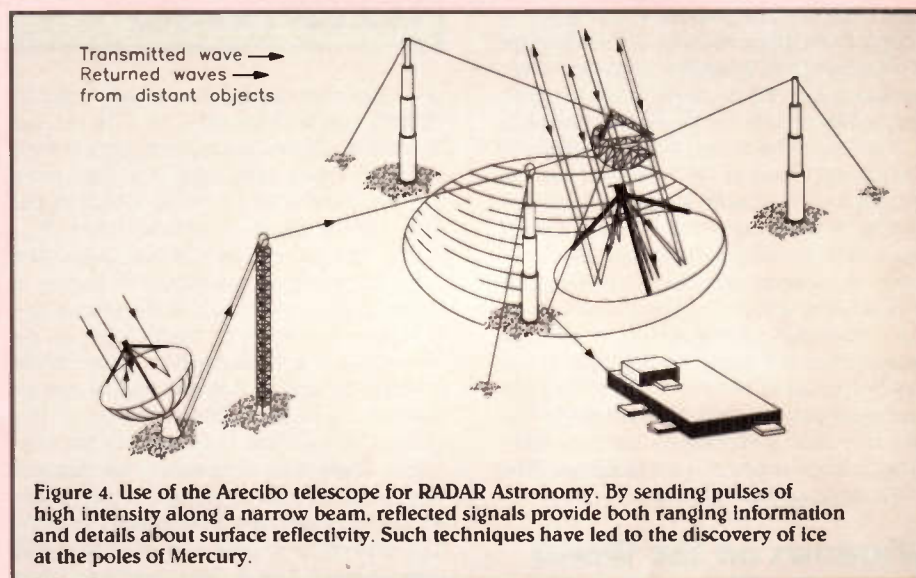

Figure 4. Use of the Arecibo telescope for RADAR Astronomy. By sending pulses of high intensity along a narrow beam, reflected signals provide both ranging information and details about surface reflectivity. Such techniques have led to the discovery of ice at the poles of Mercury.

areas of the sky will provide warning of new objects. The ranging facilities of Arecibo have been used to assist NASA with the navigation of space probes. During 1992 radar ranging was undertaken for the first time of Ganymede and Callisto – satellites of Jupiter

at a distance of 4.5 Astronomical Units. This data will prove of value to successful targeting of these objects by the Galileo mission during late 1995.

Studies of the surface of the planet Mercury during 1991 at Arecibo indicated the presence of a 'radar' bright spot near the South Pole and a similar but larger feature near the north pole. Further studies made during 1992 indicate that it is likely that the source of the south pole bright spot is ice in the floor of the crater Chao Meng-Fu.

## Probing Pulsars

Pulsars are considered to be ultra compact rotating neutron stars. Lobes of radiation emitted by such objects are swept outwards, like light beams from a lighthouse. Pulsars continue to be detected, even during studies for other features. Velocity information of such objects relative to earth can be obtained by measuring the wavelength of natural hydrogen emissions from such sources.

In one example, the pulsar 1913+16 discovered at Arecibo in 1974 orbits another compact star every eight hours. This results in changes of wavelength of the natural hydrogen emissions – becoming longer in wavelength when moving away from the earth and becoming shorter in wavelength when moving towards the earth. The estimated velocity cycle of the pulsar is indicated in Figure 6. The subsequent work

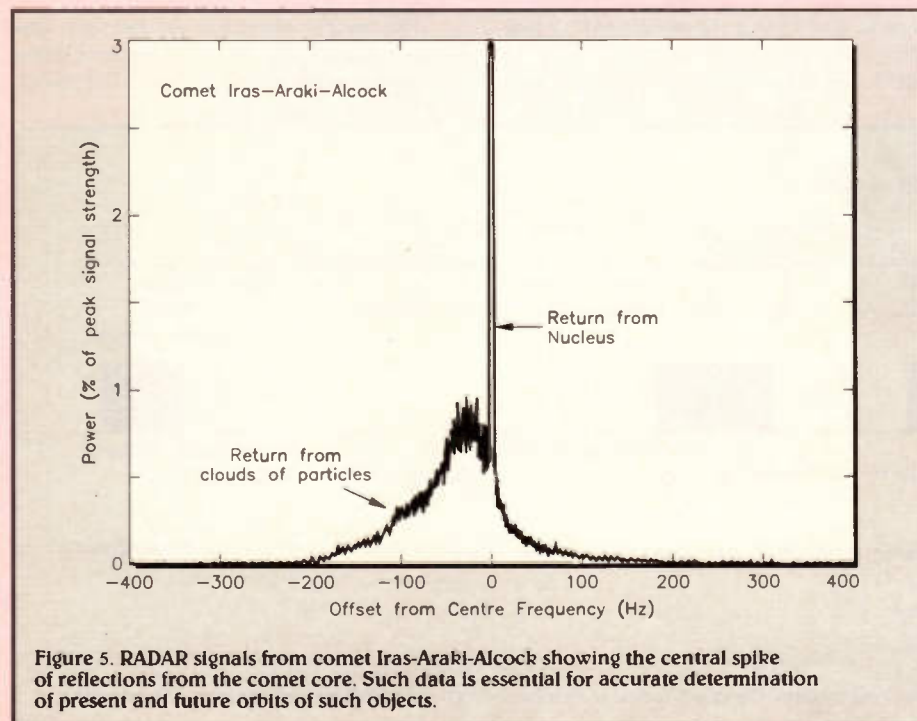
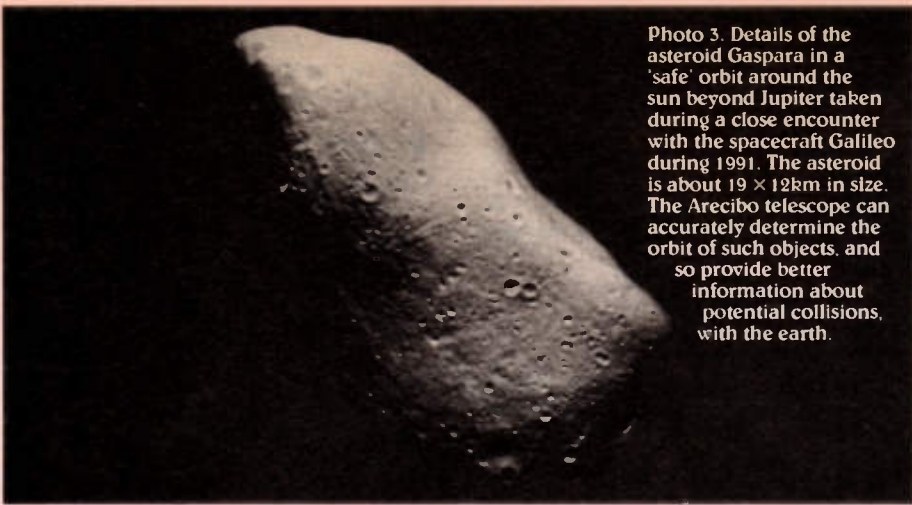

Figure 5. RADAR signals from comet Iras-Araki-Alcock showing the central spike of reflections from the comet core. Such data is essential for accurate determination of present and future orbits of such objects.





**Photo 3.** Details of the asteroid Gaspara in a 'safe' orbit around the sun beyond Jupiter taken during a close encounter with the spacecraft Galileo during 1991. The asteroid is about  $19 \times 12$  km in size. The Arecibo telescope can accurately determine the orbit of such objects, and so provide better information about potential collisions with the earth.

undertaken in monitoring the pulsar and interpreting the cyclic emissions in terms of Einstein's Theory of Relativity and the damping effect of Gravitational radiation, led to the award of the Nobel Prize for Physics in 1993 to Dr. R. A. Hulse and J. H. Taylor – the original discoverers.

In 1983, the observers at Arecibo detected a pulsar with a period of 1.6 milliseconds – equivalent to spinning at 640 times a second. The object in question was estimated to have a diameter of 6.2 miles.

Often dramatic interactions can be detected between associate objects. One large pulsar, for example, is considered to be slowly heating up a near neighbour and reducing its mass, and slowly drawing the smaller object into its orbit.

The fact that fast rotating pulsars can be detected when they are active prompts the question about detecting pulsars when they have, for various reasons, stopped rotating. Companion non-rotating neutron stars can only be detected by observing perturbations in active pulsar emissions. Perhaps galaxies are littered with dormant neutron stars which

cannot be observed directly and that this makes up for much of the 'missing' mass of the universe – the so called dark matter.

Pulsars provide a unique opportunity to measure minute changes of orbital motion. The presence of planets has been inferred in several pulsar systems. This may be the only observational technique of confirming the presence of planets in distant star systems.

Often telescopes such as the one at Arecibo have a role of identifying objects for further investigation by satellites. Thus the new ASTRO-D X-ray satellite, for example, can be used to confirm pulsar emissions by detecting variable X-ray emissions from targeted sites.

## Atmospheric Science

As well as using the various powerful transmitters for investigating features within the solar system, studies are also undertaken of characteristics of the earth's atmosphere – in particular of the ionosphere. This is a layer within the atmosphere which extends from about 62 miles above the earth to around

620 miles where it merges with the magnetosphere. The powerful transmitter sweeps a high intensity beam through a set path through the ionosphere and scattered radiation is detected by the telescope as indicated in Figure 7.

Using the upgraded systems at Arecibo it is now possible to investigate the layers within the atmosphere from close to ground level to about a distance of half the earth's radius.

Studies have shown the atmosphere to be a vast, dynamic system of interaction between layers at different levels with solar radiation being a principal component in determining patterns of temperature, chemical composition, wind velocities and electric field strengths. The methods originally developed at Arecibo are now used extensively at other observatories around the world.

Recent studies have involved use of a 'heating' facility to dump energy to regions of the ionosphere. The resulting micro-pulsations of electrical characteristics observed have led to speculation that modulation of such currents could be used for telecommunication purposes.

## The Gregorian Enclosure

As part of a \$23 million upgrade of the Arecibo telescope, a so-called Gregorian enclosure is being built at the site of one of the carriage houses as shown in Figure 8. This will improve significantly the sensitivity of the device, and simplify the existing line feed systems required to operate the telescope. Instead of having antennae sensitive to a specific series of frequencies, a two reflector system and a horn feed enclosed within an 83 metre enclosure, will provide coverage over an extensive range of frequencies. For some applications this will result in a gain of sensitivity, of a factor of ten, allowing signals from even more remote sources in the Universe to be detected.

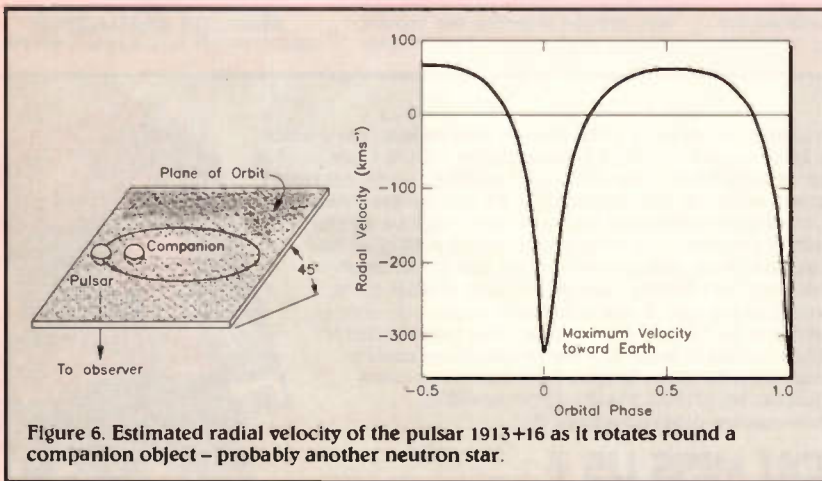

**Figure 6.** Estimated radial velocity of the pulsar 1913+16 as it rotates round a companion object – probably another neutron star.

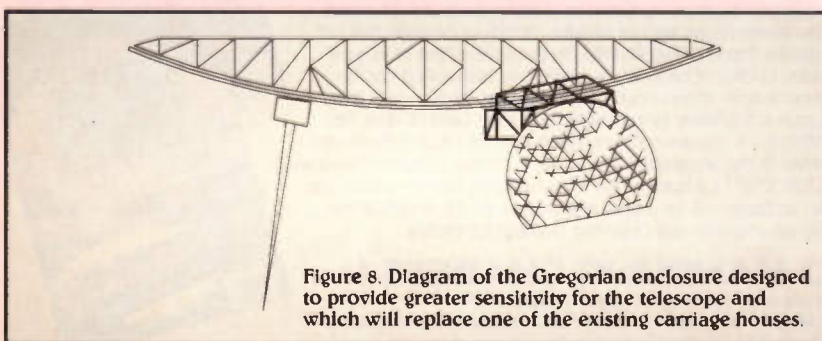

**Figure 8.** Diagram of the Gregorian enclosure designed to provide greater sensitivity for the telescope and which will replace one of the existing carriage houses.

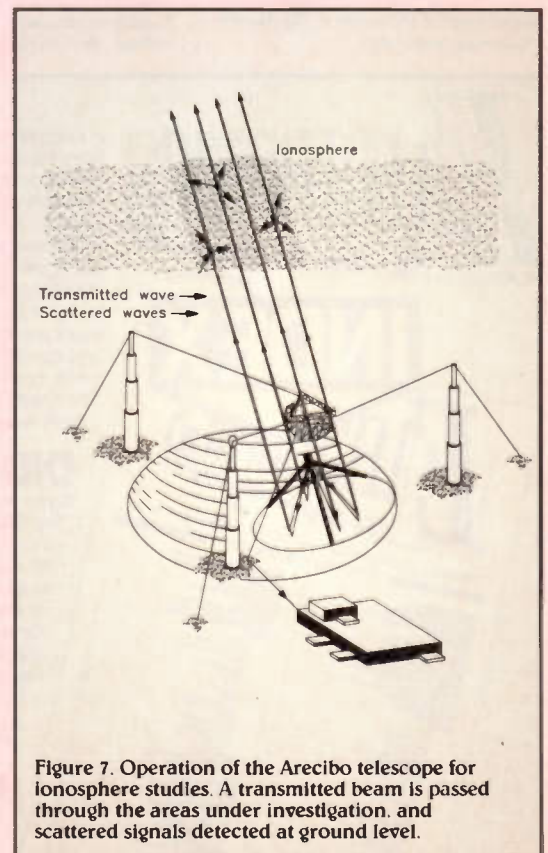

**Figure 7.** Operation of the Arecibo telescope for ionosphere studies. A transmitted beam is passed through the areas under investigation, and scattered signals detected at ground level.

The upgrading of the telescope has, however, reduced the amount of observational time available on the system.

## New Southern Horizons

Observing time in systems such as Arecibo is at a premium. There is significantly more observational work planned than can be accommodated using the Arecibo facility. Scientists have been considering the option of building a new radio telescope in the southern hemisphere for some time. The close scientific links with Brazil's scientific community have tended to favour the development of a telescope with Arecibo-like sensitivity in Brazil, probably close to the University of Rio Grande do Sul, in Porto Alegre.

Plans being drawn up for such a telescope involve a broad scientific network of centres of excellence, which include The Harvard-Smithsonian Centre for Astrophysics and Dartmouth College. The experience of the first operational phase of the telescope at Arecibo, and the current programme of upgrading will allow the most up to date technology to be incorporated into any new system.

## Have Telescope – Will Investigate

The improved facilities at Arecibo can be expected to lead to yet more exciting discoveries about the universe both within our solar system and at the edge of the known universe. Considering the relatively large

sums spent in space missions, the users of the Arecibo facility must be confident that their own methods of investigation provide excellent value for money.

## Points of Contact

National Astronomy and Ionosphere Centre,  
Cornell University,  
Space Sciences Building,  
Ithaca,  
NY, 14853-6801,  
USA.  
Tel: +1 607 255 3735.

Arecibo Observatory,  
PO. Box 995,  
Arecibo, PR 00613,  
Puerto Rico.  
Tel: +1 809 878 2612.

# ATTENTION!...ATTENTION!...ATTENTION!...ATTENTION!

## IMPORTANT NEWS FOR OVERSEAS READERS!

Obtaining components and kits for the projects featured in *Electronics* is now easier than ever in the following countries and regions:

**Middle Eastern Region**  
United Arab Emirates,  
Bahrain, Kuwait, Oman, Qatar  
Maplin Middle East Company,  
P.O. Box 47019, Harmidan Street,  
Abu Dhabi, U.A.E.

Tel: +971 2 760332  
Fax: +971 2 760317

**Lebanon**  
N&Y Controls,  
P.O. Box 175414,  
Beirut, Lebanon.  
Tel: +961 1 443 091

**African Continent**  
South Africa, Namibia,  
Botswana, Lesotho,  
Swaziland, Mozambique,  
Angola, Zimbabwe  
Maplin South Africa (Pty) Ltd.,  
P.O. Box 1846, Somerset West,  
Republic of South Africa.

Tel: +27 24 515 124  
Fax: +27 24 515 127

**Mediterranean**  
**Malta**  
CAM Services, CAM Centre,  
Off Cannon Road,  
Qommi, QRM 09, Malta.  
Tel: +356 484 650  
Fax: +356 447 174

**Gibraltar**  
Mail Order International,  
c/o Medsun, P.O. Box 225,  
93-99 Irish Town, Gibraltar.  
Tel: +350 79797  
Fax: +350 74664

**Far Eastern Region**  
**Pakistan**  
Link Pakistan,  
Suite Number 2,  
2nd Floor, I-R Plaza,  
Markaz F-10, Pakistan.  
Tel: +92 51 281 130  
Fax: +92 51 282 319

**Singapore & Malaysia**  
Tech-Con Electronics &  
Trading,  
Blk 1013 Geylang East  
Avenue 3,  
02-144 Geylang East  
Industrial Estate.

Singapore 1438.  
Tel: +65 7419918  
Fax: +65 8411228

**Hong Kong**  
Anes Electronics Company,  
13D Prime Mansion,  
No. 1 Fleming Road,  
Wanchai, Hong Kong.  
Tel: +852 891 4116  
Fax: +852 891 4122

**Countries and Regions Not Listed**  
Export Department  
Maplin Electronics plc.,  
P.O. Box 3, Rayleigh.

Essex, SS6 8LR, England.  
Tel: +44 1702 554155 xtn 326  
or 351  
Fax: +44 1702 553935  
Export catalogue and pricing  
details are available from the  
listed distributors.

**Maplin**  
ELECTRONICS

THE WORLD'S  
POSITIVE FORCE  
IN ELECTRONICS!



There are more terrific projects and features heading your way in next month's super issue of *Electronics - The Maplin Magazine*, including:

### PROJECTS MEMOPAD

An extremely useful device for the home or office, for recording short voice messages, with instant playback. Ease of use is one of the main features of the MemoPad project, with only two press-buttons as well as an On/Off switch.

### 200W MONO/STEREO AMPLIFIER

Neat and compact the 200W mono/stereo amplifier module is built around two TDA1514A high quality power amplifier ICs.

### DISCRIMINATING CONTINUITY TESTER

In addition to testing for continuity and leakage, the Discriminating Continuity

Tester checks components of all sorts – both passive and active, and is safe to use on all normal semiconductor devices. This, together with minimal current consumption, ensures exceptionally long battery life.

### SLOW ON/OFF DIMMER

This On/Off dimmer provides lamp dimming, by means of a timer rather than by manual control. Dimming times are adjustable within a wide range, 2 seconds to 1 hour on the slow dimmer mode, and 1 second to 30 minutes on the timer/dimmer mode.

### MILLENNIUM 4-20 VALVE AMPLIFIER UPDATE

Already a year old, the Millennium 4-20 valve amplifier is proving very popular, receiving good responses from indepen-

dent reviewers. During this time, one or two modifications have evolved, these are now described in this project update.

### FEATURES

Special features include: 'The Shocking Truth', the dangers of electric shock, it demonstrates that whatever its form, electricity is a killer. An interesting look at our oceans in 'Life Beneath the Waves'. Just as life began in the ocean, so too, the maintenance of life in the oceans leads to stability in ecosystems on land.

All this, plus all your favourite regulars as well!

Reserve a copy at your newsagents or take out a subscription NOW to avoid disappointment.

**ELECTRONICS - THE MAPLIN MAGAZINE**  
BRITAIN'S BEST SELLING ELECTRONICS MAGAZINE

# ELECTRONICS

The Maplin Magazine

## INDEX

INDEX - VOLUMES 1 to 13, NUMBERS 1 to 82

CONTENTS

A guide to those items...  
A-Z Index of all articles...  
A-Z Index of all projects...  
A-Z Index of all components...  
A-Z Index of all manufacturers...  
A-Z Index of all distributors...  
A-Z Index of all suppliers...  
A-Z Index of all retailers...  
A-Z Index of all wholesalers...  
A-Z Index of all exporters...  
A-Z Index of all importers...  
A-Z Index of all agents...  
A-Z Index of all brokers...  
A-Z Index of all consultants...  
A-Z Index of all contractors...  
A-Z Index of all subcontractors...  
A-Z Index of all service providers...  
A-Z Index of all equipment suppliers...  
A-Z Index of all software suppliers...  
A-Z Index of all hardware suppliers...  
A-Z Index of all materials suppliers...  
A-Z Index of all tools suppliers...  
A-Z Index of all test equipment suppliers...  
A-Z Index of all safety equipment suppliers...  
A-Z Index of all PPE suppliers...  
A-Z Index of all first aid kits...  
A-Z Index of all fire extinguishers...  
A-Z Index of all fire blankets...  
A-Z Index of all fire alarms...  
A-Z Index of all fire detectors...  
A-Z Index of all fire extinguishers...  
A-Z Index of all fire blankets...  
A-Z Index of all fire alarms...  
A-Z Index of all fire detectors...  
A-Z Index of all fire extinguishers...  
A-Z Index of all fire blankets...  
A-Z Index of all fire alarms...  
A-Z Index of all fire detectors...

A comprehensive index to *Electronics - The Maplin Magazine* is now available from Maplin. The Index covers every issue from December 1981 to October 1994. Included are details of every article, series and project published during that period. Conveniently arranged, sectionally and alphabetically, it'll take minutes instead of hours to find the exact issue number and page you need. You'll be able to rediscover a wealth of information you never knew you had! A list of all the *Corrigenda* published is also included, so you will be able to find details of changes or amendments. You'll find the index an invaluable addition to the issues of *Electronics* that you have. If your collection is incomplete, many issues are still available as back issues. The Magazine index costs just 80p NV and can be obtained (subject to availability) from Maplin Stores country-wide; by Mail Order, using the Order Coupon in this issue, or by calling the Credit Card Hotline, Tel: (01702) 554161, Order As XU87U. You'll wonder how you ever managed without it!

## DID YOU MISS US ?

If you've ever wanted to lay your hands on an elusive issue of *Electronics - The Maplin Magazine*, then we can help! Many editions are still available, as back issues. Where issues are out of print, details of projects that are still current can be found in Maplin Projects Books and Best of Maplin Projects Books. Copies of back issues (subject to availability) can be obtained from Maplin Stores country-wide; by Mail Order, using the Order Coupon in this issue, or by calling the Credit Card Hotline, Tel: (01702) 554161. If you are not sure which issue or Projects Book you require, refer to the Magazine Index (XU87U) or call Customer Services, Tel: (01702) 552911. Photocopies of out of print feature articles are available; a charge will be made, dependent on the length of the article to be copied – call Customer Services for details.

## NO HANDLING CHARGES !

If you are only ordering a copy of *Electronics - The Maplin Magazine* Index or back issues of the magazine, the normal £1.50 Mail Order handling charge does not apply!



These descriptions are necessarily short. Please ensure that you know exactly what the kit is and what it comprises before ordering, by checking the appropriate issue of *Electronics* referred to in the list.

The referenced back-numbers of *Electronics* can be obtained, subject to availability, at £2.10 per copy.  
Carriage Codes - Add; A: £1.55, B: £2.20, C: £2.80, D: £3.30, E: £3.90, F: £4.45, G: £5.35, H: £6.00.

# DID YOU MISS THESE PROJECTS?

The Maplin 'Get-You-Working' Service is available on all of these projects unless otherwise indicated.

To order Project Kits or back-numbers of *Electronics*, phone Credit Card Sales on (01702) 554161. Alternatively, send off the Order Coupon in this issue or visit your local Maplin store.

**Maplin: The Positive Force In Electronics**

All items subject to availability. Prices include VAT.



**CHRISTMAS TREE LIGHT SEQUENCER**

Give your Christmas tree an extra sparkle this year! When coupled to one or more sets of lights, this unit produces various interesting lighting sequences and fade patterns. The unit has three output channels each with a maximum output power of 400W, making it ideal for disco light sequencing, attention-grabbing shop window displays or an extremely bright Christmas tree! (Case not included in kit.)

Order as: LT69A, **£39.99**. Details in *Electronics* No. 84, December 1994 (XA84F).

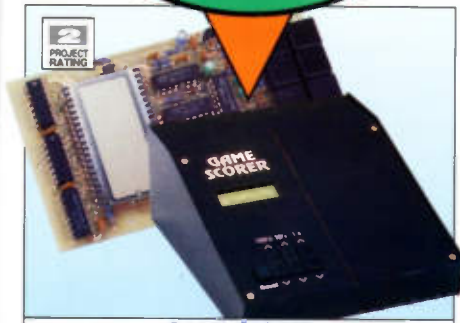

**GAME SCORER**

The ideal companion for games of all kinds that require a score to be kept. Points can be added or subtracted in units, tens or hundreds and cleared to zero at the press of a single button. (Case not included in kit.)

Order as: LT68Y, **£24.99**. Details in *Electronics* No. 84, December 1994 (XA84F).

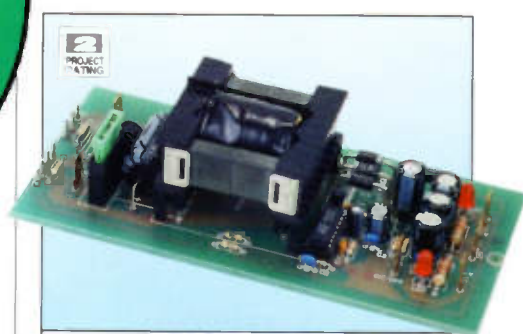

**IN-CAR AMP PSU**

Especially designed to enable the 400W Mono/Stereo Amplifier (VF40T) featured in November's *Electronics* to be used for in-car audio. Also suitable for other in-car systems requiring a  $\pm 35V$ , 300W, unregulated supply generated from the car's 12V supply. Order as: VF38R, **£66.99** H0. Details in *Electronics* No. 84, December 1994 (XA84F).

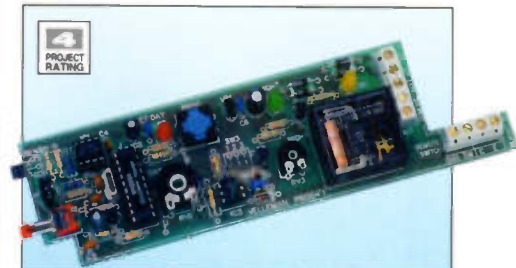

**DAY/NIGHT THERMOSTAT**

Many heating controllers offer only a single fixed temperature setting and On or Off timing. This ingenious, compact thermostat also comprises a timer allowing different temperature settings for day or night, to be automatically selected. Requires only a simple 9 to 12V AC supply.

Order as: VF36P, **£49.99**. Details in *Electronics* No. 84, December 1994 (XA84F).



**VHF CROSSED DIPOLE AERIAL**

This simple to construct VHF aerial has a hemispherical polar pattern, and is suitable for many VHF applications including the MAPSAT weather satellite receiver. (Mast not included in kit.)

Order as: LM00A, **£16.99** B2. Details in *Electronics* No. 85, January 1995 (XA85G).



**2-METRE 30W AMPLIFIER**

An RF power amplifier to boost the output power of low powered 2m equipment. Ideal for extra power when using hand-held transceivers in the car. The amplifier automatically switches from Receive to Transmit when it detects RF from the transceiver. (Case not included in kit.)

Order as: RU36P, **£39.95** D1. Details in *Electronics* No. 85, January 1995 (XA85G).

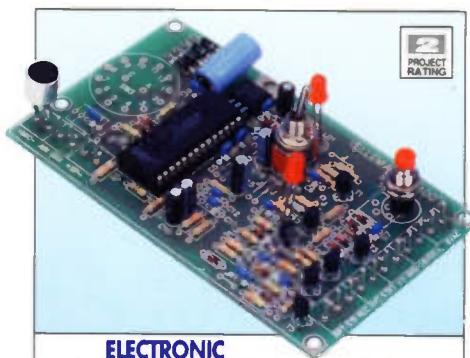

**ELECTRONIC RECORD/PLAYBACK MODULE**

Record and playback messages up to 16 seconds long, with this analogue EEPROM module. The memory is non-volatile, so no battery back-up is required. Ideal for model sound effects, answering machines, etc.

Order as: VF43W, **£29.99**. Details in *Electronics* No. 85, January 1995 (XA85G).

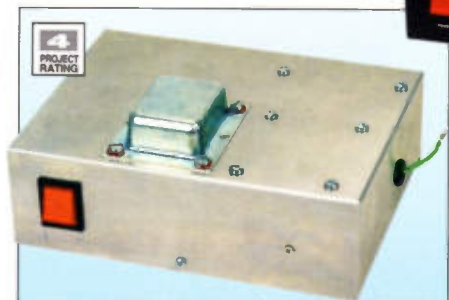

**'NEWTON' POWER SUPPLY UNIT**

A low noise, high voltage, power supply, which although designed specifically for the 'Newton' Valve Preamplifier, can also be used as the basis for many other valve audio projects.

Order as: LT75S, **£44.99** B4. Details in *Electronics* No. 85, January 1995 (XA85G).

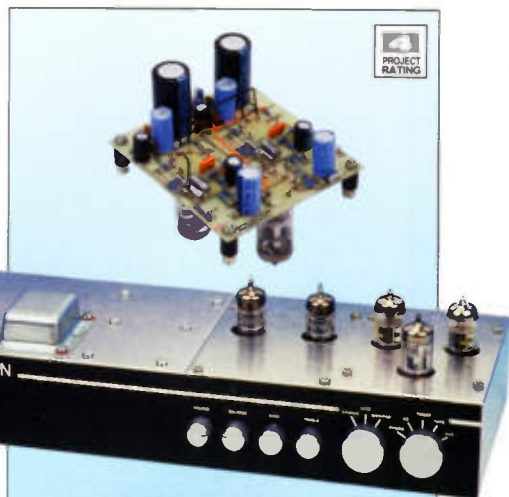

**'NEWTON' RIAA PHONO MODULE**

Part of the 'Newton' Valve Preamplifier project, this phono module comprises an RIAA equalised preamp for magnetic cartridges, and a line driver for auxiliary inputs from CD players, tuners, etc.

Order as: LT76H, **£34.99** A1. Details in *Electronics* No. 85, January 1995 (XA85G).

**CAR COURTESY LIGHT EXTENDER**

With the help of a couple of extra diodes, this project, originally featured in *Electronics* No. 44, can double as an automatically setting car anti-theft visual deterrent. (Additional components not included in kit.)

Order as: LP66W, **£3.49**. Details in *Electronics* No. 85, January 1995 (XA85G).

**NEW**

**FULL COLOUR GUIDE TO ELECTRONIC PRODUCTS**

Sept 1994–Aug 1995

# Maplin



BS 5750  
Part 2 1987

Level B:  
Quality Assurance  
RS12750

**Order your copy of the New MAPLIN Catalogue on sale Now!**  
Pick up a copy from any branch of WHSMITH, branches of John Menzies in Scotland ONLY, Eason & Son in N. Ireland ONLY, and Maplin stores nationwide for just £3.45 or post this coupon now to receive your copy for just £3.95 inc. p&g. If you live outside the U.K. send £7.30 or 18 IRCs for Airmail in Europe (including Republic of Ireland); £6.50 or 16 IRCs for surface mail outside Europe, or £12.30 or 30 IRCs for Airmail outside Europe.  
I enclose £3.95/£7.30/£6.50/£12.30 (delete as applicable).

Name .....  
Address .....  
Post Code .....

**ONLY  
£3.45**

Over 800 colour packed pages  
with hundreds of Brand New  
Products at Super Low Prices.

Available from all branches of WHSMITH, John Menzies in Scotland ONLY, Eason & Son in N. Ireland ONLY, and Maplin stores nationwide. The Maplin Electronics 1995 Catalogue – **OUT OF THIS WORLD!** Southern Africa customers please contact Maplin (South Africa) Telephone (024) 51-512-