

# E

ELECTROMUSIC • AUTOMOTIVE • TEST GEAR • SECURITY

No. 82

FULL  
SOR

# ELECTRONICS

*The Maplin Magazine*

Britain's Best Selling Electronics Magazine

OCTOBER 1994 • £2.10

Printed in the United Kingdom

## Discover the Secrets of the Hubble Space Telescope!

How to Design  
Transistor Amp  
Circuits Easily

Intelligent Car  
Interior Light  
Controller  
Project

Learn About  
Mains Safety

Low Cost  
Versatile  
Alarm System

Psychedelic  
Wah Wah Pedal  
Project  
*It's Far Out Man!*







# LOOK. HEAR.

**Take** your senses for a trip to LIVE '94, the UK's most exciting consumer electronics event.

**See** the latest hi-fi. TV. Video. Computers. Games. Camcorders. In-car. Musical instruments. Cameras. Telecoms. Satellite. Home automation.

**Experience** Capital Radio Live at LIVE – 95.8 Capital FM Stage. 1548 AM Capital Gold concerts. Dolby Home Cinema Promenade. Real Hi-Fi Village. TV Times Live Television Studio. Young Newspaper Feature. BPIA Future of Photography. Yamaha/TES National Youth Rock & Pop Awards. Games Arena. Computer Shopper PC Village. Focus on Multimedia.

**Get** your hands on a ticket. Phone the LIVE hotline or return the coupon now.

**LIVE '94**  
**THE CONSUMER ELECTRONICS SHOW**  
**EARLS COURT • LONDON**  
**20-25 SEPTEMBER 1994**

**LIVE HOTLINE:**  
**0 8 9 1 5 0 0 1 0 3**

Calls cost 39p per minute cheap rate and 49p per minute at all other times.

Please tell me more about LIVE'94 and how I can get a ticket to the UK's most electrifying event.

Name:.....

Address:.....

..... Postcode:.....

ME Please return this coupon to:  
LIVE'94, News International Exhibitions Ltd., Europe House,  
World Trade Centre, St Katharine-by-the-Tower,  
London E1 9AT.





## PROJECTS FOR YOU TO BUILD!

### PSYCHEDELIC WAH WAH PEDAL 16

Recapture the classic sound of the '70s with this superb project. Using modern techniques, this Wah Wah pedal gives unbelievable performance at a very economic price. A ready-made foot pedal mechanism makes construction easy too!

### INTELLIGENT CAR INTERIOR CONTROLLER 33

Most car interior light extenders do just what their name suggests, they keep the courtesy light on after the car doors are shut. This project does far more! It works as a courtesy light extender, plus it will turn off the light as soon as the ignition is switched on, plus, if you accidentally leave a door open, it will turn the light off after ten minutes preventing a flat battery.

### INDUCTANCE/CAPACITANCE METER ADAPTOR 49

Does your digital multimeter measure inductance and capacitance? No! Well build this project and it will!

### LOUDSPEAKER PROTECTOR 56

Prevent your valuable loudspeakers expiring with a bang with this easy-to-build and use loudspeaker protector. The unit is self powering and simply connects in line between the amplifier and the loudspeaker.

## FEATURES ESSENTIAL READING!

### ALL ABOUT THE HUBBLE SPACE TELESCOPE 4

Several years ago Hubble was hailed as the biggest astronomical observation project ever. However, due to a number of mistakes and failures Hubble failed to perform as expected. Thanks to an amazing space shuttle repair mission, Hubble is now working as intended, giving astronomers an unprecedented view of our universe.

### MAINS SAFETY IN HOBBY PROJECTS 24

Andrew Chadwick gives life-saving advice on how to design and construct mains powered projects so that they are safe.

### DESIGNING TRANSISTOR AMPLIFIER CIRCUITS 29

The humble transistor amplifier is a familiar sight, but designing circuits to behave as intended can be tricky. This article explains, in understandable terms, how modern transistor 'models' and simple maths can be used to virtually eliminate all the guesswork.

### HOW TO IMPROVE YOUR CIRCUIT DESIGN SKILLS 39

The humble scientific calculator can play an important role when designing circuits. This article starts with basic ohms law calculations and works up to reactive circuit calculations. Worked examples are included throughout. This article is the ideal starting point for the beginner who wants to learn more.

### FILTERS - HOW AND WHY? 44

Filter circuits are commonly encountered in electronic circuits. John Woodgate, explains how filter circuits work, why they are needed and how they can be designed in this authoritative new series.

### GETTING TO KNOW TEST EQUIPMENT 58

Keith Brindley continues his look at test equipment. There's plenty of practical guidance on choosing and using test equipment, plus easy to understand explanations on how various test instruments actually work.

### AUDIO POWER AMP ICs 63

In the final part of Ray Marston's maxifeature on Audio Power Amplifier ICs more tried and tested circuits are presented for you to build and use.

### UNDERSTANDING CIRCUIT SWITCHED NETWORKS 69

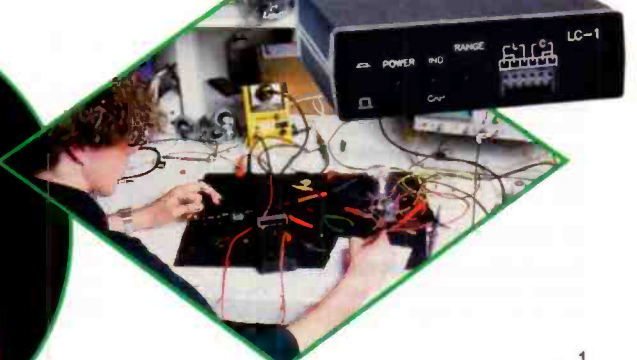
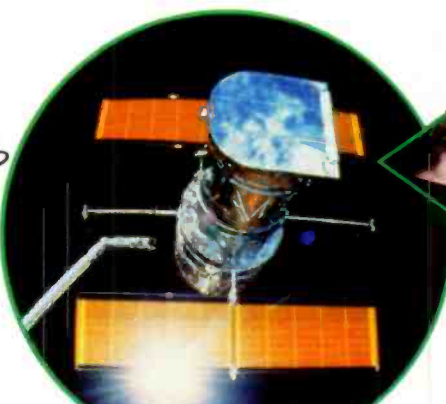
Despite the current trends for packet switched networking, circuit switched networks, such as the dial-up telephone network and ISDN, have a lot to offer the computer user. Frank Booty takes a look at modern circuit switched network technology and Dean Hodgkins demonstrates working examples of this technology in action.

### HOW TO PROTECT YOUR PROPERTY 74

The contents of your electronics workshop, shed or garage are easy pickings for today's criminals. What's more, borrowing all those lovely tools makes it easier for the burglar to break into your home - why bring his own gear if he can use yours! Protect your property for under £20.00 with this versatile alarm system!

## REGULARS NOT TO BE MISSED!

ABOUT THIS ISSUE...	2	SUBSCRIPTION COUPON	13	READERS' LETTERS	37
TECHNOLOGY WATCH	3	ORDER COUPON	14	CORRIGENDA	54
CLASSIFIED ADVERTS	10	DIARY DATES	15	NEXT MONTH	55
NEWS REPORT	11	STRAY SIGNALS	32	NEW BOOKS	IBC





# ABOUT THIS ISSUE...

Hello and welcome to this month's issue of *Electronics*! Instead of telling you about what's in this issue (I'm sure you'll enjoy finding out for yourself), there's some other interesting information.

## All Change

In case you weren't already aware, from 1.00am on 16th April 1995 all UK national telephone dialling codes will be changing (just after everyone has recovered from the London dialling code change a while back)! This national major upheaval has been named *Phoneday*. When dialling a national number, you will need to add a 1 after the 0 at the beginning of the code. For instance 0702 becomes 01702 and Inner London becomes 0171. Five cities, Leeds, Leicester, Nottingham, Sheffield and Bristol, will get entirely new codes. Premium rate (0891, 0898, etc.), free (0800), low cost (0345) and mobile phone numbers remain unchanged. BT have set up a free number to deal with any queries that you may have about *Phoneday*, Tel: 0800 01 01 01.


Why am I telling you this now, I hear you ask! No, I don't have shares in BT! It is because the *Phoneday* change is going to affect everyone who uses the telephone network, and whilst reprogramming the MODEM, fax machine, alarm auto-dialler, is an easy once-only task (if you can find the manual), trying to re-educate the kids or Great Uncle George may take a little longer... On a global front, the international access code in the UK, currently 010 will change to 00, which brings us into line with (guess who!) the rest of Europe. The change also affects people dialling from overseas. Currently, overseas callers, after dialling their international access code and the UK access code (44), dial the UK national code less the leading 0, followed by the actual number.

The *Phoneday* change means that after remembering to miss-off the 0 they will also have to remember to add a 1 as well! So, if you don't get a call from Auntie Nellie in Australia to wish you 'a very happy birthday' next year, it won't be because she's forgotten, it'll be because she can't work out how to get through! So you had better write and tell auntie your 'new' number...

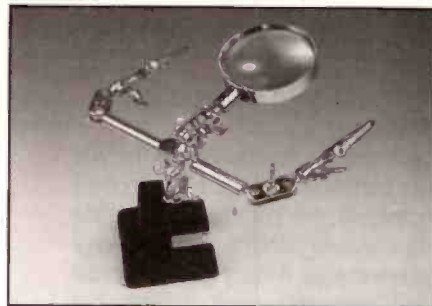
*Phoneday* doesn't stop there as some equipment, such as least cost routers (for Mercury), call barring units and private telephone exchanges, may require a firmware upgrade (new EPROM, etc.) to work properly. The supplier/manufacturer should be able to advise what modification, if any, is necessary. Good suppliers/manufacturers will provide such after sales support, the bad ones will tell you to buy a new model (so don't buy from them again!). Similarly if you are about to reprint your family or business stationery, make sure you remember to change the dialling code at the same time.

The good news is that because our telephone system is now based on digital technology, exchanges are intelligent enough to accept both the existing and new dialling codes in the cross-over period, so until *Phoneday* you will get through whichever code you use! After *Phoneday* (for about a year afterwards) if you forget to add the 1 you will get a recorded message telling you what you've done wrong and how to redial correctly.

So until next month, from the rest of the team and me, have fun with the phones and enjoy reading this issue!



## Exclusive Subscribers' Club Special Offer



On offer this month, to subscribers only, is the Helping Hand and Magnifier, pictured above – it is available for just £4.95, a saving of over 16%! If you are a subscriber, full details of how to order this really useful item are included on the special offer leaflet in this issue – if the leaflet is missing contact Customer Services on (01702) 552911. If you are not a subscriber and would like to take advantage of future special offers and other benefits of subscribing, turn to page 13 of this issue to find out more.

**ABC**  
MAPLETON COLLECTION  
CONSUMER PRESS



Front Cover Pictures:  
Fractal Background Image,  
Jim Bowler, Maplin Electronics plc.,  
© Copyright 1994. All rights reserved.

Shoemaker-Levy 9 collision with Jupiter,  
Julian Baum, © Copyright 1994,  
All rights reserved, used by permission.

Jimi Hendrix, Hulton-Deutsch Collection &  
Maplin Electronics plc., © Copyright 1994,  
All rights reserved, used by permission.

## EDITORIAL

**Editor** Robert Ball AMIPRE  
**Technical Authors** Robin Hall FBIS, G4DVV,  
Mike Holmes  
**Print Co-ordinators** John Craddock,  
Len Carpenter  
**News Editor** Stephen Waddington BEng (Hons)  
**Technical Illustrators** Ross Nisbet,  
Lesley Foster, Paul Evans, Nicola Hull  
**Project Development** Chris Barlow,  
Dennis Butcher, Alan Williamson, Nigel Skeels

## PRODUCTION

**Art Director** Peter Blackmore  
**Production Controller** Steve Drake  
**Designers** Jim Bowler, Matt Buhler  
**Layout Artists** Tracey Walker, Adrian Dulwich,  
Paul Andrews, David Holt  
**Published by** Maplin Electronics plc.,  
P.O. Box 3, Rayleigh, Essex, SS6 8LR.  
Tel: (01702) 554155. Fax: (01702) 553935.  
**Lithographic Reproduction by**  
**Planographic Studios**, 18 Sirdar Road, Brook  
Road Ind. Estate, Rayleigh, Essex SS6 7UY.  
**Printed in the United Kingdom by**  
**St Ives (Caerphilly) Ltd.**  
Mid-Glamorgan, CF8 3SU.

## MANAGEMENT

**Publications Manager** Roy Smith  
**Development Manager** Tony Bricknell  
**Drawing Office Manager** John Duddy  
**Marketing Manager** Vic Sutton

## ADVERTISING

**Jackson-Rudd & Associates Ltd.**,  
2 Luke Street, London, EC21 4NT.  
Tel: (0171) 613 0717. Fax: (0171) 613 1108.  
**Advertisement Managers** Eric Richardson,  
Jim Slater

## UK NEWSTRADE DISTRIBUTION

**United Magazine Distribution Ltd.**,  
16-28 Tabernacle Street, London EC2A 4BN.  
Tel: (0171) 638 4666. Fax: (0171) 638 4665

© Copyright 1994 Maplin Electronics plc.

Copyright: All material is subject to worldwide copyright protection, and reproduction or imitation in whole or part is expressly forbidden. Permission to reproduce printed circuit board layouts commercially or marketing of kits must be sought from the publisher.






Advertisements: Whilst every reasonable precaution is undertaken to protect the interests of readers by ensuring, as far as possible, that advertisements appearing in the current issue of *Electronics* are bona fide, the publisher and staff of the magazine cannot give any undertakings in respect of statements or claims made by advertisers, whether on printed page or on loose insert. Readers who have reasonable grounds to believe that they have been misled are advised to contact their local Trading Standards Office.

Editorial: The views of individual contributors/authors are not necessarily those of either the publisher or the editor. Where errors occur corrections will be published as soon as possible afterwards.

Publisher's Statement: Maplin Electronics plc. take all reasonable care to prevent injury, loss or damage of any kind being caused by any matter published in *Electronics*. Save insofar as prohibited by English law, liability of every kind including negligence is disclaimed as regards any person in respect thereof.

## Project Ratings

Projects presented in this issue are rated on a 1 to 5 for ease or difficulty of construction to help you decide whether it is within your construction capabilities before you undertake the project. The ratings are as follows:

-  Simple to build and understand and suitable for absolute beginners. Basic tools required (e.g., soldering iron, side cutters, pliers, wire strippers and screwdriver). Test gear not required and no setting-up needed.
-  Easy to build, but not suitable for absolute beginners. Some test gear (e.g., multimeter) may be required, and may also need setting-up or testing.
-  Average. Some skill in construction or more extensive setting-up required.
-  Advanced. Fairly high level of skill in construction, specialised test gear or setting-up may be required.
-  Complex. High level of skill in construction, specialised test gear may be required. Construction may involve complex wiring. Recommended for skilled constructors only.

## Ordering Information

Kits, components and products stocked by Maplin can be easily obtained in a number of ways.

Visit your local Maplin store, where you will find a wide range of electronic products. If you do not know where your nearest store is, refer to the advert in this issue or Tel: (01702) 552911. To avoid disappointment when intending to purchase products from a Maplin store, customers are advised to check availability before travelling any distance. Write your order on the form printed in this issue and send it to Maplin Electronics, P.O. Box 3, Rayleigh, Essex, SS6 8LR. Payment can be made using Cheque, Postal Order, or Credit Card.

Telephone your order, call the Maplin Electronics Credit Card Hotline on (01702) 554161. If you have a personal computer equipped with a MODEM, dial up Maplin's 24-hour on-line database and ordering service, CashTel. CashTel supports 300-, 1200- and 2400-baud MODEMs using CCITT tones. The format is 8 data bits, 1 stop bit, no parity, full duplex with Xon/Xoff handshaking. All existing customers with a Maplin customer number can access the system by simply dialling (01702) 552941. If you do not have a customer number Tel: (01702) 552911 and we will happily issue you with one. Payment can be made by credit card.

If you have a tone dial (DTMF) telephone or a pocket tone dialler, you can access our computer system and place orders directly onto the Maplin computer 24 hours a day by simply dialling (01702) 556751. You will need a Maplin customer number and a personal identification number (PIN) to access the system. If you do not have a customer

number or a PIN number Tel: (01702) 552911 and we will happily issue you with one. Overseas customers can place orders through Maplin Export, P.O. Box 3, Rayleigh, Essex, SS6 8LR, England. Tel: +44 1702 564155 Ext. 326 or 351; Fax: +44 1702 553935. Alternatively contact your nearest overseas Maplin Agent. See the advert in this issue. Full details of all of the methods of ordering from Maplin can be found in the current Maplin Catalogue.

## Subscriptions

Full details of how to subscribe may be found on the Subscription Coupon in this issue. UK Subscription Rate: £21.98/12 months. £10.98/6 months.

## Prices

Prices of products and services available from Maplin, shown in this issue, include VAT at 17.5% (except items marked NV which are rated at 0%) and are valid between 2nd September 1994 and 28th February 1995 errors and omissions excluded. Prices shown do not include mail order postage and handling charges, which are levied at the current rates indicated on the Order Coupon in this issue.

## Technical Enquiries

If you have a technical enquiry relating to Maplin projects, components and products featured in *Electronics*, the Customer Technical Services Department may be able to help. You can obtain help in several ways; over the phone, Tel: (01702) 556001 between 9.00am and 5.30pm Monday to Friday, except public holidays; by sending a facsimile, Fax: (01702) 553935; or by writing to: Customer Technical Services, Maplin Electronics plc., P.O. Box 3, Rayleigh, Essex, SS6 8LR. Don't forget to include a stamped self-addressed envelope if you want a written reply! Customer Technical Services are unable to answer enquiries relating to third-party products or components which are not stocked by Maplin.

## 'Get You Working' Service

If you get completely stuck with your project and you are unable to get it working, take advantage of the Maplin 'Get You Working' Service. This service is available for all Maplin kits and projects with the exception of: 'Data Files'; projects not built on Maplin ready etched PCBs; projects built with the majority of components not supplied by Maplin; Circuit Maker ideas; Mini Circuits or other similar 'building block' and 'application' circuits. To take advantage of the service, return the complete kit to: Returns Department, Maplin Electronics plc., P.O. Box 3, Rayleigh, Essex, SS6 8LR. Enclose a cheque or Postal Order based on the price of the kit as shown in the table below (minimum £17). If the fault is due to any error on our part, the project will be repaired free of charge. If the fault is due to any error on your part, you will be charged the standard servicing cost plus parts.

Kit Retail Price	Standard Servicing Cost
up to £24.99	£17.00
£25.00 to £39.99	£24.00
£40.00 to £59.99	£30.00
£60.00 to £79.99	£40.00
£80.00 to £99.99	£50.00
£100.00 to £149.99	£60.00
Over £150.00	£60.00 minimum

## Readers Letters

We very much regret that the editorial team are unable to answer technical queries of any kind, however, we are very pleased to receive your comments about *Electronics* and suggestions for projects, features, series, etc. Due to the sheer volume of letters received, we are unfortunately unable to reply to every letter, however, every letter is read – your time and opinion is greatly appreciated. Letters of particular interest and significance may be published at the Editors' discretion. Any correspondence not intended for publication must be clearly marked as such.

Write to: The Editor, *Electronics* – The Maplin Magazine, P.O. Box 3, Rayleigh, Essex, SS6 8LR.



# TECHNOLOGY WATCH!

with Keith Brindley

'Local loop' is a telephone term, relating to the individual connections between a user's phone terminal and a public telephone operator's local exchange. It is, in fact, most users' single connection to the national and international telephone system. In all but a handful of cases (only about 3% of installations), local loops are wire circuits run under or overground, and are maintained by and rented from British Telecom. This is partly historical, in that most telephone installations were originally installed in the days when the only telephone operator, of course, maintained *all* local loops (as well as all national loops for that matter). But, it is partly technical, in that the means to create new types of local loops were non-existent. Basically, to date, if you want a telephone, you have little option other than to use BT's landline local loops.

This is all set to change with radiocommunications. Many telephone operators (BT included) are developing radio-link methods of providing local loop services. These are all digitally-based, using code division multiple access (CDMA) or time division multiplex (TDM) methods to join large numbers of customers to the local exchange. At least one company (Ionica) is not a telephone operator at all, but is merely concentrating on providing a system of radio-link local loops which customers can use, merely, to gain connection to the telephone operator of their choice (whether it be BT, Mercury, British Waterways, British Rail Telecomms or whoever). While it's not going to happen overnight (earliest estimates of widespread availability are 1996), it is inevitable that it *will* happen, and BT's effective stranglehold of the *whole* telephone system could finally be broken.

## Data Day

Communications between humans are complex enough (as we have just seen), but communications between computers is a much more vague area of electronics. You only need to go regularly into your local building society to know that. The number of times the 'computer is down', whenever you

need money, is often beyond belief. After all, the building society's branch office is merely linked by private telephone line to head office, and computers are supposedly set up to send and receive data to and from each other. Most times, of course, the computers communicate effectively and well. It's just the times when I go into the building society that the link happens to be broken!

More seriously, though, something recently (well, last month's columns actually – see later) has cast my doubts on how effective two-way data communication really is. You see, the expected communications revolution, in the shape of the information superhighway, is almost upon us. For this to work well, though, a significant improvement in the way data is handled between computers will be required, and this means a significant improvement in two main areas. First, the data has to be standardised to the extent that devices can understand each other. All computers (PCs, Amigas, BBCs, Apples and so on) must be able to transfer information between each other so that they can understand and reuse transmitted data. Either the data has to be standardised to the extent (preferably) that all computers of whatever type can use the data directly, or the computers must have in-built software to be able to translate incoming data into an understandable format.

This is not as easy as you would expect. Take existing standards of data, such as encapsulated PostScript (EPS) or tagged image file format (TIF, or TIFF depending on your computer type). These are supposedly standards, yet try swapping an EPS or a TIF file between two different computing platforms without translation software, and you will nearly always have problems.

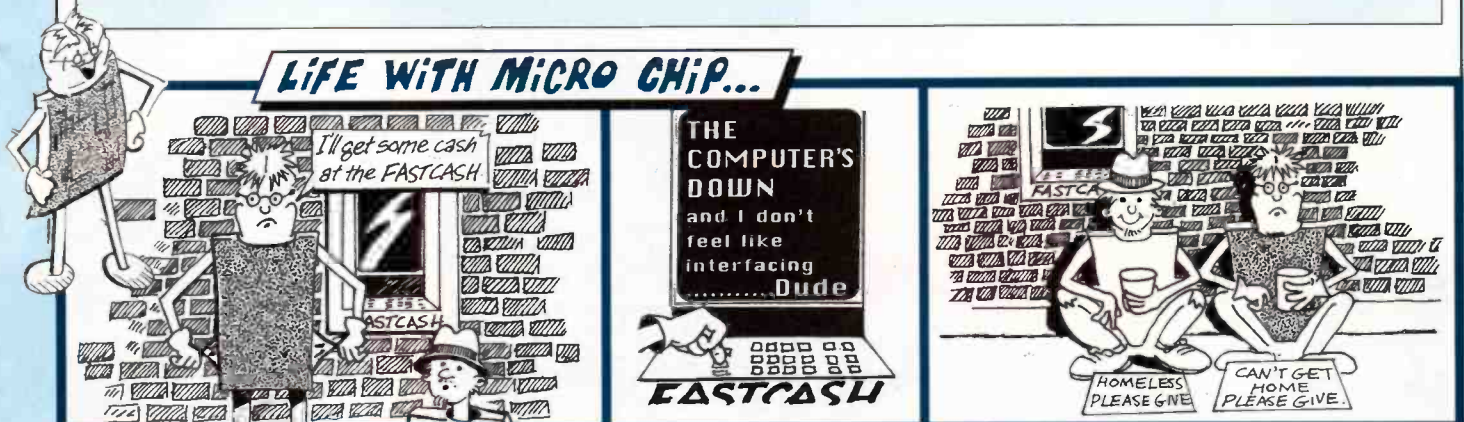
However, even if your data is standardised to the extent that the two devices can easily swap and understand each other's data files, there is the problem of transferring the information between them, whether by wire, through optic fibre, or over the air. The problems of standardisation here are even greater. Each transmission medium (copper, glass or ether) has its own transmission

properties and, hence, transmission problems.

Yet the problem is not insurmountable. Data, after all, in computer terms is merely a collection of logic 1s and logic 0s. It is only how those logic levels are arranged which defines whether the data forms an EPS or a TIF file, for a PC or an Amiga for example, or for whatever file on whatever platform. Rearrange the logic levels and the data can mean whatever you want it to, to whatever computer you choose. There is no end to this way of thought. Given any two computers and proper translation software, any file should be properly transferable between them and, after transfer, be properly usable too.

This has got to be the case, of course, if any vision of the information superhighway is to work. Can you imagine anybody's dream of the information superhighway turning into reality given today's computer communications? A case in point is *Technology Watch* – or, to be more specific, last month's *Technology Watch*. Last month was a bit hectic. I was booked to go on my holidays, but had rather overbooked my workload. As a consequence, *Technology Watch* was a little late, and fast approaching the final deadline to get it to the Maplin editorial offices in time for press. To prevent postal delays, the Editor suggested I send the copy in by modem. Nonchalantly, I said yes, and we began the 20-second process of uploading the file from me to him. Four and a half hours later, we succeeded, with my phone bill somewhat the worse for wear, and his frustration only matched by mine. Even with the literally thousands of pounds-worth of ultra-modern computer equipment at Maplin, and my half-crown's - (12½p) worth at home, we had the greatest of difficulty in exchanging the data-bits between us in anything like a correct manner, without a considerable amount of nail-biting, swearing, chiding, goading and hacking. What chance the information superhighway?

*The opinions expressed by the author are not necessarily those of the publisher or the editor.*





# HUBBLE BACK ON TRACK!

by Douglas Clarkson



Photo 1. Launch of the Hubble Space Telescope on 24 April 1990 by the Shuttle Discovery.

Shoemaker-Levy 9 Jupiter Collision  
© copyright 1994 Julian Baum,  
all rights reserved, used by permission.



The recent successful shuttle mission, to correct the flawed optics of the Hubble Telescope, has put back on track the world's most ambitious astronomy project. Success has, however, come slowly. The funding of the Hubble project named after Edwin P. Hubble, one of the greatest observational astronomers of all time, was only prised from the US Congress after European co-operation was secured. After having taken a decade and a half to design, the launch of the Hubble observatory was delayed by four years with the explosion of the shuttle Challenger in 1986.

It was not until 24 April 1990 that the shuttle Discovery finally launched the Hubble Space Telescope (HST) into orbit as shown in Photo 1. The next day the telescope was released from the payload bay. Photo 2 shows the view from the shuttle as the billion dollar satellite is released by the robot arm. It was one of the major scientific hiccups, however, when it was discovered that the optics of the main primary mirror were flawed. Thus instead of clear crisp pictures being available in 1986, these have only begun to be obtained late in 1993.

As light from the stars travels through the turbulent air of the atmosphere, wavefronts of light which have travelled across countless miles of space become distorted due to the rapid variation of density of air in their path. This tends to 'spread' light so that there is a limit to the size of an object which an earth based telescope can resolve (no matter the quality of the optics used). This limit is approximately 1 arc second. By observing above the earth's protective atmosphere, this problem would be removed and a resolution of around 0.1 arc second was expected to be achieved.

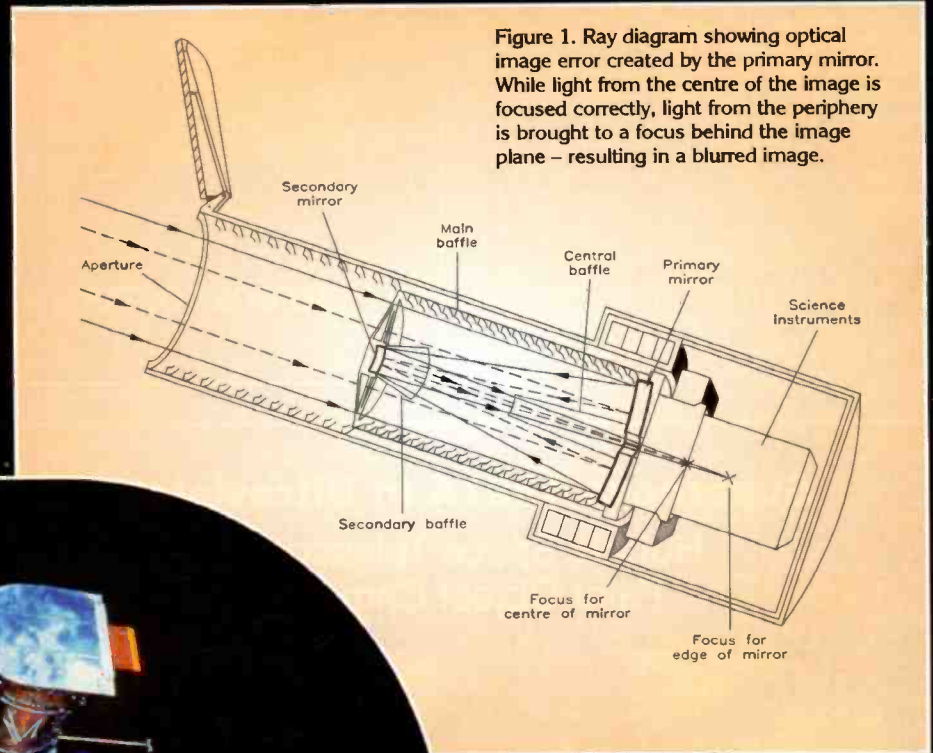
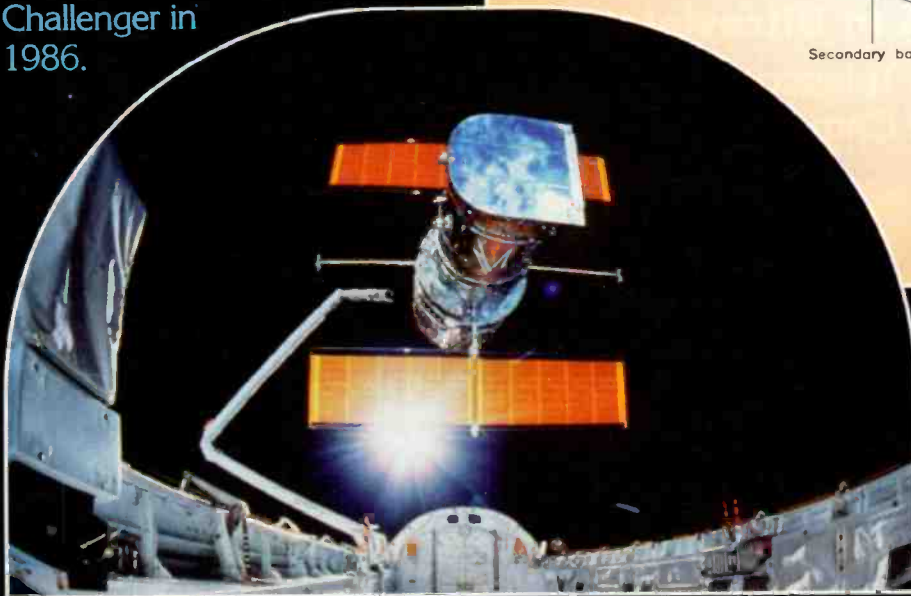


Figure 1. Ray diagram showing optical image error created by the primary mirror. While light from the centre of the image is focused correctly, light from the periphery is brought to a focus behind the image plane - resulting in a blurred image.



There has been a development recently of so called 'adaptive optics' where an array of ground based mirrors can be moved rapidly in real-time to minimise distortion due to such atmospheric turbulence. It is unlikely, however, that such a mechanism will achieve the resolution available with the HST. Also, most ultraviolet radiation is absorbed by the atmosphere - so that most UV observations must be made from space.

The other advantage of Hubble is that it can be pointed with great selectivity to any part of the sky. This is in contrast with earth based telescopes which tend to look at the north and south hemisphere star fields only.

A considerable degree of intelligence was built into the satellite in order to allow it to target specified star locations as part of its observing mission. Photo 3 indicates a section of Hubble's Star Guide Catalogue which is used to locate specific star fields. The catalogue contains degrees of brightness and positions for approximately 19 million objects, 15 million of which are used for aiming and stabilising the Hubble Telescope. In the image



Top left: Photo 2. Deployment of the Hubble Space Telescope as it was released from the payload bay on 25 April 1990. The gold coloured solar panels generate 2kW of power.

Bottom left: Photo 3. Extract from the Guide Star Catalogue - Hubble's Guide to the Universe. This contains data on 19 million objects - 15 million of which can be used for aiming and stabilising the HST.



shown, the zones on the periphery contain the guide stars with the target area located at the centre.

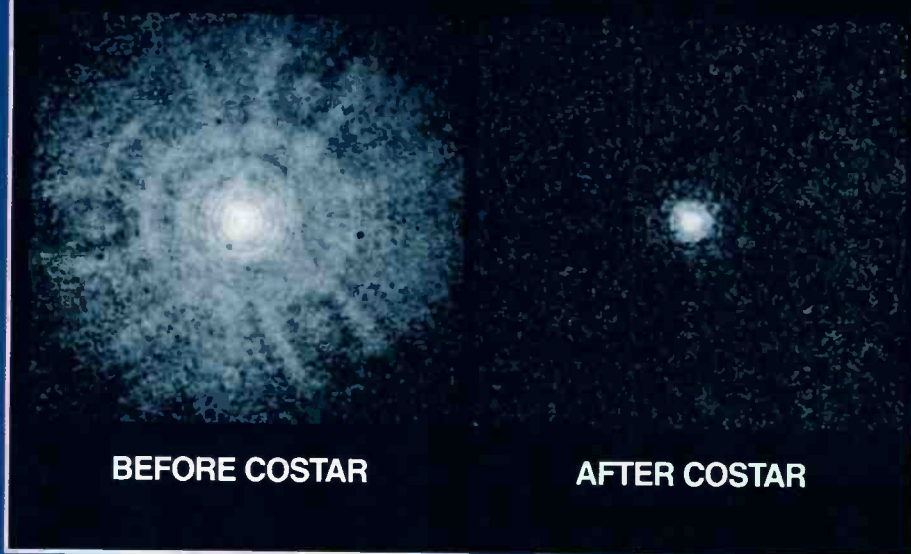
The telescope has to be carefully manipulated during each 90 minute earth orbit in order to achieve its photographic mission. During each half of the orbit the telescope has to be fixed to guide stars, locked in position for observation and then calibrated; for about half of each orbit the space telescope cannot take images.

Data from the Hubble Telescope is first beamed to the Tracking and Delay Satellite in geosynchronous orbit. From there it is beamed to a ground station at New Mexico and bounced off a domestic communications satellite for routing to space controllers at the Goddard Space Flight Centre in Greenbelt, Maryland. Then the data is relayed to the Space Telescope Science Institute in Baltimore where it is processed by astronomers.

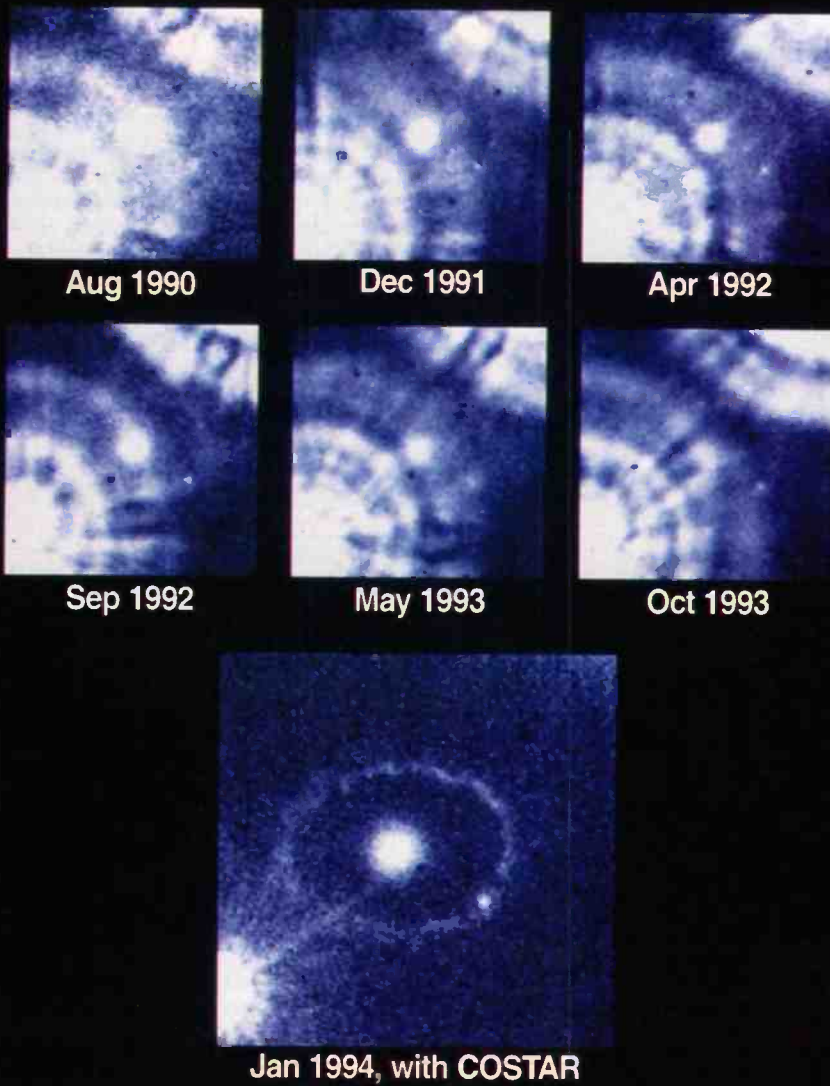
### Fuzzy Pictures

Figure 1 shows Hubble's main telescope, comprising of a large primary mirror (diameter 2.4m: 94in.) and a smaller secondary mirror. The tolerance of grinding the main

## HUBBLE SPACE TELESCOPE FAINT OBJECT CAMERA COMPARATIVE VIEWS OF A STAR



## Supernova 1987A In Ultraviolet Hubble Space Telescope Faint Object Camera



mirror was highly critical. Unfortunately the outer surface of the mirror was ground 0.002mm too flat. Thus while light reflected close to the centre of the main mirror was brought to a focus in the desired focal plane, light reflected from the outer area of the main mirror was brought to a focus behind the true one. Thus even a bright star would appear as a bright feature surrounded by rings of light which were converging on an image plane behind the camera focus plane.

### The Servicing Mission (STS-61)

From the moment that the problems with Hubble became apparent, the significance of the first planned servicing mission began to grow in importance all the time. Initial concerns about making the best decisions about the repair mission led to the formation of an International Strategy Panel. This eventually set the policy for the process of repair of the satellite. The key element of the mission was to be the deployment of COSTAR (Corrective Optics Space Telescope Axial Replacement) – a package which would correct the light paths from the faulty mirror. In the process the High Speed Photometer Experiment would have to be removed from Hubble.

While the key problem with Hubble was the defective mirror, the telescope was demonstrating other problems. Late in 1990, one of a set of gyroscopes failed with another failing in the following May. Such gyroscopes were used in the positioning of the satellite during observational manoeuvres. A fault also developed in a computer memory circuit. A fault

Top right: Photo 4. 'Before' and 'after' pictures taken with the Faint Object Camera (FOC). Prior to the service mission, images of bright objects were surrounded by a 'skirt' of light. With the COSTAR objects in place, true images of resolution 0.1 second of arc become visible.

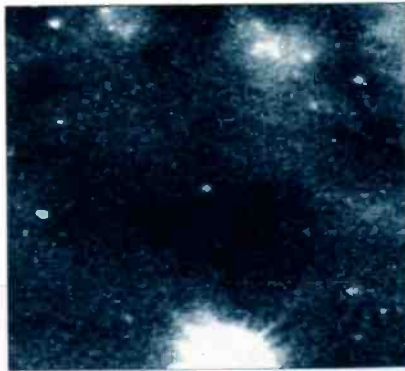
Bottom left: Photo 5. The improved Hubble pictures allow the features of the 1987A supernova to be clearly seen as separate from the previous interference from companion stars.



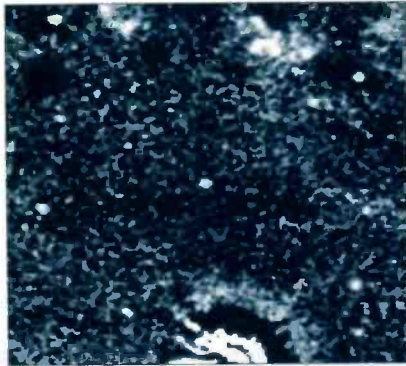
**M100, a Spiral Galaxy in the Virgo Cluster**  
Hubble Space Telescope/Wide Field Planetary Camera



WFCP-2: Wide Field Camera



WFCP-1: Wide Field Camera



WFCP-1: deconvolved



Palomar 5m on a good night

had also been observed in the design of the solar panels on Hubble. Rapid temperature changes of the supports of the panels occurred as the telescope made transits from day to night and night to day while in orbit some 370 miles above the earth. This caused the telescope to shudder and so prevent observations at such times from being made.

A series of magnetometers to sense the earth's magnetic field were used on Hubble to assist in stabilising the satellite during observational periods. When problems with these began to occur it was decided to replace them all by bolting on additional devices over the original units. The astronauts obtained training in their replacement by visiting the

Museum of Air and Space in Washington and simulating repair activity on a full-scale replica of the telescope. Other service procedures were extensively tested in simulated weightless conditions under water.

During the extensive training of the astronaut team, it became more and more obvious that a three day mission would be unlikely to provide enough time to complete all the required service procedures. At least five days would be required. There was even a consideration of two separate shuttle missions to carry out the repair. It was obvious, however, that the Endeavour shuttle would be the only one of the available four shuttles capable of supporting a five day mission. It was thus a triumph of 'going for it' that the Endeavour shuttle blasted off on 2 December 1993 into the dark night sky.

The first two days were used for the service of non-imaging systems such as the gyroscopes, electronic fuse box and faulty solar panels. One panel would not wind up and so was allowed to 'float free' from the satellite – another piece of (expensive) space litter. On the third day the Wide Field Planetary Camera was replaced and new magnetometers fitted. On day four the COSTAR module was successfully deployed by Kathryn Thornton. The package with a mass of over 200kg slid effortlessly into the heart of the Hubble Telescope. There was considerable anxiety that the delicate mechanism would be damaged during installation when its protective covers were removed. Fortunately all went well; at this stage the Hubble's computer system was upgraded to a '386', and improvised covers for the magnetometers added.

On the last day, repairs were made to the Solar Array Drive Electronics. This was when the famous 'hunt the screw' manoeuvre took place as Storey Musgrave was securing the delicate mechanism. Work was also undertaken on the electronics of the Goddard High Resolution Spectrograph. The time came at last when Endeavour released its captive hold on the satellite and Hubble was again alone in orbit with all the visible universe to scan in greater detail.

**The Party Back Home**

Scientists were apprehensive about the success of the mission. It rapidly became clear, however, that the corrective optics had been successfully deployed. Slight adjustments were made to the sets of mirrors to optimise the quality of the final images. An embargo was kept on released images until a press conference on the 13 January, at which time

Top left: Photo 6. This sequence of images indicates how Hubble's improved optics allows 'new' stars to be observed in this example in the M100 spiral galaxy in the Virgo Cluster: (top left) the best that Hubble can now display; (top right) pre-COSTAR without image enhancement; (lower left) pre-COSTAR with image enhancement; (lower right) Mount Palomar on a good night.

Bottom left: Photo 7. Spectacular detail of stars in the M100 Spiral Galaxy taken with red, green and blue filters to give a true colour picture. The pinkish regions are huge clouds of glowing hydrogen gas and identify sites of new star formation. Individual stars can now easily be resolved in this galaxy thought to be some 40 million light years distant.

**M100**

A Spiral Galaxy in the Virgo Cluster

Hubble Space Telescope  
Wide Field Planetary Camera 2



Upper panel shows the inner region of M100 imaged with the Planetary Camera at full resolution.

Image at left shows a mosaic of the three Wide Field Cameras plus the Planetary Camera.



a previous thorn in the flesh of NASA – Senator Barbara Mikulsky – declared “the trouble with Hubble is over”. This stage marked a turning point not only for the Space Telescope Team but also for NASA as a whole. Projects such as the Space Station would have had little chance of funding if the Hubble service mission had been a failure. This was the turning point that all astronomers had been waiting for. At a stroke it was now possible to see objects in a volume of the universe some 1,000 times bigger.

## The Picture Clears

Photo 4 shows the degree of correction achieved between the left image (prior to COSTAR) and the right image (after COSTAR). The images (to same scale) were taken with the European Space Agency's Faint Object Camera (FOC). In the left image the total diameter of the feature (pinpoint + halo) is around 1 arc second. In the corrected right image most of the starlight is concentrated into a 0.1 arc second circle and the blurry 'skirt' of light is completely gone.

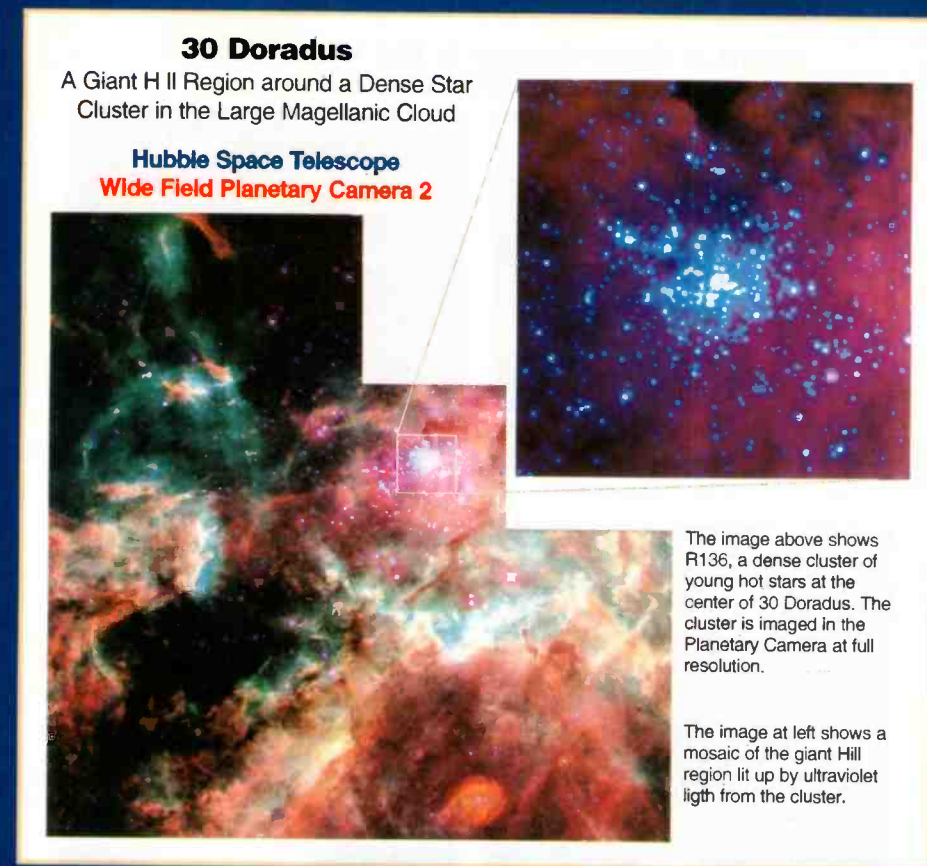
The improved resolving power of the HST can be seen also in pictures from the site of the 1987A supernova as shown in Photo 5. The pictures were taken with the ESA faint object camera. The upper first series of six pictures taken in ultraviolet indicate the centre of the supernova but with 'glare' from two com-



panion stars in the vicinity of the supernova. This prevented clear observation of features in the vicinity of the supernova.

With COSTAR optics in place, however, the cloud of ejected material from the supernova explosion is clearly visible and when photographed is equivalent to a diameter of 0.25 light year – about 200 times the diameter of the solar system as defined by Pluto's orbit. The remnant star is becoming fainter all the time. Astronomers will be keenly observing this feature – seeking to detect the rapidly rotating neutron star or pulsar which is anticipated to have been formed. Each side of the picture corresponds to 2.9 arc seconds.

It is perhaps in looking at fine detail in com-



### 30 Doradus

A Giant H II Region around a Dense Star Cluster in the Large Magellanic Cloud

Hubble Space Telescope  
Wide Field Planetary Camera 2

The image above shows R136, a dense cluster of young hot stars at the center of 30 Doradus. The cluster is imaged in the Planetary Camera at full resolution.

The image at left shows a mosaic of the giant Hill region lit up by ultraviolet light from the cluster.

Above: Photo 8. Features within the Large Magellanic cloud at some 160,000 light years distant can be resolved with Hubble. Supermassive stars in the star cluster R136 in the 30 Doradus nebula can now be resolved revealing the existence of around 3,000 such objects.

Left: Photo 9. New sharp images of the star Eta Carinae some 10,000 light years distant in the Milky Way. Details of the expanding clouds of gas and debris from the violent eruption of the star in 1841 are clearly visible.

In the top left image (Hubble at its best), the main stars appear to occupy less space and companion stars can be resolved in their vicinity. Faint stars not previously visible can now be detected. Astronomers can now use the HST to search for stars of a specific brightness characteristic of so called Cepheid stars (likely stars indicated by arrows). By identifying such stars in features such as the M100 galaxy it is hoped to be able to estimate accurately the distance to the M100 galaxy and in so doing revise values for the expansion rate, age and size of the universe. Such observations were not possible for ground based telescopes. The HST is therefore likely to set the agenda for Cosmology into the 21st century.

While this picture looks very much at the limits of resolution of individual stars, the Wide Field Cameras can take excellent pictures of extensive areas of sky. Photo 7 shows more images of the M100 spiral galaxy. The images were taken through red, green and blue filters to create a true colour picture. This level of clarity had previously only been possible for ground observation of our 'local' group of galaxies. Blue corresponds to the light from young and massive stars that have recently formed along the spiral arms. The 'pinkish' blobs are huge clouds of glowing hydrogen gas and identify sites of new star formation. The pictures give the impression of cycles of

plex star fields that the improved optics of COSTAR can be best appreciated using the upgraded WFPC-2 camera. Looking at the M100 spiral galaxy in the Virgo Cluster Photo 6 indicates (top left) the best that Hubble can now display; (top right) pre-COSTAR without image enhancement and (lower left) with image enhancement; (lower right) Mount Palomar on a good night. The Mount Palomar image taken with the 200in. Hale Telescope is limited by ground observing conditions and provides resolution of slightly better than one second of arc. Thus even without the correction optics provided by COSTAR, the Hubble Space Telescope was superior to the best ground based observatories.



## The Central Region of the Active Galaxy NGC 1068

### Hubble Space Telescope Faint Object Camera



Pre-COSTAR



With COSTAR

stellar evolution which must be taking place within all galaxies – including our own.

Recent pictures of the dense star cluster R136 in the 30 Doradus nebula as shown in Photo 8 have revealed new insights into star formation. Using the new wide field and planetary camera 2, the features of the star cluster R136 have been seen with remarkable clarity. This is a region where a cluster of super massive stars have formed out of region of gas and dust. While previous Hubble pictures were able to resolve several hundred massive stars, the new WFPC-2 camera has been able to identify over 3,000 separate stars and also measure individual size and brightness. It is by being able to observe the process of star formation in such detail that better understanding of the processes of stellar evolution in general will develop. At the distance of 160,000 light years features in the Large Magellenic cloud can be resolved at the size of 25 light days.

Recent Hubble photographs of the star Eta Carinae have shed new light on the history of this turbulent star which in 1841 became the second brightest star in the sky as the star became highly unstable. At a distance of 10,000 light years the Hubble Telescope is now able to pick out clearly the rapidly expanding shell of material, which is estimated to be moving at a speed of 2 million miles per hour (Photo 9). This material is thought to consist mainly of Nitrogen which formed within the core of the star. The picture is itself a composite of images taken in red, green and blue light. Eta Carinae has a mass some 150 times that of our sun and is itself one of the most

Top left: Photo 10. 'Before' and 'after' images of the distant galaxy NGC1068. The new image is clearly much sharper than the previous one. The galactic core of NGC1068 is considered to be a zone of intense radiation – probably due to the presence of a massive black hole.

Bottom right: Photo 11. Recent images of the Comet P/Shoemaker-Levy 9 (1993e) before its collision with Jupiter during July 1994. The upper mosaic of fragments of the comet indicate around 20 fragments with 11 of the largest fragments estimated to be between 2 to 4km in diameter.

massive and luminous known stars. These latest pictures suggest that new theories may have to be developed to explain the pattern of material ejected by the unstable star.

One of the more distant and perhaps the most mysterious objects scanned with the improved COSTAR optics is the nuclear region of galaxy NGC1068 (Photo 10). It is estimated that the galaxy is some 60 million light years distant. The galaxy is classed as a Seyfert type 2 and has a brightness of a billion solar masses. Observations indicate that the brightness of the region varies with a period of several days – suggesting the existence of a massive black hole. From the nature of the field of illumination, it is suggested that the intense illumination is caused by intense radiation from a nuclear source. Whatever the origin of energy – the new FOC/COSTAR images are of unprecedented clarity.

The excellent resolution of the HST is also

of immense value for observing features within the solar system. Pictures of higher quality than earth based telescopes were produced by computer, processing the blurred pre-service pictures; of particular interest is the Comet P/Shoemaker-Levy 9 (1993e) which collided with Jupiter during July this year. Photo 11 indicates how the improved resolution of the Hubble Telescope has made it possible to resolve in greater detail the various portions of the comet.

The upper mosaic of fragments of the comet indicate around 20 fragments with 11 of the largest fragments estimated to be between 2 to 4km in diameter. A 2km diameter fragment would have a volume of around  $33\text{km}^3$ . Assuming a density of  $0.25\text{g/cm}^3$ , the total mass of the comet could be around  $8 \times 10^{16}\text{kg}$ . If the relative velocity of the comet and Jupiter is a mere  $10,000\text{m/s}$ , the total energy of impact would be  $4 \times 10^{20}\text{J}$ . (Hubble's pictures of the collision were nothing short of spectacular!)

## The Hubble Programme

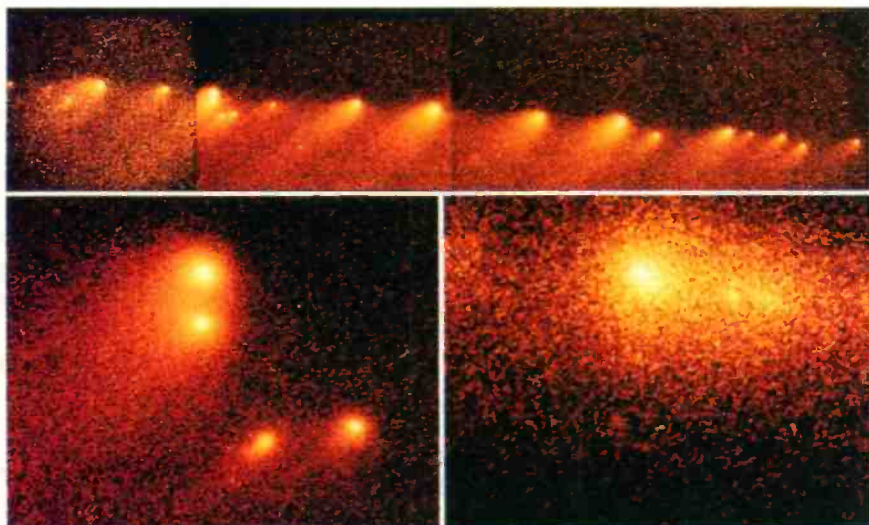
The first set of post service pictures were released during January and February 1994. Within the Solar System pictures have been taken of Pluto and Chiron, and of Jupiter and one of its moons Io. The NASA research teams do not publish specific detailed plans of observational studies, although for such a high value project, planning is likely to be intense and very detailed in order to achieve maximum benefit from the project.

## Conclusion

The Hubble Space Telescope has been designed for an operational life of between 10 and 15 years. Programmes of scientific research are likely to derive immense value from its discoveries. Many theories of stellar evolution will be reviewed in the light of Hubble's new data. Some will remain but it is likely that some will be casualties. Part of the complex set of problems arising from the

## Comet P/Shoemaker-Levy 9 (1993e)

### Hubble Space Telescope Wide Field Planetary Camera 2



Region near Brightest Nucleus  
January 1994  
After Servicing Mission

Region near Brightest Nucleus  
July 1993  
Before Servicing Mission



Hubble mission will be to store and process the vast sets of data that will be created by the Hubble Project.

The volume of data from previous NASA space probes including even Magellan will be more than dwarfed by the sheer extent of the Hubble mission.

CD-ROM would be an ideal of distributing images from the Hubble Telescope, and would pay considerable dividends in terms of awakening educational interest in science and technology.

The problem with the optics, however, has given considerable insight into the whole problem of 'how far' we can see into the universe. This limit has been dramatically extended.

Astronomers for the present are 'content' to get on with the process of observing and assimilating the data being obtained and not worrying overmuch about the next leap forward.

Observations are only going to improve if bigger and better telescopes are built in space though with present space technology these are going to remain expensive. However, it will take some time to scan the universe with the resolution of the present Hubble Telescope.

The proper work of the space telescope has really only just begun. NASA, however, after having been shaken to its core by the problem with the mirror, is perhaps more cautious in its public relations statements and is exer-

cising great care over the release of new images from the Hubble project. The public relations aspect of the project is managed by the Space Telescope Science Institute in Baltimore. One of the excellent features of NASA space projects is the relative ease of access to picture material - they are only a phone call away.

#### Point of Contact:

Space Telescope Science Institute,  
3700 San Martin Drive,  
Baltimore,  
MD 21218, USA.

Tel: +1 410 338 4707.

#### VARIOUS

**TELEQUIPMENT SCOPE** Two Channel 20MHz £120. Magazines (*Electronics*, *ETI*, *PE*, *EE*, *EPE*, *Electronics World*, *Elektron*)  
Tel: (0132) 367459 for list. Component sell off.

**FOR SALE.** Items of Electronic Test Equipment & Components, also PCB making equipment, as a result of shutting Electronics Laboratory. Tel: (0676) 533892 (Solihull) for details.

**CERAMIC CAPACITOR KIT** - £1. 3 Each values 10pF to 4n7. Total 54 Capacitors. Ideal for R.F., Filters etc. Send £1 plus S.A.E. to: 28 Blisworth Close, Yeading, Hayes, Middlesex UB4 9RF.

**SOUNDERS** 40p each, Mains Pulse Counter £5, Assembled PCBs but no Diagrams for 3 channel Sequencer £5, Tasley Sensor £4, plus other Projects. Mark, 45 Amberton Road, Leeds LS8 3AJ.

**PACE MICROLIN FAX MODEM**, 2400bps data/9600bps fax. 'As new' condition, boxed, all leads. Delrina DosFax/WinFAX Lite/COMit Software included, £100.  
Tel: (071) 331 3326 daytime.

**LASER + PSU AND LASER CONTROLLER** (LM72P and LM73Q). Laser not in perfect condition any offers Tel: Ben Haigh (0983) 292071, 8/12/94-11/1/95, or leave name and number any other time.

**BARGAINS!** 2.5kW Dimmer, RS Model 568-051, worth £65, selling £22. 5 1/4in. Disk Drive, worth £50, accept £13. 1-66A, mains to 30V.

## CLASSIFIED

Placing an advertisement in this section of *Electronics* is your chance to tell the readers of Britain's Best Selling Electronics Magazine what you want to buy or sell, or tell them about your club's activities - Absolutely Free of Charge! We will publish as many advertisements as we have space for. To give a fair share of the limited space, we will print 30 words free, and thereafter the charge is 10p per word. Placing an advertisement is easy! Simply write your advertisement clearly in capital letters, on a post-card or sealed-down envelope. Then send it, with any necessary payment, to: Classifieds *Electronics - The Maplin Magazine*.

P.O. Box 3, Rayleigh, Essex SS6 8LR. Advertisements will be published as soon as possible, space allowing. No responsibility is accepted for delayed publication or non-inclusion of advertisements.

Private individuals only are permitted to advertise in this section; commercial or trade advertising of any kind is strictly prohibited by law. Advertisements are only accepted by the Publisher on this proviso. Readers who have reasonable grounds to believe they have been misled as to the nature of an advertisement are advised to contact the Publisher and their local Trading Standards Office.

Transformer (DH31) selling £5. 15V, 4-5A Stabilised PSU, input from 100-240V, £11. Yuasa NP6-12 (XG77), £27, sell £14. Continuity Testers, just £1.50. All as new, inc. P&P. Tel: Robert (0625) 431067.  
**FOR SALE** - Fluke 77 Digital Multimeter, Brand New, in box. Worth £175 only £100. Tel: (0532) 481474 after 7.30 p.m. or week-ends. Can deliver if necessary.  
**FOR SALE** - MOTOROLA 6800-6809 Development System / ICE. £85 o.n.o.

HIACHI 6301/6303 ICE + 'C' Compiler £95. Plus various PC/non PC Computer parts / PCBs. Tel: (0243) 789057 (Chichester) for details.  
**FOR SALE** - 2 x Isolating Transformers. 240V 200VA Rs 208-535 New £37.89 + VAT each. Pair only £35.00. Tel: (0737) 552693.  
**LOGIC ANALYSER** Thandar 32 Channel up to 100 MHz Cost over £1,000. Hardly used. As new £350. Tel: (0676) 533892 (Solihull, West Midlands).  
**GIANT CLEAR-OUT!** Long list of unused components inc. ICs, Computer Accessories,

Capacitors, Resistors, some in large quantities. Send S.A.E. for list. M. J. Dean, Blenheim, Walton Lane, Bosham, Chichester, West Sussex PO18 8QF.

**ELECTRONIC EQUIPMENT** for sale. Many Pieces & Components from clearance of Electronics Laboratory. Tel: (0676) 533892 for details.

**AMIGA TO SCART LEAD**, for connecting AMIGA to Monitor or TV with a SCART Input Socket. Send £8 to: David Price, 6 Marchbank Grove, Balerno EH14 7ES.

#### WANTED

**ANY SAGE AUDIO EQUIPMENT.** Especially SUPERMOSS 200 (working or not). Tel: Tony Bricknell (0702) 554155 Ext. 244 (work) or (0702) 231427 (home).

5 1/4in. **DD BOOT UP DISK** for IBM XT Model 5160-499 also Pin-out of COMPAQ DESKPRO Monitor 12 CQM 30 Mono Monitor. All costs covered. S. Lockhart, 29 Fencedyke Way, Irvine, Ayrshire KA11 1LW.

**4 TRACK REEL TO REEL TAPE RECORDER** for home use (old one got stolen). Tel: Richard (0642) 314385.

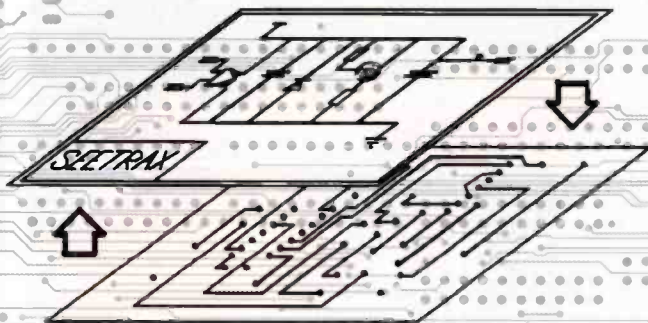
**FOR HUNDAI SUPER 286X PC COMPUTER**, Operator Handbook / Service Manual / W.H.Y. Datavise. Knights, 255 Addington Road, Irthingborough, Northants NN9 5US. Tel: (0933) 652111.

**BEST OF MAPLIN** Projects Books & Old Catalogues of any age. Tel: (01754) 830 394 (after 6pm if possible with offers).

# SEETRAX CAE - RANGER - PCB DESIGN

## Ranger1 £100

- \* Schematic capture linked to PCB
- \* Parts and wiring list entry
- \* Outline (footprint) library editor
- \* Manual board layout
- \* Full design rule checker
- \* Back annotation (linked to schematic)
- \* Power, memory and signal autorouter - £50



All systems upward compatible. Trade-in deals available.

Call **Seetrax CAE** for further information (demo packs).  
Tel 0705 591037 Fax 0705 599036

Seetrax CAE, Hinton Daubnay House, Broadway Lane,  
Lovedean, Hampshire, PO8 0SG

All trademarks acknowledged

## Ranger2 £599

- All the features of Ranger1 plus
- \* Gate & pin swapping (linked to schematic)
- \* Track highlighting
- \* Auto track necking
- \* Copper flood fill
- \* Power planes (heat-relief & anti-pads)
- \* Rip-up & retry autorouter

## Ranger3 £3500

- All the features of Ranger2 plus
- \* UNIX or DOS versions
- \* 1 Micron resolution and angles to 1/10th degree
- \* Hierarchical or flat schematic
- \* Unlimited design size
- \* Any-shaped pad
- \* Split power planes
- \* Optional on-line DRC
- \* 100% rip-up & retry, push & shove autorouter

## Outputs to:

- \* 8/9 and 24 pin dot-matrix printers
- \* HP Desk/Laser Jet, Canon BJet, Postscript (R3 only)
- \* HP-GL, Houston Instruments plotters
- \* Gerber photoplotters
- \* NC Drill Excellon, Sieb & Meyer
- \* AutoCAD DXF



# NEWS

## Report

### Acorn Go Online

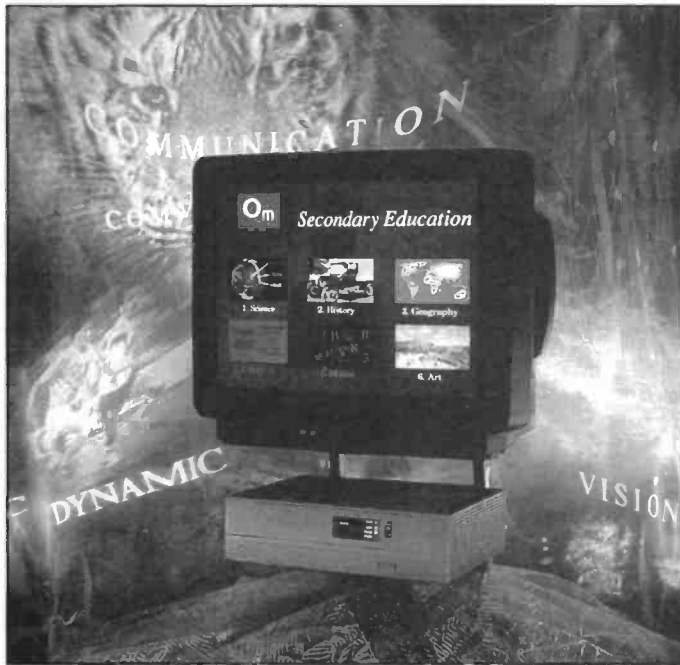
The Acorn Computer Group has announced its entry into the interactive multimedia market with the launch of Online Media, a new operation within the Acorn Computer Group.

Online Media, based in Cambridge, aims to exploit the technical expertise of the Acorn Computer Group to bring affordable interactive multimedia products and services to the huge market emerging from the information super-highway.

To achieve this aim, Online Media will be working with major players in this arena. Examples of current partners include: Olivetti; Advanced RISC Machines; Advanced Telecommunications Modules; Northern Telecom; News International; Anglia Television; Oracle; and Cambridge Cable.

Online Media's revenues will derive initially from the supply of set-top box equipment. Longer term, Online Media is looking to develop additional revenue streams in the areas of design licence sales, authorising software sales, a range of on-line services and consultancy.

The first of the new company's products, the Online Media set-top box, has already generated interest from large communications providers such as Northern Telecom and Alcatel. In the future, Online Media plans to develop products relevant to the broader multimedia market. These will include software for creating services running on set-top devices, services to support the creation of new applications for interactive use and personal multimedia devices. Contact: Acorn Computers, Tel: (0223) 254 479.



### Low Voltage Logic

Two new 3-3V CMOS logic families from Texas Instruments (TI) enable designers of portable, battery-operated and other low-voltage systems to match logic price and performance to the needs of low and mid-range applications such as telecom equipment, notebook personal computers and point-of-sale systems. Without sacrificing effective system performance, the families give designers a migration path away from traditional high-cost 3-3V logic or 5V logic.

TI's low-voltage (LV) logic family addresses the relatively low-performance requirements of cost-sensitive applications such as those in palmtop

and point-of-sale systems. As the most cost-efficient of all TI's low-voltage families, LV-HCMOS can help you create inexpensive portable and desktop PCs and other consumer items.

The low-voltage CMOS (LVC) family best fits in mid-range performance applications. LVC's meet 3-3V system needs comparable to those the '74 family meets in 5V systems. The 0.8 micron CMOS LVC family is made up of gates, medium-scale integration (MSI) flip-flops, latches, multiplexers and eight-bit and Widebus devices with a low standby power consumption rate of 20µA and a worst-case propagation delay of seven nanoseconds. Contact: Texas Instruments, Tel: (0234) 223511.

### Laptop Vision

PCMCIA wise guys Portable Add-ons have recently complemented their range of PCMCIA-compatible products with the launch of the Plug-n-Scan 256 handheld scanner, which can be interfaced to a laptop computer via the PCMCIA 2.0 compliant ScanCard supplied.

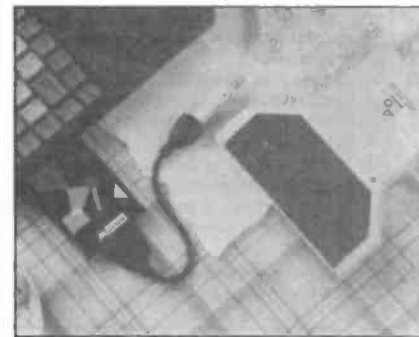
The scanner, which derives its meagre power requirements from the host computer via ScanCard, captures photographic quality images with 256 shades of grey at resolutions of between 100 and 400 dots per inch. For versatility, greyscale, halftone and line art/text scanning modes are provided.

A TWAIN device driver is included with Plug-n-Scan to keep obsolescence at bay. TWAIN (Tool Without An Interesting Name) is a scanner application programming interface standard, originally developed by a consortium including HP, Kodak, Logitech and Aldus, to ensure that software and peripherals do not suffer from incompatibility problems.

The TWAIN driver, part of the ScanKit software included in the package, includes automerge and intelligent merge so that you can scan any size of picture or document with any TWAIN-compliant software.

Applications of Plug-n-Scan include, with the appropriate software, document input via OCR, barcode reading for stock control purposes, the production of company newsletters, and even the scanning of business cards by executives on the move.

The Plug-n-Scan package retails for £299 + VAT and includes three sets of software – ScanKit, which provides TWAIN functionality and basic scanner functions; PhotoPlus, for retouching artwork and photographs; and Perceive, an OCR package. Contact: Portable Add-ons, Tel: (0483) 440777.



### Carrera Beats the Bottleneck

Carrera Technology has been doing clever things to try and speed up the humble PC. The company has announced a new Enhanced IDE controller card dramatically improving DOS and Windows performance.

Enhanced IDE increases the speed and efficiency of PC operation through greater synchronisation of motherboard and hard drive. This raises data transfer rates to around 10M-byte/sec – a 150% improvement on existing IDE drives and a figure that even expensive caching hard-drive controllers would have difficulty matching. 'Fast' IDE controllers are only capable of transfer rates of 4M-byte/sec.

"IDE drives transfer data faster than existing IDE interfaces can accept it, leading to inefficient performance and frustrated end-users", said Jez Deacon, managing director of Carrera Technology. "The new card eliminates

this problem, matching the performance of the best SCSI controllers but at a quarter of the price."

Carrera's optimism is echoed by Western Digital, responsible for much of the early development of Enhanced IDE. "New IDE controllers allow end-users to take advantage of the hugely increased bandwidth now available", said Paul Calderwood, marketing communications manager at Western Digital. "Anyone using the new generation of local bus systems will notice the difference immediately."

Another key benefit of Enhanced IDE is its ability to overcome the 528M-byte limit imposed by the system BIOS under DOS. Enhanced IDE uses Logical Block addressing to give each data block a unique 'address' allowing users to run drives of up to 8-4G-bytes. Enhanced IDE also has a secondary IDE connector supporting up to four IDE peripherals such as back-up or CD ROM devices.

Contact: Carrera Technology, Tel: (071) 830 0486.

### Direction Launch Pentium Notebook

To satisfy the needs of power-hungry mobile computer users, Guildford-based PC manufacturer Direction Technology has just launched the 3600 notebook PC. Built around a 60MHz Pentium processor, the machine is capable of running Windows NT with a considerable speed advantage over existing 486 notebooks.

Features include two PCMCIA slots (one Type II card, and one Type III) for network adaptors or fax modems, 8M-byte Ram (expandable to 40M-bytes), a TFT colour VGA display screen with 32-bit local bus controller and Windows accelerator functions, and enhanced power management facilities to ensure longer life from the NiMH battery pack.

The 3600 series case incorporates a forward-mounted 25mm trackball, palm rests for long-term user comfort, and a removable hard disk (120M-bytes as standard) for security. A speaker and microphone are built into the case, for use with the 8-bit stereo sound card incorporated into the unit as standard.

A £319 docking station is also available to convert the 3600 notebook into a high-performance desktop workstation with superb expansion potential – giving users the best of both worlds. Features include extension speakers for the sound card, a fast SCSI interface for hard disks and

CD-ROM, a monitor stand, serial and parallel ports, and a total of four ISA and VESA expansion slots.

During the next quarter, Direction will be releasing a 90MHz Pentium notebook that makes use of the latest P54C technology. In addition to this, Direction hopes to be launching a new era in notebook technology by combining the best of both worlds – with a machine that features both Pentium and RISC processors in the same case.

Contact: Direction Technology, Tel: (0483) 454400.





## AUDETTEL Test Transmissions Launched

A consortium of broadcasters, consumer electronics companies and organisations working with visually impaired and older people have come together to launch a trial of AUDETTEL, a system which brings a new aural dimension to television.

For the next four months, selected programmes on both ITV and the BBC will be broadcast with a newly-developed data signal which carries an audio commentary describing what happens in the programme during the gaps in the dialogue. A special set-top receiver is necessary to hear the commentary, either through headphones or a loud-speaker.

As part of the trial, 140 AUDETTEL receivers have been installed throughout the country, mostly by the Royal National Institute for the Blind (RNIB), as part of an audience research survey. Its use in the domestic environment will be assessed as a prelude to what may become a permanent service in the future.

Although originally developed for visually impaired and older people to give

them greater access to television, the additional audio commentary is intended to appeal to other viewers who may want to follow a programme while looking away from the screen to cook, do the ironing or service the car.

The AUDETTEL project received a significant accolade from the Royal Television Society in May winning its prestigious Communications Innovation Technology Award.

Audio description of television has already been on trial in Japan and the United States but the system used there is unsuitable for Europe because of the incompatibility of transmission standards. The objective of the consortium has been to develop a system using the same signals used by the BBC's Ceefax and Teletext on Independent Television.

Computerised audio description stations, developed within the consortium, are being used by both the BBC and the ITV programmes for all types of drama, wildlife documentaries and feature films. One of the reasons for the experiment is to determine the time taken to prepare and record descriptions of programmes and films of various types and different degrees of complexity.

ITV and the BBC will broadcast about

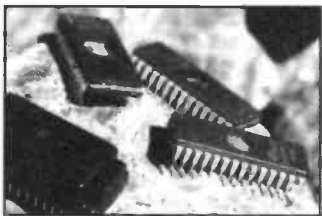


three hours of described programmes per week during the four-month period to thoroughly test the system and those people with receivers will be surveyed by RNIB about their experience of living with the system.

Further development work is under

way by Seleco, the Italian consumer electronics company, to build three prototype television sets with built-in AUDETTEL receivers and Philips have produced a modified VCR which can record audio described programmes.

Contact: RNIB, (071) 6361153.



## EPROM Emulation

SquareWave Electronics has launched MicroRom, a solid-state device that emulates a conventional EPROM, removing the need to erase and reprogramme an EPROM each time code or data is changed.

The MicroROM EPROM emulator has been designed into an 11mm-high plug module and is compatible with standard EPROM sockets. The module is handled exactly like a conventional device, and plugs into the EPROM socket. Connection is made to a PC via the centronics interface.

Once programming is complete and the connector removed, the module can remain in circuit like a normal EPROM due to its non-volatile storage capability. Consequently there is no need to blow an EPROM after programme development.

Consider it, perhaps, as an EPROM with a built-in programmer and eraser that has an unlimited number of write cycles. Contact: SquareWave Electronics, Tel: (081) 880 9889.

## Fast Access SRAM

IBM has announced a family of one-megabit SRAMs that are claimed to be among the semiconductor industry's fastest.

The new SRAMs allow system designers to optimise performance by reducing the delays associated with accessing data from memory. In second-level (L2) cache applications supporting high-performance microprocessors, operating frequencies up to 167MHz are achievable with a pipeline access time of four nanoseconds or flow-through access time of eight nanoseconds.

To optimise performance with PowerPC and Pentium microprocessors, IBM is offering burst mode versions which enable the SRAM to support functions specific to these CPUs. Availability of one-megabit SRAM with burst mode operation will alleviate access time of complexity and enhance overall performance of RISC- and high-end CISC-based processors.

Contact: IBM, Tel: (0705) 561000.

## Hewlett Packard Join Hands with Intel

Hewlett Packard and Intel have announced a joint research-and-development project aimed at providing advanced technologies for end-of-the-decade workstation, server and enterprise-computing products. The companies' efforts will encompass 64-bit microprocessor designs, advanced semiconductor processes and software optimisation.

The companies said that by pooling their respective strengths, they expect to create powerful new solutions that will deliver unprecedented performance to meet the needs of users well into the next century. The planned architecture will maintain binary compatibility with both companies' software bases.

The companies said they will work towards optimising their fundamental technologies to enhance their future product lines. The work will be conducted jointly to take full advantage of complementary capabilities in the two companies.

Contact: Intel, Tel: (0793) 696000.

## 7 Million for School Technology

A total of £7 million is being spent to enhance technology teaching in schools and colleges. The funding is being provided by The Gatsby Charitable Foundation for the Technology Enhancement Programme (TEP), managed by The Engineering Council.

TEP aims to increase the capability of students, aged 14 to 19, in technology, mathematics and science through a more practical, vocational approach.

Over the last three years schools and colleges receiving an award through the programme have had to work in partnership with local industry. In addition to the £7 million funding about £500,000 sponsorship in cash has already been donated by industrial partners to their local schools and colleges involved in the programme. Support from local companies in developing curriculum materials has also been given as help in kind by their engineers and by the donation of equipment and resources.

Contact: The Engineering Council, Tel: (071) 240 7891.

## Scalable ATM Chip

AT&T Microelectronics has introduced two components which will enable network equipment manufacturers to design competitively priced asynchronous transfer mode (ATM) switches or hub cards. Both the T7650 2-by-2 switch and the T7652 ATM layer interface (ALI) chip architectures are scalable so that network hardware can be easily expanded to meet growing demands.



When fully deployed, ATM will support reliable and cost-effective transmission of large amounts of data, video and voice traffic over a common fabric of local and wide area networks at speeds up to one gigabit-per-second.

Contact: AT&T, Tel: (0344) 865927.



## Better Pictures from Citizen

Citizen Europe has launched a 7.8in. Dual Scan Passive Colour LCD featuring Citizen's unique 'Chip-on-Glass' (COG) technology.

Citizen claim this innovative technology delivers significant benefits over conventional manufacturing techniques, which mount the chip-sets onto a board or film. Instead, the Citizen chip-on-glass technology mounts the chips directly onto the display glass. This allows dual scan addressing which doubles the refresh rate of normal passive matrix displays.

Dual scanning leads to clear, vivid colours, significantly faster response times and excellent screen clarity – unsurpassed by any other products in their class. Additional benefits include the ability to manufacture thin, lightweight and compact products.

Based on passive matrix technology, the module provides three RGB 640x480 VGA resolution. Illumination is provided by a Cold Cathode Fluorescent Tube (CCFT) and light guide. The quality and compact size make this product ideally suited for the sub-notebook and portable market.

Contact: Citizen, Tel: (0753) 584111.

## BT Unveils New Digital Satellite News Gathering Services

BT's Visual and Broadcast Services division announced in May the development of a new range of digital, satellite news gathering (SNG) services, at the annual Inter-Union Satellite Organisation Group (ISOG) meeting in London.

A key element of the new range of services is a prototype SNG communications truck, equipped with an 8M-bit/s link, able to act as a KU-band satellite earth station. BT intends to launch the new service within the next six months.

To complement the services offered using the new SNG services, BT will also be launching a non-pre-emptible C-band digital TV distribution service on Intelsat 602, satellite 63° East. This will help to meet broadcasters' needs for occasional use services in areas not yet covered by a KU-band satellite footprint. The new service will enable transmissions to the UK from regions currently generating a high volume of news stories such as Rwanda, Yemen, South Africa and Israel.

New digitally compressed SNG services will enable broadcasters to make greater use of existing satellite space capacity, thereby reducing costs.

Contact: BT Visual & Broadcast Services, Tel: (071) 728 3409.











# What's On?

## LIVE '94 THE CONSUMER ELECTRONICS SHOW

Following the successes of LIVE '93, Britain's most exciting consumer electronics event will be held this year at Earls Court for an extended period of six days. LIVE '94, which will take place between Tuesday 20 and Sunday 25 September 1994, is being run by the exhibition arm of News International, publishers of the *Times*, the *Sunday Times*, *Today*, the *Sun* and the *News of the World*.

The show will encompass the whole spectrum of entertainment, communications and home office equipment, and expects over 200,000 people to gain a hands-on preview of the consumer electronic goodies to be launched during the Christmas season. Apart from manufacturers' displays, LIVE '94 will play host to a number of seminars and features presented by experts in their fields – ranging from the home office to effective camcorder use.

Television will be well-represented – by live broadcasts from both terrestrial

and satellite networks. All the major manufacturers will be demonstrating satellite receivers and TV sets in all shapes and sizes. Video, photography and – that latest buzzword – home cinema will also be making a strong presence, and the public will be able to gain hands-on experience of the latest VCRs, camcorders, video editing equipment, Dolby Surround decoders, still cameras and accessories.

If home computers, games machines and the multimedia experience are your bag, then LIVE '94 won't let you down. Apple, Commodore, Acorn, Microsoft, Philips CD-I, 3DO and Nintendo are among the big names scheduled to appear. Audiophiles, meanwhile, will find their spiritual home in 'The Real Hi-Fi Experience', which will include manufacturers of the calibre of Lynn Products, KEF, Pioneer, NAD, Quad, Kenwood and Marantz. Special areas will be dedicated to in-car audio, and – for those who like to make their own

music – instruments from companies like Korg, Roland, Yamaha, Impact and Fender.

Of interest to many *Electronics* readers will be the communications stands, where amateur radio organisations such as the RSGB, Icom, Yaesu, Lowe Electronics and Maplin affiliate Waters & Stanton will be showing their wares. BT and Mercury will also be at LIVE '94, together with the

latest analogue and digital cellular phones.

And, of course, Maplin will be there too, on stand 3360. The 1995 Catalogue and copies of *Electronics* will be available on the stand, together with a varied selection of products from the new catalogue on show. These will include some recent additions to the Fox and Vixen home and security ranges, car audio equipment and a wide range of projects for the electronics enthusiast – such as the acclaimed Millennium valve power amplifier. We look forward to meeting you!

LIVE '94 ticket prices have been reduced since last year, with a single adult ticket costing £4 on weekdays, or £7 at weekends. Tickets for children are £3, while a £16 family ticket admits up to two adults and three children. All children up to the age of 16 must be accompanied by an adult.

For booking information, News International has set up a hot line on (0891) 500103. (39p/minute off-peak; 49p/minute at all other times). Tickets will also be available on the door, and at all stations on the London Underground system for the four weeks prior to the event. Earls Court is easily accessible by tube, via the District and Piccadilly Lines.

Ten lucky *Electronics* readers need not pay a penny for admission, and can bring a friend along for free! Just fill in the coupon on this page and send it to 'LIVE '94 Competition', P.O. Box 3, Rayleigh, Essex SS6 8LR, to arrive between 5 and 12 September. The first ten coupons to be drawn from the Editor's soup bowl on 13 September will receive a weekday double ticket by return of post, but will be notified by phone first. *Please note that all coupons received outside the stated period will be disqualified.* Good luck!

Name .....

Address .....

Post Code .....

Daytime telephone number .....

If you do not wish to cut your copy of *Electronics* photocopies or post-cards are acceptable.

### DIARY DATES

Every possible effort has been made to ensure that the information presented here is correct prior to publication. To avoid disappointment due to late changes or amendments please contact event organisations to confirm details.

**3 September.** Wight Wireless Rally, National Wireless Museum, Arretton Manor, near Newport, Isle of Wight. Free admission and free stands to both public and traders. Tel: (0983) 567665.

**4 September.** Applied Optics & Optic-Electronics Conference, Institute of Physics, York. Tel: (071) 235 6111.

**4 to 6 September.** European Computer Trade Show, Business Design Centre, London. Tel: (081) 742 2828.

**5 September.** EMC – 9th Electromagnetic Compatibility Conference, Institution of Electrical Engineers, Armitage Centre, Manchester. Tel: (071) 240 1871.

**6 September.** Annual General Meeting at Wells Hall Old School, Sudbury and District Radio Amateurs. Tel: (0787) 313212.

**6 September.** Energy '94, Olympia

National Hall, London. Tel: (071) 370 8207.

**8 September.** Hi-Fi Show, Ramada, Heathrow, London. Tel: (081) 686 2599.

**11 September.** The 13th Lincoln Ham Radio Festival - Hamfest, Lincolnshire Show Ground, Lincoln. Tel: (0522) 525760.

**11 to 24 September.** Plasma Light & Sound Show, Earls Court, London. Tel: (071) 244 6433.

**12 September.** Opening Night and Dayton '94 by Herb Asmussen OZ7SM and George Beasley G3LNS. Stratford upon Avon and District Radio Society. Tel: (0789) 740073.

**20 to 22 September.** CEMEX '94 – Circuit Equipment Exhibition, National Exhibition Centre, Birmingham. Tel: (0705) 665133.

**20 to 25 September.** Live '94, The Consumer Electronics Show, Earls Court, London. Visit the Maplin stand, number 3360, and have a chance to speak to us in person. Tel: (0891) 500103.

**25 September.** SDX Cluster Support Group Junk Sale, Maryhill Road, Glasgow. Tel: (041) 638 7670.

**26 September.** Top Band DF Construction by Geoff Foster G8UKT. Stratford-upon-Avon and District Radio Society. Tel: (0789) 740073.

**26 to 28 September.** The Sixth International Conference on Radio Receivers and Associated Systems, University of Bath. Tel: (071) 836 0190.

**26 to 29 September.** Business Computing 94, Grand Hall, Olympia, London. Tel: (071) 486 1951.

**26 to 29 September.** Mobile Business Show, Olympia, London. Tel: (071) 486 1951.

**4 October.** Talk on Electrical Safety and Regulations, Sudbury and District Radio Amateurs. Tel: (0787) 313212.

**4 to 6 October.** EDI 94, ICC, Birmingham. Tel: (081) 742 2828.

**10 October.** Inside your PC by Martin Rhodes G3XZO. Stratford upon Avon and District Radio Society. Tel: (0789) 740073.

**11 to 13 October.** Voice 94, Olympia, London. Tel: (0733) 575 020.

**15 to 16 October.** Warley National Model Railway Exhibition, National Exhibition Centre, Birmingham. Tel: (021) 558 8851.

**24 October.** QRP by Norman Field G4LQF. Stratford upon Avon and District Radio Society. Tel: (0789) 740073.

**26 to 27 October.** Instrumentation, Sandown Exhibition Centre, Sandown. Tel: (0822) 614671.

**26 to 28 October.** PEVD '94, Power Electronics & Variable Speed Drives Conference, Institution of Electrical Engineers, London. Tel: (071) 240 1871.

**1 November.** Talk & Demonstration on First Aid by St. Johns Ambulance, Sudbury and District Radio Amateurs. Tel: (0787) 313212.

**1 to 3 November.** Windows Expo, Olympia, London. Tel: (0256) 381 456.

**5 to 6 November.** Eighth North Wales Radio and Electronics Show, Aberconwy Conference Centre & The New Theatre, Llandudno. Tel: (0745) 591704.

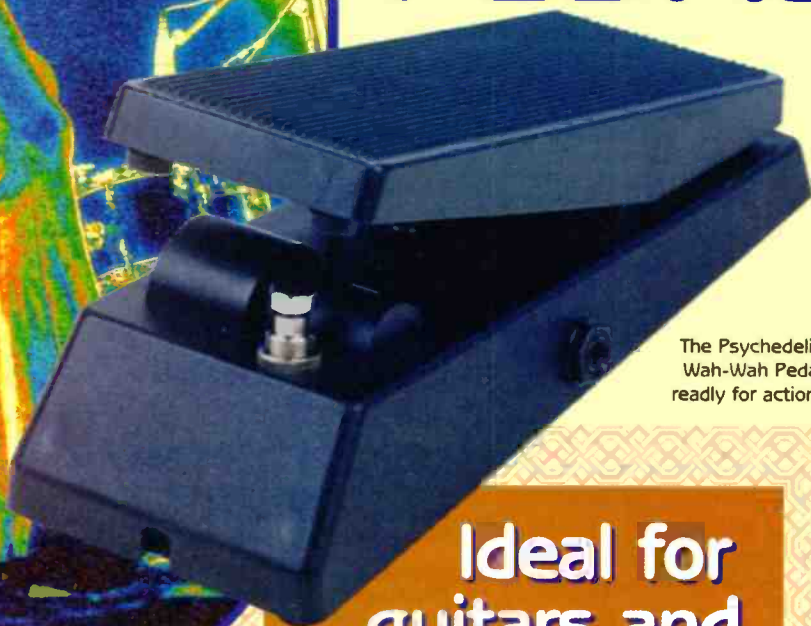
**Please send details of events for inclusion in 'Diary Dates' to: The News Editor, *Electronics* – The Maplin Magazine, P.O. Box 3, Rayleigh, Essex SS6 8LR.**



Yes, another Wah Wah pedal that uses the infamous LM13700 transconductance op amp. Unlike other designs that failed to reach the benchmark of the original Jim Dunlop Wah Wah Pedal, the Psychedelic Wah Wah surpasses it with a number of advantages. These include adjustable resonance, which determines the subtlety of the effect and adjustable range, used for both electric and bass guitars; in fact, on any electric music instruments such as keyboards and electric violins. The circuit also features a compander that reduces noise in the circuit and improves the harmonic output content, which makes for a very warm rich sound.

# PSYCHEDELIC

# WAH WAH PEDAL



The Psychedelic Wah-Wah Pedal ready for action!

Jimi Hendrix at the Isle of Wight Festival 1970. © 1994 The Hulton Deutsch Collection.

**Ideal for  
guitars and  
other musical  
instruments**

Design by Nigel Skeels  
Text by Nigel Skeels and  
Robin Hall

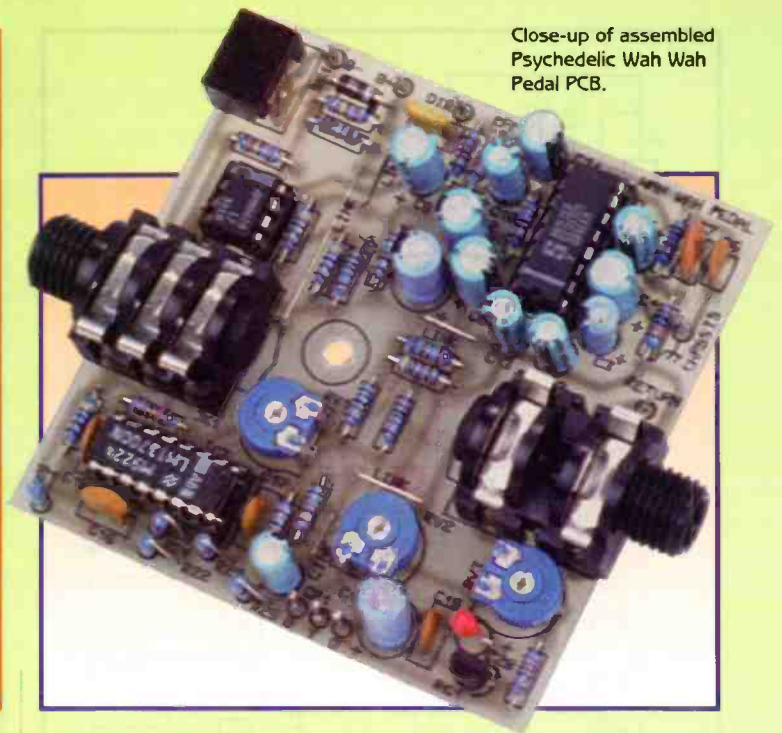
KIT  
AVAILABLE  
(LT43W)  
PRICE  
**£34.99<sup>8</sup>**  
INCLUDING CASE!



# FEATURES

- \* Powered from 9V PP3 battery or regulated power supply
- \* Regulated reference to prevent low battery voltage drift
- \* Built-in compander to minimise noise
- \* Traditional Wah Wah sound (without the crackle)
- \* Rich warm harmonic content
- \* Minimal adjustment
- \* IC design, no laborious coils to wind
- \* Adjustable resonance and range
- \* Economically priced with unbelievable performance

Close-up of assembled Psychedelic Wah Wah Pedal PCB.



FOR the uninitiated, the sound effect of a Wah Wah pedal is synonymous with many recordings of bands of the seventies. For an example listen to 'Voodoo Chile' by Jimi Hendrix, the track opens with a prime bit of wailing. The Wah Wah acts as a kind of tone boost control, and moving the pedal adjusts the frequency point at which the boost occurs.

Rhythm or lead guitar usually play through the device. When playing rhythm, the pedal is moved in time with the 'strum', and when playing lead, extra expressive abilities become available enabling almost 'infinite sustain' without screaming feedback.

## SPECIFICATION

Power supply:	+9V DC
Current consumption:	14.7mA
Maximum boost @ 1kHz:	20dB
Minimum frequency:	90Hz
Maximum frequency:	20kHz

## Circuit Description

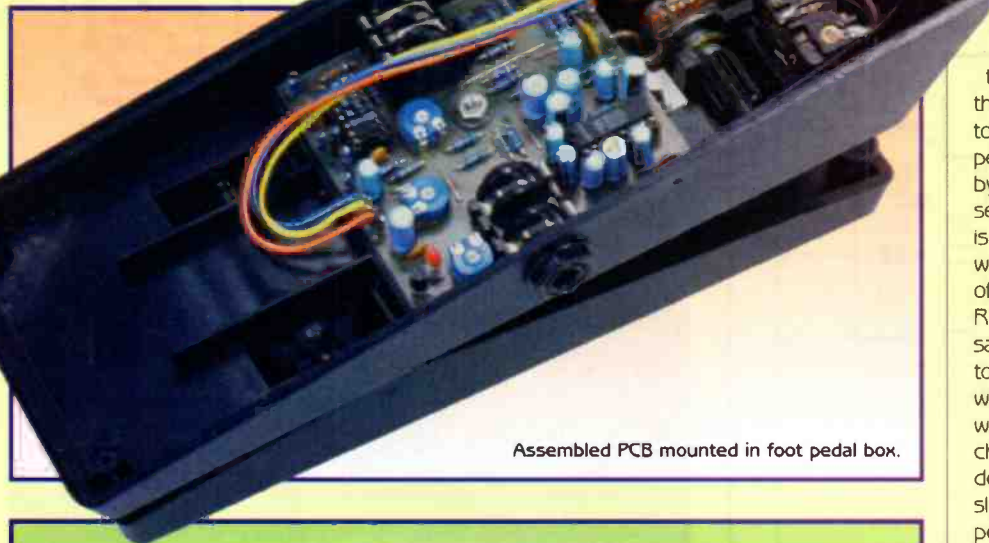
The block diagram of the Psychedelic Wah Wah Pedal is given in Figure 1, this as well as the circuit diagram in Figure 2, will help illustrate how the circuit operates. The input to the Psychedelic Wah Wah is fed to the input stage of IC1 an LF3551 op amp. This is a low-noise J-FET device and is used to buffer the input signal, thus preventing the rest of the circuit loading the input. There is no gain in this part of the circuit as seen by the direct link between the inverting input and the output.

The next stage in the circuit is IC2 an NE571. This is set up to compress the signal by the ratio of 2 to 1 before it is fed into IC3 the LM13700 dual transconductance amplifier. This is where the magic takes place, and is used here to provide two voltage-controlled tunable peaks in the audio band. This is achieved by placing both parts of the LM13700 in series with each other. The voltage change is obtained by using a 100k linear pot; the wiper of this pot is then connected to both of the amplifier bias inputs via R19 and R25. These two resistors could be of the same value thus causing both of the peaks to be on top of each other, but this is not what we are after, as the overall peak would be too narrow and not give us that characteristic Wah Wah sound that is so desirable. With this in mind, the peaks are slightly separated thus widening the overall peak and is performed by having different values for R19 and R25.

The diode bias inputs are tied to the supply rail via resistors R17 and R20 both 15k, these help to linearise the input stage of the amplifier. Capacitors C15 and C16 also set the frequency at which the gain occurs.

The gain of the first part of the LM13700 is adjusted by varying RV1, this is known as the resonance control, by increasing this, the effect is more pronounced. The overall gain of IC3 is determined by R15.

The final stage in the circuit is to expand the signal back to its original form, IC2 is again used for this operation. The idea of



Assembled PCB mounted in foot pedal box.

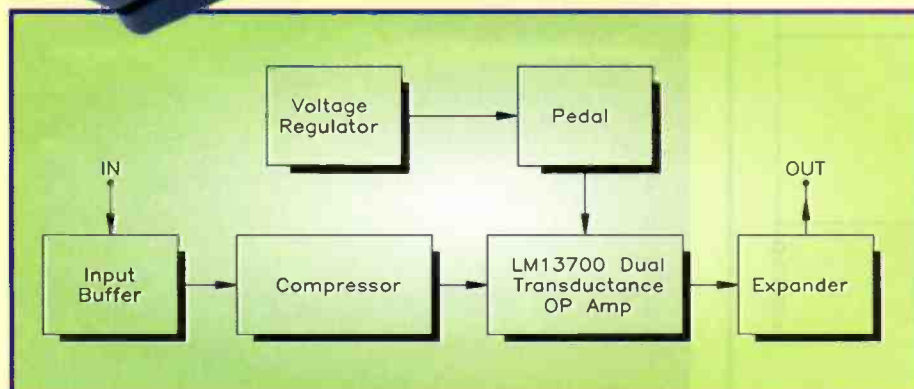


Figure 1. Block diagram of the Psychedelic Wah Wah Pedal.



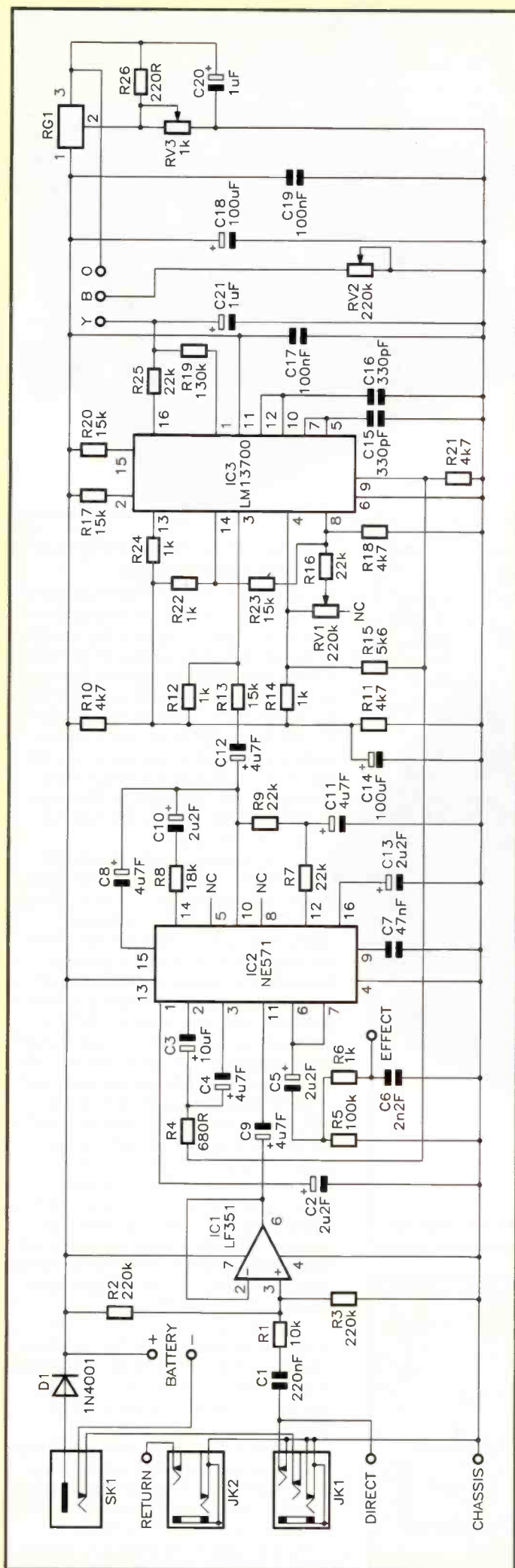


Figure 2. Circuit diagram of the Psychedelic Wah Wah Pedal.

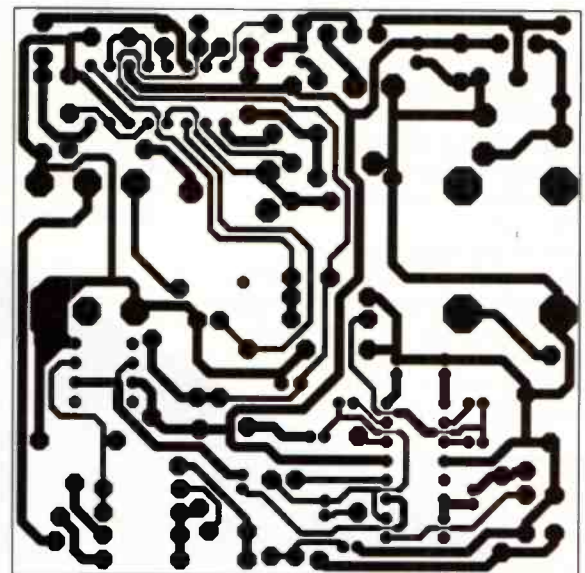
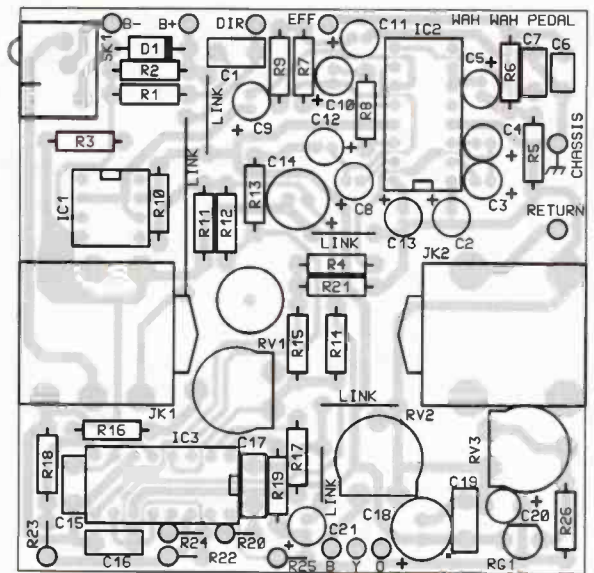
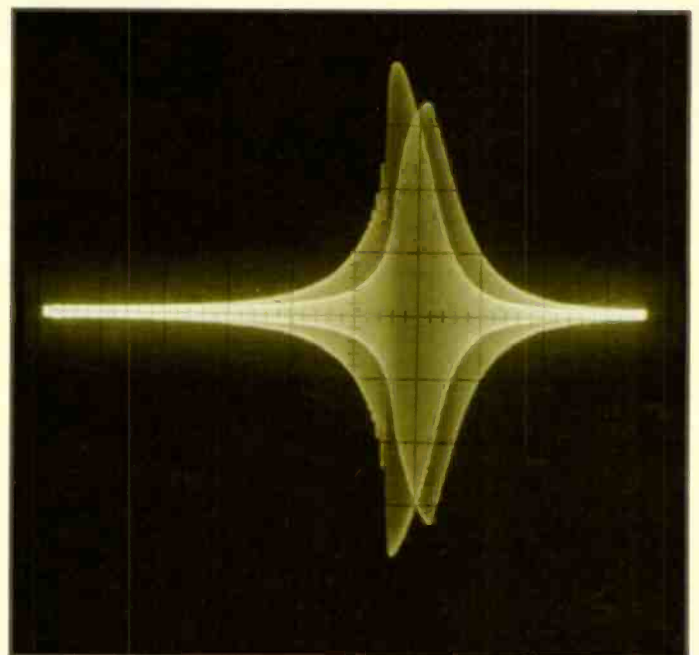


Figure 3. PCB legend and track.



Frequency sweep shown on an oscilloscope.



compression and expansion is to prevent any noise from being amplified in the system. R6 sets the output impedance of the unit and C6 is to ensure HF stability.

## PCB Construction

Construction of the Psychedelic Wah Wah is fairly straightforward, refer to the Parts List and to Figure 3 for the PCB legend and track. The sequence in which the components are placed is not critical. However, the following instruction will be of use in constructing the project. If you are new to project building please refer to the Constructors' Guide (XL79L) which is included with the kit.

Fit the smaller components first, such as the resistors and diode, noting correct polarity for the diode. Next fit the wire links which are made from wire offcuts from the resistors. Fit the capacitors next, making sure that the electrolytic capacitors and the tantalum capacitor are fitted the correct way round. Next fit the PCB pins into the relevant holes. Identify the horizontal resistor presets, fit and solder. Next, install the regulator RG1, making sure that its outline conforms to the package outline on the legend. Fit the IC sockets, correctly orientating them on the board noting that the notch at one end matches that on the legend.

Next fit the power socket 5K1, and the two jack sockets JK1 and JK2. Identify and

fit the ICs into the correct DIL sockets, correctly orientating them so that the notch on the ICs matches those on the sockets.

Finally attach the battery clip making sure that the leads are correctly positioned.

Once the PCB construction is complete, check over your work to ensure that all components have been correctly fitted and that there are no short circuits caused by solder bridges or splashes. Finally, clean all the flux off the PCB using a suitable PCB cleaning solution.

## Pedal Modification

There are a number of modifications required to be made to the foot pedal box, refer to Figure 4 for box drilling and modifications.

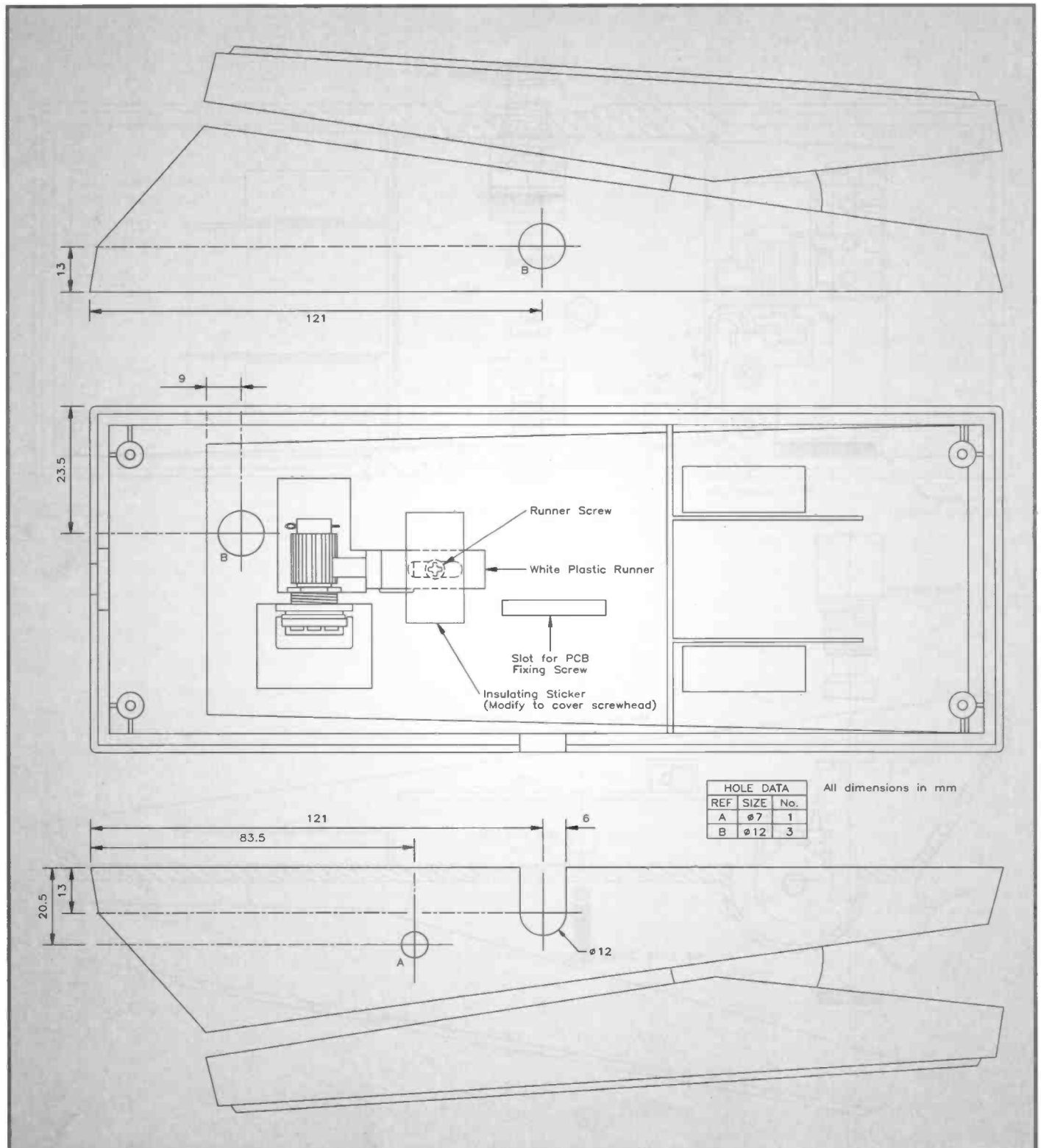


Figure 4. Foot pedal drilling and modification details.



Remove the existing cable clamp and screw. Cut a hole for the foot switch, and if necessary remove any plastic obstruction (where the original cable clamp was located). Drill a hole for the output socket, refer to Figure 4, and also cut a slot for the input socket, the reason for the slot will become apparent when the PCB is fitted. Next drill a hole for the power socket. Remove the variable resistor from the pedal (it may be helpful to loosen the white plastic runner). Carefully take the split pin from the end of the shaft and remove the cog and the washer. Next place the cog and washer onto the 100k linear potentiometer supplied in the kit. Figure 5a shows an exploded assembly view of the potentiometer. Using the holes on the cog,

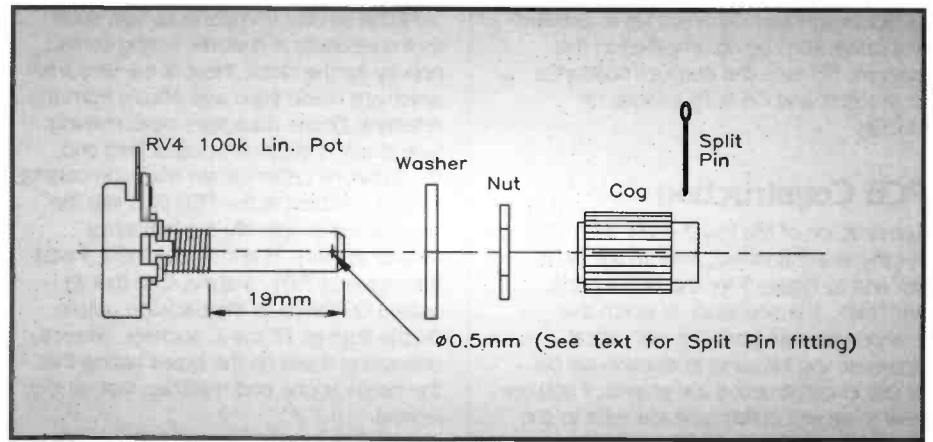


Figure 5a. Exploded potentiometer assembly.

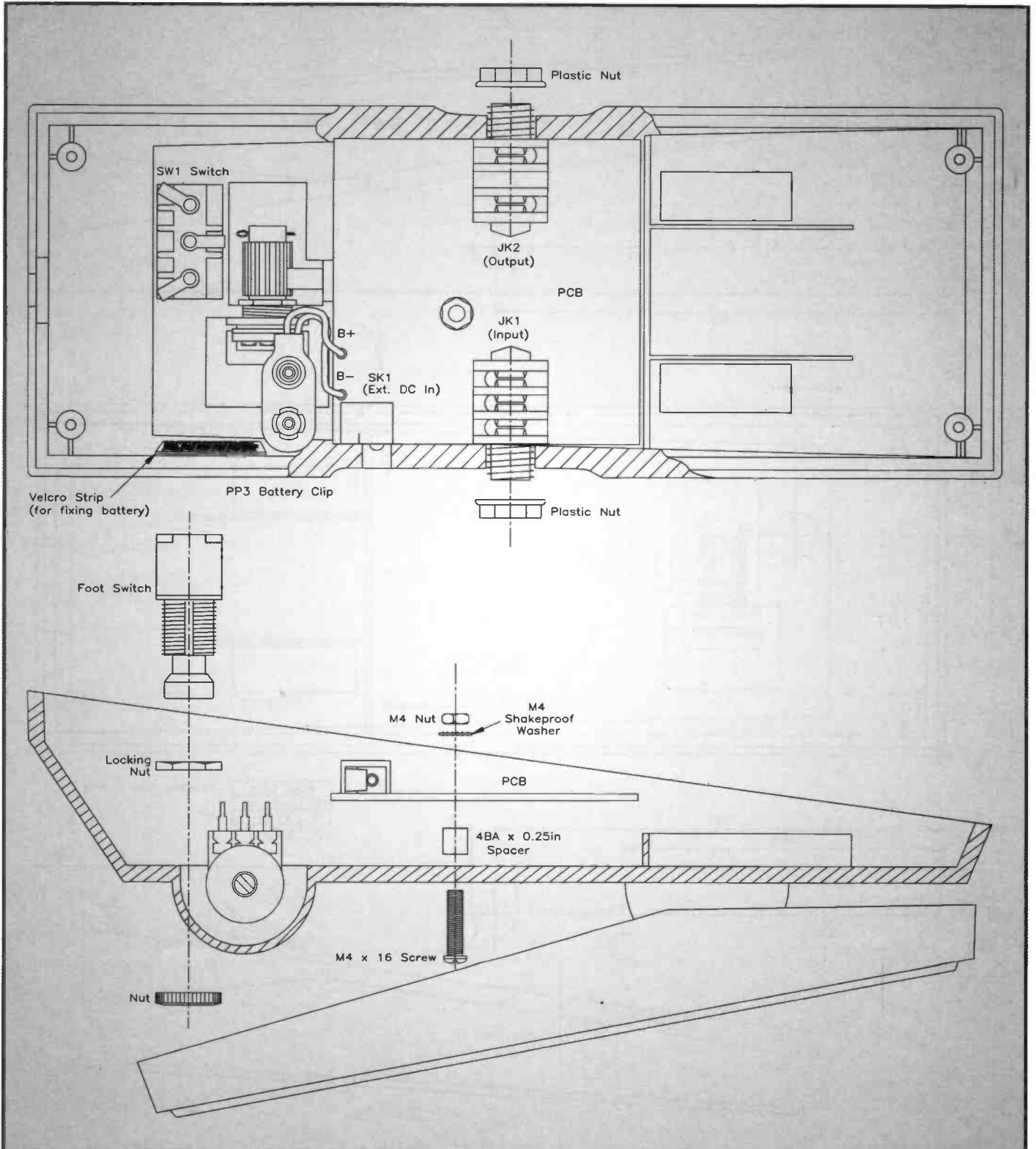
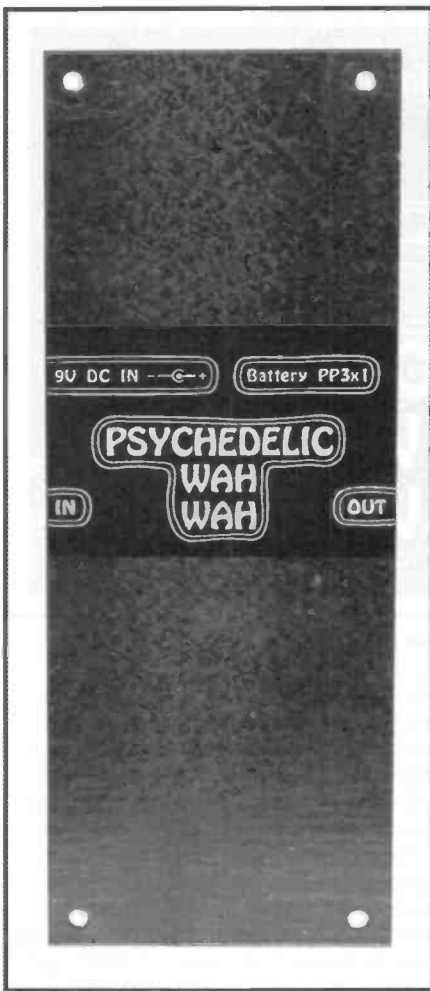
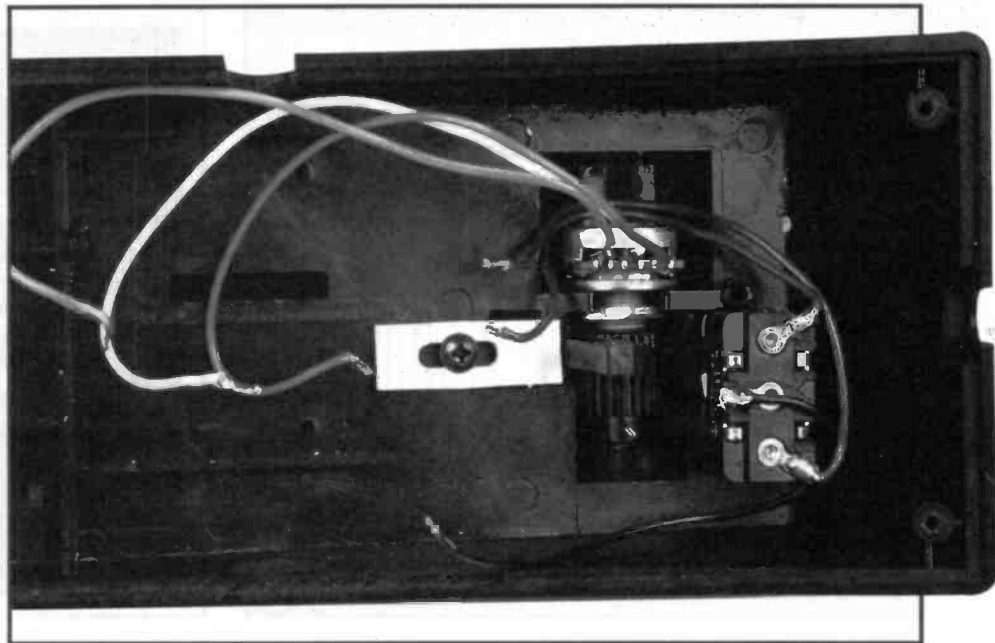


Figure 5b. Exploded assembly of the Psychedelic Wah Wah Pedal.





Baseplate label in position.



Inside the foot pedal box – the foot switch can be seen on the right.

drill through the shaft of the potentiometer and place the split pin through the hole, next bend the split pin in order to secure the cog to the shaft. Now put the finished potentiometer back into the pedal and tighten up the lock nut.

Before mounting the PCB in position, cover the white runner screw, with the strip provided on the main base panel label (KP70M), cut the strip off and stick over the screw, thus preventing contact with the PCB and possibly shorting out.

Next mount the PCB into the case, refer to Figure 5b which shows an exploded assembly view. Fit one end of the PCB with the jack socket into the hole on the side and then slide the other end into the slot provided. Mount the PCB onto the spacer, fit a shakeproof washer and bolt in position. Discard the washer from the footswitch, and mount the switch in position, adjusting it so that it will only come into contact at the very end of pedal travel (in order to switch it on or off).

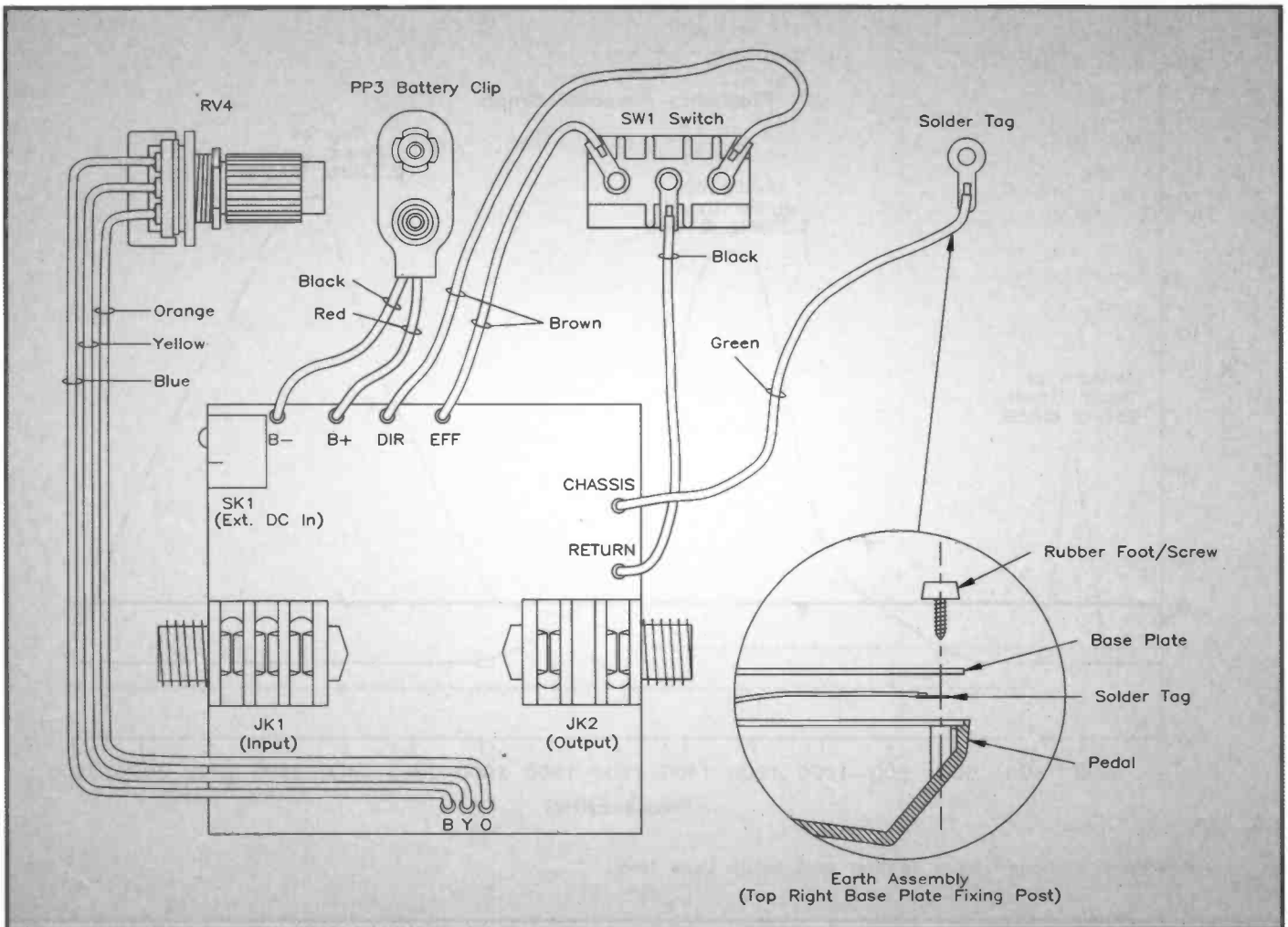


Figure 6. Wiring diagram for Psychedelic Wah Wah Pedal.



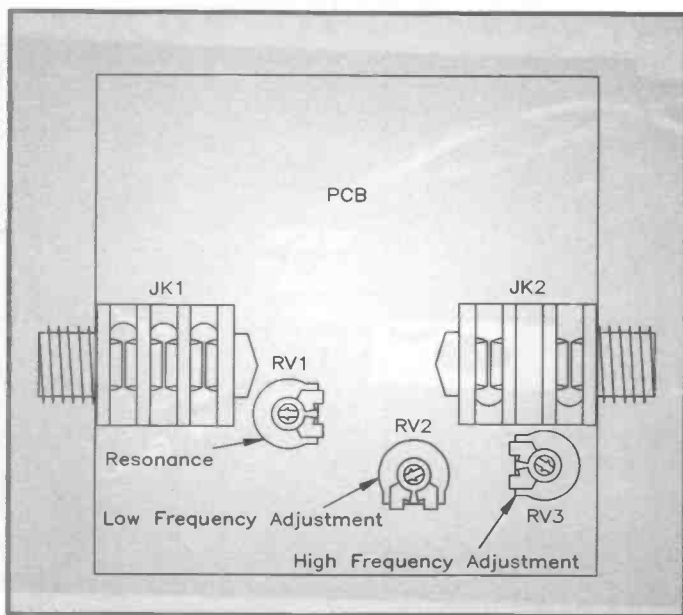


Figure 7. The resonance, low and high frequency presets on the PCB.

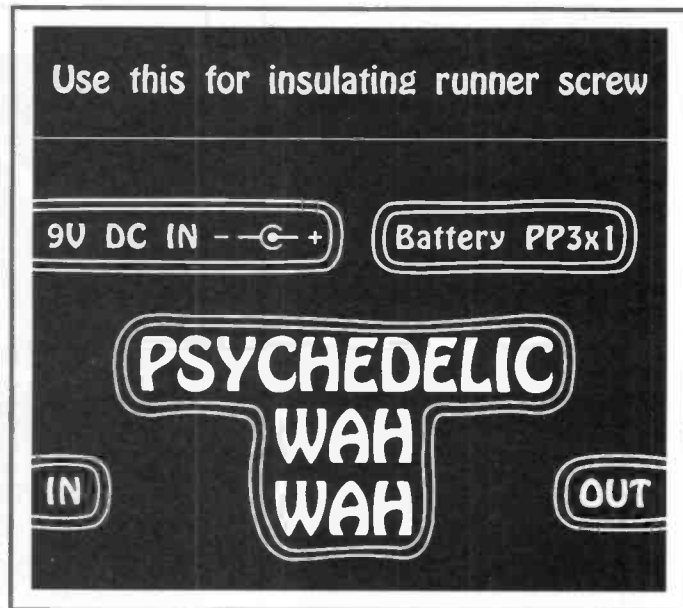


Figure 9. Psychedelic Wah Wah Pedal baseplate label.

Referring to Figure 6 the wiring diagram, connect up the potentiometer and the switch, and solder an earthing wire from the PCB to the baseplate. Lastly, attach one part of a pair of Velcro pads to the battery and the other part inside the box, this is in order to secure the battery in position.

### Test and Set up

Well now that it is built, now comes the nerve racking moment of truth, adjust the presets as near to those in Figure 7 as

possible, plug in a guitar and give it a go (see Figure 10). Make sure that the unit is switched to effect and not to bypass. If it does not work check for misplaced components, dry solder joints, and solder bridges between tracks.

To set the correct range of the unit the pedal must be pushed forward to the end of its travel (just before the switching point). In this position the higher frequencies are amplified, so now (first checking that your guitar is in tune!) play the highest note. Whilst letting the note sound adjust preset

RV3 (the high and low frequency presets are shown in Figure 7) it is correct when you hear the note at its loudest point (just like radio tuning). It may help you to hear the effect by turning the resonance to full, this is when RV1 is turned fully clockwise.

To set up the lower frequencies, move the pedal to its lowest point and play the lowest note (usually the open E string), with this note sounding adjust RV2, you will have to decide if you want it to boom out (ideal for Reggae music, special effects and feedback) or to be more conventional to

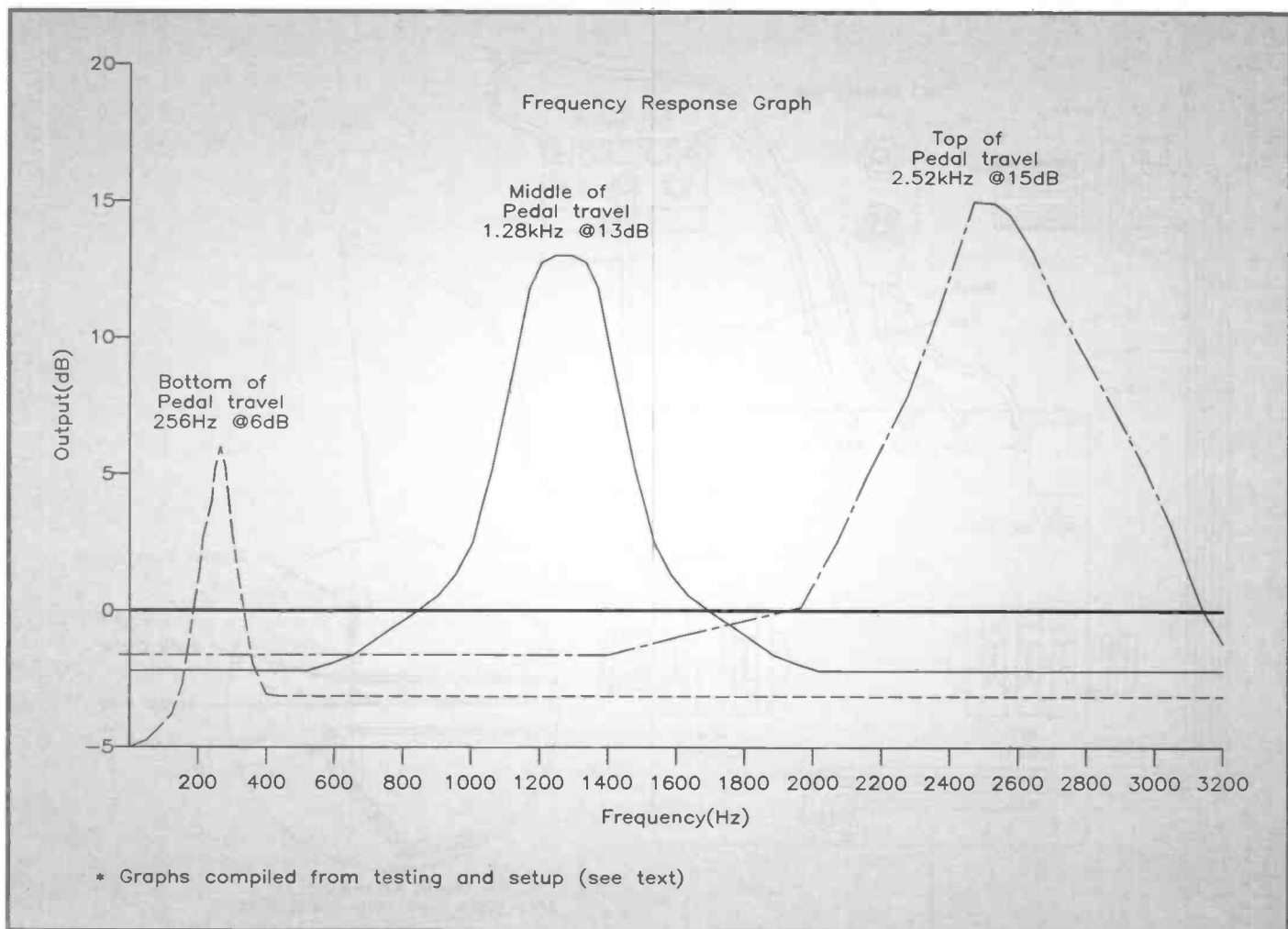


Figure 8. Typical frequency response graph.



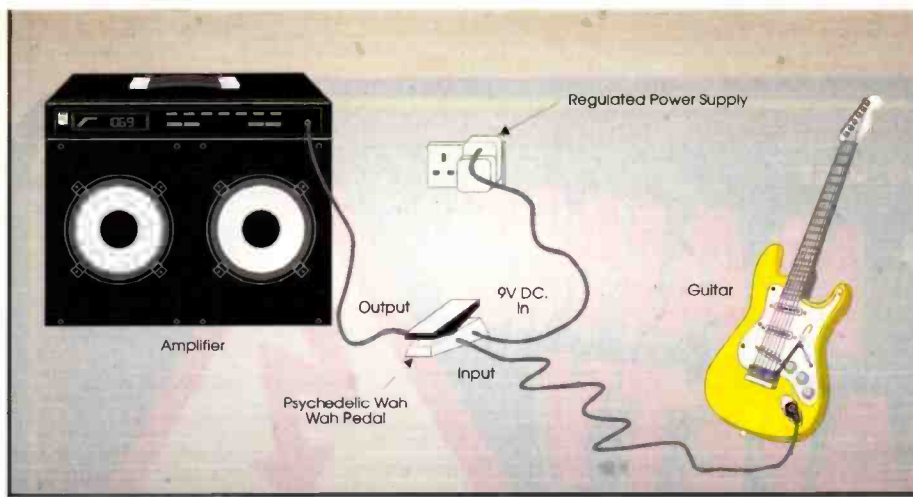


Figure 10. Psychedelic Wah Wah Pedal used in conjunction with guitar and amplifier plus optional power supply.

have a more subtle bottom end. Note, when adjusting RV2 the sound may disappear, the level that you are looking for is just before this point.

Before proceeding recheck your adjustments and realign if necessary. A typical frequency response graph is given in Figure 8.

The last setting to adjust is the resonance, you can turn it down now unless of course you want loads of lovely feedback. This setting is again a matter of personal preference, for subtle effects turn RV1 anticlockwise, for feedback turn clockwise.

To complete the project, fit the baseplate

panel label, this is shown in Figure 9 and is supplied in the kit and available separately (KP70M). Peel the backing paper off the label and stick in position on the baseplate.

## Operation

Figure 10 shows how the Psychedelic Wah Wah is used in conjunction with a guitar and amplifier (plus optional power supply if required). To operate the device once it has been set up, insert a jack plug into JK1 from a guitar or some other suitable electric instrument. The plug connects the 0V rail to the battery as well as providing a signal path. Connect a lead from the Wah Wah to the amplifier.

The main switch is then operated by pushing the foot-pedal as far forward as possible, this determines whether the signal passes through without modification (no effect) or with effect. Once switched on, moving the pedal back and forth provides the Wah Wah effect.

So all you need now, are the flared trousers, psychedelic shirt, afro hair style, and granny specs to complete the image.

## PSYCHEDELIC WAH WAH PEDAL PARTS LIST

RESISTORS: All 0.6W 1% Metal Film (Unless Specified)

R1	10k	1	(M10K)
R2,3	220k	2	(M220K)
R4	680Ω	1	(M680R)
R5	100k	1	(M100K)
R6,12,14,22,24	1k	5	(M1K)
R7,9,16,25	22k	4	(M22K)
R8	18k	1	(M18K)
R10,11,18,21	4k7	4	(M4K7)
R13,17,20,23	15k	4	(M15K)
R15	5k6	1	(M5K6)
R19	130k	1	(M130K)
R26	220Ω	1	(M220R)
RV1,2	220k Enclosed Preset	2	(UH07H)
RV3	1k Horizontal Enclosed Preset	1	(UH00A)
RV4	100k Linear Potentiometer	1	(FW05F)

### CAPACITORS

C1	220nF Monolithic Ceramic	1	(RA50E)
C2,5,10,13	2μ2F 100V Radial Electrolytic	4	(FF02C)
C3	10μF 50V Radial Electrolytic	1	(FF04E)
C4,8,9,11,12	4μ7F 63V Radial Electrolytic	5	(FF03D)
C6	2n2F Ceramic	1	(WX72P)
C7	47nF 16V Miniature Disc Ceramic	1	(YR74R)
C14,18	100μF 25V Radial Electrolytic	2	(FF11M)
C15,16	330pF Ceramic	2	(WX62S)
C17,19	100nF 16V Miniature Disc Ceramic	2	(YR75S)
C20	1μF 35V Tantalum	1	(WW60Q)
C21	1μF 100V Radial Electrolytic	1	(FF01B)

### SEMICONDUCTORS

IC1	LF351M	1	(WQ30H)
IC2	NE571M	1	(YY87U)
IC3	LM13700M	1	(YH64U)
RG1	LM317LZ	1	(RA87U)
D1	1N4001	1	(QL73Q)

### MISCELLANEOUS

JK1	Stereo PCB ¼in. Jack Socket	1	(FJ05F)
JK2	Mono PCB ¼in. Jack Socket	1	(FJ00A)
	Foot Pedal Box	1	(XY28F)
	PP3 Clip	1	(HF28F)
	1in. Velcro Strip	1 Pkt	(FE45Y)
	PCB Mtg Power Socket	1	(RK37S)
	8-pin DIL IC Socket	1	(BL17T)

16-pin DIL IC Socket	2	(BL19V)
3A Hook-up Wire Black	10m	(FA26D)
3A Hook-up Wire Blue	10m	(FA27E)
3A Hook-up Wire Yellow	10m	(FA36P)
3A Hook-up Wire Orange	10m	(FA31J)
3A Hook-up Wire Green	10m	(FA29G)
3A Hook-up Wire Brown	10m	(FA28F)
Single-ended PCB Pin 1mm (0.04in.)	1 Pkt	(FL24B)
Press Switch SPDT	1	(FH92A)
M3 Solder Tag	1 Pkt	(LR64U)
M4 x 16mm Steel Bolt	1 Pkt	(JY16S)
M4 Shakeproof Washer	1 Pkt	(BF43W)
M4 Steel Nut	1 Pkt	(JD60Q)
4BA x ¼in. Spacer	1 Pkt	(FW31J)
PCB	1	(GH88V)
Panel Label	1	(KP70M)
Instruction Leaflet	1	(XU89W)
Constructors' Guide	1	(XH79L)

### OPTIONAL (Not in Kit)

Regulated Mains Adapter	1	(YB23A)
9V PP3 Battery	1	(JY49D)
Double Screened Straight Jack Lead	1	(Y230H)
Neon Lead Green	1	(CC36P)
Neon Lead Pink	1	(CC37S)
Neon Lead Orange	1	(CC38R)
Guitar Lead	1	(CC39N)

The Maplin 'Get-You-Working' Service is available for this project, see Constructors' Guide or current Maplin Catalogue for details.

**The above items (excluding Optional) are available as a kit, which offers a saving over buying the parts separately.**

**Order As LT43W (Psychedelic Wah Wah Pedal) Price £34.99**

Please Note: Where 'package' quantities are stated in the Parts List (e.g., packet, strip, reel, etc.), the exact quantity required to build the project will be supplied in the kit.

The following new items (which are included in the kit) are also available separately.

Psychedelic Wah Wah Pedal PCB **Order As GH88V Price £3.29**

Psychedelic Wah Wah Pedal Base Panel Label

**Order As KP70M Price £2.49**

by Andrew Chadwick B.A., C.Eng., M.I.E.E.

# A Guide to

This article, part one of a two part maxi-feature examines in detail all aspects of mains safety

# MAINS SAFETY

PART ONE



**M**ANY of the projects that appear in *Electronics* are low voltage circuits that can be satisfactorily run on batteries. However, where any significant amount of power is required, a mains-derived power supply is necessary. Usually the neatest solution is to incorporate this in the same enclosure as the rest of the circuit (see Photo 1); this is fine, as long as the potential hazards of working with the mains are recognised. Poor standards of design and construction with battery-powered circuits will, at worst, lead to component damage or a flat battery; but with mains voltages, the results can be lethal. Despite this dire warning, the intention of this article is not to dissuade you from constructing any circuits using the mains, but to describe and explain the precautions that must be taken to ensure safety.

If you would rather not deal directly with mains voltages, even after reading this article, then a separate, ready-made battery eliminator type power supply might be suitable for some projects. There are a number of British Standards on the subject, which are listed in the References section (in next month's edition). These are very comprehensive, and although they cover the safety of commercially manufactured equipment, they are still a good guide to safe practice. The two most relevant to hobby construction are BS 415

and BS EN 60950. I have tried to extract all the appropriate material, but if you are interested in further details, I suggest you have a look for yourself. British Standards are available at most main libraries, and provide a great deal of useful technical information on all sorts of subjects.

The standards on safety consist of a series of requirements and details of tests to ensure compliance. Many of the tests are not feasible for hobbyist constructors, but I have mentioned some of them to give an idea of what is expected.

Although every effort has been made to ensure accuracy, the author accepts no liability for any accidents arising as a result of following the advice contained in this article.

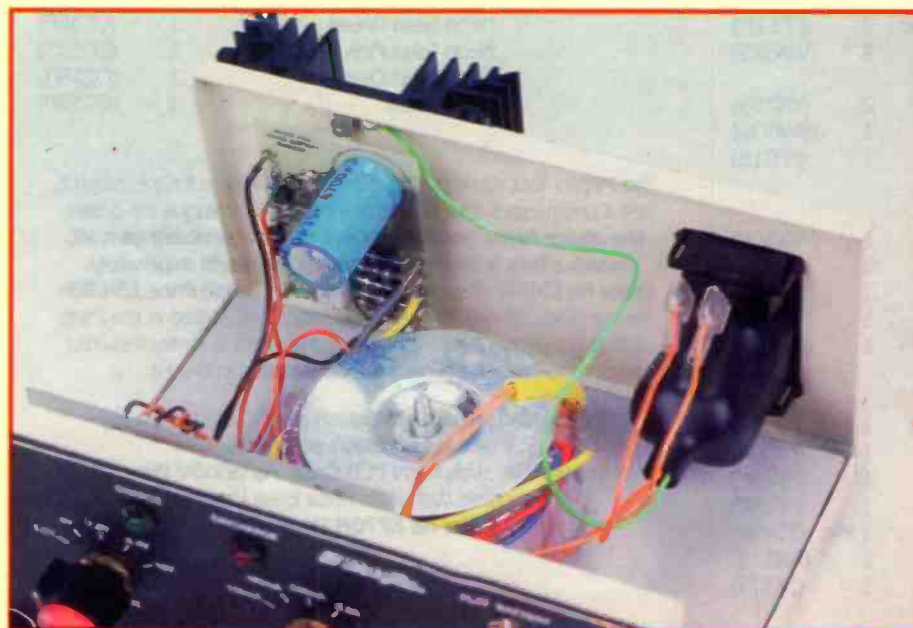
## Shock

The most obvious potential hazard of the mains is that of electric shock. Anyone who has experienced this will tell you it is very unpleasant! The current flowing through the body upsets the operation of nerves and muscles, and causes involuntary muscular contractions. If the muscles of the diaphragm and chest contract, there is a risk of asphyxiation. However, the usual cause of death is due to the current triggering the heart into a state known as fibrillation, in which it beats very rapidly and without co-ordination. Pain is felt at the points where the current enters

Current (mA)	Effect
0.5 to 2.0	Threshold of perception.
2.0 to 10	Painful sensation, increasing with current.
10 to 25	Cramp and inability to let go. Danger of asphyxiation from respiratory muscular contraction.
25 to 80	Severe muscular contraction possibly leading to bone damage. Loss of consciousness. Heart or respiratory failure.
>80	Burns at points of contact. Death from ventricular fibrillation.

Current passed hand to hand for more than 1 second.

**Warning:** Do not attempt to conduct your own experiments based on this information.



**Above: Table 1. The effect of various levels of AC current on the human body.**

**Left: Photo 1. A well laid out project: Maplin's Ni-Cd charger.**

and leaves the body and, in severe cases, burns may be caused.

The effect of various levels of current and voltage on the human body has been investigated, quite extensively, in order to determine safe limits. Table 1 summarises the results of experiments where varying AC currents were passed between cylindrical electrodes held in either hand, for periods of at least one second. It is evident that sensitivity varies a lot, but currents of 10 to 25mA are sufficient to give a serious shock. Other experiments showed that the body is slightly less sensitive to DC currents.

In the light of Table 1, it may seem surprising that the recommended trip current of residual current devices (RCDs), designed to protect against the worst effects of electric shock, is as high as 30mA. However, the



**Right: Photo 2. Electricity pylons.**

severity of a shock is very dependent on its duration. Table 1 is for shocks lasting for a second, whilst an RCD is required to operate within 40ms.

The resistance of the body actually varies with the applied voltage but, at 240V, is typically 1,000 to 2,000Ω – by applying Ohm's Law, it would appear that any contact with the mains would produce a lethal level of current. However, in a practical situation, the resistances at the points of contact are usually far more significant. These vary greatly, depending on such things as the dampness of the skin, and the type of shoes being worn. There is also a good chance that muscular contractions will throw the victim clear in a much shorter time than the one second used in the experiments.

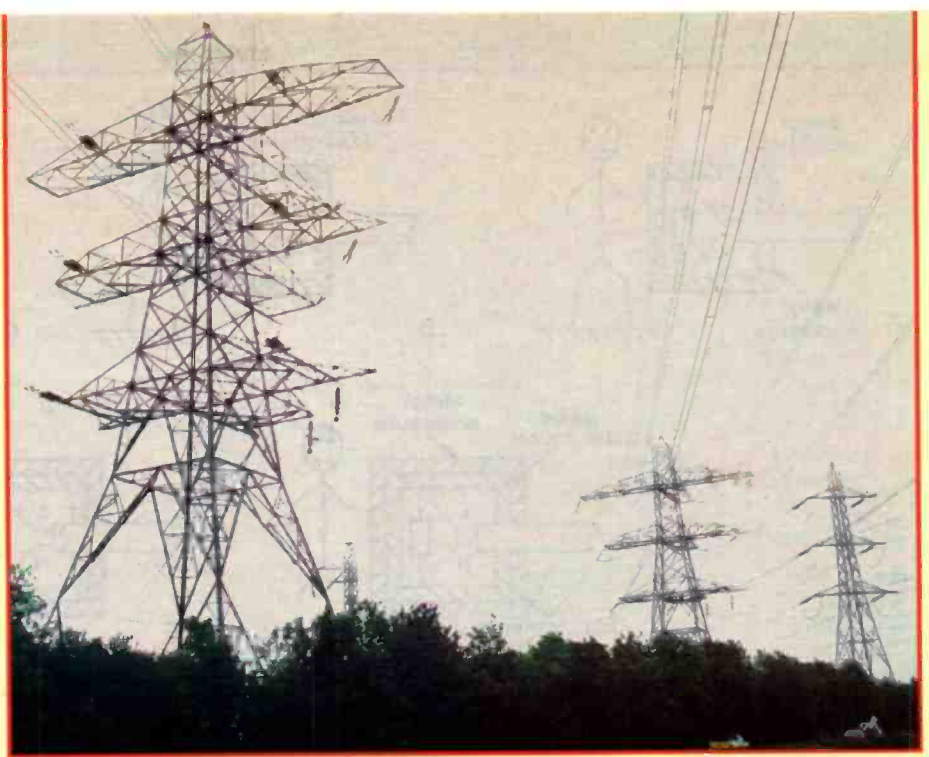
## Mains Supply Basics

Most readers will be familiar with the live, neutral and earth conductors in the power circuits in their homes. The way in which these are derived from the supply authority's circuits is shown in Figure 1. T1 is the secondary of a three-phase transformer whose primary is supplied from the grid.

The consumer's neutral terminal is connected to the star-point of the transformer, which is earthed.

The live terminal is connected to one of the three-phase conductors denoted by the colours red, yellow or blue. This is sometimes shown by a coloured disc near the authority's terminals.

The main earth terminal may be connected to the transformer earth by means of a separate conductor, often the lead sheath of the incoming cable, as shown in Figure 1(a). Alternatively, it may be connected to the neutral conductor at the authority's termi-



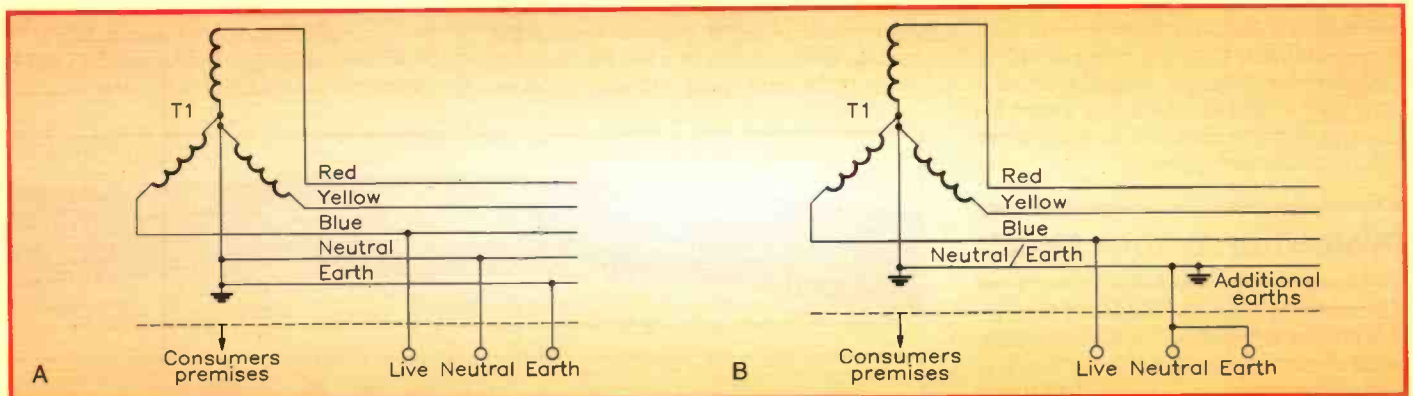
nals, thereby connecting to the transformer's earth via the neutral conductor of the supply cable, as shown in Figure 1(b). In the latter case, the neutral conductor is earthed at a number of other points to reduce the risk of a fault, in the neutral conductor, resulting in loss of the earth return path to the transformer. This system is known as protective multiple earthing (PME).

Whichever system is used, the function of the three conductors within the consumer's premises is the same; any load is connected between the live and neutral conductors. The live conductor should be at roughly 240V with respect to earth throughout the installation. The neutral conductor will normally be a few volts above earth potential due to load current flowing through the finite resistance

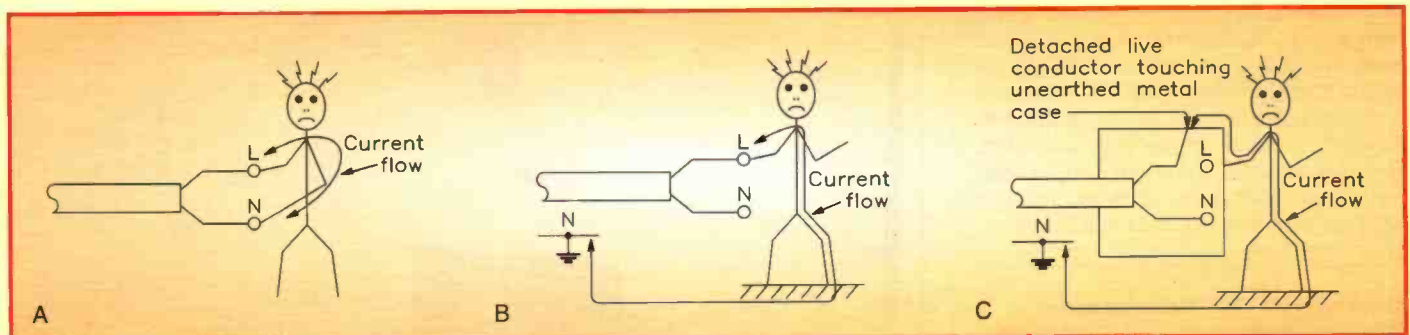
of the neutral cable. However, faults in the wiring, or crossed connections, can mean that the neutral may be at 240V, and so both conductors are classed as phase conductors, and are treated with equal respect. The earth, or protective conductor, provides an alternative path to the neutral of the supply, and can be used to give protection against electric shock, as will be described shortly.

## Types of Shock

Simultaneous contact with the live and neutral conductors of the supply is likely to result in a significant shock, due to current flowing through the body, as shown in Figure 2(a).

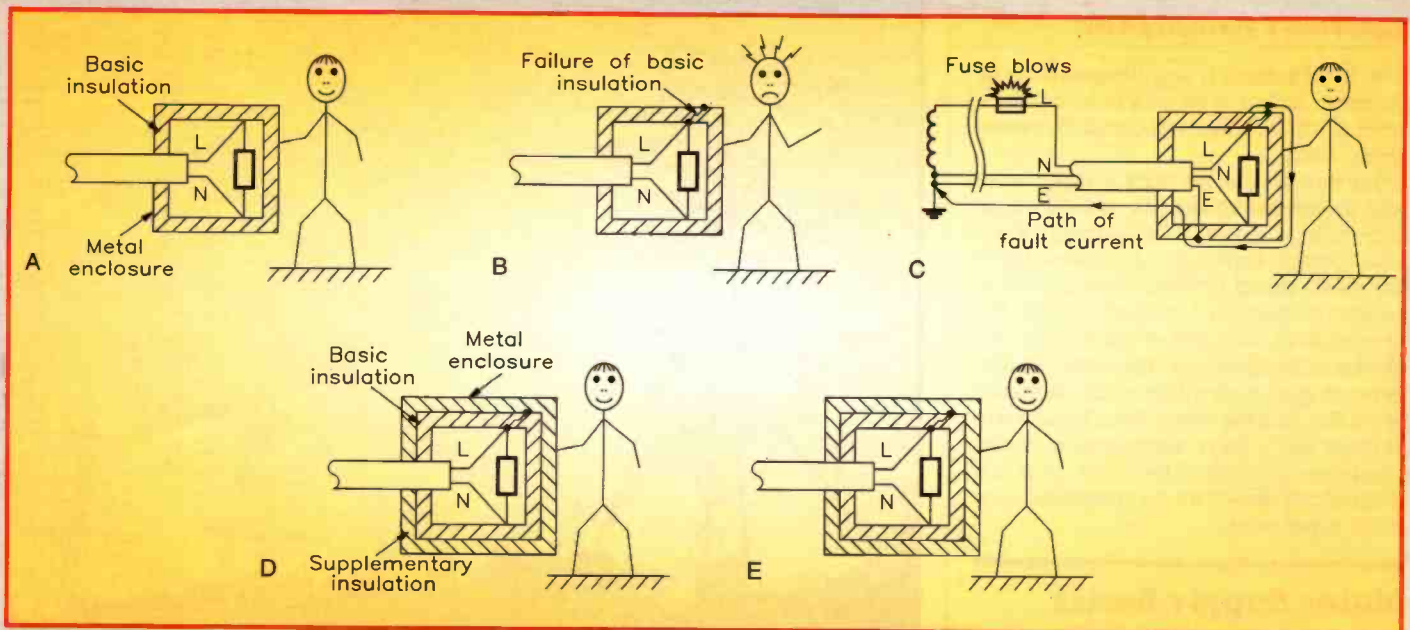


**Figure 1. Derivation of live, neutral and earth conductors from the supply authority's circuits: (a) TN-S system; (b) TN-C-S system (protective multiple earthing).**



**Figure 2. Types of shock: (a) Direct contact with live and neutral conductors simultaneously; (b) Direct contact with live conductor – current flows to neutral via the ground; (c) Indirect contact with live conductor – current flows to neutral via the ground.**





However, this kind of situation is rare; shocks are usually the result of touching a live part whilst being in contact with the earth (or any object which, itself, is in contact with the earth). Current can then flow from the live part, through the body to earth, and thereby back to the neutral of the supply which is, of course, connected to earth at some point. This is sometimes known as an earth-loop shock and is shown in Figures 2(b) and 2(c).

The live part causing the shock may be a live conductor as shown in Figure 2(b), or alternatively, a conductive part made live by a fault as shown in Figure 2(c). These two alternatives are described as direct and indirect contact respectively. Although the distinction may seem academic (especially if you are the victim), the concept is important when considering the design of equipment.

If the mains supply was not earthed, then there would be no danger of shocks to earth. Unfortunately, this is not possible in the case of the National Grid for other reasons. However, the principle is employed on a small scale in the case of a shaver socket, for example, where a safety isolating transformer reduces the danger of shock.

## Protection Against Shock

It is internationally agreed that, for an acceptable level of safety, there must be two independent provisions for shock protection. This ensures that there is no hazard both under normal conditions, and if a single fault occurs.

For domestic equipment, the first safety provision usually consists of insulating live parts. Insulation used in this way is known as basic insulation, and provides protection against direct contact. The second protective provision guards against the risk of shock in the event of failure of the basic insulation. There are two common ways of implementing this, and this gives rise to two types of equipment, known as Class I and Class II.

**Above right: Photo 3. Damaged mains cable, with inner conductors clearly visible.**  
**Right: Photo 4. A solder tag earth connection.**

**Above: Figure 3. Principles of Class I and Class II construction:**

**(a) Basic insulation on live parts is the first provision against shock:**

**(b) Failure of basic insulation leads to a risk of indirect contact shock:**

**(c) In Class I construction, connection of the metal case to earth protects against shock if basic insulation fails:**

**(d) In Class II construction, a layer of supplementary insulation protects against shock if basic insulation fails:**

**(e) Another implementation of Class II construction, where the insulating enclosure forms the supplementary insulation.**

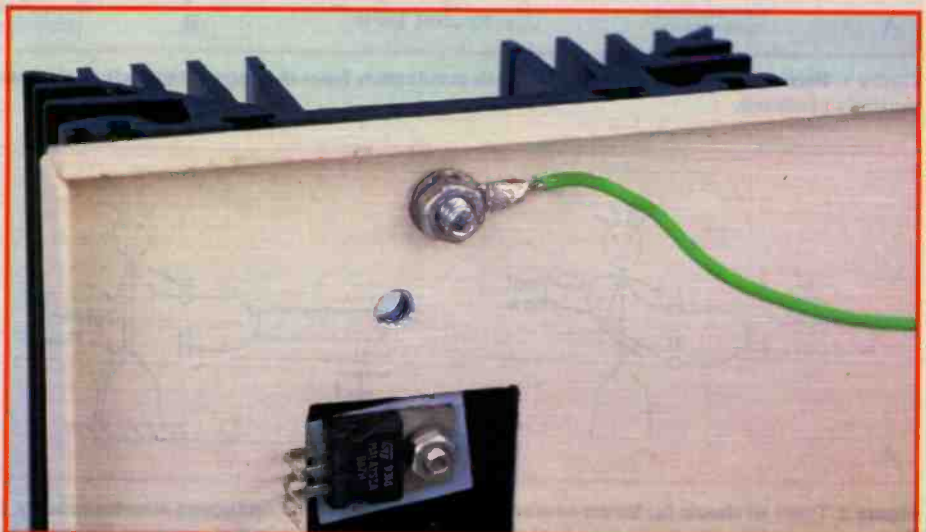
## Class I Equipment

Figure 3(a) shows a piece of equipment where the live parts are enclosed in basic insulation, and the outer case is wholly or partly made of metal. A breakdown of the basic insulation between a live part and the inside of the case could lead to a risk of an

'indirect contact' type of shock, as shown in Figure 3(b).

However, in Class I equipment, all 'accessible conductive parts', such as the case, are connected to the protective or earth conductor of the supply, as shown in Figure 3(c) (a solder tag earth connection is pictured in Photo 4). This provides the required second protective provision. Now, any fault in the basic insulation will simply cause a current to flow through the protective conductor which, if sufficiently high, will blow the supply fuse. Although the potential of the case will rise, due to the impedance of the protective conductor, correct sizing of the conductor will ensure that the size and duration of the increase are insufficient to cause a hazard.

The requirement that all 'accessible conductive parts' must be earthed applies only to those parts which might become live, on failure of the basic insulation. Small parts, such as the metal foil in a plastic badge, need not be earthed as long as they meet the Class II requirements (described in the next section).





Function of Insulation	Creepage (mm)	Clearance (mm)
Operational	2.5	1.7
Basic	2.5 (3.0)	2.0 (3.0)
Supplementary	2.5 (3.0)	2.0 (3.0)
Reinforced	5.0 (6.0)	4.0 (6.0)

Insulation in primary (mains) circuits and between primary and secondary circuits. Working voltage 250V AC, pollution degree II, material group IIIb. Main values from BS EN 60950. Values in brackets from BS 415.

Above: Table 2. Creepage and clearance distances for insulation.

Right: Table 3. Dielectric strength and resistance tests for insulation.

Function of Insulation	Test voltage (RMS VAC)	Resistance (M $\Omega$ )
Operational	1500	2
Basic	1500	2
Supplementary	1500	2
Reinforced	3000	4

Insulation test voltage for working voltage of 250V AC; resistance measured at 500V DC.

## Class II Equipment

In Class II equipment, the second protective provision is another independent layer of insulation, known as supplementary insulation, between the outer accessible surface and the basic insulation, as shown in Figure 3(d). If there is a breakdown of the basic insulation, it is unlikely that the supplementary insulation will fail simultaneously. This type is known as 'double insulated' construction, although the outer case is made of metal, it does not have to be earthed to ensure safety.

Note that even if the outer case is made of insulating material, it is assumed that dampness could effectively form a conductive layer on the outer surface, and so two independent layers of insulation are still required. An example is shown in Figure 3(e).

Alternatively, the standards allow a single layer of insulation, known as reinforced insulation, to be used in place of both basic and supplementary insulation. Obviously the reinforced insulation must have properties which are at least as good as the properties of the basic and supplementary insulation combined.

## Low Voltage Circuits

The preceding descriptions are particularly relevant to electrical equipment such as drills or hair-driers, where all wiring is at potentially hazardous voltages. In most electronic equipment, only a small part of the circuit is usually at mains voltage, and it is unnecessary (and impractical) to apply the same standards to the low voltage circuits. Instead, if the maximum voltage between any two parts of a circuit does not exceed 42.4V peak AC or 60V DC, there is considered to be no danger of electric shock, and so any part of this circuit may be accessible to the user. Note that the figures quoted are taken from BS EN 60950, and there is some minor variation in other standards. Obviously, the low voltage circuit must also be reliably separated from the hazardous circuits, both under normal and faulty conditions. This can be achieved by employing double or reinforced insulation, or an earthed conductive screen, between hazardous circuits and the low voltage circuit. Other methods are also mentioned in the standards, but note that they all involve the use of two independent protective measures or, an equally reliable single measure. A double insulated mains transformer is probably the most familiar embodiment of this principle in hobbyist projects.

Interested readers may also come across the following terms in the various standards:

safety extra-low voltage circuit; functional extra-low voltage circuit; and protective extra-low voltage circuit. These are all slightly different interpretations of the fundamental concept described above – limiting the voltage in a circuit to safe levels, and reliably separating the circuit from potential sources of hazardous voltages.

## Application to Hobbyist Construction

Many authors advise the use of an earthed metal enclosure for mains projects. This, together with the other precautions described in this article, will provide the safety of Class I construction. It is probably the simplest alternative for the hobbyist, although one disadvantage is the cost of a metal case.

Plastic enclosures are, generally, a lot cheaper. However, since the case is non-conducting, Class I construction is no longer applicable. Instead, the requirements for Class II construction must be met. This may need a little more thought, but is certainly not beyond the hobbyist – it is not sufficient to simply earth the metal of the mains transformer! The other disadvantage of plastic enclosures is that they are not as robust as metal cases.

## Earthing

The establishment and maintenance of an effective earth connection is essential for the safety of Class I equipment. The resistance between any accessible metal part and the earth terminal should be less than 0.1 $\Omega$ , when tested at a current of 1.5 times the capacity of the hazardous voltage circuit, or 25A, whichever is less. The open-circuit voltage of the test current source should not be more than 12V. At first sight, the test current may appear to be unnecessarily high, but this is, in fact, the sort of current that the earth path might have to carry in the case of a fault. It is, therefore, sensible to use a similar level of current during the test, so that any weak connections will be shown.

To obtain a realistic measurement, it is also important that any high resistance oxide films are not broken down during the test – hence the limitation on the source open-circuit voltage.

Using a multimeter to test the effectiveness of the earthing is unsatisfactory, as no significant current flows. Care is also needed to ensure that the contact resistance of the multimeter test probes does not swamp the earth path resistance.

Earth conductors must be reliably connected which in practice means using metal screws (not self-tappers), engaging in threads formed in metal, not in insulating material.

If there is a chance of vibration then a lock-nut or shakeproof washer must be used.

Any insulation used on earth conductors should be green/yellow. There must also be reliable contact between different parts of the enclosure, such as the lid and the base.

In order to give some protection against the earth becoming unknowingly disconnected, the wire to the earth terminal, in both the mains plug and the equipment, should be longer than that to the live or neutral. Then, if the flex slips, the live or neutral will be disconnected before the earth.

## Apertures

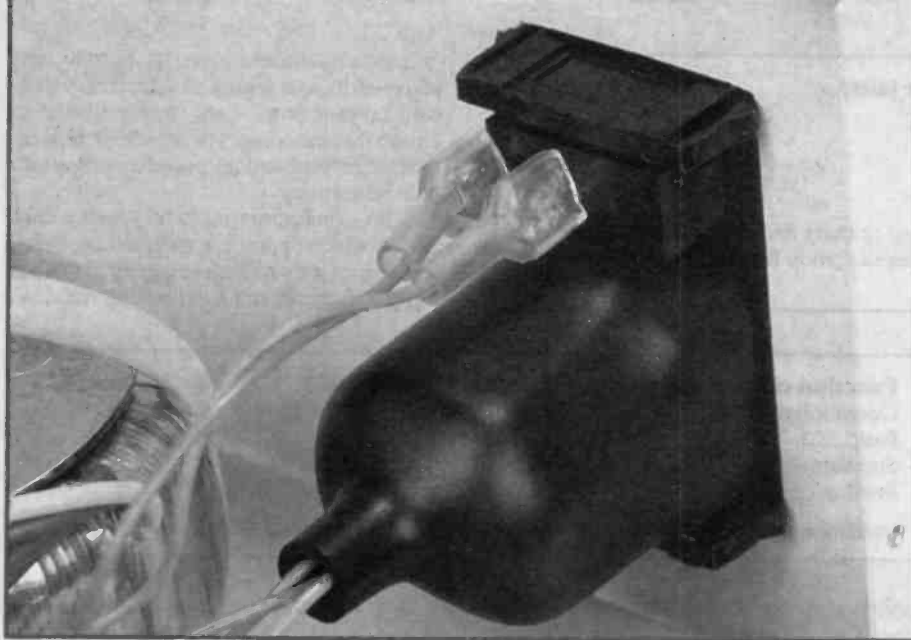
As already explained, the principle of Class I or II construction is to ensure that parts accessible to the user are not at a hazardous voltage, despite a single fault in the insulation. The standards say that this must be proved by using a test finger, which must not be able to touch live parts (either bare or covered only with enamel or lacquer), or basic insulation. During the test, the finger is inserted into any apertures in the enclosure, such as ventilation holes. If the enclosure has covers that can be removed by hand, these must be taken off before the test begins. Caps of fuseholders, or battery compartment lids, must also be taken off, even if they require a tool for removal.

Although it should be normal practice to isolate equipment from the mains before changing a fuse, a fuseholder must also prevent access to live parts should a fuse be inserted or removed with the circuit energised. For older type fuseholders, this normally means that the live connection must be made to the rear terminal. Touch-proof types do not require this precaution.

A further test is made with a straight metal rod, 15mm long, and roughly 3.5mm in diameter. The rod must not touch bare, live conductors when inserted into any aperture in the enclosure (with covers in place). Finally, openings above bare hazardous parts should be designed to prevent objects from falling through. Alternatively, they should not exceed 5mm in any dimension, or should be less than 1mm wide and of any length.

The above requirements are those specified in EN 60950. BS 415 has slightly different requirements, but the principle is the same. More stringent requirements apply to holes provided for adjustment of preset controls.





Above: Photo 5. Insulating boots in place in the Ni-Cd charger.

Right: Figure 4. Defining creepage and clearance distances:

- (a) Between terminals;
- (b) Between conductors on a PCB;
- (c) Across grooves in insulation.

In this case, a 2mm diameter pin 100mm long, simulating a screwdriver, must not touch live parts when inserted into a hole, at any angle.

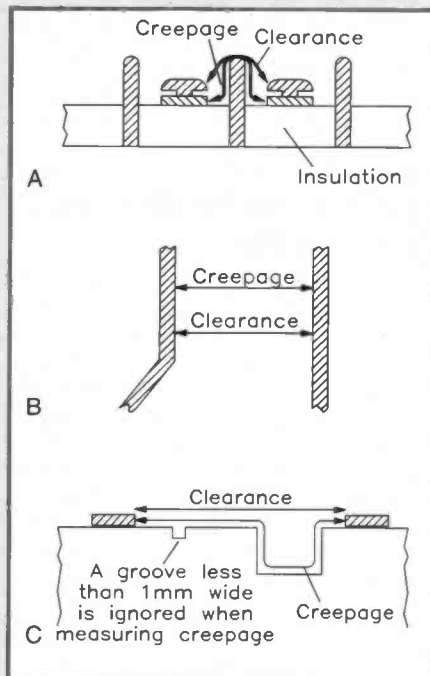
## Protection of Service Personnel

The precautions described above are intended to protect operators during normal use of the equipment. Operators are considered to be oblivious to any hazards, but will not deliberately tamper with protective measures.

The same degree of protection cannot be given to service personnel who may need to remove covers, and work on circuitry whilst it is live (for fault-finding purposes). However, they are assumed to be more aware of the hazards, and are expected to take reasonable precautions, such as isolating the mains whenever possible, before making internal adjustments. Protection should be provided against unexpected hazards, for example shielding exposed parts at mains voltages, or earthing parts that would not otherwise require earthing, for operator safety. The concept of operators and service personnel is still applicable in the hobbyist context. Any member of the family using the project becomes an operator, and must be protected on the assumption that they have no knowledge of hazards. You are likely to be called on to fulfil the role of service personnel, and so it makes sense to build in protection for your own safety when fault-finding!

One simple, but effective, precaution is to insulate all bare parts at mains voltage that could be accidentally touched. For panel-mounted mains connectors and fuseholders, special insulating boots and covers are the best solutions, as pictured in Photo 5. For other connections, use sleeving or simply a few layers of insulating tape.

Even if power is isolated, stored charge on capacitors may present a shock hazard or



energy hazard (from the spark that could be produced if a large value capacitor was accidentally shorted). If necessary, a bleeder resistor may have to be fitted across a capacitor to reduce the charge to a safe level.

## Insulation

Reliability of insulation is of paramount importance in all forms of construction.

Insulation may be of solid material, or be an air gap of suitable size which is unlikely to be reduced or bridged. Natural rubber or hygroscopic materials are not permissible. Wood is acceptable, but it must pass a complicated humidity test which, therefore, makes it an impractical insulator for the hobbyist constructor to use. However, it can be used for such things as enclosures, where it is not acting as insulation.

If a solid material, such as PVC, is employed as insulation, it must be at least 0.4mm thick. It is permissible to use thin sheet material of any thickness, but in this case more than one layer must be used, and even if one layer fails, the remainder must conform to the requirements.

The concepts of 'creepage' and 'clearance' arise when dealing with insulation. Figure 4 shows how creepage and clearance distances are measured. Creepage distance is the shortest path measured along the surface of the insulation, and provides protection against bridging of the insulation by moisture and dirt. Grooves of less than 1mm width are disregarded, as shown in Figure 4(c). Clearance distance is the shortest distance between the conductors, measured through air, and must obviously provide insulation at least equivalent to the insulating material.

Insulation must comply with the creepage and clearance distances shown in Table 2. These are worst-case values for 220 to 250V RMS supplies. They were extracted from more detailed tables in the standards which cover other operating voltages, different levels of pollution and variation of the tracking index of the insulation. The term 'operational insulation', mentioned in the table, refers to insulation used to separate live parts in order to avoid short circuits. It does not have any function in protecting against shock.

Finally, the insulation must stand the resistance and dielectric strength tests, summarised in Table 3. The standards actually specify that the equipment must meet these requirements even after a humidity test.

For Class I equipment, the basic insulation can be effectively tested by applying the tests between the live and earth, and the neutral and earth conductors. For Class II equipment, metal foil might have to be applied to the surfaces of insulation in order to perform the tests. In some cases, it would still be difficult to test the basic and supplementary insulation separately.

The high voltage tests in Table 3 must not be carried out repeatedly because they can degrade the insulation, and this would lead to failure in service.

## Reduction of Clearances

Having established the necessary clearances, it is important to ensure that these are maintained during operation. The clearances in Table 2 must not be reduced if a force of 30N is applied externally, or a force of 10N internally (30N is roughly the weight of three 1kg bags of sugar). Again, there is some variation between the different standards, with BS 415 specifying a force of 50N externally, and 2N, internally. Wiring should be fixed effectively by suitable cable clamps, or cable ties. Mains wiring and low voltage wiring should not be run in the same loom.

Clearances could be reduced if a wire becomes detached; in general, a means of fixing must be provided which is independent of that ensuring the electrical connection. For soldered joints, 'hooking-in' the wire is considered sufficient, as long as there is no risk of vibration. It is not considered likely that two wires will become loose simultaneously, and so attaching one wire to another by twisting or sleeving, for instance, is also an acceptable solution. Precautions may need to be taken against the possibility of creepage and clearance distances being reduced by dust and dirt, or by loose screws or nuts.

Next month, the concluding part deals with fire hazards, fuses, general precautions and maintenance, and examples show how these principles can be applied to hobbyist construction.

# Designing Linear Circuits

## with BIPOLAR TRANSISTORS

by J. M. Woodgate B.Sc.(Eng.),  
C.Eng., M.I.E.E., M.A.E.S., F.Inst.S.C.E.

In the early days of transistors, circuit design appeared a very complex subject, basically because overly-complex models of the transistor were used. To a certain extent this was necessary, because of imperfections in the early transistor types. These models were all right for research scientists, but gave huge and unwieldy equations even for quite simple things like voltage gain, which were virtually impossible to remember and not readily applied to practical design. They also required values for certain characteristics of the transistor to be known, which manufacturers usually did not specify, so the design failed for lack of data. Since then, the pendulum has swung perhaps too far the other way, so that we see a lot of 'make it about enough' so-called design methods.

We shall be looking at powerful design methods, which can be used in very simple forms to give approximate but practically useful answers, and which can easily be extended to deal with such things as low-noise design and high-frequency operation, even tuned amplifiers.

### DC Conditions

This is the best place to start, although it begs the question of how you decide what DC conditions you want. Some of that question will be answered almost at once, but some part will have to wait a while.

We start with a somewhat idealised case, but one which is still capable of giving useful results. In order to set up the DC conditions, expressed normally as collector current and voltage, we have to provide a bias current, to flow between the base and the emitter. Common-emitter and common-base stages can be biased in the same way, but common-collector (emitter-follower) stages often use a somewhat different circuit configuration. Generally, we shall be considering silicon NPN common-emitter circuits, but not exclusively. PNP transistors use exactly the same circuits, but with the supply polarity reversed.

The bias current can flow only if there is a voltage between base and emitter. Unfortunately, the current that flows is a very

steep function (exponential, in fact) of the voltage, and is temperature-dependent, as well as varying quite a bit from one transistor to another, even of the same type. Luckily, we can make our first simplifying assumption, provided that we always remember that, like all assumptions, it is one that we have to abandon if it is not justified in any particular case. This assumption is that if there is any base current flowing at all, the base to emitter voltage is near enough to 0.6V for any small-signal silicon transistor, and for any silicon bipolar transistor at all if the collector current is less than about 0.5A. (The corresponding value for germanium transistors is 0.2V.) This, however, applies at room temperature, and it is the temperature inside the transistor that matters, of course. If the transistor is hot, we must reduce the assumed value of base to emitter voltage by 2.5mV per degree above 20°C (or 'per kelvin', for the purists).

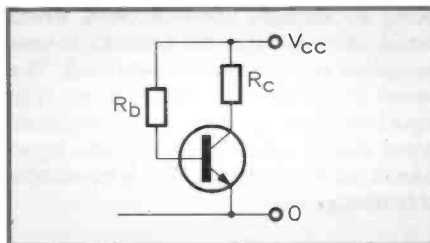


Figure 1a. Primitive bias circuit.

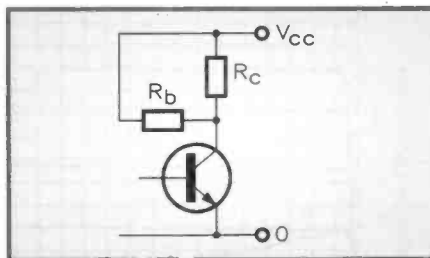


Figure 1b. Simple bias circuit.

Figure 1a shows the very simplest possibility, in which the collector load resistor takes no part in the actual biasing (provided its value is not too high).  $V_{cc}$  is the supply voltage, and we know that the base-emitter voltage is 0.6V, so the base current is  $(V_{cc} - 0.6)/R_b$ . We now need just one transistor characteristic, the small-signal current gain,  $\beta$  (beta), which is virtually always specified by the manufacturer. It

is the ratio of collector current to base current, and varies from one transistor to another of the same type. The range of values may be only 2:1, but it may be 4:1 or even more. Our bias circuits must ensure that any transistor in the range will work satisfactorily. The collector current  $I_c$ , then, is  $\beta(V_{cc} - 0.6)/R_b$ , and the collector voltage is  $V_{cc} - I_c R_c$ . Now we can see that the collector resistor value must not be too high, because if it were,  $I_c R_c$  could be larger than  $V_{cc}$ . In that case, a current as large as  $I_c$  could not flow; the collector voltage would be near zero and the transistor is said to be 'bottomed' or 'saturated'. For power transistors, the collector-to-emitter voltage under these conditions is often specified, with the symbol  $V_{ce(sat)}$ , but for small-signal silicon transistors it is typically about 200mV, very much smaller than  $V_{cc}$ , so we can make a second simplifying assumption, that  $V_{ce(sat)} = 0$ . Note that the collector voltage is less than the base voltage under these conditions, but the forward bias on the collector-base diode is only about 0.4V, so no appreciable reverse current flows at room temperature.

The problem with this circuit is that it cannot cope with a wide range of  $\beta$  values, because if the collector current is adequate with a low- $\beta$  device, a high- $\beta$  device will probably be bottomed, and for this reason, it is very

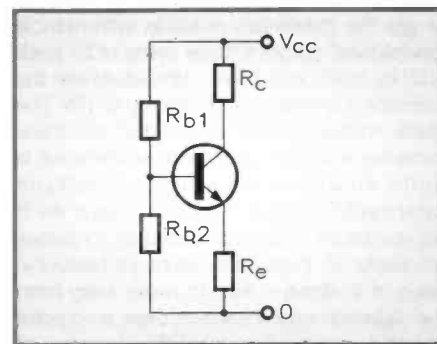


Figure 1c. Improved bias circuit.

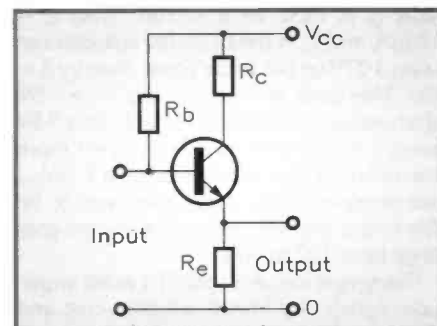


Figure 1d. Bias circuit for an emitter follower.

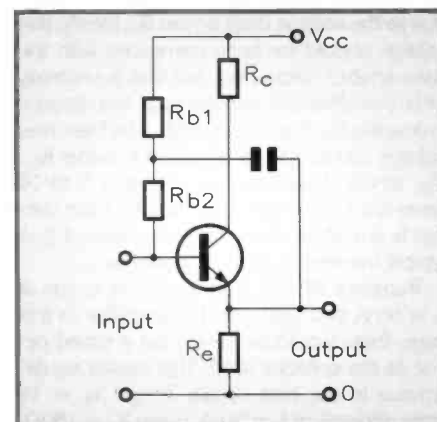


Figure 1e. Emitter follower with bootstrapped bias.  $R_{b2}$  can be much larger than  $R_{b1}$ .



seldom used. An improved circuit is shown in Figure 1b. The connection of the base resistor to the collector actually provides DC (and signal-frequency) feedback, which is very helpful in coping with both  $\beta$  values and temperature effects. We can analyse this circuit as follows. The collector voltage  $V_c$  is equal to the base voltage (0.6V, of course) plus the voltage drop across  $R_b$ . It is also equal to the supply voltage minus the voltage drop across  $R_c$ :

$$V_c = 0.6 + I_b R_b$$

$$V_c = V_{cc} - \beta I_b R_c$$

We have two equations, and two unknowns,  $V_c$  and  $I_b$ , so we can solve them. It is most convenient to find  $I_b$  first, and then to calculate  $I_c$  and  $V_c$  from it:

$$I_b = \frac{V_{cc} - 0.6}{R_b + \beta R_c}$$

Let's put in some typical values:

$$V_{cc} = 10V, \beta = 200, R_b = 1M\Omega, R_c = 5.6k\Omega.$$

Then  $I_b = 4.43\mu A$ , so that

$$V_c = 0.6 + 4.43 \times 10^{-6} \times 1 \times 10^6 = 5.03V$$

Is this a good value for  $V_c$ ? In fact, at (nearly) half  $V_{cc}$ , it is very good, because it allows us to get the maximum possible symmetrical 'undistorted' output voltage swing of 5V peak (10V Pk-to-Pk, or a 3.5V<sub>rms</sub> sine wave) with the collector going down to 0V and up to 10V. The quote marks around 'undistorted' are there because, while the onset of gross distortion is quite sharp as the collector voltage approaches zero, it is not sharp as it approaches  $V_{cc}$ , and the distortion increases gradually. So, in practice, we might tweak the value of  $V_c$  down a little, to move away from the distortion zone. However, there is no point in being very precise about this, because of what happens if we change to another transistor of the same type, but with a different value of  $\beta$ . First, let  $\beta = 100$ . Then  $I_b = 6.03\mu A$ , and  $V_c = 6.63V$ . So the collector can swing 3.37V up but 6.63V down. Now try  $\beta = 400$ . This gives  $I_b = 2.9\mu A$  and  $V_c = 3.5V$ , which means a swing of 6.5V up but only 3.5V down. It is clear that we cannot expect more than about 3V peak undistorted (or a 2.12V<sub>rms</sub> sine wave) from this stage, if we want to be able to use any transistor in the current gain range from 100 to 400.

This simple circuit is useful for small amplitude signals, for lowest possible cost and where space is at a premium, such as in models. A much better circuit is shown in Figure 1c. Here, the emitter sits at about 1V, normally, due to the voltage drop across  $R_e$ . Ideally, this voltage should be large compared with the base-emitter voltage  $V_{be}$ , but that is normally only possible for germanium transistors, unless the  $V_{cc}$  is unusually high. The base bias voltage comes from the potential divider  $R_{b1}$ ,  $R_{b2}$ , which should pass a current of 5 to 10 times the base current, so that the base voltage is not affected much by the value of  $\beta$ . A typical numerical example would be:

Transistor BF173, with  $V_{cc} = 12V$ , to run at  $I_c = 5mA$  in a high-gain RF amplifier. In this case, there would be no  $R_c$ , but a tuned circuit as the collector load. This makes no difference to the bias circuit. To get  $V_e = 1V$  approximately at  $I_c = 5mA$ , make  $R_e = 180\Omega$ . Then  $V_e = 0.9V$ , and thus  $V_b$  must be 1.5V. Minimum  $\beta$  for a BF173 at 5mA is 40, so the

maximum  $I_b = 125\mu A$ , and we make the divider current about five times this, thus using  $R_{b1} = 15k\Omega$  and  $R_{b2} = 2.7k\Omega$  as the nearest preferred values, giving  $V_b = 1.83V$ . Note that, in this simple procedure, we neglect the base current flowing through  $R_{b1}$ , but compensate for this by choosing resistor values to give a slightly high value of  $V_b$ . We also assume that the emitter current is equal to the collector current, i.e. that  $\beta$  is very much larger than 1 (this is our third general simplifying assumption). The maximum  $\beta$  for this device is 100, and it is not too difficult to calculate the true value of  $V_b$ , taking the base current into account. The results are  $I_c = 5.18mA$  for  $\beta = 40$  and  $I_c = 6.07mA$  for  $\beta = 100$ , which is likely to be acceptable.

In this circuit, the emitter resistor provides current feedback, which substantially reduces the gain available, so the resistor is often decoupled by means of a high-value parallel capacitor. When used with a collector load resistor, the optimum DC conditions depend on whether the emitter resistor is decoupled or not. The decoupled case is easier, because the emitter voltage is fixed: there is no signal voltage at the emitter. In this case, the collector can swing up to  $V_{cc}$ , but down only to  $V_e$ . It can be shown (not difficult, but tedious) that the value of  $V_c$  giving the maximum output voltage swing is given when:

$$V_c = \frac{V_{cc}(R_c + R_e)}{2R_c + R_e}$$

If  $R_e$  is not decoupled, as the collector voltage falls, the emitter rises to meet it, and the optimum working point is then:

$$V_c = \frac{V_{cc}(R_c + 2R_e)}{2R_c + 2R_e}$$

Emitter followers are often biased as shown in Figure 1d. Here, the feedback due to the large value  $R_e$  ensures that variations in  $\beta$  have only a small effect. For maximum output voltage swing, the emitter should sit near  $V_{cc}/2$ .  $R_c$  is included as a protection against  $R_e$  being accidentally short-circuited, which would otherwise cause the transistor to pass excessive current and probably fail. The variant shown in Figure 1e has a very high input impedance, because  $R_{b2}$  has almost no signal voltage across it, so very little signal current can flow through it. This is an example of bootstrapping.

## AC Coupled Load

The above analyses are all very well, provided that the next stage has an input resistance high compared with  $R_c$  (or  $R_e$  for the emitter follower, but that is almost always true). However, if the next stage is capacitively coupled, as usual, and does not have a high input resistance, we have to shift the DC working point of the first stage to get the maximum output voltage swing. It is easiest to explain how we do this by means of a set of curves of collector current against collector voltage with base current as parameter (Figure 2). However, you do not need the curves in order to find the answer: they just help (?) the explanation.

We begin by drawing the DC load line, representing  $R_c$ . This is a straight line joining  $V_{cc}$  on the horizontal axis to  $V_{ce}/R_c$  on the vertical axis. The slope (gradient) of this line represents  $R_c$ . (For the Figure 1c circuit, with  $R_e$  decoupled, substitute  $(V_{cc} - V_e)$  for  $V_{cc}$ . The undecoupled case is more difficult.) The DC collector voltage must be somewhere along this line. Now imagine another line, whose slope represents  $R_t$ , the parallel combination of  $R_c$  and  $R_t$ . We don't know where to put this line yet, but it must cross the  $R_c$  line at the optimum collector voltage  $V_c$ , where the voltage can swing down and up by equal amounts. This means that, since we assume that the collector can swing down to zero volts ( $V_{ce(sat)} = 0$ ), the  $R_t$  line must cut the horizontal axis at  $V_{cc} = 2V_c$ , and, since we know its slope, that is all we need to define its position on the graph. We just 'slide' the dotted line down, keeping the same slope, until it crosses the horizontal axis at twice the voltage at which it crosses the 12k $\Omega$  load line. We can then see that:

$$I_c = \frac{V_{cc} - V_c}{R_c}$$

and

$$I_c = \frac{(V_{cc} - V_c)}{R_t} = \frac{V_c}{R_t}$$

but

$$V_{cc} = 2V_c$$

from which we can find:

$$V_c = \frac{V_{cc} R_t}{R_c + R_t}$$

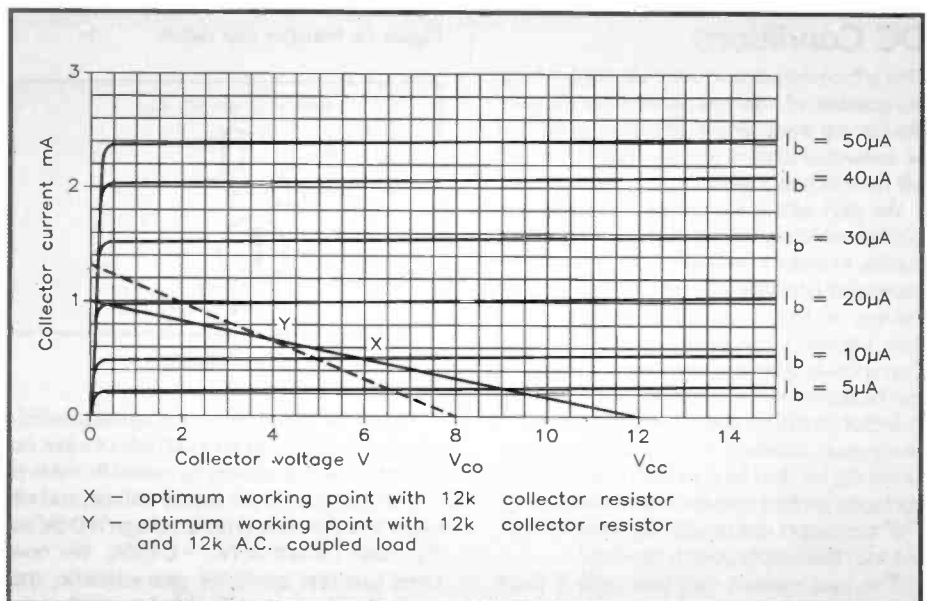


Figure 2. Diagram to clarify the optimum working point with an AC coupled load.

For example, if  $V_{cc} = 12V$ ,  $R_c = 12k\Omega$  and  $R_i = 12k\Omega$ ,  $V_c = 4V$ , instead of 6V, as it would be without  $R_i$ . Note that the maximum output voltage swing has been reduced from  $\pm 6V$  to  $\pm 4V$ .

## Signal-Frequency Conditions

Setting up the DC conditions is basic good housekeeping, and the glamorous bit is calculating gains and input and output impedances. This is where we need a good, simple model for our transistor, and we are going to use the *dependent generator* model, because it can be used in basic forms and easily extended to high frequencies and more detailed analyses. It also has the advantage of using transistor characteristics which vary little, even from one type number to another. They are, however, dependent on the collector current. Figure 3 shows our model, and the only odd thing about it is, perhaps, the current generator. This is the opposite of a voltage generator: it produces a fixed current into whatever is connected to its terminals and its internal (source) impedance is infinite.

The components in the model are:

$r_{b'e}$ , the input resistance, which is  $26\beta/I_c$  where  $r_{b'e}$  is in ohms, and  $I_c$  in milliamps.

$g_m$ , the mutual conductance, which is  $39I_c$  where  $g_m$  is in millisiemens (mA/V for old-timers) and  $I_c$  in milliamps.

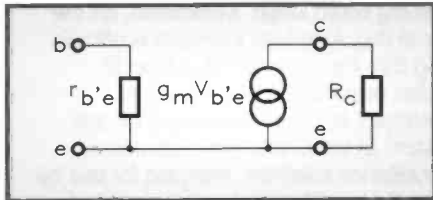


Figure 3. Dependent generator model of a bipolar transistor.

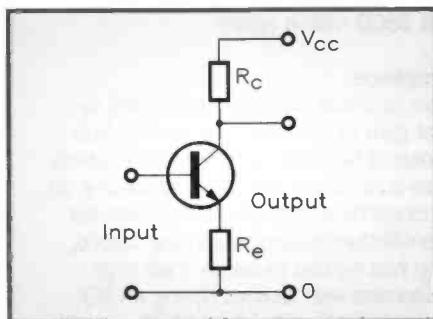


Figure 4. Circuit for setting voltage gain.

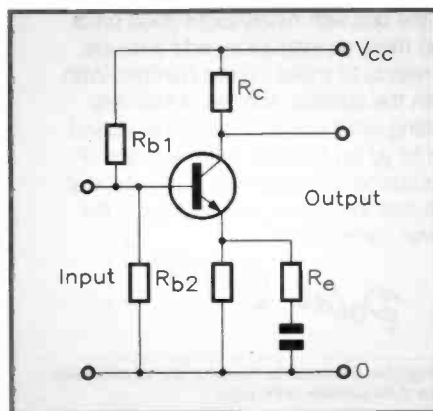


Figure 5.  $R_c$  controls the voltage gain.

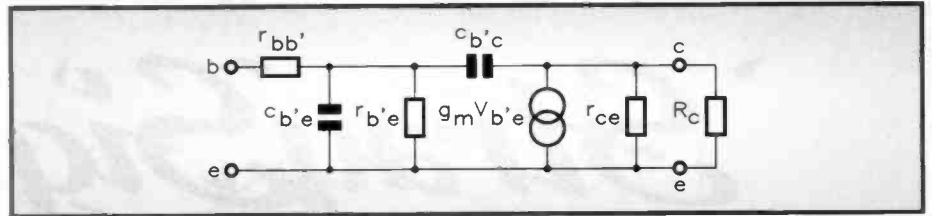


Figure 6. More refined dependent-generator model.

In principle, these values work for both silicon and germanium, but imperfections in germanium transistors usually prevent the results of calculations being more than a rough (optimistic) guide.

It may look odd that there appears to be no connection between the input and the output, but the connection is there in the  $v_{be}$  component of the value of the current generator.

We can immediately see that we have the input and output impedances 'on a plate'.  $R_c$  is, of course, the external collector load resistor, and the current generator's impedance is infinite, so to the outside world, the output source impedance is  $R_c$ , and the input impedance is simply  $r_{b'e}$ . The voltage gain of the stage is the output voltage divided by the input voltage, which is:

$$\frac{g_m V_{be} R_c}{V_{be}} = g_m R_c$$

Note the use of lower-case letters to describe components inside the model, and signal voltages as opposed to DC voltages.

If the transistor is operated as an emitter follower, the source impedance looking back into the emitter is simply  $26/I_c$  ( $I_c$  in milliamps). The input impedance at the base is  $r_{b'e} + \beta R_e$ , and this also applies to the common-emitter circuit of Figure 1d with the emitter resistor *not* decoupled. The shunting effect of the biasing resistors has to be added in, of course, but this is simply Ohm's law.

## Amplifier with Defined Voltage Gain

The use of an undecoupled emitter resistor not only enables the voltage gain of a stage to be set to a required value, but also raises the input impedance and reduces distortion (by feedback). While we could use the Figure 3 model to analyse this circuit (Figure 1d), we can use a simpler method. In Figure 4, nearly the same signal current flows through  $R_c$  and  $R_e$  (if  $\beta$  is large), so that the total input voltage is  $v_{be} + g_m V_{be} R_e$ , where  $v_{be}$  is much smaller than the second term. The output voltage is  $g_m V_{be} R_c$ , so that the voltage gain is simply  $R_c/R_e$ . For example, if  $R_c = 10k\Omega$  and  $R_e = 1k\Omega$ , the voltage gain is 10. If the transistor is operating at a very low collector current, we have to add to  $R_e$  a term equal to  $1/g_m$ . For example, if in the above case, the collector current were  $100\mu A$ , the effective emitter resistance would be  $1k\Omega + 26/0.1 = 1.26k\Omega$ . The input impedance is  $r_{b'e} + \beta R_e$ , and again the second term is normally the larger. For the example, the value would be  $1.26\beta k\Omega$ , and for  $\beta = 200$ , this is  $252k\Omega$ .

With the emitter resistor decoupled, the voltage gain is larger, being  $g_m R_c$ , but  $g_m$  depends on the collector current, so the gain varies with different samples of the same type of transistor. Even a bit of undecoupled emitter resistance, such as  $39\Omega$  in a stage where  $I_c = 1mA$ , reduces this effect, and incidentally allows a much smaller value of capacitor to be used for the same low-frequency response, as shown in Figure 5.

## Extension of the Model

Two extra resistors may be added to the model. For power transistors, the DC collector current is often not nearly independent of the collector voltage (as it is shown in Figure 2). This can be represented by a collector shunt resistor  $r_{ce}$  across the current generator. For power transistors, and for low-noise circuits fed by low-impedance sources (e.g., a moving-coil vinyl disc pick-up), the base spreading resistance  $r_{bb'}$ , which appears in series with  $r_{b'e}$  is important.

For high-frequency operation, two capacitors must be added. These are  $c_{b'e}$ , in parallel with  $r_{b'e}$ , and  $c_{b'c}$ , the feedback capacitance.  $c_{b'e}$  is approximately proportional to the collector current, and can be calculated from the transition frequency  $f_t$ , which manufacturers usually specify:

$$c_{b'e} = \frac{39I_c}{2\pi f_t}$$

with  $I_c$  in milliamps and  $c_{b'e}$  in farads. Figure 6 shows all the extra components that may be added to the model, as necessary.

Provided the operating frequency is not too close to  $f_t$ , we can calculate the gain of a tuned RF amplifier as follows. The collector load at the tuning frequency is given by  $R_d = \omega_0 LQ$  (or  $Q/\omega_0 C$ ), where  $\omega_0$  is  $2\pi$  times the tuning frequency,  $L$  and  $C$  are the components of the parallel tuned circuit, and  $Q$  is the quality factor (bandwidth/tuning frequency). The voltage gain is then simply  $g_m R_d$ . If there is a load resistance due to the next stage, this just appears in parallel with  $R_d$ . Note that the gain is proportional to  $g_m$ , and therefore to the DC collector current. It is thus somewhat surprising that IF stages in portable radios tend to operate at about 1mA, whereas for just a little increase in current, a lot more gain is available. Most of the transistors used work quite well up to 5mA, but to ensure that the stage remains stable, the tuned circuit values need to be changed at such a high gain.

## For the Future

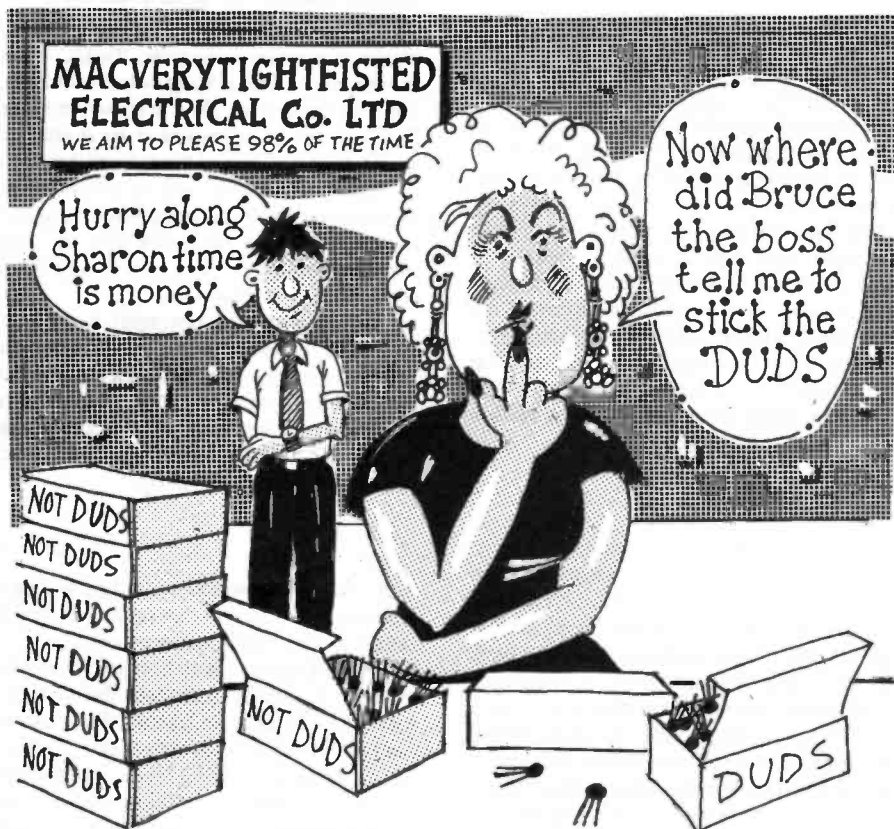
While single transistor amplifier stages can be very useful, and are essential study for beginners, better performance can be obtained by various types of multi-device 'building block'. I hope to cover that subject in a future article.

**Don't Forget  
that the New  
1995 Maplin  
Full Colour Guide  
to Electronic  
Components  
is on sale from  
2nd September '94**



# Stray Signals

by Point Contact



## New Batteries for Old

When 'yours truly' (preparing to write this column) switched on his PC, it politely asked him to set time and date, and user options (if required), adding a discreet request for a new set of batteries for its non-volatile section of RAM. It was duly fed a set of four new 1.5V AA cells, the old ones proving to have terminal voltages of 1.3V, 1.3V, 0.8V and 0.6V.

Just before throwing them away, PC recalled that, in the forties and fifties, it had been common to recharge (the then universal, and still widely used) zinc-carbon (Leclanche) type batteries, a process that could be repeated several or, with some cells, many times, providing a useful extension of their life, and considerable economy in replacement cost. The limiting factor was puncture of the zinc can, which, besides forming the negative electrode, also acted as the cell's outer container-come-strength member, covered only by a card and paper sleeve.

In a detailed article in one of the then popular electronics magazines, the author described the results of his research. Recharging with DC resulted in puncture of the can after only a few recharges, and it was found, on examination, that the zinc deposited back on the can during recharging formed a

porous friable layer of variable thickness. Nevertheless, due to the thick gauge of the zinc used, several recharges were possible before a puncture occurred. PC 'deconstructed' (the word 'destruct' only seems to exist in American English and weapons terminology and, like destroy, it does not convey quite the same meaning) one of the exhausted AA cells before throwing it away. Sure enough, it used a zinc pot as the outer container, though in the interests of economising on scarce resources, the zinc was paper-thin. Inside was the usual paper separator containing the depolariser, and down the centre of that ran the carbon rod forming the positive electrode. I suspect that these particular cells died from drying out, being housed in a compartment sandwiched between the computer's main unit and the monitor, which sits on top of it.

A dried-out cell is never going to be any good, but PC bought an extra set of new cells to experiment with. The intention was to run them down and recharge repeatedly, to see if they would take it. Following the advice in the article mentioned, they would be recharged not with 'clean' DC, or even dirty DC (straight from a rectifier with no smoothing), but with AC having a DC component. According to the article, this is a trick

used by electroplaters to achieve a good finish. In the case of the cells, it results in the zinc being redeposited in a more smooth, dense uniform layer, delaying the inevitable ultimate puncture of the can, and the subsequent death of the cell through drying out. Although modern zinc-carbon cells seem to have much thinner cans than those of earlier times, the covering is now an impermeable plastic layer, so drying out may be delayed, even if the can does puncture. Watch this space for further developments.

## Spies (and Telephone Exchanges) in the Sky

Last autumn, Motorola announced that it had completed the first round of financing, some \$800 million, for its Iridium project to launch sixty-six telecommunications satellites to create the world's first global mobile phone service. Of several proposed systems, this is the first one to move beyond the drawing board stage. Meanwhile, on the same day, American Intelligence officials said that the explosion of a Titan IV rocket over the Pacific Ocean had destroyed its secret payload, a US spy system of three solar-powered ocean surveillance satellites, intended for use by the US Navy. This explosion is said to be the most costly space accident since the 1986 Challenger shuttle disaster. The cost of the three lost spy satellites? – just \$800 million again!

## Tailpiece

Here is a nice little story recounted by that guru of analogue electronics, Bob Pease of National Semiconductor, which I am sure he will not mind my passing on. It concerns a state-of-the-art transistor manufacturing company in the 1960s, who had agreed to supply their large customers with devices having an AQL (Acceptable Quality Level) of 2% – pretty good going for those days. Sold in boxes of one hundred pieces, the tester would fill the box with ninety-eight good parts and then, as instructed, add a couple of rejects to make up the number. With both the supplier and the customers getting what was expected, this looked set to go on for ever: but then, one of the customers happened to notice that the dud transistors were *always in the same corner of the box!*

*Point Contact*

The opinions expressed by the author are not necessarily those of the publisher or the editor.

Design by Alan Williamson

Text by Alan Williamson  
and Dean Hodgkins

BEng(Hons)



# CAR Interior Light Controller



The project presented here is a very useful addition to many older, and base model cars, most of which do not have the sophisticated courtesy light feature of higher models. Fitting this project to your car will allow the courtesy light to remain illuminated for approximately 30 seconds after the vehicle's doors have been closed, unless the engine is running, in which case the light will be extinguished immediately. It also adds an extra feature which many top models do not have – in the event of a door being inadvertently left open, the courtesy light will automatically turn off after approximately 10 minutes, to avoid draining the battery.

- ★ Easy to build
- ★ Low power consumption
- ★ Simple to fit

**KIT AVAILABLE  
(LT65V)  
PRICE £9.99**

## Circuit Description

The block diagram of the Car Interior Light Controller is shown in Figure 1. Refer to Figure 2, the circuit diagram; the door open/closed sensor comprises a slow charge/discharge R/C network (R3, R4, C1) to detect a definite change in condition, and capacitors C2 & C3 to help prevent spurious operation from noise spikes; the transistor TR1 and associated components provide an inverted switch input.

Because of the slow change on the input of the NAND gate (IC1b), a Schmitt triggered variety was chosen (which has significant hysteresis) to prevent toggling of the output when the input is in between the two threshold levels.

The inverters IC1c & IC1d and associated components (C4 & R5 and C5 & R6) are positive edge detectors (ie. detecting a change from '0' to '1'); the inverter IC1d produces a pulse when the door is opened, and IC1c produces a pulse when the door is closed.

IC2 and IC3 are interior light long duration timers, specifically designed for automotive applications. Each of the timers has 'ON', 'OFF' and 'TOGGLE' inputs – the 'TOGGLE' inputs are not used in this project. The timers also have an inbuilt 14V Zener diode across the supply pins, an oscillator, a frequency divider, input debounce circuits, and a (not quite) open collector transistor with protection (load dump) diode for switching reactive loads. IC2 is used as the 'courtesy light' timer, and IC3 is used as the 'door open' timer.

The components responsible for the time-out period are R15 and C7 for IC2, and R16 & C8 for IC3. The 'OFF' input of IC2 and the 'ON' input of IC3 are triggered by the door being opened, while the 'OFF' input of IC2 and the 'ON' input of IC3 are triggered by the door being closed.

The 'extra' components around the inputs of IC2 are the 'inhibit and reset' circuitry; when the door is closed and the engine is running, diode D11 feeds a jamming voltage to the 'ON' input of IC2, preventing it from being activated. However, if the courtesy light is ON and the engine is OFF, starting the engine will cause transistor TR2 to generate a pulse which will reset IC2 and turn off the light.

Diode D12 prevents damage to the circuit from accidental reverse polarity connections. Resistor R17 limits the current to the internal



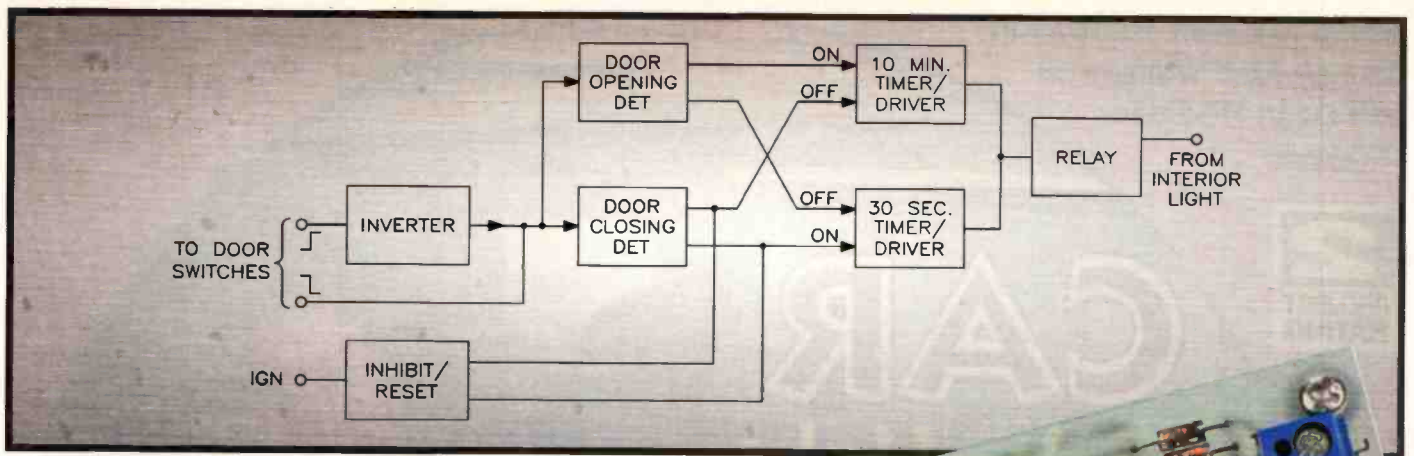


Figure 1. Car Interior Light Controller block diagram.

## Specifications

Minimum supply voltage: 9V  
 Maximum supply voltage: 15.5V  
 Quiescent current: 2.5mA @ 12V  
 Operating current: 30mA @ 12V

Zener diodes of IC2 and IC3. Capacitors C9 and C10 decouple the supply at high and low frequencies. The relay RL1 performs the light switching function; the coil of the relay is connected between the supply (after D12) and the open collector outputs of IC2 and IC3.

## Construction Details

Firstly, the car 'electrics' need to be examined. If you have a proper service manual (not the pamphlet supplied with the car), such as the popular Haynes books, then a quick glance at the electrical wiring diagram will tell you whether the interior lights are switched, via the door switches, to 'supply',

or to 'ground' (if you cannot find this information, you will have to grab your multimeter and investigate!).

If the door switches connect the interior light to 'ground' (assuming negative earth), then the following components do not need

to be fitted: R1, R2, D1, TR1. The link LK1 must be fitted in the 'GND' position.

If the interior light is switched to the 'supply', then in that case, the link LK1 must be fitted to the (+) position. Diode D2 need not be fitted.

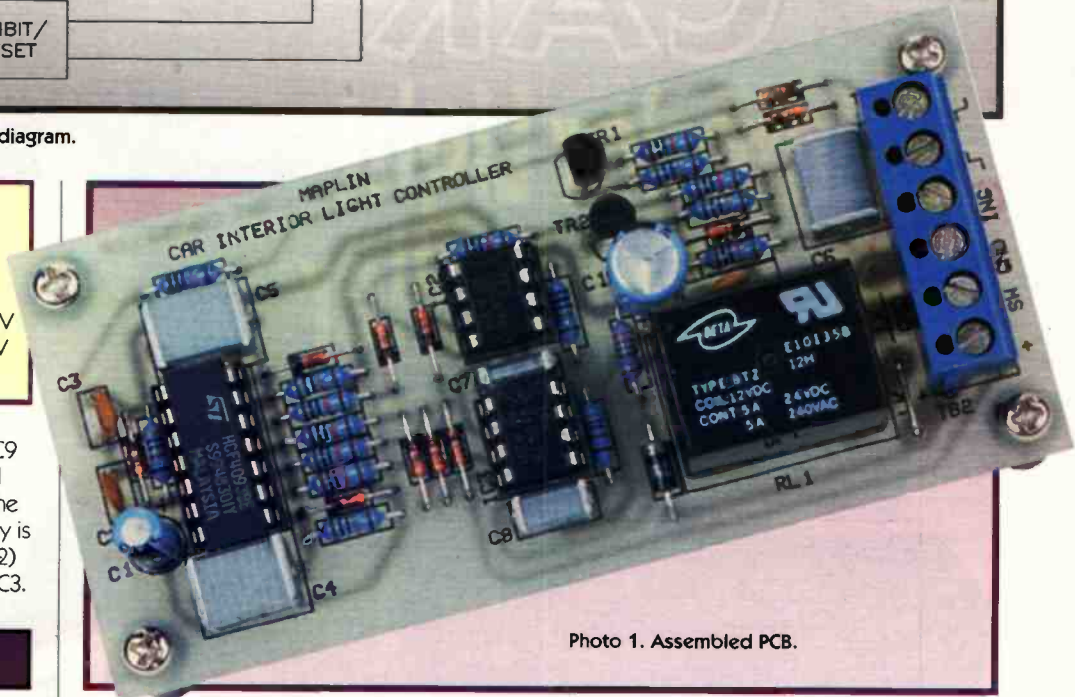


Photo 1. Assembled PCB.

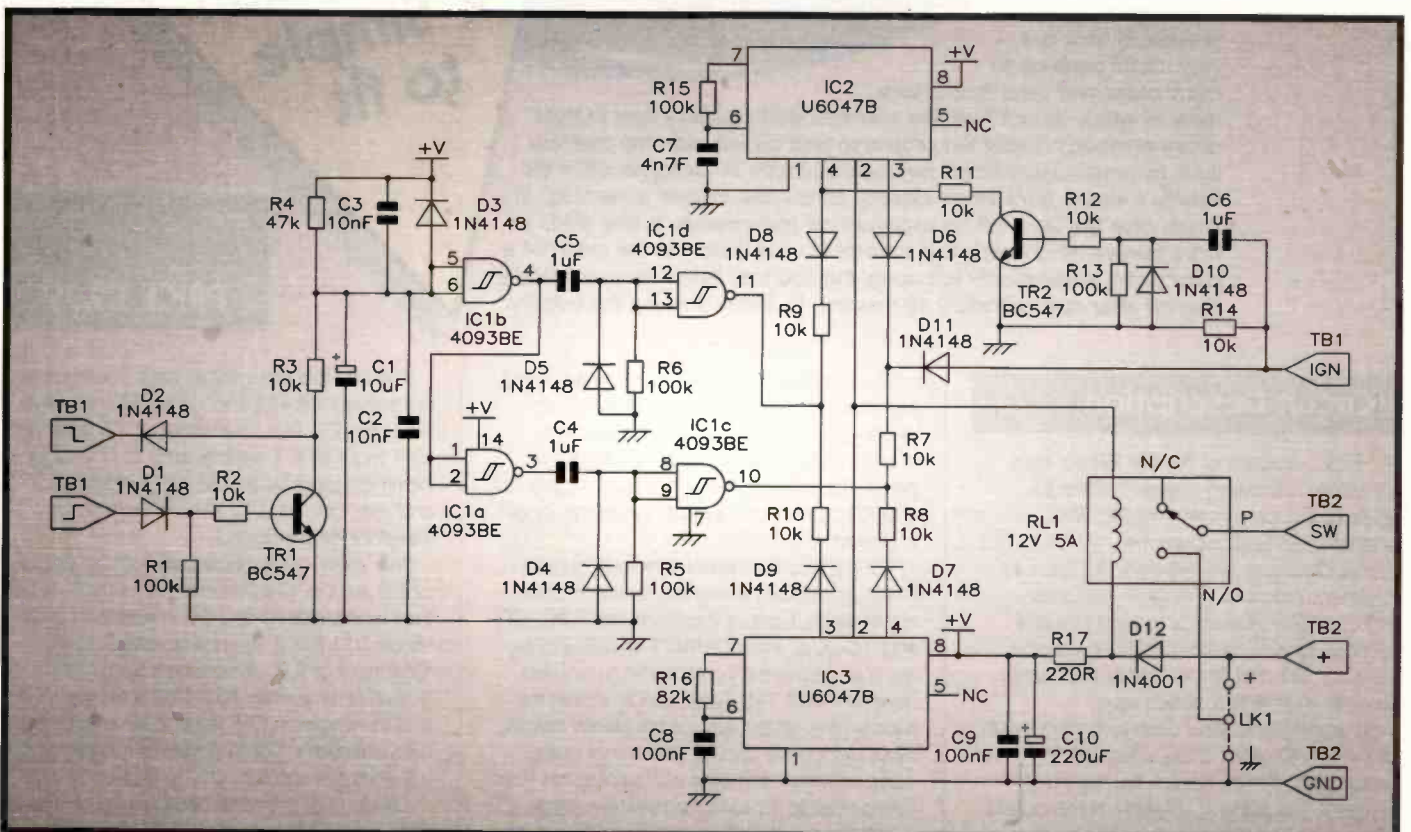


Figure 2. Car Interior Light Controller circuit diagram.

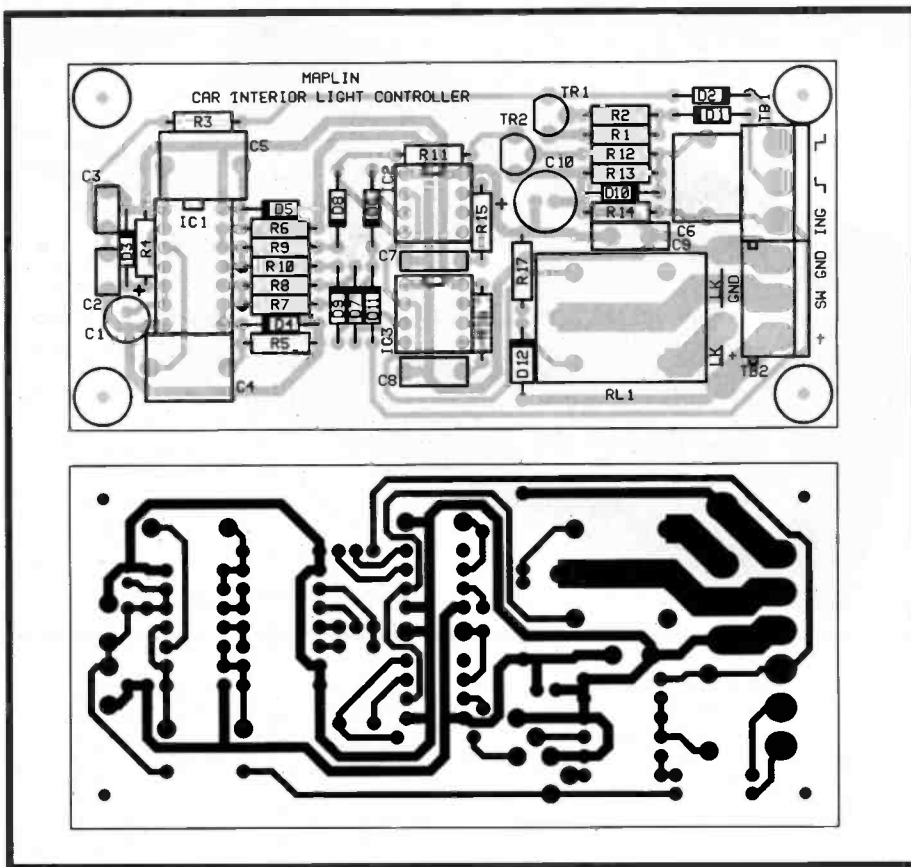


Figure 3. Car Interior Light Controller PCB legend and track.

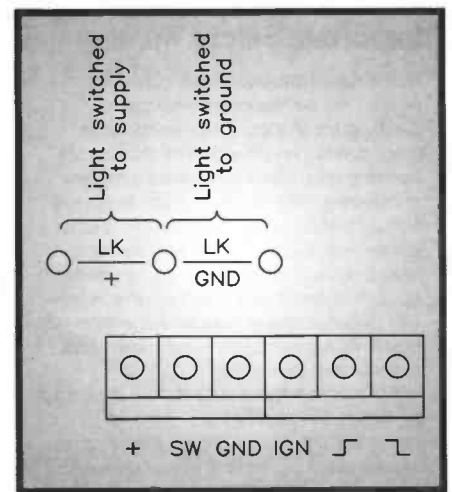


Figure 4. Car Interior Light Controller fitting LK+ or LK GND.

Construction of the module is fairly straightforward; the general rule being: begin with the smallest components first, working up in size to the largest. All of the components are mounted on a single-sided PCB, shown in Figure 3, and the assembled module is shown in Photo 1.

The recommended component assembly order is as follows: First, fit and solder the diodes D1 to D12. Care must be taken to fit the diodes the right way around; the cathode is indicated by a black band on the

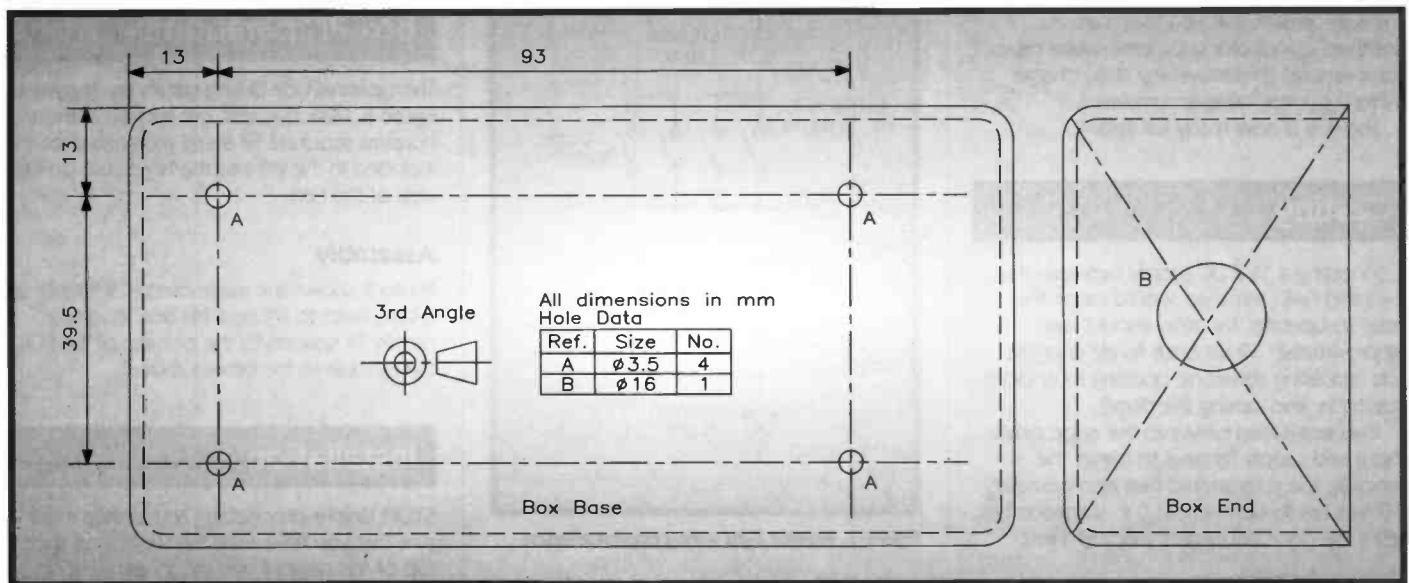


Figure 5. Car Interior Light Controller box drilling details.

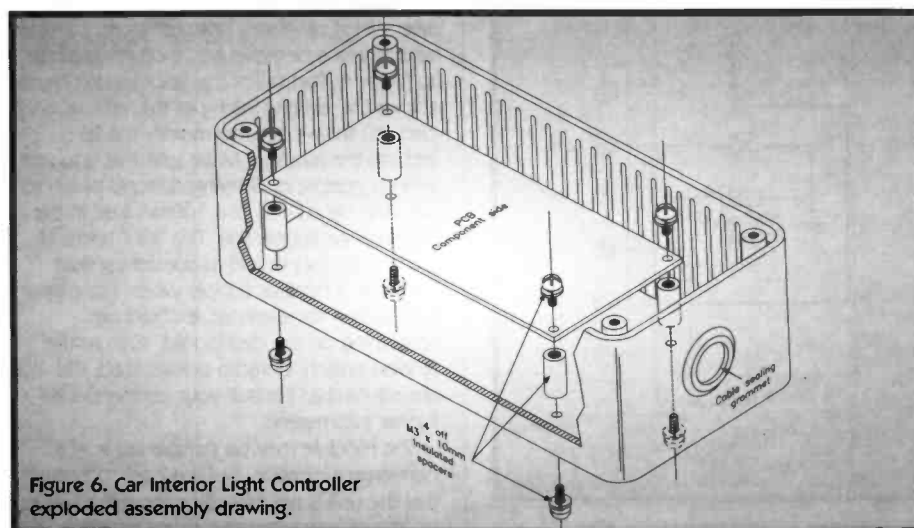


Figure 6. Car Interior Light Controller exploded assembly drawing.

body of the diode, and this must face the thick white band on the PCB legend. Next, use any lead offcuts from the 1N4001 diode (D12) to make link LK1, which should then be soldered into place (shown in Figure 4).

Mount capacitors C2 to C9 next, followed by the three IC DIL-sockets. Now, fit the transistors TR1 and TR2, taking care to ensure that the flat side of the device matches the straight edge on the PCB legend. Try not to keep the soldering iron in contact with the device leads for longer than two seconds.

Mount the two polarised capacitors (C1 and C10) next, taking care to insert the devices correctly – the negative lead is identified by a black band and (-) symbols on the capacitor's body.

Fit the two 3-way terminal blocks next – remembering to slot the blocks together before fitting to the PCB.



## Important Safety Warning

Before starting installation work, consult the vehicle's manual regarding any special precautions that apply. Take every possible precaution to prevent accidental short circuits occurring since a lead-acid battery is capable of delivering extremely high current. Remove all items of metal jewellery, watches, etc., before starting work. Disconnect the vehicle's battery before connecting the module to the vehicle's electrical system. Please note that some vehicles with electronic engine management systems will require reprogramming by a main dealer after disconnecting the battery.

Assuming a negative earth vehicle, disconnect the battery by removing the (-) ground connection first; this will prevent accidental shorting of the (+) terminal to the bodywork or engine. It is essential to use a suitably rated fuse in the supply to this project. For the electrical connections, use suitably rated wire able to carry the required current. If in any doubt as to the correct way to proceed, consult a qualified automotive electrician.

Finally, mount the relay, and build up the four 'wide' sections of tinned copper track with a thick layer of solder.

Thoroughly check your work for errors, such as misplaced components, solder bridges, and dry joints, etc. Clean any flux off the PCB using a suitable solvent.

The ICs can now be inserted into their sockets. Remember to observe the standard antistatic precautions before you handle the ICs - ensure that you touch an 'earthed' conductor (domestic water pipes, for example) to remove any static charge which you may have accumulated.

The PCB is now ready for testing.

## Testing

Connecting a 12V DC supply between the (+) and GND terminals should cause the relay to operate. The relay should take approximately 30 seconds to de-energise (i.e. simulating someone opening a car door, getting in, and closing the door).

Connect a lead between the appropriate input and supply terminal to trigger the module; the relay should take approximately 10 minutes to de-energise (i.e. someone has left a car door permanently open). Next,

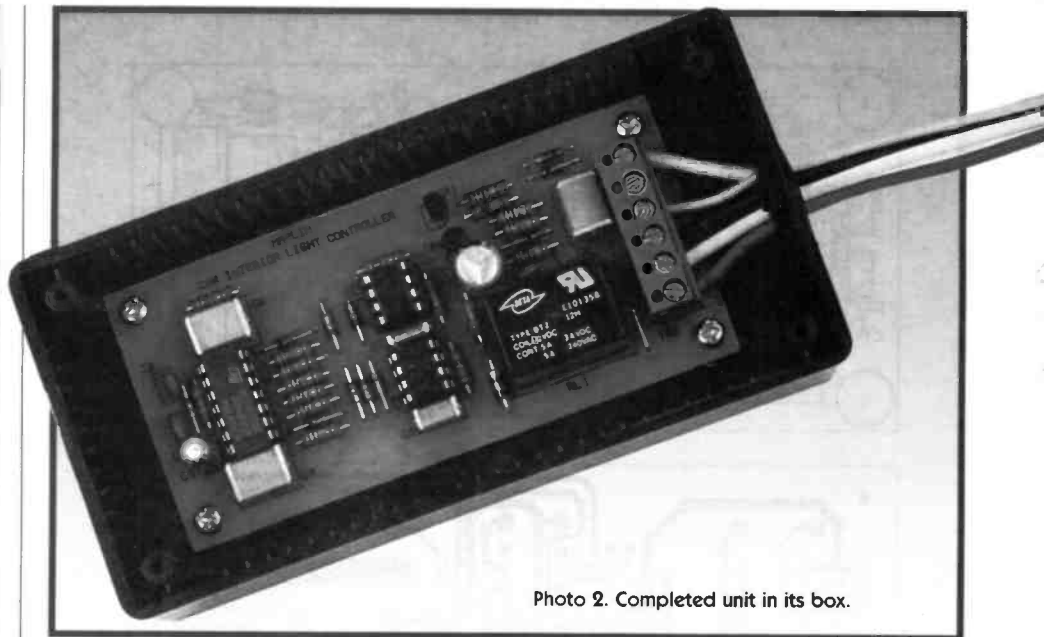


Photo 2. Completed unit in its box.

disconnect the lead from the input, the relay will energise once again; quickly reconnect the lead between (+) and 'IGN' (representing the car being started), and the relay should immediately de-energise (thus turning off the light). Leaving the lead connected to the IGN input, connect a

second lead to the appropriate input to trigger the module (representing a door being opened, with the engine running); the relay should energise (turning on the light).

Now that the module has been fully tested, it is ready for installation into a vehicle. If you wish to fit the module into the optional box, follow the drilling instructions.

## Box Preparation

The optional box drilling details are shown in Figure 5. Mark out, drill, cut and file all the holes as required. Fit a seal grommet (not included in the kit) into the large hole on the side of the box.

## Assembly

Photo 2 shows the assembled PCB fitted into a box. Refer to Figure 6 for box assembly details. Fit spacers to the corners of the PCB, the module to the box as shown.

## Installation

**STOP!** Before proceeding any further, make sure that you have read the warning at the top of this page. If you are, in any way, unsure about installation, consult a qualified automotive electrician.

Figures 7 and 8 show typical before and after wiring diagrams; refer to Figure 7 if your vehicle has a negative earth, otherwise refer to Figure 8. Part (a) of the appropriate Figure shows the existing wiring of the vehicle, and part (b) shows how to modify this to include the module. Make sure that you use wiring capable of carrying currents of up to 5A, and be sure to fit a 100mA fuse in the appropriate supply line. The 'IGN' terminal should be connected to something that provides a positive supply when the engine is running - for example, it could be something on the dashboard, such as the ignition switch, or radio power lead, etc. You are advised to consult your car manual for further information.

The module may be positioned in any convenient location, but it is best to ensure that the unit is not directly exposed to any source of high temperature, or to water.

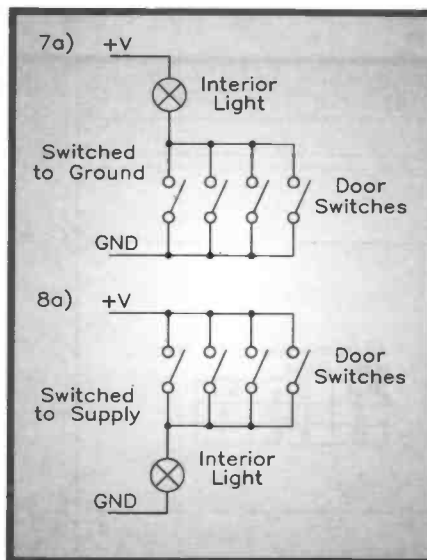


Figure 7. Interior light wiring pre-installation.

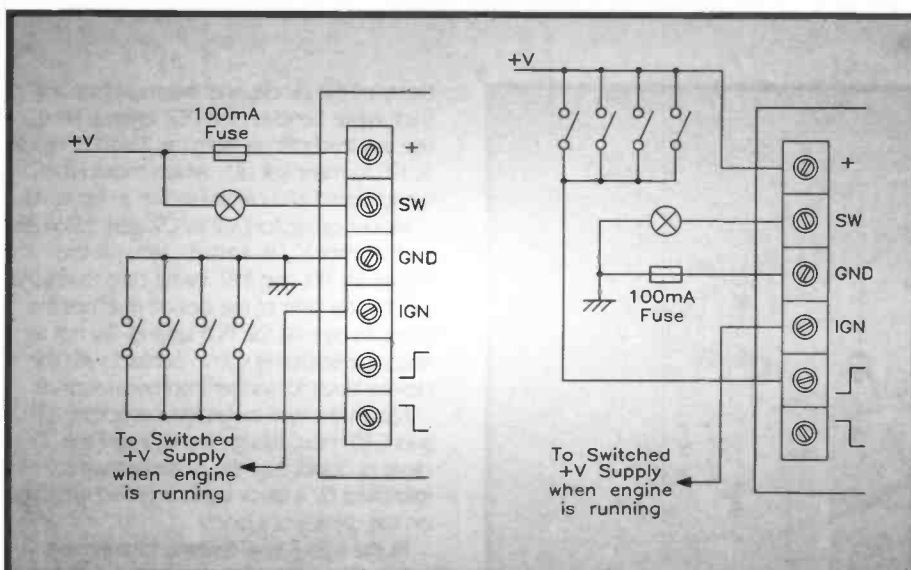


Figure 8. Interior light wiring after installation.

A readers forum for your views and comments.  
If you want to contribute, write to:

The Editor, 'Electronics – The Maplin Magazine'  
P.O. Box 3, Rayleigh, Essex, SS6 8LR.



### Active Distribution

Dear Editor,  
May I suggest, as an idea for a possible project, an 'Audio Distribution Unit', where a number of unity gain outputs, derived from one input, each has its own output buffer or line driver. As I work in electronics I often come across a situation where such a system would be better than a passive system. For example, our local hospital radio has a mixer to which we have matrixed a passive resistor network to drive tape machines, etc. Although this works, much better results will be gained from an 'electronic' method, but the professional equivalents are very costly.  
**Tom Wilson, Banbury, Oxon.**

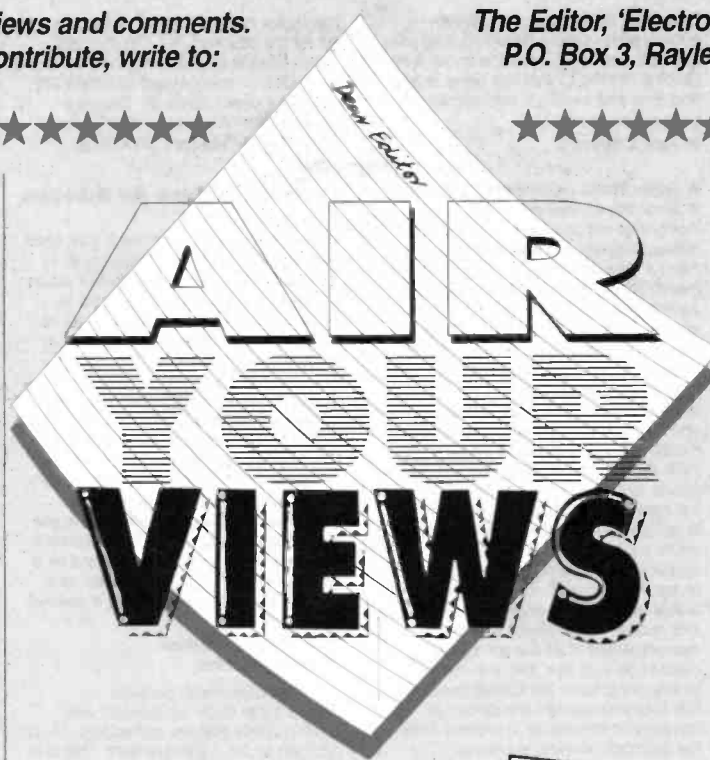
*This is a very good suggestion, since it provides each output with an individual low impedance buffer with the advantage that if there is a fault on any line, for example a short circuit, it does not affect any of the other lines. It will also ensure best HF performance by reducing the amount of screened cable that each buffer needs to drive. A likely device could be the LM837 quad op amp, offering very good audio quality and fast slew rate. Two of these can be easily accommodated on a piece of stripboard providing 1 into 4-way distribution for stereo (four ICs for eight and so on). For non-inverting unity gain operation link pins 1 & 2, 6 & 7, 8 & 9, 13 & 14 together, and connect pins 3, 5, 10 & 12 in parallel to a common bias resistor (say 47k) connected to the 0V of a ±15V supply. The input should be coupled through a 1µF polyester layer capacitor to the junction of the resistor and pins 3, 5, 10 & 12. Outputs can be taken from pins 1, 7, 8 & 14 and are able to drive into a 600Ω load impedance. Ensure the ±15V supply is regulated and well decoupled; pin 4 is +V and pin 11 is -V. It would be a good idea to have two 0.1µF ceramic capacitors connected across the supply lines, immediately adjacent to each IC.*

### I Want to be a Weather Man

Dear Editor,  
I am a radio ham and I have two computers, a BBC B and an Archimedes 3000 2Mb and 40Mb hard disk. The problem is that I want to connect one of these computers (either will do) to a device that will interface with a wind speed and direction indicator, and one of your posh temperature sensors, giving me an ongoing, on-screen line graph of readings during the day and a stored version for the night-time. I'm an operator rather than a constructor, but I once threw an SW Rx together in 38 hours.

**Trevor MacDiarmid, Cambridge.**

*It's a shame you don't have an IBM compatible PC because the 'PC Weather Station' in Issue 70 of Electronics sounds as if it is right up your street. Second-hand machines can now be obtained very cheaply from auctions, boot sales and radio rallies, even an Amstrad 1512 would do the job at a pinch! There is a wealth of software and hardware available for IBM compatible PCs specifically for amateur radio and weather use. Much of it is public domain or share-ware so it is also very cheap. You could also operate the IBM compatible PC in tandem with your Archimedes or BBC via the serial port to transfer data, etc. Newly available is the MAPSAT2 weather satellite receiver system, this comprises: crossed dipole aerial (LM00A); a superb synthesised scanning receiver (AQ49D), capable of receiving transmissions from the polar orbiting satellites, such as the Russian Meteor and American NOAA satellites; and a PC interface (AQ50E) complete with software for IBM compatible PCs*



## STAR LETTER

In this issue, Mr E. J. Scudder, of Cumbria, Gwynedd, wins the Star Letter award of a Maplin £5 Gift Token for his letter about infra-red remote controls.



### Infra-red Mystery

Dear Sir,  
First of all, a quick whinge – I might be forgiven for thinking that Maplin is currently going through a small cash-flow crisis, only because it would seem that the machine which prints the subscription address labels needs a new ribbon at least. The most recent address label that I received, stuck on the Electronics wrapper, is just one example. My first initial is 'E', not 'F' and the village is 'BLINDCRAKE', not 'BIINDCRAKE'. Is there any chance of your magazine despatch department being able to afford an efficient new addressing machine soon?  
Now for my main query. I spend much of my spare time listening to CDs, and the player has a remote control which I find helpful. The instructions tell me to sit facing the CD and aim the remote at a specific point on the front panel. However, I have found that I was able to bounce the infra-red beam off objects, such as furniture, while sitting beside the CD out of sight of its front panel. I then found that it also worked while the remote was not pointing in any particular direction, in fact that it would operate when pointed anywhere in the room, provided the beam crossed in front of the player. I am intrigued because I am not sure how this is possible. Could you explain, please?

*First of all, don't worry – Maplin isn't suffering a cash-flow crisis! On the contrary, despite the recession, Maplin has just been listed by leading chartered accountants, Price Waterhouse, as one of the fastest growing companies in Britain!*

*(12MHz 286 minimum). With a down converter and helical yagi aerial it will also receive transmissions from geostationary weather satellites (Meteosat for Europe). See page 216 of the new 1995 Maplin Catalogue for details. If you want to take advantage of such*

*Examination of your enclosed label shows that the shapes of all the letters are all there, but the imprint is lighter in some places than others. The subscription labels are produced by a very efficient high-speed line printer driven from our mainframe. The quality is no better or worse than similar address labels produced for other magazines. This method is chosen for very good reasons – speed and cost. The total number of labels is over 14,000, which then have to be immediately dispatched by courier to the mailing house (we do not mail Electronics ourselves). Given the total number of labels, it is not surprising that the odd letter is not quite as clear as it might be. The Post Office very rarely have problems in deciphering the labels, so there is no need to change! We try to keep our costs down wherever possible as it keeps the cost of a subscription down – subscribing is already cheaper than buying each issue over the newsagents counter anyway. As far as the remote control goes, you are right in that the infra-red beam can be bounced all around the room like visible light. Provided the receiver in the CD player can 'see' an adequate reflection and be able to decode the pulse train with which the infra-red light is modulated, the player will respond. Before infra-red became the common method of remote control, ultrasonics were used instead. Sometimes you could change channels on your TV by jingling a handful of coins or a bunch of keys. I once heard a story about a budgie that could whistle at ultrasonic frequencies to change the channel when Coronation Street came on!*

*weather monitoring add-on hardware and software you either need to change platform to an IBM compatible PC (build your own easily and cheaply from Maplin's range of PC parts) or, staying in the Acorn camp, upgrade to the new Acorn RISC PC with a 386/486 2nd processor fitted.*

### Getting it Taped

Dear Editor,  
Having just looked at the survey results I noticed that readers wanted more computer projects. I have a couple of problems that could be solved by new projects such as these. For example, I recently purchased an Amstrad Nc100 notepad computer, which stores its documents in an internal memory. No other storage medium is provided, apart from the option of using plug-in PCMCIA cards. As these are rather expensive I decided to look at the alternative method of backing up onto tape, as the serial port provides two way signals. The idea was to have a gadget that will convert the RS232 to TTL, then generate high and low audio tones from the logic levels. Playback would require the process in reverse, maybe using a phase-locked loop. Experimentation has shown that while it sounds simple enough, the pulses are too fast and need slowing down somehow. I need a method for recording an RS232 signal onto tape and then playing it back into the computer. Any ideas?  
I also need a small microcomputer set up like the Z80 kit you used to have. How about running a series on computers with projects, as another magazine has done recently?  
**Damian Gunner, Southwick, Sussex.**

*Back in the days when affordable micro computers first arrived on the scene (NASCOM, UK101, PET, et al) the only affordable form of program storage for home users, other than EPROM, was cassette tape. Since that time, every computer user who has ever used cassette tape has yearned for the speed and reliability of disk storage. I can still vividly remember the jubilant feeling of actually managing to find a file I had saved on tape and load it without errors! Memories of frustrated evenings spent unsuccessfully trying to re-load a program that took a week to type in still haunt me! Even during the 80s, floppy disk drives were considered a luxury by home computer users. Now we have the choice of floppy, hard, optical or RAM disc. Tape is only in regular use for data back-up, even then using special drives and high quality media. You really wouldn't want to use tape would you?*

*If you really do want to torture yourself you could try connecting up a old 300 baud modem, obtained from a computer auction, radio-rally, etc. to the RS232 port. Just output the data to the port and record the modem's audio output! Since the data rate is low, it is ideal for a cassette tape recorder. All you need to do is match the input and output levels properly, and, when it comes to reloading through the serial link, it should simply be a case of setting up your computer to receive then pressing 'play'. Be sure that you have the necessary communications software though. Bet you end up back with the PCMCIA cards though!*

*The Z80s kits we used to have? We still sell them! Kits LK67X and LT15R form the 'Z80A Development System', see page 199 of the new 1995 Maplin Catalogue. This pair of projects were treated to a 'Second Time Around' in Issue 58 of Electronics. For projects and applications for the Z80 see the 'Microcomputer/Microprocessor Interfacing' books WS85G, WT98G and WT14C. While these are still popular, it is not really viable to progress further with projects for most of the old 8-bit microprocessors, as they are rapidly heading towards obsolescence. If you are after designing and building your own processor controlled projects the best bet is to follow the current trend towards microcontrollers, such as the ST6, PIC16Cxx, TMS77C82, 80C31,*



68HC11. These contain CPU, ROM or EPROM, RAM and IO all on one chip. Low-cost development systems are available that enable assembly code to be written and debugged on an IBM compatible PC. This is so much easier than 'hand assembling' code and entering it via a hex keypad. If you add up the cost of all of the bits necessary to write and debug code, program EPROMs, plus the CPU board itself, it will cost more than a basic microcontroller development system. See pages 693 of the new 1995 Maplin Catalogue, the ST6 Starter kit DC23A costs under £150.00 and includes assembler, linker and simulator software (runs on an IBM compatible PC), a device programming unit and full documentation. We hope to publish an article giving full details of the ST6 in the future.

### Where are all the Railway Projects?

Dear Sir,  
Some time ago I asked whether some simple model railway projects could be included in the magazine, my main complaint being that you only seem to be catering for people that are electronics engineers, and not hobbyists like myself. While I can build circuits up and repair things, I cannot design my own circuits, which is why I am suggesting model projects such as a two-tone train horn, train chuffer, lighting effects, etc. All I get in response however, is promises and nothing else, so how about it?

One other suggestion – could you publish some simple circuits to help us test 555 and 741 ICs, just to make sure that it is not the IC that has gone wrong, and time and money is not wasted buying new ones?

K. Hall, Coventry.

A Train Chuffer project was published in Issue 80, so how can you say we don't keep our promises! The following railway projects are also imminent: Train Horn & Whistle will be published next month (Issue 83) – this has real sound samples of a diesel two tone horn and a steam whistle stored in an EPROM and can be interfaced with the train chuffer. Head & Tail Lamps, Auto Loop Control and Train Detection circuits will be published the month after (Issue 84), and Signal Lights will be published the month after that (Issue 85). You might think that we just 'popped them in' those issues to keep you happy, but that isn't the case, they were already scheduled to appear in those issues before you wrote your original letter! You will appreciate that projects take a little while to reach publication. The reason being is that we don't just cook up a circuit and publish it. We check with the manufacturers of all the components used to be sure that they are not going to stop production the following week. We take into account the spread of component tolerances to prevent 'only the prototype worked syndrome'. The design is thoroughly tried and tested so we know that it will work properly if built correctly – we actually guarantee that our kits will work as stated. Find another

magazine that goes to those lengths! As for the 555 and 741 ICs, the 555 Timer Module kit (Issue 69) and the Op Amp Development Board kit (Issue 68) will make useful testbeds. See also books 'IC555 Projects' (LY04E) and 'How to Use Op Amps' (WA29G).

### Putting the Case for Add-ons

Dear Sir,  
I have been a subscriber for a little while now, and although the magazine is, in the main, a good read, I believe it would benefit from having more projects to build. You provide excellent kits but do not appear to follow up these items. A particular example is the 24-Line I/O Card for the PC.

Surely this is an ideal platform for add-ons like an EPROM programmer, an IC tester, robotics control, data sampling, etc. There must be interest in these otherwise you would not be selling the rather expensive stand-alone items shown in the catalogue. It seems to me that we are losing the hobbyist element of the electronics/computing arena as a result of everything being treated as a commodity which needs to be a 'market goer'.

P. A. Murphy, Carlton, Nottinghamshire.

As far as reasonably possible we always try to follow up projects with other projects that are compatible, or are add-ons to the original project. This is to some extent dictated by what readers actually want, based on readers letters, so please continue to tell us. After all, we don't want to develop projects that

only one or two readers are interested in!

The 24-Line I/O Card is extremely popular, but it is questionable whether it is worth developing add-ons for what is already an 'add-on'. What is a better idea is to develop dedicated add-ons that do what is required from the ground up. We've already gone down this route with dedicated PC sound card, PC weather station card, digital IC tester, opto isolated card and relay card kits. The major cost tends to be the PCB rather than the electronics so having everything on one plug in card is neater, easier to build, requires less wiring and is cheaper! We're developing these dedicated add-ons as we think of them, but any suggestions you, and other readers, have are welcome! A-to-D, D-to-A and Teletext are already on the list. For those wishing to develop their own add-ons, there is a PC prototyping card with all the address decoding already on board. If any readers have circuits for general add-ons for the 24-line card, send them in and we may consider publishing the circuit as a 'non-kit' project.

An EPROM programmer, to be worthwhile, would have to be universal and be upgradeable to include new devices as they appear. Such a unit with suitable software would end up at a similar price to a commercial unit. If readers do want such a project, please write in. Developing 'one-offs' for specific cases is quite feasible using the 24 line I/O Card, hence it encourages the DIY 'hobbyist element'! The book 'Experiments with EPROMs', Stock Code WT13P, is also recommended.

## CAR INTERIOR LIGHT CONTROLLER – Continued from page 36.

Once the module has been installed, check and double-check the wiring before reconnecting the battery.

### Final Testing

Switch on your vehicle's courtesy light (so that it is activated when a door is opened), and open any one of the vehicle's doors; the light should turn on. Now, close the

door. The light should remain on for about 30 seconds, before being automatically extinguished.

Open the door again (the light should turn on) and wait for approximately 10 minutes. After this time, the light should be automatically extinguished.

Finally, get into your vehicle and close the door (the light should remain on). Now, start the engine – the light should turn off immediately.



## CAR INTERIOR LIGHT CONTROLLER PARTS LIST

RESISTORS: All 0.6W 1% Metal Film

R1,5,6,13,15	100k	5	(M100K)
R2,3,7-12,14	10k	9	(M10K)
R4	47k	1	(M47K)
R16	82k	1	(M82K)
R17	220Ω	1	(M220R)

### CAPACITORS

C1	10μF 50V Radial Electrolytic	1	(FF04E)
C2,3	10nF Ceramic	2	(WX77J)
C4,5,6	1μF Polyester Layer	3	(WW53H)
C7	4n7F Polyester Layer	1	(WW26D)
C8	100nF Polyester Layer	1	(WW41U)
C9	100nF 16V Miniature Disc Ceramic	1	(YR75S)
C10	220μF 16V Radial Electrolytic	1	(FF13P)

### SEMICONDUCTORS

D1-11	1N4148	11	(QL80B)
D12	1N4001	1	(QL73Q)
TR1,2	BC547	2	(QQ14Q)
IC1	4093BE	1	(QW53H)
IC2,3	U6047B	2	(AH44X)

### MISCELLANEOUS

RL1	12V/5A Miniature Relay	1	(JM18U)
TB1,2	3-Way 5mm PCB Terminal Blocks	2	(JY94C)
	8-Pin DIL Socket	2	(BL17T)

14-Pin DIL Socket	1	(BL18U)
PCB	1	(GH89W)
Instruction Leaflet	1	(XU90X)
Constructors' Guide	1	(XH79L)

### OPTIONAL (Not in Kit)

16-0mm Seal Grommet	1 Pkt	(JX77J)
M3 × 10mm Insulated Spacer	1 Pkt	(FS36P)
Plastic Box Type 2BA	1	(BZ28F)
Fuseholder	1	(RX51F)
1.25in. 100mA Fuse	1	(WR08J)
6A Wire Black	As Req.	(XR32K)
6A Wire White	As Req.	(XR37S)
6A Wire Red	As Req.	(XR36P)

The Maplin 'Get-You-Working' Service is available for this project, see Constructors' Guide or current Maplin Catalogue for details.

**The above items (excluding Optional) are available as a kit, which offers a saving over buying the parts separately.**

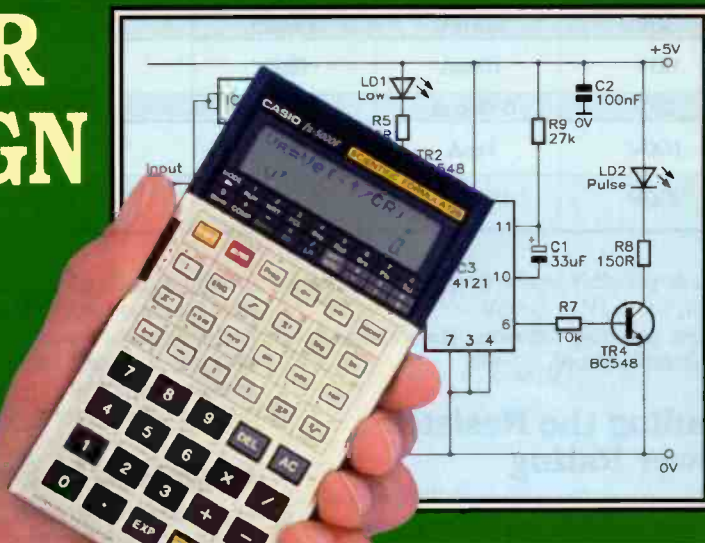
**Order As LT65V (Car Interior Light Controller) Price £9.99**

The following new item (which is included in the kit) is also available separately.

**Car Interior Light Controller PCB Order As GH89W Price £2.99**

# IMPROVE YOUR CIRCUIT DESIGN WITH THE AID OF A SCIENTIFIC CALCULATOR

by Clive W. Humphris



**H**ow many electronics hobbyists design and build their circuits on a trial and error basis? Sometimes, the costly consequence will be one of destroyed components or, more likely, faults will be generated which are often difficult to find (as the circuit under construction never worked properly in the first place).

Electronics is a mathematically based subject. Circuit parameters are determined by the values, and characteristics, of the components used to make up the design. As a result, circuit voltages and currents will, or can be made to, change in a predictable manner by carefully choosing both the active devices (transistors and ICs, etc.) and passive components (such as resistors, inductors and capacitors).

The scientific calculator is an inexpensive aid to producing circuits that work the first time. This, in turn, greatly increases your confidence and enjoyment of this absorbing pastime, thereby encouraging you to progress in your development of more complex circuit arrangements.

The features and functions of the scientific calculator will be introduced with examples of, firstly, simple DC circuits, before progressing to the more complex and interesting AC analysis.

The key presses used correspond, mainly, to CASIO models, but similarly marked functions will be available on most scientific calculators (from a variety of manufacturers).

## DC Circuit Design

An essential requirement of circuit design and analysis is 'knowing roughly' what to expect, in terms of voltages and currents, in any particular part of the circuit under construction. For example, in a circuit which uses a battery as its power source, it would be unreasonable to find large currents flowing; we would expect a few milliamps at the most. At the same time, the highest voltage measured would be that of the battery. To meet these conditions, resistors would be likely to have values measured in k $\Omega$ . Mains operated equipment could, on the other hand, have a much wider range of circuit voltages and currents.

These are general observations, but they should be borne in mind when making calculations. If, as a result of your number crunching, you produce a resistor value of only a few ohms for a resistor which is to be connected across a relatively high voltage, then a large current will flow, and this may be undesirable. Trapping the problem at this stage could prevent a costly mistake.

For DC circuits, an understanding of Ohm's Law is necessary. To demonstrate this, we will use a simple circuit (see Figure 1) of a resistor connected across a battery (which is the source of an electric current). Under ideal conditions, a new battery with negligible internal source resistance will have a voltage present, across its positive and negative terminals, of 1.5V. We can now calculate the current through the resistor and determine the correct power rating of the resistor, by using the scientific calculator's built-in functions, by applying the DC Ohm's Law and power formulae.

To find the current flowing using Ohm's Law

$$I = \frac{V}{R} \quad \{1\}$$

Input to your calculator 1.5 divided by 10,000.

The display will show 1.5<sup>-04</sup>

What does this result tell us? The <sup>-04</sup> is the exponent part of the answer; this means that, to find the decimal equivalent, the decimal point should be moved four places to the left. This now becomes 0.00015A. This is not a great deal of help when trying to understand 'just how much current is likely to flow under these conditions', especially when very small currents are present (due to large resistor values). By applying some simple rules, the results obtained can be made more meaningful.

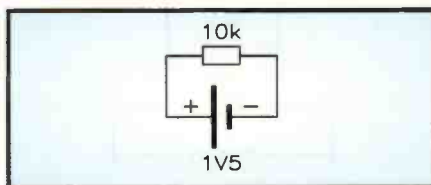


Figure 1. Simple circuit to demonstrate Ohm's Law.

If, as in this case, the resistor value is measured in k $\Omega$ , then the current will be calculated in milliamps. Similarly, if the resistance is measured in M $\Omega$ , then the current will be in microamps. Where the resistor value is in  $\Omega$ , the current will be in amps. We can now look at the problem again, and obtain a more understandable result.

Input to your calculator as follows:

$$1.5 \text{ divided by } 10 = 0.15\text{mA}$$

The answer is automatically produced in mA, as the 10 means 10k $\Omega$ .

Using the same example, if we know the current and voltage, we can determine the circuit resistance. The current is in milliamps, so the resistance must be in k $\Omega$ .

$$V = 1.5\text{V} \quad I = 0.15\text{mA}$$

What is the resistor value?

Formula:

$$R = \frac{V}{I} \quad (\text{Ohm's Law}) \quad \{2\}$$

Using your calculator, input:

1.5 divided by 0.15 = 10 (as the current is in mA, the resistor must be 10k $\Omega$ )

Knowing the current and resistance, we can then determine the source voltage.

Formula:

$$V = I \times R \quad (\text{Ohm's Law}) \quad \{3\}$$

The current is in mA and the resistance in k $\Omega$ . For practical purposes, the voltage will be measured in volts.

Input to your calculator as follows: 0.15  $\times$  10 equals 1.5V, which is our original battery source voltage.

By applying these simple rules, the opportunities for human error, caused by calculating with large numbers of zeroes, are minimised. The calculator will not make mistakes. If you have an error, it will either be your interpretation of the calculator display that is at fault, or you have pressed the wrong buttons.

Values of resistance and current can range from, say, millions of ohms, to a few microamperes. For our purposes, we can consider voltages to be measured as



V	I	R	Prove	Formulae
30V	20mA	1.5kΩ	V	$V = I \times R$
60V	10mA	6kΩ	I	$I = \frac{V}{R}$
25V	0.05mA	500kΩ	V	$V = I \times R$
100V	1mA	100kΩ	I	$I = \frac{V}{R}$
250V	0.1mA	2.5MΩ	R	$R = \frac{V}{I}$

volts or possibly tenths or hundredths of a volt, i.e. 0.1V or 0.05V.

Now, practise following the examples in the table above.

## Finding the Resistor Power Rating

As the current flows through 'R', the resistance to the current flow will be dissipated as heat within the resistor body. If the power rating of the resistor is undervalued, then it will become too hot, and eventually be destroyed. Similarly, using a physically large resistor will look untidy, be costly (albeit it will last for ever), and possibly make circuit layout difficult.

The resistor power rating can be found in one of three ways, depending upon the circuit parameters available. Each will produce the same power rating.

$$P = V \times I \quad \{4\}$$

$$P = \frac{V^2}{R} \quad \{5\}$$

$$P = I^2 \times R \quad \{6\}$$

This provides us with the opportunity to make use of the calculator's 'square' key, usually marked  $x^2$  similar.

Using the previous example of a 10k resistor connected across a 1.5V battery we proved previously that 0.15mA will flow through the resistor.

From formula {4}, we find the power rating

Input by pressing the following keys:

$$1.5 \times 0.15 = 0.225mW$$

As the current is input in milliamps, the answer to the equation will be in milliwatts. If the current were in amps, then the result would be in watts, and if current was measured in microamps, then the power rating would be in microwatts. Note 'volts' remains as volts.

Using the formula {5}, find the calculator button marked  $x^2$

Input as follows:

1.5  $x^2$  2.25 will appear on the calculator display. Now divide by 10 (which is the resistor value in kΩ), and the same power value of 0.225mW will be found.

Next, apply Power formula {6}, using the  $x^2$  key to find the square of the current, before multiplying by the resistor value of 10. Remember it is in kΩ. The same value of 0.225mW will be the result, thus proving that whichever of the formulae is chosen, the power rating will be the same. The choice of the resistor rating should be higher or equal to the calculated value, never lower. It is often wise to allow some degree of 'headroom'

for supply voltage variations, component tolerance, and reliability. For example, if the calculated power dissipation is 600mW, it would be better to choose a resistor rated 1W, rather than running a 0.6W resistor right on its limit.

## Resistors in Series

Connecting resistors in series (see Figure 2) will increase the value of the resistance present to:

$$R_{TOTAL} = R1 + R2 + R3 + \dots R_n \quad \{7\}$$

This is simple enough, until we find that the resistances to be added include mixed values (measured in kΩ and MΩ). The larger values, if written using a general format, could include many zeroes. 10MΩ, for example, in series with 120kΩ: 10,000,000 + 120,000. Plenty of opportunities for mistakes. These may well be extremes, but it demonstrates the point. When we try to multiply these values, the problem becomes even more error-prone. Our objective is to make life simpler.

The scientific calculator has a built-in Exponent function. This is available on the keyboard, and is usually labelled  $EXP$  or similar. This is simply to allow you to tell the calculator where to place the decimal point or, how many zeroes to include before or after the decimal point.

For example, add the following values: 22kΩ + 33kΩ + 4.7kΩ - this could be input as 22,000 + 33,000 + 4,700. The equivalent value would be 59,700 or 59.7kΩ. A much simpler method is to input as follows - try it you will get the same answer:

$$22 \text{ EXP } 3 + 33 \text{ EXP } 3 + 4.7 \text{ EXP } 3 = 59,700$$

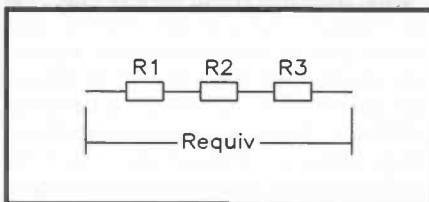


Figure 2. Resistors connected in series.

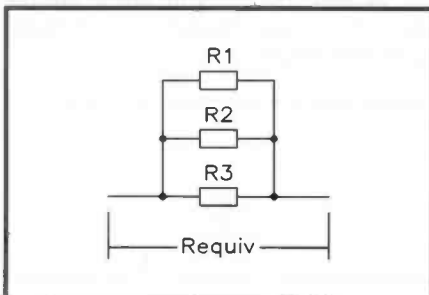


Figure 3. Resistors connected in parallel.

However, as the values all have the same  $\times 1000$  multiplier, the values could be added as  $22 + 33 + 4.7 = 59.7$  with 'k' added at the end of calculation.

When zeroes are included within numbers, either before or after the decimal point, they have no actual value 'in themselves'. Nought is nothing or zero. Noughts have what is called 'positional value' - placed after the whole number and, the value is multiplied by 10 for each nought; placed immediately after the decimal point and, the decimal or fractional part is to divide by 10 each time. The power dissipated in each resistor can be found by first calculating the current flowing through each, which is equal to the voltage across all of the resistors (in series) divided by the sum of the resistor values. Then, multiplying the square of the current by the resistor value will give the power dissipated (power formula {6}).

## Resistors in Parallel

There are two commonly used formulae which can be applied to solve this problem (see Figure 3), and the answer can be found without having to resort to noting down the intermediate values occurring within the calculations.

For two resistors:

$$R_{TOTAL} = \frac{(R1) \times (R2)}{(R1) + (R2)} \quad \{8\}$$

This can be written as:  $(R1 \times R2) / (R1 + R2)$

For any number of resistors:

$$R_{TOTAL} = \frac{1}{\frac{1}{R1} + \frac{1}{R2} + \frac{1}{R3} + \dots \frac{1}{R_n}} \quad \{9\}$$

We can use the example of having to find the equivalent value of just two resistors to introduce the scientific calculator feature of 'brackets', also known as parenthesis.

Supposing the values of R1 and R2 were 470Ω and 820Ω (the previous point about the  $EXP$  key still applies for larger values):

Input formula {8} to your calculator:

$$([ 470 \times ] 820 ) \div ([ 470 + ] 820 ) = 298.76\Omega$$

Practise yourself, but do not forget to close the brackets, or your values will become what is called 'nested' - a feature we shall use later.

The next function I would like to introduce is the 'reciprocal key', marked  $1/x$  or similar.

Taking parallel resistor formula {9} for any number of values, and you will see it is necessary to find the reciprocal (divide the value into one) for each resistor value; add the reciprocals, and find the reciprocal of the total. Sounds complicated, but the scientific calculator performs this feat with ease, without you having to write down intermediate calculations.

Suppose we use our previous values of 22kΩ, 33kΩ and 4.7kΩ. Input to your calculator as follows:

$$22 \text{ } 1/x \text{ } + 33 \text{ } 1/x \text{ } + 4.7 \text{ } 1/x \text{ } = 1/x \text{ } = 3.47$$

We know the value will be in kΩ, and so we can write it as 3.47kΩ. The resultant value will *always* be lower than the smallest value.

## Voltage and Current Dividers

Further examples in using the scientific calculator to assist with your circuit design are: determining the circuit parameters within voltage and current dividers.

### Voltage Divider

This circuit consists of a number of resistors connected in series. The source voltage is applied across the extreme ends. Each resistor junction forms a voltage tapping point. A familiar example of this can be seen in Figure 4 – two resistors connected across the supply voltage of a common-emitter transistor circuit; the junction of the two resistors supplies the correct voltage to set the transistor bias conditions. The formula to find the junction voltage of just two resistors is:

$$V_{\text{JUNCTION}} = V_{\text{CC}} \times \frac{R_2}{R_1 + R_2} \quad \{10\}$$

Suppose  $V_{\text{CC}}$  is 9V, and the resistor values are:  $R_1 = 10\text{k}\Omega$ ;  $R_2 = 3.3\text{k}\Omega$ . Calculate the junction voltage.

Input to your calculator as follows:

$$9 \times \left( \frac{3.3}{10 + 3.3} \right) = 2.23\text{V}$$

This example is chosen to demonstrate the ease of using nested brackets. In most cases, circuit evaluation using the scientific calculator requires nothing more than first taking care to write down the formula onto one line. Then, it is input as written. However, there are some exceptions where the value is required before the function is selected – finding the reciprocal of nought will, as you might expect, generate an error; this is one such example.

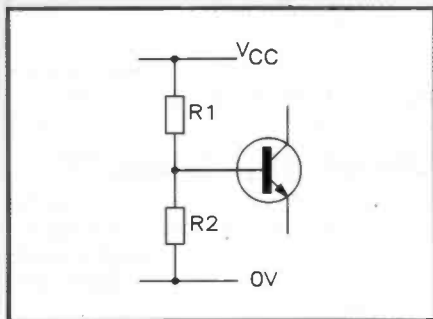


Figure 4. A 2-resistor voltage divider used to bias a transistor.

### Current Divider

When resistors are connected in parallel, or a number of resistors meet at a junction, the net result of the current flowing into that joining point will equal the current flowing out. This is known as Kirchhoff's current law – all the branch currents, when added, will equal the source or supply current (see Figure 5).

If the resistor values are known along with the source current, each branch current can be found.  $I_1$ ,  $I_2$  and  $I_3$  are calculated as a proportion of the total current, depending upon the resistor value relationships. The lower the value, the more current will flow in that branch. Branch currents are said to be *inversely proportional* to the resistor values.

Example: If the resistors have the following values, determine the branch currents when a source current of 20mA is made to flow.  $R_1 = 1\text{k}\Omega$ ,  $R_2 = 2\text{k}\Omega$  and  $R_3 = 3\text{k}\Omega$ .

The total current equals the sum of the branch currents and so, in practice, we only need to find two.

$$I_1 = I \times \frac{R_{\text{TOTAL}}}{R_1}$$

$$I_2 = I \times \frac{R_{\text{TOTAL}}}{R_2}$$

$$I_3 = I \times \frac{R_{\text{TOTAL}}}{R_3}$$

For this calculation it is first necessary to establish ' $R_{\text{TOTAL}}$ ' which is then used in each subsequent calculation. Here, the calculator memory keys come in useful: **[Min]** or similar to write to memory, and **[MR]** memory recall.

The resistors are in parallel and so the following formulae establish ' $R_{\text{TOTAL}}$ '

$$1 \left[ \frac{1}{R_1} \right] + 2 \left[ \frac{1}{R_2} \right] + 3 \left[ \frac{1}{R_3} \right] = \left[ \frac{1}{R_{\text{TOTAL}}} \right] \text{Min}$$

0.55 (note  $\text{k}\Omega$ ) will be permanently stored in your calculator memory until you decide to change it, and is now available as ' $R_{\text{TOTAL}}$ '.

Clear the display, and press **[MR]**; your calculator should show 0.55.

Calculating  $I_1$ :

Input as follows (note the relationship between mA and  $\text{k}\Omega$  means we can input the numbers directly):

$$20 \times \left( \frac{1}{0.55} \right) = 10.91\text{mA}$$

Calculating  $I_2$ :

$$20 \times \left( \frac{2}{0.55} \right) = 5.45\text{mA}$$

Calculating  $I_3$ :

$$20 \times \left( \frac{3}{0.55} \right) = 3.64\text{mA}$$

The memory keys can be extremely useful for storing fixed values (which are then available for repeated use), or for when calculations become more complex (break each formula into a number of sub formulae, and use the memory to store intermediate results). The memory can be also be added to, or subtracted from, using the **[M+]** and **[M-]** keys. Some scientific calculators will have more than one set of memory buttons.

Before we leave DC circuit calculations, the importance of ensuring you avoid problems by inputting the wrong number of zeroes, must be stressed. A 47 $\text{k}\Omega$  resistor value can be input as 47 **[EXP]** 3. 5mA, for example, would be input as 5 **[EXP]** **[/-]** 3 = 0.005A. The **[/-]** key will change the exponent to a negative value, which in this case is the same as shifting the decimal point 3 places to the left.

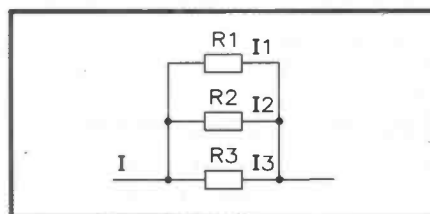


Figure 5. Current flow in parallel circuits.

However, you must ensure you have selected the correct mode on your calculator to display sufficient significant figures, or this function might appear not to work.

## AC Circuit Analysis

The formulae used for AC analysis are a little more complex than those used to find the relationship between voltage, current and resistance, expressed as Ohm's Law. However, once the relationship between the values is understood, then the scientific calculator can make life much simpler, and most importantly, you will have confidence that the answers to your mathematical problems are correct.

AC circuits comprise capacitance, inductance, resistance and the applied frequency of voltages and currents. We can now look at various aspects of AC theory to demonstrate how the scientific calculator can be used for mathematical analysis.

### Capacitors in Parallel

The formulae for capacitors connected in series and parallel are the same as for resistors, except that the series and parallel formulae are reversed. Connecting capacitors in parallel effectively increases the surface of the plate area (see Figure 6), and so the values are added directly, which is the opposite to that for resistors.

$$C_{\text{TOTAL}} = C_1 + C_2 + C_3 + \dots C_n \quad \{11\}$$

One essential difference between AC and DC calculations are the very small numbers used, when expressing some capacitance values (as  $\mu\text{F}$ , nF and pF) or, inductance values (as  $\mu\text{H}$ , mH and H). As long as the conversion table is referred to (or remembered), calculation should not be a problem.

Capacitance is measured in farads:  $\mu\text{F} = 10^{-6}$ , nF =  $10^{-9}$  and pF =  $10^{-12}$ . Inductance in henries: mH =  $10^{-3}$  and  $\mu\text{H} = 10^{-6}$ .

Here the **[EXP]** calculator key comes in useful.

Example: Three capacitors have been connected in parallel (with values of 0.25 $\mu\text{F}$ , 2 $\mu\text{F}$  and 10 $\mu\text{F}$ ). As the values are all expressed in microfarads, we can add directly:

$$0.25 + 2 + 10 = 12.25\mu\text{F}$$

However, suppose the values to be added are expressed as follows: 0.1 $\mu\text{F}$ , 4,700pF and 220nF.

The equation can be written as  $(0.1 \times 10^{-6}) + (4,700 \times 10^{-12}) + (220 \times 10^{-9})$

Now, input to your calculator as follows (note the **[/-]** key will provide the negative exponent):

$$0.1 \text{ [EXP] } \text{[-]} 6 \text{ [+]} 4700 \text{ [EXP] } \text{[-]} 12 \text{ [+]} 220 \text{ [EXP] } \text{[-]} 9 \text{ [=]}$$

The calculator will now display 3.247 $^{-07}$ , expressed in farads. To convert to  $\mu\text{F}$ , reduce the exponent by  $^{-6}$ . The number now becomes 3.247 $^{-01}$ . Shift the decimal point one place to the left (to remove the exponent), and write as a decimal: 0.3247 $\mu\text{F}$ . Many calculators



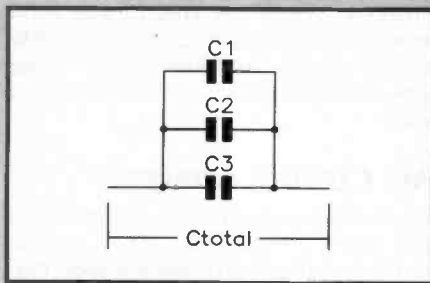


Figure 6. Capacitors in parallel.

have buttons marked **ENG** and **ENG**, or similar, which automatically adjusts the decimal point and exponent. When pressed, the 'engineering' buttons convert the number into the form where the exponent is a multiple or sub-multiple of 3, i.e.  $10^{-3}$ ,  $10^{-6}$ ,  $10^3$ ,  $10^6$ , etc.

As you become more familiar with using exponent values, you will find that there are further short cuts that you can make. The previous example used exponents of  $10^{-6}$ ,  $10^{-12}$  and  $10^{-9}$ . We could simplify the values by reducing the exponents by  $-6$ . The equation now becomes:

$$0.1 + 4700 \times 10^{-6} + 220 \times 10^{-3}.$$

Input as follows:

$$0.1 \text{ [ + ] } 4700 \text{ [ EXP ] } \text{[ / ] } 6 \text{ [ + ] } 220 \text{ [ EXP ] } \text{[ / ] } 3 \text{ [ = ]}$$

$$0.32\mu\text{F}$$

No further number conversion is necessary as the number is expressed in microfarads.

I stressed earlier that it is necessary to have some idea of the magnitude of the answer to an equation. My experience proves that whenever I am using a calculator or computer for my calculations, if I get an error, it is usually a big one, and providing I know roughly what to expect, I can detect it early, before the problem becomes compounded by further calculations. For example, using the previous values, if the answer produced an exponent of say  $-12$ , this would indicate an answer expressed as pF - clearly incorrect.

## Capacitors in Series

Connecting capacitors in series (see Figure 7) reduces their total value. This is because the plates are now effectively further apart.

The formula being:

$$C_{\text{TOTAL}} = \frac{1}{\frac{1}{C_1} + \frac{1}{C_2} + \frac{1}{C_3} + \dots + \frac{1}{C_n}} \quad \{12\}$$

Using the previous values of  $0.1\mu\text{F}$ ,  $4.700\text{pF}$  and  $220\text{nF}$ , first write the exponent values in microfarads:

$$0.1, 4700 \times 10^{-6}, 220 \times 10^{-3}$$

Input as follows, finding the reciprocals of each individual value:

$$0.1 \text{ [ 1/x ] } \text{[ + ] } 4700 \text{ [ EXP ] } \text{[ / ] } 6 \text{ [ 1/x ] } \text{[ + ] } 220 \text{ [ EXP ] } \text{[ / ] } 3 \text{ [ 1/x ] } \text{[ = ] } \text{[ 1/x ]}$$

The calculator display will show  $4.399 \times 10^{-3}$  which is expressed in  $\mu\text{F}$ . To con-

vert to the decimal equivalent, move the decimal point 3 places to the left. This now becomes  $0.004 \mu\text{F}$  or  $4.399\text{nF}$ .

The formulae for series and parallel inductance can be applied in the same way, remembering of course to include the **EXP** **[ / ]** 3 for mH and **EXP** **[ / ]** 6 for  $\mu\text{H}$ .

## Inductive and Capacitive Reactance

Reactance is the 'AC resistance to current flow' of a capacitor, or inductor, and is measured in ohms. The reactance of a capacitor decreases with increasing frequency, whilst for an inductor, the reactance increases.

The formulae provide the opportunity to introduce the **[ Pi ]**, or **[ π ]** calculator key. Pressing this will display a constant value of  $3.141592654$ , frequently used in electronic AC calculations. To access this function, we may need to use the **[ SHIFT ]** (also known as **[ INV ]**) key, but this depends upon your calculator type. Usually situated at the top left-hand corner of the calculator extended keys, it provides access to additional functions, including the 'inverse trigonometric' function (to be used later).

First, taking the formula for inductive reactance:

$$X_L = 2\pi fL \quad \{13\}$$

Suppose the applied frequency is  $100\text{Hz}$ , and the inductor has a value of  $0.2\text{H}$ . What is the inductive reactance?

Input to your calculator:

$$2 \text{ [ x ] } \text{[ π ] } \text{[ x ] } 100 \text{ [ x ] } 0.2 \text{ [ = ]}$$

which equals  $125.66\Omega$ .

Example: Frequency of  $2\text{kHz}$  and an inductance of  $5\text{mH}$ .

$$\text{Input as } 2 \text{ [ x ] } \text{[ π ] } \text{[ x ] } 2 \text{ [ EXP ] } 3 \text{ [ x ] } 5 \text{ [ EXP ] } \text{[ / ] } 3 \text{ [ = ]}$$

you should now have  $62.83$  on your display which is  $63\Omega$ .

## Capacitive Reactance

The formula for capacitive reactance is as follows:

$$X_C = \frac{1}{2\pi fC}$$

Example: Find the reactance of a  $0.1\mu\text{F}$  capacitor to an applied frequency of  $1\text{kHz}$ .

Input to your scientific calculator as follows:

$$2 \text{ [ x ] } \text{[ π ] } \text{[ x ] } 1 \text{ [ EXP ] } 3 \text{ [ x ] } 0.1 \text{ [ EXP ] } \text{[ / ] } 6 \text{ [ = ] } \text{[ 1/x ]}$$

Your calculator display will show  $1.591.55$  expressed in ohms. Converted to  $\text{k}\Omega$ , =  $1.591\text{k}\Omega$ .

## Resonant Frequency

When a capacitor and an inductor are connected in a series or parallel configuration, they will have a 'natural frequency of resonance' to an applied alternating

signal. The resonant frequency is determined by the formula:

$$F_o = \frac{1}{2\pi\sqrt{LC}} \quad \{14\}$$

This example allows the use of the square root calculator function.

Example: Find the resonant frequency of a  $0.1\mu\text{F}$  capacitor and a  $250\text{mH}$  inductor connected in either series or parallel.

To avoid the use of brackets, and the need to store subtotals, input the formula to your calculator as follows, using the equals sign to perform subtotals:

$$250 \text{ [ EXP ] } \text{[ / ] } 3 \text{ [ x ] } 0.1 \text{ [ EXP ] } \text{[ / ] } 6 \text{ [ = ] } \text{[ √ ] } \text{[ x ] } 2 \text{ [ x ] } \text{[ π ] } \text{[ = ] } \text{[ 1/x ]}$$

This returns an answer of  $1,006.58\Omega$  or,  $1\text{k}\Omega$ .

Note the **[ = ]** key must be pressed after the values for L and C have been multiplied to ensure that the square root is calculated as  $(L \times C)$ , and not just the square root of C. Also, use the **[ = ]** key before finding the reciprocal of the calculation.

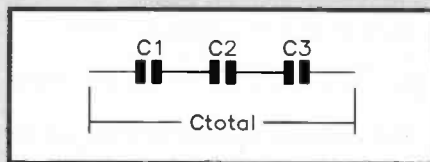


Figure 7. Capacitors in series.

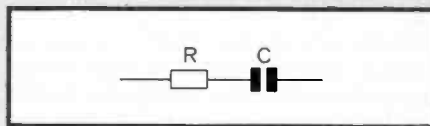


Figure 8. Series RC circuit.

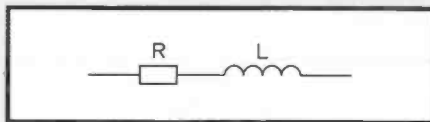


Figure 9. Series RL circuit.

## Circuit Impedance 'Z'

Impedance calculations are based on the Pythagorean theorem, where the square of the hypotenuse of a right-angle triangle equals the sum of the squares of the other two sides.

### RC and RL Series Circuits

As there is a  $90^\circ$  phase relationship between the applied voltage and the current flowing in a capacitor or inductor, we cannot, simply, add the individual voltages appearing across R and, C or L, when calculating the impedance. The formula for the RC series circuit (see Figure 8) is:

$$Z = \frac{1}{\sqrt{R^2 + X_C^2}} \quad \{15\}$$

and for the RL series circuit (See Figure 9):

$$Z = \frac{1}{\sqrt{R^2 + X_L^2}} \quad \{16\}$$

Using the series RC circuit as an example, it is first necessary to find the

reactance of C at the applied frequency. Using our previous example of a 0.1μF capacitor, with an applied frequency of 1kHz, the capacitive reactance was found to be 1,591Ω. Making the series resistor 1k; what is the circuit's impedance?

Input to your calculator:

1 [EXP] 3 [x<sup>2</sup>] + 1591 [x<sup>2</sup>] = [√]

The resultant impedance, 'Z', is 1,879.17Ω.

Again, to find the series impedance of the series RL circuit, using a previous example where a 0.2H inductor has a reactance of 125Ω at 100Hz, and connecting the inductor in series with a 500Ω resistor, we find the resultant series impedance from the following key presses:

500 [x<sup>2</sup>] + 125 [x<sup>2</sup>] = [√]

This returns a value of 515.39Ω

## Impedance of Parallel RC and RL Circuits

The formulae to find the resultant impedances are shown below.

Parallel RC (see Figure 10):

$$Z = \frac{R \times X_c}{\sqrt{R^2 + X_c^2}} \quad \{17\}$$

Parallel RL (see Figure 11):

$$Z = \frac{R \times X_L}{\sqrt{R^2 + X_L^2}} \quad \{18\}$$

Using the RC parallel circuit as our example: Suppose R = 1MΩ and X<sub>c</sub> = 500kΩ

Input to your calculator:

( [ 1 [EXP] 6 [x] 500 [EXP] 3 ] ) ÷ ( [ 1 [EXP] 6 [x<sup>2</sup>] + 500 [EXP] 3 [x<sup>2</sup>] ] ) = [√]

The value obtained should be 447213.60Ω (447kΩ) which, as we know for a parallel circuit, will always be lower than either R or X<sub>c</sub>.

The parallel RL circuit can be calculated in the same way.

## Determining the Resultant Phase Angle of the Series RCL Circuit

The scientific calculator has built in trigonometric SIN, COS and TAN functions. To demonstrate their use, consider a series RCL circuit (see Figure 12) where R = 10kΩ, and the reactance's of C and L at the applied frequency are 18kΩ and 25kΩ respectively. Calculate the resultant impedance and phase angle.

The formula for RCL series impedance is as follows:

$$Z = \sqrt{R^2 + (X_L - X_C)^2} \quad \{19\}$$

Note, if X<sub>c</sub> is larger than X<sub>L</sub>, reverse their positions. All values are in kΩ.

Input to your calculator:

10 [x<sup>2</sup>] + ( [ 25 - 18 ] [x<sup>2</sup>] ) = [√]

The circuit impedance is 12.21kΩ.

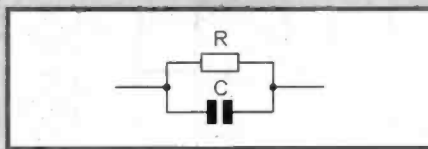


Figure 10. Parallel RC circuit.

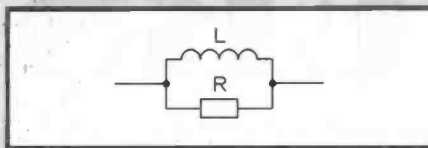


Figure 11. Parallel RL circuit.

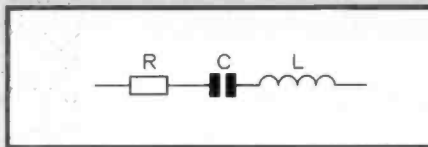


Figure 12. Series RCL circuit.

## Phase Angle

To find the phase angle, first ensure your calculator is in degrees mode, and not radians. Degrees mode is normally selected by a key marked [DEG], or similar.

The formula is:

$$\text{PHASE } \phi = \tan^{-1} \frac{X_L - X_C}{R} \quad \{20\}$$

Input to your calculator:

25 [ - ] 18 [ = ] ÷ 10 [ = ] [SHIFT] [tan]

The display will show 34.99

The resultant phase angle is therefore 34.99°.

## A More Complex Formula for Parallel RCL Impedance

Making R = 500kΩ; X<sub>L</sub> and X<sub>c</sub> 25kΩ and 18kΩ respectively (note, if X<sub>c</sub> is larger than X<sub>L</sub>, reverse their positions):

$$Z = \frac{R \times X_L \times X_C}{\sqrt{X_L^2 \times X_C^2 + R^2 (X_L - X_C)^2}} \quad \{21\}$$

Note the use of nested brackets. All values are in kΩ.

Input to your calculator:

( [ 500 [x] 25 [x] 18 ] ) ÷ ( ( [ 25 [x<sup>2</sup>] [x] 18 [x<sup>2</sup>] ] + 500 [x<sup>2</sup>] [x] ( [ 25 [ - ] 18 ] [x<sup>2</sup>] ) ) [√] =

The circuit impedance is 63.76kΩ.

## Finding Values of R and X<sub>c</sub> or X<sub>L</sub>

If we know the series RC or RL circuit impedance and its phase angle, we can determine the values of R and, X<sub>c</sub> or X<sub>L</sub>, using the SIN and COS trigonometric functions.

As an example, make the series circuit resultant impedance 'Z' = 5kΩ and the phase angle 34°. What is the value of R and, X<sub>c</sub> (for a capacitive circuit) or X<sub>L</sub> (if inductive)?

If X<sub>c</sub> and X<sub>L</sub> are both present, then the reactance is the difference between the values.

Formulae:  
To find R:

$$R = \text{COS } \phi \times Z \quad \{22\}$$

To find X<sub>c</sub> or X<sub>L</sub>:

$$X_c \text{ or } X_L = \text{SIN } \phi \times Z \quad \{23\}$$

Input to your calculator:

34 [cos] [x] 5 [EXP] 3 [ = ]

You will find that R = 4.145kΩ.

34 [sin] [x] 5 [EXP] 3 [ = ]

You will find that X<sub>c</sub> or X<sub>L</sub> = 2.796kΩ.

## Ratios of Current, Voltage and Power Gain/Loss

Determining the gain of an amplifier (measured in dB), as either voltage, current or power gain, gives us the opportunity to explore the [log] function key. Where the input and output circuit impedances are equal, we can use the simple formulae:

$$\text{Voltage gain (dB)} = 20 \log \frac{V_{\text{out}}}{V_{\text{in}}} \quad \{24\}$$

$$\text{Current gain (dB)} = 20 \log \frac{I_{\text{out}}}{I_{\text{in}}} \quad \{25\}$$

$$\text{Power gain (dB)} = 10 \log \frac{P_{\text{out}}}{P_{\text{in}}} \quad \{26\}$$

### Example of Voltage Gain

Voltage in = 0.2V; Voltage Out = 5V. Calculate the voltage gain.

Calculator input:

5 ÷ 0.2 [ = ] [log] [x] 20 [ = ]

The voltage gain is found to be 27.96dB.

### Example of Current Gain

Current in = 5mA; Current Out = 50mA. Calculate the Current gain.

Calculator input:

50 ÷ 5 [ = ] [log] [x] 20 [ = ]

The current gain is found to be 20dB. Note, as the decibel measurement is a ratio, we do not need to concern ourselves, in this instance, with the fact that current is measured in mA, or perform any conversion.

### Example of Power Gain

Power in = 20mW; Power Out = 5mW. Calculate the power loss.

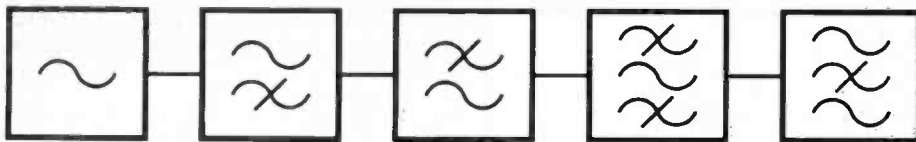
Calculator input:

5 ÷ 20 [ = ] [log] [x] 10 [ = ]

The power loss is found to be -6.02dB.

Continued on page 48.





# FILTERS

## Part 1: Why and How?

J. M. Woodgate B.Sc.(Eng.), C.Eng., M.I.E.E., M.A.E.S., F.Inst.S.C.E.

Regular readers will know that many of my articles mention the use of filters, so it seems appropriate to discuss them, generally, in a devoted series.

### What are Filters, and What are They For?

Originally, a filter circuit was one with a defined, non-flat frequency response. The concept has been extended to include circuits with flat frequency response but, with a defined, non-flat phase response, including 'phase proportional to frequency' (which is a pure time-delay). Even further extensions of the concept have been made in software engineering, as opposed to circuit design, but we will not be dealing with those.

Filters seem to have originated in fairly early developments of long-distance carrier telephone circuits, enabling one pair of wires to carry more than one conversation. Although the tuned circuits used in early radio equipment were, in fact, filters, they were generally not recognised as such.

Figure 1. A filter considered as a 'black box', with a source and load.

Figure 2. Argand diagram showing sigma and  $j\omega$  axes, and two conjugate complex poles.

Figure 3. Plot of  $T(s)$  as a surface on the Argand diagram.

Because the first filters were used in matched transmission lines (the traditional '600Ω circuits'), filter theory was constrained for many years to this one application. Most filters, however, are not used in transmission lines, and new design methods have greatly eased the achievement of near-theoretical performance, even of complex filters.

In principle, filters are used to discriminate between signals by their frequencies. One of the most obvious cases is the passive crossover network, used in multiple-driver loudspeaker systems, which is a set of filters with their inputs connected in parallel to the amplifier; and their outputs connected to the appropriate drivers. However, there are many other applications of filters in common use; for example, treble and bass tone-controls, and graphic equalisers are filters, as are the fixed- and variable-

tuned circuits in receivers. More clearly identifiable as filters are the circuits which strongly attenuate sub-carriers, such as the 19kHz and 38kHz sub-carriers of the pilot-tone stereo radio system, and the 4.43MHz colour sub-carrier of the PAL television system.

Filters are used widely in measuring instruments; one basic purpose is to define the bandwidth within which measurements are made. This is very important, since out-of-band signals may produce serious errors. I recall that soon after I entered industry, I was unable to obtain sensible answers in trying to measure the noise level of an audio amplifier, which seemed to measure far more noisy than it sounded. It was then pointed out to me that the meter I was using had a bandwidth of 5Hz to 10MHz, and I was measuring the noise in the whole of this wide band, instead of the 20Hz to 20kHz audio band! Since the noise voltage is, in principle, proportional to the square root of the bandwidth, the out-of-band noise could have been up to 22 times larger than the in-band component.

### Modern Network Theory

The old filter design methods referred to 'constant- $k$ ' and ' $m$ -derived' configurations. If you remember these, *please forget all about them*. If filters of these types need to be studied, that study should come after the new methods have been understood. Figure 1 shows a filter with source and load impedances (pure resistors), represented as a 'black box', i.e. we do not know (or care) what is inside it, only how it behaves as seen from the input and output terminals. Generally, we are interested in the ratio of output voltage  $U_o$  to source voltage  $E_s$ , but *current-mode* filters exist, where we are interested in the ratio of output to input current. The same design methods work for both, but the circuits are, naturally, different.

Here, we go into a little mathematics, but it is nothing to be frightened of. The ratio  $T = U_o/E_s$  depends on the impedances of the components within the box, some of which must be either capacitors or inductors (both may be present); a filter cannot be made exclusively from resistors! This means that the ratio is, in general, a *complex number*, containing that mysterious

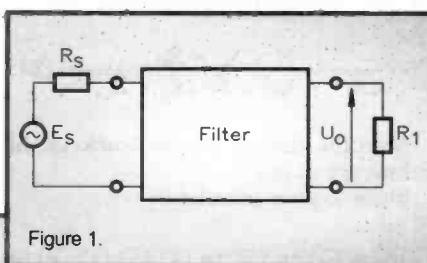


Figure 1.

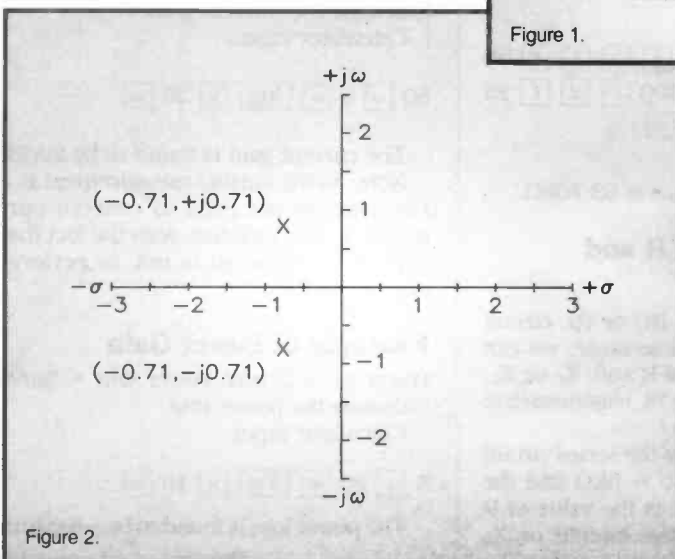


Figure 2.

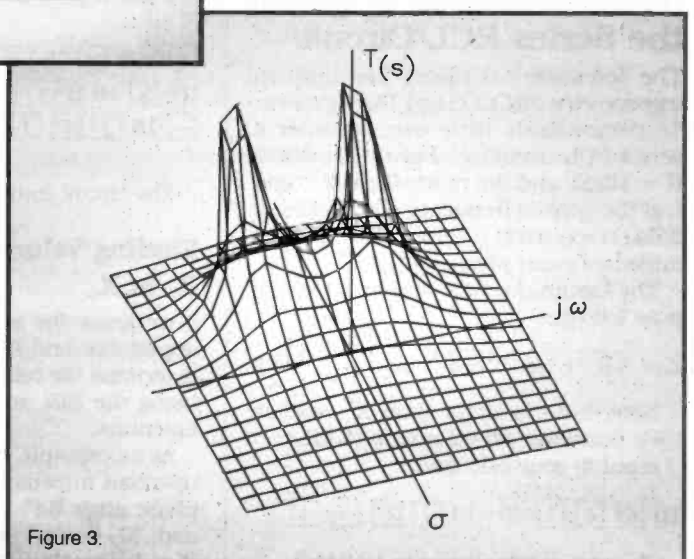
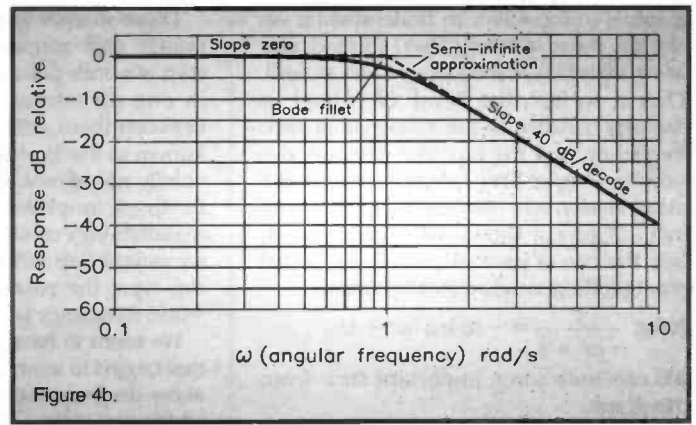
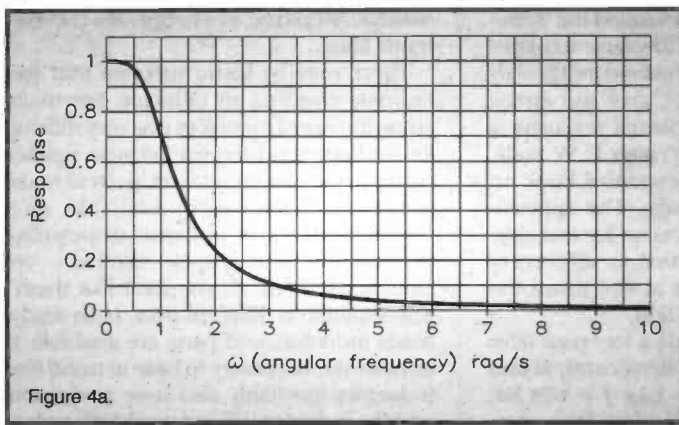


Figure 3.



quantity  $j$ , the square-root of minus 1, always associated with  $2\pi$  times the frequency  $f$ , to which the symbol  $\omega$  (omega) is given. In other words,  $T$  depends on, or is a function of,  $j\omega$ . The writing of equations is easier if we use  $s$  instead of  $j\omega$ . Furthermore, by allowing  $s$  itself to be a complex number,  $\sigma + j\omega$ , we can not only find out some very important properties of the filter (as it affects repetitive signals (sine waves or combinations thereof)), but also its effects on impulsive signals (isolated pulses or steps). The variable  $\sigma$  is associated with the energy losses in the circuit, while  $\omega$  is associated with the energy storage (in capacitors and/or inductors).

In general,  $T(s)$ , the *transfer function* of the filter, is the ratio of two functions of  $s$ , which we call  $N(s)$  (for Numerator) and  $D(s)$  (for Denominator):

$$T(s) = \frac{N(s)}{D(s)}$$

Now, interesting and important things happen when  $N(s) = 0$ , and when  $D(s) = 0$ . The first case is easier to understand; if  $N(s) = 0$ ,  $T(s) = 0$ , so  $U_o = 0$ , i.e. the output voltage is zero: the filter has infinite attenuation (in theory). Not surprisingly, the value(s) of  $s$  at which this occurs is called a *zero*. However, if  $D(s) = 0$ , the value of  $T(s)$  is infinite (almost anything divided by zero is infinite). It does not seem very likely that we can produce an infinite voltage in this way! We have to remember that  $s$  is not an ordinary number but a complex number. When we convert  $T(s)$  back into a function of  $j\omega$ , and then derive the *modulus* by a mathematical process called *rationalisation*, we find that  $|T(j\omega)|$  (read: 'mod T of j-omega') is not infinite at any physically realisable frequency. Even so, the values of  $s$  for which  $T(s)$  is infinite are important, and they are called 'poles'. An example may help; suppose:

$$N(s) = 1$$

(simple), and:

$$D(s) = s^2 + \sqrt{2}s + 1$$

(apparently not so simple, but we shall see!). This combination of  $N(s)$  and  $D(s)$  represents a *second-order* filter, so-called because the highest power of  $s$  in  $T(s)$  is the second ( $s^2$ ).

Then:

$N(s)$  is always 1, so there are no zeroes, while

$$D(s) = 0 \text{ if } s = \frac{-1}{\sqrt{2}} \pm \frac{j}{\sqrt{2}}$$

i.e. there are poles at these two values of  $s$ . Now, while we are concerned only with

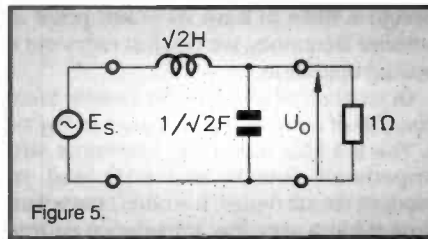


Figure 4a. Response of the normalized second-order filter plotted on linear axes.

Figure 4b. Response of the normalized second-order filter plotted on logarithmic frequency and logarithmic (decibel) response axes.

Figure 5. Second-order low-pass filter for zero source impedance and 1Ω load impedance.

sinusoidal signals,  $s = j\omega$ , so we can substitute for  $s$  in  $T(s)$  to get  $T(j\omega)$ :

$$T(j\omega) = \frac{-1}{\omega^2 - \sqrt{2}j\omega - 1}$$

We have to get rid of the  $j$  terms in the denominator and we do this (*rationalise*) by using the fact that:

$$(x + jy)(x - jy) = (x^2 + y^2)$$

We also need the ideas of the *modulus* of a complex number, written  $|(x + jy)|$ , which is an ordinary ('real') number  $\sqrt{x^2 + y^2}$ , and the *argument*, which is an angle  $\phi$ , equal to  $\arctan(y/x)$ .

Thus:

$$T(j\omega) = \frac{-1}{(\omega^2 - 1) + \sqrt{2}j\omega}$$

and the modulus of this, which represents the amplitude/frequency response of the filter, is:

$$\begin{aligned} |T(j\omega)| &= \frac{\sqrt{(\omega^2 - 1)^2 + 2\omega^2}}{(\omega^2 - 1)^2 + 2\omega^2} \\ &= \frac{1}{\sqrt{(\omega^2 - 1)^2 + 2\omega^2}} \\ &= \frac{1}{\omega^2 + 1} \end{aligned}$$

Now, when  $s = -1/\sqrt{2} \pm j/\sqrt{2}$ ,  $\sigma = -1/\sqrt{2}$  and  $\omega = \pm 1/\sqrt{2}$ .  $\omega$  can be either positive or negative, but for practical purposes the negative sign is of no significance: negative frequencies are exactly the same as positive frequencies. In fact, complex poles can only occur in pairs, with  $j$ -terms of opposite sign (*conjugate pairs*). Furthermore, while the  $j$ -term may be zero (resulting in a 'real pole'), the  $\sigma$  term must be negative. It can be shown that a positive  $\sigma$  ('real') term

implies that the network possessing such a pole is a net emitter of energy, i.e. the circuit is oscillating. This is, of course, impossible for a network of only resistors, capacitors and inductors, and if we use active devices as well, oscillation is not at all desirable if we intended to make a filter.

The argument angle  $\phi$  is the phase-shift introduced by the filter, and thus:

$$\tan\phi = \frac{\sqrt{2}\omega}{\omega^2 - 1}$$

There is one special case to consider: If, for some value of  $s$ , both  $N(s)$  and  $D(s)$  are zero,  $T(s)$  is of the form  $0/0$ , which can take any value. In this case, we have a coincident pole and zero, and we have to use deeper mathematical analysis to find out what  $|T(j\omega)|$  actually does. Luckily, this problem does not arise very often.

## Graphical Presentation

We can present any complex number,  $\sigma + jy$ , by a point  $(\sigma, \omega)$  on a graph; this is called an Argand diagram (Figure 2). It is just like an ordinary graph, but it allows us to find geometrical representations of complex numbers, and operations on them. Consider the positive part of the  $\sigma$ -axis. Movement to the right represents an increase in the value of  $\sigma$ . Movement to the left of the origin ( $\sigma = 0$ ) brings us into the area of negative numbers. If we draw an arrow (vector) from the origin to a point  $\Sigma$  on the positive  $\sigma$ -axis, multiplication of that value  $\Sigma$  by  $-1$  brings us to the point  $-\Sigma$ , and the arrow has rotated by half a turn ( $\pi$  radians or  $180^\circ$ ) anticlockwise. So, multiplying by  $-1$  is equivalent to rotating the arrow by half a turn, and this is therefore equal to multiplying by  $j$  twice. Thus, multiplying by  $j$  is equivalent to turning through a quarter turn ( $\pi/2$  radians or  $90^\circ$ ), which is the same as measuring along the  $\omega$ -axis.

This means that we can plot the pole locations  $(-1/\sqrt{2} \pm j/\sqrt{2})$  of our example, and they are conventionally indicated by crosses, as shown in Figure 2. We do not have any zeroes, but if we did - they would conventionally be indicated by small circles.

With the aid of the trusty computer, we can actually plot a perspective view of  $T(s)$  as a surface above an Argand diagram (Figure 3), and we can indeed see the two poles or, at least, the surrounding 'mountains'.

## Normalization

If we plot a graph of  $|T(j\omega)|$  against  $\omega$ , we find that it is nearly constant, at a value of 1, until  $\omega$  approaches 1. The shape of this



graph is much easier to understand if we plot the value of  $20\log|T(j\omega)|$  instead, and use a logarithmic frequency scale as well. This is, in fact, the 'level' of  $|T(j\omega)|$  in decibels, relative to the response at zero frequency, and the fact that decibels give simpler plots of filter response shapes is a major reason why electronic engineers use them. Figure 4 shows the result, and, in fact, the use of decibels makes the actual point plotting much easier because:

$$20\log \frac{1}{\omega^2 + 1} = -10 \log (\omega^2 + 1)$$

We can note some important facts from this graph:

- We have a *low-pass filter*, i.e. the response is nearly 0dB (or  $\times 1$ ) up to a certain frequency, with no peaking, and above that frequency it falls off uniformly.
- The response is -3dB (i.e. the output power is half the input power) at the frequency  $\omega = 1$ .
- The slope of the response at high frequencies tends rapidly to a constant value, which may be expressed as 12dB/octave (an octave is a frequency ratio of 2:1) or 40dB/decade (a decade is a frequency ratio of 10:1).
- We can, therefore, draw two straight lines which give a close approximation to the frequency response, except in the region around the -3dB point.

These straight lines are called the 'semi-infinite approximation' (because the lines start at a finite point and extend indefinitely in one direction only), and the space between them and the actual response is known as the 'Bode fillet', after H. W. Bode, chiefly noted now for a seminal book on feedback amplifier design. The approximation is very useful because, for example, we can tell immediately that, for all filters of this type, the response at five times the -3dB frequency is -28.5dB.

We seem to have made a low-pass filter that begins to attenuate significantly at and above the frequency  $\omega = 1$ , i.e.  $f = 1/2\pi$  Hz, which is 0.16Hz - rather a low frequency. This does not matter a bit, because to design a filter to have its -3dB point at another frequency, we can just carry out a scaling operation.

One circuit which gives the transfer function  $T(s)$  of our example is shown in Figure 5. This is a filter that works between a zero impedance source, and a 1Ω load. In modern circuit design, it is often convenient to provide a very low impedance source (e.g., an emitter follower or an op amp follower) to drive a filter which, in turn, feeds a high impedance load (emitter follower or non-inverting op amp). A filter designed the other way round, i.e. to be fed from a high impedance source (a transistor collector, for example) and to feed a low impedance load (a common-base stage, for

example) would be an example of a current-mode filter.

There may be some surprise that this example contains an inductor. For many years, the use of inductors was very difficult for the home-constructor because, neither ready-made components, or parts to make inductors, were readily available. As a result, inductors became unpopular through the 'sour grapes' reaction - 'we cannot get them, so we don't like them'. The situation is different now) both ready-made inductors and parts are available. It is, however, necessary to bear in mind that inductors inevitably also have resistance, and the inductor will not work well unless its reactance ( $2\pi fL$ ) is much larger than its resistance  $R$  at all the frequencies  $f$  of interest, i.e. its  $Q$  is reasonably high, say greater than 10.

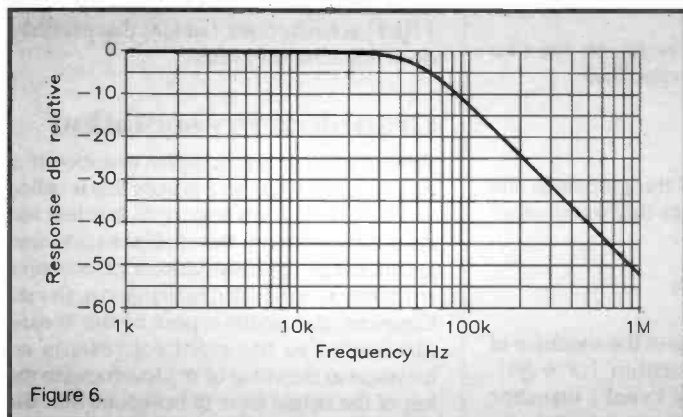


Figure 6.

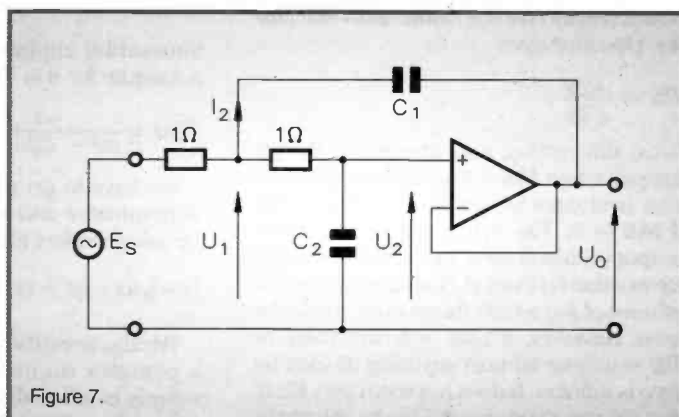


Figure 7.

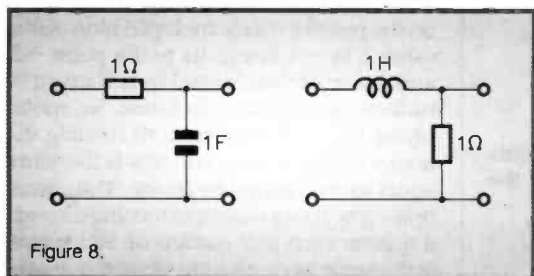


Figure 8.

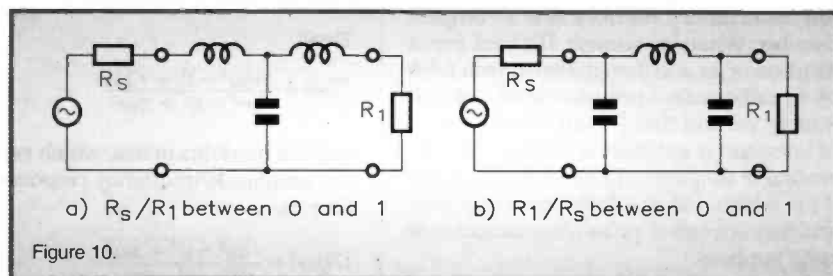


Figure 10.

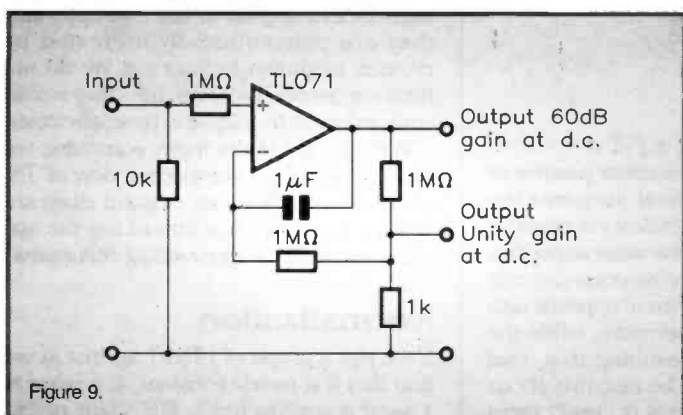


Figure 9.

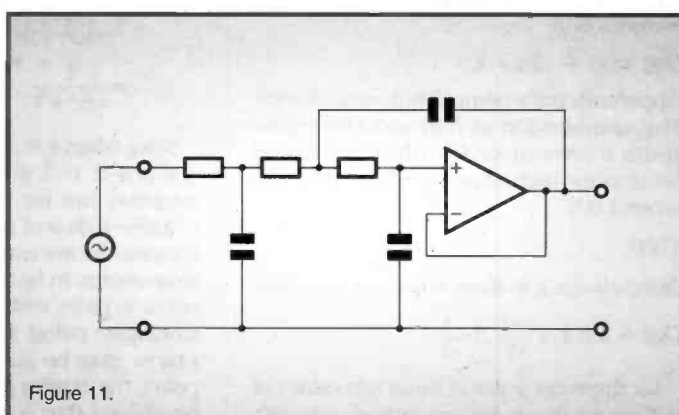


Figure 11.

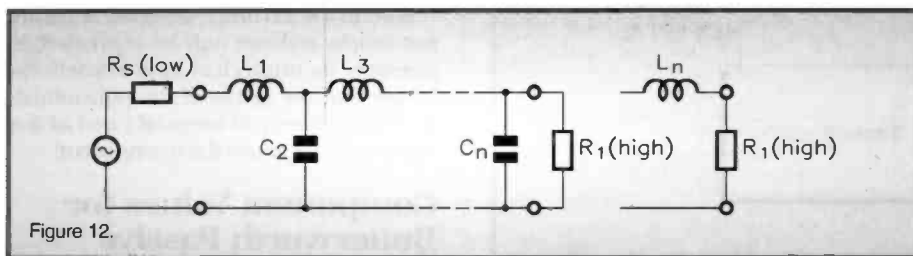


Figure 12.

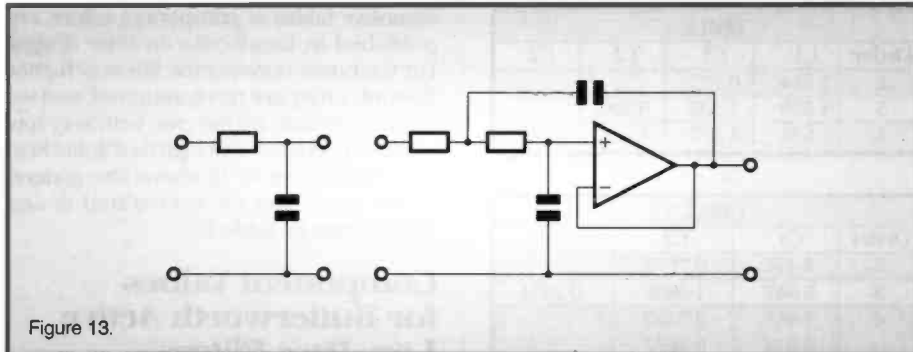


Figure 13.

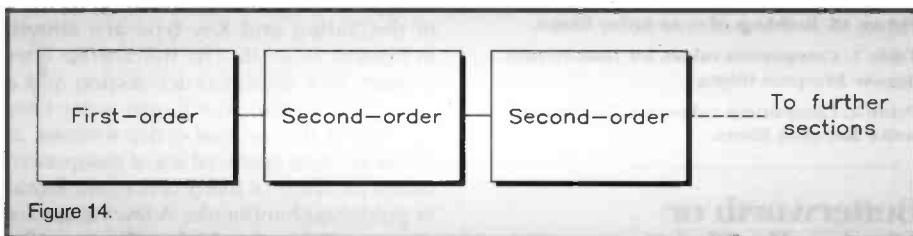


Figure 14.

Figure 12. General passive low-pass filter with low source impedance and high load impedance.

Figure 13. Basic first- and second-order active low-pass filter building blocks, or 'sections'.

Figure 14. Build-up of odd-order active filters.

To design a filter to feed a load value different from  $1\Omega$ , we can just carry out another scaling operation. This means that we need only find out how to design filters whose  $-3\text{dB}$  angular frequency  $\omega$  (not  $f$ ) is 1, and whose source impedance is zero (or nearly so) and load impedance is  $1\Omega$ . This concept of reducing everything possible to a value of 1 is called *normalization*, and the scaling processes are thus *denormalization*. We could also find out how to design filters with a finite ratio of load to source impedance, but these are less often required in home-constructor designs.

## A Usable Low-Pass Filter

Let us use the above ideas to design a passive LC filter with the following specification:

- Source impedance:  $100\Omega$
- Load impedance:  $10\text{k}\Omega$
- $-3\text{ dB}$  frequency:  $50\text{kHz}$
- Attenuation at  $200\text{kHz}$ :  $>20\text{dB}$

The semi-infinite approximation in Figure 4 tells us that, for the only type of filter that we know about at present, the attenuation at four times the  $-3\text{dB}$  frequency (often called the 'cut-off frequency', which is misleading, or the 'corner frequency', which is much better) is  $23\text{dB}$ , which comfortably meets the specification.

Because the load impedance is at least 10 times the source impedance, we can use

the 'zero source/ $1\Omega$  load' model, but the load is  $10^4\Omega$ , not  $1\Omega$ . We do the scaling operations as follows:

$$\text{Frequency scale factor } 2\text{PIEF} = 2\pi \times 50 \approx 10^3$$

We divide all the inductance and capacitance values by  $2\text{PIEF}$ :

$$L = \frac{\sqrt{2}}{\pi \times 10^3} = 4.5\mu\text{H}$$

$$C = \frac{1}{\sqrt{2} \times \pi \times 10^5} = 2.25\mu\text{F}$$

$$\text{Impedance scale factor } Z = 10^4$$

We multiply the inductance values by this factor, and divide the capacitance values (this is logical, because these operations increase the impedance of both types of component). We get:

$$L = 4.5 \times 10^{-6} \times 10^4 = 45\text{mH}$$

$$C = 2.25 \times 10^{-6} \times 10^{-4} = 225\text{pF}$$

## Effects of Losses

The theoretical response of a filter with these values is shown in Figure 6. However, we have assumed that the components are ideal, i.e. that the inductor has no resistance and the capacitor no losses. The effects of losses are quite difficult to deal with theoretically, and the best course of action is to aim for low losses. This means ferrite-cored, rather than air-cored, inductors at low and medium frequencies, and low-loss ceramic, silver mica, polystyrene or polypropylene capacitors, rather than polyester. However, there is another solution.

## Active filters

The LC filter, taken as an example above, is only one way of arriving at the chosen  $T(s)$ . Consider the circuit shown in Figure 7,

which is an example of a *unity-gain single-feedback* or *Sallen and Key* active filter (named after the two authors who fully described this type of filter). Since its operation seems mysterious, a detailed analysis is called for, but to make it reasonably brief, we will use two somewhat sophisticated ideas in circuit analysis. The first is simply to use  $s$  instead of  $j\omega$ , which is not a new idea now, and the second is to recall that, using  $s$ , the current  $I$  through a capacitor  $C$  is simply  $sCU$ , where  $U$  is the voltage across it:  $sC$  is the *susceptance* of  $C$ , the reciprocal of the reactance.

Since the op amp follower has a gain (from the non-inverting input to the output) very close indeed to 1, we have:

$$U_0 = U_2 = \frac{I_1}{sC_2}$$

so that

$$U_1 = I_1 \left( 1 + \frac{1}{sC_2} \right) \text{ (because } R_2 = 1\Omega \text{)}$$

Also

$$I_2 = (U_1 - U_0)sC_1$$

and

$$E_s = U_1 + (I_1 + I_2) \times 1 \text{ (because } R_1 = 1\Omega \text{)}$$

Thus

$$I_1 = U_0 s C_2$$

so that

$$U_1 = U_0 (1 + sC_2)$$

and

$$I_2 = U_0 s^2 C_1 C_2$$

Therefore

$$E_s = U_0 (1 + 2sC_2 + s^2 C_1 C_2)$$

and

$$T(s) = \frac{1}{1 + 2sU_2 + s^2 U_1 U_2}$$

Now, the denominator  $D(s)$  is a quadratic in  $s$ , so that, if the roots of  $D(s) = 0$  (i.e. the poles) are  $s = -\alpha \pm j\beta$ , we have:

$$(s + \alpha + j\beta)(s + \alpha - j\beta) = 0,$$

so that

$$s^2 + 2\alpha s + (\alpha^2 + \beta^2) = 0$$

or

$$\left( \frac{1}{\alpha^2 + \beta^2} \right) s^2 + \left( \frac{2\alpha}{\alpha^2 + \beta^2} \right) s + 1 = 0$$

Hence

$$C_1 C_2 = \frac{1}{\alpha^2 + \beta^2},$$

also

$$2C_2 = \frac{2\alpha}{\alpha^2 + \beta^2},$$

Thus

$$C_2 = \frac{\alpha}{\alpha^2 + \beta^2},$$

also

$$C_1 = \frac{1}{\alpha}$$

Now, we know that the poles are at  $s = -1/\sqrt{2} \pm j/\sqrt{2}$ , so  $\alpha = 1/\sqrt{2}$ , and  $\beta = 1/\sqrt{2}$  as well. Therefore:

$$C_2 = 1/\sqrt{2} \text{ and } C_1 = \sqrt{2}.$$

These values are in farads (!) because this filter, too, is normalized. We have to scale for frequency and impedance, as we did for the LC filter. However, there is one difference: our new filter has a high(ish) input impedance and a low output impedance, which does not depend on the values of the filter components. So, we do not use the impedance scaling to suit the load impedance but, to get practical values for the components. Instead of  $1\Omega$  resistors, the popular  $10\text{k}\Omega$  is quite suitable. So our  $Z$  factor is  $10^4$ , and the



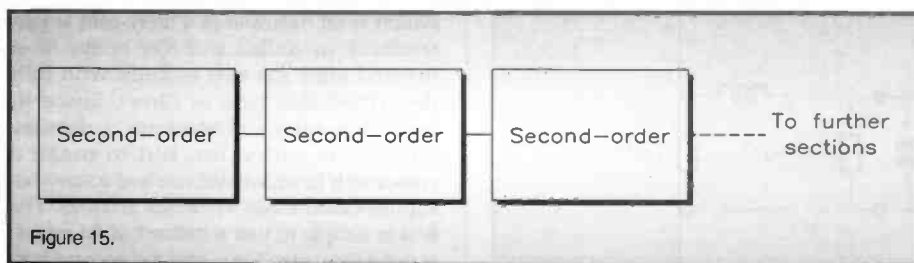


Figure 15.

capacitor values change to  $71\mu\text{F}$  and  $142\mu\text{F}$ . These are very big because  $\omega$  is still equal to 1. Suppose we want the corner frequency to be  $15\text{kHz}$ ; the  $2\text{PIEF}$  factor is  $2\pi \times 1.5 \times 10^4$  and the capacitance values change to  $753\text{pF}$  and  $1.51\text{nF}$ , which are very practical values. Note that the resistor values do not change in the frequency de-normalization process.

## Filters of Other Orders

We started with a second-order filter because the pole-zero analysis of first-order filters is so trivial that it is difficult to extend to second- and higher-order filters. Figure 8 shows two identical passive first-order low-pass filters which have a pole at  $s = 1$ , and a  $-3\text{dB}$  response at  $\omega = 1$ . The final slope of the response, above the corner frequency, is  $6\text{dB}$  per octave, or  $20\text{dB}$  per decade. In fact, for the types of low-pass filter that we shall study, the final slope is always  $6n\text{dB}$  per octave, where  $n$  is the order of the filter. It is possible to make first-order active filters, as shown in Figure 9, but they are normally only used where the corner frequency is to be very low, such that a passive filter would require very high resistor and capacitor values. The gain of the op amp, controlled by the external feedback resistors, is used to multiply the effective capacitance value; for example, with a FET-input op amp set for a closed-loop gain  $A$  of 1,000, a  $1\text{M}\Omega$  resistor and a  $1\mu\text{F}$  capacitor, a low-pass filter with a corner frequency of  $1/2\pi ACR = 1.6 \times 10^{-4}\text{Hz}$  can be made. Such filters are not normally required for home-constructor projects, but you never know. . . .

First order filters always have a single real pole at  $\sigma = 1$ . Third-order filters can be made with two capacitors and an inductor (or vice versa), as shown in Figure 10, or by combining a passive first-order filter with an active second-order filter, as shown in Figure 11. The procedures for finding component values for filters of higher than second-order are not simple.

Order	L1	C1	L2	C2
2	1.414	0.707		
3	1.500	1.333	0.500	
4	1.531	1.577	1.082	0.383

Order	C1	C2	C3
2	1.414	0.7071	
3	3.547	1.3920	0.2024
4	1.082 2.613	0.9240 0.3825	

Figure 15. Build-up of even-order filters.

Table 1. Component values for Butterworth passive low-pass filters.

Table 2. Component values for Butterworth active low-pass filters.

## Butterworth or Maximally-Flat Response

We noted that the response of our second-order filter was  $0\text{dB}$  at very low frequencies, and did not peak or rise above this value at any frequency. This characteristic is called 'maximal flatness', and filters with this property are called 'Butterworth filters', after S. Butterworth who first described them (in 1930). He showed, mathematically, that the sharpest possible rate of increase of attenuation, coupled with the absence of peaking, is achieved if  $D(s)$  is what has become known as a 'Butterworth polynomial'. 'Polynomial' simply means a sum of powers of  $s$ . There is a procedure for generating Butterworth polynomials of any order (highest power of  $s$ ), but for the present purpose a list will suffice:

Order	Butterworth polynomial in $s$	Butterworth polynomial in $j\omega$
1	$s$	$\sqrt{1 + \omega^2}$
2	$s^2 + \sqrt{2}s + 1$	$\sqrt{1 + \omega^4}$
3	$s^3 + 2s^2 + 2s + 1$	$\sqrt{1 + \omega^6}$

Beyond the 3rd order, the coefficients are not simple and can only be expressed, in practice, as numerical approximations. Notice that the forms of the polynomials are quite different in terms of  $s$  and  $j\omega$ ; it is important not to use the wrong form!

## Component Values for Butterworth Passive Low-Pass Filters

Extensive tables of component values are published in handbooks on filter design. For the home-constructor, filters of higher than 4th order are rarely required, and we can concentrate on the case with very low source impedance and high (but finite) load impedance. Figure 12 shows the general circuit form, and the normalized design data is given in Table 1.

## Component Values for Butterworth Active Low-Pass Filters

The general forms of active low-pass filters of the Sallen and Key type are shown in Figures 13 to 15. The third-order filter consists of a second order section and a first-order section. The fourth-order filter consists of two second-order sections in cascade. Once again, tables of component values for filters of many orders are found in published handbooks. A few values are given in Table 2, which will cover the majority of fairly simple applications.

## Active or Passive?

Both types of filter have their advantages: For low-frequency, small-signal use, active filters are less costly and more accurate, since capacitors are much less lossy than inductors. It is a pretty poor capacitor that has a  $Q$  of 100, whereas that is a high value for an inductor. However, they need a power supply, and accuracy falls off above the audio frequency band unless wide-band op amps are used. There are also some types of filter (not low-pass) which require many op amps, but rather few components in the passive version.

## Why Low-Pass Filters?

We have only looked at low-pass filters this time because it is possible to deduce the characteristics of most other types of filter from them: high-pass; band-pass; and band-stop. That will be the subject next month.

## IMPROVE YOUR CIRCUIT DESIGN - Continued from page 43.

### Summary

I have attempted to show how easy it is to improve your circuit design with the use of the scientific calculator. As you will see from examining the array of keys present, there are many that we have not used - nor do we need to.

The secret of good circuit analysis is knowing what to expect from the circuit that you are designing. To ensure that you get accurate results from your analysis, it is helpful to be able to break your circuits into manageable parts. A complex circuit will have many current paths in parallel with the ones you are trying to measure, and they are not always easy to

spot. To avoid this problem, design your circuit in modules, making sure that you check each stage before proceeding further. Ensure that the DC conditions are correct before determining the values of coupling or decoupling capacitors.

Where a capacitor appears in parallel with a resistor, the combination will present an impedance to the AC signal which, as we have seen, can be calculated. You probably will not be able to measure 'Z' directly, but it could represent a possible design error by effectively shorting-out your AC signal (at one particular/all frequencies). I have shown that you can easily determine the AC gain

of your amplifier by using a few key-strokes (in the right order of course!).

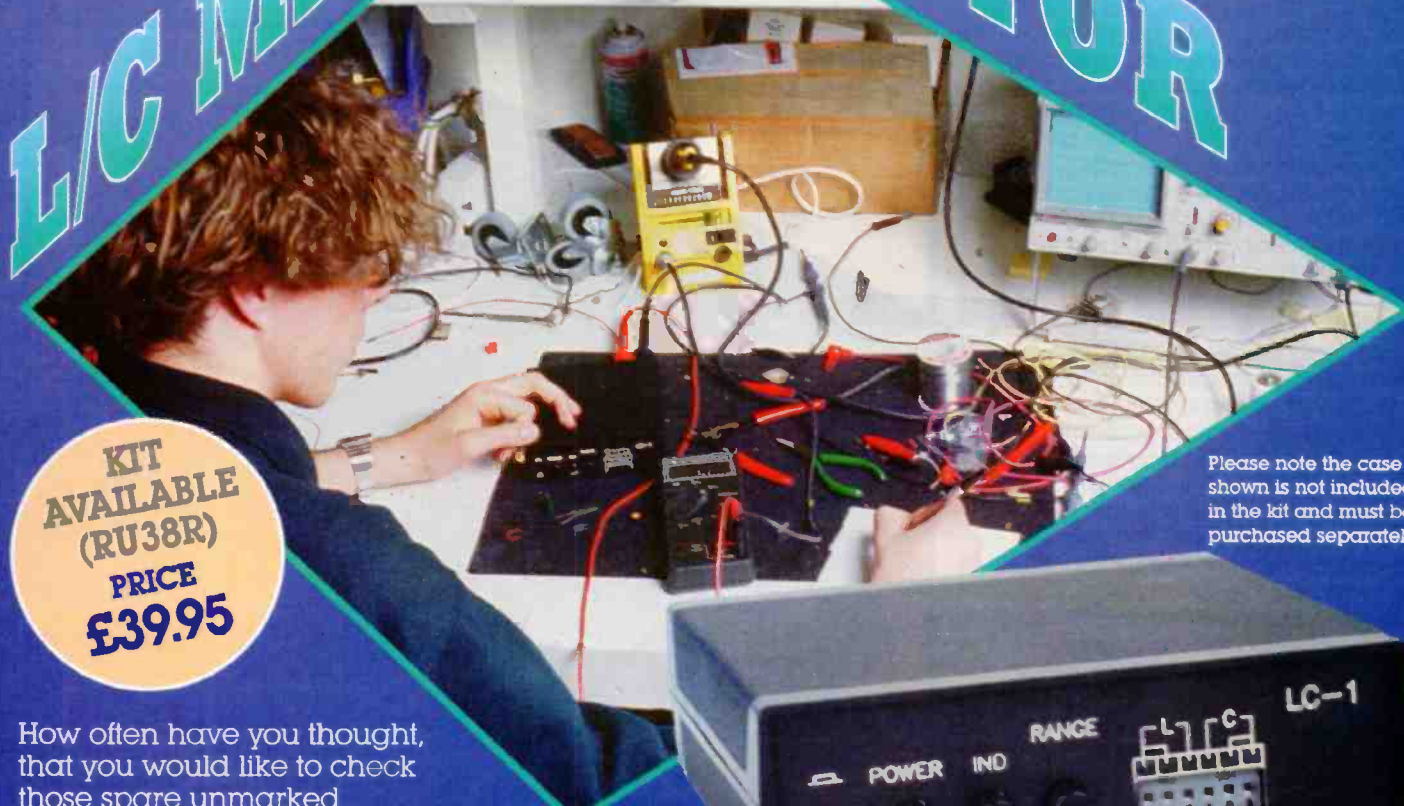
A good textbook, of which there are many, will provide a comprehensive list of commonly used formulae. Practise with your scientific calculator, and check your answers with those (usually) supplied. As you practise, you will become familiar with certain component combinations, which can be easily remembered. For example, the reactance of a  $0.1\mu\text{F}$  capacitor will be approximately the same as that for a  $250\text{mH}$  inductor at an applied frequency of  $1\text{kHz}$ , or when the impedance phase angle is  $45^\circ$ , the resistive and reactive values will be equal.

Text by Robin Hall

- \*Easy to Build
- \*On-board Regulator
- \*Calibration components included



# L/C METER ADAPTOR



**KIT AVAILABLE (RU38R) PRICE £39.95**

Please note the case shown is not included in the kit and must be purchased separately.



How often have you thought, that you would like to check those spare unmarked capacitors and inductors lying about in the bits box? They are normally kept with the thought that one day they might be useful, but when the heat is on to complete a project, they are left behind. Well, this need not be the case!

**T**HIS project will enable the hobbyist to measure those unmarked capacitors and inductors, and find out if they are in satisfactory working order, or finally retire them to the rubbish bin. Also it will be useful when having to make up precise inductor values for other projects, especially if they are not readily available as off the shelf values.

The operation of the L/C Meter Adaptor is straightforward once calibrated. A digital multimeter (DMM) or high impedance analogue multimeter is required to display the value of the component and is used in conjunction with the L/C Meter Adaptor.

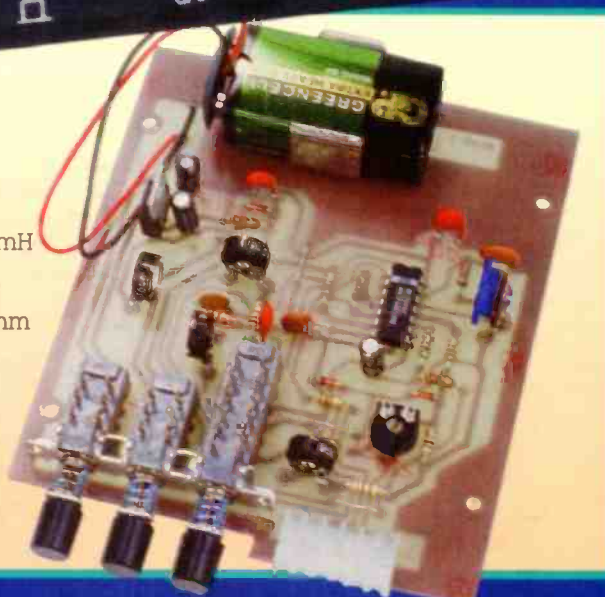
## Circuit Description

Referring to Figure 1, which shows the block diagram for the L/C Meter Adaptor, and Figure 2, the circuit

## Specification

DC power supply voltage: +9V DC  
 Supply current: 7.5mA  
 Inductance ranges: 10µH to 10mH  
 Capacitance ranges: 1pF to 2µF  
 PCB size: 120 x 102mm

Above right: The assembled PCB in the optional case. Right: Close-up of the Assembled L/C Meter Adaptor PCB.



diagram, circuit operation is as follows:

The power for the circuit is obtained from a +9V PP3 battery which is then regulated to +5V DC by a 7805 regulator.

There are effectively two circuits, each working separately, on the board. One is the capacitance section and the other the inductance section. Both operate on similar principles, that of comparison with a 'reference'

component. The difference between the two comparators is then converted to a voltage and this is measured by the meter. Using very simple multiplication factors these measurements can be equated with either inductance or capacitance values, depending on the form of measurements being taken. Both the capacitance and inductance measuring circuits have two ranges, for high and low values.



## The Capacitance Section

The capacitance section uses two separate comparators. The comparators form the basis of two sections, one which has a reference capacitor C5, located on the PCB, and the other section which has the capacitor under test. An oscillator running at about 400Hz is based around IC U1:F, R2 adjusts the frequency of operation, and sets the low capacitance calibration point.

R7 and R8 are switched out of circuit in the low range, and the oscillator's signal is coupled to the unknown capacitor through R6 and D1. Two voltage dividers are used, one formed between R6 and the capacitor under test, and the other by R8, R10 and C10. When the voltage across C5 reaches the trigger point of the Schmitt trigger U1:D, it switches. As the value of C5 is constant, IC U1:D will always switch at the same point - it is known as the 'reference comparator'.

The unknown capacitor uses U1:E, another Schmitt trigger, and in this case when the trigger point is reached, it also switches - at a different point because of the difference in capacitance between C5 and the unknown capacitor. When the outputs of the reference and the test comparator are compared, an average DC voltage is generated and this is taken to sockets J1 and J2 to be read by an analogue or digital multimeter. The larger the capacitor value the longer it will take for the test comparator to switch. This presents an even lower average DC voltage on

the test comparator's output resulting in a larger difference between the two comparators. The DC voltage is averaged by C2 and provides a stable reading for the meter.

## The Inductance Section

The inductance section operates in a similar fashion to the capacitance section, but it does not require a

comparator, as in the capacitance section.

A simple oscillator is formed by IC U1:A, C7, C9, R12, R13, R16 and R17. Two separate frequencies are available in this section, a high frequency for small values of inductances and a low frequency for larger values of inductances. The output of this oscillator runs into a buffer stage using IC U1:B, and is fed through a current-limiting resistor R18

Inside the assembled L/C Meter Adaptor.

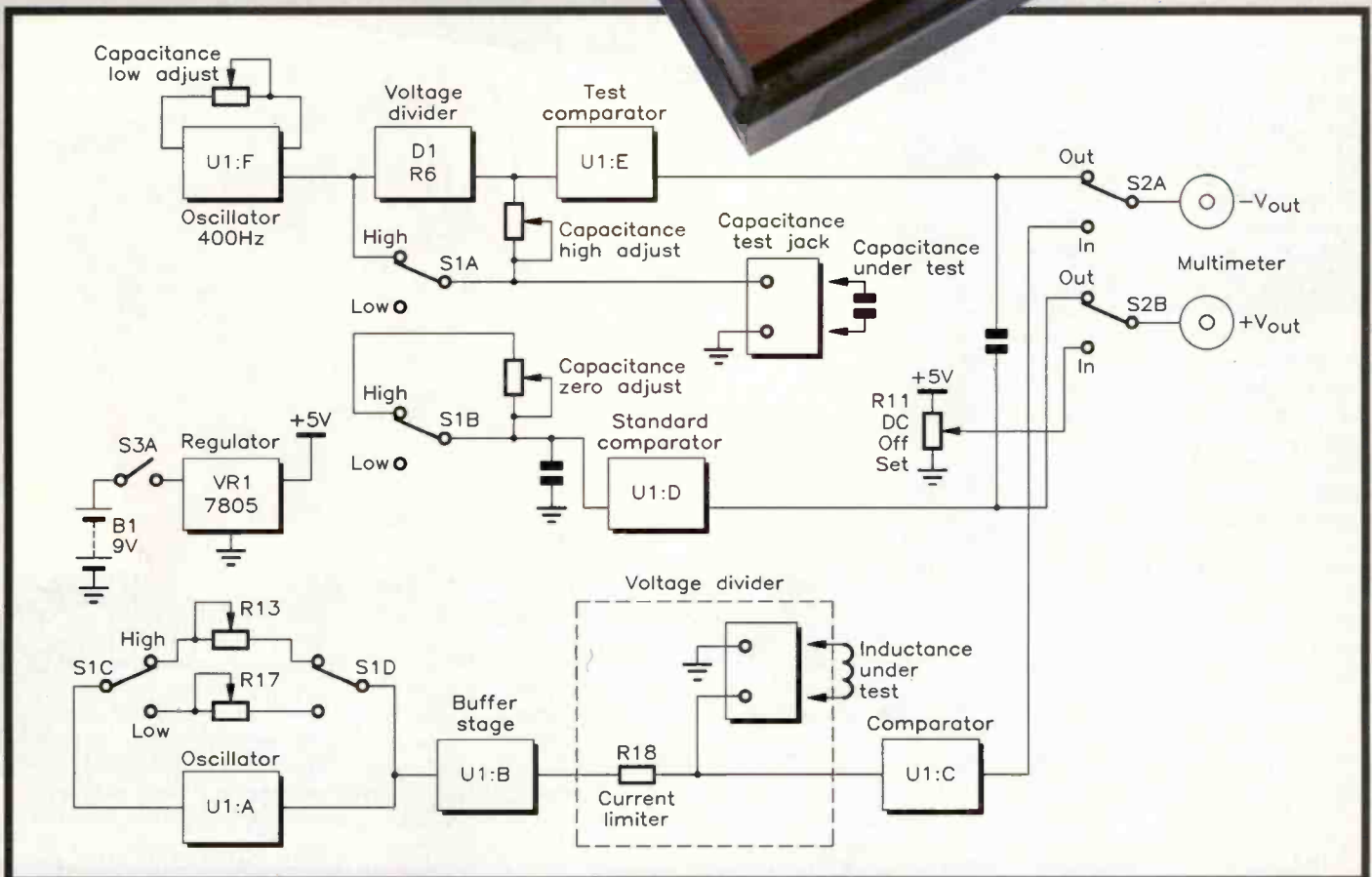
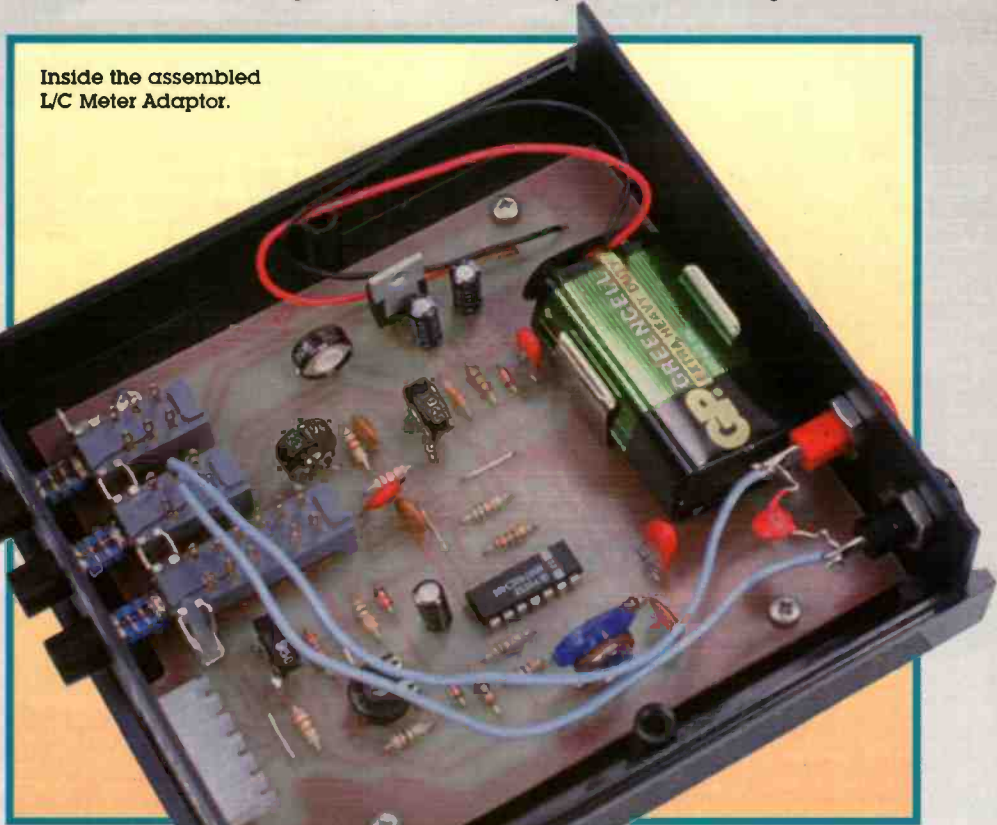


Figure 1. Block diagram of the L/C Meter Adaptor.

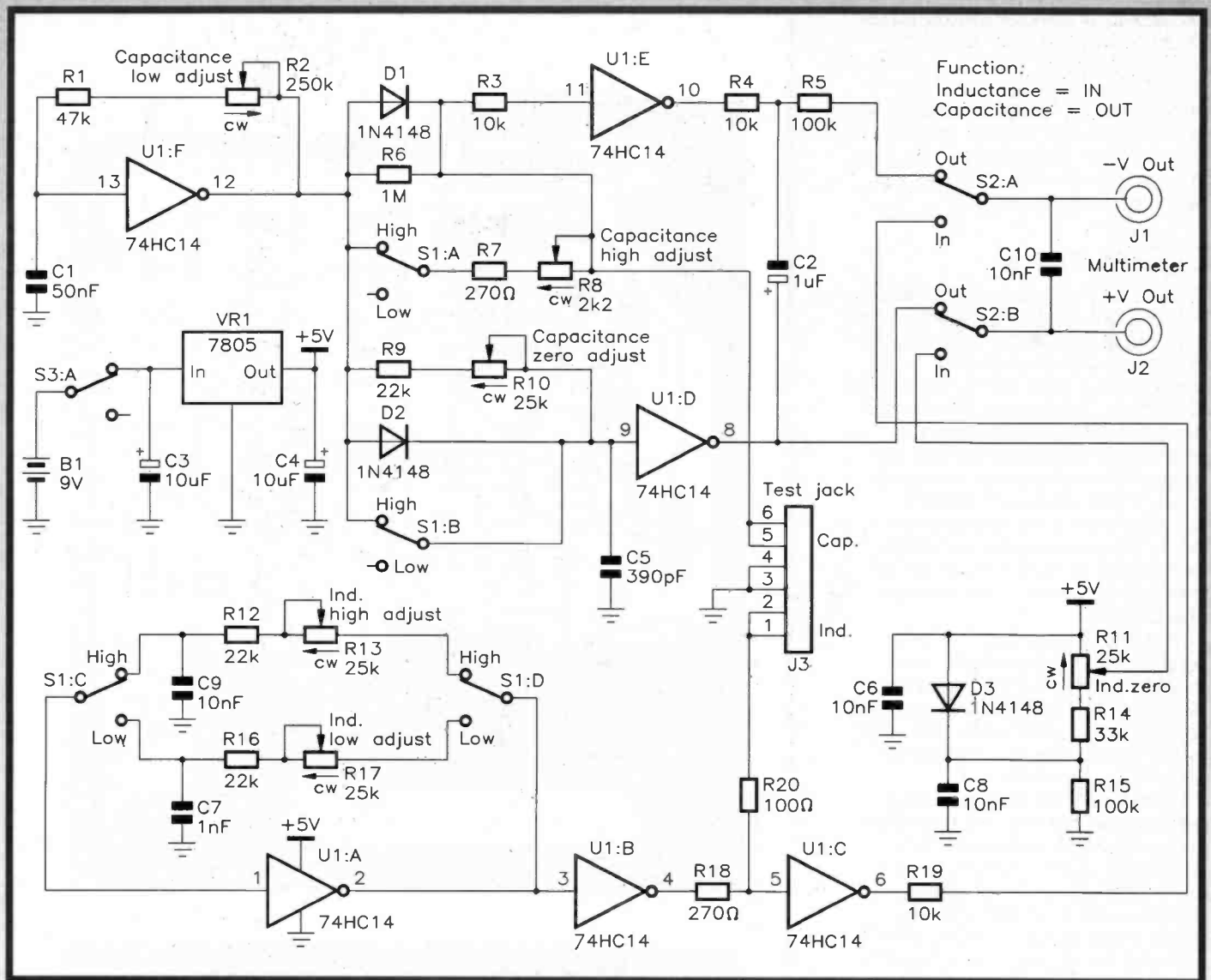


Figure 2. Circuit diagram of the L/C Meter Adaptor.

This resistor and the coil under test present a voltage divider to the input of the next comparator. When the inductance is small, it presents very little AC voltage drop across the coil being tested, and a very short voltage pulse is read by the IC U1:C in the next stage. The averaged DC level of these pulses is fed to the sockets J1 and J2 and then to the multimeter. A larger value of inductance will present a longer duration pulse on IC U1:C, resulting in a higher averaged DC output.

## Hints and Tips

There are a number of suggestions that could enhance the use of the L/C Meter Adaptor preferably before completion. Using an IC socket is generally good practice, but not essential. One is not provided in the kit, and if one is to be used a 16-pin DIL IC socket is required.

A 'fresh' 9V PP3 battery is recommended for use in the unit when built. This way the circuits will perform at their optimum levels with less likelihood of errors being made. To finish off there is a case available for the kit (RU39N), and this includes parts not supplied with the main kit. There are a number of boxes from



The kit as supplied.



the Maplin Catalogue that could be made equally suitable as a case with some drilling.

A suitable DMM such as one of the White Gold, Precision Gold or Academy models can be used, and are available from Maplin; or a high impedance analogue type with at least  $1M\Omega$  input impedance.

## Construction

The L/C Meter Adaptor kit includes the PCB, the legend and track are shown in Figure 3, and all the components required to build the project, excluding the case which is available separately. Sort out and identify the components, there are some very good instructions supplied with the kit, and they show a logical path to follow. If you are new to project building, refer to the Constructors' Guide (order separately as XH79L) for helpful practical advice on how to solder, component identification and the like.

Start first by soldering in the test connector. This must be mounted so that it hooks onto the board for mechanical stability. Now identify the resistors and fit and solder to the PCB. Install the trimming potentiometers and solder in position.

Next identify the diodes making sure that they are correctly orientated on the board. Fit and solder the capacitors, making sure that the electrolytic capacitors which are polarised are fitted correctly. The positive lead is slightly longer than the negative, which is normally identified by a series of (-) symbols marked down one side of the capacitor.

With wire off-cuts from either the resistors or capacitors, preform the off-cuts into jumper leads, then fit and solder to the relevant positions in the board.

Install the voltage regulator, with the metal heatsink facing C4. Next fit IC U1, making sure that the IC is correctly orientated on the board. A 16-pin DIL IC socket is not supplied with the kit but if required should be fitted beforehand also noting the correct orientation.

Locate and fit the switches, making sure that each switch is flush against the PCB. Now locate the wires from the PP3 battery-clip through the appropriate holes in the PCB, and solder in position.

## Set-up and Calibration

Make sure that the power switch S3 is off before connecting up the 9V PP3 battery. Connect your analogue multimeter or DMM to the output sockets of the kit (J1 and J2) and set it to a low voltage range 2 to 2.5V DC.

Use a small screwdriver or trimming tool and rotate all the potentiometers to the centre of travel. Next switch on the power and select the Capacitance Function (S2 in the 'OUT' position). Note the reading on the meter should be fairly close to zero,

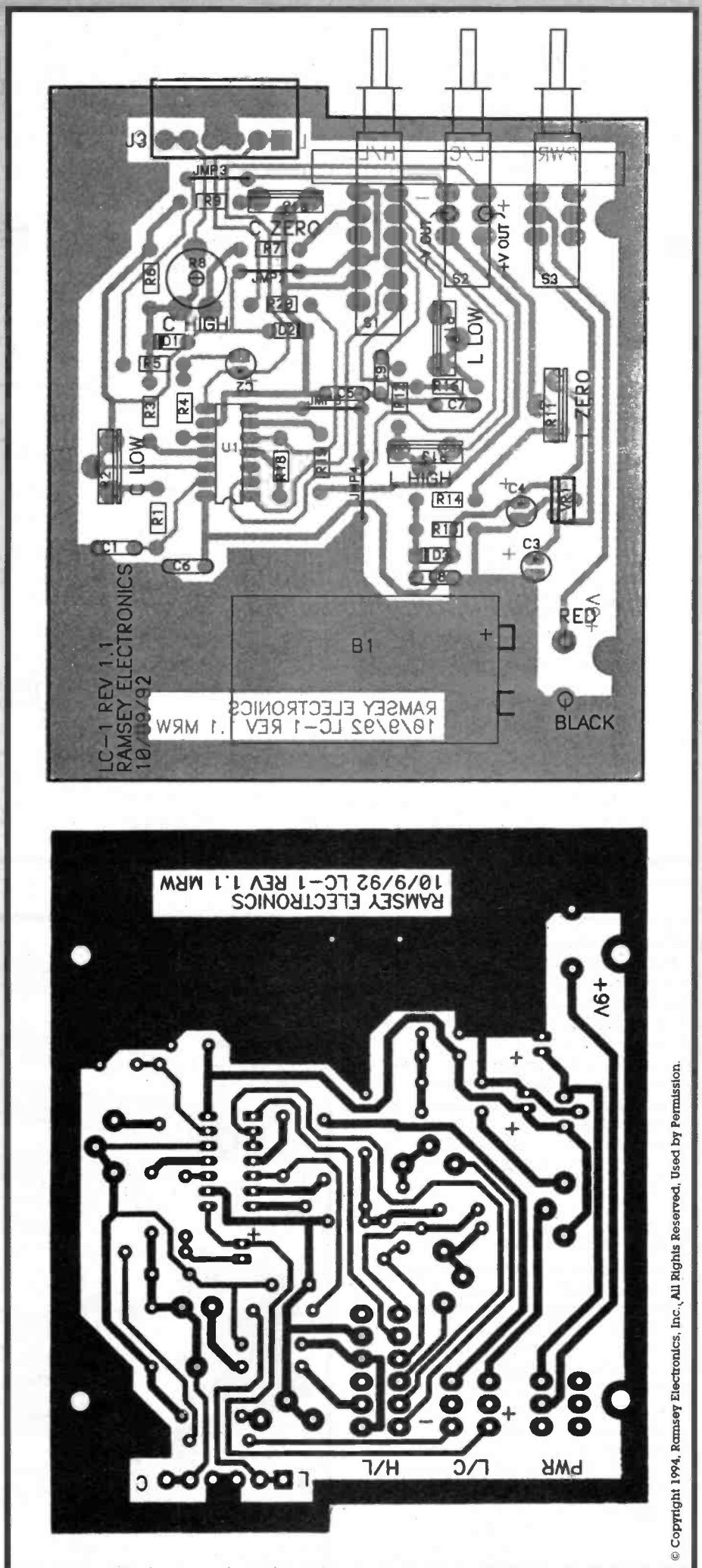


Figure 3. PCB legend and track.

If this does not read zero then adjust R10 until it does so. Some autoranging digital volt meters will change to millivolts, on other types you may have to switch to a more sensitive voltage range to make sure that it is zero. If you do not get a reading of zero volts, switch off and check the components and the PCB for any assembly mistakes.

If all is well, select the Inductance Function (S2 in the IN position), the reading should now read approximately 2.5V, but this is not critical.

Now place a wire jumper across the pins of J3 and adjust R11 until a reading of zero volts is obtained on the meter. Remember that the pins in socket J3 are doubled up, and it is possible to accidentally put the wire between commoned pins. This wire simulates an extremely small value inductance. Switch back to the Capacitance Function (S2 OUT), and select the low range (S1 IN). Insert a

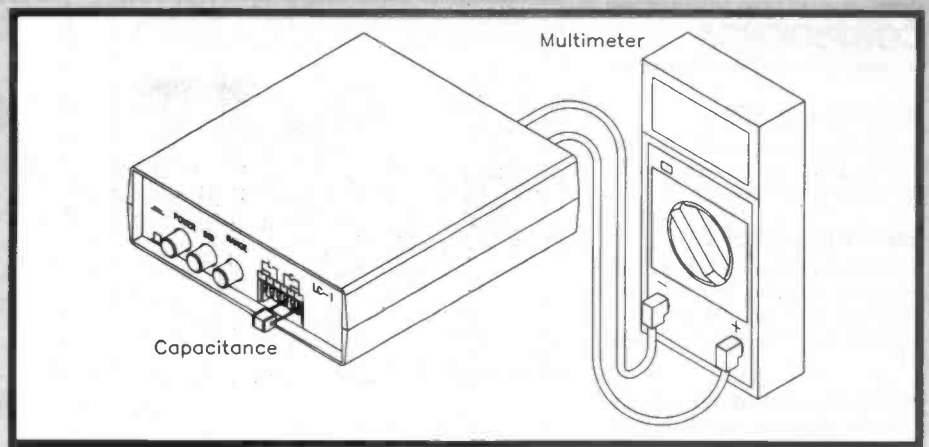


Figure 4. Typical interconnection between the unit and multimeter.

1nF capacitor (marked 1nF or 102) and adjust R2 until a reading of 1V is obtained. Next, select the high range (S1 OUT), insert a 100nF capacitor (marked 0.1 or 104) and adjust R8 until a reading of 100mV is obtained.

Switching to the inductance range, leave it on the high range, insert the 1800µH inductor (this is a large round green component marked 182) and adjust R13 until a reading of 180mV is obtained.

Now switch to the low range, and insert the 100µH coil (this is a small round green component marked 101K), and adjust R17 until a reading of 100mV is obtained.

The kit is now fully tested and calibrated and ready to go.

## Operation

Note the multiplication factor of the readings, as shown in Table 1, when using your multimeter, also the range you are using on the L/C Meter Adaptor, Figure 4. Remember, that the high and low ranges of the capacitance and inductance sections are quite different. Table 2 shows the available ranges obtainable with this project.

The L/C Meter Adaptor	
Range	Multiplication Factor
Inductance High Range	1mV = 10µH
Inductance Low Range	1mV = 1µH
Capacitance High Range	1mV = 1nF
Capacitance Low Range	1mV = 1pF

Table 1. Multiplication factors for the conversions.

Available Ranges		
	Low	High
Inductance	10µH to 800µH	100µH to 10mH
Capacitance	1pF to 2000pF	1000pF to 2µF

Table 2. Available ranges.

## L/C METER ADAPTOR PARTS LIST

### RESISTORS

R20	100Ω	1	
R7,18	270Ω	2	
R3,4,19	10k	3	S1-3
R9,12,16	22k	3	
R14	33k	1	
R1	47k	1	J1-2
R5,15	100k	2	J3
R6	1M	1	
R8	2k2 Potentiometer	1	
R10,11,13,17	25k Potentiometer	4	
R2	250k Potentiometer	1	

### CAPACITORS

C5	390pF Disc Ceramic	1
C7	1nF Disc Ceramic	1
C6,8,9,10	10nF Disc Ceramic	4
C1	50nF Disc Ceramic	1
C2	1µF 50V Radial Electrolytic	1
C3,4	10µF 50V Radial Electrolytic	2

### SEMICONDUCTORS

U1	74HC14 Hex Inverter	1
VR1	7805 5V Regulator	1
D1-3	1N914 (1N4148)	3

### MISCELLANEOUS

1nF Capacitor *	1
100nF Capacitor *	1

100µH Inductor *	1
1800µH Inductor *	1
PCB	1
Switch Array	1
Battery Holder	1
PP3 Battery Clip	1
Banana Jacks	2
6-pin Test Connector	1
12in. Hook-up Wire	1 Pkt
Instruction Leaflet	1

\* Note that these components are used for calibration only.

### OPTIONAL (Not in Kit)

CLC Plastic Case (Includes Knob Set)	1	(RU39N)
9V PP3 Battery	1	(JY49D)
Constructors' Guide	1	(XH79L)

The Maplin 'Get-You-Working' Service is available for this project, see Constructors' Guide or current Maplin Catalogue for details.

**The above items (excluding Optional) are available in kit form only.**  
**Order As RU38R (L/C Meter Adaptor) Price £39.95**  
**Order As RU39N (CLC Case) Price £14.95**

Please Note: Some parts, which are specific to this project (e.g., PCB), are not available separately.



# CORRIGENDA

## Issue 79/July 1994.

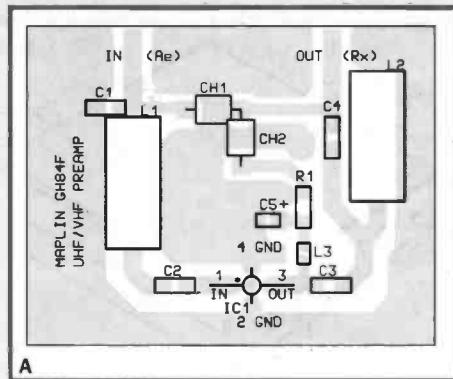
Model Train Chuffer, page 8, Parts List, RV1 & RV2 were incorrectly listed as UH15R the correct code is UH02C.

## Issue 81/July 1994.

In This Issue, page 1, page numbers incorrect, Getting To Know Test Equipment is on page 39; Secrets of Surround Sound Revealed is on page 52.

### PWM Drill Speed Controller, page 21.

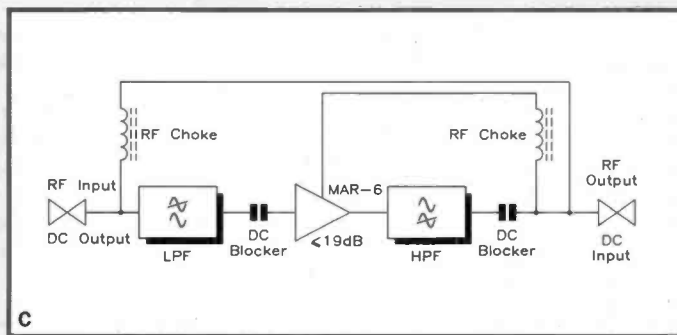
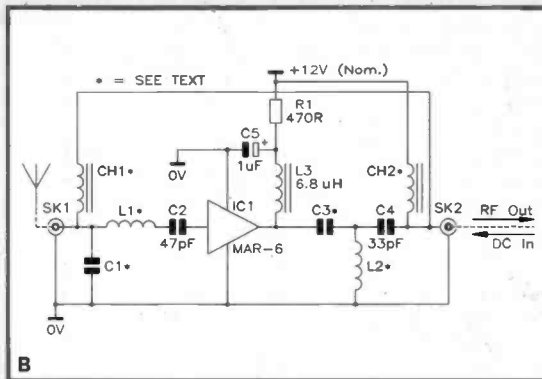
Figure 8b, the bridge rectifier is shown incorrectly. The correct orientation of the symbols are as follows: top left negative (-), top right ac (~), lower left ac (~), and lower right positive (+). On page 22, Figure 9a, the rectifier is again shown incorrectly, the correct symbols should show top left negative (-), top right ac (~), lower left ac (~), and lower right positive (+). The red and blue wires from the transformer must be connected to the top right ac (~) connections on the bridge rectifier, and the yellow and grey wires must be connected to the lower left (~) on the bridge rectifier. The red wire



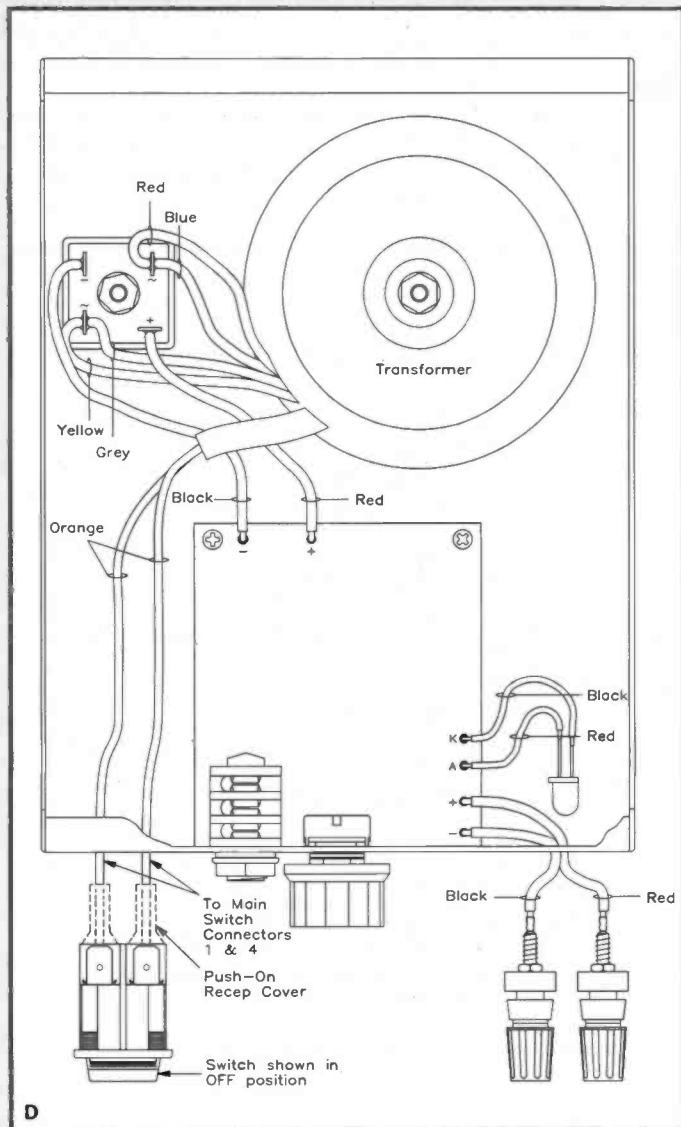
from the positive (+) on the rectifier must be connected to the positive (+) located top middle of the PCB and the black wire from the negative (-) on the rectifier must be connected to the negative (-) top left on the PCB.

Parts List, page 23, optional foot controller XY28F missing from Optional List.

VHF/UHF Preamp, page 33, circuit and block diagrams are incorrect, see below. Photos 1a and 1b, are transposed. Please note that on issue 1 PCBs there is no positive (+) symbol shown on the legend



- A Figure 7. PCB legend of the VHF/UHF Preamp.
- B Figure 3. Circuit diagram of the VHF/UHF Preamp.
- C Figure 2. Block diagram of the VHF/UHF Preamp.
- D Figure 9a. Low-voltage and transformer primary wiring of the PWM Drill Speed Controller.



for C5. C5 should be orientated with its positive lead nearest R1.

Getting to know Test Equipment, page 40, incorrect text, see correct text below; caption lower left should read "Right: A typical moving coil panel meter - 100µA."

When in series, the converter (known as a multiplier), effectively raises the total resistance, allowing the combination of movement and multiplier to measure a higher voltage. When in parallel, the converter (known now as a shunt) effectively lowers the total resistance, allowing the combination to measure higher currents. Note that in both cases, no more current passes through the movement's coil than before - i.e. only that sufficient to produce full-scale deflection of the pointer.

With an external power source such as a cell, the movement can also be used to indicate values of resistance. By connecting the movement in series with a cell and the resistance to be measured, the pointer indicates the current flowing through the resistor. As this current, from Ohm's Law, is inversely proportional to the resistance, the indication on the scale of the movement is also inversely proportional to the resistance. In effect, the scale graduated for resistance must be marked in the opposite direction to current and voltage scales - that is, the further up the scale the pointer is deflected, the lower the resistance being measured.

Using mechanical switches to switch multipliers, shunts and cells in and out of circuit with a moving-coil movement, an analogue multimeter - one capable of measurement of many ranges of voltage, current and resistance - can be constructed. Such an instrument is also known (particularly across the Atlantic) as a volt-ohm-milliammeter (VOM). The basic multimeter is shown, in block diagram form, in Figure 2.

### DC Voltage Measurements

A typical configuration of multipliers and switch, for a 50µA meter with a coil resistance of 2000Ω, is shown in Figure 3. Six ranges are available, five of which (2.5V, 10V, 50V, 250V, 1000V) are switched into the circuit via the mechanical rotary switch, while the sixth range; 5000V, is selected by the user by

connecting the positive probe into a separate connection socket that has a 80MΩ resistance in series. A separate socket is needed for two reasons. Firstly, rotary switches cannot always withstand voltages over 1000V. Secondly, plugging a probe into a separate socket for such high-voltage measurements tends to give the user a 'psychological push' into taking extreme care with the measurement.

With the switch in the 2.5V range position, it is easy to calculate that the total series resistance is 50kΩ (that is, 48kΩ + 2kΩ), so the input resistance (see later) of the meter is 50,000/2.5, or 20,000Ω/V. This is a good sort of input resistance to aim for - any lower, and the circuit you're testing with the multimeter may be loaded by the meter's resistance.

### DC Current Measurement

Figure 4 shows a moving-coil movement, shunts and switch, connected into a DC current measuring circuit. This particular meter circuit is known as a ring-shunt configuration. The ring-shunt's main advantage is that the movement is always shunted, even when the range switch is turned from one position to another. This protects it from accidental burnout even if the test leads are connected to a 'live' circuit.

### AC Voltage Measurements

The circuit for a typical AC voltage measurement is shown in Figure 5. It is similar to the DC voltage measurement circuit of Figure 2, but the input resistance is lower (around one third of that of the DC circuit). This is mainly because the applied AC voltage must be rectified by a diode rectifier before being applied to the meter. The meter movement responds to the average value of the rectified AC voltage - 0.318 of the peak value for a half-wave rectifier, as in this example. In turn, therefore, the input resistance...

Intelligent Split Charge Unit, page 49, first paragraph right column should read: Remove the +12V connection...

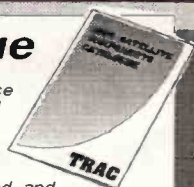
20 Metre 20W Linear Amplifier, page 62, second paragraph, stock code for the 40 Metre 20W Linear Amplifier should read (RU33L).

## 1994 Catalogue

Apart from being an excellent reference source, listing and describing in detail over 200 components, our new catalogue answers many of your most asked questions.

Bang up to date with sections on fixed and motorised systems, distributing UHF and IF signals and much more. Probably the best \*£1.95 you'll ever lend.

\*Inc. post and packing. Refunded on next purchase



## Last few Ferguson SRB1 D2MAC converted BSB receivers at the exceptional price of £29.95 !

Brand New boxed Ferguson SRB1 receivers with TRAC D2MAC software for reception of CLEAR D2MAC transmissions : Currently 4 German channels from TVSAT, plus ARTE and occasionally MCM from the French sat TDF1, all with digital sound. On screen graphics, 16:9, Audio Mix, and other usual MAC refinements.

P&P £6.90 Matching squarials £20.00

# TRAC

Commerce way  
Skippers Lane  
Middlesbrough  
Cleveland TS6 6UR



0642 468145

0642 452555

FAX 0642 440927



**Coming Soon**  
External D2MAC Card Reader for scrambled MAC channels.  
Designed specifically for Ferguson SRB1 BSB Receiver  
Call for details



There are more terrific projects and features heading your way in next month's super issue of *Electronics - The Maplin Magazine*, including:

### PROJECTS

#### TELEPHONE BELL REPEATER

Quite often, the telephone cannot be heard in other parts of the house, or in

the garden, shed or garage. This simple Phone Repeater is very useful, to those people with only a single phone socket (or even a hard-wired phone). The Telephone Bell Repeater 'sits' beside the telephone, and a piezo buzzer is remotely wired from the Telephone Bell Repeater to the required 'repeat' position.

#### MODEL TRAIN HORN AND WHISTLE

Sound-effects can be used to add an extra dimension of realism to any model train layout. With the introduction of digital recording techniques, it is now possible to obtain good quality sound reproduction. Since the sound samples for the train horn/whistle are of a relatively short duration, it is practical to store them in a non-volatile digital memory IC. This is an excellent complementary project to go with the Train Chuffer in *Electronics* Issue 79.

#### 418MHZ ENCODED TRANSMITTER AND RECEIVER

This project together with its companion, the 418MHz Encoded Receiver are a boon for security and other applications. Using these projects means that stand-alone or wire-interconnected equipment can now be linked to good effect by totally wireless means.

#### 400W MONO/STEREO AMPLIFIER

This superb amplifier is small and compact, and it certainly packs a punch! It is very versatile, being ideal for domestic use, car or caravan, and PA systems.

#### FEATURES

Special features include an informative look at 'All About Internet'; 'Designing Op Amp Stages' explains about the operational amplifier. Two new series, 'Digital Signal Processing' an introduction to this vast subject with example programs written in QBASIC; 'Repairing Radios' takes the mystery out of radio repairs. Other features include 'Quo Vadis? Computers and Information' about the direction of Information Technology and Future Electronics, plus the concluding part of 'Mains Safety'.

**PLUS ALL THE REGULAR ITEMS FOR YOU TO ENJOY!**

**ELECTRONICS - THE MAPLIN MAGAZINE**  
BRITAIN'S BEST SELLING ELECTRONICS MAGAZINE

## TECHNICAL INFORMATION SERVICES

76 Church Street, Larkhall, Lanarks, ML9 1HE

Tel: (0698) 883334 Fax: (0698) 884825

Technical Help Line (0698) 888343

We have the World's Largest Selection of:

## SERVICE MANUALS CIRCUIT DIAGRAMS

We also have 100s of Titles on TVs, VCRs, Satellites, Midi Systems, Computers, Test Equipment, etc...

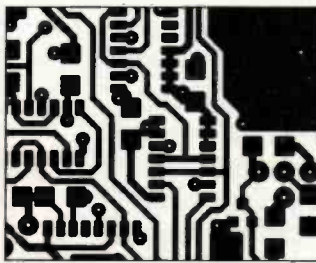
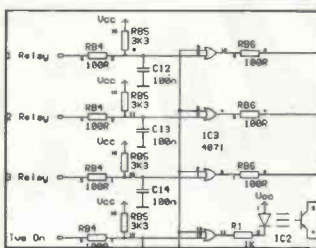
Please Phone or Send an SAE for FREE QUOTE & CATALOGUE of Publications

## PCB and SCHEMATIC C.A.D.

### EASY-PC

£98

(VAT & P+P)



- Runs on PC/XT/AT/286/386 with Hercules CGA, EGA or VGA and many emulations.

- Design Single sided, Double sided and Multilayer boards.

- Use Surface Mount components.

- Standard output includes Dot Matrix / Laser / Inkjet printers, Pen Plotters, Photo-plotters and NC Drill.

- Award winning EASY-PC is in use in over 18,000 installations in 80 Countries World-Wide.

- Superbly Easy to use.

Options - 500 piece Surface Mount library - £48.00

1000 piece symbol library - £38.00. Gerber Import facility - £98.00

For full info' please phone, fax or write to:

**Number One Systems Ltd.**



Ref: MAP, Harding Way, Somersham Road, St. Ives, Huntingdon, CAMBS, England, PE17 4WR  
Telephone:- 0480 461778 (7 lines) Fax: 0480 494042  
International:- +44 480 61778 Credit Cards Welcome





*How to prevent  
this from  
happening!*

**Text by  
Alan Williamson and  
Dean Hodgkins BEng(Hons)**

This project has been designed to protect Hi-Fi loudspeakers from damage due to faults occurring within the output stage of a power amplifier. A fault of this nature nearly always causes a large DC current to flow, and it is *this* current which 'burns out' the loudspeaker. This module will 'disconnect' the speakers as soon as a DC voltage is detected.

**Photo 1. Close up of assembled PCB.**



**Specification**

Maximum input voltage:	90V DC
Maximum contact current:	10A
Minimum safety voltage:	10V DC
No external supply needed	
PCB:	40 x 67mm



**T**HE module can be mounted in the loudspeaker cabinet, and is also suitable for protecting car stereo systems (one module per channel, of course). Note that this project must not be used in conjunction with traditional valve amplifiers; they do not require this type of protection, and the use of this module could cause extensive damage to the amplifier. This module is also unsuitable for amplifiers with less than 10V<sub>pk</sub> present at the output.

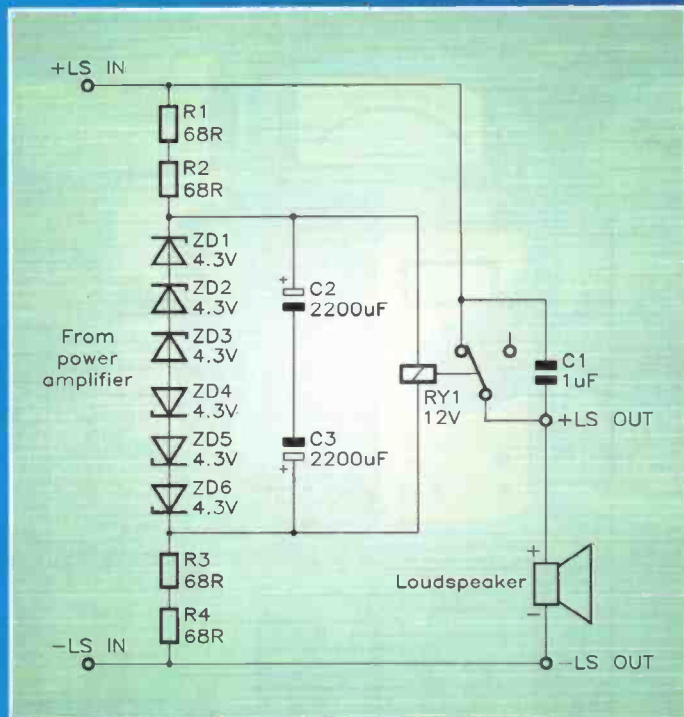
## Circuit Description

The circuit (shown in Figure 1) is very simple; the resistors R1 to R4 provide current limiting through the Zener diode chain. Note that the number of 5W resistors fitted will depend upon the peak output voltage of the amplifier (see Table 1).

The 5W resistors have a dual function: (a) they form a potential divider with the relay, and (b) they determine a time constant (in

conjunction with the electrolytic capacitors C2 & C3) that provides a short time delay, which prevents premature 'drop out' during transient clipping.

The Zener diodes prevent 'over voltage' of the electrolytic capacitors in the event of the relay coil becoming open circuit, as well as clamping the induced emf voltage across the relay coil during the collapse of the magnetic field. Note that half of the Zener diodes are orientated in the opposite

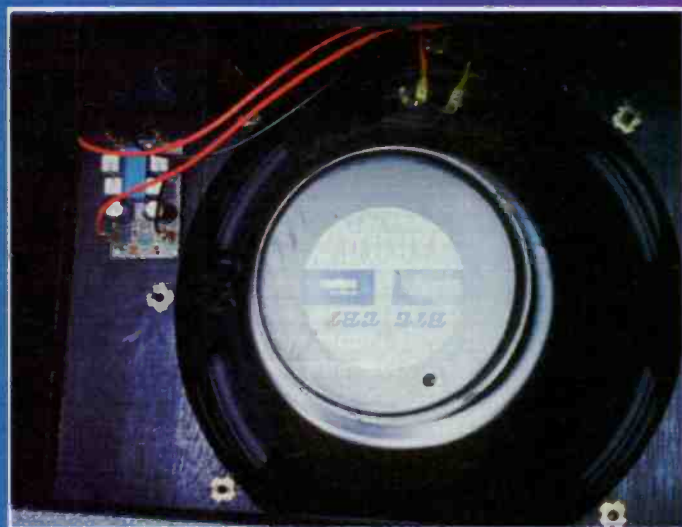
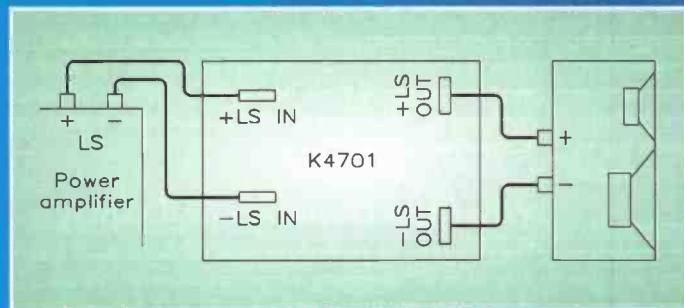


Above left: Figure 1. Loudspeaker DC Protector circuit diagram.

Above right: Photo 2. Assembled PCB installed in an amplifier.

Below left: Figure 2. Loudspeaker DC Protector wiring diagram.

Below right: Photo 3. Assembled PCB installed in the speaker cabinet.



Amplifier peak output voltage	10 to 30	30 to 50	40 to 70	50 to 90
Power output into 8Ω load (W <sub>rms</sub> )	6.3 to 56.3	56.3 to 156.3	100 to 306.3	156.3 to 506.3
Power output into 4Ω load (W <sub>rms</sub> )	12.5 to 112.5	112.5 to 312.5	200 to 612.5	312.5 to 1012.5
Number of 5W resistors fitted	1	2	3	4

Table 1. Resistor build table.

direction to the others; this is to allow an equal clamping voltage of either polarity to be provided.

In the event of the protection circuit prematurely 'dropping out' due to excessive clipping (especially at low frequencies), the DC voltage present at the output of the amplifier will operate the relay after a short time – determined by time constant; the capacitor C1 will 'snub' the relay contacts, and prevent arcing when the load (the speaker) is reconnected to the amplifier's output.



by Keith Brindley

# Getting to know



# EQUIPMENT

## PART 3

## Oscilloscopes

No electronics lab, amateur or professional, hobbyist or industrial, school, college or university, is complete without the oscilloscope. Keith Brindley takes the lid off it in his series about test equipment.

Strictly speaking, an oscilloscope is *any* device which can display waveforms. The term 'oscilloscope' is derived from the Latin word *oscillare*, meaning to swing backwards and forwards, and the Greek *skopein*, meaning to observe, aim at, examine. A number of electronic test instruments have this capability: XY plotters and pen recorders are two examples. However, the term has to be used in a general way to refer to the particular type of test instrument covered here.

While the oscilloscope is not the most common laboratory test instrument (multimeters hold that crown) it is by far the most *useful* one, allowing the innards of a circuit to be analysed in *real-time*, i.e., the oscilloscope displays what is actually occurring in the circuit at that moment. Compared with a multimeter, say, an analogue moving-coil multimeter, which can only display direct voltages and currents (or, at most, very slowly varying ones), the oscilloscope can display rapidly alternating voltages and currents. Also, a meter can only display a measurement in one dimension, i.e., the measurand's amplitude at any given time. The oscilloscope, on the other hand, displays *two* dimensions, the measurand's amplitude against the second dimension of time. In this way rapidly varying amplitudes are displayed.

This ability of the oscilloscope to display two-dimensional measurements arises from the type of display device it uses. A more technical description of what is normally called an oscilloscope is a *cathode ray oscilloscope (CRO)*, which gives a clue to the display used: a cathode ray tube

(CRT). Operation and composition of cathode ray tubes are covered in the last section.

All we need to know here is that the cathode ray tube may be used to display the two dimensions of amplitude and time. This is done by moving the electron beam in the cathode ray tube across the screen in a controlled way, so that a representation of the measurand is displayed, the vertical amplitude of which corresponds to the measurand's amplitude and the horizontal amplitude of which corresponds to units of time over which the measurand is observed.

### What the Oscilloscope Displays

The real-time or general-purpose oscilloscope is essentially used for displaying a representation of periodically varying (i.e., repetitive) measurands. Such a measurand is shown in Figure 12a, and is seen to be a fairly simple periodic voltage waveform – something you might get from a microphone picking up a steady note from a musical instrument.

To display the waveform the oscilloscope firstly has to break it down into manageable, screen-sized portions, as in Figure 12b. These portions of the waveform are then displayed in turn on the screen, as in Figure 12c, just like leafing through a child's flick-book – the only difference being that the pictures in a flick-book are minutely different so that flicking through them creates the illusion of movement, whereas the oscilloscope's pictures are all identical, creating the illusion of a *constant* picture. So, with a continuous periodic waveform, the apparent displayed representation would be just one of these portions, as in Figure 12d – trick photography at its best!

The final display is, in fact, a graph of voltage against time for this apparently single portion. This representation of a measurand which an oscilloscope makes on its screen is commonly called a *trace* – referring to the way the electron beam seems to trace out on the screen the displayed waveform.

## The Basic Oscilloscope

Figure 13 shows the action of a basic oscilloscope in block diagram form. Waveforms at various points around the diagram illustrate circuit action.

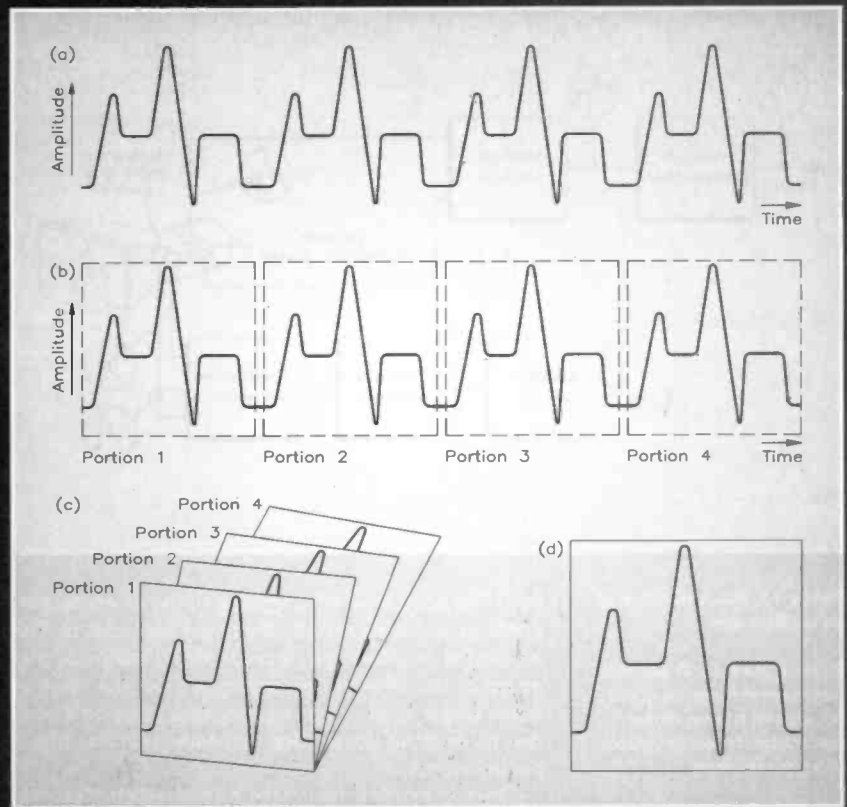
To enable the image of the measurand to be displayed, the electron beam must be moved across the cathode ray tube screen in a controlled manner. Firstly, it has to move horizontally from left to right (as viewed). When the beam reaches the right-hand side of the screen it must return to the left to begin a new trace. This whole procedure must occur at regular intervals. Secondly, the amplitude of the displayed waveform must correspond to the amplitude of the measurand, so the electron beam must be varied in a vertical manner, too. Horizontal movement of the beam creates an axis corresponding to time, vertical movement creates an axis corresponding to amplitude.

Horizontal beam movement is the effect of voltages, called *sweep* or *timebase* voltages, applied to the horizontal deflection plates of the cathode ray tube. A timebase voltage waveform which might be applied to one of the horizontal deflection plates is shown in Figure 14 – it's basically a ramp voltage. A second timebase voltage, the exact inverse of this, would be applied to the other plate. When the voltage is low, say, at point 1, the beam is deflected to the left-hand side of the screen. When the voltage is at point 2 the beam is not deflected so is in the middle of the screen. Finally, when the voltage is at point 3 the beam is deflected to the right-hand side of the screen, and so on. The shape of the timebase voltage tells us how the beam traces across the screen. When it moves from left to right it does so in a steady manner, at a constant rate determined by the steepness of the increasing voltage. However, on its return trip from right to left (known as the *flyback*) it instantly jumps back, ready to start the slower left to right movement again. An instant jump back from right to left (i.e., in zero time) ensures that a user does not see a trace on the screen as the electron beam flies back. In reality, timebase generator circuits cannot produce such an ideal timebase voltage – typically their ramps do not increase at a constant rate but vary slightly, and their flybacks take a finite but very small time.

Ramp length, i.e., the time the beam takes to sweep from left to right on the screen, is user-adjustable to allow different measurands with different timeslots to be displayed.

In order that the same part of the waveform is displayed by each sweep of the beam across the screen, a *trigger* circuit is used to detect when a particular point on the repeating waveform occurs. Consequent triggering causes a pulse to occur which literally kick-starts the timebase generator. This circuit is user-adjustable so that the point in the timeslot at which the sweep starts can be selected.

Circuits which change the incoming voltage of the mea-



surand to the voltages required by the vertical deflection plates are typically amplifiers, known as *vertical amplifiers*. Two stages of amplification are used. The first stage amplifier, known as the *vertical preamplifier*, converts the incoming signal waveform to a standard-sized waveform. To cater for different amplitudes of input signal, gain of the vertical preamplifier must therefore be user-controlled, although gain of the vertical amplifier itself is fixed.

There are a number of additions to this basic circuit which make the oscilloscope far more useful. Additions are shown in a more complex block diagram in Figure 15. At present, it's only capable of displaying DC waveforms, so the first addition is of a capacitor and switch at the Y input allowing the user to select between AC or DC waveforms.

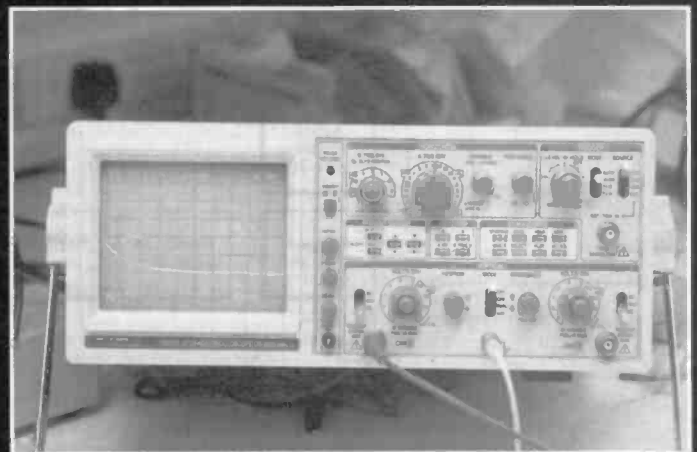
If large DC voltages, or AC voltages with a large DC bias, are to be displayed, a user-adjustable control to adjust vertical deflection voltages must be included. This is the *Y shift* control, which allows zero Y voltage to correspond with, say, the centre horizontal line. A similar control adjusts the horizontal deflection voltages, known as the *X shift*. The X shift allows the complete timeslot of the observed waveform to be moved left or right over the screen.

In many instances a user may require the oscilloscope to be triggered not from the viewed waveform, but from an external source. Thus the viewed waveform can be observed in direct comparison with a separately occurring trigger source. The *trigger selector* provides this func-

Figure 12. Showing how an oscilloscope displays a measurand as a steady image: (a) the measurand as a signal of amplitude against time; (b) breaking the signal down into screen-sized portions (c); displayed as successive images; (d) as viewed.

Below left: A basic oscilloscope.

Below right: A storage oscilloscope.





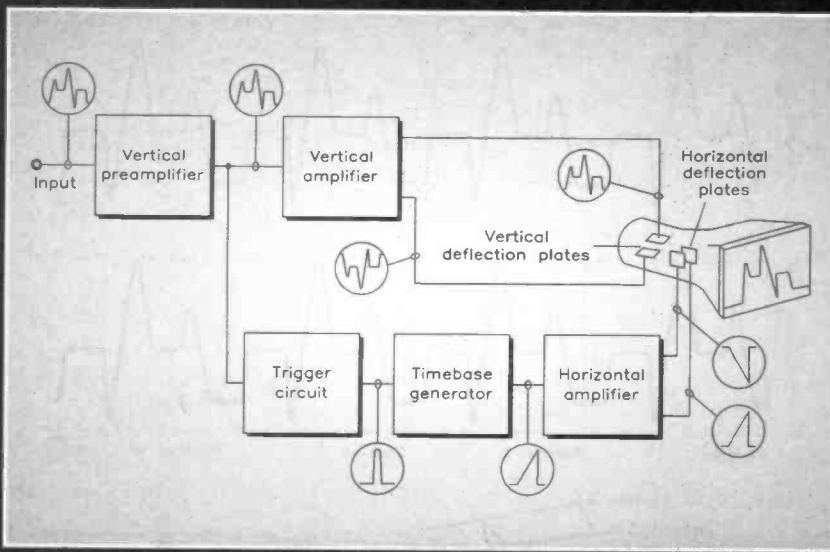


Figure 13. Block diagram of an oscilloscope.

Right: Figure 14. A possible timebase voltage, as could be applied to one of the horizontal deflection plates of an oscilloscope.

tion. The point at which triggering of the timebase generator occurs is adjusted by the *trigger level* control. The addition of an *auto-triggering circuit* allows automatic triggering of the timebase generator, without the need to adjust trigger level. Triggering may take place on a positive or negative going edge, depending on the *trigger polarity* switch.

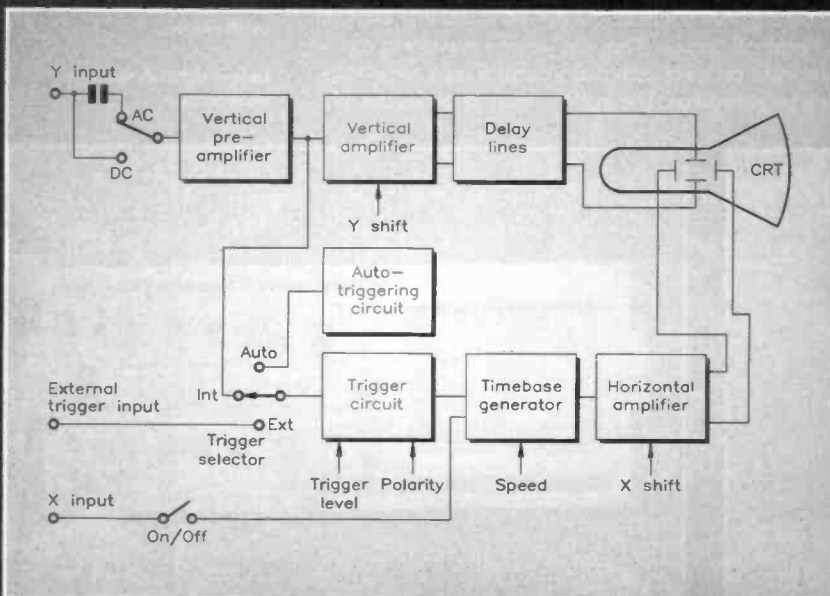
One final external input is the *X input*, which effectively allows the timebase generator to be disabled and an external voltage to control horizontal deflection. What is described here, although it is a real-time oscilloscope, is not particularly common.

## Advanced Oscilloscopes

Most practical oscilloscopes have a *dual-trace display*, that is, two traces are available so that two different waveforms can be displayed. In dual-trace oscilloscopes the electron beam is switched rapidly from one waveform to the other so that the eye perceives a constant display of two waveforms. Four-trace and even greater oscilloscopes are also available. Of course, sharing the single electron beam between two, four, or more traces means that less and less time is spent by the beam displaying any one waveform and the traces will be correspondingly dimmer. Some oscilloscopes have separate electron guns to defeat this problem, and are known as *dual-beam oscilloscopes*.

Advanced, but still real-time, oscilloscopes exist which have other features, too. Separate timebase generators (one for each trace), timebase generator delay facilities (to allow displayed traces to be offset), and input waveform delay facilities (to counteract the effect of circuit delays which would otherwise render impossible the observa-

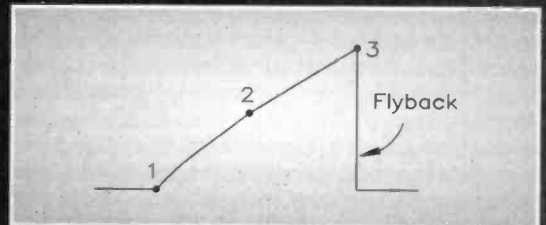
Figure 15. More complex block diagram of an oscilloscope.



tion of rapidly occurring signal changes), are some of the many features.

However complex real-time oscilloscopes are, they can only be used to observe rapidly repetitive waveforms. Also available are *non-real-time oscilloscopes* which allow the observation of non-repetitive, i.e., singly occurring waveforms which real-time oscilloscopes could not display. An example of such a singly occurring waveform is, say, the interrupt request signal to a microprocessor. This may only take place once every so often and is of only a few microseconds' duration. To display this kind of waveform a *storage oscilloscope* can be used, in which the displayed trace represents a *single* timeslot of the complete waveform which is stored within the oscilloscope.

There are two main types of storage oscilloscope: one which depends on a special cathode ray tube which maintains its display long after the electron beam has swept across it; while the other samples and stores the waveform digitally, ready for later recall and display. As you would expect, the *cathode ray tube storage oscilloscope* is cheaper than the digital *storage oscilloscope (DSO)*, but is correspondingly less versatile. The trace stored within a storage cathode ray tube cannot be repositioned or altered, whereas the digitally stored trace can be moved, magnified, contracted, erased, and displayed yet again at the user's whim, long after the recorded event. Most



storage oscilloscopes have the facility to be switched between real-time (that is, non-storage) and non-real-time (that is, storage) operation, so two separate oscilloscopes are not required to give all functions.

## Specifications

We now turn our attention to those aspects of oscilloscopes which define one device as being better or worse than another. Put another way, if you are going to buy yourself a 'scope what should you be looking for?

Most important criterion of importance – in fact the only one, really – is bandwidth. Like any electronic circuit, the oscilloscope only passes a limited range of frequency components. Components outside the bandwidth range are drastically reduced in amplitude. Obviously, the wider the bandwidth, the better the oscilloscope. Bandwidths of 10MHz or 20MHz are common in general-purpose oscilloscopes, but oscilloscopes with bandwidths up to around 250MHz (very expensive) are available for higher-frequency work. More specialist oscilloscopes (very, very expensive!) have bandwidths up to 1GHz.

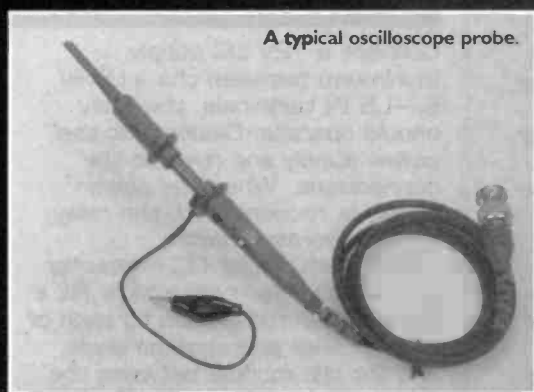
Also of consequence and related to the bandwidth is the range of amplification factors of the vertical amplifier. The greater the amplification the smaller the waveform displayable on screen. Oscilloscope screen displays are marked in a grid of 10-by-8 centimetre square divisions, known as the *graticule*. Amplification factors are denoted in volts/division or volts/centimetre, so that a factor such as 10V/div corresponds to a total screen height of 80V. Typical amplification factor ranges are from about 10mV/div to 5V/div. The better the oscilloscope the greater this range, so higher quality oscilloscopes have ranges which extend down to 1mV/div and up to 50V/div.

Bandwidth considerations discussed here apply to the Y, i.e., vertical, circuitry within the oscilloscope. However, there's little point in having a high Y bandwidth if the X circuitry does not have a similar high-frequency ability. The X 'bandwidth' corresponds to the range of settings available in the oscilloscope's timebase generator controls. Timebases in the range of 2 seconds to about 10 microseconds (times given indicate the time taken for the beam to sweep from the left-hand to right-hand side of

the CRT screen – and are generally denoted per division, e.g., 0.2 second/div to 1 microsecond/div) are common, but with oscilloscopes of higher Y bandwidths total time-base times must decrease to about 10 nanoseconds (i.e., 1 nanosecond/div) for Y bandwidths of around 250MHz, or less for specialist oscilloscopes.

## Oscilloscope Probes

The standard input resistance of oscilloscope vertical amplifiers is  $1M\Omega$ . Such a high resistance would, you might think, allow measurements of most measurands to be taken without the oscilloscope loading the measurand circuit in any appreciable way. This should be reflected in the accuracy of the measurement. However, such a high input resistance necessitates use of screened input lead to connect the oscilloscope to the measurand circuit, to prevent excessive hum pick-up. Typical screened lead capacitances are around 50 to 100pF/m (one metre of input lead is a convenient length) and this, coupled with the vertical amplifiers' own input capacitances of around 15 to 50pF (depending on make and model), makes a total input capacitance of about 100 to 150pF. With input capacitances of this order, giving a reactance of around  $140\Omega$  at 10MHz, you can see that considerable loading of high-frequency measurands could easily occur, thus affecting measurement accuracy.



A typical oscilloscope probe.

The usual solution to this problem is to use a standard accessory: the *passive divider probe*. Such probes have an attenuator within, which has the effect of increasing the resistance presented to the measurand circuit, while decreasing the capacitance. A typical probe attenuator is 10:1, which presents a resistance of ten times that of the vertical input of the oscilloscope, i.e.,  $10M\Omega$ , and one tenth of the input capacitance, i.e., about 10 to 15pF, effectively reducing loading. The attenuation which a passive 10 × divider probe causes, can be counteracted merely by increasing the vertical amplifiers' gain by the same amount.

*Active probes* are an alternative, employing a field-effect transistor (FET) amplifier which presents a high resistance and low capacitance to the measurand circuit, with unity gain (i.e., no attenuation) or even amplification. Active probes are more expensive than their passive counterparts and require a power supply, generally a small cell, for the internal FET amplifier.

## Oscilloscope Accuracy

There are three main sources of error when using an oscilloscope to take measurements. It is worth bearing these in mind simply because they can generally be compensated for if you want.

First, although probes reduce loading of the measurand circuit to a defined amount, loading *still* occurs, so voltage measurements are not necessarily as accurate as the user thinks. When using a passive probe its internal compensation capacitor must be adjusted to keep waveform distortion and amplitude error to a minimum. As a general rule this adjustment should be done every time the oscilloscope is used. The check is quite simple; the most convenient way is to observe a 1kHz square wave and adjust the capacitor for clean and square transition corners. Figure 16a shows the observed square wave

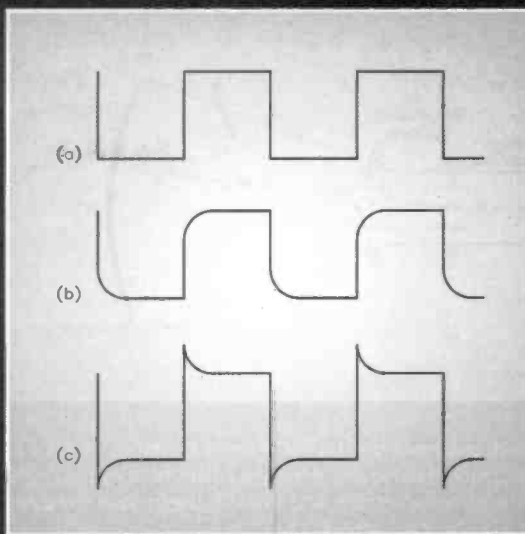


Figure 16. Viewed waveforms for an applied square wave: (a) when a passive probe is correctly adjusted; (b) when the probe is undercompensated; (c) when the probe is overcompensated.

when using a correctly compensated probe. Figure 16b shows the observed waveform when the probe is undercompensated and Figure 16c shows it when the probe is overcompensated. Many oscilloscopes have a square wave output available from the front panel, specifically for the purpose of compensating passive probes.

The second main source of errors comes from the internal oscilloscope circuits. Errors can exist due to incorrect gain in the vertical amplifiers, or to incorrect timing in the timebase generator circuits. With the vertical amplifier controls set in the calibration position, an input of, say, 1V, must produce a display corresponding to 1V vertical displacement on the screen. Similarly, with the timebase generator controls set in their calibration position, a pulse input of, say, 1 second duration must produce a waveform display corresponding to that horizontal displacement. The same square wave output used to compensate probes can often be used to check and adjust for vertical amplifier and timebase generator errors.

Finally, user errors make up the third main source. There are a number of possible problems. Parallax is the most prevalent. In most oscilloscopes the graticule is in front of, so is in a different plane from, the layer of phosphor on which the trace is inscribed by the electron beam. So, if the user observes the screen at anything other than perpendicular, parallax errors will occur in the readings. Some oscilloscopes have graticules which are on the inside of the screen, virtually in the same plane as the phosphor layer, thus reducing parallax errors to a minimum.

Non-linearity can occur on the edges of cathode ray tube screens and so important measurements should be taken in the central, say 6 by 4 division, portion of the 10 by 8 division graticule, whenever possible.

As a general rule the beam intensity should be kept as low as possible, because a dim beam produces a narrower trace than a bright beam, and so it is easier to correctly assess the beam's true centre. In a similar vein, beam focus should be checked regularly throughout measurements.

## The Cathode Ray Tube (CRT)

Shown in Figure 17 is a simplified cathode ray tube which illustrates the basis of all CRTs. It's made up from an evacuated glass tube, widened and flattened at one end to form a viewing screen. The inside surface of the screen is coated with phosphor, a material which is fluorescent and glows when electrically excited, say, when hit by electrons. A number of electrodes are positioned inside the tube to perform various functions. The main electrodes and their functions are:

- a heater – literally a coil of wire which is heated to glowing point by the application of an electric current at low voltage. The area around the heater becomes rich in electrons
- an acceleration anode electrode – held at a high positive potential (with respect to the heater) so that it attracts



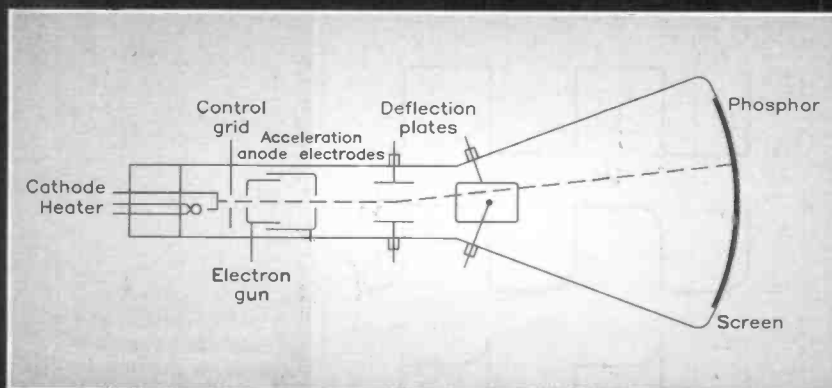


Figure 17. The cathode ray tube (CRT).

electrons from the heater. As the electrons reach this electrode their kinetic energy is such that they pass right through the electrode and towards the front of the tube, in a beam (the 'cathode ray')

- a control grid – which is held at a variable negative potential to the heater, thus repelling or not repelling the negative electrons and allowing a controlled amount through

• focusing electrode – the potential on this electrode is variable to create a beam with as small a cross-sectional area as possible when it strikes the screen. The heater, accelerating electrode, control grid and focusing electrode are often collectively known as an electron gun

• deflection plates – the potential across each pair of plates (vertical and horizontal), and the polarity of the potential (i.e., positive or negative) defines how much the electron beam is deflected away from the centre of the screen. If, say, the upper plate is positive and the lower plate is negative, the beam will be deflected up (towards the positive plate and away from the negative plate). Similarly, by varying the potentials applied to the horizontal deflection plates the beam is deflected in a left or right direction.

So, the beam direction (and thus the position where it hits the screen), strength (i.e., the brightness of the trace), and width (the thickness of the trace) are all controllable electronically, merely by changing the voltages applied to the various electrodes. Many refinements may be added to this basic cathode ray tube to improve performance, sensitivity, or beam brightness, but the operation remains more or less as discussed.

**K4701 LOUDSPEAKER DC PROTECTION UNIT – Continued from page 57.**

**Construction Details**

Table 1 shows the number of 5W resistors which must be fitted to suit the maximum peak output voltage of the amplifier. Remember that amplifiers with less than 10V<sub>pk</sub> output are not suitable for use with this module.

There are two methods which can be employed to find the approximate peak output voltage of the amplifier: the first, simply measure the voltage across the (±) PSU supply rails; the second is to determine the voltage by calculation, as shown below:

$$W = \frac{V_{rms}^2}{R}$$

$$V_{pk} = V_{rms} \times \sqrt{2}$$

Where W = Power of amplifier;  
R = load impedance  
V<sub>pk</sub> = peak output voltage of amplifier.

With a little transposition, we have:

$$V_{pk} = \sqrt{W \times R} \times \sqrt{2}$$

$$= \sqrt{W \times R} \times 1.414$$

Example: 50W into an 8Ω load

$$V_{pk} = \sqrt{50 \times 8} \times 1.414 = 28.3V$$

Construction of the module is fairly straightforward; all of the components are mounted on a single-sided PCB. The assembled module is shown in Photo 1.

The recommended component assembly order is as follows: First, fit and solder the Zener diodes. Care must be taken to fit the diodes the right way around; the cathode is indicated by a black band on the body of the diode, and this must face the thick white band on the PCB legend.

Mount the capacitors next, taking care that the two polarised

devices (C2 and C3) are inserted correctly – the negative lead is identified by a white band and (–) symbols on the capacitor's body.

Fit the four mounting tabs next, followed by the 5W resistors. The number of resistors required can be determined from Table 1. Remember to fit wire links on the PCB, in place of the resistors, if less than the full number are needed.

Finally, mount the relay, and solder the three supplied lengths of wire along the solder resist free (tinned copper track) areas, building up the tracks with a thick layer of solder.

Thoroughly check your work for errors, such as misplaced components, solder bridges, and dry joints, etc. Clean any flux off the PCB using a suitable solvent.

**Testing/Installation**

Connect a 12V DC supply (minimum) between the +LS IN & –LS IN terminals; the relay should operate. Disconnect the power supply and reverse the connections. When the power supply is reconnected, the relay should operate again.

The Loudspeaker DC Protector is now ready for connection. Fit a flat push-on receptacle to each of the amplifier and speaker leads, and link the module between the loudspeaker and the amplifier's output, as shown in Figure 2.

The project is now ready for use; it can be installed in an amplifier (shown in Photo 2), or mounted inside the speaker cabinet (shown in Photo 3).

**K7401 LOUDSPEAKER DC PROTECTOR PARTS LIST**

<b>RESISTORS: All 5W</b>			
R1 to R4	68Ω		4
<b>CAPACITORS</b>			
C1	1μF 100V Minimum		1
C2, C3	2200μF 16V Electrolytic		2
<b>SEMICONDUCTORS</b>			
ZD1 to ZD6	4.3V 1.3W Zener Diodes		6
<b>MISCELLANEOUS</b>			
RY1	12V 10A Relay		1
+LS IN, –LS IN, +LS OUT, –LS OUT	Flat Push-on Receptacle & Mounting Tabs		4
	PCB		1
	Tinned Copper Wire		As Req.

The Maplin 'Get-You-Working' Service is available for this project, see Constructors' Guide or current Maplin Catalogue for details.

**The above items are available in kit form only.**

**Order As VF44X (Loudspeaker DC Protector) Price £9.49**

Please Note: Some parts, which are specific to this project (e.g., PCB), are not available separately.

# AUDIO IC POWER AMPLIFIER CIRCUITS

## PART 3

Ray Marston presents a selection of high-power (6 to 40W) circuits in this concluding part of his mini-series.

The opening two parts outlined some of the basic principles of modern audio power amplifier design (including that of 'bridge mode' amplification and power boosting). They presented a variety of practical designs, based on ICs with maximum output power ratings in the approximate range 325mW to 5.5W. This month continues the 'audio power amplifier' theme by looking at a further selection of power amplifier ICs and their application circuits – in this case, devices with maximum output power ratings in the range 6W to 40W.

Table 1 gives basic details of the IC types; note that two of these ICs (the LM2879 and TDA2004) are 'dual' types which each house a pair of independently accessible amplifiers. The TDA2005M is a 'bridge' type which houses a pair of amplifiers that are permanently wired in the bridge or 'power boosting' configuration. Throughout this article, all ICs are dealt with in the order in which they are listed in Table 1. Practical application circuits are given for each IC type, but in some cases, only very brief descriptions of individual IC circuit theory are given.

Many of the ICs mentioned in this article have featured in Data Files in *Electronics*, whilst others have been used in previous Maplin projects. These are a source of further information and application ideas, and issue numbers have been given, where appropriate.

### TBA810S/P

The TBA810 is a very popular medium-power IC that features internal protection against accidental supply polarity inversion, and high supply-line transients, etc. It is widely used in automobile applications, in which it can deliver several watts of audio power into a 4Ω or 2Ω load when operated from a 14.4V (12V nominal) supply. Early versions of this IC carry an 'S' subscript, and have a typical signal power bandwidth of only 15kHz; modern versions carry a 'P' subscript and feature a number of performance improvements, including lower noise and a 20kHz bandwidth.

Figure 41 shows the outline and a practical application circuit for the TBA810S/P. This circuit can deliver 7W into a 2Ω speaker load; its voltage gain is determined by R2; R1 is an

DEVICE NUMBER	STOCK CODE	AMPLIFIER TYPE	MAXIMUM OUTPUT POWER	SUPPLY VOLTAGE RANGE	DISTORTION INTO 8Ω	INPUT IMP.	VOLTAGE GAIN	BANDWIDTH	QUIESCENT CURRENT
TBA810S TBA810P	QL13P	MONO	6W into 4Ω	4 to 20V	0.3% @ 2.5W	5MΩ	37dB	40Hz to 15kHz 40Hz to 20kHz	12mA
LM383T TDA2003V	WQ33L AH52G	MONO	7W into 4Ω	5 to 25V	0.2% @ 4W	150k	40dB	30kHz	45mA
LM2879	NOT AVAILABLE	DUAL	9W/CHANNEL	10 to 35V	0.04% @ 4W/CHANNEL	3MΩ	34dB	50kHz	12mA
TDA2004	NOT AVAILABLE	DUAL	9W/CHANNEL	8 to 18V	0.2% @ 4W/CHANNEL	200k	50dB	35kHz	65mA
TDA2006V	WQ66W	MONO	12W into 4Ω	±6 to ±15V	0.1% @ 4W	5MΩ	30dB	150kHz	40mA
TDA2030AV	WQ67X	MONO	18W into 4Ω	±6 to ±18V	0.1% @ 8W	5MΩ	30dB	140kHz	40mA
TDA2005M	YY70M	BRIDGE	20W into 4Ω	6 to 18V	0.25% @ 12W	100k	50dB	20kHz	75mA
TDA1520	UN79L DIS	MONO	22W into 4Ω	15 to 40V	0.01% @ 16W	20k	30dB	20kHz	54mA
LM1875N	UH78K	MONO	25W into 4Ω	20 to 60V	0.01% @ 20W	1MΩ	26dB	70kHz	70mA
TDA2050V	CP88V	MONO	32W into 4Ω	9 to 50V	0.05% @ 15W	500k	30.5dB	20kHz	55mA
TDA1514A-N7	UK75S	MONO	40W into 4Ω	±8 to ±30V	0.003% @ 32W	1MΩ	30dB	25kHz	60mA

Table 1. Basic details of the ICs described in this concluding part. DIS after Stock Code means discontinued.



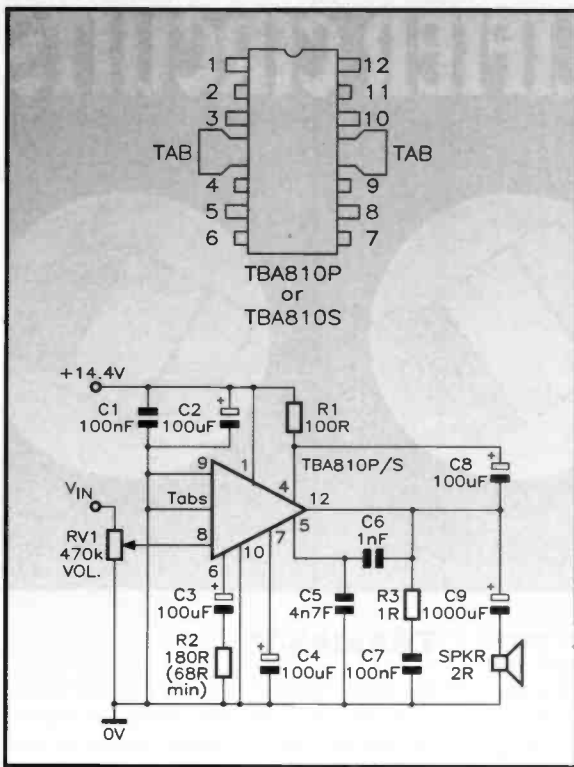


Figure 41. TBA810S/P outline and application circuit for use as a 7W amplifier in cars.

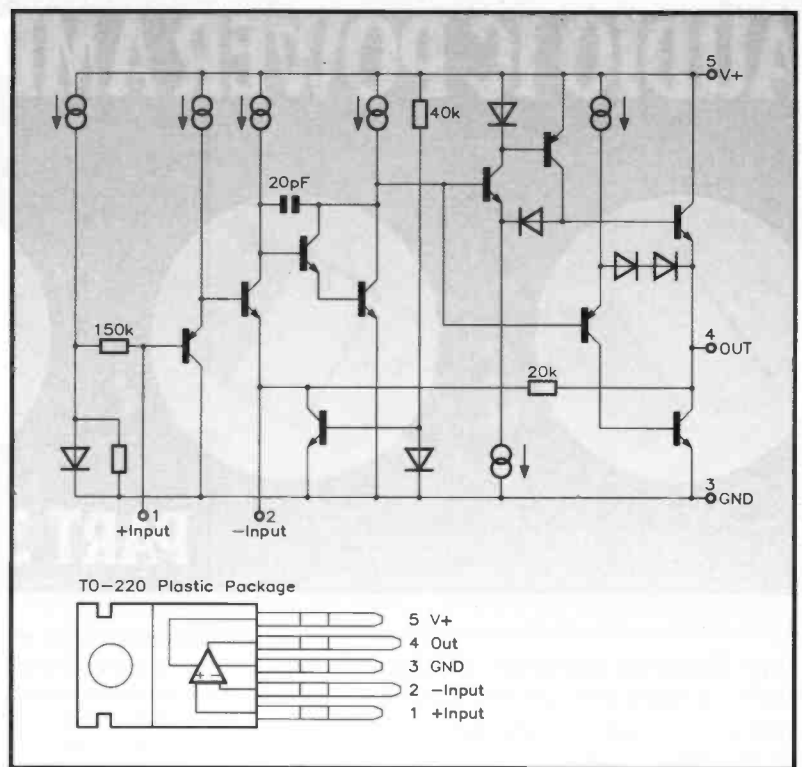


Figure 42. Internal circuit and pin notations of the LM383 (TDA2003) 8W audio power amplifier IC.

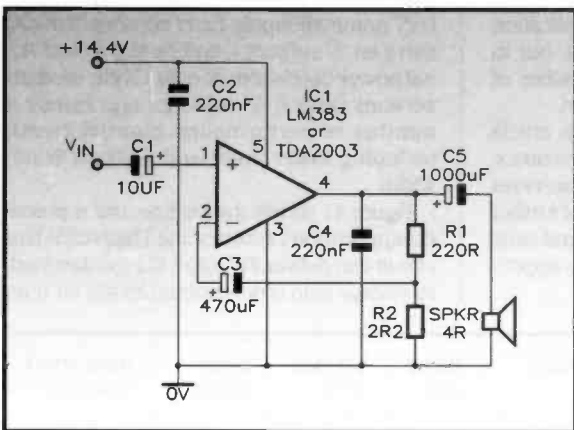


Figure 43. LM383 (TDA2003) 5.5W amplifier for use in cars.

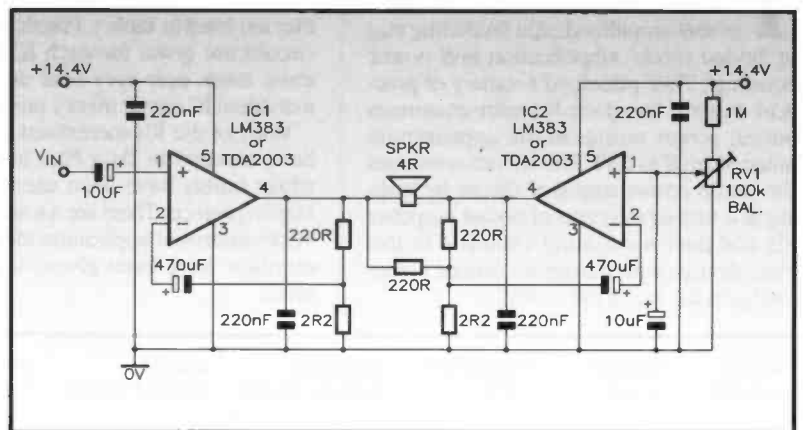


Figure 44. LM383 (TDA2003) 16W amplifier for use in cars.

output biasing resistor that is bootstrapped via C8, and R3-C7 is a Zobel network. A PCB for this IC is available from Maplin (Stock Code BR02C); see the Semiconductors section in the current Maplin Catalogue for further details.

## LM383 (TDA2003) Circuits

The LM383 and the TDA2003 are identical devices, and are described in the manufacturer's literature as 8W audio power amplifier ICs. Figure 42 shows the internal circuit and pin notations. The device is specifically designed for use in automobile applications, in which the 'running' supply voltage has a nominal value of 14.4V; at this voltage, the IC can typically deliver 5.5W into a 4Ω load, or 8.6W into a 2Ω load. The IC can, in fact, operate with any supply voltage in the range 5V to 20V, and can supply peak output currents of 3.5A. It also has a current-limited and thermally protected output stage.

The LM383 (TDA2003) is housed in a 5-pin package, as shown in Figure 42, and is a very easy device to use. Figure 43 shows how to wire it as a 5.5W amplifier for use in cars. Here, the closed-loop voltage gain is set at  $\times 100$ , via the R1-R2-C3 feedback network.

The IC is operated in the non-inverting mode by simply feeding the input signal to pin 1 via C1. Capacitors C2 and C4 are used to ensure the high-frequency stability of the IC; it is vital that C4 is wired as close as possible between pins 3 and 4.

Figure 44 shows how a pair of LM383 ICs can be connected as a 16W bridge amplifier (for use in cars). Preset potentiometer RV1 is used to balance the quiescent output voltages of the two ICs and, to thus minimise the quiescent operating current of the circuit.

The LM383 is featured in a 8W Power Amplifier project, and a kit is available from Maplin (Stock Code LW36P); see the Projects and Modules section of the current Maplin Catalogue for more details.

## LM2879

The LM2879 (Figure 45) is a dual 9W audio power amplifier IC that is housed in an 11-pin package, incorporating a large ground-connected metal heat tab that can be bolted directly to an external heatsink without need of an insulating washer. The IC can operate from single-ended power supply voltages in the range 10V to 35V. It can deliver 9W per channel into an 8Ω load, and incorporates

internal current limiting and thermal shut-down circuitry, etc. It typically generates only 0.04% distortion at 4W per channel output, and gives a 50kHz bandwidth.

The LM2879 is a very easy device to use; Figure 46 shows how it can be used as a 7W + 7W stereo ceramic cartridge amplifier, with integral bass controls that enable the response to be cut or boosted by up to 13dB at 100Hz. Figure 47 shows it connected as a bridge amplifier that can feed 12W into a 16Ω load when using a 28V supply. Note, in both of these circuits, that pin 1 provides a voltage that is used to bias the amplifier's non-inverting input terminals.

## TDA2004

The TDA2004 (Figure 48) is a dual 9W amplifier that is housed in an 11-pin package, similar to that of the LM2879 but with different pin notations. The IC can operate from single-ended supplies in the range 8V to 18V, and can provide peak output currents of 3.5A. It can deliver 9W into a 4Ω load from each channel when using a 17V supply.

Figure 49 shows how to wire the IC as a simple stereo amplifier that will deliver 4W per channel into 4Ω loads while powered

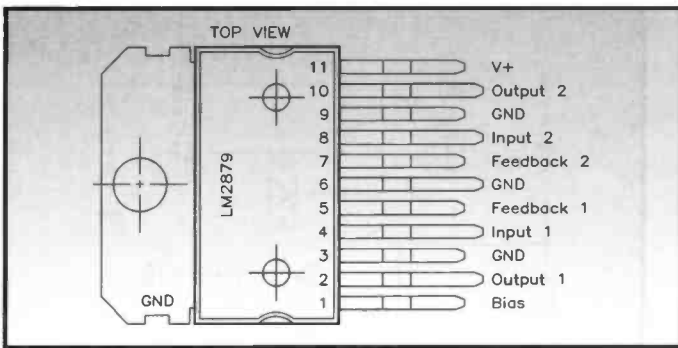


Figure 45. Outline and pin notations of the LM2879 dual 9W audio amplifier IC.

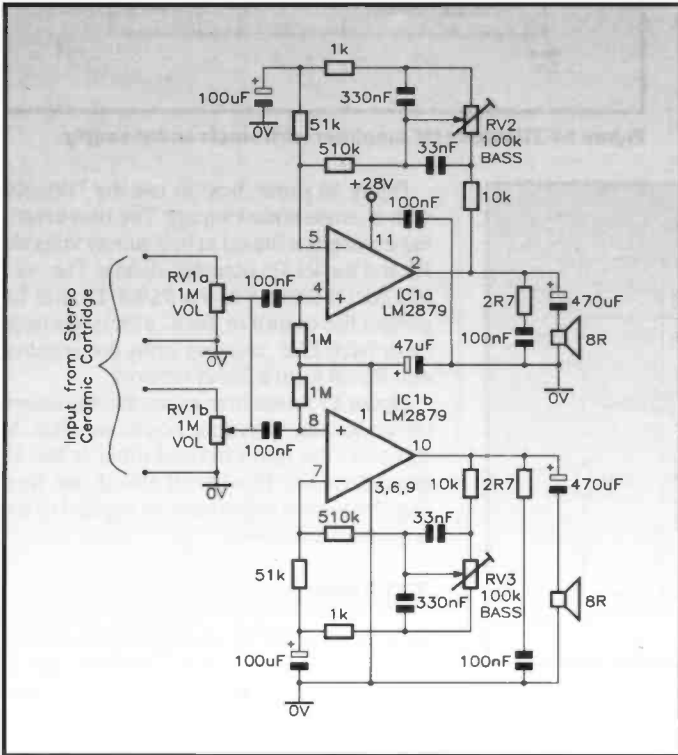


Figure 46. 7W + 7W stereo ceramic cartridge amplifier.

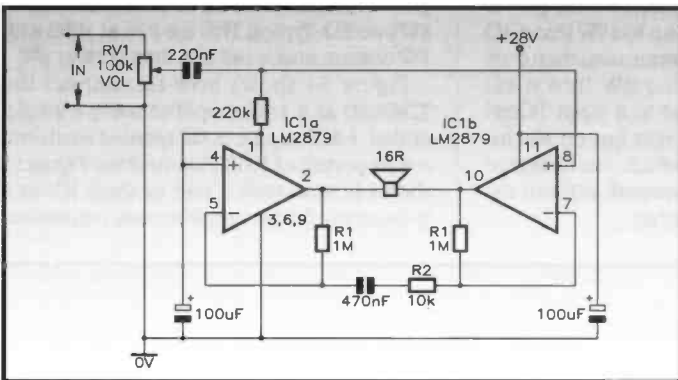


Figure 47. 12W bridge amplifier.

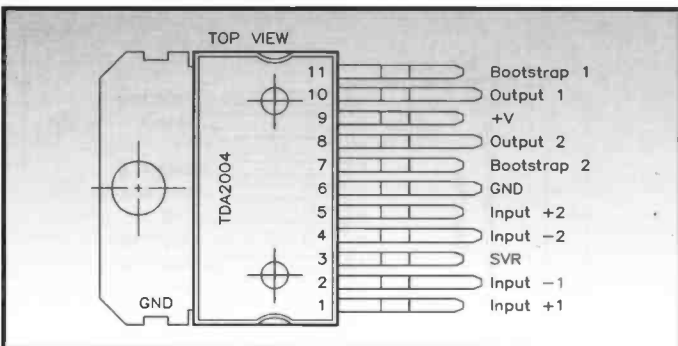


Figure 48. Outline and pin notations of the TDA2004 dual 9W audio amplifier IC.

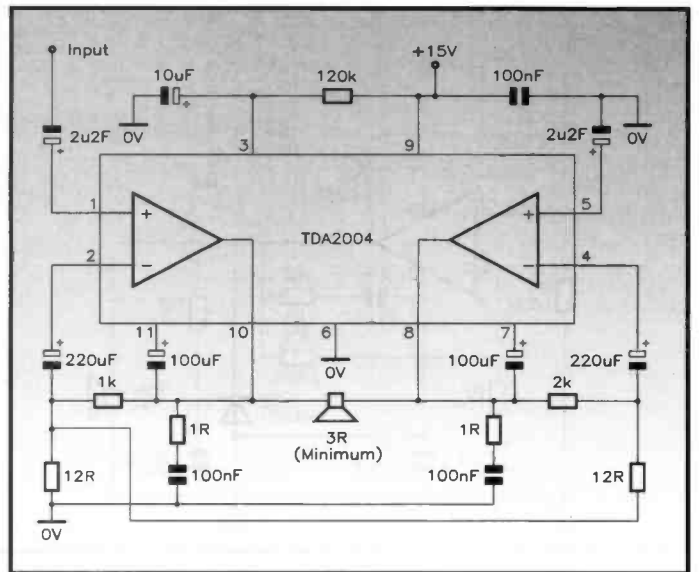


Figure 49. 4W + 4W stereo amplifier.

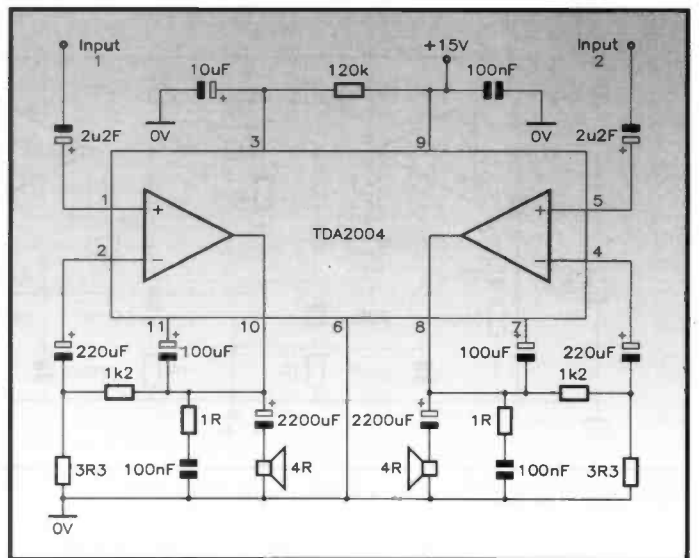


Figure 50. 20W bridge amplifier.

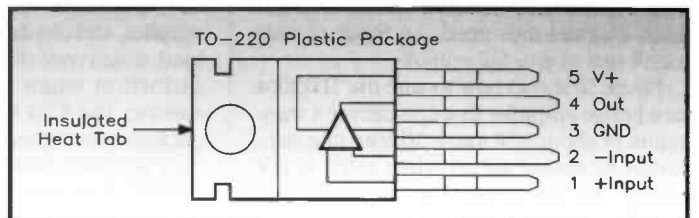


Figure 51. Outline and pin connections of the TDA2006 and TDA2030

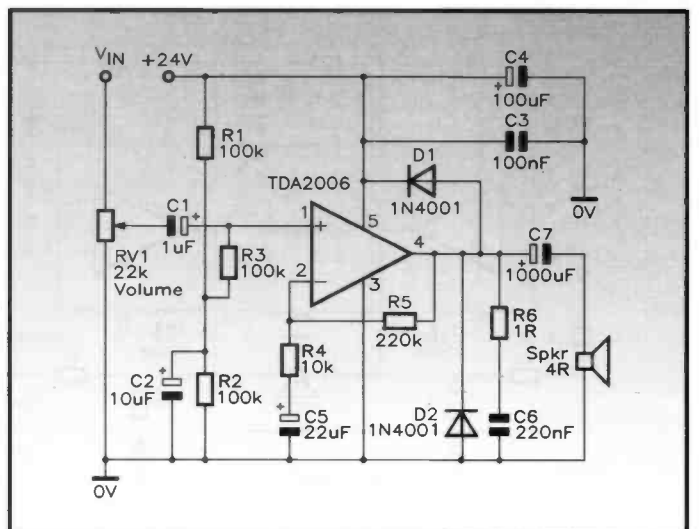


Figure 52. TDA2006 8W amplifier with single-ended supply.



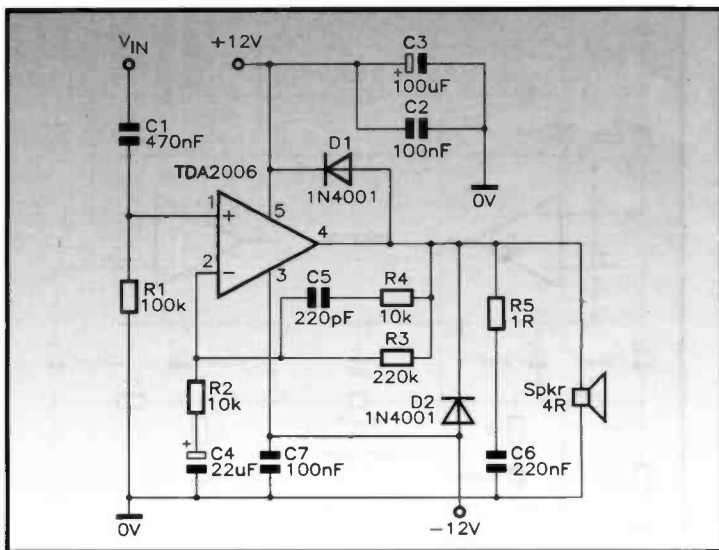


Figure 53. TDA2006 8W amplifier with split power supply.

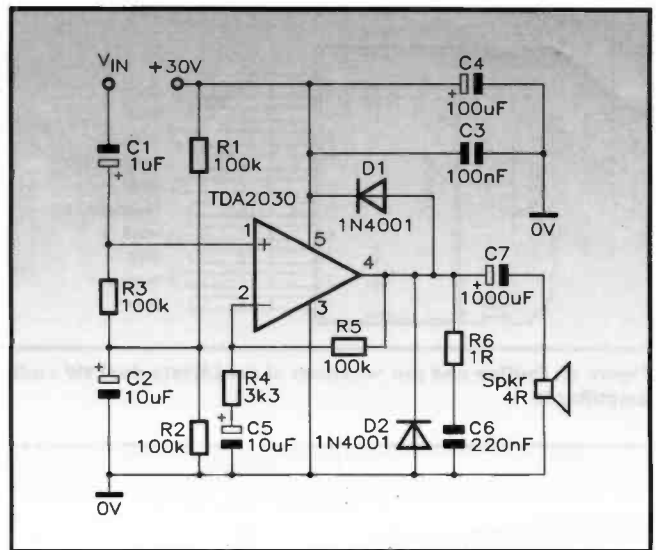


Figure 54. TDA2030 15W amplifier with single-ended supply.

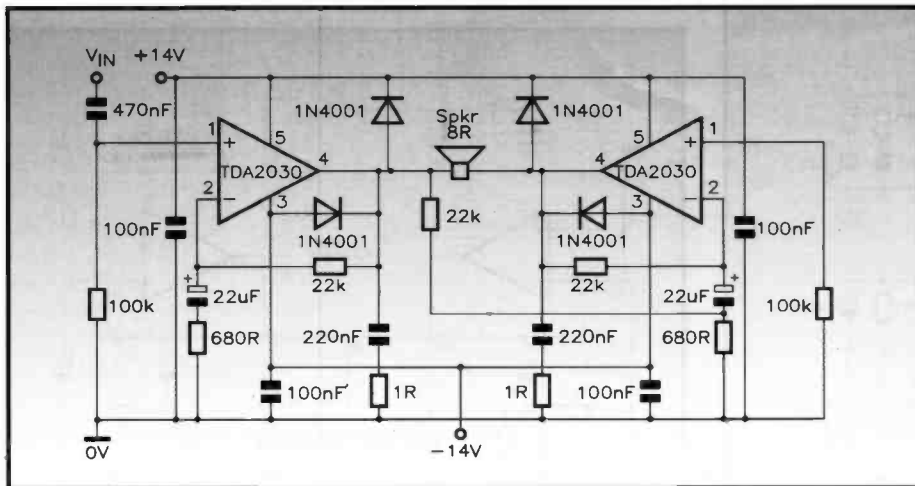


Figure 55. TDA2030 24W bridge amplifier with split supply.

from a 15V supply, generating total harmonic distortion of less than 0.2%. Note that each channel has its voltage gain set at about  $\times 364$  by the ratio of the 1k $\Omega$  and 3.3 $\Omega$  resistors, and each channel thus needs an input of only 12mV rms to give full output.

Figure 50 shows how to wire the TDA2004 as a bridge amplifier that can deliver a maximum of about 20W into a 3 $\Omega$  load (the minimum allowable value) when using a 15V supply. This circuit needs an input of about 50mV rms for full output.

## TDA2006

This is a high-quality amplifier that can be used with either split or single-ended power supplies, and can deliver up to 12W into a 4 $\Omega$  load, which typically generates less than 0.1% distortion when feeding 8W into a 4 $\Omega$  speaker. The IC is housed in a 5-pin TO220 package (see Figure 51) that has an electrically insulated heat tab which can be bolted directly to an external heatsink without the need of an insulating washer.

Figure 52 shows how to use the TDA2006 with a single-ended supply. The non-inverting input pin is biased at half-supply volts via R3 and the R1-R2 potential divider. The voltage gain is set at  $\times 22$  via R5/R4. D1 and D2 protect the output of the IC against damage from back EMF voltages from the speaker, and R6-C6 form a Zobel network.

Figure 53 shows how to modify the above circuit for use with split power supplies. In this case, the non-inverting input is tied to ground via R1. This circuit also shows how high-frequency roll-off can be applied to the amplifier via C5-R4.

## TDA2030

This very popular IC can be regarded as an updated version of the TDA2006, and is housed in the same 5-pin TO220 package with insulated heat tab. It can operate with single-ended supplies of up to 36V, or with balanced split supplies of up to 18V. When used with a +28V single-ended supply, it gives a guaranteed output of 12W into 4 $\Omega$  or 8W into 8 $\Omega$ . Typical THD is 0.05% at 1kHz with 7W output, and is still less than 0.1% at 8W.

Figure 54 shows how to connect the TDA2030 as a 15W amplifier using a single-ended +30V supply, a 4 $\Omega$  speaker load, and a voltage gain of 30dB. Alternatively, Figure 55 shows how to wire a pair of these ICs as a split-supply bridge amplifier that can deliver

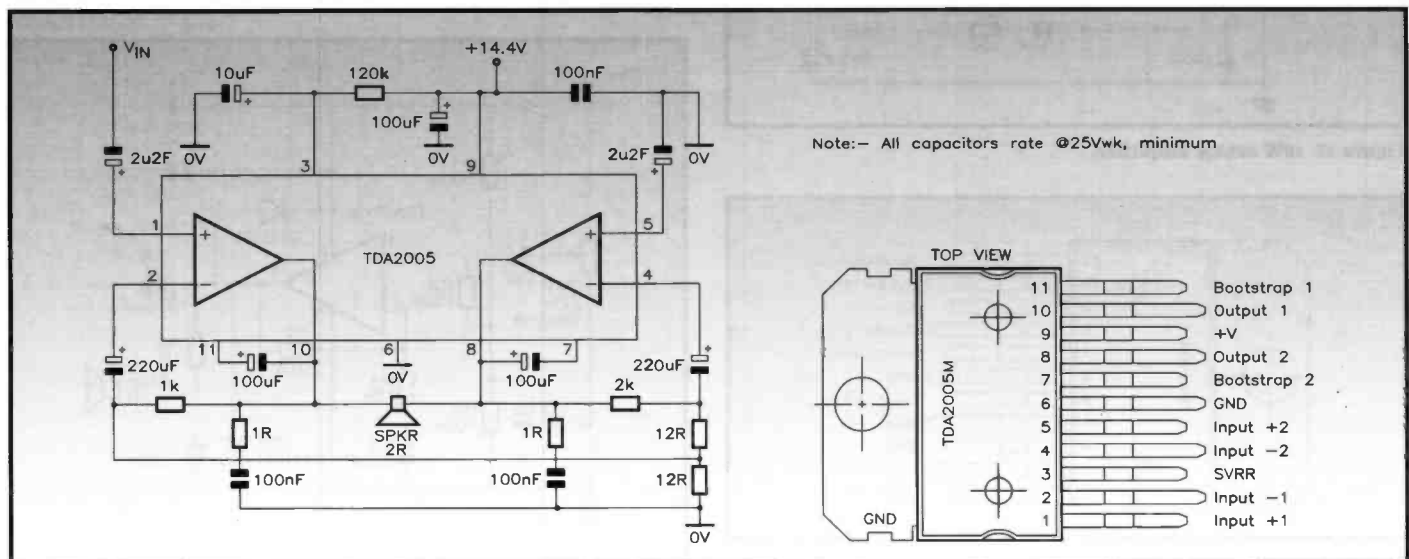


Figure 56. TDA2005M 20W power booster for use in cars.

24W into a 4Ω speaker load while generating typical total harmonic distortion of less than 0.5%.

The TDA2030 was featured in a 15W Power Amplifier project, and a kit is available from Maplin (Stock Code LT93A); see the Projects and Modules section of the current Maplin Catalogue, or issue 64 of *Electronics* for more details.

## TDA2005M

This is a 20W audio power booster IC specifically designed for use in cars, and is fully protected against output short circuits, etc. The IC actually houses two power amplifiers, which are internally connected in the bridge

configuration to provide the high power output (into a 2Ω load) from the 14.4V (nominal) power supply of a car. The IC is housed in an 11-pin package, as shown in Figure 56 (which also shows a practical applications circuit for the TDA2005M). Note that all capacitors must be rated at 25V minimum.

## TDA1520

This is a very high performance device that can deliver up to 22W into a 4Ω load, or 11W into an 8Ω load, when powered from a 33V supply, and which typically generates a mere 0.01% distortion at 16W output into a 4Ω load. The IC is housed in a 9-pin package that can be bolted directly to an external heatsink

(without the need for insulating washers) in single-ended supply applications. Figure 57 shows the IC outline and a practical application circuit for this device.

## LM1875

The LM1875 is a very high quality audio amplifier that can (when using a 60V supply) deliver a maximum of 25W into a 4Ω load; it will deliver 20W into a 4Ω load when using a 50V supply, generating a mere 0.015% distortion. The IC is housed in a 5-pin TO220 package that does not require the use of an insulating washer between its metal tab and an external heatsink in single-ended supply applications; note, however, that an insulat-

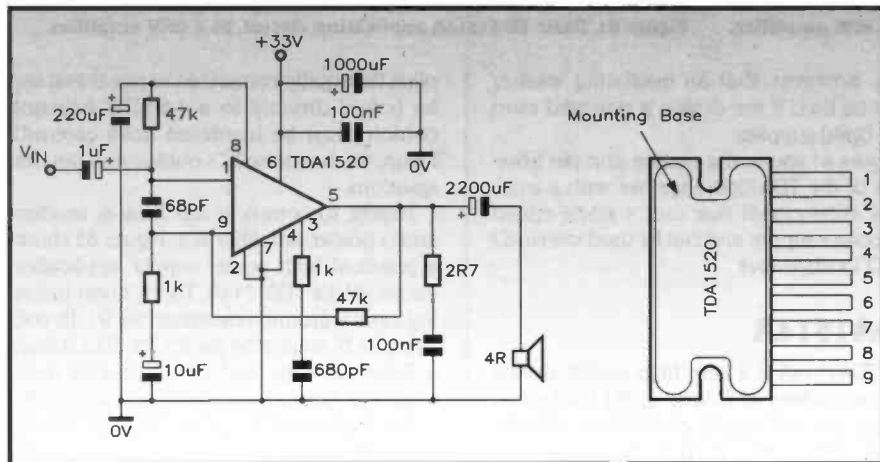


Figure 57. TDA1520 22W power amplifier.

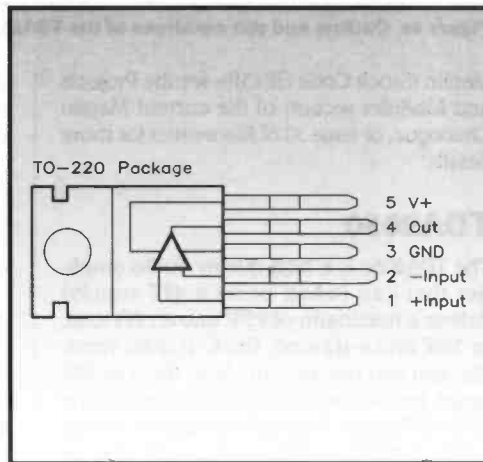


Figure 58. LM1875 outline and pin notations.

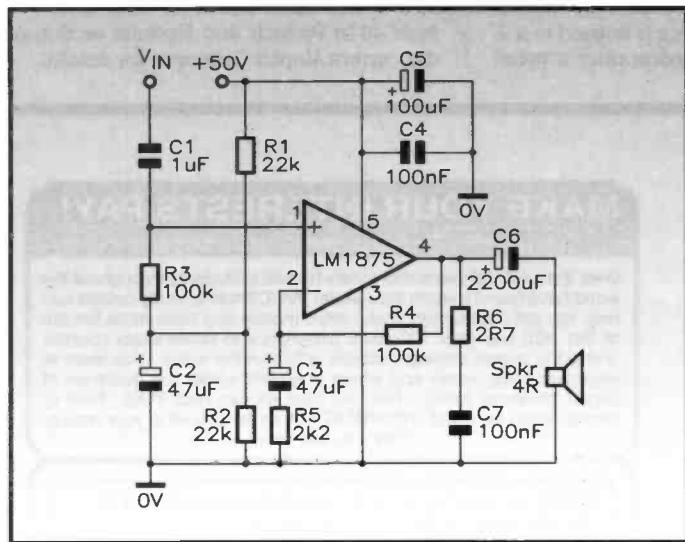


Figure 59. LM1875 20W amplifier using single-ended power supply.

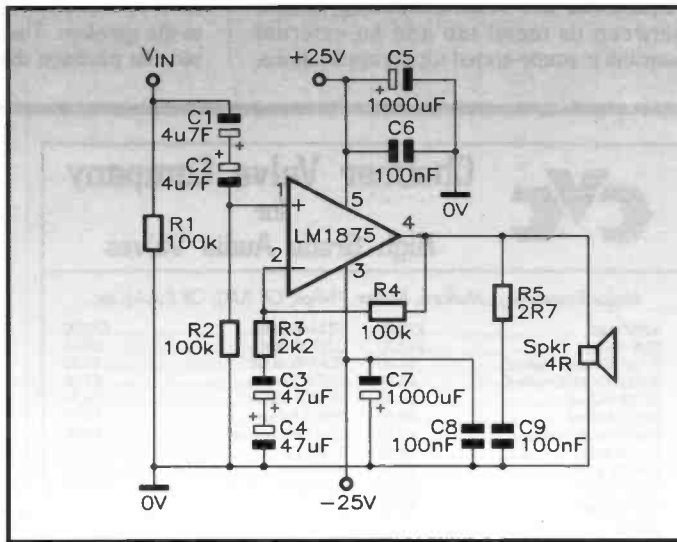


Figure 60. LM1875 20W amplifier using dual (split) power supply.

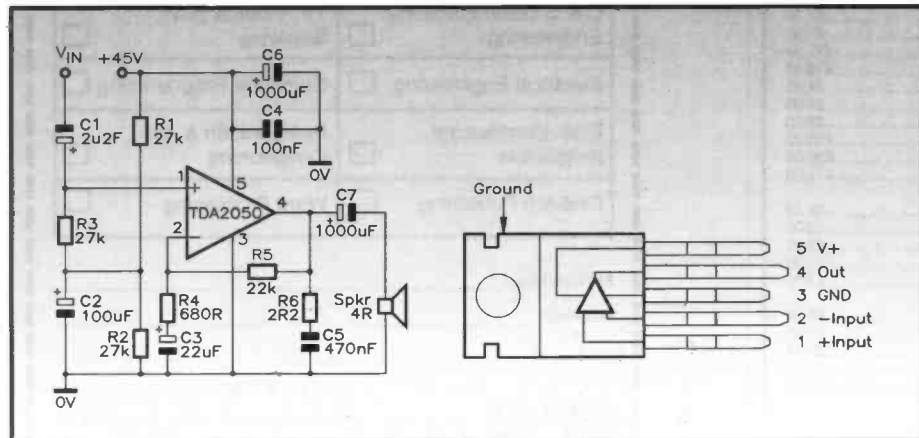


Figure 61. TDA2050 outline and basic application circuit, giving 25W into an 8Ω speaker, or 32W into 4Ω.

ing washer must be used if the device is powered from dual (split) supplies.

Figure 58 shows the outline and pin notations of the LM1875, and Figures 59 and 60 show practical 20W application circuits, using single and dual power supplies respectively. In Figure 59, the IC's output is biased to half-supply volts via R3 and the R1-R2 divider, and the voltage gain is set at  $\times 45$  via R4-R5; R6-C7 form a Zobel network across the loudspeaker and help enhance circuit stability. In Figure 60, the IC's output is zero-referenced via R2, and the gain is set at  $\times 45$  via R4-R3; note that capacitors C1-C2 and C3-C4 are wired back-to-back, to enable them to accept either polarity of input signal.

The LM1875 was featured in a 20W Audio Power Amplifier Data File in issue 30 of *Electronics*. A PCB for this IC is available from



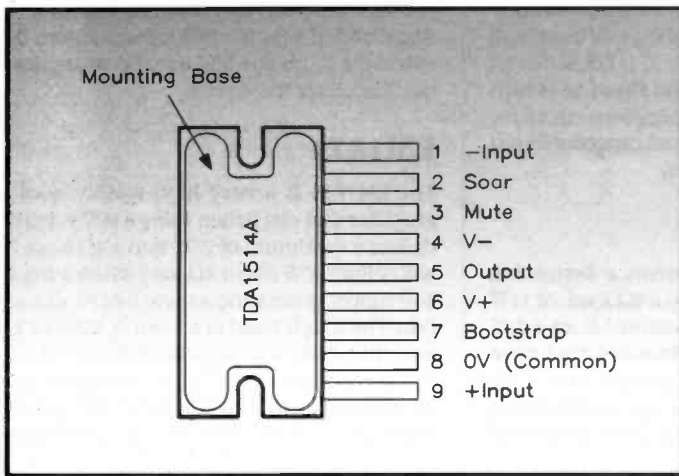


Figure 62. Outline and pin notations of the TDA1514A 40W amplifier.

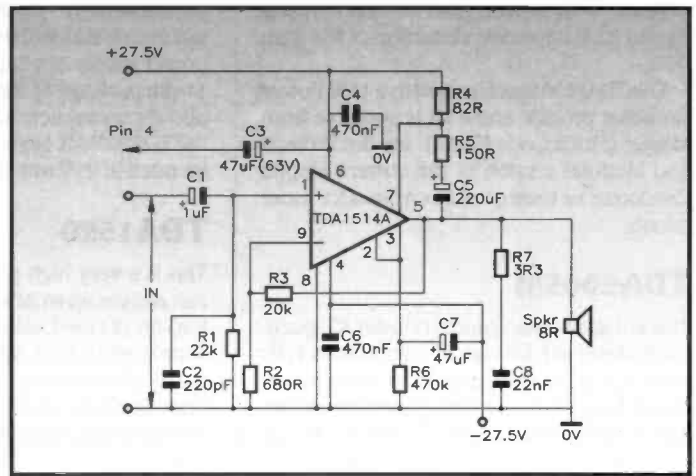


Figure 63. Basic TDA1514A application circuit, as a 40W amplifier.

Maplin (Stock Code GE13P); see the Projects and Modules section of the current Maplin Catalogue, or issue 30 of *Electronics* for more details.

## TDA2050

The TDA2050 is a high quality audio amplifier that can (when using a 45V supply) deliver a maximum of 25W into an 8Ω load, or 32W into a 4Ω load. The IC is quite versatile, and can use any supply in the 9 to 50V range, but performs best with a supply in the 38 to 45V range. It typically generates a mere 0.05% distortion when feeding 15W into an 8Ω load from a 38V supply. The IC is housed in a 5-pin TO220 package that does not require the use of an insulating washer between its metal tab and an external heatsink in single-ended supply applications;

note, however, that an insulating washer must be used if the device is powered from dual (split) supplies.

Figure 61 shows the outline and pin notations of the TDA2050, together with a basic application circuit that uses a single-ended 45V power supply, and can be used with a 4Ω or 8Ω loudspeaker.

## TDA1514A

The TDA1514A is a very high quality device that can deliver 40W into an 8Ω load when using a split 55V supply, or 40W into 4Ω from a split 42V supply. It typically generates a mere 0.0032% distortion at 32W output, and incorporates auto-mute circuitry that eliminates switch-on and switch-off surges (clicks) in the speakers. The device is housed in a 9-pin flat package that incorporates a metal

plate (internally connected to pin 4) that can be bolted directly to a 4.3°C/W heatsink (which must be insulated from ground). Figure 62 shows the IC's outline and pin designations.

Finally, to complete this look at modern audio power amplifier ICs, Figure 63 shows a practical 'split power supply' application circuit for the TDA1514A. The IC's non-inverting input is ground-referenced via R1. Its voltage gain is set at  $\times 30$  via R3-R2. R7-C8 form a Zobel network, and R6-C7 provide auto-muting at power switch-on and switch-off.

For further information, see *Electronics* (issue 40), where this IC was featured in a 50W IC Power Amplifier Data File application circuit. A complete kit for this module is available from Maplin (Stock Code LP43W); see issue 40 or Projects and Modules section of the current Maplin Catalogue for details.



## Chelmer Valve Company for High Grade Audio Valves

Major Brands e.g., Mullard, Brimar, Philips, GE (UK), GE (USA), etc.

A2900 GEC .....	£12.00	GZ34 Mullard .....	£10.00
E80F Philips .....	£10.00	GZ37 Mullard .....	£7.00
ECC81/CV4024 Mullard .....	£6.00	6CA7/EL34 GE .....	£9.50
ECC82/CV4003 Mullard .....	£6.00	6L6GA Sylvania .....	£7.00
ECC88 Mullard .....	£6.00	6SN7GT Brimar .....	£4.50
E88CC Mullard .....	£8.50	6V6GT Brimar .....	£4.00
EF86/CV4085 Mullard .....	£8.50	12AT7WC Sylvania .....	£6.00
EL84 Mullard .....	£6.00	6146B GE .....	£15.00
EL84 GE (USA) .....	£5.00	6550A GE .....	£17.50
GZ32 Mullard .....	£8.00	7581A GE .....	£12.00
GZ33 Mullard .....	£8.00		

**CVC PREMIUM:** Our own BRAND from selected worldwide sources, processed in our special facility to provide low noise/hum/microphony Pre-Amp Valves and Power Valves built-in for improved stability and reliability.

### PRE-AMP VALVES

ECC81/12A17 .....	£5.00
ECC82/12AU7 .....	£4.00
ECC83/12AX7 .....	£5.00
ECC85 .....	£4.00
ECC88 .....	£5.00
EF86 .....	£4.00
E81CC (GOLD PIN) .....	£6.00
E82CC (GOLD PIN) .....	£6.00
E83CC (GOLD PIN) .....	£6.00
E88CC (GOLD PIN) .....	£7.00
E80F .....	£9.00
E83F .....	£5.50
6SU7GT .....	£4.00
6SN7GT .....	£4.20

### POWER VALVES

2A3 (OCTAL) or (4 PIN) .....	£14.00
211 .....	£22.00
300B .....	£50.50
B11A .....	£9.50
B45 .....	£29.90
EL34/6CA7 .....	£7.50
EL84/6BQ5 .....	£4.00

### POWER VALVES - cont.

E84L/7189A .....	£5.10
KT66 .....	£9.20
KT88 .....	£12.50
KT88 (GOLD Q) .....	£18.50
6L6GC .....	£6.50
6L6WGC/5881 .....	£8.00
6V6GT .....	£5.00
6146B .....	£10.20
6336A .....	£40.00
6550A .....	£11.00

### RECTIFIERS

GZ33 .....	£4.50
GZ34/5AR4 .....	£5.00
5U4G .....	£5.00
5Y3GT .....	£3.20
5Z4GT .....	£3.50

### SOCKETS

B9A (PCB) .....	£1.60
B9A (CHASSIS) .....	£1.60
OCTAL (CHASSIS) .....	£1.75
4 PIN (UX4) .....	£3.00
4 PIN (for 211 and 845) .....	£11.00

Add £1.00 per valve for matching if required.  
Plus Post & Packing £3.00 + VAT at 17.5% for UK/Europe.  
Send/Fax order with cheque or credit card details to:

Chelmer Valve Co., 130 New London Road, Chelmsford, Essex CM2 0RG  
Tel: (0245) 265865 Fax: (0245) 490064

## MAKE YOUR INTERESTS PAY!

Train at home for one of these Career Opportunities

Over the past 100 years more than 10 million students throughout the world have found it worth their while! An ICS home-study course can help you get a better job, make more money and have more fun out of life! ICS has over 100 years experience in home study courses and is the largest correspondence school in the world. You learn at your own pace, when and where you want under the guidance of expert 'personal' tutors. Find out how we can help YOU. Post or phone today for **FREE INFORMATION** on the course of your choice. (Tick one box only!)

**GCSE/A' LEVEL** over 20 examination subjects to choose from. **ASK FOR DETAILS.**

Electronics <input type="checkbox"/>	P.C. Repair <input type="checkbox"/>
C & G Basic Electronic Engineering <input type="checkbox"/>	TV, Video & Hi-Fi Servicing <input type="checkbox"/>
Electrical Engineering <input type="checkbox"/>	Computer Programming <input type="checkbox"/>
Elec. Contracting/Installation <input type="checkbox"/>	Refrigeration & Air Conditioning <input type="checkbox"/>
Desktop Publishing <input type="checkbox"/>	Word Processing <input type="checkbox"/>

Mr/Mrs/Miss: \_\_\_\_\_

Address: \_\_\_\_\_

P.Code \_\_\_\_\_

**ICS** International Correspondence Schools, Dept. EKS A4  
312/314 High Street, Sutton, Surrey SM1 1PR.  
Tel: 0141-306 1194 (24 hours). Fax: 0141-221 8151.  
Further offers, which may be of interest, may be sent to you by ICS or other carefully selected companies.

# CIRCUIT MODE SWITCHING

by Frank Booty

**I**NTER-NETWORK communication is accomplished through the three primary switching technologies of circuit, message, and packet switching. In circuit mode networks, each circuit is dedicated to a predetermined number of users during the usage period. The telephone system is the most frequently cited example of a circuit mode switching network. In message mode networks, circuits are shared on an ad hoc basis, and entire messages are stored at intermediate nodes en route to their destinations – telex networks use message mode switching. Packet mode networks use the same circuit-sharing principles as message mode networks, but large messages are broken into smaller packets for more efficient and flexible transfer. Most of the popular local area networks (LANs) in use today are based on packet mode switching. The three types of inter-network communication outlined here are shown in Figure 1.

All three network switching techniques have advantages and disadvantages. For example, circuit mode networks offer users dedicated bandwidth, but, on the other hand, they can also waste bandwidth (under certain circumstances). Because packet mode networks have traditionally offered more flexibility and utilised network bandwidth more efficiently than circuit mode networks, some consider packet mode networks to be higher on the evolutionary scale than circuit mode networks. Recent advances in circuit mode networks however have again brought this technology to the forefront of network research and application. Hence, this article seeks to explore the state of circuit mode switching networks.

As a starting point, it is worthwhile to consider some basic concepts. One of the most common interfaces in networking is the interface between data terminal equipment (DTE) and data circuit-terminating – sometimes called data communications – equipment (DCE). DTE, typically embodied in computers, terminals or routers, requires a circuit for information transfer. DCE, typically embodied in modems or similar devices, terminates and provides clocking for a circuit. DTE is usually provided by private computing-equipment vendors. DCE is commonly offered by communications product vendors. DCE provides connection from DTE into a communications network and back again. The DTE/DCE interface, and its relationship to a communication's network, is shown in Figure 2.

## Physical-Layer Specifications

The DTE/DCE interface is described through various physical-layer communication specifications; they provide information about four different aspects of physical-layer interfaces:

mechanical, electrical, functional and procedural. Mechanical aspects of physical-layer interfaces include connector specifics, circuit to pin assignments, and connector latching arrangements. Electrical aspects of physical-layer interfaces include voltage levels that represent binary values and resistance/impedance. Functional aspects of physical-layer interface specifications assign functions (control, data, ground) to particular circuits. Finally, procedural aspects of physical-layer interfaces define those procedures associated with various data exchange operations. One example is the various electrical actions over specific circuits that together specify the loopback operation.

The best known physical-layer interface is the recommended standard 'RS-232' (which is often referred to as Electronic Industries Association – EIA – 232). For international circuit connections the Consultative Committee on International Telephone and Telegraph (CCITT) created a physical specification very similar to that of RS-232. This specification is referred to as 'V24'. A third popular physical interface, 'RS-449', is the successor to RS-232. RS-449 was created to ease the physical

limitations of RS-232, specifically the cable distance limitation. Yet another physical interface is defined by the 'X.21' specification. X.21, also created by CCITT, includes a general-purpose DTE/DCE interface specification for synchronous transmission.

Another standard is the High Speed Serial Interface (HSSI), which is a de facto industry standard developed by Cisco Systems (a key manufacturer in the circuit mode switching arena) and T3 plus Networking (a manufacturer of DS3/E3 digital service units and bandwidth managers). HSSI operates over a shielded cable at speeds of up to 52M-bits/s and, distances of up to 50ft. Functionally, it serves the same purpose as lower-speed serial interfaces (such as V35 and RS-232) in that it provides the interface to DCE for wide area network (WAN) communications. HSSI has been standardised by the ANSI EIA/TIA (TIA – Telecommunications Industries Association) TR-30.2 committee as EIA SP-2796 for the physical interface specifications, and as EIA SP-2795 for the electrical specifications. A table comparing various aspects of several of the most popular physical-layer specifications is shown in Table 1.

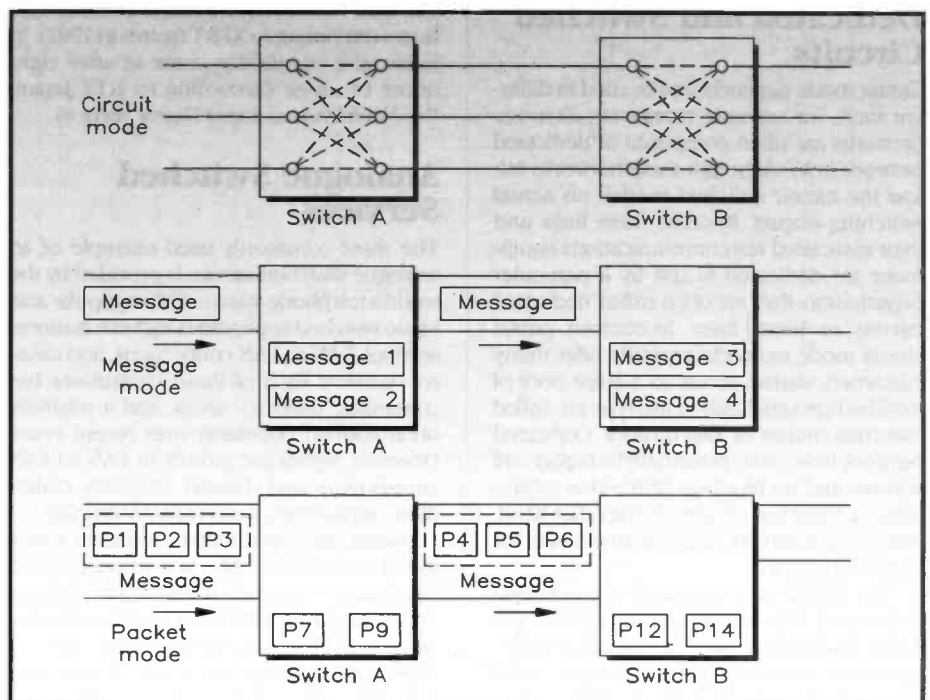


Figure 1. Three Types of switched network.

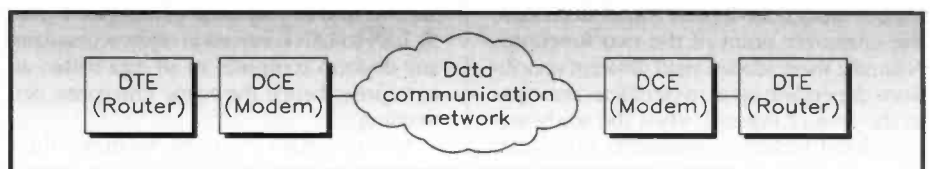


Figure 2. The DTE/DCE interface.



	Number of pins	Maximum cable length (Twisted pair)	Maximum signalling rate
RS232	25	50 feet	20K-bit/s
RS449	37	4,000 feet	10M-bit/s
X.21	15	not specified	1.92M-bit/s
V35	35	50 feet	4M-bit/s
HSSI	50	50 feet	52M-bit/s

Table 1. Comparison of some popular physical-layer interfaces.

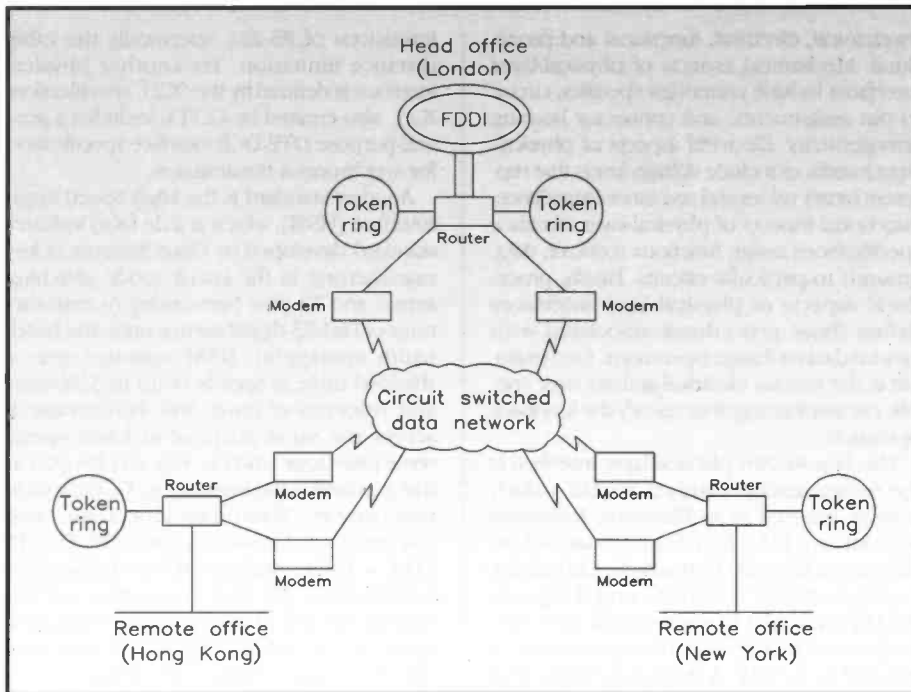


Figure 3. Connecting corporate and remote offices.

## Dedicated and Switched Circuits

Circuit mode networks can be used in different ways. For example, private circuit mode networks are often composed of dedicated network links. Although these networks follow the circuit switched model, no actual switching occurs. Because these links and their associated telecommunications equipment are dedicated to use by a particular organisation, they are often called 'dedicated circuits' or 'leased lines'. In contrast, public circuit mode networks typically offer many customers shared access to a large pool of switched circuits. Links of this type are called 'switched circuits' or 'dial-up lines'. Dedicated network links offer (potentially) a higher call volume and no blockage from other organisations. Switched circuits, on the other hand, offer route flexibility, and cost advantages for low call volumes.

The choice of a dedicated or a switched line is most dependent upon how often data will be flowing over the line. Dedicated lines are of fixed cost. Switched line costs are based on usage. In general, with all other factors being equal, dedicated lines become a more effective solution the more a line is used. Various studies have been run to determine the crossover point of the two functions. Naturally, these studies yield different conclusions depending upon: type of line; line costs in the area of interest; when the study was completed; and other parameters. In the USA, for example, it becomes more economical to use a dedicated, rather than a switched,

56K-bit/s line when the usage exceeds four hours (according to AT&T figures in 1992). In Japan, the economies come in after eight hours of usage (according to NTT Japan, INS-Net 64 versus Super Digital Service).

## Analogue Switched Services

The most commonly used example of an analogue switched service is provided by the world's telephone system. Other popular analogue switched applications include: business services, LAN to LAN connections, and disaster recovery. Each of these applications has continuing utility for users, and a relatively undiminished popularity over recent years. However, significant growth in LAN to LAN connectivity and disaster recovery makes these applications particularly interesting.

During the 1980s, many companies established office-based LANs as a means to share data between users at a particular site. As inter-networking and distributed system technologies matured, during the late 1980s, many of these companies saw the benefit of extending their LAN applications and data retrieval capabilities over wider areas. Companies began connecting their remote offices to one another and to corporate offices (see Figure 3). LAN-to-LAN connection offers access from any desktop computer to all data within an enterprise, hence the name enterprise networking.

As companies continue to move their 'mission-critical' applications from central computers to networks of smaller computers,

network 'up-time' becomes essential. Network failures can cost companies hundreds of thousands of pounds in irretrievable lost revenue. To help prevent network failures from having such an impact (on the bottom lines of their accounting balance-sheets), many companies are purchasing disaster recovery equipment and applications. Often, these applications utilise switched analogue links to open automatically new routes over which mission-critical data can flow. They can also provide backup channels for communication of network failure information to central network management sites. When the main network lines are down, this may be the only way in which notification of a network link failure can be communicated to a central location; the troubleshooting procedures can then begin.

Generally, analogue transmission technology has several serious constraints that limit its usefulness. First, analogue transmission is not as immune to transmission impairments, including problems resulting from the modulation process, as digital transmission. Second – and most importantly – analogue transmission in the telephone network is limited to speeds of under 20K-bit/s, whereas digital transmission can achieve far greater speeds. Many newer applications, such as imaging, video, and certain factory automation applications, require substantially higher bandwidth and/or lower latency than analogue services can provide. As a result of these and other benefits, digital transmission is rapidly replacing analogue transmission.

## Digital Switched Networks

Switched digital services are offered by carriers, including Ameritech (USA based), Bell Atlantic, British Telecom, Telecom Finland, France Telecom, Pacific Telesis, and others. These services are also offered by USA-based 'inter-exchange' carriers (IECs) such as Sprint and AT&T. Services offered include 56K-bit/s,  $n \times 64K$ -bit/s, and others. These services support not only the applications listed previously (voice, business services, LAN to LAN connectivity and disaster recovery), but also expand the range of possible applications to include those that require a very high data rate, and low latency. Applications falling into these categories include: imaging, video and factory automation.

Over in North America, the switched 56K-bit/s service is usually regarded as the most popular switched digital service. Switched 56K-bit/s service allows users to dial a 56K-bit/s data circuit, pay for usage by the minute, and then disconnect the call in much the same way as a voice call is disconnected. Switched 56K-bit/s service has several important strengths, not the least of which is price/performance. It is often used for such applications as video conferencing, Group IV fax, LAN to LAN connections and backup. A switched ' $n \times 56/64K$ -bit/s' service is an extension of this technology, providing multiple channels of either 56K-bit/s or 64K-bit/s service.

Switched T1 is a relatively new offering that provides high bandwidth capability for applications such as mainframe connections, channelising data, and video conferencing. Switched T1 is based on T1 technology, which was introduced by AT&T for the purpose of inter-office trunking in metropolitan areas.

In Europe, similar switched services are delivered as switched X.21 at 64K-bits/s,  $n \times 64\text{K-bits/s}$  or as ISDN (Integrated Services Digital Network).

## Integrated Services Digital Network (ISDN)

The term used to refer to a new set of digital services becoming available to end-users is 'Integrated Services Digital Network' (ISDN). ISDN involves the digitisation of the telephone network so that voice, data, text, graphics, music, video, and other source material can be made available to end-users from a single end-user terminal, over existing telephone wiring. Proponents of ISDN imagine a world-wide network much like the existing telephone network, except that digital transmission is used, and a variety of new services are available.

ISDN is an attempt to standardise subscriber services, user/network interfaces, and network and inter-network capabilities. Standardising subscriber services are aimed at ensuring a level international compatibility. Standardising the user/network interface stimulates development and marketing of these interfaces by third party manufacturers. Standardising network and inter-network capabilities is necessary to achieve the goal of world-wide connectivity by helping to ensure that ISDN networks easily communicate with one another.

The ISDN reference model is shown in Figure 4. ISDN components include: terminals, terminal adaptors (TAs), network termination devices, line termination equipment, and exchange termination equipment. ISDN terminals come in two types – specialised ISDN terminals are referred to as 'terminal equipment type 1' (TE1), and non-ISDN terminals, such as DTE equipment that pre-dates the ISDN standards, are referred to as 'terminal equipment type 2' (TE2). TE1s connect to the ISDN network through a four-wire twisted-pair digital link. TE2s connect to the ISDN network through a terminal adaptor. The ISDN terminal adaptor can either be a stand-alone device or a board inside the TE2. If implemented as a stand-alone device, the TE2 connects to the terminal adaptor via a standard physical-layer interface (for example, EIA 232, V24 or V35).

The next connection point in the ISDN network is the NT1 or the NT2. These are network termination devices that connect the four-wire subscriber wiring to the conventional two-wire local loop. In North America, the NT1 is a customer premises device that allows up to eight terminal devices to be addressed. In most other parts of the world, the NT1 is part of the network provided by the carrier. The NT2 is a more complicated device, typically found in digital private branch exchanges (PBXs), which performs layer-2 and layer-3 protocol functions, and concentration services. An NT1/2 device also exists; it is a single device that combines the functions of an NT1 and an NT2. Basic rate access (BRA) is an example of an NT1/2 interface.

A number of reference points are specified in ISDN. These reference points define logical interfaces between functional groupings such as TAs and NT1s. These reference points include 'R' (the reference point between non-ISDN equipment and a TA), 'S' (the reference point between user terminals and the NT2), 'T' (the reference point between NT1 and

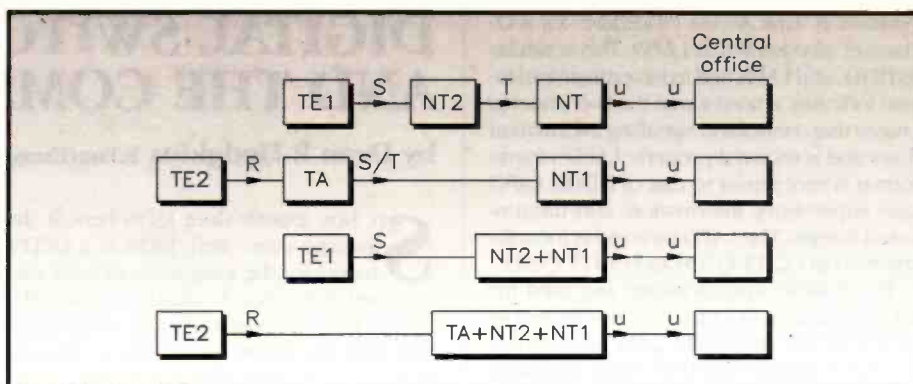


Figure 4. The ISDN reference model.

NT2 devices) and 'U' (the reference point between NT1 devices and line termination equipment in the carrier network). The U reference point is relevant only in North America, where the NT1 function is not provided by the carrier network.

ISDN's Basic Rate Interface (BRI) service offers two B-channels and one D-channel (2B+D). BRI B-channel service operates at 64K-bits/s, and is meant to carry user data; BRI D-channel service operates at 16K-bits/s, and is meant to carry control and signalling information – although it can support user data transmission under certain circumstances. BRI also provides for framing control and other overheads, bringing its total bit rate

to 192K-bits/s. The BRI physical-layer specification is CCITT I.430.

ISDN Primary Rate Interface service (PRI) offers 23 B-channels, and one D-channel, in North America and Japan, yielding a total bit rate of 1.544M-bits/s (the PRI D-channel runs at 64K-bits/s). ISDN PRI in Europe, Australia, and other parts of the world provides 30 B-channels plus one 64K-bits/s D-channel, and a total interface rate of 2.048M-bits/s. The PRI physical-layer specification is CCITT I.431.

To signal between end-user equipment and the ISDN network, a signalling protocol for use over the D-channel is defined. This protocol comprises layers 1 to 3 of the OSI reference model. Layer-2 of the ISDN signalling

## COMMONLY USED NETWORKING ACRONYMS

<b>ANSI</b>	American National Standards Institute.
<b>ATM</b>	Asynchronous Transfer Mode.
<b>BISDN</b>	Broadband ISDN.
<b>BRI</b>	ISDN's Basic Rate Interface.
<b>CCITT</b>	Consultative Committee on International Telephone and Telegraph.
<b>DCE</b>	Data Communications Equipment.
<b>DTE</b>	Data Terminal Equipment.
<b>EIA</b>	Electronic Industries Association.
<b>HDLC</b>	High-level Data Link Control.
<b>HSSI</b>	High-speed Serial Interface.
<b>IEC</b>	Inter-Exchange Carriers.
<b>ISDN</b>	Integrated Services Digital Network.
<b>LAN</b>	Local Area Network.
<b>LAPB</b>	Link Access Procedure for a B-channel.
<b>LAPD</b>	Link Access Procedure for a D-channel.
<b>NT1/2</b>	Network Termination device 1/2.
<b>OSI</b>	Open System Interconnection.
<b>PBX</b>	Private Branch eXchange.
<b>PRI</b>	Primary Rate Interface service.
<b>SDH</b>	Synchronous Digital Hierarchy.
<b>SONET</b>	Synchronous Optical Network.
<b>TA</b>	Terminal Adaptor.
<b>TCP/IP</b>	Transmission Control Protocol/Internet Protocol.
<b>TE1/2</b>	Terminal Equipment type 1/2
<b>TIA</b>	Telecommunications Industries Association.
<b>WAN</b>	Wide Area Network.



protocol is 'Link Access Procedure' for a D-channel, also known as LAPD. This is similar to HDLC and LAPB, and as its acronym expansion indicates, is used across the D-channel to ensure that control and signalling information flows and is received properly. LAPD's frame format is very similar to that of HDLC; LAPD uses supervisory, information, and unnumbered frames. The LAPD protocol is formally specified in CCITT Q.920 and CCITT Q.921.

Two Layer-3 specifications are used for ISDN signalling: CCITT I.450 (also known as CCITT Q.930) and CCITT I.451 (also known as CCITT Q.931). Together, these protocols support user-to-user circuit switched and packet switched connections. A variety of call establishment, call termination, information and miscellaneous messages are specified; they include set up, connect, release, user information, cancel, status, and disconnect. These messages are functionally similar to those provided by the X.25 protocol.

ISDN applications include high-speed image applications (such as Group IV fax), second telephone-lines in homes to serve the 'telecommuting' industry, high-speed file transfer, and video conferencing. Voice, of course, will also be a popular application for ISDN. Many carriers are beginning to offer ISDN under tariff.

It is an acknowledged fact that transmission costs are the most expensive part of long-term Wide Area Network (WAN) use. Indeed, independent research concludes that transmission costs make up nearly 90 per cent of total WAN inter-networking operating costs over a five year period. With this level of investment, it is comprehensible that significant added value in WAN communications solutions equates, at least in part, to reduced transmission costs. The main way an inter-networking vendor can offer users reduced transmission costs is to offer features that decrease required use of expensive WAN communications links. There are many ways of doing this, but arguably two of the most prominent concern data compression, and on-demand networking. Data compression features can effectively reduce the actual number of bits that must traverse a line for a given message or session. For example, compression algorithms for both TCP/IP and LAN traffic can be implemented. On-demand networking is a concept that turns routers into intelligent dialling-devices, capable of determining when remote networking must occur, and then supporting it efficiently.

## The Future for Switched Circuit Technologies

Broadband ISDN (BISDN) is being hailed as the WAN service of the future. This technology offers high bandwidth, and a single switching technology for everything from low speed data, to voice, to full motion video. Synchronous optical network (SONET) in North America, and Synchronous Digital Hierarchy (SDH) in Europe, represents BISDN's transmission technology. Asynchronous Transfer Mode (ATM) is BISDN's switch technology. ATM utilises regularly spaced micro-packets (cells), each 53 bytes in length, to transfer information. A body – the ATM Forum – has been set up to oversee and accelerate ATM standards, with a further mission of ensuring that users will be provided with the best technologies for solving large-scale inter-networking problems.

# DIGITAL SWITCHED NETWORKS AND THE CONSUMER

by Dean P. Hodgkins B.Eng(Hons)

**S**o, how exactly does ISDN benefit the average user? Well, ISDN is a CCITT model for the integration of voice and data, and that is exactly what it provides. The user is able to access a network via an ISDN line, and this single line is able to provide access for a number of channels (voice communications, data transmission, etc.).

British Telecom state that ISDN is currently available on 98% of UK exchanges – the reason for the 'missing' 2% being due to signal loss, which would be too great over the distance between the exchange and the end-user.

BT offers what is known as ISDN-2 and ISDN-30 lines. The former provides two sep-

arate data channels on one line. Each channel has a capacity of 64K-bits/s, and can be used for either voice or data transmission. The latter, ISDN-30, provides a minimum of 15 channels (it is still called ISDN-30 for historical reasons), and it is primarily used for voice calls, switched through digital exchanges. Due to its high capacity, ISDN-30 is usually implemented by using fibre-optic cable, although it can be implemented with a microwave link.

Here, at Maplin Electronics, ISDN-2 is used by our DTP (Desk Top Publishing) department. The DTP department is responsible for, amongst other things, production of the magazine pages (on computer). Once the pages are completed, they are downloaded, via

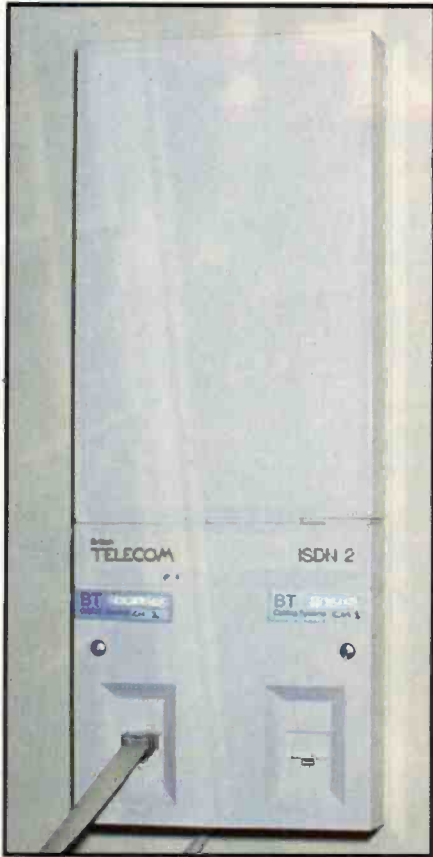


Photo 1. A Quadra 700, used to run 4Sight's ISDN manager.



Photo 2. Inside the Quadra 700, the ISDN card is visible at the rear.



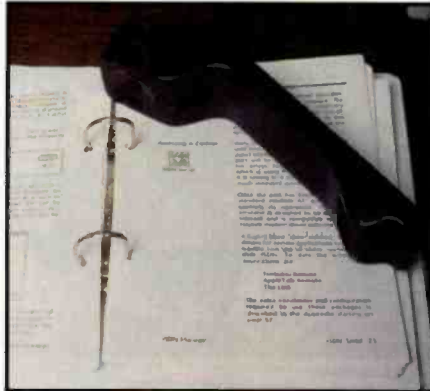


ISDN, to a 'repro bureau' (to transfer the 'pages' onto high resolution (2540 dpi) photographic film) a few miles down the road.

### The DTP Department

The DTP department at Maplin makes use of Apple Macintosh computers (see Photos 1 and 2). The computers are all inter-linked by means of a coaxial, Ethernet based LAN; they also have access to an ISDN-2 line (see Photo 3). The Macintosh computers 'access' the ISDN line via an 'interface', and a special ISDN communications package, the one commonly used is '4Sight's ISDN Manager'.

The 4Sight ISDN Manager is easy to use, and it supports two concurrent data channels,



both of which have the same 'phone number' (in other words, a normal BT ISDN-2 line). This means that, if both channels are used for simultaneous, synchronous data-transfer, a transfer rate of up to 800K/minute is achieved.

ISDN enables users to have voice e-mail (electronic mail), whereby, instead of the usual 'textual' messages, the user will be able to hear actual spoken messages. 4Sight's Manager does not provide voice e-mail, but it does allow the user to make a 'voice call' (see Photo 4). This is similar to making a call with a conventional telephone, but all dialling and connection are made by the computers. The software displays details of the call and of the caller - in other words, you can see who is calling, and decide whether or not to answer!

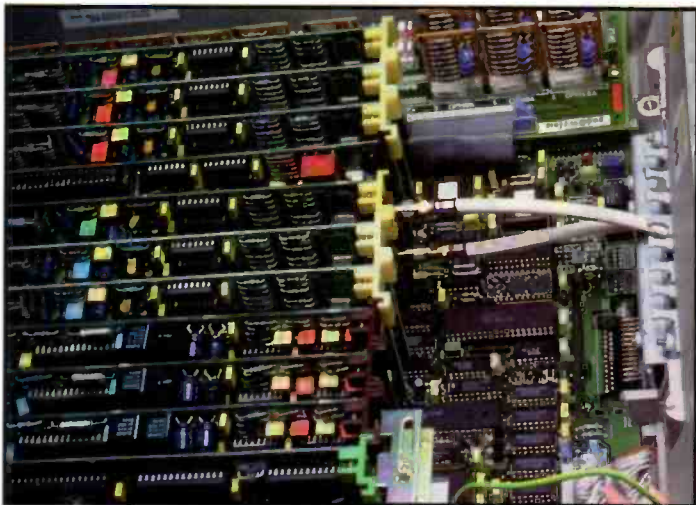
### Telesales and Customer Support

Whenever you call Maplin, your call is routed into a modern digital exchange (see Photos 5 and 6) via one of two ISDN-30 lines; the connection from the local BT exchange to the Maplin exchange being achieved by a fibre-optic link and a BT ISDN-30 terminating unit, shown in Photo 7. At present, Maplin have allocated 14 channels (i.e. the 14 channels share the same telephone number) for Credit Card Sales, and 6 channels for Customer Services. As with ISDN-2, ISDN-30 does not have to be used exclusively for voice; various other channels are used for the Cashtel service and key call, etc. The system is fully digital, and is totally controlled by computer, with channel usage being determined from a 'networking option' in the software.

### Further Information

British Telecom ISDN Helpline, Tel: 0800 181514  
4-Sight Support Line, Tel: 0202 764401

Above left: Photo 3. An ISDN-2 line terminating unit (BT).  
Above right: Photo 4. A handset enables voice communication on the ISDN-2 line.  
Below left: Photo 5. An SDX 420N digital exchange unit.  
Bottom left: Photo 6. Inside the SDX 420N; the ISDN-30 interface card is easily identified by the two white coax cables.  
Below right: Photo 7. A BT ISDN-30 interface unit; the ISDN-30 fibre optic lines terminate at this unit, with the link to the digital exchange being made by coax cable.





# STOP THIEF!

## By Installing The Versatile Multi-Purpose INTRUDER ALARM

Text by Robin Hall



### FEATURES

- \* Internal battery or external +12V DC operation
- \* Long battery life
- \* Key operated
- \* Integral loud siren
- \* Compact
- \* Visually attractive
- \* Easy to use
- \* Easy to install
- \* Integral Ni-Cd charger circuit
- \* External siren option
- \* Normally closed, normally open and tamper (24-hour) security loops
- \* Integral anti-tamper switch
- \* Siren timer

### Ideal for

- \* Garage
- \* Caravan
- \* Summerhouse
- \* Garden-shed
- \* Tool-shed
- \* Workshop
- \* Lock-Up
- \* Barn
- \* Stable
- \* Outhouse
- \* Stock room
- \* Boat
- \* Loop alarm

Although this shot has obviously been staged there were over 1 million burglaries in Britain last year! Remember burglar alarms are one of the only lawful deterrents

**A**LL too often these days one hears or reads about homes that have been broken into, and that all the thief apparently had to do was go to the unsecured tool-shed select an appropriate tool and then break into the home, and that valuable tools kept in the garden shed were also stolen. Not in the dead of night, but during the afternoon in broad daylight.

\*Up-and-over garage requires a Garage Door Sensor to operate the alarm



Price only  
**£19.99**  
 [B]  
 Order Code  
 50491



## NO MAINS? NO PROBLEM!

Not all structures are attached to main buildings, and are not so easily protected. This is especially true of garages, summerhouses, sheds and for the more rural areas, barns, stables and outhouses. In many cases they may be situated some distance away from the mains electricity supply. In the case of boats and caravans, mains electricity may not even be available, and this will cause a problem, as most alarm systems are mains powered, with battery back-up. The alarm can also be used as a 'loop alarm' for protecting valuable goods on display in a shop, or as a secondary-alarm for protecting a

shop stock room against unauthorised entry during opening hours (i.e. when the main alarm is disarmed).

There is, of course, absolutely no reason why the alarm cannot be utilised as a low-cost home or flat alarm!

## ESCALATING CRIME

With security ever in our minds, with the escalation of crime according to the latest surveys, it is gratifying to find that there is a product that fits the bill.

### The Answer

The Versatile Multi-purpose Intruder Alarm has been designed for low current operation, and can be powered from a multitude of different power sources,

Outer: The Versatile Multi-Purpose Intruder Alarm is suitable to protect a diverse range of property.

Centre: The alarm unit as supplied.

Bottom: The alarm unit installed and ready for use.

ranging from an internal battery to an external mains derived supply, even solar power is possible! Built into the alarm is a charging circuit, so that a Ni-Cd battery can act as a back-up in the event of the main supply failing. Operation of the unit is controlled by an unambiguous two position key-switch. There is a piercing alarm included within the case of the unit, but there is also provision for an external siren to be connected as well. So even on its own, the alarm can provide a very capable base for an alarm system without the complications that usually surround intruder alarms. The best news of all is that the unit is very easy to install and use, and is a fraction of the cost of a commercially installed alarm system. Anyone with basic DIY skills and tools can quickly and easily fit the alarm.

## WHAT YOU GET

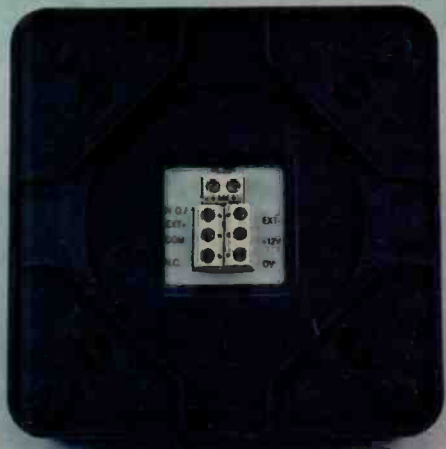
The Versatile Multi-purpose Intruder Alarm is supplied with approximately five metres of cable, cable clips, a surface reed switch, a set of keys, screws and wall plugs, and an instruction manual. With the exception of the battery which is not included, these are enough to get a basic system up and running -



## Specification

Internal power supply:	+9V DC (PP3)
Standby current (armed):	25µA @ 9V (typically)
External power supply:	+12V (nominal)
Internal siren sound level:	80dB at 1 metre
Arm/disarm time period:	20 seconds (nominal)
Alarm timeout period:	10 to 15 minutes
Operating current (alarm sounding):	70mA typical





The three terminal blocks at the rear of unit.

numerous accessories are also available to expand the system.

The stylish alarm control unit itself is made of high impact plastic, and houses the electronics at the heart of the system. A key controlled arm/disarm switch is fitted on the front panel. The internal siren is housed behind the front panel. The alarm is secured to a convenient surface by means of a mounting plate – if any attempt is made to remove the unit from the mounting plate the internal siren and external siren if fitted, will sound.

Three terminal blocks are located on the rear of the unit these enable external connections to be made. The (optional) internal battery is housed in a recessed compartment behind the rear panel.

## POWER SOURCE

Attention has been given to the power requirements of the unit. With negligible current drain when the unit is in the standby condition, and modest consumption when activated, the unit can be powered by an Alkaline 9V PP3 battery for up to six months. This is especially important, where there is no other supply available, for example a boat or caravan or remote building. However, provision has also been made to power the alarm from other external power sources. An external supply can be connected to the terminals marked '+12V' and '0V'. If an external power supply is used, and battery back-up is required, a rechargeable 8.4V Ni-Cd PP3 battery *must* be fitted instead of a normal 9V PP3 Alkaline battery. This is because a DC charging voltage is present on the alarm's battery connections when an external supply is used – applying such a voltage to an ordinary battery could cause it to leak or even explode!

The ability to connect an external power supply opens up other possibilities for alternative power sources such as solar panels or wind generators. In the rural or maritime environment such power sources are already frequently used. In such instances it would be necessary to include a Ni-Cd battery otherwise the alarm would only work when the sun shines or the wind blows!

Please note that under no

circumstances must this alarm control unit be *directly* connected to the AC mains supply it is designed for extra low voltage use only. The recommended AC mains to 12V DC adaptor, or a suitable equivalent, must be used if mains operation is required.

## SECURITY LOOPS

The three terminal blocks on the back of the unit facilitate connection to external security loops. Three distinct security loops are provided on the unit, and each one has a different part to play – this is just one of the factors that make this alarm so versatile.

The loops are as follows:

### Normally Closed Loop

The Normally Closed Loop is for use with sensors that have contacts that open ('break') when the sensor is operated (triggered). The loop may comprise just one sensor or several sensors connected in series, such that operating any of the sensors will break the Normally Closed Loop. The Normally Closed Loop connects to the terminals marked 'COM' and 'NC'. These terminals are supplied fitted with a 'shorting link'. This link *must* be removed before connecting the Normally Closed Loop. The major advantage with a Normally Closed Loop is that cutting the wires to a sensor will trigger the alarm. The Normally Closed Loop is only monitored when the alarm control unit is in the Armed state. Triggering the Normally Closed Loop starts the Entry Delay Timer, if the alarm is not disarmed within the timeout period the siren will sound.

### 24-Hour (Tamper) Loop

The 24-Hour Loop is a Normally Closed Loop that is continuously monitored when the alarm has power applied to it (i.e. the battery is fitted). Operation of this loop is exactly the same as the Normally Closed Loop described above, except that it does not matter whether the alarm is in the Armed or Disarmed state. The Normally Closed Loop connects to the pair of terminals marked '24HR'. These terminals are supplied fitted with a 'shorting link'. This link *must* be removed before connecting the 24-Hour Loop. This loop will trigger the alarm if the loop is 'broken' by wires to a sensor being cut or if the cover to a sensor, fitted with a tamper switch, is removed. The loop may also be connected to a Panic/Personal Attack button; operation of the button will trigger the alarm and cause the siren to sound *immediately*. This loop is normally used in tandem with the Normally Closed and Normally Open Loops so doubly ensuring security. Note that the 24-Hour Loop does not latch when triggered.

### Normally Open Loop

The Normally Open Loop is for use with sensors that have contacts that close ('make') when the sensor is operated (triggered). The loop may comprise just one sensor or several sensors connected in parallel, such that operating any of the

sensors will make the Normally Open Loop. The Normally Open Loop connects to the terminals marked 'COM' and 'NO/EXT+'. The Normally Open Loop is only monitored when the alarm control unit is in the Armed state. Triggering the Normally Open Loop starts the Entry Delay Timer, if the alarm is not disarmed within the time-out period of the Entry Delay Timer, the siren will sound.

Please note that the Normally Open and Normally Closed Loops are not mutually exclusive, both types can be used simultaneously in an installation.

## INSTALLATION

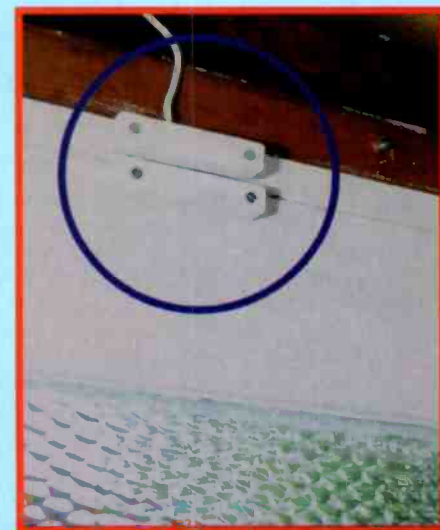
### Planning

Installing the unit is very straightforward, but it is advisable to carefully plan exactly where the alarm control unit is to be located and what doors, windows, etc., are to be protected. From this you will be able to decide which accessories, if any, are required.

It is advisable, if possible, that the alarm control unit is not installed in full view, i.e. opposite a window, and yet at the same time must be easily accessible by 'authorised' persons in order to disarm the alarm within the permitted 20 second entry period. The position of the alarm control unit must be such that it is not directly exposed to water. Cables will also need to be run to the alarm control unit so consider suitable routes to run them. If the alarm control unit is to be powered from an external power source, locate it accordingly, e.g., adjacent to an AC mains socket.

### Fitting a Door Sensor

Approximately five metres of 4-wire cable is included with the unit, and this should be sufficient to wire the supplied magnetic door sensor. Choose a suitable location for the sensor, see Figure 1. The sensor is in two halves; one half contains a magnet and the other a reed switch. The reed switch may be readily identified by the presence of the wiring terminals. The magnet should be mounted on the door itself and the reed switch should be mounted on the frame. The two halves should be positioned as close together as possible, without fouling each other or



Door Sensor (magnetic reed switch) Installed.





**Magnetic reed switch.**

the door (maximum separation with door closed 10mm).

The wiring diagram is given in Figure 2, and shows how to wire up one pair of wires to the Normally Closed (NC) contacts on the sensor. The other pair of wires, which are for the 24-Hour Loop are joined together on a spare contact. When wiring up the sensor, make a note of the colour coding used on the cable. Tack the cable in position, out of view if possible, and route it to the alarm control unit. Before cutting the cable, ensure that there is sufficient slack cable at the alarm control unit end to allow the connections to be made.

If no other sensors or accessories are to be fitted (i.e. basic installation) continue onto the next section otherwise refer to the section on Expanding the System.

### Fitting the Alarm Control Unit

If the surface onto which the mounting plate is to be fixed is subject to condensation, it is recommended that a waterproof sealant be used to seal the mounting plate to the wall. If sealant is used remove the bottom cable entry knockout on the mounting plate to allow any water droplets that may accumulate to run out. Cable entry knockouts will need to be removed as necessary to allow entry of the cables. Fix the mounting plate to the desired surface using the screws and wall plugs supplied.

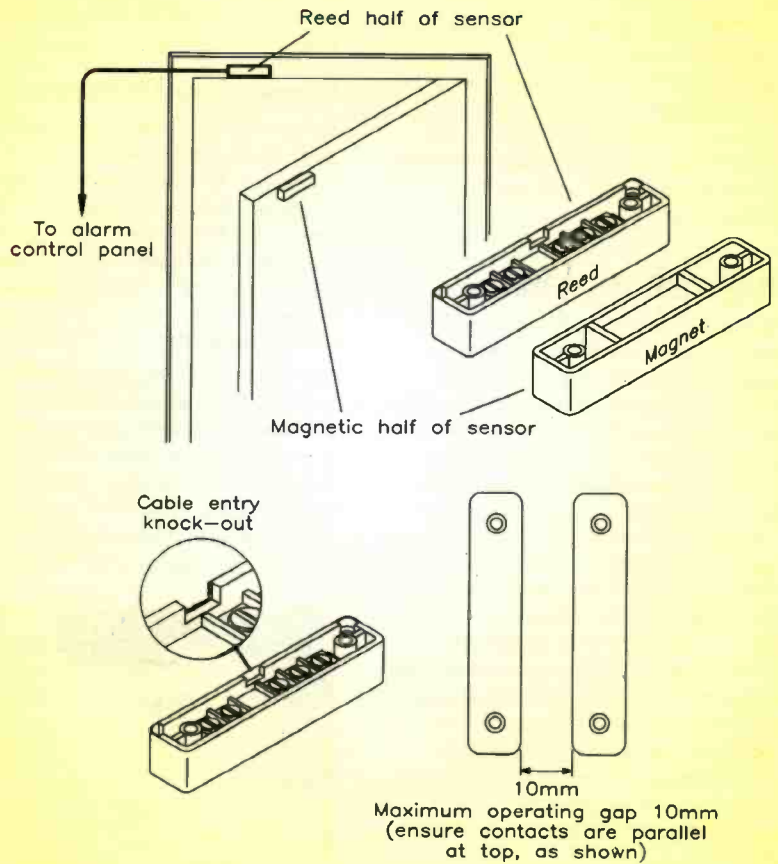
At the alarm control unit end the wires are connected as shown in Figure 2, with the Normally Closed (NC) Loop wires connected to 'NC' and 'COM' terminals - make sure that the shorting link has been removed. The tamper '24-HR' Loop wires which have been connected together on the sensor, are wired to the '24-HR' terminals on the unit - again make sure that the link has been removed first.

If a multimeter or continuity tester is available then check that the 24-Hour Loop is continuous, and that the Normally Closed Loop is continuous when the door is closed and broken when the door is open.

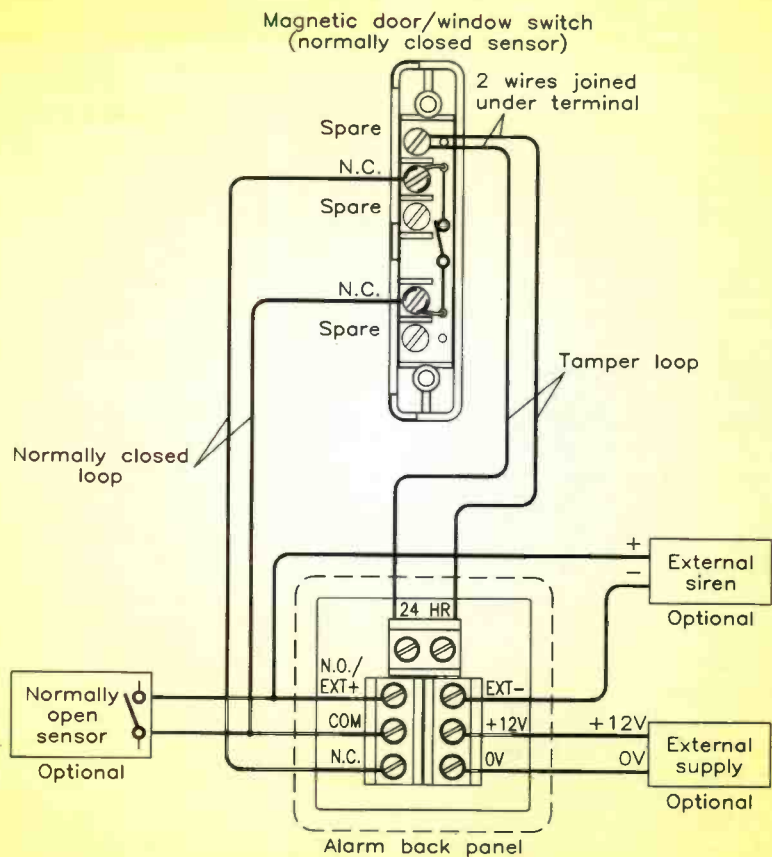
These tests are to minimise possible problems in the installation.

### Fitting the Battery

Once all wiring is complete, remove the back panel of the alarm control unit and install either an Alkaline or Ni-Cd battery as previously discussed. Note: the siren will sound as soon as the battery is connected. Since the tamper circuit



**Figure 1. Fitting the magnetic reed switch to door.**



**Figure 2. Wiring diagram showing alarm back panel and wiring up of magnetic door/window sensor.**



operates regardless of key-switch position, hold in the anti-tamper micro-switch in order to inhibit the siren. Make sure that the battery lead is located through the cut-out located on the edge of the PCB, and that it is not proud. Next refit the rear panel, ensure that the rubber battery 'pad' is located above the battery. The siren will sound once the micro-switch is released. The siren will continue to sound until the alarm control unit is correctly mated with the mounting plate.

## USING THE ALARM

Using the key provided, rotate the key-switch anticlockwise from 'Disarm' to 'Arm' and remove the key. The alarm allows approximately 20 seconds in order to exit the area, a loud warning bleep is then heard which announces that the alarm is now armed. Upon triggering a sensor, by opening a protected door, etc., the alarm allows 20 seconds for the area to be entered and the alarm disarmed. To disarm the alarm, return the key-switch to the 'Disarm' position. Failure to disarm the unit within the entry time, will cause the siren to sound. If the alarm is powered by a 9V alkaline battery, it is advisable to replace the battery every six months. Whatever means of power is used, it is advisable to carry out periodic tests to confirm that all aspects of the alarm are fully functional.

If the alarm is set off, either inadvertently or by a deliberate unauthorised entry, the siren may be silenced by returning the key-switch to the 'Disarm' position. Note that if the 24-Hour Loop is broken, the key-switch will not silence the siren. In such instances, the siren will continue to sound until the 24-Hour Loop is restored or the siren timer switches off the siren.

## EXPANDING THE SYSTEM

There are a number of optional accessories available that fully complement and expand the system. These are easily wired to the main unit using 4-wire cable.

### Magnetic Reed Switches

Extra magnetic reed switches are available for the system and are wired in series with the Normally Closed Loop. There are different styles of magnetic reed switches available and are used accordingly. All these devices trigger when a door or window is opened.

### External Siren

The External Siren is a particularly good idea if the garage, outhouse or shed is some distance from the main building. It is wired to the main unit using cable supplied with the siren, and wired up between the 'NO/EXT+' and 'EXT-'. Note that the 'NO/EXT+' is shared with the Normally Open Loop. The design is



Optional External Siren

such that the siren does not draw more than 200mA in use so it still enables the unit to obtain power from a 9V Alkaline PP3 battery. The battery has sufficient capacity to operate the siren for a number of 15 minute cycles.

It is recommended that the outdoor mini-siren is mounted on an outside wall as high as possible, such as under the eaves, to prevent tampering. It is fixed by using one screw at the top of the unit. The cable must sit in a groove at the back of the case, as this allows it to mount flush against the wall. The cable to the siren should pass through the wall directly behind the siren, or enclosed in conduit to prevent cable damage.

### External Alarm Box

Also available is an External Alarm Box, which when installed in a prominent position acts as a highly effective visual deterrent to would be thieves. If desired, the External Siren can be fitted into this enclosure.

### Garage Door Sensor

Another optional extra is the Garage Door Sensor, and this comes complete with tilt-switch, prefitted junction box, 4-wire cable and cable ties. The sensor has a mounting plate attached which enables it to be fitted to up-and-over type garage doors. The sensitivity is adjustable so that it can either activate on just a slight movement of the garage door, or when the door is in its fully open position. Figure 3 shows typical installation (Normally Open operation).

The sensor can be set to either Normally Open, or Normally Closed operation see Figures 3 and 4, which mode is selected depends on how it is positioned with respect to the vertical plane, and the way it is rotated. Junction box wiring is shown in Figure 5. It is



Optional garage door sensor fixed in position.

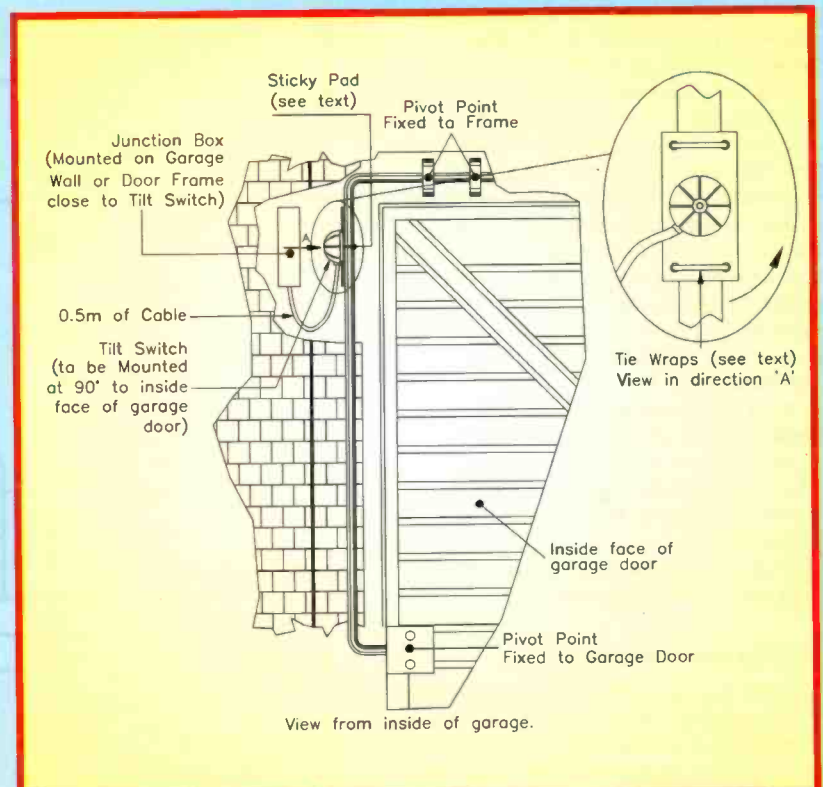


Figure 3. Fitting the garage door sensor (Normally Open operation).





Optional breaking glass sensor.

recommended that the sensor is configured for normally open operation and connected in parallel with the Normally Open Loop.

### Vibration Sensor

Another useful device for incorporation into the system is the vibration sensor. This can protect areas not covered by the other sensors or switches. Inside the device is a small weight on a spring, and this is adjusted for sensitivity by an adjustment screw, the contacts can be set for either Normally Closed or Normally Open operation. Normally Closed operation is preferable, and is more secure, see Figure 6.

### Window Protection

Extra protection is given by using Breaking Glass Detectors and Window Foil. Both are connected to the Normally Closed Loop. The Breaking Glass Detector is simply stuck in position on the window to be monitored. It is then connected, through a junction box on the window frame, to the Normally Closed Loop.

Window Foil, which is supplied on a 33m reel, should be carefully applied to a window and folded at the turns. It is taken to Window Foil Terminals which are then connected to the main unit by 4-wire cable.

Extra 4-wire cable and junction boxes are available if needed, and these enable interconnection of different sensors.

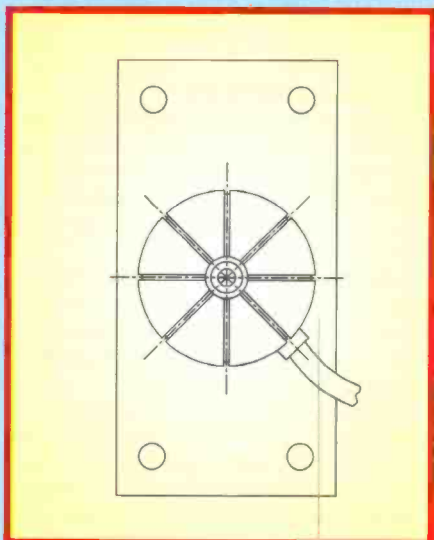
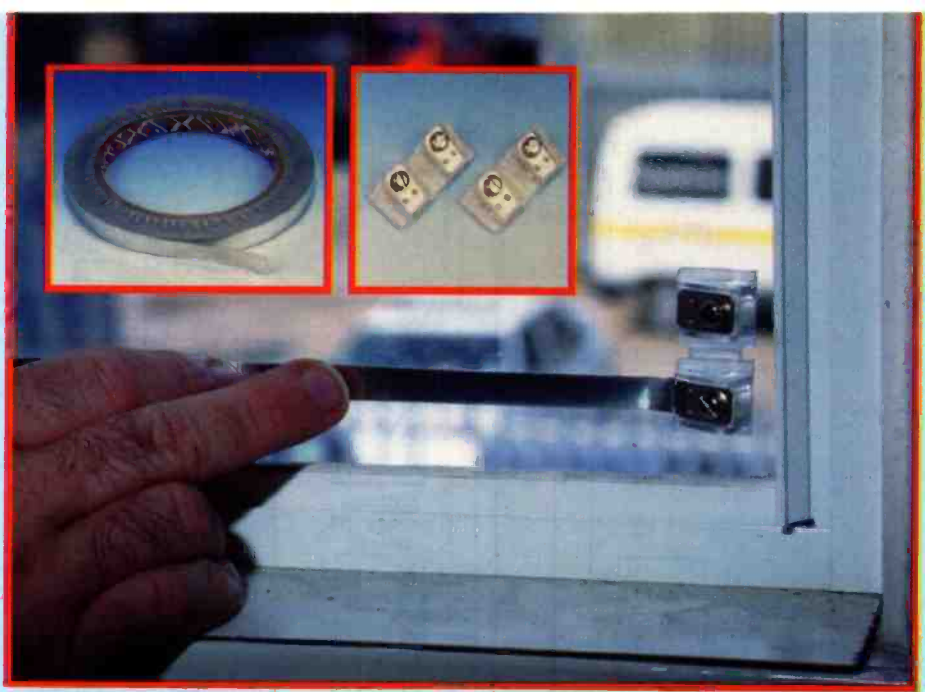


Figure 4. Garage door sensor orientated for Normally Closed operation



Fitting window foil and termination blocks.

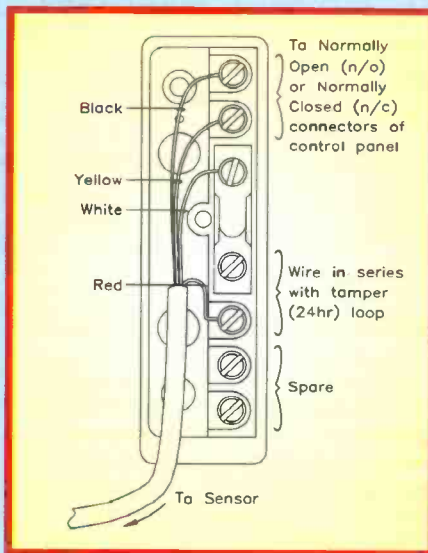


Figure 5. Junction box wiring for the garage door sensor.

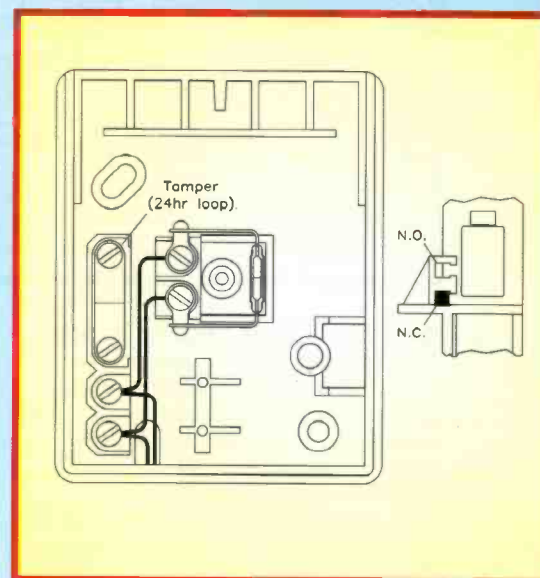


Figure 7. Panic button wiring.

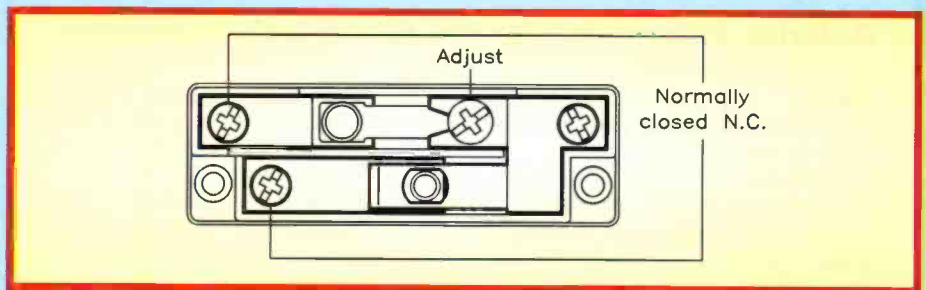


Figure 6. Vibration sensor wiring.

### Panic Button

The Top Operated Panic Button is a useful accessory in case there is an emergency, such as in the home or in a workshop, when outside attention is required. It can also trigger the alarm to scare off intruders, especially useful for single person occupancy.

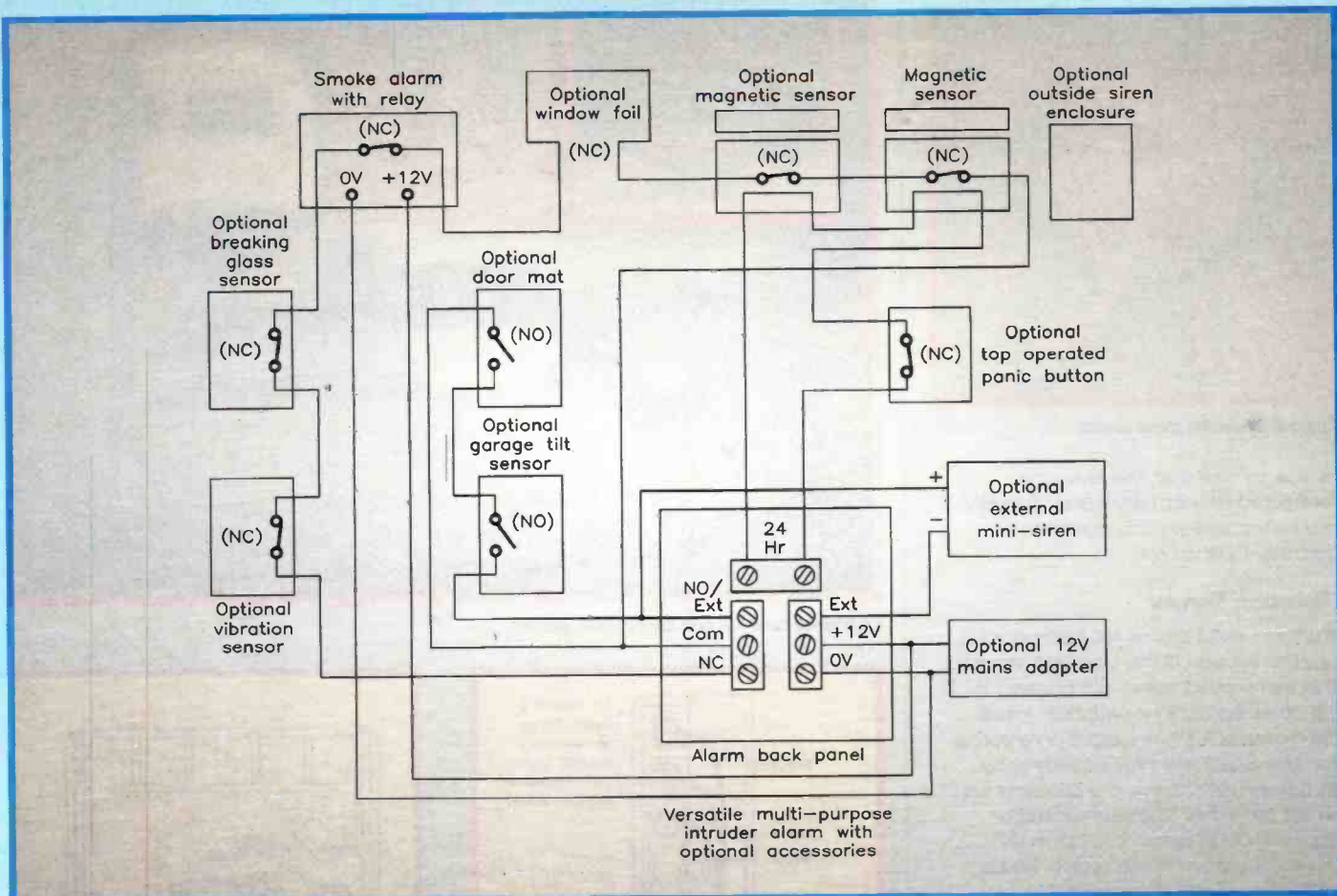
The panic button is wired in series with the 24-Hour Loop, breaking this loop immediately sounds the alarm. There is also a tamper-proof connection available, and this can also be wired in series with the 24-Hour Loop if desired, see Figure 7. Another element of security, is that once the top operated button has

been activated, resetting the button is only possible by using the key provided.

### Pressure Mat

To protect other areas near doors, a pressure mat can be used. Placed under carpet or mats near the door. The mats are Normally Open and should be wired to the Normally Open Loop via a junction box. When stepped on the pressure mat will activate the alarm. It provides a completely hidden detection method. There is a smaller sized pressure mat available that can be it to be placed along the top of a step or stair.





A wide range of accessories may be connected to the alarm control unit.

### External +12V DC Power Supply

The Versatile Multi-purpose Intruder Alarm has been designed to operate from an Alkaline 9V PP3 battery, or from a rechargeable Ni-Cd battery. In some cases it may be preferable to charge the 9V Ni-Cd PP3 battery (used in place of the Alkaline PP3 battery) on a separate charger for its initial charge, as the unit contains a trickle charge circuit,

and will take 24 to 36 hours to charge the battery.

Running the Versatile Multi-purpose Intruder Alarm from an external supply opens up a number of opportunities to expand the system by utilising other accessories which require power, thus giving further protection. Figure 8 shows how the accessories are wired to main unit.

### Smoke Alarm with Relay

With safety in mind, a Smoke Alarm Sensor with a built-in 85dB siren is also available for wiring into the system (see Photo 11). If used, the smoke alarm's relay output connects to the Normally Closed Loop. The supply for the smoke alarm is obtained from the '+12V' and '0V' terminals on the alarm control unit (external power supply required). When the smoke alarm is activated, it also triggers the main unit's siren and the outdoor mini-siren, if fitted.

## Ordering Information for the Alarm and Accessories

Product	Stock Code	Price
Versatile Multi-purpose Intruder Alarm	50491	£19.99 [B]
External siren	CW50E	£14.99
External Alarm Box	YP50E	£7.25
AC Mains Adaptor 12V DC 500mA	BZ83E	£8.99
Rechargeable Battery (Ni-Cd PP3)	HW31J	£6.25
In-line Fuseholder	RX51F	25p
500mA Fuse	WR10L	10p
Door Loop	YW48C	£2.75
Window Foil Terminations	YW51F	52p
5-way Junction Box	YW49D	60p
8-way Junction Box	FK76H	90p
12-way Junction Box	RC59P	£1.75
Surface Reed Switch	YW47B	£1.70
Recessed Reed Switch	YW46A	£1.75
Flush Reed Switch	FK77J	£1.45
Garage Door Sensor (for up-and-over-doors)	CW51F	£9.99
Glass Break Detector	FP11M	£2.65
Window Foil	YW50E	£1.99
Top Operated Panic Button	KR00A	£2.99
Metal Panic Button	YZ67Z	£5.99
Pressure Mat	YB91Y	£3.99
Stair Pressure Mat	FK79L	£2.99
Vibration Sensor	FK78K	£3.49
Smoke Alarm with Relay	KC39N	£19.99

### Junction Boxes

A range of junction boxes are available, these enable interconnecting cables to be used with the extra security devices. The three types of junction boxes are 5-way, 8-way and 12-way.

### Further Suggestions

Mention was made of alternative power sources, such as solar panels and wind generators, and these can be used to recharge the Ni-Cd battery in the main unit, instead of a conventional mains powered supply.

Levels of sunlight vary from day to day, from summer to winter, but even on a cloudy day though, it is amazing how much light falls on the solar panels to produce electricity.

On farms and on some boats there may be a wind generator available. If the voltage is compatible with the unit then this can be utilised to charge the battery.

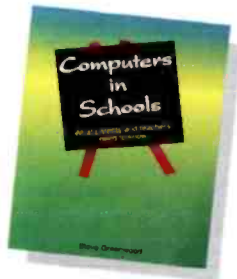
When using a supply with a larger current capability, it is recommended that a 500mA fuse is inserted into the positive line.



# NEW BOOKS

## Computers in Schools

by Steve Greenwood



The author has targeted this book towards anyone, but particularly parents and teachers, who want to learn about the computers that are becoming an indispensable part of school life. This is a topic about which parents show great concern, but are maybe too frightened to ask for more information for fear of not understanding the jargon. For parents who do not work with computers, the jargon barrier can cause many problems between parents, children, and their teachers. Where computers in schools have become a significant part of the classroom learning process, it can result in a lack of understanding or worse a total distrust of the school system. This book sets out to answer the many questions and queries that parents and teachers may have. An additional consideration is that it is the intention of the government to integrate computers or information technology (IT) in all areas of the National Curriculum.

The text explains concepts and ideas in plain English and does not assume any computer knowledge. Explanations of computing terms are explained in a glossary at the back of the book. This is an accurate, unbiased and informative book, written by a concerned and knowledgeable parent. It answers many of the questions being constantly asked by parents and teachers about all aspects of computers in education. 1993. 144 pages. 210 x 146mm, illustrated.

**Order As AA83E**  
**(Computers In Schools) £5.95 NV**

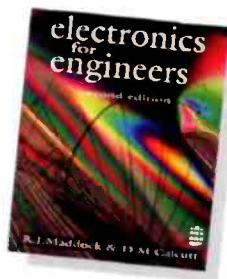
## Electronics for Engineers

Second Edition

by R. J. Maddock & D. M. Calcutt

This book provides a comprehensive course in electronics for engineering students to higher technician and first degree level. Emphasis on new technology and analytical methods mean that this book will be of most use to those wishing to bridge the gap between old and present-day integrated circuit technology. Comprehensive coverage incorporates topics like Laplace Transform State

Analysis, High-Frequency Amplifiers and VLSI. The book has summaries at the ends of chapters and features learning objectives like worked examples and problem solving exercises. Sections explain about the operation of components and the way they interact with circuits to produce both wanted and unwanted effects. Information includes use of operational amplifiers, digital devices and controlled rectifier devices. Sections on techniques of analysis explain how circuits can behave differently at AC and DC, together with transient response and digital analysis methods. Sequential analysis of synchronous and asynchronous circuits provides a way of analysing digital circuits, including useful analysis tools like Camagueh mapping for realisation of logic circuits from truth-tables, in both positive and negative logic types. Topics in the digital area also include counter technologies like synchronous types, multiplexers, timing circuits, driver logic, arithmetic circuits, and various types of ROM and RAM, including EPROMs, etc.



The analogue section explains amplifier operation, with analysis techniques and various models to simplify active components and their effects on circuit operation. In-depth discussions of circuit theory and operation help to impart exactly how a particular circuit will operate. The book covers most of the modern digital and analogue syllabus material covered in courses like ONC and HNC electronics, together with a great deal aimed at first degree level.

A good source of information for students, with numerous diagrams and illustrations. 1994. 719 pages. 240 x 190mm, illustrated.

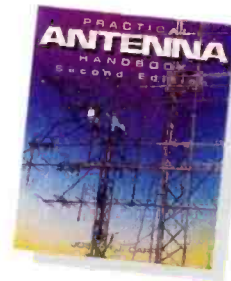
**Order As AN04E**  
**(Elecs for Engineers) £19.99 NV**

## Practical Antenna Handbook

Second Edition

by Joseph J. Carr

For those interested in building any kind of radio antenna or antenna based project, this book is for you. All the basic



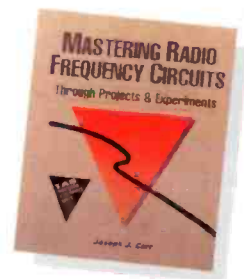
types of radio antenna are covered by this book including: high-frequency dipoles; multiband and tunable wires; hidden and limited space; directional phased-vertical and directional beam; VHF/UHF transmitting and receiving antennas; shortwave antennas; microwave; mobile and marine. They are all covered, in this in-depth book, with all the relevant theory necessary for the successful building of such antennas, including examples and construction diagrams. Radio wave propagation, transmission lines, Smith charts and matching theory are included and will prove useful when matching antennas, and working out delay and phasing problems. Sections on wave propagation and electromagnetic fields explain why an antenna works in the way it does. One of the main problems with explaining antenna behaviour is that you cannot see by looking at it if it's working efficiently. With this book you are shown diagrammatically how the wave-pattern and radiation would appear from different antennas, and there are tips on improving reception and transmission, regardless of the arrangement you are using. By the end of chapter five, all the groundwork has been put down to start looking at antennas in detail. Sections on microwave and waveguide techniques will be particularly useful to those interested in frequencies between 900MHz and 300GHz. Theory on waveguide sections, impedance matching and coupling will help to show how losses can be reduced, leading to a more efficient overall system. Microwave matching and mixing with waveguides is also discussed, along with other factors to do with transverse electromagnetic waves. Dubbed the 'Antenna Builders' Bible', and containing many additions, this book will show you how the best results can be obtained from any antenna, whether you plan to make it, buy it or repair it. 1994. 560 pages. 230 x 190mm, illustrated. American book.

**Order As AN03D**  
**(Pract Antenna H/book) £23.95 NV**

## Mastering Radio Frequency Circuits

by Joseph J. Carr

This book will be useful to those interested in radio theory, and wishing to build radio receiver or antenna based projects. It gives details of many receivers and radio based projects with explanations of the concepts behind the design theory, and reasons for approaches in design. Likely to appeal to students, electronics hobbyists, ham radio operators and shortwave listeners. The book eases the reader into the subject by explaining frequency allocations and classifications of radio signals, before going on to explain about RF components and their construction. An overview of RF tools and instruments explains how equipment is to be used for a variety of tasks and how to make measurements correctly and accurately. All the important theory about electronic and RF components is explained in the first few chapters of the book before the details of radio and amplifier designs are presented. Each chapter is filled with great ideas and circuit designs, to show by example how circuits and equipment work. Among the many projects in this book you can build various RF amplifiers and receiver preselectors, design and wind inductor coils for radio circuits, and there is a section on building and using RF bridges.



Dedicated parts of the book are used to explain frequently used, or popular items of equipment like direct-conversion receivers, signal generators and filters; equipment that will be of great interest to ham radio operators. At the end of the book are a couple of chapters on more recent technology, including pin diodes and microwave integrated circuit amplifiers, and finally a chapter on the various projects and their construction. Throughout the book there is much radio, transmission line and instrument theory, which will also prove invaluable to the home enthusiast and constructor for general interest and in the building process of the projects in the book. 1994. 411 pages. 230 x 190mm, illustrated. American book.

**Order As AN02C**  
**(Mastering RF Circuits) £17.95 NV**



**NEW**

**FULL COLOUR GUIDE TO ELECTRONIC PRODUCTS**

Sept 1994–Aug 1995

# Maplin



BS 5750  
Part 2 1987  
Level B:  
Quality Assurance  
RS12750

**Order your copy of the New MAPLIN Catalogue on sale NOW!**  
Pick up a copy from any branch of WHSMITH, branches of John Menzies in Scotland ONLY, Eason & Son in N. Ireland ONLY, and Maplin stores nationwide for just £3.45 or post this coupon now to receive your copy for just £3.95 inc. p&p. If you live outside the U.K. send £7.30 or 18 IRCs for Airmail in Europe (including Republic of Ireland); £8.50 or 16 IRCs for surface mail outside Europe; or £12.30 or 30 IRCs for Airmail outside Europe.  
I enclose £3.95/£7.30/£8.50/£12.30 (delete as applicable).

Name .....  
Address .....  
Post Code .....  
Send to Maplin Electronics,  
P.O. Box 3, Rayleigh,  
Essex, England  
SS6 8LR  
NW95

**Over 800 colour packed pages  
with hundreds of Brand New  
Products at Super Low Prices.**

**ONLY  
£3.45**

Available from all branches of WHSMITH, John Menzies in Scotland ONLY, Eason & Son in N. Ireland ONLY, and Maplin stores nationwide. The Maplin Electronics 1995 Catalogue – **OUT OF THIS WORLD!** Southern Africa customers please contact Maplin (South Africa) Telephone (024) 51-5124