

COMPUTERS · AUDIO · RADIO · TEST EQUIPMENT

No. 67

FULL
SOR

Printed in the United Kingdom



ELECTRONICS

The Maplin Magazine
Britain's Best Selling Electronics Magazine

JULY 1993 · £1.95

YOUR OWN

**Design PC Projects
with a Profiteer Card
Build a Synthesised
Digital VHF FM Tuner
Plus other Great Projects!**

HELLENIC
£2.25

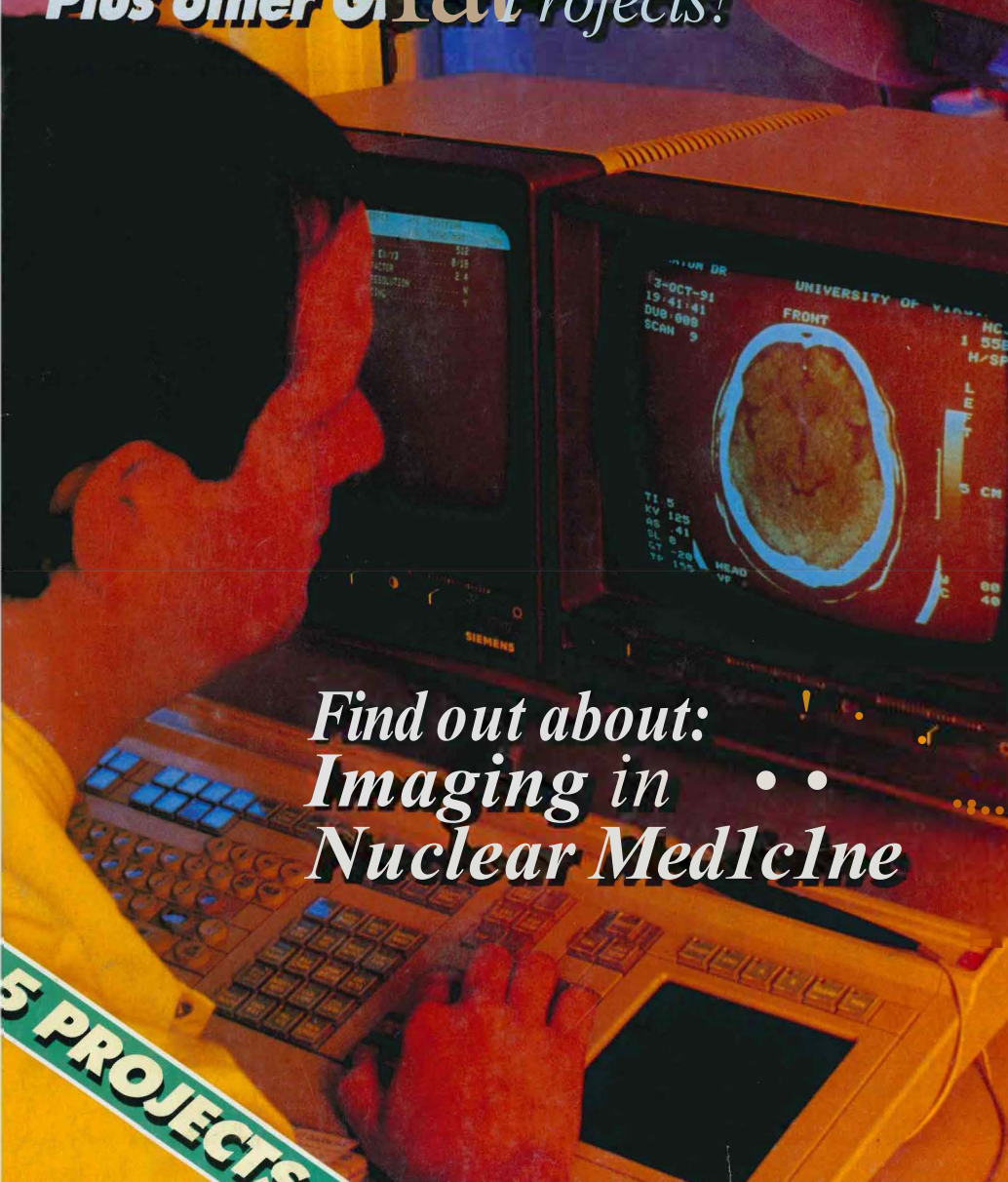

**Valve Technology -
Rediscover these
Original Field-
Effect Devices in
this New Series
Plus much more...**

*Find out about:
Imaging in
Nuclear Medicine*

5 PROJECTS



Twelve great reasons to get Electronics under cover...

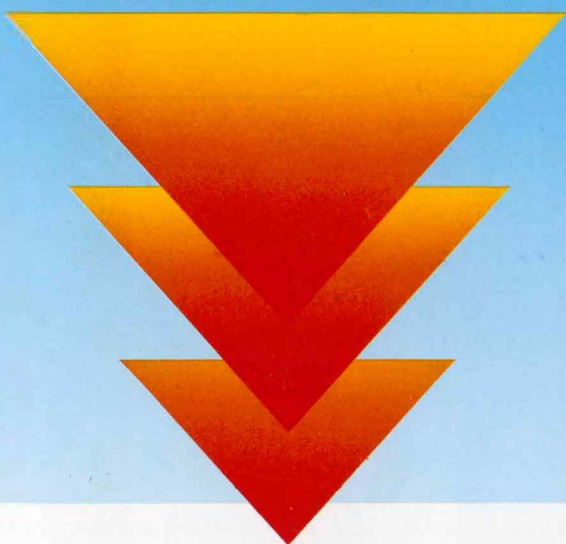

Available for the first time! The new Maplin magazine binder that holds twelve issues of Electronics, the Maplin magazine. If you have not got the world of Electronics covered, now's your chance! This great, quality binder comes in hard wearing, laminated art board, that not only looks good on your bookshelf or workshop desk, but is also a great way to build up an Electronics reference library of your own!

Now you can keep all of your copies of Electronics, the Maplin magazine, together and on hand for when you need that extra piece of information. To order your binder simply fill in the order form provided in this issue of Electronics. Only £5.95 (plus £1.20 handling charge). Order no: XH99H.



**THE NEW MAPLIN MAGAZINE BINDER...
A GREAT WAY TO GET THE WORLD OF ELECTRONICS COVERED!**

PROJECTS FOR YOU TO BUILD!

VHF FM STEREO TUNER This superb quality, Hi-Fi stereo VHF FM tuner features synthesised digital tuning, alphanumeric station naming, and can be remote controlled too! **8**

IBM PC PROTOTYPING CARD Ever wanted to design a project for your IBM PC or compatible? Been put off with the thought of having to make a double sided PCB? Then this project is for you! This ingenious card provides address decoding, bus signal buffering and provides a generous prototyping area for your own circuitry. **24**

PASSIVE DIRECT INJECT BOX Ideal for the performing or recording musician, this simple project can safely and successfully solve hum and noise problems often experienced with electro-music equipment on-stage. **32**

SOW Hi-Fi AMPLIFIER This top-notch, sweet sounding, power amplifier is ideal **40**

for Hi-Fi use. With the addition of a suitable power supply, it can even be used as a high quality in-car amplifier.

Pk-to-Pk AUDIO mV METER A useful piece of test equipment that allows the peak-to-peak signal level of an audio signal to be easily measured. **57**

FEATURES ESSENTIAL READING!

UNDERSTANDING AND USING PROFESSIONAL AUDIO EQUIPMENT Tim Wilkinson takes a look at microphone input stages and specialist microphones. **4**

HOW MEDIAL IMAGING SYSTEMS WORK Medical physicist Douglas Clarkson takes an in-depth look at the fascinating world of nucleonic medical imaging. He explains the techniques used, how the equipment works and what results can be obtained. **16**

ALLEVIATING MAINS POWER PROBLEMS Spikes, noise and glitches **36**

cause no end of problems with mains powered electronic equipment. Stephen Waddington discusses the causes and shows how to solve such problems.

THE HISTORY OF COMPUTERS A lighthearted look at the development of the modern computer. **46**

A PRACTICAL GUIDE TO USING VALVE TECHNOLOGY In the first part of this fascinating series, Graham Dixie explains how thermionic valves work and shows how they are used. The series give many opportunities for practical experimentation with 'modern' valve technology. **48**

REGULARS NOT TO BE MISSED!

ABOUT THIS ISSUE...	2	NEWSAGENTS COUPON	30	READERS LETTERS	55
GO BALLOONING COMPETITION	2	STRAY SIGNALS	31	TOP20 BOOKS	56
TECHNOLOGY WATCH	3	TOP20 KITS	39	NEWS REPORT	62
ORDER COUPON	22	CLASSIFIED ADVERTS	47	NEW BOOKS	64
8:1 IBE	23	tjfs ISSUE	54		

Revealed on page 16..

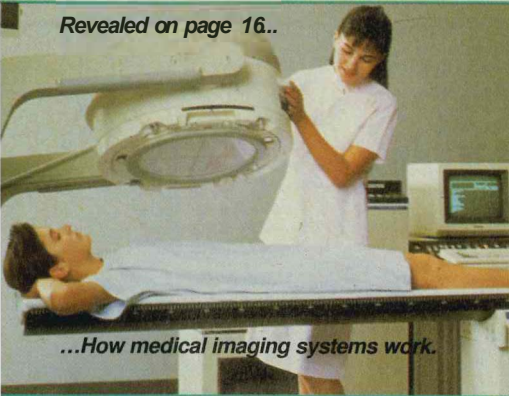

...How medical imaging systems work.

Find out more about mics. on page 41



NEW SERIES Starts on page 48.

All about using valve technology!



Design your own PC projects...

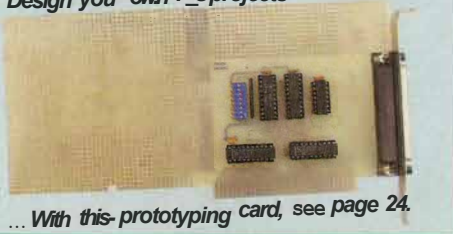

... With this prototyping card, see page 24.

Fifty Watts of music to your ears!

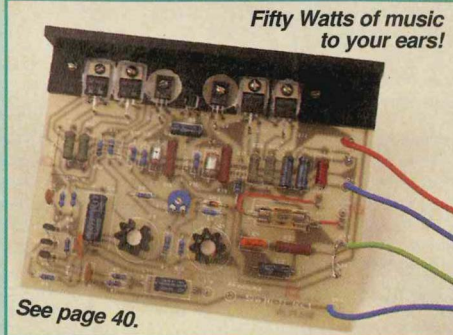

See page 40.

Ca111sh hUJ11 100pseasily!

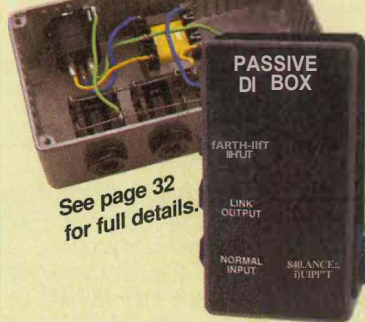

See page 32 for full details.

Measure audio signals easily...



... Build this Pk-Pk mV meter, see page 57.

High performance FM tuner!



Find out how you can build it on page 8

ABOUT THIS ISSUE...

Hello and welcome to this month's issue of 'Electronics'!

The projects this month, with one exception, all have a similar theme; namely audio – and I suppose that *even* the PC Prototyping card *could* be audio related, if it was used to build a MIDI interface! The projects however, do range widely in terms of application and appeal; Hi-Fi, test equipment, radio and electro-music. More than enough to satisfy all tastes! Continuing the audio theme, a new series starting this issue deals with valves; these 'currently in-vogue' devices are little understood by today's mainstream hobbyists – perhaps even consigned to electronic folklore of yesteryear. Graham Dixey takes us on a tour of the world of valve technology, explaining both theoretical and practical aspects of using these devices in modern applications.

Because of the popularity of last month's Go Racing Competition, I've decided to include another competition this month! See below for full details, have fun and good luck!

So until next month, I hope that you enjoy reading this issue as much as the 'team' and I have enjoyed putting it together for you!

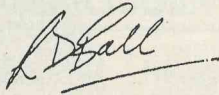

ABC
AUDIT BUREAU OF CIRCULATIONS
CONSUMER PRESS

Front cover:
© Copyright 1993
Pictor International Ltd.
Advances in medical
electronics allow detection
and diagnosis of many life
threatening illnesses.

EDITORIAL

Editor Robert Ball AMIPRE

Technical Authors Martin Pipe BSc Hons,
Mike Holmes

News Compilation Stephen Waddington,
Alan Simpson

Technical Illustrators Ross Nisbet,
Lesley Foster, Paul Evans, Nicola Hull

Project Development Tony Bricknell,
Chris Barlow, Dennis Butcher,
Alan Williamson, Nigel Skeels

PRODUCTION

Production Co-ordinator Alan Wright

Print Co-ordinator John Craddock

Art Director Peter Blackmore

Designer Jim Bowler

Layout Artist Cindy Brown

Published by Maplin Electronics Plc.,

P.O. Box 3, Rayleigh, Essex SS6 8LR.

Tel: (0702) 554155. Fax (0702) 553935.

Lithographic Reproduction by

Stirling Graphics Ltd., 16-22 West Street,
Southend-on-Sea, Essex SS2 6HJ.

Printed in the United Kingdom by
Severn Valley Press, St Ives Plc.

MANAGEMENT

Publications Manager Roy Smith

Development Manager David Goodman

Marketing Manager Vic Sutton

Drawing Office Manager John Dudley

ADVERTISING

Jackson-Rudd & Associates Ltd.,

2 Luke Street, London EC2A 4NT.

Tel: (071) 613 0717. Fax: (071) 613 1108.

Advertisement Director Colin Pegley

Advertisement Manager David Hall

UK Newtrade Distribution

United Magazine Distribution Ltd.,

1 Benwell Road, Holloway, London

N7 7AX. Tel: (071) 607 3352.

© Copyright 1993 Maplin Electronics Plc.

Copyright: All material is subject to worldwide copyright protection, and reproduction or imitation in whole or part is expressly forbidden. Permission to reproduce printed circuit board layouts commercially or marketing of kits must be sought from the publisher.

Advertisements: Whilst every reasonable precaution is undertaken to protect the interests of readers by ensuring, as far as possible, that advertisements appearing in the current issue of 'Electronics' are *bona fide*, the publisher and staff of the magazine cannot give any undertakings in respect of statements or claims made by advertisers, whether on printed page or on loose insert. Readers who have reasonable grounds to believe that they have been misled are advised to contact their local Trading Standards Office.

Editorial: The views of individual contributors/authors are not necessarily those of either the publisher or the editor. Where errors occur corrections will be published as soon as possible afterwards.

Publisher's Statement: Maplin Electronics Plc., take all reasonable care to prevent injury, loss or damage of any kind being caused by any matter published in 'Electronics'. Save insofar as prohibited by English law, liability of every kind including negligence is disclaimed as regards any person in respect thereof.

Prices

Prices of products and services available from Maplin, shown in this issue, include VAT at 17.5% (except items marked NV which are rated at 0%) and are valid between 4th June 1993 and 31st August 1993. Prices shown do not include mail order postage and handling charges, which are levied at the current rates indicated on the Order Coupon in this issue.



GET UP, UP AND AWAY

Go Hot-Air Ballooning Competition!

In this issue's super competition there's the chance to get up, up and away on an exciting champagne hot-air balloon flight over the beautiful countryside of the Gloucestershire Cotswolds!

For the two lucky winners their prize flight is as follows:

You can fly on the date of your choice, weather and flight availability permitting. You can bring along family and friends to see you off; they can even track the balloon's progress by following the retrieve vehicle. No-one knows where you will go or where you will land - flight direction and speed is entirely dependent on the wind! During the flight, at an altitude of between 500 and 2,000 feet, you will be able to crack open a bottle of bubbly and enjoy the breathtaking views - don't forget to take along a camera! At the pilot's discretion, you may even be able to try your hand at a little 'burner time' and experience the thrill of actually flying a hot-air balloon yourself! At the end of the flight, the pilot will choose a suitable place to bring you safely back to earth. The support crew will then collect the balloon and

return you to the launch site. To remind you of your exciting flight, you will receive a commemorative flight certificate signed by your pilot.

All you have to do to enter the competition is correctly answer the four questions below, write your answers on the cover-mounted entry card, fill in your name, address and daytime telephone number and post your entry. Your entry must reach us by 31st July 1993.

The senders of the first two correctly answered entries drawn after the closing date will have the opportunity to get up, up and away in a hot-air balloon!

If the cover mounted entry card is missing, you can still enter by sending your answers on a postcard (or sealed-down envelope) to: Go Hot-air Ballooning Competition, The Editor, Electronics Magazine, P.O. Box 3, Rayleigh, Essex, SS6 8LR.

Flights include full insurance. Flight operator is Civil Aviation Authority licensed. Pilots hold full UK Commercial Pilots licences. No cash alternative will be offered. Employees of Maplin Electronics and their families are not eligible to enter the competition.

1) What keeps a hot-air balloon aloft?

- a) Hydrogen
- b) Hot-air
- c) Helium
- d) Party Political Broadcasts

2) By what name were the large German passenger airships known?

- a) Zircon
- b) Das Poppön Bag
- c) Zeppelin
- d) Zechstein

3) What material are hot-air balloons made from?

- a) Ripstop Nylon
- b) Latex Rubber
- c) Silk
- d) Carbon Fibre

4) Which entrepreneur is well known for his ballooning escapades?

- a) Tiny Roland
- b) Clive Sinclair
- c) Freddie Laker
- d) Richard Branson

TECHNOLOGY WATCH!

with Keith Brindley

I write this in the very week of the launch of the country's second national commercial radio station, which also happens to be its *first* national commercial radio station playing specifically rock music. In itself this is no great technical advance; the station - Virgin 1215 AM - is (as you'll see from its name) broadcast using AM on the medium waveband, a waveband not renowned for its audio clarity, and one that doesn't have the benefits of high-fidelity stereo transmissions like those of the local FM VHF radio stations around the country or, indeed, its only national competitor in terms of content, Radio 1 (oops, sorry, One FM) from the BBC.

On the other hand, Virgin 1215 does point to a significant change in the general fortunes of the medium itself. A little while ago radio was thought to be on the decline. For years it was considered merely an old-timer, playing an ageing second fiddle to the *real* leader of the airwaves' orchestra - that hip-hop youngster with the keyboard, television. Television, of course, is the instant broadcast communication method which springs to mind when you think of our use of the ether for entertainment. And for long enough this has been rightfully so. It is television, after all, to which the great advances in broadcast communications techniques have been aimed, and it's television which has seen all but a small handful of the great modern broadcasters migrate to it. You might be an up-and-coming radio DJ making a fair amount of money, but you know you've *really* made the big-time when you get your first TV contract. Generally, listeners' and viewers' perceptions of this divide between radio and television have mirrored such attitudes not necessarily put about by the broadcasters themselves, but at least started by them in the salaries they pay their presenters.

But this is all changing and there's life in the old dog yet. Two national commercial radio stations (a third speech-based one is planned for 1995), some 50-plus local commercial stations, the BBC's five national stations (a continuous news service - Radio 6 - is also planned for next year) and all its local county-based stations, the powerful Irish long-wave pirate Atlantic 252, and a significant upsurge of a new type of radio station known as community radio, have all

indicated a regrouping of radio's forces and an advancement of arms towards some imaginary battle for the listeners that television had converted into watchers some time ago.

In practical terms, radio is already doing well in the battle. One FM, for example, pegs up many more listeners to its breakfast show (the Simon Mayo show) than any of the breakfast television shows can muster viewers. In those areas of the country in which community radio has been started, support from listeners and backers has been unprecedented. The new national commercial stations, including Richard Branson's latest venture, merely provide reinforcement troops in what appears to be a steadily growing army to fight in the war for success.

Virgin 1215 AM is, I hasten to add, my kind of radio station. Radio 4, its only real competitor to my ears, has only had my attention because there is nothing else that I consider worth listening to, and because reception of Atlantic is just not good enough from my home. So as of 12.15pm (that's the launch-time, geddit?) on Friday 30 April, I'll be listening to radio more often in my spare-time - and most certainly when I'm driving. Indeed, I'll listen to radio in my car for the first time *ever*- and it'll give me the chance to dust off my old and almost worn-out tapes of Roger Waters and Pink Floyd. Virgin's mix of rock music and just a tiny bit of chat promises a lot in my mind. (Let's hope they book up radio subcarriers on the Astra satellite soon - Ed.)

I'm certain that I'm not alone in looking forward to Virgin's new radio station. The music that it is to play is the sort of music which many people like. These are the people who, I believe, have been forgotten by already-existing alternative radio stations.

I'm also convinced that present alternatives like Radio 1 (oh, I've done it again - One FM), and even Radio 4, have been 'jacks-of-all-trades'. Until just recently, they have tried to do too much and be all-singing, all-dancing to a rather limited number of listeners. In the past they *had* to be all-singing, all-dancing, of course - with no alternative medium apart from television. I know that the greater the number of alternative radio stations there are, the lower the market share each of them can

possibly attract. But the more alternatives there are, the more closely each radio station can target potential listeners - new listeners, if they get the broadcast mix right - so the greater the market becomes in terms of listening ears. A change must take place.

It's already starting. BBC national stations are already looking to attract specialist audiences. One FM (got it right this time!) now has regular speech-based programmes on religion and arts, and is looking to increase such programmes to around an almost-unbelievable third of its total output. Radio 2 has more socially-aware programmes and news than ever before.

These changes are two-fold. First they are a vital ingredient in the BBC's plans to maintain successful national radio stations, and form an extremely far-sighted policy which should help them do this. Of course, the writing is on the wall that this must happen, but not everyone at the BBC has always been ready, able or willing to read graffiti before now.

Secondly, they pave the way for new stations like Virgin. With the BBC targeting particular types of listener, rather than just transmitting bland mixes of programmes over its stations, Virgin and others can aim at specific groups of listeners too, and be sure that the listeners will be there.

It's gratifying to be able to report that an old technology has made good once again. Usually, I spend much of my time looking at new entertainment and business technologies hitting the headlines. Generally these are digital and seem far-removed from us as users, except in their final hands-on effects. The technology behind radio, on the other hand, seems about as far away from digital entertainment as Madonna is from the real world. And hopefully Madonna will be as far away from Virgin 1215 as Cliff Richard is from the Annual General Meeting of the Atheists' Society. And I can firmly say that if Madonna's *Like a Virgin* is actually *played* on Virgin then you won't see me listening to it for the dust on my Roger Waters and Pink Floyd tapes!

Now radio, long the second-rate broadcast service to television, has a revival on its hands which looks set to make it first-rate once again. I wish the revival of radio, and Virgin in particular, all the very best.

1.//E WirK AliClItJ CHiP.:



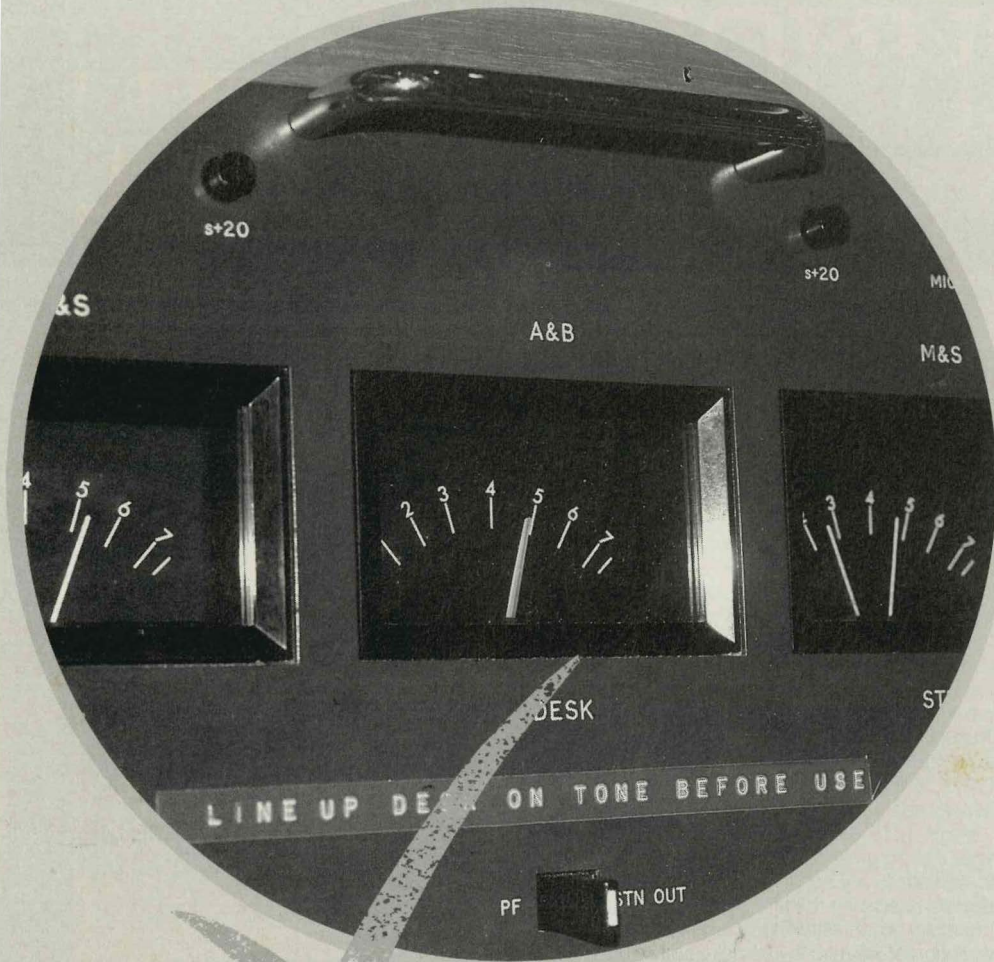

A GUIDE TO PROFESSIONAL AUDIO PART FOUR

by T. A. Wilkinson

Choosing and Using Microphones

In the last part we discussed various types of microphones and associated information, this month we take a look at techniques for using microphones in general, and methods for amplifying low level mic signals.

Microphone Amplifiers

A microphone amplifier may form part of a mixing desk or the input stage of a tape recorder, alternatively it may be a self-contained unit either for use in or out of studio situations. Mic amps that are found in budget tape recorders often leave a lot to be desired, with poor noise figures, high distortion, little headroom performance and often insufficient gain.

I guess this is because marketing men consider that a quality mic input stage has little use as a marketing tool (no gimmick value), and so resources are not 'wasted' on developing this to any decent standard.

However, the new breed of DAT recorders that are now available have forced some manufacturers to think again. The very high quality and revealing results that even budget priced digital recording equipment is capable of producing has prompted at least some improvement in mic input stages. Some manufacturers are now including fairly good quality balanced mic input stages and decent XLR type connectors on several types of portable DAT recorders. Alas, these improvements are still not enough, and many portable tape recorders, including DAT machines, will require the addition of an external high quality microphone amplifier to realise their full potential.

The noise performance, and thus overall quality of many tape recorders and mixers, can be improved immensely by the addition of a totally separate mic amp connected directly to the line inputs, and it is this type of unit to which the following considerations relate.

Designing amplifiers for microphones is a bit of an art, and there are a number of elements and requirements to consider. The basic gain requirement is fairly straightforward, but areas such as impedance and noise performance, which are largely interdependent, need more thought and understanding. High quality commercial designs will have had a good deal of thought and research put into them, and this is often reflected in the selling price.

Design Considerations

Any microphone amplifier needs to fulfil the two basic requirements of source/ load impedance matching with low noise high gain amplification. Other requirements range from low current consumption for battery operation, to sturdiness for microphone amplifiers used in outside broadcast situations. Normally, self-contained units are not designed for a particular microphone, and will therefore, need to be flexible in terms of gain and have the ability to be used with many types of microphone with greatly varying sensitivities and output levels.

Noise Performance

Audio systems, of any type, are essentially limited in their performance by noise figures, and this is a particularly difficult problem when dealing with small signal voltages. It seems that every stage is plagued by noise of one kind or another, but there are available, at quite reasonable cost, op amps and gain stages specifically designed to amplify small audio signals, without contributing significantly to the noise problem. This takes away much of the design difficulties, and allows designers to concentrate their efforts on improving other areas of the amplifier's design.

Noise can be described as any unwanted signal within a component or system, and comes in many flavours such as hum, crosstalk, RFI etc. But it is random noise which is perhaps most important for us to consider, and in particular thermal random noise.

Thermal noise, also known as Gaussian noise, is present in all conductors and components. Its spectrum is that of white noise and thus affects all frequencies, and is impossible to eliminate under normal conditions. It is generated by the random behavioural movement of the signal carrying charges and electrons. The resulting unwanted EMF (noise) across a conductor is caused by a non-linear distribution of charges within the conductor or component.

Typically, a resistor lying on your workbench at home, not connected to anything, will actually generate some thermal noise! Although it is not easy to

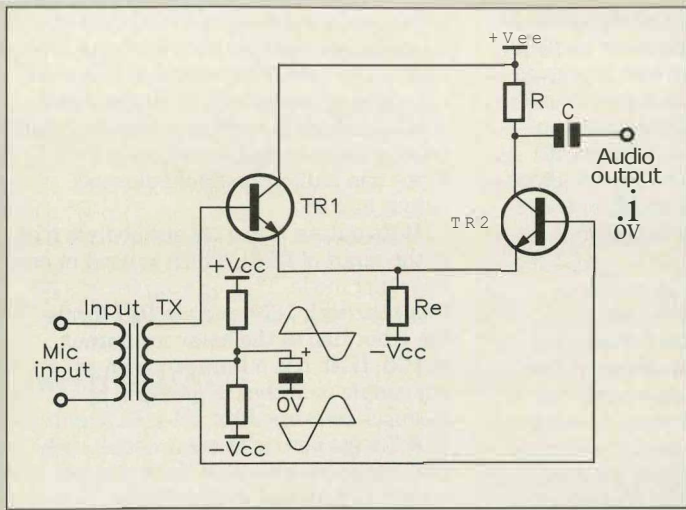

Figure 1. Simplified differential input pair.

measure, the RMS value of the thermal noise in a resistor or conductor can be predicted using the expression:

$$V_n \text{ (rms noise voltage)} = \sqrt{4kTBR}$$

Where

k is Boltzmann's constant
 $= 1.38 \times 10^{-23}$ Joules/Kelvin

T is temperature in °K
 $(K = ^\circ C + 273)$

B is the bandwidth in Hertz

R is the source resistance in Ohms

Thus the thermal noise voltage generated by a 1k Ω input resistor of a mic amp with a bandwidth of 20kHz, operated at 20°C, can be predicted using the above expression.

$$\begin{aligned} V_n &= \sqrt{4kTBR} \\ &= \sqrt{3.88 \times 10^{-13}} \\ &= 0.623 \mu V \\ &= -121 \text{ dBu} \end{aligned}$$

Remember that at this stage, no amplification has taken place, so this figure may start to become significant

when combined with other noise factors, and then amplified by a high gain amplifier stage.

If you have any interest in designing amplifiers for low-level signals, then a thorough study of noise related problems is a must. But my example here only serves as an over simplified illustration of the potential difficulties, and helps to qualify why input impedances and noise performance are interdependent: The greater the input impedance/source resistance then the larger the noise figure will be, therefore, it would be desirable to lower these to a minimum practical value.

Gain Stages

Having briefly considered noise problems, then the gain aspect is the next step. As discussed earlier, the gain of a general purpose mic amp needs to be flexible, and moreover, easily adjusted, preferably by a single control knob.

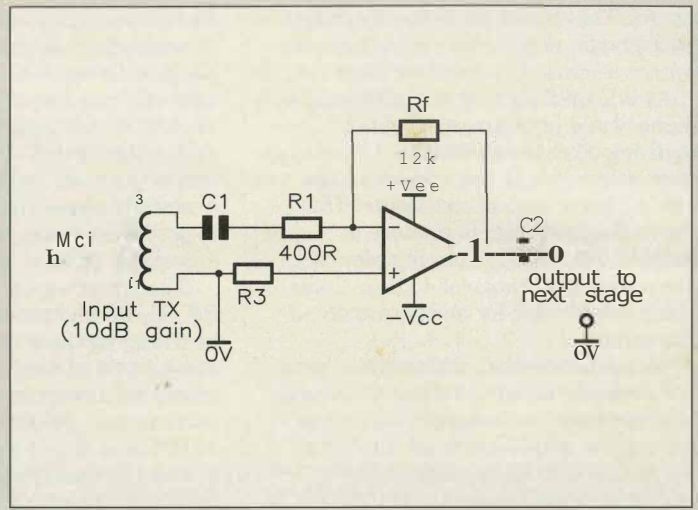

Figure 2. Typical mic amp input stage using modern op amp techniques.

How Much Gain?

Microphone sensitivities and stated nominal output levels can vary anywhere between -40dBu to less than -70dBu, depending on the particular unit, so the mic amp will need to have gain adjustment in this range. If we take into account that a difference in voltage level of only 6dB is a multiplying factor of $\times 2$, then we get some idea of the scale of the problem. A microphone with a nominal output of -60dBu will require a gain of 1,000 to bring it up to line level, and a unit with nominally -66dBu output (only 6dB difference) will require a gain of 2,000, twice that of the previous unit.

High quality, single stage, high gain (>60dB) mic amps are not really very common, due to the inherent problems of high gain, reduced bandwidth and instability. Better designs will use two or more stages for best results with the first stage presenting the correct load impedance to the microphone, together with low noise and gain adjustment

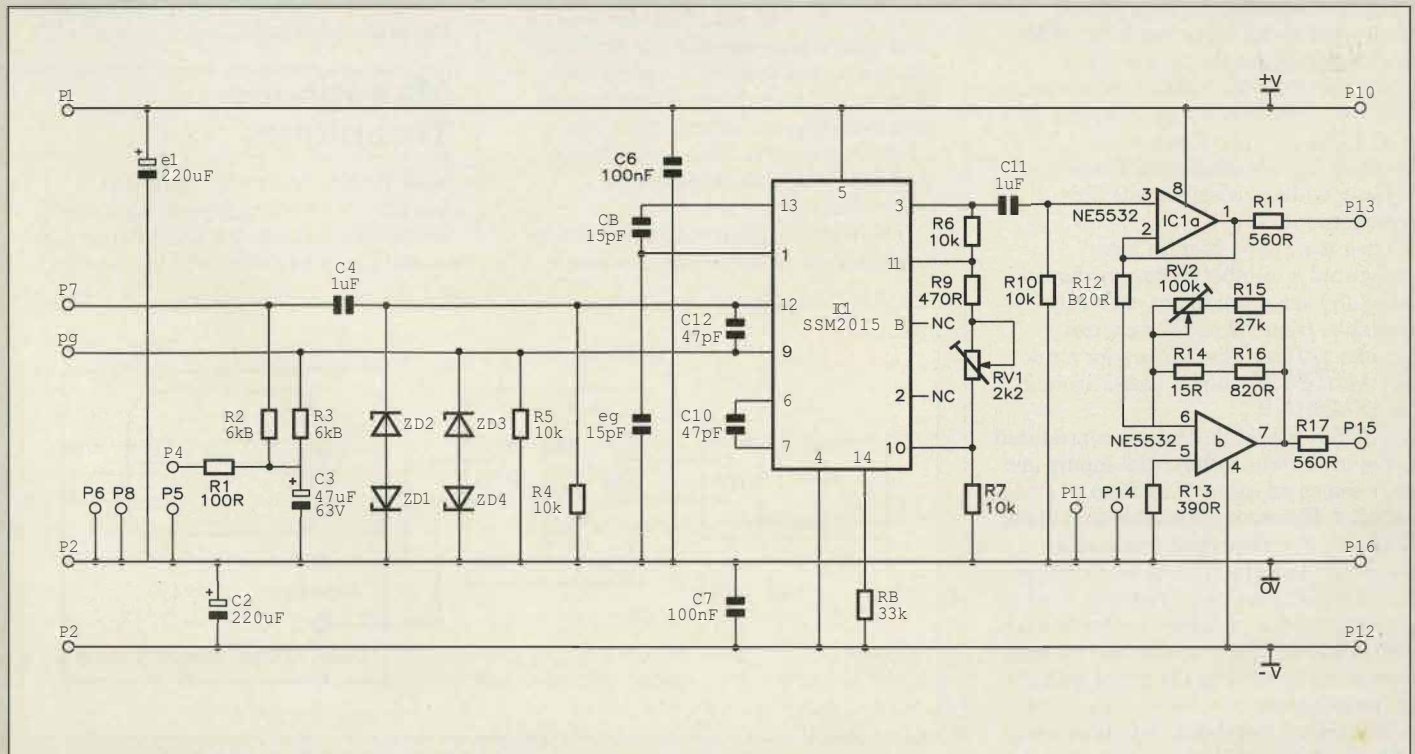

Figure 3. Circuit of mic amp based around the SSM2015 IC.

control. The second stage may provide a fixed amount of gain (low noise of course), but not as critical as the first stage.

As it is unlikely that a quality microphone would produce an output of anything more than -40dBu, it would seem reasonable to use a second stage with a gain of around this figure. This allows the first stage to produce a variable 0 to 30dB of gain in order to give a total gain range of 40dB to 70dB, which would cater for most types of microphone.

Without exception, microphones used in a professional environment will have balanced output arrangements, and so microphone amplifiers must meet this requirement. In some cases an input transformer will be used, and this may form part of the gain requirement together, with impedance matching. Other designs rely solely on electronic differential inputs, which render an input transformer unnecessary.

However, it is not uncommon to see input transformers used together with differential input stages, particularly where phantom supplies are used.

Traditionally, mic input stages were based around discrete differential input stages similar to that in Figure 1. The microphone input is fed to the transformer, which can be a step up type to contribute to the overall gain, the output of this is fed to the bases of differential pair T1 and T2. Amplified output is available at T2 collector via coupling capacitor C.

Until recently, this type of arrangement was very common and although it is still found in some new equipment, it is now more usual to encounter an Op-amp as the first stage of many mic amps. A typical example appears in Figure 2.

Again an input transformer is used, and if a turns ratio of 1:3 is used, will have an initial gain of 10dB, and an overall input impedance of 1-2k Ω . The TX output is unbalanced for direct connection to the inverting input of the op amp. The Op-amp circuit input impedance is 150 Ω and the gain is set by R_p/R_l , and with R1 at 150 Ω and Rf at 4k7, the gain is a factor of 31 (29-8dB). Thus a total amplification factor of 40dB is possible with this arrangement.

Over the years, Maplin have introduced a number of designs for mic amps and several kits are currently available. Issue 39 of 'Electronics' includes a 'Data File' feature for a mic amp kit (LP42V) that is based around the SSM2015 IC.

The full circuit diagram is reproduced in Figure 3. True differential inputs are used and so an input transformer is not included. However, a suitable unit could be added, if wished, but this would mean that the phantom power arrangements would need to be rewired. This is simply a matter of disconnecting the top ends of R2 and R3 from C4 and C5 and connecting directly to the input side of the transformer.

The circuit itself (full details in Issue 39) readily accepts balanced inputs and is equipped with a balanced output stage

for interfacing to subsequent equipment. Available gain is in the range of 21dB to 33dB, with low distortion and very good noise figures. However, in some applications, it may be found that the gain range provided is insufficient, if this is the case, it would not be too great a problem to modify the circuit in order to produce a more useful range of adjustable gain.

The gain range is set by resistors R6, R7, R9 and preset RV1, and so by changing these resistor values, the overall gain of the circuit can easily be increased. However, for optimum performance, R6 and R7 should be kept at 10k, and so any increase in gain must be done by manipulating the values of resistors R9 and preset RV1. Calculations of gain can be done using the expression:-

$$\text{Voltage Gain} = \frac{R6+R7+R9+RV1}{R9+RV1} + 3.5$$

For example, replacing R9 with a resistor value of 22 Ω and leaving preset RV1 at 2k2, would result in a gain range of roughly 20dB to 60dB, which would suit a wider range of microphone types. If even greater levels of gain are required, it would be possible to further modify the resistor values to give another 6dB of output, but this is approaching the SSM2015 operating limit of a maximum gain of 2,000 (66dB). A better solution may be to add a completely separate gain block. This would need to be included before the output balancing stage (IC2), and therefore, has to be inserted between the output side of Cn and the input of IC2a, pin 3.

The additional gain stage should be based around a high quality op amp, such as the NE5534A, which is used in the non-inverting mode with a fixed gain set at between 10 and 15dB. This would give a total gain of up to 75dB without jeopardising noise and distortion figures.

In practical terms, if this kit is to be used with a tape recorder, or similar, and connected to its line inputs, then there will usually be sufficient further gain available by adjusting the line input level control. This would make modifications to the basic circuit unnecessary.

The well designed output balancing arrangement of the circuit is a nice

touch, and comprises of a fairly conventional 'phase splitter' based around IC2a and b. The amplified output of IC1 is fed via coupling capacitor e_n to the input of IC2a, which is used as a non-inverting voltage follower and its output, via R_n , forms one half of the final balanced output at P13.

IC2a output (pin 1) is also fed via R12 to the input of IC2b, which is used in an inverting mode. This op amp inverts its input through 180° and via R17 forms the other half of the balanced output at P15. IC2b has a limited range of adjustable gain that is provided by feedback network RV2, R14, R15 and R16. Its purpose is to ensure that each half (opposing phase) of the balanced output is matched in amplitude.

It is quite important to make certain that the output pins, P13 and P15, exhibit the same amplitude in order to preserve the benefits of balanced line operation. Where possible the setting of RV2 should be done using a double trace oscilloscope, as shown in Figure 4.

The output of the audio generator should be set to around 10mV, at a frequency of 1kHz, and connected to inputs P7 and P9. Set the gain pot, RV1, to its mid position. With the scope inputs connected to P13 and P15, adjust the volts/div controls to the same settings to give a trace of 3 to 4 divisions for each waveform.

The oscilloscope 'add' or 'sum' button should now be used to add together the two out of phase inputs, and the result should be a flat line. If the trace is not flat, (i.e. very small AC waveform) then slowly adjust RV2 until a flat, or flat as possible, trace is obtained. This now indicates that the two halves of the balanced output have exactly the same voltage value.

If an input add button is not a feature of the scope used, then it is possible to achieve a reasonable balance by placing the two traces on top of each other, and adjust RV2 until they display the same amplitude.

Microphone Techniques

Most reports, interviews, and as journalists like to call them 'packages', produced for radio, are still produced in mono. The reasons for this are quite

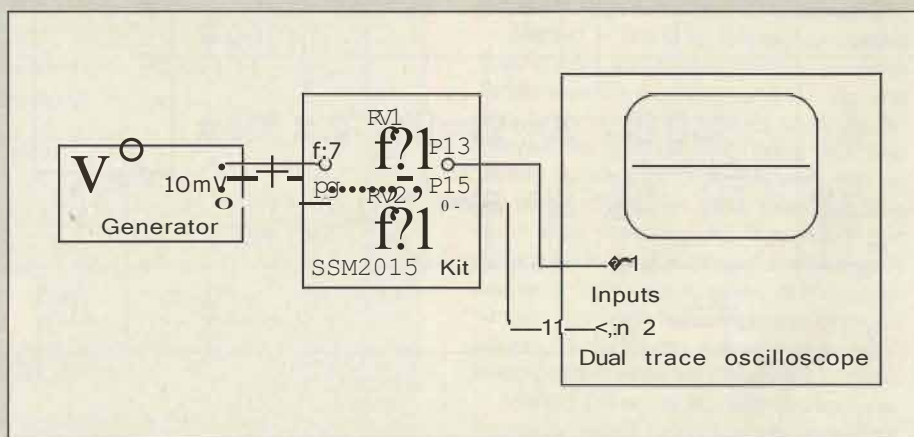

Figure 4 Setting up the output balance of SSM2015 mic amp, using a dual trace oscilloscope.

logical. Firstly, it is usually unnecessary to provide anything more elaborate such as stereo. Secondly, it is simpler and easier to use a single omnidirectional microphone in order to record, or get on air, a relatively simple interview or voice contribution.

Furthermore, many of the tape recorders used in ENG (Electronic News Gathering) will be of the 1/4in. reel to reel variety, such as the Uher 'Report Series'. These recorders record in mono onto a single track (upper or left) of the tape at 7 1/2ips. In general broadcasting terms, 7 1/2ips, mono, is the norm for speech based items, and 15ips, stereo, for musical items.

It is interesting to note that some of the studio tape recorders used in radio studios, particularly local radio, are modified to automatically switch to mono (i.e. paralleling together L and R outputs with some level adjustment) when replaying tapes at 7 1/2ips. This convention is used to enable recordings made in the field on only one track of the tape as described above, to be replayed on a stereo sound desk without the obvious loss of one channel.

This system takes away any problems of compatibility relating to journalists and contributors supplying recorded material on 1/4in. tape running at 7 1/2ips. That is to say, regardless of whether the recording has been made using either the upper or lower track, or both tracks together, it really does not matter, as when it is replayed on a studio machine, it will appear on both the left and right channels of a stereo desk.

Using a Single Microphone

A hand-held omnidirectional microphone used in an interview situation should be placed more or less equidistant between the parties, but not too close to either - a distance of about 30cm to 40cm should suit most situations. Providing both parties speak at similar levels, then an equal amount of pick-up will be the result, and each will sound balanced in relation to the other.

If there is a great deal of background noise, it may be necessary to work the mic a little closer say at 20cm, this has the effect of subjectively reducing background noise. Care will have to be taken not to run out of mic amp headroom and

to reset gain controls to compensate for the increased SPL at the mic capsule.

Once the microphone has been positioned, it should not be necessary to move it around, and due consideration must be given to rattle and other extraneous noise caused by physical handling.

Of course, when using a directional microphone in hand-held mode to conduct an interview, the microphone must be moved and directed towards the sound source in order that an equal pick-up is achieved. Unless great care is taken, handling noise will be a problem.

Handling noise is usually the result of either vibration from knocks, or physical (but minute) movement of the capsule caused by harsh movement of the microphone. Good quality units offer elastic suspension of their capsule in order to minimise handling noise.

Often, rattle type noises can be put down to poor mating of the mic cable connector with the receptacle in the mic body. One solution to this problem is to fit a specially made mating washer. This resembles a large shakeproof washer, made from a rubber material, that is fitted between the mic cable XLR connector and the mic body. The washer simply reduces any gap to a minimum, and offers a very cost-effective way of reducing connector rattle.

Special Microphones

Highly directional gun mics, and lip microphones, are two types that can be considered as special microphones for particular applications, and are worthy of at least some consideration within this feature.

Gun or rifle microphones are intended to get you nearer to a sound source because they are very directional in their pick-up pattern, and normally possess a tight cardioid response. In practice, a unit of this type can only be about twice as effective in capturing distant sounds than a standard cardioid type, but it does have many uses.

We are all familiar with the sight of gun mics, as these are typically the type of mic most often used by news film crews. In this situation, it would not be very professional to have any sort of microphone in camera shot, and a gun mic can be quite an effective method of capturing sufficiently good quality, clean

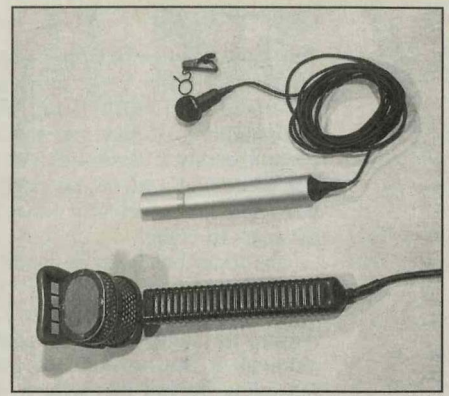

Photo 2: "Beauty and the Beast" Coles Lip Ribbon Microphone (bottom) and Sony ECM Lapel Microphone (top).

sound from some distance away. Also, gun mics are frequently used to get some 'on field' sound effects at football, rugby, or cricket matches, and similar sporting events. Again, this allows the pick-up of at least some of the players grunts and groans without the need to get in too close!

Photo 1 shows just such a microphone, this is a Sennheiser gun mic (at bottom) pictured with the familiar sight of a hairy type windshield (at top). The windshield, which has a very handy pistol grip, is really quite effective, and ideally suited to outdoor work, it even comes with its own hair-brush in order to keep it looking good! (honestly).

Another special type of microphone is the Coles lip ribbon microphone, and is the standard sports commentators microphone. It is a rather curious looking, but also a very familiar unit (see Photo 2). Ribbon microphones tend to have a figure of eight response and the lip mic is no exception, and as such will pick up sound from both the front, and the rear of the capsule.

However, it is a very insensitive microphone that requires the user to plant it firmly to his, or her, mouth with the horizontal bar resting on the upper lip - hence the name. As you may gather, this is not the most hygienic of microphones for passing around amongst commentators. Some suppliers now market a disposable plastic guard, which fits neatly over the nasty bits and can be sanitised or thrown away after use.

To produce sufficient output, the mic has to be worked very hard by literally shouting into the capsule. In practice the lip mic picks up very little sound other than that of the commentator, and this being the case, it is vital to use an additional 'effects' microphone to capture the crowd cheers (or boos) and general ambient noise. Should an effects mic not be used then there simply is very little or no crowd noise, and the commentary may as well be done from the comfort of a studio.

Ribbon mics are often considered to be very delicate units but the Coles lip mic is anything but, and copes admirably with the rigors and elements that outside broadcast work naturally brings.

There are of course many other specialist microphones that are as novel as the imagination allows, but to describe each and every one is beyond the intention of this article.

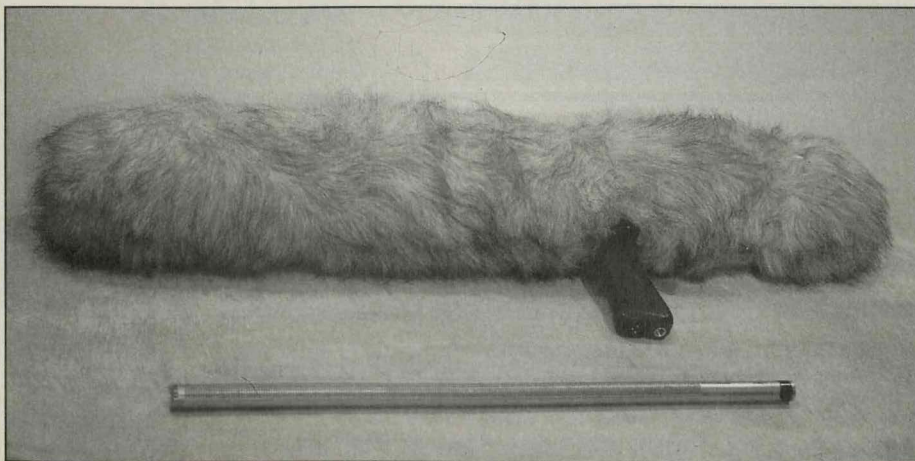

Photo 1: Sennheiser Gun Microphone and Windshield.

by Martin Pipe

This unit is a microprocessor-controlled single-conversion VHF (only) stereo FM phase-locked loop (PLL) tuner with alphanumeric display and infra-red remote control facility. It all sounds a bit of a mouthful, but when built and set up correctly it will give you earfuls of sweet (and above all, 'free!') music for years to come!

The tuner has been designed to complement the VE46A Digitally-Controlled Preamplifier, which was featured in 'Electronics', Issue 52 (April 1992); for this reason, the tuner does not have a mains power switch, although it can be switched into a 'standby' mode. The reasoning behind this (which, incidentally, is common to most modern synthesised tuners) is not the prevention of accidental power removal from the tuner - station tuning and identification (more about the latter shortly) is retained in non-volatile EPROM (electrically-erasable programmable read-only memory, sometimes also abbreviated to EEPROM) - it is because the preamplifier has an auxiliary switched mains supply outlet.

SYNTHESISED DIGITAL VHF/FM TUNER

PROJECT
RATING

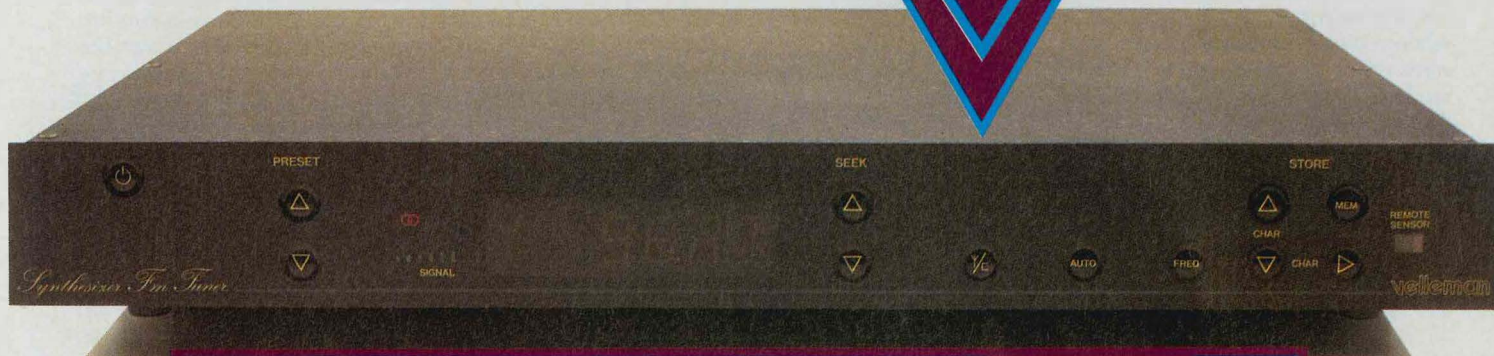

Above: The completed Synthesised Digital FM VHF Tuner. Steve Wright would be proud!

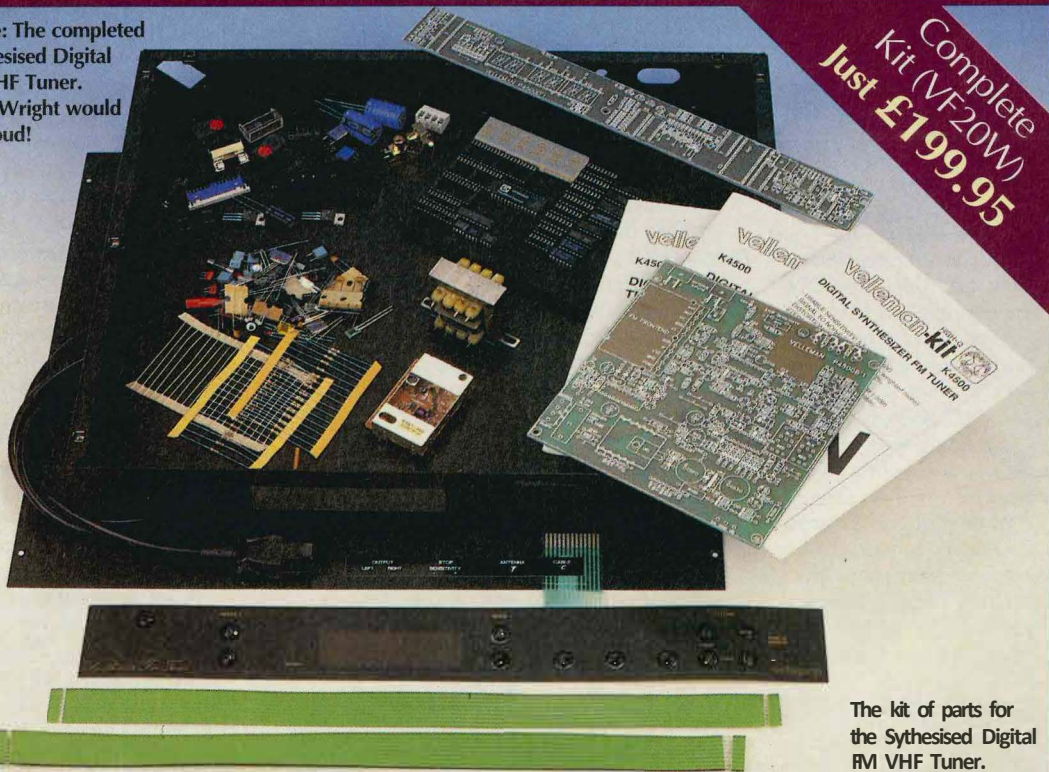

[F] [E] A 1 f U R [E] §

- * Superb Sound Quality
- * Remote Control Facility (when used with VE47B Infra-red Transmitter)
- * Complements the VE99H Stereo Valve Amplifier and VE46A Digitally-Controlled Preamplifier
- * Search Tuning-Adjustable Sensitivity
- * 8-LED Signal Strength Indicator
- * 40 Available Presets
- * Two Selectable Aerial Inputs
- * Preset Station Naming

Aerials Galore - and Lots More!

This tuner offers many features - including several not found on most, if not all, commercial units. For example, selection between two 75Ω aerial inputs is offered; one aerial could be vertically-polarised (great if you're a pirate radio freak, or 'anorak!'), while the other is reserved for horizontally-polarised signals. If you don't have two such aerials mounted on a rotator, you could have two aerials aimed in different directions, for the reception of VHF programmes from differing regions. We have a wide choice of VHF programmes in the UK - BBC radio, ILR, and the new generation of 'special interest' and community stations. And of course, there are the pirates, assuming of course that there are still some around!

A decent aerial system will pick up a sizeable proportion of this choice - and will pick it up considerably better than the 'damp piece of string' supplied with most commercially-available tuners. Perhaps this is why no such ineffectual aerial has been supplied in this kit; the designers would rather you used a proper aerial, to get the best from the unit!

On the Continent, cable TV is much more widespread than in the UK, and so this additional aerial input has been designated for connection to a cable system. Readers of 'From Up Above or Down Below', which was published in 'Electronics', Issue 58 (October 1992), will know that a VHF FM cable connection is often offered on broadband cable networks - in the few UK examples, such a facility is used for popular but weaker (more distant) broadcasters, and stereo satellite channel soundtracks (MTV Sky Movies, etc.), in addition to the BBC stations and regional ILR broadcasters.

Even with a decent aerial, mounted on your roof or wall (or, at a pinch, in your loft), there will always be stations too weak to be listenable. For this reason, an adjustable 'stop' sensitivity is provided on the rear panel: this is adjusted so that only the very weakest stations are overlooked when the tuner is operating in 'seek' mode.

More generous than most, the Synthesised Digital VHF Tuner is provided with a total of 40 presets to cope with the growing number of VHF broadcasters - compare this with the limiting 8 or 16 provided with a significant proportion of commercially-available units. But that's not all. The 'crowning glory' of this unique tuner is that each of the 40 channels can be assigned a 4-character 'identification tag', such as the abbreviated station name - pseudo-RDS if you like!

We have already mentioned the fact that this tuner has a non-volatile memory. Station frequency and identification apart, the unit also stores the selected aerial socket, and can even remember which station it was last tuned to on powering up from either 'stand-by' mode or from the mains.

An infra-red remote receiver is incorporated into the unit; this is compatible with the VE47B 15-Channel Infra-Red Transmitter (refer to 'Electronics', Issue 59 (November 1992)) that also controls the Digitally-Controlled Preamplifier. This fairly unique ('Naffsonix' midi-systems excluded!) feature may also be used beneficially in other ways. For instance, many of the more advanced 'programmable' remote controls - devices which simulate several original control units - incorporate 'timer' facilities. Some, in fact, offer as many as eight individual control

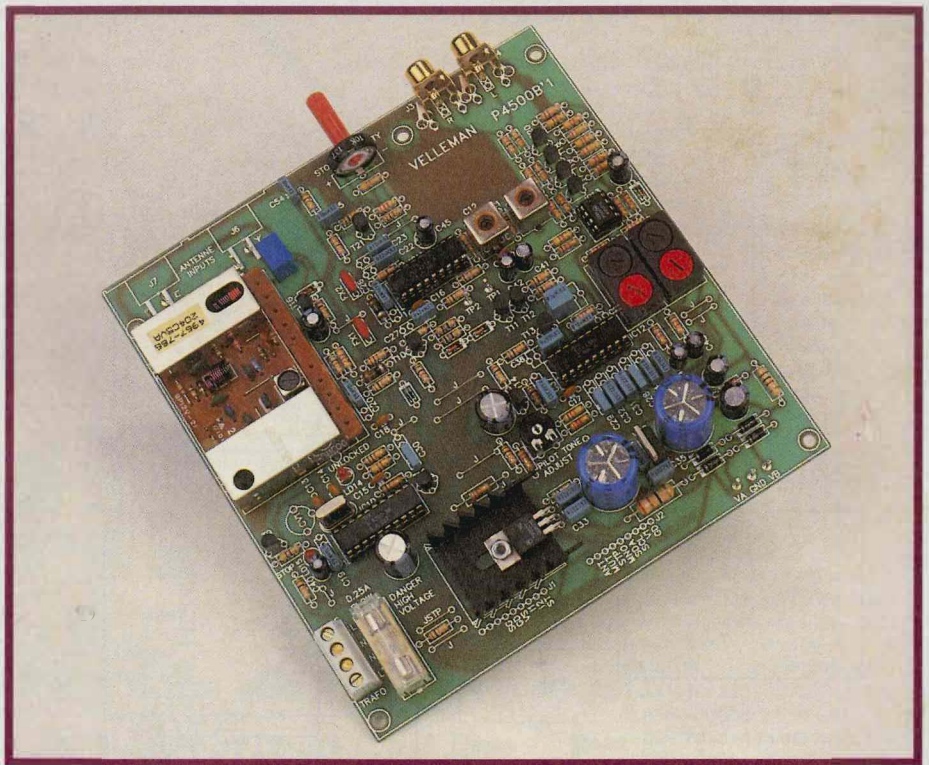

The completed Tuner/PSU PCB.

sequences over a two-week period! Just imagine, in conjunction with a timer-controlled tape machine (Galactic Timer, where art thou?), or a multi-event Hi-Fi VCR, being able to record as many as eight of your favourite radio programmes (from any of those 40 different channels) over your holiday fortnight!

Circuit Description - Analogue Section

All references in this section are made to the circuit diagram in Figure 1. Beginning at the aerial sockets (as sensible a place to start as any!), the desired input is selected by the relay, RY1, before being fed to the high quality pre-aligned tuner/IF module. Such a module greatly simplifies construction, and obviates the need for expensive RF alignment gear; the module incorporates all the necessary aerial matching, RF amplifier, mixer and oscillator circuits, which would otherwise all have to be set up correctly.

IC10 is the phase-locked loop; station selection is achieved by sending a serial data word into pin 3 of IC10, and timing information (clock) to pin 2. This serial data/clock arrangement, originally developed by Philips, is known as the Σ C bus. The serial data word instructs IC10 to produce the corresponding DC tuning voltage which, in turn, controls the local oscillator within the tuner/IF module. Apart from feeding the mixer, the local oscillator is buffered and fed back into IC10 where it is compared to the 'correct' frequency determined from the control word; this latter frequency is referenced to crystal X2. Any error between the two signals will result in a change in the DC tuning voltage, thus locking the local oscillator to the correct frequency. Due to the high stability of this system - known as 'voltage synthesis tuning' (VST) - no additional AFC control loops are required.

low-noise amplification and filtering (this removes the other frequency likely to produce the F frequency - the unwanted 'image'), the incoming VHF signal from the aerial relay is applied to the mixer, where

heterodyning (mixing) takes place with the local oscillator. The local oscillator frequency - close to that of the input - is chosen so that the heterodyning process produces a 'difference' frequency, with a high-frequency 'sum' component superimposed upon it. These two frequencies are always the same when tuning takes place, and filtering off the high frequency leaves the difference frequency - which is used as the F frequency. Filtering off everything but the F frequency - which is centred on 10.7MHz - is accomplished by ceramic filters FX1 and FX2; two such filters ensure a sharp F response, and hence a high degree of selectivity. Good selectivity is, of course, important in these modern times since the VHF broadcast band is so crowded! Because ceramic filters are notoriously lossy, an amplifier stage based around T21 is located between FX1 and FX2.

The filtered F signal is then fed to the signal input pins of IC11, which performs several different functions associated with retrieving the audio information. The signal is first processed by an F amplifier and limiting circuit that ensures optimum signal-to-noise performance over a wide range of F input levels. This signal is monitored by a noise-threshold detection circuit, which is used to mute the sound output when no station is present, or when the station is too weak to recover a reasonable quality signal. This muting control is also used to stop the automatic scanning functions of the tuner; its threshold point is determined by RV1 ('stop sensitivity'), which sets its DC reference.

The voltage at pin 11 of IC11, which is associated with the F limiting circuit, is proportional to the F signal strength. This voltage forms the basis of a signal strength meter; it feeds the non-inverting inputs of op-amps A1-8. The inverting inputs of these op-amps are connected to a potential divider chain, while their outputs are connected to eight LEDs fed from constant current sources T11 & T12.

Of course, the primary function of IC11 is that of FM demodulation. The detector is a double-tuned (LC1 and LC2) quadrature type,

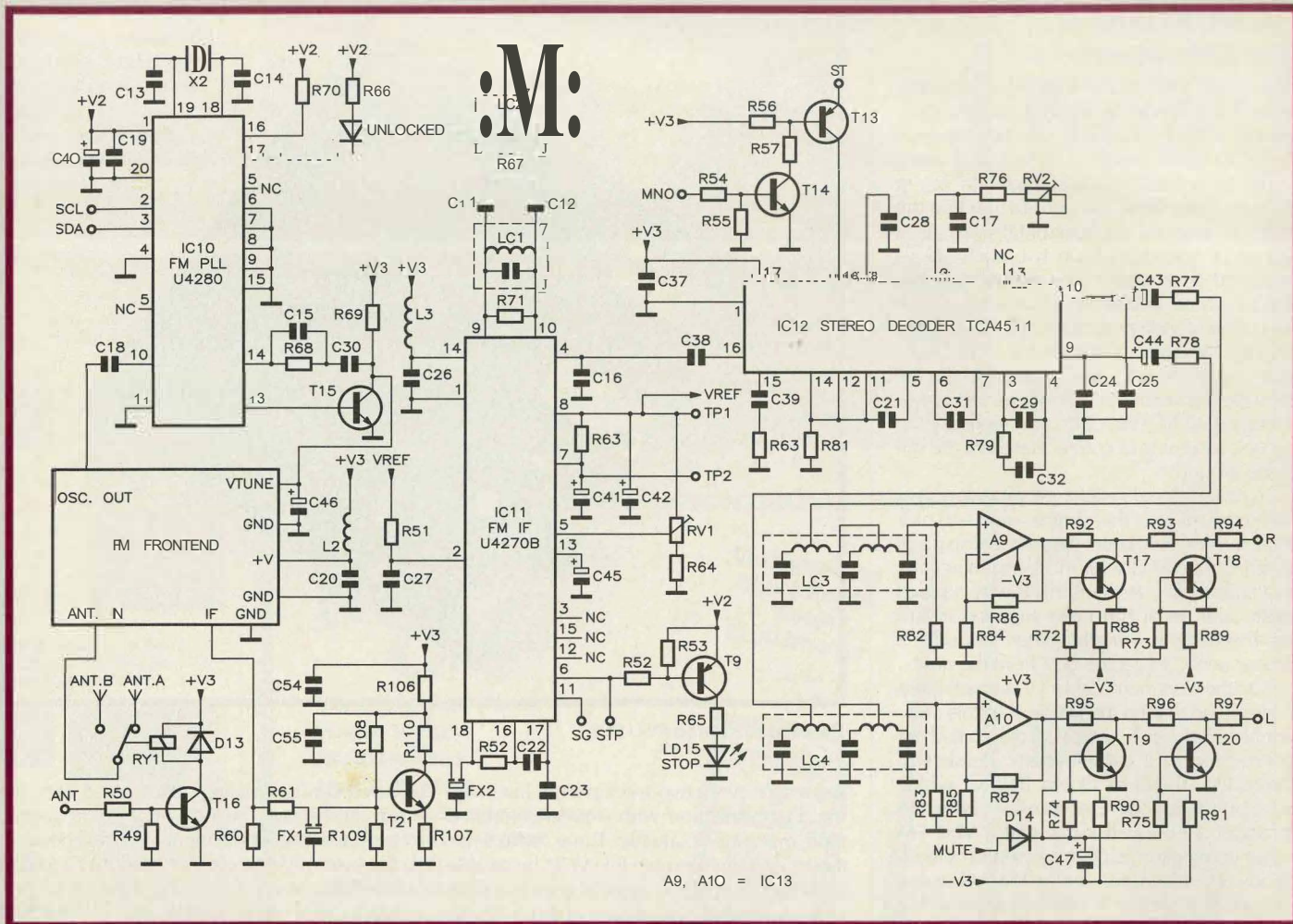

Figure 1. Circuit diagram - analogue section.

chosen as its total harmonic distortion (THD) is low. This circuit recovers the 'baseband' signal, which appears on pin 4 of IC11. Contained within the baseband is the mono 'sum' (L+R) signal, a 19kHz pilot tone, a suppressed 38kHz subcarrier, and two (upper and lower) sidebands (which contain the L-R, or 'difference', signal). The pilot tone and sidebands, together with the 'sum' signal (all that is heard on a 'mono' receiver, as everything above 15kHz is filtered off), are required by the decoder chip (IC12) for recovering the stereo audio information; these signals are coupled from IC11 to IC12 via C38.

Inside IC12, a 19kHz oscillator (reference set by RV2) is phase-locked to the frequency of the pilot tone. As you've guessed by now, the pilot tone is important. Apart from identifying a stereo transmission, its frequency (when doubled), will re-create the 38kHz subcarrier that was originally modulated with the stereo difference signal. This subcarrier is required during the 'difference' demodulation process that takes place within IC12; it was originally removed during broadcast, to conserve frequency spectrum and transmitter power. Out of interest, this mode of transmission is known as 'double sideband suppressed carrier' (DSBSC). When the missing 38kHz subcarrier has been inserted in between the two sidebands and then demodulated, the stereo difference signal (L-R, remember) will result. This, together with the mono 'sum' signal (L+R) is fed into an internal op-amp 'matrix', where algebraic manipulation of the sum and difference signals takes place to regenerate the individual L and R channels.

Adding together the sum and difference signals:

$$\begin{aligned} (L - R) + (L + R) \\ = L - R + L + R \\ = 2L \end{aligned}$$

The 'right' signals thus cancel out, leaving the left.

Subtracting the difference signal from the sum:

$$\begin{aligned} (L + R) - (L - R) \\ = L + R - L + R \\ = L + R - L + R \\ = 2R \end{aligned}$$

In this case, the 'left' signals cancel out, leaving the right.

This gives us the stereo channels, but weaker stereo signals will appear very noisy. The higher the frequency, the more significant the noise - and the modulated difference frequencies are very high up in the baseband signal. As an aside, RDS, which is centred on an even higher subcarrier frequency of 57kHz, gets round the noise problem by using quadrature phase-shift keying (QPSK), which is fairly robust for data transmission. But back to our noisy FM stereo signal! Since most people would rather listen to a quiet mono signal than a noisy stereo one, the stereo decoder can be overridden by 'forcing' the decoder into a mono mode (via pin 18). This switching is achieved by T14, which is controlled by IC2, more on this later.

The L and R signals finally appear on pins 9 and 10 of IC12. The output impedance, in conjunction with C24/C25 and C43/C44, provide AC-coupling and de-emphasis, which in the case of the UK broadcasting system is 50µs. De-emphasis (basically a treble cut) is required to compensate for pre-emphasis applied at the transmitting end. This system is used to maintain a good signal-to-noise ratio. After de-emphasis the left and

right signals are fed, via R77 and R78, to third-order low-pass filter blocks that remove the 19kHz pilot tone. This is necessary since the pilot tone may beat with a tape recorder's bias oscillator, introducing an annoying tone and spoiling an otherwise good recording. After filtering, A9 (R) and A10 (L) buffer the stereo signals and amplify them, each op amp having a gain of 11 -86dB (a factor of 3.9). The signals finally pass through the mute control circuit (comprising T17 to T20 and associated components) prior to being fed to the outside world via the two gold-plated phono sockets. The muting circuit, which is also controlled by IC2, is necessary to 'ground' the audio when the tuner is 'seeking', to avoid that nasty (potentially speaker-damaging) interstation mush. If you are one of those people, myself included, who likes to find absolutely *everything* within range (no matter how weak!), you could disable the mute facility by forcing the anode of D14 to ground potential, instead of leaving it connected to pin 17 of microcontroller IC2.

Circuit Description - Digital Section

IC1, shown with the rest of the control circuitry in Figure 2, is a dedicated infra-red receiver, which includes an input amplifier, AGC (automatic gain control), demodulator and pulse-shaping circuit. Remote control data from IC1 is sent to IC2, which is one of the 'brains' behind the system. IC2 is a type of microcontroller known as a PIC chip (Peripheral Interface Controller), and contains both ROM (Read Only Memory) and RAM (Random Access Memory), required for the execution of the programs that control the tuner.

The function of IC3 - yet another PIC chip (two micros for the price of one tuner!) - is to control the keyboard scanning and multiplexing of the alphanumeric displays via IC4, a 3 to 8 line decoder. IC3 also contains the display pattern of each character, so that less memory is required to store the station identification. IC9 is a non-volatile E²PRO M, which is responsible for storing all the user-programmed parameters - station frequency, identification and aerial selection information. On power up, T8 resets IC2 and IC3, causing them to start running their programs again. IC2 then requests data from IC9, which is then read back into IC2 and stored in its internal RAM. IC2 then tells VST chip IC10 to tune to the last station selected, and selects the relevant aerial socket. While the station is being selected, pin 6 of IC1 goes high. IC2 is made aware of this, and pulls the MUTE line high. This has the effect of turning off the signal strength indicator (its constant current source is removed), and turning on T17 and 20, thereby muting the audio output. IC2 also tells IC3 to select the correct character pattern for that station, which is stored within IC3. This pattern is then sent to IC5 and IC6, which are LED drivers. IC3 also outputs a binary code to the multiplexer IC4, ensuring that the correct information is sent to each display.

The keyboard is read into IC3 when T7 is turned on by the multiplexer; if any key is depressed at this instant, a logic 'high' from that key is then sent to one of IC2's 1/0 port. Depending upon the information received, IC2 will either request data from (when accessing a previously-preset station) or write (when storing new programme information) to IC9.

Display PCB: Construction Sequence

- 1. Wire links.** These should be soldered into the positions marked 'J' on the PCB. Bandoliered lengths of wire are supplied in the kit for this purpose.
- 2. L1.** This inductor looks like a large resistor, but is packed separately.
- 3. All resistors (R1 to R47).** Refer to the parts list, supplied with the kit, to find 'which goes where'.
- 4. IC3's clock crystal, X1.** Fit a link over the crystal - apart from holding the crystal in position, this link is used as an interconnect!
- 5. Signal diodes D1 to D12 (1N4148).** Align the band on the diode with that on the PCB legend.
- 6. 3-3V Zener diode ZD1.** Align the band on the diode with the band on the PCB legend.
- 7. Non-polarised capacitors (C1 to C6).** Check values before fitting (refer to the parts list supplied with the kit)
- 8. Electrolytic capacitors (C7 to C10).** Alignment of these polarised components is important; the stripe on the capacitor (indicating the negative side) must point away from the '+' symbol on the PCB. Refer to the parts list for the value of each capacitor. Note that C10 is mounted horizontally.
- 9. Sockets for IC1 to IC9 and DY1 to DY3.** Align the notch on the socket with that on the legend. Fit DY1 to DY3 into their sockets, aligning them with the PCB legend.
- 10. Transistors T1 to T6 (BC327) and T7/TB (BC557).** Be sure to align all transistors with their outlines on the PCB legend.
- 11. LEDs LD1 to LD13.** Each LED must be fitted so that its total height is 13mm above the PCB, i.e. the distance from the PCB to the tip of each LED is 13mm. And now for the

colours: LD1 to 8 green; LD9, 10 red; LD11, 12 yellow; LD13 red. Note that LD13 is fitted on the opposite end of the board to where the others are bunched up. A white band on the legend indicates where the cathode (shorter) lead of the LED should go.

12. Infra-red receiver diode, D. Fit 2 PCB pins from the component side of the board; D can now be fitted, as shown in Figure 3.

13. Keyboard connector. This is installed on the track side of the PCB, as shown in Figure 4. Be careful not to melt the body of the connector, as far as is possible!

14. ICs. Now that the board has now been assembled, the ICs can be inserted into their sockets - ensuring correct orientation.

15. Check your work thoroughly. Watch out for misplaced components, solder bridges and the like.

Tuner/PSU PCB - Construction Sequence

- 1. Wire links.** These should be inserted into the positions marked 'J' on the PCB legend. In the case of 'JSTP', form the link into a hoop - this link will be cut later after testing.
- 2. L2, L3.** These inductors look like large resistors, but are packed separately.
- 3. ¼ W resistors (R49 to R103; R106, R107).** Refer to the parts list for values.
- 4. R104.** Fit the 150!2, ½ W resistor in this position.
- 5. R105.** Fit the 22n, 1W resistor in this position.
- 6. Signal diodes D13 to D16 (1N4148).** Align the band on the diode with that on the PCB legend.
- 7. Rectifier diodes D17 to D20 (1N4000 series).** Align the band on the diode with that on the PCB legend.

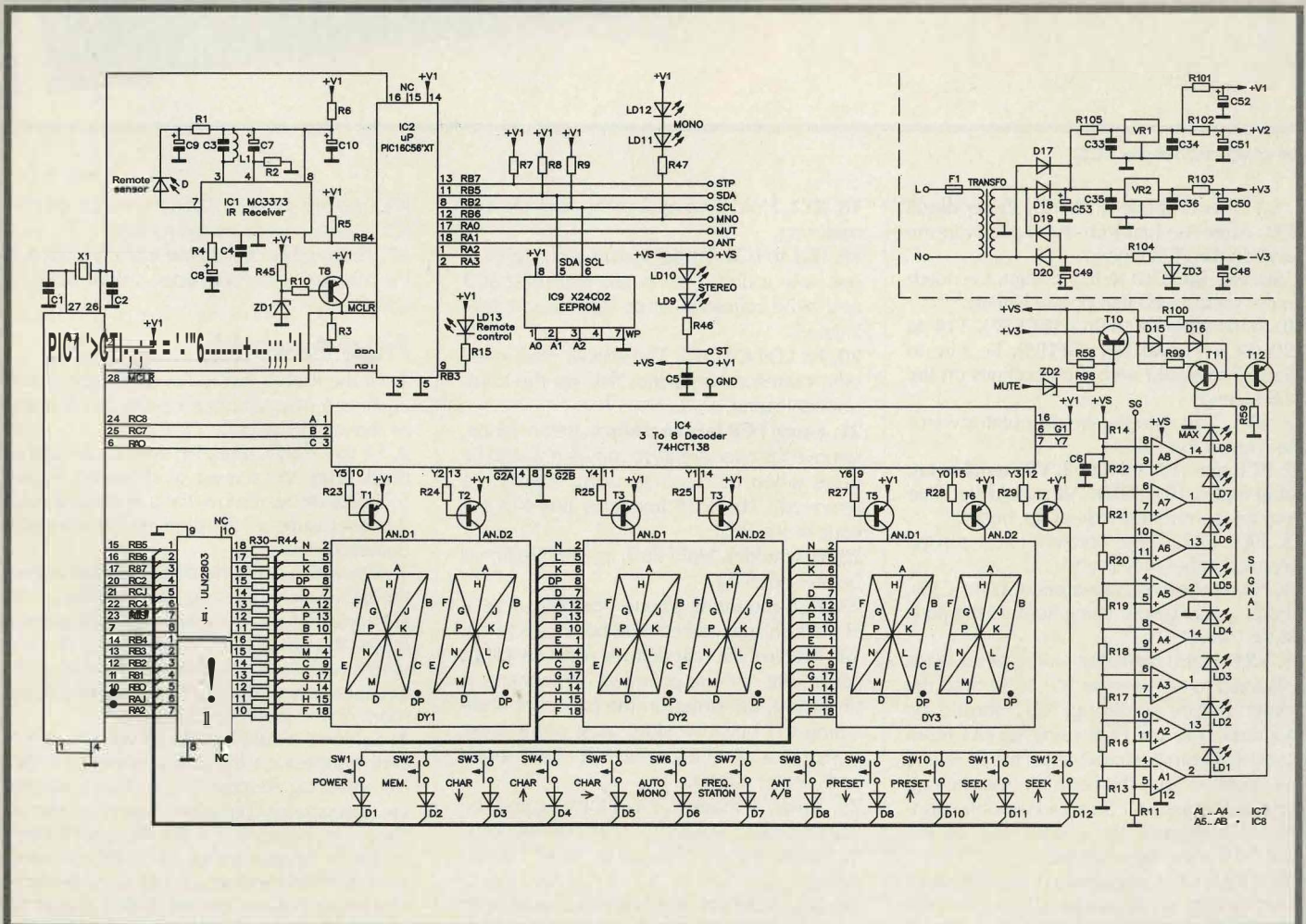

Figure 2. Circuit diagram - control section.

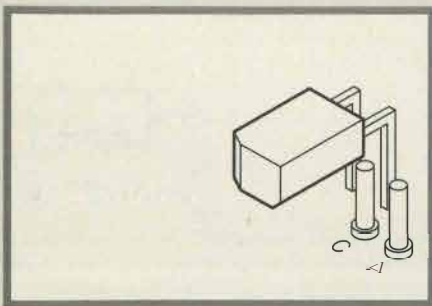

Figure 3. Fitting the infra-red receiver diode, D.

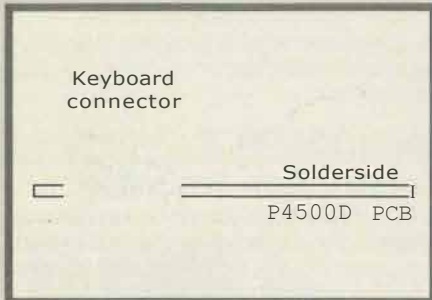

Figure 4. Fitting the keypad connector.

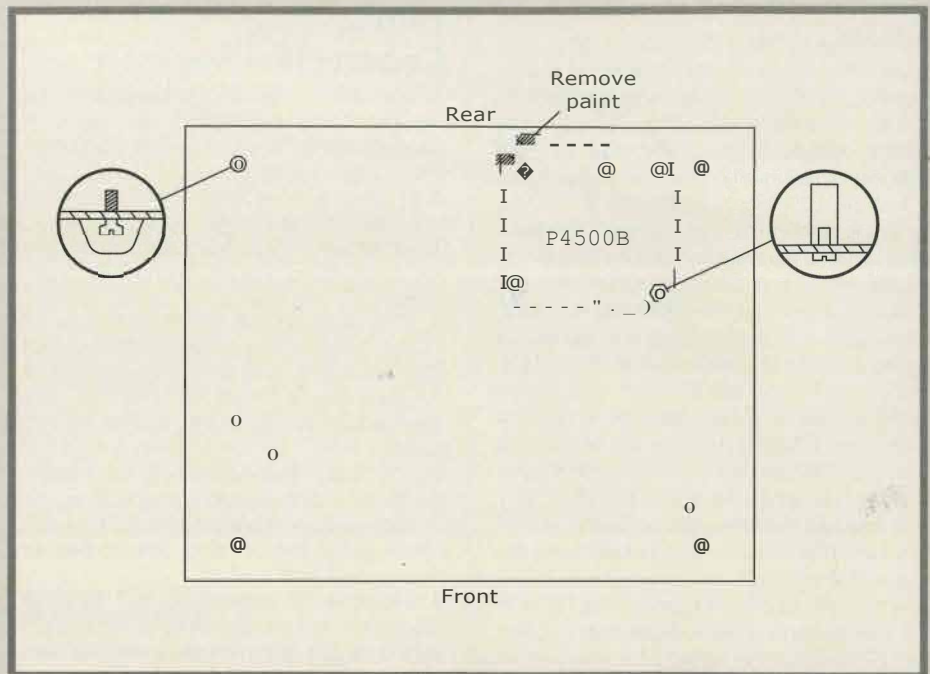
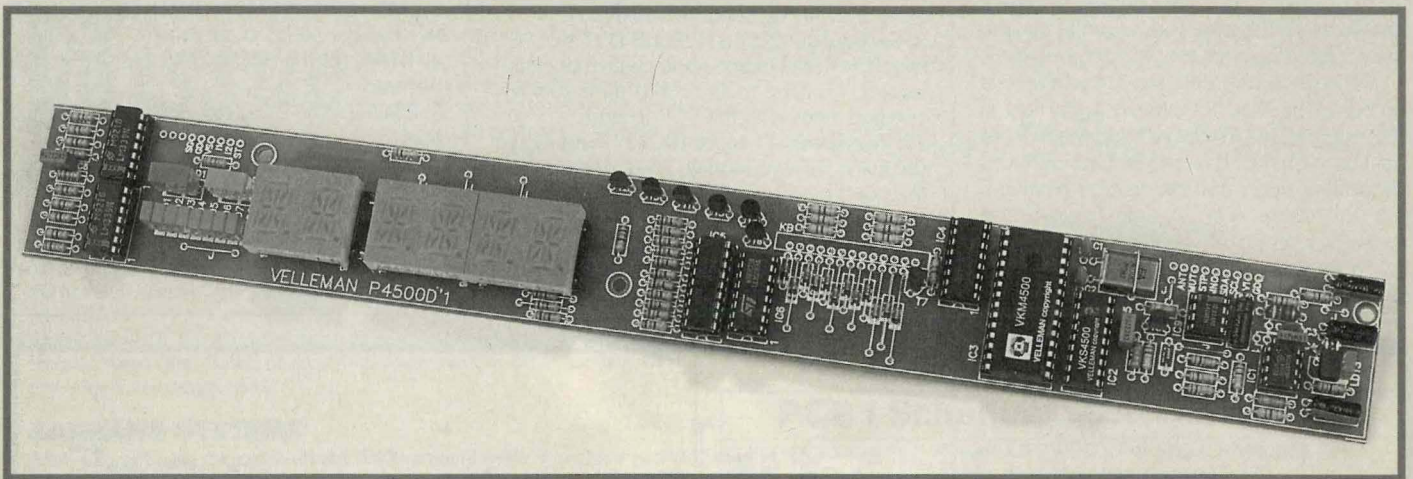

Figure 5. Cabinet base assembly details.



The completed Display PCB.

8. 9-1V Zener diode ZD2, 12V Zener diode ZD3. Align the band on the diode with the band on the PCB legend.

9. Sockets for IC10 to IC13. Align the notch on the socket with that on the legend.

10. Transistors 19 to 113 (BC557), T14 to T20 (BC547) and T21 (BF199). Be sure to align all transistor with their outlines on the PCB legend.

11. RV1. The spindle should point towards the edge of the PCB.

12. PCB pins (VA, CND x 3, VB, aerial input, cable input, TP1, TP2). All should be fitted from the component side of the board.

13. FX1, FX2. These ceramic filters can be mounted either way round.

14. Non-polarised capacitors (C11 to C39). Check values before fitting (refer to the parts list for values)

15. VR1 (7805) regulator. Note that the leads will need to be bent by 90° to fit onto the board. Before soldering, VR1 should be mounted onto the PCB using an M3 6mm screw (fed from the track side of the PCB) and nut, together with the heatsink (use thermal transfer compound!). To avoid possible short-circuit problems, the centre 'leg' of the heatsink should be removed.

16. VR2 (12V) regulator. Orientation is important; its tab should be aligned with the 'filled' region on the component legend.

17. X2. Orientation not critical.

18. RV1. Hold flush against the board before soldering.

19. LC1 to LC4. These devices will only fit in one way round. On no account must LC3 and 4 be adjusted since they are factory aligned.

20. Fit LD14, LD15. The shorter lead (cathode) corresponds to the 'flat' on the component legend.

21. 4-way PCB terminal block. Before fitting, remove the two middle terminals (this can be done when the lead securing screws are removed). The lead apertures point to the edge of the PCB.

22. Fuseholder. Hold flush against the board before soldering.

23. PCB-mounting phono ('cinch') sockets. Hold flush against the board before soldering.

24. Electrolytic capacitors (C40 to C53). Alignment of these polarised components is important; the stripe on the capacitor (indicating the negative side) must point away from the '+' symbol on the PCB. Refer to the parts list for values.

25. Tuner/IF module. Hold flush against the board before soldering. All connections, including the metal housing, must be soldered.

26. ICs. Now that the board has now been assembled, the ICs can be inserted into their sockets - ensuring correct orientation. Fit the

ICs into the sockets. Align the notch on the ICs with the notch on the sockets.

27. Thoroughly check your work. Watch out for misplaced components, solder bridges and the like.

Final Assembly

1. Fit the rubber feet to the underside of the enclosure using the black 6mm M3 screws, as shown in Figure 5.

2. Fit the 10mm threaded spacers using the black 6mm M3 screws, as shown in Figure 5. Before fitting, remove the paint from inside the enclosure as detailed in the diagram ('hatched' area)

3. Attach the socket identification label above the appropriate holes on the rear panel, first ensuring that it is free from dust and grease. Ignore the instructions supplied with the kit, which tell you to stick the label underneath the holes-there is, unfortunately, insufficient room on the panel to do this!

4. Solder a suitably-coloured wire from the earth connector of the mains connector to the M3 solder tag. Remove the paint from around the lower mains connector mounting hole, as shown in Figure 6. Fit the IEC mains connector to the rear panel, using the countersunk 8mm M3 screws, so that its earth pin is closest to bottom corner. Don't forget to include the earthed solder tag, which should be fastened against the metal bared earlier.

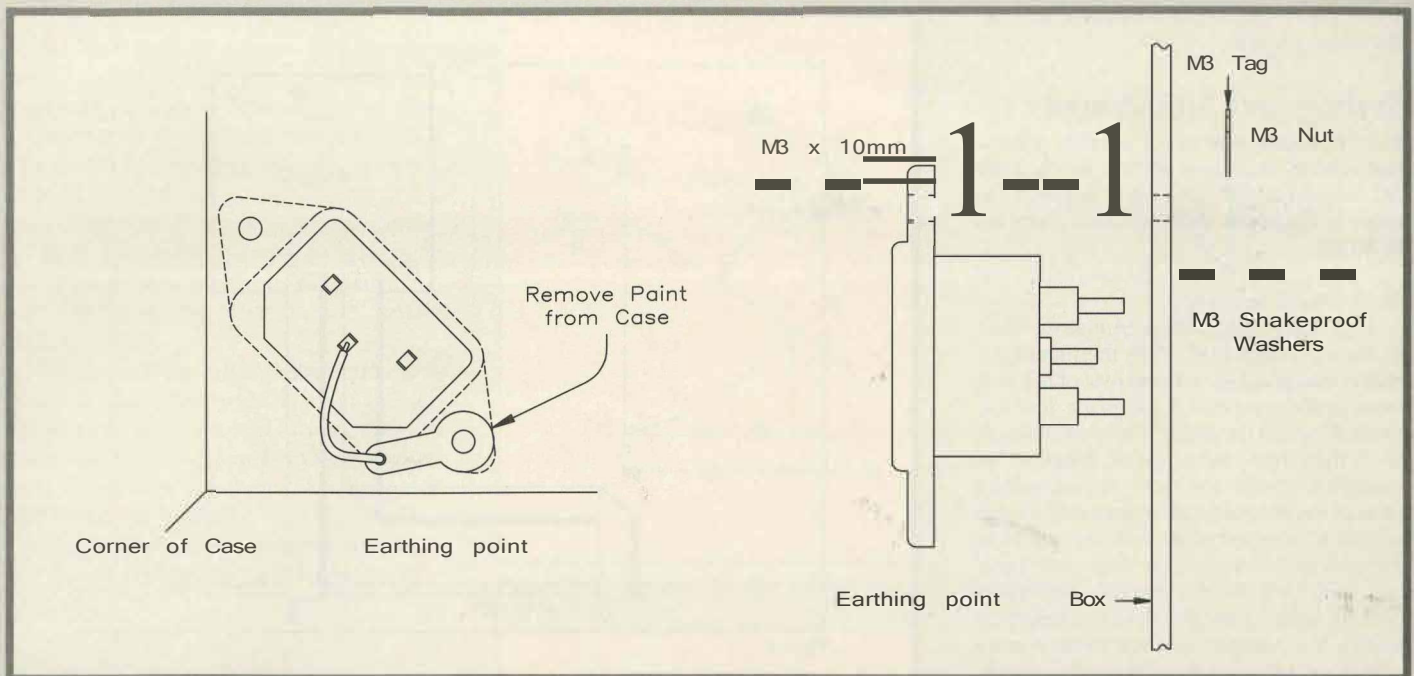

Figure 6. Mains connector installation details.

5. Fit the aerial connectors from the *inside* of the enclosure using the **black** 6mm M3 screws and nuts.
6. Fit the transformer to the chassis, using the two sets of 35mm M3 screws, 12mm spacers, shakeproof washers and nuts, as shown in Figure 7. If the supplied transformer is fitted with a mounting bracket, bend the tags away from the fixing hole (on either side of the transformer) to enable the hardware to be flush-mounted against its laminations. When the transformer has been fitted, cut off the solder tags that now point vertically, flush with the plastic housing. This is done to prevent problems caused by terminals short-circuiting via the top of the case, when this is fitted.
7. Solder the two ribbon cables to the Tuner/PSU PCB. The 'reference' wire (having a black striped down its side) should be located as shown in Figure 8.
8. Place the Tuner/PSU PCB over the threaded spacers installed in the case earlier, and fix in place using the 5mm M3 screws.
9. Now that the Tuner/PSU PCB is in place, solder the aerial connectors to the relevant PCB pins.
10. Referring to Figure 8 for details on how to 'twist' them, solder the ribbon cables to the Display PCB, ensuring that the connections on the Tuner/PSU PCB go to the correct ones on the Display PCB.
11. Now it's time to fit the front panel foil - which also features the 'Clicktouch' membrane keypad; first, though, ensure that the enclosure panel is free from dust and grease. Place the front panel foil onto the front panel, with the ribbon-film cable passing through the slot in the case. After aligning the foil over the front panel as accurately as possible, fix the right-hand half of the foil in place with sticky tape. Remove the protective backing (from the left-hand side of the foil only - do not tear it off completely), and fold it back at right angles. Rub down the left-hand side of the panel foil with a soft cloth, working from the centre to the edge - be careful not to trap any air bubbles. When the left-hand side is correctly in position, remove the sticky tape from the right-hand side, and repeat the procedure as for the left-hand side. Note that the backing will have to be split, to facilitate its removal from around the foil connector.

12. Carry out the mains wiring as shown in Figure 9. All exposed contacts (transformer primary, mains connector) should be covered, heatshrink sleeving (not supplied in the kit) being applied to the wires prior to soldering them in position. Once the wires have been soldered, the heatshrink sleeving can be pushed over the exposed connections.
13. Connect the transformer secondary windings to the PSU/Tuner PCB, as shown in Figure 9. The cut-off lugs on the top-facing side of the transformer can now be covered with insulating tape. The area of the lid, that will be located directly over the transformer when the tuner is assembled, should also be covered with insulating tape. Perspex or ABS plastic could be used as an alternative to insulating tape.

14. Fit an M3 nut to each of the studs pre-welded to the front panel, and adjust each so that the distance from the top of the nut (where the Display PCB will reside) to the inside of the front panel is between 10.5 and 11mm. Refer to Figure 10.
15. Bend the keypad's ribbon-film cable to the back of the display PCB, i.e. the solder side, where the keypad connector is mounted.
16. Fit the Display PCB onto the threaded studs - the LEDs should be flush against the front panel foil. If not, re-adjust the position-setting M3 nuts. When all is OK, lock the PCB in position with a second M3 nut on each stud.
17. Carefully fit the keypad's ribbon-film cable into its connector on the Display PCB.

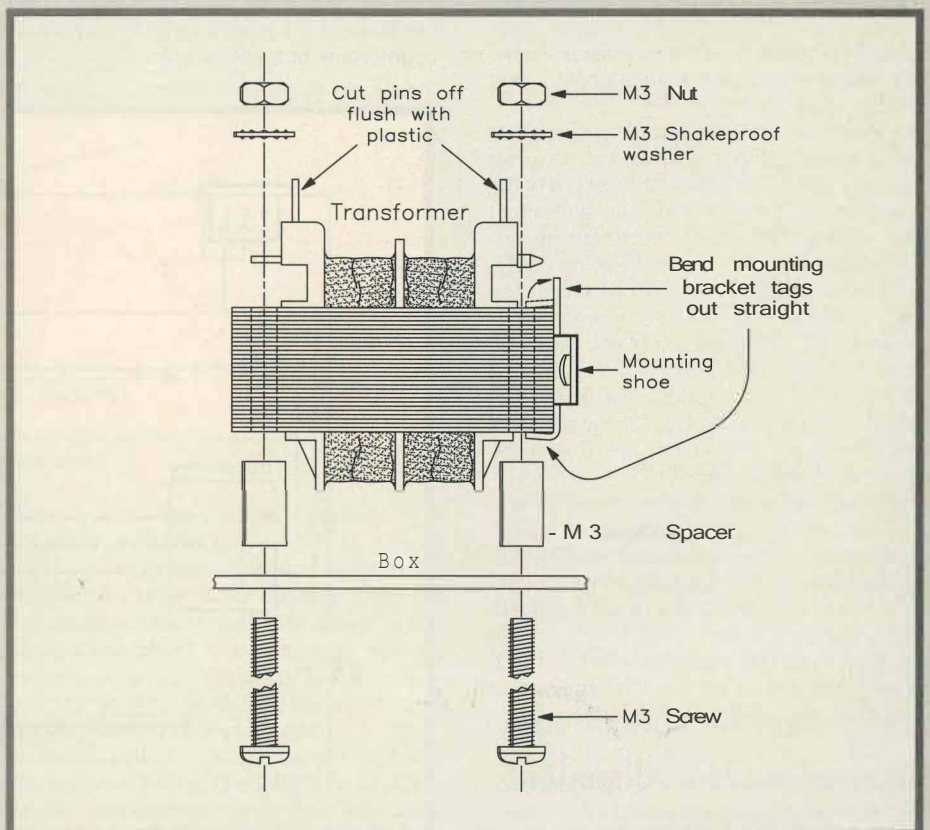

Figure 7. Fitting the mains transformer.

The cable is held in place by pushing down the locking bridge.

Testing and Adjustment

It is imperative that every possible precaution is taken to prevent electric shock. 240V AC mains can kill. DO NOT connect the tuner to the mains until the instructions say to do so.

Fit the 0-25A fuse into the fuseholder, and fit the insulation cover.

Fit a mains plug, with a 2A fuse installed, to the IEC mains lead. With the tuner's IEC mains lead plugged into the rear of the unit, measure the resistance between the 'live' and 'neutral' pins of the mains inlet plug; it should lie in the range 10Q to 100Q. Measure the resistance between the 'earth' pin and various parts of the exposed case metalwork; a value of 100mQ is expected in each case. Measure the resistance between the 'live' and 'earth' pins, and between the 'neutral' and 'earth' pins. In both cases, the reading should be infinity. If a 'Megger' type test meter is available, repeat the last test; the reading should not be less than 2MQ at 500V.

IF Alignment

1. Connect an FM aerial (75Q) to the tuner, and plug the mains lead in.
2. Push the ON/STANDBY button - the display should illuminate.
3. Select the desired input (aerial or cable). You should hear the relay clicking when the button is pressed.
4. Turn the 'Stop Sensitivity' control, located on the tuner's rear panel, fully *clockwise*.
5. Push the 'AUTO' button, until the 'MONO' indicator illuminates.
6. Select a known frequency from a powerful transmitter broadcasting between around 97 and 100MHz (for example, BBC Radio One), using the 'SEEK' buttons.
7. Connect a multimeter (preferably digital), set to its lowest DC voltage range, to TP1 and TP2. Which way round you connect the meter is unimportant, as the voltage to be measured could be of either polarity - now you see why, accuracy apart, a DMM is best for this application!
8. Screw the core of LC2 fully clockwise using a plastic trim-tool - take care to avoid damaging the core against the bottom of the component. A metal trim-tool will affect the readings obtained, and under no circumstances should a screwdriver be used - otherwise there is a good chance of the core cracking. You have been warned!
9. Adjust LC1 (also using a plastic trim tool) until a reading of 0V is obtained on the meter; at this point, LD15 should illuminate. The 'JSTP' link can now be cut (unplug the tuner from the mains first, as this link is near the transformer primary fuse).
10. Power up the tuner again, and gently turn the core of LC2 *anti-clockwise* until LD15 extinguishes - the multimeter reading will deviate from 0V. Continue adjusting LC2 until LD15 re-illuminates, and a meter reading of 0V is again obtained.
11. Disconnect the meter from TP1 and TP2. If re-adjustment of the tuner is necessary at any time, the 'JSTP' link must be remade.

Stereo Decoder Alignment

1. Select a known stereo transmitter.
2. Turn potentiometer RV2 ('PILOT TONE ADJUST') fully *anti-clockwise*.

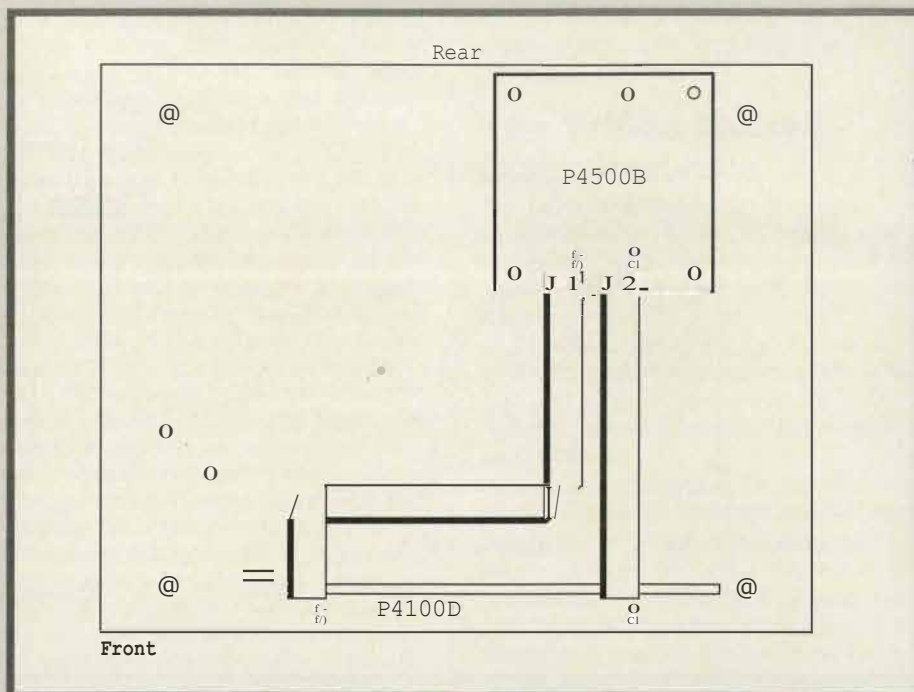

Figure 8. Ribbon cable interconnection details.

3. Push the 'AUTO' button, on the front panel, until the MONO indicator *goes out*.
4. Slowly turn RV2 *clockwise* until the stereo indicator *illuminates* - mark this position on the preset's body with a pencil.
5. Push the 'AUTO' button until the MONO indicator *illuminates*.
6. Adjust RV2 fully *clockwise*.
7. Push the 'AUTO' button until the MONO indicator *goes out*.
8. Carefully adjust RV2 until the stereo indicator *illuminates*. Mark this position with a pencil.
9. Adjust RV2 until its position is exactly halfway between the two pencil marks.

The tuner is now fully adjusted and ready for use. After disconnecting the power lead from the 13A outlet, the enclosure top cover can be fixed into position with the nine black countersunk 6mm M3 screws.

Programming the Tuner

Seeking Out Steve Wright

Press the aerial select buttons until the correct aerial has been selected. The desired station can be now found using the 'SEEK' buttons. Depending on the setting of the 'STOP SENSITIVITY' control, the tuner will halt at every sufficiently well-received station *en route* - just make subsequent presses of the 'SEEK' buttons until the wanted station is heard. When a previously-stored station is found during a seek operation, its channel number is displayed. This stops you from unnecessarily duplicating presets - although you might choose to do this on purpose - after all, 40 channels (a maximum of 20 keypresses) and a simple 'up/down' selection method (hardly direct access) could add up to a pain in the wrist!

As an alternative, continual pressure on

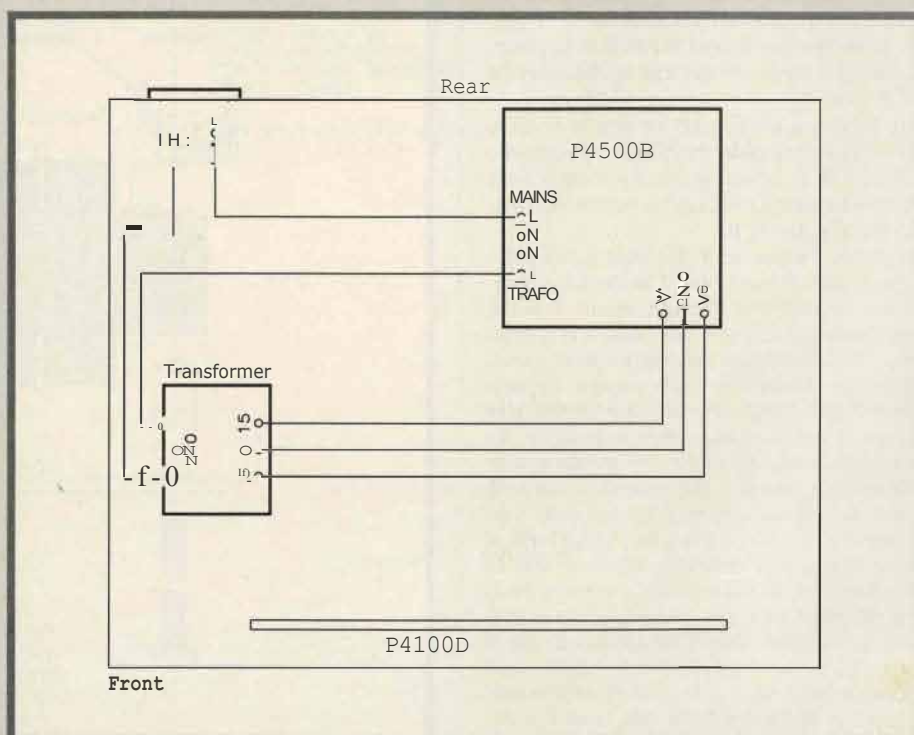
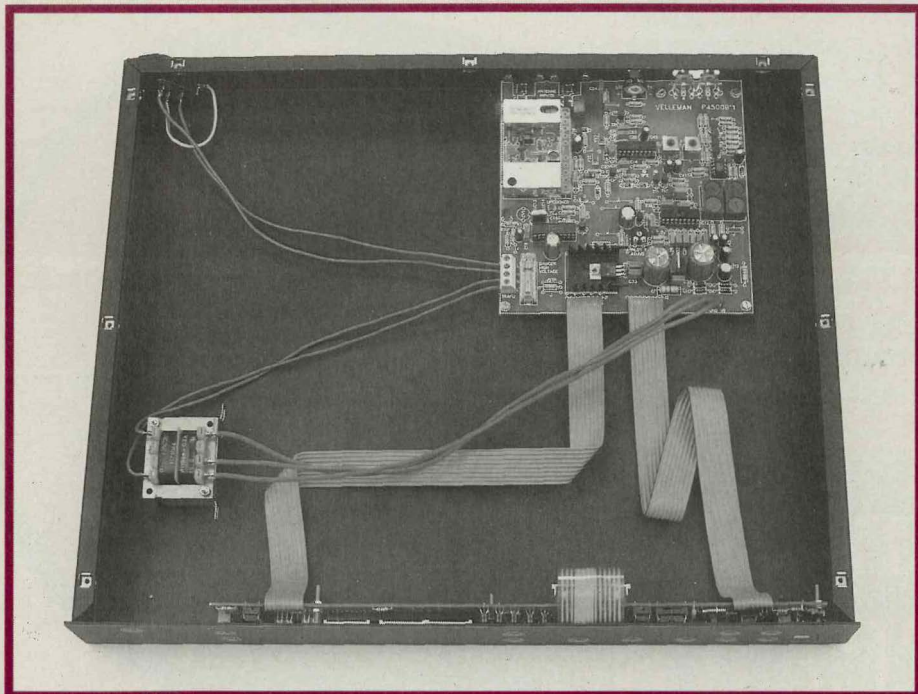

Figure 9. Transformer wiring - primary and secondary.



Internal view of the completed Synthesised Digital FM VHF Tuner.

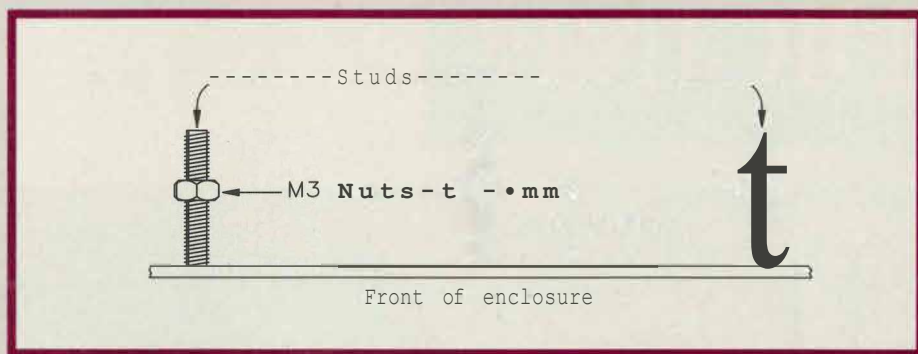

Figure 10. Correct adjustment of Display PCB position-setting nuts.

the relevant 'SEEK' key will enable you to go to a certain frequency; this is displayed on the LED display during tuning, which is a help if you already know where the station can be found. For example, Steve and the rest of his Radio One cronies can be found on 98.8MHz, in the south-east of the country.

If, for some reason, the wanted station is accompanied by a 'mushy' background noise, there are two options. The first is to get a better aerial system, or to have your existing one seen to (if it is faulty, all stations would be received poorly). This is important if you want to receive a station, but are out of the transmitter's primary service area. A low-noise aerial amplifier would help - but unfortunately most of those commercially available don't. A case for an 'Electronics' project, perhaps? The second (infinitely less preferable) is to 'force' the station onto mono operation with a deft swipe of the 'AUTO' button. If the station is stereo (most are, with the exception of a few special event stations, and a few of those dubious pirates!), the indicators on the front panel makes this clear.

If the station appears to be weak, but should not be (for example, a powerful BBC station), and the aerial installation is known to be OK, try searching for another frequency (possibly nearby). You may have unwittingly stumbled across the repeater for another, somewhat more distant, area. The signal strength meter should help you to gauge this. If the signal is too weak, the receiver will automatically revert to mono operation, and a front panel indicator will confirm this.

Putting Away Steve Wright for a Rainy Afternoon

Assuming you've now found your radio station, you will want to store it in one of the 40 available memory positions, and you will (no doubt) want to give it a name, which can be anything up to four characters long.

Press the 'MEM' key, and using the 'PRESET' up and down keys, select the memory position in which you want to store the channel's data. If you wish, you can change previously-held channel information in this way - handy on those (thankfully rare) occasions when a station moves to a different frequency - or, indeed, changes its name to something superficially trendier! To christen your preset, for example RAD1 for Steve Wright's home in the ether, use the CHAR buttons - 'up' (i) and 'down' (j) select the character, while 'right' (k) moves to the next character along in the identification. The preset information will be held in memory after the last character has been entered, and the 'right' button pressed again.

When selecting stations via the presets, the frequency is not displayed. This can be remedied by pressing the 'FREQ' button. The display will revert to showing the station identification after a few seconds. If the aerial select button is pushed twice in succession, the frequency will be permanently displayed.

Note that the Maplin 'Get-You-Working' Service is available for the Synthesised Digital VHF FM Tuner. The kit of parts for this project is available by ordering VF20W, price £199.951H. Unfortunately, we cannot offer project-specific parts (for example IC2, IC3 or the PCBs) separately.

The following items are not included in the kit, but are available separately.

Heat Shrink CP24	1m	(BF87U)
Silicone Grease Tube	1	(HQ00A)
Hex Trimtool	1	(BR48C)
Constructors' Guide		XH79L)

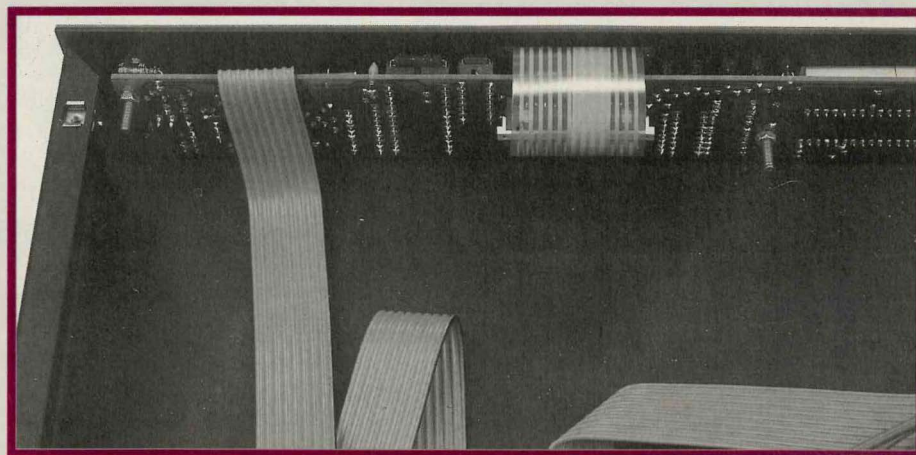

Keypad ribbon-film cable, and connector on Display PCB.

Specification

Tuning Range:	87-5MHz to 108MHz, in 50kHz steps
Sensitivity:	5-SdBu (1-8µV)
Signal-to-Noise Ratio:	80dB (A weighted)
Distortion	Mono 0-08%
	Stereo 0-2%
Channel Separation:	40dB (1kHz)
Frequency Response:	5Hz to 15Hz (-3dB)
Output Voltage:	550mV (100% modulation)
Number of Presets:	40
Supply Voltage:	220 to 240VAC*
No. of 75Ω aerial inputs:	2

* 115V tap on primary winding of mains transformer also available.

It is reassuring to find constructive uses of ionising radiation, and one of the most important is that of producing images of radioactive isotopes, which have been injected into patients. While gamma rays had been able to be detected for some considerable time, it was only around 1958 that several strands of detector technology were combined by H. O. Anger to produce an instrument that could effectively image the distribution of radioactivity within patients, and really develop the technology in a useful way. It is appropriate to consider each of these strands in turn; perhaps it is best to start with the type of radiation being imaged.

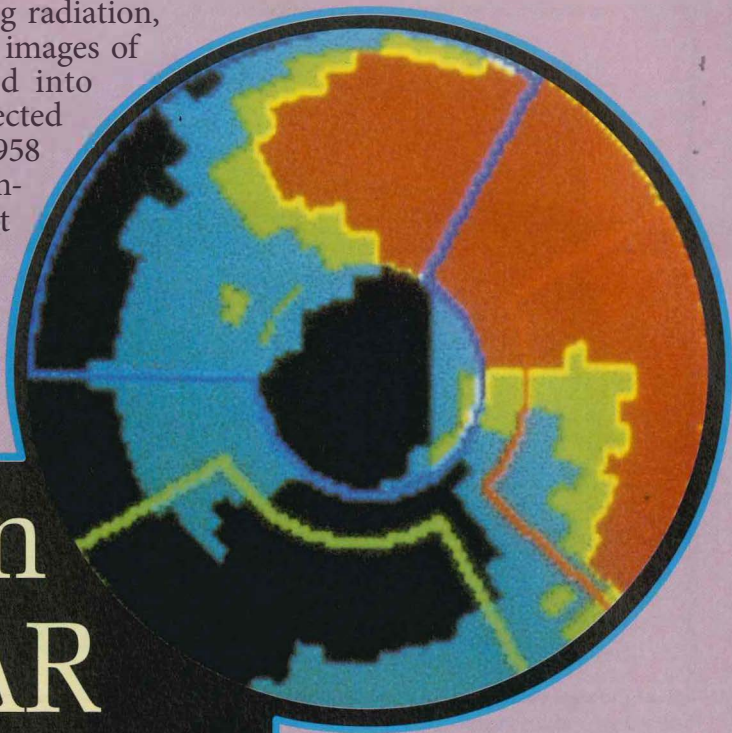

Imaging in NUCLEAR MEDICINE

by Douglas Clarkson

Gamma Rays - Energies and Absorption Characteristics

The electromagnetic spectrum is really a continuum that extends from radio, through infra-red, to visible light, X-ray, gamma ray radiation and beyond. Photons of light can be released from atoms which 'shed' energy after they have absorbed energy at some time - e.g., from a thermal collision with another atom. The energies involved in such processes are usually only in the range of a few electron volts (eV), and do not involve the nucleus of the atom.

Where energy adjustments take place within the nucleus, there can be various stages of 'settling' down to more stable energy states. Such processes involve significantly greater amounts of radiation - typically in excess of 100keV. Such gamma ray energies are classified as 'ionising radiation', with respect to their interaction with living tissue. There is an advantage in using radiation that lies in the low/medium energy range, since lower-energy gamma rays are more readily detected.

In classical or Thompson scattering, low-energy gamma rays (below about 30keV) interact with bound electrons in atoms and re-radiate a photon of similar energy, but in a different direction. In the photoelectric effect, an incoming gamma-ray photon can eject an electron (typically from K or L shells). Any energy 'left over' is passed to the kinetic energy of the ejected photoelectron. At higher energies, the Compton effect is observed; here, a loosely-bound electron is ejected by the incident photon, with reduced energy, in a new direction.

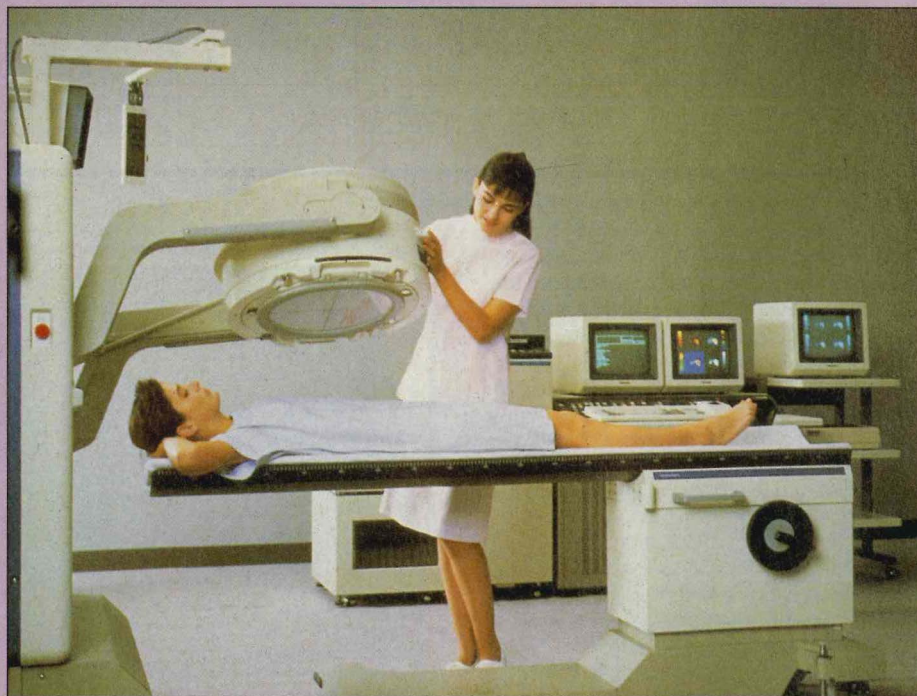

Toshiba Medical Systems gamma camera. Skeletal image obtained using Elscint Apex SP series scanning equipment.

One 'exotic' means of absorbing energy is that of pair production. This takes place when a photon of greater than 1.02MeV enters the intense field of the nucleus of an atom, and is transformed into a positron-negatron pair. This is a good example of the equivalence of matter and energy. The life of the positron, however, is extremely short - in the order of 10^{-12} seconds. After it has given up its kinetic energy, it will recombine with an electron to form two photons of annihilation radiation - each of 0.51MeV. These identical

photons travel at an angle of exactly 180° to each other. While such an exotic mode of absorption is of little relevance in gamma camera function, specific use has been made of this phenomenon in Positron Emission Tomography (PET), which is described in more detail later. Most radionuclides in routine clinical use are of lower energy than this 0.51MeV value.

For a variety of reasons, the radioisotope most commonly used in the UK is that of Technetium-99m, which has a gamma energy of 140keV and a half-life of 6 hours. This means that if a certain amount of activity of Technetium is injected initially, then the count rate will

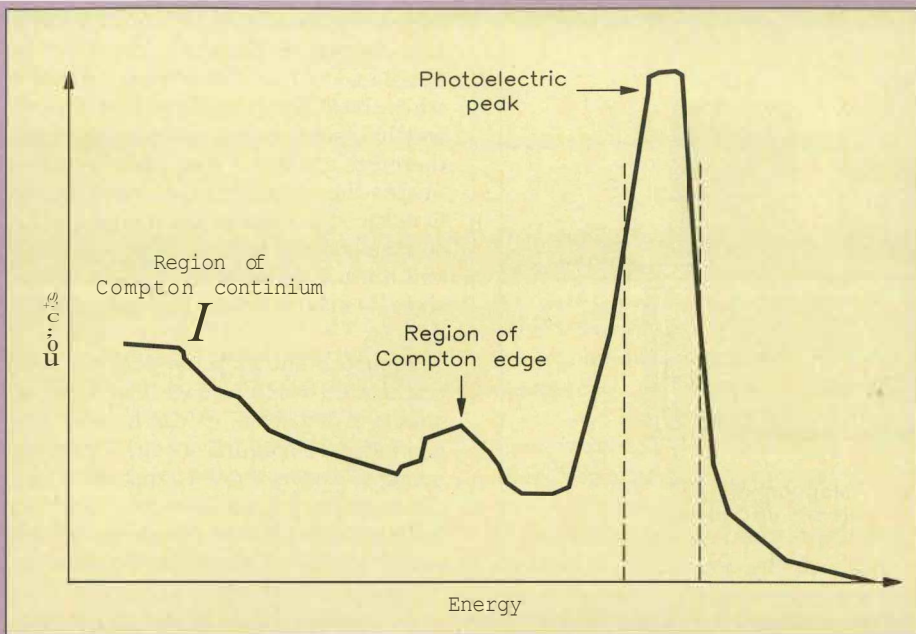

Above: Figure 1. Typical count/energy profile of a multichannel analyser of Technetium-99m, indicating the principal modes of absorption of photon energy.
 Below left: Skeletal Imaging.
 Below right: Abscess/tumour scan.

have fallen to half this value after 6 hours. A key use of Technetium is 'labelling' highly specific compounds with its activity. This allows specific metabolic processes, such as those relating to bone metabolism, lung metabolism and brain metabolism, to be readily investigated. It is common for manufacturers to provide 'kits' of a specific function for various investigations.

Figure 1 shows the typical count/energy profile of a multichannel analyser of Technetium-99m, indicating the principal modes of absorption. Each count detected by the gamma camera is associated with a specific energy. The use of a discriminator 'window' allows only events associated with the photoelectric peak to be used for imaging data. This improves the resolution of the imaging system.

Basic Detecting Principles

The principal (140keV) gamma photon of Technetium is typically absorbed within a

crystal of pure sodium iodide (NaI), to which a small amount of thallium is added. Energetic electrons released by the incident gamma ray in turn energise atoms which, in turn, release light photons at a wavelength of about 410nm, which corresponds to blue light. The thallium is introduced to increase the production of light by photons. Each photon of blue light requires about 3eV of energy. Thus, if all of the energy of a 140keV photon is converted into light, 4,200 light photons will be produced. A basic principle of the detecting technology is that the energy of the photon is proportional to the light energy detected in the crystal. The light is, in turn, coupled across an optical window and via a coupling layer to an array of photomultiplier tubes which detect the photons of light. Since photons can reflect inwards from the rim of the crystal, it is usual practice to exclude 'events' from this zone.

Figure 2 shows the basic design of the detecting crystal and array of photomultiplier tubes. Considerable problems are encountered in making the response of such tubes uniform; it is normal practice to test each camera on a daily basis with a uniform 'phantom' of a radionuclide present in water.

The NaI crystal is hygroscopic, and is contained in an air-tight shield to prevent it absorbing moisture. Due to its high coefficient of expansion, its temperature must be maintained evenly; high thermal stresses can cause the crystal to crack. Such crystals, which are typically about 17mm thick, and up to 50cm in diameter, are naturally very expensive.

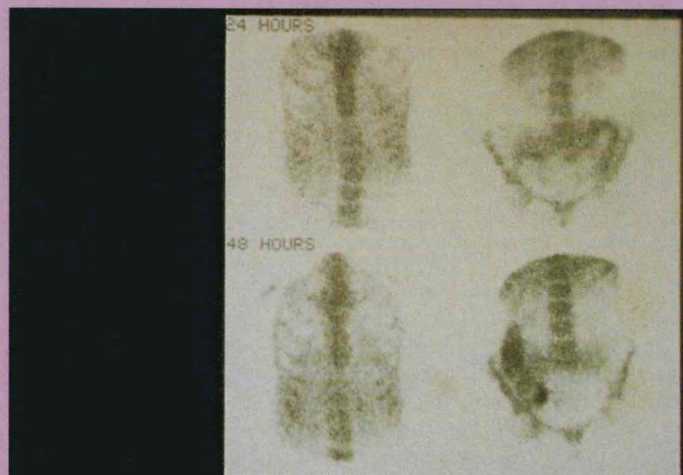
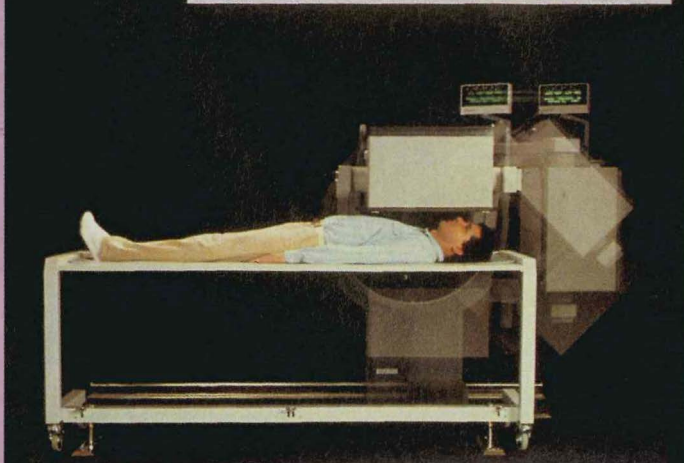
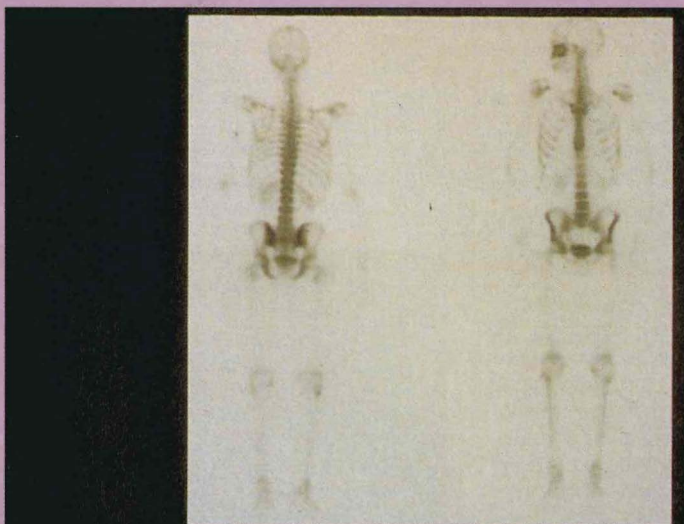

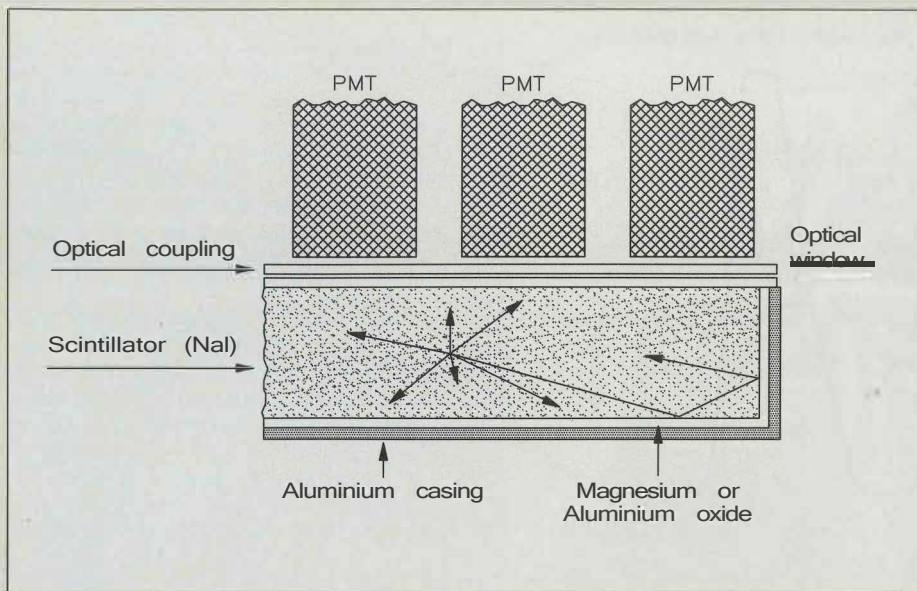

Figure 2 Basic arrangement of the detecting crystal, and the associated array of photoelectric multiplier tubes (PMTs).

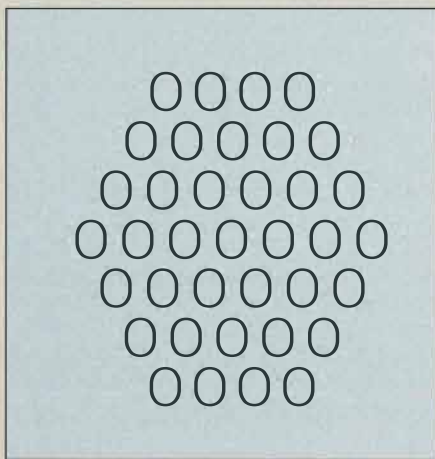

Figure 3. Typical array of photomultiplier tubes in a standard 37-element array.

Figure 3 shows a typical 37-element array of photomultiplier tubes (PMTs) on top of the crystal interface. Some new specialist designs have over 90 PMT devices. One of the basic problems with this imaging technology is that a gamma ray is not detected directly as a single co-ordinate event. The 'signature' of a gamma ray entering the detector is an expanding area of photons spreading out from the zone of principal absorption. The breakthrough in detecting technology was the development of an algorithm to estimate the point of origin of the incident gamma ray based on the strengths of signals of a single gamma event from all the photomultiplier elements. A non-linear network of resistor/capacitor components is used to implement this position-determining algorithm.

The total energy, Z , of each event is the summed energy from all of the photomultiplier tubes, and can be used to 'gate' energies corresponding to a specific absorption peak of a radionuclide. Also, where a radioisotope has more than one photoelectric peak, a series of windows can be selected for image capture. In addition, in situations where different radioisotopes are being administered (each having correspondingly different photoelectric peaks), sets of data relating to each isotope can be established separately. This may be of considerable value where dif-

ferent radioisotopes have different modes of uptake in accordance with, for example, metabolic pathways.

In the photomultiplier, photons eject electrons from the photocathode. These, in turn, are drawn down a series of accelerating anodes which allow electrons to be accelerated, 'knocking off additional electrons in the process, thereby producing a multiplying effect.

There is considerable research being undertaken into developing alternative methods of detecting gamma rays that would allow for better spatial resolution of activity.

A critical characteristic of a gamma camera is its resolution - i.e. the limit of uncertainty associated with the absolute position of each captured event. This is, in turn, reflected in the resolution of the display of gamma cameras. Matrices of 64 x 64 and 12 x 128 across the entire field of view are typical. This will translate to different imaging resolution, depending on the size of object being displayed.

The Collimator

To use a gamma camera, without any form of device to select the area from which gamma rays are captured, is very much like expecting an optical camera to work without some kind of lens! The unit used to provide this function is called a 'collimator'. Such devices tend to be extremely expensive, since complicated machining to extremely fine tolerances is required during their manufacture. In addition, they are usually manufactured out of lead and are consequently very heavy. This presents considerable problems in designing unconditionally safe and stable systems to rotate around and over patients.

One of the simplest types of collimator to consider is the so-called 'parallel-hole' collimator, shown in Figure 4. The device consists of a series of uniformly-distributed channels running through the thickness of the collimating material. The collimator acts as a 1:1 translator of object image to detected image; however, the only photons detected by such a collimator are those that arrive with a geometry to pass through open channels. It is assumed

that any gamma ray which encounters a lead 'septum' is absorbed. The image is translated without inversion; photons which have been significantly scattered, and thus 'poor' positional information, are therefore excluded from the captured image - thus improving the overall signal-to-noise ratio of the image. Higher-quality collimators tend to have longer channels and thinner walls. Both of these 'desirables' tend to increase the cost of such devices.

Figure 5 shows a converging-hole collimator, where a magnified view of objects is displayed. As can be seen, the geometry of magnification, however, operates over a limited range of object distance. Such a collimator is used for imaging the heart, thyroid or testes, where small lesions can be more readily detected.

In contrast, Figure 6 shows a diverging-hole collimator where the image from a large field of view (such as the lungs or the liver) is captured on a smaller area of the detector head.

In the design of collimators, there are a range of factors to consider; one of these is the thickness of the 'septa'. At increasing energies, gamma rays can penetrate the septa and increase the noise due to scattered radiation from the object being detected. Manufacturers can differentiate between collimators, using the thickness of the septa, as high, medium and low-energy types. Limits vary between manufacturers, but Technetium-99m (with a photopeak at 140keV) would be defined as requiring a low-energy collimator. An energy of 280keV would require a medium-energy collimator, and 410keV (for Au-198) a high-energy one.

While the wall thickness of the lead 'honeycomb' determines the effectiveness of high-energy collimators, problems related to mechanical fabrication tend to limit the wall thicknesses of low-energy collimators. While it is true that a high-

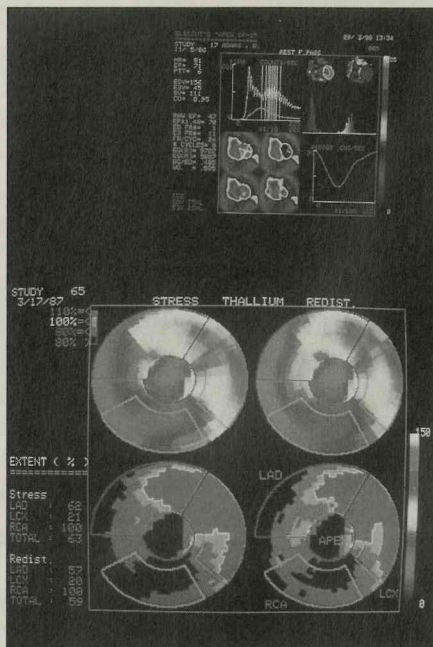

Advanced computer control is a feature of today's nuclear imaging systems. Shown are on-screen displays of the Elscint Apex SP series SPECT scanner.

energy collimator can be used to good effect with incident low-energy gamma rays, the higher-energy collimator reduces the total number of counts detected, on account of the larger amount of absorbing lead in the total collimator cross-section.

Collimators also work best when the image being captured is in the focal plane of the collimator - in the same way that a sharper picture is obtained in a camera with the image properly focused. Collimators are therefore also specified by their focal lengths. Typical values would be 9cm and 12.5cm. This can often present a problem when an area, which extends in front of, and behind, the focal plane of the collimator, is being imaged.

The spatial resolution of a gamma camera can be evaluated by imaging a thin tube filled with radioactive isotope, and locating the tube in various planes parallel to the focal plane of the collimator. The full width at half maximum (FWHM) of the line-spread function is a direct estimate of the spatial resolution of the device. Optimum values will typically be around 1cm.

Clinical Applications

Nuclear medicine - the science and technique of radionuclide imaging - has developed an extremely broad range of investigations into determining body composition and metabolic function. Developments in Computerised Tomography (CT) scans using X-rays, and Magnetic Resonance Imaging (MRI), provide superior methods of imaging body structures, yet nuclear medicine can still provide unique insights into a broad range of clinical conditions - especially where these relate to metabolic function.

One good example is that of the renogram, where the radioactivity of left and right kidneys are imaged over a given time period, in order to assess respective kidney function. The less active lower

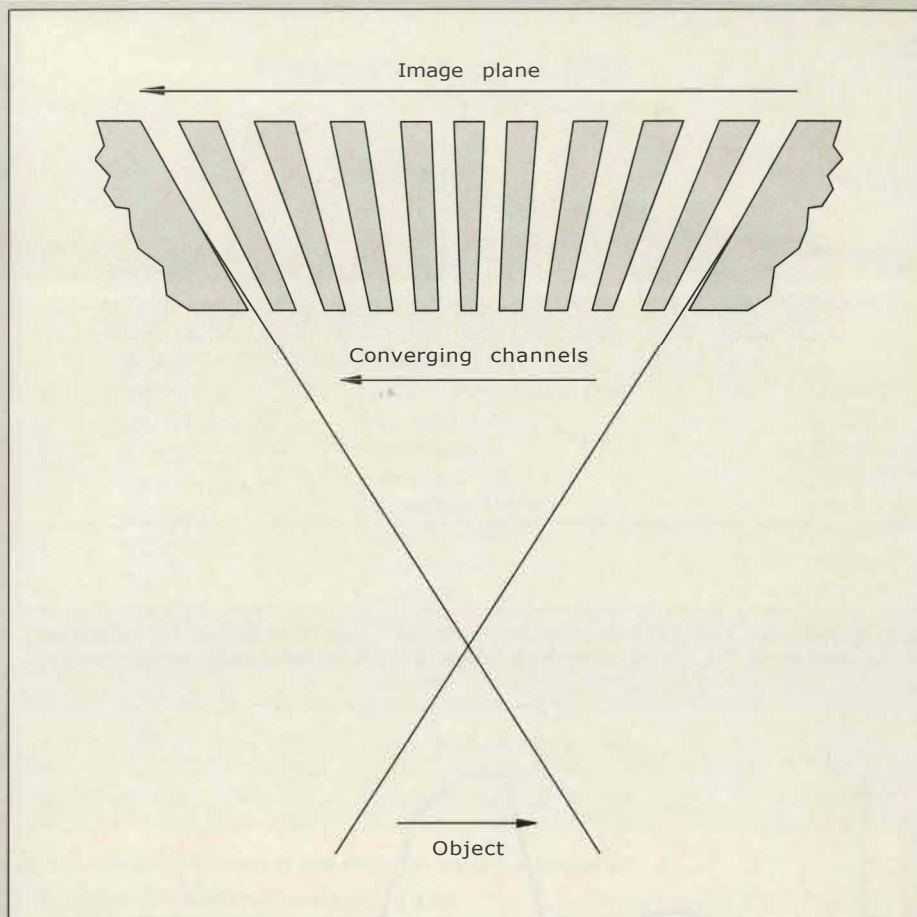

Figure 5. Design of converging-hole collimator, in which the image is magnified - enabling small features in studies to be detected.

curve of Figure 7 indicates that there is less renal activity in the right kidney than the left one. Specific areas of interest can be selected, and the total activity within such areas monitored as a function of time.

It is important to realise, however, that nuclear medicine is very much a specialist field, with a very extensive list of scientific and clinical literature. Some of the examples described, therefore, are only scratching the surface of the subject.

Gastric Emptying

Problems associated with gastric emptying can be readily investigated using radioisotope imaging. The typical dosage for the patient is a meal, to which has been added Technetium-99m (half-life 6 hours) or Indium-113m (half-life 100 minutes; energy 390keV). As part of the technique, an initial positioning liquid-dose of Technetium-99m can be given to 'line up' the stomach after which the main meal, labelled with Indium-113m, is ingested.

Lung Scans

The bloodflow, and also the travel of air, within the lung can be separately monitored using radioisotope imaging. One key test undertaken using this technique is that of detecting pulmonary embolism - a blood-clot in the venous circulation through the lung. Macroaggregates (particles between 10 microns and 40 microns in size) of albumin are labelled with Technetium-99m and injected intravenously. Mixing takes place in the venous circulation, and a very high percentage of the particles eventually becomes trapped in the lung. This ensures that all areas of adequate perfusion in the lung will become labelled with the radioactive tracer. Front and back and oblique views of the lungs can typically be obtained. Normal scans indicate areas of uniform perfusion in each lung.

In order to assess ventilation within the lung, Krypton-81m or Xenon is used. Patients inhale a bolus of the radioactive gas tracer, and hold their breath for as long as possible. In the diagnosis of pulmonary

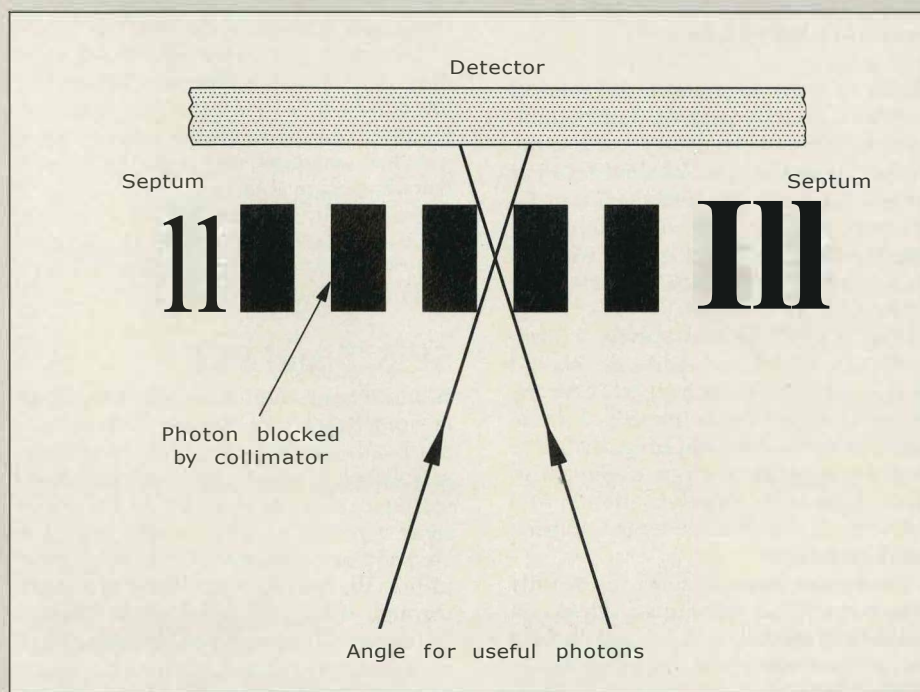

Figure 4. Design of the parallel-hole collimator, where the photons are captured with an object to image size ratio of 1:1.

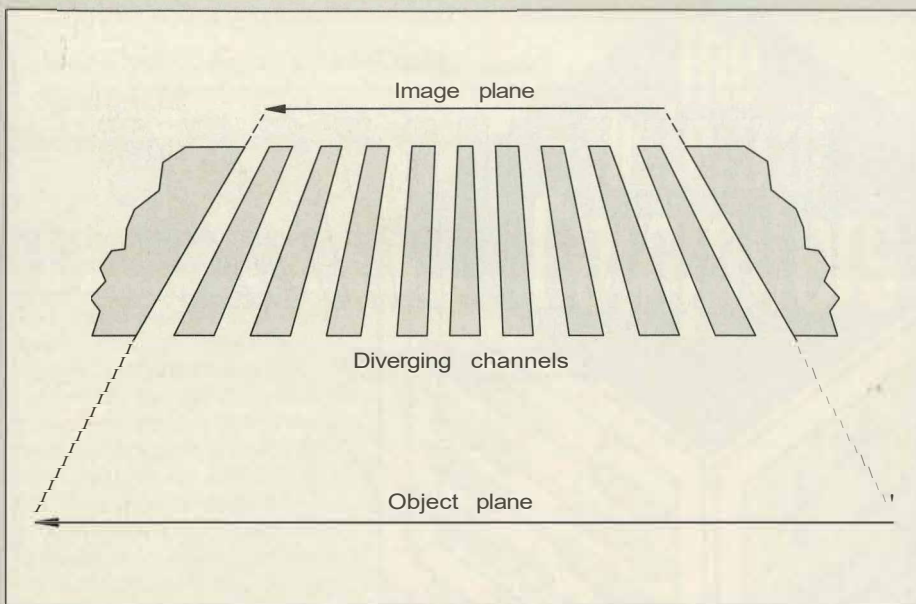

Figure 6. Design of a diverging-hole collimator, which can image larger features onto a specific detector head array. This type of collimator is of specific value in, for example, imaging the lungs.

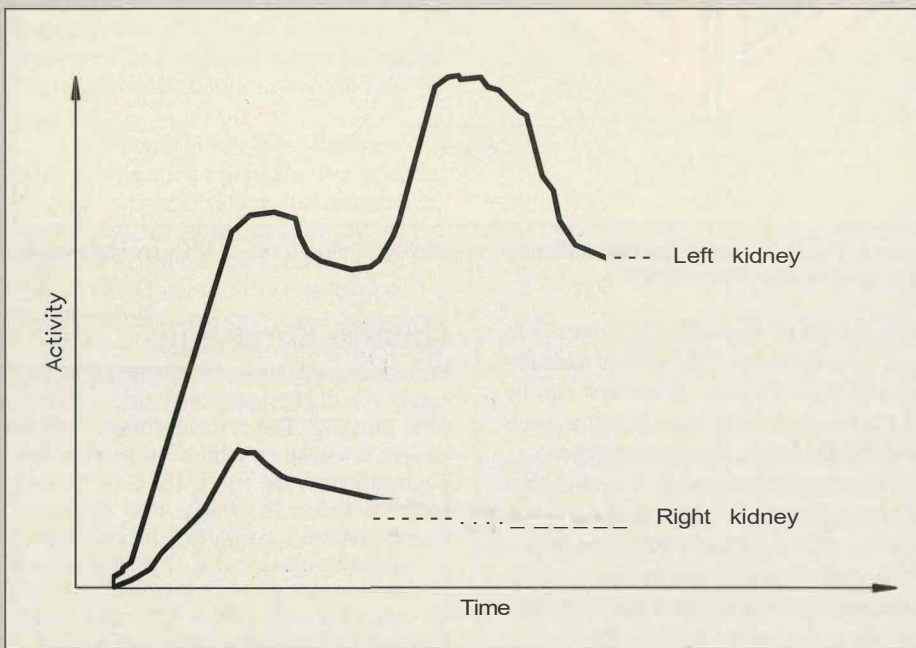

Figure 7. Renogram showing the relative uptake of tracer by both kidneys. The right kidney appears to have significantly reduced activity when compared to the left kidney.

embolism, all three diagnostic elements are used - perfusion scan, ventilation scan and plane chest X-ray. The probability of a pulmonary embolism is highest where the perfusion scan indicates a region of poor penetration, which is unmatched by a corresponding region in the ventilation scan, or abnormality in the chest X-ray.

Gallium-67, which has a half-life of 78 hours, is also used to trace areas of infection/inflammation within the lung. The uptake of the tracer takes place slowly, however, and repeat scans are required on up to four consecutive days. Such a technique is useful, however, where conventional imaging techniques would not be able to indicate such physiological conditions.

Musculoskeletal System

There are many conditions where it is required to determine metabolic activity within the bone structures related to muscular activity. It is necessary to label 'bone seeking' chemicals with a radioactive

tracer, in order to monitor the relative metabolic activity present. Technetium-99m bonded to hydroxy-methylene diphosphate (Tc-99m labelled HDP) is widely used as a cost-effective tracer for this purpose. The tracer will initially pass into the capillary blood system where it will eventually pass into the bone compartments.

The normal skeletal activity is symmetrical - i.e. left and right sides should be mirror-images of each other. There are, however, an extensive number of 'innocent causes' of apparent irregularities in such bone scans, such as degenerative joint disease in elderly patients, and excretion of excess tracer by the stomach and kidneys.

Malignant bone tumours are readily detected by this technique. These can either be of secondary (following on from an involvement elsewhere) or primary origin.

Sites of trauma within the musculoskeletal system - for example, stress frac-



Figure 8. Concept of SPECT (Single Photon Emission Computerised Tomography), where a detector head revolves round the patient, and captures data of radioisotope concentration within a 'slice' of the patient. The tissue structure resolution is poorer than both CT and MRI, but SPECT can indicate better 'regional' information relating to metabolic function.

tures - can also be readily detected using this technique. Such techniques also allow investigation into sites where bone grafting has taken place, or where healing of fractures is ongoing. Radionuclide tracing is also a useful tool in diagnosing the many varied forms of arthritis.

Cerebral Blood Flow

Over the past 30 years, techniques for the measurement of cerebral blood flow have been developed using Xenon-133 - either injected or inhaled. Such studies can now be undertaken using mobile cameras at the patient's bedside. Evaluation of data indicates a specific decay curve, with various sections that describe an aspect of the clearance of the radionuclide tracer from the cerebral blood pool. Such data is of value in diagnosis of regions of haemorrhage, and in assessing the degree of severity of head injury. While PET technology may give much better functional information, it is likely that conventional techniques will continue to provide a practical, economic way of estimating this key physiological factor.

Some centres now use specific Technetium-99m tracers, which successfully cross the brain/blood barrier, and remain trapped in brain tissue.

SPECT and PET

While most radionuclide investigations are undertaken with a single gamma-camera head, the technique has long been established of effectively imaging a cross-sectional 'slice' of a patient, in much the same way that a CT X-ray unit images a slice around a patient. While a CT unit utilises the transmission effects of a beam through tissue, SPECT (Single Photon Emission Computerised Tomography) measures activity emerging from the image slice by rotating a detecting head around the slice being investigated, as indicated in Figure 8

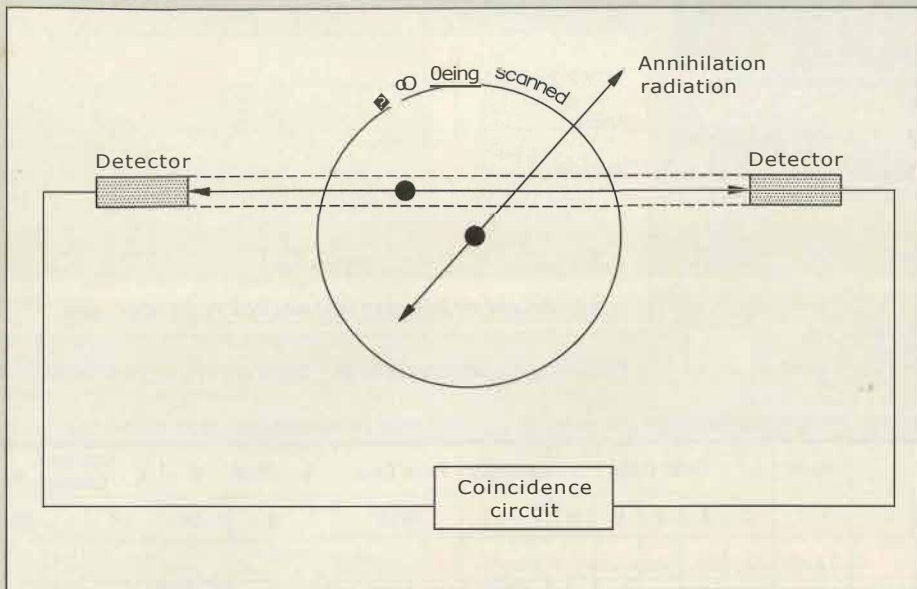
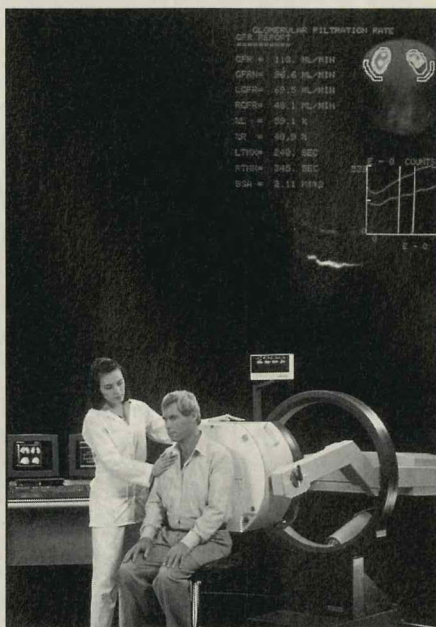

Figure 9. Basic details of a PEI' (Positron Emission Tomography) detecting system. A single pair of detectors is shown, which can detect an annihilation event of two 511keV photons. An array of such detectors around the head can map out highly specific metabolic functions within the brain, and is of considerable value in developing the understanding of cerebral functions in general.

Isotope	Half-life (minutes)	Tracer	Application
Oxygen-15	2.1	CO ₂ H ₂ O O ₂ CO	Blood flow Blood flow Oxygen uptake Blood volume
Carbon-11	20.4	CO Glucose Amino acids CO ₂	Blood volume Glucose use Protein synthesis Cerebral pH
Nitrogen-13	10.0	NH ₃ Amino acids	Blood flow Protein synthesis
Fluorine-18	110	Deoxyglucose	Glucose use
Rubidium-82	1.25	RbCl	Blood brain barrier studies
Gallium-68	68.3	EDTA	Blood brain barrier studies

Table 1. A summary of positron-emitting isotopes used in PEI' studies.



Renal images obtained using nuclear imaging.

The technique of PET (Positron Emission Tomography) is very much a research tool, and not a facility in routine clinical use. It has, however, provided much valuable information relating to brain function. Figure 9 shows the basic details of a PET detecting system. A tracer radioisotope emits a positron which, in turn (after travelling only a few millimetres), interacts with an electron to form two photons of 'annihilation radiation', each of which have equal energy of 511keV, but travel in exactly opposite directions.

An array of detectors is mounted around the head of the patient being scanned, though only a single pair is shown in the picture. Where a 'co-incidence' event is detected by a pair of such detectors, it is known that the photons originated in the path between the detectors. By summing the data captured by the detector array, a map of specific activity patterns can be established.

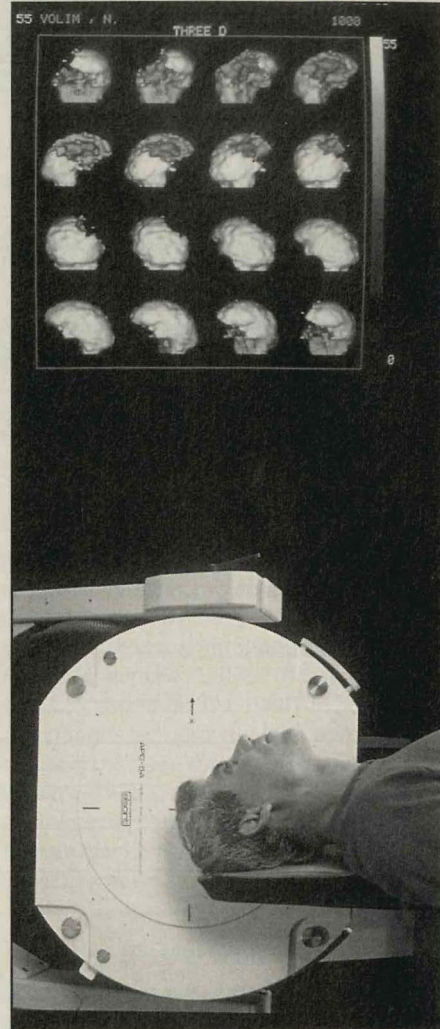

Apex scanner being used for a brain scan.

Table 1 indicates the diverse range of brain function and metabolism studies which have been developed using PET scanning.

Studies are being undertaken in a wide range of clinical applications. One group in the USA is developing techniques to differentiate between brain tumours which, having had treatment (radiotherapy/chemotherapy), are in a phase of recurrence or have been successfully treated. Such information can be of vital importance for effective clinical management of the patient.

It is frequently the case that the exact sites of the brain that contribute to forms of temporal lobe epilepsy cannot be clearly differentiated using EEG recordings or CT imaging studies. PET studies of glucose metabolism and blood flow have been used to indicate which regions are involved in abnormal activity, and as a result provide valuable guidelines for corrective surgery.

Conclusion

Nuclear medicine retains a unique role in clinical diagnosis, although much of its thunder has been stolen (by both CT (X-ray) and magnetic resonance imaging systems) as a main mode of imaging tissue structures. Developments in the technologies of detecting systems, data capture and processing have continued to improve a beneficial technology.

KIT AVAILABLE (LT14Q)
PRICE £29.95

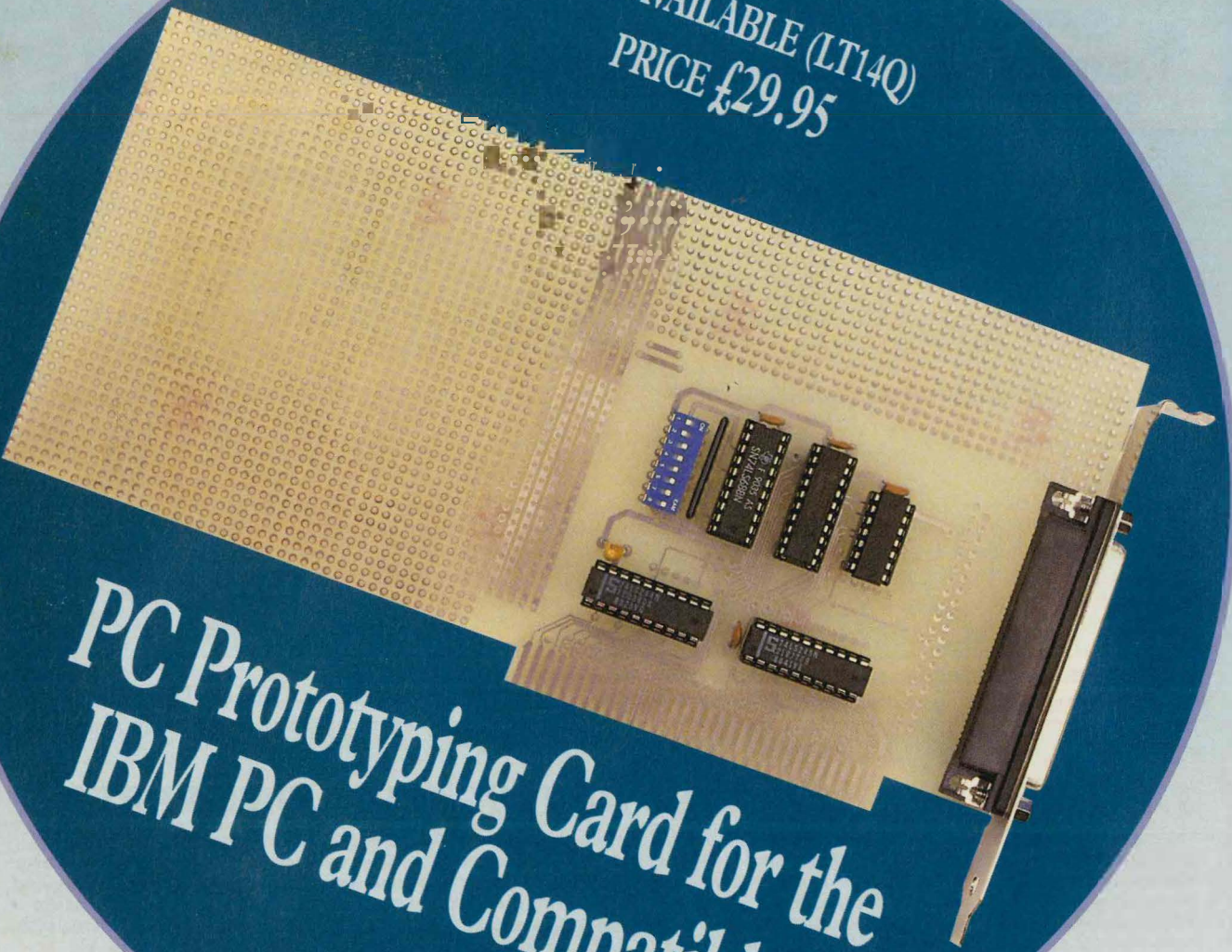

PC Prototyping Card for the IBM PC and Compatibles

Design by Tony Bricknell
Text by Tony Bricknell and
MikeHohnes

PROJECT
RATING

FEA7VRES

- * **For use with IBM PC, PC-XT, PC-AT
and compatible clones**
- * **Matrix of DIL IC spaced solder pads
and power rails**
- * **Buffered address and data lines**
- * **On-board address decoder**
- * **Selectable base address**

APPLICATIONS

- * **Prototype development of PC I/O cards**
- * **Constructing custom 'one-off
adaptor cards**

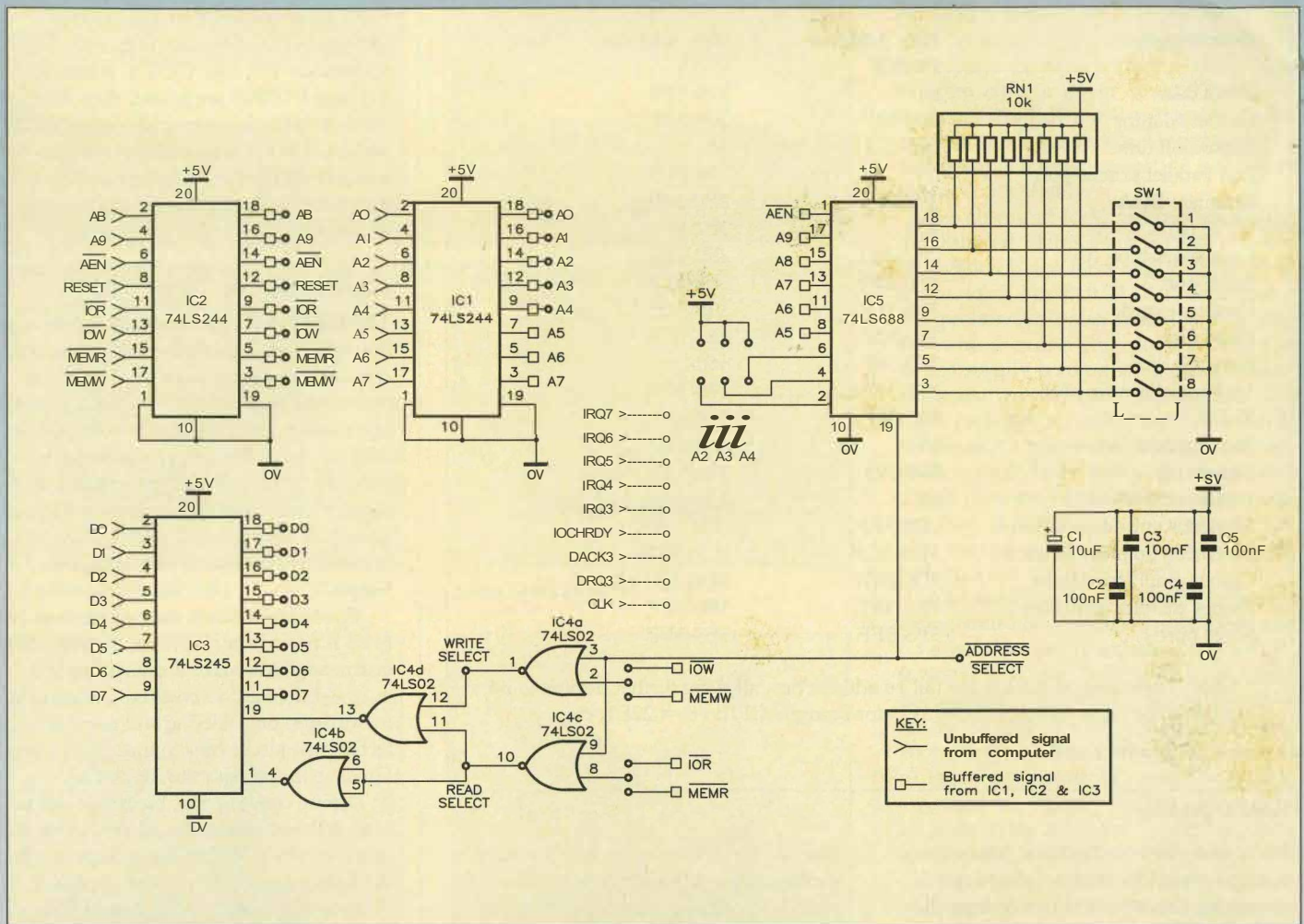

Figure 1 Circuit diagram.

This versatile project is an interface card for use with the IBM PC, PC-XT, PC-AT and compatible clones, specifically designed to allow the home constructor and experimenter to develop a custom-built expansion card for his or her PC, to perform a specific hardware interfacing task which is not catered for by any normally available cards. It will be particularly useful in the field of electronics where some special interface is needed, and equivalent industrial I/O cards are expensive. The card plugs into any one of the vacant expansion slots provided on the host PC's motherboard, and the power, control, address and data signals are made available from the computer's expansion bus. External connections can be brought out to a rear panel mounted, 37-way, female D-range connector. This connector is optional however, and other, more specific connectors can be used instead if the application demands.

Circuit Description

The PC's microprocessor deals with memory and I/O completely independently. Different sets of processor instructions are used to access memory and I/O devices, and different write and read enable signals are available from the control bus for each. Therefore, we have two separate address maps, as can be seen in Table 1 (for memory), and Table 2 (for I/O).

Table 3 shows the eight interrupts for the XT (sixteen for the AT) available

on a PC, some of which are used on the main motherboard PCB, and others for expansion cards. These tables will help with understanding how the PC Prototyping Card interfaces with the computer.

Figure 1 shows the circuit diagram of the PC Prototyping Card and the following circuit description should help the constructor understand operation of the unit and assist in fault-finding, should this become necessary.

The circuit is actually very simple, since it consists of little more than the buffering necessary to ensure protection of the

computer and the circuit under development while in use, but is, nonetheless, an important provision.

Both ICs 1 and 2 are non-inverting, octal buffers with their outputs (which are tristate) permanently enabled. These are single direction only, and buffer the computer's expansion slot address and control buses.

Address decoding is handled by IC5, an eight-bit comparator. When the data pattern on the address bus A2 to A9 matches that set by DIL switch bank SW1, via lines pulled up by SIL resistor array

Block 0	00000-0FFFF	RAM to 64k
Block 1	10000-1FFFF	RAM to 128k
Block 2	20000-2FFFF	RAM to 192k
Block 3	30000-3FFFF	RAM to 256k
Block 4	40000-4FFFF	RAM to 320k
Block 5	50000-5FFFF	RAM to 384k
Block 6	60000-6FFFF	RAM to 448k
Block 7	70000-7FFFF	RAM to 512k
Block 8	80000-8FFFF	RAM to 576k
Block 9	90000-9FFFF	RAM to 640k
Block A	A0000-AFFFF	Extended Video Memory
Block B	B0000-BFFFF	Standard Video Memory
Block C	C0000-CFFFF	BIOS Extension (e.g., EGA)
Block D	D0000-DFFFF	Other use
Block E	E0000-EFFFF	Other use
Block F	F0000-FFFFF	BIOSEEPROM

Table 1 Memory Map

Description	Hex Address	Hex Address	Note
	PC/XT	PC/AT	
Fixed disk	n/i	1F0-1F8	
Games adaptor	200-20F	200-207	
Expansion unit	210-217	n/i	
2nd Parallel printer port	n/i	278-27F	
Alternate EGA	2B0-2DF	2B0-2DF	*
GPIB (0)	2E1	2E1	*
Data acquisition (0)	2E2-2E3	2E2-2E3	
Serial port 2	2F8-2FF	2F8-2FF	
Prototype card	300-31F	300-31F	
Fixed disk	320-32F	n/i	
Network card	360-36F	360-36F	
1st Parallel printer port	378-37F	378-37F	
SI.DC	380-38F	380-38F	
2nd Bisynchronous	n/i	380-38F	*
Cluster (0)	390-393	390-393	
1st Bisynchronous	n/i	3A0-3AF	
Monochrome adaptor/printer	3B0-3BF	3B0-3BF	
Enhanced graphics adaptor	3C0-3CF	3C0-3CF	
Colour graphics adaptor	3D0-3DF	3D0-3DF	
Floppy diskette controller	3F0-3F7	3F0-3F7	
Serial port 1	3F8-3FF	3F8-3FF	

* Note: These devices decode the full 16 address bits, allowing further devices to be located in the same category above 3FF, for example GPIB (1) = 22E1, etc.

n/i = not implemented

Table 2. I/O Map

RN1, then pin 19 will go low. This activity is accompanied by the host computer requesting either a read or write from the card by pulling either IOR or IOW low respectively (for an I/O operation), or MEMR or MEMW low (for a memory operation), depending on how the links are set for the inputs of the read/write control block IC4. These are 'P14' to 'P19'.

IC3 is a bidirectional octal transceiver with tristate input/output pins. This will take the data from the PC's data bus and

place it on the Prototype Card bus when a memory write MEMW, or I/O write IOW, pulse is issued. Conversely, when a read pulse is issued (IOR or MEMR active), the data on the Prototype Card bus is placed on the PC's data bus. This data transfer takes place in conjunction with the address select line output from IC5 at pin 19, so that data is only transferred when: 1. The computer selects the address as determined by SW1; and 2. The IOR/IOW or MEMR/MEMW line is active. If links P14/P15 and

P17/P18 are joined, then the card will respond to I/O addressing (e.g., with BASIC commands 'IN' and 'OUT'). If links P15/, P16 and P18/P19 are joined, then the card, will respond to memory addressing ('PEEK' and 'POKE'). These are referenced as 'IO' and 'MEM' on the PCB legend. Figure 2 shows the expansion slot connections for the card.

Construction

The PCB is a double-sided, plated-through hole type, with a gold-plated edge connector, chosen for maximum electrical reliability and mechanical stability. However, removal of a misplaced component is quite difficult with this type of board, so please double-check each component type, value, and its polarity where appropriate, *before soldering!* The PCB has a printed legend to aid you in correctly positioning each item, see Figure 3.

The order in which the components are fitted is not critical, however, the following instructions will make the assembly task as straightforward as possible. For general information on soldering and assembly techniques, please refer to the Constructors' Guide included with the Maplin kit.

During construction, be careful not to scratch the gold-plated edge connector or splash it with solder, as this is likely to affect the operation of the card and computer.

Referring to the parts list and PCB legend, insert the resistor network RN1, and do make sure that its pin 1 marker aligns with the dot on the PCB (this is the common terminal). Next fit the dual-in-line switch SW1, ensuring that the side marked 'ON' faces towards RN1. Next, insert the five IC sockets, ensuring that the notch on each socket is aligned with the corresponding mark on the PCB legend.

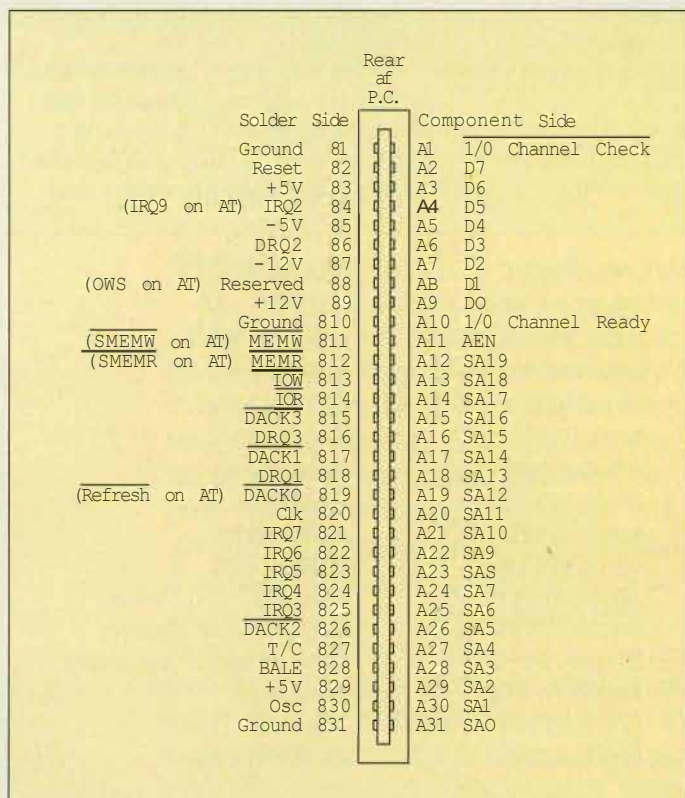
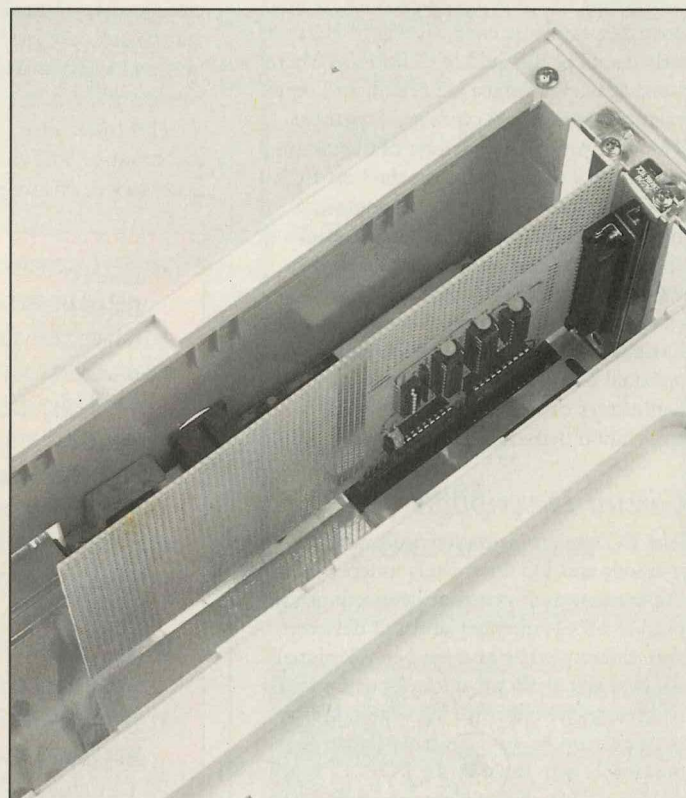

Figure 2. PC expansion slot connections.



The PC Prototyping Card installed in a computer.

Bused Signal		Hardware Interrupt		Processor interrupt number (Hex)	Function
PC	AT	Int Ctrl 1	Int Ctrl 2 AT Only		
			IRQ0	08	Timer output 0
*			IRQ1	09	Keyboard
✓			IRQ2	0A	Reserved (Int Ctrl 2 on AT)
	*		IRQ8	70	Realtime Clock
	✓		IRQ9	71	S/W Redirected to IRQ2
	✓		IRQ10	72	Reserved
	✓		IRQ11	73	Reserved
	✓		IRQ12	74	Reserved
	✓		IRQ13	75	Co-processor
	✓		IRQ14	76	Hard disk controller
	✓		IRQ15	77	Reserved
✓	✓		IRQ3	0B	Serial port 1
✓	✓		IRQ4	0C	Serial port 2
✓	✓		IRQ5	0D	Hard disk (Printer 2 on AT)
✓	✓		IRQ6	0E	Floppy disk controller
✓	✓		IRQ7	0F	Printer port 1

* IRQ2 is a bused signal on the PC only. The AT connects IRQ2 to a second interrupt controller, to fan this one interrupt out into a further 8. In order to provide compatibility with the PC, the software on the AT redirects IRQ9 to the IRQ2 handler. As a result of this, the pin on the expansion slot that is IRQ2 on the PC is IRQ9 on the AT.

Table 3 Hardware Interrupts.

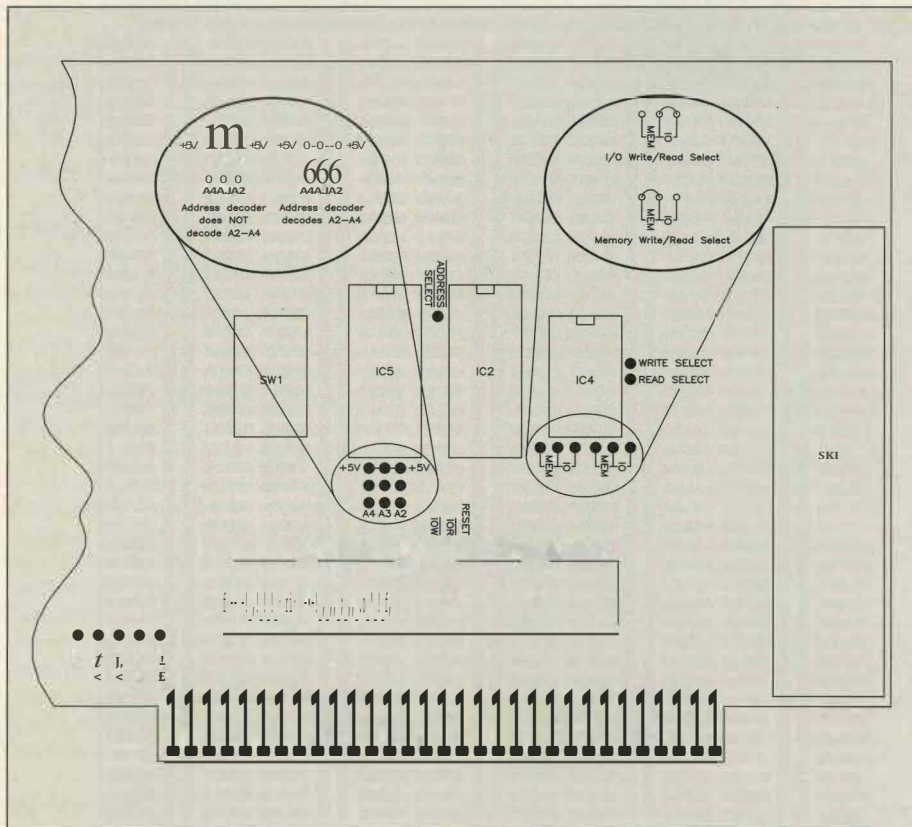

Figure 4. Pin designations on PCB.

P37 (A4) Linked to:	P38 (A3)	P39 (A2)	Lines free					Address range available
			A4	A3	A2	A1	A0	
P33	P32	P31	-	-	-	✓	✓	4
P33	P32	+5V	-	-	✓	✓	✓	8
P33	+5V	+5V	-	✓	✓	✓	✓	16
+5V	+5V	+5V	✓	✓	✓	✓	✓	32

Table 4 Configuring the number of address locations.

so that if this addressing option is chosen, then up to 32 separate address locations can be used on the card, as illustrated in Table 4.

The minimum range of available addresses is four, since the card occupies 4 bytes in the PC's memory map (the card's base address has a resolution of two bits). One card can occupy the entire 32 addresses in the space available, or it can be shared by two or more cards. If any line A2 to A4 is linked to +5V, then the corresponding DIL switch position (SW1-1 to SW1-3) *must* be 'OFF', otherwise the PC will never be able to access the card! You may have already decided how many addresses your card will need, and whether it will be I/O or memory mapped and install the necessary links as appropriate. If not, you may set up some temporary links for testing purposes, but remember that, as the PCB has double-sided, plated-through holes, these may be difficult to alter later.

As far as the DIL switch is concerned, the base address of the PC Prototyping Card is set up as follows. The settings of SW1-1 to SW1-8 can be determined by converting the required address into binary, and then taking the eight most significant bits (A9 to A2) as the settings for the switches. SW1-1 corresponds to bit A2, and SW1-8 corresponds to bit A9; a logic 1 = switch 'OFF' and a logic 0 = switch 'ON'. An example of how to determine the switch settings is shown in Table 5.

2. Turn off the computer and disconnect it from the mains supply. Installation of the card with the computer switched on may result in permanent damage to your computer and/or the card.

3. Remove the cover of your computer to expose the expansion card area.

4. Locate a suitable empty expansion slot. If using the optional 37-way D-type edge connector and mounting bracket this should be fitted as shown in Figure 6. Remove the metal blanking plate and screw (if fitted). Store the end-plate in a safe place for later replacement, should you wish to remove the Prototyping Card from your computer.

5. Carefully insert the card into the empty slot, pushing it fully home without forcing it. If applicable, use the cover screw removed in (4) above to fix the end-plate to the back of your computer.

6. Replace the cover of the computer.

Testing

When the computer is switched on, it should boot in the normal way. If not, turn it off immediately and check for solder whiskers shorting between tracks, especially on the data and address buses, and rectify.

Applications

This is a very open-ended project whose applications are really limitless! One-off prototypes, development tools, development aids, and DIY, 'cheap' versions of commercially available but more expensive cards can be made up. It should be particularly useful to the electronics hobbyist for interfacing external hardware. Figure 5

Example 1: where signals A2 to A4 are linked to the inputs of the address decoder, res:

Required base address = 0300 hex

0300 hex = 1100 0000 xx

x = don't care - as res does not decode the last two bits A1 and A0, their setting is irrelevant.

Switch number:	SW1-8	SW1-7	SW1-6	SW1-5	SW1-4	SW1-3	SW1-2	SW1-1
Address line:	A9	A8	A7	A6	A5	A4	A3	A2
Binary value:	1	1	0	0	0	0	0	0
Switch setting:	OFF	OFF	ON	ON	ON	ON	ON	ON

Example 2: where the A2 to A4 inputs on the address decoder are wired to logic 1 (+5V):

Required base address = 0300 hex

0300 hex = 1100 0xxx xx

x = don't care - as res does not decode A0 to A4, SW1 1 to 3 should be set to OFF.

Switch number:	SW1-8	SW1-7	SW1-6	SW1-5	SW1-4	SW1-3	SW1-2	SW1-1
Address line:	A9	A8	A7	A6	A5	A4	A3	A2
Binary value:	1	1	0	0	0	x	x	x
Switch setting:	OFF	OFF	ON	ON	ON	OFF	OFF	OFF

Table S Address selection.

shows basic, 8-bit I/O interfacing techniques.

Flexibility is also increased from the software point of view, by the provision of the MEMR and MEMW lines, allowing configuration of the card as memory (therefore addressed in the memory map), or alternatively the rOR and rOW lines are available, allowing the card to be configured as an I/O device of some sort, as are all the rRQ lines.

The remainder of open space over the rest of the component side of the card has matrices of plated through holes organised to a 0.1in. grid. Those above the buffering circuitry have pads interconnected in favour of transistor circuits and resistor networks, while those occupying the front half are essentially configured for DIL Ics. Five bus bars are provided down the centre of the card carrying 0V, +5V, -5V, +12V and -12V supply rails.

If the 37-way, rear panel connector is used, then all the connections (which are open-ended, i.e. not connected to anything) are brought to separate pads, contained in the rectangular legend marked 'SKI', with pin identification.

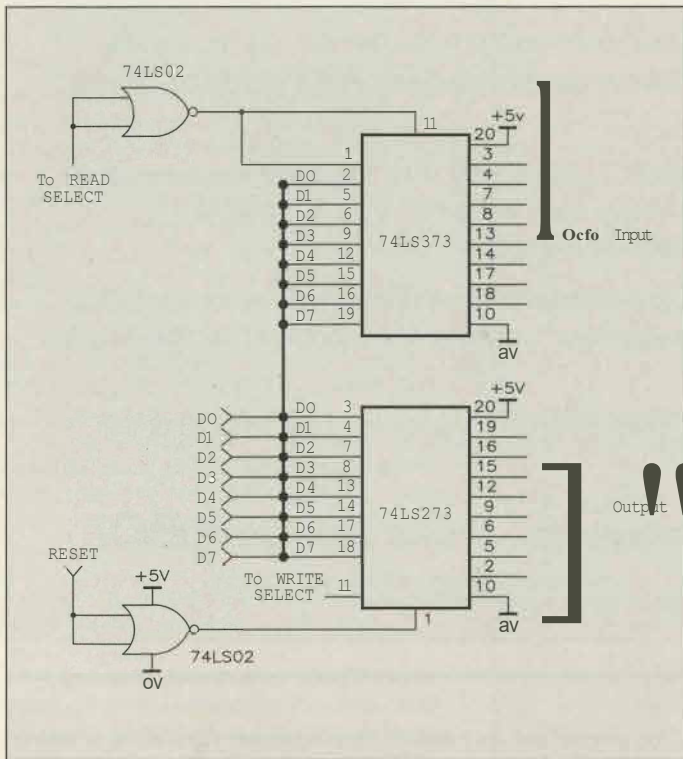
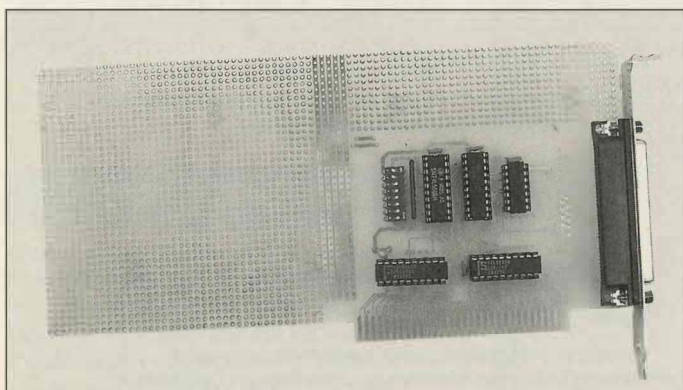

Figure 5 Suggested basic I/O circuits.



The assembled PC Prototyping Card.

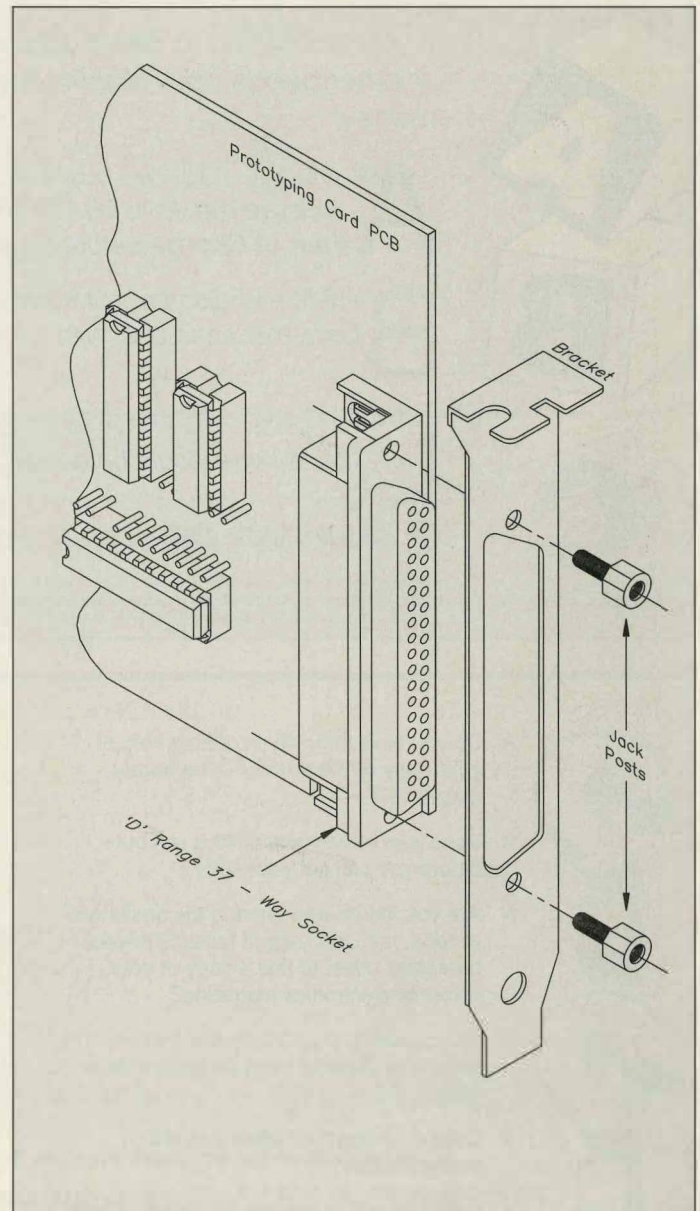

Figure 6. Connector mounting bracket assembly.

PC PROTOTYPE CARD PARTS LIST

RESISTORS				Constructors' Guide	1	(XH79L)
RN1	10k SIL Resistor	1	(RA30H)	OPTIONAL (Not in Kit)		
CAPACITORS				PLI	RA Socket 37-Way D-Range	1 (JB38R)
C1	10µF 16VTantalwn	1	(WW68Y)	PC Bracket 37-Way D-Type	1	(CR45Y)
C2-5	100nF 16V Minidisc	4	(YR75S)			
SEMICONDUCTORS						
IC1,2	74LS244	2	(QQ56L)			
IC3	74LS245	1	(YF91Y)			
IC4	74LS02	1	(YF02C)			
IC5	74LS688	1	(KP49D)			
MISCELLANEOUS						
SW1	Slimline 8-Way DIL Switch	1	(QY70M)			
	DIL Socket 14-Pin	1	(BL18U)			
	DIL Socket 20-Pin	4	(HQ77D)			
	PCB	1	(GH39N)			
	Instruction Leaflet	1	(XU20W)			

The Maplin 'Get-You-Working' Service is available for this project, see Constructors' Guide or current Maplin Catalogue for details.

The above items (excluding Optional) are available as a kit, which offers a saving over buying the parts separately.

Order As LT14Q (PC Prototype Card Kit) Price £29.95.

The following new item (which is included in the kit) is also available separately, but is not shown in the 1993 Maplin Catalogue.

PC Proto Card PCB Order As GH39N Price £23.95.

SAVE £££'s ON KITS & COMPONENTS

If you would like to **SAVE** £££'s whenever you purchase kits, components or other goods from Maplin, then follow our '*as easy as ABC*' guide to saving money!

Ask yourself - "Since I buy 'Electronics' regularly, why don't I take out a subscription? - it'll save me up to **£6.12*** and I'll have each issue delivered to my door **Free of Charge** before it's available in the shops!"

Benefit - I'll also *benefit* from having a **Subscriber's Exclusive 5% Discount Club Card** that I can use, with a few exceptions**, on purchases of over £20 from Maplin."

Complete - "All I have to do is *complete* the subscription form on page 23 of this issue, *what could be easier!*"

SAVE £££'s ON KITS & COMPONENTS - IT'S AS EASY AS ABC!

* A saving of £6.12 is based on a Direct Debit or Continuous Credit Card Subscription that includes two free issues worth £3.90 and a subscription saving of £2.22.
 ** Full details on how to make the most of the discount card are supplied with the card. Full terms and conditions are available on request.

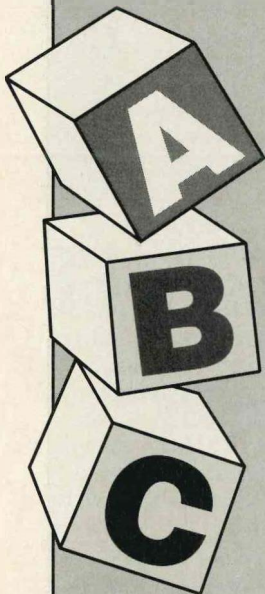

Then why not ask your friendly local Newsagent to reserve or deliver every issue of 'Electronics-The Maplin Magazine'?

Fill out the coupon (below), hand it to your Newsagent and you need never miss an issue of 'Electronics-The Maplin Magazine'.

Dear Newsagent

Please reserve/deliver (delete as applicable) each issue of 'Electronics-The Maplin Magazine' for me.

Name _____

Address _____

Signature _____

'Electronics-The Maplin Magazine' is published monthly and is distributed through your wholesaler by: United Magazine Distribution Ltd., 1 Benwell Road, London N7 7AX. Telephone: 071-700-4600.



- * Do you have difficulty in getting hold of your copy of 'Electronics-The Maplin Magazine'?
- * Does your Newsagent always sell out before you can get your copy?
- * Are you fed up with braving the onslaught of wind, rain and keep fit fanatics in your ceaseless quest to find a copy of your favourite electronics magazine?
- * Do you say to your family and friends, "I'm just going outside, I may be gone a little while...?"
- * Does your dog hide when you return empty handed?
- * Do you resort to reading the Beano, Dandy, Viz or other well known 'comics'?

Stray Signals

by Point Contact

A few weeks ago, PC wanted to take a photograph of some electronic kit laid out on his lab bench, to illustrate a magazine article he was writing - under a different pen name. For this purpose, the name of the game is clarity, which means high definition. Consequently, the two 35mm cameras were left on one side, in favour of *un appareil* using size 120 roll-film. A 1930s folding Kodak 8-on-120 (inherited from my father) was passed over, as my home-made enlarger only accepts negs up to 2 1/4 in. square (12-017-120), having been made especially for use with a folding Agfa camera owned by a certain Miss O - - , subsequently Mrs PC. The enlarger was constructed while PC was a lowly Student Assistant at Central Research Laboratories, with access to a well-equipped lab workshop, where the second-hand condenser and enlarger lenses were converted, with the aid of sundry empty tin cans and other odds and ends. The film was exposed using indirect artificial light, to avoid any deep shadows on instrument panels etc., and duly developed, in the boxroom over the garage adjoining my lab, the windows suitably blacked out for the purpose. The enlarger, now lurking in the loft, was brought down and dusted off. Disaster: the enlarger lens iris adjustment was jammed at f16. All efforts to free it, including the liberal application of penetrating oil, were of no avail. The front and rear lens-retaining rings were

unscrewed and the lens components removed, revealing the iris, which, after removing yet another retaining ring, was itself removed. It worked perfectly, showing that the problem was the internal thread of the adjustment ring being seized onto the mating external thread on the body of the lens-holder (both aluminium). Gripping the latter in a vice and applying more penetrating oil was still ineffective; there is a limit as to how tightly one dared grip the body - an oval lens mount would be little use to man or beast. At this point PC gave up for the day, meaning to give the problem more thought after a night's rest. The following day, the ring turned as sweet as a nut, the penetrating oil having evidently done its stuff, given sufficient time. I'm not quite sure what the moral of this little tale with its happy ending is, probably something like, "When faced with a seemingly insuperable problem, don't be goaded to Draconian make-or-break measures". At least pause to plan the way ahead, and sometimes - if you are lucky - the problem will go away of its own accord.

Recently PC has been having a recurrence of a problem with *Supra-spinatus Tendonitis*, otherwise known as a painful stiff shoulder. Had the problem been in the leg instead, he would undoubtedly have been laid low. When it got so bad that sleep was impossible, a visit to the doctor became inevitable. He

explained that, for some reason which we could not pinpoint, the tendon had become inflamed again, and prescribed a course of a foreign-made drug which is known in this country as 'SURGAM'. Now PC's grasp of Latin (now very rusty) was never extensive, his method of translating it into English being to knock off all the endings, look up the stems in the dictionary and juggle the words around until the result sounded plausible. (Caesar brought the spear to the slave? - unlikely; and clearly the spear didn't bring anything to anyone, so it must be: The slave brought the spear to Caesar - full marks.) However, words have always fascinated me, so I consulted the missus, who is a linguist, and she confirmed my suspicions: *surgam* is the first person singular of the future tense of the verb 'to arise'. What more appropriate name could you have for a drug that could get you on your feet again, than 'I shall arise'! Talking of words, I expect you have your own favourites: I once knew an electronic engineer whose favourite word was 'multiplicity', he dragged it in everywhere - on a multiplicity of occasions. The English language is so rich in words that many of them rarely get used. I wonder how many people don't know the difference between *Izard* and *Izzard*? Yet even so, we still insist on pressing Latin into service, quite unnecessarily. For instance, when Mrs PC and I were visiting a National Trust property recently, we saw on the wall in one of the rooms, a family tree of the (former) owners of the house. Beside the names of various of the persons listed, appeared the mysterious initials 'DSP'. Now this will undoubtedly suggest 'digital signal processing' to my readers as it did to me (but not to Mrs PC), but clearly something else was indicated. After scratching our heads and searching in vain, we finally found in tiny print right at the bottom, the legend 'DSP = *decessit sine prole* - died without issue'. Surely 'DWI' would have done just as well?

Your;;

(For the inquisitive, an *Izard* is, of course, a goatlike antelope of the Pyrenees and *Izzard* is another word for the letter Z, - simple as A to Izzard really - Ed.)

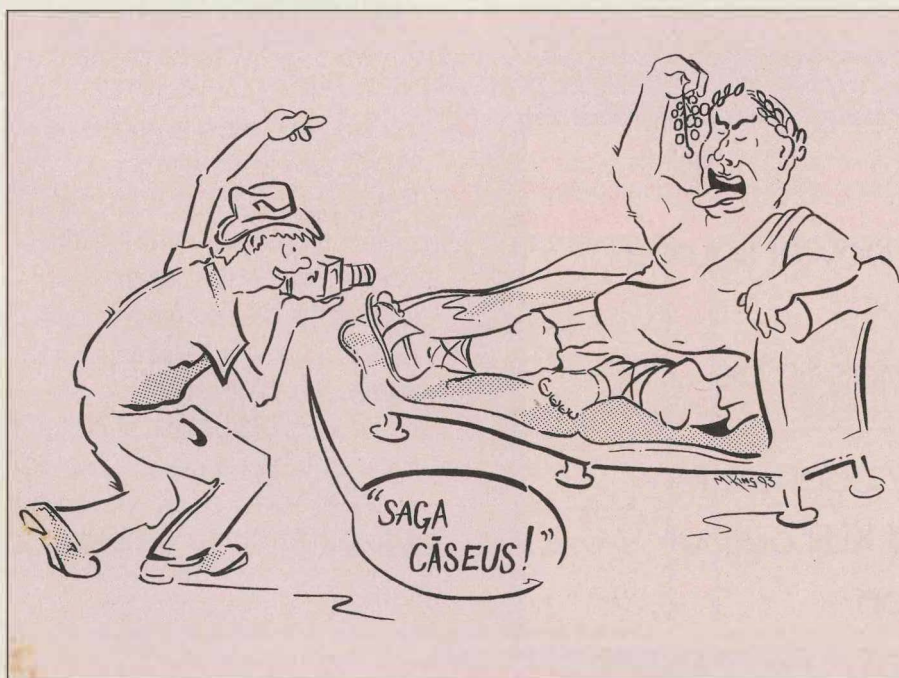

Passive Direct Inject Box

APPLICATION

- * Stage PA and recording
- * Eliminating hum loops safely
- * Direct injecting keyboards and other electro-music equipment

by Joe Fuller

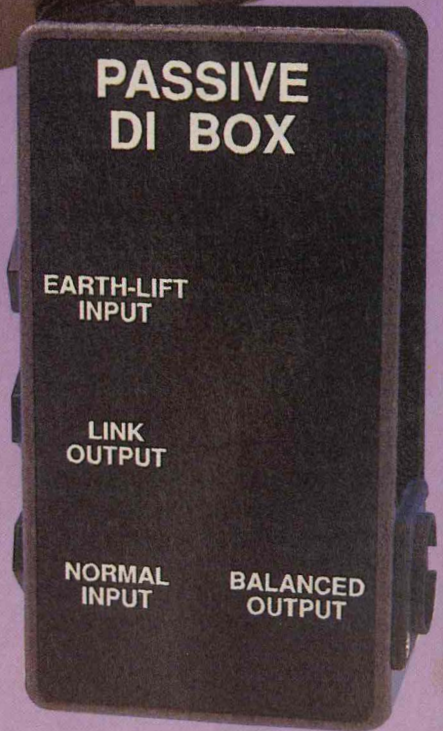
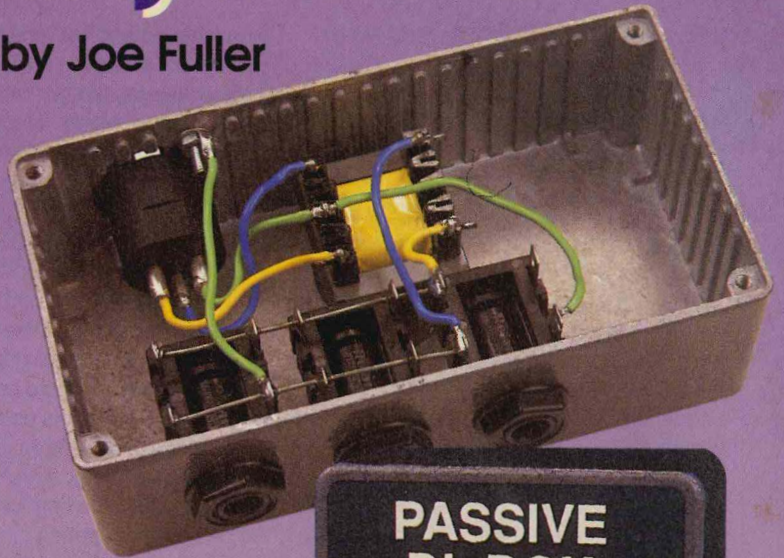

FEATURES

- * Does not require a power source
- * Earth lift facility
- * Allows line level signals to be fed into mic inputs
- * Link output for easy connection
- * ¼ in. jack input and XLR output
- * Rugged construction

To the uninitiated, a direct inject box is simply an impedance/level matching unit that is designed to allow unbalanced line level signals to be fed into a low level balanced microphone input on a mixing desk. Still confused? Well first of all let's look at why someone would *want* to feed a line level signal into a microphone input.

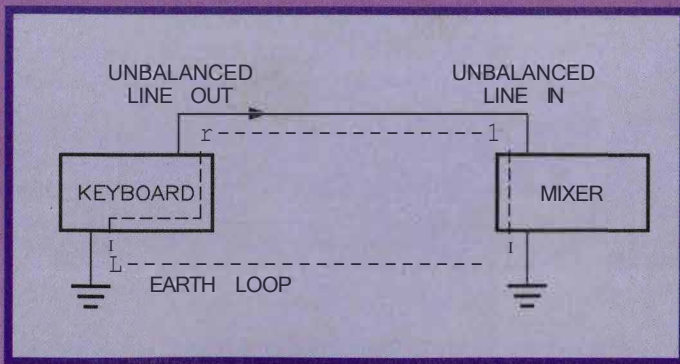

Figure 1. How an earth loop can be formed between two pieces of earthed equipment.

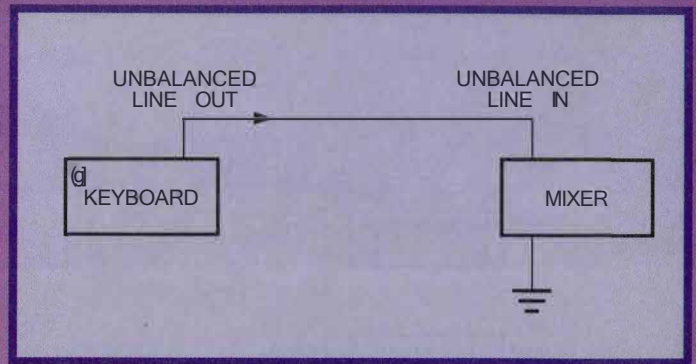

Figure 2. Even if only the mixer is earthed, hum may still be picked up in the interconnecting cable; especially if the cable is very long.

Miking Up

The & plcki'OUP. from an t, both for pt. JOSEUS or stage or n o:lkidj}. providing PA at a concert, isJQ usiiii microphone. This technique con b4t applied to a diverse range of ranging fOm -ckmS, guitar, sax, piano, etc.; to elecR>music Instrumen1s-electric guitar, eledronic toy. board and the He in the case of the tatter. where amplification is required, ft bttle amplified output from the speaker cab-net that is 'miked-up' instead of the actual instrument. Miking-up instrumen1s. principally a simple technique. Is in reality quite an art. Different Instrumen1s produce sounds of different loudness, timbre and frequency range; consequently choosing the correct microphone for the Job is pre-requisite h ensuring that the sound of the Instrumen1s is faHhfully reproduced. It is not Intended to discuss microphone techniques here; the reader is referred to Tim Wilkinson's excellent 'A Gulde to Professional Audio' series where such matters are discussed h greater depth.

Direct Inject

However, there is another technique for picking up sound from an instrument; if an instrument is of the electric/electronic variety, a direct connection can be made between the instrument and the mixing desk or recording equipment. This technique is known as Direct Inject (DI). Where cable lengths are short, the set up is simple (i.e. home recording) and the appropriate impedance/level input is available. all that is required is a screened cable with

Specification

Maximum input signal:	+18dBu
Distortion:	<0.05% @ 1kHz
Frequency response:	10Hz to 20kHz ±0.5dB
Input impedance:	20kΩ
Output impedance:	600Ω
Size:	120 x 65 x 40mm
Input connectors:	¼in. mono jack socket
Link output:	¼in. mono jack socket
Balanced output:	3-pin XLR plug

suitable connectors. Signals are usually unbalanced (signal and screen connection) and most of the time everything is fine. However, where cable lengths are long, the set up complex Or suitable Inputs are not available, then a slightly different approach is required.

Hum Loops and Level Mismatch

Any one, or all of the unfavourable combinations mentioned is more than just a little likely to introduce hum and noise. This is the scenario faced by musicians, roadies and PA crews involved in concerts (amateur and professional alike). Figures 1 and 2 show how hum can be introduced.

Long cables, will pick up hum and noise, especially when run anywhere in the vicinity of mains power cables.

Earth loops are another problem; at the risk of turning live performers into dead performers, earth wires on Class 1 mains powered equipment are all too frequently

disconnected. In an attempt to solve the problem. This highly dangerous practice may solve the problem, but also exposes all concerned to the risk of electrocution should a fault develop. The way to stop hum loops is to break the loop in the signal path, and leave the mains earth wire firmly in place.

Many mixers Intended for 'on the road' PA use are provided with microphone Inputs only, often this is because more microphone inputs are required than line inputs and it is easier to convert a mic input to a line Input than vice versa. Microphone Inputs are highly unsuitable for anything other than microphone level signals and feeding an electronic keyboard into such is likely to result in gross distortion.

Using a DI Box

Okay, so what do you do? Answer pop down to your local professional music store, part with lots of cash and buy a Super Acme DI box ... Alternatively you

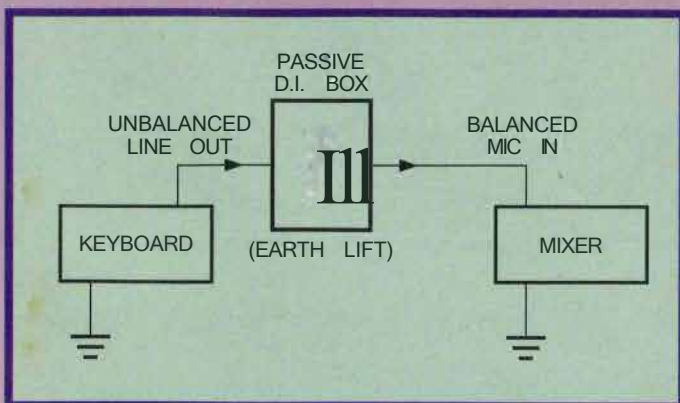

Figure 3. Using a Passive DI Box (earth lift) to prevent a hum loop being formed between two pieces of earthed equipment.

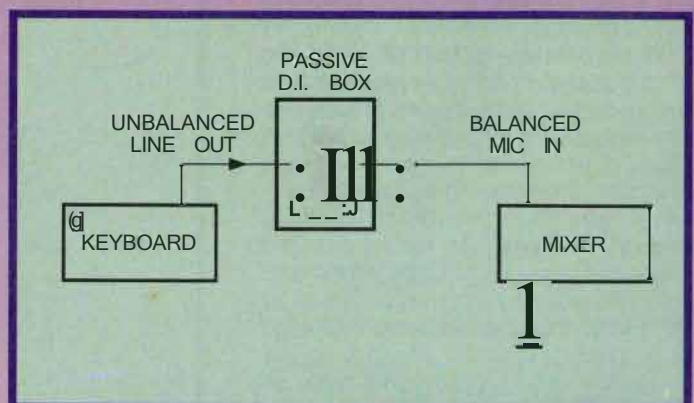

Figure 4. Even if only the mixer is earthed, better performance may be achieved if the mixer earth is 'carried through'.

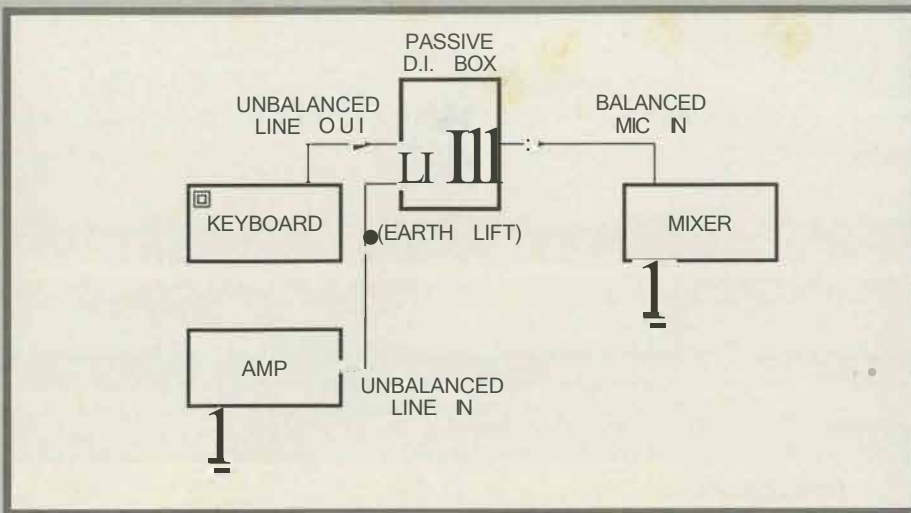

Figure 5. Using the Link Output to feed an amplifier on stage as well as the mixer.

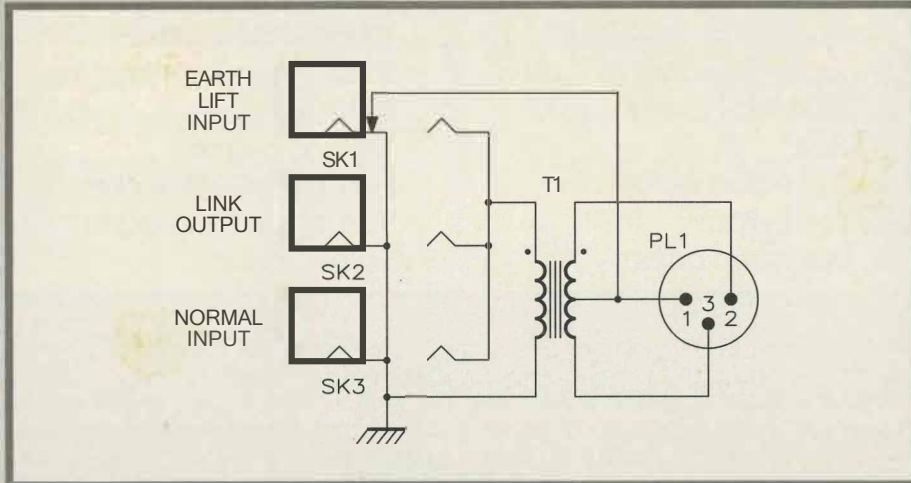

Figure 6. Circuit diagram of the Passive DI Box.

can build this natty little DI box for a less princely sum. Let's face it, it's not state of the art and you can get better performance from top-notch ready made units, but it works well, and is more than good enough for most applications. After all if you're Rick Wakeman, you wouldn't be building it yourself would you!

The DI box serves to translate the unbalanced line level signal into a balanced microphone level signal. The input is relatively high impedance - suitable for connecting to the output of a keyboard or other line level output, and the output is low impedance and suitable for connecting to a microphone input. The conversion is performed by a transformer, which also provides complete isolation between input and output (earth lift). However, in some situations it is preferable to carry through the earth.

Figure 3 shows how the DI box is used to connect an earthed keyboard to a mixer - in this case the earth lift is used to prevent a hum loop being formed. In Figure 4, where the keyboard is double insulated (unearthed) better performance may be achieved by carrying through the earth from the mixer to the keyboard. There are no hard and fast rules here; the easiest way to find out is to try both ways, the one that works best is the one to use.

Sometimes it may be necessary to provide local on stage amplification, some keyboard players prefer using their own 'combo', to hearing themselves through

the foldback system only. I certainly do - on more than one occasion, an inexperienced operator adjusted the foldback mix during a song so I couldn't hear what I was playing, it taught me to be self-sufficient. Some will disagree, but do whatever suits you best. The method of providing a split feed to both the mixer and an on-stage amplifier is shown in Figure 5.

Circuit and Construction

As can be seen from the circuit diagram shown in Figure 6, there really isn't much in the DI Box. For this reason, there is no circuit board - instead a hard-wired approach is adopted.

SK3 is the 'normal' input which provides earth carry through from input to output, as well as providing the signal path. SK1 is the 'earth lift' input; inserting a jack plug breaks the earth connection whilst still maintaining the signal path. SK2, the 'link output' is simply wired in parallel with the input sockets. The metal box, used for screening purposes and strength, is connected to the 'sleeve' contact of the jack sockets. Transformer T1 provides impedance and level matching; the centre tap of the transformer is connected to the screen pin of PL1 (pin 1), and the ends of the secondary are connected to the in-phase and out-of-phase pins of PL1 (pins 2 & 3 respectively).

If it is envisaged that the DI Box will be used with a mixer that has phantom power facilities, the connection to the

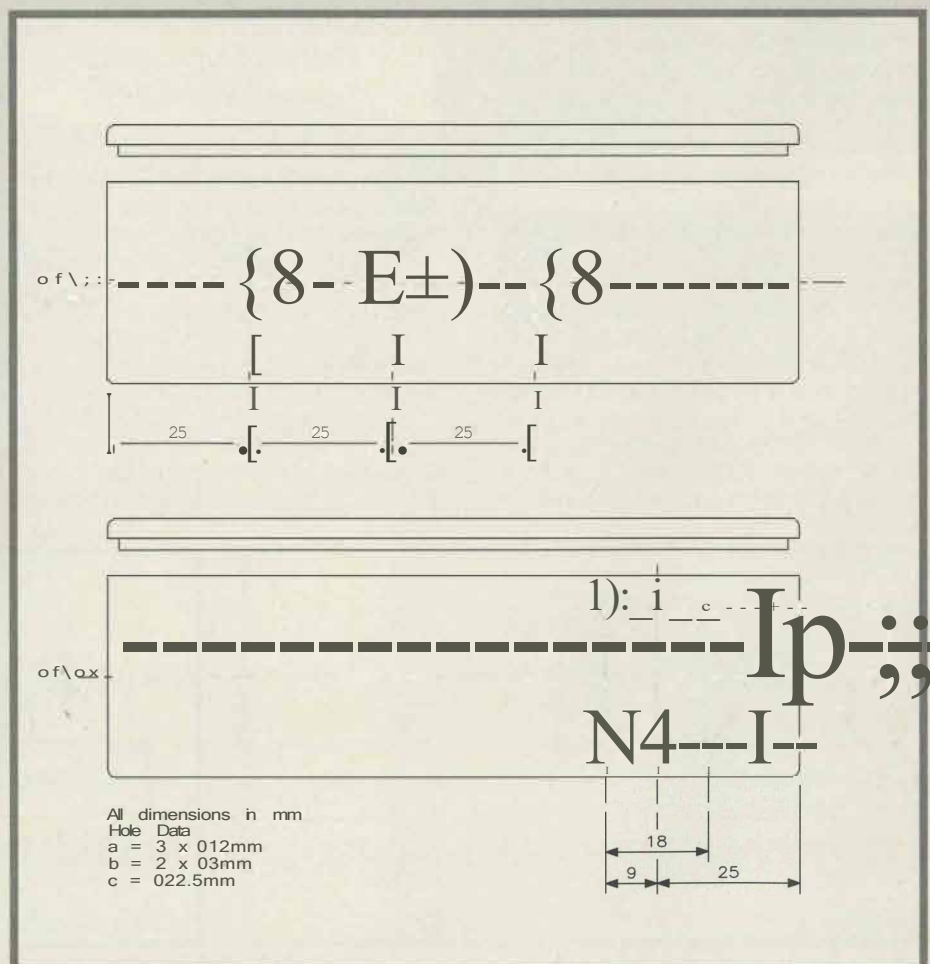

Figure 7. Box drilling details.

PASSIVE DI BOX

EARTH-LIFT
INPUT

LINK
OUTPUT

NORMAL
INPUT

BALANCED
OUTPUT

Figure 9 Label for the Passive DI Box.

transformer centre tap should be omitted. However, the connection between PLI pin 1 and SK1 should still be made.

Figure 7 shows the drilling details for the box; remember to wear goggles when drilling as flying metal swarf can inflict serious eye damage. The large hole for the XLR connector can be cut most easily using a chassis punch. If a chassis punch is not available, drill a ring of holes just inside the marked-out circle and file out the remaining fillets using a 'rat's tail' file. The hole can then be filed out to size using a half-round file.

Figure 8 shows the assembly and wiring of the DI box. It is preferable, but not essential, to remove the ribbed areas around the XLR connectors fixing holes. Removal can be achieved by using an electric drill fitted with a 'burr' bit - wear goggles as before! The transformer is secured by gluing it to the bottom of the box with epoxy resin adhesive.

Once all assembly and wiring is complete, label the sockets so that they can be easily identified. An example label, which suits the suggested connector layout is shown in Figure 9. This can be photocopied, stuck onto the bottom of the DI Box and protected with clear self-adhesive plastic film such as 'Fabian' (available from most branches of Woolworths and other similar general stores).

Testing and Use

Simply connect the DI Box as shown in Figures 3 to 5, switch on the equipment and (hopefully), after a little experimentation for the best input to use, everything should work fine. It is unlikely that problems will be encountered, but if they are, a wiring mistake is the probable cause.

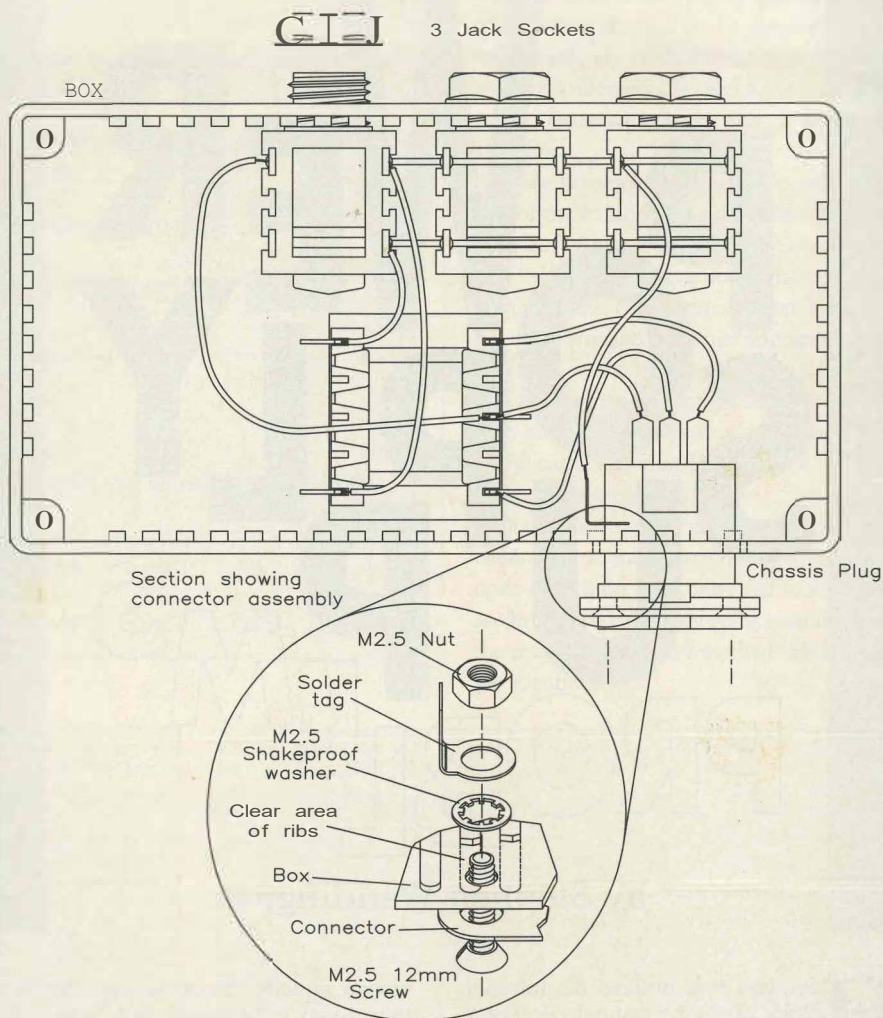

Figure 8 Assembly and wiring diagram.

Passive Direct Inject Box Parts List

SK1, 2,3	Mono Jack Socket	3	(HF90X)
PI1	Chassis XLR Plug	1	(KC54J)
TI	20kil/600n Audio Matching Transformer	1	(FD23A)
	Die-cast Metal Box DCM5004	1	(LH71 N)
	Countersunk Bolt M2.5 x 10mm	1 Pkt	(JC68Y)
	Shakeproof Washer M2.5	1 Pkt	(BF45Y)
	Nut M2.5	1 Pkt	(JD62S)
	Solder Tag M2.5	1 Pkt	(BF45Y)
	16/0.2 Wire	As Req.	(FA26D - FA36P)
	Tinned Copper Wire 20swg	As Req.	(BL13P)
	Fast setting Epoxy Resin	1 Pk	(FL45Y)
	Jack Plug 1/4in,	As Req.	(HF87U)
	Line XLR Socket	As Req.	(BW91Y or KC57M)
	Line XLR Plug	As Req.	(BW89W or KC58N)
	Twin Screened Cable	As Req.	(XR08J)
	Single Screened Cable	As Req.	(XS24B)

The above items are not available as a kit.

This project is not covered by the 'Get You Working' Service.

DOMESTIC POWER SUPPLY PROBLEM..

by Stephen Waddington

Have you ever noticed the internal clock of your personal computer drift sporadically, sometimes losing the odd minute, maybe almost one a day? How can such random variation be accounted for when you consider that the system is using a finely tuned quartz crystal at its heart? Or maybe you have sometimes heard strange noises from your stereo system as the refrigerator switches on and off. Waking up late in the morning only to discover that your digital alarm clock has reset itself?

The computer clock is not so much of a problem since it is rarely used as a ref-

erence; equally, the occasional crackle on the stereo is bearable and hardly life-threatening. Being late for work or appointments is embarrassing, but does prompt the late-riser to make alternative alarm call arrangements. What is annoying, and totally unforgivable, is returning home from a late night out, in the hope of catching Prisoner Cell Block H, and finding the video recorder, complete with as yet unrecorded blank tape installed, sitting there blinking at you (as though it's your fault), having totally forgotten the programme settings made earlier (along with all the channel frequencies!).

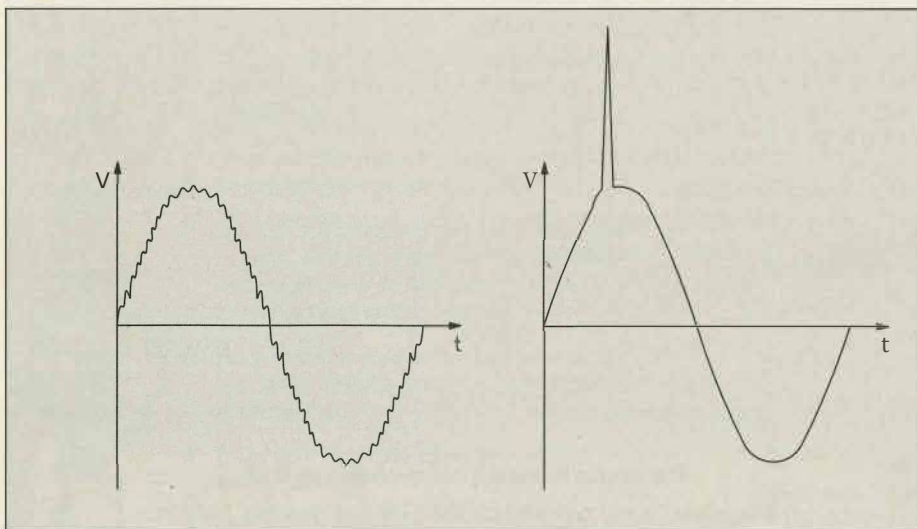

Figure 1. Examples of supply noise and transients on mains supply.

Ghoulish Supply

Is it only the Waddington household that are subjected to electrical ghouls or a freakish mains supply? The answer is no, most households are. The problems described are all due to transients, spikes and noise on the mains supply. To examine the problem further I hired a Mains Analyser and connected it to the household mains supply. The device is a form of electronic watchdog - when programmed to observe certain characteristics on a mains voltage supply, it will remain dormant until a fault condition occurs. As with an oscilloscope, a trace of the fault is provided, except in this instance the cathode ray tube is replaced by a small thermal printer. After being left connected for a period of twenty-four hours, monitoring both the live and neutral lines, the analyser spat out a profusion of graphs when subsequently interrogated. The results were incredible, with random noise appearing almost every other hour, and examples of spikes of up to 1.7kV common. Example traces are illustrated in Figure 1.

The problems described are due in the main to man-made sources, with noise generally attributed to switch arcing and electrical discharge from fluorescent and neon lamps. Spikes and high voltage transients are usually caused by the switching of inductive loads, including motors and mains transformers. As we live within a couple of kilometres of a main line railway station, it is hardly surprising that the mains supply is as noisy as the analyser revealed.

Supply Noise

Occasionally large voltage spikes can be induced on power lines by natural sources including lightning strikes and thunderstorms. Table 1 represents an attempt to summarise likely sources of mains borne interference. Electrical engineers are often quick to differentiate between spikes, transients and radio frequency interference, although the differences are subtle and are perhaps best grouped under the general heading of 'Supply Noise'. It is universally realised that the quality of the public electricity supply is not sufficient to meet the demands of computing and communications equipment, let alone quality audio equipment. Without doubt, supply noise

Spikes & Transients	Noise
Lighting Strikes	Neon Lamps
Motors	Fluorescent Lamps
Transformers	Overhead Power Lines
	Car Engines
	Thermostat Controlled Heaters (Irons, Kettles, Radiators, etc.)

Table 1. Potential Sources of Mains Borne Interference.

together with total power failure (what the Americans call 'an electrical outage') represent the major cause of electrical equipment malfunction.

Industrial solutions are numerous, and almost every piece of commercial equipment includes some form of mains filter. Additionally, suppressors are included to

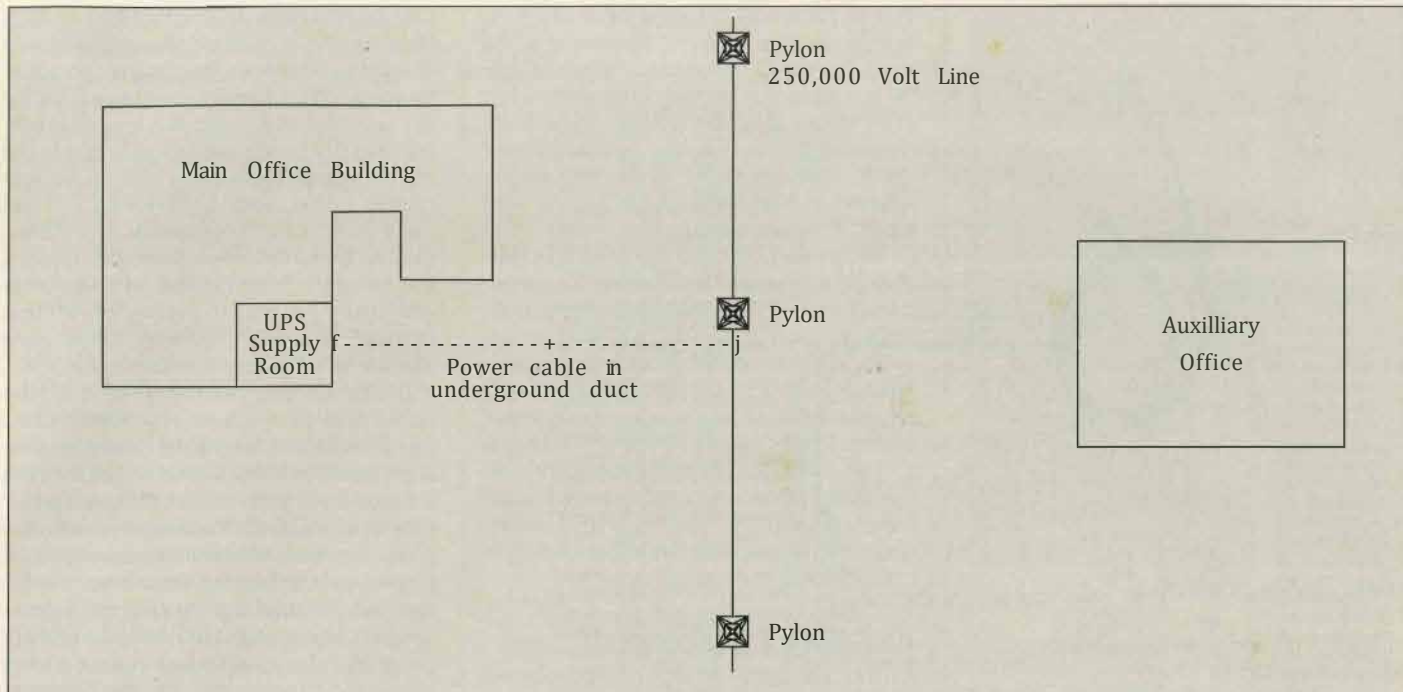

Figure 2. Plan of office complex.

eradicate noise which the equipment itself may generate (and pass back onto the line). Most large computer systems use sophisticated control equipment to maintain a constant supply voltage. Employing capacitive and inductive filtering, together with constant voltage transformers, these devices usually carry an equally sophisticated price tag.

Losing mains power completely can be catastrophic, but preventative measures are available in the form of Uninterruptible Power Supplies (UPS). Solutions usually involve a diesel generator to provide a long-term alternative supply, with a battery-backed system to give immediate short-term support. Much is down to the philosophy of the Systems Engineer, though it would be a foolhardy designer who neglected the installation of a UPS supply in a hospital or for an air-traffic control system, or indeed any application where a loss of power might result in the loss of life.

Overhead Problems

There are occasions where a UPS supply alone is not sufficient. A well-known manufacturer, who had better remain nameless, recently told of the continual failure of a series of networked computers supplied from a maintained supply. The power source was not considered to be the culprit until electricity board experts were

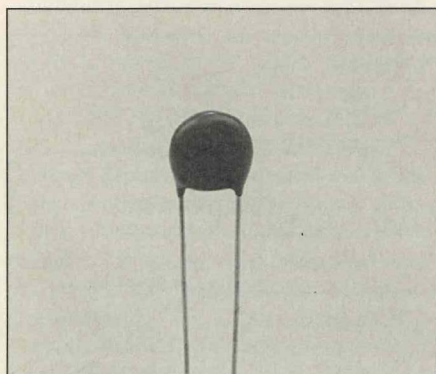

Transient Suppressor (CP76H)

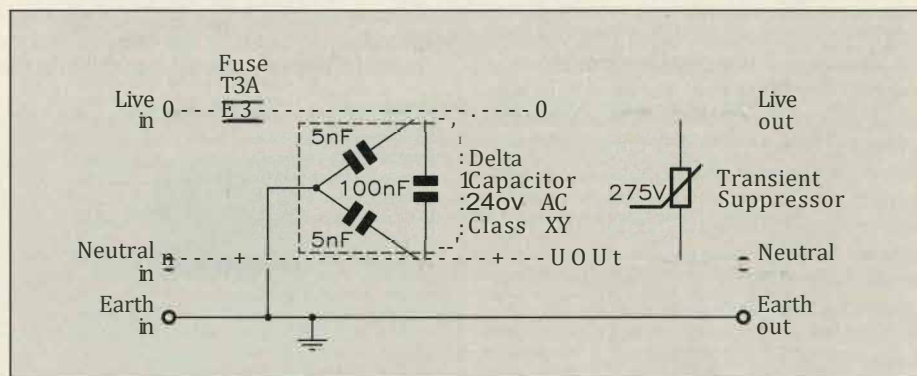

Figure 3. Basic mains filter for an earthed supply.

asked to investigate the situation. Close monitoring of all system parameters quickly identified the mains supply as being noisy. The computers which were housed in an auxiliary office were supplied from a UPS feed, from the main office building. The power cable from the main building was buried in ducts a few metres underground - Figure 2 illustrates the scenario. Unfortunately, the cable had to pass underneath a 250,000V pylon, with what appeared in hindsight to be a predictable result. Electrical noise from the pylon was induced on the UPS feed, leaving the computer switch mode power supplies unable to cope; failure was inevitable.

The moral of the story is two-fold. Firstly it is apparent that elaborate power supply design is not sufficient to avoid mains interference - protection against supply noise must be considered as a separate entity. Secondly, circuit protection must always be placed as close as is physically possible to the equipment, which it is designed to protect, since there is always the opportunity for localised interference to occur between equipment and protection devices.

Household Solution

Such talk is all very well for industrial applications, where budgets allow for extensive investigation and the purchase

of relatively expensive equipment. What of the Waddington household? Though the work of a freelance writer has copious benefits, it hardly allows for the purchase of a UPS supply or elaborate filtering equipment. Prevention is generally better than cure, though it is no good ensuring that all your equipment is suppressed if your neighbour is not equally stringent. If you live in a block of flats you might as well give up, especially when you consider that the suppression of household equipment provides little protection against any of the industrial or natural noise mentioned earlier. Fear not, for there is a relatively simple solution within the grasp of the Waddington household, and indeed the budget of every electronics constructor. The majority of mains borne interference can be eliminated by adding a couple of basic components to any mains powered project or appliance. The basic circuit which incorporates a transient suppressor and a capacitor network is illustrated in Figure 3.

Removal of Transients

Here the component responsible for clipping spikes is the transient suppressor connected across live and neutral. This semiconductor/capacitor hybrid consists essentially of two metallic plates with a metal-oxide dielectric. The device has a very high resistance up to its clamping

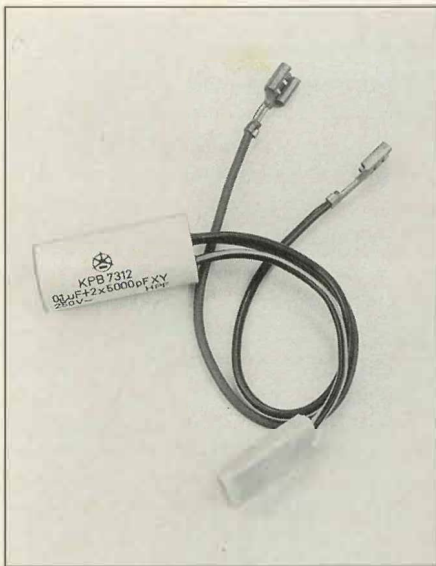

Delta Capacitor (HW07H).

voltage, V_m , and thus its impedance can usually be ignored.

Figure 4 provides an illustration of the idealised transient suppressor characteristic curve. When a transient spike appears across the supply line exceeding V_m , the impedance of the device immediately drops to a very low value while the unwanted energy is dissipated in the form of heat. The suppressor is chosen to have V_m equal to or slightly above the power supply across which it is connected. In this particular instance the transient suppressor is rated at 275V AC, though it is worth remembering that a whole host of operating values are available for the protection of equipment working at both lower AC and DC voltages.

Delta Network

Whilst the transient suppressor can adequately take care of spikes over 275V AC, the capacitor network in the form of C1, CZ and C3 in Figure 3 deals with smaller spikes and noise. Available in a single package, these three devices are referred to collectively as a 'delta capacitor' or network because of the shape of their arrangement. Delta capacitors are usually fitted to appliances in order to suppress interference at source, and prevent it going back up the mains lead, e.g. vacuum cleaner motors, etc., but they will equally remove incoming noise. Separate capacitors would be equally suitable, although they would be considerably more expensive than a single delta unit, and would needlessly complicate physical wiring arrangements.

X or Y?

A further consideration must be observed. All capacitors classified for mains use must conform to one of two standards. The basic category, Class 'X', describes capacitors suitable for connection across the mains supply between live and neutral. As such, capacitors of this type must be able to operate continuously at 250V rms and, in the event of catastrophic failure, must not explode, and must have limited flammability. In short, whilst suitable for mains connection, Class 'X' capacitors must not be used where failure would

expose personnel to an electrical shock. In such instances, Class 'Y' devices must be used. Essentially these conform to all Class 'X' requirements but are constructed to an even higher standard, and are suitable for connection between live or neutral and earth, and the delta capacitor device referred to here meets both Class 'X' and Class 'Y' requirements.

The circuit detailed in Figure 3 is suitable for equipment with an earth connection. If a circuit lacks an earth connection, as in the case of doubly insulated equipment, a slightly different tactic is required. In such instances the delta capacitor network is replaced by a single capacitor and resistor combination, as shown in Figure 5. The pair, like the delta capacitor network, can be constructed from the same basic components, but since a combination unit is available it is this which is usually used.

Existing Equipment?

Either earthed or double-insulated arrangements represent a relatively small consideration to the engineer who is devising a new circuit, since they can be incorporated as part of a Power Supply design. They do, however, pose a problem for the

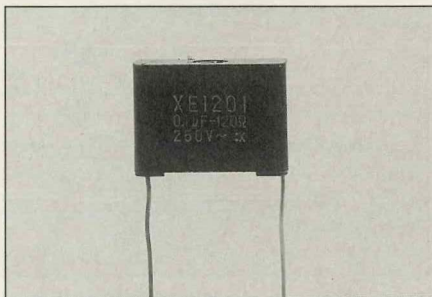

Contact Suppressor (YR90X).

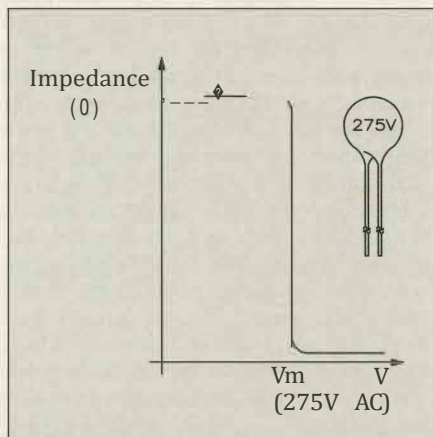

Figure 4. Idealised curve for a transient suppressor.

constructor who is considering adding them to existing domestic appliances or incorporating them into mains powered projects. When I was designing a filter for my personal computer, the idea of breaking into the mains power cable inside the device was dismissed; the power unit was clearly sealed, and to break into it could have been both dangerous and problematic. As we have already seen, it is important to apply filter circuits as close as is physically possible to the equipment that they are to protect, although safety must always be the prime consideration.

Filter circuits published in hobbyist books and the popular electronics press have, in the past, suggested mounting similar circuits within a mains plug. Such a scheme is, at best, poor, having components mounted both inside and outside the plug. A neater solution requires a small box and a length of tag strip. Internal connection to existing equipment is prevented; the completed unit is simply plugged into an adjacent mains socket enabling connection via the internal wiring of a double socket or distribution block. Alternatively, if there is some spare room inside the case of an existing project or piece of mains equipment, the circuit can be mounted internally with appropriate connection made at the mains input stage.

Ready-Made Solution

Construction is relatively straightforward, though a healthy respect for the mains voltage must be maintained at all times! In this sense it is essential that all bare terminals are insulated and fixings earthed. If you prefer not to work with the mains in this way, then Maplin can save you the bother. At £12.95 the surge protecting plug (KUZOW) is a standard three-pin mains plug incorporating a voltage dependent varistor between all three pins. Using standard 13A rated contacts and connections, the plug is intended to protect computers and other such sensitive equip-

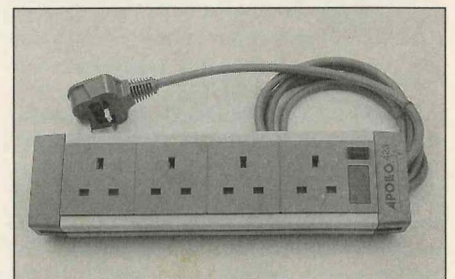

4-way Mains Socket with Spike Protector (KR41U).

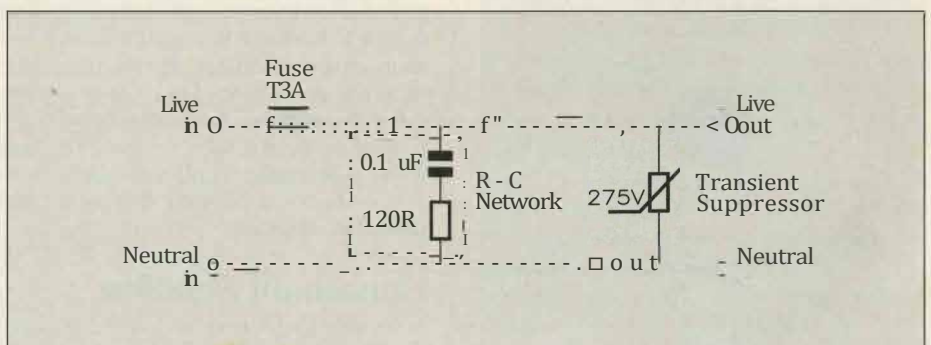

Figure 5. Mains input suppression of non-earthed equipment.



3A Filtered Plug (KU19V)



Surge Clock (KR42V)

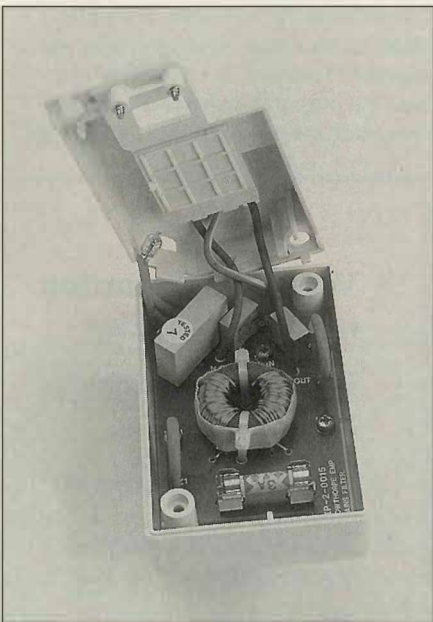

Internal view of 3A Filtered Plug (KU19V)

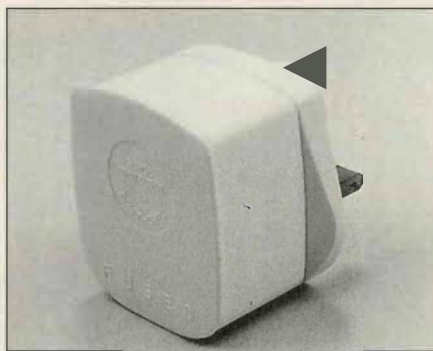

Surge Protecting Plug (KU20W).

ment. The device can be attached to a cable in place of a standard plug or, alternatively, inserted into an adjacent socket on a distribution block, thus protecting local supply as previously described.

A more up-market solution is the Spike Protector (KR41U), a 4-way mains socket

strip that re-directs transients and surges to earth, with a response time of less than ten nanoseconds. At £22.95, the unit also includes a neon lamp which glows brightly providing the protection unit is intact, the mains fuse is not ruptured and the earth connection is present. To help comply with BS6396 the socket strip is also provided with an external earth terminal to ground other desk mounted electronic equipment.

I suggest that all potentially sensitive equipment is protected with either the filter described previously or a commercial device such as those available from Maplin. When designing a piece of mains equipment, give a thought to adequate

protection from supply noise. Protection of every piece of household equipment is not always necessary, since a single filter is often able to cover several localised sockets. Certainly the 4-way mains socket is by far the best solution for computer or audio applications, protecting a series of sockets collectively.

For all-round localised protection, the 3A, Filtered Mains Plug (KU19V) would be a good choice for a computer or Hi-Fi mains lead. For £19.95 it incorporates a comprehensive noise filter for removing unwanted noise and pulses from the mains supply before the chance of entering sensitive electronic equipment. The filter includes a double wound toroidal choke with a 3-way or delta capacitor network to include the earth connection, and a pair of metal-oxide varistor surge suppressors. It is fitted with a standard 1in. size mains cartridge fuse rated at 3A (which must not be uprated).

And finally, a useful gadget for monitoring your noisy mains supply to see just how bad (or not) it actually is is KR42V (£29.95), a 'Surge Clock' which can count the number of potentially damaging surges on the supply. It will register up to nine such surges, and is active as soon as it is plugged into a socket and the socket switched on. Initially a green LED will be lit indicating a 'clean' condition. Any nasty pulse will cause the scale of red LEDs to be illuminated, and further pulses will cause the indicator to advance to the next position until the ninth is reached. Line to neutral surges voltages in excess of twice the normal peak AC supply will register; those less than 650V are not normally damaging and will not be registered. The unit is reset by disconnecting it from the supply.

Sources

'The Effects of Supply Surges and Transients', by R. Barlow, Protection of Electronic Equipment, 1989.

'A Smaller Role in The Power Game', by G. A. Steven, Electronics Weekly, November 1985.

'Spike Eater' by P. E. Roberts, Everyday Electronics, July 1988.

'Maplin 1993 Buyer's Guide to Electrical Components', Maplin Electronics.

MAPLIN'S TOP TWENTY KITS

POSITION	DESCRIPTION OF KIT	ORDER AS	PRICE	DETAILS IN	POSITION	DESCRIPTION OF KIT	ORDER AS	PRICE	DETAILS IN
1, 12	L200 Data File	LP69A	£ 4.75	Magazine 46 IXA46A)	11, 110	IBM Expansion System	LP12N	£21.95	Magazine 43 IXA43W)
2, 11)	Live Wire Detector	LK63T	£ 4.75	Magazine 48 IXA48C)	12, 111)	UA3730 Code Lock	LP92A	£11.45	Magazine 56 IXA56L)
3, 14)	MOSFET Amplifier	LP56L	£20.95	Magazine 41 IXA41U)	13, 113)	TDA2822 Stereo Amplifier	LP03D	£ 7.95	Magazine 34 IXA34M)
4, 13)	TDA70521W Amplifier	LP16S	£ 4.95	Magazine 37 IXA37S)	14, 117)	LM386 Amplifier	LM76H	£ 4.60	Magazine 29 IXA29G)
5, 15)	Courtesy Light Extender	LP66W	£ 2.95	Magazine 44 IXA44X)	15, 1-)	LM383 2W Amplifier	LW36P	£ 7.95	Catalogue '93 ICA10L)
6, 16)	Car Battery Monitor	LK42V	£ 9.25	Magazine 37 IXA37S)	16, 114)	1R Proximity Detector	LT00A	£10.95	Magazine 54 IXA54J)
7, 18)	1/300Timer	LP30H	£ 4.95	Magazine 38 IXA38RI)	17, 1-1)	Remote Power Switch	LP07H	£ 5.25	Magazine 34 IXA34M)
8, 17)	Stroboscope Kit	VE52G	£14.95	Catalogue '93 ICA10L)	18, 116)	SL6270 AGC Mic Amplifier	LP98G	£ 8.75	Magazine 51 IXA51F)
9, 19)	Lights On Reminder	LP77J	£ 4.75	Magazine 50 IXA50E)	19, 115)	Partylite	LW93B	£12.45	Catalogue '93 ICA10L)
10, 112)	Mini Metal Detector	LM35O	£ 7.25	Magazine 48 IXA48C)	20, 118)	RS232/TTL Converter	LM75S	£10.75	Magazine 31 IXA31J)

Over 150 other kits also available. All kits supplied with instructions. The descriptions are necessarily short. Please ensure you know exactly what the kit is and what it comprises before ordering, by checking the appropriate project book, magazine or catalogue mentioned in the list above.

50W HI-FI POWER AMPLIFIER

Text by Dennis Butcher
and John Mosely

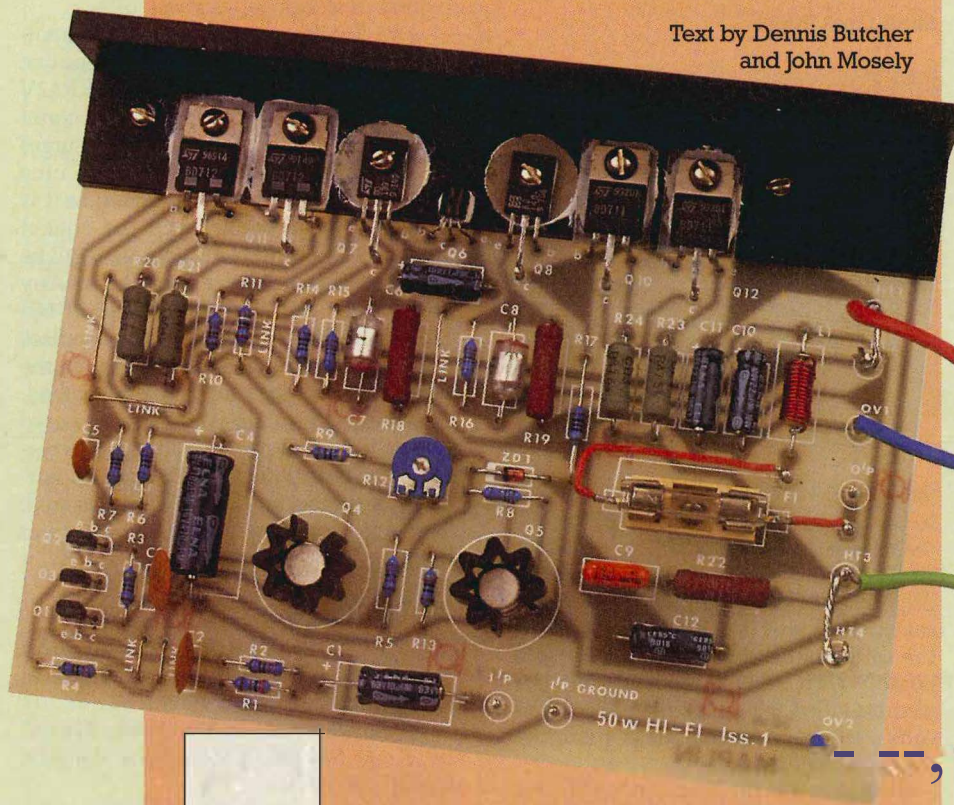

PROJECT RATING

The Maplin 50W amplifier has been around for some time, and still sells extremely well - a tribute, no doubt, to the excellent design. The amplifier can readily form the basis of a high quality Hi-Fi system. Because of the low-cost of the kit, the amplifier can be used in an active loudspeaker system, or used to drive a sub-woofer. Such applications will require the amplifier(s) to be fed from suitable filter circuits. Another possible application is in-car amplification. Although if the amplifier(s) is to be used in a car, it would still have to be fed from a $\pm 30V$ power supply. A suitable switch-mode power supply, that 'converts' the 12 to 14V output from a car battery to a suitable $\pm 30V$ power supply, was discussed in 'Electronics' Issue 46, which is also available as a kit (LP39N).

Circuit Description

The circuit, as shown in Figure 1, uses a standard DC coupled output stage, which has the advantage of avoiding the need for a large, and expensive, output coupling capacitor, and also it gives a better performance. This is particularly true at low signal levels where distortion is kept to a minimum. The input signal is AC coupled into a long-tailed pair formed by transistors Q1 and Q2, whose emitters are connected to a constant current source, Q3, Q5 and Zener diode ZD1.

One of the problems with using bipolar transistors in the output stage is thermal stability. To overcome this problem Q6 is used in the 'amplified diode' mode to control the quiescent output current, which is set by preset resistor R12. To further improve stability, Q6 is mounted on the same bracket as the output transistors Q7 to Q12. As the temperature of these output devices rises, Q6 will rise and so stabilise the quiescent current. It is necessary to bias the output transistors on, in their quiescent state, so that they are always

FEATURES

- * Very Low Distortion (<0.05% at 1kHz)
- * Unconditionally Stable
- * Damping Factor 80
- * Maximum Output 72W RMS at 1kHz (4 Ω load)
- * Noise < -100dB
- * Easy to Build

APPLICATIONS

- * Hi-Fi Systems
- * Active Loudspeaker Systems
- * Sub-Woofer Amplifier
- * In-Car Amplifier

**10:1 AVAILABLE
(LW35Q)
PRICE £19.95**

(hopefully!) operating in their linear range, and so reduce crossover distortion.

Signal voltage gain is provided by transistor Q4 which feeds a fully complementary, Darlington output stage, Q7 to Q12. The second 'half' of the Darlington pair is in fact two power transistors in parallel, Q9, Q11 and Q10, Q12. This enables high current, and powers, to be handled comfortably within the limits of the output devices, so reducing the possibility of secondary breakdown in the output devices.

Negative feedback is applied to the base of Q2 via R7 and C5, which helps to

give the amplifier its very low distortion figure, and smooth frequency response. R2 and C9 form a standard Zobel network at the output, and along with the small value inductor, L1, prevent instability at high frequencies. Output protection is provided by fuse F1.

Construction

Referring to the PCB legend in Figure 2, fit the wire links and PCB pins first (1-TTL to 4, 0V1 and 2, 0/P, 1/P, 1/P Ground). To make connections to the power transistors easier, the collectors are soldered to PCB pins as well, i.e. Q7 to

Q12 'c' positions. The resistors and Zener diode, ZD1, can now be fitted. To aid cooling, mount the power resistors R18 to R24 approximately 2 to 3 mm above the PCB. When mounting the capacitors you must ensure correct polarity of the electrolytic capacitors - the PCB legend clearly indicates where the positive end (+) should be inserted, except for C12 which is not marked for polarity on the PCB legend. For C12, the negative wire goes in the connection (-) to the right of the board, nearest to HT4. L1 is made up of 15 to 18 turns of 24 SWG enamelled copper wire wound on the body of a 1k 1W resistor. Remember to scrape off the enamel at each end of the coil before soldering to the wires of the resistor. Next the transistors Q1 to Q5 can be soldered into position. Q4 and Q5 are mounted flush on the PCB, and are both fitted with a push-on heatsink.

Bolt the heatsink to the PCB using two 1/2 in. 6BA bolts, nuts and shake proof washers. Form Q6 leads as shown in Figure 3, and solder it in situ with the flat face of the transistor flush on the top of the heatsink - remember to apply a smear of heatsink compound to the transistor face *before* soldering. When fixing the six power transistors (Q7 to Q12) to the heatsink, apply heatsink compound and bolt each transistor to the heatsink *before* soldering the leads, this will avoid undue stress on the

Specification (With power supplies shown and extra heatsink)

Power Output at 1kHz	4Q Load	SQ Load
One Channel:	72WRMS	50WRMS
Two Channel:	49WRMS	36WRMS
Input Sensitivity		
For Rated Output:	380mV	450mV
Frequency Response:	Flat from 20Hz to 28kHz	
Full Power Bandwidth		
(pulse tested at hf):	3dB down at 95kHz	
Noise:	< -100dBu	
THD:	< 0.05% at 1kHz	
Damping Factor:	80	
Input Impedance:	15kΩ	
Slew Rate:	14V/μs (at 10kHz)	

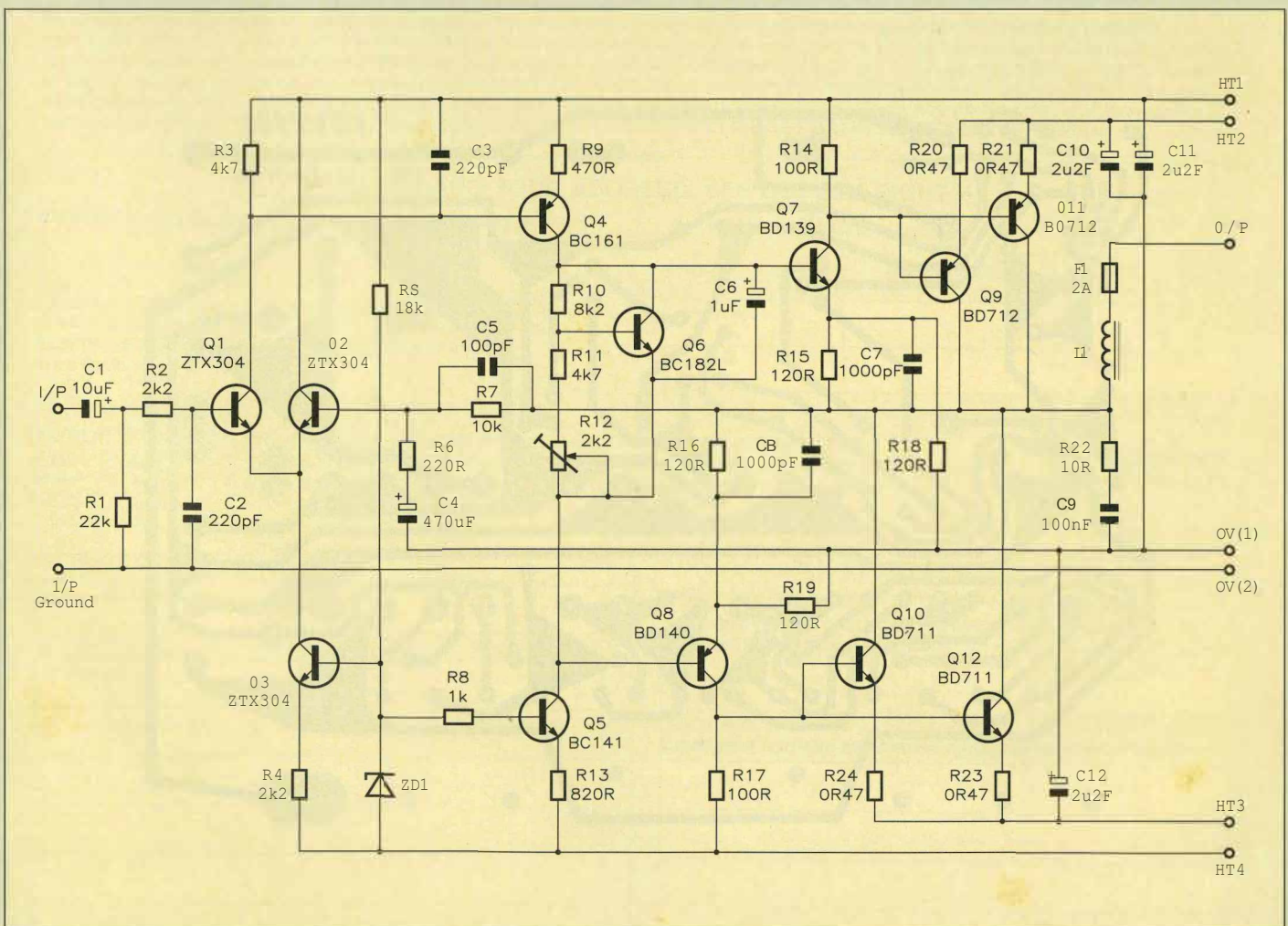

Figure 1. Circuit diagram of SOW Hi-Fi Amplifier.

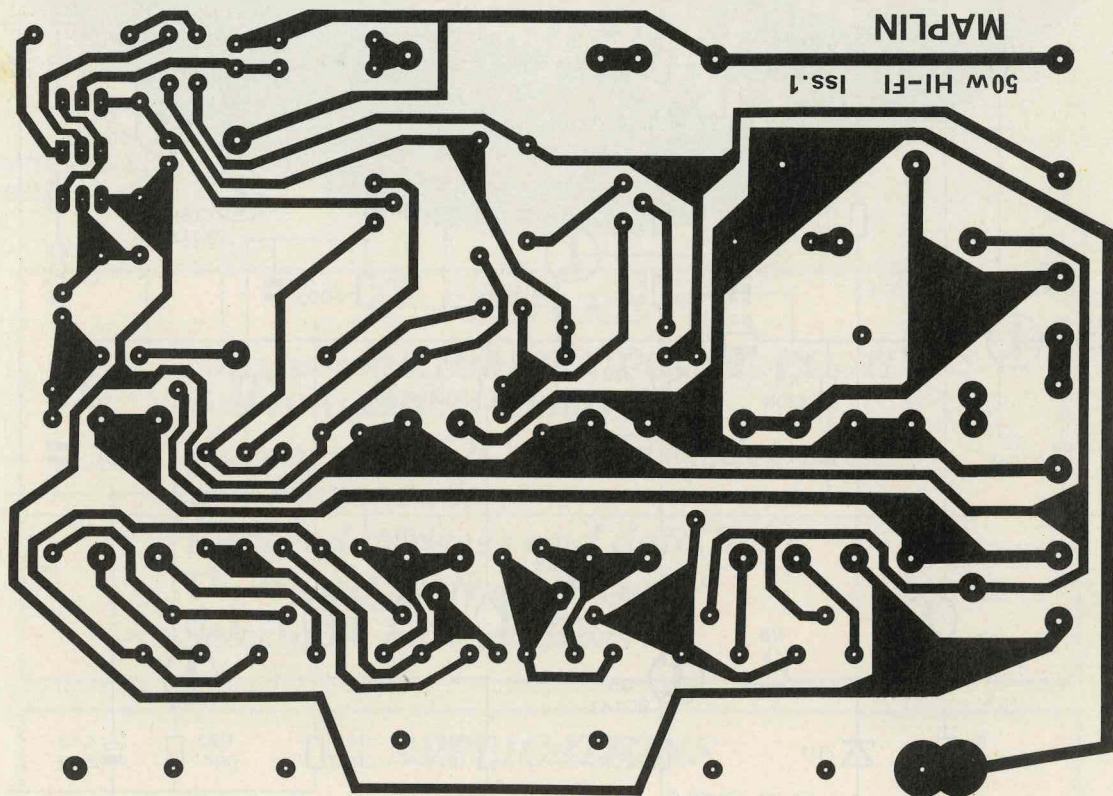
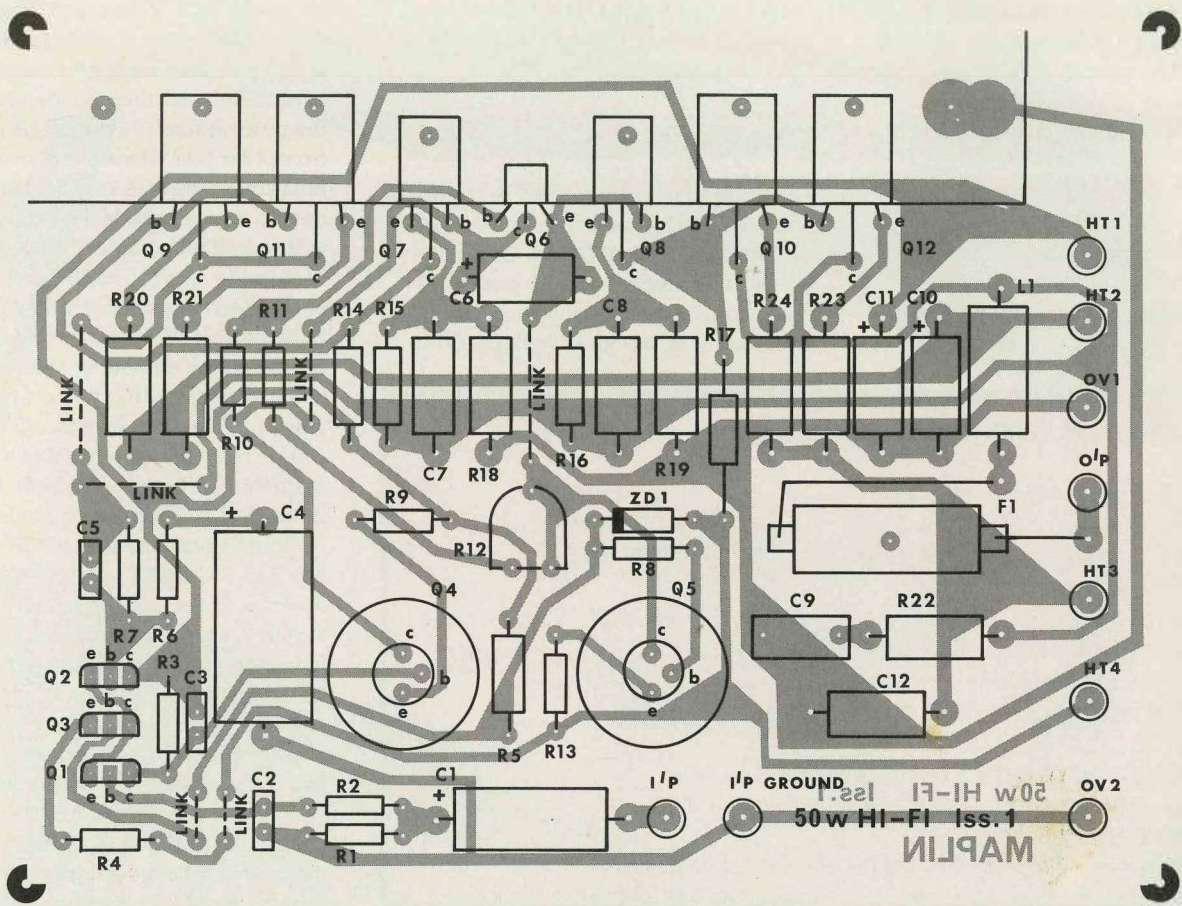

Figure 2. The PCB legend and track.

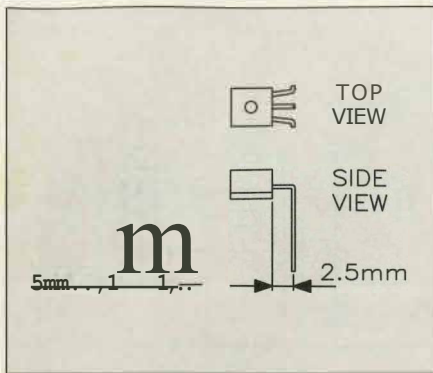

Figure 3. Forming QG leads.

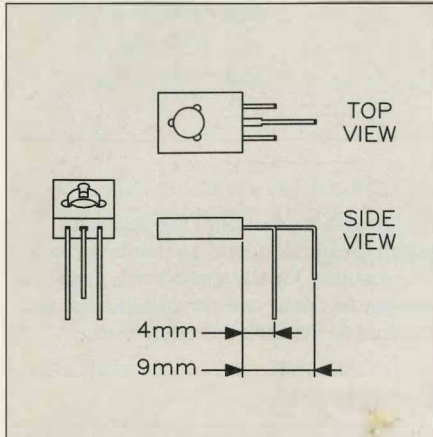

Figure 4. Forming Q7 and QB leads.

components. Now refer to Figure 4, and form the leads of 07 and 08 and fix each transistor using a 1/4in. 6BA bolt, nut and shakeproof washer. Each of these power output devices is fixed to the heatsink with an insulating kit for a T0126 package with a smear of heatsink compound on each side of the mica washer. Similarly, form the leads of 09 to 012, as shown in Figure 5, and fix in the same way as 07 and 08, but using an insulating kit for a T0220 package. Finally, fit the 20mm fuseholder onto the PCB with the 1/4in. 6BA bolt, nut and shakeproof washer. Using suitable lengths of insulated wire, connect one end of the fuseholder to F1, and the other end to the unmarked pin between O/P and Hr3.

Inspect the track side of the board for any shorts or dry joints, and check for any wrong connections, as time spent in checking now may save a lot of heartache later when testing.

Testing

Read all of the following setting up instructions before continuing with testing as this amplifier can generate a lot of heat, particularly around 04 to 012, so please check that the heatsink and the PCB are cool before touching them. When connecting to a suitable PSU, ensure that any exposed mains connections are insulated so that they cannot be accidentally touched while testing. Initially, do not make a connection to Hr2, and remove fuse, F1. Now connect a multimeter, that is set to read at least 5A DC, with the positive

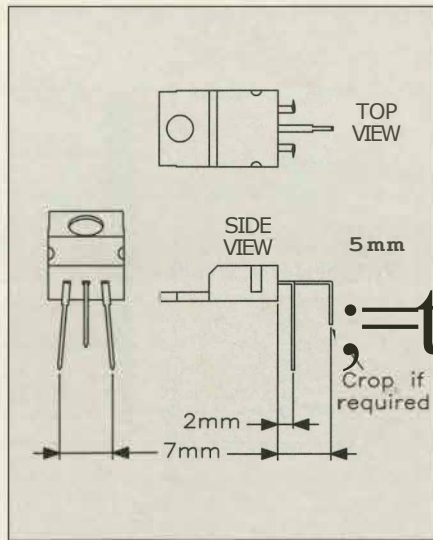

Figure 5. Forming Q9, Q10, Q11 and Q12 leads.

lead to Hr1 and the negative lead to Hr2 (on the amp). Set R12 fully clockwise and short the 1/P pin to 1/P Ground.

Connect the PSU to the mains and switch on - if the meter reading is excessive (>0.5A), turn off the power immediately and check the amp for short circuits, wrong connections etc.

If there are no problems, turn the meter down to a suitable range, and adjust preset R12 to give a quiescent current reading of 20mA ± 1mA. If 20mA cannot be achieved, disconnect the power supply from the mains, allow the reservoir capacitors to discharge, and change R11 for a 3k9Ω (supplied with the kit), then repeat this procedure. Allow the amp to warm up for 30 minutes and re-adjust preset R12 if necessary.

Switch off the PSU, disconnect the meter and connect Hr2. Replace fuse, F1 and connect a voltmeter between 0V(1) and the loudspeaker output (O/P). Switch on and check that the meter reads between +0.2V and -0.2V: If this DC offset voltage exceeds the limits, switch off and either swap 01 with 03 or 02 with 03, and repeat the voltage measure-

ment. When this part of the setup is okay, switch off, and disconnect the short circuit from the 1/P and 1/P Ground, and connect a suitable loudspeaker between O/P and 0V(1). Remember, the amplifier is capable of producing transient peaks of power in excess of 100W, anywhere in the audio frequency range from less than 20Hz to well over 20kHz, so the loudspeaker used should be capable of handling such peaks. Now switch on and apply an audio signal at a suitable level (see specification) to the input. Check that there is no audible distortion - the output sound should be clean and sharp, with dramatic musical crescendos handled effortlessly.

The completed amplifier(s) may be fitted into any suitable metal case, with a power supply, but note that the heatsink, as fitted, will not provide sufficient cooling on its own for full power operation. It is recommended that a heatsink, such as 2E (HO70M), is used for each amplifier. The best method of mounting is to 'sandwich' the rear of a housing between the two heatsinks, first smearing some heatsink compound on all mating surfaces, and securing the heatsinks with two 1/4in. No. 6 self-tapping screws.

Power Supplies - Recommended Circuits

A dual DC power supply is required for this project, capable of supplying 30-0-30V @ 2A. The mono supply is capable of powering a single 50W amplifier for mono use, while the stereo supply is designed to power 2 x 50W amplifiers. All parts are available from Maplin, but no kit is available for either PSU, and a PCB is not necessary. In general, the best way to construct either supply is by building directly into a metal case of suitable dimensions, keeping all lead lengths down to a minimum, and ensuring adequate ventilation.

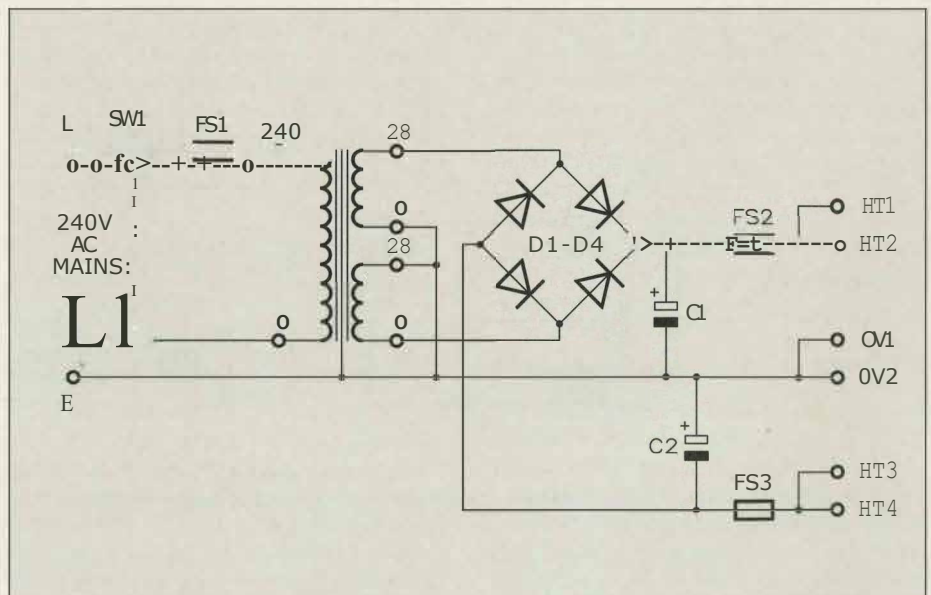

Figure 6. Circuit diagram of a mono PSU.

MONO PSU PARTS LIST

CAPACITORS

C1,C2 4700µF 63V Can Electrolytic 2 (FF27E)

SEMICONDUCTORS

D1,2,3,4 1N5402 4 (OL83E)

MISCELLANEOUS

T1 Transformer 28V 1.5A x 2 1 (WB17T)
 SW1 Red Neon Switch 1 (YR70M)
 FS1 Fuse 1 1/4in. 1A 2 (WR11M)
 FS2,3 Fuse 20mm 2A 2 (WR0SF)
 Fuseholder (FS1) 1 (FA39N)
 Fuseholder Boot 1 (FT3SO)
 Tie Wrap 102 1 (BF91Y)
 Fuseholder 20mm 2 (RX96E)
 Wire 3202 Black 1m (XR32K)
 Wire 3202 Red 1m (XR36P)
 Wire 3202 Green 1m (XR3SO)
 Miniature Mains cable 2m (XR01B)
 Strain Relief Grommet SR2 1 (LR48C)
 Push-on Receptacles 4 (HF10L)
 Push-on Receptacle Covers 4 (FE6SV)

STEREO PSU PARTS LIST

CAPACITORS

C1,2 10000µF 63V Can Electrolytic (See text) 2 (FF32K)
 or 22000µF S6V Can Electrolytic 2 (FA20W)

SEMICONDUCTORS

Rect 1 PW06 Bridge Rectifier 1 (WOSSN)

MISCELLANEOUS

T1 1S/22V Power Transformer 1 (LW34M)
 SW1 Red Neon Switch 1 (YR70M)
 FS1 Fuse 1 1/4in. 1A 1 (WR11M)
 FS2,3,4,S Fuse 20mm 2A 4 (WR0SF)
 Fuseholder 1 (FA39N)
 Fuseholder Boot 1 (FT3SO)
 Tie Wrap 102 1 (BF91Y)
 Fuseholder 20mm 4 (RX96E)
 Wire 3202 Black 2m (XR32K)
 Wire 3202 Red 2m (XR36P)
 Wire 3202 Green 2m (XR3SO)
 Miniature Mains cable 2m (XR01B)
 Strain Relief Grommet SR2 1 (LR48C)
 Push-on Receptacles 4 (HF10L)
 Push-on Receptacle Covers 4 (FE6SV)

The Maplin 'Get-You-Working' Service is not available for these projects
 The above items are not available as a kit.

SOW AMPLIFIER PARTS LIST

RESISTORS: All 0.6W 1% Metal Film (Unless specified)

R1 22k 1 (M22K)
 R2,4 22Q 2 (M2K2)
 R3,11 4k7 2 (M4K7)
 RS 18k 1 (M18K)
 R6 220Q 1 (M220R)
 R7 10k 1 (M10K)
 RB 1k 1 (M1K)
 RS 470Q 1 (M470R)
 RIO 8k2 1 (M8K2)
 RI2 2k2 Hor Encl Preset 1 (UH01B)
 RI3 820Q 1 (M820R)
 RI4,17 100Q 2 (M100R)
 RI5,16 120Q 2 (M120R)
 RI8,19 120QWW3W 2 *Kit Only*
 R20,21,22,23 R47QWW3W 4 *Kit Only*
 R22 10QWW3W 1 *Kit Only*

CAPACITORS

C1 10µF 63V Axial Electrolytic 1 (FB23A)
 C2,3 220pF Ceramic 2 (WX60O)
 C4 470µF 16V Axial Electrolytic 1 (FB72P)
 CS 100pF Ceramic 1 (WXS6L)
 C6 1µF 100V Axial Electrolytic 1 (FB12N)
 C7,8 1000pF Polystyrene 2 (BX3SO)
 CS 100nF Polyester 1 (BX76H)
 C10,11,12 2µF2 100V Axial Electrolytic 3 (FBISR)

SEMICONDUCTORS

O1,2,3 ZTX304 3 (OLS0E)
 O4 BC161 1 (OB49D)
 OS BC141 1 (OB38R)
 O6 BC182L 1 (OBSSK)
 O7 BD139 1 (OF07H)
 O8 BD140 1 (OF0BD)

O9,11 BD712 2 (WH16S)
 O10,12 BD711 2 (WHISR)
 ZD1 BZX:61C4V7 1 (OF4SY)

MISCELLANEOUS

FS1 20mm Chassis Fuseholder 1 (KC01B)
 Fuse 20mm 2A 1 (WR0SF)
 1k 1W Res 1 (CIK)
 3k9MinRes 1 (M3K9)
 PCB 1 (HO68Y)
 Heatsink 1 (HO69A)
 High Profile TOS Heatsink 2 (FL78K)
 Kit TO126 2 (WR26D)
 Kit (P) Plastic Power 4 (WR23A)
 Silicone Grease 1 Tube (HOOOA)
 Bolt 6BA x 1/2in. 1 Pkt (BF06G)
 Bolt 6BA x 1/4in. 1 Pkt (BF0SF)
 Nut 6BA 1 Pkt (BF18U)
 Shakeproof 6BA 1 Pkt (BF26D)
 Wire 3202 Red 1m (XR36P)
 Pin 2141 1 Pkt (FL21X)
 EC Wire 0.56mm 24SWG 1 Reel (BL28F)
 TC Wire 0.56mm 24SWG 1 Reel (BLISR)
 Instruction Leaflet 1 (XU21X)
 Constructors' Guide 1 (XH79L)

The Maplin 'Get-You-Working' Service is available for this project, see Constructors' Guide or current Maplin Catalogue for details.

The above items are available as a kit, which offers a saving over buying the parts separately.

Order As LW35Q (SOW .Amp Kit) Price £19.95.

Please Note: Where 'package' quantities are stated in the Parts List (e.g., packet, strip, reel, etc.), the exact quantity required to build the project will be supplied in the kit.

5. The First Computer Scientist: BABBAGE

by Greg Grant

Centenaries and other celebratory events, especially in such an arts-biased country as Britain, usually take the form of a concert, exhibition or some 'event' concerning the individual's work or the locality in which it was created. Last year, though, the celebration took a different form: the building of a machine - a quite extraordinary one. But then the man whom it celebrated was extraordinary too. He was Charles Babbage, the first computer scientist.

Born in Walworth, Surrey on Boxing Day 1791, the son of a wealthy banker, Babbage was a Fellow of the Royal Society at 24 and Cambridge's Lucasian Professor of Mathematics by the time he was 37.

Like Leibniz before him, Babbage had a polymathic mind. He was at once a prolific writer, inventor, mathematician, philosopher, scientist, mechanical engineer and industrial manager. He also had a magnificent obsession; mathematical *inaccuracy*, particularly in mathematical tables, of which he had one of the finest private collections.

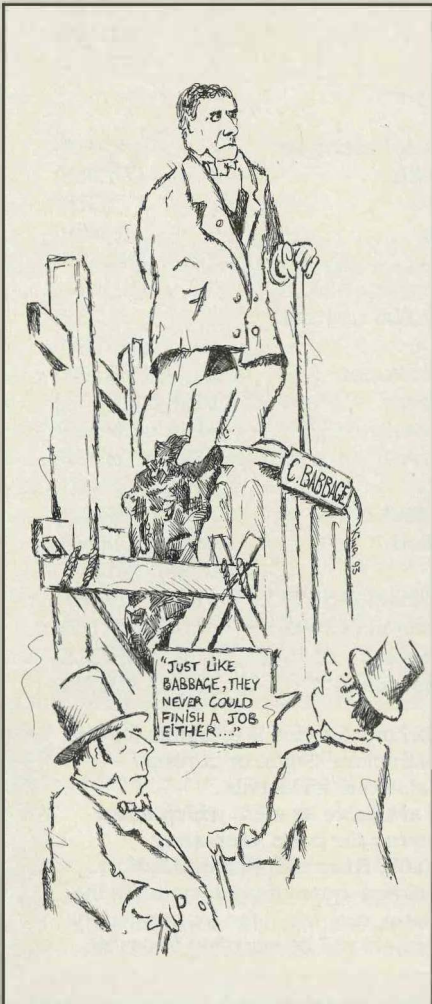

The History of Computers

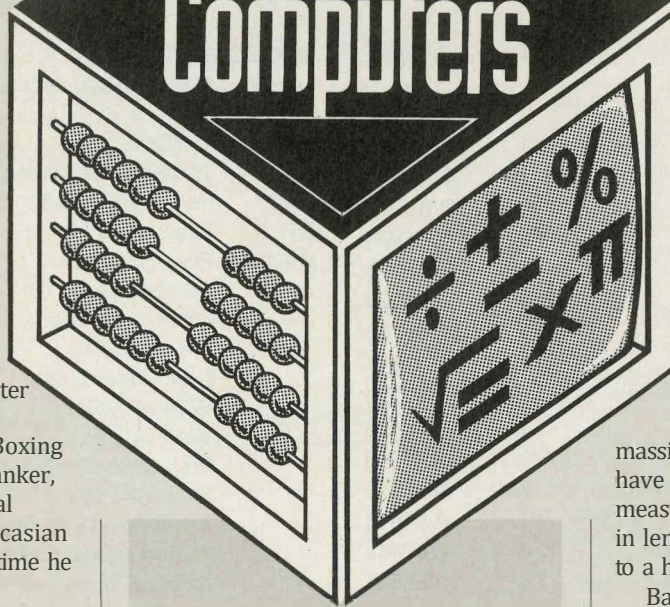

These inaccuracies affected almost every corner of national life. Babbage reckoned that the government of the day had lost some £3 million on annuities, thanks to table errors. More than this though, mistakes in navigational tables were even more disastrous. They meant the loss of ships and cargoes worldwide, in a period when seaborne commerce was the world's only bulk freighting method.

By 1821, Babbage had decided that inaccurate tables were the result of three things: Firstly; errors in the original calculations, secondly; transcription errors in the preparation for printing, and lastly; errors in typesetting and printing. All of these he concluded could be banished by mechanical calculation and greater care. This bold idea would occupy almost all of his energy and brainpower for the remainder of his long life.

The Difference Engine was Babbage's solution to table inaccuracy. The title comes from the method of operation, which was that of infinite difference. This had the advantage of eliminating the need for multiplication and division by simply reducing such processes to a succession of simple additions. Even more importantly, it makes any device based on it simpler to manufacture.

He began work on his creation

in 1824, after a period of intensive research into manufacturing techniques, workshop practice and mechanical draughtsmanship. He also evolved his own templates and jigs using toughened cardboard. Many examples of these pieces survive, and so comprehensive were his engineering-industrial investigations that he published them in book form in 1832.

The 'Engine' would have been massive had it been completed. It would have contained 25,000 parts and measured seven feet in length, three feet in width and risen to a height of eight feet.

Babbage was fortunate in his engineer-draughtsman Joseph Clements for he was also a skilled toolmaker, a trio of achievements which would be much in demand even now, but were most unusual in Babbage's day.

Eleven years of further design refinement, some manufacturing development and much frustration, came to an end when Babbage quarrelled with Clements, who had sought compensation for moving his workshop close to Babbage's house.

What, if anything, did Babbage have to show for more than a decade of intensive effort?

Only that part of the engine so familiar to us from the exhibit in the Science Museum, which, in turn, has been used as an illustration in countless books, essays and articles - except this one!

It has also become, as the Museum's Doron Swade put it, one of the most celebrated icons in the pre-history of computing. It amounts to one-seventh of the total machine, contains around 2,000 parts and is one of the greatest examples of precision engineering prior to computer-controlled manufacturing.

By 1834, the Difference Engine project had cost the British government almost £17,500.

This contrasted with the £784 it paid Robert Stephenson and Company for a steam locomotive. More to the point, Stephenson delivered and on time. Babbage did neither. Not surprisingly, the government decided that there were other, more deserving, ideas at which they could throw that kind of money!

By this time, though, Babbage was off again, fired by yet another concept for banishing inaccuracy. This was his Analytical Engine, perhaps the most demanding technical idea of the 19th

century. Although only a small portion of this leviathan was ever built, it subsequently became the foundation of Babbage's reputation as a computer pioneer. Was this reputation justified?

Yes, is the short answer to that. The Analytical Engine had been conceived as an automatic, universal machine, possessing most of the features that we associate with a present-day, general-purpose computer: it was programmable, had a central processor, a memory, and input and output devices. So why was it not completed?

Almost entirely because of its originator, who kept his brainchild under constant review and subsequent revision. Just before his death in 1871, Babbage had a visit from his fellow mathematician and Cambridge colleague John Moulton, who asked him how the Difference Engine was coming along.

His host replied that it was incomplete because he had hit upon the idea for the Analytical version. When Moulton asked if he could see this latest contraption, or even a part of it, the

answer was again 'No', and for the same reason. Babbage explained that, in the course of his work, he had thought of a different approach and so ceased working on the earlier model. As a consequence, nothing was even as much as partially completed. Moulton took his leave, saddened by the mercurial temperament that had promised so much yet delivered so little.

And this is why the only completed example of any of Babbage's machines you can see today is Difference Engine Number 2, built by engineers Barrie Holloway and Reg Crick at the Science Museum. Weighing over three tonnes and constructed from steel, cast iron and bronze, its 4,000 parts give it seven orders of difference. It was designed to calculate to 30 - yes, that is correct, three-zero - figures. Although Babbage may be regarded as the last of the mechanical calculator developers and therefore something of a dead-end, he must also be regarded as the first computer scientist. You see, he was the first to realise that what such devices

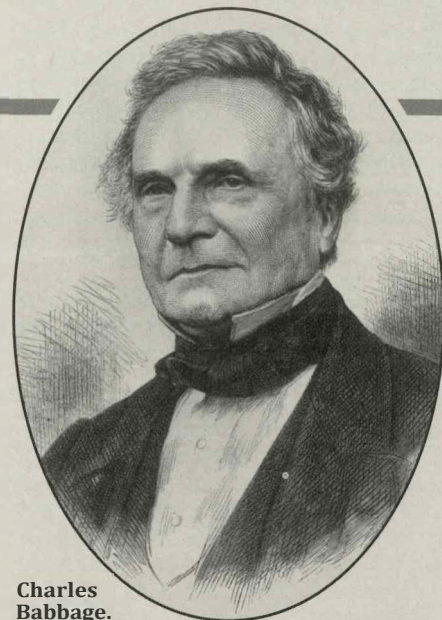

Charles Babbage.

really needed was power: he'd envisaged using steam, at that time *the* power source.

Time and technical developments would prove him wrong, of course, but only in the type of power.

Earlier, we saw how Leibniz took an interest in binary notation. Next month, we will look at the careers of the men who developed the mathematical foundations for the computer industry that we know today.

WANID

CIRCUIT DIAGRAM for a Telequipment Dual Trace D43 Oscilloscope. Tel: (0243) 786430.

FERGUSON MODEL 3T25 mini Hi-Fi radio cassette. Almost any condition (even non-working) for parts - in particular, the cabinet. Could take in exchange for Technics S17200 integrated amp in fill working condition. Prepared to travel within reasonable distance from London. Tel: (081) 346 1212.

WANTED BY ENTHUSIASTS: all components, spares, dead/unwanted items etc. (All reasonable costs met.) Contact: Mike, 1b, 12-13 Highland Gardens, St Leonards-on-Sea, East Sussex TN38 0HT. Tel: (0424) 433884 / (0831) 307973.

DOES ANYONE have any information (operations manual, service manual, circuit diagram) for a Qume Laser Ten Plus printer? Any help gratefully received and suitably rewarded. Tel: Peter Heaps, (0753) 885403.

PC MOTHERBOARDS, ETC. Need not be working. Will pay. Tel: (0268) 524968.

OSCILLOSCOPES, Frequency Generators/Synthesizers wanted, dead or alive. I will collect for free. Tel: (0443) 684228 evenings.

'BACK-UP' BOARD FOR HITACm VT-17E VCR. Must be in working order, and of reasonable cost. Contact: Webster, 37 Eermans Place, Elgin, Moray IV30 2PA. Tel: (0343) 550932.

MES 53 ORGAN CIRCUIT BOARDS WANTED. Cash available. Tel: A Barham. (071) 232 1538 (work), (081) 989 7513 (home).

T199/4A COMPUTER for spares. Also tube for Rigonda Sin. TV. Both must be cheap. Contact: Duncan Boyd, 658 West Main Street, Blackburn, West Lothian. Scotland EH47 7L1. Tel: (0506) 56429.

TWO TUNING METERS - MAPLIN ORDER CODE LB79L, now discontinued. Does anybody have any spare ones they no longer require, and wish to sell? Contact: Mr. P. Male, 17 Chestnut Close, Drake's Broughton, Pershore WR10 2BP.

CIRCUIT DIAGRAM FOR BT 'FREEWAY' CORDLESS PHONE. Also, for sale: VT-100 type terminal, £10; two 12in. woofers, £10 each. Mike Pomeroy, 90 Binningham Road, Lichfield, Staffs.

ETI VO CODER main circuit board PCB layout, original or photocopy. Contact: Hallvard Tanageras, Fjellhaug, room 2305, Sinsenveien 15, 0572 Oslo, Norway.

VALVE AUDIO PREAMPLIFIERS, preferably Leak. Tel: (0702) 202556.

COMPUTERS

20MB OF SHAREWARE and PD software for the IBM PC on 3.5in. disks. £10 (incl. P&P). Electronic circuit drawing program for

CLASSIFIED

Placing an advertisement in this section of 'Electronics' is your chance to tell the readers of Britain's Best Selling Electronics Magazine what you want to buy or sell, or tell them about your child's activities - Absolutely Free of Charge! We will publish as many advertisements as we have space for. To give a fair share of the limited space, we will print 30 words free, and thereafter the charge is 10p per word.

Placing an advertisement is easy! Simply write your advertisement clearly, in capital letters, on a post-card or sealed-down envelope. Then send it, with any necessary payment to: Classifieds 'Electronics - The Maplin Magazine',

P.O. Box 3, Rayleigh, Essex SS6 5LR. Advertisements will be published as soon as possible, space allowing. No responsibility is accepted for delayed publication or non-inclusion of advertisements.

Private individuals only are permitted to advertise in this section; commercial or trade advertising of any kind is strictly prohibited by law. Advertisements are only accepted by the Publisher on this proviso. Readers who have reasonable grounds to believe that they have been misled as to the nature of an advertisement are advised to contact the Publisher and their local Trading Standards Office.

the IBM PC, including source code in PASCAL. £5 (incl. P&P). Software written to your specifications at very reasonable prices. Contact: David Hargreaves, 51 Retreat Road, Topsham, Exeter EX3 0LF.

BBC MODEL B. Faults repair guide, circuit diagram, data, etc. £3 plus S.A.E. (A4 size). Contact: J. McMahon, 38 Honister Avenue, High West Jesmond, Newcastle NE2 3PA.

T O JILL 6502 PROGRAMMERS. Write fast, efficient and compact M/C programs easily using my Assembly Generating Compiler. Its own expandable language implements loop structures, conditional tests, string handling, I/O, integer maths, etc. in 65XX machine code. Original package runs on C64; IBM PC version also available to help program 6502 microcontroller cards, etc. or other machines. Compiler and assembler source listings can be made available if required. Expandable routine library. C64 disk has lots of demos, PC disk has lots of extra utilities. Send largish, e.g., CS S.A.E. for more details to level 3 Aurora, Church Road, Laindon, Basildon, Essex, SS15 5SL.

VARIOUS

TOPWARD (7021) OSCILLOSCOPE. 20MHz, 3-channel, immaculate condition, hardly used. Includes manual and Ix 10 probe. Still in original box. £200. Tel: (0787) 373092 (Sudbury, Suffolk) after 5.30pm.

THREE LCD 11PH11NUMERIC D0T MATRIX DISPLAYS. 4 lines x 20 characters. New and unused with full data sheet. £75. Tel: Graham, (0243) 378517 (Emsworth, Hants).

HEWLETT-PACKARD 1740A OSCILLOSCOPE. 100MHz, probes, manual. £525 o.v.n.o. Tel: (0568) 612456.

PAIR OF TRC-1008 CBS. Small enough to fit in your pocket. Retractable aerial. Still boxed and in excellent condition. Bargain at £25. Call (0823) 666291 (Wellington, Somerset) evenings only.

REVOX A77 1/2 track two-speed (9.5, 19cm/s) semi-professional stereo analogue tape recorder. Excellent condition (PRIVATELY OWNED!). Supplied with quantity of Ampex 456 professional-quality (mastering) tapes, £200. Who needs digital? Tel: Martin, (0702) 603557 (Southend-on-Sea, Essex) evenings.

HITACm V-550B 50MHz OSCILLOSCOPE, £350. Tequipment D75 50MHz oscilloscope, £250. Thandar SC II OA 10MHz battery portable oscilloscope with mains unit and carry case, £150. 46 Ridingfold Lane, Worsley, Manchester. Tel: (061) 793 4936.

NEW COMPONENTS, CLEARING WORKSHOP - NEED MORE SPACE! Assorted resistors, capacitors, diodes, ICs, etc. £10 per bag inclusive of postage and packing. Mr. D. J. Brown, 2 Glenworth Avenue, Whitmore Park, Coventry, West Midlands CV6 2HW.

TWO PHILIPS CD104 CD PLAYERS. Both have slight intermittent faults - phone for details. Prices £35 and £50, offers considered. Tel: (081) 868 2454.

WORKSHOP CLEAROUT OF ELECTRONIC COMPONENTS. Send for list, enclosing two 1st class stamps and a S.A.E. No callers please. Mr. M. Wright,

2 Duncans Road, Lishum, Co. Antrim BT28 3EP.

JOHN LINSLEY-HOOD STEREO TUNER. Professionally-built. Full Hart kit plus many extra features including FM and push-button varicap tuning. £150. For details, send S.A.E. to: Gates, 97 Craven Road, Newbury, Berks. RG14 5NL.

RADIO MODEM. This packet radio controller sits between your IBM PC and your radio. Manuals, leads and software included. Sale due to sale of radio, £155. Tel: Simon Hart (0380) 721422.

GRAFMIC EQUALISER, 5-band twin-channel with preamp £20. Remote control mains appliance switch and handset £16. Tel: (0502) 566026 (Lowestoft, Suffolk).

GILLNET CLE. !IR-OUT! Long list of unused components including ICs, capacitors, resistors, some in large quantities. All at bargain prices. Send S.A.E. for list to: M. J. Dean, 'Elenheim', Walton Lane, Bosham, Chichester, West Sussex PO15 8QF.

CLUB CORNER

CRYSTAL PALACE & DISTRICT RADIO CLUB. Meets on the third Saturday of each month at All Saints Church Parish Rooms, Beulah Hill, London SE19. Details from Wilf Taylor, G3DSC. Tel: (081) 699 5732.

ELECTRONIC ORGAN CONSTRUCTORS SOCIETY. For details of meetings Tel: (081) 902 3390 or write 87 Oakington Manor Drive, Wembley, Middlesex, HA9 6LX.

WIRRAL AND DISTRICT AMATEUR RADIO CLUB meets at the Irby Cricket Club, Irby, Wirral. Organises visits, D.F. Hunts, demonstrations and Junk Sales. For further details, contact Paul Robinson (G0JZP) or Tel: (051) 648 5892.

TESUG (The European Satellite User Group) for all satellite TV enthusiasts! Totally independent. TESUG provides the most up-to-date news available (through its monthly 'Footprint' newsletter, and a teletext service on the pan-European 'Super Channel'). It also provides a wide variety of help and information for its members. For further information, contact: Eric W. Wiltsher, TESUG, Rio House, Stalford Close, Ashford, Kent, TN23 2TH, England.

THE BRITISH AMATEUR ELECTRONICS CLUB (founded in 1966), for all interested in electronics. Four newsletters a year, help for members and more! UK subscription £8 a year. Overseas members £4, overseas members (£13.50). For further details send S.A.E. to: The Secretary, Mr. J. S. Hind, 7 Carlyle Road, West Brixford, Nottingham, NG2 7NS.

MODEL BUILDING ENTHUSIASTS? How about joining 'MERG', the Model Electronic Railway Group. For more details contact: Mr Eric Turner, Treasurer MERG, 38 North Drive, Orpington, Kent, BR6 9PQ.

It was the invention of the valve and its subsequent development that ushered in the age of electronics. It reigned supreme, for the first half of this century and into the beginning of the second until gradually, at first and then quite rapidly, it was elbowed out by the transistor (the discrete form of this was, in turn, largely displaced by the advent of more and more complex integrated circuits).

Virtually every practical application of electronics bowed to the might of the silicon devices. To the average person 'in-the-street', the impact was felt in the influence of modern electronics on the performance and physical appearance of domestic items, such as 1V receivers, radios and Hi-Fi systems, the viability of compact video equipment, in fact the whole way of modern life. Hence, in view of the obvious advantages of solid state electronics - small size, long life and reliability, economy of operation and so on - it is perhaps surprising that, in recent years, there has been a resurgence of interest in valves.

This is especially true with regard to their use in Hi-Fi amplifiers, where aficionados claim that they give a better sound than their 'silicon sisters', particularly under overload conditions, and there is more to this than mere Hi-Fi snobbery. It is fair to say though that the current generation of young electronics enthusiasts, amateur or otherwise, having completely missed out on the valve age, might make the mistake of dismissing valves as 'extinct dinosaurs'. Perhaps they might at least like to gain some understanding of the basic principles of the devices themselves and the circuits in which they can be used, even to the extent of wiring them up and having a go (and you can get quite hooked on these fascinating and quaint gadgets). Who knows - you might even find an application where a valve works better

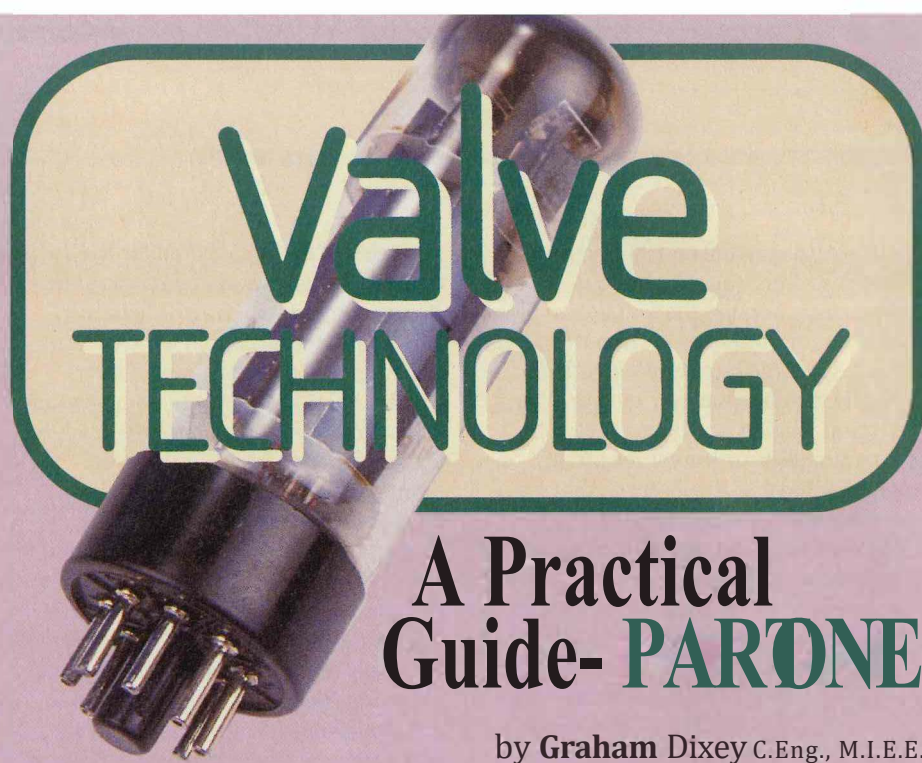

A Practical Guide- PARONE

by Graham Dixey C.Eng., M.I.E.E.

than anything else that you have tried! The aim of this series is to satisfy the curiosity of such readers in a way which, it is hoped, will be both informative and entertaining.

A Little History

The history of the thermionic valve begins in 1883. Thomas Edison, while experimenting with electric lamps, discovered that a current can be made to flow in a vacuum, from the hot filament to a positively charged metal plate also within the bulb. Later, a Professor Fleming investigated this effect further

and noticed that, when an alternating voltage was applied between the filament and the metal plate, current only flowed on alternate half-cycles - in other words, *rectification* was taking place. He took out a patent for this in 1904. Shortly afterwards, a Doctor Lee de Forest found that, by interposing a wire grid between the filament and the plate, the current flow could be *controlled*. These two devices were known, respectively, as the diode and the triode, and between them they ushered in the branch of the physical sciences that today we call 'electronics'.

A collection of old valves and various publications relating to the valve era.



Electron Emission

But how is it that electrons can be made to move through a vacuum? It begins with the *emission* of electrons from a material, which occurs when the electrons have gained sufficient energy to escape from the forces binding them to the material. There are several ways in which this can happen, as follows:

1. Thermionic emission
2. Photo-emission
3. Secondary emission
4. Field emission

Of these it is the first, thermionic emission, that is of primary interest in understanding how valves work.

Thermionic Emission

Conduction within a conducting material consists of the movement of electrons. Electrons are only available for

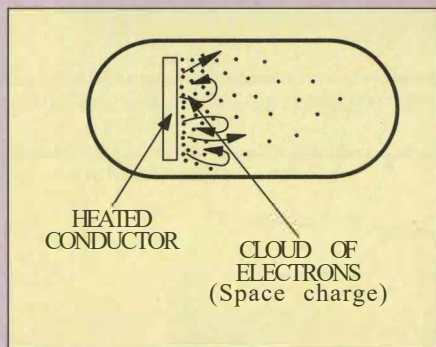
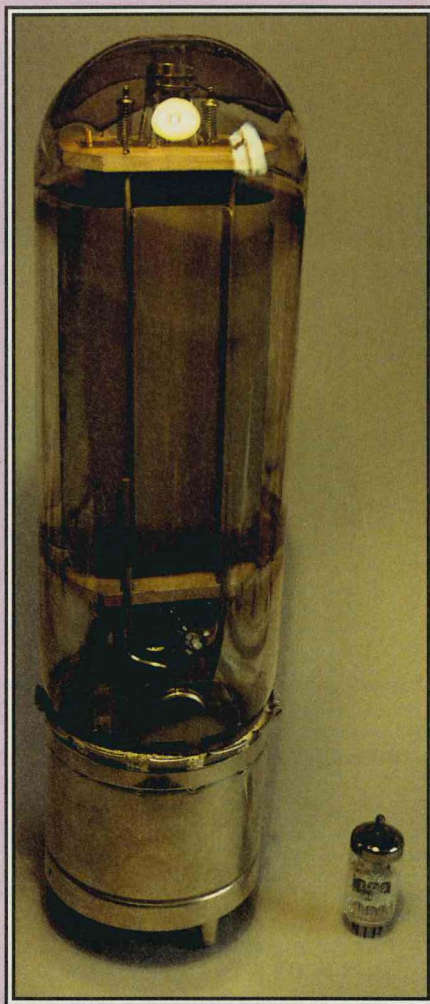

Figure 1. The space charge around a heated conductor; electrons are continually emitted from and return to the conductor's surface.



little and large; valves come in all shapes and sizes!

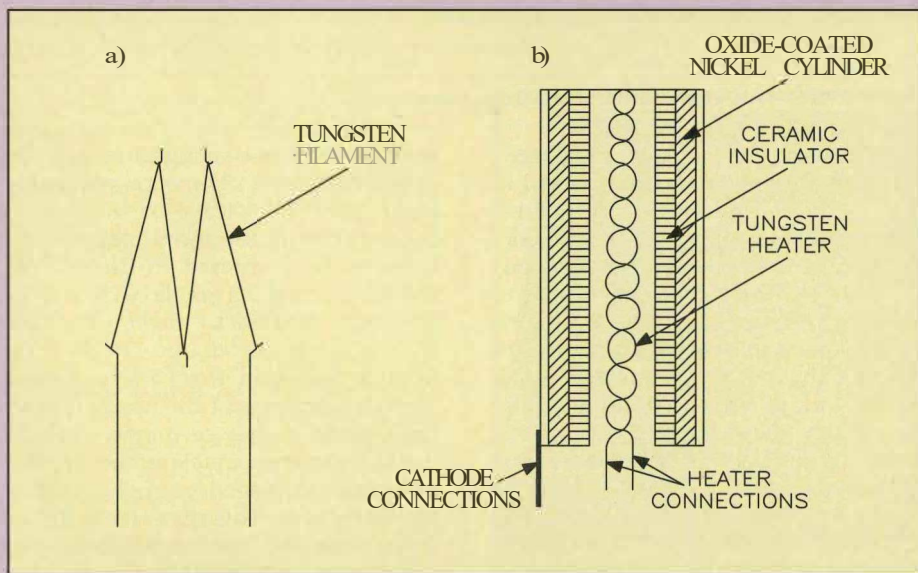

Figure 2. Construction of (a) directly heated filament and (b) indirectly heated cathode.

Material	Caesium	Copper	Mercury	Tungsten	Platinum
Work Function (eV)	1.75	4.2	4.2	4.5	6-15

Table 1. Work function for various materials.

conduction when they acquire sufficient energy to leave the parent atoms. In good conductors the amount of energy required for conduction is relatively small. If the amount of energy applied to the conductor is raised to a sufficiently high level, some electrons do more than leave their parent atoms;

they leave the surface of the material itself. What is a likely source of this energy? The answer is heat. This can be generated relatively easily for this purpose, as will be seen. When the electrons leave the conductor, several events can or will occur.

(a) Since the conductor has lost elec-

trons, it becomes positively charged; there must, therefore, be a force of attraction between the escaped electrons and the conductor itself. It is possible to anticipate from this that the electrons will be attracted back towards the conductor. This is a very important point.

(b) Electrons which have already escaped from the conductor form a negative 'space charge' which tends to repel any further electrons that try to leave the conductor.

(c) If the heated conductor is surrounded by a gas or even just air, any electrons emitted are only able to travel a very short distance before a collision with a gas molecule takes place. This slows down the electron and deflects it from its original path. Such an action is normally undesirable in valves. For this reason, the valve 'envelope' (the glass tube or container itself) is evacuated by pumping during manufacture.

Paragraphs (a) and (b) lead to the following behaviour:

Electrons are emitted from the conductor's surface at a rate dependent upon the temperature of the conductor. Once they have been emitted they experience a force of attraction drawing them back to the conductor. They will eventually return there but, since emission is a continuous process, more electrons will leave the conductor to take their place. Thus, at any time, there will be a more or less constant cloud of electrons adjacent to the conductor's surface. This cloud is termed the 'space charge' (as mentioned earlier), and the effect is illustrated in Figure 1.

The ease with which an electron may escape from a material is expressed in terms of what is called the 'work function' of the material. This is the energy, measured in electron-volts (eV), that an electron must possess before it is able to escape from that material. For the record: $1\text{eV} = 1.6 \times 10^{-19}$ Joules. Values of the work function for various materials are given in Table 1.

Generally, those materials with low values of the work function would have melted by the time that they had attained the temperature at which significant emission had occurred. But one material that does not do so is tungsten. This gives good emission at 2,300 to 2,500°C, and melts at 3,380°C. However, a valve with a pure tungsten emitter would glow rather like an incandescent lamp. This was characteristic of early valves, but modern valves have been developed in which the tungsten surface has been coated with an oxide, such as that of barium or strontium, that allows efficient emission of electrons at much lower temperatures, a mere 700°C.

Construction of Filaments and Cathodes

The emitting conductor is heated electrically, as one would suspect, by passing a current through a filament of wire.

This filament may either emit the electrons directly (in which case the device is known as a directly heated valve) or it may be placed inside a tubular 'cathode' which emits the electrons (in which case we talk about indirectly heated valves). The two types are illustrated in Figure 2. The directly heated type was employed for small battery powered valves, as in portable 1940's wireless sets for instance, the filament current being DC. The indirectly heated cathode is the standard type for mains powered valves, where the supply is AC, usually 6-3V or 12-6V, except in 1V practice where a variety of heater voltages is possible. From the fact that the heater current required for even small signal valves is about 300mA for 6-3V operation and 150mA for 12-6V operation, it is obvious that the heater alone dissipates almost 2W of power! Since the heater is the most likely point of failure in a valve (having an average life of about 2,000 to 3,000 hours), it is then also obvious why the transistor, which requires no heater power, is a more efficient and reliable device.

The Diode Valve

The diode valve is so called because it has just two electrodes - the cathode and the anode (see Figure 3). Toes correspond to the two electrodes of the original diode valve mentioned above, the cathode being the electrode that is heated and emits electrons, and the anode being the electrode that collects the electrons (notice also that these terms have passed forward into semiconductor phraseology - cathode, anode, emitter, collector!).

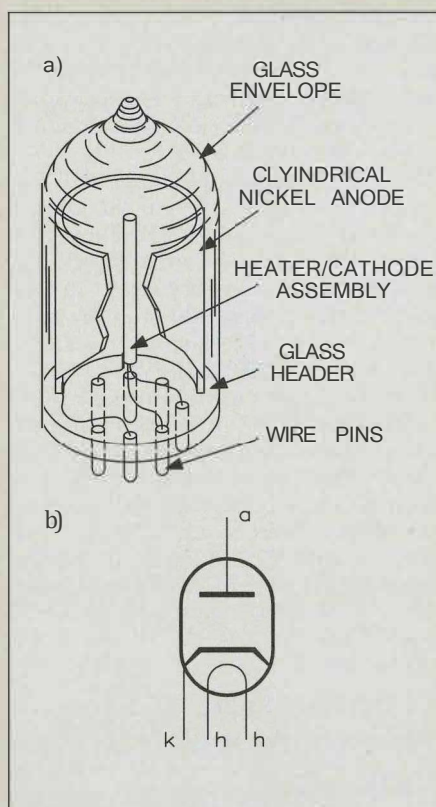

Figure 3. (a) Construction of a modern diode valve (indirectly heated type), (b) circuit symbol for a diode valve.

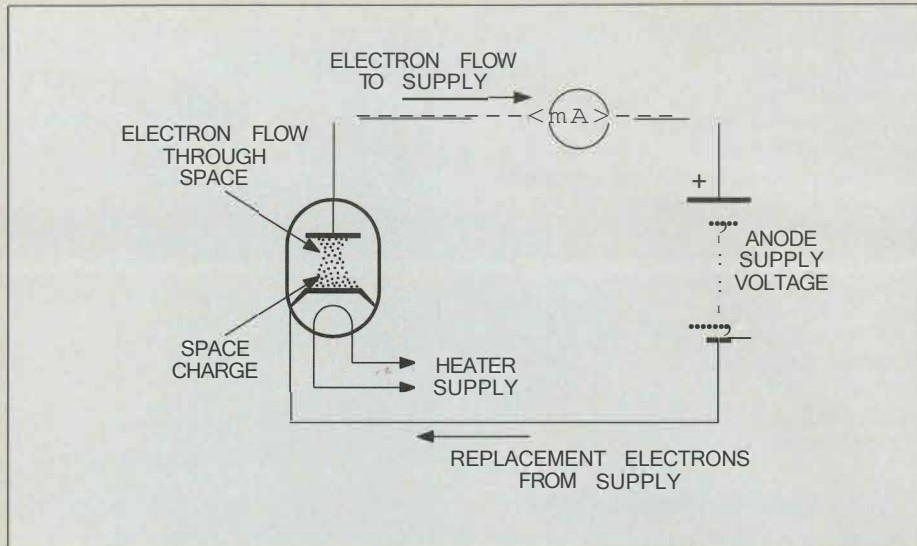

Figure 4. The flow of current in a diode valve.

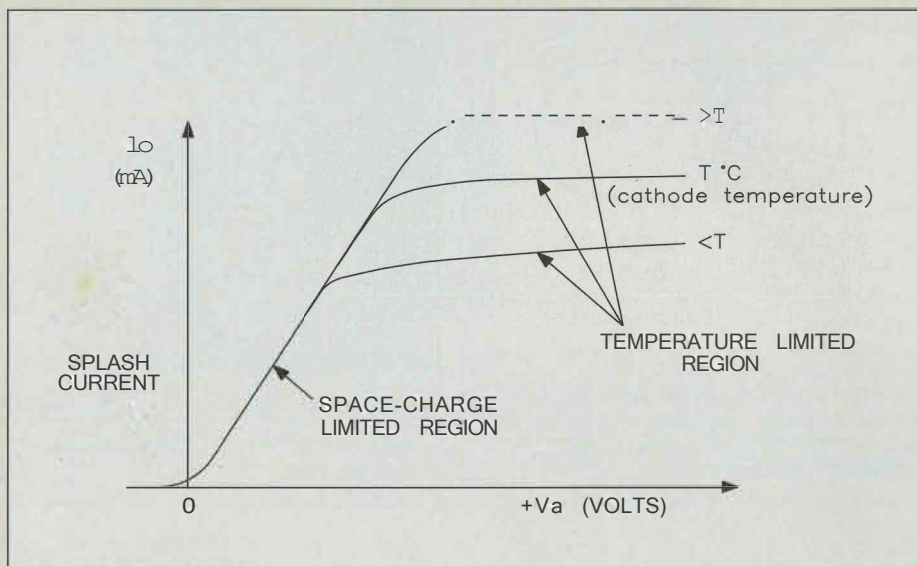

Figure 5. The static characteristics of a diode valve.

Since electrons are negative charged particles, they will only be attracted to the anode if this is given a positive potential with respect to the cathode. This explains why the valve only conducts in one direction, from cathode to anode, and not vice versa. It also explains the choice of the word 'valve' to describe the device, since a valve is, by definition, a one-way device. The Americans, however, never cottoned on to this terminology and always referred to them as 'vacuum tubes'.

The magnitude of the current flowing in a diode depends upon the number of electrons emitted and the magnitude of the voltage applied to the anode (known as the anode voltage V_a). The amount of electron emission depends upon the temperature of the cathode, which is fixed by the voltage supply to the heater, this being a constant value. The only true variable is, therefore, the anode voltage. The action of the latter in controlling the anode current can be explained as follows.

As we now know from the foregoing, the cathode is normally surrounded by a cloud of electrons known as the space charge. With zero anode voltage there is no current flow, and there is a state of equilibrium between the electrons being

emitted and those falling back onto the cathode's surface. The application of a small positive voltage to the anode causes some of the space charge electrons to be attracted to the anode, resulting in a small anode current flow. The gaps created by these electrons leaving the space charge are filled by further emission from the cathode. Electrons arriving at the anode flow to the positive supply terminal, while at the same time an *equal* number of electrons leave the negative supply terminal for the cathode. This gives rise to a continuous current flow around the circuit, which may be detected by an ammeter placed in, say, the anode lead. Figure 4 shows an illustration of this.

Diode Static Characteristics

We now start getting into the ways in which specifications for thermionic devices are presented. For the diode, these illustrate clearly the dependence of anode current upon anode voltage. Three curves have been drawn in Figure 5 for different values of cathode temperature, although in practice, as explained earlier, the cathode is held at a constant temperature.

It is interesting to note that:

(a) The current is not exactly zero when the anode voltage is zero, but has a value I_{a0} of a few microamperes. This is known as the 'splash current' and is the result of a few high energy electrons that manage to cross the interelectrode gap even without an attracting potential.

(b) In the space-charge limited region, the characteristic is nearly linear (actually following the 'three-halves' power law: $I_a \propto V_a^{3/2}$).

(c) In the temperature limited region there is little change in I_a even though there are large changes in V_a . This is because the anode is collecting electrons at the same rate as they are being emitted by the cathode.

(d) No significant current flows when the anode is negative with respect to the cathode.

The Anode Slope Resistance r_a

It is worth introducing this parameter at this time since it is one that we shall make use of later in discussing the performance of more complex valves. It is defined as shown in Figure 6, and is the value of resistance obtained by dividing a small change in anode voltage by the corresponding change in anode current. It is therefore the *reciprocal* of the slope of the static characteristic, and varies with the operating point, although fairly constant over much of the space charge limited region. This is a real value of resistance, since it represents the opposition of the valve to alternating quantities.

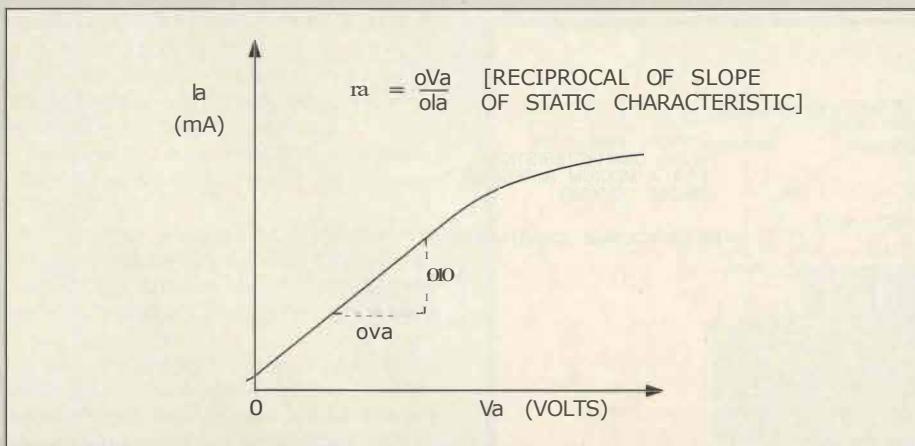

Figure 6. Defining anode slope resistance for a diode valve.

Series Circuit Operation

It is usual to operate a diode valve, which is clearly a non-linear device, in series with a resistive load, the latter being a linear device. It is possible to predict how the voltages and current in the circuit will vary by using a graphical construction. Figure 7(a) shows such a construction, while Figure 7(b) shows the diode in series with its load and defines the voltages and currents in question. A 'load line' of slope $-1/R$ is

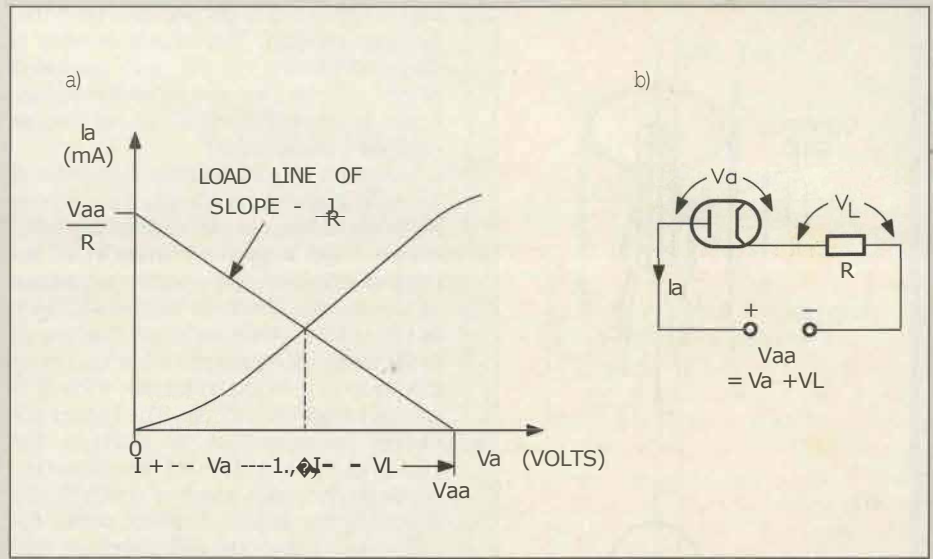

Figure 7. (a) The load line for a diode valve, (b) the diode in series with a linear resistive load.

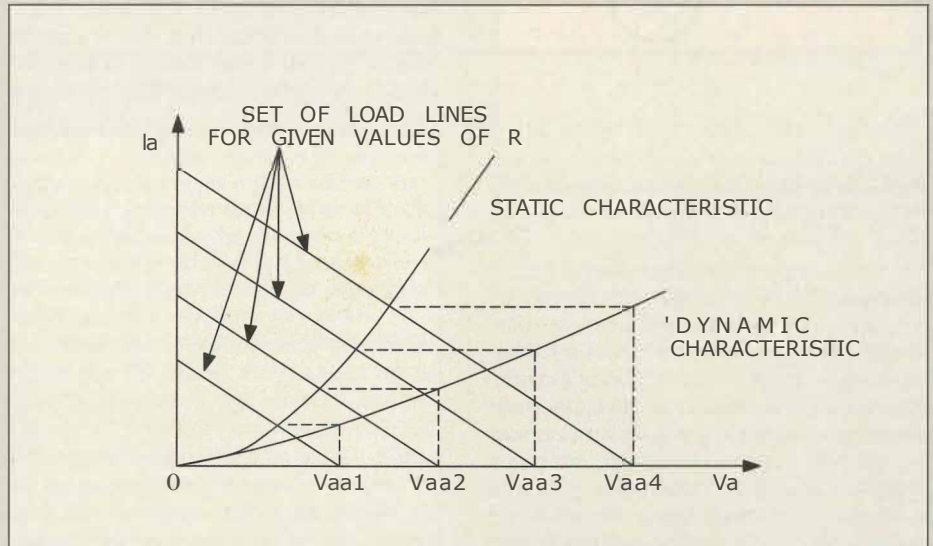

Figure 8. Obtaining the dynamic characteristics for a diode valve and its load.

voltage across the diode) and V_L (the voltage across the load).

The Dynamic Characteristic

By taking a number of different values of supply voltage V_{aa} (as would happen if the supply was alternating, for example), and assuming a constant value for the load R_L then, by drawing a separate load line for each value of supply voltage, the dynamic characteristic can be obtained, as shown in Figure 8. The points on the dynamic characteristic are obtained by projecting, horizontally, the intersection of a load line and the static characteristic until it in turn intersects a vertical line drawn from a supply voltage value. Since the dynamic characteristic is drawn for a range of values of the supply voltage, this implies that the latter is varying, in other words it is an alternating supply rather than DC, as is the case in rectification.

The Triode Valve

The diode valve is essentially a rectifier, turning AC into DC, whether these be large mains voltages or relatively small signal voltages, as in the detection of modulated radio signals, for example.

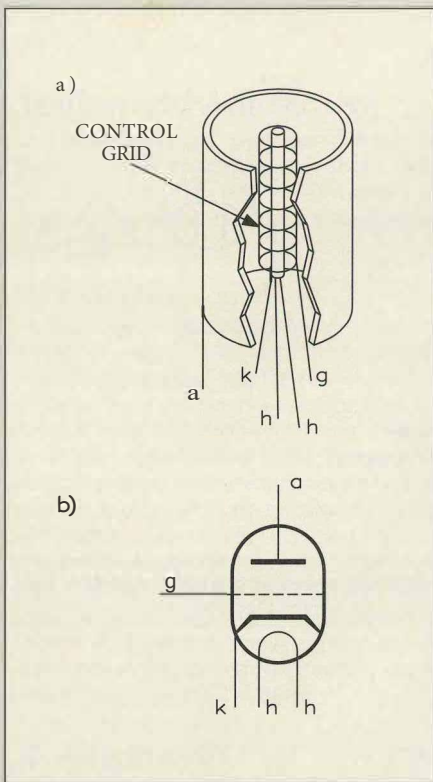

Figure 9. (a) Construction of a triode valve, (b) circuit symbol for a triode valve.

True, it can perform other useful functions as well, but one thing it cannot do is amplify a signal. For this we need to develop the basic device further. We mentioned earlier Lee de Forest's work with a diode, in which he had inserted a wire grid between cathode and anode in order to control the anode current. This was the first triode valve - triode obviously meaning 'three electrodes', although he actually called it an 'audion'. The construction of a modern triode is shown in Figure 9(a), together with its circuit symbol, Figure 9(b).

Based on what we have already seen for the diode, it has an indirectly heated cathode and an outer anode electrode. The third electrode is known as the control grid. It is quite open in form, so that there are relatively vast areas for the electrons to pass through on their way to the anode. It is, quite literally, in the vast majority of cases, no more than a single spiral of wire. In use, the control grid is taken to a potential that is negative with respect to that of the cathode. As a result, there is a *negative* potential gradient between the cathode and the control grid (tending to *repel* electrons), and a *positive* potential gradient from grid to anode, so that electrons that do get through the grid are accelerated to the anode where they are collected.

If the negative potential of the control grid is fairly small, then most electrons emitted by the cathode have sufficient energy to counter the repelling force of the grid and make it to the anode; a small percentage are turned back to the cathode so that, overall, the anode current is actually reduced in value by the presence of the grid. The more negative the grid is made then the more influence it is able to exert on the electrons which are attempting to reach the anode. Eventually, it will be able to turn back

all electrons when its negative potential is large enough. The anode current is then said to be 'cut off', and the value of grid voltage that just causes this condition is termed the 'grid cut-off voltage' - all very reasonable!

Another way to picture this effect is to see the electrons leaving the cathode as being subject to two conflicting influences - the negative repulsion of the control grid and the positive attraction of the anode. Because the control grid is very close to the cathode (the anode is far away by comparison), it can exercise quite a strong influence with only a small negative voltage. The higher the energy possessed by an electron, the more chance it has of accelerating through the open wires of the grid and reaching the anode. At some point, the influence of the grid will outweigh that of the anode, no matter what the energy level of the electrons, and the current flow will stop entirely. It's worth mentioning at this point that this is exactly how a typical Field Effect Transistor works, and which came into existence

out of the need for a semiconductor which could do the sort of jobs that the old valves used to do!

The Triode Mutual Characteristics

The behaviour described above can be understood also from the *mutual characteristics*, which are graph plots of anode current versus grid voltage for different values of anode voltage. A set of these is shown in Figure 10, the anode voltages being chosen at 50, 100, 150 and 200V. These are actual examples for the CV455 (ECC81) double-triode valve.

Note that the higher the anode voltage, the *larger* the negative grid voltage has to be in order to produce a given anode current or to cut the valve off completely. For example, if the grid voltage, V_g , is 0V then the anode current is 4mA for an anode voltage of 50V, but is 22mA when the anode voltage is increased to 200V. Also, when the

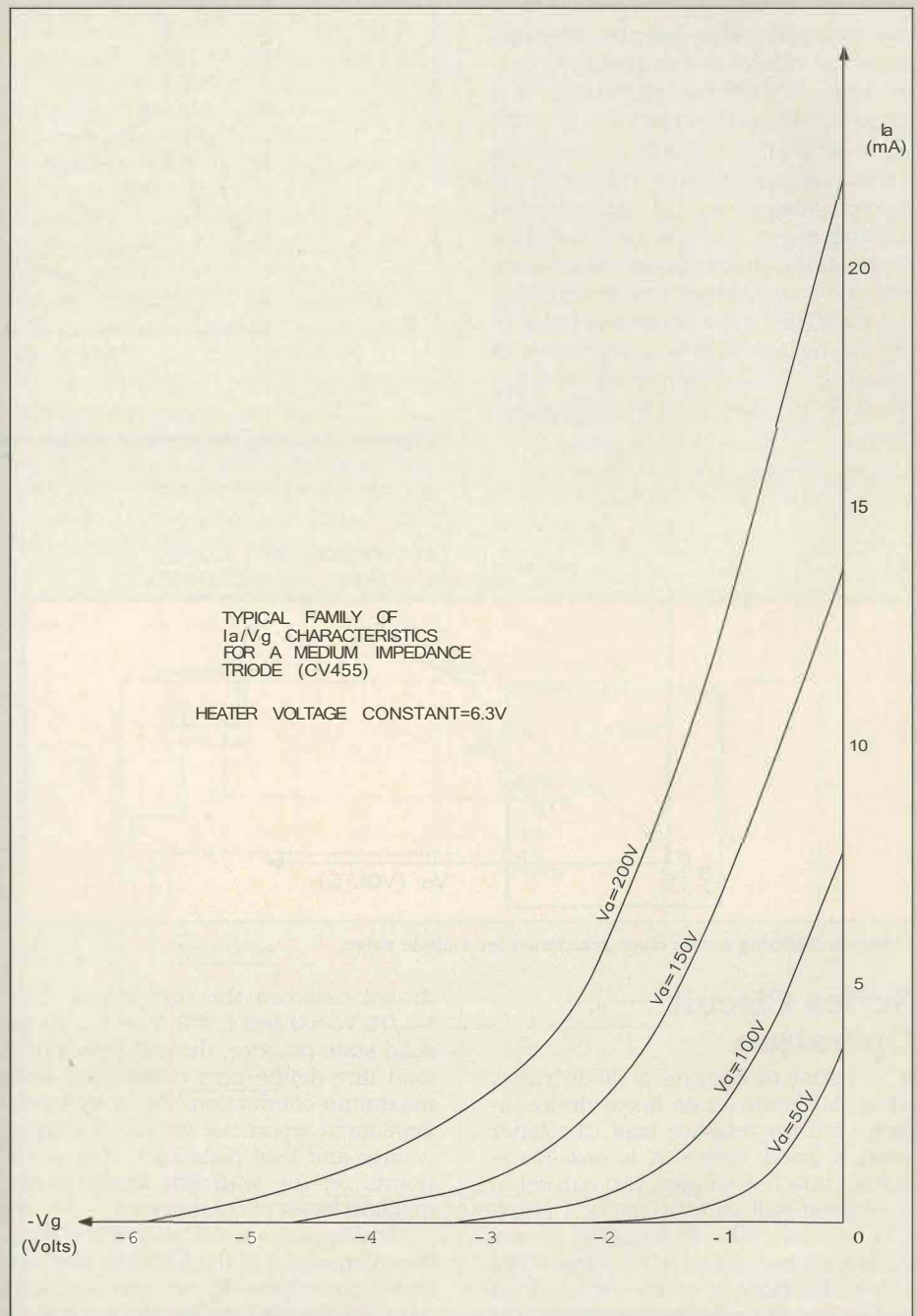

Figure 10. Family of mutual characteristics for a CV455 triode.

anode voltage is only 50V, the grid cut-off voltage is about -2V, but when the anode voltage is 200V, -6V is needed to cut off the anode current. From the foregoing explanation, this is just the behaviour that we should expect.

Mutual Conductance

The ability of the control grid to control the anode current is expressed by a second valve parameter, known as the mutual *conductance*, g_m . This is seen defined in Figure 10 as the slope of a characteristic, and is given by:

$$g_m = \frac{\text{Change in anode current}}{\text{corresponding change in grid voltage}}$$

This is an important parameter, because it is also useful for predicting the triode's performance as an amplifier. The units traditionally used for measuring g_m are mA/V (milliamps per volt) although these days, no doubt, we ought to call them mS (milli-Siemens). Old habits die hard though, as no doubt you will notice! The value of g_m for the CV455 (ECC81) is 4mA/V.

The Triode Anode Characteristics

Another set of characteristics are those plotted for anode current against anode voltage for a selection of values of grid

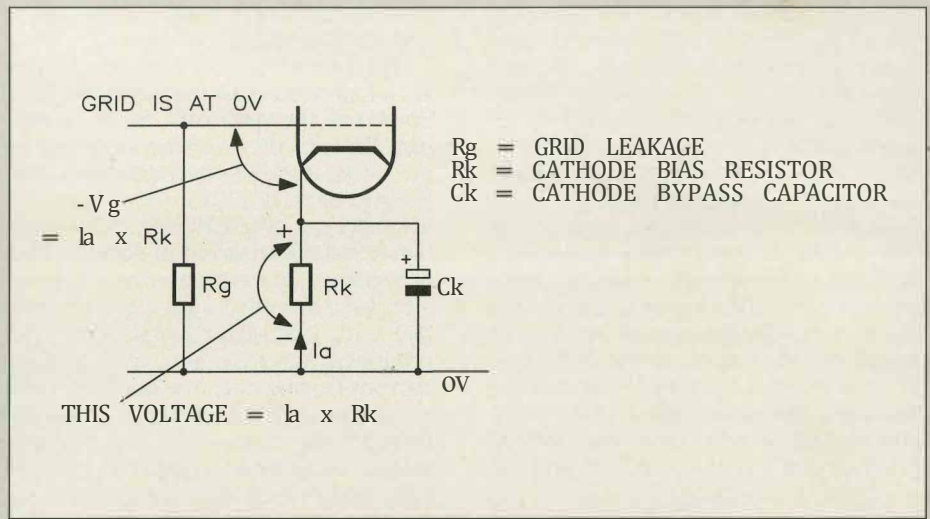

Figure 12. Method for deriving the cathode bias for a valve.

voltage. In principle these are similar to the output characteristics of a transistor (I_a/V_e for values of b), though the shape is quite different. From these it is possible to see how, for a given value of grid voltage, the anode current varies with anode voltage. There is clearly a direct, almost linear, relationship. Figure 11 shows a set of these characteristics for the CV455 (ECC81) triode. As for the diode valve, the *reciprocal* of the slope of any cmve is the anode slope resistance, r_a , of the valve. For this particular valve, it has a value of about 13-5k Ω .

Cathode Bias

We have already said that, in practice, the grid is taken to a voltage that is negative with respect to the cathode. This will be explained more fully in Part 2 when amplifiers are discussed but, for now, perhaps it is not too unreasonable to accept this basic idea. This would seem to imply that we need an actual negative DC supply and, in fact, in the early days of valve technology, such a supply was provided. In battery operated receivers a special battery was employed which comprised a number of 1-5V cells with brass tubular connec-

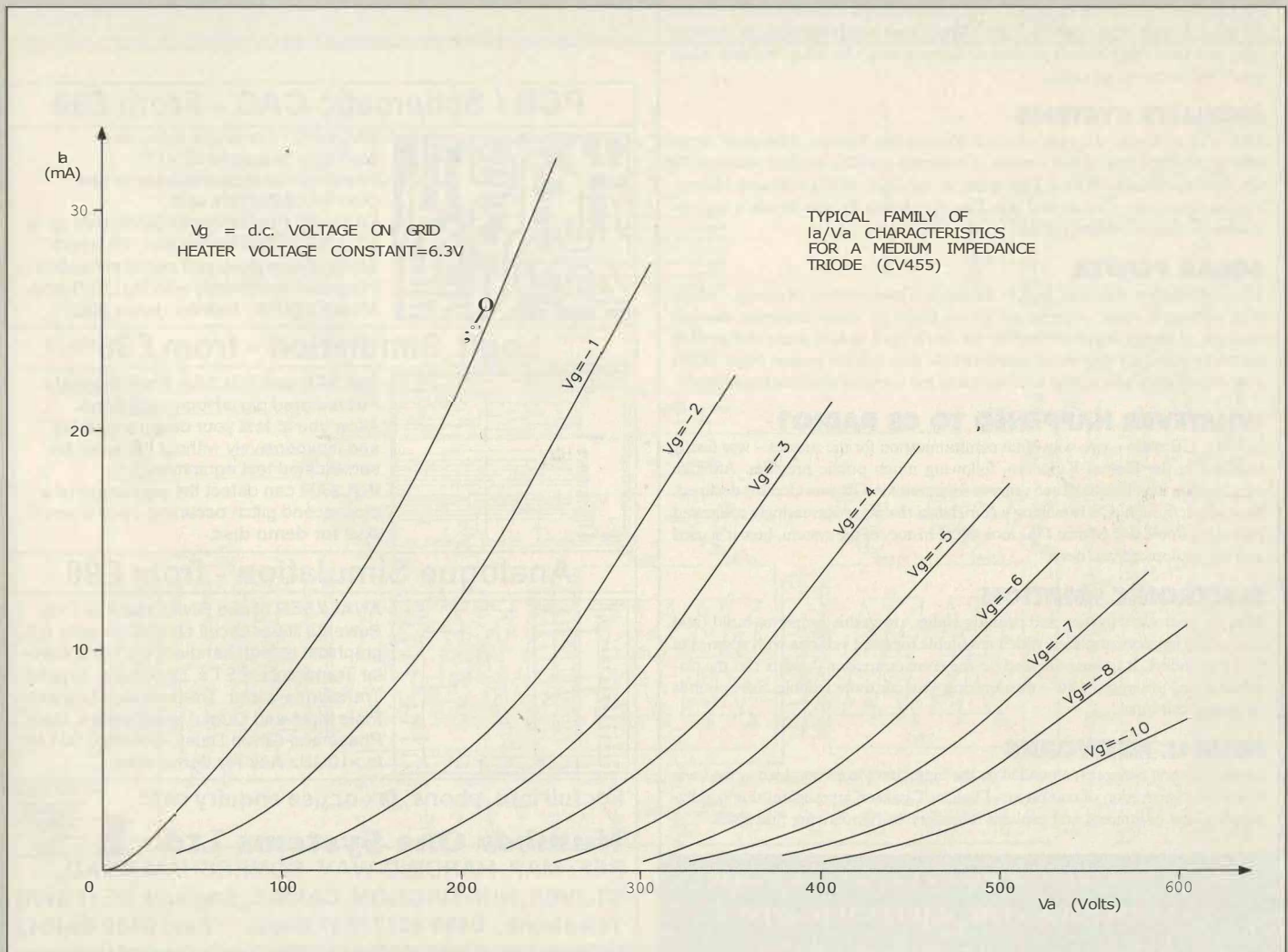

Figure 11. Family of anode characteristics for a CV455 triode.

tions, into one of which a banana plug would be fitted to select the required value of grid bias voltage. Such a method is neither desirable nor essential in the case of mains-operated equipment, and a different philosophy allows us to dispose of the separate supply completely. It works as follows.

The terms positive and negative are purely relative ones. Two voltages may be both positive *with respect to some reference*, say 0V. However, the smaller of the two voltages can be said to be negative *with respect to the other one*. Thus if we wish to make the grid of the valve negative with respect to the cathode, we only need to make the cathode *positive with respect to the grid*, to

achieve the same object. How this is done is illustrated in Figure 12.

The control grid is connected to 0V via a high value resistor (typically 1M Ω) known as the 'grid leak'. Since no current flows in this resistor there can be no voltage drop across it and, therefore, the grid must be also at 0V as far as DC is concerned. The cathode, in contrast, has a resistor inserted in series, which is bypassed by a capacitor to avoid negative feedback effects (exactly as is practice with transistor amplifiers). The product of this resistance value and the current flowing in it (the anode current I_a) produces a volt drop. A moment's thought shows that the value of this voltage drop must equal the value of

grid bias required, since the cathode will then be positive with respect to the grid by this amount.

For example, if the grid bias voltage is to be -2V when the anode current is 10mA, then the cathode resistor must have a value equal to $(2/10)k\Omega$, which equals 200 Ω , which can be rounded up to 220 Ω .

Well that's it for this month. Hopefully, this has whetted your appetite for more, which is just what you will be getting in the next issue. Not only shall we consider how to use the triode as an amplifier, but we shall also consider how to design and test such an amplifier, and look at the design of a suitable power supply for valve equipment.

NEXT



In next month's super issue of 'Electronics - the Maplin Magazine', there are some really great projects and features for you to get your teeth into! The August issue is on sale July 2nd, available from Maplin's regional stores, and newsagents countrywide, and of course by subscription (see page 23 for details). To whet your appetite, here's just a taster of some of the goodies on offer:

INFRA-RED DOOR LOCK/PORCH LIGHT

This useful project works in conjunction with the Compuguard key fob transmitter, and it allows you to open your front door by means of a solenoid-operated door catch mechanism. Never again will you have to fumble around for the right key! This circuit will also control your porch light (via an optional relay or Mains Opto Switch project) so that you won't be left in the dark when you bring home the groceries.

SATELUTE SYSTEMS

After a short break, the much-missed 'Discovering Satellite Television' series returns, with the first of two reviews of currently-available satellite receivers. In the first instalment, Martin Pipe looks at the Pace MRD-920 and Mimtec Premiere receivers - inside and out. Plus the chance for you to win a superb-quality Technisat satellite system!

SOLAR POWER

Many 'alternative scientists' look to the sun as a major source of energy - which it is; without it, there could be no life on Earth. In many countries, the vast amounts of energy supplied 'free' by the sun is used to heat water and provide electricity - and it's somewhat more credible than nuclear power! Nigel Skeels reviews a series of educational solar electricity kits currently available from Maplin.

WHATEVER HAPPENED TO CB RADIO?

In 1981, CB radio - two-way radio communication for the masses - was finally legalised in the United Kingdom, following much public pressure. After an initial boom, which lasted three years or so, interest in CB considerably declined. Nowadays, though, CB is making a comeback, thanks to increasingly congested roads. Ian Poole and Martin Pipe look at the history of the system, how it is used and the equipment you need.

ELECTRONIC IGNITION

Improve your car's starting and running ability, using this simple-to-build (and easy-to-fit) ignition amplifier, which is suitable for most vehicles with engines of 2 to 8 cylinders. It lessens the load on the contact breaker ('points') in the distributor, and prolongs its life - thus making your car more reliable. Save pounds on garage call-outs!

NEURAL NETWORKS

Artificial neural networks, modelled on the brain, have been heralded as the basis of the next generation of computers. Douglas Clarkson investigates this rapidly-growing area of interest, and explains its history and underlying principles.

Plus, of course, there's all the usual features for you to enjoy!

'ELECTRONICS - THE MAPLIN MAGAZINE'

BRITAIN'S BEST SELLING ELECTRONICS MAGAZINE.

Don't Miss Next Month's Money Saving Special Offer! - Exclusive to Subscriber's Club Members!

PCB / Schematic CAD - From £98

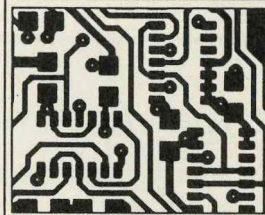

EASY-PC - For single sided and multilayer boards to 17"x17". Phenomenally fast and easy to use. Over 14,000 copies sold.

EASY-PC Professional for boards up to 32" x 32" at .001" resolution, 16 layers. Schematic capture and netlist extraction - integrates seamlessly with PULSAR and ANALYSER III. **Ask for demo disc.**

Logic Simulation - from £98

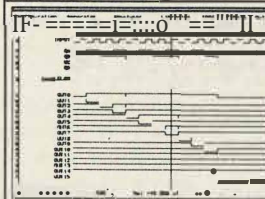

PULSAR and **PULSAR Professional** - Full featured digital logic simulators.

Allow you to test your designs quickly and inexpensively without the need for sophisticated test equipment.

PULSAR can detect the equivalent of a picosecond glitch occurring once a week! **Ask for demo disc.**

Analogue Simulation - from £98

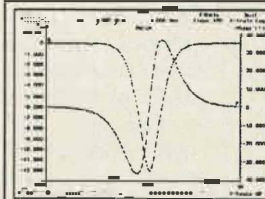

ANALYSER III and **ANALYSER III Pro**. Powerful linear circuit simulators have full graphical output, handle R's, L's, C's, Bipolar Transistors, FET's, Op-Amp's, Tapped Transformers and Transmission Lines etc. Plots Input and Output Impedances, Gain, Phase and Group Delay. Covers 0001 Hz to >10GHz **Ask for demo disc.**

For full info, phone, fax or use enquiry card

Number One Systems Ltd.  1989
REF: MAP, HARDING WAY, SOMERSHAM ROAD,
ST. IVES, HUNTINGDON, CAMBS, England, PE17 4WR
Telephone: 0480 461778 (7 lines) Fax: 0480 494042
International: +44 480 461778 Credit Cards Welcome

A Satellite Fan Writes

Dear Sir,
Being a multi-satellite enthusiast, I am forever scanning the skies, skipping from one satellite to another - and forever disconnecting and connecting SCART plugs in the process! I was thinking of buying a decoder/video/audio switching unit... until I saw the price - £199. This is ridiculous! The price of the components that make up the unit cannot total more than £50 at most. So, not wanting to shell out large amounts of my hard-earned cash unnecessarily, I was hoping to see a suitable project in 'Electronics', but as of yet I haven't seen anything along these lines. Please try to include more projects for satellite TV enthusiasts in future issues! By the way, your recent articles on satellite TV are excellent. As regards the decision to include the topic of satellite TV in your mag, I hope this isn't a one-off.
P.S. If you are short of ideas, how about: in-line IF amplifiers; threshold extension devices; switching units; bandwidth filters; in-line LNB switching units; signal splitters. The list is endless.
J. Evans, Cardiff.

Many of the project ideas that you have suggested are currently being looked into. A SECAM-to-PAL transcoder is in an advanced state of preparation, and an auto-switching PERITEUSCART switching unit is currently on the drawing board. As for the 'Discovering Satellite Television' series, you will no doubt be pleased to learn that this will be returning! Detailed equipment reviews and practical 'how-to' articles (e.g., dish installation and signal distribution) will appear in future issues - starting from Issue 68 (refer to 'Next Issue' on page 54). In the meantime, if readers have any other ideas or suggestions for satellite-related projects, please write in with details!

Doing the Locomotion

Dear Sir,
With reference to 'Electronics', which is a very good publication in every sense of the word, and a boon to many people, my main interest is in Model Railways, and your publication hardly ever gives it space. The possibilities are endless in this sphere - coloured light signalling, section signalling, actual control, carriage lighting etc. Could not one section be given over to this hobby in each issue, or at least every other publication? I have continued subscribing for years in the hope that something would appear, and I think I am right in saying that there have only been a couple of items in the last three or four years. Unless there is something on the hobby it would seem pointless to carry on, for I give all the magazines away to friends.
W. H. Hiscock, Twickenham.

Waiting in the wings, for publication in the October 1993 issue of

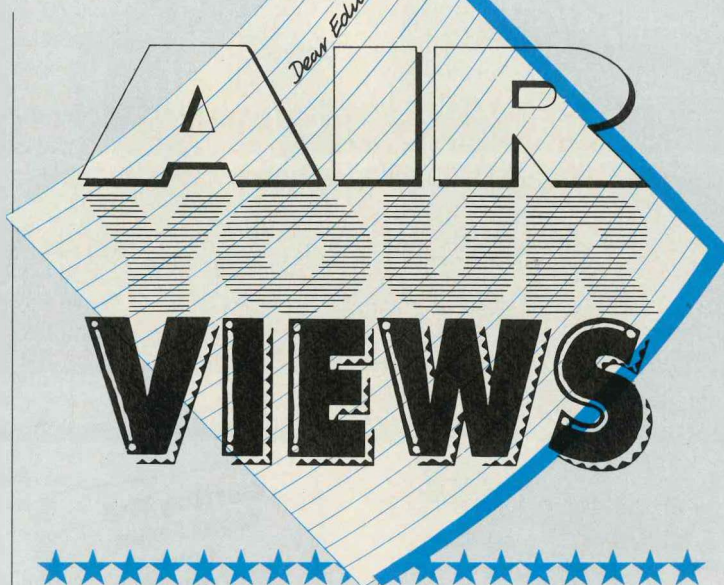

S.T.A.R L.E.T.T.E.R

This month's Star Letter Award winner of a £5 Map/in Gift Token is Mr. R G Morris C.Eng. MIEE., of Cheltenham in Gloucestershire, who raises some interesting points about the design of the 'Mini/ab' power supply project.



A Question of Design

Dear Sir,
I was very interested to see the article on the Maplin Minilab, in the June issue of 'Electronics'. Several years ago, I designed and built a similar unit, a bench power supply giving outputs of -12V, -5V, +5V and +12V. These were derived from a similar transformer, but a much simpler rectifier system. With my system, the bridge rectifier is used as two full-wave rectifiers - one for the positive supply, and the other for the negative supply. It saves one complete bridge rectifier. Thank you for the excellent magazine each month. I am glad, however, that in the June issue of 'Electronics', the number of pages devoted to advertising commercial kits is down - to just one. I much prefer projects designed by the Maplin team; there is a far better chance of the circuit diagram being 100% correct - and the PCB and other components are available separately, handy if things go wrong in the future!

Dennis Butcher from the Lab replies: There are several reasons for using two bridge rectifiers in the



'Electronics', is a Digital Multi-Train Controller. This project, designed around the latest PIG microprocessor technology, will control up to 14 individual locomotives - four of them simultaneously. It certainly seems well worth waiting for! All your other suggestions have been passed to the Lab, in time-honoured tradition. It would be nice to have some feedback from other readers on whether model railway projects would be popular.

Mini/ab 2 Firstly, it was felt that it would be wise to isolate the transformer secondary from direct connection to 0V; this proved to be beneficial because it helped to reduce the level of ripple on the 0V line and also helped to reduce general 'noise' throughout the unit (useful if it is going to be used to supply preamp circuits, etc.). Secondly, bear in mind that we had to make the unit as nearly 'bomb-proof' as possible! There was a distinct probability that a user could, would and indeed should be able to load one side of the supply far more than the other (in practice, this would probably be the +ve supply); a single rectifier was tried with 'commoned' secondaries as per Mr Morris's suggestion, but we did find that conditions could be created when either rectifier failed, due to 'lop-sided' loading, which caused more current to be drawn through one pair of diodes than the other.

Thirdly, for similar reasons to the second point, the transformer secondary could start to draw excessive current through one winding, due to odd effects of this lop-sided loading.

A Negative Reply

Dear Sir
I am interested in putting colour photographs from 35mm film on to video tape. The results obtained using colour prints were not very satisfactory. Having some 35mm transparencies and using an Bin. focal length lens in front of the video camera lens, the results were quite acceptable. This made me wonder whether an electronic reversal system could be used to

produce a positive picture from 35mm colour negatives. I wonder if you or your readers can suggest a circuit to achieve this. I feel the advantage of viewing photographs in this way, being automatically enlarged, the details can be seen more clearly, and having a longer brightness range they look more realistic. I would be grateful for any suggestions.
K. Wiseman, Cheam.

In Issue 51 (March 1992) of 'Electronics', you will find details of the 'Video Box', a low-cost video processing circuit that provides many features, such as fade to black, synchronised switching and video inversion. The video inversion facility will allow you to obtain correct 'positive' pictures from your collection of negatives. A cheaper alternative (but nowhere near as flexible!) is to use a AC-coupled common-emitter transistor amplifier, correctly terminated (generally with a 500. resistor) at its input end.

The View from 'Across the Pond'

Dear Sir,
As a long-term subscriber to the Maplin Magazine, I enjoy receiving it every month. It gives me a different perspective to the usual North American fare that I am able to purchase locally. As I have owned a C-band satellite TV system for more than ten years now, your recent articles on the European equivalent have been more than interesting. There are a lot of differences - and I don't mean just the frequency (Funny - UK Gold notably excepted, most UK satellite television programmes originate from America in the first place/-Ed)

I have a couple of requests to make. Firstly, I built the soldering station published in the November 1992 edition. It works just fine, and I find it helpful. I do, however, find that the temperature setting a bit of a hit and miss affair. At some future date, would it be possible to have your design department produce a digital temperature read-out as an add-on feature - or even a new version complete with temperature read-out? Secondly, I have been a Formula One racing fan for many years, and have attended several races (unfortunately not at Silverstone, yet!). I know that the cars each have a transponder on board that relays identity information to a central computer via a pick-up across the start/finish line. For a future magazine, how about an article on how all this is accomplished? I am sure that the Nigel Mansell fans amongst us would be interested, since the same method of time-keeping is used in 'Indy 500 Racing'. Thanks for a great magazine.
Michael J. Stonebridge, Canada.

Thanks for your suggestions - they have been noted.

These are our top twenty best selling books based on mail order and shop sales during April'93.

Our own magazines and publications are not included in the chart below.

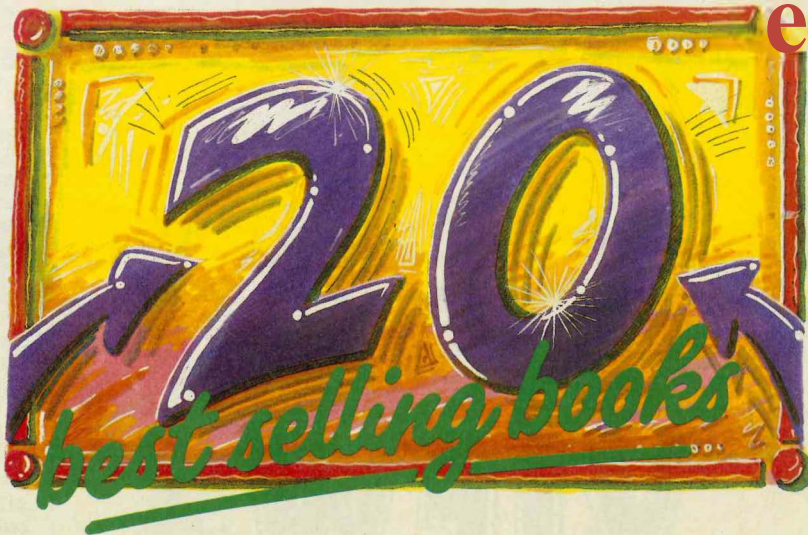

The Maplin order code of each book is shown together with page numbers for our 1993 catalogue. We stock over 250 different titles, covering a wide range of electronics and computing topics.

2

IC 555 Projects

ICSSS Projects, by E.A. Parr (LY04E) Cat. P76 Previous Position: 3 Price £2.95.

TTTTT

HOME VCR REPAIR ILLUSTRATED

Home VCR Repair Illustrated, by Richard Wilkins & Cheryl Hubbard. (WZ32K) Cat. P89. Previous Position: 2 Price £13.95.

4

A Concise Introduction to MS-DOS

NO CHANGE

A Concise Introduction to MS-DOS, by N. Kantaris. (WS94C) Cat. P98. Previous Position: 4 Price £2.95.

5

An Introduction to Loudspeakers and Enclosure Design

NO CHANGE

An Introduction to Loudspeakers and Enclosure Design, by V. Capel. (WS31J) Cat. P78. Previous Position: 5 Price £2.95.

6

MEMINEHE

TTTTT

Loudspeaker Enclosure Design and Construction, (WMB2D) Cat. P79. Previous Position: 7 Price £9.95.

Number ONE

Getting The Most From Your Multimeter

by R.A. Penfold

A unique, and very useful book, showing you how to best use your multimeter. (WP94C) Cat. P10. Previous Position: 1 Price £2.95.

7

How to Expand, Modernise and Repair PCs and Compatibles

TTTTT

How to Expand, Modify and Repair PCs and Compatibles, by R.A. Penfold. (WS95D) Cat. P102. Previous Position: 8 Price £4.95.

8

International Transistor Equivalents Guide

TTTTT

International Transistor Equivalents Guide, by Adrian Michaels. (WG30H) Cat. P66. Previous Position: 10 Price £3.95.

9

Power Supply Projects

TTTTT

Power Supply Projects, by R.A. Penfold. (XWS2G) Cat. P73. Previous Position: 6 Price £2.50.

10

THE COMPLETE VHF/UHF FREQUENCY GUIDE

TTTTT

The Complete VHF/UHF Frequency Guide, by B. Laver. (WT70M) Cat. P86. Previous Position: 12 Price £9.95.

11

How to Use Oscilloscopes and Other Test Equipment

TTTTT

How to Use Oscilloscopes and Other Test Equipment, by R.A. Penfold. (WS65V) Cat. P10. Previous Position: 9 Price £3.50.

12

The WASHING MACHINE Manual

TTTTT

The Washing Machine Manual, by Graham Dixon. (WS98G) Cat. P89. Previous Position: 11 Price £11.95.

13

Electronic Security Devices

TTTTT

Electronic Security Devices, by R.A. Penfold. (RL43W) Cat. P75. Previous Position: 14 Price £2.95.

14

SERVICING TV AND VIDEO EQUIPMENT

TTTTT

Servicing TV and Video Equipment, by Eugene Trundle. (WS76H) Cat. P89. Previous Position: 13 Price £25.00.

15

RAE MANUAL

RE-ENTRY

Radio Amateurs Examination Manual, by G.L. Benbow. (WP87U) Cat. P83. Previous Position: Res Entry. Price £6.75.

16

How To Use Op Amps

NO CHANGE

How to Use Op Amps, by E.A. Parr. (WA29G) Cat. P88. Previous Position: 16 Price £2.95.

17

Remote Control Handbook

TTTTT

Remote Control Handbook, by Owen Bishop. (WS23A) Cat. P73. Previous Position: 15 Price £3.95.

18

50 Simple L.E.D. Circuits

TTTTT

50 Simple LED Circuits, by R.N. Soar. (RF12N) Cat. P77. Previous Position: 20 Price £1.95.

19

50 Projects Using Relays, SCR's and Triacs

NEW ENTRY

50 Projects Using Relays, SCR's and Triacs, by F.G. Rayer. (RH30H) Cat. P73. Previous Position: New Entry. Price £2.95.

20

ROBOT BUILDER'S BONANZA 59 INEXPENSIVE ROBOTICS PROJECTS

TTTTT

The Robot Builder's Bonanza, by G. McComb. (WT77J) Cat. P103. Previous Position: 18 Price £14.95.

AUDIO FREQUENCY

PEAK-TO-PEAK

Design by
R. H. Pearson
G4FHU



MILLIVOLTMETER

FEATURES

- * 5mV to 50V range
- * Input impedance switchable 47k.Q or 600.Q
- * Low-cost, easy to build and calibrate

APPLICATIONS

- * Audio testing and calibration
- * Helps to avoid overloading transmitters or any audio equipment

Note: The circuit and information presented here must be considered as a basis for your own experimentation. No warranty is given for suitability in particular applications-Maplin cannot support this information in any way. However, where possible, we endeavour to check that information presented is correct and that circuits will function as stated.

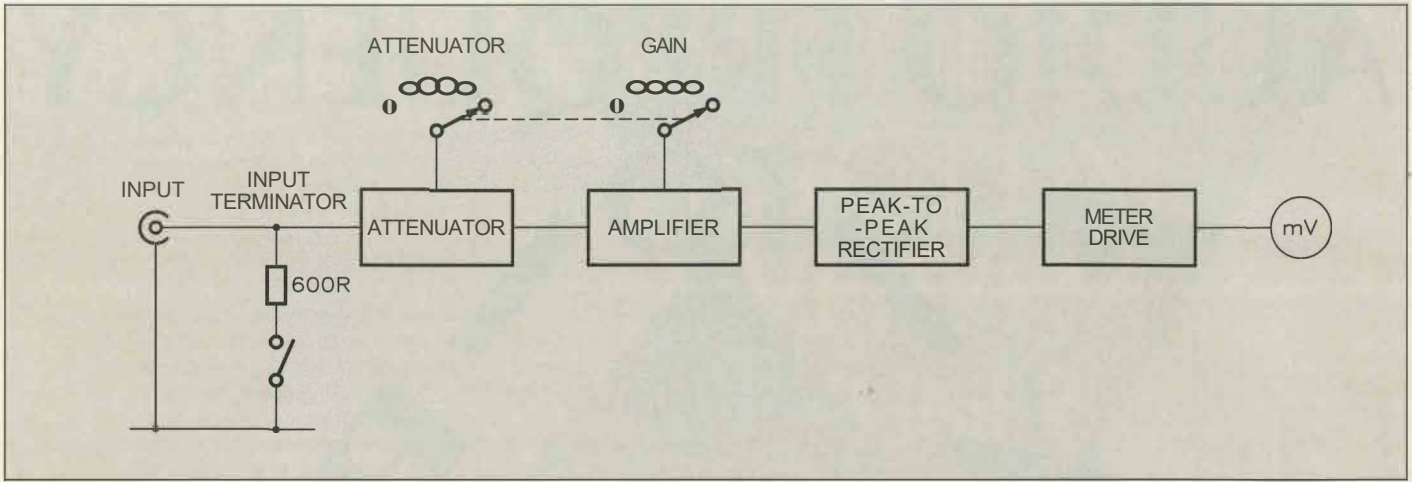

Figure 1. Block diagram.

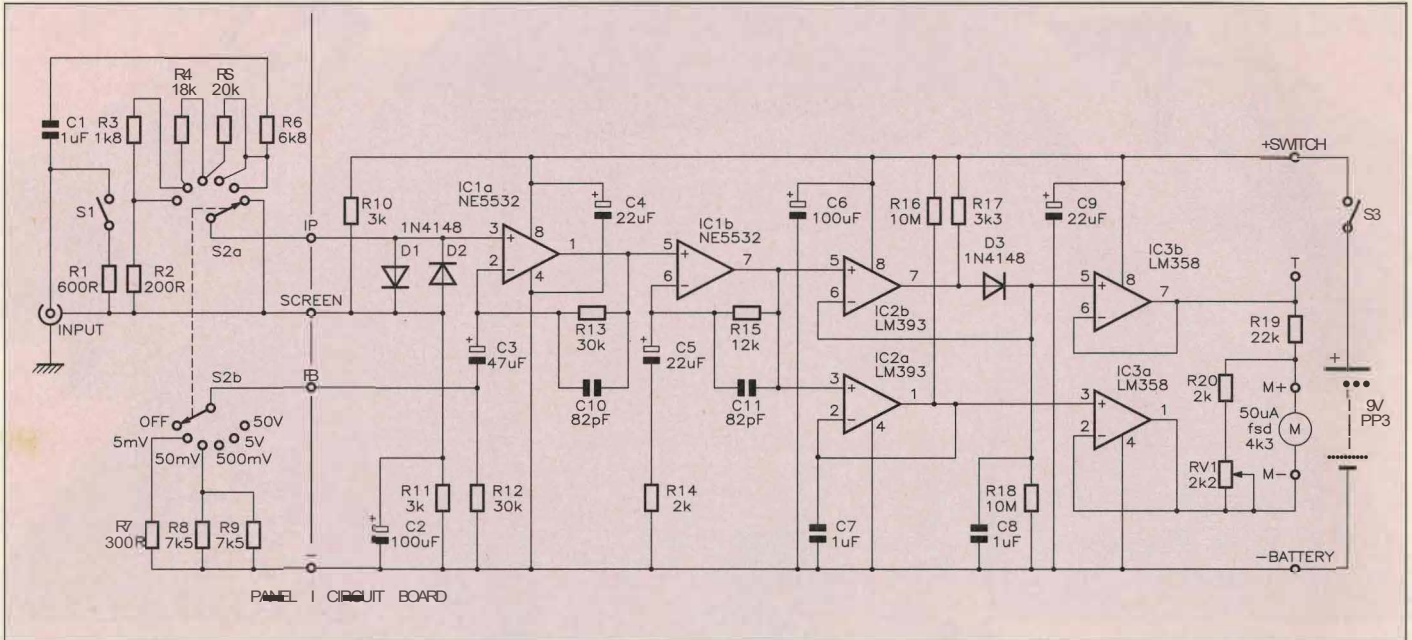

Figure 2. Circuit diagram.

When working with small signals from microphones and other audio equipment, ordinary voltmeters are quite useless. What is needed is a sensitive instrument that indicates 'peak-to-peak' (Pk-to-Pk) voltage and holds the reading long enough to be seen. This is especially important to avoid overloading a transmitter or tape recorder, or indeed any audio equipment. Ordinary multimeters, both analogue and digital, do not respond to peak values and do not have low enough voltage ranges.

Even an oscilloscope is not entirely the answer. Quite apart from the high cost and large size, it is not very convenient for continuous monitoring, or for measuring occasional peaks, unless it is a very expensive digital storage oscilloscope.

The small instrument described here fits the bill nicely, being simple and cheap to build. It responds to audio signals from 5mV to 50V Pk-to-Pk for full-scale deflection. It has an input resistance of 47k Ω , switchable to 600 Ω , so that the most common conditions for loading a microphone, or a DIN audio system, can be simulated. A block diagram of the instrument is shown in Figure 1.

Circuit Description

The heart of the measurement system is a pair of opposite polarity peak voltage detectors, that utilise the LM393 dual comparator

(IC2), as shown in Figure 2. These are arranged to produce up to 3V DC to drive a meter to full-scale deflection via the voltage follower connected amplifiers in IC3, a LM358.

The Pk-to-Pk level is held by the RC circuits,

RI 6/C7 and RI 8/C8, long enough to be registered on the meter. A two-stage amplifier, IC1 a NE5532, is used to amplify the signal level to the 3V Pk-to-Pk required by the detectors. The first stage is used to provide switched

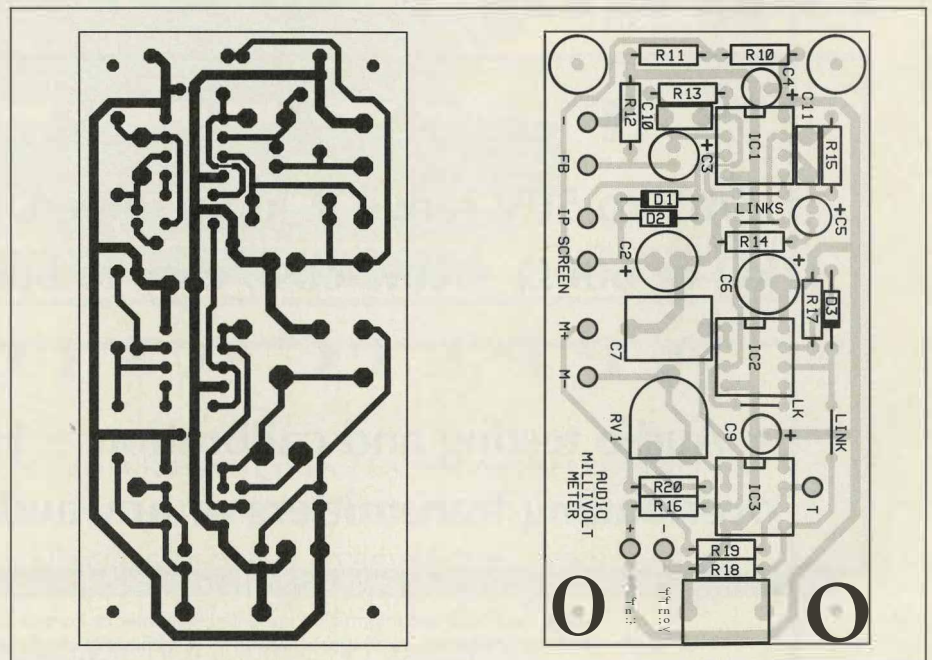

Figure 3. PCB legend and track.

gains of x100, x10 or x2, while the second stage is set to a fixed gain of :1.

An input attenuator (R1 to R6) fills in the remaining requirements in overall gain for all ranges and also provides (in conjunction with diodes D1 and D2) a measure of protection for the amplifier. Range selector switch S2a selects the attenuator, and its other half, S2b, selects the negative feedback, which controls the gain of IC 1a.

The input resistance is normally 47k Ω but this can be switched to about 600 Ω by S1.

Construction

Please note that a ready-made PCB is not available for this project. Figure 3 shows the track and legend PCB layout as used on the prototype.

Such a sensitive instrument must be housed in a metal box. One possible layout is shown in Figures 4 and 5, but this can be adapted to suit the available box, and personal taste. Panel mounted components are kept close to the panel to provide additional screening, with all leads kept as short as possible.

When soldering the precision resistors around the range switch, care should be taken to avoid overheating. Their wires can be left up to about 10mm long, providing the resistors are positioned close to the panel to improve screening.

The input lead must be screened, with the screening braid being the *only* connection back to 'Screen' on the PCB. The screening is connected to the metal panel but is not common with the battery negative connection '-'. In fact, its potential is half the battery voltage, and is set by potential divider R10 and

R11. The feedback circuit lead 'FB' and its companion, the negative supply '-' should not be screened, but can be loosely twisted together. There are enough solder tags on the switches to hold components on the panel, with the negative ends of resistors R7, R8 and R9 connected to a solder tag screwed to a stand-off insulator. Alternatively, a simpler and cheaper method is to use a piece of copper-clad circuit board that is fixed to the panel by a suitable screw, washer and nut, or possibly by superglue or impact adhesive. Of course, if a screw and nut are used, then an insulating groove will have to be cut to prevent the resistors shorting to the panel. See Figure 6.

The circuit board should be mounted as close to the bottom of the metal box as is practicable, but ensure there are no short circuits from connections on the PCB to the box. If necessary, a layer of insulating tape can be applied to the box beneath the PCB. The battery should be insulated from the box and secured by some suitable means and, unless the box is unusually large, should fit comfortably in the space alongside the PCB, without any fixings.

1mm pins can be used to simplify connection of wires to the PCB i.e. the points labelled '-', 'FB', 'IP', 'Screen', 'M-', 'M+', 'Battery-', 'Switch', '+' and the test point 'T'. Care should be taken to ensure that all of

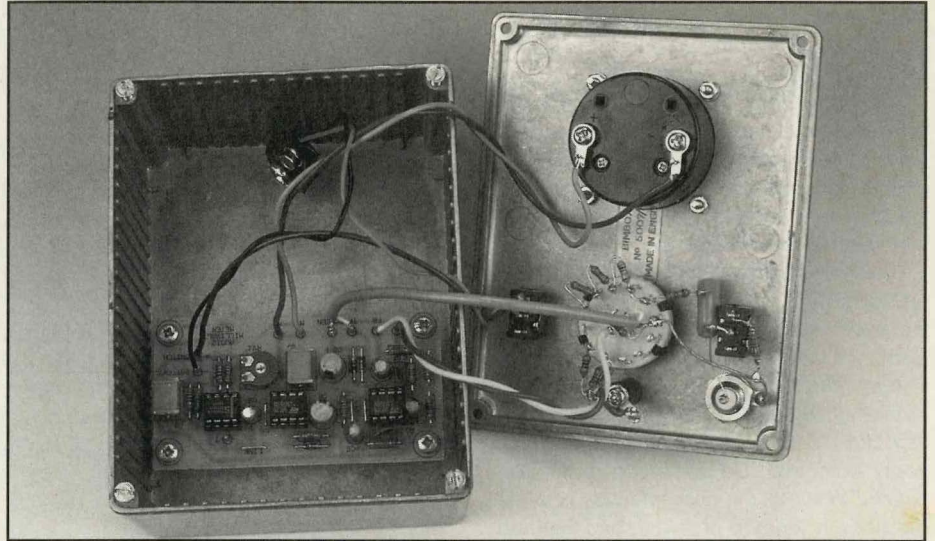

The Peak-to-Peak Audio Millivoltmeter prior to final assembly.

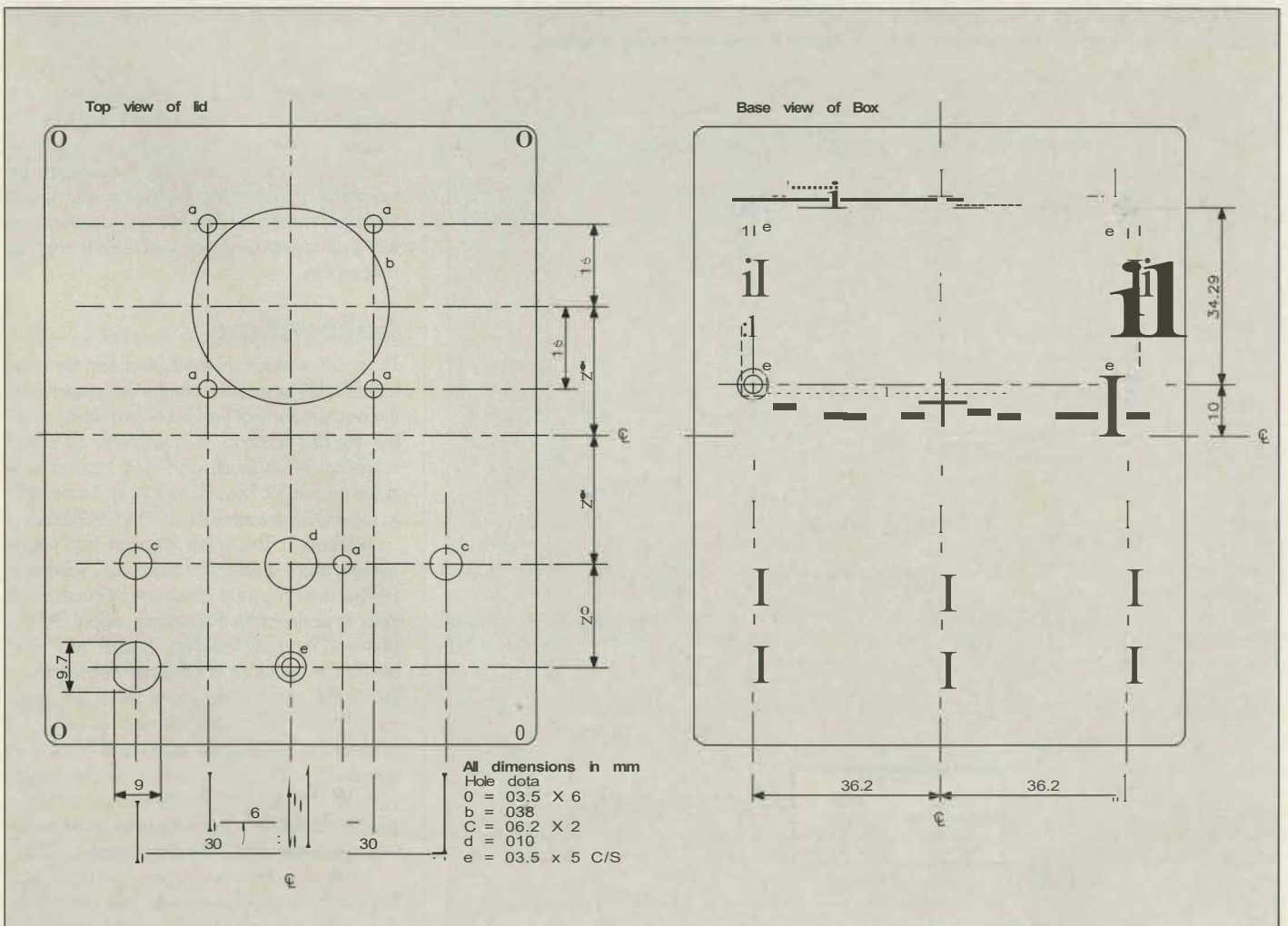

Figure 4. Box drilling details.

the polarised components have been fitted with correct polarity/orientation.

Component Options

Resistors R1 to R15 must have a 1% tolerance, but considering how remarkably cheap 1% resistors are to buy, then it is worth using these throughout. Do not use electrolytic capacitors except where polarised types are shown. A 5-way, 2-pole switch is suitable for S2, but a 6-way is more readily available and this provides an 'OFF' position as shown. However, this position is not really necessary. A 'make-before-break' switch is preferred so that IC 1a does not lose its bias when the switch is operated. If only a 'break-before-make' switch is available, then add a 1M5Q or 2M2Q resistor from S2a pole to the screen connection (using very short wires).

The circuit works happily with a PP3 battery down to about 6 or 7V. However, it is better to use a rechargeable PP3 which has a more stable voltage and will be cheaper in the long run, especially if the instrument is inadvertently left switched on.

The specified 50µA meter has an internal resistance of 43000., but if a meter is used that has a significantly lower value, then add resistance in series with the meter to make it to about the required value. If you need to check the resistance of the microammeter, be especially careful, as such instruments are easily damaged. Do *not* use a multimeter, directly, to test it! The only safe way is to put a resistor in series to protect it, and then use a battery, or other DC supply voltage, *not exceeding* $R(k\Omega)/20$ to produce an arbitrary indication. A safe combination would be 220kΩ and 9V. Note the indication on the

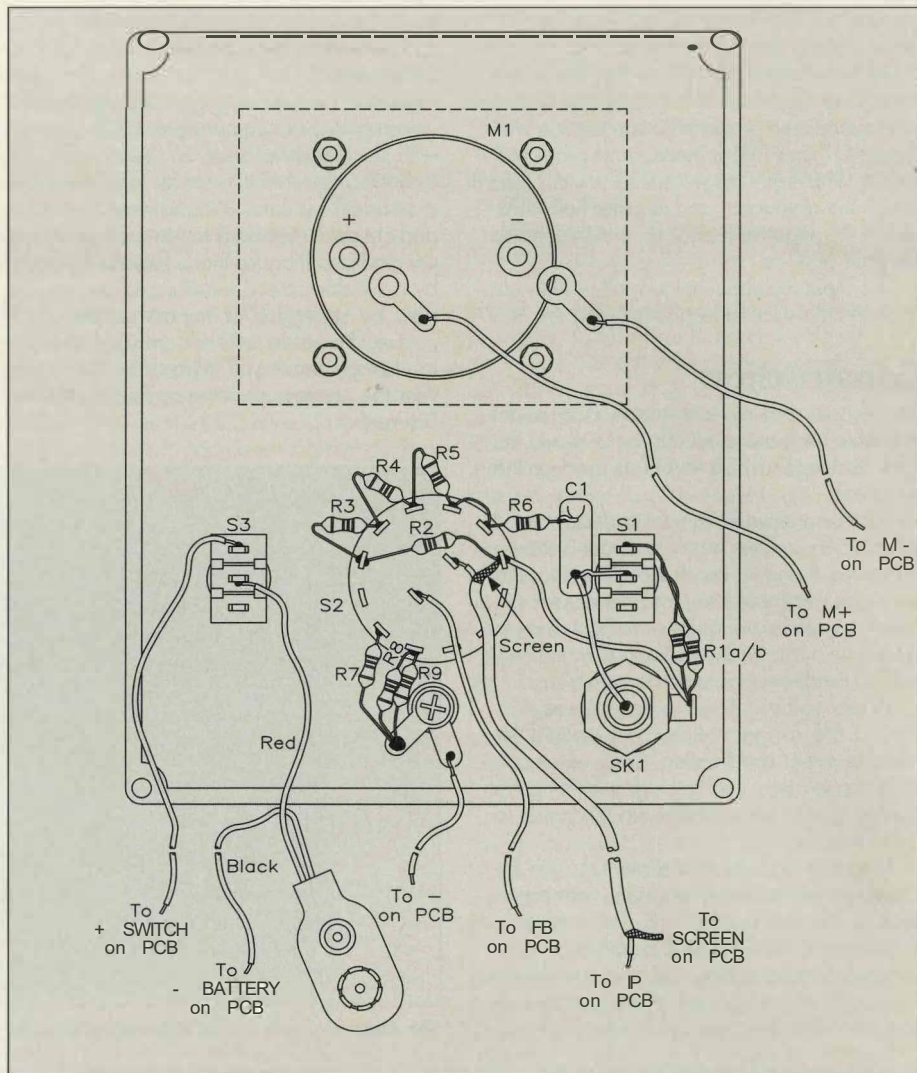

Figure 6. Internal wiring diagram.

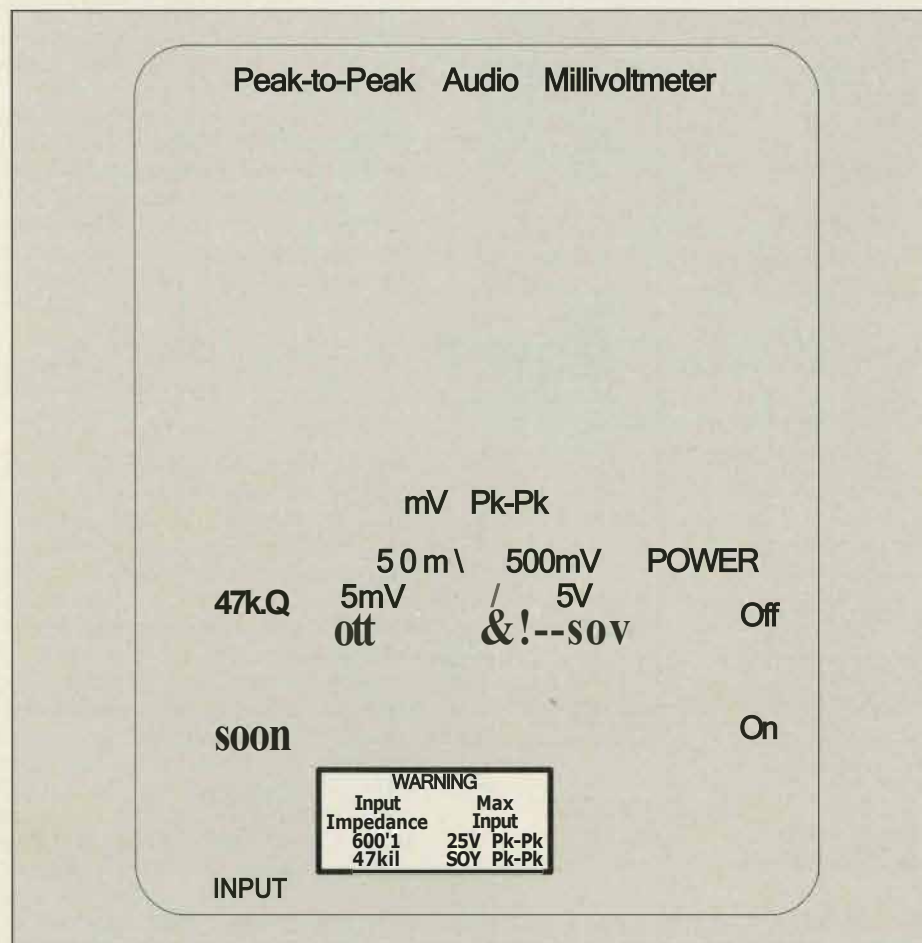

Figure 5. Suggested front panel layout.

microammeter, and then connect across it a variable resistance and adjust it to halve the indication. Remove the variable resistor and measure its resistance which should then be the same as that of the microammeter. Great precision is not necessary for this task because RVI will correct any reasonable errors during calibration.

Calibration

There are several methods that can be used for calibration and the choice will depend on the equipment that you have available. In all but the first method, it is *essential* to use a screened input lead, and it is best to calibrate on the 5V Pk-to-Pk range. Do *not* switch in the 6000. resistor, R1, during calibration.

Method 1: This is the simplest, and needs nothing more specialised than a DC voltmeter. *Before* inserting any integrated circuits, and prior to connecting the battery, apply 3V DC between the pins labelled 'I' and 'M-' and set RVI to produce a full-scale deflection on the 50µA meter. No more need be done apart from removing the test circuit and adding the integrated circuits and battery. A couple of 1.5V cells in series, and a potentiometer (say 5kΩ), will suffice to produce the precise 3V. Leave the voltmeter in its monitoring position while the adjustment is made.

Method 2: If an oscilloscope and an audio frequency signal generator are available, then calibration can be direct, in terms of the Pk-to-Pk voltage measured on the oscilloscope.

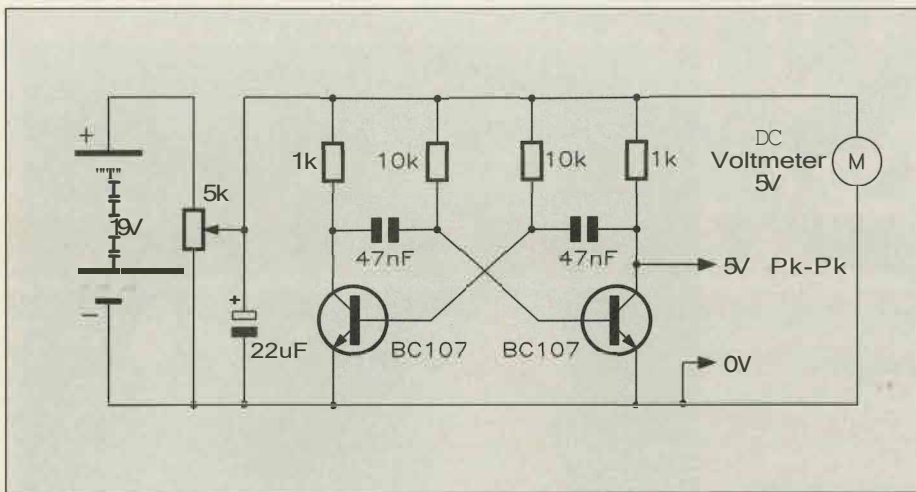

Figure 7. Calibrator test circuit.

Use a frequency somewhere in the 2kHz to 4kHz range (not critical) and set RVI to give a full-scale reading on the 5V range when 5V Pk-to-Pk is applied to the meter input.

Method 3: If an audio signal generator is used, relying upon an internal voltmeter to standardise the signal level then it is likely to give rms voltage indication. So to obtain, say 5V Pk-to-Pk for a sinusoidal waveform, set to $5/2 \cdot 8284 = 1.768V$ RMS. If an ordinary multirange voltmeter is used as the standard (no matter whether analogue or digital) the same rule will apply except that some such general-purpose instruments are not accurate in the audio frequency range. Also, almost none of them will read accurately with non-sinusoidal waveforms.

Method 4: Make a 'lash-up' circuit of an astable multivibrator as shown in Figure 7. The Pk-to-Pk amplitude of the output is very nearly the same as the collector supply voltage, which can be measured on any ordinary DC voltmeter. Adjust the potentiometer to produce 5V DC and then use the output waveform to calibrate the 5V range.

Using the Millivoltmeter

Because of the peak holding action, and the high sensitivity of the millivoltmeter, it will frequently happen that the pointer crashes over beyond full-scale reading and stays there, for what may seem an alarming long time after

an overload has occurred. But if the circuit has been correctly constructed, the overload will not be damaging to the microammeter. The time delay has been chosen to be as short as possible for convenient use, but it can be shortened or lengthened, by reducing or increasing R16 and R18, if desired.

It is essential to always use a screened lead to connect to the instrument, otherwise stray pick-up from 50Hz, and other unwanted signals, will mask any measurements.

The AC coupling capacitor, C1, and the associated resistors are there to prevent any DC components of the signal reaching the meter. This is absolutely essential in a general-purpose instrument, but it does restrict some applications.

For example, a low-frequency square waveform will develop 'sagging' tops and bottoms on the attenuator side of C1 and result in a larger than expected Pk-to-Pk indication. This is a purely systematic error and not a fault.

S1 connects a 600Ω resistor in parallel with the input, which is sometimes useful when working with 600Ω impedance audio equipment. However, it is important that there is no significant dc potential present at the measurement point, because of the low value resistor.

With the input termination set to 600Ω, the maximum Pk-to-Pk input voltage is 25V. Otherwise the maximum Pk-to-Pk input voltage is 50V.

The low frequency roll-off is -3dB at 5Hz and the high frequency roll-off is -1 dB at 30kHz and -3dB at 50kHz.

Peak-to-Peak Millivoltmeter Parts List

RESISTORS: All 0-6W 1% Metal Film (Unless specified)

R1 *	1k2//1k2 (600!1)	2	(M1K2)
R2	200!1	1	(M200R)
R3	1k8	1	(M1K8)
R4	18k	1	(M18K)
	2	1	20
		1	
R7	300	1	(M300R)
R8,9	7k5	2	(M7K5)
R10,11	3k	2	(M3K)
R12,13	30k	2	(M30K)
R14,20	2k	2	(M2K)
R15	12k	1	(M12K)
R16,18	10M	2	(M10M)
R17	3k3	1	(M3K3)
R19	22k	1	(M22K)
VR1	2k2 Hor End Preset	1	(UH01B)

* Use two 1k2 resistors in parallel to obtain exactly 600!1.

CAPACITORS

C1	1μF Met Polyester	1	(BX82D)
C2,6	100μF 16V Min Electrolytic	2	(RA55K)
C3	47μF 16V Min Electrolytic	1	(YY375)
C4,5,9	22μF 16V Min Electrolytic	2	(YY36P)
C7,8	1μF Poly Layer	2	(WW53H)
C10,11	82pF Ceramic	1	(WX55K)

SEMICONDUCTORS

IC1	NE5532	1	(UH35Q)
IC2	LM393	1	(UH30H)
IC3	LM358	1	(UJ34M)
DI,2,3	1N4148	3	(QL80B)

MISCELLANEOUS

M1	2in. Pan Meter 50μA	1	(FM98G)
51	SP Slide	1	(FF77J)
52	Rotary SW6	1	(FH43W)
53	SPST Ultra Min Toggle	1	(FH97F)
SK1	HQ Co-ax Socket	1	(FEI0L)
	or BNC Round Socket 5.0	1	(HH18U)
	1mm Pins 2145	1 Pkt	(FL24B)
	Box DCM5007	1	(LH72P)
	PCB Fibreglass 5m Sngl	1	(HX01B)
	Knob BK12	1	(RW755)
	PP3 Ni.Cd Battery	1	(HW31J)
	or PP3 Alkaline Battery	1	(FK67X)
	PP3 Clip	1	(HF28F)

OPTIONAL ITEMS (For Calibrator)

10k	2	(M10K)
1k	2	(M1K)
5k 18-Turn Preset	1	(WR48C)
47nF Poly Layer	2	(WW375)
22μF 16V Minelect	1	(YY36P)
BC107	2	(QB31J)
PP3 Battery	1	(FK58N)

The Maplin 'Get-You-Working' Service is not available for this project.

The above items are not available as a kit.

NEWS

Report

New Video Sync Separator IC

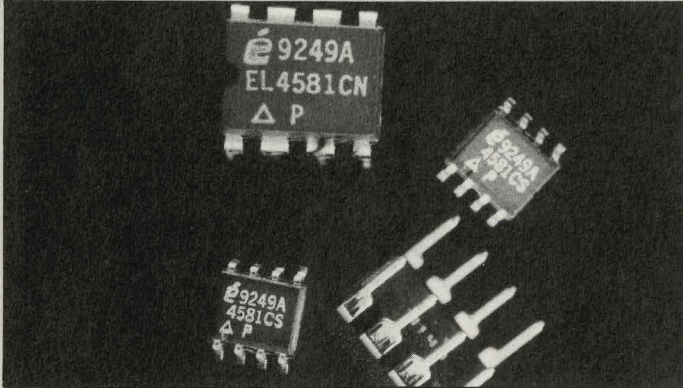

The EL4581 is a precision video synchronisation separation circuit for use in NTSC, PAL and SECAM systems. Pin-compatible with the LM1881 but capable of better performance, the EL4581 is a CMOS circuit which extracts timing information, including composite and vertical sync, burst/back porch timing and odd/even field information from

standard negative-going video signals with amplitudes from 0.5V to 2V Pk-to-Pk.

This IC is ideal for special effects generators and vision mixer systems, test equipment, signal distribution, displays, imaging and data capture, and is available in 8-pin DIP and surface-mount packages. Contact: Elantec (071) 482 4596.

Fighting Crime with Technology

Andersen Consulting have had a heavy hand in developing a High Definition Thermal Imager which can 'see' people or vehicles, in daylight or darkness, up to 10km away - even when shrouded from normal sight. The new product is based on a tank thermal imager, yet is more powerful, only a quarter of its size, and half its weight and cost. Not surprisingly, the unit has already achieved advance orders of £1m (although we do not know how much of this has come from the Army!). Details: Andersen (071) 438 3476.

Meanwhile, a UK police force are making use of a PC-based multimedia database, which will assist the force in its suspect identification process. Video tapes of suspects are sent to Police Headquarters where the video images are scanned and stored in digital format. When a person witnesses an offence, they will have their description of the offender entered directly into one of the designated PCs. The database will then extract photographs of every record which matches the description and show these on the screen, 12 at a time.

Lets hope the data protection enforcement agency has given the system the all-clear, or the police force in question could find itself in the dock!

However, it could be that MCI Communications have more than an edge over the UK police. With just one intelligent, multimedia device - part telephone, part television and part computer - users will be able to call up distant parties and see them while they speak. The system, which sounds not unlike a videophone, will make use of multimedia wireless communications and distributed processing.

CD-ROM Update

Canon, Fujitsu and Sony are working on Compact Disc-Read Only Memory optical drive products. The initial products, says "Computergram", will be digital images of colour photographs covering a wide range of subjects; these will be of interest primarily to the publishing industry. The manufacturers hope that the new development will lead to increased sales of their workstations, and PCs that have CD-ROM drives installed. The world of multimedia is alive and kicking!

Jeux Sans Frontieres

Despite all the problems facing the world, the EC has found time to reach agreement on copyright rules for cross-border cable and satellite channels. This will establish the principle of one broadcast, one copyright, with the aim of preventing a copyright haven existing in a member state.

Meanwhile Intel, together with Microsoft, are about to announce a personal computer that will work with a cable TV receiver system to provide access to, and control of, interactive services offered via cable. As well as up to 500 cable TV channels, the box will give access to extensive home shopping services, plus an array of databases.

Then there is the fibre optic Advanced Broadcast Video Service high-speed transmission network being developed by Pacific Bell. This will provide superior motion, colour and sound applications in the film and broadcast worlds. It will deliver one-way transmission of mono or DX standard colour formats compressed to 45Mbps with up to four audio channels. The system is already on offer in California at a pricey \$200 a day.

1993 Young Electronic Designer Awards



Pictured are the three winners of the 1993 Young Electronic Designer Awards, flanked by co-sponsors Ken Sanders, Managing Director of Texas Instruments (right) and Robert Johnston, Personnel Director of Mercury Communications (left). 18-year old senior winner, Philip Pegden of Tonbridge School, designed a computerised quadrophonic sound effects system for theatres. Intermediate winner Nicola Hay (second

left) of Woldingham School in Surrey achieved her success with an electronic device to monitor water contamination in brake fluid (now a requirement of the MOT). Junior winner Emma Lye (second right) of Bancroft's School in Essex won her prize with an 'electronic elbow', which tests the temperature of a baby's bath water. The awards were presented by HRH The Duke of York at the Science Museum.

Charging for Congestion?

Driving into London in the future will not only be a time-consuming matter, but also costly. The Transport Minister is proposing to introduce road-pricing in an attempt to ease congestion in London. Many experts believe, however, that this is likely to force traffic onto other, non-chargeable, roads, while confirming the Government's ideological commitment to indirect, rather than direct, taxation.

The idea is for every vehicle to be fitted with an electronic identifier, which would allow its movements to be monitored by some 4,000 roadside beacons. Drivers would be charged on a monthly basis, or buy pre-paid vouchers. No-one is doubting that this system will be hugely expensive (and

unpopular) to implement; a simpler idea might be to ease the flow of traffic by eliminating bottlenecks, and those journey-delaying one-man buses from certain routes. Or perhaps to provide sensible investment in public transport, particularly rail services, rather than seiling off the most profitable routes.

Perhaps the Department of (Road) Transport, whose logo is a motorway bridge, will call in the services of Euro-Tunnel to build some underpasses in the most congested areas. But in the meantime, the troubled company is allowing the UK and French PTTs to route their fibre optic telecommunications cable through the Channel Tunnel, where they will provide a substitute to existing submarine cables.



Plans for PCN Cable

The cable industry is seeking the OK from the DTI to offer local PCN services, making use of the frequencies originally allocated to the now-merged Mercury and Unitel operations. Meanwhile, BT will have completed its cable television network in West London by 1995. This will be the only area in the UK where the company is licensed to offer television services over its phone network, but it is to be hoped that BT will be able to run next-generation entertainment services throughout its network from 1997.

According to the ITC, some 30 cable operators are now providing telephone services, with a total of 150,000 exchange lines in operation - an increase of 363% over the past year. Cable telephony operators, though, must be finding it hard going, what with the competition from the cellular operators. Cellnet now has 100,000 subscribers for its low-use mobile service, Lifetime - and the company is expecting to double this number by the end of the year. By comparison, Vodafone, despite launching its low-cost service first, has only managed to sign 85,000 customers for its LowCall service. In fact, fewer cellular users have opted to change to the low-cost tariffs, with the number of business users showing healthy increases.

On the global front, figures published by Ericsson suggest that the UK comes third in the cellular usage stakes. The US accounts for nearly 10 million, Japan 1.7 million and the UK 1.3 million, closely followed by Germany, Italy, Canada, and Sweden.

Cleaning Up

A consortium of UK companies has found that there is a range of satisfactory alternatives to using CFCs for cleaning electronic assemblies. There is an urgent need to find a suitable alternative cleaning method, because the environmental impact of CFCs has led to the removal of their use as a cleaning option. Production of CFC113, the most common CFC used for defluxing, is due to be phased out

I, Claudius

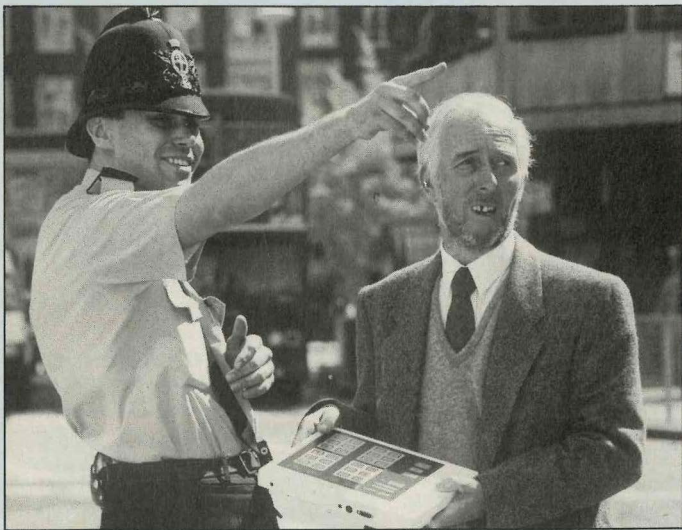

BT itself has developed a new portable speech communications device called Claudius I (named after the Roman emperor with impaired speech) to help people who have voice problems. When connected directly to the telephone, the unit allows people with speech impairment to communicate with others. Being portable, it can also be used in face-to-face public situations; Claudius I weighs only 1kg, including the built-in rechargeable battery that provides around two hours of mains-independent operation.

completely by January 1995. Details of the break-through can be obtained from the DTI on (071) 215 1332.

More Good News for Radio Amateurs

The Radiocommunications Agency has allocated additional frequencies to radio amateurs for unattended digital communications, while removing the 430 to 431MHz restriction in the North East of England. The additional frequencies follow the request from the RSGB to extend the frequencies available to the amateur radio packet network. As a result, access to packet radio mailboxes will be subsequently enhanced. A mailbox, by the way, is a facility for storing information sent via the packet network to addressed amateurs, and subsequently forwarding it as requested by the proposed recipient.

At the same time, The European Radiocommunications Office is undertaking two public consultation exercises. Comments are invited on the Detailed Spectrum Investigation covering 3.4 to 105GHz, and on the second phase covering the 29.7 to 960MHz spectrum. Key issues and terms of reference are available from: David Court, ERO, Holsteinngade 63, DK-2100 Copenhagen, Denmark. Tel: +45 35 43 24 42.

Flying High

Airline passengers have notched up a total of 25 million in-flight calls on the GTE Airfone service. The service is now available on some 2,000 aircraft operated by 12 US airlines. GTE is now planning to install personal computers and fax connections to airline seats, the LCD computer screen being mounted on the back of the seat directly in front.

Not exactly flying high, but certainly covering much ground, will be the world's longest high-fibre submarine cable. The armoured-plated GPT cable, which contains 24 independent fibres, will be installed between Scotland and Northern Ireland.

PICTURE CAPTION CHALLENGE

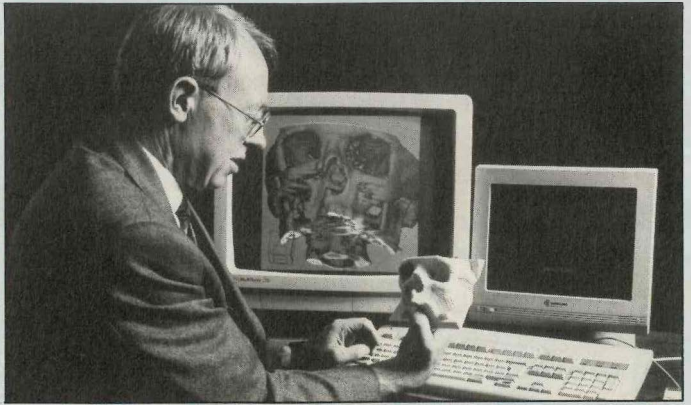

Very much a hands-on contest this month. No prizes, but what is happening?

* New electronic twist to Shakespeare's *Hamlet*.

* New WP operator finds traces of the *previous user.

The latest attempt at a workable man-machine interface.

* Now who put *that* in my lunch-box?

Not quite right. Actually, the photograph shows a scientist working on the BT-sponsored Phoenix Research Project, which has succeeded in creating new computer modelling software. This software has changed the face of plastic and reconstructive surgery.

Events Listings

Now Open: 'Flight' Aeronautics Gallery, and 'The Secret Life of the Fax Machine'. Science Museum, London. Tel: (071) 938 8000.

15 June to 3 October. The Electric Guitar 1930-1970. Design Museum, London SE1.

19 June. All Formats Computer Fair. Novotel, London W6.

19 to 20 June. Biggin Hill International Air Fair. Tel: (0959) 572277.

Till 20 June. SuperBike. An exhibition of the Olympic gold medal bicycle. Science Museum, London. Tel: (071) 938 8000.

22 June. (Also 21 July) Thames Barrier Closure. 0900 hours. Spectators welcome.

22 to 24 June. Software Development '93, Wembley Conference and Exhibition Centre, London. (Entrance fee only £5.00, if you take along the coupon printed below!) Tel: (081) 742 2828.

14 and 15 August. Vintage Model Rally. Old Warden, Bedfordshire. Tel: (0442) 66551.

6 and 7 November. The 7th North Wales Radio and Electronics Show, Aberconwy Conference and Exhibition Centre, Llandudno. Tel: (0745) 591704.

Please send details of events for inclusion in 'Diary Dates' to: The Editor, 'Electronics' - The Maplin Magazine, P.O. Box 3, Rayleigh, Essex SS6 8LR.

£5.00 OFF ON THE DAY!

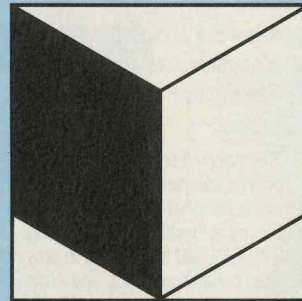

**WEMBLEY
CONFERENCE &
EXHIBITION CENTRE
LONDON**

**I BUSINESS ISSUES
I DEVELOPMENT TOOLS
I MULTI PLATFORM
SOLUTIONS**

SOFTWARE DEVELOPMENT 93

BLENHEIM ONLJNE

Show opening times

Tuesday 22 - Wednesday 23 June

10am - 5.30pm

NEW BOOKS

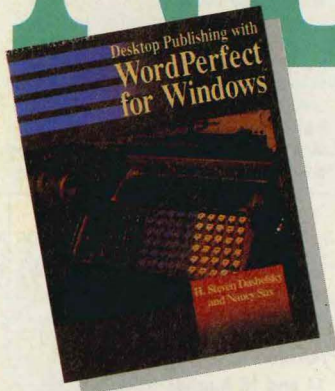

Desktop Publishing with WordPerfect for Windows

H Steven Dashefsky and Nancy Sax

Until recently, the majority of word processors had few, if any, desktop publishing (DTP) features and most DTP programs had few word processing features. Early versions of popular DTP programs did not have a spell checker which meant that text had to be created on a word processor, and then imported into the DTP program to create the page layout. Recently the difference between the two types of program has become blurred, with both types of program converging into very similar programs. Word processors have improved their DTP capabilities, and DTP programs are adding word processing features such as spell checkers. WordPerfect for Windows is an excellent program that combines both functions extremely well. Although fundamentally a word processor, it can perform almost any DTP feat that the typical user might require. One of the main advantages of working under the Windows environment is the ability to multitask on 386 based machines. This allows the user to stay in the word processor program and run a different program in another window, and switch back and forth between the programs. With the addition of dynamic data exchange (ODE), a feature of Windows, programs that can use DOE, such as certain spreadsheets, can send data to WordPerfect very easily. Similarly, artwork can be imported from other programs.

WordPerfect for Windows is a 'what you see is what you get' (WYSIWYG) word processor so allows you to see your documents and numerous new page layout features. With the availability of high-quality printers, the office can now turn out documents that were once the exclusive domain of graphic designers and typographers.

This book will show you how to create reports, newsletters and other professional looking documents by the use of clear, step-by-step instructions and extensive screen shots that demonstrate how to: use a mouse; master basic editing skills; maximise your printer fonts and graphics capabilities; create and manipulate columns; save time with macros and stylesheets; import and work with graphics; create and edit headers and footers. This well written and informative book is for anyone who wants to learn WordPerfect for Windows, and particularly for its DTP features. 1992. 382 pages. 234 x 187mm, illustrated. American book.

OrderAs WZ94C
(DTP With W/PerWin) £16.50NV

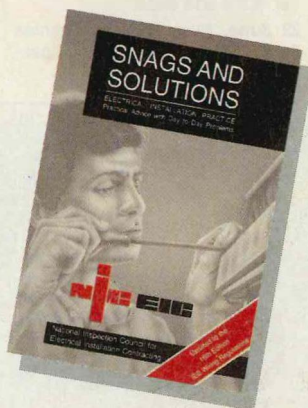

Snags and Solutions - Electrical Installation Practice

NICEIC

This handy little book, now in its 4th edition, has been prepared by members of the National Inspection Council for Electrical Installation Contracting (NICEIC) and is intended to provide practical advice on the application of the 16th edition of the IEE Wiring Regulations (WZ90X). The answers to the many problems that are encountered daily by electricians and electrical installation contractors are provided, also emphasises the wiring problems found by NICEIC inspecting engineers in the course of their visits to various establishments throughout the country.

The book is written in an easy to follow style with the first nine chapters covering topics ranging from cables and wiring systems, earthing, electric shock through to special environments and emergency services. The last two

chapters cover verification and certification and statutory requirements. In these chapters it is emphasised just how important it is to inspect and test additions and alterations to existing installations, with recommendations on checks that should be made to the installation. An invaluable aid for all electricians and electrical installations contractors. 1992. 146 pages. 208 x 145mm, illustrated.

OrderAs WZ938
(Snags & Solutions) £9.95NV

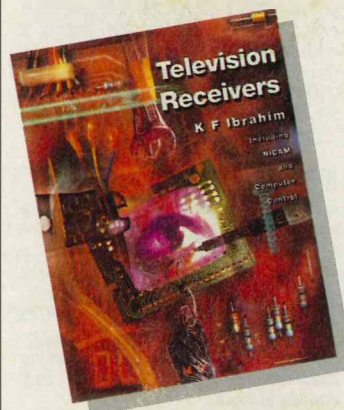

Television Receivers

by K F Ibrahim

Television receivers have undergone a rapid transformation in terms of the processing techniques and the circuitry used. TV development has been dominated by the use of ICs, and digital techniques and microprocessor technology. For the TV engineer, or student, knowledge of these new technologies and techniques is essential in the understanding of modern TV receivers. This book sets out to comprehensively explain the use of discrete and IC components in modern TV receivers. The text is profusely illustrated with diagrams, many of which are practical circuits currently used by TV receiver manufacturers.

The book provides a thorough coverage of TV receiver theory and practise, starting from basic principles of monochrome and colour reception through to digital processing of TV signals. A full explanation of NICAM digital stereo and computer controlled TV receivers is included, as well as comprehensive coverage of digital techniques, that are used in modern TV receivers. The book will be particularly useful for students studying STEC level II, III, IV, City and Guilds courses and anyone involved in courses with television reception as a subsidiary topic. The TV servicing engineer will find this book a useful source of reference reading. 1992. 230 pages. 245 x 189mm, illustrated.

OrderAs WZ91Y
(Television Receivers) £10.99NV

The Secret Life of Quanta

by Dr. M. Y. Han

It is an unfortunate fact that the vast majority of people are woefully, and dangerously, uninformed about science. A basic understanding of science, for all citizens, must be an essential goal if we and our children are to participate productively in the development of our society, economy and culture. In a relatively short period of time the 'high tech' has achieved very rapid progress all across the industrial world, and in so doing, has brought about a wide range of significant benefits to us as well as profound changes in the way we live and work.

This down-to-earth book sets out to explain to non-scientists how the laws of quantum physics operate in high technology devices and processes, with which we have almost daily contact. The author has focused on electrons and atoms, which are at the bottom of everything around us. An understanding of the fundamental concepts of atomic structure and of the physical nature of the chemical bond that holds atoms in molecules together, provides the tools for answering other questions: how matter in the solid state behaves; how semiconductors, superconductors and

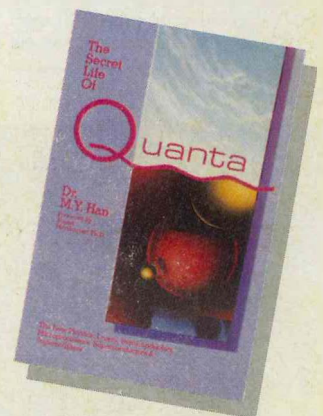

lasers work; and even what is essential about nuclei and 'elementary' particles. The author goes on to describe the basic principles that are used by scientists and engineers everyday in the creation and development of the remarkable new technologies that regularly appeared, such as lasers, fibre optics, microprocessors and superconductors.

The book avoids mathematical equations, and is written in a very enjoyable way, and will be invaluable to anyone who wishes to acquire a greater understanding of quantum physics. Highly recommended.

1990. 190 pages. 228 x 153mm, illustrated. American book.

OrderAs WZBBV
(The Life of Quanta) £10.95NV

YOUR OWN HI-FI KARAOKE FOR ONLY £49.95

Originally priced at £79.95 **SAVE £30**



Watch as you sing, sing as you watch! All you require is your own VCR, TV and Hi-Fi (if you don't have a Hi-Fi near your TV set, see our special offer below).

YOUR GUARANTEE
Every Pro-Sound Karaoke purchased comes with a FULL MONEY-BACK, NO QUIBBLE GUARANTEE IF NOT DELIGHTED WITH THE PRODUCT.

Karaoke dimensions
360 x 72 x 233mm.

Note: Offer open to UK residents only. Overseas customers please call 0702 552911.



At your next party give your friends a surprise that will give them 'Stars in their Eyes!' You've probably seen the TV programme where contestants try to sound like well-known singing idols. Now you, your family and friends can get that professional sound, singing and harmonising to your favourite hits. You'll hear the backing music just like the original hit, and you sing the words when they appear on your TV screen. Your super Hi-Fi Karaoke with its built-in adjustable echo machine makes your voice sound great. Overnight you could become a STAR! Britain's best value stereo Hi-Fi Pro-Sound Karaoke comes complete with everything you, your family and friends, need for a fun-filled party, including 1 FREE, HIGH QUALITY KARAOKE TAPE containing 16 popular songs, instruction manual, connection leads and FREE, HIGH QUALITY MICROPHONE specially designed for vocal use.

- * INCLUDES FREE KARAOKE VIDEO TAPE WITH 16 SONGS!
 - * INCLUDES FREE HIGH QUALITY VOCAL MICROPHONE SPECIALLY DESIGNED FOR KARAOKE
 - * Many Karaoke video tapes available at all good video stores
 - * Total audio/visual entertainment Connection leads supplied* Link the Karaoke to your VCR/TV for great family fun
 - * recording your voice and music Built-in echo machine Cassette deck recorder connection for 4 microphone inputs - 4 times the fun
 - * Ideal for your PARTY BARBECUES Make your 'CLUB-NIGHT' a FUN KARAOKE PARTY NIGHT!
- Link your Karaoke to your VCR and Hi-Fi, and sing along with your favourite song whilst following the words as they appear on your TV screen. Friends will be amazed at the 'professional sound' you can create. With the built-in fully adjustable echo machine, you can add long reverb for Smoother Ballads, and fast repeat to Rock 'n' Roll and you're a STAR! *Suitable for phono inputs on your Hi-Fi phono. DIN or SCART audio output on rear VCR.

3 MICROPHONE PARTY PACK

Three great Karaoke microphones specially designed for vocal use. You and your friends will be able to harmonise like the professionals.

Stylish low-impedance, unidirectional, dynamic microphones with built-in on/off switch, in 3 popular colours, Red, Blue and Yellow. All are supplied with approx. 3 metres of cable terminated in a mono 1/4" jack plug. Three times the fun for only £19.95!



KARAOKE VIDEO TAPES

Each tape shows entertaining video films with the words to each song clearly shown on your TV screen. The Karaoke tape has superb sound and picture quality and comes in a high quality protective case.

Note: Karaoke video tapes are available from all good video shops.

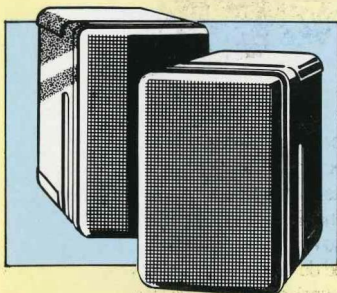
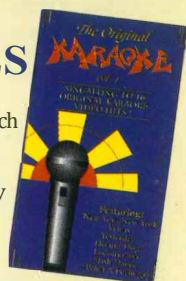

NO HI-FI? NO PROBLEM!

If you don't have easy access to a Hi-Fi system, don't worry! Used in combination with your VCR and Pro-Sound Stereo Karaoke, these amplified speakers eliminate the need for a Hi-Fi system. A built-in 20W per channel amplifier together with bass, treble, volume and on/off controls, brings you a high quality independent speaker system giving you a really professional sound for only £49.95 per pair!

ELECTRONICS

CREDIT CARD HOTLINE

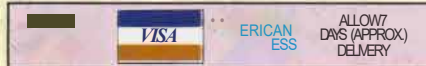

24 HOUR SERVICE PHONE NOW!

0702 5-58664

All items are subject to availability, all prices include VAT

Access D Amex D Visa D D.elete as required

If ordering by Credit Card please sign.....

Expiry date of Credit Card

Visit our stores at BIRMINGHAM, BRIGHTON, BRISTOL, CARDIFF, CHATHAM, COVENTRY, EDINBURGH, GLASGOW, ILFORD, LEEDS, LEICESTER, LONDON (EDGWARE, FOREST HILL and HAMMERSMITH), MANCHESTER, MIDDLESBROUGH, NEWCASTLE UPON TYNE (The Metro Centre, Gateshead), NOTTINGHAM, PORTSMOUTH, READING, SHEFFIELD, SOUTHAMPTON and SOUTHEND-ON-SEA. Plus NEW STORES opening soon in MILTON KEYNES, SLOUGH and STOCKPORT. Phone 0702 552911 for further details of your nearest Maplin store.

Order Coupon		Send this coupon to P.O. Box 3, Rayleigh, Essex SS6 8LR			
Quantity	Carriage Each	Description	Code	Price	Total
	£5.50	HI-FI STEREO KARAOKE MIXER	50064	£49.95	
	£2.55	AMPLIFIED SPEAKERS	50065	£49.95	
	£1.40	3 MICROPHONE PACK	50066	£19.95	
Name _____			Total Carriage _____		
Address _____			Max. charge per order for carriage is £5.50.		
_____			Handling _____		
_____			Post Code _____		
_____			Total _____		
I authorise you to debit my Credit Card account for the cost of goods despatched.					
Credit Card No. _____			_____		

!!Ti2o

SERIOUS SOUND SERIOUS SAVING

HIGH QUALITY PROFESSIONAL 100W POWER AMPLIFIER KIT - SAVE £30

* Ideal for Instrument Amplification * Stage Foldback * Small Venue P.A. * Studio Monitor Amplifier



1992/3 Catalogue Price **£159.95**

NOW ONLY [ill]

£129.95

Order Code **LT11 M**

This superb amplifier kit brings together five of the best and most popular 'Audio Building Blocks', to produce an amplifier of unrivalled sound quality at the price. The Power Output Stage is an excellent 150W MOSFET design which is currently Maplin's Best Selling Audio Kit. It is complemented by the excellent performance of the SSM2016 Differential Preamplifier which has also featured in Maplin's 'Top 20' kits. The superb audio stages are supported by a High Quality Power Supply Unit, sophisticated Monitoring Circuitry and a Thermal Protection System. Housed in a rugged 19in. rack mounting case, this outstanding amplifier is designed for longevity, purity of sound reproduction and ease of integration with other professional equipment.

The kit contains everything you need to build this superb amplifier and is supplied complete with comprehensive constructional information.

Features:

- * Standard 19in. 2U Rack Mounting Case
- * 100W RMS Power Output
- * Balanced Line Input
- * Loudspeaker Protection
- * Switch-on Mute
- * Thermal Protection

Typical Specification:

Rated Load Impedance: 4 to 80
Maximum Power Output:
40, 105W RMS
50, 90WRMS
THD@ 75W (1 kHz): 0.02%
Frequency Response: 10Hz to 40kHz, -1dB

For a friendly welcome and the best of service, visit your local Maplin store: BIRMINGHAM; Sutton New Road, Erdington. BRIGHTON; 65 London Road. BRISTOL; 302 Gloucester Road. CARDIFF; 29-31 City Road. CHATHAM; 2 Luton Road. COVENTRY; 12 Bishop Street. EDINBURGH; 126 Dairy Raad. GLASGOW; 264-266 Great Western Road. ILFORD; 302-304 Green Lane. LEEDS; Carpet World Building, 3 Regent Street. LEICESTER; Office World Building, Burton Street. LONDON EDGWARE; 146-148 Burnt Oak Broadway. LONDON FOREST HILL; 107-113 Stanstead Road. LONDON HAMMERSMITH; 120-122 King Street. MANCHESTER; 8 Oxford Road. MIDDLESBROUGH; Linthorpe Road. NEWCASTLE-UPON-TYNE; Unit 4, Allison Court, The Metro Centre, Gateshead. NOTTINGHAM; 86-88 Lower Parliament Street. PORTSMOUTH; 98-100 Kingston Road. READING; 129-131 Oxford Road. SHEFFIELD; 413 Langsett Road, Hillsborough. SOUTHAMPTON; 46-48 Bevois Valley Road. SOUTHEND-ON-SEA; 282-284 London Road. Plus NEW STORES opening soon in MILTON KEYNES, SLOUGH and STOCKPORT. Phone 0702 552911 for further details. Subject to availability. Price subject to change. Price inclusive of VAT. [E] indicates a carriage charge of £5.50.

Maplin

ELECTRONICS

CREDIT CARD HOTLINE

0702554161

Mail Order to: P.O. Box 3, Rayleigh, Essex S56 SLR