



BRITAIN'S BEST SELLING ELECTRONICS MAGAZINE

No. 52

# ELECTRONICS

*The Maplin Magazine*

APRIL 1992 • £1.60



## VIRTUAL REALITY HAS ARRIVED!

See inside...

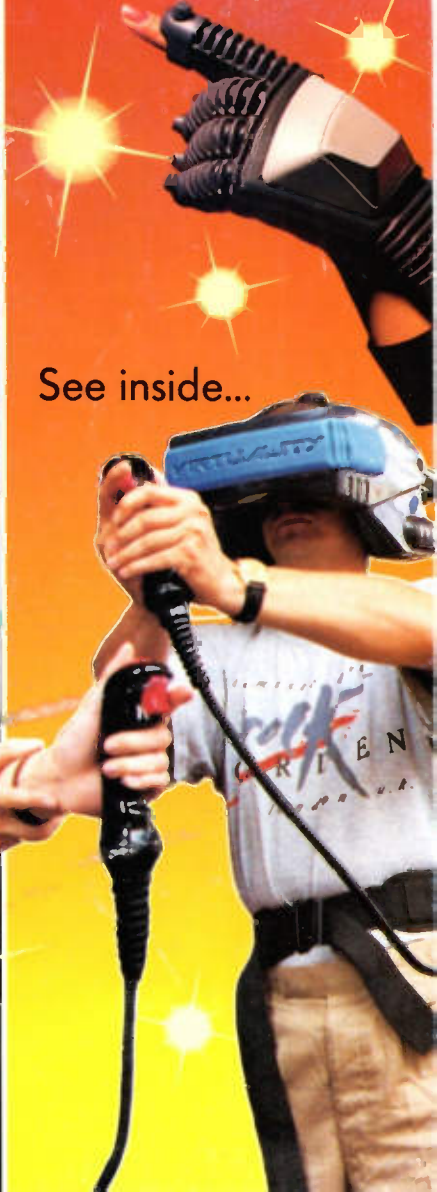

**\* Understanding Aircraft Navigation** \* **New Series – Video Processing Systems** \* **A Digital Preamp for you to build** \* **Hi-Fi Valve Amp** **PLUS!** How to... Use bridge circuits, Build an audio patchbay, Design logic circuits, and much more!

# IT'S A JUNGLE OUT THERE.



## MEET ONE OF THE KINGS!

There are more new radio-controlled cars and accessories available now, than ever before. In fact, it's a jungle out there! Now you can own one of the kings of that jungle.

High performance, ready-built,  $\frac{1}{10}$  scale racers whose only limit to performance is your imagination.

The Jet Cat (GL41U, featured above), is a great introduction to the world of modular model racing, the concept of which allows you to build up a radio-controlled model with components that meet your specification and budget.

Two other models complete the 'racing pack'. Radicator (GL36P, see below), is a 2-wheel drive racer with a chassis constructed from strong T-6 aluminium and special engineering plastics to keep the weight as low as possible, ensuring quick, agile handling. Radicator is tough enough for the entry-level driver, yet versatile enough to be a challenging platform for the experienced driver.

The Bullet (GL37S, see below), lives up to its name and is a real 'gold edged' winner. The Bullet utilises gold anodised, aircraft grade T-6 aluminium for the chassis, motor bracket and shock absorbers.

In its first-ever American regional R.O.A.R. off-road competition, a pre-production prototype of the Bullet defeated all comers and turned in the fastest lap in 2WD competition!

All three racers come unpainted (paints not supplied), so you can choose your own individual design.

All you need to add to the cars is the 2-channel radio transmitter and receiver set (XJ47B), a Ni-Cad racing pack, e.g. (YP90X) and a racing motor of your choice. See the 1992 Maplin Catalogue for the full range of radio-controlled models and accessories or call in to your local Maplin store for helpful, expert advice. Prices for cars from as low as £59.95, phone 0702 554161 now. All items subject to availability.



# CONTENTS

APRIL 1992 VOL. 11 No. 52

## EDITORIAL

■ Hello and welcome to another issue of 'Electronics'! As usual, there is a super collection of projects and features, plus all of the usual regulars. Monthly production of this magazine is quite a task. From project and article conception, through to the final preparation of the magazine pages and the battle against looming deadlines. The latest technological development that will make production more efficient is the installation of a local area network (LAN). A LAN is a means of interconnecting computers so that programs, data and resources (such as printers and hard drives), can all be shared by the users of the network. 'Electronic mail' can be sent between users, eliminating the need for messages to be jotted down on pieces of paper. Text files for articles, parts lists, drawings and PCB designs, can be transferred between departments without a single floppy disk being exchanged! When articles are ready to be printed out, the network automatically stores the files, places them in a queue and prints them on the appropriate departmental printer, releasing the users' computers for the next task. It all adds up to a comprehensive, but easy to use system where some two dozen users can communicate effectively, accurately and easily. Finally all that remains for me to say is I hope that you enjoy reading this issue as much as the 'high-tech team' and I have enjoyed putting it together for you!

*R. Ball*

ABC 33,837

- Editor Robert Ball
- Project Development Chris Barlow, Gavin Cheeseman, Tony Bricknell, Alan Williamson.
- Technical Authors Mike Holmes, Martin Pipe
- Consultant Author Alan Simpson.
- Technical Illustrators Paul Evans, Lesley Foster, Ross Nisbet, Nicola Hull.
- Production Co-ordinator Alan Wright.
- Print Co-ordinator John Craddock.
- Advertising Co-ordinator Kathy Peters
- Publications Manager Roy Smith
- Development Manager Dave Goodman
- Advertising Manager Vic Sutton
- Drawing Office Manager John Dudley.
- Art Designers Peter Blackmore, Jim Bowler.
- Published by Maplin Electronics Plc.
- Colour Separations Stirling Graphics Ltd. 16-22 West Street, Southend, Essex SS2 6HJ
- Printed by Severn Valley Press, Caerphilly, Mid Glam. CF8 3SU
- Distributed by United Magazine Distribution Ltd. 1-11 Benwell Rd, London N7 7AX
- Mail Order P.O. Box 3, Rayleigh, Essex SS6 8LR
- Retail Sales: (0702) 554161 ■ Retail Enquiries: (0702) 552911 ■ Trade Sales: (0702) 554171
- CashTel: (MODEM) (0702) 552941
- General: (0702) 554155
- Fax: (0702) 553935 ■ Telex: 995695

Copyright. All material is subject to worldwide copyright protection and reproduction or imitation in whole or part is expressly forbidden. All reasonable care is taken to ensure accuracy in preparation of the magazine, but Maplin Electronics plc cannot be held legally responsible for its contents. Where errors occur corrections will be published as soon as possible afterwards. Permission to reproduce printed circuit board layouts commercially or marketing of kits must be sought from the publisher.  
© Copyright 1992 Maplin Electronics plc  
Advertisements. Whilst every reasonable precaution is undertaken to protect the interests of readers by ensuring, as far as possible, that advertisements appearing in the current issue of 'Electronics' - The Maplin Magazine - are bona fide, the publishers and the staff of the magazine cannot give any undertakings in respect of statements or claims made by advertisers, whether on printed page or insert.  
Editorial. The views of individual contributors/authors are not necessarily those of either the publisher or the editor.  
Cover Picture © Copyright 1992 Alan Craddock/Young Artists.

## PROJECTS

### 8 16-WAY AUDIO PATCHBAY

■ A flexible, modular system, ideal for use in home or semi-professional recording studios.



### 24 DIGITAL PREAMPLIFIER

■ Features digital control of input selection, volume, tone and balance.



### 32 INFRA-RED VIDEO LINK

■ The concluding part of this project describes receiver construction, system setup and use.



### 48 FUNTRONICS: THE FLASHER

■ This beginners' project is a simple LED flasher circuit.

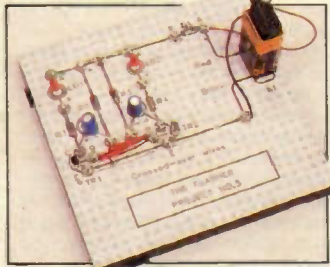

### 56 HI-FI STEREO VALVE AMPLIFIER

■ Construction details are given in the final part of this project.

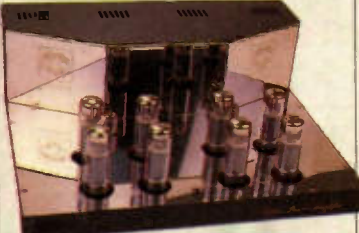

### 73 DATA FILE: VOLTAGE REGULATORS

■ A comprehensive guide to using fixed positive and negative voltage regulators.



## FEATURES

### 4 ELECTRONICS IN AVIATION

■ This issue, Chris Yates deals with aircraft navigation.



### 16 VIDEO PROCESSING SYSTEMS

■ This new series deals with all aspects of video.

### 40 VIRTUAL REALITY

■ Using computers to create an artificial world, for entertainment and serious purposes.



### 44 MODERN BRIDGE CIRCUITS

■ This new series deals with bridge circuits and their uses.

### 51 MICROCOMPUTER TESTING

■ The concluding part deals with software and test programs.

### 64 SEQUENTIAL LOGIC

■ State diagrams and karnaugh maps are used in the design of logic circuits.

## REGULARS

- 2 NEWS REPORT
- 21 SUBSCRIPTIONS
- 22 ORDER COUPON
- 23 STRAY SIGNALS
- 43 CLASSIFIED
- 55 TOP 20 KITS
- 70 NEWSAGENTS' COUPON
- 71 AIR YOUR VIEWS
- 72 TOP 20 BOOKS
- 79 NEW BOOKS

Prices shown in this issue include VAT at 17.5% (except items marked NV which are rated at 0%) and are valid between 6th March 1992 and 30th April 1992.

# NEWS

## Report

### UK-Crypt

While on the subject of satellite TV, an interesting new product has been recently introduced by Cambridge Computer, a company that had its original roots in Uncle (sorry, Sir) Clive Sinclair. The stylish RD480-Extra is one of the new breed of Integrated Receiver-Decoder (IRD), having a built-in Videocrypt decoder – which, as discussed below, appears now to be an essential item! Apart from the decoder, other features include a generous 99 programmable channels (upon adding a positioner and motorised dish, you have a multi-satellite system which represents excellent value for money), stereo sound, full remote control and a 'favourite programme selection' facility. Another major feature is that the unit is designed and manufactured in the UK; in Irvine, Scotland to be precise. The RD480-Extra system retails for £269.95 with 60cm dish, or for £299.95 with 80cm dish.

Incidentally, although an 80cm dish may require planning permission, it does allow experimentation with the reception of (often lower-powered) satellites other than Astra. However, with interference problems (caused by the adjacent Eutelsat 11 F3 craft) being reported on Astra channels viewed using a 60cm dish, the Government may be forced to relax its planning regulations.



### Europe Sans Frontières?

If you own a satellite TV system, you will have noticed the bewildering (and, sadly, increasing) number of channels that have unintelligible pictures. This is due to the several weird and wonderful types of 'scrambling' used to prevent unauthorised reception of television programmes, mostly subscription services. Many of the decoders required are not legally available in this country, and are unlikely ever to be.

An interesting case is that of Filmnet, a subscription film service intended for the Benelux countries, Scandinavia and nowhere else, in this case for copyright reasons. Unlike some European film channels, Filmnet's main output of English (sorry, American) language movies retains its original soundtrack, and as a result is of much interest over here in the UK. To help matters, the scrambling system used is the easily-hacked 'Satpak' system,

developed by Matsushita in Japan. As a result, 'pirate decoders, sold at ludicrously high prices have been available, for some time, by mail order from various companies – and a number of specialist stores (including those instructed by BSKyB not to supply such items!). The problem with such decoders is the fact that Filmnet would (understandably) make minor changes to the scrambling method, leaving the pirate decoders unusable. Pirate companies would soon figure out how to make the simple changes to their decoders, charging their customers exorbitant amounts of money for modifications. Last autumn, Filmnet's sound changed from the 6.6MHz FM subcarrier to a NICAM-based digital audio system, and not surprisingly a number of UK manufacturers jumped on the bandwagon, producing over-priced NICAM decoders.

For those of you about to spend good money on these, the answer is simple – forget it! Filmnet is currently dual-luminating on the Astra satellite with a D2-MAC service (ironically encrypted in a system known as 'Eurocrypt') in addition to its existing one. When all of its subscribers have been supplied with new receiver-decoders (supplied, not surprisingly, by Philips), then the Satpak-encoded channel will close down – rendering many thousands of pirate decoders useless. As a consolation, until Filmnet can distribute the required Eurocrypt 'smart-cards', the service remains soft-scrambled and watchable by those with the required equipment (available only as considerably 'marked-up' imports, with the exception of the new Amstrad SRD600) – for the moment. But, unfortunately, despite a Unified Europe, you will not be able to purchase a Filmnet smart-card over here – despite the ready market that Filmnet has.

A seemingly insular 'scramblemania' seems to be proliferating amongst European satellite operators. With a united Europe around the corner, and the cultural and economic opportunities that it brings, many broadcasters are being forced into adopting this very short-sighted approach by the greedy actors' unions and film companies. There are other reasons, however. MTV, the highly popular Astra-based music channel, has cited that cable operators are illegally distributing their programming. However, this is a feeble excuse and will be no barrier to those targeted. In common with Eurosport and Lifestyle, two other Astra-borne channels contemplating scrambling, MTV will lose audiences (fewer people will be willing to subscribe) and, as a result, its essential sponsorship/advertising revenue will drop. The likely scrambling system used will be that used by our very own Sky Television – who themselves are considering encoding all their channels, including the currently clear Sky One and Sky News (a point worth bearing in mind if you are

### Speeding the Social Welfare Payment

That which is being claimed as the largest known civil project involving changes to management and human resources, is being masterminded by Andersen Consulting for the Department of Social Security. Fortunately this is the largest and highest budget, UK government department which will help pay for the £1.5 billion operation. The project, which has now completed stage one, will have an impact on every man, woman and child in the UK and covers National Insurance and benefits information for around 60 million people. The aim of the project, says

Keith Burgess, managing partner at Andersen, was to re-shape the DSS's way of doing business – to become customer focused, allowing individual's information to be accessed immediately, and for transactions to be processed much more quickly and accurately.

The development, which it is hoped will show some £150 million a year cost savings by 1995, will link some 1,800 offices, 70 mainframe computers, 41,000 computer terminals and 100,000 employees in local DSS and Employment offices. A positively comforting thought for the growing number of unemployment claimants and pensioners.

considering buying an Astra receiver system primarily to receive Sky – particularly if you are an ex-pat living in Europe). Videocrypt (developed by Thomson in France), like the similar Eurocrypt, is virtually 'unhackable' but, due to the way in which the video signal is messed up, (a picture line 'cut-and-rotate' system is used), it leaves the decoder-equipped viewer with a rather grotty picture – a rather unfortunate side-effect, over which there is little or no control.

Interestingly, at the time of writing, four transponders on the controversial Eutelsat 11 F3 satellite are already being used for European TV use – and three of them are scrambled using weird and wonderful encryption systems. So much for an open yet united Europe!

### Filling Each Unforgiving Second

It is reported that Hewlett-Packard has produced an atomic clock that resembles a desktop computer together with a digital display. The clock which is accurate to within a second every 1.6 million years comes with a five-year guarantee.

### Wanted! One Robot!

Calling all technofreaks! The voluntary organisation 'Leisure Free', based in Manchester, is seeking to build a moving, talking robot (similar to the one featured in the film 'Short Circuit') for the entertainment and education of underprivileged children.

Leisure Free currently owns a double-decker bus, called the 'Fun Bus', which it uses for leisure activities and day trips. Recently, the Fun Bus has taken groups of children to Camelot, Knowsley Safari Park, roller-skating discos and pantomimes. Future events planned include camping weekends, canal trips and go-karting.

With respect to the robot, any help from any electronic, mechanical and design engineers would be gratefully appreciated, as would offers of sponsorship. In addition, if you have any of the following parts 'going spare', Leisure Free would be delighted to use

- them in the construction of the robot:
- ★ A sophisticated computer/remote control system
- ★ Tractor Base and Wheels
- ★ Two Sinclair C5 motors
- ★ Two sealed 12 to 18 volt lead-acid batteries
- ★ A small colour CCTV camera
- ★ A two-way radio transmitter and receiver
- ★ A LCD TV screen
- ★ Several small motors for movable parts
- ★ Arms with maximum movement
- ★ Linear Pistons and Servos
- ★ A Speech synthesiser
- ★ A colour monitor
- ★ Robot Skeleton
- ★ Lights, Wire, Switches
- ★ Any other removable parts

If you are able to help in any way, please phone David Epstein on (061) 796 7840, or write to Leisure Free, P.O. Box 25, Prestwich S.O., Manchester M25 7UJ.



### Kid's Stuff

PCs, says the US Channel Marketing organisation, will outnumber children in US households by the end of the decade. By then each household will have an estimated 2:2 PCs. Last year some seven million home computers were sold, thanks to the fall in prices, reduction in size and an increase in home businesses. Presumably these estimates take into account the latest statistics from Dataquest, which reveal that, for the first time since 1983, worldwide computer sales actually fell last year. Particularly badly hit were sales of PCs, which account for nearly half of all computer sales, and mainframe machines. However, demand for supercomputers showed a rise of 14%.



## The Mad Professor Quits OFTEL

Sir Bryan Carsberg, the UK's Director General of Telecommunications, dubbed 'the mad professor' (apparently a BT staff term) by TRR, the industry monthly review, is quitting the quango for the Office of Fair Trading, in June. The independently minded Carsberg leaves behind much telecomms confusion. Despite the liberating policies of the government, BT still retains over 95% of the market, users still believe they are paying too high tariffs, while the major US carriers are poised to make a large indent in the UK market. As 'TRR' asks, "who is watching the watch dog?" OFTEL, they say, adopts an inept and lackadaisical handling of consumer complaints. Faced with a major problem, the Body often dithers and wrings its collective hands. It is to be hoped that Carsberg's successor will be less academic or more business-like. In the meantime, BT must be toasting the departure of Carsberg, whose role in life appeared to be that of kicking BT around whether deserved or undeserved.

## Breaking the Pipeline

Engineering company Raychem has designed a dual-wall pipe protection material for automotive brake and fuel lines, which meets major motor manufacturers specifications for thick wall protection. The company points out that damage to brake and fuel lines, caused by stones and other road debris, has been exacerbated by such developments as wider tyres, front-wheel drive and four-wheel drive which can result in damage to pipe coatings. The Raychem polyolefin tubing is heat-shrunk over the pipeline to give dual-wall protection. Even if the outer layer is damaged, an adhesive layer bonding the material to the pipeline will prevent moisture ingress. Details: (0793) 528171.



## Maplin Catalogues Replace Vinyl at WHSMITH

Leading high street music retailer, WHSMITH, is getting out of vinyl LPs. This decision, says the company, reflects the rapid decline in vinyl sales which now accounts for less than three per cent of the retail chain's total music business.

"The market has been in long-term decline since the rise of CDs in the mid 1980's and the rate has increased significantly in the last 18 months," explains senior product group manager Brian Worrall. "Record companies have been cutting back on the amount of vinyl they release and on the number of existing titles they hold." However, the chain will continue to sell 7in. vinyl singles, where local conditions warrant, as they remain popular with younger music buyers and are experiencing a less dramatic decline. However, on the bright side, Smith's are reporting record sales of the '92 Maplin Catalogue, and fresh supplies are having to be rushed out from the Maplin Warehouse!

## PICTURE CAPTION CHALLENGE



Building by design, or on site calculating? What is going on? No prizes, but lashings of ingenuity.

- ★ Engineer searching his database to order essential supplies of cement.
- ★ Engineer calculating his on-site

overtime and bonus rates.

- ★ Local Borough official calculating the new Council tax.

Wrong on all counts. It is a publicity picture for the new Sony Data-Disc-man and cellular telephone.

Maybe the space saved in displaying vinyl at WHSMITH's will be devoted to the installation of the Audiocatalogue, a new service designed to assist the purchase of recorded music in large retail outlets. Once in operation, it allows customers to consult a musical database via an Interactive terminal. Using a tactile screen, the user is guided through a selection process, and can then listen to an extract from the chosen disk and see the record sleeve and information on the disk.

ISDN, the fast telephone networking technology, is used to update the different locations daily. The data input centre digitises any new information – sound, text or pictures – and sends it via the ISDN network to each shop. Very much in the category, has to be seen and heard to be believed.

## Sony Sticks to It

The daily industry bible, 'Computergram', reports that Sony Corporation has unveiled a tiny tape recorder that uses a cassette about the size of a postage stamp, called the Scoopman. Also looking to the future, chip manufacturer Intel is forecasting that, by the end of the century (the year 2000 looks like being a very high tech place), the company will have developed the Micro 2000, a processor which will pack 100 million transistors onto a single square inch of silicon, over 80 times the present levels!

Still looking to the future, a leading authority is suggesting that the PC will more resemble a large filofax system, incorporating telephony, TV and fax. Still on the future trail, it is rumoured that Compaq is talking to Swatch about developing a laptop at under £400. Presumably it will come with exchangeable wrist straps.

## Events Listings

4/5 March. The Networked Economy. A major conference which brings together the individuals with the power to shape the telecommunications future. Paris. (081) 868 4466.

10/12 March. CADCam '92, NEC Birmingham. (071) 404 4844.

10 March to 31 May. Catching The Action – Muybridge and The Chrono-photographers. MOMI, London. (071) 928 3232.

11/18 March. CeBIT '92 Major European technology event. Some 5,000 exhibitors will be on show in some 21 different halls. Hanover. (081) 688 9541.

24/26 March. NEPCON Electronics. Your chance to meet Maplin (MPS Stand 2600) in person! NEC Birmingham. (081) 948 9800.

24/26 March. Scottish Computer Show, Glasgow. (061) 832 4242.

31 March to 2 April. CD-ROM Europe '92, Brighton. (0895) 622233.

1/2 April. Virtual Reality '92, London. (071) 931 9985.

1/8 April. The Hanover Fair. The big one. Take extra walking boots. (081) 688 9541.

7/10 April. The Which Computer? Show + Communications '92. NEC Birmingham. (081) 940 3777.

11/25 April. International Science Festival, Edinburgh. (031) 556 6446.

13/15 April. Cable and Satellite '92. Olympia, London. (081) 940 3777.

24/26 April. The Third MIDI Music Show, Hammersmith, London. (081) 549 3444.

12/14th May. The Portable Computer Show, Olympia, London. (081) 868 4466.

Please send details of events for the Diary Listings to The Diary Editor, 'ELECTRONICS'.

# Complete your tools with Antex Soldering Irons

The art of accurate soldering is to maintain the bit temperature at the optimum level.

Antex fixed setting, thermally balanced, high efficiency irons maintain constant tip temperature and offer a wide range of soldering bits to suit your particular application.

For the more sophisticated applications, control at lower temperatures is essential. In these cases an adjustable temperature soldering iron is required. Also available are soldering stations with the option of digital temperature read out.

Antex products are designed for precision soldering to meet the demands of precision electronics.

Ask for Antex by name at leading Electronics distributors.



# ANTEX

Antex Electronics  
2 Westbridge Ind. Est.,  
Tavistock, Devon PL19 8DE  
Telephone: (0822) 613565  
Fax: (0822) 617598

# ELECTRONICS

IN

AVIATION



## Part Four Navigation by Chris Yates

The art of navigation once required little more than a sextant and compass, with which you could fix your position to within a few hundred yards almost anywhere on the globe. That method stayed in use until the advent of electronic beacons and latterly navigation satellites. Today it has been superseded by the silicon chip offering even greater degrees of accuracy.

Nowhere are these electronic aids more widely used than in the world of aviation, where precise navigation is of paramount importance to safety in the skies. Many aircraft can be heard transmitting, and identified from, their often curious signals interspersed throughout the radio spectrum. They form a part of Air Traffic Control (ATC) jargon; controllers can often be heard instructing pilots, "direct to the GOW... ..intercept the ILS... ..lock onto the localiser."

### History

Like many modern day electronic devices, navigation aids have their origins in the midst of war, and three – Mother, Oboe and Loran – played a significant role in the Allied success over Nazi Germany.

Mother was a development of IFF; a system which allowed ground controllers to interrogate incoming bombers by radar to determine whether they were friend or foe. When installed in airfield control towers, a radar equipped aircraft could do the same with Mother, but obtain a range measurement and bearing to its home base.

In contrast, Oboe found important work on outbound missions by the Pathfinder Force of the RAF, by positioning their aircraft to within 20 or 30 yards above particular factories in the Ruhr. Essentially this was achieved by measuring the aircraft's position very precisely from two ground stations in Britain, and undoubtedly contributed to destroying the Nazi's industrial strength.

At the same time, much research was being conducted into the problem of long-range navigation, particularly over the vast expanse of the North Atlantic, where it was possible to become hopelessly lost and end up ditching in the sea. Thus Loran was born, a development from GEE ground radar; in which two stations 1000 miles apart, transmitted a pulsed 2MHz signal which could be

Left: Concorde flying over a Racal Avionics Instrument Landing System Localiser Aerial at Luton Airport.

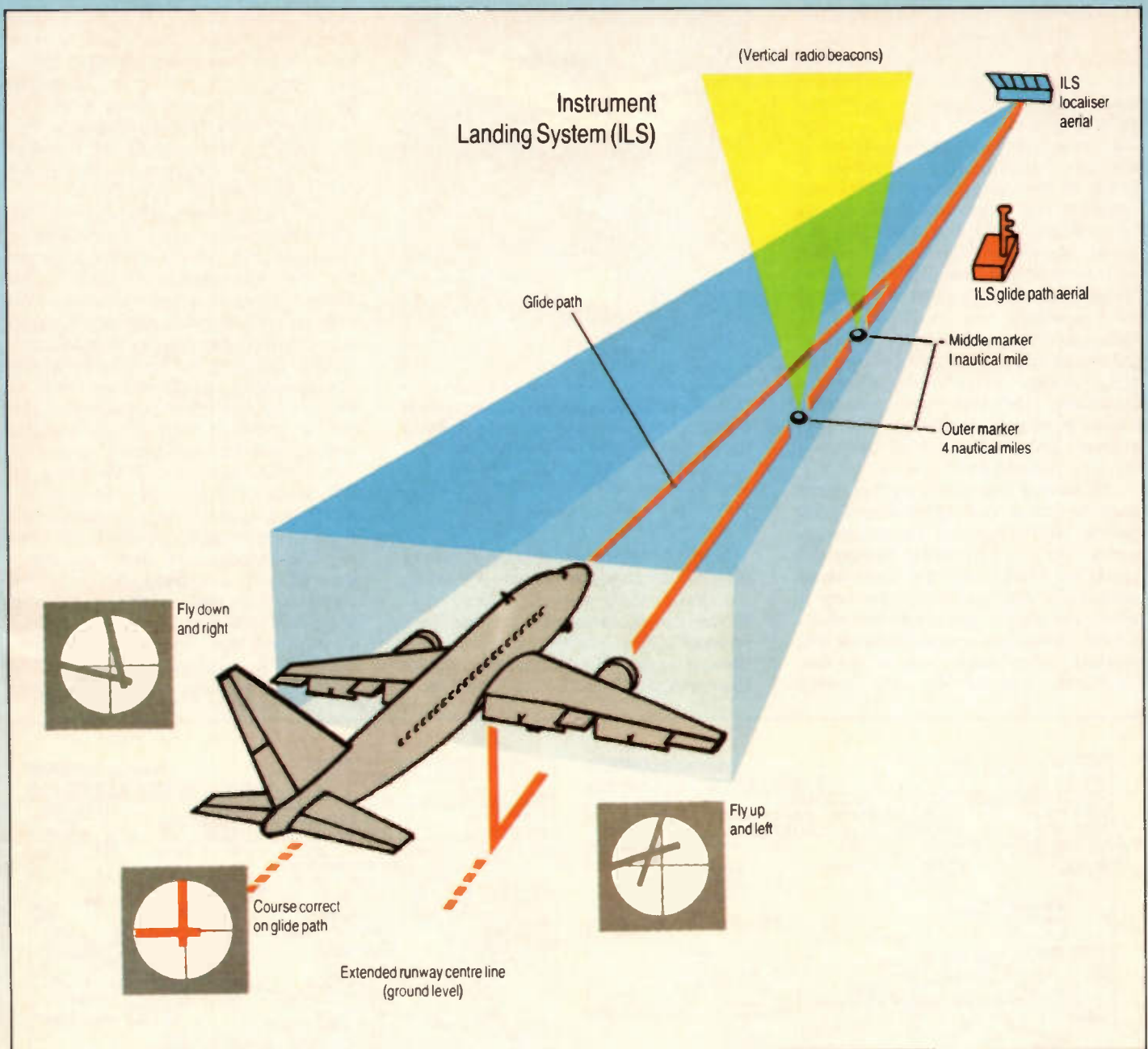

Figure 1. The Instrument Landing System.

used for highly accurate position fixes. The key to Loran's success was synchronisation – a problem solved by the development of precise quartz master clocks installed at each station. By 1945 Loran coverage had been extended not only over the North Atlantic, but much of Europe and the entire Pacific. It is still much in use today, particularly by aircraft overflying some of the more inhospitable areas of the globe.

## Modern Day

Since the explosion in international air travel, our skies have become increasingly crowded, and consequently greater emphasis has been placed on the use of navigation aids. This is particularly true in the critical descent to an airport. Here the most important aid is ILS or Instrument Landing System. ILS is really three systems in one, providing a pilot with a constant indication of whether he is left or right of the approach track, his position in relation to an ideal glide path to the runway and distance to

touchdown. Figure 1 illustrates the operation of the ILS.

The left or right indication is given by a device called the Localiser. This transmits its signals on either side of the runway centre-line, but they overlap in a beam approximately five degrees wide along the approach centre-line. This information is normally read from a twin needle cockpit mounted instrument. The needle pivoting from the top of the unit operates like a windscreen wiper and is triggered by localiser signals, the one on the left moves up and down, and is sensitive to the glide-path transmitter. When these two needles are lined up at right angles in the centre of the instrument, the aircraft is on a precise alignment for landing. Of course the pilot still requires some indication of range, and this is achieved by the use of marker beacons. Located at four miles, one mile and occasionally on the runway threshold, they trigger both visual and audible cockpit warnings.

ILS can allow suitably equipped aircraft to be landed by automatic pilot, and is divided into three categories:

Cat 1 – Allows autopilot operation down to a 60 metre decision height with runway visual range (RVR) over 800 metres.

Cat 2 – Allows autopilot operation down to a 60 metre decision height but with RVR over 400 metres.

Cat 3 – Allows autopilot operation without any height limit but an RVR of 200 metres in the final phase of landing.

Many modern jetliners are now equipped to a Cat 3c standard which means they can auto-land with a runway visual range down to zero – obviating the need to divert to an alternate airfield in poor visibility.

Navigation by electronic means is not only confined to airports, and three specific types of navigational aid (navaid) are widely used to define the location of airways.

The Non Directional Beacon (NDB) is perhaps the most common device. This has a range of around one hundred miles and transmits a continuous steady tone and morse code signal in the MF sector of the radio spectrum. In use, an automatic direction finder or radio compass is tuned to the appropriate NDB, and indicates the relative position of the transmission source. NDBs are prone to interference, and it is not unknown for the Automatic Direction Finder (ADF) display to direct pilots to the nearest thunderstorm cell. Although not an NDB in the strictest sense, it's interesting to note that the BBC Radio Four transmitter at Droitwich (198kHz) is marked on some aviation charts as an ADF source, should the usual beacons become unreadable.

At airway intersections it is more usual to find a VHF Omni-directional Range (VOR) beacon. Broadcasting in the 108 to 117.95MHz navigation band, the VOR uses one antenna to radiate an AM carrier containing a reference signal plus identification, but 48 further antennae transmit the bearing information via a double sideband sub-carrier. By using

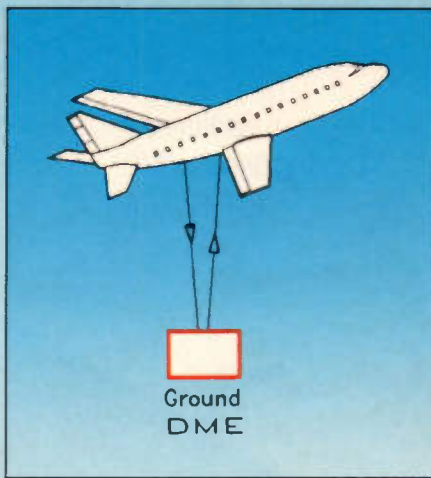

Figure 3. To obtain a distance measurement an aircraft in flight sends a pulsed signal to the ground DME, this returns the signal and an on-board computer calculates the time delay producing a distance display in miles and tenths.

VORs, a pilot can obtain precise directional data on which to steer. However, they cannot supply distance measurements, so for that reason VORs are often paired with a device called Distance Measuring Equipment (DME). The DME is a

direct descendant of Mother, and relies on the fact that radio waves travel at a constant 186,000 miles per second in order to calculate distance. Figure 2 shows ILS/DME landing charts, which indicate all the beacons in the vicinity of London Heathrow, and Figure 3 shows the principle of operation of DME.

In the present day system, an on-board transmitter broadcasts a pulsed signal, which is then returned by the appropriate ground DME station. Cockpit computers time the interval between the two signals and produce an LED display in miles and tenths. Despite the fact these highly sophisticated systems are still in regular use in most countries of the world, modern airliners still carry self-contained navigation aids for use should the various beacons be off the air or otherwise unavailable.

The Doppler system operates by monitoring aircraft velocity by means of doppler radar, and direction from a gyro or radio compass. An on board computer processes the data and produces the required navigational information. Also operating independently of ground stations is the INS Inertial Navigation System. Again

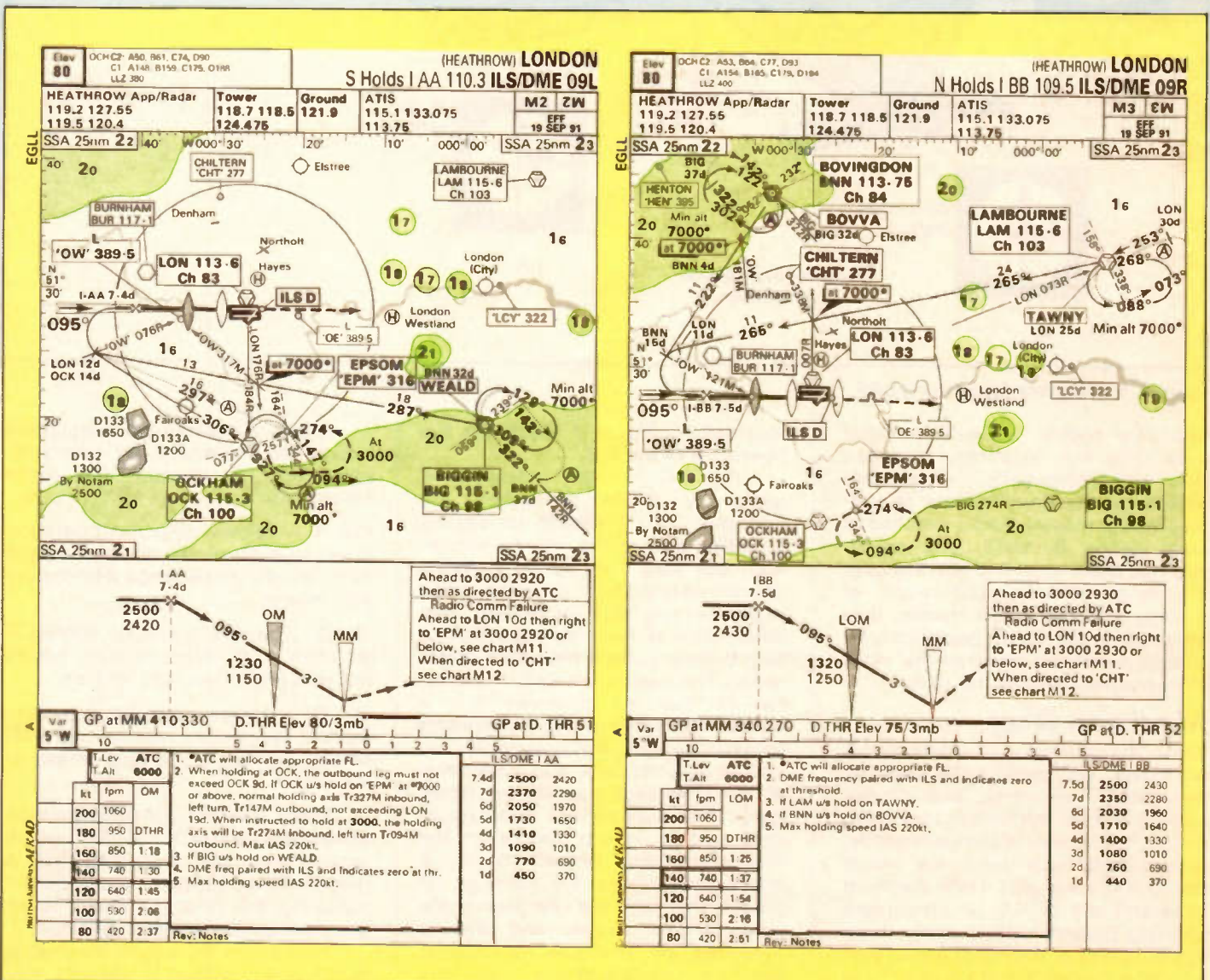
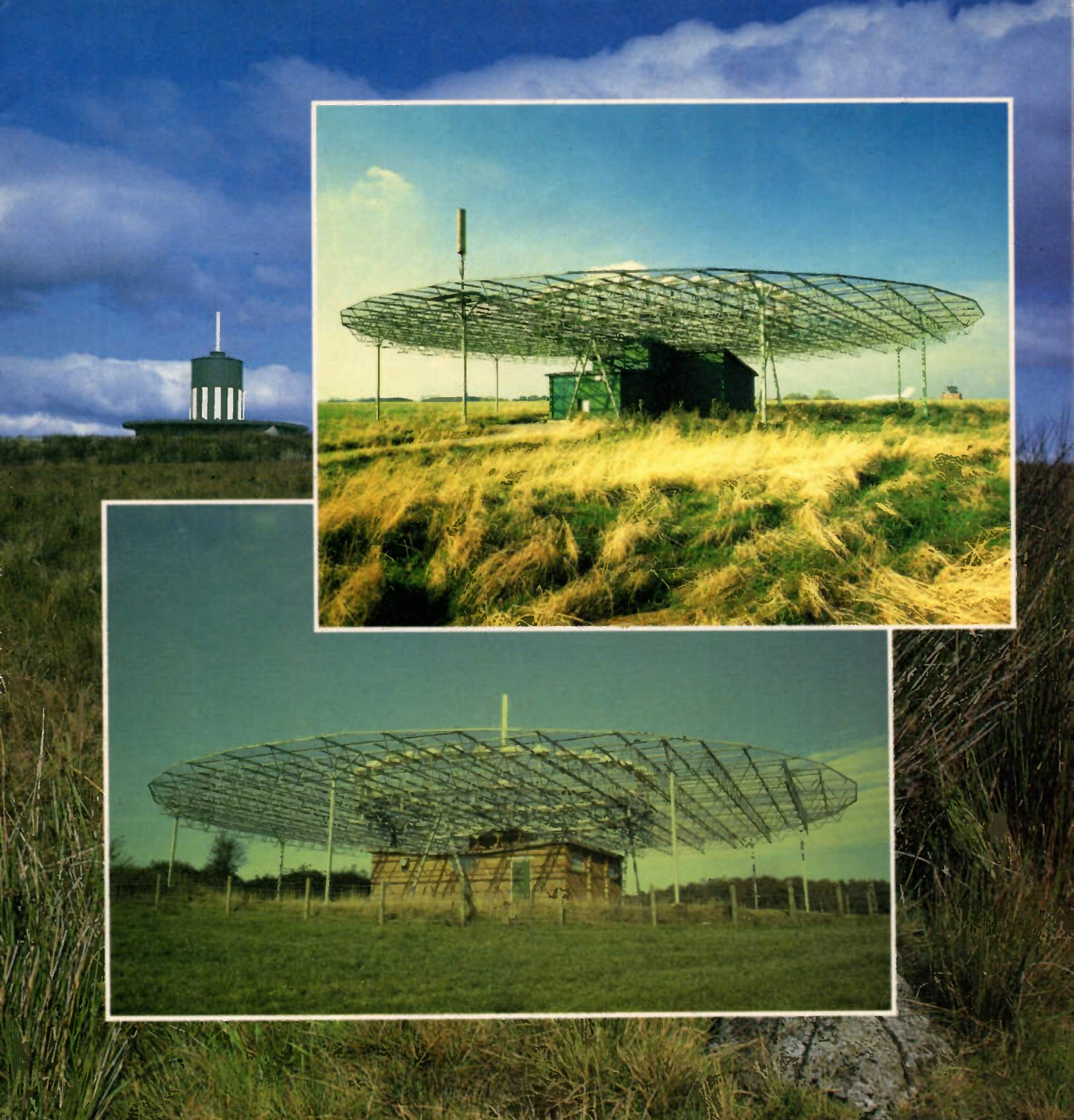

Figure 2. ILS/DME landing charts indicate all the beacons in the vicinity of London Heathrow. Bovingdon, Ockham, Biggin, Burnham and London are VOR/DME's, whilst the remainder are marker beacons. The maps shown illustrate the approach patterns for a landing on runway 09 left and right from both the Northern and Southern 'holds' or 'stacks'.





this is based upon a computer but the data is culled solely from gyroscopic accelerometers. With INS it is possible to pre-program flight details, and the output will then instruct the autopilot of the required routing. It is common for INS to be used in this way when ATC clears aircraft to take direct tracks without reference to radio beacons.

Of course much of the previously discussed network is redundant when over-flying oceans or inhospitable landmass. Here the VLF/Omega and Loran long-range navigation systems come into their own. VLF/Omega is based upon sixteen communication stations situated in

different parts of the world. Their signals are used to determine aircraft position to an accuracy within 1-5 nautical miles, anywhere on the earth's surface! VLF/Omega and Loran are supplemented by precision time-keeping and a system of radio reporting points based on lines of longitude, which is to maintain separation from other aircraft.

### In Use

As this complex and highly sophisticated network of navigation aids has developed, so too has state-of-the-art equipment with which to monitor them. One of the latest devices is the Racal RNS 5000 Multi Sensor Navi-

**Main picture: VOR at Brecon.  
Above left: VOR and DME at Mayfield.  
Above right: VOR and DME at Biggin.**

gation System. This ingenious unit can process data received from a selection of Loran, VLF/Omega, Inertial, VOR, DME and Global Positioning by Satellite (GPS) sensors, and output navigational information for the pilot, and instructions to the Flight Director and Autopilot. From an initial programming of aircraft position the RNS 5000 selects DME to steer-by, and automatically creates a priority list of all those within range. It will continue to update

*Continued on page 14.*

# 16-Way Audio Patchbay



**A**ny person who has worked in a 'proper' studio must have noticed something resembling an ancient telephone exchange near the mixer. This is the patchbay and is simply a means of connecting any output to any input in the studio. The basic idea behind patchbays is to make life easier; instead of rummaging around behind racks of equipment whenever you want to reconnect something, the most commonly used inputs and outputs are taken to the patchbay where they can be simply connected together using short cables. Connecting sockets together using short leads is known as patching, a term that is almost certainly derived from the early days of the telephone.

by **Tony Bricknell**

## Features

- ★ Balanced, unbalanced or 'insert point' versions
- ★ Normalised or non-normalised operation
- ★ One PCB for all options
- ★ High loss signal path

## Applications

- ★ Recording studios
- ★ Home recording
- ★ Theatres
- ★ P.A. Systems



Semi-professional and home studios tend to use 1/4in. jack patchbays rather than the more expensive Bantam mini-jack type, mainly because of the lower cost, but also because most electro-musical instruments are fitted with 1/4in. jack sockets, allowing the use of simple jack-to-jack cables.

This patchbay is configured as two rows of sockets, one above the other. It is conventional to designate the lower sockets as signal inputs, while the sockets above will often be the output from the same device. If a signal comes out of a socket, it is said to be an output; if you can feed a signal into it, then it is an input socket. Examples of inputs are: mic/line inputs, effects returns, insert returns, aux returns, etc. Typical outputs are: direct channel outputs, group outputs, monitor outputs, aux sends, insert sends, etc.

## Normalised... or Not?

Normalising is the one subject that seems to confuse people when planning a patchbay. Normalising is used when you do not simply want to use the patchbay as an extension to existing inputs and outputs, but to interrupt a signal path, allowing an audio processing device to be inserted into the signal path. An example is the mixer insert point, where you may want to insert, say, a compressor or graphic equaliser.

Referring to Figure 1a, if we were to take the send and return connections from a mixer's channel insert point and wire them into a non-normalised patchbay, no signal flows unless an external device is plugged in to complete the circuit. Figure 1b, however, shows the same mixer connections taken to a normalised patchbay. It can be seen that, when no external devices are plugged in, the signal path is automatically routed, through the jack sockets, from the send to return.

Actually, most patchbays are only semi-normalised rather than fully normalised. Plugging a jack into either socket on a fully normalised bay would break the signal path. However, for greater flexibility, it is more advantageous if only the input socket is normalised; this way the signal path is only interrupted when a plug is inserted into an input socket.

The reason for not fitting switch contacts to the upper (output) socket is that we now get

the benefit of using the patchbay as a signal splitter. Plugging a lead into the top socket doesn't break the original signal path, but we now have a split feed that can be processed and fed back through a spare channel. This is often called a 'sniff and break' system — the bottom socket breaks the normalised signal path while the top socket just allows us to 'sniff' the passing signal without affecting its path. A simple application of this feature would be to split a signal, process one part of it, which could be panned to one side, and pan the unprocessed sound to the other.

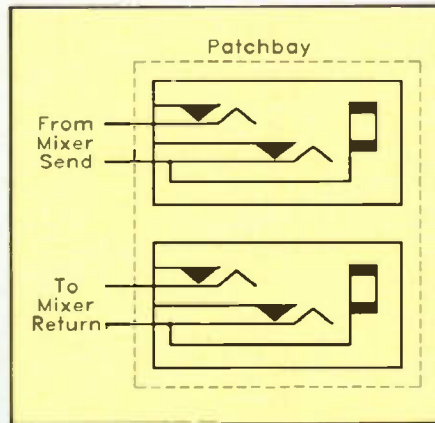

**Figure 1a. Signals from an Insert Point taken to a non-normalised patchbay.**

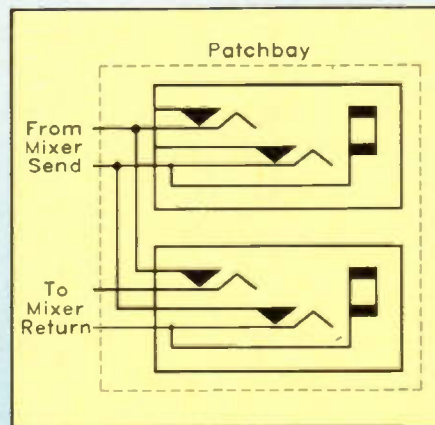

**Figure 1b. Signals from an Insert Point taken to a normalised patchbay.**

As most patchbays utilise semi-normalised connections, the term has tended to slip into misuse so that semi-normalised bays are more often referred to as normalised.

## The Key

There is one non-audio connection that is handy to bring out to a patchbay and that's the key input, which is sometimes found on the back of compressors and gates. Unfortunately, these are wired up in different ways depending on the manufacturer and are aimed at handing control over to the key

input when a jack is inserted. As a jack must be inserted, to wire the unit up to the patchbay, you may end up with permanent key control, whether you require it or not. The only solution here is to consult the owners manual and find out how the key input socket is wired. However, most rack mounted equipment is designed to be used with a patchbay, so you shouldn't encounter too much trouble.

## Planning for a Patchbay

Designing the layout of your patchbay is quite important as, with careful planning, you can have a patchbay that requires only short patch leads making the whole unit cheaper and less prone to extraneous noise pick-up. As with your mixer, it is good practice to allow for future expansion by building a patchbay that is bigger than your present requirements so that when you get new pieces of gear, you simply wire them in. Example patchbay layouts are shown in Figure 2, and Figure 3 shows the wiring layout of a typical home studio.

Where practical, use separate patchbays for normalised and non-normalised functions, Gate pulses and Control Voltages, balanced and unbalanced signals rather than having a mixture on one patchbay. Table 1 suggests connections that should be brought out to a patchbay and indicates whether the connection should be normalised or not.

All mixer insert points must, obviously, be normalised, but you may wish to normalise other connections so that the patchbay defaults to the way you normally use it, leaving little or no patching to do before you start work. This is handy in a small studio where certain effects are always connected to certain aux sends and returns, unless a patch lead is inserted to change the layout.

Non-normalised sockets are used when all you want is a simple extension lead from the inputs and outputs of equipment that are not permanently connected into the system. Signal effects and processors are often wired in this way.

Care must be taken to ensure that the input and output of an effect are not connected together through a normalised pair of sockets. Failure to do this will cause the equipment in question to oscillate when no plugs are inserted in the patchbay — not a clever thing. Also, two outputs should never be allowed to become



Channel Inserts

Group Inserts

Aux

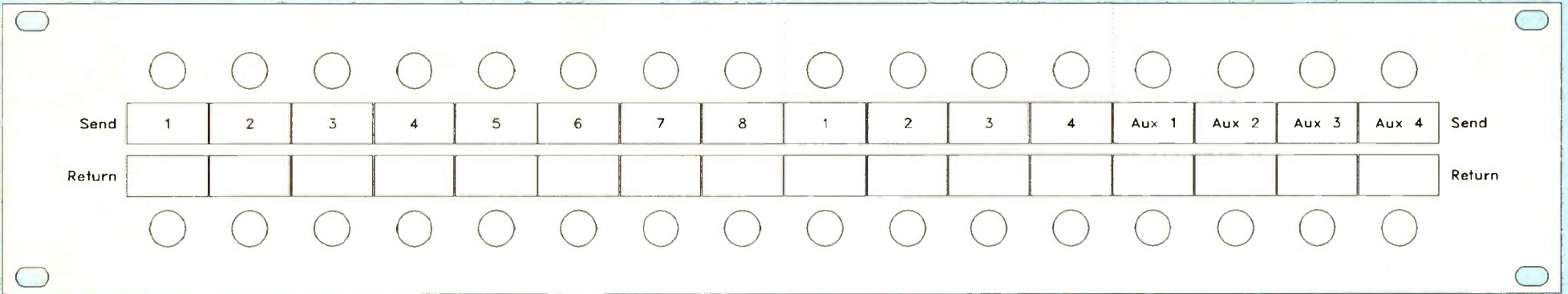

Effects

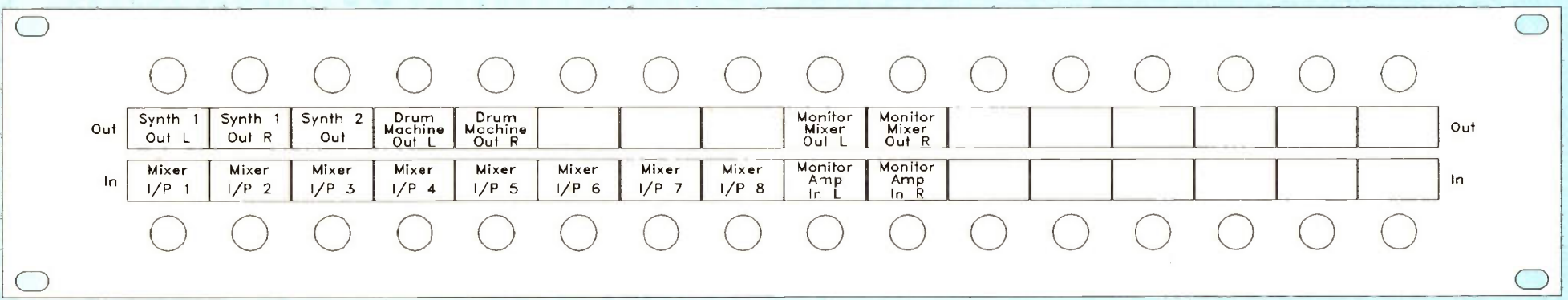
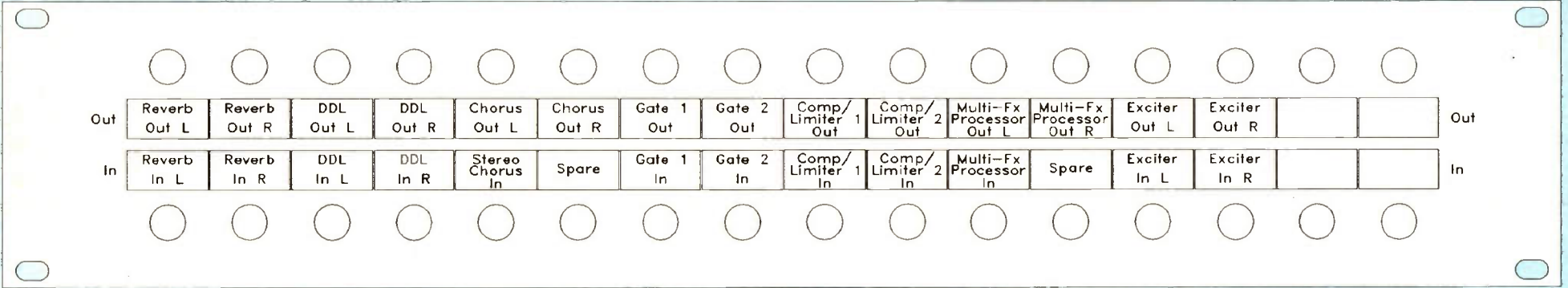
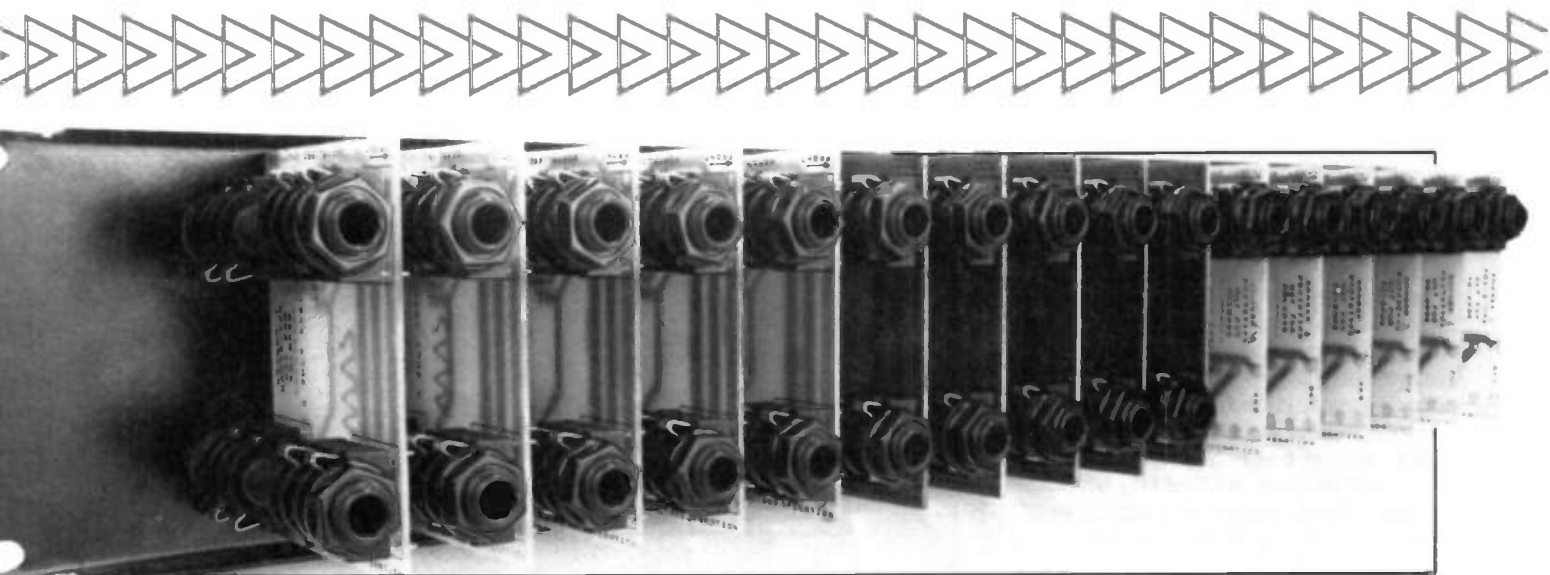

Figure 2. Example patchpanel layouts.



**Photo 1. A fully populated patchbay panel.**

connected together through normalised contacts! Speaker level signals should not be routed via a patchbay as inadvertently patching them into a mixer input could incur a costly repair bill.

It is possible to patch MIDI signals using stereo jacks; however, a physically separate patchbay should be used to remove the possibility of erroneous connections and subsequent damage that it may cause.

## Making the Right Connection

Mount the patchbay with the sockets facing forward rather than upward as they will collect less dust. If they must face upwards, be sure to place a cloth over the sockets when the studio is not in use. Wiring to and from

Signal	Normalised
Line input to mixing desk	No
Channel insert points	Yes
Group insert points	Yes
Effects sends from desk	No
Effects returns to desk	No
Input to effects	No
Outputs from effects	No
Line inputs to Multitrack	Yes
Line outputs from Multitrack	Yes
Line inputs to 2-Track	Yes
Line outputs from 2-Track	Yes
Key inputs	Consult Manual

**Table 1. Patchbay signal connections.**

Version	SK1	SK2	SK3	SK4	LK1	LK2
Unbalanced	Mono	Mono	Mono	Mono	Not Fitted	Not Fitted
Balanced	Stereo	Stereo	Stereo	Stereo	Not Fitted	Not Fitted
Insert Point	Mono	Mono	Not Fitted	Stereo	Fitted	Fitted

**Table 2. PCB options.**

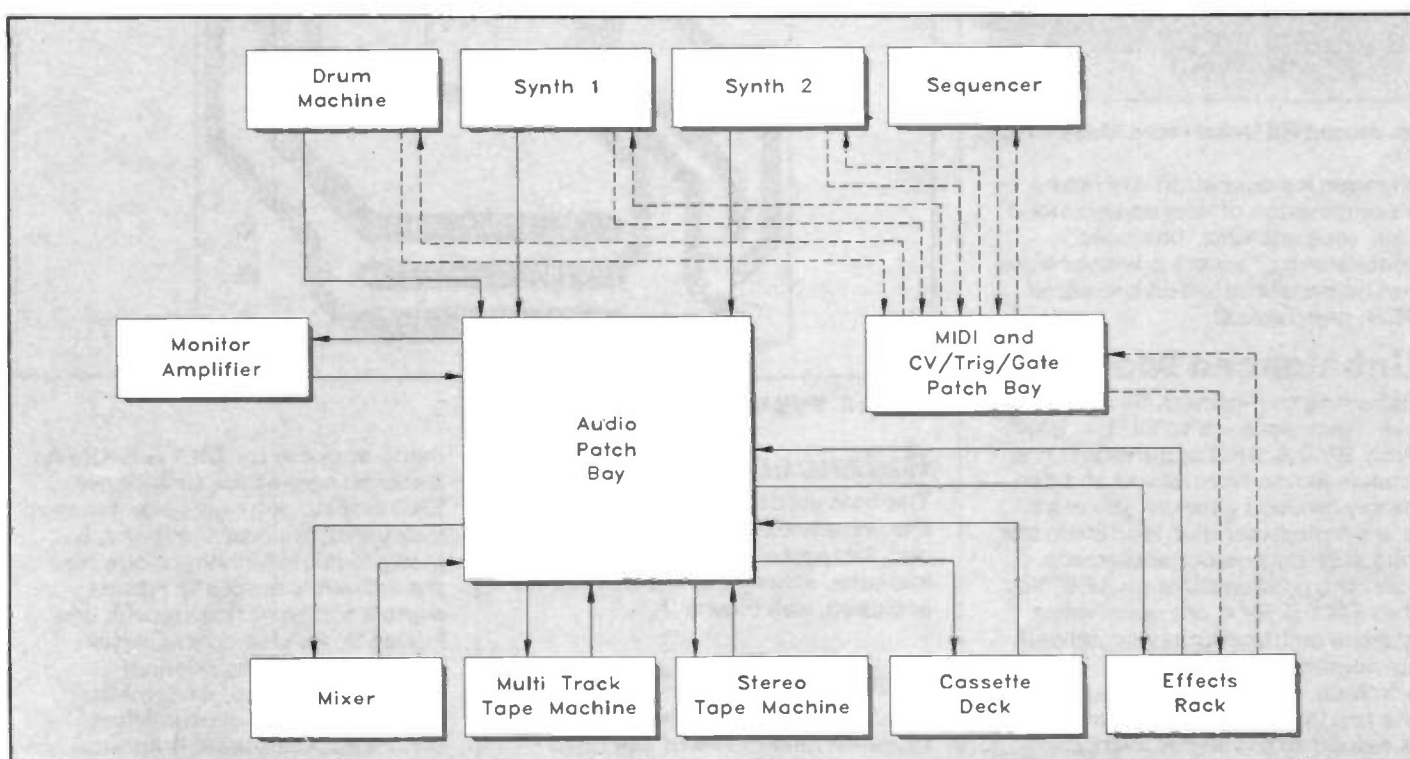

**Figure 3. Wiring layout of a typical home studio.**

the patchbay should be made using separate screened cables. As insert points are often connected using stereo jacks, twin-core screened cable can be used to carry the send and return signals if the cable run is under 10 feet or so.

It is not necessary to connect absolutely every signal to a patchbay, but do make sure that any connections that are changed on a regular basis are brought out. The real essentials are the effects units, the mixing desk's sends and returns and the insert points.

## Printed Circuit Board

A PCB is available allowing a single channel patchbay module to be constructed. Figure 4 shows the circuit diagram used to generate the PCB and Figure 5 shows the track and legend. Provision is made for normalised or non-normalised operation – simply reversing the circuit board in the patchbay

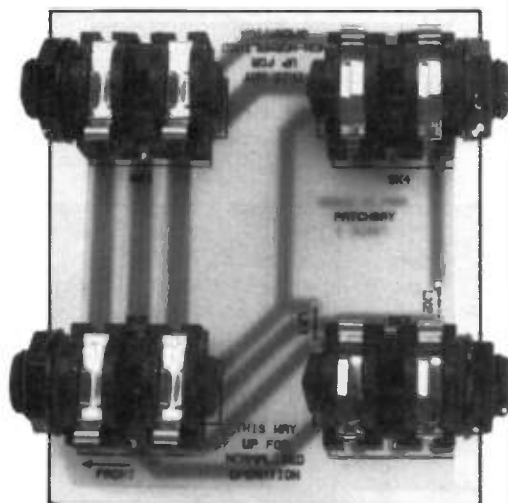

An assembled Unbalanced Module PCB.

changes its operation. By fitting a combination of stereo and mono 1/4in. jack sockets, balanced, unbalanced or insert point versions can be constructed on the same PCB, see Table 2.

## Unbalanced Module

Referring to Figure 6, fit mono 1/4in. jack sockets to SK1 – SK4. With SK2 & SK3 uppermost, the module is non-normalised and can simply be used when all you want is a simple extension lead from the inputs or outputs of equipment. Turn the module through 180° so that SK1 & SK4 are uppermost and the unit becomes normalised (or semi-normalised to be precise!). By plugging a lead into the top (output) socket, access is gained to the signal without breaking the link between the top and bottom socket.

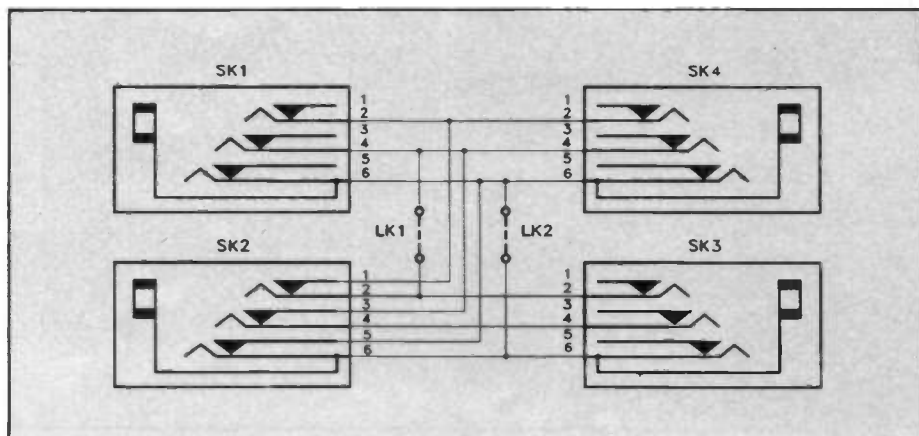

Figure 4. Circuit diagram.

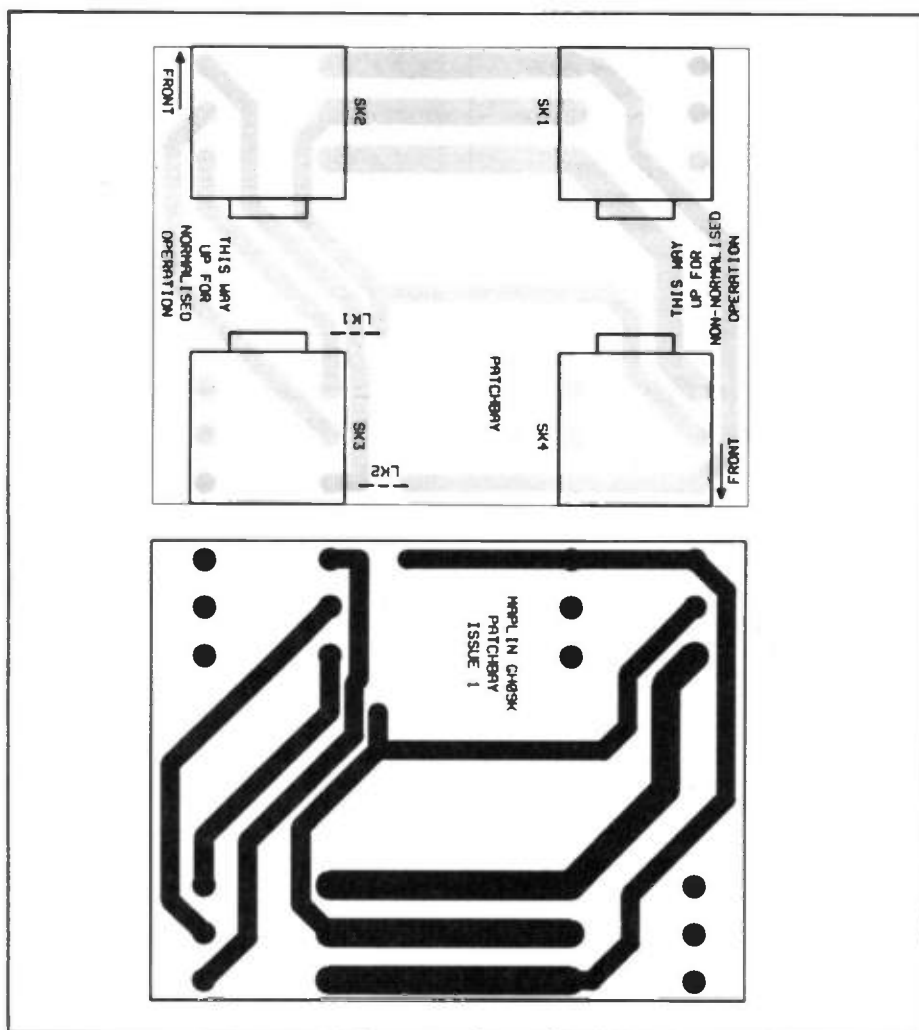

Figure 5. PCB legend and track.

## Balanced Module

The balanced module is identical to the unbalanced module in operation but, instead of fitting mono sockets, stereo 1/4in. jack sockets are used, see Figure 7.

## Insert Point Module

Most Insert Point connections found on mixers are of the form of stereo 1/4in. jack sockets, see Figure 8. By fitting LK1 & LK2,

mono sockets for SK1 & SK2 and a stereo socket for SK4 (leave SK3 empty), we now have a stereo jack connection to the mixer, but mono 1/4in. jack connections for the individual send and return signals to the outside world, see Figure 9. As this configuration is only designed to be used with insert points, a normalised operation only is available (you cannot rotate the PCB as with the balanced/unbalanced versions).

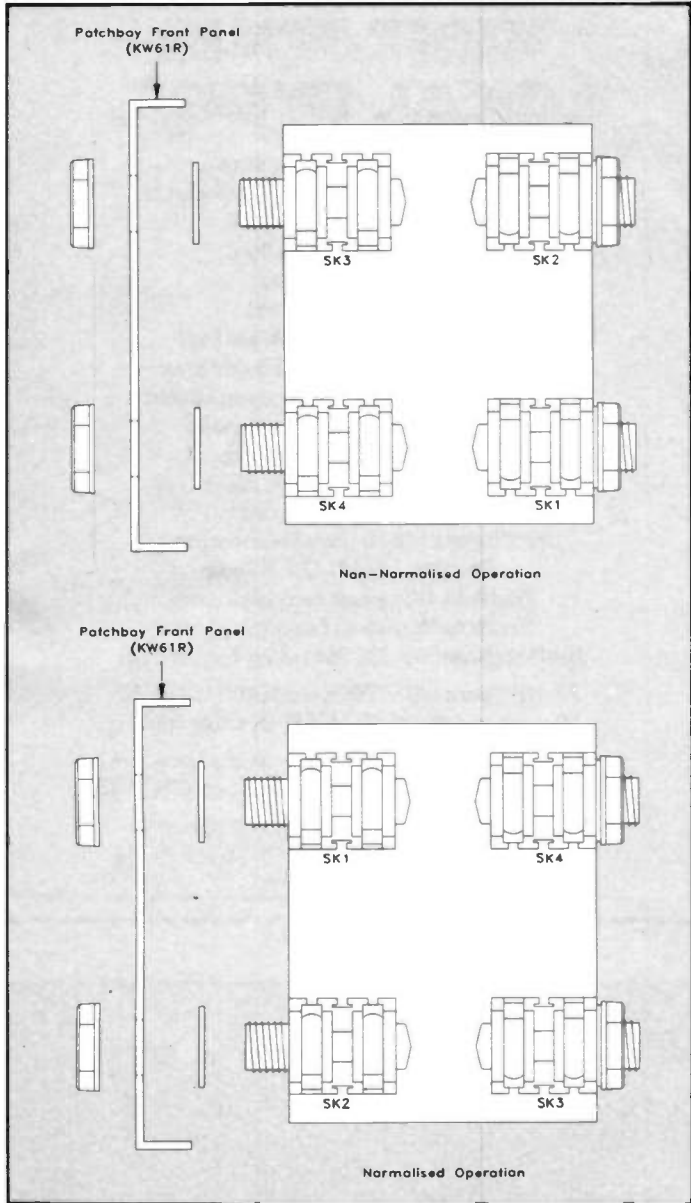
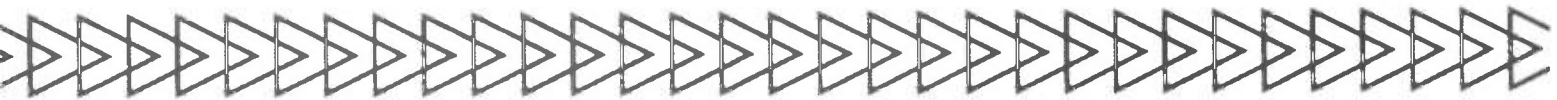

**Figure 6. Unbalanced module.**

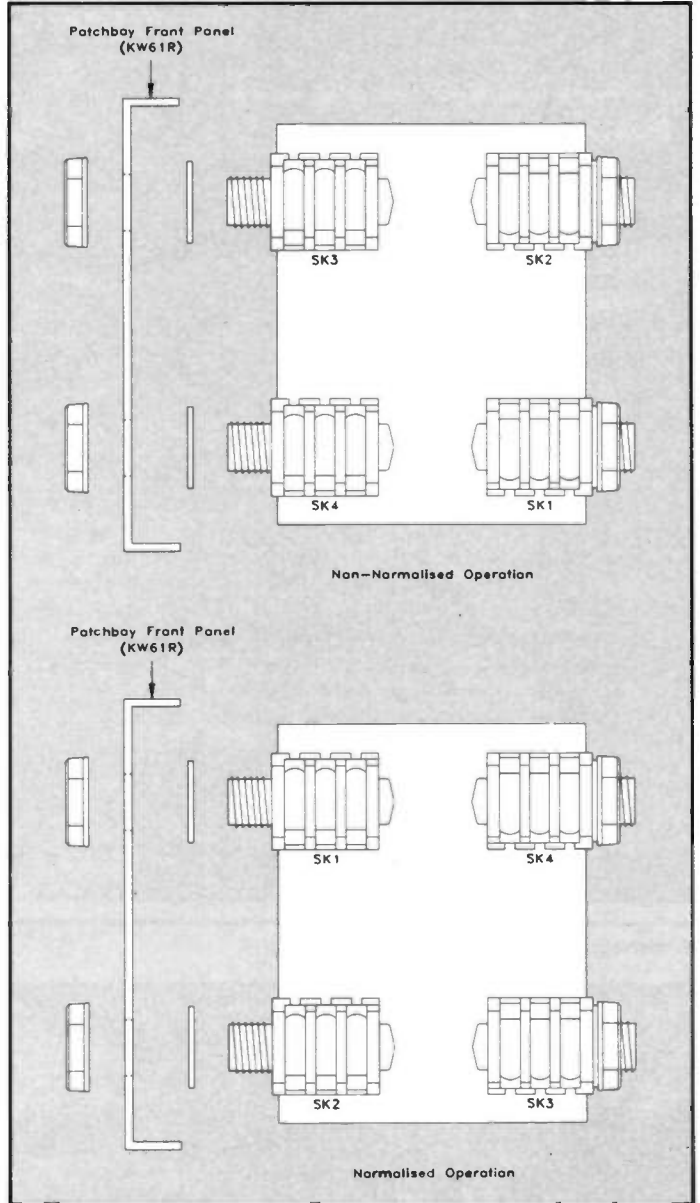

**Figure 7. Balanced module.**

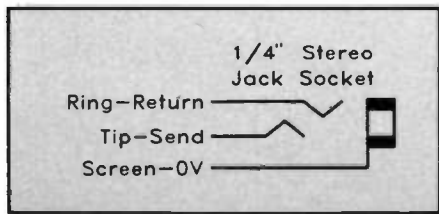
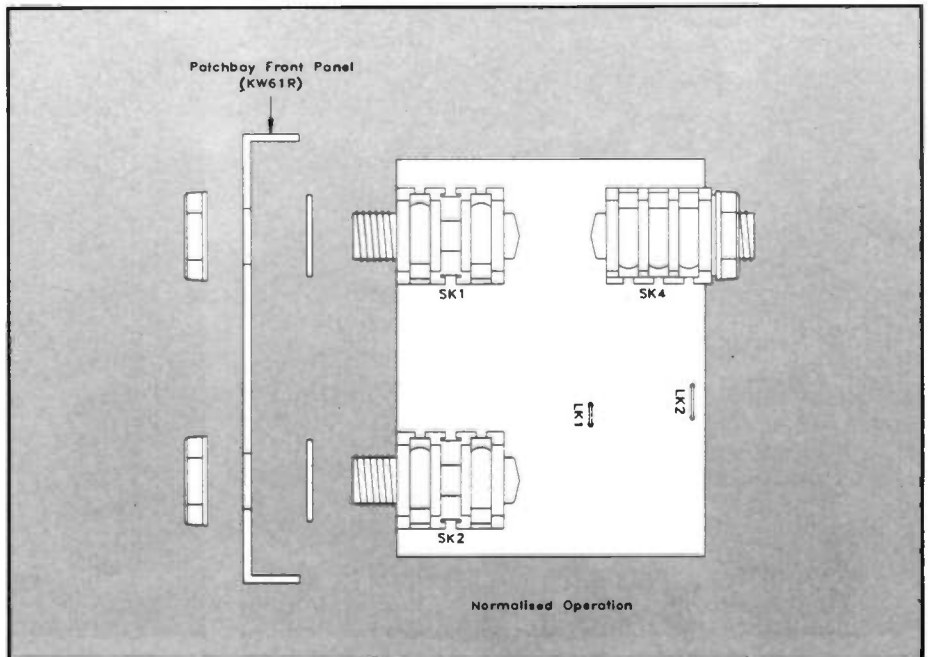

**Figure 8. Stereo Insert Point jack connections.**

## Patching Up

A 19in. wide, 2U high black Jackfield panel is available (Order Code KW61R), allowing up to 16 PCBs to be mounted vertically, see Photo 1. A white area for labelling purposes is printed alongside each socket.

For connections between sockets on the patchbay, it is worthwhile considering the packets of moulded coloured leads (Order Code YZ32K) as the colours help to avoid confusion.



**Figure 9. Insert Point module.**

## UNBALANCED MODULE PARTS LIST

SK1,2,3,4	Mono PCB 1/4in. J/Skt	4	(FJ00A)
	Patchbay PCB	1	(GH09K)

## BALANCED MODULE PARTS LIST

SK1,2,3,4	Stereo PCB 1/4in. J/Skt	4	(FJ05F)
	Patchbay PCB	1	(GH09K)

## INSERT POINT MODULE PARTS LIST

SK1,2	Mono PCB 1/4in. J/Skt	2	(FJ00A)
SK4	Stereo PCB 1/4in. J/Skt	1	(FJ05F)
LK1,2	Links	2	Fitted
	Patchbay PCB	1	(GH09K)

## OPTIONAL PARTS LIST

Patch Lead Set	As Req	(YZ32K)
Rack Jackfield	1	(KW61R)
Instruction Leaflet	1	(XT60Q)
Constructors' Guide	1	(XH79L)

The Maplin 'Get-You-Working' Service is available for this project, see Constructors' Guide or current Maplin Catalogue for details.

**The above items are not available as kits.**

The following new item is not shown in the 1992 Maplin Catalogue.

Patchbay PCB **Order As (GH09K) Price 1+ £2.65.**  
**4+ £2.25.**

# FOR BARGAINS AND MORE, VISIT YOUR LOCAL STORE.

For personal service, visit our shops at:

- Birmingham** Sutton New Road, Erdington.
  - Brighton** 65 London Road.
  - Bristol** 302 Gloucester Road.
  - Cardiff** 29 City Road.
  - Chatham** 2 Luton Road.
  - Glasgow** 264-266 Great Western Road.
  - Leeds** Carpet World Building, 3 Regent Street.
  - London** 146-148 Burnt Oak Broadway, Edgware.  
120-122 King Street, Hammersmith.
  - Manchester** 8 Oxford Road.
  - Newcastle-upon-Tyne** Unit 4, Allison Court,  
The Metro Centre, Gateshead.
  - Nottingham** 86-88 Lower Parliament Street.
  - Reading** 129-131 Oxford Road.
  - Sheffield** 413 Langsett Road, Hillsborough.
  - Southampton** 46-48 Bevois Valley Road.
  - Southend-on-Sea** 282-284 London Road, Westcliff.
- Plus NEW stores in LIVERPOOL and SOUTH LONDON.  
 Opening soon. Ring 0702 552911 for further details.

# MAPLIN STORES NATIONWIDE.

Electronics in Aviation continued from page 7.

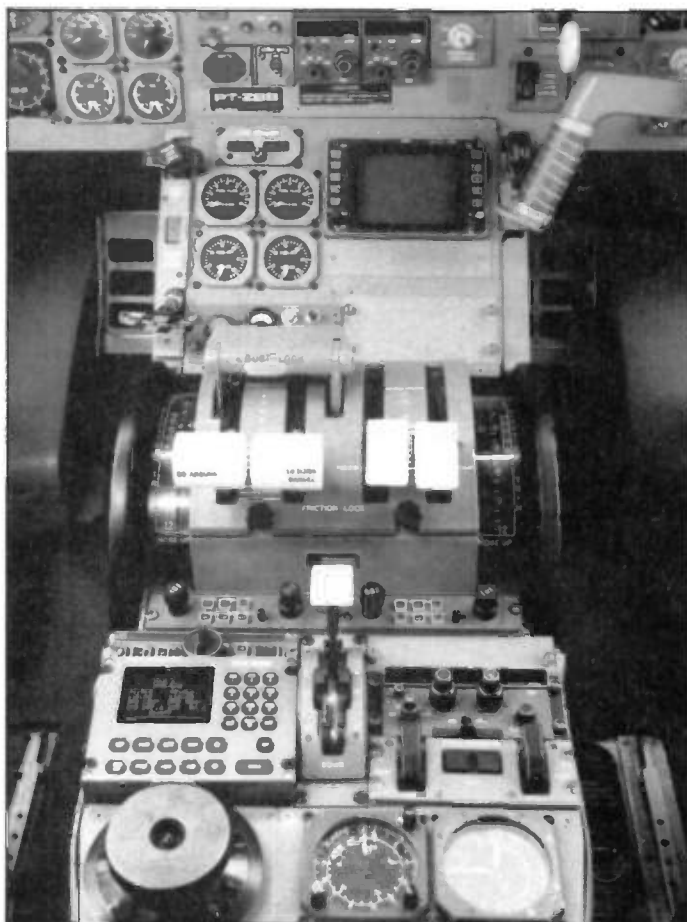

Racal Avionics RNS 5000 worldwide navigation management system – Above left: Installed in an Embraer Brasilia aircraft. Above right: Installed in a major civil aircraft.



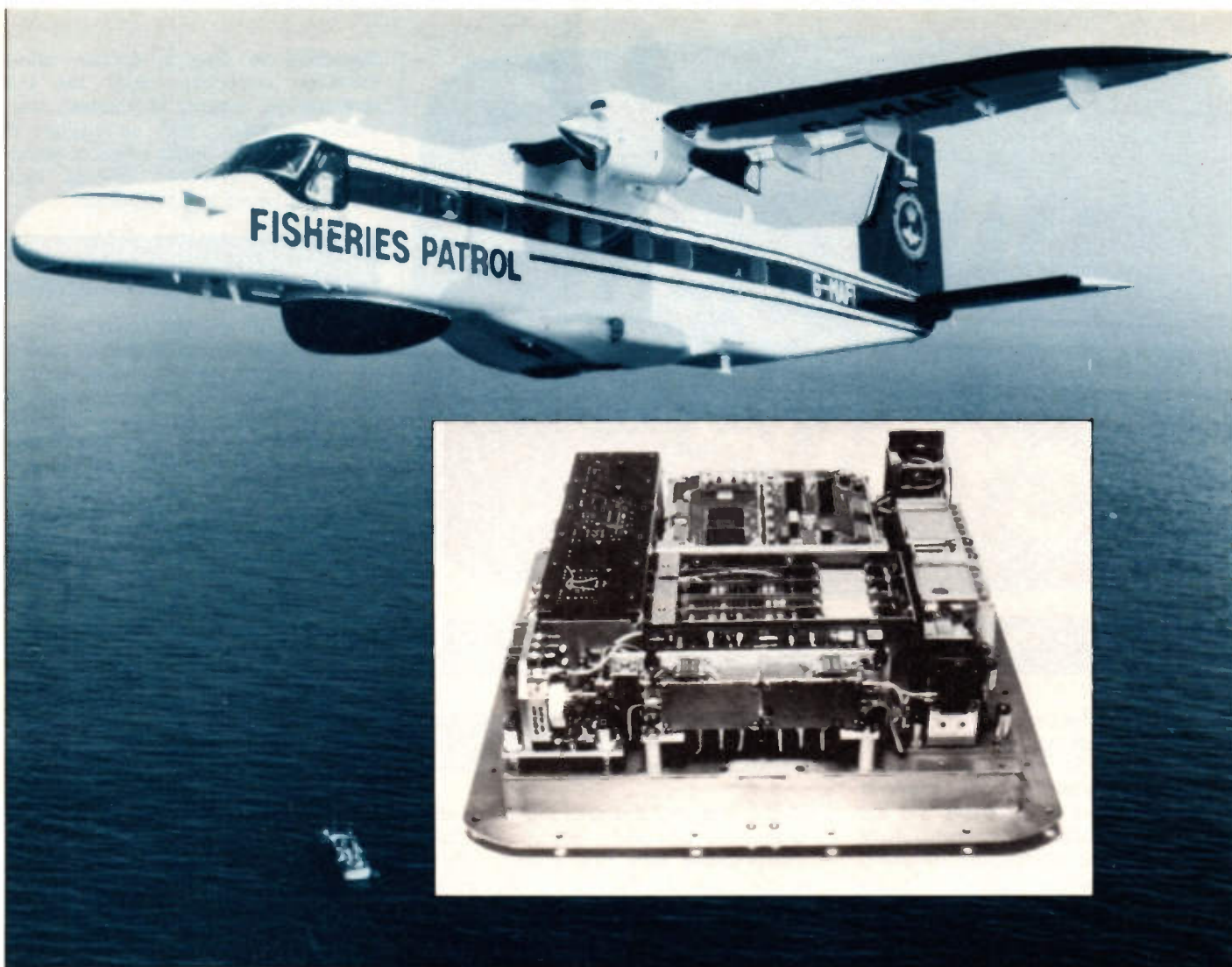

Racal Avionics Doppler 90 – Inset: Inside the electronics unit. Main picture: The fisheries patrol aircraft aboard which the unit is installed.

and monitor that list for the entire journey.

Should the pilot prefer to fly by VOR/DME, the system will select such stations from its own extensive database, and at extremes of range, switches to long range aids, providing continuous data with the minimum of flight crew involvement. Those are just a few of an impressive array of functions all easily accessible by the push of a button, and clearly displayed on a sunlight readable cockpit mounted cathode ray tube based display. One interesting feature is that DME measurements are corrected from slant to plan range, without which an aircraft at 36,000ft directly overhead the DME station would still appear to be six miles distant!

## Future Development

In time many of the current navigation aids will eventually be superseded by more advanced designs. It is worth noting that the Microwave Landing System (MLS) and Precision DME (P-DME) are two such developments about to creep in. MLS is similar in principle to the Instrument Landing System, but because it operates at much higher frequencies, it offers a number of advantages, including a higher de-

gree of accuracy. The P-DME is earmarked to replace airfield marker beacons and will provide pilots with a continuous distance to touchdown readout.

Both these systems are currently being evaluated by the CAA Flying Unit – the body responsible for testing and maintaining navigation aids – and will eventually be introduced at major UK airports. Whilst the racal RNS 5000 is capable of providing position fixing from the

NAVSTAR Global Positioning Satellites, this method of long range navigation is still restricted to military use. It is believed that it will be some time yet before it ousts conventional terrestrial systems.

## Acknowledgement

The Author and the Publisher would like to thank the Civil Aviation Authority, British Airways, and Racal Avionics Ltd. for allowing reproduction of photographs and maps.

### Terminology

ATC	Air Traffic Control
ILS	Instrument Landing System
MLS	Microwave Landing System
NDB	Non Directional Beacon
VOR	VHF Omni-directional Range beacon
DME	Distance Measuring Equipment
P-DME	Precision Distance Measuring Equipment
INS	Inertial Navigation System
VLF/Omega	Long Range Navigation System
Loran	Long Range Navigation System
GPS	Global Positioning by Satellite
IFF	Identification Friend or Foe
AD	Automatic Direction Finder
LED	Light Emitting Diode
Localiser	Radio beam marking out the centre-line of the runway and approach path.

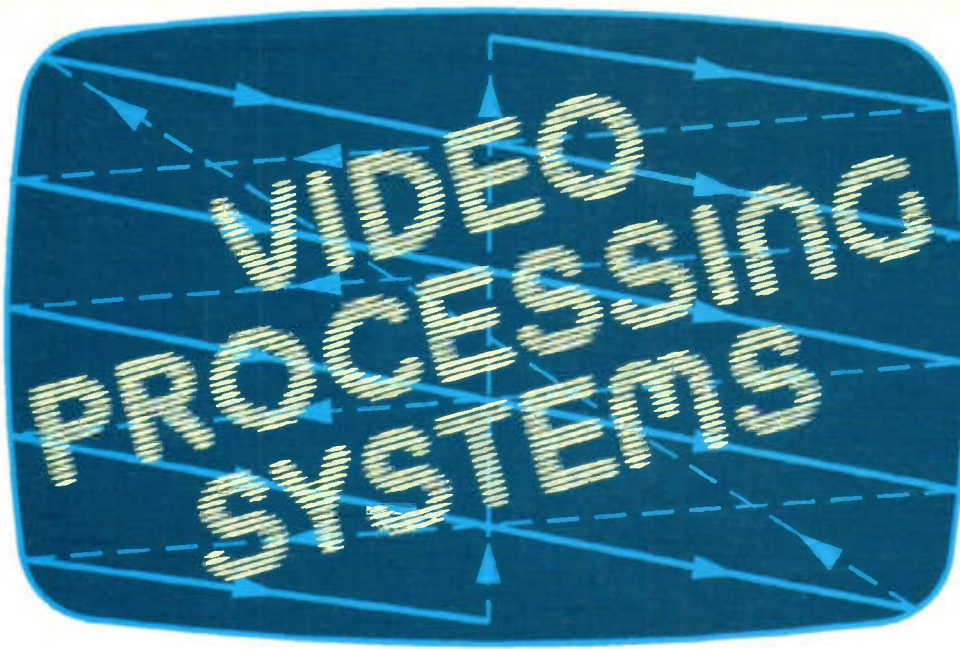

## Part One by J. A. Rowan

This article is the first of a short series on video processing equipment. From its beginnings in the broadcast television world, when the only example seen by the man in the street was the television receiver, video equipment has spread very widely into industry, business management and to some extent the home. All computers now have at least a rudimentary video output system, and video processing techniques are finding widespread use in many fields of human endeavour, not merely as a display medium but as an important tool. 'Computer enhancement', which is usually a software application of 2-D or 3-D spatial filtering, routinely used for many years in the video world, has been used in fields from archaeology to zoology to extract useful information from pictures where none seems to exist. And yet, in the electronics industry in general, video seems to be an almost unknown quantity. Highly qualified engineers are stumbling over problems in interpretation of their results which were routine matters to BBC engineers in the late Thirties. A vast quantity of low to medium tech video equipment is being 'installed' and 'maintained' by security company technicians who are unable even to tell whether the equipment is working properly.

I hope in these articles, to bring the fundamentals of video to a wider audience of working engineers and technicians, and to bring some of the more subtle features of our broadcast television system to the attention of design engineers who may not have a background in video. I will attempt to keep to practical matters, and to minimise the maths involved. However, to understand why the implementation of some apparently simple process turns out to be very difficult and expensive does require a knowledge of the basics, along with a little history here and there to show why things were ever done that way at all.

## The Series

This article will describe video signals generally, referring mainly to the monochrome 625 line system. This entered use in Britain in the early Sixties, with the first transmission of BBC2. The next article will move on to colour, concentrating on the PAL system used in Britain, but with reference to the other major world standards and the recent component and digital systems. The treatment is not exhaustive, and many points mentioned briefly will be covered in greater depth in subsequent articles, where they are relevant to particular equipment or techniques. For those

interested in digging deeper, many excellent textbooks cover the full engineering details of current television systems, and principles of operation of the major types of equipment. Few, however, discuss real-world problems and techniques.

## TV Picture Composition

A modern TV picture contains about 300,000 distinct picture points, which need to be conveyed from one place to another in order to bring the magic of television into your home. Parallel transmission on that scale is unthinkable, so a serial system is used to carry the data in just one channel. The picture is divided up into almost horizontal lines, these lines then being transmitted sequentially with synchronising information separating successive lines. The current system uses 575 lines to carry a complete picture, with additional lines for synchronising purposes bringing the total to 625. It is, however, largely based on the 405 line 'high resolution' television system which went into public use in Britain in 1936. Many apparently poorly-designed aspects of the system date back to decisions made when active devices were expensive, unreliable and space-consuming valves. A little extra complication in the signal format was well worth the trouble if the receiver could thereby be simplified.

## Synchronisation

It is obviously necessary for the television receiver to display the picture with all the lines in the right place i.e. in the same order in which they were scanned by the camera and with

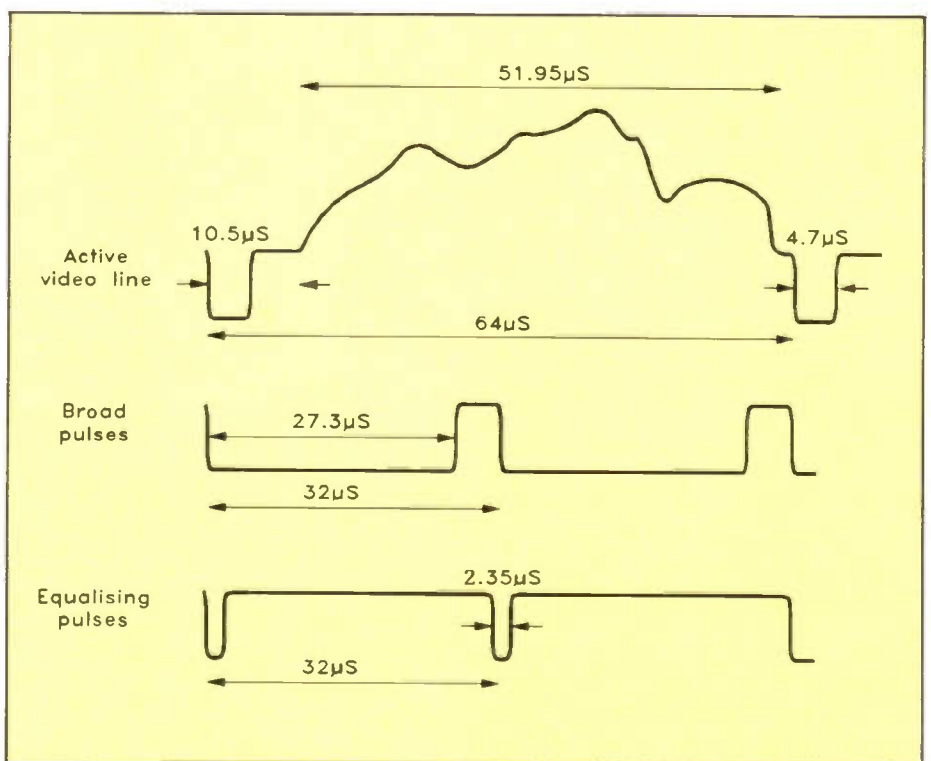

Figure 1. Line length, active video timing and pulse widths.

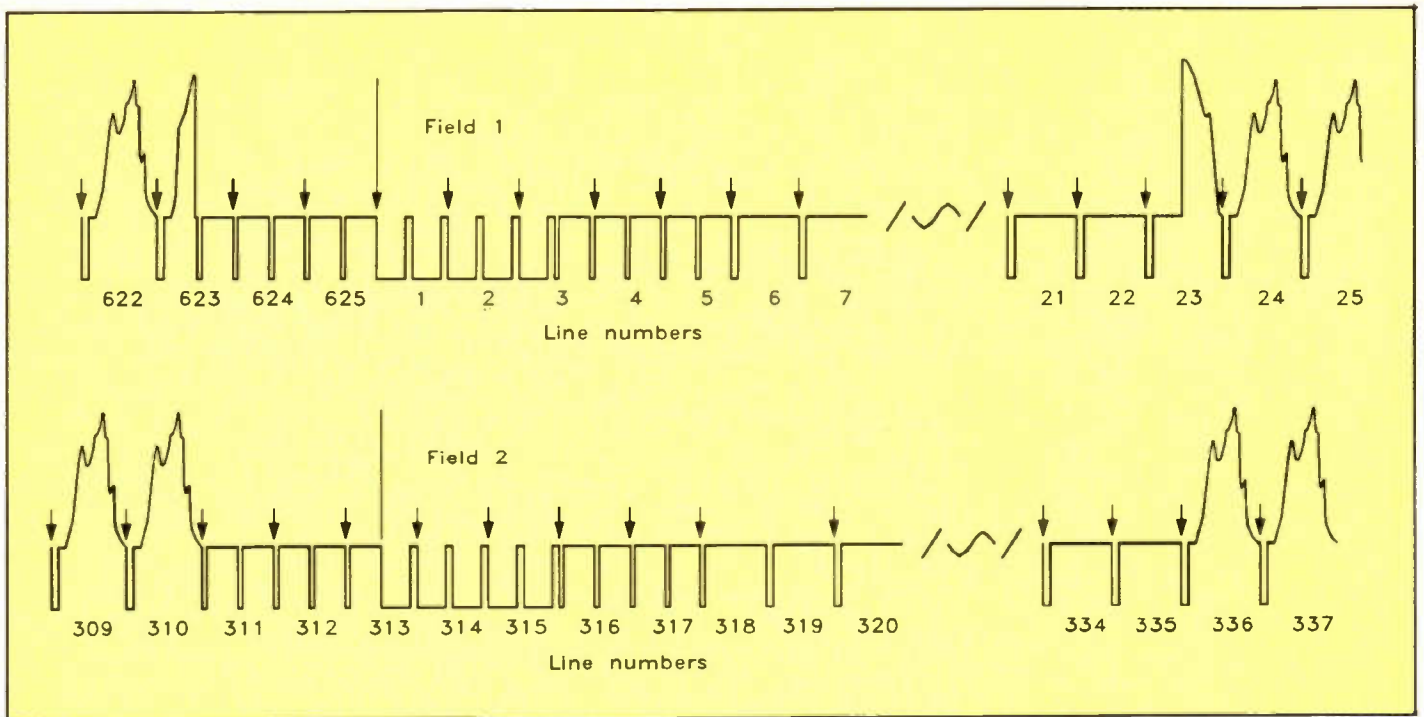

Figure 2. Vertical synchronising periods of fields 1 and 2. Horizontal sync reference is the leading (negative-going) edge of the horizontal sync pulse, and is identified above with arrows. It must be maintained throughout the vertical blanking period – the 25 lines without picture information. The vertical sync reference is the leading edge of the first broad pulse, and field 1 is defined as that which begins with simultaneous vertical and horizontal references. The equalising pulse immediately after the end of the last broad pulse is required as a horizontal sync reference in field 2. The diagrams above refer to 625-line (CCIR) European standard. 525-line (EIA) video is similar, but six broad pulses and two sets of six equalising pulses are used and the vertical blanking period is not tightly specified.

the left-hand edge of the picture at the left-hand edge of the screen. To achieve this, two kinds of synchronising information are necessary. In the days when the only practical display device was the magnetically-scanned cathode ray tube (CRT) the magnetic field had to have time to reverse at the end of each picture line so that the next line would begin in the right place. This time could not be used for picture information so it was a convenient place to put a horizontal synchronising pulse, which actually told the receiver when to reverse its scan. Similarly, during the time required for the vertical scan to retrace, the vertical synchronising ('sync') pulse was transmitted. The receiver had to have a simple (and cheap) way to respond to these pulses and to distinguish clearly one from the other. The method chosen was to use pulses whose voltage levels did not overlap with those carrying picture information, and to use a much longer pulse for the vertical sync than for horizontal. In this way, a level detection circuit could pick out both sync

pulses from a complete ('composite') video signal, and an integrator and further level detector could be used to locate the longer vertical sync pulse. This basic system was modified by the need to keep transmitting horizontal sync during the vertical pulse to avoid start-up problems in the receiver, and by the use of an interlaced picture.

Figures 1 and 2 show the relationship between sync pulses and the actual video information; Figure 1 shows the relative timing of line length related waveforms, whilst Figure 2 shows the start and ends of odd and even fields, the vertical blanking period and associated sync waveforms.

## Interlacing

The film industry had long ago established that an appearance of smooth motion could be produced by displaying a series of still images, each differing a little from the one before. About 25 distinct pictures were re-

quired per second, but flicker was objectionable at less than about 50 images per second. The solution chosen was to use 24 pictures per second but to display each picture with two flashes of illumination to remove, or at least considerably reduce, the flicker. However, if the same technique were simply applied to television, the bandwidth required to transmit a complete picture 50 times a second or so would be prohibitive. It was found that an acceptable visual performance was possible if the picture was transmitted in two sets of alternate lines, the second set filling in the gaps left by the first set. This technique, called interlace, halves the bandwidth required at the expense of an increase in system complexity, loss of vertical resolution and some visual artifacts. The half-pictures are called fields, the complete picture being a frame. The principle of interlacing is illustrated, albeit in a simplified 5-line system, in Figure 3.

Frame rate was chosen to be 25Hz, rather than the 24 pictures per second of film, to conform to our mains

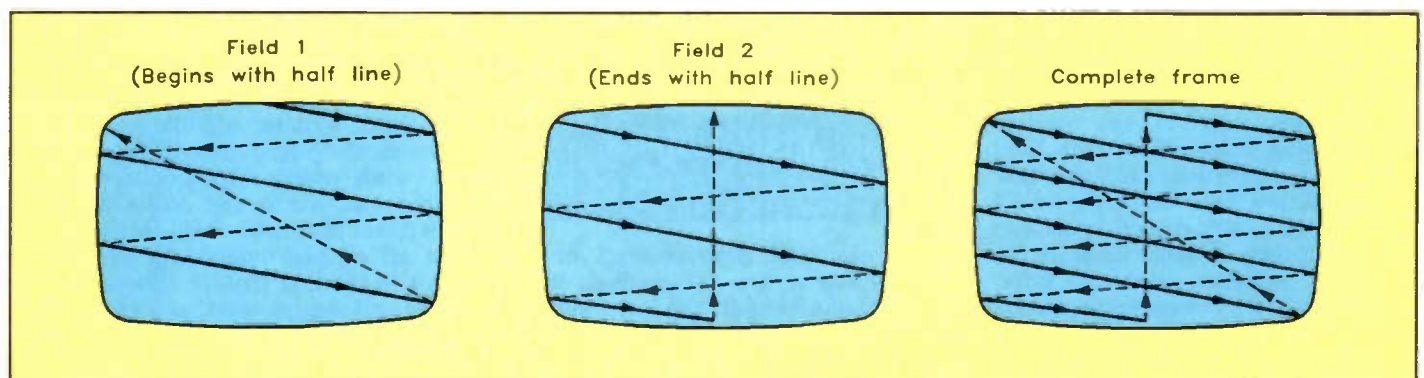

Figure 3. Simplified line structure of a 5-line interlaced picture.

frequency of 50Hz. The picture of an early TV set was affected by mains hum to some extent, and the use of a noticeably different frequency for video would have led to highly objectionable 'beat patterns'. Films, by the way, are normally shown on 50Hz TV systems at 25 pictures per second, making them run four per cent faster than they were shot. Nobody ever notices!

---

*“On the whole, interlace is acceptable as little televised material contains ‘difficult’ still pictures. Computer displays, on the other hand, consist almost entirely of this type of picture, so interlace is not generally used in the computer world.”*

---

With moving pictures, interlace works well, and stationary pictures are reasonable if the vertical detail is not too fine and the pictures come from an interlaced source, such as a camera. However, some more primitive character or caption generators can produce what are in effect two identical fields which are then alternately displayed in slightly different positions. The resulting picture appears to jitter at 25Hz. Similarly, a still picture 'frozen' from a moving sequence is usually a single field, and if this is simply repeated to form the second field then jitter will occur. A better technique is to synthesise the second field from the first by averaging adjacent pairs of lines to make the interlacing line between them. The resulting picture then looks truly stationary, but at the cost of using a digital field store. More sophisticated character generators do provide an interlaced picture, where one field is different from the other, but even then the use of very graceful fonts with thin lines can cause trouble. Some lines can appear in one field but not the other, and will then flicker very badly.

On the whole, interlace is acceptable as little televised material contains 'difficult' still pictures. Computer displays, on the other hand, consist almost entirely of this type of picture, so interlace is not generally used in the computer world. A recent development in some luxury TVs is the use of a frame store to accept interlaced pictures but display full pictures at 50Hz. A much more solid picture results, but at present at considerable cost.

A further drawback to interlace lies in the complexity of the vertical synchronising information. One field ends with a complete line and the other with a half-line. This difference would cause a simple vertical sync detector to trigger at slightly different times for the two fields, and they would not interlace exactly. It was necessary to add the half-line-period equalising pulses and to continue them through the vertical sync pulse, so that both vertical sync periods looked as similar as possible to

an integrator. Those equalising pulses which do not correspond to correct line sync timings must then be removed in some way. Most TV receivers use some form of phase-locked loop ('flywheel') for horizontal scanning, and when extra pulses arrive half-way between horizontal sync pulses they are simply ignored. A common technique in professional equipment is to drive a non-retriggerable monostable of about 50 $\mu$ S period with all the negative-going edges, which will then automatically ignore the additional pulses.

Some older monochrome cameras generate video with so-called random interlace. This simply means that horizontal and vertical scanning run independently of each other and the position of lines on the monitor vary from one frame to the next. Very often, there is just one large vertical sync pulse and of course no equalising pulses. This is not really a problem in the surveillance business, where a recognisable picture is all that matters, but occasionally such a camera is used in a small production system as a caption camera. Some processing equipment is willing to accept this type of video, and it may only be when a recording is played back that anything is seen to be amiss.

## Unused Lines

The design of cathode ray tubes and their associated scanning circuits has improved considerably over the last fifty years or so, and the basic specifications of the 625 line system are over thirty years old. The apparently large and wasteful 25 blank lines between fields was necessary to allow the CRT electron beam to be returned to the top of the screen and was none too generous at the time. Many of those lines are now used to carry public, private and technical information, so the waste is not as serious as it appears. There was much mystery fifteen or so years ago when lines of rapidly-moving dots appeared at the top of the picture on some TV sets, and much speculation in even the electronics press as to the cause. As most people now know, this was due to the transmission of Teletext information on some of the unused lines. Similarly, some of the time originally allowed for horizontal beam flyback is now used to carry a colour synchronising signal, and within broadcasting organisations is often used to carry the sound channel.

## Signal Standards and Gamma Correction

The electrical characteristics of the video signal are standardised to a remarkable extent. Video today is almost always distributed as composite video, which carries both visual and synchronising information. The maximum amplitude of monochrome com-

posite video is one volt peak-to-peak, although a colour signal may be larger and surveillance cameras often produce excessively high video levels. The relative amplitudes of picture and sync were decided after tests on TV transmissions with low signal strength. With gradually reducing RF level, loss of synchronisation should occur at about the time that the picture becomes unwatchable. We use a ratio of video to sync of 7 to 3, while the Americans chose 10 to 4, not far different.

The visual information of a video signal, then, is represented by a voltage varying from zero at black level to 700 millivolts at the maximum brightness possible. The link between voltage and CRT brightness is not a proportional one, however. The cathode ray tube has a severely non-linear relationship between drive voltage and light output, being approximately exponential with an index of about 2.2. This is known as the 'gamma' of the CRT. In order that the CRT should reproduce the brightness of the original scene correctly, the overall TV system must contain a corresponding exponential converter with the reciprocal index i.e. about 0.45. This was an area where receiver simplification was vital, even though only one corrector was required for monochrome, and so the process was carried out in the camera. All video signals between the camera's gamma corrector circuits and the CRT are therefore logarithmic representations of picture brightness, a fact apparently unknown in the computer world and to some manufacturers of TV computer graphics systems. Look closely at the 'sixteen grey scales' your computer can display on its screen and see if the top two levels appear to differ in brightness by a subjectively similar amount to the bottom two.

## Signal Interconnections and Termination

Video signal frequencies can range as high as 5.5MHz in the British system, and transmission line effects are significant in carrying video more than a few centimetres. Cable must be coaxial and must be terminated correctly, the standard cable impedance being 75 ohms. Some equipment has video inputs which have internal terminating resistors, while others have pairs of connectors leading into high impedance input stages. This latter type is termed a 'loop-through' input and a small number of these can be daisy-chained without significant loss of signal. Many loop-through inputs have a switch nearby which connects a 75 ohm load across the connectors. All switches in a daisy chain should be set to 'off' or 'high impedance' except the last in the line. The 75 ohm switch of this unit should be on, or if not present then a terminator should be fitted to the unused connector.

The lack of a terminator on a cable run, or more than one being fitted, are

the most common 'faults' in video systems. The most obvious symptom on a short cable is that the level is incorrect, either twice the correct level with no terminator or only two-thirds if two are fitted. This may not be so obvious in a monochrome surveillance system where there is no test equipment and where monitor contrast is turned up or down to suit lighting conditions at the camera. A faulty monitor can be replaced by a new one, which is then found to have insufficient contrast either because the old one was unterminated or the new one has its switch on and the line is already terminated. More subtle mis-termination faults are due to reflections within the cable, and if the source termination is good the effects will not be visible at the end of the cable, but only part of the way along it. If several monitors are daisy-chained on a long cable, severe ringing may be visible on vertical picture edges on some monitors but not others, and never on the last one in line. For the same reason, the cable must form a single line with no branches.

Video is usually DC coupled within equipment since video differs from audio in that most processing techniques require an accurately defined DC level. Inputs are normally AC coupled to avoid problems with standing DC on the line, though steps are usually taken to avoid this. Seventy-five ohms is quite a low resistance and a few volts DC across an input resistor or terminator is enough to heat it up considerably or even burn it out. Professional equipment normally has DC coupled outputs which are adjusted so that black or blanking level is at ground voltage. Outputs of cheaper equipment are often AC coupled, and then the low frequency response must be maintained well below 50Hz.

As with audio, hum loops may be a problem. A long run of video cable may have to be run parallel to mains wiring and a rack full of equipment inevitably has complex connections between earths. Some equipment is totally floating with respect to mains earth but this is unusual. There is no balanced transmission standard corresponding to that used in professional audio, but equipment which is likely to receive a video signal from a considerable distance will often have floating inputs, with the signal taken differentially between coax inner and screen.

The industry standard connector for composite video is the 75 ohm BNC bayonet-locking connector, although for many years the much larger UHF screw-locking type was used. The latter may still be found on relatively recent surveillance equipment. Both types of connector are available in 50 or 75 ohm versions, as are the corresponding terminators, so be careful. Unfortunately, the RCA phono connector of uncertain impedance is also in common use on domestic video equipment, and recently the dreadful Peritelevision (SCART) connector has become popular, at least with manufacturers.

## Resolution

Resolution is a subject surrounded by mystery. 'Lines' and 'Megahertz' are bandied about freely and attempts are made to relate them to 'pixels'. How many pixels has a monochrome monitor, and why is the frequency response of a video recorder quoted in lines? Why is the vertical resolution of a camera or monitor not equal to the number of scan lines used for active video (the 575 that contain picture information)?

Again we must go back to film. Film has no scan lines and the picture is never represented electronically, so a purely physical method had to be used to specify resolution. Alternate black and white lines of various widths were used to test lenses and focusing geometry and the thinner the lines, the more severe was the test. Resolution came to be specified in terms of line width, which was quoted as the number of black and white lines that would fit the height of the image. The limiting resolution was the most common specification, being the largest number of lines per picture height that could be distinguished by eye in the developed film, but for many purposes

---

*“When electronic cameras appeared, it was natural to continue to use the same resolution specifications but there were differences between the media.”*

---

it was also necessary to know the relative contrast of fine lines compared to large black and white blocks. Resolution was normally the same in vertical and horizontal directions, except for the anamorphic lenses used for compressing wide-screen pictures into the standard image format.

When electronic cameras appeared, it was natural to continue to use the same resolution specifications but there were significant differences between the media. The most obvious was that resolution was no longer the same in all directions. Video signals are continuous in the horizontal direction but are sampled vertically by the scan line structure. While the horizontal resolution of a camera depends only on the physical characteristics of the image sensor, the vertical resolution is limited by the number of scan lines. It is not, however, a simple matter of resolution lines equalling scan lines, largely because of interlace. If, for example, exactly 575 black and white lines were fitted into the height of an image and perfect lens and camera geometry was assumed, then all the black lines would be scanned during one field, and all the white lines during the other. The resulting subjective picture would not be 575 black and white lines, but solid black and white

pictures alternating at 25Hz, a very disturbing strobe-like effect. In fact, stationary alternating lines can be seen up to about 350 lines per picture height, the exact number differing from one observer to another, and between one monitor and another. Beyond this point the lines appear to flicker and blur and resolution is meaningless.

Horizontally, things are much more straightforward, but bear in mind that the lines referred to in resolution specifications are still quoted per picture height and not width. In other words, a 400 line grating chart will have  $400 \times \frac{1}{3}$  lines across the width of the picture as the ratio of width to height of a normal television picture is 4:3. Such a grating will appear in the video signal as an alternating voltage, the frequency depending on the size of the grating lines. As a rough guide, 400 lines is equivalent to 5MHz, within a few per cent. Resolution charts are usually marked in lines but broadcast charts often have gratings marked in megahertz. Strictly speaking, this is incorrect, as these frequencies are not a property of the chart but only exist when scanned by a correctly adjusted camera operating on the 625 line standard. However, 'spatial frequency' is something often spoken of as the physical or optical equivalent of the electronic frequency of video signals.

Monochrome monitors have horizontal limiting resolutions specified in the same way as cameras, as the highest frequency input which can be seen by eye on the screen at normal contrast and brightness settings. Occasionally, the bandwidth of the video amplifier in the monitor is quoted, but even in cheap monitors this is usually well in excess of that required to pass a signal at the limiting resolution of the CRT and is therefore usually irrelevant. Colour monitors and solid-state cameras are not so easy. In both cases a picture line is not continuous but is separated into 'pixels'. In theory, the limiting resolution of both devices can be found by assuming that each pixel can display or see one line. A camera with 512 pixels horizontally should just be able to resolve  $512 \times \frac{3}{4} = 384$  lines per picture height. In practice, aliasing (moiré patterning) will appear at spatial frequencies approaching this limit, and probably a clean picture will only be obtainable up to about three-quarters of the theoretical maximum. With colour computer monitors, the pitch (distance between adjacent phosphor lines of the same colour) is often quoted instead of the number of pixels, which must then be calculated from the screen size.

And the specification of video recorder bandwidth in lines? This practice only occurs in connection with low bandwidth systems such as VHS and Betamax. It allows simple comparison of camera and VTR so that neither is seriously limited by the performance of the other. The same relationship between lines and frequency exist as with cameras, with a 'resolution' of 240 lines denoting a 3MHz bandwidth.

## Signal Measurement

Lastly, a brief look at monochrome video measurements and specifications. Most audio specifications also apply to video, but usually with much wider tolerances, particularly in monochrome. Non-linear distortion of one per cent is considered reasonable

“ Measurement of signal-to-noise ratio is quite difficult, as the sync pulses prevent straightforward level measurement as in audio.

Various weighting and filtering standards exist, and in practice when noise is measured, a commercial test set is used. ”

for non-broadcast processing equipment, signal-to-noise ratios of 50dB are quite good and a somewhat relaxed view is taken of frequency response flatness. On the other hand, a linear phase response within the quoted bandwidth is very important and frequencies and timings must be accurate.

Measurement of signal-to-noise ratio is quite difficult, as the sync pulses prevent straightforward level measurement as in audio. Various weighting and filtering standards exist, and in practice when noise is measured, a commercial test set is used. Most of these are sufficiently expensive to rule out noise measurement by anyone but manufacturers, broadcasters and very large video facilities companies. In general, if a piece of equipment appears unduly noisy, a visual comparison with a good specimen is usually the best way to decide whether action is needed.

“ Besides some form of test generator, the only equipment really necessary to deal with monochrome video is a good picture monitor and some form of oscilloscope. ”

A frequency sweep can be used for precise measurement of bandwidth and ripple but in view of the importance of phase, it does not tell the whole story. Observing the pulse response of a video system gives a good indication both of frequency and phase response and is the normal test method. A variety of test pulses are used, but the most common and generally useful is the '2T pulse and bar'. The 'pulse' is a 700mV raised cosine 200nS wide at the half-amplitude point and repeated at line rate. It therefore contains harmonics

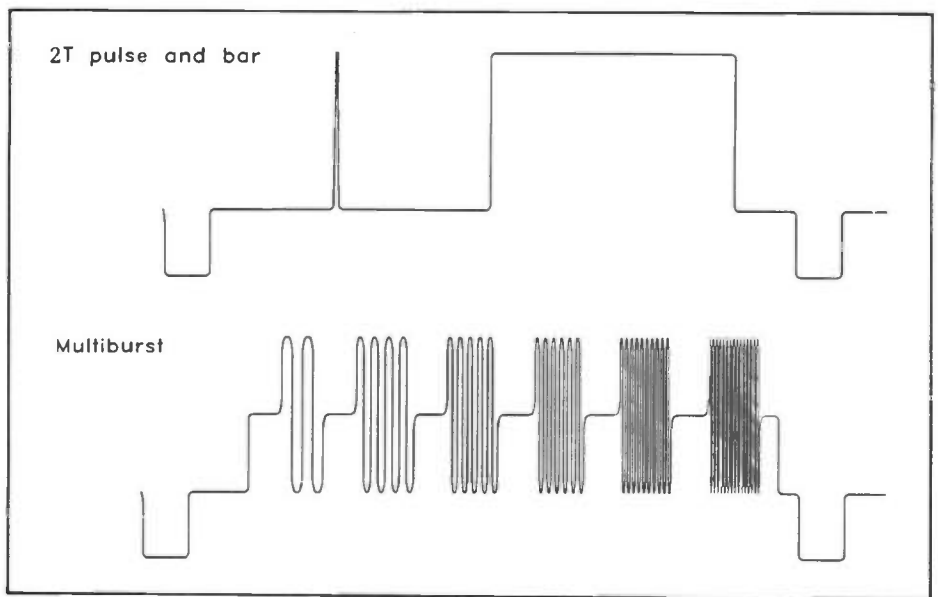

Figure 4. Common waveforms used for testing the performance of video equipment.

of 15625Hz up to about 5MHz, and any gain or phase change within that band will appear as a change in the height and shape of the pulse, and distortion around its base. The 'bar' is a 25 $\mu$ S wide raised cosine pulse, effectively a stretched version of the 200nS pulse, with the same amplitude and rise and fall times. Since the edges are far enough apart not to interact, a separate view of the rise and fall dynamics of the system under test may be seen. The height of the bar will not be affected by high frequency losses and forms a reference for the height measurement of the short pulse.

The usual frequency sweep occupies a field and can run from one cycle per line (15625Hz) to about 6MHz. Markers are usually inserted at 1MHz intervals. The other common frequency response test signal is multiburst, a collection of six or so bursts of spot frequencies across a line period. Non-linear distortion is measured using a staircase waveform, any linearity errors causing the steps to become unequal in height. Rather than try to actually measure the steps in millivolts, the waveform is passed through a differentiator and the heights of the resulting pulses are amplified and measured.

Examples of common test waveforms are shown in Figure 4.

Other monochrome test signals exist, normally each for a specific purpose such as the crosshatch used for adjustment of monitor geometry and colour monitor convergence. Many of these signals are available from most TV pattern generators, though pulse and bar and the frequency test signals are usually found only on the broadcast and top-end professional test generators. Neither a constant-amplitude sweep nor a cosine-shaped pulse are easy or cheap signals to produce. Colour equipment requires a further set of signals, designed to expose more subtle shortcomings that do not affect monochrome pictures.

Besides some form of test generator, the only equipment really necessary to deal with monochrome video is

a good picture monitor and some form of oscilloscope. A real television waveform monitor is nice to have, but it is basically a limited-range oscilloscope with a few filters and some sophisticated TV triggering. A general purpose oscilloscope is far more generally useful, if slightly less convenient, and

“ For any video work, a delayed timebase and external triggering are essential. Practically all modern oscilloscopes have line and field TV triggering, but beware of those that switch between line and field automatically depending on the timebase range. That is fine most of the time but now and then you will disagree with it. ”

is much cheaper. A bandwidth of 20MHz is adequate, though for colour work 40MHz is advisable. For repairs involving digital video or other high-speed logic, 60 or even 100MHz may be necessary. For any video work, a delayed timebase and external triggering are essential. Practically all modern oscilloscopes have line and field TV triggering, but beware of those that switch between line and field automatically depending on the timebase range. That is fine most of the time but now and then you will disagree with it. A channel one output is useful for certain fault-finding techniques but otherwise not too important. The picture monitor should ideally have underscan and external sync, but any monitor is better than none. A 12 inch screen size is a good compromise between portability and usefulness. Oddly enough, a monochrome monitor is as necessary as a colour monitor for colour work, and for alignment of three-tube cameras it is essential.

# SUBSCRIBE TO



- \* Save over £1! Yes, save money by taking a subscription, it's cheaper than buying each individual copy.
- \* TWO FREE ISSUES if you agree to subscribe by Direct Debit or Continuous Credit Card.
- \* FREE delivery to your door, there are no additional carriage charges.

- \* It's bursting at the seams with projects and interesting features to read.
- \* It's streets ahead of its rivals, with full colour pages and far less advertising space.
- \* Plus – News, reviews, readers letters, competitions and lots, lots more besides!

To subscribe just send a cheque/postal order for £8.58 made payable to Maplin Electronics, P.O. Box 3, Rayleigh, Essex SS6 8LR. OR you can take advantage of our offer of two free issues by completing the coupon below and agreeing to pay by Credit Card or Direct Debit. The two free issues offer only applies if you use one of these two methods of payment. Simply fill in the 'Payment by Credit Card' or 'Payment by Direct Debiting Mandate' and return it to Maplin. Every time, about 1 month before your subscription is due, we will send you a letter giving details of the subscription rate and telling you the date on which we will charge your Credit Card or debit your bank account. If you do not wish to continue your subscription, you have until that date to let us know, and we will then cancel your authority to bill your Credit Card or cancel your mandate. Otherwise, if you do nothing, your subscription will continue. The authority or mandate you give us does not allow us to charge anything other than the Maplin Magazine subscription. The benefit to you is that you no longer need to remember to re-new your subscription or send off any more cheques or postal orders. Payment is made automatically.

#### OVERSEAS SUBSCRIBERS

Subscription rates for 6 issues are: £11.00 (or 30 IRC's) in Eire, Europe and surface mail outside Europe; £25.00 (or 68 IRC's) Air Mail outside Europe.

## TAKE THE NEXT 2 ISSUES OF THIS MAGAZINE FREE!!

Because we're so certain that now you've seen the Maplin Magazine you'll want to receive it regularly, we're offering to send you the next two issues free of charge with absolutely no obligation to continue. Just fill in the details below and if after receiving two issues you do not wish to continue, just let us know at least one month before the next issue is due and we will cancel your subscription. The two free issues will be yours to keep whatever you decide. If you already have a subscription, fill in the details below and we'll add two issues free of charge to your current subscription. SEND NO MONEY NOW. About 2 weeks before the third issue is due, we will charge you £8.58 for the next six issues, unless you have cancelled. This offer is not available to those already paying by Direct Debit or Continuous Credit Card or those who have stopped payment by either method within the last two years. Please start my subscription with issue 53. THIS OFFER IS OPEN TO RESIDENTS WITH U.K. ADDRESSES ONLY.

EITHER

### ★ PLEASE ADD YOUR ADDRESS, SEE BOTTOM RIGHT ★

**PAYMENT BY CREDIT CARD.** Please charge my Credit Card Account

Customer Number (if known) .....

Access  Visa  American Express

I authorise you until further notice in writing to debit my CREDIT CARD account by £8.58 and in future, with any amounts which, after notification, MAPLIN ELECTRONICS PLC may debit thereto in respect of my subscription to the Maplin Magazine.

Account No.									
Signature							Date		

OR

**PAYMENT BY DIRECT DEBITING MANDATE** in favour of Maplin Electronics plc, P.O. Box 3, Rayleigh, Essex SS6 8LR.

Direct Debit payment option is only open to customers with bank accounts in the U.K. including Channel Isles, Isle of Man and N. Ireland. Please note: Instructions cannot be accepted to charge Direct Debits to a Deposit or Savings Account.



Bank Sort Code  _ _ _ _ _ _ _	Bank Account Number  _ _ _ _ _ _ _ _ _ _ _ _ _ _ _ _ _
----------------------------------	---

Name of Account to be debited
-------------------------------

The Manager

I authorise you until further notice in writing to charge my account, with you, any amounts which MAPLIN ELECTRONICS PLC may debit thereto by Direct Debit in respect of my subscription to the Maplin Magazine.

I will inform the bank in writing if I wish to cancel this instruction.

I understand that if any direct debit is paid which breaks the terms of this instruction, the bank will make a refund.

Signature	Date
-----------	------

Enter your address and Maplin customer number, if known.

	Post Code

If you wish, you can put this form in an envelope and address it to: Maplin Electronics, Freepost, P.O. Box 3, Rayleigh, Essex SS6 2BR.





# Stray Signals

by Point Contact

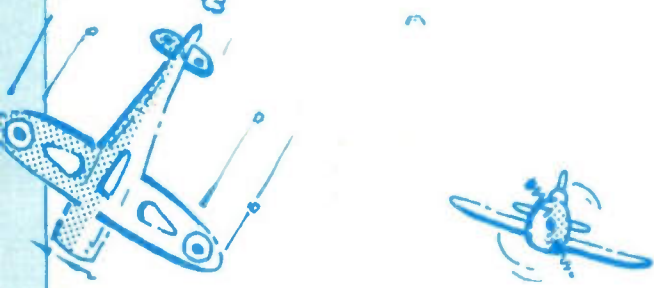

The politician is a strange animal, as we all know. As I write, he is wringing his hands about the falling proportion of 6th Formers taking maths and science, and the inevitable subsequent shortfall of engineers. At the same time, he is exhorting defence electronics companies to diversify into consumer goods, to absorb some of the growing tide of unemployed electronics engineers. (Someone should tell him a company cannot be involved in both defence and consumer electronics: for the former you need approved Quality Assurance, Documentation and Drawing Office departments etc., and it is not permitted to run different standards for defence and non-defence products. The result is an overhead structure with which you can never compete with consumer oriented producers.)

Hopefully, by the time you read this the economic recovery will have started, but too late for many (ex-)workers in electronics. Perhaps all those youngsters shunning engineering in favour of studies in the arts and humanities are on the right track? After all, would-be engineers have a fairly tough training to cope with before they are finally qualified, and electronic technicians and technician-engineers also have to negotiate a pretty stiff course.

Point Contact had, in the dim and distant past, a somewhat checkered academic progress. A middling career through the 6th Form was followed by a less than successful year at Imperial College, leaving no option but National Service before a final belatedly successful attempt at an engineering degree.

Marking degree papers is quite a business, requiring markers who are thoroughly conversant with the syllabus – almost invariably college lecturers themselves. Point Contact was fortunate enough in his two year stint in the RAF to get on to a 56 week air radar fitters' course.

Allowing for a couple of weeks at the RAF Cardington kitting-out camp, eight weeks square-bashing, a little leave and a couple of spells in RAF hospitals; this didn't leave much time over, to exercise my new-found skills at repairing Al10 and other airborne radars then in service. Now technical skills were in very short supply in the RAF – BSc Eng Part 1 (Failed) being a National Serviceman's passport to a fitter's course – so it was not possible to have the examination papers on the course marked by people who knew anything at all about the subject – marking was done by admin clerks. So the questions had to be of the multiple choice variety with three wrong answers and one right one, just tick the box by the answer you think is right. After a quick glance to make sure a candidate hadn't ticked more than one box per question, the clerk would lay a check sheet over your paper and count the ticks showing through the holes where right answers should appear. If one had a background of 'A' level Physics and had been paying attention on the fitters' course, the right answer was usually pretty obvious, though the questions were cleverly designed and some of them made you really think. On the other hand, some of the wrong answers proffered for the benefit of the less able (such as one thick lad who was only there because his father was a Squadron Leader) were frankly hilarious. My favourite is:

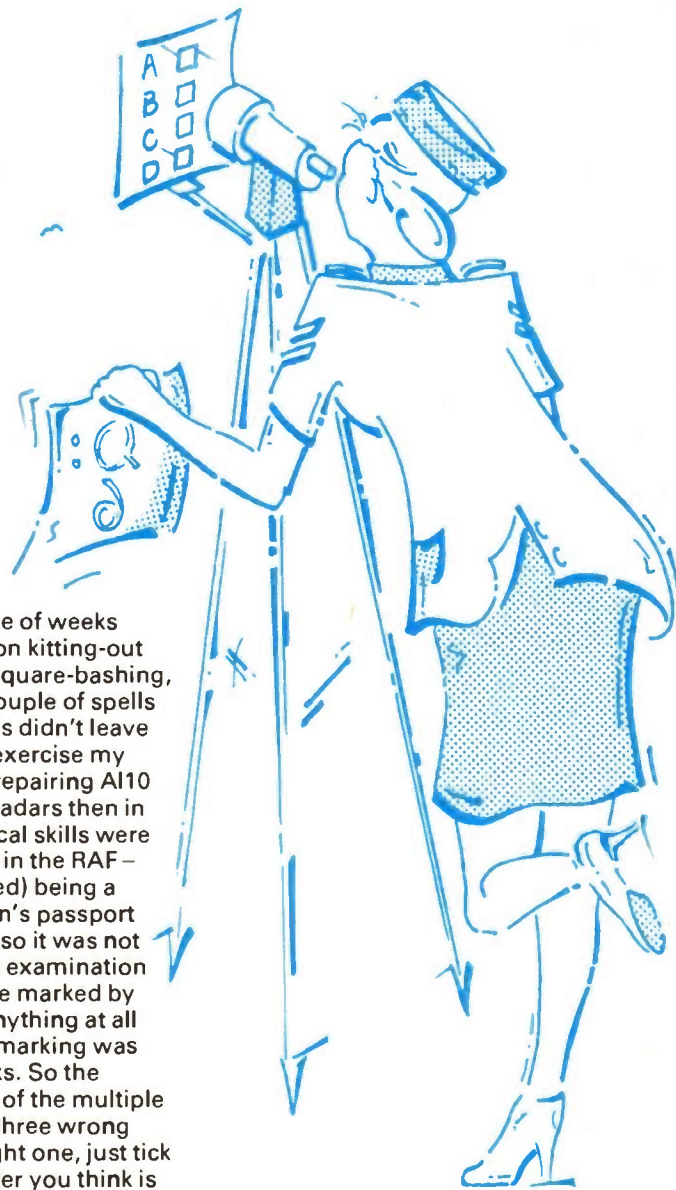

The resonant frequency  $f$  of a tuned circuit is given by:

$$f = \frac{1}{2 \times \pi \times \sqrt{L \times C}}$$

To increase the resonant frequency would you:

- a) Increase the value of C?
- b) Increase the value of L?
- c) Decrease the value of C?
- d) Change the value of  $\pi$ ?

Yours sincerely,

*Point Contact*



# Velleman

## Review

by Tony Bricknell

# Digital Controlled Preamplifier K4100



Please note:  
the remote control  
unit is not included  
in the kit.

A separate preamplifier is almost indispensable for controlling a power amplifier such as the K4000 Valve Amplifier. This is the way things used to be in the old days before 'integrated amplifiers' came along. When choosing such an item, ease of operation, and a comprehensive array of inputs/outputs, are generally foremost in most peoples minds. The K4100 offers Phono (suitable for moving magnet/high output moving coil cartridges), CD and Tuner inputs, two Tape Monitor loops, and a Graphic Equaliser loop. All the back panel inputs and outputs use high quality, gold-plated phono sockets for maximum contact reliability. Input selection, volume, balance and tone circuits are

digitally controlled through a membrane keypad incorporating LED displays for all functions. A switched mains output allows the K4100 to turn the rest of the installation on and off through its own power switch. In addition, an optional remote control (K4101) is available, allowing the preamplifier to be operated from the comfort of your armchair.

### Circuit Description

Figures 1 and 2 show the circuit diagrams for the digital microprocessor and audio signal processor sections respectively. A block diagram of the complete system is detailed in Figure 3. This should assist you when following the circuit description or fault-finding the completed unit.

Starting with the audio section, IC8 and associated components form a low noise, stereo phono preamplifier with RIAA equalisation. All audio inputs are fed into IC7, a digitally controlled stereo audio processor, through a simple potential divider constructed from two resistors. These are required to match the level of the input signal to that required by IC7. The output of the source selector is fed, via IC9, to the record outputs for the two cassette decks, and also to the input of an external graphic equaliser. The return from the graphic equaliser is fed back into IC7 to be processed by the volume, tone and balance controls. The final output from IC7 is taken through IC10, to the line output sockets and also

## FEATURES

- ★ Inputs for Phono, CD, Tuner and two Cassette Decks
- ★ Graphic Equaliser loop
- ★ LED display of all settings
- ★ Full digital control of all functions
- ★ Switched mains output
- ★ Optional IR remote control

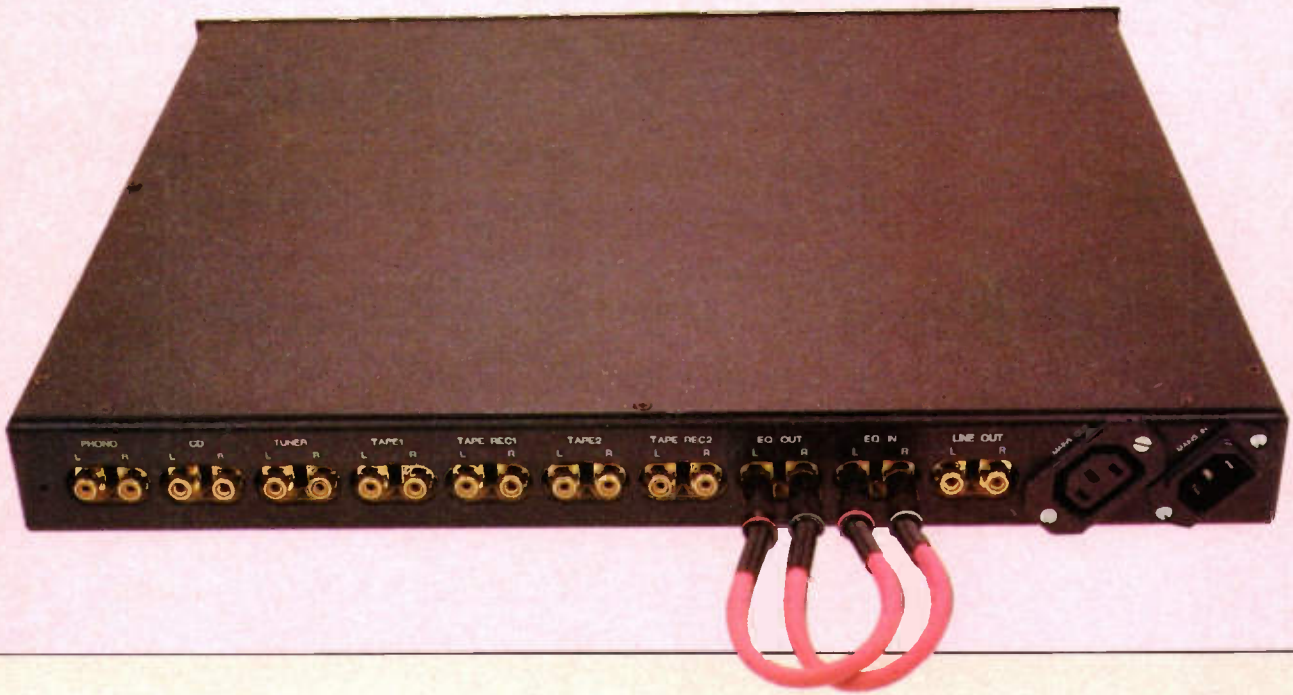
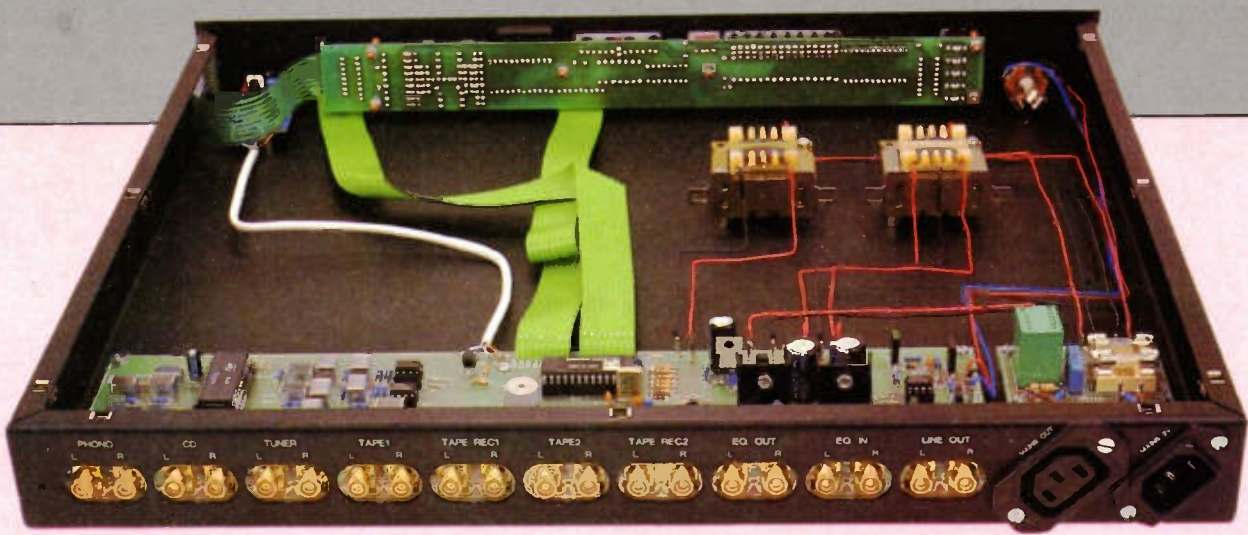

to the headphone amplifier formed by IC11, T3 and T4.

IC6, a one-time-programmable microcontroller, forms the heart of the microprocessor section, controlling all functions of the preamplifier. Operational commands enter this IC from either the keyboard matrix or through the infra-red receiver circuit formed by IC1.

IC2, IC3, IC4 and IC5 are LED display drivers, which latch serial data output from IC6. IC6 also generates the I<sup>2</sup>C BUS serial data, required to control the audio processing IC, IC7.

A switched mains output is provided by RY1 and T2, allowing power to the whole hi-fi system to be controlled through the K4100.

## Construction

The K4100 is constructed on no fewer than four PCBs, so read the assembly instructions in the manual supplied with the kit thoroughly, before even thinking about picking up a soldering iron! Pay particular attention to any modification sheets hidden between the pages of the manual. To aid component identification, a small leaflet detailing component outlines, circuit diagram symbols, etc. is included with the kit. Carefully follow the

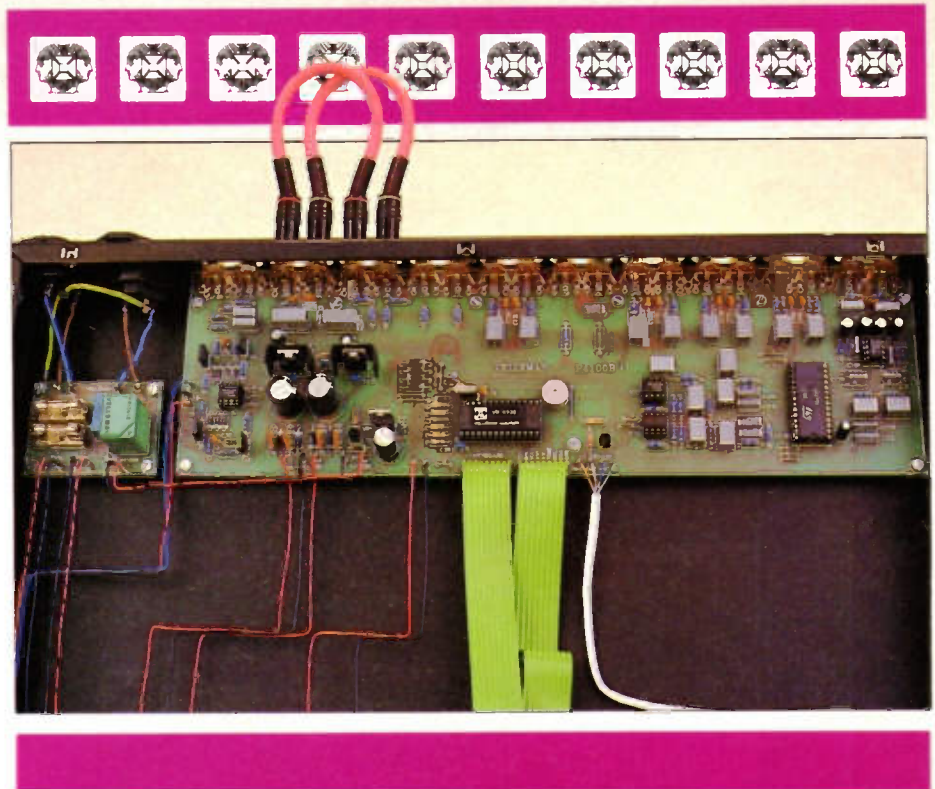

Top: interior and rear views of the completed unit. Above: the main PCB in situ.

Figure 1. Digital Microprocessor circuit diagram.

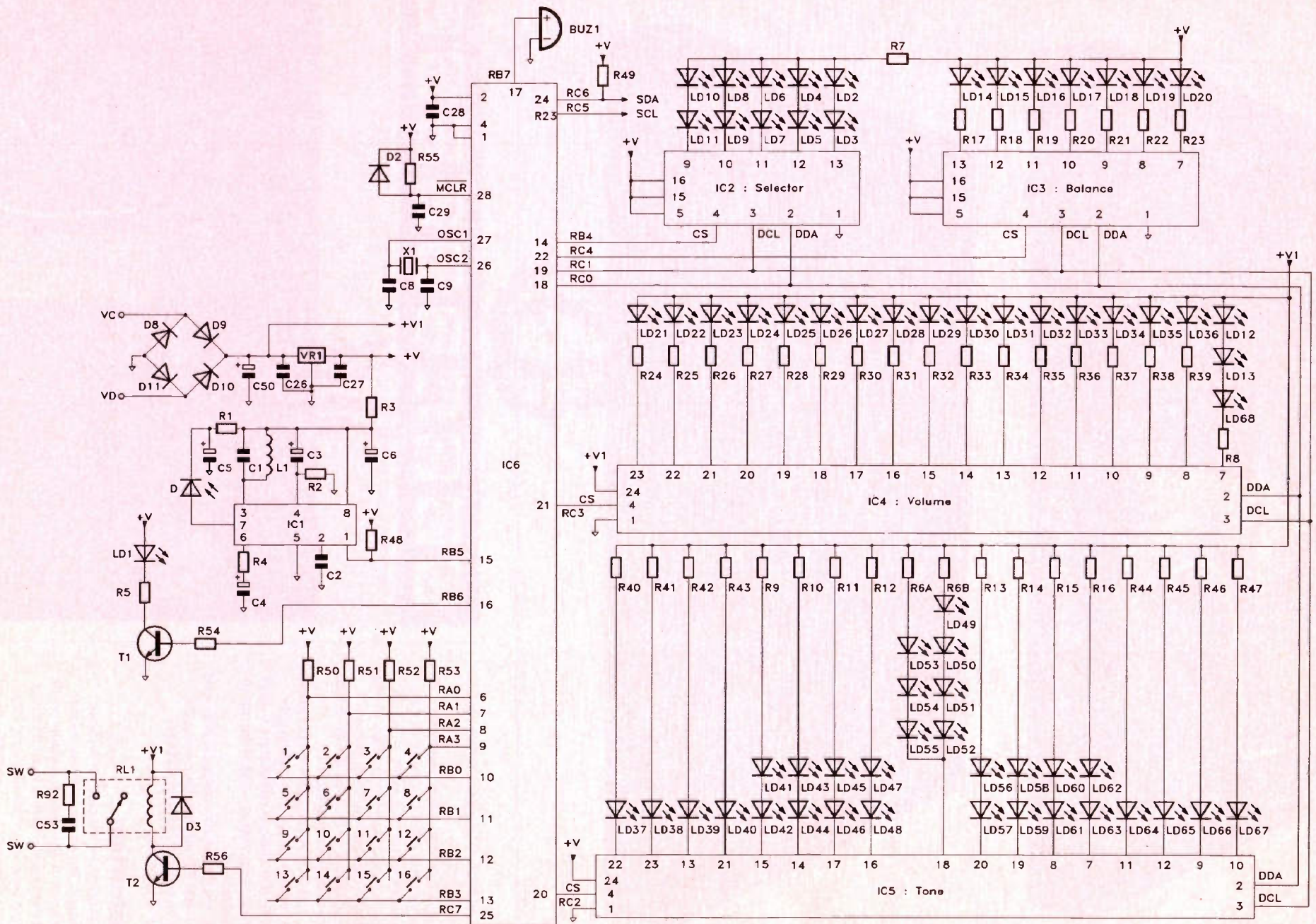

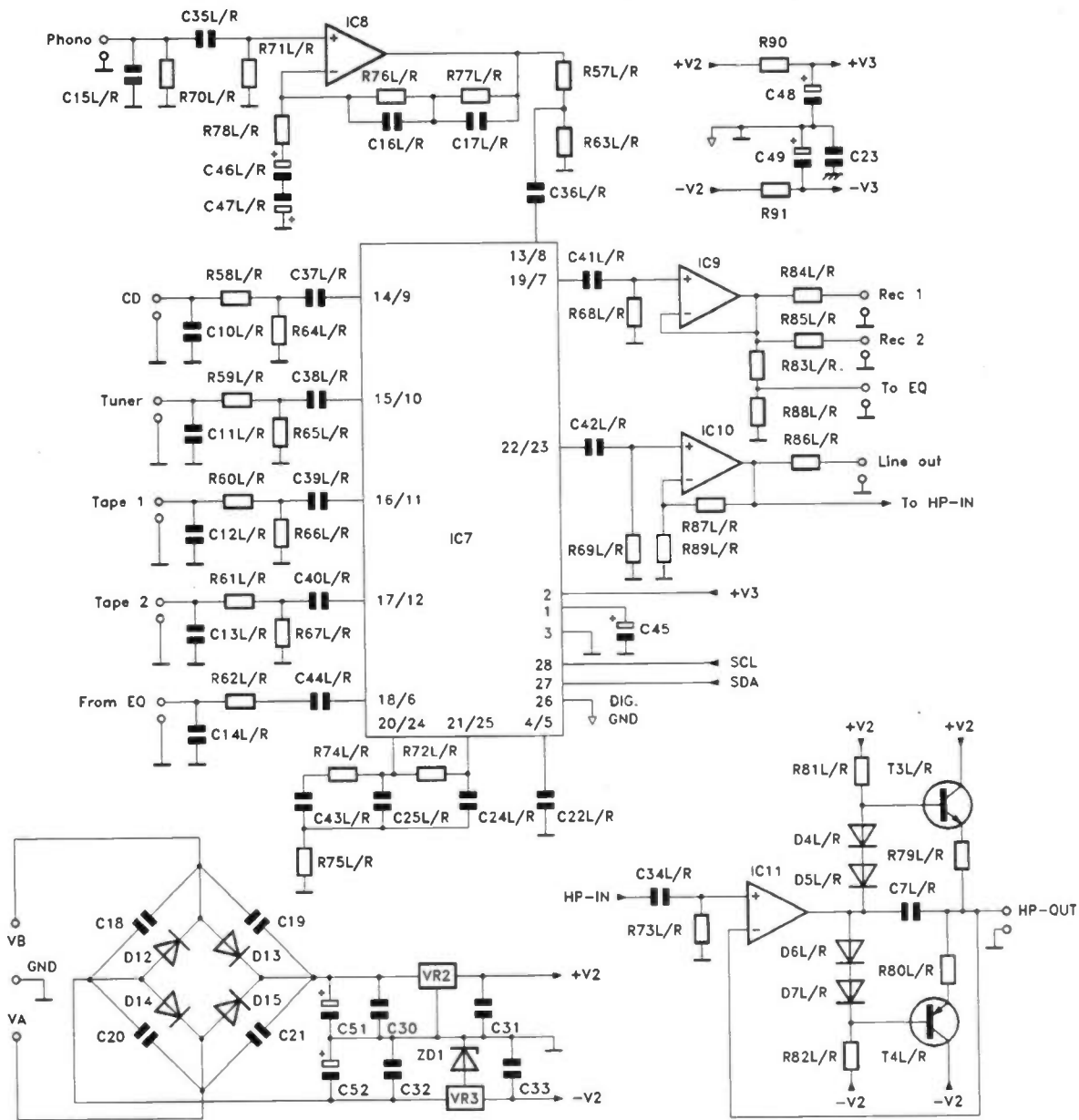

Above: Figure 2. Audio Signal Processor circuit diagram.

Right: Figure 3. K4100 block diagram.

assembly instructions, as the sequence in which the components are fitted is quite important. However, it is worthwhile to take note of the following modifications:

### All PCBs

When fitting the PCB pins, fit them from the legend side of the PCB, pressing them in place using a hot soldering iron.

### Preamplifier Module P6711P

The resistors used are all 5%, 3 band, metal film (beige body, gold tolerance band). LED LD1 is a red rectangular LED.

### Display Module P4100D

All the resistors are 5%, 3 band, metal film (beige body, gold tolerance band). When fitting the LEDs, it is highly recommended that a thin strip of paper, card, or black plastic is 'woven' between each group. This will stop illuminated LEDs 'lighting up' adjacent LEDs.

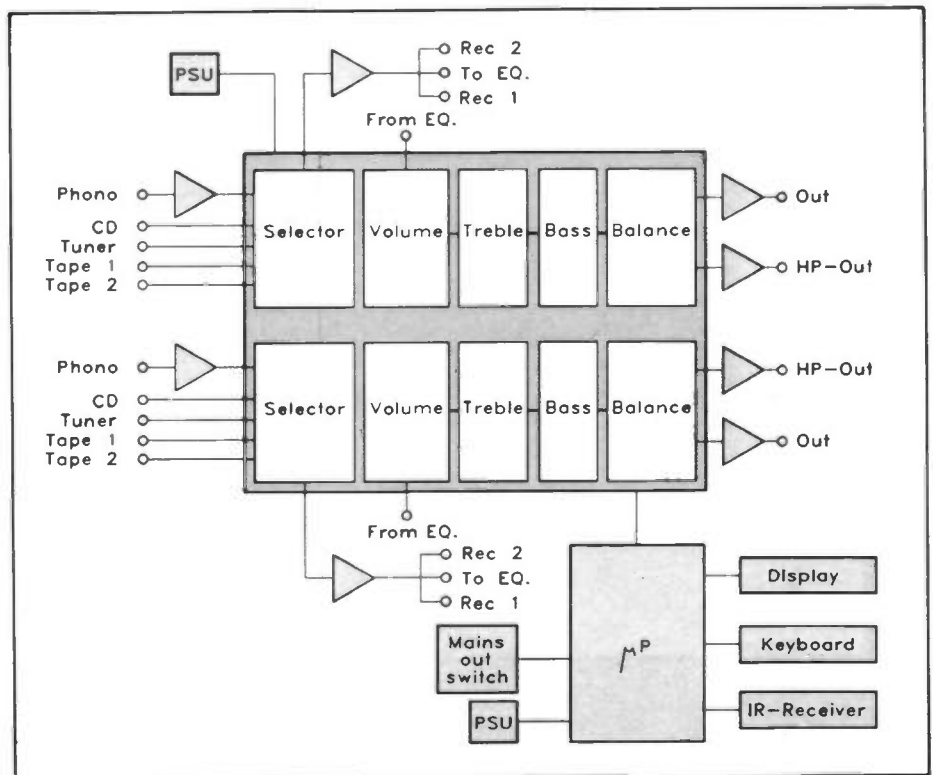

## Basic Module P4100D

Resistors R48 through R57; R59 through R62, R90 and R91 are all 5%, 3 band metal film (beige body, gold tolerance band). All other resistors are 1% metal film (blue body). The colour code for resistors R79L, R79R, R80L and R80R is Red, Violet, Black, Gold, and *NOT* as stated in the manual! Capacitors C7L, C7R, C8 and C9 are 18pF Ceramic and *NOT* 19pF!

## Enclosure and Wiring

With reference to Figure 4, fix the four rubber feet to the box, using black M3 bolts. Fit the 10mm stand-offs to the remaining 18 holes on the bottom plate as stated in the construction manual. However, two of the holes require the paint on the inside of the box to be removed, to make good contact between the stand-off and the metal housing. These are the third rightmost hole at the back and the rearmost of the two holes on the far left-hand side of the unit, see Figure 4.

For all interconnection wiring, refer to Figure 5, *NOT* the figure detailed in the construction manual.

Mains connections to and from the

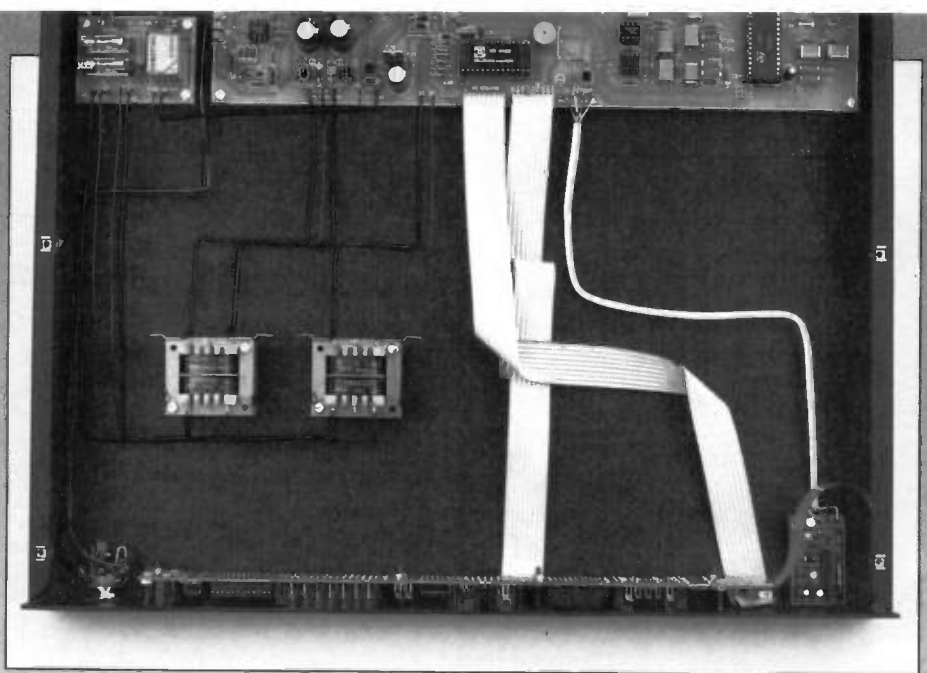

Interconnection wiring between the various modules.

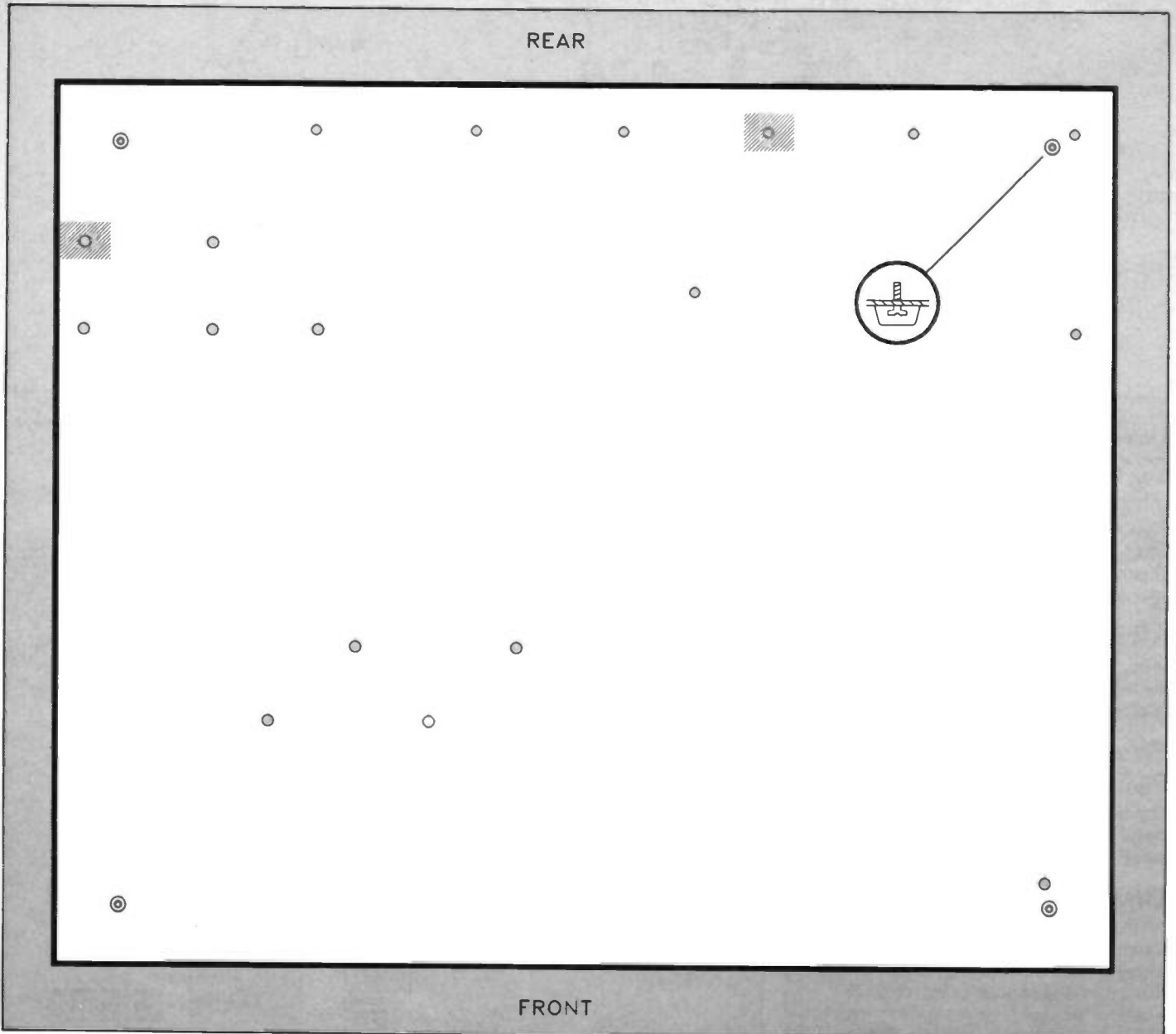

Figure 4. Box fixings.

**Input Sensitivity/Impedance**

PHONO	5.5mV/50k
CD	500mV/32k
TUNER	360mV/22k
TAPE 1	360mV/22k
TAPE 2	360mV/22k

**Rated Output Voltage**

Line	1V
Tape	360mV
Equaliser	180mV

**Signal/Noise Ratio**

Phono	75dB (A weighted, rated output)
Tape/CD/Tuner	100dB (A weighted, rated output)

**Audio Controls**

Volume	-68dB to +10dB, in 2dB steps
Muting	-68dB
Balance	0 to -38dB, in 3dB steps
Bass	±15dB at 100Hz, in 2.5dB steps
Treble	±15dB at 10kHz, in 2.5dB steps

Total Harmonic Distortion	0.01%
Frequency Response (-3dB)	8Hz to 150kHz
Channel Separation	90dB
Crosstalk Between Inputs	-98dB
RIAA Deviation	±0.5dB (20Hz to 20kHz)
Headphone Output Power	280mW into 32Ω
Power Consumption	6W max.
Dimensions (W×H×D)	420×50×350mm

relay module P4100R should be made with C6A mains cable (remove the outer sheath, leaving three single insulated wires). Note that the green/yellow earth wire connects to a solder tag screwed to the rear left-hand side of the relay module.

For SW, RY, TRAF01 and TRAF02 connections, use red/black solid core 'bell' wire.

Connection to the headphone socket should be made using blue, red, and black solid core 'bell' wire for the left, right and 0V terminals, respectively.

The infra-red preamplifier module P6711P is connected to the basic module P4100B with 4-wire, solid core 'telephone' cable.

All other construction procedures should be carried out in accordance with the manual supplied with the kit.

**Testing and Use**

Replace the European style mains plug on the supplied power cord with a suitable 13 amp mains plug. If the K4100 is to be used in a system without a graphic equaliser, two short phono-to-phono

Left: Table 1. Specification of Prototype.

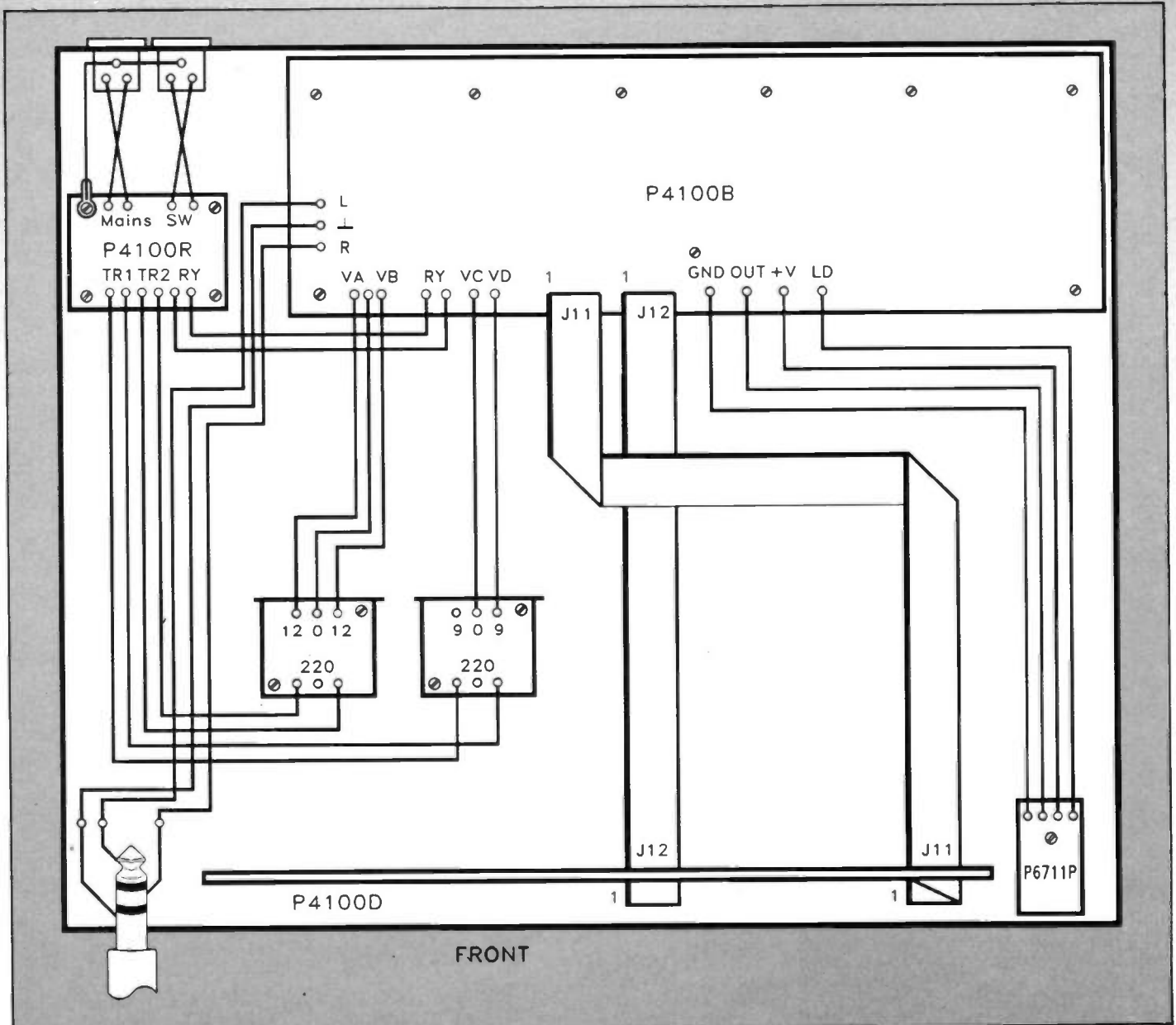

Figure 5. Wiring diagram.



cables will be required to link the 'EQ OUT' to the 'EQ IN' sockets.

On connecting the preamplifier to the mains supply, the REMOTE SENSOR LED should be illuminated, indicating that

Above: The Preamp and optional remote control.  
Below: Table 2. Component checklist.

the K4100 is in 'Standby' mode. Using a suitable multimeter, check that there is approximately 0V DC and 0V AC present on the TAPE REC and LINE OUT sockets. Lightly press the POWER key to turn the unit on. The PHONO, BALANCE (centre) and TONE (flat) LEDs should now be lit. Again, check that there is 0V DC and 0V

AC present on the TAPE REC and LINE OUT sockets.

Test the function of all the keys and LED displays according to the assembly instructions in the manual *BEFORE* connecting an amplifier and speakers!

The K4100 has one preset memory that stores all settings (except input selection). To enter the current configuration into memory, simply press the MEM key. This will now be the default setting when the unit is powered up (note that disconnecting the mains supply from the K4100 will cause the memory contents to be lost). At any time, to recall the stored settings, press the CALL key.

Finally, Table 1 gives the technical specification of the prototype. Table 2 is a component check list of all items contained in the kit.

## Availability

The Velleman K4100 is available as a kit from Maplin Electronics by mail-order or through their numerous regional shops, **order code VE46A Price £199.95** . An optional infra-red remote control, giving armchair control of all functions, is also available, **order code VE47B Price £39.95**.

### Resistors

R1,40,41,46,47,55	1k 5% Metal Film	6
R2	39k 5% Metal Film	1
R3	47R 5% Metal Film	1
R4	22R 5% Metal Film	1
R5,20	220R 5% Metal Film	2
R6A	470R 5% Metal Film	1
R6B,17-19,21-23	330R 5% Metal Film	7
R7,90,91	10R 5% Metal Film	3
R8	100R 5% Metal Film	1
R9-16	1k2 5% Metal Film	8
R24-39,42-45,56	1k5 5% Metal Film	21
R48-54	10k 5% Metal Film	7
R58L,58R	10k 1% Metal Film	2
R63L-69L,63R-69R	47k 1% Metal Film	14
R70L-73L,70R-73R	100k 1% Metal Film	8
R74L,74R	20k 1% Metal Film	2
R75L,75R	5k1 1% Metal Film	2
R76L,76R	33k 1% Metal Film	2
R77L,77R	390k 1% Metal Film	2
R78L,78R	680R 1% Metal Film	2
R79L,79R,80L,80R	27R 1% Metal Film	4
R81L,81R,82L,82R,		
84L-86L,84R-86R	1k 1% Metal Film	10
R83L,83R,88L,88R	2k 1% Metal Film	4
R87L,87R,89L,89R	470R 1% Metal Film	4
R92	150R 1/2W	1

### Capacitors

C1	3n9 Poly Layer or Ceramic	1
C2,23	47nF Poly Layer or Ceramic	2
C3	2µ2 Electrolytic	1
C4	4µ7 Electrolytic	1
C5	10µF Electrolytic	1
C6	47µF Electrolytic	1
C7L,7R,8,9	18pF Ceramic	4
C10L-14L,10R-14R	47pF Ceramic	10
C15L,15R	180pF Ceramic	2
C16L,16R	2n2 Poly Layer or Ceramic	2
C17L,17R	8n2 Poly Layer or Ceramic	2
C18-21	10nF Poly Layer or Ceramic	4
C22L,22R	15nF Poly Layer or Ceramic	2
C24L,24R,25L,25R	68nF Poly Layer	4
C26-33	100nF Ceramic	8
C34L,34R,35L,35R	220nF Poly Layer	4
C36L-43L,36R-43R	1µF Poly Layer	16
C44L,44R	2µ2 Poly Layer	2
C45	10µF Electrolytic	1
C46L,47L,46R,C47R,48,49	100µF Electrolytic	6
C50	1000µF Electrolytic	1

C51,52  
C53

### Semiconductors

D1	BPW41 IR Receiver Diode	1
D2,3,4L-7L,4R-7R	1N1418	10
D8-15	1N400X	8
ZD1	2V4 Zener Diode	1
T1,2	BC547 or similar	2
T3L,3R	BD135 or BD137 or BD139	2
T4L,4R	BD136 or BD138 or BD140	2
IC1	2183	1
IC2-5	U3088M	4
IC6	VK4100 or PIC16C55	1
IC7	TDA7304	1
IC8,9,11	TL072	3
IC10	5532	1
VR1	7805	1
VR2	7810	1
VR3	7908	1
LD1,17,49-55	Red Rectangular LED	9
LD2-11	Orange Square LED	10
LD12,13	Red Square LED	2
LD14-16,18-48,56-67	Green Rectangular LED	46
LD68	Red 5mm Flashing LED	1
XT1	4MHz Crystal	1

### Miscellaneous

J1L-10L,J1R-10R	PCB Mounting Phono Sockets	20
BUZ1	PCB Mounting Buzzer	1
L1	4700µH Coil	2
J13	PCB Cable Connector	1
F1	250mA Fuse	1
F2	6.3A Fuse	1
RY1	PCB Mtg Fuse Holders	2
	Relay	1
TR1	10-Way Ribbon Cable	2
TR2	9-0-9V Transformer	1
	12-0-12V Transformer	1
	Self-Adhesive Front Panel	1
	Self-Adhesive Rear Panel	1
	Eurocon Chassis Plug	1
	Eurocon Chassis Socket	1
	Mains Cable	1
	1/4in. Stereo Jack Socket	1
	P4100B PCB	1
	P4100D PCB	1
	P4100R PCB	1
	P6711P PCB	1
	Case and Fixings	1





# CAGED. BUT SHOULD IT BE HUNG?

On reflection, yes! Our Mains Inspection Lamp has a hook (better than Frank Brunos) at the top, allowing you to hang it, leaving both of your hands free to get on with those important tasks like work, instead of hunting for a place to put the light. An additional feature is the simple but effective reflective strip that is found on the bright orange protective bulb cage surround.

Complete with a 6 metre long power cable and with an on/off switch fitted to the blue handle, this lamp is ideal for working conditions where extra light is needed such as your garage, workshop or garden shed, etc.

ZC19V Inspection Lamp £5.95 Inc. VAT (plus £1 handling charge by post), and available from Maplin shops nationwide. All you need to do, is add a 13A mains plug (available as unbreakable rubber type HL58N only £1.60), and a 60 watt max bulb and there you glow!

## Inspection lamp... Inspect our price!

# INFRA-RED VIDEO LINK

B Y G A V I N C H E E S E M A N

## Part Two: The Receiver

### Specification of Prototype

Power Supply	
Voltage	12V to 14V
Power Supply	
Current	200mA
Video Bandwidth	4MHz approx.
Video Output	
Level	1V peak-to-peak
System Operating	
Range	100m maximum

Last month's issue detailed the Infra-red Video Link Transmitter; this month we will look at the receiver.

### Circuit Description

The receiver circuit diagram is shown in Figure 1, while Figure 2 shows the PCB legend. The circuit can effectively be split into two parts; the preamplifier, and the main video processing circuit. The receiver uses two separate supply rails, in a similar way to that of the transmitter. The receiver lens focuses the infra-red energy onto photodiode PD1. High-frequency peaking is also required in the receiver, to compensate for the poor frequency response of the photodiode. IC1 amplifies the received signal from the photodiode, providing a gain that increases with frequency but falls off at around 4MHz (the highest video frequency that can be resolved using this system). Part of the signal is fed back via IC1d and field effect transistor TR1, which serves as a simple Automatic Gain Control (AGC) at the initial preamplification stage.

The signal, taken from IC1c, is then fed to the second stage of the circuit comprised of IC2 and associated components. Preset RV5 is configured as a level

Completed  
Infra-red Video  
Link, with top  
cover removed to  
show internal  
construction.

## FEATURES

- ★ Range up to 100m
- ★ 12V operation
- ★ Replaces long video cables

## APPLICATIONS

- ★ Point-to-point video link
- ★ Security systems
- ★ General communications

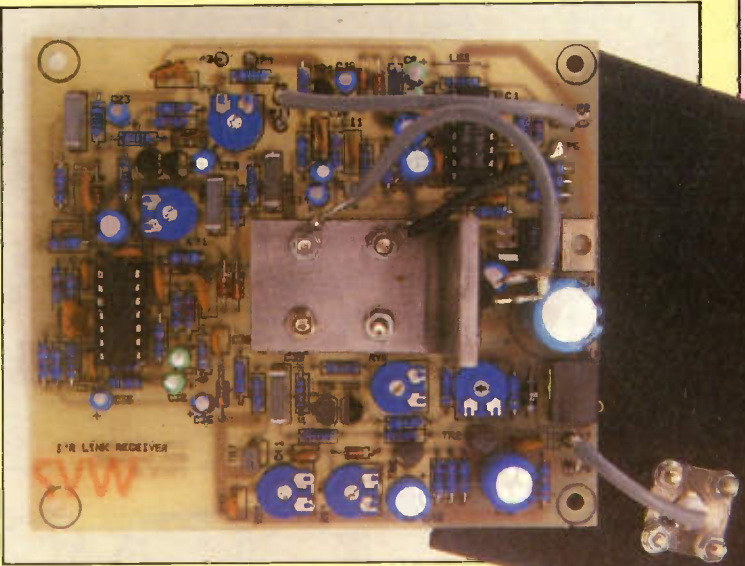

Assembled PCB.

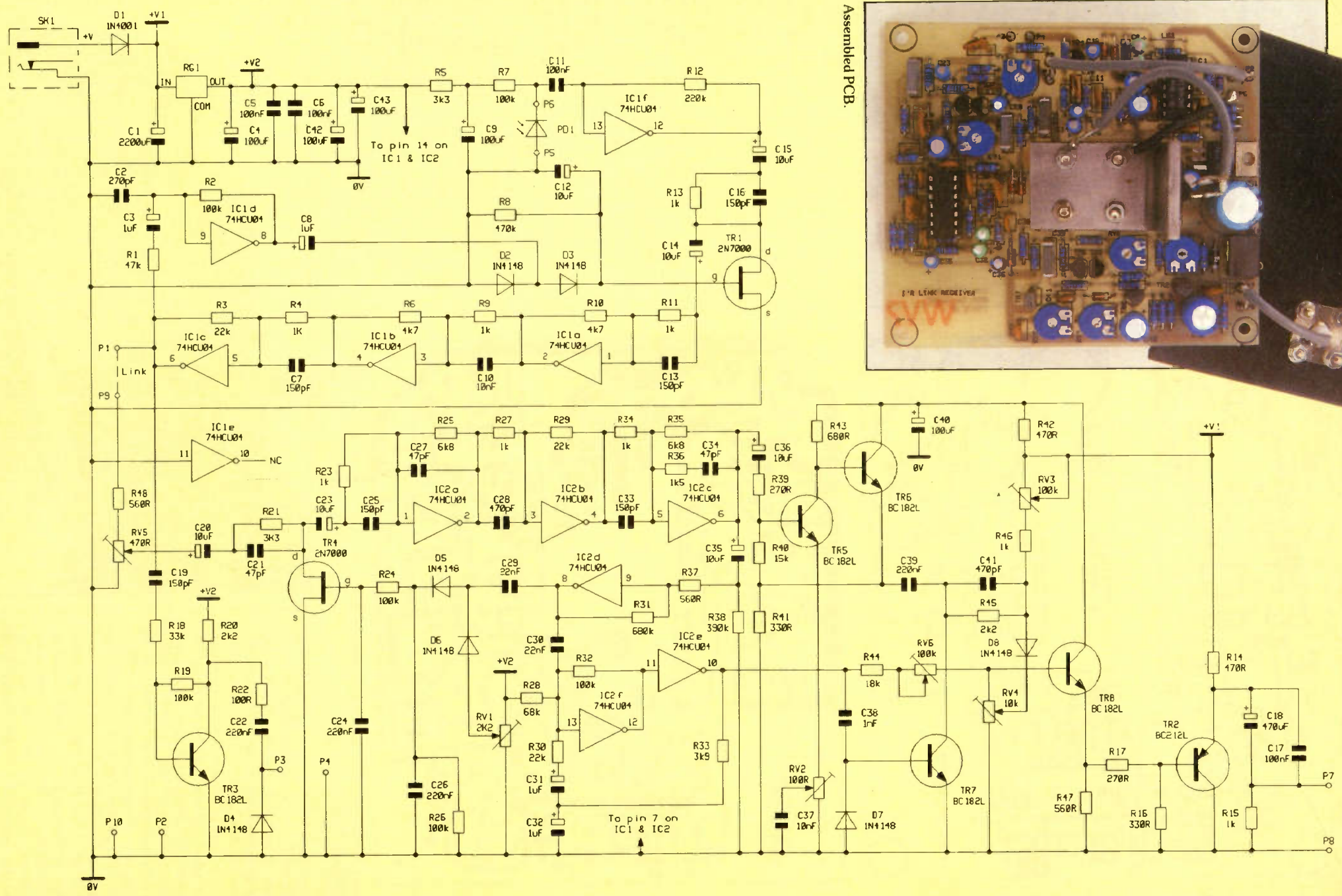

Figure 1. Circuit diagram.

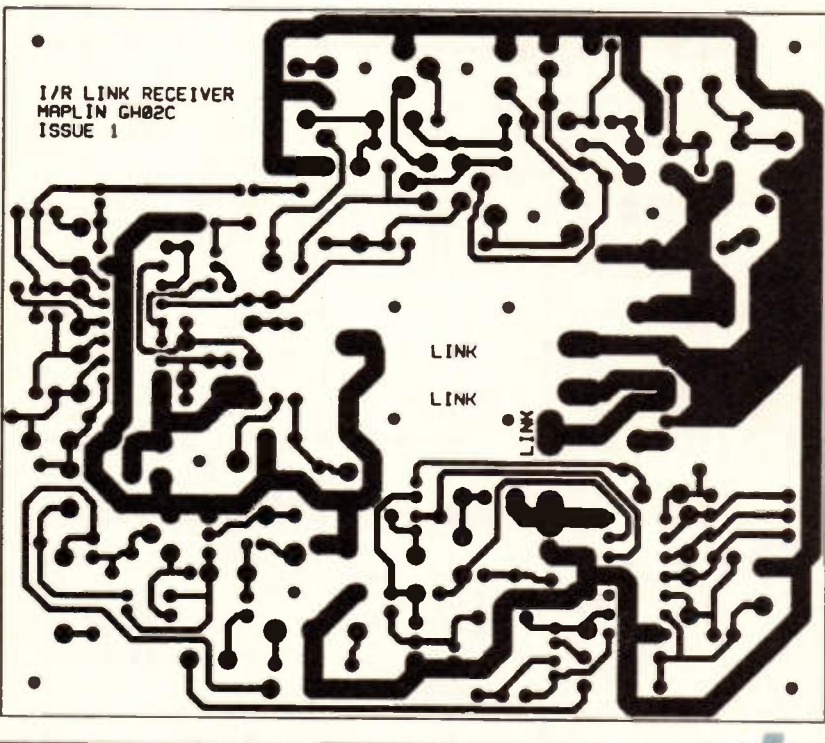
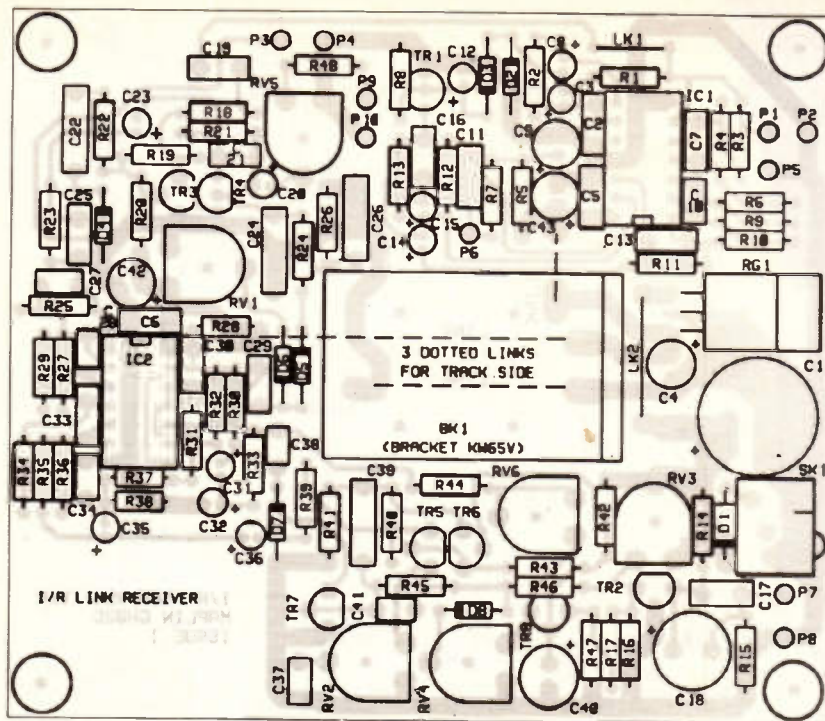

Figure 2. PCB legend and track.

control, enabling the optimum signal level to be set for the next stage. IC2a, b and c act as an amplifier and filter stages; IC2d, TR4 and associated components forming a secondary AGC circuit. Preset resistor RV1 sets the level at which the AGC operates. IC2e and f act as a sync separator, which recovers the composite sync pulses and cleans them up. Preset resistor RV6 sets the final sync level. The luminance part of the signal is processed separately via TR5, TR6, TR7 and associated components, this stage largely rejecting the sync component of the signal. RV2 limits the high frequency response of the signal, effectively providing a 'sharpness' control. Both the sync and luminance signals are recombined at the base of transistor TR8. Preset resistor RV3 determines the black level, while RV4 sets the luminance level. The recombined

signal is buffered by TR2, providing an output suitable to drive a standard video monitor.

An additional section of the circuit, made up from transistor TR3 and associated components, provides a rectified but unfiltered output derived from the pre-amplifier stage. This could be useful for reference purposes when the final transmitter and receiver units are physically aligned. This output is not calibrated, and is only intended to provide a reference.

### Receiver Construction

The majority of receiver construction techniques are very similar to those of the transmitter (described in part 1), and have therefore been omitted from this part.

The infra-red receiver diode (PD1) is mounted differently from the transmitter diode, as can be seen from Figure 3. The diode is held in place using the 'Double Bubble' epoxy resin adhesive, which is supplied in the kit. It is important that the leads of the diode do not touch the metal bracket. To this end, a small piece of green plastic filter is used to insulate the diode from the bracket. The leads of the diode should be cut to a length of approximately 10mm and should be bent outwards to reduce the possibility of unwanted shorting. A short length of screened lead is used to connect the diode to P6 and 0V. PLEASE NOTE: the green filter material is used only as an insulator, and should not be used as a filter in front of PD1. The body of PD1 effectively sits on the upper edge of the filter, so that there is a clear line-of-sight path between it and the Fresnel lens.

There are two wire links on the component side of the PCB. A component lead off-cut may be used for LK1; however, LK2 carries the main supply rail to regulator RG1, and must therefore be somewhat thicker. Suitable tinned copper wire is supplied in the kit for LK2.

In addition to the component side links, there are three links on the track-side of the PCB, each of which require special attention. To help with positioning these links (which are marked on the PCB) correctly, Figure 4 shows the links on the track side. It is important that these links are made up from insulated wire, to prevent them from shorting to other tracks, pads or component leads.

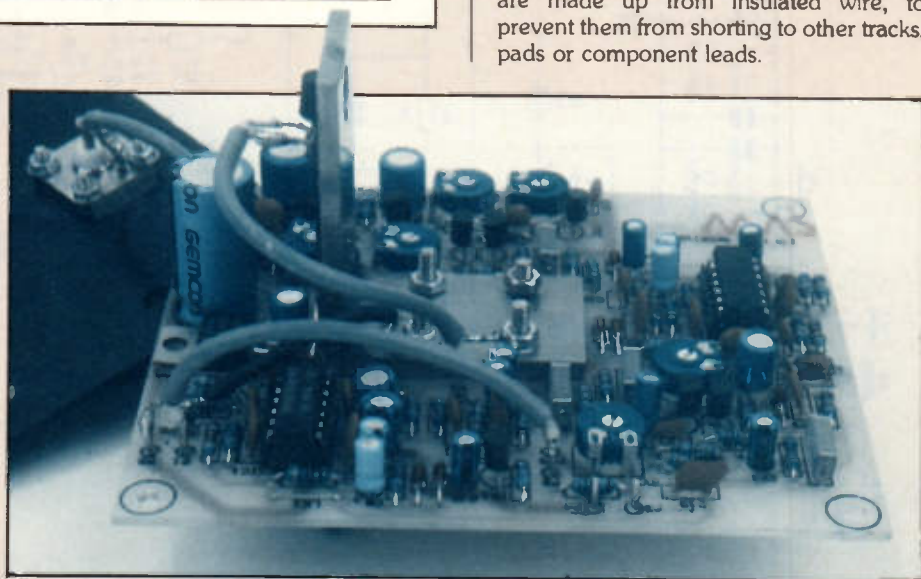

Close-up of PCB, showing mounting (and wiring) of PD1, the photodiode.

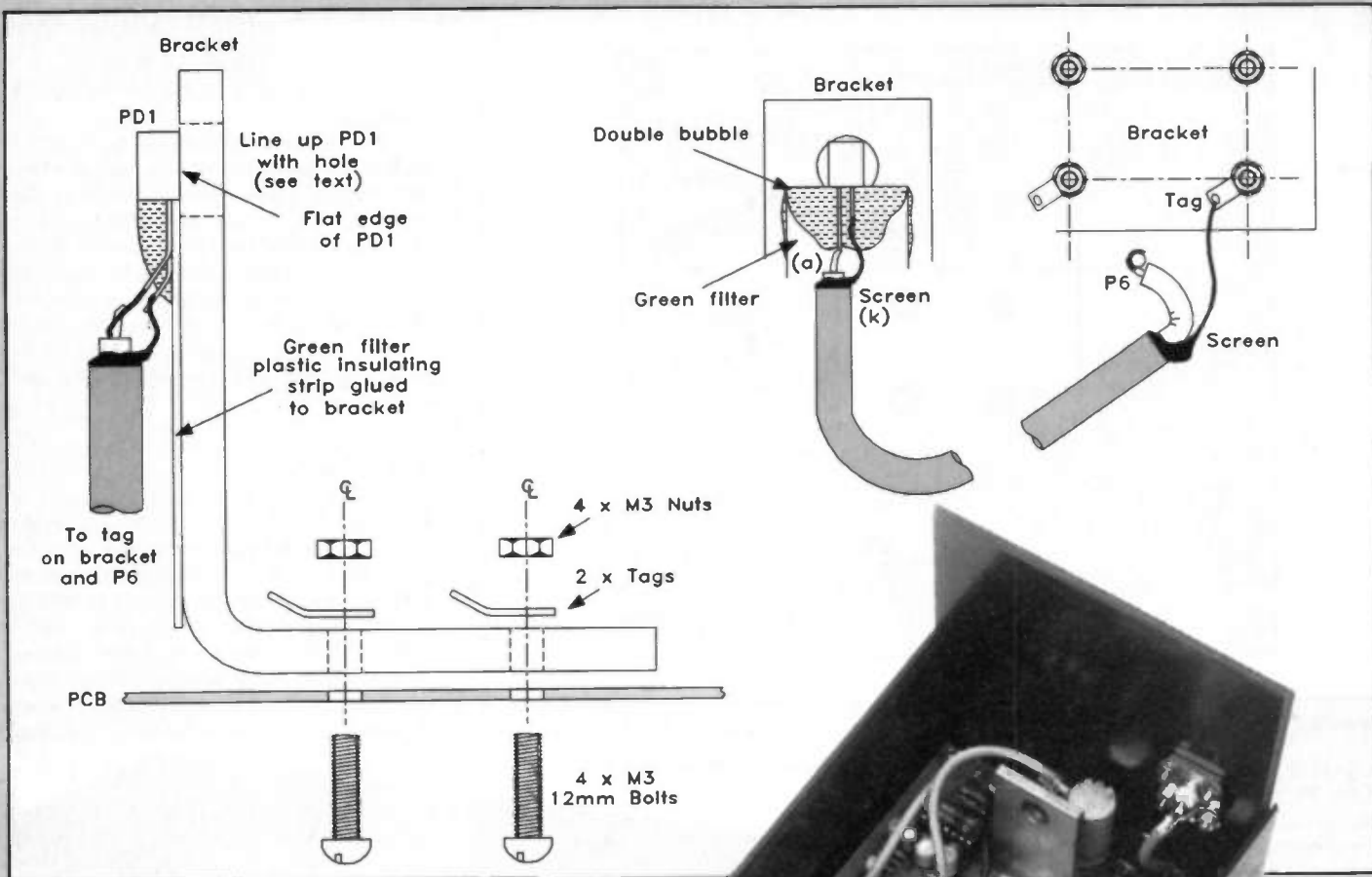

Figure 3. Mounting PD1.

It is necessary to earth the diode bracket to prevent the introduction of noise into the preamplifier section of the circuit. The bracket is connected to ground via pin 5, using a short length of insulated wire. For optimum performance it is important that the length of this wire is kept short, and that wire of a suitably thick gauge (as supplied in the kit) is used.

The output from the preamplifier



Assembled Infra-red Video Link Receiver with top lid removed, showing internal assembly detail.

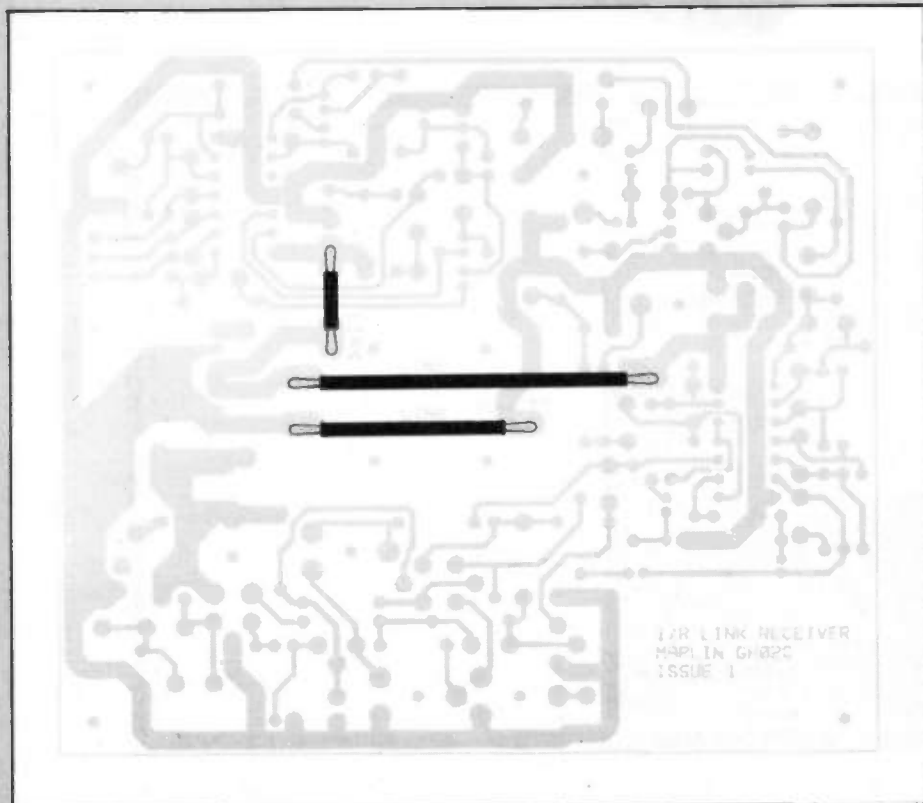

Figure 4. Track-side links.

section of the circuit is available between P1 and P2, and is connected to the input of the video processing section (P9 and P10) via a length of screened cable. This approach is adopted to reduce the level of external noise introduced into the system, and it is recommended that the cable is kept as short as possible; this also applies to the other screened connections as well. The PCB wiring information is shown in Figure 5.

### Housing

An undrilled case is supplied with each of the transmitter and receiver kits. The box has slots to hold the Fresnel lens in place. In each case, the PCB is mounted using four M3 nuts and bolts, 1/4in. spacers being used to position the PCB at the correct height in the case. The PCB is mounted so that the 'diode bracket' is positioned, as accurately as possible, at a distance of 270mm from the lens. This is approximately the focal length of the lens, and has been found to provide optimum range (see Figure 6). Using the supplied case, a suitable spacing between the diode and lens will be achieved if the drilling details are followed closely (see Figure 7). Figure 8 illustrates how to mount the PCB in the case.

The Fresnel lens, as supplied, is too

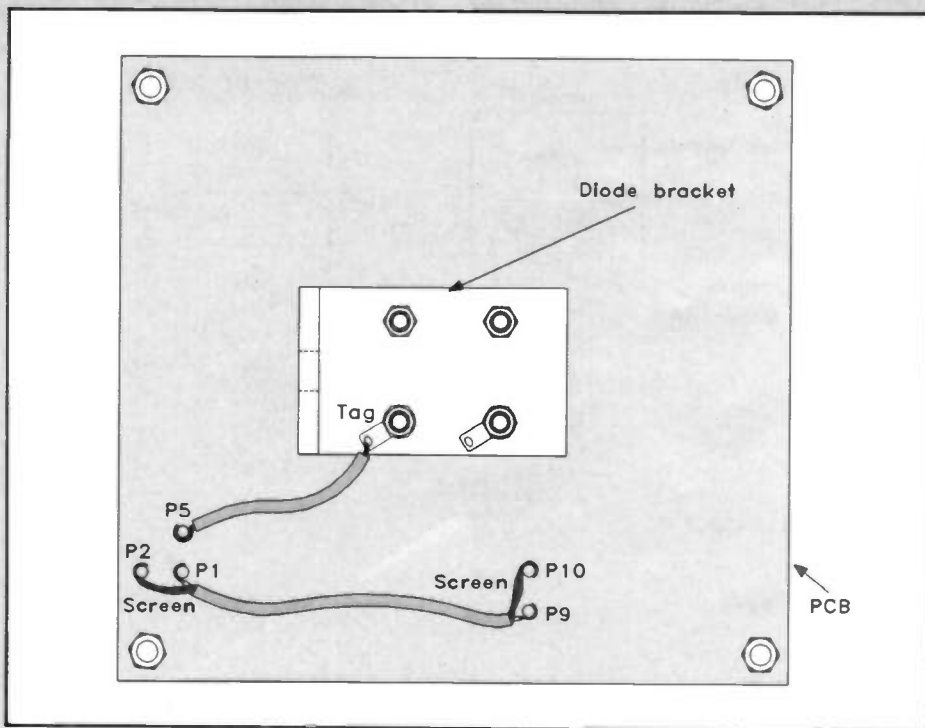

Figure 5. PCB wiring.

large to fit into the end of the box supplied in the kit, and a box to hold a lens of this size would not be practical in many cases. It is therefore necessary to cut the lens, so that it can be accommodated by the box, to dimensions of 103 × 103mm (see Figure 9). Although the lens material is easy to cut using ordinary scissors, it is important to ensure that the lens is cut as carefully and

as accurately as possible to ensure a correct fit.

The video output socket is mounted on the rear panel of the box, and is wired onto the appropriate pins on the PCB; the screened lead provided in the kit is used to wire it to the appropriate pins of the PCB.

The video lead should be screened to prevent unwanted radiation or external noise pick-up, which could create interference. The power socket is of the PCB-mounting type, and does not require any external wiring.

### Testing

Before the receiver is powered up, it is recommended that you check your work to make sure that there are no dry joints or solder bridges. In order to test the receiver fully, it is necessary to have the matching transmitter (available in kit form, stock code LP59P). There are 6 preset resistors on the PCB, which require setting up to suit each individual installation. Preset resistor RV1, which sets the AGC level, has

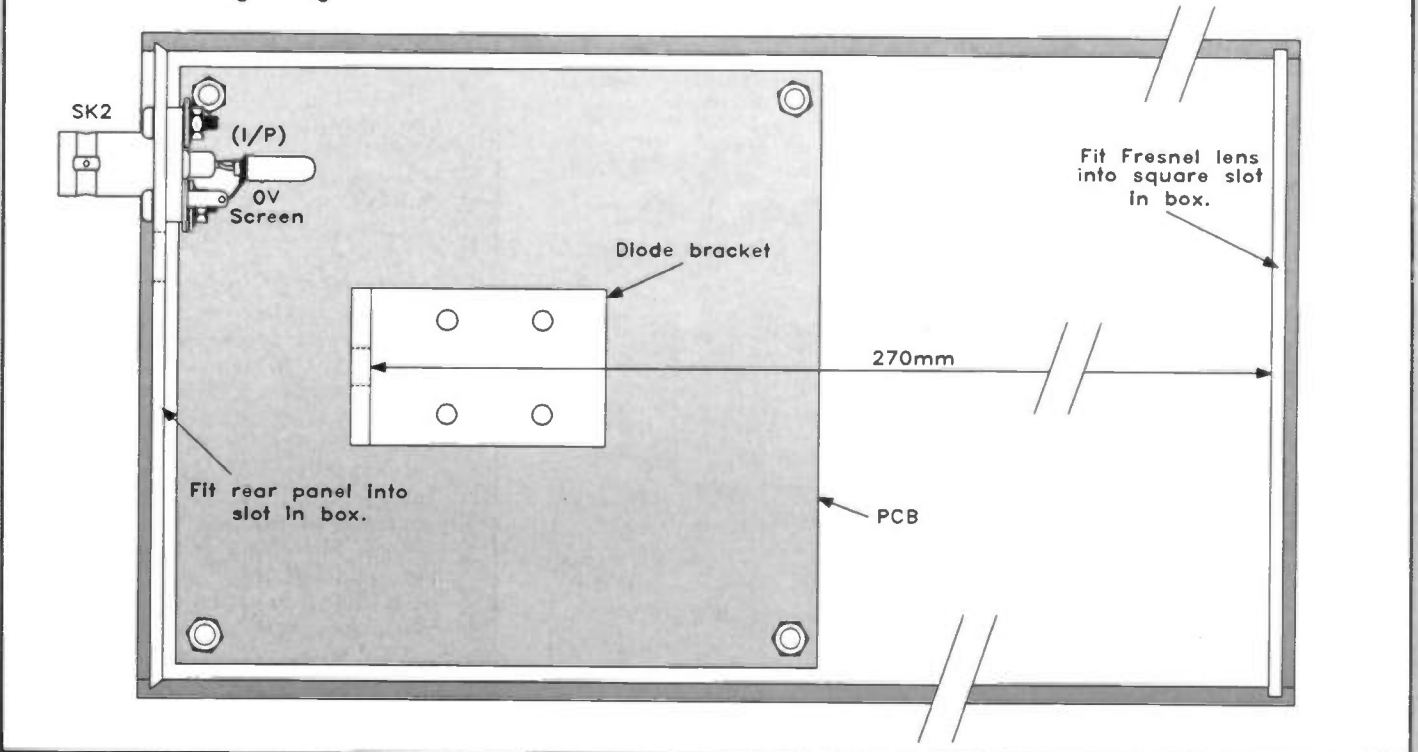
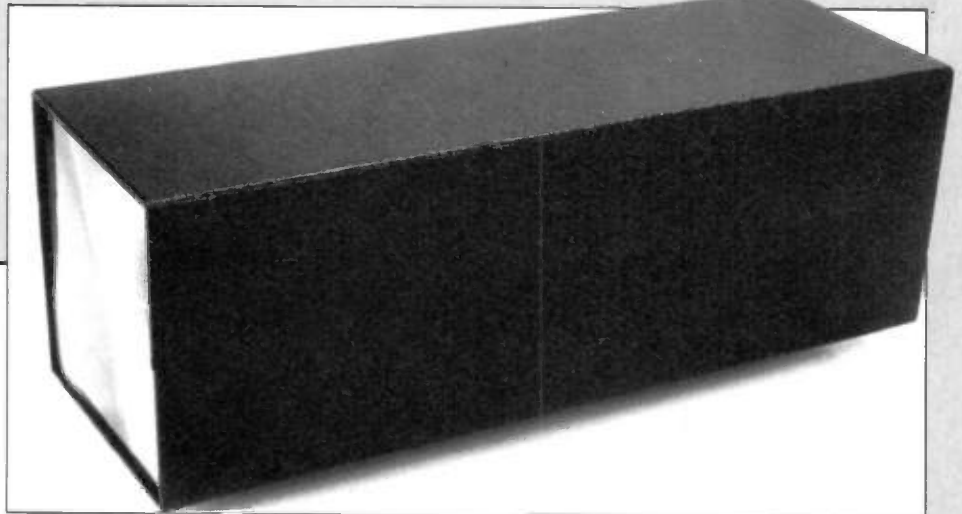
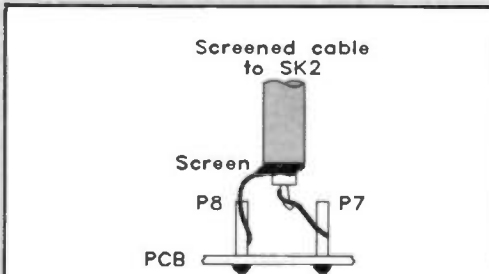

Figure 6. Positioning the PCB in the case; wiring SK2.

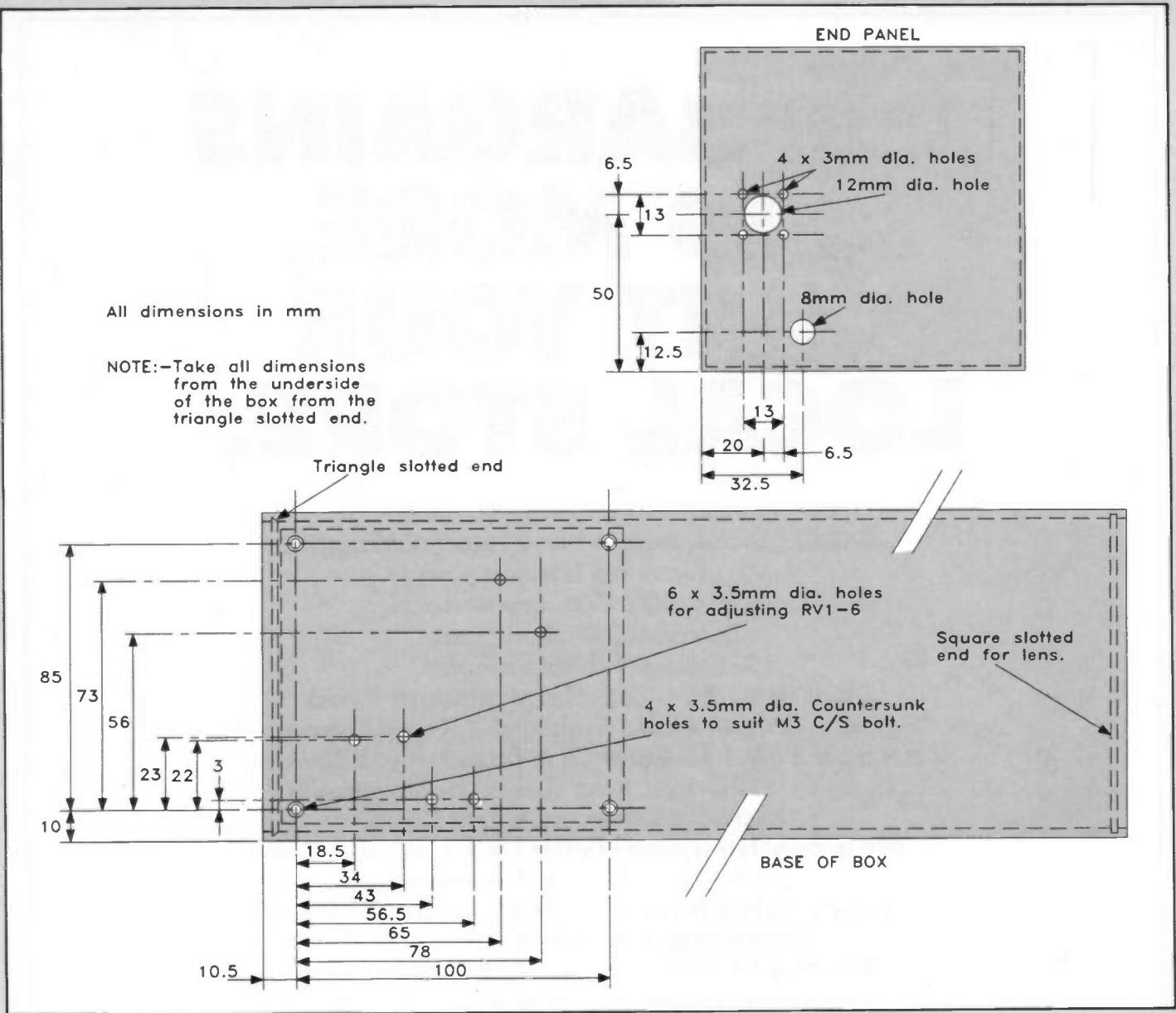

Figure 7. Drilling details.

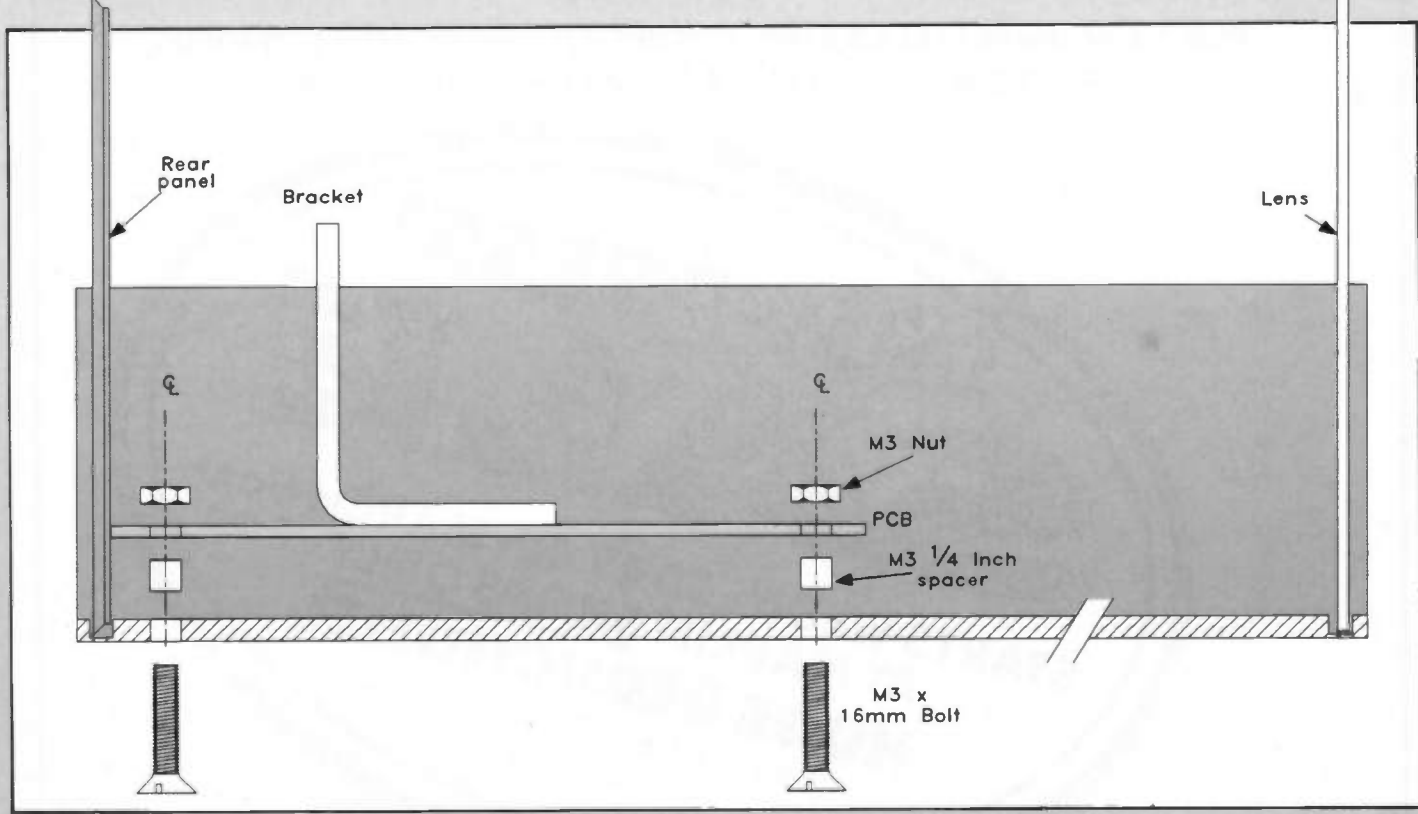

Figure 8. Mounting the PCB.

# FOR BARGAINS AND MORE, VISIT YOUR LOCAL STORE.

For personal service, visit our shops at:

**Birmingham** Sutton New Road, Erdington.

**Brighton** 65 London Road.

**Bristol** 302 Gloucester Road.

**Cardiff** 29 City Road.

**Chatham** 2 Luton Road.

**Glasgow** 264-266 Great Western Road.

**Leeds** Carpet World Building, 3 Regent Street.

**London** 146-148 Burnt Oak Broadway, Edgware.

120-122 King Street, Hammersmith.

**Manchester** 8 Oxford Road.

**Newcastle-upon-Tyne** Unit 4, Allison Court,  
The Metro Centre, Gateshead.

**Nottingham** 86-88 Lower Parliament Street.

**Reading** 129-131 Oxford Road.

**Sheffield** 413 Langsett Road, Hillsborough.

**Southampton** 46-48 Bevois Valley Road.

**Southend-on-Sea** 282-284 London Road, Westcliff.

Plus NEW stores in LEICESTER, LIVERPOOL and SOUTH LONDON.

Opening soon. Ring 0702 552911 for further details.





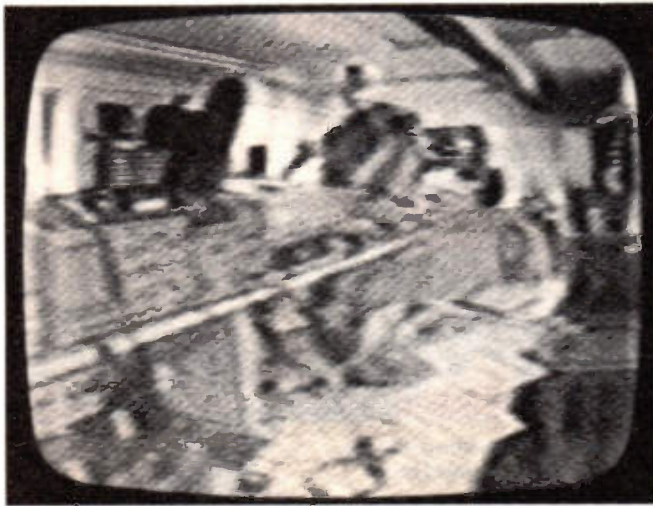
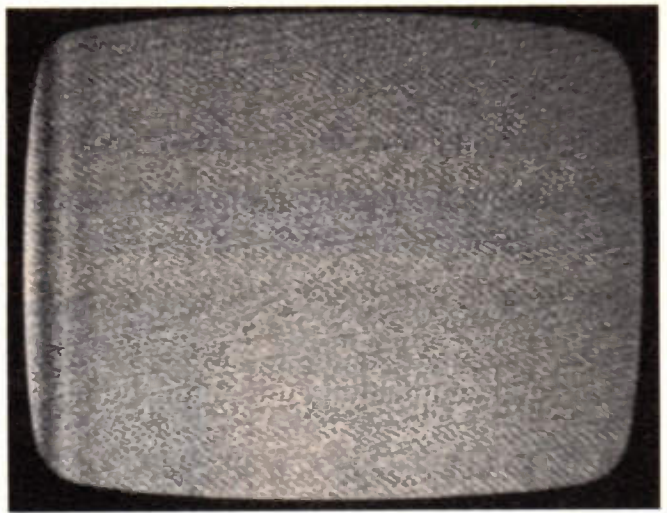
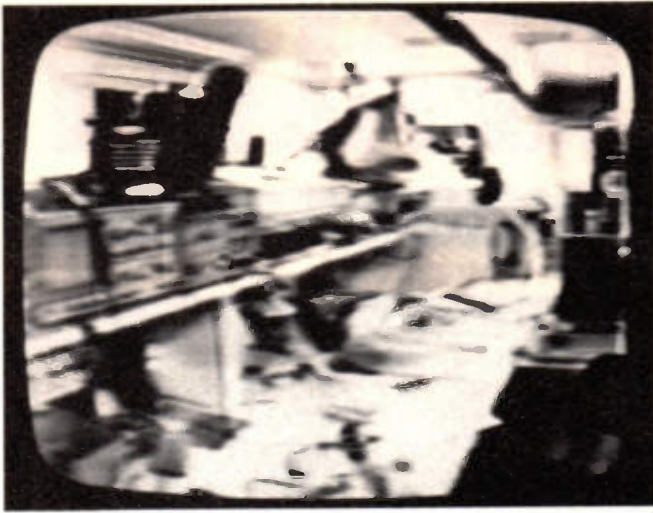

Off-screen photos showing when: (a) the system is well set up and adjusted; (b) there is incorrect alignment between Transmitter and Receiver, resulting in just noise; (c) the signal presented to the receiver is weak, resulting in a noisy picture; (d) there is little or no picture synchronisation. The picture material for (a) to (d) above was captured by the Maplin Monochrome CCD Camera, which was featured in issue 50 of 'Electronics'.

a large effect on the final output level. The frequency response of the circuit is adjusted using RV2, which acts as a low-pass filter. RV3 adjusts the black level, and RV4 sets the luminance level. RV5 adjusts the input level to the video processing circuit, while RV6 sets the sync level. If you have access to an oscilloscope, you could monitor the output, adjusting the presets individually until a satisfactory output

waveform is obtained; however, it is relatively easy to adjust the circuit by observing the picture and adjusting the appropriate presets until acceptable results are obtained. This 'picture' method produces the same results (or even superior ones!), allowing the circuit to be adjusted to suit individual monitors. In most cases it is possible to align the unit without the box lid in place, in which case there will be no

problem in gaining access to the presets; however, there are suitable access holes, shown as part of the drilling information, for the presets in the PCB.

For optimum picture quality, it is important that the optical alignment of the transmitter and receiver units is correct. Because the field of view is quite narrow, alignment can be quite critical and some

*Continued on page 62.*

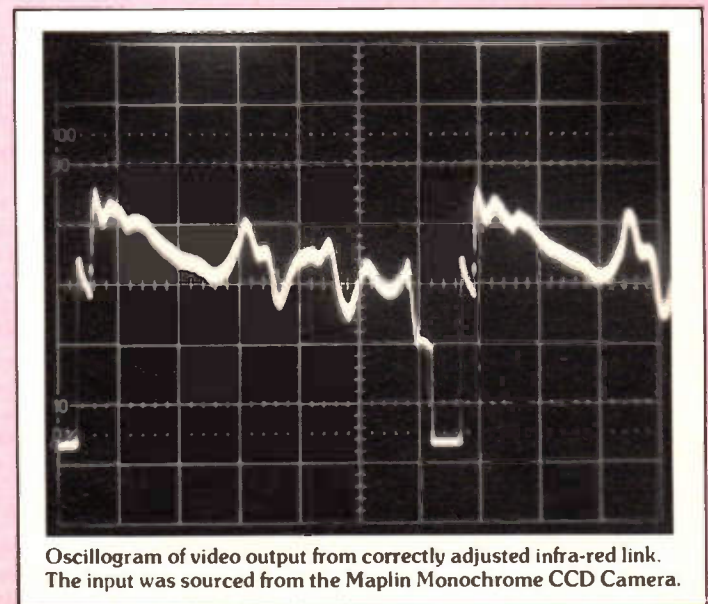
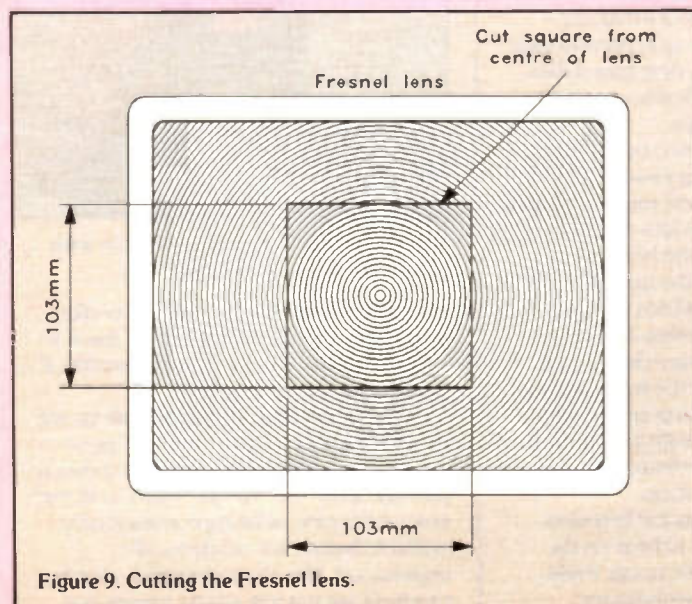

# VIRTUAL REALITY

by Frank Booty

**T**he key to a better understanding of the information, to which we all now have access, is the development of 'multi-media', 'data visualisation' and 'virtual reality'. These technologies could help exploit information that every organisation now collects, but fails to employ effectively, if at all.

Data is raw facts and figures. But information has meaning, and can assume a variety of forms. Data is turned into information by applying intelligence to it. Currently, machine based systems can only convert a limited amount of the data available into information.

Meanwhile data is being collected and generated at a rate that far outstrips any ability to make sense of it – the problem then is that, while the raw material is being created in abundance, people are struggling with the tools available to turn it to their advantage. This is because the most complex interpretive senses possessed by the human race are visual and aural. The world is taken in through the eyes, ears and other senses as patterns, and objects and events are instantly identified as such. Allied with this is a response system with split-second reflexes. Conversely, other forms of information, such as arises from the man-made or 'unnatural' world, are cryptically symbolic (numbers, abstract concepts and so on), and require more effort to interpret. And our latest machines are now subjecting us, to use one of the most recently coined twentieth century phrases, to 'information overload'.

If there is to be an understanding of the volume and complexity of the information now available to us, people will have to look beyond symbolic processing to ways of marrying their more natural, advanced interpretive abilities and physical responses with the power of computing.

Such then is the significance of the technologies of 'multi-media', 'data visualisation' and 'virtual reality'. They are *not* amusement arcade side shows, but central, if not crucial, to the future of information technology, because they force back the boundaries of the human/computer interface.

'Multi-media' presents sound and moving images to the human mind and allows interaction with information. 'Data visualisation' takes complex multi-dimensional data and converts it into pictorial forms that can be interpreted more easily. But 'Virtual reality' allows the computer screen, as we now know it, to be dispensed with entirely, allowing the user to actually 'step into' the information itself, as if entering a parallel world.

'Multi-media' makes what is known accessible, while 'data visualisation' seeks to discover what is hidden. 'Data



The joystick like hand-held units can be combined with the 'Vissette' for fully mobile interaction in a scanned area.

visualisation' takes mass data and turns it into information from which the user can extract knowledge. It is inevitable that 'data visualisation' and 'multi-media' overlap. They pursue the common goal of that of an intuitive and powerful interface with information. A major development here is the introduction of the time dimension to the computer environment.

Graphics brought a spatial dimension to computers, introducing images and allowing data to be presented as charts and graphs. Sound and video are inherently time based, but much data has a time dimension too. The conventional methods of representing time – as an axis on a graph, as a sequence of snapshots, etc – are limited. The best way to represent time is to use time. Animating time based data enables us to understand processes and trends with greater insight.

As radio was subsumed by television, so 'multi-media' and 'data visualisation' are being subsumed by 'virtual reality'. 'Virtual reality' widens the bandwidth to add a physical dimension to the human computer interface. It is the logical conclusion of a process which began with the use of mouse driven icons in an environment representing a desk top. It extends the metaphor of the interface to reality itself, and in so doing enables the user to not only interact with and interpret data, but to actually *experience* and participate in the information.

'Virtual reality' brings the broadest range of human faculties to bear on the computer. If the computer, using 'multi-media' and visualisation techniques,



The 'Space Glove' enables interaction with objects in the virtual environment.

can deliver data in such a way as to take advantage of these faculties, then there is a good chance of mastering the wealth of information being faced.

Currently, 'virtual reality' systems are viewed as crude entities, but with great potential, as we shall see. Indeed, industry pundits opine that 'virtual reality' is in the unique position of being commercially available before it is academically understood. The commercially available products are not just arcade games, but

include such goodies as toolkits for creating virtual worlds, and objects to go in them.

The first 'virtual reality' machine for the leisure industry, i.e. as in arcade games and such, stemmed from W Industries Ltd, of Leicester, who launched it at the Wembley Conference Centre in March, 1991.

The main piece of apparatus is a helmet-like item of head-gear, to be worn by the user, and containing a stereo pair of colour liquid crystal displays. It is intended that the computer-generated, 3-D image from these displays follows the head movements of the wearer, who is thus given the impression of being totally immersed in an artificial world. The visor system is dubbed a 'Visette' by W Industries and it also includes quadrophonic sound for a suitably complementary 3-D aural space.

One system is designed for a user standing or moving within a defined scanned area, within which the 'Visette' visor provides the interface with the virtual world. Interaction with the virtual world is provided by a hand-held unit.

Also included with the arcade machine is what W Industries refers to as a 'sit-down module' – a kind of high tech armchair with a joystick on each arm, with which the player controls the entertainment experiences: 'VTOL', where users take the controls of a Harrier jump jet; 'Battlesphere', a space adventure where head tracking is used as a means for target alignment; 'Crash Course', a destruction Derby experience complete with accessories providing a hood, steering wheel, four speed gearbox and foot pedals; and a powerboat racing experience.

The level of graphics and simulation is said to be very similar to that achieved by flight simulation software of the sort often included with computer graphics systems, except that one feels more a part of the scene with 360 degree vision. However, one of the problems with current flat LCD screen technology is that these displays are somewhat limited in resolution, i.e. 375 by 284 pixels in this machine. So as to hide the jagged edges which result from using a large viewing angle of 60 degrees in the horizontal plane – which, incidentally, is the magic number which makes the difference between perceiving the image as a picture, and having the impression of being actually in the scene – there is a blurring filter in front of the screens. Thus users have to put up with a soft image which might be less distracting than a jagged one.

More than one unit can be linked together so users can play or fight with real opponents instead of the computer, in teams as well as solo, which makes for an interesting advancement over the usual type of arcade game. The helmet features a microphone for communication with other team members.

The 'Virtuality Space Glove' supplies information to the computer about the position and attitude of the wearer's hand and fingers to enable interaction with objects in the virtual environment. Then

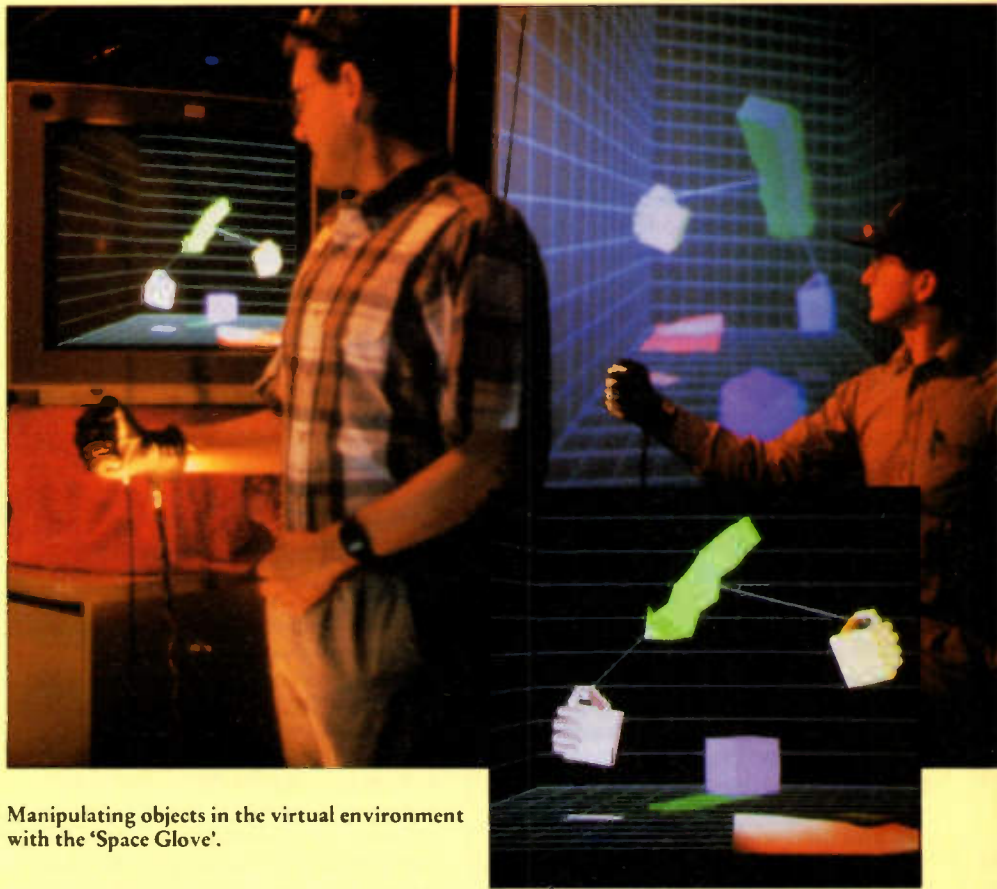

Manipulating objects in the virtual environment with the 'Space Glove'.

there is the 'Virtuality Force Feedback Glove' which provides *tactile* feedback to the wearer. The 'Touch Glove' provides all the benefits of the space glove, but with the addition of finger mounted pneumatic glands which induce the sensation of feeling to the user.

As well as arcade games, W Industries is also involved in more serious uses of virtual reality. The 'Virtuality Space Suit', for instance, is a rugged, full body exo-skeleton for use in a variety of applications, from space station human factors research to entertainment.

IBM researchers have built a prototype general purpose artificial world that can be re-configured quickly and easily for many different uses. The objective is to create a generic system for generating virtual reality containing 3-D stereoscopic representations of physical objects with which many persons can at once interact, perhaps from remote locations, as if the synthetic environment actually existed.

The prototype is multi-sensorial, involving sight and sound, gesture and speech recognition. The computer generated model speaks for itself, in fact, reciting events that appear on the screen and producing sounds associated with them. It also recognises human speech and responds when spoken to. Eventually the researchers want to incorporate the human faculties of touch and feel into their system, and maybe even taste and smell.

The sort of flexible architecture for virtual reality, which the new IBM system represents, would allow scientists to create new environments to explore, and in which they can perform experiments that

might otherwise be impractical (too big, too small, too dangerous, too hypothetical). It would also enable them to extract meaning from data – e.g., from weather satellites, medical scanners or astronomical telescopes – otherwise too complex to interpret.

What distinguishes the new IBM virtual world from most others is that, while the others may be visually interesting, not much takes place in them which was not predetermined; for example, a specific action that takes place when a button is pressed. By contrast, everything in the IBM virtual world is calculated and interacts with users in real time. Most other models of virtual reality are particularised, committed largely to their designed-for applications. IBM's virtual world is, by comparison, generalised, allowing applications to be changed very flexibly.

In effect, the IBM researchers are working toward the creation of a basic architecture for an almost limitless constellation of virtual laboratories from which scientists in many different disciplines will be able to penetrate horizons hitherto unreachable, by 'being there', inside a molecule, a violent storm or a distant galaxy.

Workers in other fields – such as medicine, economics, space exploration – will doubtless want to use these virtual laboratories for a variety of purposes they can at present scarcely imagine. Surgeons might be able to perform 'phantom surgery' to rehearse difficult procedures before the actual real operations are carried out. Astronauts might fly over the simulated surface of an alien planet, to

get a feeling for what actually being there might be like.

By basing interactions with the virtual world on the ways in which people interact naturally with the real world, the IBM team hope to make virtual laboratories easy to learn and use. Also, by presenting computer data in a variety of ways to multiple senses, the communication of information may be far more effective.

The virtual world system is the product of talents and skills drawn from three research groups at IBM's Thomas J. Watson Research Centre in Yorktown Heights, New York, under the leadership of Daniel Ling. A key innovation in the architecture is the 'dialogue manager' that makes it possible to build virtual worlds that can be quickly and easily re-configured.

The 'dialogue manager' is based on work by Jim Rhyne, and its function is to allow the separation of the virtual world's content – what happens in it – from its style, or how one interacts with it. This makes it possible to use the same code – that is, sets of rules or computer instructions – to style the output of many different applications. The dialogue manager also makes it easy to change the method of interaction, say switching from gesture to speech input, or to text from spoken output.

This currently consumes a lot of computing power – involving no less than six RISC (Reduced Instruction Set Computing) System/6000 Power Workstations. The computers are fastened together, in a way that both amasses computing power and distributes it, so that two users could just as well be five or six users (with additional RISC System/6000s), and need not even be located in the same room but in different places across the country or around the world.

Such capability, says Ling, would further facilitate the growing amount of collaboration – in 'colaboratories' – that is taking place as desk-side computing capability continues to grow in power and affordability. While Ling's virtual reality system would be very expensive, he is looking into a not too distant future when such computational power and versatility can reside in a *single machine*.

## ROBODOC

An example of the potential use of virtual reality techniques is to be found at the University of California, where researchers, together with scientists from IBM, have developed a state-of-the-art, pre-surgical planning and robotic system that is being used successfully in surgery to help replace the arthritic hips of dogs with artificial joints.

The pre-surgical planning system allows the surgeon to use the computer to determine the appropriate size and location of the implant, based on the properties of the bone as revealed by computer tomography (CT) images. Using the input from this program, the IBM robot controls the movements of a small rotary cutting tool to carve out a cavity in the top of the dog's thigh bone to precisely accommodate the metal implant. The robot is a single arm machine similar

to those used in factories to assemble electronic components.

The performance of this operation on dogs is expected to pave the way for robot-assisted hip surgery in humans in the near future. More than 160,000 total hip replacement operations are performed on humans each year in the US, with a comparable number done in Europe. Certain breeds of dogs are prone to a congenital hip problem called dysplasia, requiring about 1,000 hip replacement operations annually, so the dogs are actually the first to benefit and are *not* merely being used as experimental animals.

Accurately positioning the implant in the body and tightly fitting it to the surrounding bone are both critical to the success of hip replacement surgery. With the robot, the team at the University are able to cut the bone to the dimensions of the prosthesis about 40 times more accurately than with hand-held tools. The robot is very steady and the team is able to program the robot with the exact dimensions of the prosthesis so that there is a perfect match to the bone. This is impossible to do manually.

Prior to the operation, the dog undergoes a minor surgical procedure to implant three small calibration pins in its femur – two pins one each side by the knee, one near the pelvis. The pins serve as reference points, to aid the robot in finding its way around the dog's femur during surgery.

A CT scan is then performed on the dog's thigh, and 3-D X-ray images of the bone are fed into the IBM workstation based surgical planning system, called 'Orthodock'. This provides 3-D reconstructions of the femur which the surgeon can view on the computer screen, along with the implant.

The surgeon, using his expertise, manipulates these images of the bone and the implant on the screen to ascertain the appropriate placement of the implant inside the femur. The resulting data contains the implant's intended co-

ordinates in the bone which are then used by the robot to cut a cavity of the correct size and location.

The robot's accuracy reduces the gap between the bone cavity and the implant. A small gap minimises movement between the implant and the thigh bone, which should improve the stability of the implant, reduce pain after surgery, speed the attachment of the implant to the bone and enhance the patient's ability to walk normally.

Hip implants are used to replace joints that have been damaged by arthritis, trauma, tumours and other causes. The implant or prosthesis has two main parts that duplicate the natural joint's ball and socket. The metal femoral component is a ball with a stem that is inserted in a cavity cut into the top of the femur, or thigh bone. The ball mates with a metal and plastic socket, or acetabular component, which replaces the natural socket in the pelvis. The cavity for this part of the implant is still created with hand-held tools by the surgeon.

Joint IBM and University of California research and development work to adapt a robot for surgical use began in 1987. Scientists at IBM's Thomas J. Watson Research Centre in Yorktown Heights, New York, adapted 'AML/X', an IBM-invented, advanced robot programming language, and developed sensing techniques for use in the research. Together with the researchers at the company's Palo Alto Scientific Centre in California, they developed calibration and imaging techniques used by the robot to ensure the accurate location and shape of the cavity.

IBM and the University began the project because it was felt they could use the robotic technology developed during the past 15 years to contribute to bio-medicine. The successful use of the robot in a hip replacement operation is seen as an "exciting step in the experimental process."

Although the robots may eventually find uses in other operations in which



Virtual reality games arcades already exist.

precision cutting is needed, such as eye and ear surgeries, facial bone reconstructions, or excising brain and other tumours, they will *not* replace surgeons in the operating theatre. The robot is still only a surgical tool to enhance the abilities of the surgeon. In the future, there is a good role for virtual reality to play which will benefit all work done in the operating theatre.

Obvious applications for 'Virtual Reality' include machine and vehicle instruction for trainee operators, battlefield scenario training for the military, and not least, remote control of robots giving a human the equivalent of direct hands-on, on-the-spot involvement in dangerous environments such as on the surface of a hostile planet (Venus for instance), in chemical and radioactive environments or even for hazardous and unpleasant underground work, such as sewer maintenance and mining.

Others are not so obvious. One such example cited recently, and which illustrates the capacity of virtual reality to make the incomprehensible easier and quicker to understand, is where a stocks and shares speculator can have all his investments depicted as fields of wheat. While the crop in any one field is still short and green it is not yet 'mature', and this translates as meaning that the value of the shares are still relatively weak and should not be transacted. When the crop is ripe it should be immediately 'harvested' and



The arcade 'sit-down modules'. Inset: The 'Vissette' visor generates an internal 3D display on LCD screens.

sold, meaning that the shares are now strong and selling them should make a quick killing on the market. The imagination could be taken further – presumably a sudden drought or fire destroying the crop represents a stock market crash!

When the technology reaches this stage it may be time to consider the more sinister possibilities of virtual reality. At

some time in the future it may be possible that the whole of mankind might be living in a total and complete, nursery-land like fantasy world, cushioned and protected against the harshness of everyday reality by what will be by then a highly evolved virtual reality technology. You could spend your whole life playing absorbing computer games, without realising that what you're actually involved in is work.

## VARIOUS

**H & H 100W SLAVE** £50 each, 100W + 100W Maplin Mosfet (inc. PSU and Bridging unit) £45. Lecson API 50W + 50W £30, SME arm £20. Maplin mixer boards £15, Eventide digital harmoniser £35 30W amps £18. Phone Jeff (0895) 638562.

**AYR TELETEXT DECODER** Model T1. Ceefax, Oracle & Remote Control from any PAL TV. No internal modifications to television required. Offers invited. E. Turner. Tel: (0689) 853846 (Orpington).

**VINTAGE RADIO**, Murphy model A4, working, uses ac/pen. output valve as frequency changer! Circuit diagram and specification. £30. George Wood, 19 Ragleth Road, Church Stretton, Shropshire, SY6 7BN.

**LEAK STEREO 70 TUNER**, amplifier. Sandwich loudspeakers. Garrard 401 deck & SME arm, Sony TC377 Tape-corder. Offers around £150 for the lot. All items in full working order & perfect – yes, perfect condition. All items must go because we need the space, sensible offers considered. Tel: (0245) 450050 Evenings.

**FULLY WORKING** (Demo given) Toshiba ADDRESS System, model AD-2T. Swap for DBX noise reduction system (e.g. model 220 or NR1), etc.) Phone Drew after 6pm on (0270) 764624 (Sandbach).

**FREE TO GOOD HOMES** – large mixed bags of components, ICs, resistors, capacitors, transistors, diodes etc. All must go. Send £1.50 for post and package to D. Johnston, 11 Kedleston Road, Derby DE3 1FL.

**SONY SL-8080UB BETA VCR** with full service manual. New heads fitted, but needs setting up. £30. Tel: (0342) 842617 (Surrey).

**GIANT CLEAROUT!** Long list of unused components including ICs, capacitors, resistors, some in large quantities. All at bargain prices. Send SAE for list. M.J. Dean, Blenheim, Walton Lane, Bosham, Chichester, West Sussex. PO18 8QF.

**BATTERY POWERED** portable LED oscilloscope, cased. Timebase range display, sine wave oscillator, BNC leads. Useful for GCSE Electronics. £38 including postage. S Yousaf, 137 The Crescent, Slough, Berkshire, SL1 2LF.

**THUNDER TF200 LCD** Frequency Meter, 10kHz to 200 MHz, never used, £50 for quick sale. Tel: (0892) 542268.

**PCBs FOR E&MM** active speaker design (published 5/83) with instructions £2; 12 Mazda/Mullard valves, various types, free or £1 posted. Tel: (081) 689 8372.

# CLASSIFIED

If you would like to place an advertisement in this section, here's your chance to tell our 33,837 readers what you want to buy or sell, or tell them about your club's activities – absolutely free of charge. We will publish as many advertisements as we have space for. To give a fair share of the limited space, we will print 30 words free of charge. Thereafter the charge is 10p per word. Please note that only private individuals

will be permitted to advertise. Commercial or trade advertising is strictly prohibited.

Please print all advertisements in bold capital letters. Reference Boxes are available at £1.50 each. Please send replies to address below quoting Reference Box Letters. Please send your advertisement with any payment necessary to: Classifieds, Maplin Mag., P.O. Box 3, Rayleigh, Essex SS6 8LR.

**ELECTRONICS & MUSIC MAKER**, 50 issues to June 1985, 6 demo tapes. £20 inc. postage. Fred Wright, 23 Merrion Close, Moorside, Sunderland, Tyne & Wear SR3 2QP, Tel: (091) 5288664.

**RADIO CONSTRUCTOR**. Bound volumes 17-21 (1963-8). Perfect condition. Offers. Vaughan Butler, Tel: (0270) 767673.

**TEKTRONIX SCOPE**. A type 545A in good working order. 30MHz, 12ns rise time, Main and Delayed sweep. Two plug-in units. D type. 1mV, 300KHz to 50mV, 2MHz; CA type. 50mV, 10ns risetime (pre-amp only). Complete with trolley and manuals for all units. £100. John Dakin, 'Stack Polly', Woodbank Lane, Woodbank, Chester, CH1 6JD. Tel: (0244) 880035.

**MAPLIN 4800 SYNTH**, Tektronix Dual Beam Scope, PSION Organiser comms link, 32K EPROM pack, Commodore 8010 modems, HP2602A printer ribbons, Swiss-made pulse counters, valves. Offers/Swap, Phone Mike (0604) 755785.

**LM13P PROXIMITY DETECTOR**. Completed and working. Also an LW83E ultrasonic detector, completed but not working. Both items in good condition, £8 each. Write to: M. Hyland, 45 Amberton Road, Leeds LS8 3AJ.

## MUSICAL

**MAPLIN ORGAN**: Professionally constructed as per specifications for MES 55 in solid wood cabinet (Includes 50W amp, 2 keyboards, pedalboard, autorhythm, drawbars, original spec., diagrams etc).

Original cost £750 – 6 months hard work, but sensible offers around £150 considered. Tel: (0245) 450050.

**ORGAN BUILDERS!** All parts for working, nearly completed 2 x 61 note 7 footage MES53 Organ. Oak roll-top cabinet, both 27 & 13 note pedalboards, rotor, rhythm unit, MES25 base and pedal unit, all instructions. £250 o.n.o. Tel: (0793) 823513 (Swindon).

**YAMAHA BK20** Electronic Organ. Two keyboards and 13 note pedalboard in modern walnut-veneered cabinet. Specification includes true rotor speaker system and drawbar-type tone controls. Superb condition £350. Tel: (0702) 339204.

## COMPUTERS

**EASY-PC**. PCB Design software for IBM PC/XT – PC/MS DOS (512K min.) CGA, EGA or VGA compatible. Installation disk + User manual. £75 o.n.o. Send SAE to Martin for more details. 11a Barkhams Lane, Littleport, Ely, Cambs, CB6 1NN. I also have several parallel printer cables, will sell for £2.50 each. Miracle Technology WS4000 MODEM, external type, V21 & V23 modes, £30 o.n.o. Tel: (0892) 542268.

**TATUNG EINSTERN** with two disk drives. Good condition, £25. Also Tasword wordprocessor, comms and games software, serial & parallel cables. Spectrum emulator and software for above, £20. £40 the lot. Tel: (0483) 414767 evenings.

**A4 PLOTTER**, holds 6-pens HPGL language, parallel and serial ports, as new £150. Miracom WS4000 V21-23 modem £50. Phone Peter (0883) 714070.

**COMPAQ DESKPRO 386**, 25MHz with 60MB hard disk, 2x5¼in. floppies, VGA colour monitor, 4MB RAM plus coprocessor. Suit business or speed freak! £1,100. Tel: (061) 796 6683.

**6801 MICROCONTROLLER**. 4K RAM, 4K EPROM, 68A54 serial I/O. CPU as per 6800, with extra Instruments – multiply, etc. £10. Tel: (0533) 861199 (Leicester).

**BBC MASTER 128K**, two 40/80 track DS drives, excellent condition £195. Tel: (0533) 861199 (Leicester).

**IBM CLONE**. 286/12MHz. 1MB RAM. SVGA. 1-44MB FD, 40MB HD, 2 serial ports, 1 parallel port, 1 games port, desktop case, 102-key keyboard. Offers £780+. Also, machine as above but with no monitor or hard drive, £390. MS-DOS 4.01 £50. Tel: (0443) 685228.

**APPLE IIe**, 2 disk drives and card, numeric keypad, disks, manuals, 80 column text card, dongle, 2 printer cards, power supply needed. Offers? Phone Glen (081) 558 2368 evenings.

## WANTED

**ACORN ATOM** with manual. Preferably expanded to 12K and fitted with F.P. ROM and VIA. Also interested in PSU and recorder for use with ATOM. Phone Paul (0782) 632600.

**MULLARD MODULE LP1185** in working order. Also application circuits of LP1169 and LP1181. Phone Ken (081) 398 5766.

**AMSTRAD PC-MM** Monochrome monitor, connector pin details for the above monitor. Details to: A. Heuze, 15 Truro Close, Congleton, Cheshire, CW12 3BD, Tel: (0260) 280113.

**INSTRUCTION MANUAL** for Amstrad DMP3000 printer. Loan or buy. K. Rutter, 1 Pen-Rhwy, Felinwryn, Cardigan, Dyfed SA43 1RN. Tel: (0239) 810214.

**DESPERATELY WANTED** – CB Radio (40 channel) and antenna for car fitting. Anything up to £20, but can exceed. Please Tel: (0884) 820882 after 5pm and ask for A. Legg.

**INSTRUCTIONS OR SERVICE MANUAL** for Telequipment D75 dual trace, dual sweep oscilloscope. Costs paid. Tel: (0709) 895707 (Rotherham).

**LASER VISION AND CD VIDEO DISCS WANTED**. All kinds of interest (European PAL system only). Please send list with prices and instructions on how to pay to: Havard Hovdet, Box 160, N-9410 Borkenes, Norway.

**WANTED: A circuit diagram** for a Digital Frequency Meter 1 – 30MHz. Any help greatly appreciated. David Higgins, The Vicarage, Bishop Sutton, Bristol, BS18 4UR.

# MODERN

# BRIDGE

# CIRCUITS

Part 1 by Ray Marston

A bridge is a passive network that, when used in conjunction with a suitable energising generator and a balance detector, enables values of inductance (L), capacitance (C), or resistance (R) to be accurately and inexpensively measured, or matched. Bridges were the instruments for measuring R, C, and L values, right up until the late 1970s, when they were replaced in many applications by the multimeter and its derivatives. Nowadays, bridges are used mainly as either cheap-and-simple 'service' type instruments that give an approximate (within a couple of percent) measurement of a component value, or (at the opposite end of the scale) as 'laboratory' type instruments, that make measurements with very high precision. Both types of instrument are described in this new three-part series.

Closely associated with the conventional bridge are the resistance-matching and ratio-matching bridges (which enable resistors to be directly or decade-ratio matched to within 0.003% or better), the C or R 'substitution box' (which enables component values to be determined with good precision, using either comparison or substitution techniques), and the 'potentiometric' bridge (which enables voltages to be measured, or compared, with very high precision). This series looks at the theory, practical circuitry, and usage techniques of all of these types of instrument.

Modern component-measuring bridges come in two popular general classes, these being the DC-energised type which can accurately measure resistance values from a few ohms to a few megohms, and the low-frequency (usually 1kHz) AC-energised type which, as well as measuring resistance, can measure capacitance from about 10pF to 100µF, and inductance from about

10µH to 100H. Both types of instrument are derived from the 'ancient' (1843) Wheatstone bridge circuit, and it is well worth studying this in order to learn the finer points of bridge design.

## The Wheatstone Bridge

The 1843 pattern Wheatstone resistance-measuring bridge uses the basic circuit shown in Figure 1, and consists of a pair of DC-energised potential dividers ( $R_2/R_1$  and  $R_y/R_x$ ) with a sensitive meter wired between them.  $R_2/R_1$  have a 1/1 division ratio, and are known as the 'ratio arms' of the bridge;  $R_x$  is the 'unknown' resistor, and  $R_y$  is

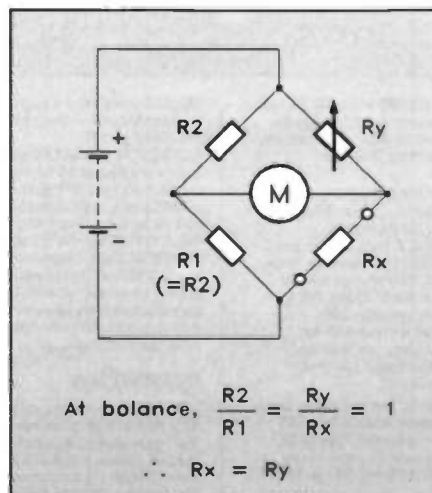

Figure 1. Original (1843) version of the basic Wheatstone bridge.

a calibrated variable resistor. In use,  $R_x$  is fixed in place and  $R_y$  is then adjusted until a zero or 'null' reading is shown on the meter, at which point the two dividers are generating equal output voltages and the bridge is said to be 'balanced',

or 'nulled'. Under this condition, the ratio  $R_y/R_x$  equals  $R_2/R_1$ , which equals unity. The  $R_x$  value thus equals that of  $R_y$ ; the bridge's balance is not influenced by variations in energising voltage.

A major feature of this original version of the Wheatstone bridge is its very high *null sensitivity*. Thus, if the bridge is energised from 10V DC, 5V is developed across all resistors in the balanced condition, and the meter will read zero volts; a shift of a mere 0.1% will then give a 5mV reading on the meter. In practice, this circuit can, when using a fairly simple null-detecting DC amplifier, be expected to have a 'null sensitivity' factor (i.e. percentage out-of-balance detection value) of about 0.003%.

## Improvements on the basic Wheatstone Bridge

A major disadvantage of this 1843 vintage bridge is that  $R_y$  needs a vast range of values if it is to balance all possible values of  $R_x$ . In 1848 Siemens overcame this problem by introducing the modification shown in Figure 2. Here, the  $R_2/R_1$  ratio can be any desired decade multiple, or sub-multiple, of unity. The following basic truths apply to this circuit:

- (i) At balance,  $R_2/R_1 = R_y/R_x$
- (ii) At balance,  $R_1 \cdot R_y = R_2 \cdot R_x$
- (iii) At balance,  $R_x = R_y \cdot (R_1/R_2)$

From (iii) it is obvious that, at balance, the value of  $R_x$  equals that of  $R_y$  multiplied by the  $R_1/R_2$  ratio, and that one easy way to vary this ratio is to give  $R_2$  a fixed value, and make the  $R_1$  value switch-selectable. Such an arrangement can be seen in the multi-range DC Wheatstone bridge circuit, shown in Figure 3, which is based on one used in a well-known high quality '1970s style' laboratory instrument.

The circuit shown in Figure 3 can

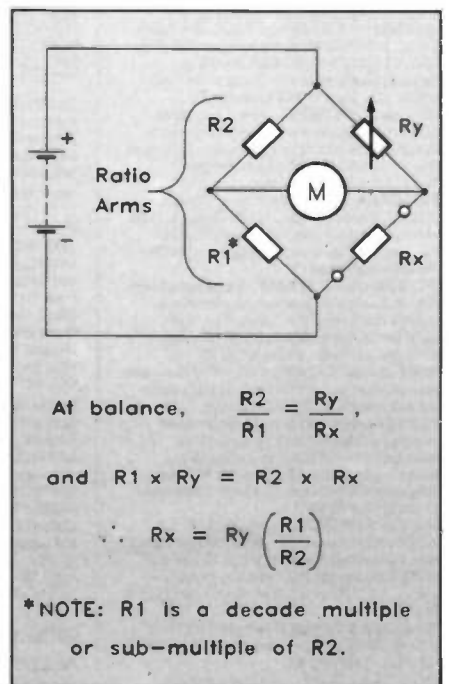

Figure 2. Conventional version of the Wheatstone bridge.

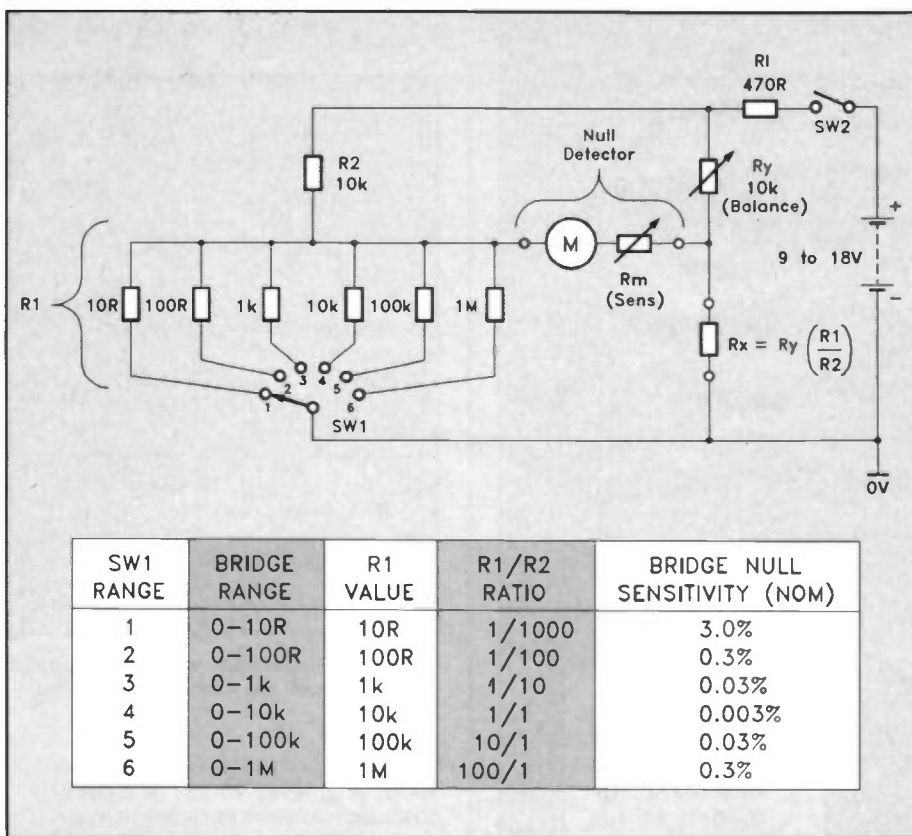

Figure 3. Circuit, and tabulated details, of a conventional Wheatstone version of a 6-range DC resistance-measuring bridge.

measure DC resistances from near-zero to 1M $\Omega$ , in six switch-selected decade ranges.  $R_y$  is a calibrated 10k $\Omega$  variable resistor,  $R_L$  controls the sensitivity of the balance-detecting centre-zero meter, and  $R_L$  limits the bridge current to a few mA. The table of Figure 3 points out the major weakness of this 1970s version of the Wheatstone bridge – its null sensitivity (which is proportional to the  $R_x$  test voltage) degenerates in proportion to the  $R1/R2$  ratio's divergence from unity. Thus, the sensitivity is nominally 0.003% on the 10k $\Omega$  range, where the  $R1/R2$  ratio is 1:1, but degenerates to 0.3% on the 100 $\Omega$  and 1M $\Omega$  ranges, where the  $R1/R2$  ratios are 1/100 and 100/1 respectively.

To be of any great practical value, the circuit of Figure 3 must be used with a sensitive null-balance detector. Figure 4 shows a  $\times 10$  DC differential amplifier that can be used in conjunction with an external analogue multimeter to make such a detector; this circuit must use its own independent 9V battery supply.

The external multimeter can be set to its 2.5V DC range for low-sensitivity measurements, or to its 50 $\mu$ A or 100 $\mu$ A range for high-sensitivity readings. In the latter case the circuit must first be balanced before use, by shorting its input terminals together and trimming the multi-turn 10k $\Omega$  SET BALANCE control for a zero reading on the meter.

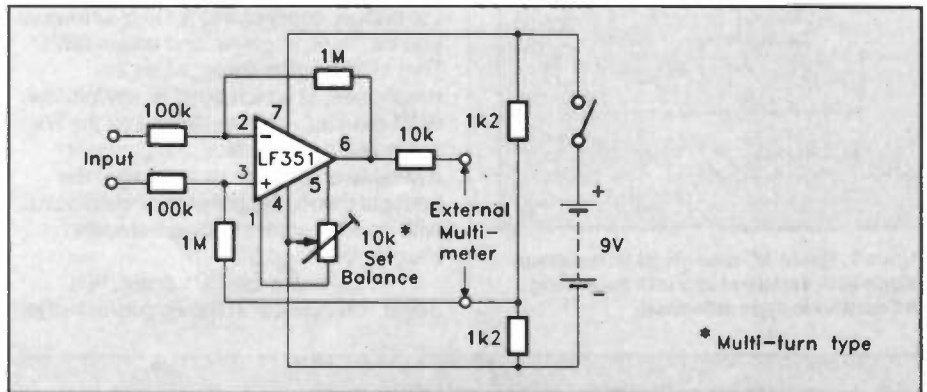

Figure 4. DC null-point amplifier, for use with an external multimeter.

The Wheatstone bridge circuit of Figure 2 can be arranged in three other ways (as shown in Figure 5), without invalidating the three basic 'balance' truths. In each case,  $R1/R2$  are known as the bridge's ratio arms. Note that the bridge's signal-source and detector terminals can be transposed without upsetting the circuit's balance equations; this is also true of several types of C and L bridge (these will be described in Part 2 of this series).

The most useful Wheatstone bridge variation is that of Figure 5a; Figure 6 shows a modern 6-range version of this and, as the accompanying table points out, its great advantage over the design in Figure 3 is that its null sensitivity (which is proportional to the  $R_y/R2$  ratio at balance) is very high on all ranges. In fact, it varies from 0.003% (at  $R_y$ 's full scale balance value), to 0.03% at one tenth of full scale, and so on. This particular circuit can thus, by confining all measurements to the top 9/10 of the  $R_y$  range, measure all resistance values in the 1 $\Omega$  to 1M $\Omega$  range, with excellent null sensitivity.

A Wheatstone bridge can be energised from either an AC or DC source, without upsetting its balance truths. Figure 7 shows an AC-energised version in which the balance condition is obtained via an infinitely-variable pair of ratio arms made up by RV1. In this case, balance-sensitivity is so high that balance detection can be made via a pair of earphones.

Figure 8 shows a 5-range version of this circuit; it spans near-zero ohms to near-infinity, with good precision

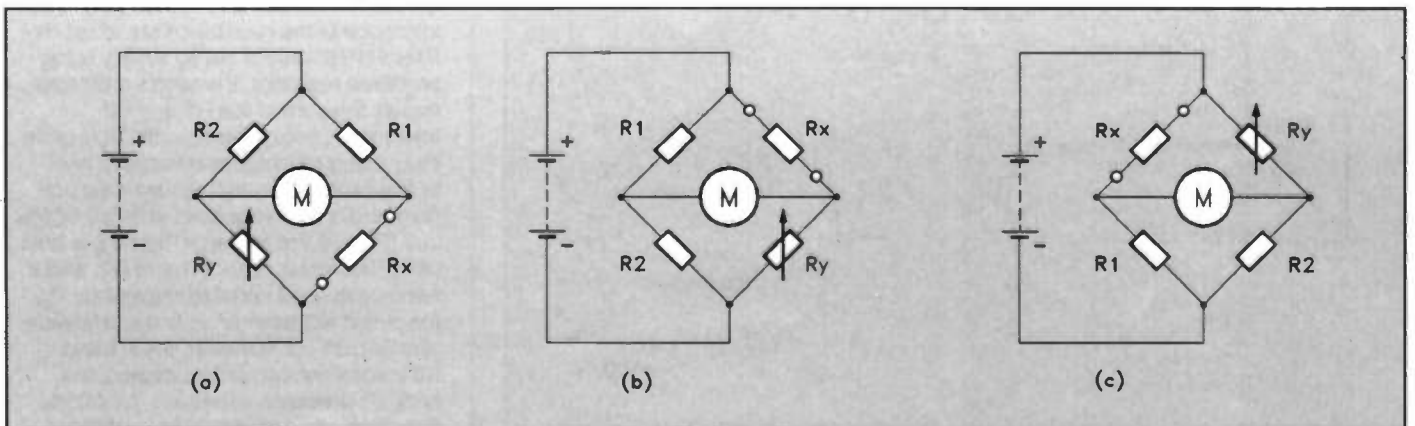

Figure 5. Each of these three alternative versions of the Wheatstone bridge has the same 'balance' formulae as the Figure 2 circuit.

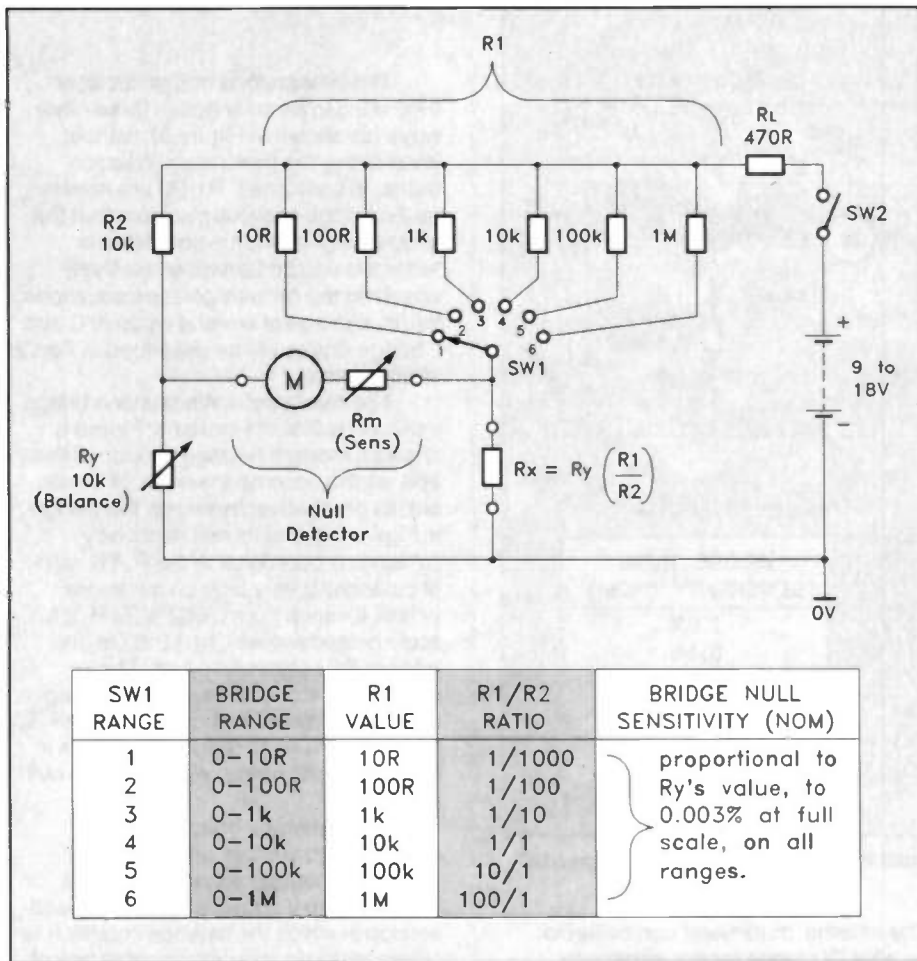

Figure 6. Circuit, and tabulated details, of a high-sensitivity Wheatstone version of a 6-range DC resistance-measuring bridge.

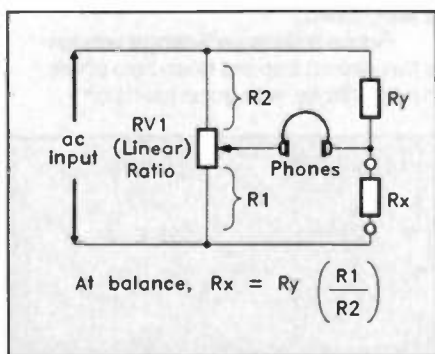

Figure 7. Basic AC-energised Wheatstone bridge with variable ratio-arm balancing and earphone-type detection.

between 10Ω and 10MΩ. The RV1 'ratio' equals unity when its slider is at mid-range; the diagram shows the typical scale markings of this control, which must be hand-calibrated on test. To use the bridge, connect it to a 1kHz sine-wave source, fix  $R_x$  in place, and adjust SW1/RV1 until a null is detected on the earphones, at which point  $R_x$  equals the SW1 resistor value multiplied by the RV1 scale value. In practice, a balance is available on any range, but to get the best precision, the balance should occur with an RV1 scale reading between roughly 0.27 and 3.0.

To calibrate the RV1 scale, fit a 10kΩ, 1% resistor in the  $R_x$  position, then

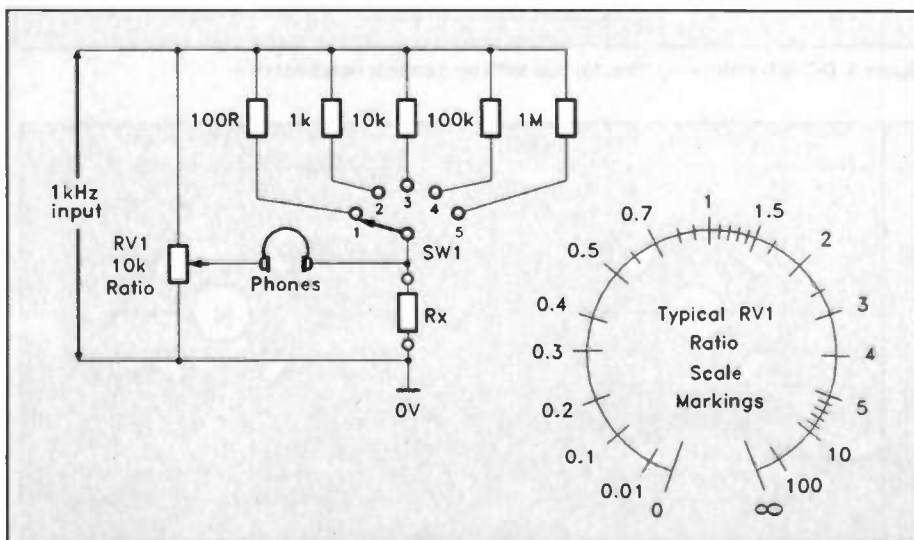

Figure 8. 5-range resistance bridge, with typical RV1 scale markings.

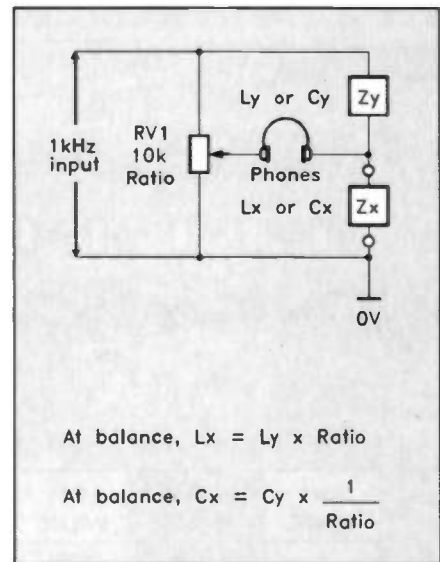

Figure 9. A Wheatstone bridge can be used to balance both capacitive and inductive reactances.

move SW1 progressively through its 100Ω, 1kΩ, 10kΩ, 100kΩ, and 1MΩ positions and mark the scale at each sequential balance point as 0.01, 0.1, 1 (mid-scale), 10, and 100. Repeat this process using  $R_x$  values that are decade multiples or sub-multiples of 1.5, 2, 3, 4, 5, and so on, until the scale is adequately calibrated, as in the diagram.

## Resolution and Precision

The three most important features of a bridge are (apart from its measurement range) its *balance sensitivity* (which has already been described), its *resolution*, and its *precision*. The term *resolution* relates to the sharpness with which the  $R_x$  value can be read off on the bridge's controls. Thus, in Figures 3 and 6,  $R_y$  gives a resolution of about ±1% of full scale if it is a hand-calibrated linearly-variable resistor, or of ±0.005% of full-scale if it takes the form of a 4-decade resistance box. The resolution of the circuit of Figure 8 varies from ±1% (at a '1' ratio), to ±2% (at a 0.3 or 3.0 ratio), to ±5% (at a 0.1 or 1.0 ratio), and so on.

The term *precision* relates to the intrinsic accuracy of the bridge, assuming that it has perfect balance-sensitivity and resolution, and equals the sum of the R1/R2 ratio tolerance and the tolerance of the resistance standard ( $R_y$ ). If the R1/R2 ratio is set by simply using precision resistors, the ratio's precision equals the sum of the R1 and R2 tolerances; note, however, that it is quite easy using techniques described later in this series, to match resistors so that ratio errors are reduced to only ±0.005%.

Thus, if the circuit of Figure 6 is built using 1% resistors for R1 and R2, and a hand-calibrated variable resistor for  $R_y$ , the circuit will have an intrinsic precision of only ±3%. If, however, the R1 and R2 values are correctly matched, the bridge's precision will rise to ±1.005%. Precision can be further increased, to ±0.105%, by using a ±0.1% multi-



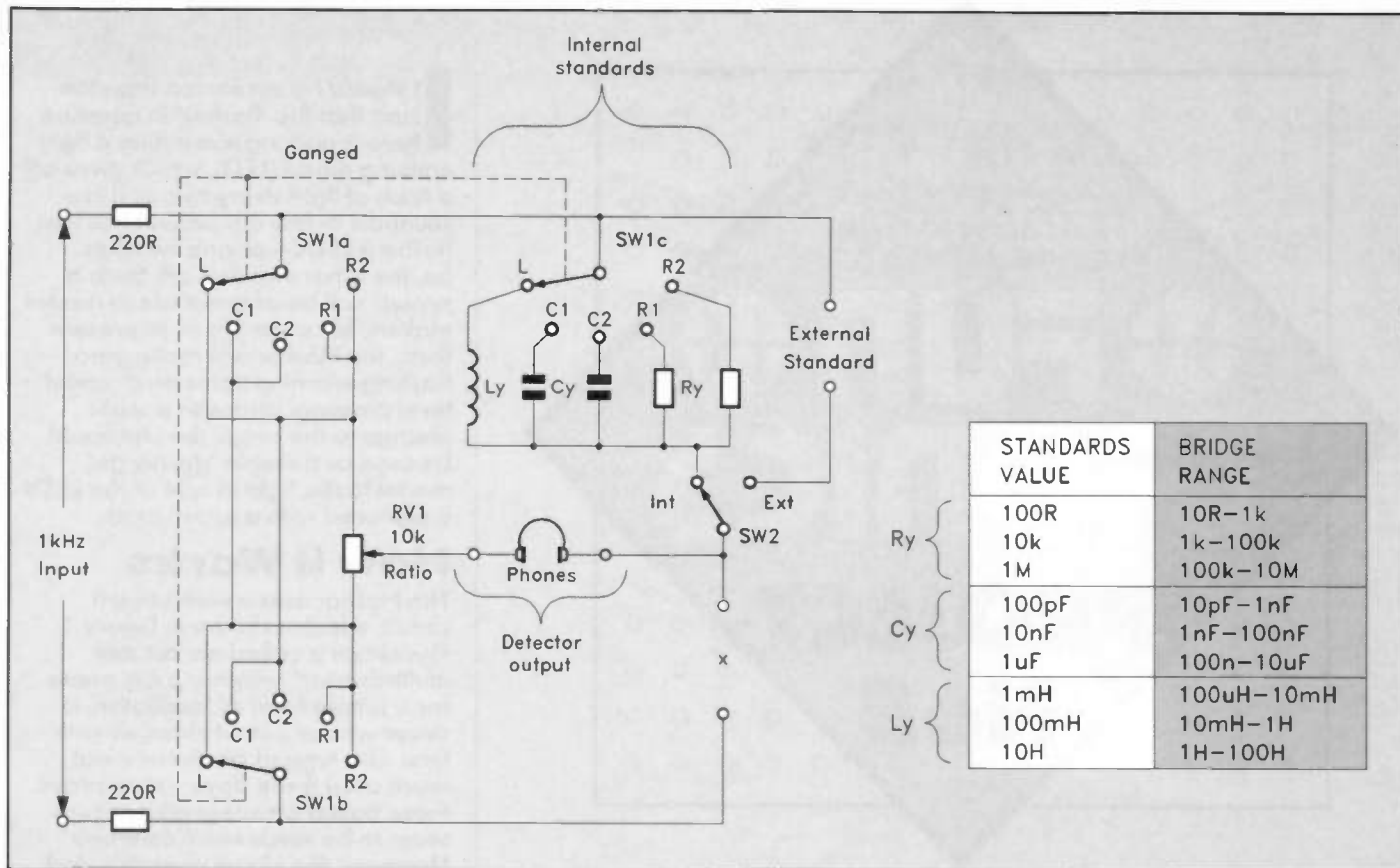

Figure 10. 'Service' type L-C-R bridge with earphone-type detector.

decade resistance box in the  $R_y$  position. In reality, additional errors may creep in when measuring very low or very high values of resistance, due to the resistances of switches and leads when measuring low values, and leakages when measuring high values.

The overall quality of a bridge depends on its balance-sensitivity, its resolution, and its precision. Thus, the circuit of Figure 6 has excellent sensitivity and potentially good resolution and precision. As a result, it could be used as the basis of either a cheap and simple

'service' instrument, or as a precision laboratory instrument, depending on the details of its construction. The design in Figure 8 however, has intrinsically poor resolution and precision, and should thus only be used as the basis of a basic service instrument.

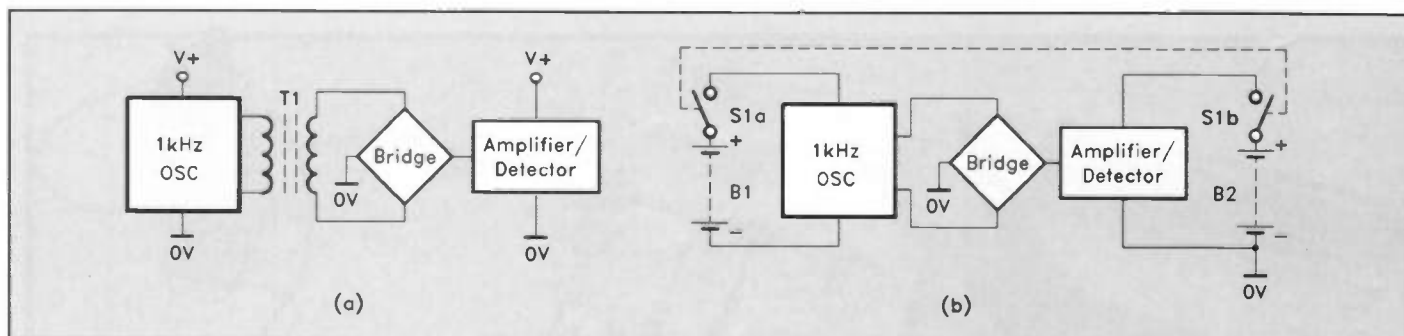

Figure 11. Alternative ways of providing a bridge with independent energisation and detection.

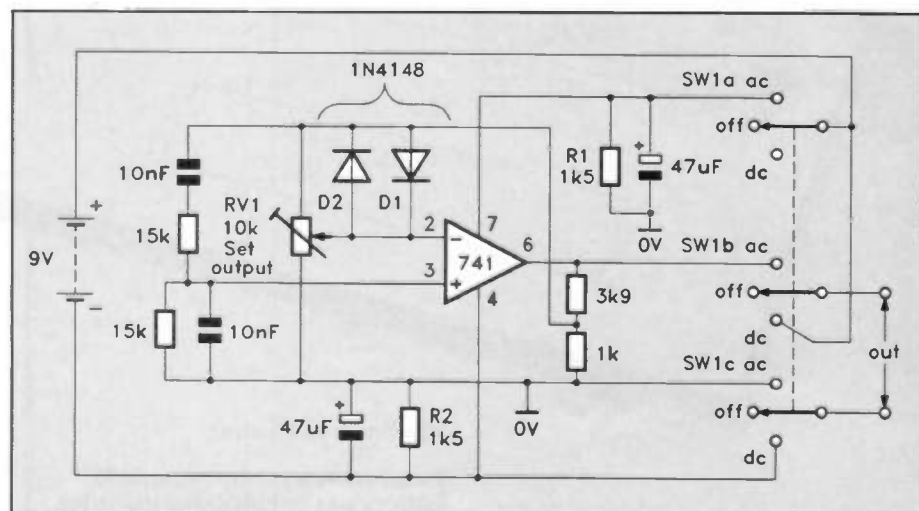

Figure 12. Bridge energiser, giving 9V DC and 5V peak-to-peak 1kHz outputs.

## Service-Type C and L Bridges

An AC-energised Wheatstone bridge can measure both reactance and resistance, and can thus also measure capacitance (C) and inductance (L). Figure 9 shows how the circuit in Figure 7 can be used to measure C and L values. This can be achieved by replacing  $R_x$  and  $R_y$  with reactances of equivalent types, provided that  $C_x$  or  $L_x$  are reasonably pure and have impedances (at 1kHz) which are greater than approximately  $1\Omega$ , and less than  $10M\Omega$ . The problems with trying to measure inductance using this circuit are that accurate inductors (for use in the  $Z_y$  position) are hard to get, and that inductive impedances are only  $6.28\Omega$  per mH at 1kHz. The only problem in

*Continued on page 70.*

All  
You Need  
to Build Your Own

# FUN TRONICS

## PROJECT No5

# THE FLASHER

Text by Robert Penfold

It should be explained from the start that the 'flasher' in question here is nothing more than a light emitting diode (LED), which gives off a flash of light every two or three seconds! In fact this project has two flashing LEDs – as one switches on, the other switches off. Such a project will be of great use to model makers, for example. In its present form, the Flasher will make great flashing warning lights on a model level crossing, and with a slight change to the circuit the unit could be used as a simple 'go/no-go' model traffic light (if one of the LEDs is replaced with a green one).

### How it Works

The Flasher uses a well-known circuit, which is shown in Figure 1. This circuit is called an 'astable multivibrator', which is a big name for a simple form of 'oscillator', a circuit whose output changes with time. This type of oscillator is not much used these days – nowadays those based on integrated circuits seem to be much more common. However, this circuit operates well enough as a simple flasher.

The circuit uses a type of component which has not been used in previous 'Funtronics' projects. The components in question are C1 and C2, known as 'capacitors'. A capacitor is a device which can store electricity, but not quite like a rechargeable battery!

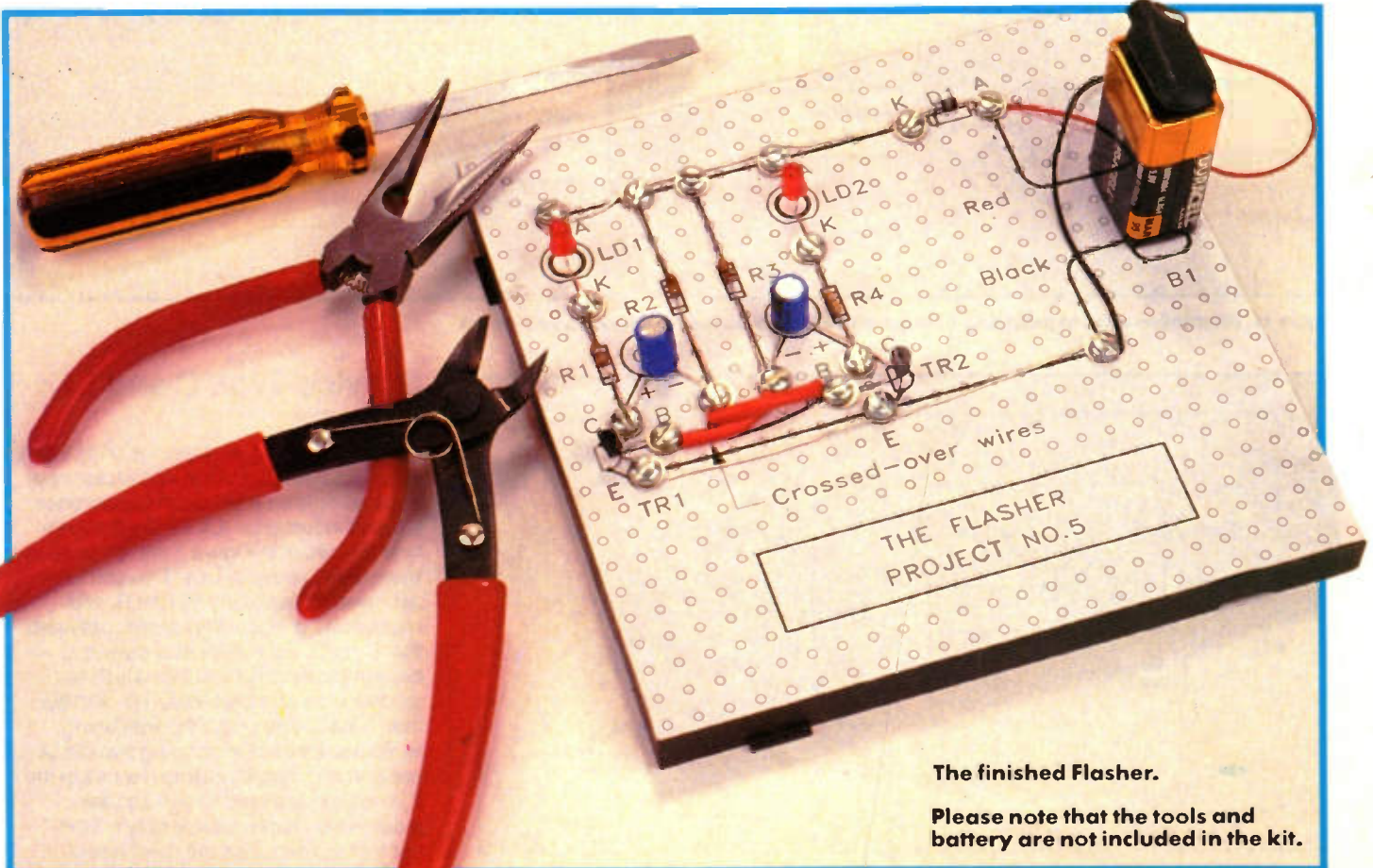

The finished Flasher.

Please note that the tools and battery are not included in the kit.

Capacitors charge up to whatever voltage (within reason) you feed into them, and not to some specific voltage, as is the case with a rechargeable battery. The amount of electricity that a capacitor can hold is quite low by battery standards, although this factor does depend on the value of the component's 'capacitance' (the higher the capacitance, the more electricity can be stored). The capacitors in this circuit have quite a high value – but you would need thousands of them to hold the same amount of electricity as one small battery!

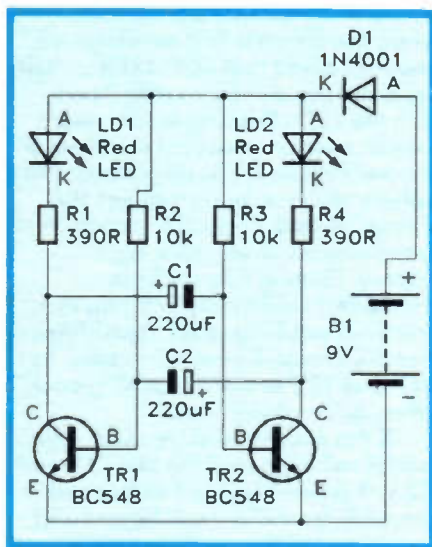

**Figure 1. The circuit diagram of the Flasher. When D1 switches on, D2 switches off, and vice versa.**

Capacitors are often used with resistors in 'timing' circuits, which are at the heart of every oscillator. The capacitor is charged with electricity via a resistor, and the rate at which this charging takes place depends on the values of these two components. The higher their values, the more slowly the capacitor voltage rises.

If, at the start, TR1 is 'on' and TR2 is 'off', C1 can charge via R3. This continues until the voltage is high enough to turn on TR2. The collector voltage of TR2 then drops, and C2 begins to charge through R2. At the same time, C1 discharges through R3, LD1, and R1. Eventually, the charge on C2 is high enough to switch on TR1 again, C2 discharges through R2, LD2 and R4, and the circuit flips back to its original state. It continues working in this way, with C1 and C2 charging/discharging, and the two transistors switching on and off. As one switches on, the other switches off.

Each transistor drives an LED indicator (LD1 and LD2), both of which flash on and off in sympathy with the transistors that control them. R1 and R4 limit the current through the LEDs to a safe level. The rate of the flashing is controlled by the values of R2, R3, C1, and C2.

With the values supplied in the kit, there is one flash about every two or three seconds. D3 is the protection diode that is included in all of the "Funtronics" circuits. If you get the battery round the wrong way it will block the flow of electricity and protect the main circuit.

## Getting it Together

Firstly, read through this section and then *carefully* follow its instructions, one step at a time. Refer to the photographs of the finished project if this helps.

1. Cut out the component guide-sheet provided with the kit (which is a full-size copy of Figure 2), and glue it to the top of the plastic board. Paper glue or gum should be okay. Do not soak the paper with glue, a few small 'dabs' will do.

2. Fit the link-wires to the board using the self-tapping screws and washers provided. The link-wires are made from bare wire. Loop the wire, in a *clockwise* direction around each screw to which it must connect, taking the wire under the washers. Do not fully tighten a screw until all the leads that are under it are in place, and do not over-tighten the screws, otherwise the plastic board may be damaged. Make sure that any wires which should not interconnect are not allowed to touch together. Be especially careful about this in the section of the board around TR1 and TR2 where two wires cross over one another. These two wires must not be allowed to touch. Ideally they should be fitted with pieces of PVC sleeving to ensure that they cannot short circuit together.

3. Recognise and fit the components, in the order given

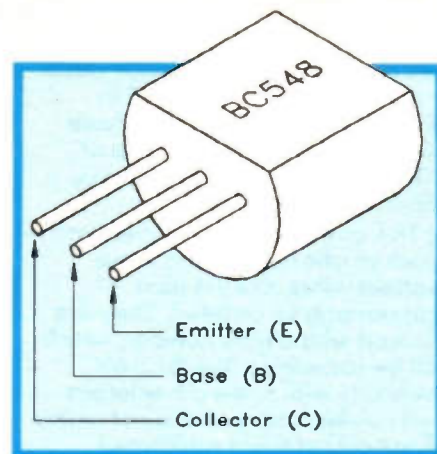

**Figure 3. Transistor lead identification.**

below, using the same method as for the link wires. Cut the components' wires so that they are just long enough to loop around the screws; otherwise long leads left flapping around may touch each other (this is known as a 'short-circuit') and may stop your circuit from working.

a) The first components to be fitted are resistors R1 to R4. These are small sausage-like components having a leadout wire at each end, and several coloured bands around their bodies. For R1 and R4 these colours are orange, white, brown, and gold. The colours for R2 and R3 are brown, black, orange, and gold. These first three bands tell us the value of the resistor. R1 and R4 have a value of 390 ohms, which is often written as  $390\Omega$  or 390R for short. R2 and R3, however, have a value of 10,000 ohms (written as 10 kilohms or  $10k\Omega$  for short). The fourth band tells us how near to the given value the resistor is likely to be. This fourth band is known as the 'tolerance' band. Unlike diodes or transistors, it does not matter which way round resistors are connected. As will be revealed later, R2 and R3

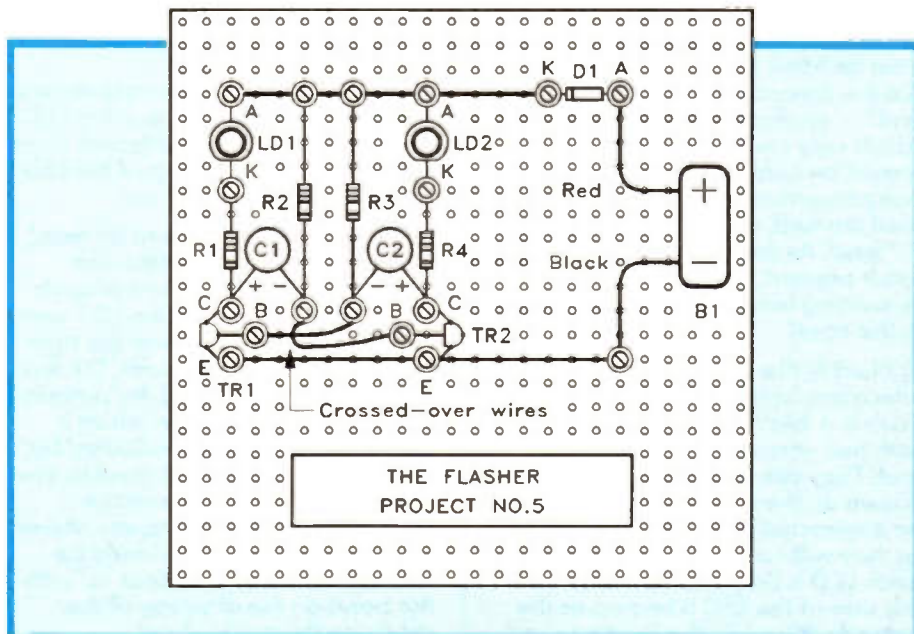

**Figure 2. The layout of the components. Note that the crossed-over wires must NOT touch one another.**

can be replaced with higher value resistors (included in the kit) to give a lower flashing rate. These resistors, which have a value of 100k, are colour-coded brown, black, and yellow.

b) TR1 and TR2, which have small black plastic bodies and three leadout wires, are the next components to be fitted. They are marked with a type number, which will be something like 'BC548', probably with some other letters and numbers as well. Do not worry about any of these additional markings, which are not important. You must make sure that TR1 and TR2 are connected to the board correctly – line them up with the outline on the guide-sheet.

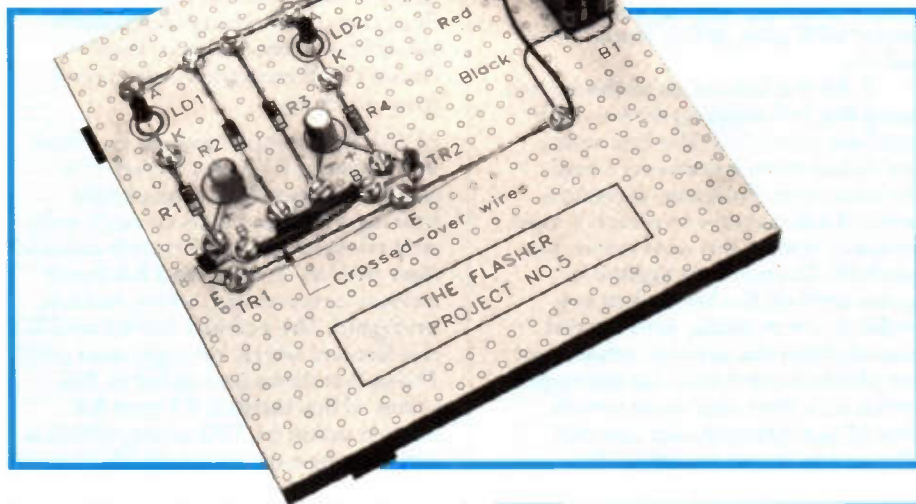

Figure 3 identifies the three leadout wires, helping to make this task fairly easy.

c) The two capacitors, C1 and C2, look like little tin cans with two wires coming from the base. With most capacitors it does not matter which way round they are connected. However, these are high-value (220 microfarad, usually written as 220 $\mu$ F) 'electrolytic' types, which must be fitted the right way round. On the component guide-sheet, '+' and '-' symbols are used to show which way round the capacitors should be connected. The actual components might only have one lead marked, which is usually the '-' lead. As there are only two leads present, you will know that the remaining lead must be the '+' one in this case!

d) Next fit the LEDs, LD1 and LD2, which are both of the same type. Each is a 'blob' of clear red plastic, with two wires coming out of one end. They are fitted in the positions shown on the guide-sheet, and *must* be connected the right way round – or they will not light up. One side of each LED is flattened (the lead on this side of the LED is known as the cathode (K), while the lead on the other, rounded, side is called the anode (A)). The LED, the circuit

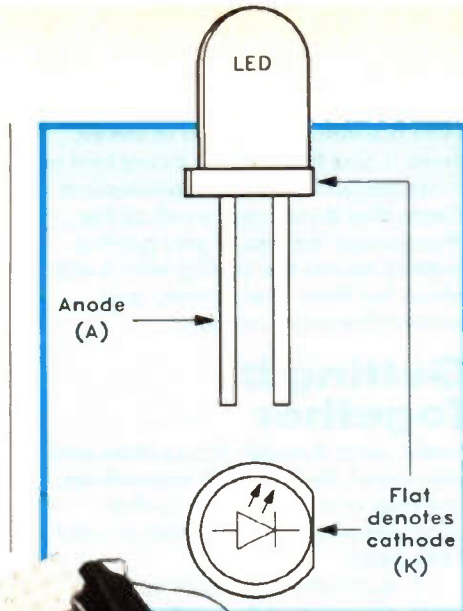

Figure 4. LED circuit symbol and connections.

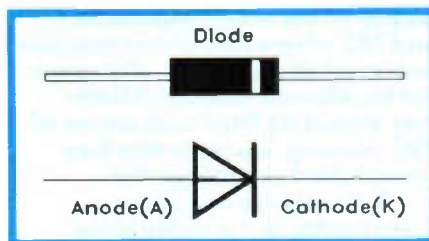

Figure 5. Diode symbol and connections.

symbol and connections are shown in Figure 4. Make sure that the LEDs are fitted so that the 'flattened' sides line up with the drawing of the LED printed on the guide-sheet.

e) The next component to be fitted is D1, which is a small tube-like component having a lead at each end of its black body. Like LD1 and LD2, it must be connected the right way round (In other words, D1 is a 'polarised' component). Its 'polarity', which tells us the way in which it must be positioned, is indicated by a white (or silver) band close to one end of the body. D1, its circuit symbol and connections, are shown in Figure 5. The diode should be fitted so that the band lines up with the band on the drawing of the diode on the guide-sheet.

f) Lastly fit the battery connector and battery, B1; the connector must

be attached to the board with its coloured leads the correct way round. The battery connector has two press-stud clips on a piece of plastic and two wires coming from it, coloured red and black. The red and black leads should be connected as shown on the layout sheet. The 9V PP3 type battery should be connected to the battery connector, it will only fit properly one way round.

## Testing and Use

After carefully checking all the wiring, connect the battery and look at the LEDs. It often takes oscillators a little while to operate correctly – when the circuit is first powered up, you might find that both LEDs switch on, but it should soon settle down, with the LEDs flashing in turn, each for just over one second at a time. If the unit fails to work, disconnect the battery at once, and re-check the wiring, paying particular attention to the diodes, transistors, and battery. Getting any of these connected incorrectly will stop the unit from working at all. Also check that the crossed-over wires near to TR1 and TR2 are not touching each other, or anything else.

If this project is to be used with model railways and the like, D1 and D2 will probably need to be used remotely from the main board and connected to the main unit via a couple of two-way cables. You do not have to use red LEDs – green, yellow and orange types are also available. Blue LEDs are made, but are extremely expensive! Smaller and larger LEDs are also available, and any of these should work properly with this circuit.

If you require a faster flashing rate, use smaller value capacitors for C1 and C2. Reducing the value of each from 220 $\mu$ F to 22 $\mu$ F will increase the flash rate to several a second. Increasing the values of R2 and R3 will reduce the flash rate – replacing the currently fitted 10k resistors with the 100k resistors supplied in the kit will result in the LEDs switching over every ten seconds or so. If you only change one resistor the LEDs will flash for unequal times. One will switch on for just over a second, while the other will switch on for ten seconds or so at a time.

## Availability

The Funtronics Flasher is available from Maplin Electronics, through our chain of regional stores, or by mail order, **order code LP96E** **Price £2.95.**

**There's another Funtronics Project to build next month!**

# MICRO-COMPUTER TESTING & FAULT FINDING

by Alan Pickard

## Part Five – Software

**M**icrocomputer testing and fault-finding requires a good working knowledge of electronics – particularly digital electronics and the use of appropriate test equipment. Although a microcomputer technician is not required to be a software expert to the same degree as a programmer (or other software specialist), the more experience and understanding of software gained, the greater will be the effectiveness of attempts to fault-find.

A logical approach to any fault-finding situation is essential, preventing wasted time, and even (additional) damage occurring to a microcomputer system. Isolation of a fault to the appropriate hardware area is important, but knowing whether a fault is hardware or software-originated (perhaps a combination of both!) is more than useful. Many misleading 'clues' can be observed, which may be interpreted as being software-originated when the cause is a hardware malfunction, and vice versa. Assuming that a technician has mastered the hardware approach to fault-finding, this article will deal with appropriate software, including operating systems, number systems and some simple test programs.

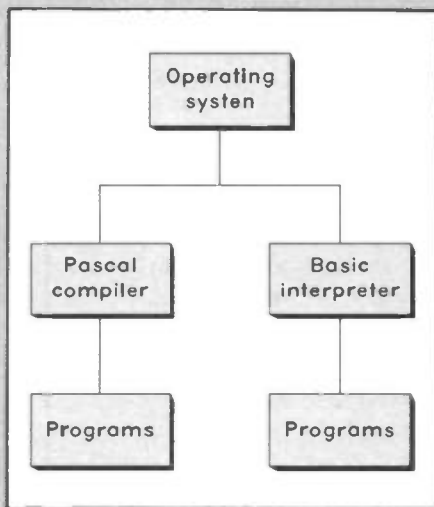
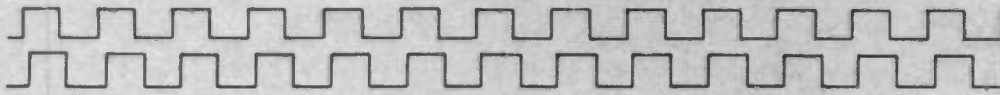

Figure 1. High-level programs in relation to an operating system.

### Operating Systems

In Part 1 of the series, two examples of operating systems were discussed: the BBC Micro operating system, based on the 6502 MPU (see Figures 7 and 8, Part 1); and the Einstein micro which uses a standard CP/M operating system, running on a Z80 MPU (Figures 9 and 10, Part 1).

It is assumed that the user of a microcomputer system can 'drive' it i.e. knows how to use operating system commands, and how to operate such utilities as a text editor/wordprocessor, a high-level language interpreter or compiler (e.g. BASIC, PASCAL), and an assembler (e.g. ZASM).

### Definitions

An operating system is a fairly large program (usually disc-based), which enables other programs to be run 'under' it. A PASCAL compiler, for example, is said to run under the operating system, but is itself a program which enables PASCAL programs to be run.

Figure 1 shows how PASCAL programs and BASIC programs could be run

under a common operating system. In each case the PASCAL compiler, and BASIC interpreter, would need to be written for that particular operating system. A BASIC interpreter written for a disc-based BBC Micro, for example, would not run on an Einstein (CP/M) operating system.

High-level languages are programming languages which enable programs to be written using English-like words (such as PRINT, GOTO, FOR...NEXT), known as 'keywords'. Although the syntax of the particular language must be observed with practice and experience, it becomes fairly easy to write programs at this high level. 'High-level' means that the programmer is not aware of the basic activity of the microcomputer i.e. the processing of 1s and 0s. BASIC programs are 'interpreted' into machine code instructions, line by line. This interpretation, or conversion, process takes place each time that the program is run. A compiler, however, converts (or 'compiles') the entire program into a machine code 'object' file, which is then stored. This file contains the program which is subsequently run each time. For example, a PASCAL high-level language program is written in source code (keywords and symbols), which is then compiled into object code (machine code program). This is further illustrated in Figure 2. The original high-level program can be disposed of, although this is not provident if the program needs to be modified at a later stage.

Assembly language is at a lower level than high-level, but it would be inaccurate to refer to it as 'medium' level, because it is much closer to the activity of the microprocessor than high-level programming. Assembly language uses mnemonics, rather than keywords. These are usually (but not always) acronyms. In other words, their letters are used as an aid to memory. For example, LDA stands for Load the Accumulator. Similarly, NOP stands for No

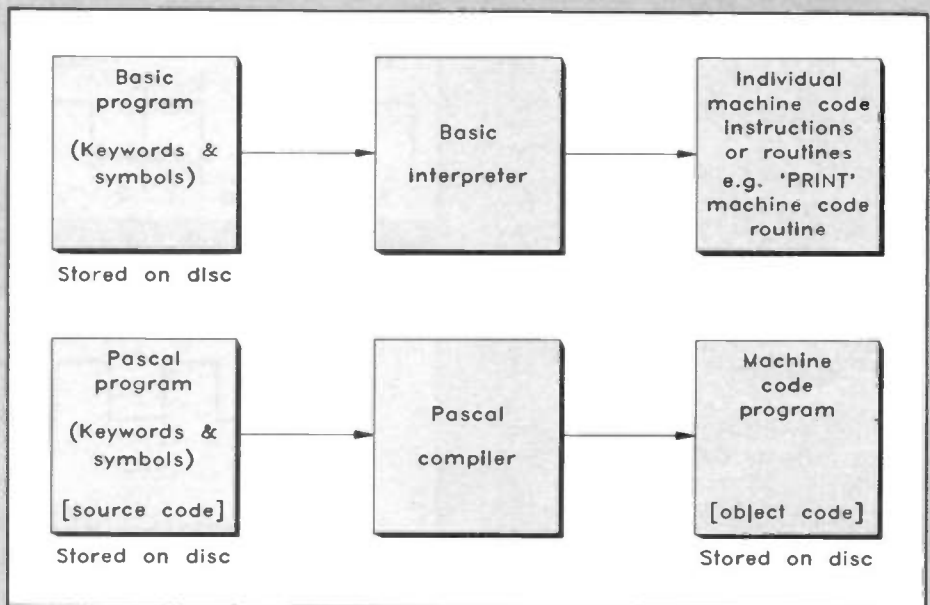

Figure 2. Program interpretation (above) and compilation (below) processes.

Operation, while RTS stands for Return To Subroutine.

An example of a complete instruction line from an assembly language program is:

LDA £33

where LDA is the mnemonic, and £33 is the data value being operated on (£ denotes an 'immediate' data value, rather than an address). The mnemonic represents the opcode, which is one of the instructions in the instruction set of the particular MPU, in this case the 6502. The opcode represented by LDA has a specific hexadecimal code, e.g. A9, which represents the 8-bit binary code 1010 1001 (number systems will be dealt with separately later).

Another example of an assembly language instruction is;

STA 2000

which means Store the contents of the Accumulator in memory location 2000. Again, STA is the mnemonic which represents the MPU opcode, while 2000 represents 2 data bytes, although these are actually an address. Another word for the data part of the instruction is the 'operand'.

assembly language

instruction = mnemonic + data  
= opcode + operand

An assembler is used to convert the above, 'assembling' it into machine code.

Machine code is a programming 'language' which operates at the most basic microprocessor level. The microprocessor does not 'understand' high-level language, assembly language, or even hexadecimal codes. It can only deal with binary, i.e. combinations of 1s and 0s arranged in 8-bit groups or bytes. In an 8-bit MPU such as the 6502 or Z80, 16-bit values or 16-bit addresses are dealt with as pairs of bytes.

In Part 4 listings were included, in the logic analyser description, which show 'disassembled' assembly language programs. These consist of assembly language mnemonics and data (representing opcodes and operands), with their corresponding machine code in hexadecimal (see Test Programs later).

Writing programs in machine code is time-consuming and tedious. It is also very error-prone (even if using hexadecimal code) and impractical, except for very simple, short programs. Machine code programs, which are the only programs the actual microprocessor will run, can originate from:

1. A high-level language compiler (here, keywords are converted into a machine code program).
2. A high-level language interpreter (in this case, keywords are translated into machine code instructions, line by line).
3. An assembler (assembly language converted to a machine code program).
4. A monitor program, which accepts

machine code instructions directly (into individual memory locations).

A monitor program is like an operating system, but is much less sophisticated. It is a ROM-based program which 'runs' the microcomputer system, so that it can read the keyboard, write to the screen and enable instructions to be entered into the system. This enables simple operations to be performed, including the input of machine code programs.

## Number Systems

A good understanding of the number systems used in microcomputers (binary, decimal and hexadecimal) is important, if not essential, when testing and finding faults. An understanding of ASCII (covered in Part 2) is also essential.

## Test Programs

Simple test programs, especially ones which are known to work correctly, can be invaluable when carrying out tests and fault-finding. A Z80 example is the following:

### Program 1

ORG 0100H; program start address  
0100 JP 0100H; jump back to 0100H

This simple program, which was included in Part 1, can be used to investigate address and data bus activity. It can also be used to verify Z80 timing diagrams. In other words, waveforms can be examined on A0-A15, D0-D7, MREQ, RD, WR and RFSH.

By using the oscilloscope and referring to the Z80 instruction set, it is also possible to estimate the execution time of the Jump instruction.

### Program 2

ORG 0100H  
0100 IN A, (30H); read Port A  
0102 JP 0100H ; repeat

This program, written in Z80 assembly language, can be used to monitor MPU control lines MREQ (memory re-

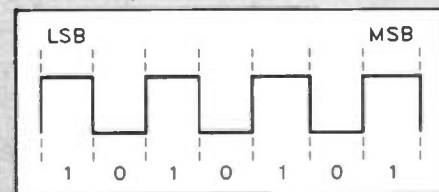

Figure 3(a). ASCII code (7 bits) signal waveform ('U' = 1010101).

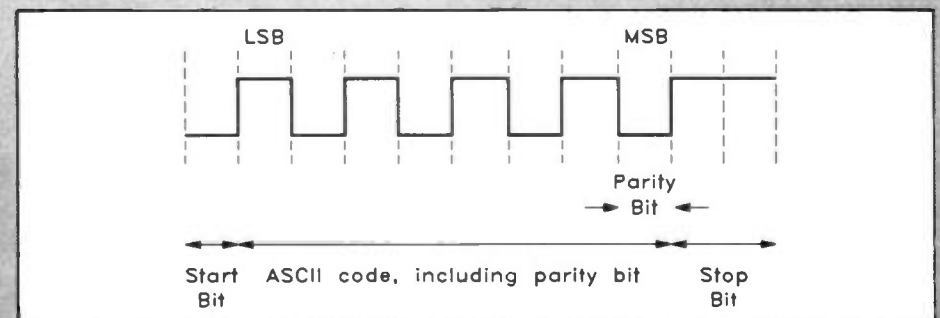

Figure 3(b). ASCII code (8 bits) including start and stop bits ('U' = 01010101).

quest), IORQ (input/output request) and also the Chip Enable line (CE) of, for example, the Z80 PIO chip. (N.B. The Chip Enable line is sometimes known as Chip Select, CS.)

The IORQ control signal can be used on one channel of a dual-trace oscilloscope, to synchronise its timebase, while the second trace is used to examine M1, MREQ and, for the Z80 PIO, CE.

## Program 3

The Einstein microcomputer has a standard RS232 serial socket, enabling data to be serially transmitted and received. By fitting a 'loop back' plug (which is simply a DIN plug with TX/RX and RX/TX connected), a single byte of data can be transmitted and received for test purposes.

A suitable Z80 program to achieve this is as follows:

```

ORG 0100H
START: LD DE,MSG1
      LD C,09H
      CALL 05H
      LD A,25H
      OUT (11H),A
TXMIT: LDA A,55H
      OUT (10H),A
RXRDY: IN A,(11H)
      AND A,02H
      JP Z,RXRDY
      IN A,(10H)
      CP A,55H
      JP Z,TXMIT
RST 38H
MSG1: DEFM 'SERIAL LOOP BACK'
      DEFM 'TEST$'
      END START
  
```

The program operation can be verified using an oscilloscope, and it is possible to view the ASCII character 'bit pattern'. The character transmitted in this program is in the line:

LD A, 55H

where 55H = 0101 0101 = 'U' in ASCII. Once the program is working correctly, different values can be substituted into this line (and the corresponding line; CP A, 55H) for further verification. Figure 3(a) shows the ASCII code signal waveform for the letter 'U', while Figure 3(b) shows the waveform (including parity), and also the start/stop bits. Note that the LSB/MSB order of the waveform is the opposite way round to the ASCII bit pattern order. LSB = least significant bit, MSB = most significant bit.

## Program 4

A suitable test program for inspection by logic analyser is as follows:

```
0100 LD A, OFFH ; load accum with OFFH
0102 LD (0200H), A ; copy contents of accum into 0200H
0105 INC A ; inc conts of A (OFFH - 100H)
0106 RST 38H ; reset
```

This is disassembled as follows:

### Z80 DISASSEMBLER

LOC	ADDR	CODE (DATA)	MNEMONIC
000	0100	3E FF	LD A, £FF
007	0102	32 00 02	LD (£0200),A
017	0200-WRITE	FF	
020	0105	3C	INC A
024	0106	FF	RST £38
029	00FF-WRITE	01	
032	00FE-WRITE	07	
035	0038		

An explanation of this listing was given in Part 4 (Figure 7). See also Part 4, Figure 3.

A further useful exercise would be to put a software fault into this (or another) program, and use it as a logic analysis fault-finding exercise.

## Program 5

When looking at waveforms in Part 1, the following program was included:

```
10 P%=&3000
20 [ SEI
30 .start
40 STA &FCOO
50 STA &FCOO
60 JMP start
70 ]
80 CALL &3000
```

This program enables 6502 clock waveforms  $\emptyset 1$  and  $\emptyset 2$  to be observed on an oscilloscope.

## Program 6

The following program, written in BBC BASIC but containing assembly code (lines 80 to 130), is used to test the chip select lines of any VLSI device in the micro:

```
10 *KEY10 OLD M RUN M
20 CLS
30 DIM CODE 20
40 P%=CODE
50 INPUT "ADDRESS", M$
60 M%=EVAL("&" + M$)
70 IF M%=0 THEN END
80 [SEI
90 SEC
100 .again
110 LDA M%
120 BCS again
130 ]
140 CALL CODE
```

When the program is run, an address input into the program (via line 50), for example &FEC0, will produce a waveform which can be measured on pin 23 of the ADC chip, IC73, as shown in Figure 4.

```
160 LDY £&FF
170 .LOOP1 LDX £&FF
180 .LOOP2 DEX
190 BNE LOOP2
200 DEY
210 RTS
220 ]
```

When this program is run from BASIC, it assembles the section of the program within the square brackets into a machine code program. It lists the assembled machine code, with the original assembly language program alongside it:

```
1500 A9 7F LDA £&7F
1502 8D 62 FE STA &FE62
1505 A9 05 LDA £&05
1507 8D 60 FE STA &FE60
150A 20 1B 15 JSR &151B
150D A9 0F LDA £&0F
150F 8D 60 FE STA &FE60
1512 20 1B 15 JSR &151B
1515 A9 05 LDA £&05
1517 8D 60 FE STA &FE60
151A 60 RTS
151B AO FF LDY £&FF
151D A2 FF .LOOP1 LDX £&FF
151F CA .LOOP2 DEX
1520 DO FD BNE LOOP2
1522 88 DEY
1523 DO F8 BNE LOOP1
1525 60 RTS
```

## The IBM-PC

Any article or book dealing with micro-computer fault-finding cannot exclude the IBM-compatible PC, although some would argue that it represents a radical departure from the more conventional component level and hardware 'hands on' techniques of servicing.

PCs, usually running the MS-DOS operating system, are 16-bit micro-processor-based machines of a very

## Program 7

This BBC BASIC program, which consists almost entirely of BBC assembler (lines 50 to 220), is a good example of a control program. It switches a motor on and off via a user port, the data register of which is 'memory mapped' at &FE60.

```
20 P%=&1500
30 CLS
40 [
50 LDA £&7F
60 STA &FE62
70 LDA £&05
80 STA &FE60
90 JSR &151B
100 LDA £&0F
110 STA &FE60
120 JSR &151B
130 LDA £&05
140 STA &FE60
150 RTS
```

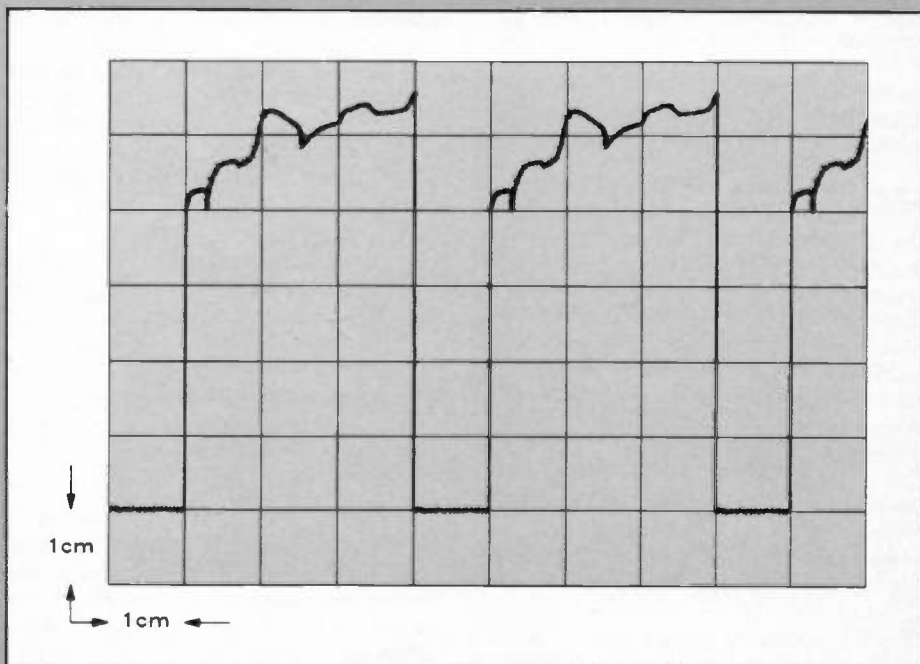

Figure 4. ADC output waveform. The oscilloscope parameters are 1V/cm sensitivity, 1µs/cm timebase.

modular design. They comprise a main board, or 'motherboard', which also contains memory chips and has various plug-in 'daughter boards'. These usually comprise a monitor display card (VGA, CGA, etc.), floppy/hard disc controller and serial/parallel I/O board. The PC system is normally also equipped with floppy disc drives, a hard disc drive and a physically separate keyboard and monitor. Although the circuit boards, or 'cards', can be easily extracted, and may even be repaired down to component level, the PC philosophy is more of a 'board-swap and replace' method. In business environments and large organisations, where the PC is considered to be a cheap item, it is usually cost-effective to replace modules rather than have (and pay for) time spent on repairs.

The motherboard is a particularly problematic unit to repair due to its size, and the frequent use of surface-mounted VLSI devices such as the 16-bit 80286 MPU, a 68-pin device which is not easily unsoldered from the circuit board. Whilst it may not be realistic to scrap such a board, a replacement on a trade-in basis may be appropriate.

The PC is a disc-based system, but it has a 'boot-up' ROM, which contains various diagnostic programs. These include memory tests, which are carried out on power-up, and various other tests which can be called up by the user. These 16-bit machines do not therefore lend themselves to conventional bench repair work because of their built-in diagnostic routines and hardware construction. However, a good knowledge of 8-bit hardware and software fault-finding techniques will be useful in identifying problem areas, and being able to make the appropriate decisions for fault rectification.

The PC can itself provide fault-finding assistance. Good examples of this are the use of the logic analyser package (covered in Part 4), and an interface which provides oscilloscope waveforms on the PC screen. Diagnostic software routines test such things as memory, disc reading and writing, etc.

## MS-DOS

The IBM-compatible PC is a disc-based machine running under an operating system known as MS-DOS (Microsoft Disc Operating System). The word 'disc' denotes the presence of the operating system on disc rather than being contained permanently in a ROM. The main advantage of a disc-based system is that it is more flexible, enabling more than one type of operating system to be run. A PC usually runs MS-DOS, but could alternatively run PC-DOS or OS/2. In other words an application program may be available, which is written to run under PC-DOS but not MS-DOS. By using a PC-DOS operating system disc to 'boot up' the system, the user can run the said program. A further, and perhaps more useful, advantage of disc-based systems is

that if an operating system is upgraded, and a further version implemented, this can be effected on an existing machine by purchasing the appropriate disc (or discs). This is obviously much more convenient than fitting a replacement ROM device. In addition, the user can still use the old version if required.

The operating system enables the user to type in commands, such as those which load a particular program, permit examination of directories or format discs. It also reads the keyboard, writes to the screen and so on.

An example of an MS-DOS command is DIR, followed by Return or Enter. This provides a list of files on the disc of the currently logged drive which could be, for example, floppy disc drive A (denoted by the system prompt on the screen):

```
A>_
```

where the underscore symbol represents the flashing cursor.

MS-DOS is in three main sections:

```
MSDOS.SYS
IO.SYS
COMMAND.COM
```

The first section (or file), MSDOS.SYS, is the core of the operating system. The second one, IO.SYS, is also known as the Basic Input Output System (BIOS) and allows the core to communicate with the hardware. The last file, COMMAND.COM, is the Command Processor which interprets what is typed at the keyboard. If this information is in the correct form, the COMMAND.COM program finds and executes the appropriate command (e.g. DIR, which lists files in the current directory).

If the DIR command is used on the system disc itself, only COMMAND.COM will be listed. The other two, although present, are 'hidden' to avoid inadvertent deletion (deletion of COMMAND.COM can be restored by MSDOS.SYS).

MS-DOS has over twenty built-in commands (normally referred to as 'resident commands'), instantly available to the user since they reside in memory (RAM). Examples of internal commands are:

```
DIR lists current directory
DEL deletes a file
TYPE types a file on to the screen
COPY copies a file
MD makes (creates) a directory
CD changes a directory
RD removes (deletes) a directory
REN renames a file
DATE prints date on screen
TIME prints time on screen
```

In addition to these internal commands, there are over forty 'transient' commands, which are to be found on the system and utility discs supplied by the manufacturer of the operating system. Examples of these are:

```
FORMAT a program which sets up tracks and sectors on a new disc
```

```
PRINT enables files and screen output to be sent to a printer
SYS enables the operating system to be copied on to a new disc
LABEL allows the user to give a disc a 'label', or title
DISKCOPY copies the whole of a disc on to another disc
CHKDSK reads a disc, and states memory used and remaining
BACKUP used to archive files from a hard disc
```

The operating system of a PC uses 'structured' directories, so-called because each of the programs can be stored in a system of sub-directories, which in turn can contain sub-directories. A hierarchical storage system, like a family tree, enables data and text to be stored in some sort of order, rather than being grouped haphazardly. Figure 5 illustrates this.

A hard disc is a very useful component of a microcomputer system, because it can store one or more large applications programs, which can then easily be run (or 'invoked') as required, without the tedium of loading the program from floppy discs each time. A hard disc provides faster transfer of data than a floppy disc, but care must be taken to ensure that all important software, whether applications, utilities or user files, are backed up on to floppy discs. If a hard disc became faulty, corrupted or subjected to a computer virus, all software could be lost.

Utility programs are those which enhance the use of an operating system by making it easier, and perhaps quicker, to use. They are not usually part of the standard operating system, and provide extra features. An example of a utility program is DISKPARK.EXE. This program sends the appropriate command signal to a hard disc drive for 'parking' the read/write heads on an unused track, so that if the machine is moved or carried, data on the hard disc surface will not be damaged. The 'EXE' extension denotes that the file is executed after typing 'DISKPARK' on the keyboard. Another example is MEMTEST.EXE which, as its name suggests, tests memory devices. GWBASIC.EXE is a BASIC interpreter, which allows the inputting of BASIC programs from the keyboard, or from (and to) disc. PRO-COMM PLUS (also known as PCPLUS) is a program which enables two computers to pass data between each other.

## Conclusion

This five-part series has attempted to cover a large amount of ground, in terms of both hardware and software techniques, when dealing with the testing and repair of microcomputers. Anyone wishing to go further would be advised to read books such as those recommended at the end of this article.

However, the best way of consolidating the knowledge gained from reading these articles is to put it into practice, whilst observing the usual precautions of safety and equipment care.



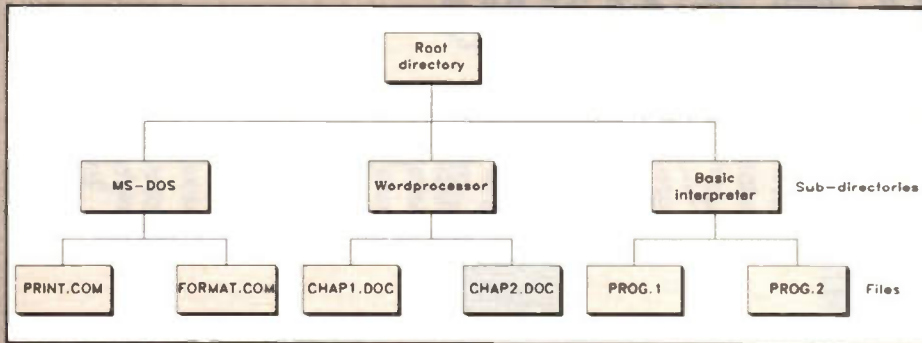

Figure 5. PC directory, showing the so-called 'tree' structure.

## Summary

In Part 1, we looked at basic microcomputer hardware, and the use of circuit/layout diagrams. In addition, we defined memory maps and operating systems. Clock waveforms were also covered.

In Part 2, we looked at I/O circuits. Coverage was given to interfacing generally, while the keyboard and video monitor were looked at in some detail.

In Part 3, disc drives were discussed. Floppy disc theory and practice, including the operation of drive mechanisms, was covered. Adjustments and alignment were talked about separately, specific reference being made to the floppy disc exerciser. The hard disc was also described, although testing and fault-finding is limited to

specialist manufacturers' support.

In Part 4, we looked at the various types of test equipment relevant to microcomputer repairs. Logic analysers were covered in detail.

In this final instalment, software and test programs relating to the whole series have been described. An introduction to the IBM-compatible PC and its usual operating system has been included, although the PC is really a subject in its own right.

## The Last Word

It should now be apparent that a logical approach is always required when dealing with microcomputer malfunctions. Caution is always a good idea, and experience is

something which can only be acquired with time. The more an intuitive approach can be applied, the easier it is to ignore misleading clues, and interpret unhelpful error messages. A good integrated knowledge of hardware and software is very useful, and avoids confusion in a fault-finding situation.

## Further Reading

Service Personal Computers  
Michael Tooley  
WP52G  
£25.00 NV

Computer Engineer's Pocket Book  
Michael Tooley  
WP69A  
£10.95 NV

Hard Disc Pocket Book  
Mike Allen and Tim Kay  
WT03D  
£12.95 NV

How to Expand, Modernise and Repair  
PCs and Compatibles  
R. A. Penfold  
WS95D  
£4.95 NV

Understanding PC Specifications  
R. A. Penfold  
WT26D  
£3.95 NV

# MAPLIN'S TOP TWENTY KITS

POSITION		DESCRIPTION OF KIT	ORDER AS	PRICE	DETAILS IN
1.	(1)	LED Xmas Star	LP54J	£ 6.25	Magazine 48 (XA48C)
2.	(2)	Live Wire Detector	LK63T	£ 4.25	Magazine 48 (XA48C)
3.	(3)	Car Battery Monitor	LK42V	£ 7.95	Magazine 37 (XA37S)
4.	(6)	Courtesy Light Extender	LP66W	£ 2.75	Magazine 44 (XA44X)
5.	(5)	MOSFET Amplifier	LP56L	£19.95	Magazine 41 (XA41U)
6.	(7)	Mini Metal Detector	LM35Q	£ 6.45	Magazine 48 (XA48C)
7.	(4)	Vehicle Intruder Alarm	LP65V	£ 9.95	Magazine 46 (XA46A)
8.	(9)	L200 Data File	LP69A	£ 3.95	Magazine 46 (XA46A)
9.	(8)	TDA7052 Kit	LP16S	£ 4.45	Magazine 37 (XA37S)
10.	(13)	Partylite	LW93B	£10.25	Catalogue '92 (CA09K)
11.	(14)	Low Cost Alarm	LP72P	£12.95	Magazine 45 (XA45Y)
12.	(10)	1 300 Timer	LP30H	£ 4.95	Magazine 38 (XA38R)
13.	(11)	MSM6322 Data File	LP58N	£11.45	Magazine 44 (XA44X)
14.	(12)	IBM Expansion Sys	LP12N	£18.25	Magazine 43 (XA43C)
15.	(16)	PWM Motor Driver	LK54J	£ 9.95	Best of Book 3 (XC03D)
16.	(-)	RE ENTRY LM383 8W Amplifier	LW36P	£ 7.45	Catalogue '92 (CA09K)
17.	(-)	RE ENTRY TDA2822 Amplifier	LP03D	£ 6.95	Magazine 34 (XA34M)
18.	(15)	Siren Sound Generator	LM42V	£ 4.25	Magazine 26 (XA26D)
19.	(17)	Simple Melody Generator 1	LM43W	£ 2.75	Magazine 26 (XA26D)
20.	(19)	LM386 Amplifier	LM76H	£ 3.75	Magazine 29 (XA29G)

Over 150 other kits also available. All kits supplied with instructions. The descriptions are necessarily short. Please ensure you know exactly what the kit is and what it comprises before ordering, by checking the appropriate project book, magazine or catalogue mentioned in the list above.

## Maplin

Do you Enjoy your work?  
Or would you prefer to  
Work at what you enjoy?

If you are an electronics enthusiast and looking for an interesting career with a future, Maplin has the answer.

We often have vacancies for

## Branch Managers Assistant Managers and Counter Staff

New Stores opening all over the UK

### VACANCIES IN SOUTH LONDON

These vacancies are being created as a result of the Maplin expansion programme and offer real prospects for a secure and exciting career.

Retail experience would be a great asset, and to become part of the team, you do need to be self-motivated and have a cheerful personality.

Applicants must also be smartly dressed and have a good working knowledge of electronic components.

We offer excellent working conditions and job security, a first class basic salary plus commission, pension scheme and generous staff discounts.

If you are seeking an interesting career in a High Tech Environment, then write to us

**NOW!**

Send full career details and an indication of the area you prefer to:  
Mrs Christine Goddard, Personnel Manager,  
Maplin Electronics plc, Valley Road, Wombwell, Barnsley S73 0BS.

# Velleman K4000

# Stereo Valve Amplifier

## Part Two by Alan Williamson

The Velleman K4000 valve power amplifier is a large and expensive project, and no doubt you would, if you had bought one of these kits, be itching to get the amplifier up and running. But it is definitely not a good idea to be over-eager and rush to try and build it in ten minutes. Put a little extra time and effort into the job, as mistakes could be costly and time consuming to rectify. If you begin to start feeling tired or distracted at any point while building the amplifier, then leave it until another day.

### Assembly of the Power Supply Module P4000PS

Fit the wire links identified as 'J' on the PCB using the pre-cut lengths supplied.

**ATTENTION:** for the wire link between C7 and C8, use a 5cm piece of the 18 swg (1.25mm) tinned copper wire provided.

#### Specifications

Output power:	2 × 200W music power 2 × 95W rms in class A/B1 2 × 15W in class A
Output impedance:	4 or 8Ω using ultra-linear output transformers
Power bandwidth max. output:	10Hz to 60kHz (−3dB)
Frequency band:	4Hz to 100kHz (ref. 1W, −3dB)
Harmonic distortion:	0.08% (1kHz, 1W) 0.63% (1kHz, 95W)
Signal-to-noise ratio:	>102dB (A weighted at 95W)
Channel separation:	>67dB (at 95W)
Input impedance:	100kΩ
Input sensitivity:	0dB (775mV for 95W)
Damping factor:	25
Overall feedback:	18dB

#### Diodes

Fit and solder the diodes as follows:

D1 (1N4148). Ensure correct polarity, cathode is marked by a band at one end of the body.

Fit D2 through to D5 (1N4000 types), again paying attention to polarity.

Fit D6 through to D9 (1N5408), as above.

#### Resistors

Fit and solder the resistors R1 and R2, these are ¼W 22kΩ (coded red, red, orange).

Fit the following 1W resistors at a height 5mm above the PCB. A £1 coin and a 20p piece can be used as spacers under the component to achieve the correct height.

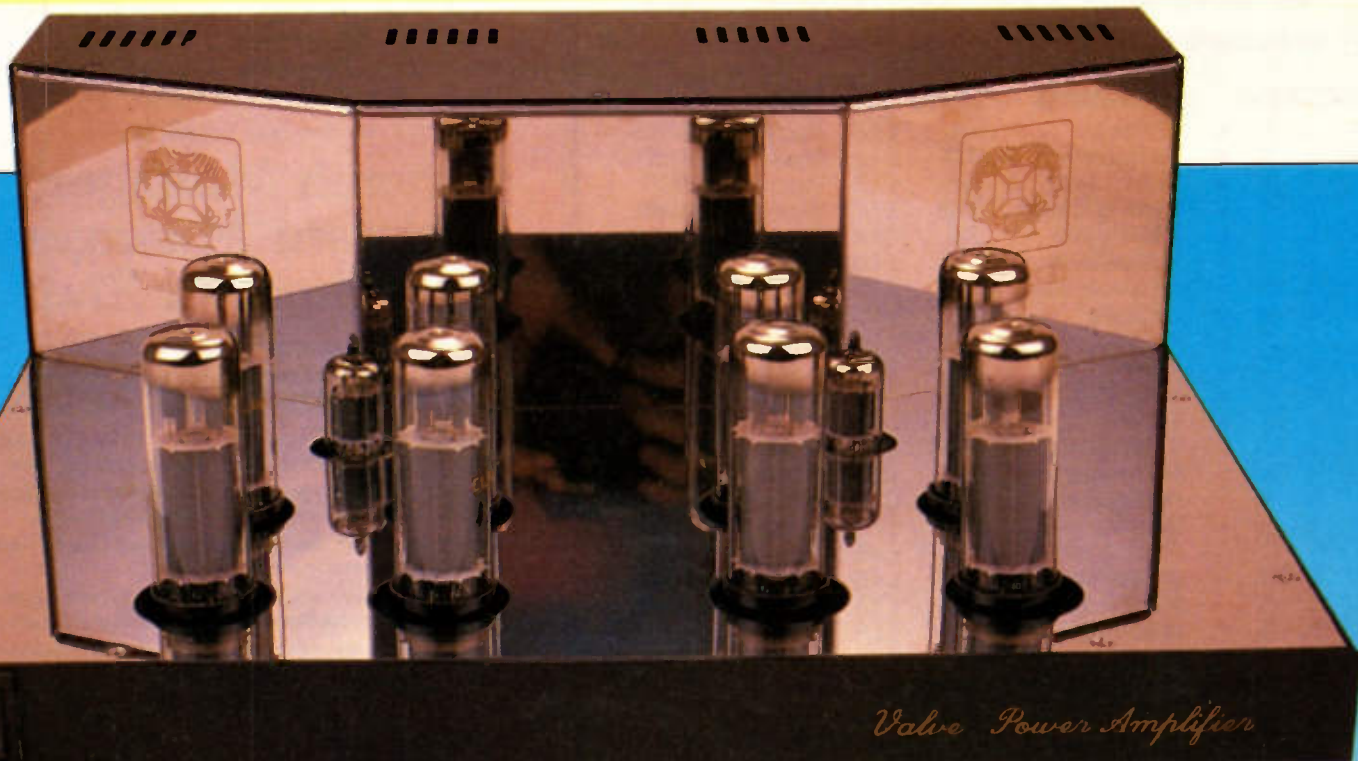

*Valve Power Amplifier*

Fit R3 through to R5, 680k (coded blue, grey, yellow), then R6 and R7, 15k (brown, green, orange).

Fit the three fuse holders for F1 through to F3.

Fit the eight PCB-pins for the '+V1', '+V3', '-V' terminals and the two 'GND' terminals; all pins are inserted from the *component* side.

Fit the two six-pole screw terminal connectors at the places marked 'J1' and 'J2'.

## Capacitors

Fit capacitor C1, 1 $\mu$ F polylayer MKM type.

Fit the following electrolytic capacitors, ensuring correct polarity!

C2 and C3, 47 $\mu$ F 100V (may be marked as higher voltage).

C4, 100 $\mu$ F 100V (or higher).

C5 and C6, 100 $\mu$ F 400V (or higher).

C7 through to C10, 200 or 220 $\mu$ F, 450V (or higher).



Assembled preamplifier board.

## VERY IMPORTANT

Solder a length of 18 swg wire along the solder resist free, tinned copper track between the points 'GND' at the left side of the PCB, and the point 'GND' at the right side of the PCB. Also apply an extra thick layer of solder to all the remaining tinned track surfaces.

## Assembly of the Preamplifier Module P4000PR

### Resistors

Fit the 1/4W resistors as follows:

R57L and R57R, 100k (coded brown, black, yellow).

R58L and R58R, 8k2 (violet, red, red).

Fit the 1/2W resistors:

R59L and R59R, 47k 1/2W (brown, black, yellow).

Fit the valve socket V5, and be sure to solder the centre connection also.

Fit the 12 PCB-pins at the positions 'IN', 'OUT', 'GND', 'V3' and 'f1/f2'.

### Capacitors

Fit the capacitors as follows:

C19L and C19R, 22pF ceramic. You could if you choose opt for high grade

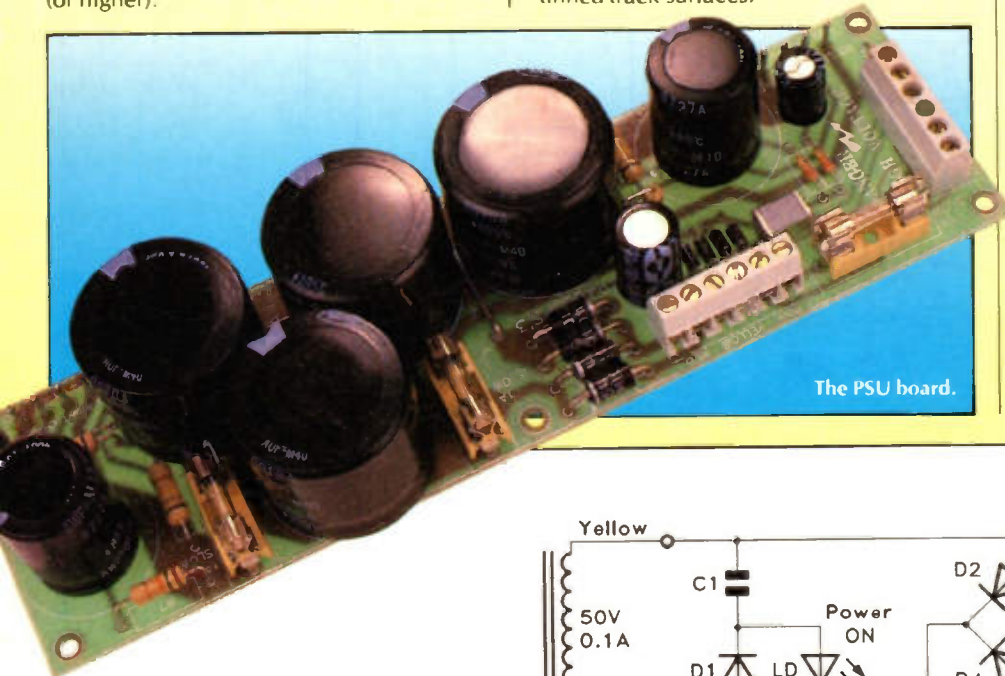

The PSU board.

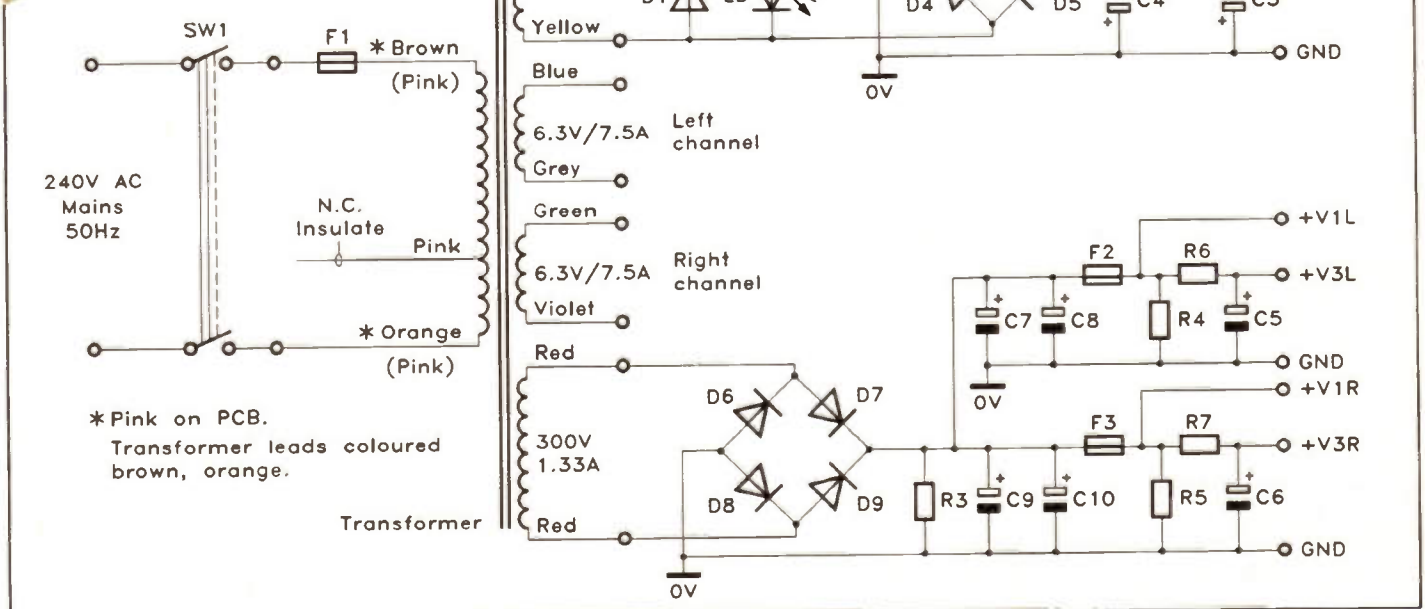

Circuit diagram of the power supply.

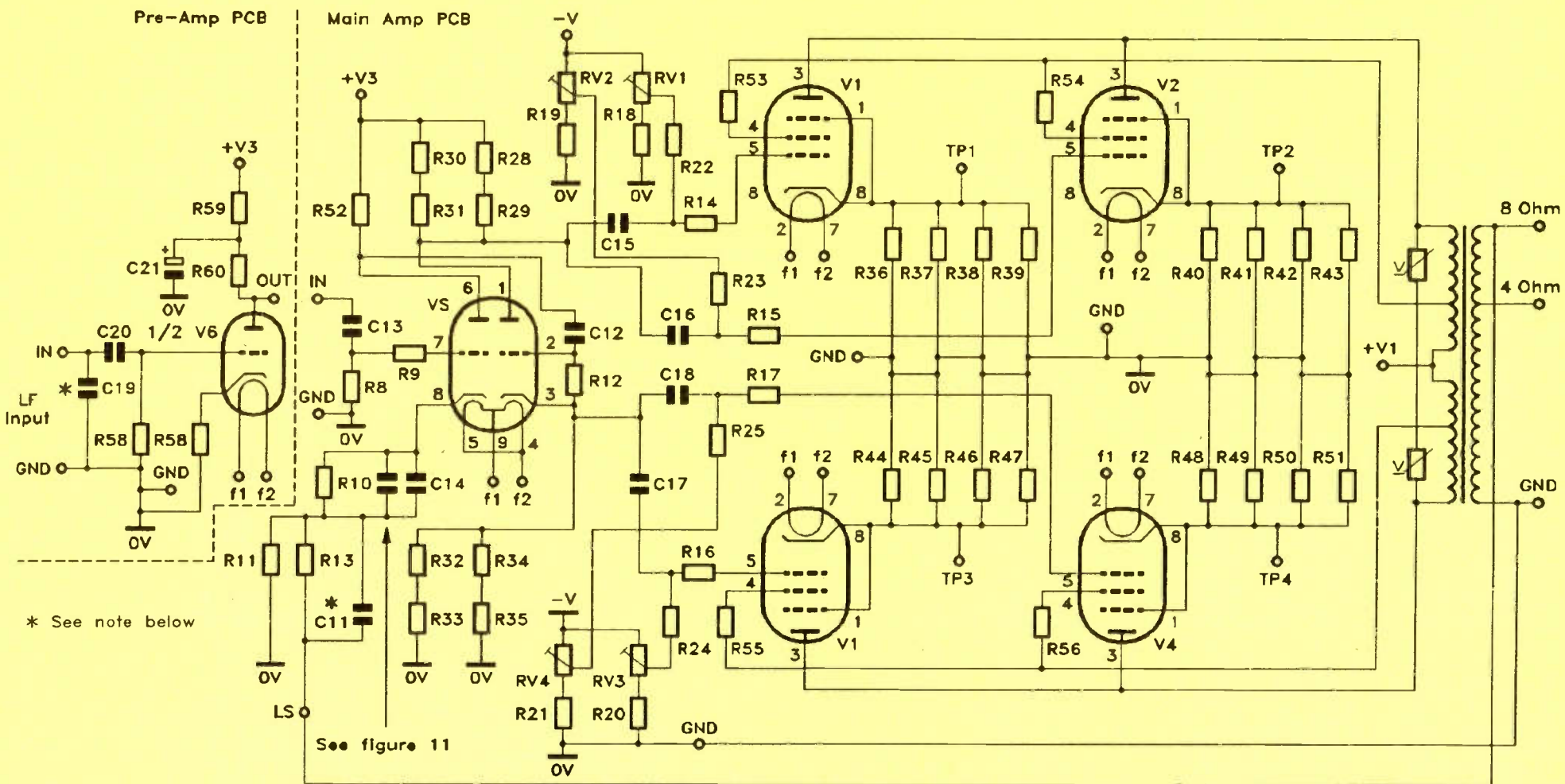

Circuit diagram of one complete amplifier. Components marked \* are the alternative polystyrene types described under the amplifier assembly section in the text. The modification improves sound quality and removes any 'graininess' from the stereo image.

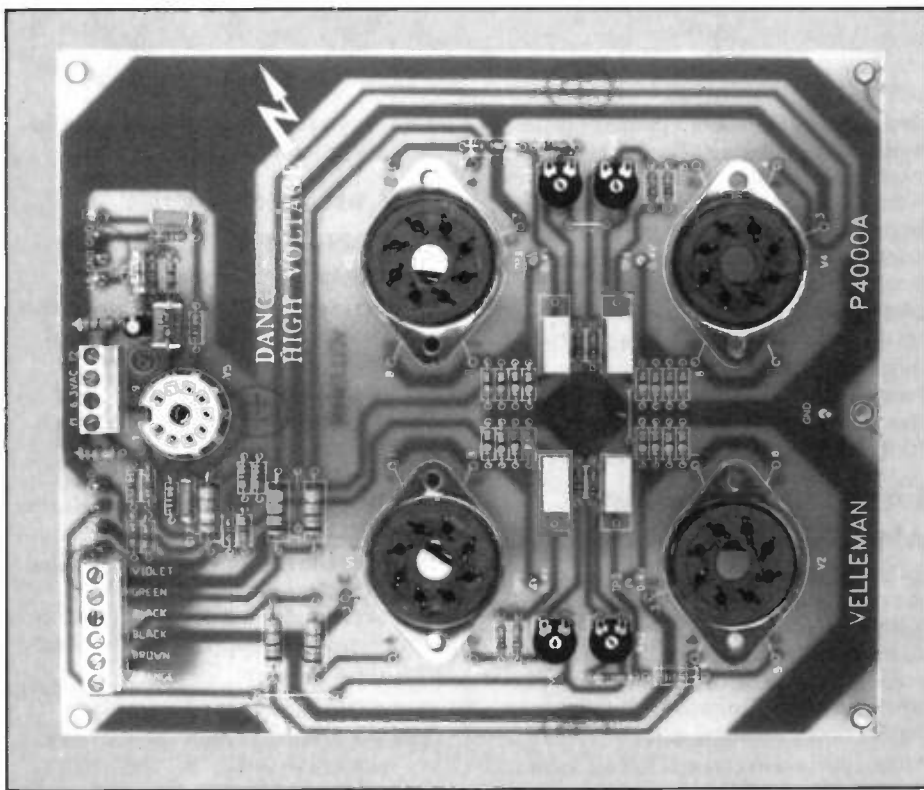

Topside of an assembled main amplifier module.

polystyrene types in these positions, e.g. Maplin order code BX24B.

Fit C20L and C20R, 470nF polylayer MKM type (sometimes marked as u47).

Fit C21L and C21R, 10 or 22 $\mu$ F 350V electrolytic capacitors. Pay attention to the polarity! If 220 $\mu$ F capacitors are supplied, make sure to leave enough room to fit the PCB mounting screws!

## Assembly of the Amplifier Modules P4000A (two PCBs)

On each PCB in turn, fit the wire links at the positions marked 'J' on the PCB.

### Resistors

Fit the 1/4W resistors as follows:

R8, 1M (coded brown, black, green).

R9, 22k (red, red, orange).

R10, 820 $\Omega$  (grey, red, brown); but note that R10 is mounted on top of a 1 $\mu$ F polylayer MKM type capacitor.

R11, 180 $\Omega$  (brown, grey, brown).

R12, 1M $\Omega$  (brown, black, green).

R14 through to R17, all 10k (brown, black, orange).

R18 through to R21, all 100k (brown, black, yellow).

R22 through to R25, 220k (red, red, yellow).

R28 through to R35, 47k (yellow, violet, orange).

R36 through to R51, 39 $\Omega$  (orange, white, black).

R13, 1k5 (brown, green, red).

The following resistors should be fitted at a height of 2mm above the PCB; a 5p coin is useful here as a spacer. These are:

R26 and R27, 220 $\Omega$  1/2W (red, red, brown).

R52, 390K 1W (orange, white, yellow).

R53 through to R56, 180 $\Omega$  1W (brown, grey, brown).

Fit the trimming or adjustment preset potentiometers RV1 through to RV4, all 100k.

### Capacitors

Fit the capacitors as follows:

C11, 2n2 ceramic, or you can choose optional high grade polystyrene types e.g. Maplin order code BR37S.

C12, 18nF polylayer MKM type.

C13, 47nF polylayer MKM type.

C14, 47 $\mu$ F electrolytic capacitor.

Pay attention to correct polarity!

C15 through to C18, 22nF 630V (may be marked as higher voltage).

Fit the 13 PCB-pins at the positions 'V1', '+V3', '-V', 'GND' (4 off), 'LS', 'IN' and 'TP1' through to 'TP4' (6 off).

Fit a six-pole screw terminal connector for 'J5', and a four-pole screw terminal connector for 'J4'.

Fit the valve socket for V5.

**ATTENTION:** when mounting the V5 socket, take care that all the pin connections and the central retaining pin are *fully inserted into the PCB*. Then solder the central pin *first* using sufficient solder to hold the socket in place.

### Fitting the four Octal Valve Sockets for V1 through to V4

In turn, align each valve socket with the legend on the PCB; note that there is a location notch on the central pin. Pass the valve socket (solder tag end) through the hole in the PCB from the *component* side, then temporarily fix it in place using M3 nuts and M3  $\times$  12mm screws (with the M3 nuts on the solder side).

Now connect the valve sockets solder terminals numbers 1, 3, 4, 5 and 8 to the corresponding solder pads on the PCB, using the pre-cut lengths of uninsulated wire supplied. Take care that the connection wires are not too tight and are bent at an angle of 90 degrees.

Refer to the sheet 'NOTE K4000' and fit the VDRs as shown.

### Connecting the 6-3V AC Heater Wiring

The 6-3V valve heater supply has to be connected to terminals 2 and 7 of all the valve sockets V1 through to V4. Make the

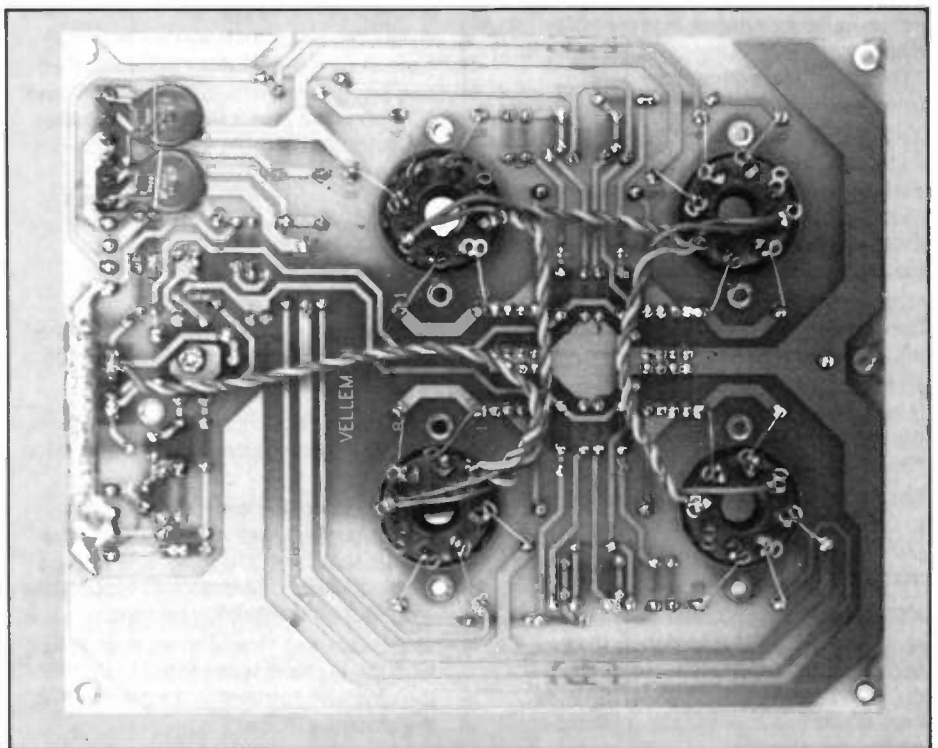

Underside of one of the main amplifier PCBs showing heater wiring.

connections, using the 3202 type (heavy gauge) Blue and Green insulated 2.5mm wire (*DO NOT USE WIRE THINNER THAN 1.5mm!*).

Follow these instructions carefully. The layout of the heater wiring has been designed to reduce hum by the application of differential cancellation in each parallel pair. The principle is that each wire is 3.15V AC in opposite phase to the other, and the pair balanced around earth potential. The wire pairs should be tightly twisted together. This ensures that the radiated emf from one is cancelled by that of the other, and is a long established practice in valve circuits.

Use the two heater connection solder tags of each valve socket to 'daisy chain' the heater wiring from one socket to the next in series. The 6.3V heater wiring is then branched off to the J4 connector, and soldered to the PCB at the terminals of 'f1' and 'f2' (legend on the component side). To be on the safe side, it is advisable to check with a multimeter that a short-circuit does not exist between the two 6.3V heater wires, although you will get a reading of 440Ω because of R26 and R27. It is these resistors which 'float' the heater pair about 0V.

Having now completed the heater wiring, you can then remove the temporary M3 fixing hardware from the valve sockets.

**CHECK THE COMPLETED PCBs AND WIRING THOROUGHLY FOR SOLDER WHISKERS, BRIDGES OR DRY OR UNSOLDERED JOINTS BEFORE MOUNTING INTO THE CHASSIS.**

## Assembly into the Chassis

Fit the rubber feet into the four corners of the bottom of the chassis using M3 × 10mm screws.

Fit the mains connector into the hole marked 'MAINS' using two countersunk M3 screws, and connect the earth link using the 3202 gauge, 10cm long Green/Yellow wire.

Fit the two 'INPUT' phono connectors to the back-panel. Use a multimeter to check that a connection does not exist between the phono sockets and the earthed case (otherwise earth-loop hum may result).

Fit the six loudspeaker terminals to the back-panel; the black terminals are allocated the '0' connection.

Fit the mains switch and the LED holder into the openings in the front panel. Glue the switch in place using the sachet of 'Double Bubble' epoxy.

The mains switch can then be wired to the IEC mains connector (two outer terminals), using the two-core, 6 amp mains cable.

**ATTENTION:** the terminals of the mains switch should *not* be soldered, instead, use the spade receptacles supplied with the kit! Prepare two lengths of the two-core mains cable with a pair of these at one end of each.

Slide the insulating boot over the cable,

and connect the mains input receptacles to the uppermost pair of contacts of the switch. Now fit the second piece of the 6 amp mains cable through the insulation boot, then connect this to the middle two contacts of the switch. Slide the insulating boot fully over the switch and secure in place using a cable tie.

Wire up the LED, using the Red and Black 'hook-up' wire (Red to the anode or longest lead). Twist the pair together and then insert the LED into the bezel. Finally, fix the LED in place using the pinch-ring.

## Fitting the Amplifier Modules

Fit all the PCB mounting hardware into the positions shown on the sheet 'NOTE K4000', as follows: after inserting the 12mm screws through the bottom panel, screw down the 8mm threaded spacers tightly onto the 12mm screws, followed by the 10mm threaded spacers.

Mount the two main amplifier modules onto the threaded spacers; the holes in the top cover plate will give you an idea of the PCB position. Fix these in place using 11 of the M3 × 6mm screws.

Fit the preamplifier module PCB onto the thread spacers at the back right-hand side of the chassis, nearest to the phono connectors.

### DO NOT FIT THE PSU PCB AT THIS STAGE OF CONSTRUCTION.

Make the following connections to the preamplifier module.

Connect the phono sockets to the inputs of the preamplifier marked 'IN' and 'GND', using a length of the 'high grade screened audio cable' (the preamplifier module is divided by a dotted line into the two Left and Right halves, take this into account when wiring the preamplifier to the main amplifiers and phono connectors).

Connect the preamplifier's outputs (Left and Right) to the inputs (marked 'IN' and 'GND') of the respective main amplifier modules, again using the 'high grade audio cable'.

## Fitting the Output Transformers

You now need to fit the ZD043 type output transformers to the right- and the left-hand sides of the back panel. To do so, proceed as follows:

Pass a fixing bolt through the back panel, then fit a rubber insulating disc over each bolt.

Turn the amplifier onto its back, with the rubber feet hard up against a wall or similar solid, vertical surface, and use a block of wood underneath to support the amplifier off the speaker terminals.

Then place each transformer over its bolt with the lead-out wires at the bottom of the case and pointing in the direction of the amplifier PCBs.

*Do not* fit the second neoprene disc and dished washer to the transformer at this

stage, as you will find it easier to wire up the speaker terminals first.

## Output Transformer Connections

Make the following connections.

Connect the thick Blue wire of the output transformer and a length of Orange bell wire (0.5m gauge) to the Red speaker terminal marked '8 ohm'.

Connect the thick Red wire and a length of White bell wire (0.5m) to the Black terminal marked '0'.

Connect the dual thick Yellow wires to the other Red terminal marked '4 ohm'.

The neoprene mat and the dished washer and nut can now be fitted and the transformer tightened down, but not too tight! Repeat the procedure for the other transformer.

The bell wires provide for negative feedback to each amplifier. The Orange bell wire which connects to the speaker terminal marked '8 ohm' (Blue wire of the output transformer) is now soldered to the pin marked 'LS' on the amplifier PCB.

The White bell wire connected to the speaker terminal marked '0' (Red wire of the output transformer) is soldered to the pin marked 'GND' (the pin next to 'LS') on the amplifier PCB.

Next, connect each of the thin (HT primary) wires from the output transformer to the corresponding positions on the amplifier PCB, i.e., connect the thin Orange wire to the 'J5' terminal marked 'ORANGE' and so on.

Repeat the above process for the other output transformer.

**CHECK THE WIRING THOROUGHLY ONCE MORE, BECAUSE AFTER THE NEXT STAGE IT WILL NO LONGER BE ACCESSIBLE TO CORRECT ANY MISTAKES.**

## Fitting the Mains Transformer

*The mains transformer has a 220V tap that must be insulated using heatshrink sleeving.*

Now the mains transformer, 8D002, can be fitted to the back panel in a similar fashion as were the output transformers.

Make the following connections.

Connect both the Green and the Violet thick wires of the power supply transformer to terminals 'J4', marked '6.3VAC', of the left amplifier PCB.

Connect both the Blue and the Grey thick wires to the terminals 'J4' marked '6.3VAC', of the right amplifier PCB. Also connect the terminals 'f1' and 'f2' of the right amplifier module to the corresponding solder pins 'f1' and 'f2' of the preamplifier module, using the 3202 gauge Blue and Green wires, twisting them together in the process. This is the heater supply for the preamplifier stages.

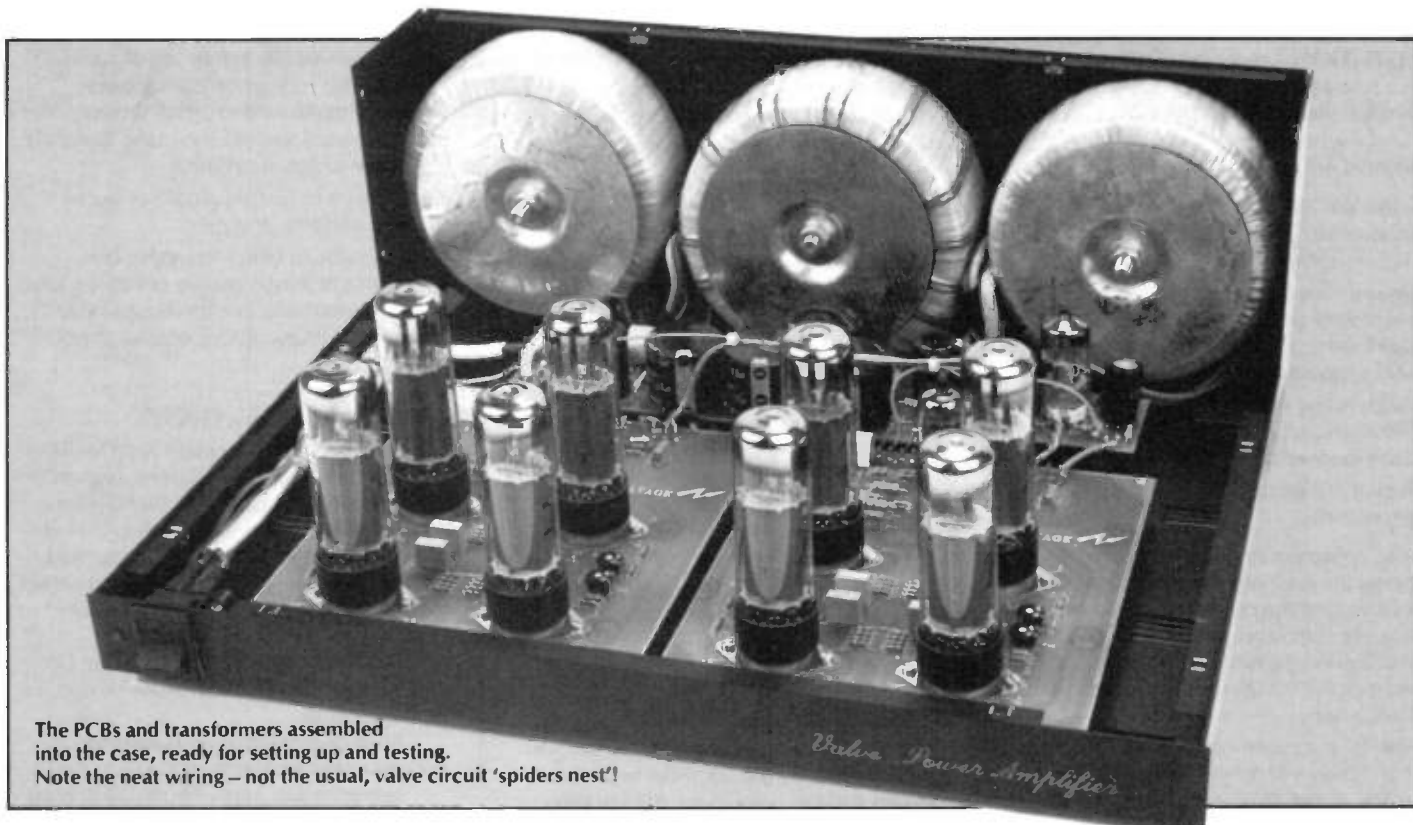

The PCBs and transformers assembled into the case, ready for setting up and testing. Note the neat wiring – not the usual, valve circuit ‘spiders nest’!

**ATTENTION:** secure the wiring of the transformers to the bottom of the case, making *sure* that the wiring cannot come in contact with the ‘power supply PCB’. Use the cable ties provided.

**IMPORTANT:** the lead out wires of the right output transformer should pass under the *power supply* module, and *not* under the preamplifier module.

## Fitting the Power Supply Module

The power supply module can now be fitted onto its threaded spacers and fixed in place using five M3 × 6mm screws. Make the following connections.

Connect the Brown and Orange wires of the power supply transformer to the terminals marked ‘PINK’ on the power supply PCB. Also connect the Yellow and Red wires of the mains transformer to the terminals marked ‘YELLOW’ and ‘RED’ respectively.

Connect the previously wired mains switch (middle terminals) cable pair to the terminals marked ‘MAINS’ on the power supply PCB, and fit a thick wire link between the terminals ‘SW1’ of the power supply module.

Connect the mains voltage indicator LED wire pair to the terminal marked ‘LD’ of the power supply PCB. The Red wire from the LED is connected to the terminal marked ‘A’, and the Black wire is connected to terminal ‘C’.

## Initial Testing

Now it is time to check the supply voltages.

**CAUTION:**  
MANY TERMINALS AND TRACKS ON THE PCBs CARRY MORE THAN 400 VOLTS! PLEASE BE VERY CAREFUL.

Insert into the fuse holder F1 the ‘T’ or Time-lag type (anti-surge) 5 or 6A fuse provided, but *do not* fit F2 or F3 with

a fuse!

Connect the mains lead to the amplifier and plug into a 13A power socket. Turn the amplifier’s mains switch on and check the LED has illuminated.

Now check the following voltages using a multimeter set to the 10 or 20V AC range: A voltage reading of 6.3VAC should be across the terminals marked ‘6.3VAC’ of each amplifier PCB.

The same voltage reading should also be present between terminals 2 and 7 of sockets V1 through to V4, and terminals 5 and 9 for V5 and V6.

Reset your multimeter to read 500V DC (or more). Approximately +430V DC should be present between ‘GND’ and one of the terminals of the fuse holders ‘F2’ and ‘F3’ on the power supply PCB. There should also be a reading of approximately –50V at the ‘–V’ pins. Be careful to observe the correct polarity when using an analogue meter.

**NOW TURN THE AMPLIFIER OFF AND DISCONNECT THE MAINS LEAD FROM THE POWER SOCKET.**

If all the expected voltages are present, the remaining connections can be made, but:

**WAIT A COUPLE OF MINUTES UNTIL THE ELECTROLYTIC CAPACITORS DISCHARGE THE DANGEROUS HIGH VOLTAGE IN THE POWER SUPPLY.**

Re-measure the above mentioned high voltage points again.

Connect the points marked ‘+V’, ‘+V3’, ‘–V’ and ‘GND’ of each amplifier PCB with the corresponding points on the power supply PCB, using the uninsulated wire supplied with the kit. The ‘GND’ connection must be made using a piece of the 18 swg tinned copper wire.

Connect the ‘V3’ pins of the preamplifier (observing the left and right channels) to the ‘V3’ pins of the amplifier modules using the RED bell wire (0.5m).

## Testing and Adjustments

### A: Right Channel

**ALL OF THE FOLLOWING VOLTAGES ARE TO BE MEASURED AGAINST GROUND (MARKED ‘GND’ ON THE PCB).**

Fit the fuse holder ‘F3’ with a ‘T’ or Time-lag type 1A fuse. Short-circuit the preamplifier inputs using shorting links. Fit the V6 valve socket (preamplifier) with an ECC82 (may also be marked 12AU7, CV491, CV4003) type valve. Fit valve socket V5 with an ECC83 (or 12AX7, CV492, CV4004) type valve. Ensure correct valve orientation! (You may have to push firmly.)

Re-connect the mains lead and, after switching on the power, check the following voltages:

+430V DC at pin ‘+V1’.

+350V DC at pin ‘+V3’.

–50V DC at ‘–V’ (pay attention to the polarity when using an analogue meter).

+430V DC at pin 3 of each valve socket V1 through to V4.

**SWITCH OFF THE AMPLIFIER AND REMOVE THE MAINS LEAD.**

Turn all the trimming potentiometers RV1 through to RV4 fully anti-clockwise (to the left). Insert four EL34s (or 6CA7, CV1741) type valves into their sockets (pay attention to the position of the valve holder notch!).

**IMPORTANT:** connect an 8Ω 5W resistor between the output terminals (0 and 8Ω), since the output of a valve amplifier must always be terminated!

## Quiescent Current Adjustment

Re-connect the mains supply and switch on the amplifier. Wait a couple of minutes for the valves to become warm.

**ATTENTION:** the following voltages serve as a reference for the quiescent current through the power output valves. *Be very careful* when adjusting RV1-RV4, and observe the adjusting sequence.

Select the 2V DC range on your multimeter, preferably fitted with probe clips (e.g. Maplin order code HF21X).

Measure the voltage at test point 'TP3', and slowly turn the preset RV3 clockwise (right) using a preset tool (e.g. BR49D) until a reading of 0.2V is obtained.

Measure the voltage at test point 'TP1', and also carefully adjust to 0.2V in the same manner using RV1.

Repeat this procedure for 'TP4' and 'TP2' respectively.

Wait approximately 10 minutes and then repeat the previous procedure, this time re-adjusting the presets (in the same sequence) for a reading of 0.4V instead of 0.2V. Wait a further 10 minutes, then recheck the voltage readings, re-adjust if necessary.

At 0.4V the current of each valve equals  $0.4/(39/4) = 41\text{mA}$ . This is sufficient to supply about 15W in class A.

**TURN THE AMPLIFIER OFF AND WAIT A COUPLE OF MINUTES UNTIL THE ELECTROLYTIC CAPACITORS DISCHARGE THE DANGEROUS HIGH VOLTAGE IN THE POWER SUPPLY.**

Check it is safe by measuring these high voltage points again, and if so connect an  $8\Omega$  5W resistor between the output terminals (0 and  $8\Omega$ ) of the left channel. Now fit fuse holder F2 with a 1A fuse and

repeat the quiescent current adjustment procedure for the left channel.

It would also be a good idea to recheck the readings after a week's use.

Once the set-up procedure has been completed, the amplifier can be turned off. The shorting links (at the inputs) and the  $8\Omega$  resistors can now be removed.

Before fitting the covers, check both the power supply and the amplifier modules for components that are mounted too high and might foul the top covers.

The amplifier chassis can now be completed. First fit the chrome cover around the power supply and the transformers (use the black anodised countersunk screws), followed by the black transformer top cover plate (also using the black countersunk screws). After that, the chromed cover for the amplifier modules can be fitted using the remaining screws (not anodised).

## Using the Amplifier

If everything has gone to plan so far, you can now install the amplifier into your stereo system. If you have  $8\Omega$  speakers then use the  $8\Omega$  speaker terminals.  $4\Omega$  speakers (or less) should be connected to the  $4\Omega$  speaker terminals; if your speakers are between 4 and  $8\Omega$ , try both taps for whichever sounds best.

**NEVER DISCONNECT THE SPEAKERS WHILE THE AMPLIFIER IS TURNED ON AND NEVER CONNECT LOUDSPEAKERS TO BOTH THE 8 AND  $4\Omega$  OUTPUTS AT THE SAME TIME.**

It is normal that the valves and the chassis will become very warm during use. Therefore make sure to install the amplifier in a well ventilated position, and certainly *not* inside a closed cabinet!

Also be sure to site the amplifier out of reach of children and pets!

It is advisable to check the valve bias conditions at least a couple of times a year during normal use, but for those of you who live on music, more regular checks are required.

## Valve Replacement

The expected life of an EL34 is up to 5000 hours under normal conditions, and an ECC82/3 should last up to 10,000 hours, but the performance of the valves do fall off well before these figures are reached. As a general rule, replace the output valves every 1000 hours and the intermediate valves every 2 to 3 thousand hours.

When the output valves are due to be replaced, good quality types should be sought after.

New output valves will require re-biasing as explained above.

We wish you many hours of listening pleasure!

The Velleman K4000 Valve Amplifier Kit is available from Maplin Electronics, through our chain of regional shops, or by mail order.

**Order Code VE99H Price £499.95** 

The Maplin 'Get-You-Working' Service is available for this project, see Constructors' Guide or current Maplin Catalogue for details.

## Infra-red Video Link continued from page 39.

perseverance may be required when optically aligning the system. It is recommended that the system is initially aligned at short-range in order to make sure that both the transmitter and receiver are operating correctly. A DC voltage relating to the signal strength is available between P3 (output) and P4 (0V); this output is designed to be used for optical alignment purposes only, and is not calibrated in any way. The output on P3 has a relatively high impedance, and so any measurements should be made with a multimeter (of sensitivity of at least  $20000\Omega/V$ ).

## Mounting Considerations

As with the transmitter, it is necessary to provide a secure mounting point for the finished receiver unit. This may be achieved in a variety of ways; one method, used for the prototype, makes use of small speaker stands (stock code GL18U), which are supplied in pairs with a selection of different types of bracket. These stands are particularly useful as they allow the bracket to be moved freely for alignment purposes, and a clamp holds them securely in place when alignment is complete. There are obviously many different methods of mounting the transmitter and receiver units, and the most suitable method must be chosen to suit each individual situation.

If used outdoors, it is important that both the receiver and transmitter are suitably waterproof. Silicone rubber sealant (stock code YJ91Y) is useful for this

purpose. It is essential to make sure that water does not enter the unit, as this may cause irreversible damage.

## Applications

The system should provide reasonable performance if the guidelines mentioned are adhered to. The quality of picture is obviously not as good as that from a TV receiver, or a direct connection to a video monitor, due to the reduced bandwidth. However, it is sufficient for general-purpose surveillance applications where fine detail is less important. It is particularly important that the transmitter and receiver are fixed securely in place, and are aligned in such a way that there is a clear line-of-sight path between the two units. It is essential to position the link so that the transmitter and receiver lenses are kept out of direct sunlight; the lenses can produce a very high temperature at the focal length in direct sunlight, and this may damage the unit. The area of the PCB around the focal length has been deliberately kept clear of high-profile components so that any damage is minimised. Nevertheless, direct sunlight focused into the unit can damage the receiver diode and surrounding components. In some cases, it may be found useful to fit a hood over the transmitter and receiver cases so that the lenses are shielded from sunlight. With regard to the infra-red link itself, it should be remembered that objects blocking the line of sight will prevent the system from operating.

The ambient environment (especially the light level) dictates the maximum range of the infra-red link. Under typical environmental conditions, a range of up to 100m may be expected from the link; however, if the optical path is attenuated (for example, by fog or heavy rain), reduced range can be expected.

There are many varied applications for the Infra-red Video Link, and it is outside the scope of this article to discuss all of these. However, a few ideas are included, which illustrate the versatility of the unit and also its limitations.

The system finds a wide variety of applications in the area of security, where it may be used to link a security camera to a video monitor. This is particularly useful between two buildings on the same premises. In this case, the infra-red link obviates the need for long external cable runs. Clearly, the system is only practical where the buildings are close enough together, and where there is a direct line-of-sight path between the transmitter and receiver. A similar arrangement inside a building will allow video information to be transmitted along corridors, for example.

Experienced constructors may wish to experiment with different modes of transmission. In addition to video transmission, it may also be possible (with the use of additional circuitry) to transmit other formats, such as digital information or speech. Possibly the simplest method of achieving this is to apply a carrier to the



input of the transmitter, which is frequency modulated with the data to be transmitted. At the receiver end, the original data can be retrieved by demodulating the carrier. The use of Frequency Modulation (FM) reduces the possibility of signal degradation by interference from external sources. When using the link for purposes other than video transmission, the user may wish to bypass the video processing part of the circuit, as this may produce unwanted distortion. Access to the unprocessed

signal is provided by P1 in the receiver. An input signal can be fed directly to the output stage of the transmitter via P3 (in this case link LK1 is not fitted on the transmitter PCB). Experimenters must ensure that any external apparatus connected to either the receiver or the transmitter in this way does not exceed the maximum ratings for any of the components in the circuit. In particular, signals applied to P3 of the transmitter should not be allowed to swing below 0V, and should

be limited to a maximum amplitude of +5V.

If this system is used in an environment lit by mains lighting, you may find that its 50Hz frequency modulates the beam. To reduce this problem, it is recommended that the receiver is pointed away from artificial light sources if possible. The effect of the modulation is usually only noticeable when the received signal is weak, and should not be a problem over short distances.

## INFRA-RED VIDEO LINK RECEIVER PARTS LIST

### RESISTORS: All 0.6W 1% Metal film (Unless specified)

R1	47k	1	(M47K)
R2,7,19,24,26,32	100k	6	(M100K)
R3,29,30	22k	3	(M22K)
R4,9,11,13,15,23,27,34,46	1k	9	(M1K)
R5,21	3k3	2	(M3K3)
R6,10	4k7	2	(M4K7)
R8	470k	1	(M470K)
R12	220k	1	(M220K)
R14,42	470Ω	2	(M470R)
R16,41	330Ω	2	(M330R)
R17,39	270Ω	2	(M270R)
R18	33k	1	(M33K)
R20,45	2k2	2	(M2K2)
R22	100Ω	1	(M100R)
R25,35	6k8	2	(M6K8)
R28	68k	1	(M68K)
R31	680k	1	(M680K)
R33	3k9	1	(M3K9)
R36	1k5	1	(M1K5)
R37,47,48	560Ω	3	(M560R)
R38	390k	1	(M390K)
R40	15k	1	(M15K)
R43	680Ω	1	(M680R)
R44	18k	1	(M18K)
RV1	Hor Encl Preset 2k2	1	(UH01B)
RV2	Hor Encl Preset 100Ω	1	(UF97F)
RV3,6	Hor Encl Preset 100k	2	(UH06G)
RV4	Hor Encl Preset 10k	1	(UH03D)
RV5	Hor Encl Preset 470Ω	1	(UF99H)

### CAPACITORS

C1	2200μF 16V PC Elect	1	(FF60Q)
C2	270pF Ceramic	1	(WX61R)
C3,8,31,32	1μF 63V Minelect	4	(YY31J)
C4,9,42,43	100μF 10V Minelect	4	(RK50E)
C5,6,11,17	100nF 16V Minidisc	4	(YR75S)
C7,13,16,19,25,33	150pF Ceramic	6	(WX58N)
C10,37	10nF Ceramic	2	(WX77J)
C12,14,15,20,23,35,36	10μF 16V Minelect	7	(YY34M)
C18	470μF 16V PC Elect	1	(FF15R)
C21,27,34	47pF Ceramic	3	(WX52G)
C22,24,26,39	220nF Polylayer	4	(WW45Y)
C28,41	470pF Ceramic	2	(WX64U)
C29,30	22nF Ceramic	2	(WX78K)
C38	1nF Ceramic	1	(WX68Y)
C40	100μF 16V Minelect	1	(RA55K)

### SEMICONDUCTORS

RG1	μA7805UC	1	(QL31J)
IC1,2	74HCU04	2	(UB04E)
TR1,4	2N7000	2	(UF89W)
TR2	BC212L	1	(QB60Q)
TR3,5,6,7,8	BC182L	5	(QB55K)
D1	1N4001	1	(QL73Q)
D2,3,4,5,6,7,8	1N4148	7	(QL80B)
PD1	Infra-red Photodiode	1	(YH71N)

### MISCELLANEOUS

SK1	PCB 2.5mm DC Pwr Skt	1	(FK06G)
SK2	BNC Square Socket	1	(YW00A)
	Fresnel Lens (Large)	1	(KW60Q)
	I/R Video Case	1	(GL48C)
	Bracket	1	(KW65V)
	PCB	1	(GH02C)
P1 to P10	Pin 2145	1 Pkt	(FL24B)
	DIL Socket 14 pin	2	(BL18U)
	Pozi Screw M3 × 16mm	1 Pkt	(JC70M)
	M3 × 12mm Steel Screw	1 Pkt	(JY23A)
	Steel Nut M3	1 Pkt	(JD61R)
	M2.5 × 12mm Steel Screw	1 Pkt	(JY31J)
	Steel Nut M2.5	1 Pkt	(JD62S)
	M3 Spacer × 1/4in.	1 Pkt	(FG33L)
	Miniature Coax	1m	(XR88V)
	Double Bubble Sachet	1	(FL45Y)
	TC Wire 1.6mm 16swg	1 Reel	(BL11M)
	Wire 16/0.2mm 10m Blk	1 Pkt	(FA26D)
	Isotag M3	1 Pkt	(LR64U)
	Filter Green	1	(FR33L)
	Instruction Leaflet	1	(XT45Y)
	Constructors' Guide	1	(XH79L)

The Maplin 'Get-You-Working' Service is available for this project. see Constructors' Guide or current Maplin Catalogue for details.

**The above items are available as a kit, which offers a saving over buying the parts separately.**

**Order As LP99H (I/R Video Link Rx) Price £39.95.**

Please Note: where 'package' quantities are stated in the Parts List (e.g. packet, strip, reel etc.), the exact quantity required to build the project will be supplied in the kit.

The following new items (which are included in the kit) are also available separately, but are not shown in the 1992 Maplin Catalogue.

**Video Link Rx PCB Order As GH02C Price £4.25.**

**I/R Video Case Order As GL48C Price £14.95.**

**Fresnel Lens (Large) Order As KW60Q Price £9.95.**

**Bracket Order As KW65V Price £2.45.**

# Design and Application of SEQUENTIAL LOGIC

PART FOUR

by Graham Dixey  
C.Eng., M.I.E.E.

There is a technique that makes it possible to design a counter to any base or to follow any desired sequence. It is based upon the use of logic that forces changes of state to occur at the appropriate times. In simple cases it is possible to deduce the required logic by examining the sequence for the particular counter design. Otherwise, such methods become a matter of intuition or even a form of 'suck it and see' design. A formal method, applicable in any case, removes the guesswork completely. This method is known as the 'mapping method', since it is based upon the application of the Karnaugh map, which is employed to simplify logical expressions that have been extracted from the data that specified the required design. Such a method is easy to implement, no matter how obscure the counter sequence required, and only asks for a systematic approach in the first instance, plus a proper understanding of how to minimise logical expressions using the Karnaugh map.

## State Diagrams

It is necessary at the outset to state fully the requirements for the design, so that it is clear just what it is that we are trying to achieve. Pictures speak louder than words, so they say, therefore there is some value in using diagrams as well as the written word in a specification. The type of diagram that helps us in this context is known as a 'state diagram', two simple examples being shown in Figure 1.

Figure 1(a) shows the state diagram for a 'divide-by-three up counter with reset' while the diagram of Figure 1(b) shows a 'divide-by-three up/down counter'. It will be noticed that this type of diagram consists of a number of circles joined by 'arrowed flow lines'. Each of the circles represents a state of the counter, a symbol for that state appearing inside the circle. Thus, in both of the cases shown, the

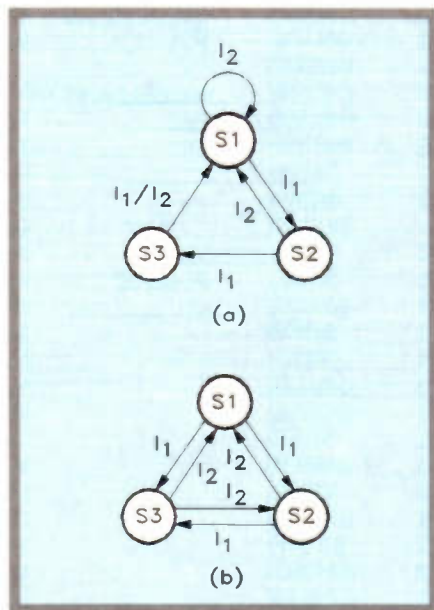

Figure 1. State diagrams for (a), a divide-by-three up counter with reset and (b), a divide-by-three up/down counter.

symbols are S1, S2 and S3, these being the first, second and third states of the counter. Thus:

S1 = 00; S2 = 01 and S3 = 10.

Taking the Figure 1(a) first, it should be noted that a flow line marked with the symbol I<sub>1</sub> runs from S1 to S2, then to S3 and, finally back to S1. This symbol I<sub>1</sub> means 'input condition number one' and, in this example, corresponds to the normal up-counting direction of the counter. In other words, it shows that when input condition one is selected, the counter starts at state S1 (00), then goes to S2 (01), then to S3 (10), before returning to initial state S1 in order to repeat the same sequence.

Now to take the other symbol I<sub>2</sub>. It follows logically that this means 'input condition number two' which, in the case

of this counter, occurs when a reset is applied. The flow lines marked with the symbol for this condition, namely I<sub>2</sub>, show what the counter does when the reset is applied. If the counter is in the state S2, it returns to state S1; it does the same thing, of course, if it is in the final state, S3. What it does if it is in state S1 already, is shown by the flow line that 'loops back' upon itself at the S1 symbol; this indicates that it remains in the state S1.

It will be noticed that the flow line between states S3 and S1 is marked with both symbols, I<sub>1</sub>/I<sub>2</sub>, because this particular flow line is applicable for both input conditions. Whether counting normally or resetting, the state changes from S3 back to S1. Rather than draw two separate flow lines, each with its own symbol, we economise and share a common flow line. This situation is not unusual.

If the above has been understood, there should now be no difficulty in deciphering the state diagram of Figure 1(b). This simply has two sets of flow lines, one clockwise set marked I<sub>1</sub> for UP counting, the other set, going anti-clockwise, marked I<sub>2</sub>, for DOWN counting.

## State Allocations and Input Conditions

In the early stages of the counter design, it is necessary to list the states that will exist in the counter sequence. These can then be given the appropriate symbols and will also allow us to determine the number of flip-flops required. These are usually listed in a state allocation table. In this allocation table we must also assign reference letters to each of the flip-flop Q outputs. Following this we must describe the input conditions. Thus, the first stage of the design of the 'divide-by-three resettable counter' (as described by the state diagram of Figure 1(a)) might appear as follows:

- (i) There are TWO flip-flops.
- (ii) Let their Q outputs be A (LSB) and B (MSB) respectively.
- (iii) Assign the states:

State	Q outputs	
	B	A
S1	0	0
S2	0	1
S3	1	0

- (iv) Let the control input be Z, such that:
  - (a) Z = 0 for input condition I<sub>1</sub> (normal UP counting).
  - (b) Z = 1 for input condition I<sub>2</sub> (resetting).

This can be summed up in a 'state table' as shown in Figure 2. This is only a preliminary table, just to emphasise the basic idea of a state table. A more comprehensive table will be developed later.

What does this tell us? To make it clearer what the state table means, a blank line has been included through the

Present state		Control input Z	Next state		Comments
B	A		B	A	
0	0	0	0	1	} Normal UP counting
0	1	0	1	0	
1	0	0	0	0	
0	0	1	0	0	} Resetting
0	1	1	0	0	
1	0	1	0	0	

Figure 2. Initial state table for 'divide-by-three counter with reset'.

middle of the table. This emphasises that the first three lines of the table (for  $Z = 0$ ) refer to the normal UP counting sequence. What is particularly important is the inclusion of two columnar divisions, headed PRESENT and NEXT states. Reading horizontally between these headings, we learn what the following state should be for the value of Z chosen.

For example, for the three lines where  $Z = 0$ , we see that the next state after  $BA = 00$  is  $BA = 01$ ; the next state after  $BA = 01$  is  $BA = 10$  and the next state after  $BA = 10$  is  $BA = 00$ . This describes the sequence of the UP counter exactly.

The other three lines, where  $Z = 1$  shows us that, whatever the initial state of BA, the next state of BA will always be 00, i.e. reset as required by the design.

What is important about the above type of table is that it is all about *changes* that have to be brought about when going from one counter state to the next. It is possible to see from the table just which Q outputs should change (and in which way) when these counter state changes occur. The design of the logic is wholly concerned with making these changes take place, at the correct points in the sequence, by controlling the logic levels at the J and K inputs of the flip-flops. For this reason, this type of counter design can only be implemented with JK-type flip-flops and not with D-types. That shouldn't really be too much of a constraint. What we must be clear about though, is how the logic levels at the J and K inputs of the flip-flops affect what happens when the flip-flop is clocked. A further feature of these counters is that they will always be synchronous types. This means that all flip-flops in the counter will be clocked simultaneously from a common clock source; the logic that we design will then determine which flip-flops change and which do not. It is now necessary to examine the mechanism of JK flip-flop control inputs in a little more detail.

## The Excitation Table for the JK Flip-Flop

It is possible to define the functions of the J and K inputs by means of a table that shows any changes in the Q output after the flip-flop has been clocked. There are

Present state ( $Q_n$ )	Next state ( $Q_{n+1}$ )	Control Required	
		J	K
0	0	0	X
0	1	1	X
1	0	X	1
1	1	X	0

Figure 3. The excitation table for the JK flip-flop.

four possible combinations of logic levels that can be applied to these two inputs. Therefore, the excitation table so produced will have four lines, one for each combination. The table can also include 'don't cares' (denoted by an X), which are valid when the same effect would be achieved whatever the logic level at either of the inputs. This excitation table is shown in Figure 3 and can be explained as follows.

The first column is headed 'present state' (denoted by  $Q_n$ ) and is the state of the Q output immediately before the application of a clock pulse. There are only two possible values for this state, logic 0 and logic 1. We use this state twice to give the four lines of the table. The second column, headed 'next state' ( $Q_{n+1}$ ), is for the logic level that Q will go to (if it changes) after the clock pulse has been applied. The final two columns, headed jointly 'control required' list the logic levels that, applied to the J and K inputs, would cause the action described in the first two columns; some don't cares will be found in these last two columns. Taking each line in turn, the table can be interpreted as follows:

In the first line, we assume that Q is initially logic 0 and remains at logic 0 after clocking. This would be achieved

for either of the two sets of values of J and K given:

i.e.  
either  $J = 0$  and  $K = 0$  or  $J = 0$  and  $K = 1$ .  
The value of K obviously doesn't matter and is, therefore, a 'don't care'.

In the second line, it is assumed that, once again, the initial value of Q is logic 0 but this time clocking the flip-flop causes Q to change to logic 1. Again there are two cases for J and K for which this is true:

Either  $J = 1$  and  $K = 0$  or  $J = 1$  and  $K = 1$ .  
Again the value of K doesn't matter and becomes a 'don't care'.

In the third line, we now assume that the initial value of Q is logic 1 and that the clock causes it to change to logic 0. The two combinations of J and K that would allow this are:

Either  $J = 0$  and  $K = 1$  or  $J = 1$  and  $K = 1$ .  
In this case the value of J is the 'don't care' condition.

Finally, in the fourth line, it is assumed that, when the value of Q is initially logic 1, clocking causes no change in its value. The two combinations for this condition are:

Either  $J = 0$  and  $K = 0$  or  $J = 1$  and  $K = 0$ .  
Again the value of J gives the 'don't care' condition.

The first two columns define the four possible 'transitions' that a Q output is capable of making, while the columns headed J and K state what logic levels must be applied to J and K in order to obtain those transitions. Figure 4 is a summary of the excitation table, which will be found useful as a reference when carrying out a counter design.

## The Full State Table

The simplified state table given previously showed what changes in the Q outputs needed to occur to give the desired action, according to the value of the control input Z. The excitation table of Figure 3 tells us what logic levels must be applied to the J and K inputs, at any given instant of time in order to produce the changes.

For example, the first line of the state table, repeated here:

Present state		Control input Z	Next stage	
B	A		B	A
0	0	0	0	1

The 0-to-0 transition requires that  $J = 0$  and  $K = X$

The 0-to-1 transition requires that  $J = 1$  and  $K = X$

The 1-to-0 transition requires that  $J = X$  and  $K = 1$

The 1-to-1 transition requires that  $J = X$  and  $K = 0$

Figure 4. Summary of the excitation table of Figure 2.

tells us that:

Flip-flop B must make a 0-to-0 transition, in which case  $J = 0$  and  $K = X$ , while flip-flop A must make a 0-to-1 transition, when  $J = 1$  and  $K = X$ .

This type of statement can also be made about all the other lines of the state table so that, eventually, we should know exactly what logic levels should be at present at the J and K terminals of each flip-flop in order to obtain all the right transitions at the Q outputs. A logical way of providing this information is to extend the state table sideways to the right, into what may be called a 'switching table', by adding on columns for the J and K inputs of each flip-flop. Having done that we shall be in a position to go onto the next step, where we shall make use of all this carefully plotted data.

The full state table for the 'divide-by-three counter with reset' is shown in Figure 5.

We now have four extra columns, one for each J and K input for each of the two flip-flops to be used in this design. Each of these columns tells us exactly what the level should be at that input at that point in the sequence. What we have to do now is design logic circuits, using gates, that will automatically produce each of these columns as counting proceeds. To do this we consider each input (J or K) in turn, each as a totally separate exercise, and design the driving logic for it. This is where the Karnaugh map comes in. But before we actually do any mapping, there is another peculiarity that may have been noticed in the state table that needs explaining.

## Making Use of Redundant States

When a counter is designed for a length less than the maximum possible, a number of redundant states appear. In the case of the counter being considered here, there are only three states: 00, 01 and 10. However, using two flip-flops it is possible to have a maximum of four states, the fourth state being 11. This latter state is the redundant state in this case. Other counter designs will introduce a much greater number of redundant states. For example, a decade counter (10 states) would need to use four flip-flops, which allow up to 16 states to be obtained; in such a case, there are no less than six redundant states.

What are the values of these? More than might be supposed! Because the redundant states can never exist in the final counter design, the J and K control inputs for them are of no interest. In other words, we *don't care* what values they take up! Therefore, we can list all of the redundant states in the state table, and fill the J and K columns within them with 'Xs'. Those well versed in the use of Karnaugh maps will appreciate that the more squares that can be filled with '1s', the simpler the final expression will be. And this means that the hardware, namely the

Present state		Control	Next state		Flip-flop controls			
B	A		B	A	J <sub>B</sub>	K <sub>B</sub>	J <sub>A</sub>	K <sub>A</sub>
0	0	0	0	1	0	X	1	X
0	1	0	1	0	1	X	X	1
1	0	0	0	0	X	1	0	X
1	1	0	X	X	X	X	X	X
0	0	1	0	0	0	X	0	X
0	1	1	0	0	0	X	X	1
1	0	1	0	0	X	1	0	X
1	1	1	X	X	X	X	X	X

Figure 5. The full state table for the 'divide-by-three' resettable up-counter.

logic gate circuit, will also be simpler. By including the 'Xs' of the redundant states in the mapping operation, we can let them stand for '1s' if it helps us to obtain a simpler result. It sounds as if it is a bit of a fiddle, but is quite valid as a technique and makes life a lot easier.

The above explains why the J and K columns, in the table of Figure 5, have been filled with 'Xs' for those lines corresponding to the redundant state 11. This is true for both values of Z.

## The Karnaugh Maps

Now that the state table is complete, enough data is available to fill in the Karnaugh maps. There will be one of these for each J and K input. Thus, there will be four Karnaugh maps since there are two flip-flops.

These Karnaugh maps are shown in Figure 6, from which it will be seen that extensive use has been made of the 'don't cares'. This technique has been especially useful in the case of the K inputs for both flip-flops, allowing us to fill in all eight squares of the map. This gives a minimisation of '1'. Thus, the K inputs

require no driving logic as such, but will be permanently connected to logic 1. The minimisation for the J inputs also makes use of don't cares, leaving a two-variable expression in each case.

## Implementing the Design

Each of the expressions derived from the Karnaugh maps needs to be implemented by the choice of suitable gating. As we have seen, the K inputs need no gating but the J inputs require simple gate combinations to drive them. Taking each in turn:

The input J<sub>A</sub> needs the term  $J_A = \bar{B}\bar{Z}$ , that is the AND of  $\bar{B}$  and  $\bar{Z}$ , each of these variables being first inverted. The input J<sub>B</sub> needs the term  $J_B = A\bar{Z}$ , that is the AND of A and  $\bar{Z}$ , only Z being inverted first. It is usually considered good practice, indeed it is often more economical on chip types, to implement all of the driving logic with a single logic type, such as NAND logic. In a simple case such as this, no real advantage is gained, since in both cases two gate packages would be required. Thus, in this example, direct

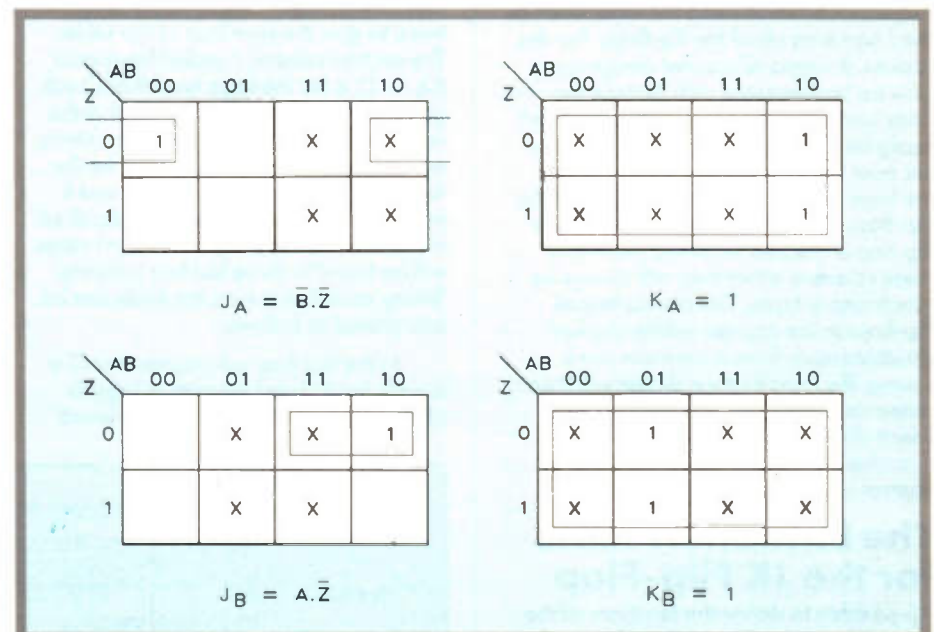

Figure 6. The Karnaugh maps and minimised expressions obtained from the state table of Figure 5.

implementation using INVERTER plus AND packages will be used. The required driving logic is shown in Figure 7, while Figure 8 shows the complete counter design.

## A Second Example – 'Divide-by-Eight Up/Down' Counter

In spite of the simplicity of the counter design in Figure 7, all of the salient points for the design of any synchronous counter have now been covered. To emphasise the technique, we shall now consider a slightly more complex counter, one which is able to reverse its direction of counting

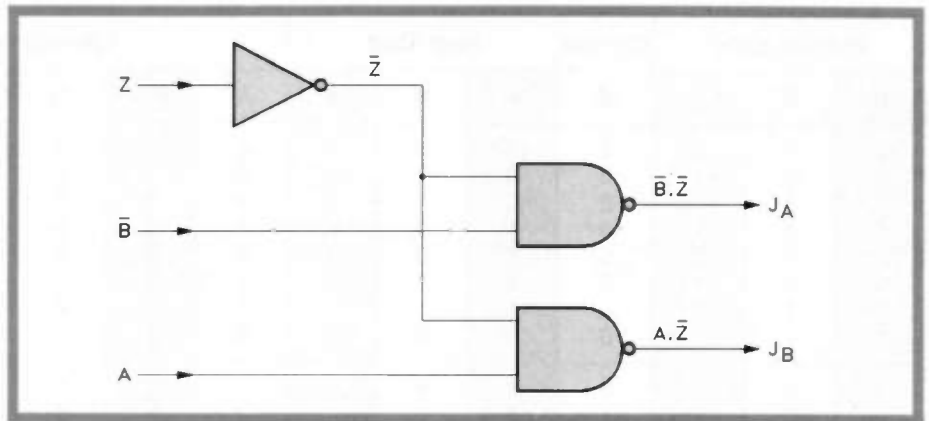

Figure 7. The driving logic for the J inputs of the divide-by-three counter.

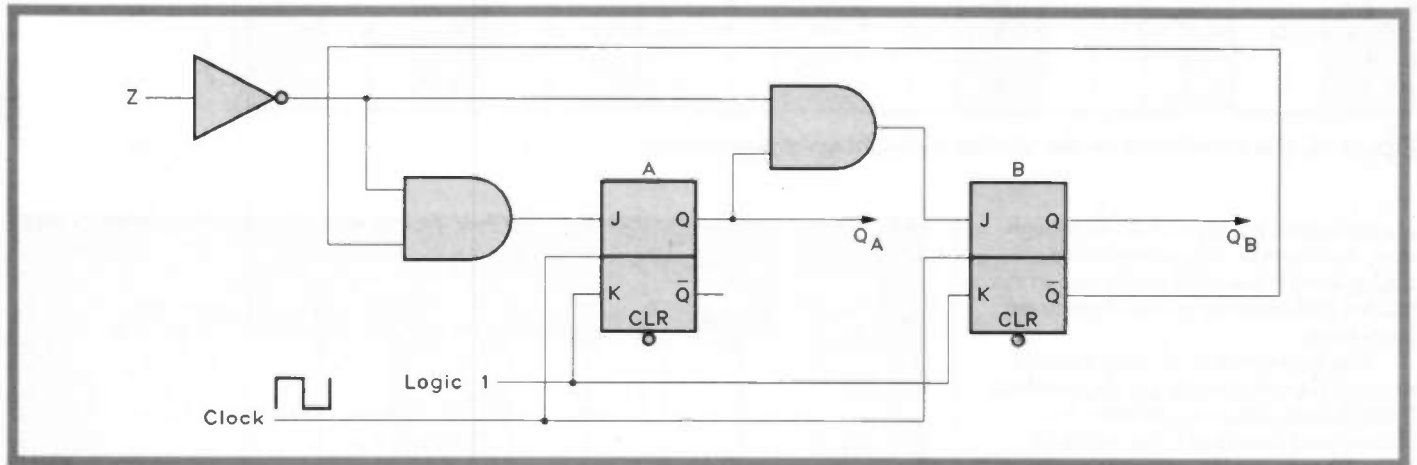

Figure 8. The complete circuit for the 'divide-by-three counter with reset'.

at the flick of a switch. As before, we start by drawing its state diagram (Figure 9).

This figure shows two sets of flow lines, those in the clockwise direction indicating the normal UP sequence, and those in the anti-clockwise direction indicating the reverse DOWN sequence. Once the states S1–S8 have been defined, the NEXT states for the state table will be obvious.

We must now define the basic parameters for the counter, as follows:

- (i) There are *three* flip-flops (since there are *eight* states).
- (ii) Let their Q outputs be A (LSB), B and C (MSB) respectively.
- (iii) Assign the states:

State	Q outputs		
	C	B	A
S1	0	0	0
S2	0	0	1
S3	0	1	0
S4	0	1	1
S5	1	0	0
S6	1	0	1
S7	1	1	0
S8	1	1	1

- (iv) Let the control input be Z, such that:
  - (a)  $Z = 0$  for input condition  $I_1$  (normal UP counting)
  - (b)  $Z = 1$  for input condition  $I_2$  (reverse DOWN counting).

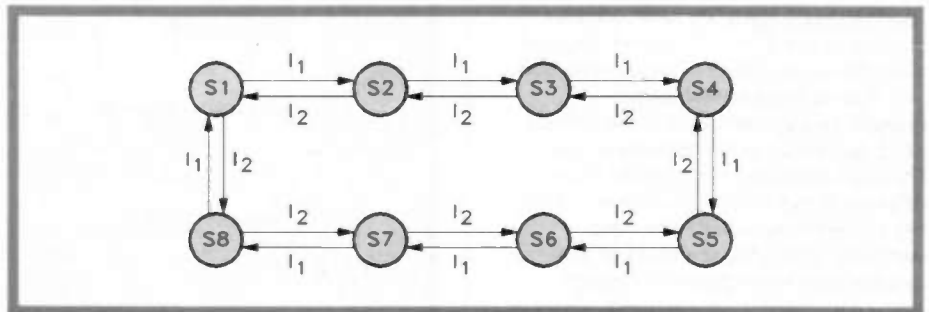

Figure 9. The state diagram for a 'divide-by-eight up/down counter'.

We can now draw the state table and, in this case, we go straight to the full table, filling in the values in the J and K columns by noting the changes required at the Q outputs and using our knowledge of the JK excitation table. This state table is shown in Figure 10. There are no 'don't cares' resulting from redundant states, since this is a pure binary counter taking up all of the eight possible states. This table is shown in Figure 10.

Once the state table is complete, the Karnaugh maps can be filled in (Figure 11) and the minimisation carried out in the usual way. The greater complexity of the counter means more complex expressions for the driving logic. However, both J and K inputs for flip-flop A (the LSB) have a minimisation of '1', requiring only that they are wired to the logic 1 level. This places the flip-flop permanently in the 'toggle' mode, which is hardly surprising.

The other expressions are rather more complex, especially those for the MSB flip-flop (C). However, they are consistent in being OR type expressions, which leads very naturally to implementation with NAND logic alone. The full circuit for this counter is shown in Figure 12. The driving logic can be fully implemented using just two NAND gate packages, one of which (a 7400 quad 2-input NAND package) is fully utilised, including using one gate as an inverter. The other package is a triple 3-input NAND package, also fully used, one gate being wired as a 2-input gate. The total chip count is just *four*, including the flip-flop chips.

## Appendix – The Karnaugh Map

While it is not possible in an article such as this to give a full introduction to the

Present state			Control	Next state			Flip-flop controls					
C	B	A	Z	C	B	A	J <sub>C</sub>	K <sub>C</sub>	J <sub>B</sub>	K <sub>B</sub>	J <sub>A</sub>	K <sub>A</sub>
0	0	0	0	0	0	1	0	X	0	X	1	X
0	0	1	0	0	1	0	0	X	1	X	X	1
0	1	0	0	0	1	1	0	X	X	0	1	X
0	1	1	0	1	0	0	1	X	X	1	X	1
1	0	0	0	1	0	1	X	0	0	X	1	X
1	0	1	0	1	1	0	X	0	1	X	X	1
1	1	0	0	1	1	1	X	0	X	0	1	X
1	1	1	0	0	0	0	X	1	X	1	X	1
0	0	0	1	1	1	1	1	X	1	X	1	X
0	0	1	1	0	0	0	0	X	0	X	X	1
0	1	0	1	0	1	0	0	X	X	1	1	X
0	1	1	1	0	1	0	0	X	X	0	X	1
1	0	0	1	0	1	1	X	1	1	X	1	X
1	0	1	1	1	0	0	X	0	0	X	X	1
1	1	0	1	1	0	1	X	0	X	1	1	X
1	1	1	1	1	1	0	X	0	X	0	X	1

Up Counting

Down Counting

Figure 10. The state table for the 'divide-by-eight up/down counter'.

principles and practices of the Karnaugh map, one must, usually, assume some background knowledge on the part of the reader, and a few notes would not come amiss here.

The map contains as many squares as there are combinations of the variables. Each of these squares represents one unique combination of these variables. Thus, if there are only two variables, there are  $2^2 = 4$  squares on the map. If there are three variables there are  $2^3 = 8$  squares and if there are four variables then there are  $2^4 = 16$  squares. Beyond that it becomes rather more complicated.

The variable combinations represented by each square are written as co-ordinates along the map edges. These co-ordinates will provide X and Y references according to which variables are plotted horizontally and which vertically. Taking the simplest first, the two variable maps shown in Figure 13(a), the variables are A and B. Variable A is plotted horizontally and variable B, vertically. This fact is indicated at top left of the map. The possible values of A and B are written along the top and left map edges as 0 and 1 respectively. These give the square co-ordinates as with any other type of map.

For example, the top left square identifies  $A = 0$  and  $B = 0$ ; the top right square identifies  $A = 1$  and  $B = 0$ ; bottom left is  $A = 0$  and  $B = 1$ ; bottom right is  $A = 1$ ;  $B = 1$ . The Boolean terms represented by these squares, in exactly the same order, are:  $\bar{A}\bar{B}$ ;  $A\bar{B}$ ;  $\bar{A}B$  and  $AB$ . From this we can see that when a variable has the value 0 (zero), it is written with the bar over it.

Jumping now to the map of Figure 13(c), since there are four variables, there are 16 squares, giving rise to a similar number of combinations. The lowest combination is when all variables are zero together: map square top left with the co-ordinates 0000, which corresponds to the

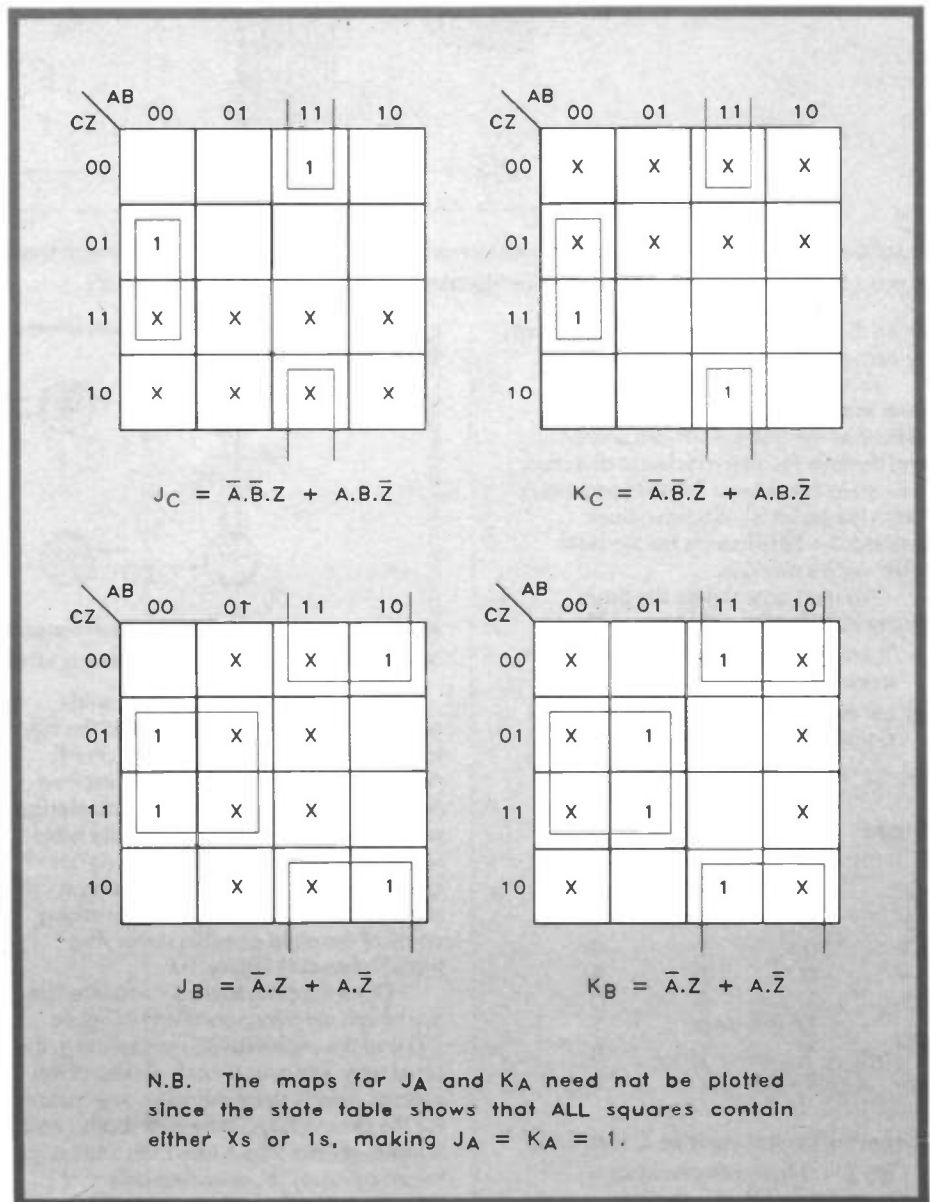
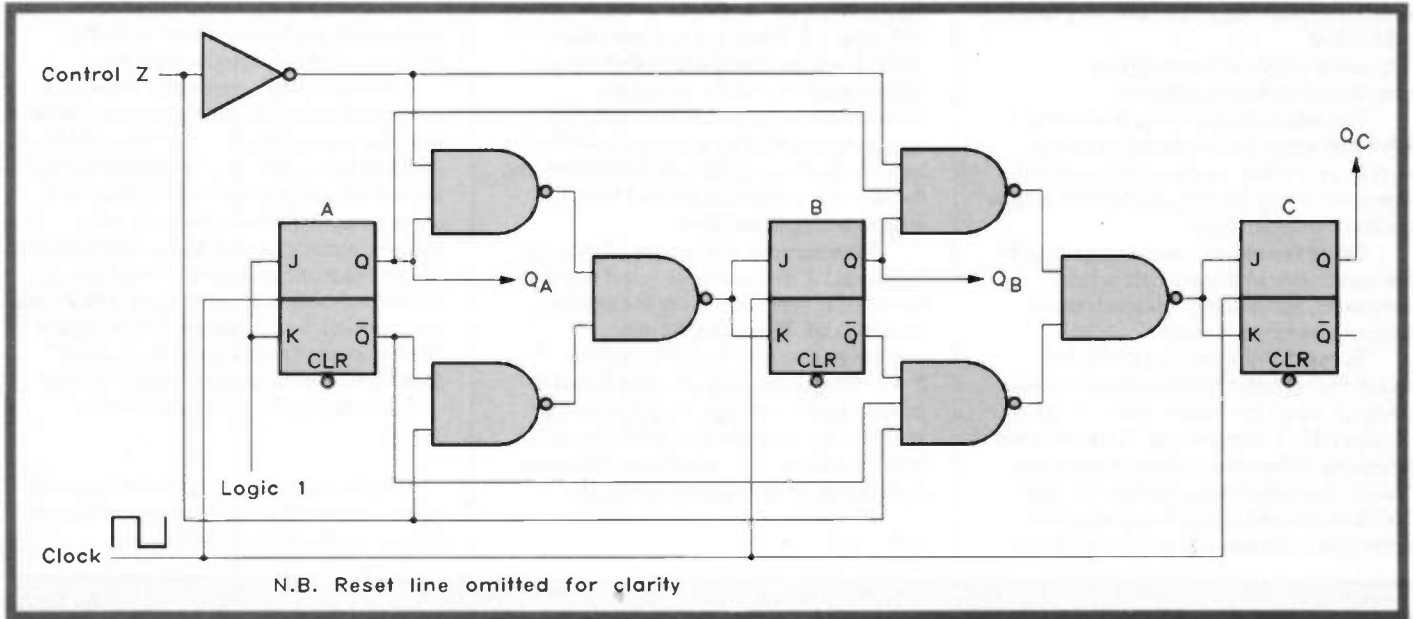

Figure 11. The Karnaugh maps and minimised expressions obtained from the state table of Figure 10.

N.B. The maps for  $J_A$  and  $K_A$  need not be plotted since the state table shows that ALL squares contain either Xs or 1s, making  $J_A = K_A = 1$ .



**Figure 12. The complete circuit for the 'divide-by-eight up/down counter'.**

Boolean term  $\bar{A}.B.C.D$ . It would be tedious to consider all 16 squares one after the other, so let us just take the other three corners.

Top right:  $A = 1; B = 0; C = 0$  and  $D = 0$ . Map co-ordinates are 1000 and the Boolean term represented by this square is  $A.B.C.\bar{D}$ .

Bottom right:  $A = 1; B = 0; C = 1$  and  $D = 0$ . Map co-ordinates are 1010 and the relevant Boolean term is  $A.B.C.\bar{D}$ .

Bottom left:  $A = 0; B = 0; C = 1$  and  $D = 0$ . Map co-ordinates are 0010 and the relevant Boolean term is  $\bar{A}.B.C.\bar{D}$ .

Notice carefully the order of the co-ordinates along the edge, starting from

the origin at top left, namely: 00, 01, 11 and 10. This is not arbitrary and must be adhered to. The governing rule is that there is a change in the logic value of *one variable only* when going from one square to an adjacent one. Adjacent squares are always considered vertically or horizontally, never diagonally. There is another rule about adjacent squares,

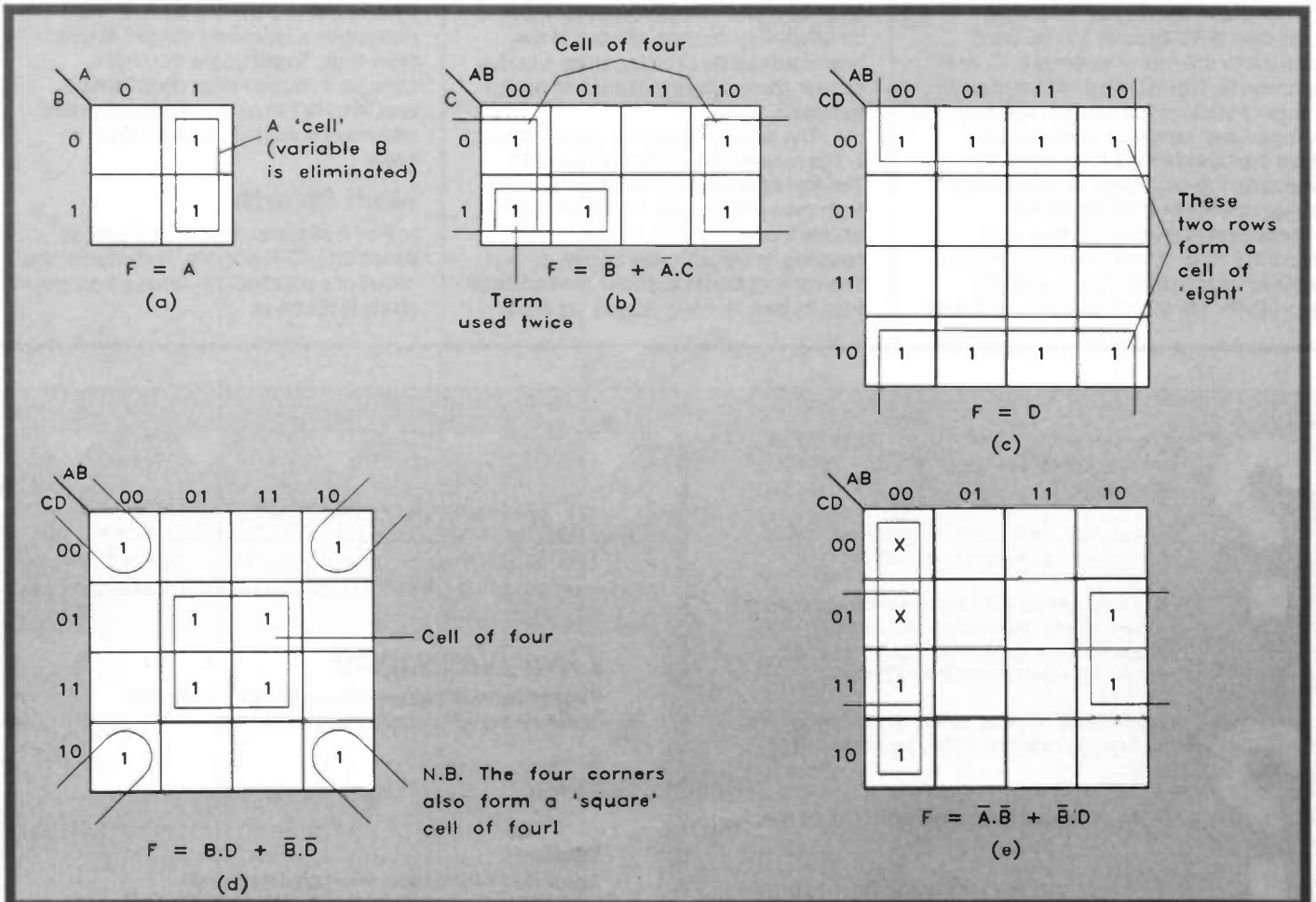

**Figure 13. Some examples of minimisations using the Karnaugh map.**

which is vital to remember but may seem odd at first:

'Opposite edges of the map are considered as being adjacent'.

This means that any square on the left-hand edge is considered as being next to its partner on the right-hand edge. The same is true for top and bottom edges on four-variable maps.

Once the above ideas are grasped the remainder of the process is fairly automatic, not placing too much strain on one's cerebral matter!

To use the map each square, for which the relevant Boolean term is either a logic 1 or a 'don't care', has a '1' or an 'X' placed in it accordingly. Otherwise it is left blank. When the squares have been filled in this way the pattern of '1s' (and 'Xs') is examined to see if any square or rectangular shapes are produced. If so,

they are ringed, as shown in the examples of Figure 13. These groups are called 'cells'. It will be found that within these cells at least one of the variables, sometimes two, is present in both of its logical forms, that is as a logic 0 AND as a logic 1. Such variables are eliminated and the new expression extracted from the map in a simplified form.

For example, in the case of map (a) in Figure 13, the two right-hand squares have '1s' in them and form the smallest possible cell. These two squares correspond to  $A = 1, B = 0$  and  $A = 1, B = 1$ . Notice that it is variable B that is present both as a logic 0 and as a logic 1. This is the variable that is eliminated, leaving only  $A = 1$ , which simply means A. In Boolean terms, the expression:

$$A\bar{B} + AB = A.$$

This is a fundamental algebraic truth which we have arrived at by the techniques of Karnaugh mapping.

This is a simple example. Now, as a suggested exercise, see if you can follow how the examples shown in maps (b) to (e) have been solved. It requires nothing more than extending the principles just used. To consider how the cells were formed, remember the ideas stated above about adjacent squares at the edges of the map. Another point to note is that cells can overlap, which means that a square can be used as many times as we like. Don't get carried away though, the final aim is as few cells as possible, not as many!

In the next part of this series we shall look at some other synchronous counters, this time in the form of MSI chips.

#### Modern Bridge Circuits continued from page 47.

measuring capacitance is that the  $C_x$  value is proportional to the reciprocal of the RV1 'R' scale markings. If the basic bridge is used to measure both R and C, this snag can be overcome if RV1 is fitted with a reversing switch. Such an arrangement, shown in the multi-range L-C-R 'service'-type bridge of Figure 10, means that only a single scale (of the type shown in Figure 8) is needed.

The circuit in Figure 10 is quite versatile; SW2 enables it to be used with either internal or external L, C, or R standards. The mid-scale value of each range is equal to the value of standard used on that range, as can be seen from the table of Figure 10. Once this instrument is calibrated, it can be used to help create its own alternative measurement standards; thus, if an accurate 10nF standard is fitted in place, a 100nF standard can be created by moving RV1 to the '10' position, and then

wiring capacitors in parallel across the 'X' terminal until a null balance is obtained, at which point the  $C_x$  value equals 100nF. This 100nF standard can then be wired into the bridge and used to help create a 1 $\mu$ F standard, and so on.

The circuit in Figure 10 can be built exactly as shown, or as a self-contained instrument with integral oscillator and detector circuits. In the latter case, it must be noted that the oscillator must be effectively 'floating' relative to the balance detector circuitry, since a bridge cannot share common input and output terminals.

The designer has two basic options in this respect, as shown in Figure 11. The first option is to power both circuits from the same supply, but effectively isolate the oscillator by transformer-coupling its output to the bridge, as in (a). The other option is to power the oscillator from its own 'floating' supply, as shown

in (b); this latter option is highly efficient, and is generally to be preferred.

Figure 12 shows a practical battery-powered 'bridge energiser' that can give either a 9V DC output, or an excellent 1kHz sinewave output with a peak-to-peak amplitude of 5V. The oscillator is diode-stabilized Wien type, which is effectively operated from a split supply, derived from the battery via R1 and R2; it has a low-impedance output, and consumes a quiescent current of less than 4mA. To set up the oscillator, connect its output to an oscilloscope and trim RV1 to give a reasonably pure sinewave output of about 5V peak-to-peak.

### Next Month

In Part 2 of this series, we will look at precision L-C-R bridges, and discuss the circuit of a practical 18-range laboratory-grade instrument.



► Do you have difficulty in getting hold of your copy of 'Electronics - The Maplin Magazine'?

► Does your Newsagent always sell out before you can get your copy?

► Are you fed up with braving the onslaught of wind, rain and keep fit fanatics in your ceaseless quest to find a copy of your favourite electronics magazine?



► Do you say to your family and friends, "I'm just going outside, I may be gone a little while ..."?

► Does your dog hide when you return empty handed?

► Do you resort to reading the Beano, Dandy, Viz or other well known 'comics'?

Then why not ask your friendly local Newsagent to reserve or deliver every issue of 'Electronics - The Maplin Magazine'?  
Fill out the coupon (below), hand it to your Newsagent and you need never miss an issue of 'Electronics - The Maplin Magazine'.

### Dear Newsagent

Please reserve/deliver (delete as applicable) each issue of 'Electronics - The Maplin Magazine' for me.

Name .....

Address .....

Signature .....

'Electronics - The Maplin Magazine' is published monthly and is distributed through your wholesaler by: United Magazine Distribution Ltd., 1 Benwell Road, London N7 7AX. Telephone: 071-700-4600.



**A readers forum for your views and comments.  
If you want to contribute, write to:**

**The Editor, 'Electronics – The Maplin Magazine'  
P.O. Box 3, Rayleigh, Essex, SS6 8LR.**

### **Not a Coil Winding Tip**

Dear Editor,  
The design of air-cored inductors by selecting the right dimensions is a process which, the textbooks make clear, is distinctly approximate. In general it's quicker to wind, measure and adjust. Recently I needed a 1mH inductor capable of carrying 5A continuously. Applying a few of the 'approximate' formulae produced the interesting result that, for coils of conventional shape, the inductance is determined primarily by the length of wire used.  
For a 5A rating the coil needs to be 18 swg, and it turns out (no pun intended!) that 24 metres of this (Maplin order code YN81C) is what is needed.

I ordered a couple of reels and, on impulse before winding my coil on the bobbin I had made, measured the inductance of the wire on its plastic reel as supplied. This came out to be 0.96mH.  
Liberal impregnated with resin of the sort used for fibreglass car repairs, this produced a robust choke for under £3 with minimal effort. I hope this information may be useful to anyone else needing a heavy duty choke but not wanting to laboriously wind it.  
**N.P.E. Wheeler, Sutton, Surrey**

*Thank you for the tip. In fact a common type of loudspeaker crossover choke construction is exactly like this, so it should not be regarded as 'bodging' or cheating, and the plastic reels make neat, ready-made coil formers. Perhaps other readers might like to take the 'research' further and measure one or two of the other sizes of enamelled wire on reels?*

### **A and B Confusion**

Dear Editor,  
My faithful digital tachometer has failed and I cannot find a replacement anywhere, not even in the Maplin catalogue! My car engine is timed at exactly 1500 rpm and analogue instruments (including the car's rev counter) are not sufficiently accurate. I would welcome news of a Maplin project to build such a device. I'm sure this would be popular; what do you think?  
On another tack – page 41 of issue 51 shows a picture of an old style telephone box with buttons A and B clearly shown. The caption states that the buttons differentiated between one penny pieces and two shilling pieces – nothing of the sort! You inserted money and made your call. When the other party answered, you pressed button A and your coins dropped into the cashbox. Until this button was pressed, the other party could not hear your voice. If there was no reply, or if you suspected you were connected to a wrong number, then you pressed button B and your money was returned to you down a chute.  
**J. French, Cornwall**

# AIR YOUR VIEWS



## STAR LETTER

*This Month John Brown, from South Ockendon in Essex receives the Star Letter Award of a £5 Maplin Gift Token for his letter.*



### **Valve Confusion**

Dear Sir,  
Tut, Tut, also Dear, Dear; I mean, how could you?  
The K4000 Amplifier, Page 8, paragraph 2 (March 1992):  
"the cathodes are always NEGATIVE with respect to the grid" and "the cathode of the other valve is driven POSITIVE with respect to the grid".  
With respect, someone is thinking NPN, or has never used a valve (or 'toob'). Just to go back a little over thirty years, a similar (but rather better) circuit was 'Top of the Amps' in the form of the Dynaco 40 watt mono amp.  
The phase-splitter was simpler, with DC coupling between the first stage and the phase splitter, thus removing one LF phase shift. In addition, it follows the precept that one FIRST makes a minimum-distortion amplifier, and THEN adds negative feedback to make it better.  
My old firm, Avel Products (now Avel Lindberg Ltd.) made them in the UK by agreement with Dave Hafler, using toroidal mains and output transformers. When Hi-Fi News reviewed it, they said 'WOW' (and they were not referring to the wow that one gets with a poor turntable!)  
A niggle: the poor little phase-splitter is run without bias, R2 being returned to cathode. I know that the ECC83 is a hi-mu twin-triode, and that grid current will produce around a volt if R12 is high (1M $\Omega$  or more) and that may

be all right for a cheap domestic set, where every penny saved helps to run the Chairman's Jag. – but in a Hi-Fi amp?  
While I am spending postage, I may add that I think that the Maplin Mag. is excellent; interesting, 'with it' and catering for a wide-range of age, skills and applications, so please continue the good work (but I will be watching!) – Nice to know you're human, though!

*Alan Williamson Replies:*  
*Thank you for your letter (and the circuit diagram of the Dynaco A470) pointing out the technical inaccuracy in the K4000 review. I have checked my original article which is correct – somehow or other the words 'grid' and 'cathode' have been transposed (if this statement was true, the valves wouldn't last long, a few milliseconds at most!). There are many stages that occur in between the handing over of an article and its publication; mistakes will invariably happen and I apologise for this error. We will endeavour to prevent this sort of thing happening again!*  
*As for the circuit topology, we cannot do much about this as it is not a Maplin design, but I agree with you.*  
*The value of R12 is 1M $\Omega$ , which ensures that the grid is always NEGATIVE with respect to the cathode. More and more valve amplifiers are using toroidal transformers. Jadis is just one that springs to mind.*

*I suspect that an instrument such as you describe would be purchased more cheaply as a ready-made, commercial unit rather than as a kit, and this is usually the case with many similar ideas, which is why you do not also find multimeter and calculator kits in the catalogue. Even if there is a genuine demand for a rev-counter test instrument, there may still be problems getting specific component parts easily enough to make it worthwhile and affordable, e.g., the inductive pick-up clamp for a start. While we are already starting to use custom-designed plastic boxes and such, there remains the difficulty of matching the commercial manufacturer's total resources for making custom parts for a specific product. Sorry about the A-B button error – we are obviously not old enough to remember, or have forgotten, how to use them!*

### **AWOL Component**

Dear Sir,  
I thought that, as I seem to spend a significant amount of time reading the letters you receive, I ought to contribute a few words myself. A good point to start with is to say how pleasantly surprised I was this Christmas. It was one of those rare times when an item from my order to you, jumped out of the parcel prior to dispatch. After a grumble of annoyance I sent my despatch note back to you on the 22nd of December, not expecting to hear from you until well into the new year. I cannot emphasise my delight when, on Christmas Eve, I received a reply from you and the missing goods appeared on my doorstep on the 31st. Using this as an example, I am not surprised that you are BS approved stockists. In your February edition Mr. Waters mentioned a colour catalogue. I would like to add my voice to his in asking that you consider it seriously. As long as it did not raise the price too much I would find colour pictures much more pleasing and also easier to choose whether to buy something or not. If more people felt like me, would your sales increase?  
**Neil Turner, Lymington, Hants**

*Thank you for your letter, it's nice to be told occasionally that we are doing something right, and not just hear about all the things we're doing wrong.*  
*As we said earlier, a colour catalogue will obviously come eventually, but first we need to get our current monochrome set-up changed over to electronic scanning and such-like for use with more modern DTP style type-setting production. This is very involved and, for the catalogue, won't happen for another year at least. After that colour could (in theory) be easily introduced. Right now a full colour catalogue would be prohibitively expensive using the old 'stick-and-paste' technology.*



These are our top twenty best selling books based on mail order and shop sales during January '92. Our own magazines and publications are not included in the 'chart' below.

# 20 best selling books

**2**

**A Concise Introduction to MS-DOS**

NO CHANGE

A Concise Introduction to MS-DOS, by N. Kantaris. (WS94C) Cat. P101. Previous Position: 2. Price £2.95.

**3**

**How to Expand, Modify and Repair PCs and Compatibles**

NO CHANGE

How to Expand, Modify and Repair PC's and Compatibles, by R. A. Penfold. (WS96D) Cat. P104. Previous Position: 3. Price £4.95.

**4**

**IC 555 Projects**

NO CHANGE

IC555 Projects, by E.A. Parr. (LY04E) Cat. P85. Previous Position: 4. Price £2.95.

**5**

**Power Supply Projects**

Power Supply Projects, by R. A. Penfold. (XW52G) Cat. P83. Previous Position: 6. Price £2.50.

**6**

**An Introduction to Loudspeakers and Enclosure Design**

An Introduction to Loudspeakers and Enclosure Design, by V. Capel. (WS31J) Cat. P87. Previous Position: 5. Price £2.95.

**Number ONE**

**Getting The Most From Your Multimeter**

by R. A. Penfold

A unique, and very useful book, showing you how to best use your multimeter. (WP94C) Cat. P80. Previous Position: 1. Price £2.95

**7**

**How to Use Oscilloscopes and Other Test Equipment**

How to Use Oscilloscopes and Other Test Equipment, by R.A. Penfold. (WS65V) Cat. P80. Previous Position: 8. Price £3.50.

**8**

**International Transistor Equivalent's Guide**

International Transistor Equivalents Guide, by Adrian Michaels. (WG30H) Cat. P76. Previous Position: 11. Price £3.95.

**9**

**EMINENCE**

**HIGH POWER LOUDSPEAKER ENCLOSURE DESIGN AND CONSTRUCTION**

Loudspeaker Enclosure Design and Construction, (WM82D) Cat. P88. Previous Position: 18. Price £9.95.

**10**

**A Concise Advanced User's Guide to MS-DOS**

A Concise Advanced User's Guide to MS-DOS, by N. Kantaris. (WS44X) Cat. P102. Previous Position: 9. Price £2.95.

**11**

**THE COMPLETE VHF/UHF FREQUENCY GUIDE**

The Complete VHF/UHF Frequency Guide, by B. Laver. (WT70M) Cat. P93. Previous Position: 15. Price £5.95.

**12**

**SCANNERS**

**A User's Guide**

Scanners, by Peter Rouse. (WP47B) Cat. P93. Previous Position: 13. Price £8.95.

**13**

**THE WASHING MACHINE MANUAL**

The Washing Machine Manual, by Graham Dixon. (WS98G) Cat. P96. Previous Position: 10. Price £11.95.

**14**

**Electronic Security Devices**

Electronic Security Devices, by R.A. Penfold. (RL43W) Cat. P84. Previous Position: 16. Price £2.50.

**15**

**ELECTRONIC CIRCUITS**

The Maplin Electronic Circuits Handbook, by Michael Tooley. (WT02C) Cat. P82. Previous Position: 7. Price £10.95.

**16**

**More Advanced Power Supply Projects**

More Advanced Power Supply Projects, by R. A. Penfold. (WP92A) Cat. P77. Previous Position: 17. Price £2.95.

**17**

**Remote Control Handbook**

Remote Control Handbook, by Owen Bishop. (WS23A) Cat. P83. Previous Position: 12. Price £3.95.

**18**

**SERVICING TV AND VIDEO EQUIPMENT**

Servicing TV and Video Equipment, by Eugene Trundle. (WS76H) Cat. P96. Previous Position: 19. Price £25.00.

**19**

**MASTERING ELECTRONICS**

Mastering Electronics, by John Watson. (WM60Q) Cat. P74. Previous Position: Re-Entry. Price £5.99.

**20**

**TOWERS' INTERNATIONAL TRANSISTOR SELECTOR**

Towers' International Transistor Selector, by T.D. Towers. (RR39N) Cat. P76. Previous Position: Re-Entry. Price £19.95.



# 78xxx/79xxx SERIES VOLTAGE REGULATORS

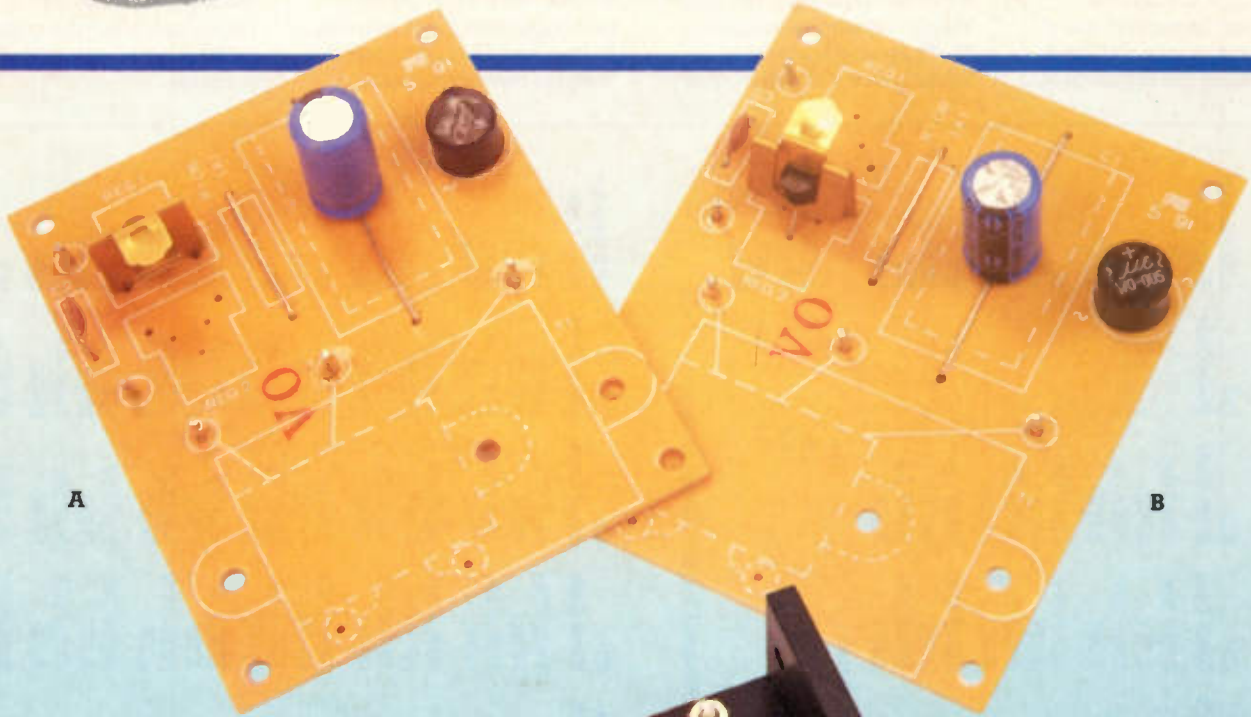

A

B

'Data Files' are intended as 'building blocks' for constructors to experiment with and the components suggested, provide a good starting point for further development.

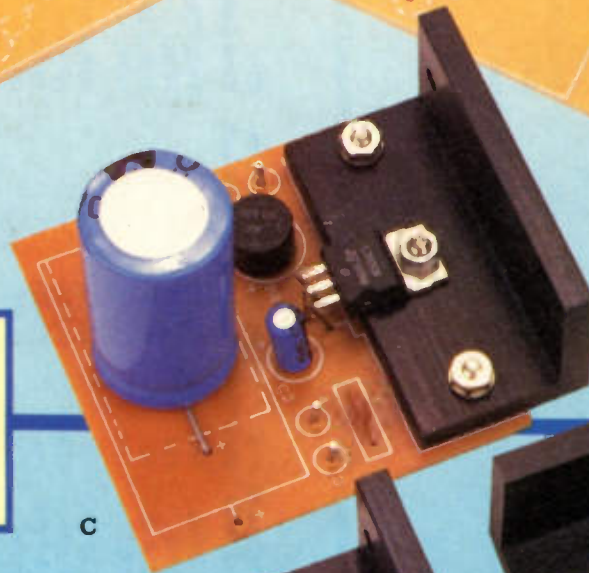

C

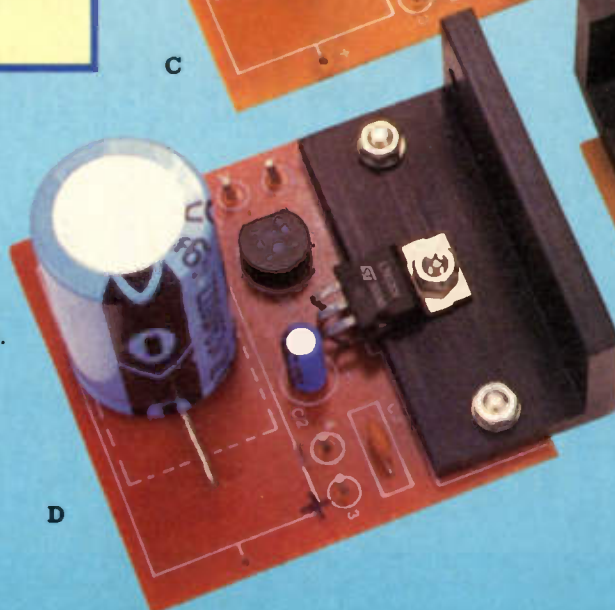

D

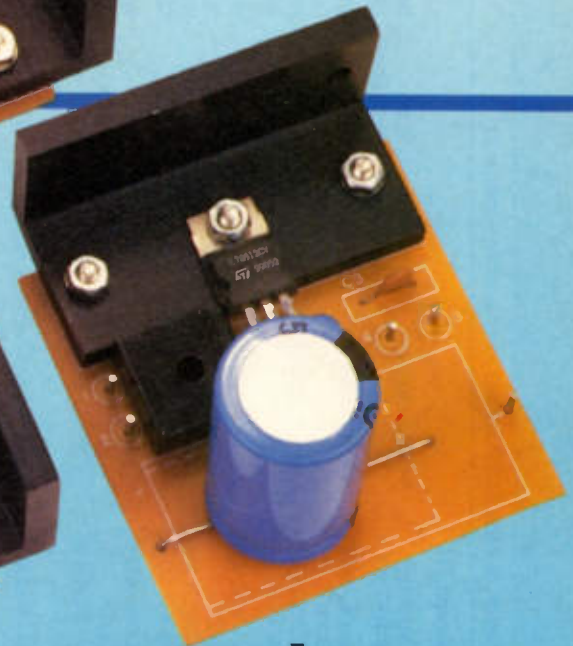

E

- A. 100mA positive regulator PCB.
- B. 100mA negative regulator PCB.
- C. 1A negative regulator PCB.
- D. 1A positive regulator PCB.
- E. 2A positive regulator PCB.





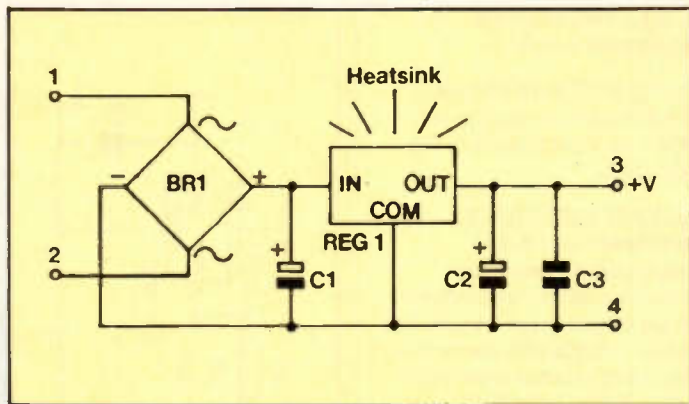

Figure 2a. Circuit diagram for positive regulators rated between 500mA and 2A (refer to Groups 2 and 3 of Table 1).

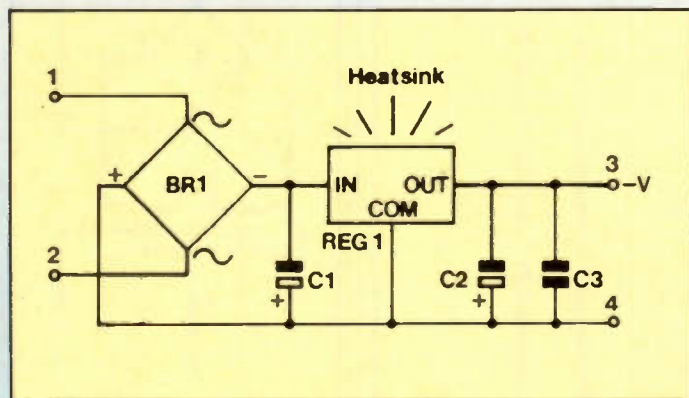

Figure 2b. Circuit diagram for negative regulators rated between 500mA and 2A (refer to Groups 2 and 3 of Table 1).

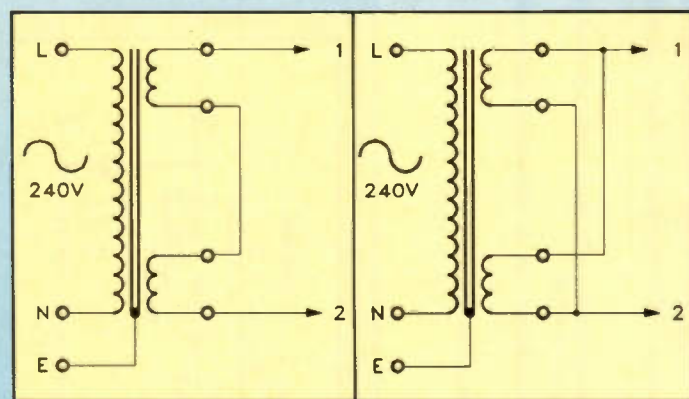

Figure 3a above left: Transformer connections for series windings.  
Figure 3b above right: Transformer connections for parallel windings.

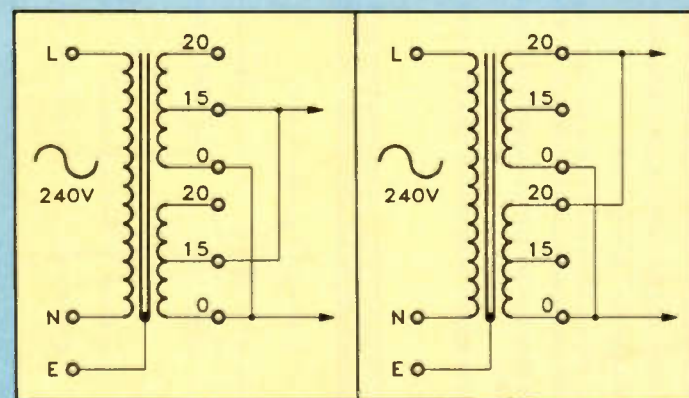

Figure 4a above left: Parallel connections for multi-tap transformer (for use with 12V, 2A regulator of Group 3 in Table 1).  
Figure 4b above right: Parallel connections for multi-tap transformer (for use with 15V, 2A regulator of Group 3 in Table 1).

pass transistor. It is measured in  $\Omega$  or  $m\Omega$ .

**OUTPUT NOISE VOLTAGE** is the RMS AC voltage at the output, with a constant load and no input ripple, measured over a specified frequency range.

**SHORT-CIRCUIT CURRENT** is the maximum current available from the regulator with the output shorted to ground. This value is lower than the maximum output current, due to the current fold-back circuitry.

## Function of the Capacitors

The function of C1 (all regulator PCBs) is to store enough energy between the rectifier pulses to provide a smooth supply rail with minimal ripple (under full load conditions), thus preventing regulator 'drop out'. The latter condition occurs when the supply rail falls below the regulator's minimum input voltage.

The purpose of C2 (500mA

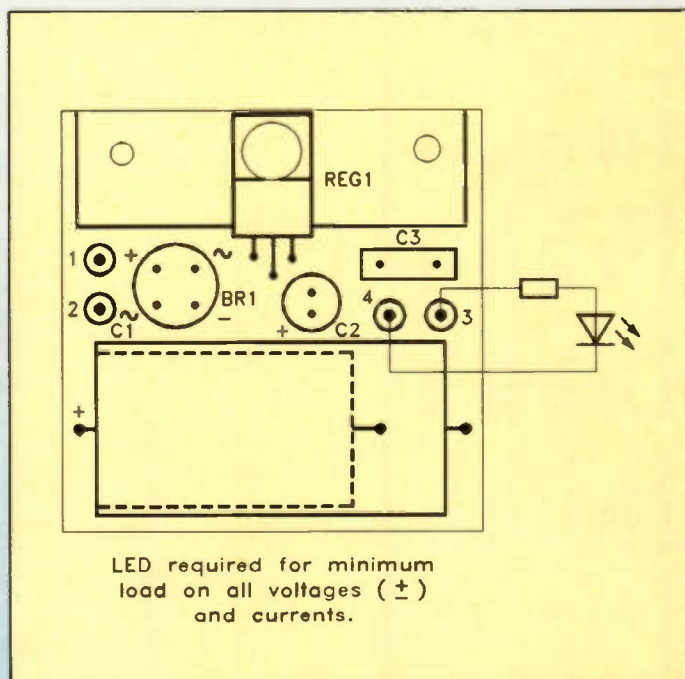

Figure 5. YQ40T PCB, intended for use with fixed-voltage positive regulators rated at between 500mA & 2A (see Groups 2 & 3 of Table 1).

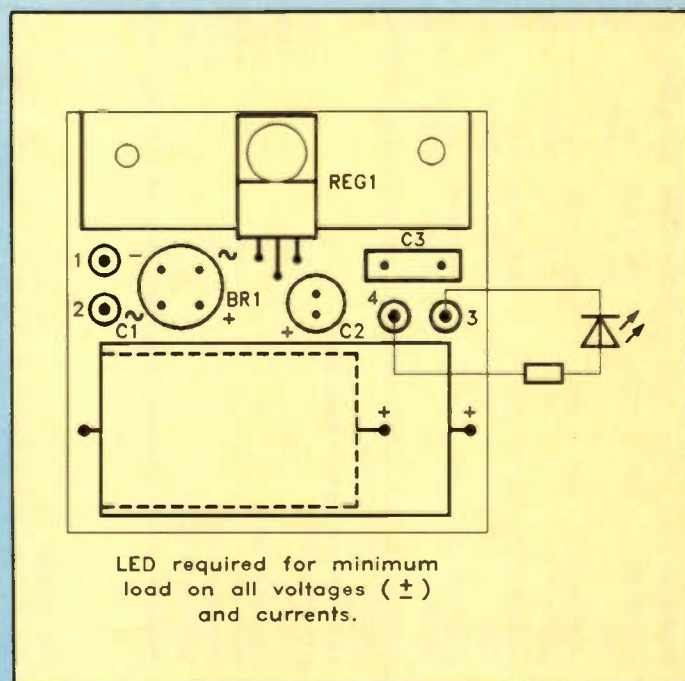

Figure 6. YQ41U PCB, intended for use with fixed-voltage negative regulators rated at between 500mA & 2A (see Groups 2 & 3 of Table 1).

to 2A PCBs only) is to provide decoupling, and prevent instability in the regulator.  $10\mu\text{F}$  is sufficient for most applications; however, the value of C2 can be increased in circumstances where the peak current of the load circuit exceeds the maximum current of the regulator.

The ceramic capacitor C3 (C2 on 100mA PCB) provides high-frequency decoupling, which aids stability.

## General Comments

1. The average output ripple on 2A regulators is 10mV peak-to-peak; for all others it is 5mV peak-to-peak.

2. Use M2.5 hardware for attaching the regulator to the heatsink.

3. Please note that the mounting tab of all regulators is an electrical connection, and this fact should be borne in mind when mounting the device on a heatsink.

A mounting kit (e.g. WR23A or QY45Y/JR78K) should therefore always be used, unless:

(a) In the case of negative voltage regulators, the heatsink is at the same potential as the input voltage.

(b) In the case of positive voltage regulators, the heatsink is at 0V potential.

(c) The heatsink is completely electrically isolated.

Unless greaseless insulating washers are used, remember to use heat transfer compound (HQ00A or FL79L), to aid thermal conductivity between the IC and the heatsink.

4. To provide power-on indication, a standard 5mm LED should be connected between the output of the regulator and ground, via a series resistor of suitable value (see Table 1 for values). Such an arrangement is compulsory for negative regulators - this is to prevent the off-load output voltage decreasing excessively (i.e. going more negative).

PCBs are available for the 78/79 series fixed voltage regulator:

100mA PCB (YQ39N) Price £2.95

0.5/1.2A +V PCB (YQ40T) Price £1.48

0.5/1A -V PCB (YQ41U) Price £1.48

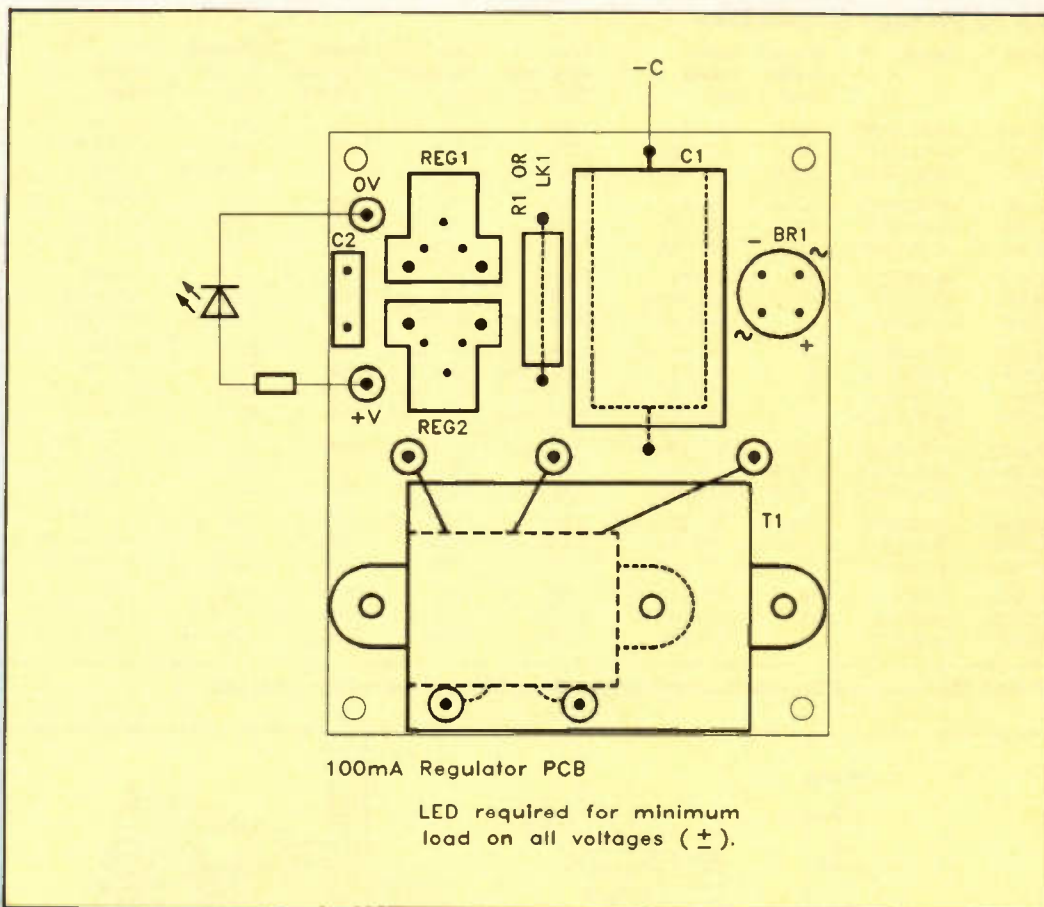

Figure 7. YQ39N PCB, shown populated for use with 100mA fixed-voltage positive regulators (see Group 1 of Table 1).

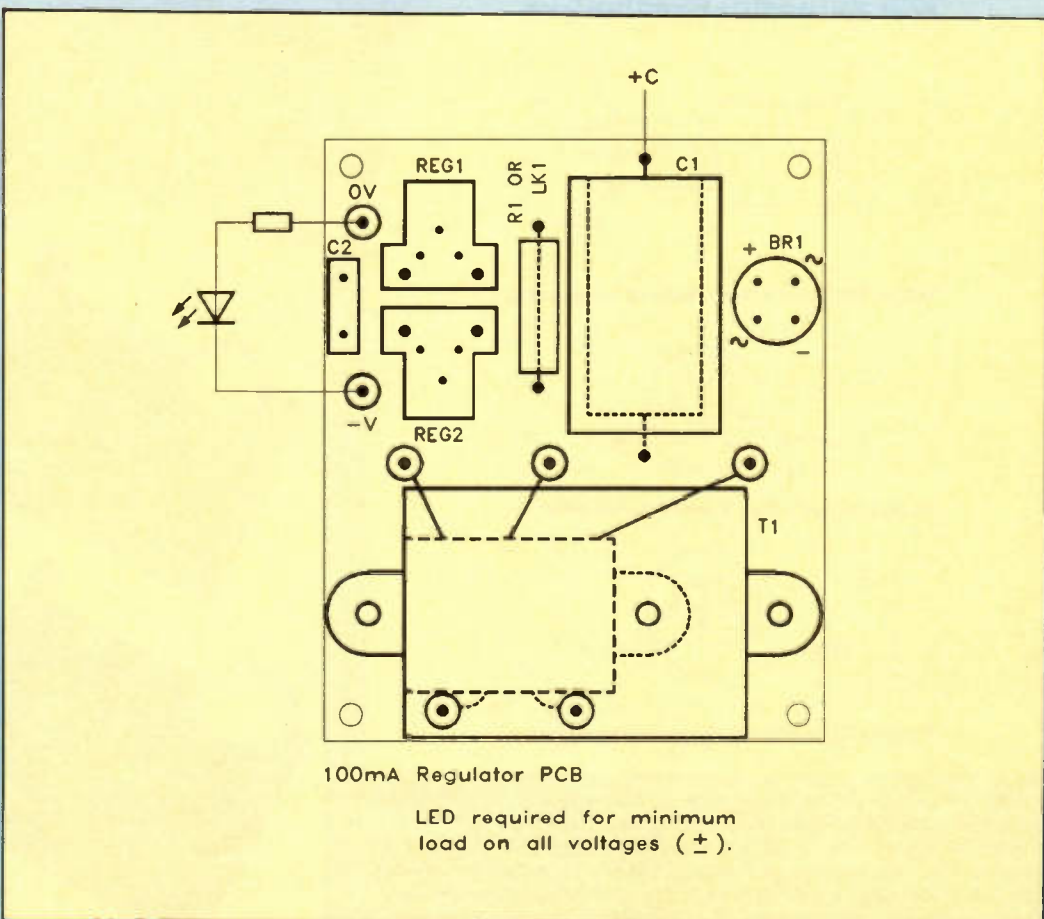

Figure 8. YQ39N PCB, shown populated for use with 100mA fixed-voltage negative regulators (see Group 1 of Table 1).

### 78/79 Voltage Regulators

Order	Type No.	Output Current (max)	Output Voltage (typ)	Line Regulation (typ)	Load Regulation (typ)	Ripple Rejection (dB) (typ)	Quiescent Current (typ)	Input Voltage Range	Output Resistance	Output Noise Voltage	Short Circuit Current	Case Style
QL26D	uA78L05AWC	100mA	-5V ±4%	0.36%	0.4%	62dB	3mA	7V to 30V	0.2Ω	40μV	-	TO92r
WQ77J	uA78L12AWC	100mA	-12V ±4%	0.25%	0.25%	54dB	3mA	14.5V to 35V	0.2Ω	80μV	-	TO92r
QL27E	uA78L15AWC	100mA	+15V ±4%	0.25%	0.25%	51dB	3.1mA	17.5V to 35V	0.2Ω	90μV	-	TO92r
QL28F	uA78M05UC	500mA	+5V ±4%	0.06%	0.4%	80dB	4.5mA	7V to 25V	0.05Ω	40μV	300mA	P1d
QL29G	uA78M12UC	500mA	+12V ±4%	0.07%	0.2%	80dB	4.8mA	14.5V to 30V	0.05Ω	75μV	240mA	P1d
QL30H	uA78M15UC	500mA	+15V ±4%	0.07%	0.17%	70dB	4.8mA	17.5V to 30V	0.05Ω	90μV	240mA	P1d
QL31J	uA7805UC	1A	-5V ±4%	0.06%	0.2%	78dB	4.2mA	7V to 25V	0.017Ω	40μV	750mA	P1d
QL32K	uA7812UC	1A	+12V ±4%	0.085%	0.07%	71dB	4.3mA	14.5V to 30V	0.018Ω	75μV	350mA	P1d
QL33L	uA7815UC	1A	+15V ±4%	0.075%	0.055%	70dB	4.4mA	17.5V to 30V	0.019Ω	90μV	230mA	P1d
UJ54J	uA78S05UC	2A	-5V ±4%	100mV max	80mV max	54dB	8mA	8V to 35V	0.017Ω	40μV	500mA	P1d
UJ55K	uA78S09UC	2A	-9V ±4%	130mV max	100mV max	47dB	8mA	12V to 35V	0.017Ω	60μV	500mA	P1d
UJ56L	uA78S12UC	2A	-12V ±4%	240mV max	150mV max	47dB	8mA	15V to 35V	0.018mΩ	75μV	500mA	P1d
UJ57M	uA78S15UC	2A	-15V ±4%	300mV max	150mV max	46dB	8mA	18V to 35V	0.019mΩ	90μV	500mA	P1d
WQ85G	uA79L05AWC	100mA	-5V ±5%	1%	0.2%	60dB	3mA	-7V to -25V	-	40μV	-	TO92n
WQ86T	uA79L12AWC	100mA	-12V ±5%	1%	0.2%	55dB	3mA	-14.5V to -35V	-	80μV	-	TO92n
WQ87U	uA79L15AWC	100mA	-15V ±5%	1.5%	0.3%	52dB	3mA	-17.5V to -35V	-	90μV	-	TO92n
WQ88V	uA79M05UC	500mA	-5V ±4%	0.14%	1.5%	60dB	1mA	-7V to -25V	-	125μV	140mA	P1n
WQ89W	uA79M12UC	500mA	-12V ±4%	0.075%	0.55%	60dB	1.5mA	-14.5V to -30V	-	300μV	140mA	P1n
WQ90X	uA79M15UC	500mA	-15V ±4%	0.06%	0.45%	59dB	1.5mA	-17.5V to -30V	-	375μV	140mA	P1n
WQ92A	uA7905UC	1A	-5V ±4%	0.06%	0.2%	60dB	1mA	-7V to -25V	-	125μV	750mA	P1n
WQ93B	uA7912UC	1A	-12V ±4%	0.085%	0.07%	60dB	1.5mA	-14.5V to -30V	-	300μV	350mA	P1n
QL36P	uA7915UC	1A	-15V ±4%	0.075%	0.055%	60dB	1.5mA	-17.5V to -30V	-	375μV	230mA	P1n

Table 2. Electrical and physical characteristics of 78xxx/79xxx series voltage regulators.

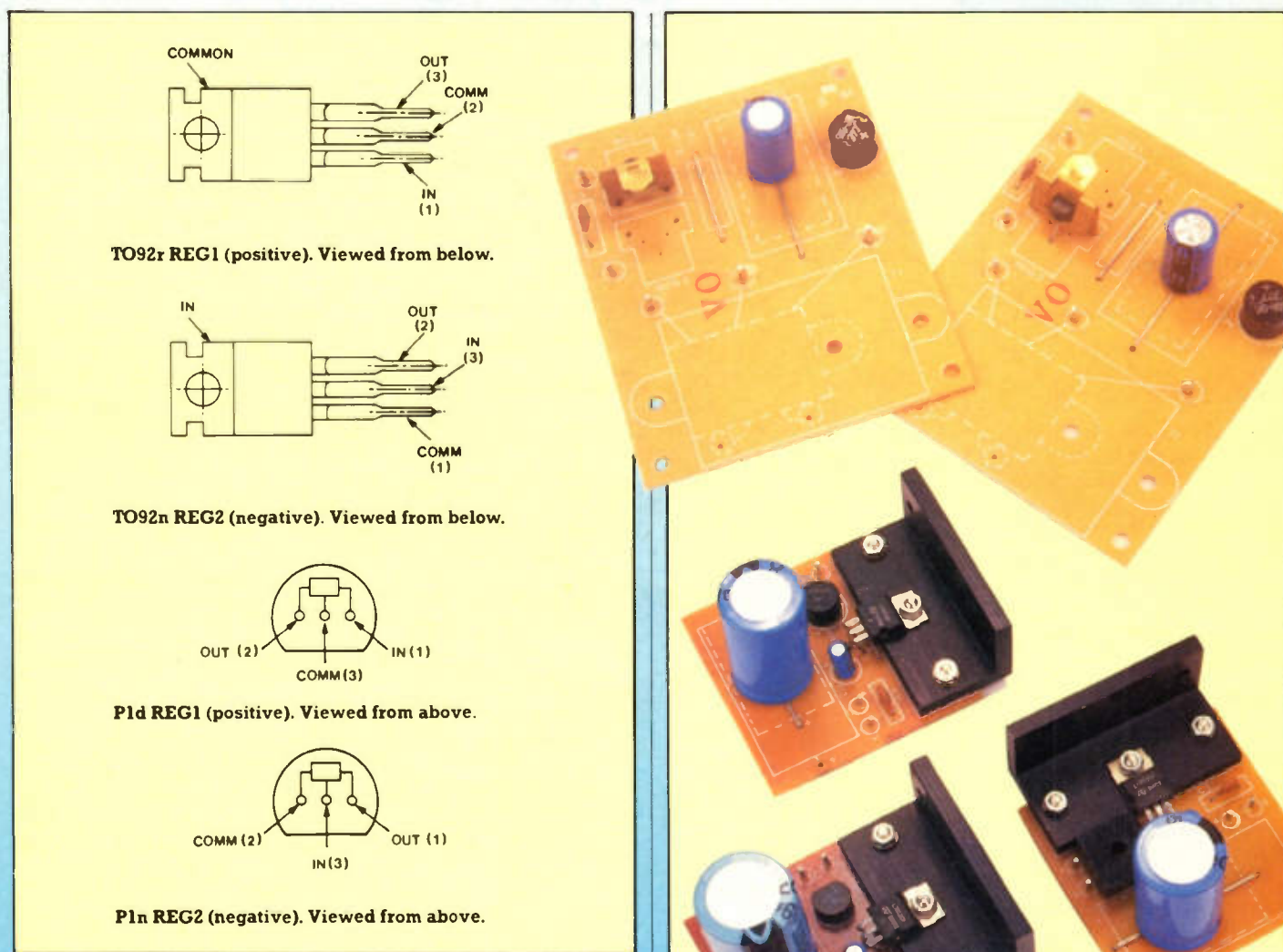
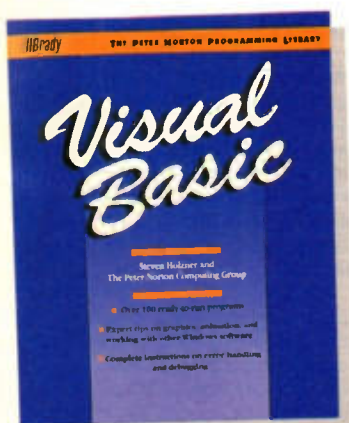

Figure 9. Package styles and pin-outs for the regulators. The TO92r/n case styles are used for the 100mA  $\mu$ A7xLxxAWC devices, listed in Group 1 of Table 1. The P1d/n case styles are used for the others, which are featured in Groups 2 and 3 of Table 1. Note that the pin-outs of positive and negative devices are different - be sure to place the device in the correct position on the PCB. 'REG 1' denotes a positive device, while 'REG 2' denotes a negative version - as shown in Figures 1 and 2.



# NEW BOOKS



## Visual Basic

by Steven Holzner and Peter Norton

Visual Basic is a tremendous toolbox of programming resources. This book explains how to create your own screen display windows, beginning with the essentials, and following the natural course of Windows programming development, starting with a simple blank window, and then adding colour, graphics, 'buttons' and text boxes, which Visual Basic calls 'controls'. Dialogue boxes, messages and menus can also be added, going onto more advanced topics that real Windows applications deal with, the clipboard, bitmaps, icons and error handling. There are chapters on debugging and dynamic data exchange, allowing the user to communicate with other Windows applications like those from Microsoft.

The orientation of the book will be on seeing how programs work and getting functioning results, which will require an understanding of the processes, and the authors explain all the concepts involved, beginning with the fundamentals of Windows and 'buttons', then the Windows and essential Visual Basic programming concepts. This will form the foundation for the remainder of the book.

Coverage is then task orientated as much as possible, where most of the successive chapters are purposely designed to cover one specific type of Visual Basic control, for example buttons, list boxes, 'combo' boxes, dialogue boxes, or menus. Expertise is gained in this way by building windows piece by piece, steadily adding more

power to the applications, allowing complexities that might arise to be handled in a systematic, gradual way.

All of which makes for quite an ambitious plan, learning how to design and put to work serious Windows applications with a minimum of trouble and it might seem that it requires an awful lot of programming. In fact, Visual Basic is a whole different story. Getting Windows programs running and producing real results is simply a matter of designing what you want on screen and then letting Visual Basic handle the details.

To use the book properly, some familiarity with BASIC is required. Also needed are Windows V3.0 or later; a mouse; and a copy of the Visual Basic software, any version. American book. 1991. 449 pages. 235 x 187mm, illustrated.

Order As WZ21X  
(Visual BASIC)

£23.45 NV

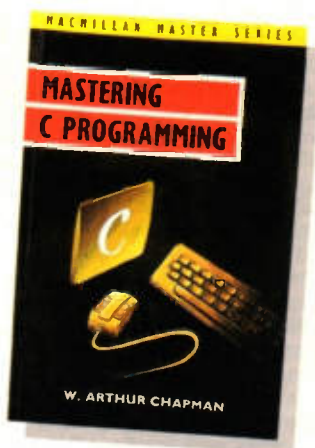

## Mastering C Programming

by W. Arthur Chapman

Every home micro and PC has come with a BASIC of some description for many years now, because originally it seemed reasonable that first time programmers would need the 'Beginner's All purpose Symbolic Instruction Code' (BASIC) to learn to write their own programs, since the language was designed by an educational committee for the purpose of teaching computer programming.

A decade or more later this is still the case, and what's more, having once gone through the presumably laborious

process of learning BASIC in the first place, many home programmers still won't leave it. This in spite of the fact that BASIC is hopelessly inadequate for producing programs of any speed or sophistication, which has given rise to the enormous variety of different updates, extensions and compilers etc. In other words, programmers won't give up BASIC in favour of another high level language which is much more able to produce the programs they require, and so BASIC has to be upgraded in an attempt to keep pace with the demands made on it.

Looking for an alternative high level language? You can do a lot worse than C. Unfortunately, C is 'weird' and 'foreign looking' to the average BASIC veteran. This book is intended as a first course in C programming. It is equally suitable for anyone new to programming as it is for those already familiar with another language. Access to a computer running C is assumed, and with this condition the text is conducive to self study, and all the examples have been tested using Turbo C V2.0 running on a PC, but the transportability of C should make them equally acceptable to other C compilers.

The main aim is to introduce C and to provide the essentials of the language. Throughout the book a number of rather more substantial programs are developed to provide a context for the use of C in rather larger projects, and each is discussed and developed from the start. Three main programs are dealt with in detail, these being a calculator, a line editor and a simple bridge tutor.

As you work through the material you should develop a good understanding of C and C programming. If, by the time you have completed it, you have found C both challenging and fun and desire to continue with it and move onto more advanced books on the subject, then this book will have achieved its purpose.

Why C? Because its speed and power is being recognised by an increasingly wide variety of programmers and users for a similarly diverse range of applications. These include both military and industrial systems control and robotics, as well as mainframe and PC applications software. Some large scale mainframe operating systems are written in C. Transputers use C, it will do anything you like, from the mundane to the exotic. It has been hailed as *the* programming language for the twenty-first century, so read this book and find out what all the fuss is about. 1991. 307 pages. 234 x 155mm, illustrated.

Order As WZ09K (Mastering C)  
£5.99 NV

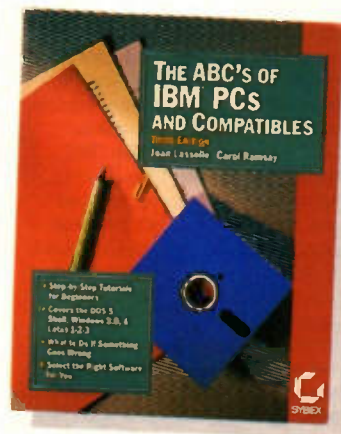

## The ABCs of IBM PCs and Compatibles

Third Edition

by John Lasselle and Carol Ramsay

This book provides a quick and painless method for gaining skill and confidence with your new PC. It is an engaging, hands-on guide, written especially for beginners, now in an up-to-date third edition, featuring the latest in hardware and software. This popular tutorial covers everything from starting up the system to calmly coping with unexpected results, all in an easy-to-follow, jargon-free style, including lessons which you can master in minutes.

Some of the topics dealt with include PC essentials: from setting up the system, assembling, plugging in and switching on your hardware, to using essential operating system commands; Disk do's and don'ts; learning the proper way to care for and handle floppy disks, and how to organise and find your way around a hard disk; DOS 5 and Windows 3; exploring the ins and outs of these state-of-the-art PC operating environments through a series of practical tutorials; All about applications: what they are, how to use them, and how to choose them to meet your needs, plus step-by-step, sample work sessions with WordPerfect 5.1 and Lotus 1-2-3. Release 3.1; Troubleshooting in detail: find out exactly what to do if something goes wrong - with troubleshooting tips throughout the text, and extensive problem-solving checklists.

You will also find a look at the world of 'add-ons', from fancy monitors and printers to communications equipment, some coverage on the special capabilities of the 386 computers, and more. American book. 1991. 247 pages. 228 x 193mm, illustrated.

Order As WZ06G (ABCs of PCs & Compat)  
£17.95 NV

## WordPerfect 5.1 Made Easy

Covers Versions 5.0 and 5.1  
by Mella Minberg

This book is for the beginner or newcomer to WordPerfect® or the intermediate user. In here you will find everything you need to complete your documents, from instructions for installation to directions for printing your text with fancy fonts and special characters.

The book covers both of WordPerfect's recent versions: version 5.0 and version 5.1. Since its introduction more than five years ago, WordPerfect has continued to improve, expand and develop. WordPerfect version 5.0, released in May 1988, became a best-seller because of its ability to do the basics such as type, edit, and print documents with ease, along with its more advanced features, such as outstanding printer support and many desktop publishing capabilities. Version 5.1, released in November 1989, offers additional features to make the program even easier to use: mouse support, pulldown menus and new features enabling the user to create the correct layout for mathematical equations, produce tables and import spreadsheets. The capabilities of both versions are described in this book: those that refer to only one or the other version are clearly marked as such.

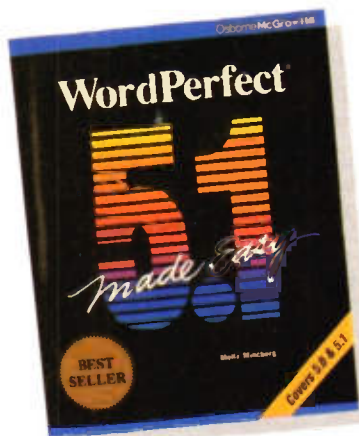

The book is divided into four main sections: Getting Started, Part I, Part II, and the Appendices. The 'Getting Started' section describes the computer equipment, the various keys on the keyboard and how to start and end a WordPerfect session. 'Part I' explains the the WordPerfect fundamentals. You will learn how to type, edit, save and print documents. You will also discover how to perform such essential tasks as altering margins and tabs, using headers and footers, moving text and spelling checking.

Part II moves on to cover WordPerfect's special word processing features, including file management capabilities, special print options, fonts and graphics for DTP, columns and tables and merging. The 'macro' capabilities and those extra features that beyond the bounds of typical word processing, into such areas as WordPerfect's math and sorting capabilities are also covered. The Appendices are important only for

certain WordPerfect users. 'A' is for those who have not yet installed WordPerfect. 'B' is for users who wish to customise the default settings for particular needs; 'C' is only relevant if your computer has a mouse. 'D' contains a list of the files on the master WordPerfect disks, useful for customisations, and a complete list of the codes inserted into WordPerfect documents, useful for advanced text editing. 'E' offers sources for additional support. American book. 1990. 1071 pages. 234 x 185mm, illustrated.

Order As WZ12N  
(WordPerfect 5.1) £19.95 NV

## Encapsulated PostScript

Application Guide for the  
Macintosh and PC  
by Peter Vollenweider

This book presents a detailed and clear introduction to the PostScript® language, including information on how text, graphics and images may be mixed at the PostScript level using the Encapsulated PostScript file (EPSF) format as an interchange standard. EPS files may be imported for example by Aldus PageMaker, or Xerox Ventura Publisher.

The contents of this book include detailed information on Adobe's latest version (2.0) of the Encapsulated PostScript file (EPSF) specification and version 3.0 of the document structuring convention specifications: includes a look at colour support, the HyperCard application, LearnPS, the Adobe Type Manager (ATM) and the Art Importer by Altsys; EPS effects by SmartArt and TypeAlign, and the PostScript interpreter operating on the IBM mainframe; and concentrates on the mixing of PostScript files, and the PostScript-related Macintosh and IBM PC programs, and provides information on networking PostScript based hardware.

It all sounds a bit intimidating but this is a practical instruction book written for all desk top publishers at all levels of expertise, PostScript designers and programmers, and those dealing with computer communications between minis, micros and mainframes with a graphics emphasis.

Students of computing, graphics, art and design who are learning page description languages and PostScript as an introduction to programming will

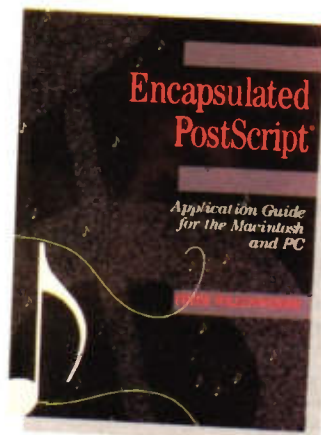

find the material contained within this book both easy to understand and enjoyable to use, and it will remain a quick and easy reference guide. In addition PostScript is important to anyone at all involved in DTP at any level, for whom this book will be very instructive. American book.

PostScript® is a registered trademark of Adobe Systems Inc. All other brand and product names are trademarks or registered trademarks of their respective companies and are acknowledged. 1990. 243 pages. 235 x 173mm, illustrated.

Order As WZ11M  
(Encap PostScript) £18.99 NV

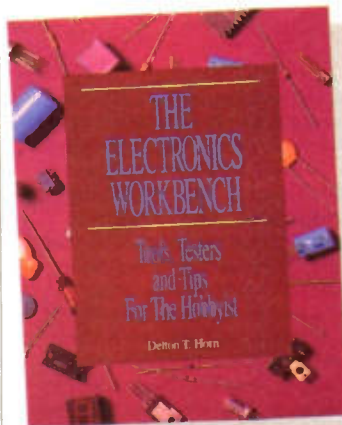

## The Electronics Workbench

Tools, Testers and Tips for  
The Hobbyist  
by Delton T. Horn

A complete guide to selecting electronic test and circuit design equipment. With such a wide range of electronic test devices available, deciding which instruments to buy is often the most difficult part of setting up an efficient, well-stocked workbench. Many hobbyists end up overspending or burdening themselves with a lot of unnecessary equipment, simply because they didn't understand the specifications and features of the products they purchased.

The book provides you with a complete overview of everything you will need to know to design a permanent or portable workbench that best suits your specific needs. The following major categories are covered: multimeters, frequency meters, signal injectors and tracers, digital test equipment, oscilloscopes, LCR bridges and capacitance meters, signal generators and semiconductor testers and much more.

Throughout, detailed explanations of the characteristics and capabilities of the various models are included. Whether you are an electronics hobbyist or a professional technician setting up your own shop, this book can save you time and money by giving you a reliable set of guidelines with which to choose the right equipment. American book. 1991. 253 pages. 235 x 187mm, illustrated.

Order As WZ20W (Electronics  
Workbench) £16.50 NV

## Electronics

by G. Waterworth

This book is primarily intended as a text for electrical engineering students, but is equally useful for the amateur hobbyist and is a companion volume to 'Electric Circuits', WZ07H (reviewed in 'Electronics' number 51). It describes all the common semiconductor devices and how they work and how they are used in various circuit schemes. The topics are arranged in the traditional order for semiconductor devices: diodes, BJTs, FETs and op-amps, followed by their applications in a variety of electronic subsystems such as amplifiers, oscillators, non-linear circuits, power amplifiers, regulated power supplies, power electronics systems, combinational and sequential logic circuits. This should enable the reader to use these worked examples alongside any of the standard textbooks in electronics.

The text at the beginning of each chapter is deliberately brief, but a comprehensive range of techniques and equations is developed from basic principles. Some of the math gets a little hairy in places, but it doesn't get in the way of understanding the basic principles of the device in question, while at the same time satiating number-happy theoreticians.

The author has attempted to give an engineering approach to the subject by including questions that have a sound application and a realistic solution. Examples are included for both discrete and IC devices. The book uses up-to-date techniques and

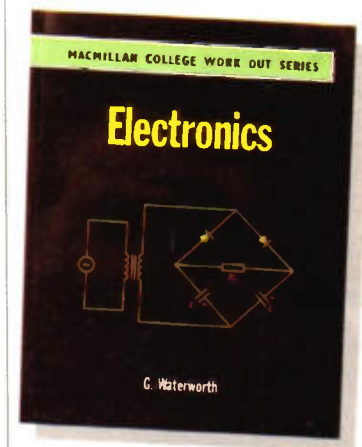

devices and includes questions on the current mirror, bootstrapping, the constant current source, the Miller effect, the cascode circuit, feedback amplifiers, differential amplifiers, instrumentation amplifiers, IC regulators, switch mode regulators, chopper control, programmable logic arrays, synchronous counter design, and logic hazard detection.

Extensive use has been made of device models in analysing circuit operation, and in the case of the bipolar transistor, both the *h*-parameter and the model based on the Ebers-Moll equation have been included. 1991. 257 pages. 275 x 210mm, illustrated.

Order As WZ17T  
(Electronics) £9.99 NV

# Twelve great reasons to get Electronics under cover...



Available for the first time! The new Maplin magazine binder that holds twelve issues of Electronics, the Maplin magazine. If you have not got the world of Electronics covered, now's your chance! This great, quality binder comes in hard wearing, laminated art board, that not only looks good on your bookshelf or workshop desk, but is also a great way to build up an Electronics reference library of your own!

Now you can keep all of your copies of Electronics, the Maplin magazine, together and on hand for when you need that extra piece of information. To order your binder simply fill in the order form provided in this issue of Electronics. Only £5.45 (plus £1 handling charge). Order no: XH99H.

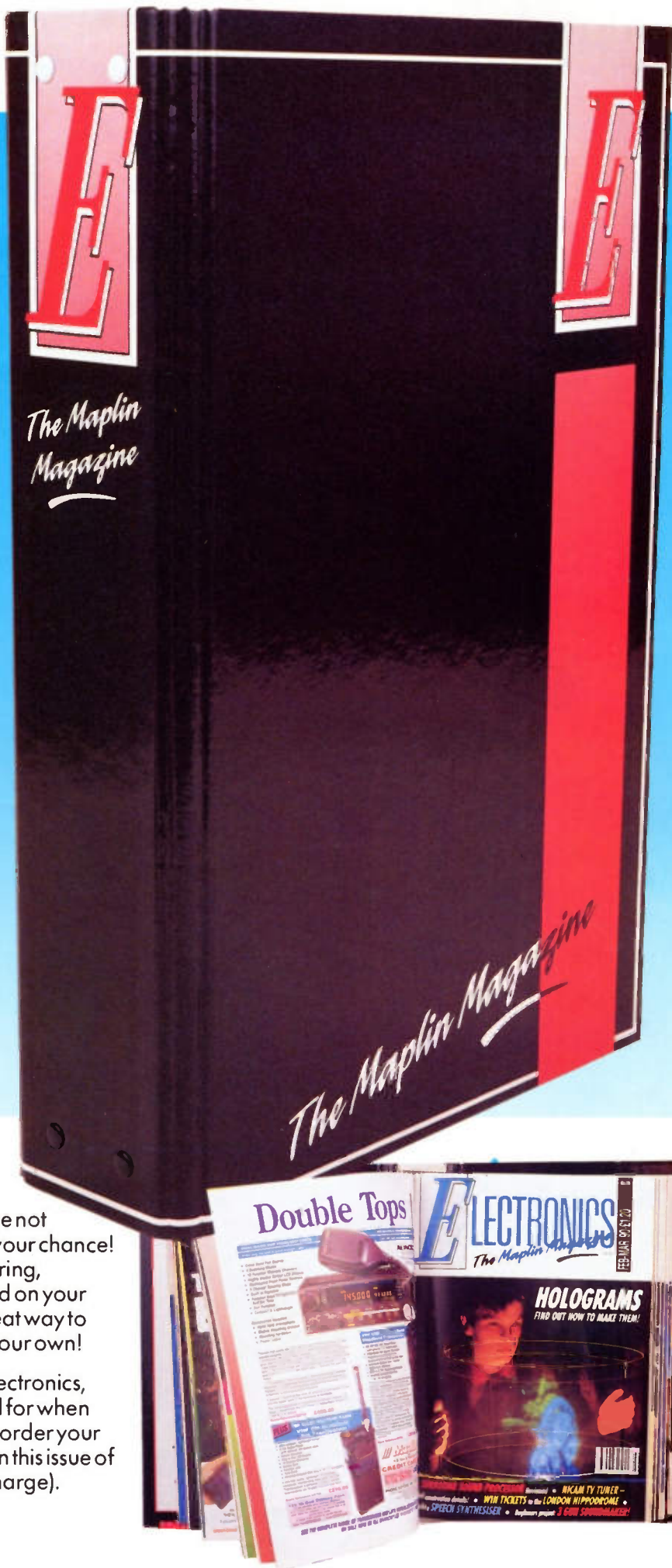

**THE NEW MAPLIN MAGAZINE BINDER...  
A GREAT WAY TO GET THE WORLD OF ELECTRONICS COVERED!**

1992 BUYER'S GUIDE TO ELECTRONIC COMPONENTS

# Maplin

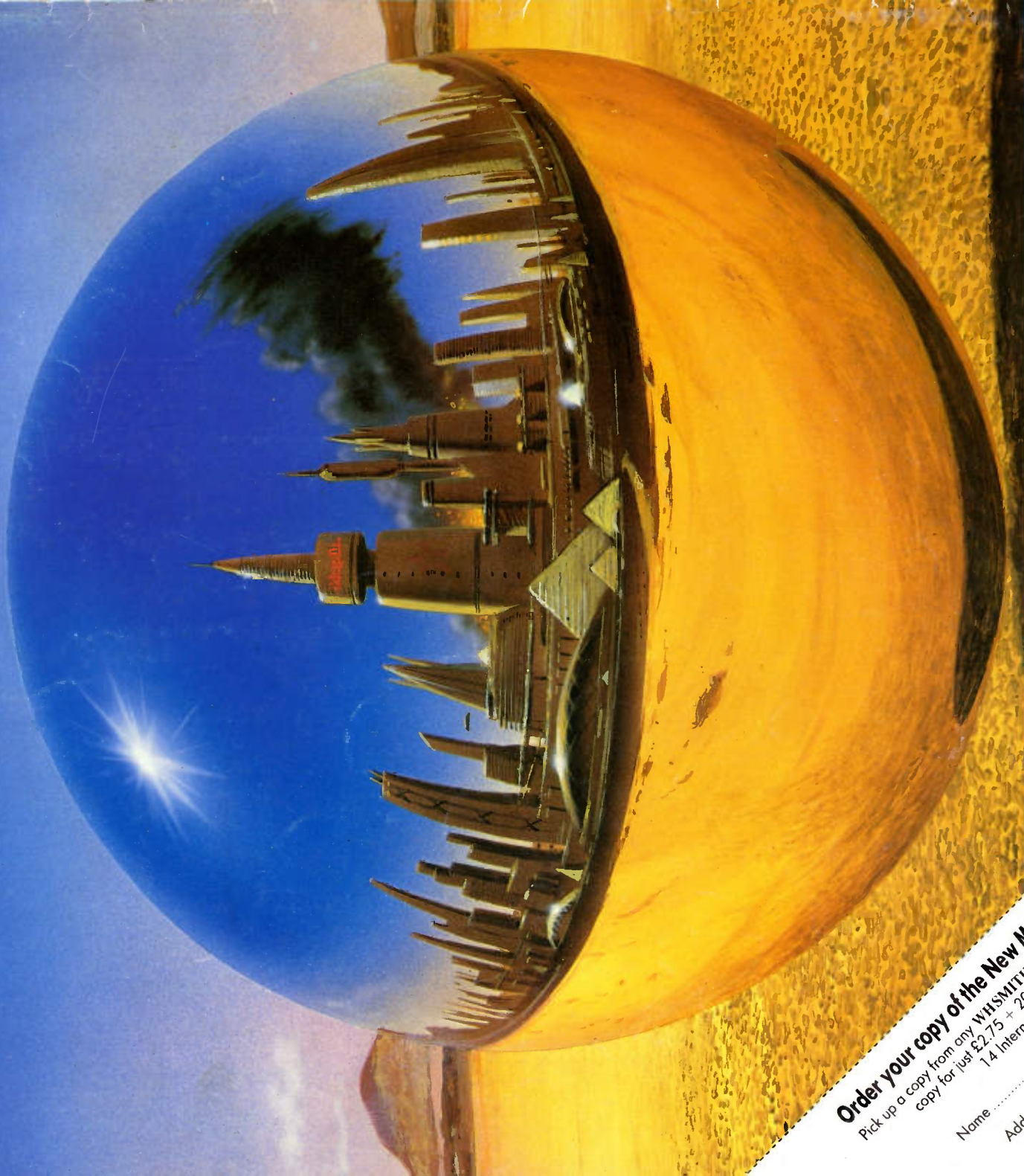

Over 600 product packed pages with  
more than 600 brand new products.

On sale now, only £2.75

Available from all branches of WHSMITH and  
Maplin shops nationwide. Hundreds of new products  
at super low prices!

**Order your copy of the New MAPLIN Catalogue on sale NOW!**

Pick up a copy from any WHSMITH for just £2.75 or post this coupon now to receive your  
copy for just £2.75 + 20p p&p. If you live outside the UK, send £4.85 or  
14 International Reply Coupons. I enclose £2.95.

Name .....

Address .....

Post Code .....

Send to Maplin Electronics,  
P.O. Box 3, Rayleigh,  
Essex S56 8LR.

MM92