

# INDUSTRIAL ELECTRONICS

JUNE 1965 5s 0d

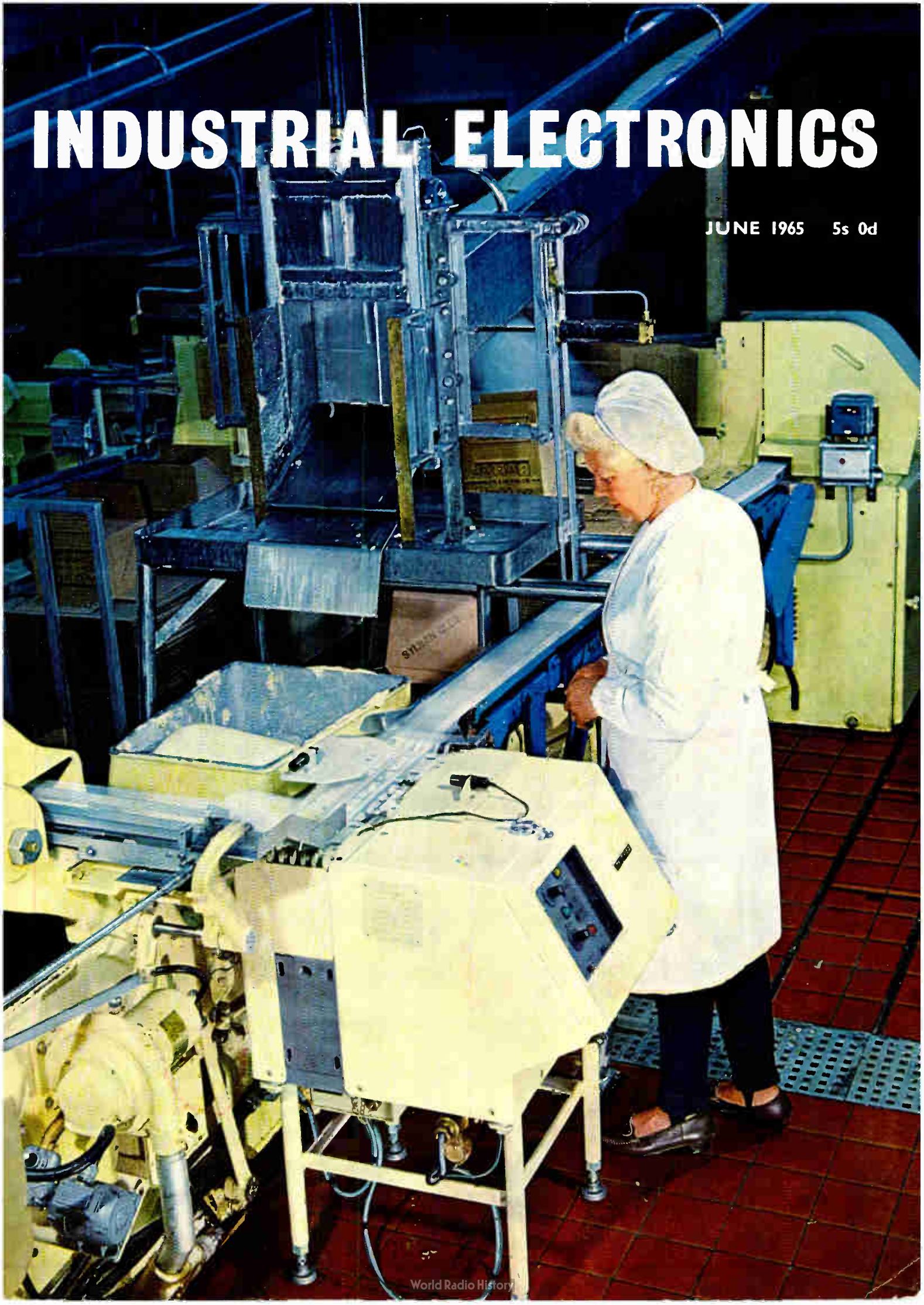

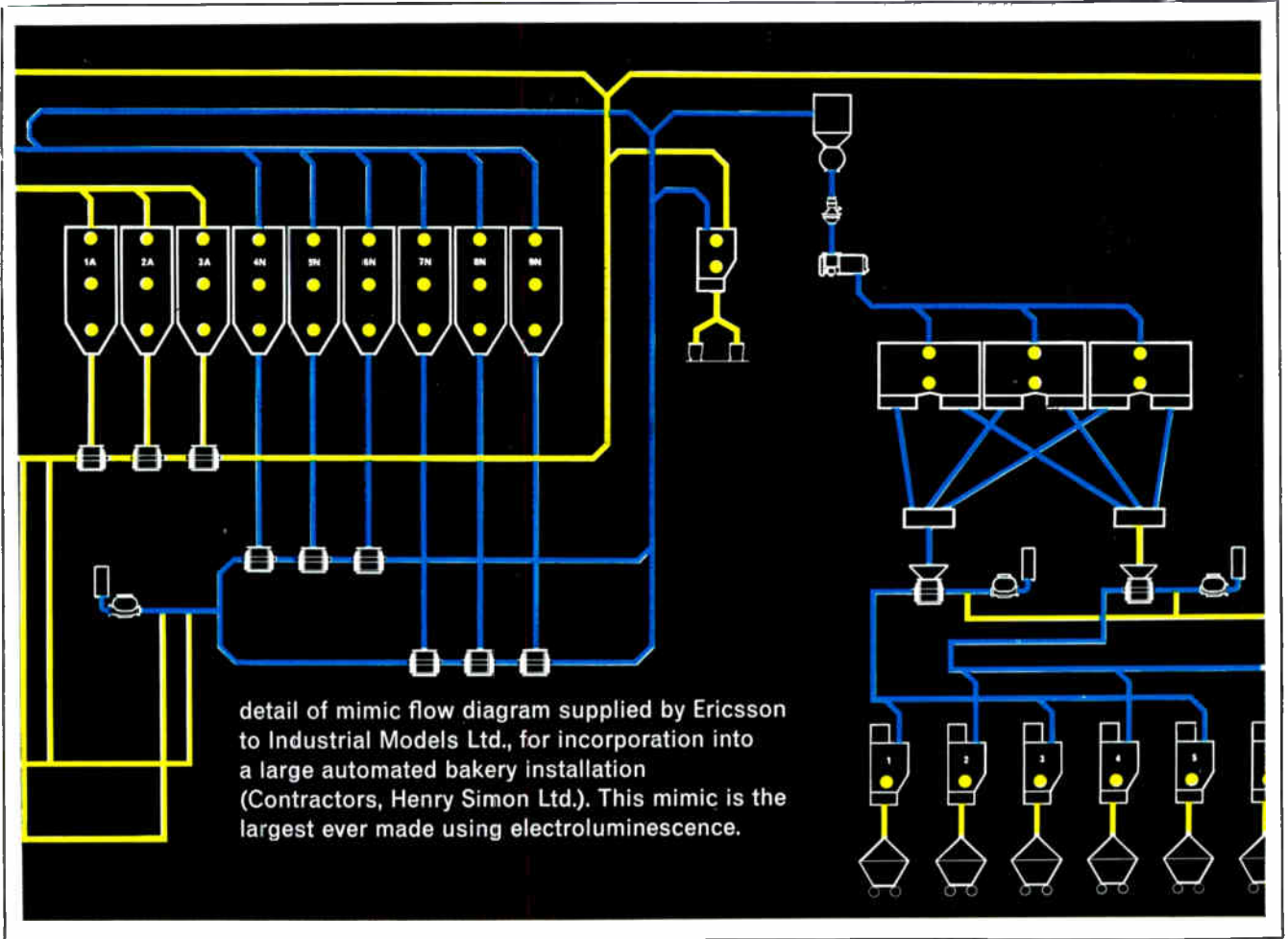



# electroluminescence

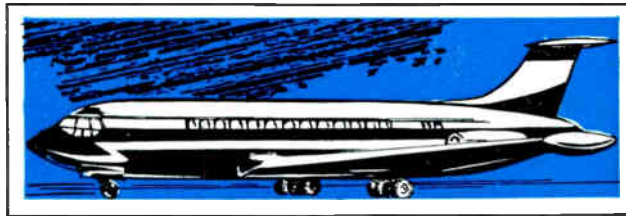
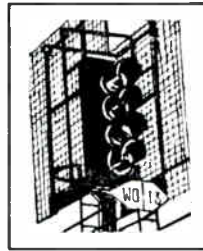
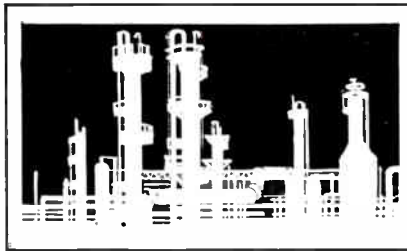
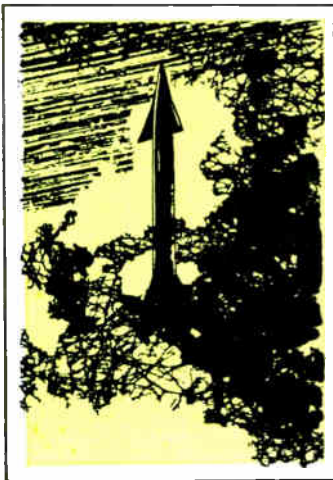

**for mimic control and flow display**

Electroluminescence offers a particularly flexible type of display, with a wide range of colours and the ability to display fine detail beyond the range of economically comparable systems. The Industrial and Educational applications are limitless and many industries are already taking advantage of its exceptional versatility. For further information please contact: Physics Division, Ericsson Telephones Ltd., Beeston, Nottingham.



**ERICSSON TELEPHONES LTD • ETELCO LTD**

A Principal Operating Company of the Plessey Group.

Registered Office: 22 Lincoln's Inn Fields, London, W.C.2. Tel: HOLborn 6936

Head Office and Main Works: Beeston, Nottingham. Tel: 254831. Telex: 37666

ER 107

---

# INDUSTRIAL ELECTRONICS

Automation      Instrumentation      Control

---

Volume 3

Number 6

June 1965

## Contents

Editor-in-Chief    **W. T. COCKING, M.I.E.E.**

Editor                                    **T. J. BURTON**

Advertisement Controller    **G. H. GALLOWAY**

Advertisement Manager    **R. H. C. DOHERTY**

Production                                **D. R. BRAY**

Drawing Office                        **H. J. COOKE**

257    **Comment**

258    **A Digital Device for Measuring Torque** *by M. J. Craddock and W. J. Brittain*  
A revolutionary form of torquemeter is described which is a major advance on all previous methods of torque measurement. Comprising a new type of torsion-meter with digital readout, accuracy is claimed to be within 0.25% ± one digit for the specified operating range.

262    **Automatic Control for Volumetric Filler** *by S. C. Whiteford*  
The use of automatic control of a machine for filling packs of butter to correct weight has resulted in an annual saving of considerably more than the capital cost of the equipment. The apparatus is described in this article and the cover picture shows a butter-packing station operating under its control.

266    **The Speech Reinforcement System of St. Paul's Cathedral** *by J. L. Goodwin*  
In order to secure satisfactory sound reinforcement in a large building, such as St. Paul's Cathedral, it is necessary to delay the sound signals to some of the loudspeakers. This is accomplished with the aid of magnetic recording technique, the delay being dependent on the spacing of the record and playback heads.

274    **A Practical Approach to Analogue Computers** *by D. S. Terrett, B.Sc.(Hons.)*  
Industry has come to realize the importance of the analogue computer as a serious design tool, not only in basic research but in practical engineering. This article assesses the computer in its technical aspects and discusses the various computer components in relation to their practical function. In restating these basic principles, the author gives a complete first introduction to analogue computers for the engineer in industry.

*continued overleaf*

---

© Iliffe Electrical Publications Ltd., 1965

*Permission in writing from the Editor must first be obtained before letterpress or illustrations are reproduced from this journal. Brief abstracts or comments are allowed provided acknowledgment to the journal is given.*

Published on the first Thursday after the 5th of each month by

Iliffe Electrical Publications Ltd., Dorset House, Stamford Street, London, S.E.1

Managing Director: W. E. Miller, M.A., M.I.E.E.E.

Telephone: Waterloo 3333.    Telegrams/Telex: Electronics Iliffepres 25137 London

ANNUAL SUBSCRIPTION, HOME £3 0s. 0d.    OVERSEAS £3 10s. 0d.  
CANADA and U.S.A. \$10.00.

---

# INDUSTRIAL ELECTRONICS

Automation      Instrumentation      Control

---

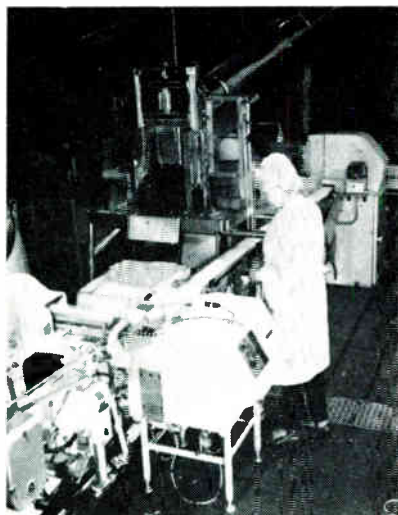

## OUR COVER

This month's front cover picture once again illustrates the ubiquity of electronics. It shows one of a number of electronically-controlled butter packing and weighing stations operating at the Woolwich plant of Dairy Produce Packers Ltd. Elsewhere in this issue an article describes the equipment and its operating advantages.

## ● TO SAVE YOUR TIME

We will assist you to obtain further information on any products or processes described or advertised in this issue. Just use the enquiry cards included in this journal.

## Contents *continued*

- 282 **Non-Contact Pyrometer for Moderate Temperatures**  
An instrument for measuring temperatures in the range 200-1,000 °C is described. The measurement is effected by comparing the radiation at two different wavelengths in the infra-red region.
- 287 **Control Design Data—Bridged-T Compensating Networks: I Frequency-Response Methods**  
*by N. G. Meadows, B.Sc.*

### What's On and Where?

A regular feature which lists forthcoming events. Professional meetings, symposia, conferences and exhibitions are included. For easy reference this item is positioned facing the inside back cover.

## Features

- |     |   |     |  |
|-----|---|-----|--|
| 264 | <b>Data Communication Demonstration</b>             | 285 | <b>Data Logging for M.V. 'Zealandic'</b> |
| 265 | <b>Control System for Automatic Nailing Machine</b> | 286 | <b>Anglo/French Secondary Radar</b>      |
| 272 | <b>Electronics Aids Eye Movement Research</b>       | 289 | <b>New Apparatus</b>                     |
| 278 | <b>Malaysia and Hong Kong linked by Telephone</b>   | 301 | <b>Traffic Control System for M.4</b>    |
| 280 | <b>Electronic Crane Control</b>                     | 302 | <b>Industrial News</b>                   |
| 281 | <b>Electronic Methane Detector and Alarm</b>        | 305 | <b>New Books</b>                         |
| 284 | <b>Analogue Computer at Colborn Vitafeeds</b>       | 306 | <b>Manufacturers' Literature</b>         |
|     |   | 48  | <i>Classified Advertisements</i>         |
|     |   | 53  | <i>Index to Advertisers</i>              |

---

## Next Month

An article dealing with the use of electronic techniques in coal mining will appear in the July issue. Other articles will include a description of a hydraulic method of handling fruit.



For further information  
circle 203 on Service Card

... And Now  
nearest to the ultimate for  
**MOULDED**  
**HIGH STABILITY CARBON RESISTORS**

**TYPE, STYLE, RATING, OHMIC RANGE AND TOLERANCE**

WELWYN TYPE	R.C.S.C. style to DEF 5115	WATTS RATING @ 70°C	MAX. VOLTAGE	R.C.S.C. style to DEF 5112	WATTS RATING @ 70°C	MAX. VOLTAGE	MIL. R. REF.	WATTS RATING @ 70°C	MAX. VOLTAGE	OHMIC RANGE @ 1%, 2% & 5%
C85	RFG3-0.0625	1 1/6	150	—	—	—	RN 55D	1 1/8	200	10Ω-300K
C80	RFG3-0.125	1 1/8	200	RC4-L	1/8	200	RN 60D	1 1/4	300	10Ω-1M
C81	RFG3-0.25	1 1/4	250	RC4-M	1/4	250	RN 65D	1 1/2	350	10Ω-1M
C82	RFG3-0.5	1 1/2	350	RC4-N	1/2	350	RN 70D	1	500	10Ω-5M
C83	RFG3-1.0	1	500	RC4-P	1	500	RN 75B	1	500	10Ω-10M
C84	RFG3-2.0	2	750	—	—	—	RN 80B	2	750	10Ω-10M

**STORAGE:** After 12 months storage, the maximum change in resistance will not exceed 0.7%.

**STABILITY:** For 2,000 hours full load operation at 70°C, the typical change of Welwyn Moulded Insulated High Stability Carbon Resistors is:—

LOW VALUES	0.2%	} Limits in DEF 5115 1½% to 3%
MEDIUM VALUES	0.5%	
HIGH VALUES	1.0%	

For 10,000 hours full-load operation at 70°C, the typical change of Welwyn Moulded Insulated High Stability Carbon Resistors is:—

LOW VALUES	0.5%	}
MEDIUM VALUES	1.0%	
HIGH VALUES	2.0%	

**TEMPERATURE COEFFICIENT:**

In the general range of -0.025% per °C

WRITE NOW FOR FULL DETAILS



**WELWYN ELECTRIC LIMITED**

BEDLINGTON - NORTHUMBERLAND - ENGLAND

Telephone: Bedlington 2181-9 - Telegrams: Resistor Bedlington.

FACTORIES IN AUSTRALIA AND CANADA

# minar

a NEW modular chassis system designed by the

# BBC

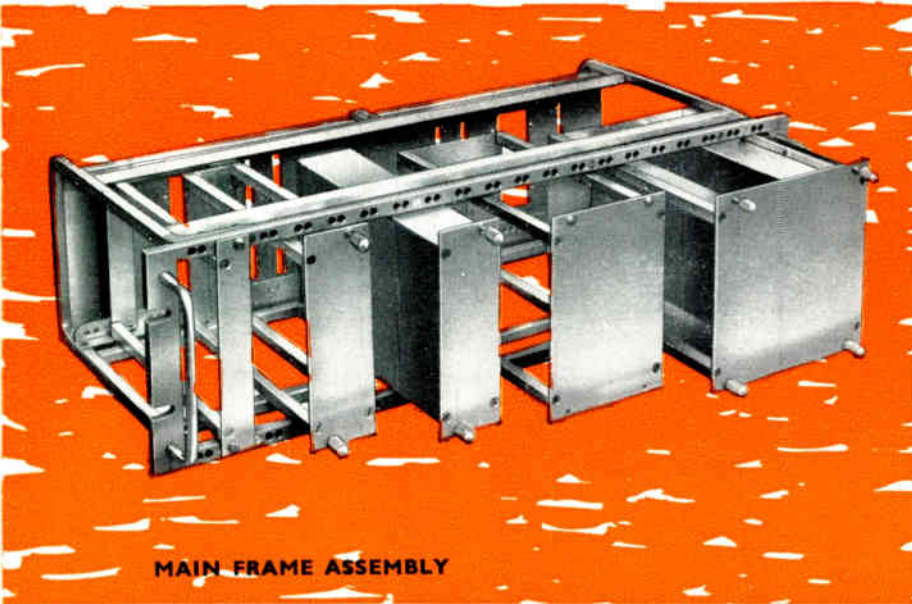

**MAIN FRAME ASSEMBLY**

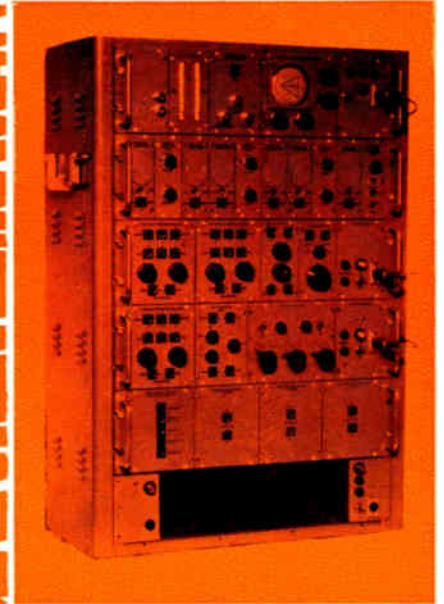

**CASE & LID ASSEMBLY**

**MODULE**

**CHASSIS**

Minar is based on a standard 19 inch x 5¼ inch panel in the form of a miniature rack into which units of various sizes may be inserted. The mechanical construction is straightforward and the overall assembly of units is capable of being used either in a standard 19 inch bay or in a portable carrying case. Space does not permit listing the numerous advantages this design affords when compared with similar systems. *We acknowledge our indebtedness to the British Broadcasting Corporation for permission to manufacture to their design.*

**A·P·T** **ELECTRONIC INDUSTRIES LIMITED**

CHERTSEY ROAD, BYFLEET, SURREY

Phone: Byfleet 41131/2/3/4 PABX Grams: APTRAN, BYFLEET

**PLEASE SEND ME FULL INFORMATION ON THE MINAR SYSTEM**

Name .....

Company .....

Address .....

Position .....

IE2/LEE



JUNE 1965

# STC components review

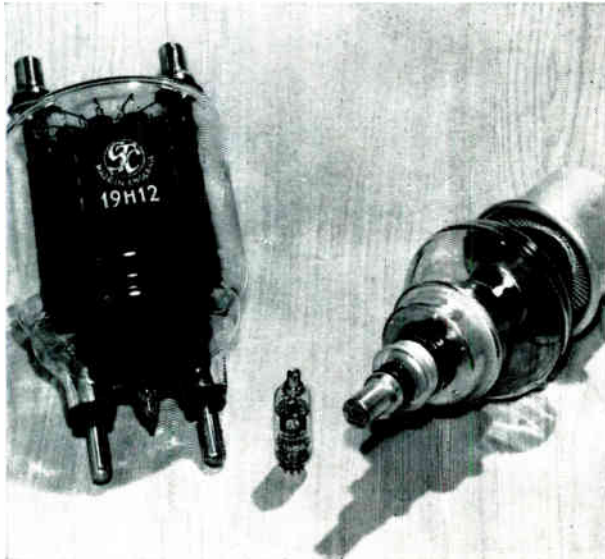

## Vacuum rectifier valves

STC produce a comprehensive range of vacuum rectifier valves for applications which include high voltage power supplies, line charging and overswing damping. Notable features are the high power dissipation combined with compact structure of the forced-air-cooled type 2J/262E and the low pulse impedance of the type 19H12 (23Ω at 30A).

### ABRIDGED DATA

Code	CV No.	Fil Heater		Max. p.i.v. (kV)	Peak I <sub>a</sub> (A)	Average I <sub>a</sub> (A)	Max. P <sub>a</sub> (W)
		(V)	(A)				
19E2	265	4	2.1	4	12	—	—
19G6	371	4	0.5	6	0.18	0.03	—
S19G6*	4057	4	0.5	6	0.18	0.03	—
S19G6F*	4042	4	0.5	5	0.18	0.03	—
19G3	277	4	1.4	7	0.4	0.05	—
19H4	2180	2.5	1.7	20	0.18	0.03	—
19H5	490	4	4	20	0.35	0.125	—
19H12	—	4	12	25	30	—	50
705A	3587	5	5	30	0.4	—	60
ESU112	—	4	12	40	1.1	—	130
ESU77	2160	4	12	50	1.1	—	130
2J/262E	—	5	40	50	7.5	1.5	1500
LS945	—	5	12.5	100	4	0.75	100

\*Special quality valves

Write, 'phone or telex for Data Sheets to STC Valve Division, Brixham Road, Paignton, Devon or London Sales Office, Footscray, Sidcup, Kent. Telephone: FOOTscray 3333. Telex: 21836.

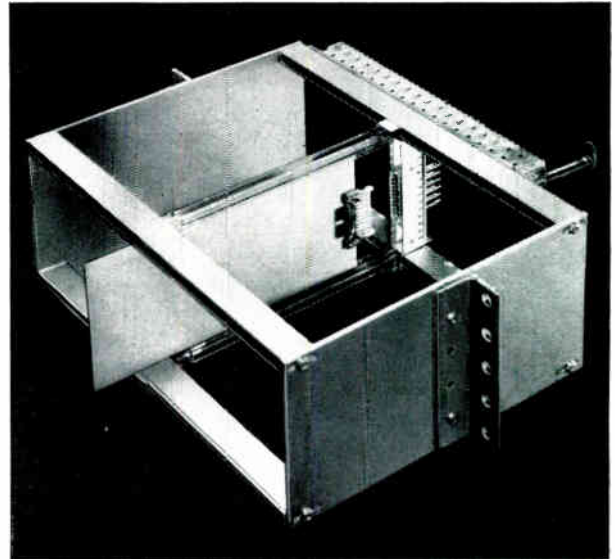

## Equipment design and construction with ISEP

International Standard Equipment Practice covers a range of parts from connectors to cubicles. The system offers a rational solution to the problems inherent in the overall process of building electronic equipment.

The ISEP system is modular, but has enormous scope for dimensional variety. This gives the designer freedom of design ingenuity whilst keeping costs low through standardization of parts. All parts are available from STC "off the shelf". The mechanical work in producing dimensional variation is simple and minimal. No metal finishing is involved.

With ISEP hardware, the development prototype will be nearer to the production version than with other systems. In both instances assembly is fast and simple. No special tools are needed and no jigs are required. Standard parts either snap together or have built-in locations for screwing.

Write, 'phone or telex for full details to Electronic Services, STC, Edinburgh Way, Harlow, Essex. Telephone: Harlow (STD code OBS96) 26811. Telex: 81146.



### Thermal delay switches

STC manufacture an extensive range of reliable and inexpensive switches which afford a choice of heater voltages, delay times and contact ratings as shown in the following table.

Thermal delay switches are particularly suitable for delaying the application of h.t. voltage to electronic tubes which require a pre-heat time; they may also be used for switching 3-phase circuits from star to delta arrangements and for automatically re-closing a circuit breaker after a temporary current surge has caused it to trip. These applications are fully described in booklet MS/117 available on request from the address given below.

**ABRIDGED DATA**

Code	Base	Heater		Delay time at 20 C (sec.)		Contact ratings on make			
		V	A	Min.	Max.	a.c.		d.c.	
DLS10	B4	4.0	1.5	30	90	250 1 000	5.0 0.2		
DLS15	B4	4.0	0.75	30	90	240 1 000	5.0 1.0		
DLS16	1D-8	6.3	0.48						
DLS23	1O-8	2.5	1.0						
S45C 1D†	Small water octal	6.3	1.0	35	50	250	5.6	250	3.0
S 751K	B7G	.0	0.104	65	85	100	1.0	220	1.0
S102 1K (VLS631)	B7G	6.3	0.5	44	66	100	1.0	220	0.5
S102 1G	B7G F								
S103 1K	B7G	27	0.115	36	54	100	1.0	220	0.5
S104 1K	B7G	6.3	0.5	25	35				
S105 1K	B7G	27	0.115	20	30				
S106 1K	B7G	*9	0.165	40	65				
S107 1K	B7G	6.3	0.5	8	15				
S108 1K	B7G	24	0.13	36	46				
S109 1K	B7G	6.2	0.5	72	98				
S30 2K (6N030T)	B9A	6.3	0.5	20	40				
S102 2K	B7G	6.3	0.5	44	66				
S104 2K	B7G	6.3	0.5	25	35	250	1.0	250	0.5
S204 2K	B7G	6.3	0.5	25	35				
SS110 1D:	Small water octal	5.3*	0.5*	90*	110*	100	1.0	220	0.5
DLS24	B7G	6.3	0.5	Reverse action 55 sec. to open		240 500	1.0 0.2	—	—

† Snap-action switch. ‡ Double switch in common envelope. \* Per section.

Write, 'phone or telex for Data Sheets to STC Valve Division, Brixham Road, Paignton, Devon or London Sales Office, Footscray, Sidcup, Kent. Telephone: FOOTscray 3333. Telex: 21836.

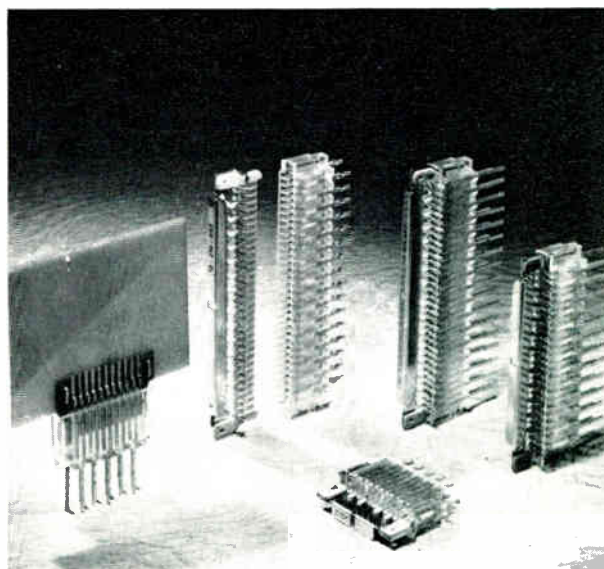

### Edge connectors with high density contact grouping

ISEP (International Standard Equipment Practice) edge connectors from STC have contacts with a pitch of only 0.1 in. (2.54 mm) between contact centres. The connectors are the answer to the equipment engineer's requirements for high density, multi-pole edge connectors for use on printed circuit boards carrying large numbers of miniature components.

Designed initially for connection between equipment wiring and plug-in boards within ISEP racking, these connectors are equally suited for use on other types of chassis or cabinets. Principal features of ISEP connectors are:

- Three sizes: 11, 25 and 33-way.
- Only connector to meet B P O tests in full. 0.1 in. contact pitch conforms to latest international standards.
- Precious metal contacts rolled flat from wire to eliminate sharp edges.
- Available with wrap or solder tags.
- Plastic coding combs guarantee correct insertion.
- Fully integrates with ISEP racking system.
- Competitively priced.

Write, 'phone or telex for full details and prices to STC Electro-Mechanical Division, West Road, Harlow, Essex. Telephone: Harlow 21341. Telex: 81184.



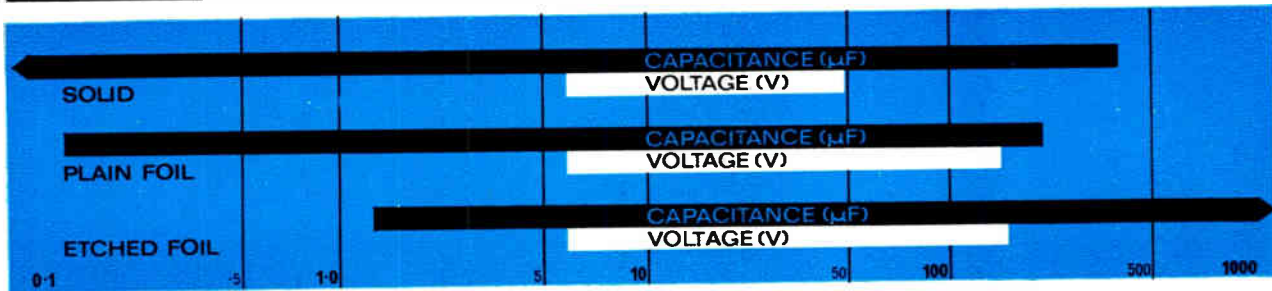
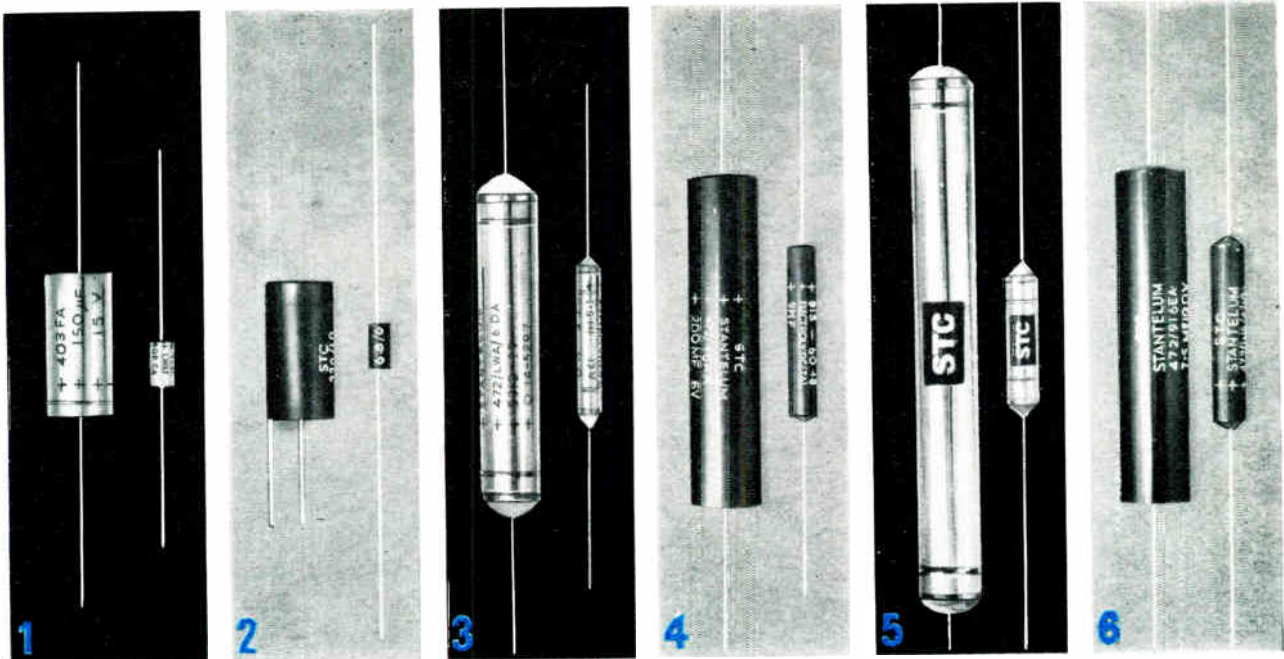

### High quality tantalum capacitors

**1 SOLID METAL CASE**

-55°C to +125°C  
Full Qualification Approval (DEF 5134A-1)

**2 SOLID RESIN CASE**

-55°C to +85°C  
Radial and axial terminal wires

**3 STANDARD PLAIN FOIL**

-55°C to +85°C  
Fully Type Approved (RCS 134 B) Polar and non-polar

**4 HIGH TEMPERATURE PLAIN FOIL**

-55°C to +125°C  
Can also withstand severe shock and vibration conditions. Polar and non-polar

**5 ETCHED FOIL**

-55°C to +85°C  
Greatly increased capacitance to volume ratio. Polar and non-polar

**6 SPECIAL QUALITY PLAIN FOIL**

-55°C to +85°C & -55°C to +125°C  
For equipment demanding the highest quality. Polar and non-polar

Write, 'phone or telex STC Capacitor Division, Brixham Road, Paignton, Devon, or London Sales Office, Footscray, Sidcup, Kent. Telephone: FOOTscray 3333. Telex: 21836.

**STC**  
COMPONENTS GROUP

high-grade components by

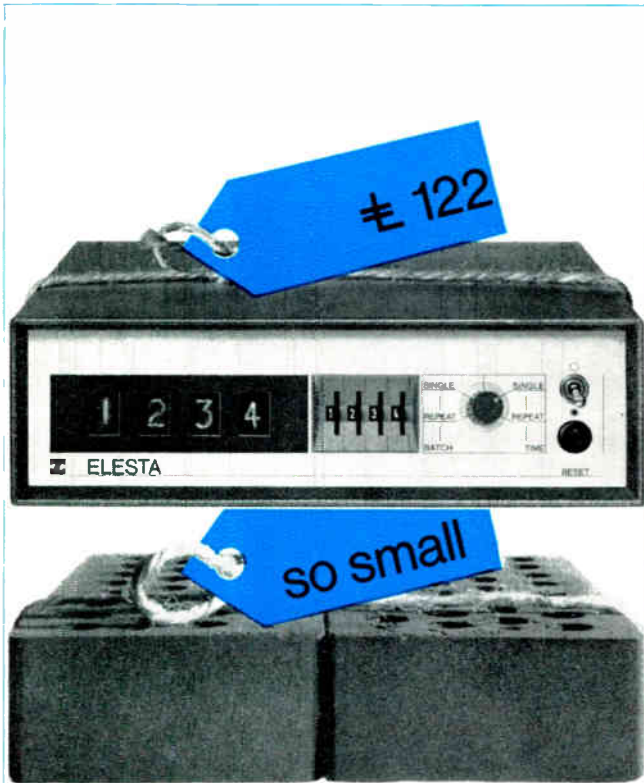

never before.....  
 \*such versatility  
 in electronic.....  
 such compactness  
 counters.....  
 such a low price

**\*count**

Electronic Counter-Timer for industrial use.

One instrument for universal use

**\*measure**

Simple pre-selection with external relay. Counting with electronic reset, internal 100 kc/s precision time reference

**\*control**

- Max counting rate of 100 kc/s
- Numerical display
- Fingertip pre-selection
- Relay output
- Electrical output

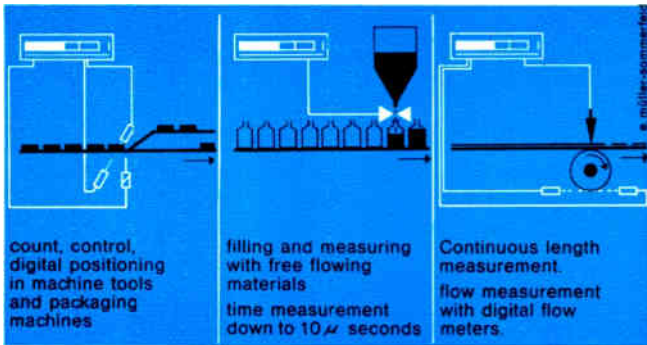

WANstead 4461

**ELESTA**

34 Cambridge Park, LONDON E. 11  
 WANstead

**encapsulated ergonomics**  
 "HUMAN ENGINEERING IN A NUTSHELL"

Widney Dorlec have designed a prefabricated method of making either a simple instrument cabinet or a suite of control positions for a missile launching station. The system comprises of a range of extruded members and precision corner castings. Assembly is by means of the simple, quick, rigid central bolt. Just take a hack saw, a spanner and build to your own needs. Alternatively we can construct to your own design and specification.



.... to make this



**TELESCOPIC SLIDES.** For maximum efficiency modern equipment demands a regular maintenance. Our range of telescopic slides offers the most convenient means of complete accessibility.

**WIDNEY DORLEC**

Write now for comprehensive illustrated literature  
 HALLAM, SLEIGH & CHESTON LTD :  
 P.O. BOX 133, BAGOT STREET, BIRMINGHAM, 4.  
WD58



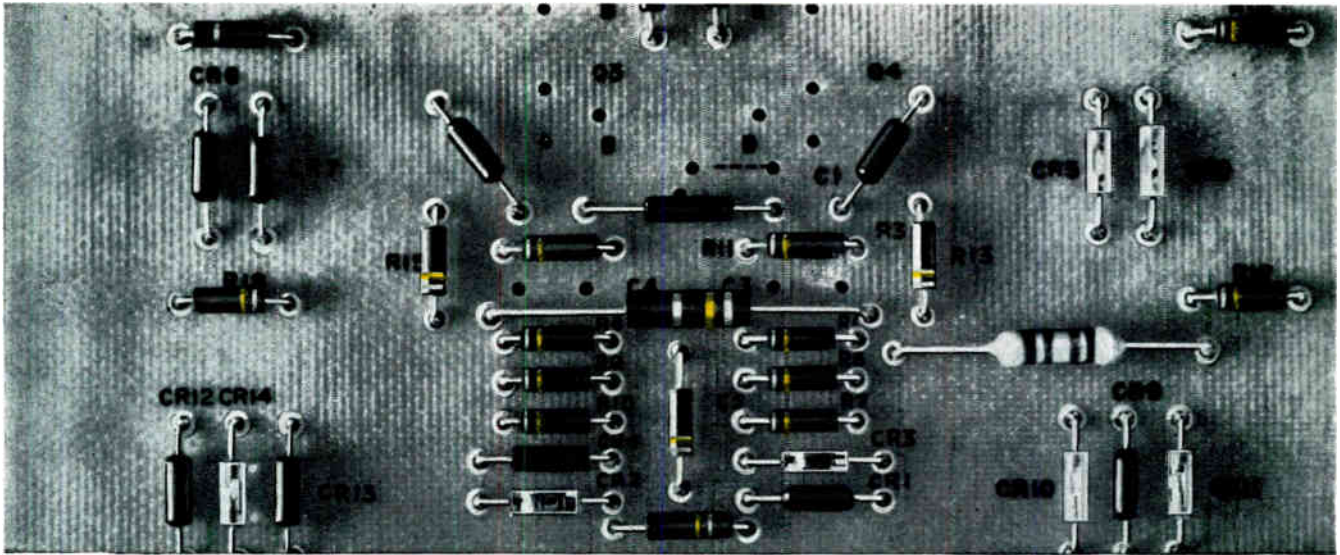

Now you've got so far...

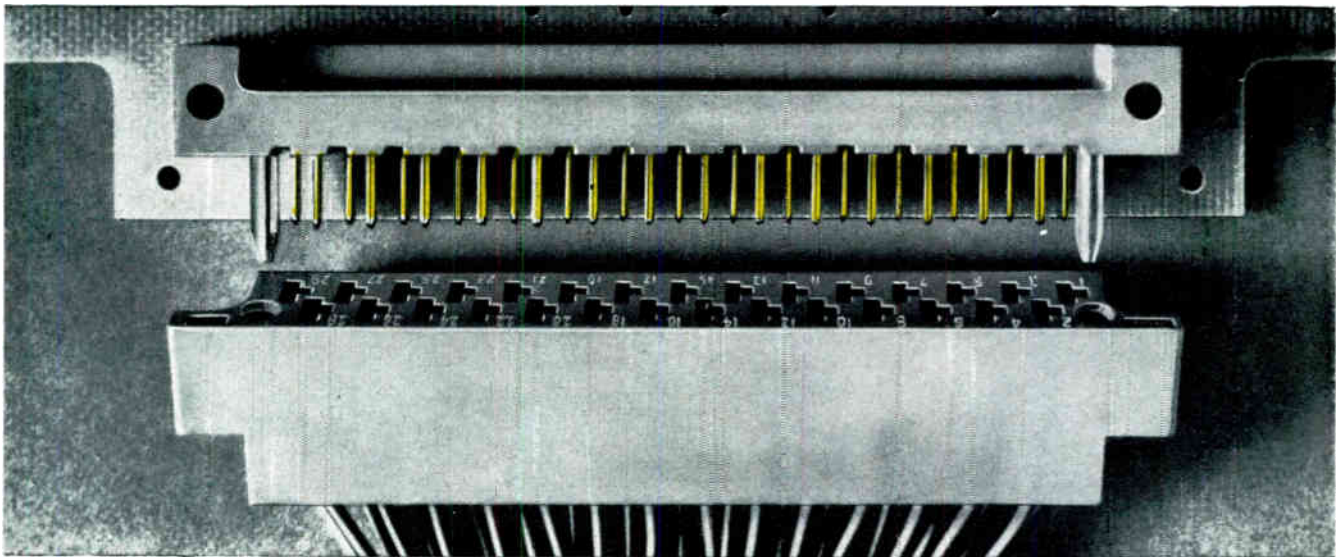

...finish the job with the best connector

For any solid state design requiring connectors with from 17 to 47 contacts, AMP-BLADE connectors add the finishing touch. They provide smooth, uninterrupted current flow, greater overall efficiency and production economy.

**Tab Housing Construction.** Each male tab is rigidly staked to the board, ensuring excellent contact with printed circuitry and eliminating board warpage.

**Receptacle Housings.** Snap-in receptacle contacts float, ensuring correct alignment and freedom from wear.

**Large Contact Areas.** Contacts provide 3" 'long' areas of contact, eliminating rocking and plating wear. Special contact spring ensures uniform pressure.

## AMP-BLADE printed circuit connectors

incorporating AMP controlled compression crimp for lowest applied cost.

**Crimped, Snap-in Design.** Receptacle contacts are crimped automatically to cables at rates up to 4000 per hour, using automatic machines. Snap-in assembly means no unused contacts. Single contacts can be changed or replaced as required.

**Gold Plating.** Gold plating over nickel is standard. X-ray control ensures thickness uniformity which prevents metal creep and oxide build-up.

There is much more to it than is given here. Send for full particulars and data.



TERMINAL HOUSE, STANMORE, MIDDX. STONEGROVE 6341  
U.S.A. • AUSTRALIA • CANADA • FRANCE • GERMANY  
HOLLAND • ITALY • JAPAN • MEXICO • PUERTO RICO  
AMP AND AMP-BLADE ARE REGISTERED TRADE MARKS OF AMP INC.  
AP 290

**All five have these features —**

**bright 6 x 10 cm displays**

**illuminated, no-parallax graticule**

**small spot size, uniform focus**



**full-passband triggering**

**plug-in unit adaptability**

Here are five oscilloscopes of the same family — but each with a distinct personality. All five oscilloscopes use the new Tektronix 1-A series plug-in units or any of the 17 different "letter-series" units for extraordinarily broad coverage of application needs.



Most versatile is the type 547, a single-beam instrument providing dual-beam performance in most applications. With automatic display switching between its two time bases, the type 547 permits alternate presentation of the same signal at two different sweep speeds, or two different signals at two different sweep speeds and sensitivities. With a new Type 1A1 or 1A2 Plug-in Unit, the Type 547 has all the performance characteristics needed for demanding applications:

**Wide Band Response**—dc to 50 Mc/s dual-trace displays at sensitivities to 50 mv/cm.

**High Sensitivity**—500  $\mu$ v/cm (uncalibrated) single-trace displays at 2 cps to 15 Mc/s, 5 mv/cm dual-trace displays at dc to 28 Mc/s (with Type 1A1).

**Calibrated Sweep Delay**—for precise time measurements

**Fixed-Tuned Delay Line**—for uniform transient response

The Type 546 has all the features of the Type 547 less automatic display switching.

The Type 544 has one time base and six steps of sweep magnification from 2X to 100X.

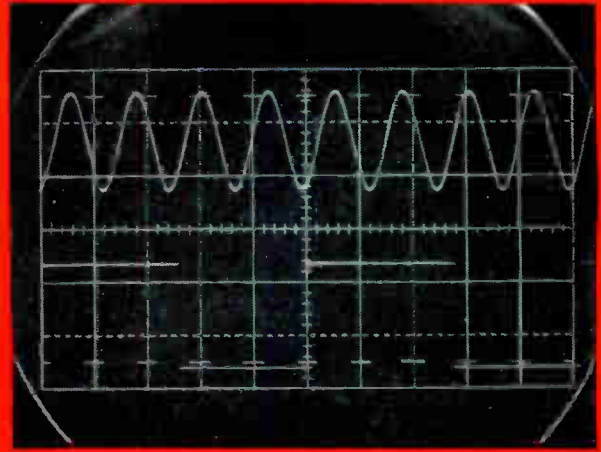

2 signals—different sweep speeds (with Type 547 and 1A1 unit)

Upper trace is Channel 1/A sweep, 1  $\mu$ sec/cm.

Lower trace is Channel 2/B sweep, 10  $\mu$ sec/cm.

# TEKTRONIX OSCILLOSCOPES

The 545B is an improved version of the Type 545A, which has proved itself of great service to a multitude of laboratories and industries throughout the years and has been considered a standard by which other oscilloscopes can be judged.

With the new Type 1A1 Plug-in Unit, the Type 545B provides dc to 33 Mc/s operation at sensitivities to 50 mv/cm—dc to 23 Mc/s at 5 mv/cm dual-trace and 2 cps to 14 Mc/s at approximately 500  $\mu$ v/cm single-trace—sweep speeds to 20 nsec/cm, calibrated sweep delay, plus these new and improved features:

New crt—for high resolution, uniform-focus traces.

New 6 x 10 cm display area—for greater viewing ease.

New vertical amplifier—for greater stability and reliability.

New fixed-tuned delay line—for uniform transient response.

New internal illuminated graticule—for no-parallax viewing.

New trigger circuits—for triggering beyond 30 Mc/s.

The Type 543B is similar to the Type 545B but has one time base and wide-range sweep magnification of 2X to 100X.

## Main Characteristics

	PASSBAND 1	SWEEP RANGE	SWEEP DELAY	SWEEP MAGNIFIER	PRICE
<b>Type 543B</b>	DC to 33 Mc/s	0.1 $\mu$ sec/cm to 5 sec/cm in 24 calibrated steps, variable uncalibrated from 0.1 $\mu$ sec to $\approx$ 12 sec/cm	None	2X, 5X, 10X, 20X, 50X, 100X	£531
<b>Type 545B</b>			1 $\mu$ sec to 10 sec	5X	£634
<b>Type 544</b>	DC to 50 Mc/s	Same characteristics as Type 546 plus Automatic Delay Switching, which provides equivalent dual-beam performance for most applications.	None	2X, 5X, 10X, 20X, 50X, 100X	£534
<b>Type 546</b>			0.1 $\mu$ sec to 50 sec	2X, 5X, 10X	£711
<b>Type 547</b>					£762

Type 1A1 Plug-in Unit is priced at £244

Type 1A2 Plug-in Unit is priced at £132

1 Passband is with one of the new amplifier plug-ins, Type 1A1 or 1A2, at 50 mv/cm. Each of these dual-trace units provides maximum passband for all Tektronix Oscilloscopes that accept Letter-Series Plug-Ins. Pack Mount Models also available.

Prices shown are free of duty subject to Treasury direction

**TEKTRONIX U.K. Ltd.**

BEAVERTON HOUSE STATION APPROACH  
Telephone: Harpenden 61251 Telex: 25559

HARPENDEN

HERTS

For Overseas enquiries—

TEKTRONIX CANADA Ltd. Montreal, Quebec & Toronto (Willowdale) Ontario

TEKTRONIX Ltd. Albany House, St. Peter Port, Guernsey, C.I. TEKTRONIX INTERNATIONAL A.G., P.O. Box 57 Zug, Switzerland

TEKTRONIX AUSTRALIA PTY Ltd. P.O. Box 488 Sydney New South Wales TEKTRONIX Inc. P.O. Box 500 Beaverton, Oregon, U.S.A.



**D**EPENDABLE WORKMANSHIP  
**E**XPERIENCED OPERATORS  
**L**ARGE STOCKS OF ALL MATERIALS  
**A**CCURACY AND RELIABILITY  
**N**ATIONWIDE SERVICE  
**C**OMPLETE CATALOGUE ON REQUEST  
**O**RTHODOX OR UNUSUAL, WE MAKE IT

VULCANIZED FIBRE · LEATHEROID · PRESSPAHN · COMPOSITE  
INSULATION · SILICONE & EPOXY BONDED GLASS FIBRE  
BAKELITE SHEET, TUBE & ROD · COPPER CLAD LAMINATES  
MICA AND MICANITE · AND PRECISION MACHINED  
AND PRESSED PARTS IN ALL INSULATION MATERIALS

ANGLO-AMERICAN VULCANIZED FIBRE COMPANY LTD, CAYTON WORKS, BATH STREET, LONDON, E.C.1. CLE: 8484 (15 LINES)



IT ALL ADDS UP TO  
***Delanco***





**Porcelain**
**Steatite**

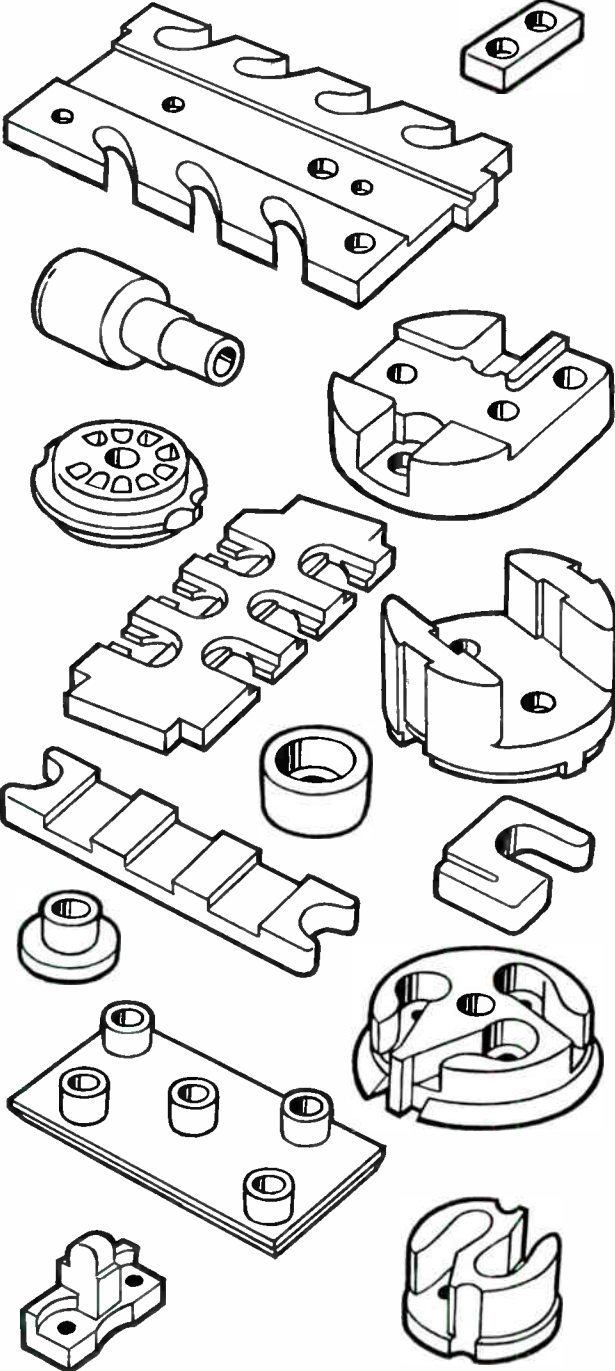

## V. G. PORCELAIN CO LTD

GORST ROAD  
PARK ROYAL  
LONDON, N.W.10

Telephones:  
ELGAR 1411/7  
Telex:  
London 25589

## ISOLA- base-materials:

for printed circuits for all purposes.

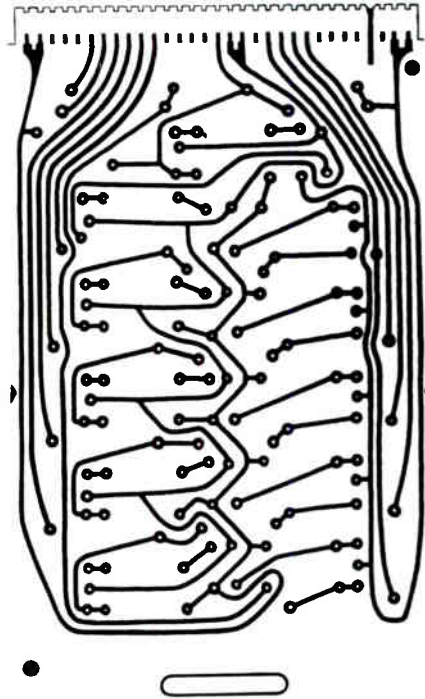

### SUPRA-CARTA-Cu quality 96

Supporting-material: laminated paper on phenolic resin base, top quality for radio and television-industries and for other commercial applications, corrosion-proof, non-burning according to ASTM D 635-56 T, cold-punchable.

### SUPRA-CARTA-E-Cu

Supporting-material: laminated paper on epoxy resin base, low dielectric-loss factor for all frequencies, high resistance values, track resistant, good mechanical strength.

### VERRODUR-E-Cu

Supporting-material: fibre glass laminate on epoxy resin base with highest electrical and mechanical characteristics in extreme climates. quality 100: corresponding to NEMA-Part 10, G 10 quality 110: corresponding to NEMA-Part 10, G 11 Ask for our technical information-bulletins and samples.



**Isola Werke A. G.**  
5160 Düren

Federal Republic of Germany  
U. K. agent: J. M. Harding Assoc. J. E. E.  
12 Offington Gardens, Worthing, Sussex



# MORE, precise..rugged..versatile

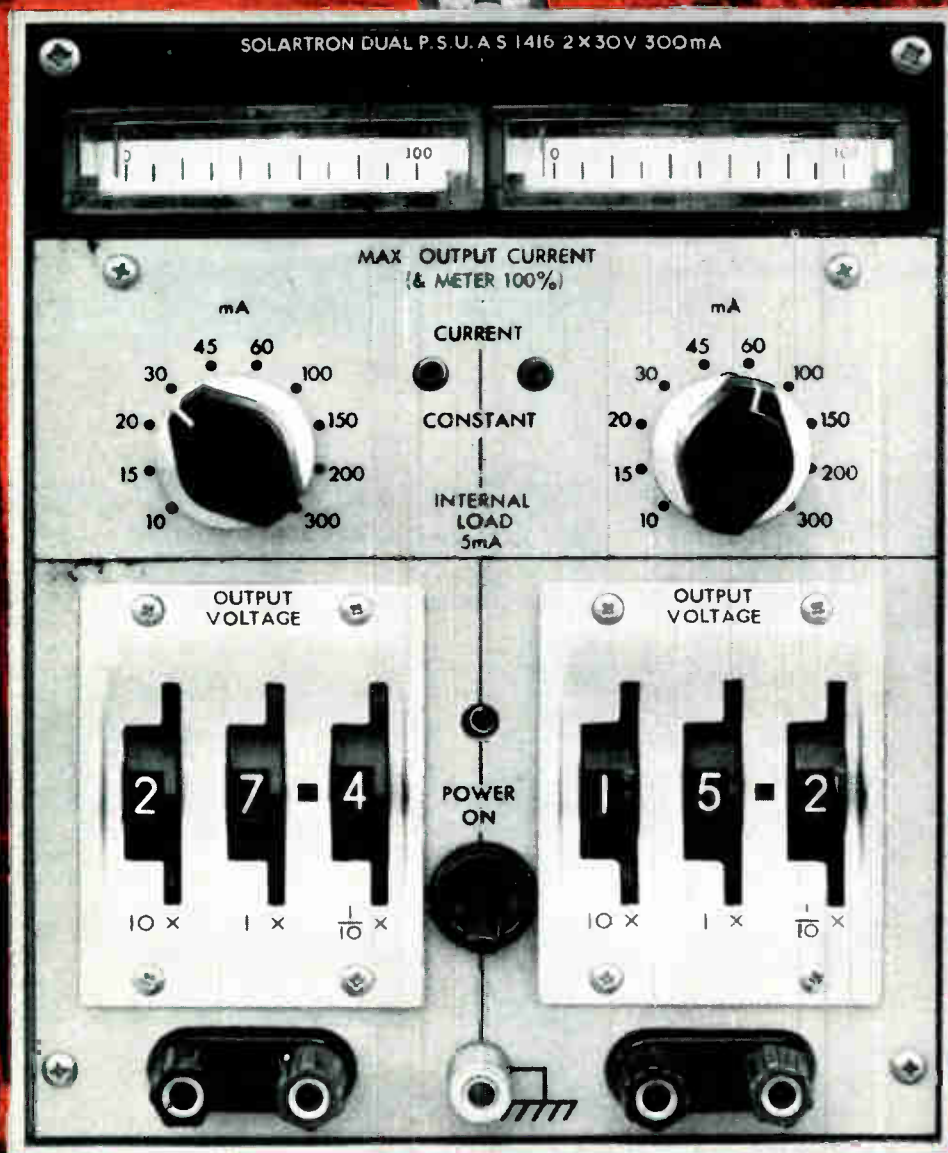

AS1410  
range of  
Power Supplies  
11 units  
0-300mA to  
0-5A



# .. the standard of the future NOW!

What do you expect of a laboratory power supply?

This is what **SOLARTRON** offers you

The AS 1410 Range surpasses in all parameters the accepted standards of today – establishing the norm by which future designs will be judged. No existing equipment can improve on their performance.

Consider some of these features:

- \* **Constant Voltage/Constant Current output characteristic with automatic changeover at any predetermined level.**
- \* **0.25% typical decade voltage setting with supplementary smooth variable control.**
- \* **10,000:1 Regulation against mains variation.**
- \* **0.05% basic long term stability over 1000 hours and temperature coefficient of 0.01% per °C.**
- \* **1 milliohm DC output resistance and 2 μsec response to full load transients.**

These alone justify our claims – there are additional benefits.

A new method of meter ranging ensures that open scale readings are obtained at all current settings.

Specified ripple and noise are < 500 μV peak to peak but external modulation facilities allow low frequency signals to be superimposed at any desired level.

Long life and stability of parameters are guaranteed over an ambient temperature range 0–50°C and even higher temperatures can be tolerated.

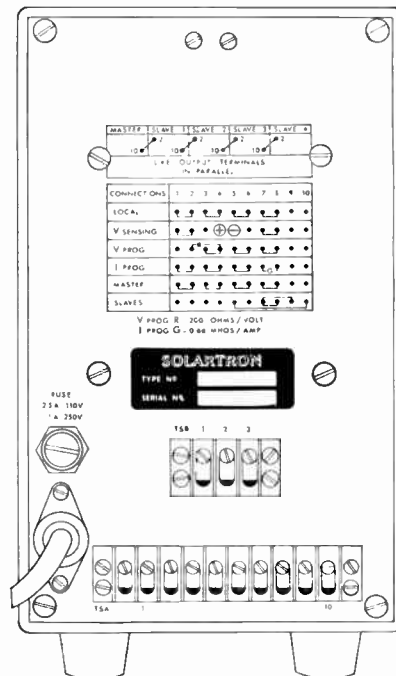

Full remote programme facilities for determining both voltage and current are combined with voltage sensing of remote loads and slaved parallel operation of multiple units.

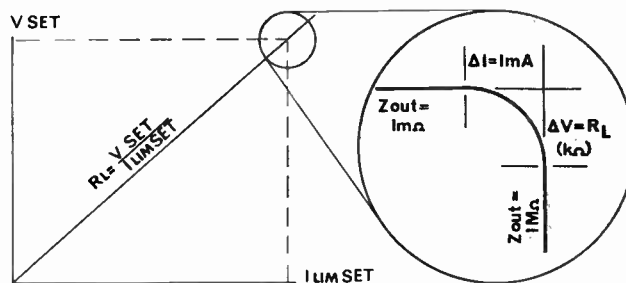

Automatic CV/CI changeover characteristic

## SOLARTRON

For Data Systems · Transducers · Computers  
Military Systems · **Electronic Instrumentation**

**THE SOLARTRON ELECTRONIC GROUP LTD.**  
Farnborough Hants  
Telephone · Farnborough (Hants) 44433  
Telex · 85245 Solartron Fnbro  
Cables · Solartron Farnborough  
**A MEMBER OF THE SCHLUMBERGER GROUP**

# Dawe digital voltmeter

## Type 652

An inexpensive, multi-range voltmeter with millivolt sensitivity, and 4-digit display with automatic decimal point.

### Main Features:

- ★ 0 to 1,000V d.c. in four ranges.
- ★ Available with 0.1%, or 0.2% full scale accuracy.
- ★ Input impedance 2.2 megohms.
- ★ Measures floating or earthed sources with reversible terminal polarity.
- ★ Reading retention facility.
- ★ Compact, lightweight, portable.

Two models are available:

TYPE 652A with standard cell reference voltage, accuracy  $\pm 0.2\%$  f.s.d., minimum measurement 2 mV;

TYPE 652AX with zener diode reference, accuracy  $\pm 0.1\%$  f.s.d., minimum measurement down to 1 mV.

By using suitable transducer circuits other characteristics can be measured.

### BRIEF SPECIFICATION

#### Range

0 to 1,000V d.c. in four ranges: 1-000V, 10-00V, 100-0V and 1,000V f.s.d. and 2% overspill on each range.

#### Overload Protection

Up to 500V on 1-V range and 1,500V on the other ranges.

#### A.C. Rejection

50 dB at 50 c/s.

#### Readout Time

For average readings, 2 seconds. Full scale, about 5 seconds.

#### Reading Retention

Reset may be operated externally by biased switch connected to jack socket in the rear panel.

#### Power Supply

110V and 200 to 250V, 50 to 60 c/s, A.C. mains 30 VA approximately.

#### Enclosure

Robust metal case with carrying handle. Finished blue, chrome bezels and light grey panels.

#### Dimensions

7½ in x 6 in x 11 in high, approximately.

#### Weight

9lb approximately.

**U.K. List Price:**  
652A £98.                      652AX £115.



# DAWE

Full technical data from —

**DAWE INSTRUMENTS LTD., WESTERN AVE., LONDON, W.3 Tel: AC09n 6751**

A member of the *Siemens* group of companies





**When a  
breakthrough  
is imminent...**

# Sellotape

REGD. TRADE MARK

## products in the electrical industry

When a breakthrough is imminent 'SELLOTAPE' Electrical Tapes will be found contributing to the safety and reliability of heavily loaded, hard-worked components in motors, transformers, relays and coils. And in miniaturised components, particularly, where space for insulation is minimal, these specialised products carry out such essential jobs as the insulation of windings subjected to impregnation or baking, the securing of lead-out posts, and the holding of component parts during assembly and manufacture. But 'SELLOTAPE' Electrical Tapes take this sort of thing in their stride, because they have been developed in close collaboration with Electronic engineers to keep abreast of the constantly changing techniques of this fast growing Industry.

And for the installation contractor and maintenance engineer the 'SELLOTAPE' range provides the most advanced products available for such jobs as cable jointing and splicing, buss-bar wrapping, cable form make up and all general insulation purposes.

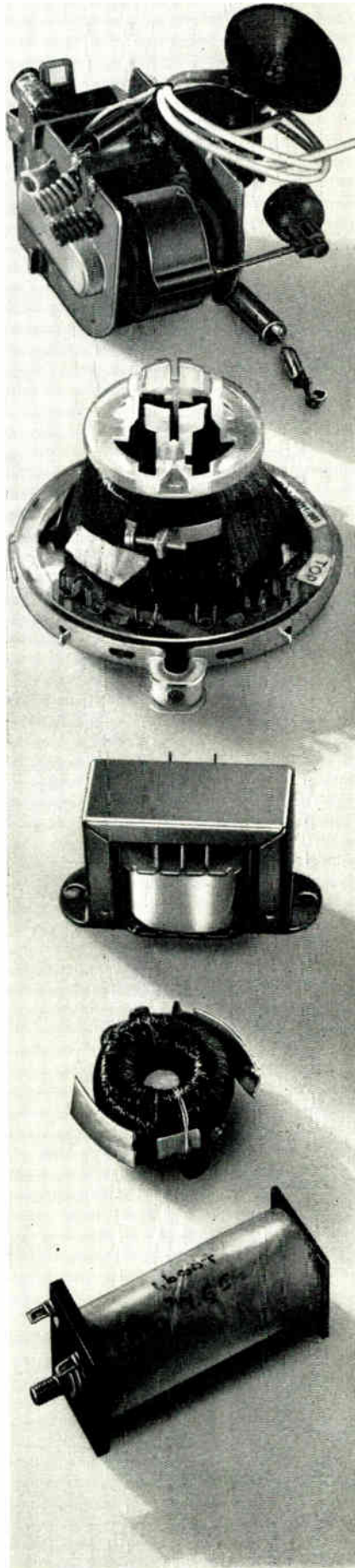

# Sellotape

REGD. TRADE MARK

## electrical tapes as specified materials

Go-ahead designers in the electrical industry think of 'SELLOTAPE' Electrical Tapes as basic materials, each one an essential part of a component or particular operation, designed to cut the cost of a product, simplify its manufacture and improve its performance.

Jobs like this require tapes with high tenacity, resistance to solvents and high temperatures and often severe physical stresses. All this in addition to a stringent list of electrical requirements including high insulation properties. The examples shown here illustrate typical products in which 'SELLOTAPE' Electrical Tapes are incorporated at the design stage.



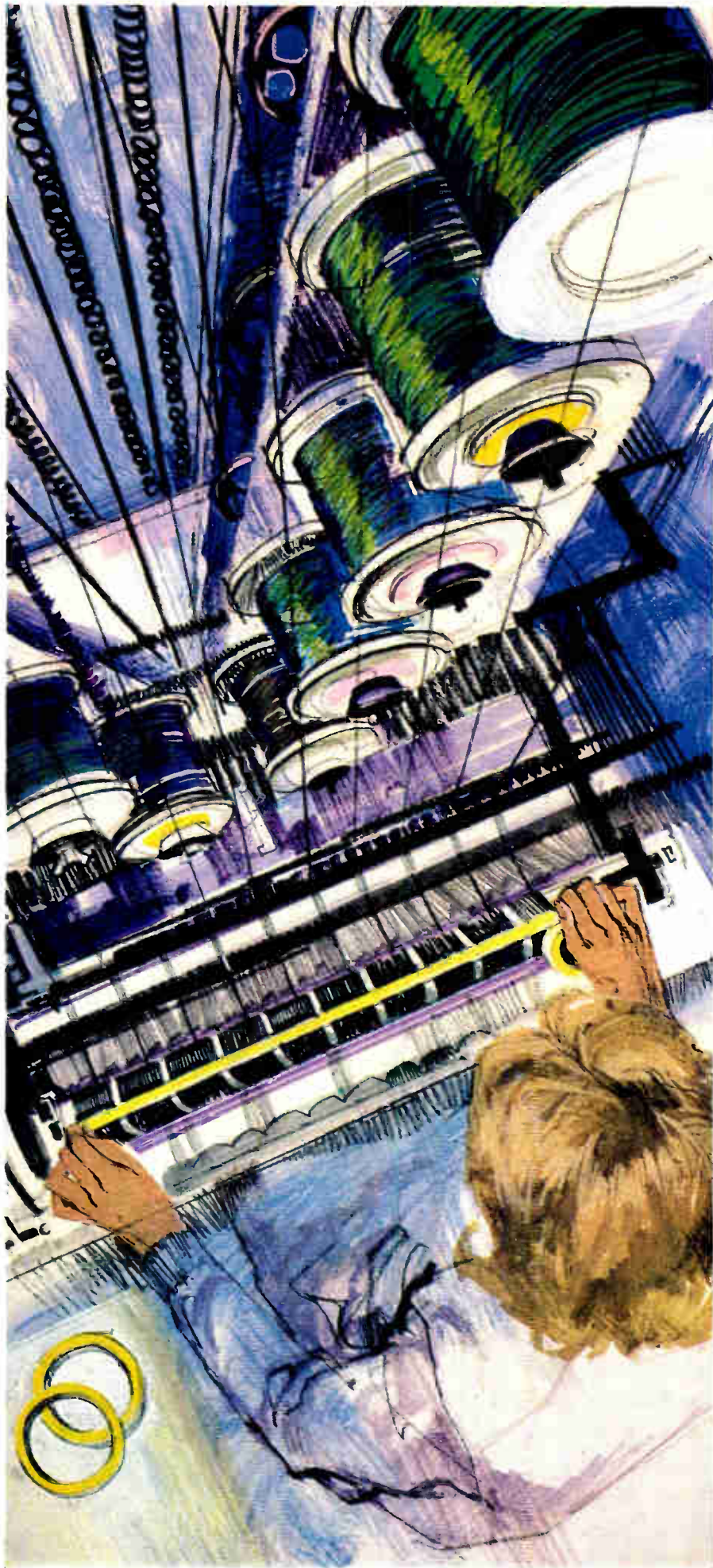

# Sellotape

REGD TRADE MARK

## electrical tapes serve industry's pacemakers

Start thinking about 'SELLOTAPE' when your equipment is at the design stage. That's when it really pays to put 'SELLOTAPE' in the picture. The chart on the back of this folder lists the principal characteristics of the 'SELLOTAPE' Electrical range to help you to make your own selection. Be sure you have chosen the right tape by talking over your requirements with your 'SELLOTAPE' Electrical Products representative who is always happy to call and advise you. 'SELLOTAPE' Electrical Tapes belong to a varied range of self-adhesive products, plain or printed, all contributing to increased industrial efficiency. There are tapes used in the packing of manufactured goods, tapes that help to impart and preserve finish on metals, plastics, wood etc, and others that prevent corrosion in many situations.

**Sellotape Products Limited**  
Industrial Division  
Sellotape House  
54-58 High Street  
Edgware · Middlesex  
Telephone: Edgware 2345



"Sellotape" is the registered trademark of Adhesive Tapes Limited



# “Sellotape” Electrical Tapes

TAPE	COLOURS	DIMENSIONS		AVERAGE PROPERTIES				
		Roll Length	Thickness (in)	Tensile strength (per inch width)	Elongation at break	Adhesion to Metal (oz/in width)	Breakdown voltage	Volume resistivity at 50% R.H. ohms cm
Polyester Silicone 1601	Transparent	36 yds	0.0025	22 lbs	60%	23	6,000 v	1 x 10 <sup>15</sup>
Polyester Thermosetting 1607	Yellow	72 yds	0.0022	22 lbs	60%	42 uncured	5,000 v	5 x 10 <sup>15</sup>
Heavy Duty Polyester Thermosetting	Yellow	72 yds	0.0031	48 lbs	100%	42 uncured	7,000 v	5 x 10 <sup>15</sup>
Double-sided Polyester Thermosetting 1609	Yellow	36 yds	0.0033	22 lbs	60%	35 uncured	5,000 v	3 x 10 <sup>15</sup>
Polyester Electrical 1610	Transparent	72 yds	0.0019	22 lbs	60%	32	5,000 v	1 x 10 <sup>15</sup>
Extra Thin Polyester Thermosetting 1613	Yellow	72 yds	0.0014	10 lbs	60%	32 uncured	3,000 v	9.4 x 10 <sup>1</sup>
High Strength Polyester Thermosetting 1614	Yellow	36 yds	0.007	100 lbs	80%	71 uncured	13,000 v	2 x 10 <sup>16</sup>
Creped Paper Thermosetting 2701	Buff	60 yds	0.009	18 lbs	16%	42 uncured	1,300 v	1 x 10 <sup>12</sup>
Acetate Electrical 1314	Transparent	72 yds	0.0028	18 lbs	15%	32	5,000 v	1 x 10 <sup>14</sup>
Heavy Duty Polythene Electrical 1408	Black and Grey	100 ft	0.013	21 lbs	200-250%	30	22,000 v	1 x 10 <sup>16</sup>
Polythene Electrical 1409	Black, Blue, Green, Red, White, Yellow,—To special order—Grey, Brown, Light Green, Violet, Pink, Cream, Orange	36 yds	0.0065	13 lbs	175%	32	11,500 v	5 x 10 <sup>16</sup>
Vinyl Electrical 1503 (Transparent) 1514 (Coloured)	Transparent, White, Blue, Green, Yellow, Red, Black	72 yds	0.0021	19 lbs	25%	30	3,500 v	1 x 10 <sup>14</sup>
P.V.C. Electrical 1702	White, Black, Blue, Light Green, Red	25 yds	0.008	15 lbs	100%	23	8,500 v	1 x 10 <sup>13</sup>
Aluminium Foil 4801		50 yds	0.0032	20 lbs	7%	53		

## Polyester Silicone—1601

Having a silicone polymer adhesive, this tape has excellent insulation resistance and retains its electrical properties during continuous usage at 140 C. Adhesive remains stable at much higher temperatures and is therefore ideal for masking during resin coating and bonding processes. Also used for “stopping-off” in chemical etching and plating processes.

## Polyester Thermosetting—1607

Has an adhesive which cures at elevated temperatures to give high bond strength with good solvent resistance. The tough 0.001” polyester film provides high insulation properties and the tape has a working temperature range of -50 C to +180 C. Unique ‘anti-static’ treatment reduces curling. For use in transformers, chokes, relays, solenoids etc.

## Heavy Duty Polyester Thermosetting—1608

Having the general properties of Polyester Thermosetting—1607 (above) with increased strength and insulation values given by .002” film. Used in motor and switch-gear production where higher strength, abrasion resistance, rigidity and electrical insulation is necessary.

## Double-Sided Polyester Thermosetting—1609

Thermosetting adhesive is bonded to both sides of pure 0.001” polyester film, one surface being protected by an easily removed paper interleave. Heat stable for short periods up to 180 C, the bond strength and solvent resistance will increase on curing. Used in stick-wound coil production, this tape will secure and insulate lead-out posts primary windings and leads.

## Polyester Electrical—1610

A 0.001” polyester film coated with thermoplastic adhesive, this release coated tape has excellent insulation properties and is chemical and abrasion resistant. Non-corrosive, it is extremely thin and therefore ideal for use where space is limited. It is used on components subjected to impregnation and potting procedures, for inter-winding insulation, solder joint insulation and the binding and finishing of relays, transformers, chokes etc.

## Extra-thin Polyester Thermosetting—1613

Employing 0.0005” polyester film and a thermosetting adhesive structure, 1613 is specially developed for securing, holding, binding and interleaving insulation on miniaturised and small wound components. Only 0.0014” thick it is capable of continuous operation at 130/155 C and for short periods up to 180 C. Though thin, a special treatment ensures ease of handling.

## High Strength Polyester Thermosetting—1614

Specially developed for the heavy electrical industry for binding armature windings and cables on large motors, alternators, generators etc. and as a slot liner. Its 0.005” polyester base, coated with a tenacious thermosetting adhesive ensures high tensile strength, abrasion resistance and insulation values.

## Creped Paper Thermosetting—2701

An impregnated, creped paper backing coated with a thermosetting adhesive. 2701 will withstand processing temperatures of 180 C and is suitable for continuous electrical operation at 105 C. Used in production of coils, transformers, motors, relays etc. for holding, lead binding, insulation, slot liner binding and coil finishing.

## Acetate Electrical—1314

Based on 0.002” cellulose acetate film with thermo plastic adhesive, the extreme purity, high insulation properties and moisture resistance makes this tape invaluable for coilwinding applications. Release coating makes it easy to unwind and eliminates breaking. 1314 will withstand all normal impregnation procedures.

## Heavy Duty Polythene Electrical—1408

A tough electrical insulation tape having a heavy corrosion-resistant adhesive mass on an 0.010” thick polythene film. It will not crack or craze and since it is unaffected by weathering it is used for such rugged applications as underground cable splicings, underground cable wrapping and overwrapping junction-boxes in wet or corrosive conditions.

## Polythene Electrical—1409

Most advanced of general purpose insulation tapes, 1409 is based on stable 0.005” polythene film coated with a long-ageing adhesive. It has excellent insulation properties, is moisture and chemical resistant and moulds well to irregular surfaces. Available in three colours to B.S. 2746 for coding purposes.

## Vinyl Electrical—1503 and 1514

Consisting of unplastified p.v.c. film (0.0012” thick) coated with thermo-plastic adhesive, it is used as a low cost insulation medium in non-corrosive conditions. It retains electrical properties even when subject to 50 C. Available in colours for coding and identification of leads, electrical parts etc. and can be printed with circuit diagrams, part numbers, warning notices and advertising matter.

## P.V.C. Electrical—1702

A waterproof general-purpose tape with a working temperature range of 0 C to 50 C. Used in component finishing and for insulating cables buss-bars etc. in damp and oily conditions. Colour range makes it ideal for coding and identification.

## Aluminium Foil—4801

Based on conductive aluminium foil coated with a thermoplastic adhesive, 4801 is used as an earthing strip on fluorescent tubes and, because of its reflective properties, as a heat shield for electronic components and for thermal insulation wrapping. It is also ideal for electrostatic screening on radio equipment and for current pick-up lines for model racing circuits.



NEW CURRENT  
PROPORTIONING OUTPUT MODEL  
STAND AA 654 INTERPLAS '65

what factors  
govern your choice  
of a temperature  
controller / indicator ?



- Low price?
- Accuracy and reliability?
- Minimal attention for operation and maintenance?
- Rugged ability to withstand vibration?
- Easy-to-read scale covering only the required range?
- Vertical or horizontal mounting?
- Ability to be shipped fitted to panels?
- Quality materials and craftsmanship?
- Speedy delivery?
- Manufacturer's process control and application experience?

ONE 'YES' IS REASON ENOUGH TO INVESTIGATE THE

**HONEYWELL SERVOTRONIK**

# ....say yes to the HONEYWELL to meet your temperature c

CHECK THESE EVERY-MODEL FEATURES Null balance servo system \* Thermocou  
compensation \* Calibrated accuracy—  $\pm 1\%$  f.s.d. \* Suppressed zeroes available  
required \* Intrinsically safe models available \* 5-inch scale \* Broken sensor p  
jewels, no springs \* Solid state construction \* Full range of thermocouples and  
of panel space — and money!

## VERTICAL SCALE

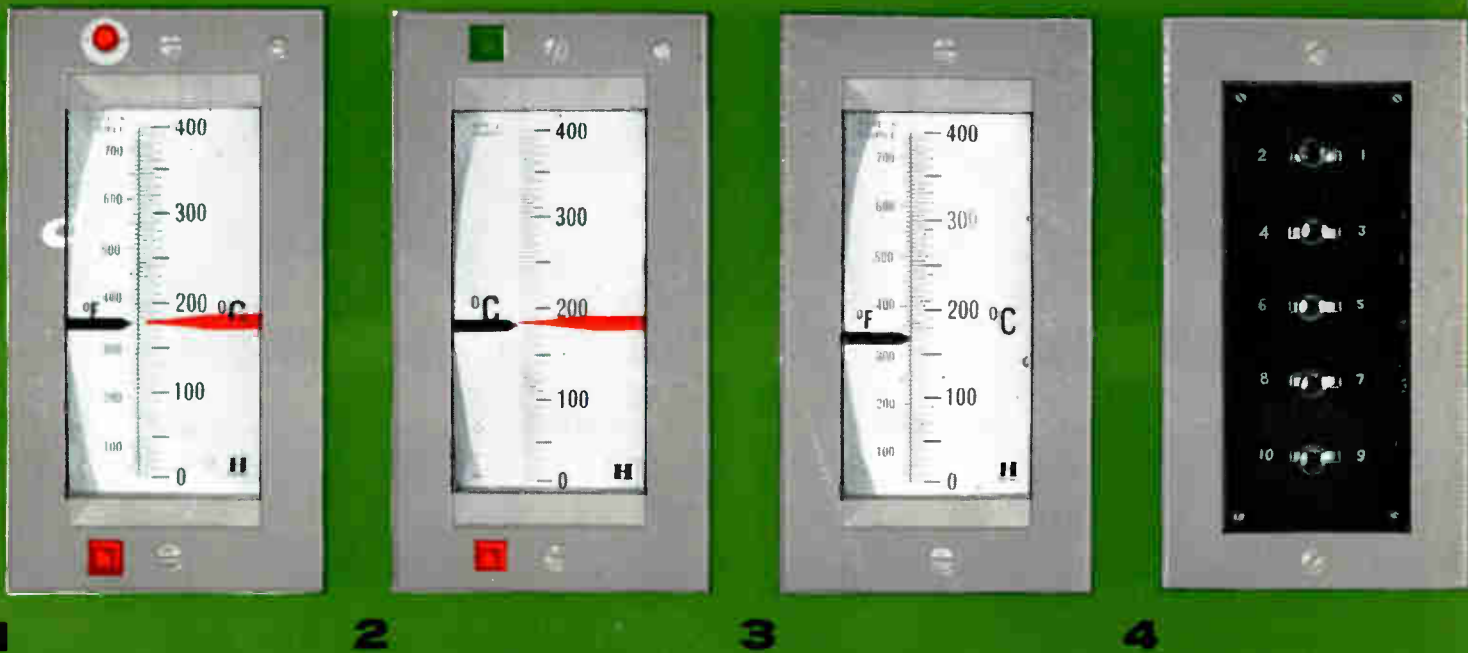

### TEMPERATURE CUT-OFF

**1**

Vertically and horizontally mounted Servotronic instruments for excess temperature safety cut-off. These sentinel type instruments will shut off process power or fuel input should process temperatures exceed a pre-determined safe limit. Fitted with manual reset and alarm lamp. Control relay contacts rated at 5A, 250V non-inductive. Accurate set point adjustment over 5% to 95% scale length.

### TEMPERATURE INDICATION/CONTROL

**2**

Vertically and horizontally mounted Servotronic instruments providing indication and on/off, three zone or anticipatory control action. For on/off or two position control one contact is made below set point, one above; differential 0.25% f.s.d. For three zone control, the centre zone is adjustable from 1% to 4% of full scale. Anticipatory control provides extremely accurate pulse proportional control by varying ratio of 'on time' according to deviation of variable from set point. Proportional band 1.5% f.s.d.



# SERVOTRONIK—there's a type control/indication requirements

le, resistance thermometer or millivolt actuation \* Automatic cold junction  
\* High impedance input \* No zeroing or adjustments for external resistance  
protection \* Robust, power driven indicator \* Vibration resistant—no pivots, no  
resistance bulbs available \* Simple set-point adjustment \* Maximum economy

## HORIZONTAL SCALE

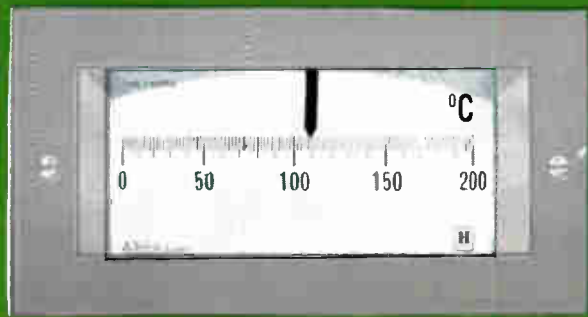
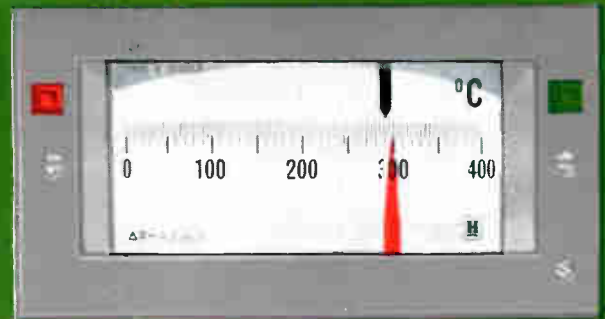
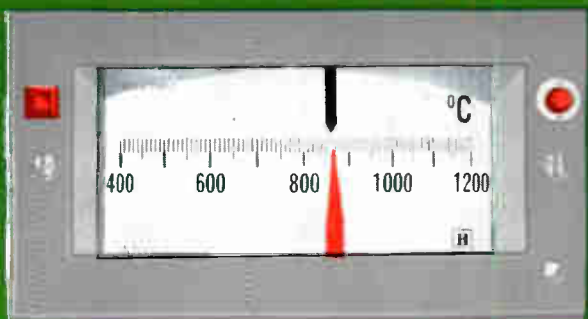

### TEMPERATURE INDICATION

**3**

Vertically and horizontally mounted Servotronik instruments for temperature indication only.

**4**

Where up to six or ten points are to be monitored in turn, a matching six- or ten-points unit can be provided. Switching units for thermocouple or millivolt actuation include a filter circuit.

# Honeywell

# Honeywell ServotroniK cuts out on-site calibration, combines ruggedness with accuracy, saves valuable panel space

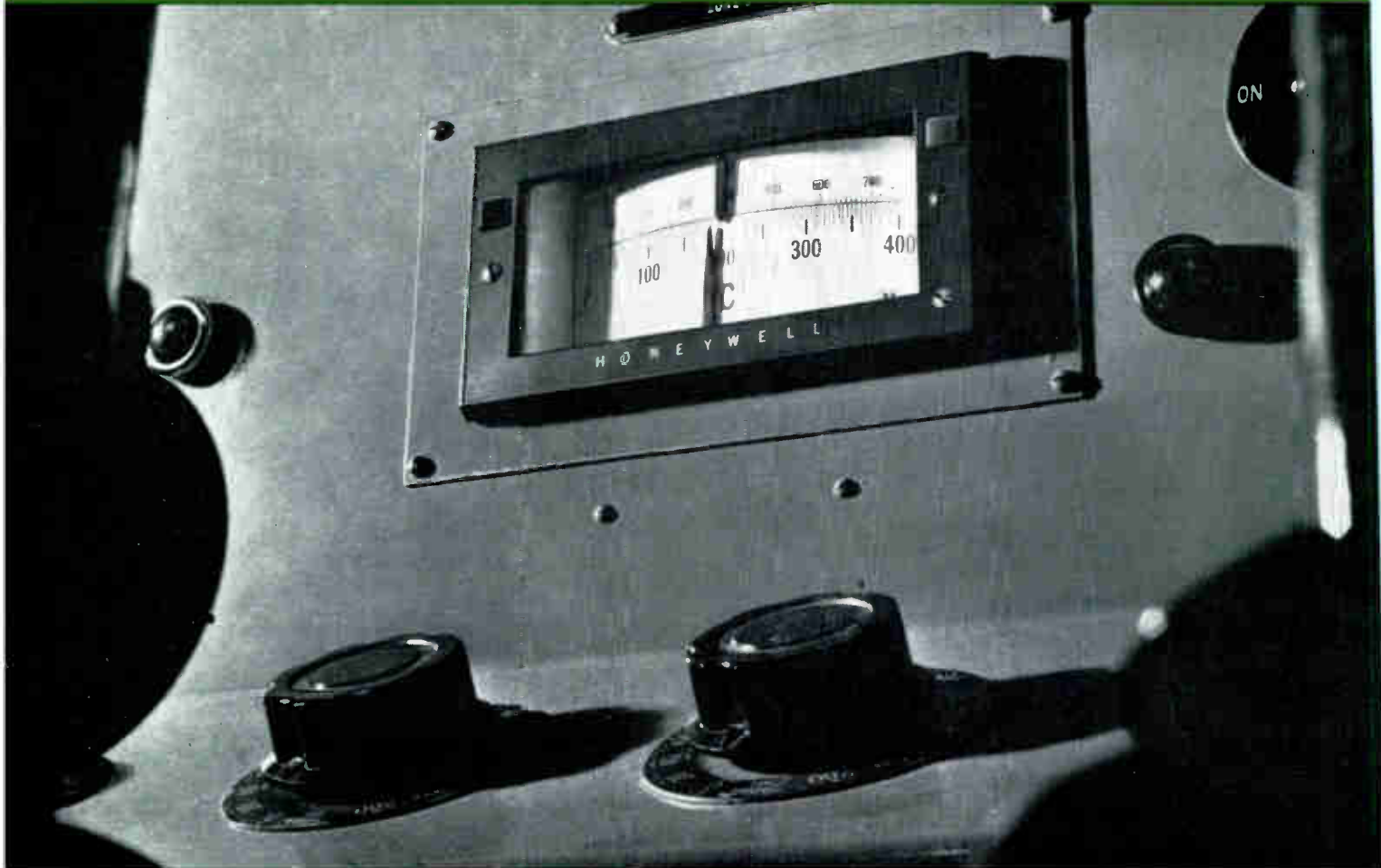

Contact your nearest Honeywell Branch Office for further details of the ServotroniK

<b>BELFAST</b>	Honeywell Controls Ltd., 296 Albert Bridge Road, Belfast, Northern Ireland. Belfast 56131
<b>BIRMINGHAM</b>	Honeywell Controls Ltd., Sutton New Road, Erdington, Birmingham 23. Warwicks. Erdington 6271
<b>CARDIFF</b>	Honeywell Controls Ltd., Room 19, Glamorgan Buildings, Frederick Street, Cardiff, Wales. Cardiff 26491-93
<b>REPUBLIC OF IRELAND</b>	Honeywell Controls Ltd., 38 Upper Mount Street, Dublin, Republic of Ireland. Dublin 65929
<b>MOTHERWELL</b>	Honeywell Controls Ltd., Newhouse Industrial Estate, Motherwell, Lanarkshire, Scotland. Motherwell 4145
<b>LEEDS</b>	Honeywell Controls Ltd., 5-7 New York Road, Leeds 2. Leeds 2-8535
<b>LONDON</b>	Honeywell Controls Ltd., Great West Road, Brentford, Middlesex. Atlas 9191
<b>MANCHESTER</b>	Honeywell Controls Ltd., Civic Centre, Wythenshawe, Manchester 22. Mercury 3214
<b>MIDDLESBROUGH</b>	Honeywell Controls Ltd., 59-61 Albert Road, Middlesbrough, Yorkshire. Middlesbrough 44331
<b>SHEFFIELD</b>	Honeywell Controls Ltd., Suffolk House, Suffolk Road, Sheffield 2, Yorkshire. Sheffield 78981

## Honeywell

**INDUSTRIAL PRODUCTS GROUP**

**HONEYWELL CONTROLS LIMITED**

Great West Road  
Brentford Middlesex Atlas 9191



**HONEYWELL INTERNATIONAL**

Sales and Service offices in all principal cities of the world.

Manufacturing in United Kingdom, U.S.A., Canada, Netherlands, Germany, France, Japan  
SAD 18

HC 56 465



*We invite you  
to a demonstration*



*of a remarkable new technique*



***Consolidated Vacuum  
will be demonstrating  
the NEW...***

***PlasmaVac***

***Sputtering Unit***

***for thin-film deposition...***

***...at the Washington Hotel, Curzon Street, London, W.1.  
on the 6th-7th-8th July 1965.***

CVC's new PlasmaVac sputtering unit offers the micro-electronics industry, the optics industry and other thin-film industries the first real chance to increase product yields to a level which can make the films available for large-scale

use in consumer products. The first low-energy sputtering unit offered commercially, it has many advantages over deposition equipment utilizing diode sputtering or conventional evaporation.

- ★ Deposits widest selection of materials.
- ★ Accessory... it will fit most bell-jar systems.
- ★ Closer deposition control.
- ★ Improved film adherence.
- ★ Greater uniformity of film composition and thickness.
- ★ Coats all substrate materials including plastics.
- ★ Through-hole coating capability.
- ★ Coats curved surfaces.

Write now for your invitation to . . .

***Consolidated Vacuum***

a division of BELL and HOWELL LTD.

14, Commercial Road, Woking, Surrey.  
Telephone Woking 5633





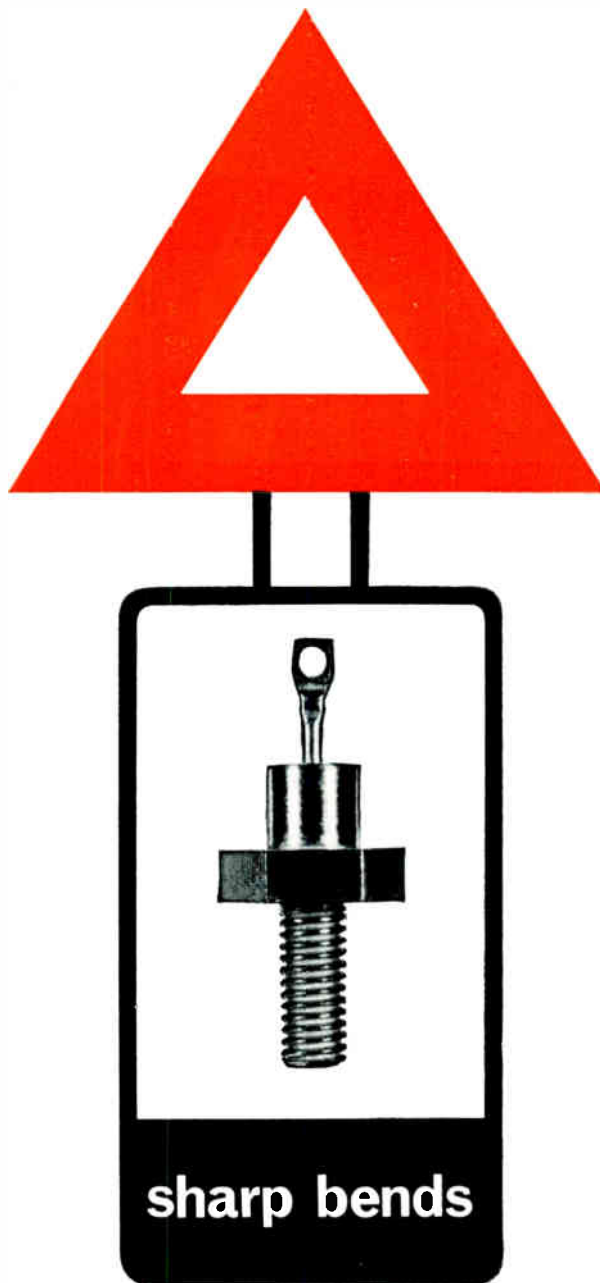

Over 300 of them: wicked square corners that can't be cut. There's one in the performance curve of every IR zener. Ask for details of zeners from 400mW to 50W, and 3.6V to 200V. The 1W and 10W range is fully type approved.



## INTERNATIONAL RECTIFIER

Immediate off-the-shelf delivery from IR distributors—phone

COLCHESTER 6173 · CRAWLEY 28700 · GLASGOW DOUGLAS 8671 · (LANCS) TOOMOROEEN 602 · LEEOS 35111  
LEICESTER 68561 · (LONDON S.E.27.) GIPSY HILL 6166 · (MIDDLESEX) SKYPORT 1314 · PORTSMOUTH 20455

INTERNATIONAL RECTIFIER CO. (GREAT BRITAIN) LTD · HURST GREEN · OXTED · SURREY · TELEPHONE OXTED 3215 · TELEX RECTIFIER OXTED 8819



**NOW**

**-200° to 1600°C**

**'BIKINI'**

Regd. Trade Mark

**temperature instruments for use with *thermocouples* as well as resistance bulbs**

- \* Potentiometric accuracy
- \* High impedance input circuit
- \* Stable against varying supply voltages and ambient temperatures
- \* Solid-state control switching to 0.2% differential. (No photo-cells)
- \* Precision long-sweep slide wire with resolution of 0.1%

Many thousands of these low-cost, potentiometric, servo-operated, fully transistorised instruments have given maintenance-free service for over four years. They are the obvious choice for all temperature applications. Write for leaflets listed below.

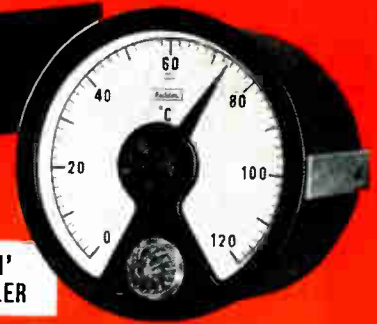

**'BIKINI' CONTROLLER**



**'BIKINI' INDICATOR/CONTROLLER**

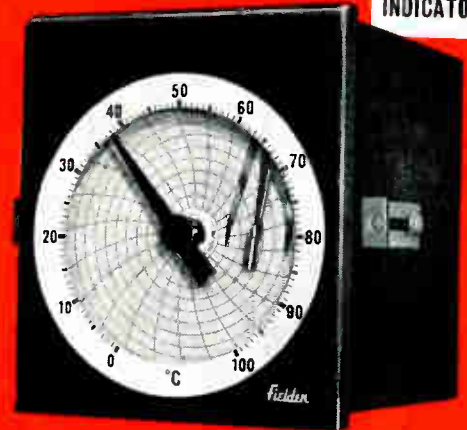

**'BIKINI' RECORDER/INDICATOR**

**THERMOCOUPLE INSTRUMENTS**

**RESISTANCE BULB INSTRUMENTS**

INSTRUMENT	SCALE LENGTH	CALIBRATION ACCURACY	MAX DISTANCE—MEASURING POINT TO INSTRUMENTS	APPROX. SIZE	WRITE FOR LEAFLETS	INSTRUMENT	SCALE LENGTH	CALIBRATION ACCURACY	MAX DISTANCE—MEASURING POINT TO INSTRUMENTS	APPROX. SIZE	WRITE FOR LEAFLETS
Indicator	12½"	± 0.5%	App. 1000 yds. (500 $\Omega$ )	6" dia.	BIK PT/2/1	Controller	9"	± 0.5%	300 feet	4½" dia.	BIK 1
Ind/Controller	12½"	± 0.5%	App. 1000 yds. (500 $\Omega$ )	6" dia.	BIK PT/2/1	Indicator	12½"	± 0.5%	300 feet	6" dia.	BIK 2/C
Recorder/Ind	13"	± 0.5%	App. 1000 yds. (500 $\Omega$ )	8½" x 7½"	BIK PT3/1	Ind/Controller	12½"	± 0.5%	300 feet	6" dia.	BIK 2/C
Rec./Ind/Cont	13"	± 0.5%	App. 1000 yds. (500 $\Omega$ )	8½" x 7½"	BIK PT3/1	Recorder/Ind	13"	± 0.5%	300 feet	8½" x 7½"	BIK 3
Rec./Ind/Prop.Cont	13"	± 0.5%	App. 1000 yds. (500 $\Omega$ )	8½" x 7½"	BIK PT3/1	Rec./Ind/Cont	13"	± 0.5%	300 feet	8½" x 7½"	BIK 3
						Rec./Ind/Prop.Cont	13"	± 0.5%	300 feet	8½" x 7½"	BIK 3 & EPC3

\* 185 Standard temperature ranges — many available from stock

Whatever your instrumentation problem—consult Fielden on temperature, pressure, level, control systems.

**Fielden**

**FIELDEN ELECTRONICS LIMITED · WYTHENSHAW · MANCHESTER**  
 Telephone: Wythenshawe 3251 (6 lines)      Telegrams: Humidity Manchester      Telex: 06531  
 Branch Offices: London, Walsall, Harrogate, and Scotland.  
 Overseas Subsidiaries: AUSTRALIA: Fielden Electronics (Aust.) Pty. Ltd., 61 Belula Ave., Vermont, Victoria, and 107 Alexander Street, Crows Nest, New South Wales. ITALY: Fielden Electronics Italiana, Milan.  
 Agents throughout the world.



# Give it the works!

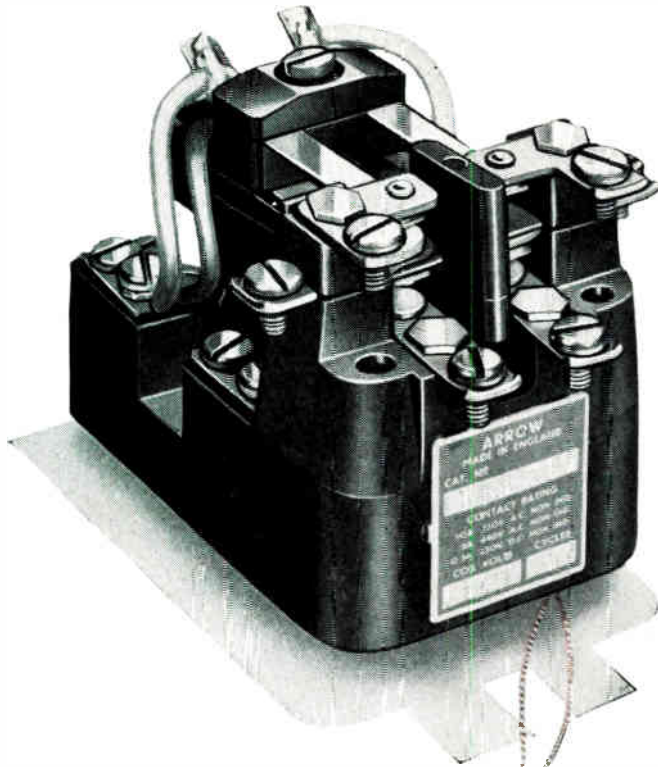

We, at ARROW, understand the responsibility which rests on any engineer's shoulders whose job it is to specify relays. Therefore, knowing our products as we do, we welcome every opportunity to send samples, as we are confident of the results. Illustrated is a small general purpose relay—30 different circuits are offered on the same base. Why not 'give it the works'—you'll get good value for money!



## ARROW ELECTRIC SWITCHES LTD

BRENT ROAD · SOUTHALL · MIDDX

Telephone: SOUthall 2442

A56



# INTEGRATED CIRCUITS

*comprehensive range of low cost  
commercial types now available*

**WE HAVE THE SOLUTION TO YOUR PROBLEMS  
AT OUR FINGERTIPS . . .**

- \* high performance
- \* low price level
- \* now available



**WESTINGHOUSE BRAKE AND SIGNAL CO. LTD. 82 YORK WAY, KING'S CROSS, LONDON N.1. TERminus 6432 Telex 2-3225**



# INDUSTRIES WHERE RACAL COUNTS



STEEL MAKING

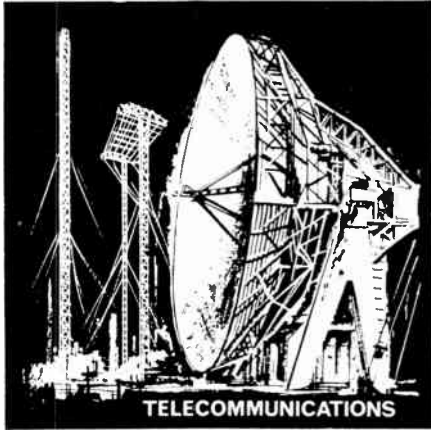

TELECOMMUNICATIONS



AVIATION



RESEARCH & DEVELOPMENT

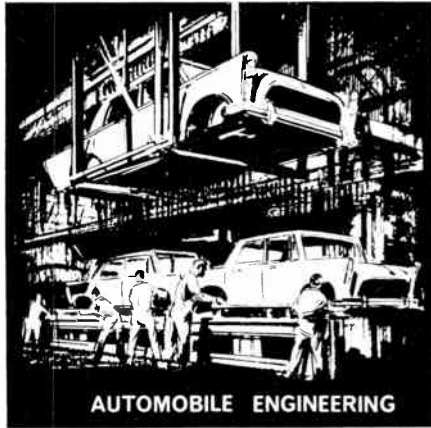

AUTOMOBILE ENGINEERING



PAPER MAKING

### SA.550

For precision digital frequency measurement up to 100 Mc/s Time and period measuring facilities are included in this compact all solid state counter.

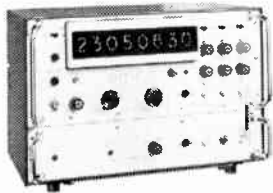

### SA.501A

A ferrite-core counter designed for the industrial environment, for precision speed and ratio measurement.

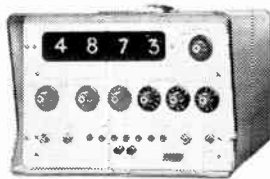

Production engineers of the Perkins Manufacturing Company, Peterborough, say that they have obtained greater accuracy of measurement without increasing production costs by introducing Racal Digital Instrumentation on diesel engine test beds.

Many other industries are finding that they can increase efficiency and improve end products by employing Racal Instrumentation in their manufacturing processes.

RACAL INSTRUMENTS LIMITED, Dukes Ride, Crowthorne, Berkshire  
Telephone: Crowthorne 2272/3 and 3763  
Grams/Cables: Bracknell Telex 84166



For further information circle 229 on Service Card

**PNP**

**PLANAR PASSIVATED**

2H1254 2H1255 2H1256 2H1257 2H1258 2H1259 HT100 HT101	TO-18 Case	A unique range of double-diffused 100 Mc/s switching transistors. BV . . . . up to 50V hFE . . . . specified max/min values within range 14 - 150 V <sub>ce(sat)</sub> 0.3V t <sub>d</sub> + t <sub>r</sub> 25nanosec
2N1254-9		

2H1254-9 Type Approved CV 7484-9

2N1131 2N1131A 2N1132 2N1132A 2N1132B	TO-5 Case	Medium power general purpose transistors available in either TO-5 or TO-18 case style. Min f <sub>t</sub> 60 Mc/s BV . . . . up to 60V hFE . . . . specified max/min values within range 20 - 200 V <sub>ce(sat)</sub> 1.5V
2N721 2N722		

**NPN**

**PLANAR PASSIVATED**

2N706 2N706A 2N706B 2N707 2N708 2N753 2N914	TO-18 Case	A preferred range of 300 Mc/s transistors with excellent switching characteristics. BV . . . . up to 56V hFE . . . . specified max/min values within range 9 - 120 V <sub>ce(sat)</sub> 0.4V
2N717-720A 2N870-1 2N910-2 2N956 HT400-1		

2N696-9 2N1613 2N1711 2N1893 2N1889-90	TO-5 Case	70 Mc/s medium power general purpose transistor available in either TO-18 or TO-5 case style. BV . . . . up to 120V hFE . . . . specified max/min values within range 20 - 100 V <sub>ce(sat)</sub> 1.5V

Manufactured at their Glenrothes, Scotland, factory the Hughes range of Silicon Transistors is centred on those types having the broadest basis of common "preference" by the various Authorities specifying world-wide Military and Aviation equipment requirements. The use of these types in your prototype equipment will avoid expensive re-design at the production stage. For commercial applications, the HT100/1 and HT1400/1 complementary devices offer the opportunity of "going Silicon" at surprisingly low cost.

**SPECIFY HUGHES TRANSISTORS**



Write now for complete data on the full range of Hughes semi-conductor products, which also includes:— Germanium and Silicon Switching Diodes, Silicon Power Diodes and Rectifiers, Voltage Reference (Zener) Diodes, High Voltage Cartridge Rectifiers.

**HUGHES INTERNATIONAL (U.K.) LTD**

GLENROTHES . FIFE . SCOTLAND

Sales Office

HEATHROW HOUSE, BATH ROAD, CRANFORD, HOUNSLOW, MIDDLESEX

Telephone : SKYport 9584/5 & 9961/2

Telex 23613

M & P HM 24



**If the high-current rectifiers in your equipment are not multi-cell devices, you're paying too much and getting too little! Here's why...**

**MOTOROLA  
"MULTI-CELL"\*  
OBSOLETES  
THEM ALL!**



Until a recent breakthrough in design, everyone built high-current, semiconductor rectifiers the same way. As the heart of the device, they employed a single, large rectifier junction that had to be increased in size as the current requirements were increased. A major trouble with this outmoded design is that large-area rectifier junctions cannot be made without significant imperfections — and the larger the junction area, the greater the number of imperfections. And yet, today, everyone is still making high-current rectifiers in this same old way! Everyone, that is, except Motorola.

The Motorola Multi-Cell Rectifiers employ a number of virtually perfect small-junction, medium-current units connected in parallel to handle high currents of practically any desired rating. This new design breakthrough eliminates the many problems associated with large-junction rectifiers and provides these specific advantages: (1) increased maximum current handling from 400 amps to 1000 amps and more; (2) increased surge capacities up to 6 times greater than other units;

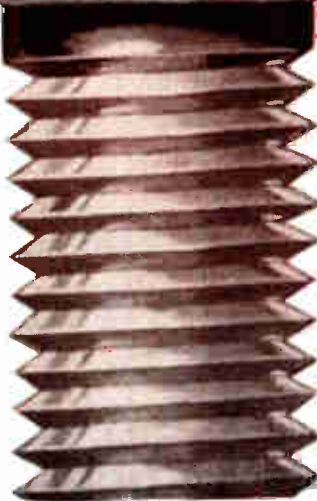

(3) greater reliability with up to 25% reserve capacity; (4) reduction of the need for current-balancing accessories in many applications; (5) less expensive than single-junction units.

Only Motorola — a company already producing more than 20 million rectifier cells annually — has already developed the stabilized volume production necessary to ensure near-perfect matching of the electrical characteristics of each cell in these multi-cell devices. And only such volume production could provide you with these high-quality devices at prices less than what you are paying for the less desirable single-junction units.

Come aboard! Prove to yourself that Motorola multi-cell, high-current rectifiers will improve your equipment performance. Contact your Motorola Distributor now for full data on this competitively priced and fully proven range —  
**CELDIS Ltd. 4 TRAFFORD ROAD, RICHFIELD ESTATE, READING, BERKSHIRE. Phone 56256/55391**



**MOTOROLA**

**Semiconductor Products Inc.**

YORK HOUSE · EMPIRE WAY · WEMBLEY · MIDDLESEX · DILIGENCE 0944

\*PATENTS PENDING

# TRANSDATA

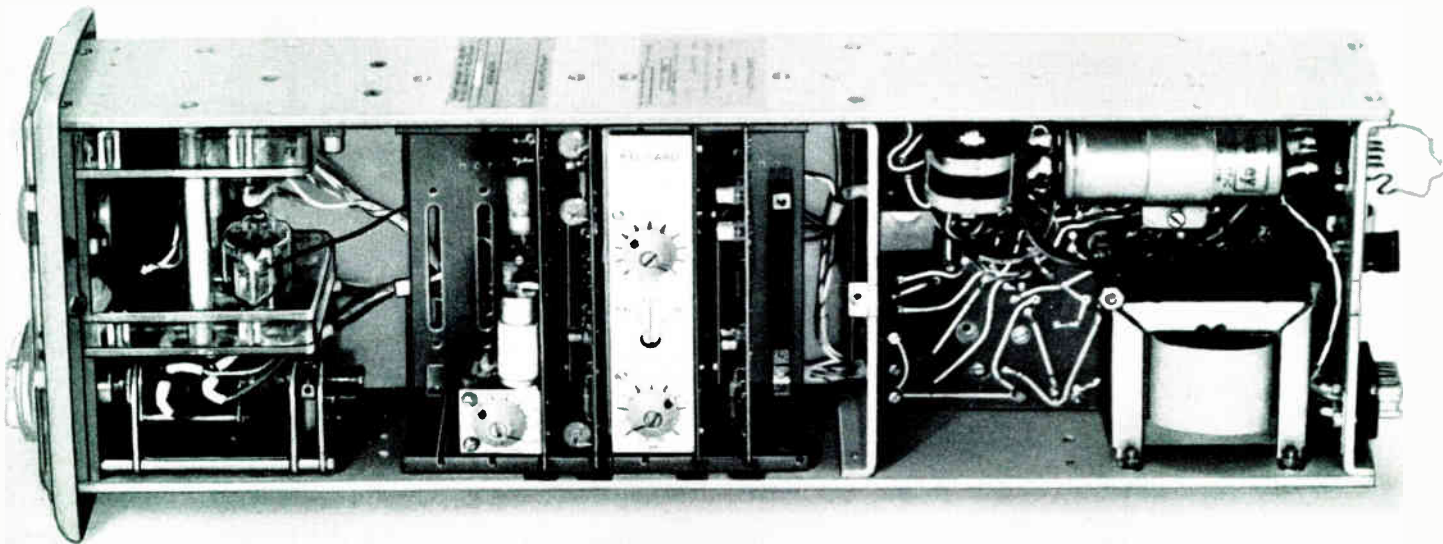
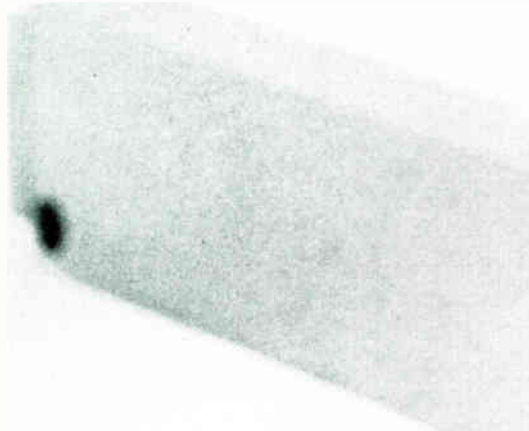

This is one of the most flexible systems of process measurement and control. It consists entirely of single-purpose measuring, converting, controlling, computing and alarm units related by a standard signal to form simple or complex integrated schemes.

Individual units such as these three-term analogue controllers are built on the 'Minicard' system, a modular method of construction using combinations of standard chassis and cases, power-supply units, over thirty plug-in 'Minicard' printed-circuit cards, and numerous front-presentation arrangements.

Modular units, the latest techniques in solid-state electronics, printed circuitry, and high-grade components are employed throughout to ensure flexibility, accuracy, reliability and ease of servicing.

May we send you further details of the Kent Transdata system?

For further information circle 231 on Service Card





## Adaptive Control

We hear a lot nowadays about adaptive control or, as it is sometimes put, about machines which can learn. Most people find such ideas rather mysterious and can hardly credit the possibility of a machine adapting itself to its environment or learning. In fact, the seeming mystery arises from the modern habit of using anthropomorphical terms to describe machines. It is done, of course, with the aim of providing a simple description of some special attribute of the machine. In our opinion, it not only fails to do this but actually confuses the reader.

What then is an adaptive machine? Basically, it is one which automatically changes its parameters so that some optimum of performance is obtained. Normal control systems have their basic parameters fixed by the designer. In an adaptive system, some of these parameters are variable, and variable by the machine itself.

When its starts to operate, these parameters have certain initial values and so a certain performance is secured from the whole system. The machine is arranged so that it alters the value of one of these parameters by a small amount with the result that the performance changes. This result is compared with the previous one and if, according to some inbuilt criterion, it is better or worse the next trial value is made in the same or in the opposite direction.

In all but the simplest systems a computer is usually involved in the control system and under its control a number of parameters are varied in turn to seek the required performance.

Adaptive systems are similar to, if not fundamentally the same as, self-optimizing systems. The technique involved is commonly called 'hill climbing'. The performance criteria here is, say, maximum output. The machine monitors its output and is arranged so that if a change in a parameter brings about an increase of output it always makes a further change in the same direction, whereas if the change reduces the output it goes back to the original condition and the next step is in the opposite direction.

One practical difficulty arises when the process is one in which the output does not rise continuously to its optimum; for example, in one where the output rises to a subsidiary maximum, falls and afterwards rises to a higher value. The system is likely to set itself on the subsidiary maximum and never go beyond it and the trough to the true maximum. There are ways out of this difficulty of course.

However it may be arranged there is no true learning, nor is any intelligence involved. The machine merely works on a trial and error basis and, since it stores successful courses of action and tries these first the next time, the process is one which simulates learning.

A revolutionary form of torquemeter is described which is a major advance on all previous methods of torque measurement. Comprising a new type of torsionmeter with digital readout, accuracy is claimed to be within 0.25% or  $\pm$  one digit for the specified operating range.

# A DIGITAL DEVICE FOR MEASURING TORQUE

By M. J. CRADDOCK, M.S.I.T.\*  
and W. J. BRITAIN, A.M.I.Mech.E.†

\* Dawe Instruments Ltd.,  
† Ford Motor Company Ltd.

**P**RESENT-DAY mechanical power-transmission systems have reached a high level of efficiency. For example, the figures quoted by the Ford Engineering Research Centre at Birmingham for the maximum efficiency of a modern motor-car gearbox are 89-92% in bottom or third gear, rising to more than 96% in top gear. These figures are, of course, representative only. They will vary widely from one gearbox to another, and even for one particular gearbox depending on the speed and torque transmitted.

To obtain a full picture of the performance of a power transmission system, it is therefore necessary to measure simultaneously the torque and speed of rotation of both input and output shafts for the full range of torque and speed over which the system operates. Measurements must be repeated for each gear ratio.

These considerations are embodied in the Dawe Type 1502 Digital Torquemeter, a system developed by Dawe Instruments Ltd. from an original design by the Ford Engineering Research Centre‡. The first instrument of its kind commercially available anywhere in the world, it measures torque and speed simultaneously with an accuracy of better than 0.25% under favourable conditions; it may be synchronized with any other equipment or with another torquemeter; and it is suitable for a wide range of speed and torque and hence for a large number of applications.

## Historical Considerations

The traditional device for measuring torque is the well-known brake dynamometer. This is basically an absorption device, some form of mechanical brake measuring the torque transmitted by the shaft as it rotates. This measurement, together with a separate measurement of speed, enables the power to be calculated. For a particular shaft, rotating at  $N$  rev/min, the power  $P$  transmitted is given by

$$P = \frac{2\pi NT}{33,000} \text{ (horsepower) } \dots \dots \dots (1)$$

where  $T$  is the torque transmitted by the shaft in lb-ft. Thus, when  $P$  is measured directly,

$$T = \frac{33,000 P}{2\pi N} \text{ (lb-ft) } \dots \dots \dots (2)$$

Variations on this method have been in use for a very long time, power generally being measured indirectly, for example in terms of the heat it produces. However, it is only possible to obtain a high degree of accuracy with extremely bulky and costly apparatus which still has inherent disadvantages. Measurements must be made at a constant speed, and speed must be measured separately. Any variation in speed, or any time lag between the two measurements, will adversely affect the results.

Rather more sophisticated is the torsionmeter approach, which has no direct effect on power transmitted. Torque (the moment of the force exerted about the axis of the rotating shaft) is the product of the tangential force  $F$  (Fig. 1) and the radius of application  $r$ . Thus

$$T = Fr \text{ (lb-ft) } \dots \dots \dots (3)$$

This torque  $T$  exerts a twisting action on the shaft, the angle of twist being a function of the torque  $T$ , the dimensions of the shaft and the modulus of rigidity  $G$ , provided the elastic limit of the shaft is not exceeded. Referring again to Fig. 1, it can be shown mathematically that

$$\alpha = \frac{32TL}{\pi D^4 G} \text{ (radians) } \dots \dots \dots (4)$$

‡ Patent No. 946140.



Dawe type 1502 digital torque-meter, with torsionmeter unit on the left

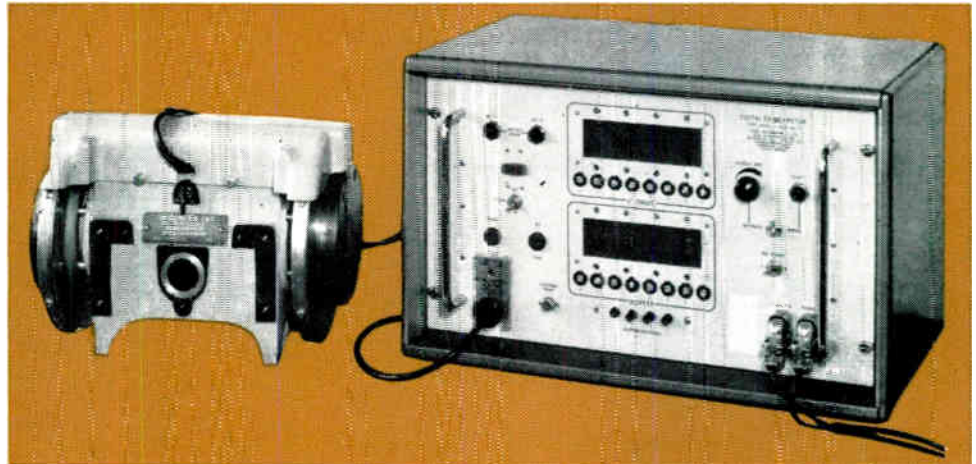

or

$$T = \frac{\pi D^4 \alpha G}{32L} \text{ (lb-ft) } \dots \dots \dots (5)$$

Thus if  $\alpha$  is measured directly, and  $G$ ,  $D$  and  $L$  are known, the torque  $T$  can be calculated. It should be noted that  $G$  is to some extent dependent on temperature.

Torsionmeters are not new, having existed in various forms for many years. In the course of time, many refinements have been introduced, mainly in the methods by which the angle  $\alpha$  is measured. One type in common use today uses the strain gauge technique and another, very widely used in the marine field, makes use of the variation in the air gap of a differential transformer. However, a survey of existing instruments reveals many disadvantages, such as insufficient accuracy or the need for sliprings.

Fords required a system capable of measuring torque and speed simultaneously with an accuracy of 1% or better, for the speed range 100–5,000 rev/min and torques of the order of 100–1,000 lb-ft. The system was to avoid the use of sliprings, if possible, and after some initial experiments it was decided that requirements could only be met by an entirely new torsionmeter with some form of digital readout. A system based on the measurement of time

seemed the most likely to succeed, and this approach was adopted.

Work on the project began in 1959, with a fully working prototype in operation during 1960. Six such prototypes were actually built by Ford, before the design was taken over by Dawe. The first Dawe prototype was completed in 1961 and followed closely on the design of the Ford originals, all of which are still in operation at the Ford Engineering Research Centre

**Principles of Operation**

The principle of the system adopted is shown in Figs. 1 and 2. The torsionmeter comprises a uniformly calibrated shaft (Fig. 1) on each end of which are fixed slotted discs  $D_1$  and  $D_2$ . When at rest under no-load conditions, slot  $S_1$  should line up exactly with slot  $S_2$ , but when a torque is applied the shaft twists so that disc  $D_2$  will lag behind disc  $D_1$  and slot  $S_2$  will take up a position  $S_2'$ . The angle  $\phi$  provides a measure of the angular twist  $\alpha$  of the shaft, which in turn is proportional to the applied torque [equation (5)].

The angle  $\phi$  is measured photoelectrically. Twenty evenly-spaced radial slots cut in the circumference of each disc are illuminated from a single central light source and scanned

Fig. 1. Principle of the torsionmeter

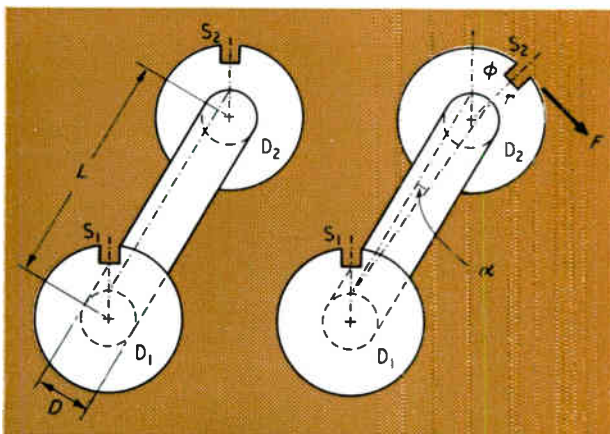
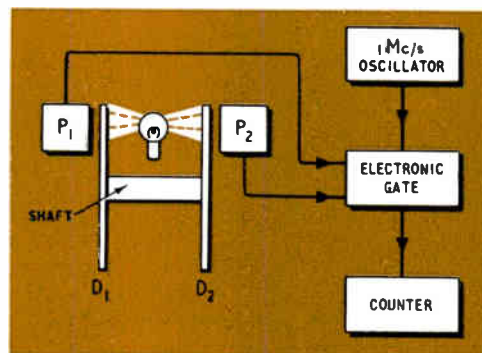

Fig. 2. Principle of the torsionmeter/torque-meter system





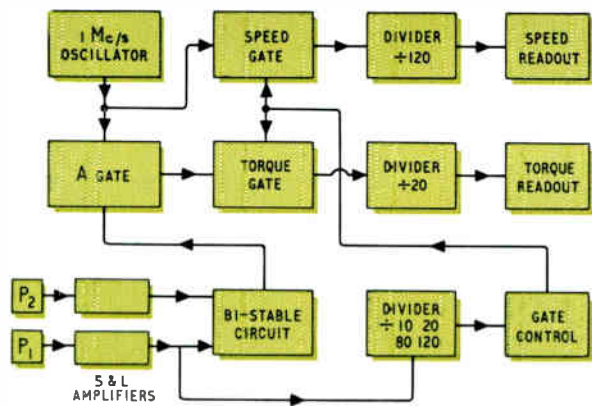
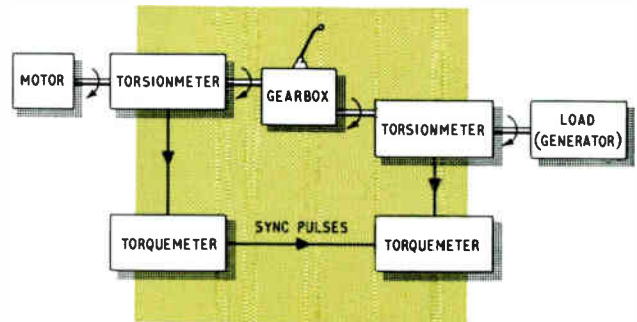

Fig. 3. Block diagram of the digital torquemeter

Fig. 4. (Below) Block diagram of a system for measuring gearbox efficiency



by separate photocell units  $P_1$  and  $P_2$  (Fig. 2). This gives rise to two trains of pulses which, for no-load conditions, are coincident at any speed. When a torque is applied, however, the twist of the torsionmeter shaft and the resulting relative displacement of the discs  $D_1$  and  $D_2$  causes the pulses from  $P_2$  to lag behind those from  $P_1$ .

The torquemeter itself is virtually a special-purpose chronometer. A master oscillator producing 1-Mc/s reference pulses is applied to a gating circuit controlled by the pulses from the photocells. Pulses from  $P_1$  open the gate and pulses from  $P_2$  close it. Thus the length of time for which the gate is open is dependent on the angle of twist. A separate gating circuit uses one train of pulses to measure speed.

### Practical Considerations

The practical system adopted by Dawe in the Type 1502 Digital Torquemeter uses the above principles but with considerable refinement. The electronic measuring

system (torquemeter) and the torsionmeter are two separate units, the latter comprising a shaft of accurately calibrated stiffness mounted between two lubricated bearings giving extremely low rotational losses. At each end of the shaft is mounted a steel disc with 20 radial slots at its periphery, a set of interchangeable shafts being available to enable different torque ranges to be covered. Micrometer screw adjustment is provided for the photocells in the horizontal plane.

The torquemeter itself (Fig. 3) houses the 1-Mc/s crystal oscillator, two four-decade counters, dividing circuits and gating circuits. Pulses from the photocell  $P_1$  are passed to a shaping and limiting amplifier, and are divided by 20 to give one pulse per revolution. This pulse is used to control a single-shot (speed) gate which allows the 1-Mc/s reference pulses to pass. On initiating a count, the speed gate is opened by a pulse from  $P_1$ , and remains open for one revolution, when it is closed by the next pulse. The gate then remains closed until reset.

Torque is obtained using pulses from both photocells, a bistable circuit being triggered into the ON state during the interval between corresponding pulses from the two trains. This opens a second (A) gate, which permits the passage of 1-Mc/s reference pulses, the gated pulses being fed to a third (torque) gate, operating in synchronism with the first (speed) gate. Thus the torque count occupies the same period as the speed count.

Very early in the development of the torquemeter it was realized that zero alignment of the slots on the two discs would present considerable difficulty. This was partly overcome by providing the pickups with micrometer screw adjustment, but a more serious objection to zero alignment was the effect of hunting for the last digit under no load. Under optimum conditions, hunting occurred between the readings 0000 and 9999 which was obviously undesirable, while a negative zero error produced a large erroneous count at light loads.

The problem was solved by offsetting the discs  $3^\circ$  and arranging the constants of the instrument to give identical speed and torque readings at no load, whatever the shaft speed. Considering speed readout, the angular displacement between successive slots is  $18^\circ$ , equivalent to 360 degrees of movement. Under no load, by the same token, torque readout is produced by the angular offset of  $3^\circ$ , equivalent to 60 electrical degrees. To obtain a reasonable torque readout it is necessary to frequency divide the torque count by 20; hence to obtain the same readout for speed

*Prototype torquemeter constructed by Ford. Six such instruments are still in use at the Ford Engineering Research Centre*

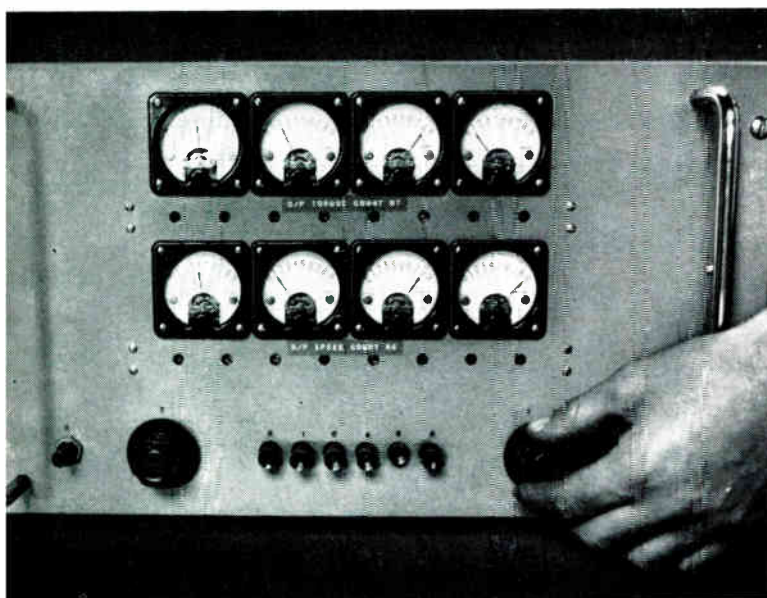

under no load, it is necessary to divide the speed count by 120. Both counts are then fed to four-decade digital displays.

From the equation of the instrument it can then be simply shown that

$$\text{speed} = \frac{500,000}{\text{speed readout}} \text{ (rev/min) } \dots \dots \dots (6)$$

Also, since  $K$ , the torsional stiffness of the shaft, is given in lb-ft/3° twist,

$$\text{Torque} = \frac{K \text{ (torque readout-speed readout)}}{\text{speed readout}} \text{ (lb-ft) } \dots \dots (7)$$

To eliminate torsional vibration effects, readings from the 20 slots are averaged over each revolution. Facilities are also provided for summing the readings over one, two, four or eight shaft revolutions, chosen by selecting further frequency dividers, to adjust the number of digits displayed. Measurements may also be obtained automatically at various repetition rates, or may be initiated by a push-button or input pulse. These facilities are particularly important in applications where it is necessary to synchronize the torquemeter with other equipment. The display remains visible until reset, either manually or automatically.

The standard torsionmeter will operate satisfactorily over the speed range 100–5,000 rev/min with an overall accuracy of 0.25% or ± one digit, whichever is the greater. Standard interchangeable shafts can be supplied for torques of 1–2,000 lb-ft. Pre-amplifiers built into the equipment enable the torquemeter to be mounted up to 50 ft from the torsionmeter and test rig.

The torquemeter itself is fully transistorized, and although normally mains-powered, it may be driven from batteries if necessary. The standard torquemeter, designed for 19-inch rack-mounting, measures 19 × 10 × 12½ in. and weighs 34 lb. A bench model is available.

#### Advantages and Applications

The advantage of the system is its extreme flexibility, and the ease with which it can be adapted to suit particular

requirements. Although the bulk of the Ford work has been in the torque range 100–1,000 lb-ft, Fords have used the instrument to measure torques of the order of ounce-inches. Where it is necessary to carry out measurements using an existing shaft, a special torsionmeter may be built up using custom-built discs and suitable photoelectric pickups, such as the Dawe Type 1503/1. It is, of course, necessary to know the distance between the discs, the modulus of rigidity and the diameter of the shaft.

The classic application is the measurement of gearbox efficiency, using synchronized torquemeters on input and output shafts. The gearbox is driven by a motor and drives a suitable load such as a generator (Fig. 4). Two digital torquemeters have been used in this way on a test rig at Fords since 1960. Fords have also used the instrument to measure the efficiency of other transmission system components, and they shortly hope to install a torquemeter in an actual vehicle to measure the performance in situ. They are also planning to use the torquemeter for testing vehicle generators, and although they have no plans for doing so at present it could equally well be used for quality control checks on the production line.

Continuous monitoring would also be possible, and one such application is suggested by an enquiry received for an installation in a vessel. Three digital torquemeters were required to monitor continuously the torque and speed of three independent marine engines required to work in conjunction with each other.

Altogether the instrument is extremely versatile, and will find applications wherever it is necessary to measure or monitor mechanical power transmission with any accuracy. Automobile, marine and aeronautical engineers will have innumerable uses for it, since it represents a significant advance on all previous methods of torque measurement.



*Using the digital torquemeter to measure the speed and output from a gearbox at the Ford Engineering Research Centre, Birmingham*

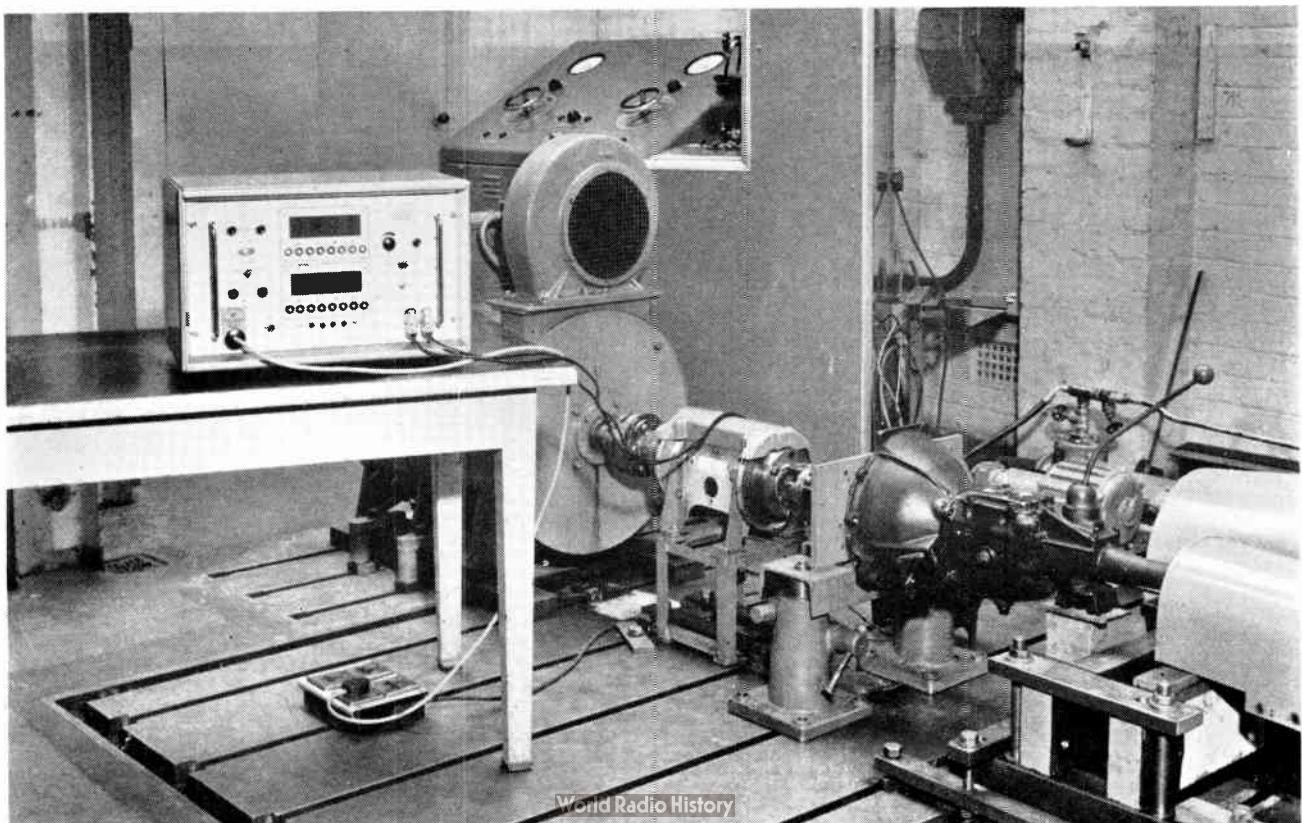



# Automatic Control For Volumetric Filler

By S. C. WHITEFORD, A.M.I.E.E.\*

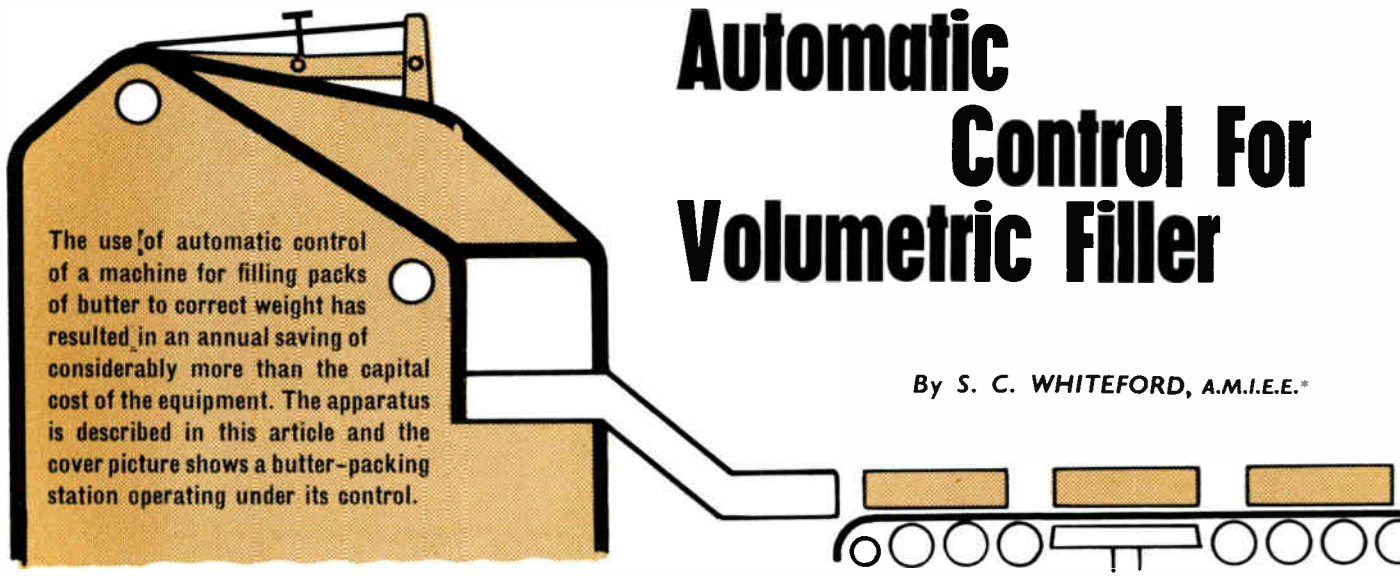

The use of automatic control of a machine for filling packs of butter to correct weight has resulted in an annual saving of considerably more than the capital cost of the equipment. The apparatus is described in this article and the cover picture shows a butter-packing station operating under its control.

WITH the advent of stricter regulations regarding the sale by weight of pre-packaged products and the ever-increasing speeds of packaging lines, the use of high-speed automatic checkweighers for quality control has proceeded apace. Such checkweighers, utilizing modern transistorized circuits, have achieved a high degree of reliability, measuring package weights with an accuracy of 0.2% at rates up to 200 per minute. The use of channelling mechanisms ensures that only those packages falling within a fairly narrow weight band are allowed to proceed further, the remainder being discarded for subsequent re-packaging.

\* Telomex Ltd.

*A view of a butter-packing machine*

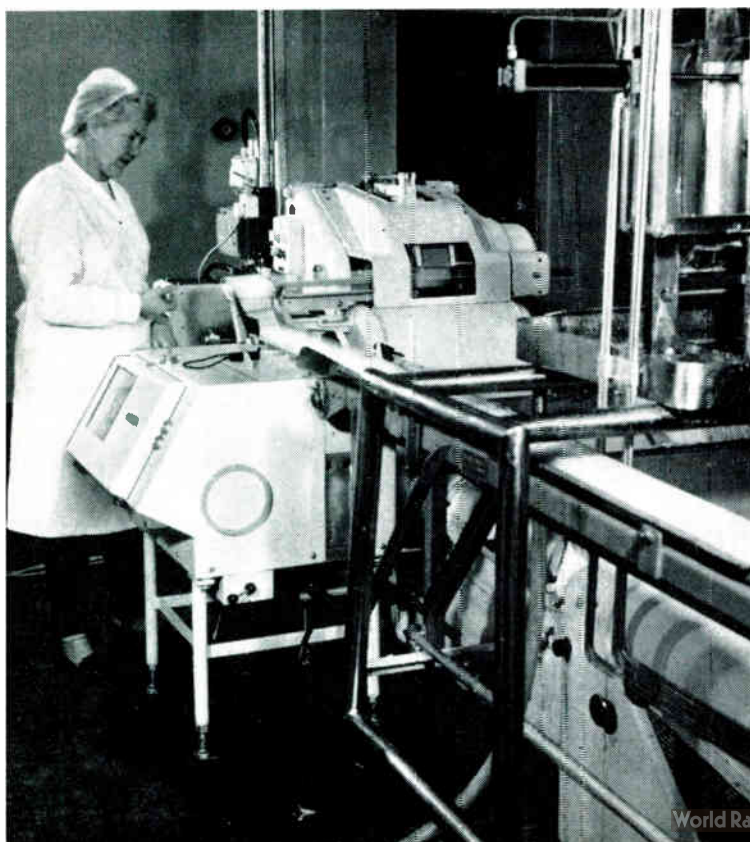

At the same time, many types of filler dispensing fixed quantities by volume or time cycle, to packaging lines, have been considerably improved in their performance without, however, eliminating the necessity for frequent manual adjustments in order to take account of changing product density and flow characteristics. The use of a 'feedback' unit between the checkweigher and filler now provides automatic control for the latter and replaces inefficient manual control.

A brief consideration of the statistics surrounding the performance of a typical filler may illustrate the problems arising during the development of the control system described later.

If a sufficient number of consecutive packs over a short period of time from the filler are weighed and the results plotted, the 'bell' curve shown in Fig. 1 (a) is obtained. Provided that the right number of consecutive packs is used in the sample, and this obviously varies from filler to filler, depending on the type of filler and product to be handled, the curve gives a statistical evaluation of the filler's short-term performance and is capable of mathematical definition. It is a simple matter to calculate the mean weight and the standard deviation, denoted by sigma and indicating a measure of the spread on either side of the mean value. In fact, 99.7% or nearly the whole population, falls within  $\pm 3$  standard deviations. Thus, to ensure that virtually no packs are underfilled below the weight level indicated at point A, the filler has to be set to overfill by an average amount equal to AC.

Now, although the standard deviation values generally remain constant, the mean weight may rise or fall due to changes in product density or flow characteristics resulting in a bell curve as shown in Fig. 1 (b) when the results are plotted over a longer period of time. Comparison of the two curves indicates the obvious conclusion that the overall mean level must be set sufficiently high to offset this varying condition resulting, in many cases, in an uneconomic amount of overfill.

In the butter-packing factory where the automatic control system under discussion was tried and proved over nine months of experiments, observations were made on a manually-controlled packing line prior to the automatic test runs. By manual control it is meant that an operator was employed in order to carry out average pack weight spot



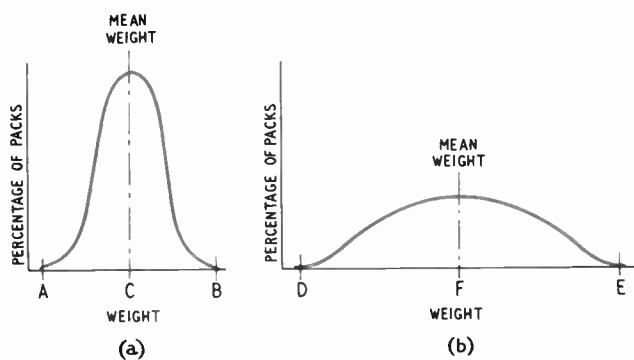
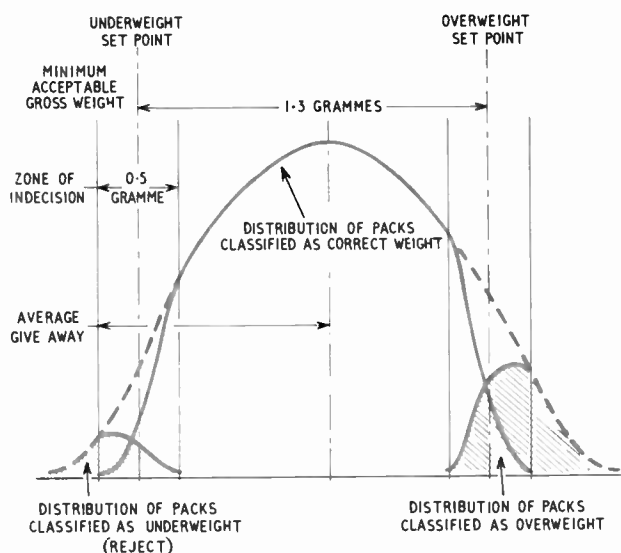

Fig. 1. Short-term scatter (a) and overall scatter (b) of the weight of butter packs

Fig. 2. This diagram illustrates the setting of the automatic control system



checks from time to time, making adjustments to the filler as appropriate. The observations showed that the filler short-term scatter (Fig. 1 (a), A-B) amounted to 0.6 gramme and the overall scatter (Fig. 1 (b), D-E) amounted, not surprisingly, to 3.0 grammes, resulting in an average excess overweight of

$$\frac{3.0 - 0.6}{2} = 1.2 \text{ grammes (0.53\%)}$$

The excess percentage added up to the astonishing total of some 13 tons of product per line during a working year at an approximate cost of £5,000.

The first stage in the experiment was to insert an automatic checkweigher into the line as close to the output stage of the filler as was practicable. The checkweigher now provided a 100% weight check of all packs, and was set up to segregate packs into three categories, underweights, correct weight, and overweight. Fig. 2 shows the condition of setting. The two checkweigher set points were set 1.3 grammes apart, with the low-to-correct set point set to ensure that packs below a set minimum weight were always classified as reject. (The zone of indecision about each set point should be noted. This is inherent in all checkweighers, and the width of the zones indicates the weighing accuracy of the checkweigher.) It was fairly obvious that in order to make some sense of the settings shown in Fig. 2, the checkweigher could have a zone of indecision no wider than 0.5 gramme.

Now, by using the operator as a 'feedback' link between the checkweigher and filler (i.e., by visually observing the trend of the checkweigher indicators) the average give-away was reduced to 0.8 gramme and the classification percentages to 13% underweight, 65% correct, 22% overweight. This was achieved at the cost of considerable concentration on the part of the operator and concern on the part of the production manager at the amount of underweight packs to be recovered.

The next stage was that of mounting a servo motor to the filler control shaft and completing the servo loop by connecting a small computer unit between the checkweigher and servo motor. Since the function of the automatic control system in this case was that of correcting for shifts in the mean weight, a statistical sampling method was used, the sample length being largely dependent upon the mini-

imum number of packs encompassing the short-term filler scatter, in this case ten packs.

Fig. 3 shows a schematic diagram of the system employed. The weigh head produces an analogue output signal proportional to weight within a given weight range. This signal is used for both classification and servo units. As the packs are conveyed over the weigh head by the conveying system, a timing circuit triggered by a photocell detector gates the weigh head signal simultaneously to the classifying discriminator and pulse stretch unit, and at the same time triggers a counting circuit. When the fixed number of packs have passed over the weigh head, the computed arithmetic mean weight of the sample is compared with a fixed reference and the high or low correcting circuit turned on to drive the correcting motor as appropriate, the motor remaining on for a period of time proportional to the difference between the computed mean and the set reference. A fixed period of time later, sufficient to allow for the completion of the maximum allowable correction time and for completely corrected packs to arrive at the weigh head, the counting circuit commences another sample, the sequence repeating continuously.

The sampling rate obviously depends very largely on the distance (i.e., number of packs) between the filler and checkweigher. In the butter-packing line a sample rate of four per minute was obtained.

The system is capable of computing the arithmetic mean weight of the sample with a high degree of accuracy equal to

$$\frac{\text{Checkweigher measuring accuracy}}{\sqrt{N}}$$

where  $N$  represents the sample number of packs. In this particular case the accuracy obtained was

$$= \frac{0.5}{\sqrt{10}} = 0.16 \text{ gramme}$$



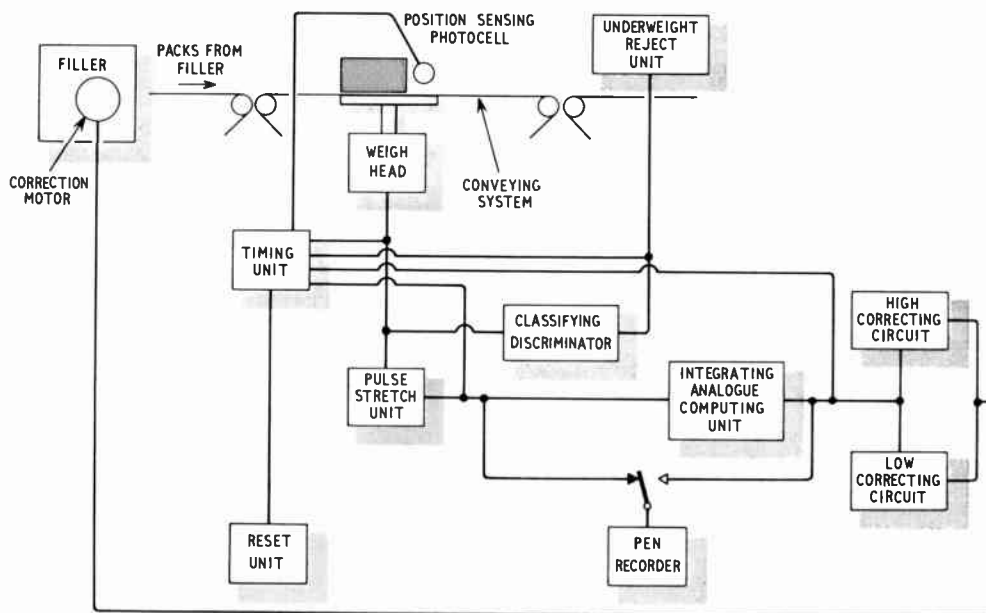

Fig. 3. Block diagram of the control system

The correcting circuits were designed so as to include a 'no-correction' zone equal in width to the computed accuracy obtained and equispaced about the fixed reference.

Consideration had to be given to the possible occurrence of random grossly underweight packs due to product sticking in the filling head. By inserting clamp circuits at signal levels equivalent to, say,  $\pm 2$  grammes at the pulse stretch unit, the effect of random packs differing from the desired mean weight by more than 2 grammes or whatever the limit is set at, is greatly reduced.

Finally, when the production flow breaks down, a reset circuit cancels any outstanding correction signal and resets the complete servo unit to await the restart of the line, since different conditions may prevail at restart.

In operation, with the fully automatic control system, an overall scatter of 1.3 grammes was consistently achieved, showing an average saving of 0.85 gramme per pack (0.38%) when compared with manually-controlled conditions, amounting to a product saving of some 9.5 tons during a working year, approximately £3,800, an amount considerably more than twice the capital cost of the checkweigher and servo control unit.

#### Acknowledgments

The author wishes to thank Mr. W. Isbell, of Dairy Produce Packers Ltd., for his co-operation during the experiment.

## Data Communication Demonstration

The last 10 years have seen a minor revolution in British business during which production and management have undergone radical changes. One of the major contributions to this change has been the general acceptance of computers as a management tool.

However, in many applications the facts and figures are not being made available quickly enough. Some computers, working at high speed, are processing data which, due to outdated methods of communication, are hours, days or in some cases weeks old.

To be really effective the data should be processed immediately it is generated. Market trends, stock positions and other statistical information that changes rapidly must be subject to immediate scrutiny. Modern communication techniques can now provide fast access to and from a computer installation ensuring that maximum computer usage is obtained, no matter how far the data origination points are from the processing centre.

The transmission of computer data over public telephone lines from London to Stockholm and back was recently

demonstrated by Standard Telephones & Cables Ltd. Data was also transmitted over an 800-mile telephone circuit taking in a large number of public telephone exchanges to show what can now be achieved on a regular commercial basis using data communications equipment.

Both the STC GH-201 system used for the London-Stockholm link and the GH-205 system used for the round-Britain trip operate at 600 to 1,200 bits per second over ordinary telephone circuits.

The GH-205 is approved for operation with the GPO's Datel 1A data link and uses a new 'scrambled binary' exclusive to STC, for the protection of data against errors introduced by line faults, surges and exchange relay 'clicks'.

The slow-speed GH-107 data transmission system, which uses GPO low-cost telex lines, was also demonstrated. STC forecast a substantial demand for this kind of equipment from organizations that need to transmit data from punched paper tape to a remote collection point at speeds up to 400 characters per minute.

**For further information circle 40 on Service Card**

# CONTROL SYSTEM FOR AUTOMATIC NAILING MACHINE

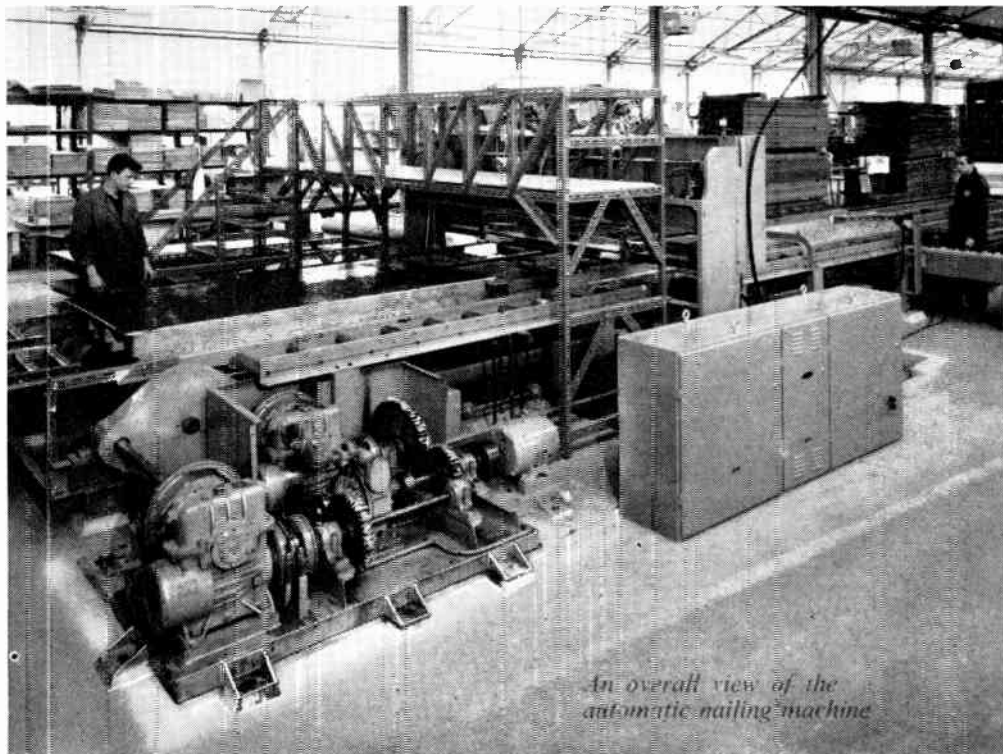

*An overall view of the automatic nailing machine*

**E**QUIPMENT which automatically controls five motors, six electric clutches, four electric brakes, five solenoids and a variable-speed drive has been fitted to a new type of automatic nailing machine with a fully-automatic conveyor feed designed to drive as many as eight 2½-in. nails simultaneously into floor and roof panels up to 28 ft long. The output is equivalent to that achieved by approximately 16 men working by hand.

Known as the Automatic Open Bank Conveyor Feed Nailing Machine, it has been made by Matthew Wylie & Co., of Glasgow, for Swiftplan Ltd., who specialize in factory-made buildings of timber and other materials, and in partitioning and joinery generally. Electrically powered by direct current, the machine is planned to accept floor and wall panels 4 ft in width and from 8 ft to 28 ft long. The control equipment was designed and built by Westool, who also manufactured the electromagnetic clutches and brakes and solenoids.

A continuous chain conveyor, whose speed is infinitely variable except during the nailing sequence (when the flow is constant to synchronize with the stroke of the nailing machine), transports assembled jig-clamped panels along to a table conveyor under the nailing heads. The chain conveyor's speed is regulated by means of a variable speed gear connected through a Warner clutch-brake coupling, and the action of the equipment is controlled by push-button from the adjacent control desk. As the panels approach the nailing heads, micro-switches automatically ensure the correct level for nailing and when the panel reaches the table-centre under the heads, both panel and table-centre rise as one integrated unit until the top surface of the panel is at the required level for nailing. Again, the raising and lowering mechanism is controlled through a clutch-brake coupling.

After the first set of nails has been driven in at a pre-selected distance from the edge of the panel a micro-switch from the main drive brings on an ancillary indexing drive unit controlled by a high-torque clutch coupling. This unit operates another clutch-brake coupling, providing motion through a reduction gear to another clutch, on which is mounted a cam plate with toes equally spaced on its periphery. These toes actuate a microswitch to dis-

engage first motion clutch and engage the brake. The motion of the nailing stroke releases the brake and energizes the clutch, in turn revolving the cam plate till the next cam toe engages. This cycle continues till the panel being nailed clears a microswitch intercepting the nailing cycle. When the nailing operation is completed a further microswitch brings the conveyor back into the normal starting position.

The whole of the above sequence is automatic. The operator is only required to place the materials on the conveyor and start the sequence by operating a pushbutton. Detection circuits are fitted to ensure that sufficient nails are available and that the board is in the correct position, both horizontally and vertically. Memory circuits are fitted to ensure continuance of sequence after restoration of power should emergency-stop, power failure or fault conditions automatically stop the sequence.

*The drives to the conveyor and table raising mechanism*

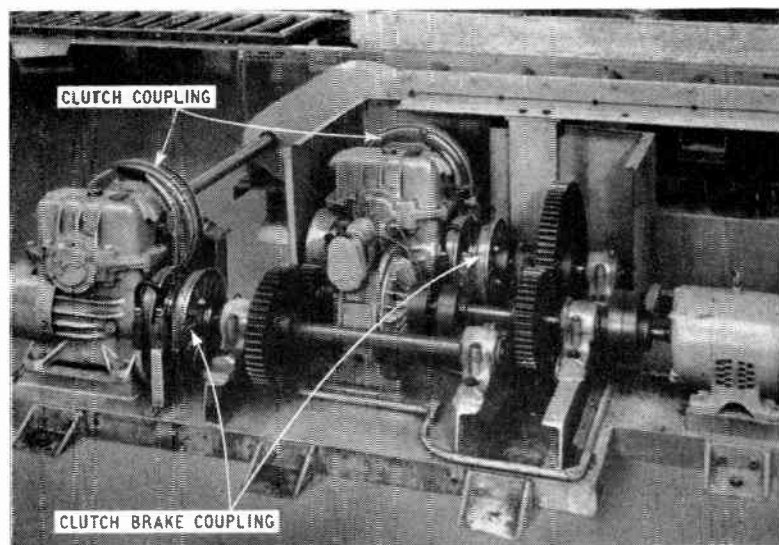



By J. L. GOODWIN, A.M.I.E.E.

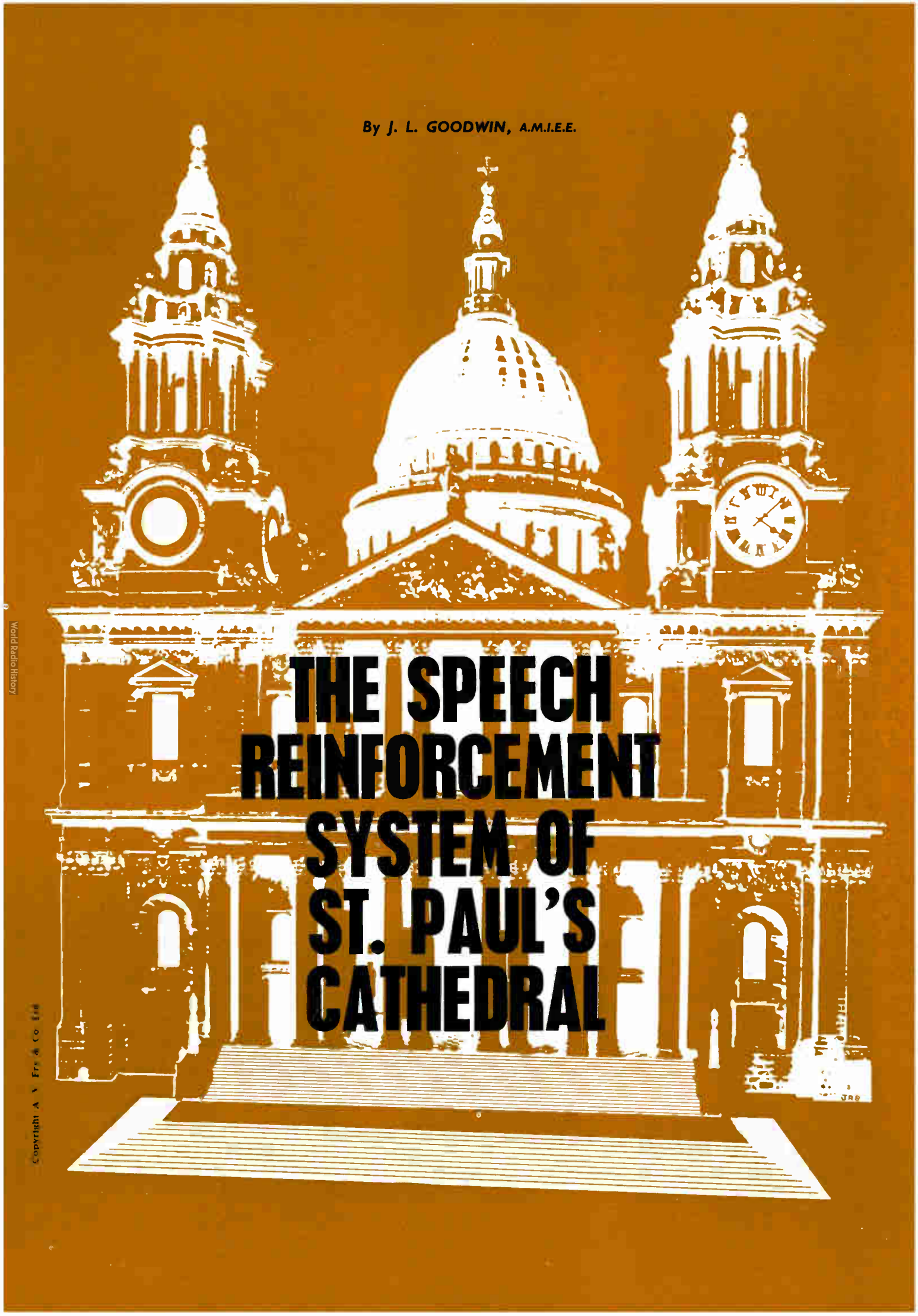

**THE SPEECH  
REINFORCEMENT  
SYSTEM OF  
ST. PAUL'S  
CATHEDRAL**

In order to secure satisfactory sound reinforcement in a large building, such as St. Paul's Cathedral, it is necessary to delay the sound signals to some of the loudspeakers. This is accomplished with the aid of magnetic recording technique, the delay being dependent on the spacing of the record and playback heads.

THE problems facing the sound engineer remain very much the same. Distances and the reverberation time in the Cathedral do not alter with the passage of time; only new methods of finding an answer to some of the problems are evolved.

To reinforce the spoken word in these surroundings one has to contend with a mid-frequency reverberation time of 11 seconds when the Cathedral is empty but this improves to 6 seconds when most of the seats are filled. Even so, the projection of speech across the 100-ft diameter of the dome area under the highly-reverberant conditions still remains a formidable task.

These problems call for the utmost precision in loudspeaker siting and for equipment giving the maximum fidelity with a carefully-balanced frequency response.

The new system, recently installed, uses the same principles of controlled time delays, established by the Building Research Station some 13 years ago<sup>1</sup>, following an earlier series of experiments carried out by Haas and Meyer of the University of Göttingen<sup>2</sup> in 1949.

#### Loudspeakers

Fig. 1 shows a plan of the Cathedral indicating the positions of the loudspeakers which project sound over a distance in conjunction with the time-delay system, and the cross-hatched areas show where the extremely low-level, multiple loudspeakers are brought into operation when large congregations fill the extremities of the Cathedral.

Line-source loudspeakers, consisting of a number of units, are arranged in a vertical line and driven in phase to

produce a directional pattern narrow in the vertical plane. To project the sound across the dome area, which is just in excess of 100 ft, line-source loudspeakers 11 ft in length were sited near to the two principle speaking positions, the pulpit and lectern. The cabinet contains two lines of loudspeakers one running the full length to cover the low frequencies, and the other, one-quarter of the length for frequencies above 1 kc/s. The directional characteristic of this type of loudspeaker was published in a previous article<sup>3</sup> but for reference it is repeated here in Fig. 2.

The distances for sound to be projected in the nave and transepts are of the order of 40 ft and at these positions loudspeakers of 6 ft length are used. Speech from the altar and sanctuary area is reinforced from a pair of 8-ft long line-source loudspeakers and in this case the sound is projected at the centre of the congregation under the dome from a position above the sanctuary. This creates the illusion of speech emanating from the altar and further reinforcement is given by bringing into circuit the pair of speakers covering the dome area. As in all other cases of primary sound being followed by delayed sound, the system is designed to ensure that the primary sound arrives first by a time interval of between 5 and 35 milliseconds in order to preserve the correct sense of direction.

When speech is being reinforced from the pulpit or lectern, the chancel stalls are covered by sound from a pair of loudspeakers 6-ft long, mounted at each side and facing east. These are automatically switched off when any of the sanctuary microphones are made alive.

Throughout the whole plan for loudspeaker layout it has been essential to ensure that the reinforced sound is directed accurately to the area of seating and to see that only those speakers that are absolutely necessary are brought into circuit. The minor areas around the extremities of the transepts, not within the range of the line-source loudspeakers, are covered with small cabinet loudspeakers arranged to feed sound some 8 or 9 ft at a very low level. In the gallery seats, miniature cabinets are arranged in the pews to serve about three persons each, again at a very low

Fig. 1. Simplified plan of the ground floor of St. Paul's Cathedral, showing the principal loudspeaker and microphone positions.

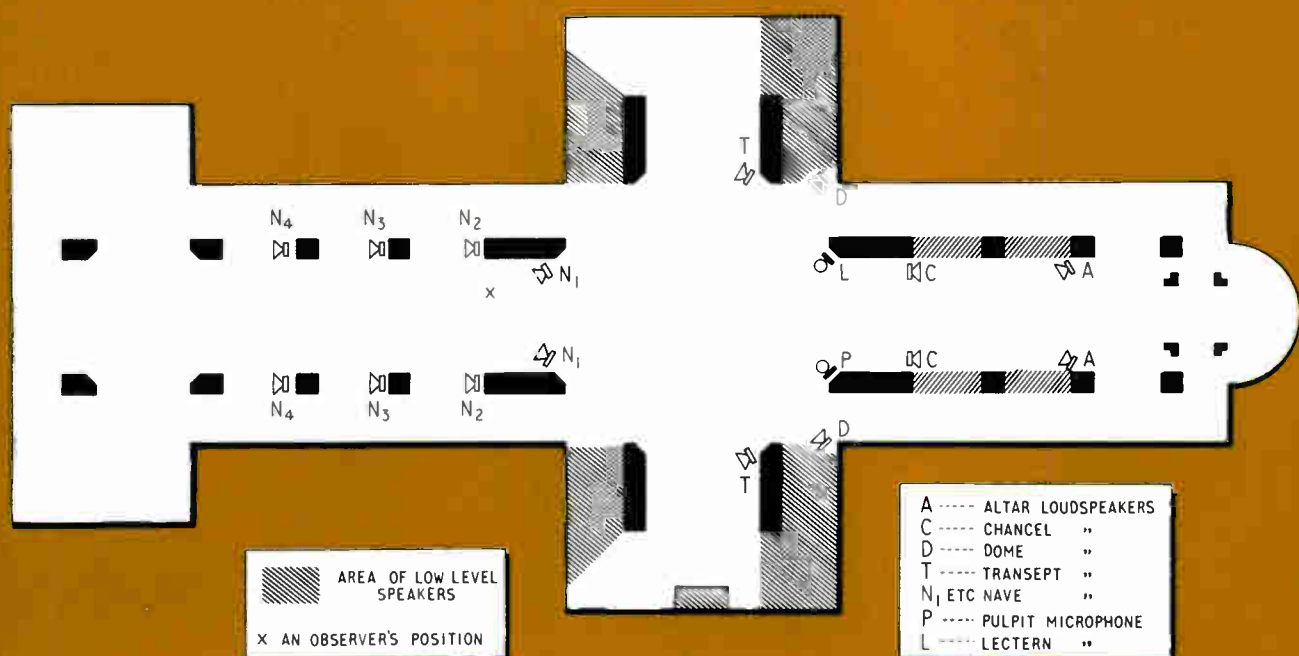



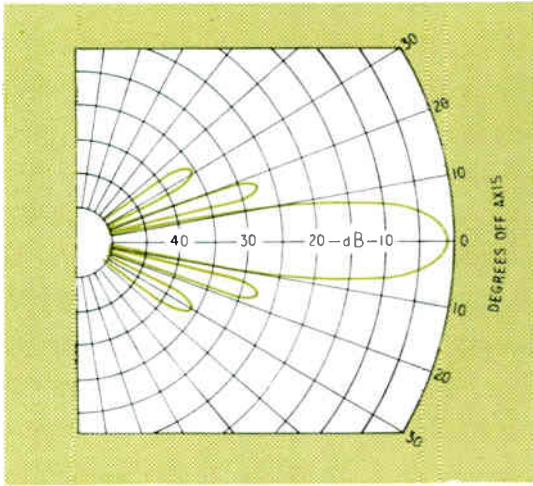
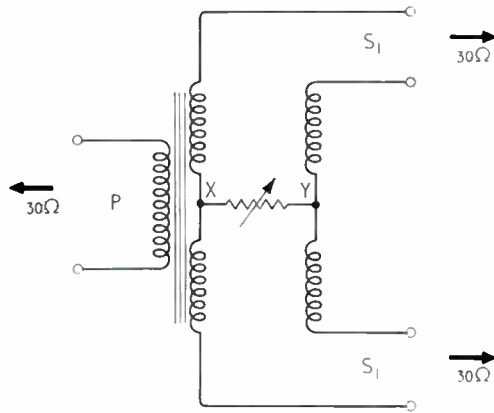

Fig. 2. Directional characteristic in the vertical plane of an 11 ft line-source loudspeaker at 1,000 c/s

Fig. 3. Connections of a hybrid transformer used to split the signal of a low impedance microphone



level. All these circuits are switch-controlled and only used when there is a congregation present.

### Microphones

During the course of the design of the system it was apparent that it would be advantageous to all parties concerned if microphone circuits could be installed in such a manner that they could be shared by a broadcasting organization.

The complete loudspeaker and microphone system was being permanently cabled and in consultation with the Surveyor to the Fabric and representatives of the B.B.C., a scheme was devised to install microphone termination points standard to the B.B.C. and to split all microphone circuits by using balanced hybrid transformers in each channel.

At the principal speaking positions of lectern and pulpit, the B.B.C. installed a second microphone channel so that two microphones could be mounted for grade-one broadcasts.

When the sound system was initially designed, STC 4038 ribbon microphones were specified and as these were acceptable for broadcasting, the main alteration in the system was to add the hybrid transformers and to divert the cable runs, so that terminations could be made in the broadcasting control room. Fig. 3 shows the way connections were made to a hybrid transformer on this installation. The primary 'P' is connected to the microphone and the four parts of the secondary are arranged so that equal impedances connected to  $S_1$  and  $S_2$  cause a minimum voltage to appear at the points X and Y. The balance resistance is made variable and is 'tuned' for minimum voltage across its terminals.

During operation, any out of balance voltage (caused by one of the parties connected to  $S_1$  or  $S_2$  having applied a load lower than normal) will be developed across XY and will have no adverse effect on the level fed to the other. Similarly, noise generated in one arm will be greatly attenuated in the other arm in a correctly-balanced arrangement. With careful balancing 30 dB rejection is obtained



Fig. 4.(a) Typical microphone and mounting shown on the lectern. The small assembly at the side of the microphone carries a signal lamp. (b) The relationship of the directional microphone and loudspeaker at the lectern

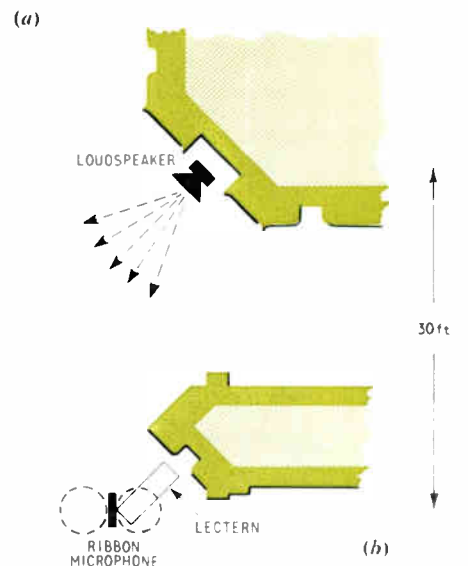



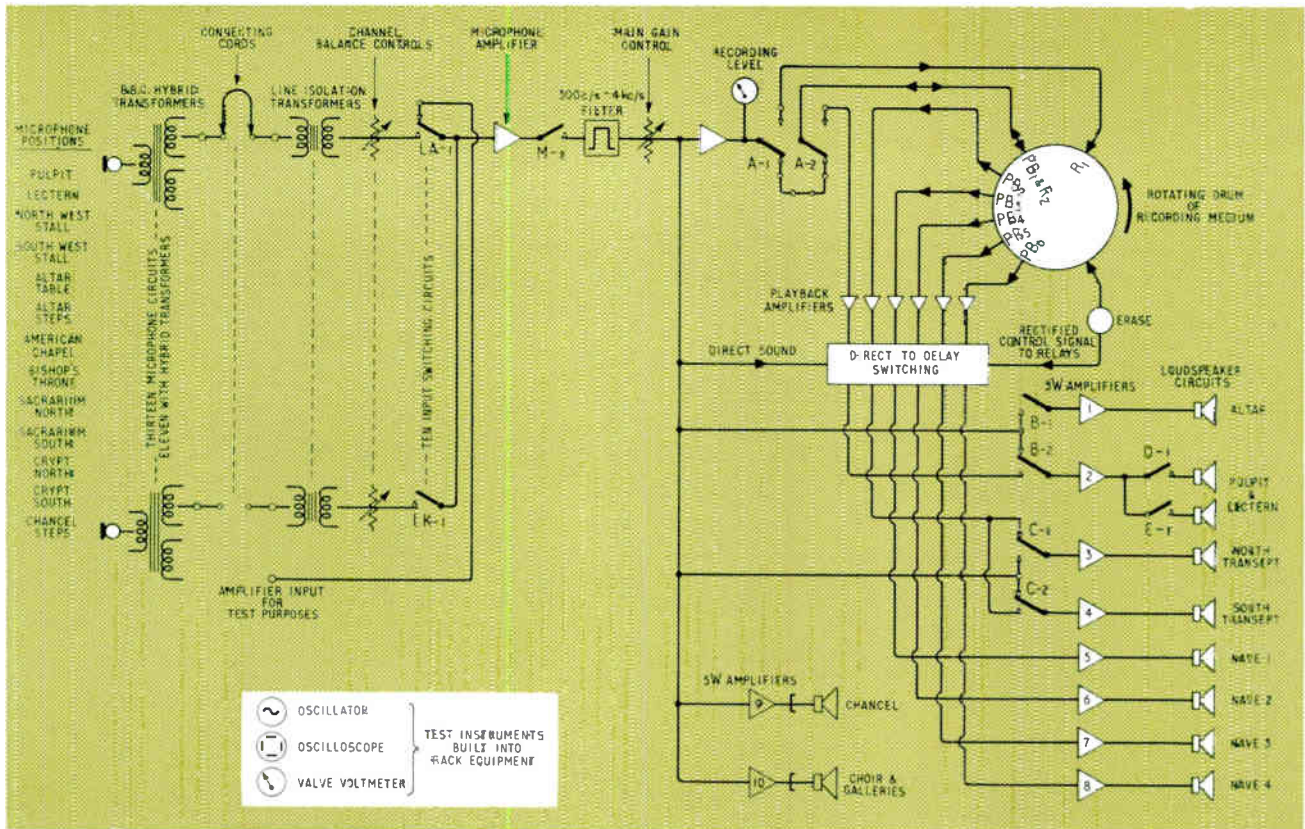

Fig. 5. Simplified block schematic diagram of the audio circuits omitting spare equipment and the supervisory and monitoring points

and an insertion loss of only 3 dB is incurred between the primary and either secondary. This deterioration of signal can be tolerated in a system using microphones delivering the maximum possible signal and where a good cabling system has been installed with twin-twisted and screened cable. Almost all of the thirteen circuits are treated in this manner so that at any time a normal broadcast can take place without the installation of extra equipment. Once these facilities are permanently installed, the time saving on all subsequent occasions is considerable, apart from the added advantage that the installation remains tidy and no additional temporary cables have to be laid.

The microphone and mounting at the lectern are illustrated in Fig. 4 (a) while Fig. 4 (b) shows the relationship between the microphone and loudspeaker characteristics. The relative angles are critical at this position in order to obtain the maximum signal from the human voice and the minimum of interference from the line-source loudspeaker which, as will be seen, is to the side and rear of the microphone.

For the purposes of sound reinforcement in a reverberant building where the feedback margin is small, it is advantageous, with the right type of microphone, to bring the voice input closer to the instrument. The popularity of the neck, or lavalier, microphone has been largely brought about by its use in television where a small microphone is needed close to the person using it. This type has been recently used by the clergy in one of our largest churches and a number are now available for use in St. Paul's Cathedral. Any small difficulties of putting the microphones on are quickly overcome by persons keen to use them; once on, the person's mouth is at a fixed distance from the instrument and, within the length of connecting cable the wearer is free to move about without impairing volume level or quality of sound reproduction. The greatest benefit of

using this type of instrument is at the lectern and pulpit and by careful siting of the microphone sockets there need be no difficulty in the wearer making connection.

### The System

Any audio system is an assembly of switching, fading and amplification units prepared to meet the specific requirements of the client and environmental conditions. In the St. Paul's Cathedral system an additional requirement is for every element to be transistorized.

Apart from fulfilling the basic requirements, the system designer must allow for maintenance and for the safeguarding of vital elements in the event of breakdown. It is, therefore, customary in systems of this nature to include a number of strategic testing points and though these are not shown in Fig. 5, they are evident in Fig. 6, which is a close-up of the power amplifier and output control panel.

The microphone signal is switched at low-level using relays having platinum contacts, such as LA, and a sequential switching by relay M, in the high-level part of the microphone signal circuit, follows the closing of any individual microphone circuit. This process obviates clicks and by using carefully-shielded and balanced circuits, noise is kept below the audible level.

The naturalness and intelligibility of speech is not impaired by restricting the band width to 300 c/s to 4,000 c/s and attenuating by a minimum of 12 dB per octave outside these figures. In a reverberant building it is essential to





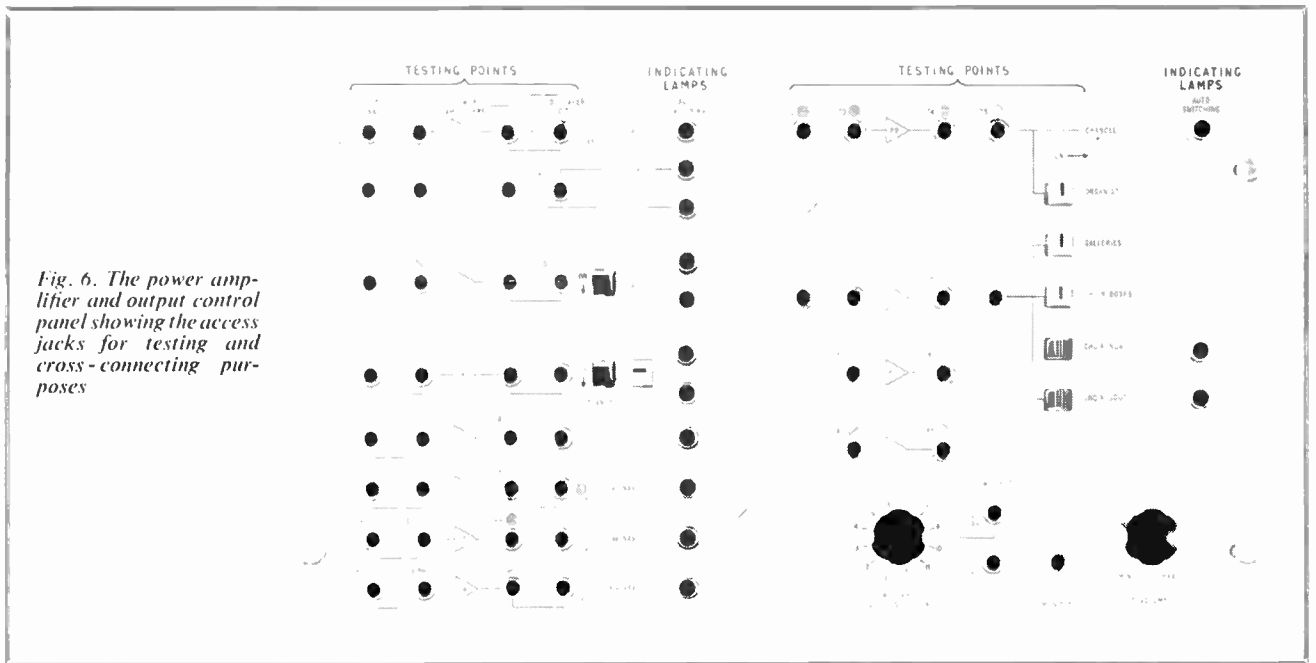
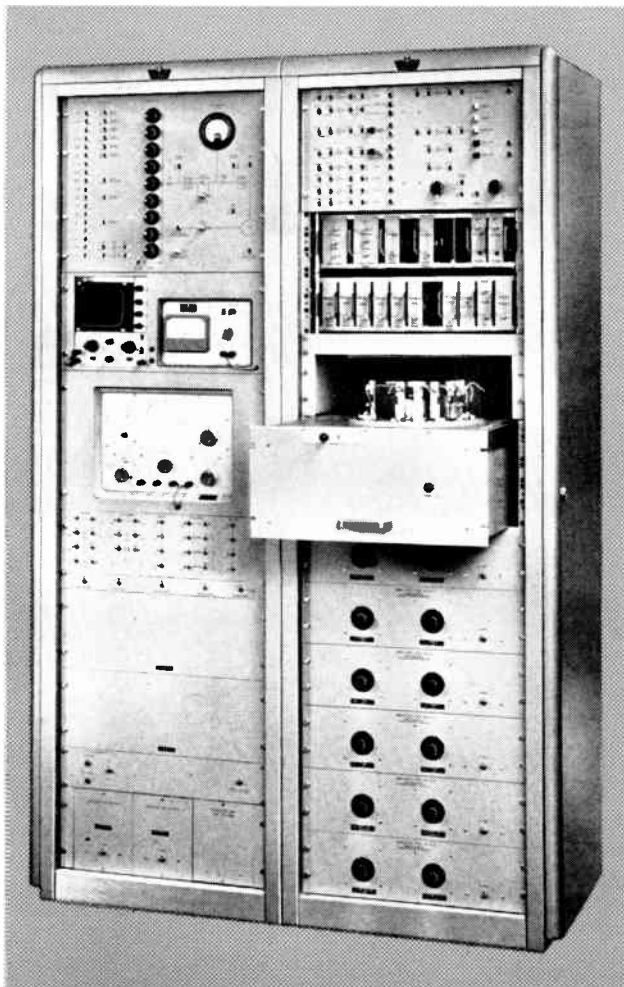

Fig. 6. The power amplifier and output control panel showing the access jacks for testing and cross-connecting purposes

Fig. 7. The drum unit is shown here withdrawn from the equipment cubicle, and the cover panels have also been removed from the area housing the record and replay amplifiers. The panels below the drum carry pairs of 5-watt amplifiers and with the exception of the test equipment in the left hand bay, all are fully transistorized



reduce the low frequencies and with some voices it is an advantage to reduce the upper sibilants. A filter precedes the main gain control and at this point the signal divides into direct sound and that which is to be recorded. The direct sound at a level of  $-20$  dB in 600 ohms is made available for certain switching circuits and for amplification by amplifiers 9 and 10 to which are connected all loudspeaker circuits taking the permanent direct signal. The signal to be recorded passes through the record amplifier and through the contacts of relay A to one of the two recording heads  $R_1$  and  $R_2/PB_1$ . A number of playback heads around the drum periphery relay the recorded signal through playback amplifiers, a switching network and a number of 5-watt amplifiers connected to the principal loudspeaker circuits.

The precision drum unit, which revolves at 80 rev/min, is of interest in that it uses a band of magnetically-loaded synthetic rubber (neoprene) as the recording medium. The surface is lubricated constantly with a thin film of silicone oil and in-contact heads, sprung lightly against the neoprene and mounted in a concentric groove around the drum periphery, are used for the normal functions of erase, record and playback. The record and playback heads are identical and this simplifies the arrangement of the switching circuits. A similar recording medium is used on the new Post Office talking clock, TIM<sup>1</sup>, and it is expected that an excess of 10,000 hours of use will be possible before any appreciable wear on the heads is noticeable. A signal/noise ratio on the overall system of 45 dB has been obtained and though not up to broadcasting standard, it is more than adequate for high-quality sound reinforcement. Fig. 7 shows the record-replay unit withdrawn from the main cubicle and most of the head units can be seen around the periphery of the drum.

When designing speech delay systems two criteria have to be watched, time and sound level. Both have been fully discussed by Parkin and Scholes<sup>1</sup> and it will suffice to say that the system designed should allow for the delayed sound to be over-delayed by 5 to 35 milliseconds, and in order to preserve realism the delayed sound level should not be more than 7 dB up on that of the primary sound. Considering the case of the direct sound being projected across the dome area this will take 120 milliseconds to arrive at an

observer at X (see Fig. 1). The sound emanating from loudspeaker  $N_1$  will take 16 milliseconds to arrive at the observer and the position of the playback head  $PB_3$  is adjusted relative to  $R_2/PB_1$  to give a total time of 127 milliseconds.

This principle is followed when calculating the subsequent delays and levels until the entire length of the nave and the transepts has been covered. When the sound source moves to the microphones in the sanctuary, the primary sound is reinforced from two line-source loudspeakers mounted several feet above the floor level and they project the sound at the congregation in the dome area. The sound to be recorded is now applied at head  $R_1$  and the main dome line-source loudspeakers take their signal from head  $R_2/PB_1$ , used as the first playback head.

It will be seen that all the system delays are increased by the time interval proportional to transferring the sound recording from  $R_2$  to  $R_1$ . The loudspeaker and recording switching is coupled to the respective microphone circuit that is selected, so that at all times the correct combination of loudspeakers is brought into operation with the movement of the sound source. This feature improves realism and is a contributory factor in obtaining high intelligibility from the system. Other switching sequences occur as the primary sound moves from pulpit to lectern and in this case only the respective main line-source loudspeaker is in use for the dome area. The transept loudspeakers are arranged to alternate from a short to a long time delay according to which microphone is in use.

The erase oscillator output, apart from supplying the erase and bias signals is arranged to hold up a relay which in turn controls the switching network after the playback amplifiers. If the erase oscillator should fail and not erase the previously recorded signal a warning lamp will be lit on the remote control panel and the power amplifiers will receive the direct sound signal in place of that from the playback heads. It is preferable for there to be some interference in the sound received, by the whole system being fed with the direct signal, rather than a breakdown in the erase circuit causing repetition of the phrase and subsequent over-recording.

### The Remote Control Console

Relay switching permits the use of very simple primary operating circuits to select any required microphone and from this condition any automatic sequence of recording the loudspeaker switching can conveniently be arranged. The microphone switching is also arranged to be self-cancelling so that consecutive switching causes the automatic cancellation of a previously established circuit.

The control equipment is geographically laid out to be similar to the disposition of the microphones and loudspeakers in the building itself and by using illuminated push buttons for the microphone selection, it is a simple matter for the operator to follow the movement of the service on the control panel.

The panel is shown in Fig. 8 with an operator with his hand on the main gain control, the only variable control that is altered after the initial balancing tests on the system. The gain is adjusted to give the correct audible level at the control point which is a maximum distance from the principal line-source loudspeakers and in full view of the service. On the meter the modulation level to the recording amplifier may be monitored.

The loudspeakers in circuit at any particular time are indicated by a green light on the panel and these, coupled with a red display from a microphone circuit, give an instant picture of the working circuits. There are occasions, such as special services, when the automatic switching sequence



Fig. 8. An operator at the remote control panel. The lamp immediately above the gain control lights if the erase oscillator fails and at the same time the recording system is taken out of operation

is not suitable. To meet these conditions the automatic switching is routed through a set of loudspeaker keys arranged at the side of the console panel. In the centre normal position, auto-selection is given and an operation to the left prevents it, while a movement to the right gives manual selection.

All the control is effected over a flexible multicore cable which joins a movable console to the building wiring. The relay switching results in the maximum variations being effected in the audio circuits without these having to be routed to the control panel.

Test equipment, such as an oscillator, oscilloscope, and a valve voltmeter forms part of the rack equipment so that monthly test routines can be conveniently carried out. The test routines check all parts of the system and should give a warning of any deterioration that might take place so that corrective action could be taken before an actual failure. In a building of such national importance, there are occasions when it is used for services at extremely short notice and at which very large congregations are present; it is therefore desirable that the system is maintained in full working order.

The author wishes to thank Messrs. Standard Telephones and Cables Limited for permission to publish this material and the Director, The Building Research Station, who, as the scientific adviser to the Dean and Chapter of the Cathedral, co-operated in the acoustical design of the system.

### References

- <sup>1</sup> 'Speech Reinforcement Systems' by P. H. Parkin, B.Sc., A.M.I.E.E. and W. E. Scholes, B.Sc., *Wireless World*, February 1951.
- <sup>2</sup> 'The Influence of a Single Echo on the Audibility of Speech': A Dissertation by H. Haas for a Doctor's Degree, under the supervision of Professor E. Meyer, University of Gottingen. Building Research Station Library Communication No. 363.
- <sup>3</sup> 'Speech Reinforcement in St. Paul's Cathedral' by P. H. Parkin, B.Sc., A.M.I.E.E. and J. H. Taylor, A.M.I.E.E. *Wireless World*, February 1952.
- <sup>4</sup> 'The New Post Office Speaking Clocks' by R. R. Walker B.Sc. (Eng.), A.M.I.E.E. *Post Office Electrical Engineer's Journal*, Vol. 56, Part 1, April 1963.



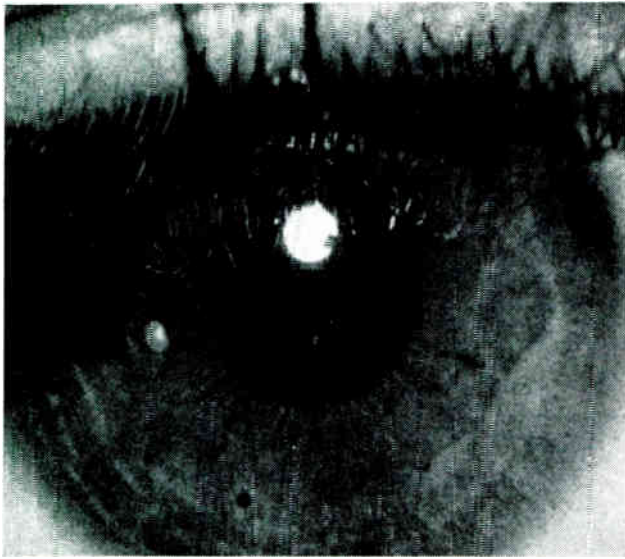

# ELECTRONICS AIDS EYE- MOVEMENT RESEARCH

A TRANSISTORIZED data-processing system specially developed by M.E.L. Equipment for Reading University is now being used in the extensive study of visual perception.

The human eye, in addition to being capable of voluntary movement, makes a number of small involuntary movements when 'fixating'; that is, when the gaze is fixed on a stationary point. These involuntary movements are of three classes: drift, saccades and tremor, and their magnitudes are subject to individual variation. The drift is a slow movement at a velocity of about 5 min arc/sec. Saccades are fast movements which tend to compensate

for drift and are typically of 40 millisecc duration, 6 min arc median magnitude. Tremor comprises small amplitude oscillations of 20 sec arc with a frequency range of approximately 20 to 150 c/s. The correlation between these various movements is at present being studied in the Physics Department at the University.

The person on whose eye the measurements are to be made steadies his head by resting it against a frame and biting on a fixed dental mould. Also, he wears a contact lens to which is attached a plastic stalk carrying a small mirror. Light is reflected from the mirror via an optical system on to two photomultiplier tubes. The system is

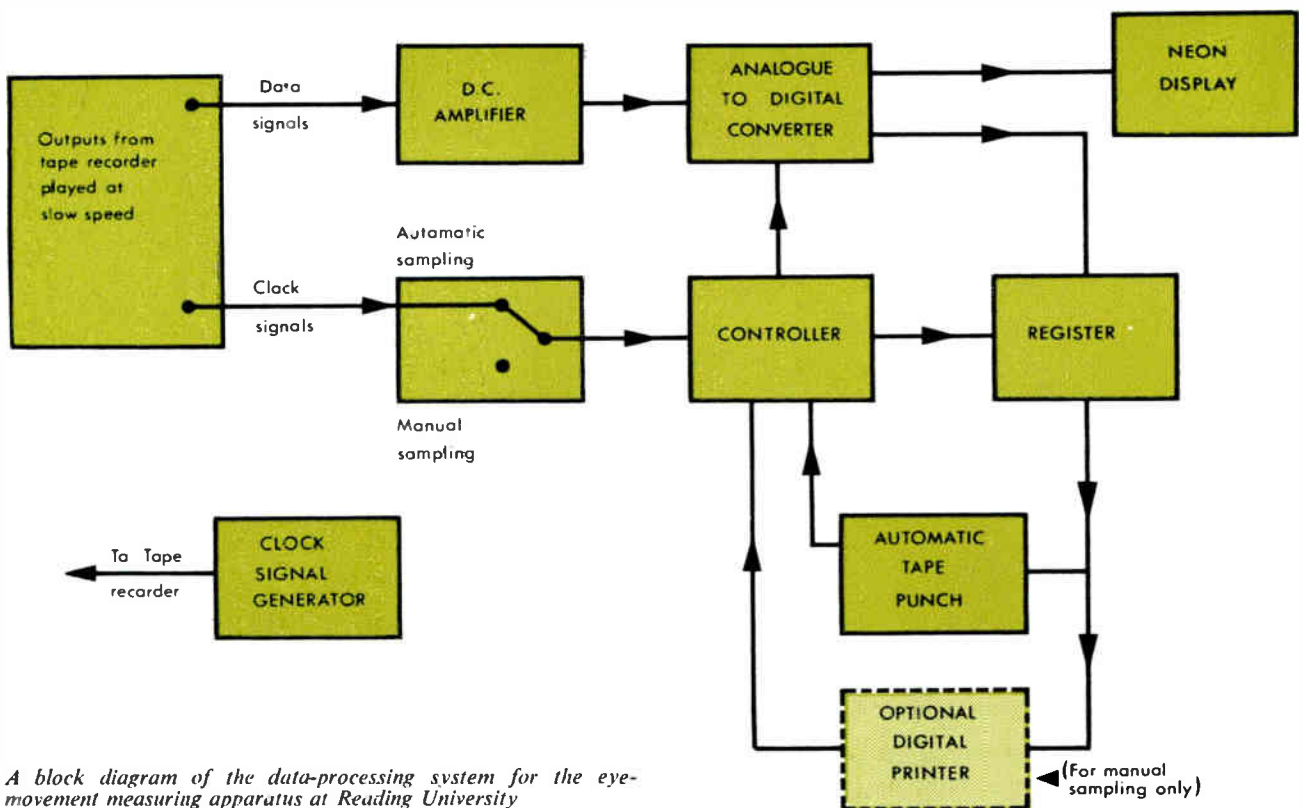

A block diagram of the data-processing system for the eye-movement measuring apparatus at Reading University

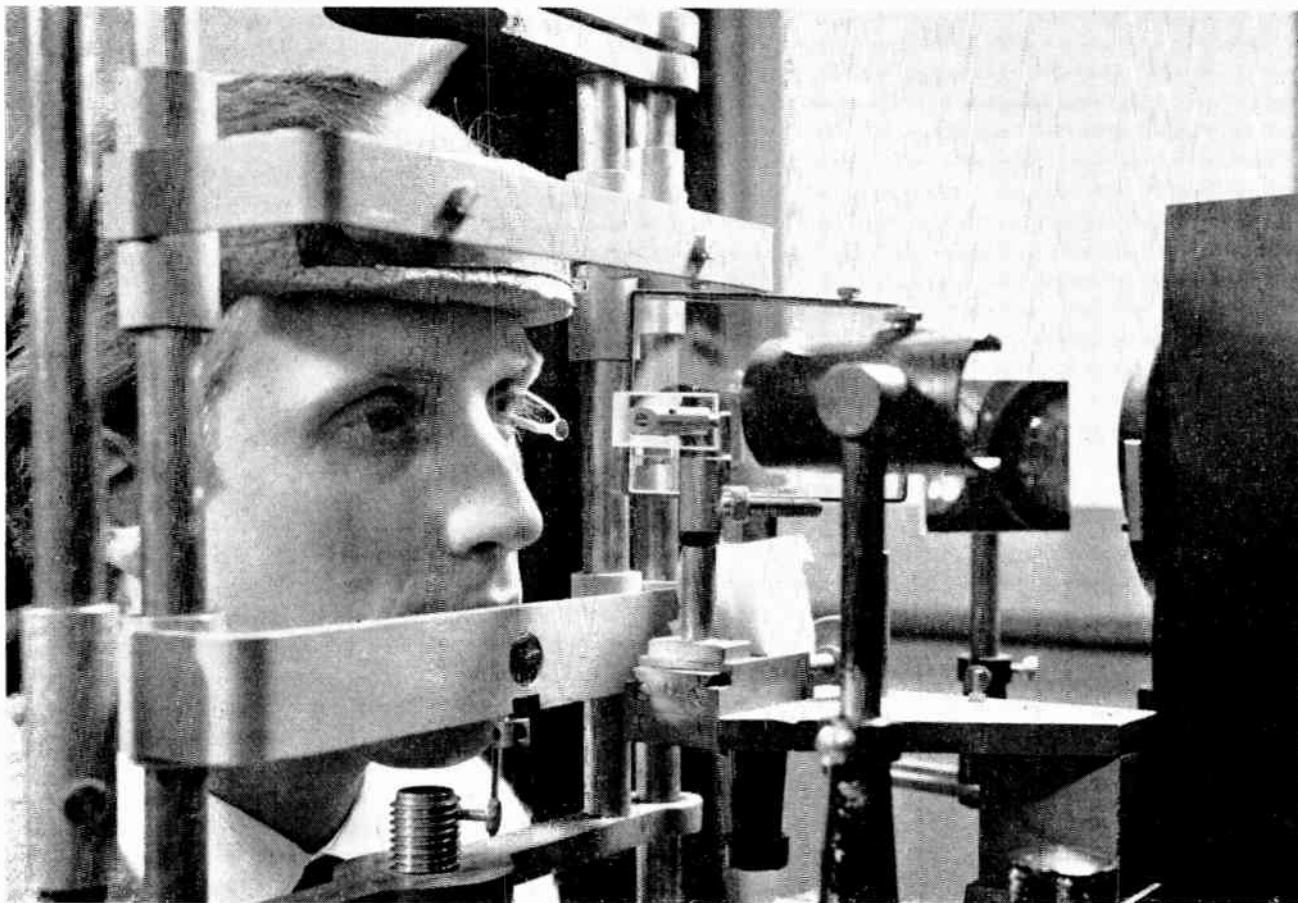

*The subject wears a contact lens to which is attached a small mirror, and his head is held steady in a frame*

designed so that the amount of light falling on one photomultiplier is proportional to the vertical component of the eye movement, while the light on the other photomultiplier is proportional to the horizontal component.

The outputs from the two photomultipliers are recorded on separate tracks by a high-speed magnetic-tape recorder at speeds of up to 60 in./sec. The data is converted into binary-coded decimal form on punched-paper tape so that it may be presented to a computer for analysis.

The data conversion is carried out by the M.E.L. equipment. First, one track is completely processed and then the other. The tape is replayed at a minimum speed of  $1\frac{7}{8}$  in./sec which gives a maximum reduction of 1 : 32 of the recording speed. The signal is passed to a d.c. amplifier, and very short samples of 0.8 msec duration are taken, the sampling rate being determined by a clock signal previously recorded on the tape. The samples are digitized and passed to a register, and the flow of data is controlled so that it does not exceed 110 characters/sec, which is the maximum speed of the punch.

In addition to the tape read-out, the equipment incorporates a digital printer for use when sampling manually, and a neon-tube binary-coded decimal display for checking and setting up the overall system.

The punched tape provides a permanent record of the measurements from which analytical information, such as the median saccadic movement of the eye, can be readily obtained by an appropriately programmed computer.

*The equipment processes the data into a form suitable for presentation to a computer*

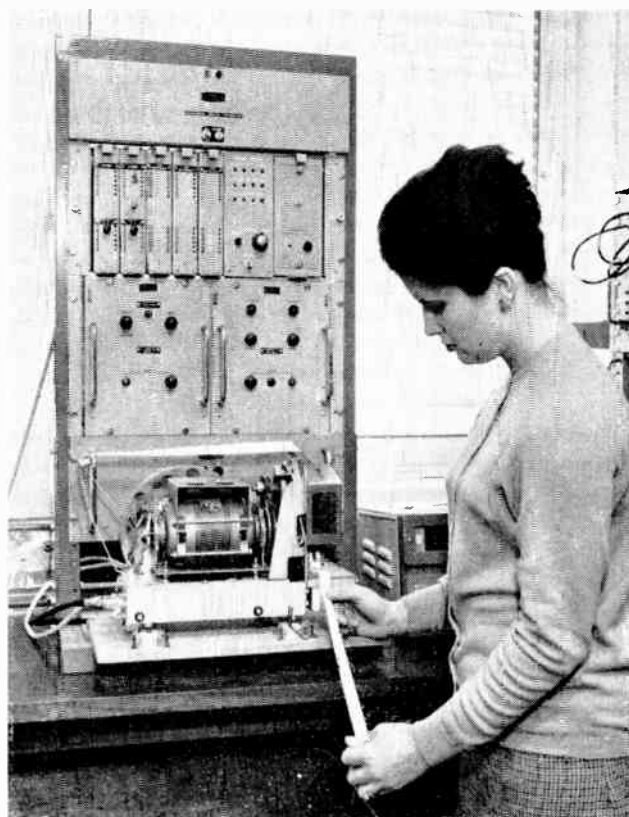



Industry has come to realize the importance of the analogue computer as a serious design tool, not only in basic research but in practical engineering. This article assesses the computer in its technical aspects and discusses the various computer components in relation to their practical function. In restating these basic principles, the author gives a complete first introduction to analogue computers for the engineer in industry.

**I**NVARIABLY the question arises—which is better, an analogue or a digital computer? The answer is that neither is always better; the best choice depends on the particular problem to be solved. While there are many considerations, in general, the principal advantage of the analogue computer is speed, while the advantage of the digital computer is accuracy.

The speed advantage of the analogue computer arises from the fact that while the digital computer performs its calculations with discrete numbers in sequence, the analogue computer has all components (summers, integrators, etc.) performing their operations simultaneously and continuously. Thus, the digital computer must wait until each calculation is completed before moving on to the next. The more complex the problem, the more calculations are required and the longer the time required for solutions. The time required for solutions on the analogue is virtually independent of the complexity of the problem. A typical analogue computer solution takes from 10 to 60 seconds, with 20 seconds a good average figure. One large analogue computing laboratory which has acquired a digital computer for checking purposes reports an analogue speed advantage of over 100 to 1 in some problems.

This speed advantage is especially important if a problem is to be solved for many parameter variations. The stiffness of a spring, the wing span of an aeroplane, and the gain of a pneumatic controller are all examples of parameters that can be set on potentiometers and varied between runs, enabling the operator to judge quickly the effects of any change in parameters. In a design problem with many adjustable parameters, this speed advantage usually enables the optimum design to be reached more quickly than by digital methods.

The accuracy of an analogue computer is limited by the accuracy of the electrical components, and three significant figures is the limit of accuracy presently attainable in medium-sized problems. On a digital computer, the accuracy is determined chiefly by the number of binary places retained in calculation and, with sufficient equipment and time, high accuracy can generally be achieved.

Today's analogue computer has a substantial record of achievement, especially in solving problems of guided-missile trajectories and air-frame design. Its use is spreading rapidly into other fields, including process simulation, analysis of control systems, power plant design, etc.

At first sight, the numerous dials, switches and indicators

make the analogue computer appear complex. However, the computer consists of a large number of a few basic types of similar building blocks. This is why the average engineer can be taught to operate it in as little as 8 hours; with a week of practice and study he can successfully set up and run worth-while problems. This article has been written for such an engineer—one who has heard of what analogue computers can do, and who wants to know how the computer would help to solve his engineering problems and thus increase his engineering efficiency.

Although several types of analogue computers are available, the basic principles of all of them are similar, so that a description of one type will provide an adequate introduction to the field. Reference will be made to the EAL PACE 231R electronic computer as a typical general-purpose analogue computer to illustrate details of equipment.

### Electrical Analogue of a Physical Variable

On an analogue computer, physical variables such as weight, temperature or area are represented by voltages; that is, voltage is the electrical analogue of the variable being analysed, which can be mechanical, hydraulic, pneumatic or even electrical in nature. Arbitrary scale factors relate voltages in the computer to the variables in the problem. The computer components are designed to operate within an output voltage range of  $\pm 100$  V, and all computer variables are scaled to lie within this range. Thus, a temperature  $T$  which can vary from 0 to  $1,000$  °C is represented on the computer by a voltage that varies from 0 to  $+100$  V ( $100$  V =  $1,000$  °C;  $1$  °C =  $0.1$  V). The scale factor would be  $\frac{1}{10}$  volt per degree Centigrade.

As another example, a displacement  $x$  which varies from  $-5$  to  $+10$  inches could be represented by a voltage that varies from  $-50$  to  $+100$  V, and the scale factor would be 10 volts per inch.

The computer components are interconnected so that the voltages in the computer are related by the same mathematical equations as the original physical variables. Thus, if a voltage on the computer represents temperature in a chemical reactor, and is scaled for 1 volt per 5 degrees Centigrade, a graph showing this voltage increasing from 10 to 100 volts would mean that the reactor temperature varied from 50 to 500 degrees. It is from this analogy between the problem variable and the computer voltage that the analogue computer derives its name.

### Computer Elements

The computer consists of a few basic components, or building blocks, which perform mathematical operations such as addition, subtraction, multiplication, division, integration, etc. The basic components are (1) amplifiers, (2) potentiometers, (3) multipliers and (4) function generators. These components can be connected to solve a variety of equations.

In practice, the computer elements are connected, or patched, to set up (and solve) the equations which are derived from the dynamics of the system to be analysed. The interconnections are made by means of a patch panel. Every computing component has its input and output terminations

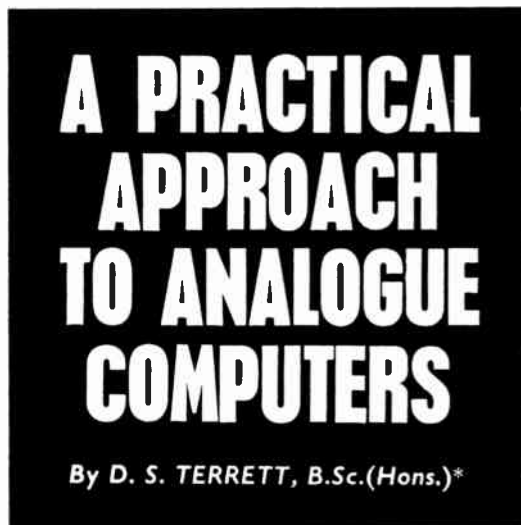

\* Electronic Associates Limited.

on this panel, and leads can be run between any two holes on the panel, connecting the components in any desired manner. The panel is removable, and problems are usually patched externally to the computer. Hence the machine is not tied up while the connections are being made; problems can be patched on individual patch panels while the computer is solving another problem.

### The Amplifier

The basic computer component is the amplifier, a direct-coupled amplifier with d.c. gain of 100 million or greater. This means that an input voltage of  $10^{-8}$  volt (only 0.01 microvolt) could produce an output of a volt or more. There is also a sign (phase) change associated with the amplifier; that is, a positive voltage input produces a negative voltage output, and vice-versa. The symbol for an amplifier is shown in Fig. 1.

### Summing Amplifier

The amplifier can be used to add voltages as shown in Fig. 2.  $R_1$  and  $R_2$  are called input resistors, and  $R_f$  is the feedback resistor. Applying Kirchhoff's law for current at the summing junction, we have:

$$i_{R_1} + i_{R_2} + i_f + i_g = 0$$

where  $i_g$  is the input current to the amplifier. If the voltage at point S is  $e_g$ , applying Ohm's law:

$$\frac{X - e_g}{R_1} + \frac{Y - e_g}{R_2} + \frac{Z - e_g}{R_f} = -i_g \quad \dots (1)$$

The amplifier itself is designed to draw as little grid current ( $i_g$ ) as possible from the inputs  $X$  and  $Y$ . As  $i_g$  is negligible in comparison with the other current ( $i_g \ll 10^{-10}$  amp), the right-hand side of equation (1) can be set equal to zero without significant error. Since the amplifier output  $Z = Ae_g$ , where  $A$  = the gain of the amplifier,  $e_g = Z/A$ . Substituting  $-Z/A$  for  $e_g$  in equation (1) and solving for the output voltage  $Z$ :

$$Z = -\left(\frac{X}{R_1} + \frac{Y}{R_2}\right) / \left[\frac{1}{R_f} + \frac{1}{A}\left(\frac{1}{R_1} + \frac{1}{R_2} + \frac{1}{R_f}\right)\right] \quad \dots (2)$$

Now we see the reason for the extremely large gain,  $A$ . If  $A$  is sufficiently large, we may ignore the terms involving  $1/A$ , and obtain the approximations:

$$Z = -\left[\frac{R_f}{R_1}(X) + \frac{R_f}{R_2}(Y)\right] \quad \dots (3)$$

If all three resistors are equal, then  $Z = -(X + Y)$ . Except for the sign reversal, we have succeeded in adding two voltages. If all resistors are equal, the error introduced by ignoring the  $1/A$  terms is less than 3 parts in 100 million.

This method is not limited to two inputs. With additional input resistors, three or more voltages can be added.

### Multiplying by a Constant

When the input and feedback resistors are equal, the amplifier is a simple summer. However, when the input resistor is a fraction of the feedback resistor, the output ( $Z$ ) equals the input ( $X$ ) multiplied by the factor ( $R_f/R_1$ ), as shown in equation (3).

Hence if the feedback resistor  $R_f$  is 10 times the input resistor, the output voltage is 10 times the input voltage.

In actual computer diagrams the resistors are not drawn, but a gain of 1 or 10 is indicated, as shown in Fig. 3.

With a single input (gain of 1) the amplifier is simply an inverter (Fig. 4). With summers and inverters, subtraction can be performed as shown in Fig. 5. The amplifier at left is simply an inverter; the amplifier at right is summing its two inputs.



Fig. 1. High-gain amplifier. The input voltage is multiplied by gain  $A$  ( $10^8$  or greater); minus sign indicates phase reversal in amplifier

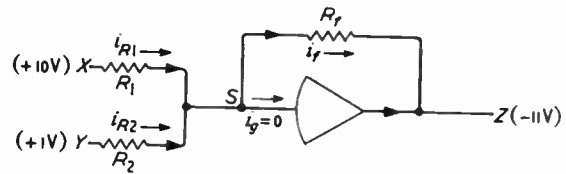

Fig. 2. High-gain amplifier used as a summer

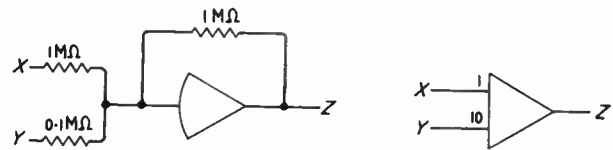

Fig. 3. Summing amplifier (left) and its computer symbol (right). Output  $Z = -(X + 10Y)$

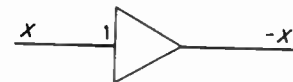

Fig. 4. With only one input as shown an amplifier is simply an inverter

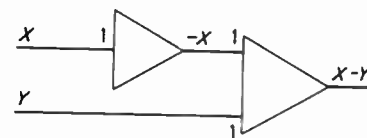

Fig. 5. Amplifiers used for subtraction. Here two amplifiers are used to obtain  $X - Y$

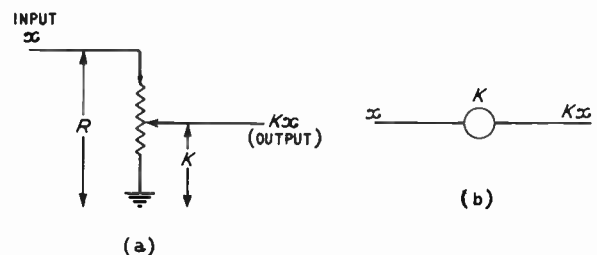

Fig. 6. A potentiometer is simply an attenuator (a); symbol for a potentiometer is a circle (b)



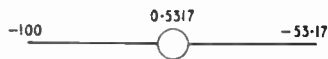

Fig. 7. Producing a constant ( 53.17 volts) by using the reference voltage and a potentiometer

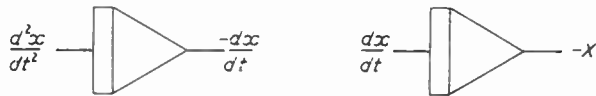

Fig. 8. Integrator symbol is a rectangle against a triangle

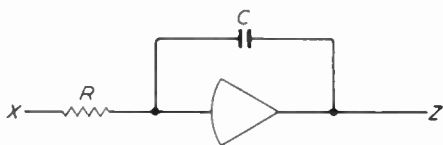

Fig. 9. Integrator is simply an amplifier with a feedback capacitor

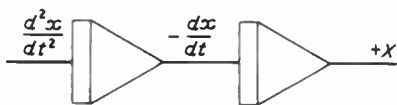

Fig. 10. Each integration reduces the order of the input derivative

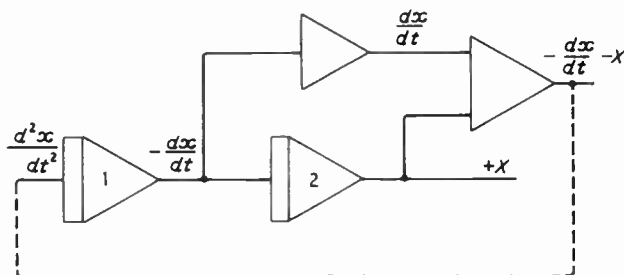

Fig. 11. Summing the  $dx/dt$  and  $x$  terms provides the right side of equation (5); thus equation (5) is satisfied by joining the output and input as shown by the dotted line

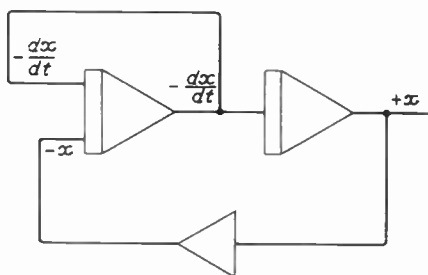

Fig. 12. Integrator can sum as well as integrate

### The Potentiometer

We can now add and subtract voltages, change sign (multiply by  $-1$ ) and multiply by 10. To multiply a voltage by a factor other than 1 or 10, a potentiometer ('pot' for short) is used. Fig. 6 shows a potentiometer schematic at (a) and the symbol for a potentiometer (a circle) at (b). In practice, a large number of potentiometers are used and the photograph shows the appearance of a potentiometer panel on a computer. Fig. 7 illustrates the use of a potentiometer.

In Fig. 6(a) the voltage on the arm of the potentiometer is  $K$  times the input voltage, where the factor  $K$  can be set to any value between zero and unity. Potentiometers on the computer can be equipped with calibrated dials, and the values of  $K$  set directly on the dials, if high accuracy is not required.

However, this setting can be in error for several reasons, electrical loading, mechanical misalignments of the dial, backlash, etc. To avoid these errors and to set a potentiometer very accurately, the potentiometer is set by monitoring its output with the actual load connected to the potentiometer wiper. Each potentiometer is equipped with a switch which, when depressed, disconnects the input terminal of the potentiometer from the circuit and connects it to a fixed reference voltage ( $+100$  volts). The arm of the potentiometer is monitored on a voltmeter that draws no current and the dial is rotated until the correct reading is obtained. For example, to set a potentiometer to 0.5317, the operator depresses the switch and then rotates the dial until 53.17 volts appear on the meter (Fig. 7). When the switch is released the potentiometer, now set correctly to 0.5317, is reconnected into the circuit.

### Reference Voltage

At various points in a problem, constant voltages of different values are required. These are supplied from highly stabilized circuits which provide d.c. voltages of  $+100$  and  $-100$  volts. These reference voltages are made available on the patch panel. To produce constant voltages other than 100 volts, the potentiometers are used in conjunction with the reference voltage. For example, if the potentiometer in Fig. 7 is set to 0.5317, and connected to the  $-100$  volt reference, the output is  $-53.17$  volts.

### The Integrator

The basic equations of physics and engineering are differential equations; that is, variables expressed in terms of their derivatives, or rates of change. The following is a simple ordinary differential equation:

$$\frac{d^2x}{dt^2} + \frac{dx}{dt} + x = 0 \quad \dots (4)$$

If one has  $d^2x/dt^2$ ,  $dx/dt$  can be obtained by performing one integration. If one has  $dx/dt$ , one can obtain  $x$  by performing an integration of  $dx/dt$ . Mathematically, this is written:

$$\int \frac{d^2x}{dt^2} dt = \frac{dx}{dt} + C_1; \int \frac{dx}{dt} dt = x + C_2$$

The device that performs integration in the analogue computer is called an integrator (Fig. 8).

The integrator itself is simply an amplifier with a capacitor as its feedback\* (Fig. 9). Comparing Fig. 9 with Fig. 3, one can see that the integrator and summer are identical except for the feedback; the integrator uses a capacitor, the summer a resistor.

\* Making the same approximations as before (ignoring the input current to the amplifier and dropping all terms involving the factor  $1/A$ ), we obtain the expression for the output of an amplifier with a feedback capacitor (Fig. 9)

$$Z = -\frac{1}{RC} \int x dt$$

Potentiometers on the 231-R. Each 'pot' is switched for setting to high accuracy

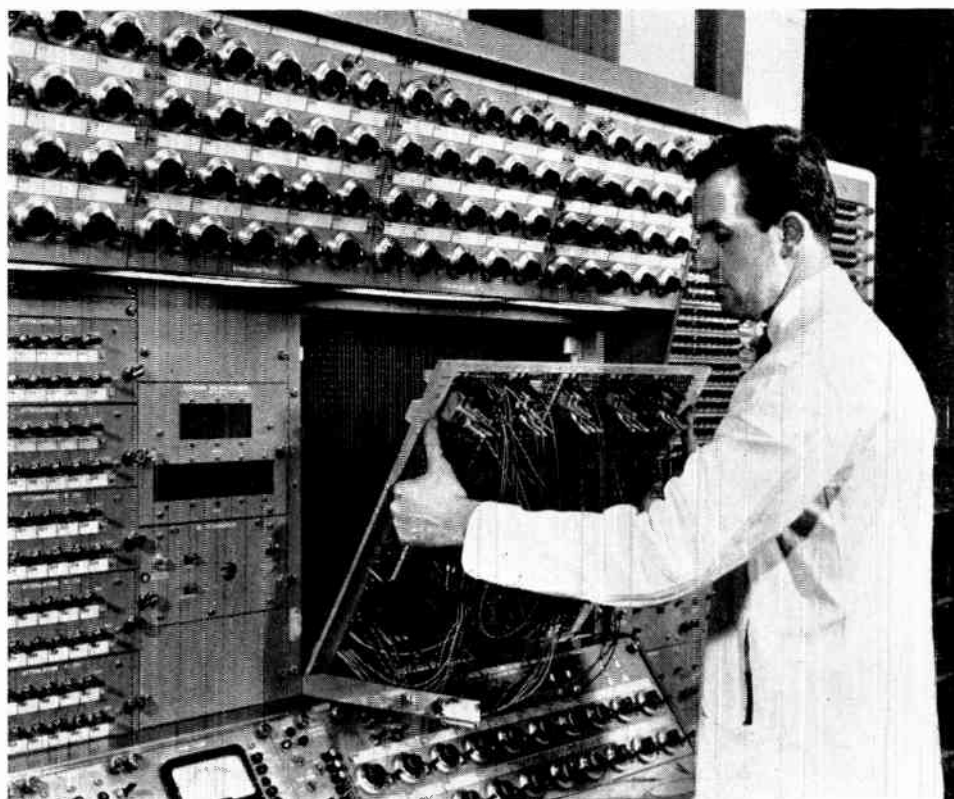

If several input resistors are used, the amplifier integrates and adds simultaneously: that is, the output is the negative of the integral of the sum of the inputs. If the inputs are  $x_1, x_2, \dots, x_n$ , and the corresponding input resistors are  $R_1, R_2, \dots, R_n$ , then the output is:

$$Z = \int_0^t \left[ \frac{x_1}{R_1 C} + \frac{x_2}{R_2 C} + \dots + \frac{x_n}{R_n C} \right] dt$$

### Simple Programming

The output of an integrator is always one order lower than the input. Conversely, the input of an integrator is always one order higher than the output. The fact is the key to setting up and using the analogue computer.

The basic steps in setting up the differential equations of the analogue computer are:

- (1) Start with the highest-order derivative.
- (2) Integrate the highest-order derivative to obtain the next lower-order derivative.
- (3) Repeat the process to obtain all derivatives of desired order.
- (4) Multiply each term by the desired constants, as given by the equation.
- (5) Add the terms as given by the equation.
- (6) Satisfy the equation by closing the loop with the proper terms.

Equation (4) will be used as an example. The first step is to rewrite the equation with the highest-order derivative on the left side:

$$\frac{d^2x}{dt^2} - \frac{dx}{dt} - x \dots (5)$$

This equation says that the highest-order derivative must equal the sum of the two terms on the right-hand side.

If we have a second-order derivative, we can obtain the first-order derivative by one integration, and then obtain  $x$  by a second integration, as shown in Fig. 10.

We wish to add  $dx/dt$  and  $x$ , but with the same sign. Thus we invert the term  $(dx/dt)$  and add it to  $x$  by using an adder, as shown in Fig. 11. The output of the summer is now the desired sum on the right-hand side of equation (5), with the proper signs.

Equation (5) also says that this sum must equal  $d^2x/dt^2$ . This is realized by connecting the output of the summer (that is, the sum of the two terms in equation (5)) to the input of the first integrator (which was assumed to equal  $d^2x/dt^2$  at the beginning of the problem). The circuit in Fig. 11 now satisfies the equation (5) and all voltages inside the circuit must change only as demanded by equation (5).

Equation (5) might represent an actual physical situation such as a wheel motion. The wheel system is now simulated by the circuit in Fig. 11. The variable  $x$  (which would be wheel displacement) can be examined at the output of integrator 2; the term  $dx/dt$  (which would be the velocity of the wheel) can be examined at the output of integrator 1; the term  $d^2x/dt^2$  (which would be the acceleration of the wheel) can be examined at the output of the summer or at the input of integrator 1. Note that the displacement, velocity and acceleration of the wheel all are simulated by voltages in the circuit of Fig. 11.

The circuit shown in Fig. 12 uses the summation provided by the integrator (at left) to eliminate the separate summer shown at far right in Fig. 11. As the sum of the inputs  $(-dx/dt - x)$  is equal to  $d^2x/dt^2$ , this circuit also satisfies equation (5). Figs. 11 and 12 both solve the same problem, but Fig. 12 uses one less element.

(To be continued)





# MALAYSIA and LINKED BY

Recently the Jesselton (Sabah) to Hong Kong telephone cable link was put into operation. This follows by two months the opening of the Singapore to Jesselton cable. This completes an important phase in the SEACOM project by linking Singapore and Hong Kong by a high-quality telephone system capable of carrying 80 two-way conversations simultaneously.

The SEACOM project is the South-East Asia section of the Commonwealth round-the-world telephone cable and was initiated in the summer of 1964.

A significant departure from the 80-circuit design of the round-the-world cable so far laid between the U.K., Canada,

◀ *An assembled repeater capsule having its 'tail' cable connected. This is the short length of cable used for splicing the repeater into the main undersea cable. There is a repeater every 26 nautical miles along an 80-circuit cable and every 17 nautical miles along a 160-circuit cable*

*The initial test period of the 300 individual super-quality components that go into an undersea amplifier — tubes, capacitors, resistors, coils — often exceeds the normal working life of commercial-grade components. Here, a skilled technician assembles the component parts of an amplifier unit for a submarine telephone cable repeater*

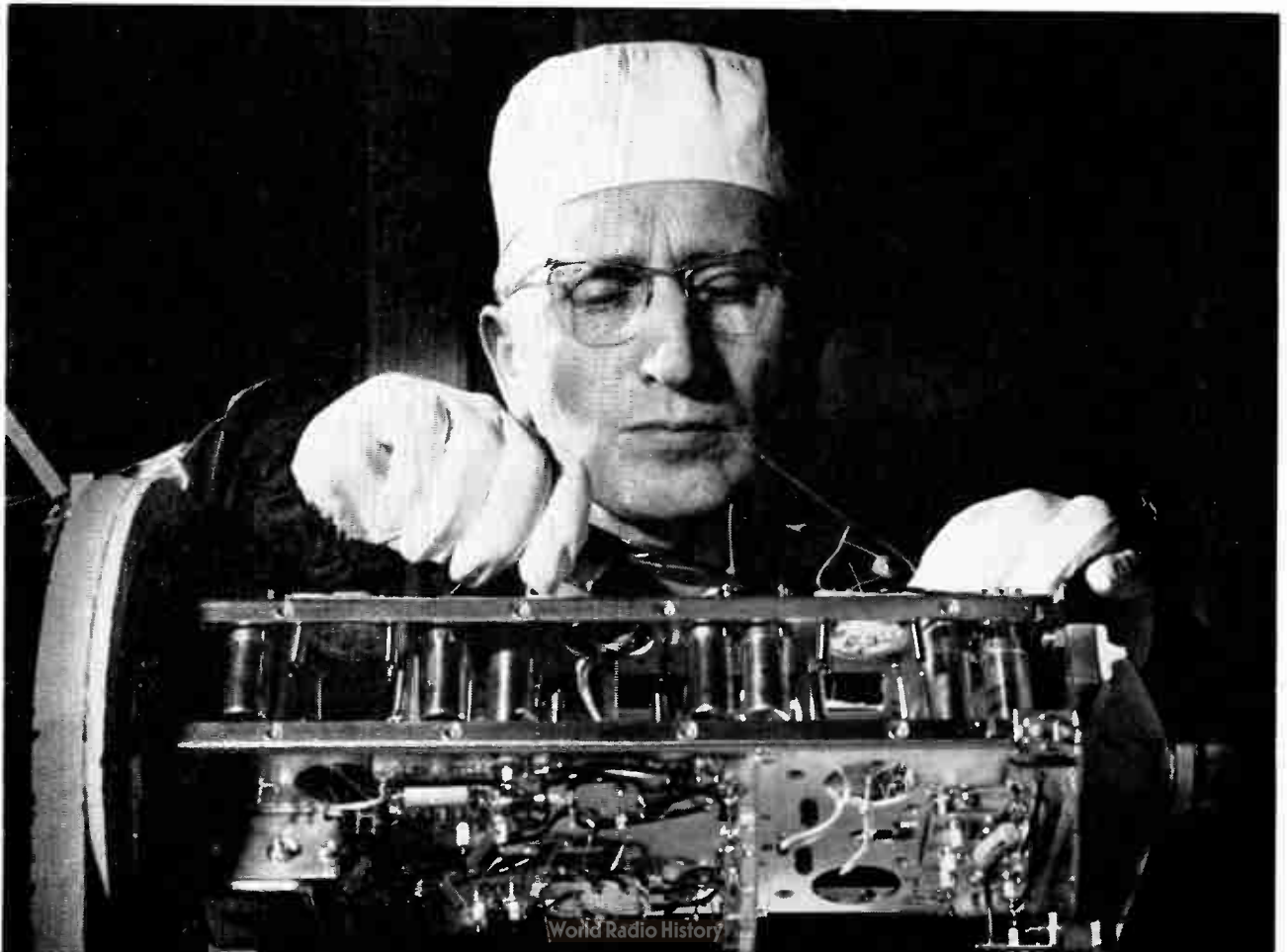

# HONG KONG TELEPHONE

New Zealand and Australia was announced recently for the next phase of SEACOM. This is the use of 160-circuit equipment on the route between the American island of Guam, Madang (New Guinea) and Cairns, Australia. The whole SEACOM project, linking Singapore to Australia, is scheduled for completion by the end of 1966.

Standard Telephones and Cables will supply the complete 160-circuit system for this route. For the SEACOM project, STC are supplying cable, shore-terminal equipment and undersea repeaters (amplifiers) worth more than £8M. Shown here are a number of pictures illustrating the assembly and testing of some of the STC component parts.

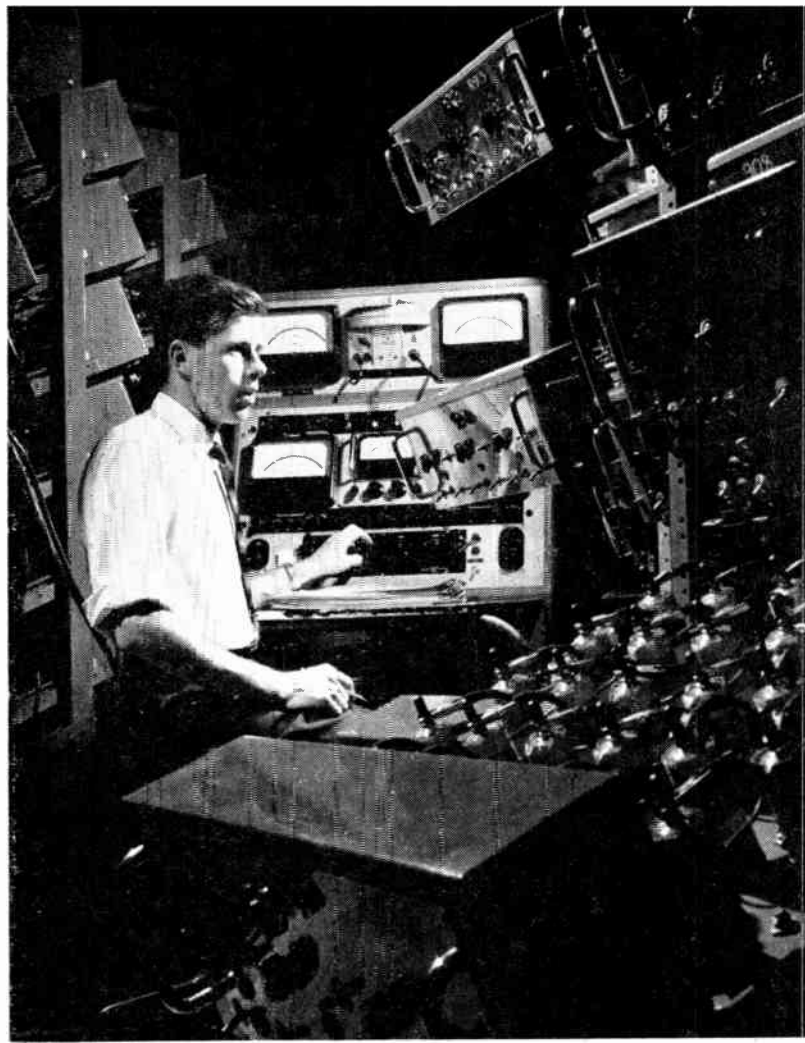

▲ *“Married” to special test equipment for months on end, these special quality valves (electron tubes) are being closely watched for any minute tendency to deterioration in performance. This ultra-safe testing procedure is essential to ensure that the undersea cable repeater in which they will be fitted will operate without fault for at least 20 years*

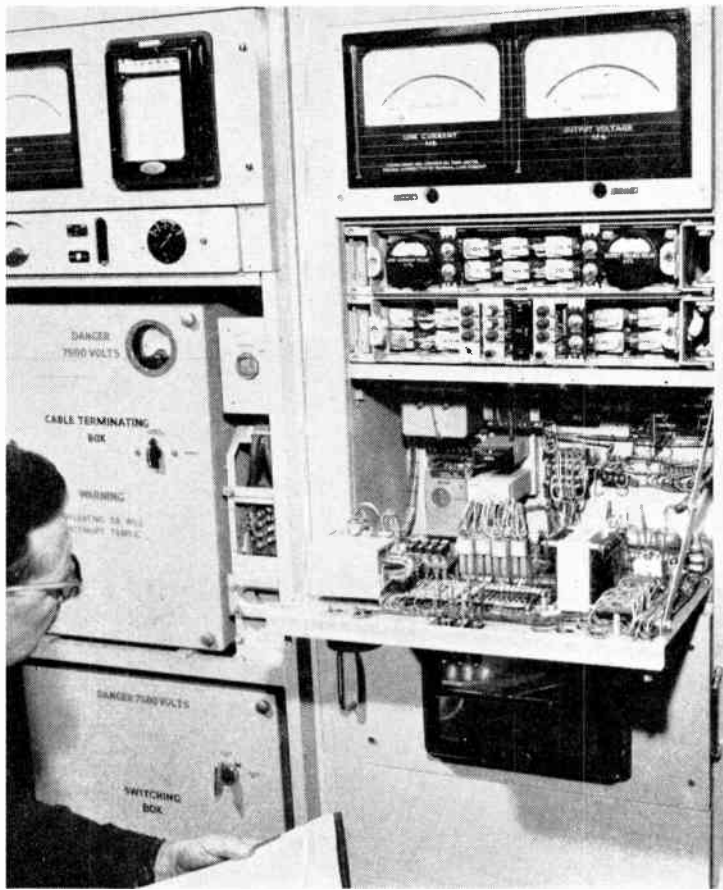

▼ *Two lengths of lightweight undersea telephone cable are being spliced. Absolute uniformity in the physical and electrical characteristics of the cable and joint is essential to ensure distortion-free transmission of the 160 simultaneous two-way telephone conversations that this cable will carry between Guam and Australia*



▲ *Uninterrupted power for SEACOM is available from the equipment that feeds a closely-controlled direct current through the centre core of the cable (which is also carrying 80 or 160 two-way conversations) to operate the repeater amplifiers along the route. Very close control of current is essential to ensure that the repeater valves are not subjected to any strain that will shorten their 20-year design life. Equipment like this is installed at each shore terminal station and is designed in such a way that failure of one terminal through fault or power interruption will not put the cable out of action*





*A single operator is free to move about the floor with Motorola's new electronic crane control, which permits remote-control of bridge cranes without a cab operator*

A compact lightweight portable control system designed to streamline the operation of overhead bridge cranes has been announced by Motorola Overseas Corporation, U.S.A.

The crane-control unit is worn around the waist of the operator and allows him to operate the crane alone, without another man in the cab and without a remote control 'pendant' to restrict his movements about the floor. The

unit is designed to duplicate all the manual controls used in crane operation and transmits a wide variety of frequency-modulated coded signals to associated receiver equipment on the bridge of the crane. These components decode the signals and translate them into crane movements. (Up to five separate crane motors, each with five speeds forward and reverse, can be controlled. As many as five auxiliary controls are available in the unit to match each individual control requirement.)

The system operates in the frequency band from 72 to 76 Mc/s. It incorporates additional security measures: a key-type on-off lock, a push-to-operate ('dead man') switch, motor control switches that automatically return to neutral when released, and two-button control such as the magnet release. Maximum safety is achieved by an elaborate system of coded signals to prevent false or accidental operation. The controls themselves can be manipulated even with gloved hands.

It is claimed that because the operator is at the scene of action, he can make quicker and better decisions and can perform instant and accurate spotting that permits immediate handling of precision operations without damage to material or machines. Goods can also be stored closer together.

**For further information circle 41 on Service Card**

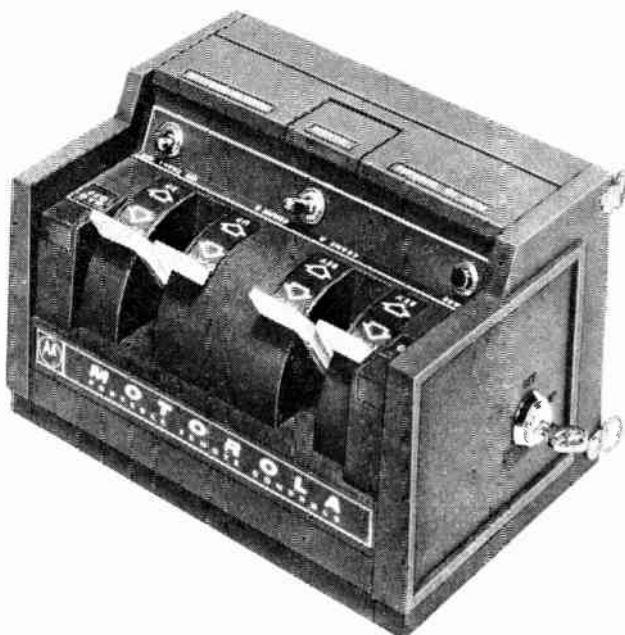

*The f.m.-transmitter/control box of Motorola's new electronic crane control system is worn around the waist of the floor operator*

### ★ FOR THE BUYER

You must have read about a number of products and processes in this issue of which you would like further details. You can obtain this information very easily by filling in and posting one or more of the enquiry cards to be found inset

# Look at M-OV's wide range of

## MICROWAVE COMPONENTS

### for Communication, Industrial and Defence Projects

M-O V have now increased their range of microwave components by no less than *seventeen* devices. The commercial introduction of so many microwave products at one time is due to the vast experience of M-O V's 600 engineers, and their extensive R & D

facilities devoted to microwave technology. Modern quality-control methods ensure repeatability of characteristics over long and short production runs. **No other European manufacturer can match the capability of M-O V in the field of microwave technology.**

- 6 Waveguide-to-coaxial transitions
- 3 Waveguide isolators
- 2 Coaxial isolators
- 2 High-performance hybrid mixers
- 1 X-band source
- 1 Fast X-band two-way diode switch
- 1 Fast X-band one-way diode switch
- 1 X-band diode attenuator

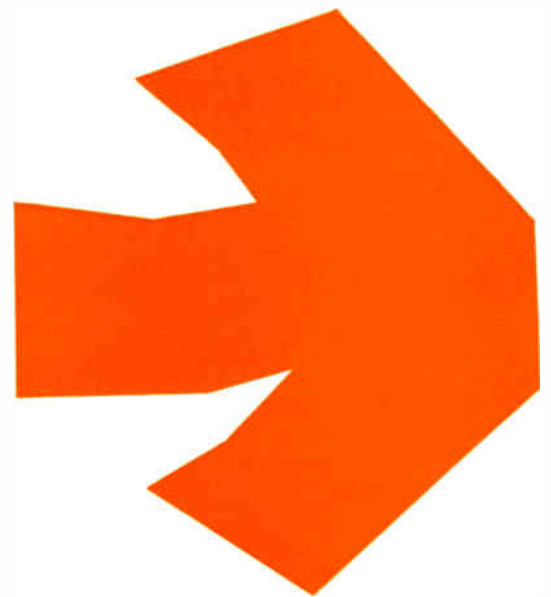

For further information please write to :

**THE M-O VALVE CO LTD**  
Brook Green Works  
Hammersmith  
London W6  
Telephone RIVerside 3431  
Telex 23435

Postage  
will be  
paid by  
Licensee

No postage  
stamp necessary  
if posted in  
Great Britain or  
Northern Ireland

BUSINESS REPLY CARD  
Licence No. PAM. 1138

**THE M-O VALVE CO LTD**  
**BROOK GREEN WORKS**  
**HAMMERSMITH**  
**LONDON W6**



# M-O V MICROWAVE COMPONENTS SHEET 1

## Waveguide-to-coaxial transitions

	Description	Frequency band (Gc/s)	VSWR	Connectors	
				Waveguide	Coaxial
WTS1	S-band side-entry	2.5-4.1	0.8	WG10	C or N (50 ohm)
WTS4	S-band rear-entry	2.5-4.1	0.8	WG10	C or N (50 ohm)
WTC2	C-band side-entry	4.1-7.0	0.8	WG13	C or N (50 ohm)
WTC5	C-band rear-entry	4.1-7.0	0.8	WG13	C or N (50 ohm)
WTX3	X-band side-entry	7.0-11.5	0.8	WG16	C or N (50 ohm)
WTX6	X-band rear-entry	7.0-11.5	0.8	WG16	C or N (50 ohm)

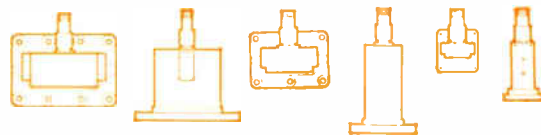

## Isolators

Frequency range (Mc/s)	Power handling capacity (W)	Forward loss (dB)	Reverse loss (dB)	VSWR	Connectors
<b>Waveguide</b>					
CIC4 5925-6425	10.0	0.35	35	1.02	WG14
CIC5 5925-6175	10.0	0.5	25	1.06	WG14
CIC6 6175-6425	10.0	0.5	25	1.06	WG14
<b>Coaxial</b>					
CIS1 2500-4000	3.0	1-2	20-35	1.2-1.5	C (50 ohm)
CIC3 4000-7000	3.0	2	20*	1.5	C (50 ohm)

\*Over frequency range 5000-6000 Mc/s.

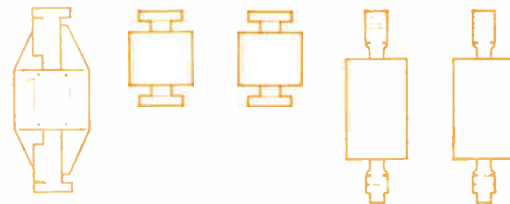

## High-performance hybrid mixers

	Application	Frequency band (Mc/s)	R.F. power level (mW)	Capacitance (pF)	Connectors
HMC1	Transmitters	5925-6425	30-40	20 (Modulation input)	WG14
HMC2	Receivers	5925-6425	1-2	20 (I.F. output)	WG14

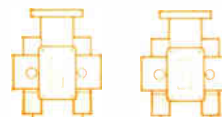

## X-band source

	Frequency available (Gc/s)	Electronic tuning range (Mc/s)	Output power (mW)	Input	Connector
SSX1	7.0-12.4	100 (at 7.0 Gc/s) 150 (at 12.4 Gc/s)	30 (at 7.0 Gc/s) 10 (at 12.4 Gc/s)	30 V d.c. 250 mA	WG16



## Fast X-band diode switches

	Frequency band (Gc/s)	Insertion loss (dB)	Isolation (dB)	Switching time (ns)	Connectors
DSX1 two-way	7.0-12.4	2	20	1	WG16
DSX2 one-way	7.0-12.4	2.5	25	1	WG16



## X-band diode attenuator

	Frequency band (Gc/s)	Insertion loss (dB)	Attenuation (dB)	VSWR	Connector
DAX1	7.0-12.4	1	30	1.5 at minimum attenuation 2.0 at maximum attenuation	WG16



## Tear out for future reference

### REPLY CARD

Please send data sheets for:

- Waveguide-to-coaxial transitions
- Waveguide isolators
- High-performance hybrid mixers
- X-band source
- Fast X-band diode switches
- X-band diode attenuator

and  brief information on your other products

NAME BLOCK CAPITALS PLEASE

POSITION

COMPANY

ADDRESS

TELEPHONE

EXTN

For further information please write to:

**THE M-O VALVE CO LTD**

Brook Green Works

Hammersmith

London W6

Telephone RIVerside 3431

Telex 23435

**FILL IN** the reply-paid card now for free data sheets on one or more of the new micro-wave components. And if you would like information about our other products, tick in the appropriate box on the card. We will then see that details are mailed to you without delay.

# Electronic Methane Detector and Alarm



An automatic methane (firedamp) detector developed by the Mining and Materials Handling Division of English Electric has now received Ministry of Power approval for use in coalmines, and also in factories (in Class 2(c) pentane hazards). The detector continuously monitors the percentage of methane present in the surrounding atmosphere and provides a visual alarm when a preset danger level is exceeded. It is a completely automatic portable device suitable for operation by unskilled personnel.

Although in its present form the detector has been specifically designed for use in coalmines, it has applications in many other spheres such as the gas, oil, chemical and petrochemical industries. Remote-indicating models are under development, and the device may be also used for the detection of other hazardous gases, among them hydrogen, propane, butane, coal gas and ethyl alcohol.

The detector is self-contained and powered by a rechargeable lead-acid battery which is sufficient for ten hours' continuous operation. In service, the methane-air mixture diffuses automatically to two heated sensing elements housed inside flame traps located at the top of the detector, making it possible to detect the presence of methane close to the roof of the mine workings. Each sensing element takes the form of a thermocouple sealed in a glass bead over which a heater coil is wound. One element, the detector element, is coated with a catalyst, while the other (compensating) element is untreated. The methane oxidizes on the coated element causing a rise in temperature. The compensating element is unaffected, and the difference in thermocouple voltages is fed to a transistor switching amplifier, which controls the current to the omni-directional alarm lamp. In a 60° window

above the alarm lamp is a meter reading 0-3% methane which is operated directly by the difference signal from the sensing elements. The operation of the detector can be simply and quickly checked at any time by holding it upside down. A gravity-operated switch is arranged to energize the alarm lamp and move the meter needle to full-scale deflection, showing that the battery, alarm lamp, amplifier and meter are serviceable.

If in operation either sensing element should fail a lamp behind a blue glass is energized, showing the word 'Fail'. Should the meter fail, the alarm, consisting of two bulbs in parallel, will still operate when the preset level is exceeded; if the alarm and associated amplifier fail, the meter itself will still read.

The lower compartment of the detector which contains the battery is made of steel and a magnetic lock prevents unauthorized tampering. When open, access can also be gained to the potentiometer which controls the alarm switching level.

In its present portable form the detector weighs 4 lb and its overall dimensions are 3½ in. × 2¼ in. × 12 in. high.

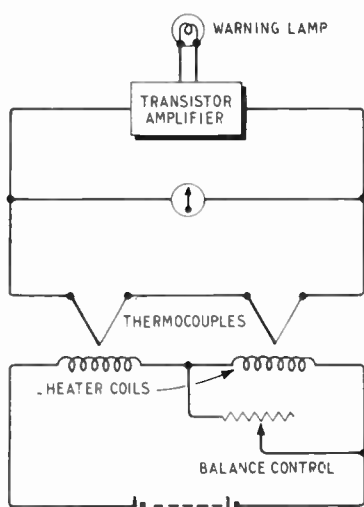
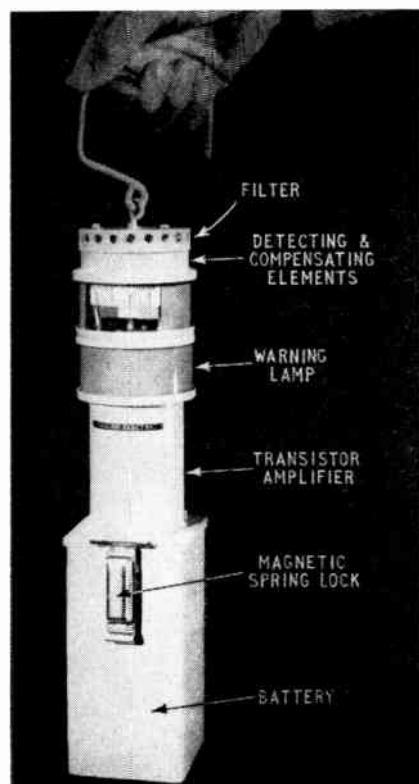

Fig. 1. A simplified circuit of the detector

The new English Electric methane detector showing the disposition of the main component parts

For further information circle 42 on Service Card



An instrument for measuring temperatures in the range 200–1,000 °C is described. The measurement is effected by comparing the radiation at two different wavelengths in the infra-red region.

# Non-Contact Pyrometer For Moderate Temperatures

*An Infra-Red Instrument for 200 - 1,000 °C*

THE best-known radiation pyrometer is the disappearing filament type, in which the brightness of the filament of a lamp inside the instrument is matched to the brightness of the image of the body under observation. A red filter is often used, to facilitate making a brightness match independently of colour. Such an instrument can be used with moderate accuracy down to about 700 °C: for example, it has been used for measuring valve-cathode temperature<sup>1</sup>, but the accuracy of the results there depended on prior knowledge of the emissivity of the cathode surface and of the absorption of the glass envelope of the valve. By contrast, visual estimates of high temperatures are based on colour rather than intensity, ranging from red hot to white hot, and are thus independent of the adaptation of the eye to different brightness levels.

The human eye's judgment of what is white is based on experience, as has been emphasized by Land's experiments on colour reproduction and as becomes obvious every time one drives a car for long with yellow headlamp bulbs. Since daylight is our basic experience, white light is by definition light such as that from the sun and average daylight (C.I.E. illuminant C) is equivalent to radiation from a surface at a temperature of 6,500 °K. The wavelength in microns of maximum radiation is related to Centigrade temperature of the radiating body by the formula

$$\lambda_m = \frac{1.43 \times 10^4}{5(T + 273)} \quad \dots (1)$$

so that the maximum energy of illuminant C falls at 4,400 Angstroms.

Two difficulties arise in measuring lower temperatures by radiation. The first is that total radiation is proportional

to the fourth power of the absolute temperature (Stefan's law) so that a drop from 6,500 °K to 1,000 °K (a dull red) reduces the total energy available from a given surface by 1,784 times and a drop to 500 °K reduces the energy by a factor of 35,561; and the second is that the wavelength of peak radiation moves out of the visible into the infra-red. The curves in Fig. 1 show the energy distributions between 200 °C and 500 °C. Both difficulties can be overcome by using a photoconductive cell to measure infra-red radiation. In order to use the slope of the distribution curve and not its intensity (compare visual estimate of temperature by colour rather than brightness) measurements are made at two wavelengths, such as those indicated by the dotted lines in Fig. 1, and the ratio of these two intensities indicates the temperature.

It is clear from Fig. 1 that maximum sensitivity is

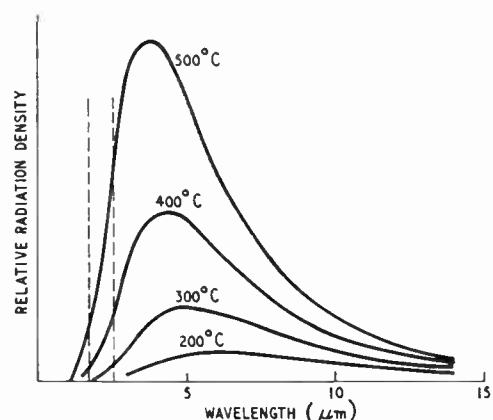
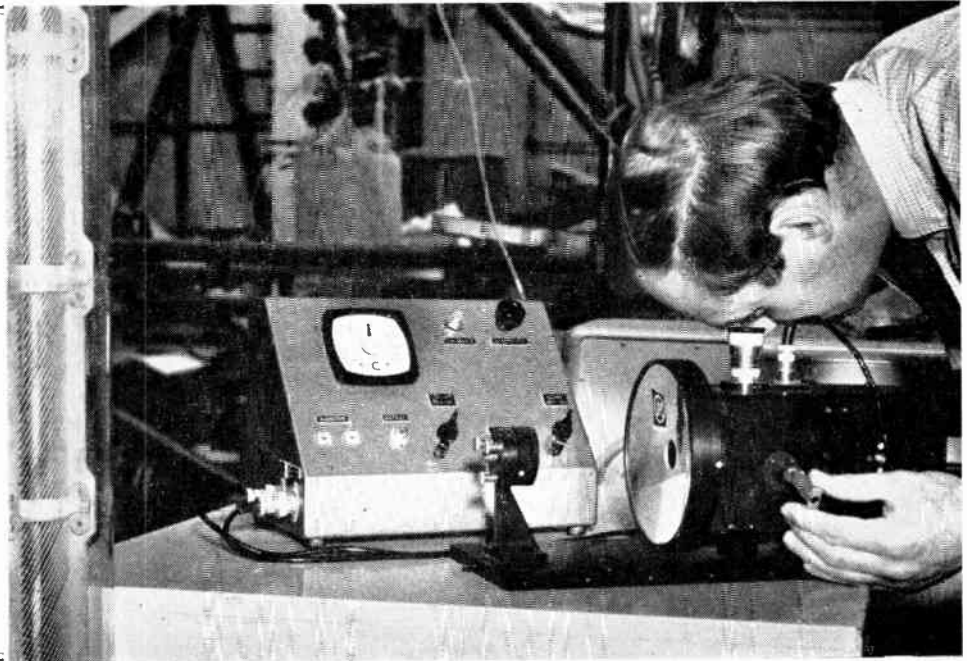

Fig. 1. Spectral distribution of black-body radiation for temperatures from 200 to 500 °C



Fig. 2. Infra-red ratio pyrometer  
—visual selection of target area



achieved if the two wavelengths are sufficiently close to remain within the left-hand slope of the curve at the highest temperature used. The lowest temperature which can be measured is limited by sensitivity (which in turn is limited by photocell noise) and in an instrument which has been developed by G. K. Caulton at the Heston Laboratories of Atomic Power Constructions Ltd., Fig. 2, the range of temperatures covered is 200 °C to 1,000 °C.

Since the use of a ratio of two wavelengths reduces the dependence of the instrumentation on the emissivity of the body being measured and cancels the effect of attenuation between source and pyrometer (provided the attenuation is the same for both wavelengths) it is important to keep the measurement independent of any gain factors in the instrument. Therefore the same photocell is used for both wavelengths, with optical switch-

ing of the radiation through alternative filters; and the same amplifiers are used with gating of the output into the appropriate channel in synchronism with the optical beam switching (Fig. 3). The mirror which shares the beam between the two photocells oscillates at 30 c/s, but in addition the radiation is chopped at 900 c/s to facilitate design of the amplifiers. These two frequencies are synchronized by deriving them from a single oscillator, using a divider as indicated in Fig. 3 to provide the lower frequency. The common-amplifier pass-band is centred around 900 c/s and final noise smoothing is effected by a separate storage circuit in the output of each channel. To avoid the need to perform a direct division in forming the ratio of the two outputs, the amplifier gain is adjusted by a feedback system so that one signal is brought to a standard value. The magnitude of the other signal can then be scaled to

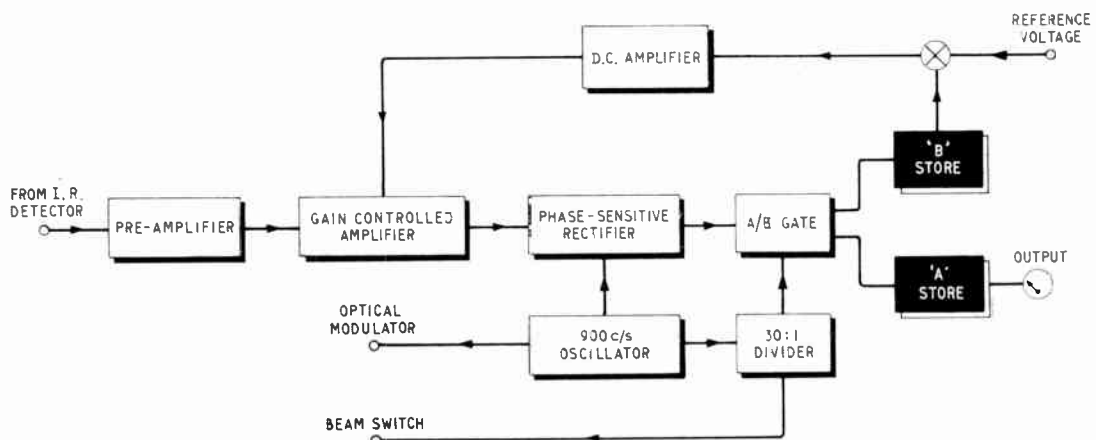

Fig. 3. Schematic diagram of the electronic system of the non-contact thermometer



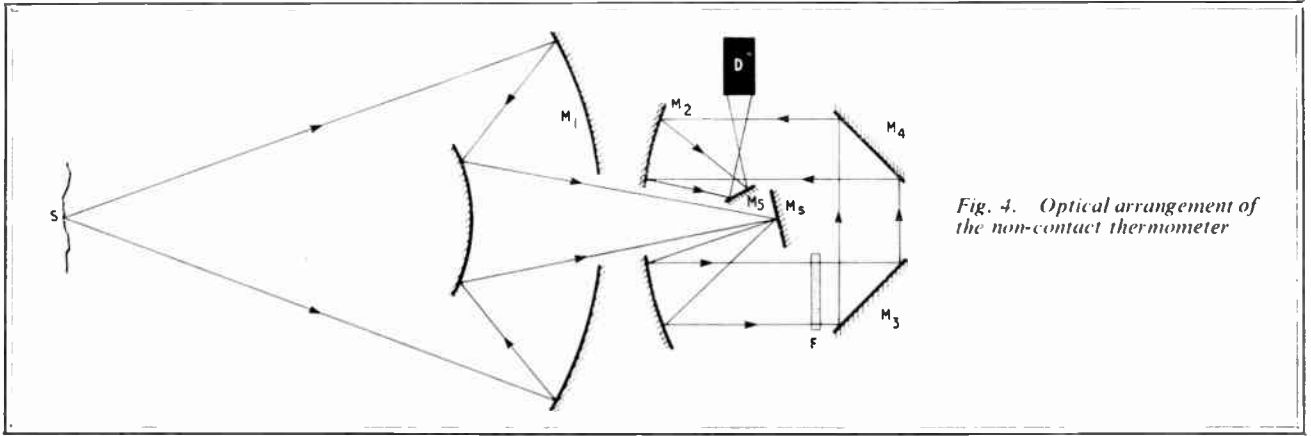

Fig. 4. Optical arrangement of the non-contact thermometer

read the ratio of the two. Noise is minimized by using signal storage so that the reading is averaged over one second, and random fluctuations are about  $\pm 1^\circ\text{C}$  at  $300^\circ\text{C}$ .

The optical arrangement is shown schematically in Fig. 4. Radiation collected by mirror  $M_1$  is focused on the beam-switching mirror  $M_3$ . The latter is inclined permanently downwards, so that it reflects radiation to the lower half of  $M_2$ , but oscillates sideways about an axis in the plane of the paper so as to direct the radiation through one or other of two filters at  $F$ . After passing through the appropriate filter the radiation is reflected via the mirrors  $M_3$ ,  $M_4$  to the upper part of  $M_2$  which focuses it via  $M_5$  on to the infra-red detector. For setting up the instrument to read on a chosen spot, a removable mirror and eyepiece allow the user to look back through the optical system at the point from which it receives radiation.

The instrument illustrated in Fig. 2 is portable and can be operated from batteries; and it can operate in any orientation needed to observe the desired spot. It is normally constructed to focus on an object 24 inches from

the instrument, but this can be modified to any greater distance. It was originally designed for observing hot spots in nuclear reactor components, where the attachment of thermocouples might be undesirable. But it obviously has many other applications, such as measuring the surface temperature of calendar rolls or perhaps of automobile engine or brake parts during tests. The non-contact feature makes it valuable for measuring the temperature of rotating parts, provided temperature averaged over the moving surface is sufficient.

A further development of the instrument consists of a simplified optical system with variable focus from 20 in. to infinity and a facility for replacing the collecting mirror system by a lens.

#### Reference

<sup>1</sup> 'Electrical Measurement of the Cathode Temperature of Diodes', D. A. Bell, J. C. Cluley and H. O. Berkday, *Brit. Journ. of App. Phys.*, Vol. 3, No. 10, p. 322, Oct. 1952.

## Analogue Computer at Colborn Vitafeeds



An analogue computer supplied by Electronic Associates Ltd. has been installed at Colborn Vitafeeds Ltd. mill at Canterbury. It is used to work out the proper proportions of the ingredients of animal feeds. Most ingredients have many constituents, such as protein, fat, etc., and it is common to use 15 or so ingredients. A required constitution of feed may be reached in many different ways by juggling with the proportions of the ingredients but the cost will not be the same. The computer enables the effect of varying the proportions to be quickly worked out.

For further information circle 43 on Service Card



ONE of the most advanced 'electronic watchkeepers' to go to sea finished its trials at Greenock, Scotland, recently aboard the new 7,946 tons refrigerated cargo vessel *Zealandic*. The watchkeeper, or marine data logger, has been designed and developed by English Electric-Leo-Marconi Computers in conjunction with the owners of the new vessel, The Shaw Savill Line. The ship has been built by Alexander Stephen and Sons of Linthouse, Glasgow.

The logger is in the engine room. It continuously monitors the operation of 350 points in the ship's main engines, auxiliary machinery, the refrigeration equipment and the refrigerated cargo spaces.

Immediately any malfunction occurs, the logger raises the alarm by sounding a klaxon, flashing a warning light and printing out in red type on the alarm record printer full details of location of fault and the time it occurred. As soon as the logger detects that the trouble has been cleared, a further print-out takes place, this time in black type showing the time the fault was corrected. This pro-

vides a permanent record of faults and correction for subsequent analysis.

At each watch change the logger automatically produces a complete record of the condition of each of the 350 points. In addition the ship's engineer can at any time obtain either a complete log of all points or one of selected groups of them—main engines and auxiliaries, refrigeration plant and auxiliaries or auxiliaries alone. These logs are produced on a second printer which also uses red type to show any channel which is in alarm at the time.

While the print-outs are being made the logger continues to scan all the points because it is vital that the alarm detection system should never be interrupted. Should any channel go off-limits while the routine log is being printed the alarm printer will immediately record it and the klaxon will sound.

Other special features of the logger include continuous calculation of the shaft horse power of the main engine. This is key information in assessing the efficiency of the ship.

The ship's engineer can also make a spot check on any point at the flick of a switch, the value of the point being immediately shown in inch-high illuminated figures on the front of the logger.

The logger also watches itself and will report if its own temperature or equipment go off-limits at any time.

*This shows the complete data-logger*

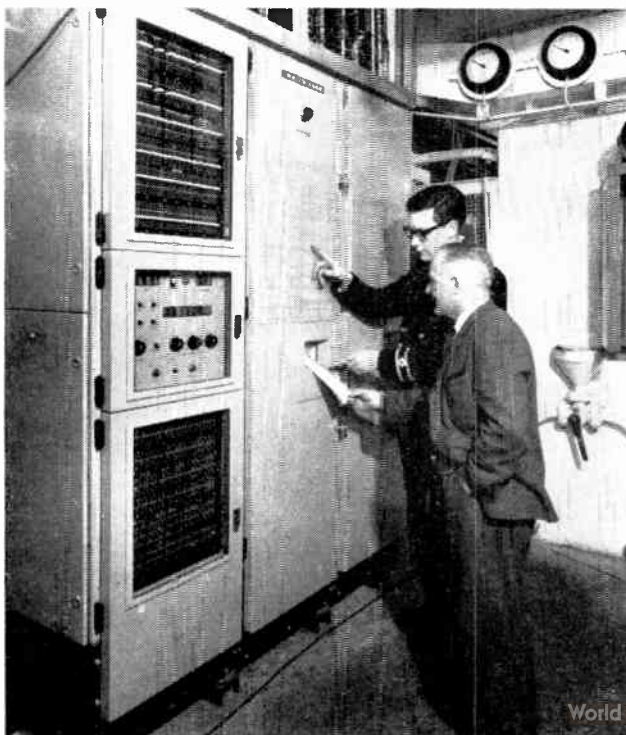

#### **Operation of the Basic System**

As the watchkeeping equipment requires electrical inputs, some means of converting the variables into equivalent electric signals must be included in the system. Such devices, known as transducers, are attached to measurement points throughout the system, and produce electric signals proportional in magnitude to pressure, differential pressure, temperature, flow, r.p.m., level, s.h.p., etc. The watchkeeping unit is, therefore, built up from several sub-units; the operation of these is described below:

#### **Scanning Unit**

All incoming signal lines are connected to the scanning unit. Its function is to switch each line in turn to a common channel or highway for transmission to the next



sub-unit. The switching elements are glass-sealed reed relays with gold-plated contacts. These relays have been satisfactorily tested in excess of  $10^8$  operations, which, in terms of operational life is better than 60 years' continuous working. The relays are sequenced from a control unit, and can operate at speeds of up to 50 points per second, but a scanning speed of two points per second is considered suitable for a marine system. Thus the standard 100 point watchkeeping system will give a complete scan of the engine room every 50 seconds.

#### A.D.C.

The next sub-unit is the analogue-to-digital converter (a.d.c.) which converts each incoming signal in turn to a digital form, the value of which is proportional to the magnitude of the signal, and therefore to that of the variable. This conversion is done to facilitate handling by

the next stages. Following the a.d.c., the highway divides into two channels; one for alarm announcement and print-out; the other for logging and display.

#### Alarm Announcement

For alarms the output is routed to a comparator, where it is compared with a preset reference to determine whether or not an off-limit condition exists. The reference settings can vary considerably for different variables; for example, exhaust temperatures are much higher than, say, cooling water returns. The equipment ensures, therefore, that the correct reference is selected and applied to the comparator for a given input signal.

The references are set by pinboard, and can be readily altered to suit different conditions.

An output from the comparator occurs only when an abnormality is detected.

## Anglo/French Secondary Radar

An entirely new secondary radar system, SECAR, developed jointly by The Marconi Company and Compagnie Française Thomson Houston (CFTH), was demonstrated recently under full operating conditions at Marconi's Rivenhall establishment.

SECAR provides a comprehensive data link between an air-traffic controller and any aircraft fitted with a secondary radar transponder. Information concerning position and movement can be extracted automatically from the aircraft, without attention from the aircrew.

Secondary radar is a fully automatic air-to-ground data link system, designed to extract information on aircraft positions and movements as an aid to air-traffic control. This is achieved simply by transmitting interrogation signals to the aircraft from a ground station. These signals are

received by a special airborne equipment (a transponder), which will then automatically transmit a coded reply.

SECAR provides up to six interrogation modes and each mode corresponds to a definite question, 'Who are you?', 'What is your height?', etc. There are four civil and three military modes, but the mode which establishes identity is common to both systems. The ground interrogation signal contains either two or three pulses, whose time separation defines the mode of interrogation. The reply signal from the airborne transponder consists of up to twelve pulses accurately positioned between two framing pulses. When decoded, the information can be displayed to the operator in a number of different ways, depending on the operational requirements of the station.

**For further information circle 44 on Service Card**



*This shows a close-up of the SECAR aerial and turning gear, taken from the rear. Modification kits, including a special rotating waveguide joint, are available to mount the SECAR aerial on any Marconi or CFTH primary radar aerial system*

# Bridged-T Compensating Networks: 1 Frequency-Response Methods

By **N. G. MEADOWS, B.Sc., A.M.I.E.E.\***

**B**OTH a.c. and d.c. servo systems can be compensated by inserting bridged-T networks in the error channel. The characteristics of such networks are presented in the following sections.

### Transfer Functions

The transfer function for the network of Fig. 1 is

$$\frac{e_0}{e_1} = \frac{Z_1(Z_2 + Z_3 + Z_4) + Z_2Z_3}{Z_1(Z_2 + Z_3 + Z_4) + Z_2(Z_3 + Z_4)} \dots (1)$$

$$= \frac{Y_4(Y_1 + Y_2 + Y_3) + Y_2Y_3}{Y_4(Y_1 + Y_2 + Y_3) + Y_3(Y_1 + Y_2)} \dots (2)$$

For the specific networks of Figs. 2 and 3 the common transfer function is:

$$\frac{e_0}{e_1} = \frac{T_1T_2s^2 + (T_2 + T_3)s + 1}{T_1T_2s^2 + (T_1 + T_2 + T_3)s + 1} \dots (3)$$

with  $T_1 = C_1R_1$ ,  $T_2 = C_2R_2$  and  $T_3 = C_2R_1$ . If  $T_1 = T_2 = T$  and  $T_3 = k^2T$ , where  $k^2 = R_1/R_2 = C_2/C_1$  is a design variable for the network, the transfer function becomes

$$\frac{e_0}{e_1} = \frac{T^2s^2 + (1 - k^2)Ts + 1}{T^2s^2 + (2 + k^2)Ts + 1} \dots (4)$$

Writing  $S = sT$  gives the non-dimensional form

$$\frac{e_0}{e_1} = \frac{S^2 + (1 + k^2)S + 1}{S^2 + (2 + k^2)S + 1} \dots (5)$$

$T$  is hence a time scaling parameter.

### Frequency Response

For the dimensional frequency response,  $s = j\omega$ , with  $S = j\omega T = jx$  in non-dimensional form. Equation (5) then gives

$$\frac{e_0}{e_1} = \frac{1 - x^2 + j(1 + k^2)x}{1 - x^2 + j(2 + k^2)x} \dots (6)$$

with

$$\left| \frac{e_0}{e_1} \right| = \left[ \frac{(1 - x^2)^2 + (1 + k^2)^2x^2}{(1 - x^2)^2 + (2 + k^2)^2x^2} \right]^{1/2} \dots (7)$$

and

$$\begin{aligned} \angle e_0/e_1 &= \tan^{-1} \frac{(1 + k^2)x}{1 - x^2} - \tan^{-1} \frac{(2 + k^2)x}{1 - x^2} \\ &= -\tan^{-1} \frac{x(1 - x^2)}{x^4 + k^2(3 + k^2)x^2 + 1} \dots (8) \end{aligned}$$

The phase lags for  $x = \omega T < 1$ , leads for  $x = \omega T > 1$  and is in-phase for  $x = 0$ ,  $x = \infty$  giving  $|e_0/e_1| = 1$ . An in-phase condition also occurs for  $\omega_c = 1/T$  with

$$\left| \frac{e_0}{e_1} \right| = \frac{1 + k^2}{2 + k^2}$$

In Fig. 4 basic geometrical relationships are given for the network. From the figure the maximum phase lag or lead is given by

$$\phi_m = \tan^{-1} \frac{1}{2[(2 + k^2)(1 + k^2)]^{1/2}} \dots (9)$$

Maximum phase lag or lead, for variation of  $k$ , occurs when  $k = 0$ , and is

$$\phi_m = \tan^{-1} \frac{1}{2\sqrt{2}} = 19^\circ 28'$$

Larger values can be obtained by using the general network for which  $T_1 \neq T_2$ . This will be discussed next month.

### Design Considerations

#### D.C. Servo Systems

The bridged-T network can be used as a lag-lead compensator for a d.c. servo. As the network attenuates frequencies near  $\omega_c = 1/T$  most heavily, the effect of a system resonance peak in this region may be reduced. The

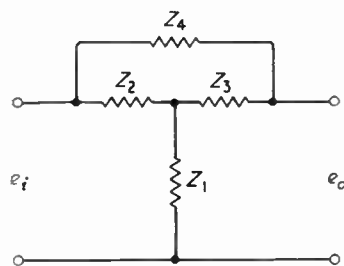

Fig. 1. General bridged-T network

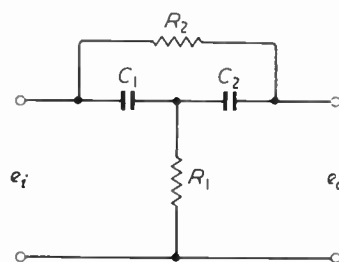

Fig. 2. Servo compensating network

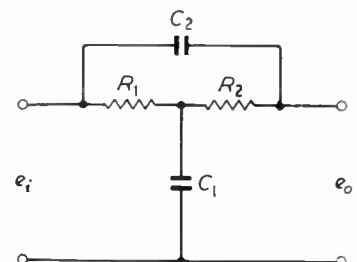

Fig. 3. Alternative form



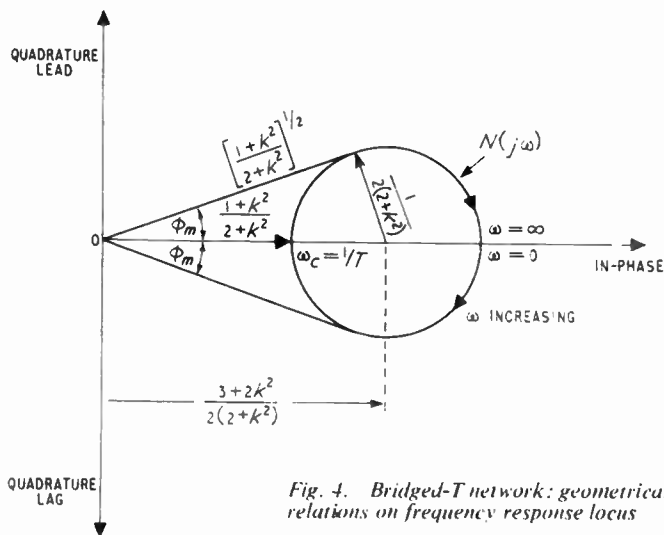

Fig. 4. Bridged-T network: geometrical relations on frequency response locus

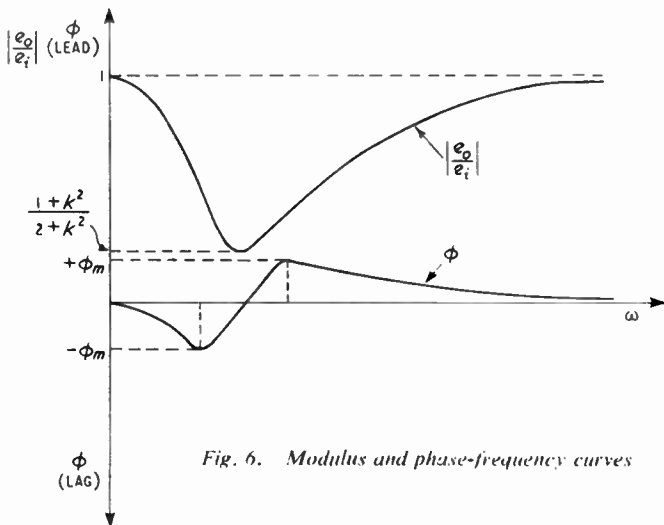

Fig. 6. Modulus and phase-frequency curves

Fig. 5. Compensated and uncompensated system loci

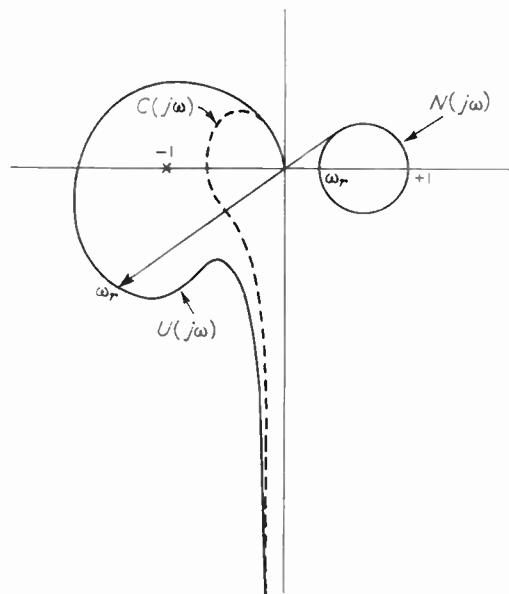
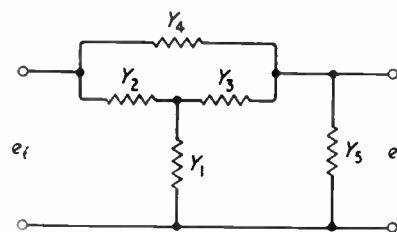

Fig. 7. Loaded bridged-T network



high- and low-frequency ends are not materially affected. Fig. 5 shows a typical Nyquist locus for a system with lightly-damped open-loop poles. For compensation by a bridged-T network, with frequency response  $N(j\omega)$ , the compensated locus is as sketched at  $C(j\omega)$ . The loci for  $U(j\omega)$  of the uncompensated system and  $N(j\omega)$  are compounded from the usual vector product basis; i.e., for vectors  $R_1 \angle \alpha$  and  $R_2 \angle \beta$  the vector product is  $R_1 R_2 \angle \alpha + \beta$ . When compensated the initially-unstable system becomes closed-loop stable as the locus does not enclose the  $-1$  point. For open-loop poles with a damping factor less than 0.5 the unequal time-constant form of network is preferable, as will be shown in Part 2, in which pole-zero cancellation methods will be discussed.

#### A.C. Systems

For an a.c. servo system of carrier frequency  $\omega_c$ ,  $T = 1/\omega_c$  is a network time constant. The value of  $k$  determines the attenuation at the carrier frequency. The network gives an output approximately proportional to the input-error

signal plus a derivative term, providing carrier modulation frequencies are relatively small compared to  $\omega_c$ . A small value of  $k^2$  gives a larger proportion of error-rate term. This is exemplified by reference to the typical modulus- and phase-frequency curves of Fig. 6. The notch filter action is not so sharp as that of the parallel-T network.

#### Network Loading Effects

The preceding analysis assumes the load across the network output terminals to be infinite. If the network is loaded by an admittance  $Y_5$ , as shown in Fig. 7, the transfer function becomes

$$\frac{e_o}{e_i} = \frac{Y_4(Y_1 + Y_2 + Y_3) + Y_2 Y_3}{(Y_4 + Y_5)(Y_1 + Y_2 + Y_3) + Y_3(Y_1 + Y_2)} \dots (10)$$

If  $Y_5$  constitutes an appreciable load its influence on the transfer function should be considered. Comparison of equations (2) and (10) shows that an added term  $Y_5(Y_1 + Y_2 + Y_3)$  occurs in the pole determining equation for the loaded network.

# LDEP instrumentation

## Potentiometric Recorder/Controllers

- Strip, Disc and Multipoint Recorders
- Wide range of input units
- Fast response
- 10 days delivery

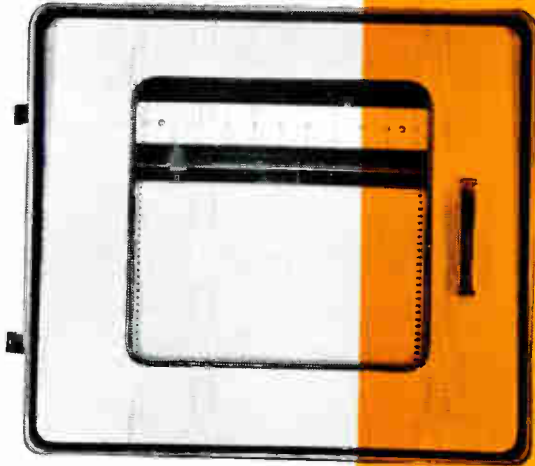

## Three Term Controllers

- Non interacting terms
- Remote mounting auto/manual control station
- Adjustable output
- 10 days delivery

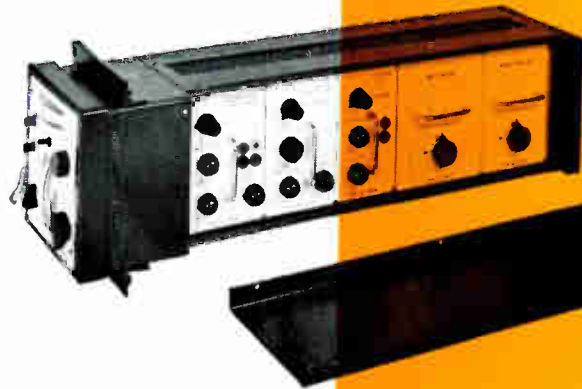

## Temperature Controllers

- Fully transistorised
- 0.1°C repeatability
- Contact and proportional control
- 10 days delivery

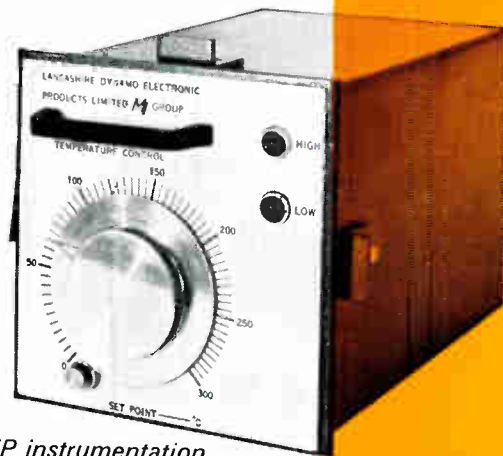

Send for literature on the complete range of LDEP instrumentation

**LANCASHIRE DYNAMO ELECTRONIC PRODUCTS LIMITED, RUGELEY, STAFFS.**  
PHONE: RUGELEY 371. TELEX: 36135.



**LDEP** INDUSTRIAL  
AUTOMATION



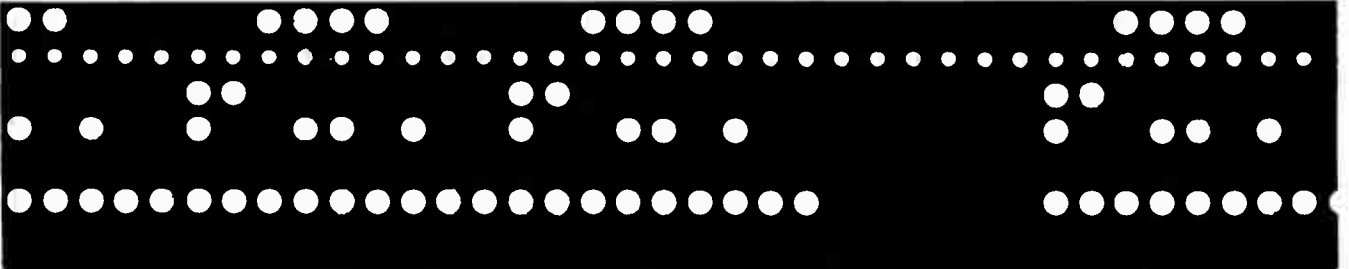

# **EA** accessories for automation

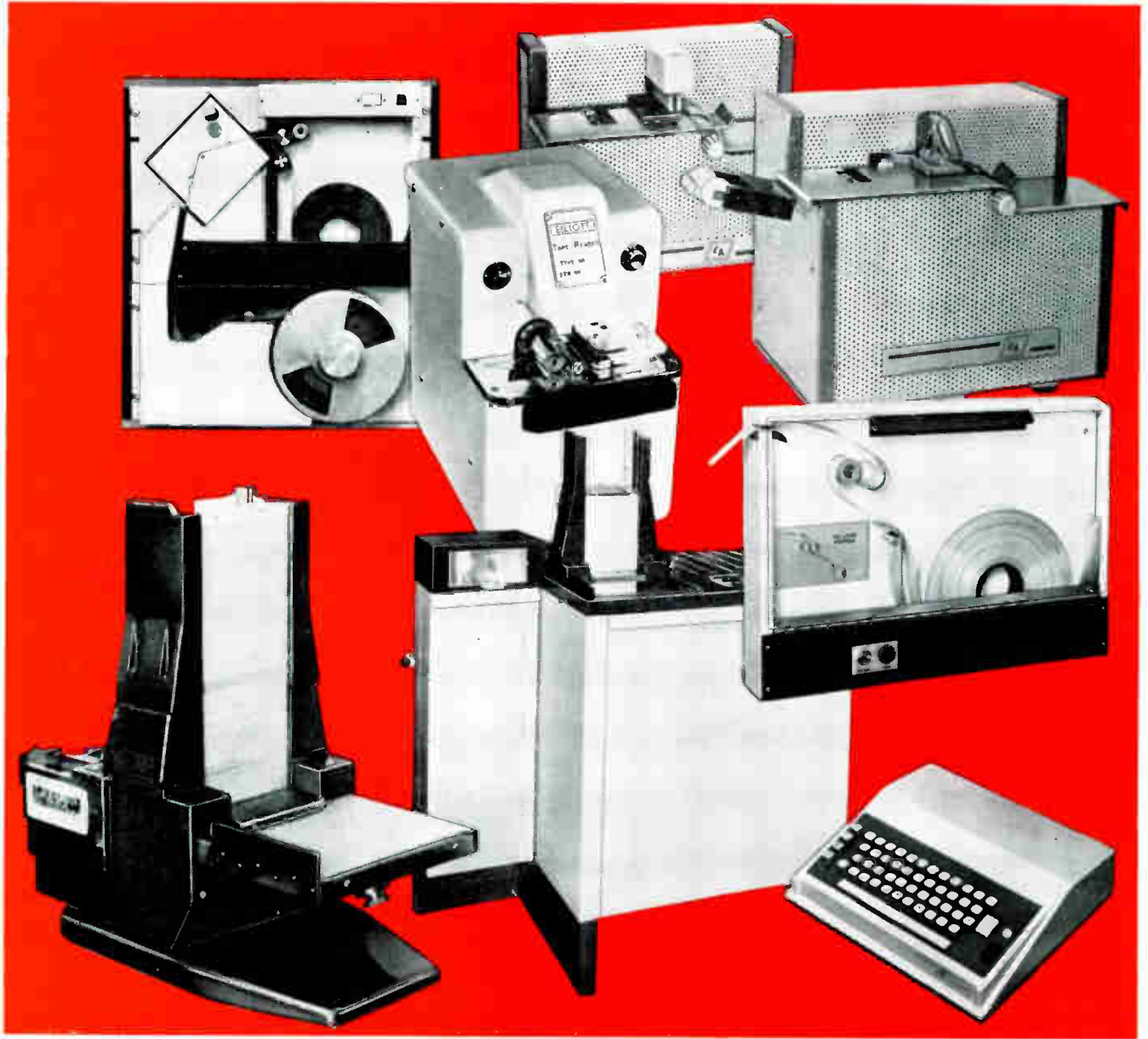

We manufacture a wide range of Punched Paper Tape and Punched Card equipments for Automation and the Computing Industry. For full details regarding all our products write for literature.

Elliott Automation Accessories Ltd., 70 Dudden Hill Lane, London N.W.10. Tel: Wil 8070 EA A member of the Elliott-Automation Group

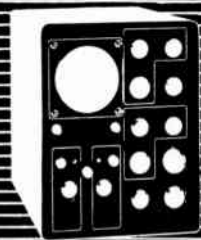

# NEW APPARATUS

ELECTRONICS  
INSTRUMENTATION  
CONTROL

## 1. Telephone Switchgear Inspection Tools

A set of inspection tools for examining contacts and wipers on telephone step-by-step switchgear has been introduced by P. W. Allen & Co.

This set, known as the ALLEN Type TS, consists of a battery-containing handle, 3 light probes and small mirror attachments.

Being able to put a light and, where required, a small mirror right up against a contact, even inside multiple rows, the contact face can easily be viewed.

The set is suitable for the inspection of contacts, wipers and mechanisms of all kinds of uniselectors, two-motion selectors and relays.

The small probes are less than  $\frac{1}{8}$  in. in diameter with mirrors of the same width. Magnifiers of either  $\times 2$  or  $\times 3$

mounted on the probes allow for close viewing with suitable low-power magnification.—*P. W. Allen & Company, 253 Liverpool Road, London, N.1.*

For further information circle 1 on Service Card.

## 2. Flexyfinger

The 'Flexyfinger' introduced by Queff Engineering is a miniature and flexible mechanical grab for retrieving small objects from near-inaccessible places.

The 'Flexyfinger' has been designed for single-hand operation. Depressing the moulded knob at one end of the finger causes four hardened steel claws to open simultaneously. On release of this knob, the claws automatically close and hold any shape of article located

within them. This action may be performed with the 'Flexyfinger' bent at any angle or even formed in a circle.

The Mk 1 version (6 in. reach) sells at 13s. 11d. and the Mk 2 (12 in. reach) at 14s. 11d.—*Queff Engineering Ltd., Industrial Components Division, Durban Road, Bognor Regis, Sussex.*

For further information circle 2 on Service Card

## 3. Plastic Foam Extruded Section

Extruded sections in all grades and qualities of urethane foam and polyethylene, with practically no limitations on shape, are now available from the Non-Sag Seating Co. The production technique used by Non-Sag enables shaped parts to be produced in plastic foams, giving an exceptionally clean cut, in many cases better

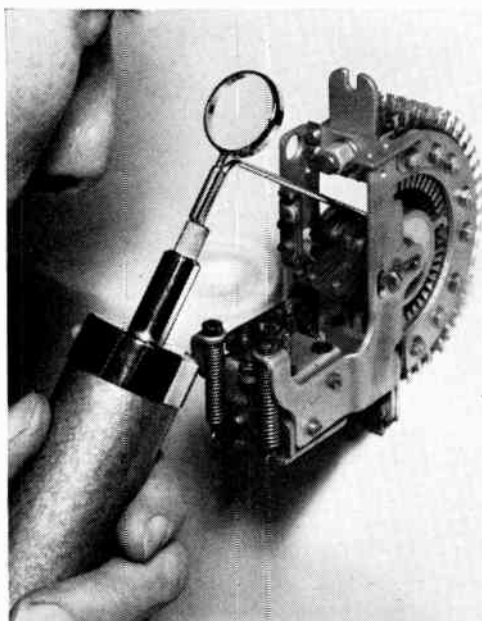

1

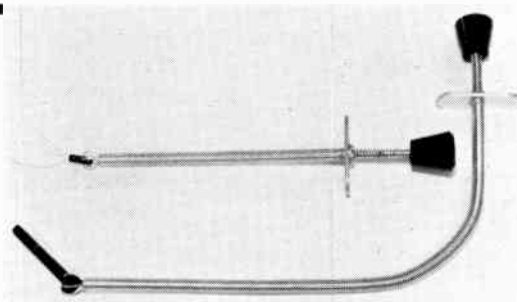

2

3

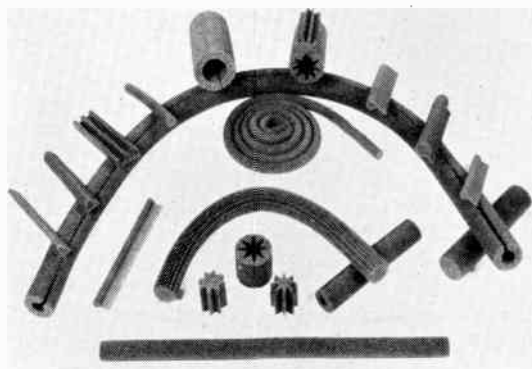

# NEW ELECTRONICS INSTRUMENTATION CONTROL

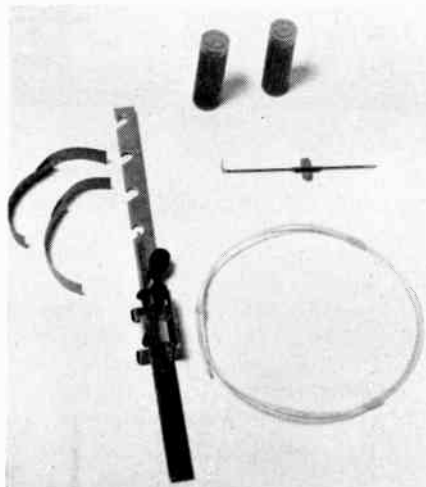

4

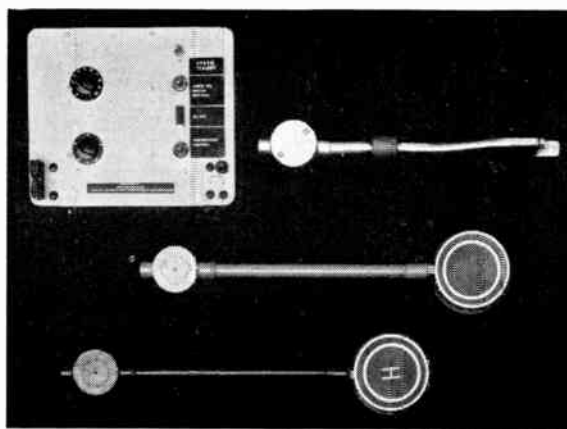

5



6



7

than rubber extrusions or mouldings.

Plastic foam is considerably less expensive than rubber, particularly with non-standard runs. Other features include less weight and greater resistance than natural rubber to oil, water and acids.

Non-Sag offer a special prototype service to design engineers and manufacturers, free of charge, and there are no tooling charges, regardless of the size of order.—*Products Division, Non-Sag Seating Co. Ltd., Dashwood Avenue, High Wycombe, Bucks.*

For further information circle 3 on Service Card

## 4. Conversion Kit for Chart Recorders

A complete conversion kit for inking systems of round chart recorders is being marketed by The Esterbrook Pen Co. The kit is called the Mark-Trol. This universal marking system for round chart recorders is supplied as a do-it-yourself kit to convert instruments from the existing inking method to a more up-to-date system using sealed ink cartridges and a hard-wearing stylus point.

The Mark-Trol marking conversion kit can replace over 90% of round chart marking devices now in use. It will fit 1-, 2-, 3- and 4-pen recorders.

The kit comprises a stylus with mounting tabs, ink tubing, cartridge holder and bracket, disposable ink cartridges and self-adhesive tapes.—*The Esterbrook Pen Company Ltd., Moland Street, Birmingham 4:*

For further information circle 4 on Service Card

## 5. Road Ice Warning System

The purpose of the 'Static' Icelert, introduced by Findlay, Irvine, is to sense potentially dangerous road surface conditions resulting from the combination of low temperature and moisture. The presence of these conditions automatically energizes the contactors controlling the under-road heating mats.

The equipment consists of four main parts: 1, a road surface temperature sensing probe; 2, a road surface moisture sensing probe; 3, a remote electronic control box to which the three probes are connected. The control box is mains operated, and contains a 5 A, 240 V relay for energizing the main contactors.

A temperature control knob is carried on the control box, which can be set to close the relay at any desired road surface temperature in the range 25 to 45 °F. The presence of

moisture, snow or ice automatically causes the relay to close at a temperature 5 °F higher. Thus the circumstances of a wet road and temperature falling towards freezing point result in the heating mat being switched on in time for the heat to reach the surface before ice has formed.

Also on the control box is a control knob for adjusting the power of the heater contained in the snow and ice detector. Signal lamps indicate the mains supply being on, the heater in the snow/ice detector being energized and the relay being closed. The control box is suitable for wall-mounting and must be placed in a weather-proof cabinet. It measures 11½ in. wide × 10 in. high and 3½ in. deep. The basic system sells at under £100.—*Findlay, Irvine Ltd., Penicuik, Midlothian.*

For further information circle 5 on Service Card

## 6. Heavy-Duty Impulse Counter

The latest addition to the English Numbering Machines range of electrical impulse counters is a sealed unit developed for operation under adverse environmental conditions. The heavy-duty case is drip- and dust-proof and is resistant to accidental blows and other industrial hazards. The window



is protected by a spring-loaded metal cover.

This non-resettable counter provides a 5-digit display to 99999 with a maximum counting speed of 500 per min. It can be supplied to operate from 12, 24, 48 or 110 V d.c., 115 and 230 V 50 c/s and 115 V 60 c/s a.c. The counter will operate satisfactorily within  $\pm 10\%$  of the nominal voltage. Overall size:  $3\frac{1}{4} \times 3\frac{1}{4} \times 3\frac{1}{8}$  in. with  $\frac{1}{4}$ -in. conduit entry.—*English Numbering Machines Ltd., 25 Queensway, Enfield, Middlesex.*

For further information circle 6 on Service Card

## 7. 10-Kilojoule Flash Tube

A xenon flash tube rated at 10 kilojoules has been developed for application with high-energy solid-state laser systems by Nelas Division of Thermal Syndicate Ltd. and the International Research and Development Co.

This lamp incorporates a robust lead seal with excellent thermal conductivity characteristics capable of withstanding the large axial shock pressures and thermal energies associated with high-energy pulses.

The lamp, which has an operational lifetime of not less than 1,000 discharges at 10 kJ and 2.4 kV, when operated with a series inductance of 450  $\mu$ H, gives a pulse period of 3.3 msec between one-third peak heights.—*Nelas Division of International Research & Development Co. Ltd. & Thermal Syndicate Ltd., Fossway, Newcastle upon Tyne 6.*

For further information circle 7 on Service Card

# ELECTRONICS

## 8. Ultra-Violet Spectrometers

A range of ultra-violet emission spectrometers is being introduced in Britain by Philips Scientific Equipment, a Division of M.E.L.

An important feature of the spectrometers is the automatic computation of measurements. They provide a direct reading on digital indicator tubes, printer or paper tape of the actual concentrations of the elements being analysed. Samples can be analysed for up to twenty-four elements in one or two minutes, a speed necessary for the quality control of modern production processes.

The first unit, a vacuum spectrometer, is a 1.5-metre instrument cover-

ing the spectral range 1,600 to 3,500 angstroms with a linear dispersion of 5.5 angstroms per millimetre, and is intended primarily for production control in industries where analysis in the far ultra-violet region is required.

The second spectrometer is a 1.5-metre air-path instrument and is also primarily intended for production control. It covers the spectral range 2,000 to 6,000 angstroms with a linear dispersion of 5.5 angstroms per millimetre. It can be used for the analysis of solid and powdered samples including non-ferrous metals, soils and minerals. Additional applications are the analysis of additives and the determination of wear metals in lubricating oils, and the analysis of other liquid samples.

The third spectrometer is a 2-metre air-path instrument. It enables direct reading and photographic recording to be carried out simultaneously, and is intended for research purposes. The spectral range is 2,000 to 8,000 angstroms with a linear dispersion of 4.5 angstroms per millimetre.

Of the two measuring consoles available with the spectrometers, the larger provides for manual and semi-automatic operation, as well as for the fully automatic operation of nine preset analysis programmes. Twenty elements can be measured in sixty con-

centration channels with individual adjustment of zero and sensitivity setting for each channel. The smaller measuring console has the same specification except that the pre-programming facility is not included.

In addition two excitation units are available with the units. The picture shows one of the measuring consoles.—*The M.E.L. Equipment Co. Ltd., 207 King's Cross Road, London, W.C.1.*

For further information circle 8 on Service Card

## 9. Electronic Summator

Landis & Gyr are introducing to Britain a Sodeco electronic summator for use in conjunction with Sodeco impulse counters or Sodecprint printing counters. The SC 58 is designed for use in circumstances where it is necessary to display the sum of impulses from several different sources on one counter. It incorporates the most modern techniques including plug-in elements, transistors and printed circuitry.

The method of operation is that the various impulses are stored, independently of their order of arrival, in memory circuits. A scanning oscillator of a suitable frequency periodically explores these memories and discharges them. The output of the summator



8



9

# NEW ELECTRONICS INSTRUMENTATION CONTROL

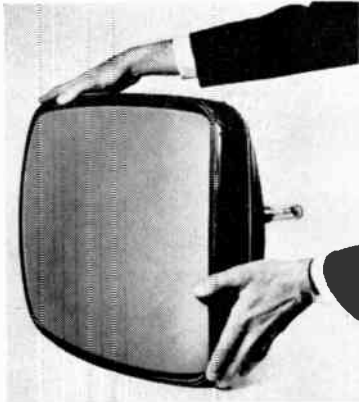

10

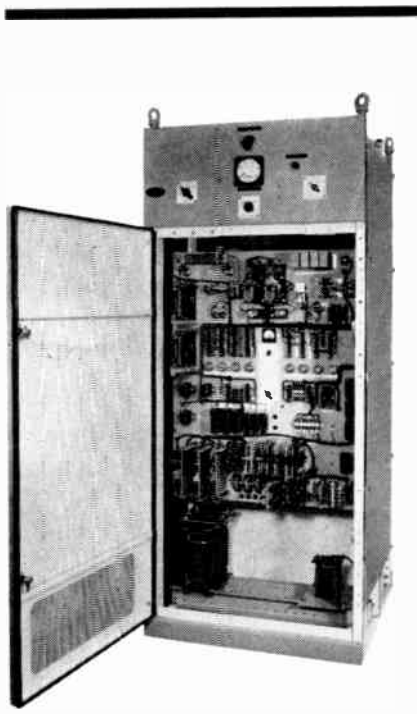

11

12

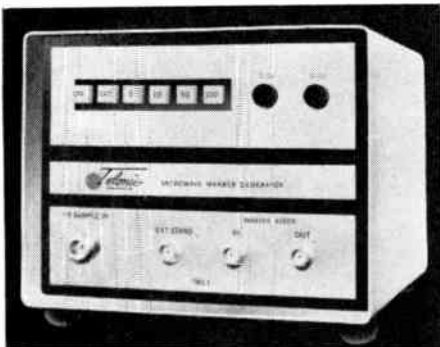

can be connected directly to a high-speed counter type SC 60 (up to 250 impulses/sec). Alternatively, by connecting a pulse shaper type 2Tul to the output, all types of Sodeco impulse counters can be used, including the Sodecprint printing counters.

Any number of input circuits can be accommodated as required up to a maximum of 24, and input signals may be from any Sodeco photocell system, electro-mechanical contacts or electrical impulses of various forms and duration. Models are available to operate on a supply of 110, 125, 220 or 250 V/50 or 60 c/s a.c. Each has a standardized front dimension of 144 × 144 mm.—*Landis & Gyr Ltd., Victoria Road, Acton, London, W.3.*

For further information circle 9 on Service Card

## 10. Brighter Colour Television Tube

Sylvania have announced a 25-in. rectangular colour television picture tube which can operate with a brightness 43% higher than in conventional colour tubes. It has a 90° deflection angle.

The rare earth element, europium, is an ingredient of the new red phosphor in the tube; this phosphor has brightness and colour rendition properties considerably superior to conventional red phosphors. It permits the green and blue phosphors to be used in their natural state without deadening agents, thus increasing the overall 'white' brightness. The extra brightness, in turn, permits the use of a lower light transmission panel, resulting in increased picture contrast.

The spectral energy distribution of the new phosphor provides a natural red which remains unchanged with increased beam current density; the colour chroma is therefore maintained over the full range of brightness conditions encountered in normal use. Due to the white body of the red phosphor, the tube face is white when not in operation instead of the usual yellow cast.—*Sylvania International, 21 rue du Rhône, Geneva, Switzerland.*

For further information circle 10 on Service Card

## 11. Thyristor Motor Drives

The range of A.E.I. 'Emotrol' equipment has been extended to include thyristor drives for motors up to 120 h.p. In this series accuracy is within 0.2% of top speed with a speed range of 60:1 which can be increased by a factor of 3:1 by field control techniques. Reversing equipment can be supplied if required.

There is an increasing demand for

d.c. motor drives which give a wide stepless speed range held within close limits, irrespective of changes in load and fluctuations in supply voltage and frequency. A.E.I. 'Emotrol' equipments are being used for such duties in many industries including textiles, plastics, paper and printing, machine tools, and steel.—*Associated Electrical Industries Ltd., Electronics Group, New Parks, Leicester.*

For further information circle 11 on Service Card

## 12. Marker Generator

The model TMS-1 microwave marker generator, an instrument recently announced by Telonic Engineering, Inc., is now available in the U.K. from Livingston Laboratories. It provides accurate markers on swept-frequency displays.

Designed for use with a sweep generator, the TMS-1 will operate on any frequency within the range 5 Mc/s–10 Gc/s. Marker intervals of 5, 10, 50 or 100 Mc/s, accurate to ±0.001%, are selected by front-panel pushbuttons. Other markers at intervals of 2 Mc/s to 200 Mc/s may be generated by application of a signal of the appropriate frequency to a front-panel socket.—*Livingston Laboratories Ltd., 31 Camden Road, London, N.W.1.*

For further information circle 12 on Service Card

# INSTRUMENTATION

## 13. Portable Cable Tester

The Ferranti Cable Tester Type PCT.11/50 has been specifically designed for the testing of 11-kV cable joints and installations. It is a completely self-contained, portable unit in a robust sheet steel case measuring 23 in. by 16 in. by 11 in.

All the controls are on the top panel of the unit and two lengths of screened coaxial cable are provided to connect the output to the cable under test. Also provided are a length of copper foil for the earth connection and a rod to discharge the cable after test.

The unit has the following continuously rated d.c. outputs which are smoothly variable from zero to maximum: 25–0–25 kV to earth, for testing between conductors; and 25 kV d.c. to earth—negative output only—for testing between conductor and sheath.

The maximum continuous charging

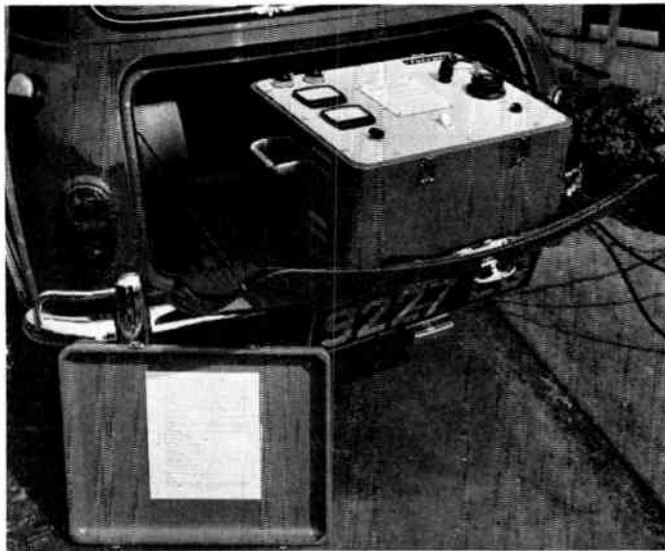

13

with an optional d.c. power supply, will operate for over 4 hr on its self-contained rechargeable batteries, or can operate from any common a.c. or d.c. source.

Four operating modes include each channel singly, alternate or chopped electronic switching between channels, or both channels added algebraically. In the added-algebraically mode, channel 2 can be inverted for differential operation. Other features include a sweep range from 0.5  $\mu$ sec/div to 0.5 sec/div, a  $\times 10$  sweep magnifier, and an adaptable triggering system which includes automatic and channel 1 only.—*Tektronix U.K. Ltd., Beaverton House, Station Approach, Harpenden, Herts.*

For further information circle 14 on Service Card

### 15. Cell-Testing Voltmeter

A pivotless cell-testing voltmeter has recently been introduced by Crompton Parkinson. The instrument is designed for use in checking the e.m.f. of lead-acid and other types of storage cell.

The case is of moulded insulating material to eliminate risk of short circuits when carrying out tests and the instrument is of comparatively high resistance to enable it to be used on cells of small output capacity. The 3-0-3 volts single-range instrument is suitable for checking individual cells only; the double-range pattern can be used on individual cells and on batteries of up to 30 V total output.

All delicate components such as the pivot, jewel bearing and control spring have been eliminated, the movement being suspended between two ribbons of tough beryllium-copper held in tension. As a result the instrument can withstand the roughest handling.

A leather carrying case for the instrument and its attachments can be supplied, provided with a lock and key and adjustable strap. The total weight complete with attachments is approximately 12 oz.—*Crompton Parkinson Ltd., Crompton House, Aldwych, London, W.C.2.*

For further information circle 15 on Service Card



14



15

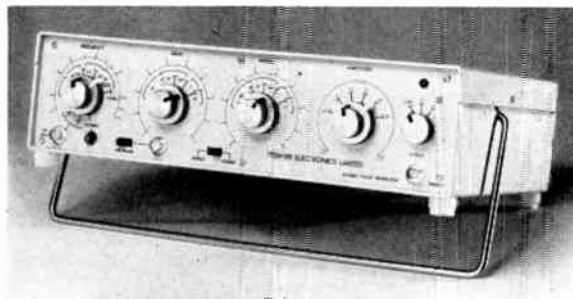

16

current available is 5 mA and the unit is suitable for operation on any 50/60 c/s, single-phase supply between 220 and 250 V.—*Ferranti Limited, Hollinwood, Lancs.*

For further information circle 13 on Service Card

### 14. Lightweight Oscilloscope

Combining portability with high performance, even under severe condi-

tions, the Tektronix type 422 oscilloscope has been designed primarily for the engineer in the field. It measures 6 $\frac{1}{4}$  in. high  $\times$  8 $\frac{1}{2}$  in. wide  $\times$  16 in. deep and the 4-in. rectangular c.r.t. provides a bright sharp dual-trace display under high ambient light conditions. Weight: approximately 20 lb with power supply.

Bandwidth is from d.c. to 15 Mc/s and maximum sensitivity of 10 mV/div. (1 div.=0.8 cm). The type 422,

### 16. Double Pulse Generator

A solid-state double pulse generator, Type TSA 628, has been introduced by Venner Electronics. Using silicon semiconductors throughout, the TSA 628 has a frequency range of from 2.5 c/s to 2.5 Mc/s used as a single-pulse generator, and from 2.5 c/s to 2 Mc/s as a double-pulse source. Three methods of operation are provided: free running, triggering



from a 2 to 50 V external pulse or from contacts, and push button.

A switched attenuator permits outputs of 20, 10, 5, 2, 1 and 0.5 V to be attained, a fine control allowing a minimum setting of 0.2 V. Output impedance is 100  $\Omega$  at 20 V and 50  $\Omega$  at other attenuator settings.

True positive and negative pulses with respect to earth can be selected. Rise and fall times are 10 nsec leading edge, 15 nsec trailing edge, and pulse width and delay circuits are continuously variable from 100 nsec to 10 nsec. The pre-pulse output is  $\pm 5$  V minimum (unloaded) a.c. coupled, width 100 to 150 nsec.

The TSA 628 measures 14½ in. wide  $\times$  3¾ in. high  $\times$  10½ in. deep.—*Venner Electronics Limited, Kingston By-Pass, New Malden, Surrey.*

For further information circle 16 on Service Card

### 17. 17-in. Electrostatic X-Y Indicator

High linearity and uniform spot size over an 8  $\times$  11 in. area, known as the quality rectangle, are features of the wide-band 17-in. large display c.r.t. indicator announced by Fairchild Camera and Instrument Corporation, U.S.A.

This type 737A wideband 17-in. indicator provides 1-Mc/s bandwidth for all three axes (X, Y and Z) and utilizes an electrostatically-deflected c.r.t. Fine spot size permits over 700-line resolution and high brightness permits daylight viewing.

Risetime is 0.35  $\mu$ sec with less than 2% overshoot, while sensitivity is 0.1 V/div (or 1.0 V full scale) with continuous adjustment range of 0.1 V to 0.5 V/div. Bandwidth is d.c. to 1 Mc/s (3 dB down), for signals of all amplitudes within the quality rectangle.

Deflection linearity is nominally 1% overall within the quality rectangle.

The 737A features balanced inputs on the X and Y amplifiers. Common-mode rejection is better than 60 dB at d.c. and 40 dB at 1,000 c/s. The permissible common-mode offset voltage is  $\pm 15$  V. Z-axis input terminals are available for positive- or negative-going signals to brighten the c.r.t. Z-axis bandwidth is d.c. to 1 Mc/s with a risetime of 0.35 nsec; 5 volts fully modulates the c.r.t.—Available in the U.K. from *Aveley Ltd., South Ockendon, Essex.*

For further information circle 17 on Service Card

### 18. Frequency Controller

Kent Precision Electronics have developed a solid-state circuit which is fitted within the mechanical assembly of their standard calibrated control instrument for control, protection or warning in frequency-monitoring applications.

The system consists basically of a frequency-to-d.c. converter which develops a d.c. signal proportional to the input signal frequency, accurately over a small range, say 45–55 c/s. The input frequency is initially converted to a pulse output of the same frequency which is then fed to a linear integrator, the output of which is fed to the input of a standard KPE calibrated control instrument. The extra frequency-to-d.c. converter circuit is built as a printed-circuit card within a standard 'Elite' type instrument case and derives its power supply from that of the rest of the instrument. The auxiliary supply to the instrument is normally the mains a.c. voltage and the instrument can be used to monitor the frequency of its own auxiliary supply, if required. Alternatively it can be used to monitor a secondary input.

Single or dual instruments are available as standard, the dual instrument having concentric control knobs as

shown in the photograph. In each case an internal relay with change-over contacts rated at 5 A 240 V a.c. is made to operate at the set point. Alternatively, the output may consist of thyristor proportional or ON/OFF control elements. — *Kent Precision Electronics Limited, Vale Road, Tonbridge, Kent.*

For further information circle 18 on Service Card

### 19. Automatic Noise Figure Meter

Wessex Electronics announce details of an automatic noise figure meter, the Auto-Node type 792-A covering 10 Mc/s to 26.5 kMc/s.

Produced by Kay Electric Co., U.S.A., this all-solid-state fast-acting sensitive system constantly monitors noise on a direct-reading (dB) meter.

Input frequency is continuously variable from 10 to 120 Mc/s to provide quick and easy operation with almost all receivers. A self-contained hot-wire noise source provides low v.s.w.r. from 10 to 900 Mc/s and precisely known noise output so that the overall system accuracy is better than  $\pm 0.5$  dB.

The Kay 792-A will make highly stable automatic noise-figure measurements from 10 to 900 Mc/s and is

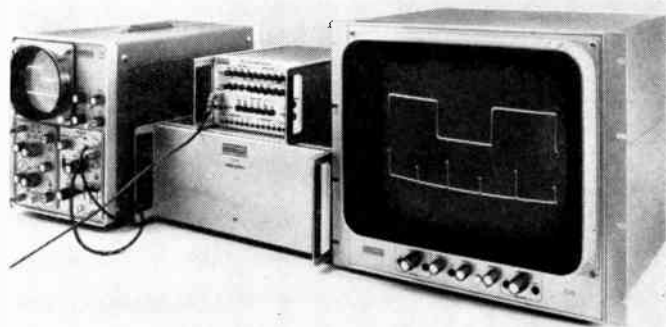

17

19



18





## worth its weight in butter

Metaphorically, that is. It's the MC 200X checkweigher with our new computerized servo control system.

A leading dairy produce packing company has installed ten of these machines in their new factory.

And within a year they'll have paid for themselves. True! Scientific tests have proved it, as they say.

The company themselves carried out the tests. They tested an MC 200X exhaustively. For nine months.

They found that, within a year's production, our checkweighers will have made such a

product saving that they'll more than cover their own capital and installation cost.

That's because of our checkweighers' extremely fine accuracy (this particular machine works to a tolerance of 0.25 gms).

And because the highly sophisticated computerized servo system controls the filling equipment with an accuracy that wasn't possible before.

We'd like to tell you more about our new servo control system, but there isn't really room. For one thing, what it does depends on what you want it to do. And that depends on what your product is.

By the way, the MC 200X isn't just worth its weight in butter. It's really worth far more. It's also worth more than its weight in sausages, dried milk, vegetables, etc.

Like to see how it weighs up to your product? Why not get in touch with us? You'll find us at QUEEN STREET, HORSHAM, SUSSEX  
Telephone: HORSHAM 60111.

# TELOMEX

laboratory weighing accuracy on any factory floor

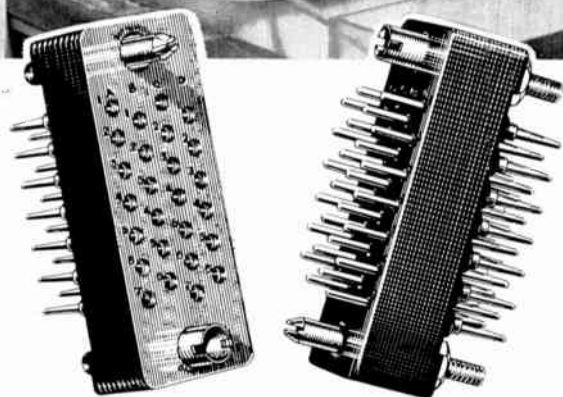
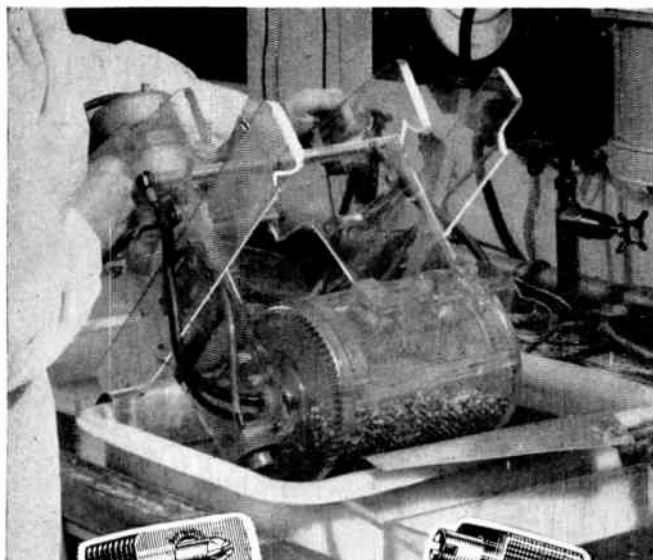

## Standard Micronectors

A range of miniature plugs and sockets by **McMurdo** for rack panel and hire mounting. Gold plated contacts, Nylon P.F. or Melamine moulding. Solid drawn aluminium covers with top or side entry and rigid cable clamps.

9.14.18.26.37.41.50 ways  
R.C.S.C. Quality approved

*Can be supplied with taper tag terminations as illustrated for use with A.M.P. Series 37 receptacles*



**Gold Plating**  
Micronector contacts in an intermediary stage of gold plating

# McMurdo

**McMurdo Instrument Co. Ltd.**

Rodney Rd., Portsmouth, Hants.  
Tel. Portsmouth 35555. Telex 8612.

Contact our Sales Office for details of our full range

when quality counts...



# SODECO COUNTERS

for  
**London  
Airport  
Car Park**

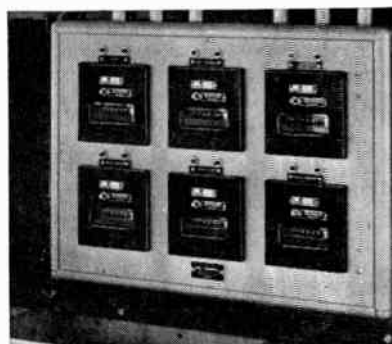

Photographs by courtesy of the Witton-Kramer division of GEC (Engineering) Ltd.

Sodeco counters were chosen by GEC for their photo-electric control equipment at London Airport multi-storey car park.

For administrative convenience two remote reading counter cabinets are installed, one at the car park entrance, the other in the superintendent's office.

These automatically record the progress of cars from floor to floor. With two entrances and exits on central floors it is necessary for the counters to be able to register simultaneous movement at four points on each floor. When only ten car spaces are left on any floor an automatic alarm is sounded and an indicator shows the floor concerned.

DR/SC/3A



**PRODUCTS**  
MEASURE  
COUNT CONTROL  
**PRECISELY**

**LANDIS & GYR LTD**  
VICTORIA ROAD  
ACTON · LONDON W3  
ACORN 5311



For further information circle 239 on Service Card

**ADCOLA**  
PRODUCTS LIMITED  
(Regd Trade Mark)

**SOLDERING  
EQUIPMENT**

**SPECIALISING FOR THE  
SOLDERING JOINTING INDUSTRY**

**Illustrated**

$\frac{3}{16}$ " BIT INSTRUMENT  
(LIST 64)  
IN  
PROTECTIVE SHIELD  
(LIST 700)

ALL VOLT RANGES  
FROM  
6/7 TO 230/250 V

BRITISH & FOREIGN PATS.  
& REG. DESIGNS, ETC.

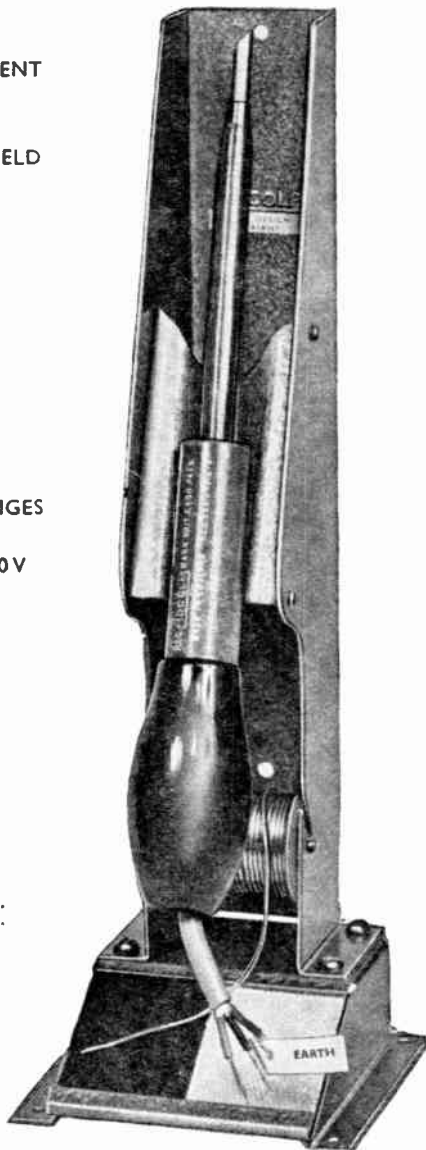

Apply Direct for Catalogues :

**ADCOLA PRODUCTS LTD.**

**ADCOLA HOUSE**

**GAUDEN ROAD**

**LONDON, S.W.4**

Telephones MACaulay 4272 and 3101

Telegrams SOLJOINT LONDON S.W.4

*Industrial Electronics June 1965*

G\*

31

# Let the

## INDUSTRIAL ELECTRONICS

### READER ENQUIRY SERVICE

# help you to obtain more information

To obtain further details of any of the coded items mentioned in the Editorial or Advertisement pages of this issue, please complete one or more of the attached cards circling the appropriate reference number(s). Your enquiries will be passed on to the manufacturers concerned and you can expect to hear from them direct in due course. Cards posted from abroad require a stamp.

**PLEASE USE CAPITAL LETTERS**

Pour obtenir tous renseignements sur les produits codés mentionnés dans les articles ou dans les pages publicitaires de ce numéro, nous vous prions de remplir une ou plusieurs des cartes ci-jointes en encerclant le ou les numéros de référence appropriés. Vos demandes de renseignement seront transmises aux fabricants intéressés qui, en temps voulu, vous feront parvenir une réponse. Il est nécessaire d'affranchir les cartes postées de l'étranger.

**PRIÈRE D'UTILISER DES CARACTÈRES D'IMPRIMERIE**

Weitere Einzelheiten über irgendwelche Artikel, die auf redaktionellen oder Anzeigenseiten erscheinen, erhalten Sie, indem Sie eine oder mehrere der beigefügten Karten ausfüllen und die entsprechende(n) Kennnummer(n) einrahmen. Ihre Anfrage wird an den Hersteller weitergeleitet, und Sie werden dann direkt von ihm hören, Karten, die im Ausland aufgegeben werden, müssen frankiert werden.

**BITTE IN BLOCKSCHRIFT AUSFÜLLEN**

Per ulteriori particolari in merito agli articoli menzionati nel testo o nelle pagine pubblicitarie di questo numero, Vi preghiamo di completare una o più delle schede allegate chiudendo in un cerchietto il numero o i numeri di riferimento. La Vostra richiesta sarà inoltrata ai fabbricanti interessati che Vi risponderanno direttamente. Le schede dall'estero devono essere regolarmente affrancate.

**SI PREGA DI COMPILARE LE SCHEDE A  
TAMPATELLO**

Con objeto de obtener más detalles de cualquiera de los artículos mencionados en las páginas editoriales o de anuncios de este número, sírvase rellenar una o más de las unidas tarjetas poniendo un círculo al número o números de referencia. Sus consultas serán transmitidas a los fabricantes interesados de quienes tendrán noticias directamente a su debido tiempo. Las tarjetas enviadas desde el extranjero requieren franqueo.

**SÍRVASE ESCRIBIR CON LETRAS MAYUSCULAS**

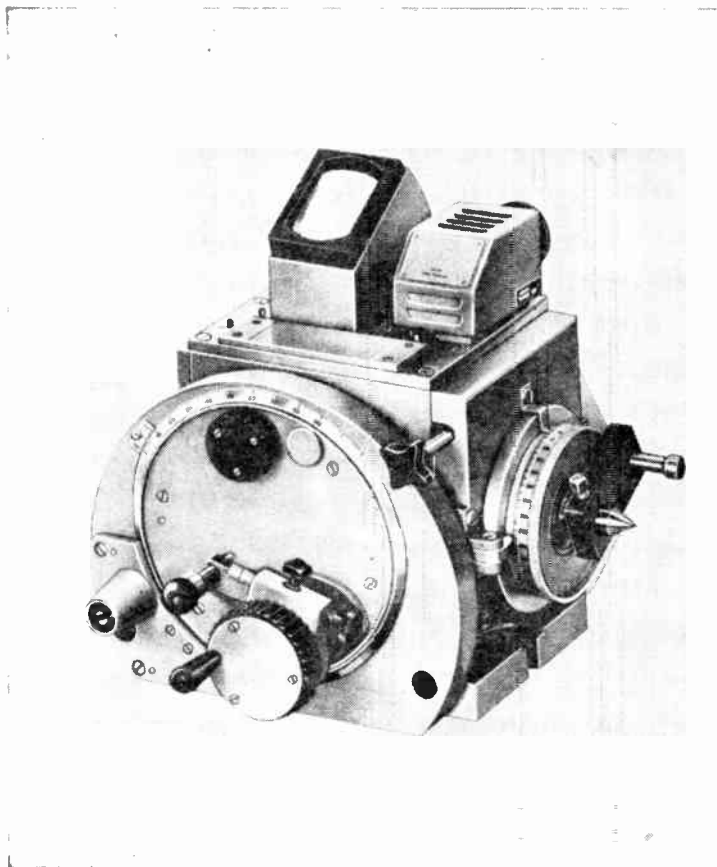

TOOL MAKERS' MICROSCOPES

ABBE METROSCOPES

UNIVERSAL  
HORIZONTAL  
METROSCOPES

ANGLE DIVISION  
TESTERS

UNIVERSAL  
MEASURING  
MICROSCOPES

SMALL BORE  
MICROSCOPES



JENA—THE HOME OF ZEISS

# ZEISS

## OPTICAL DIVIDING HEAD P.3

This new Zeiss instrument is a development of the very popular Optical Dividing Head I30, which has proved indispensable over the years, wherever five-limit divisions are a pre-requisite of production. The P.3 is beautifully styled and includes a number of completely new features.

Angular values are indicated on a projection screen, which considerably reduces working fatigue.

Scale values now read to 3 sec. instead of 10 sec. on the I30 model.

A specially designed pre-selecting device enables the operator to set the minutes and seconds of the following angular value. Complete with tailstock. There are no mechanically stressed elements immediately engaged in the dividing process, which eliminates wear and tear.

The Optical Dividing Head P.3 is equally effective as: a dividing instrument; a division checking instrument; part of a camshaft Testing Equipment.

**Price £896.0.0**

*For further information and details of the Carl Zeiss Jena range of Mechanical Instruments for Length and Screw-Thread Measurements, Opto-Mechanical Instruments for Measuring lengths, Screw-Threads and Contours please contact:*

**C.Z. SCIENTIFIC INSTRUMENTS LTD.**

**Zeiss England House, 93/97, New Cavendish Street, London, W.1. Tel: LANgham 0571/5**

# NEW ELECTRONICS INSTRUMENTATION CONTROL

extended in range by the Kay micro-wave Mega-Node argon noise sources to complete measurements up to 26.5 kMc/s.

The continuously variable range of input frequencies permits use with a wide variety of receiver i.f.s. In addition the equipment offers a wide operating range of input noise levels, -75 dBm to 0 dBm for a nominal 1.0 Mc/s bandwidth. It requires only 33 dB of external gain between its i.f. input and its lowest-output noise source. Switched attenuation of 41 dB in one-dB steps and an effective a.g.c. with a dynamic range of 40 dB are provided.

The instrument rapidly checks receiver noise against known controlled noise level. Any changes in receiver noise are immediately shown on the direct reading panel meter which continuously reads measured noise figure. Available from *Wessex Electronics Ltd., Royal London Buildings, Baldwin Street, Bristol, 1.*

For further information circle 19 on Service Card

## CONTROL

### 20. Ultrasonic Sensing for Mining

The latest development in Sonac ultrasonic sensing and control equipment, designed to withstand the exacting conditions of the mining industry, is introduced by Westool.

It is the intrinsically safe two-part Modular Sonac, which has been developed to improve the interchangeability, ease of maintenance and effectiveness of the Sonac range. It will now be suitable for controlling and switching applications in hazardous areas below ground.

The intrinsically safe version has modified circuitry to comply with Ministry of Power Certificate No. I.S.1409 Class I and Factory Inspectorate No. 3280. In addition it conforms to BS 1259. The sensors are supplied complete with mounting units which prevent mechanical damage.

Sonac, a system based on acoustic energy for detecting the presence of an object and activating a response, has already gained great acceptance. It comprises a control unit and two magnetostrictive transducers. One

sensor is responsible for transmitting ultrasonic vibrations, the other for receiving. Any interruption causes a response.—*Westool Ltd., Bishop Auckland, Co. Durham.*

For further information circle 20 on Service Card

### 21. Pneumatic Controllers

The ZA series controllers, now available from Delta Controls, provide a linear pneumatic output signal in the range 3-15 p.s.i.g. in a group of fourteen models covering the range from 0-25 in. w.g. to 0-10,000 p.s.i.g. Adjustments are provided for variation of the proportional band from 25-100% both in the 'direct' and 'reverse' directions and the stainless-steel nozzle is provided with a ratchet-lock micrometer which allows for zero adjustment when used on 100% proportional band or to set the required band on other outputs.

A pneumatic relay and two gauges indicating supply and output pressures are fitted integrally with the instruments

visible through a window mounted in the lid. The consumption is 0.1 c.f.p.m. of air at 20 p.s.i.g. and the air flow through the relay is 6.5 c.f.p.m. at 15 p.s.i.g.

The pressure sensing elements in standard models are fabricated in brass or phosphor bronze but identical models are also available with stainless steel throughout where in contact with the process medium. The mechanism is fitted into a welded steel instrument case with a splash- and dust-proof lid with all external surfaces finished in corrosion-resistant grey enamel.—*Delta Controls Ltd., 40 Richmond Road, Kingston-upon-Thames, Surrey.*

For further information circle 21 on Service Card

### 22. Hydramotor Gas Valves

An HO Hydramotor series of gas valves which features a positive tight shut-off, making the valves particularly suited to the control of industrial and commercial gas burners, is being marketed by Robert Maclaren & Co.

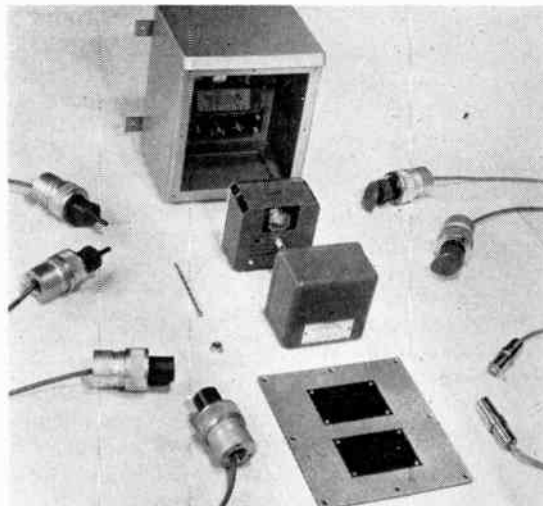

20

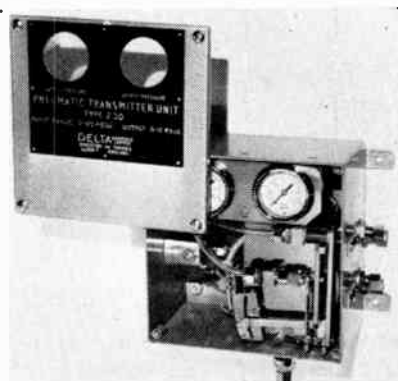

21

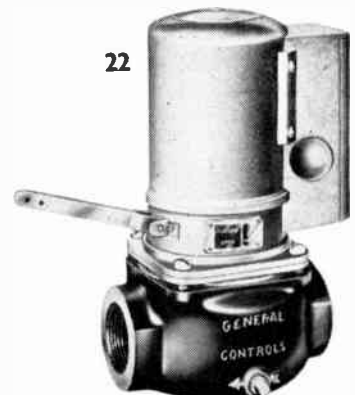

22



The valves can be used for manufactured liquefied petroleum and natural gas.

The valve is spring loaded, making it fail-safe. Operating on a 5 p.s.i. maximum gas pressure, the valve has a 10-sec nominal opening time but will close in 1 sec on current failure.

As it is electro-hydraulically operated, there is no gear train, with a consequent minimum of maintenance.

Both the motor and pump are hermetically sealed. The valve can be supplied for either on/off or for high/low and off control.

When in operation, a pump driven by an electric motor applies hydraulic pressure to the diaphragm which drives the valve stem downwards against heavy spring pressure.

When the stem has travelled its full length, the limit switch opens, the pump motor cuts off and an electromagnetic relief valve holds the stem in position until the control circuit is broken; the spring-loaded stem then returns the valve to its normal closed position.

Alternative mounting angles are available. Location of the valve is governed by a minimum ambient temperature of 10 °F and a maximum of 125 °F.

The HO series is in cast iron with an aluminium and stainless steel trim. Deliveries are from stock. Pipe sizes for the HO series are from 1 to 3 NTP inches but larger capacities up to 6 in. are available in the H.117 and H.118 ranges—*Robert Maclaren & Co. Ltd., Eglinton Works, Kilbirnie Street, Glasgow, C.5.*

For further information circle 22 on Service Card

### 23. Infra-Red Filters for Process Control

Analysis of infra-red absorption spectra is an accurate method of determination of unknown compounds. The introduction of the technique to in situ process control has been delayed by the lack of a reasonably priced, rugged, compact wave-number-selecting component

STC now offers a choice of infra-red filters for filtering in the range 5,000 to 1,400 wavenumbers. STC make these filters for a specified wavelength and bandwidth, thus enabling the quantitative detection of a particular compound to be effected.

The filters will function in a crude

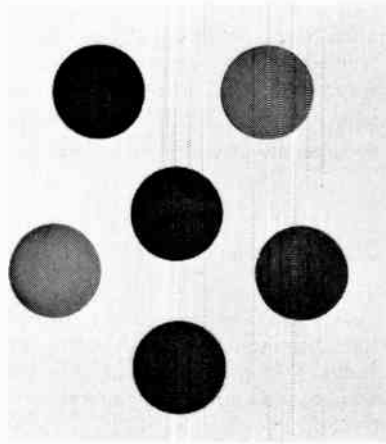

23

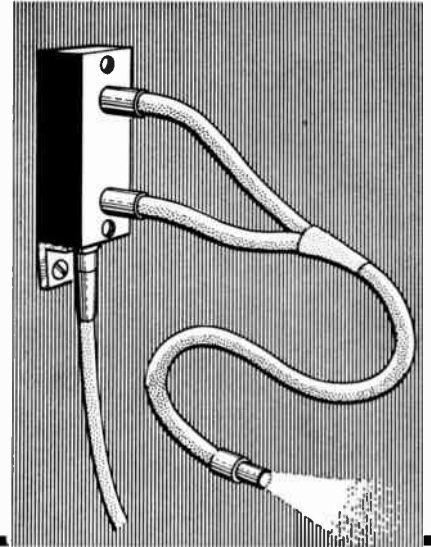

24

optical system and their light weight of a few grams and small size of  $\frac{7}{8}$  in. diam. by  $\frac{1}{8}$  in. thickness, combined with their ruggedness, allow their use in conditions which would be impossible with conventional equipment.

The technique of examination does not require the removal of a sample of the compound, so that use of the filters is another step in the process of automation.

These components have many other uses. Applications include pyrometers for the more accurate measurement of temperature, systems for the detection of poisonous or explosive atmospheres, and measuring chemical and physical properties in the laboratory.—*Standard Telephones and Cables Ltd., Semiconductor Division (Rectifiers), Edinburgh Way, Harlow, Essex.*

For further information circle 23 on Service Card

### 24. Fibre-Optic Photo-Detectors

The Donner Electronics range of fibre-optic 'sensors' and ancillary equipment is now available from Digitizer Techniques. Each 'sensor' consists of a bundle of fibres which function as a highly efficient light-pipe.

Used in conjunction with a light-source and photo-cell, these units may be employed for a variety of photo-detection purposes. Distance between light-source and detection head may be

from several inches down to 0.02 in. Multiple units with a common light-source or photo-cell permit simple AND/OR logic control.—*Digitizer Techniques Ltd., 26 Sheen Road, Richmond, Surrey.*

For further information circle 24 on Service Card

## COMPONENTS

### 25. Solid-State Light Source

A light source designed to replace incandescent bulbs as sources for light sensors has been announced by Texas Instruments. This is the TIXLO1 solid-state light emitter.

The TIXLO1 is a planar gallium arsenide diode which emits near infra-red light, spectrally matched to T.I. and other silicon light sensors. The unit gives an increased sensitivity and efficiency over incandescent sources and a greatly extended life.

The TIXLO1 measures only  $\frac{1}{8}$  in. in diameter and  $\frac{1}{16}$  in. high. The package, originally introduced with the LS600 silicon light sensor, allows for the emitters to be mounted directly in  $\frac{1}{8}$  in. printed-circuit boards.—*Texas Instruments, Inc., Semiconductor Building, 13500 North Central Expressway, Dallas, Texas, U.S.A.*

For further information circle 25 on Service Card

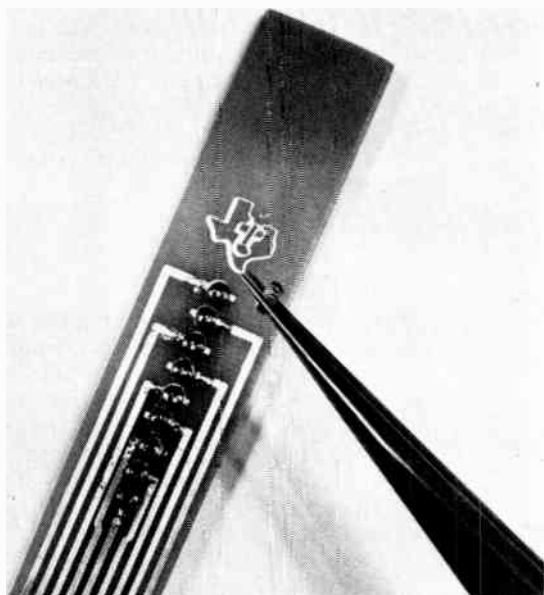

## 26. Bellows-Sealed Stop Valve

A high pressure bellows-sealed stop valve has been developed by The Hymatic Engineering Co. Known as the SEV209-004, it is designed as a general performance standard valve for the chemical and nuclear industries.

Its working media include radioactive coolants such as water, steam or carbon dioxide, highly toxic or volatile gases and many other hot gases and liquids. Leakage to atmosphere is prevented by a mechanical seal of S129 stainless steel under a high compressive load. A back seat is incorporated in the design as an additional safety precaution. The mechanical arrangement of the valve is such that the working parts are outside the gas stream, and only the valve body, poppet and bellows assembly are presented to the working medium. In this way the choice of materials for the working parts is widened so that non-compatible lubricants and finishes may be used.

To give resistance to corrosion and good welding properties the valve body is manufactured in 18/8 stainless steel type EN58B titanium stabilized. The Hymatic SEV209-004 has a smooth-coned poppet sealing on a sharp-edged seat, initially giving line contact and therefore a high specific sealing load.

The normal working pressure range is 0 p.s.i. to 3,000 p.s.i. at temperatures from  $-270^{\circ}\text{C}$  up to  $+400^{\circ}\text{C}$ . The maximum valve lift of 0.030 in. gives

an equivalent orifice diameter of 0.076 in. when the valve is fully open.

The Hymatic SEV209-004 bellows sealed stop valve measures 3.3 in. by 2 in. by 1 in., weighs 1.2 lb, and the connections are 1-in. long bodywelded stubs. Normally available for key operation, the valve can be supplied with handles and pipe connections for welding.—*The Hymatic Engineering Co. Ltd., Glover Street, Redditch, Worcs.*

For further information circle 26 on Service Card

## 27. Primerless T.R. Cell

An S-band T.R. cell type JF.20 has been developed by Ferranti. The cell, which has been designed to provide protection for travelling-wave tubes or parametric amplifiers used in pulsed radar systems, has a radio-active filling and therefore does not need an external primer supply. Within the frequency limits 2,700 Mc/s to 3,100 Mc/s the v.s.w.r. is less than 1.25 and the insertion loss is typically 0.3 dB.

Where crystal receivers are in use, the JF.20 used in conjunction with another recent development, a varactor diode limiter type 104SSS, provides adequate receiver protection (spike  $\approx 0.07$  erg/pulse) for an insertion loss of less than 1.0 dB without any external power supplies being required.

Receiver protection is provided by



26

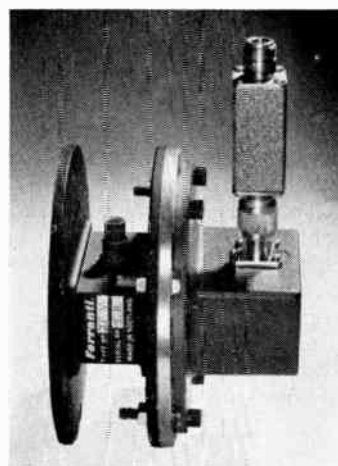

27

28

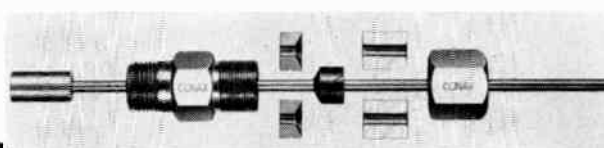

the JF.20/104SSS combination even when the radar is not operative, thus dispensing with the need for a mechanical waveguide shutter.

The JF.20 is rated at 100 kW peak, 100 W mean.—*Ferranti Ltd., Kings Cross Road, Dundee, Scotland.*

For further information circle 27 on Service Card

## 28. Split-Packing Gland

West Instrument announce that a stainless-steel Conax split-packing gland is available for use with bulb thermometers and similar applications requiring a pressure seal on the smaller diameter capillary tube after the larger diameter bulb passes through the gland body.

Split seat and follower form compression elements for sealant inside gland body. Probes are not damaged because of soft sealant, and immersion can be adjusted as required. Temperature range is  $-185$  to  $+1,000^{\circ}\text{C}$  and pressures up to 7,500 p.s.i. — *West Instrument Ltd., The Hyde, Brighton 7, Sussex.*

For further information circle 28 on Service Card

## 29. Improved Transistor Sockets

The range of Sealectro p.t.f.e. transistor and integrated circuit sockets accommodating TO-18 and TO-5 based

# NEW ELECTRONICS INSTRUMENTATION CONTROL

devices now incorporates improved tubular resilient contacts.

The redesigned beryllium-copper contacts have a nickel plate and gold finish. The tubular shape facilitates the attachment of wiring leads.—*Sealectro Limited, Hersham Trading Estate, Lyon Road, Walton-on-Thames, Surrey.*

For further information circle 29 on Service Card

## 30. Miniature Relay

Line Electric Co., U.S.A., now has available a high quality miniature 4-pole d.t. relay.

The Series JA features a nylon dust cover and gold-flashed silver contacts rated at 3 A, non-inductive. The rugged design of the JA makes it well suited to meet the requirements of

computers, logic systems and data-processing equipment.

The JA is a general purpose relay available in 4-pole d.t. standard contact arrangements for a.c. or d.c. operation. Standard configuration features solder terminals and 3-48,  $\frac{3}{16}$  in. mounting stud. The unit can be used with a 94-79 and 92-80 plug-in socket.—*Line Electric Company, 249 River Street, Orange, New Jersey, U.S.A.*

For further information circle 30 on Service Card

## 31. Small Solenoids

A variety of small solid-pole, open-yoke, pull-type solenoids have been added to their Decco range by Expert Industrial Controls Ltd. The company has taken considerable trouble to ensure quiet a.c. operation and an elimination of residual magnetism on d.c.

Various dimensions and fixing arrangements are available, together

with differing plunger configuration for long- and short-stroke solenoids. The cross-sectional area is about 1 in. square and the stroke is a maximum at  $\frac{1}{8}$  to  $\frac{1}{2}$  in.—*Expert Industrial Controls Ltd., Lount Works, Ashby-de-la-Zouch, Leics.*

For further information circle 31 on Service Card

## 32. Cable Trunking

The Insuloid Manufacturing Co. have introduced a range of cable trunking which incorporates many time and cost saving features. The trunking is slotted throughout its length and each slot has a narrow opening which permits cables to be 'led out' at any point. These small openings are so designed that they prevent the cables from breaking free during assembly. Wiring runs can be segregated with snap-in bridging pieces and the cover has a self-retaining 'snap action' fixing.

This cable trunking is grooved in the base to facilitate quick and accurate drilling and has a clean profile for parallel stacking. It is available in four sizes and with three different slot positions. Being manufactured in strong lightweight rigid p.v.c., it is corrosion resistant and requires no attention after it has been installed.—*Insuloid Manufacturing Co. Ltd., Sharston Works, Leestone Road, Wythenshawe, Manchester 22.*

For further information circle 32 on Service Card

## 33. Pushbutton Assemblies

The range of pushbutton assemblies made by Mayr is now available from STC. The flexibility of the system gives multiple combinations of button hold and button release conditions. These include independent and mutual release assemblies with mutual release in groups, if required, or with common release.

As well as varying multiples of hold and release buttons, each, in turn, being able to perform a variety of switching functions, the Mayr assemblies can contain 'pulse' buttons in the same unit. A large number of electrical and mechanical combinations are possible. Switch assemblies of differing construction (high and low power) can be supplied on the same switch-button chassis. Each button can be made to perform a specified number of make, break or changeover operations.

Most of the ranges are available with banks of 12 buttons. The construction allows for very close vertical

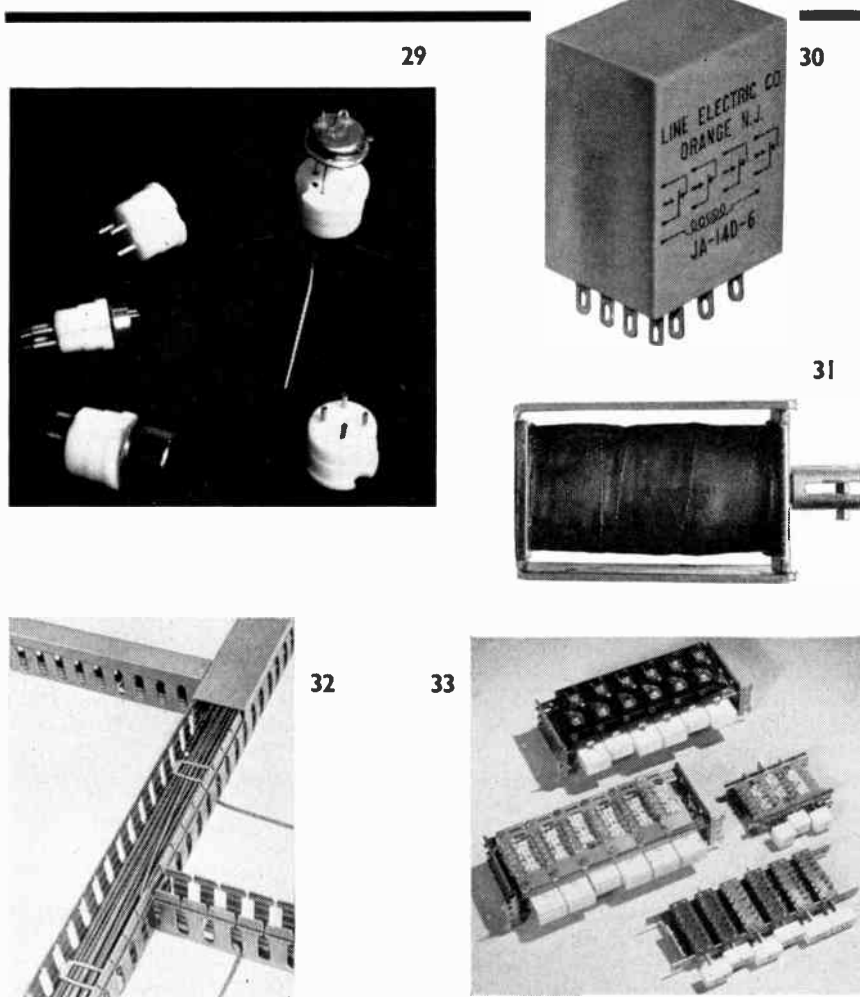



# Perivale Controls

range of  
**MINIATURE  
PLUG-IN  
RELAYS**

**Light Current and Heavy Duty Types**

### Features

Designed and manufactured by Perivale Controls over six years ago, the PC Miniature Plug-in Relay was first of its kind then—and it still leads. Built-in features of this wholly British relay include:

- ★ Complete interchangeability with most relays of foreign manufacture.
- ★ Operational accuracy derived from unique setting techniques.
- ★ High quality but competitive prices.
- ★ Speedy delivery even for specials.

### Specials

Flexibility of design is such that special derivatives seldom present a problem. Speedy delivery is offered as a service and enquiries for small or large quantities are invited.

### Standards

Over 100 different standard types for diverse applications. Designed for long term reliability and cost economy PC Miniature Plug-in Relays have standard operating voltages in the range 4 volts to 140 volts D.C. with a wide tolerance on nominal, and a myriad of contact configurations allowing for single or multiple operations in various combinations of make/break/changeover.

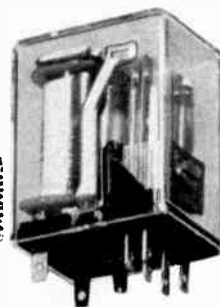

PC 2. Relay with Socket

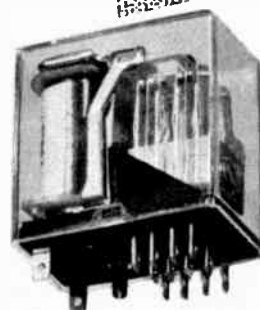
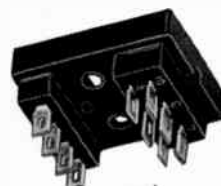

PC 4. Relay with Socket

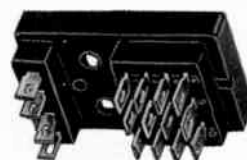

PC 4. Printed Circuit Relay Socket mounted on  $\frac{1}{8}$ " board.

## PERIVALE CONTROLS COMPANY, LIMITED

40 TELFORD WAY · EAST ACTON · W. 3.

A **DAVALL** Instrumentation Company

SHEPHERDS BUSH 1015 (5 Lines)

# S.E. 423/1E STRAIN GAUGE AMPLIFIER

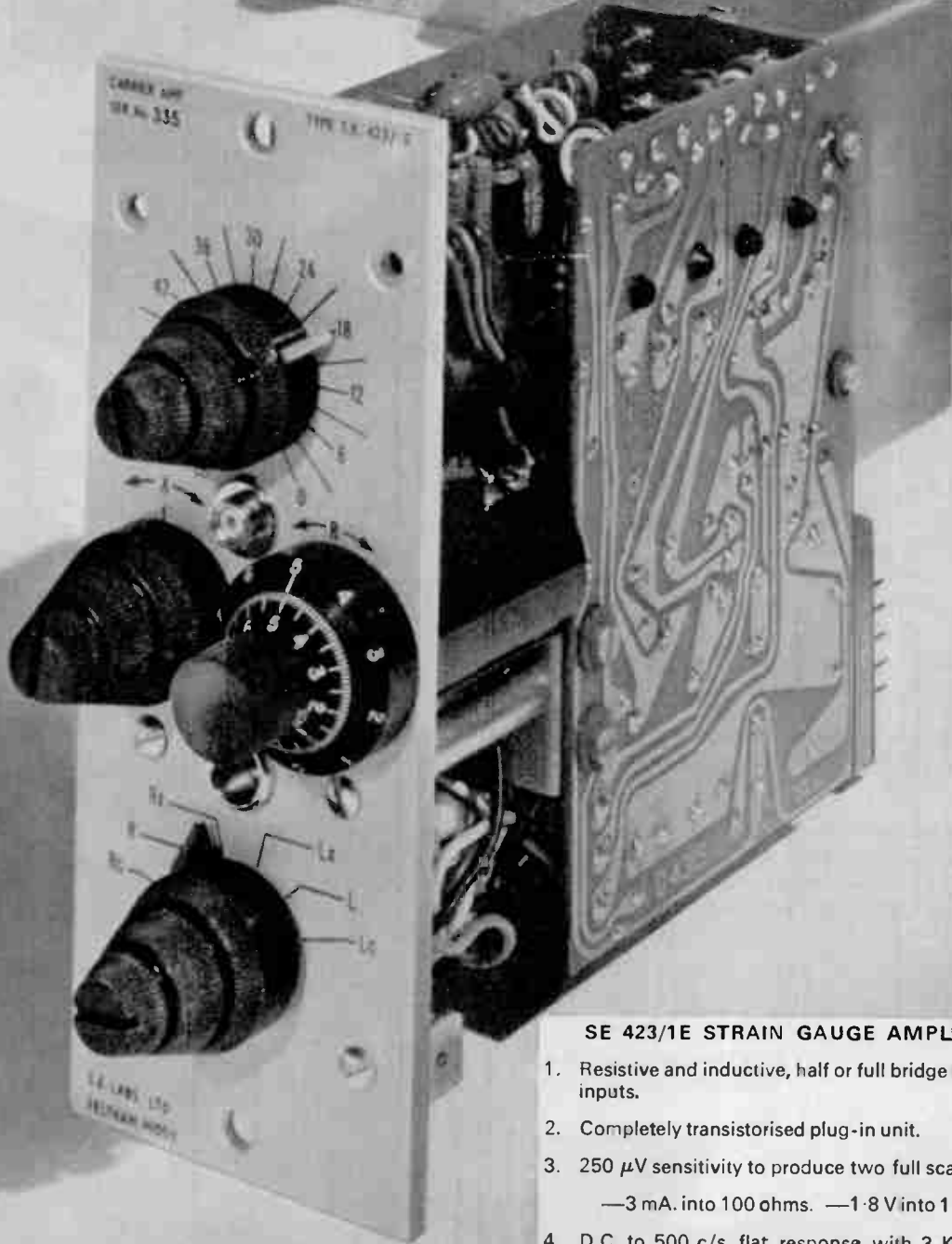

## SE 423/1E STRAIN GAUGE AMPLIFIER

1. Resistive and inductive, half or full bridge transducer inputs.
2. Completely transistorised plug-in unit.
3. 250  $\mu$ V sensitivity to produce two full scale outputs  
—3 mA. into 100 ohms. —1.8 V into 100 K ohms.
4. D.C. to 500 c/s flat response with 3 Kc/s Carrier frequency—8 Kc/s version available.
5. Multi-channel operation.

**S.E.**  
**LABORATORIES**

## S E LABORATORIES | ENGINEERING | LTD

A subsidiary of S.E. Laboratories (Holdings) Ltd.

606 North Feltham Trading Estate, Feltham, Middlesex. Telephone: Feltham 5876

COMPLETE INSTRUMENTATION SYSTEMS

and horizontal stacking of the banks. The buttons have removable transparent covers for the insertion of identification colour signals or written characters.—*STC, Electro-Mechanical Division, West Road, Harlow, Essex.*

For further information circle 33 on Service Card

## PRODUCTION AIDS

### 34. Automatic Coil Winder

Now available from R. H. Cole Electronics is the Aumann winding unit model WE-K. This machine is basically identical to the model WE but is fitted with a special tailstock which, on opening, also opens the guard, and automatically re-sets the counter to zero and the wire guard to its starting position on the coil. On closing the tailstock the machine is automatically re-started. This saves time in mass production, and permits the operator to supervise more machines.

The companion model is WEL-K with three speed steps. Both machines can be fitted with the punched-card counter, as shown in the photograph (mounted on the front of the machine, on the left-hand side). The number of turns, allowing for over-run, is punched on to the card and inserted into the counter: the machine will then stop automatically when the pre-set number of turns is reached.

This counter is particularly useful when coils have to be wound which incorporate a different number of turns (i.e., transformer coils with taps) and it is then not necessary to re-set the counter but only to introduce a consecutive series of cards.—*R. H. Cole Electronics Ltd., 7-15 Lansdowne Road, Croydon, Surrey.*

For further information circle 34 on Service Card

### 35. Electrically-Heated Batch Ovens

The range of electrically-heated batch ovens available from Hedin has been extended and improved. Sixteen standard sizes (from 3 ft × 2 ft × 2 ft up to 6 ft × 6 ft × 6 ft) are now available, designed alternatively for shelf or trolley loading, and with a choice of horizontal or vertical forced air circulation—a range of 30 models in all.

Fully automatic temperature indication and control are provided for the standard temperature range of 300 °C, or for the alternative ranges of 125 °C

or 425 °C. Excess temperature protection is also standard on all models. Elements are totally enclosed, and have a low surface rating; they are electrically interlocked with the fan.

Typical applications include varnish baking, rubber or resin curing, paint stoving, plastics powder drying, and aluminium heat treatment. — *Hedin Ltd., Fowler Road, Hainault, Ilford, Essex.*

For further information circle 35 on Service Card

### 36. Binocular Thermocouple Welder

Spembly Technical Products announce a thermocouple welding unit, specially designed for the welding of thermo-

couple hot junctions between wires as small as 0.001 in. diameter.

For this work the unit is equipped with a binocular microscope complete with built-in illumination for the twin manipulators to assist the operator in positioning wires. The wires are welded by means of a hand held argon shielded electrode which is supplied as part of the unit.

The latest accessory in the Spembly range of capacitor-discharge fine wire welding equipment is specifically designed for the making and attaching of thermocouples to specimens, etc., in the laboratory, by both spark and spot welding techniques.

This accessory, which is priced at £75, is also provided with extension facilities for other hand tools and

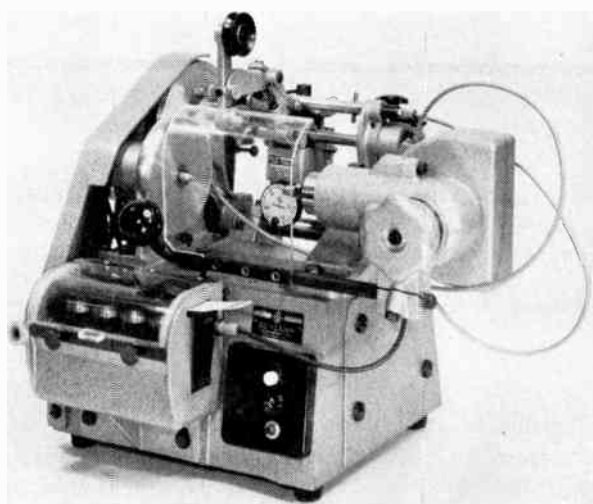

34

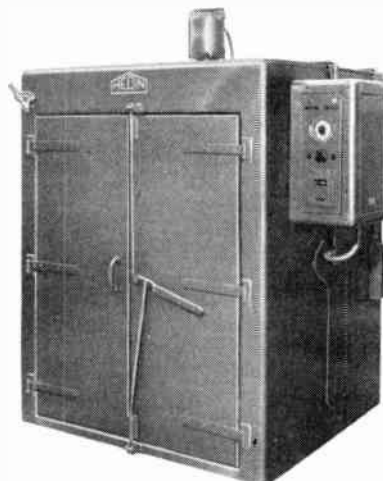

35

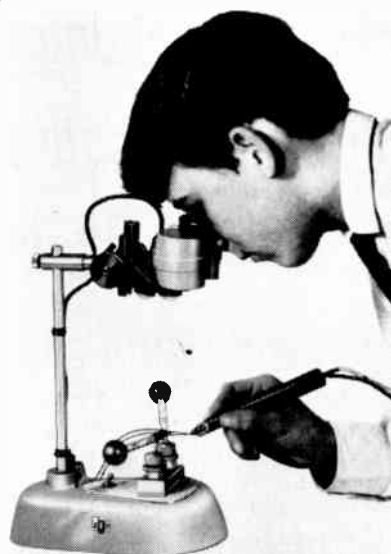

36



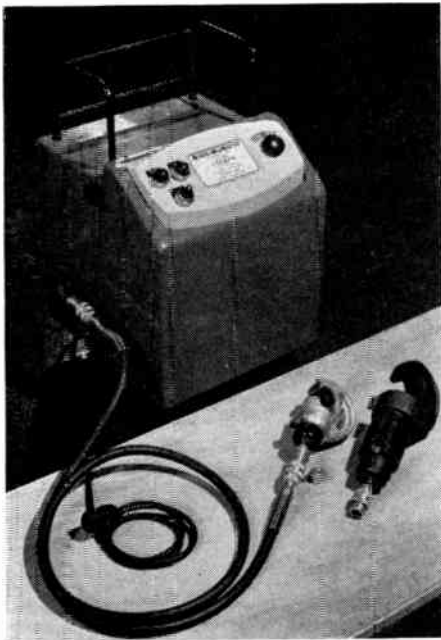

37

accessories in the S.T.P. range.—*Spemby Technical Products Ltd., Trinity Trading Estate, Sittingbourne, Kent.*

For further information circle 36 on Service Card

### 37. Electro-Hydraulic Crimping Unit

Now available from BICC-Burndy is a full-cycling electro-hydraulic crimping unit for use with Burndy Corp. crimping heads.

The unit develops 10,000 lb/sq in. and then releases pressure. It can be stopped at any stage in the cycle and will hold this pressure until the cycle is restarted and completed.

There is an emergency release knob should the operator require to release pressure without completing the cycle. The motor is double wound, for operation at either 110 or 240 V.—*BICC-Burndy Ltd., Parr, St. Helens, Lancs.*

For further information circle 37 on Service Card

### 38. Cylindrical Wrapping Machine

A machine designed to apply a 360° plus overlap-wrap of self-adhesive tape to cylindrical objects between  $\frac{1}{4} \times \frac{1}{2}$  in. diameter and  $\frac{3}{8}$  to 2 in. long has been introduced by Sellotape. The function of the tape can be insulation,

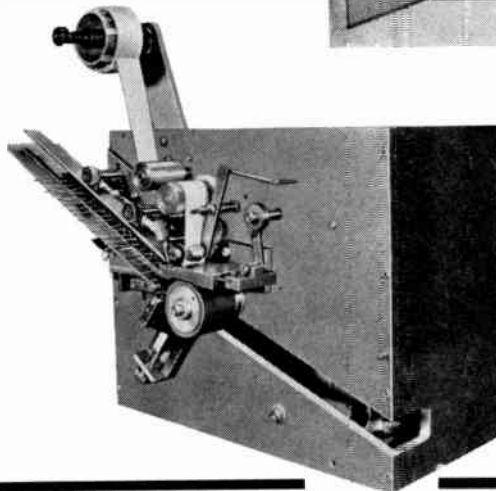

38

masking, or labelling. With the addition of photo-electric cell equipment the machine can be used to apply pre-determined lengths of 'Sellotape' printed tape, cut to exact register with the label's text.

A variable-speed motor is fitted to give an operating range of from 10 to 100 components a minute.

The machine operates on a 250-V single-phase 50-c/s supply. It will cope with the over-wrapping of cylindrical articles such as capacitors and resistors, aluminium cans, and batteries.—*Sellotape Products Ltd., Industrial Division, Sellotape House, 54/58 High Street, Edgware, Middlesex.*

For further information circle 38 on Service Card

### 39. Automatic Feed and Flow Controllers

The '60' series controllers now being manufactured by The 30-98 Co. Ltd. will maintain process variables at any selected value by regulating the feed of dry materials or the flow of liquid materials.

Provided with connections for the addition of indicating and recording instruments, these controllers accept electrical signals from transducers, compare them with other input signals or with a reference, and give an electrical output signal capable of adjust-

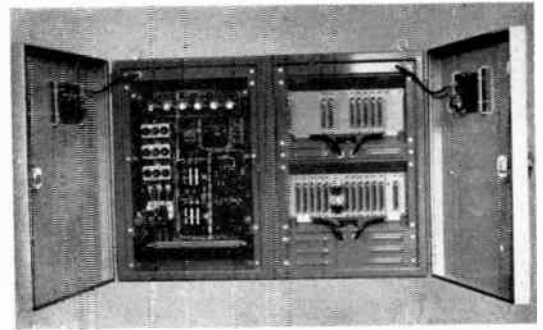

39

ing the delivery rate of solid or liquid metering devices.

The '60' series controllers are based on a series of transistorized plug-in units comprising power packs, input and output stages, etc., which are assembled to a plug and socket connected rack, housed in wall or floor mounting cabinets or international 19-in. racks, together with the associated motor control gear. Each plug-in unit comprises a separate stage of a process controller and is produced in economic size batches. By combining suitable plug-in units, a controller can be readily designed for any specific duty.

The output of the '60' series controller may be matched to the response time of any process under control and hunting is eliminated by giving an 'inch and pause' signal to a servo motor. Both pulse length and the waiting period between pulses are proportional to the deviation of the input signal from 'mean' and in some applications to the rate of change of deviation.

The modular construction system used for the '60' series controllers extends to the cabinets in which they are housed. Any number of equipment racks from 1 to 8 can be housed in a standard range of cabinets.—*The 30-98 Co. Ltd., Gatwick House, Povey Cross Road, Horley, Surrey.*

For further information circle 39 on Service Card ]

*Illustrated here is one of the diversionary signs on the M.4. The bottom picture shows the diversionary instructions illuminated while in the top picture they are invisible*

# TRAFFIC CONTROL SYSTEM FOR M.4

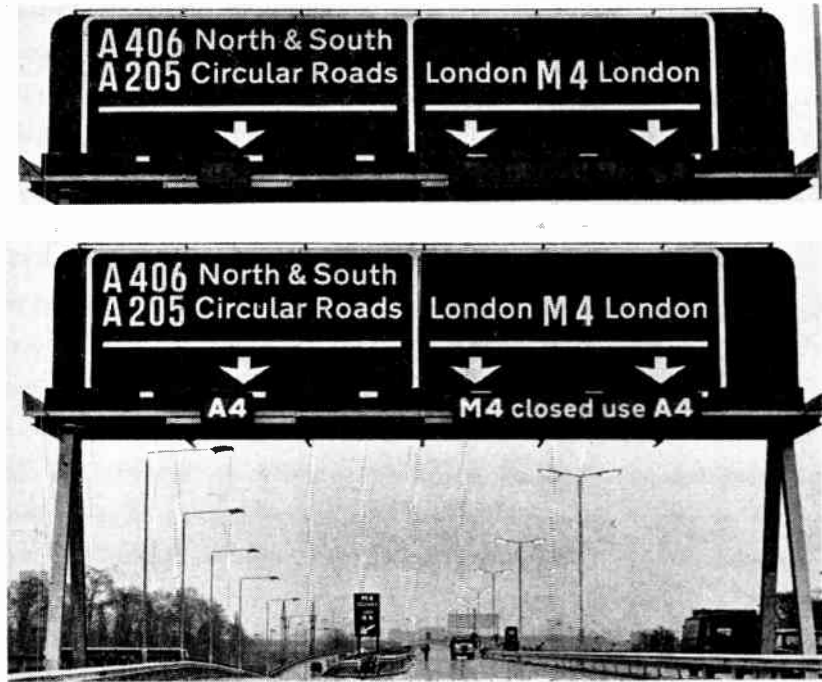

**W**HEN the new Chiswick to Langley M.4 motorway opened, an interesting electronic monitoring system to check and control traffic on the motorway came into operation.

This is basically an electronic mimic diagram of the Chiswick-Langley road system which has been specially designed by the Ministry of Transport in conjunction with the Traffic Signs Division of Willing Lumi-Neon Limited.

## To Pinpoint Traffic Build-up

A rectangular unit, 8 ft by 2 ft 6 in., the mimic diagram has been installed at the Hounslow Police Station to enable police to pinpoint traffic build-up and, if necessary, to operate specially developed emergency traffic signs which may be illuminated to divert vehicles away from the motorway.

Reading 'M.4 CLOSED USE A.4', some twenty-three signs, incorporating the Willing 'Secret' sign system which allows their aspects to be virtually 'invisible' during normal

smooth-flowing traffic conditions, have been affixed to five gantries and several posts which have been erected at key points along the new extension.

## Alarm Signals

A series of detector loops in the new road and detector boxes fitted to hand-rails, will send pulses to a counting unit and indicator lamps on the mimic diagram.

By this method police will be able to keep a careful and continuous check on vehicles moving over the elevated section of the M.4. In the event of a vehicle stopping on the road for more than a predetermined period, alarm signals at the police control centre will warn of a possible breakdown or accident.

In addition, the mimic diagram incorporates a series of meters which will automatically measure the weight of traffic flow across the elevated section of the motorway. Numerator meters will also count the number of vehicles passing along all four lanes of the carriageway.



*This shows the mimic diagram installed at Hounslow Police Station*





## Personal News

N.S.F. Ltd. have appointed **W. H. Sanderson** and **R. Wilson, F.C.A.**, as directors of the Company. Mr. Sanderson is now works director. Mr. R. Wilson is now a director in charge of accounts and administration and retains the secretaryship of the Company.

**James J. Shallow** has been appointed to the Board of Directors of Ultra Electronics Ltd. and becomes deputy chairman and chief executive. **Dr. Frank W. Stoneman**, previously joint managing director, has been appointed managing director.

**C. Glover, M.B.I.M., M.Inst.M.S.M.**, has been appointed general manager of Thorn Electronics Ltd. He will be in complete control of production, engineering, sales and general policy.

**John H. F. Wilken** has been appointed general sales manager of Vidor Ltd., Mr. Wilken went to Vidor from Hoover Ltd.

## Industrial Electronics

T. J. Burton, who has been Assistant Editor of *Industrial Electronics* since its start, has succeeded W. T. Cocking as Editor.

W. T. Cocking, M.I.E.E., has become Editor-in-Chief of both *Industrial Electronics* and *Wireless World*. He has been associated with the latter journal for 35 years and became Editor of *Wireless Engineer*, one of the forerunners of *Industrial Electronics*, in 1946.

**S. Scott MacTaggart** has joined Solartron as publicity and press relations manager. He was formerly group press officer with AEI Electronics. **Don Griffin**, who has been handling publicity aspects for Solartron, takes over as manager, Technical Publications.

**John Jesper Eades** has been appointed head of the newly-formed International Group of The Plessey Company. Mr. Eades, who is 45, joined ATE in 1950 and was appointed to the Board two years later. He was the company's sales director from 1953 to 1964.

Feedback Ltd. have announced that **J. Hale, B.Sc.(Eng.), A.M.I.E.E.**, formerly the production manager, and **E. G. Bell, A.M.I.E.E.**, formerly the sales manager, have been appointed as directors.

**William McMillan** has been appointed chief information officer of the British Standards Institution. He will be responsible to the Director of BSI for all aspects of the Institution's public relations activity. Mr. McMillan formerly handled technical press affairs for Standard Telephones and Cables.

**Geoffrey Charlish** has joined Standard Telephones & Cables as technical press officer. He will be responsible in all media for technical aspects of the Company's activities, including products, developments and applications.

Bailey Meters and Controls Ltd. have elected **P. H. Crowther** to the board of directors, and appointed him deputy managing director of the Company.

**David Balfour, M.A.(Cantab.), A.M.I.E.R.E.**, has been appointed head of engineering by Brush Clevite Company Ltd., of Hythe, Southampton. Before joining Brush Clevite, Mr. Balfour was employed by Decca Radar and Plessey (U.K.) Ltd.

Advance Electronics have appointed **Leslie Minikin, B.Sc.**, as their technical representative to cover the counties of Hertfordshire, Bedfordshire, Huntingdon, Buckingham and Cambridgeshire.

**R. C. H. Russell, M.A., A.M.I.C.E.**, has been appointed director of the DSIR's Hydraulics Research Station at Wallingford, Berkshire. He succeeds **F. H. Allen, M.A., M.A.I., M.I.C.E.**, director since 1959, who was appointed in January to be principal assistant to Sir Solly Zuckerman, scientific adviser in the Cabinet Office.

**K. A. Ward** has joined Belling and Lee as advertising manager and is responsible for all the Company's sales promotion activities. Mr. Ward was previously head of publicity for Pain-ton of Northampton. **G. F. Redgrave** becomes technical publications manager and is responsible for all technical information issued by Belling & Lee.

**J. I. Bernard, B.Sc.(Tech.), M.I.E.E.**, has accepted an invitation to join the Board of Oliver Pell Control Ltd. Mr. Bernard was formerly director and secretary of the Electrical Development Association.

**D. G. Hucker**, who until recently was works manager of W. H. Sanders, has now joined Microwave Associates at Luton where he will be responsible for all aspects of the Company's production activities.

Dewhurst & Partner announce the appointment of **Dennis Graham Troll, B.Sc.(Mech. Eng.)**, as chief development engineer to the Company.

## Obituary

Sir Edward Appleton, G.B.E., K.C.B., F.R.S., who was one of our foremost radio physicists, died on 21st April at the age of 72.

He was perhaps best known for his early work on one of the ionized layers in the upper atmosphere which reflect radio waves. In 1924 he proved the existence of the Appleton layer.

Among his many appointments were: Wheatstone Professor of Experimental Physics, Kings College, London; Jacksonian Professor of Natural Philosophy, University of Cambridge; Principal and Vice-Chancellor, Edinburgh University; and Secretary of the Department of Scientific and Industrial Research.

Sir Edward Appleton received many honours for his work including the Nobel Prize for Physics in 1947.

## Company News

A new company, **English Electric Automation Ltd.**, is being formed by English Electric to consolidate this group's experience and resources in the development and sale of automation systems and equipment. The chairman of this new management company is E. Eastwood, C.B.E., Ph.D., M.Sc., M.I.E.E.

**Wessex Electronics Limited** have moved to new offices at Royal London Buildings, Baldwin Street, Bristol 1. Telephone Bristol 26952.



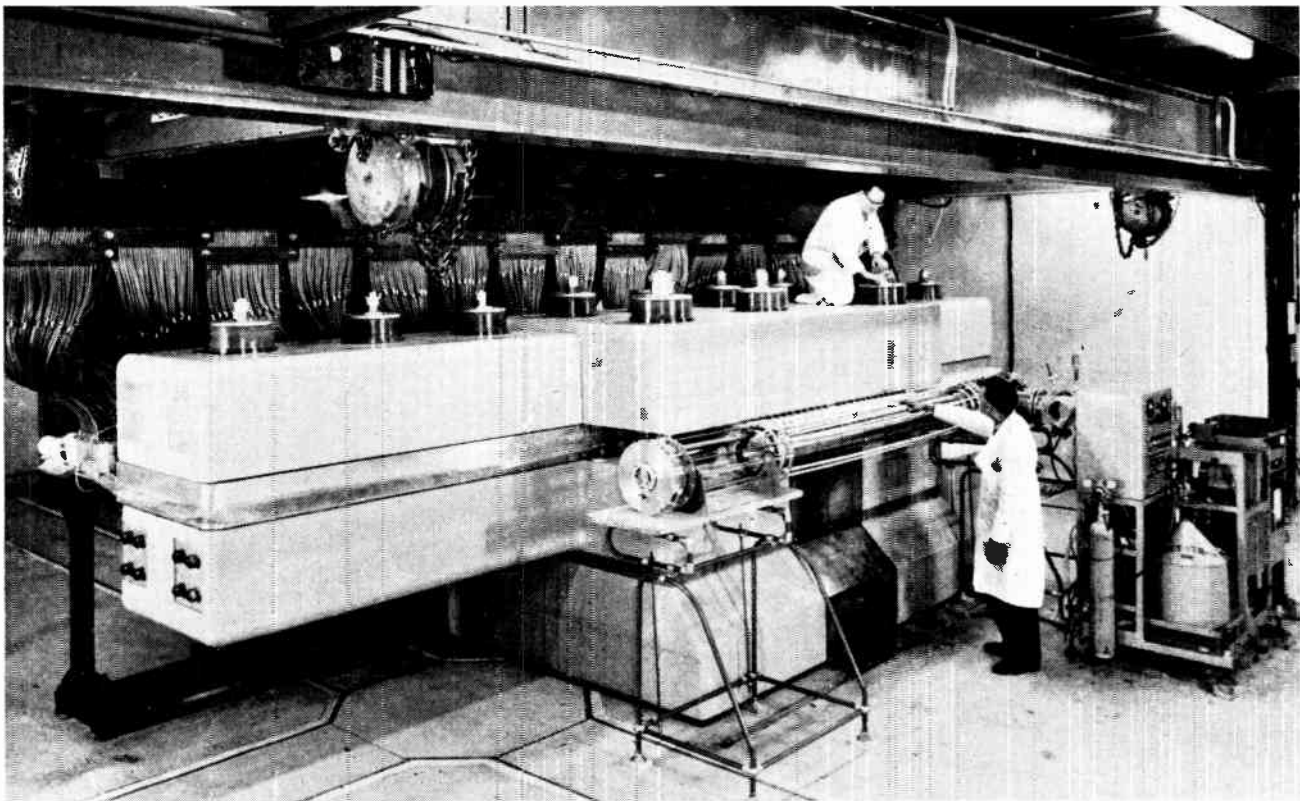

**THE THETATRON EXPERIMENT.**—Research at the U.K.A.E.A.'s Culham Laboratory is aimed at the controlled release of power from nuclear fusion. This Thetatron experiment is one of its largest assemblies. The two concrete blocks (centre), which sandwich the current collector plates, are encased in frames filament-wound with glass fibre and Scott Bader 'Crystic' polyester resin. The ultimate designed strength of the casing was taken as 20,000 p.s.i.

Hysol Corporation of New York have now opened offices in the U.K. at Corney Road, Chiswick, W.4, under the name of **Hysol International**. They offer to the electronics/electrical power industry a complete range of epoxy and urethane electrical insulating materials for the impregnating and encapsulating of all types of electrical components.

**British Aircraft Corporation** announces that an Industrial Products Group has been established within the Stevenage works of its Guided Weapons Division. The Group is engaged in the design and manufacture of automatic test equipment, computer and data handling equipment, servo control equipment and industrial instrumentation.

**Zuse KG of Bad Hersfeld, Germany**, manufacturers of programme-controlled digital computers, has been taken over by **Brown, Boveri & Cie A.G. of Mannheim**, but will continue to operate as an independent company within the Brown Boveri group.

On the acquisition by **Marconi Instruments Limited**, St. Albans, of a controlling interest in W. H. Sanders (Electronics) Limited, Stevenage, R. E. Burnett and S. G. Spooner have been elected directors, the former being appointed chairman of the board of directors.

**Process Pneumatics Ltd.**, who hold large stocks of filters, regulators and lubricators as well as air cylinders, valves and compressors, have now moved to larger premises at Process House, Catherine Grove, London, S.E.10. (Telephone: Tideway 8161).

**S. Smith & Sons (England) Ltd.** announce the formation of a new organization to be known as Kelvin Electronics Co., which will promote specialised electronic instrumentation and control systems for industrial applications. The main products of the new company are: ultrasonics and other non-destructive test apparatus, recording and laboratory test equipment, boilerhouse instrumentation and process control and data-handling equipment.

**BUOYS FOR OCEAN SURVEY.**—Maritime nations have recently shown considerable interest in oceanographic surveys, in order to improve their knowledge of the behaviour of ocean currents, salinity and temperature. Such surveys require a large number of underwater observations to be made. Up to the present, these have been done by lowering suitable instruments into the water from ships, but this tends to be an expensive and slow method. Now from **EMI-Cossor Electronics Ltd.** of Dartmouth, Nova Scotia, has come this device. It is a vehicle for gathering underwater data for recording or relaying to a monitor ship, aircraft or shore station. It consists of a sub-surface float containing the measuring equipment, which is moored to the bottom by a taut wire. A slack rope carrying the electric cables links this float with a surface buoy containing the radio and recording equipment. Buoys can remain on station for many months and one ship could monitor a large number of buoys, so effecting a considerable saving in expense and time.

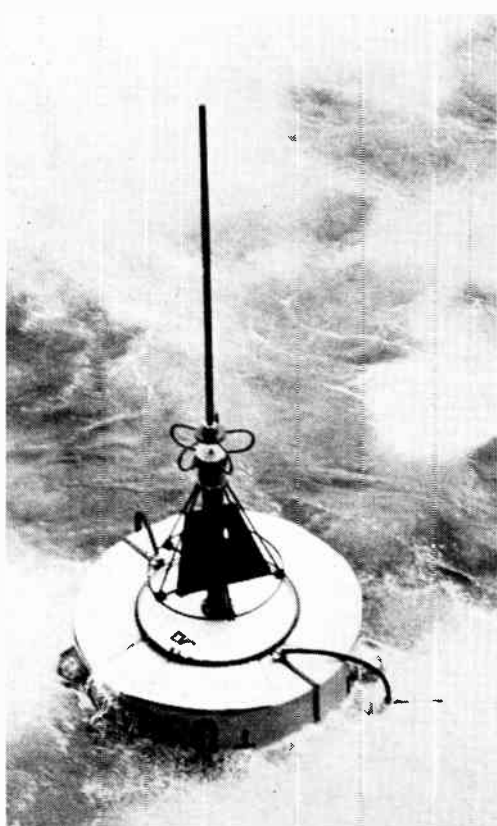

### Plessey Launches New Components Group

The first major step in Plessey's planned realignment of resources has been announced recently. Later this year a new Components Group is to be formed.

This new Group will handle the wide range of component activities currently carried on by four Plessey subsidiaries: Plessey-UK Ltd., Garrard Engineering Ltd., Semiconductors Ltd., and Ericsson Telephones Ltd.

It will comprise 22 decentralized companies and divisions producing among them thousands of different components in the electrical, electronic and electro-mechanical fields.

### Transatlantic Communication at 2,500 Words per Minute

Equipment has recently been installed in the Victoria Street head office of Esso Petroleum which will raise the speed of transatlantic communications more than twenty-five times. Up to now, using the conventional teleprinter machines, day-time transmission of messages between London and New York has been at the rate of 100 words per minute; but with the new equipment—the first commercial installation of its kind in Europe—messages are stored in a magnetic tape memory and are later transmitted in ten to fifteen minute bursts at a rate of more than 2,500 words/min.

Under the old system the estimated traffic of 25 million words for this

**INDUSTRIAL X-RAY SERVICE.**—A radiologist of Palmer Aero Products preparing a magnesium-alloy aircraft wheel for X-ray examination. The installation comprises several units for light alloys and heavy metals. Castings up to a maximum section thickness of 6 inches of steel can be examined. This industrial X-ray service is available to outside clients, both in the test house at the Palmer factory in Penfold Street, London, N.W.8, and in the form of mobile units

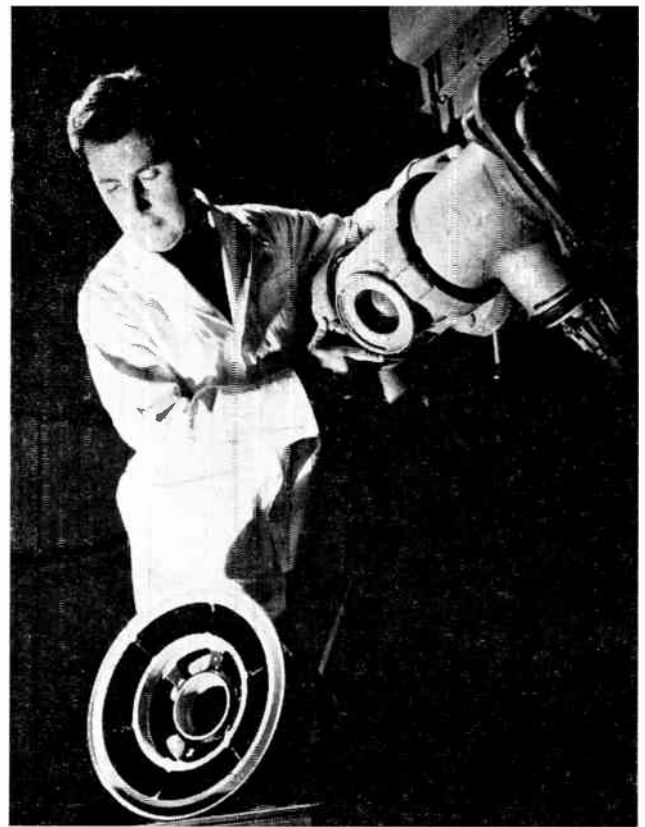

year would have taken 4,300 hours of cable transmission time; with the new equipment the period will be reduced to 172 hours, resulting in a significant saving in costs.

The equipment is manufactured by Data Communications Inc. and contained in a cabinet approximately 68 in. high, by 24 in. deep, by 44 in. wide. It consists of four magnetic tape storage units (called Databanks), each comprising a 200-ft endless loop of tape which can store 120,000 characters and moves at 7½ in./sec during transmission. The transatlantic circuit is

provided by Western Union International in conjunction with the G.P.O.

### Integrated Circuits from Northern Ireland

It is announced that Centralab Ltd., a recently established Anglo-American Company, is to start production at Antrim, Northern Ireland, of electronic components. These are integrated miniature electronic circuits for radio and television sets, tape recorders and computers and will provide multi-component packs of the same reliability as those used in rockets, at prices competitive with those of components currently made in Britain; a wide range of ceramic capacitors will also be made and factory construction should be completed early next year.

This news reflects the growing attraction of the electronics industry to Northern Ireland where other firms making domestic or industrial electronic equipment include I.C.T., Short Bros. & Harland, S.T.C. and Grundig.

### Roton-Vactric Europa Test Laboratory Opened

Rotron-Vactric Europa, the operating subsidiary of Vactric Control Equipment, announces that the new aerodynamics laboratory constructed at Breda in the Netherlands is now operating.

It provides an advisory service to match the most suitable air-moving device to electronic or industrial equipment which requires cooling or ventilation.

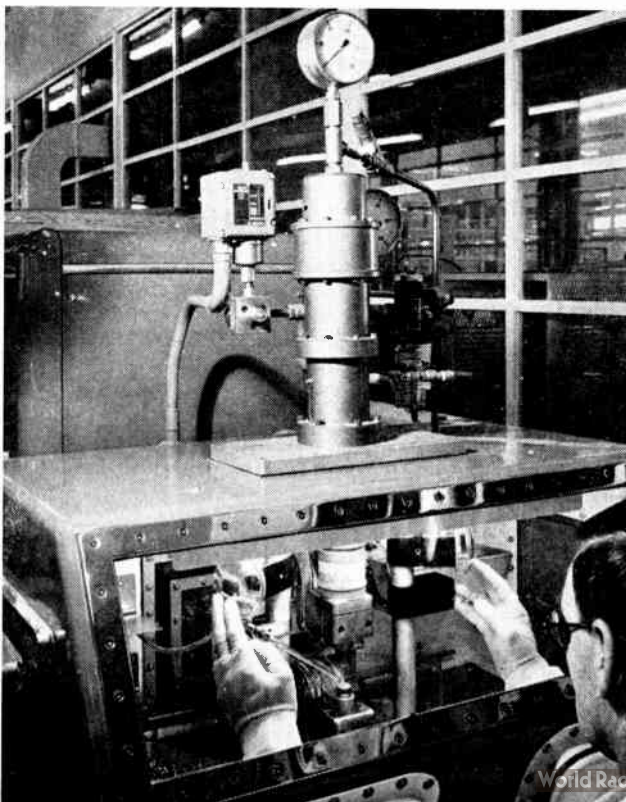

### PROJECTION WELDING SPEEDS TRANSISTOR PRODUCTION.

— Projection welding of a transistor can be carried out at Ferranti Ltd. The operation is performed in a controlled dry nitrogen atmosphere, ensuring permanent stability of dice surface conditions. This machine which uses a two-stage ram is capable of making a large number of high quality welds (welding cycle: 7 sec) and has been sold to other semiconductor manufacturers in the U.K.





## NEW BOOKS

### **The Radio Amateur's Handbook 1965**

Pp. 700. Compiled and published by the American Radio Relay League, Newington 11, Connecticut, U.S.A. Price \$5.50.

The forty-second edition of *The Radio Amateur's Handbook* continues to be the standard manual of amateur radio communication, construction and design. It is revised in the light of current needs as a radio construction manual, reference work, and training text for class or home study.

The chapters on the theory of radiocommunications have been brought up to date and material on equipment construction has been revised to include new designs. There are transmitters and receivers for every level of cost and constructional ability, for every amateur frequency range, and for special purposes such as mobile and portable operation. Theory and constructional material is included for other important amateur station equipment such as test and measuring instruments, and antennas.

Special communications methods such as sideband and teletype are treated in sufficient detail to allow students to understand the basic principles; and suitable equipment is described. Theory and practice of American amateur mobile radio equipment is covered, and the use of transistors and other semiconductors is included whenever applicable.

The chapter on valves and semiconductor characteristics and valve base diagrams has also been brought up to date.

### **Closed-Circuit Television Handbook**

By LEON A. WORTMAN. Pp. 286. W. Foulsham & Co. Ltd., Yeovil Road, Slough, Bucks. Price 42s.

This is an American handbook on closed-circuit television. It is written in an easy-to-understand manner and serves as a guide to the potential user. The basic principles of c.c.t.v. systems are explained and illustrated. The equipment requirements, from a simple system using one camera and one monitor to exotic systems, are explained.

Throughout the book the systems and equipment described are of American design and manufacture. However this does not detract from its usefulness since there are many British and Continental companies producing first-class closed-circuit television equipment.

### **Instruments Electronics Automation Year Book and Buyers' Guide**

Edited by T. G. WILLIAMS. Pp. 568. Published by Morgan Brothers (Publishers) Ltd., 28 Essex Street, London, W.C.2. Price 50s.

This is the first edition of this annual. The publisher's aim in producing this most useful reference book is 'to provide a comprehensive work of reference covering the related fields of instruments, electronics and automation for use by technical and commercial departments in industry and those engaged in research'. As far as is possible in 568 pages this aim has been met.

The book is arranged in six major sections headed: Manufacturers' Addresses; Buyers' Guide; Illustrated Products; Who's Who; and Trade Names, Association Addresses and Equipment Surveys.

### **Linear Analysis of Electronic Circuits**

By G. M. GLASFORD. Pp. 580 + vii. Addison-Wesley Publishing Co., Inc., Reading, Massachusetts, U.S.A., and 10-15 Chitty Street, London, W.1. Price £5 13s.

The author, currently Professor of Electrical Engineering at Syracuse University, developed this text for a fundamental course in electronic circuits. It provides the technical background necessary for the analysis and design of electronic circuits and deals extensively with those aspects which lend themselves to linear analytical techniques.

### **Probability and Information Theory with Applications to Radar: 2nd Edition**

By P. M. WOODWARD. Pp. 136 + x. Pergamon Press, Headington Hill Hall, Oxford. Price 35s.

### **Pulse Generators in Industrial Electronics**

Edited by SHELDON LITWIN. Pp. 128 + viii. Originally published in the U.S.A. by John F. Rider. Published in the U.K. by Iliffe Books Ltd., Dorset House, Stamford Street, London, S.E.1. Price 16s.

This book provides an introduction to pulse generators and wave-shaping circuitry using transistor, diode and valve design. The circuits are analysed in a step-by-step manner which can be readily understood by readers.

No particular academic course is aimed at in this book, but readers with a knowledge of basic electronics will gain most information from it.

### **The Electronics Book List**

Edited by G. W. A. DUMMER and J. MACKENZIE ROBERTSON. Pp. 147. United Trade Press Ltd., 9 Gough Square, Fleet Street, London, E.C.4. Price 20s.

This is a list of over 1,000 titles classified under 50 different subject headings.

### **Textbook of Algebra**

By G. CHRYSAL. Vol. 1, pp. 584 + xxii, Vol. 2, pp. 628 + xxiii. Chelsea Publishing Co., 50 E. Fordham Road, N.Y. 68, N.Y., U.S.A. Price (both volumes) \$4.70 (paper), \$7.90 (cloth).

The book starts with the fundamental laws and processes of algebra but it is not intended for the use of absolute beginners. Vol. 2 starts with permutations and combinations and ends with probability.

### **Lectures on Magnetoionic Theory**

By K. G. BUDDEN. Pp. 82. Blackie & Son Ltd., 5 Fitzhardinge Street, Portman Square, London, W.1. Price 30s.

### **Energetic Processes in Follow-up Electrical Control Systems**

By A. A. BULGAKOV. Pp. 126 + xii. Pergamon Press Ltd., Headington Hill Hall, Oxford. Price 40s.

This book deals with closed-loop systems under sinusoidal operating conditions. Where a non-linear element occurs the fundamental component of the output is taken as the output response. The treatment is mathematical.



### **Diodes et Transistors utilisés en Commutation.**

By R. LYON-CAEN. Pp. 329 + x. Masson et Cie., 120 Boulevard St. Germain, Paris VIe. Price 69 F.

Written in French, primarily for electronic engineers, researchers, teachers and students, the first half of the book discusses the manufacture and properties of crystal structure and semiconductors, with chapters on diodes and transistors following.

The emphasis throughout is on semiconductor theory and methods of measuring characteristics and the final chapters discuss the application of semiconductors in switching circuits.

### **Acoustique et Electroacoustique, Vol. 1.**

By JEAN-JACQUES MATRAS. Pp. 271. Editions Eyrolles, 61 Boulevard St. Germain, Paris Ve. Price (including postage and packing) 30.14 F.

The first of two volumes which analyses the propagation, perception and production of sound. Stress is laid upon new theories deriving from recent studies in telecommunications and a full mathematical treatment balances a more descriptive discussion. The book, in French, is bound in soft covers and has many illustrations, drawings and graphs. The previously published second volume deals with loudspeakers, microphones, recorders and reproducers of sound and architectural acoustics.

### **Solar Plasma Geomagnetism and Aurora**

By SYDNEY CHAPMAN. Pp. 141. Blackie & Son Ltd., 5 Fitzhardinge Street, Portman Square, London, W.1. Price 32s 6d.

### **Measurements of the Electrical Properties of Electronic Tubes and Valves : Part 7**

I.E.C. Publication 151 : Part 7. Pp. 13. Available from British Standards Institution, 2 Park Street, London, W.1. Price 10s.

In the series of I.E.C. Publications 151, Part 7 has now been prepared. This gives methods of measurement of equivalent noise resistance of electronic tubes and valves due to shot effect and partition noise. The methods are based on current practice in the measurement of equivalent noise resistance.

### **Data Acquisition and Processing in Biology and Medicine, Vol. 3.**

Edited by K. ENSLEIN. Pp. 344 + ix. Pergamon Press Ltd., Headington Hill Hall, Oxford. Price £5.

This book comprises the Proceedings of a Conference held in Rochester, U.S.A., in 1963.

## **Manufacturers' Literature**

**Manually Preset Indicating Controller.** To measure liquid volumes in separate batches a presettable controller has been designed which can be fitted to any of the Parkinson Cowan 'S' type industrial liquid meters—for use on water, chemicals, petroleum derivatives and food products up to 200 °F (93 °C) in temperature. Periodic total readings are possible, batch completion is automatically controlled and remote visual or audible alarms can be provided.

*Parkinson Cowan Measurement, Terminal House, Grosvenor Gardens, London, S.W.1.*

**For further information circle 45 on Service Card**

**Precision Tubes.** The present trend in the development of specialized metal tubing, including a description of some of the metals and their properties, is outlined in this well-illustrated 84-page booklet produced by

*Accles & Pollock Ltd., Oldbury, Birmingham.*

**For further information circle 46 on Service Card**

**Permanent Magnets for Repulsion Devices.** The aim of this 9-page technical bulletin, No. 4 in a series on permanent magnets, is to give a general idea of the scope and limitations of magnetic repulsion devices and to indicate the broad principles of their design.

*Permanent Magnet Association, 301 Glossop Road, Sheffield, 10.*

**For further information circle 47 on Service Card**

**Polarized Relays.** A 3-page leaflet on the range of Siemens & Halske polarized relays, which illustrates the five main types with brief technical details, may be obtained from

*B & R Relays Ltd., Temple Fields, Harlow, Essex.*

**For further information circle 48 on Service Card**

**Lecture Demonstration Equipment, General Thermionics.** This 12-page publication describes a comprehensive range of modular demonstration-panel teaching aids covering basic valve applications in communications, radar, control and pulse circuitry. Details are also given of accessories used for panel interconnection, component changes, fault-finding exercises, etc.

*Philco International Ltd., South Street, Bishop's Stortford, Herts.*

**For further information circle 49 on Service Card**

**EICO 1965 Short Form Catalogue.** This 48-page 2-colour short-form catalogue features hi-fi/stereo components, test instruments, radio-telephones, amateur radio equipment, etc., manufactured by

*EICO Instrument Co., Inc., 131-01 39th Avenue, Flushing, New York 11352, U.S.A.*

**For further information circle 50 on Service Card**

**Industrial Planar Selector.** An 8-page brochure tabulating the range of silicon planar diodes, transistors and integrated circuits available for equipment design where germanium devices were previously necessary. Their benefits include high junction temperature ratings, low leakage current and guaranteed long term stability. Useful multi-lingual descriptions of technical symbols are appended.

*S.G.S. Fairchild Ltd., 23 Stonefield Way, Ruislip, Middlesex.*

**For further information circle 51 on Service Card**

**Miniature Components.** A large selection of technical data sheets may be obtained which include the features, sizes, weights and mountings of an extensive range of small d.c. and a.c. motors, transformers and switches. Drawings, graphs and performance tables are provided to make for easy reference and motors can be designed to customer's individual requirements.

*E.M.I. Sound Products Ltd., Component Division, Blyth Road, Hayes, Middlesex.*

**For further information circle 52 on Service Card**

**Precision Resistor Selector Chart.** A handy, finger indexed booklet enabling a speedy choice of resistor to be made according to a range of criteria: resistance tolerance, minimum inductance, dimensions, long term stability, temperature coefficient, etc.

*Alma Components Ltd., Park Road, Diss, Norfolk.*

**For further information circle 53 on Service Card**

**Sweep Generators.** A series of numbered reference sheets outlining the various applications to which sweep generators may be put, e.g., frequency identification, r.f. voltage detection, measurement of power supply dynamic impedance, etc. Clear diagrams and typical tube displays are given.

*Livingston Laboratories Ltd., 31 Camden Road, London, N.W.1.*

**For further information circle 54 on Service Card**

# Extended range of EEV Ignitrons now available with coaxial construction

All Ignitrons with the International size letters A to D in the range manufactured by

**English Electric Valve Company Limited**

at Lincoln, can now be supplied in co-axial construction form. This range, already established as the

most comprehensive in Europe, is now extended to incorporate those Ignitrons previously available from The English Electric Company at Stafford: these will continue to be available under their original type numbers. (AR10T, AR14T and AR31).

INTERNATIONAL SIZE LETTER	EEV TYPE NO.	AMERICAN† EQUIVALENT	APPLICATION
A	BK66 (AR31)	5550	A.C. resistance welding
B	BK42 (AR14T) BK442 *	5551A 7669	
C	BK24 (AR10T) BK168 BK444*	5552A 5822A 7671	
D	BK146	5553B	
C	BK44	5554	Power rectification and control
D	BK46	5555	
A	BK416 BK428	7703 —	Capacitor discharge
D	BK178	—	
E	BK194	—	

† These equivalent type numbers are usually prefixed with the identifying code letters of the manufacturer concerned.

\* Co-axial construction.



Full information on the complete range of Ignitrons available from EEV may be obtained from the address at the foot of the page. Enquiries from Government departments and overseas customers should be directed to the Sales Department, Chelmsford, Essex, England, Telephone: Chelmsford 3491 (Ext. 262) Telex: 99103, Telegrams: Enelectico, Chelmsford.

**ENGLISH ELECTRIC VALVE COMPANY LIMITED**

CARHOLME ROAD, LINCOLN, ENGLAND. Telephone: Lincoln 26352

Telex: 56114, Telegrams: Enelectico, Lincoln | AGENTS THROUGHOUT THE WORLD

**EEV**

AP239

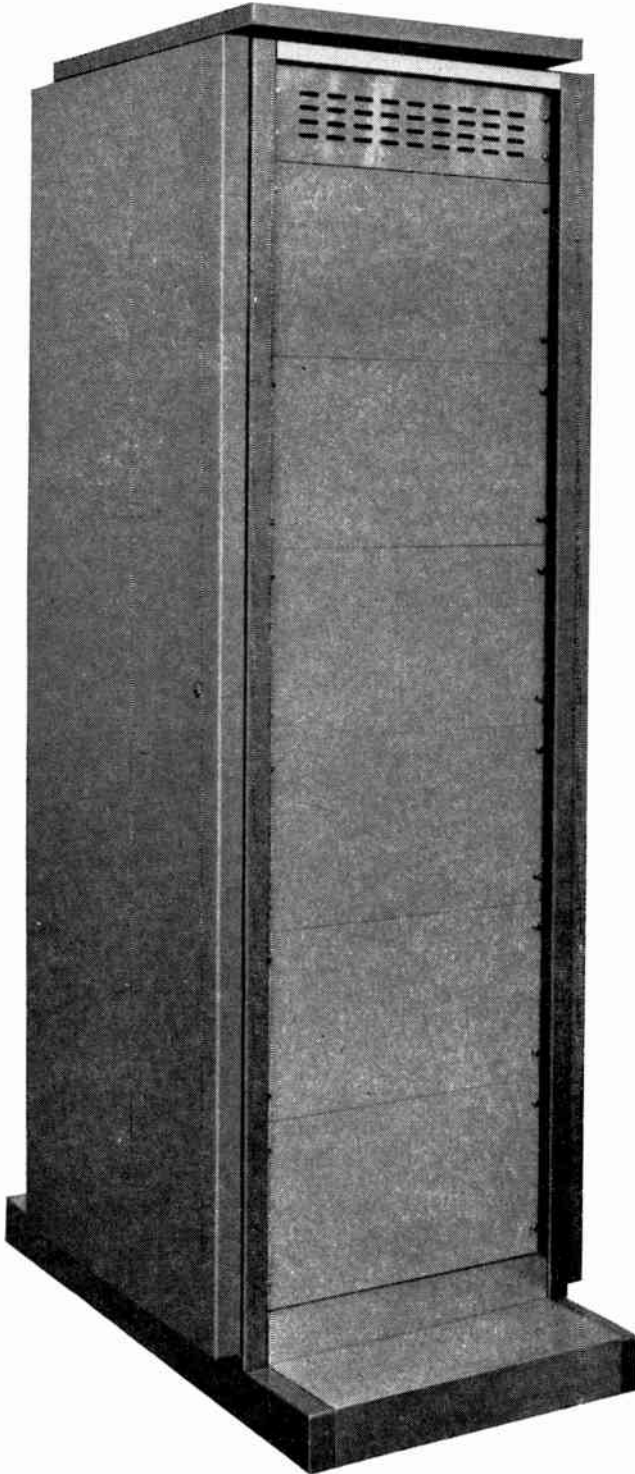

# SQUARE FORM IMRAKS

at no extra cost

This new "square" form of styling is now available, as an optional alternative to the existing "radiused" design, on 95 models in the International Series of Imraks. These include all sizes of cubicle, enclosed, totally enclosed, induced ventilation and forced ventilation racks. When you buy any of these Imraks, you can choose the type of styling you prefer . . . at no extra cost!

On all but induced ventilation racks, these new square form racks have an attractive raised "mushroom" top to allow adequate ventilation (on induced ventilation racks the top is fitted in direct contact with the rack). These new style Imraks do, of course, still provide all the facilities offered by this versatile racking system, such as: choice of panel mountings, shortened doors, meter panel units, castors, lifting eyes, desk and drawer units, blowers, etc

A new range of low cost mobile bases and fixed plinths, designed to match the styling of the square form Imraks, has also been introduced with a model to suit each plan size of rack

Send today for full details and information on other new Imhof products

other new products include

new Imrak withdrawable desk units mounted on ball bearing telescopic slides, new small cases including carrying cases, new sizes of 600 series cases, new sizes of 1520 and 1550 cases, new induced ventilation fan units, new chassis runners, 18 new handles and paper protected aluminium panels

**IMHOFS**

Dept. No. 2/6 Ashley Works  
Cowley Mill Road Uxbridge Middlesex  
Telephone Uxbridge 37123 Telex 24177  
Telegrams IMCASE-UXBRIDGE-TELEX

**Alfred Imhof Limited**

Agents in Algeria Australia Belgium Brunei Canada Denmark Finland  
France Germany Holland Iraq Israel Italy Jordan Kuwait Lebanon  
Malaysia Mexico Morocco New Zealand Nicaragua Norway Portugal  
Saudi Arabia South Africa Southern Rhodesia Sudan Switzerland  
Syria Thailand Tunisia U.S.A. Zambia

W.7



# CONTROL

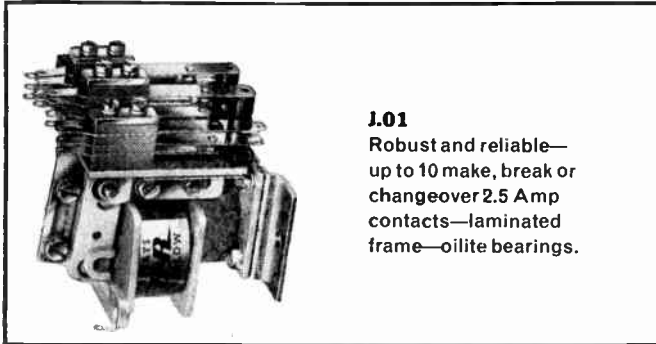

**J.01**  
Robust and reliable—up to 10 make, break or changeover 2.5 Amp contacts—laminated frame—oilite bearings.

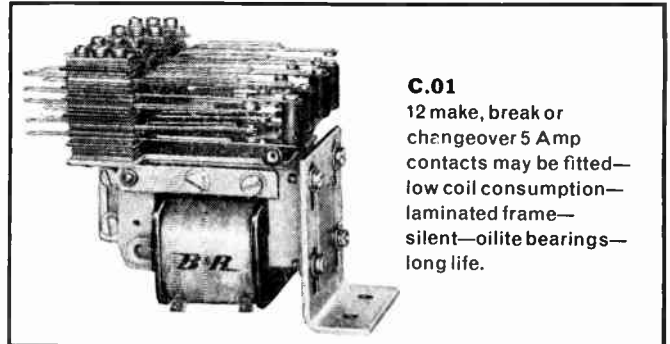

**C.01**  
12 make, break or changeover 5 Amp contacts may be fitted—low coil consumption—laminated frame—silent—oilite bearings—long life.

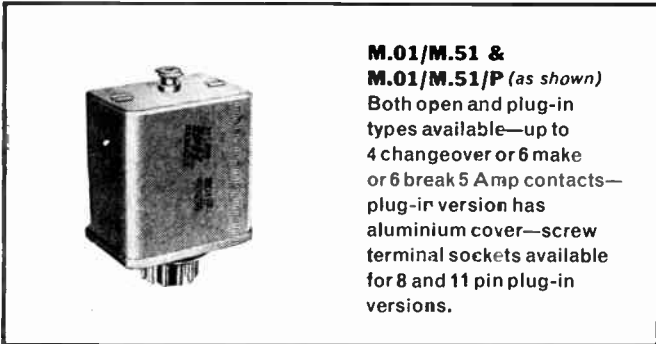

**M.01/M.51 & M.01/M.51/P (as shown)**  
Both open and plug-in types available—up to 4 changeover or 6 make or 6 break 5 Amp contacts—plug-in version has aluminium cover—screw terminal sockets available for 8 and 11 pin plug-in versions.

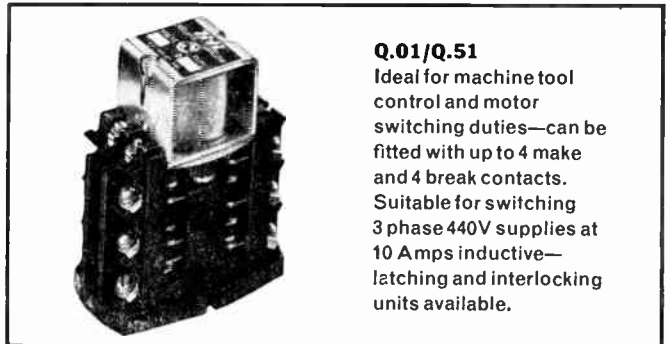

**Q.01/Q.51**  
Ideal for machine tool control and motor switching duties—can be fitted with up to 4 make and 4 break contacts. Suitable for switching 3 phase 440V supplies at 10 Amps inductive—latching and interlocking units available.

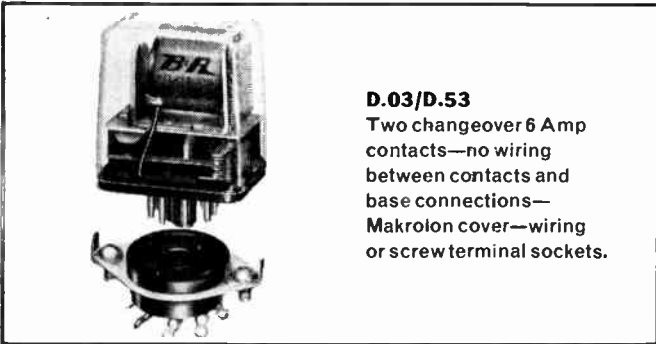

**D.03/D.53**  
Two changeover 6 Amp contacts—no wiring between contacts and base connections—Makrolon cover—wiring or screw terminal sockets.

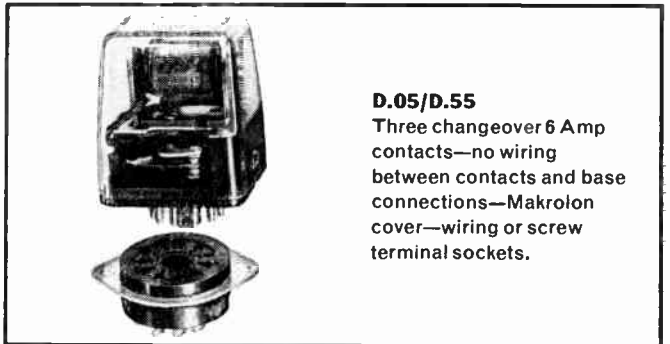

**D.05/D.55**  
Three changeover 6 Amp contacts—no wiring between contacts and base connections—Makrolon cover—wiring or screw terminal sockets.

Control equipment requires versatile and reliable relays. The B. & R. relays shown here have different advantages for different applications, covering all requirements.

If you are concerned with any aspect of control, mechanisation or automation, these relays, which may be supplied for A.C. or D.C. operation, merit your closest attention.

All are well designed, meticulously tested, quality relays.

Write or 'phone for details:

**B & R RELAYS LIMITED**  
Temple Fields, Harlow, Essex. Telephone: Harlow 25231-4. Telex: 81140. Cables: Brelay—Harlow.

*Best in Relays*

between

# 5pF and 250,000pF

## your choice is easy...

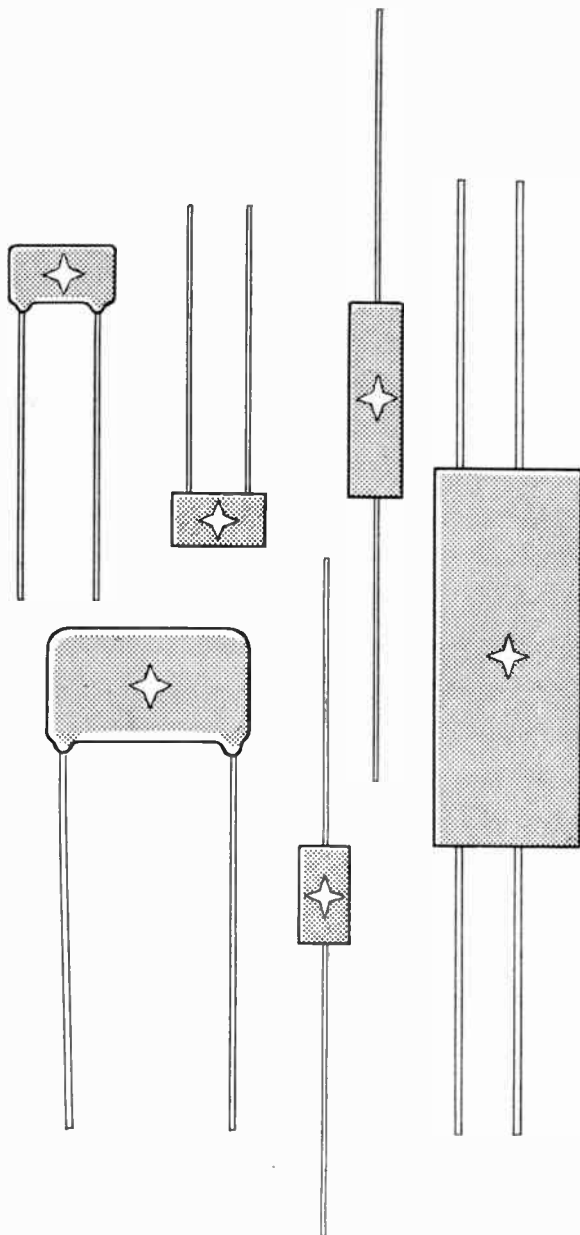

### SILVER STAR CAPACITORS

## cover all your needs

The standard range of Silver Star® capacitors contains a wide variety of sizes in encapsulated or dipped finishes. Your needs are covered, for any nominal capacitance value between 5 and 250,000 pF can be supplied—generally with a tolerance as close as  $\pm 0.5\%$ .

All Silver Star capacitors are of fired construction giving them unrivalled stability. A rigid system of process control throughout manufacture ensures that their outstanding electrical properties are consistently maintained.

In addition, every Silver Star capacitor is checked before we send it to you for four critical characteristics—capacitance, power factor, proof voltage and insulation resistance. Only components that meet the stringent Silver Star standards are supplied.



*You can choose your requirements with these free data sheets. Just ask for them.*

## Johnson Matthey

**JOHNSON, MATTHEY & CO., LIMITED**  
**73-83 HATTON GARDEN, LONDON, E.C.1**

**Telephone: Holborn 6989**

**Telex: 21465**

*Vittoria Street, Birmingham, 1*  
*75-79 Eyre Street, Sheffield, 1*

*Telephone: Central 8004*  
*Telephone: 29212*

GD 131

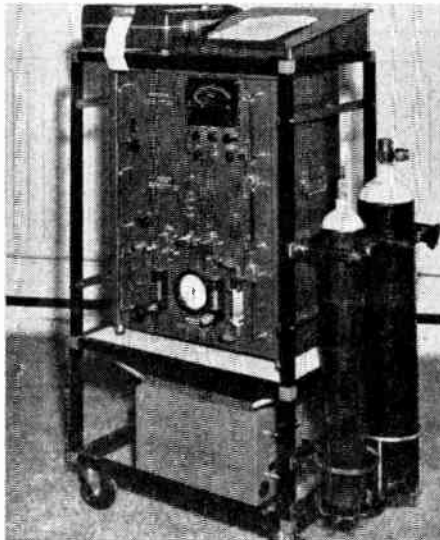
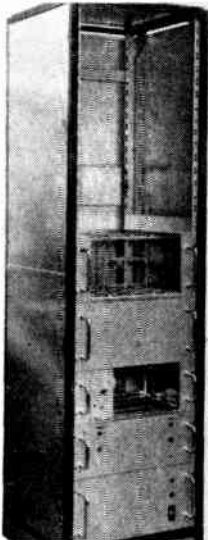
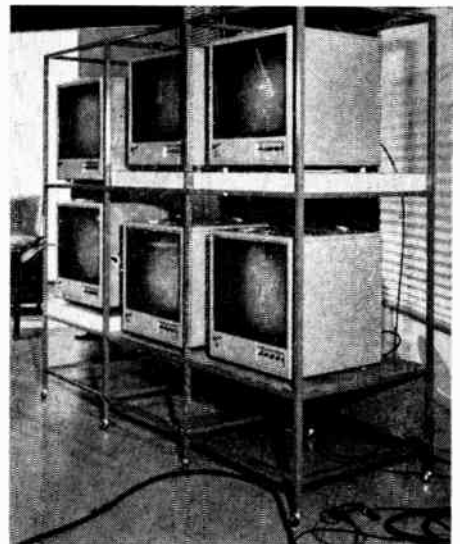
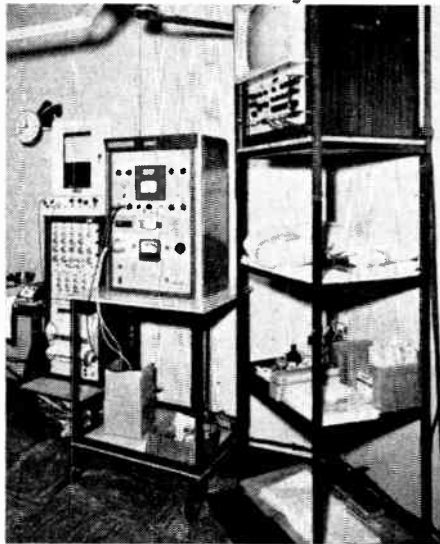

## clean, simple—look terrific

**What's that?** Structures made with Dexion Speedframe system.

**What's it for?** Test consoles and benches; trolleys, switchgear mountings, monitor stands; one-off work units or complete furnishing and equipment projects.

**What's it do?** Gives any-size, rigid square-tube frames in moments (not confined to 90° angles). Tailor-made for every project, yet costs less than ready-made frames!

**What's the catch?** No catch. No welding, bolting, finishing, painting or skill either.

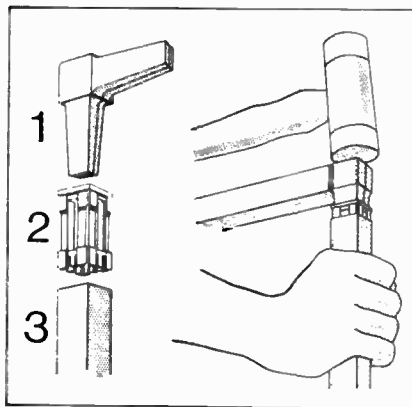

**What's it need?** Very little money to buy it. Perhaps a hack-saw to cut it. A mallet to knock it together.

**The Speedframe joint:**

Made up of three simple components  
**1. casting** which, when hammered into the tube, is wedged by an  
**2. insert** which in turn jams tight inside the  
**3. tube** to keep the joint weld-firm.

**You could do with Speedframe in your next project.** We'll be delighted to send you material specifications, fresh ideas on Speedframe in electronics, further details of Dexion products. Send in the coupon now.

Please send me these booklets immediately.



Name .....

Position .....

Company .....

Address .....

Phone .....

**Dexion Ltd.**

B.214MY.

Speedframe Division,  
 Dexion House, Empire Way,  
 Wembley Park, Wembley, Middlesex.  
 Tel: Wembley 1281



# DOUBLE BEAM COSSORSCOPE 2300

Model 2300 is a compact, precision calibrated oscilloscope designed specifically for high-sensitivity, low-frequency applications in electrical engineering, servo analysis, electro-mechanical transducer displays, electro-myography and electro-cardiography. A double-gun cathode-ray tube is employed. Two identical amplifiers are provided with a choice of either single-ended or differential inputs.

The triggering system provides four modes of operation: Auto, A.C. Slow, A.C. Fast, and D.C., and the sweep may be triggered from any selected point on the positive or negative slope of the signal. Mechanical triggering is available, whereby an external contact closure, developed across the MECH and COMMON terminals of the oscilloscope by the apparatus under test, will trigger the time-base, an external voltage source being unnecessary. Single-stroke operation can be primed or triggered by a push-button.

- Frequency response d.c. to 200 kc/s (-3 dB)
- Identical Y amplifiers 1 mV/cm to 50 V/cm
- 19 calibrated timebase ranges 5 sec/cm to 5  $\mu$ sec/cm
- Voltage calibration  $\pm 3\%$  and time calibration  $\pm 3\%$
- Mechanical triggering Z modulation and equal X-Y facilities



**COSSOR**  
A Member of the Raytheon International Group

**COSSOR INSTRUMENTS LTD.**  
The Pinnacles, Elizabeth Way,  
Harlow, Essex, England.  
Tel: Harlow 26862 Cables: Cossor Harlow

# Versatility

This Fostronic Instrument is capable of measuring temperature, humidity, pH, pressure, gas constituents, etc., and of providing many modes of Control.

*If you have a temperature control problem, we can help you.*

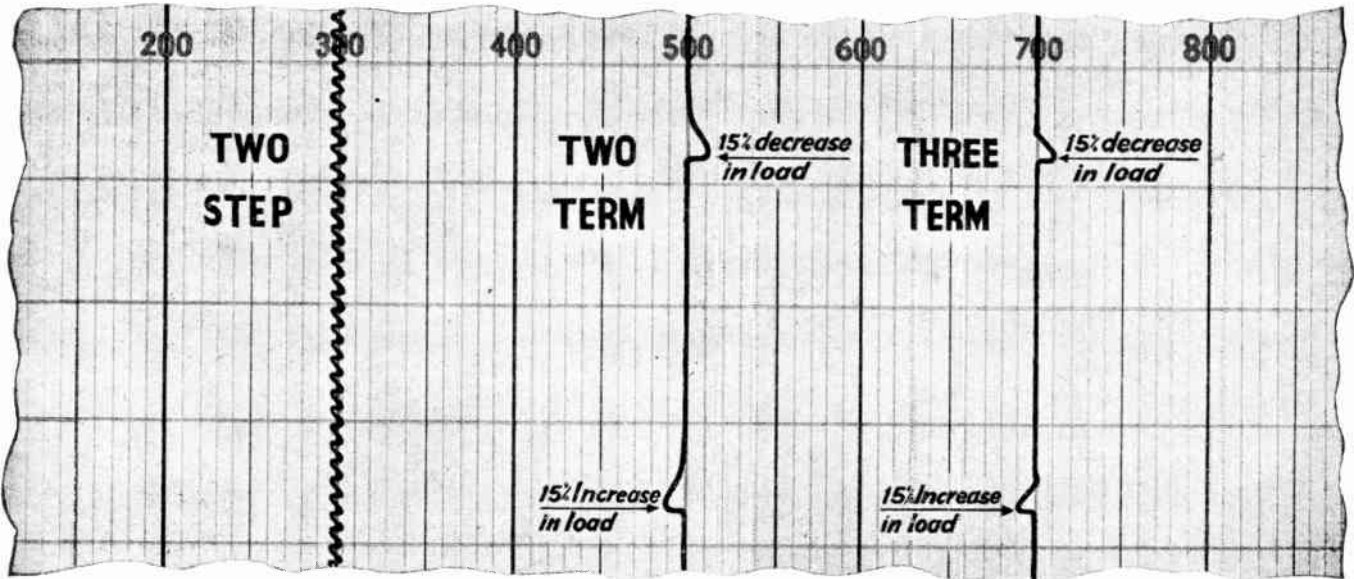
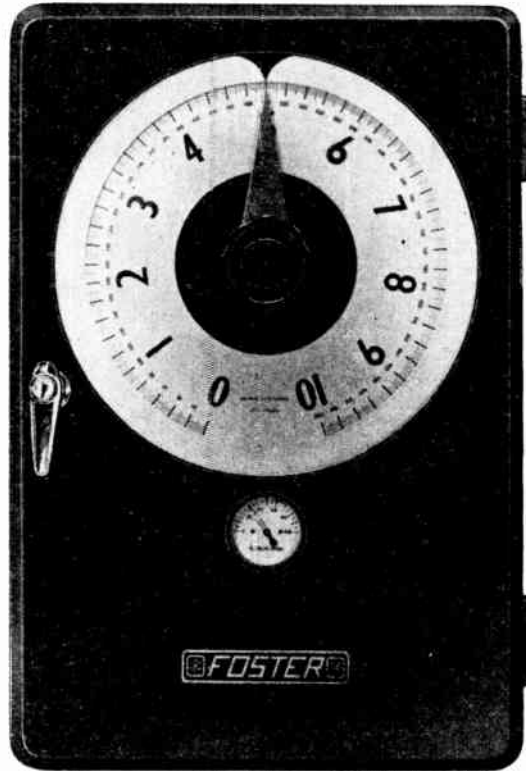

For full details contact :

Actual records of temperature control by Fostronic Instruments



**for temperature measurement and control**

**FOSTER INSTRUMENT CO LTD • LETCHWORTH • HERTS • ENGLAND**

Members of B.I.M.C.A.M., S.I.M.A. and S.I.R.A.

• Telephone : Letchworth 2201 (7 lines)

• Telegrams : Resilia, Letchworth

WT24F(R1)

For further information circle 250 on Service Card

For further information circle 251 on Service Card

# Do you have the LATEST INFORMATION on...

- TECHNICAL DEVELOPMENTS
- NEW PRODUCTS
- COMPANY NEWS
- INVESTMENT PRICE CHANGES
- REPORTS AND DIVIDENDS
- CONTRACTS
- APPOINTMENTS IN INDUSTRY
- FORTHCOMING EVENTS
- DEVELOPMENTS OVERSEAS



Complete weekly survey costs only 1s. 6d.

Week by week **ELECTRICAL REVIEW** reports progress in all branches of electrical technology: generation, distribution, utilisation. It also covers nuclear power technology, describes international advances, discusses latest equipment, techniques, applications. In addition to its technical coverage, **ELECTRICAL REVIEW** provides up-to-the-minute news of commercial developments, marketing policies, and contracts open to tender. As Britain's leading journal in its field, it is essential reading for everyone in the industry and users of electrical equipment. **EVERY FRIDAY.**

To:— **ILIFFE ELECTRICAL PUBLICATIONS LIMITED**  
Dorset House, Stamford Street, London, S.E.1

Please supply **ELECTRICAL REVIEW** each week at a cost of £5.0.0 per annum.

Remittance will be sent on receipt of your invoice.

NAME .....

ADDRESS .....

.....

**OXLEY DEVELOPMENTS CO. LTD**

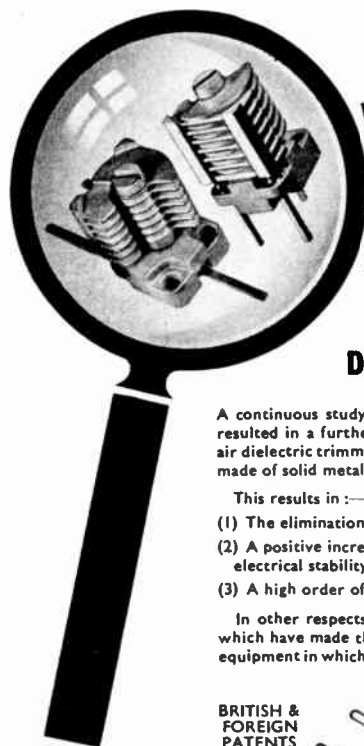

# OXLEY

## SUBMINIATURE AIR DIELECTRIC TRIMMERS

A continuous study in the laboratory and in the field has resulted in a further development in Oxley subminiature air dielectric trimmers, the rotor and the stator both being made of solid metal.

This results in:—

- (1) The elimination of practically all soldered joints.
- (2) A positive increase in mechanical rigidity and improved electrical stability.
- (3) A high order of consistency in capacity.

In other respects the trimmers retain all those facilities which have made them the inevitable choice of professional equipment in which reliability is the dominant requirement.

BRITISH & FOREIGN PATENTS

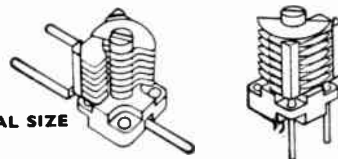

ACTUAL SIZE

Write for technical details of these and other Oxley products  
**OXLEY DEVELOPMENTS CO. LTD., ULVERSTON, LANCASHIRE**

For further information circle 252 on Service Card

NUMBER ONE IN ELECTRICAL CONNECTORS...



## HERMETICALLY SEALED CONNECTORS

High Pressure, High Temperature, Low Leak Types from 1-100 Contacts.

**CANNON ELECTRIC (GREAT BRITAIN) LTD.**  
25-27 Bickerton Road  
Upper Holloway, London, N.19  
Tel.: ARChway 3088





Sensitivity  $40\mu\text{V}(1^\circ\text{C})$

Multi-Million Operational life

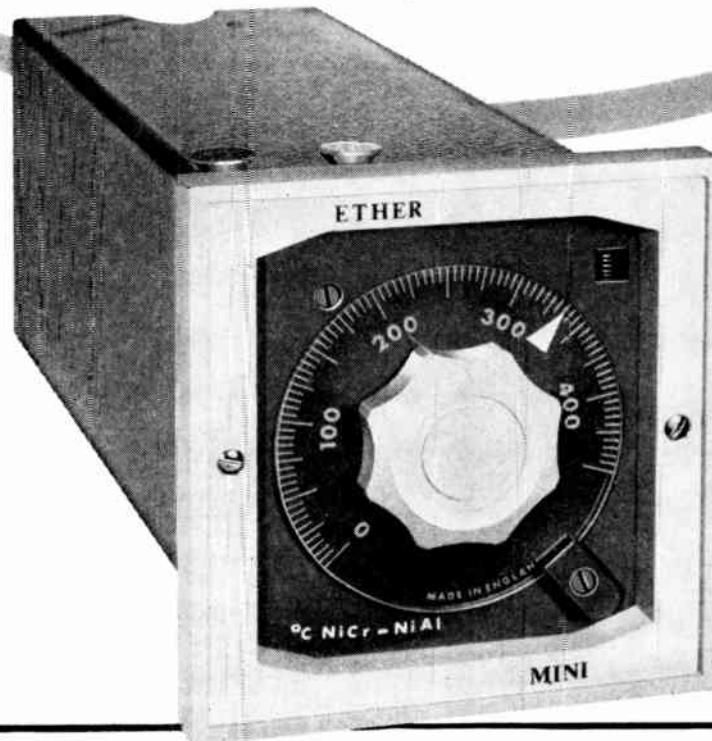

See ETHER on  
**Stand AA655**  
at INTERPLAS  
Exhibition  
OLYMPIA  
June 16-26

**ETHER**

## TRANSISTORISED TEMPERATURE REGULATOR

MINI TYPE 17-90

### *Accurate, Reliable Temperature Control up to $2000^\circ\text{C}$*

The difference signal between the output of a thermocouple and an internal reference voltage is fed to a transistorised amplifier to operate a relay. The relay will operate on an input signal differential of less than 40 microvolts, equivalent to less than  $1^\circ\text{C}$ , with base metal thermocouples, and less than  $2^\circ\text{C}$  with precious metal types. Provision is made for increasing this differential by a factor of 10 where very close control is not required.

The relay has a life expectancy of several million operations at maximum load rating. Set point is adjusted by a precision potentiometer, and read by the position of an illuminated cursor on a calibrated scale. A signal lamp is provided to show the control condition. Standard ranges from £27-10-0.

**ETHER**  
LIMITED

Send for full details to:—

CAXTON WAY, STEVENAGE, HERTFORDSHIRE  
Telephone: Stevenage 3040-55

For further information circle 254 on Service Card

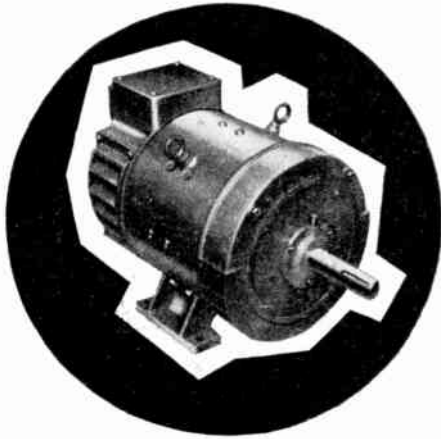

'X' type D.C. motors,  $\frac{1}{2}$  - 40 h.p.

You can't say **DEPENDABLE**  
without **EPE**

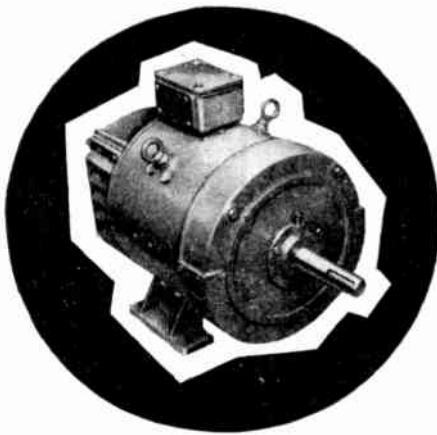

'Y' type D.C. motors,  $\frac{1}{2}$  - 40 h.p.

## D.C. Motors for electronic speed control



THE ELECTRICAL POWER ENGINEERING CO. (B'HAM) LTD.  
EPE WORKS, BROMFORD LANE, BIRMINGHAM 8  
Telephone: STEchford 2261  
Grams: Torque Phone, Birmingham

For further information circle 255 on Service Card

## NEW! ELECTRONIC COMPONENTS

**SMALL BUTTERFLY TYPE TRIMMER**  
C.952  
Capacity 12.8 pF each side  
'015" Gap.  
Can be fitted with locking collar in which case type No. is C.953.

**TUBULAR TRIMMER**  
S.56.12  
P.T.F.E. Dielectric  
30 pF mx.

**AM/FM GANG CAPACITOR**  
C.87.302  
Fitted geared drive.  
Capacity 392 x 15 pF.  
AM only version available.  
Air gap '0125"  
Capacity 326 pF each section.

**STAND-OFF INSULATOR**  
TS.1531  
Peak working voltage 8 K.V.  
Insulation-Sintered aluminium oxide.  
Various terminations available.



### WINGROVE & ROGERS LTD

DOMVILLE ROAD · LIVERPOOL 13  
Telephone: Stoneycroft 2265  
LONDON OFFICE, 75 Uxbridge Road · Ealing · W5 · Tel EALING 7046/7

For further information circle 256 on Service Card

## NEW an invaluable work of constant reference

### ELECTRONICS DATA HANDBOOK

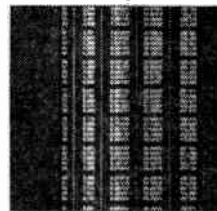

## Electronics Data Handbook

Martin Clifford

The amount of data needed in the study of electronics today is very considerable, and the problem is to be able to find it readily. This handbook, by providing in one volume the formulae most frequently required, reduces the task of locating information. ELECTRONICS DATA HANDBOOK will be invaluable as a work of constant reference for students and technicians alike.

16s net by post 16s 10d  
158pp illustrated

obtainable from  
leading booksellers

Published for

**ILIFFE Books Ltd.**

DORSET HOUSE

STAMFORD STREET

LONDON S.E.1

# THESE FEATURES

AND 19 PAGES OF INTERPRETATIVE NEWS

## Electrically conducting plastics

by J. H. Lupinski, General Electric Research Laboratories, Schenectady, U.S.A. Chemical research has revealed molecules which may provide polymers with new properties.

## Atmospheric re-entry

by J. L. Stollery and J. K. Harvey, Imperial College, London. Astronauts are now using the atmosphere's braking effect to control their descent.

## Physique, personality and disease

by Linford Rees, St. Bartholomew's Hospital, London. Correlations between body size and psychological make-up appear to be scientifically valid.

## The Earth's upper mantle

by T. F. Gaskell, British Petroleum Co Ltd. Convection currents in its plastic layer could explain continental drift.

## Fluidized beds

by P. N. Rowe, U.K. Atomic Energy Authority. They provide effective means of heat exchange and of bringing chemicals into contact.

## Thermoluminescence

by M. J. Aitken, Oxford University. A solid state phenomenon used for measuring radiation dose and dating pottery.

## The inheritance of behaviour

by P. L. Broadhurst, University of Birmingham. Laboratory studies with rats show how emotional behaviour is inherited.

## Automatic fact retrieval

by W. S. Cooper, University of Erlangen, West Germany. A machine to answer questions about stored information poses problems of linguistics and logic.

SCIENCE JOURNAL brings the new answer to the problem of keeping posted across the whole field of scientific and technological progress. Every month it interprets the forward thinking of each discipline for those working in others.

**superbly produced, profound yet immensely readable**

# SCIENCE JOURNAL

OUT 26 MAY 4s.

FROM ILIFFE  
FOR PROGRESS  
IN SCIENCE AND  
TECHNOLOGY



**RAYTHEON**

# TWO WATT PHOTOCELL

THE '5M' SERIES—  
NEWEST ADDITION TO THE  
CLAIREX RANGE OF  
PHOTOCELLS

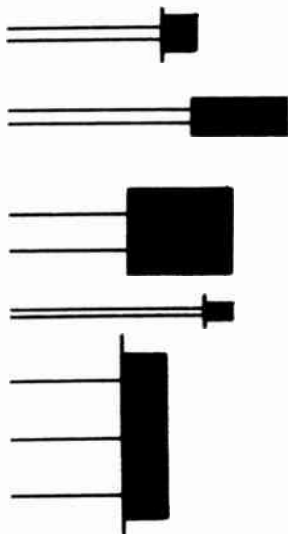
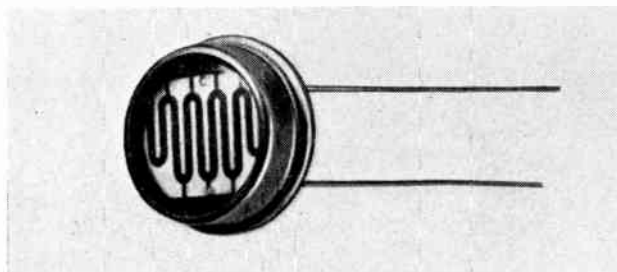

**OVER 50 STANDARD  
TYPES**

**6 PACKAGE TYPES**

**6 STANDARD  
SENSITIVE  
MATERIALS  
CdS and CdSe**

### SOME INTERESTING FEATURES

Type 3C material (CdSe) developed specifically for photo-choppers:— rise time <math><0.4\text{ msec}</math>, fall time <math><3.0\text{ msec}</math>.

CL 703 series—dual element types.

Type 5 material matches response of the human eye.

Small size series—T018 transistor can.

*Send for copy of 16 page catalogue*

# WALMORE

**ELECTRONICS LTD**

11-15 BETTERTON ST., DRURY LANE, LONDON, WC2 Tel: TEMple Bar 0201-5



## ● RUBBER ACCESSORIES

Ask for Cat. No. MEI/62C/IE

**METWAY • KEMP TOWN • BRIGHTON 7**



the world's guide  
to the British  
plastics industry

# British Plastics YEAR BOOK 1965

The recognised guide to the plastics industry—its products, suppliers, materials, leading executives. Carefully revised for this 35th edition, it is complete, compact and fully up-to-date. It makes precise information on any aspect of the industry available to you at a moment's notice.

The information is contained under 11 sections: General: Materials: Manufactured Products: Services: Plant: Trade Names: U.K. Addresses: Overseas Addresses: Who's Who: Technical Data: Indexes.

50s net by post 53s 3d 9¼ ins. × 6¼ ins. 650 pp.

obtainable from leading booksellers

Published for British Plastics by  
**ILIFFE Books Ltd.**

DORSET HOUSE STAMFORD STREET LONDON S.E.1

*Industrial Electronics June 1965*

For further information circle 261 on Service Card

For further information circle 264 on Service Card

## INEXPENSIVE & RELIABLE

Remember the name — EMI Shaded 2 Pole Motor Type Z. Consider the reliability — over 3,000 hours running without re-oiling — able to withstand continuous mechanical overload. Send for the Type Z data sheet.

■ Geared motor — approximate speeds 2,900 r.p.m. geared down to 16 r.p.m. ■ Low resistance rotor with copper bars and end plates. ■ Rotor has critically skewed bars for smooth running—dynamically balanced to special limits where required. ■ Sizes approx.  $2\frac{1}{2}'' \times 3'' \times 1\frac{3}{4}''$ . ■ Weight  $17\frac{1}{4}$  oz. (standard), 21 oz. (Long Bearing A Motor). ■ Low mechanical noise — no electrical interference.

## EMI SHADED 2 POLE AC MOTORS

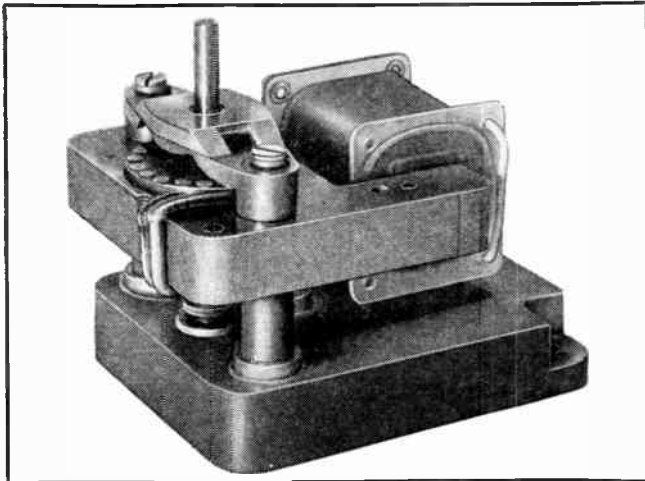

Full details from:  
**EMI SOUND PRODUCTS LIMITED, COMPONENTS DIVISION, HAYES MIDDLESEX.**  
TEL.: HAYES 3888 · EXT. 2515

For further information circle 262 on Service Card

## VITALITY BULBS

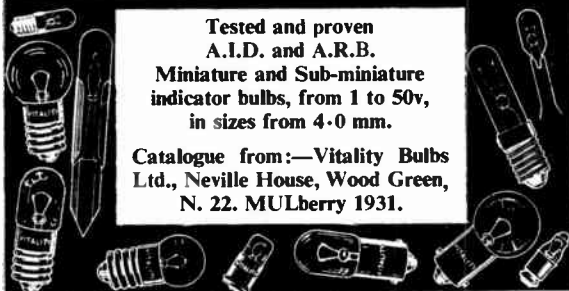

Tested and proven  
A.I.D. and A.R.B.  
Miniature and Sub-miniature  
indicator bulbs, from 1 to 50v,  
in sizes from 4.0 mm.

Catalogue from:—Vitality Bulbs  
Ltd., Neville House, Wood Green,  
N. 22. MULberry 1931.

For further information circle 263 on Service Card

## ELECTRONICS PRINTED CIRCUITS

An extremely comprehensive service is available to industry which is unique in its scope and unprecedented in its quality of workmanship and speed of service while at the same time giving that all important individual attention and very competitive price terms that every buyer seeks.

The service consists of inclusive facilities for the design, development, and large scale production of all types of electronic equipment, instruments, etc., together with all processes involved in the design, development and production of printed circuit boards.

The unique location of T.E.S. Ltd., allows this first class service, which is to be found nowhere else, to be brought to your doorstep by an almost daily transportation service to 100 miles all for the price of a telephone call. Shanklin 3096.

Special attention will be given to very welcomed enquiries from customers outside the U.K.

**TRANSMETRIX ELECTRONIC SYSTEMS LTD.**  
Hyde Works, Shanklin, Isle of Wight, Hants

# ROTAX MINIATURE RELAYS

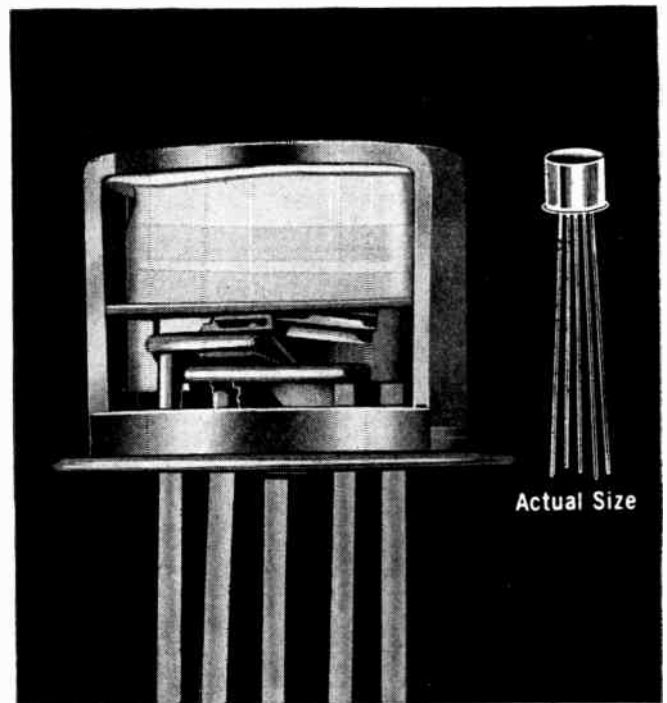

TO-5 size... robust...  
and gold-plated for dry circuitry

Rotax miniature relays are now available in a full range including specially sensitive and magnetic latching types. Of all-welded construction, these relays will withstand high shock and vibration, and meet or exceed DEF 5124. They are hermetically sealed and gas-filled.

The three types—standard, magnetic latching, and sensitive—have SPDT contact arrangement, with DPDT also available on the standard range. All Rotax miniature relays are continuously rated to 1,000,000 operations at 0.5 amps, 28V d.c., resistive load at 125°C. or 100,000 operations at 1.0 amp. There is a choice of 25 different Rotax miniature relays covering d.c. coil voltages from 4.5 V to 75 V.

Rotax miniature relays could help solve your miniaturisation problems. Interested? Then ring Elgar 7777, Ext. 302—now.

**ROTAX**  
INSTRUMENTATION DIVISION

ROTAX INSTRUMENTATION DIVISION  
WILLESDEN JUNCTION, LONDON, N.W.10. TELEPHONE ELGAR 7777

# CLASSIFIED ADVERTISEMENTS

**FULLY DISPLAYED** : 55/- per single column inch.  
**SEMI-DISPLAYED** : 45/- per single column inch.  
**RUN-ON** : 4/6 per line of approximately 7 words.  
Where an advertisement includes a Box Number 1s. extra.  
**SERIES DISCOUNTS** : 12 insertions, 15%.  
Remittances payable to "Industrial Electronics".

Copy is required by 23rd of the month for insertion in the following month's issue, by 17th of the month if proofs are required.

Address to :  
Classified Advertisement Dept.  
Industrial Electronics  
Dorset House, Stamford St., London, S.E.1.

## SITUATIONS VACANT

### EXPERIENCED ELECTRONIC ENGINEERS OR TECHNICIANS

As the manufacturers of a wide range of electronic equipment, we require keen and efficient men with good electronic backgrounds, preferably qualified to O.N.C. standard, to work in our Service Department.

They will be expected to contribute the maximum effort to ensure that our instruments are correctly serviced, and returned to the customer with the minimum of delay.

In exchange for this effort they will receive excellent salaries, be given an opportunity to broaden their knowledge and will be in line for promotion to the more senior posts within the organisation.

*Apply in writing to:* The Personnel Officer, Dawe Instruments Ltd., Western Avenue, Acton, W.3

438



# MICHELIN

require a

## DESIGN ENGINEER (ELECTRONICS)

... to undertake design and experimental work in the application of electronics to a wide and interesting range of industrial processes. The duties will involve the construction and testing of prototypes developed from original ideas and the subsequent application of the devices to production problems.

Candidates should be in the age range 25-35 with a Higher National Certificate in electronic subjects and should have had suitable experience of industrial electronics in bench and design work. The vacancy will be of particular interest to men who are keen to apply new technical developments in a practical way, and who are able to work on their own initiative with a minimum of supervision.

The post carries an attractive salary and the Company offers excellent conditions of service. Housing assistance will be given if required and removal expenses will be paid.

*Applications to:* Recruitment Manager (Ref: T.0253 IE)  
Michelin Tyre Co. Ltd., Stoke-on-Trent, Staffs.

435

### INDUSTRIAL STAFF LIMITED

offer you wide coverage of skilled labour to meet increased production requirements. I.S.L. service is complete, including wages, travelling expenses, P.A.Y.E., insurances, pension schemes and holidays. The simplest, most efficient method of meeting production peak problems. Ring MAL. 8728.

439

### UNIVERSITY OF NEWCASTLE UPON TYNE Second Chair of Electrical Engineering

APPLICATIONS are invited for the newly created Second Chair of Electrical Engineering. Candidates should have a special interest in the field of light electrical engineering. The successful candidate will be required to take up duty at a date to be arranged as early as possible in the academic year 1965/66. Salary in accordance with the professorial scale (£3,400 × £125—£4,025 per annum) with membership of F.S.S.U.

Further particulars may be obtained from the undersigned with whom applications (15 copies), together with the names of not more than three persons to whom reference may be made, must be lodged not later than Tuesday, 8th June, 1965. (Applicants from outside the British Isles may submit one copy only.)

E. M. BETTENSON  
REGISTRAR  
UNIVERSITY OF NEWCASTLE UPON TYNE  
6 KENSINGTON TERRACE  
NEWCASTLE UPON TYNE 2

409



# CONTROL AND INSTRUMENTATION

As a result of continued expansion, applications are invited for the following posts in the Division concerned with the control and instrumentation of nuclear power stations:—

## 1 Electronics Engineer

The work involves the specification, design and testing of Data Processing Systems. Experience of digital equipment design is necessary for this post and knowledge of large digital systems will be an advantage. Applicants should be between 25 and 32 years of age and possess an engineering degree or equivalent qualification.

## 2 Instrumentation Engineer

The engineer will cover all instrumentation aspects associated with the provision of plant data to a large Data Processing System. He should be capable of theoretical analysis of the performance of measuring equipment and be familiar with the problems of measurement in the presence of electrical interference. Applicants should be between 25 and 35 years of age and possess a Higher National Diploma or Certificate.

## 3 Nucleonics Engineer

A design engineer is required to work on electronic circuits associated with nucleonics equipment (used in civil nuclear power stations). He will be responsible for the specification and design of equipment, and for the surveillance of subcontractor designs. Experience of semiconductor circuit design is essential; a knowledge of field effect transistors would be an advantage. Applicants should be between 25 and 35 years and possess a degree or equivalent.

Please send full details, quoting reference 1806 IN, to:—

# ENGLISH ELECTRIC

TECHNICAL STAFF OFFICER  
ENGLISH ELECTRIC HOUSE  
STRAND, LONDON, W.C.2

[432]

## ARTICLES FOR SALE

### PHOTO-ELECTRIC CONTROLS

for industry

Quick delivery Send for Catalogues

### Hird-Brown Limited

Flash Street, Bolton, Lancs.  
Tel. 27311

[305]

## CAPACITY AVAILABLE

### AIRTRONICS LTD.

for coil winding, assembly and wiring of electronic equipment, transistorised sub-units, sheet metal work. 3a, Walerand Road, London, S.E.13. Telephone: LEE Green 1706.

[439]

DESIGN & PROTOTYPE CONSTRUCTION.—Somerset Electronics Ltd. Phone Shepton Mallet 2219.

[387]

## EDUCATIONAL

A.M.I.E.R.E., A.M.I.Mech.E., City & Guilds, G.C.E., etc. Become a Technician or Technologist for high pay and security. Thousands of passes. For details of Exams. and Courses in all branches of Electronics, Engineering, etc., write for 156 page Handbook — FREE. B.I.E.T. (Dept. 192), London, W.8.

[380]

# SMITHS

## MOTOR ACCESSORY DIVISION

### ELECTRICAL METHODS ENGINEER

A vacancy has arisen for an Electrical Engineer to join our Production Engineering Team.

His duties will include the design of test equipment for flow line production. He will also be involved in the design of special purpose equipment in the Machining and Finishing Departments. Such equipment will include transistorised amplifiers, pulse shapers and oscillators.

Applicants should have H.N.C. in Electrical Engineering and should have experience in electrical engineering applied to mass production techniques. O.N.C. coupled with suitable experience will be considered.

Please write in confidence giving full details of training and experience to the:

Employment Officer  
S. SMITH & SONS (ENGLAND) LTD.  
Motor Accessory Division  
Cricklewood Works, London, N.W.2

[436]

## PATENTS

\* Patent No.: 797,599 "entitled "Electrical Connector, particularly for the Pins of a Valve", is for sale or licence. For details apply to CHATWIN & COMPANY, Chartered Patent Agents, 253 Gray's Inn Road, London, W.C.1.

[437]

The Proprietors of British Patent Nos. 851,177 and 851,178 relating to "Electrical read out devices" and "Weighing systems", desire commercial working of these patents in the United Kingdom by Licence or otherwise. Replies to Box 434, Industrial Electronics.

TO INSERT AN  
**ADVERTISEMENT**  
IN THE  
**CLASSIFIED SECTION**  
TELEPHONE  
**INDUSTRIAL ELECTRONICS**  
WATERLOO 3333  
EXT. 210

# Start a new life in the ROYAL AUSTRALIAN AIR FORCE

Vacancies exist for both single and married men who are British or naturalised British subjects and are qualified to serve in the following RAAF trades:

**Air Frame Fitters : Aero Engine Fitters  
: Armament Fitters : Electrical Fitters :  
Instrument Fitters : Radio Technicians  
: Telecommunications Technicians : Tele-  
graphists (Morse code required)**

Starting pay and allowances range from £A19-£A22 per week for single men and £A25-£A28 per week for married men according to trade and experience and start on the day of enlistment.

Successful applicants join the RAAF in Britain and receive free passage to AUSTRALIA for themselves and their wives and children.

Conditions of service include free medical and dental care, pension or gratuity on completion of service and generous annual leave. All members are given a free initial issue of uniforms and clothing.

If you are between the ages of 18 and 42, are fully qualified in one of these trades, and are interested in starting a new life in a young and expanding country, write to:—

**RAAF CAREERS OFFICER, AUSTRALIA HOUSE, STRAND, LONDON, W.G.2.**

*Applications are also invited from experienced technical personnel holding University degrees, or Higher National Certificates for a limited number of vacancies for Technical Officers.*

[433



## GROUP BUYER ELECTRONIC COMPONENTS

A man of tact, knowledge and negotiating ability is needed for the above position. He should be a qualified Electronic Engineer, preferably with experience in the purchasing or allied fields.

The successful applicant, who will liaise with senior staff throughout the Group, will be capable of working largely on his own initiative in ascertaining requirements, assessing suppliers and placing Group Purchase Contracts.

A substantial salary awaits the right man. Please send full details, quoting reference IN1216J, to Technical Staff Officer, English Electric House, Strand, London, W.C.2.

**'ENGLISH ELECTRIC'**

**CENTRAL PURCHASING OFFICE  
STAFFORD**

[440

IF YOU REQUIRE

**DATA PROCESSING STAFF**

WHY NOT ADVERTISE

IN THE

**JULY ISSUE**

OF

**DATA  
PROCESSING**

FULL DETAILS FROM

Classified Advertisement Manager

Dorset House, Stamford Street, S.E.1

WAT: 3333 Ext: 210

### BOOKS

"BASIC Mathematics for Radio and Electronics." By F. M. Colebrook, B.Sc., D.I.C., A.C.G.I. Revised and enlarged by J. M. Head, M.A. (Cantab.). Presents in readable form a complete course in basic mathematics for engineering students of all kinds and leads on to the more advanced branches of mathematics of increasing importance to radio engineers. In this section the chapter covering the application of mathematics to radio has been revised and enlarged, while new subjects covered include Stability, Linear Differential Equations, Elementary Statistics, Short Cuts to Numerical Calculations and an Introduction to Matrices. Will be invaluable to those requiring a refresher course as well as to those without previous knowledge of the subject. 17s 6d net from all booksellers. By post 18s 7d from Iliffe Books Ltd., Dorset House, Stamford Street, S.E.1.

"TELEVISION Receiving Equipment." By W. T. Cocking, M.I.E.E. The fourth edition of one of the most important British books on television deals in a comprehensive manner with television receiver equipment and gives many practical details and much design data. The circuits of a television receiver are split into a number of sections and a separate chapter is devoted to each. Other chapters deal with general principles, the signal, superheterodyne interference problems, special circuits, the aerial, the complete receiver, faults and servicing. 30s net from all booksellers. By post 32s 4d from Iliffe Books Ltd., Dorset House, Stamford Street, S.E.1.

"TELEVISION Engineering: Principles and Practice." Vol. III: Waveform Generation. By S. W. Amos, B.Sc. (Hons.), A.M.I.E.E., and D. C. Birkinshaw, M.B.E., M.A., M.I.E.E. The third volume of a comprehensive work on the fundamentals of television theory and practice, written primarily for the instruction of B.B.C. Engineering Staff. This volume gives the application in television of sinusoidal, rectangular, sawtooth and parabolic waves and shows the mathematical relationship between them. The main body of the text is devoted to the fundamental principles of the circuits commonly used to generate such signals, the treatment being largely descriptive in nature and therefore less mathematical than that of the previous volume. The work is intended to provide a comprehensive survey of modern television principles and practice. 30s net from all booksellers. By post 31s 3d from Iliffe Books Ltd., Dorset House, Stamford Street, London, S.E.1.

### CHANGE OF ADDRESS

SETPOINT LTD. have moved to 168/172 Old Street, London, E.C.1. Telephone: Clerkenwell 8312.

# ARE YOU A THRUSTER?

A recent survey divided industrial companies into two main types, THRUSTERS and SLEEPERS. SLEEPERS let the competition overtake them, and their management and methods are behind the times. THRUSTERS fix medium and long term objectives, using modern methods. They have vigorous management teams and positive development programmes for their personnel and products.

MTE is a THRUSTER. A young trained management team, modern methods and products, and the climate for individual initiative are the essential ingredients of a young and vigorous company, which has already made its mark, and is now looking forward to its next major expansion programme in all fields.

We believe that our future depends upon the recruitment and development of first class men, and products. We now require men who will join us on the ground floor of a number of new projects, and we want "thruster" types. These men will already be with manufacturers or users in the motor control gear or allied fields, probably with "sleeper" companies and looking for a change to a "thruster" company. They will be looking for an opportunity to use their own initiative to produce the results which can bring high rewards. They will be given ample scope to develop their own original ideas, to assist in new product planning and new market penetration, and they can look forward to a stimulating and rewarding career.

TWO TYPES OF MEN ARE REQUIRED—Experienced men will be given the scope which their knowledge commands, and responsibility will be offered to them as fast as they can take it. Younger men, in the 20-25 age group, will be able to join teams where further training will fit them early for responsible and rewarding positions.

## SALARIES WILL MATCH THE MEN

POSITIONS	EXPERIENCE REQUIRED	REFERENCE
● Outside Sales Engineers (All Areas)	Sales/Engineering background—outside sales experience preferred but not essential.	JJ/1/I
● Market Analyst	A new job—investigating market for new and existing products—Sales/Engineering background—sound knowledge of markets, applications and competition.	JJ/2/I
● Component Design—Engineers & Detail Draughtsmen.	Mechanical and electro mechanical design or detail draughting.	NHO/1/I
● Contracts/Application Engineers.	Control gear engineering background—conventional and/or static. Industrial electronic experience for latter.	BLB/1/I
● Inside Sales Engineers (Head Office)	Sales estimating or contracts/application experience—prospects of outside sales work later.	BLB/2/I
● Group Starter Board Designer.	Experience in the design of fault-rated boards and control centres. This is a senior position.	BLB/3/I
● Test Engineers	Test-bed experience of conventional and/or solid state control equipment.	BLB/4/I
● Opportunity in Production Management.	Engineer/Scientist to take charge of Control Panel production—25 to 27 years old with 3 to 5 years' production experience. This is a senior position with considerable scope.	IY/1/I
● Buyer	3 to 5 years' experience of industrial buying, preferably in the electro/mechanical field.	GWC/1/I

Write now for an application form quoting the appropriate reference number to:



## MTE CONTROL GEAR LIMITED

PROGRESS ROAD, LEIGH-ON-SEA, ESSEX

Telephone: Southend 524281

8978



For further information circle 266 on Service Card

# for precise speed control use a **HEENAN DRIVE**

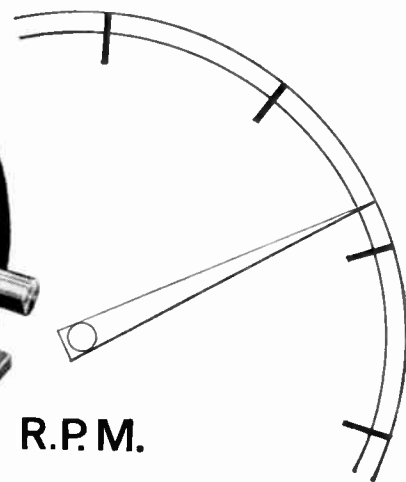
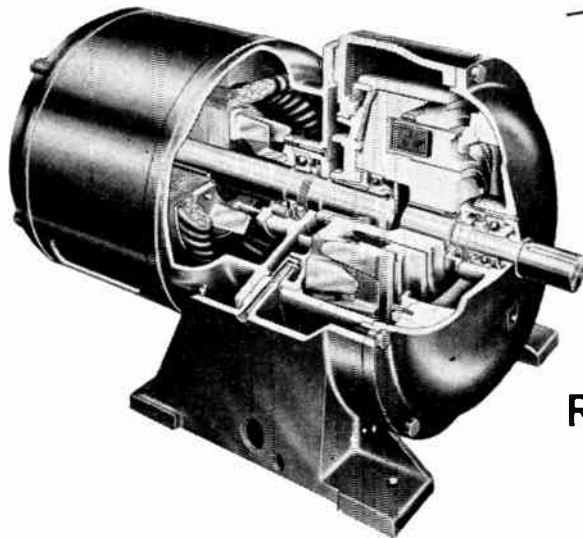

R.P.M.

Today, modern machines and processes require more than just Variable Speed; they need a drive which is capable of dealing with many diverse requirements, e.g.:

- Infinitely Variable Speed from maximum to zero against constant torque
- Controlled acceleration and deceleration
- Local or remote control
- Torque control
- Very close speed holding
- Synchronisation of individual drives, etc., etc. . . .

The AJUSTO-SPEDE and DYNASPEDE DRIVES can provide the above, and many more features, with compact, robust equipment.

*REMEMBER - there is NO substitute for experience*



**Heenan & Froude Ltd** · WORCESTER · ENGLAND

K-24 A-63

For further information circle 267 on Service Card

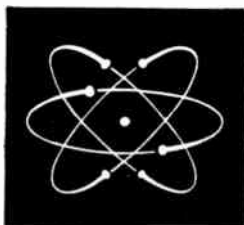

## **UNIFIED CIRCUIT THEORY IN ELECTRONICS AND ENGINEERING ANALYSIS**

a new approach to solving non-steady state problems

J. W. Head, M.A.(Cantab.), F.Inst.P., A.M.I.E.E., F.I.M.A.  
C. G. Mayo, M.A., B.Sc., M.I.E.E.

This important new book shows how the output, or response, of a linear system may be formulated, whatever the nature of the input may be. Steady-state conditions present no mathematical difficulties, but decidedly more advanced techniques are required when dealing with the non-steady state.

The authors advocate the use of operational calculus to solve these problems because the directness and simplicity of working makes it easy for practising engineers and students alike to appreciate the significance of each necessary process. The book is written in an easy style and shows that the basic ideas associated with operational calculus and the impedance concept are extremely easy to grasp — and once understood have a high 'resolving power.'

UNIFIED CIRCUIT THEORY IN ELECTRONICS AND ENGINEERING ANALYSIS is written by practical mathematicians in simple, straightforward language to provide practising engineers and students with a powerful tool for evaluating linear circuit responses irrespective of the input. Although the examples are expressed mainly in terms of electrical systems the methods employed are equally applicable to a wide variety of other fields.

unified circuit  
theory in  
electronics and  
engineering analysis

a new approach to solving  
non-steady state problems

J.W. Head MA Cantab F Inst P AMIEE EIMA  
C.G. Mayo MA BSc MIEE

obtainable from leading booksellers

**42s net** by post 43s  
174 pages 20 illustrations

**ILIFFE Books Ltd.** DORSET HOUSE STAMFORD STREET LONDON S.E.1

A.P.T. Electronic Industries Ltd. ....	2	Fielden Electronics Ltd. ....	18	Painton & Co. Ltd. ....	<i>Cover iv</i>
Adcola Products Ltd. ....	31	Foster Instrument Co. Ltd. ....	41	Perivale Controls Co. Ltd. ....	33
Aircraft Marine Products (G.B.) Ltd. ....	7	G.E.C. of U.S.A. ....	54	Racal Instruments Ltd. ....	21
Anglo-American Vulcanized Fibre Co. Ltd. ....	10	Hallam, Sleigh & Cheston Ltd. ....	6	Rotax Ltd. ....	47
Appointments Vacant.....	48	Heenan & Froude Ltd. ....	52	S.E. Laboratories (Eng'g) Ltd. ....	34
Arrow Electric Switches Ltd....	19	Honeywell Controls Ltd. ....		Saunders-Roe & Nuclear Enterprises Ltd. ....	53
B & R Relays Ltd. ....	37	Hughes International (U.K.) Ltd. ....	22	Science Journal .....	45
Bell & Howell Ltd.....	15, 16	Imhof, Alfred, Ltd.....	36	Sellotape Industrial Ltd. ....	
British Plastics .....	46	International Rectifier Co. Ltd. ....	17	Solartron Electronic Group Ltd. ....	<i>Loose insert</i> 12, 13
C.Z. Scientific Instruments Ltd. ....	32	Isola-Werke A.G. ....	11	Standard Telephones & Cables Ltd. ....	3, 4, 5
Cannon Electric (Great Britain) Ltd. ....	42	Johnson, Matthey & Co. Ltd. ....	38	Tektronix U.K. Ltd. ....	8, 9
Celdis Ltd. ....	23	Kent, George, Ltd. ....	24	Telegraph Condenser Co. Ltd. ....	
Classified Advertisements ...	48	Lancashire Dynamo & Electronic Products Ltd. ....	27	Telomex Ltd. ....	<i>Cover iii</i> 29
Cossor Instruments Ltd.....	40	Landis & Gyr Ltd.....	30	Transmetrix Electronic Systems Ltd. ....	47
Dawe Instruments Ltd. ....	14	M.O. Valve Co. Ltd. ....	25, 26	Unified Circuit Theory .....	52
Dexion Ltd. ....	39	McMurdo Instrument Co. Ltd. ....	30	V.G. Porcelain Co. Ltd.....	11
E.M.I. Sound Products Ltd. ....	47	Metway Electrical Industries Ltd. ....	46	Vitality Bulbs Ltd. ....	47
Electrical Power Engineering Co. (B'ham) Ltd.....	44	Oxley Developments Co. Ltd. ....	42	Walmore Electronics Ltd. ....	46
Electrical Review .....	42			Welwyn Electric Ltd. ....	1
Electronics Data Handbook ...	44			Westinghouse Brake and Signal Co. Ltd. ....	20
Elesta Electronics Ltd. ....	6			Wingrove & Rogers Ltd. ....	44
Elliott Automation Accessories Ltd. ....	28				
English Electric Valve Co. Ltd. ....	35				
Ericsson Telephones Ltd. ....	<i>Cover ii</i>				
Ether Ltd.....	43				

For further information circle 268 on Service Card

**c o n t i n u o u s**

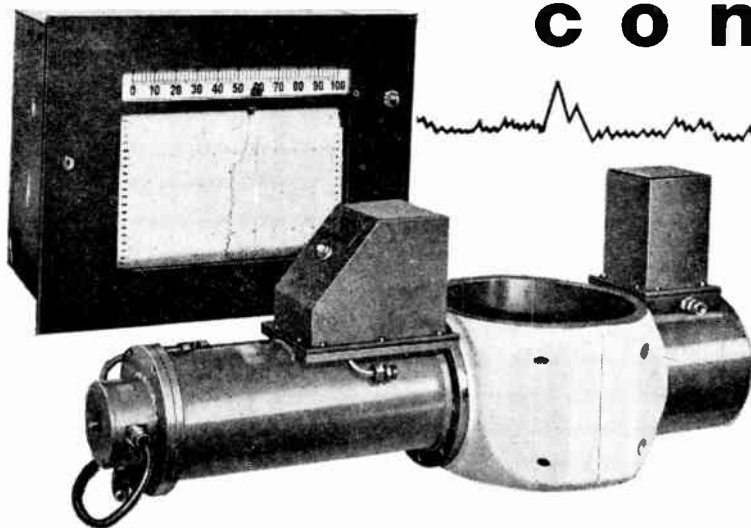

**indication of  
DENSITY**

The Density Gauge Type 336 is designed for accurate continuous indication of density or solids content of liquids, slurries and certain solids in industrial process lines. Considerable economy can be obtained by accurate control of material density during plant start-up and running. Automatic control of dilution, evaporation, bleeding, etc., releases skilled staff from routine testing. The great advantage of this type of gauge is that the small source minimises radiation risks and the instrument automatically standardises itself, eliminating all manual control.

No contact is made with the material to be measured, and readings are preserved on a recorder chart. Installation is extremely simple, the gauge need only be clamped around the pipe through which the material is passing, and once calibrated there is nothing more to do, except switch on. Readings are direct, automatic, and continuous. Gauges are available to fit pipe lines from 2" to 24" in diameter, the optimum size being 10 ins.

Prices range from £800

Write for full technical details

**SAUNDERS-ROE & NUCLEAR ENTERPRISES LTD.** OWNED BY NUCLEAR ENTERPRISES (G.B.) LTD. AND WESTLAND AIRCRAFT LIMITED

NORTH HYDE ROAD, HAYES, MIDDLESEX Phone: Hayes 3800

Our products also include :- Sulphur Plant Monitors, Laboratory Sulphur Meters and Betalights (illumination without power)

# silicon performance at germanium prices

Chart shows where you can use 43 low-cost epoxy-encapsulated silicon planar transistors

Without boosting component cost, you can build extra reliability into your circuits with this family of transistors from General Electric Company of U.S.A.

They have all the characteristics you look for. High power gain. Low noise. Low Ico. High mechanical strength. Small size: they fit the TO-18 outline, except for their 250-mil height.

General Electric, U.S.A., simply eliminates the usual high-cost, glass-to-metal seals and passes the savings on

to you. These transistors have a unique solid epoxy housing on a planar passivated surface, for excellent device stability and long life. Millions of these transistors have gone into field use over the past two years.

Clip the chart now, while you think of it. Or—for data on other applications—contact International General Electric Company of New York, Ltd., Lincoln House, 296 High Holborn, London, W.C. 1, or *General Electric Company, Dept. EC-65-03, 159 Madison Ave., N.Y., N.Y. 10016, U.S.A.*

APPLICATIONS	FEATURES	TYPE	$h_{FE}$ min.	$h_{FE}$ max.	$BV_{CEO}$	$f_t$ (typ) mc	POSSIBLE REPLACEMENT FOR
 <p><b>SMALL SIGNAL AMPLIFIERS</b> d.c. Beta Groupings</p> <p>Instrument &amp; High Fidelity pre-amplifiers, (2N3391, 2N3391A)</p> <p>Oscillators, and amplifiers, and mixers to 30 mc.</p>	Ultra High Beta	2N3390	400	800	25	160	Possible replacement for most germanium and silicon alloy transistors used in both amplifier and low frequency switching circuits including: 2N1302, 1304, 1306, 1308.
	High Beta, Low Noise; 1.9 db. typ. N.F.	2N3391	250	500	25	160	
	High Beta, Controlled Low Noise; 1.9 db typ. N.F.	2N3391A	250	500	25	160	
	$h_{FE}$ min = 150	2N3392	150	300	25	140	
	$BV_{CEO}$ = 25 volts	2N3393	90	180	25	140	
	Extra Low Price	2N3394	55	110	25	140	
	Spread Type: 2 groups*	2N3395	150	500	25	140	
	Spread Type: 3 groups*	2N3396	90	500	25	140	
	Spread Type: 4 groups*	2N3397	55	500	25	140	
	Spread Type: 5 groups*	2N3398	55	800	25	140	
	$h_{FE}$ 13 typ. at 20 mc.	2N2711	30	90	18		
	$h_{FE}$ 16 typ. at 20 mc.	2N2712	75	225	18		
Low $C_{OB}$ : 5 pf. max.	2N2715	30	90	18			
Low $C_{OB}$ : 5 pf. max.	2N2716	75	225	18			
<p><b>SMALL SIGNAL AMPLIFIERS</b> a.c. Beta Groupings</p> <p>Audio amplifiers; video amplifiers; hi-fi and stereo amplifiers; Garage door openers; dictaphone equipment; organ circuits.</p>	$BV_{CEO}$ = 25 volts; 2.8 db. typ. N.F.	2N2923	90 <sup>A</sup>	180 <sup>A</sup>	25	160	Possible replacement for most germanium and silicon alloy transistors used in both amplifier and low frequency switching circuits including: 2N1302, 1304, 1306, 1308.
	$h_{FE}$ min = 150; 2.8 db. typ. N.F.	2N2924	150 <sup>A</sup>	300 <sup>A</sup>	25	160	
	$h_{FE}$ min = 235; 2.8 db. typ. N.F.	2N2925	235 <sup>A</sup>	470 <sup>A</sup>	25	160	
	Spread Type: 5 groups*: 2.8 db. typ. N.F.	2N2926	35 <sup>A</sup>	470 <sup>A</sup>	18	160	
	Spread Type: 4 groups*: 2.8 db. typ. N.F.	16A667	55 <sup>A</sup>	470 <sup>A</sup>	18	160	
	Spread Type: 3 groups*: 2.8 db. typ. N.F.	16A668	90 <sup>A</sup>	470 <sup>A</sup>	18	160	
	Spread Type: 2 groups*: 2.8 db. typ. N.F.	16A669	150 <sup>A</sup>	470 <sup>A</sup>	18	160	
	High ac Beta: 2.8 db. typ. N.F.	16A567	400 <sup>A</sup>	800 <sup>A</sup>	18	160	
<p><b>MEDIUM POWER AMPLIFIERS AND SWITCHES</b></p> <p>These device types satisfy circuit needs with higher dissipation requirements and high voltage breakdown.</p>	900 mw, 25 volts	2N3402	75	225	25	160	Can be used to replace most NPN germanium types in industrial circuits. Also can be substituted for the following in some circuits: 2N696, 2N697, 2N1711.
	900 mw, 25 volts $h_{FE}$ = 180 min.	2N3403	180	540	25	160	
	900 mw, 50 volts	2N3404	75	225	50	160	
	900 mw, 50 volts $h_{FE}$ = 180 min.	2N3405	180	540	50	160	
	360 mw, 25 volts	2N3414	75	225	25	160	
	360 mw, 25 volts $h_{FE}$ = 180 min.	2N3415	180	540	25	160	
	360 mw, 50 volts	2N3416	75	225	50	160	
	360 mw, 50 volts $h_{FE}$ = 180 min.	2N3417	180	540	50	160	
<p><b>SWITCHES</b></p> <p>Types recommended for use in medium speed computer circuits</p> <p>For peripheral equipment*.</p>	Similar to 2N914	2N3605	30	—	14	350	Possible substitute for 2N914, 2N706, 2N708.
	Similar to 2N708	2N3606	30	—	14	350	
	$V_{CE(SAT)}$ = 0.3 volts max, $t_d$ = 60ns $t_r$ = 35ns	2N2713	30	90	18	200	For use in low frequency industrial switching circuits.
	$t_s$ = 85ns $t_f$ = 40ns Spread Type: 3 groups*	2N2714	75	225	18	200	
<p><b>HIGH FREQUENCY AMPLIFIERS</b></p> <p>From audio to 200 mc am, fm, and TV application at video: 4.5, 10.7, 45, 88-108 and 54-216 mc. UHF Oscillator (16G2)</p>	Max. oscillation freq.: 800mc	16L62	20	40	30	250	Possible substitute for: 2N916, 2N760; possible replacement for many MADT, PADT, and EMSA types.
	Max. available gain: 22.6 db. @ 100mc	16L63	35	70	30	300	
	Min. $h_{FE}$ = 60	16L64	60	120	30	350	
	Spread Type: 3 groups*	16L60	20	120	30	—	
	Max. available gain: 40.7 db. @ 10.7 mc	16L42	20	40	18	250	
	$C_{OB}$ = 3.5 pf max.	16L43	35	70	18	300	
	Min. $h_{FE}$ = 60	16L44	60	120	18	350	
	Spread Type: 3 groups* UHF Oscillator, VHF Amp-; 4.0 db. typ. N.F.	2N3663	20	—	12	1100	

\* Each type is supplied in narrow spread beta groups distinctively colour coded.

<sup>A</sup> Specified by a.c. beta.

**GENERAL ELECTRIC COMPANY OF U.S.A.**





## Meetings

### Society of Electronic and Radio Technicians

33 Bedford Street, London, W.C.2 (Phone: Covent Garden 1152).

16th June, 7.15 p.m. at The Branch Engineering College, Cookridge Street, Leeds. 'Dual-Standard Television'.

## Conferences, Symposia and Colloquia

10th June. One-day symposium on 'Quantitative Aspects of Hearing'. Held at National Physical Laboratory, Teddington, Middlesex. Organized by The Institute of Physics and The Physical Society, 47 Belgrave Square, London, S.W.1 (Phone: Belgravia 6111).

15th-18th June. Conference (in conjunction with exhibition) on 'Metal Heat Treatment'. Held at Bingley Hall, Birmingham. Sponsored by "Industrial & Process Heating", 103 Waterloo Road, London, S.E.1 (Phone: Waterloo 3388).

30th June-2nd July at University College, London. Joint I.E.R.E./I.E.E. symposium on 'Microwave Applications of Semiconductors'. Papers and requests for further information should be sent to The Secretary, Joint Organizing Committee, Symposium on Microwave Applications of Semiconductors. The Institution of Electronic and Radio Engineers, 8-9 Bedford Square, London, W.C.1.

5th-6th July. Conference on 'Low Level Radioactivity Measurements—Limitations and New Techniques'. Held at The Imperial College of Science and Technology, London, by The Institute of Physics and The Physical Society. Applications for tickets to: I.P.P.S., 47 Belgrave Square, London, S.W.1 (Phone: Belgravia 6111).

9th-10th July at Cavendish Laboratory, Cambridge. Conference on 'Inelastic Scattering of Electrons by Solids'. Organized by The Institute of Physics and The Physical Society, 47 Belgrave Square, London, S.W.1 (Phone: Belgravia 6111).

18th-21st July at Birmingham University. Conference on 'The State of the Art in Numerical Analysis'. Organized by The Institute of Mathematics and its Applications, 29 Gordon Square, London, W.C.1 (Phone: Euston 6070).

1st-2nd Sept. at the I.E.E., Savoy Place, London, W.C.2. International conference on 'U.H.F. Television'. Sponsored by the I.E.E., the I.E.E.E., the I.E.R.E. and the Television Society. Organized from 8-9 Bedford Square, London, W.C.1 (Phone: Museum 1901).

6th-10th Sept. Convention on 'Machines for Materials and Environmental Testing'. Held at the Manchester College of Science and Technology, Manchester. Organized jointly by The Institution of Mechanical Engineers and The Society of Environmental Engineers from 1 Birdcage Walk, London, S.W.1 (Phone: Whitehall 7476).

8th-10th Sept. Symposium on 'Electronics in Industry'. Held at The University of Durham, Durham. Organized jointly by The Ministry of Technology and The Institution of Electronic and Radio Engineers from Wellbar House, Gallowgate, Newcastle-upon-Tyne, 1 (Phone: Newcastle-upon-Tyne 27575).

13th-18th Sept. Engineering Materials and Design Conference. Held in conjunction with an exhibition at Olympia, London. Organized by Industrial & Trade Fairs Ltd., Commonwealth House, 1-19 New Oxford Street, London, W.C.1 (Phone: Chancery 9011).

20th-25th Sept. International conference on 'Thermionic Electrical Power Generation'. Held at The Institution of Electrical Engineers, Savoy Place, London, W.C.2 (Phone: Covent Garden 1871). Organized jointly by I.E.E. and O.E.C.D. European Nuclear Energy Agency.

21st-23rd Sept. Symposium on 'Applications of Microelectronics'. Held at Department of Electronics, The University, Southampton. Jointly organized by the I.E.E. and I.E.R.E. from The University of Southampton.

21st-24th Sept. First European Conference on Magnetism, Vienna. To be held at Technischen Hochschule, Vienna. Conference Secretariat: Verein Deutscher Eisenhüttenleute, 4 Dusseldorf, Breite Strasse 27.

23rd-24th Sept. Conference on 'Non-Metallic Thin Films'. To be held at Chelsea College of Science and Technology, London. Organized by The Institute of Physics and The Physical Society, 47 Belgrave Square, London, S.W.1 (Phone: Belgravia 6111).

## Exhibitions

### 11th-20th June. Paris

International Air and Space Show, Le Bourget Airport, Paris. Organized by U.S.I.A.S., Rue Galilee, Paris 16.

### 15th-18th June. Birmingham

Industrial Process Heating Exhibition (concurrently with conference). Held at Bingley Hall, Birmingham. Organized by Business Publications, 103 Waterloo Road, London, S.E.1 (Phone: Waterloo 3388).

### 15th-19th June. London

1st Pumping Exhibition, Earls Court, London. Organized by Iliffe Exhibitions Ltd., Dorset House, Stamford Street, London, S.E.1 (Phone: Waterloo 3333).

### 15th-19th June. London

NAVREX—Noise and Vibration Reduction Exhibition, Earls Court, London. Organized by Iliffe Exhibitions Ltd., Dorset House, Stamford Street, London, S.E.1 (Phone: Waterloo 3333).

### 16th-26th June. London

Interplas 65—The International Plastics Exhibition in Europe for 1965, Olympia, London. Organized by Iliffe Exhibitions Ltd., Dorset House, Stamford Street, London, S.E.1 (Phone: Waterloo 3333).



# WHAT'S ON AND WHERE

Continued

## 8th-17th July. London

Mining Machinery Exhibition, Olympia, London. Organized by Municipal and Industrial Exhibitions Ltd., 3 Clements Inn, London, W.C.2 (Phone: Chancery 1200).

## 27th Aug.-5th Sept. Stuttgart

Deutsche Funkausstellung 1965—The German Radio and Television Exhibition. Held on the Killesberg in Stuttgart. Organized by Stuttgarter Ausstellungen-GmbH, 7 Stuttgart 1, Am Kochenhof 16.

## 7th-11th Sept. Basle

INEL 65 International Exhibition of Industrial Electronics, Basle, Switzerland. 61 Clarastrasse, 4000 Basle (Phone: Basle (061) 323850).

## 9th-19th Sept. Paris

Salon International de la Radio et de la Télévision, Paris.

## 13th-18th Sept. London

Engineering Materials and Design Exhibition. Held in conjunction with a conference at Olympia, London. Organized by Industrial & Trade Fairs Ltd., Commonwealth House, 1-19 New Oxford Street, London, W.C.1 (Phone: Chancery 9011).

## 14th-22nd Sept. Utrecht

HET Instrument 1965 Exhibition, Royal Dutch Industries Fair, Utrecht. Further details from: Cooperative Vereniging, 'HET Instrument' u.a., Sparrenlaan 2, Soest, Holland (Phone: Soest (02955) 3047).

## 28th Sept.-1st Oct. Brighton

Medical Electronic and Instrumentation Exhibition (in conjunction with The European Symposium on Medical Electronics) at Exhibition Hall, Brighton, Sussex. Organized by Events Promotions Ltd., Ashbourne House, Alberon Gardens, London, N.W.11 (Phone: Meadway 5555).

## 2nd-10th Oct. Ljubljana, Yugoslavia

XIIth International Exhibition on Modern Electronics. Details from: Gospodarsko razstavisce (Ljubljana Fair), Ljubljana, Titova 50, Yugoslavia.

## 4th-13th Oct. London

Business Efficiency Exhibition, London (Olympia). Organized by Business Equipment Trade Association, 64 Cannon Street, London, E.C.4 (Phone: Central 7771).

## 13th-19th Oct. Dusseldorf

3rd International Congress and Exhibition of Measuring Instrumentation and Automation (Interkama), Dusseldorf, Germany. Represented by John E. Buck (Trade Fair Agencies) Ltd., 47 Brewer Street, Piccadilly, London, W.1 (Phone: Gerrard 7576).

## 3rd-10th Nov. Oslo

Automatica 65—an exhibition of automatic control. Held in the Exhibition Hall, Skoyen, Oslo. Details from: Studiesel-skapet For Norsk Industri, Forskningsveien 1, Oslo 3.

### Radio Show Cancelled

The organizers of The 1965 Radio Show have now announced that it is cancelled. The show was to have been held at Earls Court, London, from 25th Aug. to 4th Sept.

## New Exhibitions

**ALTEX the Automatic Laboratory Techniques Exhibition** is to be held at the Royal Horticultural Hall, Westminster, London, S.W.1, from 1st to 3rd February 1966. Sponsored by Laboratory Equipment Digest it is believed that ALTEX will be the first exhibition of its kind in the world to be devoted exclusively to the application of the latest automatic, semi-automated and fully-automated apparatus. The exhibition is being organized by Southern Exhibitions Ltd., 11 Liverpool Terrace, Worthing, Sussex (Phone: Worthing 6584).

**The International Medical Engineering and Automation Exhibition, 'MEDEA '67'**, will take place at Earls Court, London, from March 13th to 18th 1967. Organized by Industrial Exhibitions Limited, it is the successor to that company's International Medical Electronics Exhibition held in 1960. The new title indicates the trend of the exhibition which will cover all aspects of biological engineering, medical electronics and instrumentation, medical automation, hospital physics, electro-medical and X-ray equipment, and related techniques. It will be open to exhibitors from all countries and a special section will be offered to non-commercial organizations such as hospitals, research institutions and universities.

A national conference will be held during the exhibition and is now being discussed by an exploratory committee. Another committee, headed by L. A. Woodhead, a member of the Council of the Scientific Instrument Manufacturers Association, will deal with exhibition matters.

## Courses

### Value Analysis

**20th-23rd July.** 'Value Analysis'. I.Prod.E. Summer School 1965 at Loughborough College of Technology. Further details from: The Institution of Production Engineers, 10 Chesterfield Street, London, W.1 (Phone: Grosvenor 5254).

### Value Engineering

Value Engineering Ltd., specialists in techniques for reducing prime cost in engineering and other industries, are co-operating with a number of leading Universities and Colleges of Technology in providing one-day orientation programmes for senior management.

They are also conducting, in co-operation with several colleges and universities, four-day training workshop programmes for teams from industry. A four-day workshop programme is scheduled for September at Nottingham University. The Polytechnic School of Management Studies (Regent Street) also envisages a further series of seminars or a workshop programme.

Value Engineering is an arrangement of techniques which: 1, makes clear each function the customer wants from a product or service; 2, establishes the appropriate cost for each individual function and/or for each group of functions by comparison, market criteria, theoretical evaluation or by a combination; 3, causes the necessary knowledge, creativity and initiative to be used to accomplish each function for that cost.

More information about these courses is available from Lamb, Ruck Keene Partners Ltd., 12 Buckingham Street, London, W.C.2 (Phone: Whitehall 7573).

### Computer Programming and Operation

Elliott-Automation have announced both programming and operators' courses for the NCR Elliott 4100 multi-purpose computer.

The programming courses last three weeks and start on 5th July, 6th September and 1st November.

The operators' courses last three days and commence 1st September, 5th October and 30th November.

More details from: Computer Education Dept., Scientific Computing Division, Elliott Brothers (London) Ltd., Borehamwood, Herts. (Phone: Elstree 2040).



# TAKE A LEAF OUT OF OUR BOOK



We mean that literally. Our "book" is composed of Technical Bulletins, which give full details and specifications of our wide range of capacitors—a range which is second to none.

By taking a leaf out of our book, you will be benefitting by our experience—experience which for nearly sixty years has been devoted to one end: the maintenance of a high level of reliability which has become the standard by which capacitors everywhere are judged.

## 'DRITAN' TANTALUM CAPACITORS

These extremely reliable solid electrolyte tantalum capacitors are setting new standards for performance in transistorised equipment for Industrial and Services applications. High capacitance values, small physical size, wide temperature range (up to 125° with suitable voltage derating), impedances of a fraction of an ohm in the megacycle range, and dramatic reductions in dissipation factor are features which make "Dritan" capacitors the finest available to the electronic engineer today. Obtain full details by sending for T.C.C. Bulletin No. 83 (Issue 2).

*Qualification Approval has been granted for "Dritan" capacitors to DEF 5134-A and DEF 5134-A-1.*



## THE TELEGRAPH CONDENSER CO. LTD

NORTH ACTON • LONDON • W.3 Telephone: ACOrn 0061 (16 lines) Telex: 261383  
also at CHESSINGTON, SURREY and BATHGATE, SCOTLAND

*Industrial Electronics June 1965*



For further information circle 202 on Service Card

**PAYNTON  
METLOHM<sup>®</sup>  
NEW  
METAL FILM  
RESISTORS**

out-date and out-perform  
conventional resistors

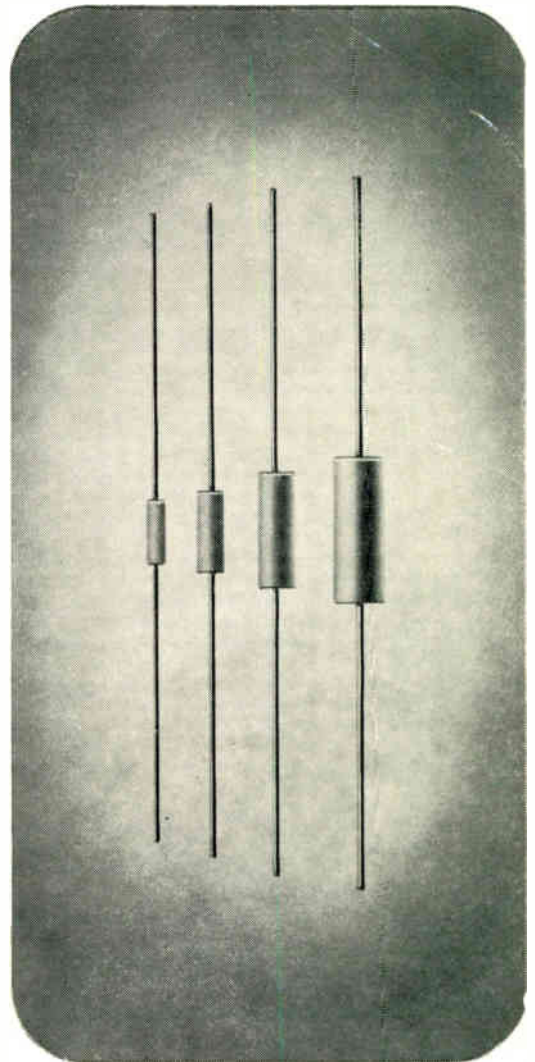

Painton introduce Metlohm — the fourth generation of film resistors. This metal film resistor possesses exceptional stability coupled with a full temperature coefficient range down to 25 p.p.m. or better, thus enabling today's engineers to work to closer limits than ever before. Capable of replacing existing film resistors with advantage, Metlohm provides the electronic and electrical industries with a quality resistor having higher resistance values than previously possible within such a confined envelope.

# PAYNTON RELIABILITY

to which are added  
FAST DELIVERY & KEEN PRICES  
Send for your evaluation pack of the  
4 standard types now in production.



**Painton**  
& CO. LIMITED

KINGSTHORPE · NORTHAMPTON  
Telephone: 34251 Telex 31576 Grams: Ceil, Northampton

Overseas Associated Companies Australia Painton Australia Pty. Ltd. Benelux Painton S.A. Germany Painton G.m.b.h. Italy Painton Italiana Sweden Svenska Painton A.B. U.S.A. Painton Inc.