

INDUSTRIAL ELECTRONICS

APRIL 1965 5s 0d

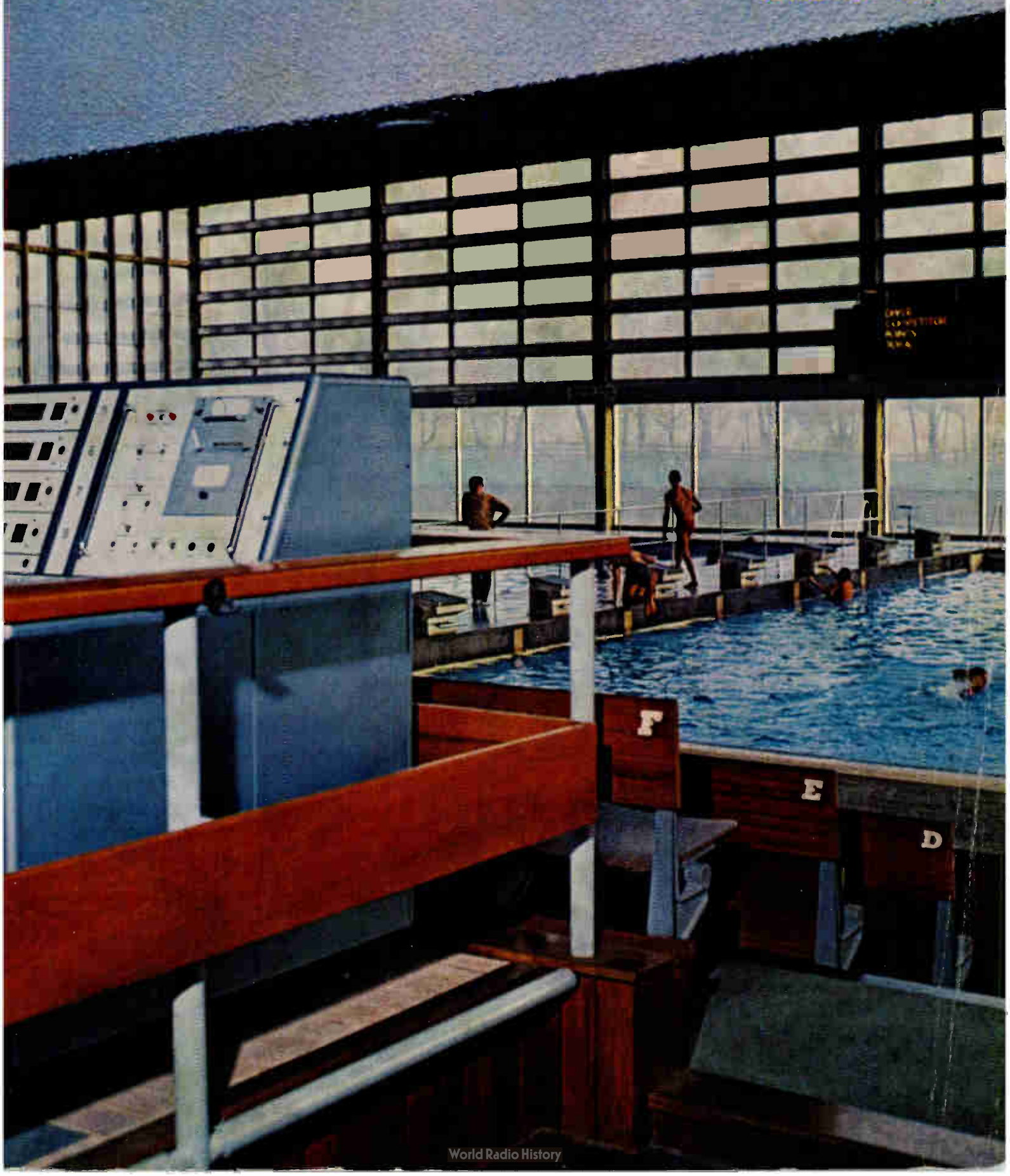

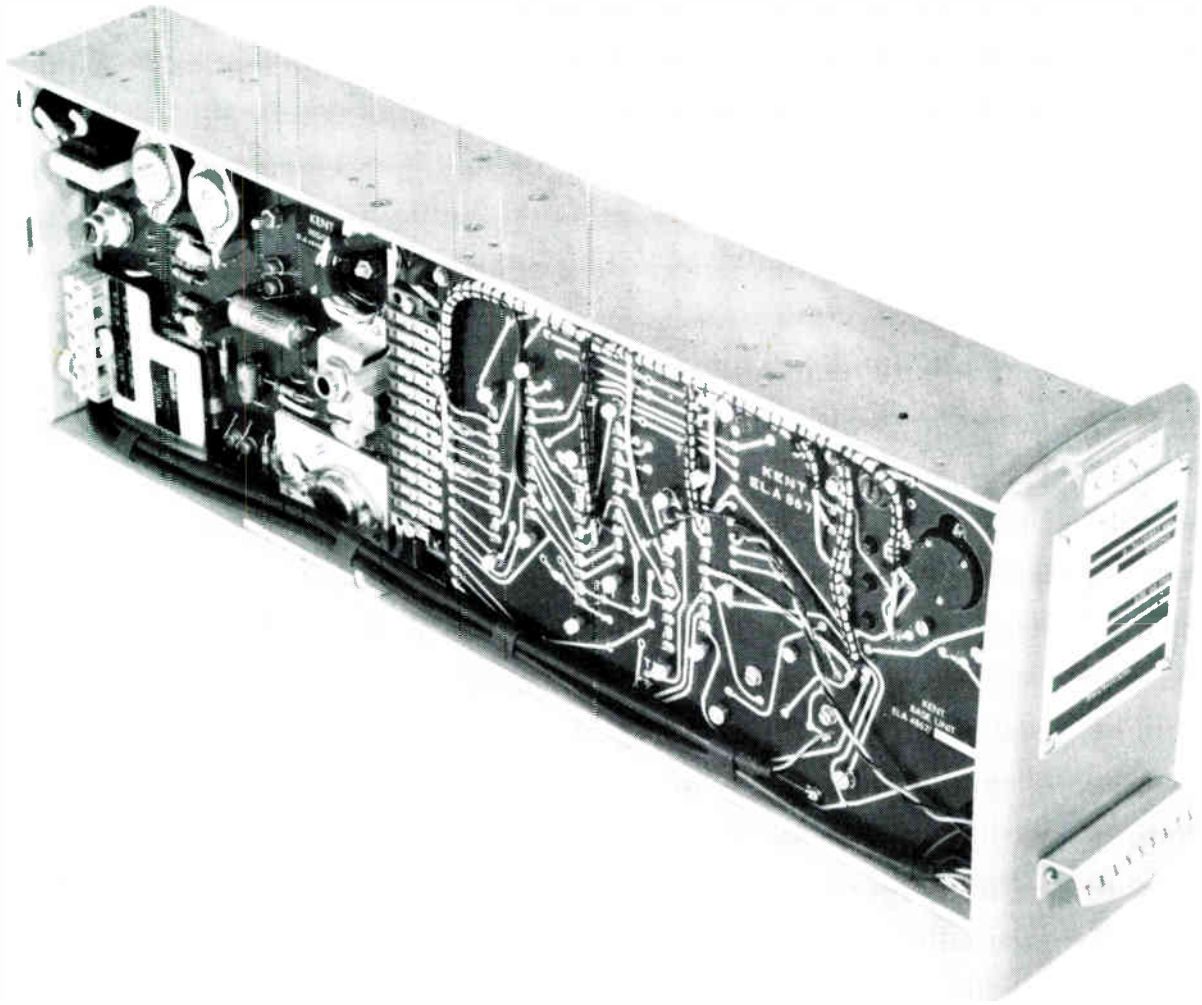

T R A N S D A T A

One of the most flexible systems of process measurement and control. It consists entirely of single-purpose units related by a 0 to 10mA signal and incorporating the latest techniques in solid-state electronics. Custom-built integrated schemes, however simple or complex, are designed on the individual but economical basis of selecting from a comprehensive range those basic items needed to perform the necessary measurement, conversion or control functions.

Modular construction, printed circuitry and high-grade components are employed throughout to ensure flexibility, accuracy, reliability and ease of servicing.

May we send you further details of the Kent Transdata system?



For further information circle 200 on Service Card

INDUSTRIAL ELECTRONICS

Automation Instrumentation Control

Volume 3

Number 4

April 1965

Contents

Editor **W. T. COCKING, M.I.E.E.**
Assistant Editor **T. J. BURTON**
Consulting Editor **T. E. IVALL**
Advertisement Controller **G. H. GALLOWAY**
Advertisement Manager **R. H. C. DOHERTY**
Production **D. R. BRAY**
Drawing Office **H. J. COOKE**

- 157 **Comment**
- 158 **Electronic Swim Timing Apparatus** *by D. R. Ollington*
Apparatus for timing the competitors in a swimming bath is described. It enables a considerable improvement in accuracy to be obtained and gives an immediate print-out of the results.
- 162 **Electronics in Textile Machines - 2** *by R. Greenwood, B.Sc.*
In the cotton industry delicate strands called rovings are wound on to bobbins and the bobbin speed must be closely controlled for good winding. This article describes a control system specially developed for this purpose.
- 166 **Automated Forge Hydraulics** *by James Franklin*
Some of the special hydraulic equipment which has been developed for use in the automatic control of forging is described in this article. By greatly reducing the cycle time it has enabled a big reduction to be made in the number of times that the work has to be reheated.
- 170 **Weighing in Industrial Processes**
Various ways of obtaining automatic weighing are discussed in this article. The methods often include the automatic control of the feed to, and the discharge from, a weighing hopper.
- 177 **Soaking-Pit Instrumentation at Samuel Fox**
Sixteen oil-fired soaking pits and three continuous pre-heat furnaces at the Stockbridge Works of Samuel Fox are now fitted with electronic instrumentation and control. Details of the complete system are given in this short article.

continued overleaf

© Iliffe Electrical Publications Ltd., 1965

Permission in writing from the Editor must first be obtained before letterpress or illustrations are reproduced from this journal. Brief abstracts or comments are allowed provided acknowledgment to the journal is given.

Published on the first Thursday after the 5th of each month by
Iliffe Electrical Publications Ltd., Dorset House, Stamford Street, London, S.E.1
Managing Director: W. E. Miller, M.A., M.I.E.R.E.

Telephone: Waterloo 3333. Telegrams/Telex: Electronics Iliffepres 25137 London

ANNUAL SUBSCRIPTION, HOME £3 0s. 0d. OVERSEAS £3 10s. 0d.
CANADA and U.S.A. \$10.00.

INDUSTRIAL ELECTRONICS

Automation Instrumentation Control

Contents *continued*

- 178 **Linear and Non-Linear Servomechanisms** *D. R. Towill, M.Sc., B.Sc.(Eng.)*
This article reviews the main characteristics of servomechanisms and also deals with the assessment of their performance. Some notes on testing methods are also included.
- 185 **Control Design Data—Third-Order Servomotor Systems**
by N. G. Meadows, B.Sc.
- 187 **Automated Diesel Engine Test Plant**
Manually-operated engine-testing dynamometer equipment at the Dunstable plant has been converted to fully automatic operation. This feature describes the equipment and gives details of some of the advantages gained by fitting automatic control.

What's On and Where?

A regular feature which lists forthcoming events. Professional meetings, symposia, conferences and exhibitions are included. **For easy reference this item is positioned facing the inside back cover.**

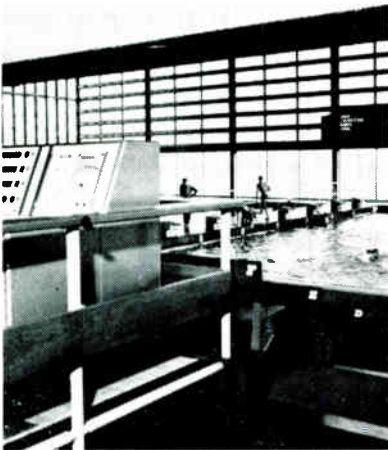

OUR COVER

This illustrates part of the Olympics-standard swimming bath at the National Recreation Centre provided by the L.C.C. at the Crystal Palace. This swimming bath is provided with one of the world's most advanced race-timing and score display systems. Elsewhere in this issue the electronic race-timing equipment is described.

● TO SAVE YOUR TIME

We will assist you to obtain further information on any products or processes described or advertised in this issue. Just use the enquiry cards included in this journal.

Features

- | | | | |
|-----|--|-----|---|
| 161 | Rapid Growth of S.E.R.T. | 189 | New Apparatus |
| 165 | Data Display at Auctions | 201 | Rotary Switches with Two Million Design Variations |
| 169 | Plessey Introduce Dust Detection Equipment | 202 | Industrial News |
| 176 | Automatic Effluent Sampling | 205 | New Books |
| 184 | STC Computer for Communications Networks | 206 | Manufacturers' Literature |
| 188 | High-Speed Data Logger for Defence Ministry | 46 | <i>Classified Advertisements</i> |
| | | 49 | <i>Index to Advertisers</i> |

Next Month

A feature article in next month's issue is a preview of the Radio and Electronic Component Show which opens at Olympia, London, on 18th May. A plan of the exhibition, list of exhibitors and descriptions of some of the interesting component trends in 1965 are included in this article. Other articles include one on the application of a closed-circuit television system at Dover harbour and another on sonic aids for the blind.

For further information
circle 203 on Service Card

WELWYN

METAL FILM RESISTORS TO DEF 5115 STYLE RFG7

RANGES AND RATINGS

WELWYN TYPE	DEF STYLE 5115 DRAFT	WATTS RATING at 70°C	MAXIMUM VOLTAGE	OHMIC RANGE AT $\pm 2\%$, $\pm 1\%$ and $\pm 0.5\%$
M807	RFG7 - 0.125	0.125	200	100 Ω - 100K Ω
M817	RFG7 - 0.25	0.25	250	100 Ω - 100K Ω
M827	RFG7 - 0.5	0.5	350	100 Ω - 100K Ω

TEMPERATURE COEFFICIENT: AVAILABLE AT ± 50 p.p.m./°C
AND AT ± 100 p.p.m./°C

DIMENSIONS

WELWYN TYPE	BODY LENGTH MAX.	BODY DIA. MAX.	LEAD LENGTH MAX.
M807	0.437"	0.165"	1.625"
M817	0.615"	0.210"	1.625"
M827	0.822"	0.275"	1.625"



WRITE NOW FOR FULL DETAILS



WELWYN ELECTRIC LIMITED

BEDLINGTON - NORTHUMBERLAND - ENGLAND

Telephone: Bedlington 2181-9 - Telegrams: Resistor Bedlington.

FACTORIES IN AUSTRALIA AND CANADA

Paper Capacitors do more jobs better — Plessey-UK offers **168 different standard kinds**

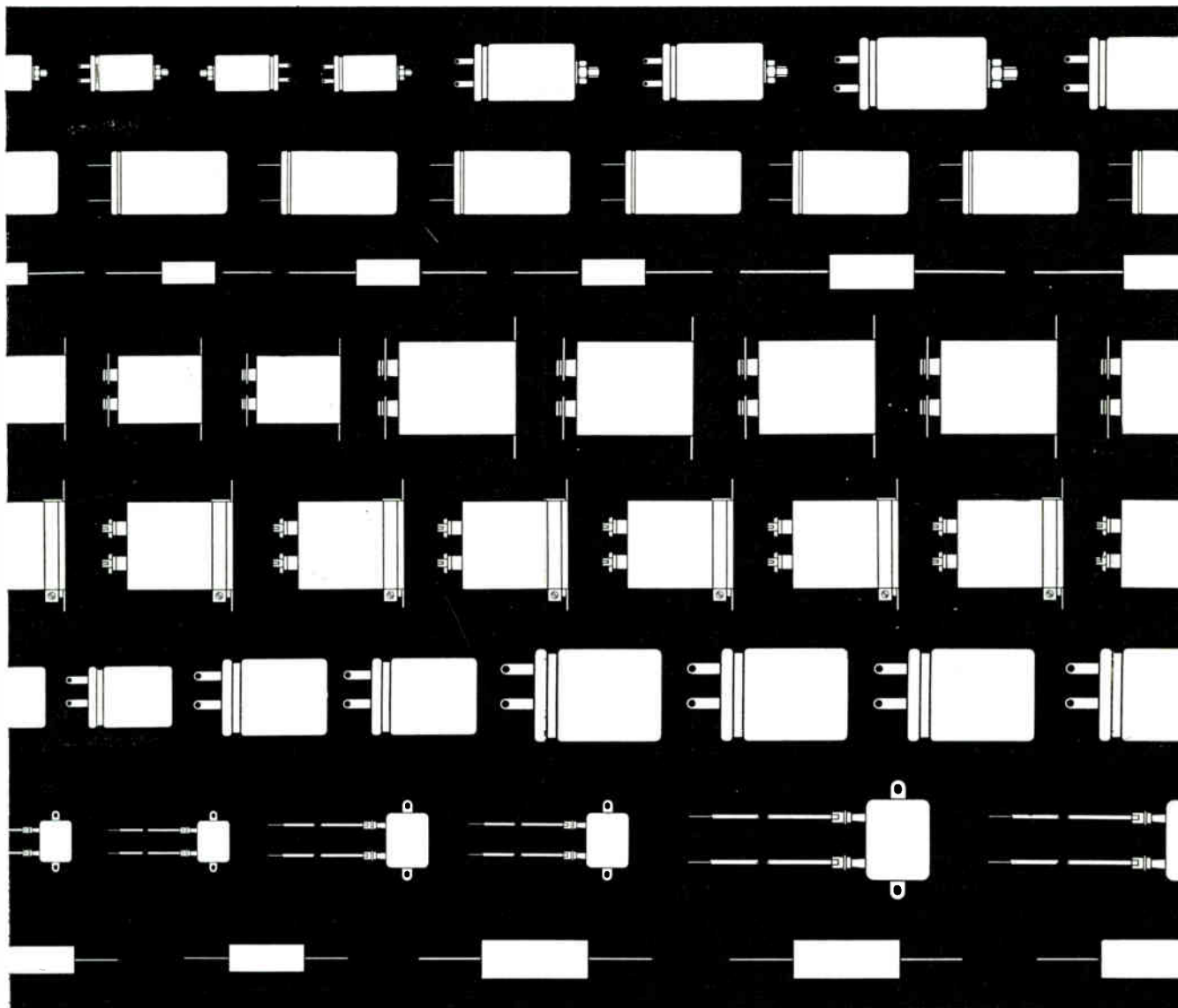

Plessey-UK makes a vast range of capacitors, and so has no axe to grind for 'papers'. But the fact remains that by continuously upgrading performance through the development of new impregnants, new electrode materials, and even new papers—Plessey-UK has made the paper capacitor class more versatile than any other. The Plessey-UK range of 168

standard paper capacitors includes aluminium tubes, plastic-sleeved tubes, round aluminium cans, rectangular rolled-seam cans, rectangular sheet-metal cases and 'bathtub' types—and you can have many of them in 4 weeks or less. Please write to Plessey-UK for details on these capacitors that do more jobs for less money.



PLESSEY-UK LIMITED / CAPACITOR DIVISION / SWINDON GROUP
KEMBREY STREET / SWINDON / WILTSHIRE
Telephone SWINDON 6211 / Telex 44180 PLESSEY SWINDON / Telegrams PLESSEY SWINDON TELEX

Overseas Sales Enquiries to:

PLESSEY INTERNATIONAL LIMITED
KEMBREY STREET / SWINDON / WILTSHIRE
Telephone SWINDON 6211 / Telex 44180 PLESSEY SWINDON / Telegrams PLESSEY SWINDON TELEX



DM

DATA LOGGING EQUIPMENT

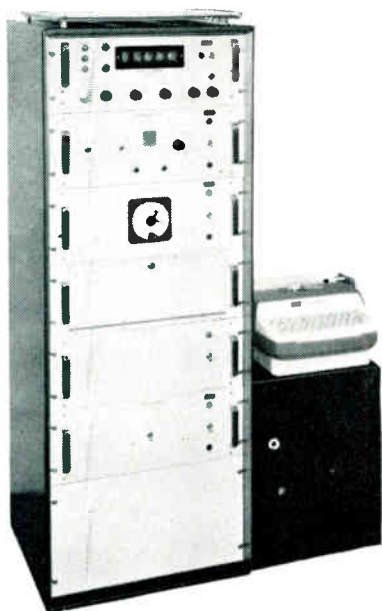

- * Up to 1000 channels
- * Resolution down to 1µV
- * Accuracies to 0.01%

Please write for further information to :

DIGITAL MEASUREMENTS LIMITED
 SALISBURY GROVE MYTCHETT ALDERSHOT HANTS
 TEL : FARNBOROUGH 3551

I. E. R. C. for the only

COMPLETE

range of semiconductor dissipators.

The Therma-Link Series are available for low power applications and are designed for the following mounting methods :

- Rivet
- Screw
- Stud



These types will fit all mechanical tolerance T05, T018 outline transistors.



TXB2P



TXBE



TX

FEATURES

- Beryllium Copper material
- Black Cadmium finish
- 30% reduction in junction temperature, giving greater transistor reliability
- 100g shock tested, also unaffected by 15g, 10c/s to 2Kc/s

The Fan-Top dissipator for use with existing circuitry; will meet the vibration specifications mentioned above.



TXBF

The TXBC dissipator has been designed to lower the transistor profile, by utilising the thickness of a printed circuit board and be self-retaining.



TXBC

The Therma-Link Series is available with Beryllium Oxide insulating washers.



Winston Electronics Limited

Govett Avenue · Shepperton · Middlesex Telephone: Walton on Thames 26321

A comprehensive range of heat dissipating components for valve and semiconductor devices.

When a breakthrough is imminent

... you will find 'SELLOTAPE' Electrical Tapes contributing to the safety and reliability of heavily loaded, hard-worked components in motors, transformers, relays and coils. And in miniaturised components, particularly, where space for insulation is minimal, these specialised products carry out a host of essential jobs such as the insulation of windings during impregnation or baking, the securing of lead-out posts and the holding of parts during assembly and manufacture. 'SELLOTAPE' Electrical Tapes take this sort of thing in their stride, because they have been developed in close collaboration with electronic engineers to keep abreast of the constantly changing techniques of this fast growing Industry.

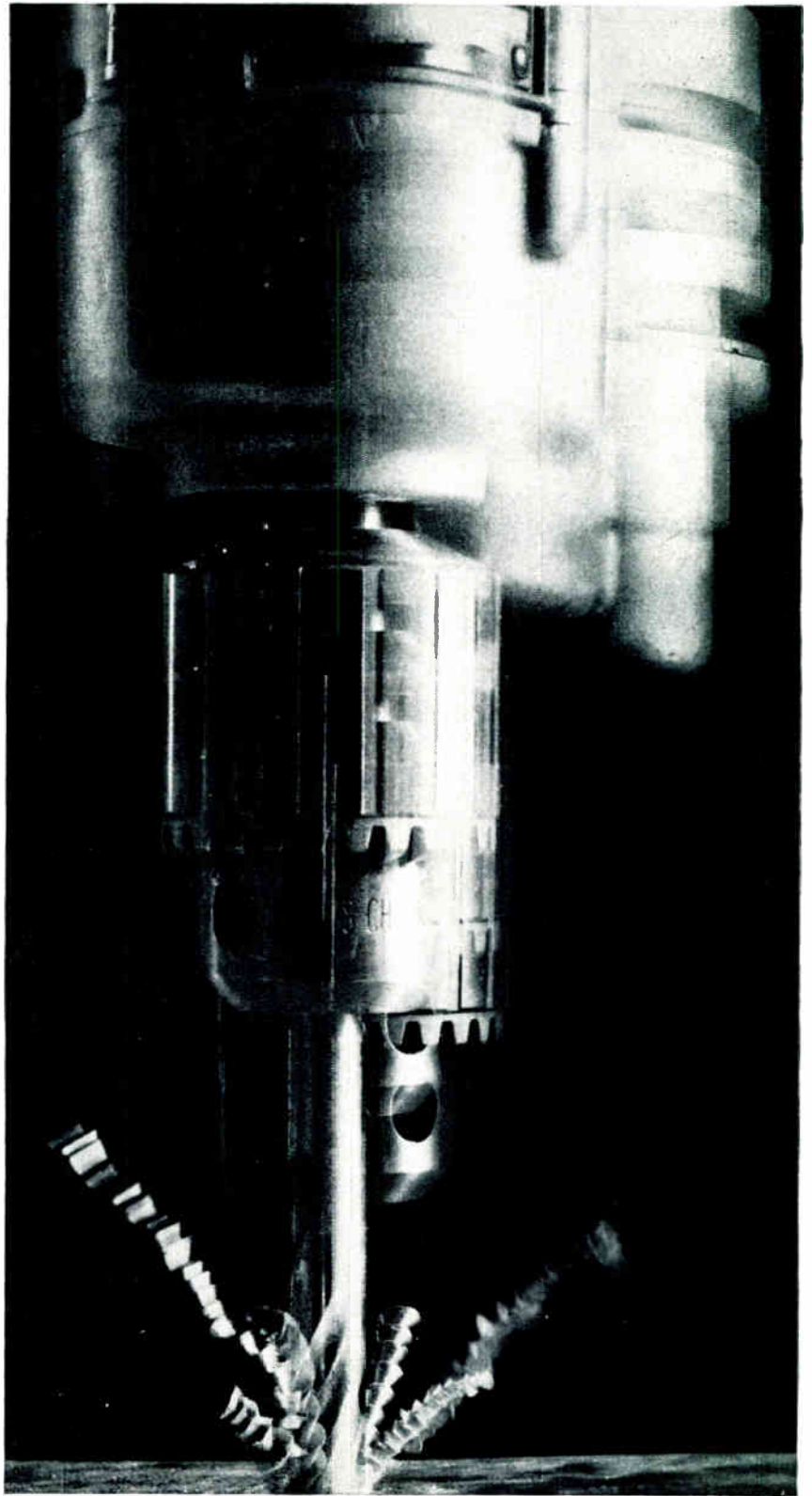

Sellotape

REGD. TRADE MARK

Sellotape

REGD TRADE MARK

polyester thermosetting tapes like it hot!

They have to because they have been developed for use in electronic components that are heat processed during manufacture or that operate at high temperatures. The tapes are based on various gauges of Polyester film, noted for its excellent volume resistivity and high dielectric and mechanical strength. The film is coated with thermosetting adhesive, which, on curing has increased bond strength and solvent resistance. The result is a range of electrical tapes designed to meet the stringent requirements of component manufacturers.

'SELLOTAPE' Extra-Thin Polyester Thermosetting Tape 1613—the thinnest in the range, specially developed for use in miniaturised components, and where maximum conformability is required.

'SELLOTAPE' Polyester Thermosetting Tape 1607—the most widely used in the range, shown in the drawing securing fine windings on a stick wound coil. The 0.001" based tape remains stable at 180°C for short periods and can be used continuously at 130°/155°C.

'SELLOTAPE' Heavy Duty Polyester Thermosetting Tape 1608—has that extra degree of toughness and insulation required on heavy coils etc. An ideal casing for capacitors.



Sellotape

REGD TRADE MARK

electrical tapes

'SELLOTAPE' Double-Sided Polyester Thermosetting Tape 1609—simplifies many tricky securing and holding operations in coil manufacture. 0.001" thick film is coated on both sides with thermosetting adhesive, providing the ideal means of securing lead-out posts, starting off, insulating and securing primary windings and leads, and in holding interleaves.

'SELLOTAPE' High Strength Polyester Thermosetting Tape 1614—a 0.005" based tape for the extra tough jobs found in the production of large motors, turbines, switchgear and heavy duty heater pads. Also used for 'ground insulation' in domestic appliances and equipment.

... and a special paper-based thermosetting tape for low cost components—'SELLOTAPE' Creped Paper Thermosetting Tape 2701—will withstand processing temperatures of 180°C and continuous electrical operation at 105°C. Good insulation and moisture resistance properties make the tape an obvious choice for use in coils, transformers, relays etc. for holding, lead and slot liner binding, and finishing off.

Write for full details of the complete range of 'SELLOTAPE' Electrical Tapes or call in one of our technical representatives to ensure that you use the right tape for the job.

Sellotape Products Limited
Industrial Division
Sellotape House
54-58 High Street
Edgware, Middlesex
Telephone: Edgware 2345

electrical tapes serve industry's pacemakers



'Sellotape' is the registered trade mark of Adhesive Tapes Ltd.

1.8 *usecond*

1.0 *usecond*



NEW COINCIDENT CURRENT MEMORIES

Newest of the proven R Series systems, the RS and RZ are practically identical—except for memory cycle time, and price. The RS has a cycle time of 1.0 microseconds and access of 420 nanoseconds, while the RZ has a cycle time of 1.8 microseconds with access time of 650 nanoseconds. For a significant improvement in cycle/access time there is only a moderate increase in price. If your immediate requirements are for a 1.8 system, but if you anticipate needing a 1.0 system in the future, the RZ is an ideal selection. The 1.8 RZ can be quickly and economically converted into a 1.0 RS—just by connecting in a new stack, replacing two printed circuit boards, and making minor component changes. Both models have a capacity of 16,384 words—in 4,096 modules, 8 to 56 bits per word. (Illustrated is the 8,192 model.) Temperature range is 0°C to 45°C without the use of stack heaters or compromising gadgetry. MTBF is high—a product of the stringent derating practices that have yielded unswervingly high performance from the Ampex R Series systems. Because of their modular magnetics, both systems are easily expandable with minimal circuit redundancy. A wide variety of options are available: data bus selection, zone control, parity generation and checking, built-in or remote testing facility. For details, call your Ampex representative, or write Ampex Great Britain Limited, Acre Road, Reading, Berkshire. Telephone: Reading 84411.

AMPEX

The most versatile low priced oscilloscope system in the world



OSCILLOSCOPE CD 1400

- * **5" Double-Gun Cathode Ray Tube**
- * **Plug-In X and Y Modules**
- * **Wide-Band, High DC gain, and Differential Y amplifiers**
- * **Single and Double time bases**
- * **Bench or rack mounting**

A complete system using a 5" double-gun, P.D.A. cathode ray tube giving large, bright, high resolution displays. Both X and Y systems plug-in and provide direct drive to the C.R.T. plates giving complete flexibility. The CD1400 is normally supplied in a bench case with a carrying handle which may be used as a tilt stand. An alternative version is available in a special case designed for rack mounting.

SOLARTRON

For—Data Systems · Transducers · Computers
Military Systems · **Electronic Instrumentation**

1. Wide Band Amplifier CX 1441

Bandwidth : DC to 15 Mc/s
Rise Time : 24nsec (approx)
Sensitivity : 100mV/cm to 50V/cm in
(at max. bandwidth) 9 calibrated ranges
Max. Sensitivity : 10mV/cm (DC—1Mc/s)
Measuring Accuracy : $\pm 5\%$

2. High Gain Differential Amplifier CX 1442

Bandwidth : DC to 75 Kc/s
Sensitivity : 1 mV/cm—5V/cm in 12 calibrated ranges
Max. Sensitivity : 100 μ V/cm 3 c/s—20 Kc/s
In phase rejection : 60 dB approximately
Measuring Accuracy : $\pm 5\%$

3. Time Base Unit CX 1443

Range : 0.5 μ sec/cm—200msec/cm in 18 switched ranges,
variable control with 'cal' position.

Measuring Accuracy : $\pm 5\%$
Trigger Source : Y1, Y2, or Ext. (+ve or —ve)
Time Base Modes : Normal-Auto-HF Sync
X Expansion : X1 to X5 continuously variable

4. Sweep delay time base unit CX 1444

Performance as CX 1443 but including sweep delay
up to 100m/sec. Nominal jitter 1 : 10⁴

THE SOLARTRON ELECTRONIC GROUP LIMITED

Victoria Road · Farnborough · Hants
Telephone · Farnborough (Hants) 3000
Telex · 85245 Solartron Fnbro
Cables · Solartron · Farnborough

A MEMBER OF THE SCHLUMBERGER GROUP

Dawe 6W audio oscillator Type 440B

Fields of use include :

laboratory measurement of distortion, gain and frequency response of high quality audio amplifiers. High output power matching into a load impedance of 3.75 ohms, 15 ohms and 600 ohms, provides ample power to drive loudspeakers or small vibration generators.

Main Features :

- ★ 20 c/s to 20 kc/s in 3 decade ranges.
- ★ High output, 6 watts, with low distortion.
- ★ Frequency response 0.5 dB.
- ★ Balanced or unbalanced output.
- ★ High thermal and electrical stability.
- ★ Long scale, 60 ins.

U.K. List Price £98.



DAWE

Full technical data from:—

DAWE INSTRUMENTS LTD., WESTERN AVE., LONDON, W3 Tel: ACOrn 6751

A member of the *Spang* group of companies

SPECIFY HUGHES DIODES

Hughes — originators of the world's first sub-miniature all-glass diode — manufacture at their Glenrothes, Scotland, factory an unequalled range of germanium and silicon devices for the most diverse diode applications. Add Hughes service and second-to-none product quality and solve your diode problems in the simplest way — SPECIFY HUGHES.

... diodes with superior performance and maximum reliability

GERMANIUM SWITCHING DIODES

HG1005 HG1006 HG1012	Point-Contact	PIV $I_F @ 1V$ $I_b @ 50V$ Capacitance	up to 100V > 5mA < 50 μ A 0.2pF	CV448 CV7041 CV7130
HG5003 HG5004 HG5008 HG5009	Gold-Bonded	PIV $I_F @ 0.8V$ $I_b @ 50V$ Capacitance Stored charge	up to 100V > 100mA < 25 μ A 0.4pF 400pC	CV7076 CV7127 CV7128
HD1810 HD1840 HD1841 HD1870 HD1872	Gold-Bonded	PIV $I_F @ 0.7V$ $I_b @ 10V$ Capacitance Stored charge	up to 50V > 100mA < 5 μ A 1.5pF 65pC	
HPS1670 HPS1672	Ultra-Fast Point-Contact	PIV $I_F @ 1V$ Reverse recovery time	up to 20V 10mA 0.8 nanosec	

SILICON SWITCHING DIODES

1N643 1N643A 1N806 1N809	High voltage diffused	PIV $I_F @ 1V$ Capacitance Stored charge	up to 200V 100mA 5pF 500pC	
1N914 1N914A 1N916 1N916A 1N3064 1N3067	Diffused Planar	PIV $I_E @ 1V$ $I_b @ 20V$ Capacitance Stored charge	up to 75V 20mA < 0.025 μ A 2pF 60pC	CV7367 CV7368
HD5000 HD5001 HD5004	Ultra Fast	PIV $I_F @ 1V$ $I_b @ 5V$ Capacitance Stored charge	up to 20V 5mA < 0.2 μ A 1pF negligible	

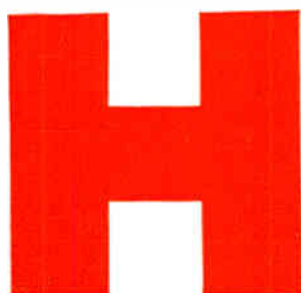

Write now for complete data on the full range of Hughes semiconductor products, which also includes:—Silicon sub-miniature power diodes/rectifiers, Voltage reference (zener) diodes, High voltage cartridge rectifiers, PNP and NPN Silicon Transistors.

HUGHES INTERNATIONAL (U.K.) LTD

GLENROTHES - FIFE - SCOTLAND

SALES OFFICE: HEATHROW HOUSE, BATH ROAD, CRANFORD, HOUNSBLOW, MIDDLESEX

Telephone: SKYPORT 9584/5, 9961/2

Telex: 23613

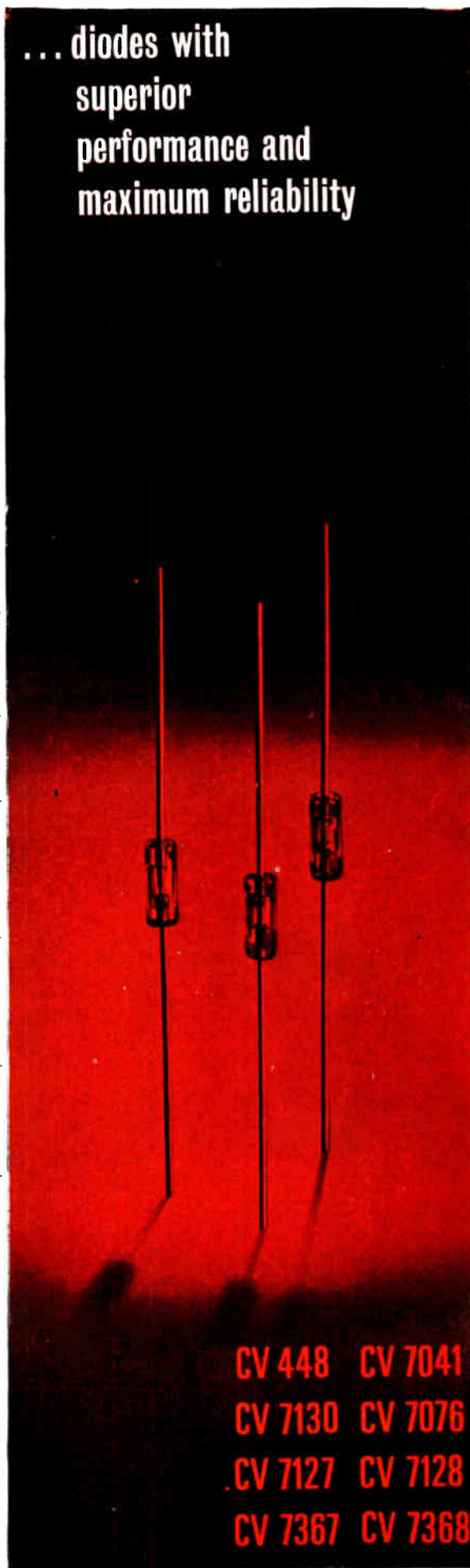

CV 448 CV 7041
CV 7130 CV 7076
CV 7127 CV 7128
CV 7367 CV 7368

Delayed and mixed sweeps plug-in units DC-40 Mc/s Oscilloscope CD 1220



- * Delayed and mixed sweeps
- * Large 6cm x 10cm display
- * Plug in Y units
- * Tunnel diode trigger circuits
- * Measuring Accuracy 3%

FOUR PLUG-IN Y UNITS ARE CURRENTLY AVAILABLE:

	Bandwidth	Sensitivity	In Phase Rejection	X10 Gain
Single Trace Unit CX 1256	40 Mc/s (-3dB ± 1dB)	50mV/cm -50V/cm		
Dual Trace Unit CX 1257	DC-24 Mc/s (-3dB ± 1dB)	50 mV/cm -50V/cm		
each channel				
High Gain Differential Unit CX 1258	DC-100 Kc/s	100µV/cm	80dB	
High Gain Wide Band Unit CX 1259	DC-40 Mc/s	50 mV/cm		5mV/cm DC-24 Mc/s

Wide, basic sweep range, second time-base generator and ability to record fast, single shot transients, contribute toward making the CD 1220 a high quality, general purpose instrument suitable for the examination of the most complex waveforms. Some of the many fields of application include communication, telemetry, television, automation and power engineering. Timebase delay permits investigation of pulse trains and allows pulse-to-pulse interval, time difference and signal jitter measurements to be accurately made.

Please write or telephone requesting further particulars or to arrange a demonstration.

MAIN UNIT CD 1220

	Range	Expansion	
Time Base A	0.1µsec/cm -12 sec/cm	x 5 (20µsec/cm maximum speed)	Comprehensive Trigger Modes
Time Base B	2µsec/cm -1 sec/cm	x 5 (maximum speed 0.4µsec/cm)	Trigger: Facilities as time-base A may also be used to delay time-base A

SOLARTRON

For-Data Systems · Transducers · Computers
Military Systems · Electronic Instrumentations

THE SOLARTRON ELECTRONIC GROUP LIMITED
Victoria Road · Farnborough · Hants.
Telephone · Farnborough (Hants) 3000
Telex · 85245 Solartron Fnbro
Cables · Solartron Farnborough
A MEMBER OF THE SCHLUMBERGER GROUP

POWER



SEMICONDUCTOR DEVICES

SILICON DIODE TYPE FN 300

300 amperes up to 1500 volts P.I.V.

Fully hard soldered junction
for optimum reliability.



THYRISTOR TYPE 71T

250 amperes 1200 volts forward
and reverse voltage

Compression bonded junction
eliminates thermal cycling problems.

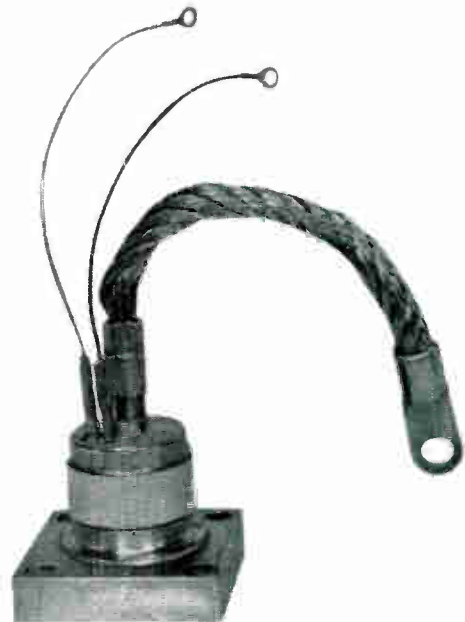

WESTINGHOUSE BRAKE AND SIGNAL COMPANY LIMITED

82 YORK WAY, KING'S CROSS, LONDON, N.1. TEL: 1 ER 6432 Telex 2-3225

For further information circle 215 on Service Card

This is a combined transformer, rectifier and controller... just like the other six Dexion Slotted Angles.

Transforming—a mountain of small components into tidy, instant-selection, small part storage.

Rectifying—production line bottlenecks (Dexion conveyors—work stations—trolleys).

Controlling—for change. It's easier, quicker and cheaper with Dexion Slotted Angle adapt at the turn of a spanner.

And all 7 Dexion Slotted Angles are **Versatile**—tailor-made equipment need no longer be expensive.

Flexible—adjust or dismantle equipment at a moment's notice.

Economic—with 7 Angles to choose from you always get the right strength for a particular structure.

But don't take our word for all this. You need facts, case histories, proof

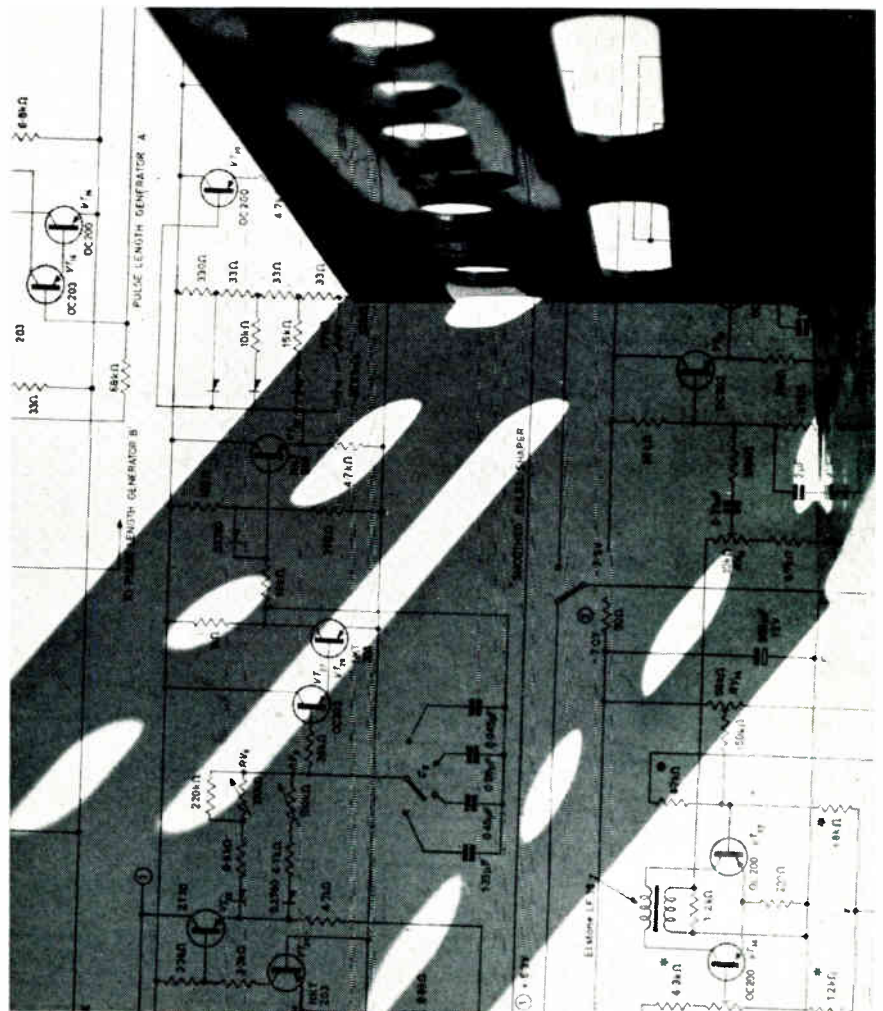

Here are the Angles.

The largest and most stringently tested range in the world.

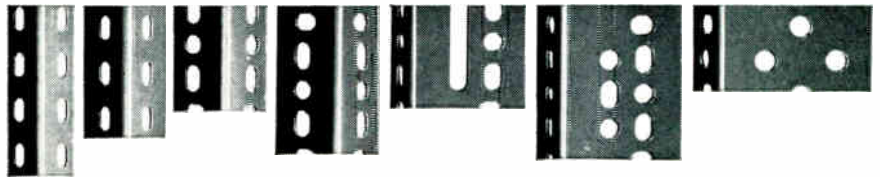

100 125 140 160 225 260 Steel Channel 345

And this fully illustrated literature isolates problem areas—offers solutions—and is free. *Clip the coupon and post it today.*

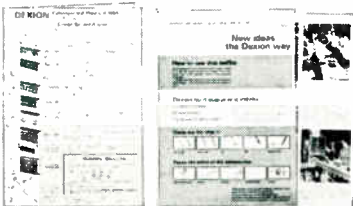

Name

Position

Company

Address

Phone

Dexion Ltd

Storage & Materials Handling Division,
2/4 Empire Way, Wembley, Middlesex.
Telephone: WEMbley 1281

B194/A

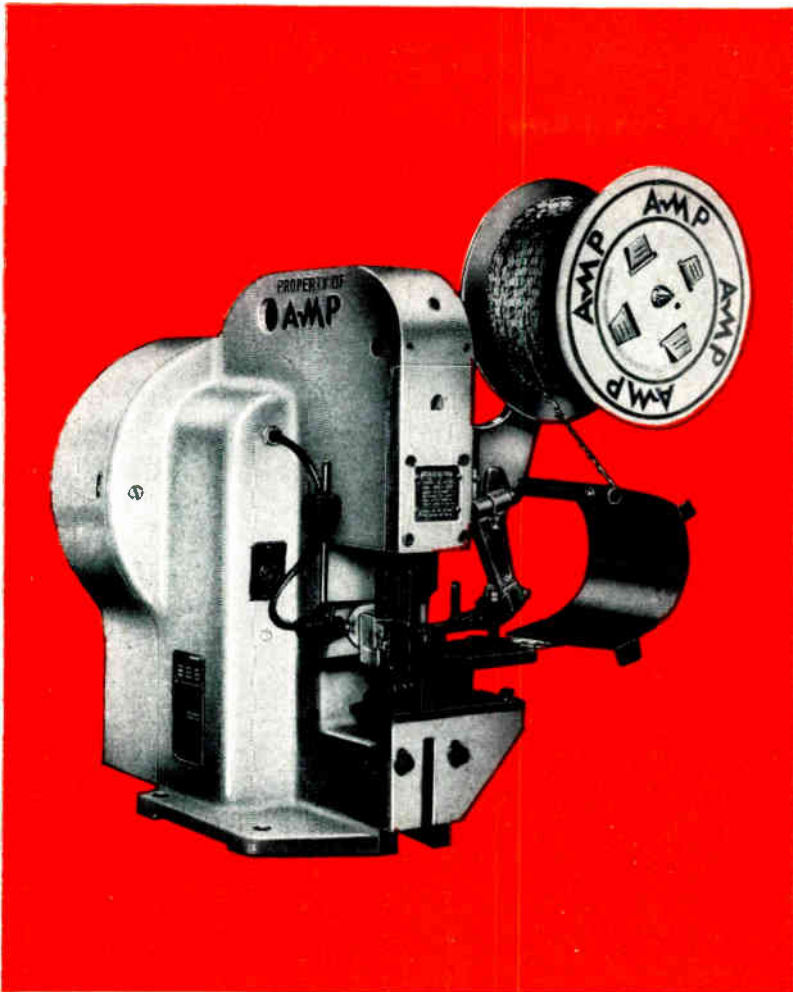

AMP-O-LECTRIC automachine for strip terminals

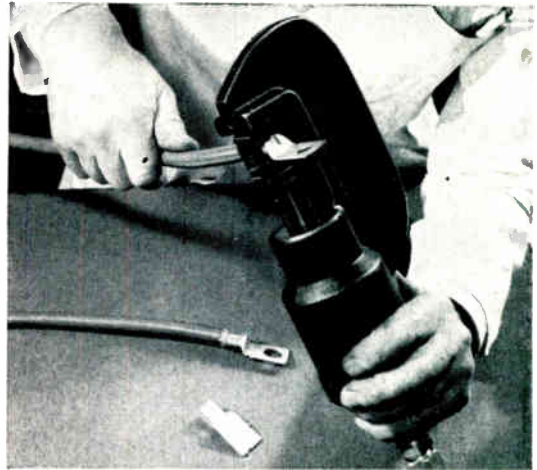

DYNA-CRIMP heavy duty tool

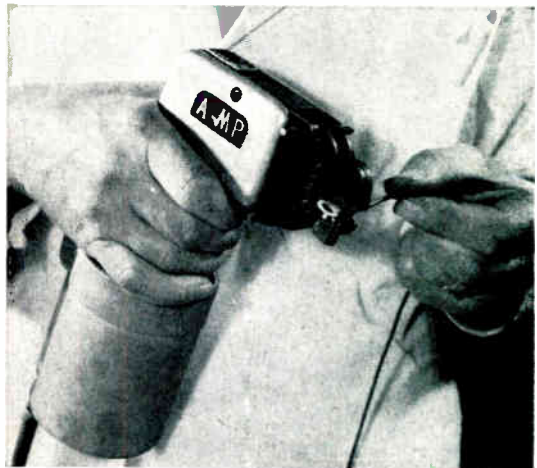

Pneumatic hand tool

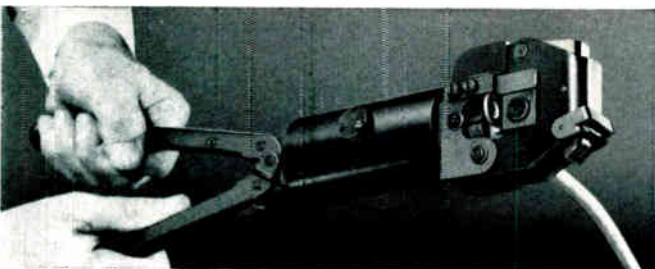

DYNA-CRIMP hand hydraulic tool



CERTI-CRIMP hand tool

AMP see the job through—at any level

There is A-MP tooling for every production level and wire size. Types include hand tools, pneumatic and hydraulic hand or bench fitting models and automatic Amp-o-lectric machines which permit continuous terminations at speeds up to 4000 per hour.

Success is inevitable, as every A-MP tool applies a compression crimp that is automatically controlled. Results are absolutely consistent, and are electrically and

mechanically reliable irrespective of termination speed or operator ability.

Let us help you to get the most efficient terminations, quickly and at lower cost.

AT THE R.E.C.M.F. EXHIBITION

AMP will announce an entirely new method of wire termination, within a programme covering every aspect of wiring systems on all scales of production.

This exciting concept will be beyond the most optimistic hopes and expectations of the electrical and electronic industries.

REMEMBER AMP — STAND NO. 313

AMP
AIRCRAFT-MARINE
PRODUCTS (G.B.) LTD



TERMINAL HOUSE, STANMORE, MIDDX. TEL: STOnegrove 6341

A-MP products and engineering assistance are available through associated companies in: U.S.A. · Australia · Canada · France · Germany · Holland · Italy · Japan · Mexico · Puerto Rico

A-MP, AMP-O-LECTRIC, DYNA-CRIMP & CERTI-CRIMP ARE TRADE MARKS OF AMP INC.

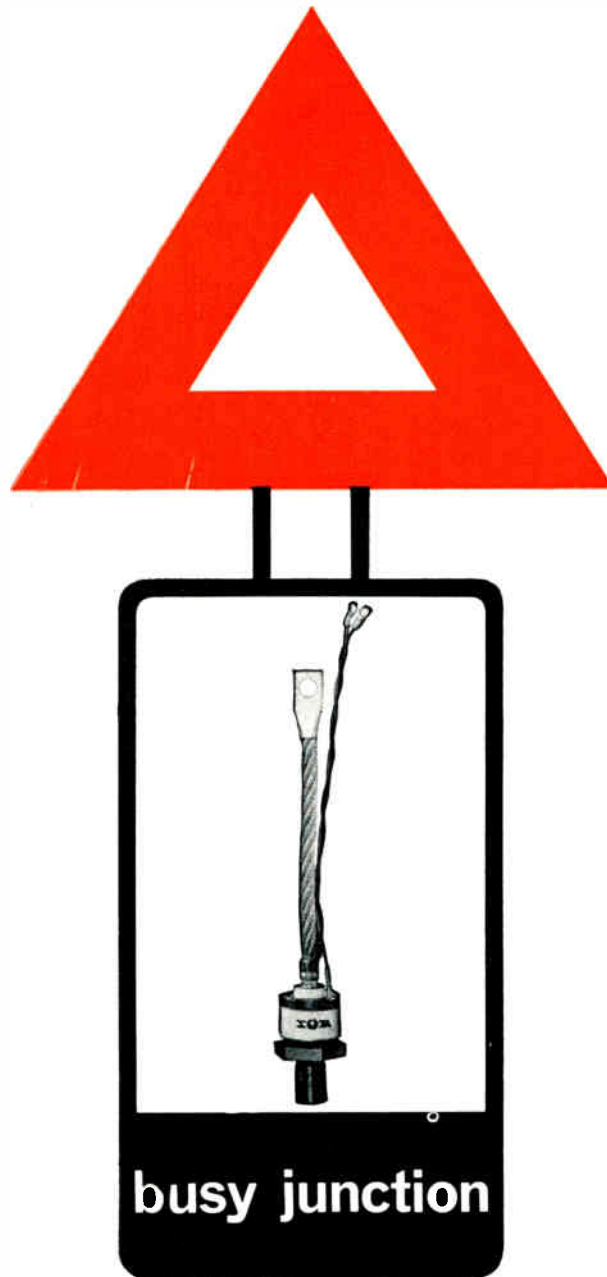

Heavy currents ahead. IR control them with new heavy duty epitaxial thyristors. Currents up to 150 A, PRV up to 1300. Give yourself new power over power; find out exactly what these new IR power thyristors can do.

IR INTERNATIONAL RECTIFIER

Immediate off-the-shelf delivery from IR distributors - phone

COLCHESTER 6173 · CRAWLEY 28700 · GLASGOW DOUGLAS 8671 · (LANCS) TODMORDEN 602 · LEEDS 35111
LEICESTER 68561 · (LONDON S.E.27.) GIPSY HILL 6166 · (MIDDLESEX) SKYPORT 1314 · PORTSMOUTH 204E5

INTERNATIONAL RECTIFIER CO. (GREAT BRITAIN) LTD · HURST GREEN · OXTED · SURREY · TELEPHONE OXTED 3215 · TELEX RECTIFIER OXTED 8819 

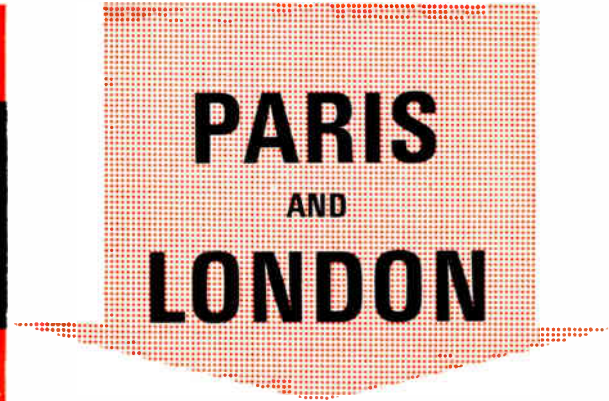

At the two leading European radio and electronic component shows, Ersin Multicore – the World's Finest Cored Solder, will be prominently exhibited.

In Paris and London, Technical, Laboratory and Management personnel from the Multicore Works will be in attendance to meet Manufacturers' staffs. Club facilities will be available to the Trade at both shows.

A full range of Ersin Multicore 5-core Solders will be shown, including Savbit Alloy, which prolongs the life of soldering iron bits by 10 times. Extra fine gauges of solder, as thin as 34 s.w.g., 0.23 mm., incorporating 5-cores of non-corrosive flux, will also be shown.

Daily demonstrations will be given of the Multicore Solderability Test Machine, developed by the Electronic Engineering Association in collaboration with the International Electrotechnical Commission, with a view to establishing it as a standard for testing the solderability of round wires.



*The Finest
Cored Solder
in the World*

April 8th - 13th
**ELECTRONIC COMPONENTS
SHOW**

PARC DES EXPOSITIONS
PORTE DE VERSAILLES
PARIS

STAND 5-C
ELECTRO-ACOUSTIC SECTION

May 18th - 21st
**RADIO & ELECTRONIC
COMPONENTS SHOW**

OLYMPIA - LONDON
STAND 168
REAR SECTION OF MAIN HALL

MULTICORE SOLOERS LTD · MULTICORE WORKS · HEMEL HEMPSTEAD · HERTS · TELEPHONE: BOXMOOR 3636

CHMS 32

STC components review

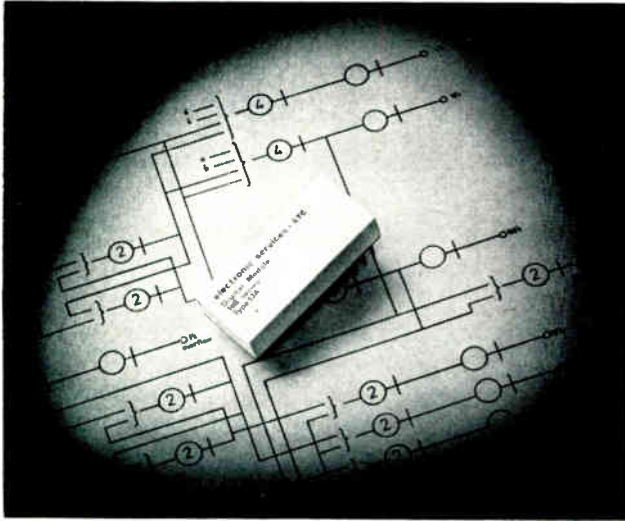

Digital circuit modules Series 10A and 10B

The STC series 10A and 10B digital modules are logic elements for use in decisional logic (control) systems or arithmetic logic (data handling) systems. Intended for low to medium speed applications up to 10kc/s, the design is characterized by very sharp pulse edges ensuring positive response and noise immunity.

Silicon transistors are used throughout. Designed life is 20 years minimum. Ambient temperature range is -10°C to $+70^{\circ}\text{C}$.

Volume production of these assemblies of conventional components results in reduced costs for the user when compared with the cost of purchasing, mounting and soldering individual components and testing the assembly. The 10AB series includes the following functions:

Gates	Inverters	Buffers
5-input	Low-power	Low-power
4-input	Medium-power	Medium-power
3-input	High-power	High-power
2-input		

Multi-stables

Multi-input gated bistable
Medium delay monostable
High delay monostable

Peripheral equipment circuits

Output squarer
Low-power d.c. output switch
Medium-power d.c. output switch
High-power a.c. output switch

For data sheets and prices, use Reader Enquiry card or write, 'phone or telex Electronic-Services—STC, Edinburgh Way, Harlow, Essex. Telephone: Harlow 26811 Telex: 81146.

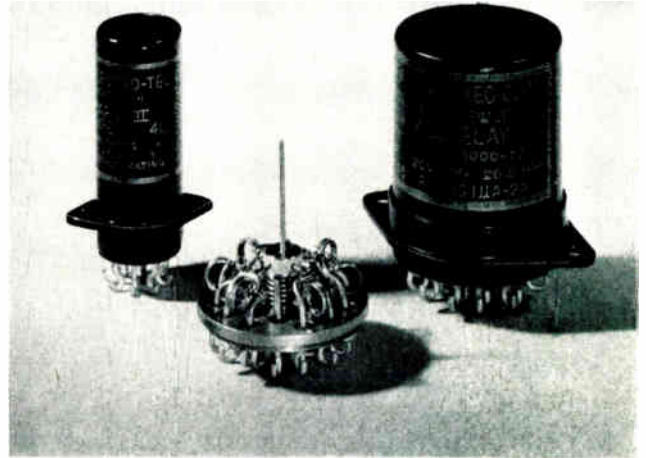

'Electro-Tec' wedge action gold contact relays

'Electro-Tec' wedge action relays are multi-pole relays with a unique wipe operation for each contact. One end of the pole, or moving contact, is anchored in the relay header. The other end is firmly joined to the actuator mechanism. Because the movable contact face is angled, a positive wiping action is developed during both make and break movements. In addition, contact pressure increases during overtravel and there is no contact bounce. These innovations make possible greatly increased contact with long operating life when compared to conventional relays. Identical gold contacts will handle 1.2A or 2A. The relays will operate in ambients up to 200°C .

Developed originally for aviation and missile operations, wedge action relays are now produced in quantity at the right price for critical industrial applications.

For data sheets and prices, use Reader Enquiry card or write, 'phone or telex STC Electro-Mechanical Division, West Road, Harlow, Essex. Telephone: Harlow 21341. Telex: 81184.

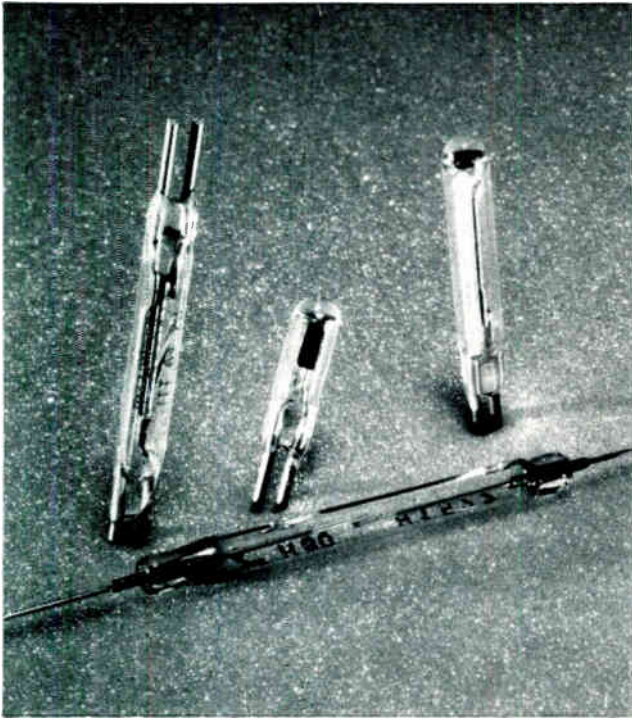

Reed switches and relays

Four basic types of STC reed switches and relays are manufactured with more than a hundred variations within the basic designs. The reeds are enclosed in sealed glass envelopes filled with inert gas. This construction provides millions of maintenance-free operations for each switch.

The reeds can be operated by permanent or electro-magnets. The very small Pigmy reed is a make switch with both leads at one end of the envelope. The F-Type make switch also has leads at one end and the F-Type changeover reed a pair of leads at each end.

The Herkon reed is the world's most reliable reed switch. Hundreds of thousands are in use in telephone exchanges and similar applications. Failure rates have been negligible. Of special interest to designers of data logging and similar equipment is the HR84 relay system where special Herkon devices, with up to six reeds per relay, are mounted on magnetic iron strips. The strips, as well as acting as a magnetic circuit for the relays, hold the units in position.

For data sheets describing the above and other reed switches and relays, use Reader Enquiry card or write, 'phone or telex STC Electro-Mechanical Division, West Road, Harlow, Essex. Telephone: Harlow 21341. Telex: 81184.

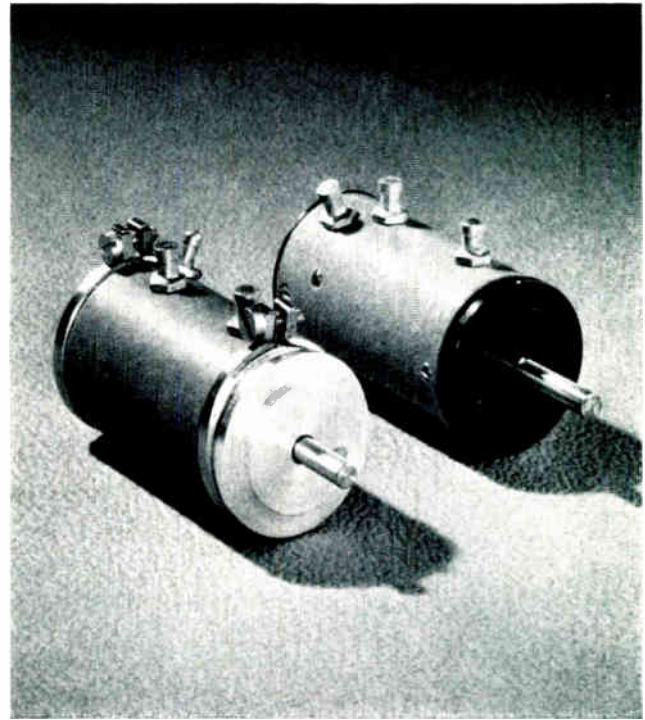

Miniature helical potentiometers

The P15 Series of miniature helical potentiometers are 3, 5 and 10 turn pots. with an external diameter of only 0.875 in. (22,2mm). The units are available up to a maximum resistance of 120k Ω and with an independent linearity of 0.5%. Maximum dissipation is 2.5W at 40°C ambient. The standard unit has a $\frac{1}{8}$ in. diameter shaft and is for mounting with a $\frac{1}{4}$ in. x 32 TPI bush.

New Design

Shown in the foreground of the photograph is the latest design of this range of potentiometers. Electrical ratings and accuracy are as for the original design, but performance is improved through the use of nylon bearings to give longer life and better sealing against entry of foreign matter. Other improvements include: connection of the slider to the slipping using a sliding contact, and increase of stop torque through the mounting of the stops in the aluminium end caps.

Both of the above ranges of miniature potentiometers have the linearity and accuracy of bigger helical potentiometers.

For full details ask for data sheet. Use Reader Enquiry card or write, 'phone or telex P.X. Fox, General Control Potentiometers, Standard Telephones and Cables Limited, West Road, Harlow, Essex. Telephone: Harlow 21341. Telex: 81184.

PARIS COMPONENTS EXHIBITION

STC components will be displayed on the ITT stands at the Salon des Composants Electroniques, Paris, April 8-13th.

high-grade components by

STC

COMPONENTS GROUP

A portable digital data recorder from £1000



Takes DC voltages from thermocouples, strain gauges, transducers etc. and records 20 outputs in printed form in less than seven seconds. This powerful monitoring system has been made possible by the introduction of the Solartron Integrating Digital Voltmeter.

This low price high-performance voltmeter has high sensitivity and will reject unwanted signals in series and common mode. It is thus ideally suited to Data Recording applications. To match this outstanding instrument, Solartron have developed a comprehensive range of fully compatible data logging modules. These are assembled in standard cases following the layout shown below. Blank panels are supplied to replace any units not required, permitting expansion by easy stages.

Performance Highlights · Sensitivity : $10\mu V$
 Accuracy : 0.05% · Common Mode Rejection : up to 120dB
 Inherent Series Mode Rejection : 30dB (long term)

No. of Channels : 20, 50 or 100
 Scanning Rate : Maximum 3 per second
 U.K. list price £700 – £2,800
 depending on facilities provided.

DIGITAL VOLTMETER LM1420			EXTERNAL RANGE UNIT LU1475
PRINTER OR PUNCH DRIVE LU1466 LU1467	OFF LIMIT UNIT LU1464	DIGITAL CLOCK LU1463	SCANNER LU1461
PRINTER OR PUNCH DRIVE LU1466 LU1467	OFF LIMIT UNIT LU1464	RESISTANCE THERMOMETER UNIT LU1462	LINEARISER LU1465

SOLARTRON

For – Data Systems · Transducers · Computers
 Military Systems · Electronic Instrumentation

A comprehensive Data Sheet and further information is available on request.

THE SOLARTRON ELECTRONIC GROUP LIMITED
 Victoria Road · Farnborough · Hants.
 Telephone · Farnborough (Hants) 3000
 Telex · 85245 Solartron Fnbro
 Cable · Solartron Farnborough
A MEMBER OF THE SCHLUMBERGER GROUP

M&P 5195

STC RELAYS UNISELECTORS COUNTERS FOR ALL CONTROL APPLICATIONS

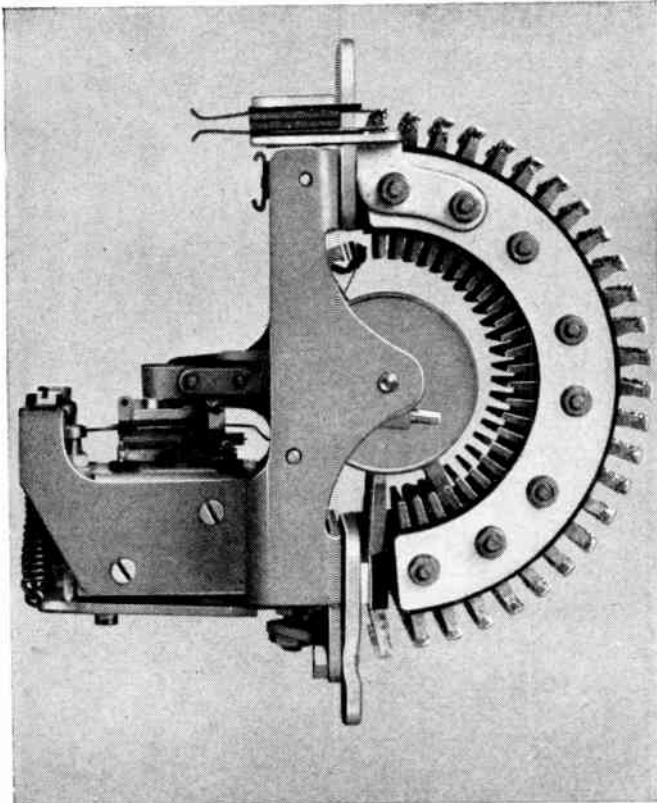

Expert advice on the selection of electro-mechanical components for control applications is readily available from the Components Division of Livingston Control Ltd., who can make delivery of all types from stock immediately.

UNISELECTORS

Heavy duty up to 10 banks.

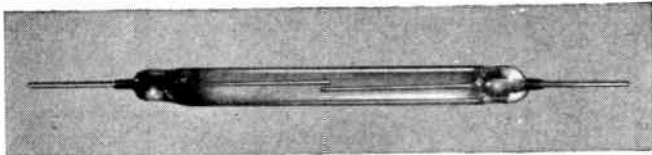

DRY REED RELAYS

HERMETICALLY SEALED

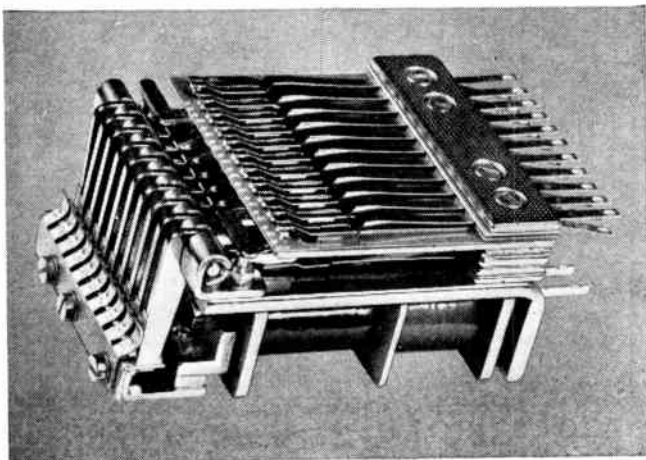

MAGNETIC COUNTERS

NEW APPROACH TO COUNTING AND BATCHING

For full details of the above, please contact:—

LIVINGSTON CONTROL LTD



GREYCAINES HOUSE,
BUSHEY MILL LANE,
WATFORD, HERTS.
Telephone: Watford 41291.

Send now for the "LIVINGSTON MODULAR CONTROL FOR INDUSTRY" catalogue

NAME

COMPANY

ADDRESS

IE 4/65

VACUUM

The International Journal and Abstracting Service for Vacuum Science and Technology and their Applications in Research and Industry
Co-ordinating Editor: A S D Barrett

Board of Editors:

A H Beck, *Engineering Laboratories, University of Cambridge*
 B B Dayton, *Consolidated Vacuum Corporation, Rochester, New York*
 K Diels, *E Leybold's Nachfolger, Köln-Bayenthal, Germany*
 J M Dunoyer, *Faculté des Sciences de Nantes, France*
 P A Redhead, *National Research Council, Radio and Electrical Engineering Division, Ottawa*
 E Thomas, *École Royale Militaire, Centre des Sciences Nucléaires, Brussels*
 J Yarwood, *Department of Mathematics and Physics, The Polytechnic, Regent Street, London*

A monthly journal which has become established in forty countries as the most influential publication on vacuum. This is essentially due to the authoritative collection of papers contributed by international experts, and to the unbroken record of documentation on all aspects of vacuum research and engineering.

Some papers from recent issues:

Stresses in evaporated silicon monoxide films - M A Novice; The effect of frequency on the electrical resistivity of granular metal films - A A Hirsch, N Friedman and S Bazian; The electrical properties of silicone films polymerized by electron bombardment - L Holland and L Laursen; Ceramics and ceramic-to-metal sealing - W H Kohl; Microbalance for measuring evaporation rates in vacuum - M M Freundlich; Use of a cylindrical projection tube for the study of pre-breakdown emission for protrusions on extended surfaces - I Brodie and I Weissman; Structure of thin layers of magnesium fluoride: Theoretical interpretation of their formation (French and English) - M Bourg and A Bourg; Mass spectrometer for the study of sputtering - A J Smith, D J Marshall, L A Cambey and J Michael

A free specimen copy will be sent on request together with details of subscription rates. Please write to the most convenient address below, mentioning this journal.
Pergamon Press Ltd
Headington Hill Hall, Oxford
Pergamon Press Inc, 44-01 21st Street
Long Island City, New York 11101

Porcelain

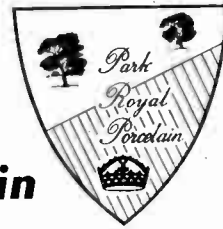

Steatite

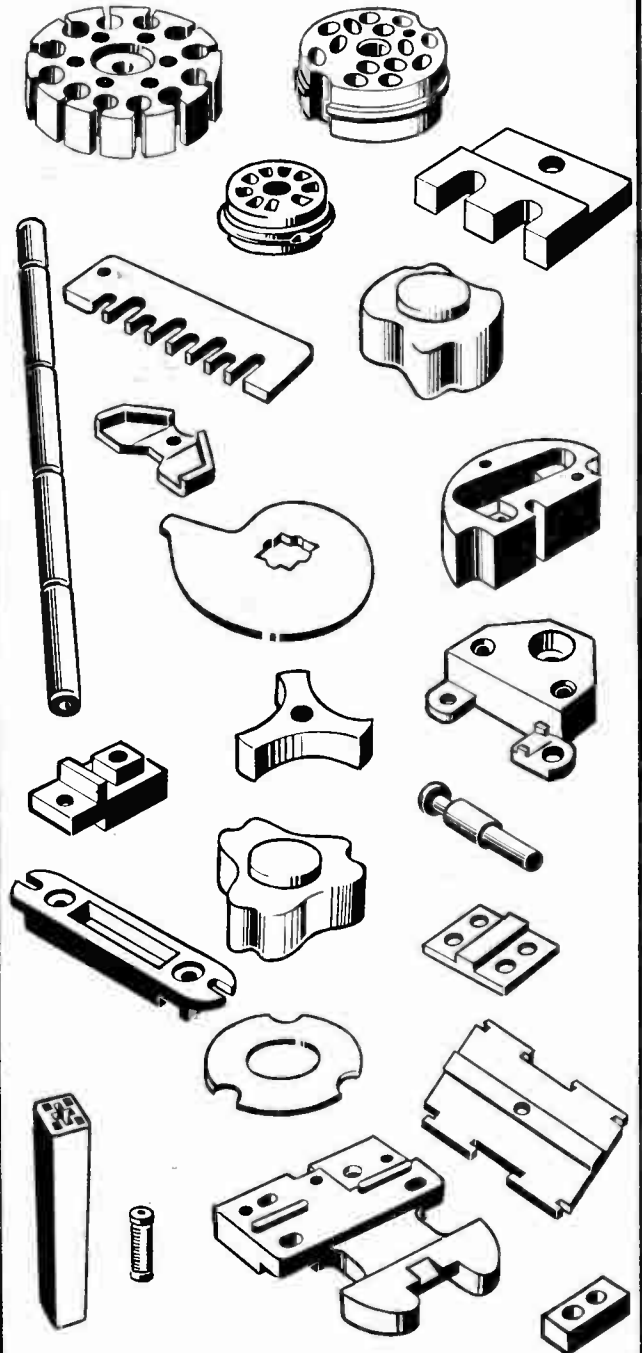

V. G. PORCELAIN CO LTD

**GORST ROAD
 PARK ROYAL
 LONDON, N.W.10**

**Telephones:
 ELGAR 1411/7
 Telex:
 London 25589**

Sensitivity $40\mu\text{V}(1^\circ\text{C})$

Multi-Million Operational life

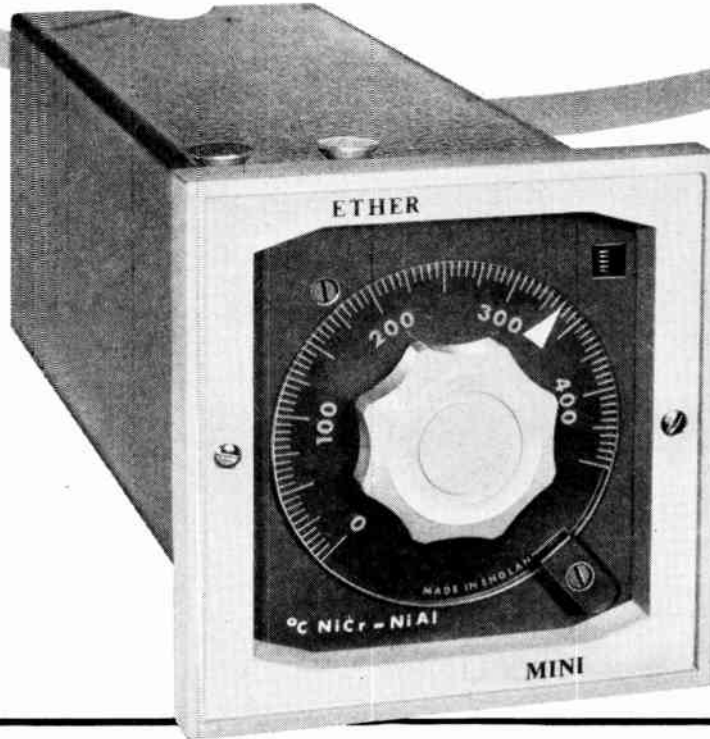

ETHER

TRANSISTORISED TEMPERATURE REGULATOR

MINI TYPE 17-90

Accurate, Reliable Temperature Control up to 2000°C

The difference signal between the output of a thermocouple and an internal reference voltage is fed to a transistorised amplifier to operate a relay. The relay will operate on an input signal differential of less than 40 microvolts, equivalent to less than 1°C , with base metal thermocouples, and less than 2°C with precious metal types. Provision is made for increasing this differential by a factor of 10 where very close control is not required.

The relay has a life expectancy of several million operations at maximum load rating. Set point is adjusted by a precision potentiometer, and read by the position of an illuminated cursor on a calibrated scale. A signal lamp is provided to show the control condition. Standard ranges from £27-10-0.

ETHER
LIMITED

Send for full details to:—

CAXTON WAY, STEVENAGE, HERTFORDSHIRE
Telephone: Stevenage 3040-55

the same clear readout...

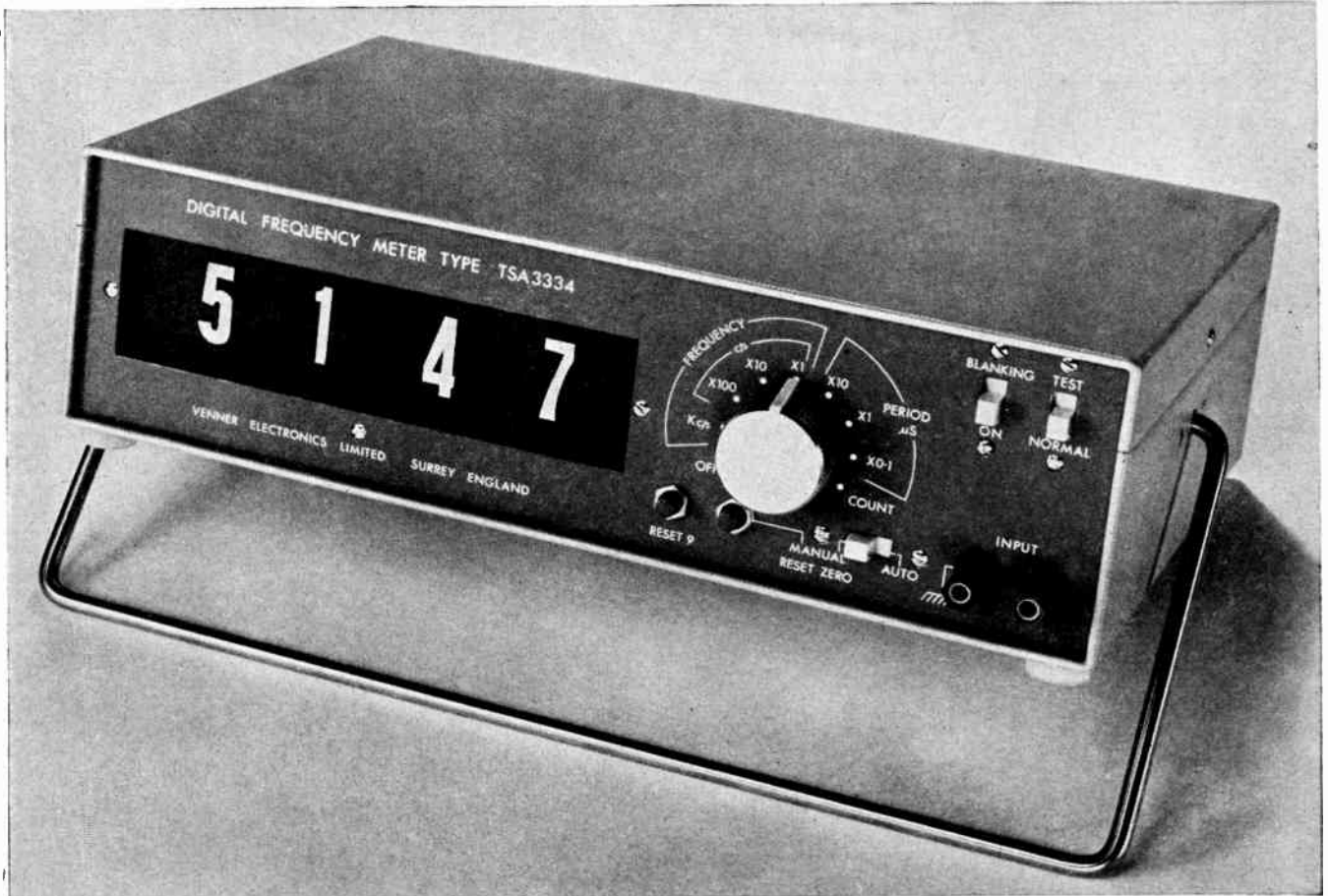

...and more in the box

TSA3334 MK111 Frequency Meter and Counter

- Blanking circuit now fitted, switching off display whilst count progresses
- Improved sensitivity — now 100mV
- Period measurement over 1, 10 and 100 cycles
- Count facility added, 1.2 Mc/s maximum
- Operates off one 12V battery or A.C. mains
- Price £135 (U.K. only)

Complete technical details on request from

VENNER

VENNER ELECTRONICS LIMITED
KINGSTON BY-PASS · NEW MALDEN · SURREY · MALDEN 2442

Overseas subsidiaries
VENNER A. G. BÜRGERNZIELWEG 16 · 3006 BERNE · SWITZERLAND
VENNER N. V. HELMSTRAAT 3 · DEN HAAG · HOLLAND

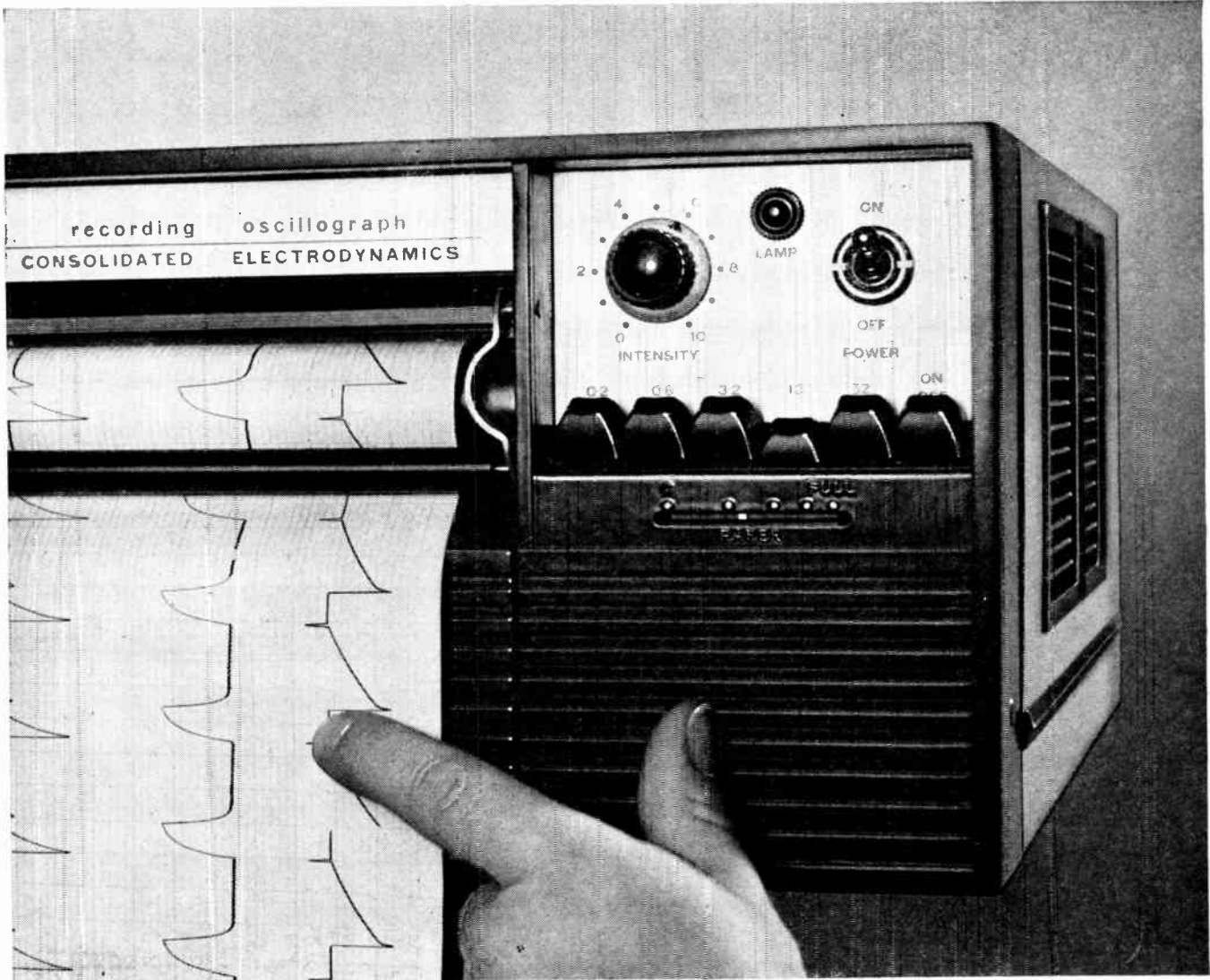

Big recorder capabilities in a package this small?

YES! Consolidated Electro Dynamics' 5-124 direct print U.V. oscillograph has a wide range of features which, coupled with its small size, make it a natural choice for environments where versatility and portability are important. The 5-124 measures just 7½" x 13" x 15½" and weighs only 40 lbs. Yet, it can record data from d-c to 13,000 cps on 18 channels using standard Consolidated Electro Dynamics 7-300 series galvanometers ... is capable of writing speeds up to 50,000 inches per second on 7-inch wide records ... and has five record speeds instantly selected by pushbutton. Furthermore, it can

be loaded in just 10 seconds and is simple to operate. Simplicity of this recorder means reliability. It seldom needs maintenance.



No record magazine is required, thereby eliminating spindles or the need for paper threading. Modular construction—all four basic modules being exposed by removal of the cover—for ease of inspection. Optional accessories include: Automatically exposed grid line system and trace interruption; trace numbering; a full-record-width electronic flash timing system; heated galvo block; special slow and higher record speeds; and record take-up unit.

For further information, write for Bulletin 5124. For rapid delivery, call Mr. R. T. Lancaster.

Consolidated Electro Dynamics

A division of BELL & HOWELL LIMITED

14 Commercial Road, Woking, Surrey. Telephone: Woking 5633

CONTROL

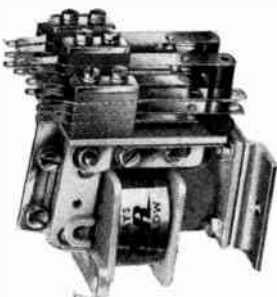

J.01
Robust and reliable—up to 10 make, break or changeover 2.5 Amp contacts—laminated frame—oilite bearings.

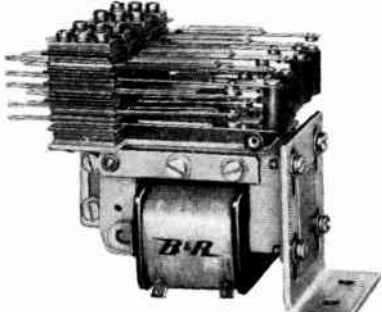

C.01
12 make, break or changeover 5 Amp contacts may be fitted—low coil consumption—laminated frame—silent—oilite bearings—long life.



M.01/M.51 & M.01/M.51/P (as shown)
Both open and plug-in types available—up to 4 changeover or 6 make or 6 break 5 Amp contacts—plug-in version has aluminium cover—screw terminal sockets available for 8 and 11 pin plug-in versions.



Q.01/Q.51
Ideal for machine tool control and motor switching duties—can be fitted with up to 4 make and 4 break contacts. Suitable for switching 3 phase 440V supplies at 10 Amps inductive—latching and interlocking units available.



D.03/D.53
Two changeover 6 Amp contacts—no wiring between contacts and base connections—Makrolon cover—wiring or screw terminal sockets.

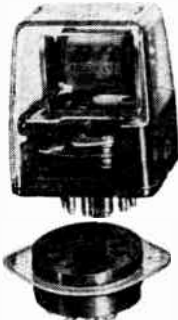

D.05/D.55
Three changeover 6 Amp contacts—no wiring between contacts and base connections—Makrolon cover—wiring or screw terminal sockets.

Control equipment requires versatile and reliable relays. The B. & R. relays shown here have different advantages for different applications, covering all requirements.

If you are concerned with any aspect of control, mechanisation or automation, these relays, which may be supplied for A.C. or D.C. operation, merit your closest attention.

All are well designed, meticulously tested, quality relays.

Write or 'phone for details:

B & R RELAYS LIMITED

Temple Fields, Harlow, Essex. Telephone: Harlow 25231-4. Telex: 81140. Cables: Brelay—Harlow.

Best in Relays

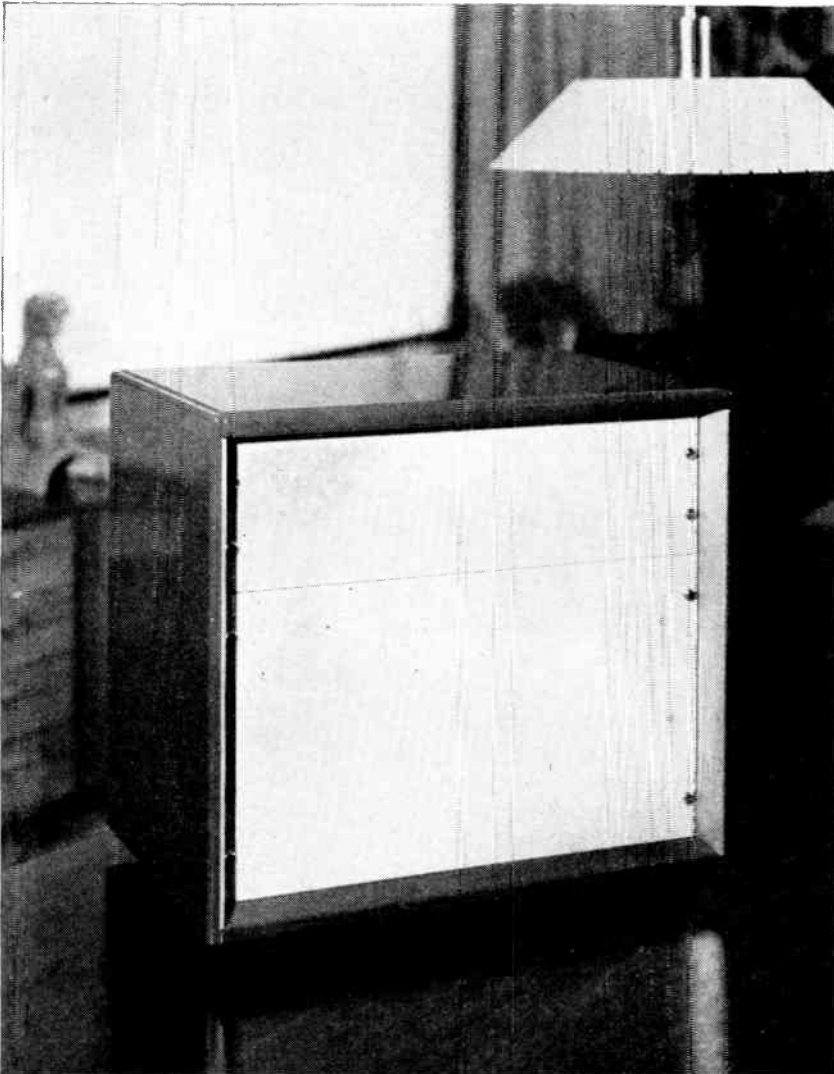

a case of good design

1500 Series There are 14 models in this series — all with the same attractive recess to the front panels. Two different depths are available and the case we illustrate is type 1520B. Price (complete with panels) £9.17.3

Good design demands: a really attractive appearance combined with practicability — at an economical cost. These three essentials are “built-in” to more than 100 standard Imhof instrument cases. To prove the point, we show here a typical example from their range — look at the lines! Look at the price! The standard of manufacture and finish is, of course, of a superb quality that will satisfy the requirements of the most discerning. Send today for Imhofs’ 48 page catalogue on Instrument Cases — it contains full dimensional details of their range and is lavishly illustrated in full colour

IMHOFS

ALFRED IMHOF LIMITED

Dept. No. IE/4 Ashley Works Cowley Mill Road Uxbridge Middlesex
Telephone Uxbridge 37123 Telex 24177 Telegrams IMCASE-UXBRIDGE-TELEX

Agents in Algeria Australia
Belgium Brunei Canada Denmark
Finland France Germany Holland
Iraq Israel Italy Jordan Kuwait
Lebanon Malaysia Mexico Morocco
New Zealand Nicaragua Norway
Portugal Saudi Arabia South Africa
Southern Rhodesia Sudan Switzerland
Syria Thailand Tunisia U.S.A. Zambia

W6

DOUBLE BEAM COSSORSCOPE 2300

Model 2300 is a compact, precision calibrated oscilloscope designed specifically for high-sensitivity, low-frequency applications in electrical engineering, servo analysis, electro-mechanical transducer displays, electro-myography and electro-cardiography. A double-gun cathode-ray tube is employed. Two identical amplifiers are provided with a choice of either single-ended or differential inputs.

The triggering system provides four modes of operation: Auto, A.C. Slow, A.C. Fast, and D.C., and the sweep may be triggered from any selected point on the positive or negative slope of the signal. Mechanical triggering is available, whereby an external contact closure, developed across the MECH and COMMON terminals of the oscilloscope by the apparatus under test, will trigger the time-base, an external voltage source being unnecessary. Single-stroke operation can be primed or triggered by a push-button.

- Frequency response d.c. to 200 kc/s (-3 dB)
- Identical Y amplifiers 1 mV/cm to 50 V/cm
- 19 calibrated timebase ranges 5 sec/cm to 5 μ sec/cm
- Voltage calibration $\pm 3\%$ and time calibration $\pm 3\%$
- Mechanical triggering Z modulation and equal X-Y facilities

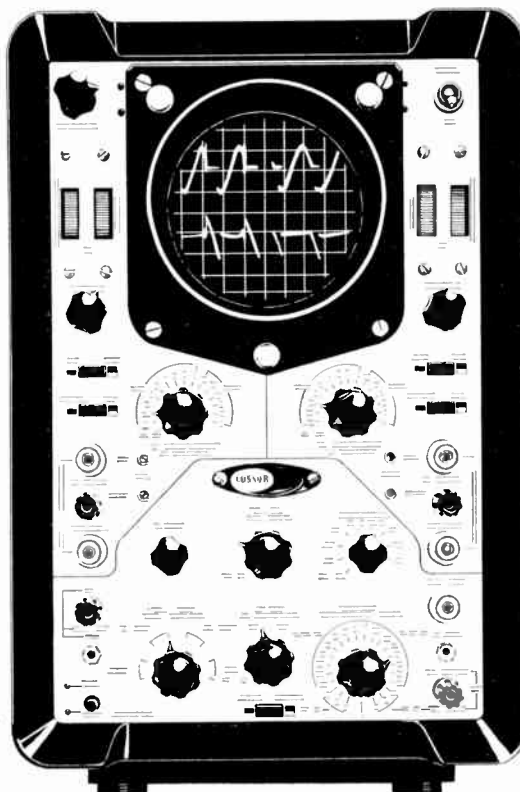

COSSOR
A Member of the Raytheon International Group

COSSOR INSTRUMENTS LTD.
The Pinnacles, Elizabeth Way,
Harlow, Essex, England.
Tel: Harlow 26862 Cables: Cossor Harlow

Automation

It is surely rather remarkable that this widely-used word has never been adequately defined. Even the experts seem unable to define it clearly and succinctly. When asked, they usually embark on a long dissertation about automation which always seems to be so vague that their listeners are little the wiser. One thing is always insisted upon; this is that automation is more than automatic control. Further, there is often an insistence that automation involves some automatic 'thinking' by the machine; this means that automation eliminates the need for thinking by a machine operator, just as automatic control eliminates his need to turn control knobs.

This sort of vague descriptive definition does not help very much when one wants to decide whether a given system is automation or just automatic. Just where does a complex automatic control system cease to be merely such a system and become automation?

Quite a lot of people behave as if there were no difference between the two and seem to regard automation as being just a lot of automatic control. Certainly, the word automation is being freely used in this way.

The matter is far from an academic one. How can one sell automation to non-technical people when one cannot explain in simple terms what it is? Most explanations make it sound like automatic control plus a mysterious something.

In our October 1962 issue there was an article 'Step by Step Automation', in which automation was regarded as the automatic processing of information which is gathered automatically from the plant and which is used, after this processing, to control the plant. While we do not disagree with this, we do not think it goes far enough.

Consider a simple automatic control system having proportional plus derivative feedback. A signal derived from the output of the system (which is information gathered automatically from the plant) is compared with a standard signal to produce an error signal. This is then differentiated and this derivative signal is added to the error signal in a proper proportion and the combined signal is used to control the plant. All this is information processing; it also embodies the mathematical operations of subtraction, differentiation, multiplication by a constant and addition. It could thus be said that the system embodies a computer. Any definition of automation which enables such a simple automatic control system to come within it is obviously unsatisfactory.

We do not want to be entirely destructive in our criticism and before we conclude we are going to suggest a definition for automation. We suggest that 'Automation is a form of automatic control in which two or more interdependent parameters of the process are controlled automatically to produce some desired result by signals which are derived from information gathered automatically from the process and which may be combined with signals stored within the system'.

The key words are 'interdependent parameters', for these necessitate quite a complex control mechanism and, usually, some kind of optimizing process.

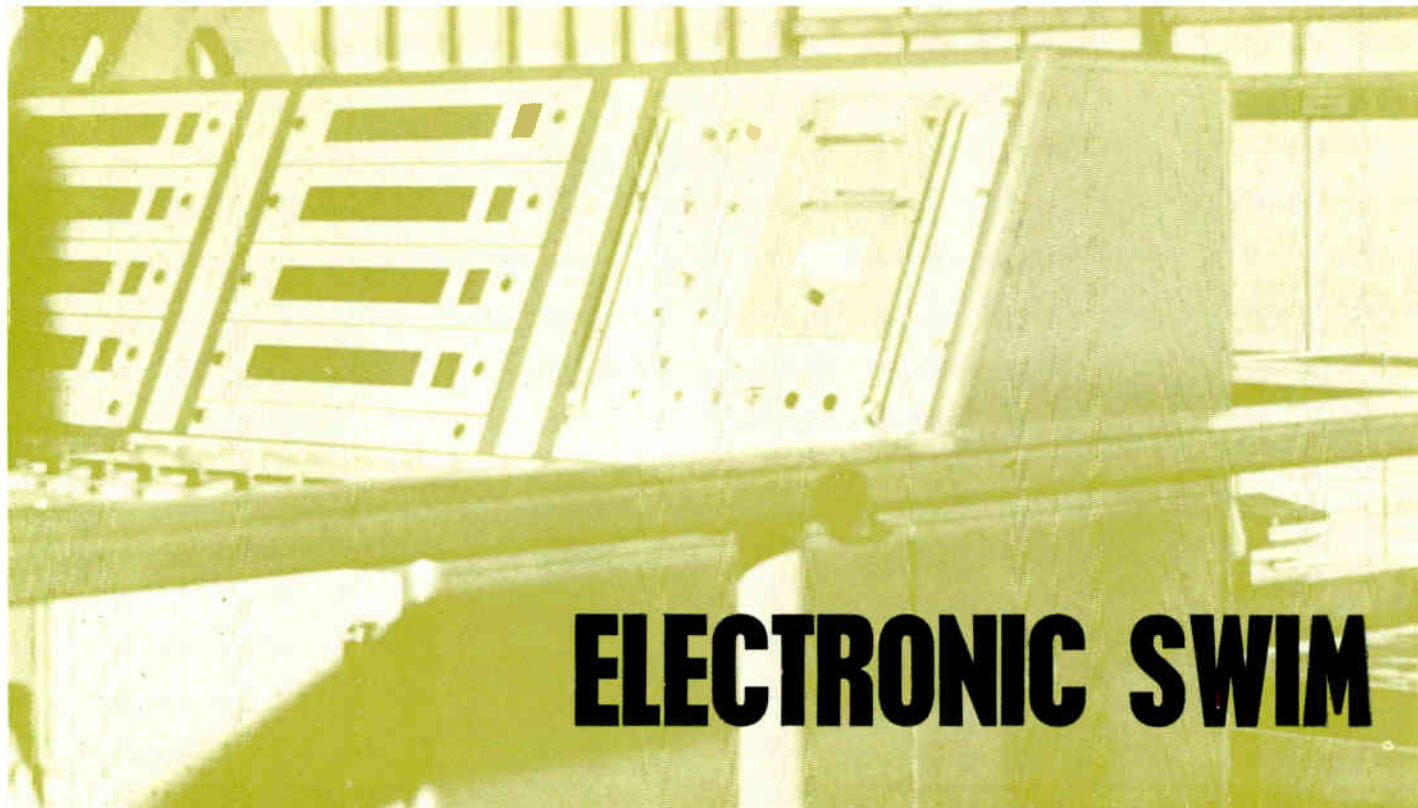

ELECTRONIC SWIM

Apparatus for timing the competitors in a swimming bath is described. It enables a considerable improvement in accuracy to be obtained and gives an immediate print-out of the results.

THE upsurge in interest in competitive swimming emphasizes the need for more advanced race timing than has been available previously. Stop-watch timing is, of necessity, subject to human error and it may be the ability of a timekeeper who decides whether a race is won or lost rather more than the ability of the swimmer. Apart from recording race results, more comprehensive timing equipment is required to aid swimmers, when training, to combine a rapid start with a clean entry into the water. The electronic swim-timing apparatus (ESTA) to be described has already been installed at the Crystal Palace bath and is available for installation in any other bath where competitive swimming is carried out.

General

The start of a race is controlled by the pressing of a button which initiates a starting signal produced by a high-frequency horn fitted inside the starting block at the end of each swimming lane. The competitors stand on the blocks for all races except the back stroke. When the horn sounds the competitor would normally feel a vibration through his feet apart from the audible indication of the horn. This means that deaf swimmers can compete on equal terms with those of good hearing. At the start of the back stroke race the swimmers are in the water and hold on to a sprung handle on the block.

A further advantage of fitting a horn in each starting block is that all competitors receive a signal at the same time. As shown in Fig. 1, in cases where a starting gun is used there is a considerable difference between the times that competitors on opposite sides of the bath actually hear the signal. This is because sound travels at approximately 1,100 feet per second, which amounts to 1 msec for each foot between the starting gun and the competitor. For a pool 35 yards wide with the starter at one side, the competitor on the farther side would hear the gun 0.1 sec after the competitor nearest the starter. This could represent the difference between success and failure as was shown in a recent race timed by ESTA when the swimmer in lane 5 recorded a time of 1 min 4.919 sec and was placed first, the swimmer in lane 7 a time of 1 min 4.921 sec and placed second. Had the race been started by a gun the starter in the conventional position the swimmer in lane 7 would have heard the shot 0.016 sec sooner than the swimmer in lane 5 and would then have reversed the order of finish and won the race by a margin of 0.014 sec.

The timing equipment is connected in such a way that a crystal oscillator controls pulses occurring every $1/1,000$ th of a second and these are fed to a bank of high-speed counters, one chain of counters being provided for each swim lane in use. When the starting signal is given, pulses are fed into all counters simultaneously. At this point the competitors are leaving the starting blocks and entering the water. Circuitry is arranged so as to provide a warning signal should a competitor leave the starting block prior to the starting signal being given. This warning can be used to operate a rope, which drops across the pool, and simultaneously to sound a horn.

When the swimmers reach the far end of the bath they are required to touch a rubber pad which runs the full width of the lane. This pad contains a stainless-steel plate and, spaced from this, a network of sprung wires. When the competitors press on the rubber pad, the wires touch the steel plate and the contact thus made is recorded back at the timing console. The movement of the pad is roughly $\frac{1}{4}$ in. and this distance is arranged so as to make up the total 55-yard length of the bath. The signal



ELECTRONICS
INSTRUMENTATION
CONTROL

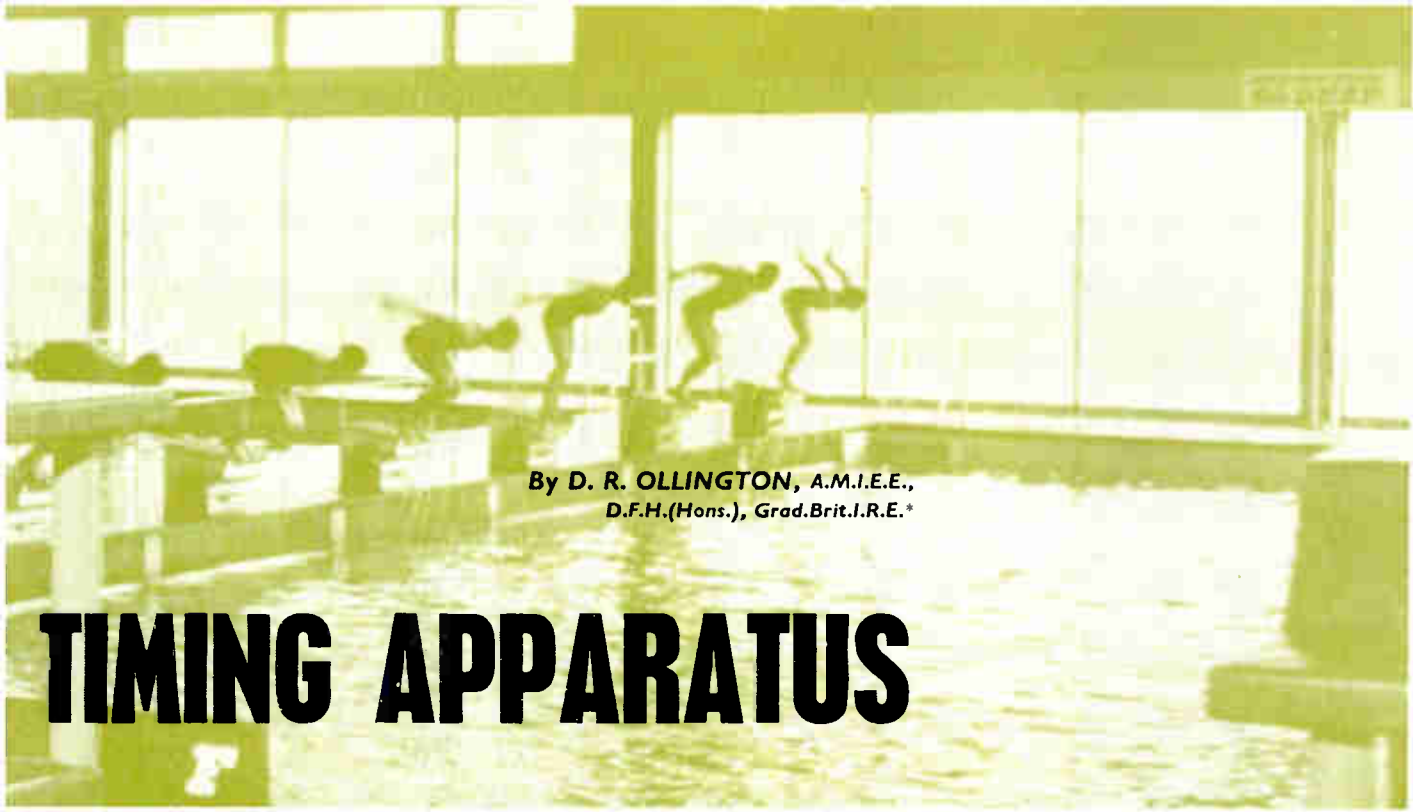

By D. R. OLLINGTON, A.M.I.E.E.,
D.F.H.(Hons.), Grad.Brit.I.R.E.*

TIMING APPARATUS

produces causes a lap counter to be indexed negatively.

To explain this point it should be stated that the lap counter is set prior to the beginning of a race for the total number of laps expected. Every time the swimmer reaches one or other end of the bath (both ends of which are equipped with pads) the lap counter is negatively indexed. A contact is fitted on the counter so that when it reaches zero the pads are switched direct to the 'stop' circuitry of the timing system. When the swimmer reaches the pad at the end of the race and touches it, the high-speed counter corresponding to that lane will indicate the total number of thousandths of a second that have elapsed between the start of the race and that competitor finishing. A decimal point is inserted appropriately so that the answer reads direct in minutes and seconds.

As each competitor reaches the end of the race, so the respective high-speed counters stop and an automatic electronic position indicator shows the position of each swimmer in the race.

The position indicator will operate correctly although only a fraction of a second may separate two swimmers. It will also accommodate a dead heat, although this is very unlikely to occur with such close timing.

The timing equipment would normally be under the surveillance of a judge who at this point would press a button to transfer the results to a printer, thus making a written record. If he feels that only a minor infringement has taken place he may override the disqualifying ruling given by the equipment.

Technical

The equipment is shown in block diagram form in Fig. 2 and has been designed with reliability as a paramount feature since technical personnel will not necessarily be available on site should a failure occur. Where possible, circuitry has been duplicated so that in the unlikely circumstance of a failure occurring non-technical

* Venner Electronics Ltd.

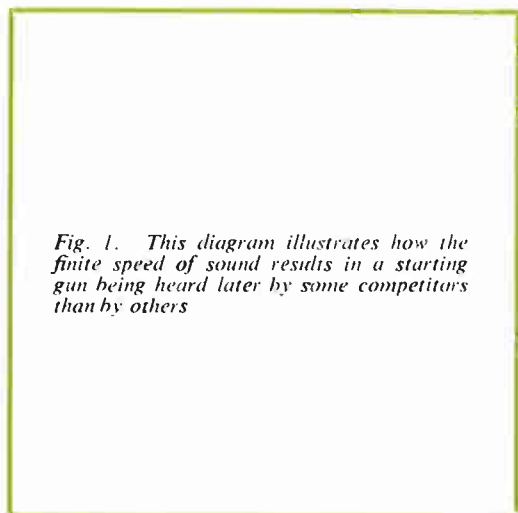
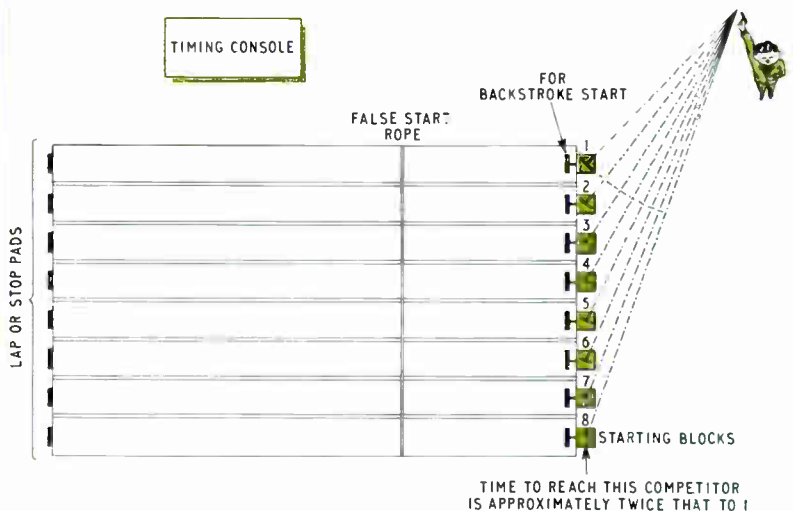

Fig. 1. This diagram illustrates how the finite speed of sound results in a starting gun being heard later by some competitors than by others



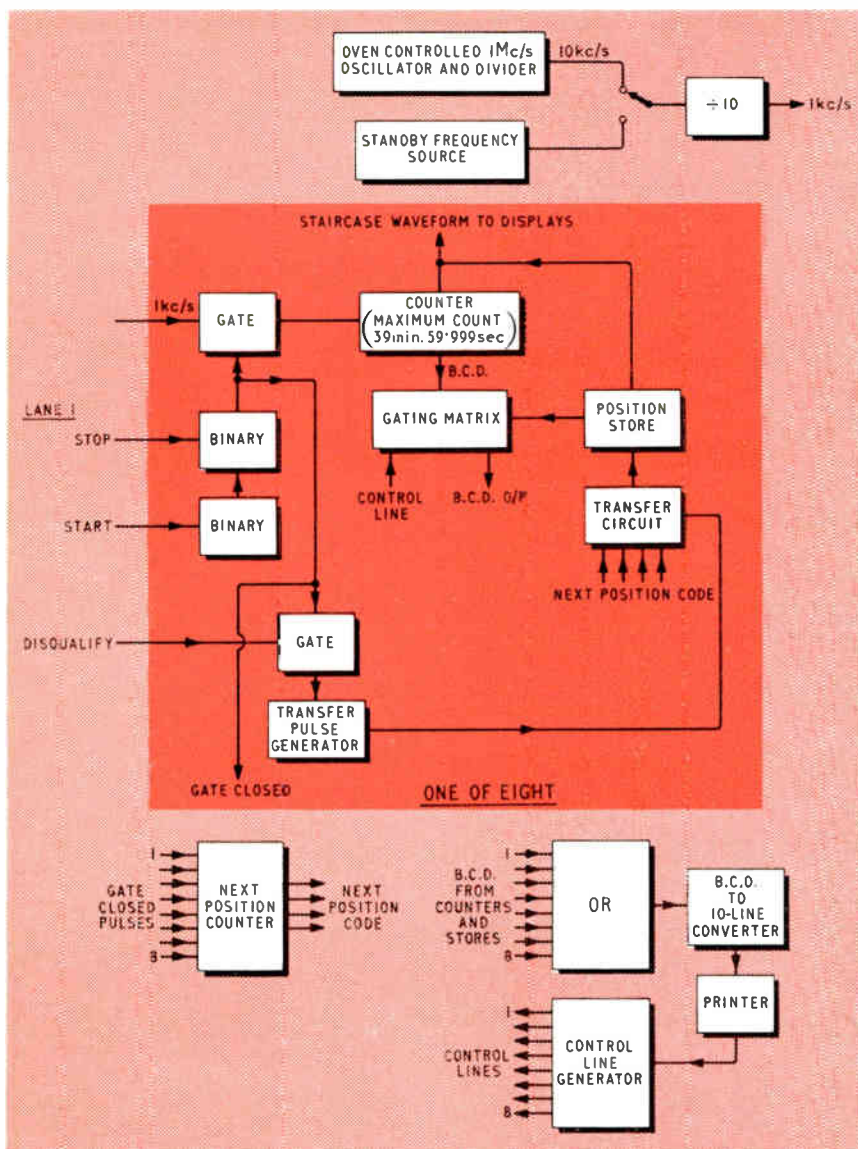
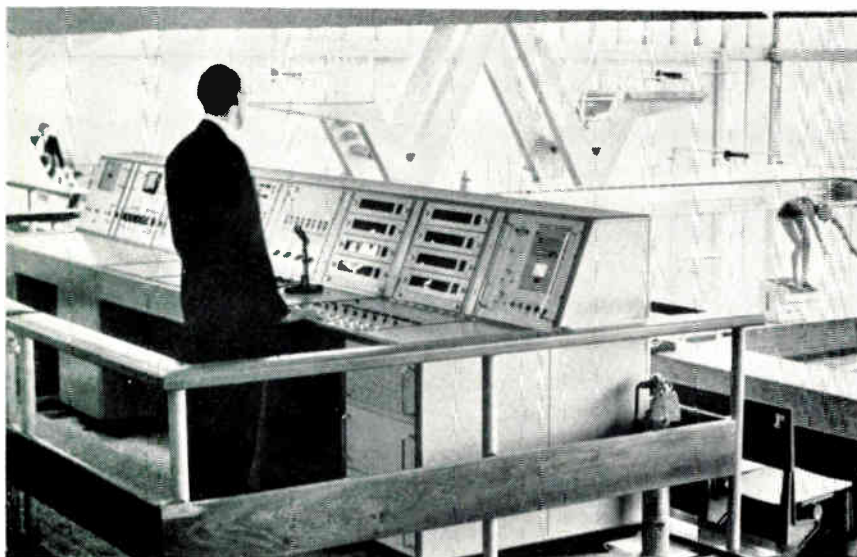

Fig. 2. Block diagram of the timing apparatus

A view of the control panel



personnel can ensure that the equipment will still function. The standard frequency source from which the millisecond time pulses are derived is such a duplicated item. A 1-Mc/s crystal is mounted in an oven and held at a temperature of approximately 70 °C. The crystal is maintained in oscillation by a transistor circuit. A second oscillator is mounted alongside and runs continuously. A switch is mounted on the front panel so as to select either one or other crystal. The accuracy of these oscillators is ± 1 part/million, which represents approximately one second error in twelve days.

The output of the oscillator passes to a number of transistorized bistable stages which divide the input frequency of 1 Mc/s to an output frequency of 1,000 c/s. This signal is then passed to a counting chain via a gate, one such chain being provided of each swimming lane in the pool. The counters are constructed, once again, from bistable stages arranged to form scales-of-ten, six or three.

The resultant count is displayed by means of moving-coil display units and the presentation is made digitally in minutes and seconds with the decimal point being inserted appropriately. Seven display indicators are used, thus providing a maximum indication of 39 min 59.999 sec. Adjacent to this set of indicators is one indicator which gives the position of this particular competitor in the race. This is driven from a further piece of circuitry which will be described later.

All the gates are opened simultaneously when the start button is pressed and the horns sounded. The stop pulse is obtained from the stop pad via the lap counter previously mentioned. Each set of indicators corresponding to a swimming lane can be removed in a simple operation and a new panel inserted in the console within a minute or so. This is particularly useful in the event of a bulb failure.

The position indicator is interesting since it will discriminate between two results within a thousandth of a second of each other. What, in fact, happens is that a scanner looks at the state of the gate of each lane and, in fact, does so at a scanning rate of 1 kc/s; i.e., a scan of the eight gates is completed in 1 msec. As soon as the stop pulse occurs on the appropriate lane the gate closes. The scanner will now note the arrival of the pulse and arrange for the pulse to be fed to a separate decade counter. The count of '1'

thus made will appear on an indicator adjacent to the elapsed time already mentioned. When the second competitor reaches the end of the race the gate corresponding to his lane will close, the scanner will note the change in the state of the gate and will pass the pulse to the decade counter previously mentioned, which will now indicate '2', diode gating being used to ensure that the '2' thus obtained will appear adjacent to the result in that particular lane. This process will carry on until the competitors in all lanes have completed the course. The system has not, in fact, been described in full and it can be seen from this description that a dead-heat in two lanes would not be correctly indicated. In fact, the system does provide for such an occurrence and also for omitting a disqualified competitor.

Once all the results have been obtained a print command signal can be fed to the printer, which will now print the times for all eight lanes, together with the position of the competitor in the race. The printed record will appear generally as follows:—

8	0 1	3 1	2 5 0	7
7	0 1	3 1	3 2 8	8
6	0 1	2 3	4 5 6	3
5	0 1	1 9	6 4 2	2
4	0 1	2 9	4 2 6	4
3	0 1	3 0	2 9 4	5
2	0 1	1 9	5 2 4	1
1	0 1	3 1	2 2 6	6

The paper is printed with two red lines, the line on the left separates the minutes and seconds and the one on the right represents the decimal point. The first figure is the lane number, the last the position. Thus, the competitor in lane six, in the example, was placed 3rd, his time being 1 minute, 23.456 seconds. It should be noted that all eight lanes are printed, even when there are less than eight competitors. Unused lanes would be shown with the time at zero and the position printed as C (for cancelled). If desired, more than one set of printed results can be obtained merely by operating the printer the required number of times.

In addition to the circuitry which has been described, the console also includes a set of relays which are controlled by the starting button and also microswitches fitted inside the starting block. One of the microswitches is arranged to close as long as the competitor is standing on the block. If the competitor leaves the block, and therefore the micro-switch opens prior to the start button being depressed, then a light is illuminated on the panel and the printer is arranged to add a 'D' to the result in the column where normally a position is indicated. Thus, in the above example, if the competitor in lane 4 had been disqualified the result would have appeared as:—

4	0 1	2 9	4 2 6	D
---	-----	-----	-------	---

In fact, however, if the light is switched on the starter would normally stop the race. This he can do by arranging for the start horns to be sounded continuously and for a rope to be dropped in the water about one-third of the way down the bath. If he desires, the illumination of any competitor's disqualifying light can automatically sound the horns and drop the rope. Similar facilities exist when starting a back stroke race. In the relay race the competitor in the water is required to touch the stop pad at the end of the bath prior to the next swimmer leaving the starting block. Once again, if the microswitch in the starting block opens prior to the pad being touched the team would be disqualified. The equipment would operate the disqualifying light even if the infringement was only



in terms of a thousandth of a second. In this case a judge might overrule the circuitry should he feel the infringement was not a visible one.

The training facility which this equipment offers, of measuring the time between the start signal being given and the swimmers leaving the blocks, has been found to be of considerable use. So far as is known, this facility does not exist on any other timing equipment installed in baths. The lane timing displays results exactly as previously described, and, in fact, the lane positions are also given, so that if a number of swimmers train together there is an air of competitiveness, even during the training phase, to achieve the shortest reaction time. The equipment can also, as a training facility, measure the time elapsed between the swimmer in the water touching the pad and another swimmer leaving the start block as in a relay race.

It is to be hoped that the timing facilities described will be installed in a large number of pools so that the constant shortening of race times can continue and can be recorded with a precision which embodies no element of human error. It is perhaps interesting to note that the initial installation of a timing system such as described is liable to be one of disappointment in so far as a competitor is concerned, since in comparison with stop-watch timing the equipment indicates a slightly longer time. This is because it is not possible to anticipate the start signal and consequently the timekeeper's reaction time would occur between the start signal being given and the stop watch being pressed. At the end of the race, however, the timekeeper can see a swimmer about to touch the end of the bath and will therefore attempt to stop his watch at the instant that the swimmer's hand touches the end of the bath. At the end of the bath, therefore, there will be no reaction time since the end-point will be simultaneous. The time shown on the stop watch will now be less than the interval between the start signal being given and the swimmer reaching the end of the bath. It will be clear that the shorter stop-watch time is, in fact, due to inaccuracy of timing which ESTA eliminates.

Acknowledgments

The whole system, which is covered by British Patent No. 25487/63, Dg. 39271/63, was conceived by the Chief Engineer's Department of the London County Council whose engineers were responsible for the detailed design of much of the equipment used and who selected for inclusion in the project an electronic timing system designed and produced by Venner Electronics Ltd.

Rapid Growth of S.E.R.T.

In the first ten weeks that application forms have been available the Society of Electronic and Radio Technicians has received 479 applications for membership. The Membership Committee has held two meetings and recommended the election of 137 members, 188 associates and 41 students, a total of 366.

The Society has established nine local sections, eight of which are running regular meetings.

ELECTRONICS IN TEXTILE

2. Winding Speed Control on the Cotton Speed Frame

In the cotton industry delicate strands called rovings are wound on to bobbins and the bobbin speed must be closely controlled for good winding. This article describes a control system specially developed for this purpose.

AS mentioned in the previous article, the machine known in the cotton industry as a speed frame is used to draw out a number of 'rope-like' slivers into fine and delicate strands known as rovings and then wind these rovings on to bobbins ready for the next and final process of spinning the fibrous material into threads.

The drawing-out section of the speed frame process serves to attenuate the weight per unit length of the sliver and to bring the fibres parallel by pulling the sliver through a series of pairs of rollers; each pair of rollers rotates faster than the previous pair. This section of the machine is known as the drafting system and is visible on top of the machine in the photograph of Fig. 1 and shown diagrammatically in the basic machine cross-section in Fig. 2(a). The finely drawn rovings are delivered from the drafting system to be wound on to bobbins to form the special shaped packages shown in the photograph.

The fibres in the roving as it emerges from the last pair of rollers are lying only loosely together and this exceptionally weak strand must be twisted slightly to give it some

strength before it can be wound on to the bobbin. This twisting action is accompanied by passing the roving down the hollow leg of a counterbalanced rotating arm known as a flyer. The twisted roving emerging from the hollow leg of the flyer is wound on to the rotating bobbin with the bobbin moving up and down relative to the flyer to build up the layers of roving on the package. The special tapered end shape of the package is formed by reducing the up and down traverse of the lifter mechanism each time a layer is made and this shape is important for the stability of the end coils on the package in subsequent handling.

As shown in the mechanical block diagram of the conventional machine, Fig. 2(b), the speed of delivery of roving from the drafting zone and the rotational speed of the flyers are constant. Therefore, it is necessary to reduce the rotational speed of the bobbin each time a layer of roving has been laid on the package and the machine prepares to wrap another layer of larger diameter. This speed reduction must be closely related to the effective thickness of the roving to maintain a constant surface speed on the package and in a conventional speed frame it is accomplished by indexing the position of the belt on the cone-pulley variable-speed drive shown in the mechanical block diagram. The output from the variable-speed pulley is coupled to the bobbin drive through a differential gear box and, incidentally, also serves to drive the variable lifter mechanism.

The cone-pulley belt is indexed in predetermined steps

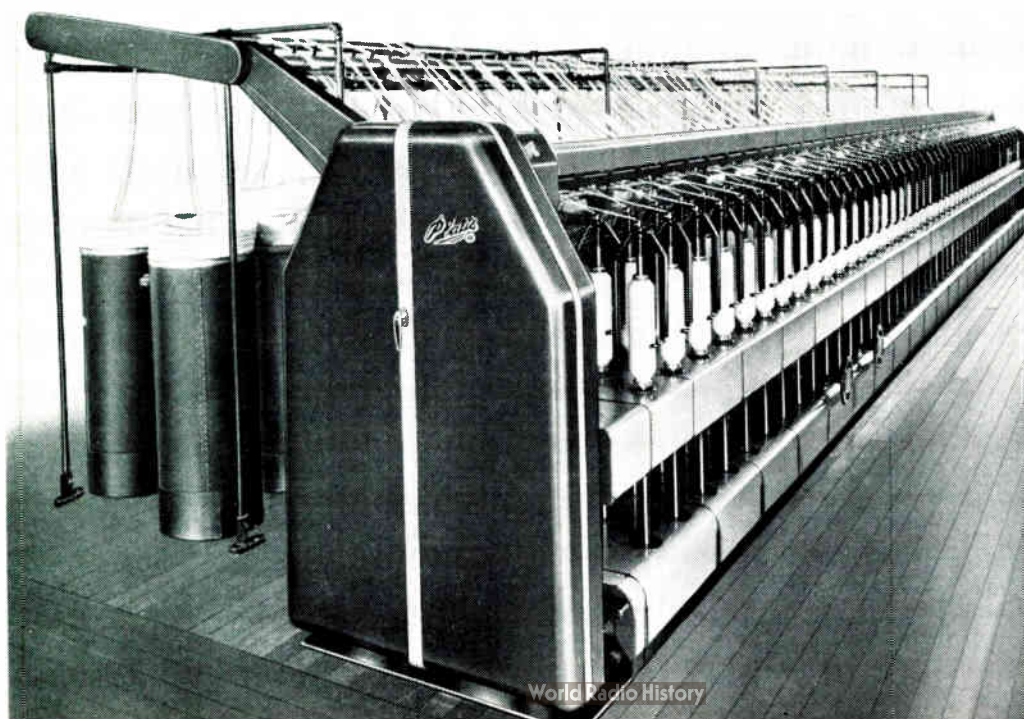

Fig. 1.—A conventional speed frame with roving being wound on to bobbins in the foreground

MACHINES

By R. GREENWOOD, B.Sc.*

by a mechanical gear and ratchet system and this system is pre-set according to the thickness of roving being produced at that particular time. It is necessary to re-set this device each time a different thickness of roving is required and because the effective thickness of a fibrous roving cannot be measured precisely this has to be related to weight per unit length measurements. To maintain a constant linear speed of the roving at each stage of the process it is essential that the speed change is accurately matched to the increase of package diameter. In the winding of strong elastic materials this problem is not usually met because the material itself, coil wire for example, can be used to transmit the winding tension and power and thus maintain speed matching. Cotton roving, however, is a weak, non-elastic material that requires exact matching of the winding-on speed to delivery speed to prevent accumulation and subsequent disruption of the roving from a slight decrease in package surface speed or progressive attenuation of the roving and possibly breakage due to a slight increase in package surface speed. It is also found that changes in the state or distribution of fibres in the sliver can give rise to differences in effective roving diameter and in the conventional present mechanical system this gives rise to faulty roving on the package.

As new higher speed and higher capacity textile machines are being developed the need has arisen for a more precise method of controlling the winding-on function of the speed

* T.M.M. Research Ltd.

frame and we have developed an electronic closed-loop system to do this. This system is interesting in that although the basic object of the mechanism is speed control of the bobbins this was finally accomplished by using what is in effect a closed-loop position-control servo-system acting on the roving as it emerges from the drafting rollers.

Early experiments were directed at methods of sensing the instantaneous diameter of the package and setting the bobbin speed accordingly, but these attempts were unsuccessful because of our inability to measure accurately the diameter of the soft fluffy surface by devices that would be free from fibrous contamination and not interfere with the textile process involved. We also met considerable difficulty from the torque sensitivity of the electrical variable-speed devices used as direct replacements of the cone-pulley system.

In seeking an alternative approach we examined the tension in the roving as it passes from the last drafting roller into the top of the flyer leg and found that a tension level of approximately 3 oz wt proved to be a remarkably reliable indication of correct winding-on conditions. If the bobbin speed rose above the required value the roving tension would increase and conversely would fall as the bobbin speed fell below the required value. Therefore if it is possible to measure this tension by some form of transducer we could tackle the problem of winding-on control by the new approach of varying the bobbin speed to keep the winding tension constant throughout winding rather than set a speed related to the average diameter and hoping that the tension remained constant throughout the layer.

The immediate difficulty in this proposal was how to measure the tension in the roving. There are many electronic devices available for measuring forces of this order but in each case examined textile processing factors prohibited their use. The transducer or its sensing mechanism could only be allowed to make the lightest contact with the roving, otherwise it stopped the introduction of twist into the roving and the roving would break. The part of the transducer in contact with the roving tended to gather stray fibres which could alter its measuring characteristics and eventually lead to mechanical failure. We were virtually faced with the problem of wanting to measure a low value of tension in a fast-moving weak roving without actually touching the roving. Examination of the roving as it passes from the last drafting roller to the flyer top

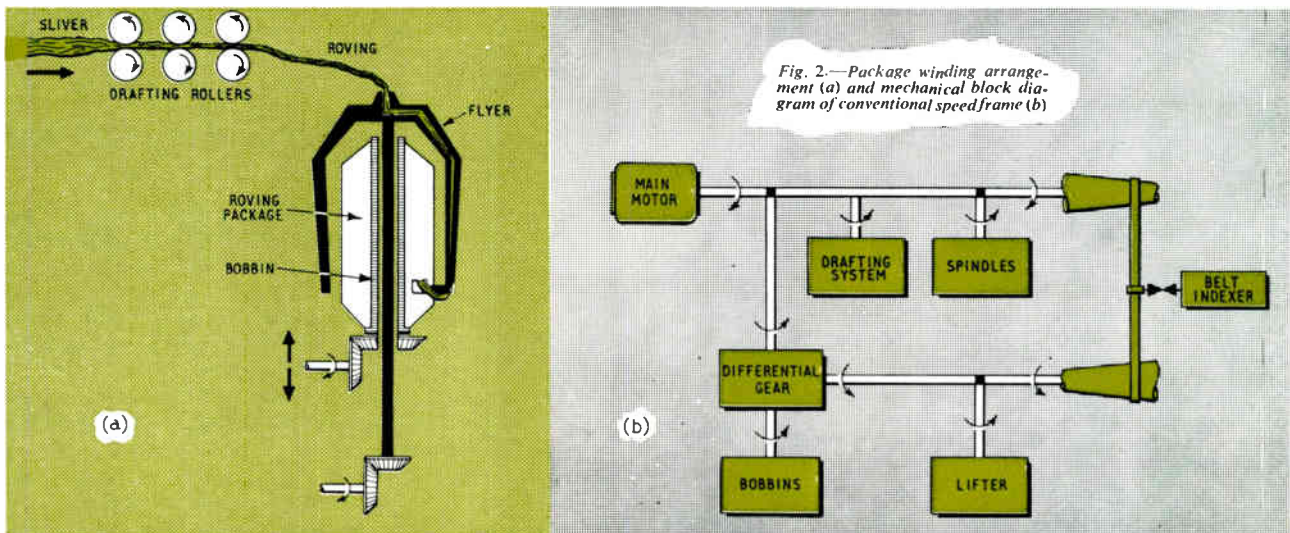
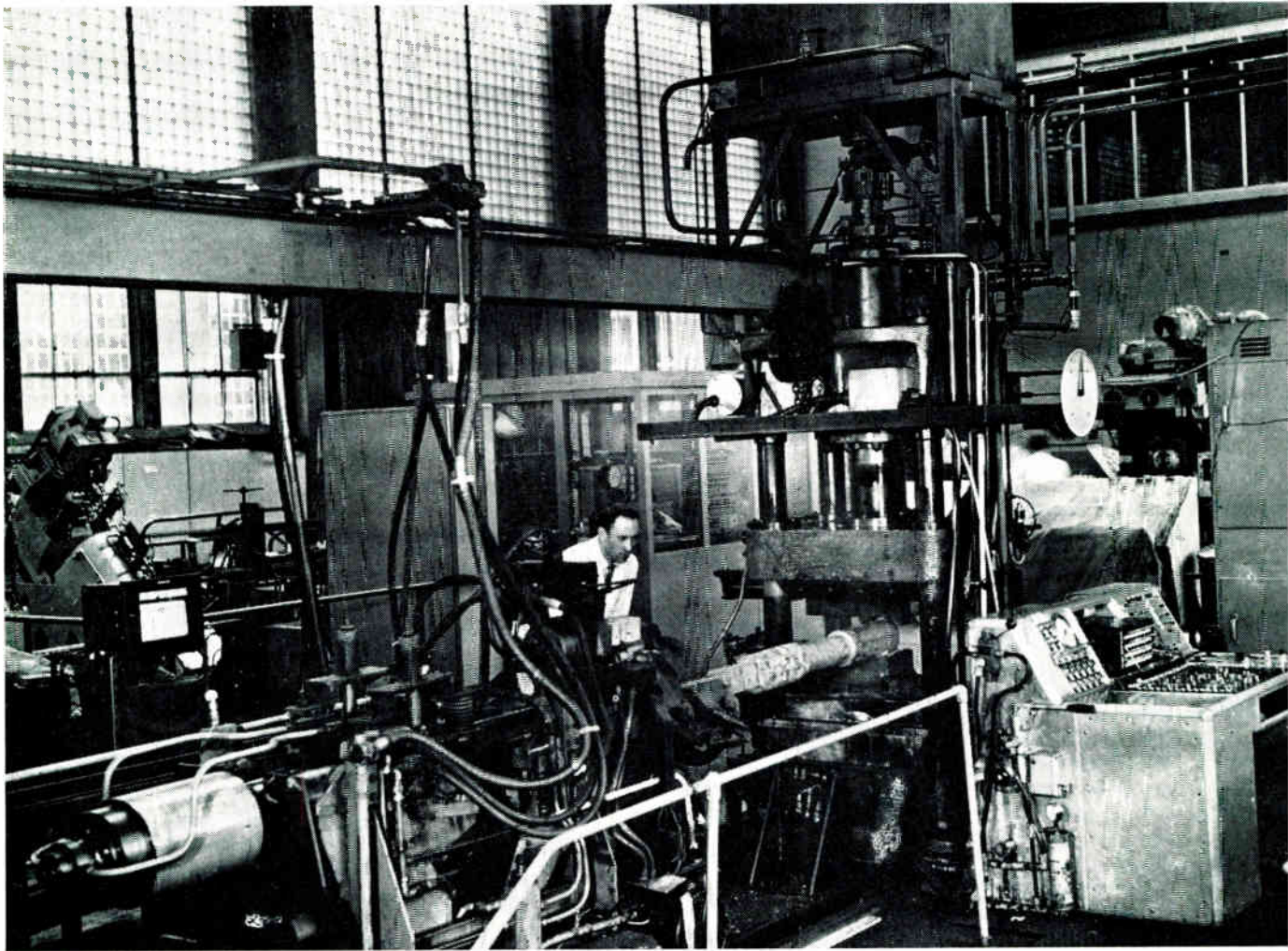

Fig. 2.—Package winding arrangement (a) and mechanical block diagram of conventional speed frame (b)



Automated forging plant at BISRA's Sheffield laboratories, showing (left foreground) manipulator, (centre) 200-ton press, (right foreground) operating desk, and (behind desk) the control unit

Some of the special hydraulic equipment which has been developed for use in the automatic control of forging is described in this article. By greatly reducing the cycle time it has enabled a big reduction to be made in the number of times that the work has to be reheated.

AUTOMATE

IN the February issue A. Hadfield described a digital position-control system providing integrated control of the movements of a hydraulic forging press and its manipulator. Much of the original work in automated forging has been done by the British Iron & Steel Research Association, who have recently completed a programme of research and development in this field. The experimental plant they have been using (in their Sheffield Laboratories) is a combination of specially constructed equipment and commercial units of the type described in February. Based on a small 200-ton press, the plant has an integrated manipulator and an automatic tool-changing facility. Although in some respects it is simpler than the commercial installation described by Mr. Hadfield (e.g., in the electro-hydraulic and position-control equipment), it is also more advanced in one particular—the ability to perform a complete forging sequence automatically under programme control. Once the programme has been set up and a hot

ingot loaded into the manipulator, the automatic forge is started and there is then no need for further human intervention until the forged component is complete and ready to be unloaded. Programme control is not yet available on any commercial forging presses at present in operation, but is likely to be a practical reality by about 1967.

One of the principal reasons for using automatic methods in forging is to increase the speed of working so that a complete forging can be produced with only one heating of the ingot, if possible. With conventional, slower, equipment the work usually has to be reheated, once or several times, during the forming sequence, and this accounts for a large proportion of the cost of forging. To increase the speed of operation it is necessary to reduce the time taken for each squeeze of the press tool and also the time intervals between successive squeezes. Position-control, integrated manipulators and overall programme control all contribute to the reduction of these time intervals. In such systems

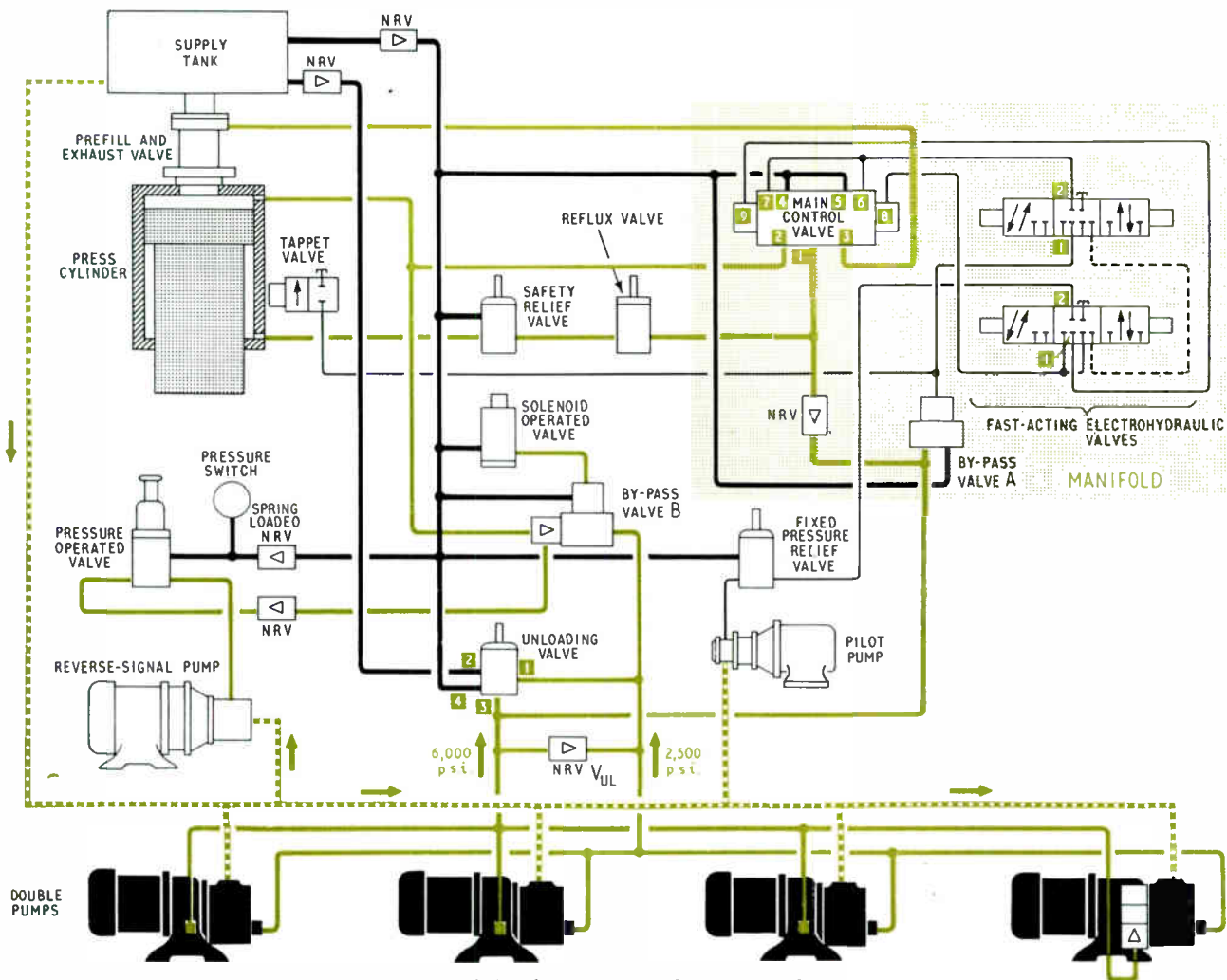

Fig. 1. Simplified hydraulic circuit of the 200-ton forging press

FORGE HYDRAULICS

By JAMES FRANKLIN

the use of high-speed electronic equipment for the information-processing functions has thrown emphasis on the mechanical equipment, in particular the hydraulics, as the major source of time delay. The BISRA workers have therefore devoted a good deal of attention to the design of a fast-acting hydraulic system for their experimental forging press.

In an earlier BISRA plant the single press cylinder was operated straightforwardly from a three-position directional valve (downstroke, neutral, return-stroke). The stroking cycle time was over 3 seconds and the integrated manipulator had to wait for the press to complete its movements. In the existing plant a slightly more elaborate hydraulic system has been used, and as a result the stroking cycle time has been reduced to about 1 second (that is, assuming a free-approach stroke of 2 inches and a tool penetration into the work of 1 inch). The features of the hydraulic system mainly responsible for the higher speed are two special

valves. A large capacity prefill and exhaust valve directly associated with the press cylinder and a fast-acting electrohydraulic valve allowing control of the hydraulic power from small electrical switching signals are provided.

A simplified diagram of the hydraulic system is shown in Fig. 1. The press ram is a 10½-in. diameter double-acting cylinder with a 10-in. diameter piston rod, and the squeeze is applied to the work by the downstroke of the piston. Hydraulic oil under pressure is supplied from four double high-speed piston pumps made by Towler Brothers (Patents) Ltd. Driven at 1,440 r.p.m. by electric motors, they are divided into low-pressure sections, delivering



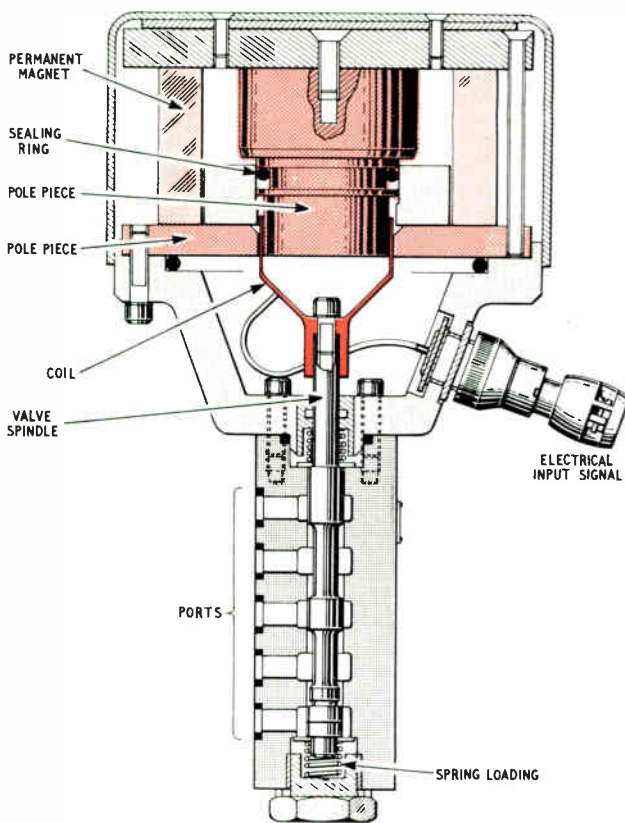

Fig. 2. Construction of the Towler fast-acting electrohydraulic valve

280 cu in./sec of oil at 2,500 p.s.i., and a high-pressure section delivering 140 cu in./sec of oil at 6,000 p.s.i. The oil is drawn into the pumps from a storage tank mounted above the main press cylinder and is pumped through the system of control valves into the press cylinder. When the pumps are off-loaded (that is, when press is not stroking) their output is returned through valves to the supply tank. The main control valve is operated by a low hydraulic (pilot) pressure applied through the fast-acting electrohydraulic valves, which in turn are actuated by electrical signals from the electronic control system.

The various units shown in Fig. 1 will now be described in more detail. The function of the reverse-signal pump is to provide a maximum pressure signal to reverse the press (start the return stroke). When this pump reaches a pressure manually set on the adjacent pressure-operated valve, this valve opens and passes oil back to the supply tank through a spring-loaded non-return valve. The back pressure created by this non-return valve actuates a pressure switch, which initiates an electrical signal to reverse the press.

The pilot pump supplies the oil that is used to actuate the main control valve and other high-pressure valves. The pilot pressure used is determined by the setting of the associated fixed-pressure relief valve. Once started, the pilot pump runs up to the set pressure and is never unloaded.

In the main hydraulic power unit the low-pressure sections of the pumps are off-loaded automatically when the output of the high-pressure sections reach a predetermined pressure, which is sensed at port 3 of the unloading valve. At this set pressure the valve spindle is lifted and the oil delivered from the low-pressure pumps passes back to the tank via port 1 and port 2. The non-return valve V_{UL} prevents the high-pressure pumps from being by-passed when the unloading valve opens.

Variation of forging speed is obtained by progressively switching in or out the electrical drives of the pumps, to give different total flowrates of oil. Fine control of flowrate for this purpose is provided by a metering valve (not shown) which can be adjusted to give any flowrate up to 2,000 in.³/min.

By-pass valve B, when open, allows the output of the pumps to pass back to the supply tank. When, however, it is closed by the action of the associated solenoid valve, it causes the oil from the pumps to pass either to the press cylinder or to the supply tank via the main control valve (ports 2 to 4) if the last-mentioned is not actuated. By-pass valve A is also a pump by-pass valve, operated by hydraulic pilot pressure, and is used to load the high-pressure pumps on the down and return strokes of the press ram.

The main control valve for the press cylinder is actuated by the lower of the two high-speed electrohydraulic valves, which is operated in one direction to connect the pilot oil supply at port 2 to port 1 and thence to port 9 of the main control valve. The pilot oil pressure at port 9 moves the control valve spindle, connecting port 1 to port 2 and port 3 to port 5. Also, port 9 is connected to port 7, and as a result pilot-pressure oil passes to port 2 of the upper electrohydraulic valve. This is energized and port 2 is connected to port 1, so pilot pressure oil is applied to by-pass valve A, thereby closing it and loading the high-pressure pumps. The function of the upper electrohydraulic valve is to off-load the pumps and so provide the dwell time required at the top of the press stroke to allow for manipulator movement.

When the main control valve is actuated the pump output passes through its ports 1 and 2 and directly into the top of the press cylinder, so that the ram moves down. The oil consequently displaced from the lower compartment of the cylinder passes through the base of the safety relief valve and thence to the reflux valve. Initially the ram descends freely under gravity, at a greater speed than that given by the pumps, and the purpose of the reflux valve is to control the rate of fall by controlling the rate of flow of the oil displaced from the cylinder.

During the initial part of the downstroke the prefill valve on top of the press is opened. The purpose of this prefill valve is to allow a large volume of low-pressure oil to flow rapidly from the supply tank into the press cylinder while the ram is descending under gravity. This results in a fast free-approach stroke of 10 in./sec, and greatly reduces delay in the subsequent hydraulic pressure build-up in the cylinder. When the press tool touches the work the prefill valve closes automatically and the pumps then apply pressure to give the selected forging speed (up to 3.5 in./sec at pressures up to 2,500 p.s.i. and up to 1.75 in./sec at pressures up to 6,000 p.s.i.). The prefill valve also rapidly exhausts the large volume of oil in the cylinder during the return stroke of the ram.

If the ram were operated with, say, the top tool missing, the tappet valve would be actuated and this would divert to exhaust the pilot pressure oil holding by-pass valve A closed. As a result the pumps would be off-loaded as a safety measure.

On receipt of a 'return stroke' signal from the electronic thickness-control system, the lower of the two electrohydraulic valves is reversed, and consequently the main control valve is reversed. As a result the output of the pumps is applied to the lower compartment of the press cylinder via the reflux valve and the relief valve. The ram then starts its return stroke at a speed of 11.5 in./sec. The pump output pressure is also applied to the operating port of the prefill valve, which opens to exhaust the oil displaced from the upper compartment as the ram rises. At a predetermined point on the return stroke the ram movement is stopped by the electronic thickness-control system.

The fast-acting electrohydraulic valves, developed by Towler Brothers, achieve their high speed by the use of an electromagnetic actuator of low electrical and mechanical inertia. Conventional types of solenoid valve are slow in operation, mainly because of the time required for the magnetic flux to build up in the core (periods up to 50 milliseconds are common). In the Towler valve this problem is avoided by the use of a light moving coil and fixed permanent-magnet structure, rather similar to that of a moving-coil loudspeaker; and, in fact, the device will operate at speeds equivalent to the lower end of the audio-frequency range. In contrast to the conventional solenoid-valve principle, the magnetic flux is provided continuously by the permanent magnet, and the build-up of current in the small low-inductance moving coil of the Towler valve is comparatively rapid.

The structure of the fast-acting valve is shown in simplified form in Fig. 2. When a d.c. switching signal (normally up to 60 W) is applied to the moving coil the resulting magnetic flux interacts with that of the magnet, and the coil assembly and valve spool are moved downwards against the opposing force of the spring loading. As a result the hydraulic oil circuits through the valve are switched. When the d.c. input signal ceases the coil and valve spool

return to their original rest position under the action of the spring and the oil circuits are switched back.

The narrow gap between the moving coil and the magnet pole-pieces is a possible danger point for clogging by dirt particles in the contaminated atmosphere of a forging plant, so the volume surrounding the moving coil is filled with oil. A secondary advantage of this oil filling is that the electronic power dissipation of the coil is increased, and heavy operating currents can be used without causing overheating. Furthermore the oil seal on the valve spool can be eliminated and as a result of the reduced friction the response speed of the valve is increased.

With this moving-coil actuator, forces of the order of 20–30 lbf can be applied to the valve spool. Since the mass of the spool is only a few ounces its acceleration is consequently very high, and in fact the valve can be opened in 6–8 milliseconds. Between 1 and 2 cu in. of oil can be passed in less than 15 milliseconds.

Plessey Introduce Dust Detection Equipment

The operation of solid-fuel boilers, particularly in power stations, requires equipment which can reliably indicate the presence or absence of a flow of coal or flue dust. The usefulness of such a device can obviously be extended by adding a controlling function, such as the opening and closing of valves, or filling and emptying of hoppers.

A suitable equipment developed by the Aircraft Electrical Division design laboratory of Plessey-UK Limited consists of a high-gain wide-band amplifier with its input and output connected to a pair of frequency-matched ultrasonic transducers. Positive feedback from output to input causes the amplifier to oscillate at the resonant frequency of the transducers, approximately 50 kc/s.

When dust falls between the transducers, the attenuation

in the feedback loop reduces the degree of input/output coupling and the oscillation ceases. When the dust stops, the feedback increases and the amplifier again oscillates.

The oscillatory signal is rectified and amplified and applied to a relay, which energizes a lamp and so indicates the presence or absence of dust.

Variable amplifier gain is provided to cater for variations in cable lengths. A variable time delay is also included to avoid the intermittent indication of absence of dust due to voids in the dust flow.

Features of the system are that indication is a function of the mass of dust flowing, and that the loss of efficiency from 'filming over' of windows that occurs with photocell systems is eliminated.

Shown here is a schematic diagram of the dust detection equipment

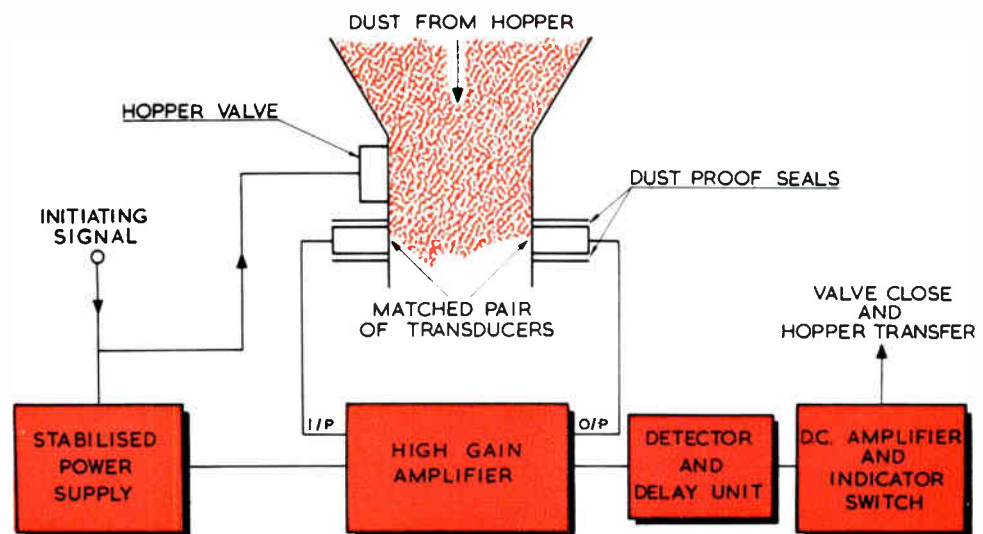

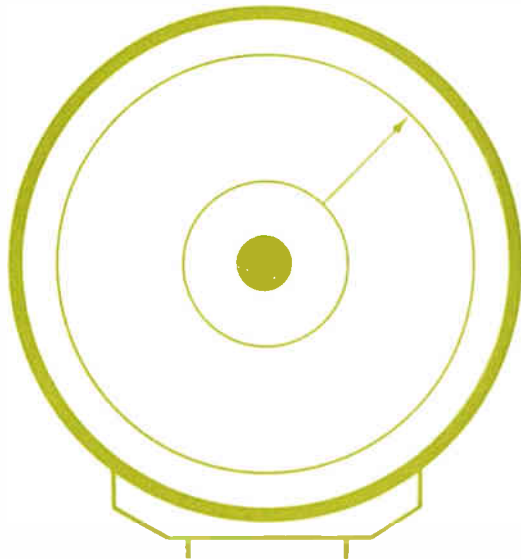

Various ways of obtaining automatic weighing are discussed in this article. The methods often include the automatic control of the feed to, and the discharge from, a weighing hopper.

WEIGHING IN INDUSTRIAL PROCESSES

WEIGHING IN INDUSTRIAL PROCESSES

WEIGHING IN INDUSTRIAL PROCESSES

THE three basic measurements, length, mass and time provide most of the control parameters on which industrial processes depend. All three of these quantities lend themselves to automatic measurement, either independently, in association with each other, or with other parameters such as temperature.

The processing industries, dealing with raw materials, food, chemicals, metals, have been developing on lines aiming towards full automation for many years. Both batch systems and continuous processes lend themselves readily to automatic control with improved quality and consistency of the end product.

In such industries weighing provides one of the fundamental means of control. The application of weighing in automation has been the subject of extensive research and development, resulting in the latest techniques in electronics and fluid-control systems being applied in this field.

Open-Loop Weight-Control System

The basic principles of weight control in a batch-weighing system are simply illustrated in Fig. 1 which shows a manually-controlled weighing cycle handling a single raw material.

Here a powdered or granular material is fed by a belt

conveyor, or perhaps a screw feeder, from a storage hopper into a weigh hopper and the weight of material in the weigh hopper is indicated on a dial.

An operator is necessary whose duty is to watch the movement of the scale pointer over the dial and to stop the motor driving the feeder when a predetermined weight of material has been delivered into the weigh hopper. He also has to check that he has the correct weight, to discharge the material from the weigh hopper and when the hopper is empty and the discharge door closed, to restart the feeder and initiate another cycle. He must also keep a watchful eye on the supply of material. The accuracy of each weighing depends upon his alertness and his skill in cutting off the feed at precisely the right instant.

Closed-Loop Weight-Control System

This simple system may be converted into an automatic closed-loop system by modifications as shown in Fig. 2. The scale dial is fitted with sensitive electric contacts, which are readily adjustable, to operate a circuit at any predetermined weight within the capacity of the scale.

In addition to acting as a measure of weight the dial now functions also as a comparator. The electric signal order of a few milliamperes because of the sensitivity of the making of the contacts in the dial is only of the order of a few milliamperes, therefore an electronic amplifier and a relay are introduced in the circuit so that a signal of appreciable

This article is based on one of a series of lectures delivered in Russia to the U.S.S.R. Committee for Co-ordination of Scientific Research by a team of technical personnel from W. & T. Avery Ltd.

strength can be passed on to the controller, which controls the sequence of operations.

After a starting signal has been given to the controller, the feeder delivers material to the weigh hopper and is automatically stopped by the correct weight signal from the scale contacts. The correct weight of material is on call in the weigh hopper from which it may be discharged by a signal denoting that the subsequent process is ready to receive it.

A zero contact on the dial checks that the weigh hopper has completed the discharge and another contact on the hopper doors acts as an interlock to prevent the start of the next cycle until the doors are closed. The closure of the doors can also be used to ensure that the discharged material has been taken into process and can serve to regulate the rate of weighing to suit the rate of production.

A level detector in the supply hopper is then all that is required to make this batch-weighing system fully automatic, repetitive and self-regulating.

Batch Weighing

The type of equipment represented in Fig. 2 forms the basis of many batch-weighing and pre-determined weight units.

Most commercial applications require a faster speed of operation than can be obtained from the simple form just described, so that improvements and additional features have to be incorporated to increase the operational speed without any loss in weighing accuracy.

By means of a two-speed feed the bulk of the material can be delivered into the weigh hopper at high speed. One contact on the scale dial or lever slows the feed to a dribble rate when the scale pointer approaches the pre-set weight.

The slow dribble feed makes it possible to have a consistent cut-off and the combination of the two speeds of feed give a short cycle time with high accuracy.

Accuracy of final weight is further improved by advancing the actual setting of the contact, or other sensing device, to compensate for the slight time delay in the operation of the control system.

The weight of material in flight at the instant of cut-off is balanced by the impact force between the falling column and the surface of the material already in the weigh hopper and compensation for this is not required as is so often erroneously supposed. This theory applies only to freely falling columns of material, and when power driven jets are used the effect of their impact must be considered and compensated for.

Fig. 3 shows a 4306 flour weigher working in conjunction with a motorized turntable unit. The operator fits the empty sacks and removes the full ones, while the weighed batches are discharged automatically as each opened sack comes into position under the scale hopper.

A single 4306 is capable of up to 360 weighings per hour (six per minute) over its range of capacities from 50 lb to 168 lb (25 kg to 75 kg) varying according to the flow characteristics of the material. Accuracy to within $\pm 1\%$ is given which meets the requirements of the British Weights and Measures Authority.

For weighing meals, pellets, cubes, crumbs, flake-maize and similar feed stuffs at high speeds a different machine is recommended. Fig. 4 shows a type 4308 which has a modified feed control to handle these more difficult materials. The main high-speed feed is again by belt which discharges into the weigh hopper and at the same time maintains a level of material in a subsidiary hopper, whence a dribble feed is maintained by an electric vibrator.

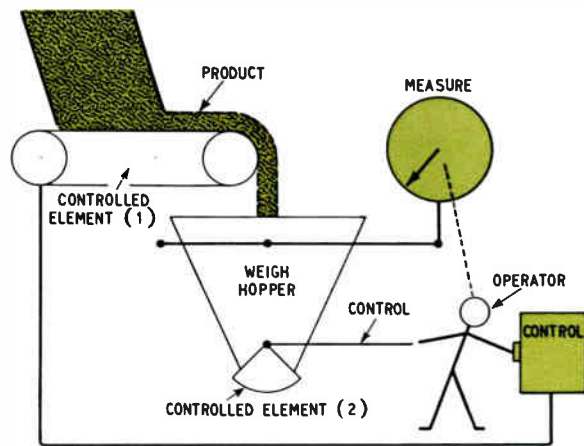
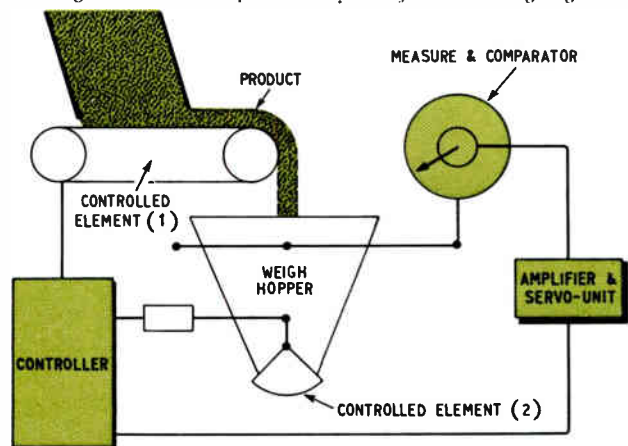

Fig. 1. Diagrammatic form of an open-loop weighing system with manual operation

Fig. 2. Closed-loop control system for batch weighing



The electric vibrator gives a far more accurate control of dribble feed of the lumpy materials than can be obtained by other feed systems. Up to 600 weighings per hour of 25 kg or up to 480 weighings per hour of 50 kg are obtainable with this scale.

Compound Batch Weighing

In production process work it is frequently required to blend or mix a number of different materials in certain proportions. There is no doubt that the most accurate method of proportioning is by weighing, as this eliminates errors due to variation of density, etc.

This compound batching of a number of materials may be carried out by an extension of the simple systems previously described.

All the ingredients may be weighed separately or cumulatively in a single weigh hopper. Separate weighing takes longer but gives a fair degree of accuracy because the scale capacity need not be greater than the maximum required weight of any one ingredient. Cumulative weighing still takes a long time but cuts out the separate discharge



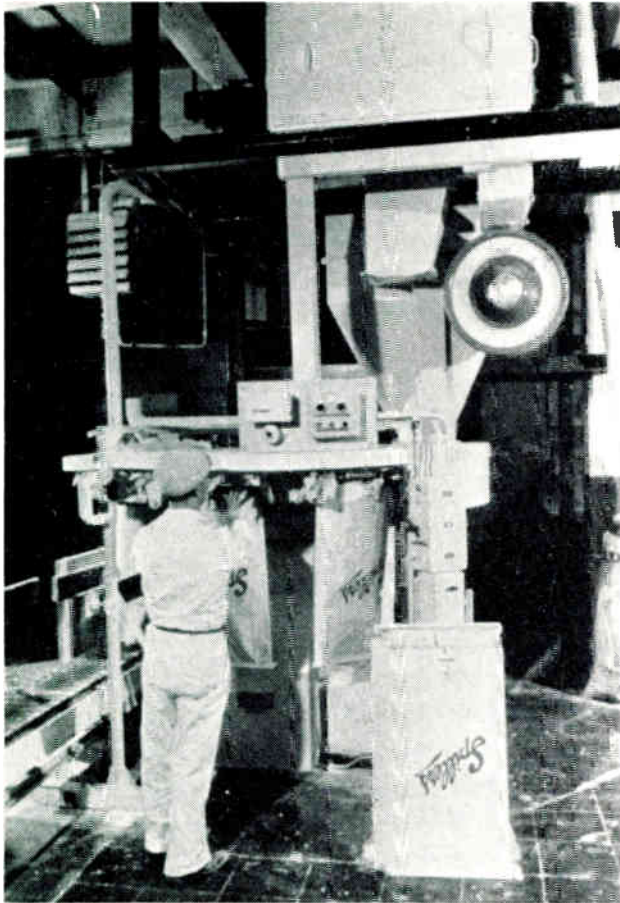

Fig. 3. Avery 4306 flour weigher with motorized turntable

times for individual ingredients. However, a large capacity weigh hopper is needed and the minor scale division may be too coarse for those materials which are required only in small proportions.

The single weighing unit is obviously the cheaper and is worth considering if time is unimportant and very accurate weighing of small quantities of some ingredients is unlikely to be required.

At the other extreme we can have a separate weigh hopper and scale for each ingredient. The system has several advantages. All weighings take place simultaneously so that production rate can be as fast as it is possible to handle the materials. Each hopper scale can be of ideal capacity for each material. If there are difficult materials requiring specially-shaped hoppers, feed or gate gear these can be provided in any individual case.

Trace ingredients can be weighed on scales of suitable size and accuracy and incorporated in the system.

Grouping of the material silos, the conveyors, etc., is much less involved than when a number have to be clustered around a single weighing point.

Fig. 5 shows an unusual mobile batch-weighing unit, for producing ready-mixed concrete, equipped with a weighing system of 6,000-lb capacity \times 10-lb divisions ($3,000 \text{ kg} \times 5 \text{ kg}$) on the dial. Three compounding pointers are provided for proportionate weighing of sand, gravel and cement prior to mixing.

A somewhat different approach is illustrated in Fig. 6, which depicts a closed-loop control for the continuous weighing of strip material. The measuring head and comparator receives the weight of strip and if this is outside

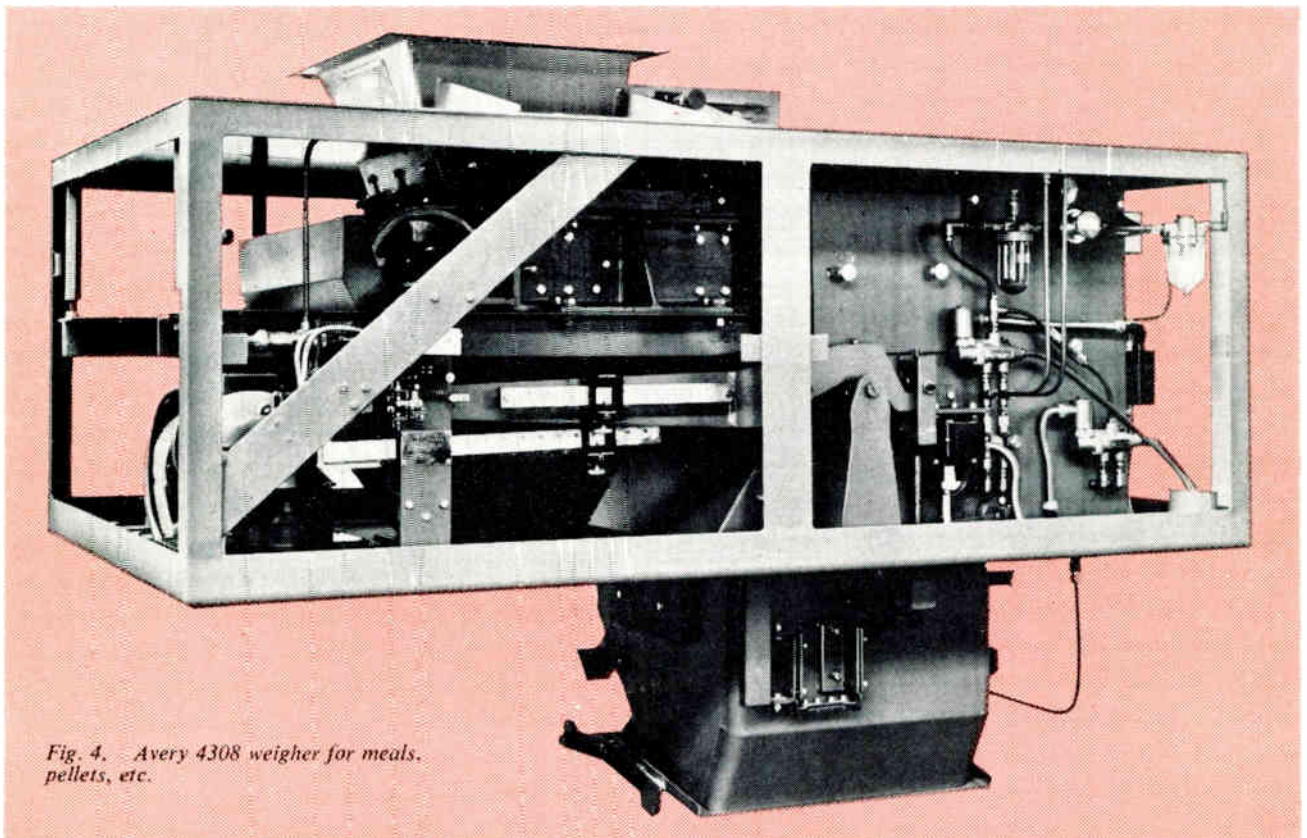

Fig. 4. Avery 4308 weigher for meals, pellets, etc.

preset tolerances, passes a signal to the amplifier and servo unit which, in turn, via the controller unit, passes the correcting factor to the controlling element which adjusts the position of the lower roller accordingly.

Liquids are not so easily handled as are solids and Fig. 7 shows a diagrammatic layout of a closed-loop control system giving a constant rate of flow, by the loss of weight method.

In this case the tank, with its contents, rests on the scale platform and the weight compensator is set at its extreme position so that a balance is obtained.

The weight compensator (i.e., poise) which is motorized, is then set to return at a predetermined speed, or rate, as required for the process.

If the liquid is not running from the tank at the correct rate the steelyard will either rise or fall and should this happen then, via the amplifier and servo unit, the controller and the controlling element, the discharge valve is either closed or opened until a balanced condition is produced and maintained.

The filling of liquid into drums and casks is yet another important industrial application of weighing. Fig. 8 shows a special scale which automatically compensates for the weight of empty casks, and controls filling to the required gallonage through a Roberts patent valve. To avoid over-frothing, a sub-surface filling valve is automatically lowered into the cask and retracted as the level of the liquid rises.

An automatic cask-feeding trolley is incorporated to place the empty cask on the scale and the filled drum on a disposal carrier, where it is sealed before disposal. Between 60 and 90 eleven gallon (50 litres) casks per hour can be handled by the scale.

The filling of small oil drums quickly and accurately



over a dial scale fitted with an electronic switch and Roberts patent valve is illustrated in Fig. 9. When the starter button is pressed, the empty drum is automatically tared off, the filling valve opens, and closes when the precise weight of oil is in the drum.

Scale-Operated Control Devices

The simple system of adjustable and sensitive contacts on the dial is perfectly satisfactory when only one material is handled by a scale, but when six or more materials are weighed in a single hopper the complexity of such contacts become impracticable. During the past two decades many ingenious and efficient methods of providing multiple and adjustable scale-operated contacts have been evolved, using servo-techniques, photo-electrics, pneumatics and electric analogue devices.

Two very successful scale control units have been evolved. The first is the analogue generator, a sensitive precision device, something like a potentiometer in general construction, and actually built and calibrated on the scale-pointer spindle. The friction of extra bearings and alignment difficulties are eliminated by this construction.

A contact wiper arm rotates with the scale spindle and divides the voltage across the terminals into a ratio which is in an exact proportion to the weight on the scale. These analogue voltage generators are calibrated to a linearity approaching 1 part in 10,000.

In a batching system a voltage is set up manually, say



Fig. 5. Mobile batch weigher for the proportionate weighing of sand, gravel and cement

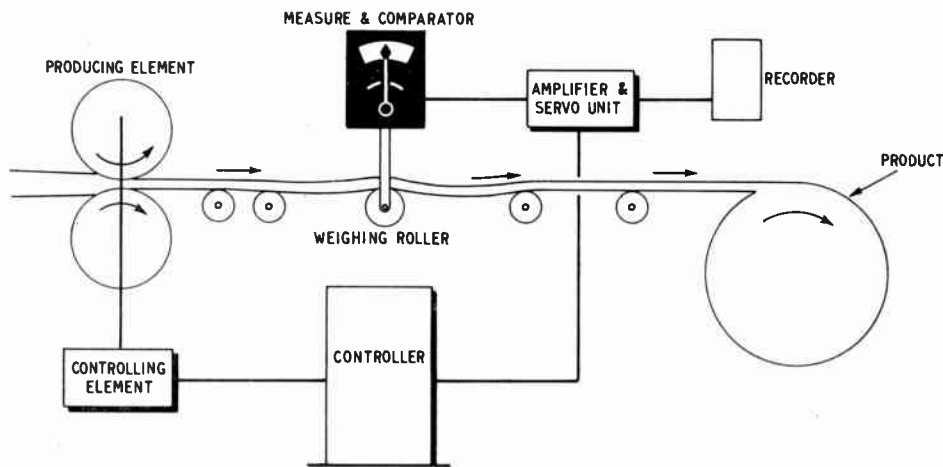

Fig. 6. Diagrammatic form apparatus for the continuous weighing of strip

on decade switches, or by other means, in an electric bridge system to represent the required weight of a material. When the scale pointer reaches this weight the analogue generator feeds into the bridge an exactly equal and opposing voltage and the state of electric balance is used to operate the feed controls through amplifiers, relays and contactors.

The system lends itself readily to presetting by various methods. The input can be in various forms such as punched card, or tape, reader, or manual control by decade switching. The output can be an electrically-operated typewriter or tabulator, or a punched card, or tape, machine, while remote indication of weight either in digital form or by dial can be provided.

After the initial push-button operation the sequence of operations, of schemes using such equipment, usually takes the following pattern.

The programme sequence controller completes the circuits linking the input machine to the transducer, which then receives its instructions and starts the weighing operation.

The weighing cycle completed, the programme sequence controller breaks the input circuits and links the transducer, through the digitizer unit, to the output circuits, causing the factual information to be passed to, and recorded by, the output machine.

The cycle of operations can, if required, be repeated any number of times without further manual effort.

As will readily be appreciated the introduction, and use, of the analogue transducer opens up an enormous field of possibilities in the automatic handling and control of materials in *all* kinds of industry.

A second scale control system is based on an optical digital encoder. A glass disc carries a coded representation of weight values in a Gray binary code, produced in a black and transparent pattern on photographic emulsion. Usually there are about twelve rings of information plus a ring of alternating black and white marks for stop-fraud operation. Each ring is read by a transistor type photoelectric cell, the light energy being provided by a single long filament lamp on the other side of the disc.

The disc is mounted on the scale dial indicator spindle and its angular displacement from the zero weight position is proportional to the load on the scale.

The unit is of particular advantage where a digital output is required from a scale, for example, to operate printing mechanisms, digital computers etc.

In batch weighing the required weights of the various ingredients are set up by switches, punched cards, etc., in binary form and when coincidence of preset code and actual weight code occurs the feed-cut-off is operated.

The digital encoder system has advantages over the analogue system in that there are no physical electric contacts and no digitizing unit is required to convert the signal from analogue to digital for print-out etc.

Force Cells

In recent years there has been an increasing use of force transducers in place of orthodox mechanical weighing systems. Several forms of transducer have been developed and the strain gauge load cell has become the type most frequently used.

The type usually employed is compact, and can be

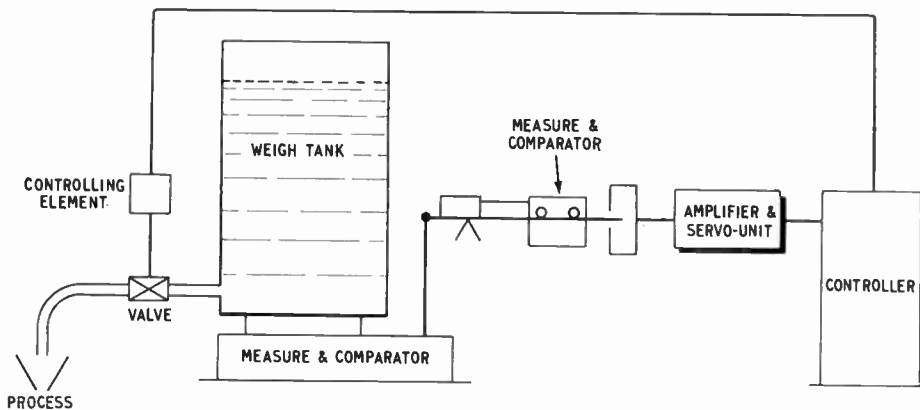

Fig. 7. In this closed-loop control system a constant rate of liquid flow is obtained

obtained in a range for capacities from 50 lb (25 kg) to 200,000 lb (100,000 kg) and, of course, load cells of much heavier capacity are commercially available. These capacities can be as high as 800 tons (800,000 kg).

In the strain gauge load cell the load supporting element is a very stiff spring and takes the form of a vertical pillar in the higher capacities and a circular ring in lower capacities. Other forms such as toroidal tubular rings and variations of the shape of the pillar are exploited by various makers.

The deformation of the load supporting element, or strain element, is very small, amounting to about 0.12 mm, and cannot readily or conveniently be measured accurately by direct mechanical methods.

However, the deflection is readily measured by electrical means and to this end strain gauges are bonded to the strain element.

These suffer the same amount of deformation as the surface of the main strain element to which they are bonded and in doing so their electric resistance alters. Precision cells are obtainable with errors due to linearity and hysteresis not exceeding 0.1% of the full-load capacity.

In practice two strain gauges are mounted with their conductors parallel to the strain axis and two at right angles. The former are termed active gauges because they are affected by the load, and the latter are called passive gauges because they are only affected by the strain due to Poisson's ratio. The passive gauges serve to compensate for the effects of temperature on the active gauges. In the better cells, designed for precision work, there are additional compensating devices to balance other temperature effects, such as the thermo-elastic coefficient of the strength of the material of the strain element.

A well-designed load cell is efficiently compensated against temperature changes but must be at a uniform temperature all over. Any local heating, causing one side of the cell to be warmer than the other, upsets the temperature compensating system.

The science of weighing depends upon the measurement of vertical forces due to the mass of a body. It is therefore absolutely essential to ensure that only vertical forces due to mass are transmitted to the load cells in a weighing system.

This point does not always receive the attention its importance merits when load cells are installed by the inexperienced.

In every engineering load-cell weighing applications a combined mechanical system, incorporating a horizontal free-motion ball-bearing assembly together with a self-aligning feature, is fitted above each load cell. The free-motion unit takes care of side thrusts due to the differential expansion of structure and foundations due to changes of temperature or other causes, and the self-aligning unit accommodates for angular misalignments due to deflection of structural members under load.

Load cells in themselves are simple and robust but it is fatal to load them beyond a certain point well below the elastic limit of the material of the strain element, or slip of the bonding between the strain gauges may take place with permanent damage to the calibration.

In cases where severe shock loading of the weighing machine is expected overload protection devices can be arranged. These usually take the form of springs which deflect under shock load and allow the weighing hopper or platform to strike solid stops and prevent the shock load from reaching the load cells.

An alternative, but more expensive method is to have the load supporting structure 'dead' and raise the load to the weighing position by means of a hydraulic lifting unit.

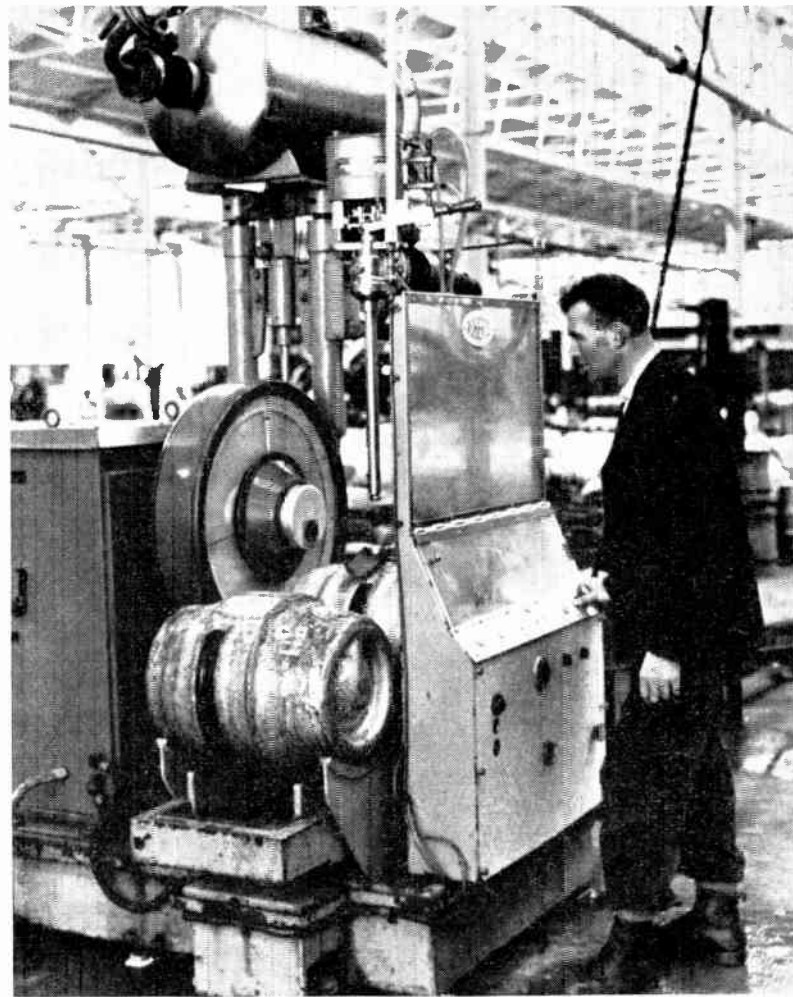

Fig. 8. This photograph illustrates the filling of casks to a definite weight

Fig. 9. Filling small oil drums



Load cells may be used to support the weigh hoppers in batch weighing systems. Preferably three cells should be used to take advantage of the principle of a three-point support which is virtually immune to the effects of structural deflection, whereas in a four-point support structural deflection may cause an uneven distribution of load between cells with a consequent overloading of one of them.

Like levers, no two load cells are exactly the same and means must be provided for matching electrically their output so that an unevenly distributed load on the scale will give the same reading no matter how it is placed.

Load cells can operate the same weight control systems as orthodox mechanical scales having an electric output and vice-versa.

Instrumentation of load cells depends basically on the balancing of an electric-bridge circuit into which the load cell output is fed.

The dial may be fitted with automatic ranging, automatic or manual taring, and adjustable contacts for operating controls. There is provision for mechanically driving a torque-synchro-transmitter which can be electrically coupled to an identical receiver driving a repeater dial at a considerable distance.

When a digital output is required in addition to the dial a digital encoder can be mechanically driven from the servo-motor gear train. Alternatively, when dial indication is unnecessary a digitizer unit may be operated directly from the load cell circuit. Digital electric output enables electric typewriters, totalizing printers, card and tape punching machines etc., to be operated.

Every industry has its own peculiar weighing problems, some are quite easily solved but some are so complex that, one might say, common arithmetic has been replaced by calculus, and the wonders of yesterday are commonplace today.

Automatic Effluent Sampling

The Arkon instrument division of Walker Crossweller has developed an automatic sampling device for applications where it is necessary to take periodic samples of industrial or sewage effluent for routine chemical analysis.

It is designed for use with the effluent flow measurement system developed by the company in which a standard Arkon recorder is used to record flow rate and total volume of effluent flow by means of a dip tube/air reaction technique.

A microswitch is used to bring the sampling device into operation. The contacts of the microswitch are opened or closed by the last figure roller of an integrator, incorporated in the recorder, which keeps a digital record of the running total of effluent flow. The system operates with the dip tube in a weir tank or in a side measuring chamber of a venturi flume; in the case of the weir tank, the microswitch opens a solenoid valve which allows the sample to be drawn off, and with the flume, starts a peristaltic or 'squeeze tube' pump which draws off the sample.

To ensure that samples are taken at intervals proportional to the volume of effluent flow, the microswitch is operated once or twice during each revolution of the last figure roller of the integrator, and the overall frequency of sampling is made dependent upon rate of flow.

The microswitch operates through a timer and relay unit which ensures that sampling continues for the desired period and that the correct quantity is drawn off. This works quite independently of the microswitch and allows sampling to continue even if the microswitch contacts are opened before the sample is complete and, similarly, also ensures that sampling ceases at the end of the period even if the microswitch contacts remain closed.

The advantage of using a peristaltic pump is that solids in suspension are drawn off with the sample, and no moving parts of the equipment come in contact with the liquid.

For further information circle 47 on Service Card

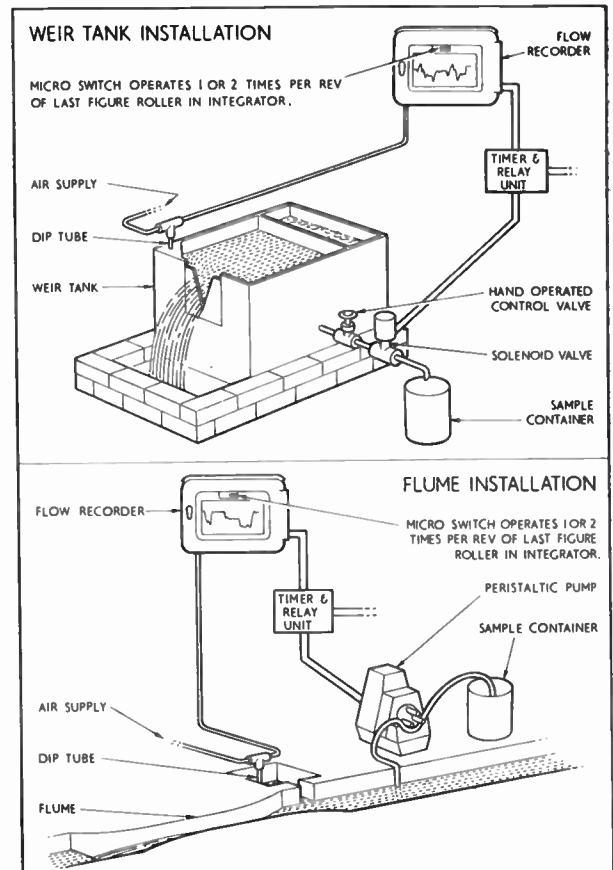

The diagram shows the main features of the automatic sampling device for use with the effluent flow measurement system with a weir tank or venturi flume

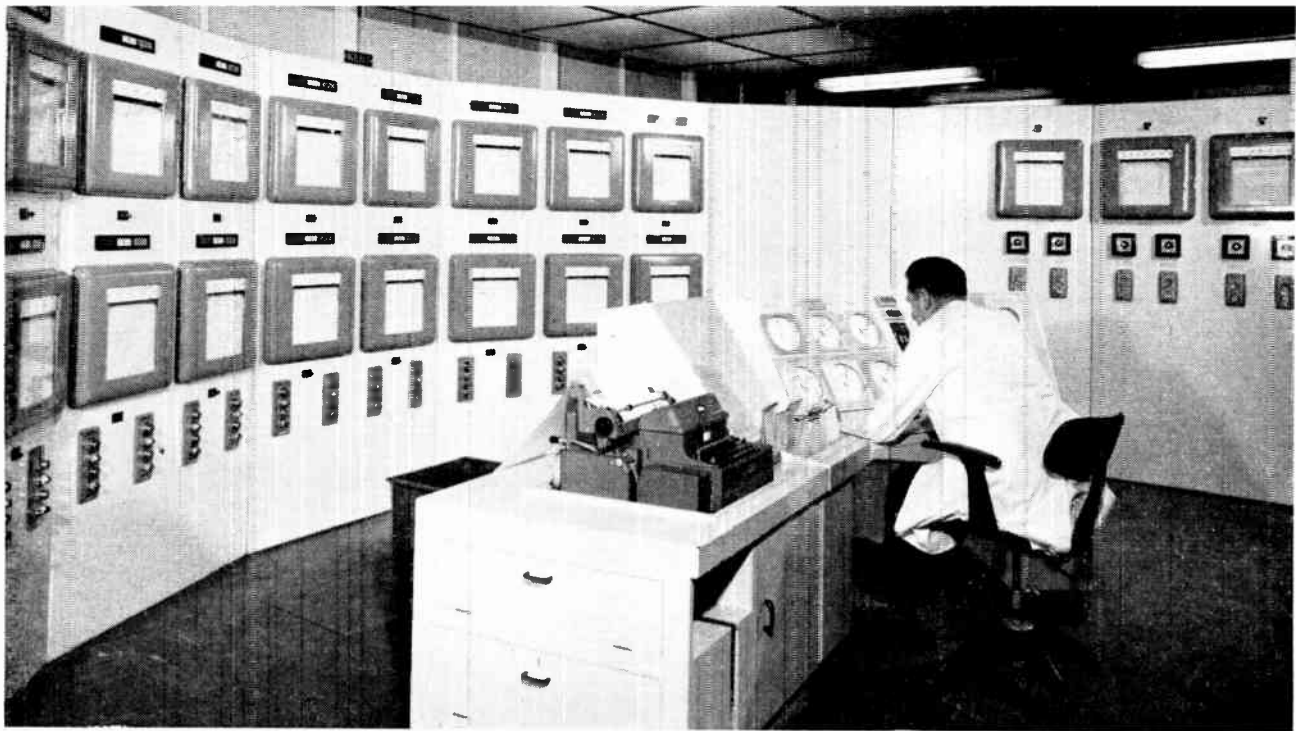

Soaking-Pit Instrumentation at Samuel Fox

GEORGE KENT have supplied and installed instrumentation and controls for sixteen oil-fired soaking pits and three continuous pre-heat furnaces at the Stockbridge Works of Samuel Fox.

This electronic equipment replaces a hydraulic system which consisted of a battery of control panels some 150-ft long. In the new installation the operator remains seated at a control console which, on the operation of a pit-selector switch, displays variables such as pit temperature, pit pressure, air flow and oil flow. At the same time the selector switch connects a single set of controls to the appropriate pit. These controls have auto/manual change-over, manual control of all control outputs and manual adjustment of desired values, air/oil ratio, maximum oil flow, steam/oil ratio and pit pressure. The operator can adjust the value or ratio of any variable and can also change from automatic to manual control or vice versa. A computerized data logger provides print-out of all important measured variables and provides a regular three-minute check on any departure from pre-set standards.

Conventional recording has been dispensed with in the operational control room except for pit and pre-heat furnace temperatures. These are plotted by electronic recorders mounted on a panel in front of the control desk. Two spare recorders are also mounted on this panel so that, in the event of any suspected recorder failure, a spare can be quickly substituted by plugging in a flying lead.

Adjacent to the operational control room there is a functional-instrument room which houses transmitters, controllers and relay circuits. All the controllers are fully transistorized Kent 'Transdata' units but valves and dampers are pneumatically operated. In emergency conditions the valves on all the soaking pits can be controlled by hand from the functional-instrument room.

For experimental purposes ten recorders are provided which can be plugged in to measure any ten variables throughout the soaking-pit battery. Alarm conditions are

monitored on pit temperature (desired and actual values), steam/oil ratio and air/oil ratio.

All panels are housed in an enclosed air-conditioned area in which the temperature is maintained at a comfortable working level.

This shows a close-up of the console which provides the operator with complete control of the installation



LINEAR AND NON-LINEAR SERVOMECHANISMS

By D. R. TOWILL, M.Sc., B.Sc. (Eng.), A.M.I.Mech.E., A.M.I.Prod.E.*

This article reviews the main characteristics of servomechanisms and also deals with the assessment of their performance. Some notes on testing methods are also included.

A SERVOMECHANISM is a closed-loop control system used to control the position, speed or acceleration of an inertia load. The load may take many physical forms ranging from radar aerials to machine-tool tables. Four characteristics define the servomechanism; they are,

- It is error actuated, and hence there must be constant comparison between the desired and actual load behaviour, the difference between these two quantities being termed the error.
- There is normally power amplification, and this implies that a low power error signal is used to control a high power source operating some form of motor.
- There is a mechanism, or mechanical drive, driving the load. Some form of gearing is often used between the motor and load, due to the normal high cruise speed of the motor. This gear ratio may be used as an adjustable parameter at the design stage to better the servomechanism performance.
- Operation is completely automatic.

The basic components of a servomechanism are thus

transducers, where necessary for converting a signal into an electrical analogue, a signal amplifier, a motor, a mechanical drive and gearbox, and some form of inertia load. In order to obtain satisfactory performance from the servomechanism (i.e., to make sure that the load follows the desired behaviour in a satisfactory manner) it is necessary to shape the servomechanism behaviour by the incorporation of stabilizing networks, and/or subsidiary feedback loops, thus introducing a secondary range of components. Typical block diagrams are shown in Figs. 1 and 2. Fig. 1 shows a system stabilized by rate feedback, and Fig. 2 shows a system stabilized by a phase-advance network. The relationship between stability and response will be examined later.

The Function of a Servomechanism

In the general case there will be three signal sources acting on the servomechanism. Firstly, there is the genuine command signal telling the servomechanism about the desired performance expected of it. Secondly, there are 'noise' signals, which may be injected at any point, due to structural vibrations, etc., and which distort the command signal, thus giving the servomechanism false information. Finally, there may be load disturbances, such as wind forces, etc., which deviate the load from the desired behaviour. Since by the nature of operation the servo must have an error signal to generate a force or torque on the load, it follows that such wind forces, etc., can only be reacted by the servo if an error signal is present. If θ_i is the command signal, N is the noise

* Royal Military College of Science.

Fig. 1. Block diagram of a servomechanism stabilized by rate feedback

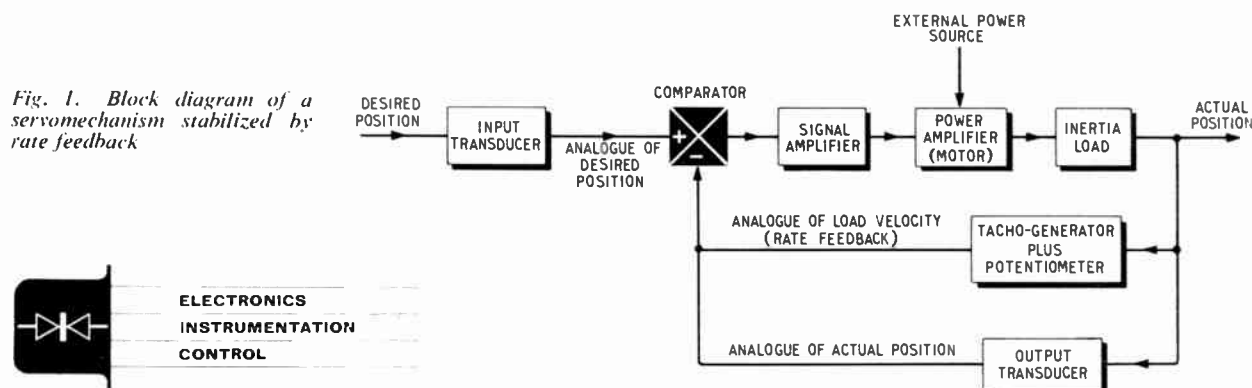
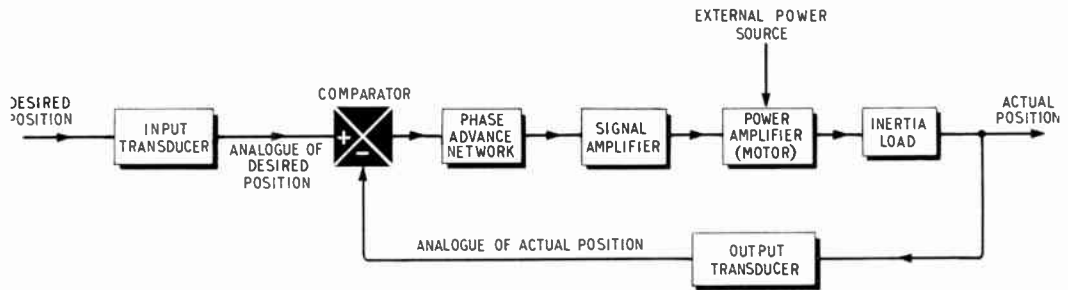

Fig. 2. Block diagram of a servomechanism stabilized by a phase-advance network



signal, and L is the load disturbance signal due to windage loads, etc., then the performance requirements are¹,

$$\left. \begin{aligned} \frac{\theta_o}{\theta_i} &\approx 1.0 \\ \frac{\theta_o}{N} &\approx 0 \\ \frac{\theta_o}{L} &\approx 0 \end{aligned} \right\} \text{simultaneously}$$

In order to follow the command signal in a satisfactory manner, without passing an excess amount of noise, it is necessary for the servomechanism to discriminate between these two signals. Unfortunately it is rare to be able to remove all the noise signal and yet simultaneously pass all the command signal. A compromise is therefore often necessary, and sometimes we have to use a performance criterion, which will combine the error due to both following the command signal and to the noise. However, at the design or testing stage it is often sufficient to consider the performance due to following the command signal only, and base acceptability on this performance alone. We shall only consider the command signal in the following discussions.

Signal Definition

Signal inputs to a servomechanism are normally random functions of time, as shown in Fig. 3. Although it is possible to analyse the properties of such signals, it has been custom-

ary to assume that servomechanisms can be designed and tested using deterministic signals such as step functions, ramp functions, acceleration functions, or sinusoidal functions (Fig. 4). The use of such deterministic signals is justified because, on a transient response basis, the random signal, for a very short trace, may often be reasonably approximated by a signal of the form²

$$\theta_i = a + bt + ct^2$$

which is the sum of a step-displacement function, step-velocity function and step-acceleration function. The performance may therefore be expressed in terms of the response to all or any of these signals. Alternatively, it is possible to express the performance in terms of the steady-state response to a sinusoidal signal for linear servomechanisms, and since the response to these deterministic signals may be computed with relative ease, many methods have been developed for analysing and synthesizing servos to such inputs.

Linearity and Non-Linearity

Before discussing servomechanism response and stability in detail, it is necessary to define linearity and non-linearity. A servomechanism is termed linear if the behaviour of the servomechanism can be adequately described, for all operating modes, by a single linear differential equation with constant coefficients. The differential equation will therefore appear in the following form,

$$A_0 D^r \theta_o + A_1 D^{r-1} \theta_o + \dots + A_r \theta_o = B_0 D^q \theta_i + \dots + B_q \theta_i$$

where the A and B terms are constant.

The following properties of a linear system may also be looked on as an alternative working definition.

- The non-dimensional response, θ_o/θ_i to any input signal, is independent of the amplitude of the signal applied to the servo.
- The response of the system to a signal of magnitude $(X + Y)$ is the sum of the response to signals of magnitude X and Y applied separately.
- A unique transfer function

$$F(D) = \frac{\theta_o}{\theta_i} = \frac{B_0 D^q + \dots + B_q}{A_0 D^r + \dots + A_r}$$

exists, which enables the response to any signal to be computed.

If a servomechanism is linear, a necessary, but not sufficient condition is that the force or torque exerted on the load is proportional to the motor input signal.

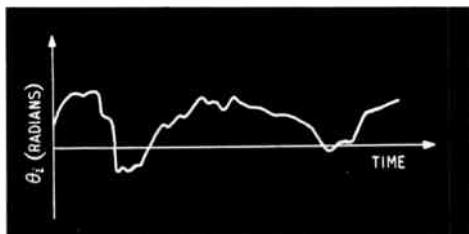

Fig. 3. Typical input signal to a servomechanism

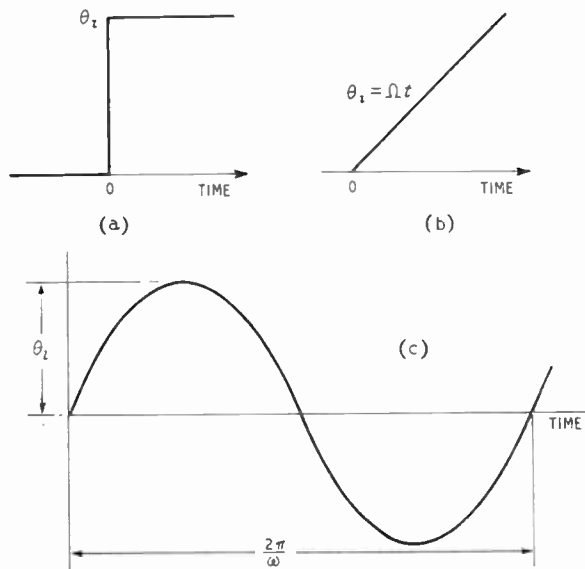
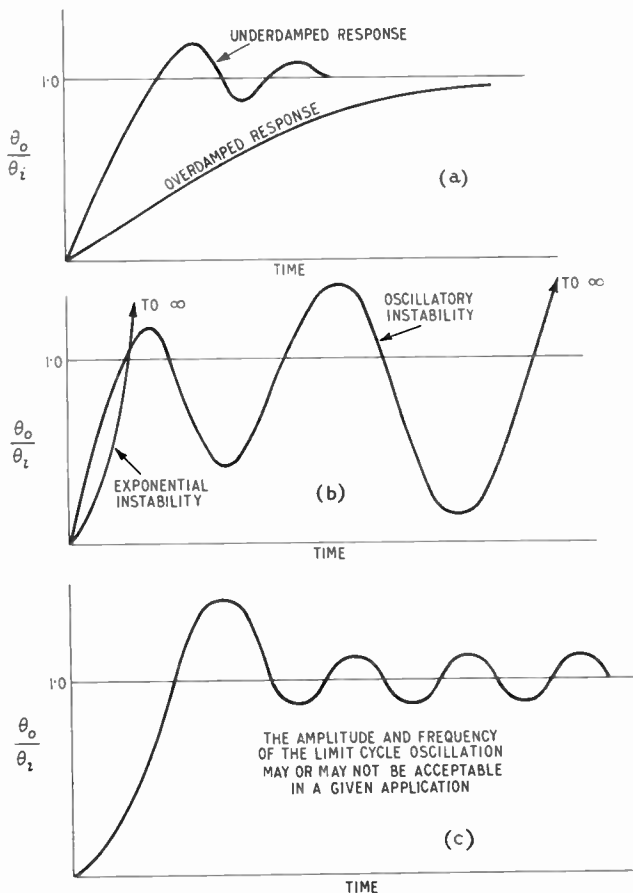

Fig. 4. Deterministic input signals used for servomechanism design and test purposes; (a) step function input, (b) ramp function input and (c) sinusoidal excitation

Fig. 5. Response of (a) and instability (b) in a stable linear servomechanism and limit cycle instability (c) possible in a non-linear servomechanism



Conversely, a non-linear servomechanism is simply a servomechanism whose behaviour cannot be adequately described by a single linear differential equation with constant coefficients. It follows immediately that the principle of superposition does not apply, and that a unique transfer function does not exist.

Stability and Response

A stable linear servomechanism is a servomechanism whose behaviour follows the desired behaviour. Mathematically, the system is linearly stable if, following an excitation of the servo, $\theta_o \rightarrow \theta_i$ as $t \rightarrow \infty$. For a certain non-linear system, a further possibility exists, since the system may continuously oscillate about the desired mean position. This phenomena is known as a 'limit cycle', and may or may not be a desirable feature, depending on the nature of the application. If a limit cycle is acceptable in a particular servomechanism, then the maximum limit cycle amplitude and minimum limit cycle frequency must be clearly specified. Under such conditions, a limit cycle lying within the specification would be defined as a stable system, while a limit cycle lying outside the specification would be defined as an unstable system³. Linear and non-linear instability is shown clearly in Fig. 5.

Response in a stable servomechanism is defined as the manner in which the actual behaviour follows the desired behaviour. As we shall see later, satisfactory servomechanism response may be interpreted in many ways, depending on the form of excitation used. In order to obtain a fast response, and at the same time retain a reasonable stability margin, it is necessary to use suitable signal shaping such as phase-advance or rate feedback, or alternatively subsidiary feedback loops may be introduced.

Fig. 6. Step function response of a simple linear servomechanism; (a) response and (b) block diagram

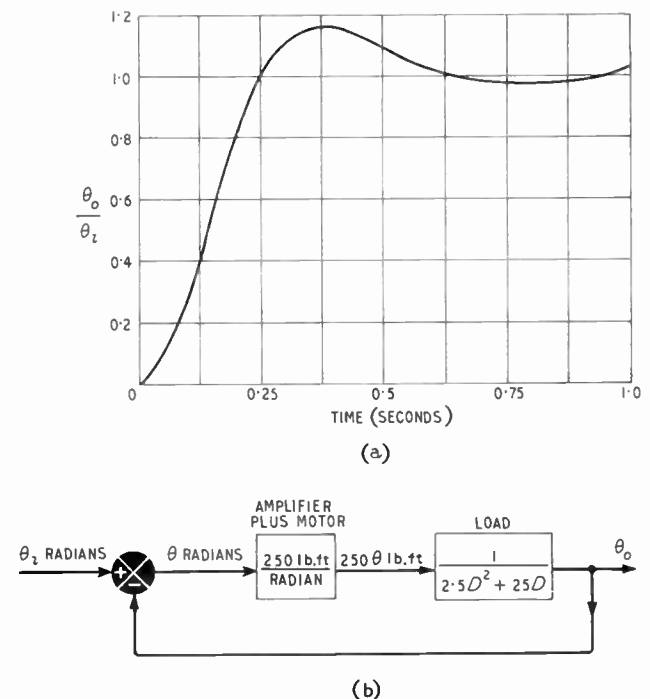

Types of Non-Linearity

Non-linearities may occur anywhere in the servomechanism, and may be due to inherent physical limitations of manufacturing processes and components, or due to inherent non-linear relationships between physical quantities. Additionally it is often advantageous deliberately to introduce non-linear elements to improve the system performance, or to obtain simplicity, reliability and a higher power/weight ratio, which is an important consideration in servomechanisms designed for portable equipment.

For the large class of servomechanisms which are basically linear in concept and performance, there may exist, at small amplitudes of operation, significant non-linearities such as dead zone and hysteresis, which may be due to manufacturing tolerances, etc., while at large amplitudes of operation physical phenomena such as valve or magnetic saturation occur which limit the motor output and hence introduce a significant non-linear mode of operation. As an example of a servomechanism which is basically linear in operation, let us consider a simple servomechanism for controlling the position of a gun mounting. The total moment of inertia of the motor, gearbox and mounting, referred to the servomotor is 2.5 slugs ft², and there is viscous damping associated with the load of 25 lb ft/radian/sec. The signal amplifier together with the motor has a gain of 250 ft lb/radian error. As shown in Appendix 1, with no non-linearities present, the servomechanism will have a damping ratio of 0.5, and an undamped natural frequency of 10 radians per second; the associated step function response is shown in Fig. 6, and will, of course, be independent of the input amplitude.

Let us now consider quite separately, the effect of two quite different kinds of non-linearity on the step function response

of such a servo. Fig. 7 shows the step function response for the servo when the signal amplifier has a dead zone of ± 0.01 radian, and the step function magnitude is 0.02 radian. Two points are immediately obvious, firstly, the output never reaches the same steady value as the input, but settles down to a value of about $0.65 \theta_i$, and secondly the servo has a slower speed of response. For example, the time required to reach $\theta_o/\theta_i = 0.5$ has increased from about 0.145 second for the linear servo to 0.25 second for the dead zone servo. For the purpose of this discussion these equations have been solved graphically. The method of solution is outside the scope of this article; more details can be obtained from references 2 and 3.

Fig. 8 shows the step function response for a saturation type non-linearity where the saturation occurs at 0.30 radian, and the step magnitude is 0.60 radian. The equations of motion are listed in Appendix 3, and have also been solved graphically. Comparing Figs. 6 and 8 it can be seen that the peak percentage overshoot has been reduced slightly, and that the time required for the saturated servo to reach $\theta_o/\theta_i = 0.5$ has increased to about 0.18 second. These two simple examples clearly show the effect of certain non-linearities on the transient response of the basic servomechanism. The reader is warned, however, that the effect of non-linearities is not always so easy to predict, and the detailed effect can be much more, or much less, spectacular.

Fig. 7. Step function response of a servomechanism with dead zone; (a) response for $\theta_L = 0.01$ radian, $\theta_i = 0.02$ radian and (b) block diagram of the servomechanism

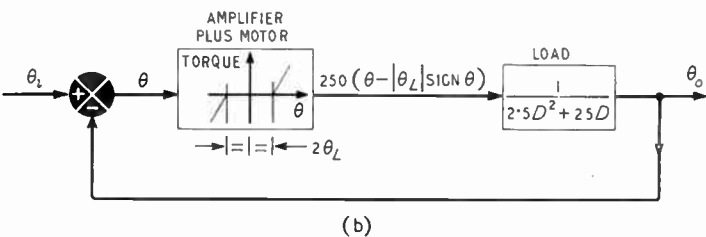
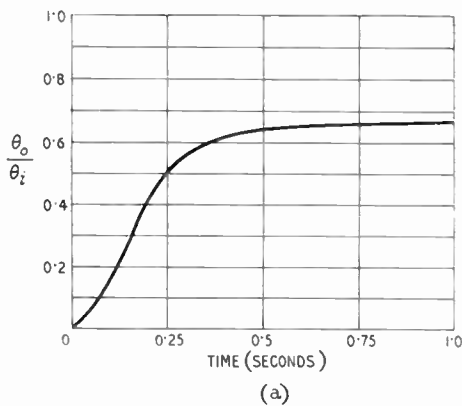
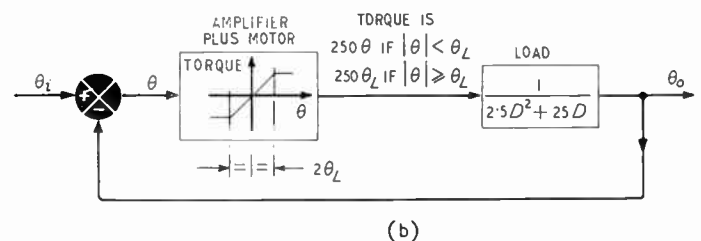
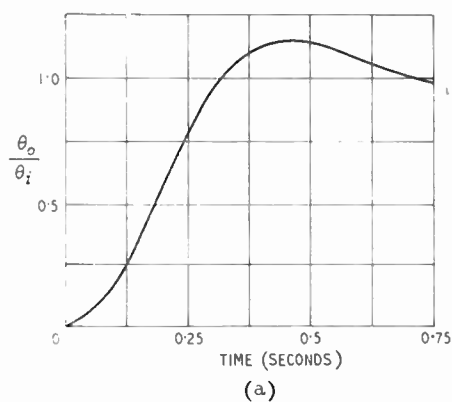

Fig. 8. Step function response of a servomechanism with saturation; (a) response for $\theta_L = 0.30$ radian, $\theta_i = 0.60$ radian and (b) block diagram of the servomechanism



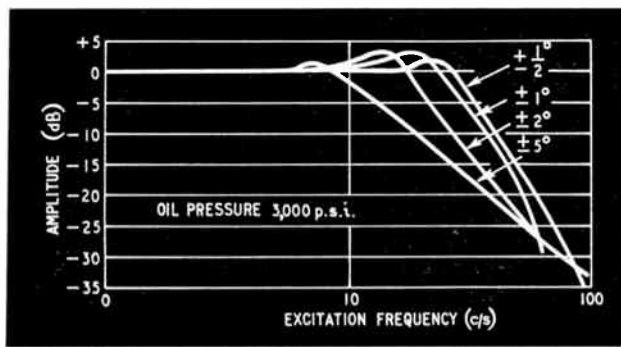

Fig. 9. Frequency response of electro-hydraulic position servo as function of input amplitude

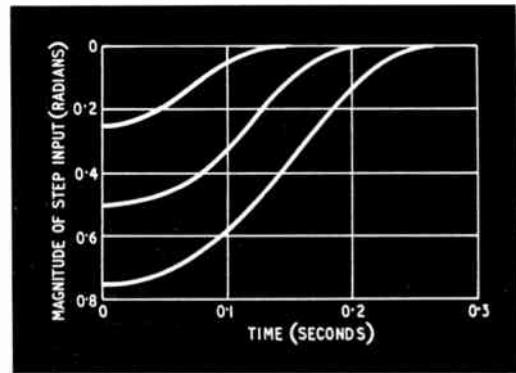

Fig. 10. Step function response for an optimum bang-bang servomechanism

Certain servomotors, particularly hydraulic and pneumatic, tend to be non-linear in operation because of control port shaping and inherent coupling between fluid flow and load dynamics. Since such motors have certain advantages over electric motors⁴, the non-linear effects of using fluid power are accepted. Fig. 9 shows the experimental frequency response obtained for an electro-hydraulic servomechanism suitable for actuating the control surface of a large guided missile. The dependence of the response on the amplitude of the input command signal is clearly shown by noting, for example, the peak amplitude ratio or the frequency at which the amplitude ratio drops below unity (0 dB).

Lastly, for reasons of improvement of the servomechanism response, non-linear elements such as relays may be included⁵. Such bang-bang servos, when suitably compensated, may be designed to give always a faster response than the best linear servo it is possible to design using the same servomotor. The bang-bang servo demands that the torque developed by the servomotor is constant in magnitude but takes the sign required to reduce the error. Fig. 10 shows the step-function response for an optimum bang-bang servomechanism, the word optimum in this sense meaning the servomechanism which follows the input command signal from *A* to *B* in the minimum time. The dependence of the response time on the amplitude of the excitation signal is clearly shown.

Assessment of Servomechanism Performance

We have seen some of the difficulties which arise from trying to specify the performance of servomechanisms containing non-linearities, since the response may be heavily dependent on the amplitude of the excitation signal. There may also exist non-linear phenomena which are completely outside the scope of this article⁶, which may not be acceptable in a particular application.

A reasonable basis for specifying non-linear servomechanisms is to use the same types of assessment as for linear systems, and to add that the various limits must not be exceeded whatever the amplitude of the excitation signal. The normal method of specifying the performance of linear

servomechanisms is to use one or more of the following performance measures.

- Percentage overshoot following a step-function input.
- Time to reach a given percentage of the step-function input.
- The steady-state error following a ramp-function input.
- The peak amplitude ratio between output and input for sinusoidal excitation.
- The bandwidth or maximum frequency at which the amplitude ratio between output and input is 0.707.

These specifications are shown pictorially in Fig. 11. For a more detailed description of these methods, the reader is referred to reference 7. Open-loop methods of specification will not be dealt with here; the fundamental performance criterion should always refer to closed-loop or 'servomechanism' transfer functions. As mentioned previously the theoretical values for these performance specifications may often be obtained with relative ease for linear servomechanisms.

A method of specification which is somewhat different from the above is the direct measurement of the servo transfer function⁸: i.e., referring back to our definition of a linear servomechanism we would attempt to measure $F(D)$ directly. The concept of a non-linear transfer function is more difficult to define, particularly as there is no unique correlation between the transient and frequency response of a non-linear servomechanism. However, for a given excitation signal, it is normally possible to determine a transfer function which describes the performance of the servomechanism for that particular excitation mode and amplitude.

Testing Servomechanisms

Current commercially-available servo test equipment generally consists of a signal generator to generate a sinusoidal excitation, and a device either to measure the phase angle and amplitude of the servomechanism response, or measure the in-phase and quadrature components of the amplitude. This type of equipment is particularly suitable for open-loop methods of testing. Step and ramp function generators may also be included as part of the test equipment, thus allowing a wide range of tests to be performed⁹.

The main exception to this type of equipment is the direct measurement of the servomechanism transfer function $F(D)$, and thus requires that limits be placed on acceptable transfer



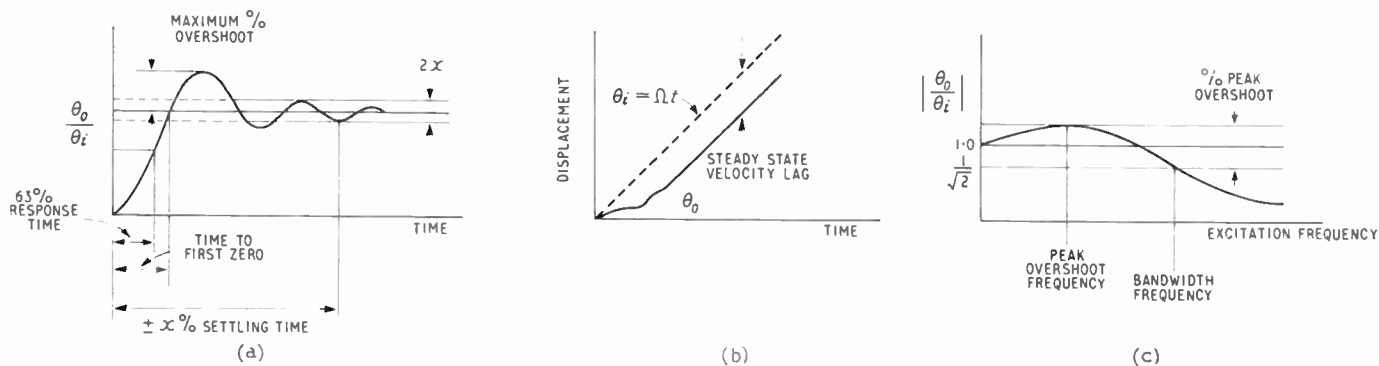

Fig. 11. Illustration of some common methods of specifying servo performance; (a) performance standards based on the step-function response, (b) performance standard based on the response to a ramp function or step velocity demand and (c) performance standards based on the steady-state frequency response

function coefficients. Reference 8 describes in detail the principles on which a suitable transfer function computer has been designed.

It is quite some time since the possibility of using random or quasi-random signals rather than deterministic signals was first discussed¹⁰, but to date this method of testing has not proved popular. The main argument in favour of this method of test is that all frequencies and amplitudes of interest are included in the test signal. The performance of the servomechanism is then usually assessed by the mean-square error criterion defined by,

$$\frac{1}{2T} \int_{-T}^T (\text{servo error})^2 dt$$

where $2T$ is the test sampling time.

Consideration of the use of random signals for testing and assessment purposes leads naturally to the possibility of using the actual or expected command signal as a test signal¹¹. Such a method of testing would be ideal for non-linear systems, since non-linear phenomena could be detected under actual conditions, and the time required for testing is much less and the interpretation of the results much simpler. Equipment of possible use in this field is the repetitive function synthesizer¹², which allows the expected command signal to be simulated, and the performance of the servomechanism assessed by determining the mean-square error in following this signal.

We may summarize the present state of the art of testing non-linear servomechanisms by saying that the standard linear test procedures, extended to cover a range of signal amplitudes, will yield much useful information but methods based on random signals or repetitive waveforms simulating the command signal expected in the working environment may be particularly useful for assessing the performance of such non-linear servomechanisms. The whole approach to servo testing is in a state of flux at the present time, and the next few years are likely to see some rather exciting developments, particularly in the field of acceptance testing.

Acknowledgments

The author wishes to acknowledge with thanks the permission of the Dean, Royal Military College of Science, to publish this article. The author also wishes to acknowledge with thanks the assistance of the E and IT Dept. Drawing Office, led by Mr. R. C. Baigent.

References

- ¹ Towill, D. R., 'Performance Advantages of Certain Non-Linear Servomechanisms', R.M.C.S., E.P. Tech. Note No. 18, 1964.
- ² Truxal, J. G., 'Automatic Feedback Control Systems Synthesis', McGraw Hill, 1955.
- ³ Chestnut and Mayer, 'Servomechanisms and Regulating System Design', Vol. II. John Wiley and Sons, 1955.
- ⁴ Towill, D. R. and Carne, C. M., 'The Servomotor Potentials of the Piston Type Air Motor', Part I, R.M.C.S., E.P. Tech. Note No. 2., 1964.
- ⁵ Towill, D. R., *ibid.*, E.P. Tech. Note No. 18.
- ⁶ West, J. C. 'Analytical Techniques for Non-Linear Control Systems', English Universities Press, 1960.
- ⁷ Gibson, J. E., Rekasius, Z. V., McVey, E. S., Sridhar, R., and Leadham, C. D., 'A Set of Standard Specifications for Linear Control Systems', *Applications and Industry*, May 1961.
- ⁸ Levinge, R. W., 'Computer Takes Derivatives to Find Transfer Functions Directly', *Control Engineering*, Vol. 8, November 1961.
- ⁹ Sumray, E. J., 'A Survey of Servo System Test Equipment', *British Communications and Electronics*, March 1961.
- ¹⁰ Seifert, W., 'Experimental Evaluation of Control Systems by Random Signal Measurements', 1953 I.R.E. Convention Record, Part I, Radar and Telemetry.
- ¹¹ MacDowall, J., 'Testing Non-Linear Servomechanisms', 13th G.W. Course Thesis, Royal Military College of Science, 1963 (Classified).
- ¹² James, J. R., and Potok, M. H. N., 'Repetitive Function Synthesizer and Spectrum Display', *Electronic Engineering*, December 1963.

Appendix I

For the basic linear servomechanism, the equations of motion are,

$$\theta = \theta_i - \theta_o \quad \dots (1.1)$$

$$\text{Motor torque} = K\theta = J \cdot D^2\theta_o + f \cdot D\theta_o \quad \dots (1.2)$$

hence the relationship between output and input may be written,

$$\theta_i = \theta_o + \frac{f}{K} D\theta_o + \frac{J}{K} D^2\theta_o \quad \dots (1.3)$$

or

$$\theta_i = \theta_o + \frac{2\zeta}{\omega_n} D\theta_o + \frac{D^2\theta_o}{\omega_n^2} \quad \dots (1.4)$$

where

$$\omega_n = \text{undamped natural frequency} = \sqrt{\frac{K}{J}}$$

and

$$\zeta = \text{damping ratio} = \sqrt{\frac{f^2}{4KJ}}$$

For such a basic linear servomechanism, the maximum percentage overshoot to a step function stimulus is a function only of f .

For a servomechanism with

$$K = 250 \text{ lb ft/radian}$$

$$J = 2.5 \text{ slugs ft}^2$$

$$f = 25 \text{ lb ft/radian/sec}$$

$$\omega_n = \sqrt{\frac{K}{J}} = \sqrt{100} = 10 \text{ radians/sec}$$

$$\zeta = \sqrt{\frac{25^2}{4 \times 2.5 \times 250}} = \sqrt{\frac{1}{4}} = 0.5$$

Appendix 2

For a dead-zone servomechanism, with a symmetrical dead zone in the motor/amplifier combination of $\pm\theta_L$, the equations of motion are,

$$\theta = \theta_i - \theta_o \quad \dots (2.1)$$

$$\text{Motor torque} = 0 = J \cdot D^2\theta_o - f \cdot D\theta_o \quad \dots \text{for } -\theta_L < \theta < \theta_L \quad (2.2)$$

$$\text{Motor torque} = K[\theta - \theta_L(\text{sign } \theta)] = J \cdot D^2\theta_o + f \cdot D\theta_o \quad \dots \text{for } -\theta_L \geq \theta \geq \theta_L \quad (2.3)$$

Appendix 3

For a basic servomechanism with saturation of the motor output, the equations of motion are,

$$\theta = \theta_i - \theta_o \quad \dots (3.1)$$

$$\text{Motor torque} = K\theta = J \cdot D^2\theta_o + f \cdot D\theta_o \quad \dots \text{for } -\theta_L < \theta < \theta_L \quad (3.2)$$

$$\text{Motor torque} = K\theta_L \cdot \text{sign } \theta = J \cdot D^2\theta_o + f \cdot D\theta_o \quad \dots \text{for } -\theta_L \geq \theta \geq \theta_L \quad (3.3)$$

STC Computer for Communications Networks



The computer now finds a place in communications networks to control the routing and switching of messages. Standard Telephones and Cables Ltd. have produced the 8300 ADX system for this purpose. At a switching centre the computer examines all incoming messages for destination, priority and security and routes them accordingly.

For further information circle 48 on Service Card

Third-Order Servomotor Systems

By N. G. MEADOWS, B.Sc., A.M.I.E.E.*

MANY split-field and armature-controlled servomotors are closely characterized by the transfer function

$$F(s) = \frac{K}{s(s^2 + 2\zeta\omega_n s + \omega_n^2)} \quad \dots (1)$$

Here K includes a gain factor, with ζ and ω_n specifying the non-zero open-loop pole locations. For a split-field motor the poles are real, but if tachogenerator feedback is applied for damping purposes the motor, amplifier and local feedback path may have an overall transfer function which has complex open-loop poles. This may also occur for an armature-controlled servo without external feedback. Data for transfer functions with real poles are given in the following sections.

The Split-Field Motor

No External Feedback

The basic control scheme is shown in Fig. 1. Transfer functions for linear operation are given below.

With the switch s of Fig. 1 open, the open-loop output/error transfer function is

$$\frac{\theta_0}{\theta} = F(s) = \frac{nkAK_m/2JL_f}{s(s + F/J)(s + R_f/L_f)} \quad \dots (2)$$

or

$$F(s) = \frac{K}{s(s + a)(s + b)} \quad \dots (3)$$

In these equations

n = gear ratio

A = amplifier voltage gain

K_m = motor shaft torque/unit field current unbalance

$1/a = J/F$ = mechanical time constant

$1/b = L_f/R_f$ = electrical time constant of motor field
 k = volts/rad potentiometer constant.

At the load shaft, $J = n^2J_m + J_L$ where J_m is the motor moment of inertia and J_L that of the load.

The viscous friction coefficient at the load shaft is

$$F = n^2F_m + F_L$$

Open-loop poles are at $s = 0$, $s = -F/J$ and $s = -R_f/L_f$: these are always real. In the form of Eqn. 1 this implies $\zeta \geq 1$, with $a = b$ for $\zeta = 1$.

The error voltage is $e = k\theta/2$, where $\theta = \theta_1 - \theta_0$ is the angular error.

For the closed-loop transfer functions,

$$\frac{\theta_0}{\theta_1} = \frac{F(s)}{1 + F(s)} \quad \dots (4)$$

and

$$\frac{\theta}{\theta_1} = \frac{1}{1 + F(s)} \quad \dots (5)$$

The system is Type 1, with a 'velocity lag' on closed-loop giving a steady-state position error of

$$\theta_{ss} = \frac{2FR_f}{nkAK_m} \quad \dots (6)$$

If R_f is large to give L_f/R_f small, θ_{ss} will tend to be large.

Stability

On closed-loop, via equations (3) and (4),

$$\frac{\theta_0}{\theta_1} = \frac{K}{s^3 + (a + b)s^2 + abs + K} \quad \dots (7)$$

The characteristic equation (C.E.) is derived from the denominator of this equation as

$$s^3 + (a + b)s^2 + abs + K = 0 \quad \dots (8)$$

For the maximum gain K_{max} at which instability just occurs the system will have an s.h.m. mode, for which $s = j\omega$.

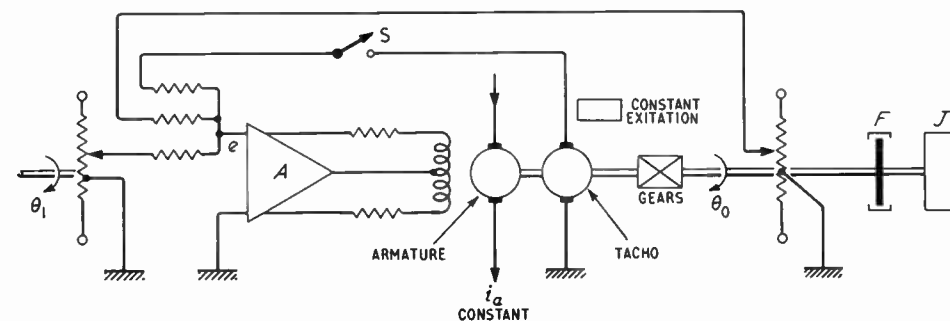

Fig. 1. Position control servo

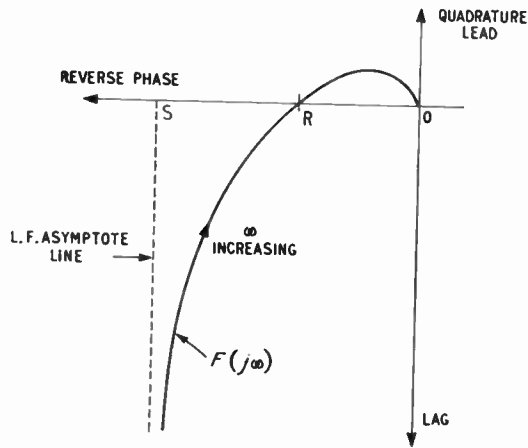

Fig. 2. Type 1 Nyquist locus

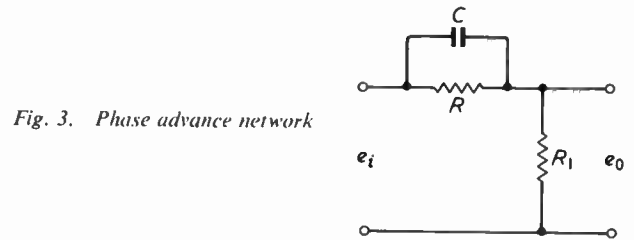

Fig. 3. Phase advance network

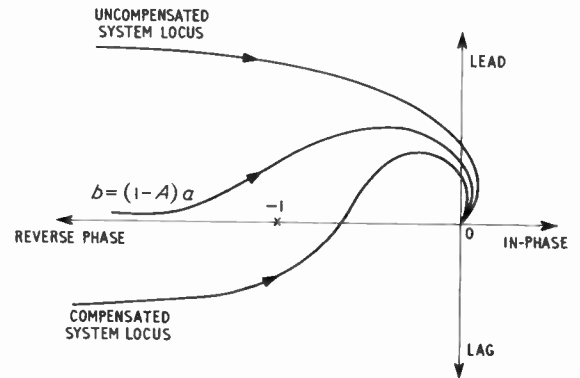

Fig. 4 (Right). Loci for compensated and uncompensated type 2 systems

Substituting this in the C.E. gives

$$\omega_m^2 = ab$$

as the oscillation frequency and

$$K_{max} = ab(a + b)$$

Frequency Response Locus

For the Nyquist locus, with $s = j\omega$ in equation (3),

$$F(j\omega) = \frac{K}{j\omega(a + j\omega)(b + j\omega)}$$

The locus has the form shown in Fig. 2 with

$$|OR| = \frac{K}{ab(a + b)}$$

At low frequencies the locus approaches a vertical asymptote to the left of the quadrature axis, with

$$|OS| = K(a + b)/a^2b^2$$

The negative real part decreases continuously as ω increases.

Negligible Viscous Friction

If F is small enough to be neglected then

$$\frac{\theta_0}{\theta} = \frac{K}{s^2(s + a)} \quad \dots (9)$$

with $K = nK_mAk/2$ and $a = R_f/L_f$. This is a Type 2 system with no velocity lag, and is closed-loop unstable. With phase-advance compensation using the network shown in Fig. 3 in the error channel, the compensated open-loop transfer function becomes

$$\frac{\theta_0}{\theta} = \frac{K(s + b)/A}{s^2(s + a)(s + b/A)} \quad \dots (10)$$

where

$$A = \frac{R_1}{R + R_1}$$

and $b = 1/CR$ (Fig. 2).

The C.E. is

$$s^4 + (a + b/A)s^3 + ab/As^2 + Ks + Kb = 0 \quad \dots (11)$$

For maximum gain conditions, with $s = j\omega$,

$$\omega_m^4 - \frac{ab}{A}\omega_m^2 + \frac{K_m b}{A} = 0 \quad \dots (12)$$

and

$$\omega_m^2 = \frac{K_m/A}{a + b/A} \quad \dots (13)$$

from the real and imaginary parts. These equations give

$$\omega_m^2 = b \left[\left(\frac{1}{A} - 1 \right) a - \frac{b}{A} \right] \quad \dots (14)$$

and

$$K_m = b \left(\frac{b}{A} + a \right) \left[\left(1 - A \right) a - b \right] \quad \dots (15)$$

This necessitates $b < (1 - A)a$ if the compensated locus is to cut the negative real axis to give a stable system on closed-loop. If $b = (1 - A)a$ the locus is asymptotic to this axis as ω approaches zero. The compensated system is stable if the -1 point lies to the left of OA . Typical loci are shown in Fig. 4.

Conclusion

Servomotors with transfer functions giving real open-loop poles are considered, with reference to Type 1 and 2 systems. In the next data sheet of this series systems giving complex open-loop poles will be discussed.

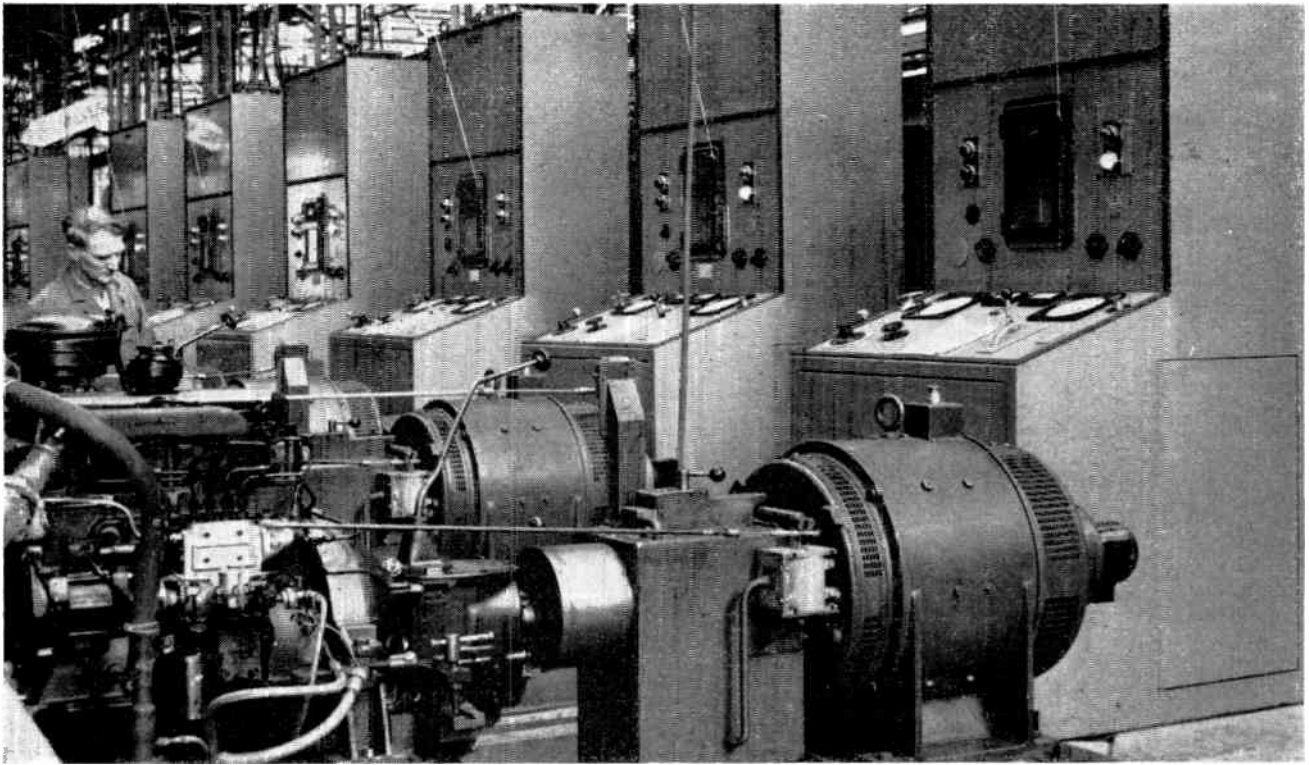

Fig. 1. A group of dynamometers and their control cubicles on the diesel engine test bed

Automated Diesel Engine Test Plant

Automatic control equipment for the conversion to fully-automatic operation of the previously manually-operated engine-testing dynamometer equipment at the Dunstable commercial vehicle factory of Vauxhall Motors has recently been supplied by Bruce Peebles & Co., of Edinburgh. This conversion has been made to enable the existing test-bed installation to cope with the factory's greatly increased output of Bedford diesel engines, and also because of an increase in the number of engine types and a requirement for more comprehensive testing.

Each of the twenty-two sets of equipment controls one of the 40-kW variable-speed d.c. dynamometers, and enables the engine under test to be subjected to any one of a number of pre-determined load/speed test cycles. The required programme is encoded on a 24-track plastic card (colour-coded according to the test cycle it represents), and the passage of the programme card through a reader provides the necessary control signals to the two independent closed-loop control systems. Any required combination of 200 load settings and the same number of discrete speed steps can be selected, and the total test time can be pre-set to any value up to 75 minutes. A two-channel chart recorder provides a permanent record of each test run.

In a typical test cycle the diesel engine is first motored by the dynamometer at a low speed while the valves and the fuel injection system are checked and adjusted by hand. The motoring speed is then increased to 1,000 r.p.m. and the fuel supply is turned on; once the engine is running, the automatic control equipment takes charge, and the

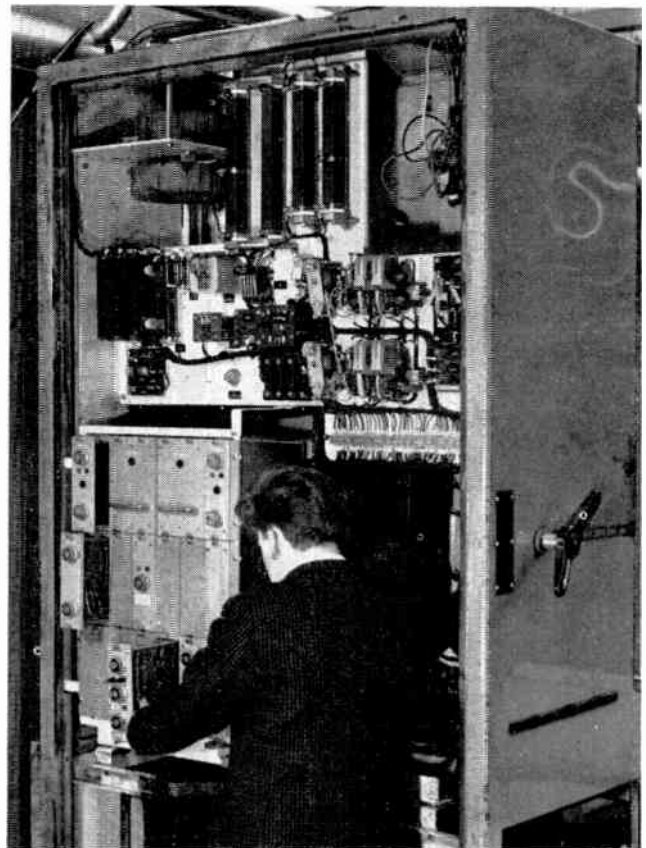

Fig. 2. A view of one of the control cubicles during conversion

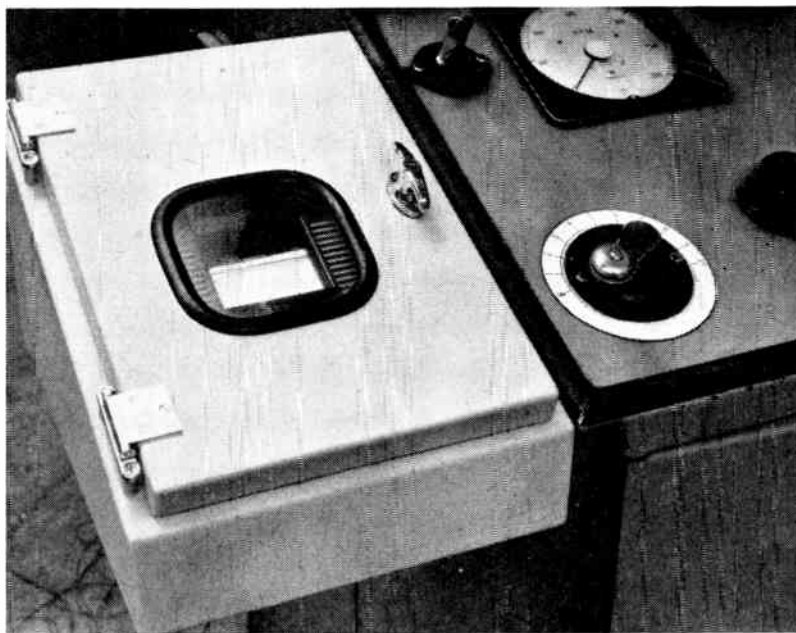

Fig. 3. One of the programme card readers in position on a modified control cubicle

required test cycle is begun. The test can if necessary be interrupted by hand at any time.

The speed and the load are separately controlled. In the speed control circuit a speed-dependent voltage from a tacho-generator is compared with a voltage proportional to the required speed; the amplified 'error signal' difference between the two voltages supplies the control winding of a magnetic amplifier, the output of which is fed to the field winding of the dynamometer to control the machine speed. In the load control circuit a similar comparison is made between a voltage proportional to the load-dependent armature current of the dynamometer and a pre-set voltage representing the required engine load: in this instance the amplified error signal controls a servo-motor which, in turn, operates the engine throttle. The speed response of the load control loop has been so designed as to prevent the possibility of engine faults such as uneven injection being masked by the automatic control.

The reduced armature voltage 'motoring' supply for the initial low-speed running is obtained from an auxiliary transformer/rectifier set in each control cubicle. During normal test running the d.c. output from the various dynamometers is returned to the 6.6-kV a.c. supply through one of two 600-kW d.c. motor/synchronous a.c. generator sets.

For further information circle 49 on Service Card

High-Speed Data Logger For Defence Ministry

Solartron have recently supplied a data-recording system to the Ministry of Defence, for high-speed transient recording on punched paper tape.

The system is equipped with 10 high-speed channels, the signal on each of which is recorded on one track of magnetic tape using an f.m. system. The tape is replayed at a lower speed and the data is digitized and recorded on

a second tape recorder. This, in turn, is replayed at a lower speed and the digital data transferred to punch paper tape. The overall speed reduction is 512 : 1, with an input sampling rate of 10,000 per second on each channel. Other tracks of the tape recorder are used to record elapsed time in p.c.m. code and a 10-kc/s time marker.

Since the equipment is capable of taking 10,000 samples per second on each of 10 channels for a duration of 24 minutes, editing facilities are provided. The f.m. signal is replayed and displayed on an oscilloscope while simultaneously elapsed time, as derived from the p.c.m. track, is displayed digitally. The paper tape output contains channel identity, time measured value, and sampling rate.

The 40 low-speed inputs are multiplexed on to 8 tracks of the second recorder again using an f.m. system, and each input is sampled 10 times a second. De-multiplexing is by a scale-of-5 counter which gives a 'digitized' command signal to the analogue-to-digital converter. A zero-shift control allows each input to be selected in turn.

No editing is provided for the low-speed channels, and as an option the data may be processed directly on to paper tape during replay without passing through the digital magnetic-tape stage. The system functions are sub-divided so that it is possible for editing and paper tape punching to proceed simultaneously.

For further information circle 50 on Service Card

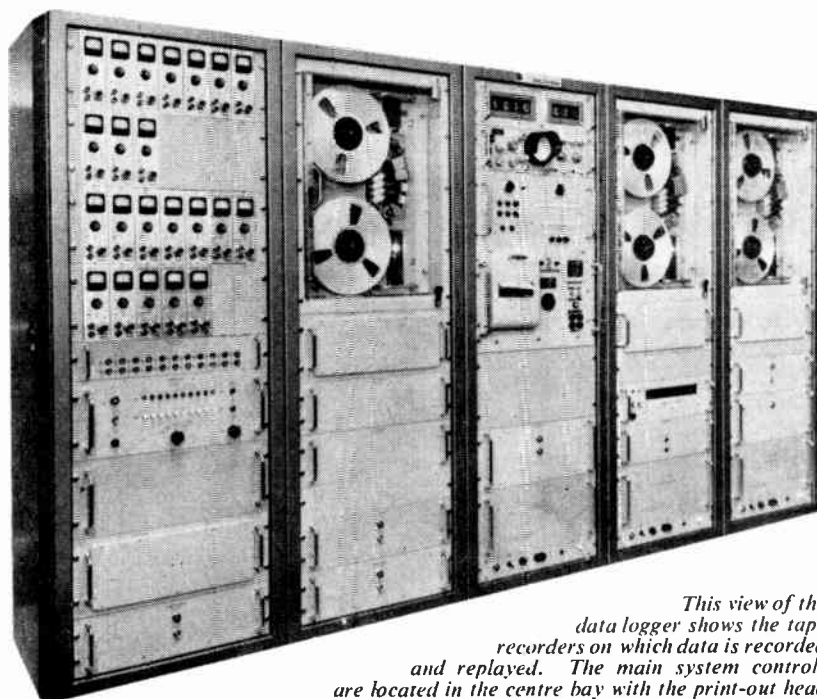

This view of the data logger shows the tape recorders on which data is recorded and replayed. The main system controls are located in the centre bay with the print-out head

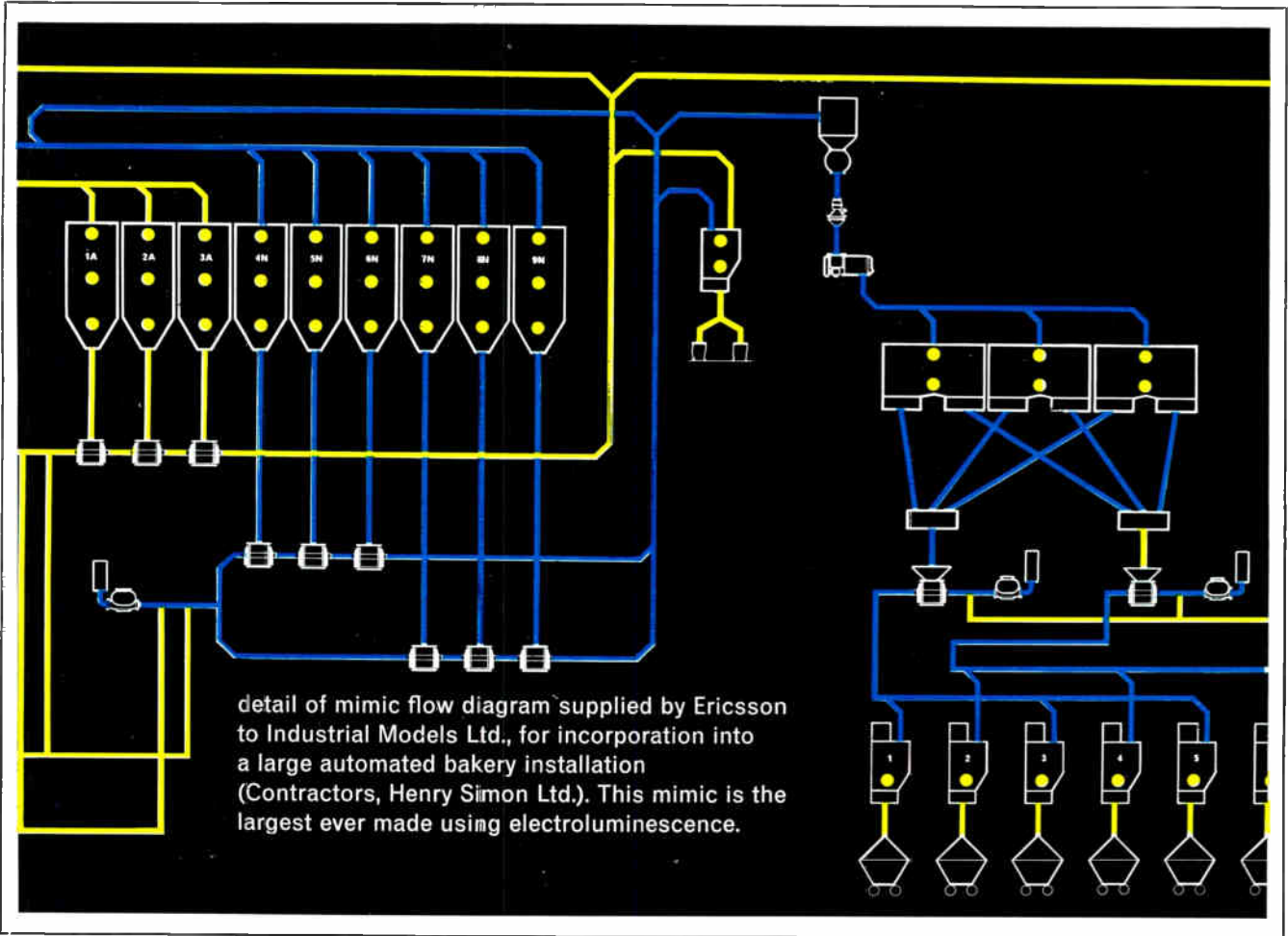

electroluminescence

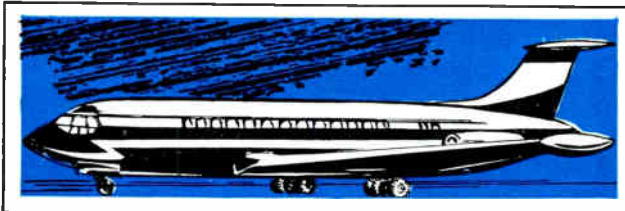
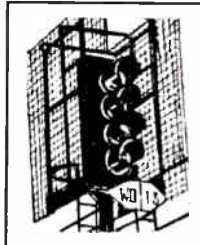
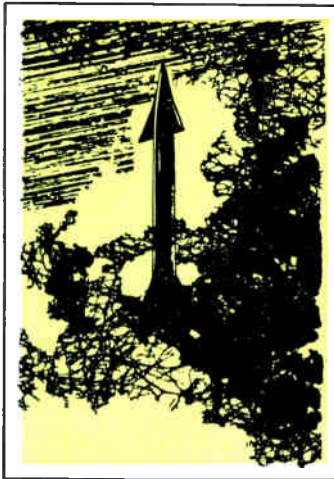

for mimetic
control and
flow display

Electroluminescence offers a particularly flexible type of display, with a wide range of colours and the ability to display fine detail beyond the range of economically comparable systems. The Industrial and Educational applications are limitless and many industries are already taking advantage of its exceptional versatility. For further information please contact: Physics Division, Ericsson Telephones Ltd., Beeston, Nottingham.



ERICSSON TELEPHONES LTD • ETELCO LTD

A Principal Operating Company of the Plessey Group. Registered Office: 22 Lincoln's Inn Fields, London, W.C.2. Tel: HOLborn 6936
Head Office and Main Works: Beeston, Nottingham. Tel: 254831. Telex: 37666



Today's finest value
for only

£20

STABILISED POWER SUB-UNIT

MODEL 4931

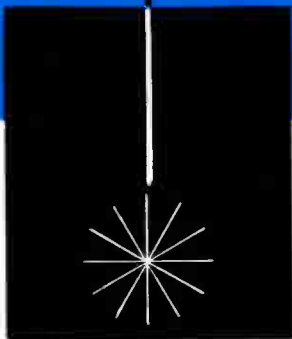
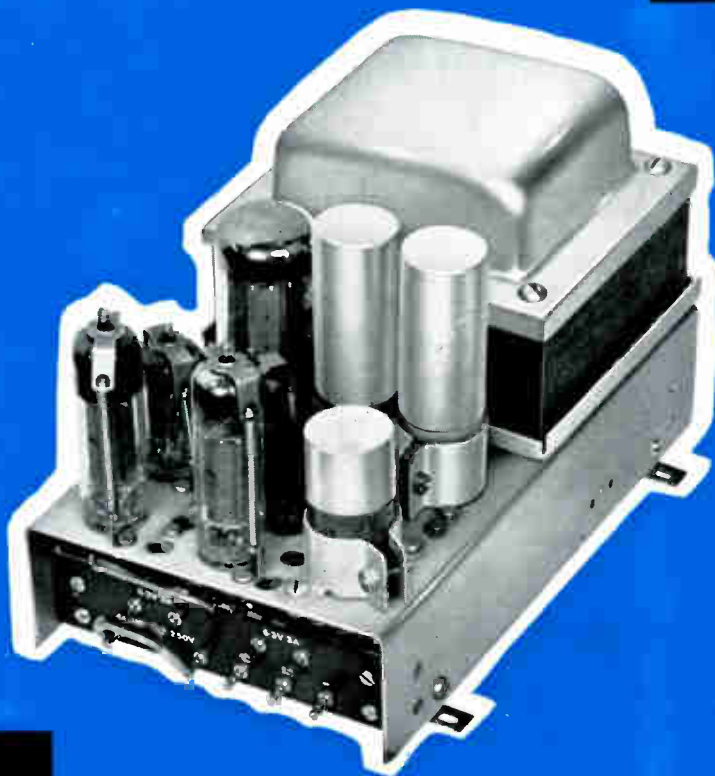
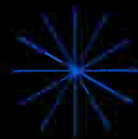

This very small unit, supplying **250** or **300 V.D.C.** at **150 mA. max.** is ideal for building into your equipment. At this price, with a stability of $\pm 0.1\%$ it is **no longer** worthwhile designing your own power pack.

Please send details on the following stabilised power sub-units:—

- 4931. 250 or 300V.D.C. at 150mA.
- 4964. 150 or 200V at 150mA.

4931

4964

Name _____

Company _____

Address _____

Detach and send to: —

A·P·T

**ELECTRONIC
INDUSTRIES
LIMITED**

CHERTSEY ROAD, BYFLEET, SURREY
PHONE: BYFLEET 41131 2 3 4 PABX GRAMS: APTRAN, BYFLEET

IE 465

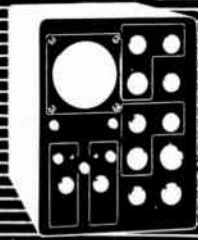

NEW APPARATUS

ELECTRONICS
INSTRUMENTATION
CONTROL

1. Portable Air Conditioner

A portable air conditioner designed for domestic or office use is now available from Hygro-Robot. Known as the Executive Mk 11A, it sells for under £20 and will efficiently condition a room of up to 2,000 cu ft capacity.

The unit works on the evaporative principle, stale dry air drawn in by a fan being washed and forced under pressure against the sides of a zig-zag filter with an effective length of 5 ft 4 in. The construction of the unit allows the humidified air to pass through three pressurizing stages before being released clean, fresh and with the correct moisture content for optimum comfort. Smoke and other impurities are eliminated by the filter, but because the humidified air is not forced through the filter unit, the system is self-adjusting and cannot over-humidify.

Two-speed control is provided for normal or rapid use, and the unit is virtually silent in normal operation. The 7-pint water tank requires topping up only once a day in winter; in summer, when the device is used for cooling, it will run for four or five days on one filling. Power consumption is only 20 W.

Each unit is supplied with one spare filter, and additional filters are available in packets of three. Each filter lasts an average of six or seven weeks, depending on the amount of dust and dirt in the atmosphere. Where disinfection or deodorization is also required, special water-soluble chemicals may be used. Average operating cost is less than 2d. per 24 hours of continuous operation, including the cost of replacement filters.—*Remington Rand Ltd., Remington House, 61-65 Holborn Viaduct, E.C.1.*

For further information circle 1 on Service Card

2. Cable-Pulling Telemeter

The latest addition to the series of miniature telemetry transmitters produced by Industrial Electronics Corp. is the model T-62R cable-pulling telemeter, consisting of an f.m./f.m. 1-3 channel transmitter and a battery.

During cable-pulling operations, conductor breakage constitutes an appreciable hazard. The T-62R permits maximum speed in pulling a cable through a conduit by detecting the strain on each conductor and transmitting the resultant signals through the conduit or along the pulling cable to a receiver. The instantaneous strain measurements can then be displayed on appropriate gauges.—*Industrial Electronics Corporation, Post Office Box 862, Melbourne, Florida, U.S.A.*

For further information circle 2 on Service Card

3. Perforated 'Speedframe'

Dexion have announced an addition to their 'Speedframe' square-tube construction system, perforated tube. Available in both black and grey, it is suitable for use in storage racks, counters, window displays, etc., where simple rapid adjustment is an important requirement. The increase in price over unperforated Speedframe is a maximum of 6d per ft.

The tube itself is 1 in. square, 18 gauge cold-rolled mild steel punched on one face with $\frac{1}{4}$ in. diameter holes at 2-in. centres. Adjustable shelf brackets which drop easily into the perforations of the tube are also supplied; they are drilled with one $\frac{3}{16}$ -in. hole to make it easy to screw the shelf in position if desired.—*The Dexion Group, Empire Way, Wembley, Middlesex.*

For further information circle 3 on Service Card

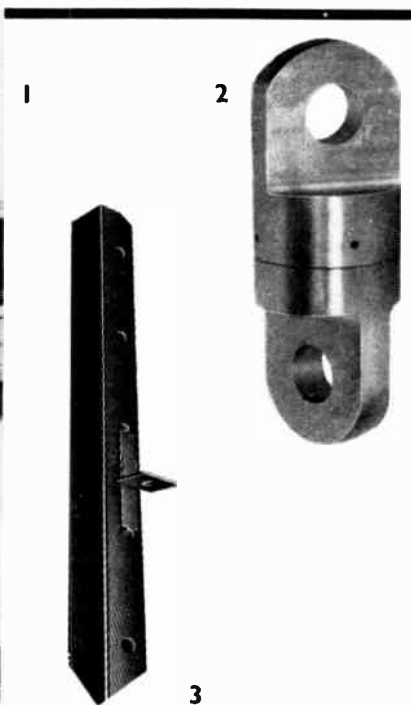

4. Marine Telephone Systems

A range of marine telephone systems is now being marketed by AEI. The Navcom system provides navigational telephones and the Incom system inter-

communication telephones. Both systems operate from 12-V or 24-V d.c. ship's LP mains, or secondary batteries, or, with a power unit, from ship's a.c. mains.

Navcom provides telephone communication between two points or between a master station and up to six out-stations. Multi-way and single-way stations are provided in metal-cased units (illustrated, left) for bulkhead, panel or console mounting, and in ivory or black moulded-plastic cases for desk or bulkhead fitting in cabins and offices.

Incom will carry up to either 10 or 20 simultaneous conversations between telephone instruments and is a system where speech clarity is the primary aim. Stations are selected by turning a rotary switch and pressing a 'call' button. Simple to install and maintain, Incom is supplied in a metal case for bulkhead, panel or console mounting, and in black (illustrated, right) or ivory plastic models for cabin desk use or bulkhead fitting.—*Associated Electrical Industries Ltd., Telecommunications Division, Marine Communications Department, Woolwich, London, S.E.18.*

For further information circle 4 on Service Card

5. Domestic Water Meter

Complete resistance to chemically aggressive water, and higher discharge capacity are two main advantages of the 'PSM' rotary-piston domestic water meter recently introduced by the Mechanical Meter Division of George Kent and at present available in ½-in. (illustrated) and ¾-in. sizes.

This unit follows the basic compact design of the 'JSM' meter: it uses the same 'straight-through' flow design and tamper-proof liquid-filled sealed counter but embodies a thermoplastic working chamber (shown on the right of the photograph), the non-corrodible property of which permits accurate long-term measurement of the most aggressive water and gives an exceptionally long working life. The high low-flow accuracy of the 'JSM' is fully maintained in the 'PSM' range.—*George Kent Ltd., Biscot Road, Luton, Beds.*

For further information circle 5 on Service Card

6. Key Reset for Counters

Hengstler announce the introduction of a detachable-key reset feature for

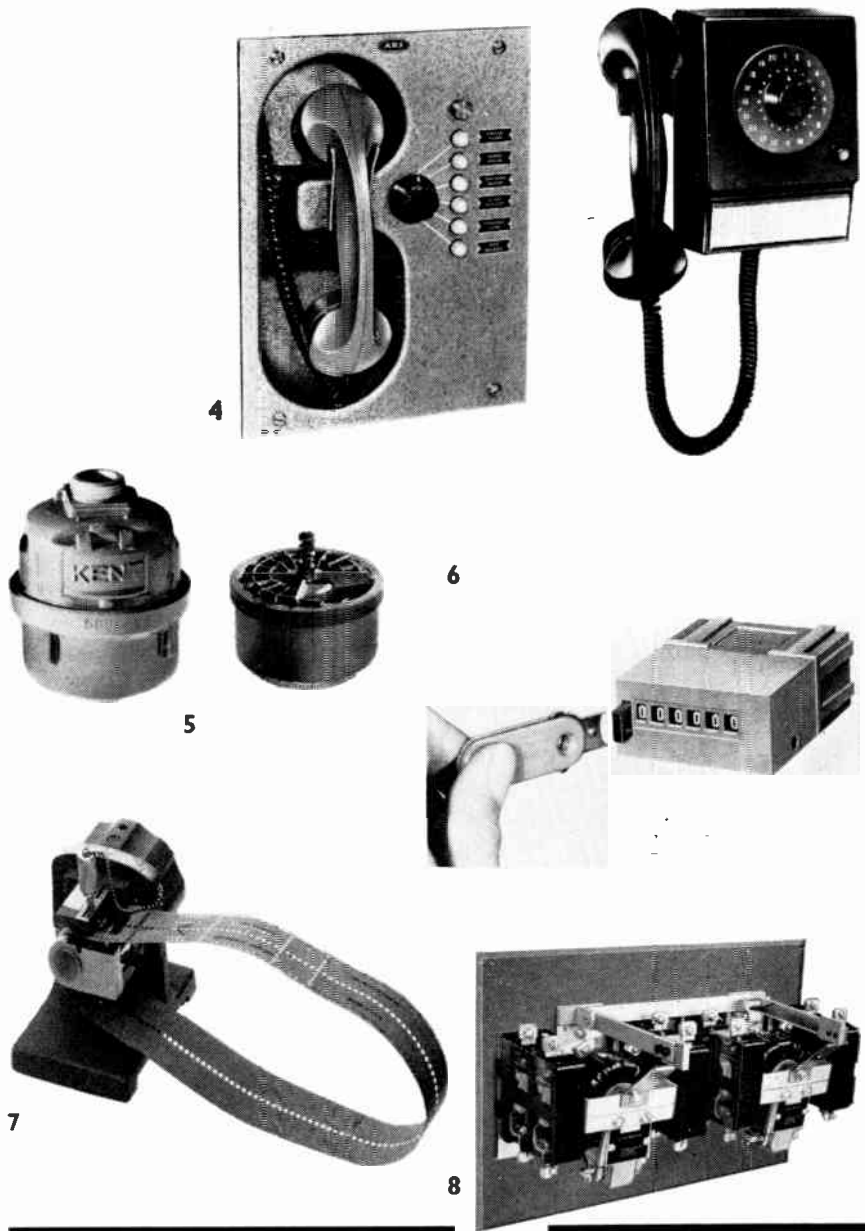

security purposes, available as an optional extra on all versions of their range of F 043 electromagnetic counters and FA 043 predetermined electromagnetic counters, at no additional cost. The illustration shows the special key which, when partially inserted on the left side of the normal reset button, displaces the obstructing member and permits full insertion to complete the reset function.

In addition to the previously available arrangements (i.e., non-reset, manual reset only, electrical reset only, and manual and electrical reset) this new feature provides both normal key resetting and key resetting coupled with electrical resetting. For example, in a situation where predetermined counters with electrical resetting are used, re-

cycling is automatic after each batch, but only the person with the key can operate the manual reset to preset the new number.—*J. Hengstler Co. Great Britain Ltd., Highbridge Street, Waltham Abbey, Essex.*

For further information circle 6 on Service Card

7. Simple Tape Punch

A tape punch for the vertical control of pre-printed forms has been announced by Analex Corp. of Boston, Mass. It is designed to punch 6 or 8 lines per inch or a combination of both on flat or looped 12-channel tape.

This simple mechanism may be used on paper, mylar or Analex's pre-printed paper-backed mylar tape. A sprocket guides the tape forward or backward

for easy tape stepping and perfect control. Positioning devices assure accurate placement and printed tapes are easily read in the punching position.—*Anelex Corporation, 150 Causeway Street, Boston 14, Massachusetts, U.S.A.*

For further information circle 7 on Service Card

8. Latching Mechanisms

Brookhirst Igranic is extending the scope of its size 00 relays by the introduction of latching mechanisms in two forms, one to suit a.c. energized relays, the other for d.c. energized relays (illustrated). When two relays are mounted side-by-side and equipped with a latching mechanism, one relay latches in the operated position when its coil is energized and the second relay of the pair is used to release the first.

The BHI size 00 relay is a front-connected unit of block design, similar to the 800 range of block contactors, and is supplied with either an a.c. or a d.c. magnet. From one to eight switching poles can be actuated and these can be arranged to provide any combination of 'make' and 'break' units. The contact arrangement can be changed, very simply, by means of a screwdriver. The contacts are silver, have two breaks per pole and are rated at 10 A 600 V a.c.—*Brookhirst Igranic Ltd., Elstow Road, Bedford.*

For further information circle 8 on Service Card

ELECTRONICS

9. Rugged Transmitter-Receiver

A portable transistorized radio transmitter-receiver station has been introduced by Redifon. Known as Manpack GR345, it weighs only 22 lb and provides switch selection of 10,000 individual channels in the operating frequency range 2 to 12 Mc/s. Switch selection of channels is achieved by use of a frequency synthesizer.

The station operates on s.s.b., a.m. and c.w. The output power is 15 W p.e.p. On s.s.b. and c.w. operation the receiver sensitivity is 1.4 μ V and on a.m. it is 3 μ V. A sealed, rechargeable 12-V nickel-cadmium battery provides the power for the unit.—*Redifon Ltd., Communications Division, Broomhill Road, London, S.W.18.*

For further information circle 9 on Service Card

10. R.F. Signal Generator

The Paco G.30, an inexpensive signal generator covering the frequencies from 120 kc/s to 240 Mc/s in seven switched bands, is now available from K.L.B. Electric at £24 15s. The wide coverage makes it suitable for most experimental and alignment work.

The r.f. output, which is in excess of

100 mV, can be internally or externally modulated, the internal modulation being supplied at 400 c/s. The depth of modulation is adjustable from 0-50% by a control knob. The 400-c/s modulating frequency is also available at two sockets on the front panel.—*K.L.B. Electric Ltd., 335 Whitehorse Road, Croydon, Surrey.*

For further information circle 10 on Service Card

11. Pulse Generator Modules

Two additional output units have been introduced for the Philips modular pulse generator system by M.E.L.

Power output module PM5728 will provide 12-V pulses into a load of 50 Ω at 100% duty cycle. Low loads can also be connected at reduced duty cycles. Automatic overload protection is incorporated to prevent the output transistors from damage.

Simultaneous positive and negative outputs are available and a continuously-variable attenuator is provided. The rise and fall times are continuously variable in two ranges from 20 nsec to 10 μ sec, and the maximum repetition rate is 10 Mc/s.

The fast rise time output module PM5736 will provide two identical pulse outputs of 0.7 V into 50 Ω . The rise time is only 0.3 nsec and fall time is 1.5 nsec. Maximum repetition rate is 10 Mc/s, and the pulse width is variable from 4 nsec to infinity. The



9



10



11



12



13

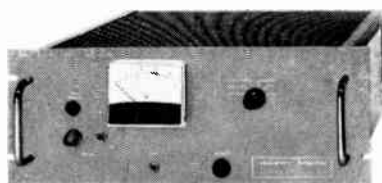

14



15

twin outputs can be utilized for reflection and similar measurements.

The twin outputs also provide a simple method of obtaining double pulses. One pulse is obtained direct from one output of the generator, and the second is obtained from a simple open-circuited cable acting as a delay line connected to the other output. The result is double pulses with a spacing equal to twice the delay of the cable plus the internal delay of the PM5736. In this way repetition rates of up to 200 Mc/s can be simulated.—*The M.E.L. Equipment Co. Ltd., 207 King's Cross Road, London, W.C.1.*

For further information circle 11 on Service Card

12. Analogue-Digital Converter

An addition to the range of control devices produced by Moore, Reed and Co. is an electromechanical analogue-digital converter in which one step of a stepper-motor drive produces a one-digit change of an encoder output.

Applications include conversion of 2-phase or 3-phase a.c. signals into digital codes, binary or Gray code.

Used with a subtractor, the unit will produce an analogue synchro, resolver or potentiometer output from a digital input. The converter will respond to a pulse train from a programme unit, fed through transistorized logic circuitry to the stepper-motor driving the encoder, to give simultaneous analogue and digital signals for control or indication purposes.

The use of precision gears incorporating anti-backlash techniques permits inaccuracies (stepper motor input/synchro output) to be reduced to the order of 5 minutes of arc. The unit, whose outside dimensions are approximately $5 \times 1\frac{1}{2} \times 2\frac{1}{4}$ in., is available with binary V-scan. Gray or Gilham code digital outputs.—*Moore, Reed & Co. Ltd., Woodman Works, Durnsford Road, London, S.W.19.*

For further information circle 12 on Service Card

13. '2-P Scan' Shaft Encoders

Two recognized methods of avoiding readout ambiguity from shaft encoders are the V-scan brush disposition on a binary disc and reflected codes, such as the Gray code. Both methods have the disadvantage of requiring a

complete set of logic with brush-choosing or decoding from digit to digit. The time taken for readout is, therefore, proportional to the number of digits involved.

A new method of encoding, '2-P Scan', in which an unambiguous binary signal can be achieved with only one flip-flop operated by the least significant digit has been developed by Moore, Reed and Co. It has been given type approval for airborne military application in the size-18 13-bit self-select encoder. The time for complete readout is that taken for the flip-flop to select the appropriate set of brushes via its collector ring and is independent of the number of digits. Built-in high-reliability diodes prevent the possibility of sneak-circuits.—*Moore, Reed & Co. Ltd., Woodman Works, Durnsford Road, London, S.W.19.*

For further information circle 13 on Service Card

14. Laboratory Amplifier

Aveley Electric have developed a low-distortion source of a.c. power suitable for operation with servo-mechanisms, synchros and tachometers. This series of laboratory amplifiers has been designed for work where high continuous outputs of up to 60 W are required.

The amplifiers are available in two types, a high-impedance model with four separate output windings, each of 70 V, which may be connected in series or parallel, and a low-impedance model with outputs at 4, 8 and 16 Ω as well as at 600 Ω isolated winding. Both models are available with meters which are calibrated at 0-150 V and 0-300 V, and can be used to set the output bias and balance from a switch in the front panel.

At full power the distortion is less than 1% over the entire bandwidth and is less than 0.5% at 1 kc/s. The frequency range is from 20 c/s to 20 kc/s ± 0.5 dB, and rise time is better than 15 μ sec.—*Aveley Electric Ltd., South Ockendon, Essex.*

For further information circle 14 on Service Card

15. Tape Recorder

Now available from Pullin Photographic, the Akai 44S is a four-track, three-speed ($7\frac{1}{2}$, $3\frac{3}{4}$ and $1\frac{7}{8}$ i.p.s. with provision for 15 i.p.s.) machine, capable of stereo and monaural recording and playback.

The frequency response is 40 c/s-14 kc/s ± 3 dB at $7\frac{1}{2}$ i.p.s., 40 c/s-8.5 kc/s ± 3 dB at $3\frac{3}{4}$ i.p.s. and 40 c/s-4.5 kc/s ± 3 dB at $1\frac{7}{8}$ i.p.s. with respective wow and flutter levels of less than 0.15%, 0.25% and 0.35% r.m.s. at these

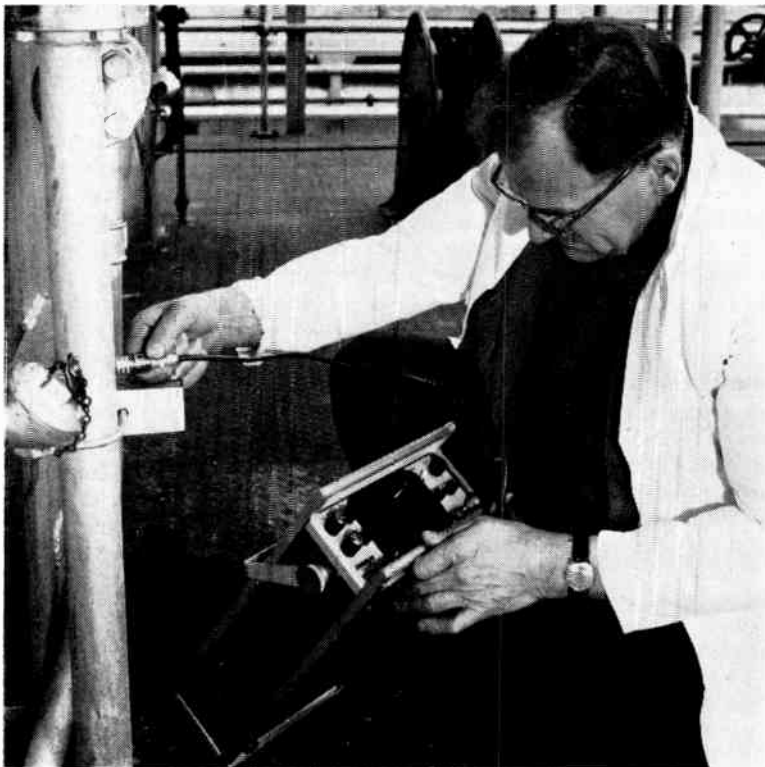

16



17

18

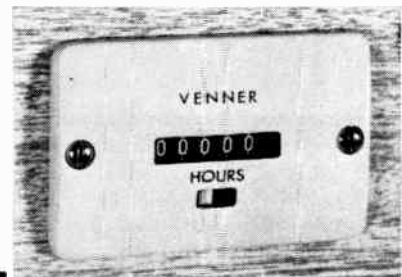

speeds. A 5-in. speaker is incorporated for monitoring, and the high quality of the 6-W (3-W per channel) amplifier is achieved by the use of additional matched speaker enclosures.—*Pullin Photographic, 11 Aintree Road, Perivale, Middlesex.*

For further information circle 15 on Service Card

INSTRUMENTATION

16. Portable Thickness Gauge

The latest ultrasonic gauging equipment to become available from Dawe Instruments is the type 1805A Sonoray 30. Although designed primarily for battery-operation in the field, it has accuracy and resolution equal to those of most large production-line units. The type 1805A is a compact (15 × 9½ × 4½ in. high), lightweight (16 lb complete) instrument normally powered by its own rechargeable battery. It can, however, be operated from the mains and is suitable for both flaw detection and thickness gauging.

The generator produces pulses at 1.5 to 5.0 Mc/s, the reflections of which are recorded on a 2½-in. square screen. The scale can be expanded until the full width represents ½-in. thickness of steel. Gauging accuracy is ±0.005 in. for thicknesses in the range 0.1 to 6.0 in. For flaw detection, where the need for accuracy is less critical, the range extends up to 100 in.

Transducers are normally of the piezo-electric Z-type. The standard instrument is supplied with a 6-ft transducer coupling cable, but cables of up to 200 ft length may be employed without need for modifications. Straight-beam, angle-beam, through-transmission and immersion testing may be used.—*Dawe Instruments Ltd., Western Avenue, Acton, London, W.3.*

For further information circle 16 on Service Card

17. Dissolved Oxygen Meter

Pro-Tech Advisory Services in collaboration with Pro-Tech Inc., U.S.A., have developed a range of dissolved oxygen meters. The first to be released, model SM.100 portable dissolved oxygen and electronic temperature meter, has a range from 0 to 15 p.p.m.

The modular circuit incorporates a fast-response automatic temperature compensator which operates between 2 °C and 35 °C. Other features include a 5-in. robust taut-band mirror-scale panel meter which can be illuminated for night work. The instrument weighs approximately 3 lb and measures 5½ × 7½ × 2½ in.—*Pro-Tech Advisory Services Ltd., 21 High Street, Rickmansworth, Herts.*

For further information circle 17 on Service Card

18. Hours-Run Indicator

Venner has introduced a synchronous motor-driven hours-run indicator, type SHR1, for use with any apparatus operating on controlled frequency a.c. It reads in tenths of an hour up to 99,999.9 hours, with automatic restart at zero. If required, the instrument can be supplied to register minutes instead of hours.

Applications include life tests, materials consumption, the running time of pumps and electronic equipment, and the indication of servicing and maintenance periods on automatic lathes and similar factory machinery.

Two types are available, surface-



19

mounting with provision for cable or conduit entry, or flush-mounting. A four-way terminal block allows for operation from three alternative voltages, 100/120 V, 200/250 V, 380/460 V, 50 c/s. Consumption is 2.2 W at 240 V. Dimensions (flush-mounted version): 3 in. wide, 2¼ in. deep, 2 in. high. Price £3 2s 6d (surface-mounted, £3 8s 6d).—*Venner Ltd., Kingston By-Pass, New Malden, Surrey.*

For further information circle 18 on Service Card

19. Portable Strain Bridge

A portable strain-measuring bridge, Philips type PR9205, now available from The M.E.L. Equipment Company, weighs just over 10 lb and is suitable for field use in a variety of industries. It may be used with strain-gauge transducers of 120 Ω to 2 kΩ resistance in half- or full-bridge configuration.

Balance is indicated by a moving-coil meter and is effected by a helical potentiometer control having a 3,600° scale calibrated in μ-strain. Short-term measurements can be made quickly and accurately, while the accuracy of long-term measurements is ensured by high stability and accurate zero readjustment facilities. Changes in ambient temperature have little effect on the instrument, drift being less than 1 μ-strain/°C between -10 and +40 °C.

The zero point may be adjusted independently of the measuring range. With the instrument set up, the zero balance range is ±10,000 μ-strain and the measuring balance range is ±8,250 μ-strain, giving a total calibrated range of ±18,250 μ-strain. Accuracy is better than 1% ±6 μ-strain. The instrument is completely transistorized and operates from internal rechargeable batteries. It may also be operated from five ordinary unit cells, changes in voltage between 5.5 and 7.5 V having no effect on performance. Dimensions are 11½ × 10½ × 7 in.—*The M.E.L. Equipment Co. Ltd., 207 King's Cross Road, London, W.C.1.*

For further information circle 19 on Service Card

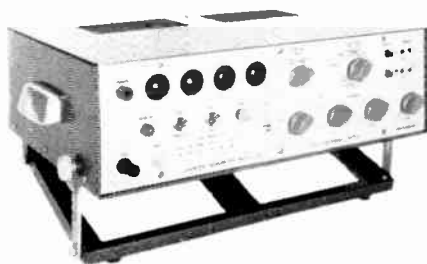

20

20. Versatile Counter/Tachometer

J.A.C. Electronics are now in production with the type 357 transistorized digital frequency and time-interval meter with a fully-variable crystal-controlled timebase to provide a direct read-out in any predetermined units (e.g., r.p.m.). Its features include a high input impedance and an easy-to-read in-line display with an overspill indicator giving an effective 7-figure read-out for a 4-figure display cost.



21

Count periods between 1 msec and 10 sec in 1-msec steps are available for the measurement of frequencies from 0.1 c/s to 300 kc/s; the counting intervals may also be controlled manually or externally by signals and/or contact closures for the general determination of the number of events per unit time. Magnetic or photo-electric (with integral lamp unit) probes are available for use in tachometry applications.—*J.A.C. Electronics Ltd., Station Estate, Blackwater, Camberley, Surrey.*

For further information circle 20 on Service Card

21. Portable Signal Generator

The latest generator in the Waveforms 'precision-in-miniature' series, the 511A, is a sine- and square-wave generator that weighs 5 lb and measures 6 in. high by 4¼ in. wide by 6 in. deep. Frequency range is from 10 c/s to 12 Mc/s sine, and from 10 c/s to 120 kc/s square. Frequency reading is on a 3¼-in. dial in conjunction with a decade range switch. Frequency accuracy is ±3%.

The output is 3 V into 50 Ω with connection via terminals for field convenience. Square-wave rise time: 0.5 μsec. Sine-wave distortion is 0.25% at 1 kc/s, 1% at 1 Mc/s, and 2% at 10 Mc/s. Frequency response: ±1 dB. The instrument features a four-position step attenuator (20 dB per step) and a continuous fine output control.—*Waveforms, Inc., 333 Sixth Avenue, New York, N.Y. 10014, U.S.A.*

For further information circle 21 on Service Card

CONTROL

22. 'Queue' Detector and Controller

An electronic device for preventing the formation of dangerously long 'queues' in conveyor lines has been introduced by Fords (Finsbury). Its main function is to switch off the upstream machine when there is a stoppage or slow-down in a downstream machine, causing a 'build-back' dangerous to the former. It was specifically designed for bottling lines but can be simply adapted for use on any conveyor system on which regularly spaced objects, or regularly spaced batches of touching objects, pass from machine to machine.

This queue detector and controller operates not by pressure but by the action of a lever reaching over the track. This actuates an electronic

this storage space
no longer required

this storage space
no longer required
either!

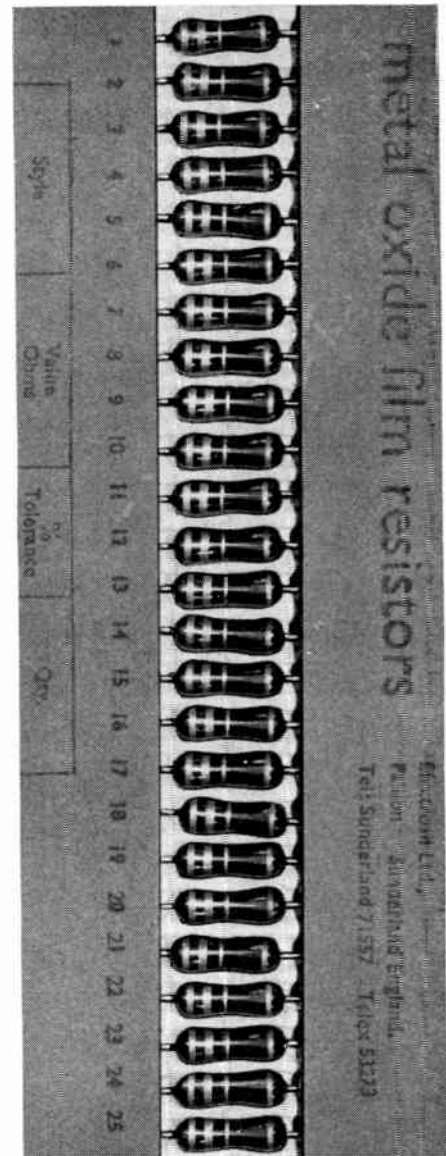

triple rating means triple economy

Brilliant design and the use of metal oxide fused to a glass substrate, enables each Electrosil resistor to perform three roles:— Semi-precision, high stability and general purpose. Three applications for the price of one. Resistor stocks now need only be one-third the size. Powerful factors in industry are adopting this Electrosil concept—are saving space, effort and cash, getting more reliability in performance. TR resistors are approved to DEF.5114A and by the G.P.O. to D.2228A. Employ resistors the modern way—let Electrosil show you how.

	TR4	TR5	TR6	TR8	Stability
Semi-precision	$\frac{1}{10}W$	$\frac{1}{5}W$	$\frac{1}{2}W$	$\frac{1}{2}W$	0.5%
High stability	$\frac{1}{5}W$	$\frac{1}{2}W$	$\frac{1}{2}W$	1W	1%
General purpose	$\frac{1}{2}W$	$\frac{1}{2}W$	1W	2W	2%
Ohmic range	51 Ω - 150K	10 Ω - 470K	10 Ω - 1M	100 Ω - 1.4M	
Standard Tolerances (All types) 1% 2% 5%					

get glass-tin-oxide reliability with



Write today for full details

ELECTROSIL LIMITED

PALLION, SUNDERLAND, CO. DURHAM

Tel: Sunderland 71557. Telex 53273

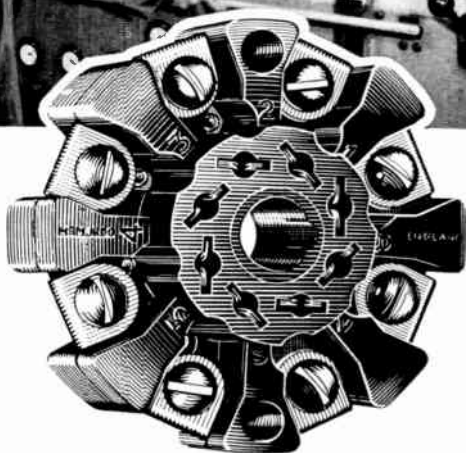

Octal Socket

McMurdo B8/UPM Moulded International Octal Socket with screw terminations for top surface mounting. Specially designed for plug-in relays with octal bases.



Press Room
9 stage Transfer Press making valveholder skirts.

McMurdo

McMurdo Instrument Co. Ltd.

Rodney Rd., Portsmouth, Hants.
Tel. Portsmouth 35555. Telex 8612.
Contact our Sales Office for details of our full range

LG SODECO COUNTERS



Sodecprint 1Tpb3.

SODECO *print*

IMPULSE COUNTERS . . .

. . . give direct reading of results on an indicating counter as well as printing them on a paper tape. They provide three functions: counting; printing, and resetting to zero. These can be controlled remotely, or by an automatic operating cycle, or by the push button provided on the instrument.

The 1Tpb3 is a decimal counter with six digits.

The 1Tpb4 is a time counter for hours, minutes, seconds and tenths of a second.

The 1Tpb7 is fitted with independent monodecade counting elements.

The 1Tpb8 is a date counter indicating either
—days, months, hours, minutes
—days, months, years, hours
—days, hours, minutes.

It is possible to combine two of these in a single instrument.

LANDIS & GYR

LANDIS & GYR LIMITED

Victoria Road . Acton . London W.3 . ACORN 5311

Industrial Electronics April 1965

For further information circle 238 on Service Card

ADCOLA
PRODUCTS LIMITED
(Regd Trade Mark)

**SOLDERING
EQUIPMENT**

**SPECIALISING FOR THE
SOLDERING JOINTING INDUSTRY**

Illustrated

$\frac{3}{16}$ " BIT INSTRUMENT
(LIST 64)
IN
PROTECTIVE SHIELD
(LIST 700)

ALL VOLT RANGES
FROM
6/7 TO 230/250 V

BRITISH & FOREIGN PATS.
& REG. DESIGNS, ETC.

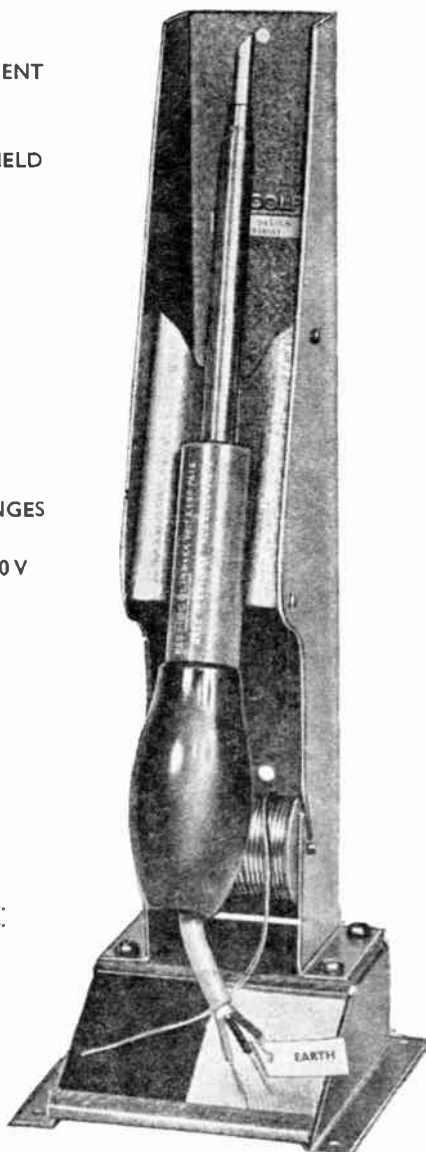

Apply Direct for Catalogues :

ADCOLA PRODUCTS LTD.

ADCOLA HOUSE

GAUDEN ROAD

LONDON, S.W.4

Telephones MACaulay 4272 and 3101

Telegrams SOLJOINT LONDON S.W.4

Industrial Electronics April 1965 G*

Let the

INDUSTRIAL ELECTRONICS

READER ENQUIRY SERVICE

help you to obtain more information

To obtain further details of any of the coded items mentioned in the Editorial or Advertisement pages of this issue, please complete one or more of the attached cards circling the appropriate reference number(s). Your enquiries will be passed on to the manufacturers concerned and you can expect to hear from them direct in due course. Cards posted from abroad require a stamp.

PLEASE USE CAPITAL LETTERS

Pour obtenir tous renseignements sur les produits codés mentionnés dans les articles ou dans les pages publicitaires de ce numéro, nous vous prions de remplir une ou plusieurs des cartes ci-jointes en encerclant le ou les numéros de référence appropriés. Vos demandes de renseignements seront transmises aux fabricants intéressés qui, en temps voulu, vous feront parvenir une réponse. Il est nécessaire d'affranchir les cartes postées de l'étranger.

PRIÈRE D'UTILISER DES CARACTÈRES D'IMPRIMERIE

Weitere Einzelheiten über irgendwelche Artikel, die auf redaktionellen oder Anzeigenseiten erscheinen, erhalten Sie, indem Sie eine oder mehrere der beigefügten Karten ausfüllen und die entsprechende(n) Kennnummer(n) einrahmen. Ihre Anfrage wird an den Hersteller weitergeleitet, und Sie werden dann direkt von ihm hören, Karten, die im Ausland aufgegeben werden, müssen frankiert werden.

BITTE IN BLOCKSCHRIFT AUSFÜLLEN

Per ulteriori particolari in merito agli articoli menzionati nel testo o nelle pagine pubblicitarie di questo numero, Vi preghiamo di completare una o più delle schede allegate chiudendo in un cerchietto il numero o i numeri di riferimento. La Vostra richiesta sarà inoltrata ai fabbricanti interessati che Vi risponderanno direttamente. Le schede dall'estero devono essere regolarmente affrancate.

SI PREGA DI COMPILARE LE SCHEDE A
TAMPATELLO

Con objeto de obtener más detalles de cualquiera de los artículos mencionados en las páginas editoriales o de anuncios de este número, sírvase rellenar una o más de las unidas tarjetas poniendo un círculo al número o números de referencia. Sus consultas serán transmitidas a los fabricantes interesados de quienes tendrán noticias directamente a su debido tiempo. Las tarjetas enviadas desde el extranjero requieren franqueo.

SÍRVASE ESCRIBIR CON LETRAS MAYUSCULAS

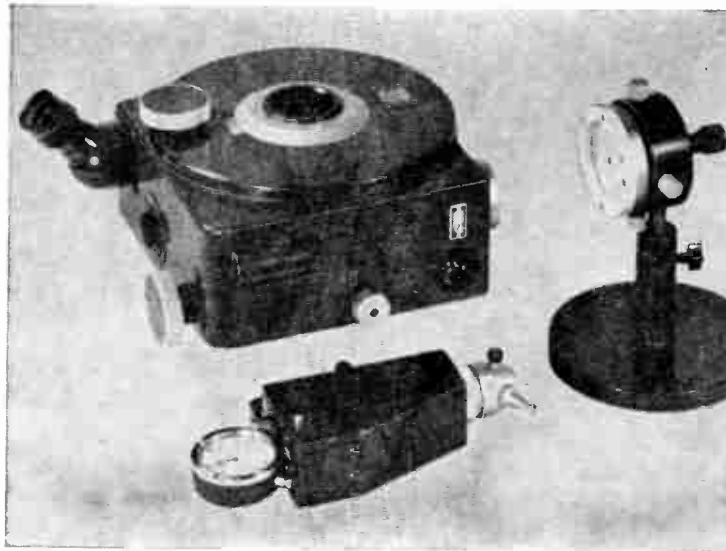

TOOL MAKERS' MICROSCOPES
 ABBE METROSCOPES
 UNIVERSAL
 HORIZONTAL
 METROSCOPES
 ANGLE DIVISION
 TESTERS
 UNIVERSAL
 MEASURING
 MICROSCOPES
 SMALL BORE
 MICROSCOPES

ZEISS



ANGLE DIVISION TESTER

This new circular division tester can be employed as follows:

- (a) Setting the angles for the machining of indexing plates, circular notched discs, gear wheels, worm wheels (made according to the individual indexing method) and all methods for dividing large circles.
- (b) Inspecting dividing heads, circular machine tables, gear wheels, circular notched discs, polygons, etc.

This single division tester incorporates its own auto-colomation optical system.

SPECIAL FEATURES :

- ★ Extremely high accuracy
- ★ Measuring range to dividing circle 0-360°
- ★ Can be used in horizontal or vertical plane
- ★ Scale reads to 1 second
- ★ 180° readings eliminate eccentricity errors in the divided circle

For further information and details of the Carl Zeiss Jena range of Mechanical Instruments for length and Screw-Thread Measurements, Opto-Mechanical Instruments for Measuring lengths, Screw-Threads and Contours please contact :

C.Z. SCIENTIFIC INSTRUMENTS LTD.

ZEISS ENGLAND HOUSE, 93-97 NEW CAVENDISH STREET, W.1. Tel. : LAN 0571-5

timing circuit which automatically re-sets to zero each time an object, or batch of objects, has passed. Should the objects come to a halt on the track, or should a queue of touching objects form, the lever is held stationary and the upstream machine will be switched off. Restarting of the upstream machine can be automatic, but manual restarting may be preferred for safety reasons.

The advantages claimed for this instrument, which can be fitted to a conveyor system in about two hours, are protection of machines, operators and products; saving of down-time; saving of space by reducing conveyor length; and the possible introduction of additional machines into an existing conveyor system.—*Fords (Finsbury) Ltd., Chantry Avenue, Kempston, Bedford.*

For further information circle 22 on Service Card



22

23. Level Control Equipment

To complement their existing series of liquid differentiating equipments, Elremco are manufacturing a range of level control units. One of these, the ERC/1, has been designed to operate from a.c. supplies of 100-440 V 40/60 c/s. The makers claim for it a sensitivity better than 5 kΩ, without the aid of a sensitivity setting control.

Able to control the emptying or filling of a tank or container, etc., or alternatively, to give a high or low signal, the ERC/1 has output contacts rated up to 5 A 250 V a.c. or 2 A 440 V a.c. The photograph shows one of a range of level probes which are available for use with the ERC/1 controller.—*Electrical Remote Control Co. Ltd., The Fairway, Bush Fair, Harlow, Essex.*

For further information circle 23 on Service Card



23

24



25

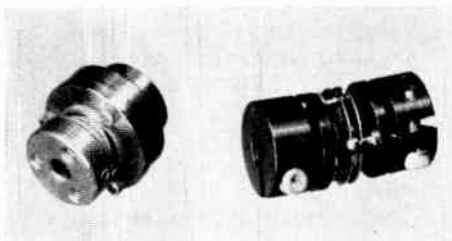

24. Pressure Overload Protectors

Two devices now available in the U.K. from Kynmore Engineering Co., and intended for use with air-data computers, airspeed indicators, altimeters, pressure controllers, etc., are the EMS types DU and DUN pressure gates. Although designed primarily for pneumatic or hydraulic gauging, these pressure gates will also find applications in electro-pneumatic-hydraulic equipment, etc., where pressure-sensitive devices must be protected from overloads.

The type DU, designed for use in hydraulic circuits, consists of a cylindrical light-alloy body containing a spring-loaded stainless-steel piston. When fluid pressure rises to exceed the spring load, the piston closes, pre-

venting further fluid from passing. A spring-adjusting screw allows the closing pressure to be set within wide limits, so that the five models in the present DU range provide continuous protection from 15 to 5,000 p.s.i.

The type DUN (illustrated) operates on similar principles but is designed for the lower pressures of pneumatic systems. Construction is slightly more complex, the piston forming the on/off gate being suspended by diaphragms and closed by an O-ring. Four models are available for pressures ranging from 1.4 to 84 p.s.i. A wide range

of connectors and adaptors is available for both types.—*Kynmore Engineering Co. Ltd., 19 Buckingham Street, London, W.C.2.*

For further information circle 24 on Service Card

25. Slip-Clutches and Couplings

A range of miniature slip-clutches and couplings are now available from Bowmar Instrument, for use in servo-mechanisms and other small mechanical devices.

The slip-clutches are in two sizes which can be pre-set to slip at torques

between 2 oz in. and 20 oz in. Various combinations of shaft sizes can be accommodated from 0.12 in. to 0.25 in. and these are clamped by means of two set screws in the hub. These units are particularly suitable for the protection of multi-turn precision potentiometers in servo systems.

The precision couplings are in two sizes, one for transmitting up to 8 oz in. torque without backlash, the other for 16 oz in. Shaft sizes from 0.12 in. to 0.25 in. can be accommodated at each end. Shafts are held either by a set-screw hub or by a split-collet type of hub. These couplings are primarily designed for coupling synchros to servo drives where shafts with two pairs of bearings are required to be coupled together.—*Bowmar Instrument Ltd., Sutherland Road, London, E.17.*

For further information circle 25 on Service Card

COMPONENTS

26. Miniature Servo Amplifier

A miniature servo amplifier for general applications has been announced by Kollsman Instrument. This miniature, high-temperature, 400-c/s amplifier was initially produced for missile and aircraft applications where size, weight, low cost and operation under adverse environmental conditions were of particular importance.

The unit weighs 1 oz., has a volume of less than 0.8 cu in., and a maximum power output of 3.5 W, with a factory preset gain of up to 4,000 to 1. It is capable of working to its specification within an ambient temperature range of -55°C to $+125^{\circ}\text{C}$ with a gain stability of ± 1 dB up to 60 dB. It requires a synchro-type mount for direct fixing to the gear plate.—*Kollsman Instrument Ltd., The Airport, Southampton, Hampshire.*

For further information circle 26 on Service Card

27. High-Power Photocells

Now available from Walmore Electronics is the CL5M series of compact high-power photocells manufactured by Clairex Corp., U.S.A. These $\frac{1}{2}$ -in. diameter units are rated at 2 W continuous dissipation and are mounted in robust glass/metal enclosures with gold-plated leads and case.



26

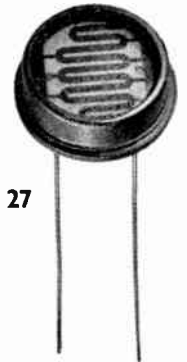

27

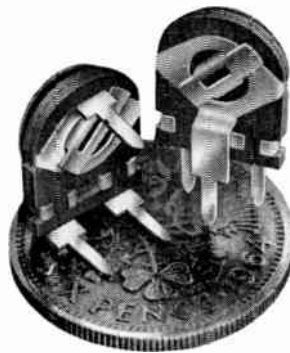

28

29

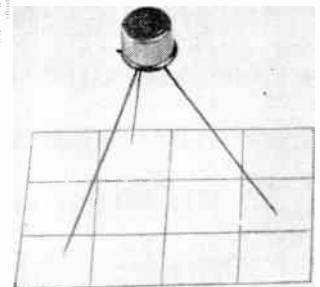

A choice of photo-sensitive materials is available: cadmium sulphide and cadmium selenide. This offers a variety of combinations of spectral response, sensitivity and response time to suit different applications.—*Walmore Electronics Ltd., 11-15 Betterton Street, Drury Lane, London, W.C.2.*

For further information circle 27 on Service Card

28. Miniature Preset Potentiometer

The type 62, a screwdriver-adjusted preset potentiometer made by Morganite Resistors, measures approximately 12×9 mm. The resistance range available is from $100\ \Omega$ to $1\ \text{M}\Omega$. Power rating: 0.2 W at an ambient temperature of 40°C .

Tags are spaced to suit standard 2.5-mm (0.1-in.) module piercing. The contact can be adjusted from either side of the component and the resistance track is protected against accidental damage during adjustment.

Of the two versions offered, both

plug directly into the printed-circuit board. The type 62H mounts horizontally and the type 62V mounts in an upright position.—*Morganite Resistors Ltd, Bede Trading Estate, Jarrow, Co. Durham.*

For further information circle 28 on Service Card

29. Unijunction Transistor

The U.S. General Electric silicon unijunction transistor type 2N2160, now available from Jermyn Industries, is a three-terminal device having a stable 'N' type negative-resistance characteristic over a wide temperature range.

A stable peak-point voltage, a low peak-point current, and a high pulse-current rating make this device useful in oscillator timing circuits, trigger circuits and pulse generators, where it can serve the purpose of two conventional silicon or germanium transistors. The 2N2160 is particularly intended for applications where circuit economy

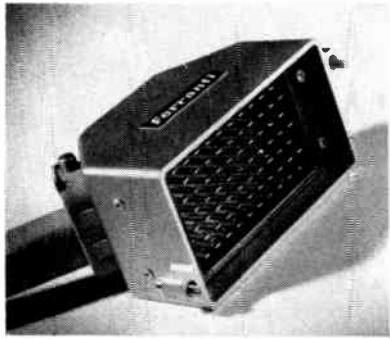

30

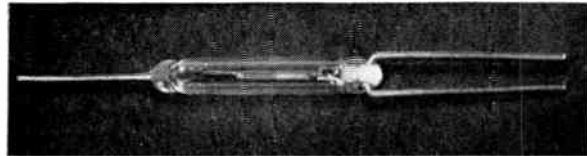

32

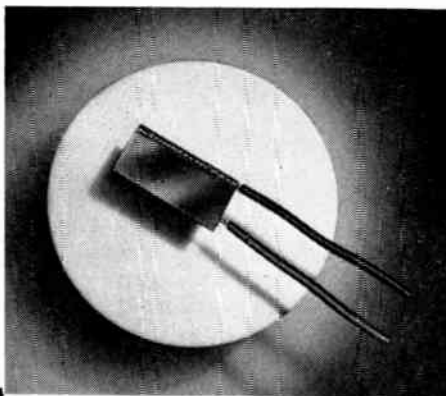

33



31



34

is of primary importance. All leads are electrically isolated from the case.—*Jermyn Industries, Vestry Estate, Vestry Road, Sevenoaks, Kent.*

For further information circle 29 on Service Card

30. Low-Force Connector Covers

The Ferranti low-force electrical connector has for some time been in use as a back-mounting connector for rack-mounted equipment; but, as it can also be used as a free plug or socket for front-panel applications, Ferranti have introduced a range of aluminium-alloy covers suitable for use with 35-pole, 70-pole and 91-pole plugs or sockets.

Captive screws enable the covered plug or socket to be locked securely to the equipment, in which screwed holes or bushes must be provided. Cable outlets are available in three positions: top entry, angle entry and side entry. A strong glass-loaded nylon cable clamp, which will accept a wide

range of cable diameters, is attached to each cover. The clamp is easily adjusted by means of a single screw which requires only moderate tightening to ensure a firm grip on the cable. As the clamp is tightened, the space vacated by the cable is shielded by a sliding tongue attached to the compression saddle.—*Ferranti Ltd., Kings Cross Road, Dundee, Scotland.*

For further information circle 30 on Service Card

31. Miniature D.C. Motor

Globe Industries Inc. (U.K.) have announced the type SD permanent-magnet type motor which operates on 3 to 50 V d.c. and develops 0.3 oz in. torque at 10,000 r.p.m. continuous duty. Measuring $\frac{3}{4}$ in. in diameter by $1\frac{3}{8}$ in. long, the motor mounts with standard servo clamps or by tapped holes and pilot.

Various output speeds are available, from 5,000 to 22,000 r.p.m., and motors can be fitted with speed governors

or planetary gearheads. Units are designed to meet appropriate MIL environmental specifications, and are compatible with other size 8 rotating equipment.—*Globe Industries Inc. (U.K.) Ltd., P.O. Box 22, Kinbex House, Wellington Street, Slough, Bucks.*

For further information circle 31 on Service Card

32. Change-over Dry-Reed Switch

The latest Gordos dry-reed switch available from B & R Relays is a mechanically-biased change-over switch. Known as type MR201 it has an overall length of 3.09 in., a glass length of 1.2 in. and a glass diameter of 0.2 in. The contact rating is 10 VA at a maximum of 0.25 A.

The contact material used, called 'Di-met', combines gold for stability, copper for low resistance and added alloys for hardness and durability; these prevent 'sticking' or 'cold welds'. The main features of 'Di-met' are very low contact resistance and 'inrush' capacity for switched tungsten lamps and similar loads. Plating thickness is kept to a minimum, but allows for control of drop-out or operating differentials. In appearance one blade is silver in colour and the other copper-gold.

The full range of Gordos dry-reed switches can now be supplied with either 'Di-met' or diffused-gold contacts. In addition to other uses the MR201 can be incorporated in B & R's R03 and R04 dry-reed relays.—*B & R Relays Ltd., Temple Fields, Harlow, Essex.*

For further information circle 32 on Service Card

33. Silicon Photocells

Hird-Brown have announced the introduction of a series of n-p silicon photovoltaic cells made by National Semiconductors of Canada, the first in the series being type NSL-703 P.

The minimum output of this cell at 500 ft candles is 400 μ A (with a 1-k Ω load), and open-circuit voltage is 0.42 V. Average speed of response is 15 μ sec. The photocell measures: 0.394 in. long, 0.197 in. wide, 0.010 in. thick, and has 4 in. long flexible leads.—*Hird-Brown Ltd., Flash Street, Bolton, Lancs.*

For further information circle 33 on Service Card

34. Size 08 Synchros

Synchros in international frame size 08 are now being designed and manufactured by Vactric Control Equipment. Control transmitters, control transformers and control differential transmitters are included in the range.

NEW ELECTRONICS INSTRUMENTATION CONTROL

The synchros are designed to meet the British Spec. DEF.148 and the American Spec. MIL-S-20708A.

The components are constructed from corrosion-resistant material throughout and design features include positioning of the grommet holes in the end cover at 45° to avoid sharp bends in the leads and to reduce the space required for mounting, as well as silk-screen printing for identification in preference to an aluminium name plate.

The maximum electrical error of the synchros is 7 minutes of arc, and the operating frequency is 400 c/s. For the control transformers and control differential transmitters the nominal primary voltage (stator line to line) is 11.8 V, while for the control transmitters it is 26 V.—*Vactric Control Equipment Ltd., Garth Road, Morden, Surrey.*

For further information circle 34 on Service Card

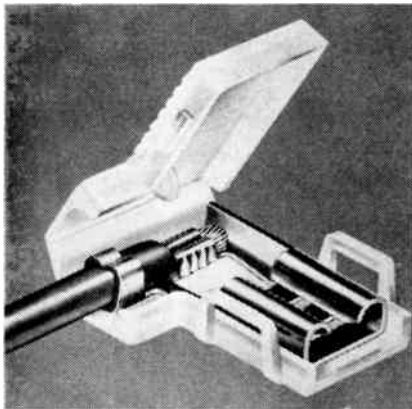

35

35. Insulated Connector

Aircraft-Marine Products (G.B.) are introducing an addition to the .025 series of Faston connectors, with a novel snap-lock nylon insulator available.

The insulator, which can be supplied from a wide range of colours, is clean, dry and foolproof. Matched tooling for applying the connector at all levels of production is available.—*Aircraft-Marine Products (G.B.) Ltd., Terminal House, Stanmore, Middlesex.*

For further information circle 35 on Service Card

36. Three-Deck Sealectboards

Three-deck Sealectboards, providing substantially increased programming flexibility, have been announced by Sealectro. These units retain the cordless programming features, but additionally provide a third contact deck in the vertical plane.

The front panel of the board has holes located along the x and y axes in columns and rows. On the first deck, all of the contacts at each row are electrically bussed together; the

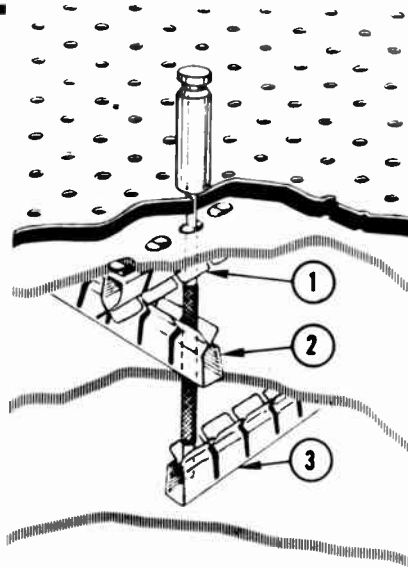

36

second deck has all of the contacts at each column bussed together, and the third deck has all of the contacts at each row bussed together. By inserting shorting or skip pins at appropriate points, any combination of decks can be electrically connected.

The diagram illustrates a skip pin connecting the first and third decks while no electrical connection is made to the second deck. Alternatively, the contacts on the third or lowest deck may be in the form of insulated single sockets. Additional two-deck pins can be supplied to accommodate components such as diodes and resistors.—*Sealectro Ltd., Hershram Trading Estate, Walton-on-Thames, Surrey.*

For further information circle 36 on Service Card

37. Robust A.C. Solenoids

The availability of a range of a.c. solenoids with solid epoxy-resin cast coils and a high force/weight ratio has been announced by Parmeko. This development is intended to meet the increasing need for efficient and reliable actuators in automatic control systems for machines and other manufacturing processes.

Known as the 'Sixty Series', this range is rated for continuous duty and comprises five sizes in progressive force steps, each with an alternative push or pull type. Coils can be supplied for voltages from 12 to 440 V, 40-60 c/s. Winding and encapsulation techniques give complete protection from moisture, oil and electrical or mechanical shock.

Standard models are fitted with base clamps for vertical mounting, and alternative side-mounting clamps are also available. Spade terminals project from the coil face to give simple push-on or soldered connections.—*Parmeko Ltd., Percy Road, Aylestone Park, Leicester.*

For further information circle 37 on Service Card



37

38. Compact 10-msec Delay Line

Advanced sonic wire packaging techniques by Sealectro have led to the development of the Delttime model 214A, a compact magnetostrictive delay line permitting up to 10 msec delay and 10,000 bits data storage capacity.

Measuring $1\frac{1}{8} \times 10\frac{1}{2} \times 11\frac{1}{2}$ in., the model 214A achieves the same performance as the previous 10-msec model in less than half the volume, and is compatible with all of Delttime's standard circuit modules.—*Sealectro Ltd., Hershram Trading Estate, Walton-on-Thames, Surrey.*

For further information circle 38 on Service Card

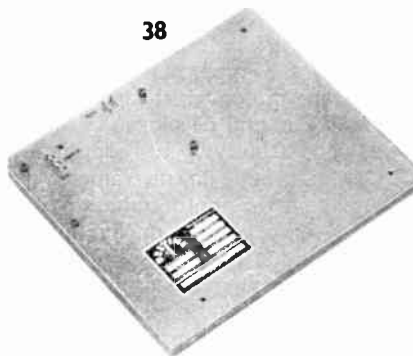

38

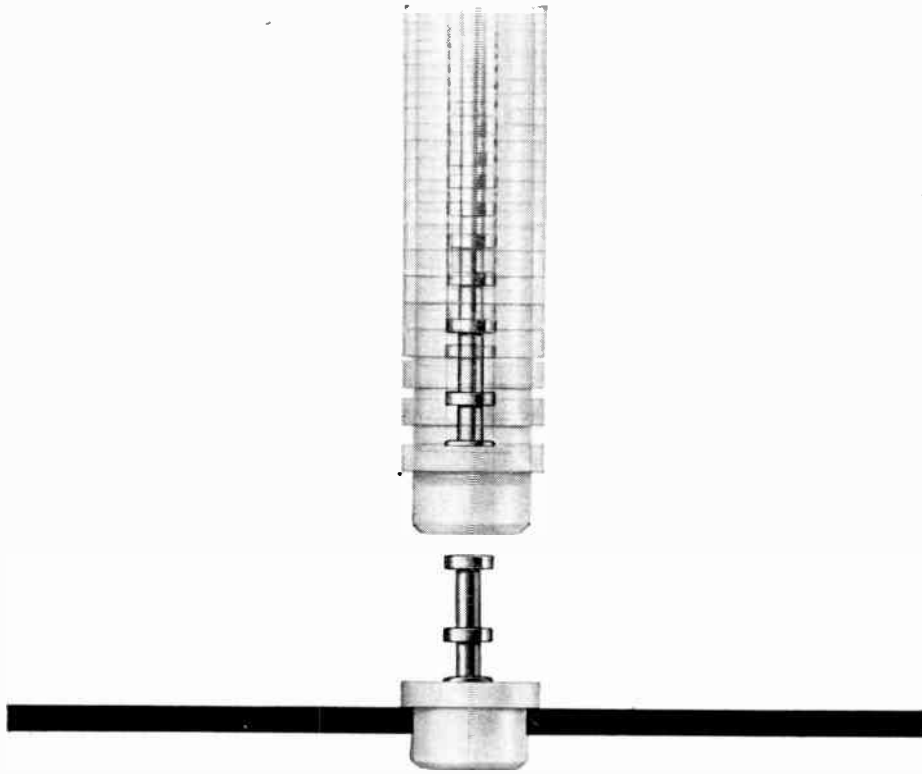

1 - 2 - 3 - **IN** STALLED !
permanently installed—in a matter of seconds!

Did you know that the best terminals are also the easiest to install? 'Press-Fits' are installed with a simple tool and just press home; they are then firmly and permanently in position, no nuts or washers being needed because of their one-piece construction. The 'Press-Fit' line includes stand-offs, feed-throughs, probes, plugs, test jacks and covers most requirements, but non-standard units can be made to specification. The colour-coded P.T.F.E. body has superlative insulating properties, permitting the tiniest sizes to be used. Remember, only Sealectro make 'Press-Fits' and only 'Press-Fits' have the quality control for insured performance.



SEAELECTRO

®

PRESS-FIT

MINIATURE · SUB-MINIATURE · MICRO-MINIATURE

SEE HOW 'PRESS-FITS' SAVE SPACE!

THESE SPECIMENS ARE ACTUAL SIZE

Because P.T.F.E. has a particularly high voltage breakdown rating, miniaturization is safe with 'Press-Fits'.

P.T.F.E. TERMINALS



SEAELECTRO LIMITED

HERSHAM TRADING ESTATE · WALTON-ON-THAMES · SURREY · TEL: WALTON-ON-THAMES 26285

TRANSDUCERS

FOR PRESSURE MOVEMENT ACCELERATION USE VARIABLE RELUCTANCE



A

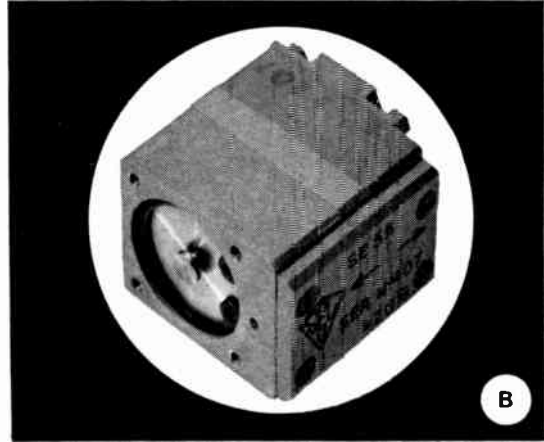

B



C

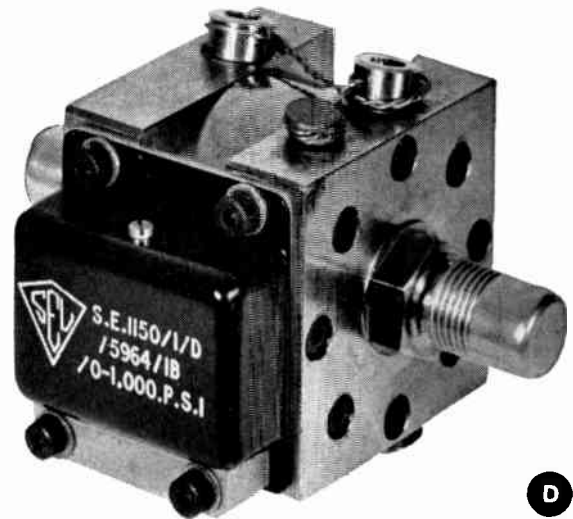

D

- A** SE 95 —A range of displacement units covering ranges from 0.050" up to 0.8".
- B** SE 55 —Accelerometers with low cross-sensitivity with ranges from 1G up to 100G. Damped with silicone fluid to provide high frequency response.
- C** SE 75 —A flush mounting pressure transducer manufactured from stainless steel for use at temperature up to 200°C (392°F)
- D** SE 1150—Similar to SE 75 in construction and temperature, and suitable for differential and gauge pressure. Ranges from 0.1 to 0.6000 lbs/in².

Large output, small gain and zero drifts, high temperature operating low sensitivity to "G" effects, and capable of withstanding high overloads.



COMPLETE INSTRUMENTATION SYSTEMS

S E LABORATORIES | ENGINEERING | LTD

A subsidiary of S.E. Laboratories (Holdings) Ltd.

606 North Feltham Trading Estate, Feltham, Middlesex. Telephone: Feltham 5876

PRODUCTION AIDS

39. Versatile Console Welder

The Weltek Division of Wells Electronics Inc. has developed a versatile console welder that will do micro-soldering, microwelding, and diffusion bonding. The model 700 'Polytronic' welder includes a miniature a.c. power supply, an all-purpose weld head, a micro-positioner, binocular 'swing away' Stereozoom viewer, light source, and many accessories. The power supply may be cycled continuously at fast rates, and energy pulses are controllable from 1 msec up to 800 msec. Both constant-current and constant-voltage sources are available with automatic resistance feedback controls.

The 700 has been designed primarily for laboratory and experimental use but can also serve as a production line machine. The weld head can do five different kinds of miniature welding, as well as microsoldering and diffusion bonding; the equipment can normally be set up for a particular function in less than 5 min. The force range is from 3 oz to 20 lb. The head is also equipped with an electronic lock-out device, a micrometer tip-spacing adjustment, and digital read-out. The micro-positioner is accurate to ± 0.0005 in. and the viewer provides magnification from $\times 7$ to $\times 30$.—*Weltek Division, Wells Electronics Inc., 1701 S. Main Street, South Bend, Ind. 46623, U.S.A.*

For further information circle 39 on Service Card



39

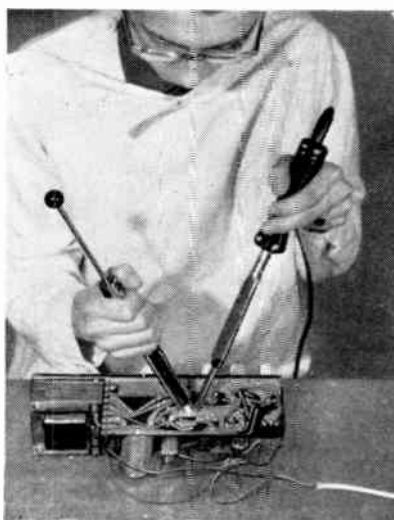

40

40. Solder Remover

W. Greenwood Electronic has introduced a precision tool for the rapid removal of solder from printed circuits and other solder joints. This patented device is available from stock at 79s 6d.

The nozzle of the tool is placed adjacent to the solder joint and on depression of the release button the hot solder is immediately and completely sucked into the nozzle. Re-loading is easily carried out by pressing the piston knob and the tool is then ready for the next operation.—*W. Greenwood Electronic Ltd., 677 Finchley Road, London, N.W.2.*

For further information circle 40 on Service Card

41. Power Press Load Monitor

The Saunders-Roe Division of Westland Aircraft have developed a system for monitoring loads in power presses based on foil strain gauges.

The foil strain gauges can either be attached to the frame of the press or are incorporated in a special load cell which is located at some point in the operating machinery of the press. A 'Peak Strain Indicator' gives a meter indication of the peak strain under impact load conditions. The instrument has a single-stroke action and it can be re-set either manually or automatically. Alternatively it will indicate the highest impact load which has occurred over a number of cycles.

The use of d.c. circuits in the instrument enables a direct calibration of the indicator to be obtained, and an internal calibration facility is provided which permits the accuracy to be

41



checked quickly and easily. Switching facilities can be provided for multi-channel operation and for the summation of several inputs. An overload trip circuit is available to operate a relay for visual or audio warnings, the trip level being adjustable over the full range of the indicator.—*Strain Gauge Department, Westland Aircraft Limited, Saunders-Roe Division, Osborne, East Cowes, Isle of Wight.*

For further information circle 41 on Service Card

42. Pure Hydrogen Unit

Johnson, Matthey & Co. announce the development of a compact, inexpensive unit for the production of

NEW ELECTRONICS INSTRUMENTATION CONTROL

ultra-pure hydrogen by the silver-palladium diffusion method; it will give an output of 1 cu ft/hr. The unit, which is simple to operate, is primarily intended for use in research and development laboratories, but will also be especially useful in the heat treatment of metals and semiconductor materials, in catalytic hydrogenations and in gas chromatography.

Known as the A.1 diffusion unit, it has an attractive two-tone aluminium alloy case, is 22 in. high, weighs 14.7 lb. and is supplied on a laboratory retort stand. For operation, it needs only to be connected to a 220/250 V a.c. supply via a power regulator, and to a hydrogen cylinder.—*Johnson, Matthey & Co. Ltd., 73-83 Hatton Garden, London, E.C.1.*

For further information circle 42 on Service Card

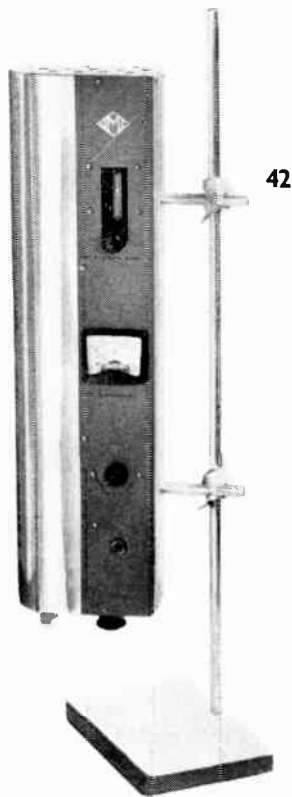

42



43

43. 5½-cu ft Oven

Fisons Scientific Apparatus have announced a laboratory-size oven which will operate at temperatures up to 400 °C. It has a stainless-steel interior measuring 24 × 20 × 20 in. high (5.5 cu ft) and is supplied with two shelves. A patented airflow system is incorporated which ensures that the temperature differential throughout the working chamber is kept to an absolute minimum, irrespective of shelf loading.

Temperature is controlled by adjustable-contact thermometer with an accuracy of ±1 °C. Two 1,500-W heating elements are incorporated; one only is used for temperatures up to 150 °C and the second booster heater is used above this. The oven is fitted with castors to give ease of movement, or alternatively it can be supplied mounted on an angle-iron frame.—*Weyco Division, Fisons Scientific Apparatus Ltd., Loughborough, Leics.*

For further information circle 43 on Service Card

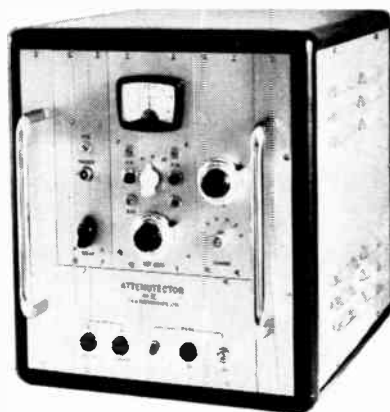

44

44. Ultrasonic Flaw Detector

C.N.S. Instruments announce that their redesigned ultrasonic flaw detector, the Attenutector Mk. IV, is now available. This instrument, designed for the non-destructive testing of plastics and graphite, is suitable for a variety of other applications such as the detection of bubbles in liquids, the checking of the bonding of plastic to plastic, plastic to metal, or metal to metal, and the variation of density in liquids.

The instrument operates on a through-transmission principle and immersion techniques are recommended to avoid any variation in contact between probes and specimen. Standard probes are available for frequencies from 250 to 650 kc/s and other frequencies up to 2 Mc/s can be provided to special order.—*C.N.S. Instruments Ltd., 61 Holmes Road, London, N.W.5.*

For further information circle 44 on Service Card

45. Industrial pH Measurement

The pH measurement of liquids flowing under pressure in industrial processing systems is simplified and made more reliable by a Philips unit announced by The M.E.L. Equipment Co. Ltd.

The unit comprises a glass and stain-

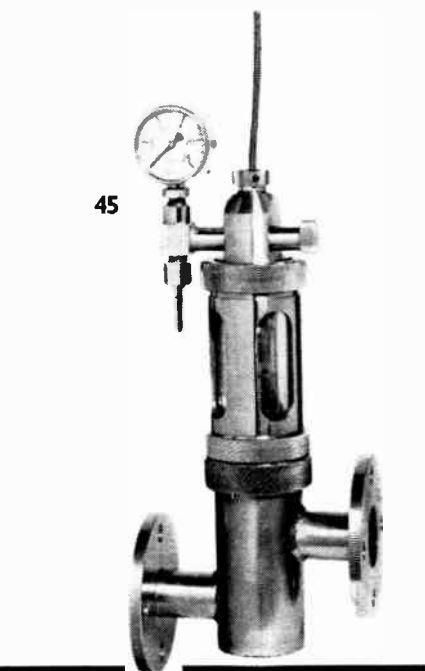

45

less-steel housing with inlet and outlet connections and is fitted with a single rod pH electrode.

Facilities are provided for connection to a compressed-air or inert-gas cylinder, and for applying pressure to the reference cell electrolyte. This pressure opposes that due to the liquid in the processing system, and there is consequently no unwanted passage of liquid through the porous ceramic membrane of the electrode, and no contamination of the reference electrolyte.

The unit operates at pressures of up to 25 atmospheres. It is available as a standard catalogue item designated WMZ-1024, and a number of different fittings can be supplied.—*The M.E.L. Equipment Co. Ltd., 207 King's Cross Road, London, W.C.1.*

For further information circle 45 on Service Card

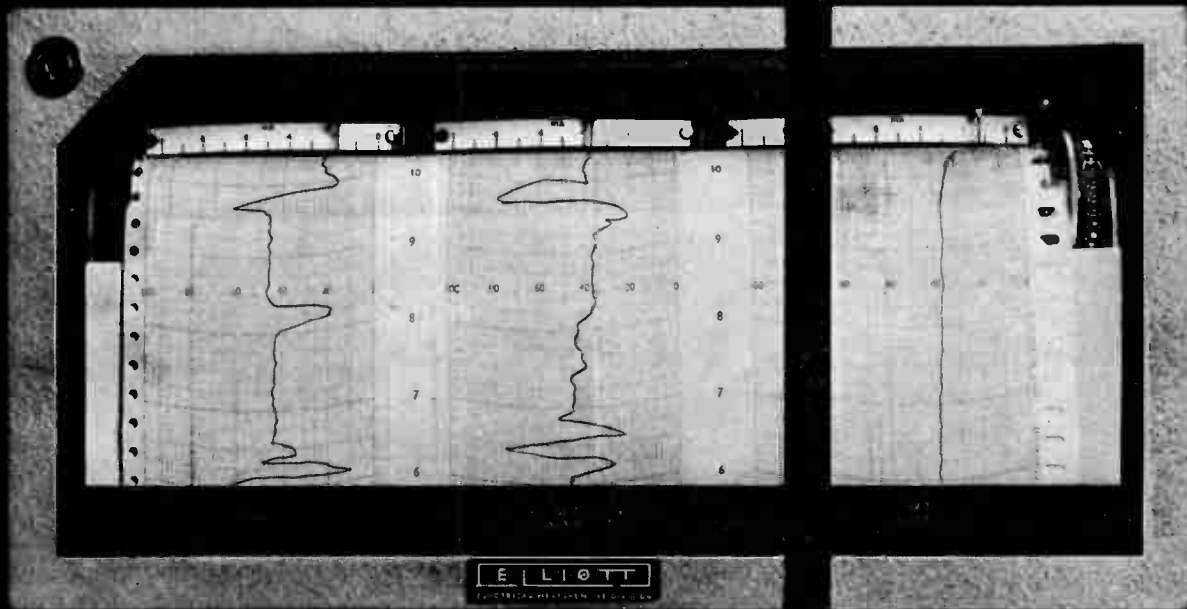

**Now that we've cut it down
to the perfect size...**

**we've
slashed
this much
off the price!**

By the full application of Value Engineering, Elliott have further improved the technical performance of the Emrec Recorder—and, just as important, have made big cuts in costs by new production methods. These benefits are passed on to you, the customer, by providing a compact 2-, 3-, 4- or 6-channel recorder, only 8½" high and

12" deep. Other features include * A new expendable cartridge inking system to give a clear high-definition trace * 3"-wide track * 5½ hours (at 1"/hour) visible at a glance * Self-contained strip lighting fitted as standard.

Other models are also available with * Electronic over-ride alarm and control

facilities * Dynamometer movements * Electrical suppression of ranges * Remote change of chart speeds.

With these improved performance facilities and a much reduced price, the Emrec Mk II is a *must* for all those interested in direct writing recorders.

Write now for full information or, better still, ask for a demonstration



Electrical Measurement Division
ELLIOTT BROTHERS (LONDON) LIMITED
Century Works, Lewisham, London SE13. TIDeway 1271

 A Member of the Elliott-Automation Group

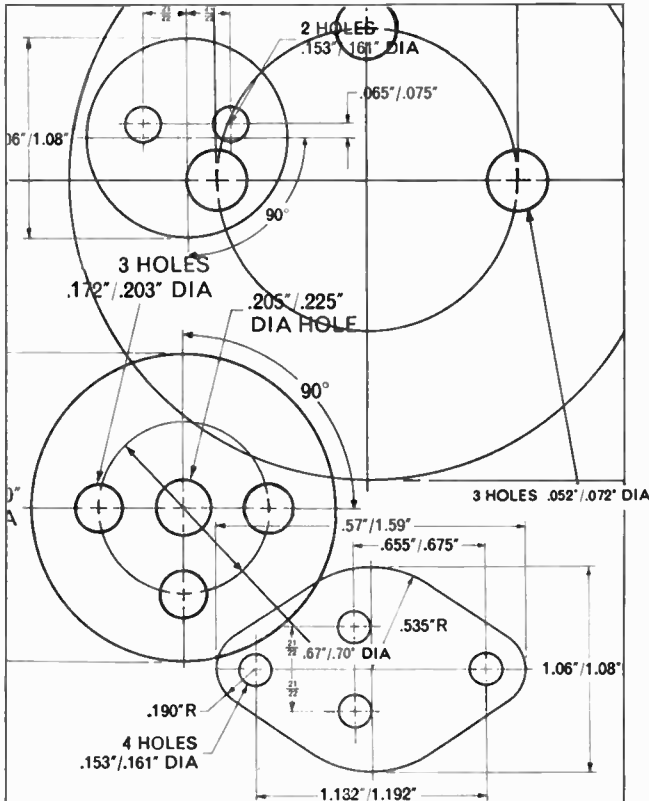

Beryllia- Now available for the electronic industry

Already well-known in the field of nuclear engineering, beryllia is beginning to play an important part in electrical and electronic applications. It offers a unique combination of properties :-

- High thermal conductivity — equal to that of aluminium
- High electrical resistivity
- Low dielectric loss

These special properties of beryllia enable it to solve problems of heat dissipation which often arise in the use of transistors, rectifiers, diodes and other semi-conductor devices. And beryllia is especially useful in the higher frequency regions, where capacitance effects caused by conventional insulators would otherwise be prohibitive. A range of standard base washers is available from stock — for full details write for illustrated brochure. A quick service is offered for parts machined to special requirements and quotations for small or large quantities will be gladly submitted on receipt of a sketch or drawing.

CONSOLIDATED BERYLLIUM LIMITED

—an associate company of



Enquiries to: Imperial Smelting Corporation (N.S.C.) Limited
St. Andrew's Road, Avonmouth, Bristol Tel: Avonmouth 3631

CYCLONOME STEPPING MOTOR

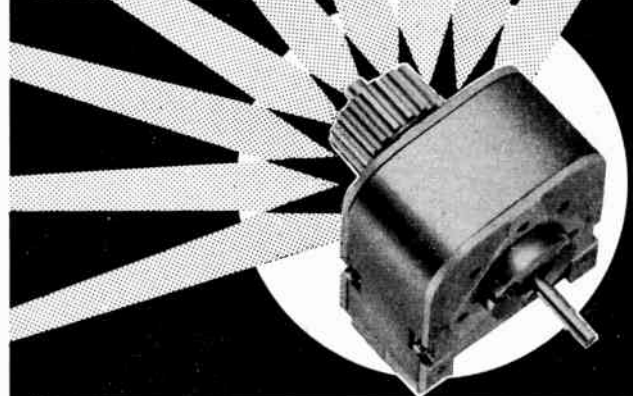

A simple approach to accurate Positioning, Counting, Converting, Synchronizing. Plus, positive magnetic start-stop action—at variable synchronous and asynchronous stepping rates.

TORQUE & SPEED — delivers up to 5 inch-ounce torque in precise 18° steps—at up to 1000 steps/second.

RELIABLE — only one moving part — no brushes, cams or ratchets.

ACCURATE — 18° ± ¼"

VERSATILE — operates on a wide variety of single drive circuits without complex sequential switching.

SPACE SAVING — requires only as little as one cubic inch of space.

POWER SAVING — maintains higher holding torque without standby power.

The CYCLONOME is a single phase, high torque, synchronous stepping motor that provides fast response stepping, instant stopping in precise 18° steps, delivering torque in exact proportion to and at the same rate as the input, i.e., —10 pulses = 10 steps. The motor uses only magnetic rotor-stator forces to convert frequencies or pulses into 18° start-stop shaft rotations. Clutches, brakes and ratchets are completely eliminated and there are no brushes or slip rings to wear out.

The same motor without any changes can be driven from 60 cycle line power, oscillators flip flop circuits, pulse R.C. Circuits, on off relay circuits, commutators and manual switches.

For full details on these and other Sigma motors write to—

Sole U.K. representatives **Ad. AURIEMA Ltd**
125 GUNNERSBURY LANE,
ACTON W3 (Telephone ACOrn 8762)

A Moduline switch

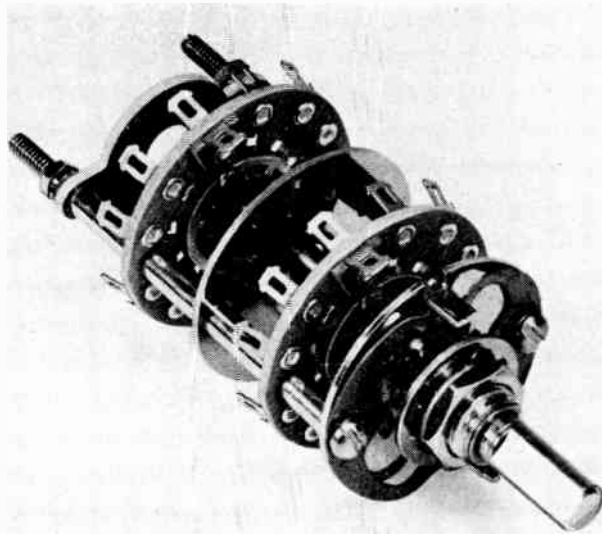

ROTARY SWITCHES WITH TWO MILLION DESIGN VARIATIONS

A new concept in rotary switch design and fabrication has made it possible for original equipment manufacturers in the electronics and electrical industries to design any of 2,000,000 switch possibilities . . . and have the switches assembled and despatched to them from a U.K. factory seven days after receipt of design instructions.

The rotary switches, called Moduline, will be produced by Diamond H Controls Ltd., in the U.K. The company is a subsidiary of Oak Electro/netics Corp., Illinois, U.S.A., developers of the switch.

Engineering Drawings Eliminated

Utilizing the principle of modular fabrication, Moduline switches are quickly designed using a catalogue and easy-to-use order card. Engineering drawings are eliminated since the design characteristics of a switch are designated by a series of eight numbers (17 digits), which are selected from the catalogue and written on the order card.

Using prefabricated components, Diamond H can quickly assemble the switches following the design configurations indicated on the order card. The Moduline system provides millions of variations, all with factory-assembled quality. The proven assembly system guarantees consistent quality for all switch variations without slowing down the 7-day or less delivery schedule.

A price list is also provided permitting the user to determine the price which he will be charged.

Design and Ordering Procedure

Using the catalogue the first number entered in the order card designates the basic switch size and detent angle. The engineer can select from six sizes. The second number entered in the order card designates the sections, contacts and switching configurations—101 choices. The third number indicates the number of rotational stops required. The fourth set of numbers is the code for the front shaft length. Table V, the fifth set of numbers, is the code for front shaft detail such as the type of flat. The sixth set codes the front shaft angle; the seventh, the type of bushing and locating key; and the eighth set determines the location of sections, shields, marker plate and the rear shaft length.

The order card is completed by including the name of the company, quantity of switches required, delivery date, and other details.

The Moduline system is not intended to replace the normal custom-built service for large quantities of switches. It provides custom-built facilities for quantities up to about 100 off at economical prices. For quantities above 100, users would normally find it cheaper to order individually-designed switches.

For further information circle 51 on Service Card

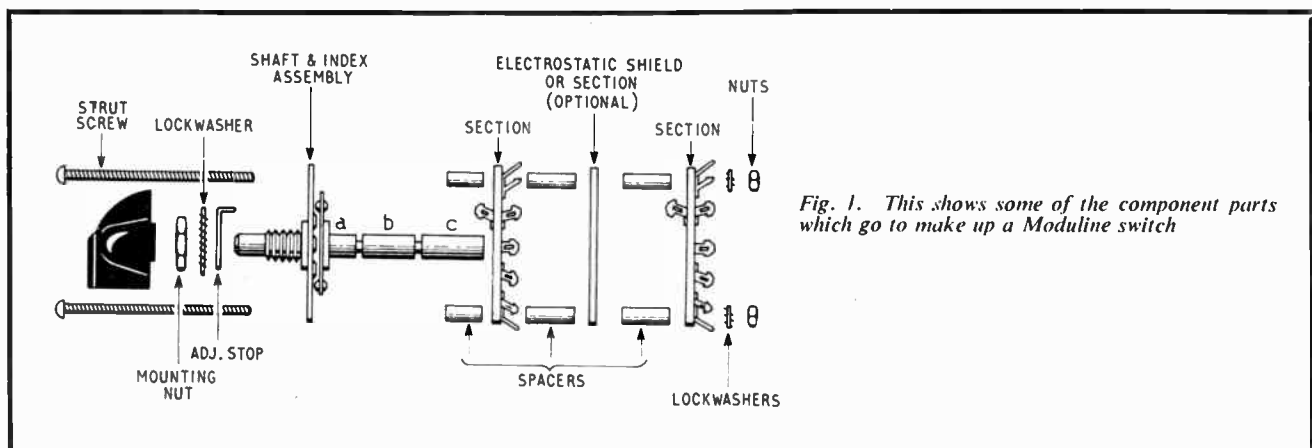

Fig. 1. This shows some of the component parts which go to make up a Moduline switch



Personal News

The Postmaster General has approved the appointment of **D. A. Barron, C.B.E.**, deputy engineer-in-chief of the Post Office, to be engineer-in-chief in succession to Sir Albert Mumford, K.B.E. **J. H. H. Merriman, O.B.E.**, assistant engineer-in-chief, is to be new deputy engineer-in-chief, and **F. J. M. Laver**, staff engineer, at present on loan to the Treasury as an assistant secretary, will be an assistant engineer-in-chief.

A. C. Cossor Ltd. announce that **Richard C. Norwood** has been appointed managing director. **Professor C. L. Calosi** will continue as a director of the company in addition to his responsibilities for all European operations as vice-president of Raytheon Company.

Advance Electronics Ltd. have appointed **M. A. Burchall, A.M.I.E.R.E.**, as chief engineer, Volstat Division, at the group's Hainault works.

English Electric Valve Co. Ltd. announce the appointment of **Hugh Menown, M.Sc.**, as manager in charge of the Gas Tube Division.

Robert J. Cannon, the chairman of Cannon Electric (G.B.) Ltd., has announced his retirement, and **Michel C. Bergerac** has been appointed his successor. **George H. Stone** has been appointed sales director, and **Thomas H. Templeman** has been appointed company secretary.

Graham Miller, B.Sc., has been appointed general sales manager of Wayne Kerr Ltd.

Maxam Power Ltd. have appointed **Brian Wilson** as sales engineer in the London area.

H. Rothwell, works director of Brookhirst Igranic, has been appointed general manager of the company's Chester works; he succeeds **A. G. Herring**, who will continue his association with the company as a consultant to the sales director. **A. J. Ball** has joined the company and has been appointed to the board as production director.

Group Captain Edward Fennessy, C.B.E., is joining The Plessey Co. Ltd. to undertake a major management responsibility in the electronics area. He was formerly managing director of Decca Radar Ltd.

Painton announce that **G. P. Green** has been appointed head of publicity. He will be responsible for all aspects of press liaison, publicity material, advertising and exhibition design.

International Computers and Tabulators Ltd. announce that **A. G. B. Burney, O.B.E.**, has been appointed a director.

Digital Measurements Ltd. announce that **Air Vice-Marshal F. W. Long** has been appointed their consultant for liaison with the Armed Services, Government Departments and industry.

Miss H. Pool and **Mr. J. McKenzie Newman** have been appointed to the board of directors of Sifam Electrical Instrument Co. Ltd.

Charles A. R. Pearce, M.Sc., M.I.E.E., M.I.M.E., has been appointed deputy managing director of Ericsson Telephones Ltd./Etelco Ltd.

Clary Ltd., a subsidiary of the Clary Corporation of America, have appointed **John A. McDermid** as branch manager responsible for London sales.

J. J. Churchill Ltd. have appointed **John Hibbert** as technical sales manager of their recently established Pneumatics Division.

Company News

Plannair Ltd. have appointed Kyokuto Boeki Kaisha Ltd. of Tokyo as exclusive representative in Japan for the sale of their equipment including fans, blowers and wafters.

G.E.C. (Electronics) Ltd. have come to an arrangement with the Ministry of Aviation under which they take complete charge of the Applied Electronics Laboratories at Stanmore, Middlesex.

TESTING CAMERA SHUTTER SPEEDS BY OSCILLOSCOPE—A Tequipment S43 oscilloscope with a specially engraved scale which gives a direct reading in milliseconds is used to test camera shutter speeds at Jason Adams Optical Company Ltd., Surbiton. An oscilloscope has been found to be the most accurate means of measurement. The shutter is evenly illuminated, and the light passing through it falls on a photocell. The time-base of the oscilloscope is triggered by the amplified photocell output, which is also applied to the Y-deflector plates of the cathode-ray tube. The degree of deflection measures the amplitude of light passing through the shutter, and the scale directly relates amplitude to lens aperture. Jason Adams also use Tequipment oscilloscopes for checking flash synchronization and measuring the light transmission of lenses

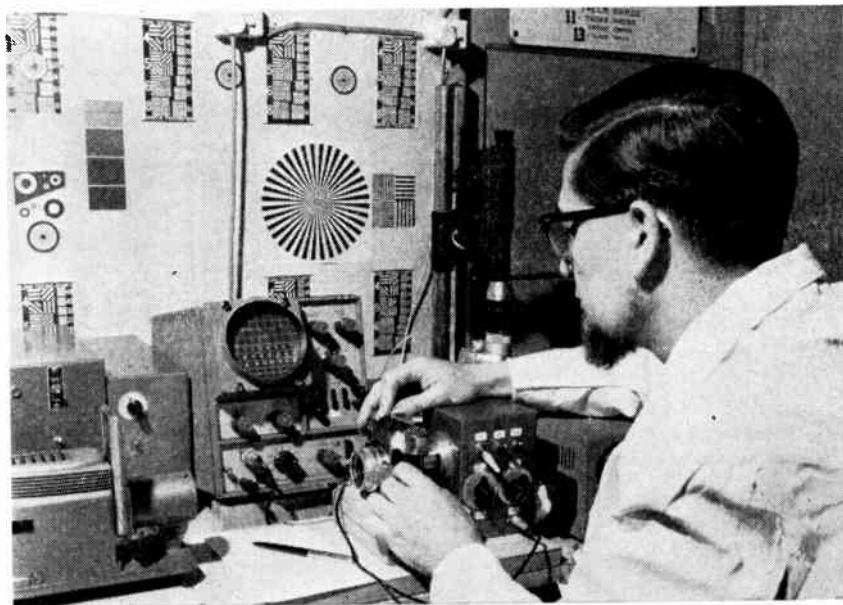

Elliott Traffic Automation Ltd., a member of the Elliott-Automation Group, has set up a Transportation Survey Department to carry out transportation surveys and associated work for local authorities, major industrial organizations and public transport undertakings. The new department will work in close collaboration with Birmingham University's Department of Transportation and Environmental Planning.

George Kent Ltd. have, by a proposed exchange of shares, offered to take over Evershed & Vignoles Ltd. together with that company's subsidiaries. The directors of Evershed & Vignoles propose to recommend acceptance of the offer and the £380M British American Tobacco Co. Ltd. have undertaken to accept in respect of its controlling interest in Evershed & Vignoles.

The Specialized Components Division of **The Marconi Co.** have moved into a new headquarters at Billericay Works, Radford Crescent, Billericay, Essex. Telephone: Billericay 3431.

The Bank of London & South America and English Electric-Leo-Marconi Computers have formed a company to provide comprehensive computer services, including marketing, for commerce and industry initially in Latin America. The company is registered in the U.K. and is named **Intercontinental Data Services Ltd.**

The Cambridge Instrument Company has recently transferred its Medical Sales Department from London to premises adjacent to its factory and research laboratories. Enquiries relating to medical instruments should now be made to: Medical Department, Cambridge Instrument Co. Ltd., 18 Carlyle Road, Cambridge. Telephone: 61832.

A N.M.R./E.S.R. Spectroscopy Research Laboratory has been opened by **Varian Associates Ltd.** at Walton-on-Thames, Surrey. The research programme will be supervised by Dr. A. Horsfield, and he will also have special responsibilities for E.S.R. activities. N.M.R. Research will be directed by Dr. J. Feeney. Depending on the work load on equipment and staff, it will be possible from time to time to accept samples from laboratories requiring spectra to be run, and the staff will help with interpretations where necessary. Initially the laboratory facilities will include a V-4502 X-Band E.S.R. spectrometer and an HA-100, 100-Mc/s N.M.R. spectrometer.

NEW THIN-FILM STORE FOR HARWELL—First delivery of a new magnetic thin-film store system has been made to the United Kingdom Atomic Energy Research Establishment at Harwell by the manufacturers, E.M.I. Electronics. The equipment will be used as a general-purpose buffer store in high-speed data logging. 128 words each containing 16 bits are used, and the read/rewrite cycle time is $\frac{1}{2}$ μ sec; the high speed ensures a shorter 'dead time' than can be obtained with current equipment. The storage elements are made by vacuum evaporation of a nickel-iron alloy in a magnetic field on to glass plates. Special printed-circuit and soldering techniques are used to assemble a complete store which is built up of an appropriate number of 64-word planes, each word containing 50 bits. At present, the store capacities are in the range 128 to 1,024 words. Conventional printed-circuit panels are used for the drive and sense electronics which are built on a 19-in. racking system. The picture shows an engineer inserting one of the store drive panels during final assembly of the system at E.M.I.'s Hayes Laboratories

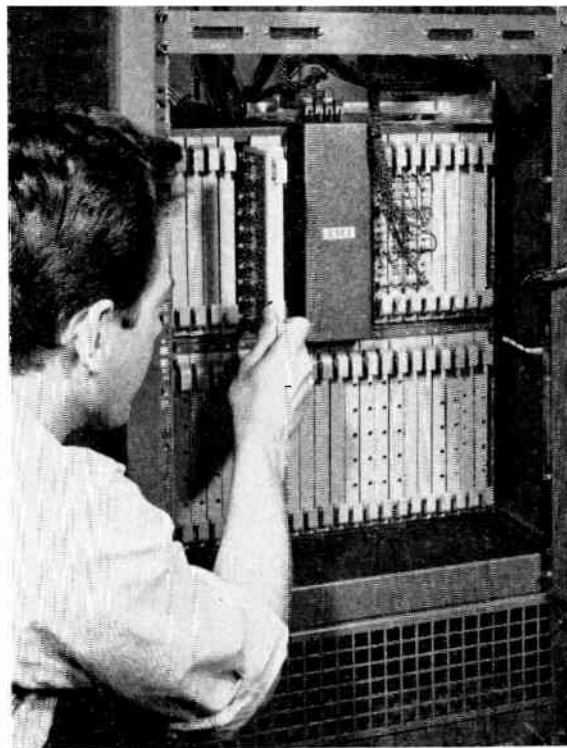

Hudson Electronics Ltd. have moved to new premises at Peall Road, Croydon, Surrey. Telephone: Thornton Heath 9771-6.

The M-O Valve Co. Ltd. has reached a licensing agreement with Microwave Electronics Corp., Palo Alto, California, under which M-O V. will manufacture and market in the U.K. a range of low-noise metal/ceramic travelling-wave tubes. Production is scheduled to begin in 1966.

Svenska Painton, which recently became a wholly owned subsidiary of the Painton group of companies, announce a change of address. All enquiries should now be addressed to Svenska Painton AB, Erik Tegels Väg 35, Spanga, Sweden. Telephone number 08/36 28 50.

Hagglunds of Sweden have formed a British subsidiary company to be known as **Hagglund Industrial Ltd.** The new company will deal initially with the parent company's extensive range of welding products. The address is Chantry Road, Kempston, Beds.

Aircraft Marine Products (G.B.) Ltd. have announced that a new division, 'Ampliversal', has assumed all marketing and servicing responsibilities of the M & R (maintenance and repair) division.

BTR Industries Ltd. have transferred the marketing of printed circuits to Palmer Aero Products Ltd., Printed Circuits Factory, Blackwater Station Estate, Camberley, Surrey. Telephone: Camberley 5294.

Electronic Associates Ltd. have opened a new northern area office at Robert's House, Manchester Road, Altrincham, Cheshire.

Lexor Electronics Ltd. have announced the formation of a wholly-owned subsidiary company, **Lexor Dis-Boards Ltd.**, which will specialize in the field of power distribution. A new factory is being planned, but until this is in commission the company will trade from 25/31 Allesley Old Road, Coventry. All orders and correspondence relating to Lexor Dis-Boards should now be addressed to the new company.

The London office of **International Electronics Ltd.** is now situated at Parkway House, Sheen Lane, East Sheen, London, S.W.14. Telephone: Prospect 9914. All orders and correspondence should be sent to this address.

A Scottish sales centre has been established by **Dewrance-Triangle Ltd.** at 6 Park Terrace, Glasgow, C.3. Former Dewrance Scottish area manager R. W. C. Jeffrey will be in control of the new centre, assisted by G. G. Mathieson and D. Cullen. Service facilities are also available from the new address.

C. A. Cook Ltd. have been newly established as a subsidiary of R. H. Cole Ltd. The company will concentrate on the design and manufacture of all types of electrical wave filters, delay lines and related components, and is under the technical direction of C. A. Cook. Enquiries should be addressed to the Works and Laboratories at No. 1 Heron Trading Estate, Wickford, Essex.

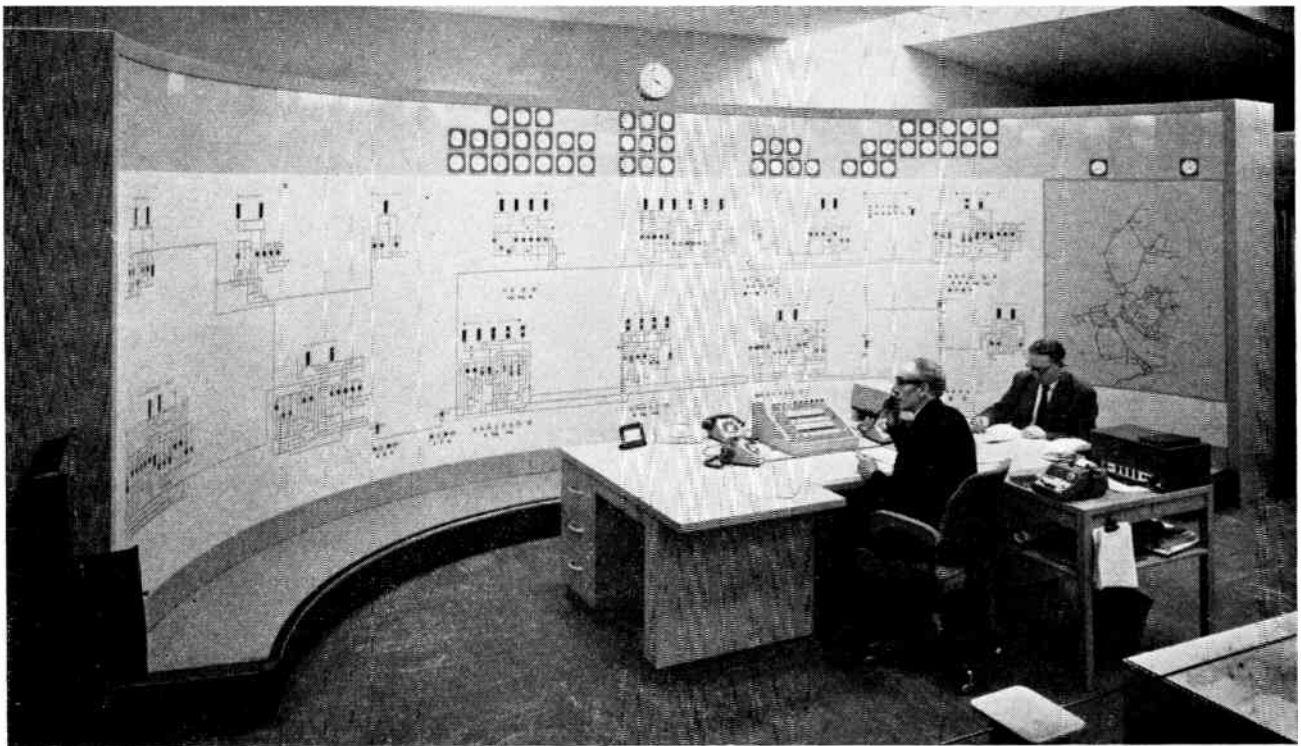

CONTROLLING MERSEYSIDE'S GAS SUPPLIES—From this 30-ft mimic diagram of Merseyside's gas distribution system, two men control gas supplies to over 430,000 domestic and industrial consumers. Controls built into the diagram enable valves and equipment to be operated at remote gas storage centres and at strategic points on the area's 3,000 miles of gas mains. The diagram is part of a new remote supervisory control and indication installation by Automatic Telephone & Electric Co. Ltd. at the North Western Gas Board's Wavertree service, stores and distribution centre in Liverpool. In the new installation, the mimic diagram is faced with one-inch mosaic tiles which incorporate the controls and diagram, and which can be rearranged to keep in step with new developments and modifications to the existing distribution system. The large-scale map on the right of the diagram, showing the main gas distribution network, will shortly be equipped with pressure-indicating lamps which will give instant warning of any change in pressure

Livingston-Roband Agreement

Livingston Laboratories Ltd. and Roband Ltd. have recently announced an agreement whereby both Livingston and Roband are to market, and provide service facilities for, the Roband range of oscilloscopes, in the U.K.

These new precision oscilloscopes are constructed with a number of replaceable printed-circuit boards, each board controlling one main function of the instrument. When servicing is necessary a 'phone call to either Livingston or Roband will establish which board is faulty and a replace-

ment will be posted to the customer within 24 hours. Alternatively, it can be arranged that a service engineer calls to service the instrument.

Oscilloscopes for Hire

A new hiring service has been established by Livingston Laboratories. Initially, oscilloscopes will be available, but other instruments will be offered as the scheme develops.

Until the plan is fully established, a service area of 100 mile radius of London will be observed; this limit will be extended as soon as possible.

For further information circle 52 on Service Card

The Institution of Electrical Engineers

The Council of the Institution of Electrical Engineers have elected to honorary membership Admiral of the Fleet the Earl Mountbatten of Burma for his distinguished services to the United Kingdom and Commonwealth in war and peace, and for his contributions to the progress of electrical and electronic science and engineering.

The forty-third award of the I.E.E. Faraday Medal has been made to Dr. Vladimir K. Zworykin for his notable scientific and industrial achievements, including the invention of the iconoscope, and for his important role in medical electronics.



PLASMA WELDING—For miniature thermocouples of 1 mm diameter and smaller, a specialized version of plasma welding has been developed by BICC Mineral Insulated Cables Division, Prescot. The equipment illustrated is capable of forming insulated hot junctions on thermocouples down to 0.25 mm overall diameter. These thermocouples are equally suitable for high- or low-temperature work in the most exacting conditions



NEW BOOKS

The Elements of Pulse Techniques

By O. H. DAVIE, M.I.E.E. Pp. 197 + ix. Chapman & Hall Ltd., 11 New Fetter Lane, London, E.C.4. Price 35s.

After an initial chapter dealing with the properties of a pulse, there are chapters on its generation, amplification and measurement. Methods of delaying pulses are described, and the book concludes with a discussion of applications.

The treatment is mainly descriptive, there being very little mathematics in the book. Both valve and transistor circuit diagrams are included in roughly equal proportions.

Basic Electronic Circuits

Parts 1 and 2, bound in one volume. Pp. 239. The Technical Press Ltd., 112 Westbourne Grove, London, W.2. Price 42s.

This book has been produced by a special Electronics Training Investigation Team of R.E.M.E. working in conjunction with Technical Training Command of the R.A.F. and Decca Radar Ltd. The two parts are also available separately bound.

The book is intended primarily to be used as a continuation of an earlier set of books, 'Basic Electronics', but it is also designed to fit into another series, 'Basic Radar'. The treatment follows the same style as that of these other volumes and it is stated that the primary object of this book is to help in the training of apprentices and recruits who aim to become electronics technicians at the operator or repairman level.

The book is admirably suited to this end.

Emploi des Tubes Electroniques et des Transistors

By J. FAGOT. Pp. 266. Masson et Cie., 120 Boulevard St. Germain, Paris VIe. Price F46.

Radiation and Noise in Quantum Electronics

By WILLIAM LOUISELL. Pp. 303 + xvi. McGraw-Hill Publishing Co. Ltd., Shoppenhangers Road, Maidenhead, Berks. Price £5 16s.

The treatment of the subject is highly mathematical. Chapter 1 deals with the Dirac formulation of quantum mechanics, chapter 2 with elementary quantum systems, and chapter 3 with operator algebra. The remaining chapters cover quantization of the electromagnetic field, interaction of radiation with matter, quantum statistics and quantum statistics of attenuators and linear amplifiers. It is most definitely a book for the specialist with a good knowledge of the higher mathematics.

Industrial Electronics Measurement

Edited by ALEXANDER SCHURE. Pp. 128 + viii. Iliffe Books Ltd., Dorset House, Stamford Street, London, S.E.1. Price 15s.

This is a very elementary book describing the kind of apparatus used for simple measurements. Of American origin, it deals in five chapters with voltage, current and power measurements, bridge and potentiometer circuits, non-electrical quantities (i.e., transducers and their applications), and temperature, frequency and phase measurement.

Work Study: A Practical Primer

By ANDREW RAE. Pp. 127. Odhams Books Ltd., 96 Long Acre, London, W.C.2. Price 15s.

As the sub-title of this book indicates it is intended as an introduction to the subject of work study. For the uninitiated it concisely describes how investigation of the work done in an organization can produce the best possible use of the men, machines and materials available. For those with an understanding of work study this book provides a number of useful reminders of the fundamental principles—in particular that no work study can be carried out successfully without the co-operation of the people concerned with the work.

The book is suitable for all levels of management and for all types of industry.

Quartz Oscillator Crystal Units : Part 3

British Standard 2271 : Part 3. Pp. 26. British Standards Institution, 2 Park Street, London, W.1. Price 12s 6d.

As part of the British Standard specification B.S. 2271, the BSI has recently issued this Part 3, a 'Guide to the use of quartz oscillator crystal units'. The object of this part is to provide both users and manufacturers of crystal units with guidance and information on the considerations affecting the selection and use of the units. It also draws attention to some of the more fundamental questions a user should consider before ordering a unit for a new application.

Electrical Interference

By ROCCO F. FICCHI. Pp. 262 + ix. Iliffe Books Ltd., Dorset House, Stamford Street, London, S.E.1. Price 50s.

This book is primarily concerned with the means which may be adopted to ensure that communications apparatus does not suffer from interference generated by nearby electrical equipment; included in this are unwanted frequencies produced by transmitting equipment. Proper screening, filtering and earthing are the main means of interference reduction and must usually be applied both to the interference producing apparatus and to the receiving equipment.

The book provides a good discussion of the subject and will certainly direct the attention of the newcomer to the subject to the important matters.

Guide Technique de L'Electronique Professionnelle: 4th Edition

Pp. 1,500, two volumes. Published by Publéditec, 13 Rue Charles Lecocq, Paris 15e. Price 160 F.

This very comprehensive publication is intended as a guide to the French electronics and allied industries. Printed in four languages, French, English, German and Italian, it is compiled in ten major sections. The major sections are: French achievements in the field of electronics; index to advertisers; technical catalogues; the French electronic technical press; short-form manufacturers' catalogue; alphabetical manufacturers' listing; cumulative alphabetical products listing; alphabetical listing engineering firms; professional structure of the industry; and professional directory and information.

Solid Circuits and Microminiaturization

Edited by G. W. A. DUMMER. Pp. 346. Pergamon Press Ltd., Headington Hill Hall, Oxford. Price 60s.

This book forms the Proceedings of the Conference held at West Ham College of Technology in June 1963.

Basic Environmental Testing Procedures for Electronic Components and Electronic Equipment

I.E.C. Publication 68. Available from British Standards Institution, 2 Park Street, London, W.1. Price 6s. 3d. each part.

I.E.C. Publication 68 describes a standard general procedure for climatic and mechanical robustness tests, designed to assess the durability under various conditions of use, transport and storage, of electronic components and electronic equipment.

It is issued in the form of several booklets. Part 1 : General (Publication 68-1) gives a general description of the framework of the test procedure and how it is to be used. Part 2 : Tests (Publication 68-2) describes the different tests in detail; each test is identified by a letter of the alphabet and is issued in the form of a separate booklet.

The two parts are intended to be used in conjunction with each other.

I.E.C. Publication 68-2-11, describes Test Ka, which determines the resistance of a component to deterioration from salt mist. The test is intended mainly for evaluating the quality and uniformity of protective coatings, particularly for similar materials, on a comparative basis.

Processed Disk Records and Reproducing Equipment

British Standard 1928 : 1965. Pp. 18. British Standards Institution, 2 Park Street, London, W.1. Price 6s.

Following the issue of the second edition of IEC Publication 98 'Recommendations for lateral-cut commercial and transcription disk recordings', a revision has been prepared of the corresponding British Standard, B.S.1928. Except for six modified clauses, the revision of B.S.1928 now published is technically identical with the IEC Publication.

It gives definitions of technical terms and specifies dimensions and other characteristics necessary to ensure interchangeability.

Analysis of Nickel: For Use in Electronic Tubes and Valves

British Standard 3727 : Parts 11 and 13. Pp. 7 (each part). British Standards Institution, 2 Park Street, London, W.1. Price 4s. each part.

In the B.S.3727-series of standards, these two new parts have been published. They are Part 11 'Determination of silicon, 0.001-0.020 per cent (photometric method)' and Part 13 'Determination of titanium (photometric method)'.

Each part of B.S.3727 specifies the reagents, analytical procedure and other details necessary for determining the amount of an alloying element or impurity normally found in nickel for electronic purposes.

The methods given in this series have been found to give reliable and repeatable results, and are primarily intended as reference methods in case of dispute. Further methods of analysis are being prepared to deal with aluminium, boron, carbon, tungsten, sulphur and zinc.

Dimensions of Electronic Tubes and Valves : 7th Supplement

I.E.C. Publication 67. Pp. 31. Available from British Standards Institution, 2 Park Street, London, W.1. Price £1.

This publication is in loose-leaf form and the following

standard sheets are included in the supplement for insertion in the loose-leaf folder: Small wafer octal bases with coaxial lead; gauge for octal base with coaxial lead; gauge for base E 8-11; septar 7-pin base gauge; B 7 A base pin No. 4 sleeve position gauge; gauge for base E 8-11; E 12-70 base; and E 12-74 base. Outlines for two bases are also included. They are: T 9 outlines used with E 12-70 base and T 12 outlines used with E 12-74 base. Special gauges for cathode-ray tubes which are also specified are: G-124 reference line gauge and G-112 reference line gauge.

Manufacturers' Literature

Thermistors for Solid State Thermal Switching. A new range of thermistors for detecting excessive temperature in industrial equipment is described in this STC 4-page leaflet MK/189. Thermistors are so small (typically 4.73 mm diameter sphere) that they can be incorporated into electrical windings of motors, transformers, etc.

Standard Telephone and Cables Ltd., Semiconductor Division, Footscray, Sidcup, Kent.

For further information circle 53 on Service Card

Precision Counting at a Glance. Complete details are given in this 48-page catalogue of the current range of 'Albion' mechanical and electromechanical counting devices. These vary from simple hand-held ratchet counters, through electromagnetic counters of all kinds to others attached to wheels for length measurement.

B. F. Carter & Co. Ltd., Albion Works, Bolton, Lancs.

For further information circle 54 on Service Card

Ferranti Argus Direct Digital Control. This 26-page booklet deals with Argus digital computer control systems for the automatic control of continuous or batch processes. Ten diagrams show some circuit design features and control panel layout. A comparison table of the Argus 100 and 300 is included.

Ferranti Ltd., Automation Systems Division, Simonsway, Wythenshawe, Manchester 22.

For further information circle 55 on Service Card

Multi-Port Rotary Switch Valves for Gases and Liquids. This 8-page catalogue, SV/1, gives full details of an extensive range of multi-port multi-bank valves for fluid systems (air, gases, liquids, vapours) using metal or plastic tubing up to $\frac{1}{2}$ in. o.d. These are also available with integral rotary switch for simultaneous control of electrical and fluid circuits.

Drallim Industries Ltd., Bourne Works, Station Approach, Whyteleafe, Surrey.

For further information circle 56 on Service Card

LDEP 'Stardrive' Adjustable Speed Drives. This 20-page brochure describes and illustrates a range of adjustable speed drives for driving industrial plant. All standard units provide for speed setting over a 20 : 1 range from no-load to full-load conditions. Stardrives are available with ratings from $\frac{1}{4}$ to 150 h.p.

Lancashire Dynamo Electronic Products Ltd., Rugeley, Staffs.

For further information circle 57 on Service Card

Queue Users Arrival Recording Techniques. A range of data analysers, 488 series, is described in this 8-page publication. Each analyser is based on a number of electromagnetic counters with digital display and facilities for feeding numbers into each counter.

English Numbering Machines Ltd., Queensway, Enfield, Middlesex.

For further information circle 58 on Service Card

Extended range of EEV Ignitrons now available with coaxial construction

STAND No. 164
RECMF SHOW OLYMPIA

All Ignitrons with the International size letters A to D in the range manufactured by **English Electric Valve Company Limited** at Lincoln, can now be supplied in co-axial construction form. This range, already established as the

most comprehensive in Europe, is now extended to incorporate those Ignitrons previously available from The English Electric Company at Stafford: these will continue to be available under their original type numbers. (AR10T, AR14T and AR31).

INTERNATIONAL SIZE LETTER	EEV TYPE NO.	AMERICAN† EQUIVALENT	APPLICATION
A	BK66 (AR31)	5550	A.C. resistance welding
B	BK42 (AR14T) BK442 *	5551A 7669	
C	BK24 (AR10T) BK168 BK444*	5552A 5822A 7671	Three phase welding
D	BK146	5553B	
C	BK44	5554	Power rectification and control
D	BK46	5555	
A	BK416 BK428	7703 —	Capacitor discharge
D	BK178	—	
E	BK194	—	

† These equivalent type numbers are usually prefixed with the identifying code letters of the manufacturer concerned.

* Co-axial construction.



Full information on the complete range of Ignitrons available from EEV may be obtained from the address at the foot of the page. Enquiries from Government departments and overseas customers should be directed to the Sales Department, Chelmsford, Essex, England, Telephone: Chelmsford 3491 (Ext. 262) Telex: 99103, Telegrams: Enelectico, Chelmsford.

ENGLISH ELECTRIC VALVE COMPANY LIMITED

CARHOLME ROAD, LINCOLN, ENGLAND. Telephone: Lincoln 26352

Telex: 56114, Telegrams: Enelectico, Lincoln | AGENTS THROUGHOUT THE WORLD

EEV

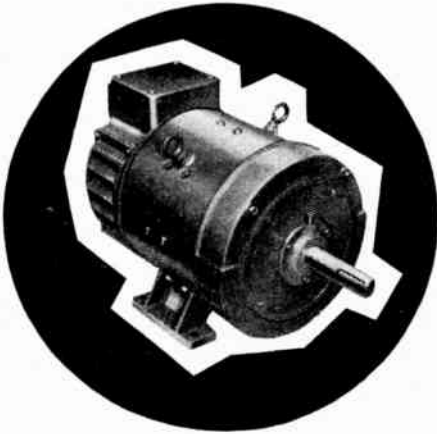

'X' type D.C. motors, $\frac{1}{4}$ - 40 h.p.

You can't say **DEPENDABLE**
without **EPE**

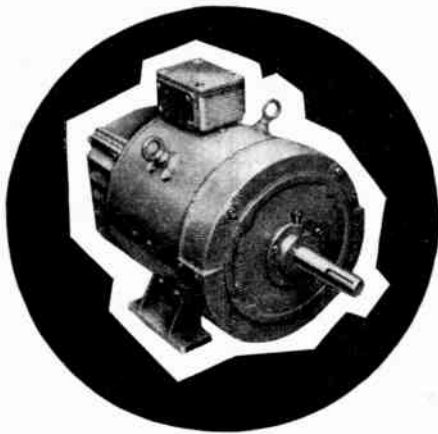

'Y' type D.C. motors, $\frac{1}{4}$ - 40 h.p.

D.C. Motors for electronic speed control



THE ELECTRICAL POWER ENGINEERING CO. (B'HAM) LTD.
EPE WORKS, BROMFORD LANE, BIRMINGHAM 8
Telephone: STEchford 2261
Grams: Torque Phone, Birmingham

MICRO-MINIATURE ELAPSED TIME AND EVENTS INDICATORS

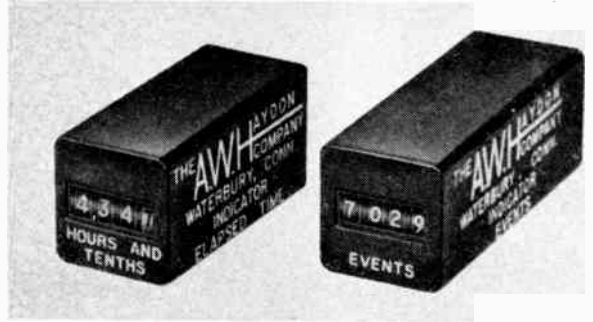

THE **A.W.H.** AYDON COMPANY elapsed time and events indicators are particularly intended for the aircraft and missile industry because of their small size and weight, ruggedness and wide operating temperature range.

	Elapsed Time Indicator		Events Indicator
Series	19200	19200 D	19500
Voltage	115v, 400cps	23-29v. D.C.	115v, 400cps or 23-29v. D.C.
Power Input	0.5W. max.	0.5W. max.	1.5W. max.
Weight	$\frac{3}{4}$ oz.	$\frac{3}{4}$ oz.	$\frac{3}{4}$ oz.
Size	$\frac{1}{2}$ " x $\frac{1}{2}$ " x $1\frac{1}{16}$ "		$\frac{1}{2}$ " x $\frac{1}{2}$ " x $1\frac{5}{16}$ "
High Temperature	85°C or 125°C		
Low Temperature	-54°C or -65°C		
Shock	200G, 2.5 m.secs.		
Vibration	20G, 10-2000 cps		
Acceleration	50G		10G

WALMORE ELECTRONICS LTD

11-15 BETTERTON ST., DRURY LANE, LONDON, WC2 Tel: TEMple Bar 0201-5



MUREX

THE LEADING MANUFACTURERS OF SINTERED PERMANENT MAGNETS

Murex specialise in the manufacture of permanent magnets by the powder metallurgy technique and a standard range of over 550 different types is available. Murex sintered permanent magnets are particularly suitable for applications requiring magnets of small size and complex shape to close limits. Moreover, their excellent magnetic properties and stability are consistently maintained in mass production quantities. Murex technical personnel are always available to assist in design problems relating to permanent magnets and full details of the Murex range of magnets are available upon request.

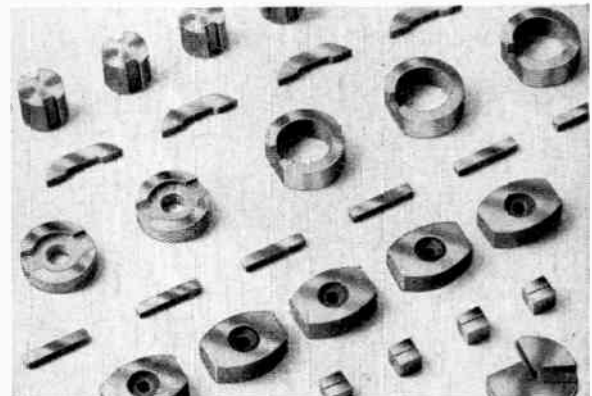

★ *High Quality* ★ *Intricate Shapes* ★ *Closely Controlled Tolerances*
★ *Consistent Flux Densities* ★ *High Performance* ★ *Uniformity of Size*

M33

MUREX LTD · RAINHAM · ESSEX
(Powder Metallurgy Division)

Telephone: Rainham, Essex 53322 Telex 28632
Telegrams: Murex, Rainham-Dagenham Telex

PHOTO CHOPPER AMPLIFIERS by Fenlow

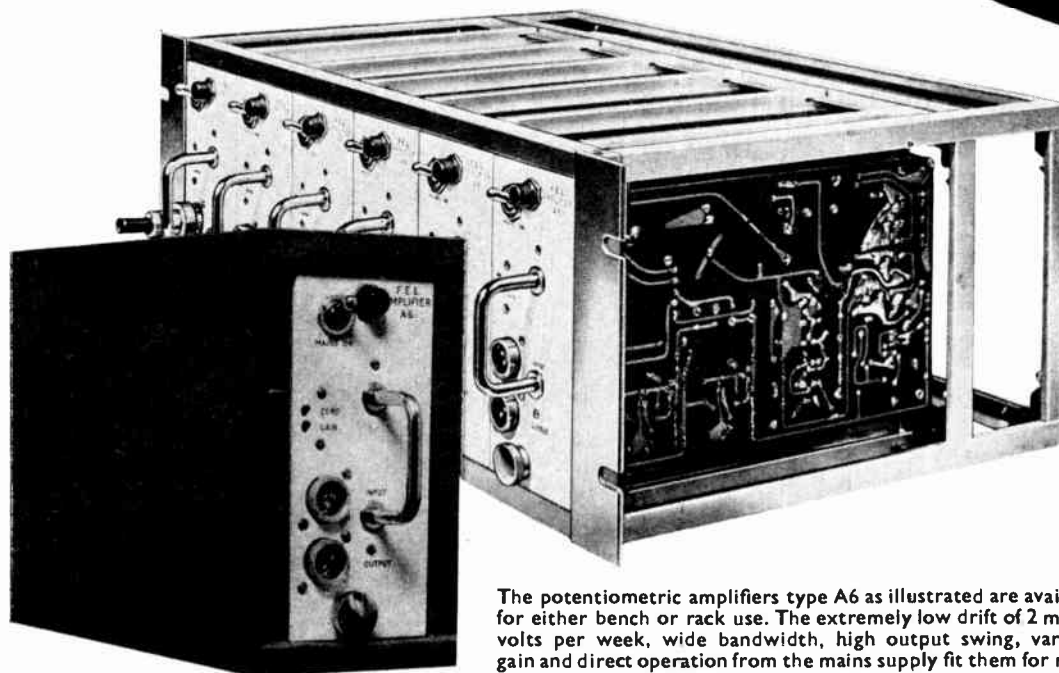

The potentiometric amplifiers type A6 as illustrated are available for either bench or rack use. The extremely low drift of 2 microvolts per week, wide bandwidth, high output swing, variable gain and direct operation from the mains supply fit them for many applications.

FENLOW ELECTRONICS LTD. Springfield Lane Weybridge Surrey
Tel. Wey. 43978

c o n t i n u o u s



indication of DENSITY

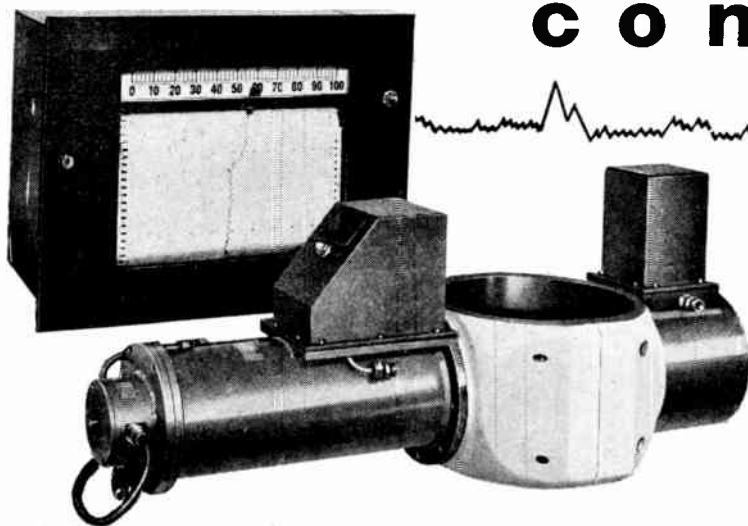

The Density Gauge Type 336 is designed for accurate continuous indication of density or solids content of liquids, slurries and certain solids in industrial process lines. Considerable economy can be obtained by accurate control of material density during plant start-up and running. Automatic control of dilution, evaporation, bleeding, etc., releases skilled staff from routine testing. The great advantage of this type of gauge is that the small source minimises radiation risks and the instrument automatically standardises itself, eliminating all manual control.

No contact is made with the material to be measured, and readings are preserved on a recorder chart. Installation is extremely simple, the gauge need only be clamped around the pipe through which the material is passing, and once calibrated there is nothing more to do, except switch on. Readings are direct, automatic, and continuous. Gauges are available to fit pipe lines from 2" to 24" in diameter, the optimum size being 10 ins.

Prices range from £800
Write for full technical details

SAUNDERS-ROE & NUCLEAR ENTERPRISES LTD. OWNED BY NUCLEAR ENTERPRISES (G.B.) LTD. AND WESTLAND AIRCRAFT LIMITED
NORTH HYDE ROAD, HAYES, MIDDLESEX Phone: Hayes 3800

Our products also include :- Sulphur Plant Monitors, Laboratory Sulphur Meters and Betalights (illumination without power)

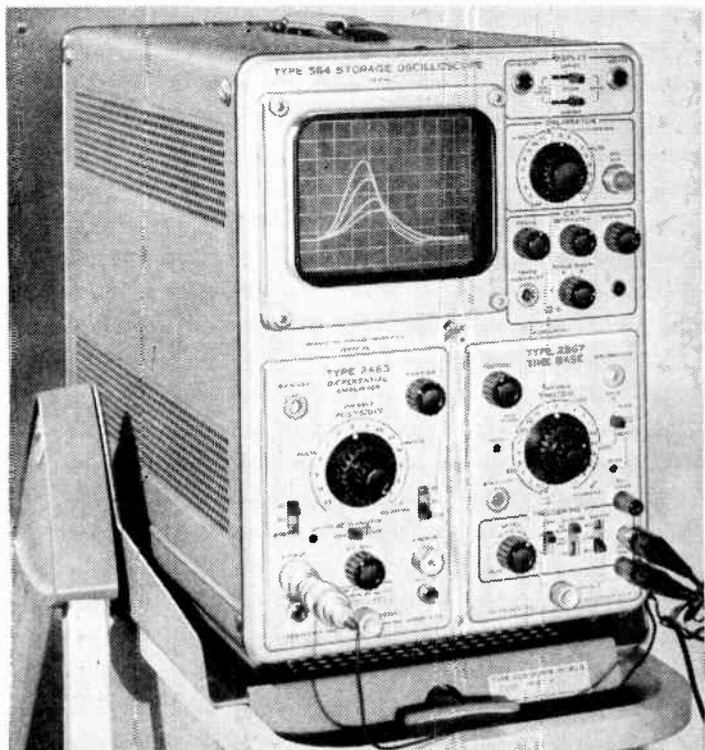

Storage and general purpose facilities are combined in the **TEKTRONIX** **564**

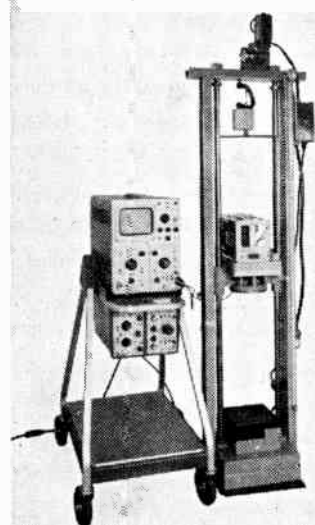
The Type 564 in a typical mechanical measurement. Waveforms on screen represent shock imparted on the device under test when dropped from successively increasing heights. Trace is calibrated vertically at 8.6 g/cm and horizontally at 2 msec/cm. Storage facility permits easy analysis of shock data without need for multiple exposure photography.

... As a Storage Oscilloscope

Single traces at low and medium speeds are stored for at least one hour, and erased in $\frac{1}{2}$ second. A unique split screen permits storage or conventional operation over the whole screen, or storage on either half with conventional operation on the other half.

... As a general-purpose Oscilloscope

When you don't need stored displays, the Type 564 operates for you as a conventional oscilloscope, with all the versatility afforded by interchangeable vertical-deflection amplifiers and time-base generators.

Amplifier Plug-In Units Offer:

DC to 1 Mc/s at 50 mv/cm — Type 2A60	£45.0.0.
DC to 300 kc/s at 1 mv/cm — differential input — Type 2A63	£62.0.0.
DC to 4 Mc/s at 50 mv/cm — Type 3A75	£74.0.0.
Dual-Trace, DC to 650 kc/s at 10 mv/cm — Type 3A72	£116.0.0.
0.06 cps to 300 kc/s at 10 μ v/cm — differential input — Type 2A61	£163.0.0.
DC to 5 kc/s at 10 μ strain/cm — carrier amplifier — Type 3C66	£168.0.0.
Dual-Trace, DC to 10 Mc/s at 10 mv/cm — Type 3A1	£183.0.0.
Four Trace, DC to 2 Mc/s at 20 mv/cm — Type 3A74	£246.0.0.
0.4-nsec risetime at 2 mv/cm, sampling — Type 3S76	£459.0.0.
0.35-nsec risetime at 5 mv/cm, sampling with 100k Ω 2 pf input — Type 3S3	£623.0.0.

Time-Base Plug-In Units Offer:

1 μ sec/cm to 5 sec/cm, 5x magnifier, single sweep — Type 2B67	£88.0.0.
Same as Type 3B3 (below) except delay not continuously calibrated and no single sweep — Type 3B1	£222.0.0.
Normal and Delayed Sweeps, 0.5 μ sec/cm to 1 sec/cm, calibrated delay from 0.5 μ sec to 10 sec, single sweep — Type 3B3	£238.0.0.
0.2-nsec/cm to 10 μ sec/cm equivalent, for sampling — Type 3T77	£272.0.0.
Type 564 (without plug-in units)	£403.0.0.

Rack Mount Model also available

Prices shown are free of duty, subject to Treasury direction.

Tektronix U.K. Ltd. Beaverton House · Station Approach · Harpenden · Herts
 Telephone: Harpenden 61251 · Telex: 25559

For overseas enquiries:—

TEKTRONIX Ltd, Albany House, St. Peter Port, Guernsey, C.I. · TEKTRONIX CANADA Ltd, Montreal, Quebec & Toronto (Willowdale), Ontario
 TEKTRONIX AUSTRALIA PTY. Ltd, P.O. Box 488, Sydney, New South Wales
 TEKTRONIX INTERNATIONAL A.G., P.O. Box 57, Zug, Switzerland · TEKTRONIX INC, P.O. Box 500, Beaverton, Oregon, USA

For further information circle 252 on Service Card

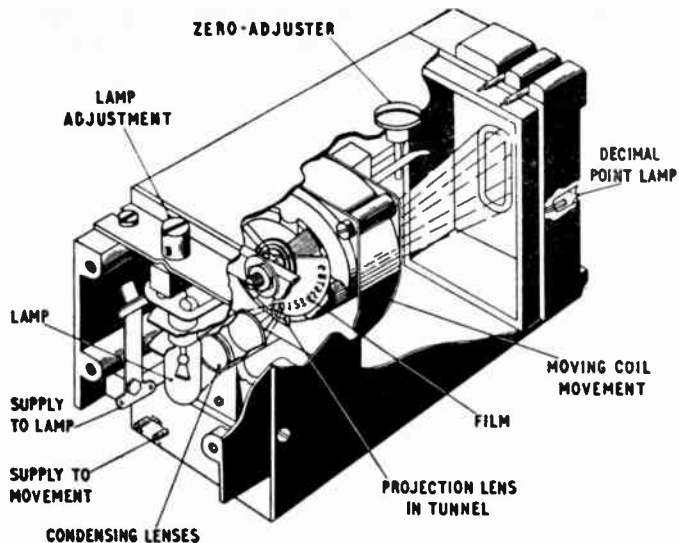

- One plane image.
- Single lamp.
- Bright readout with wide viewing angle, 160°.
- Decimal point in correct position.
- Economy in decoding from binary input.

The DIGIVISOR

The E.A.C. Digivisor is a ten position—one plane—in-line readout device that will display the digits 0-9 upon command and is the only device of its kind available with a brightness of 60 foot lamberts.

The Digivisor is capable of being used for analogue, decimal or binary inputs, and the Mark 2 pattern, illustrated here, projects a figure $\frac{7}{8}$ " high employing a robust high torque moving coil movement which carries a translucent scale through a simple optical system using a single commercial lamp.

Write for leaflet 409

THE ELECTRICAL APPARATUS COMPANY LTD



ST. ALBANS

For further information circle 253 on Service Card



$\frac{1}{8}$ " BSP

instrument valves by ...

HONE

- ★ TESTED AT 5,000 p.s.i.
- ★ POSITIVE SHUT-OFF
- ★ FINE CONTROL
- ★ IN STAINLESS STEEL, MONEL or BRASS
- ★ P.T.F.E. or METAL SEATS
- ★ STRAIGHT THROUGH or ANGLE CONNECTIONS

Write or telephone for full information to:—

HONE INSTRUMENTS LIMITED

19 Eldon Park, London, S.E.25 Tel.: ADDiscombe 3117 GD476

For further information circle 254 on Service Card

INEXPENSIVE & RELIABLE

Remember the name — EMI Shaded 2 Pole Motor Type Z. Consider the reliability — over 3,000 hours running without re-rolling — able to withstand continuous mechanical overload. Send for the Type Z data sheet.

- Gearing motor — approximate speeds 2,900 r.p.m. geared down to 16 r.p.m.
- Low resistance rotor with copper bars and end plates.
- Rotor has critically skewed bars for smooth running—dynamically balanced to special limits where required.
- Sizes approx. $2\frac{1}{2}$ " \times 3" \times $1\frac{1}{4}$ ".
- Weight 17 $\frac{1}{4}$ oz. (standard), 21 oz. (Long Bearing A Motor).
- Low mechanical noise — no electrical interference.

EMI SHADED 2 POLE AC MOTORS

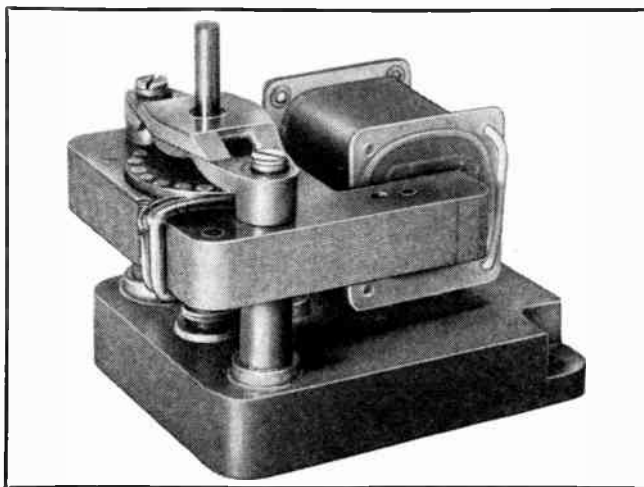

Full details from:—
EMI SOUND PRODUCTS LIMITED, COMPONENTS DIVISION, HAYES
MIDDLESEX. TEL.: HAYES 3888 • EXT. 2515

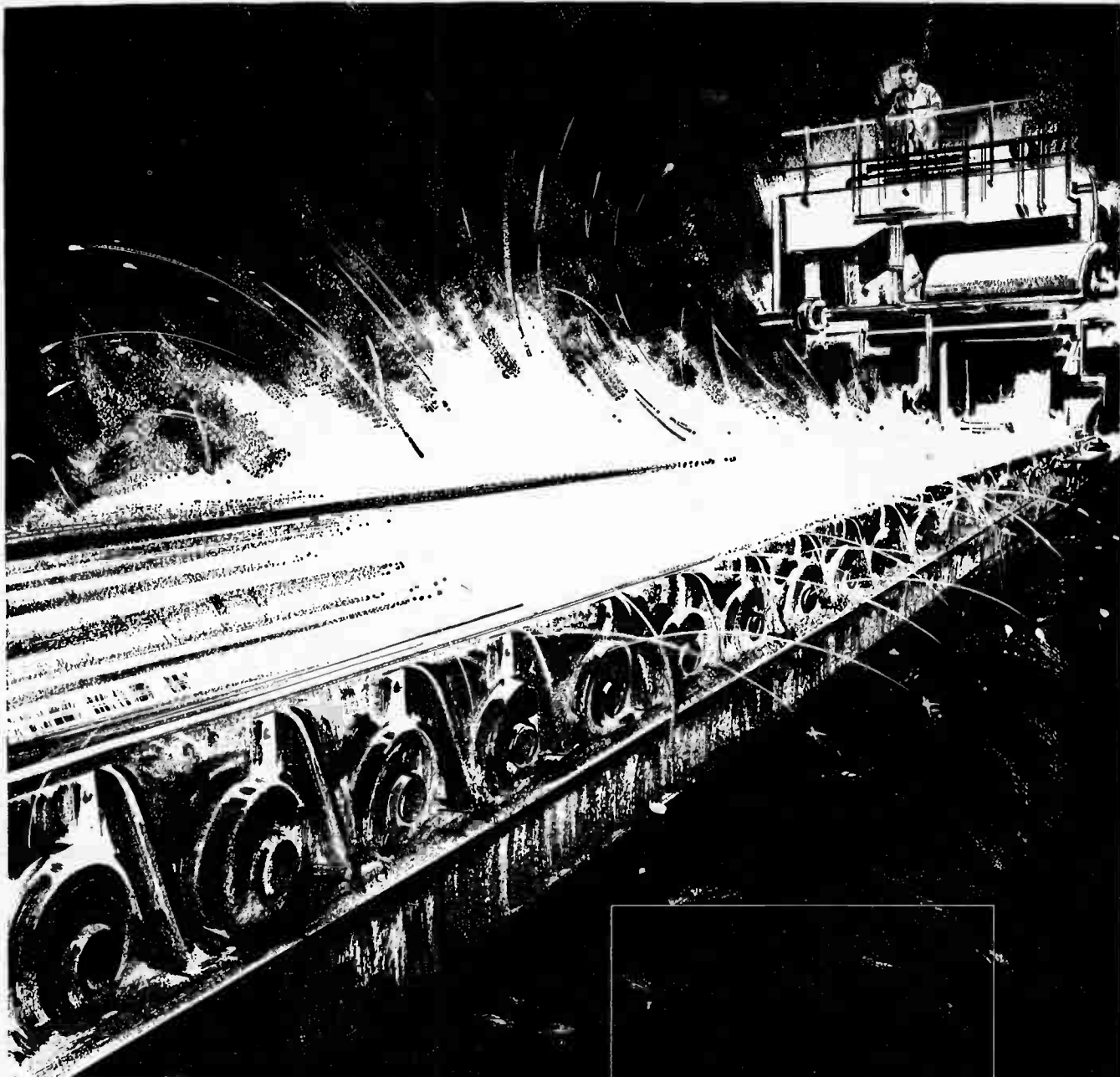

In one of the largest steel-rolling plants in Europe the problem of measuring thickness variations between 0.5% and 2% at strip speeds of 100 to 2,000 ft/min has been overcome. Normal thickness gauge accuracy of about 1% was inadequate. The problem was solved by the employment of Racal digital instrumentation. This equipment measures the ratio of the outgoing and incoming steel strip velocities and presents the thickness variation on a digital read-out to an accuracy of 0.1%. Provision is made in the system to compensate for differing diameters of the deflector rolls. Simultaneous analogue and digital recording of the information can be provided.



SA.501A
A FERRITE-CORE
COUNTER
DESIGNED FOR
THE INDUSTRIAL
ENVIRONMENT,
FOR PRECISION
SPEED AND
RATIO
MEASUREMENT.

STEEL IS WHERE RACAL COUNTS



RACAL INSTRUMENTS LIMITED, Dukes Ride, Crowthorne, Berks.
Telephone: Crowthorne 2272/3 and 3763
Grams/Cables: Bracknell Telex 84166

RI/A68

CLASSIFIED ADVERTISEMENTS

FULLY DISPLAYED : 55/- per single column inch.
SEMI-DISPLAYED : 45/- per single column inch.
RUN-ON : 4/6 per line of approximately 7 words.
Where an advertisement includes a Box Number 1s. extra.
SERIES DISCOUNTS : 12 insertions, 15%.
Remittances payable to "Industrial Electronics".

Copy is required by 23rd of the month for insertion in the following month's issue, by 17th of the month if proofs are required.

Address to:
Classified Advertisement Dept.
Industrial Electronics
Dorset House, Stamford St., London, S.E.1.

SITUATIONS VACANT

**YORKSHIRE
IMPERIAL**

YORKSHIRE IMPERIAL METALS LIMITED

have two vacancies in their

ELECTRICAL ENGINEERING DEPARTMENT

1. **Electronic Maintenance Supervisor**
2. **Electronic Maintenance Technician**

The work will involve the maintenance, calibration and installation of a wide variety of industrial electronic equipment.

Applicants must have a knowledge of solid state circuiting for the supervisory post. Some experience is also desirable in one or more of the following fields:

1. Non-destructive testing equipment
2. Machine Control
3. Communications

Consideration will also be given to men with experience of electronics in the Services.

The Company is the largest of its kind in Europe and offers attractive conditions of employment which include a Pension and Life Assurance Scheme and Profit Sharing Scheme.

Applications, giving details of age, experience, qualifications and present salary, should be marked "Reference 6168—Confidential" and addressed to:

**The Personnel Officer (Leeds),
YORKSHIRE IMPERIAL METALS LIMITED
P.O. BOX 166, LEEDS.**

[397]

FISONS PHARMACEUTICALS LIMITED

ELECTRONICS ENGINEER FOR BIOLOGICAL RESEARCH

An immediate vacancy exists in the Pharmacology Department of the Research Laboratories of Fisons Pharmaceuticals Limited, Holmes Chapel, Cheshire, for an Electronics Engineer. This is a senior appointment to a new post considered to be fundamental to the work of the department. The successful candidate will be responsible to the Chief Pharmacologist for designing and equipping a laboratory workshop and the design and construction of equipment to aid the search for new ethical medicines.

Applicants should have a professional qualification or equivalent practical experience in a similar post and be interested in applying electronic techniques to pharmacological research problems.

The Department is part of a vigorous and expanding research organisation based in a pleasant rural district.

The company is a member of the FISONS GROUP of Companies and Group Contributory Pension and other welfare schemes operate.

The Company works a five-day week and conditions of work are excellent. Three weeks' annual holiday.

Applications, which will be treated confidentially, should be sent to the Research Personnel Assistant, Fisons Pharmaceuticals Limited, Holmes Chapel, Cheshire.

[392]

SURREY EDUCATION COMMITTEE

Kingston College of Further Education
Kingston Hall Road, Kingston-upon-Thames

GRADE B ASSISTANT LECTURER in ELECTRICAL AND ELECTRONIC WORK required for 1st September, 1965, to teach light current subjects to Final Electrical Technicians standard. Wide experience in field of Industrial Electronics essential. A knowledge of electronic measurement techniques an advantage.

Salary £830-£1,450 p.a. plus London allowance of up to £60 p.a. Additions within the scale are allowed for graduate qualifications and/or approved training.

Full particulars and application form can be obtained from the Principal on receipt of a stamped addressed octavo size envelope. Application must be returned as soon as possible. Please quote reference 7/IE.

[386]

IMPERIAL CHEMICAL INDUSTRIES LIMITED
VACANCIES ON TEES-SIDE



INSTRUMENT MANAGERS

Heavy Organic Chemicals Division has vacancies at both Billingham and Wilton for Instrument Managers on its petroleum-chemical plants and for work in its Instrument Development Group. On a plant an Instrument Manager usually controls a team of craftsmen, is expected to be familiar with the principles and practice of control engineering and instrument technology and in due course will work with others on the application of "on-line" digital computers to chemical plants.

In the Development Group he would be concerned with one of three specialist fields of Instrument Engineering—either Control, "on-line" Process Analysis or Electronics. The group offers a specialist service to all Departments of the Division and develops advanced instruments to meet unusual process requirements. The basic qualification required is a good Degree in Physics, Electrical Engineering or Chemical Engineering. Previous similar experience would be an advantage though appropriate training will be given to suitable candidates. There are good career prospects and there is interchange of personnel between instrument jobs within the organisation including opportunities for advancement outside the instrument field. Pension Fund and Profit-sharing Schemes are in operation. Please write giving age and brief details of qualifications and experience to:—

Engineering Personnel Officer, Imperial Chemical Industries Limited, Heavy Organic Chemicals Division, Wilton Castle, Nr. Middlesbrough, Yorkshire.

Quoting Reference No. I.E. 784.

[394]

BABCOCK & WILCOX LTD

invite applications from

ELECTRONIC ENGINEERS **for** **COMPUTER MAINTENANCE**

The successful applicant will be responsible for the maintenance of the equipment in a large analogue computer centre. Education to HNC standard or considerable experience is required, and a knowledge of analogue computers is desirable. Opportunities for programming are available. Salary will be commensurate with qualifications and experience.

Detailed applications should be addressed to the

Assistant Secretary (Ref TBW/RJW)
Babcock & Wilcox Ltd.
209 Euston Road, London, N.W.1

[395]

A vacancy exists for the position of
EDITORIAL ASSISTANT

on the staff of *Industrial Electronics*. Applicants should be able to write clearly and have had some formal training in electronics together with some experience in the electronics industry. They should preferably be 25-30 years old. Applications should be addressed to the Editor.

**HYDRAULIC, ELECTRICAL,
 ELECTRONIC ENGINEER/WRITERS**

TECHNICAL AUTHORS

Required for permanent positions in our branch offices throughout England and Wales.

Apply to:—
 A. W. Publications Ltd.
 203 Blackfriars Rd.
 London, S.E.1

Some vacancies suitable for ex-service personnel with engineering experience and wishing to take up handbook writing. [396]

INDUSTRIAL STAFF LIMITED

offer you wide coverage of skilled labour to meet increased production requirements. I.S.L. service is complete, including wages, travelling expenses, P.A.Y.E., insurances, pension schemes and holidays. The simplest, most efficient method of meeting production peak problems. Ring MAL. 8728. [391]

EDUCATIONAL

A.M.I.E.R.E. (A.M.Brit.I.R.E.), City & Guilds, G.C.E., etc., bring high pay and security. 'NO PASS—NO FEE' terms. Over 95% successes. For details of Exams and courses in all branches of Electronics Engineering, etc., write for 148 page Handbook—FREE. B.I.E.T. (Dept. 192), 20, Wright's Lane, London, W.8. [380]

**PLEASE MENTION
 INDUSTRIAL ELECTRONICS
 WHEN REPLYING TO
 ADVERTISEMENTS**

CAPACITY AVAILABLE

AIRTRONICS LTD.

for coil winding assembly and wiring of electronic equipment, transistorised sub-units, sheet metal work. 4 Ashmead Road, London, S.E.8. Telephone: TIDeway 2249. [311]

DESIGN & PROTOTYPE CONSTRUCTION.—Somerset Electronics Ltd. Phone Shepton Mallet 2219. [387]

ARTICLES FOR SALE

PHOTO-ELECTRIC CONTROLS

for industry

Quick delivery Send for Catalogues

Hird-Brown Limited

Flash Street, Bolton, Lancs.

Tel. 27311 [305]

PATENTS

EXPLOITATION OF PATENTS

The Proprietors of British Patent Nos. 857,691, 859,431 and 859,432 relating to "Improvements in electrical weighing scales", "Improvements in electrical force measuring systems" and "Electrical weighing systems", desire commercial working of the patents in the United Kingdom by Licence or otherwise. Replies to Box I.E. 398.

BUSINESS OPPORTUNITIES

Electronic Engineer (capital available) seeks participation in or purchase of existing business. Box I.E. 399.

For further information circle 262 on Service Card

**CABLE STRAPPING AND
 BANDS BY METWAY PRODUCTS**

"STUDWAY" BLACK PVC STRAPPING
 2 widths—5/16" and 1/4"
 Cartons of 25 yard coils with studs

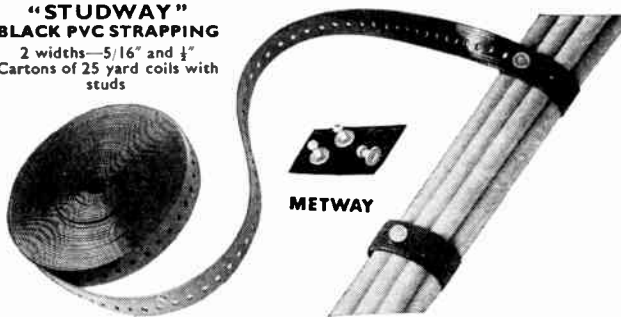

"NEATWAY" PLASTIC BANDS
 4 sizes—2 1/2, 5 1/2, 6 1/2, 7 1/2. Self Locking

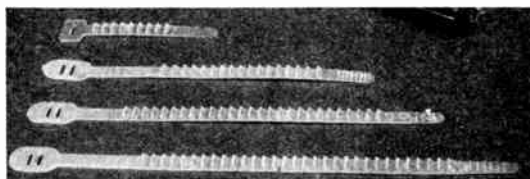

● FOR FULL DETAILS OF THESE AND OTHER PLASTIC CLIPS, SADDLES AND CLEATS—ASK FOR CAT. No. OHS/10/1E.

See us at R.E.C. Show, Olympia, May 18-21. Stand 471

METWAY • KEMP TOWN • BRIGHTON 7 • SUSSEX

For further information circle 263 on Service Card

**OXLEY PRINTED
 CIRCUIT SOCKETS**

The OXLEY printed circuit sockets are designed for direct mounting on .1" module printed circuit board with standard .050" minimum diameter holes, and accepts our standard plug Type 50P/156.

The mounting is arranged so that the plugs may be inserted in a plane parallel to the printed circuit board thus permitting close stacking of circuit boards.

Sockets can be supplied from 1 to 12 ways, colours can be in black, brown, red, orange, yellow, green, blue, violet, pink, grey and white

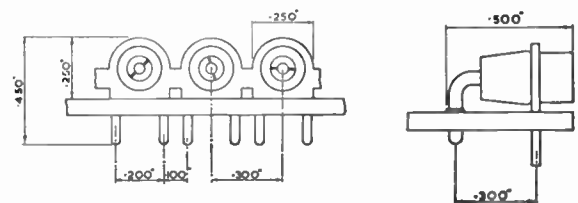
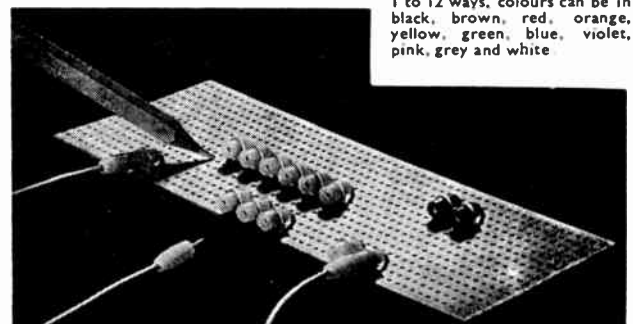

Write for technical details of these and other Oxley products

OXLEY DEVELOPMENTS CO. LTD.
 ULVERSTON, LANCASHIRE Tel: Ulverston 2567

For further information circle 264 on Service Card

HE KNOWS IT'S AS ACCURATE AT

AS IT IS AT

10 KILOCYCLES

10 CYCLES

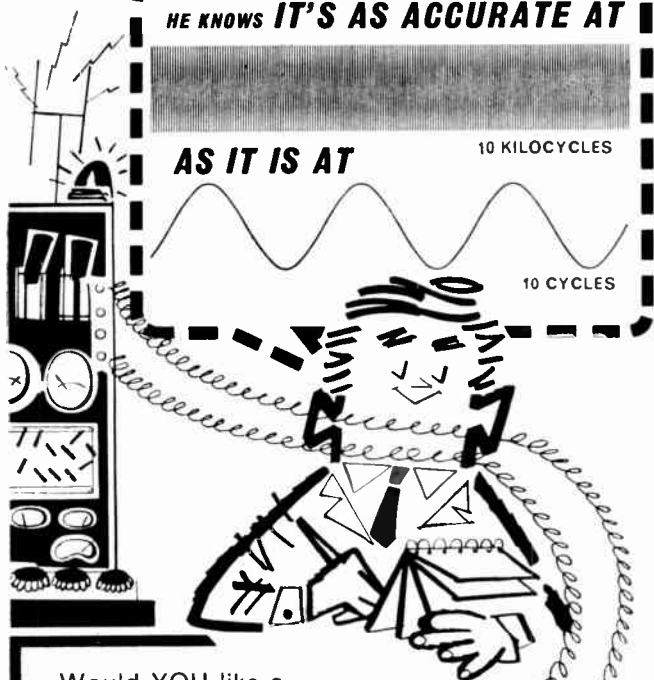

Would YOU like a multirange test set that is accurate over a wide frequency range?

THEN YOU NEED A SELECTEST

Ranges are selected by two multi-position wafer switches capable of continuous rotation in either direction without mechanical interlock. Colour codings are used for easy identification of the voltage, current and resistance ranges. There is a polarity reversing switch on the Super 50.

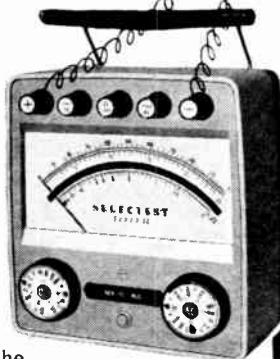

SUPER K	
39 self-contained ranges	0 to 5,000 ohms 0 to 1,500 volts A.C. & D.C. 0 to 15 amps A.C. & D.C.
External shunts and multirange transformer available to increase current ranges to 750 amps. D.C. and 300 amps. A.C.	
TRADE PRICE £17.16.0 (Leather case extra)	
SUPER 50	
32 self-contained ranges	0 to 20 megohms 0 to 2,500 volts A.C. & D.C. 0 to 10 amps A.C. & D.C.
External shunts and multirange transformer available to increase current ranges to 250 amps D.C. and A.C.	
TRADE PRICE £20.18.0 (Leather case extra)	

Automatic overload cut-out on both models. Accuracy complies with the latest British Standard Specification.

IMMEDIATE DELIVERY See our leaflet for full details.

SEI

THE SALFORD

S&C

selectest

SUPER K

SUPER 50

SALFORD ELECTRICAL INSTRUMENTS LTD
PEEL WORKS SILK STREET SALFORD 3 Tel: BLAckfriars 6688
London Sales Office: Brook Green Hammersmith W6. Tel: Riverside 5245
A Subsidiary of THE GENERAL ELECTRIC CO. LTD. OF ENGLAND

A.P.T. Electronic Instruments Ltd.	28	Landis & Gyr Ltd.	30
Ad Auriema Ltd.	36	Livingston Control Ltd.	19
Adcola Products Ltd.	31	McMurdo Instrument Co. Ltd.	30
Aircraft Marine Products (G.B.) Ltd.	13	Metway Electrical Industries Ltd.	48
Ampex Great Britain Ltd.	6	Multicore Solders Ltd.	15
Anglo-American Vulcanized Fibre Co. Ltd.	50	Murex Ltd.	39
Appointments Vacant	46, 47, 48		
		Oxley Developments Co. Ltd.	48
B & R Relays Ltd.	24		
Bell & Howell Ltd.	23, 45	Painton & Co. Ltd.	Cover iv
		Pergammon Press Ltd.	20
C.Z. Scientific Instruments Ltd.	32	Pleasley U.K. Ltd.	2
Cannon Electric (Great Britain) Ltd.	49		
Classified Advertisements	46, 47, 48	Racal Ltd.	43
Cossor Instruments Ltd.	26	Research & Engineering Controls Ltd.	45
Dawe Instruments Ltd.	8	S.E. Laboratories (Eng'g) Ltd.	34
Dexion Ltd.	12	Salford Electrical Instruments Ltd.	49
Digital Measurements Ltd.	3	Saunders-Roe & Nuclear Enterprises Ltd.	40
		Science Journal	48
E.M.I. Sound Products Ltd.	42	Selectro Ltd.	33
Electrical Apparatus Co. Ltd.	42	Sellotape Industrial Ltd.	4, 5
Electrical Power Engineering Co. (B'ham) Ltd.	38	Solartron Electronic Group Ltd.	7, 10, 18
Electrosil Ltd.	29	Standard Telephones & Cables Ltd.	16, 17
Elliott Bros. (London) Ltd.	35		
English Electric Valve Co. Ltd.	37	Tektronix U.K. Ltd.	41
Ericsson Telephones Ltd.	27	Telegraph Condenser Co. Ltd.	Cover iii
Ether Ltd.	21	Transmetrix Electronic Systems Ltd.	44
Fenlow Electronics Ltd.	40	V.G. Porcelain Co. Ltd.	20
		Venner Electronics Ltd.	22
Hersey-Sparling Meter Co. Ltd.	44	Vitality Bulbs Ltd.	44
Hone Instruments Ltd.	42		
Hughes International (U.K.) Ltd.	9	Walmore Electronics Ltd.	38
		Welwyn Electric Ltd.	1
Imhof Ltd.	25	Westinghouse Brake and Signal Co. Ltd.	11
Imperial Smelting Corpn. Ltd.	36	Winston Electronics Ltd.	3
International Printers	44		
International Rectifier Co. Ltd.	14		
Kent, George, Ltd.	Cover ii		

For further information circle 265 on Service Card

NUMBER ONE IN ELECTRICAL CONNECTORS...



DPDMA PLUGS

Standard rack/panel connectors featuring "Little Caesar" Rear-Release System and crimp, snap in contacts.

Visit us on STAND 233 at the R.E.C.M.F. EXHIBITION

CANNON ELECTRIC (GREAT BRITAIN) LTD.
25-27 Bickerton Road
Upper Holloway, London, N.19
Tel.: ARCHway_3088



INDEX TO ADVERTISERS

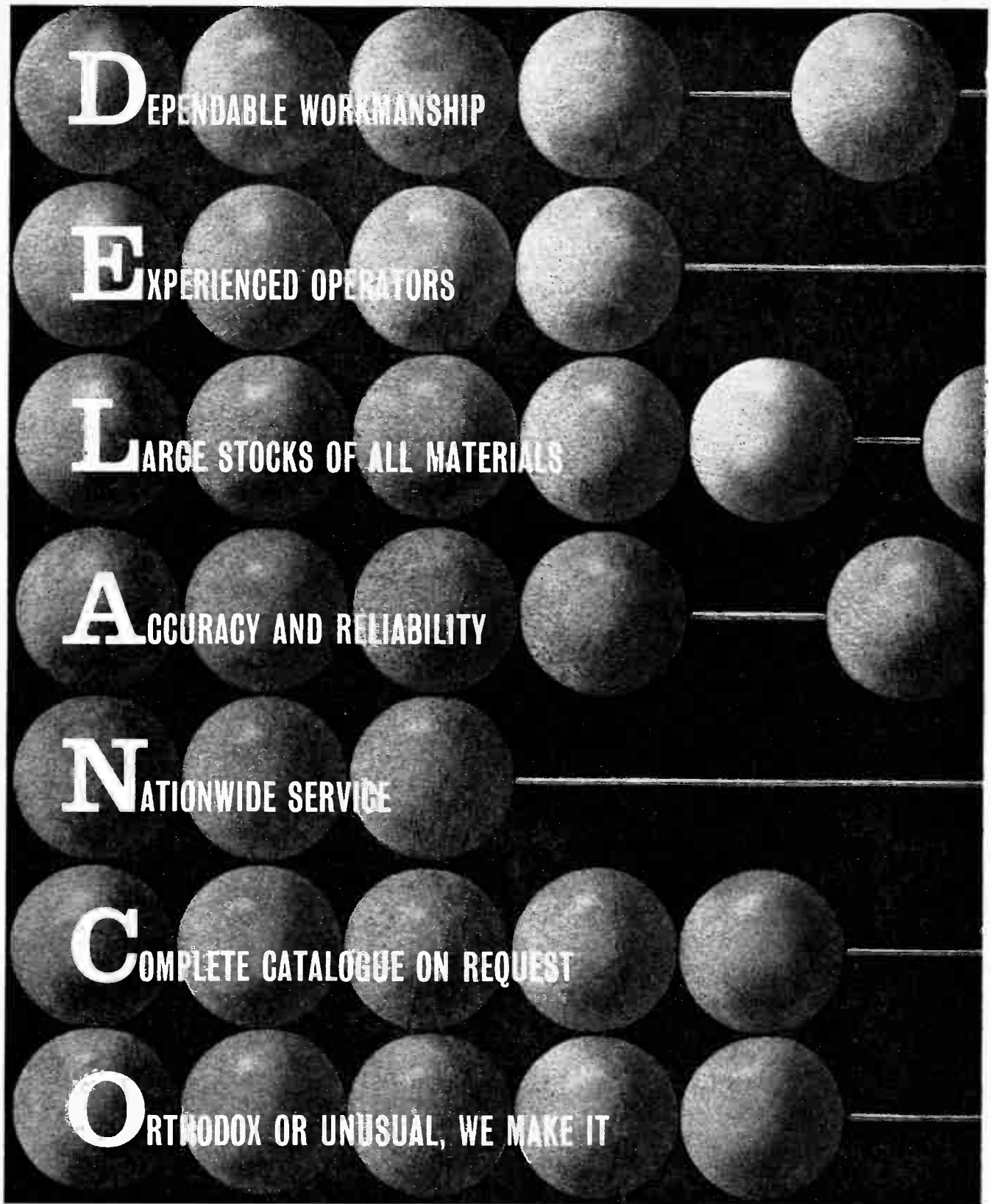

DEPENDABLE WORKMANSHIP

EXPERIENCED OPERATORS

LARGE STOCKS OF ALL MATERIALS

ACCURACY AND RELIABILITY

NATIONWIDE SERVICE

COMPLETE CATALOGUE ON REQUEST

ORTHODOX OR UNUSUAL, WE MAKE IT

VULCANIZED FIBRE · LEATHEROID · PRESSPAHN · COMPOSITE
INSULATION · SILICONE & EPOXY BONDED GLASS FIBRE
BAKELITE SHEET, TUBE & ROD · COPPER CLAD LAMINATES
MICA AND MICANITE · AND PRECISION MACHINED
AND PRESSED PARTS IN ALL INSULATION MATERIALS

ANGLO-AMERICAN VULCANIZED FIBRE COMPANY LTD, CAYTON WORKS, BATH STREET, LONDON, E.C.1. CLE: 8484 (15 LINES)

IT ALL ADDS UP TO
Delanco





Meetings

Institution of Electronic and Radio Engineers

All meetings will be held at 9 Bedford Square, London, W.C.1, and tickets will be required, unless otherwise stated.

12th Apr. 5.30 p.m. Joint I.E.E./I.E.R.E. meeting at Savoy Place. 'Solid Circuits in Computers'.

14th Apr. 6 p.m. at the London School of Hygiene and Tropical Medicine, Keppel Street, Gower Street, London, W.C.1. 'B.R.E.M.A. Colour Television Home Viewing Tests'. (This replaces the previously-announced meeting entitled 'Solid State Scanning Circuits'.)

21st Apr. 6 p.m. at the London School of Hygiene and Tropical Medicine, Keppel Street, Gower Street, London, W.C.1. 'Effect on the Ionosphere of Nuclear Explosions'.

28th Apr. 6 p.m. 'Synchronously Tuned Methods of Harmonic and Intermodulation Distortion Analysis'.

12th May, 6 p.m. Joint I.E.R.E./I.E.E. meeting at the London School of Hygiene and Tropical Medicine, Keppel Street, Gower Street, London, W.C.1. 'Random Access Mass Stores'.

19th May, 6 p.m. 'A Groove Control System for Phonograph Disc Cutting Equipments'.

Institution of Electrical Engineers

All meetings will be held at 5.30 p.m. at Savoy Place, London, W.C.2, unless otherwise stated.

12th Apr. Joint I.E.R.E./I.E.E. meeting at Savoy Place. 'Solid Circuits in Computers'.

14th Apr. 'Acoustics and Telephone Transmission—Examples of the Problems of Human Judgment'.

26th Apr. 'Standards and Converters'.

27th Apr. 'A Travelling Field Theory of Induction-Type Instruments and Motors'.

30th Apr. 'Equipment and the Results of Tests with the Nimbus Meteorological Satellite'.

4th May. 'Computers in the Petroleum Industry—Past, Present and Future'.

12th May, 6 p.m. at the London School of Hygiene and Tropical Medicine, Keppel Street, Gower Street, London, W.C.1. Joint I.E.R.E./I.E.E. meeting. 'Random Access Mass Stores'.

12th May. 'Television Recording'.

13th May. 'Effect of Weather on Performance of an 8 mm Radar'.

Institution of Mechanical Engineers

All meetings will be held at 6 p.m. at 1 Birdcage Walk, London, S.W.1, unless otherwise stated.

14th Apr. 'Investigation into the Failure of Gas Circulators and Circuit Components at Hinkley Point Nuclear Power Station'.

26th Apr. Discussion on 'Boiler Design and Materials for Gas-Cooled Nuclear Reactors'.

29th Apr. 6.30 p.m. 'Process Control' (Graduates and Students Section).

30th Apr. 'Automation in an Engine Laboratory'.

Society of Electronic and Radio Technicians

33 Bedford Street, London, W.C.2 ('Phone: Covent Garden 1152).

29th Apr. 7.15 p.m. at London School of Hygiene and Tropical Medicine, Keppel Street, Gower Street, London, W.C.1. 'Some Problems of Computer Maintenance'.

Conferences, Symposia and Colloquia

22nd Apr. One-day symposium on 'Direct Digital Control'. Held at Northampton College of Advanced Technology, London. Organized by The Society of Instrument Technology, 20 Peel Street, London, W.8 ('Phone: Park 3755).

27th–28th Apr. Seminar on 'Critical Path Method'. Held by Production Engineering Research Association (PERA) at their headquarters at Melton Mowbray, Leicestershire ('Phone: Melton Mowbray 4133).

11th–13th May. Conference on 'Financial Management and Post Control'. Organized by the Production Engineering Research Association of Great Britain (PERA) and held at their headquarters at Melton Mowbray, Leicestershire ('Phone: Melton Mowbray 4133).

12th–14th May. Convention on 'Steam Plant Availability'. Held at Intercontinental Hotel, Pembroke Road, Ballsbridge, Dublin, Eire. Organized by The Institution of Mechanical Engineers.

13th–14th May. Conference on 'New Materials and Processes in Instrument Manufacture'. Held by British Scientific Instrument Research Association at Grand Hotel, Eastbourne. Applications for registrations to: SIRA, South Hill, Chislehurst, Kent ('Phone: Imperial 5555).

17th–18th May. Symposium on 'Acoustics in Engineering and Architecture'. Organized by and held at College of Technology, Broadway, Letchworth, Herts. ('Phone: Letchworth 3911).

17th–20th May at the I.E.E., Savoy Place, London, W.C.2. Joint I.E.E./I.E.R.E. international conference on 'Components and Materials used in Electronic Engineering'. Registration forms and further information from I.E.R.E., 9 Bedford Square, London, W.C.1.

18th–20th May. Conference on 'Design Engineering and Management'. Organized by the Production Engineering Research Association of Great Britain (PERA) and held at their headquarters at Melton Mowbray, Leicestershire ('Phone: Melton Mowbray 4133).

15th–18th June. Conference (in conjunction with exhibition) on 'Metal Heat Treatment'. Held at Bingley Hall, Birmingham. Sponsored by "Industrial & Process Heating", 103 Waterloo Road, London, S.E.1 ('Phone: Waterloo 3388).

30th June–2nd July at University College, London. Joint I.E.R.E./I.E.E. symposium on 'Microwave Applications of Semiconductors'. Papers and requests for further information should be sent to The Secretary, Joint Organizing Committee, Symposium on Microwave Applications of Semiconductors, The Institution of Electronic and Radio Engineers, 8-9 Bedford Square, London, W.C.1.



WHAT'S ON AND WHERE

Continued

5th-6th July. Conference on 'Low Level Radioactivity Measurements—Limitations and New Techniques'. Held at The Imperial College of Science and Technology, London, by The Institute of Physics and The Physical Society. Applications for tickets to: I.P.P.S., 47 Belgrave Square, London, S.W.1 ('Phone: Belgravia 6111).

13th-18th Sept. Engineering Materials and Design Conference. Held in conjunction with an exhibition at Olympia, London. Organized by Industrial & Trade Fairs Ltd., Commonwealth House, 1-19 New Oxford Street, London, W.C.1 ('Phone: Chancery 9011).

21st-24th Sept. First European Conference on Magnetism, Vienna. To be held at Technischen Hochschule, Vienna. Conference Secretariat: Verein Deutscher Eisenhüttenleute, 4 Dusseldorf, Breite Strasse 27.

Exhibitions

8th-13th Apr. Paris
Salon International des Composants Electroniques in Paris. Organized by Fédération Nationale des Industries Electroniques (FNIE), 16 rue de Presles, Paris, 15e ('Phone: 273-24-70).

21st-30th Apr. London
International Engineering Exhibition, London (Earls Court and Olympia). Organized by F. W. Bridges & Sons Ltd., Commonwealth House, 1-19 New Oxford Street, London, W.C.1 ('Phone: Chancery 9011).

24th Apr.-2nd May. Hanover
Hanover Fair. U.K. representatives Schenkers Ltd., Royal London House, 13 Finsbury Square, London, E.C.3 ('Phone: Metropolitan 9711).

13th-19th May. London
International Photo-Cine Fair, Olympia, London. Arranged by British Organisers Ltd., 52 Grafton Way, London, W.1 ('Phone: Euston 7930).

17th-21st May. London
8th International Instrument Show, Grosvenor House, Park Lane, London, W.1. Held by B & K Laboratories Ltd., 4 Tilney Street, London, W.1 ('Phone: Grosvenor 4567).

17th-22nd May. Birmingham
Business Efficiency Exhibition, Birmingham (Bingley Hall). Organized by the Business Equipment Trade Association, 64 Cannon Street, London, E.C.4 ('Phone: Central 7771).

18th-21st May. London
Radio and Electronic Component Show at Olympia, London. Organized by Industrial Exhibitions Ltd., 9 Argyll Street, London, W.1 ('Phone: Gerrard 1622).

19th-25th May. Amsterdam
Electronic Exhibition, Amsterdam. Organized by Elvabé, Molenallee 63A, Wilp, Gld., Netherlands.

19th-27th May. London
Pakex 65—International Packaging Exhibition, Earls Court, London. Organized by Industrial & Trade Fairs Ltd. and F. W. Bridges & Sons Ltd., Commonwealth House, 1-19 New Oxford Street, London, W.C.1 (Chancery 9011).

25th-27th May. Dundee
'Electronics in Action' Exhibition, Marryat Hall, City Chambers, Dundee. Organized by the Scottish Section of the I.E.E. and I.E.R.E. from Electrical Engineering Dept., Queens College, Dundee ('Phone: ODU2 23181).

15th-18th June. Birmingham
Industrial Process Heating Exhibition (concurrently with con-

ference). Held at Bingley Hall, Birmingham. Organized by Business Publications, 103 Waterloo Road, London, S.E.1 ('Phone: Waterloo 3388).

15th-19th June. London
1st Pumping Exhibition, Earls Court, London. Organized by Iliffe Exhibitions Ltd., Dorset House, Stamford Street, London, S.E.1 ('Phone: Waterloo 3333).

15th-19th June. London
NAVREX—Noise and Vibration Reduction Exhibition, Earls Court, London. Organized by Iliffe Exhibitions Ltd., Dorset House, Stamford Street, London, S.E.1 ('Phone: Waterloo 3333).

16th-26th June. London
Interplas 65—The International Plastics Exhibition in Europe for 1965, Olympia, London. Organized by Iliffe Exhibitions Ltd., Dorset House, Stamford Street, London, S.E.1 ('Phone: Waterloo 3333).

25th Aug.-4th Sept. London
Radio Show, Earls Court, London. Organized by Industrial & Trade Fairs Ltd., Commonwealth House, 1-19 New Oxford Street, London, W.C.1 ('Phone: Chancery 9011).

7th-11th Sept. Basle
INEL 65 International Exhibition of Industrial Electronics, Basle, Switzerland. 61 Clarastrasse, 4000 Basle ('Phone: Basle (061) 323850).

9th-19th Sept. Paris
Salon International de la Radio et de la Télévision, Paris.

13th-18th Sept. London
Engineering Materials and Design Exhibition. Held in conjunction with a conference at Olympia, London. Organized by Industrial & Trade Fairs Ltd., Commonwealth House, 1-19 New Oxford Street, London, W.C.1 ('Phone: Chancery 9011).

14th-22nd Sept. Utrecht
HET Instrument 1965 Exhibition, Royal Dutch Industries Fair, Utrecht. Further details from: Cooperative Vereniging, 'HET Instrument' u.a., Sparrenlaan 2, Soest, Holland ('Phone: Soest (02955) 3047).

28th Sept.-1st Oct. Brighton
Medical Electronic and Instrumentation Exhibition (in conjunction with The European Symposium on Medical Electronics) at Exhibition Hall, Brighton, Sussex. Organized by Events Promotions Ltd., Ashbourne House, Alberon Gardens, London, N.W.11 ('Phone: Meadway 5555).

4th-13th Oct. London
Business Efficiency Exhibition, London (Olympia). Organized by Business Equipment Trade Association, 64 Cannon Street, London, E.C.4 ('Phone: Central 7771).

13th-19th Oct. Dusseldorf
3rd International Congress and Exhibition of Measuring Instrumentation and Automation (Interkama), Dusseldorf, Germany. Represented by John E. Buck (Trade Fair Agencies) Ltd., 47 Brewer Street, Piccadilly, London, W.1 ('Phone: Gerrard 7576).

27th-30th Oct. London
R.S.G.B. Radio Communications Show, Seymour Hall, London. Organized by P. A. Thorogood, 35 Gibbs Green, Edgware, Middlesex.

Courses

20th-23rd July. 'Valve Analysis'. I.Prod.E. Summer School 1965 at Loughborough College of Technology. Further details from: The Institution of Production Engineers, 10 Chesterfield Street, London, W.1 ('Phone: Grosvenor 5254).

Two-week Tektronix Instrument Courses. Three separate courses repeated at intervals of approximately one month. Held at Guernsey. Full details from Tektronix U.K. Ltd., Beaverton House, Station Approach, Harpenden, Herts. ('Phone: Harpenden 61251).

'Machine Tool Automation'. Four-week courses held by The Department of Production and Industrial Administration, The College of Aeronautics, Cranfield, Bedford ('Phone: Cranfield 321).

REGARDEZ!

There will be many
arresting things in **Paris**
between the 8th and 13th April



in
particular

the very latest developments
in capacitor design which can be seen
on **T.C.C. Stand No. 161 Allée 14**
at the

SALON INTERNATIONAL DES COMPOSANTS ELECTRONIQUES

tres bon! tres magnifique! les plus merveilleux!

THE TELEGRAPH CONDENSER COMPANY LTD

North Acton · London · W.3 · Telephone: ACO rn 0061 · Telex 261383

also at CHESSINGTON · SURREY and BATHGATE · SCOTLAND

For further information circle 202 on Service Card

PAINTON RELIABILITY

at the right price for these

FIVE NEW CONNECTORS

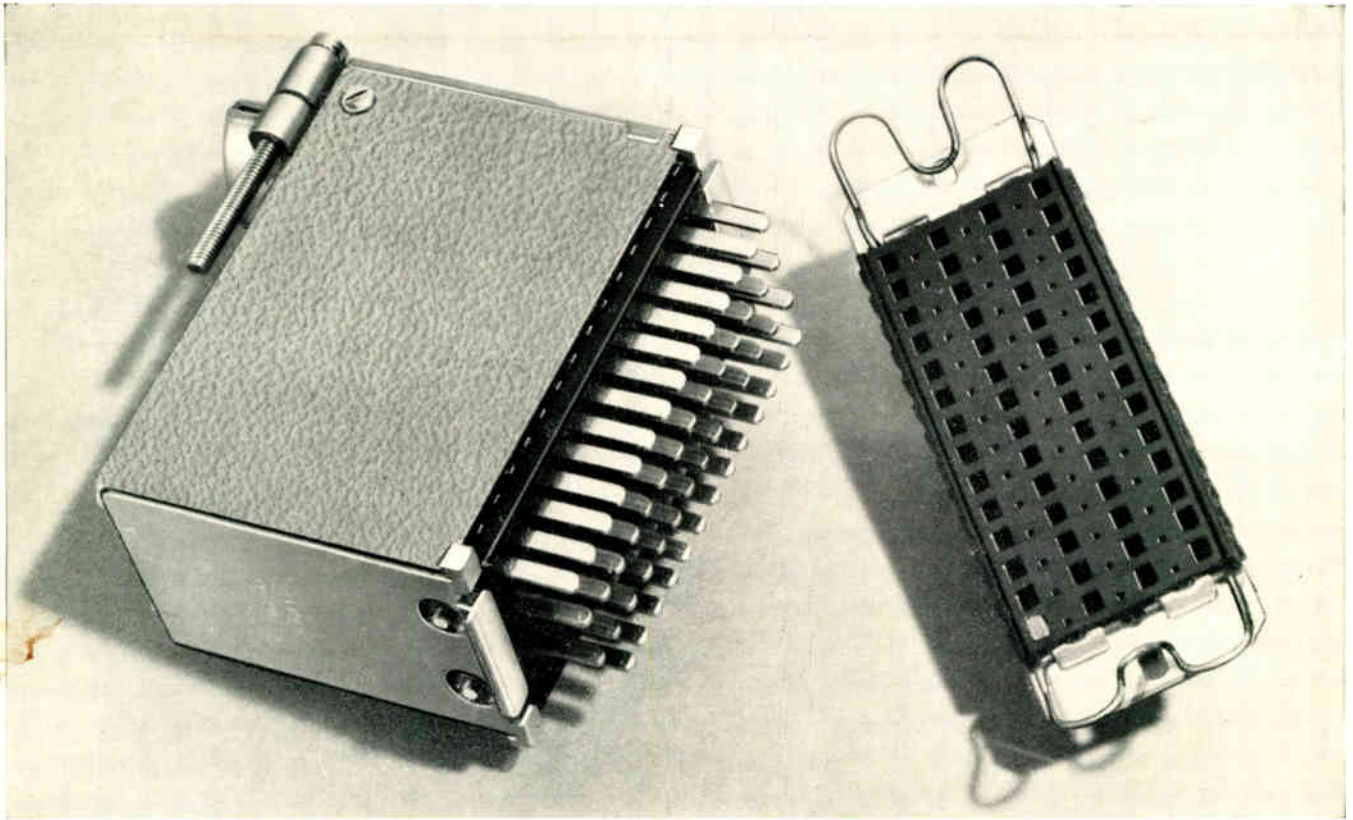
**35** WAY**47** WAY***55** WAY**59** WAY**71** WAY

These new additions to the Painton **159 Series** Connectors embody the space-saving configuration and high standards of reliability already well established for this range of components, and are offered at sensible prices. Send for leaflet P.S. 12

* This type specially developed for the G.P.O. & approved by them as PO203.

Painton
& CO LIMITED

KINGSTHORPE · NORTHAMPTON

Tel: 34251 (10 lines) · Grams: "Ceil" Northampton · Telex 31576

Overseas Associated Companies **Australia** Painton Australia Pty. Ltd. · **Benelux** Painton S.A. · **Germany** Painton G.m.b.H. · **Italy** Painton Italiana · **Sweden** Svenska Painton A.B. · **U.S.A.** Painton Inc.