

INDUSTRIAL ELECTRONICS

JANUARY 1964 5s 0d

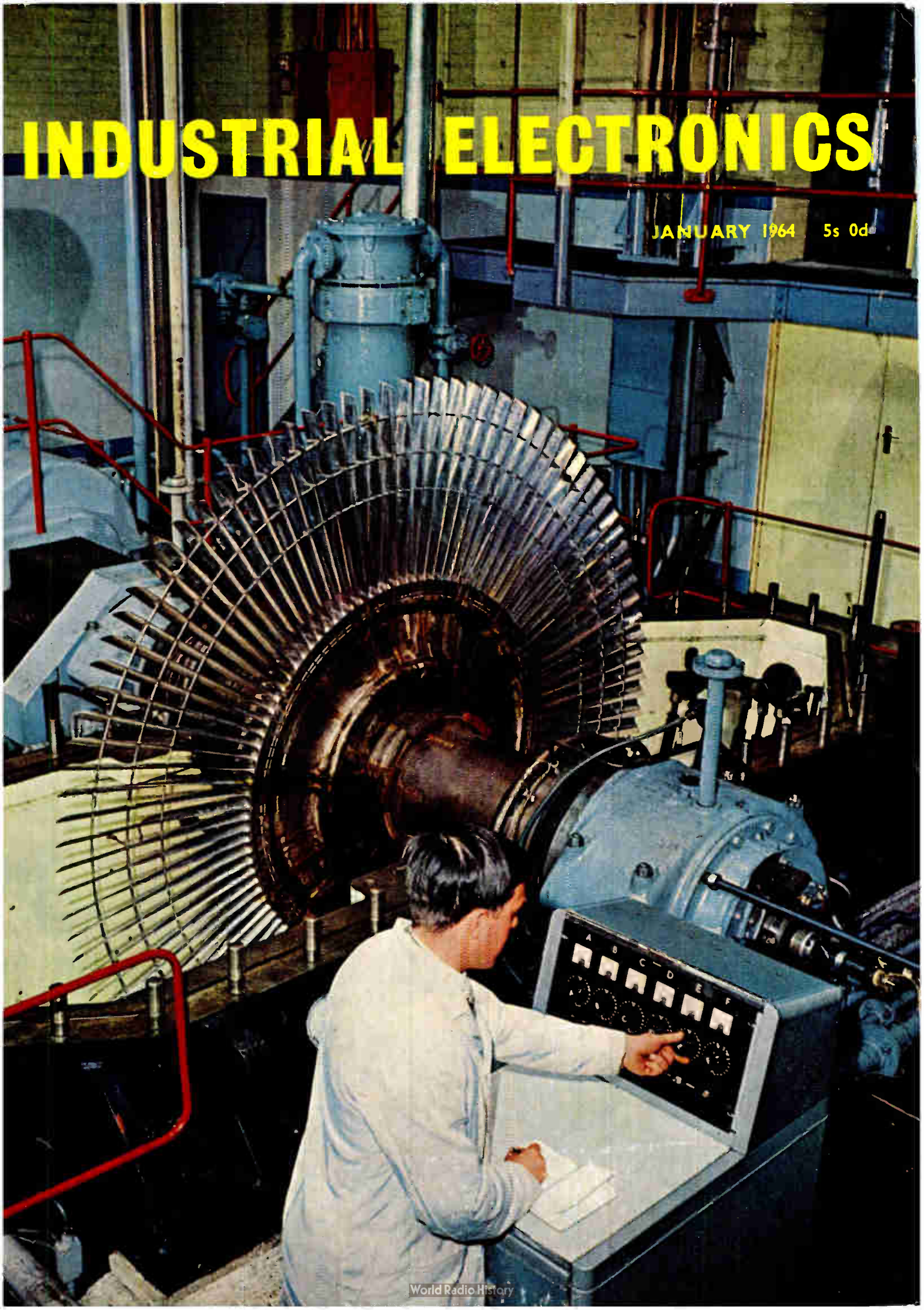

MULLARD OFFER THE WIDEST CHOICE OF LOW-COST POWER TRANSISTORS

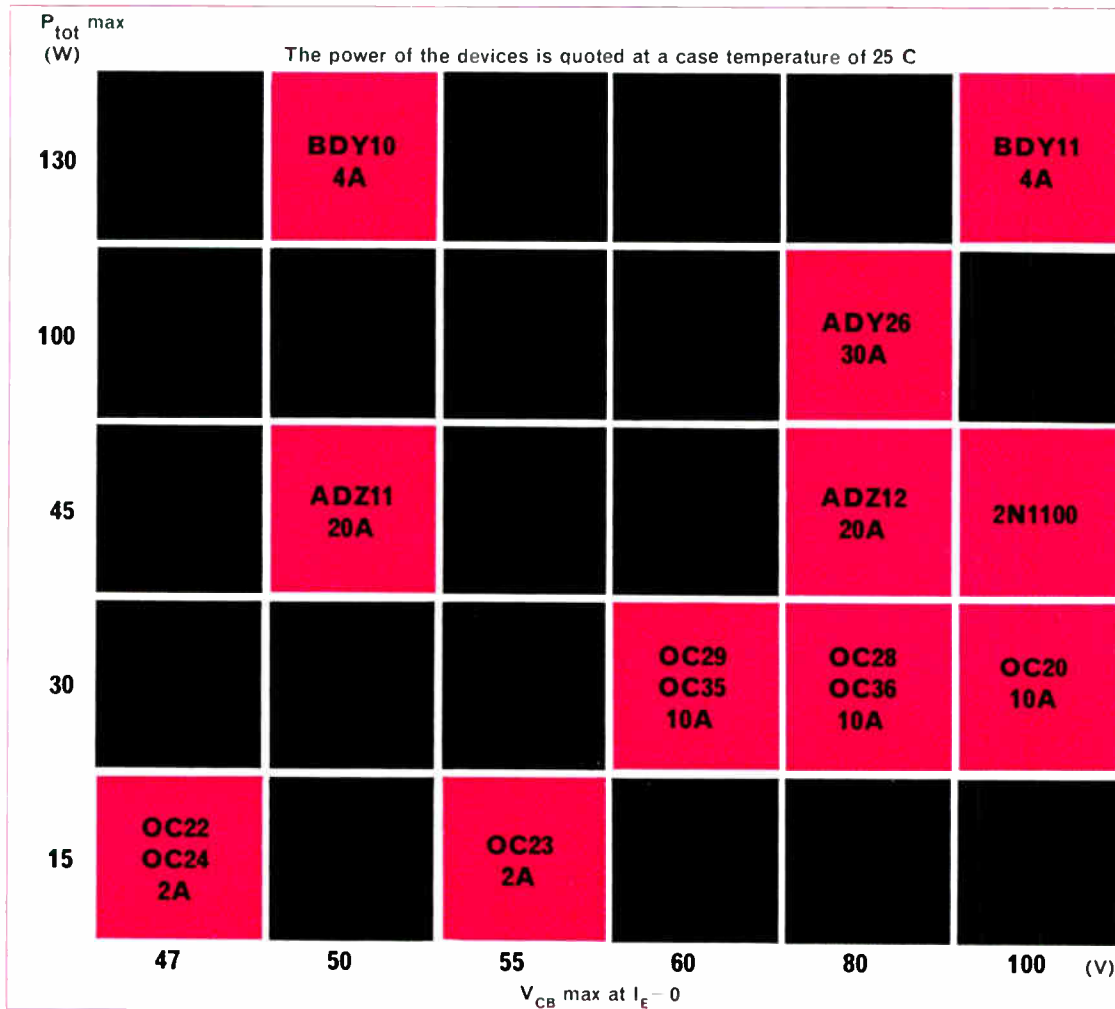

Mullard offer a ready and reliable supply of the widest range of low-cost power transistors commercially available. With the addition of new germanium and double-diffused silicon types, power coverage is now extended to 130W.

The steady introduction of Mullard power transistors of proven performance has resulted in a range meeting a wide variety of requirements and applications.

Select from the chart above the types required for your particular application and contact Mullard for details of price and performance.

MULLARD LIMITED
Industrial Semiconductor Division, Mullard House, Torrington Place, London, W.C.1.
Telephone: LAngham 6633



MIS 1001

Industrial Electronics January 1964

INDUSTRIAL ELECTRONICS
incorporating ELECTRONIC TECHNOLOGY

INDUSTRIAL ELECTRONICS

incorporating *ELECTRONIC TECHNOLOGY*

INDUSTRIAL ELECTRONICS
incorporating ELECTRONIC TECHNOLOGY

Volume 2 Number 1 January 1964

contents

Editor **W. T. COCKING, M.I.E.E.**
Assistant Editor **T. J. BURTON**
Advertisement Manager **G. H. GALLOWAY**

1	Comment
3	Feed Drives for Automatically-Controlled Machine Tools <i>by M. Monk, B.Sc.</i> Automatic control of machine tools is best achieved when the control system and the machine are designed together. Even when this cannot be done, relatively simple modifications to the drives of the machines usually result in an adequate performance. In this article the mechanical requirements are discussed.
10	Computer Corrects Wagon Wastage <i>by P. J. Robins</i> The use of a computer to control wagons has been tried experimentally in the Cardiff area of British Railways. It has been found possible as a result to work with 11% fewer wagons. The article explains why this is so and how the system is applied.
14	Vibration Measurement in Steam-Turbine Blade Development <i>by I. Finbow, B.Sc.(Eng.)</i> In modern large turbines the blades in the exhaust stages are very long and so subject to large centrifugal forces. As a result, great care must be taken to avoid severe resonant vibration under operating conditions. This article describes equipment which is used to measure the performance of a prototype assembly.
30	Tank Logging System <i>by J. T. Dobson</i> Automatic recording of the level and temperature of the contents of storage tanks is important in some industries. This article describes a system which enables a large number of tanks to be monitored using largely common apparatus.
35	Transistorized Non-Linear Function Generator <i>by P. Kundu, M.Sc. and S. Banerji</i> A non-linear function generator is realized by the cascade connection of logarithmic, exponential and linear stages. The magnitude and sign of the exponent of the overall non-linear response function of the system may be set by adjusting the gain and phase of the linear stage respectively, while the coefficient may be varied by varying the quiescent voltage across the emitter-base junction of the exponential stage, or by the current through it. The output then varies directly or inversely as the power or root of the input having its magnitude according to the adjustment made.

Published on the first Thursday after the 5th of each month by
ILIFFE ELECTRICAL PUBLICATIONS LTD.
Managing Director: W. F. Miller, M.A., M.Brill.I.R.E.
Dorset House, Stamford Street, London, S.E.1.
Telephone: Waterloo 3333.
Telegrams: Wirenger, London, Telex
Cables: Wirenger, London, S.E.1.

ANNUAL SUBSCRIPTION, HOME £3 0s. 0d.
OVERSEAS £3 10s. 0d.
CANADA and U.S.A. \$10.00.

continued overleaf

TS CONTENTS CONTENTS CONTENTS CONTENTS CONTENTS CONTENTS CONTENTS CONTENTS CONTENTS CONTENTS CONTENTS CONTENTS
 CONTENTS CONTENTS CONTENTS CONTENTS CONTENTS CONTENTS CONTENTS CONTENTS CONTENTS CONTENTS CONTENTS CONTENTS
 CONTENTS CONTENTS CONTENTS CONTENTS CONTENTS CONTENTS CONTENTS CONTENTS CONTENTS CONTENTS CONTENTS CONTENTS
 CONTENTS CONTENTS CONTENTS CONTENTS CONTENTS CONTENTS CONTENTS CONTENTS CONTENTS CONTENTS CONTENTS CONTENTS
 CONTENTS CONTENTS CONTENTS CONTENTS CONTENTS CONTENTS CONTENTS CONTENTS CONTENTS CONTENTS CONTENTS CONTENTS
 CONTENTS CONTENTS CONTENTS CONTENTS CONTENTS CONTENTS CONTENTS CONTENTS CONTENTS CONTENTS CONTENTS CONTENTS
 CONTENTS CONTENTS CONTENTS CONTENTS CONTENTS CONTENTS CONTENTS CONTENTS CONTENTS CONTENTS CONTENTS CONTENTS
 CONTENTS CONTENTS CONTENTS CONTENTS CONTENTS CONTENTS CONTENTS CONTENTS CONTENTS CONTENTS CONTENTS CONTENTS
 CONTENTS CONTENTS CONTENTS CONTENTS CONTENTS CONTENTS CONTENTS CONTENTS CONTENTS CONTENTS CONTENTS CONTENTS
 CONTENTS CONTENTS CONTENTS CONTENTS CONTENTS CONTENTS CONTENTS CONTENTS CONTENTS CONTENTS CONTENTS CONTENTS
 CONTENTS CONTENTS CONTENTS CONTENTS CONTENTS CONTENTS CONTENTS CONTENTS CONTENTS CONTENTS CONTENTS CONTENTS
 CONTENTS CONTENTS CONTENTS CONTENTS CONTENTS CONTENTS CONTENTS CONTENTS CONTENTS CONTENTS CONTENTS CONTENTS
 CONTENTS CONTENTS CONTENTS CONTENTS CONTENTS CONTENTS CONTENTS CONTENTS CONTENTS CONTENTS CONTENTS CONTENTS
 CONTENTS CONTENTS CONTENTS CONTENTS CONTENTS CONTENTS CONTENTS CONTENTS CONTENTS CONTENTS CONTENTS CONTENTS

contents

CONTENTS CONTENTS CONTENTS CONTENTS CONTENTS CONTENTS CONTENTS CONTENTS CONTENTS CONTENTS CONTENTS CONTENTS
 CONTENTS CONTENTS CONTENTS CONTENTS CONTENTS CONTENTS CONTENTS CONTENTS CONTENTS CONTENTS CONTENTS CONTENTS
 CONTENTS CONTENTS CONTENTS CONTENTS CONTENTS CONTENTS CONTENTS CONTENTS CONTENTS CONTENTS CONTENTS CONTENTS
 CONTENTS CONTENTS CONTENTS CONTENTS CONTENTS CONTENTS CONTENTS CONTENTS CONTENTS CONTENTS CONTENTS CONTENTS
 CONTENTS CONTENTS CONTENTS CONTENTS CONTENTS CONTENTS CONTENTS CONTENTS CONTENTS CONTENTS CONTENTS CONTENTS
 CONTENTS CONTENTS CONTENTS CONTENTS CONTENTS CONTENTS CONTENTS CONTENTS CONTENTS CONTENTS CONTENTS CONTENTS
 CONTENTS CONTENTS CONTENTS CONTENTS CONTENTS CONTENTS CONTENTS CONTENTS CONTENTS CONTENTS CONTENTS CONTENTS
 CONTENTS CONTENTS CONTENTS CONTENTS CONTENTS CONTENTS CONTENTS CONTENTS CONTENTS CONTENTS CONTENTS CONTENTS
 CONTENTS CONTENTS CONTENTS CONTENTS CONTENTS CONTENTS CONTENTS CONTENTS CONTENTS CONTENTS CONTENTS CONTENTS
 CONTENTS CONTENTS CONTENTS CONTENTS CONTENTS CONTENTS CONTENTS CONTENTS CONTENTS CONTENTS CONTENTS CONTENTS
 CONTENTS CONTENTS CONTENTS CONTENTS CONTENTS CONTENTS CONTENTS CONTENTS CONTENTS CONTENTS CONTENTS CONTENTS
 CONTENTS CONTENTS CONTENTS CONTENTS CONTENTS CONTENTS CONTENTS CONTENTS CONTENTS CONTENTS CONTENTS CONTENTS
 CONTENTS CONTENTS CONTENTS CONTENTS CONTENTS CONTENTS CONTENTS CONTENTS CONTENTS CONTENTS CONTENTS CONTENTS

continued

44 Production and Properties of High-Intensity Ultrasonics
by B. Brown, B.Sc., Ph.D.
 The first of a series, this article deals with the basic properties of the three different kinds of transducer commonly employed, the magnetostrictive, the piezoelectric and the electrostrictive.

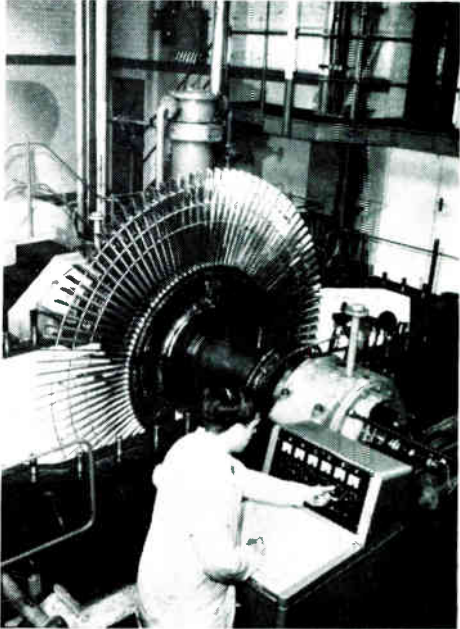

OUR COVER
 The cover picture shows a prototype of the exhaust stages of a large steam turbine being prepared for tests for vibration in the Rugby Works of The English Electric Co. Ltd. Up to 18 strain gauges can be fitted and any six of them used simultaneously. The selector console can be seen in the foreground.

FEATURES

7	Pneumatic Sound Generator	34	Illustrated News
8	Electronic Gas-Control System	42	Automatic Seat Reservation System for B.E.A.
15	Research Development Production Exhibition & Conference	43	Transistorized Ultrasonic Probe
16	Shipyards Install Dynamic Balancer	47	Illustrated News
17	Equalization of Level	48	Industrial News
17	'Oscar' Will Control Steel-making	51	New Books
18	Equipment Review	52	Manufacturers' Literature
		39	<i>Classified Advertisements</i>
		40	<i>Index to Advertisers</i>

Next Month

The February issue will contain an article dealing with an automatic statistical analyser which has many applications including the analysis of road vehicle noise. Other articles will deal with the doppler effect in aircraft navigation and with a special camera for the multiple reproduction of a single image, which finds application in solid-state technology.

TO SAVE YOUR TIME

We will assist you to obtain further information on any products or processes described or advertised in this issue. Just use the enquiry cards to be found in the front of the journal.

© Iliffe Electrical Publications Ltd., 1964

Permission in writing from the Editor must first be obtained before letterpress or illustrations are reproduced from this journal. Brief abstracts or comments are allowed provided acknowledgment to the journal is given.

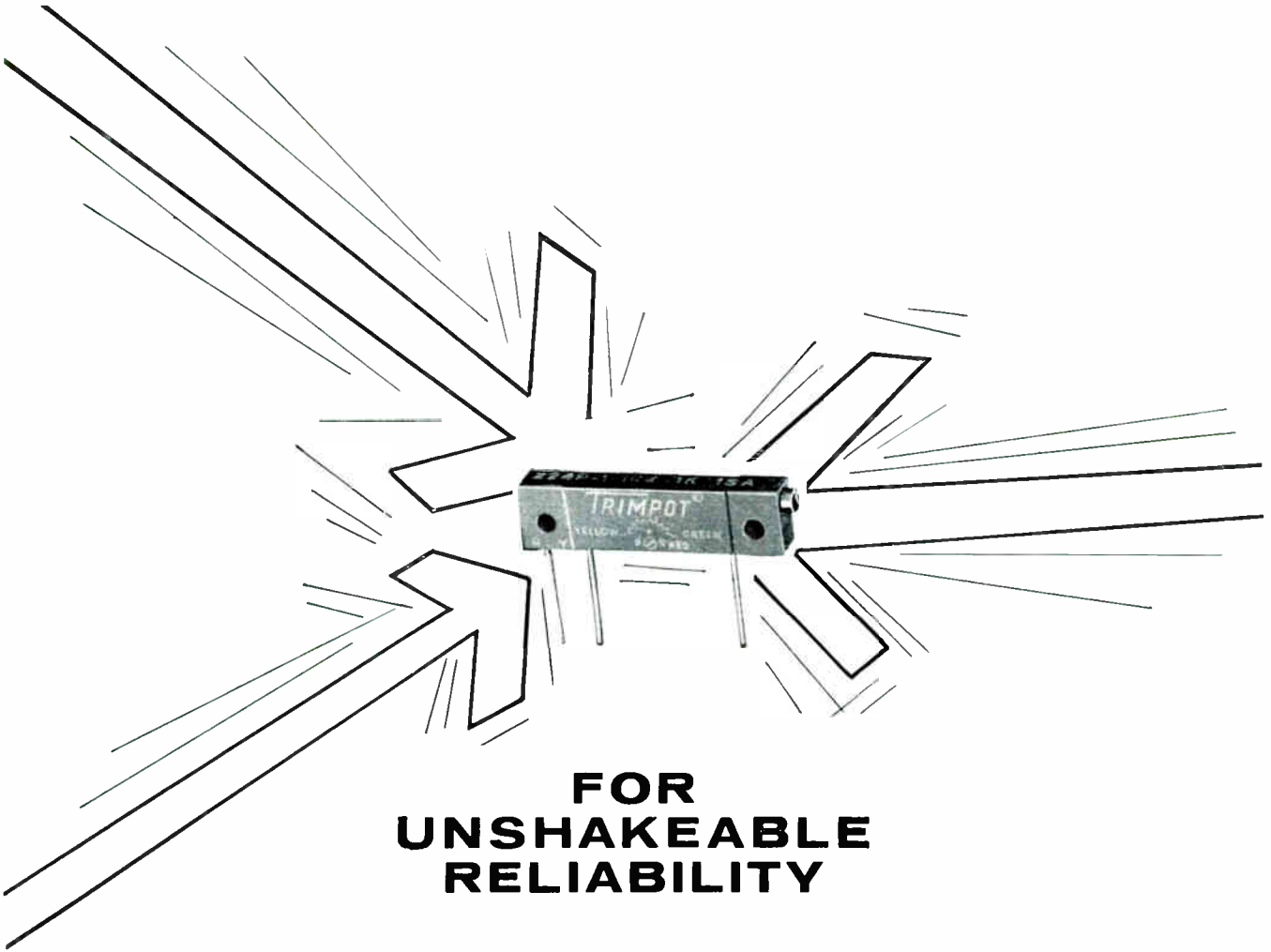

FOR UNSHAKEABLE RELIABILITY

THE PAINTON BOURNS TRIMPOT TYPE 224 Wirewound Potentiometer is a high performance component, widely specified where extreme reliability is of prime importance.

Excellent shock, vibration and acceleration stability are achieved by the self-locking adjustment screw. The component is sealed against humidity, liquids and potting compounds and operates at a temperature of 175°C. Three different terminal configurations are available (Stranded insulated leads, solder-lugs or printed circuit pins).

Stringent quality control and inspection are enforced for each individual component to ensure that the tight limits of the manufacturing specification are rigidly adhered to.

The 224 is one of the Northampton-produced items from the comprehensive range of Bourns Trimpot Potentiometers. Please write for full details.



Painton

& CO. LIMITED

KINGSTHORPE · NORTHAMPTON

Tel: 34251 (10 lines) Grams: 'Ceil' Northampton Telex: 31576

Australia Painton (Australia) Pty. Ltd. · Benelux Painton S. A. · Sweden Svenska Painton A. B. · U.S.A. Painton Inc.

PHENOMENON

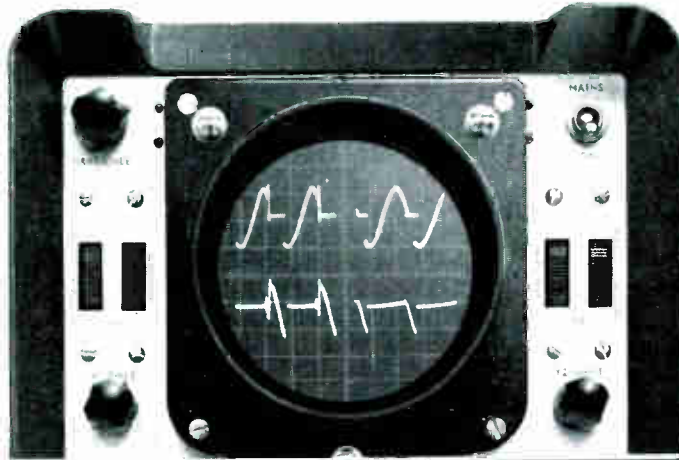

FIXED!

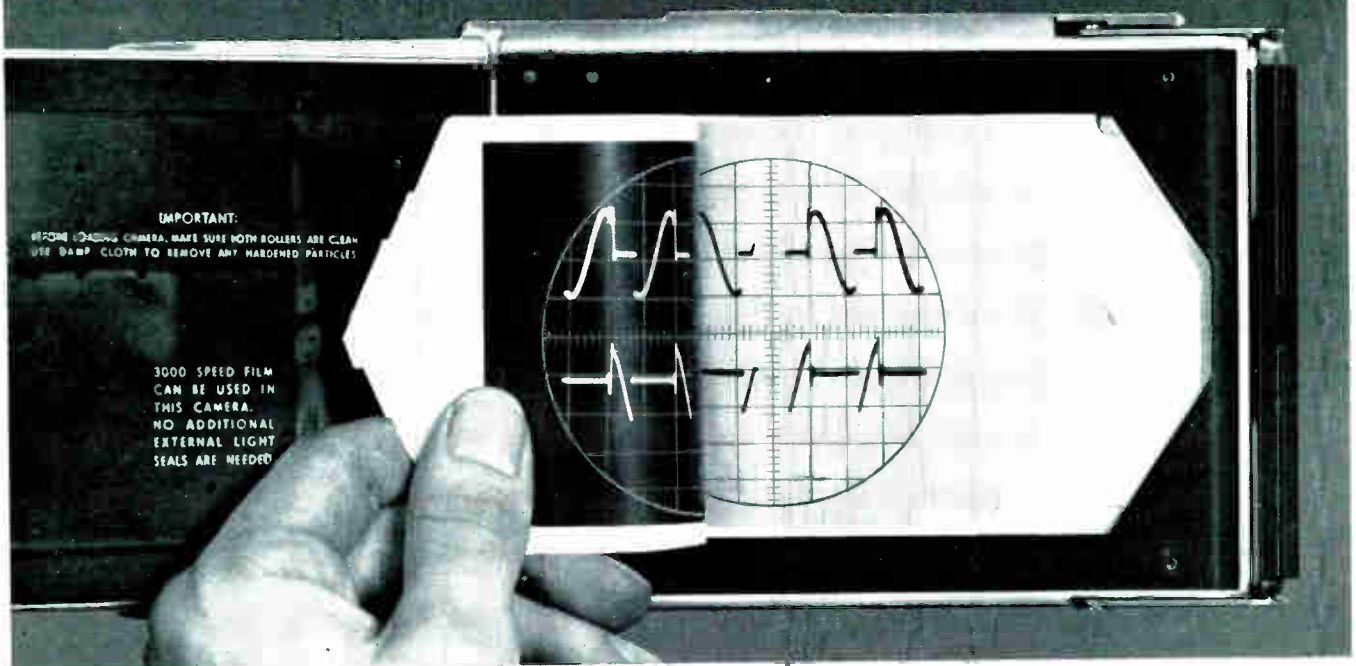

WITH THE **COSSOR** UNIVERSAL TYPE A OSCILLOSCOPE CAMERA

- Oscillograms in 2-10 seconds.
- Employs Polaroid® Land picture rolls with speeds up to 10,000 ASA
- Interchangeable film backs and lenses enable a wide variety of specifications to be met.
- Special hood provides parallax-free viewing of graticule area while the event is being recorded.
- Camera fits all Cossoroscopes and adaptors are available to fit other equipments.
- Lenses supplied in pre-focused mounts, fine focussing only required, with maximum apertures f 1.5, f 1.9, f 2.8 and f 3.5 with Object-Image ratios from 1:1 to 1:0.5
- Multiple exposures on one print, up to 7 at 1:1 or 13 at 1:0.5. Objective/Image ratios, can be obtained and the camera backs can be rotated through 90°.
- Camera backs available for Polaroid® Land picture rolls types 42, 46L, 47, 48 and 410. Polaroid® Land 4" x 5" film types 52, 55 P/N and 57, 35 mm and 120 roll film. Also 4" x 5" MPP and Graflex film holders.

**Registered trade Mark of the Polaroid Corporation.*

FOR FULL SPECIFICATION PLEASE WRITE TO:—

COSSOR COSSOR INSTRUMENTS LIMITED (Subsidiary of A. C. Cossor Limited and of Raytheon Company, U.S.A.)
THE PINNACLES, ELIZABETH WAY, HARLOW, ESSEX. TELEPHONE: HARLOW 26862

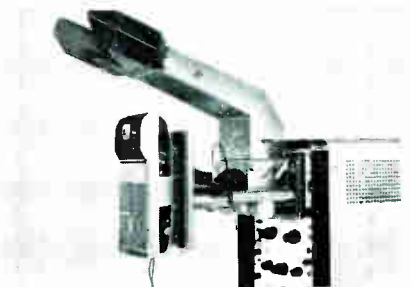

a toggle switch to fit that space?



certainly

MEC Type TS Miniature Toggle Switches the smallest switches available, 0.25 inch diameter mount 9 to the square inch Single-pole change-over with quick make, quick break action Mechanical life in excess of 40,000 operations Current rating 1A at 50 volts d.c. Two models, TS70, silver contacts, 10 milliohms contact resistance, TS71, gold-plated contacts, 6 milliohms contact resistance Temperature range 0°C to 85°C Prompt delivery.

Send for full details, price list. Miniature Electronic Components Ltd., St. Johns, Woking, Surrey. Tel. Woking 5211.

m-e-c

All-glass holders result in closer control of oscillator frequency

Miniature and subminiature quartz crystal units
available from Mullard

Outstanding benefits are offered by the Mullard range of all-glass encapsulated, AT-cut quartz crystal units in comparison with metal-encased units. In particular, the glass-encapsulated units have a smaller ageing effect, a smaller initial tolerance, a higher activity, and a higher Q-factor than is obtained with the metal-encased type. These benefits all contribute towards a closer and more stable control of oscillator frequency.

The Mullard glass-encapsulated units are available in miniature and sub-miniature forms, corresponding to the British styles D and J for the metal-encased units. The British, Nato, and U.S. equivalent styles for the glass-encapsulated crystal units are shown in the table below. The frequency range covered by the units is from 3.5 to 87Mc/s.

ALL-GLASS HOLDERS

All-glass holders afford the solution to many of the problems associated with metal cases since the vacuum technology developed for valves can be directly applied to crystal units. When quartz crystal elements are encapsulated in metal cases there is difficulty in preventing moisture and soldering residues being trapped inside. Evacuation of the metal cases introduces the likelihood of leaks which may result in random changes in performance. These problems can be overcome with glass-encapsulation but the B9A and B7G valve envelopes are too large for equipment where transistor and miniature techniques are applied. Consequently, all-glass equivalents of the style D and style J miniature and sub-miniature metal cases have been developed for the Mullard quartz crystal units.

A booklet has been prepared giving details of the properties and electrical behaviour of the Mullard all-glass quartz crystal units. For a copy of this booklet, please use the reader reply card of this journal (see reference number opposite).

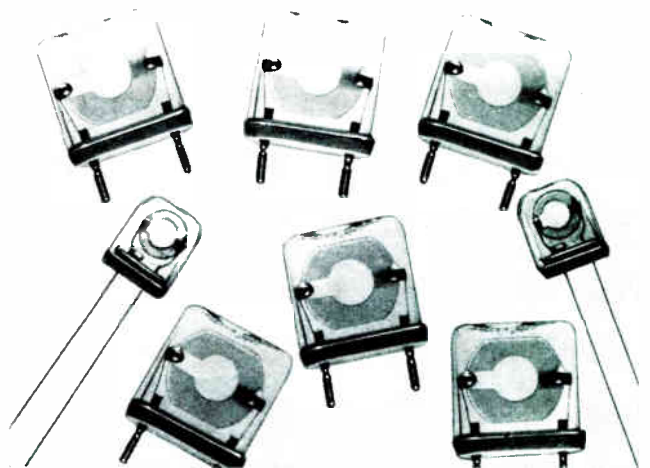

Selection of Mullard all-glass quartz crystal units showing miniature and sub-miniature holders

Comparison table of metal and equivalent glass holders for crystal units

		Metal Holders		
		British service type	U.S. military type	Nato style
Miniature	D		HC-6/U	1
Subminiature	J		HC-18/U	3
		Equivalent Glass Holders		
		British service type	U.S. military type	Nato style
Miniature	*		HC-26/U	13
Subminiature	*		HC-27/U	14

* British type numbers not yet allocated

What's new from Mullard

New encapsulation technique for Vinkors

A new encapsulation technique for Vinkor adjustable pot-core assemblies provides the protection offered by synthetic-resin encapsulation whilst still allowing full inductance adjustment. The pot-core itself is not encapsulated. The technique will have particular application where it is desired to take full advantage of the temperature characteristic of the ferrite, because the core is not subjected to the stresses arising from the differential expansion between the ferrite and the encapsulating resin.

In the new technique, the windings are vacuum encapsulated as a unit together with an outer sleeve and linking struts. The lead-out wires from the windings are taken inside the struts to terminal pins cast in the base of the sleeve. The windings, lead-out wires, and terminal pins are therefore completely protected. The ferrite core is assembled around the windings in a second operation.

The new assembly is suitable for mounting on a printed-wiring board or for panel mounting. At present, the encapsulation technique has been applied to the 25mm diameter Vinkor assemblies but development work applying the technique to 14 and 18mm

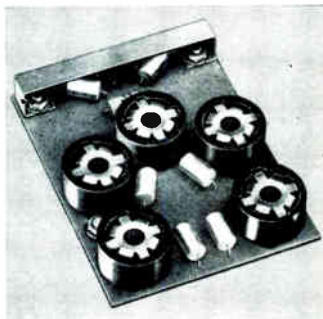

Vinkors is in progress. Life tests on encapsulated units to the Service specifications of H5 and H6 are being carried out.

IMPROVED MAGNET POWDER

A new magnet powder now available has an improved performance in comparison with the existing M1 powder. The new powder, type M3, replaces the M1 type in a wide variety of applications where flexible or resin-bonded magnets are required. Typical applications where these magnets have been used include picture shift magnets for television, magnetic door seals, and magnetic lettering for display purposes.

The powder consists of a sintered barium ferrite material $BaOFe_{12}O_{19}$ sieved to a critical size combining economy with good performance in the bonded magnet. The powder may be bonded with plastic or rubber to form flexible magnets, or with resins to form rigid magnets.

The magnetic performance of the finished magnet depends considerably on the amount of binder used. As a guide, a standard test slug has a typical BH_{max} value of 0.40×10^6 gauss-oersted in comparison with 0.35×10^6 gauss-oersted for the M1 powder.

New industrial triode joins range

An industrial power triode, type TY4-400, has been introduced to fill the gap in the present range between the TY3-250 and the TY5-500. The new valve is an improved version of the well-established TY3-250, and will find application in equipment where a power rating higher than that provided by the existing valve is required.

The anode voltage, anode dissipation, and grid dissipation of the TY4-400 are higher than those of the TY3-250, giving the new valve a superior high-frequency performance. The higher anode dissipation is particularly useful for vibration amplifiers, providing the equipment with an additional safety margin when operating into loads of poor power factor. The increased grid dissipation, 40W for the TY4-400 in comparison with 30W for the TY3-250, enables valves in industrial r.f. heating equipment to withstand better the temporary overloads that may occur.

100 LITRE PER SECOND PENNING PUMP

A Penning pump with the fast pumping speed of 100 l/s for air is now available. This unit, the VPP-100, can be used in nuclear physics or space research applications, and is an ideal fine vacuum pump for coating units in such applications as the manufacture of thin-film circuits.

The pumping action of the VPP-100 begins at a pressure of 5×10^{-3} torr and continues until the pressure has fallen to 10^{-10} torr. Over this range, with an anode voltage of 3kV the pumping speed is nominally 100 l/s for air. In the design, care has been taken to keep the stray magnetic field to a minimum. The unit is constructed of stainless steel and has a maximum bake-out temperature of 450°C.

This type of Penning pump has considerable advantages over the oil diffusion pump when used on ultra-high vacuum coating units. To prevent contamination of the

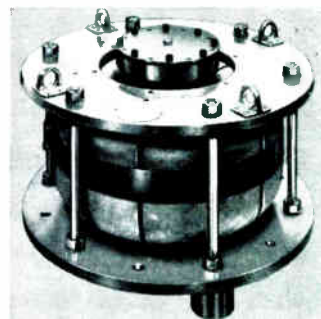

material being deposited during the manufacture of thin-film circuits, it is necessary to ensure that the vapour pressure of other unwanted materials in the vacuum chamber is as low as possible. When oil vapour from a diffusion pump is present, it is very difficult to achieve this condition because the high temperatures required to evaporate the materials used for deposition causes the oil vapour to "crack".

Many materials before being used in vacuum are stoved in hydrogen, and hydrogen taken up by the material may be liberated by the high evaporation temperature. The pumping speed for hydrogen of a Penning pump is two or three times higher than that for air whereas the diffusion pump has a much slower pumping speed for light gases. To achieve ultra-high vacua, it is an essential part of the technique that all component parts of the vacuum system should be de-gassed by baking. The presence of an oil charge and the use of water cooling make this an impossible task on a diffusion pump. The Penning pump is designed for ultra-high vacuum uses and can be heated to 450°C without impairment of its performance.

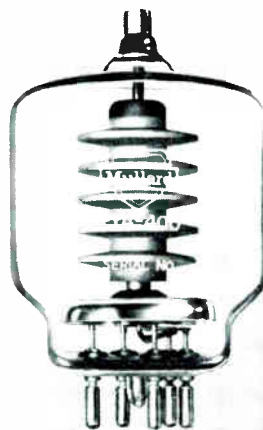

The TY4-400 is designed basically for industrial service and is ideal for use in plastic welders and preheaters, and in audio-frequency relay amplifiers. The value of output power (continuous rating) for a class C oscillator at 50Mc/s is 1.0kW and for class B audio amplifier applications the load power is 1.5kW per pair.

Reader Enquiry Service

Further details of the Mullard products described in this advertisement can be obtained through the Reader Enquiry Service of Industrial Electronics, using the appropriate code number shown below.

All-glass quartz crystal units	206
New Vinkor encapsulation technique	207
Penning Pump VPP-100	208
Industrial triode TY4-400	209
Magnet powder M3	210



Mullard Limited, Mullard House, Torrington Place, London, W.C.1. Telephone: LANgham 6633

CAM 7

C.I.C.'s *Linifilm*
Potentiometric Transducers
measure linear motion to
5 MILLIONTHS*
of an inch...

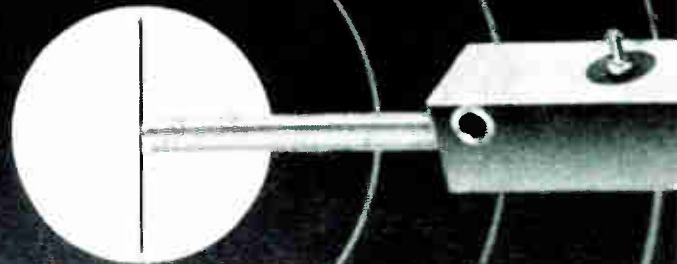

over strokes to 30 inches
with
**INFINITE
RESOLUTION**

MODEL 111 — Ruggedized
1" Square, single or dual
outputs, maximum stroke 30".

MODEL 112 — Compact
1/2" x 1", single or dual
outputs, maximum stroke 4".

MODEL 113 — Miniature
1/2" diameter, single or dual
outputs, maximum stroke 4".

MODEL 114 — Sub-miniature
1/4" x 5/16" x 1 1/4", single or
dual outputs, maximum stroke 1".

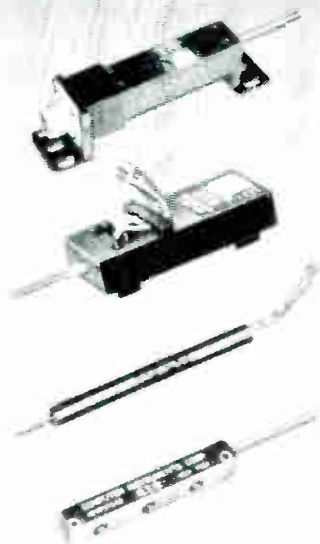

- No amplification required
(300 Volts output per/inch)
- AC or DC
- Linear and non-linear
outputs to .01%
- Various mounting and shaft
configurations available

* 1/1,000 of the thickness of this page.

WRITE FOR DETAILS

CIC EUROPEAN SERVICE

COMPUTER CONTROLS LIMITED, 19 BUCKINGHAM STREET, LONDON, W.C.2

Tel. TRA 2371 · TELEX 24504

CABLES · COMPUTROLS LONDON

World Radio History

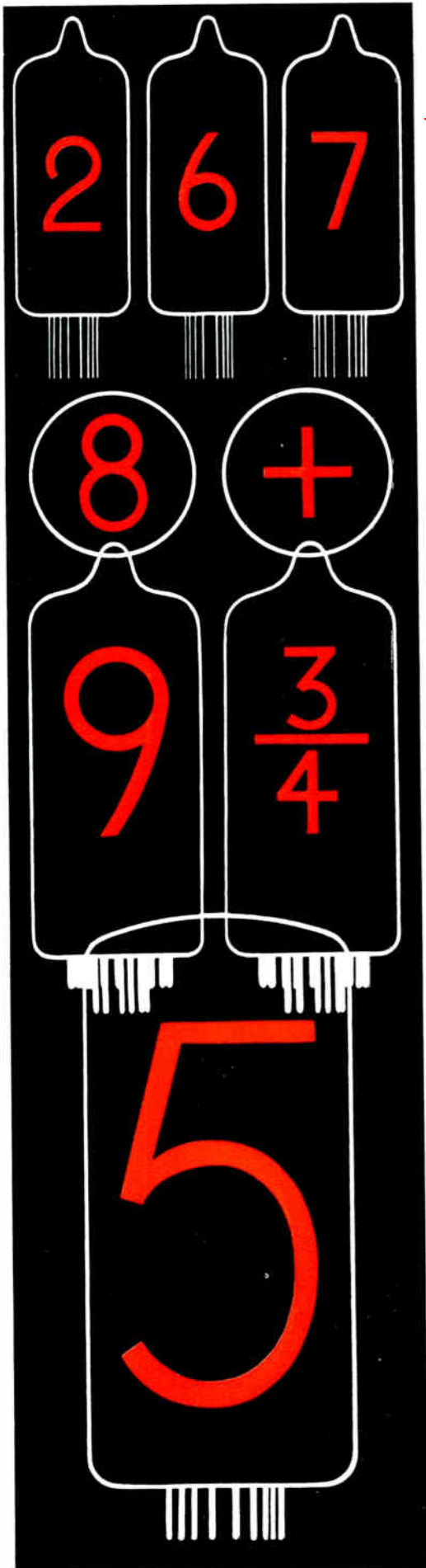

*DIGITRON DISPLAY

FOR INSTANTANEOUS READOUT

Digitron type cold cathode readout is now universally accepted as the most economical and versatile method of presenting numerical and character display.

Their vivid presentation and wide angle viewing facility enable these robust tubes to be viewed quite easily over long distances even in areas of high ambient light. A wide variety of well proportioned character sizes are available in side viewing and end viewing types with wire ended or "pin-base" terminations.

Methods of initiating the readout can be from virtually any switching source ranging from simple mechanical or electro-mechanical devices to cold-cathode counting tube or transistor circuits.

If you are looking for a low-cost, reliable, long life and brilliant method of displaying numerical or character information Digitron tubes are worthy of your consideration.

For data and application information about Digitron Display tubes please write to the address below.

TYPE	Characters	Character Height	Nominal current	Viewing	Base	Equivalents
GR2J	+ and —	18 mm .709"	1.5 mA	SIDE	B26A	
GR4J	$\frac{1}{4}$ $\frac{1}{2}$ $\frac{3}{4}$ 1	30 mm 1.181"	3.5 mA	SIDE	B26A	
GR10J	0 — 9	30 mm 1.181"	4.5 mA	SIDE	B26A	Z522M*
GR10K	0 — 9	19 mm .748"	2 mA	END	B17A	
GR10M	0 — 9	15.5 mm .610"	2 mA	END	B13B	Z520M B5031*
GR10N	0 — 9	60 mm 2.362"	10 mA	SIDE	B17A	
GR10X	0 — 9	15 mm .591"	2 mA	SIDE	FLYING LEAD	ZM1080*

*Near Equivalents

*Digitron is an Ericsson Registered Trade Mark.

TUBE DIVISION · TECHNICAL SERVICE DEPT.

ERICSSON TELEPHONES LIMITED
ETELCO LIMITED

A Principal Operating Company of the Plessey Group



ERICSSON TELEPHONES LIMITED · TUBE DIVISION · BEESTON · NOTTINGHAM TEL: 254831 ER67

now!

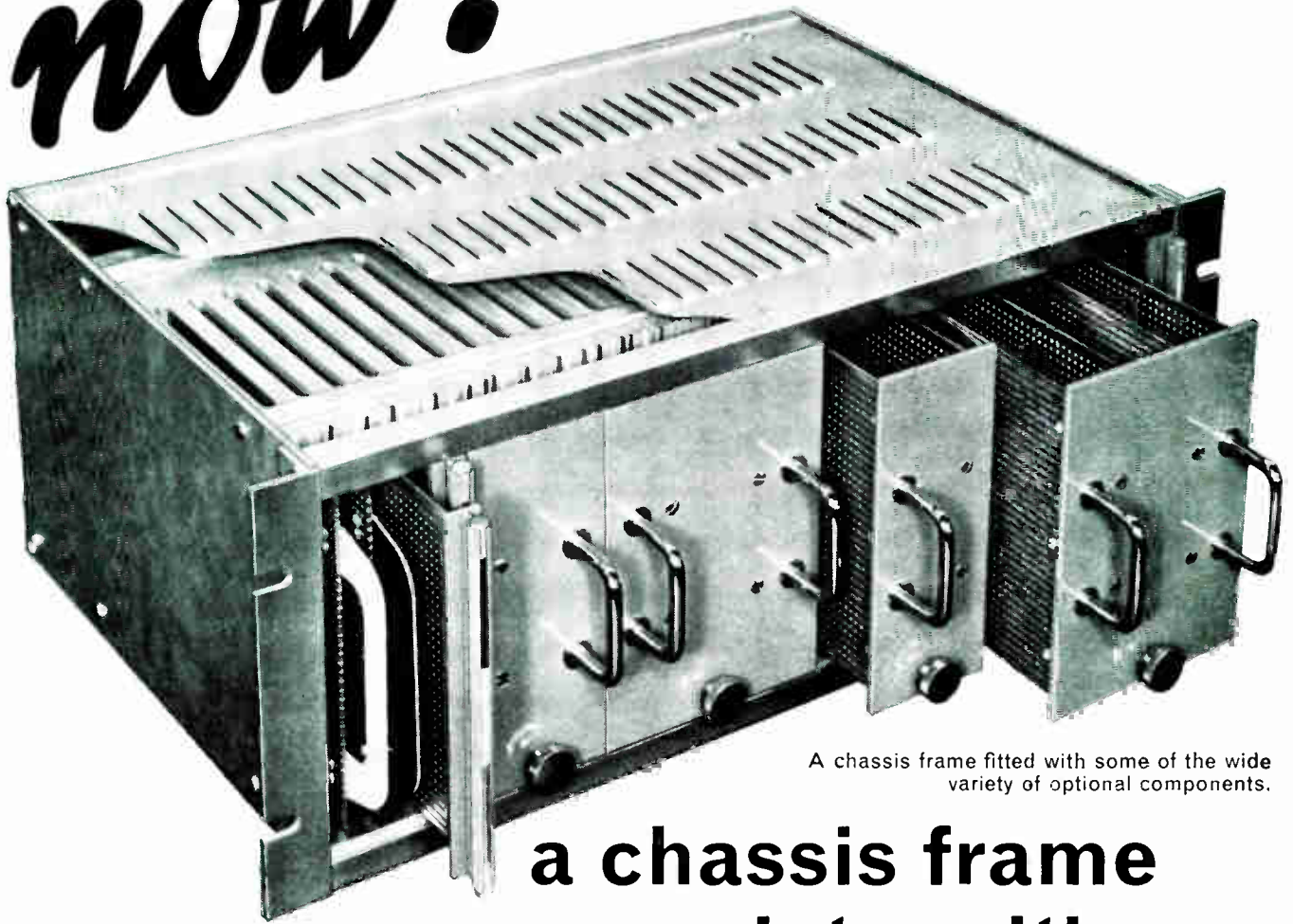

A chassis frame fitted with some of the wide variety of optional components.

a chassis frame complete with 28 pairs of circuit card guides for only £7 19 6

IMHOFS
MODULAR CHASSIS SYSTEM

MCF/4010 19" wide x 7" high x 11⁷/₈" deep. Price: £7.19.6. complete with 28 pairs of guides.

MCF/5010 19" wide x 8³/₂" high x 11⁷/₈" deep. Price: £8.8.0. complete with 28 pairs of guides.

Sizes to suit individual requirements can be made to special order.

An entirely new type of chassis frame is now available, designed for housing unedged printed circuit cards and chassis. Each frame is supplied complete with 28 pairs of guides, the design of which allows adequate ventilation between cards. A unique polarizing and edge connector retaining block is incorporated in each guide and colour coding facilities are provided. A wide range of new components is also available to suit these chassis frames. Send for full details.

IMHOFS

ALFRED IMHOF LIMITED

Dept. No. IE 1 Ashley Works Cowley Mill Road Uxbridge Middlesex
Telephone Uxbridge 37123 Telex No. 24177 Telegrams IMCASE-UXBRIDGE-TELEX

Agents in

Algeria Australia Belgium Denmark Finland France Germany Holland Italy
Malaysia Morocco New Zealand Nicaragua Northern Rhodesia Norway Portugal
South Africa Southern Rhodesia Sweden Switzerland Thailand Tunisia U.S.A.

Whatever your **TRANSFORMER** problem

**... OUR CATALOGUE WILL HOLD
ITS SOLUTION!**

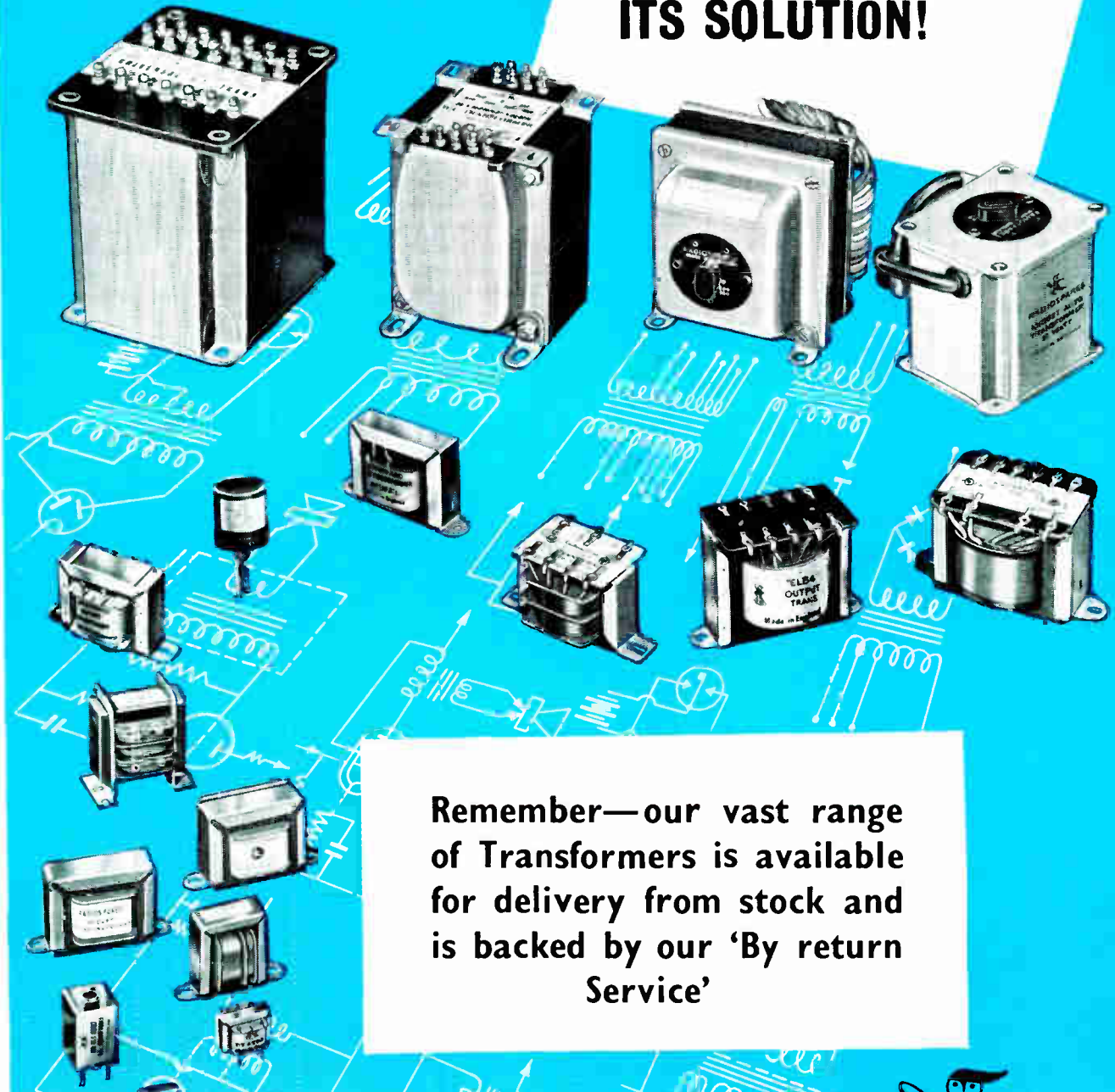

Remember—our vast range of Transformers is available for delivery from stock and is backed by our 'By return Service'

Radiospares Ltd.

48 MAPLE STREET · LONDON W.1 · ENGLAND

Telephone: EUSton 7232 (8 lines)

TELEGRAMS: RADOSPERES, WESDO, LONDON

CABLES: RADOSPERES, LONDON, W.1.



A new achievement in instrument design...



Harmony

Harmony Types 36 & 36C
3.4" x 1.8"
Harmony Type 36B (with bezel)
3.76" x 2.1"

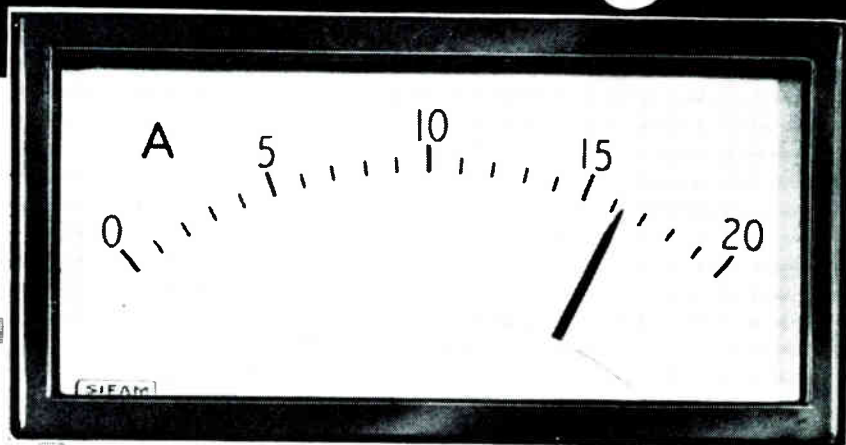

Sifam Harmony...
with concealed movement and
alternative fixing methods.



The rear view of the instrument above and the sketch below illustrate the way in which the movement is concealed completely behind the panel, whilst only the dial of the instrument is visible from front of panel. The instrument can be easily fixed by means of two screws, by means of the separate bezel (if fitted), or by a clamp from the back as shown above.

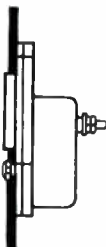

- The flush fitting slim bezel enhances the appearance of any instrument panel, and the forward-mounted scale plate facilitates illumination, when required.
- The lowering of the movement centre behind the panel provides the advantages of a shorter angle of deflection, without loss of scale length, which gives maximum linearity on the extremities of the scale, and a large radius arc for ease of reading.
- The lance pointer permits distant observation, but its fine point is designed for reading off precise values.
- Scale arcs and markings can be supplied in accordance with the new British Standards recommendations, or to customers' requirements.
- Interchangeable bezels can be supplied in colours to blend with customers' equipment. These bezels can be added subsequently if desired.

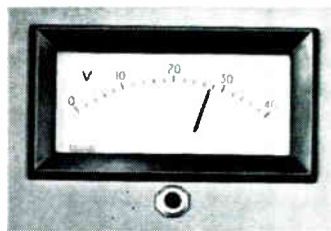
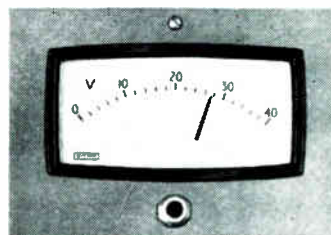
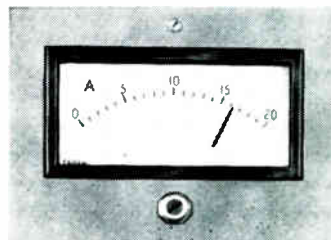

Above:
Harmony Type 36 (rectangular without bezel)
Harmony Type 36C (curved front without bezel)
Harmony Type 36B (rectangular with bezel)
Scale lengths: 2.62 in. (66.5 mm)

The Sifam Technical Representative can show you the new Harmony Instruments immediately, or we will gladly send you Data Sheet 106/H on request.



Instruments

SIFAM ELECTRICAL INSTRUMENT CO. LTD. Woodland Road, Torquay, Devon
Telephone: Torquay 63822/3/4

The first major advance in potentiometer design for years ...

After many years of research and development Reliance now announce an entirely new concept in the design of multi-turn wire wound potentiometers. This, combined with new manufacturing techniques provides extremely low inertia, low torque, high law accuracy and multiple tapping facilities for non linear functions. The unit is available in two distinct separate versions :

1. SERIES SYN 11-00 A Synchro Mounting Unit incorporating precious metal winding and precision ball races.
2. SERIES HEL 11-00 A $\frac{3}{8}$ " diameter Bush Mounting version, plain bearing with standard resistance windings, still retaining high electrical characteristics.

- ★ RESISTANCE RANGE: 20 ohms—150 K ohms.
- ★ LINEARITY: $\pm 0.1\%$ or $\pm 0.25\%$ absolute as required.
- ★ TAPPING ACCURACY: $\pm 0.1\%$.
- ★ MOMENT OF INERTIA: 0.0004 gm. cm. sec².
- ★ STARTING TORQUE: Synchro Mounting Version 3 gm/cm. or better.
Bush Mounting Version 1 oz.in. nominal.
or Sealed Version 2 oz.in. nominal.
- ★ ROTATION LIFE: > 1,000,000/360° sweeps.
- ★ NUMBER OF TURNS : Any number up to 10.

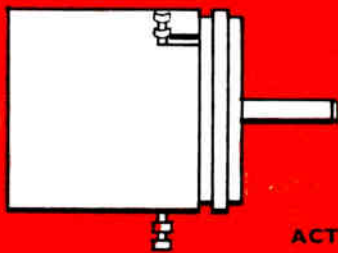
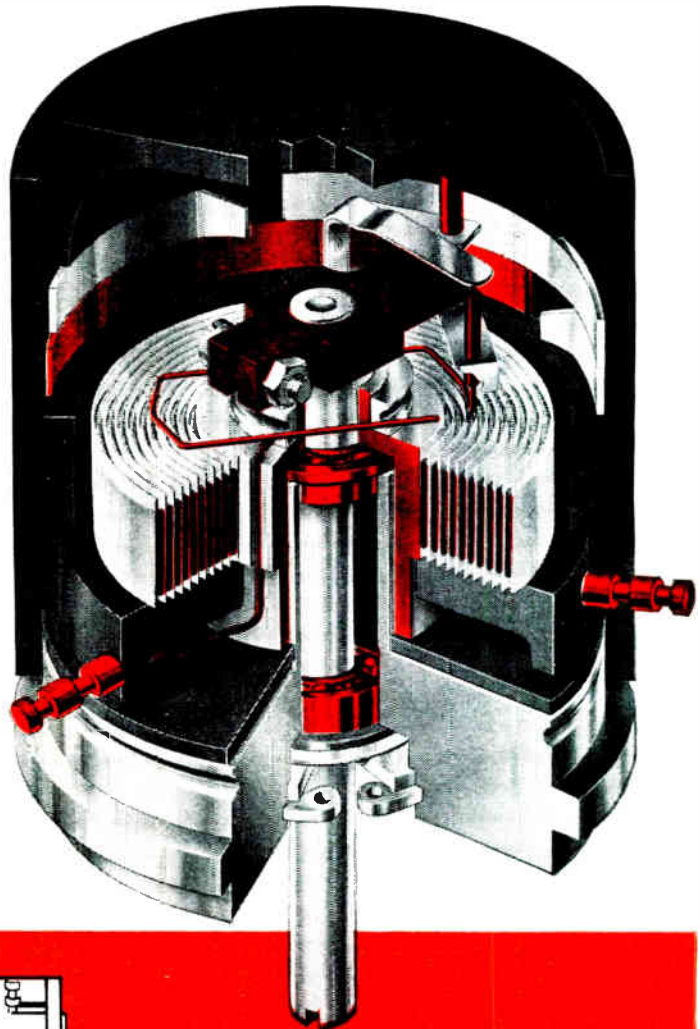

SYN 11-00 SERIES

ACTUAL SIZE

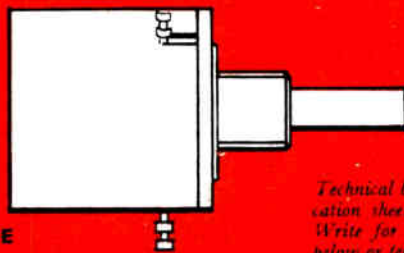

HEL 11-00 SERIES

Technical brochure and specification sheets are now ready. Write for them to address below or telephone: LARKSWOOD 84047



TAKES THE LEAD IN POTENTIOMETERS

RELIANCE CONTROLS LIMITED, RELCON WORKS, SUTHERLAND ROAD, WALTHAMSTOW, E.17

Telephone No. LARKSWOOD 8404/7 · Telegrams: Reltrol, London, E.17

A MEMBER OF THE BOOKER GROUP OF COMPANIES



THIS IS THE NEW CORREX TRIPAMP —

MAGNETIC AMPLIFIER? YES! Driving a conventional type relay with provision for up to 4 off, 5 Amp S.P.C.O.

CLOSE DIFFERENTIAL RELAY? YES! The Amplifier can operate from low level d.c. signals at any preset value within the operating range and **SWITCHING DIFFERENTIAL IS ADJUSTABLE AS WELL.** Over fine to coarse dials from 1-60% over its full operating range.

RELIABLE YES! Printed circuit and no thermionic or moving parts apart from the relay which is adequately type tested.

IN ADDITION, IT'S VERSATILE! Having a low input this 2 inch module can be fitted into an Inhof IMRACK or to mount separately in flush panel mounting style is therefore admirably suitable for operating from primary transducers, i.e. thermocouples, resistance bulbs, photo cells, strain gauges, load cells, magnetic switches, contact thermometers, etc.

This versatile unit just 2" x 5¹⁵/₁₆" x 7¹/₄" in size provides a control or trip function on any varying low level monitor signal which is, or can be, converted to direct current ALL FOR JUST £19.15.0 (LIST)

	<p>PHOENIX TELEPHONES LIMITED GROVE PARK, LONDON N.W.9 Telephone: COLindale 7243 Telegrams: PHONOFENIX LONDON N.W.9.</p>	<p>A.I.D. & C.E.G.B. Approved</p>
--	--	--



Trinistor

SILICON CONTROLLED RECTIFIERS



500 mA to

250 A

25-700 V

Full range of gate drive and controller
units readily available



Please write for full details to:—

Dept. IE 1/64 Rectifier Division, Semiconductor Department,

WESTINGHOUSE BRAKE AND SIGNAL CO. LTD., 82 YORK WAY, KING'S CROSS, LONDON, N.1.

Tel: TERminus 6432. Telex No. 2-3225.

POST OFFICE 1000 TYPE

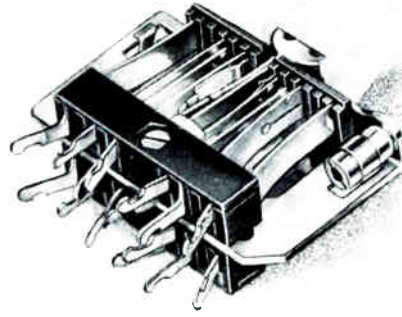
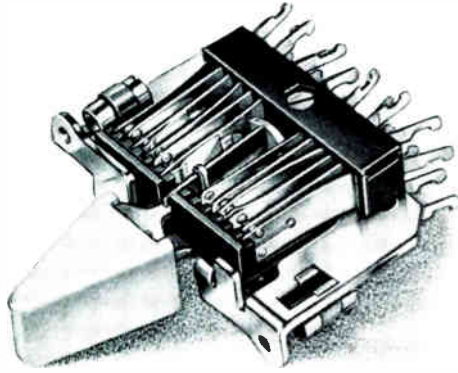

Mechanical Actions:

- LOCK LOCK
- LOCK STOP
- NON-LOCK LOCK
- NON-LOCK STOP
- NON-LOCK NON-LOCK



Miniature Lever Key

Designed to replace existing telephone keys, the new miniature lever key, now available from TMC, is a compact, space saving switching device of smart modern appearance. The functionally shaped moulded handle is available in several colours. The mechanical action includes a double pivot which ensures positive locking in either the normal or operated positions, and virtually eliminates follow-through of the handle on double-throw keys. A sliding, comb-shaped plate, actuated by the key handle, operates the pre-fabricated spring set. Up to twelve contact springs can be operated by each throw of the key—a total of four changeover actions in either direction.

Twin silver contacts are supplied as standard for switching 300 mA 100 V d.c. non-inductive loads. Several contact arrangements, in all switching actions, are available on excellent delivery.



TELEPHONE MANUFACTURING COMPANY LIMITED

Dept. D · Telephone Equipment Division · Components Unit
Martell Road · West Dulwich · London S.E.21 · England · Telephone: GIPsy Hill 2211 · Telex: 28115

A MEMBER OF THE  GROUP OF COMPANIES

SOLDERING MINIATURE COMPONENTS

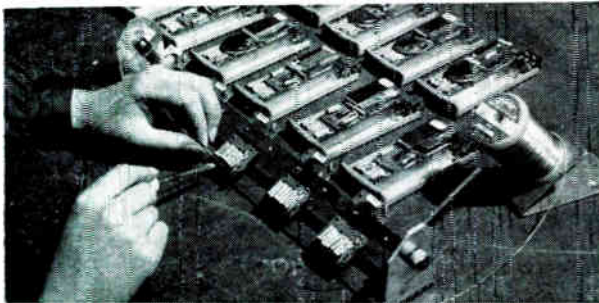

Multicore being used to solder connections on pocket receivers—part of the Westrex personal call system.

CHOOSE THE BEST SPECIFICATION OF ERSIN MULTICORE SOLDER FOR YOUR PRODUCTION SOLDERING PROCESS

The continual reduction in size of electronic components may make it advisable for you to use new specifications of Ersin Multicore Solder to obtain maximum efficiency and reliability. Alloy, diameter of the solder, type and percentage of flux in the solder and wear of soldering iron bits are all points to be considered.

ALLOYS

Generally only 60/40 or Savbit Type 1 alloys should be used. Savbit will promote soldering efficiency by reducing considerably the wear of miniature soldering iron bits.

DIAMETERS

18 s.w.g. to 22 s.w.g. are the gauges most suitable. Ersin Multicore is also available in even gauges down to 34 s.w.g.

The use of gauges of 18 s.w.g. and finer will reduce the amount of solder used per joint with consequent saving in cost of solder and reduction in flux residue. The following table gives details of the number of feet per lb. of fine gauges. Compare these lengths with 60/40 16 s.w.g. which has 102 feet per lb.

SWG	FEET PER LB	
	60/40	SAVBIT No. 1
18	182	170
19	262	244
20	324	307
22	538	508
24	865	856
26	1292	1279
28	1911	1892
30	2730	2695
32	3585	3552
34	4950	4895

FLUX

The rapid soldering of miniature components makes it essential that the flux in the solder shall be very active and fast, yet of course entirely non-corrosive. Ersin Type 362 flux, incorporated in Ersin Multicore Solder, has won world wide recognition for utmost reliability and consistent high quality. It complies with all relevant British and U.S.A. Government specifications.

As standard the flux percentage by weight of solder is 3.4%. **Now available for production soldering processes is Ersin Multicore Solder with 362P flux in 60/40 and Savbit No. 1 alloys. These solders have a flux percentage of 1.6 and 1.55 respectively, less than half that hitherto incorporated in standard Ersin Multicore Solder.**

To promote the extra rapid spread of the considerably lower percentage of flux contained in the cores and to deodorise the resin base, an exclusive agent, Pentacol, has now been combined with the flux. The well-known, approved, non-corrosive qualities of Ersin flux type 362 remain unchanged.

Ersin Multicore Solder with 362P flux thus provides the same high speed soldering as standard Ersin Multicore Solder with the advantage that less fumes are liberated during the soldering process and less flux residue is left. Due to the lower percentage of flux, a greater amount of solder is obtained for a standard length of wire. Economies are achieved by the fact that it is often possible to use a finer gauge of the new solder to provide the same amount of solder on a joint as compared with the standard Multicore product.

All Multicore Solders are covered by one or more of the following Patents: 433,194; 675,954; 704,763; 721,881.

SAMPLES FREE to Production Engineers

We will be delighted to send free samples of any of the above specifications to production engineers who apply for them on their Company's notepaper. Please state alloy and gauge required, and if samples should be in standard Ersin Multicore Solder or 362P low flux content solder.

We will also send a complimentary copy of the technical reprint "Erosion of Soldering Iron Bits."

ERSIN

Multicore

SOLDER

MULTICORE
SOLDERS LTD.
HEMEL
HEMPSTEAD
HERTS.

Telephone: BOXMOOR 3636

CHHE33

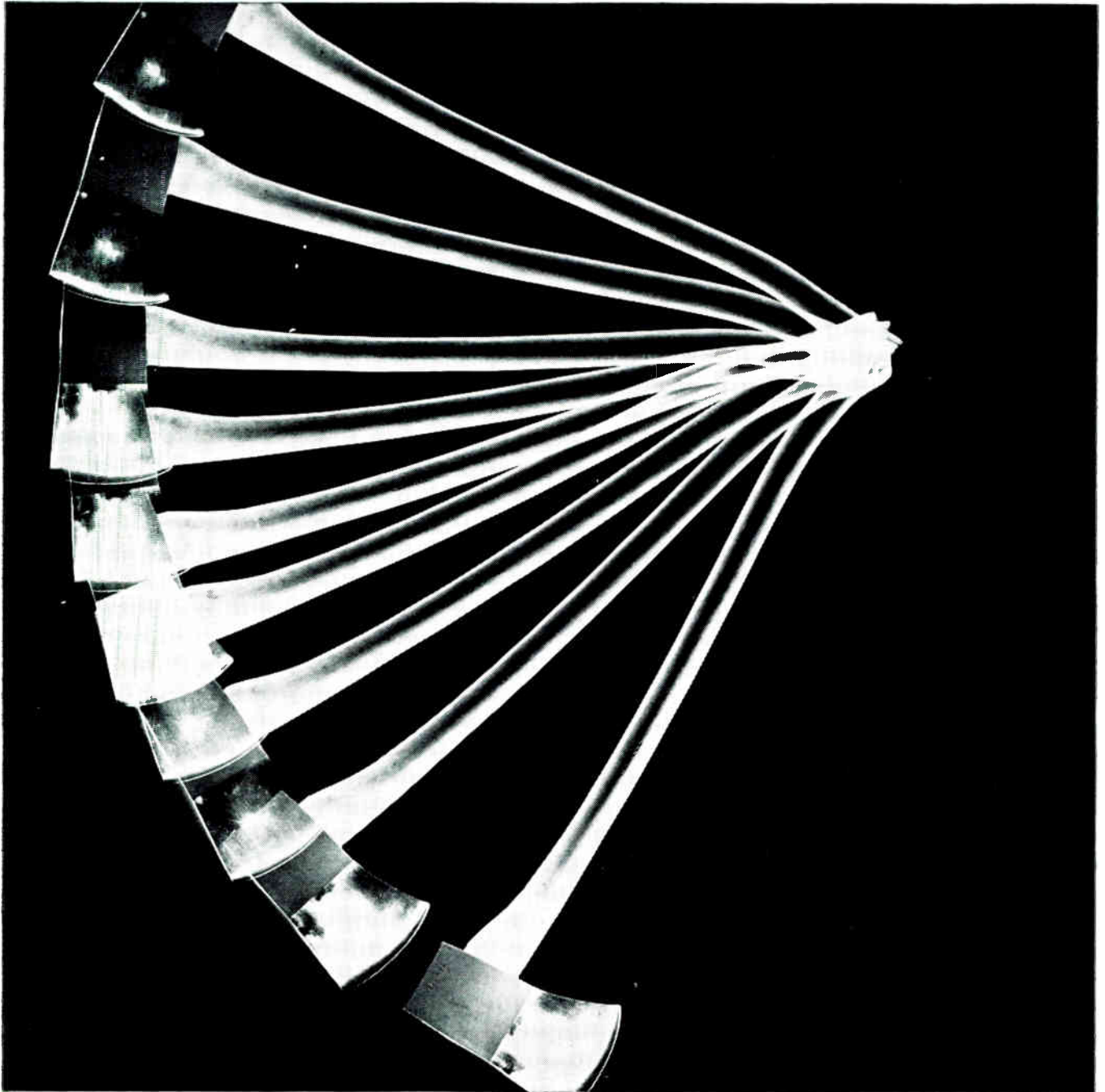

Cheapest way to chop

DC to AC — with an AEI Synchronous Chopper. It fits a standard B9A 9-pin thermionic valve holder, is suitable for feeding both high resistance and transformer-coupled low impedance circuits, its low noise level allows a 1 microvolt signal to be detected. Typical applications are: recording thermo-couple and ionisation chamber outputs; drift correction in analogue computer amplifiers; general instrumentation. Stability is high, operational life is long. Available in two models: CK3 for 50 c/s; CK4 for 100 c/s.

CK3 & CK4 SYNCHRONOUS CHOPPER

WRITE FOR DETAILS AND TECHNICAL DATA TO: AEI INSTRUMENTATION DIVISION, INSTRUMENT AND METER DEPARTMENT, TRAFFORD PARK, MANCHESTER 17



Associated Electrical Industries Limited
Instrumentation Division

S M302

Potting shed?

Araldite epoxy resins are ideal for potting—but this is not a potting shed. Here Araldite is being used to seal capacitor windings at Telephone Manufacturing Co. Ltd. The Araldite filler cures, with negligible shrinkage, to form a complete seal. It adheres strongly to metal surfaces—provides perfect insulation and resists tracking. It is impervious to moisture. Araldite sealing formulations pour and cure at room temperature. In many cases curing can be speeded up by heating.

May we send you a copy of our publication 'Araldite epoxy resins in the electrical industry'?

ARALDITE EPOXY RESINS ARE USED:

- for casting large high-grade electrical insulators and insulation around equipment such as transformers, switchgear components etc.
- for impregnating, potting and sealing electrical windings and components.
- for constructing glasscloth laminates in electrical, nuclear, mechanical and aircraft engineering.
- for bonding metals, ceramics, glass, rubber, plastics, wood etc.
- for constructing tools for forming plastics or sheet-metal, patterns for moulding foundry sand, jigs and fixtures for checking accuracy of assembly etc.
- for chemical resistant-flooring and floor surfacing.
- for anti-corrosion protection of wood, concrete, metals etc.

Araldite epoxy resins

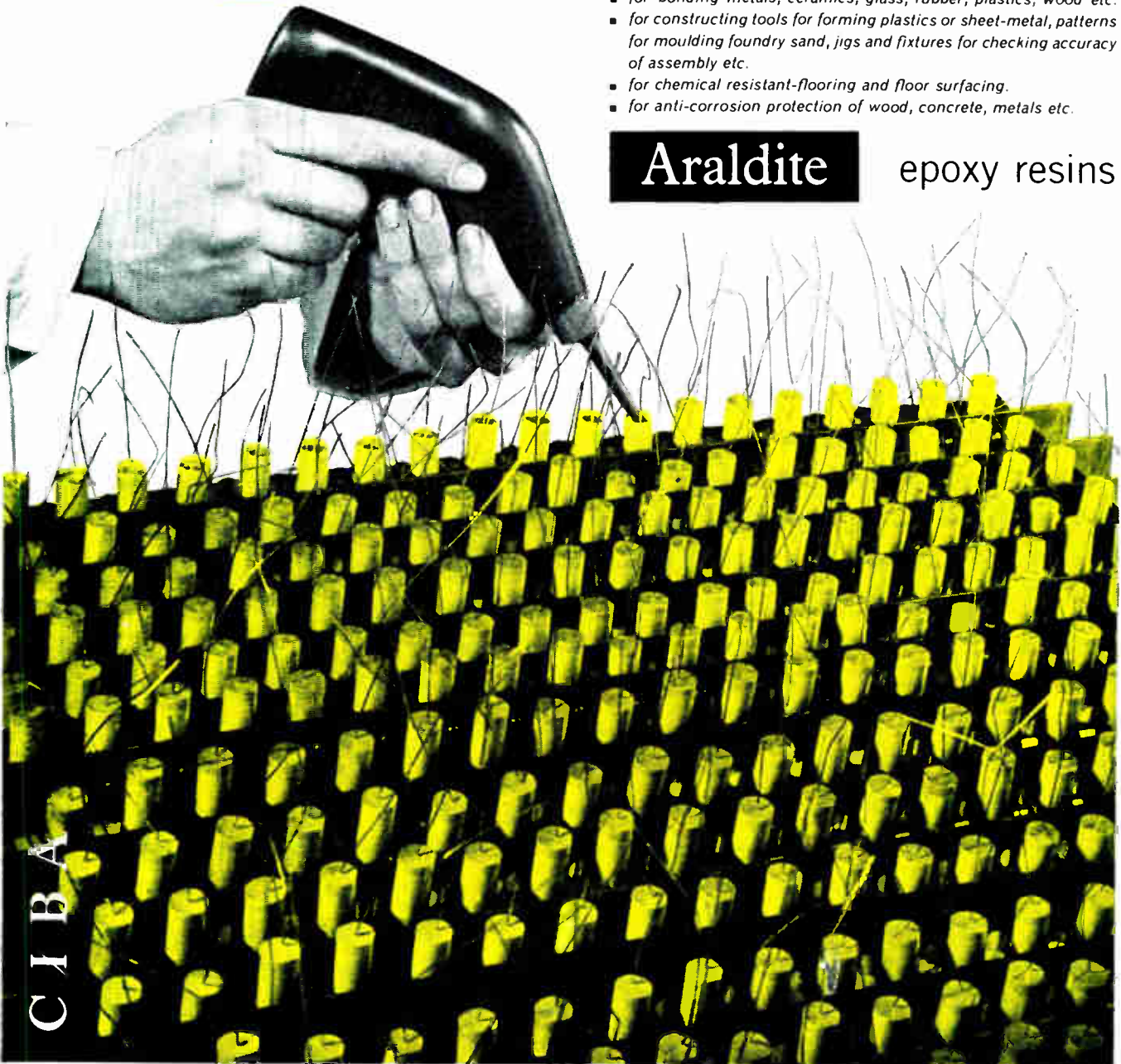

C I B A

Araldite is a registered trademark CIBA (A.R.L.) LIMITED DUXFORD CAMBRIDGE TELEPHONE: SAWSTON 2121
41787

Methods of solving complicated problems to derive the fullest advantage from modern computers

Numerical methods for high speed computers

**G. N. Lance, M. Sc. Ph. D. M.A.I.S.
A.F.R. A.E.S.**

This book assembles the most useful numerical methods developed by research mathematicians, with the particular aim of explaining the facilities that computers offer. Most of these methods have never been published before except to a very limited readership and all have been tested for their practical value. The book will be found invaluable by mathematicians, programmers, engineers, physicists, and scientists generally.

42s net by post 42s 11d 166 pp.

from leading booksellers

Published for

DATA PROCESSING

by **ILIFFE Books Ltd** DORSET HOUSE
STAMFORD STREET LONDON S.E.1

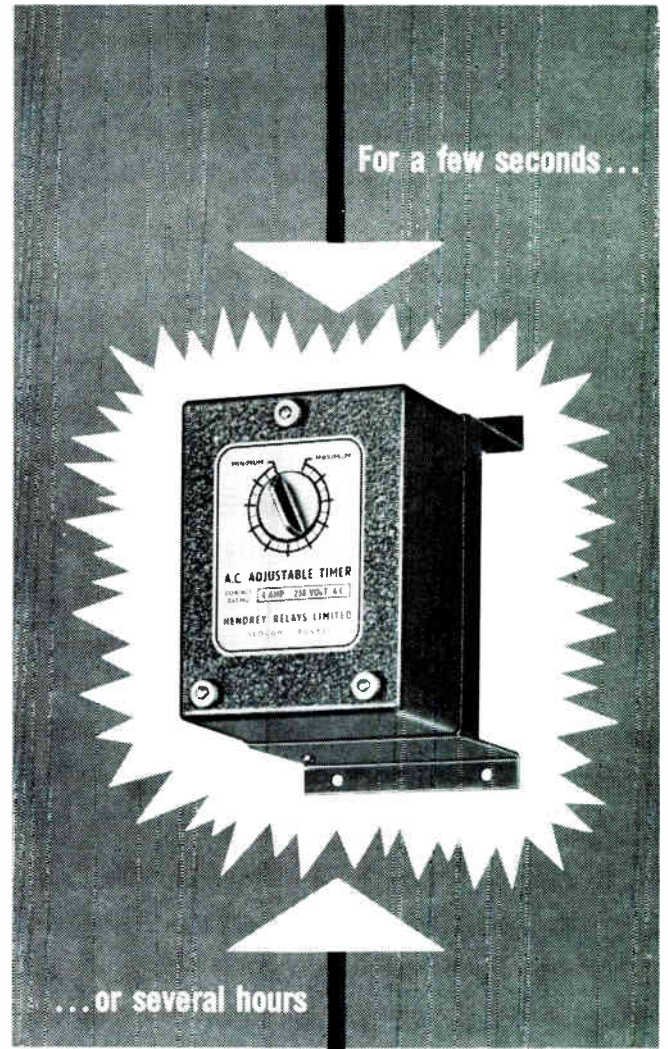

The Hendrey A.C. Adjustable Timer

Incorporates a small self-starting, synchronous motor, which when energised, is arranged to operate a micro-switchette after a pre-determined adjustable time delay has expired. Automatically resets on de-energising. The minimum time delay setting is in all cases 10% of the maximum. Types are available for delays of up to several hours. Adjustment between minimum and maximum settings is by means of indicating knob.



SPECIFICATION

COIL and MOTOR
— Wound for 110 V. or 230 V. 50 c.p.s.
Consumption 8 V.A. approx. total.

SWITCH
— Micro-switchette

RATING
— 4 amps. at 230 V. A.C.

DELAY
— The minimum delay setting recommended is approximately 10 seconds.

DIMENSIONS
— Width 3" (77 mm)
Height 4 1/2" (115 mm)
Projection 4 1/2" (105 mm)
4 x 0.152" (3.85 mm) dia. fixing holes.
Weight 2 lb. (0.907 k.g.)



HENDREY RELAYS LTD., 390-394 BATH ROAD, SLOUGH, BUCKS.

Telephone: Burnham 609 611

Grams: Hendrelay, Slough

MANUFACTURING ELECTRICAL ENGINEERS
CONTROL AND LABORATORY APPARATUS
On Admiralty, Principal Ministries and Post Office Lists,
A.R.B. & M.O.A. Approved Design and Inspection.

STC

JANUARY 1964

components review

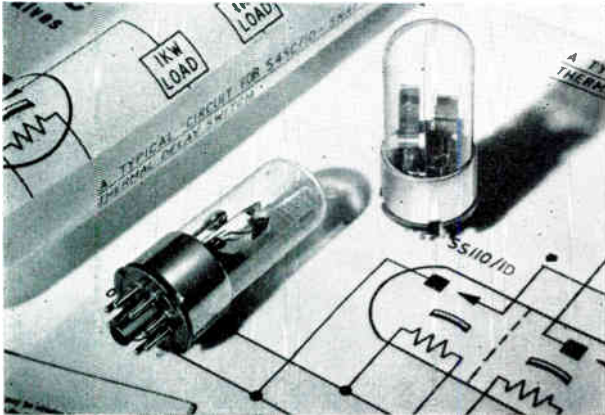

NEW SNAP ACTION AND DOUBLE THERMAL DELAY SWITCHES

STC introduce two switches of novel design: TYPE S45C/1D is a snap action single pole changeover switch which features high contact pressure and a rapid make and break action. It is designed for switching on comparatively high powers (up to 250V at 5A a.c.). The nominal switching delay time is 42 seconds, and by connecting a number of switches in series, one may obtain multiples of the delay time given by a single switch. TYPE SS110/1D consists of two mechanically separate switches mounted in a common glass envelope, each unit giving a maximum closing delay time of 110 seconds. The switches can be used independently or in conjunction with one another. When used in a circuit which gives a delay comprising the sum of the two making times and the two opening times, the switch unit will give a delay of about 240 seconds; this delay is virtually independent of heater voltage variation and ambient temperature and retains close tolerance throughout switch life. Thermal delay switches are very suitable for providing delay times between the application of heater voltage and other circuit voltages, particularly anode voltage to indirectly heated valves. In addition, they can be used as v.l.f. relaxation oscillators, for switching 3-phase circuits from star to delta arrangements when starting induction motors, and for automatically re-closing a circuit breaker after a temporary current surge has caused it to trip. These applications are fully described in STC booklet MS/117 which is available on request.

ABRIDGED DATA * per section

	Base	V _h (V)	I _h (A)	Delay time at 20 °C		Contact Ratings (Max.)	
				Min. (sec)	Max. (sec)	On make	On break
S45C/1D	Small Wafer Octal	6-3	0.75	35	50	250V 5A a.c. 250V 3A d.c.	250V 5A a.c. 250V 3A d.c.
SS110/1D	Small Wafer Octal	6-3*	0.5*	90	110	100V 1A a.c. 220V 1A d.c.	50V 0.1A d.c.

Write, 'phone or Telex for data sheets to STC Valve Division, Brixham Road Paignton, Devon. Telephone Paignton 58685, Telex 4230 or London Sales Office, Footscray, Kent. Telephone FOOTscray 3333, Telex 21836.

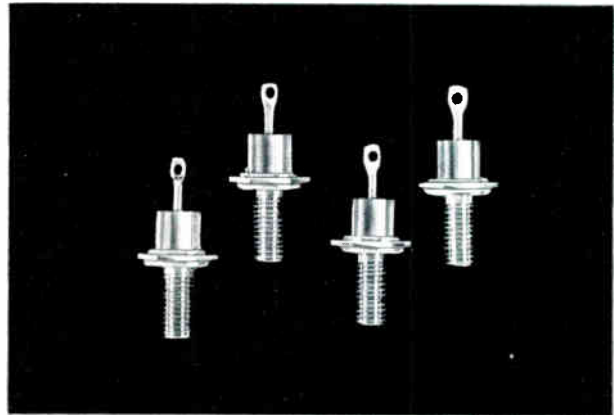

SILICON ZENER REFERENCE DIODES Z5 10W DISSIPATION

These new additions to the STC range of Zener diodes are available in standard preferred values from 8.2 volts to 100 volts inclusive. Good Zener characteristics with sharp turn-over, low slope resistance and low leakage current are predominant features. Their voltage drop is essentially independent of current over a wide current range which makes them suitable for d.c. voltage regulation, clipping, limiting and surge protection within the bounds of their maximum ratings.

ABRIDGED DATA
ELECTRICAL RATINGS AT 50 °C STUD TEMPERATURE
 Nominal voltage range 8.2 to 100.0 V
 Voltage tolerances 5%, 10% & 20%
 Maximum power dissipation 10 W
TEMPERATURE RATINGS
 Maximum working junction temperature 150 °C
 Storage temperature range -65 to 150 °C
 Standard outlines IEC 1-103
 VASCA SO-10
 JEDEC DO-4

POWER DERATING CURVE

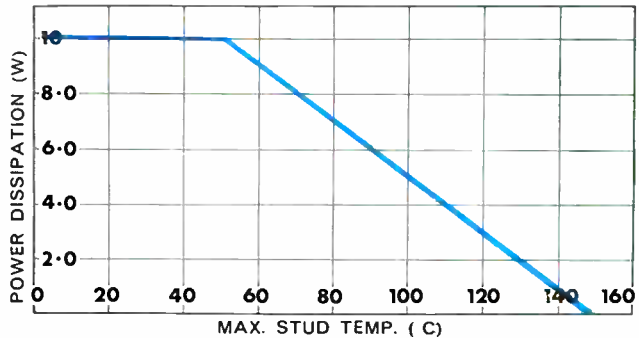

Write, 'phone or Telex for fuller data to STC Semiconductor Division (Rectifiers), Edinburgh Way, Harlow, Essex. Harlow 26811, Telex 81146.



STC REED RELAYS & HIGH-CLASS SWITCHES AT MODEST COST

To meet rapidly expanding demand, relays incorporating Herkon, 'Pygmy' and 'F' type dry reed inserts are now being made by STC in England. The reed units are manufactured automatically to ensure uniformity and stability of characteristics and rigorous quality controls ensure hundreds of millions of maintenance-free operations at fast switching speeds. The relays illustrated are only a fraction of the full range. Numerous types with a large selection of windings (voltage range 1½V-72V) are available and include open, screened, and resin encapsulated types, available for wire-in, plug-in, or for printed circuit mounting. Recent laboratory tests show that Herkon reliability is now the highest in the world.

STOCK AND QUICK DELIVERY OF ELECTRO-MECHANICAL PRODUCTS

Uniselectors.....ex-stock.
 Midget Relays.....all codes, ex-stock.
 P.O. 3000 } samples very quickly
 P.O. 600 } production orders
 Two-in-one } commenced in 2/3 weeks.

NEW P.O. TYPES

Microswitch Range Designed for Heavy Current working, Microswitches rated from 5 to 25A. Coil Range: 1V to 240V d.c. Two 15A contacts or four 5A change-over.

Heavy Duty 8 change-over or make-before break, silver or platinum contacts.

Keys, Plugs, Jacks, Lamps wide variety ex-stock.

Write, 'phone or Telex for Data Sheets and prices to STC Electro-Mechanical Division, West Road, Temple Fields, Harlow, Essex. Telephone: Harlow 21341. Telex 81184.

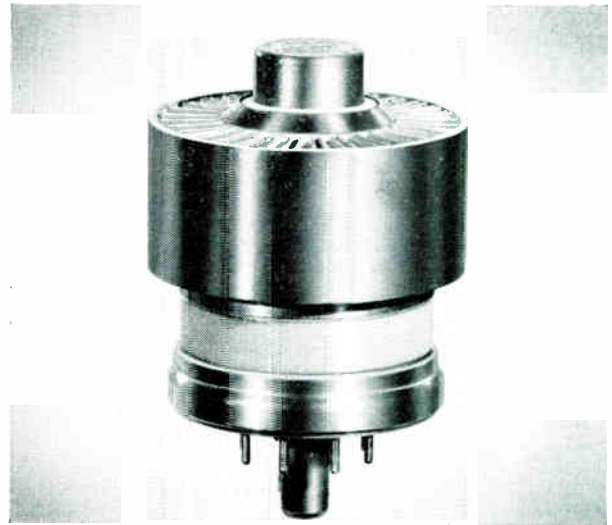

FORCED AIR COOLED TETRODES

DIRECT EQUIVALENTS TO USA TYPES

ABRIDGED DATA

TYPE	CONSTRUCTION	AMPLIFIER CLASS	TYPICAL OUTPUT (W)	f. MAX. (FULL RATINGS) (Mc/s)
4CX250B	ceramic/metal	AB1 (SSB)	300	500
4X250B				
4X150A	glass/metal	C (FM)	370	500
4X150D				
		AB1 (SSB)	300	150
		C (FM)	370	150

All the above have oxide-coated unipotential cathode (V_h=6V, except 4X150D where V_h=26.5V)

These valves are compact, require only moderate air cooling, and they are, therefore, ideal for mobile equipments (CW or pulse).

The construction of the valves is conducive to cavity mounting which is essential for operation at frequencies up to 500 Mc/s.

The diagram below illustrates a 400 Mc/s amplifier circuit using a coaxial line cavity. This and other applications are fully described in new booklet MS/123.

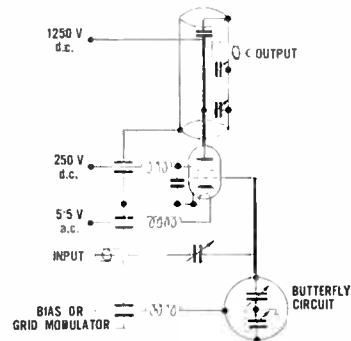

Write, 'phone or Telex for Data Sheets and Booklet MS/123 to STC Valve Division, Brixham Road, Paignton, Devon, Telephone Paignton 58685, Telex 4230, or London Sales Office, Footscray, Kent. FOOTscray 3333. Telex 21836.

STC components review

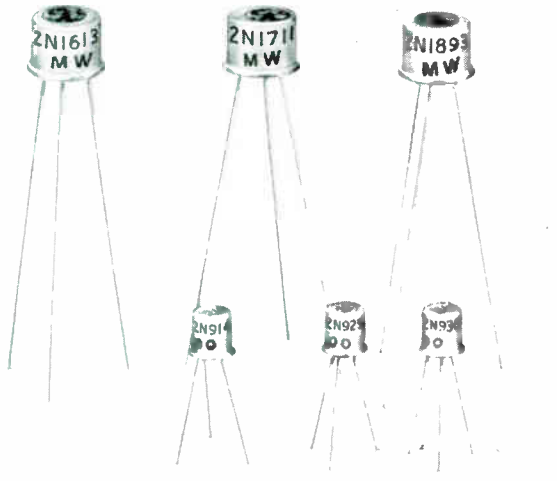

JEDEC SILICON PLANAR TRANSISTORS

Range further extended.

2N914. This transistor is designed as a high-speed saturated logic switch and v.h.f. amplifier. It has an extremely low saturation voltage and is ideal for use in applications where a performance is required superior to that of the 2N708. TO-18 case.

2N929 and 2N930. High performance low level transistors with minimum values for f_T of 300 Mc/s. They have a 4 dB (max) noise figure and are particularly suitable for use in the input stages of measuring amplifiers. The 2N930 has a higher current gain than the 2N929. TO-18 case.

2N1613 and 2N1711. High voltage transistors suitable for general purpose amplification and switching applications. They have a collector dissipation of 800 mW, a 60V collector-base voltage rating and very low leakage currents. The 2N1711 has a higher gain and a lower noise figure than the 2N1613. TO-5 case.

2N1893. This transistor is intended for general purpose industrial applications, e.g. computers and communication equipment operating from a 60V supply voltage. TO-5 case.

The JEDEC types listed above are now added to the standard STC range of silicon planar transistors which already includes:—

2N706	2N743	2N2234
2N706A	2N744	2N2235
2N708	2N753	2N2236
		2N2237

Write, 'phone or Telex for data sheets to STC Semiconductor Division (Transistors), Footscray, Sidcup, Kent. Telephone FOOTscray 3333. Telex 21836.

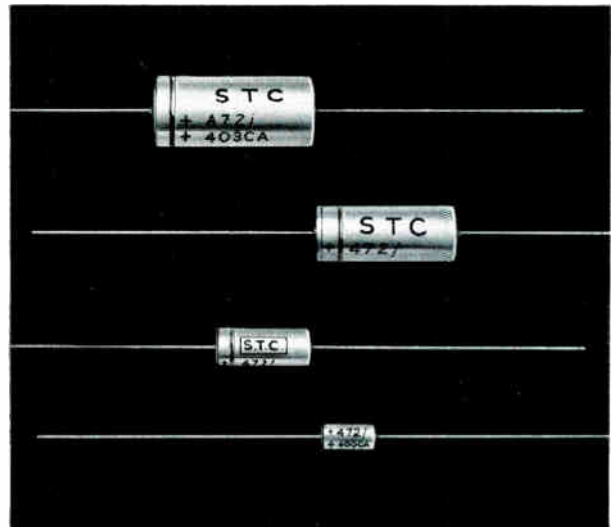

SRDE APPROVAL FOR STC SOLID TANTALUM CAPACITORS

Departmental Approval Certificate Number NS. 3020/2, covering STC Solid Tantalum capacitors, has been granted by the Ministry of Aviation. The approval is based on a successful test programme carried out by SRDE to Draft DEF 5134-A-1 and is pending the finalization of this specification.

The STC solid tantalum capacitor series was extended recently by the addition of a 50 volt rating. Rated working voltages at 85°C are now: 50V, 35V, 20V, 15V, 10V and 6V d.c. This range of capacitors is manufactured entirely in the United Kingdom under full Quality Control and all units are aged for 7 days before shipment.

Capacitors to 5% and 10% tolerances are now available, in addition to the standard 20% capacitance tolerance.

- Designed to DEF 5134-A-1 and MIL-C-26655/2 (Styles CS12 and CS13)
- Temperature range: -55°C to +125°C (with voltage derating above +85°C)
- Humidity classification: H6 (DEF 5011)
- Capacitance range: 0.47µF to 330µF.

Performance data available on request.

In addition to this range, STC manufacture the following wet-electrolyte tantalum capacitors: TYPE APPROVED FOIL, HIGH TEMPERATURE FOIL, SPECIAL QUALITY FOIL.

Write, 'phone or Telex for Data Sheets to STC Capacitor Division, Brixham Road, Paignton, Devon or London Sales Office, Footscray, Kent. Telephone FOOTscray 3333. Telex 21836.

STC

COMPONENTS GROUP

high-grade electronic components by

ANOTHER WORLD BEATER IN THE LEKTROKIT RANGE

LEKTROKIT RACK SYSTEM

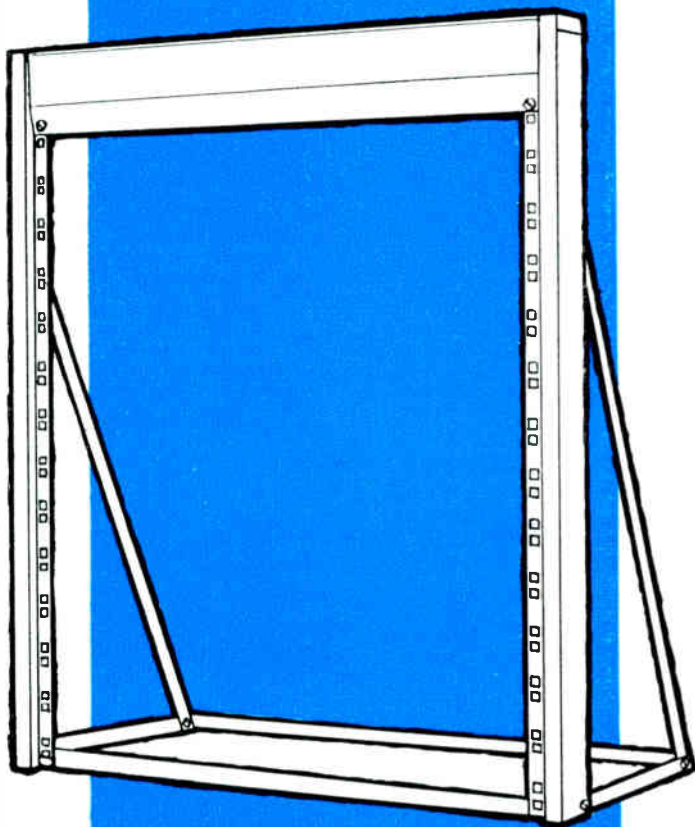

The Lektrokit Rack Construction System is a natural extension of the widely used Chassis Construction System and comprises a range of simple and inexpensive component parts, from which standard equipment racks can be constructed quickly and cheaply.

SPECIAL FEATURES of the Lektrokit Rack System include:

- ★ Assembled racks and trolleys are light in weight but strong and of pleasing appearance.
- ★ Complete versatility - static racks for floor or bench mounting, mobile racks and trolleys, can all be constructed from the same limited range of components.
- ★ Unlimited expansion potential of the assembled racks, laterally as well as vertically.
- ★ Parts are supplied singly or in kit form.
- ★ The components are low priced and can normally be supplied ex-stock.

For full details of the Lektrokit Rack System write for the new illustrated 24-page Rack System Handbook, sent free of charge and without obligation.

Please send my free copy of the
NEW RACK SYSTEM HANDBOOK
 Also send a copy of the
CHASSIS SYSTEM HANDBOOK

Name _____
 Company _____
 Address _____

Detach and send to :—

A.P.T

**ELECTRONIC
INDUSTRIES
LIMITED**

CHERTSEY ROAD, BYFLEET, SURREY
PHONE: BYFLEET 41131/2/3/4 PABX GRAMS: APTRAN, BYFLEET

I.E.164

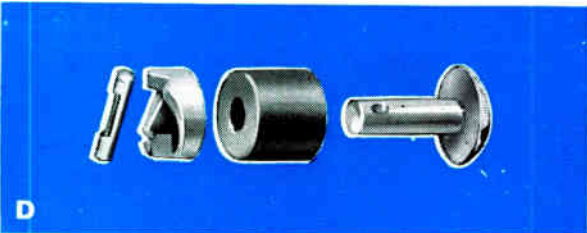
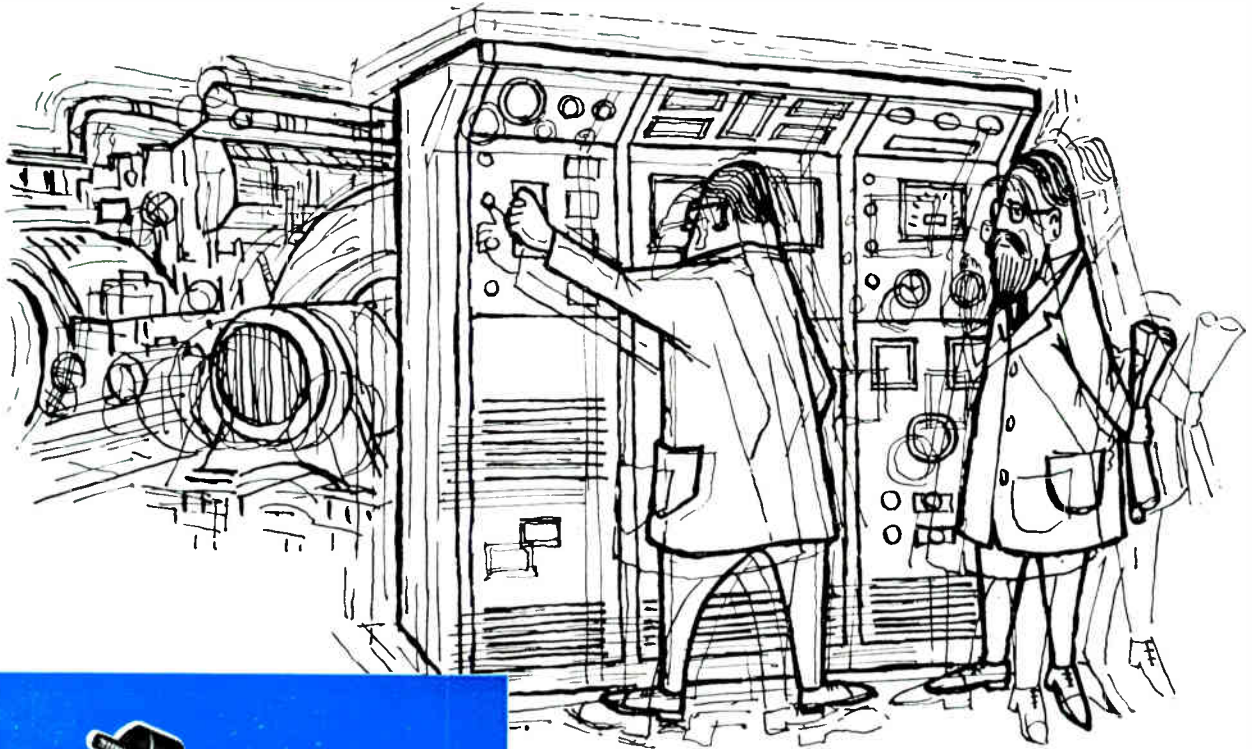

VIBRATION?

The wide use of electronic equipment in industry, often in close proximity to machinery, presents new vibration problems. Every effort should be made to eliminate the trouble at its source by the use of Silentbloc machinery mountings, bearings and couplings; but local precautions in the electronic apparatus itself are also desirable, and there is an extensive Silentbloc range of devices for this purpose. A few are described here.

A. Bonded rubber/metal stud mountings for supporting apparatus of light weight. There is a range of sizes of various degrees of stiffness.

B. Ring-type resilient mountings giving extra flexibility for shock insulation of sensitive equipment. Available in sizes to suit a great variety of applications.

C. Instrument mountings for general service offering good insulation with a useful degree of mechanical stability. Sizes and characteristics for every conceivable purpose.

D. "Vibrex" panel fasteners—quick one-hand action, with or without electrical and mechanical insulation between panel and base. Easier to fit than any other panel fastener: simple drilling of panel and base; no screwing, tapping, sweating or brazing.

MOUNTINGS • BEARINGS • "VIBREX" PANEL FASTENERS

ANTI-VIBRATION DEVICES BY

SILENTBLOC

Andre Rubber Co. Ltd. is another Silentbloc Company

SILENTBLOC LTD • MANOR ROYAL • CRAWLEY • SUSSEX

Telephone: Crawley 27733 Telegrams: Silentbloc Crawley

Silentbloc products are also manufactured by Silentbloc (Australia) Pty. Ltd., Melbourne Broadway/S304

...AIMING AT THE ULTIMATE IN RESISTOR TECHNOLOGY

WELWYN "METOX"

MINIATURE METAL OXIDE RESISTORS NOW WITH

SELECTION TOLERANCE $\pm 1\%$ and $\pm 2\%$

In addition to the normal Total Excursion and Selection Tolerance ranges, the most versatile Metal Oxide Film resistors available today are NOW obtainable at close Selection Tolerances at $\pm 1\%$ and $\pm 2\%$

TYPE AND TOLERANCE	OHMIC RANGE
F25 @ $\pm 1\%$	100 Ω - 22K
$\pm 2\%$	47 Ω - 50K
F20 @ $\pm 1\%$	100 Ω - 22K
$\pm 2\%$	47 Ω - 100K

WRITE NOW FOR FULL DETAILS



WELWYN ELECTRIC LIMITED

BEDLINGTON - NORTHUMBERLAND - ENGLAND

Telephone: Bedlington 2181-8 - Telegrams: Resistor, Bedlington

FACTORIES IN AUSTRALIA AND CANADA

Comment

Traffic control is a field in which electronics is beginning to play a part. We recently referred to the help which closed-circuit television can give. However, this is only an aid at places where manual control is still employed, for it only helps the controller to see better what is happening.

The ideal would seem to be the completely automatic control of the traffic lights throughout a whole town by means of a computer. The scheme calls for vehicle sensors to be built into roads on the approaches to all traffic lights and connected to a central computer, which is thus continuously fed with information on the number of vehicles approaching every traffic light in the town.

The computer processes this information and works out an optimum pattern of traffic-light switching to deal with the traffic and then directly controls the lights to conform to that pattern. It repeats this process as the traffic pattern changes, so that the lights always work to an optimum pattern for the traffic as it actually exists.

This is not a pipe dream. Such a system actually exists on a small scale. A pilot scheme was tried in Toronto a few years ago, and a permanent one is now being installed. At the moment it controls only 100 traffic lights. By the end of this year it will control 1,000. Existing traffic lights are used with a converter box to permit the computer to take control. The vehicle sensors are inductive loops in the roads. The communication channels between the computer and the sensors and lights are all narrow band.

It is reported that the small-scale pilot scheme cut the average delay to vehicles by 11% in the evening and by 25% in the morning rush hours and increased speeds from 12 m.p.h. to 16 m.p.h. The saving of cost to vehicle users is put at £1 million a year. To obtain the same improvement by road works would cost £15 million, whereas the cost of the computer system is around £1-£2 million only.

The performance of the Toronto system as it grows to completion will be watched closely. If it turns out as successful as it promises to be, we think that computer control will undoubtedly become increasingly adopted.

Linked Traffic Signals

Computer traffic control is envisaged for the future in Liverpool. In the meantime, a new linked system of traffic lights is being installed and the first section of it came into operation on 5th December. Road vehicle detectors are fitted to sample the traffic flow and feed information to a master timer which controls the timing sequence of eleven sets of lights. This timer

contains three pre-set plans of operation for the lights and it automatically selects the most suitable for the prevailing traffic conditions. In the future, 38 new traffic signals are to be added and nine others modified to work within the system.

These are early steps in a plan which has been approved by the Liverpool City Council's Development and Planning Committee for eventual computer control. The present scheme has been

designed with the knowledge that computer control will be needed in the future and so, presumably, in such a way that it will fit into it.

Units

We are all now familiar with m.k.s. units, especially in the rationalized form, and most of us still know what is meant when they are spoken of as the Giorgi system. Some may be puzzled by m.k.s.a.; strictly, this is *the* Giorgi system, and is based on the metre, kilogramme, second and ampere as the basic physical quantities.

We now have s.i. (or S.I., according to taste) units. Although they have been in existence for quite a long time few people have heard of them and certainly will not know what is meant when they first meet the name. The letters stand for 'Système Internationale' and as far as most people are concerned s.i. is merely another name for m.k.s. However, it is actually based on six units, the metre, kilogramme, second, ampere, degree Kelvin, and candela, and is a common system of units not only for mechanics, electricity and magnetism but also for thermodynamics and light.

In our field m.k.s. units (or should we now call them s.i. units?) have been largely adopted. This is probably because most of them are in any case the usual practical units. One common exception is the tendency still to measure flux density in lines per sq cm or gauss instead of webers per sq metre. Physicists have been much slower than engineers to change to m.k.s., however, and still freely use c.g.s. units.

A change of units is not easy to get used to. One acquires a 'feel' for the size of things in a set of units and it takes a long time to get this in a different set. Many people who are equally at home with inches and centimetres get quite lost with miles and kilometres!

By bringing light and thermodynamics into the m.k.s. system we think that the s.i. units are particularly to be welcomed. At first sight, it is surprising that the candela has had to be introduced into the system of units in order to accommodate light. The candela is a measure of the power emitted from a source of light. Since light is an electromagnetic radiation just as much as a radio wave, the obvious thing to do is to measure light power in watts. Very roughly, the candela is $\frac{1}{4}$ watt. Clearly the candela has been brought in to the s.i. unit system to bring light within it without having to change the whole existing system of light units.

Such a change would have caused great inconvenience to illumination engineers and as a matter of practical politics the retention of the candela is doubtless the right thing. We ourselves, however, would have preferred

to see the watt made the basis of light units! This is just because we do not have any 'feel' for light units. When we use them, which is not often, we have to translate them into electrical terms to get an idea of magnitudes.

While on the subject of light it may be worth while to point out a difference of usage of the word 'intensity'. In light it is used in connection with power, whereas in radio it is employed in connection with field strength; that is, volts/metre. The radio engineer who has to refer to a book on light can get very confused by this.

Phonon

Bell Telephone Laboratories report a laser material which generates phonons as well as emitting photons. This is magnesium fluoride doped with nickel ions. Before we go any further, it will be as well to say what phonons and photons are. We make no apology for doing so, because engineers do not use these terms much, and 'phonon' suggests something to do with sound! They are both quanta; a phonon is a quantum of thermal energy in a crystal lattice, a photon is a quantum of electromagnetic radiation.

The new laser thus not only emits electromagnetic radiation, as do all lasers, but the crystal lattice of the material is thermally excited into vibration. The crystal can be at 20 °K or at 78 °K and the phonon frequency is 10^{13} c/s with a photon wavelength of 1.62 microns.

Electro-Medical Apparatus

Regulations covering interference to radio and television from electro-medical apparatus have been laid before Parliament and give the Postmaster General power to control such interference. They come into force on 29th November 1964 and require manufacturers, assemblers and importers of electro-medical apparatus to ensure that when it is used it does not exceed prescribed limits of radiated field strength and terminal voltage. The limits are those now specified by the Ministry of Health for short-wave diathermy units.

However, these limits may exceptionally be inadequate, as when the apparatus is used unusually close to receivers. In such a case, the user may be required to eliminate the interference.

p-MOST

In American literature this term has come into use. Its significance is by no means obvious. 'MOST' is an acronym of 'metal-oxide semiconductor transistor' while 'p' stands for hole-conducting. The term 'p-MOST' thus means a hole-conducting metal-oxide semiconductor transistor. It is a field-effect device having a high input impedance.



FEED DRIVES FOR AUTOMATICALLY-CONTROLLED MACHINE TOOLS

Automatic control of machine tools is best achieved when the control system and the machine are designed together. Even when this cannot be done, relatively simple modifications to the drives of the machines usually result in an adequate performance. In this article the mechanical requirements are discussed.

By M. MONK, B.Sc., A.M.I.E.E.*

THE design of an automatically-controlled machine tool calls for close collaboration between the control system and machine designers, and this collaboration is most essential in the consideration of the feed drives. There are two basic decisions to be taken which are:

- (a) The means of energy conversion; that is, the means by which the control instructions are converted into mechanical motion, and
- (b) The method by which the mechanical motion is converted into relative motion between workpiece and cutter.

The choice of mechanisms is wide and it is the duty of the designers to achieve an adequate performance at the lowest cost. It frequently happens that the various drives on a machine tool require different mechanisms.

In the ultimate, starting with an entirely new design, the whole concept of the machine can be considered in the light of the required control characteristics. It is more usual, however, to be faced with an existing design which cannot be altered in its basic concepts for reasons of machining performance or existing manufacturing facilities, or simply the cost of re-design. Fortunately it is frequently possible to modify the drives to a sufficient extent without adding too much to the cost of the machine, or incurring too great a development charge.

The demands made on a feed drive by automatic operation can be examined by dividing such controls into three broad categories:

1. Systems requiring only control of feed speed.
2. Point-to-point positioning systems.
3. Systems requiring control of slide position while in motion.

Variable-Speed Feeds

The simplest form of control is that of continuously-variable-speed drives for the feed motions. The advantages to be gained are: rapid and remote selection of feed speeds; the ability to change the feed while running to obtain the best cutting conditions; and simplification, with consequent cost reduction of the feed gearboxes.

In choosing the feed drives the machine tool manufacturer may also wish to prepare the way for the addition of more sophisticated forms of control to meet future requirements.

However, most needs are met by standard industrial variable speed d.c. motor controls driving the machine through its normal leadscrews or racks. An example is shown in Fig. 1 of a skin-milling machine in which the gantry is driven along the bed by a 5 h.p. motor controlled by an A.E.I. Emotrol equipment giving a speed range of 2 to 120 in. per minute.

Some manufacturers are taking advantage of the increasing availability of reasonably priced hydraulic motors and valves to fit variable speed hydraulic drives. It is not possible to state that in general one form of control is cheaper or better than the other; much depends on the facilities required and the form of construction of the machine.

Variable-speed feed drives demand no special characteristics of the mechanical parts of the drive that are not demanded by change-speed gearboxes. Efficiency, of course, affects the power required and hence may affect the cost to a greater extent than that of a gearbox.

Backlash is of importance only in climb milling where the cutter tends to push the sliding element forwards through its backlash zone. Stick-slip (that is, the tendency at low speeds for the motion to break down into a series of jerks) should not be present if good surface finish is to be obtained.

The control must be capable of a wide range of speed if gearchanges are to be entirely eliminated and speed ranges of 100:1 are not unusual. The worst difficulty is the 'rapid traverse' problem. To save time when the machine is to be moved without cutting, it needs to be traversed at a speed much higher than the top feed rate. This may need some special provision such as a clutch change, a clutch-coupled induction motor, an auxiliary hydraulic power supply or a similar appropriate mechanism.

A more complex form of variable-speed feed drive is used on the Asquith ram type milling and boring machines an example of which is seen in Fig. 2. The horizontal drive is taken through a rack and pinion and the vertical movement of the spindle box is provided by a screw, the moving masses being about 50 tons and 23 tons respectively. The feed motors in both cases are 12.5 h.p., d.c., and provide a 60:1 speed range in two stages, 33 to 1 by varying the armature

*Electronic Control Engineering Department, A.E.I. Electronic Apparatus Division.

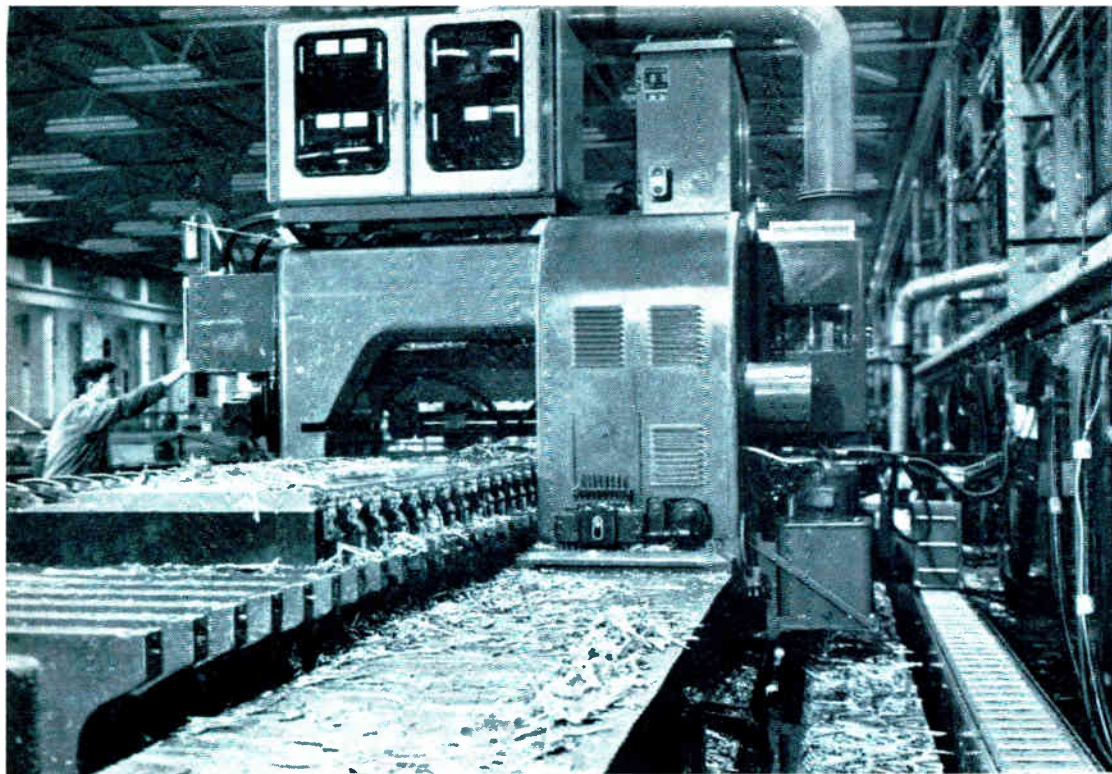

Fig. 1. A skin-milling machine fitted with A.E.I. Emotrol drive for the crossbeam

voltage and 1.8 : 1 by field weakening. This has the advantage of keeping the size of the generator to a minimum while maintaining a high motor torque at low speeds.

The two motions can be controlled simultaneously by means of a 'steering' control which enables the operator to guide the cutter round a face or profile, the combined vector feed rate remaining constant. In order to achieve this the feeds are designed to be reversible without discontinuity and, when switched to 'steering', can be controlled right down to zero speed.

Rapid traverse of the motions is also obtained from the corresponding feed motor by selection of a fixed reference. Fig. 3 shows the horizontal traverse gearbox and alongside the machine can be seen the control cubicles containing the

feed-speed regulators, auxiliary control gear, and a variable-speed regulator for the spindle. It is interesting to note that the spindle power is provided by the same type of system and in the machine illustrated is capable of 50 h.p.

Co-ordinate Setting

For point-to-point positioning systems there is a different set of requirements. In this case the accent is upon speed of positioning, because setting time is wasted time as far as the cutter is concerned. The feed drives need to be designed to move the slides in the shortest time to the set position to an acceptable degree of accuracy and to leave them undisturbed during the machining operation.

The characteristic that is of primary importance is stick-

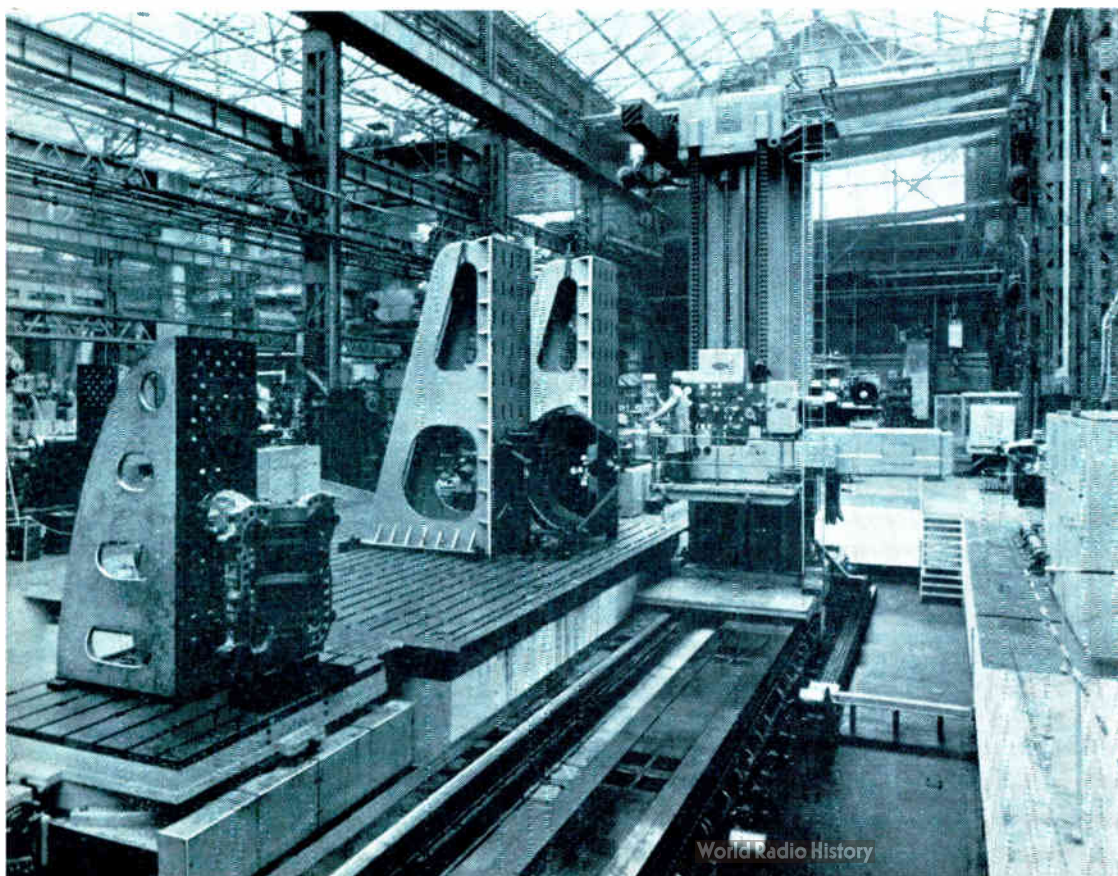
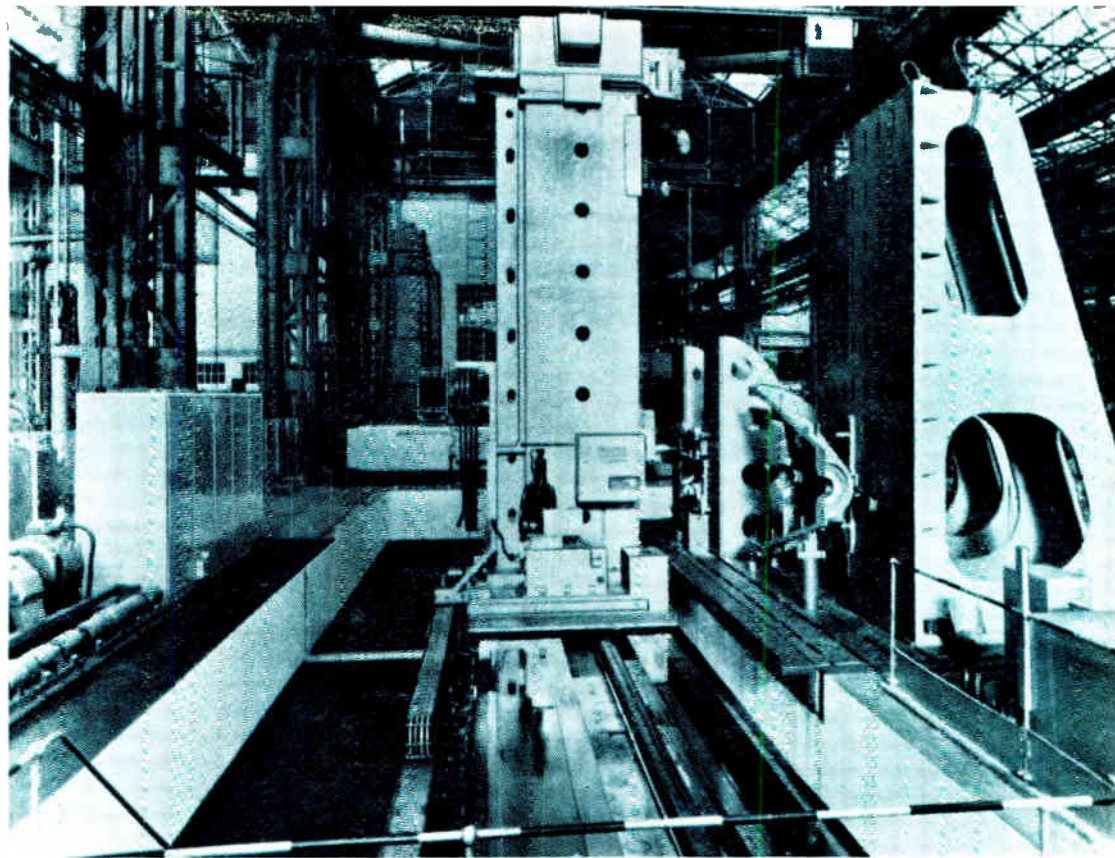

Fig. 2. Asquith 6-in. spindle ram type boring machine with variable-speed electric drives for the column, spindle box and spindle

Fig. 3. A view of the Asquith 6-in. spindle boring machine, showing the column feed drive gearbox



slip. Naturally, if the slide will not move in increments substantially less than the discrimination required, accuracy of setting will be impaired. It is also important that the slides should be straight and orthogonal to an acceptable tolerance otherwise much of the control-system accuracy is wasted.

Backlash is of little consequence unless the control system is designed to hold the slide in position during the machining operation, in which case it needs to be very small to avoid any risk of disturbance by the cutter forces. It is more usual to clamp the slides during cutting.

The most important characteristic of the control system is that it should achieve a consistent approach to the required position. If there is any tendency to run on a short distance beyond the set position, the amount should be constant, and unless it is negligibly small, approach to the set position must be made always from one direction. Unidirectional approach is also necessary if the measuring system has backlash, for instance if the leadscrew is used for measuring purposes.

Fig. 4 is an illustration of a method of reducing stick-slip to negligible proportions. It is the method adopted by Messrs. H. W. Kearns & Co. Ltd. nine years ago for the table drive of their automatically-controlled boring machines and is still being used. The drive layout has been re-arranged so that it is as direct as possible and is also quite separate from all other drives. The gearbox is mounted on the end of the bed and is coupled directly to the leadscrew driving shaft while the leadscrew itself consists of two short lengths of screw of large diameter held between substantial thrust races. It transmits thrust to the table by means of a half-nut running the whole length of the table. Friction is reduced by forced lubrication to the table ways. With this drive it is possible to move the table in steps of 0.0003 in.

Power is provided by a Ward-Leonard controlled variable-speed d.c. motor. The gearbox has two speeds selected by electromagnetic clutches, the higher speed being used for quick power traverse only. Positioning time for a typically average distance of 6 in. is about 8 seconds for an overall accuracy of ± 0.0003 in. and repeatability of ± 0.0001 in.

Profiling Systems

The demands made on the feed drives by copy-profiling systems and by continuous tape-control systems are very

similar, and both are more severe than those made by other forms of drive. There are some differences. In profiling systems where more than one axis is controlled it is not essential that the axes should be orthogonal, nor that the feeds should have the same dynamic response. These result from the inherent interaction between controlled axes which is not present in tape-controlled systems where the axes are quite independent. On the other hand, dynamic response needs to be better because there is no automatic way of warning the copying system of an approaching change of direction. In tape control, where the whole sequence of movement is specifically planned, the vector feed can be slowed down in advance of a sudden change.

Each drive must be capable of a continuous range of speed from the maximum feed rate required, through zero to maximum in the reverse direction. Breakdown into discontinuous motion at low speeds is only tolerable if the increments of movement are sufficiently small for the consequent deterioration of surface finish to be acceptable.

Backlash must be very small not only to avoid marking the workpiece at reversal points, but to allow the best performance to be obtained from the drives by removing the tendency to instability that backlash introduces.

The need for high performance makes higher demands on the mechanical parts of the drives in the realms of efficiency and compliance. High performance drives tend to be expensive and the greater the power, the greater the cost,

Fig. 4. Table leadscrew for a Kearns horizontal boring machine. This engages with a long half-nut fixed to the underside of the table

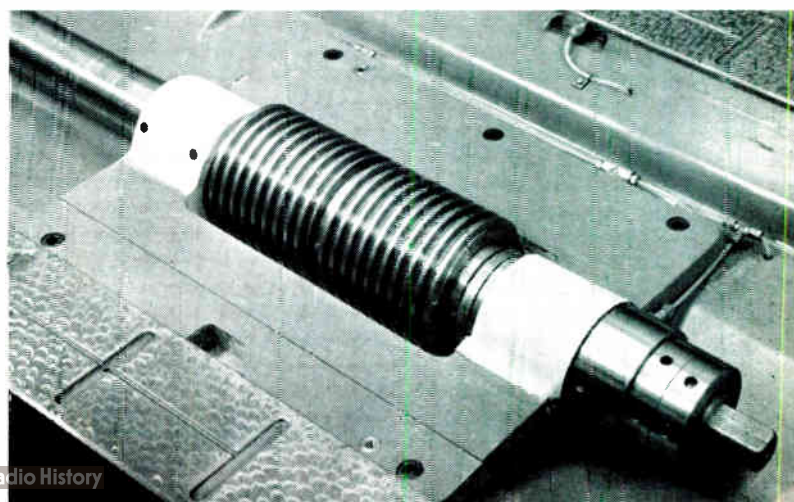

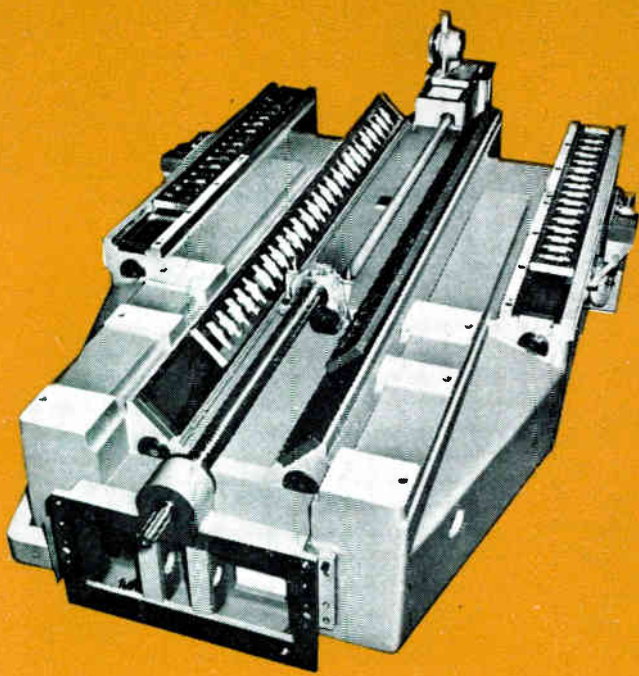
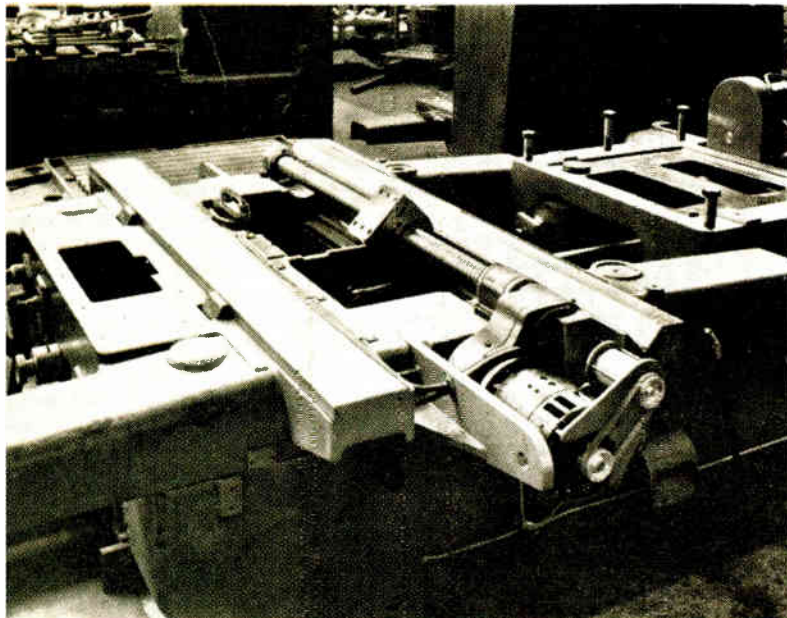

Fig. 5. Base of Newall 2657 jig borer showing roller ways and recirculating ball-bearing leadscrew

consequently, it is usually worthwhile improving the whole efficiency of the drive system.

One of the most useful aids to efficiency is the re-circulating ball leadscrew which has an efficiency of about 90%, compared with 25 to 30% for a conventional screw—allowing a reduction of 3:1 in the power required. It also has the advantage that backlash can be virtually eliminated. The effective backlash of a ball screw and its mountings can be expected to be about 0.001 in. to 0.002 in. compared with 0.007 in. to 0.020 in. for conventional screws. These are practical figures taken over a period of time, not the best figures obtained when new. Pre-loading, by using two nuts, is necessary to improve the compliance. The main dis-

Fig. 6. Cross-slide assembly of magnetic tape-controlled Coventry Gauge and Tool jig borer type 250



advantage of ball screws is that of cost; wear is reduced, but still takes place.

A new type of screw is becoming available in which the clearances between the flanks of the threads of nut and screw are filled with oil under pressure in such a manner that the gaps on each side of the threads are maintained constant.

The arrangement has the advantage of high stiffness and high efficiency with no wear, but of course the special oil supply and piping are an added cost.

Other devices such as the rack and pinion and the hydraulic ram are equally effective in reducing losses, but a rack and pinion has backlash which it is difficult to eliminate and the ram is compliant. A rack is capable of a high stiffness, but careful design is necessary to ensure that compliance is not introduced by insufficient support for the pinion.

A further reduction in loading can be made by reducing the slide friction. Friction is only one component of the total load which also includes cutter reaction and inertia forces, so a reduction is not so effective as an improvement in drive efficiency. The advantage is best felt on large machines

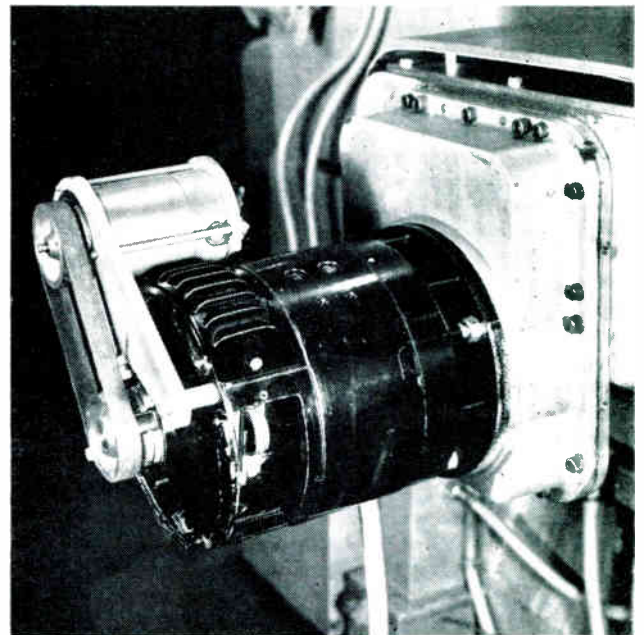

Fig. 7. Table drive gearbox for magnetic tape-controlled Newall 1520 c.c. jig borer

where the moving mass is considerable. Methods consist of partially or wholly supporting the slide on rollers, linear ball bearings, oil or air.

Fig. 5 shows the base of the Newall 2657 machine which has been used for point-to-point positioning, profile milling and continuous tape control.

The roller supports for the cross slide and the ball bearing leadscrew are both illustrated.

The need for a rapid response rate implies that the drives must be capable of transmitting high frequencies. These may be of the order of 50 c/s for very light drives, but are more usually of the order of 5 to 20 c/s. It is clear that no mechanical resonances can be allowed to exist below these levels and preferably should have frequencies at least twice as high. There may be severe difficulties facing the machine designer in obtaining such responses, which imply high drive stiffnesses. It is obviously incumbent upon the control designer not to demand more than is really necessary.



Fig. 8. Cam machined on tape-controlled Newall 1520 machine. Profile surface finish is 6.5 microinches centre-line average

The high performance demanded by continuous tape-controlled machines has led to the frequent use of hydraulic drives. At present, it is the only satisfactory way of obtaining high frequency response at powers over 1 h.p. Electrical drives are able to give an adequate performance below this level, but above 1 h.p. a penalty is paid in loss of response.

With the improvements in efficiency previously mentioned machines which used to require 1 to 2 h.p. can now be controlled by $\frac{1}{2}$ h.p. motors. Examples of this are the Kearns type 451 horizontal borers and the Matrix type 250 jig borer, the cross-slide assembly of which is shown during erection in Fig. 6. Both have been fitted with continuous magnetic-tape control in three axes.

Fig. 7 shows the $\frac{1}{2}$ h.p. motor used for driving the table of the Newall 1520 jig borer. The motor is geared 5:1 to a 0.1-in. pitch ball-bearing leadscrew. The ways, which are in a V and flat arrangement, are of scraped cast iron with one-shot lubrication. Overall drive backlash measured as lost motion at the table is about 0.001 in. The table drive stiffness is approximately 308,000 lb/in. giving a mechanical frequency response of 84 c/s. Power is provided by a shunt wound d.c. motor whose armature current is controlled by transistors which are switched on and off at 400 c/s. Speed feedback is provided by a belt-driven tachogenerator. The frequency response of the speed regulator is 50 c/s, and that of the closed position loop 20 c/s.

This system was described in an earlier article in *Industrial Electronics* (November 1963, p. 733). The performance of both machine and control system have enabled high quality work to be produced an example of which is the cam shown in Fig. 8. A normal cutter gave a surface finish of 32 microinches which was subsequently improved to 6.5 microinches by skimming the surface with a 1-in. diameter grinding wheel mounted in the spindle.

PNEUMATIC SOUND GENERATOR

A high-intensity sonic source for various types of research work has been announced by Branson Instruments Inc., U.S.A.

Called the Pneumatic Sound Generator, the new unit is designed primarily for research work in chemical, physical and allied fields where material must be subjected to a high degree of concentrated vibratory energy.

The intense sonic energy generated by the device has been used for defoaming, heatless drying and for smoke and dust agglomeration. In addition, recent experiments indicate that the sonic generator has a beneficial effect in accelerating chemical reactions, controlling combustion

rates, and in the emulsifying and atomizing of various liquids.

The Pneumatic Sound Generator is driven by compressed air, steam or other gases and has no moving parts. When coupled with a conical horn, the sonic energy is directed forward while the driving gases are driven rearward. This allows the unit to be used in applications where contamination by the driving gas is unacceptable.

The generator operates in the 10 to 12 kc/s range and is capable of emitting an energy level of 167 dB at 5 in. and 162 dB at 10 in. It weighs 2 lb and with the conical horn is 6 in. in diameter.

For further information circle 51 on Service Card

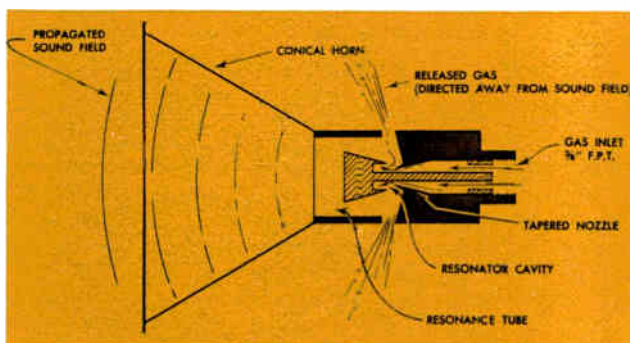

Pneumatic Sound Generator operates on compressed air or gas, has no moving parts. Driving gases are exhausted through slot

Right: Generator kit consists of sound generator, ear protectors and carrying case



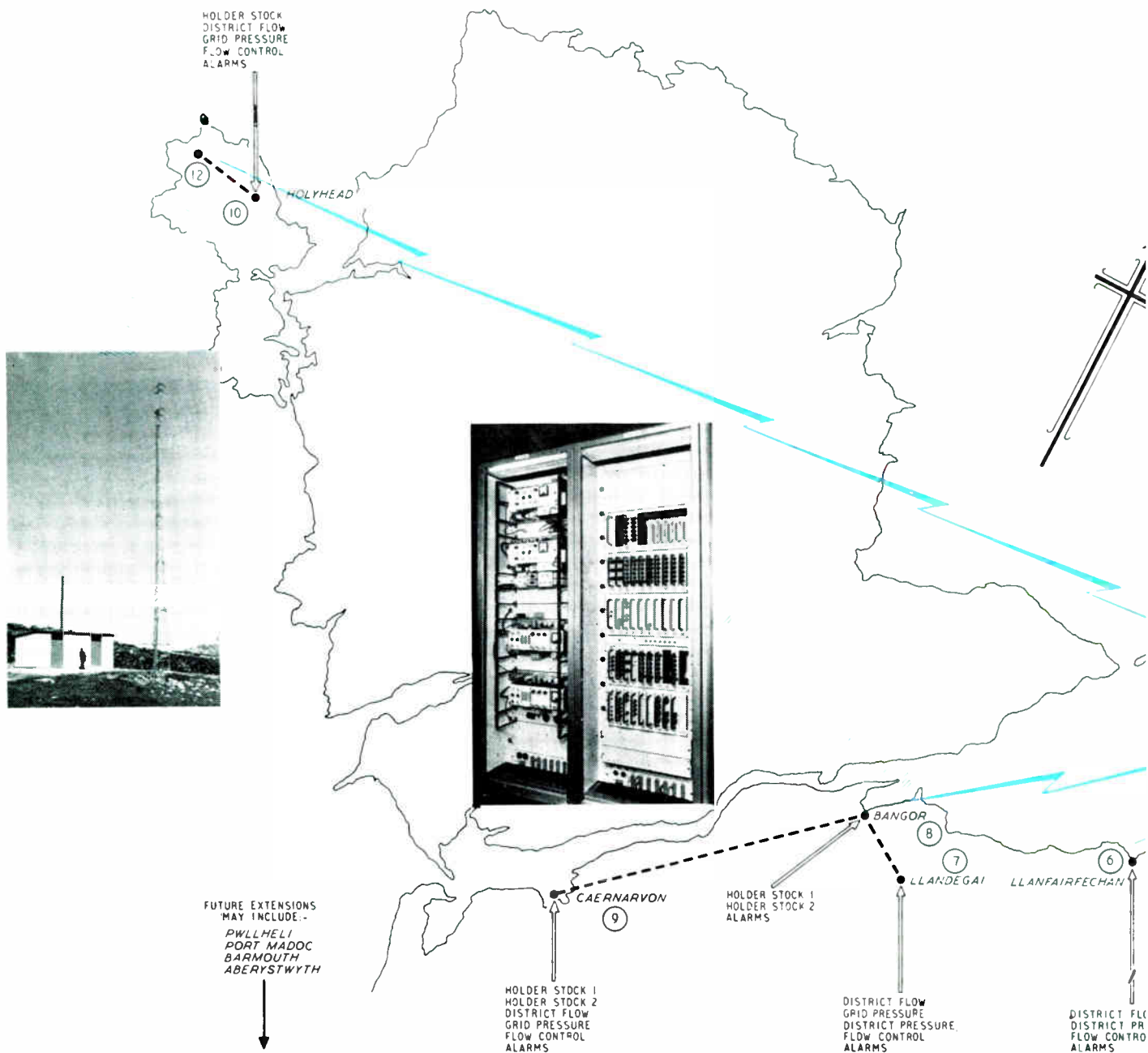

WITH the advent of automation, increased productivity and a more critical approach to operating efficiency, many organizations are becoming increasingly concerned with the efficient interchange of data and control information between a central or control station and a number of remote stations.

This is certainly true of the gas-supply industry and in at least one area, namely that covered by the North Wales Gas Grid, many of the problems of data collection from and control of remote stations at a central point have been solved by the installation of a u.h.f. telemetry system. This telemetry scheme, the first of its kind in the world, was supplied by Pye Telecommunications. It links ten major remote stations in a 200-mile long gas grid to a control centre at Rhyl. With this it is possible for the Controller at the central station to measure variables such as grid pressure, flow and stockholding at any of the ten stations. In addition remote control of flow and pressure are provided along with many alarm facilities.

In this system, digitally-coded signals are transmitted

sequentially to each of the outstations by u.h.f. radio links, via a radio repeater station at the Great Orme's Head. Upon receiving the interrogation signals the transmitter at an outstation becomes operative and signals, representing the parameters to be measured, are automatically transmitted back to the control centre. There the parameters are displayed and printed-out by an electric typewriter.

Two standard 100-baud telegraph channels are used to convey the digital telemetry signals. All outstations are allocated the same frequencies and thus a time division multiplex system involving transmitter switching is employed. Each station is scanned sequentially, and pauses for self-reporting alarms are interlaced with the scanning. A complete system scan occupies some two minutes, after which it becomes quiescent. During such times the controller is free to speak over the links with any outstation, but if necessary the scanning may be interrupted for this purpose.

This system has now been operating successfully for several months and the users state that it has made possible greater utilization of stock and increased efficiency.

ELECTRONIC GAS-CONTROL SYSTEM

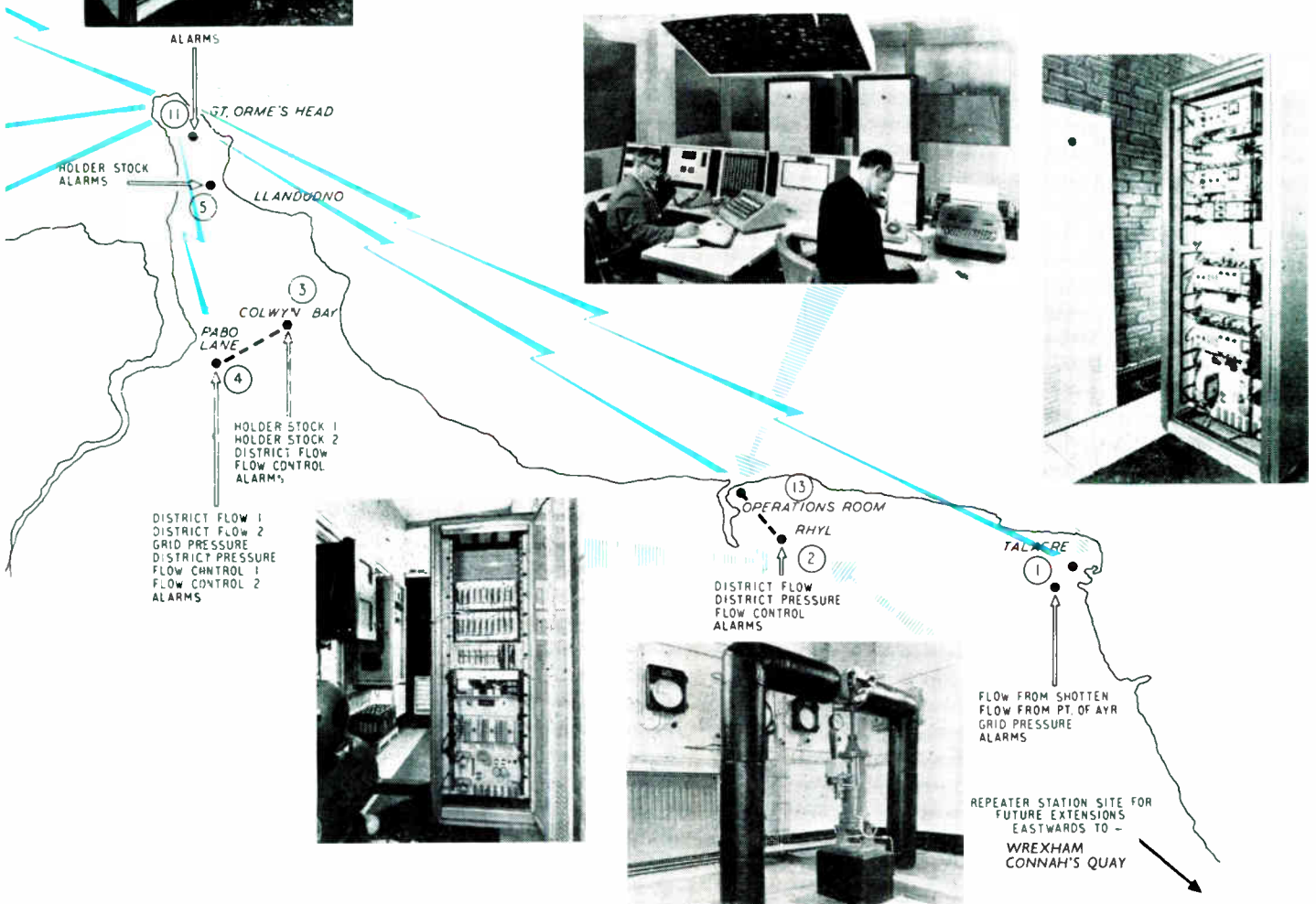
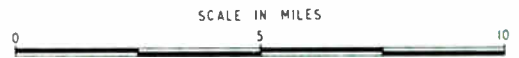
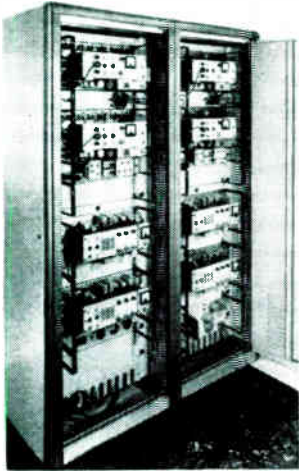

A schematic diagram showing the monitored and controlled functions in the North Wales gas grid u.h.f. radio telemetry system

The use of a computer to control wagons has been tried experimentally in the Cardiff area of British Railways. It has been found possible as a result to work with 11% fewer wagons. The article explains why this is so and how the system is applied.

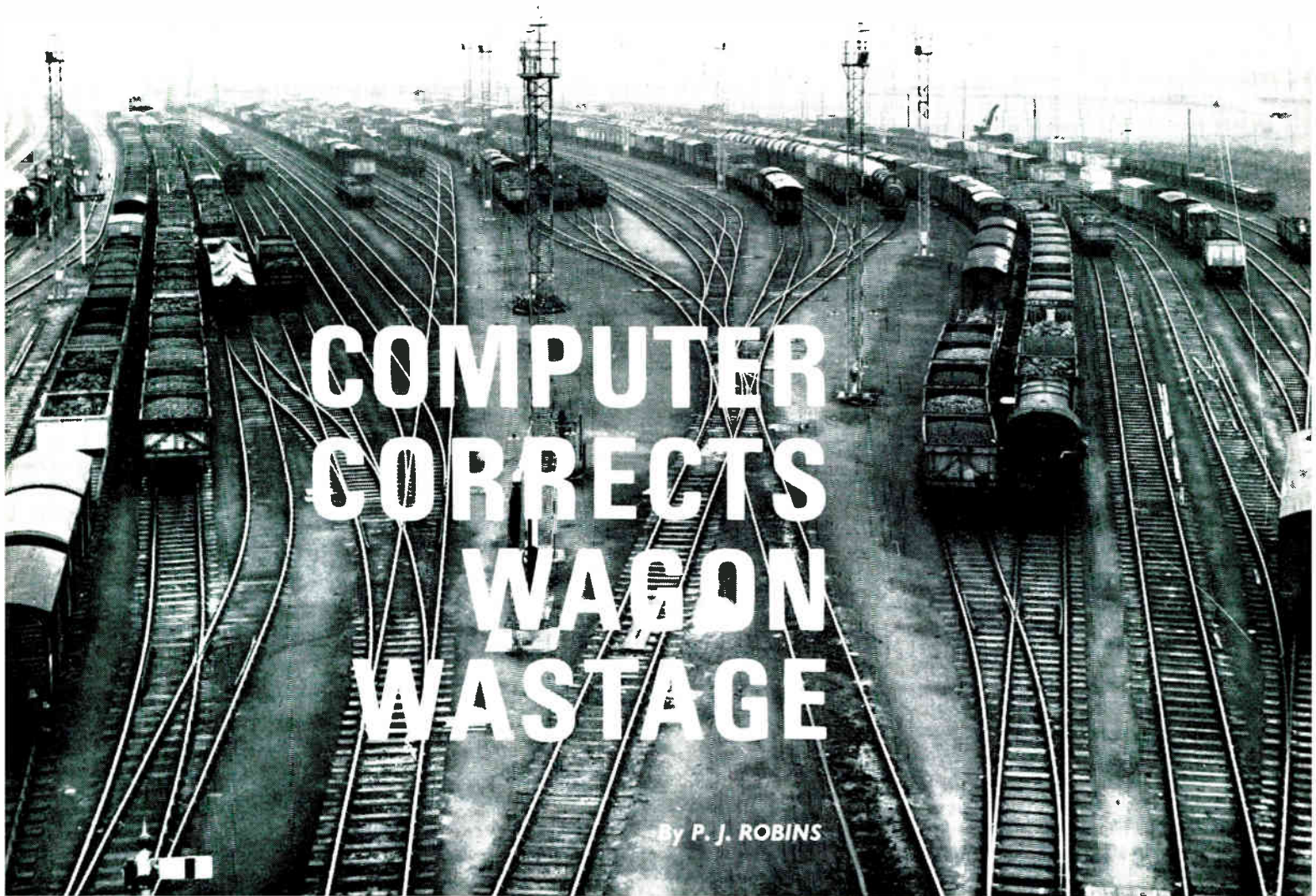

COMPUTER CORRECTS WAGON WASTAGE

By P. J. ROBINS

BRITISH Railways has a problem of too many wagons and difficulty in finding the ones it wants. Until recently, like the Old Lady in the Shoe, it scarcely knew how to sort out its wagon family. Reduction schemes based on inspired guesstimates failed to bring about a fall in fleet size and produced acute local shortages. It was an enigma to which there seemed at one time to be no practical solution.

Now, an experiment at Western Region's Cardiff District using computer control is giving promising answers. It has cut down the average wagon population there by eleven per cent. High-speed data processing of rolling stock movement is keeping to a minimum the numbers of surplus wagons, in spite of demand fluctuation.

The old solution to the problem of rise and fall in requirements was an adequate wagon reserve standing idle for much of its life. A first attempt to rationalize this situation was made soon after World War 2. It was then realized that replacement of rolling stock, much of it the worse for wartime wear, would impose an enormous capital burden on the railway

system if conducted to old standards. To keep the problem within practical bounds, each Region was divided into Districts. Within each District was established a number of locations or areas of responsibility. These varied from small branch lines to part of a large docks system.

Part of the current method of control is a summary of wagons held at each location. This is submitted regularly but it has become easy to adjust figures so that wagons could be held against a local estimate of business demand. Aggravating this trend was the impossibility of processing information fast enough for it to be significant.

At its best, the arrangement recorded only a broad sample of wagons in a District and because it was not self-checking proved susceptible to considerable error. However it was a start in control systems and much of the organization has been used in the Cardiff investigation.

Research into more precise methods of wagon control began about four years ago. The Operational Research Unit of British Transport Commission (now British Railways Board) was called upon to show why arbitrary reductions to

General view of part of Continuous Process Control Unit at Cardiff. Left to right are the keyboard, high speed output punch, typewriter, control panel and low speed output punch of the English Electric KDN2 computer. Under the clock is a digital read-out screen for abstracted data



what appeared to be a more efficient number (750,000) could give startling shortages.

O.R.U. calculated mathematically the number of wagons required by the system as it then existed. The number was 950,000, about the total held by all Regions. By injecting estimated loss of traffic and the effect of several proposed modernization schemes into this same formula it can be shown that using traditional control methods a fleet of 800,000 wagons is required at the present time. The railway aim is, in fact, to slim down the figure to 500,000.

In 1959 O.R.U. teamed up with Western Region and its Traffic Research Unit through a joint working party. The aim was to balance scientific and practical application by making best use of theoretical studies and directly equating

them with real operational requirements. Western Region considered that, of its many Districts, Cardiff was probably the most representative.

The team was soon able to show that, with the problem reduced to a simple find-and-supply requirement, any control system should fulfil four functions. It had to be:

1. Complete in itself and not relying on external factors,
2. Standardized and catering for all types of wagons at any location,
3. Continuous and operating in real time, not in history or in forecast, and
4. Designed so that information had to be quickly assimilated.

Any system was, therefore, to be dynamic and based on continuous change. This could be change of position or change of condition, i.e., loading state, repair, scrap, etc.

To test some of the theoretical methods, Tondy, a sub-control area of Cardiff, was used. It had a 3,000 wagon population of between 30 to 40 different types at 24 locations. Here, the current Cardiff control was crystallized.

Like many other complex problems the solution proved to be scientifically simple. If wagon types in an area could be physically counted and recorded the only way in which that statistical population could change would be by arrival and departure of trains. These were already being reported to Train Movement Controllers who were responsible for their working over defined sections of track.

The first step was to add a little extra information to the existing train reports and after a physical count at Tondy the system was tried by using a soft-board on which were hung numbered tabs.

In those early days, one concern was how to turn a semi-theoretical system operated by specialists into one which the guards, shunters and men along the line could understand and work efficiently. To achieve this, Western Region planned



Columns of keys are arranged to allow input of command, train number, location number, wagon type number, state and quantity. This is one of two keyboards used for injecting train composition data which goes to transit store

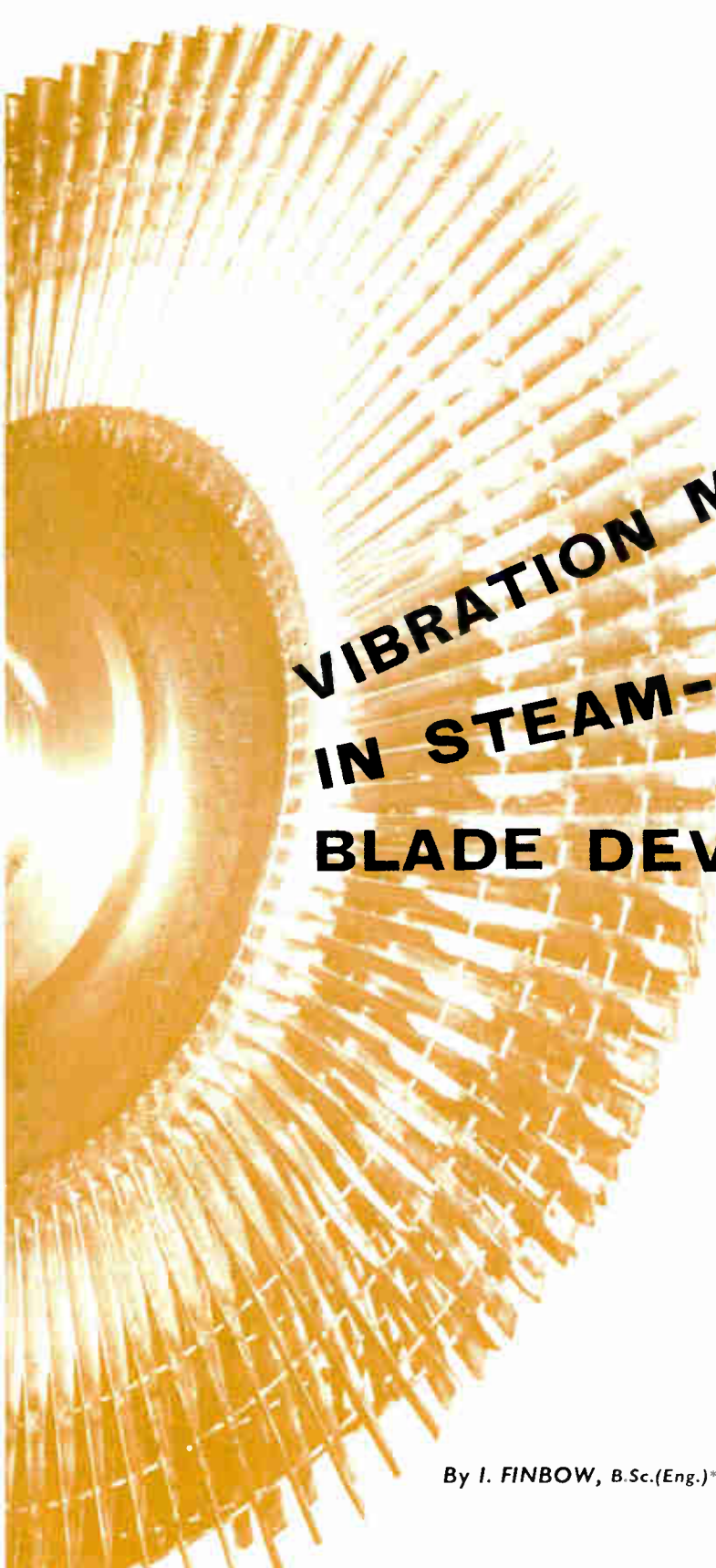

VIBRATION MEASUREMENT IN STEAM-TURBINE BLADE DEVELOPMENT

By I. FINBOW, B.Sc.(Eng.)*

In modern large turbines the blades in the exhaust stages are very long and so subject to large centrifugal forces. As a result, great care must be taken to avoid severe resonant vibration under operating conditions. This article describes equipment which is used to measure the performance of a prototype assembly.

THE designer of modern steam turbines must be able to predict accurately the stresses to which components are to be subjected in service in order to ensure trouble-free operation of the machines. In particular, the rotating turbine blades must be designed to resist fatigue failure resulting from combined stresses due to centrifugal loading and vibration.

For land-based power-generating plant, the trend in recent years has been to produce turbo-machines of very large power output. The associated large steam flows have made necessary the development of long blades in the exhaust stages of the turbines. Such blades are subject to very large centrifugal loading and great care must be taken to avoid severe resonant vibration under normal operating conditions.

It is standard design practice in the English Electric Company to calculate the natural frequencies of all blading. However, in addition, it is considered wise to carry out rotational tests on actual blade assemblies for last-row blades of new designs to confirm that resonant vibrations are avoided by an adequate margin. In fact, prototype blade assemblies are built and tested well in advance of the manufacture of the actual production-type blades to allow for research and development work to be carried out.

The vibration test facility in the laboratory at the English Electric Rugby Works consists of a wheelcase, inside which the bladed wheels are rotated at variable speed by an electric motor, the test casing being evacuated to minimize heating due to windage. The blades are excited into vibration by jets directed at the blades and suitably arranged to simulate the exciting forces in the turbine. The vibratory responses of the blades are detected by wire resistance strain gauges, suitably positioned around the assembly to identify the modes of vibration. The strain gauges and associated leads are attached using Araldite cement. The leads are taken through

*Steam Turbine Research Dept., The English Electric Co., Ltd.

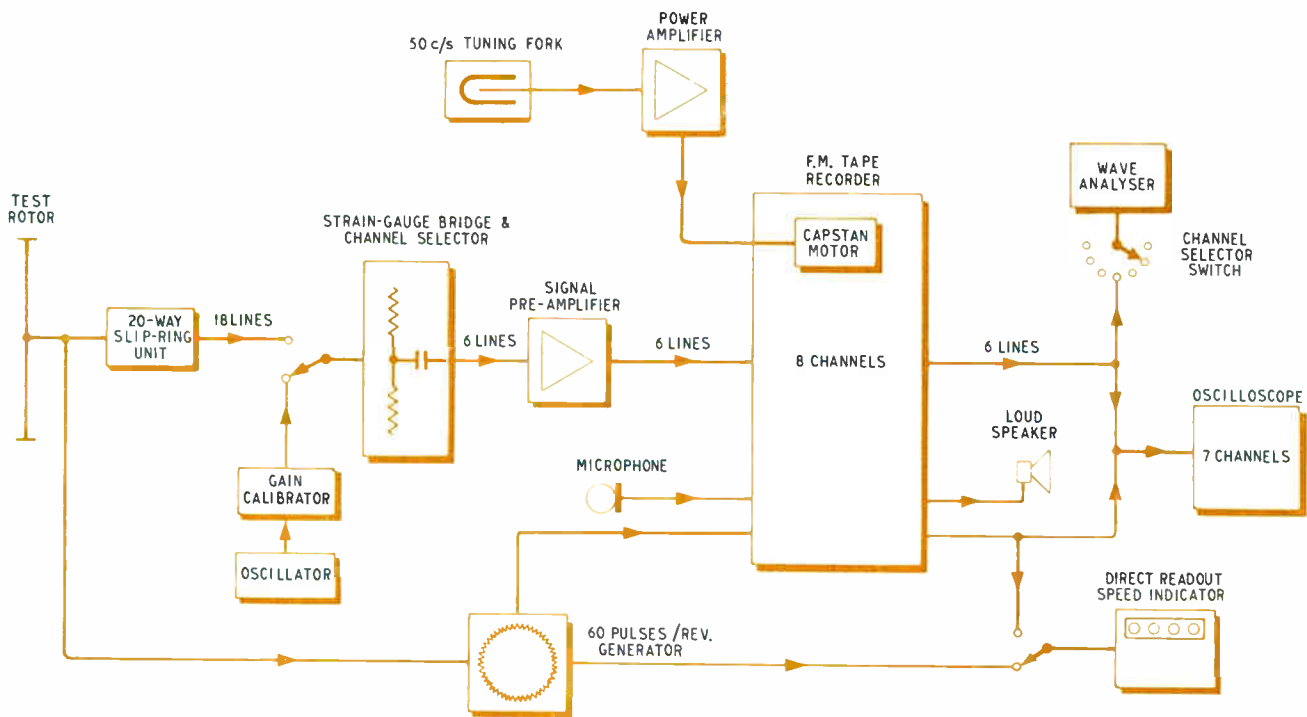

Fig. 1. Schematic diagram of the measuring equipment which deals with the outputs of up to 18 strain gauges mounted on the turbine assembly

the shaft bore to the free end where terminal blocks are situated. Connections are there made to a multi-channel slip-ring unit, through which the strain-gauge signals are brought out to the electronic recording system. The photograph on the front cover shows the wheelcase and prototype assembly of blades being prepared for a test.

Electronic Instrumentation

A diagrammatic sketch of the test instrumentation is shown in Fig. 1.

Simple dynamic strain-gauge circuitry with d.c. excitation is usually employed. Up to 18 strain gauges can be wired up through the slip-ring unit and any six of the gauges can be selected for simultaneous recording on the six-channel recording system.

The strain-gauge selector console, which is in the foreground of the front cover photograph, contains six channels of pre-amplifiers and is situated near to the slip-ring unit. The amplified signals are fed to the laboratory control room, which houses the recording and supervisory instrumentation.

An eight-channel frequency-modulated magnetic-tape recorder is used. Six channels are allocated to the strain-gauge signals. The seventh channel is used to record a speed marker of 60 pulses per revolution generated by the test rotor. Finally, the eighth channel records a commentary given by the engineer in charge of the test. In order to maintain constant tape speed, the capstan motor of the recorder is driven from a power amplifier which is fed by a signal derived from a tuning fork oscillator.

The output from the speed channel is fed into a digital frequency counter, the gating time of which is set to give the speed in r.p.m. The 6 channels of strain-gauge signals are continuously monitored by oscilloscopes having a common timebase

The system is calibrated by feeding signals from an oscillator

at the pre-amplifier input and then measuring the overall voltage gain.

On replaying the test tapes, the rotor speed is given by the frequency counter and wave analysers are used for harmonic amplitude and frequency analyses of the strain-gauge responses. These analyses are supplemented by photographic reproductions of oscilloscope traces or ultra-violet recordings, from which the phases can be measured.

Research Development Production Exhibition & Conference

An exhibition which aims to be a practical shop window of innovation, efficiency and scientific achievement is to be held at Olympia, London, from 4th to 9th May. This is the Research Development Production: Progress 1964 Exhibition. At this many of the country's established firms will display technically advanced products and methods and in this new industries are being encouraged to show how they plan to keep ahead.

At the same time a supporting conference, with the theme 'Industry Shapes Its Future', is to be held at Olympia. The Federation of British Industries, Department of Scientific and Industrial Research, British Productivity Council, and Institution of Production Engineers will each sponsor a day, providing speakers eminent in their specific fields.

The exhibition is being sponsored by 'The Times Review of Industry and Technology'. All enquiries concerning the exhibition and conference should be made to Andry Montgomery Ltd., 11 Manchester Square, London, W.1 (telephone: Hunter 1951) or to the Production Exhibition Dept., at Printing House Square (telephone: Central 2000, Ext. 400).

SHIPYARD INSTALL DYNAMIC BALANCER

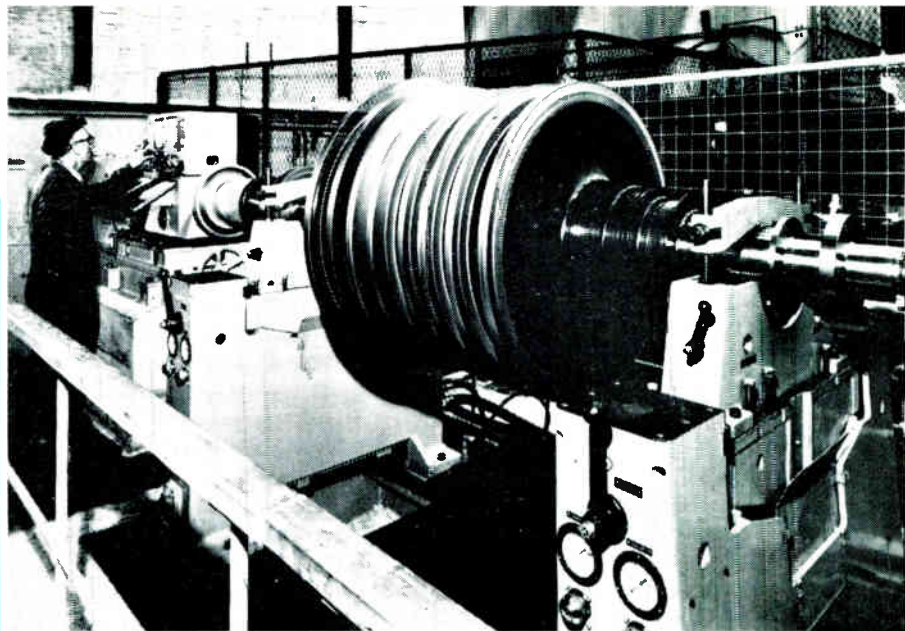

This shows the balancing machine installation at Cowes

A NEW 22,000-lb Avery electro-dynamic balancing machine has been installed at the Cowes shipyard of J. Samuel White. This is now being used in White's engine works for balancing rotors of steam and gas-turbines.

This instrument is designed to cut down the time taken to balance a rotor and to reduce the labour required. It automatically indicates to the machine operator both the angular position and amount of unbalance simultaneously, in two planes of the rotor under test.

Rotors weighing up to 22,000 lb and measuring 20-ft long can be accommodated by the machine. Drive is by a 50 h.p. motor which is coupled to the rotor by a 4-speed gearbox. The starting gear can bring even the largest rotor up to speed in 8 min and by regenerative braking it can be brought to rest within about 1 min.

Operation of Indicating Unit

The rotor to be balanced is supported on the two spring-mounted bearings which have a low natural transverse frequency. The difference between the mass and geometric axes of the rotor causes it to oscillate the supporting system thus producing electric currents in moving-coil pick-ups on the pedestal. The amplitude of this signal depends on the oscillation, its frequency being the same as the speed of the rotor. Wattmeters within the indicating unit compare the current produced in the pick-ups with currents of constant magnitude and identical frequency generated by each phase of a two-phase alternator driven from the main spindle.

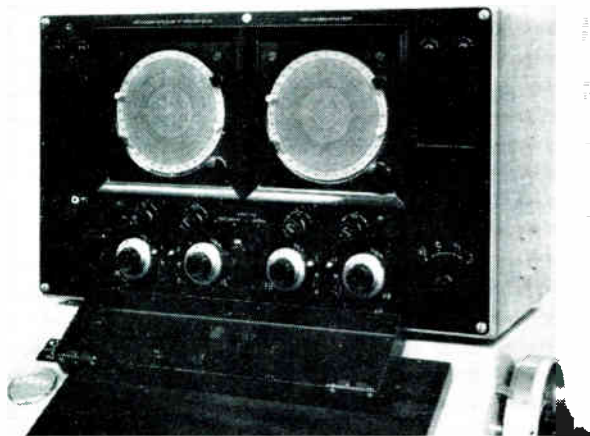

Illustrated here is the twin vectormeter indicating head

Two identical vectormeters are provided on the indicating unit to give readings of unbalance in two measuring planes; the left-hand one indicating that end of the rotor nearest to it and the right-hand one the farthest end. For each of the vectormeters there are two wattmeter units and a light source. The arrangement is such that the movement of one of the wattmeters deflects the light spot vertically, by a tilting mirror, while the second wattmeter deflects it horizontally. This light source appears on the vectormeter dial as a brilliant circular spot and its angular position shows the point of unbalance on the rotor in relation to a pre-determined datum line. Its distance out from the centre indicates the magnitude of the unbalance.

This visual indication can be 'locked' to obviate the necessity of recording results while the rotor is brought to rest and the balancing correction made. If the correction has been done accurately, on making a further run with the rotor the spot will stay in the centre of the graticule. A sensitivity switch gives magnified indication of spot distances.

When a rotor is initially set up on the machine it is, normally, in a state of unbalance. As an aid to calibration two weights of known magnitude—these could be, say, 3 or 4 oz each depending on the size of rotor—are placed on the rotor at known radii; one at one end and one at the other 90° to it. The positions of the trial weights are in sectors opposite to initial out of balance points noted in a preliminary run. From the readings of the vectormeters resulting from these known weights it can be observed that a 3-oz weight throws the light spot out to, say, 30 divisions on the scale. Any proportion of these divisions is the same proportion of the known weight. Normally the vectormeters are supplied with scaled graticules having 90° coordinates which allows for correction in two of four positions around the rotor.

To prevent the removal or addition of material in one plane upsetting the other plane there are two potentiometers mounted in the indicating head which are adjusted by the operator when setting up the machine. When the planes have been set for a batch of similar rotors the potentiometers can be set and locked until a different type of rotor is balanced.

So far J. Samuel White have balanced four rotors on the new machine. They say it takes them about one quarter of the time taken when using the old static balancing machine it replaced. In addition a total of five men were needed to operate the old machine and its auxiliary electrical equipment whereas the new machine can be worked by one or two men.

For further information circle 52 on Service Card

EQUALIZATION OF LEVEL

A TECHNICAL problem which was recently encountered by the Instrumentation Division of Lancashire Dynamo Electronic Products Limited (M.I. Group), Rugeley, Staffordshire, concerns the equalisation of levels in a plant having a widely variable throughput feeding a number of distribution channels. Due to the inherent nature of the plant, and the channels, it was not possible to assume a constant setting for all control valves into the channels and assert that the flow would be shared equally among them. It was, therefore, necessary to devise something that would measure the total flow, from this deduce the average flow, and control each of the valves so that all output channels took the same proportion of the flow.

This was achieved by utilizing one flow measuring device for each channel, and as it was necessary to measure depth of flow, the L.D.E.P. 'Quantimeter', an equipment designed to measure the level of liquid or free flowing solid materials in bulk storage containers by electrical capacitance methods, was used. The outputs of all the 'Quantimeters' were fed into the simple adding circuit shown in Fig. 1, which consists of a number of resistors, one for each 'Quantimeter', commoned into a single load resistor of low resistance. The rectifiers prevent a faulty average arising if one channel is higher than the others. As the 'Quantimeter' output is a current rather than a voltage, and the individual resistors are very high compared to the load resistor, each 'Quantimeter' is unaffected by the workings of the others. The sum of all

the outputs is then indicated by the voltage across the final resistor, which is measured by a potentiometric instrument. A re-transmission potentiometer on this instrument indicates the total flow, which is also recorded. The position of the re-transmission potentiometer also provides indication of the depth which should be flowing over each valve. Therefore, the signal from the re-transmission potentiometer is fed into a number of comparison systems, one for each valve, and hence 'Quantimeter', and compared with the actual 'Quantimeter' output. Any difference is used to operate relays to drive motorized actuators, raising and lowering the valves until all are operating at an equal depth.

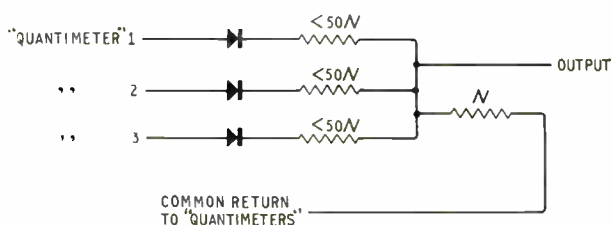

Fig. 1. Simple adding circuit used to obtain the total flow from measurements of the individual flows in a number of channels

OSCAR Will Control Steelmaking

A COMPUTER called 'OSCAR' (Oxygen Steelmaking Computer and Recorder) has been developed by A.E.I. Automation to meet the demand for more accurate control of oxygen steelmaking processes. By providing closer control, the computer ensures economic production and consistent quality.

From input data regarding the required weight, analysis and temperature of steel and from other data relating to plant variables, OSCAR calculates and commands the correct charge-weight of scrap, ore, lime and oxygen.

There are two types of OSCAR computer: analogue and digital. Both are designed to solve the oxygen steelmaking equations and each has special features which make it suitable for its own type of application. The analogue computer acts as a calculating machine and provides the operator with controlling data faster and with more precision than is possible with tables and graphs used at present. The digital computer, on the other hand, is capable of automatically controlling the whole process from data fed into it by sensing devices.

Production data and schedules can be fed into the digital computer automatically, making it possible for control of the process to be integrated with a larger automation scheme for the entire steelmaking area. Production and process records can also be printed out automatically.

Using OSCAR, end-point conditions are achieved more accurately with significant reduction in manufacturing costs. For example, the percentage of all heats having an end-point temperature within 10°C of a desired value may be expected to increase from 30% (with no computer) up

to 70% (with computer). Other advantages include more consistent operation of the converter, a reduction in the number of 'after-blows' and a longer lining life.

For further information circle 53 on Service Card

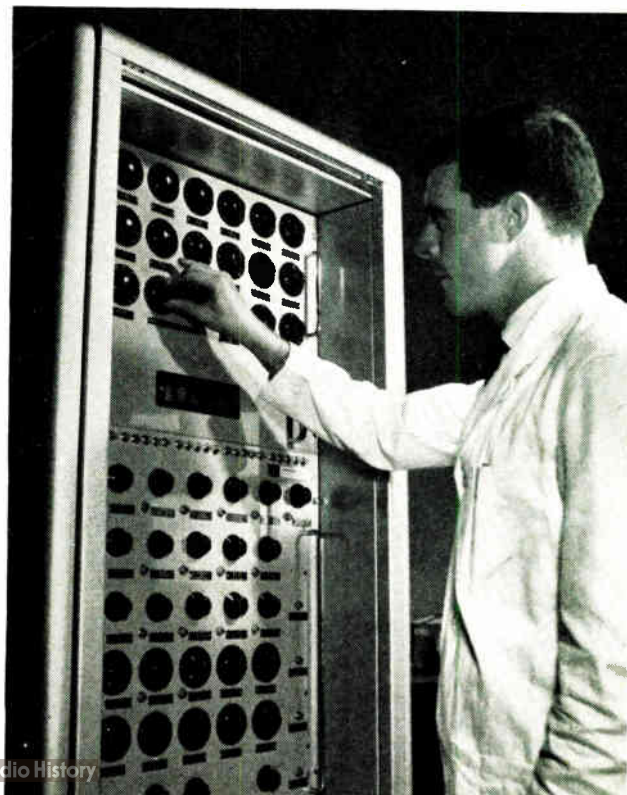

EQUIPMENT REVIEW

1. Distribution Amplifiers

Two new distribution amplifiers for use in broadcasting are announced by E.M.I. Electronics. Designed specifically for first class colour and monochrome performance, the new video distribution amplifier type 251 is a semiconductor plug-in module with an integral stabilized power supply. With 4 W power input, the unit provides four isolated outputs at standard level, each into 75 Ω .

Special design features demanded by modern t.v. studio operational techniques include highly stable gain and output terminal voltage at all ambient temperatures, and provision for inserting synchronizing pulses independently on any or all of the outputs. As an alternative to a variable front panel gain control, the gain of any distribution channel may be fixed by the choice of a gain defining resistor fitted to the particular channel on the rack mounting frame.

Pulse distribution amplifier type 252 accepts all television pulse waveforms—mixed sync, mixed blanking, line drive and field drive. The pulses are cleaned and amplitude stabilized, and four isolated outputs are provided as in the type 251.

A compact assembly, using silicon glass-fibre based printed wiring boards, and an all-semiconductor design permit each unit to be contained in a rectangular aluminium case, measuring only 3.25 in. high, 2 in. wide and 13 in. deep.—*E.M.I. Electronics Ltd., Hayes, Middlesex.*

For further information circle 1 on Service Card

2. Foot-Control Switch

The range of Herga foot-control switches has now been extended to meet a regular demand for a switch having a 'press-on, press-off' action suitable for use on a.c. voltages up to 460 V.

The model 523/15PP is similar in appearance to other models in the 523 range, but contains heavy-duty micro-switch type contacts to carry 15 A at up to 250 V and 5 A at up to 460 V a.c.,

together with a reliable alternate actuator.

It can be used either direct for single-pole switching or with a contactor-type starter in circumstances where the operator requires to remove his foot from the pedal while the machine continues to run until stopped by another pressure on the pedal.—*Herga Electric Ltd., Wallingford Road, Uxbridge, Middlesex.*

For further information circle 2 on Service Card

3. D.C. Solenoids

A series of d.c. solenoids of the short-stroke high-force variety designed to Continental specifications has been produced by Expert Industrial Controls. The series comprises sixteen solenoids

for use with hydraulic and pneumatic valves.

Single- or double-acting solenoids, with or without free travel, are available with minimum forces of up to 30 lb, rising to 60 lb. Terminal boxes and glands comply with British and Continental specifications.

The solenoids can also be supplied with base plates interchangeable with Decco oil-immersed solenoids, or suitable for fitting to JIC valves.—*Expert Industrial Controls Ltd., Lount Works, Ashby-de-la-Zouch, Leicestershire.*

For further information circle 3 on Service Card

4. 3.51 Micron Gas Laser

Capable of penetrating atmospheric absorption and optical interference for optimum laser communications, a Raytheon gas laser has been introduced that operates at a wavelength of 3.51 μ . Near the centre of the middle infra-red region, this wavelength affords a minimum absorption 'window' in the atmosphere.

The laser and its power supply are packaged together in a cabinet of 0.2 cu ft volume. Weighing less than 10 lb and fitted with a carrying handle, this unit is easily portable and can operate from any convenient 115-V 60-c/s lighting circuit. Voice communications are possible with the addition of an

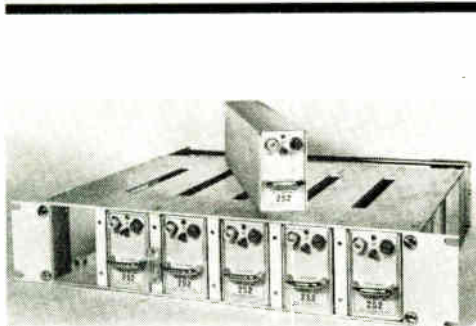

1

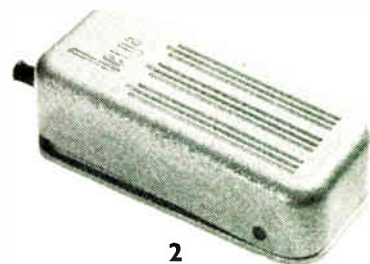

2



3

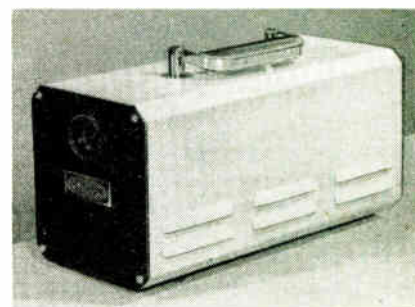

4

optional modulator circuit that can be installed in the same case.

Output power is approximately 0.25 mW while divergence of the plane-polarized beam is only 20 minutes of arc, uncollimated. Bandwidth is 110 Mc/s. The 6-in. quartz laser tube is filled with helium-xenon gas and has Brewster windows. Configuration of the resonator cavity allows a 3-in. clearance for intra-cavity experiments.—*Raytheon-Elsi, S.p.A., Villagrazia, Palermo, Italy.*

For further information circle 4 on Service Card

5. Band Rejection Crystal Filters

Damon Engineering has developed a series of low-loss, high attenuation, band-rejection crystal filters. Primarily designed for use in radar and missile systems, these highly selective notch filters eliminate undesired signals and mixer products as well as 'clutter' without degrading sensitivity.

A typical example is the model 5109A (illustrated), an 8-pole Chebyshev band-rejection filter currently being utilized in a doppler radar system. This filter has a centre frequency of 10.4 Mc/s, a 6-dB bandwidth of 4 kc/s and a 60-dB bandwidth of 1.5 kc/s. Passband ripple is ± 0.5 dB maximum over a 200 kc/s band. Insertion loss is 1.5 dB. Source and load impedance is 470 Ω . The unit meets all electrical

specifications over a temperature range of -35°C to $+75^{\circ}\text{C}$. Dimensions: $3\frac{1}{4}$ by 1 by $\frac{3}{8}$ in.—*Damon Engineering, Inc., 240 Highland Avenue, Needham Heights, Mass., U.S.A.*

For further information circle 5 on Service Card

6. Dew-Point Controller

The Cambridge dew-point controller incorporates a hygroscopic element to measure the relative humidity of the air and a mercury-in-steel thermometer system to measure the temperature. From these two values the water vapour pressure, and thus the dew point of the air, is determined. A second mercury-in-steel system measures the temperature of the cool surface, and when the surface temperature approaches dew point a pair of contacts make and actuate the regulating equipment.

The controller is fitted with a circular chart on which a solenoid-operated pen records the periods during which the regulating equipment is in operation. The instrument normally operates as a blind controller, but pens can be fitted if required for recording relative humidity and the difference between the ambient and cold-surface temperatures. The normal temperature range of the instrument is 7 to 38°C (20 to 100°F).—*Cambridge Instrument Co. Ltd., 13 Grosvenor Place, London, S.W.1.*

For further information circle 6 on Service Card

7. High-Voltage Rectifiers

To meet the need for a high-voltage rectifier for TV sets, oscilloscopes, radar power supplies, electrostatic painting apparatus and similar applications, Photronic Controls offer a range of components suitable for peak reverse voltages from 6 to 12 kV.

These rectifiers are coated with stable SiO_2 film and have sharply defined reverse breakdown characteristics. The oxide-protected junctions afford exceptional stability and reliability. Since the stability of elements in the avalanche breakdown region has been greatly increased by the complete surface passivation technique and as the sharply defined breakdown characteristics perform clipping, elements are safe from destruction even in the breakdown region.

Maximum input voltages range from 4.2 to 8.4 kV r.m.s. and maximum output current is 30 mA d.c. Dimensions are 10.5 mm diameter, length 45 mm plus 40 mm leads.—*Photronic Controls Ltd., Randalls Road, Leatherhead, Surrey.*

For further information circle 7 on Service Card

8. Paper Tape Dispenser

A dispenser for automatically feeding paper tape to medium-speed tape readers available from Creed is suitable for use with friction feed readers and has been designed to eliminate tape drag, even when feeding from a full 1,000-ft reel.

A small electric motor is used to rotate the storage reel, so unwinding the tape and feeding it into a small 4-in. by 3-in. magazine. When some six inches of tape have accumulated in this magazine, the storage reel motor is brought to rest by a microswitch fitted in the bottom of the magazine and operated by the pressure of the tape. The motor then remains at rest until the reader has drawn off the stored tape. This method of feed control ensures that the reader never has to take a strain of more than the weight of a few inches of tape.

Adjustable for 5-, 6-, 7- and 8-track tapes ($\frac{1}{8}$, $\frac{7}{8}$ or 1 in. wide), the dispenser can operate at speeds up to 10 in./sec—fast enough to work with readers operating at up to 100 characters/sec.—*Creed & Co. Ltd., Telegraph House, Croydon, Surrey.*

For further information circle 8 on Service Card

9. Automatic Announcing Equipment

An automatic announcing system by Trix for the British Railways Southern Region station at Eastbourne has been developed.

The equipment consists of a central amplifier rack, together with control panels to provide microphone

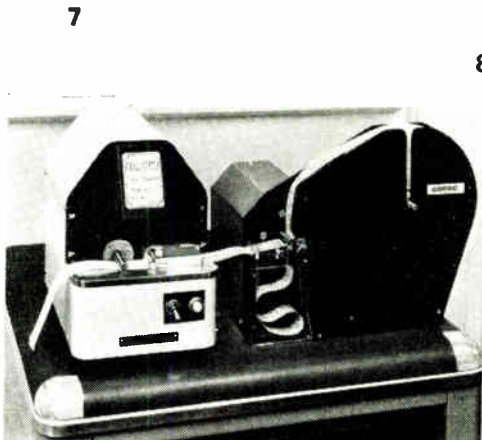
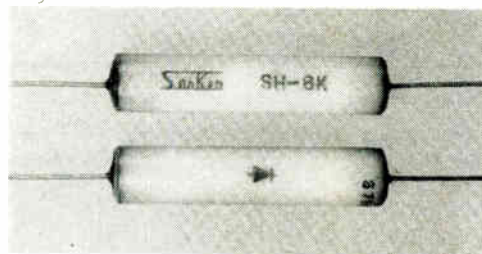

EQUIPMENT REVIEW

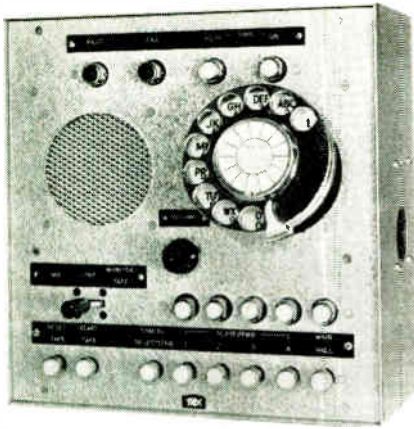

9

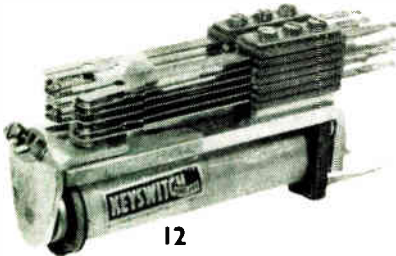

12



10

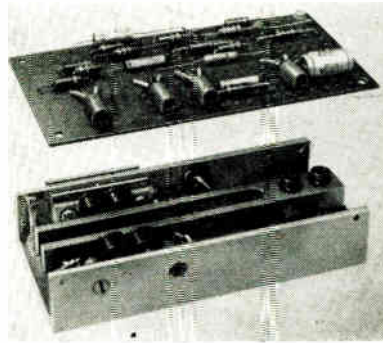

11



13

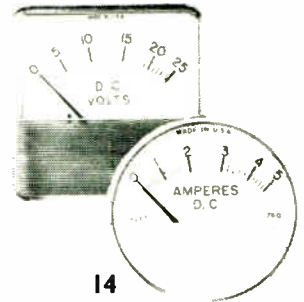

14

announcements from any of three positions, and works in conjunction with an automatic announcer unit. This has storage facilities for as many as 40 announcements of up to one minute's duration, and any announcement can be selected by dialling the appropriate number at any one of three control positions.

One control unit is provided for each of three ticket-inspectors' positions, each being equipped with platform selection switches and the control equipment for the automatic announcer unit. The control units include loudspeakers for monitoring any recorded announcement without its being played over the main public address system. There is also a recording unit which, when coupled to the automatic announcer unit, enables the appropriate announcements to be taped for subsequent use.—*Trix Electronics Ltd., 1-5 Maple Place, Tottenham Court Road, London, W.1.*

For further information circle 9 on Service Card

10. Miniature Low-Noise Amplifier

A low-noise amplifier for general laboratory use has been announced by Quan-Tech Laboratories. This fully transistorized unit, designated model 206, provides selection of three fixed gain settings of 10, 100 and 1,000 at

bandwidths of 1 Mc/s, 650 kc/s and 500 kc/s, respectively. Maximum output is rated at 3 V r.m.s. and distortion is less than 1% at maximum rated output.

Equivalent input noise for full bandwidth (input shorted) is less than 10, 7 and 6 μ V for gains of 10, 100 and 1,000, respectively. Typical narrow-band noise voltage is 5×10^{-9} V per root cycle, and noise current 3×10^{-12} A per root cycle above 1 kc/s.

The model 206 is mains-powered. In addition, built-in rechargeable nickel-cadmium batteries in an automatic recharging circuit are available as an optional feature. The entire instrument is packaged in a cabinet measuring only $4 \times 7 \times 6$ in., including all controls.—*Livingston Laboratories Ltd., 31 Camden Road, London, N.W.1.*

For further information circle 10 on Service Card

11. Solid-State Decoders

The Datex Division of Elliott-Automation has developed a range of transistorized decoding and programming units incorporating 'Minilog' solid-state logic modules.

These decoders have been designed to accept any binary code and convert it to pure binary or decimal form for digital indication and recording. They are particularly suitable for processing the output from shaft encoders or other

analogue-to-digital converters. Information can be fed in either by means of switched contacts or in voltage form. Output signals can be used for further logic operations or to drive relays and solenoids. A 12-bit code conversion can be accomplished in less than 50 μ sec.

Facilities are provided for indefinite storage of input information, or for continuous decoding. Stabilized power supplies are built into the equipment. The 'Minilog' modules are fully encapsulated and mounted on standard boards which fit into a robust industrial case, suitable for wall-mounting.—*Elliott-Automation Ltd., 34 Portland Place, London, W.1.*

For further information circle 11 on Service Card

12. 600 Type Relay

Keyswitch Relays have announced their 600 type relay. This relay is essentially a smaller version of the BPO 3000 type, and is usefully employed in applications where the larger contact assemblies of the 3000 type are not required, and where small physical size and higher switching speeds are more important.

This unit is capable of normal operate and release times down to 10 msec and 5 msec respectively, and despite its smaller size can be supplied with the normal make, break, changeover, 'K' (make before break), 'X' (early) and 'Y'

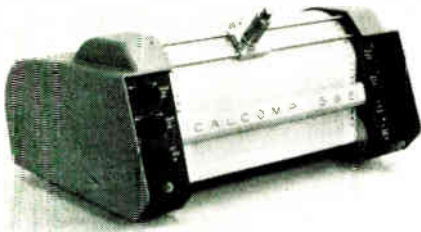

15

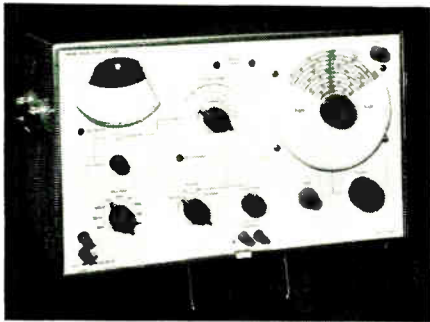

16

compensation, enabling an accuracy of 0.01% to be maintained over a wide temperature range.

There are several variants of the basic unit available and the customer has the choice of hermetically sealed or unsealed outer cases. Prices range from £25 to £50, depending on specification.—*Furzehill Laboratories Ltd., Theobald Street, Borehamwood, Herts.*

For further information circle 13 on Service Card

14. Panel Meters

A series of high visibility d.c. 2½-in. panel meters is announced by Hoyt. Both No. 740 (round) and No. 793M (square) meters have anti-static treated distortion-free fronts; the masked portion adds attractiveness and complements the clear, sharp, long scales. Both meters are available in milliammeter, ammeter or voltmeter ranges.—*Hoyt Electrical Instrument Works, Inc., Burton-Rogers Co., Sales Division, 42 Carleton Street, Cambridge 42, Mass., U.S.A.*

For further information circle 14 on Service Card

15. Low-Cost Digital Plotter

Direct punched tape-to-plotter operation at less than half the cost of conventional systems using analogue plotters is announced by the Electronics Division of Scientific Furnishings. An inexpensive adapter unit, manufactured in the U.K., directly couples the output of a standard tape reader to a Calcomp digital incremental plotter which is actuated by high-speed stepping motors thus eliminating the digital-to-analogue data translators used in conventional systems. This completely digital operation also eliminates problems of drift and gain settings encountered with analogue plotters, and provides a high order of accuracy.

The use of the digital incremental technique for symbol generation as well as for plotting provides complete flexibility in selection of curve identification symbols, scale markings, labelling and titling. This flexible automatic annotation is achieved by sub-routine programming and an extensive library of programmes is available for this purpose as well as for many specific plotting applications.

The plotter may also be used directly on-line with a medium or small computer (coupling adapters are available for most computer types) or off-line from magnetic tape in conjunction with large scale computers. The Calcomp digital plotters operate at 18,000 steps/min with an accuracy of ±0.0025 in. on charts of 12 or 31 in.

in width and 120 ft in length.—*Scientific Furnishings Ltd., Electronics Division, Poynton, Cheshire.*

For further information circle 15 on Service Card

16. Wave Analyser

Marconi Instruments have announced the type TF2330 wave analyser, covering the frequency range 20 c/s to 50 kc/s. It has many uses in testing all types of audio equipment: harmonic and intermodulation distortion, noise and hum levels, can be measured down to -75 dB; unknown signals can be identified and their frequency and voltage determined. Basically it is a highly selective tuned voltmeter with a 6-c/s bandwidth. A.F.C. may be selected to lock the tuning to the input signal, thus obviating continual re-tuning and ensuring accurate meter readings.

The input range is 3 µV to 300 volts with absolute calibration for measurements in terms of voltage or dBm; alternatively the sensitivity may be adjusted for relative measurements in percentage or dB. Two signal outputs are provided. A variable voltage at the frequency of the signal component under investigation may be used for external monitoring. The instrument may also be employed as a b.f.o. with an output frequency coincident with the voltmeter tuning; this makes an ideal measurement system for frequency-response characteristics.

Semiconductor devices are used throughout the instrument and the stabilized power unit will accept a wide range of mains and battery inputs. The weight is 24 lb. An external recorder may be connected in series with the voltmeter.—*Marconi Instruments Ltd., St. Albans, Herts.*

For further information circle 16 on Service Card

17. V.L.F. Phase Comparison Receiver

Wayne Kerr-Gertsch have introduced a solid-state receiver designed to calibrate precision oscillators against standard-frequency broadcasts. Known as the model PCR-1 v.l.f. phase comparison receiver, the unit is intended for use with local frequency standards accurate to one part in 10⁷ or better. Making frequency comparisons against carrier-stabilized l.f. and v.l.f. transmissions, the PCR-1 permits comparisons to an accuracy of 5 parts in 10¹⁰ to be made in one hour.

The receiver is a self-contained unit incorporating a built-in strip-chart recorder and a two-speed phase-locking servo system providing a very narrow effective bandwidth (r.f. bandwidth is approximately 2% of the input frequency, pre-detection bandwidth 10 c/s, and

(late) actions in combination as required up to a total of 18 contact springs. In heavy duty applications, the maximum current rating per contact spring is 10 A.

Operating coils are available for voltages between 1 V and 175 V d.c. (resistance range 1 Ω to 10kΩ), and up to 440 V a.c. with added components and special coils.—*Keyswitch Relays Ltd., 120-132 Cricklewood Lane, London, N.W.2.*

For further information circle 12 on Service Card

13. Tuning Fork Frequency Standards

The G.5000 series of compact transistor-maintained tuning fork frequency standards has been announced by Furzehill Laboratories. The unit comprises a basic tuning fork of alloy steel mounted in a light but rigid frame with the necessary drive and output coils, surmounted by a panel carrying the necessary maintaining and/or shaping circuitry.

The frequency range available is from 25 c/s to 5 kc/s. From 250 c/s to 5 kc/s the output frequency is provided by the fork itself; below 250 c/s the fork frequency is suitably subdivided by low-ratio dividers. The transistorized circuitry is stabilized against battery variations and (except in the sealed units) it also incorporates thermistor - controlled temperature

EQUIPMENT REVIEW

servo-bandwidth 0.02 or 0.0002 c/s). Front-panel frequency selection allows rapid switching between channels within the 10-kc/s to 100-kc/s range. The PCR-1 operates to a sensitivity of 0.1 μ V into 50 Ω for stable phase-locked tracking, and measures 19 in. wide, 7 in. high and 14 in. deep.—*The Wayne Kerr Laboratories Ltd., New Malden, Surrey.*

For further information circle 17 on Service Card

18. General Purpose Electrometer

Electronic Instruments have recently introduced an improved general-purpose vibrating-capacitor electrometer. The ranges cover from 0 to 10 mV up to 0 to 1,000 mV with an input resistance better than $10^{11} \Omega$ on the 1,000 mV range. New features include a variable back-off voltage with a range of $\pm 1,300$ mV and provision for plug-in input components. The drift rate is very low (less than 0.1 mV in 12 hr).

Accessories include a current and voltage measuring unit capable of measuring currents down to 10^{-12} A full-scale and resistance up to $10^{16} \Omega$ as well as a pH measuring accessory having an accuracy and discrimination of ± 0.002 pH and a full-scale reading of 0.1 pH.—*Electronic Instruments Ltd., Lower Mortlake Road, Richmond, Surrey.*

For further information circle 18 on Service Card

19. Inexpensive Data-Logging Systems

Digital Measurements are now manufacturing a range of 40 standard digital data-recording systems costing from £1,100 to £2,680, to meet the majority of data-logging requirements.

The data loggers are in single 20-, 40- and 80-channel versions and the speed of operation extends up to 18 words/sec. The systems available are suitable for use with a wide range of transducers and any variable which can be converted into electrical signals can be recorded. The use of a high-accuracy (0.01%) digital voltmeter for analogue-to-digital conversion and reed relays for signal switching enables operation down to 10- μ V levels.

The outputs are recorded either by automatic electric typewriter, paper-strip printer, or paper-tape punch. The output word can consist of the five digits from the analogue-to-digital converter, together with auxiliary characters such as channel identification, polarity, space, etc. The punch output can be in any standard computer code requiring up to eight holes per character. Other configurations having up to 1,000 inputs and additional modules for linearization, alarm setting, etc., can be supplied.—*Digital Measurements Ltd., 25 Salisbury Grove, Mytchett, Aldershot, Hants.*

For further information circle 19 on Service Card

20. Capacitor Range Extended

The range of electrolytic capacitors manufactured by Plessey has now been extended to include low-voltage, very high capacitance, units up to 50,000 μ F at 6 V d.c. working. Typical applications in professional and industrial equipment include telephone switch-board circuitry and, particularly where complete freedom from very small voltage fluctuations is essential, low-voltage power-supply smoothing circuits.

Anodes are of the etched-foil type, and the external aluminium case can be fitted with a shrunk-on p.v.c. insulating sleeve. Mounting is by horizontal or vertical clamps.

There are fifteen values in the extended range between 1,000 μ F and 50,000 μ F with a tolerance of -20% and $+50\%$; working voltages of up to 70 V d.c. are available in the smaller values.—*Capacitor Division, The Plessey Co. (U.K.) Ltd., Kembrey Street, Swindon, Wilts.*

For further information circle 20 on Service Card

21. Low Impedance Accelerometer

The Consolidated Electro-dynamics Division of Bell & Howell announce the piezoelectric accelerometer type 4-280,

claimed to be the first instrument of its kind to incorporate miniature impedance-matching electronics as an integral part of the transducer. The piezoelectric sensing element and emitter-follower electronics are combined in a single unit less than one cubic inch in volume. This integral package effectively eliminates both noise and signal attenuation problems normally associated with crystal transducers.

The accelerometer features 100- Ω output impedance, operating to 250 peak-g from 6 c/s to 6 kc/s over temperatures from -50 to $+93$ $^{\circ}$ C. Voltage sensitivity is 20 peak-mV per peak-g at 25 $^{\circ}$ C and 100 c/s with a 50-k Ω load. Output voltage is limited to 14 V peak-to-peak without distortion at room temperature. The unit is stud-mounted and is directly interchangeable with almost all accelerometer-emitter-follower (or cathode-follower) systems.

The type 4-280 achieves even distribution of compression across the crystal by using a seismic mass which is point-loaded by a ball and compliant diaphragm. This technique assures 'sensitive-axis isolation', maximizing the piezoelectric effect in the desired axis while minimizing response to motion in the cross-axis. Cross-axis response

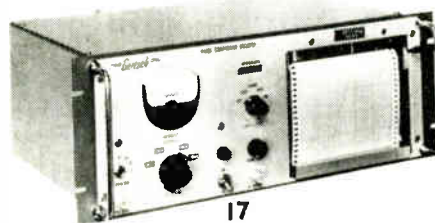

17

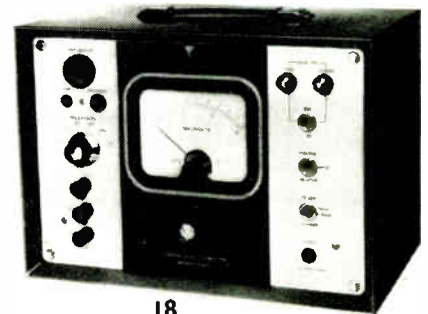

18

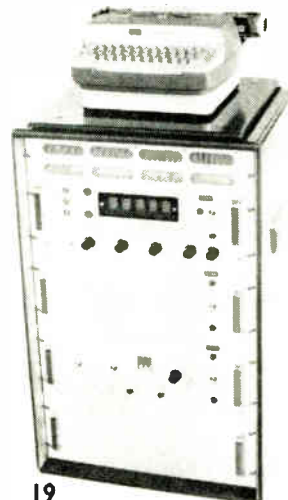

19



20



21

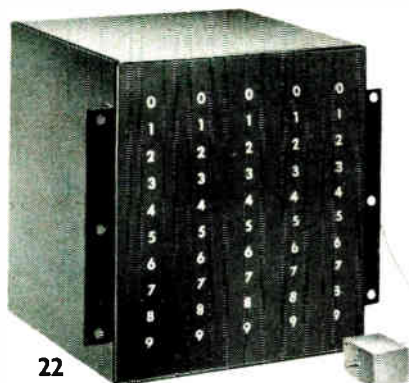

22

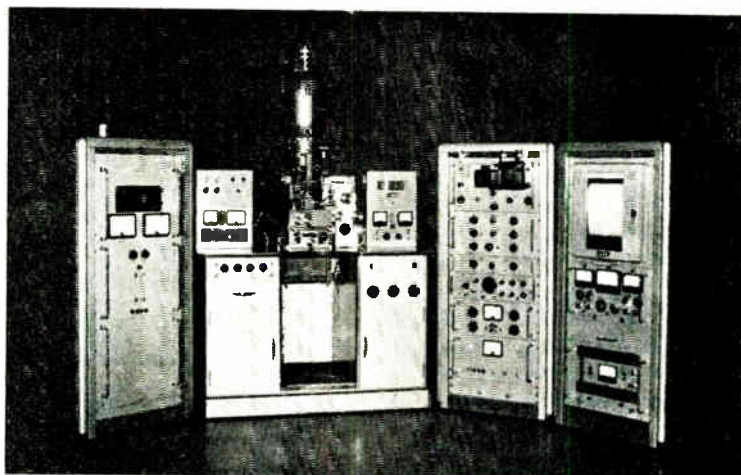

23



24

is 5%, amplitude linearity is 1% and power requirements are $28\text{ V} \pm 2\text{ V}$ at 2mA maximum. The weight is 1.5 oz.—*Consolidated Electrodynamics Division of Bell & Howell Ltd., 14 Commercial Road, Woking, Surrey.*

For further information circle 21 on Service Card

22. Electronic Turns-Counter

Theta have announced a device, designated as N-TRAK, which displays the number of turns traversed by a remotely-located shaft. It consists of a 1-cu in. pulse generator operating on the optical principle and a solid-state decade counter. The display may be located at any distance away from the transmitter.

Maximum shaft speed is 10,000 r.p.m. and the breakaway torque is 0.05 in.-oz. The maximum count is 999,999 at one count per turn.—*Theta Instrument Corporation, Saddle Brook, New Jersey, U.S.A.*

For further information circle 22 on Service Card

23. Microscan X-Ray Analyser

An improved version of the Cambridge scanning electron-probe X-ray micro-analyser, the Microscan Mark 11A, has been announced.

The modifications, many of which can

be retrospectively applied to earlier instruments, include: improved X-ray spectrometer with interchangeable crystal drums covering a Bragg angle range of 10° to 65° ; facilities for two-channel operation; more versatile specimen stage and air lock, permitting mounting or replacement of specimens and standards up to one inch in diameter without materially affecting column vacuum; ultra-slow scan unit for more accurate quantitative line analyses; new optical microscope and camera; improved filament changing facilities, etc.—*Cambridge Instrument Co. Ltd., 13 Grosvenor Place, London, S.W.1.*

For further information circle 23 on Service Card

24. Anti-Microphonic P.T.F.E. Cables

B.I.C.C. have developed a process which they are now using in the manufacture of miniature anti-microphonic (low noise) p.t.f.e. insulated coaxial cables. This enables a semiconducting layer of graphite to be applied to the surface of the extruded p.t.f.e., despite the low coefficient of friction.

Electronic equipment utilizing micro-signals is often required to operate under extreme conditions of heat and chemical attack. In addition, coaxial and screened cables in such equipment

may be subject to movement, causing minute self-generated voltages in the outer conductors or screens. In many cases the resulting interference cannot be tolerated.

To counteract this effect a conducting layer may be placed in close contact with the wire braid, thus neutralizing the electrical charges. But, if this layer is not also in close contact with the insulation, capacitance interference can be created.

The B.I.C.C. graphite adhering process renders cables largely immune from these types of interference, and they can operate in a temperature range from -75 to $+240^\circ\text{C}$.—*British Insulated Callender's Cables Ltd., 21 Bloomsbury Street, London, W.C.1.*

For further information circle 24 on Service Card

25. Transistorized Oscillator

A portable, general-purpose transistorized oscillator has been introduced by STC. Known as the 74306-A, it covers the frequency range 10 kc/s to 20 Mc/s in eight bands. Operation is from dry cells housed in the oscillator case or from an external d.c. supply.

This oscillator, which uses printed-circuit techniques in its construction, delivers output levels of 0 to -50 dBm

EQUIPMENT REVIEW

by conduit box on the side of the instrument.—*British Rototherm Co. Ltd., Merton Abbey, London, S.W.19.*
For further information circle 33 on Service Card

34. IBM Disc Storage

IBM have announced the 1302 disc storage unit, with which over 1,000 million characters of information can be made available on-line to a data processing system. The 1302 has been developed from the 1301 disc file. The main differences are: four times the capacity, twice the data rate, and a reduction of over 40% in the cost per million characters.

Retrieval times are also reduced with the new file. Two independent access arms per module give four times the information available, without taking time to move the arms. With a single module, using 200 character records, any one of 2,320 records can be read within 0.05 sec; any one of 23,200 records can be read within 0.1 sec; and any one of 580,000 records within 0.25 sec. With ten modules, any one of 5,800,000 records can be retrieved in not more than 0.25 sec.

The 1302 is available in two models: model 1 has one module of storage with 117 million characters and two access mechanisms; model 11 has two modules of storage with 234 million characters and two access mechanisms on each module.—*IBM United Kingdom Ltd., 101 Wigmore Street, London, W.1.*
For further information circle 34 on Service Card

35. X-Ray Dosemeter

Electronic Instruments have announced the model 37C X-ray dosimeter. This is a portable instrument which has a 35 cu. cm ionization chamber and will measure from 0 to 0.3 mr up to 0 to 100 r. As a dose rate meter the instrument will measure from 0 to 0.3 mr/min up to 0 to 100 r/min.

Ionization chambers of 3.5 and 350 cu. cm effective volume are available which permit a tenfold increase or decrease of sensitivity. The instrument, which is largely transistorized and operates from readily-obtainable batteries, can also be used for measuring potentials, low current and charges. A recorder output is provided.—*Electronic Instruments Ltd., Lower Mortlake Road, Richmond, Surrey.*
For further information circle 35 on Service Card

36. Noise Tube Power Supply

Two features of the Nore microwave noise tube power supply are the built-in pulse modulator and the automatic ignition of the noise tube.

The built-in pulse modulator, a 50/50

square-wave modulator of either 400 c/s or 1 kc/s, can be free-running or externally triggered. Ignition of the gas discharge tube is fully automatic and no manual operation is required. Protection of the tube from premature ignition is obtained by an h.t. delay system.

The unit gives a stabilized current supply with pre-set control of currents up to 200 mA. Provision has been made for modification to accommodate currents greater than 200 mA. The unit is supplied in cabinet form or for standard 19 in. rack mounting.—*Roberts Electronics Ltd., Hermitage Road, Hitchin, Herts.*
For further information circle 36 on Service Card

37. 6-Position Co-ax Switch

Telonic has announced a manually-operated high-performance r.f. switch that may be used at frequencies up to 1,500 Mc/s. This single-pole, 6-position type is equipped with either BNC or TNC connectors and is housed in a silver-plated steel case complete with switching knob. The model TS-200 has a positive detent action, is designed with a non-shorting input circuit, and has an operative life of over 100,000 cycles.

This 50-Ω unit has cross-talk rejection

of at least 70 dB, insertion loss of 0.1 dB and v.s.w.r. less than 1.1:1, all at 1,000 Mc/s. The switch is so constructed that d.c. wafer sections may be ganged to the shaft for operating circuits other than r.f. These wafer sections may be specified in single-pole, 6-position and double-pole, 6-position types. Typical applications include laboratory work, and field and airborne aerial system switching.—*Livingston Laboratories Ltd., 31 Camden Road, London, N.W.1.*
For further information circle 37 on Service Card, 5

38. Plug-in Decade

Panax are offering an inexpensive plug-in decade assembly ready to build into electronic counting equipment for industrial, laboratory and school science purposes. The unit, which is produced in two versions, is identical with that used in the Panax SA-102 series nucleonic scaler and employs a high-quality printed circuit and reliable components.

The type TD.1 has scaling rates of up to 5,000 counts per sec and a resolving time of 200 μsec. The alternative unit, type TD.2 has a maximum scaling rate of 50,000 counts per sec and a 20-μsec resolving time. The decade tubes are the Mullard Z504S and Z505S respectively. Each type requires a 12-V power



33

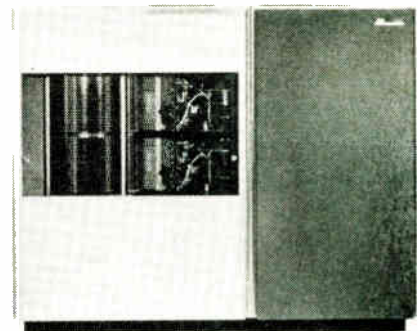

34



35

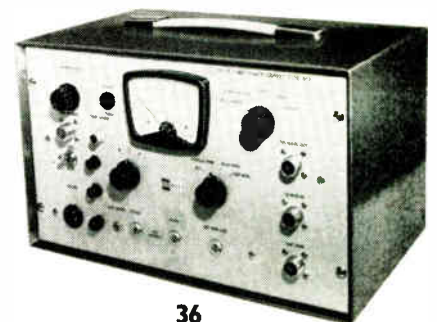

36

supply and input pulses of 12-V amplitude, positive. Overall dimensions are: 5½ in. long by 2¾ in. high by 1¾ in. wide. The designed fixing centre is 1.8 in.—*Panax Equipment Ltd., Holmesthorpe Industrial Estate, Redhill, Surrey.*

For further information circle 38 on Service Card

39. Electrical Cabinets

A range of metal cabinets for electrical and electronic equipment is being marketed by W. Pinder and Son. Initially 16 sizes are available, single-door models ranging from 36 in. high, 15 in. wide and 10 in. deep to 72 in. high, 39½ in. wide and 17 in. deep, and double-door models ranging from 40 in. high, 56 in. wide and 17 in. deep to 72 in. high, 88 in. wide and 17 in. deep. The biggest double-door models have a wide area between the doors for mounting a control panel, and locking handles are standard on all models except on the smallest, which have screw fastenings for the door.

The cabinets are robustly made of welded 14-gauge pressed steel sections, and all doors are sealed with oil resistant rubber. Basic cable entry plates are standard and extra holes and louvres can be provided. Finish can be grey primer or stoved gloss colour. Mounting plinths are available for the bigger

models.—*W. Pinder & Son Ltd., King Street, Peterborough.*

For further information circle 39 on Service Card

40. Standard Frequency Receiver

A fully transistorized superheterodyne receiver specially designed for the reception of all international frequency transmissions is announced by Wayne Kerr. Known as the Wayne Kerr-Gertsch model RHF-1, its sensitivity permits reception of these transmissions anywhere in the world.

The model RHF-1 is suitable for the checking of oscillator calibration and frequency standards to an accuracy of up to one part in 10⁷. It has a wide range of applications including precision time measurements and pulse code modulation. Beat frequencies may be observed by the connection of oscilloscopes to output terminals provided.

The power source can be either 115/230-V a.c. mains or a 12-V battery. Operating frequencies are normally 2.5, 5, 10, 15, 20 and 25 Mc/s, but up to three frequencies between 2.5 and 25 Mc/s may be added. The usable sensitivity is 1 µV and the signal plus noise to noise ratio is better than 10 dB at 3 µV input.—*The Wayne Kerr Laboratories Ltd., New Malden, Surrey.*

For further information circle 40 on Service Card

41. High Power Silicon Rectifiers

Photronic Controls have extended their range of components by the addition of 24 types of high power silicon rectifiers capable of handling loads from 2.5 to 100 A.

The MP-1 series have a maximum forward current of 2.5 A with a maximum surge of 32 A for 1 sec; the TH08 series have a maximum forward current of 8 A with a maximum surge of 50 A for 1 sec; and the corresponding figures for the TH20 series are 17 A and 120 A for 1 sec. These three types are available with input voltages ranging from 100 to 250 V and p.i.v. from 250 to 750 V.

The TH-100 series have a maximum forward current of 100 A with a surge current of 320 A for 1 sec. All the rectifiers feature very low reverse current and are suitable for an ambient storage temperature range from - 65 to + 175 °C.—*Photronic Controls Ltd., Randalls Road, Leatherhead, Surrey.*

For further information circle 41 on Service Card

42. Programme Boards

Selectro have announced the availability of custom designed programme boards. The boards are designed and manufactured on the basic principle of the Sealectoboard whereby a matrix

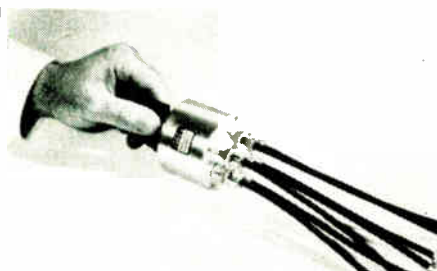

37

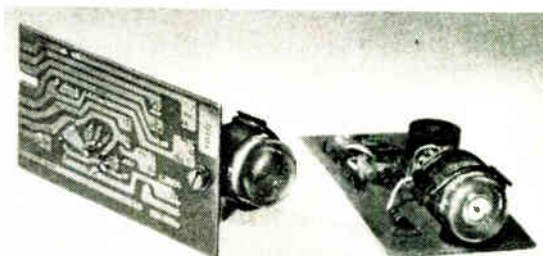

38

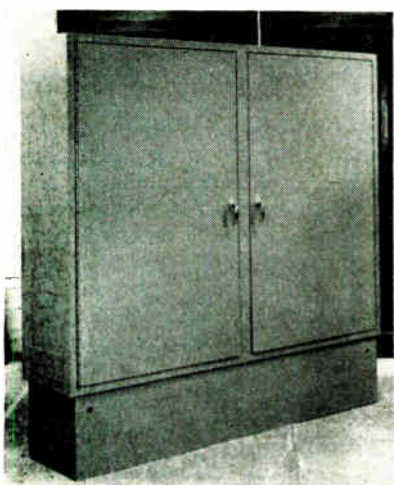

39

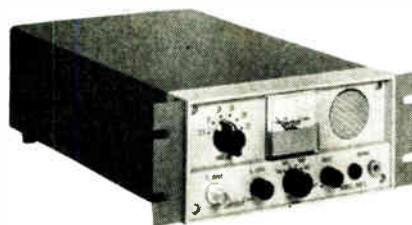

40

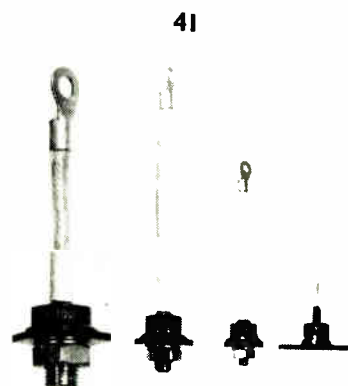

41

EQUIPMENT REVIEW

between an X- and Y-axis is provided for multi-channel switching without patch cords: shorting pins, or component holders, are plugged in the matrix at the desired coincident point between axes.

Custom designed boards are provided in any configuration, panel markings, colours, or mounting facilities.—*Sealectro Corporation, Hershams Trading Estate, Walton-on-Thames, Surrey.*

For further information circle 42 on Service Card

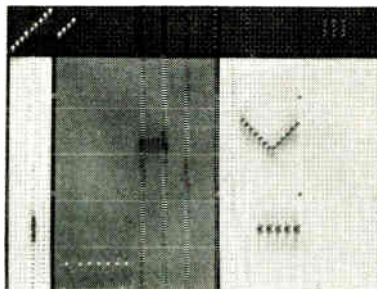

42

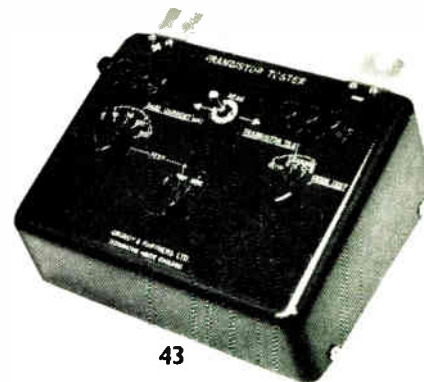

43

43. Transistor Tester

Grundy & Partners are manufacturing an n-p-n/p-n-p transistor tester designed for use in conjunction with all multi-range meters of 1 mA basic movement or better, preferably with inbuilt overload protection. The mounting terminals enable the unit to be mounted directly on to a Universal Avo-Meter.

Measurements which can be made include collector-emitter, and collector-base leakage current. Diodes are tested in the forward direction by passing a current of up to 10 mA depending on the forward resistance. The reverse current is checked at a potential of 9 V.

A useful measurement of current gain can be made on transistors up to 800-mW dissipation and a reasonable indication is given for higher powers. Base input currents available are: 10, 50, 100 and 500 μ A. The collector voltage is fixed at 4.5 V.

It is possible, using the two sets of terminals provided, to match or compare two similar transistors or diodes under exactly the same conditions. Provision is made for testing the internal battery under load, thus eliminating the possibility of error due to battery failure. Price of the instrument is £5 19s. 6d. each ex-works.—*Grundy & Partners Ltd., 3 The Causeway, Teddington, Middlesex.*

For further information circle 43 on Service Card

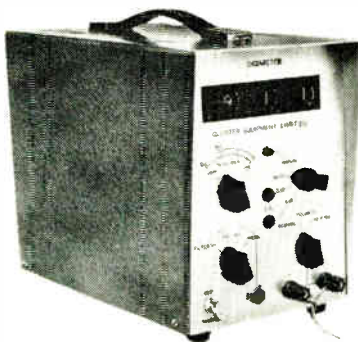

44



45

44. Compact Digital Voltmeter

Gloster Equipment announce the model BIE 2123 'Digimeter', a portable 3-digit a.c./d.c. voltmeter having four ranges from 0 to 0.999 up to 0 to 999 V with manual polarity and range changing facilities. Accuracy on d.c. measurement is the greater of $\pm 0.2\%$ of reading or ± 1 digit, and on the a.c. ranges $\pm 0.5\%$ of reading or ± 1 digit.

The unit is designed for a sampling rate of 1 reading per sec with 'press-to-read' facilities. Good frequency response characteristics allow precision measurements to be made over the entire audio range.

Input impedance on the a.c. ranges is approximately 180 k Ω at 50 c/s, and on

d.c. either 1 or 15 M Ω depending on the range selected.—*Gloster Equipment Ltd., Hucclecote, Gloucester.*

For further information circle 44 on Service Card

45. Low Noise Audio Pre-Amplifier

Furzehill Laboratories have announced the P.A.80 battery-operated solid-state pre-amplifier with a frequency response from 20 c/s to 20 kc/s.

Because of its compactness (3 $\frac{1}{8}$ by 1 $\frac{1}{8}$ by 2 $\frac{1}{4}$ in.) it can easily be added to any existing equipment. The voltage gain is 34 dB with a signal-to-noise ratio of better than -60 dB at 1 mV input. Input and output impedances are greater than 30 k Ω and less than 100 Ω , respectively. Harmonic distortion is less than 0.3% at 150 mV output.

Three 4-V cells give a life of 350 hr, but if required, the unit is available without batteries to enable it to be integrated in other equipment.—*Furzehill Laboratories Ltd., Theobald Street, Borehamwood, Herts.*

For further information circle 45 on Service Card

46. Digital-to-Analogue Converter

General Radio have announced a digital-to-analogue converter with a high-speed storage system that permits use with intermittent as well as continuous binary-coded decimal inputs.

The type 1136-A selects any three consecutive or the last two columns of an input up to nine columns. The converter operates with four-line b.c.d. inputs or, with an accessory matrix cable, with 10-line inputs from GR type 1150-series counters.

The nominal $\pm 0.1\%$ overall accuracy includes the effects of moderate line-voltage and temperature variations, linearity, repeatability, and long-term stability. Output is switch-selected as either 1 mA with 15-k Ω source impedance or 100 mV with 100- Ω source impedance.

Conversion rate is up to 10,000 per sec, and storage transfer time is 50 μ sec.—*Claude Lyons Ltd., Valley Works, Hoddesdon, Herts.*

For further information circle 46 on Service Card

47. High Current Capacitors

Vitramon Laboratories have announced their first all-British component, comprising a range of high-current porcelain capacitors suitable for r.f. power applications.

These miniature components can carry r.f. current of up to 60 A at 2 kV a.c., with capacitance tolerance of $\pm 1\%$ for the following values: 500, 875, 1,250, 1,625 and 2,000 pF; 250, 625 and 1,000 pF units ($\pm 2\%$) are available for currents up to 30 A at 2 kV.

Based on capacitors produced to



46

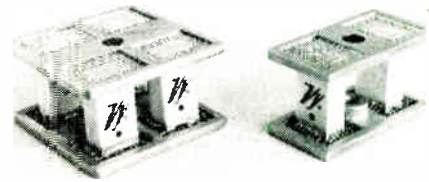

47



48



49

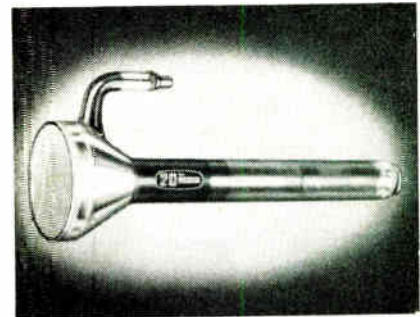

50

draft DEF.5138-41, the construction effectively dissipates generated heat, so that body temperature rise in ambients of up to 100 °C will be as low as ½ °C/A, with a maximum capacity drift of 0.05%.—*Vitramon Laboratories Ltd., 45 Holloway Lane, Harmondsworth, Middlesex.*

For further information circle 47 on Service Card

48. Colour Bar Generator

RCA Great Britain have announced the WR-L64A N.T.S.C. colour bar generator, the first of a range of British produced test instruments designed for colour television. This is a self-contained portable unit providing colour bars, dots or crosshatch pattern modulated on an r.f. carrier. Also incorporated is a colour-beam selector switch.

The colour bar pattern is invaluable for enabling the complete operation of the colour receiver to be checked in the absence of a colour programme or test card while the dot and crosshatch patterns are essential for setting up convergence and linearity. The beam selector enables single colours to be displayed to facilitate colour purity adjustments.

In addition to its use for development and service work the WR-L64A will find application in technical colleges for colour training courses and for dealer

demonstrations. It is housed in a sturdy metal case and weighs 20 lb. An r.f. output cable and the colour beam selector leads (when required) are the only connections to the colour receiver. The colour-bar generator will be available early this year, and will cost £75.—*RCA Great Britain Ltd., Lincoln Way, Windmill Road, Sunbury-on-Thames, Middlesex.*

For further information circle 48 on Service Card

49. Snap-Action Delay Switch

A snap-action thermal-delay switch, known as the S45 C/ID, is available from STC. Designed for switching comparatively high powers (up to 250 V at 5 A, a.c.), the switch is a single-pole change-over device featuring high contact pressure and a rapid make and break action. Nominal switching delay time is 42 sec, and, by connecting a number of switches in series, multiples of this delay time can be obtained.

Thermal-delay switches are suitable for providing the delay between the application of heater voltage and other circuit voltages, such as anode voltage, to indirectly-heated valves and tubes. In addition they can be used as v.l.f. relaxation oscillators, for switching 3-phase circuits from star to delta arrangements when starting induction motors and for re-closing a circuit-breaker after a temporary current surge

has caused it to trip.—*Standard Telephones and Cables Ltd., Valve Division, Footscray, Kent.*

For further information circle 49 on Service Card

50. Projection C.R. Tubes

20th Century Electronics have developed a range of high-brightness projection cathode-ray tubes, having various face curvatures. A 2-in. diameter version (illustrated), known as the M2G-342, has been designed especially for use in aircraft head-up display equipment.

Flight information in symbolic form is projected from the face of the tube to appear at infinite focus in a partially-silvered mirror in the pilot's line of sight. The pilot can then view the display and the route ahead at the same time without moving his head.

The order of tube brightness achieved is shown by the need for the display to be visible against a background of 10,000 ft-lamberts, such as sunlit cloud. An essential feature of the tube is that it can be replaced without disturbance to the scan and focus units. To this end, very tight tolerances have been achieved on the diameter and straightness of the neck and on the normality of the tube face to the neck axis.—*20th Century Electronics Ltd., King Henry's Drive, New Addington, Croydon, Surrey.*

For further information circle 50 on Service Card

TANK LOGGING SYSTEM

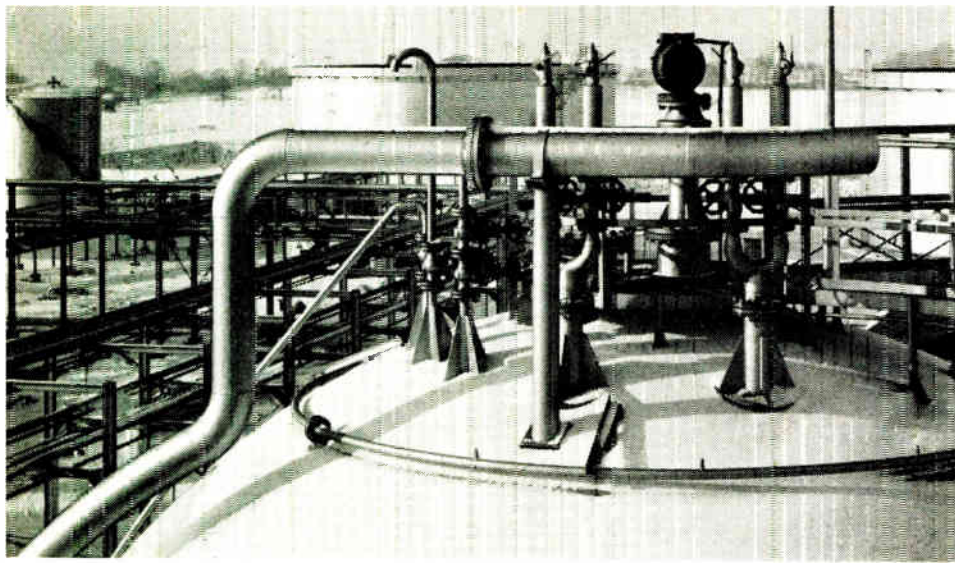

Precise tank gauge mounted on a spherical tank

THE Evershed Tank Logger is a specialized form of data logger. Therefore, before describing the system in detail, it will be useful, as an introduction, to consider briefly data loggers in general.

With the increasing complexity of plant and processes, the

amount of information to be logged has increased in many cases to the point that manual logging has become too laborious and difficult in terms of both time and accuracy. For example, consider how long it would take to read and record 100 indications, and also to what accuracy these readings would be.

Alternatively, another example is in the guided-missile field where the check-out and telemetry instrumentation has out-stripped manual interpretation. It is clearly evident then how the need has arisen for equipment which will automatically read and print information to a precise accuracy. Taking this as a definition of a data logger, it is interesting to reflect that data loggers existed pre-war, long before the term became prevalent, in the form of the coin-operated weighing machines which provided a printed record of weight.

To revert to industrial data loggers, a considerable range is available. The majority of industrial measurements are in analogue form, either as an electrical signal or as shaft position, and the first essential is a unit to convert analogue signals to a form acceptable to the printer, which is inherently a digital device. The basic requirement is, therefore, an analogue-to-digital converter. This generally is common equipment, that is to say, it is time-shared by a number of measuring points and must be preceded by a selection unit, the purpose of which is to select, and also identify, the measuring point that is connected to the a.d.c. at any one time.

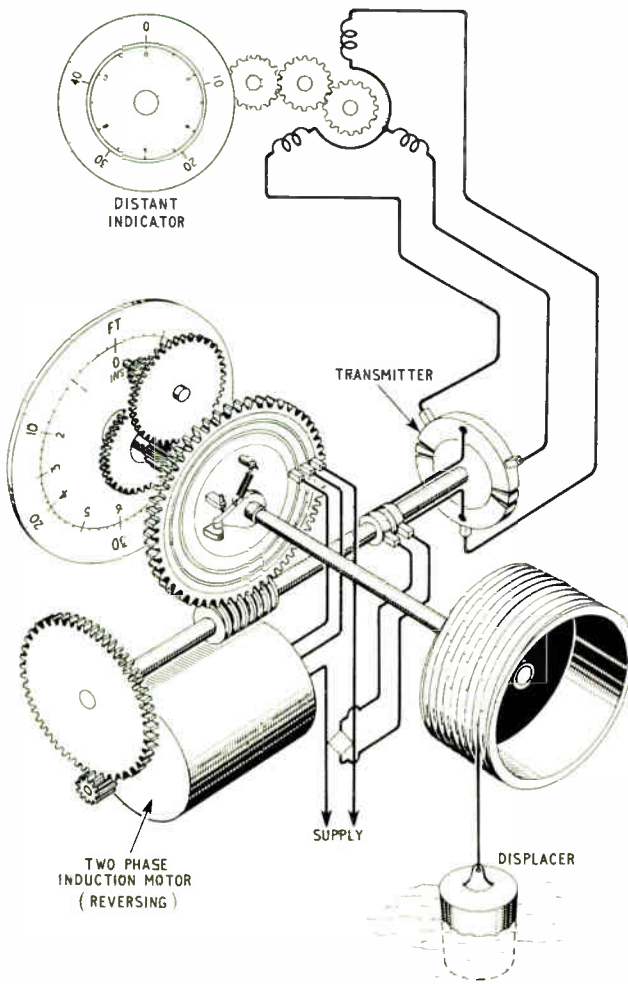

Fig. 1. Details of the tank gauge and the remote indicator

Analogue-to-Digital Conversion

Analogue-to-digital conversion is a subject on its own, but basically this type of equipment breaks down into two groups—electronic encoding of analogue voltage or current, and electro-mechanical encoding of analogue shaft position. A typical example of the electronic type is the count-down version where the most significant digit is first inserted, compared with the analogue signal, and either accepted or rejected. The next highest significant digit is then switched in and again a comparison takes place, and so on until the complete cycle has been run through. An example of the electro-mechanical type, more generally known as a shaft digitizer, is the Gianini disc and its descendants which, in essence, consists of an elaborate multi-way switch with either brush or photo-electric pick-ups.

Both types of a.d.c. have one important thing in common. In order to economize on circuitry and cost, they both

Automatic recording of the level and temperature of the contents of storage tanks is important in some industries. This article describes a system which enables a large number of tanks to be monitored using largely common apparatus.

By J. T. DOBSON*

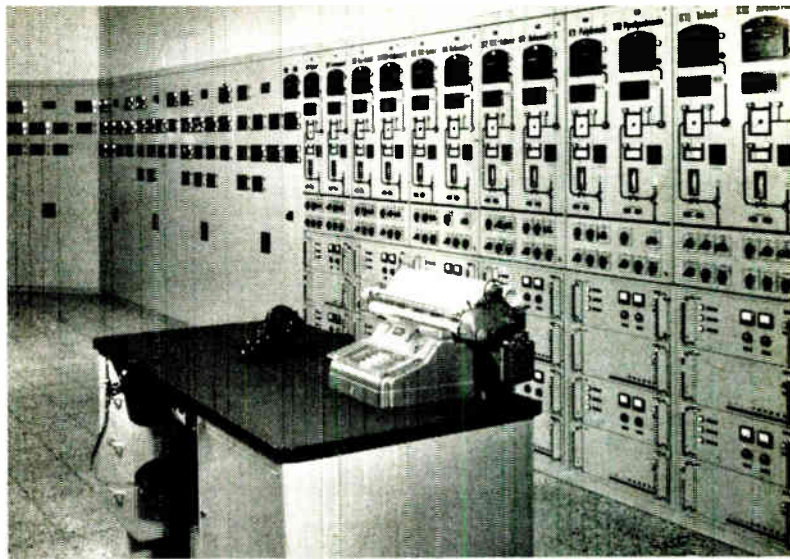

Control panel of a German refinery. Decideaders are mounted in a mimic diagram

encode in one of the various information codes, as opposed to the more orthodox decimal code. The reason for this is obvious if it is considered that the binary code can represent any value between 0-100 with only seven digits. Unfortunately, however, it is not possible to feed the binary output of the a.d.c. directly into the printer. The latter requires a decimal input and hence a translator is interposed, the purpose of which is to translate the binary output of the a.d.c. into a decimal code. In point of fact, this is not a separate unit, but generally forms an integral part of the a.d.c.

Choice of Printer

At this point, the type of printer has to be considered, as this determines how the output of the analogue-to-digital converter is handled. Printers can also be broadly divided into two classes, parallel types (i.e., printers which can accept a number of digits simultaneously) or the series type which can only accept one digit at a time. The former have an apparent advantage in that the output of the translator can be fed directly into the printer, but with the series type it is necessary to provide additional equipment in order to

interrogate the translator and feed the output into the printer one decade at a time. As will be seen later, however, this apparent disadvantage in the series type is more than offset by the extra facilities that it can provide. These then are the basic units of a data logger, and the manner in which they are used to provide an integrated system will become clear if the tank logger is considered in detail.

The Evershed Tank Logger, although available for general purpose data logging, was designed to operate in conjunction with Evershed transducers, and in particular with the Precise Tank Gauge, used to give very accurate readings of level in bulk storage tanks.

Measurement and Transmission of Level

Referring to Fig. 1, this indicates schematically the operation of the tank gauge. The displacer is suspended from the winding drum, part of its weight being supported by the liquid and the remainder by a helical spring. One end of the spring is attached to the spindle of the winding drum which also carries a contact, operating between two contacts mounted on a disc. The disc is geared to a reversing motor. Under static conditions, the contact attached to the spindle is in the neutral position. A change

* Evershed & Vignoles Ltd.

Fig. 2. Block diagram of the system

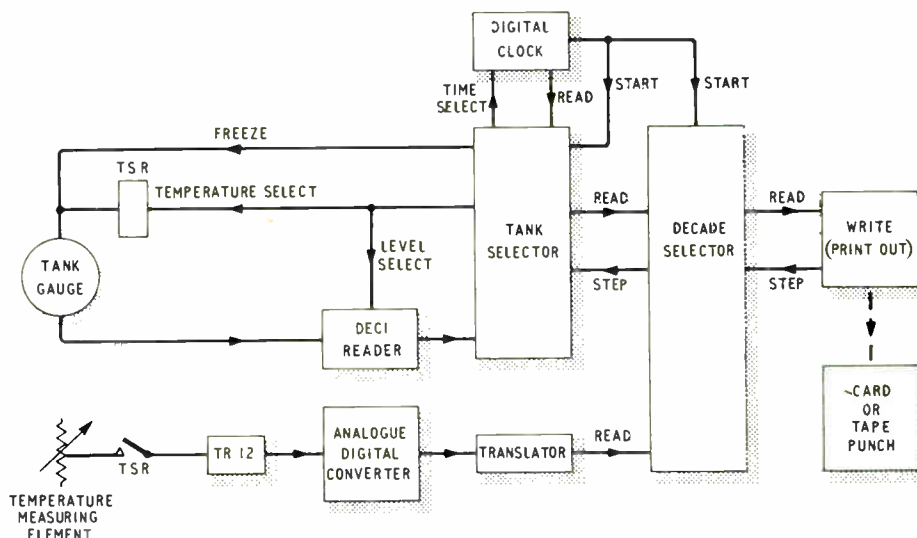

of level causes a movement of the displacer which establishes a connection between the centre contact and one of the disc mounted contacts. A circuit is thereby established for the motor which rotates in the direction appropriate to the signal and raises or lowers the displacer until the centre contact returns to the neutral position, breaking the circuit to the motor.

Transmission to the remote indicator is by means of the Evershed Powerotor System. The transmitter consists of a rotary switch having three brushes connected to three windings in the stator of a small motor fitted in the remote indicator.

Rotation of the transmitter causes a change in the polarity of the brushes resulting in a rotation of the magnetic field in the stator of the receiving indicator, so that its permanent-magnet armature rotates in synchronism with the transmitter. The receiver motor can be geared to drive either analogue or digital indicators.

Referring to the block diagram, Fig. 2, the output from the tank gauge is connected by three wires to the receiver motor in the Decireader. This is a specialized form of shaft digitizer providing digital indication with read-out facilities, and consists of a five-decade cyclometer type of movement driven from the shaft of the receiver motor with each decade wheel driving the wiper of a 10-way switch. The main advantage with this type of shaft digitizer is that the wipers are normally disengaged and are only in contact with the switch outlets during an actual log. This is achieved by means of a solenoid which, when energized, engages the five wipers on to the five printed-circuit cards forming the switch outlets. The solenoid simultaneously engages a star-wheel device. This arrangement, therefore, avoids the continuous rubbing action which is present with the more orthodox read-out shaft digitizers, and thus virtually eliminates contact wear. Fig. 3 illustrates a Decireader, showing the printed-circuit switch cards and their respective brushes.

The output of the Decireader feeds into the tank selector which is basically a multi-way switch, its purpose being to select each Decireader in a predetermined sequence, and connect it to the decade selector. The decade selector is also basically a multi-way switch, scanning the decades of the Decireader and sequencing the selected digit in each

Fig. 3. Decireader with front panel removed to show (A) a printed-circuit board contact and (B) a wiper in the disengaged position

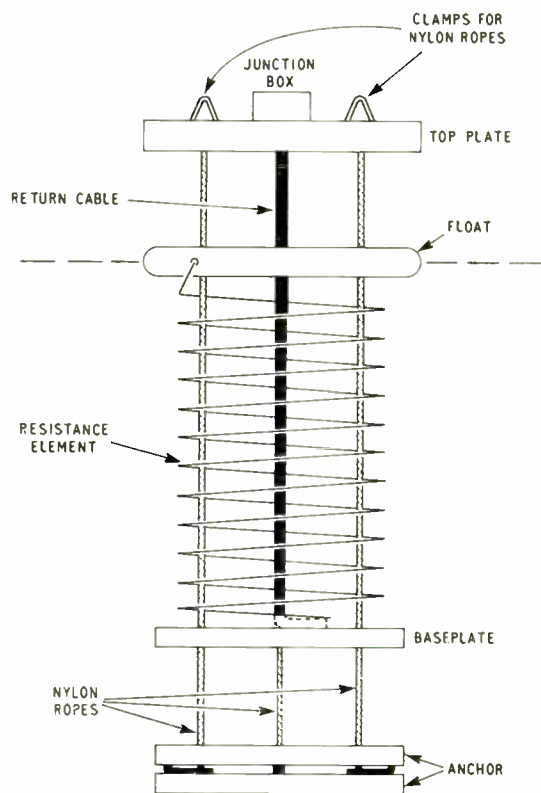
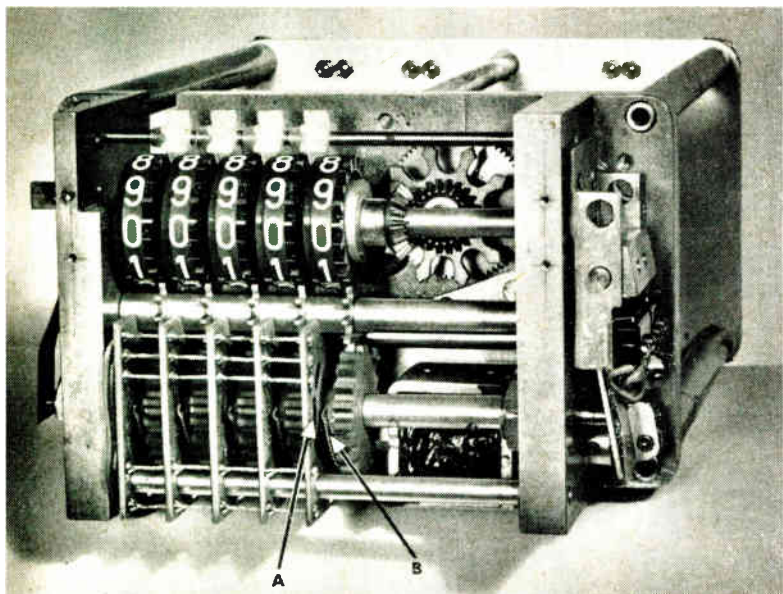

Fig. 4. Detail of the average temperature gauge

decade into the printer. Both tank and decade selectors use cold-cathode trigger tubes in order to provide an inexpensive but reliable form of static switching.

The printer is the familiar adding/listing machine which is in general office use, but is fitted with solenoids to provide electrical inputs. The fact that it is preceded by a decade selector indicates that it is a series input printer. The reason for this choice over the parallel entry printer is that the inherent calculating properties of the machine can be utilized for such things as conversion factors or totalizing. It also has another important advantage over other types of series printers such as the electrically-operated typewriter, in that the latter requires one print operation per digit, whereas with the former the digits are entered in series but printed en masse in one operation, thus providing a considerable mechanical advantage by minimizing wear and tear.

The digital clock at the top of the block diagram is another form of shaft digitizer which, by means of a synchronous motor driving a pawl and ratchet, steps four decade switches to provide time in digital form on a 24-hour basis. Its purpose is two-fold, firstly to provide the controlling pulses to start the log at pre-set intervals, and secondly to give the time entry at the commencement of the log sheet. The description is simplified if, at this stage, the operation of the logger is considered in terms of level only, omitting temperature measurement.

The start of a log is initiated by the 'start' pulse emanating from the digital clock at the pre-determined time. This is steered into both the tank and decade selectors, activating both units. The tank selector selects the digital clock and simultaneously a common signal is transmitted to all tank gauges, the purpose of which is to 'freeze' the gauges and prevent them from responding to any change of level, thus providing a datum line for the log. As soon as the digital clock has been selected, a circuit is completed, via the decade selector, for the digit stored in the tens-of-hours decade.

The receipt of this digit causes the printer to signal back to the decade selector that it is ready for the units-of-hours decade. The decade selector then switches the first decade out and the second decade in. This feedback technique ensures that each digit is stored before calling up the subsequent digit. This cycle of events is repeated until all decades from the digital clock have been read. The receipt of the last time digit in the printer resets the decade selector which then provides a 'print' signal causing the stored digits to be printed out, and simultaneously pulses the tank selector. As a result the tank selector releases the digital clock and energizes the solenoid of the first Decireader.

The Decireaders are arranged to provide their own point number identification. The decimal output of the Decireader is therefore preceded by the tank number. The fact that the Decireader has been energized is then detected, and the tank number and each decade of the Decireader is scanned by the decade selector, the interaction between the printer and the decade selector being as before. Receipt of the last decade digit is detected and causes the decade selector to provide the print signal, also stepping the tank selector, releasing the first Decireader and energizing the second. This cycle of events is then repeated until all Decireaders have been scanned, release of the last Decireader causing the tank and decade selectors to reset to the 'off' position.

Self-Checking Circuits

Various self-checking features are incorporated. For instance, in the event of a fault, such as a disconnected wire affecting only one tank, a 'jump' feature is initiated causing a blank space where that tank would normally be printed. Interlock facilities are provided so that it is impossible for the decade selector to scan the succeeding Decireader until the preceding Decireader has been released. Other facilities have been incorporated to cover various level conditions such as turbulence, in which case the tank number and value are printed in red. The selector units are arranged in rack-mounted 10-way units, an example of which is shown in Fig. 5.

Temperature Measurement

Dealing now with the temperature print-out, the temperature measuring element in the tank consists of a resistance thermometer of a high temperature coefficient nickel wire (Fig. 4). This is contained in a nylon tube pre-formed into a helical coil, suspended from a float and ballasted to equal the specific gravity of the liquid. By this means the coil is always completely immersed and evenly distributed throughout the liquid, thus reading true average temperature. The resistance thermometer is connected to an amplifier, the output of which consists of a d.c. signal proportional to temperature, and which is directly connected into the analogue-to-digital converter. This is a transistorized medium-speed self-balancing feedback type, using the count-down mode of operation. The a.d.c. uses a binary decimal code to provide the necessary economies in circuitry, but because the printer can only accept a decimal input, the a.d.c. incorporates a translator to convert the binary decimal code back into decimal form acceptable to the printer.

The maximum capacity of the printer is 10 digits. Nine are used for level consisting of three for tank number, five for the actual level, and a symbol digit for millimetres. When both level and temperature are required, therefore, the decade selector is extended, the first part being as before and printing out the level. This time, however, the print feedback does not step the tank selector, but causes the extension of the decade selector to scan the output of the translator, and a receipt of the last temperature digit initiates the print out of the temperature and causes the tank selector to step. A

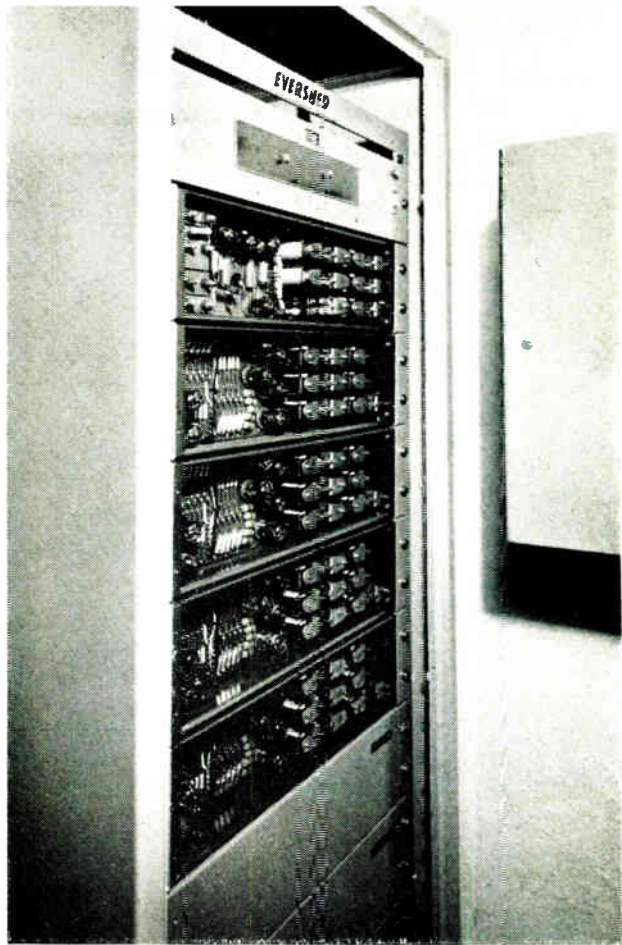

Fig. 5. Ten-way selector units in a standard rack

further difference in the case of temperature is that the tank selector, in addition to selecting the particular Decireader, operates the temperature selector relay, TSR in Fig. 2, individual to each tank and consisting of a dry-reed relay, the contacts of which switch the respective resistance thermometer into the common amplifier. The temperature is selected simultaneously with the Decireader, is digitized while the decade selector is scanning the Decireader, and is sequenced into the printer as soon as the decade selector has printed level.

One final point, which again emphasizes the choice of the adding/listing machine, is the fact that various sizes of machine are available, the choice of machine depending upon the application and also the availability of a range of units to provide a direct read-out from the printer for conversion into punched tape or punched cards for further manipulation.

The field of application for data loggers is rapidly expanding, and in particular there is a need for a second generation of loggers scaled down in both cost and complexity for the smaller process industries, and it is with this in mind that the Evershed Tank Logger has been designed.

Experimental Wireless

A few early volumes of *Experimental Wireless* are available free to any library wishing to complete a set. They were the property of the late H. A. M. Clark and one volume each of Vols. 2-5 inclusive is available. Applications should be addressed to the Editor, *Industrial Electronics*. In the event of there being more than one request for the same volume it will be allocated to the library whose request is first received.

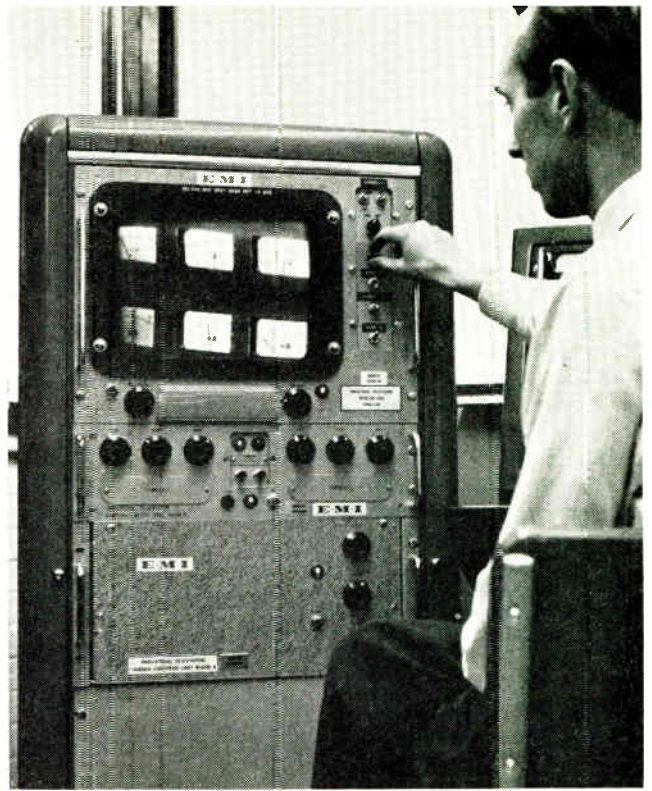
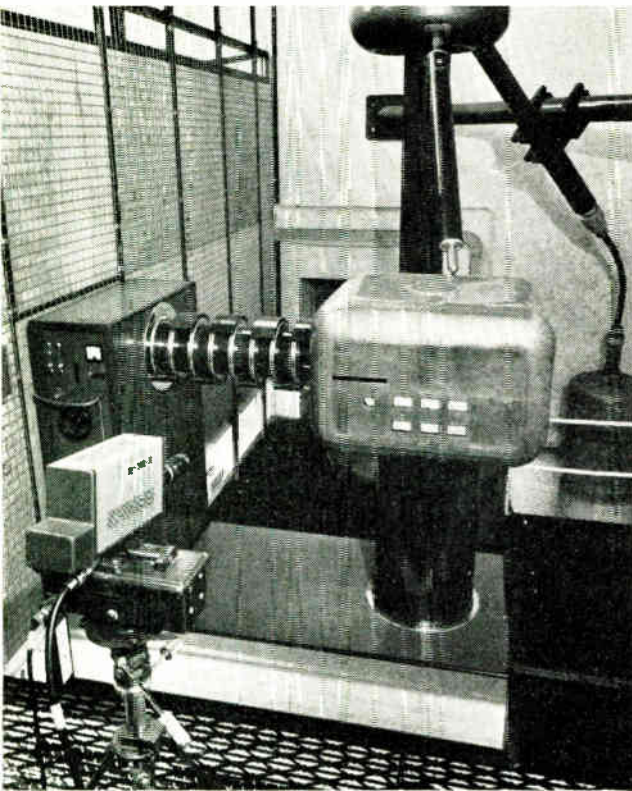

1



2



3



1 Radiation-measuring instruments used in the Central Electricity Generating Board's nuclear power stations throughout the United Kingdom are accurately calibrated before going into service with the aid of remotely-controlled closed-circuit television equipment supplied by E.M.I. Electronics. At Berkeley Nuclear Laboratories in Gloucestershire, a 400-kV accelerator produces high-energy gamma-rays and neutrons in known quantities for calibrating gamma-ray and neutron monitors. It is not safe for staff to remain near the high-voltage terminal during operation, so a type 6 closed-circuit television camera (left-hand picture) transmits the readings on the accelerator meters to a receiver in a control room some yards away (right-hand picture).

2 Elliott-Automation's new gas laser for teaching and research purposes is also suitable for a wide range of applications in new communication systems. The laser produces a coherent beam of plane-polarized light with a wave-length of 0.6328μ and a bandwidth of under 1 Mc/s.
For further information circle 54 on Service Card

3 A 'Probomat' system controlling a Moore No. 3 jig borer in Elliott-Automation's Inertial Navigation Division. The machine is engaged on the production of precision parts for the Elliott inertial guidance system of Britain's Blue Steel deterrent. The 'Probomat' point-to-point numerical machine tool control system is now manufactured and marketed by Elliott-Automation under licence from the Warner and Swasey Corp. of Cleveland, U.S.A.
For further information circle 55 on Service Card

TRANSISTORIZED NON-LINEAR FUNCTION GENERATOR

By P. KUNDU, M.Sc. and S. BANERJI*

A non-linear function generator is realized by the cascade connection of logarithmic, exponential and linear stages. The magnitude and sign of the exponent of the overall non-linear response function of the system may be set by adjusting the gain and phase of the linear stage respectively, while the coefficient may be varied by varying the quiescent voltage across the emitter-base junction of the exponential stage, or by the current through it. The output then varies directly or inversely as the power or root of the input having its magnitude according to the adjustment made.

NON-LINEAR function generators perform a basic operation which is essential in computers¹, in volume compression and expansion of a signal², in non-linearity correction of a transmission system³, and in the design of feedback control systems. As a result, there is a growing need for a non-linear function generator having a smoothly variable response function so that the operating performance of a system depending on its incorporation may be properly optimized. The response of such a system may then indicate the power or the root of a quantity or the values of their reciprocals directly, or it may provide a means for controlling the gain of an a.c. amplifier so that the magnitude of its output signal may vary directly or inversely as that of an input signal raised to an exponent greater or less than unity⁴. With the aid of this function it becomes feasible to generate an inverse pair of response functions required in a compandor system and the functions may, if necessary, be modified from the conventional root and square-law relation to any other pair of complementary functions so as to have a more effective means of combating noise in a communication channel.

An important application of non-linear amplifiers is in the non-linear amplitude transformation of a television signal and is known as gamma correction. Here the receiver and transmitter characteristics are matched with a view to producing a pleasing reproduction of intermediate brightness. This matching may be achieved with any two single-valued functions such that one is the inverse of the other and a decision on a standard optimum pair needs experiment with a variable-exponent non-linear amplifier. The conventional use of a root-law video amplifier at the transmitter to correct for the 2 to 2.5 power of the receiver c.r. tube screen brightness electrode voltage-transfer characteristic is not the only way of obtaining a proper tonal rendition in black-and-white pictures, or for correcting the tonal and chromatic distortion in coloured systems. There are other sources of non-linearities and a necessity as well for adjusting the overall transfer characteristic of the system to a value other than unity. The value of gamma required varies widely with the

types of camera tubes and also with the characteristics of the films employed as programme material.

Of the few methods developed for the generation of non-linear functions, the use of biased diodes with auxiliary load resistors⁵, though quite common, requires a large number of stages for closely approximating a desired curve. Furthermore, it has the basic disadvantage of giving a step-by-step correction which introduces discontinuities when the function is differentiated. On the other hand, the methods depending on the use of the non-linear current-voltage relationship of valves⁷, or of some semiconductor elements like silicon carbide varistors⁸, are unsuitable for many applications because the values of transfer gradient of the response function are limited by the inherent characteristics of the elements used, and a variation of which needs a great deal of empirical adjustments and experiment. It is the purpose of this article to show how these various limitations may be overcome and how considerable simplification of the design of a non-linear function generator⁹ may be introduced by the technique¹⁰ of using an inverse pair of non-linear operations together with a linear one. It is further shown that a

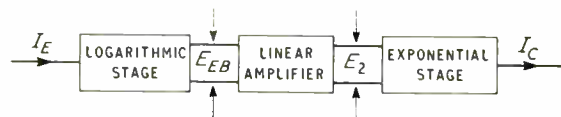

Fig. 1. Block diagram illustrating the principle of the non-linear amplifier

theoretical basis can be established on which a logical approach may be made to the design of a practical system for realizing a general means of generating a non-linear function whose coefficients as well as exponents may be varied continuously. Experimental results are also presented here and they are found to corroborate closely the theoretical assumptions on which this system has been based. Within the stipulated operating conditions the accuracy of the results is primarily limited by the temperature effect, and it comes within 2% if readings are taken when the ambient temperature is maintained reasonably constant and the power supply is properly stabilized.

Theory of Operation

The block diagram of Fig. 1 illustrates the basic principle of operation of the system. The signal is passed in succession through logarithmic, linear and exponential stages. The output of the exponential stage is then a function of the input signal with the linear gain as an exponent of the function.

The theory of semiconductors predicts an exponential current-voltage relationship and the exponential device can

* Jadavpur University, Calcutta.

be converted to a logarithmic device by interchanging the dependent and independent variables.

The symmetrical voltage form equations showing the intrinsic d.c. properties of transistors are expressed (assuming that the surface leakages are negligible and the internal ohmic drops can be neglected over the operating range) as follows¹¹:

$$I_E = I_{ES}(\epsilon^{E_{EB}/p} - 1) - \alpha_I I_{CS}(\epsilon^{E_{CB}/p} - 1) \quad (1)$$

$$I_C = -\alpha_N I_{ES}(\epsilon^{E_{EB}/p} - 1) + I_{CS}(\epsilon^{E_{CB}/p} - 1) \quad (2)$$

where I_{ES} and I_{CS} denote the magnitudes of the emitter and collector direct currents respectively at large reverse bias and with the other electrode short-circuited and are given by

$$I_{ES} = \frac{I_{EO}}{1 - \alpha_I \alpha_N}, \alpha_N I_{ES} = \alpha_I I_{CS}$$

$$I_{CS} = \frac{I_{CO}}{1 - \alpha_I \alpha_N}, p = \frac{kT}{q}$$

The direction of the current is taken to be positive if the conventional direction of current is into the p-type or out of the n-type material.

Here I_{CO} is the reverse saturation current of the collector junction with the emitter open; i.e., $\epsilon^{E_{CB}/p} \ll 1$, $I_E = 0$.

α_N is the transistor current gain in normal operating condition; i.e., with emitter forward-biased and collector reverse-biased.

I_{EO} is the current which flows across the emitter junction when the emitter junction is reverse biased and the collector current is zero; i.e., $\epsilon^{E_{EB}/p} \ll 1$, $I_C = 0$.

α_I is the current gain with the transistor in inverted operating condition; i.e., the collector junction is forward biased while the emitter is reverse biased.

E_{EB} stands for the voltage drop from p-type material to the n-type material across the emitter junction.

E_{CB} stands for the drop across the collector junction with the same polarity convention.

A junction is forward biased when E_{EB} or E_{CB} is positive and reverse biased when E_{EB} or E_{CB} is negative.

In a p-n-p junction transistor if the collector is shorted to its base then the input characteristic may be represented by the equation

$$I_E = I_{ES1}(\epsilon^{E_{EB}/p_1} - 1) \quad (3)$$

Now I_E and E_{EB} may be expressed as

$$I_E = I_{EQ1} + I_{E1} \text{ and } E_{EB} = E_{EQ1} + E_1 \quad (4)$$

where I_{EQ1} denote the quiescent emitter current for the quiescent emitter base voltage E_{EQ1}

Then

$$E_{EB} = p_1 \ln \left(\frac{I_{E1} + I_{EQ1} + I_{ES1}}{I_{ES1}} \right) \quad (5)$$

This shows a logarithmic current-voltage relation over the region $I_{E1} \gg I_{EQ1} + I_{ES1}$. When the voltage is amplified by a linear amplifier having a gain γ then the amplifier output is

$$E_2 = \gamma E_{EB} + E_{EQ2} \quad (6)$$

where E_{EQ2} may be the quiescent voltage at the amplifier output.

The collector current of the p-n-p exponential stage with a

signal applied to its input from the amplifier output is given by equation (2)

$$I_{C2} = -\alpha_{N2} I_{ES2}(\epsilon^{E_2/p_2} - 1) - I_{CN2}(\epsilon^{E_{CB2}/p_2} - 1) \quad (7)$$

The parameters with the subscript 2 are for the exponential stage. When E_{CB} exceeds for a few tenths of a volt then $\epsilon^{E_{CB}/p_2} \approx 0$ and equation (7) is given by

$$\frac{I_{C2}}{\alpha_{N2} I_{ES2}} + \frac{\alpha - \alpha_I}{\alpha_I} = -\epsilon^{E_2/p_2} \quad (8)$$

Substituting the values of E_2 we get

$$\frac{I_{C2}}{\alpha_{N2} I_{ES2}} + \frac{1 - \alpha_I}{\alpha_I} = -K \left(\frac{I_{E1} - I_{EQ1}}{I_{ES1}} + 1 \right)^{\gamma \frac{p_1}{p_2}} \quad (9)$$

where $K = \epsilon^{E_{EQ2}/p_2}$

Hence

$$I_{C2} = -\alpha_{N2} I_{ES2} \left[K \left(\frac{I_{E1} - I_{EQ1}}{I_{ES1}} + 1 \right)^{\gamma'} + \frac{1 - \alpha_I}{\alpha_I} \right] \quad (10)$$

where $\gamma' = \gamma p_1/p_2$ and $\gamma' = \gamma$ if $p_1 = p_2$.

When $E_{EQ1} = 0$, $I_{EQ1} = 0$ and the minimum input current is such that $I_{E1} \gg I_{ES1}$ then the output current is

$$I_{C2} = -\alpha_{N2} I_{ES2} \left[K \left(\frac{I_{E1}}{I_{ES1}} \right)^{\gamma'} + \frac{1 - \alpha_I}{\alpha_I} \right] \quad (11)$$

It may then be seen that $I_{E1}/I_{ES1} \gg 1$ and $(1 - \alpha_I)/\alpha_I \ll 1$

normally and as such $K \left(\frac{I_{E1}}{I_{ES1}} \right)^{\gamma'} \gg \frac{1 - \alpha_I}{\alpha_I}$ over a wide range

of values for K which may be an integer or a fraction. Under these conditions, the output current is given by the expression

$$I_{C2} = -\alpha_{N2} I_{ES2} K \left(\frac{I_{E1}}{I_{ES1}} \right)^{\gamma'} \quad (12)$$

Exponents as Variable

1. *Power or Root Law.*—In order that the output current may vary as the power or root of the input current, the linear gain of the system may be adjusted to a value greater or less than unity. The expression given in equ. (12) shows that the desired relation is followed within the limits of the stipulated conditions.

2. *Reciprocals of the Power or Root Law.*—In order that the output may vary as the reciprocal of the input raised to any exponent, it is necessary that γ' in equ. (12) should be negative. This may be achieved by providing another 180° phase shift to the amplifier considered above. Further the quiescent voltage E_{EQ2} should be forward biasing and adjusted so that for the maximum operating input current

$$K \left(\frac{I_{ES1}}{I_{E1}} \right)^{\gamma'} \gg \frac{1 - \alpha_I}{\alpha_I} \quad (13)$$

$$I_{C2} = -\alpha_{N2} I_{ES2} K \left(\frac{I_{E1}}{I_{ES1}} \right)^{-\gamma'} \quad (14)$$

Coefficients as Variable

The coefficient of the expression given in equ. (12) consists of the multiplying factor K , the value of which depends on the emitter-base quiescent potential of the exponential stage. The value of K is greater or less than unity depending on whether the emitter-base of the p-n-p exponential stage is forward biased or reverse biased.

Fig. 2. Circuit diagram of the experimental set up

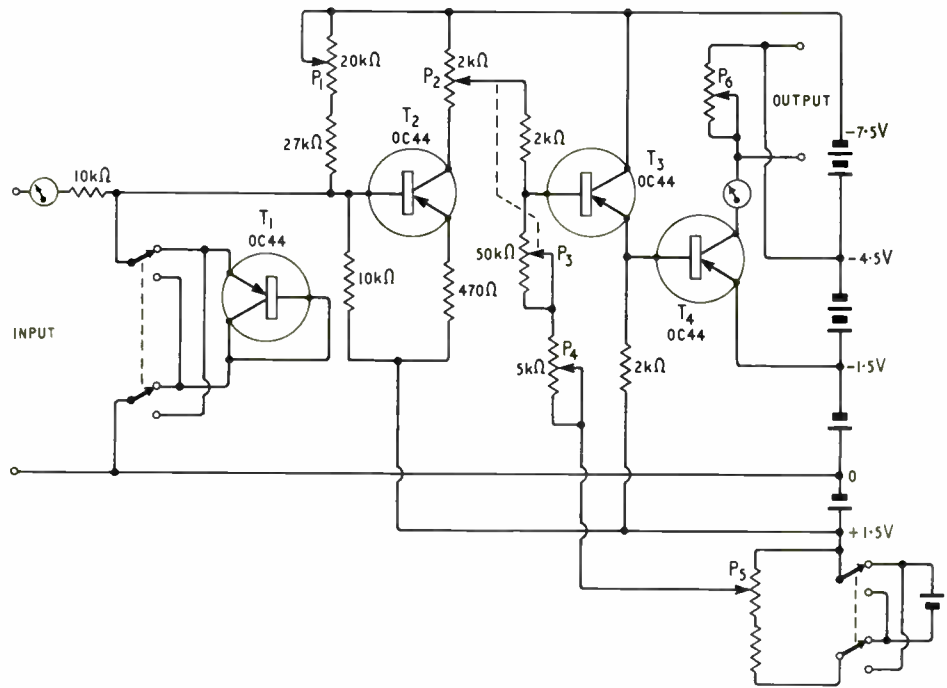

When E_{EQ_2} is positive

$$K = e^{E_{EQ_2}/P_2} = -\frac{I_{CQ_2} + I_{CS_2}}{\alpha_{N_2} I_{ES_2}} + 1 \quad (15)$$

where I_{CQ_2} is the quiescent collector current. For $E_{EQ_2} = 0$, $I_{CQ_2} = -I_{CS_2}$ and then $K = 1$. When, however, E_{EQ_2} is positive and is so adjusted that

$$I_{CQ_2} \gg I_{CS_2} (1 - \alpha_1)$$

the value of K is given by

$$K = -\frac{I_{CQ_2}}{\alpha_{N_2} I_{ES_2}} \quad (16)$$

and equ. (12) is then given as $I_{C_2} = I_{CQ_2} (I_{E_1}/I_{ES_1})^{K'}$ (17) I_{CQ_2} is thus a multiplying factor of the expression and may be varied by varying E_{EQ_2} .

When the polarity of E_{EQ_2} is reversed, the multiplying factor K of equ. (12) is given as $K = 1/e^{E_{EQ_2}/P_2}$ and as a result, the equ. (12) is then multiplied by a factor less than unity; i.e., it is then divided by the factor $e^{E_{EQ_2}/P_2}$.

Circuit Details

The diagram of Fig. 2 shows the details of the circuit elements used to realize the non-linear transfer function as enunciated in the previous section.

Logarithmic Stage

Here the logarithmic relation is provided by interchanging the dependent and independent variables of the p-n-p junction transistor T_1 whose collector has been shorted to its base. The current input is applied through the emitter-base junction through a high resistance thus simulating a constant-current source. When both the source and load resistances are very large in comparison to the forward junction resistance, the voltage across the junction becomes a logarithmic function of the input current as given in the equ. (5).

Linear Stage

The logarithmic stage is followed by the linear system consisting of a common-emitter amplifier T_2 followed by an emitter-follower T_3 . Negative feedback has been provided to the amplifier to increase the input impedance, to improve

Fig. 3. Current voltage characteristics of OC44 type transistor: (A) transistor connected as diode with collector shorted to base. The characteristic shows the variation of emitter to base voltages for respective input currents; (B) transistor in common-emitter connection. The characteristic shows the collector current variation against the base-emitter voltage

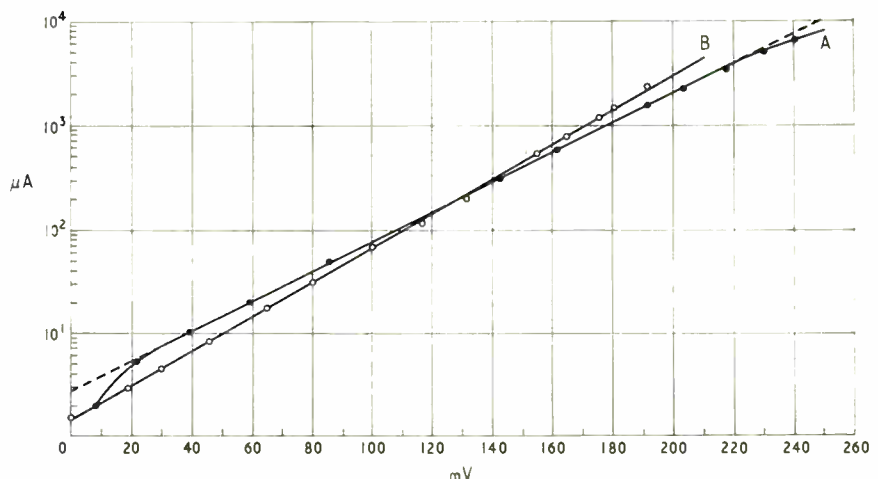

the linearity and to decrease the instability due to temperature variation. One of the biasing resistances P_1 at the base to T_2 is made variable in order to balance the diode junction quiescent potential to T_1 when the input is shorted and thus the quiescent current through the junction may be made zero for zero input. The gain γ of the linear system may be varied above or below unity by tapping the collector load P_2 to T_2 . P_2 may be ganged to the variable resistance P_3 in the base of T_3 so that the adjustment of gain does not appreciably disturb the biasing condition of T_3 . The variable resistance P_4 connected in series with P_3 is used as a fine control for setting the value of gain γ precisely, while the base-emitter quiescent potential of the emitter follower may be varied by P_5 so as to adjust the operating point of the exponential stage T_4 according to the desired value of the coefficient of the overall non-linear function. The inter-stage coupling network between T_2 and T_3 has been designed in such a manner that the source impedance presented to the emitter-follower T_3 remains reasonably low at all settings of the amplifier gain controls so that the output impedance of T_3 may also remain low and it may thus provide a source of low impedance for driving the common-emitter exponential stage.

Exponential Stage

The exponential relation between the collector current and the base-emitter junction potential is utilized here. The multiplication factor of the output current may be varied by the base-emitter quiescent potential and may be set by the potentiometer P_5 in Fig. 2. In the experimental observation the overall response has been studied by noting the collector current or the voltage developed across a load resistor of T_4 . The value of the resistor should be such that the collector potential should neither go below the knee of the current-voltage characteristics of the transistor nor should it be so high that the rated collector dissipation is exceeded over the total range of output current variation.

Experimental Observations

Individual Responses

The overall operation of the system depends on the individual operation of the three basic circuit elements described previously. The dynamic responses of the three individual stages have therefore been measured with the complete circuit under the actual operating condition so that the loading effect on each circuit of the following one could be accounted for, and the overall range and limitation of the system properly estimated.

Logarithmic Response

The emitter-current-emitter-base voltage characteristic of the p-n-p junction transistor with the collector shorted to its base is shown in Fig. 3. The linearity of the curve drawn on semilog paper shows an essential logarithmic relation between the current and voltage over several decades of input current as given by equ. (5). At the extreme ends, however, there is a gradual deviation of the curve from a straight line. At the lowest currents, this is due to the fact that the saturation current I_{ES1} becomes comparable to the input current I_{E1} , and as a result, the logarithmic relation is not maintained and an increased junction voltage is recorded. There is, however, a correcting effect due to the shunting of the increasing diode forward resistance by the load resistance resulting in an increased input current compared to the actual diode junction current. The linearity is thus extended to a little lower input current. At higher currents the effect of internal ohmic drops, which were neglected in eqs. (1) and (2), become appreciable and the measured terminal voltages record a higher value than the actual junction potential. Despite these deviations, the logarithmic relationship is seen to hold practically from $8 \mu\text{A}$ to 2 mA giving the respective

output voltages from 32 mV to 200 mV, which is adequate for most of the applications considered. The intercept by the linear extrapolation of the curve on the current axis gives the value of $I_{ES1} = 2.75 \text{ mA}$ and the slope gives a value of $p_1 = 30.3 \text{ mV}$.

Exponential Response

The collector-current and emitter-base voltage characteristic with a reversed bias potential of -3 V at the collector terminal of the transistor T_4 used as the exponential stage has been plotted on the same graph used for the logarithmic stage and is shown in Fig. 3. It shows a slight change in the slope from that obtained for the diode connection which, however, is not apparent from the transistor eqs. (1) and (2). This change of slope is perhaps due to the collector bias potential which causes a reduction of the amount of recombination in the base region and of the effective base width through collector space charge widening resulting in a higher alpha and a steeper carrier density gradient respectively. These changes, however, do not affect the essentially exponential relation between the output current and the input voltage to any appreciable extent as can be seen from the observed curves in Fig. 3. In fact the linearity of the curve on the semilog paper is extended down to much lower values of input voltage. This can be explained from the collector current equ. (8)

$$I_{C2} = -\alpha_{N2} I_{ES2} \left(e^{E_2/p_2} + \frac{1 - \alpha_I}{\alpha_I} \right)$$

which shows that the value of $\frac{1 - \alpha_I}{\alpha_I}$ is much less than unity

for the type of transistor used here, and, as a result, the exponential relationship is extended to much lower values of junction voltages. At higher currents the effect of internal ohmic drops is less due to the lower base current and the exponential relation holds good practically from $2 \mu\text{A}$ to 2 mA for the corresponding input voltages of 8 mV to 190 mV. The upper limit of the linearity of the curve may be set by the thermal effect due to collector dissipation which actually increases the collector current as may be seen at the higher currents in the characteristics. The intercept made by the linear extrapolation of the curve on the current axis gives the value of

$$\alpha_{N2} I_{ES2} = 1.48 \text{ and the slope of the curve } p_2 = 26.2 \text{ mV.}$$

Amplifier Characteristics

The amplitude response of the amplifier-emitter-follower stage for any gain set above unity is shown in Fig. 4, curve A. The dotted line shows the response when the exponential stage is disconnected. The amplifier response is in itself perfectly linear but the non-linearity starts due to the loading effect of the exponential stage input when the amplifier output reaches 180 mV, indicating the corresponding exponential collector current of 1.5 mA. This is slightly less than the upper limit of allowable operation for the exponential stage, and the range of operation may be extended by further reduction of the amplifier output impedance. It has, however, been found that the available range with the present arrangement is quite adequate for most of the applications considered and secondly the collector current of T_4 should not be above 2 mA to avoid the effect of collector dissipation.

Overall Response

The overall transfer characteristics of the system are noted for both positive and negative values of exponents of the non-linear function. With positive values, the characteristics obey a power law or root law according as the exponent is greater or less than unity; while under similar conditions but

with negative values, it varies inversely as the power or root law function.

Power Law

The power law transfer characteristic A shown in Fig. 5 is plotted with the linear gain set at 3.3 as shown in curve A in Fig. 4, with zero emitter-base quiescent potential of the exponential stage. The straight line A in Fig. 5 drawn through points obeying individual responses is seen to pass through few experimental points only. This is because the input currents here are mostly limited to lower values where the logarithmic relationship is not maintained. In order to shift the input currents to higher values, the emitter-base quiescent potential of T_4 is made negative to such an extent that this stage remains at cut-off till the input current is above $10 \mu\text{A}$ when the input characteristics of T_1 are accurately logarithmic. The transfer characteristics B and C are then drawn for different E_{EQ_2} potentials on the log-log co-ordinates as shown in Fig. 5. The curve C is seen to be precisely linear over the output current range $3 \mu\text{A}$ to 1.5 mA ; i.e., a range of 1:500. The fall of output currents from about 1.5 mA is due to the falling of linear gain of the amplifier as may be seen from the response curve A in Fig. 4.

The curves A, B and C in Fig. 5 are drawn respectively for $E_{EQ_2} = 0, -75 \text{ mV}$ and -125 mV and they are found to follow a power law having the transfer gradient 3.8 in each case, as observed from the respective slopes of the curves. The value of the transfer gradient γ' should be equal to the linear gain γ when $p_1 = p_2$, otherwise it should be given by:— $\gamma' = \gamma p_1/p_2$. This shows that any inaccuracy of the exponent may be corrected by varying the gain of the linear system. Here the value of γ' comes out to be 3.816 and this agrees closely with the observed values from the curves in Fig. 5.

The parallelism amongst the curves A, B and C shows that the coefficient of the non-linear function may be accurately multiplied by a number according to the value of E_{EQ_2} . The multiplication factor calculated from $K = e^{-E_{EQ_2}/p_2}$ for respective values of curve B and C are 1/19.6 and 1/119 and their ratio is 6.06, while the experimental values come out as 6.1 as may be observed from the vertical displacement of curve B from C. Here the coefficient of the curve in B is actually divided by a number 6.1 yielding the curve C for the particular values of the negative potential $-E_{EQ_2}$. The output currents calculated from equ. (12) by substituting the values of the constants obtained from the individual response curves for various values of input currents agree closely with those obtained in the experimental curves.

Root Law

To observe the root-law variation, the gain of the linear stage is adjusted precisely to such a value less than unity that the overall response varies as the square root of the input. The amplitude response of the amplifier and the corresponding overall transfer characteristic are shown in curve B in Fig. 4 and in Fig. 6. The linear gain obtained from Fig. 4 is 0.44 and from Fig. 6 the transfer gradient $\gamma' = 0.5$. The value of γ' when calculated from $\gamma p_1/p_2$ comes out as 0.508.

The values of the output currents have been calculated from equ. (16) for the respective input currents with different

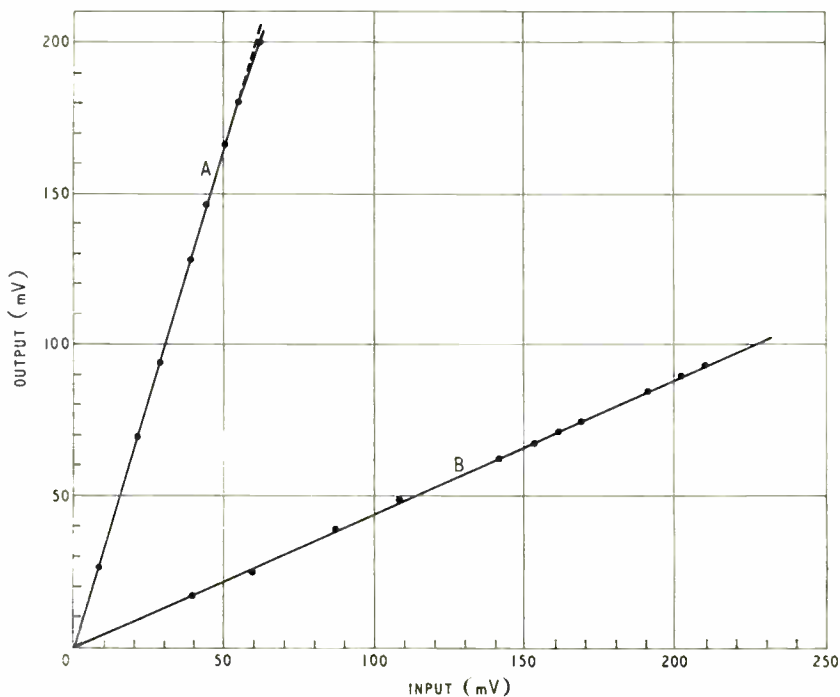

Fig. 4. Input-output characteristics of the linear amplifier: (A) for gain greater than unity; (B) for gain less than unity

E_{EQ_2} and have been found to be in close agreement with those obtained experimentally in Fig. 6. The ratio of I_{CQ_2} for curves B and C is adjusted to 10 by properly setting E_{EQ_2} . The parallel displacement between the curves B and C also

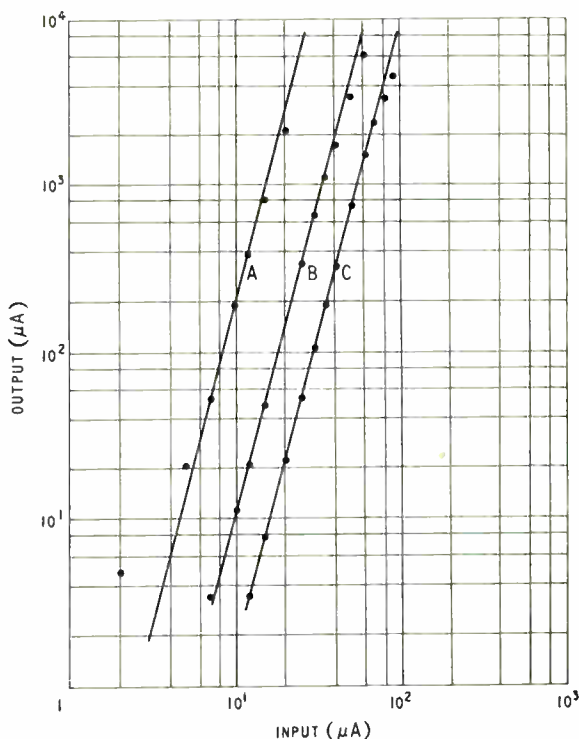

Fig. 5. Overall transfer characteristics of the non-linear amplifier in power-law operation: Curve (A) $E_{EQ_2} = 0$, Curve (B) $E_{EQ_2} = -75 \text{ mV}$, Curve (C) $E_{EQ_2} = -125 \text{ mV}$

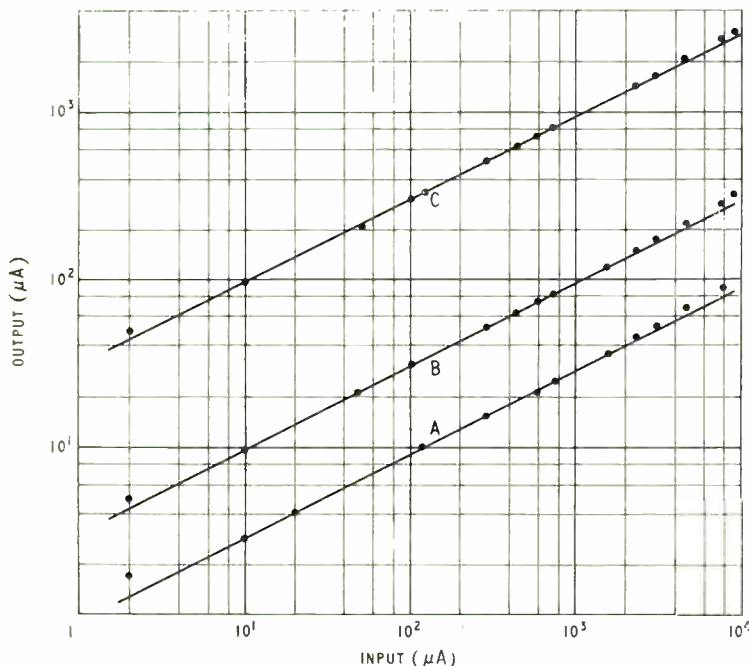

Fig. 6. Overall transfer characteristics under root-law operation for three different forward-bias conditions in the exponential stage

shows a ratio of 10 throughout the operating range, as seen in Fig. 6.

In order to check the accuracy with which the output current indicates the square root of the input the value of the multiplier I_{CQ_2} is accordingly adjusted by E_{EQ_2} to make the co-efficient unity and the experimental values are shown in the table for the respective currents.

TABLE

I_{E_1} (μA)	20	50	100	432	1,530	2,300
I_{C_2} (μA)	4.36	7	10	21.0	39.7	49
% error	-2.26	-0.85	0	+0.96	+1.28	+2.08

Inverse Law

The same device may further be used to provide an output varying inversely as the power or root of an input if an additional 180° phase shift is introduced in the existing amplifier. Instead, this has been realized effectively by reversing the diode input terminals as well as the polarity of the input signal. The gain of the amplifier is set to a value less than unity and the response curve is shown in Fig. 7. The emitter-base potential of T_4 is adjusted according to relation (13) and then the collector current of $500 \mu A$ flows for zero input. The response characteristics as shown in Fig. 8 shows accurately a reciprocal of a root-law relation over the input current range of $10 \mu A$ to $3 mA$, and the transfer gradient γ' is observed to be 0.61. The corresponding $\gamma = 0.53$ and when it is multiplied by the ratio of p_1/p_2 it gives $\gamma' = 0.61$. The input current range as compared to the previous case is extended to higher input current due to the absence of amplifier loading in this case.

Discussion

The non-linear response function with variable exponents realized in the system described may further be extended to logarithm or exponential functions by properly adjusting the

gain of the linear stage. If the gain γ is very much less than unity, a wide variation of input current in the logarithmic stage will produce a very small variation of the output current in the exponential stage. Thus only a small portion of the exponential curve is used and the output varies practically as the logarithm of the input. When, however, the gain is very much greater than unity, a very small variation in the logarithmic stage produces a wide variation in the exponential stage thereby producing at the output effectively an exponential variation of the input. The non-linearity of response may thus be varied from logarithmic to exponential function through root to power-law relations and may as well be varied as the reciprocals of these functions by proper adjustment of the circuit condition. Hence any mathematical function which can be approximated by a power series can be generated by using a number of such function generators in combination.

The experimental circuit provides a basic arrangement with which the various non-linear functions are found to be realized accurately, and it is only necessary to incorporate necessary modifications for particular applications. In order that the circuit may be used as a gamma corrector in a television system, the video signal input to the device should be d.c. restored with the black level set at earth potential and the video signal positive-going. For direct transmission of negative films from telecine equipment and for direct recording

on to positive film in video recording equipment, the gamma value of the gamma corrector should effectively be negative and the video signal input should be negative-going. In such cases, the terminals of the junction T_1 in Fig. 2 should be reversed and the quiescent current of the exponential stage T_4 be set at the highest permissible value by the quiescent base potential, set by P_5 , so as to satisfy the relation (13) necessary for the inverse root-law variation, over the largest possible range. The compression and expansion of a signal may be carried out by controlling the gain of an amplifier as in the conventional cases, but with a control voltage derived from the desired signal through a non-linear device such as this. The exponent of the non-linear variation may be set by adjusting the linear gain of the device described here.

The frequency response of the experimental circuit shown in Fig. 3 remains within 3 dB for frequencies from d.c. to 5 Mc/s. This range, though not quite wide enough for some

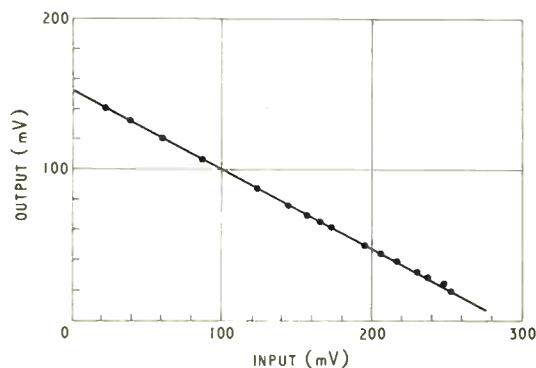

Fig. 7. Gain characteristics of the linear amplifier when set for inverse operation

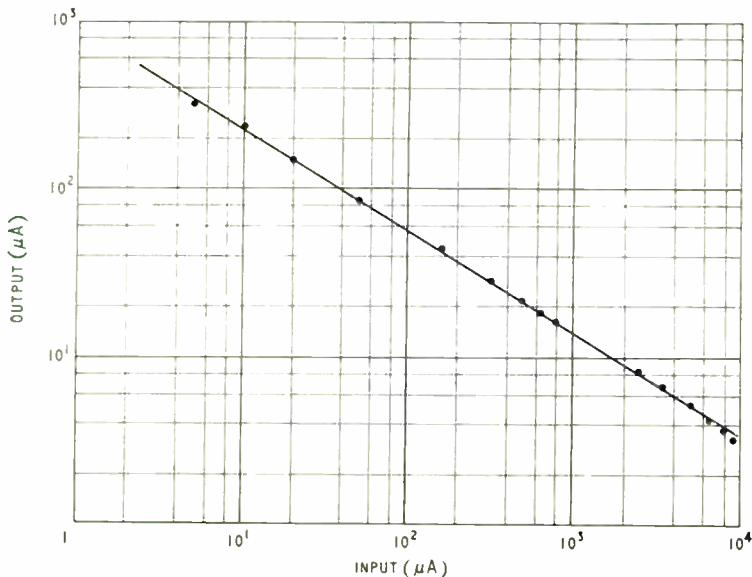

Fig. 8. Overall transfer characteristics in typical inverse-law operation

of the television systems, may suitably be improved by using transistors having a higher alpha cut-off frequency than those used here.

Range

The range of operation is set by the limitations of the logarithmic characteristic for low input currents and by the exponential as well as the logarithmic characteristics at higher currents, while there may be further limitations due to thermal dissipation and due to the non-linearities of the amplifiers. The range is limited by the input consideration for $\gamma < 1$ and the output variation for $\gamma > 1$ approximately. For the root-law case the total input variation is seen to lie between $10 \mu\text{A}$ to 1.5 mA ; i.e., a range of about 1:150, over which the root law is obeyed precisely. For $\gamma > 1$ the power law is maintained accurately over the output current range from $3 \mu\text{A}$ to 1.5 mA giving a range of 1:500. The output varying as a reciprocal of the root law function of the input is found to be maintained for input from $10 \mu\text{A}$ to 3 mA ; i.e., a range of about 1:300.

Temperature Effect

A major problem encountered in d.c. transistor circuits is the drift caused primarily by random changes of temperature. One of the salient features of the system is that the variation in the logarithmic stage T_1 due to a change of temperature tends to be compensated by the corresponding variation in the exponential stage T_2 as may be seen from the equ. (12), since the temperature sensitive coefficient of the logarithm stage appears as the ratio with the respective coefficient of the exponential stage. Hence there is a tendency of compensation in the variation of p_1 by that of p_2 and I_{ES_1} by I_{ES_2} and the compensation is maximum when $p_1 = p_2$ and $\gamma = 1$. The value of p_1 is very nearly equal to p_2 and possibly may be made almost equal by applying a negative potential to the collector of T_1 instead of shorting it to the base directly. The value of γ , however, depends on the desired non-linear function and as such cannot be adjusted for optimum temperature compensation. Present observations have been made with high-stability resistors and power-supply system and about the ambient temperature 32°C . The accuracy of the results obtained is seen to be within 2% and is expected to improve further if elaborate arrangements are made for

maintaining the temperature constant. It may, however, be mentioned that in applications where the a.c. variations are of importance, as in the case of gamma correction in television, where a.c. couplings may be made with d.c. restoration both at the input as well as in the exponential stage, the effect due to temperature is hardly of any consequence since the exponent of the non-linear function may be made to remain unaffected with proper design over normal temperature variations. In applications having d.c. couplings in particular, such as computers, some precise arrangement for temperature control is necessary to maintain accuracy of the results. Two interesting methods^{12,13} one aiming at compensation of the individual response characteristic with temperature sensitive elements, and the other to control the ambient temperature with temperature sensing elements, have been discussed in the literature and may be applied in this case quite conveniently.

Conclusion

The principle of operation and a method of realization of a device which yields an output varying directly or inversely as the n th power or root of an input signal have been presented here. An analysis of the principle together with the experimental results demonstrate that the exponent as well as the coefficient of the nonlinear response function may be varied continuously, the former by adjusting the linear stage gain, the latter by adjusting the emitter-base junction potential of the exponential stage. Drift, one of the major sources of error, is primarily due to temperature variations and is required to be minimized by controlling the temperature and stabilizing the power supply system.

Acknowledgment

The authors wish to thank Professor J. S. Chatterjee for his kind interest during the progress of the work.

References

- W. J. Karplus and W. W. Soroka, 'Analog Methods', 2nd Edn., p. 78; McGraw Hill.
- C. W. Carter Jr., A. C. Dickieson and D. Mitchell, 'Application of Companders to Telephone Circuits', *Trans. A.I.E.E.*, Vol. 65, p. 1079. December 1946 supplement.
- D. G. Fink, 'Handbook of Television Engineering', 1st Edn., pp. 8-15, McGraw Hill, New York, 1957.
- P. Kundu and S. Banerjee, 'Transistorized Multiplier and Divider and its Applications'—under publication.
- B. M. Oliver, 'Tone Rendition in Television', *Proc. I.R.E.*, Vol. 38, pp. 1288-1301, November 1950.
- See pp. 5-50 of reference 3.
- B. M. Oliver, 'A Rooter for Video Signals', *Proc. I.R.E.*, Vol. 38, pp. 1301-1305, November 1950.
- E. Brown and P. M. Walker, 'The Design of Function Generators Using Silicon Carbide Nonlinear Resistors', *Electronic Engineering*, Vol. 30, pp. 154-157, March 1958.
- C. J. Savant Jr. and R. C. Howard, 'Multiplier for Analog Computers', *Electronics*, Vol. 27, pp. 144-147, September 1954.
- P. Kundu and S. Banerjee, 'A Variable Gamma Amplifier', *Proc. I.E.E.E.*, Vol. 51, p. 867, June 1963.
- J. J. Ebers and J. L. Moll, 'Large Signal Behavior of Junction Transistors', *Proc. I.R.E.*, Vol. 42, pp. 1761-1772, December 1954.
- N. M. Schaeffer and G. W. Wood, 'The Application of some Semiconductors as Logarithmic Elements', *Proc. I.R.E.*, Vol. 42, pp. 1113-1116, July 1954.
- M. W. Rignal, 'A Constant Temperature Transistor Enclosure', *Electronic Engineering*, Vol. 33, pp. 452-455, July 1961.

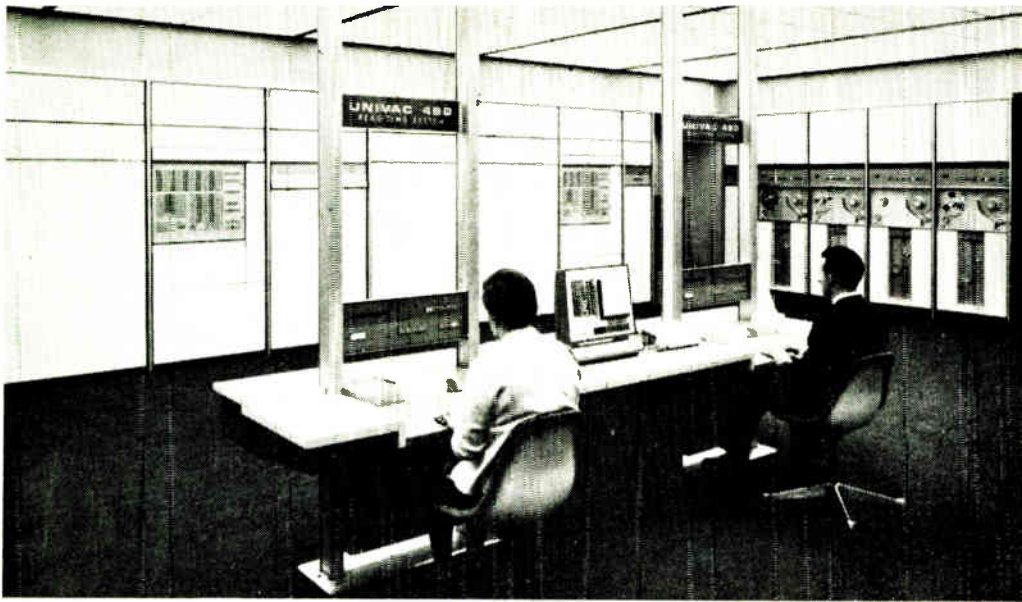

The Univac 490 real-time computer system to be installed by B.E.A. at their new West London air terminal in mid-1964

AUTOMATIC SEAT RESERVATION SYSTEM FOR B.E.A.

B.E.A. have placed an order worth £2½ million with the Univac Computer Division of Remington Rand for an electronic seat reservation system, said to be more advanced than any comparable system at present in operation. The initial installation of a pair of Univac 490 real-time computers, which will begin by the middle of the year, will enable about 200 booking offices in the U.K. to determine, by means of units known as 'Unisets', the availability of seats on any flight scheduled up to ten months ahead.

The Unisets, which will be made in England by Sperry, comprise three sub-units: a console, a keyboard unit and a



A B.E.A. booking clerk using a Uniset, part of the automatic seat reservation system

printer. Though each of these functions independently, the three together form an integrated unit which provides all the necessary facilities for interrogation and booking. To make the recording of information as simple as possible and to cater for the needs of busy offices, the Uniset incorporates a 'fermat panel': this, while allowing the clerk to record passenger details in any sequence, ensures that they always reach the computer in a standard order.

The Univac 490, in addition to handling queries on seat availability, bookings and cancellations, will amend files which contain full flight details, passengers' names, addresses, telephone numbers, special dietetic needs, car-hire requirements and any other relevant information. The provision of two computers permits a continuous day and night reservation service to be given, since a single processor handles the entire reservations workload so that the second processor is constantly available for other work and for preventive maintenance. Periodically, the role of the computers is switched.

The basic requirement of a system to handle such large quantities of data on a real-time basis is a massive storage capacity. The configuration used by B.E.A. will include 32,768 words of core store in each computer and a combination of FH880 drum units, each of which stores some 4,000,000 characters with an average access time of 17 msec and Fastrand drum units, each with a 65,000,000 character capacity and an average access time of 92 msec. Demands on the system are far more exacting than could be met by a less sophisticated random-access system. The necessity to use data such as passenger names, which can easily be misspelt, means that the computer must be able to recognize and process input data based on incorrect or minimal detail.

Two-way communication with 200 or more remote units poses other problems: at any moment, the 490 may be required to process a series of characters emanating from, or despatched to, different booking clerks. As each character is sent or received, it is accompanied, on parallel control lines, by a unit identifying pattern whose function is to enable the system automatically to unscramble the sequence of the message. As each remote unit has a unique pattern, a separate storage area is assigned to each for input and output. This automatic message assembling feature, known as the externally specified index, is an important factor in reducing the problems faced in handling a large scale real-time system.

From January 1965 this system will control all B.E.A. flight inventories and by the beginning of 1966 it will accommodate full details of every passenger booked. The computer installation will include conventional magnetic tape units and an on-line 1,004 card processor with a card reader and punch and line printer, since it is envisaged that the system will eventually also be used for conventional data processing and large scale statistical applications.

TRANSISTORIZED ULTRASONIC PROBE



THE latest addition to the rapidly growing range of ultrasonic equipment is the Dawe Type 1130 Soniprobe, a fully transistorized portable unit intended mainly for research work and small-scale production.

The Soniprobe may be used instead of conventional tank-mounted transducers for cleaning small components in a beaker or dish, but its main fields of application are such specialized tasks as the fragmentation of biological tissue, the acceleration of enzymatic or chemical activity, the dispersal of solids in liquids, homogenization, separation and similar operations, as well as the drilling of precision holes in hard materials by impact grinding.

The Soniprobe is driven from a mains-operated transistorized full-wave generator of 100-W average, 200-W peak output at about 20 kc/s. The eight-position step switch selects the power level between 0 and 100 W, while a tuning control and meter provide easy adjustment of the output to the most efficient frequency for a given application. A high-efficiency fan-cooled lead zirconate titanate

transducer transforms the output from the generator to mechanical energy at the same frequency. A titanium bar of 'stepped-horn' shape concentrates and intensifies the energy from the transducer and focuses it into the probe tip.

A continuous-flow processing chamber may be fitted to the Soniprobe, a water-cooling jacket being incorporated for use when the processing fluid must be maintained at sub-ambient temperatures. The rate of flow of the fluid is simply controlled by altering the position of the probe tip relative to the outlet. The processing chamber is sealed with O-rings and the entire system can be made safe for use with hazardous materials.

The probe is 14 in. long by 2½ in. diameter and weighs 3 lb. The generator measures 13 by 8½ by 5½ in. high and weighs 20 lb. It can be plugged into any 200-250 V, 50-60 c/s mains socket; power consumption is about 150 W.

For further information circle 56 on Service Card

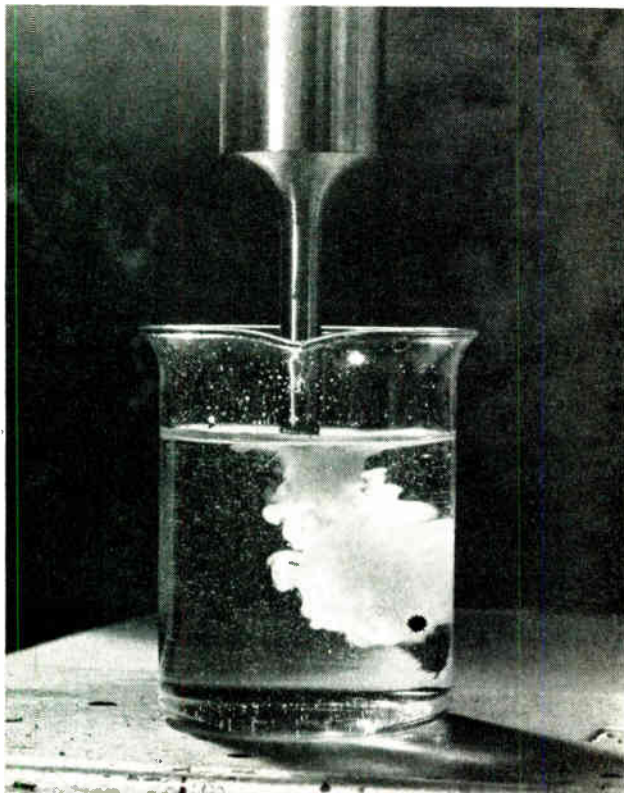

The emulsification of surface oil in water, immediately after insertion of the probe

The continuous-flow processing chamber fits neatly over the 'stepped horn', the processing fluid entering from the right, and discharging into the beaker through the lower nozzle. The cooling water connections can be seen at the bottom of the chamber

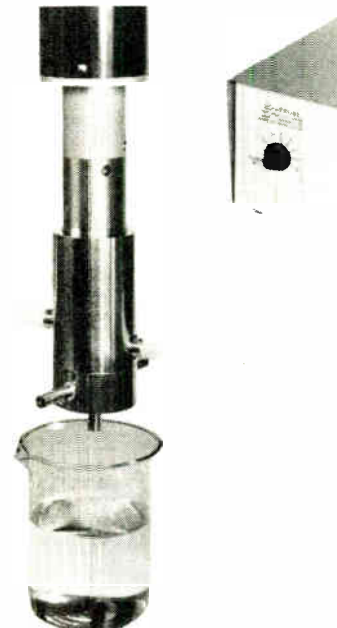

The first of a series, this article deals with the basic properties of the three different kinds of transducer commonly employed, the magnetostrictive, the piezoelectric and the electrostrictive.

PRODUCTION AND PROPERTIES OF HIGH-INTENSITY ULTRASONICS

By B. BROWN, B.Sc., Ph.D., A.Inst.P.*

Royal College of Advanced Technology, Salford.

IN recent years the development of several industrial processes involving the application of high-intensity ultrasonics has taken place and it seems likely that this field of activity will widen considerably. A number of manufacturers offer industrial ultrasonic equipment for various processes and this equipment is of widely varying design, even when intended for the same process. Consequently, there is often some confusion among industrial engineers and scientists not only as to when and why ultrasonics may be applied to a particular process, but as to which is the most suitable equipment for their purpose. It is in order to assist such people that this article on the production and properties of high-intensity ultrasonics has been written.

Ultrasonics is loosely defined as sound waves propagated at a frequency above the upper limit of frequency detectable by the human ear. In practice, this refers to frequencies greater than about 16 kc/s. However, many so-called ultrasonic applications utilize sound waves which are quite audible and it has become common practice in industry to use the term ultrasonics even when referring to frequencies in the audible range.

There are various methods available for the production of ultrasonic waves but the frequency required and the medium into which the wave is to be propagated usually decides the most suitable method of production. Mechanical generators, such as sirens, whistles, etc. are used for the production of ultrasonics in gases, and, in certain cases, liquids. In fact, the liquid whistle finds considerable use in industry for emulsification and dispersion. However, for most industrial applications of ultrasonics electrical methods are used. Electrical generators produce electrical oscillations at ultrasonic frequencies and at powers ranging from a few watts to several kilowatts. These oscillations are then converted into mechanical vibrations in order to produce the ultrasonic waves and the device for converting this electrical energy into mechanical energy is known as a transducer. Two types of transducer are used in industrial equipment, magnetostrictive and piezoelectric transducers. Occasionally, electrostrictive transducers are referred to in the literature but the operation of such transducers is comparable to that of piezoelectric transducers, the difference being that the term piezoelectric is used to refer to naturally occurring materials such as quartz while electrostrictive refers to artificially manufactured materials such as barium titanate.

Magnetostrictive transducers are based on the magnetostrictive effect discovered by Joule in 1847. This effect refers to the ability of a rod of magnetic material to change its length when subjected to the influence of a magnetic field parallel

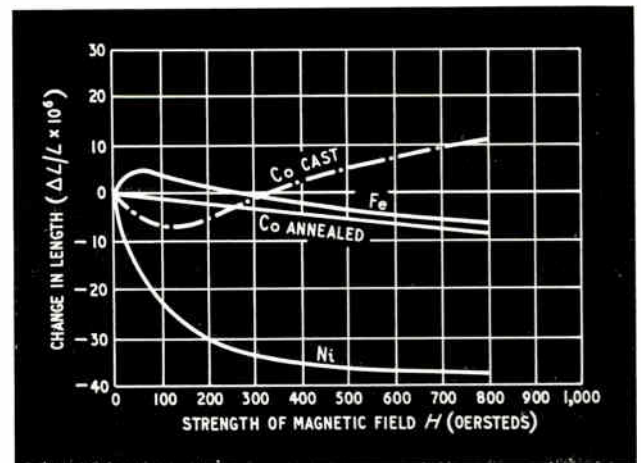
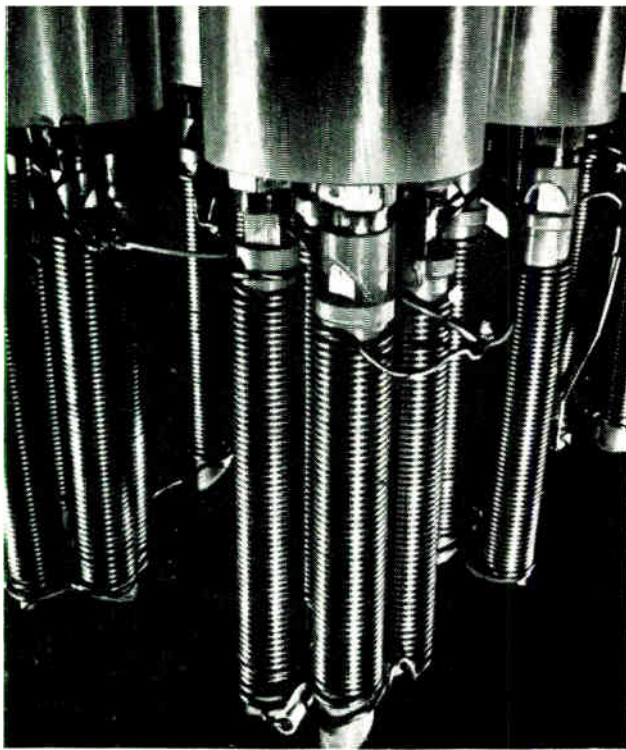

Fig. 1. The relation between magnetic field strength and change of length is shown here for several materials



Magnetostrictive transducers. Several transducers are screwed into each of the coupling units at the top

Courtesy Ultrasonics Ltd.

to itself. The length can either increase or decrease depending on the material, and the strength of the applied field and changes in length for various materials are shown in Fig. 1. As the temperature increases, the magnitude of this effect decreases and at the Curie point of each particular material, it disappears altogether. However, since the Curie point for most magnetostrictive materials lies above 350 °C, this is not a disadvantage. Magnetostrictive transducers generally consist of laminated metal stacks upon which a coil is wound. Typical transducers for industrial use are illustrated in one of the photographs. Electrical oscillations from a suitable generator are applied to the coil thus producing an oscillating magnetic field, and hence periodic changes in the length of the metal stack. If the dimensions of the metal stack are such that it is at mechanical resonance with the applied electrical oscillations, then the deformation of the rod can be quite great. Limitations are normally imposed by the stresses which the material can stand, of course. Hence, in order to obtain a large amplitude of vibration, magnetostrictive and also piezoelectric transducers are always operated at resonance. It is evident, therefore, that a particular transducer is only suitable for operation at one frequency depending on its dimensions and hence electrical generators for driving particular transducers are normally designed to provide an output at a fixed frequency. For many applications a variable power output is not necessary, and thus several commercial generators provide a fixed frequency and also a fixed power output. The shape of a magnetostrictive transducer is often determined by the use for which it is intended. Undoubtedly, the simplest form of transducer is a laminated rod and this finds extensive use in industry. As the frequency increases, however, and the resonant length of the rod becomes less, then so-called window-type transducers are used. These transducers considerably reduce the loss in magnetic flux which would result with rod transducers by providing a closed path. Since the transducer length decreases as the operating frequency increases, this gives rise to an upper limit of frequency at which magnetostrictive transducers can be used. For industrial use the highest operating frequency of magnetostrictive transducers is 40 kc/s but most transducers are operated at 13 kc/s or about 20 kc/s. As will be seen later, there are obvious advantages to be gained by

working at lower frequencies. Magnetostrictive transducers are not often operated directly into a medium but are usually connected to the medium by the use of coupling rods. These are merely rods of various materials which are an integral number of half wavelengths long and the transducers are soldered, cemented or firmly screwed to them. These coupling stubs are clearly shown in a photograph of a large ultrasonic cleaning plant. Each coupling stub has several rod transducers firmly screwed to its base. Magnetostrictive transducers possess many suitable properties for industrial use and these may be summarized as follows:—

1. Rugged construction enables them to withstand the severe knocks likely in many processes.
2. High power output is available.
3. Efficient operation in the frequency range 5 to 40 kc/s.
4. Simple mounting techniques are possible.
5. Able to drive high impedance loads such as liquids and solids.
6. Large size installations are possible by the use of several transducers.

The piezoelectric effect is exhibited by certain naturally occurring crystals such as quartz and Rochelle salt and it is the name given to a change in dimensions of the crystal when an electrical potential is applied across its faces. The electrostrictive effect is very similar and is exhibited in certain man-made materials, notably barium titanate and lead zirconate. If a piezoelectric crystal, such as quartz, is placed in an alternating electrical field, then the crystal is alternately expanded and compressed, producing longitudinal ultrasonic oscillations in the surrounding medium. If the electrical oscillations are adjusted to be at resonance with the fundamental mechanical frequency of the crystal then the amplitude of the oscillations will be a maximum. Since the natural frequency of crystals is inversely proportional to their thickness, at high frequencies crystals are very thin and brittle and for high intensity output an upper frequency limit of about 2 Mc/s is imposed. At lower frequencies the crystals are much thicker and this imposes a lower limit on frequencies attainable

Rapiclean 900 ultrasonic cleaning plant, showing the coupling units

Courtesy Ultrasonics Ltd.





The 80/40-W Soniclean equipment is transistorized
Courtesy Dawe Instruments Ltd.

due to the very high voltage which must be applied. The use of electrostrictive materials such as barium titanate and lead zirconate enables lower frequencies to be used since these crystals require a much lower operating voltage than quartz. Even with these crystals however a lower limit to the frequency obtainable is imposed by internal heating effects which increase to an extent that they can cause the crystal to become depolarized, and hence lose its electrostrictive properties. At present, barium titanate crystals are used down to about 40 kc/s while composite lead zirconate transducers are used down to 25 kc/s. Artificial crystals such as barium titanate offer many advantages over quartz, such as lower cost of production, and most commercial piezoelectric equipment utilizes these man-made crystals. Undoubtedly,

the main disadvantage of barium titanate is its comparatively low Curie point. This is about 120 °C and limits its use at high intensities. However, the development of lead zirconate as a transducer material has undoubtedly helped in this direction since its Curie point is considerably higher, about 320 °C. Piezoelectric crystals are coupled to the medium in which the ultrasonics are to be propagated by various means depending on the particular application. Frequently, the crystals are cemented to a face plate and this is common practice in cleaning equipment. For applications such as drilling or welding, the crystals are often coupled to the work by so-called velocity transformers which have the function of considerably increasing the amplitude of the vibrations.

Power supplies for piezoelectric transducers can be very simple, operating at a fixed frequency and power output. In many cases, no rectification is included in the circuits used with a resulting pulsed output. To avoid confusion as to power output with such generators, most manufacturers have adopted a nomenclature quoting average power output and peak power input; i.e., a 500/125-watt generator refers to 125 W average output with 500 W peak power. Transistorized power supplies are also on the market and extremely compact units are now available.

Cavitation

The fundamental laws governing the propagation of ultrasonic waves are quite simple. The velocity of the wave in any medium is constant and is equal to its frequency multiplied by its wavelength. When low intensity waves pass through a fluid they suffer some reflection at any interface separating two media having different acoustic properties, and hence standing waves may be set up. However, as the ultrasonic intensity increases, a most important effect known as cavitation occurs in liquids, and standing waves are no longer prevalent. Cavitation is the name given to the formation and subsequent collapse of minute bubbles or cavities in the fluid. As the ultrasonic waves pass through the fluid, rapidly fluctuating pressures are set up due to the alternate periods of compression and rarefaction associated with the wave. In the rarefaction cycle, provided the negative pressure is strong enough to overcome the forces binding the fluid, the fluid is literally torn apart producing small cavities. These cavities tend to be formed round small nuclei of dissolved gas or dust, etc., in the fluid. In the succeeding compression cycle, the cavities collapse and as the cavity walls impinge on the small nucleus, a violent shock wave is produced. The pressure associated with the collapse of cavities has been estimated to be several hundreds of atmospheres and these enormous pressures associated with cavitation have a very disruptive effect on the fluid and upon any material contained therein. One of the photographs shows the erosion of a stainless steel probe of 1/2-in. diameter brought about by cavitation. One end of the probe was coupled to a transducer and the photograph shows the other end which was dipped into water. The erosion was obtained after the probe had been in use for about 100 hours and it provides striking evidence of the powerful forces acting during cavitation. It has been shown that cavitation intensity increases as the ultrasonic frequency decreases and hence, since many ultrasonic applications require intense cavitation, fairly low frequencies are used. Higher-frequency waves have a certain advantage though, in so far as they can be beamed or directed in a liquid, and this can prove useful in certain cleaning processes. The forces associated with cavitation are responsible for many applications of high-intensity ultrasonics including cleaning, dispersion, emulsification, etc., and there seems little doubt that the use of high intensity ultrasonics in industrial processes will steadily increase as its potentialities are more widely realized.



The erosion of the end of a stainless-steel probe of 1/2-in. diameter brought about by 100 hours of cavitation. The scale is of mm





HONEYWELL TO MAKE COMPUTERS IN SCOTLAND

FOR the first time, medium and large scale magnetic tape computers are to be made at Newhouse in Scotland. This announcement that new manufacturing arrangements have been established in Scotland, following an agreement with the Board of Trade, was recently made by the Honeywell Electronic Data Processing Division.

Shown here is some of the 'hardware' which will shortly be under assembly at Newhouse.

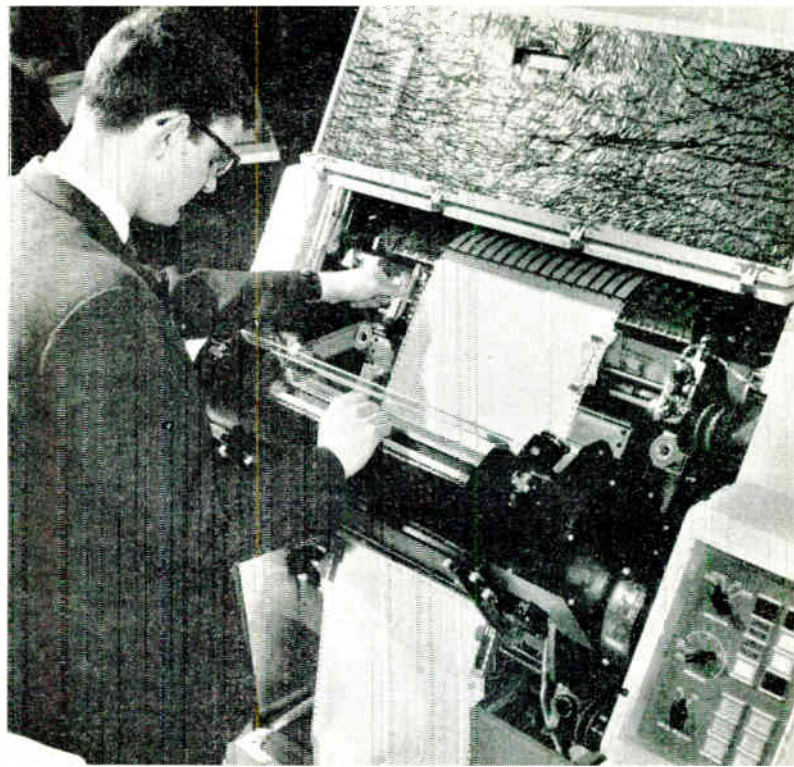

This high speed printer achieves a printing speed of 900, 120-character lines per minute with 9 carbon copies



A test engineer is seen here performing pre-delivery checks on a Honeywell data-processing system

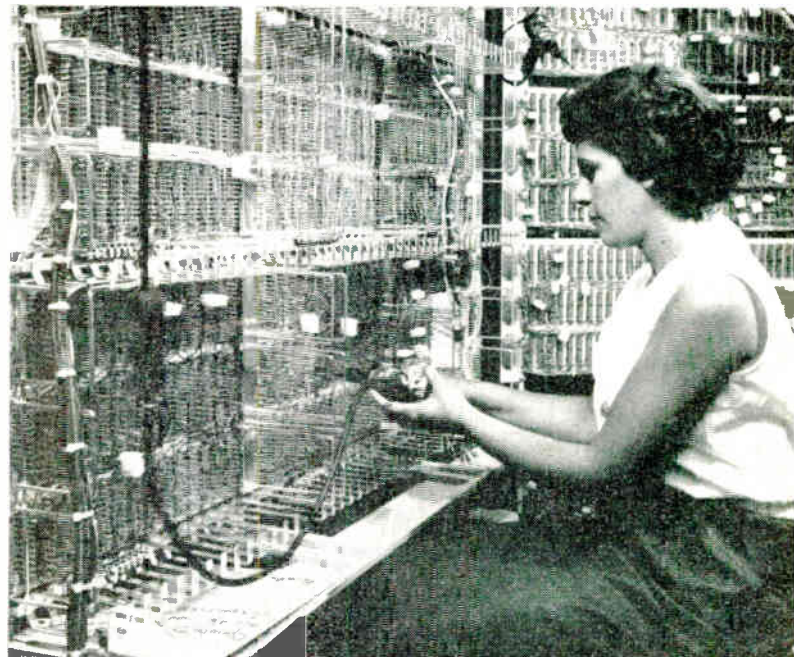

Wiring the central processor of a Honeywell 400 medium-scale computer system



About half the wiring of the Honeywell 400 computer is handled by this automatic wire-wrap machine, which can perform eight complex wiring operations per minute



Personal and Company News

Marconi Instruments Ltd. announce that Professor H. E. M. Barlow has been elected to the board of directors.

The Instrumentation Division of **Southern Instruments Ltd.** announce that they have concluded a marketing agreement with Kistler Instruments Ltd. of Winterthur, Switzerland, covering the distribution in the United Kingdom of the Kistler range of pressure, acceleration and load transducers, and associated charge amplifiers.

Aircraft-Marine Products (G.B.) Ltd. have announced a major reorganisation of their marketing. The company has now been split into five major divisions: consumer products, power and aircraft, electronics, special accounts, and M. & R.

Walmore Electronics Ltd. have been appointed the sole U.K. distributors for Silicon Transistor Corporation, whose activities are concentrated on high power devices.

A licensing agreement has been concluded between **The Wayne Kerr Laboratories Ltd.** and United Systems Corporation of Ohio, U.S.A. The agreement provides for the marketing by Wayne Kerr in the U.K. and eventual manufacture of the 'Digitec' range of digital voltmeters.

Alan D. Hudson, B.Sc., has been appointed general manager of the **International Marine Radio Company** of Croydon, a subsidiary of STC and part of the STC radio division. This follows the sale to STC of Hudson Electronic Devices Ltd., a manufacturer of land and marine mobile radio equipment. Expansion of business in private communication equipment has resulted in a move by STC Ltd. to a new regional headquarters office and warehouse at Dixon Road, Brislington, Bristol (telephone: Bristol 78021). In charge of the new headquarters is regional sales manager Paul Humphrey.

English Electric Valve Co. Ltd. have announced the appointment of R. R. Thompson, A.M.I.E.E., as assistant manager in charge of the Display Tubes Department. The company also announce the appointment of an exclusive agent to handle their business in Iraq. The company concerned is: Leon Kouyoumdjian, Sa'addon Street, Aliwiya, Baghdad, Iraq.

Westool Ltd. have signed a sales and manufacturing concession agreement with a French company who will market their range of solenoids to French industry. The concessionaire is Warner France S.A., 175-179 Boulevard Saint-Denis, Courbevois, Seine.

Ferranti Ltd. announce the appointment of Dr. Peter Aylett, Ph.D., M.Sc., B.Sc., as sales manager of the Ferranti Automation Systems Division.

Dr. William Prager has been appointed consultant at the **IBM Zurich Research Laboratory**. He will assist in forming a group to undertake research in the areas of pure and applied mathematics and mechanics to complement the mathematical research programmes of the Thomas J. Watson Research Centre in Yorktown, New York.

B. G. Frost has been appointed West Midlands representative for the **British Rototherm Co. Ltd.**

The first mail segregating, grading and facing machine installation to be exported by Elliott-Automation is now in operation in Winnipeg General Post Office. The system comprises one segregating, two grading and four facing machines, similar in design to those already supplied to the Southampton, South-East London District, Liverpool and Glasgow sorting offices of the British Post Office

For further information circle 57 on Service Card

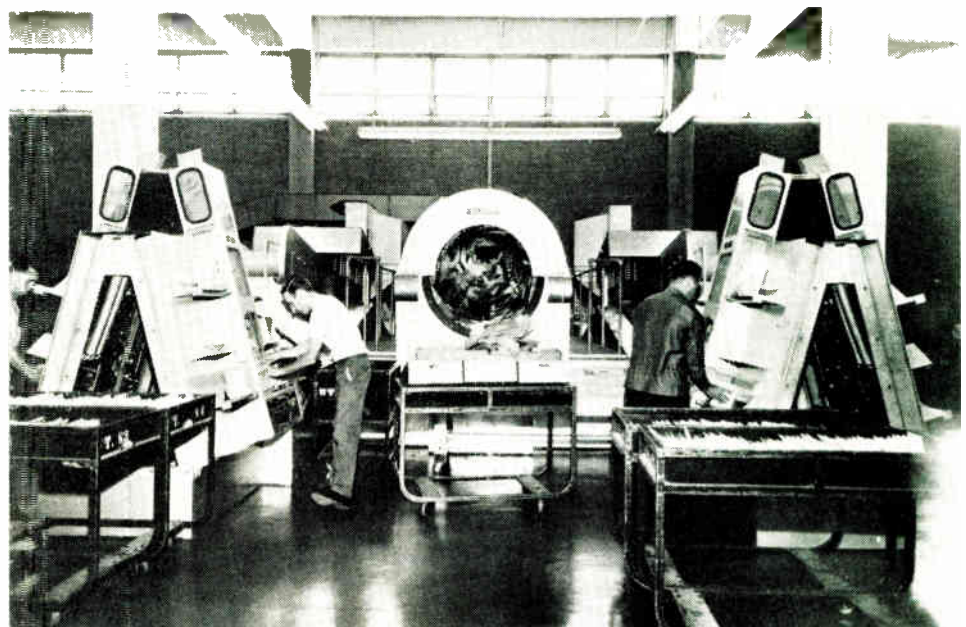



Located near Humosa in Northern Spain, this troposcatter aerial array serves one of the stations providing multi-channel voice and teletype service for U.S.A.F. operations in Western Europe extending from England across the Bay of Biscay through Spain. The span from England to Spain utilizes the highest power amplifiers ever to be incorporated into a troposcatter system. The aerial and feed horn structures for Humosa and other sites were fabricated and hot dip galvanized by Painter Brothers Ltd., a member of the B.I.C.C. Group

J. R. Burchall has joined the Systems Division of the **Solartron Electronic Group Ltd.** as systems applications engineer. He will be responsible for the preparation of applications information for both data logging modules and data logging systems.

Mervyn Instruments Ltd. are to move to Brighton from Woking. The move will provide additional facilities for all the groups in the company. Correspondence should now be directed to The Hyde, Brighton 7, Sussex. Telephone: Brighton 66271.

Cable & Wireless Ltd. announce the following appointments with effect from 1st February 1964, consequent on the retirement on 31st January of R. H. Hensman, O.B.E., F.C.I.S., secretary, after 43 years' service: H. A. Cox, M.B.E., F.C.I.S., to be secretary; A. A. Willett, F.C.I.S., to be deputy secretary; and H. T. F. Withnall, to be assistant secretary.

Rank Cintel announce the appointment of Sound Systems Ltd., 11 Upper Liffey Street, Dublin, as distributors in Eire and Northern Ireland for the full range of Rank Cintel industrial electronic metal detectors and laboratory instruments.

Malcolm D. Widenor, president of North Atlantic Industries Inc. of New York, has announced the appointment of **Aveley Electric Ltd.** as exclusive sales representatives in the United Kingdom for its instruments and servo devices.

L. S. Wiggins has been appointed sales manager of **Stewart Aeronautical Supply Co. Ltd.**

Nuclear Corporation of America have appointed **E.M.I. Electronics Ltd.** exclusive distributors in the United Kingdom for the Nucor range of radiation and health monitoring instruments.

The B.B.C. announces the retirement of **A. R. A. Rendall**, O.B.E., Ph.D., B.Sc., M.I.E.E., head of Designs Department, Engineering Division, and the appointment of **S. N. Watson**, M.I.E.E., to succeed him.

Hewlett-Packard Ltd. are expanding their production facilities at Dallas Road, Bedford. The increased production area will be used for the manufacture of both new and existing lines of electronic instruments.

H. Andrewes, technical sales executive of the **Dubilier Condenser Co. (1925) Ltd.** has retired.

It has been announced that **David J. Griffin** has been appointed technical sales manager of **Celdis Ltd.**, Surbiton, who are now stocking Motorola semiconductors in the United Kingdom.

Avo Ltd. (M.I. Group) has appointed **Wireless Electric Ltd.**, of Bristol, as main distributors of Avo instruments for the counties of Hereford, Wiltshire, Dorset, Devon, Gloucester, Somerset, Hampshire, Cornwall, and all Wales with the exception of Caernarvon, Anglesey, Denbigh and Flint.



This radar aerial (left) looks out over world's longest causeway spanning the 24-mile-wide Lake Pontchartrain near New Orleans, Louisiana. Raytheon radars and marine radiotelephones have been installed at the two bascule bridges, eight miles out from each shore, where ships cross the roadway. To safeguard motorists who 'go to sea' in their cars in foggy weather, causeway personnel keep a radar watch for loose barges or disabled vessels that might stray from regular ship channels and drift towards the bridge

A. C. Sturney, a member of the board of directors of **The International Nickel Company (Mond) Ltd.**, has retired after completing 36 years with the company.

Brigadier J. D. Haigh, O.B.E., M.A., M.I.E.E., has been appointed planning manager of the Swindon Group of **The Plessey Company (U.K.) Ltd.** He will be mainly concerned with analysing the effects on the electronic component market of the rapid changes in equipment design philosophy, and advising the company of the industry's likely future requirements. Dr. G. B. B. Chaplin, M.I.E.E., who since 1959 has been technical manager of the Roke Manor Research Laboratory, has been appointed chief scientist of the company.

Polypenco Ltd., manufacturers of industrial plastics, announce the appointment of Kenneth Forbes (Plastics) Ltd. as their distributors for standard stock shapes in the Manchester area.

The Marconi International Marine Co. Ltd. announces the retirement of J. R. C. Johnson, who has been the company's contracts manager for the past ten years. He will be succeeded by G. H. W. Johnson.

Obituaries

The death of Roland John Kemp, deputy director of engineering and research of The Marconi Co. Ltd. occurred on 22nd November 1963. Born in 1901, he joined Marconi's in 1917 and has been well known for his work on direction finding.

S. F. Pearce died on 18th November 1963 at the age of 49. He was with the Electrical Research Association which he joined in 1933. His work was mainly concerned with radio interference.

500,000,000 Valves

On 19th November there was a ceremony at the Blackburn factory of Mullard Ltd. to celebrate both the production of the 500 millionth valve at that factory and also the 80th birthday of S. R. Mullard, M.B.E., the founder of the firm. In 1920 he founded the Mullard Radio Valve Co., which produced the well-known Ora valve, and he is still a director of Mullard Ltd.

The Blackburn factory was started in 1938 and then produced chiefly components and wire. It now makes valves, mainly receiving types, and the activities are by no means confined to their assembly for tungsten and molybdenum wire and even glass are made there from raw materials.

Industrial Electronics Binding Service

For subscribers to *Industrial Electronics* requiring their first volume to be bound, a service is available at a reasonable cost. The total cost including binding with index in publishers' cloth case, without journal covers and advertisements, is 30s post free.

For binding, complete volumes should be sent to: Associated Iliffe Press Ltd., Binding Dept., 4-4A Iliffe Yard, London, S.E.17, with the name and address of the consignor enclosed. The remittance together with a note confirming despatch should be sent to Associated Iliffe Press Ltd., Publishing Dept., Dorset House, Stamford Street, London, S.E.1.

The binding work normally takes 6-8 weeks.

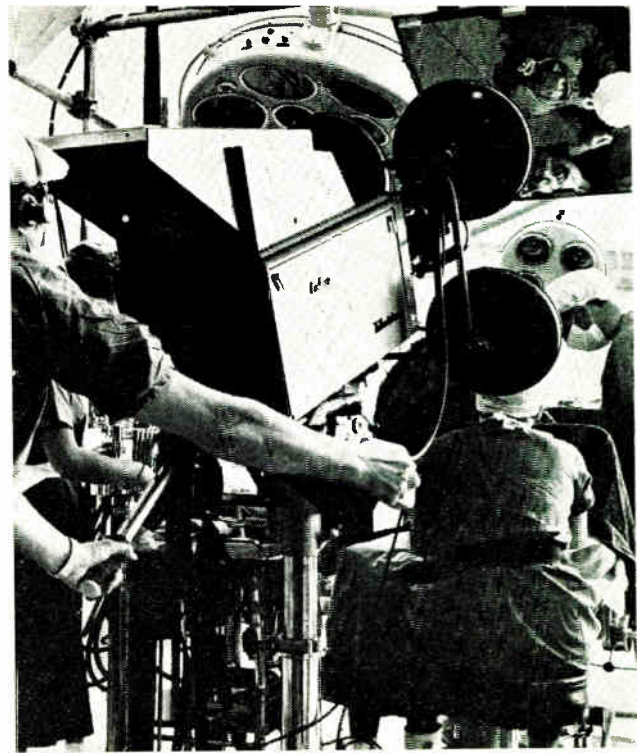

The Marconi vidicon colour camera, shown here in one of the operating theatres at Hammersmith hospital, has been designed to cater for all medical television applications. Contained in a slightly pressurized air-tight casing to guard against the ingress of explosive anaesthetics, it is a compact, lightweight unit with facilities for complete remote control. The picture produced by the camera is of a high quality which is maintained throughout the signal processing and distribution equipment for final projection on to a 9 x 12 ft screen by a colour projector

For further information circle 58 on Service Card

Automation at the Consumer end of the Brewing and Catering Industries

For the first time anywhere, you can ensure quick and reliable service by ordering your own drink or meal by remote control. Whether in a pub, restaurant, road house or hotel, the picture of the future may be similar to that at the Flag Inn, Hardman's Lane, Bromley Cross, Near Bolton, where customers use an automatic system for ordering their drinks.

The system, which has been developed by Millington & Boardman Controls Ltd., is extremely simple and straightforward. On the table is a dial unit, similar to a telephone; on the menu there are listed some 100 items of food and drink, each having a two-digit code. The customer simply dials the items of his choice in the order in which he wants them. The message is routed via a central control unit, similar to an internal telephone exchange, to an Addo X machine which prints a ticket showing the number of the table and the code numbers, and totals the price of the complete order. The food or drink required is then served by the kitchen staff or barman and passed to the waiter together with the ticket. A copy of the ticket is retained in the machine.

The advantages of automation in this field are several: it obviates irritating delays in the absence of waiters, allows an establishment to cater for more people with existing staff, and provides a check on the items ordered.

This inexpensive system could equally well be applied to storekeeping where normally, if delays are to be avoided, there have to be sufficient storemen to cope with peak periods, which may consequently lead to overstaffing at other times. Orders could be dialled from any department at any time, and a reciprocal signal from the store could be used to indicate that the items ordered are ready for collection, e.g., by means of a light on the dialling unit. Such a scheme could easily be taken a stage further, with the printer acting as an integral part of a simple stock control system.

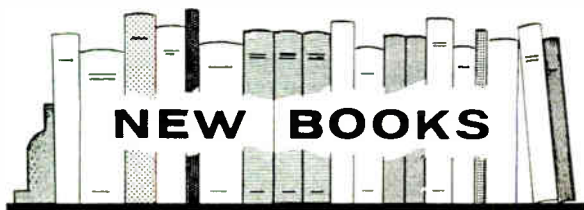

A Guide to the Design and Construction of Electronic Equipment

Pp. 88. The Electronic Engineering Association, 11 Green Street, London, W.1. Price to members 20s; to non-members 42s.

The E.E.A. has produced this guide to provide a summary of the many considerations involved in the design and construction of certain categories of electronic equipment.

The subjects covered include, environmental and design considerations, constructional practices, post-manufacturing and customers' services, an index to specifications etc., and a model equipment specification. These categories do not include domestic radio and television equipment or equipment for military applications or for special environments such as explosive atmospheres, although even in these cases many of the considerations will still apply.

The guide is aimed at both manufacturers and users and it is designed to stimulate mutual understanding between those who specify equipments and those who make them.

Advances in Electronic Circuit Packaging, Vol. 3.

Edited by LAWRENCE L. ROSINE. Pp. 457 + vi. Rogers Publishing Co. Inc., 3375 South Bannock, Englewood, Colorado, U.S.A. Price \$16.50.

This book forms the proceedings of the Third International Electronic Circuit Packaging Symposium which was held at Boulder, Colorado, from 15th to 17th August 1962.

Design and Operation of Digital Computers

By Dr. GERHARD HAAS. Pp. 272. Howard W. Sams & Co. Inc., Indianapolis 6, Indiana, U.S.A. Price \$6.95.

This book is a translation of one originally published in German in 1962. It is intended for the newcomer to computers and starts with a general discussion of the basic principles including binary arithmetic. The various sub-units of computers are described and then components and circuits.

Enamelled Copper Conductors (Self-fluxing) Part 1: Round Wire

British Standard 3188: Part 1A: 1963. Pp. 33. British Standards Institution, 2 Park Street, London, W.1. Price 4s. 6d.

Since the first part of this standard, for round wire, was published in 1960, there has been a steady demand from industry for a specification for very fine enamelled wires down to those of 0.0006 in. diameter.

To meet this demand, Part 1A of B.S.3188 has now been issued, which deals with round wires of diameter 0.0014 in. and under.

One of the greatest difficulties in using enamelled wires lies in cleaning the enamel from the wire to obtain a good electrical connection. With self-fluxing enamel, however, this difficulty is largely overcome; a solder test is included in the specification.

Tests are also given for the flexibility and adherence of the enamel covering, its electric strength and its continuity.

Television Engineering

Pp. 577 + viii. Distributed by Blackie & Son Ltd., 5 Fitzhardinge Street, Portman Square, London, W.1. Price £12.

This book forms the Report of the International Television Conference, which was organized by the Electronics and Communications Section of the Institution of Electrical Engineers in association with the Institute of Radio Engineers, the British Kinematograph Society, and the Television Society and held in London from 31st May to 7th June 1962. It contains the papers read at the Conference and reports of the discussions which followed them.

Magnetic Tape for Automatic Data Processing

British Standard 3658:1963. Pp. 20. British Standards Institution, 2 Park Street, London, W.1. Price 6s.

Manufacturers and users of magnetic tape will welcome a new specification in the series of British Standards for the data-processing industry.

In this Standard requirements are set out for the physical characteristics of magnetic tapes used for digital recording, covering such points as dimensions, accuracy and behaviour under varying ambient conditions.

In addition to this, a whole section is devoted to the testing of tapes, in which two separate test procedures are described to suit the varying needs of users. Some sections of industry, research laboratories for instance, require completely perfect tapes with no 'drop-outs' (faults in the tape, resulting in loss of signals), and, for their needs, the standard specifies individual testing of tapes. In other industries, it is possible to use tapes with faults, provided that the incidence of these and their positions are known. The second testing procedure allows for the quality of a tape to be assessed on a statistical basis, tapes being graded according to the imperfections discovered.

B.S. 3658 has been submitted as an official proposal of the United Kingdom to a committee of ISO (International Organization for Standardization) and was reviewed at an international IEC meeting in Copenhagen last autumn.

Sensitive Switches Part 1: Terminology

Pp. 13. International Electrotechnical Commission Publications 163-1 (1963). Available from British Standards Institution, 2 Park Street, London, W.1. Price 13s. 6d.

This I.E.C. publication relates to general circuit sensitive switches for use in telecommunication equipment, etc.

Part 1 deals with terminology and also covers general requirements and measuring methods.

Physics of Failure in Electronics

Edited by M. F. GOLDBERG and JOSEPH VACCARO. Pp. 255. Cleaver-Hume Press Ltd., 10-15 St. Martin's Street, London, W.C.2. Price 60s.

This is the Proceedings of the Symposium on the Physics of Failure in Electronics which was held in Chicago on 26th and 27th September 1962. It comprises 23 papers.

Fixed Mica Dielectric Capacitors Part 1: General Requirements and Tests

British Standard 2132: Part 1: 1963. Pp. 23. British Standards Institution, 2 Park Street, London, W.1. Price 12s. 6d.

In this Part 1 of B.S.2132, general requirements and tests are given for mica capacitors with either metallized or foil electrodes, of rated voltages not exceeding 750 V d.c. or 250 V

a.c. (r.m.s.), capable of handling a power not exceeding 200 VA and a current not exceeding 0.5 A (for metallized types) or 3.0 A (for foil types).

The aim of the standard—the latest in a series dealing with components for telecommunication and similar equipment—is to ensure that the capacitors will function satisfactorily under given temperature and humidity conditions, and will be able to withstand both mechanical shock, as might be received for instance in transit or during operation, and normal assembly processes, such as soldering.

The tests specified in this standard are fully described either in the standard itself or in B.S.2011 to which reference should be made.

The capacitors covered by this standard are suitable for use in one or more of the following temperature ranges and humidity conditions: Rated ambient temperature ranges -40°C to $+100^{\circ}\text{C}$, -40°C to $+70^{\circ}\text{C}$, -25°C to $+70^{\circ}\text{C}$, and -10°C to $+55^{\circ}\text{C}$, categories 40/100, 40/70, 25/70 and 10/55, respectively, and humidity classes: 56, 21, 4A and 4 (see B.S. 2011).

The Electronic Data Processing Symposium

Pp. 606 + x. Sir Isaac Pitman & Sons Ltd., Pitman House, Parker Street, Kingsway, London, W.C.2. Price 75s.

This book contains the Proceedings of a symposium held at Olympia, London, on 4th–6th October 1961.

Digital Computer Technology and Design Vol. 1

By WILLIS H. WARE. Pp. 245 + xviii. John Wiley & Sons Ltd., Glen House, Stag Place, London, S.W.1. Price 60s.

This first volume covers mathematical topics, principles of operation and programming. The mathematical part comprises a discussion of binary numbers and all the various binary codes developed from them which have application to computers. There is also a chapter on logical algebra. Apart from this the emphasis throughout is on elementary programming.

Manufacturers' Literature

Solartron 247 Analogue Computer System. A 20-page brochure which gives relevant specifications for the Solartron 247. The computer's advanced features, central address system, potentiometer setting, automatic address commutator, dual digital timer, integrator time constants and non-standard networks are dealt with in full detail. Ensuing pages describe the operations of the various units which are combined to form a flexible system.

The Solartron Electronic Group Ltd. (Instrument Division), Victoria Road, Farnborough, Hants.

For further information circle 59 on Service Card

Cambion Catalog 700. This 176-page catalogue lists the current range of 'Cambion' products. They include terminals, coil forms, coils, chokes, capacitors, connectors, component clips, terminal boards, etc. Over 50,000 items are described in this publication; drawings showing dimensions and electrical specifications are given for most components.

Cambion Electronic Products Ltd., Cambion Works, Castleton, Nr. Sheffield.

For further information circle 60 on Service Card

Marconi Instruments 1963-64. In thirteen major sections and 208 pages, associated Marconi Instruments companies, their products and their distributors are listed. Now produced bi-annually this catalogue is considered a 'must' for most electronic

engineers. It illustrates and specifies the complete range of Marconi instruments under the headings: Modulated Signal Generators and Noise Generators, Oscillators and Waveform Generators, Voltmeters and Attenuators, Oscilloscopes, Response Analysers, Counters and Frequency Meters, Power Meters, Impedance Bridges and Q Meters.

Marconi Instruments Ltd., St. Albans, Hertfordshire.

For further information circle 61 on Service Card

Plessey Machine Tool Numerical Co-Ordinate Control. This publication No. 578 deals with the latest Plessey-U.K. machine tool control system. In 18 pages it gives details of a flexible control system that may be applied to a wide variety of machine tools.

The Plessey Co. (U.K.) Ltd., Ilford, Essex.

For further information circle 62 on Service Card

Arcoelectric Switches & Signal Indicator Lamps. Described in this 29-page catalogue is the current range of components produced by Arcoelectric. In this specifications, dimensions and prices are given.

Arcoelectric Switches Ltd., Central Avenue, West Molesey, Surrey.

For further information circle 63 on Service Card

Londex Photo-Electric Equipment. In this 10-page publication the Londex photoelectric equipment is described. This includes long range weatherproof extension heads for phototransistor units, an electromagnetic counter (500 per min) and a photoelectric batch counting unit.

Londex Ltd., 207 Anerley Road, London, S.E.20.

For further information circle 64 on Service Card

Vitramon Capacitors. Porcelain and ceramic capacitors produced to both U.S. Mil and DEF specifications are included in this 8-page Bulletin No. 27. The porcelain capacitors range in value from 1 to 4,700 pF and are rated at 300 to 500 V d.c. Ceramic capacitors range from 10 to 10^4 pF and are rated at 200 V d.c.

Vitramon Laboratories Ltd., 45 Holloway Lane, Harmondsworth, Middlesex.

For further information circle 65 on Service Card

Polarad Microwave Spectrum Analyzers. Starting with a brief description of the principles and applications of spectrum analysers, this 40-page brochure goes on to describe 11 instruments. The series of analysers together cover the frequency range 10 Mc/s to 100 Gc/s.

Polarad Electronic Instruments, 34-02 Queens Blvd., Long Island City 1, New York, U.S.A.

For further information circle 66 on Service Card

'Dialco' Sub-Miniature Illuminated Push Button Switches & Matching Indicator Lights. In this 8-page catalogue No. L-169A, with the self-descriptive title, over 70 items are listed.

Dialight Corporation, 60 Stewart Ave., Brooklyn, New York 11237, U.S.A.

For further information circle 67 on Service Card

Transformers for Transistorized A.F. Amplifier Circuits. These four data sheets, AT.1 to 4, give details of a new range of standardized transformers for transistor a.f. power amplifiers.

Gardners Transformers Ltd., Somerford, Christchurch, Hants.

For further information circle 68 on Service Card

★ FOR THE BUYER

You must have read about a number of products and processes in this issue of which you would like further details. You can obtain this information very easily by filling in and posting one or more of the enquiry cards to be found inset in the front of the journal.



INSTRUMENTATION SERVICE TO INDUSTRY

10 DAYS DELIVERY

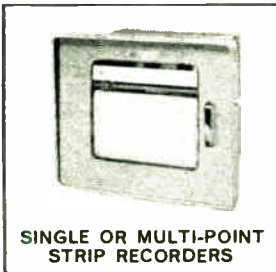

SINGLE OR MULTI-POINT
STRIP RECORDERS



DISC RECORDER

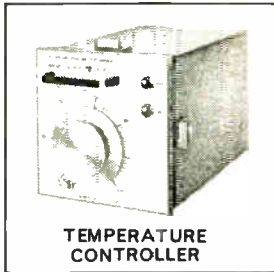

TEMPERATURE
CONTROLLER

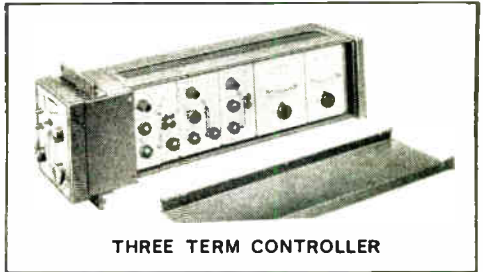

THREE TERM CONTROLLER

For instrumentation problems that cannot wait LDEP have made it possible for a competitive range of instruments to be available on a 10 day delivery.

Full information on the range of single and multi-point strip and disc chart recorders, temperature controllers and three-term controllers is available simply by contacting Control and Instrumentation Division:-

**LANCASHIRE DYNAMO ELECTRONIC PRODUCTS LTD
RUGELEY, STAFFS. Tel: Rugeley 371**



ULTRASONIC

ACCURACY 0.2%
TYPICALLY

IN LINE DIGITAL
READOUT

PRE-SET TANK
FILLING AND
EMPTYING

LEVEL GAUGE

HYGIENIC (NO
PROBE OR FLOAT)

ALL TRANSISTOR
OPERATION

FOUR TANK
MEASUREMENTS
ON ONE
INSTRUMENT

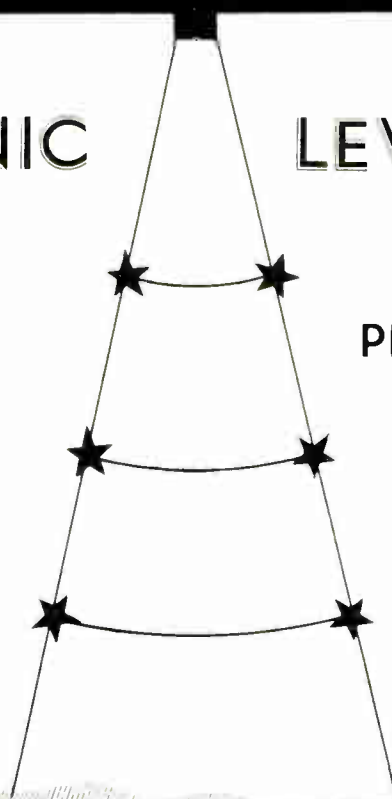

STAND 27
AT THE
EXHIBITION OF THE
INSTITUTE OF PHYSICS
AND THE PHYSICAL
SOCIETY

ELECTRONIC APPLICATIONS (COMMERCIAL) LIMITED

ENDEAVOUR HOUSE, NORTH CIRCULAR ROAD, LONDON, N.W. 2.

TELEPHONE, SPEEDWELL 4651

CABLES, ECHOING LONDON.

100 MΩ/V

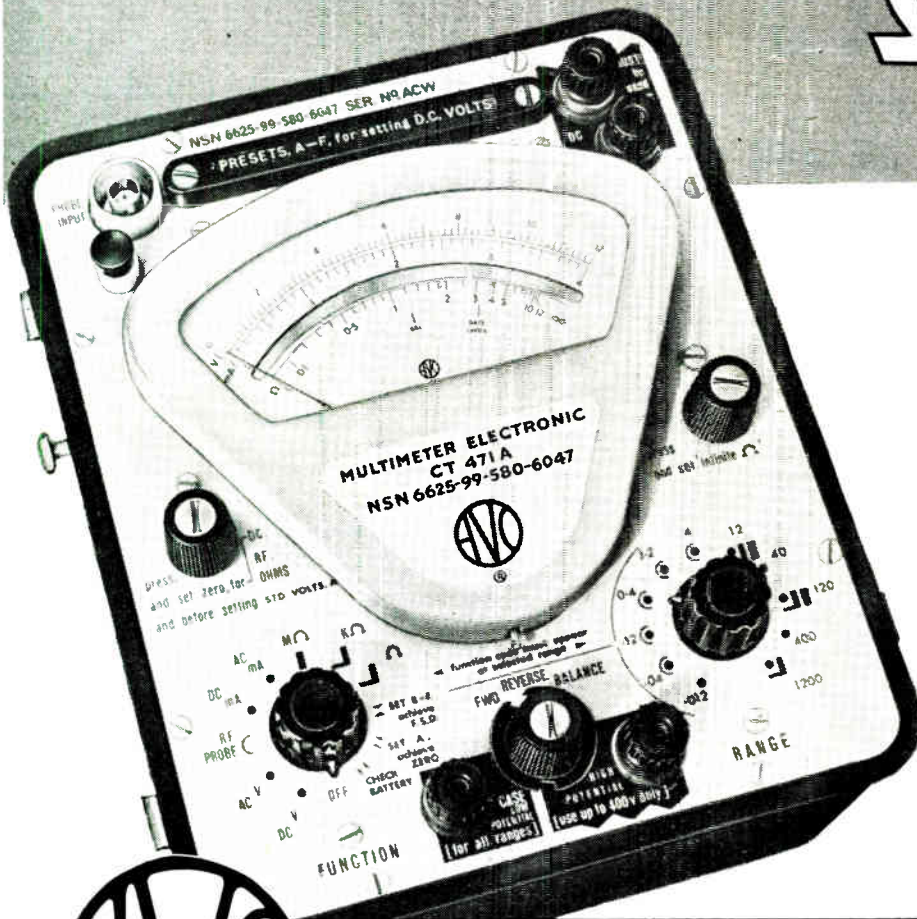

- ★ 57 Ranges.
- ★ D.C. to 1,000 Mc/s.
- ★ All voltage and current readings on only two linear scales.
- ★ 5" scale length.
- ★ 2% accuracy on d.c.
- ★ Comprehensive d.c. standardising facilities to 0.5% short term.
- ★ Battery operated.

**robust as
the AvoMeter**



TRANSISTORISED MULTIMETER CT471A

RANGES

d.c. Voltage:
12mV to 1,200V f.s.d. in 11 ranges

d.c. Current:
12μA to 1.2A f.s.d. in 11 ranges

a.c. Voltage r.m.s.:
12mV to 1,200V f.s.d. in 11 ranges

a.c. Current r.m.s.:
12μA to 1.2A f.s.d. in 11 ranges

r.f. Voltage r.m.s.:
40mV to 4V f.s.d. in 5 ranges
extending to 400V with capacitive divider

Resistance:
12Ω to 120MΩ f.s.d. in 8 ranges

A portable battery operated multi-range meter using semi-conductors throughout, of high stability and with an accuracy of $\pm 2\%$ on d.c. voltage.

Three basic scales cover all measurements. The two main scales, used for all voltage and current measurements, are linear and the third scale, used for resistance measurements, indicates increasing resistance towards full scale deflection.

Zero adjustment is effected on any d.c. range without disconnecting the meter from the circuit under test. Provision is made for centre zero operation on d.c. voltage. A

reversing facility enables both positive and negative d.c. voltages and current to be measured without reversing the connections.

Provision is made for checking the condition of the batteries and a d.c. standardising facility enables ranges up to 1.2V to be individually corrected to an accuracy of 0.5%. The battery supply is automatically disconnected when the cover is replaced on the instrument. Supplied with high impedance r.f. probe, capacitive divider (division ratio 100-1) and 50Ω and 75Ω terminating pads.

Ask AVO for Leaflet 376

AVO LTD AVOCET HOUSE · 92-96 VAUXHALL BRIDGE ROAD · LONDON S.W.1

Telephone: VICTORIA 3404 (12 lines)



The **BIGGEST** range of

Accessories of all kinds

ELECTRONIC EQUIPMENT

ALL YOUR ELECTRONIC EQUIPMENT — SPARES — ACCESSORIES FROM ONE SOURCE

NEW!



BEULAH D.808 C.C.T.V. CAMERA

● A de-luxe version of the well-known D.800 Camera

- The new D.808 has :
- Automatic Light Control.
 - Video Output.
 - 4.8 mc/s Resolution (625 lines).
 - Black Level Clamp.

... The Lowest Priced Industrial C.C.T.V. Camera with all these features!

£250 inc. lens.

DEFERRED PAYMENT TERMS AVAILABLE: £62:10s. deposit, and 24 monthly payments of £8:15s.

Also

limited number of D.800 Cameras available from stock at £236:5s. complete with lens or £59:5s. deposit and 24 monthly payments of £8:5:2.

★ C.C.T.V. CAMERAS AVAILABLE FROM 79 Gns.

plus 7/6 p. & p. (complete with lens) OR AS A COMPLETE KIT (less lens and vidicon) £48.

ANOTHER BEULAH FIRST!

BEULAH 1400 — 14" MONITOR
78 GNS.

BEULAH "850" — 8½" MONITOR
Special terms for quantity orders. **72 GNS.**

LOWEST PRICED Transistorised Industrial T.V. VIDEO MONITORS

- Specially designed to work in conjunction with the wide range of economy type C.C.T.V. Cameras now available.
- Designed for use in either vertical or horizontal plane.
- Can be used in Cars, Aircraft, Ships, Trains, etc.
- Coaxial input is arranged for linked loop working.
- Models supplied against special order for operation from 12 v. battery.
- Smallest Transistorised Types available in the U.K.
- Housed in strong metal cases.
- Designed for continuous working.
- Six Beulah Monitors can be stacked on a shelf only 9" deep and 28½" wide.
- All controls situated at the front of the Monitors.
- Ventilation no problem in stacking — negligible heat is generated.



C.C.T.V. DEMONSTRATIONS DAILY IN OUR OFFICES

● D.T.V. TRANSFORMER SERVICE

When you order from the D.T.V. Group you have the advantage of access to the largest stocks in the U.K. Your specification is compared with the stock types and, if we are unable to supply, the order is immediately passed to our own Factory and an estimate is despatched to you without delay. The D.T.V. Service saves you time and money by supplying standard components wherever possible.

Examples of Stock Items:

D.T.V. 1-0058-250 WATT ISOLATION TRANSFORMER

Input 200-230-230v. Output 200-230-230v. Double wound in steel box. £6:1s.

D.T.V. 1-0059-500 WATT ISOLATION TRANSFORMER

Input 230 v. Output 230 v. Double wound in metal box. £9:1:6.

D.T.V. 1-0060-1000 WATT ISOLATION TRANSFORMER

Input 230 v. Output 230 v. Double wound. £11:1s.

Alternative input and output voltages available. State requirements when ordering. Quantity prices on application.

MAINS TRANSFORMER

Input 0-200-220-240 v. Output 300-0-300 v. at 80 mA. 1.5 A. 6.3 v. 3 A. 22/6 inc. postage.

GULTON TRANSDUCERS Type 1404

With these special features:

- Small Physical Size.
- Interchangeable Receiver and Transformer Heads.
- High Q, High Efficiency.
- Wide Beam Width.
- Shielded Non-Interference Housing.

FOR:

- Industrial Automation.
- Remote T.V. Control.
- Model Control.
- Intruder and Circuit Alarms.
- Gate, Tool and similar Controls.

New, reduced prices due to increased sales
Two for **£5** or

SINGLE UNITS **55** - EA.

Quantity prices on application (U.K. prices only).



● THE D.T.V. GROUP ARE SOLE DISTRIBUTORS OF GULTON TRANSDUCERS ●

NEW ESSENTIAL COMPONENT KIT No. 1404K

Two 1404 Transducers, one 40 kc/s 5:1 Transformer, contains the seven Transistors required for both transmitter and receiver, two Transducer Plugs, one TX/RX Circuit Diagram.

£7:5s.

(U.K. Price) inc. P. & P.

NEW! BEULAH E.H.T UNIT 8-12 kV. D.C. R.F. UNIT

A compact, high voltage unit for Electronic and T.V. Equipment. Peak output 12 kV. at 500 microamps. The oscillator valve is a 6P25 and the D.C. is smoothed by a 20 kV. .0005 μF capacitor or a 15 kV. .001 μF capacitor. Ample shielding is provided to prevent radiation.

£12:10s. ea. net

D.C. required 300 v. at 30 mA./6.3 v. at 1 A.

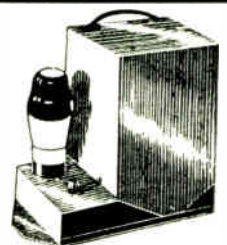

ALL YOUR ELECTRONIC EQUIPMENT — SPARES — ACCESSORIES FROM ONE SOURCE

... all on call from the

D.T.V. GROUP GIP 6166 (P.B.X.)

Day & Night Ansafone Service

DEPT. I.E., 126 HAMILTON ROAD, WEST NORWOOD, LONDON, S.E.27

★ Our new premises bring together under one roof the combined resources of an up-to-date factory, stores and offices and will result in an even better service to our many customers.

● **TERMS of BUSINESS**
C.W.O., Pro Forma or approved account.

(we are sole U.K. Distributors for Grundig Measuring Instruments)
the world's finest test equipment
three outstanding instruments from the Grundig range

GRUNDIG OSCILLOSCOPE G.5/7

A new oscilloscope, incorporating many features not usually found in an oscilloscope of this price.

Screen diameter: 3½" flat.

Persistence: Mean, decrease to 1% of initial brilliance in 50 ms.

Vertical Amplifier

Deflection sensitivity: Better than 18 mV/cm p-p

Frequency range: D.C. 0-5 Mc/s (-3 DB)

Rise-Time: 0.08 micro seconds

Overshoot: Not more than 2%

Calibration voltage: 1 V.D.C. ± 2%

Four Range Attenuator

Time Base

Free running or triggered

Synchronisation and Triggering

Internal or external, positive or negative, at signal or mains frequency.

● Weight 17½ lbs. ● Size 15¼" × 10¼" × 5¼"



GRUNDIG RV56 VALVE VOLTMETER

The RV56 is an improved version of the well-tried valve voltmeter RV54 with a mean-value rectification. It is distinguished from the earlier model by an extended frequency range. Twelve push button selected overlapping ranges, and a large scale, calibrated in voltage and level, simplify use and measurement. The instrument can also be used as a very stable wide-band amplifier.

Test Ranges:

0 ... 1/3/10/30/100/300 mV.
1/3/10/30/100/300 V.

-90 ... + 50 dBv

-90 ... + 52.5 dBm

Frequency response: 10 c/s ... 1 Mc/s

Input impedance: 1 MΩ Shunted by 30 pF

Maximum admissible D.C. voltage at test point: 400 V

Output impedance: approx. 600Ω

Mains supply: 50/60 c/s, 125, 220 V ± 10% approx. 40 VA

● Size 11¼" × 7¼" × 6½" ● Weight 12 lbs.

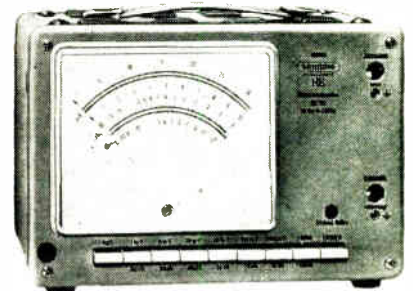

GRUNDIG GRID DIP RESONANCE METERS 701 and 709

The Grid Dip meters Types 701 and 709 each consist of a compact, mains operated oscillator. The coils are arranged to plug into the instruments in such a manner that they can be easily coupled to the circuit being tested. A meter indicates the oscillator grid current. A four-position switch changes the function of the instrument.

Write for full details of the Grundig range of over 60 Measuring Instruments.

Frequency Ranges:

Six ranges are provided by plug-in coils, the frequency being direct reading from the tuning scale.

Type 701

Range	Frequency Range
1	1.7 ... 3.7 Mc/s
2	3.7 ... 8 Mc/s
3	8 ... 17 Mc/s
4	17 ... 40 Mc/s
5	40 ... 100 Mc/s
6	100 ... 250 Mc/s

Frequency accuracy: ± 1.5%

Switch selection:

- R (E) Receiver
- A (W) Absorption Wavemeter
- G (G) Grid Dip Oscillator
- O (S) Modulated Oscillator

● Weight 2¼ lbs. ● Overall Size 8" × 3" × 2½"

Type 709

Range	Frequency Range
1	100 ... 250 kc/s
2	250 ... 500 kc/s
3	500 ... 1200 kc/s
4	1.2 ... 3 Mc/s
5	3 ... 8 Mc/s
6	8 ... 20 Mc/s

General Information:

- Valve: EC92
- A.C. Mains Supply: 110/220 Volts.
- 40 ... 60 c/s,
- consumption approximately 10 Watts
- Case: Steel, Silver-grey finish



ALL YOUR ELECTRONIC EQUIPMENT — SPARES — ACCESSORIES FROM ONE SOURCE

If it calls for transient storage then it calls for **CAWKELL**

REMSCOPE 741 with plug-in amplifiers

The most flexible instrument of its kind costing no more than a good ordinary oscilloscope. Unique events or high-speed transients can be stored for up to a week, with 5 to 10 minutes display whenever desired. Choice of single-beam, double-beam, or multi-trace display by means of interchangeable plug-in amplifiers:—

**2-CHANNEL
BEAMSWITCH
AMPLIFIER
TYPE 741/2**

Allows 2 simultaneous phenomena to be displayed for comparison.
Direct coupled.
Differential input.
Price: £120

**TRACE SHIFTER
AMPLIFIER
TYPE 741/1**

For easy comparison of sequential signals 2, 4, or 8 steps. Min. interval between steps 5µs.
Price: £75

**Y AMPLIFIER
TYPE 741/3**

For normal single-beam display. Band-width 1.5 Mc/s which is consistent with writing speed.
Price: £38

— leaders in storage instrumentation!

When Cawkell produced the storage channels used for the 'ZETA' experiments at Harwell they became the first company to manufacture storage oscilloscopes in the United Kingdom. As leaders in the field, Cawkell are in a unique position to advise on problems involving the capture and retention of high-speed phenomena. In the photograph below, the Cawkell Remscope 741 is being used to record the angular acceleration of a diesel engine by an electric motor under arctic conditions. This information can be stored for up to a week for detailed study whenever required.

Basic price (without amplifiers)
£612

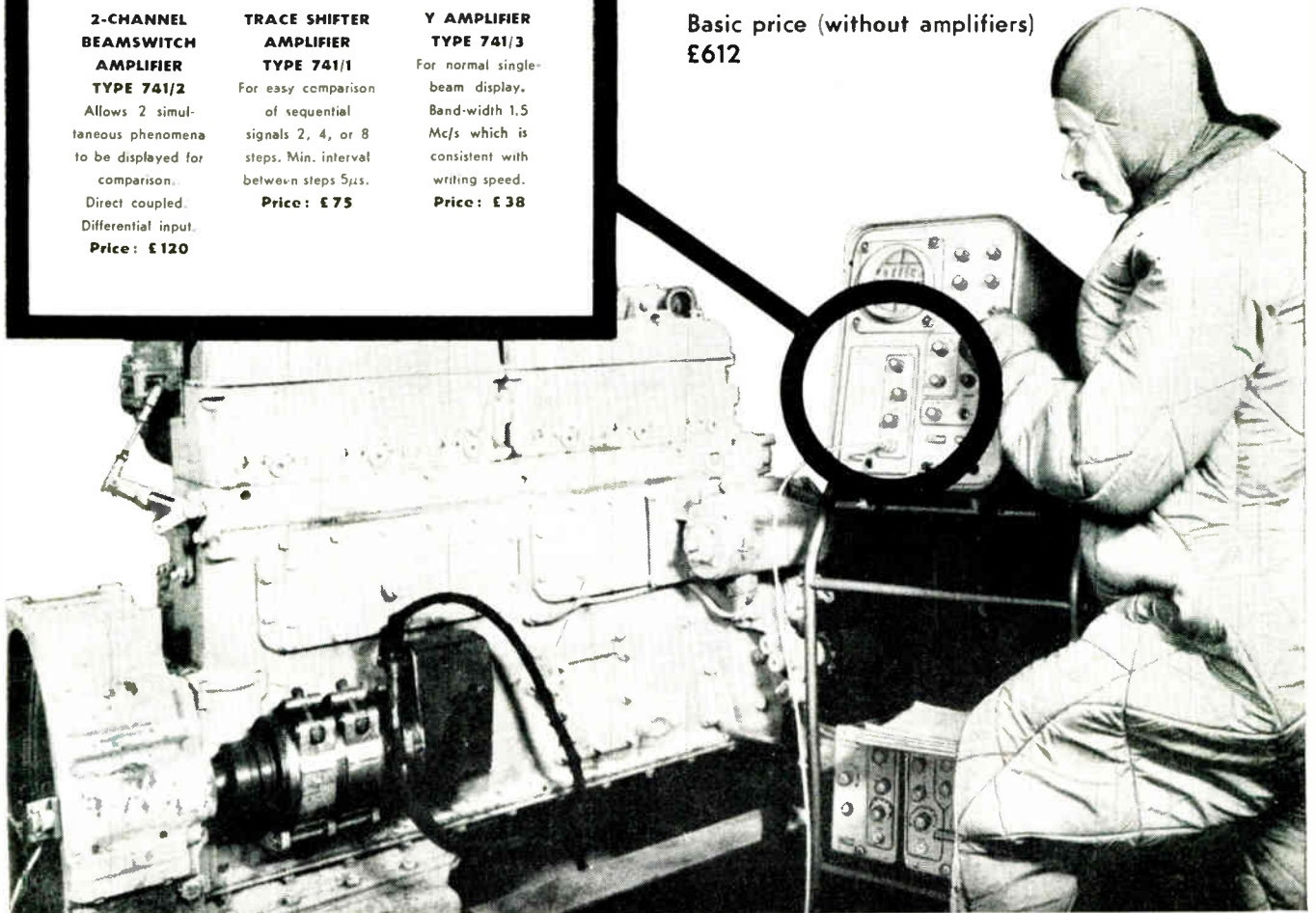

CAWKELL RESEARCH & ELECTRONICS LTD · WESTERN AVE · ACTON · LONDON W.3 · ACORN 6751 · A MEMBER OF THE *Simms* GROUP OF COMPANIES

NOW... an even wider range of WESTON CLEAR FRONT contemporary instruments

The Weston Clear Front Contemporary Series now includes square, rectangular, miniature and fan shaped instruments.

Clear moulded covers give excellent light transmission. Behind the new-look face is the traditional accuracy and reliability of Weston instrumentation. For current or voltage measurement. Cover masks available in 7 attractive colours.



SANGAMO WESTON LIMITED
ENFIELD · MIDDLESEX · ENGLAND

Telephone: Enfield 3434 (6 lines) and 1242 (6 lines)
Telegrams: Sanwest Enfield Telex - 24724

Scottish Factory: Port Glasgow, Renfrewshire. Branches:
London, Glasgow, Manchester, Newcastle-upon-Tyne, Leeds,
Liverpool, Birmingham, Nottingham, Bristol, Southampton.

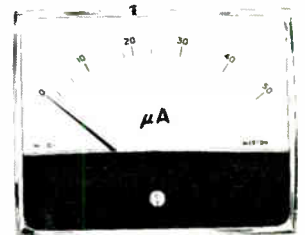
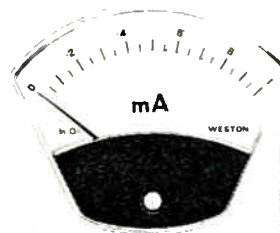
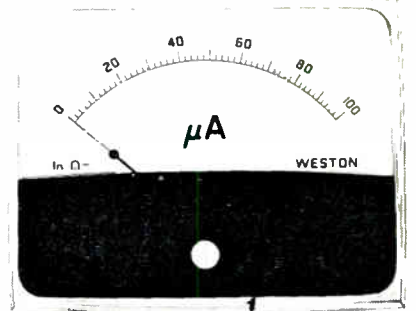
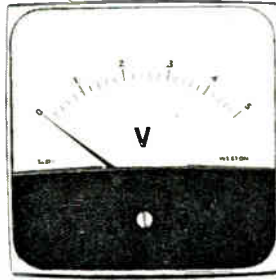
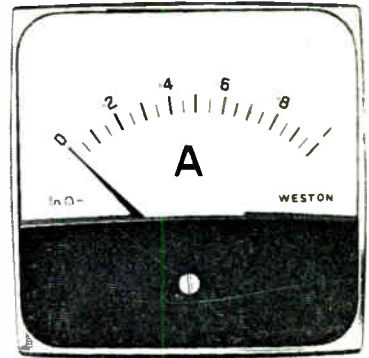
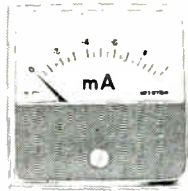
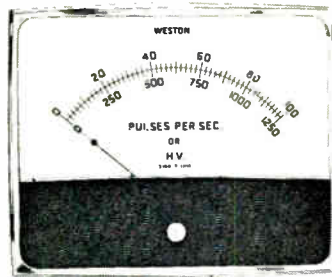

For further information circle 243 on Service Card

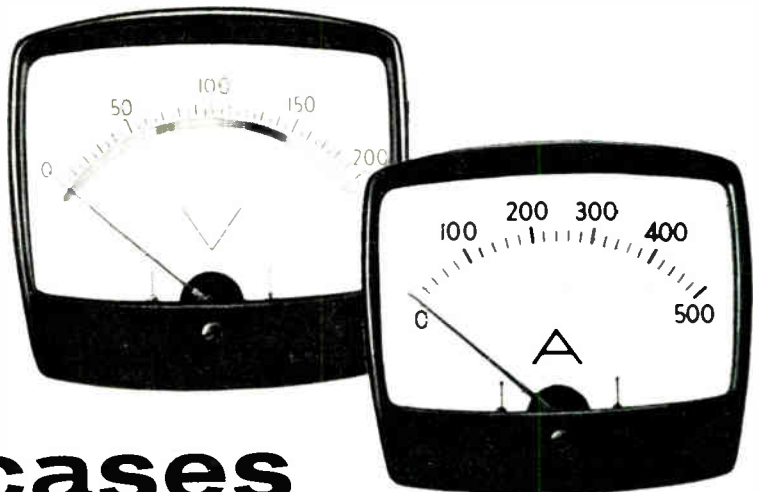

Faces for cases

Elegant cases and legible faces give these Ferranti Style 'A' instruments a contemporary look, but they are more than good looking! Robust in construction, and designed to give minimum rear projection, they are interchangeable with standard 2½" and 3½" round flush instruments and are available with fine scale with or without mirror, or bold scale.

Three standard colours are available in Black, Red and Light Grey. Other colours can be supplied to customers' special requirements. Very good delivery on all types.

FERRANTI LTD., MOSTON, MANCHESTER Tel: Fallsworth 2071
LONDON OFFICE: KERN HOUSE, 36 KINGSWAY, W.C.2. TELEPHONE: TEMple Bar 6666

FERRANTI
First into the Future

FI 221

For further information circle 244 on Service Card

ARE YOU UP-TO-DATE WITH YOUR SOLDERING TECHNIQUE?



There is a large range of instruments (BIT sizes 1/32 in. to 13/32 in.) and accessories marketed under the names of . . .

ADAMIN and LITESOLD

Get the brochures and see for yourself what others are using!

A new Adamin mains model is the C10L, shown on a Bench stand, which we also manufacture. This model is probably the smallest mains voltage model in the world. BIT DIAMETER, 3/32 in. LENGTH, 7 in. WEIGHT, 3/4 oz. (Less Flex). HEATS IN 30 seconds.

Brochures A & L33

post free from the sole proprietors:—

LIGHT SOLDERING DEVELOPMENTS LTD.

28 SYDENHAM ROAD, CROYDON, SURREY. Telephone: CROYdon 8389

For further information circle 245 on Service Card

“A generally excellent introduction to computers”

The Post Office Electrical Engineering Journal

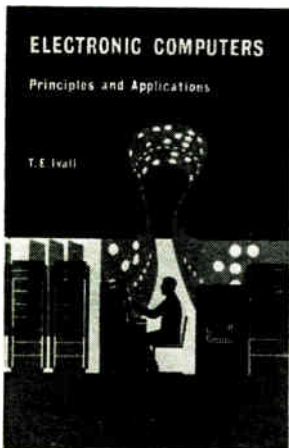

ELECTRONIC COMPUTERS

Principles and Applications

by T. E. Ivall

SECOND EDITION

A non-mathematical introduction to the operating principles of electronic computers, primarily written for technicians, engineers and students with some knowledge of electronic or radio techniques. Both digital and analogue computers are covered, there is a chapter on recent developments and finally the evolution of the more “intelligent” machines, of the future is discussed.

from leading booksellers

25s net by post 26s.

263 pp. inc. 32 plates

Published for “Wireless World” by

ILIFFE Books Ltd.,

DORSET HOUSE

STAMFORD STREET LONDON S.E.1

For further information circle 246 on Service Card

further thoughts by ‘Cathode Ray’

ESSAYS IN ELECTRONICS

M. G. SCROGGIE
B.Sc., M.I.E.E.

obtainable from leading booksellers

This new book may be regarded as a sequel to an earlier book by ‘Cathode Ray’ SECOND THOUGHTS ON RADIO THEORY, but widened in scope to include electronics. The essays, adapted from the popular ‘Wireless World’ series, are grouped according to subject and arranged in logical sequence.

This is a book that every electronic engineer, and for that matter every electrical engineer, should read. It can be guaranteed that no one will fail to learn something to his advantage. It presents difficult and tricky questions vividly and clearly so that they can be readily grasped.

42s net by post 43s 1d
301 pages 204 illustrations

Published for ‘Wireless World’ by

ILIFFE Books Ltd.

DORSET HOUSE
STAMFORD STREET LONDON SE1

For further information circle 247 on Service Card

PROMPT DELIVERY

Many Types
Ex Stock

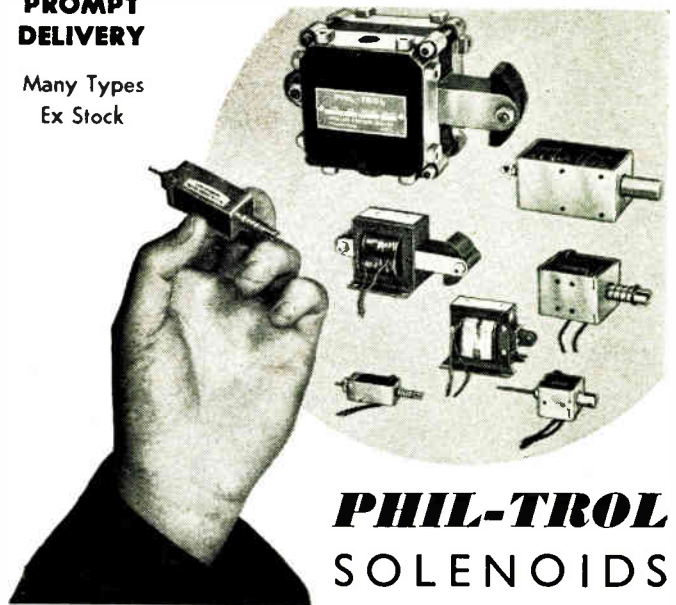

PHIL-TROL SOLENOIDS

Type 45 with spring return and thrust as shown in the hand is one of the most popular of the Phil-trol range—can be arranged in banks with 3/8" spacing suitable for typewriter keys, etc. Phil-trol offer a complete range of AC and DC miniature, medium and large solenoids. Push or Pull, spring return and C.O. switched models if desired.

Send for leaflet No. 108a and complete price list.

PHILLIPS CONTROL (G.B.) LTD.

Dept. K7, Farnborough Rd., Farnborough, Hants

Telephone: Farnborough 1120

Grams & Cables: Philtrol, Farnborough, Hants

Just issued!

METWAY 1964

**TERMINAL BLOCK
CATALOGUE**

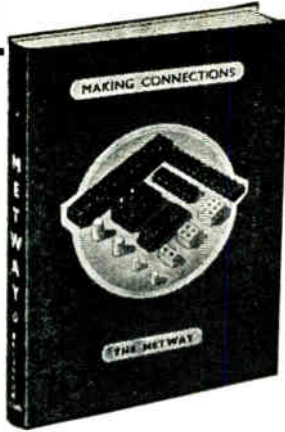

175 PAGES OF TERMINATIONS

**Block Connectors
to suit every application . . .**

We are proud to announce our new catalogue detailing the widest range of Terminal Blocks ever collected into one catalogue. Included also are numerous other useful Wiring Accessories—Rubber Grommets, Plastic Cable Bands, Clips, Saddles, etc.

● Please note that this extensive catalogue can only be sent against direct application on Trade Letter Heading.

Ask for Cat. No. ME1/62/IE

METWAY · KEMP TOWN · BRIGHTON 7

For further information circle 249 on Service Card

OXLEY BARB INSULATORS TYPE 062

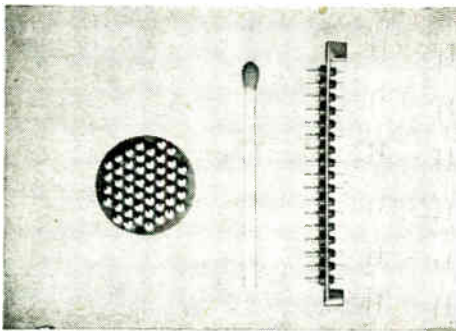

Working voltage] 500 V DC
Capacity less than .5 pF
Temperature range -55°C to +200°C
Resistance to pull in either direction 3 lbs.
Chassis thickness = 22/24 SWG = .022"/.028" = 0.56/0.72 m/m.
Mounting hole dia. .062" = 1.58 m/m.

A new subminiature insulator, which is speedy to assemble, and with outstanding physical characteristics. The P.T.F.E. bush, which is supplied with the heavily silver plated brass 'barb' partly inserted, is located in an ordinary .062" dia. hole and the barbed spill is pressed firmly through the assembly, thus expanding the P.T.F.E. bush on the far side of the chassis and locking the complete assembly firmly in the chassis.

Write for technical details of these and other Oxley products:

OXLEY DEVELOPMENTS CO. LTD.

ULVERSTON, LANCASHIRE

visit the largest
annual world
exhibition
in the electronics field

from February 7th to 12th, 1964
in Paris, Porte de Versailles

at
THE
INTERNATIONAL
EXHIBITION
of

ELECTRONIC

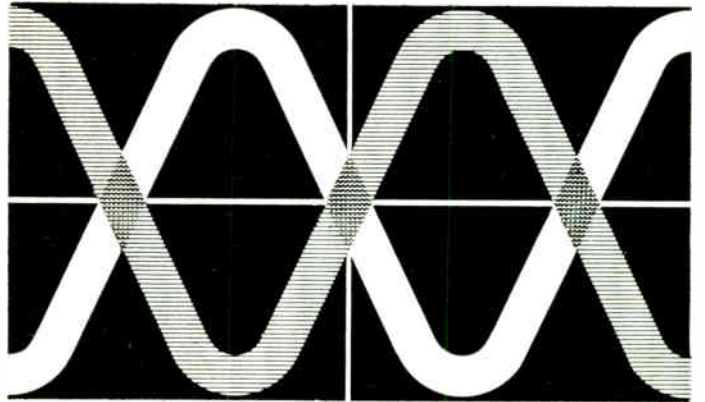

COMPONENTS

All components, tubes and
semi-conductors
measuring and control equipment
electro-acoustics . . .



For all
inquiries and
information apply to :

S.D.S.A., 23 rue de Lubeck
Paris 16ème PASSY 01-16

HIGH VOLTAGE PAPER ELECTROPHORESIS UNIT

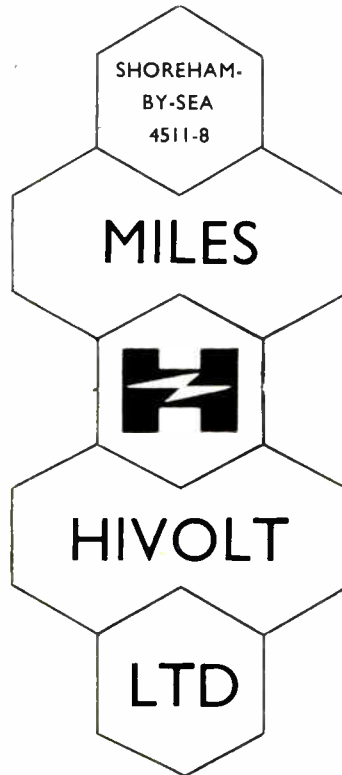
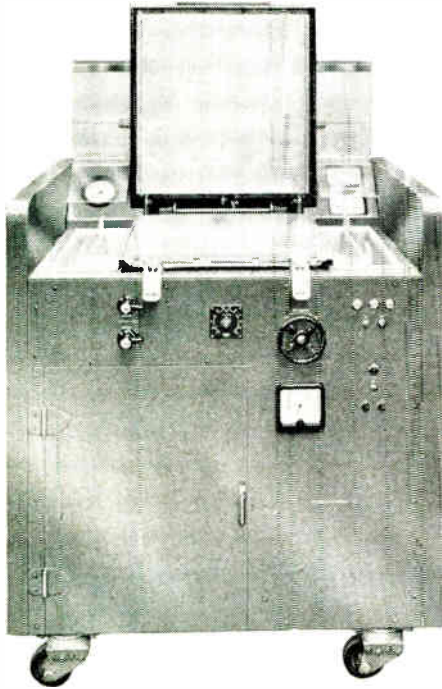

- Hivoltage—10 kV.
- Hicurrent—500 mA.
- Square Plates for 2 dimensional analyses—20" × 21".
- Low cost.
- Foolproof Safety Devices.
- Self-Contained.
- Hicooling Efficiency.
- Hiquality results rapidly obtained.

OLD SHOREHAM ROAD · SHOREHAM-BY-SEA · SUSSEX

Please write or telephone for full details of the above or any other high voltage requirements

For further information circle 252 on Service Card

NOW from United States capacitor technology come...

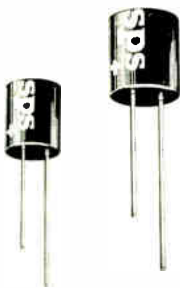

SPS SUBMINIATURE ALUMINIUM FOIL ELECTROLYTIC CAPACITORS

The most modern and efficient capacitors obtainable today.

For 8 years SPS International has been producing in the U.S.A. a range of miniature lightweight capacitors designed to cope with every extreme of temperature. Now the whole benefit of this experience has been brought to the new SPS factory at Shannon, Ireland, making the same high-quality capacitors available at short notice to any part of Britain. SPS capacitors guarantee complete reliability and long life thanks to the techniques of total encapsulation perfected over a long period in the U.S.A.

Available in 42 standard ratings, with intermediate values at no extra cost. For complete technical information and assistance write or telephone SPS International Ltd., European manufacturing arm of a leading U.S. supplier of quality capacitors.

Ideal for transistorised communications equipment, portable radios, hearing aids, electronic instruments, audio cross-over networks, hi-fi tuners and amplifiers, recorders, test equipment and other low voltage circuits.

Capacitance: —20% + 100% of rated capacity
Dissipation Factor: Less than 8% at 50 WVDC
D.C. Leakage: Less than 6 μ A after 1 min. applied WVDC

Operating Temperature: 65°C at rated WVDC



SPS INTERNATIONAL LIMITED
 SHANNON AIRPORT, IRELAND Tel.: Shannon 245

For further information circle 253 on Service Card

Introduction to Electronic Computers

F. GRUENBERGER, *The Rand Corporation*
 and D. McCracken, *McCracken Associates, Inc.*

This brief introductory book, by two well-known authors, is for a course in digital computing. No prior knowledge of the subject, and no mathematics beyond that offered in the secondary schools is necessary. The approach is general, but uses for its illustrations the IBM 1620. The goal is understanding, not number-getting. The reader will comprehend the power, scope—and limitations—of electronic computing. 176 pages, 23s.

Systems Design for Computer Applications

H. N. LADEN, Ph.D., *Chief, New Systems Development, Chesapeake & Ohio Railway Co.*
 and T. R. GILDERSLEEVE, *UNIVAC Division, Sperry Rand Corp.*

This book describes how to organize systems of information processing for optimum use of the computer. It bridges the gap between management problems and programmers. This is the first book to deal with the technical problems preceding programming for computers. It concerns itself with those aspects of computer use not subject to automation, that is, the system design aspect rather than the programming aspect. 336 pages, 57s.

John Wiley · Interscience
 Glen House · Stag Place · London SW1

INDUSTRIAL ELECTRONICS

Press date for the February 1964 issue is
first post 23rd January 1964

CLASSIFIED ADVERTISEMENTS

Advertisement Rates. 6d. per word, minimum charge 6/-, each paragraph charged separately. Remittances payable to "Industrial Electronics", Dorset House, Stamford St., S.E.1. Series discount of 15% is allowed for 12 consecutive insertions.

Box Numbers are available at an additional charge of 2/- to defray cost of registration and postage. Replies should be addressed Box No. 0000, c/o "Industrial Electronics", Dorset House, Stamford Street, London, S.E.1.

Semi-Display advertisements with centralized lines £1/15/- per single column inch, Display advertisements £2/10/- per single column inch—no additional charge for Box Numbers. The Publishers are not responsible for clerical or printers' errors although every care is taken to avoid mistakes.

SITUATIONS VACANT

UNIVERSITY COLLEGE OF NORTH WALES
BANGOR

APPLICATIONS ARE INVITED for the post of Senior Technician in the Department of Psychology. Experience in electronics essential.

Salary will be on a scale rising from £760 to £900 per annum.

TWO copies of the application giving details of age, qualifications and experience together with the names of two referees should be sent to the Registrar by January 15th, 1964.

[2042

MISCELLANEOUS

PHOTO-ELECTRIC CONTROLS for industry

Send for catalogues

HIRD-BROWN LIMITED
FLASH STREET, BOLTON

Telephone 27311

[2027

CAPACITY AVAILABLE

AIRTRONICS LTD.

for coil winding assembly and wiring of electronic equipment, transistorised sub-units.

4 Ashmead Road, London, S.E.8

Telephone: Tideway 2249

[2043

SERVICES OFFERED

Precision Sheet Metal Work for the Radio & Electrical Trade. Chassis, Panels, Brackets, etc. Power Press Capacity up to 100 tons. Press brake capacity up to 105 tons 8ft. x 7/32in. All spray and stove finishes. A.I.D. approved. — The Kaymet Company, Kaymet Works, Sylvan Grove, London, S.E.15. Telephone: NEW Cross 6644.

[2036

SCRAP METAL

Non-ferrous Scrap Metals, all grades, Swarf, Off-cuts, etc., purchased at highest rates.

H. Barnett Ltd.,
Victor Road, London, N.7.

Est. 1865

ARCHway 5461

[2041

BOOKS, ETC.

"BASIC" Mathematics for Radio and Electronics." By F. M. Colebrook, B.Sc., D.I.C., A.C.G.I. Revised and enlarged by J. M. Head, M.A. (Cantab.). Presents in readable form a complete course in basic mathematics for engineering students of all kinds and leads on to the more advanced branches of mathematics of increasing importance to radio engineers. In this section the chapter covering the application of mathematics to radio has been revised and enlarged, while new subjects covered include Stability, Linear Differential Equations, Elementary Statistics, Short Cuts to Numerical Calculations and an Introduction to Matrices. Will be invaluable to those requiring a refresher course as well as to those without previous knowledge of the subject. 17s 6d net from all booksellers. By post 18s 6d from Iliffe Books Ltd., Dorset House, Stamford Street, S.E.1.

For further information circle 254 on Service Card

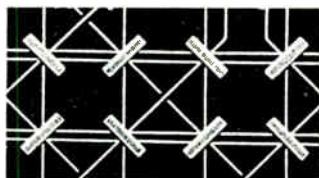

for all interested in ferrite
materials and their
applications in computers

Square-Loop Ferrite Circuitry

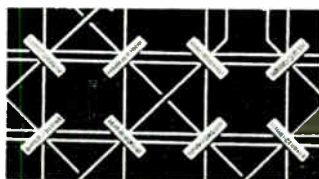

storage and logic techniques

C. J. QUARTLY M.A.

Describes the behaviour of square-loop ferrite materials and their application in memory stores for digital computers, both in large computers and in small data handling equipment. Early chapters describe the historical developments and then discuss the properties of square-loop materials in general. Various systems—coincident drive storage, word address storage and faster storage—are then described in detail. Further chapters explain fully non-destructive read-out, the construction of stores, special purpose stores, circuits in storage systems, logical circuits, multi-apertured logical elements and counting circuits using more than two flux levels.

42s net by post 42s 11d. 100 pages, 92 diagrams

obtainable from leading booksellers

ILIFFE Books Ltd. DORSET HOUSE, STAMFORD ST. LONDON, S.E.1



ELECTRONIC EXCHANGES

G.E.C. (Telecommunications) Ltd. require the following engineers in connection with the development of electronic exchanges:—

- 1. CIRCUIT ENGINEER** to work on the design of DC-DC converters and electronic ringing current generators. He will in addition assume general responsibility for the evaluation of the power requirements of the electronic exchanges at present under design.
- 2. AN ENGINEER** with a sound knowledge of the Strowger system who would like to join a team engaged on the development of small electronic exchanges. This vacancy will attract an ambitious engineer with an inventive turn of mind who wishes to break away from the conventional.

Qualifications: Men probably in their late 20's with a few years relevant experience, are required. A degree, professional qualification or H.N.C. is preferred.

Apply: with full but concise details to the

Staff Officer

G.E.C. (Telecommunications) Ltd., Coventry

UHF 1300 Mc/s



2N2808

SILICON PLANAR TRANSISTOR

Max. Frequency of Oscillation: 1300 Mc/s min.
 Noise Factor: 5dB max. at 200 Mc/s
 Power Gain: 20dB min. at 200 Mc/s
 Total Dissipation: 0.3W at 25°C case temperature

WALMORE ELECTRONICS LIMITED

11-15 BETTERTON STREET DRURY LANE LONDON WC2 TEL TEMPLE BAR 0201-5

For further information circle 256 on Service Card

LAPLACE TRANSFORMS FOR ELECTRICAL ENGINEERS

By B. J. Starkey, *Dipl. Ing., A.M.I.E.E.* A presentation of the theory of Laplace transformation in which a physical vocabulary rather than a purely mathematical one is used as far as possible. This method of analysis has become

of increasing importance to electrical engineers in many fields, and the work is designed to provide them with a thorough treatment of the subject in a language with which they will be familiar.

30s. net BY POST 31s. 2d.

From leading booksellers, published by **ILIFFE Books Ltd.**, Dorset House, Stamford Street, London, S.E.1

Index to Advertisers

Adcola Products Ltd.	19	Hendrey Relays Ltd.	18	Radiospares Ltd.	9
A.E.I. Ltd. (Instrumentation Division)	16	Iliffe Books Ltd.	18, 36, 39, 40	Reliance Controls Ltd.	11
Appointments Vacant	39	Imhof, Alfred, Ltd.	8	Sangamo Weston Ltd.	35
A.P.T. Electron Industries Ltd. ...	24	Lancashire Dynamo Ltd.	29	SIFAM Electrical Instruments Ltd.	10
Avo Ltd.	31	Light Soldering Developments Ltd.	36	Silentbloc Ltd.	25
CIBA (A.R.L.) Ltd.	17	Metway Electrical Industries Ltd. ...	37	SPS International Ltd.	38
Computer Controls Ltd.	6	Miles, Hivolt Ltd.	38	Standard Telephones & Cables Ltd.	21, 22, 23
Cossor Instruments Ltd.	2	Miniature Electronic Components Ltd.	3	Telcon Metals Ltd.	Cover iii
Dawe Instruments Ltd.	34	Mullard Ltd.	Cover ii, 4, 5	Telephone Manufacturing Co. Ltd.	14
Direct T.V. Replacements Ltd. ...	32, 33	Multicore Solders Ltd.	15	Walmore Electronics Ltd.	40
Electronic Applications (Commercial) Ltd.	30	Oxley Developments Co. Ltd.	37	Welwyn Electric Ltd.	26
EMI Electronics Ltd.	27, 28	Painton & Co. Ltd.	1	Westinghouse Brake & Signal Co. Ltd.	13
Ericsson Telephones Ltd.	7	Parmeko Ltd.	Cover iv	Wiley J. & Sons Ltd.	38
Ferranti Ltd.	35	Phillips Control (G.B.) Ltd.	36		
F.N.I.E.	37	Phoenix Telephones Ltd.	12		
		Plannair Ltd.	20		

WHEN YOU BUY

TELCON HIGH PERMEABILITY TOROIDAL CORES

YOU BUY

THE PRODUCT OF FORTY YEARS EXPERIENCE

Telcon Pioneered the Production of Strip Wound Cores which are available in

MUMETAL, SUPERMUMETAL
RADIOMETAL, SUPER RADIOMETAL
H.C.R. ALLOY
PERMENDUR AND SUPERMENDUR

All these alloys are manufactured EXCLUSIVELY by Telcon Metals Limited at Crawley, Sussex, where melting, hot and cold rolling, slitting and core fabrication are carried out under close technical

supervision. Inspection starts with the raw materials, is maintained throughout the production processes and ends with an individual magnetic test on every finished core.

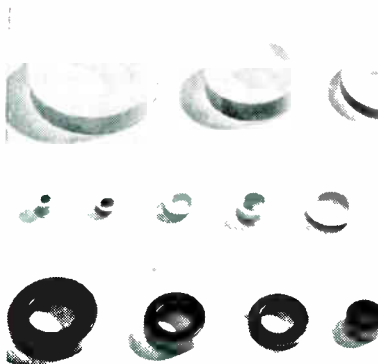

Typical Spiral Cores

WHEN YOU BUY
TELCON CORES
YOU BUY
RELIABILITY

Cores are available in a wide variety of sizes and strip thicknesses down to 0.000125" (3 microns) and full technical information will gladly be sent on request. Core finishes can be made to suit customer requirements which include epoxy resin and other coatings, metal casings and sealed boxes of various plastic combinations.

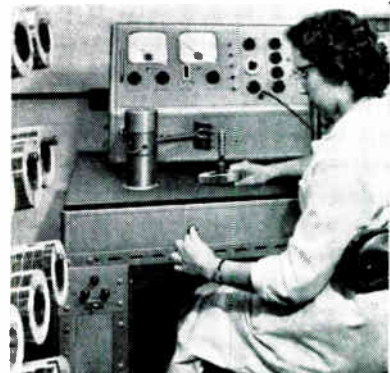

Test Gear for Cores

FOR SPIRAL CORES - WHATEVER THE APPLICATION



BUY TELCON



Telcon Metals Ltd. P.O. Box No. 12, Manor Royal, Crawley, Sussex. Phone: Crawley 28800. Grams: Telcon Crawley. Telex 87248

Member of the **BICC** Group of Companies

For further information circle 202 on Service Card

PARMEKO

TRANSFORMERS AND CONTROL AMPLIFIERS



5092 series Transformers and Chokes

A simple open frame assembly and the use of low-cost, non-loss laminations have enabled Parmeko to keep production costs for the 5092 series to a minimum. Ideal for general purpose applications, transformers and chokes in this series have facilities for upright or horizontal mounting. A terminal panel is incorporated and studs for inverted mounting can be provided as an optional extra.

Write for List No. 210 giving full technical specifications.

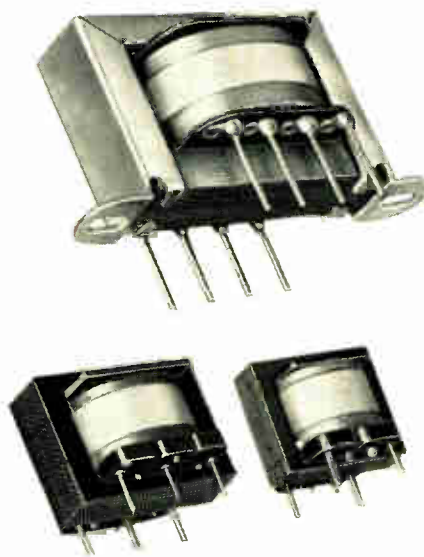

Transformers for transistor circuit applications

Illustrated here are just three from the wide Parmeko range of transformers for transistor circuit applications. New designs are continually being produced by our research and development departments for use in computers, control systems, guided missiles and switching circuitry among many other applications. Quotations will gladly be submitted for specific design requirements.

Write for list No. 270 giving full technical specifications.

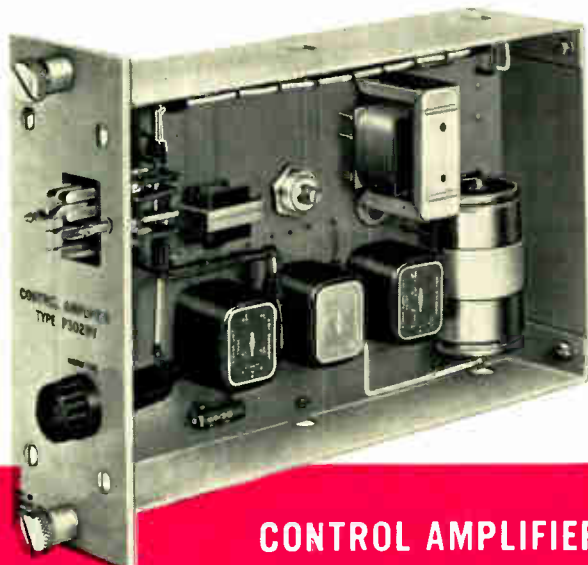

CONTROL AMPLIFIER

This amplifier provides in one unit all the requirements for controlling silicon controlled rectifiers. It consists of three basic Parmeko potted circuit elements arranged to provide a reference supply, a D.C. error integrating amplifier, and a phase shifting gate firing circuit. These combined facilities make it ideal for use in equipment for such applications as motor speed control, power supply regulation, and alternator voltage regulation. Write for List No 790 giving full technical specifications.



GENERAL PURPOSE D.C. AMPLIFIER

This unit answers the need for a low cost D.C. amplifier with good stability, accuracy and reliability. Two types are available, providing push-pull or single-ended output. Both make use of a well-proven transistorised chopper technique and incorporate Parmeko potted circuit elements. All components are generously rated, giving almost indefinite life under normal operating conditions. Write for List No 800 giving full technical specifications.

PARMEKO LIMITED • PERCY ROAD • LEICESTER • ENGLAND

Telephone Leicester 32287 • Telegrams Parmeko Leicester