

INDUSTRIAL ELECTRONICS

JUNE 1963 5s 0d



BICC

in Television

BICC manufacture every type of cable and associated product that is necessary for the transmission and reception of the visual image—including camera cables and polypole couplers, coaxial distribution cables, power cables, equipment wires and downloads. Transmitting aerial towers are supplied and erected by the British Insulated Callender's Construction Company Limited.

BICC products contribute to the development and expansion of the television industry.

British Insulated Callender's Cables Limited
21 Bloomsbury Street London WC1

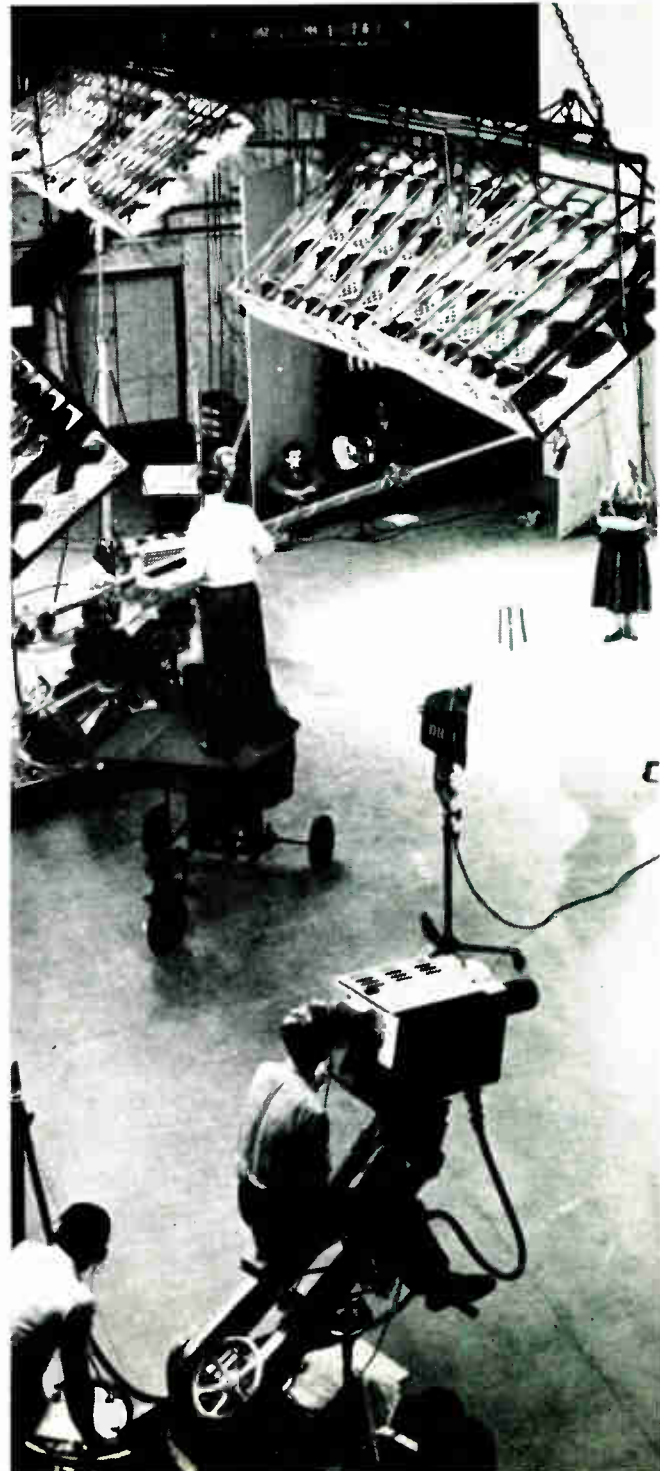
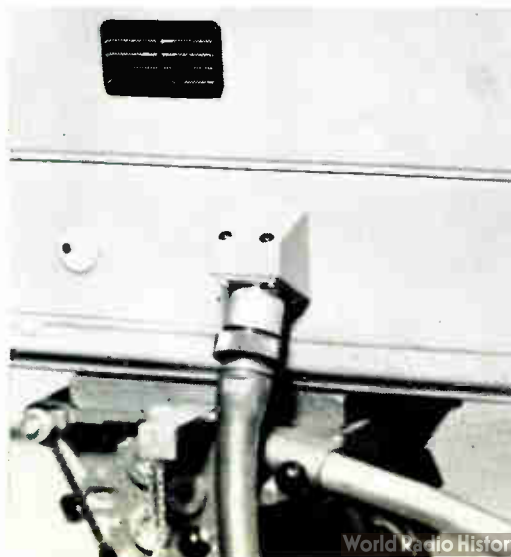
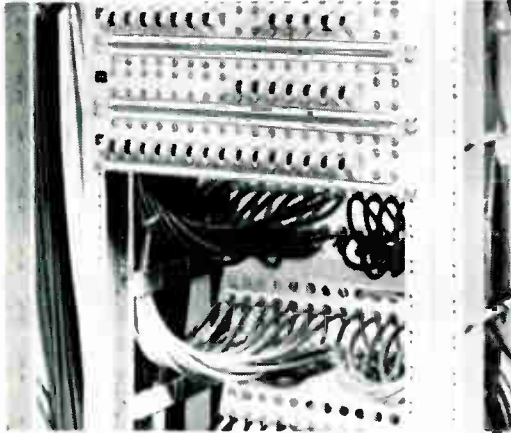
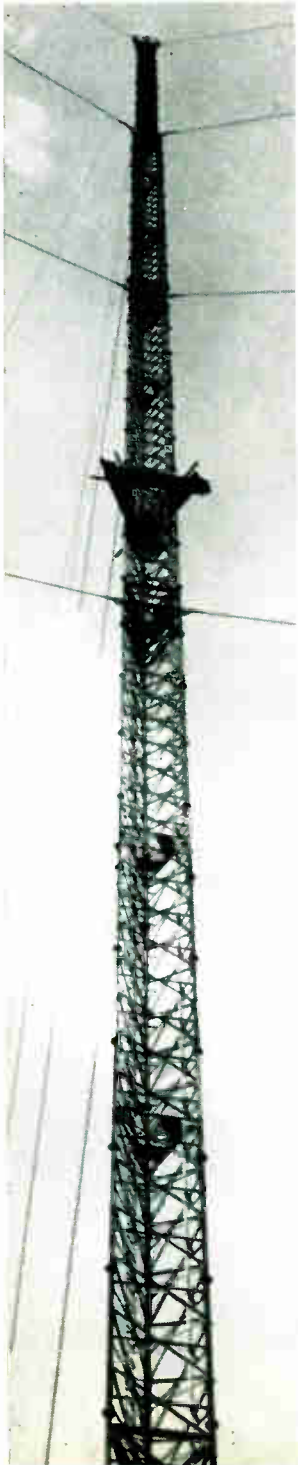



INDUSTRIAL ELECTRONICS

incorporating *ELECTRONIC TECHNOLOGY*



Volume I Number 9 June 1963

contents

Editor **W. T. COCKING, M.I.E.E.**
Assistant Editor **T. J. BURTON**
Advertisement Manager **G. H. GALLOWAY**

- 451 **Comment**
- 453 **Electronic Control of Register in a Flying Splice Machine**
by J. C. Mawer
In printing the end of one reel of paper is pasted to the start of the next reel without stopping the machine. When the paper has been partially pre-printed registration problems arise. This article describes electronic methods of controlling the registration.
- 456 **Programming Techniques for On-line Computer Processing**
by Dina St. Johnston, B.Sc.
When a computer is used for on-line control, the data is provided from many sources. It is the programme which controls the collection and processing of this data and hence turns static equipment into a powerful control tool. Some ways of accomplishing this are described in the article.
- 459 **Applications of Storage Tubes in Instrumentation—Pt. I**
by F. J. Horley
Storage cathode-ray tubes are particularly useful when dealing with transient phenomena because it enables them to be observed at once and without the delay associated with photographic techniques. This article describes two different types of tube and deals with their application.
- 463 **High-Current Stabilized Power Supply** *by C. D. S. Gaskill*
With large current outputs problems of power dissipation and overload protection become especially important in stabilized power-supply units. The article describes a switch-inductor method for units with outputs from 5A to 100 A.
- 465 **Crystallography and Cathodoluminescence**
by H. P. Rooksby, B.Sc. and E. A. D. White, Ph.D.
Some of the rare earth niobates and tantalates have properties which may result in improvements to the screens of cathode-ray tubes and the coatings of fluorescent lamps. Of particular interest is the possibility of developing a near black fluorescent screen for cathode-ray tubes.

continued overleaf

Published on the first Thursday after the 5th of each month by
ILIFFE ELECTRICAL PUBLICATIONS LTD.
Managing Director: W. E. Miller M.A., M.Brit.I.R.E.
Dorset House, Stamford Street, London, S.E.1.
Telephone: Waterloo 3333.
Telegrams: Wirenger, London, Telex
Cables: Wirenger, London, S.E.1.

ANNUAL SUBSCRIPTION, £3 0s. 0d.,
CANADA and U.S.A. \$8.50.



CHOOSE G.E.C. FOR DISC SEAL VALVES

(take your pick from this complete and remarkable range)

Here is a complete range of disc seal valves offering powers to 1kW and frequencies up to 4000 Mc/s.

In co-axial circuits over the frequency range 500–2000 Mc/s the DET24 gives outputs of 15W to 1W, but several DET24's paralleled in a radial cavity will give increased output at television UHF frequencies. Below 500 Mc/s, simple lumped circuits can be used to give a performance superior to double tetrodes of comparable rating.

	DET22	DET23	DET24	DET29	ACT22	ACT28A
Pout (W)	2.5	2.5	10	1.5	35	1000
frequency (Mc/s)	1500	1500	1000	4000	1000	350
Va (V)	350	350	400	450	600	1500
Fa (W)	10	10	20	10	75	1500

Our technical information centre is ready to help with your application problems. Write for full data sheets on these or other M-O V products, or telephone RIVerside 3431, Telex 23435.

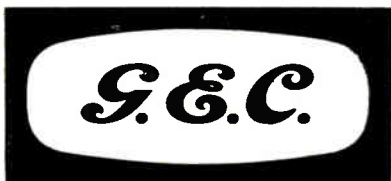

M-O VALVE CO LTD

BROOK GREEN WORKS · HAMMERSMITH · LONDON W6

The first major advance in potentiometer design for years ...

After many years of research and development Reliance now announce an entirely new concept in the design of multi-turn wire wound potentiometers. This, combined with new manufacturing techniques provides extremely low inertia, low torque, high law accuracy and multiple tapping facilities for non linear functions. The unit is available in two distinct separate versions:

1. **SERIES SYN 11-00** A Synchro Mounting Unit incorporating precious metal winding and precision ball races.
2. **SERIES HEL 11-00** A $\frac{3}{8}$ " diameter Bush Mounting version, plain bearing with standard resistance windings, still retaining high electrical characteristics.

- ★ **LINEARITY:** $\pm 0.1\%$ or $\pm 0.25\%$ absolute as required.
- ★ **TAPPING ACCURACY:** $\pm 0.1\%$.
- ★ **MOMENT OF INERTIA:** 0.0004 gm. cm. sec².
- ★ **STARTING TORQUE:** Synchro Mounting Version 3 gm cm. or better.
Bush Mounting Version 1 oz.in. nominal.
or Sealed Version 2 oz.in. nominal.
- ★ **ROTATION LIFE:** Greater than 1,000,000 360 sweeps.

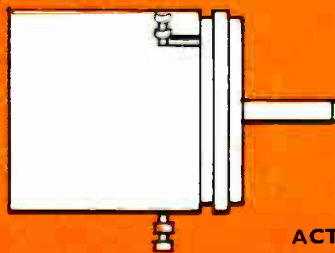
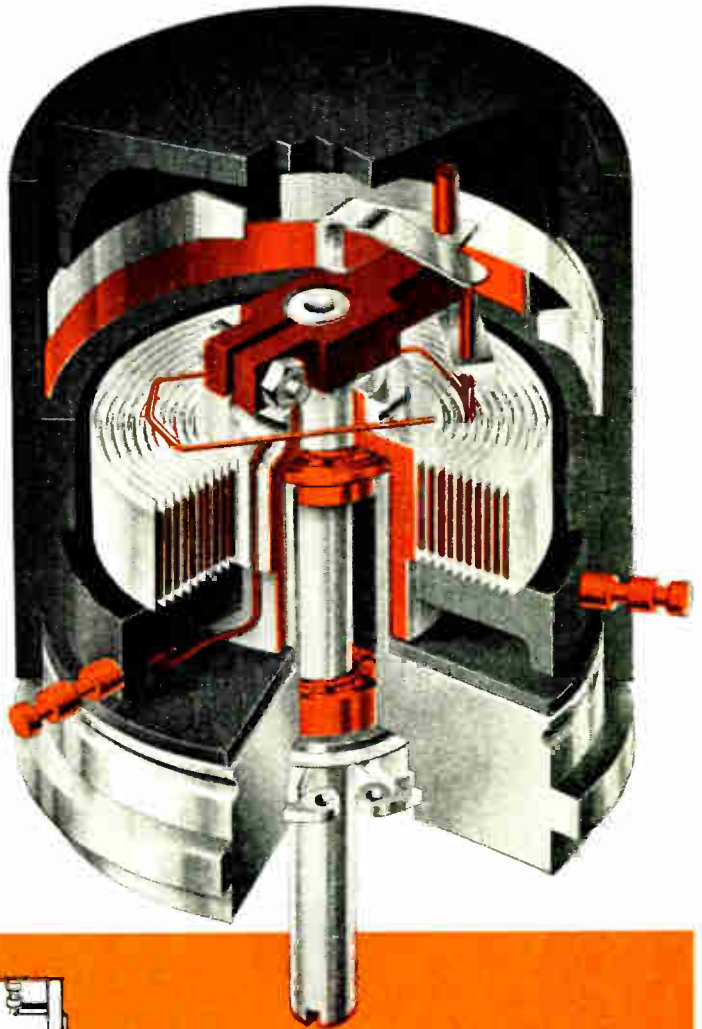

SYN 11-00 SERIES

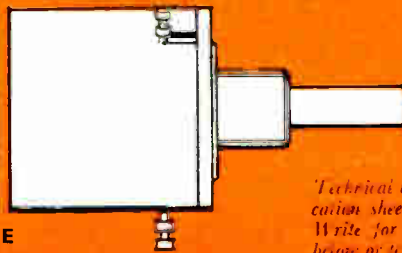

HEL 11-00 SERIES

ACTUAL SIZE

Technical brochure and specification sheets are now ready. Write for them to address below or telephone: LARKSWOOD 84047



Relcon TAKES THE LEAD IN POTENTIOMETERS

RELIANCE CONTROLS LIMITED, RELCON WORKS, SUTHERLAND ROAD, WALTHAMSTOW, E.17

Telephone No. LARKSWOOD 8404/7 · Telegrams: Reltrol, London, E.17

A MEMBER OF THE BOOKER GROUP OF COMPANIES

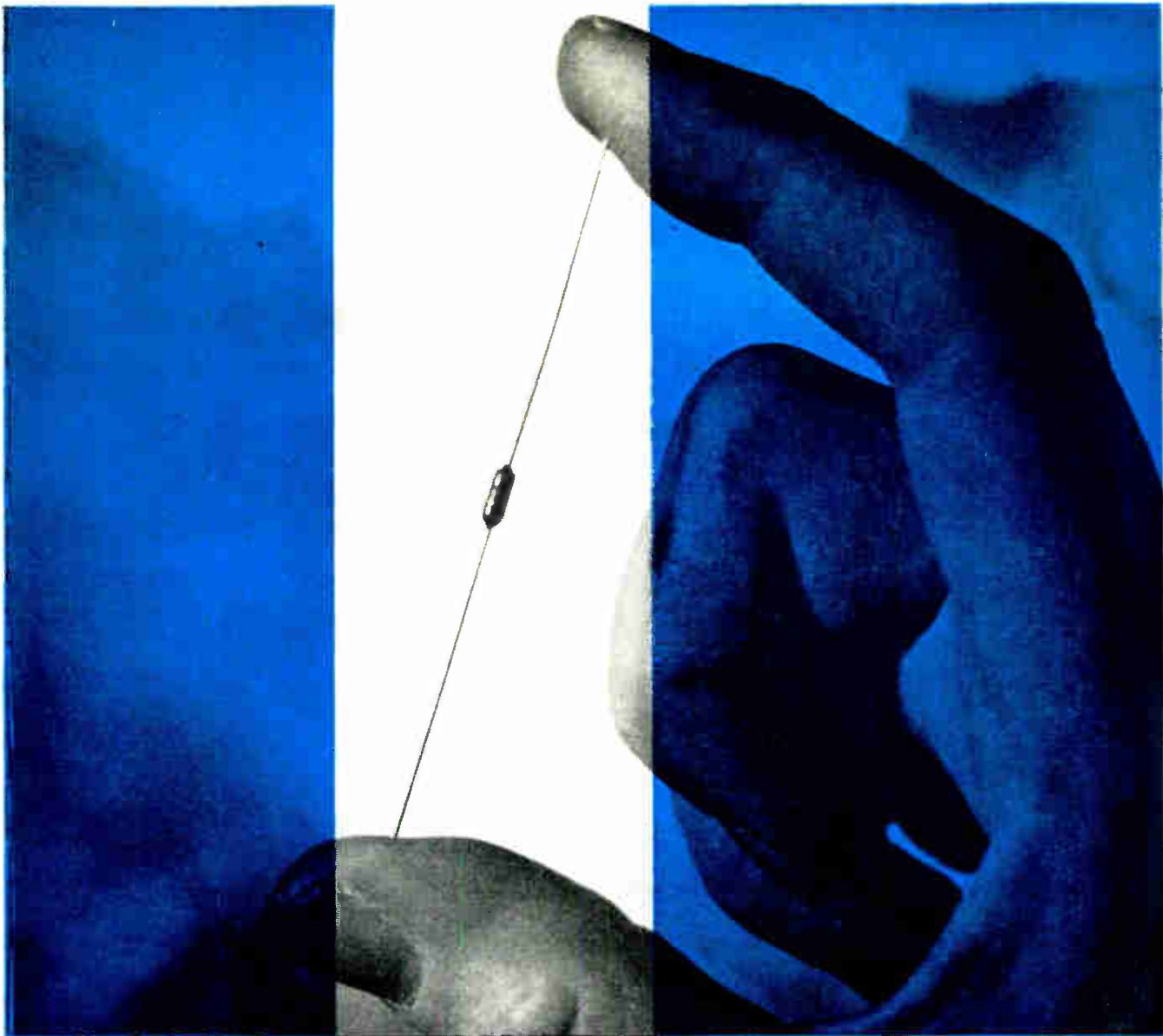

FULL $\frac{1}{4}$ W
RATING
AT 70°C
FROM 51 Ω
TO 150 K Ω

ELECTROSIL C-07 RESISTORS

Metal oxide film on glass substrate gives exceptional stability. Standard tolerances 2%, and 5%. Temperature coefficient does not exceed ± 250 ppm/°C. Average drift is under 1% after 2000 hrs. $\frac{1}{4}$ W @ 70°C. Overall size only 0.250 x 0.090 ins. Exclusive 'Spinseal' insulation gives extreme resistance to moisture or mechanical damage. Colour coded. A 1% version, the $\frac{1}{4}$ W N55, has a temperature coefficient not exceeding ± 100 ppm/°C. For full details of these and other resistors in the Electrosil range, write today—

COLNBROOK BY-PASS



COLNBROOK · SLOUGH · BUCKS
TELEPHONE: COLNBROOK 2196-2996

SOLARTRON

**DECADE PULSE GENERATOR
TYPE GO 1005**

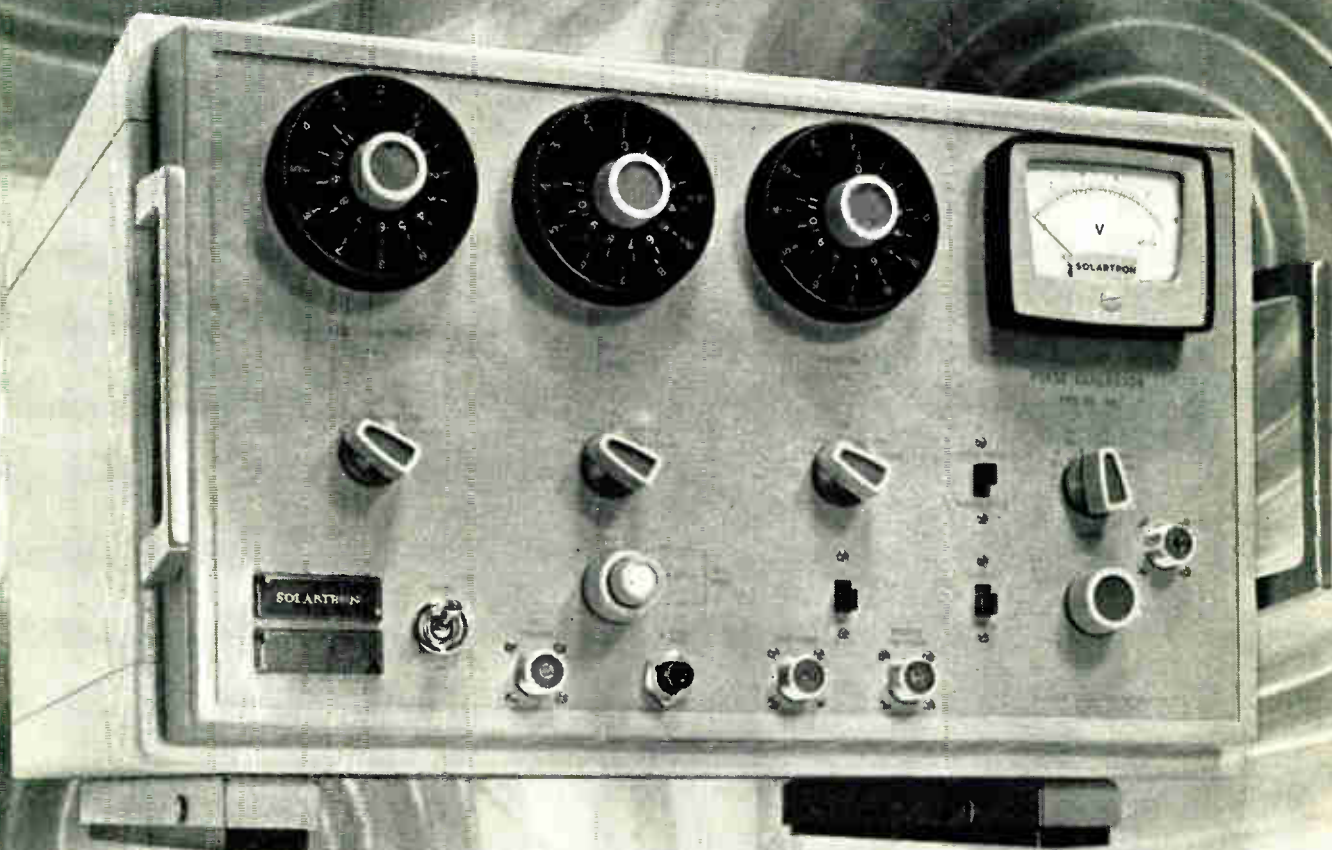

**A tool for progress
in every Industry**



For further information
circle 206 on Service Card

SIGNAL SOURCES

PULSE GENERATORS

Solartron Pulse Generators provide D.C. coupled rectangular pulses with fast rise and fall times and negligible overshoot. Incrementally graduated controls for pulse duration, period and delay ensure high resolution and repeatability of setting; whilst retaining extreme simplicity of operation.

DECADE PULSE GENERATOR GO 1005.
Pulse repetition frequency 10 c/s – 1 Mc/s $\pm 5\%$.
Pulse duration 250 nsec – 100 msec $\pm 5\%$.
Pulse amplitude 0.7 V to 100 V $\pm 3\%$.
Rise time 0.3 volts, 20 nsec.
Pulse delay time 250 nsec – 100 msec $\pm 5\%$.
Direct monitoring of pulse amplitude by means of a $3\frac{1}{2}$ " moving coil meter.

PULSE GENERATOR GO 1101.
Pulse repetition frequency 10 c/s – 500 kc/s $\pm 10\%$.
Pulse duration 1 μ sec – 100 msec $\pm 10\%$.
Pulse Amplitude 0.5 V – 100 V $\pm 10\%$.
Rise time 0.3 volts less than 10 nsec negative going – less than 20 nsec positive going.
Delay time 1 μ sec – 10 msec $\pm 10\%$.
This unit also provides a square wave output from the internal period generator, and will square suitable triggering wave forms.

SINE WAVE OSCILLATORS.

Wide range of sine wave oscillators are available within frequency range from 0.01 c/s to 800 Mc/s.

WIDE RANGE OSCILLATOR CO 546.
Frequency range 25 c/s – 500 kc/s $\pm 1.5\%$ or 1 c/s in five switched ranges.
Harmonic distortion less than 1% .
Hum level less than 0.1% of maximum output.
Output level continuously variable 0–10V r.m.s.
Output attenuator 0–60 dB in 1 dB steps 600 ohms impedance.

R.C. OSCILLATOR CO 1004.2
Frequency range 10 c/s – 1 Mc/s in five ranges Accuracy $\pm 2\frac{1}{2}\%$.
Harmonic distortion less than 1% .
Modulation with hum less than 0.3%.
Balanced output up to 20 V r.m.s. from each side into loads greater than 20 k Ω , –up to 10V r.m.s. into loads of 600 ohms or greater.

LF DECADE OSCILLATOR OS 103.2
0.01 c/s – 10 kc/s.
STABILISED AMPLITUDE SIGNAL GENERATOR DO 905
350 kc/s – 50 Mc/s.
PRECISION SIGNAL GENERATOR D1001
50 kc/s – 860 Mc/s.

THE SOLARTRON ELECTRONIC GROUP LTD. (Instrument Division)
Victoria Road, Farnborough, Hants.
Telephone: Farnborough (Hants) 3000
Telex 8545 Solartron Fnbro.
Cables: Solartron, Farnborough.

M & P S138



SILICON POWER DIODES . . .

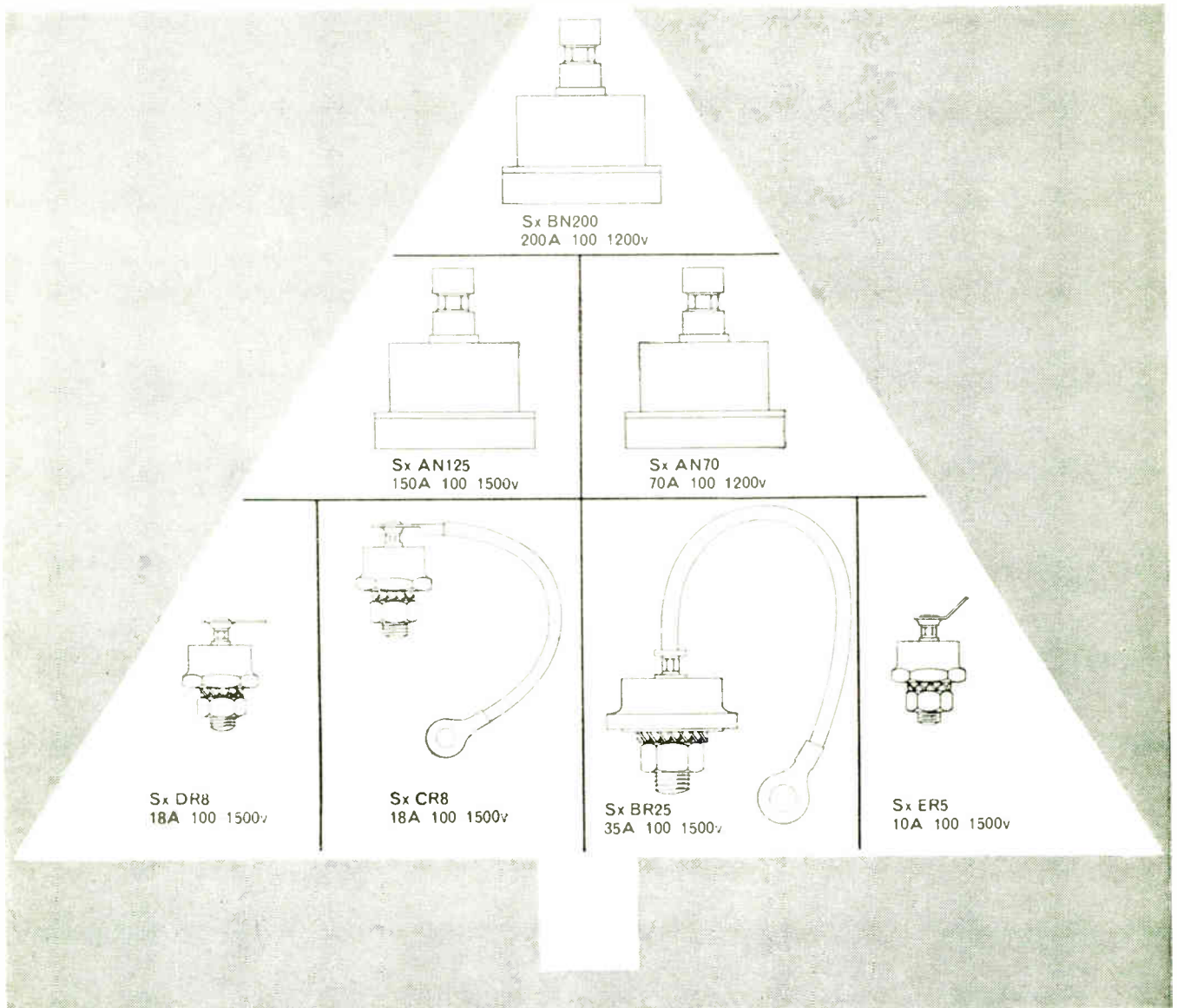

Westinghouse can offer the widest range of silicon power diodes available
Westinghouse can also supply cooling structures for either natural convection or forced-air-cooling to give the best possible rating in the most economical way

Please write for full details to : Dept. 1E 6163 Rectifier Division, Semiconductor Dept.
WESTINGHOUSE BRAKE AND SIGNAL CO LTD
82, York Way, King's Cross, London, N.1. Tel: TERminus 6432 Telex No 2-3225

SPECIFY RELIABILITY WITH ...

H Rugged, sub-miniature
all glass construction

H High conductance

H Low leakage

H Operation up to 200°C

H 

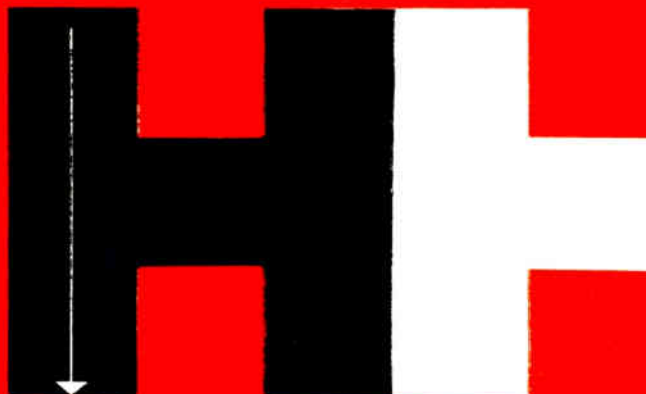

HUGHES INTERNATIONAL (U.K.) LTD

Silicon General Purpose and Computer Diodes

- Extremely low reverse leakage over wide temperature range
- Max. average power dissipation 200mW
- Nominal capacitance at -10V 5pF
- Operating and storage temperature range -65°C to 200°C

CV7040
CV7332

GENERAL PURPOSE DIODES

Type	P.I.V.	Maximum Average Rectified Current (mA)	Max. Reverse Current " 25 C	P.I.V. (μA)	100 °C
HS1020	200	165	0.020	2.0	
HS1001	150	120	0.050	5.0	
HS1004	50	120	0.050	5.0	
HS1007	150	90	0.050	5.0	
HS1010	50	90	0.050	5.0	

- Low capacitance
- Typical recovery time 1.5 nanosec
- Typical stored charge . . 60pC
- Max. Power dissipation (25°C) 250mW

DIFFUSED PLANAR COMPUTER DIODES

Type	Maximum Inverse Voltage	Minimum Forward Current (mA @ 1V)	Max. Reverse Current " 25 C	Max. Reverse Current " V	Maximum Capacitance (pF @ 0V)
1N251	30	5	0.1	10	—
1N252	20	10	0.1	5	2
1N914	75	10	0.025	20	4
1N914A	75	20	0.025	20	4
1N916	75	10	0.025	20	2
1N916A	75	20	0.025	20	2

- Typical recovery time (to 1mA) 0.5 nanosec
- Max. capacitance at 0V 1pF
- Max. power dissipation 75mW

ULTRA FAST RECOVERY COMPUTER DIODES

Type	Min. Breakdown Voltage " -100μA	Maximum Average Rectified Current (mA)	Max. Reverse Current " 25 C	Max. Reverse Current " 100 °C
HD5000	20	12	0.2	2.0
HD5001	20	12	1.0	10.0
HD5004	15	12	1.0	20.0

WRITE NOW for complete data on the full range of Hughes semi-conductor products, which also includes: Silicon Power Diodes and Rectifiers ● Germanium Point-contact and Gold-bonded Diodes ● Voltage Reference Devices ● High Voltage Cartridge Rectifiers ● Voltage Variable Capacitors ● PNP and NPN Silicon Transistors — or ask for a Sales Engineer to call.

HUGHES INTERNATIONAL (U.K.) LTD

KERSHAW HOUSE, GREAT WEST ROAD, HOUNSLOW, MIDDLESEX TEL: HOUNSLOW 5222 MC & P HM16

★ See us at stand no. H.25 at the 1st Industrial and Process Heating Exhibition (Heatex '63), Alexandra Palace, London, June 17-21



THIS IS THE NEW CORREX TRIPAMP —

T5300

MAGNETIC AMPLIFIER? YES! Driving a conventional type relay with 200 mA or up to 300 mA 6 Amp S.P.C.G.

CLOSE DIFFERENTIAL RELAY? YES! The Amplifier can operate from low level signals at any preset value within the operating range and

SWITCHING DIFFERENTIAL IS ADJUSTABLE AS WELL. Over due to coarse (10%) or fine (50%) over its full operating range.

RELIABLE YES! Printed circuit and no thermionics or moving parts apart from the relay which is adequately type tested.

IN ADDITION, IT'S VERSATILE! Having a low input this 2 inch module designed to fit into an Imhof IMRACK or to mount separately in flush panel mounting style, is therefore admirably suitable for operation from primary transducers, i.e. thermocouples, resistance bulbs, photo cells, thermopiles, load cells, magnetic switches, control thermometers, etc.

This versatile unit just 2" x 5¹⁵/₁₆" x 7¹/₄" in size provides a control or trip function on any varying low level monitor signal which is, or can be, converted to direct current ALL FOR JUST £19.16.5d.



PHOENIX TELEPHONES LIMITED
GROVE PARK, LONDON N.W.9
Telephone: COLindale 7243 Telegrams: PHONOFENIX LONDON N.W.9

**A.I.D. &
C.E.G.B.**
Approved

Resistors are no problem - if you're a HARWIN customer

Says Mini Tronic

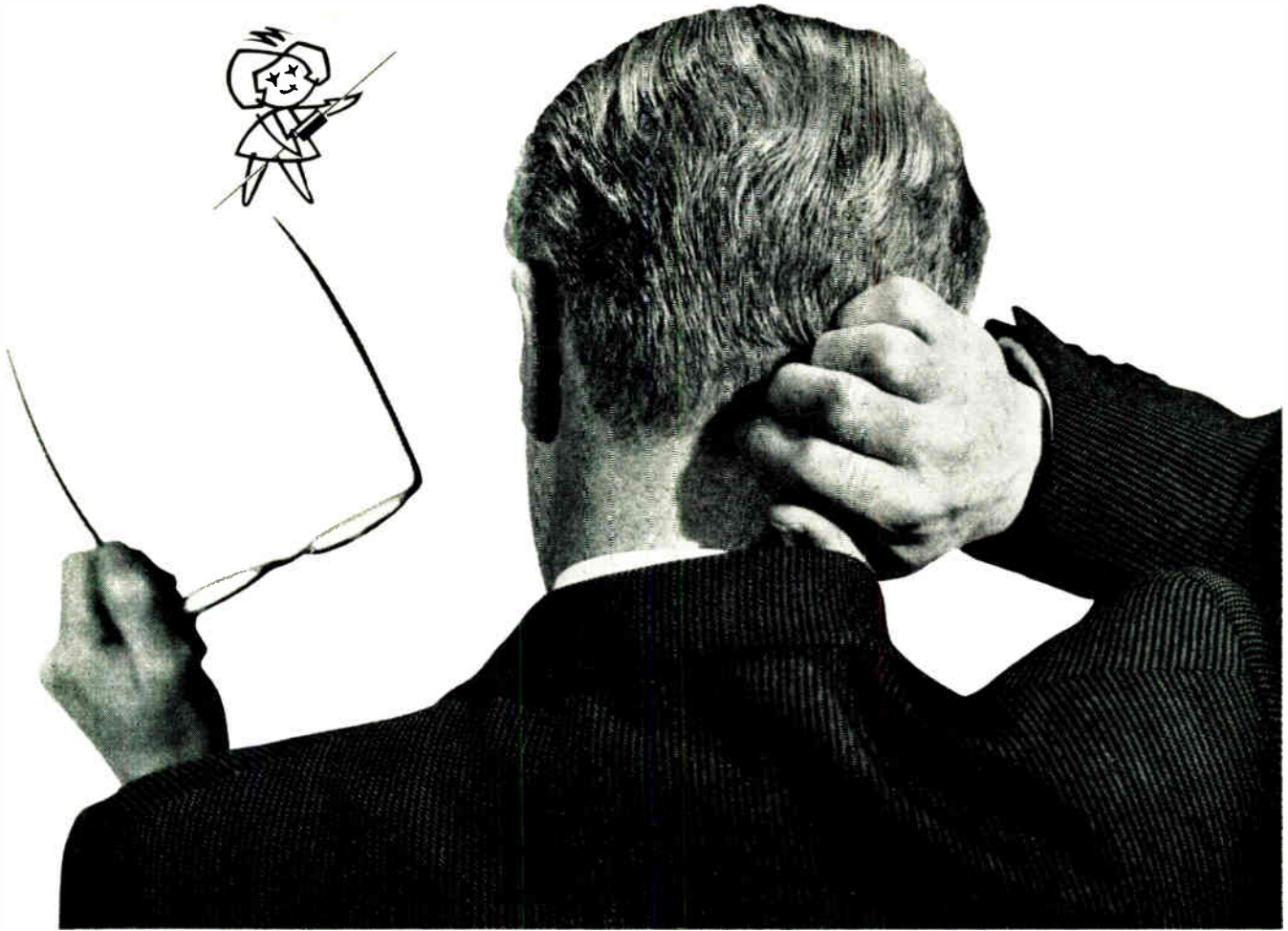

PRECISION WIREWOUND RESISTORS

Resistance Range
1 Ohm to 30 megohms
Tolerance Range
 $\pm 1\%$ to $\pm 0.015\%$
Temperature Coeffi-
cient better than 24
parts per million.



GREAT FOR MINIATURE ELECTRONIC COMPONENTS



HARWIN have a really fine range of precision wirewound resistors with wire or lug terminations, low temperature coefficient, in either normal, encapsulated or hermetically sealed styles. Harwin Engineers' service is unsurpassed, better get in touch with them right away, for a firm price, and reliable delivery or details of our full range.

**HARWIN ENGINEERS LTD · RODNEY ROAD · PORTSMOUTH
HAMPSHIRE · TELEPHONE: PORTSMOUTH 35555 (4 lines)**

HARWIN

CAPACITORS



for all applications

TYPES

DRY ELECTROLYTIC · METALLISED PAPER (HUNTS PATENTS)
METALLISED PLASTIC FILM (HUNTS PATENTS)
PLASTIC FILM · FOIL & PAPER · SILVERED MICA
STACKED MICA · CERAMIC · POWER CERAMIC
TRANSMITTING AND SPECIAL R.F. TYPES

APPLICATIONS

RADIO AND TELEVISION EQUIPMENT · ELECTRONIC EQUIPMENT
POWER FACTOR IMPROVEMENT · CAPACITOR MOTORS
FLUORESCENT LIGHTING · PHASE SPLITTING
H.F. AND R.F. HEATING · IGNITION AND INTERFERENCE SUPPRESSION
TELEPHONE INSTALLATIONS

A. H. HUNT (Capacitors) LTD., WANDSWORTH, LONDON, S.W.18. Tel: VANdyke 6454

Factories also in Essex, Surrey and North Wales

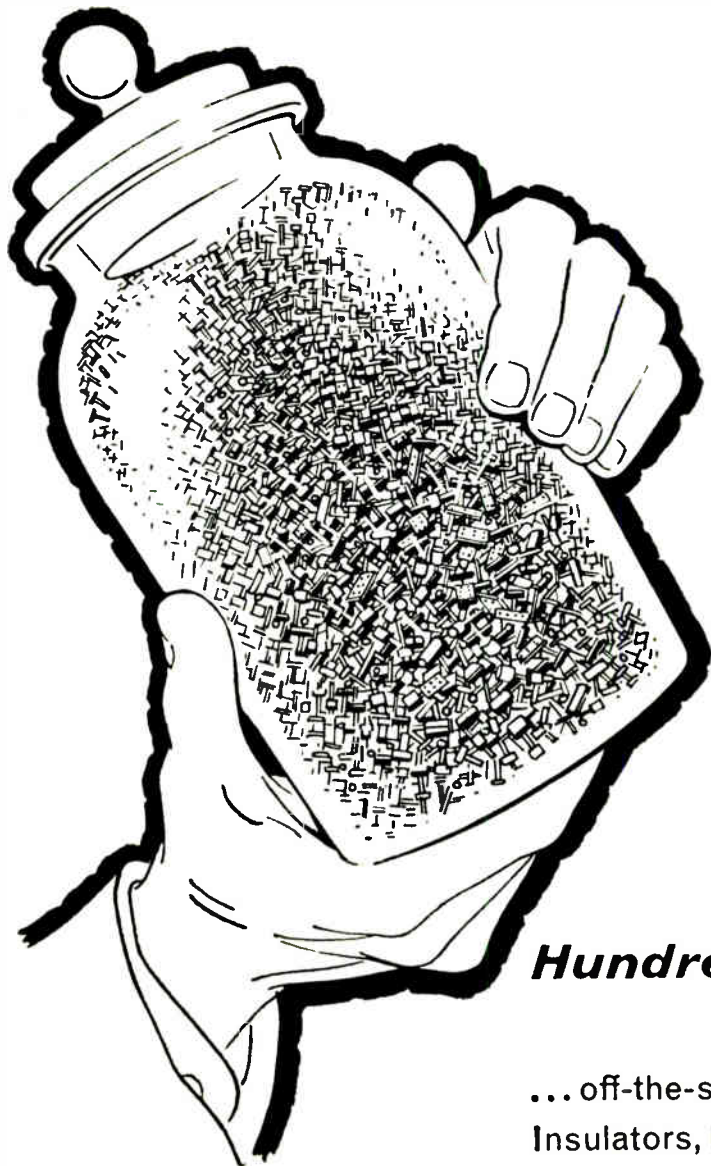

Hundreds and thousands...

...off-the-shelf — or specially designed for *you*.
Insulators, Lugs, Stand-offs, Brackets, Terminal
Boards, Chassis Fittings, etc. Watch-maker
precision, rigid inspection, post-haste service.

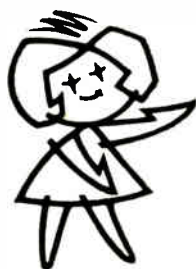

As Mini-Tronic says:
*'When time and space are tight,
HARWIN see you right'*
Just telephone or write

**HARWIN ENGINEERS LTD • RODNEY RD • PORTSMOUTH
HAMPSHIRE • TELEPHONE : PORTSMOUTH 35555 (4 lines)**



GREAT FOR MINIATURE ELECTRONIC COMPONENTS

300 VOLT TANTALUM FOIL CAPACITORS FROM THORN



Tansitor type HV Tantalum capacitors are axial-type foil capacitors specially designed for use at high voltages. They make it possible to operate at 300V in a single cell construction, over a temperature range of -55°C to $+85^{\circ}\text{C}$, or at 250V from -55°C to $+125^{\circ}\text{C}$. Advantages inherent in the type HV series are lower leakage currents, lower power factor and higher capacitance of -55°C and greater stability of capacitance over the entire temperature range. The fact that higher voltages can be carried with one capacitor only means that significant reductions in size can be realised. Meets the requirements of MIL-C-3965B.

TECHNICAL DATA

Case Sizes:	Diameter $3/16''$ to $17/32''$ Length $3/8''$ to $27/8''$
Voltage:	200 VDC to 300 VDC
Temperature Range:	-55°C to $+125^{\circ}\text{C}$
Capacitance:	$0.13\mu\text{F}$ to $35\mu\text{F}$
Tolerance of Capacity:	15%
Polar & Non Polar Construction	

For full details of the complete range of Tantalum Capacitors please write to:-

THORN ELECTRICAL INDUSTRIES LIMITED, SPECIAL PRODUCTS DIVISION, Gt. Cambridge Road, Enfield, Middlesex. Tel: Enfield 5353



DTV13

*When your work
is worthy
of the world's
finest instruments...*

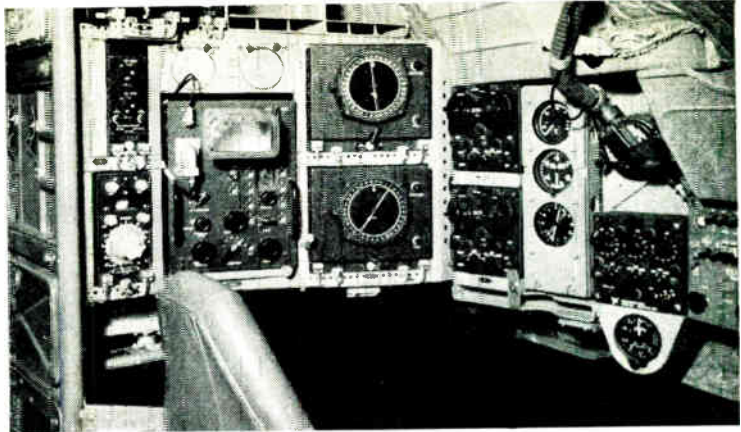

TF 2701

Marconi Instruments FOR BRIDGES

The TF 2701 In Situ Universal Bridge (illustrated) will measure normal resistors, capacitors and inductors; or either component of a parallel R-C combination; or components which form one arm of a three-terminal network. This facility is particularly useful for the measurement of components mounted on printed circuit boards. Bridge source and detector are transistored, operating from internal 9 V batteries.

Measurement. Ranges: 0.002 pF to 11,000 μ F in eleven ranges, 1 μ H to 110 kH in ten ranges, 0.01 Ω to 110 M Ω in nine ranges. Internal frequencies 1 kc/s and 80 c/s.

Price £170

Please write for full particulars of these versatile instruments. Address your enquiries to **Marconi Instruments Limited** at your nearest office.

TF 2700 Universal Bridge

0.5 pF to 1,100 μ F, 0.2 μ H to 110 H at 1 kc/s, 0.01 Ω to 11 M Ω at d.c. L, C or R measurements at a.f., 20 c/s to 20 kc/s with external oscillators.

TF 868B Universal Bridge

1 μ H to 100 H, 1 pF to 100 μ F; at 1 and 10 kc/s. 0.1 Ω to 100 M Ω at d.c.

TF 1313 $\frac{1}{4}$ % Universal Bridge

0.1 μ H to 110 H, 0.1 pF to 110 μ F; at 1 and 10 kc/s. 0.003 Ω to 110 M Ω at d.c.

TF 1342 Low-Capacitance Bridge

0.002 pF to 1,111 pF at 1 kc/s. Shunt resistance: 1 to 1,000 M Ω

TF 1245 Circuit Magnification Meter

Q from 5 to 1,000, 1 kc/s to 300 Mc/s. External oscillators.

TF 704C Dielectric Test Set

Precise determination of permittivity and power factor in dielectrics from 50 kc/s to 100 Mc/s

A GOOD NAME FOR GOOD MEASURE

Area Offices:

English Electric House, Strand, London, W.C.2. Telephone: COVent Garden 1234
40 Whiteladies Road, Bristol 8. Telephone: Bristol 39639
23/25 Station Square, Harrogate Telephone: Harrogate 67454

Head Office—Home and Export Sales:

St. Albans, Herts., England. Telephone: St. Albans 59292

**MARCONI
INSTRUMENTS**

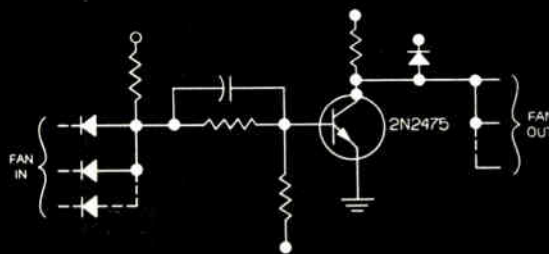

Achieve ultra-high switching speeds at currents up to 100 ma

WITH NEW RCA SILICON PLANAR EPITAXIAL 2N2475

Now, RCA combines the latest silicon technology, including planar epitaxial structure and subminiature junctions, in the ultra-high-speed 2N2475. Check these outstanding features:

- Ultra-High Frequency Capability...Gain-Bandwidth Product—800 Mc typical
- High Beta At High Currents...Min h_{FE} of 20 at $I_C = 50$ ma
- Low Saturation Voltage... $V_{CE}(\text{Sat}) = 0.4$ volt max.
- Low Output Capacitance...(C_{ob}) = 3 pf. max.
- Low Charge Storage Time...(t_s) = 6 nsec. max.
- Short Turn-On Time...(t_{on}) = 20 nsec. max. at $I_C = 20$ ma
- Short Turn-Off Time...(t_{off}) = 15 nsec. max. at $I_C = 20$ ma

The exceptional stability and ruggedness of the planar epitaxial structure, and its combination of outstanding performance features make the 2N2475 an excellent choice for switching applications. This transistor is available for immediate delivery in production quantities.

Call your RCA Representative today for further information on the 2N2475, and ask him about RCA's broad line of Silicon Planar Epitaxial Transistors, now including the RCA

2N709. For additional technical data, write

RCA Great Britain Ltd. Sales Division,

Lincoln Way, Windmill Road, Sunbury-on-Thames, Middlesex

ELECTRICAL CHARACTERISTICS AT 25°C

	MIN.	MAX.	UNITS
h_{FE} ($I_C = 1.0$ ma, $V_{CE} = 0.3$)	20	—	—
h_{FE} ($I_C = 20$ ma, $V_{CE} = 0.4$)	30	150	—
h_{FE} ($I_C = 50$ ma, $V_{CE} = 0.5$)	20	—	—
I_{CBO} ($V_{CB} = 5V$, $I_E = 0$)	—	0.05	μa
V_{CE0} (S_{VS}) ($I_C = 10$ ma, $I_B = 0$ Pulsed)	6	—	volts
C_{ob} ($V_{CB} = 5V$, $I_E = 0$)	—	3.0	pf
t_s ($I_C = I_{B1} = I_{B2} = 5$ ma)	—	6	nsec
t_{on} ($I_C = 20$ ma, $I_{B1} = I_{B2} = 1$ ma)	—	20	nsec
t_{off} ($I_C = 20$ ma, $I_{B1} = I_{B2} = 1$ ma)	—	15	nsec
h_{fe} ($I_C = 20$ ma, $V_{CE} = 2V$, $f = 100$ Mc)	6	—	—



THE MOST TRUSTED NAME IN ELECTRONICS

FOR FULL DETAILS AND SPECIFICATION PLEASE WRITE OR PHONE

RCA GREAT BRITAIN LIMITED, Sales Division, Lincoln Way, Windmill Road, Sunbury-on-Thames

ASSOCIATE COMPANY OF RADIO CORPORATION OF AMERICA.

Telephone: Sunbury 5511

FERRANTI MICRONOR

MINIATURISED

SOLID STATE CIRCUITS
NOW AVAILABLE

- VERY LOW DELAY TIMES (ZSS1A & ZSS2A) 15nSec typical
- HIGH RELIABILITY PLANAR TECHNIQUES
- CONVENTIONAL CIRCUIT ASSEMBLY-8 LEAD TO-5 BASE (SB-8-1)
- LARGE OUTPUT VOLTAGE SWING (ZSS1A & ZSS2A) 1.5v
- HIGH POWER OUTPUT (ZST2A) 30v, 100mA
- HIGH PACKING DENSITY REDUCED HEIGHT TO-5 ENCAPSULATION
- NO MONITORING PROBLEMS—COLLECTOR COMMON TO CASE

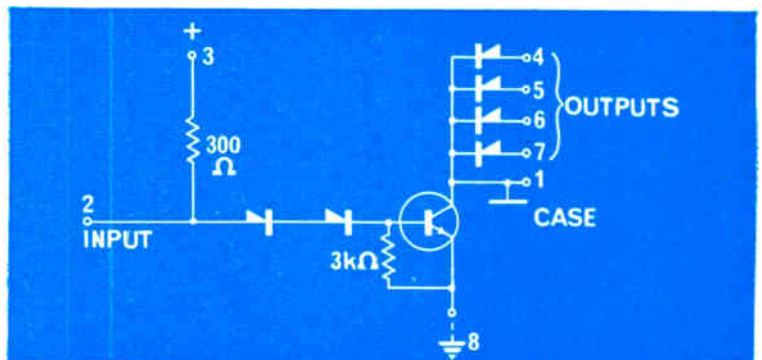

(ZSS1A) SINGLE ENTRY NOR GATE

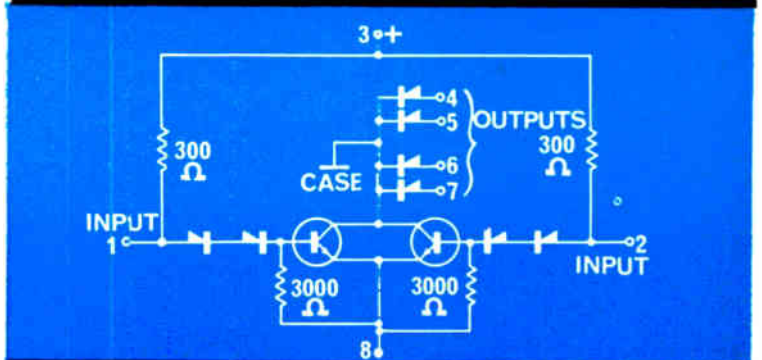

(ZSS2A) DOUBLE ENTRY NOR GATE

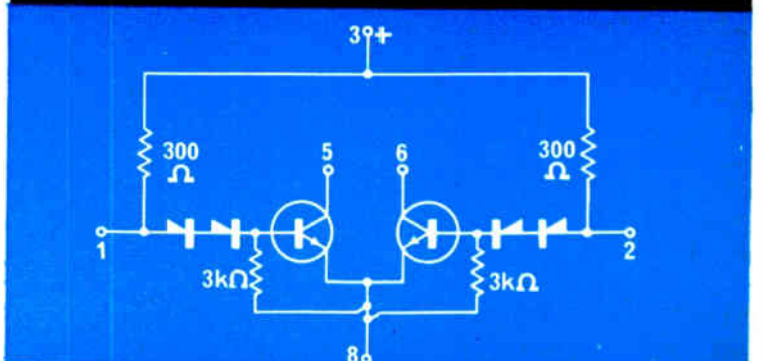

(ZST2) TWIN POWER DRIVER

The numbers in the above diagrams indicate the lead numbers.

Write now for information to:

FERRANTI LTD · GEM MILL
CHADDERTON · OLDHAM · LANCS
Telephone : MAIn 6661
London Office Telephone : TEMple Bar 6666

FERRANTI
First into the Future



**HIGH SPEED PRINTER
TYPE ED 1176**

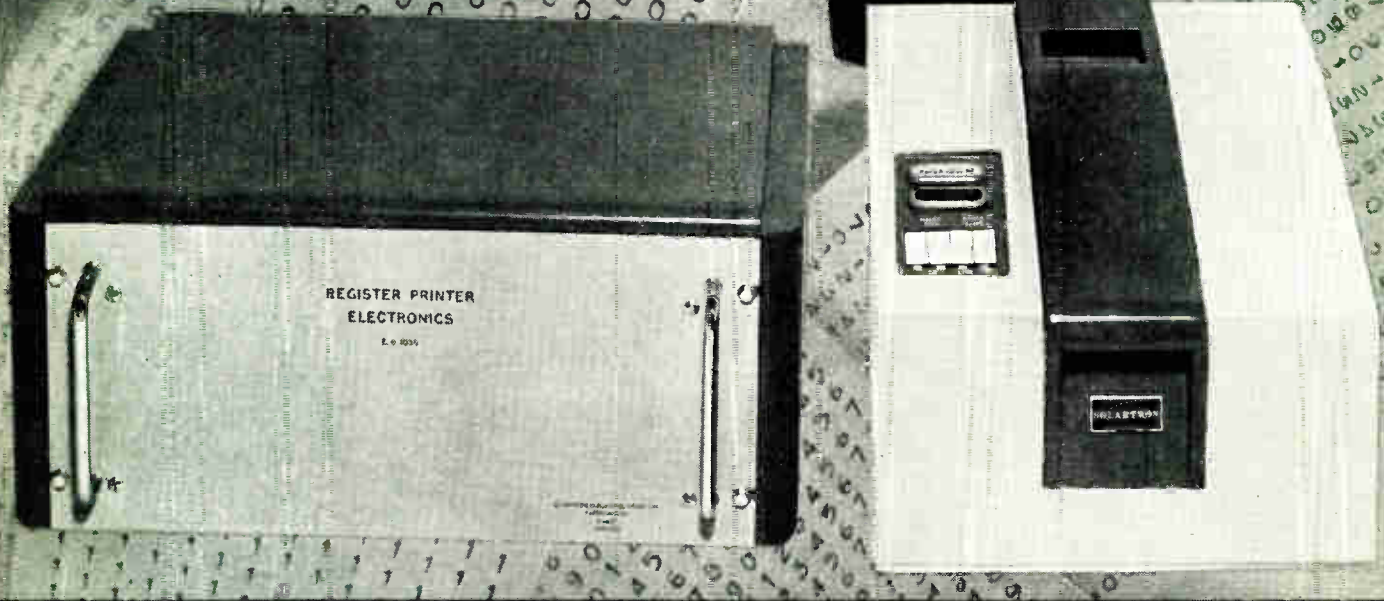

**A tool for progress
in every Industry**



For further information
circle 217 on Service Card

HIGH SPEED PRINTERS

Solartron High Speed Printers were the first equipment of this type in the £1,000 price range to offer recording speeds of 10 lines/sec., each line containing 14 characters. Simplified mechanical design together with continued development ensures the high degree of reliability of Solartron High Speed Printers. This unique facility is now offered with the Solartron ED.1175 and Solartron ED.1176 Printers.

The Solartron Register Printer ED.1176 allows significantly higher effective print speeds than are obtainable from a printer of the direct type. The Printers can be 'printing out' during the time that the data gathering system is deriving information for the next reading.

In both Printers 15 characters are located on each of 14 continuously rotating print wheels which are struck as required by mechanically operated hammers. An ordinary typewriter ribbon is fed between the paper and the print wheels. Print out is on a strip of paper $2\frac{5}{8}$ " (6.7 cm) wide. The normal paper supply is in rolls

but facilities for fan-fold may be made available. The control electronics is contained in a case separate from the print head and is suitable for standard rack mounting.

SPECIFICATION:

Speed: 10 lines/sec.

Number of columns: 14

Characters: 0123456789+-.*/ and blank

Column pitch: 6 per inch (0.424 cm/column)

Line pitch: 6 per inch (0.424 cm/line)

Paper: $2\frac{5}{8}$ " (6.7 cm) wide, roll or fan-fold

Inking: Normal typewriter ribbon

Dimensions: *Print Head* $8\frac{1}{2}$ " high x $11\frac{1}{8}$ " wide x 15" overall free standing 21.6 cms x 28.2 cms x 38 cms

Electronics Unit (for rack mounting) $8\frac{3}{4}$ " high x 19" wide x 14" deep 22.2 cms x 48.2 cms x 35.6 cms.

INPUT REQUIREMENTS:

DIRECT PRINTER ED.1175

Parallel decimal

(one-out-of-N 15 wires per column)

Information to be maintained for at least 80mS after print command

REGISTER PRINTER ED.1176

Parallel decimal

(one-out-of-N 15 wires per column)

or parallel binary coded decimal

(4 wires per column)

'Write' command causes information to be stored within about 1mS after which input information may be released.

Significant wires between -6V and -12V, others at earth

Write for explanatory leaflet
giving full details.

THE SOLARTRON ELECTRONIC GROUP LTD., (Systems Division)

Victoria Road, Farnborough, Hants.

Telephone: Farnborough (Hants) 3000

Telex 8545 Solartron Fnbro.

Cables: Solartron, Farnborough

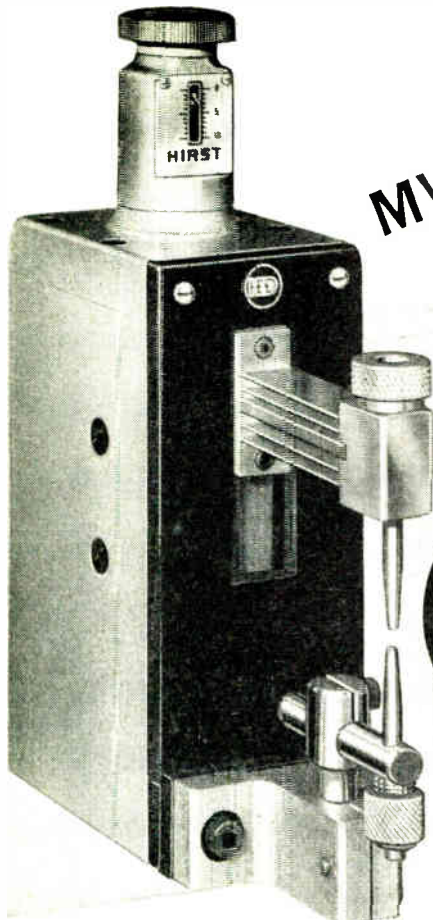

MV1 PRECISION MICROMINIATURE WELDING HEAD

for the welding of miniature and micro-miniature modules and fine wire work

The problem of welding 'more and more' of 'less and less' has been closely studied by HED and the MV1 Head is the result of many years' research and welding 'know-how'. Distinctive features include: For currents up to 2,000 amps or higher with energy storage. Vertical Head Action ensuring linear electrode movement eliminating any wiping action. Excellent visibility at electrodes. Ultra sensitive action. Ideal for glove box applications for welding in dust-free controlled temperatures.

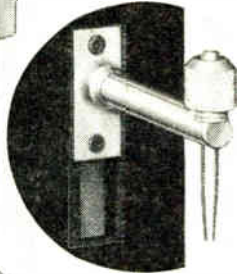

CAPACITOR DISCHARGE MAGNETISING EQUIPMENT

for the rapid and consistent charging of magnets and magnet assemblies

This equipment together with a range of standard jigs has been developed to provide very high magnetic forces by using multi-turn coils and also current transformers with one turn secondaries. The very wide range of power control enables both small and large magnets to be charged from the same power unit. Due to the high peak magnetising forces available, magnets with high coercive characteristics and ceramic magnets can be saturated without difficulty.



Stand 477

REC-MF EXHIBITION

RESIN CASTING and ENCAPSULATION

With many years' experience in the production of toroids and coils for use in units of their own manufacture, HED are now fully equipped for the production of potted circuits and mechanical mouldings including Encapsulated Electronic Circuits, High Voltage Bleeder Resistor networks and potential dividers; impregnation of low and high voltage transformers and coils; encapsulated delay lines; instrument type current transformers; electro-mechanical units, etc.

★ *Technical representatives will be on the stand for consultation and advice. Literature available on request.*



HIRST ELECTRONIC LTD.

GATWICK ROAD, CRAWLEY, SUSSEX.

Crawley 25721-2-3-4

COMPONENTS REVIEW

JUNE 1963

WORLD'S FASTEST COLD CATHODE TRIGGER TUBE

The special gas mixture and structure, incorporating a biased shield electrode and priming discharge gap, enables the G1/371K tube to achieve ionization times of less than 5 μ sec and recovery times as low as 10 μ sec: figures several orders smaller than those obtained with most tubes in this category.

These remarkably short times permit the use of circuitry with small time constants, resulting in squarer wave-forms and allowing high operating speeds.

The tube may be used for a variety of purposes including square, exponential and saw-tooth pulse generators, count rate meters and in gate, flip flop and counter circuits: indeed this tube can be used in a special ring counter at input frequencies up to 100 kc/s.

The G1/371K is being used in a variety of equipments, including the STC CADF (Commutated Aerial Direction Finder) which, instead of having a mechanically rotated aerial, has aeriels electronically selected in high speed rotation. Using two or more CADF units spaced apart, a fix on an aircraft position can be displayed on a cathode ray tube immediately the aircraft transmitter is operated.



Trigger tube G1 371K

B7G Base

Abridged Data

Anode supply voltage	270 to 360 V
Anode maintaining voltage	180 V
Cathode current, average	2 to 10 mA
Trigger bias	0 to 165 V
Trigger voltage	
(a) for ionization within 25 μ sec	185 V
(b) for ionization within 5 μ sec	195 V
Priming gap current	0.2 to 0.5 mA

Write, 'phone or Telex for Application Report MS/118 to STC Valve Division, Brixham Road, Paignton, Devon or London Sales Office, Footscray, Kent. Telephone FOOTscray 3333. Telex 21836.

Industrial Electronics June 1963

miniature SELENIUM RECTIFIERS for low-cost reliability

STC miniature selenium rectifiers are designed for use in electronic circuits calling for a diode of good reverse/forward resistance ratio and closely controlled characteristics. When used in place of thermionic valves, these rectifiers virtually eliminate problems of heat dissipation and a.c. hum, and save the cost of provision of heater power, valve bases and associated wiring. Of small size, they are easily accommodated in circuits and are suitable for most applications including modulators and demodulators, discriminators, logical circuits, limiting diodes, asymmetrical resistors, etc.

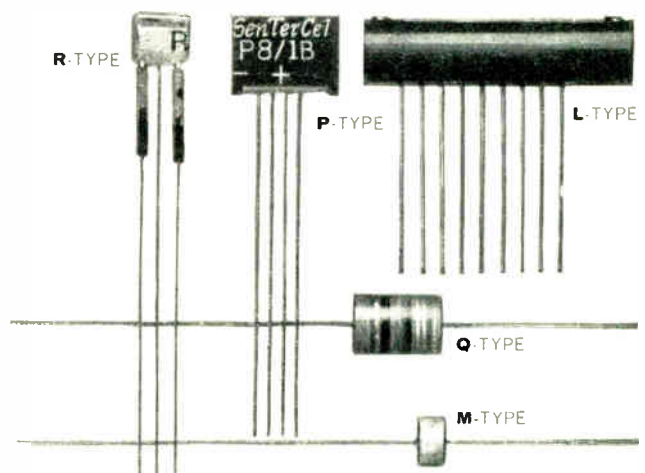

Actual size

Type	Description	Remarks
M	Single plate in aluminium case, available with insulating sleeve if required.	Half-wave devices fitted to axial leads.
T	Two aluminium case sizes. One or two plates or from three to five plates.	
Q	Up to five plates in series in moulded nylon case.	
MQ	As for Q but: hermetically sealed and tropicalized ceramic case.	Available in half-wave, doubler, push pull or bridge configuration with multiple leads.
P	Up to five plates in moulded rectangular plastic case shaped for automatic insertion.	
R	A skeleton form of P for use in restricted space.	
L	Cylindrical case in two sizes for up to ten or up to twenty plates.	

The Rectifier plates are of four basic types and their characteristics and ratings offer a wide range of voltage and current selection.

Write, 'phone or Telex for data sheets and applications booklet to: STC Rectifier Division, Edinburgh Way, Harlow, Essex. Telephone Harlow 26811. Telex 81146.



SILICON PLANAR DOUBLE TRANSISTORS RANGE EXTENDED

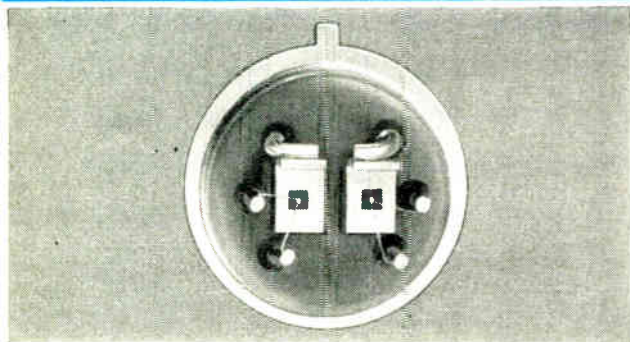

The range of STC silicon planar double transistors has now been increased to four devices including both matched and unmatched pairs. Each pair is mounted on a 6-lead header and encapsulated in a TO-5 case, the transistors being electrically isolated.

BFY20. This is a matched pair of BFY18 silicon planar transistors. The common mounting minimizes the temperature difference between the two transistors, making the device ideal for use in d.c. amplifiers.

Brief Data

f_T	($V_{CE} = 9V, I_C = 10mA$)	245 Mc/s	(Typ)
I_{CBO}	($V_{CB} = 9V, I_E = 0$)	10 nA	(Max)
h_{FE}	($I_C = 100\mu A, V_{CB} = 0$)	10	(Min)
V_{BE}	(matched to within)	10 mV	
P_{CM}	(total)	600 mW	

BFY21. This is similar to the BFY20 but the two transistors are unmatched. It is suitable for use in circuits where two v.h.f. amplifiers are required to work in close proximity.

BSY42. A pair of silicon epitaxial planar transistors of the BSY26, BSY27, 2N708 class for use in v.h.f. switching circuits at mean current levels up to 100 mA.

Brief Data

f_T	($V_{CE} = 9V, I_C = 10mA$)	200 Mc/s	(Min)
I_{CBO}	($V_{CB} = 9V, I_E = 0$)	25 nA	(Max)
h_{FE}	($V_{CE} = 2V, I_C = 10mA$)	25 - 120	
V_{BE}	($I_C = 10mA, I_B = 1mA$)	0.9 V	(Max)
P_{CM}	(total)	600 mW	

BSY43. A pair of silicon epitaxial planar transistors of the BSY28, BSY29, 2N743, 2N744 class. This is similar to the BSY42 but is intended for use at higher frequencies.

Brief Data

f_T	($V_{CE} = 9V, I_C = 10mA$)	300 Mc/s	(Min)
I_{CBO}	($V_{CB} = 9V, I_E = 0$)	50 nA	(Max)
h_{FE}	($V_{CE} = 2V, I_C = 10mA$)	25 - 120	
V_{BE}	($I_C = 10mA, I_B = 1mA$)	0.85 V	(Max)
P_{CM}	(total)	600 mW	

Write 'phone or Telex for the latest Data Sheet to STC Transistor Division, Footscray, Sidcup, Kent. Telephone FOOTscray 3333. Telex 21836.

STC NOW MARKET JFD PRODUCTS

To supplement the range of high quality components manufactured by the Capacitor Division, the decision has been taken to market Variable Piston Trimmer Capacitors and other components of the JFD ELECTRONICS CORPORATION OF NEW YORK. The agency covers the United Kingdom and the other countries in the European Free Trade Area (Austria, Denmark, Finland, Norway, Portugal, Sweden and Switzerland).

The quality of JFD products is in keeping with that of STC's and they are used extensively in military, commercial and industrial projects throughout the US and Canada. A high degree of uniformity and reliability is maintained by JFD Quality Control Engineers and comprehensive environmental tests ensure conformity to the applicable requirements of MIL-C-14409A.

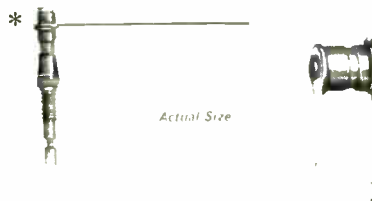

* Pin-Trim Series — world's smallest piston trimmer capacitor

VARIABLE PISTON TRIMMER CAPACITORS

These consist of a highly stable dielectric cylinder of glass, quartz or ceramic containing a piston assembly which gives a completely linear tuning characteristic. There are hundreds of standard units ranging down to the PIN-TRIM series which are the smallest piston capacitors in the world.

METALLIZED INDUCTORS

The metallized inductors utilize a silver film fired permanently on to a glass cylinder and offer the ultimate in inductor simplicity and stability. They have a high Q over a broad frequency and temperature range and unusually high stability under conditions of severe shock and vibration and over a wide temperature range.

LC TUNERS

Combining a precision variable piston capacitor with a metallized inductor, JFD LC-tuners provide an exceptionally compact tunable circuit.

DELAY LINES

There is a large selection of both Lumped Constant and Distributed Constant delay lines available for either printed circuit or conventional mounting.

Stocks of all these components will be maintained in the United Kingdom.

Write, 'phone or Telex for catalogues to STC Capacitor Division, Brixham Road, Paignton, Devon or London Sales Office, Footscray, Kent. Telephone FOOTscray 3333. Telex 21836.

COMPONENTS REVIEW

VAPOUR COOLED TRIODE

The Type 3Z/253E is a power triode with mesh construction of filament and grid. Having an amplification factor of 36 and a mutual conductance of 50 mA/V, this valve has remarkably low drive power requirements. For example, a pair of valves operating in push-pull will develop 30 kW of output power in class AB1 or 90 kW in class AB2 (with 450 W total drive power) and hence are ideal for high power vibrator applications.

The coaxial connexions to grid and anode permit operation at high frequencies (50 Mc/s maximum at 12kV anode voltage) and a typical performance in the Class C grounded-grid mode is 40 kW output for 4 kW cathode drive power.

ABRIDGED DATA

TYPE	V _i (V)	I _i (A)	μ	gm (mA/V)	P _a MAX. (kW)	P _o MAX. (W)
3Z/253E	8	125	36	50	24	500

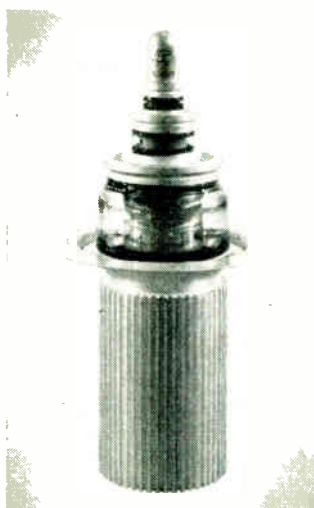

Boilers with internal or external condensers are available. Forced-air cooled or water cooled versions can also be supplied under codes 3J 253E and 3Q 253E respectively.

Vapour Cooled Triode Type 3Z/253E

For full details write or 'phone for Data Sheets to STC Valve Division, Brixham Road, Paignton Devon or London Sales Office, Footscray, Kent. FOOTscray 3333.

Write, 'phone or Telex for Booklet M/103 which outlines the ranges of STC Components and lists the technical publications available.

IEC FERRITE POT CORES

STC have introduced a range of Ferrite Pot Cores which conform in dimensions to the International Electro-Technical Commission proposals for standard Ferrite Inductor Cores.

The first of such cores, size 18 mm x 11 mm, is now in production. Samples are available from stock, and are offered in three standard permeability levels; two of which are provided with an inductance adjustment assembly which lies completely within the confines of the Ferrite Core. A typical example is described in the table below.

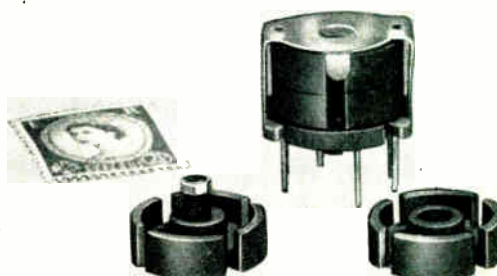

TYPICAL CORE CHARACTERISTICS

Code	Core size	Specific Inductance Nano Henries per turn without adjustor	Effective Permeability	Nominal Air Gap	Temperature Coefficient
E/18/11/160 SA 500	18 mm dia. 11 mm height	160 3%	73 3%	0.275 mm	Less than + 120 P.P.M. per C between 10 C to 60 C
E/18/11/315 SA 500	18 mm dia. 11 mm height	315 3%	145 3%	0.1 mm	Less than + 240 P.P.M. per C between 10 C to 60 C
E/18/11/2800 SA 500	18 mm dia. 11 mm height	2 800 25%	1 300 25%	Nil	Less than + 2 000 P.P.M. per C between 10 C to 60 C

The cores, with air gaps, are provided with an inductance adjustment assembly which enables the inductance to be set, using a non-magnetic screw-driver, after assembly of the coil. This provides a minimum adjustment range of 8% and a maximum of 16% through 5 turns of the adjusting screw.

TYPICAL Q VALUES

Code	Inductance	Frequency	Q
E/18/11/160 SA 500	3 Milli Henries 500 Micro Henries	100 Kc/s 200 Kc/s	400 400
E/18/11/315 SA 500	1.5 Henries 25 Milli Henries	10 Kc/s 30 Kc/s	100 300

Coil former, terminal plates and spring clamp can be supplied if required.

For full details of these new ferrites, write, 'phone or Telex STC Magnetic Materials Division, Edinburgh Way, Harlow, Essex. Telephone Harlow 21421. Telex 81146.



Standard Telephones and Cables Limited

COMPONENTS GROUP · FOOTSCRAY · SIDCUP · KENT

Telephone FOOTscray 3333 Telex 21836

S32A gains new important feature



In order to derive maximum benefit from the latest wide band version of the S32A Serviscope* an H.F. Synchronisation facility has been added to the triggering arrangements. Otherwise the specification of the S32A remains unchanged. The following is a brief summary. (A leaflet giving full details will be supplied on request).

CRT: 3" flat-faced PDA operating at 3.5kV. Mounted at an easy viewing angle.

AMPLIFIER: Dual Range DC—10Mc/s at 100Mv/cm; DC—1Mc/s at 10Mv/cm.
INPUT ATTENUATOR: Calibrated direct reading in volts/cm, from 10mV/cm to 50V/cm. AC or DC input.

TIME BASE: Calibrated, with 18 pre-set sweep speeds from 1μ sec/cm—1 sec/cm. Variable control for intermediate speeds.

TRIGGERING: Automatic or selective. TV and HF sync. positions.

DIMENSIONS: 13½" x 8" x 6½".

WEIGHT: 16 lbs.

PRICE: £72.

Ask for our Short Form Catalogue, or for full details of individual instruments.

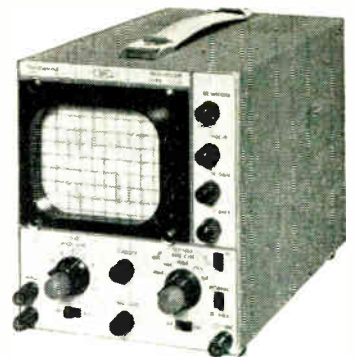

S51 Single-beam Serviscope* for industrial and educational use. £45.

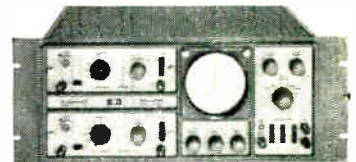

D33R Rack mounted double-beam oscilloscope with interchangeable Y amplifiers. £125 with general purpose amplifier.

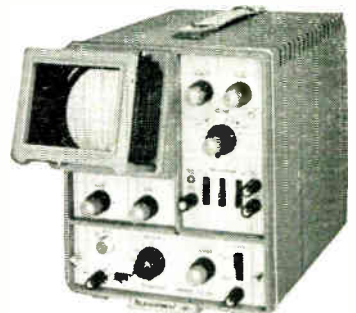

S43A Single-beam wide band laboratory oscilloscope with interchangeable Y amplifiers. £92 with general purpose amplifier.

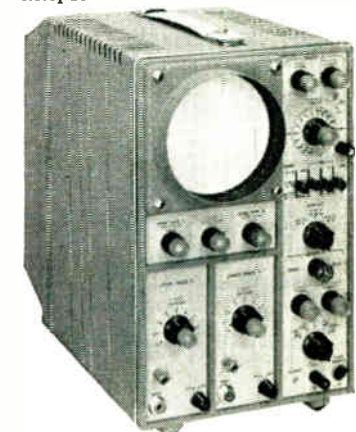

D55A Double-beam oscilloscope with trigger delay, for advanced laboratory applications and computer industry. £260.

TELEQUIPMENT

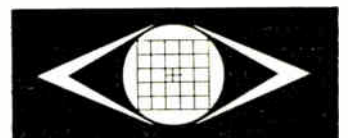

* Serviscope is a registered trade mark of
 Telequipment Limited, 313 Chase Road, Southgate, N.14. Fox Lane 1166

If it calls for transient storage then it calls for **CAWKELL**

- leaders in storage instrumentation!

REMSCOPE 741 with plug-in amplifiers

The most flexible instrument of its kind costing no more than a good ordinary oscilloscope. Unique events or high-speed transients can be stored for up to a week, with 5 to 10 minutes display whenever desired. Choice of single-beam, double-beam, or multi-trace display by means of interchangeable plug-in amplifiers:—

**2-CHANNEL
BEAMSWITCH
AMPLIFIER
TYPE 741 2**

Allows 2 simultaneous phenomena to be displayed for comparison. Direct coupled. Differential input.

Price: £120

**TRACE
SHIFTER
AMPLIFIER
TYPE 741 1**

For easy comparison of sequential signals. 2, 4, or 8 steps. Min. interval between steps 5µs.

Price: £75

**Y
AMPLIFIER
TYPE
741 3**

For normal single-beam display. Band-width 1.5 Mc/s which is consistent with writing speed.

Price: £38

When Cawkell produced the storage channels used for the 'ZETA' experiments at Harwell they became the first company to manufacture storage oscilloscopes in the United Kingdom. As leaders in the field, Cawkell are in a unique position to advise on problems involving the capture and retention of high-speed phenomena. In the photograph below, the Cawkell Remscope 741 is being used to record the angular acceleration of a diesel engine by an electric motor under Arctic conditions. This information can be stored for up to a week for detailed study whenever required.

Basic Price (without amplifiers) £612

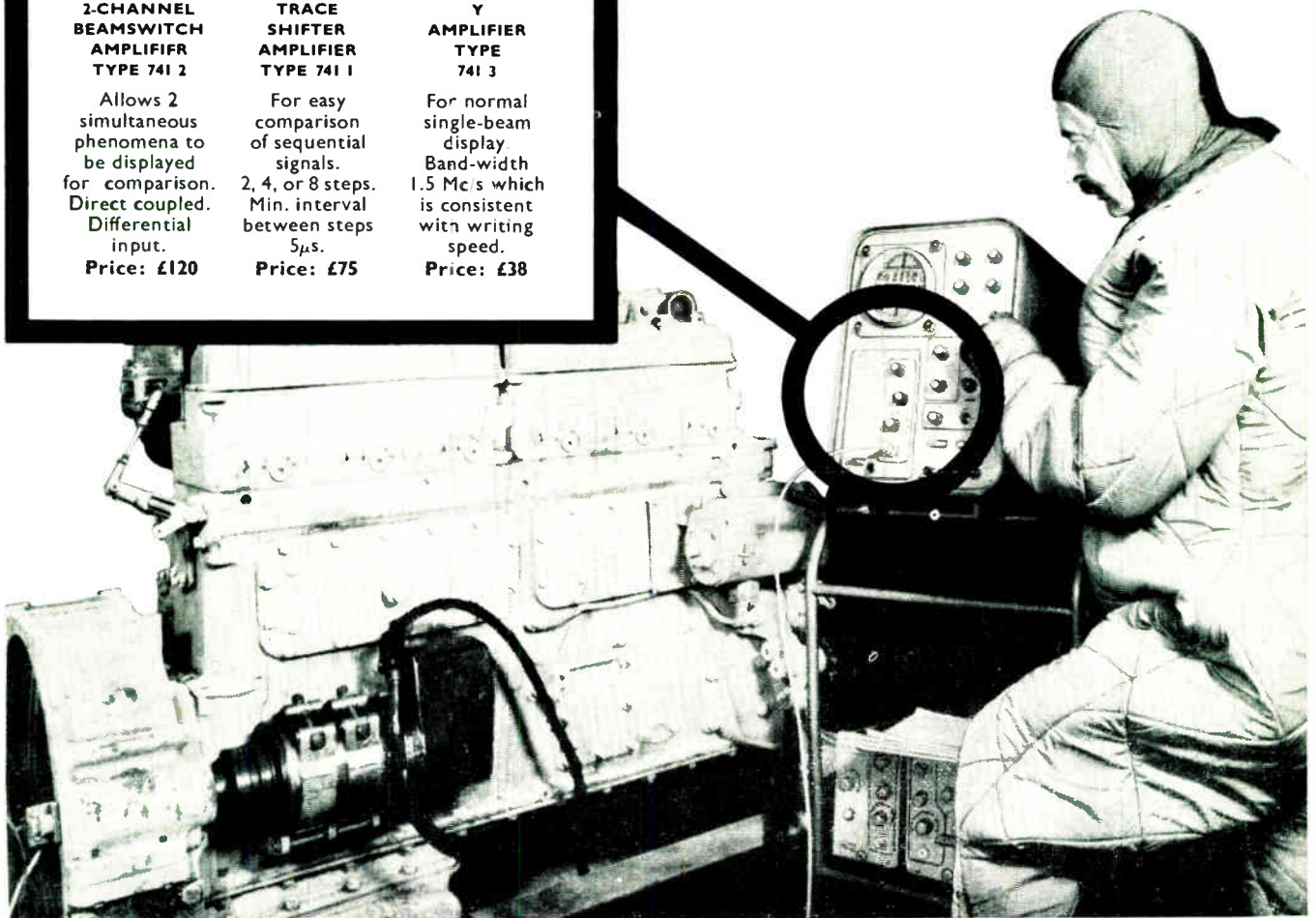

CAWKELL RESEARCH & ELECTRONICS LTD · WESTERN AVE · ACTON · LONDON W.3 · ACORN 6751 · A MEMBER OF THE *Simms* GROUP OF COMPANIES

420 CONTACTS

PER SQ. INCH

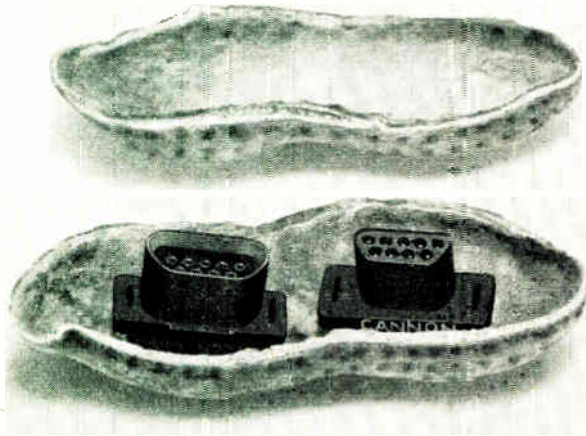

MINIATURIZATION IN A NUTSHELL

CANNON MICRO-D PLUGS

FOR MICROMINIATURE APPLICATIONS

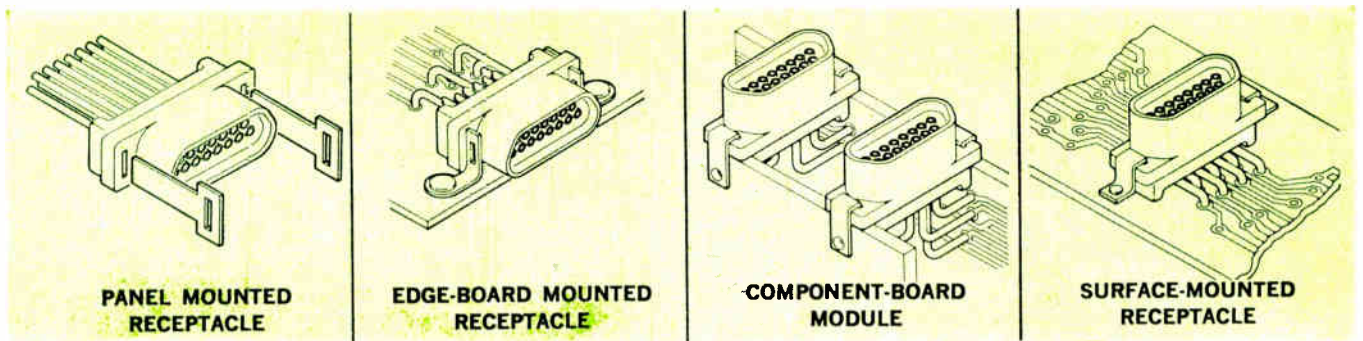

IMAGINATIVE ENGINEERING FOR THE SPACE ERA.

Cannon Micro-D Plugs are especially designed for applications where highly reliable, extremely small, lightweight plugs are required...will meet or exceed the applicable environmental requirements of MIL-C-8384B. They can be used for rack and panel, cord to panel, cord to cord, or printed board applications—can be dip soldered directly to printed circuit boards. The Micro-D employs

Micropin® and Microsocket® contacts, giving a contact spacing on .050" centres allowing a contact density of up to 420 contacts per square inch. In addition to the Micro-D, these high density contacts can also be utilized for Printed Board Applications, Interconnecting Wafers, Micro Modules, Welded Electronic Packages, and many others. For complete information write to:

CANNON ELECTRIC (Great Britain) LTD., 168/172 OLD STREET, LONDON, E.C.1. Tel.: CLERkenwell 4954

European Enquiries: Cannon Electric International Inc., Bornem, Belgium. Telephone: (03) 77.06.14.

Scandinavian Enquiries:
Sweden: Ab Gosta Backstrom, Box 12089 Stockholm 12.
Denmark: Tage Schouboe, 7 Skyttegade, Copenhagen.
Norway: Morgenstjerne & Co., Wessels Gate 6, Oslo.
Finland: OY Chester AB, Uudenmaankatu 23.A., Helsinki.



Comment

The Research Committee of the Brit.I.R.E. has recently carried out a survey of research activities and has issued a report entitled 'Radio and Electronic Research in Great Britain'. The Committee has taken the view that there is not enough research going on and that too much is directed towards fashionable things like low-temperature physics and plasma physics to the neglect of propagation, network theory, colour television, etc.

It recommends the formation of a Radio and Electronics Research Council comprising representatives of top-level management, universities and chief scientists of government establishments. It considers that the Council should depend on working parties and be in a position to implement as well as to review their recommendations.

What is meant by research is not defined in the Report; in fact, it does say that the borderlines between fundamental and objective research and advanced development are not easy to define. We suspect that the kind of research considered by the Committee is mainly that undertaken with a definite object in view; the kind, in fact, that blends imperceptibly into advanced development. It seems to us that this is the only kind of research which could be controlled by a Council.

However, what many people mean by research is something quite different. It is something much more closely akin to a seeking after knowledge for its own sake. This kind of research does not so well lend itself to control by committees. Unfortunately, the complexities of modern investigation are so great that teamwork and expensive apparatus are more and more needed. Large sums of money become necessary and before work can start some controlling body has to be satisfied that the research project is worth while. The research at once becomes objective and the inevitable delay involved in any committee kills enthusiasm.

It does seem, therefore, that the old kind of research, what many think of as true research, is a dying thing. We think that this is a pity but we do not see how it can be avoided. Fortunately, from a national point of view, it is a thing which affects every country in the same way and it looks as though everywhere in the future research will become more and more objective.

Objective Research

Even when there is a definite object in view research is not always successful. The direct attempt to solve a particular problem may even delay the answer, for what is really needed is often more fundamental knowledge.

One thing for which people have been looking for a long time is a black screen cathode-ray tube. The normal c.r. tube has a white screen and the

illuminated trace on it has to be much brighter than the brightness of the unexcited part of the screen. In a television picture, for instance, picture black is the white screen and picture white has to be whiter than white!

There is news that a black screen may be a possibility. An article elsewhere in this issue reports some research work on materials which may lead to this, even if it is not yet a practical proposition. This is quite different from the

COMMENT (Continued)

so-called dark-trace tube used in some war-time radar displays, but it would probably mean that the picture would have to be viewed from the scanning side of the screen. So even if a dark screen becomes possible its application may not be easy.

Materials

The importance of materials in engineering is obvious. Imperial College of Science and Technology is introducing a 10-months' full-time course on the science of materials. Prospective entrants should possess an engineering, science or metallurgy degree, diploma in technology or an equivalent qualification. There are three terms in the course and in the first term students are required to attend eight lectures a week on compulsory subjects comprising the physics and chemistry of the solid state, thermodynamics, statistical thermodynamics, crystal symmetry and structure, imperfections in solids and the preparation and properties of materials. Practical work is included.

After the first term properties of materials continues compulsory at one lecture a week. The course is otherwise then divided according to the specialized interests of the students. In electrical engineering thin films, semiconductors, masers and lasers, dielectrics, ferroelectrics and magnetism are included. In physics, on the other hand, the emphasis is on crystals, super-conductivity, electron physics and the electron theory of metals.

The course begins each year on the first Tuesday in October and its aim is to produce a new type of scientist, a materials scientist. The student is not restricted to the set courses under the main headings of chemical engineering, chemistry, electrical engineering, metallurgy, mechanical engineering and physics. He can attend lectures on any suitable combination of subjects from each.

This gives an unusual flexibility to the course for it enables a student, in effect, to select a course which is closely tailored to his special interests. It is a venture which we think ought to succeed.

Lasers

Bell Telephone Laboratories have found laser operation in nitrogen, carbon monoxide, bromine and sulphur hexafluoride. Over 150 different frequencies are now obtainable in gaseous lasers in the wavelength range 0.6118 to 28.053 microns.

From I.B.M. comes news of a way of converting laser light beams to microwaves.

A quartz crystal is included in the resonating system of a ruby laser. The ends of the quartz and of the ruby have reflective coatings and the light and microwave velocities are matched. So-called reactive mixing is used; the laser beam alters the index of refraction of the quartz and, presumably, makes its response nonlinear. It then provides an output at the difference between two frequencies in the laser beam.

Lasers may seem a far cry from industrial electronics and certainly we know of no industrial application for them. Things move so rapidly now, however, that the wise man keeps an eye on all new developments.

Redundancy

We said last month that language is a kind of code which functions well only because it contains great redundancy. It has been pointed out to us that if redundancy is an essential to communication it is not redundancy! In a sense our critic is right, for the word 'redundancy' has the primary meaning of 'superfluous'.

We used the word in the way in which it is commonly employed in connection with the reliability of electronic apparatus. Here redundancy is often used to ensure reliability. For example, two radio receivers are provided with automatic change-over switching so that should a failure occur in one the other will come into operation to prevent the failure from interrupting communication.

As long as there is no failure one receiver is redundant, but as soon as a fault occurs that redundant receiver becomes an essential to communication.

The redundancy of language is very similar. Language can be used without redundancy only if writer and reader both understand the meanings of words precisely. In the ordinary course of events they do not. If a writer is to be certain that he will not be misunderstood he must say what he wants to say in several different ways and using different words. To a reader who understands perfectly from one of the ways, the others are redundant. But if he fails to understand, the others are essential.

Good writing and the proper use of words are matters with which we are naturally greatly concerned. We are not, however, among those who advocate great conciseness in writing for this is achievable only by eliminating redundancy and thereby increasing the risks of a failure of communication.

Electronic Control of REGISTER

By J. C. MAWER*

in a Flying Splice Machine

In printing, the end of one reel of paper is pasted to the start of the next reel without stopping the machine. When the paper has been partially pre-printed registration problems arise. This article describes electronic methods of controlling the registration.

WHEN pre-printed material is introduced into a newspaper or other printed periodical there are two problems to be overcome in control. One is the problem of ensuring that the pre-printed material is accurately registered with that being printed. The other is splicing the tail end of one reel of pre-printed material to the leading end of the next in such a manner that registration is maintained. This means that if the pre-printed material consists of a blank page and a colour page then the tail end of a colour page must be attached to the leading end of a blank page or the printing press will not produce the required result. Both problems are capable of electronic control and this article describes two possible methods of controlling the latter problem, by controlling a flying splice equipment.

A sketch of a flying splice machine is shown in Fig. 1 from which it can be seen that at least two reels of paper are positioned on the machine, one feeding into the printing process and the other ready to be fed in. These reels are mounted on arms so that the arms can be rotated to bring the new reel or incomer into the position already occupied by the running reel. There are flying pasters and a knife so that as the new reel comes into position it is pasted on to the tail end of the running web and what is left on the running web reel is cut off. The exhausted reel can then be removed and replaced by a fresh one. In order to make a

successful joint it is necessary that there should be negligible snatch between the running web and the incomer. The peripheral speed of the two reels must therefore be constant. Various means exist for obtaining this condition but they seriously hinder the normal methods of registration.

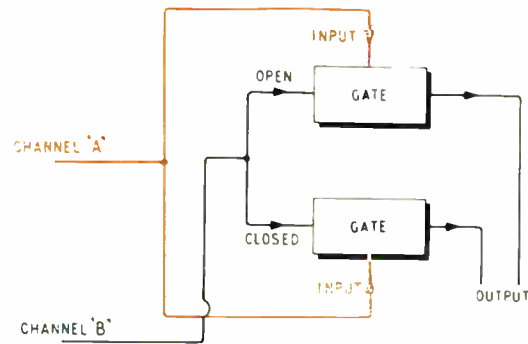

Fig. 2. Diagram of a simple control system to ensure registration

The simple method of control of registration imposes one criterion on the incoming reel. That is that its peripheral length must be an integral multiple of the length of one complete sheet. That is, if the colour sheet and blank sheet referred to earlier had a total combined length of 21 in. then the peripheral length of the incomer must be 21, 42, 63, etc., in. If this criterion is established then when the incomer and the running web are at the same peripheral speeds, a point marked on the incomer at, say, the beginning of a blank sheet will always appear in the same relationship to the beginning of a blank sheet on the running web. This may occur at every sheet on the running web, every second sheet or every third sheet, but relationship is maintained.

Photoelectric equipment can be used to inspect the running web for a mark printed on it at the beginning of a blank sheet and compare this with the mark on the incomer at the same position.

One possible way of doing this is shown in block form in Fig. 2. Channel 'A' receives a long pulse from a mark on the incomer which may be a metal reflecting tag, extending for a distance of, for example, ± 1 in. about the desired point. Channel 'B' receives a short pulse generated by the registration marks on the running web. The pulse on the incomer is passed through the two gates into two separate stores and the pulse from the running web changes over

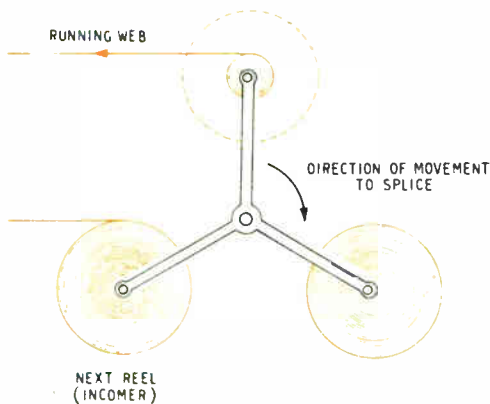

Fig. 1. This diagram shows the running web coming from a nearly exhausted reel of paper with the next full reel ready to come up to replace it

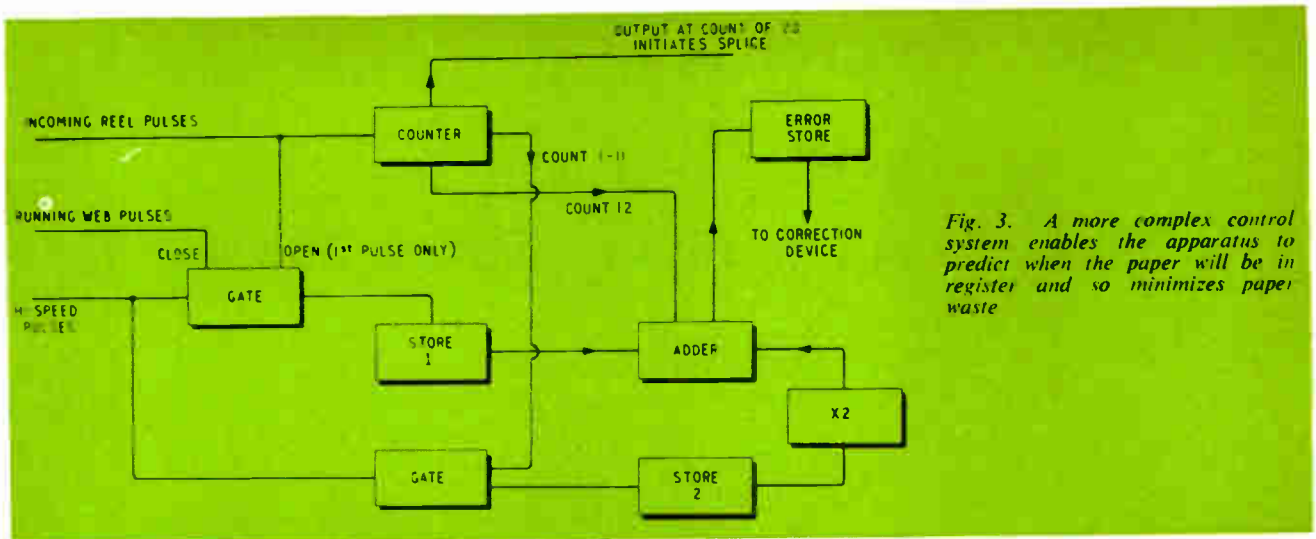
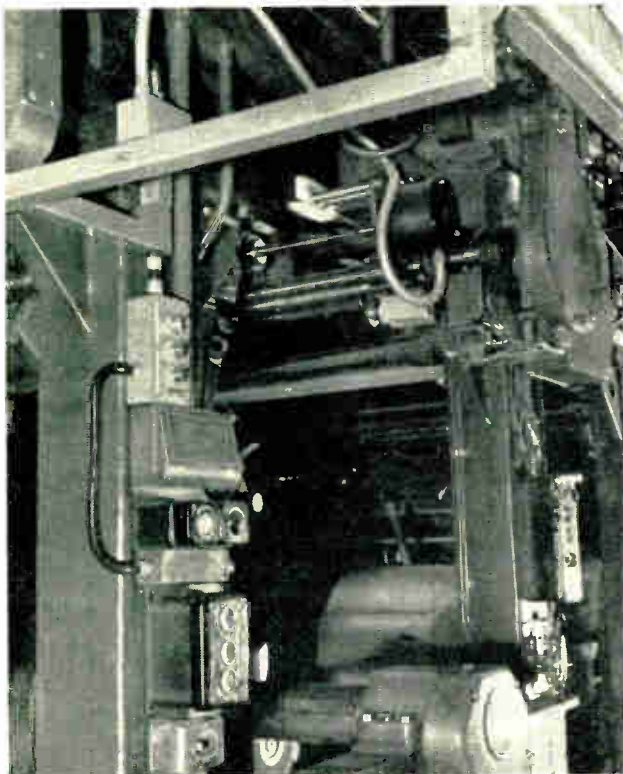

Fig. 3. A more complex control system enables the apparatus to predict when the paper will be in register and so minimizes paper waste

these two gates. Thus when the running web pulse is in the correct relationship to the incomer pulse the quantity of signal in the two stores is equal and the difference between them is zero. If, however, there is any error then the difference between the two stores will be equal to the amount of the error, and the polarity of the difference will indicate the direction of the error. This signal can then be used to ensure accurate registration either by changing the speed of the incomer for a short time until the error vanishes, or by changing the speed of the running web. In the former case a device such as a differential gearbox might well be used between the machine driving the running web and the system driving the incomer, so that a correction signal can be inserted into the third shaft of the differential

box to change their relative speeds until the error is zero, or, when the running web is altered, a loop before the main machine can be increased or decreased by means of a jockey roller until the error is corrected. This system has the advantage that registration can be achieved as soon as the incomer has been run up to the correct speed and held until the flying splice is made; this being made at the discretion of the operator. The disadvantage is the criterion mentioned before, that the incomer must have an accurately known peripheral length. This may involve the removal of several inches of paper from the outside of the reel to establish a correct length, and so result in a considerable amount of waste.

The second possible method of control utilizes a pre-



The $\frac{1}{10}$ in. web pulse head unit is on the upper right and the push-button controls at the lower left of the picture

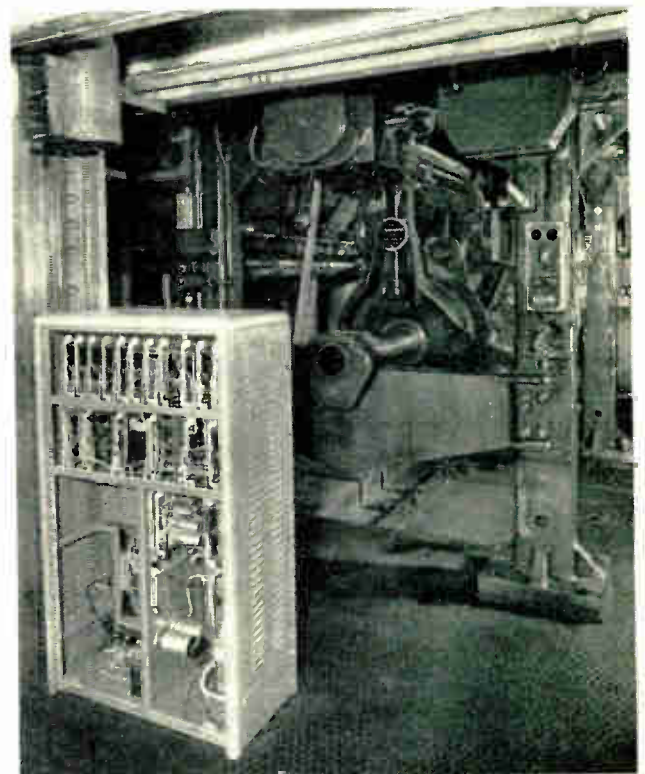

The main control cubicle containing standard plug-in printed-circuit card units

dictive technique and the control system required is shown in block form in Fig. 3. There are three input channels, one receiving pulses from the incoming reel whenever a fixed registration point passes the scanning system, one receiving pulses from the running web whenever the registration mark passes a scanning head, and one receiving a train of high speed pulses generated by the speed of the running web. When the operator decides that the running web is nearly exhausted he initiates the splicing action which then calls for computation on the part of the equipment. The first reel pulse after the operator has decided that splice can take place opens a gate and admits the stream of pulses from the running web speed, which correspond to, for example, $\frac{1}{10}$ in. of web movement, to be fed into a store. This stream of pulses is stopped by the first pulse from a register mark on the running web, and the number in the store is then indicative of the difference between the two register marks at that particular point in time. However, this difference will be a constantly varying factor due to the difference in peripheral length between the actual incomer and a theoretically desirable incomer. Therefore the high speed web pulses are fed into a further store while the incomer makes ten complete revolutions. This store has a limited capacity equal to the number of pulses occupied by one complete sheet length on the run-

ning web. Therefore, at the end of the tenth reel rotation, the number in the store indicates how far the relative position on the two webs will change during ten reel pulses. Twice this number, plus the error observed initially, will then be the error between actual and required positions after a further ten reel pulses.

In practice this number is achieved by the use of a frequency-doubler circuit which feeds the normal high speed web pulses to the store during the first error measuring phase, then doubling the frequency of the high speed web pulses into the store during the ten reel rotations measuring phase. The final number in the store is inspected to see whether it is greater or less than half a sheet length and a correction is made on the running web by means of a loop jockey roller, so that the predicted error will be zero after the second set of ten reel rotations. This is accomplished by holding all other factors in the machine constant and moving jockey rollers in a correction loop by an amount sufficient to increase or decrease the running web length by the correct amount. This correction is completed by the ninth reel rotation after correction starts, and on this reel rotation the flying splice equipment is ready to perform a splice on the tenth reel rotation. During simulated trials on this equipment a splicing accuracy consistently better than 1 in. was maintained.

Tape Recorders Help Silence Vehicle Exhaust Systems

Society is becoming increasingly noise-conscious, but most people cannot remember a particular noise for very long. So noise-abatement experiments are relying more and more on tape recordings made during comparative tests.

Development engineers at Morris Motors' Radiator Branch use two E.M.I. tape recorders for measuring the acoustic performance of vehicles' exhaust systems under light engine load. One of the tape recorders is also used for recording transient noise conditions and for the cold testing of exhaust systems in the laboratory.

When vehicle exhaust noise is to be analysed, the car or van is parked on hard standing in an open place. Two microphones are placed one at each side of the tail pipe in such a manner that they are not in direct contact with the exhaust gas. One microphone is connected to an RE 321 portable tape recorder and the other to a noise level meter. Tape recordings and dB readings are taken for engine speeds of 2,000, 3,000, 4,000 and 5,000 r.p.m.

Back in the laboratory, the recordings obtained are individually transcribed on to a closed loop of tape fitted to a TR52 tape recorder. Analysing equipment is used to obtain one-third octave spectrograms and the overall noise level is set to correspond with the particular engine speed being measured. The spectrograms so obtained enable a comparison to be made between different exhaust systems fitted to a particular vehicle.

Tape recordings are also made of transient noise conditions and a closed loop made of each complete noise cycle. Signal loss due to the gap between the erase and record head on the TR52 tape recorder is utilized to switch the filters in the one-third octave spectrometer. This is done by rectifying the signal from the extension loudspeaker output and using the resulting d.c. to operate a relay which, in turn, switches the one-third octave filter mechanism. The 600- Ω line output from the tape recorder is used to supply the signal to the filter input.

It is thus possible to obtain automatically a pen recording of loudness against time for each one-third octave filter

setting. This enables a three dimensional graph to be constructed of loudness vs frequency vs time.

During cold testing of exhaust systems in the laboratory, the TR52 tape recorder plays back a recorded tape of 'white noise' (constant amplitude noise at all frequencies audible to the human ear). A re-entrant loudspeaker unit is used to drive noise into the inlet end of the exhaust system. Noise emitted from the tail pipe is then picked up by a microphone and analysed in the usual way.

Attenuation of the silencer can be found by replacing it with a section of exhaust pipe and repeating the experiment. The difference between the two spectrograms obtained is equal to the attenuation.



Exhaust noise from a Morris 1100 being recorded

When a computer is used for on-line control, the data is provided from many sources. It is the programme which controls the collection and processing of this data and hence turns static equipment into a powerful control tool. Some ways of accomplishing this are described in the article.

Programming Techniques for On-line Computer Processing

By DINA ST. JOHNSTON, B.Sc.*

THESE days digital computers are used in very many fields for widely differing jobs. It is not uncommon to find the same type of computer being used to solve entirely different problems. The explanation of this versatility lies in the 'Software'; that is, the programming. Each job performed by a computer has in general its own tailor-made programme and it is this programme which interprets every nuance of the job in minutest detail into a code which can be understood and followed by the computer. In mathematical and some business accountancy fields, this arduous task can be relieved to some extent by autocodes but with the exception of standard mathematical functions it is true to say that every problem solved by a computer requires a unique programme to be written. Further, a unique programme design is also required, and this relies to a large extent on the techniques gained by experienced

programmers who have worked previously on a similar job.

The applications to which computers have been used so far can be categorized into scientific, commercial, statistical, process control, tele-processing and military. The first three of the above categories cover off-line applications and the latter three categories cover on-line applications, sometimes called real time. Similar techniques can be employed to write programmes for different applications within the same category and thus recognized methods of data handling are being evolved.

Many people are now familiar with off-line programming as more and more scientists, accountants and mathematicians employ computers for part of their day-to-day work. However, on-line programming is as yet a relatively new subject and the manner in which it is used to solve process control problems is still in the early stages of development. One of the most advanced schemes employing these techniques is that of the information and data handling system of the new Spencer Works of Richard Thomas & Baldwins, near Newport, Monmouthshire. The complete scheme will use a system of computers to translate customers' orders into work schedules which control each section of the plant. Further, the actual plant operations will be monitored and compared with the proposed schedule, so forming feedback which is used in the preparation of subsequent schedules. Some parts of the plant will be directly controlled by computer, but generally the operations will be carried out manually from instructions transmitted by the computer to the operator. The operations to be programmed for the on-line computer of this system fall into five groups, and as each group uses different programming techniques they will be described individually below.

* Vaughan Programming Services.

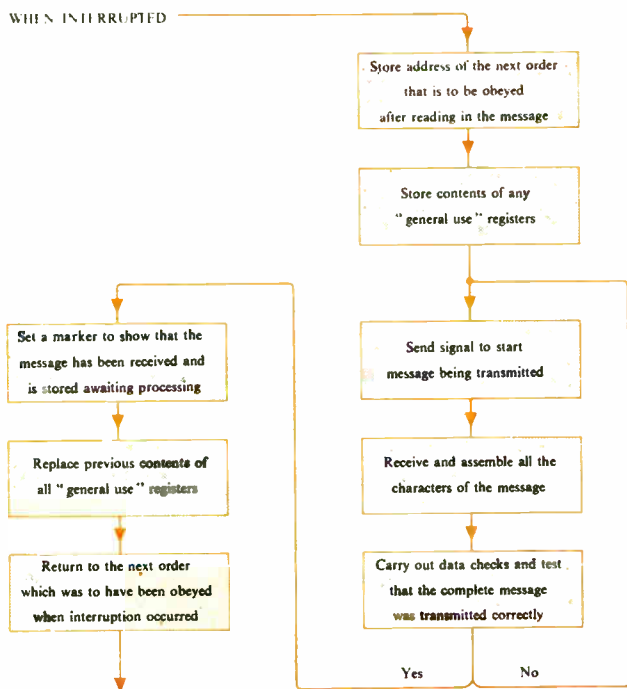

Fig. 1. Flow diagram for input of data using 'interrupt' technique

Data Collection

A major on-line function of the computing system is to receive the feedback data from the plant. Operators at various parts of the works will use the keyboard associated with their job to key in relevant pieces of information. This means that information will arrive at the computer from a number of input channels and at essentially a random time.

There are three ways of writing a programme to take data into a computer:

1. If the data can be guaranteed to be available when required by the computation then the programme can contain orders demanding characters from specified peripheral equipment as required. This is the normal off-line situation.



General view of one of the computing systems in the computer room at the Spencer Works of Richard Thomas & Baldwins Ltd. The computer is housed in the cabinets on the left, the film store is at the back and the programmer's console at the front. The control console is on the right and is shown in greater detail in another photograph

2. If the data is originated during the running of the programme a method of regularly scanning the peripheral equipment can be used. In this method, when there is no information available the programme transfers itself to carry out other operations it may be required to perform and returns in a sufficiently short time to examine the input channels so that no information is missed.
3. Alternatively, the equipment can be arranged so that a signal is sent from the input device to the computer when there is some data available to be read. This signal interrupts the normal sequence of operations called for by the programme and transfers it to a special routine. A typical flow diagram of such a programme is shown in Fig. 1.

Because of the random nature of the input method 1 is unsuitable for receiving information keyed-in from the plant. The choice lies, therefore, between the latter two. Generally the scanning method is preferable if the frequency of input is reasonably regular and also if the quantity is large compared with the rest of the processing; that is, the chances are high of receiving an input when the equipment is scanned. The interruption method is best used when the input is irregular and there are sufficient other operations to be carried out by the computer for time to scan to be wasteful. Input from the plant falls into this category and so the keyboards have been designed to contain a push-button which will initiate the 'interrupt' function of the computer.

Displayed and Printed Data

All the instructions and information necessary for the minute by minute working of the plant will be transmitted from the computer to a number of printers and visual displays located in the works. The initiation of the numerous forms of output varies. In some cases they are a direct result of some action in the works which has given rise to a keyed-in message which when processed has triggered a print out or a display. In other cases the initiation is by real time and for this purpose the programme contains orders to read a digital clock which is included in the computer equipment. It can be seen, therefore, that the requirements for the organization of the outputs are large and varied.

Printers, being mechanical devices, are slow to operate when considered relative to the speed of electronic equipment, so although the computing speeds are sufficient to prepare the various outputs, the printers themselves hold

up the machine if the computer tries to send a second character while they are still printing the first. The means of holding up the computer is a signal, called a busy line, which is set by the printer when it receives a character and reset when the character has been printed. The state of this busy line can be stored in a register called a control word and then a hold-up may be prevented by writing the programme to contain orders which examine the control word before trying to produce the output for each character.

Time sharing can now be achieved between various output devices and/or computation as follows. If the control word test shows that the printer is still busy with the previous character then the computer is programmed to transfer to some other routine, which might relate to another printer. A flow diagram of a programme which time shares between two printers is shown in Fig. 2.

Equipment Checks and Alarms

Obviously it is normally expected that all the individual units of the computing system will be operating correctly; 'all systems go' in fact. However, it is essential in a system

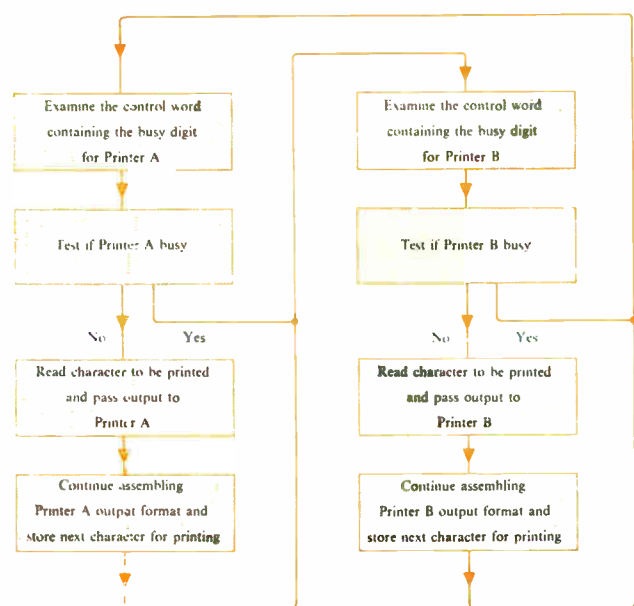

Fig. 2. Flow diagram showing time sharing between two printers

of this complexity to be able to detect rapidly any fault, even a transient one, as soon as it occurs. In order that this can be achieved a number of registers containing go/no-go bits of information are incorporated in the computer. The programme is written so that these registers are interrogated at frequent intervals to establish that the equipment is operating satisfactorily and thus preventing the stored data from becoming corrupted.



The control console which is situated in the computer room

If the contents of one of these registers indicates a fault condition the programme leaves its normal path and transfers itself into an alarm routine. This starts with a computer instruction which will flash one of the red lights mounted on the operator's console. The flashing light, which is accompanied by a bell, gives the operator warning that something is wrong.

Meanwhile the programme continues by printing some details about the fault on a page printer. It of course depends on the nature of the fault as to how far the rest of the equipment can be operational.

Manual Commands

The operator's console can also be used to initiate any action required from the computer. Various types of action can be instigated in this manner, such as, changing some criterion of the plant, or accepting a new set of work schedules into the system, or merely requesting information which the computer holds about the work going on in the plant. Each course of action is identified by a coded reference number and is known as a manual command.

To use this facility the operator sets the appropriate manual command reference number on the rotary switches at the right-hand side of the console and then presses an illuminated button on the same panel. As with the keyboards, the frequency with which this button is pressed is purely random and so for the same reasons it has been designed to interrupt the programme. The programme then follows a sequence of orders which read and decode the switch settings and according to their value sets markers for the appropriate action routines.

A further feature of the part of the programme which

caters for these manual commands is a routine to produce a descriptive output on a page printer. This is obtained every time the action button is used, and means that there is always a permanent record of all external requests.

Summary and Analysis Information

Although the primary requirement of this on-line application is to direct operations on the plant and close the feedback loop to enable further scheduling, there is a great quantity of data being collected during the process. To make the most use of the system it is desirable that this data be condensed and stored in a form such that diverse summaries and analyses can be carried out by subsequent off-line programmes.

To achieve this, some organisation of the data is carried out by the basic part of the on-line programme. As complete elements of information are formed about a unit in the plant, for example a slab, they will be written on to a magnetic backing store, each element being identified so that it can be cross-referenced with like elements.

The section of the programme which writes the completed elements on to the backing store is a further example of time sharing on the 'busy' control word principle, so it can be interwoven with the programmes dealing with other peripheral devices. There now exists a situation whereby all the features of a programme are constantly available, hence giving the appearance of simultaneous working and immediate response to a number of external stimuli.

Plate-on Printed Circuit

Illustrated here is a printed circuit board, being checked for dimensions, which has been produced by the plate-through-hole technique. This is one of the two basic techniques for producing printed circuits. With this, the copper conductors are plated on to an insulated base material. A major advantage is that the copper can be plated through holes to provide continuous connections between both sides of the board.

Microcell Ltd., the manufacturers of this particular board, have developed a plate-through-hole technique which they claim gives higher mechanical strength and greater design flexibility than conventional printed circuits.

For further information circle 98 on Service Card



Storage cathode-ray tubes are particularly useful when dealing with transient phenomena because it enables them to be observed at once and without the delay associated with photographic techniques. This article describes two different types of tube and deals with their application.

Applications of STORAGE TUBES in Instrumentation



By F. J. HORLEY*

THE use of storage tubes in instrumentation is becoming increasingly more popular as time goes on and since the American tubes first became commercially available in 1954 some considerable improvement in the quality and types of tube available has taken place. One of the main advantages to be gained by using such tubes is that a transient phenomenon may be studied at the moment it occurs without recourse to photographic techniques and as these tubes are capable of presenting a bright display of over 2,000 ft-lamberts it is possible to view the transient waveform as a brilliant, non-flickering, uniform display.

Storage tubes fall into a number of different categories and it is the intention of this paper to describe two of the main types that are at present being applied to instrumentation. These are the electrical-in-visual-out type, known as the direct-view storage tube, and the electrical-in-electrical-out type.

Direct-View Tube

The memory in all types of storage tubes consists of a number of tiny capacitors which retain a charge depending on the energy that falls on them from an electron gun source.

The memory consists of a wire mesh which has a dielectric coated on one side in such a way that the holes in the mesh are not obstructed. Fig. 1 is a micrograph through a section of one of these meshes, magnified 200 times; the fine detail can be appreciated and so too can the actual holes in the mesh. Both the mesh and its insulator are formed by vacuum deposition techniques.

The tube itself is shown in Fig. 2. Here the storage mesh can be seen positioned directly behind the phosphor on the tube face; it is placed with its dielectric-coated side away from the face. It can also be seen that the tube has two separate gun assemblies; one is the writing gun which supplies a high energy beam of electrons focused and deflected in the normal way, and the other is a flood gun which supplies a parallel beam of low energy electrons to cover the whole area of the screen.

The operation of the flood gun can be considered

* Sales Manager, Cawtell Research & Electronics Ltd.

analogous to the action of a normal triode with the storage mesh acting as the control grid. Initially, this mesh is charged with a negative potential, thus 'cutting off' emission from the flood gun. In this condition the tube face appears black. As the signal information to be studied is fed on to the writing gun, electrons from this gun strike the storage mesh in the pattern of the information to be studied. Wherever these electrons strike the dielectric coating of the storage mesh, secondary emission occurs and this leaves the potential of the written areas of the mesh less negative than the other parts. In effect, a charge pattern has been written on to the mesh. Flood gun electrons now penetrate right through those holes in the storage mesh which are within the area of the charge pattern, but not elsewhere. They reach the screen and excite the phosphor on the tube face, to form a display. Erasure of the complete display is accomplished by a pulse, or train of pulses, that restores

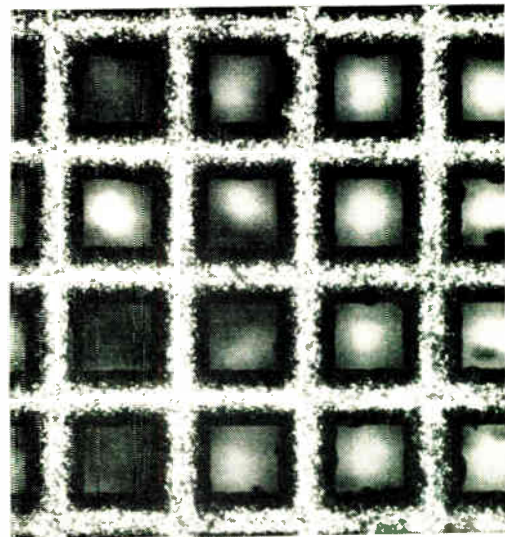

Fig. 1. Micrograph magnified 200 times of wire mesh in storage tube

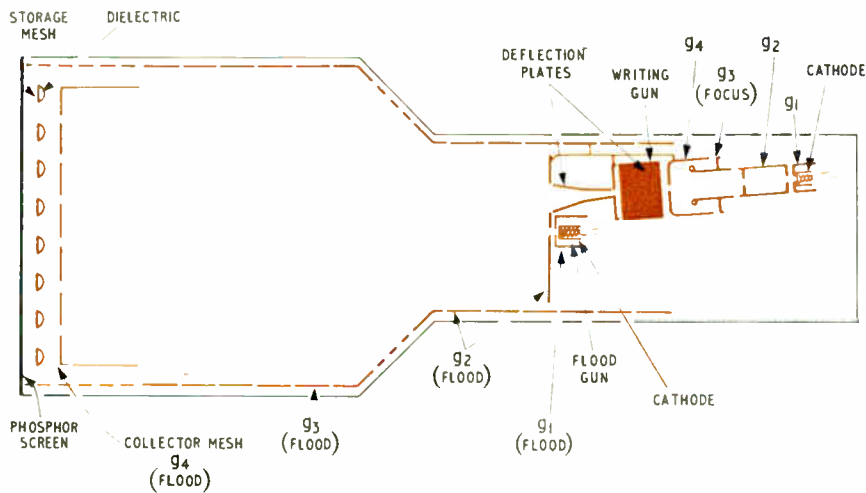

Fig. 2. Arrangement of storage tube of the direct-view type

the storage surface to its original potential, making it everywhere opaque to flood gun electrons.

The limitation on the viewing or display time is set by an ionization effect which takes place within the tube. The high current electron beam from the flood gun releases ions from the residual gas in the tube and these ions settle on the storage mesh causing its potential to rise slowly. This allows flood gun electrons to reach the screen and so increase the overall background fluorescence. By pulsing the flood gun, it is possible to obtain a display time of two hours. This does, however, reduce the intensity somewhat. By switching off the flood beam current (i.e., storage without displaying a signal) it is possible to store the signal for long periods. The limitation on this storage time is dependent on the leakage resistance of the dielectric used to cover the mesh; it is usually of the order of one week.

These tubes are available in what is known as the bistable type or the half-tone type. The bistable type of tube is only capable of producing two-state pictures; it gives longer display times without recourse to special electronic circuits, but it is more susceptible to damage through misuse; it also has a slow writing speed. The half-tone tube can store and reproduce tone gradations and is less susceptible to damage. It has an appreciably faster writing speed than the bistable tube.

Electrical-in-Electrical-out Tube

The memory of this type of tube is again a fine mesh metal screen which is coated on one side with dielectric material, but the phosphor screen is replaced by a metal plate and there is no flood gun. A scanned electron beam is directed against the dielectric surface of the mesh and writes a charge pattern on it, as with the other type of tube. Fig. 3 shows a simplified diagram of one of these tubes which consists of a writing gun and deflection system, storage mesh and signal collector electrode.

The information to be examined is fed into the writing gun whose electron beam charges the storage mesh to the pattern of the phenomena under examination. To 'read out' this information, the storage mesh is scanned by an unmodulated electron beam from the same writing gun and the storage mesh is adjusted to a potential which allows areas of the mesh that do not contain written information to cut off this electron beam. The part of the mesh containing information in the form of a charge pattern permits a portion of the electron beam to pass through it, and the amount passed corresponds to the signal charge on the mesh. This is then transmitted to the signal collector

electrode. Thus, an amplitude-modulated current corresponding to the charge pattern written on the mesh is received at the signal electrode. The output signal is thus electrical and of the same form as that originally applied to the writing gun. As the charge pattern is only used to modulate the electron beam a considerable number of 'read outs' from the stored information is possible.

Up to 30,000 'read outs' can be obtained with these tubes without appreciable tone degradation; this gives a display time of from 6 to 10 min depending on the information stored and the scan system used.

These tubes do, however, require special electronic circuitry as they have to be operated in a particular sequence, for instance, erase, prime, write and read. There are tubes requiring less complex circuitry but these are of the single 'read out' type, which means that the stored information must be photographed from a display tube as it is 'read out', before it can be examined.

This simplified description of both tubes is only intended as a guide to their operation. The reader wishing to study in more detail will find adequate published information, 1, 2, 3, 4, 5

Storage Oscilloscopes

These instruments are now being manufactured in a number of countries throughout the world, and Table I gives characteristics of two Remscope models. In any oscilloscope used for studying single transients a limiting factor is the maximum writing speed which can be recorded from the cathode-ray tube, whether the signal is recorded photographically or stored in the tube. Wide bandwidths and fast rise-times are sometimes claimed for instruments but they are of no advantage if the writing speed of the storage tube employed is not fast enough to match them.

The bandwidth of the Y-amplifier is related to the rise-time and the latter factor is a measure of the fastest signal which will be passed without appreciable degradation. For example, the rise-time of the Remscope type SO1

TABLE I

Instrument	Remscope	Remscope
Model No.	SO1/740	741
C.R.T. No.	E702	E702
Screen Size	10 cm	10 cm
Writing Speed	2.4 cm/μsec	1 cm/μsec
Y amplifier 3 dB Bandwidth	4 Mc/s	1.5 Mc/s
Rise time	0.1 μsec	0.2 μsec
Display time, max.	2 hr	10 min
Storage time	1 week	1 week

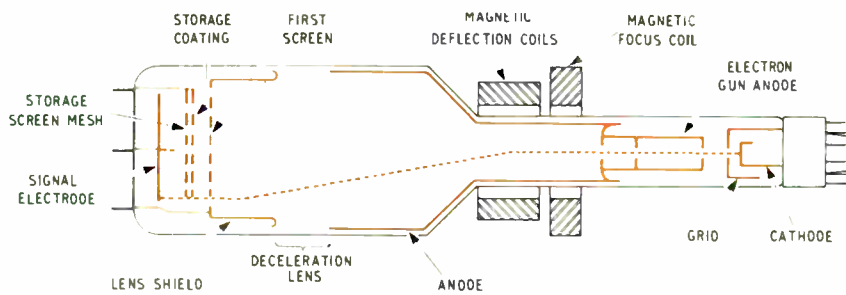

Fig. 3. Simplified diagram of the arrangement of an electrical-in-electrical-out storage tube

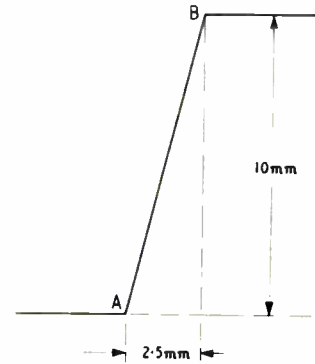

Fig. 4. Waveform used to illustrate the effect of amplifier rise time

Y-amplifier is $0.1 \mu\text{sec}$ and a reduction of rise-time (i.e., increase in bandwidth) would not extend the usefulness of the instrument. The figure of $0.1 \mu\text{sec}$ is more than adequate to cope with any signal which necessitates a writing speed of $4 \text{ cm}/\mu\text{sec}$ when displayed at reasonable amplitude.

To see a very fast signal on the Remscope it is necessary to keep the horizontal and vertical writing speeds down to a minimum by reducing the displayed amplitude and the timebase velocity. Obviously if the signal display is made too small no useful information can be extracted from the image. The minimum useful image size on a storage-tube screen, taking into consideration the resolution of the tube, is with a vertical deflection of 10 mm and a horizontal displacement of 2.5 mm .

If we have a leading edge AB displayed as shown in Fig. 4 its length will be 10.3 mm approx. If, as in the case of the Remscope type SO1, this length is to correspond to a velocity of $4 \text{ cm}/\mu\text{sec}$ (i.e., the maximum writing speed of the E702A tube used) the duration of the edge will be $1.03/4 \mu\text{sec}$; i.e., $0.26 \mu\text{sec}$ approx.

The Remscope type SO1 Y-amplifier rise-time is $0.1 \mu\text{sec}$. If a leading edge with a rise-time of $0.26 \mu\text{sec}$ is fed in the resulting output will have a rise-time of $\sqrt{(0.26)^2 + (0.1)^2} = 0.28 \mu\text{sec}$ approx.

This represents an increase of 7% in the rise-time. In other words the degradation produced by the Y-amplifier on any signal which could be displayed at reasonable amplitude on the E702A tube is small.

Of course, faster signals can be viewed if they are repetitive, but as storage oscilloscopes are primarily designed for the study of single transients, the expense of an amplifier giving better performance on repetitive signals is not justified. There would be some advantage in increasing the bandwidth for use as a normal oscilloscope though this is more than cancelled out by the additional expense, in an already expensive instrument. To design and sell a storage oscilloscope primarily for normal oscilloscope use is quite uneconomic, if the instrument embodies this type of storage tube.

Picture Monitors

Most commercial instruments in this field are of American origin and this is not surprising in view of the fact that at least 90% of electrical-in-electrical-out storage tubes are produced in the United States.

The Cawkell 'Vistastore', however, represents a consider-

able British achievement in this field; it has been designed and manufactured in the United Kingdom and is believed to be the only picture storage monitor commercially available outside the United States. The instrument can store and display complete television pictures for up to approximately 10 minutes and it has considerable potential in both the medical and industrial fields. Storage is achieved on a 1,000-line resolution storage tube.

In America, the Image Instrument Company together with the Raytheon Company have produced commercial instruments incorporating electrical-in-electrical-out storage tubes but the writer has no first hand experience of these instruments.

Water Hammer in Small-Bore Pipes

One application of the direct-view tube is in the study of transients experienced when water hammer occurs in pipes. The test rig contains a 48-ft coil of $\frac{1}{2}$ -in. copper pipe

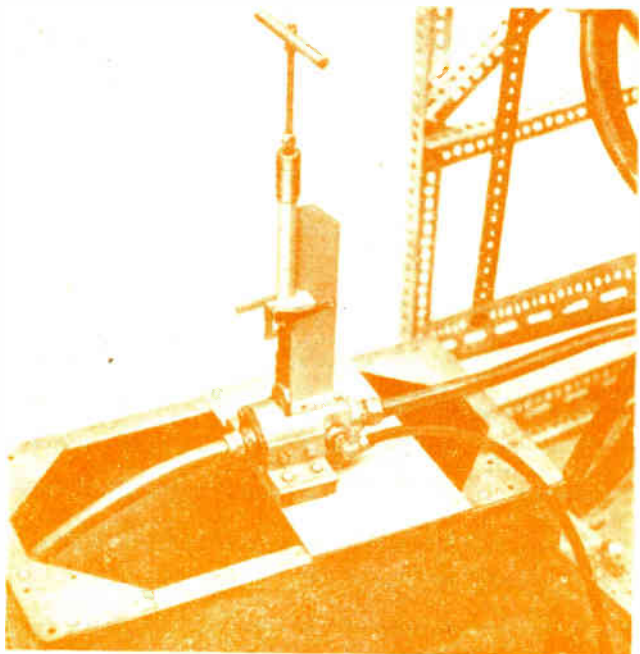

Fig. 5. Valve used to produce water hammer in a pipe

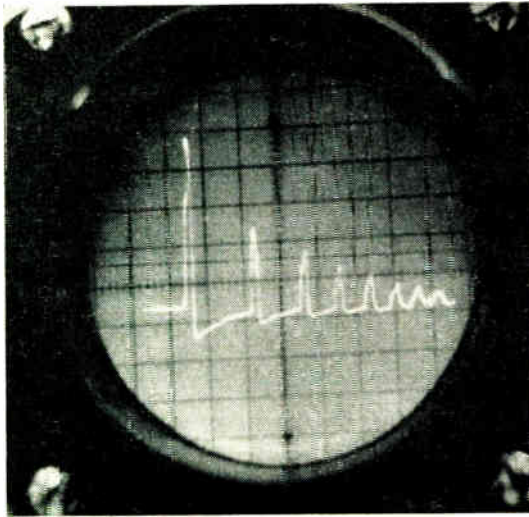

Fig. 6. Water hammer signals displayed on a Remscope

which is fed from a constant head tank (at a pressure of 22 p.s.i. absolute). The flow of water (velocity 6 ft/sec) is interrupted by a valve which is specially designed to cut the water flow off instantaneously and produce water hammer. A pressure transducer is attached to this valve, the transducer itself being of the capacitive type and forming part of an oscillating circuit. The r.f. signal from this oscillator is fed into a frequency discriminator whose output is rectified and fed to an output stage which gives a d.c. voltage output proportional to the pressure being measured. The signal is then fed into the Remscope.⁶

The special valve to produce water hammer is shown in

Fig. 5 and consists of a plunger which is kept open under spring tension; when this spring tension is released the valve rapidly closes and shuts off the water. At this instant, the kinetic energy of the moving water is changed to potential energy (i.e., pressure) and the rise in this pressure at the valve causes a compression wave to travel from the valve towards the reservoir. On reaching the reservoir this wave is reflected back as an expansion wave.

The changes in pressure are picked up on the pressure transducer and a typical train of signals received is shown in Fig. 6. This is a photograph of the signals as they were actually displayed on the direct-view storage tube fitted to the Remscope; these photographs were taken 10 minutes after the trace had been written on the tube. The first peak in the trace represents the compression wave down the pipe when the valve is closed. This wave is reflected back from the reservoir as an expansion wave and at this point the pressure, due to this expansion wave, falls to the vapour pressure of water, and a cavity is, therefore, momentarily formed at the valve. This can be seen from the trace by the fact that the pressure falls to zero after the first peak indicating the formation of such a cavity. This cavity then collapses, due to the static pressure of the reservoir, and the sequence of events is repeated in the form of reflections from the valve to the reservoir and back again; the pressure waves gradually decrease in amplitude due to the friction of the pipe walls. This waveform shows the variation of pressure with time; the first peak represents a pressure of 250 p.s.i. absolute and the horizontal scale is 100 msec/cm.

The phenomena of water hammer is being studied both for its own sake and also to obtain a technique which can be applied to conventional and plastic materials with a view to determining appropriate loading factors which are required in the calculation of pressure ratings for pipes.

(To be continued)

FILM SCANNING AND MEASURING MACHINE

Installed in the Physics Department of Glasgow University is a Ferranti/Sogenique special measuring machine which forms one of the main items of evaluation equipment for the British National Hydrogen Bubble Chamber Project.

When high energy nuclear particles are injected into a bubble chamber, they interact with the nuclei of the liquid in the chamber. This liquid is in a superheated condition and the passage of any charged particle causes localized boiling of the liquid, a tell-tale stream of bubbles being left along its path. The main point of interest is the collision of the incoming particle with the resident nuclei. When this collision occurs new particles are produced and the trace of bubbles moving away from the point of collision is the main feature of interest. Hundreds of thousands of photographs are taken of these events, and it is necessary to scan and measure the pictures on a special film measuring machine.

The Ferranti/Sogenique machine has precision X and Y moving stages which carry the film under an optical scanning system. The operator controls the movement of the

machine along the track which is shown in magnified form on a projection screen. At discreet intervals X and Y co-ordinates of the track are taken. Each stage is fitted with a Ferranti Moire fringe measuring system which is capable of giving a resolution of 1μ . The electronics are so designed that the co-ordinates of points can be punched out on paper tape in coded form while the stages are still in motion; this represents a great reduction in the time required to measure the events, as compared with conventional methods.

Associated with the machine and the digitizer is an electronic system to control the high performance hydraulic servo mechanisms which continuously position the table with respect to the scanning system. Fine adjustments can be made to an accuracy of around $\frac{1}{2} \mu$ by a hand-controlled mechanism in order that precision measurements may be taken of the centre of the tracks. Developments are well advanced to make the whole process completely automatic, and this will provide a further reduction in the time taken to evaluate the event.

For further information circle 99 on Service Card

With large current outputs problems of power dissipation and overload protection become especially important in stabilized power-supply units. The article describes a switch-inductor method for units with outputs from 5 A to 100 A.

HIGH-CURRENT STABILIZED POWER SUPPLY

By C. D. S. GASKILL *

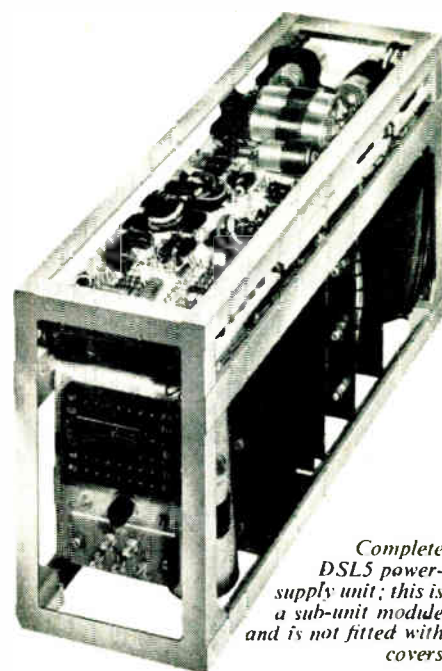

Complete DSL5 power-supply unit; this is a sub-unit module and is not fitted with covers

EFFICIENCY is rarely a matter of great importance in a stabilized power supply when the output current is below about 5 A. However, above this current the amount of heat dissipated in conventional series stabilizers may become an embarrassment. Not only does this heat raise the temperature of other equipment, but the heat sinks necessary to dissipate the power become extremely large.

This is particularly true of power units employing a current-limiting protection technique. The main advantage of this method of protection is the self-resetting facility that it offers if correctly designed. It is desirable that the current delivered by the unit when short-circuited be greater than the full-load current. The reason for this is illustrated in Fig. 1. This shows the output characteristics of power units employing two different versions of the current-

limiting method of protection. The dotted curve shows the output-voltage/output-current characteristic for a unit employing the re-entrant technique. The advantage of this characteristic is that it greatly simplifies the design of a unit employing conventional series-stabilizer techniques. This is because on short-circuit the current flowing is very much less than the full-load current and, therefore, the additional power the series element is called upon to dissipate under these conditions is relatively small. This system is quite satisfactory where the load on the unit is entirely ohmic (Load line L_1).

However, semiconductor equipment which the power unit will drive is much more likely to have a load line approximately to L_2 . From this it can be seen that there are at least two intersections between the load line and the output characteristic, and hence two stable output voltages E_1 and E_2 . It can be shown that a unit with such a characteristic

*International Electronics Ltd.

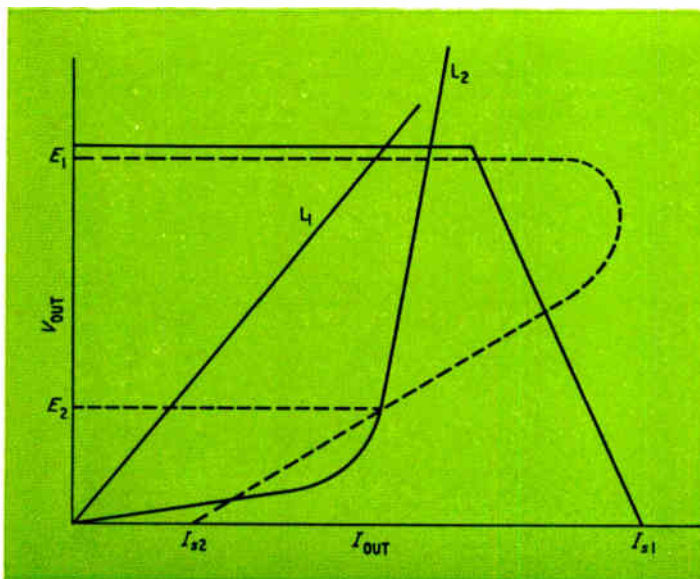
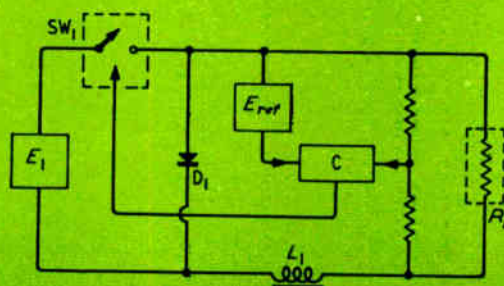
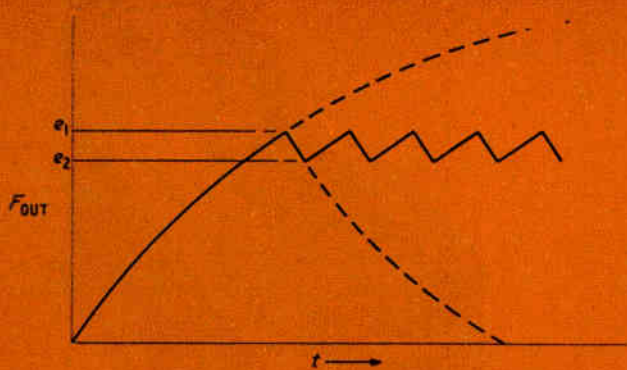

Fig. 1.—The re-entrant stabilizer characteristic (dotted) gives small power dissipation on short-circuit but causes trouble with a load line like L_2 . The solid-line characteristic leads to high power dissipation

Fig. 2.—Basic arrangement of switch-inductor stabilizer





Left: Fig. 3.—Output voltage plotted against time for the switch-inductor stabilizer of Fig. 2. Right: Fig. 4.—Diagram illustrating the arrangement of the new stabilizer

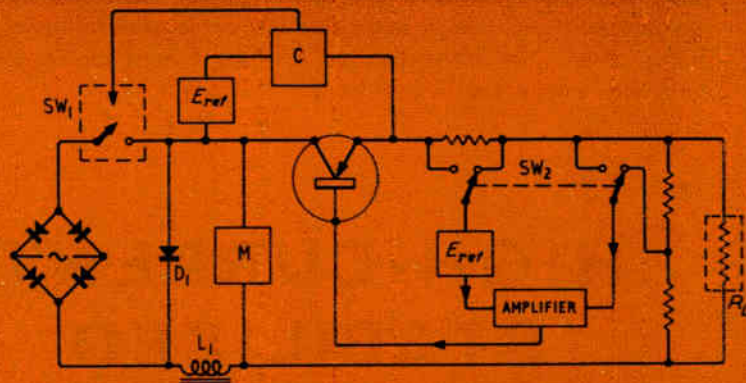

switched on into a load with a characteristic similar to L_2 will inevitably 'lock' at the incorrect output voltage E_2 . The only way to ensure that a power unit cannot lock in this manner is to provide an output characteristic similar to the one given by the solid line in the diagram. It can be seen that in this case only one intersection between the load line and the output characteristic is possible and, therefore, there is no possibility of 'lock out'.

This system has a disadvantage from the point of view of the power-unit designer; a very large power must be dissipated in the series element if a conventional series stabilizer is used. It is, therefore, desirable to employ a much more sophisticated stabilization technique. Fig. 2 illustrates the basic principles of such a system. An unstabilized d.c. supply E_1 is connected via a switch SW_1 and a choke L_1 to the load R_L . When SW_1 is closed the current in the load, and hence the voltage across it, rises exponentially with time constant R_L/L_1 (see Fig. 3). When a pre-determined voltage level e_1 across the load has been reached, the comparator C, which compares a proportion of the output voltage with a reference source, causes the switch SW_1 to open. The collapsing flux in the inductor L_1 causes the potential across it to reverse in polarity and the commutating diode D_1 starts to conduct. The inductor L_1 is now effectively in parallel with the load R_L , and the voltage across the load declines with time constant R_L/L_1 .

However, at a slightly lower voltage e_2 , the comparator recloses SW_1 and the voltage once again starts to rise. The system therefore oscillates causing the output voltage to remain within the limits set by e_1 and e_2 . This mean output voltage is very nearly independent of input voltage and load current.

However, this system, which has been known for some time, is quite useless for supplying current to electronic equipment for two reasons. First, a relatively large amplitude triangular waveform is superimposed on the output voltage and, secondly, the recovery time of the output voltage for a step change in load is unacceptably long. This is a disadvantage which has been common to date in all power supplies employing series inductors.

Fig. 4 illustrates a design method which overcomes both these disadvantages. A conventional series stabilizer is interposed between the load and the output of the switch-inductor stabilizer. The switch is now operated, however, by the voltage difference across the series element of this conventional stabilizer (Prov. Pat. No. 9266/60). By this means the mean voltage across the series element can be kept very low, typically about 2 V, and is independent of the output voltage setting of the series stabilizer. The internal dissipation is therefore also independent of the output voltage setting.

The switch SW_2 operates when the output current exceeds

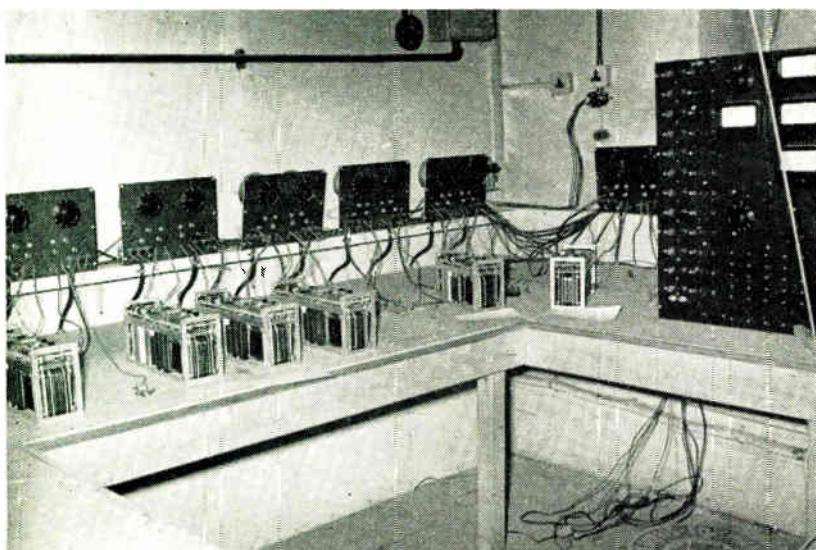

Part of the 'soak' room which is maintained at 45 °C. Every unit has a 24-hour test at full load before final test and despatch

a preset value and causes the constant-voltage stabilizer to be converted to a constant-current stabilizer, thereby producing an output characteristic similar to the solid line given in Fig. 1. Even at short-circuit, therefore, there is no rise in internal dissipation.

To overcome the second disadvantage, it is necessary to place in parallel with the output of the switch-inductor section of the stabilizer a very large capacitor in series with a small resistor. The value of the capacitor necessary, typically 0.25 farad, is, of course, quite impracticable and the capacitance is generated electronically by a Miller system M. A further advantage of this is that by careful design of the Miller system, coupled with correct selection of the choke inductance, the necessity for reservoir capacitors may be eliminated and the system fed with raw full-wave rectified a.c. Apart from the saving in space produced by the elimination of the reservoir capacitors, the r.m.s. current drawn from the secondary of the mains

transformer is also reduced, enabling the size of this component to be reduced.

All the switches employed in the system are, of course, transistors or silicon-controlled rectifiers. This system has also large advantages when used as a constant-current supply feeding such things as the focus coils of large klystrons. International Electronics can produce units with outputs of up to 100 A for such purposes with extremely high stabilities and very low dissipation. Often, such stabilizers may occupy less than one-fifth of the volume occupied by magnetic amplifier systems having the same output.

In the constant-voltage field a 5-A unit working on the principles described above is in current production and a 15-A unit is to be announced shortly.

A considerable amount of work is being undertaken on constant-current units for specific applications both in the radar and particle accelerator field.

Some of the rare earth niobates and tantalates have properties which may result in improvements to the screens of cathode-ray tubes and the coatings of fluorescent lamps. Of particular interest is the possibility of developing a near-black fluorescent screen for cathode-ray tubes.

CRYSTALLOGRAPHY AND CATHODOLUMINESCENCE

By **H. P. ROOKSBY, B.Sc., F.Inst.P.*** and **E. A. D. WHITE, Ph.D.***

THE preparation and study of new materials of many different types is an important part of present-day research. The need for improved properties applies particularly to material of electronic importance, where increasingly stringent performance requirements arise almost daily. To meet these demands there has been a marked increase in material research, where new compounds are prepared and studied by techniques which have only become available over the last two decades. Two families of elements are of particular interest for these studies, since they show in their compounds interesting electrical, magnetic and fluorescence effects. These are the transition elements (e.g. V, Cr, Mn, Fe) and the rare earth elements (e.g. Y, La, Nd, Gd). The former have been intensively studied for many years, but owing to the difficulty of separation of the rare earth elements comparatively little use has been made of their compounds until modern chemical separation techniques made available high purity materials at comparatively low cost.

As part of a fundamental research programme a family of compounds with marked cathodoluminescent properties has been made by combining in equimolecular parts a rare earth oxide (A_2O_3) with either the pentoxide of niobium or that of tantalum (B_2O_5). The compounds are prepared in

powder form or as sintered compacts, following the usual processes of mixing the raw materials and firing at the high temperatures known to ceramic technology. Temperatures in the range 1,350 °C to 1,500 °C are required to obtain properly developed single phase materials.

The rare earth oxides used in these experiments include those of lanthanum, neodymium, gadolinium, dysprosium and yttrium. These form with niobia and tantalum compounds of general composition ABO_4 . Some of the physical properties of the compounds were investigated, and it was found that under cathode-ray bombardment they were notably luminescent. The crystal structures were also examined and it was apparent that, except for $LaTaO_4$, they all had the same basic atomic arrangement. The variations between them appeared to be confined to minor changes in interatomic distances associated principally with the known differences in radii of the combining rare earth ions.

Crystal Structure

The crystal structure was identified with that of a natural mineral known as fergusonite, the composition of which approximates to $Y(Nb,Ta)O_4$. Further study revealed that the structure, although monoclinic and of low symmetry, was a slightly deformed version of that of tetragonal scheelite or calcium tungstate, $CaWO_4$. It proved possible to

* The General Electric Company Limited, Central Research Laboratories, Hirst Research Centre, Wembley, England.

demonstrate that, with the majority of the compounds containing niobia, an increase of temperature to about 800 °C removed the monoclinic deformation observed at room temperature, and above 800 °C a true scheelite-like structure was assumed. This behaviour was reversible, the deformation reappearing on cooling down again to room temperature.

This did not happen with the corresponding compounds made with tantalum instead of niobia. On increase of temperature, the magnitude of the structure deformation was gradually reduced, but even at 1,300 °C it had not been eliminated. This probably denotes a difference in the strengths of chemical bonding between the niobium and tantalum compounds.

The striking cathodoluminescence properties of CaWO_4 have been known and utilized for very many years. Synthetic CaWO_4 powder is widely used for example on the screens of certain types of cathode-ray tubes and in the luminescent coatings of some high-voltage fluorescent lamps. The similarity between the crystal structures of the rare earth niobates and tantalates and that of calcium tungstate and other isostructural tungstates is therefore of some interest. In both families, the rare earth compounds and the tungstates, a similar feature of the crystal structure may be a factor influencing the property of cathodoluminescence.

However, cathodoluminescence has also been found in niobate and tantalate compounds of similar formula, but which are apparently unrelated structurally to the above series. These include AlNbO_4 , AlTaO_4 , as well as the corresponding compounds containing Ga, In and Sc—that is other trivalent Group III elements. It is interesting to note that other combinations of these trivalent-pentavalent oxides do not show luminescence: the effect appears to be restricted solely to the compounds of ratio $A_2O_3:B_2O_5=1:1$. This suggests that there is some common feature in these compounds, possibly a localized arrangement of atoms, which promotes luminescence.

Unlike many conventional luminescent materials the activity is not due to the presence of traces of an activator. Phosphors such as Cu activated ZnS or Mn activated

Zn_2SiO_4 (willemite) suffer from the disadvantage that under conditions of electron bombardment, diffusion of the activator to the surface of the crystallites occurs and the luminescent efficiency drops. This condition, which is particularly noticeable at high intensity bombardment, is called 'burn' and may be seen in most c.r.t.s which have been subjected to prolonged scanning with a high intensity beam over a restricted area. Since the new family of materials do not contain activators this type of 'burn' is absent and they may consequently be expected to have a very long life. At the present stage of development the luminescent efficiency is lower than for conventional phosphors, but further work may overcome this problem.

Colour

Whereas the colour of the luminescence of these materials covers a wide range from pinks, blues, greens and yellows to almost white (YTaO_4), the body colour of the compounds is in all cases white. In order to achieve a high contrast between black and white regions, for example in a television screen, it is necessary to use a high intensity beam so that the conventional white phosphor appears black. If a phosphor could be prepared with a black body colour the necessary excitation current would be reduced. With conventional phosphors this is a difficult problem since additives which darken the phosphor also kill the luminescence. In the rare earth niobates, however, it is possible to incorporate small amounts of manganese or iron oxide in the structure which has the effect of giving a very dark brown or black colour without impairing the luminescence. In this circumstance it would be necessary to view the phosphor on the bombarding side.

Although this work has shown some interesting and novel features it does not represent a 'break through' to a revolutionary new device or material. It has, however, contributed to our knowledge of the relationship between structures, compositions and physical properties which is necessary to materials research, and which ultimately should enable us to provide the electronics engineer with a wide range of materials to incorporate in his black boxes!

LOW-COST COUNTING FOR THE SMALLER FIRM

Cans, cakes, bags, bottles, pills, packets—counting these on the factory floor can be like counting sheep. Boredom sets in, concentration wavers, mistakes are made and output drops.

Cheaper ways—in which the costly, error-prone human element can be replaced by inexpensive automatic counting equipment—are outlined in a D.S.I.R. booklet recently published, *Counting and Weighing**. At prices which need not deter even the smallest firm, they mean greater accuracy, less waste and higher speeds.

The steps from human operation to full-scale mechanical or electrical control can be progressive. Savings at one stage can be invested in the next. Where simple modifications can be made to existing equipment, these are proposed. And where new devices are called for, care is taken to confine these within a realistic price framework.

From mechanical equipment capable of 500 counts a minute costing only a few pounds, the scale rises to £30-£100 for 10,000-counts-a-second electronic units (these work equally well at lower rates, of course). The most expensive batch-counting layout put forward costs no more than £150.

Weighing systems are more complicated. Dial conversion units complete with controls for conventional weighing

machines vary from £200-£500: a typical installation measures 50-168 lb at 360 weighings an hour. Wider ranges—1 lb to 1,000 tons, say—can be achieved by linking electric load cells: these versatile devices cost as little as £100 apiece. Complete checkweighing systems, on the other hand, rise to about £1,500.

The range of counting and weighing equipment available—much of which can be used to control other processes as well—is as wide as these prices indicate.

This theme will recur as more booklets appear in the same series, *Automation at Low Cost*. In this series it is planned to provide practical suggestions on how to set about improving productivity in such fields as process and quality control, liquid handling and machining and assembly.

INFORMATION WANTED?

If you require further details of products or processes described or advertised in INDUSTRIAL ELECTRONICS you will find it convenient to use the enquiry cards which will be found in the front and back of the journal.

* *Counting and Weighing*, published by H.M.S.O. and available free from The Library, D.S.I.R., State House, High Holborn, W.C.1.

Thermoelectric and Thermomagnetic Cooling

(Concluded from page 444 of May issue)

Some applications of thermoelectric cooling are discussed and then the possibilities of thermomagnetic cooling are considered. This form of cooling depends on the Ettingshauser effect and has certain advantages, but is most effective at very low temperatures.

Let us now consider briefly the principles which are involved in the application of thermoelectric cooling. It will be recalled that cooling from 100 °C down to 0 °C is now possible but, for a temperature differential of this order, the c.o.p. is very low and the available cooling power rather small. In practical applications one likes to use a temperature differential of no more than 40 or 50 °C so that the coefficient of performance approaches 50%. If a power source capable of delivering an unlimited current were available, a single thermocouple of the appropriate cross-section would yield whatever cooling power we liked to choose. If, however, a limit of about 10 amps d.c. is set on the current, one can get only about $\frac{1}{4}$ watt cooling per couple. Larger cooling powers are then obtained by using a multi-couple cooling unit. The essential features of a cooling unit are shown in Fig. 8. The elements are joined by metal links

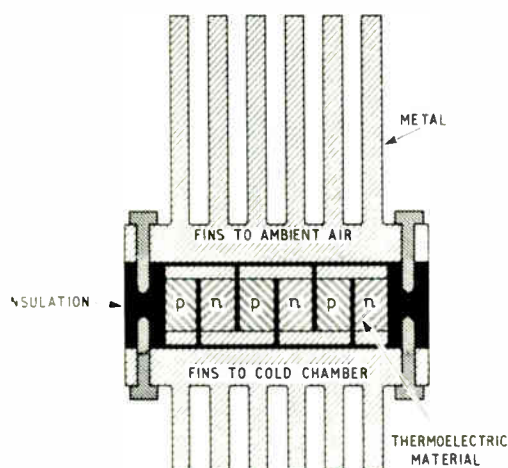

Fig. 8. Principle of construction of a thermoelectric cooling unit

which are electrically insulated from one another but in good thermal contact with either the heat source or the heat sink.

It is certainly possible to make a refrigerator (suitable for domestic use or even larger) using a thermoelectric cooling unit. However, the performance is far worse than that of a conventional compressor unit and, even with its advantages of silence and no moving parts or obnoxious gases, a large thermoelectric refrigerator is not yet an economical proposition. It seems generally agreed that an increase in z from about 3×10^{-3} to $6 \times 10^{-3} \text{ deg}^{-1}$ will be needed before thermoelectric cooling units, of about 50-watts cooling power or more, become worthwhile.

For a cooling power of about 10 watts the thermoelectric unit seems more attractive; a notable feature of thermoelectric refrigeration is that the c.o.p. is almost independent of the cooling power while other types of refrigeration become less efficient as the cooling power is reduced. One of the photographs shows a 160-couple cooling unit with about 10-watts cooling power capable of working off a 12-volt battery. Another photograph shows the same unit mounted on fins and suitable for insertion in a cold-box of about $\frac{1}{2}$ cu ft capacity.

Thermoelectric cooling really comes into its own for still smaller cooling powers. A particularly important application is a thermostat for maintaining an enclosure at constant temperature near or below room temperature. Here use is made of the fact that reversal of the current through a cooling unit produces a heating effect. Conventional thermostats with resistance heaters must operate at about 70 °C so as to get a reasonable heat loss to balance the heat input. In the system shown in Fig. 9 the amplified out-of-balance current from a thermistor is used to modify the standing current through the heating and cooling unit. A similar application which uses only a single semiconductor thermocouple is the automatic dew-point hygrometer* shown in Fig. 10. In this

* A thermoelectric dew-point hygrometer and a unit for maintaining thermocouple reference junctions at 0 °C have been described by Mr. J. Bean of Salford Electrical Instruments Ltd. in the December 1962 issue of *Industrial Electronics*.

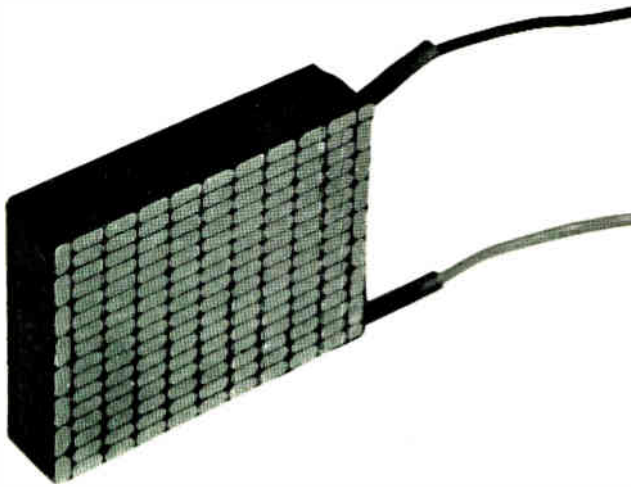

160-couple thermoelectric cooling unit with about 10 watts cooling power

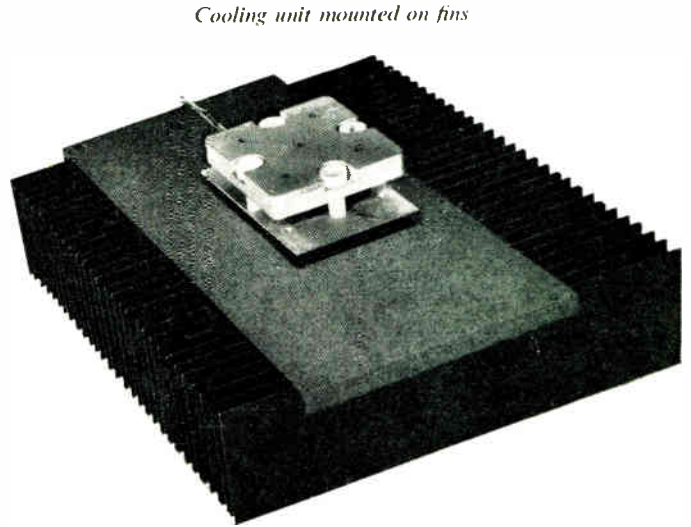

Cooling unit mounted on fins

case the direction of the current through the thermocouple is controlled by the amplified output from a photocell which intercepts light reflected from the mirror. Frost-points below -50°C can be determined by this method if a multi-stage cooling unit is employed.

The Ettingshausen Effect

In 1887, Baron von Ettingshausen, an Austrian botanist and geologist, discovered that the application of a transverse magnetic field to a conductor carrying a current produced a transverse temperature difference. The Ettingshausen coefficient P is defined in Fig. 11, and is thermodynamically related to the Nernst coefficient (defined as $Q = E_y/\nabla T_x H_z$ where E_y is the transverse electric field produced by a longitudinal temperature gradient ∇T_x) in just the same way that the Peltier and Seebeck coefficients are related. Thus

$$P\kappa = QT.$$

The Ettingshausen effect has formerly been regarded, even more than the Peltier effect, as a scientific curiosity rather than an exploitable phenomenon. However, let us consider what factors would influence its performance as a means of refrigeration.

Using our thermodynamic relation, the rate of transverse heat flow per unit area corresponding to a current density i_x is $QT_c H_z i_x$ and this is opposed by half the Joule heating

($y i_x^2/2\sigma$), where y is the transverse length dimension, just as in the case of a thermoelectric cooler. At the optimum current density the maximum net rate of heat flow is $\frac{1}{2} Q^2 T_c^2 H_z^2 \sigma / y$. The transverse temperature difference under no-load conditions builds up to a value ΔT_{max} such that the electrically-induced heat flow is balanced by thermal conduction. It is found that:

$$\Delta T_{max} = \frac{1}{2} z_E T_c^2$$

where

$$z_E = (QH_z)^2 \sigma / \kappa$$

There is a complete analogy between thermomagnetic cooling and thermoelectric cooling and between the thermomagnetic figure of merit z_E and the thermoelectric figure of merit z . The equations become identical if we substitute QH for α ; QH is sometimes referred to as the thermomagnetic power.

Ettingshausen Effect in Extrinsic and Intrinsic Semiconductors

Let us now examine the origin of the Ettingshausen effect. We consider first a one-carrier or extrinsic semiconductor as shown in Fig. 12(a). On the application of a magnetic field the electrons experience a Lorentz force and tend to move in a transverse direction. However, a Hall-effect field builds up so that in equilibrium there is no net lateral current flow. If all the electrons had the same velocity there would be no heat flow either. But in practice there are faster-than-average and slower-than-average electrons and the scattering effects on the two groups are unequal. For example, the assumption of simple scattering of carriers by the thermal vibrations of the lattice implies that the fast electrons are more strongly scattered than the slow electrons. Thus the fast electrons move with the Hall field and the slow electrons move against it; the top becomes hot and the bottom becomes cold. This segregation of hot and cold carriers is not a very efficient process and moreover it tends to vanish at very strong magnetic fields. The expression for QH is given in Table 1 where e is the electronic charge and τ is the relaxation time of charge carriers which have an energy E . If μ , the mobility, is measured in $\text{cm}^2\text{V}^{-1}\text{sec}^{-1}$ then H must be measured in units of 10^6 Oe. The maximum value of the thermomagnetic power, which is reached when $\mu H = 1$, is also given. The corresponding expression for α is given in Table 1 for comparison. At the optimum value of α the term in square brackets is equal to about $2kT$ whereas the

Table 1
EXPRESSIONS FOR THE SEEBECK COEFFICIENT AND THE THERMOMAGNETIC POWER

Coefficient	Condition	Expression
α	Extrinsic	$\pm \frac{1}{eT} \left[\frac{\langle \tau E \rangle}{\langle \tau \rangle} - \eta \right]$
QH	Extrinsic	$-\frac{1}{eT} \frac{\mu H}{1 + \mu^2 H^2} \left[\frac{\langle \tau^2 E \rangle}{\langle \tau^2 \rangle} - \frac{\langle \tau E \rangle}{\langle \tau \rangle} \right]$
QH	Extrinsic (optimum H)	$-\frac{1}{2eT} \left[\frac{\langle \tau^2 E \rangle}{\langle \tau^2 \rangle} - \frac{\langle \tau E \rangle}{\langle \tau \rangle} \right]$
QH	Intrinsic ($\mu_n = \mu_p = \mu$)	$\frac{1}{eT} \mu H \left[\frac{\langle \tau^2 E \rangle}{\langle \tau^2 \rangle} + \frac{E_g}{2} \right]$

Quantities bracketed thus $\langle \rangle$ represent values averaged over all energies E .

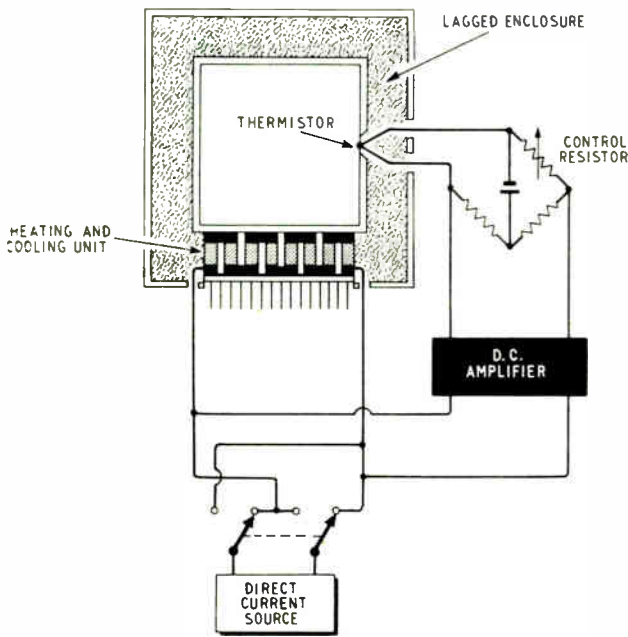

Fig. 9. Thermoelectrically-controlled constant-temperature enclosure

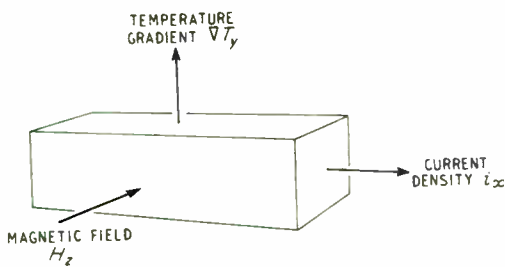

Fig. 11. Definition of the Ettingshausen effect. A current density i_x in a transverse magnetic field H_z produces a temperature gradient ∇T_y . The Ettingshausen coefficient is $P = \nabla T_y / i_x H_z$

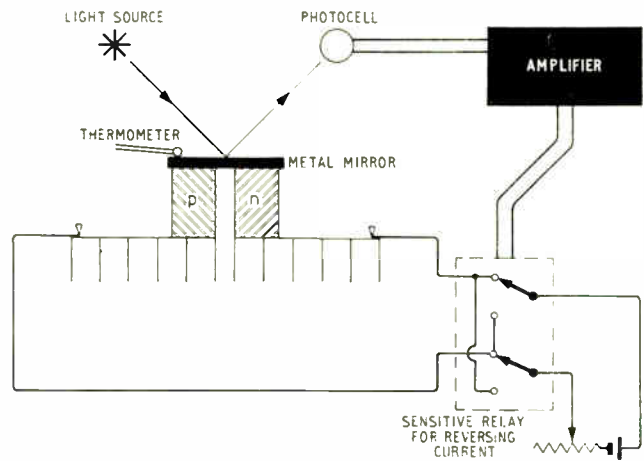

Fig. 10. Thermoelectrically cooled dew-point hygrometer

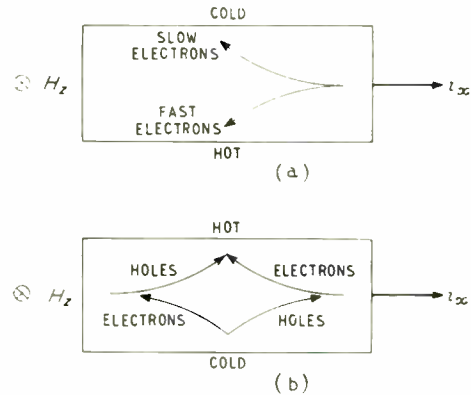

Fig. 12. Ettingshausen effect in (a) an extrinsic n-type conductor and (b) an intrinsic conductor

term in square brackets in the expression for QH is only about $\frac{1}{2} kT$. Moreover, the magnetoresistance effect in a high field reduces the ratio σ/κ . Thus, even supposing that the high magnetic field corresponding to $\mu H = 1$ is available, Ettingshausen cooling seems far inferior to Peltier cooling.

Now, however, let us consider an intrinsic semiconductor. Fig. 12(b) shows that the Lorentz force drives both electrons and holes to the same side of the bar. Since the electrons and holes can recombine, the flow of electron-hole pairs can continue indefinitely. Two new features are apparent in this case as Delves has recently pointed out. The recombination or generation of electron-hole pairs liberates or absorbs a considerable amount of ionization energy so that we expect the heating and cooling effects to be more pronounced than in the one-carrier case. Also, the Ettingshausen coefficient should not fall to zero in high magnetic fields. The expression for QH is given in Table 1; it is assumed that the electron and hole mobilities are equal. Remembering that

$$\sigma(H) \approx \sigma(0)/(1 - \mu^2 H^2)$$

where $\sigma(0)$ is the electrical conductivity with no magnetic field, and that

$$\kappa(H) \rightarrow \kappa_L \text{ as } H \rightarrow \infty$$

we see that at the highest magnetic fields

$$z_E \rightarrow \frac{\sigma(0)}{\kappa_L} \left\{ \frac{1}{eT} \left[\frac{\langle \tau^2 E \rangle}{\langle \tau^2 \rangle} + \frac{E_g}{2} \right] \right\}^2$$

If we were in a position to alter the energy gap E_g at will, keeping the other parameters (i.e., μ , m^* , κ_L) constant we should find that z_E would rise as E_g became smaller and in fact overlapping bands appear to be desirable although too much overlap may invalidate our basic assumptions. It seems that the best balance between the requirements of high Q and high σ will be found in semi-metals or very narrow gap semiconductors rather than larger gap semiconductors.

We may make some estimate of the potentiality of Ettingshausen cooling compared with Peltier cooling by setting $E_g = 0$. We might then expect the partial electrical conductivities of electrons and holes σ_n and σ_p to be equal to the electrical conductivity of a similar one-carrier semiconductor with $\eta = 0$. The two effects are compared in Table 2.

If the electron mobility is greater than the hole mobility by a factor b (usually b is appreciably greater than unity) one finds that z_E is reduced by a factor $4b/(1+b)^2$. Furthermore it has been assumed that $\mu H \gg 1$ for electrons and holes. If H is 10,000 Oe as for a fairly large laboratory

Table 2

Comparison of Ettingshausen with Peltier cooling. It is assumed that the electron and hole mobilities are equal and that the Fermi level lies at the band edge(s)*

Term	Peltier	Ettingshausen	Gain for Ettingshausen Effect
Electrical conductivity	σ_n	$\sigma_n + \sigma_p$	2
Thermal conductivity†	$\kappa_p + \kappa_L$	κ_L	$\sim 1\frac{1}{2}$
Square of Seebeck coefficient or of thermomagnetic power	$\left[\frac{\langle \tau E \rangle}{\langle \tau \rangle}\right]^2$	$\left[\frac{\langle \tau^2 E \rangle}{\langle \tau^2 \rangle}\right]^2$	$\frac{25}{16}$
Figure of merit	z	z_E	4.7

* The latter condition implies that the energy gap must be zero for the case of the Ettingshausen effect.

† κ_L is the electronic thermal conductivity.

magnet, μ must be appreciably greater than 10,000 cm²/V sec for both electrons and holes. Finding a material with such a high hole mobility is likely to be the greatest difficulty. Almost certainly thermomagnetic cooling will be a tool for low temperature (e.g., liquid nitrogen region) rather than room temperature use. Apart from the above requirements, the effective mass and lattice thermal conductivity criteria apply as for thermoelectric materials; i.e., we might use alloys of high atomic weight.

Is there any hope, then, of finding a suitable thermomagnetic material? Surprisingly enough a moderately good one is already available. It is none other than a Bi-Sb alloy with a composition (95Bi-5Sb) close to that of the thermoelectric material already mentioned. The alloy, when undoped, combines most of our requirements. It has equal numbers of electrons and holes, the hole mobility, although not being as high as the electron mobility, still being higher than that of other known materials. The energy gap is about zero.

The first results reported by Cuff and his colleagues indicate an Ettingshausen figure of merit of 5×10^{-3} deg⁻¹ at 80° K (i.e., about the same as the thermoelectric figure of merit in zero magnetic field). A magnetic field of about 5,000 Oe is needed in approaching the limiting high-field performance. There seems no doubt that this figure of merit

will be improved upon as the alloys of Bi and Sb become more widely studied and there seems every likelihood that z_E will exceed the value of z for a thermoelectric material even in its optimum magnetic field. If this proves to be the case the other advantages of thermomagnetic cooling will be:

- (1) Only one material is needed.
- (2) Additional cooling power for a given current is achieved by altering the dimensions of the sample; it still remains a single sample.
- (3) If a multi-stage device is required so as to give a larger than usual lowering of temperature the arrangements are simpler than for a thermoelectric cascade. In a thermoelectric cascade, either a complex arrangement of thermocouples is needed or else a stack of cooling units, with appropriate insulation between layers, must be used. A similar method can be employed in thermomagnetic cooling but in this case one can make a cascade more simply by varying the cross-section between the hot and cold faces as shown in Fig. 13; the simplest of the thermoelectric cascades, a small 2-stage device, is illustrated for comparison.

Conclusions

To sum up the present position, then, and to anticipate future developments, we now have thermoelectric cooling units whose performance is well suited to a variety of applications requiring a cooling power of up to about 10 watts in the room temperature region. Although it is difficult to foresee sensational improvements in room-temperature thermoelectric materials, the 2 to 1 improvement in figure of merit which would make larger scale thermoelectric refrigeration more attractive can certainly not be ruled out on any theoretical grounds.

In order to achieve a comparable performance (i.e., a comparable $\Delta T_{max}/T$) at lower temperatures a correspondingly higher value of z is needed so that zT is as large as at room temperature. Thus if z can be made appreciably greater than 10×10^{-3} deg⁻¹ at liquid nitrogen temperature, low temperature cooling units should find useful applications. Steps towards this situation have already been taken as a result of the work on Bi-Sb alloys as thermoelectric materials. Quite probably, however, electronic cooling in the low temperature region may be undertaken using the Ettingshausen rather than the Peltier effect.

No mention has been made of the phonon-drag effects which can enhance both the thermoelectric and thermomagnetic coefficients at low temperatures. It may well be that work on phonon-drag will lead to really large improvements in the figure of merit, but it would be rash to make any predictions at the present time.

Bibliography

Thermoelectric Cooling

- A. F. Ioffe, 'Semiconductor Thermoelements and Thermoelectric Cooling' (Infosearch, London) (1957).
 H. J. Goldsmid, 'Applications of Thermoelectricity' (Methuen, London) (1960).
 G. E. Smith and R. Wolfe, 'Thermoelectric Properties of Bismuth-Antimony Alloys', *J. Appl. Phys.*, Vol. 33, p. 841 (1962).
 R. Wolfe and G. E. Smith, 'Effects of a Magnetic Field on the Thermoelectric Properties of a Bi-Sb Alloy', *Appl. Phys. Letters*, Vol. 1, p. 5 (1962).

Thermomagnetic Cooling

- R. T. Delves, 'The Prospects for Ettingshausen and Peltier Cooling at Low Temperatures', *Brit. J. Appl. Phys.*, Vol. 13, p. 440 (1962).
 J. L. Weaver, K. F. Cuff, G. M. Enslow, S. R. Hawkins, R. B. Horst and C. F. Kooi, 'Thermomagnetic Properties of Bi(95)Sb(5)', *Bull. Amer. Phys. Soc.*, Vol. 7, p. 495 (1962).

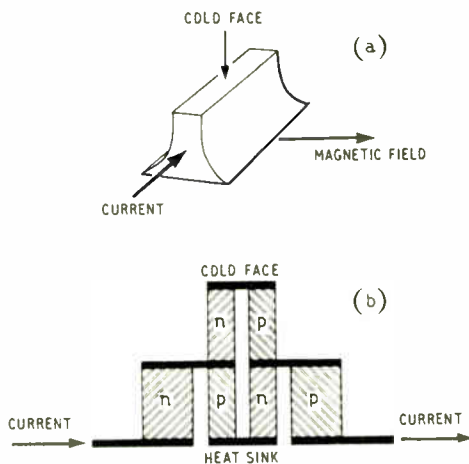
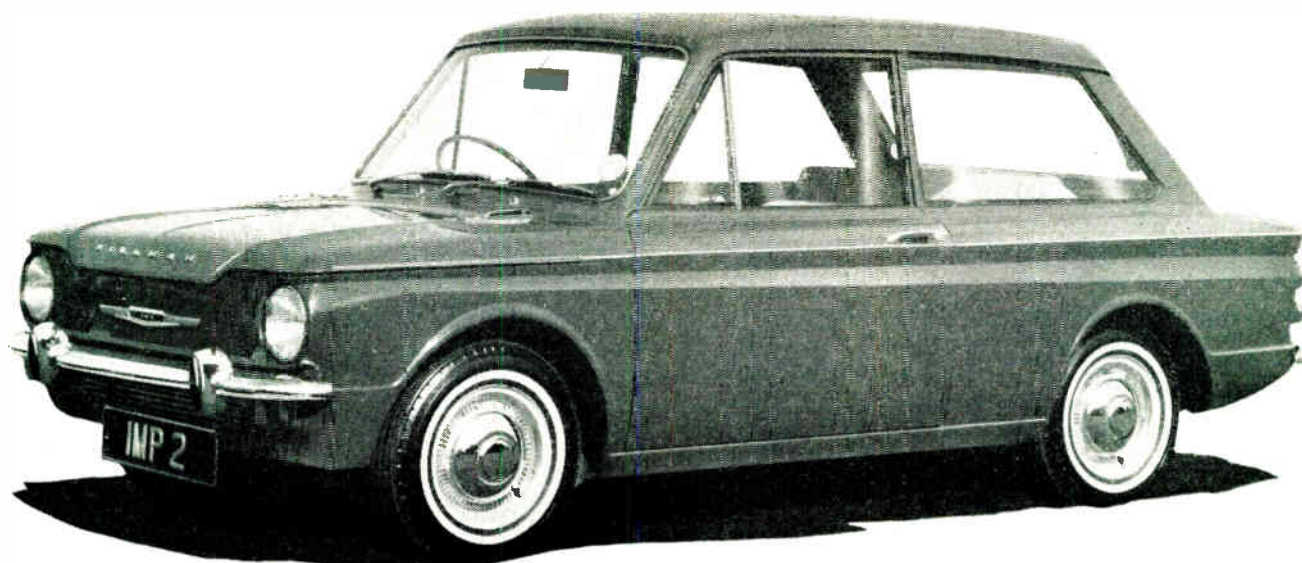

Fig. 13. An infinite-stage Ettingshausen cooler compared with a 2-stage Peltier cooler

- Ettingshausen cooler
- Peltier cooler



The many novel design features of the new Hillman 'Imp' are matched for interest by the advanced techniques involved in its manufacture. This article describes the computer controlled production system and the electronically controlled gear-box/rear axle test rigs.

ELECTRONICS IN THE PRODUCTION OF THE 'IMP'

COMPUTER controlled production and the use of electronically controlled test rigs are two examples of the way in which electronics is playing a part in the manufacture of the Hillman 'Imp'.

An I.C.T. 1301 computer is the basis of an integrated production control system now in operation at the Rootes' car factory at Linwood, Scotland. The essential purpose of this system is to minimize delay on the final assembly line by ensuring that each component is in the right place at the right time; in addition, the computer will provide sales, accounting and statistical data.

The first stage in the setting up of the system is the compiling of a computer specification file: cards are punched directly from the engineering specifications, and the data transferred to the computer's memory store. Consequently, when fed with the model assembly list number (plus the numbers of non-standard units, in the case of alternative versions of the vehicle), the computer will print out or punch into cards a complete specification of the vehicle concerned, with details of each component required.

Once the specification file has been established, the manufacturing control procedure can be started. Rota cards, one for each batch of identical vehicles, are prepared from a daily list of cars ordered; the data punched into these cards comprise the model assembly list number, the unit number or numbers of any non-standard units, colour code number, and identification data such as batch number, date, etc.

Each day's batch of rota cards is automatically fed into the computer, at the rate of 600 cards per minute, to give the production programme for the tenth working day thereafter. The computer produces for each vehicle: (1) a specification tally to be attached to the car body to provide information for operators on the assembly track; (2) a printed body schedule showing the bodies required from Pressed Steel, whose plant adjoins the Linwood factory, and is connected to it by a bridge conveyor; (3) data distribution cards which are sent to Pressed Steel and returned by them with the body to which they refer; (4) parts requirement cards to be used as the input for stock control and supplier scheduling applications.

As the car bodies leave the Pressed Steel plant, the appropriate specification tally is attached to each and, at the same time, the data distribution card accompanying the body is fed into a data transmission system. An input unit scans the card and automatically transmits from the Pressed Steel works selected sections of the data to output stations at various points along the

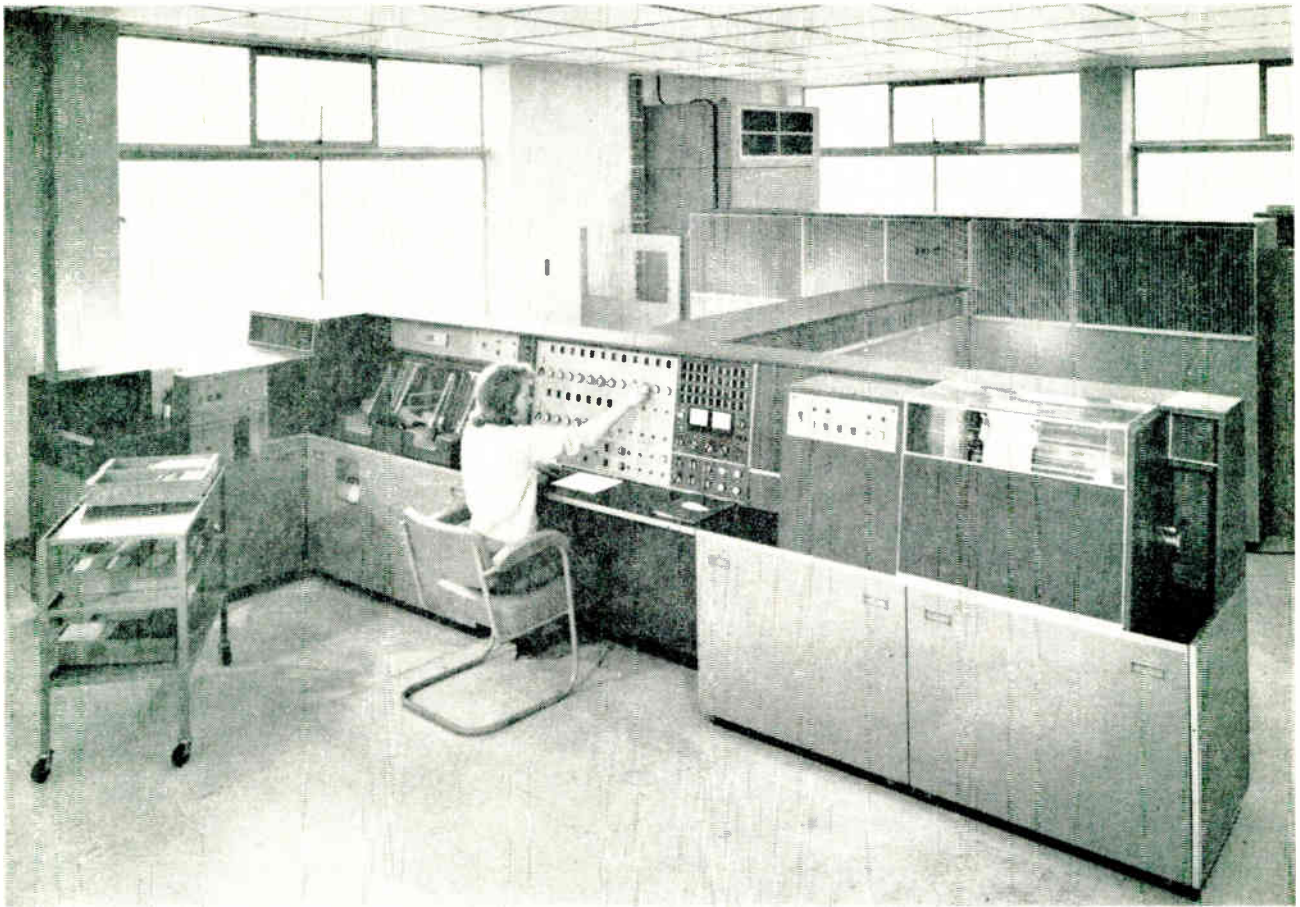

▲
The heart of the production control system — an I.C.T. 1301 computer

An Imp gear-box/rear axle unit being checked with an electronically controlled test rig
 ▼

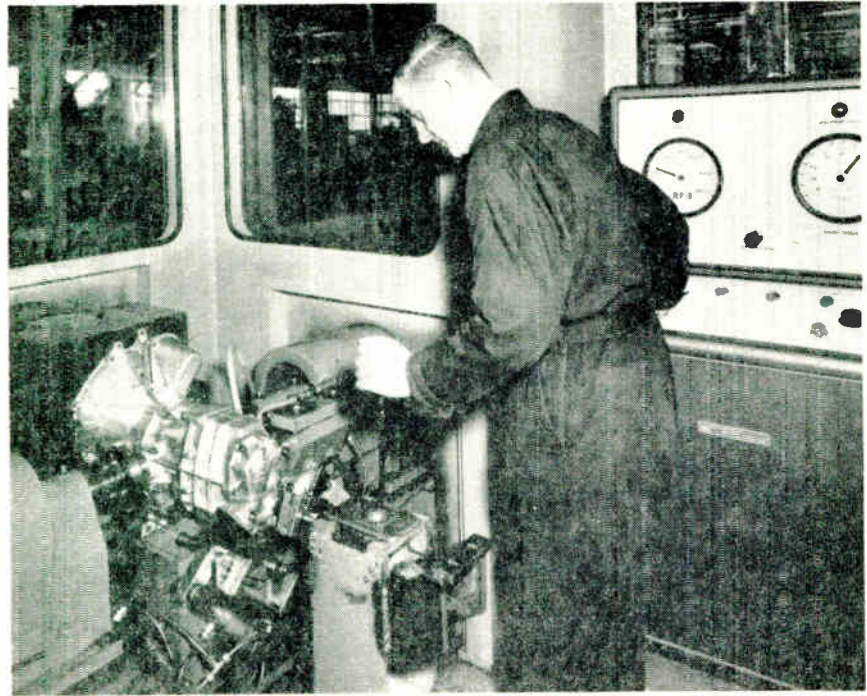

assembly track at Linwood, where the information is printed out. Operators on the track thus have advanced knowledge of the components required for the bodies which will shortly reach them.

Five electronically controlled, combined gear-box/rear axle test rigs form part of the 'Imp' production plant. This equipment, designed and manufactured by Lancashire Dynamo Electronic Products, allows each gear-box, rear axle unit to be tested under accurate speed and loading conditions to ensure correct assembly and minimum noise level.

A drive motor is connected to the input end of the gear-box through a flexible coupling and an electromagnetic clutch; the output ends of the axle half-shafts are connected to loading motors via flexible couplings and a sliding mechanism powered by a pneumatic ram. The pneumatic controls used to operate the mechanical engagement of the input and output shafts, etc., are mounted on a remote control station together with the electrical controls and indicators.

The drive motor is a variable speed d.c. machine with the supply for the armature provided by a Ward-Leonard motor-generator set:

the required control of the drive motor speed is achieved by means of a 'closed loop' system and hence the power needed is only that necessary to overcome the losses. The loading on each half-shaft of the rear axle is effected by employing two d.c. motors which act as generators: one functions as a 'master' and the other as a 'slave', to keep the differential between the two half-shafts to within one r.p.m. (not more than 4% of the actual shaft speed). Over-run and reverse conditions can be simulated.

The armature voltage of the driving motor is controlled to provide an infinitely variable speed range from 100 to 5,000 r.p.m. at a constant torque of up to 30.5 lb/ft. The loading motors will, in addition, provide up to 9 lb/ft over-run torque for an overall gear-box/rear axle ratio from 17.6:1 to 3.85:1.

Under steady-state conditions the armature current of the driving motor is maintained to within $\pm 0.5\%$ of its value at full load and the speed of the gear-box input drive shaft to within $\pm 0.25\%$ of maximum speed, i.e. to within 12.5 r.p.m. At any fixed load, with supply voltage variations of $\pm 7\frac{1}{2}\%$ of the nominal value, the input drive shaft speed is maintained to within 1% of maximum speed, i.e. ± 50 r.p.m.

In order to provide the required load-torque characteristics, the load motors have a constant absorption h.p./speed characteristic for speeds from 284 to 1,300 r.p.m. and a constant maximum torque speed characteristic for speeds from 6 to 284 r.p.m.



▲ A supervisor taking production data from the output printer at the pre-mount point in the final assembly line

The I.C.T. output printer at the engine and transmission assembly point ▼

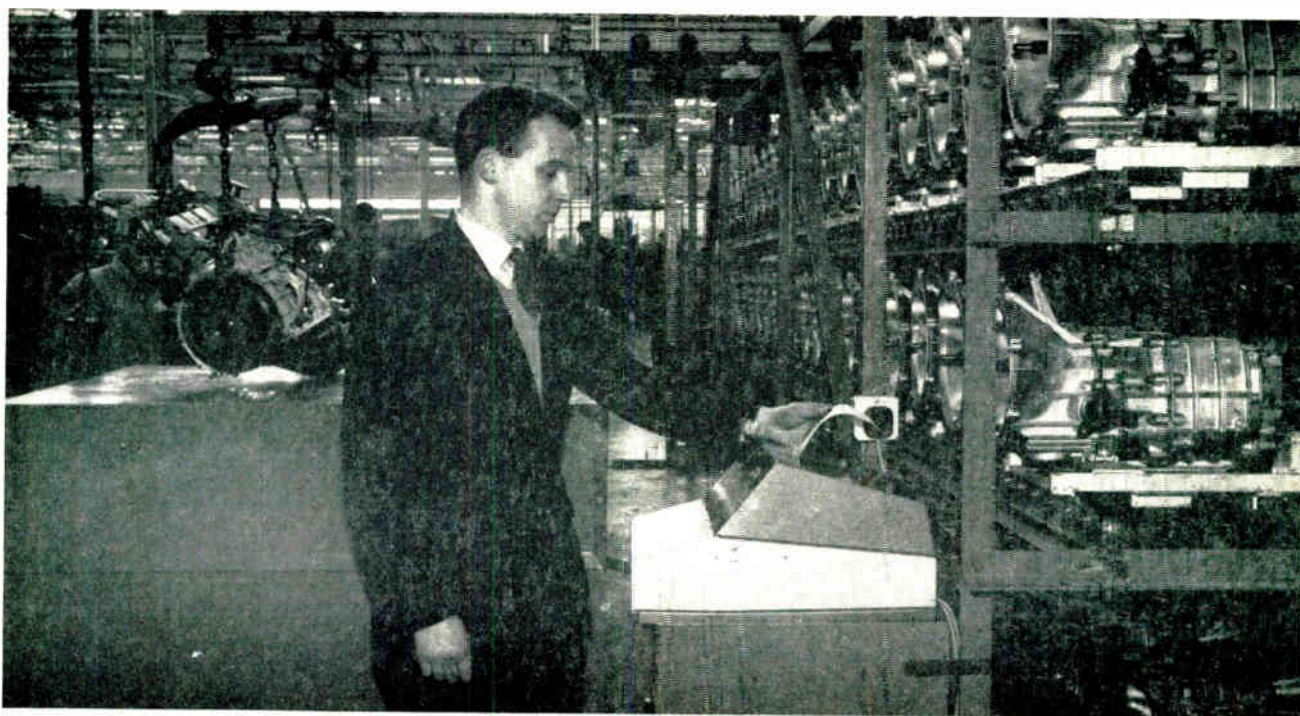

RADIO AND ELECTRONIC COMPONENT SHOW

FROM the user's point of view the components exhibitions are always interesting for they invariably bring sharply into focus the latest developments for an enormous variety of electronic and electrical equipment.

This year was no exception and visitors to the Radio and Electronic Component Show were able to see a selection of up-to-the-minute components ranging from miniature components-for-components to component parts of large and complex systems.

In this issue we include a report on some of the many interesting items shown. For those concerned only with specific items we are presenting the report in classified sections following this introductory article.

Needless to say, a large number of the devices are either unique or will not fit neatly into one of the categories.

For example, a number of logic units were to be seen at the show. In particular Elliott Brothers (31) were exhibiting their new Minilog F series. The basic element in this series is half the size of earlier logic elements and up to five times as fast in operation. It is capable of accepting signal frequencies of up to 2 Mc/s. A main feature of this design is that, with suitable elements, any logical func-

tion can be performed without redundancy. The series comprises, at present, three basic modules. Unit F1 is a double logic type of two gates, each having a fan-in of 4 and a fan-out of 3 or vice versa. F2 is a one logic function unit with a fan-in of 2 and a fan-out of up to 20. F3 is a counter stage with a fan-in of 4 and a fan-out of 4 plus and minus; it has set and re-set input facilities. Twenty-four Minilog units can be fitted by their pins to a 10 × 8 in. plug-in panel, with a patch-board one side to provide versatile logic functions with ease. To make these units completely self-contained Elliotts have also produced a stabilized power supply for mounting on the plug-in panels—it occupies the space of six Minilogs.

An item which indicates the increasing application of ferrites was shown by Stability Radio Components in the form of their 'Filter Feed-Thru' (32). This is basically a π -filter incorporating two 1,000-pF capacitors and an inductance created by a ferrite bead inside the ceramic tube which forms the dielectric for the two capacitors. Insertion loss is about 30 dB at 30 Mc/s rising to 80 dB at 100 Mc/s.

Entirely different types of filter were exhibited by Brush

For further information about specific items circle the appropriate number, shown in brackets in this review, on the Service Card

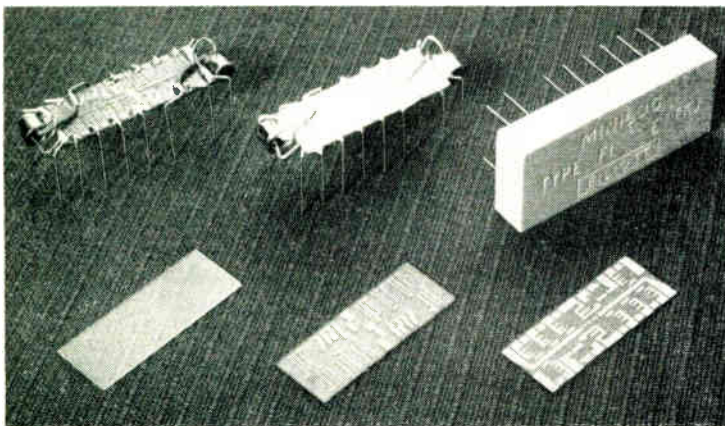

▲ This illustrates step-by-step the construction of an Elliott Minilog unit. Resistors and capacitors are deposited on a glass substrate

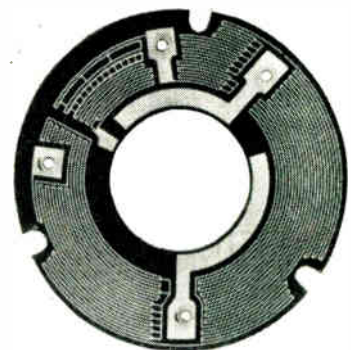

▲ Technograph displayed a range of etched-foil and printed circuit resistors. This assembly, used in the Avominor, is a resistor group for 10.4 Ω and 113 Ω . It is used for the ohmmeter ranges and includes switch contacts (34)

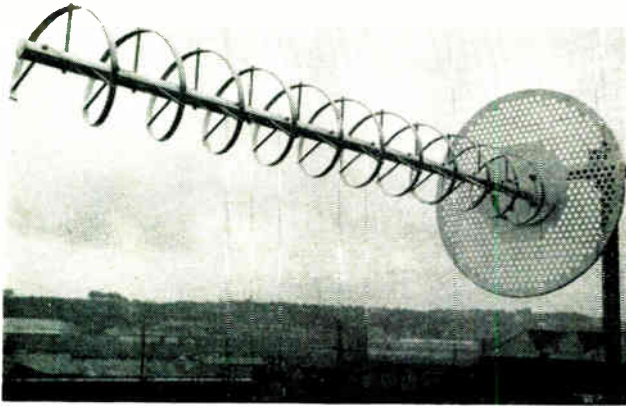

▲ One of a range of aerials shown by J-Beam. This is a u.h.f. helical type. Features include a front to back ratio of the order of 20 dB and a good bandwidth. No insulators are used to support the radiating system and therefore the whole of the aerial is at d.c. earth potential. This enables lightness to be combined with strength of construction (40)

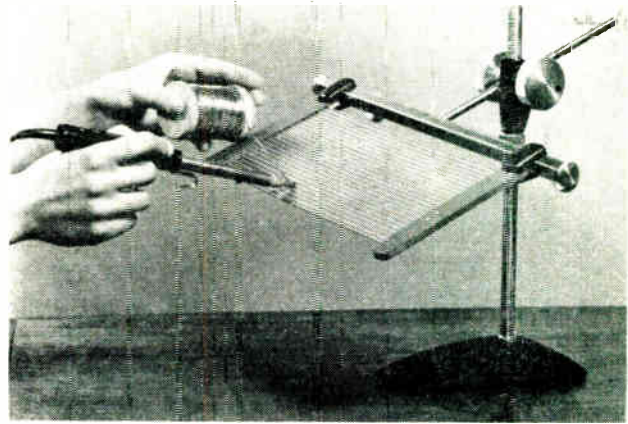

▲ This assembly stand is one of several new Veroboard accessories introduced at the show by Vero Electronics. It enables a circuit card to be held in almost any position. Cards measuring up to 8 x 12 in. from 1/32 to 1/8 in. thick can be accommodated in this jig (41)

Crystals. These are units based on piezoelectric ceramic material. The range includes types for use in i.f. circuits, miniature ladder filters and interstage coupling. One of these, 'T.O.-01 Transfilter' (33), is a piezoelectric disc vibrating at the first overtone of its fundamental radial mode. It forms a 4-terminal network with a relatively high input impedance (2 kΩ) and a low output impedance (300 Ω). Insertion loss (power) at 455 kc/s is only 2 dB and the bandwidth is 4 to 7%, depending on the loading.

Another piezoelectric device was demonstrated by Mullard. In this a slab of piezoxide (35) was used to fire a conventional sparking plug when subjected to pressure from a rotary cam. The voltage across the plug is proportional to the mechanical pressure and the thickness of the slab. A pressure of 7,000 p.s.i. generates 400 V per millimeter of thickness.

A further development of Araldite was featured by Ciba (A.R.L.) Ltd. (36). This is their 'Araldite E-Pak'—a system for the high-speed encapsulation of components. This system consists of the use of moulded cases and pre-formed Araldite pellets, appropriate in shape and size to the component to be protected. As supplied, the pellet is not fully cured and under heat it melts, fills the mould, and sets to form a high strength solid.

Sellotape demonstrated the advantages of tapes with thermosetting adhesives and introduced a new extra thin polyester tape which utilizes 0.0005 in. Melinex film (37).

Developments of another kind were obvious on the stand of B.I.C.C. Miniature and sub-miniature coaxial cables (38) with paste-extruded p.t.f.e. dielectrics were featured. This extrusion technique has the advantages of uniformity and absence of air pockets. An experimental type of air-spaced p.t.f.e. r.f. cable, though only 1/4 in. overall, has a capacitance of less than 12 pF/ft and a relative permittivity of less than 1.2.

Permark demonstrated a packaged unit for the rapid dispensing and fitting of identification sleeves (39) to cables. This comprises a pneumatically-operated expanding tool, pneumatic magazines together with a dispenser unit. The units are contained in a cabinet measuring 11 x 18 x 15 1/2. It has a total capacity of 11,000 identification sleeves, carried by 11 individual magazines.

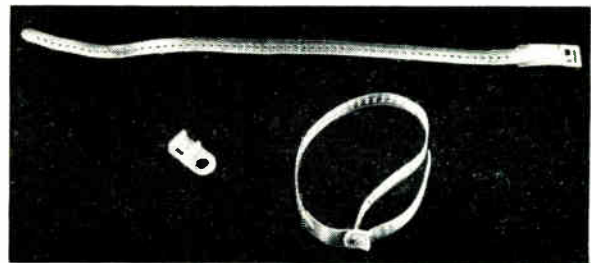

▲ Hellerman were showing this new cable strapping for the first time. It is known as 'Helastrap' and is a one-piece strap and buckle (with fixed spigot): it is made from nylon (42)

Steatite & Porcelain Products (43) were showing a selection of low-loss ceramic pressings, extrusions and precision ground products. Included in these were samples made from Alumina 961, a 96% alumina ceramic of low cost and general purpose application where high strength is needed. It also has the properties of high thermal conductivity and extreme hardness together with excellent h.f. performance.

A public address speaker for high intensity 'speech only' applications was one of the exhibits of Goodmans. This P.A.100 unit (44) is a miniature horn loaded column capable of handling 100 W input; it measures only 27 x 9 x 3 in. The line source characteristics of this unit ensure that the sound energy is concentrated where required and the effects of reverberation are minimized. A 100-V line transformer is fitted tapped at 100, 25 and 10 W.

Prominent among the many new devices shown by the M-O Valve Co. Ltd. was a range of four double-gun c.r.t.s (45) designed to cover all likely applications in the high-grade oscilloscope field. They are the 1000H, 1000J, 1300H and 1300J. A new compact construction ensures closer tolerance on pattern distortion (reduced from 2 1/2% to 1%) and greater sensitivities and scan amplitudes. Auxiliary electrodes provide for retrace blanking at gun potential, independent astigmatism adjustment and trace superimposition. Sensitivities are as follows: 1000H and 1300H, S_x 18 V/cm, S_y 6.5 V/cm, 1000J and 1300J, S_x 18 V/cm, S_y 4.5 V/cm.



Resistors

PROBABLY the most basic and widely-used component is the resistor in all its forms. Although the common carbon resistor was one of the first types produced in quantity it still accounts for the major part of resistor production. Manufacturing techniques and materials for carbon resistors have, of course, improved through the years but the basic concept remains the same.

Finely powdered conducting material, such as graphite or carbon, is mixed with a powdered insulating material together with a plastic binder. This mix is then compressed into the form of a rod with a wire lead embedded part way into each end. The whole is encapsulated to provide protection; typically the rod is sealed in a ceramic tube or encapsulated in a thermosetting plastic. Advantages of composition resistors are low cost, small size, good frequency-response characteristics and resistance values ranging from about 10Ω to $20 M\Omega$. They are normally available with resistance tolerances of 20, 10 and 5%, and with wattage ratings of up to 2 W. Disadvantages are that composition resistors are subject to ageing effects and have high voltage and temperature coefficients. In addition, tolerances of less than 5%, are difficult to achieve in mass production. Composition resistors are, therefore, classified as general-purpose types.

The second major category for resistors includes those referred to as high-stability types, such as pyrolytic or cracked-carbon, wirewound and the metal or metal-oxide-film resistors. All of these are capable of providing stable resistance to within 1%.

Pyrolytic or cracked-carbon resistors are produced by the deposition of material at high temperature on to an insulating substrate; ceramic tubes are normally used as the core or substrate. The tubes are placed in a high-temperature oven, at about $1,000^\circ\text{C}$, and a gas, usually carbon containing, is introduced. By varying temperature, the amount of gas and the duration of time of deposition, resistive films of various thicknesses are produced on the substrate. Resistances up to many thousand ohms can be obtained by the control of film thicknesses. Higher resistance values are obtained by cutting a continuous spiral through the film over its full length.

Advantages of this type of resistor are that they have negligible voltage coefficient, very low temperature coefficient and excellent frequency-response characteristics up to about 30 Mc/s. They represent a good compromise between composition and precision wirewound resistors. Resistance values from about 50Ω to $100 M\Omega$ are made, but higher values can be produced. The normal tolerance for this type is 1% and they are available with power ratings up to 2 W.

Metal-film resistors have the same general construction as cracked-carbon types except that the film consists of metal or metal alloy. These may use glass or ceramic tubular or flat substrates on to which the film is evaporated at a high temperature in vacuo. A wide range of resistance values and temperature coefficients can be obtained by process control techniques. Metal-film resistors have sizes, voltage and power ratings equivalent to the cracked-carbon

types, but the resistance range covered is less. Typically, the resistance range covered is 100Ω to $5 M\Omega$; tolerances of 1%, are normal. Protective encapsulations for this type included ceramic tubes, resin potting and resin-based paint.

A variant of the metal-film resistor is to be found in many of the microcircuits being developed at present. In these, similar evaporation techniques are used with masks over the substrate to control the position and area of deposition.

Finally, we have the well-known wirewound type of resistor. These simply comprise resistance wire wound on an appropriate former. Nickel-chromium, nickel-copper, manganin and constantan are typical of the many materials used for the production of resistance wire. Values from 0.1Ω to $20 M\Omega$ are obtainable and while they are produced to standard tolerances of 0.1, 0.5, 1 and 2%, closer limits can be set if necessary. The lowest standard tolerance is usually 0.02%. In addition to the accuracy, long-term stability, typically of the order of 1%, is one of the major advantages of this type. Methods of winding vary, but where low inductance is required bifilar winding is used. In this winding the wire is bent back on itself at the mid-point so that the two halves are side by side. A second low inductance winding method used is that of winding the resistor in sections, alternate sections being wound in opposite directions. A technique used to reduce the temperature coefficient is that of winding half of the resistor with wire with a low positive temperature coefficient and the other half with wire with a low negative temperature coefficient.

At the components show many of these standard types of fixed resistor described were shown along with others, including pre-set and variable resistors and potentiometers.

Many resistor manufacturers were showing metal-oxide types and in fact Electrosil (46) devoted their complete display to these. They featured the introduction of triple ratings for the popular sizes which means that, according to the rating applied, the same resistor can be used for semi-precision, high-stability or general-purpose applications. By employing a new spiralling technique, the range of their NJ60 $\frac{1}{4}$ W and CJ20 $\frac{1}{2}$ W resistors has been extended from 68Ω – $110 k\Omega$ to 10Ω – $470 k\Omega$.

Welwyn Electric (47) also introduced at the show their ranges of metal-oxide-film resistors. These included the

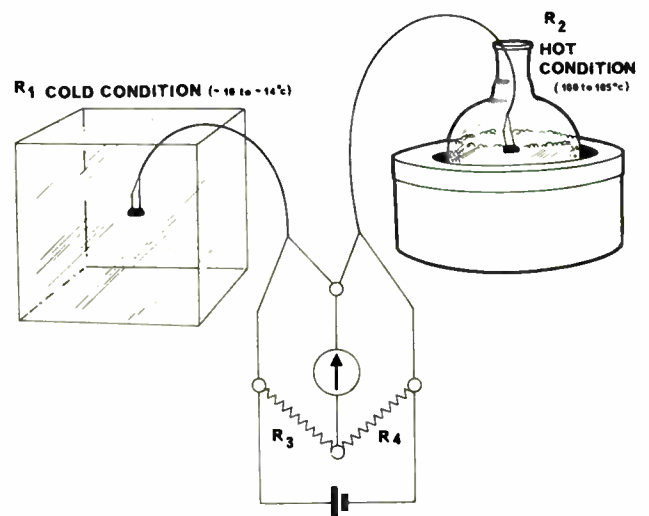

This arrangement was used by Electrothermal to demonstrate the stability of their range of 'Precistors'. These are wirewounds of values from 0.5Ω to $10 M\Omega$ with tolerances down to 0.01% and a stability of better than $\pm 0.03\%$. (48)

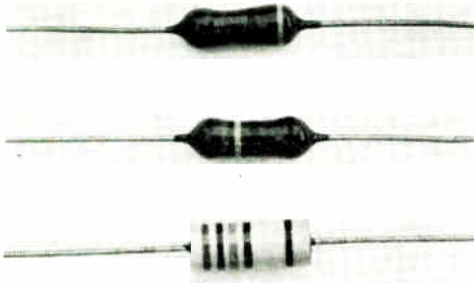

These Erie metal oxide high stability resistors illustrate two methods of encapsulation. The first potting in resin (top) and the second sealing in a ceramic tube (bottom). All of these are $\frac{1}{2}$ W units (49)

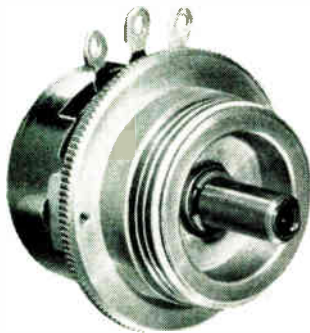

Many special types of potentiometer for professional applications were shown at the exhibition. This Plessey unit features a moulded carbon track and is designed for continuous rotation; it is available in most standard resistance values (50)

A forerunner of group of special potentiometers based on international (N.A.T.O.) dimensions was featured by Salford Electrical. Known as their frame size 11 unit (approx. 1-in. diam.), it is a 2 W wirewound unit with values from 500 Ω to 50 k Ω ($\pm 5\%$). Resolution is from 0.15% to 0.06% and the linearity is $\pm 0.5\%$. Up to 12 extra taps can be provided and up to 4 units can be ganged together in any phase (51)



'Metox' high voltage, high power and precision ranges. Their standard range of metal film resistors is designed to conform to DEF 5114. It will be available in $\frac{1}{8}$, $\frac{1}{4}$ and $\frac{1}{2}$ W ratings; values covered are from 100 Ω to 1 M Ω , at tolerances down to 1%.

Two ranges of metal film resistors were shown by Alma (56) at this exhibition for the first time. The first is the MA range with a long-term stability of $\pm 0.1\%$ and a temperature coefficient of 0.002% per $^{\circ}\text{C}$. This range is fully encapsulated in resin tubes. It is confidently expected that this range will meet the climatic and technical requirements of the DEF 5114 specification to H1 from -55°C to 120°C . The second, known as the MB range, has relaxed specification for commercial applications and a reduced price. The temperature coefficient is $\pm 0.005\%$ per $^{\circ}\text{C}$ and the long-term stability is $\pm 0.3\%$ for the first 1,000 hours use.

These are but a few of the multitude of metal-film resistors introduced this year and it would appear that expansion in the production of this type is one of the main trends in this field of fixed resistors.

A second trend that was apparent at the show was one of increased varieties and quantities of precision wirewound resistors. Most manufacturers were displaying new ranges or additions to their existing ones.



Two of the range of Morganite 'Filmet' metal film resistors designed to meet the DEF5114 specification (52)

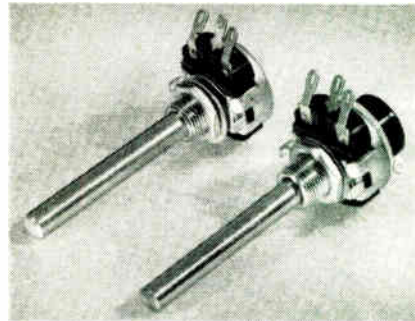

Morganite miniature type 30 carbon potentiometers are claimed to have good resistance to humidity and good stability without sealing. Also a twin-pronged wiper ensures a low level of rotational noise. The type 30 is only 22-mm in diameter and competitively priced (53)

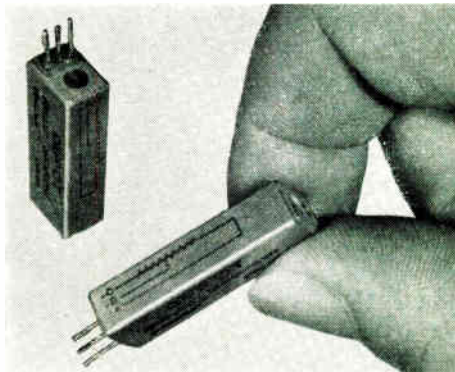

This Ancillary Developments A.D.O. 'Oxipot' trimmer potentiometer indicates a trend in the type of component. It is believed to be the first of its kind to use an oxide film element. It can be produced in values up to 3 M Ω ($\pm 20\%$) with a power rating of 0.1 W and it maintains its stability over an ambient temperature range of -50°C to 150°C (54)

These two model 031 wirewound trimmer potentiometers are two of the latest products of Miniature Electronic Components. Measuring approximately 0.75-in. long they are available in values from 10 Ω to 20 k Ω ($\pm 10\%$) with a linearity of $\pm 1\%$. Continuous power rating at 70°C ambient is 0.5 W (55)





Capacitors

ONE of the early investigators of capacitors, J. H. Winckler, of Leipzig, states*:

... the first time he tried the Leyden experiment he found great convulsions by it in his body; and that it put his blood into great agitations; so, that he was afraid of an ardent fever, and was obliged to use refrigerating medicines. . . . His wife (whose curiosity, it seems, was stronger than her fears) received the shock twice, and found herself so weak, that she could hardly walk. . . .

Fortunately, unlike the Wincklers, we now know con-

*'The History and Present State of Electricity' by Joseph Priestley, 1775.

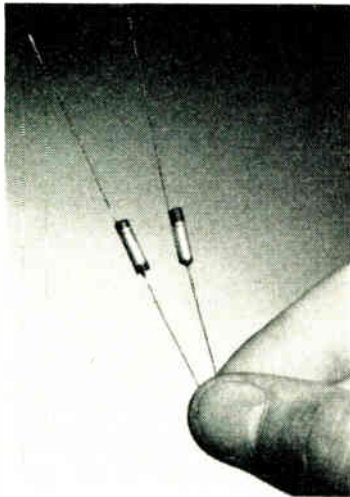

Smallest in the Plessey 'Castanet' series of tantalum capacitors, this type K features a fully supported anode and an insulated case

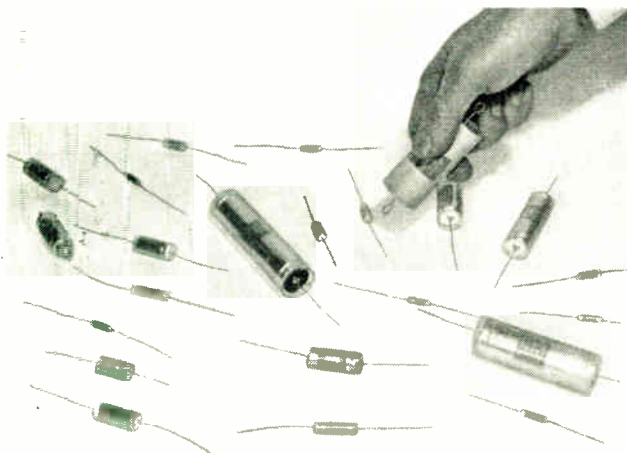

As seen at the exhibition—a selection of the new E.M.I. high-reliability capacitors

siderably more about capacitors—so much so that details fill many volumes. However, a simple capacitor can be briefly described as two parallel conducting plates separated by a dielectric material. In most cases the dielectric material indicates the broad application of the capacitor, and it is in the development of dielectric materials that most effort has been spent.

In general, the two main aims of the capacitor manufacturers are: (a) Improvement of reliability and (b) Increased capacitance/volume ratio.

For the designers of microminiature sub-assemblies many new capacitors have been developed and were displayed at the exhibition. Typical of these is the Frie 'Microcap' ceramic units (57). Four popular values were featured on their stand, these being 1,000, 2,200, 4,700 and 10,000 pF with a working temperature range of -40°C to 85°C and a working voltage of 30 V d.c. The diameter of the 10,000 pF capacitor is 0.2 in. and that of the 1,000 pF only 0.08 in.

The 'Greycon' range of metallized paper capacitors produced by Dubilier (58) represent a trend at the show of new techniques which are being used to improve reliability and reduce costs. These Greycons are impregnated in vacuo in a polymerized synthetic resin and completely



This actual-size picture illustrates one of the developments in solid tantalum capacitors shown by Hunts (60)

The Jackson miniature trimmer

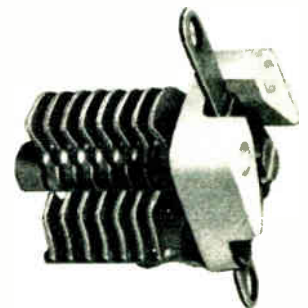

encased by injection moulding in a plastics material. The result is a capacitor with an insulation resistance of not less than 10,000 M Ω at 20°C and an operating temperature range, with no derating, of -40°C to 85°C . Most standard capacitance values are available from 0.0001 to 1 μF ; working potentials covered include 150 to 600 V d.c.

The development of modern plastics materials has done much to improve the reliability and capacitance/volume ratio of capacitors. Polystyrene, polythene, p.t.f.e. and polyethylene terephthalate ('Melinex' or 'Terylene') have advantages as dielectrics and epoxy resin has proved to be a first-class material for encapsulation of components. Therefore it is not surprising that at the components show there were hundreds of examples of the application of modern plastics.

One excellent example on the T.C.C. stand was in the form of their recently introduced miniature metallized polyester capacitors (59). These are moulded units using metallized polyester (polyethylene terephthalate) foil. The dielectric properties of the polyester film plus the encapsulation enable these to meet the stringent requirements of the

continued on page 479

CIC EUROPEAN SERVICE announces :

ON THE TARGET!



SINE-COSINE FILM POTS

*** 0.015% ACCURACY!**
*** INFINITE RESOLUTION!**

ELIMINATE LOADING ERRORS

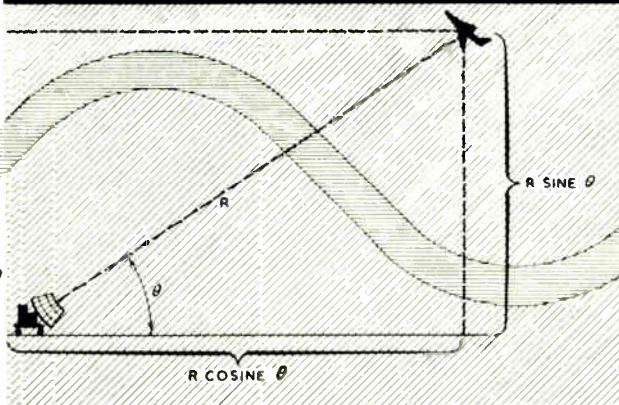
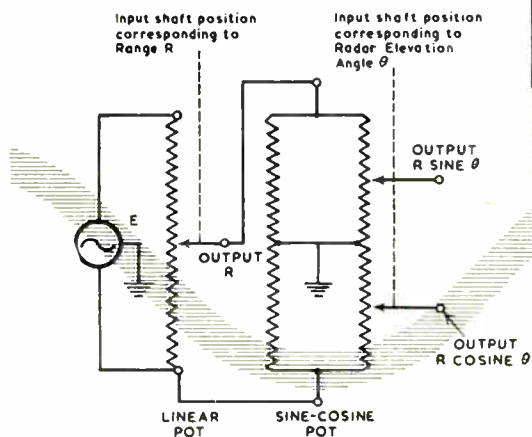

COMPARE SYSTEMS ERROR YOURSELF!

Typical example of Radar Tracking System Problem: To accurately locate target

Range to Target: 50,000 yards
Radar Elevation Angle: 45°

Error with conventional Resolvers

Loading Error and Quadrature	35
Resolution	30
Linearity	50
Total Error	115 yds

Error with C.I.C. Film Pots

Quadrature due to Inductance	0
Resolution	0
Linearity (incl. load)	8
Total Error	8 yds

WRITE TO US OR TELEPHONE FOR COMPLETE DATA SHEETS

Radar Display and Tracking Systems, Inertial Guidance and Fire Control, Analogue and Air Data Computers, Tube Scanning, and many Control Applications are served with CIC Pots, linear and non-linear, from ½ inch to 5 inch diameter, single or multi-gang, with or without taps, including 3- and 10-turn types, and low-torque low-inertia units.

FIRST IN FILM POTS

Computer Controls Ltd, 19 Buckingham Street, London, W.C.2
TRAlgalor 2371



Data...

For further information circle 229 on Service Card

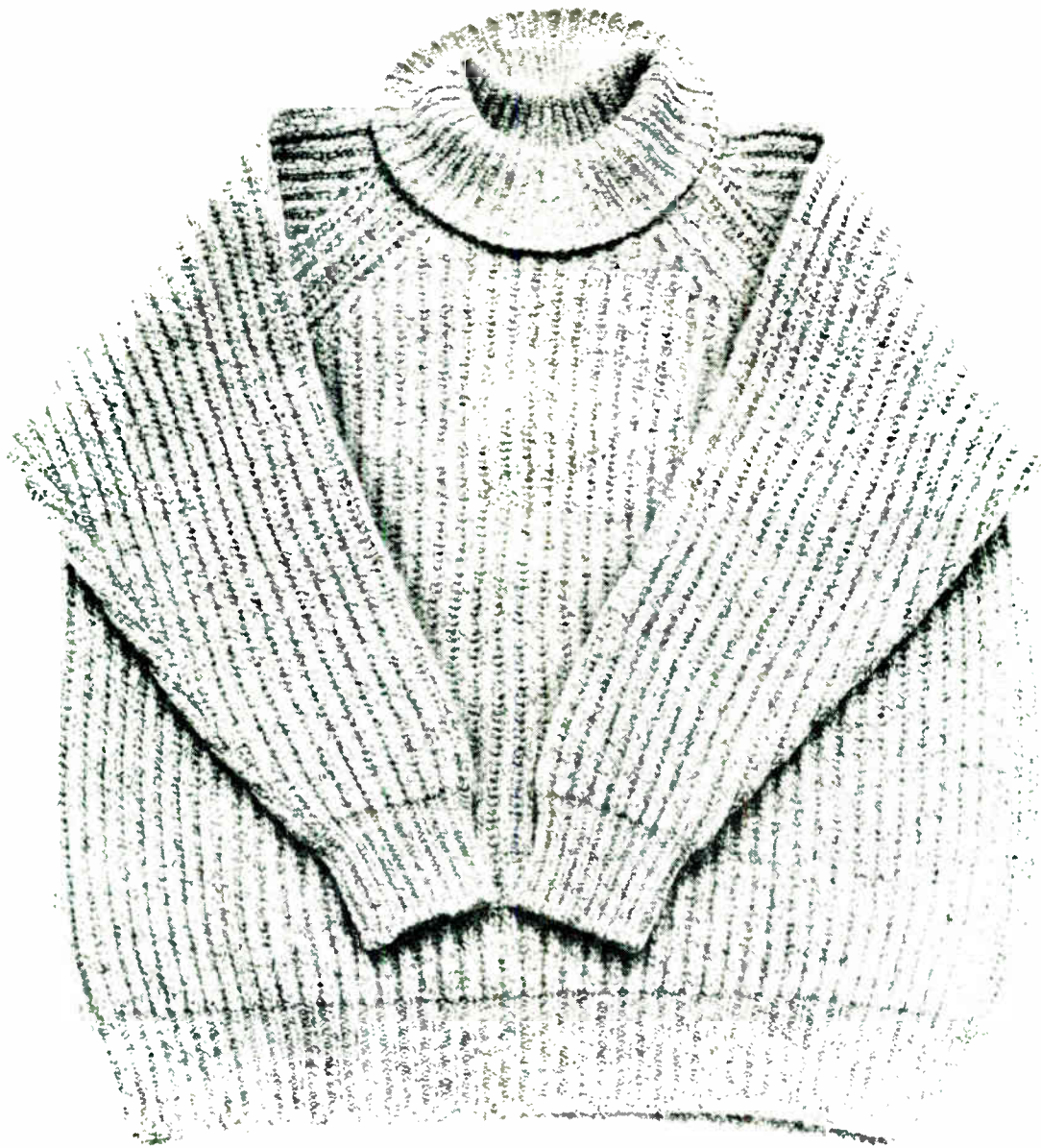

Processed

Two Elliott computers—the 503 and the 803. Price range: £20,000 to £200,000. Between them, they cover the chief scientific and industrial applications. □ First, the 503. Built to meet the increasing demand for high speed computers for use in research and development. The 503 has no competitor as a replacement for older/smaller/slower installations. And its low price puts it within reach of organisations that now use computing centres. □ The National-Elliott 803 is the smaller machine, from which the 503 has been developed. With over 120 already delivered, the 803 is far and away the most successful British computer. □ The two systems are compatible—programs written for the 803 can be used on the 503. Elliott's provide Autocode, ALGOL 60, and over a hundred library programs—and an active users' association provides for exchanges of application programs. If you're thinking about a computer, call early on Elliott's who can do much of your thinking for you.

The Elliott 503 100,000 operations per second. 8192 word magnetic core store. $3\frac{1}{2}$ microsecond cycle time. Up to 131,072 word auxiliary core store. Input by 8-channel punched paper tape at 1,000 characters per second. Typewriter controlled. Incorporates time-sharing of peripheral data-transfers. High-speed input and output devices include punched card input/output, magnetic tape and line printer. Interrupt facilities.



**computing
division**

ELLIOTT BROTHERS (LONDON) LIMITED
ELSTREE WAY BOREHAMWOOD HERTFORDSHIRE ELSTREE 2040

 A Member of the Elliott-Automation Group

this is self-adhesive tesamoll

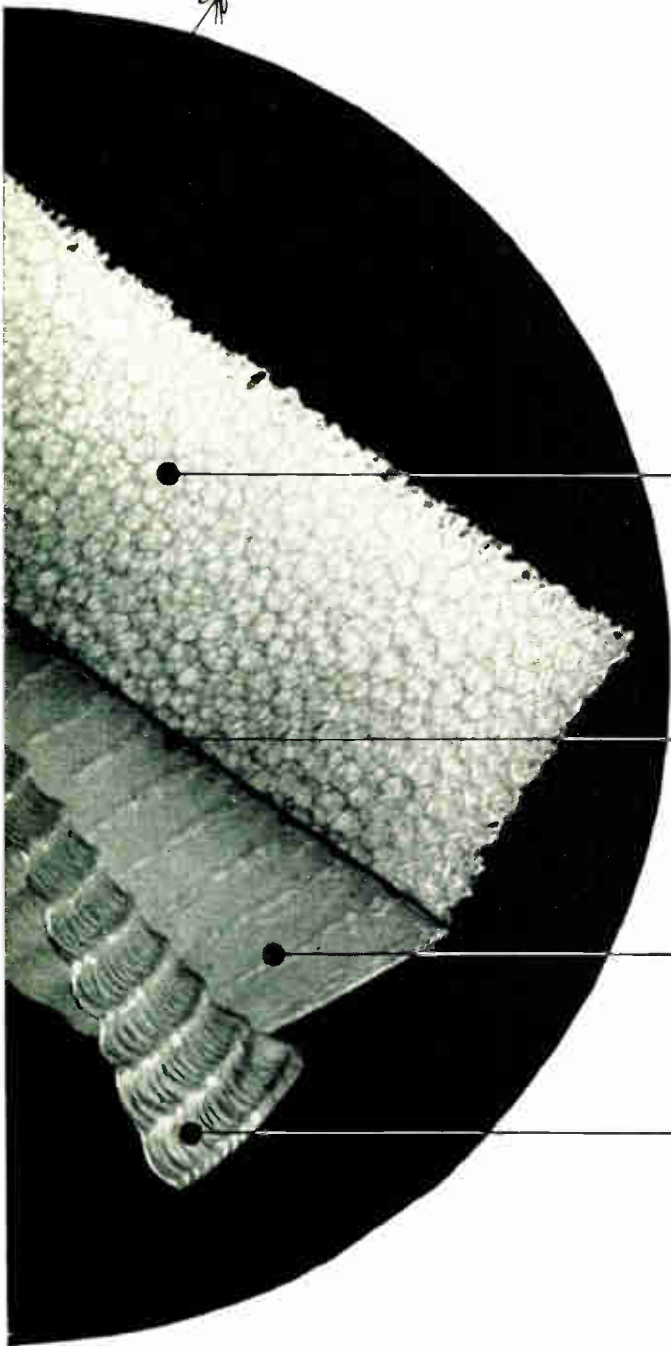

Tesamoll magnified approx 4 times

Tesamoll can solve many of your problems of:
DUST SEALING & CUSHIONING
NOISE & RATTLE ELIMINATION
SHOCK ABSORPTION & SEATING
GASKETS, MOUNTING & JOINTING

At the same time Tesamoll gives you:
REDUCED COSTS
GREATER PRODUCTION
INCREASED EFFICIENCY

1. The special urethane foam of Tesamoll is an inert, synthetic material with a high degree of chemical and physical stability. Its unique, interconnected, cellular structure compresses easily and has a constant and gentle 'push back'. It is electrostatically neutral and tends to repel dust and other gas or air borne particles. The foam is rot proof and is unaffected by light, oxygen or ozone except for a slight change of colour.

2. The foam of Tesamoll cannot be parted from its base tape. It is chemically and permanently laminated to the tough P.V.C. carrier tape during manufacture. Only Tesamoll is produced on the special, patented machines which give it this extra reliable and exclusive feature.

3. The special, pressure-sensitive adhesive of Tesamoll is extremely powerful and sticks instantly to any clean, dry surface. Self-adhesion saves production time, simplifies assembly, makes pre-positioning quicker and more positive.

4. The corrugated P.V.C. backing of Tesamoll protects the powerful adhesive right up to the moment of fitting when it peels off easily and quickly—another time-saving factor.

Tesamoll is rapidly replacing many of the accepted materials for dust sealing, seating, cushioning and shock absorption, and at the same time giving results not possible with other materials such as felts and foam rubber.

Tesamoll is produced in standard thicknesses of $\frac{1}{8}$ ", $\frac{1}{4}$ ", $\frac{3}{8}$ " and $\frac{1}{2}$ ". A variety of stock widths are available up to 4" but it can be produced to a maximum of 18" wide.

Free Technical Booklet and Samples



tesamoll

SELF-ADHESIVE URETHANE FOAM

Write today to:
SEALDRAUGHT LTD., Chandos House, Buckingham Gate, London, SW1
Tel: ABBey 3571

 Is the registered Trade Mark of P. Beiersdorf & Co. A. G. Hamburg

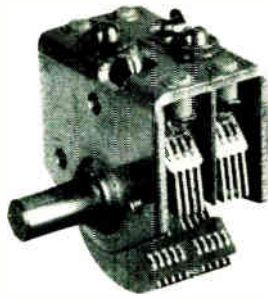

▲
One of the many variable capacitors of the 'Polar' range displayed by Wingrove & Rogers (61). This is their C.7922 gang with built-in trimmers. It measures $\frac{3}{4} \times 1\frac{1}{8} \times 1\frac{1}{8}$ in, and each section has a capacity of 120 pF

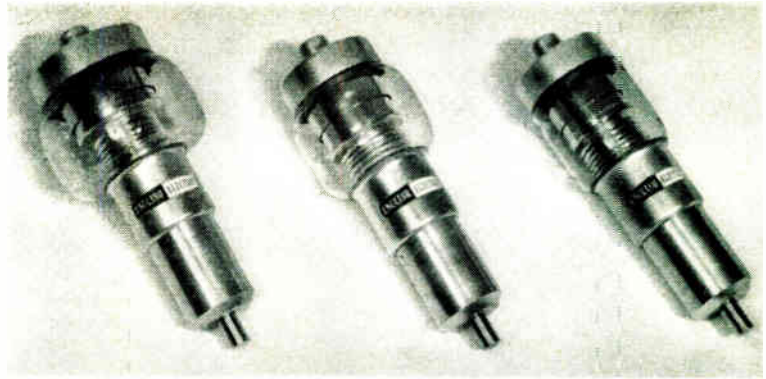

▲
A selection of the E.E.V. vacuum variable capacitors

H.5 DEF-5011 specification. Four standard values from 0.01 to 0.1 μ F are currently available with a working potential of 250 V d.c. and insulation resistance of 50,000 M Ω . Dimensions of the 0.1 μ F version are 10 mm \times 7 mm \times 13.5 mm.

Another range of capacitors exemplifying the use of modern plastics was introduced by E.M.I. Electronics (62). Until recently these have been manufactured and used exclusively by E.M.I. for professional and Services equipment. An analysis, covering about 100,000 of these capacitors, yielded a mean failure rate of 0.000028% per 1,000 hours. Two types were shown—'miniature' and 'standard'. The 'miniature' types are available with values from 0.0001 to 0.04 μ F and the 'standard' range covers 0.047 to 10 μ F. These capacitors are constructed of polyethylene terephthalate film interleaved with either tin or aluminium foil.

Although it appeared that the numbers of variable capacitors seen at the exhibition was outweighed by fixed capacitors, the development of variable capacitors is far from stagnant.

A novel space-saving technique was evident in the con-

struction of a new range of air dielectric capacitors shown by Plessey (63). Plastic pips are inserted in both stator and rotor vanes to ensure accurate meshing and reduce the distance between the plates without fear of a short circuit. This reduces the physical size and also reduces microphony effects.

Jackson Brothers were displaying a number of new components including a stable miniature air dielectric trimmer (64). This has an end area of $\frac{1}{2}$ in. square and is constructed with silver-plated brass vanes mounted on siliconed ceramic insulation. This combination results in a trimmer with a temperature coefficient of 50 parts per million per $^{\circ}$ C. Three standard units were shown: one with 2.5 pF minimum capacity and a swing of 5 pF; the second a 3 pF minimum and an 8.5 pF swing; and the third also a 3 pF minimum with an 11.5 pF swing.

For an entirely different application, English Electric Valve Co. (65) were featuring a series of four basic groups of vacuum variable capacitors. All of these are rated to carry 40 A at signal frequencies up to 27 Mc/s. Models with capacitance ranges from 5–50 pF to 10–2,000 pF are produced with a minimum of standard parts.



Connectors

WITH the increasing use of equipment built in modular sections, connectors of all shapes, sizes and pin and socket configurations have been developed. These include printed-circuit edge connectors, plugs and sockets for cables, miniature instrument types and conventional terminal blocks.

Amphenol were showing a new family of microminiature connectors (66) which provide contact densities from 100 to 175 per square inch. These are types 220, 221, 222 and 223. All use the same contacts which may be crimped to their leads before being inserted in the connector. This design using one basic type of contact for all connectors

has the advantages that the quantities held in stock are reduced and connectors can be available at prices which work out as low as 7d. per way.

A further example of the many miniature connectors was shown by Cannon Plugs in the form of their 'Micro-strip' (67). This employs miniature pin and socket contacts spaced on 0.05 in. centres in a single row. Strips of either pins or sockets may be purchased in any length

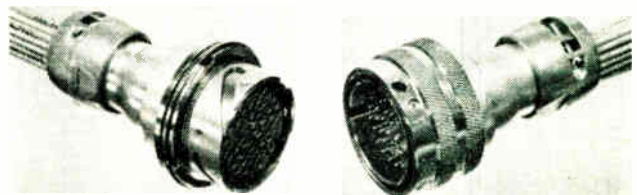

▲
The aluminium Mark 6 connector from the Plessey range

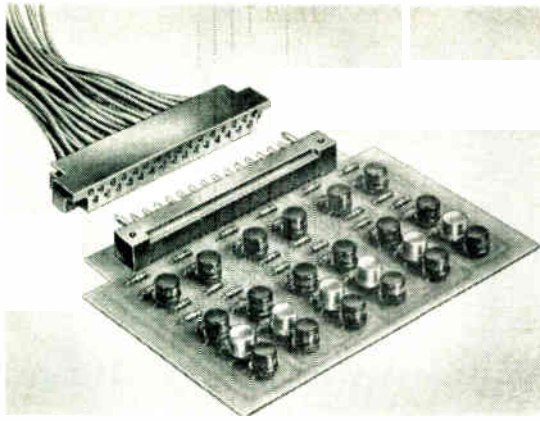

▲ The AMP-Blade high density printed circuit edge connector

up to 6 in., which provide a maximum of 120 contacts. The 'Microstrip' is 0.07 in. thick and 0.381 in. wide and can be cut to the required length by the user.

To provide the designer with a high-density printed-

circuit-board edge connector Aircraft-Marine Products introduced their AMP-Blade (68). This is a two-piece connector, having the tab or prong housing permanently fixed to the board by staking the tab tines. Pre-cripped snap-in receptacle contacts are inserted into the housing cavities of the separate socket as required. AMP-Blades are available in 17, 23, 29, 35, 41 and 47 way configurations.

Greenpar Engineering featured at the show their series 'GP' and 'S' coaxial connectors (69). The series 'S' are sub-miniature, screw lock connectors of their own design for coaxial cables with an overall diameter between 0.06 in. and 0.12 in. They are produced to M.O.A. and A.R.B. requirements. The impedance is 50 Ω and the v.s.w.r. is not greater than 1.15:1 at a frequency limit of 6,000 Mc/s. Various plugs, jacks and adaptors are also available.

A range of ceramic terminal connectors (70) shown for the first time was one of the thousands of components shown by Plessey. These are strips designed to provide anchoring points having high insulation resistance and high working and flashover voltages. Manufactured from low-loss ceramic, the strips are produced with a choice of from 1 to 12 anchoring slots spaced $\frac{1}{4}$ in. apart. Working voltage between adjacent slots is 1.5 kV and insulation resistance is greater than 2×10^7 M Ω .



Switches

VERSATILE switches with built-in reliability are a pre-requisite for most electronic equipments. These may be manually or electromagnetically operated. They may range from simple high-speed microswitches to heavy-duty rotary

switches or multi-contact relays. All of these requirements, and more, were met by the vast range of different types on show.

N.S.F. were exhibiting their complete range of switches and relays including the well-known 'Oak' rotary wafer switches. One of the latest, Model FC (71), is a 12-position switch designed to provide a high degree of insulation combined with low r.f. loss. The stator and rotors are made from low-loss ceramic. Multi-sections are available with maximum switching arrangements per section ranging from 1 pole, 12 way to 6 pole, on/off.

Multi-bank push button switches are finding ever increasing uses in control equipment and many firms were showing various types with illuminated button, some with legends.

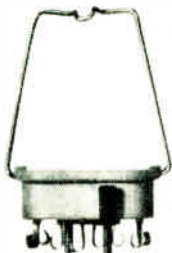
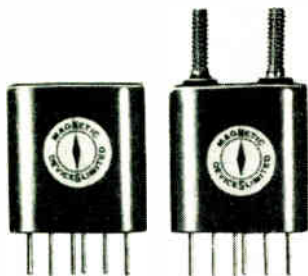

◀ The Magnetic Devices subminiature relay series 336 (72)



▲ A 4-direction joystick controller by Pye Switches

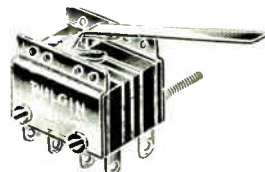

▲ These two variants of the Bulgin S800 microswitch illustrate the developments in this field. The basic unit is a single pole changeover type rated at 5A 250 V (non-inductive). It measures $\frac{1}{16}$ x $\frac{3}{32}$ x $\frac{3}{16}$ in. (73)

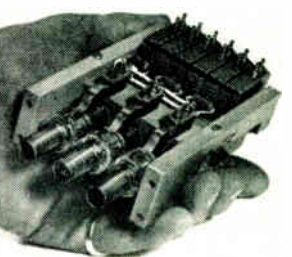

▶ The E.M.I. push-button switch

One type displayed by E.M.I. (74) was originally developed for broadcast and recording work. This is of interlocking design with each button illuminated to indicate operation. Each switch can be provided with up to 12 changeover contacts and up to 14 buttons can be included in one frame.

Rendar Instruments were featuring a double-pole change-over slide switch which has been designed for inclusion in units such as microphones. Gold-plated contacts result in a contact resistance between 4 and 8 mΩ. The current rating is 500 mA at 50 V a.c. and 250 mA at 250 V a.c. (75).

Pye Switches have specialized in joystick controller (76) switches of all types. One of these, shown at the exhibition, the 4-direction joystick controller, provides switching facilities relating to the direction of movement of the control stick. Four separate switches are incorporated. These can be of various types with a selection of switch functions.

Typical of the many relays on view is the Magnetic Devices plug-in type 336 (77). This is a hermetically-sealed unit measuring 0.8 × 0.35 × 1 in. and providing various contact assemblies up to double pole changeover. The contacts are rated at 2 A 30 V d.c. or 250 V a.c. and the unit weighs only ½ oz.



Semiconductors

THE rate of development of semiconductors is so rapid at present that a report on the latest achievements is almost out of date in the time taken to write and print it. Switching speeds have been increased to the nanosecond range, operating frequencies of megacycles were reached long ago and rectifier currents of 100 A are attained with production units. The miniaturization of transistors is now limited only by the physical size of the case and terminals, necessary to house the active element and provide contact facilities.

Mullard provided visitors to the show with their usual excellent display of semiconductors and valves. Two items were particularly interesting—one having definite industrial applications immediately, while the other, an experimental device, shows great promise for the future. The first item is a 4-element photoconductive relay (78) comprising a filament lamp surrounded by four separate photoconductive cadmium sulphide elements, sealed in a glass envelope. When the lamp is energized the resistance of each cell falls from many megohms to a few ohms, resulting in a unit analogous to a 4 make-and-break contact relay. The second item (79), an experimental planar device only 0.050 in. diameter, has been designed to be soldered direct to a micro-circuit substrate. It is an n-p-n transistor with a high current amplification factor (between 40 and 120 at 10 mA I_c) and a cut-off frequency of 300 Mc/s. Maximum power dissipation is 300 mW and the maximum junction temperature 170 °C.

Hughes International were also showing a range of new planar devices some with recovery times of 1.5 nsec and others for operating frequencies of 300 Mc/s. One of the most interesting developments made public at the exhibition by Hughes is a series of solid-state constant-current regulator devices (80). These are two-terminal devices exhibiting current-limiting action comparable to the voltage-limiting action of the zener diode. They are to be made available in current ranges from 100 μA to 200 mA with a tolerance of ±5% of the specified current. Operating potential range of the regulator is 10 to 40 V and current regulation within this range is better than ±1%. The units measure 1 in. long × 0.5 in. diameter.

Silicon avalanche rectifiers were introduced at the show

by Standard Telephones and Cables. Rectifiers in this new R.A.S. 300 series (81) have a nominal rating of 1.25 A but are able to dissipate reverse transient energy of 4 kW without damage; maximum reverse working voltage is 1 kV.

S.T.C. were also showing a new range of 'Miniflake' (82) transistors: planar epitaxial silicon transistors without cases and supplied with or without connecting leads.

A.E.I. featured their silicon controlled rectifiers (83) and introduced two new additions to the range—the 80 and 100 A s.c.r.s. An outstanding characteristic of these is their excellent trigger sensitivity. The trigger potential is 3.5 V and the current required to fire the rectifiers is 300 mA. Both the 80 and 100 A types are available with peak reverse voltages from 25 to 400 V and are ideally suited for high-power static control applications. They can, in fact, control powers of the order of tens of kilowatts with a control signal power of less than 2 W. A.E.I. also introduced a controlled avalanche rectifier—a 10 A device with a crest working reverse voltage of 1.2 kV.

A further range of silicon epitaxial planar transistors (84) was to be seen on the stand of Brush Crystal. These are high power, high-frequency devices numbered BSY51, 52, 53, 54, 55 and 56. They are sealed in a TO-5 can and will dissipate up to 3 W at 150 Mc/s. Another series, 3TX002, 3 and 4, will dissipate up to 60 W at 150 Mc/s.

Ferranti featured developments in silicon solid-state integrated circuits for both linear and digital applications. These are manufactured by producing a number of separate minute regions which function as components (resistors,

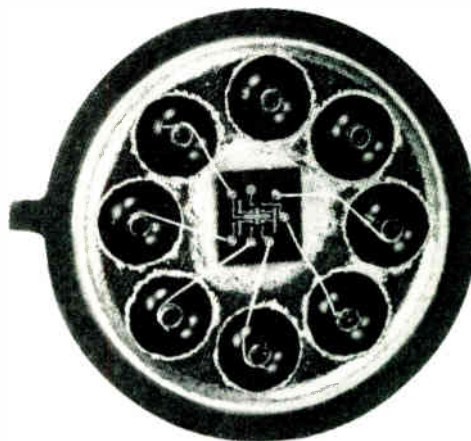

A much enlarged view of one of the unencapsulated SGS-Fairchild Micrologic elements shown at the exhibition

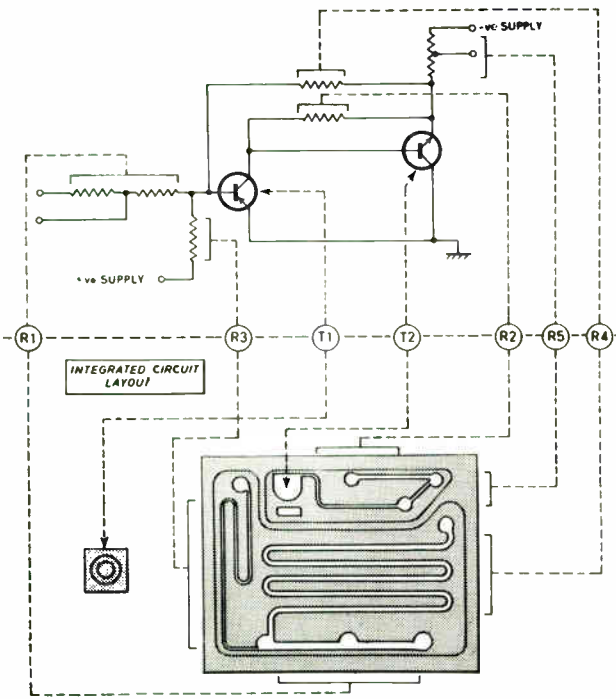

This illustrates the layout of a Ferranti 'Microlin' silicon micro-circuit constructed from two silicon chips containing 2 transistors and 6 resistors

capacitors, diodes and transistors) within one or more pieces of silicon. Most of these are mounted in modified transistor cans. The 'Microlin' (85) circuit elements were shown functioning as (a) a servo amplifier (b) d.c. amplifier and (c) h.f. wideband (>100 Mc/s) amplifier. A second range

This novel form of heat sink, for natural cooling, was shown by the Westinghouse Brake & Signal Co. The fins are inclined 45° to the vertical. Cold air enters along the front of the heat sink, passes diagonally over the fins and leaves at the back. A similar heat sink mounted above does the same and so on. In this way the upper heat sinks are not affected by the warm air from the lower ones. These heat sinks can be built into a column 6-ft high. Such a column may carry 18 silicon diodes with a total rating of up to 1,800 amperes (88)

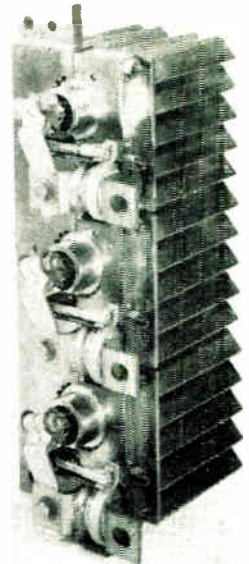

known as 'Micronor' (86) elements were demonstrated performing most logical functions.

SGS-Fairchild introduced two low-noise low-level transistors. Both are silicon planar devices in the TO-18 case and typical noise figures at 1 kc/s are 2 dB (2N2483) and 1.8 dB (2N2484). The 2N2484 (87) features a minimum h_{FE} of 30 at 1 μ A and 100 minimum at 10 μ A. Collector-emitter voltage is 60 V. Applications of the new transistors include low-noise high input impedance (1 M Ω) amplifiers, 10 μ A switching circuits and a unique multivibrator having a 10^6 to 1 frequency ratio.



Instruments and Equipment

BY moving the venue of the components show from Grosvenor House to Olympia more exhibition space has been made available. This has meant that more companies can participate and each may occupy more space. Understandably so, the exhibition has therefore expanded in size and scope. This year one could see a greater number of complete instruments and equipments on display. To fit in with the title of the exhibition these may be called component parts of systems.

Marconi Instruments were indeed displaying component parts of a complete instrumentation system. Although each item is self-contained two oscillators and three attenuators in their new '2000' range (89) all conform to a fixed size and shape enabling 3 units to be slid side-by-side into a modular rack-mounting case, suitable for a 19-in. rack.

These are part of a series of instruments whose sizes are based on sub-divisions of standard 19-in. rack dimensions, with the object of making possible the assembly of complete instrumentation systems in a rack form. The new transistorized a.f. and m.f. oscillators, TF2100 and TF2101, provide respectively 4 V and 1 V into a 600- Ω unbalanced load. TF2100 covers 20 c/s to 20 kc/s and TF2101 covers 30 c/s to 550 kc/s.

Another interesting instrument shown by A.E.I. is the new voltage surge indicator (90). This is a pocket-sized device designed to measure the amplitude of voltages down to 0.5 μ sec duration. A voltage level may be set between 100 V and 1.5 kV and immediately a voltage surge exceeding the set value appears at the terminals, an indicator light comes on. The dial may then be turned to measure the actual value of the surge.

Despite the versatility and portability of present-day multi-range meters, they frequently have limitations, for example, when used on transistor circuitry. Avo were demonstrating their transistorized multimeter (91) developed to overcome these problems. Designed around a chopper amplifier, having a full-scale sensitivity of 12 mV, it may be used for the measurement of d.c. and a.c. voltage and current and resistance. With the probe r.f. voltages between 10 mV and 4 V may be measured.

The development and extensive use of equipment built in sub-sections has created a demand for a large variety

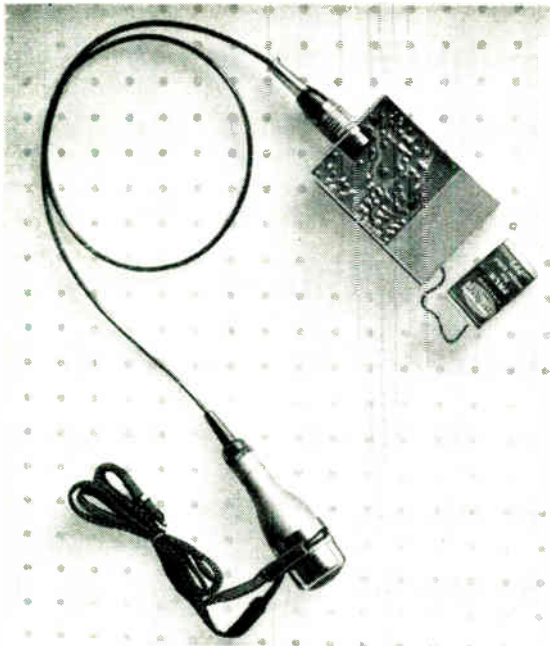

To provide complete freedom of movement for broadcasters and entertainers Lustraphone have developed a radio microphone and were showing the complete system at the show. This comprises a microphone, pocket-sized transmitter and battery-powered transistor receiver. The transmitter operates in the 174.6-175 Mc/s band, has a power output of 10 mW and an a.f. frequency response from 30 c/s to 15 kc/s (93)

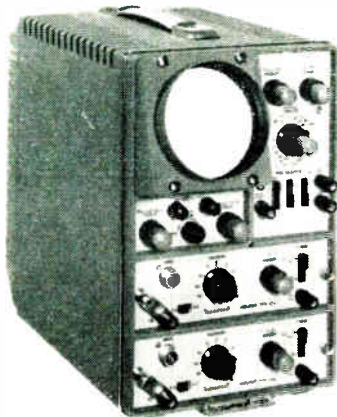

Shown for the first time at the R.E.C.S., this Telequipment type D43 oscilloscope is a versatile 4 in. double-beam unit. It provides a complete system covering extreme requirements with a range of plug-in modules, at a realistic price. Bandwidth, 15 Mc/s; sensitivity, 100 μ V/cm; common-mode rejection, 10,000:1 (94)

of power supplies. International Electronics have specialized in design and production of these and were displaying models for most applications.

Probably the most interesting of these is a 5 A modular unit (92) which employs a new switched inductor method of stabilization. This technique, apart from giving a substantial reduction in volume, gives a very large increase in the efficiency over conventional units. A measure of efficiency can be judged by the fact that when operating into a short-circuit load the heat generated by the unit is only slightly greater than the heat generated normally.

For further information on specific items circle appropriate number, shown in brackets, on Service Card

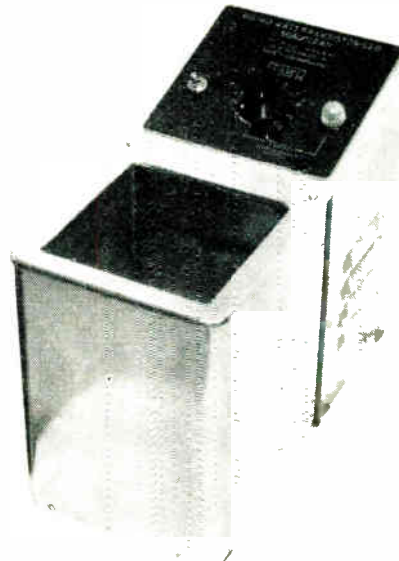

Designed for the rapid cleaning of small and delicate parts this transistorized ultrasonic cleaner, type 1141B, was one of the many equipments shown by Dawe Instruments. The type 1141B is an 80-40 W unit with a 3 pint stainless steel tank (95)



This millisecond stopclock, type TSA3314, was one of the new instruments shown by Veimer. It is capable of split second timing over the timing range 0.1 ms to 27.8 hr. It will carry out virtually any timing function and can accept positive or negative pulses or contact closures to start or finish a time period (96)

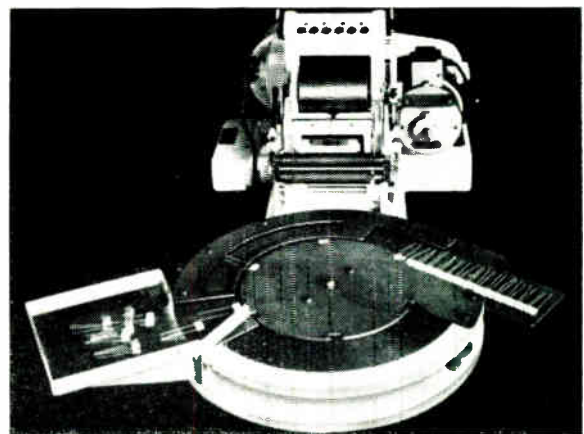

Rejafix were showing a range of component printing including this model Essex F. This has been designed to mark and code by letterpress components such as flat capacitors. It is fitted with a turntable incorporating automatic location and ejection devices. The printing rate is 3,000 items per hour (97)

EQUIPMENT

review

1. Medium-Class Computer

A general-purpose computer designed to permit smaller businesses and industries to convert to electronic data-processing with low initial expenditure has been introduced by U.S. General Electric.

Called the GE-215, the new machine is second of a planned family of computers and will be compatible with the larger GE-225 and all programming units now used with that computer. Programmes are available for simplified transition from punched card/tabulator systems to the GE-215.

The new computer has a magnetic core memory of either 4,000 or 8,000 words. Instruction time is 35.6 μ sec. Auxiliary equipment that can be used with the GE-215 system includes an 18-million-character memory, up to eight magnetic tape handlers, document handler, card reader, card punch,

printer, paper tape system, and data communications controller. — *International General Electric Co. of New York Ltd., 296 High Holborn, London, W.C.1.*

For further information circle 1 on Service Card

2. Transparent Meters

Taylor have announced the 'Clarity' range of moving-coil meters in transparent mouldings. Special attention has been paid to styling and the transparent case allows a maximum amount of light to fall on the scale, resulting in shadowless readings.

Three different sizes are available with scale lengths of 2 $\frac{1}{4}$, 3 and 4 in. Ranges commence from 10 μ A and the meters are also available as milliammeters, ammeters, voltmeters, etc. In most cases the instruments can be

supplied with self-contained components; dual ranges can also be provided.

The meters incorporate centre pole movement, which provides inherent magnetic shielding, robustness and stick-free operation. The meters can also withstand overloads of up to 10,000% without damage to the coil or pointer.—*Taylor Electrical Instruments Ltd., Montrose Avenue, Slough, Bucks.*

For further information circle 2 on Service Card

3. High-line Differential Pressure Transducer

Latest addition to the C.E.L. range is a high-line differential pressure transducer type CPD.12. The unit employs similar high-sensitivity elements to those used in the CP.12 gauge models.

Besides giving a stepless output of up to 1.5 volts for 5,000 p.s.i., the transducer may be shock loaded to 10,000 p.s.i. on either side without zero shift or damage. The calibrated range is 5,000 p.s.i. but measurements over a 500 p.s.i. range are practicable.

Frequency response is flat to 5,000 c/s. Energization is normally 40 V d.c. max. Price of the standard unit is £36.—*Coutant Electronics Ltd., 711 Fulham Road, London, S.W.6.*

For further information circle 3 on Service Card

4. Subminiature Pentode

Low noise amplification of extremely weak signals of the order of 5×10^{-14} A is possible with the Raytheon



1

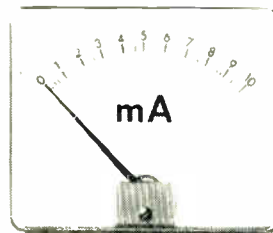

2



3



4

subminiature pentode CK587 which draws only 0.0075 W total under typical operating conditions.

This pentode, 1 in. long with a 0.230 by 0.290 in. cross-section, is expected to find applications as an amplifier of small responses from ion chambers, photomultipliers, proportional counters, biological transducer probes, etc.—*Raytheon-ELSI, S.p.A., Piazza Cavour 1, Milano, Italy.*

For further information circle 4 on Service Card

5. Event Marking Galvanometers

Consolidated Electroynamics have introduced event marking galvanometers types 7-371, 7-372, 7-373 (with sensitivities of 400 μ A, 6 mA and 25 mA respectively) which enable light beam oscillographs to 'double' as event recorders. The three models feature a wide selection of sensitivities and response times.

When the galvanometers are installed in an oscillograph, the presence or absence of an event can be indicated by the presence or absence of a trace. Event information can be displayed with direct time correlation to analogue information. Especially significant is the fact that the response time capability of this system is many times that of the pen type.

When a signal current is applied, the galvanometer suspension activates a shutter to expose a mirror which is attached to the adjustable front connection post. Under 'signal' conditions, a straight line, similar to a static reference trace, is recorded, maintaining its fixed position regardless of the

signal amplitude. When the 'no signal' conditions exist, the shutter is in place in front of the mirror, and the trace disappears. By adjustment of the galvanometer's front post, the trace can be positioned horizontally on the record.—*Bell & Howell Ltd., Consolidated Electroynamics Division, 14 Commercial Road, Woking, Surrey.*

For further information circle 5 on Service Card

6. P.C. Test Point Connector

Printed circuit test point connectors, series 672, are available from Continental Connectors in 4, 5, 6, 8, 16, 28, 42 and 63 contact arrangements. They have recessed and protected flowing pin terminals mounted at right angles to the test socket, and dip solder to printed and etched wiring boards with complete ease of alignment (except 672-10, which align with solder cups for direct wiring). Each socket grips and holds securely a standard 0.080 in. test probe and the moulded body acts as a convenient handle for insertion and withdrawal of printed wiring boards.

Single contact series type TJ can be conveniently located at any position on the printed wiring board for easy test take-off points. Current rating on all types is 3 A continuous and 4 A maximum.

TJ.8 features a moulded-in stabilizing stud, in addition to the single pin used on types TJ.4 and TJ.6. The stud acts as an extra protection against movements of the test point connector during probe insertion, and eliminates transfer of this motion to the soldered

connector, where breakage could occur. — *Continental Connectors, Industrial Estate, Long Drive, Greenfield, Middlesex.*

For further information circle 6 on Service Card

7. Plug-in Remanent Relay

The series 355 remanent relay, produced by Magnetic Devices can now be offered as a plug-in unit: two versions are available, enclosed or hermetically sealed. Various plug-in headers are used, from 8 pin to 25 pin.

The remanent relay core has a high magnetic retentivity: the armature will 'latch up' on receipt of a signal, remaining so indefinitely without power until the core flux is cancelled. This is effected either by a current reversal in the operating winding or by use of a separate winding.—*Magnetic Devices Ltd., Newmarket, Suffolk.*

For further information circle 7 on Service Card

8. Silicon Cartridge Rectifier

A high voltage silicon cartridge rectifier rated at 2 kV r.m.s., 35 mA has been introduced by International Rectifier Co.

Designated type 35CR2, this new cartridge has been designed specifically for equipments where selenium rectifiers might otherwise be used: due to its much lower forward voltage drop (10 V at 35 mA) and low leakage current, the heat generated by the rectifier is much less. It will operate in ambient temperatures up to 100 °C.

The cartridge consists of selected diodes connected in series and mounted in an insulating tube $\frac{1}{2}$ in. in diameter and 3.5 in. long.—*International Rectifier Company (Great Britain) Ltd., Hurst Green, Oxted, Surrey.*

For further information circle 8 on Service Card

9. A.C. Toggle Switch

This Bulgin toggle switch has been designed to meet heavy duty requirements of up to 10 A at 250 V, 50 c/s. It is suitable for a.c. only. Body, front bezel and operating dolly are all moulded in glossy black or white phenolic to give the best possible insulation and maximum safety factor, even under adverse climatic conditions. Fixing is by push-in spring fit to a rectangular hole 0.665 by 0.525 in. and electrical connection is made to nickel silver rear solder-tags, which are also shaped to take $\frac{1}{8}$ in. female AMP push-on connections. The general front-of-panel appearance of this com-

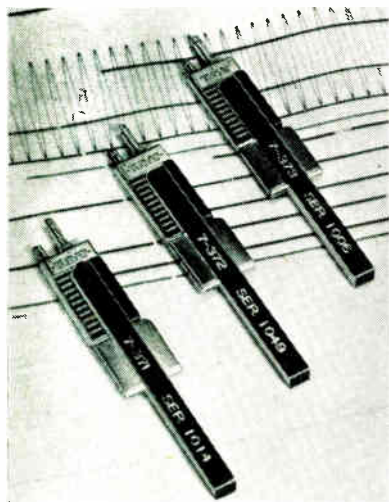

5

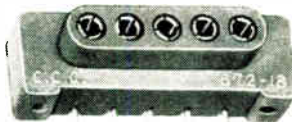

6

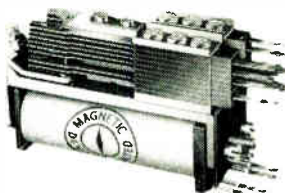

7



8

ponent matches the No. D.803 neon signal lamp.—*A. F. Bulgin & Co. Ltd., Bye Pass Road, Barking, Essex.*

For further information circle 9 on Service Card

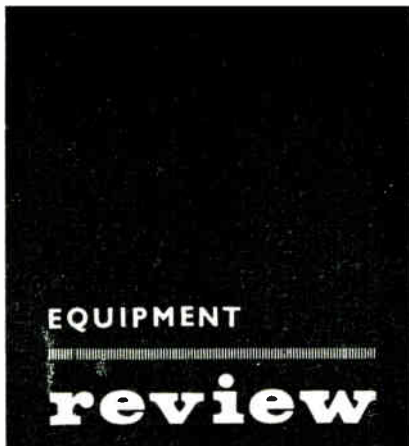

9

10. Electronic Stethoscope

The Swiss-made Phonak electronic stethoscope marketed by Williams and Pile (Medical Supplies) is designed to provide amplification of heart and lung sounds with unwanted noise reduced to a minimum by means of a 3-position frequency selector.

In position 1 the lowest frequencies are cut out to facilitate respiratory examinations, etc. Position 2 is for cardiological examinations and includes the low and middle frequencies, but not the high frequencies which tend to produce noise via the natural resonances of the body. Position 3 cuts out the high and low frequencies to provide a narrow middle frequency band for the detection of special cardiological noises.

The 4-stage transistorized amplifier is fitted with a fingertip volume control and is housed in a stainless steel case measuring 9 by 1½ in. diameter. An additional lead can be fitted for connection to recording apparatus.—*Williams & Pile (Medical Supplies) Ltd., 324 Court Road, Orpington, Kent.*

For further information circle 10 on Service Card



10

11. Mains Adjustment Unit

Weir Electronics have announced an instrument which provides an output voltage switchable to +5%, +10%, or +15% of any input voltage within a range of 180 to 270 V, 50-60 cycles, up to a loading of 200 VA.

The main application is to enable the effects of mains voltage variations on equipment to be determined conveniently without the use of variable transformers.

This 'mains adjustment unit' is available with a variety of output sockets and measures 14 in. long by 3 in. by 3 in. (approx.). Price: £8 10s.—*Weir Electronics Ltd., Durban Road, South Bersted, Bognor Regis, Sussex.*

For further information circle 11 on Service Card



11

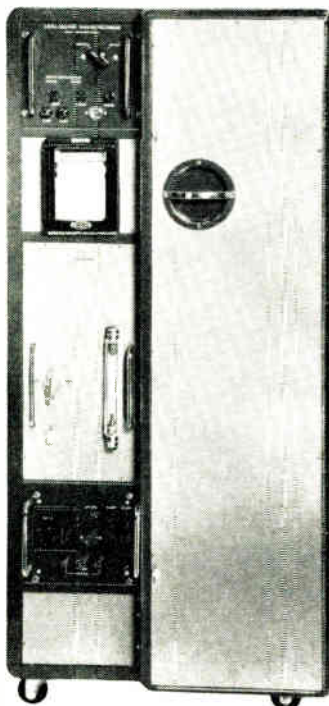

12

12. Sulphur Dioxide Recorder

Mervyn Instruments have developed an instrument for the continuous automatic measurement and recording of the sulphur dioxide pollution of the atmosphere. With the introduction of this instrument the means are available to assess counter-measures now being

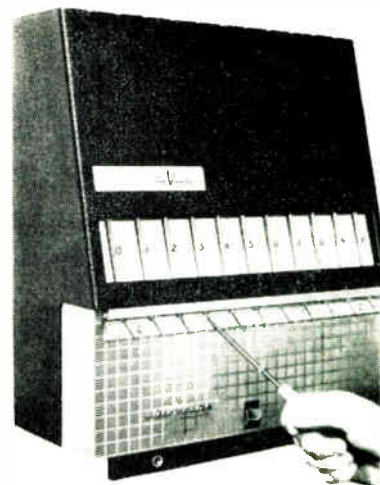

13

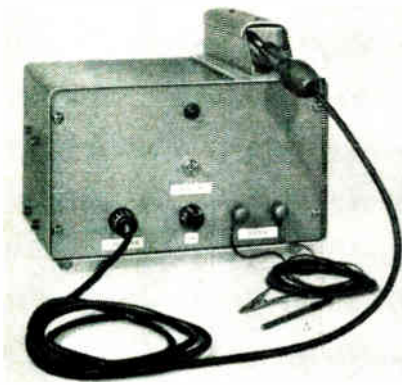

14

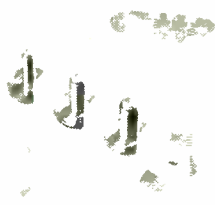
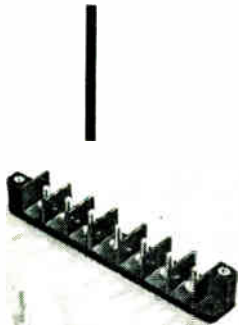

15

16

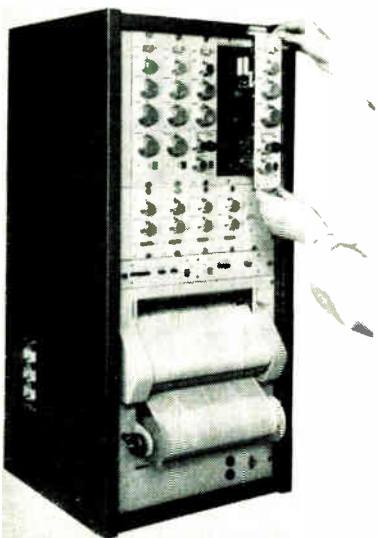

taken to comply with the Clean Air Act.

The unit is housed in a single rugged, plastic covered, aluminium cabinet divided vertically into two compartments: the left-hand one contains recording and control gear; the right-hand one is thermostatically controlled and contains the absorption column and conductivity cells. When in use this latter compartment is sealed by a close fitting door; the operation of the absorption column system can, however, be viewed through a full-length Perspex observation window.

The range of concentrations which can be recorded is from 0-50 parts in 10^6 with a sensitivity of 2 parts in 10^6 , the output record being presented on a 3-in. wide chart. The instrument will maintain its accuracy under all climatic conditions for many years without maintenance or calibration.

Apart from its use by health authorities for checking pollution, it is also suitable for large users of combustible fuels who wish to monitor gaseous effluents. The recorder can be installed either in an existing building or, if preferred, in a small weatherproof hut and will operate for eight days without attention.—*Mervyn Instruments Ltd., St. John's, Woking, Surrey.*

For further information circle 12 on Service Card

13. Sleeve Fitting Machine

Hellermann have announced a combined dispenser and sleeve fitting machine which, it is claimed, will fit sleeves in half the time taken by hand assembly.

The Sleevemaster, which is mechanically operated (no air pressure or electricity required) enables up to 12 sleeves to be fitted in one operation. It holds 10 colours, plus neutral (pink) P.V.C. sleeves from 0.75 mm to 5.5 mm i.d., and a visual check on colour and identification mark can be maintained by the operator.—*Hellermann Electric Ltd., Gatwick Road, Crawley, Sussex.*

For further information circle 13 on Service Card

14. Low-Voltage Supply

C. F. Taylor have produced an isolated low-voltage supply unit for soldering irons and continuity testing, which can be supplied with either 6-V or 12-V output sockets.

A buzzer is incorporated in this unit for circuit continuity testing. Mains input tappings are provided, and another feature is the guarded rest for a soldering iron situated on the top right-hand side of the unit.

Price: quantities up to 100 off, £6 6s. each; quantities over 100 off, £5 10s. each. Optional extras: continuity testing lead and soldering iron.—*C. F. Taylor (Electronics) Ltd., Wokingham, Berks.*

For further information circle 14 on Service Card

15. Nylon Terminal Blocks

A comprehensive range of nylon terminal blocks manufactured by Ward Brooke is now generally available.

Electrical characteristics are maintained through a temperature range from -60°C to $+110^{\circ}\text{C}$ and a relative humidity range up to 100%. Circuit identification is by both colour and terminal number.

Special buttresses between studs eliminate risk of short-circuit between adjacent ring terminal sleeves and the design provides a high flashover distance, good terminal shielding and long creepage path with a minimum weight penalty. Up to 8 ring type terminations can be accommodated per stud on the smallest 6BA or 6UN range.

Types available include, panel-mounting multi-connector blocks, through-panel blocks with both solder spill and screw terminal connectors, shrouded blocks; all with a complete selection of accessories.—*Ward Brooke & Co. Ltd., Westbourne Street, High Wycombe, Bucks.*

For further information circle 15 on Service Card

16. High Speed Pen Recorder

Constructed entirely of transistorized plug-in units, the Devices 4-channel pen recorder type M.4 is capable of covering a wide range of industrial and medical applications. Each pre-amplifier is fitted with an interchangeable sub-unit which provides specific switching facilities and controls to match different types of transducers; a transistor chopper technique is employed, giving a maximum d.c. sensitivity of $2.5 \mu\text{V}/\text{mm}$ with negligible drift.

Two interchangeable writing systems are available: hot stylus on heat-sensitive paper, writing in rectilinear co-ordinates, or ink-pen on untreated paper, writing in curvilinear co-ordinates. Four recording pens each have an excursion of 5 cm and a frequency response of 0-75 c/s (3 dB). Provision has been made to insert up to 8 recording pens each with an excursion of 2.5 cm and combinations of pen grouping can be achieved, e.g.

17

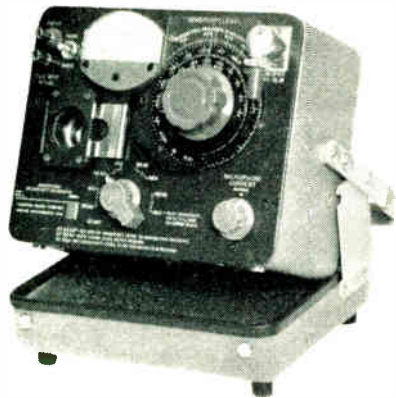
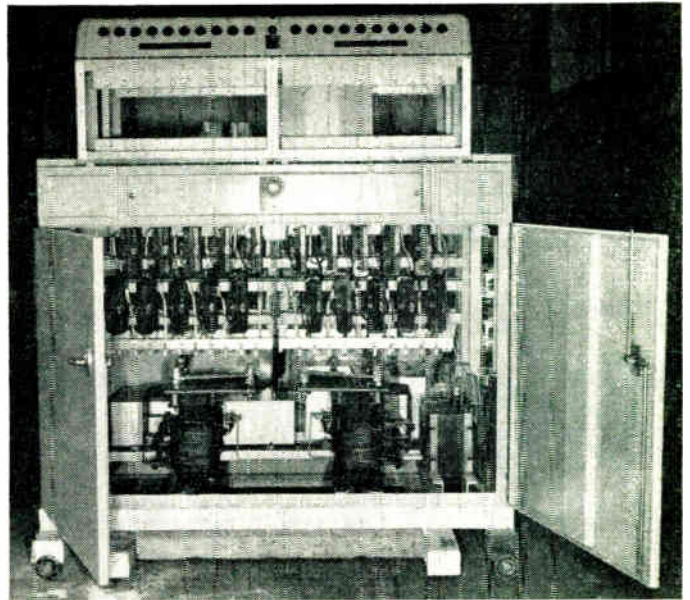

18

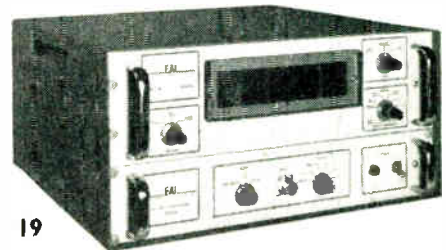

19

2 pens with 5 cm excursion and 4 pens with 2.5 cm excursion.

Twelve paper speeds from 100 mm/sec down to 2.5 mm/min are available with pushbutton control. A servo system maintains paper speed accuracy to $\pm 1\%$, and paper wander is kept to within ± 0.5 mm.

The type M.4 can be coupled to a tape recorder for long term monitoring applications; by making full use of tape-speed variation, the effective direct-writing frequency response, using the pen recorder on play-back, can be extended to over 2 kc/s.—*Devices Sales Ltd., Electronic Instruments Division, 13-15 Broadwater Road, Welwyn Garden City, Herts.*

For further information circle 16 on Service Card

17. Heating Element Wire Tester

Electromech Appliance's C.163 wire tester is used to determine the suitability of chrome alloy wire for electric heating purposes, when operating at high temperatures (800 to 1,000 °C).

The equipment stabilizes the electric supply to $\pm 1\%$, and the temperature of the sample is adjusted by means of

a saturable reactor with fine control.

Up to 40 samples may be tested simultaneously and are subjected to a 2-min cycle of heating and cooling. Price: £2,200.—*Electromech Appliance Ltd., 1 Twalling Road, Barnet Green, Birmingham.*

For further information circle 17 on Service Card

18. Microphone Calibrator

A microphone calibrator, which reduces a primary calibration technique to a simple procedure requiring no calculations, has been announced by General Radio. The type 1559-A microphone reciprocity calibrator is designed for absolute calibration of piezoelectric microphones used in the firm's sound-level meters and analysers. Sensitivities from -55 to -65 dB (ref. 1 V/ μ bar) are measured to ± 0.2 dB ($+0.1$ dB times frequency in kc/s) from 20 c/s to 2.5 kc/s, and to ± 0.7 dB at frequencies from 2.5 to 7 kc/s.

The calibrator uses the closed-coupler reciprocity procedure generally regarded as the most accurate method of determining microphone sensitivity. The many calculations included in the

procedure are automatically performed by a built-in analogue computer, and the entire calibration may be made quickly and simply by unskilled personnel.

The calibrator can also be used as a precision acoustic source to calibrate sound-level meters from 20 c/s to 8 kc/s.—*Claude Lyons Ltd., Valley Works, Hoddesdon, Herts.*

For further information circle 18 on Service Card

19. A.C./D.C. Digital Voltmeter

A solid-state, programmable four-digit (with fifth overranging digit), automatic-ranging a.c./d.c. digital voltmeter has been introduced by Electronic Associates. The series 5002 includes all the features of the series 5001 for d.c. measurements. It has a.c. ranges of 1, 10, 100, 1,000 V with 20% overrange, and an accuracy of $\pm 0.06\%$ of full scale plus 1 digit absolute accuracy to 5 kc/s; $\pm 0.1\%$ to 10 kc/s. The a.c. input impedance is constant at 1 M Ω for all ranges over the entire bandwidth.

The unit has manual, remote command and can be automatically ranged by a front panel switch; it includes



20



21

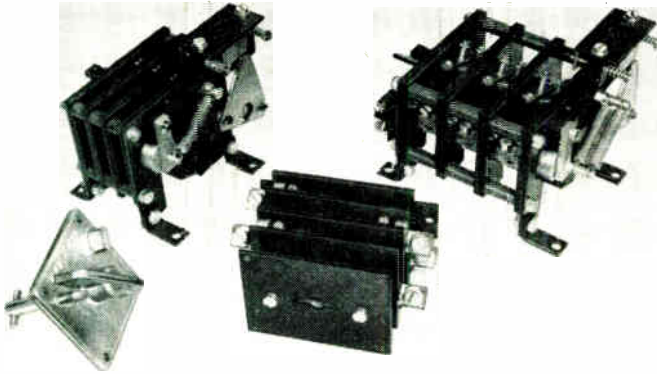

22

10 M Ω constant impedance on all d.c. ranges or up to 1,000 M Ω on the 10 V range; floating input; automatic over-voltage protection; internal, external or manual trigger modes, complete with binary and decimal outputs from an output storage buffer. With a power source of 115/230 V, 50/60 c/s the series 5002 is designed for 19 in. rack mounting.—*Electronic Associates Ltd., Victoria Road, Burgess Hill, Sussex.*

For further information circle 19 on Service Card

20. pH/mV Meter

The type GLD pH meter made by Seibold of Austria is being introduced in the U.K. and Commonwealth markets by H. G. Stevens.

This versatile instrument doubles as a millivolt meter and is consequently suitable for Redox and dead-stop measurements, and for potentiometric analysis. Temperature control is either automatic or manual, and a temperature probe as well as a combined unit-electrode are standard equipment.

The mirror-backed 6-in. scale with

graduations of 0.05 pH and 10 mV corresponds with the measuring accuracy of 0.025 pH and 5 mV. Input resistance is in excess of 10¹² Ω and voltage fluctuations of $\pm 15\%$ do not affect the accuracy. Nor do variations in frequency: the instrument can be used on both 50 or 60 c/s.

The amplifier has good zero stability and is capable of supplying other indicating or recording instruments. The outer casing is a dust-proof light-alloy casting and the electrode stand with clamps for both electrode and temperature probe can be attached to it.

The U.K. price of the GLD, complete with the above equipment and minor accessories is £119 10s.—*The H. G. Stevens Co. Ltd., 16 Coverdale Road, Cricklewood, London, N.W.2.*

For further information circle 20 on Service Card

21. Electro-Pneumatic Converter

An electro-pneumatic converter has been announced by Fielden Electronics. This is a robust weatherproof unit which converts direct current into a pneumatic pressure within the range 3–15 p.s.i. and is intended primarily

for use in conjunction with diaphragm-operated control valves. While the standard unit has an input current of 0–15 mA, units for other current ranges can be supplied, e.g. 0–10 mA, 4–20 mA, and the converter can therefore be used with process controllers having electrical outputs, electrical transmitters, or it can be operated from a manually-controlled current.

The small size of the unit makes it suitable for mounting direct on the control valve and oil damping minimizes the effect of vibration without materially affecting the speed of response. The movable beam is mounted on metal flexures; no adjustable linkages or pivots are employed.

A non-bleed type air relay is used to provide the large volume of air for rapid operation of the control valve and, apart from the very small amount of air required by the primary valve, air is only required from the compressor when the pressure to the control valve is increasing. The electrical energy required to operate the unit is very low and a Certificate of Intrinsic Safety has been granted for the use of the converter with a Fielden process controller.—*Fielden Electronics Ltd., Wythenshawe, Manchester 22.*

For further information circle 21 on Service Card

22. 'On-Load' Isolators

Asquith Electrics have recently extended their range of 'on-load' isolators to include a heavy-duty model with a rating of 120 A. Identified as the HIF series, four alternative types can be supplied: 2 or 3 main poles and with or without an additional 5 A auxiliary switch.

All models are provided with a door interlocking mechanism, padlocking in the off-position, and insulated protective covers. Manufacturing and testing is in accordance with B.S. 861:1955. Breaking capacity: 400%, continuous current rating.—*Asquith Electrics (Colne) Ltd., Walton Street, Colne, Lancs.*

For further information circle 22 on Service Card

23. High Precision Cutting Machine

Now available from Caplin Engineering is a machine which is capable of automatically slicing semiconductor metals such as silicon, germanium, etc., and also quartz, ferrites, ceramics, glass and other hard materials. This machine, known as the Auto Q-35, employs an annular saw, the inner periphery of which presents a very thin cutting edge (0.0065 to 0.008 in.) thus

EQUIPMENT

review



24

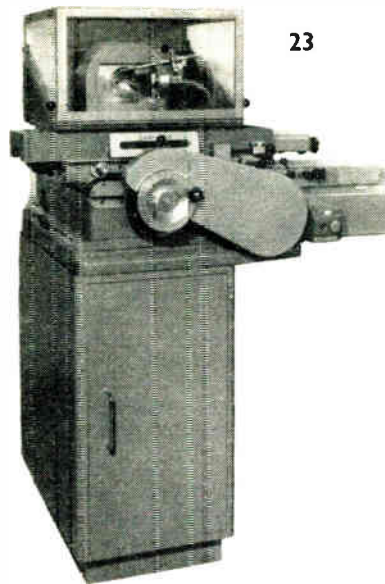

23

minimizing the amount of material wasted. Once the crystal or ingot has been mounted at the correct orientation the machine is started and will continue to cut automatically until the crystal is completely sliced. Great accuracy can be obtained in respect of repeat slice thickness and parallelism (within 200 μ in.).

Safety devices are incorporated and the machine is equipped with automatic coolant feed, etc., and is mounted on a cabinet containing the sedimentation tank and pump for the coolant fluid. Price: £1,410 ex works. *Caplin Engineering Co. Ltd., Elton Park Works, Hadleigh Road, Ipswich, Suffolk.*

For further information circle 23 on Service Card

24. Transistorized Stroboscope

The Dawe type 1209A transistor Strobobflash employs a high-intensity xenon flash tube which is particularly useful where accurate colour rendering is necessary or where the ambient lighting is intense.

The unit has a direct range from 300 to 15,000 flashes per min in three overlapping full-scale settings from 0 to 1,500, 5,000, and 15,000 flashes per min. The frequency meter reading is accurate to $\pm 1\%$ of f.s.d. when standardized against mains frequency, a special switch position being provided to give a check on the calibration by comparison with the mains frequency when this is accurately known.

Flash duration is 5 to 10 μ sec depending on the flash rate; the mean power of the flash tube is up to 6 W at the higher rates.

The type 1209A weighs 8 lb and measures $7\frac{1}{4}$ by $7\frac{1}{4}$ by $8\frac{1}{2}$ in. high. Power consumption is 24 W. — *Dawe Instruments Ltd., Western Avenue, Acton, London, W.3.*

For further information circle 24 on Service Card

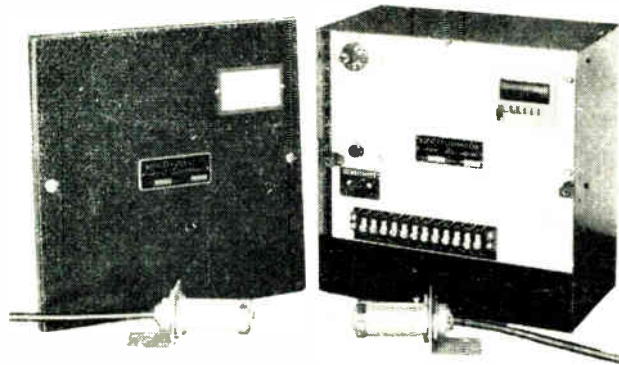

25

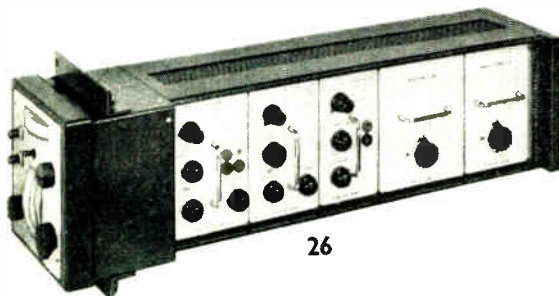

26



27

25. Photo-Electric Counter

Buckleys (Uvral) are now extending their Majik-I range of photo-electric controls with a totalizing counter having a maximum counting rate of 3,000 per min. It has been designed to provide a compact, versatile unit, robustly constructed for industrial service.

Initiation of the count is by interruption of a light beam and a variety of heads is available, including long range units. The equipment is fully transistorized and utilizes printed circuits on plug-in boards. A 6-figure display counter is normally fitted within the control unit, but can be mounted externally. Resetting of the

counter is by manual operation but, if required, electrical reset may be incorporated for remote control.—*Buckleys (Ural) Ltd., Beta Works, The Embankment, Putney, London, S.W.15.*

For further information circle 25 on Service Card

26. Three-Term Controller

Lancashire Dynamo has introduced a three-term controller, series 3TC.1, either in a form suitable for panel mounting where it is not often necessary to adjust the terms or in a 'side-ways' presentation, so that all terms can be adjusted. In this latter case, the desired value control and meters can be detached and mounted on the panel where required. The operational amplifiers are of hybrid construction with plug-in circuit cards. The proportional bandwidth is adjustable from 3 to 300%. The integral acting time or reset is adjustable from 5 sec to 40 min in two ranges, and the derivative acting time or rate is between 1 and 180 sec. The three terms are completely non-interacting, enabling the most complex control loop to be optimized mathematically should this be required.—*Lancashire Dynamo Electronic Products Ltd., Rugeley, Staffs.*

For further information circle 26 on Service Card

27. Microwave Power Dividers

A series of Ramcor power dividers, to be marketed in this country by Roberts Electronics, is designed to provide precise power supplies in systems or laboratory applications. The dividers cover the full frequency range from 1 to 10 Gc/s with exceptionally low v.s.w.r. and negligible insertion loss.

The devices divide the input into precisely equal outputs, and since no dissipative elements are employed the input signal is not attenuated before being divided. Special units are available for operation below 1 Gc/s and for power splits into 3, 4, 5, or 6 outputs.—*Roberts Electronics Ltd., 17 Hermitage Road, Hitchin, Herts.*

For further information circle 27 on Service Card

28. Magnetic Heads

Epsilon announce that they can supply magnetic heads for any tape width up to 1 in. with 1 to 16 tracks.

Track widths available at short notice are 0.040, 0.045, 0.050, 0.080, 0.090, 0.10 and 0.25 in. but any track width can be made to order; gaps can be from 0.0001 in. upwards.

The impedance at 1 kc/s of each winding may be within the range 4 to 150 Ω (or up to 500 Ω if required).

Heads can be made to SBAC or IRIG standards. The photograph illustrates 8 track and 16 track magnetic heads.—*Epsilon Industries Ltd., Faggs Road, Feltham, Middlesex.*

For further information circle 28 on Service Card

29. High-Speed Batch Counter

A high-speed electronic batch counter with wide applications is now being manufactured by Racal Instruments.

In addition to counting and batching articles moving along a conveyor belt, counting paper sheets, etc., the SA.532 can be used for the high-accuracy measurement of lengths of such materials as paper, glass, rubber, plastic or metal.

It will operate at speeds of up to 25,000 per second, and batch up to 9,999. A facility for pre-batch warning is included, and the total number of batches is indicated on a separate 4- or 5-digit mechanical register which can be re-set independently of the main counter. Outputs are provided for the operation of external relays or control mechanisms.

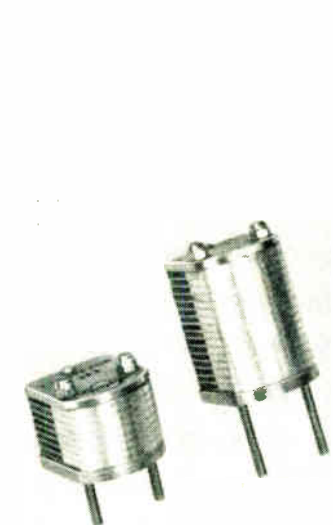

28

This unit, which is designed to work in conjunction with any suitable transducer, is 12 in. wide by 7 in. high by 7½ in. deep.—*Racal Instruments Ltd., Bracknell, Berks.*

For further information circle 29 on Service Card

30. Electronic Voltmeter

The type 1806-A electronic voltmeter by General Radio measures a.c. and d.c. voltages to 1,500 V and resistances from 0.2 Ω to 1,000 M Ω , with accuracy of $\pm 0.2\%$ of indicated value. Frequency range is to 1,500 Mc/s.

Input impedance for d.c. measurements is 100 M Ω , and for a.c. is 25 M Ω in parallel with 2 pF on all ranges but the highest (1,500 V), where it is 25 M Ω in parallel with 15 pF. Open-grid a.c. measurements are possible up to 1,500 V.

This instrument includes a compact probe for use where space is limited. The large meter is especially easy to read since only two voltage scales are needed. Power requirements are 105 to 125 (or 210 to 250) V a.c., 50 to 60 c/s.—*Claude Lyons Ltd., Valley Works, Hoddesdon, Herts.*

For further information circle 30 on Service Card



29



30

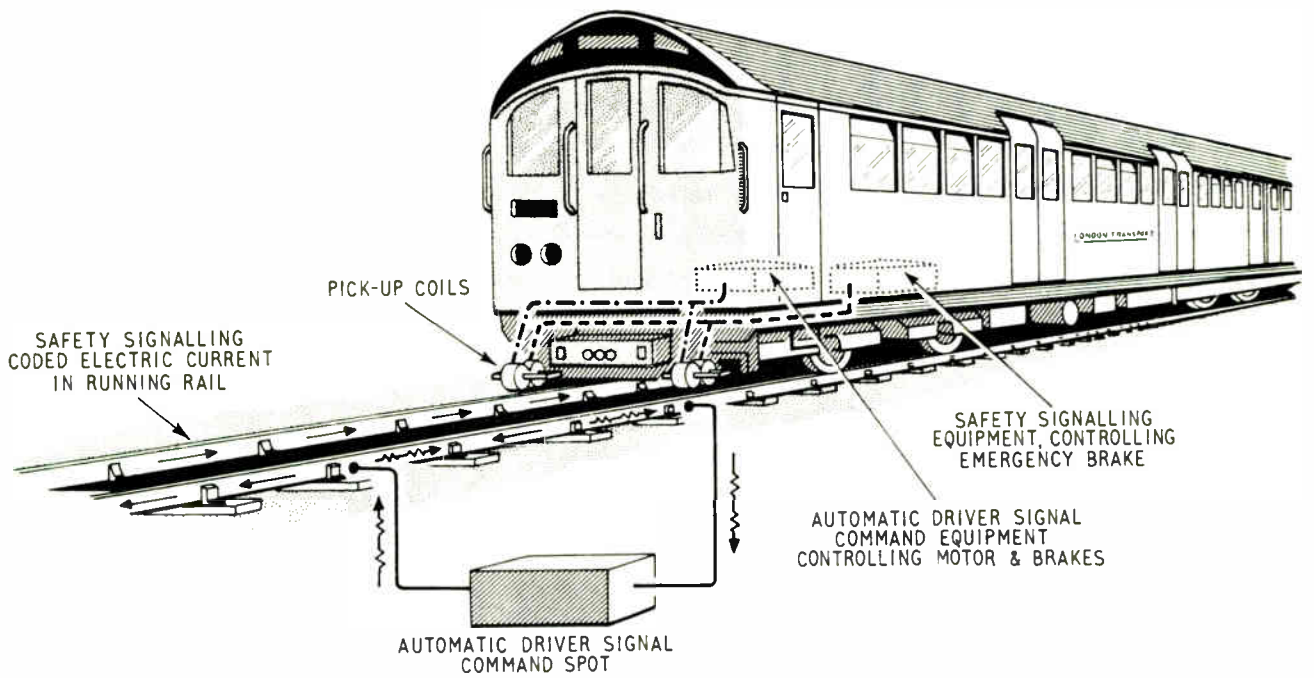

This drawing shows the position of the control equipment and indicates the safety signal current and the driver signal current

'DRIVERLESS' TRAIN EXPERIMENT

TRIALS of experimental equipment have been started by London Transport to decide the feasibility of driving trains automatically.

A District Line train has been specially equipped and

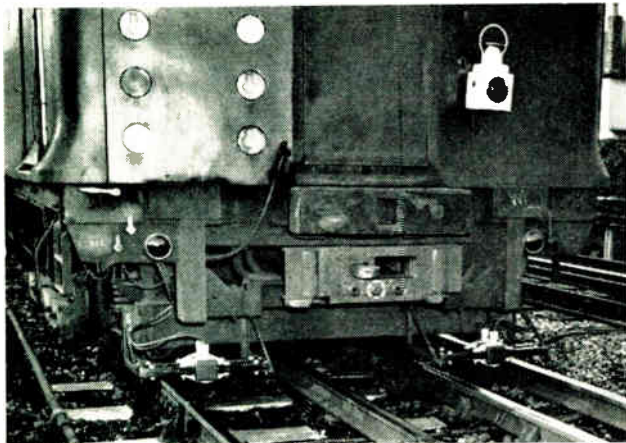

The pick-up coils can be seen mounted on the front of this experimental train

the first tests are being carried out along a one-mile stretch of track between South Ealing and Acton Town.

The train is fitted with a dual system of control to provide all the facilities for switching on and off motors and for the application and release of brakes with pro-

vision for an automatic overriding safety control to stop the train before it approaches too near to a train in front.

All of the requirements of these systems are achieved by passing coded currents through the running rails. These currents induce control signals into pick-up coils which are mounted at the front of the train at each side.

The safety signal is basically a 125-c/s carrier modulated by 420, 270 or 180 pulses per minute. A modulation of 420 p.p.m. indicates that the track is clear and running speed is unrestricted. A modulation of 180 p.p.m. means restricted speed while 270 p.p.m. is the code required for the train to start. Should there be no safety signal received by a moving train an overriding control circuit comes into action and causes the brakes to be applied.

In addition to the coded safety signalling system, which ensures that the train cannot run on the track unless it

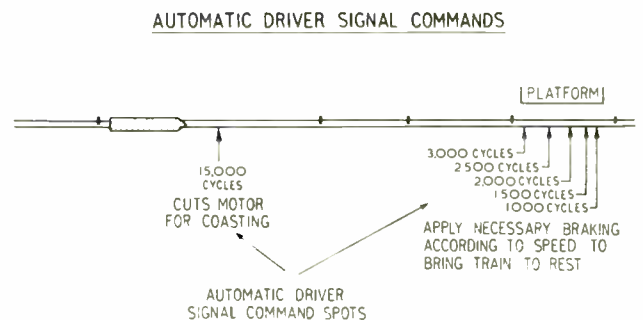

This diagram shows the automatic driver signal commands

is safe to do so, there is a separate system called the automatic driver signal command. This is provided to initiate all of the driving requirements. The automatic driver commands are given to the train by feeding pulse-modulated a.c. into short sections of one running rail. The actual frequency of the a.c. signal is variable and indicates the speed at which the train is required to run at that point on the track. For simplicity a value of 100 c/s has been used to equal 1 m.p.h.

The principal purpose of the automatic driver command is to control the braking system of the train.

In operation, the command signal in part of the track induces a signal in a separate pick-up coil. The frequency of the signal is counted electronically and compared with that produced by a tachometer connected to one of the train

wheels. This comparison indicates whether the train is going faster or slower than it should, and as a result the difference signal causes brake application or release to maintain the correct predetermined speed of the train. The automatic driver signal command sections are also used to provide a signal to switch off the motors when the train has reached a high enough speed for it to coast to the next station.

It is anticipated that a motorman will replace the conventional driver and guard. His duties will be to open and close the doors and to press the start button of the automatic driving system. Trains will also be fitted with conventional driving controls so that in the event of a failure the motorman can take over and drive the train manually.

HIGH VACUUM MELTING PLANT

This high vacuum melting plant at Telcon Metals' Crawley factory produces 1,500 tons per year of high purity alloys* and basic metals for the electronic, instru-

ment and aircraft industries. Impurities are removed by evaporation in the high frequency induction furnaces.

*For further information circle 100 on Service Card

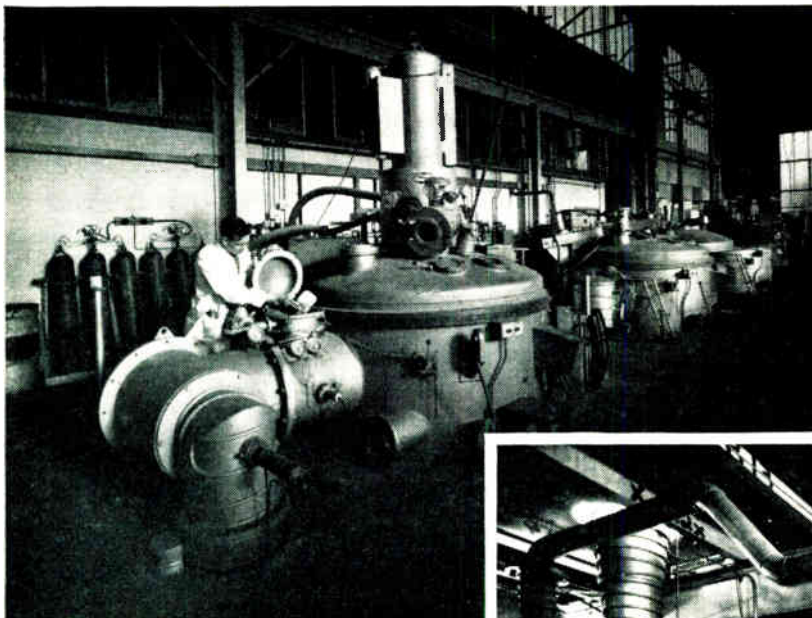

◀ This photograph shows an operator making an addition to the sample lock of one of the high frequency induction furnaces in the high vacuum melting plant

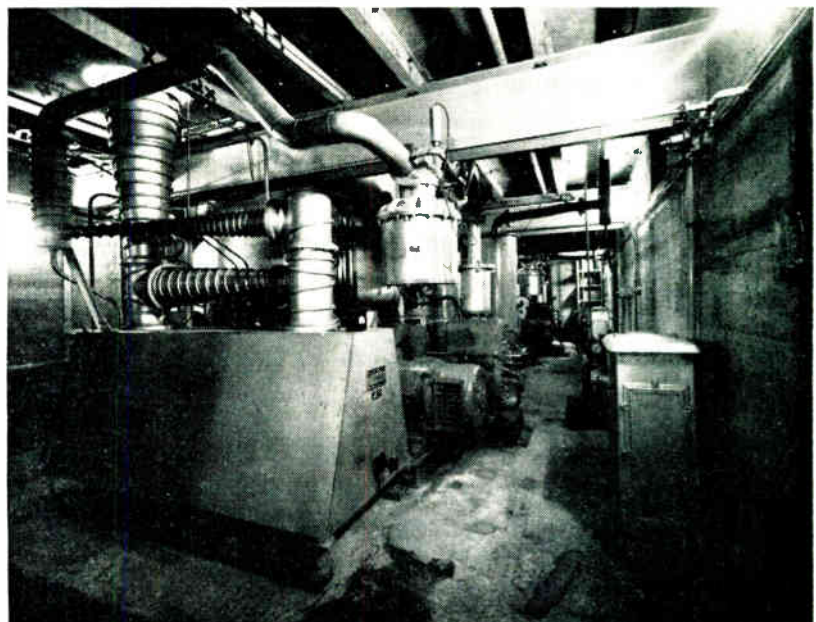

► Shown here is the furnace pumping equipment which is installed below ground level in the recently completed extension of Telcon's Crawley factory

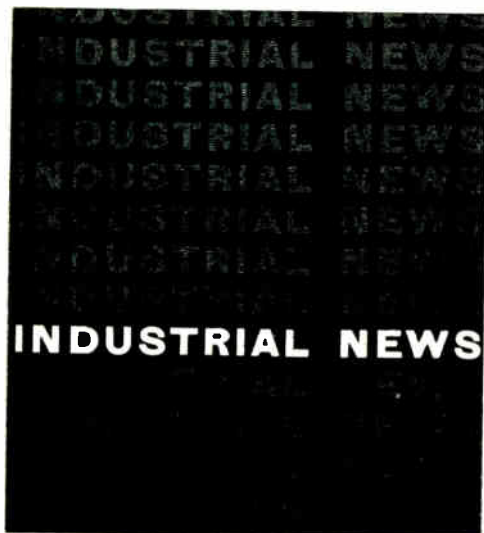

Personal and Company News

Thorn Electrical Industries Ltd. have formed a new company with the title Thorn Electronics Limited. This incorporates subsidiary companies and electronics divisions of T.E.I. namely: Nash & Thompson Ltd., Ferguson Electronics Division, Industrial Control Systems Division and Microwave Components Division. The address for the new company is 105-109 Judd Street, London, W.C.1, and the telephone number is Euston 4433.

T. H. Kelsey, M.A.(Cantab.), M.I.E.E., has been appointed vice-chairman of **G.E.C. (Engineering) Ltd.** and W. D. Morton, M.A.(Cantab.), A.M.I.E.E., A.M.I.Mech.E., becomes general manager of the company's Witton Engineering Works.

Miles Hivolt Ltd. have been appointed sole U.K. agents for Lemos S.A. of Switzerland, manufacturers of electrical connectors.

Hans U. Berlinger, Leugrubstrasse, Waltikon-Zumikon, Zurich, Switzerland, has been appointed continental technical sales representative of the **Ferranti Numerical Control Division.**

International Research and Development Co. Ltd. have a controlling interest in Systems Computers Ltd. This was previously wholly-owned by Joyce, Loebel & Co. who retain the remaining interest.

Mullard Equipment Ltd., Crawley, Sussex, is now marketing ultrasonic equipment directly instead of through a distributor.

J. Hughes, B.Sc., Ph.D., has joined **Vactric Control Equipment Ltd.** as chief scientist.

Colonel F. R. Peathey-Johns, M.B.E., B.Sc.(Eng.), M.I.Mech.E., M.Brit.I.R.E., has joined **Gresham Lion Electronics Ltd.**

Friden Ltd. have opened a branch in Wellington House, Wellington Street, Glasgow. Maurice A. Silver is manager.

H. E. R. Shand, C.A., has relinquished his directorship of **Mullard Ltd.**

Closed-circuit television is being used in the Marconi W.T. Co's research laboratories to produce a large easily-viewed picture of small objects. A group of four planar transistors is shown on the screen of the tube in the picture magnified 300 times. The dark line across the screen is a human hair

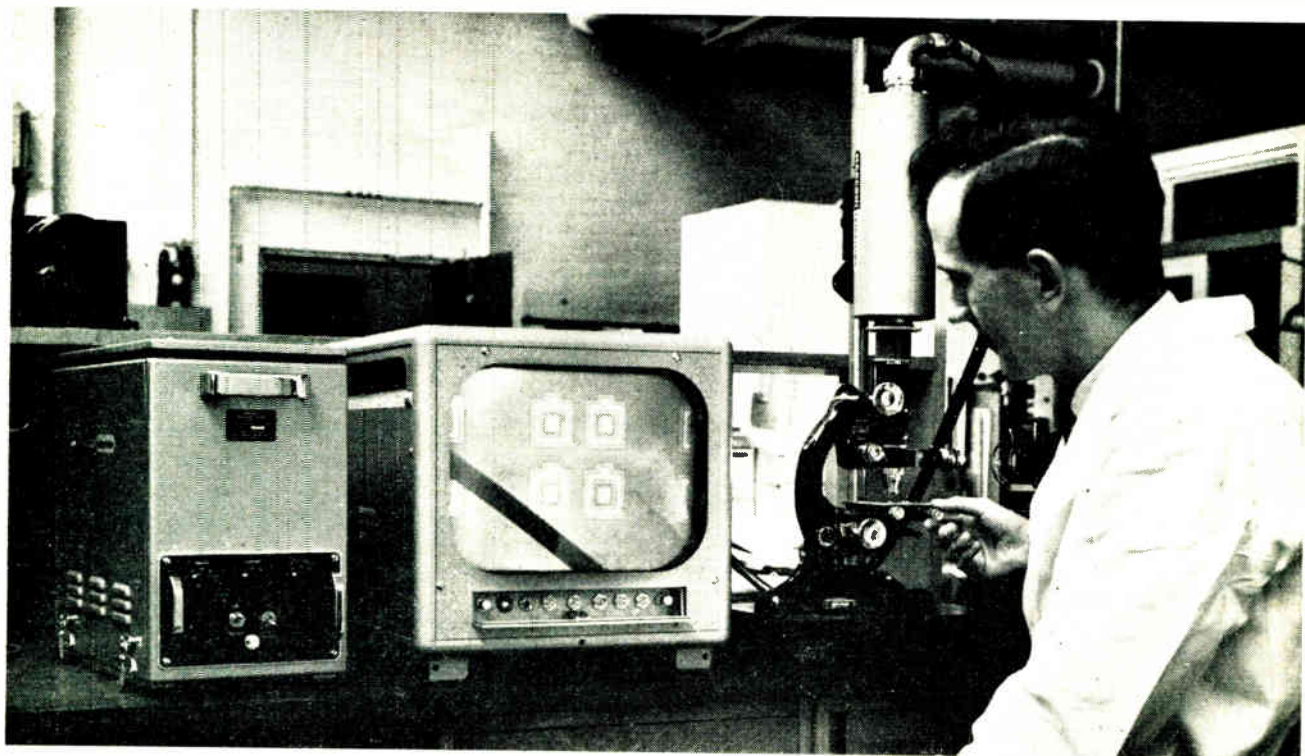

A giant travelling-wave tube, 8 ft long and 10 in. diameter, being processed in its magnetic focusing coils in a 14-ft pit at the Hirst Research Centre of the General Electric Co. Ltd. The tube is for operation at 400 Mc/s and has an electron beam 4-in. in diameter which travels a 6-ft path between cathode and collector. The tube has an output of 200 kW for an input of 500 W

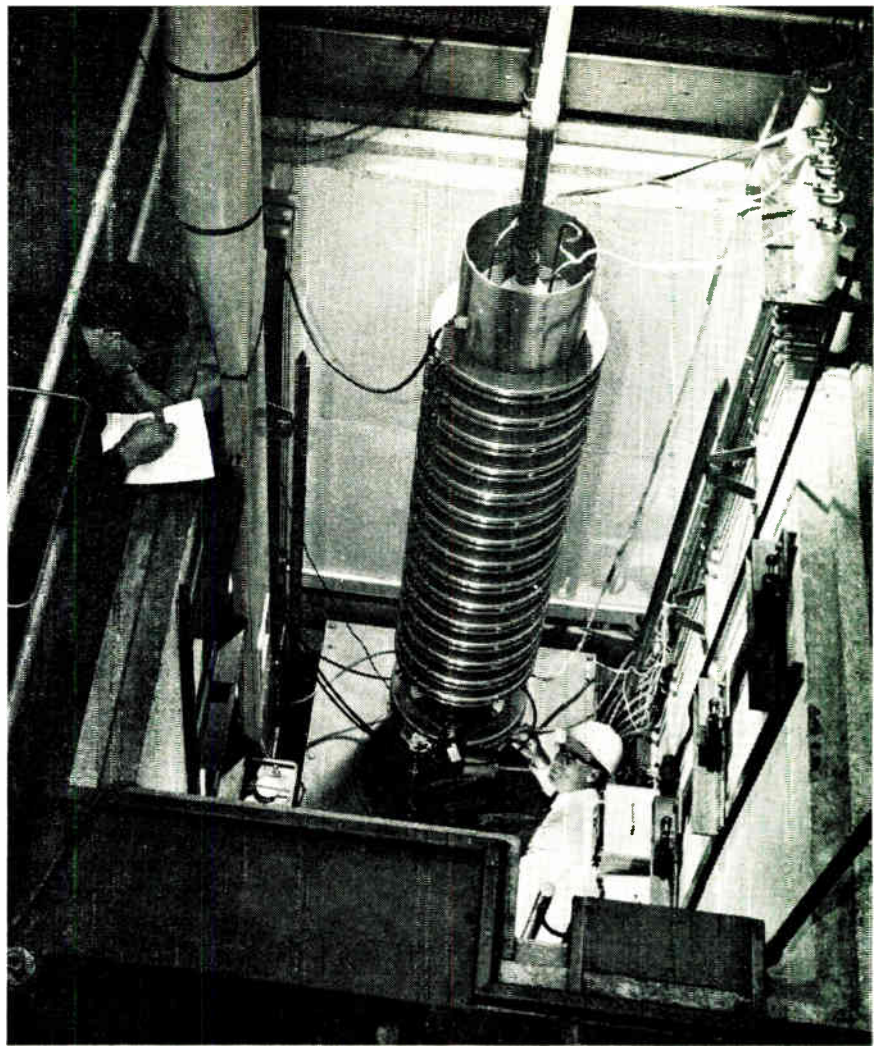

Sasco Ltd. have been appointed stockists for, and representatives of, **SGS-Fairchild** and can supply from stock silicon planar transistors, diodes, special products and micrologic.

I. John Billera, executive vice-president of **U.S. Industries Inc. Great Britain Ltd.**, has been elected to the Board.

Kenneth Graham Smith has joined the board of **Simms Motor & Electronics Corporation Ltd.**

Hector Slade is relinquishing his appointment as managing director of the **Garrard Engineering & Manufacturing Co. Ltd.** but is remaining a member of the board. He is succeeded as managing director by **T. H. Pritchard**.

Mullard Ltd. have formed a new division, the **Transmitting and Microwave Division**, to handle the development, manufacture, sale and servicing of transmitting and r.f. heating valves, magnetrons, klystrons, travelling-wave tubes and vacuum pumps and gauges. **P. S. Britton** is general manager with **J. Balcombe** as deputy commercial manager, and the division operates from **Queensway, Waddon, Surrey**.

R. J. F. Howard has been appointed managing director of **Brookhirst Igranic**.

N. W. Hunt has been appointed manager of the **Quartz Crystal Division** of **Brush Crystal Co. Ltd.**

The section of **A.E.I. Southern Regional Office**, previously at **Crown House, Aldwych**, has moved to **Tyssen Street, Dalston, London, E.8** (telephone: **Clissold 8661**).

E. P. Stanton, M.B.E., B.Sc.(Eng.), Ph.D., M.I.E.E., M.I.E.L. has been appointed chief inspector of **The Plessey Co.**

R. H. Ellis has been appointed specialist sales engineer for the south-east of England for **Consolidated Electrodynamics Division** of **Bell & Howell**. His address is **156 Church Lane East, Aldershot, Hampshire** (telephone: **Aldershot 22472**). **J. S. Bradford, 20 Langdale Road, Bramhall, Stockport, Cheshire** (telephone: **Bramhall 5190**) holds a similar appointment for the north of England and Scotland.

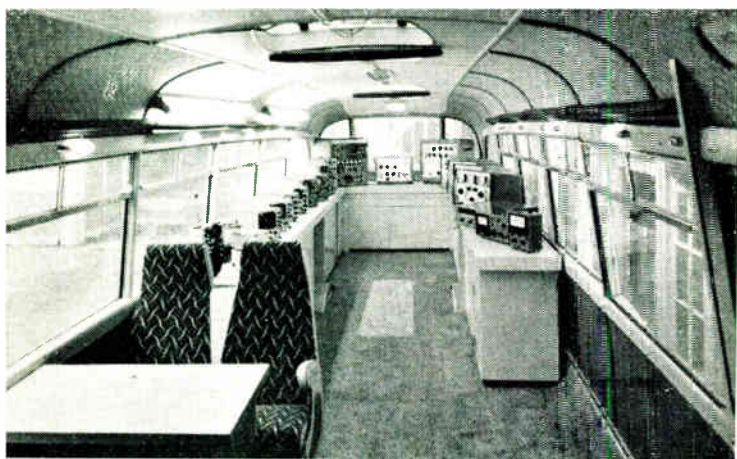

Rank Cintel Ltd. and Telequipment Ltd. are co-operating in the provision of a mobile demonstration unit to show a range of their companies' laboratory instruments. The picture shows the interior of the unit which is available to visit by appointment companies, Government establishments, universities and technical colleges

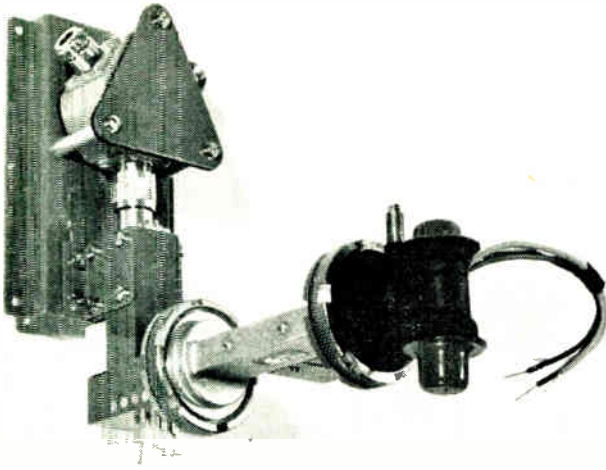

Mullard low-noise solid-state parametric amplifier has a noise figure of 3 dB and a bandwidth of 25 Mc/s. It is for operation in the band 2.7-3.3 Gc/s

PERSONAL AND COMPANY NEWS [continued]

J. L. Woollett, A.M.I.Mech.E., A.M.I.E.E., M.I.M. & S.M., has been appointed general manager of the Aerial and Electronic Division at the Congleton Factory of **Aerialite Ltd.**

Metallic Seamless Tube Co. Ltd. have changed their address and are now at 115 Hockley Street, Birmingham 19 (telephone: Northern 9301).

Roberts Electronics Ltd., of 17 Hermitage Road, Hitchin, Herts., have been appointed agents for Sperry Microwave Electronics.

Acheson Colloids Ltd. have closed their Rochdale office. Their northern branch is now at 11th Floor, St. Andrew's House, Portland Street, Manchester 1.

Obituary

T. W. Bennington, of the B.B.C. Research Department, died on 13th March at the age of 63. He joined the Corporation in 1934 and for many years has been chiefly engaged on work connected with wave propagation via the ionosphere. He was also a regular contributor to *Wireless World*.

Cryosystems Ltd.

This is a new company which has been set up with the encouragement of the National Research Development Corporation and will undertake the design and manufacture of engineering systems involving cryogenics. The member companies are: British Aircraft Corporation, Hymatic Engineering Co. Ltd., C. A. Parsons & Co. Ltd. and Petro-carbon Developments Ltd. The board comprises H. M. Finnieston, B.Sc., Ph.D. (chairman), G. B. Longbottom, B.Sc., T. B. Pritchard, F.C.A., and W. L. Seddon, B.Sc. (Tech.), and the address is 40 Broadway, London, S.W.1.

Society of Technical Publications Contractors

This is a new society formed to maintain the professional standards of this new industry which exists to produce servicing manuals, parts lists and other publications for manufacturers. The secretaries are Industrial and Financial Secretariat Ltd., 53 Finsbury, London, E.C.3.

A.T. & E.—General Dynamics Agreement

Automatic Telephone and Electric Co. Ltd. and the Stromberg-Carlson Division of General Dynamics Corporation have reached an agreement whereby the latter will distribute in the U.S.A. equipment manufactured by A.T. & E. It is expected that manufacture in the U.S.A. of A.T. & E. designs will start later on. The equipment is the CM multiplex apparatus.

Selective Paging Committee

An association of firms interested in selective paging has been formed to agree technical details, formulate standards and represent members in discussions with the licensing authority for the mutual interest of both purchaser and supplier. The member firms are: Autophone Ltd., Multitone Electric Co. Ltd., Page Boy Co. Ltd., Philips Electrical Ltd., Standard Telephones & Cables Ltd., Tele-Nova Ltd. and Ultra Electronics Ltd. The address is 12-20 Underwood Street, London, N.1.

Electrical Appliance Association

This association is a sister one to the Radio and Television Retailers' Association and will have the same president, officers and council. It has been formed to give formal expression to the fact that over 90% of R.T.R.A. members handle electrical appliances.

Two 250-ft demountable aluminium masts have been supplied to the Australian Post Office. They are made in sections each 6-ft high and containing a stairway and expanded metal platform. Access Equipment Ltd. have supplied the masts using tubing supplied by Alcan Industries Ltd

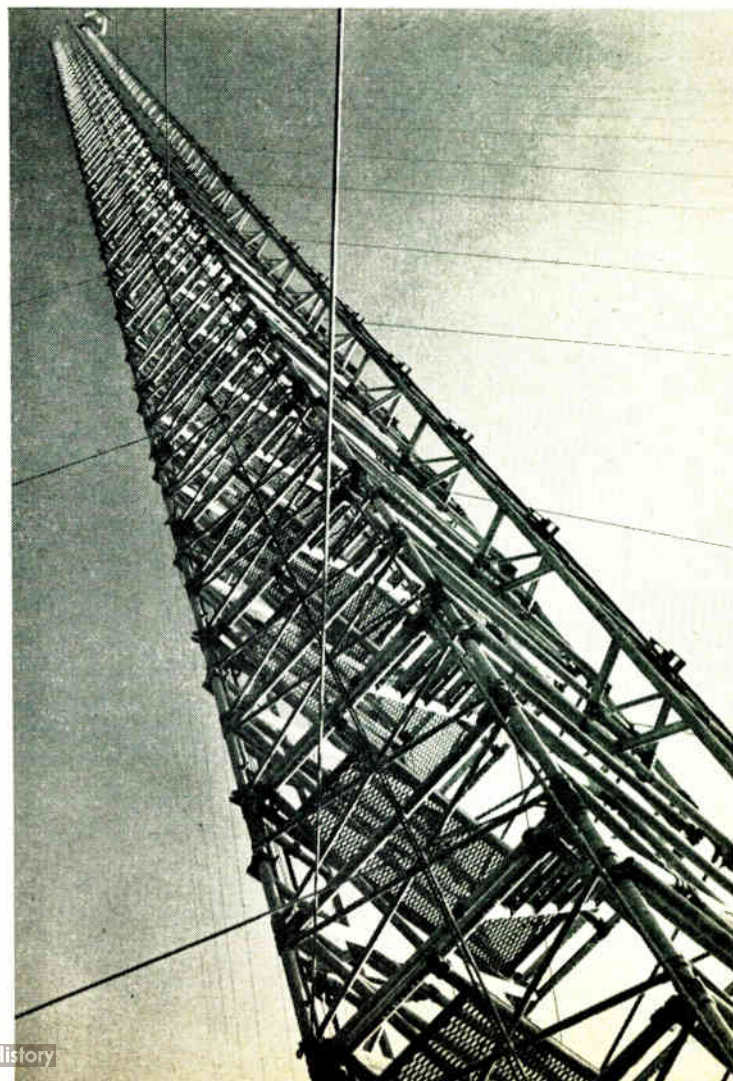

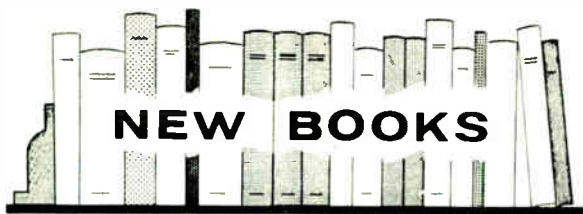

The Dynamics of Automatic Control Systems

By E. P. POPOV. Pp. 761 + xiii. Pergamon Press Ltd., Headington Hill Hall, Oxford. Price 75s.

This book is a translation from the Russian. No indication is given of the date of publication of the Russian edition, but the translation and publication of this edition alone must have taken a considerable time. When one adds to this the time needed for writing and publishing a book as long as this one, it is clear that one cannot expect to find any recent developments treated in it. To say this is not to disparage the book in any way; it is inevitable with any large book, and especially in a translation.

Even if the latest things are not treated, the book is an exceptionally good one. It is certainly one which will be of great use to all designers of automatic control systems who are equipped mathematically to benefit from it. Mathematics are very freely used, but the treatment is by no means entirely mathematical. There is a great deal of descriptive material.

The book is in five parts. Part 1 is entitled General information about automatic control systems and starts with an introduction explaining their form; then follow chapters on transients in regulation systems, methods of improving such systems and problems in their theory.

Part 2 deals with Ordinary linear automatic regulation systems. This forms a major part of the book for in it are covered the setting up of equations, stability criteria, choice of structure and parameters, and criteria for the transient response. The stability criterion most used is attributed to Mikhailov. It is acknowledged that in 1932 Nyquist first applied a frequency criterion of stability to amplifiers, and it is claimed that in 1936 A. V. Mikhailov first applied it to automatic regulators. The well-known Hurwitz and Routh stability criteria are referred to, but among algebraic criteria most references are to a Vyshnegradskii criteria.

Part 3 covers Special linear automatic regulation systems; by this is meant systems with delay, distributed parameters, and discontinuous (pulse) systems. Part 4 covers Non-linear automatic regulation systems, and Part 5 explains Methods of plotting the regulation-process curve.

Throughout the book the treatment is very thorough and detailed. In spite of the English editor's statement that much of the Russian sentence structure has been preserved, since it was impossible to alter it without complete re-writing, few difficulties of language will be encountered. The diagrams are rather poor, however, being mostly rather small with the result that lettering is sometimes hard to distinguish. The one really serious fault in a book of this kind is the complete absence of an index.

Lasers

By BELA A. LENGVEL. Pp. 125 + xi. John Wiley & Sons Ltd., Glen House, Stag Place, London, S.W.1. Price 55s.

This is a most useful little book to anyone interested in lasers. It starts by giving background material on radiation in a section in which light, coherence and incoherence, emission, absorption and amplification are briefly treated. There is then a general description of lasers, followed by

analytical problems where threshold conditions, cavities and linewidths are discussed.

The next two sections cover solid-state and fluid state (liquid and gaseous) lasers, and the book ends with a discussion of applications and development. The treatment is only moderately mathematical, but the reader should have a fair background of modern physics if he is to make the best use of the book.

Permanent Magnets and Magnetism

Edited by D. HATFIELD, Ph.D., M.Sc.(Eng.), F.I.M., M.I.E.E. Pp. 556 + xii. Iliffe Books Ltd., Dorset House, Stamford Street, London, S.E.1. Price 105s.

The book has 13 chapters by 12 different authors. Professor Andrade opens with an introductory chapter which covers the history of the subject. Dr. McCaig has two chapters, one on magnetic units and the other covering the fundamental basis of permanent magnets, while Professor Brailsford deals with ferromagnetic theory.

The classification and properties of materials are treated by J. Hinsley. The book then begins to take a more practical turn with Dr. Edwards' chapter on magnet design. Chapters on applications, manufacture and testing follow; magnetic stability is considered by J. E. Gould, and the final chapters cover the development of the industry, current research and development and future trends.

The book gives a most comprehensive treatment of the subject and it is by no means highly mathematical.

Basic Industrial Electricity

By VAN VALKENBURGH, NOOGER & NEVILLE, INC. Vol. 1, Pp. 131; Vol. 2, Pp. 129. John F. Rider Publisher Inc., 116 West 14th Street, New York 11, U.S.A. Price \$7 (both volumes).

The authors of these paper-backed books are training consultants to industry and the U.S. Navy, and the books provide an elementary training course which depends a great deal upon pictorial presentation. Vol. 1 starts with power distribution and covers illumination, electro-mechanical machinery control, electromechanical servo control systems and fluid control systems. Vol. 2 continues with industrial fluid control and goes on to explain process control and product inspection, remote monitoring and control, electric welding and heating, and concludes with miscellaneous industrial control systems.

E.E.A. Guide to the Servicing and Testing of Electronic Equipment containing Semiconductor Devices

Pp. 10. Electronic Engineering Association, 11 Green Street, Mayfair, London, W.1. Price 3s.

This little booklet covers codes of practice, soldering techniques, printed circuit boards, and semiconductors. In the words of its compiler, 'This is not a design handbook—it is a collection of hints and tips on how not to finish up with more faults than you started with'.

Climatic and Durability Testing of Components for Telecommunication and Allied Electronic Equipment (B.S. 2011 : 1963)

Pp. 53. Published by the British Standards Institution, 2 Park Street, London, W.1. Price 42s.

Telecommunication and similar electronic equipment may have to function in very varied conditions of use and climate, including extremes of humidity, cold and heat. A British Standard designed to simulate the severe conditions which such components may have to withstand was first drawn up in 1954. A revised edition of B.S. 2011 gives basic methods for the climatic and durability testing

of components for telecommunication and allied electronic equipment, and is intended to ensure a high degree of reliability during use, transit and storage.

It should be used in conjunction with the standard specification for the component under test, which indicates the applicable basic tests in B.S. 2011, their severity and the performance limits.

The standard is divided into two parts: Part 1 gives definitions, some standard atmospheric conditions and component classifications, while full details of the basic test procedures are given in Part 2. The tests cover cold, dry and damp heat, bumping, vibration, storage, mould growth, salt mist, low air pressure, change of temperature, sealing, soldering and robustness of terminations. Each test is printed as a separate section to allow for the revision of individual tests and the insertion of new ones.

The European Computer Users' Handbook

Computer Consultants Ltd., Cecil Court, Enfield, Middlesex. Price 84s.

This is a specialized production printed from typescript on one side of the paper and is in loose-leaf form with a binder. It contains names and addresses of computer manufacturers and lists of and short notes on digital computers, calculators, analogue computers and peripheral equipment. In addition, there are sections on data transmission equipment, software, computer installation, organizing a computer department and details of recommended digital computers.

It is claimed that the book names all computers and that it is up to date (January 1963).

The Radio Amateur's Handbook. 40th Ed.

Pp. 751. American Radio Relay League, West Hartford, Connecticut, U.S.A. Price \$5.

Manufacturers' Literature

Mullard Price List and Supplementary Data. A 21-page, pocket-sized booklet containing the current prices, and where applicable purchase tax, for Mullard c.r.t.s, valves, semiconductors and capacitors. The supplementary data includes some transistor and valve base connections and information on non-linear resistors.

Mullard Ltd., Mullard House, Torrington Place, London, W.C.1.

For further information circle 101 on Service Card

GR Handbook of Voltage Control: With the Variac. This interesting 40-page brochure deals with Variac autotransformers. The contents include theory and principles, circuits and some specific applications of Variacs. This General Radio publication is available from

Claude Lyons Ltd., Valley Works, Hoddesdon, Herts.

For further information circle 102 on Service Card

Automatic Testing of Synchros to MII-S-20708A. In this 4-page leaflet brief details are given of a fully automatic checking system for synchros.

Muirhead & Co. Ltd., Beckenham, Kent.

For further information circle 103 on Service Card

RF Test Equipment for Quantitative Measurements. This is a 4-page, short-form catalogue published by Jerrold Electronics, U.S.A. It gives brief, but relevant data, for 4 sweep generators, 2 marker generators, 3 measurement comparators and a number of r.f. test sets. Available from

Systems Engineering Services Ltd., 34 Bloomsbury Street, London, W.C.1.

For further information circle 104 on Service Card

A New Magneto Telephone. This 4-page leaflet gives some details of a T.M.C. telephone which is intended for use in sparsely populated areas.

Telephone Manufacturing Co. Ltd., Martell Road, London, S.E.21.

For further information circle 105 on Service Card

Germanium Plating Rectifiers: Water Cooled. This 12-page 'Engineering Publication 10-1/2' deals with the range and scope of Westinghouse rectifiers designed for electroplating power supplies. The equipments described all incorporate germanium rectifiers and represent a marked increase of power: volume ratio over the previously marketed selenium range.

Westinghouse Brake and Signal Co. Ltd., 82 York Way, King's Cross, London, N.1.

For further information circle 106 on Service Card

Brush Surface Analyser Console 21 6000. A 2-page leaflet that describes a new analyser now available from Brush Instruments Division of Clevite Corporation, U.S.A. It is used to analyse the surface of metals, plastics, glass, ceramic and organic coatings. It produces on a direct-writing recorder the roughness, waviness, total texture, and average microinch finish of the surface. Distributed by

Aveley Electric Ltd., South Ockendon, Essex.

For further information circle 107 on Service Card

The Emitape Book. In this 26-page booklet the manufacturing processes of E.M.I. magnetic tape are described. The current grades of tape are listed and complete specification for each grade given along with various tape accessories.

E.M.I. Sales & Service Ltd., Emitape Division, Hayes, Middlesex.

For further information circle 108 on Service Card

Platt-Stearns Electro-Magnetic Clutches and Brakes. This 4-page leaflet describes the Stearns SMR electromagnetic clutch and gives details of the various types. Distributed by

Oliver Pell Control Ltd., Cambridge Row, Barrage Road, London, S.E.18.

For further information circle 109 on Service Card

A.E.I. Hall Effect Field Probes and Multipliers. A 6-page leaflet, publication No. 2240-81, which describes the range of Hall-effect devices now being produced by

Associated Electrical Industries Ltd., Instrumentation Division, Trafford Park, Manchester 17.

For further information circle 110 on Service Card

G.E.C. Semiconductor Automatic Static Exciters Type SCR-VL. In this 8-page leaflet a range of static exciters is described. These are designed to supply the full field excitation and provide accurate voltage regulation for a wide range of alternators up to about 500-kVA rating.

G.E.C. (Engineering) Ltd., Rectifier & Control Engineering Division, Birmingham 6.

For further information circle 111 on Service Card

Panoramic Microwave Spectrum Analysers. This 20-page booklet includes comprehensive data on three panoramic spectrum analysers for r.f. and microwave bands (10 to 44,000 Mc/s). Instructional material on the operation and application of the instruments is also included.

Singer Metrics Division, The Singer Manufacturing Co., 915 Pembroke Street, Bridgeport 8, Connecticut, U.S.A.

For further information circle 112 on Service Card

★ FOR THE BUYER

You must have read about a number of products and processes in this issue of which you would like further details. You can obtain this information very easily by filling in and posting one or more of the enquiry cards to be found inset in the front and back of the journal.

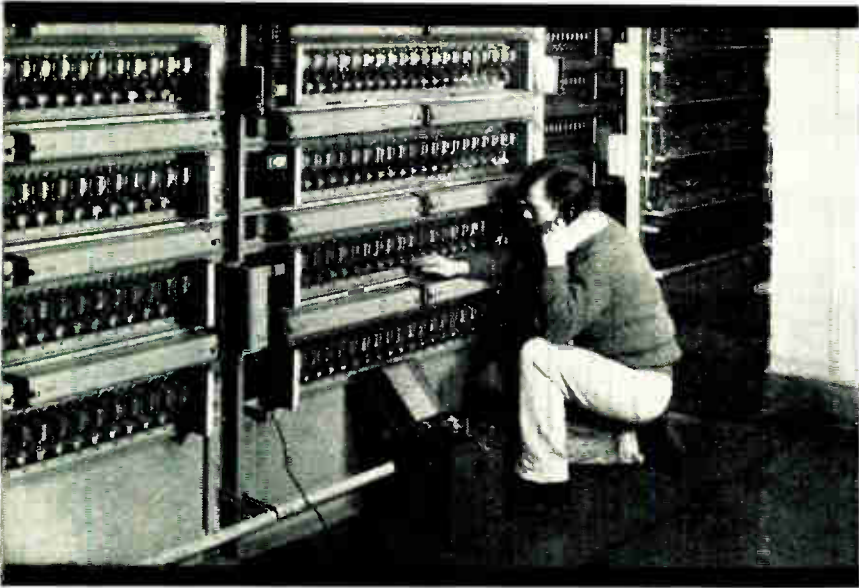

STC

PVC insulated & sheathed INTERPHONE CABLES

Approximately 150 miles of cable of various sizes, from 1 to 300 pairs, for the PAX Telephone System at the new Spencer Works, Monmouthshire, was manufactured by the STC Rubber and Plastic Cable Division, Newport. The complete system was supplied and installed by Standard Telephones and Cables Limited, who are the main communications contractors to RTB.

Write, 'phone or Telex for literature



Standard Telephones and Cables Limited
RUBBER & PLASTIC CABLE DIVISION
CORPORATION ROAD · NEWPORT · MON.
Telephone Newport 72281 · Telex 49368

Blast furnace at Richard Thomas & Baldwins Spencer Works, Monmouthshire, one of Europe's largest and most modern steelworks and strip mills.



63/2H



Soldering Instruments and Equipment

Illustrated

$\frac{3}{16}$ " BIT INSTRUMENT (List No. L64) IN PROTECTIVE UNIT (List No. 700)

ALL VOLT RANGES
6/7 to 230/50
VOLTS

BRITISH & FOREIGN PATS.
& REG. DESIGNS. ETC.

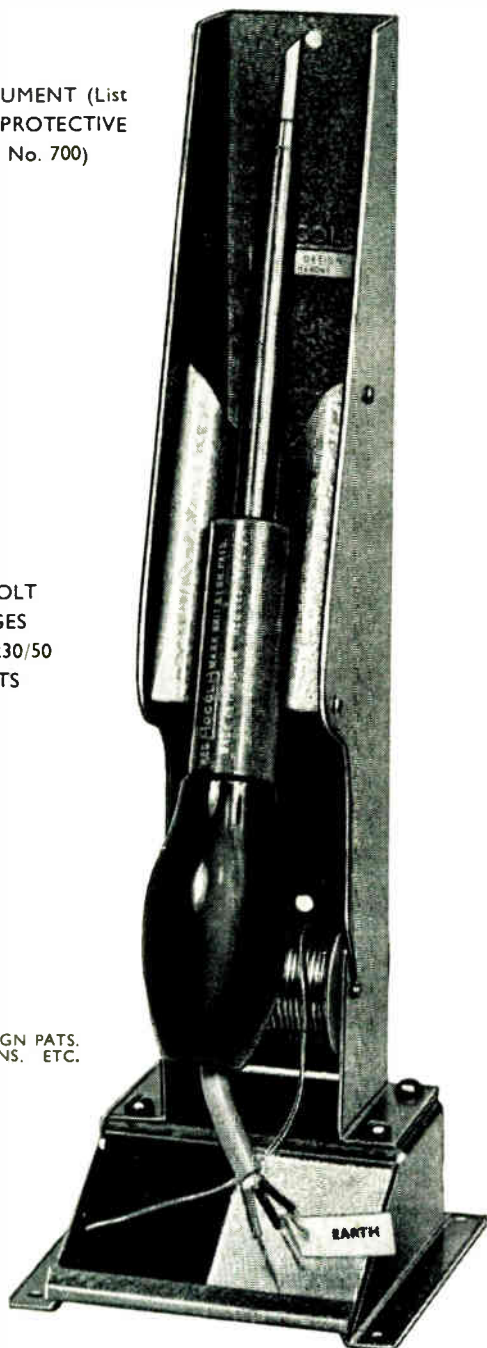

Traditional British Quality and Workmanship
ADCOLA PRODUCTS LIMITED

Head Office, Sales and Service

ADCOLA HOUSE, GAUDEN ROAD, LONDON, S.W.4

Telephones MACAULAY 3101 & 4272

Telegrams SOLJOINT LONDON S.W.4

AUSTRALIAN OFFICE: 673 WHITEHORSE ROAD, MONT ALBERT,
MELBOURNE, VICTORIA

A NEW DEVELOPMENT by MUREX LTD—High permeability SINTERED IRON POLE PIECES of complex shape

Powder Metallurgy once again contributes to reduced costs by enabling complex shapes to be manufactured in high permeability iron for magnetic applications.

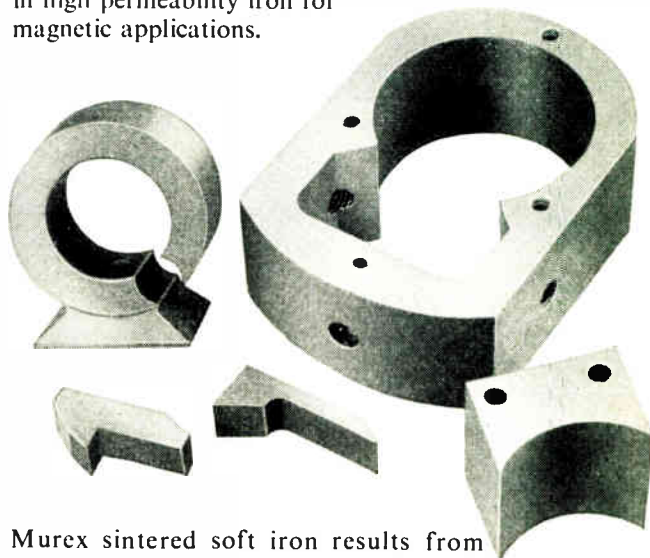

Murex sintered soft iron results from experience gained over many years in the manufacture of composite assemblies of magnet material and soft iron pole pieces by the 'Sincomax' Technique. Inevitably, there were applications which could not efficiently utilise the unique properties of this process. Therefore, separate iron parts of high permeability were developed to fulfil this requirement.

Some of the benefits obtained from sintered iron are:-

- a Controlled density.
- b Excellent tensile strength.
- c Close tolerances maintained without additional machining.
- d Consistent magnetic properties.
- e Complicated shapes accurately reproduced.
- f Density 7 g/cc.
- g Maximum permeability $\mu=1500$ when $H=6$ Oersteds and $B=9000$ gauss.

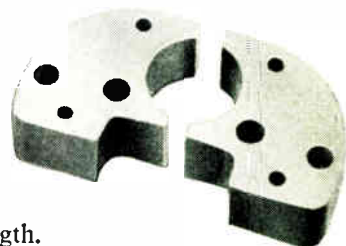

Technical personnel are always available to assist in design problems, and advise on the applications of soft iron and all magnetic materials offered by Murex Limited.

MUREX LTD (Powder Metallurgy Division)

Rainham, Essex Rainham, Essex 3322

Telex 28632 Telegrams: Murex, Rainham-Dagenham Telex

London Sales Office: Central House, Upper Woburn Place, W.C.1. Tel: EUSton 8265

WONDERFUL NEWS!

IN ELECTROLYTIC CAPACITORS

ALUMINIUM FOIL CAPACITORS FOR TRANSISTOR AND OTHER LOW VOLTAGE CIRCUITS

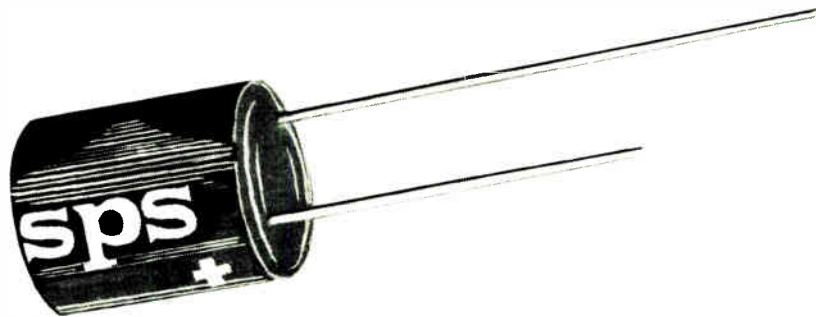

ALL-MOULDED PLASTIC ENCAPSULATION

- ★ HERMETICALLY SEALED ALL-PLASTIC ENCASMENT
- ★ ULTRA-SMALL SIZES WITH CAPACITIES TO 200 μ F
- ★ CLOSE TOLERANCE DIMENSIONS
- ★ LEAD SPACING TO $\pm .015''$
- ★ HIGH RELIABILITY BY CLOSE QUALITY CONTROL PROVEN IN THE EXACTING U.S. MARKET
- ★ SURPRISINGLY LOW COST
- ★ FAST DELIVERY

SPSI

TECHNICAL

CAP. TOL. — 20% + 100% OF RATED
DISSIPATION FACTOR EXTREMELY LOW —
LESS THAN 8% AT 50 WVDC
D.C. LEAKAGE EXTREMELY LOW — LESS THAN 6 μ A
AFTER 1 MIN. APPLIED WVDC
OPERATING TEMP. 65°C AT RATED WVDC

sps

INTERNATIONAL LTD.
SHANNON AIRPORT
IRELAND

FOR FULL INFORMATION WRITE OR PHONE:

SHANNON 245

What makes these tubes so outstanding?

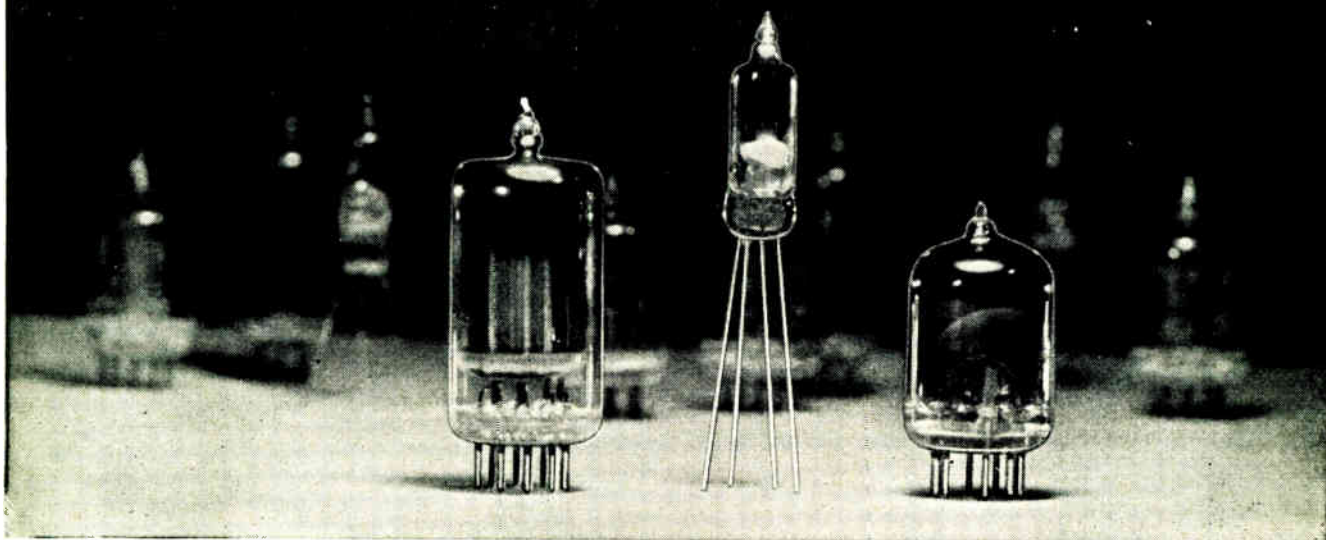

Photograph actual size

Have you considered the advantages of using Trigger Tubes? In many applications, such as logic circuits, timers, counters, sequence switching and high impedance relay operation their performance is considerably better than many other active devices and certainly they can be cheaper. They are not damaged by severe transient overloads, they give visual indication of current flow and their characteristics are virtually independent of temperature. These new tubes with their pure molybdenum cathodes are manufactured to closer tolerances than previously available—they are in fact a race apart—price wise, life wise and reliability wise. In all probability they will outlast the useful life of their parent equipments. Here are some other details—

	GPE.120.T	GTE.120.Y	GTE.130.T
Anode Working Range	175—275V a.c.	150—275V d.c.	170—280V d.c.
Preferred Anode Current Range	Max. 50mA mean	1—5mA	Max. 25mA mean
Trigger Striking Voltage	121—126V d.c.	115—122V d.c.	128—137V d.c.



Ericsson Telephones Ltd.
 Tube Division
 Technical Services Department
 Beeston, Nottingham.

further information will be sent on request.

ERICSSON

ERICSSON TELEPHONES LIMITED • HEAD OFFICE: 22 LINCOLN'S INN FIELDS • LONDON W.C.2 • TEL. HOLBORN 6936
 ER46

Setting new standards

for instrument presentation . . .

CLARITY

**A NEW RANGE
WITH A
NEW LOOK
FROM**

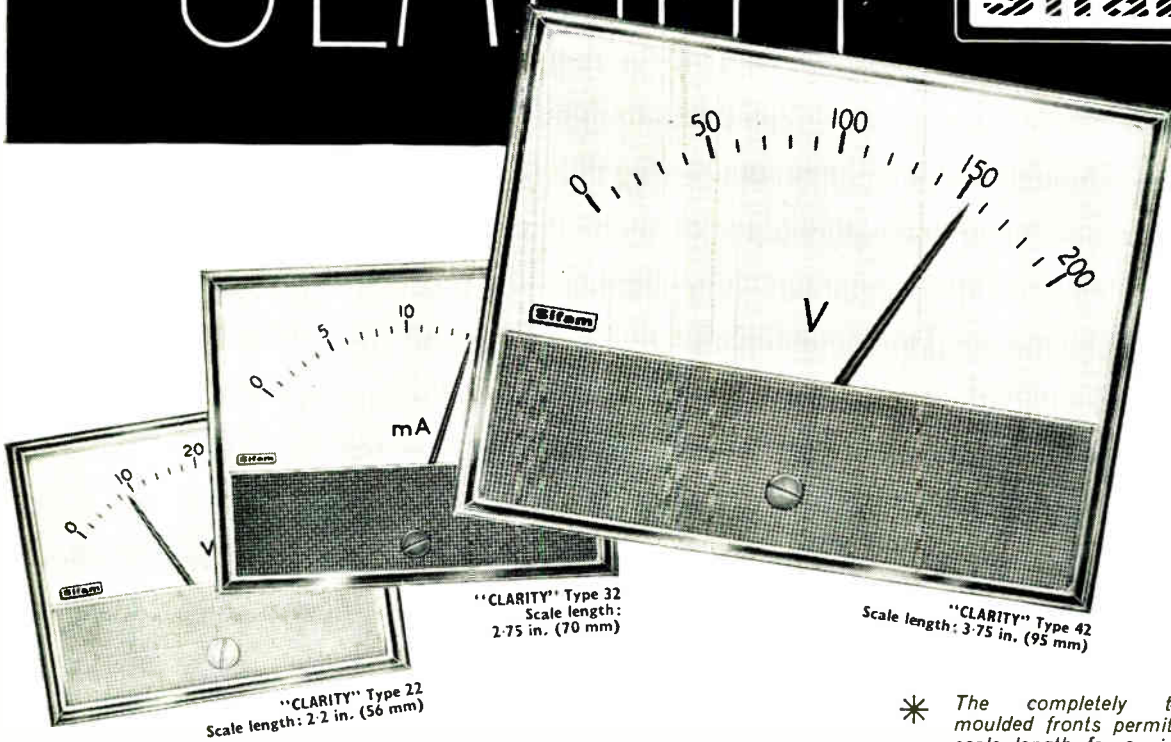

"CLARITY" Type 32
Scale length:
2.75 in. (70 mm)

"CLARITY" Type 42
Scale length: 3.75 in. (95 mm)

"CLARITY" Type 22
Scale length: 2.2 in. (56 mm)

The new SIFAM "CLARITY" instruments are the result of a long period of development, for which the name "CLARITY" was chosen at the beginning of the programme as best expressing the most striking features of instruments designed to fulfil the demand for clean, modern and functional presentation. Designers will find the "CLARITY" range completely satisfactory for use in equipment following the contemporary approach to styling - particularly when considering ergonomic factors. Scale arcs or markings can be supplied in accordance with the new British Standard recommendations or to individual requirements.

- * The completely transparent moulded fronts permit a greater scale length for a given frontal area.
- * The lance type pointer is readily visible when the instrument is read at a distance, whilst its fine point allows accurate reading of indicated values.
- * Interchangeable masks are available in a choice of contemporary colours to blend with customers' equipment.
- * Elimination of solid surround provides both greater clarity and readability.



Let us arrange for a Sifam Technical Representative to show you the new "CLARITY" range or write for the new Data Sheet 106.C.

Instruments

SIFAM ELECTRICAL INSTRUMENT CO. LTD. Woodland Road, Torquay, Devon
Telephone: Torquay 63822/3+4

UNCOMMON MARKET...

DELANCO Organisation's Technical Know-How masters the intricate and unusual in component manufacture

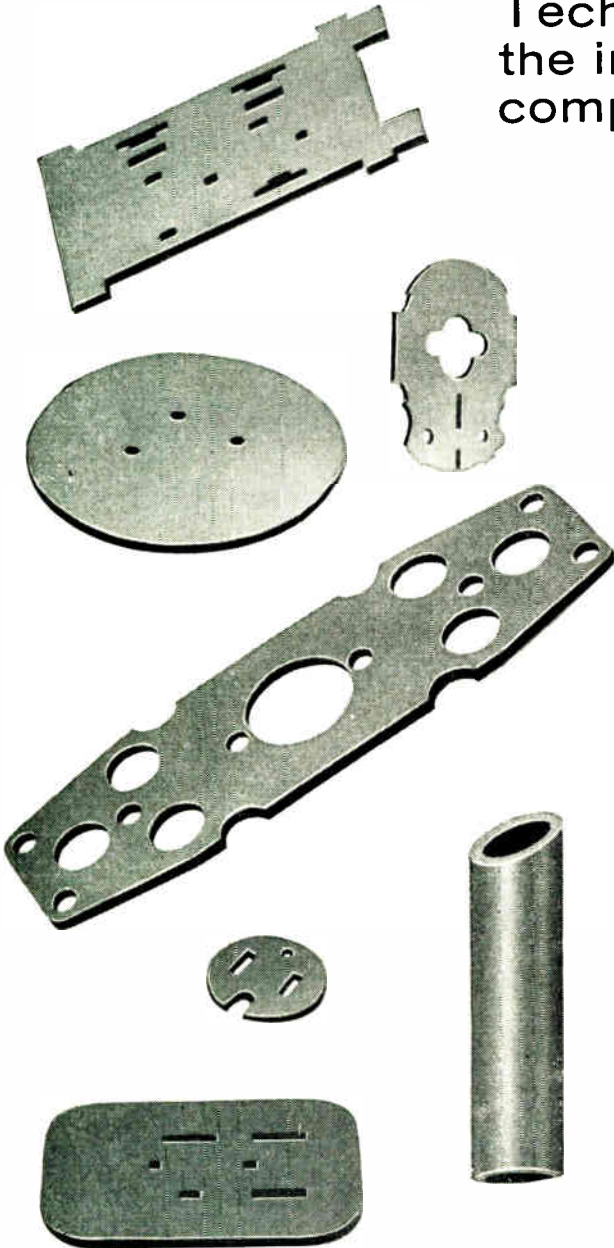

Anything uncommon in the way of design calling for the ultimate in tool design skills, is a natural for the Delanco Company. We specialize in the manufacture of components in all types of electrical insulation materials.

Vulcanized Fibre, S.R.B.P. and S.R.B.F. Epoxy glass fibre, Nylon, P.T.F.E., Presspahn, Leatheroid, Varnished cambric and in fact every material used in electrical insulation. For heat resistance and insulation Mica and Micanite.

Processes include presswork, forming, routing, moulding, turning, milling and machining.

Our customers include Manufacturers of Domestic and Electrical equipment, Instruments, Motor cars, Aircraft, ships, printing and business machinery, Computers, electric motors dynamos and starters. Copper-clad laminates for printed circuitry are supplied as panels ready for printing.

Technical representatives are based throughout the country, and are available at any time to call and discuss your needs.

Technical catalogues are available and will be sent immediately on request.



Delanco

INSULATION MATERIALS AND COMPONENTS

ANGLO-AMERICAN VULCANISED FIBRE CO. LTD · Cayton Works · Bath Street · London · E.C.1
Phone: CLE 8484 · Grams: PROMPSERV, LONDON · Delanco Works · Leonard Street · London · E.C.2



RD750/1N3730

UNIPLANAR* silicon diode for

- High speed, high current, core driver
- Computer switching
- Miniaturised power supplies

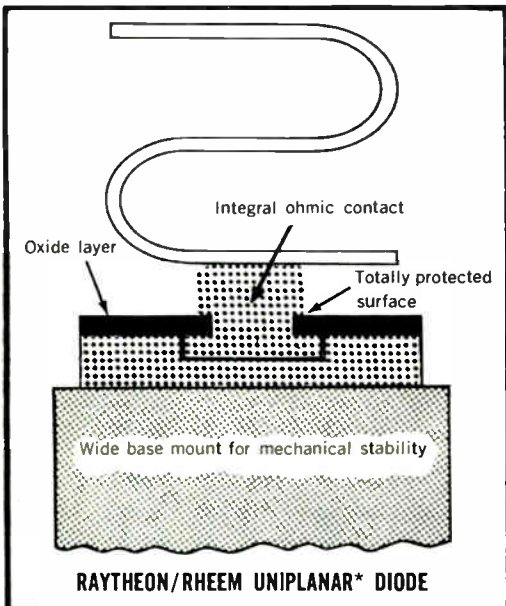

brief details: switching speed . . . 15 nanoseconds
 forward conductance 1 Amp at 1 volt
 power dissipation . . . 750mW at 25°C
 switching current range 1.0mA to 5A
 subminiature size . . . 0.107" diameter

*The UNIPLANAR technique gives significant improvements in silicon diode performance—particularly in reliability. It gives excellent shock and vibration resistance, more uniform characteristics and a 300°C storage capability.

WALMORE ELECTRONICS LTD.

11-15 Betterton Street, Drury Lane, London, W.C.2. • Telephone: TEM 0201/5 • Telex: London 28752

For further information circle 239 on Service Card

For further information circle 240 on Service Card

Tension Gauge

For checking and adjusting springs of all kinds; especially to adjust contact pressures on relay springs for automatic telephone stations, to check pressures and tensions on switches, brushes of motors, and in the production and service of Radios, TV, Record Changers, Tape Recorders, Typewriters, Pianos, Cameras, Projectors, Calculators, Dial Indicators and gauges of all kinds.

dia. of dial	size	weight
36 mm	000	0.3-3 g
	00	0.6-6 g
	0	2-15 g
	1	3-30 g
	2	5-50 g
	3	10-100 g
	4	20-250 g
77 mm	5	50-500 g
	6	100-1000 g
	7	200-2000 g
	8	300-3000 g
	9	400-4000 g
	10	500-5000 g

GEORG KARSTENS GMBH
 7304 RUIT/Stuttgart – W. Germany
 Cables: Gekarstens Stuttgart – Telex 07-23 498
 Mfrs. of Measuring Tools and Instruments – Cylindrical Grinders

METEOR COIL WINDERS

(SWISS MADE)

No gears to cause backlash

Suitable for winding wires as small as 0.0004 in. diameter. Arranged for single or multiple winding; layer shortening device available. Traverse is obtained by magnetic clamping on to a non-reversing steel tape. Extremely fine reversal settings by micro limit switches. Stops automatically if wire breaks.

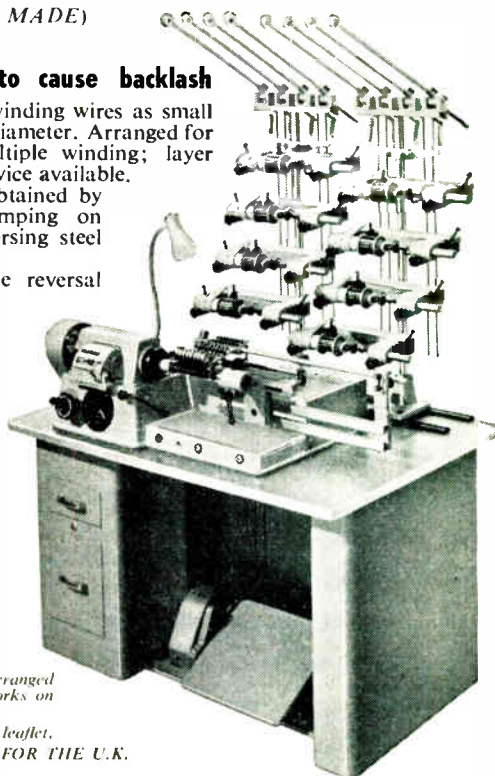

Demonstrations arranged at our London works on request.
 Please write for leaflet.
 SOLE AGENTS FOR THE U.K.

ACBARS LTD.

331-3 WALWORTH ROAD, LONDON, S.E.17 RODney 7822

FARNELL

PSO TRANSISTORISED POWER SUPPLY UNITS



PSO 5 AMP MODEL
OPEN CHASSIS
MODELS HAVE
EXTERNAL SENSING
FACILITIES
5 AMP AND 2 AMP
MODELS CAN BE
FACTORY FITTED
WITH ELECTRONIC
CUT-OUTS

Over forty low voltage stabilised transistor power supply units are in current production and, in most instances, available from stock bench or open chassis types in 1, 2, 5, 10 & 100 amp ranges.

Special models can be designed to customers' specifications. For full technical details and price list write for fully illustrated leaflets.

FARNELL INSTRUMENTS LTD.
LIGHT INDUSTRIAL ESTATE, YORK ROAD
WETHERBY, YORKSHIRE
Telephone: Wetherby 2691/2/3

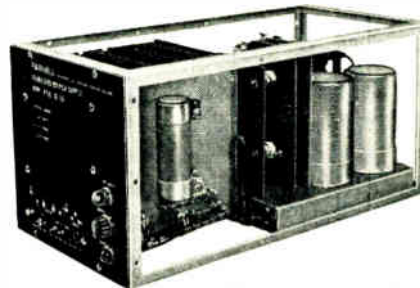

PSO 10 AMP MODEL
SHOWING PANEL
MOUNTED IN 'B'
POSITION (END
FITTINGS)
WITH SPECIAL TERMINALS
FOR PARALLEL
CONNECTION

SEE THE FULL RANGE OF FARNELL INSTRUMENTS AT THE INSTITUTES OF ELECTRONICS EXHIBITION MANCHESTER, IN JULY. WRITE FOR FREE TICKETS

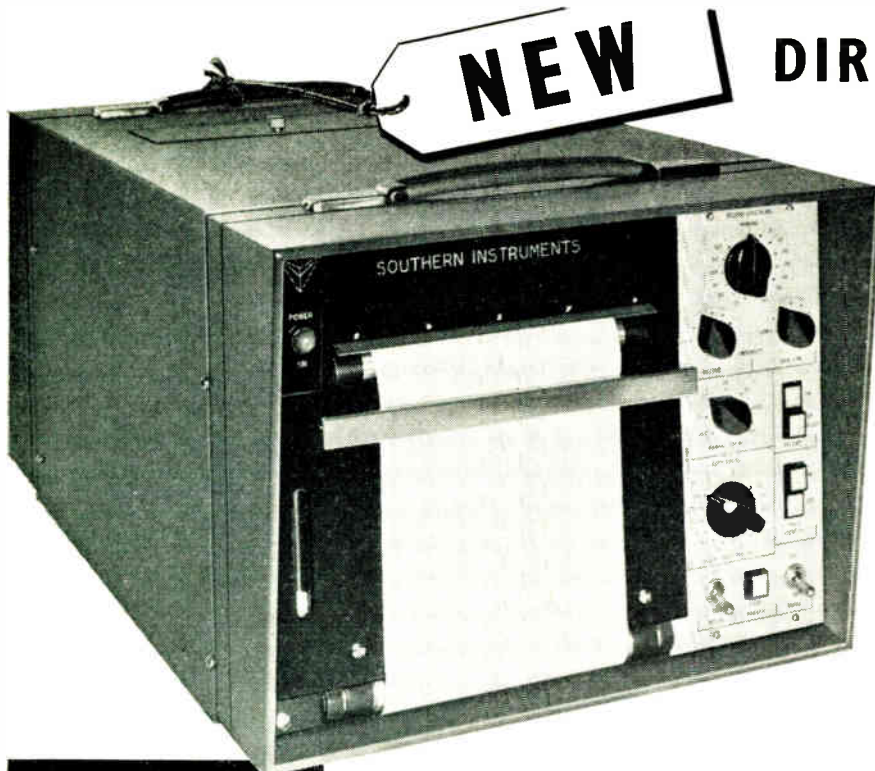

DIRECT RECORDING ULTRA-VIOLET OSCILLOGRAPH Series MI250

- ★ direct recording—no chemicals
- ★ d.c. up to 10,000 cycles per second
- ★ up to 18 channels
- ★ trace amplitude 6 inches
- ★ automatic trace identification
- ★ event marker
- ★ datum traces
- ★ crystal controlled timing lines
- ★ adjustable intensity grid lines
- ★ paper supply indicator
- ★ pre-set record length
- ★ automatic re-spooling
- ★ 12 speeds 0.02 to 100 inches per sec.
- ★ remote control facilities



Telephone or write for a demonstration to
SOUTHERN INSTRUMENTS LTD
INSTRUMENTATION DIVISION
FRIMLEY ROAD CAMBERLEY SURREY. Tel. CAMBERLEY 3401

INDUSTRIAL ELECTRONICS

Press date for the July 1963 issue is first post 26th June 1963

CLASSIFIED ADVERTISEMENTS

Advertisement Rates. 6d. per word, minimum charge 6/-, each paragraph charged separately. Remittances payable to "Industrial Electronics", Dorset House, Stamford St., S.E.1. Series discount of 15% is allowed for 12 consecutive insertions.

Box Numbers are available at an additional charge of 2/- to defray cost of registration and postage. Replies should be addressed Box No. 0000, c/o "Industrial Electronics", Dorset House, Stamford Street, London, S.E.1.

Semi-Display advertisements with centralized lines £1/15/- per single column inch, Display advertisements £2/10/- per single column inch—no additional charge for Box Numbers. The Publishers are not responsible for clerical or printers' errors although every care is taken to avoid mistakes.

PATENTS

Patent No: 869,447 entitled "Apparatus for the remote control of Calculating Machines" is for sale or licence. Full details apply to CHATWIN & COMPANY, Chartered Patent Agents, 253, Gray's Inn Road, London, W.C.1.

[2028

BOOKS, ETC.

"WIRELESS Servicing Manual" (9th Edition). By W. T. Cocking, M.I.E.E. A carefully revised edition of the handbook known since 1936 as an invaluable, comprehensive guide for radio servicemen and others. Completely up to date, it deals in a lucid, practical way with the problems that arise in the repair, maintenance and adjustment of modern wireless receivers. All recent developments in receiving equipment have been incorporated and the servicing of frequency-modulated v.h.f. receivers—a development of great importance to all servicemen—is thoroughly covered in a completely new chapter. Here is a work of proven value to professional and amateur, written by a widely known authority on modern radio engineering. 17s 6d net from all booksellers. By post 18s 8d from Iliffe Books, Ltd., Dorset House, Stamford Street, London, S.E.1.

"ADVANCED Theory of Waveguides." By L. Lewin. Sets out various methods of treating problems arising in work on this complex subject. The author has selected for discussion a number of topics as representative of the field in which the centimetre-wave engineer is engaged, many of the examples being concerned with the rectangular waveguide. 30s net from all booksellers. By post 31s from Iliffe Books Ltd., Dorset House, Stamford Street, London, S.E.1.

"RADIO Interference Suppression: As Applied to Radio and Television Reception." By G. L. Stephens, A.M.I.E.E., 2nd Ed. An up-to-date guide to the various methods of suppressing electrical interference with radio and television reception. Many practical applications are given, particular attention being paid to the problem of interference at television frequencies. Other chapters deal with the design and choice of suppressor components, methods of locating the source of interference, and suppression at the receiver itself. 10s 6d net from all booksellers. By post 11s 2d from Iliffe Books Ltd., Dorset House, Stamford Street, S.E.1.

"RADIO Circuits: A step-by-step Survey." By W. E. Miller, M.A.(Cantab.), M.Brit.I.R.E. Revised by E. A. W. Spreadbury, M.Brit.I.R.E. associate editor of WIRELESS & ELECTRICAL TRADER. This established introduction to super-heterodyne receiver circuits has been greatly enlarged and brought completely up to date with the inclusion of transistor and f.m. receivers; there are new chapters covering battery receivers and car radio sets, while the modern a.m./f.m. receiver is fully described. Mathematics and obscure theoretical considerations are entirely omitted, and over 80 easy-to-follow circuit diagrams are explained in a simple but practical manner, splitting up the circuit into sections and working from the aerial terminal through to the loudspeakers. 15s net from all booksellers. By post 15s 10d from Iliffe Books Ltd., Dorset House, Stamford Street, London, S.E.1.

MISCELLANEOUS

PHOTO-ELECTRIC CONTROLS for industry

Send for catalogues

HIRD-BROWN LIMITED
FLASH STREET, BOLTON
Telephone 27311

[2027

For further information circle 243 on Service Card

OXLEY DEVELOPMENTS CO. LTD.



OXLEY

SOLDERLESS WRAPPED JOINTS

CHARACTERISTICS

Chassis thickness ... 16-18 SWG—048 064"—1.2/1.6 mm
Capacity ... Less than 1.5 pF
Operating temperature ... -55 C to +200 C

The Oxley "Barb" solderless wrapped connector is a speedily assembled lead through, of outstanding electrical and mechanical characteristics.

The spill is nickel flashed and solder dipped and spun to British P.O. Specification No. M38. Insert the bush in a .156 dia. plain hole in the chassis, and press the barbed spill firmly but slowly through the bush; the latter expands, particularly on the far side of the chassis, and results in the insulator becoming an integral part of it.

In addition to its excellent qualities, a considerable saving of time is effected in assembly. Supplied in sealed packets of 100 and 1000.

ACTUAL SIZE



BRITISH & FOREIGN PATENTS

OXLEY DEVELOPMENTS CO. LTD ULVERSTON, LANCs.

For further information circle 244 on Service Card

NO ESCAPE!



Slackened screws will not drop out of these Terminal Blocks! The specially designed chimney tops hold them securely in place. 'Captive-way' Terminal Blocks, supplied in 12-way lengths, are available in 5, 10, 20 and 30 amp sizes. They are made of flexible P.V.C., easy to cut so customers have no difficulty in making up blocks to individual requirements.

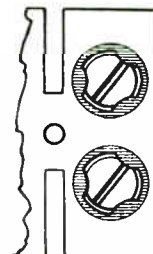

METWAY CAPTIVEWAY FLEXIBLE Terminal Blocks

List No.	Rating Amps.	Price Each	Prices are for a 12-way strip, and are subject to Trade and Wholesale discounts
34201	5	2 8	
34203	10	5 -	
34205	20	9 4	
34207	30	11 4	

Obtainable through all good wholesalers or direct. Prompt delivery. For full details ask for Catalogue No. ME1 62 IEC

METWAY · KEMP TOWN · BRIGHTON 7

For further information circle 245 on Service Card

REDUCE DEVELOPMENT COSTS OF SEMI-CONDUCTOR CIRCUITRY

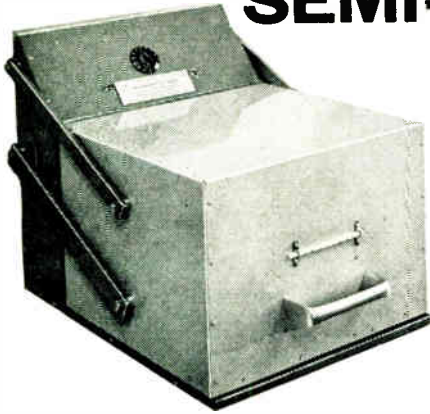

The extensive use of temperature sensitive semi-conductor devices in modern electronic circuitry has demanded the testing in the development stage of these circuits under elevated temperature conditions.

The LAB-OVEN allows a unit under test to remain undisturbed on the base while its temperature is raised to the controlled level or dropped to room ambient. Furthermore, wires for power supplies, test instruments, etc., may extend from the unit, and although these may prevent the oven closing down completely, this will not affect the working temperature, since the unit under test is raised by the thermally insulated platform inside the oven, and the hot air level will be brought down to cover the unit. Moreover, quick changes of components may be effected with a soldering iron without the necessity of removing the test unit, nor is time lost in waiting for the oven to recover its temperature, since the hot air trapped inside the oven may be immediately lowered over the test unit.

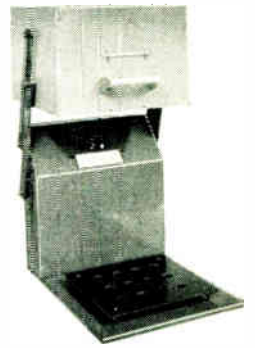

WITH CONTRONICS LAB-OVEN

SPECIFICATION OF STANDARD MODEL

Overall size: 19½" deep x 16" wide x 16" high.
Oven Cubic Capacity: 1 ft. Cube approx.
Temperature Control: Transistorised Thermostatic regulator 15°C.-100°C. plus or minus 1°C.
Temperature Gradient: Approximately 2°C.
Thermometer: Side fitting mercury thermometer.
Heating Element: 275 watt element.

PRICE £58 . 0 . 0

We shall be glad to advise on your own Control problems, for we design and manufacture Electronic Equipment to customers' specialised requirements. Standard units include:—Photo-electric relays, High-speed Batching Counters, Mis-feed protection Controls, Infra-red alarms, Daylight Intensity Switches, Electronic Tachometers, Proximity relays, Time Delay relays, Sequential Timers.



CONTRONICS

LIMITED

Blackdown, Nr. Aldershot, Hants. Tel. Deepcut 236

Suppliers to the U.K.E.A., G.P.O., etc. and leading companies in the Industry

For further information circle 246 on Service Card

VITALITY BULBS

FROM 1V to 50V IN SIZES FROM 4.5mm to 18mm DIAMETER

Vitality's 30 years' specialized experience is at your disposal. Write or phone for information on all types of miniature and sub-miniature filament lamps, to:—

Vitality Bulbs Ltd.
Neville Place, Wood Green,
London, N.22

VITALITY BULBS LTD., NEVILLE PLACE, WOOD GREEN, N.22. Phone: BOW 3616

For further information circle 247 on Service Card

Numerical methods for high speed computers

G. N. Lance, M.Sc. PH.D., MAIS, AFR A.E.S.

This book assembles the most useful numerical methods developed by research mathematicians, with the particular aim of explaining the facilities that computers offer. Most of these methods have never been published before except to a very limited readership and all have been tested for their practical value. The book will be found invaluable by mathematicians, programmers, engineers, physicists and scientists generally.

42s net by post 42s 11d 166 pages from leading booksellers

Published by ILIFFE Books Ltd.

DORSET HOUSE, STAMFORD STREET, LONDON, S.E.1

Index to Advertisers

Aebars Ltd. 35	Farnell Instruments Ltd. 36	Reliance Controls Ltd. 2
Adcola Products Ltd. 30	Ferranti Ltd. 15	R.C.A. (Gt. Britain) Ltd. 14
Anglo-American Vulcanised Fibre Co. Ltd. 34	Harwin Engineers Ltd. 9, 11	Sealdraught Ltd. 28
Appointments Vacant 37	Hirst Electronic Ltd. 18	Sifam Electrical Instruments Ltd. 33
Aircraft-Marine Products Ltd. <i>Cover iii</i>	Hughes International (U.K.) Ltd. 7	Solartron Electronic Group Ltd. 4, 5, 16, 17
British Insulated Callender's Cables Ltd. <i>Cover ii</i>	Hunt, A. H. (Capacitors) Ltd. 10	Southern Instruments Ltd. 36
Cannon Electric Co. Ltd. 24	Iliffe Books Ltd. 38	SPS International Ltd. 31
Cawkell Research & Electronics Ltd. 23	Karstens George GMBH. 35	Standard Telephones & Cables Ltd. 19, 20, 21, 29
Computer Controls Ltd. 25	Marconi Instruments Ltd. 13	Tequipment Ltd. 22
Contronics Ltd. 38	Metway Electrical Industries Ltd. 37	Thorn Special Products Ltd. 12
E-A Data Processing Ltd. 26, 27	M.O. Valve Ltd. 1	Vitality Bulbs Ltd. 38
Electrosil Ltd. 3	Murex Ltd. 30	Walmore Electronics Ltd. 35
Ericsson Telephones Ltd. 32	Oxley Developments Co. Ltd. 37	Westinghouse Brake & Signal Co. Ltd. 6
Eric Resistor Ltd. <i>Cover iv</i>	Phoenix Telephones Ltd. 8	

How AMP Saves You Money

If you don't use 'em — don't pay for 'em!

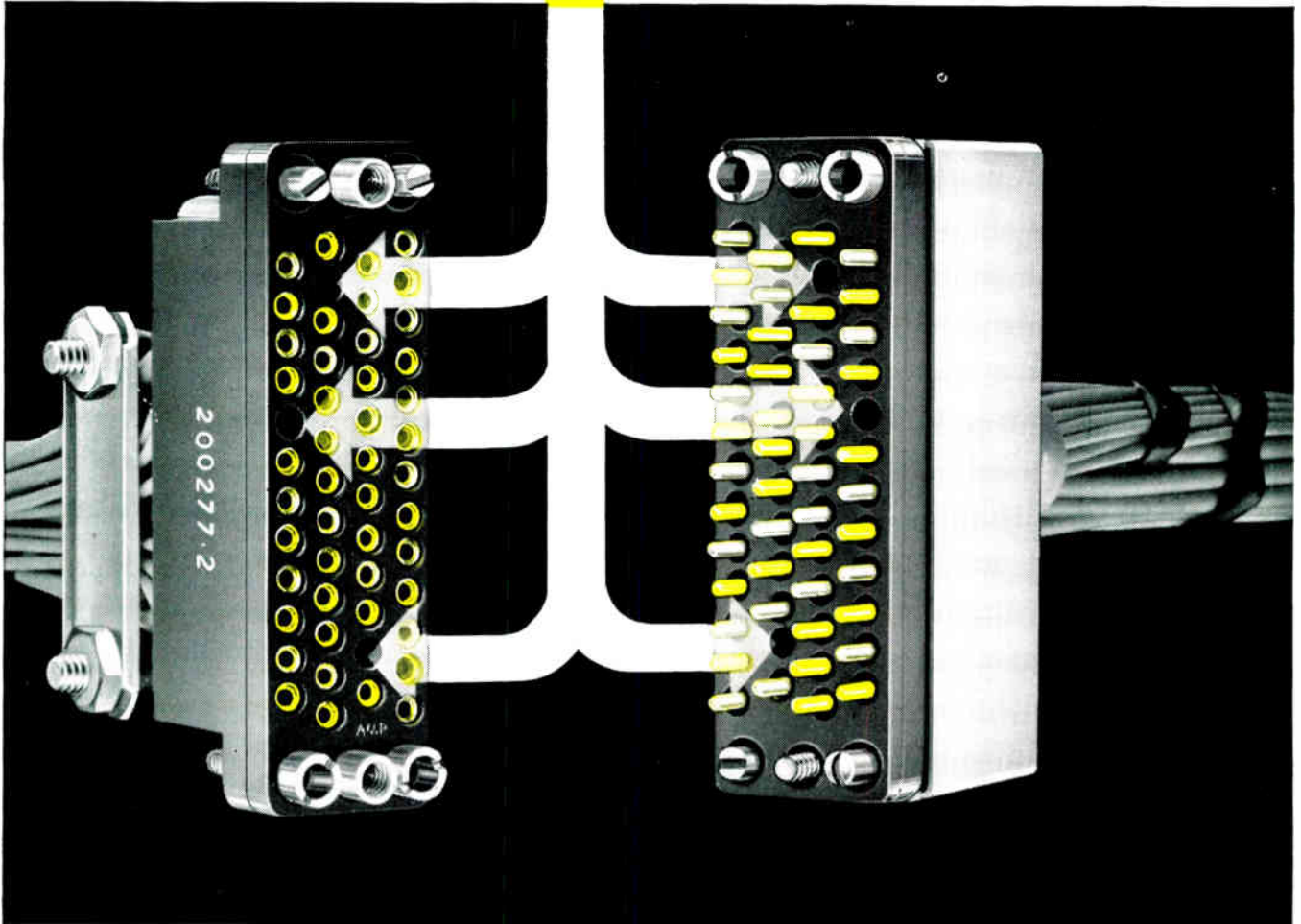

A-MP M Series Connectors give you custom-built plugs and sockets, with the exact number of contacts you need. Precious metal contacts can be confined to those circuits in which they are essential. For example, you can have a 50-way connector incorporating 41 circuits; of these, any combination of contacts can be gold or tin plated as required. The result is economy without detracting from performance. The range of mouldings accommodates up to 104 pins and sockets. Application tooling is supplied for all production levels. You can have a hand tool for small scale work, a tape-fed pneumatic tool for medium outputs and finally, the exclusive A-MP automatic machine for crimping up to 1600 terminations per hour for higher production levels.



AIRCRAFT-MARINE PRODUCTS (GT. BRITAIN) LIMITED

Head Office: AMPLO HOUSE, 87/89 SAFFRON HILL, LONDON, EC1
Tel: CHAncery 2902 (7 lines) Telex: 23513 Cables: AMPLO LONDON TELEX

SOUTH AFRICA DISTRIBUTOR: E. S. MOWAT & SONS (PTY) LTD, 51-57 MILNE STREET, P.O. BOX 437, DURBAN, NATAL
ASSOCIATED COMPANIES IN U.S.A., AUSTRALIA, CANADA, HOLLAND, FRANCE, GERMANY, ITALY JAPAN AND MEXICO

.11' 223

For further information circle 202 on Service Card



Building in Miniature...



...is child's play with
ERIE Styles Y and Z
capacitors

Small physical size

Y  0.022in long
0.098in dia.

Z  0.300in long
0.098in dia.

Wide capacitance range

Y  2 to 1000pF

Z  13 to 1500pF

Available in a wide range of temperature coefficients and specially developed Erie Super-N dielectrics—patents pending
Finished with protective lacquer as illustrated or with Erie 'Epitex' insulation

ERIE*

RESISTOR LIMITED

SOUTH DENES, GT. YARMOUTH

Telephone: Great Yarmouth 4911

*Registered Trade Mark