

INDUSTRIAL ELECTRONICS

APRIL 1963 5s 0d

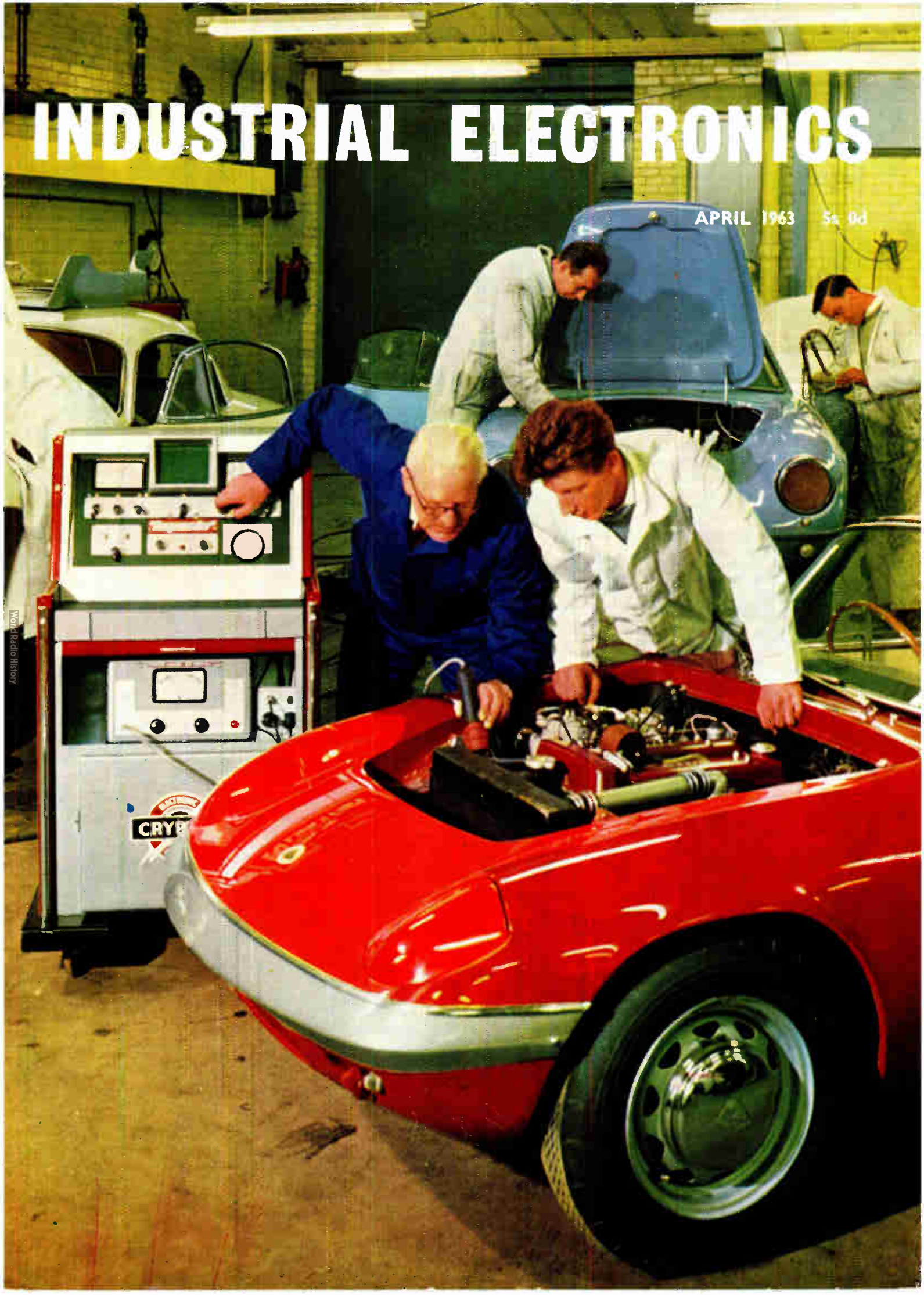

World Radio History



LOOK—NO CONTACTS!

NORBIT STATIC SWITCHES for automatic control systems NEVER NEED MAINTENANCE

No maintenance, no 'sneak circuits', operation in *any* position, constant speed and a life unaffected by the number of operations.

These are only some of the many reasons why electrical and electro-mechanical engineers, in increasing numbers, are using Norbit static switches instead of relays in a wide variety of automatic control and alarm applications, from lift systems to food processes.

Since they use no moving parts contactless Norbit switches need no adjustments, no cleaning and suffer no mechanical wear or variation in operating speed. Time wasting 'cut and try' methods are also eliminated during system design—using Norbits you can plan your complete system on paper and know that what you plan will work in practice.

Furthermore, one basic Norbit gives you any switching function you need. No contacts, no sparking, no heat to dissipate,

unaffected by detrimental atmospheres—dust, abrasive particles, humidity, corrosive fumes, hazardous atmospheres—the reliability of Norbit static switches has been proven in practice and by exhaustive quality testing.

Here's all you need to know How does the Norbit switch if it uses no contacts? Just regard the Norbit as a switch which does not open or close, but one which either conducts or does not conduct. Furthermore, there's *no need* for you to know any electronic theory to understand Norbits and apply their many advantages.

Free to the practical engineer Write for a free copy of 'Static Switching Simply Explained'. This booklet gives you a completely non-mathematical explanation of Norbit static switches—what they can do and how they can be used. Write today for this practical guide to contactless switching using Norbits.

MULLARD EQUIPMENT LIMITED

MANOR ROYAL, CRAWLEY, SUSSEX
Telephone Crawley 28787



INDUSTRIAL ELECTRONICS

incorporating *ELECTRONIC TECHNOLOGY*



Volume I Number 7 April 1963

contents

Editor **W. T. COCKING, M.I.E.E.** 347

Assistant Editor **T. J. BURTON**

Advertisement Manager **G. H. GALLOWAY**

Comment

349 **Oscilloscopes in the Modern Garage** *by E. E. Morgan*

The use of the cathode-ray oscilloscope for the routine testing of internal combustion engines is described in this article. The effect on the oscilloscope traces of various ignition faults is illustrated.

354 **Electronic Control in Heating and Air-Conditioning** *by F. B. Rider, B.Sc.*

The application of electronic control to the heating and air-conditioning of buildings is discussed and it is shown how improved control can be obtained by using a combination of proportional and integral action.

359 **Friction and Wear Studies** *by Denis Taylor, M.Sc., Ph.D.*

This article discusses the way in which radioactive tracer techniques are used to study wear. The applications include wear on pistons and cylinder walls, tungsten carbide cutting tools and rubber tyres.

376 **Analogue-to-Digital Conversion in On-Line Data Handling Systems** *by W. E. Willison*

The need for analogue-to-digital conversion in on-line data handling and computer-control systems is discussed. The basic techniques are considered and a practical converter is described.

380 **Automatic Eddy-Current Tester** *by W. E. Schall, B.Sc.*

The principles of eddy-current testing were discussed last month. In this article they are applied to automatic equipment which can sort good and bad specimens as they come off a production line.

383 **Current Distribution in a Hall Plate** *by D. Midgley, B.Sc.(Eng.), Ph.D.*

This article shows how a resistance mesh may be used to simulate a Hall plate and then how a computer can be programmed to solve the equations of the mesh. In this way the current distribution can readily be computed.

continued overleaf

Published on the first Thursday after the 5th of each month by
ILIFFE ELECTRICAL PUBLICATIONS LTD.
Managing Director: W. E. Miller M.A., M.Brit.I.R.E.
Dorset House, Stamford Street, London, S.E.1.
Telephone: Waterloo 3333.
Telegrams: Wirenger, London, Telex
Cables: Wirenger, London, S.E.1.

ANNUAL SUBSCRIPTION, £3 0s. 0d.,
CANADA and U.S.A. \$8.50.

Data Processing
Fast Data Collection
System Centralization
Multiple Outstations
Error Correction

with **STC** Telephone Speed

DATA TRANSMISSION SYSTEMS

- Wide variety of applications.
- Error detection and correction giving maximum throughput of accurate data.
- Round-the-clock automatic transmission and reception.
- Tapes can be punched in advance and transmitted to suit traffic conditions.
- Manual, semi-automatic or fully automatic control.
- Small specific data transmission facilities or large integrated systems.

Write, 'phone or Telex for leaflets R/137, R/145



Standard Telephones and Cables Limited

INTEGRATED ELECTRONIC SYSTEMS DIVISION
BURLEIGH HOUSE · GREAT CAMBRIDGE ROAD · ENFIELD · MIDDLESEX
Telephone ENField 5343 · Telex 21409

GTE 120 Y TRIGGER TUBE



PROCESS TIMER

Perfectly adequate for simple repetitive timing but hardly a practical proposition for the hundreds of timing applications in industry.

For simple reliable electronic timing and sequence switching without fuss the answer is inexpensive Trigger tubes.

Operating directly from rectified mains, they require no special power supplies, they are not affected by severe transient overloads, they give visual indication of current flow and their characteristics are unchanged by temperature fluctuations. Reliable to the point of outlasting the useful life of their parent equipments, Ericsson Trigger tubes meet the most exacting industrial and commercial requirements. The simple timing circuit illustrated gives for example an accuracy of better than 1%. For tube data and other timing circuits please write to the address below.

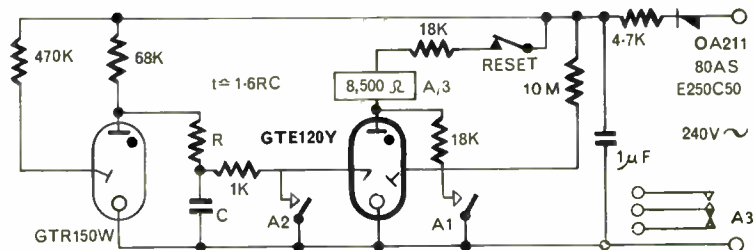

Tube Division
Technical Services Dept.,
Beeston, Notts. Tel: 254831.

ERICSSON TELEPHONES LIMITED
ETELCO LIMITED

For further information circle 205 on Service Card

RIST'S CABLES SERVE MANY INDUSTRIES



Missiles



Automobiles



Aircraft and Electronics



Houses and Factories

RIST'S WIRES & CABLES LTD NEWCASTLE, STAFFS (NEWCASTLE STAFFS 51221/9)

Industrial Electronics April 1963

For further information circle 206 on Service Card

ENCAPSULATED AND CURED AT ROOM TEMPERATURE

... in minutes with easy-to-use Silastomer® silicone rubber.

In three simple operations and with no special equipment you can encapsulate components in silicone rubber. This silicone rubber—Cold-Cure Silastomer—sets at room temperature and offers you all the well-known properties of oven cured Silastomer. Easy and quick to use, Cold-Cure Silastomer is available in three different viscosities to suit different processing techniques. The remarkable properties of Cold-Cure Silastomer include:

Operating temperature range—50 C to +250 C

Outstanding electrical insulation

High thermal conductivity

Effective protection against moisture, dust, oxidation, weathering, ozone, corona and mechanical shock.

Free Sample Write for a free sample and for our booklet on Cold-Cure Silastomer which gives full information on properties and applications.

®Silastomer is the registered trade name of a comprehensive range of silicone rubbers made and marketed by Midland Silicones Ltd.



MIDLAND SILICONES LTD *first in British Silicones* (Associated with Albright & Wilson Ltd. and Dow Corning Corporation)
68 Knightsbridge, London, SW1 Tel: KNightsbridge 7801 Area Sales Offices: Birmingham, Glasgow, Leeds, London, Manchester Agents in many countries

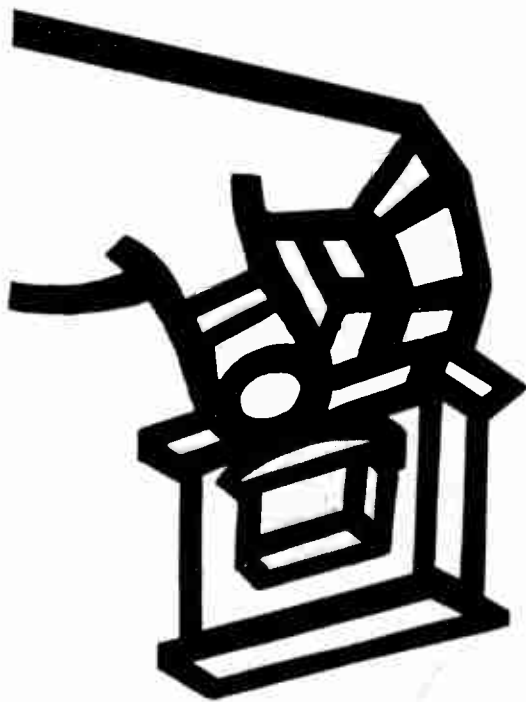
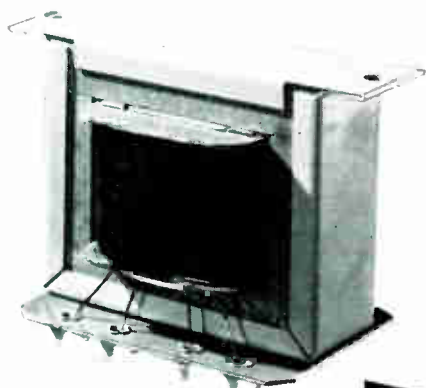

Industrial Electronics
April 1963

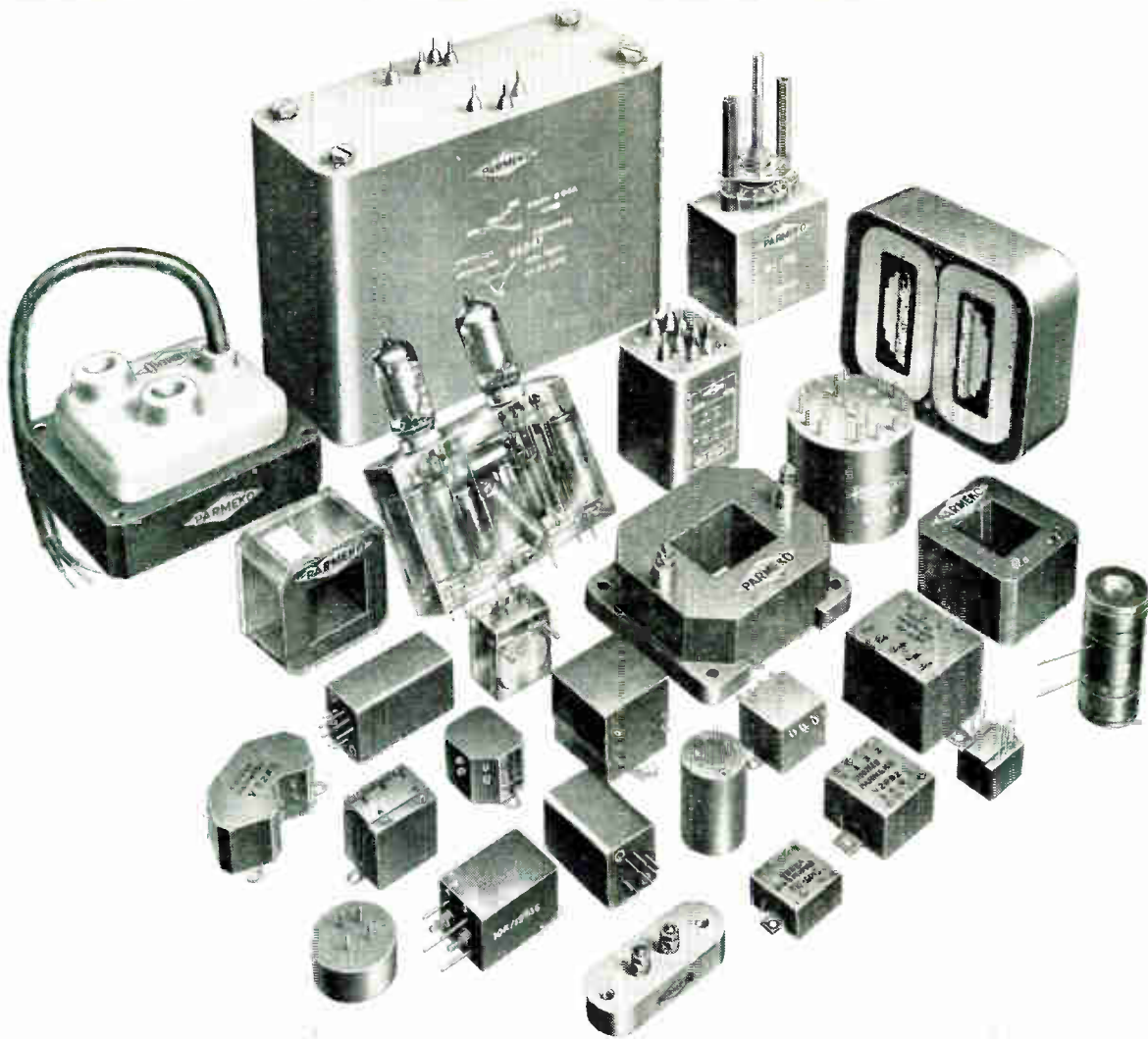

This great variety . . .

Araldite epoxy resins are used :

- for casting high grade solid electrical insulation
- for impregnating, potting and sealing electrical windings and components
- for producing glass fibre laminates
- for producing patterns, models, jigs and tools
- as fillers for sheet metal work
- as protective coatings for metal, wood and ceramic surfaces
- for bonding metals, ceramics etc.

. . . part of the range of radio and electronic components by Parmeko Ltd, Leicester, emphasises the versatility of Araldite epoxy resins for potting and encapsulation. Low shrinkage and the absence of volatiles during the curing process enable a simple casting process to be used, even with units of complicated shape. Components may be fully embedded and no voids are formed.

The resin adheres strongly to metals, ceramics etc., so that brackets, attachments and terminals can be cast *in situ*. The cured resin provides excellent insulation up to very high voltages, gives full protection against moisture or damage, and withstands tropical conditions. By the use of suitable fillers, either a clear or opaque appearance is obtained, without detriment to the electrical properties or the strength of the components.

Araldite

EPOXY RESINS

Araldite is a registered trademark

CIBA (A.S.L.) LIMITED, DUXFORD, CAMBRIDGE. TELEPHONE SAWSTON 2121

Vibrex quick-action fasteners

have hundreds of uses in every industry

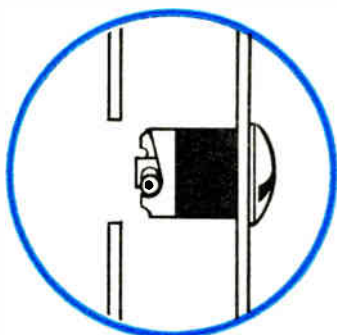

VIBREX fastener is assembled through hole in panel . . .

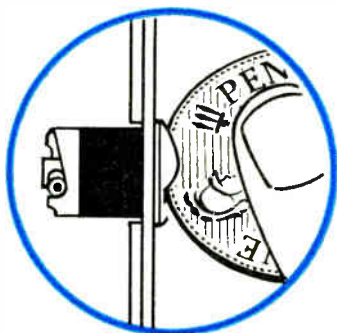

. . . inserted in hole in base . . .

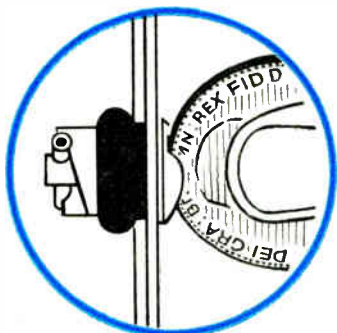

. . . a half-turn of the head locks or unlocks instantly . . .

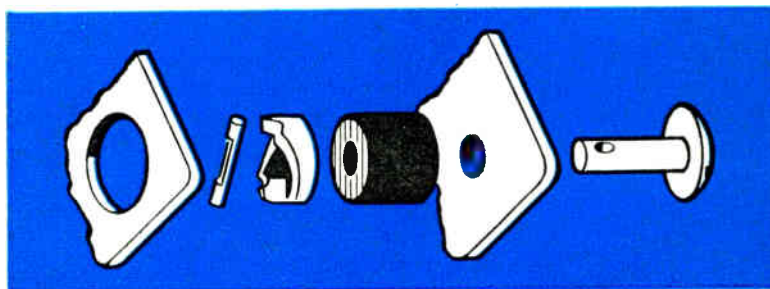

SIMPLICITY:

only two holes to drill—no tapping, brazing, welding or rivetting.

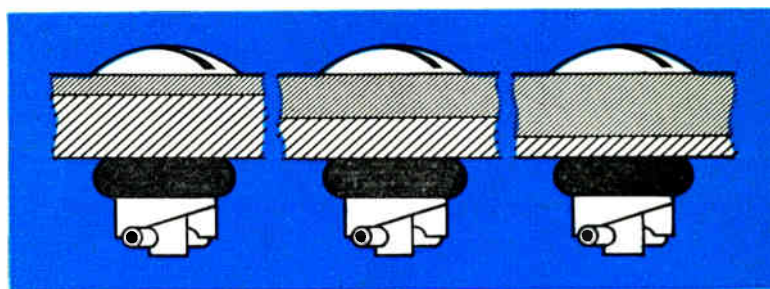

ADAPTABILITY:

standard VIBREX fasteners are available to accommodate any combination of panel and base thickness up to 1". Greater thicknesses to special order.

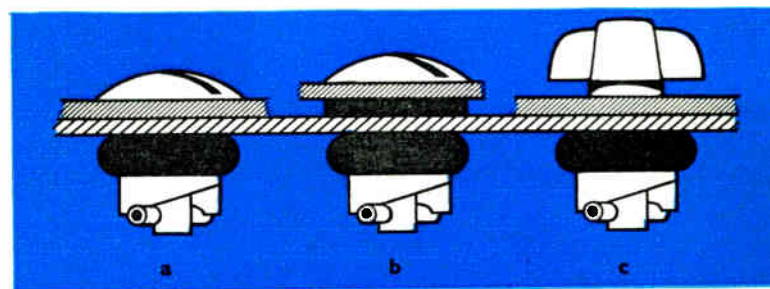

CHOICE OF TYPES:

as well as the standard type (a), VIBREX fasteners can be supplied with rubber cushions (b) giving electrical and mechanical insulation. In certain sizes, either type is available with wing head (c) instead of the standard slot head.

Vibrex quick-action panel fasteners by

SILENTBLOC

SILENTBLOC LTD
MANOR ROYAL · CRAWLEY · SUSSEX
Telephone: Crawley 27733 Telegrams: Silentbloc Crawley

Andre Rubber Co. Ltd. is another Silentbloc Company

Silentbloc products are also manufactured by Silentbloc (Australia) Pty. Ltd., Melbourne Broadway/S207



COMPONENTS REVIEW

APRIL, 1963

SCR's for POWER SWITCHING AND CONTROL

These new devices, the most recent addition to the range of Silicon rectifier devices made by STC, are backed by a joint research and development programme undertaken by the Rectifier Division and Standard Telecommunication Laboratories.

The range, now available from stock, comprises 1, 3 and 25 ampere units with ratings up to 400 volts, all fabricated by a double diffusion process. The device construction is simple but robust, standard packages being used:

Devices actual size



Following the usual STC coding system for all diffused-junction rectifiers, the type numbers are completed by the addition of two digits representing one tenth of the rated crest working voltage as follows—

Rated CWV	1 ampere Codes	3 ampere Codes	25 ampere Codes
50	CRS 1/05AF	CRS 3/05AF	CRS 25/05AF
100	CRS 1/10AF	CRS 3/10AF	CRS 25/10AF
200	CRS 1/20AF	CRS 3/20AF	CRS 25/20AF
300	CRS 1/30AF	CRS 3/30AF	CRS 25/30AF
400	CRS 1/40AF	CRS 3/40AF	CRS 25/40AF

RATINGS (Absolute Maximum values)	CRS 1/--AF	CRS 3/--AF	CRS 25/--AF
Mean Forward Current (Full Conduction Angle)	1.0A† 0.3A*	3A† 1A*	25A† 10A*
Peak Repetitive Forward Current	3.3A†	10A†	75A†
Crest Working Reverse Voltage	50 to 400V	50 to 400V	50 to 400V
Peak Forward Blocking Voltage			
Case/Stud Temperature	150°C	125°C	135°C

ELECTRICAL CHARACTERISTICS (at 25°C)			
Forward On Voltage	1.5V	2.0V	1.5V
..... max.			
Holding Current (Minimum to hold ON)	20 mA	25 mA	50 mA
Forward Blocking Current	1 mA	1 mA	5 mA
..... max.			
Reverse Current at Rated CWV	1 mA	1 mA	5 mA
..... max.			
Gate Trigger Current (Minimum value to trigger all devices)	20 mA †at 65°C case *at 125°C case	20 mA †at 75°C stud *at 125°C stud	50 mA †at 100°C stud *at 120°C stud

Write, 'phone or Telex for Data Sheets and prices to STC Rectifier Division, Edinburgh Way, Harlow, Essex. Telephone Harlow 26811. Telex 81146.

MINIATURIZATION 1.5 micron dielectric

A 25 volt STANTELAC capacitor range has now been introduced. This series will be a considerable aid to development engineers who are particularly interested in the miniaturization of low voltage electronic equipment.

The technique employed is an STC development based on the use of an aluminium foil coated with a synthetic resin. The thinness of this integrated dielectric is not limited by the usual considerations of handling and winding etc., and is made to suit the required working voltage. This results in an exceptionally high capacitance-to-volume ratio, particularly at lower voltages.

ACTUAL SIZE

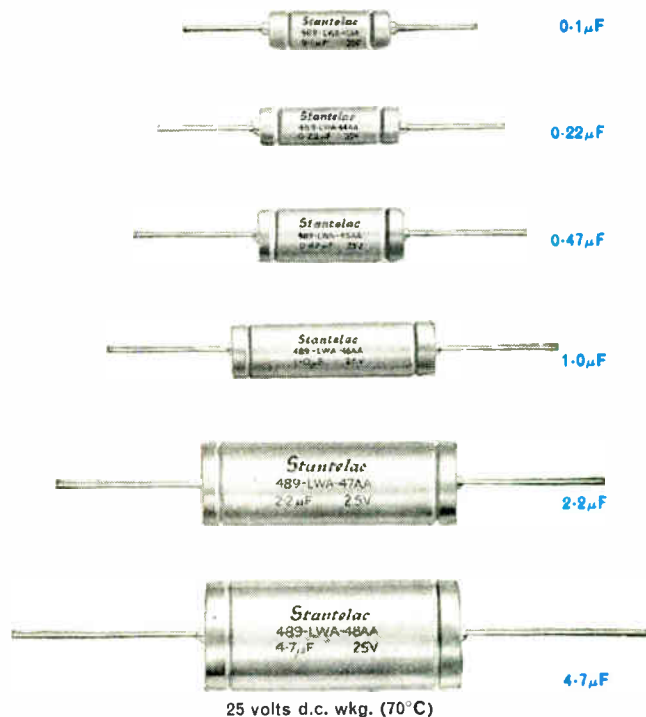

STANTELAC capacitors are ideal for use in place of foil/paper, metallized paper and polyester types to gain an improved space factor and a general improvement in electrical characteristics. The capacitors will have a wide field of application in computers, modern telecommunication equipment and in transistorized equipment generally. The 50 volt and 100 volt ranges are now well established as high quality components. These ranges have recently been expanded and now include over twice the number of capacitance values previously available.

Write, 'phone or Telex for Data Sheets to STC Capacitor Division, Brixham Road, Paignton, Devon or London Sales Office, Footscray, Kent. Telephone FOOTscray 3333. Telex 21836.

FRAME GRID VALVES FOR WIDE BAND AMPLIFIERS

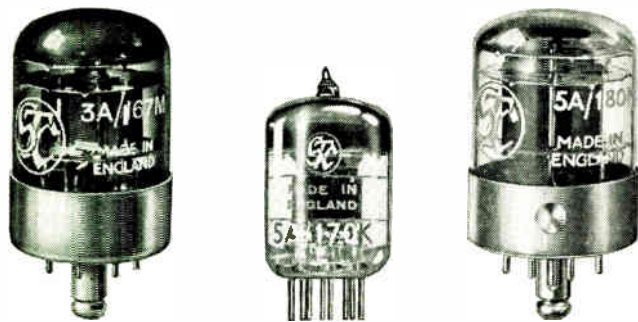

	3A/167M	5A/170K	5A/180M
TYPE	3A/167M (CV5112)	5A/170K (CV3998)	5A/180M
Figure of Merit	370	185	180
g_m	47	16.5	32 mA/V
I_a	40	13	26 mA
P_a max	6.5	3.3	6 W

The STC range comprises 3 valves, a triode and two beam tetrodes all of which are characterized by a high mutual conductance in ratio to capacitance yielding a high Figure of Merit.

Type 5A/170K is suitable for multistage, high gain amplifiers. Where a higher power level is desired Type 5A/180M may be used.

Triode 3A/167M is particularly suitable for cascode connexion and cathode follower applications. A combination of these two circuits is illustrated below.

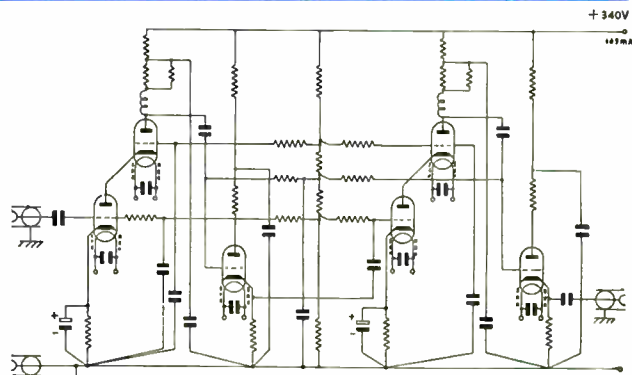

6 valves type 3A/167M in a wideband, low noise amplifier (5.5 kc/s to 37.5 Mc/s). Voltage gain 200. Details on request.

Write, 'phone or Telex for Data Sheets to: STC Valve Division, Brixham Road, Paignton, Devon or London Sales Office, Footscray, Kent. Telephone FOOTscray 3333. Telex 4230.

PERMALLOYS & PERMENDUR MAGNETIC MATERIALS

PERMALLOY 'C'
for highest initial permeability, useful for wide-band frequency transformers, current transformers, chokes, relays and magnetic shielding.

PERMALLOY 'B'
has lower initial permeability than Permalloy 'C' but has a higher value of flux density. It is suitable for use where high permeability to an alternating field superimposed upon a steady polarizing field is required.

PERMALLOY 'D'
for very high resistivity without undue lowering of the maximum flux density. Variation of permeability with frequency is small. Ideal for H.F. applications.

PERMALLOY 'F'
very rectangular hysteresis loop with a retentivity of at least 95% of its saturation value; high flux density and low coercive force. Ideal for saturable reactors, magnetic amplifiers, digital computers, memory devices, etc

V-PERMENDUR
for high permeability with a very high value of maximum flux density. Finds special application for use as high quality receiver diaphragms, also motor generators and servo-mechanisms in aircraft where weight and volume are important factors.

PHYSICAL PROPERTIES AND GENERAL MAGNETIC CHARACTERISTICS

	Permalloy 'B'	Permalloy 'C'	Permalloy 'D'	Permalloy 'F'	V-Permendur
Specific Gravity	8.3	8.8	8.15	8.4	8.2
Electrical resistivity—microhms per cm cube	55	60	90	26	26
Initial permeability μ_0	2 000 to 4 000	15 000 to 40 000	1 800 to 3 000	400 to 1 000	700 to 1 000
Maximum permeability μ_{max}	15 000 to 40 000	50 000 to 150 000	12 000 to 20 000	200 000 to 400 000	3 000 to 6 000
Magnetising force for μ_{max} -oersteds	0.20 to 0.40	0.025 to 0.04	0.2 to 0.5	0.03 to 0.10	2.0 to 6.0
Maximum flux density-gauss	16 000	8 000	13 000	14 000	24 000
Coercive force in oersteds for $B_{max}=5 000$ gauss	0.15	0.03	0.15	0.05*	2.3†
Remanence in gauss for $B_{max}=5 000$ gauss	4 000	3 500	3 500	13 000*	16 000†
Hysteresis loss in ergs/cc/cycle for $B_{max}=5 000$ gauss	160	40	200	220*	12 500†
Total loss in watts/lb for $B_{max}=5 000$ gauss 50 c/s 0.015 in. sheet	0.11	0.04	0.2	0.3*	4†

*for $B_{max}=14 000$ gauss † for $B_{max}=20 000$ gauss

Write, 'phone or Telex for Technical Data Sheets to STC Magnetic Materials Division, Edinburgh Way, Harlow, Essex. Telephone Harlow 21421. Telex 81146.



HERMETIC SEALS

-two ranges

Two new ranges of STC glass-to-metal hermetic seals are in full production. One range is made up of six lead-through type capacitor end seals, particulars of which are given in the table below:

Type	O/A Dia. (in.) (mm)	Lead-Through Int. Dia. (in.) (mm)	Ins. Res. at 500 V d.c. (MΩ)	Proof Voltage (kV)
H1G35 (VK35A)	0.163 4,140	0.035 0,889	30 000	1.1
H1G36 (VK36A)	0.242 6,146	0.035 0,889	30 000	1.5
H1G37 (VK37A)	0.360 9,144	0.055 1,397	30 000	2.2
H1G38 (VK38A)	0.498 12,649	0.055 1,397	60 000	3.2
H1G39 (VK39A)	0.674 17,119	0.055 1,397	60 000	3.2
H1G40 (VK40A)	0.934 23,723	0.055 1,397	60 000	5.4

The other new range of hermetic seals consists of one basic three-pin refrigerator seal available with a variety of pin lengths to suit customers' specific requirements. The pins may also be grooved at one or both ends if required. Principal details are given in the drawing and table below:

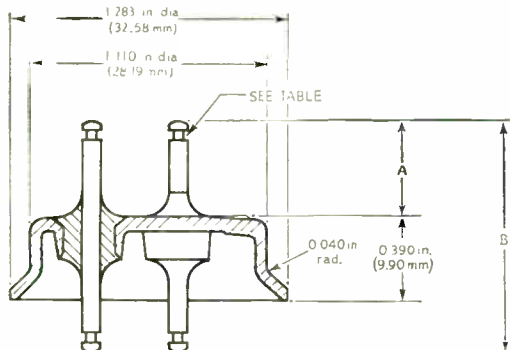

Type	Dim. A (in.) (mm)	Dim. B (in.) (mm)	Pins Grooved
H3G54 (VK54A)	0.358 9,093	1.016 25,806	None
H3G55 (VK55A)	0.406 10,312	1.062 26,974	None
H3G57 (VK57A)	0.375 9,525	1.031 26,187	Bottom
H3G58 (VK58A)	0.438 11,125	1.094 27,787	Top and Bottom
H3G62 (VK62A)	0.375 9,525	1.031 26,187	Top

Write, 'phone or Telex for Data Sheets to STC Valve Division, Brixham Road, Paignton, Devon, or London Sales Office, Footscray, Kent. Telephone FOOTscray 3333. Telex 21836.

THREE NEW RELAYS

TYPES 24 AND 25

These miniature industrial relays and sockets are now available to industry. They are interchangeable in form, fit and function with well-known continental types. For maximum economy, the preferred configuration is 2-changeover contacts (Type 24) or 4-changeover contacts (Type 25), with coil voltages as required.

To ensure optimum reliability of performance, silver/gold contacts are used together with a cover formed from non-gassing plastic. For a.c. operation, suitable STC quality rectifiers are available; voltages should be specified with order.

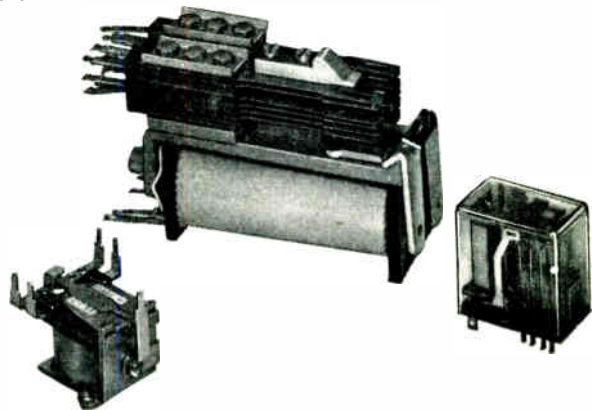

TYPE 11200 TWIN RELAY

These are, basically, 2 × PO 3000 Type relays, but special flat coils are fitted, together with two special armatures each operating one springset. One or two windings can be supplied for each core. For 50 V d.c. working, 1 000–2 000 ohms coils are used but they are available from 5–3 000 ohms if required. The Type 11200 twin relay is recommended where price and space-saving are important considerations.

TYPE 11301 'DOLLAR' RELAY

A d.c. relay for general use where space and cost are important and where high current capacity is not required. 'Dollar' relays are available for 6, 12, 24, 48 or 60 volts working with coil resistances from 100–6 000 ohms. They have one changeover contact which will switch either 0.3 A at 50 V d.c. or 1.0 A at 50 V d.c. depending on contact material.

OTHER TYPES

Other types in the STC ranges include reed switches and relays, PO 3000 Types and PO 600 Types. PO 3000 Types are available in quantity with ten days delivery.

Write, 'phone or Telex for STC relay literature and prices to STC Electro-mechanical Division, West Road, Harlow, Essex. Telephone Harlow 21341. Telex 81184.



Standard Telephones and Cables Limited
COMPONENTS GROUP • FOOTSCRAY • SIDCUP • KENT



BRUSH QUARTZ CRYSTAL UNITS

Brush Crystal Company Limited manufacture a wide range of crystal units and are familiar with the problems of frequency selection and control and it is our policy to keep ahead with the crystal units tailored to meet existing and future demands. It is for this reason that we are now able to offer units manufactured to meet the Defence Specification DEF5271A. These possess zero frequency-temperature coefficient AT cut crystal elements which are capable of meeting current requirements for miniaturised communication systems.

Brush replacement Quartz Crystal Units for existing equipment are available to a wide range of specifications. The high stability gold plated units are wire mounted in hermetically sealed metal containers. Brush Quartz Crystal units in low loss evacuation glass envelopes are particularly recommended for low ageing rates.

Brush Crystal Co. Ltd. are playing an expanding role in electrics and electronics. They are alert to the increasing demands of the industry and now add the vast technical resources of the Clevite Corporation of America to their own twenty-five years of experience. This makes it possible to devise, plan and produce the most versatile range of products in Europe—for either tailor-made or mass-produced devices in all divisions. Brush are quickly making a name for themselves as the company you can rely on for advanced know-how, competitive prices and good delivery.

KEEP
YOUR
EYE
ON

BRUSH



BRUSH CRYSTAL

COMPANY LIMITED • HYTHE • SOUTHAMPTON • Telephone Hythe 3031

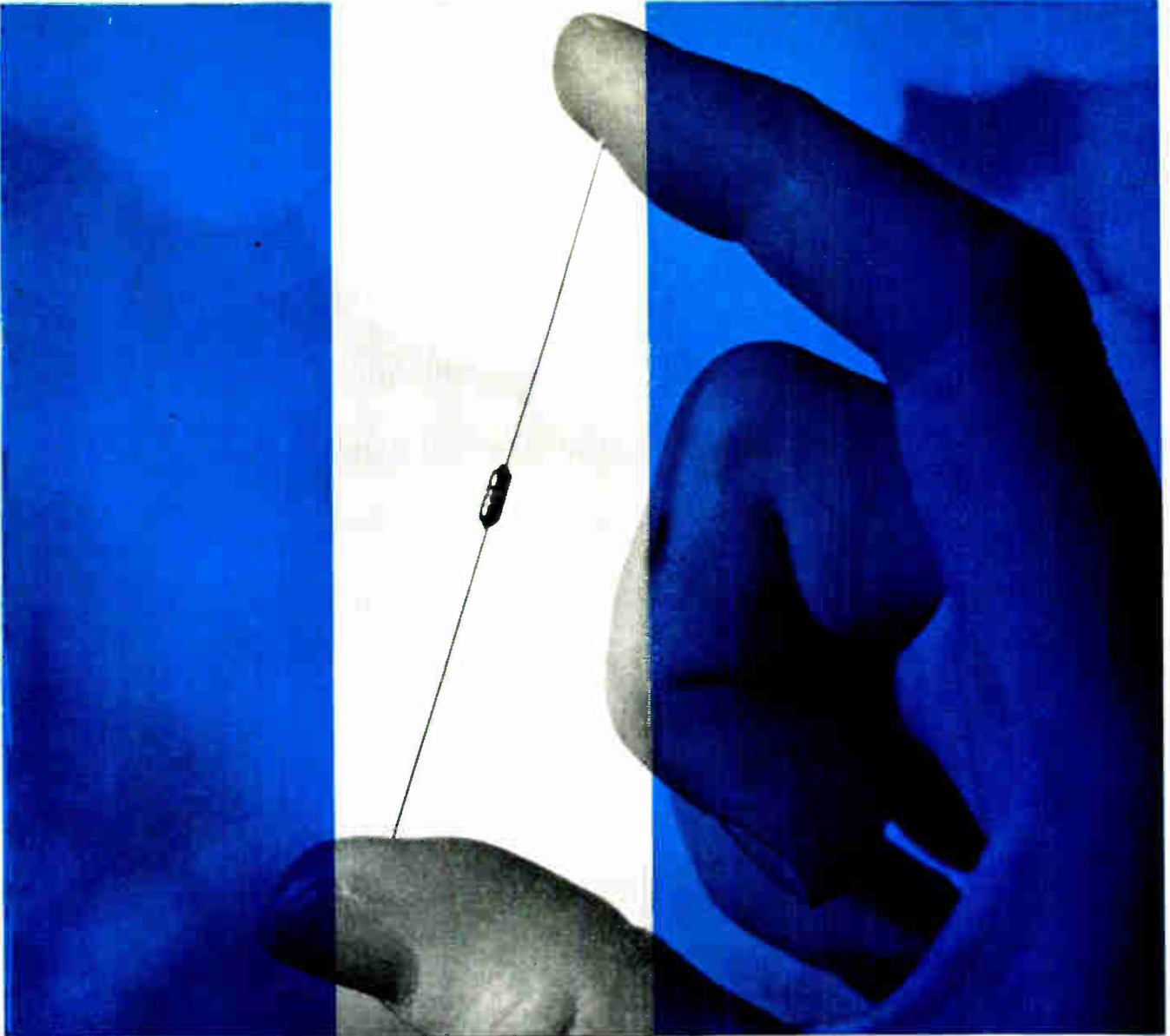

FULL $\frac{1}{4}$ W
RATING
AT 70°C
FROM 51 Ω
TO 150 K Ω

ELECTROSIL C-07 RESISTORS

Metal oxide film on glass substrate gives exceptional stability. Standard tolerances 2% and 5%. Temperature coefficient does not exceed ± 250 ppm/C. Average drift is under 1% after 2000 hrs. $\frac{1}{4}$ W @ 70 C. Overall size only 0.250 x 0.090 ins. Exclusive 'Spinseal' insulation gives extreme resistance to moisture or mechanical damage. Colour coded. A 1% version, the $\frac{1}{4}$ W N55, has a temperature coefficient not exceeding ± 100 ppm/C.

For full details of these and other resistors in the Electrosil range, write today—

COLNBROOK BY-PASS



COLNBROOK · SLOUGH · BUCKS
TELEPHONE: COLNBROOK 2196-2996



A PROMISE IS A PROMISE IS A PROMISE

Thanks not least to the finest postal service in the world you get Harwin Components when we promise them. Insulators, Lugs, Stand-offs, Brackets, Terminal Boards, Chassis Fittings, etc. Reliable, precise, rigidly inspected, and delivered to you post haste.



As Mini-Tronic says:
*'When time and space are tight,
HARWIN see you right'*
Just telephone or write

**HARWIN ENGINEERS LTD · RODNEY ROAD · PORTSMOUTH
HAMPSHIRE · TELEPHONE: PORTSMOUTH 35555 (4 lines)**

GREAT FOR MINIATURE ELECTRONIC COMPONENTS



SPECIFY RELIABILITY WITH ...

H Rugged, sub-miniature all-glass construction

H Low leakage

H Operation up to 90 °C

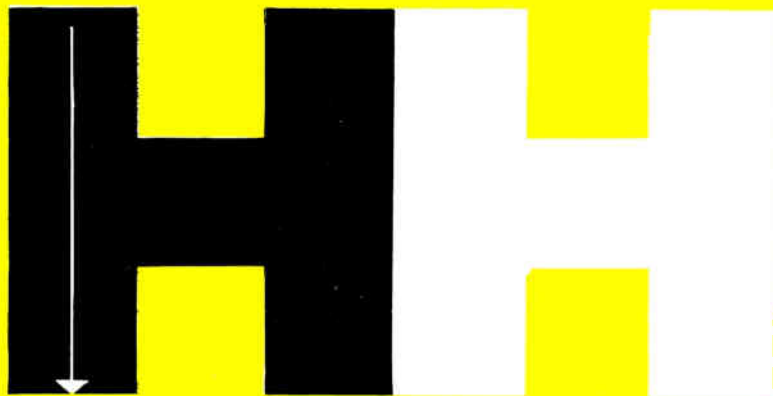

HUGHES INTERNATIONAL (U.K.) LTD.

Germanium General Purpose and Computer Diodes

- High forward conductance
- Max. Average power dissipation—80mW
- Nominal capacitance—0.2pF @ -10V



POINT-CONTACT GENERAL PURPOSE DIODES

- CV448**
- CV7041**
- CV7130**

Type	P.I.V.	Max. D.C. or Mean Forward Current (mA @ 25 °C)	Min. Forward Current @ 1V (mA)	Max. Reverse Current @ -50V (µA @ 25 °C)
HG1005	100	45	5	50
HG1006	100	45	5	100
HG1012	75	45	5	100

- Extremely high forward conductance
- Max. stored charge 350pC @ 10mA
- Nominal capacitance—0.4pF @ -10V
- Max. average power dissipation 80mW



GOLD-BONDED COMPUTER DIODES

- CV7076**
- CV7127**
- CV7128**

Type	Min. Breakdown Voltage	Max. D.C. or Mean Forward Current (mA @ 25 °C)	Max. Forward Voltage (@ 100mA)	Max. Reverse Current @ 25 °C (µA @ 1V)
HG5003	100	100	0.8	25 —50
HG5004	70	100	0.8	25 —50
HG5008	40	100	0.8	25 —30

- High forward conductance
- Typical stored charge @ 10mA—HD 1810 ... 125 pC
HD 1840/1 ... 110 pC
HD 1870/1 ... 66 pC
- Nominal Capacitance 1.5pF @ 1V



FAST RECOVERY COMPUTER DIODES

- CV**
- Approval Pending**

Type	P.I.V.	Max Forward Voltage		Max. Reverse Current @ -10V (25 °C)
		@ 10mA	@ 100mA	
HD1810	50	0.45	0.75	5µA
HD1840	30	0.45	0.70	10µA
HD1841	20	0.45	0.70	20µA
HD1870	15	0.42	0.70	15µA
HD1871	10	0.42	0.70	20µA (@ -5v)

Write now for complete data on the full range of Hughes semi-conductor products, which also includes:—
Silicon General Purpose and Computer Diodes
Silicon Power Diodes and Rectifiers
Voltage Reference Devices
High Voltage Cartridge Rectifiers
Voltage Variable Capacitors
PNP and NPN Silicon Transistors

— or ask for a Sales Engineer to call



HUGHES INTERNATIONAL (U.K.) LTD

KERSHAW HOUSE, GREAT WEST ROAD, HOUNSLOW, MIDDLESEX TEL: HOUNSLOW 5222

MC&PHM14

*When your work
is worthy
of the world's
finest instruments...*

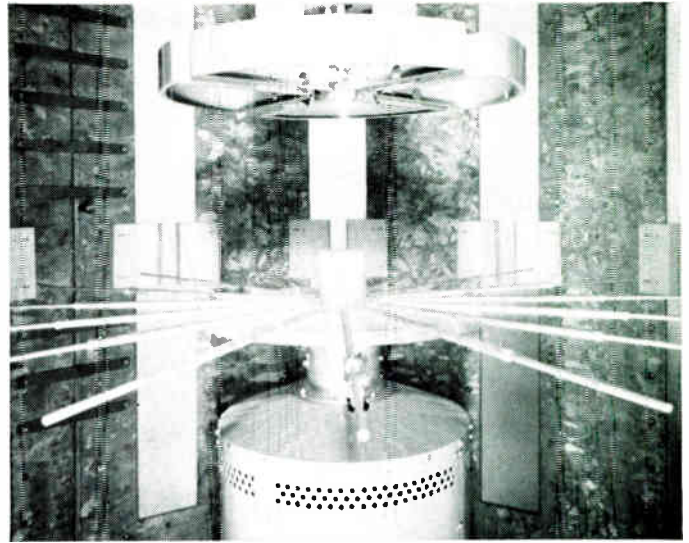

Marconi Instruments Type TF 1245 CIRCUIT MAGNIFICATION METER

with Oscillators Types TF 1246 and TF 1247.

* Direct measurement of Q-factor from 5 to 1000. Inductance and self-capacitance of coils, inductance and power factor of capacitors, phase angle of resistors, characteristics of transmission lines, and many other quantities can be evaluated.

* Frequency range: 1 kc/s to 300 Mc/s. Choice of external oscillators — type TF 1246 covering 40 kc/s to 50 Mc/s in 8 bands, type TF 1247 covering 20-300 Mc/s in 6 bands. Suitable i.f. oscillators may be used below 40 kc/s.

* Capacitance range: 7.5 to 500 μ F.

* Delta-Q control facilitates measurements on low-loss insulators and simplifies batch testing.

* Price: Q-meter type TF 1245 — £150. Oscillators type TF 1246 and TF 1247 — £90 each. Optional accessories include dielectric loss and series loss test jigs, and a range of 21 fully screened inductors.

Please write for full technical particulars of this and other Marconi instruments for circuit and component testing. Address your enquiries to **Marconi Instruments Limited** at your nearest office.

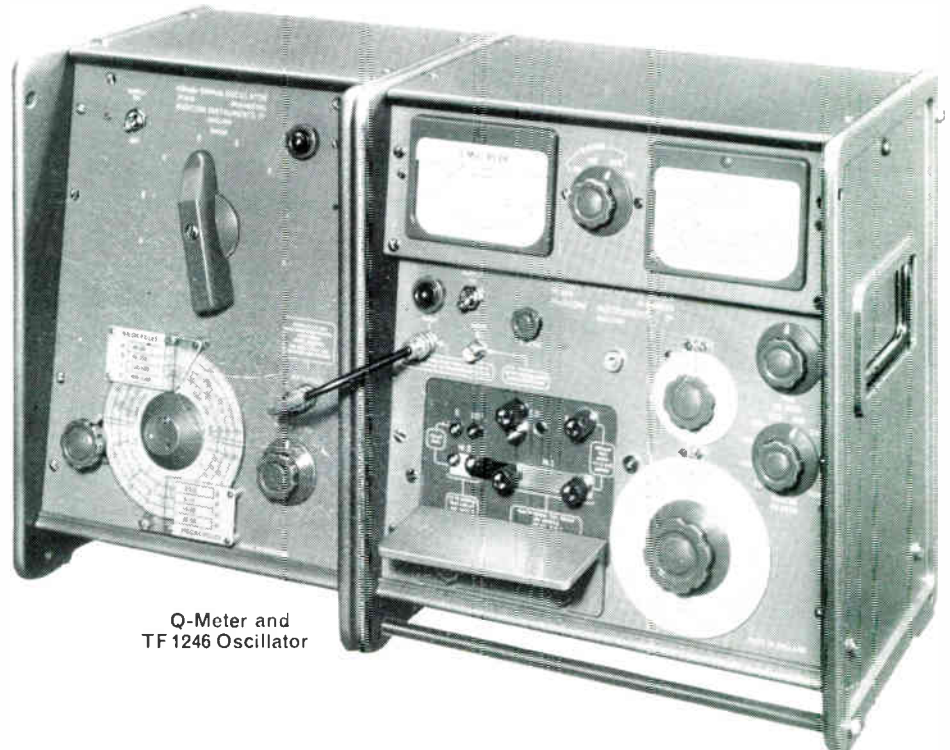

Q-Meter and
TF 1246 Oscillator

A GOOD NAME FOR GOOD MEASURE

Area Offices :

English Electric House, Strand, London, W.C.2. Telephone: COVent Garden 1234
40 Whiteladies Road, Bristol 8. Telephone: Bristol 39639
23/25 Station Square, Harrogate. Telephone: Harrogate 67454

Head Office Home and Export Sales :

St. Albans, Herts., England. Telephone: St. Albans 59292

**MARCONI
INSTRUMENTS**

TC 227

Let the

INDUSTRIAL ELECTRONICS

READER ENQUIRY SERVICE

help you to obtain more information

Circle the code numbers of the items in which you are interested. Insert your name and address, etc., in block capitals and post the card to us.

We will communicate with the manufacturers concerned and arrange for the information you require to be sent to you without obligation.

(No postage stamp is required if posted in Great Britain or Northern Ireland)

Is this your own copy ?

Each month INDUSTRIAL ELECTRONICS will bring you news of the latest applications, the most recently announced equipment, produced by the rapidly expanding electronics industries of the world.

It is invaluable to all management and production executives, and engineers, in industry generally, who need to be informed of the latest developments in electronic aids to industry.

**MAKE SURE OF YOUR COPIES
USE THE ORDER CARD NOW**

INDUSTRIAL ELECTRONICS

READER ENQUIRY SERVICE

APRIL 1963 — For further information circle appropriate number

Editorial code number—	1	2	3	4	5	6	7	8	9	10	11	12	13	14	15
16	17	18	19	20	21	22	23	24	25	26	27	28	29	30	31
34	35	36	37	38	39	40	41	42	43	44	45	46	47	48	49
52	53	54	55	56	57	58	59	60	61	62	63	64	65	66	67
70	71	72	73	74	75	76	77	78	79	80	81	82	83	84	85
86	87														
Advertisement code number—	200	201	202	203	204	205	206	207	208	209	210	211	212	213	
214	215	216	217	218	219	220	221	222	223	224	225	226	227	228	
232	233	234	235	236	237	238	239	240	241	242	243	244	245	246	
247	248	249													
250	251	252	253	254	255	256	257	258	259	260	261	262	263	264	
265	266	267													

I would also like details of.....

Your Name..... Position held.....

Name of Firm.....

Address.....

Nature of Business.....

PLEASE USE BLOCK CAPITALS

Postage will be paid by Associated Iliffe Press

No Postage Stamp necessary if posted in Great Britain or Northern Ireland

BUSINESS REPLY CARD
Licence No. SE 591

**"INDUSTRIAL ELECTRONICS",
DORSET HOUSE,
STAMFORD STREET,
LONDON, S.E.1**

APRIL 1963

INDUSTRIAL ELECTRONICS

SUBSCRIBER'S ORDER FORM

Subscription Rates

Home and Overseas £3. 0s. 0d.
USA and Canada \$8.50

Please supply

INDUSTRIAL ELECTRONICS monthly for the next 12 months

I will remit on receipt of invoice

NAME.....

ADDRESS.....

Postage will be paid by Associated Iliffe Press

No Postage Stamp necessary if posted in Great Britain or Northern Ireland

BUSINESS REPLY CARD
Licence No. SE 591

**"INDUSTRIAL ELECTRONICS",
DORSET HOUSE,
STAMFORD STREET,
LONDON, S.E.1**

Let the

INDUSTRIAL ELECTRONICS

READER ENQUIRY SERVICE

help you to obtain more information

INDUSTRIAL ELECTRONICS

READER ENQUIRY SERVICE

APRIL 1963 — For further information circle appropriate number

Editorial code number—	1	2	3	4	5	6	7	8	9	10	11	12	13	14	15
16	17	18	19	20	21	22	23	24	25	26	27	28	29	30	31
32	33	34	35	36	37	38	39	40	41	42	43	44	45	46	47
48	49	50	51	52	53	54	55	56	57	58	59	60	61	62	63
64	65	66	67	68	69	70	71	72	73	74	75	76	77	78	79
80	81	82	83	84	85	86	87								

Advertisement code number—	200	201	202	203	204	205	206	207	208	209	210	211	212	213
214	215	216	217	218	219	220	221	222	223	224	225	226	227	228
229	230	231	232	233	234	235	236	237	238	239	240	241	242	243
244	245	246	247	248	249	250	251	252	253	254	255	256	257	258
259	260	261	262	263	264	265	266	267						

I would also like details of.....

Your Name..... Position held.....

Name of Firm.....

Address.....

Nature of Business.....

PLEASE USE BLOCK CAPITALS

Circle the code numbers of the items in which you are interested. Insert your name and address, etc., in block capitals and post the card to us.

We will communicate with the manufacturers concerned and arrange for the information you require to be sent to you without obligation.

(No postage stamp is required if posted in Great Britain or Northern Ireland)

Is this your own copy ?

Each month INDUSTRIAL ELECTRONICS will bring you news of the latest applications, the most recently announced equipment, produced by the rapidly expanding electronics industries of the world.

It is invaluable to all management and production executives, and engineers, in industry generally, who need to be informed of the latest developments in electronic aids to industry.

**MAKE SURE OF YOUR COPIES
USE THE ORDER CARD NOW**

Postage will be paid by Associated Iliffe Press

No Postage Stamp necessary if posted in Great Britain or Northern Ireland

BUSINESS REPLY CARD
Licence No. SE 591

**"INDUSTRIAL ELECTRONICS",
DORSET HOUSE,
STAMFORD STREET,
LONDON, S.E.1**

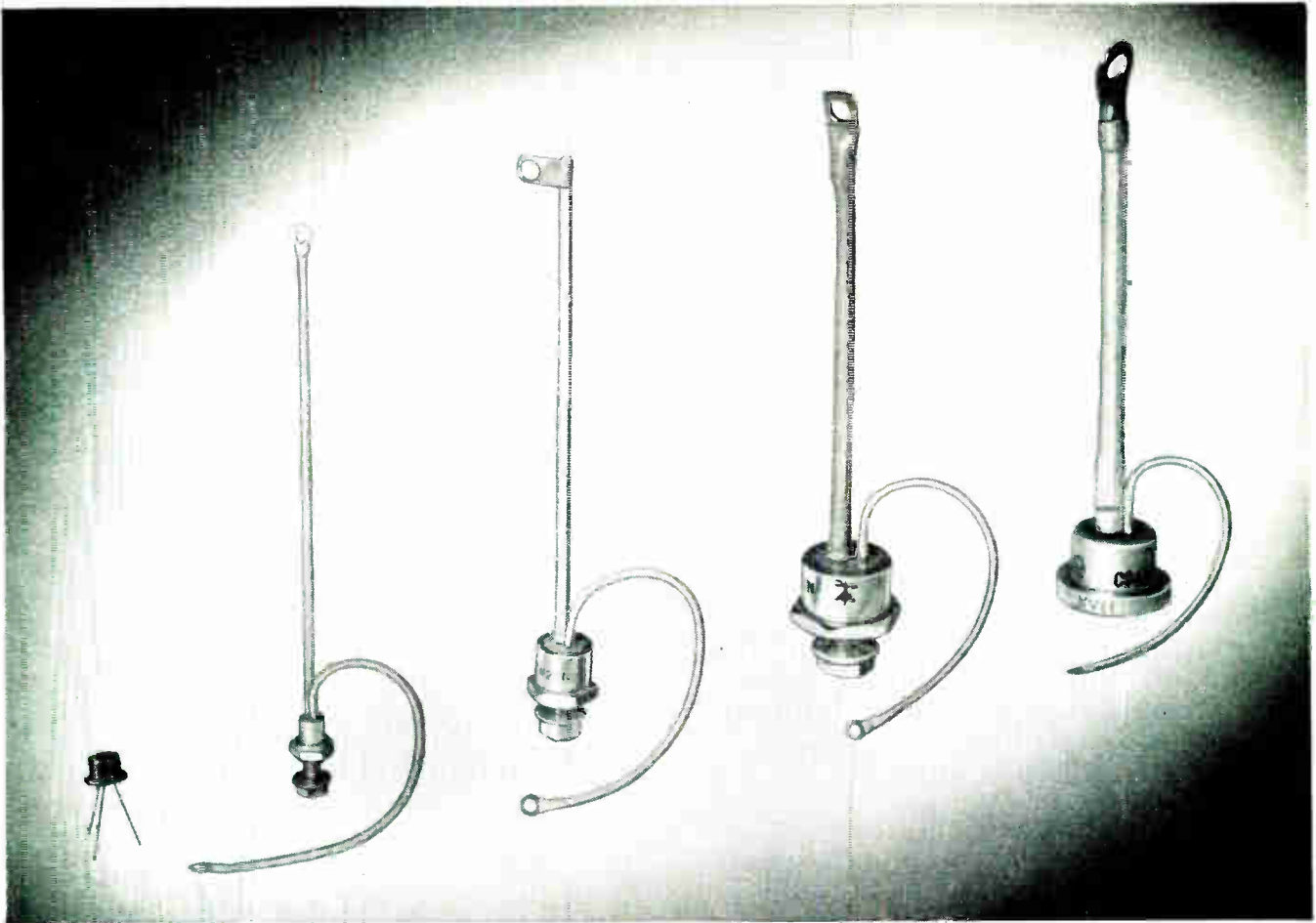

 **WESTINGHOUSE** 

'TRINISTOR'

SILICON CONTROLLED RECTIFIERS

With current outputs of 500 mA, 1A, 10A, 16A, 26A and 70A at voltages of from 25 to 400 volts, there is a Westinghouse 'TRINISTOR' silicon controlled rectifier to suit every application.

For full details write to Dept. I.E. 4/63, Rectifier Division, Semiconductor Department.

WESTINGHOUSE BRAKE AND SIGNAL CO. LTD
82 YORK WAY · KING'S CROSS · LONDON N1 · TERMINUS 6432



OSCILLOSCOPE TYPE CD 1015

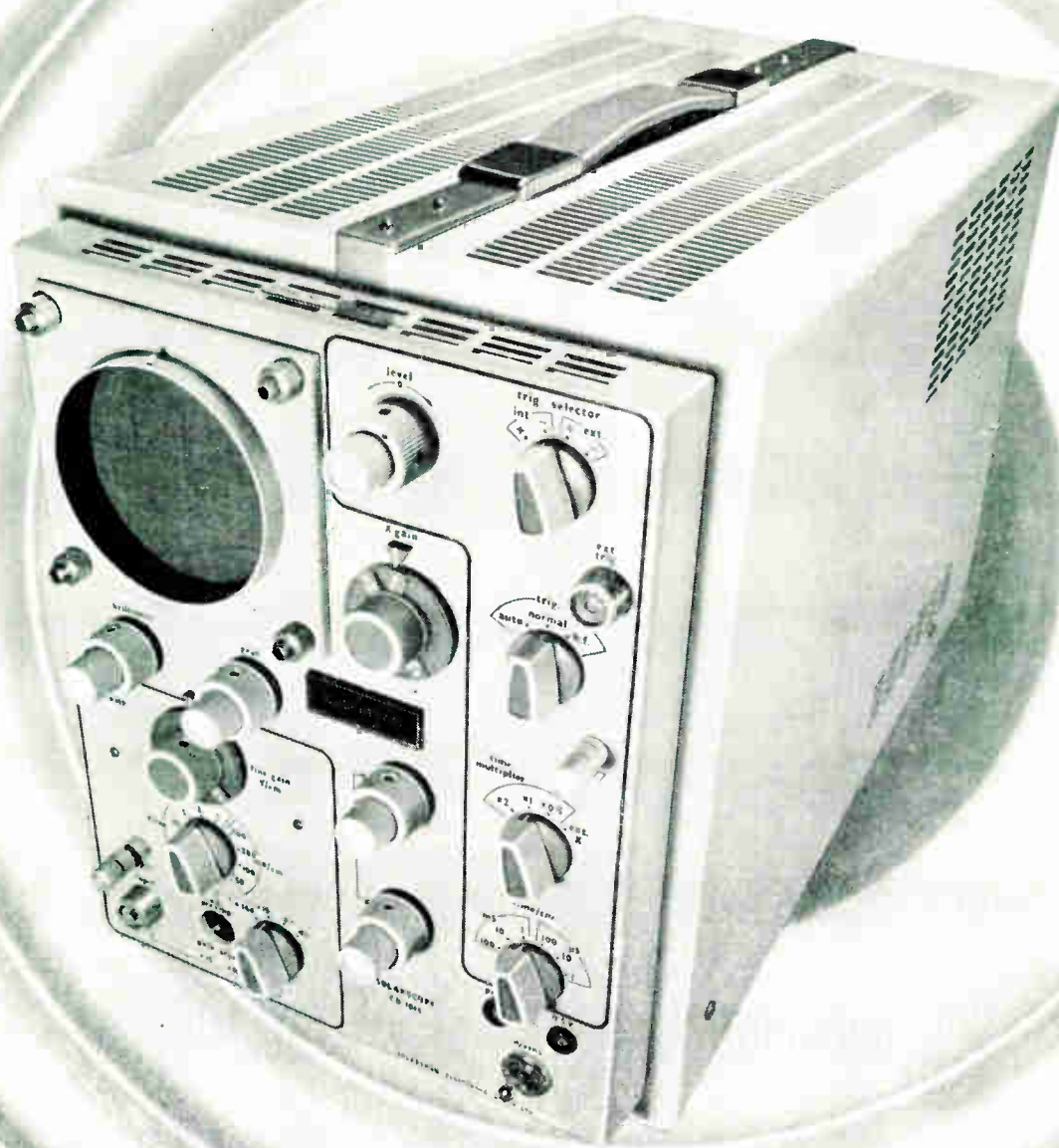

**A tool for progress
in every Industry**



OSCILLOSCOPES

OSCILLOSCOPE CD 1015

A wide band portable oscilloscope which displays very bright well-defined traces over the whole time base range making it equally suitable for the study of fast pulse phenomena or L.F. servo signals. An outstanding high gain pre-amplifier permits direct investigation of low level signals from transducers, r.f. detectors, semi-conductors and other low level sources.

The wide range time base circuit is simple to use; automatic triggering eliminates complicated adjustments. In addition, normal triggering with adjustable trigger level or H.F. sync may be selected.

The full bandwidth D.C. to 15 Mc/s (-3 db) is maintained to a maximum sensitivity of 50 mV/cm; higher sensitivities to 500 μ V/cm are achieved with a bandwidth from 5 c/s to 900 Kc/s. A coaxial cable provides 0.25 μ sec of signal delay with negligible mismatch on rise times down to 3 Nanosec.

The time base velocity range is from 0.5 μ sec to 200 msec/cm and is increased to 0.05 μ sec/cm with X10 expansion.

OSCILLOSCOPE CD 1014.3

A double beam, portable, oscilloscope with a bandwidth of D.C. to 5 Mc/s on both channels and a sensitivity of 100 mV/cm. Sensitivities up to 1 mV/cm can be obtained on one channel with a bandwidth of 2.5c/s - 20 Kc/s.

The time base velocity range is from 1 μ sec/cm to 1 sec/cm with X10 expansion giving a maximum sweep velocity of 0.1 μ sec/cm.

OSCILLOSCOPE CD 1016

A rack mounting double beam oscilloscope similar in characteristics to the CD 1014.3 described above. The mechanical design permits the instrument to be mounted in a 19" P.O. rack occupying a panel height of only 5 $\frac{1}{4}$ ".

OSCILLOSCOPE CD 1012

A general purpose laboratory oscilloscope which gives a bright well-defined trace of 6 cm amplitude with a bandwidth of D.C. -25 Mc/s at sensitivities up to 50 mV/cm. Greater sensitivities up to 500 μ V/cm are achieved with a bandwidth 2.5c/s - 500 Kc/s. A matched coaxial cable provides 0.2 μ sec of Video delay with negligible distortion.

The time base velocity range is from 100 Nanosec/cm to 5 sec/cm and is increased to 20 Nanosec/cm with X5 expansion. A single sweep facility permits photography of fast transients.

OSCILLOSCOPE CD 1212 (CT.484)

Services version of the CD 1012 described above, which employs plug-in pre-amplifiers as follows:

The Wide Band Pre-Amplifier CX 1251 has a bandwidth of D.C. to 40 Mc/s with sensitivities up to 50 mV/cm and the Pre-Amplifier CX 1252 provides a dual trace display with a bandwidth of D.C. to 24 Mc/s at sensitivities up to 50 mV/cm.

This instrument has been engineered to meet the conditions of K 114B.

Detailed information will be gladly sent on request and Solartron Engineers are available to discuss applications.

Write to:

THE SOLARTRON ELECTRONIC GROUP LTD. (Instrument Division)

Victoria Road, Farnborough, Hants.
Telephone: Farnborough Hants 3000
Telex: 8545 Solartron Fnbro
Cables: Solartron, Farnborough

MC&P S142



Data...



Chair from Heals of London

Processed

Two Elliott computers—the 503 and the 803. Price range: £20,000 to £200,000. Between them, they cover the chief scientific and industrial applications. □ First, the 503. Built to meet the increasing demand for high speed computers for use in research and development. The 503 has no competitor as a replacement for older/smaller/slower installations. And its low price puts it within reach of organisations that now use computing centres. □ The National-Elliott 803 is the smaller machine, from which the 503 has been developed. With over 120 already delivered, the 803 is far and away the most successful British computer. □ The two systems are compatible—programs written for the 803 can be used on the 503. Elliott's provide Autocode, ALGOL 60, and over a hundred library programs—and an active users' association provides for exchanges of application programs. If you're thinking about a computer, call early on Elliott's who can do much of your thinking for you.

The Elliott 503 100,000 operations per second. 8192 word magnetic core store. $3\frac{1}{2}$ microsecond cycle time. Up to 131,072 word auxiliary core store. Input by 8-channel punched paper tape at 1,000 characters per second. Typewriter controlled. Incorporates time-sharing of peripheral data-transfers. High-speed input and output devices include punched card input/output, magnetic tape and line printer. Control interrupt facilities.



**computing
division**

ELLIOTT BROTHERS (LONDON) LIMITED
ELSTREE WAY BOREHAMWOOD HERTFORDSHIRE ELSTREE 2040
 A Member of the Elliott-Automation Group

VITRAMON

high reliability micro-miniature capacitors

"VITRAMON"— world famous name in capacitors — now produce these essential components in their new factory at Harmondsworth. A unique manufacturing process; rigid production control and testing; the use of high quality materials ensure the high degree of reliability guaranteed by "VITRAMON" Capacitors.



Actual size

porcelain
monolithic body
high stability
low loss
axial-radial leads

CAPACITANCE RANGE	1—4,700 pf
TEMPERATURE RANGE	—55°C to +125°C
CHANGE IN CAPACITY over temperature range	2%
PREDICTABLE within	5 ppm
STABILITY	0.05%
VOLTAGE COEFFICIENT	nil
PROOF VOLTAGE 10 seconds	
500 volts rating	2000 volts
300 volts rating	1200 volts
POWER FACTOR	
20°C	0.0006
125°C	0.0010
INSULATION RESISTANCE	
20°C	100,000 megohms
125°C	10,000 megohms
WEIGHT of VY 16	2.32 gm
CAPACITY per cubic inch	.06 μ t
RELIABILITY	After testing at 150% of rated voltage for 2000 hours at 125°C, power factor is .003 maximum and insulation resistance 10,000 megohms (measured at 125°C) for all parts.



Actual size

ceramic
high capacity/volume
precision case
radial leads
extreme reliability

CAPACITANCE RANGE	10—10,000 pf
TEMPERATURE RANGE	—55°C to +125°C
CHANGE IN CAPACITY over temperature range	30%
PREDICTABLE within	5%
STABILITY	approx. 5%
VOLTAGE COEFFICIENT	—0.1% per volt
PROOF VOLTAGE	
10 seconds	
200 volts rating	800 volts
POWER FACTOR	
20°C	0.025
125°C	0.015
INSULATION RESISTANCE	
20°C	100,000 megohms
125°C	1,000 megohms
WEIGHT	0.5 gm
CAPACITY per cubic inch	1 μ t
RELIABILITY	After testing at 200% of rated voltage for 1000 hours at 150°C, power factor is .025 maximum and insulation resistance 1000 megohms (measured at 125°C) for all parts.



"VITRAMON" "VY" and "VK" are trademarks which are the property of Vitramon, Incorporated, Monroe, Connecticut, U.S.A. Products included in this advertisement are made by Vitramon Laboratories Limited in accordance with the specifications and quality standards of the trademark owner.

For further details please write to

VITRAMON LABORATORIES LTD.

© Vitramon Laboratories Limited 1963
MC & P V2

45 Holloway Lane, Harmondsworth, Middlesex, Telephone: Skyport 1829
Export Enquiries: Dage Corporation, 219 East 44 Street, New York 17, N.Y.

Very High Speed

COMPUTER TRANSISTORS

Silicon n.p.n. Planar Epitaxial Types

- * EPITAXIAL STRUCTURE
Low saturation voltage
- * PLANAR
Low leakage current and very high stability
- * LOW STORAGE TIME
8-35 n.sec. max.

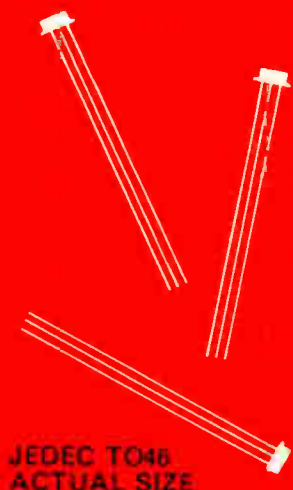

FERRANTI

First into the Future

JEDEC TO46
ACTUAL SIZE

JEDEC TO18
ACTUAL SIZE

RATINGS	ZT 709	ZT 1708	ZT 2205	ZT 2206	ZT 2475		CHARACTERISTICS AT 25°C	ZT709	ZT1708	ZT2205	ZT2206	ZT2475	TEST CONDITIONS	
Collector Base Voltage V_{CB0}	15	25	25	25	15	Volts	Collector Reverse Current I_{CBO}	0.05 μ A	0.25 μ A	0.25 μ A	0.25 μ A	0.05 μ A	$V_{CE} = 15$ volts	
Collector Emitter Voltage V_{CE0}	6	20	20	20	6	Volts	DC Current Gain h_{FE}	20-120					$V_{CE} = 0.5$ V $I_C = 10$ mA	
Emitter Base Voltage V_{EB0}	4	3	3	3	4	Volts		20 min.	20 min.				$V_{CE} = 1$ V $I_C = 10$ mA	
											40-120			$V_{CE} = 1$ V $I_C = 10$ mA
													30-150	$V_{CE} = 4$ V $I_C = 20$ mA
Dissipation 25°C Amb. Temp.	300	300	300	300	300	mW	Storage Time t_s max.	6 nS				6 nS	$I_C = I_{B1} = I_{B2} = 5$ mA	
									25 nS	25 nS	35 nS		$I_C = I_{B1} = I_{B2} = 10$ mA	
							Case Outline	TO-18	TO-46	TO-18	TO-46	TO-18		

FERRANTI LTD · GEM MILL · CHADDERTON · OLDHAM · LANCs
 Telephone: MAIn 6661 · London Office: Telephone TEMple Bar 6666

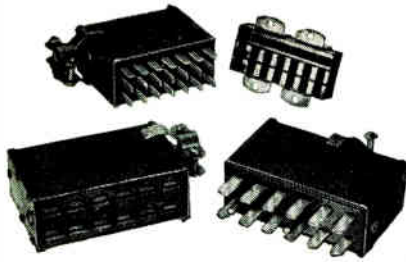

**JONES MINIATURE (SERIES 300)
JONES STANDARD (SERIES 400)**

- Steel shell with phenolic insulators.
 - Insert arrangements from 2 to 36 contacts.
 - Contacts rated at 5 amperes (series 300) and 15 amperes (series 400).
 - Contacts are blade type, self wiping
 - Phosphor bronze socket contacts, silver plated.
 - Silver plated copper pin contacts.
- Write for Jones Catalogue**



CA-"KE"/M8-"K" CONNECTORS

- Continuous operation at 350°F.
 - Utilise regular MIL.C.5015 insert arrangements.
 - Intermateable with MIL.C.5015 connectors.
 - Steel hardware.
 - Fluorinated silcan rear grommet for skydrol and kerosene resistance (CA-"KE" only)
 - Crimp type contacts of silver plated copper.
 - Vibration and moisture proof characteristics, per MIL.C.5015 (CA-"KE" only).
- Write for appropriate Catalogue**



UK-"M8" SERIES

- Continuous operation at 350°F.
 - Designed to pass BMS test specifications.
 - Utilise regular MIL.C.5015 insert arrangements.
 - Intermateable with MIL.C.5015 connectors.
 - Monoblock fluorinated silcan insulator.
 - Kerosene resistant.
 - Crimp contacts of copper, silver plated.
 - Aluminium or steel hardware.
 - Superior vibration and moisture proof characteristics.
- Write for UKMS Catalogue**



XLR EP AUDIO CONNECTORS

Ideal for Audio/Video applications on which they are currently used extensively.

- Insert arrangements: 2 to 18 contacts. (EP series), 3, 4 and 5 contacts (XLR series).
 - Silver plated brass contacts rated between 7.5 and 20 amperes.
 - Working voltages from 200 to 600 V a.c.
 - Insulators of moulded melamine and neoprene.
 - Low noise level when subjected to shock (XLR series only)
 - Unique latch lever coupling mechanism for easy and rapid engagement/disengagement.
 - Positive polarisation.
 - Grounding/earthing provision through one longer socket contact (XLR series only).
 - 15 shell styles.
- Write for XLR or EP Catalogue.**



TYPICAL EXAMPLES OF
CANNON
CONNECTORS

MADE IN

GREAT BRITAIN

One tends to associate the symbol CANNON PLUGS with electrical connectors manufactured in the U.S.A., but in actual fact, over 60 per cent of the Cannon connectors sold in Great Britain are manufactured entirely at the Cannon factory in London.

The facilities of Cannon Electric (Great Britain) Limited, include:

connector research, development, design and engineering; a fully equipped test laboratory; machine and model shops; toolroom; injection and compression moulding machines; quality control and inspection, etc.

All the divisions of the Company are manned by highly competent, qualified personnel with many years background of technological "know-how". The Sales and Engineering Departments provide a Technical Service of the highest calibre and the Company will gladly undertake development contract work.

Cannon Electric (Great Britain) augments and supplements the activities of the parent company factories in the U.S.A. and contributes in no small way in helping to maintain the name CANNON as the world's foremost manufacturer of electrical connectors.

CANNON
PLUGS



CANNON ELECTRIC (Great Britain) LTD., 168/172 OLD STREET, LONDON, E.C.1. Tel: CLERkenwell 4954

European Enquiries: Cannon Electric International Inc., Bornem, Belgium. Telephone: (03) 77.06.14.

Scandinavian Enquiries: Sweden Ab Gosta Backstrom, Box 12089 Stockholm 12

Denmark: Tage Schouboe, 7 Skyttegade, Copenhagen.

Norway: Morgenstjerne & Co., Wessels Gate 6, Oslo,

Finland: OY Chester AB., Helsingfors, N. Esplanadgaten 37.A., Helsinki.

Comment

The National Research Development Corporation is becoming better known but is still not as widely appreciated as it should be. It operates under the Development of Inventions Act 1948, with subsequent amendments. It is a public body which exploits commercially those patent rights derived from inventions made in the research establishments of Government Departments and the Research Council; it acts as a liaison centre between Universities and Technical Colleges on the one hand and industry on the other and can assume responsibility for patenting and exploiting inventions; it can act to support the individual inventor. It can support the development of inventions and sponsor research which is likely to lead to inventions of practical importance.

Some of the major, and most expensive, of the projects with which N.R.D.C. is concerned are Hovercraft, electronic computers, and Dracone (flexible barge). It is also dealing with fuel cells, image intensifiers, television bandwidth compression, and flat cathode-ray tubes.

The financial arrangements of the Corporation are rather unusual. It can raise money only by borrowing from the Board of Trade at Treasury rates of interest within a ceiling of £10 million to June 1969. This money is supposed eventually to be repaid. The only revenue is from the patent rights. Its liabilities to the Board of Trade are now around £6 million. In the last accounting year it had an excess of expenditure over income of some £1 million and its receipts from the exploitation of inventions amounted to roughly £276,000.

These details are taken from the Report and Statement of Accounts 1961-62 (H.M. Stationery Office) which deserves careful study by all interested in the work of N.R.D.C. It is clearly brought out in the Report that what is needed to put matters right is for one of its projects to turn out a winner. Although this is possible it is unlikely in the nature of things. There is rarely any difficulty in exploiting an invention which promises well commercially. The whole point about N.R.D.C. is that it exists to exploit inventions which are not commercially attractive. It does, therefore, seem very unlikely that N.R.D.C. can obtain an adequate return from them, except on a very long term basis.

It appears that within very few years N.R.D.C. will have exhausted its borrowing powers. If it is to continue its operations, therefore, it is necessary that urgent consideration should be given to its finances.

Pneumatics

A threat to the supremacy of electronics in the digital computer field is arising. It seems that it is now possible to carry out all the ordinary logical operations without electronics, using jets of air or a liquid! The component parts involved are not in the form of valves, pistons, diaphragms, etc., joined by a complex network of pipes. They are compact modules without moving

parts made by printed circuit methods.

There are 'pipes', of course, but they are in the form of channels about 0.01 in. in width and some 0.02 in. in depth. They can be cut into one face of a board and made into closed pipes by sealing another board to it as a cover. One simple way of producing an AND circuit is to provide two input channels which meet at 90° where they open into a relatively wide channel. The output channel is on the other side of the wide

COMMENT (Continued) channel and makes an angle of 45° with each of the input channels.

A jet of air passing down either input channel passes across the wide channel to strike the farther wall and miss the output channel, so that it passes away to 'earth'. If there are jets of air simultaneously in both input channels they strike each other on emerging from their channels and are each deflected 45° to form a common beam which then passes across the wide channel to enter the output channel.

Various other arrangements are possible and feedback can be introduced to provide a storage unit. They are discussed in an article, 'Calculating with Jets', by Dr. A. E. Mitchell of the I.B.M. Research Laboratory, Zurich, in the 7th March issue of *New Scientist*. Something like 80 American companies and universities are working on the subject. The Russians, too, are interested and according to Bulletin No. 582 of 7th March of the Soviet Information Service they are using printed or etched circuits on metal, plastic or ceramic plates. They call the method pneumonics.

This word seems quite appropriate even if it does make one think of pneumonia! According to the dictionary 'pneumonic' is actually the adjectival form of pneumonia, so the association is a very natural one.

The new devices are claimed to be very simple, reliable and cheap to make. The fluid types are especially interesting for control applications because in some cases they can be inserted in the liquid which is to be controlled, since the two liquids can be the same.

Compared with electronics, pneumonics is a very slow system. Switching time is about 1 msec. It is unlikely, therefore, that it will compete with the electronic digital computer for data processing on any large scale. However, for control purposes in manufacture it may be a very different story. Many processes are quite slow and the faster response of electronic apparatus may be unnecessary.

Optical Transistor

It was reported in *The Times* for 7th March that the International Business Machines Corporation is developing a new type of transistor. Gallium arsenide is the material employed. On the input side electrical power produces light, and this light regulates the current in the output circuit. Because of the light control, a thin base region is not needed and the new transistor is claimed to be easier to make. The new transistor has already been operated as an oscillator at 1 Mc/s and it is said that it may ultimately be operable in the kMc/s range.

We await with interest a more detailed description of the device. It is clear, however, that there is nothing inherently improbable about it. Most semiconductors are affected by light. Incident light energy creates electron-hole pairs and so increases the conductivity. The output side of the device thus looks quite straightforward.

The input side is not so clear, however, and it would seem as if something akin to laser action must take place. The input electrical energy must stimulate electron energy changes which result in the generation of light. We referred in December (p. 179) to a new laser, developed by the General Electric Research Laboratory, Schenectady, which employs gallium arsenide and is excited by an electric current. This laser produces infra-red and to prevent overheating it is pulsed and cooled with liquid nitrogen or helium.

If the basis of the new transistor is similar it may be that it also requires refrigeration. That would be a pity for it would make it so awkward and expensive to use that it would be unlikely to find general favour. It would be a pity because the new transistor appears to possess one outstanding advantage over ordinary types, namely, the absence of internal feedback. If the connection between input and output is by a light beam there is at first sight no reason to suppose that there will be any feedback effects. However, this may not be true. It may be that changes of current in the output semiconductor affect the absorption of light and hence the amount reflected back to the input semiconductor where it might well affect the laser action.

It seems more probable that something unwanted like this should happen than that we should at last be in sight of a truly one-way amplifier!

Oh What a Beautiful Morning

It is not often that new developments in electronics are reported in the daily press before we hear about them, as in the case just referred to. More often the dailies report applications, as in the *Daily Express* for 6th March. This paper carried a report that an 'electronic-brain' was used to produce the *Oklahoma City Times*. The whole newspaper was produced automatically by a computer controlling unmanned Linotype machines. The computer itself was controlled by perforated tape punched by typists. The computer then processed the information to produce an output tape for controlling the Linotype machines. This output tape contained the normal machine instructions for column widths, type face, justification and so on. In effect, the computer carried out from punched tape the work that compositors normally do from typed copy.

Oscilloscopes in the Modern Garage

By E. E. MORGAN*

The use of the cathode-ray oscilloscope for the routine testing of internal combustion engines is described in this article. The effect on the oscilloscope traces of various ignition faults is illustrated.



Crypton Motorscope engine tester connected to an engine

DEVELOPMENTS in design, better fuels and lubricants, and new materials have all contributed to the greatly increased performance and higher speeds of the motor car engine of today.

These developments have, however, set new problems for those on the service side of the motor industry. First, they are finding that the skill and experience of their mechanics is no longer enough to maintain the close limits to which, for instance, the ignition system must operate if the full power of the engine is to be developed.

Secondly, engine repairs are giving way to the fitting of replacement parts which does not demand the same standard of skill. Paradoxically, however, diagnosis has assumed greater importance, for with rising labour costs no garage can afford time-wasting 'hit-or-miss' methods of fault finding.

It is for these reasons that just as in other fields instruments have been called to the aid of production, so are they now being employed to speed-up engine service to ensure that motorists continue to get peak performance from their engines and that if they do get trouble it is rectified quickly and at reasonable cost.

This new approach to engine servicing has gained considerable impetus from the introduction by Crypton of a range of engine testers which includes a cathode-ray oscilloscope.

The use of an oscilloscope in engine testing has removed one long-standing drawback in earlier types of equipment: i.e., difficulty of operation. In Crypton models employing the 8½-in. oscilloscope, the operator has only three controls to operate—a rotary pattern selector and horizontal 'hold' and 'spread' controls. Moreover, he also has only four connections to make to the engine as indicated in Fig. 1, which shows a simplified ignition circuit diagram of a 4-cylinder engine.

The oscilloscope operates from 200/250 volts single-phase a.c. and uses an electrostatic-deflection system with post-deflection acceleration on the tube. Signals are fed through capacitance probes, one of which is used to produce the trigger for the timebase comprising a thyratron feeding

* Crypton Equipment Ltd.

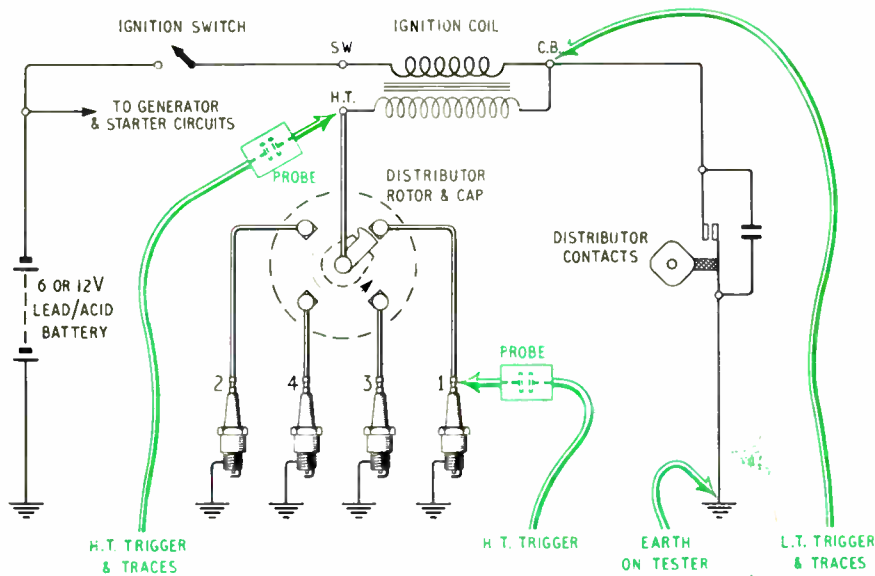

Fig. 1. Typical ignition circuit showing where the test leads are connected

push-pull deflection. The trigger signal from the probe connected to No. 1 spark plug is used to trigger the thyatron, thus discharging a capacitor, which derives its charge from the e.h.t. supply via a very high resistance. In order to avoid possible damage from and to the e.h.t. supply, special design features have been developed (which have been patented) to obviate the possibility of loading on this circuit. The signal is taken through a cathode-follower, which forms part of the push-pull deflection circuit.

The flyback trace is blanked out by an appropriate signal from the cathode-follower to the grid of the tube. The signal deflection, fed from the other probe, is attenuated and is then passed to the vertical deflector plates. It is also used to brighten the trace when a transient occurs. A clear, bright trace is produced at any engine speed up to 5,000 r.p.m. or higher.

To compensate for any ageing of the components, means of adjustment are provided, but these are concealed by a cover to reduce the possibility of unauthorized alteration. These embrace tube brightness, focus, vertical and horizontal adjustment and a kilovolt scale calibrator.

Because of its importance in ignition testing, the kilovolt scale must be kept to an accuracy of 1 kV or less and it is for this reason that the unit has a built-in standardizer.

In operation, the mechanic connects to the engine as shown in Fig. 1 and then turns the rotary switch to the first position, which gives him the primary pattern for one cylinder. This, with the second position which superimposes the traces for all cylinders, shows the condition of coil, condenser and breaker points, the dwell-angle (contact point gap) and any overlap or variation. A normal single-cylinder primary trace is shown in Fig. 2 and poor condenser and contact point performance are shown in Fig. 3 (a) and (b).

The next check is on the secondary circuit and this covers coil polarity windings, the h.t. wiring and connections. Fig. 4 shows a normal secondary trace for one cylinder, and Fig. 5(a) the picture presented by a coil connected in reverse. This test is important since coil polarity has a distinct effect on ignition performance and as many coils are now marked + or - instead of S.W. and C.B. the risk of reverse connection has greatly increased. Fig. 5(b) shows the effect of an open secondary winding in the coil. As

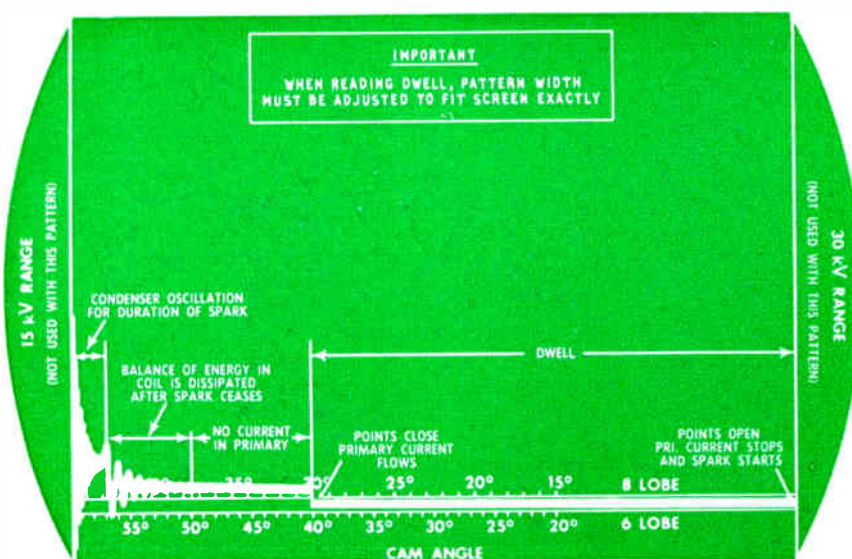

Fig. 2. Primary pattern for one cylinder only

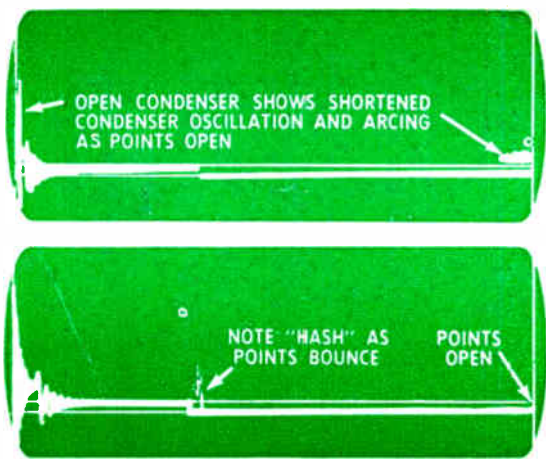

Fig. 3. The effect of an open condenser in the distributor is shown at (a) and that of unsatisfactory points at (b)

on the primary side, secondary traces from all cylinders can be superimposed and the trace which would appear as the result of excessive resistance in one plug lead is shown in Fig. 5(c).

The next pattern gives the facility, long wanted by the service station, of checking sparking plug operation while under firing and compression conditions. In this pattern a complete sweep of the entire secondary ignition cycle is obtained and the high-tension impulses are 'paraded' in firing sequence with No. 1 cylinder on the right of the screen and succeeding cylinders starting from the left. The graticule is calibrated on one side up to 15 kV and up to 30 kV on the other. Reference to this enables the operator to obtain an accurate measure of the required firing voltage for each cylinder as well as the maximum available voltage for the entire ignition system.

An exclusive feature of the Crypton oscilloscope is to be found in this section. Because on such a pattern the vertical trace would be very faint owing to the speed of the spot, a pulse is applied which both brightens and de-focuses the spot at the top. This makes for much easier and accurate reading.

A normal firing pattern for a six-cylinder engine is shown in Fig. 6(a) where all firing voltages are around the usual of 8-9 kV. Various faults would be shown as in Fig. 6(b) where only Nos. 1 and 2 cylinders are firing normally. An open plug circuit is indicated on No. 3 by the firing voltage going right off the screen. No. 4 shows a large plug gap or an additional series gap in the circuit, while the complete absence of a voltage trace for No. 5 plug indicates an earthed plug or plug lead. Series resistance or a fouled plug would give a broken, low reading trace as shown for No. 6 cylinder.

It has been found in practice that plugs which have had a fair amount of use may show normal and regular firing voltages yet will 'miss' under load. A quick and quite reliable check for this condition can be made by opening the throttle to 2,500 or 3,000 r.p.m. and quickly closing it again. The pattern will condense to the left of the screen and the firing voltages will increase momentarily as the compressions increase. Any plug or plugs showing a kV reading in excess of two-thirds of the normal coil output voltage are suspect; see Fig. 6(c).

To determine the maximum coil output it is only necessary to remove one plug lead and read off the kV figure on the 30-kV scale.

It is often not realized among garage mechanics that the rotor gap can seriously affect ignition performance. This is evidenced by the fact that they can often be seen filing it or even scraping it on a concrete floor to produce a nice bright surface, unaware of the extra gap they are introducing. A quick check for this condition can be made by removing a lead at the plug and shorting it to earth. The kV necessary to jump the rotor gap alone will then be shown as in Fig. 6(d).

Although not conclusive, another very useful indication given by the firing voltage parade is of unbalanced carburetors on a twin unit engine. Here the patterns of half the cylinders which may be receiving a weak mixture will show a higher firing voltage.

In the largest Crypton engine tester the oscilloscope circuitry is used for compression condition testing, an exclusive and patented feature.

A special revolution counter with a full scale reading of only 150 r.p.m. is provided, with means for adjusting to zero with the engine running at about 800 r.p.m. The circuit provides a pulse which appears superimposed on the

Fig. 4. Secondary pattern for one cylinder only

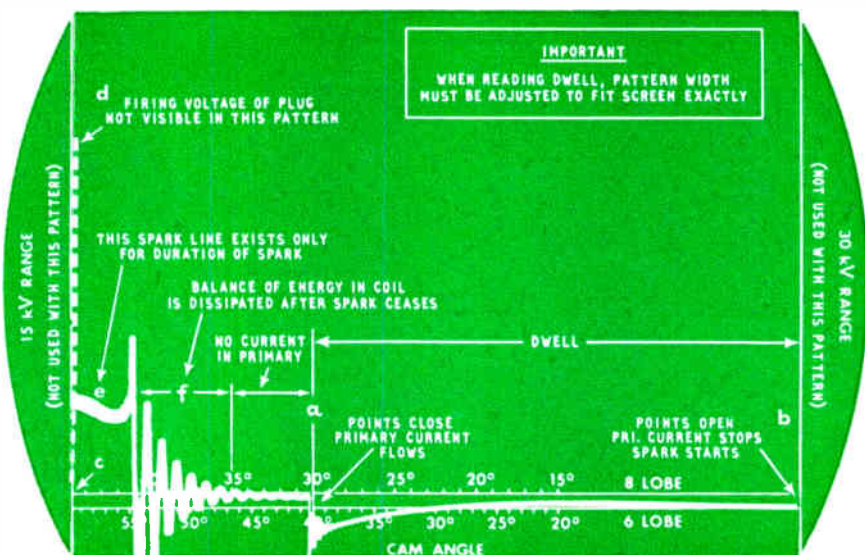

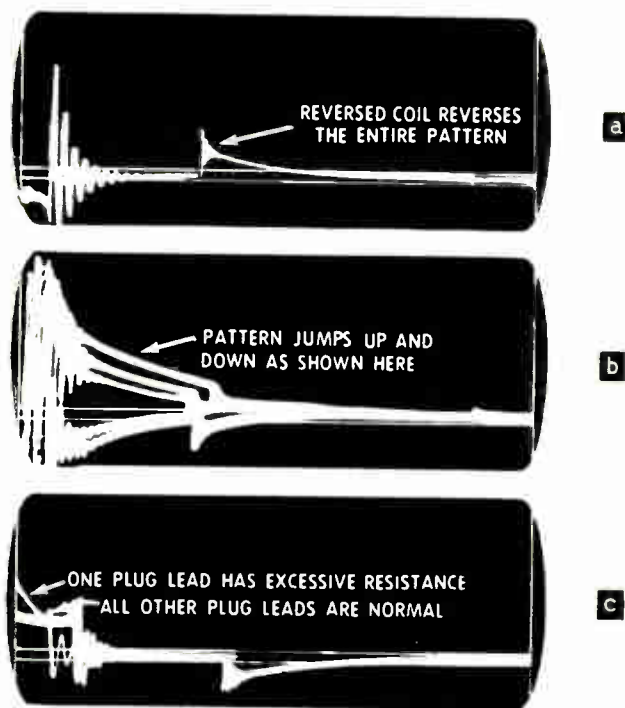
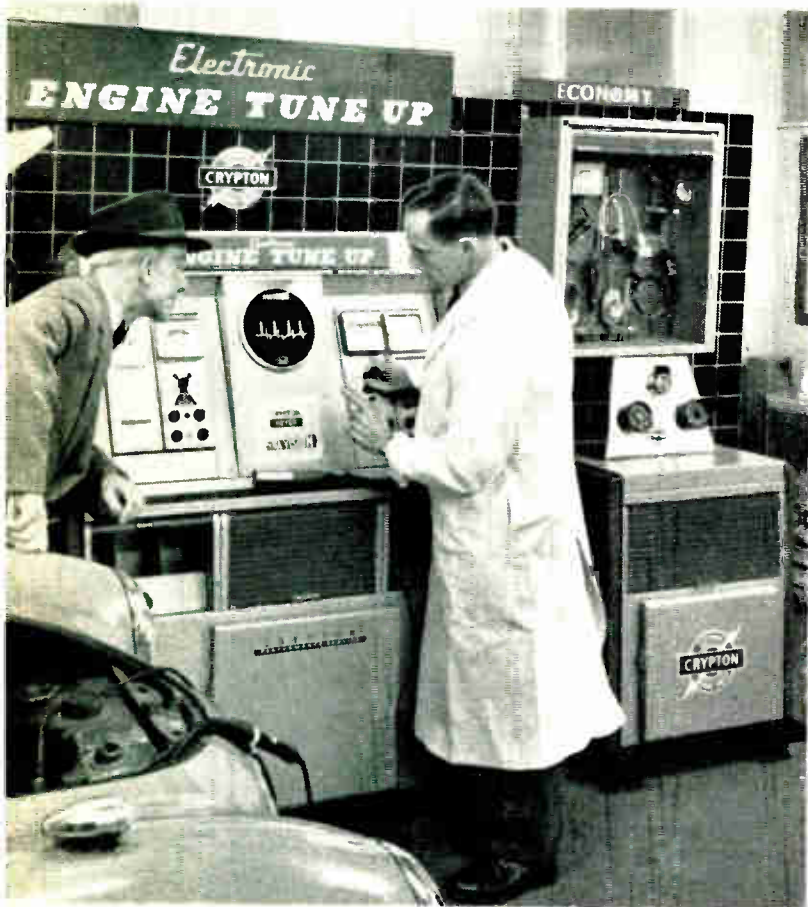

Fig. 5. Some typical faults. (a) reversed coil. (b) 'open' inside coil. (c) excessive resistance

Left: Crypton Dynascope engine tester includes electronic compression testing

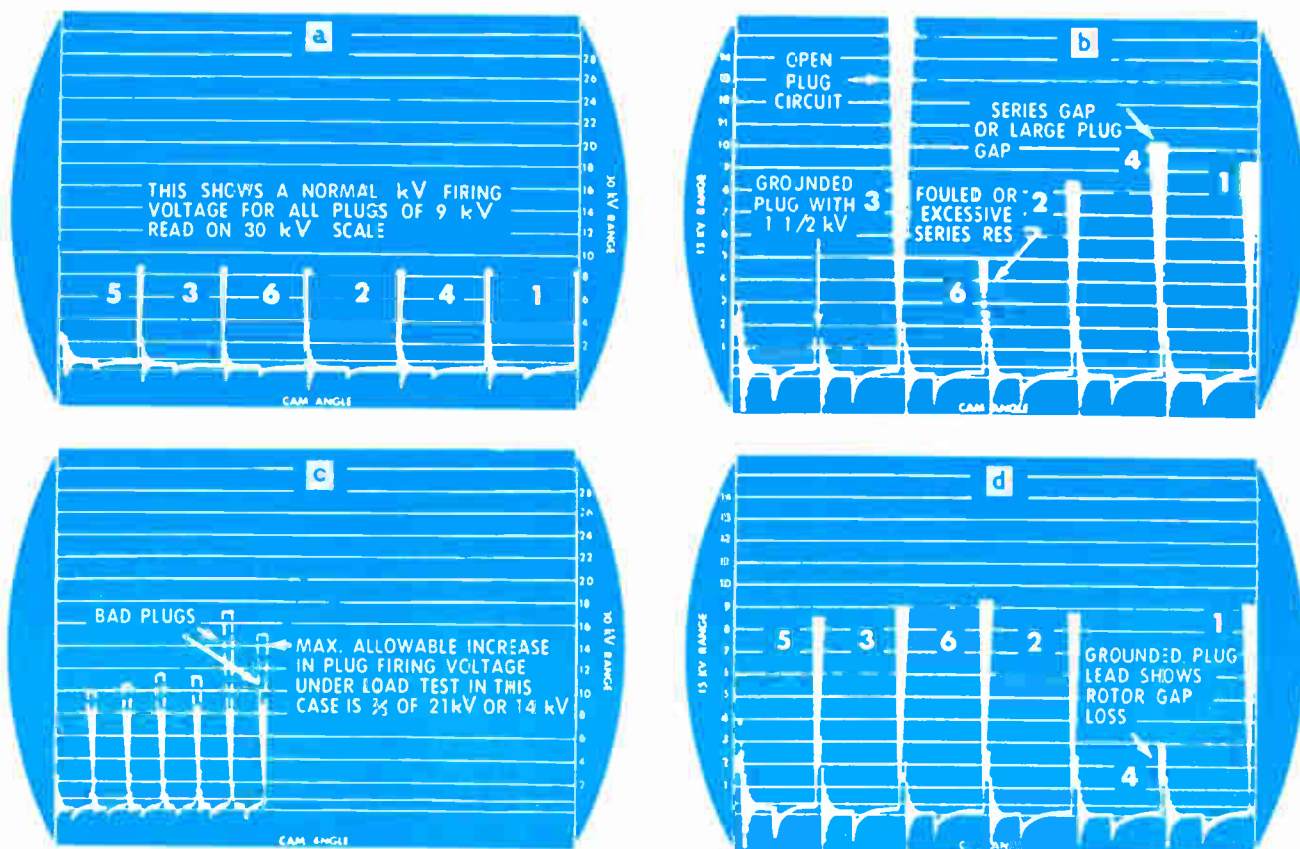

Fig. 6. Normal and abnormal plug firing patterns are shown at (a) and (b). The effect of sudden acceleration on the firing pattern is indicated at (c) and the effect of rotor-gap loss at (d)

oscilloscope trace and this can be aligned with any cylinder. The pulse is allowed to pass to the test lead and will short-circuit the contact breaker on any chosen cylinder. The resulting drop in r.p.m. is shown on the revolution counter and gives a reliable indication of the power contribution of each cylinder. As small a change in engine speed of 10 revolutions can be measured.

There is one more position on the rotary selector switch which is not at the moment used. A special socket has been provided on the input circuit so that, without modification, the oscilloscope can be used for any future test development such as noise or vibration measurement.

To provide complete engine testing and tuning facilities, Crypton testers incorporate a combined volts/cam angle/r.p.m. meter, an ignition meter and a stroboscopic power timing light and an exhaust gas analyser.

The ignition meter, through an electronic circuit, enables the operator to measure both centrifugal and vacuum advance. Using the timing light to illuminate the marks

on the engine, he increases the revolutions when, of course, the marks will move away from each other as advance of the spark occurs. By operating a control, an electronic delay between the spark in No. 1 cylinder and the flash in the light is progressively introduced until the marks line up again. This delay is shown in degrees on the meter and indicates the amount of total advance which has taken place. By removing the pipe to the vacuum advance unit on the distributor, the amount of advance contributed by this and the centrifugal mechanism can be determined.

The availability of Crypton oscilloscope engine testers and the carefully devised sequence of tests (which are always carried out in the same order, irrespective of the make and type of car) has brought testing times down to a level where an ignition test can be made in five minutes and a complete engine analysis in as little time as twenty minutes. That they are meeting the requirements of the motor service industry is proved by the rapidly increasing numbers that are now being used.

SWIMMING RACES TO BE TIMED BY ELECTRONICS

Automatic electronic race timing equipment has been installed in the swimming pool at the Shell Centre on London's South Bank. This six-lane pool can be used for international events and the equipment must therefore conform to A.S.A. regulations.

More than 400 transistors and 1,500 cold-cathode trigger tubes are employed in the unit which indicates and times in split seconds a variety of swimming events, including water polo and diving. The results and timing are displayed on a 13 ft × 8 ft indicator using a lamp matrix digital indicator system. The complete equipment was designed and built by Ferguson engineers and installed under the supervision of Ewbank and Partners, the consulting engineers.

Due to the regulations stipulating three time-keepers in each lane, a fully automatic system could not be made.

The control console—7 ft long × 4 ft 8 in. high × 3 ft deep—is simple to use and needs only one operator. The operation cycle is set in motion by the starter's pistol and

upon receiving the push-button finish signals from the time-keepers the apparatus calculates the average time for each lane in accordance with the regulations and presents this information to the judge in the control room. The judge is then able, at his discretion, to switch the information through to the public indicator board.

The timing of swimming races by the equipment is achieved by running 18 electronic clocks—three for each lane. These clocks are initiated by the starting pistol at the commencement of the race.

At the end of the race three time-keepers operate electrical stop switches in the same way that they would normally operate the conventional stop watch, and the equipment averages these three times in a manner which conforms to the A.S.A. rules. By this means it is possible to separate accurately the difference in time between two competitors who finish almost together.

For further information circle 50 on Service Card

This picture shows in the top right-hand corner the glass-wall room containing the control console and, left of centre, the display panel

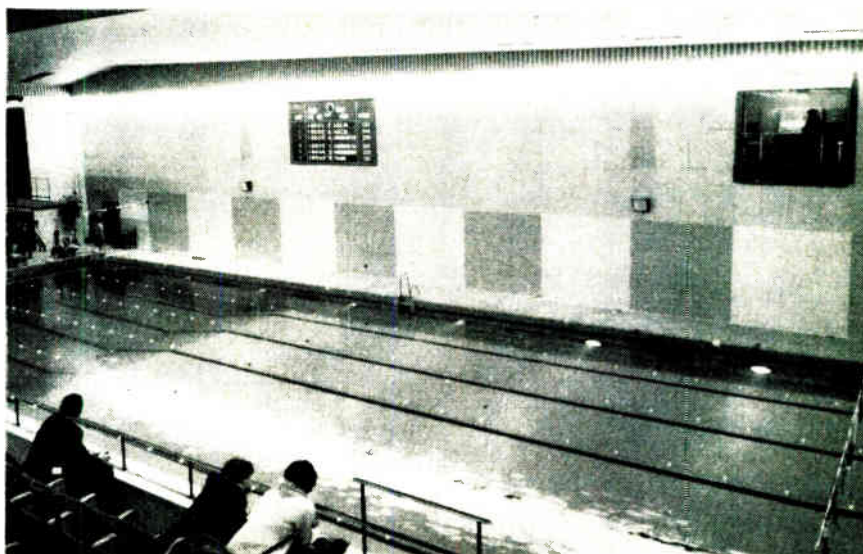

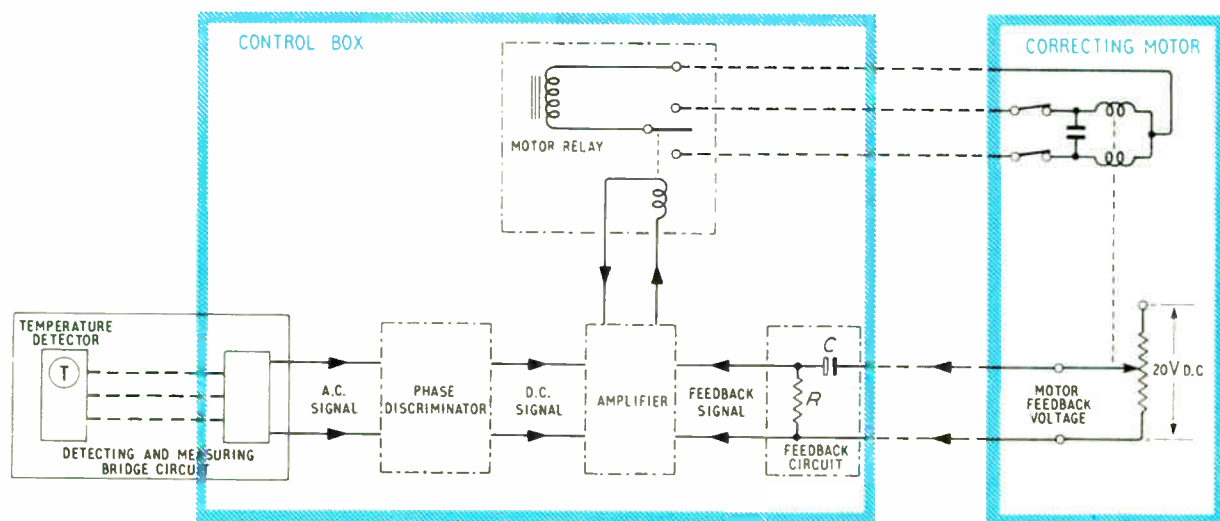

Fig. 1. Block diagram of simple proportional plus integral control as employed in the Duotronic controller

setting represents the number of degrees of temperature change at the detector which will cause 100% valve movement. For example, a typical proportional band width of 10 °F implies that a 10 ° change in temperature will cause the valve to move from 0 to 100% open. The desired valve setting is normally taken at the middle of the proportional band so that in practical terms this means that a controller set at (say) 70 °F with a 10 °F proportional band setting, would cause the valve to open fully if the temperature should drop to 65 °F, and to close fully if the temperature should rise to 75 °F.

It will be noticed in the above example that the desired temperature is only achieved when the valve is 50% open, and this represents a heat input exactly balancing the heat losses. At all other loads, calling for the valve to be at different positions, some deviation from the desired value will continue to persist in order to balance the bridge against the new valve position. Such continuing deviation for all loads other than that represented by a valve 50% open, is defined as proportional offset and is an inherent property of every proportional controller whether electronic or operating on any other system.

It is possible to reduce proportional offset by narrowing the proportional band setting, but this increases the valve movement for a particular deviation, and under certain plant conditions the valve may move too far so that overshoot is caused and hunting is set up. There is, therefore, a definite limit to which the proportional band can be reduced, and still continue to give stable control. Because of the very rapid response characteristic of the Satchwell Monotronic controller and its sensitive detector element, this lower limit of proportional band setting is considerably smaller than with other types of proportional controller. It is in this respect that electronic techniques have brought greatly improved performance to purely proportional control at a cost little greater than that of previously available electro-mechanical controllers.

It is seen from the foregoing that a further problem exists in cases where proportional offset is not acceptable. In the past, various means have been devised to measure load variations (e.g. by measuring the temperature of the air coming in from outside) and to use this information to compensate for proportional offset by resetting the control point of the main temperature detecting element.

Such methods have their disadvantages. They cannot

completely remove offset, but only reduce it. They can only compensate for one kind of load variation for each compensating detector used; thus if a detector is placed outside, this only compensates for load variations due to changes in outside air temperature. No account is taken of changes in heat gains within the room, and if the latter are also to be taken into account, additional compensating detectors are required. The system, therefore, becomes very complicated, and is extremely difficult to set up and commission without long thermal trials. Furthermore, such compensating thermostats or detectors incur considerable additional wiring, and therefore increase installation costs.

The Duotronic controller has introduced to the air-conditioning field for the first time the principle of proportional plus integral action, which entirely removes offset and at once solves all these problems.

The principle of integral action has been applied for some years in the industrial process control field, where such an action having time constants appropriate to process control has been achieved by pneumatic means. Some of the time constants involved in the air-conditioning field are very long, and no convenient means of producing adequate integral action was available in this field until the advent of the Duotronic controller.

Operation of the Duotronic Controller

The same principles of temperature detection and Wheatstone bridge methods are used as in the case of the Monotronic controller. However, the valve position feedback signal is treated differently. Instead of using a potentiometer directly in the bridge network, it is used as a potential divider in order to feed a certain d.c. voltage signal into a separate section of the electronic circuit which does two things: first, it feeds into the amplifier circuit a signal proportional to the valve position, which is balanced against the deviation signal derived from the Wheatstone bridge. Thus the initial action of the controller is purely proportional, and the valve moves by an amount corresponding to the deviation signal.

At the same time, however, the d.c. feedback voltage is used to charge a capacitor which is allowed to discharge slowly through a suitable resistance giving an appropriate time constant. As this slowly discharges, the proportional feedback signal gradually disappears, with the result that

the signal from the Wheatstone bridge and detector circuit is no longer balanced. This causes a further valve movement, which in turn brings about a new feedback signal, once again charging the capacitor and balancing the bridge circuit. The valve stops, until the capacitor discharges, and it then inches forward again. In this way the valve continues to move by small increments, intermittently, until the bridge detects no further deviation from the desired value. Thus offset is entirely eliminated. At the same time control stability is achieved because the valve moves initially only by an amount proportional to the deviation; the remainder of its movement taking place in small ever decreasing steps, eliminating offset but without any tendency to over-swing. Obviously the time constant of the capacitor-resistance network must be suitable to the plant in question, and for this reason a choice of three time constants of 15 minutes, 30 minutes and 60 minutes is available. The selection is by a knob on the control panel, and may thus be chosen to suit the plant after installation. The only other adjustments on a basic Duotronic controller are the desired value, and the proportional band. The latter can be set to quite a wide value since the integral action takes care of the eliminating offset. Fig. 1 is a block diagram of the single-stage Duotronic controller.

Field experience with this controller has shown it to be capable of dealing with very wide load fluctuations with a high degree of stability. Even oscillations set up by substantial load variations are rapidly attenuated. In fact, it has even been said that the controller is capable of "thinking for itself", since it is capable of correctly positioning a valve which has been over-sized, or an uncharacterized damper—factors which can seriously upset the correct operation of a purely proportional controller.

The scope of application of the Duotronic controller is thus extremely wide, as it can handle the most arduous plant conditions likely to be experienced in the heating and air-conditioning field. It is, nevertheless, extremely simple to install; only six wires are needed between the

control box and the heating valve motor and three wires to connect the room temperature detector to the control box. The control unit has three adjustments only.

In the foregoing, reference has repeatedly been made to 'temperature' as the parameter controlled and to 'motorized valve' as the correcting unit, supplying 'heat'. This has been done for simplicity of explanation. It should be noted that detecting elements are also available for pressure and humidity, and that the correcting may be applied by a heating or cooling valve, a humidifier, an electric step controller, a damper or set of dampers—indeed, any equipment which can be operated by a positioning motor. Up to three such units can be operated in sequence by Duotronic controllers, and a dead zone may be applied between two stages for economy purposes. A typical example might be the control in sequence of a heating valve, fresh air and recirculated air dampers and then, after passing through an adjustable dead zone, a chilled water valve. An example of such a scheme is shown in diagrammatic form in Fig. 2.

Space relative humidity can be controlled by applying such a sequence to a dewpoint plant, controlling the saturated air temperature after passing a spray washer; the air which is thus controlled to a known dewpoint value is subsequently reheated to the required space dry bulb condition controlled by means of a single-stage Duotronic controller with room temperature detector. Since the dewpoint and amount of reheat are both known, the ultimate relative humidity is determined. Fig. 3 shows a dewpoint and reheat scheme of this type.

It is sometimes recommended that the dewpoint be reset with variation in space relative humidity due to moisture gains arising from equipment in the room. In such cases, resetting in this manner is unnecessary with the Duotronic controller, because the integral action enables the dewpoint plant to be controlled direct from space r.h. without instability or offset. Two types of humidity detector are available, one making use of an element saturated with lithium chloride solution, the other using a specially pre-

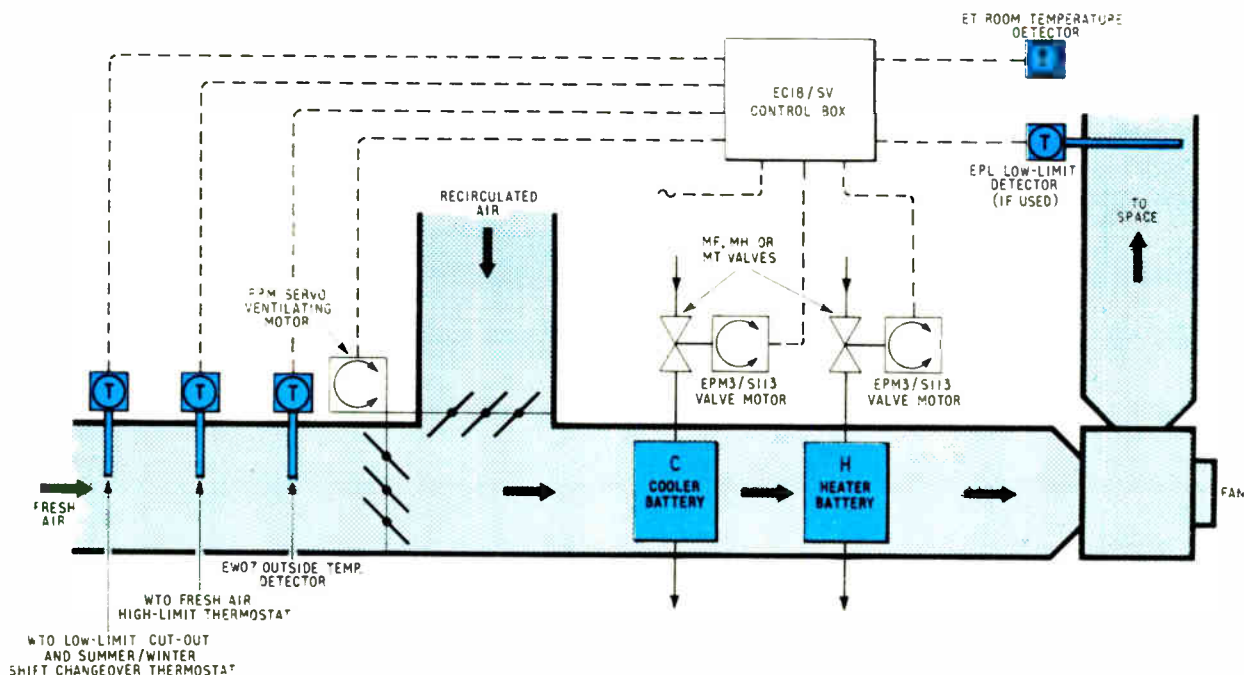

Fig. 2. Duotronic control applied to a combined heating, ventilating and cooling system

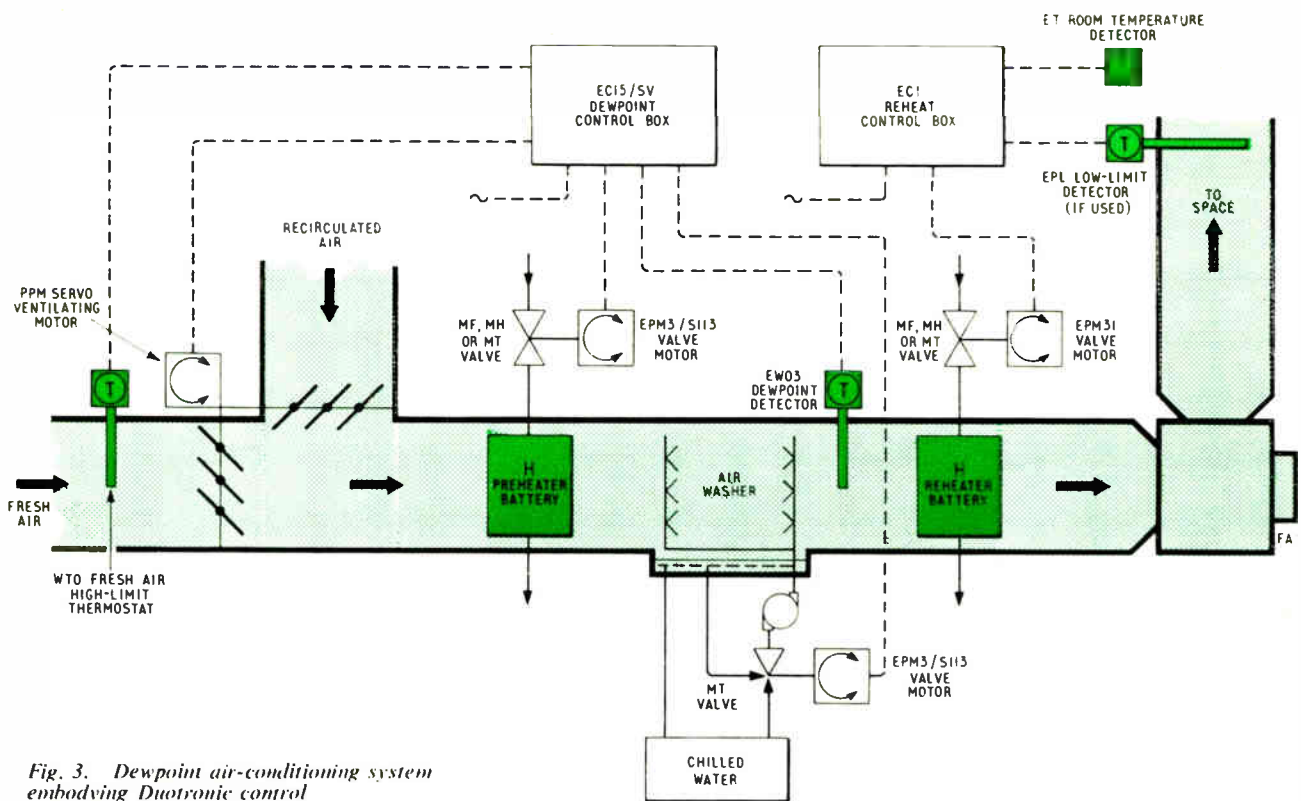

Fig. 3. Dewpoint air-conditioning system embodying Duotronic control

pared polystyrene wafer. Both of these result in resistance changes, which can be detected by the Wheatstone bridge in the controller. Thereafter, the control action is as described above.

Some Typical Applications

Computer Rooms.—Space temperature is controlled by a Duotronic controller operating a heater battery and cooler battery in sequence. Space humidity is controlled by a second Duotronic instrument (with humidity detector) operating in sequence a humidifier and a cooler for de-humidification.

Operating Theatres.—The dewpoint of a common air plant is controlled by a two-stage Duotronic box operating the preheater and cooler batteries in sequence; the air thus treated then branches to a pair of operating theatres, each with its own reheater battery. Space temperature in each theatre is controlled by individual Duotronic controllers operating the reheater battery valves; space relative humidity automatically follows from the fact that air at constant dewpoint is raised through a given number of °F. Local setting facilities are provided on a panel in the theatre sister's office, so that the temperature in each theatre can be selected to suit the needs of the surgeon; the average requirement of humidity can also be set by changing the dewpoint. When the temperature is changed (by means of the hand-setting potentiometer) a second potentiometer ganged to the first simultaneously modifies the dewpoint, so that the resulting space r.h. is held approximately constant.

High-Velocity Induction Units.—The current trend towards very tall buildings with large areas of glass has increased the popularity of the induction unit system, in which air is distributed from a central plant at high velocity. The condition of the air is controlled to a particular schedule, which may be different as between winter and summer; for example the air may be supplied at a constant

temperature of, say, 55 °F in winter, but at a temperature which is varied in accordance with the outside temperature during summer. This is termed outside compensation of air temperature, and a typical schedule might be for the air to be supplied at 80 °F when it is 55 °F outside, falling to 55 °F when it is 80 °F outside. In each room of the building the air thus treated is fed to induction units where it is discharged through nozzles in such a manner as to entrain room air, causing the latter to recirculate and mix with the supply air. The mixture is passed over a coil through which heated or chilled water may be passed. The building is divided into zones according to geographical aspect and height, and the requirements of each zone are matched by circulating water at a suitable temperature. Here again, the water may be at constant temperature or may be compensated; i.e., varied in relation to the outside temperature, solar effect, etc. In the above manner heating or cooling can be obtained as required, the final result frequently being tempered by some form of local manual or thermostatic control in each room.

Duotronic equipment specially designed to take into account the sun's effect upon buildings has been applied with marked success to the control of the individual zone water circuits, and standard Duotronic equipment is used on the main air plant. In both cases the individual schedules called for can be provided by the use of inside and outside temperature detectors, and a combination of Wheatstone bridges. Using electronics, it is a very simple matter to derive the sum of the output signals from an inside temperature bridge and an outside temperature bridge. Where the refinement of solar effect is also required, an additional solar bridge is employed with special detectors sensitive to the sun's radiation. By adjusting the voltage supplied to each bridge, individual adjustment of the amount of authority, due to the outside temperature or to the sun's effect, can be provided in an extremely neat manner.

FRICITION AND WEAR STUDIES

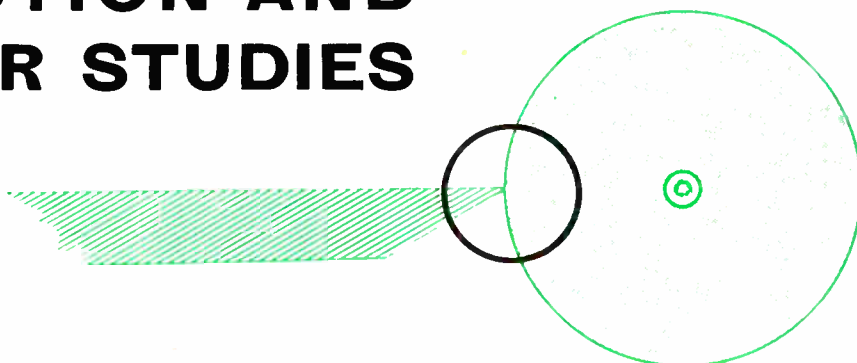

By DENIS TAYLOR,
M.Sc., Ph.D., F.Inst.P.*

This article discusses the way in which radioactive tracer techniques are used to study wear. The applications include wear on pistons and cylinder walls, tungsten carbide cutting tools and rubber tyres.

RADIOACTIVE tracer techniques can be conveniently employed for the study of friction and wear problems. In earlier times in studying the wear problems in piston engines, long running times were involved, the engine had to be dismantled and careful cleaning and weighing of the worn components was necessary. In the new techniques made possible by the availability and easy production of radioactive materials, the ordinary cast-iron piston rings are activated (usually by neutron bombardment in a nuclear reactor) and then installed in the test-engine. It is then only necessary to measure the amount of radioactive iron in the circulating lubricating oil under the required test conditions. This system is illustrated in Fig. 1.

This is an extremely powerful technique, which has been applied to the study of wear on air cleaner performance, the sulphur content of the fuel, the use of different grades of lubricating oil, the use of lubricating oil with different additives, the effect of bearing load, the effect of operating temperature, and many other variations. In all cases it is only necessary to monitor the radioactive iron in the circulating lubricating oil to determine the wear. This

involves passing the oil through a monitoring compartment containing the radiation detector connected to a counting circuit, the output of which is presented on a meter and gives the activity of the oil passing through the compartment.

The main isotopes produced under neutron bombardment in a nuclear reactor are Iron 55 (Fe^{55} with a half-life of 2.9 years) and Iron 59 (Fe^{59} with a half-life of 46 days), and so in this case a relatively long irradiation time (of the order of a month) is necessary. On the other hand, the activity is slowly decaying (relatively speaking) so that long test experiments are possible. Oil pumped through the system carries with it any abraded particles; these abraded particles will be characteristically radioactive in the same proportion as the wearing parts. Hence, by measuring the radioactivity of the oil containing the abraded particles, the amount of wear can be determined. Greater precision of measurement is possible using a sampling system, in which a sample of the oil is removed to a radioactivity assay apparatus, but for many purposes the continuous monitoring system illustrated in Fig. 1 is preferred.

One of the simplest tests is that of investigating the wear with different lubricating oils as a function of load. The sort of results which may be obtained are shown in Fig. 2.

Plessey Nuclonics Ltd.

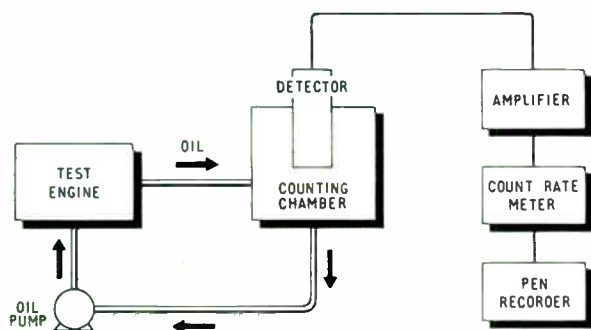

Fig. 1. Typical system for engine wear studies

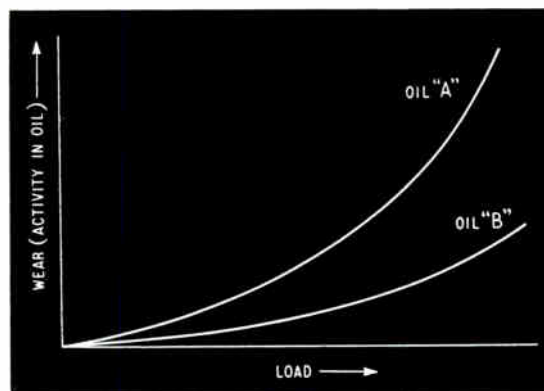

Fig. 2. Wear data experiment for two lubricating oils

In some engine tests the oil may be at a high temperature, and as some types of radiation detector are temperature sensitive, and will not operate at high temperatures, special methods have to be employed. If the sampling method is employed the oil sample can be cooled before being introduced into the assay apparatus. With a continuous monitoring system, a heat exchanger (to extract the heat) and a heater must be introduced in the pipe line on either side of the counting chamber so that the oil passing in the vicinity of the detector in the counting chamber is at an acceptable temperature.

Further Measuring Techniques

Many variations of this basic scheme have been used in engine studies. Thus, in some cases, apart from measuring piston-ring wear, it is of interest to determine how much the ring rotates in its groove. This is normally accomplished by incorporating in the test ring a small piece of cobalt, which becomes activated along with the iron on neutron irradiation in the nuclear reactor. In fact the cobalt becomes activated to a much greater extent than the iron and it is convenient to monitor the position of the cobalt from outside the engine with suitable radiation detectors. Two Geiger counters have been employed positioned at 90° to one another, and the relative changes in their responses allows the position of the ring and its movement to be ascertained.

It is also possible to carry out more elaborate investigations by introducing two different radioactive tracers so that the wear problems on two different surfaces can be studied simultaneously. Thus, chromium can be introduced into the cylinder wall of the engine (this gives Cr⁵¹ which emits a 0.32 MeV gamma ray after irradiation), and iron in the piston rings (this gives Fe⁵⁹ which emits gamma rays of 1.1 and 1.3 MeV after irradiation). It is then possible to sort the pulses from the radiation detector into two groups, the first group corresponding to the gamma rays of 0.32 MeV and the second group corresponding to gamma rays of 1.1 and 1.3 MeV. This is possible if a scintillation counter is used as the radiation detector, because the counter behaves as a proportional device in this case and gives output pulses whose heights are linearly proportional to the energy of the gamma rays producing them. Fig. 3 shows the pulse height distribution (usually called the energy spectrum) for a sample containing Cr⁵¹ and Fe⁵⁹. By counting only the pulses corresponding to the first channel (see Fig. 3) the wear corresponding to the piston rings is measured, whereas by counting only the pulses in the second channel the wear corresponding to the cylinder wall is measured. Hence, it is only necessary to use a two-channel pulse-height analyser with the two channels adjusted to correspond to Cr⁵¹ and Fe⁵⁹ respectively. Fig. 4 shows schematically the different components of the system.

Other Applications

The same tracer technique may be employed for the study of a number of other wear problems. Thus, irradiated tungsten carbide cutting tools have been used by a number of investigators for studying tool life. Tests have also been made of gear wear and wire-drawing die wear as a function of operating conditions, lubricant, etc.

Investigations have also been made of rubber tyre wear by adding radiophosphorus (P³²) as triphenyl phosphate to the rubber compound used to produce the test tyre. Radiophosphorus (P³²) has a half-life of 14 days and emits beta-particles of 1.7 MeV in the decay process. Beta-particles are very much less penetrating than gamma-rays, and special counters with thin windows* must be used. In

* The 'window' of a radiation detector must be penetrated by the beta-particles to reach the sensitive volume and be detected.

this case it is convenient to mount the detection apparatus in a suitable way to measure the amount of radioactive rubber released into the air by the wearing of the tyre tread on the roadway on rotation.

Still another application is the measurement of wear in blast furnace linings. The preferred method here is to insert pellets of radioactive cobalt (Co⁶⁰) in the brick lining at various depths, and for convenience at locations well separated around the wall of the furnace. Wearing of the wall will cause these pellets to drop into the furnace product, and as the presence (or absence) of the pellets in their initial positions in the wall can be determined by monitoring the external wall of the furnace with a Geiger counter instrument, the amount of wear at any time is readily determined. Radiocobalt (Co⁶⁰) emits gamma rays of energy 1.1 and 1.3 MeV and this provides sufficient penetrating power for the radiations to be detectable from the outside of the furnace wall. It will be appreciated that for this application it is desirable to choose a radioisotope with an appreciable half-life as the wall wear may be relatively slow. However, this means that some activity remains in the pellet after it has completed its work. Fortunately, this doesn't matter because the pellets are so diluted in the blast furnace product that although radioactive steel is produced it is harmless. Still another technique which is particularly useful for studying material transfer between sliding and impacting materials is to fabricate the material as a hemispherical slider which is then irradiated in a nuclear reactor. The slider is then moved along the surface of a flat test strip and the quantity of radioactive material transferred to the strip (i.e., the wear) determined by means of autoradiography.†

Conclusions

The method of studying wear problems using radioactive tracers has several major advantages. Some of these have already been mentioned; the omissions will be remedied here. The advantages are:

1. High sensitivity in establishing the state of wear, reaching 10⁻⁸ gram in a typical case;
2. Possibility of simultaneous detection of wear in several details during the actual process of operation without dismantling the machine or disturbing the conditions of operation;

† Radioactive materials affect a photographic plate and an autoradiograph is a photographic record of the radiation from radioactive materials in an object. The photograph, therefore, provides information regarding the location and amount of radioactive material.

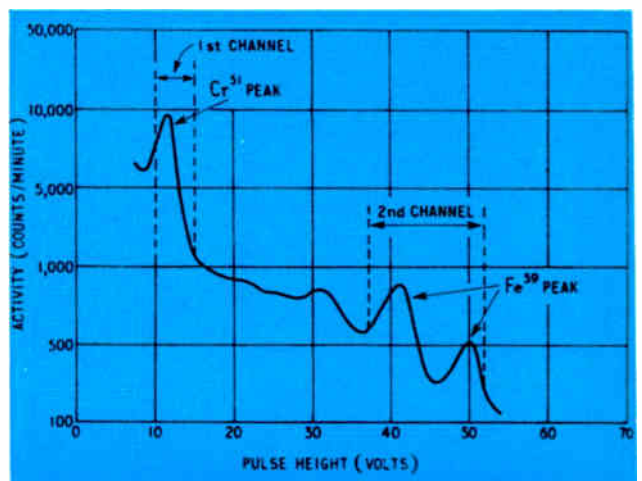

Fig. 3. Pulse height distribution for sample containing Cr⁵¹ and Fe⁵⁹

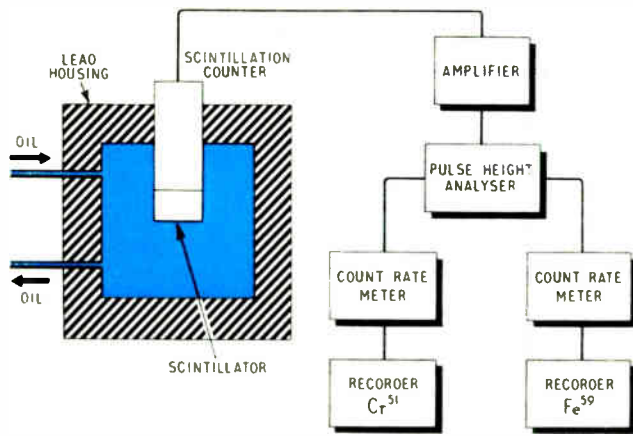

Fig. 4. Two-channel analyser for engine wear studies

3. Convenience of automatic recording ;
4. Application of autoradiography in studying the phenomena of metal transfer ;
5. Because of the high sensitivity of the method, the time required for carrying-out an experiment is very much reduced and results are much more accurate.

These advantages are considered in more detail by B. D. Grazin, 'The Use of Radioactive Isotopes in the Study of Wear of Machine Parts', *Proceedings of Inter. Conf. Atomic Energy*, Geneva, Vol. 15, pp. 160-166, August, 1955.

At the present time much use is being made of these techniques, but it is apparent that applications will continue to increase. Apart from general studies of friction and wear, the tracer method may be used to determine the actual area of contact of rubbing surfaces, investigation of the influence of lubricant-film thickness on metal wear, etc. Much has been done in investigating the wear of cutting instruments and the effect of the conditions of cutting which, in turn, has allowed the solving of several theoretical cutting problems.

Electronic Temperature Control

The Kelvin Hughes Division of S. Smith & Sons have developed a very accurate temperature control system, for maintaining the temperature of an oven at a specific point, with a short-term stability of 0.01 °C.

In this, four heating resistors of an oven have equal resistances but unequal temperature coefficients. At the required temperature the bridge is balanced: deviation from the set temperature results in an unbalance of the bridge.

Direct current is used for supplying the heating power, superimposed on which is an a.c. signal so that the balance condition of the bridge may be determined. An a.c. amplifier followed by a phase-sensitive detector provide a d.c. signal proportional to the temperature error. This error signal controls a simple d.c. amplifier, which, in its turn, controls the d.c. heating power. The whole thus forms a closed-loop proportional temperature controller.

The advantage claimed for this system is that overshoot is impossible and therefore much higher loop gains may be used than are possible with normal thermostatic systems. It is also unnecessary to use large thermal masses to achieve stability, so that if required very rapid warm-up times are possible, and the system may also be heavily lagged to reduce heat losses and further improve the performance.

The schematic diagram shows the basic essentials of such a system; there are, however, many possible variations: it is not necessary, for instance, to have all four arms of the bridge in the oven. The system is capable of operation over a very wide range of temperature and power levels, providing suitable resistance elements are used. For a quartz crystal oven recently developed, two of the resistors were of copper wire and the other two of Eureka wire of low temperature coefficient of resistance. With this simple system and without any elaborate precautions, the performance over short periods was 0.1 °C per hour with a long-term stability of 0.25 °C. Using a double system with the inner system a few degrees above the outer: stabilities of the order of 0.01 °C per hour with long-term stability of 0.05 °C have

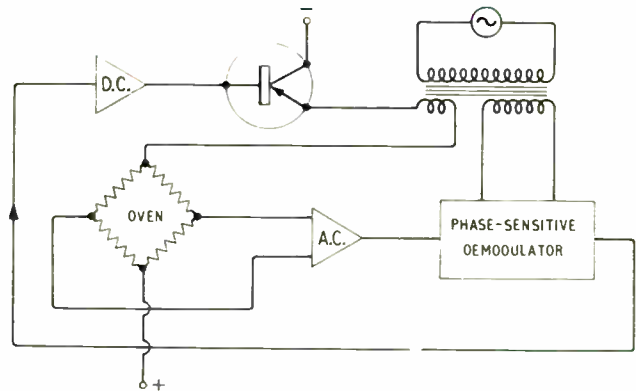

been obtained, and it is thought that these do not represent the limits of the system. It is anticipated that the price of the simpler form of oven quoted above, including, say, a crystal oven, will be in the region of £35.

For further information circle 51 on Service Card

INFORMATION WANTED?

If you require further details of products or processes described or advertised in INDUSTRIAL ELECTRONICS you will find it convenient to use the enquiry cards which will be found in the front and back of the journal.

APPLICATIONS
ILLUSTRATED

Robotugs



A

FIVE years ago E.M.I. Robotugs were classed as an interesting development with a promising future. Today installations of these driverless electric tugs are being used in many factories to provide an efficient means of transport.

The basic system comprises a battery-driven tug, a loop of wire buried into, or tacked to, the floor and an a.c. energizing source to provide a current through the loop of wire. The alternating current produces a magnetic field around the wire and the sensing coils, one on each front side of the tug, have e.m.f.s. induced into them. When the tug is directly over the guide wire the induced signals are equal. If the tug is not directly over the wire then the induced signals are not equal and the resulting difference signal is amplified and fed to the steering motor to make the tug follow the guide wire.

Experience and development have resulted in many improvements to the basic system. To avoid collisions between tugs, the track is energized in sections and one section behind each one occupied is automatically de-energized and cannot be energized until the front tug is clear of its section. This means that there is always one 'dead' section between tugs. Other improvements include multi-branch tracks, facilities for pre-programming each tug to stop at any 'station' and automatic routing and retrieval.

Illustrated here are a number of Robotug installations showing tugs doing a variety of jobs.

For further information circle 52 on Service Card

B

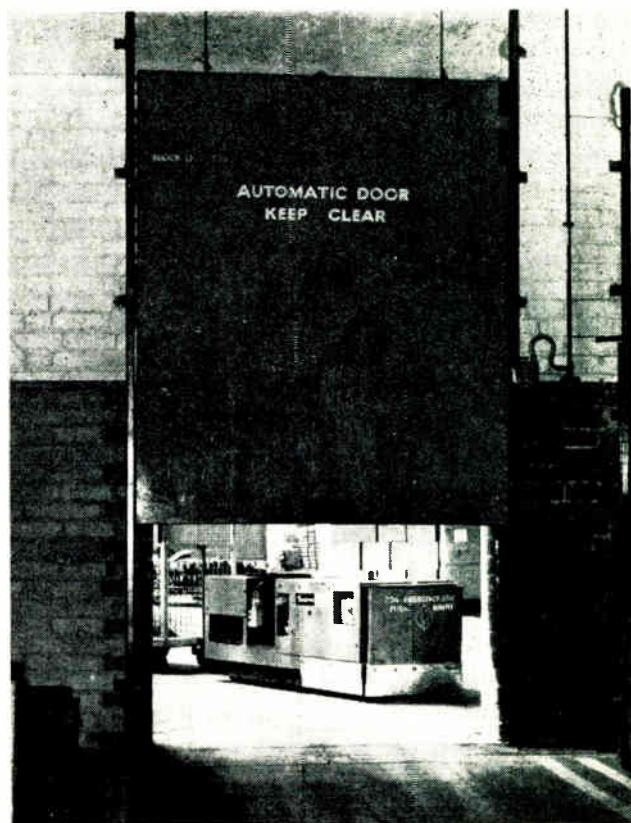
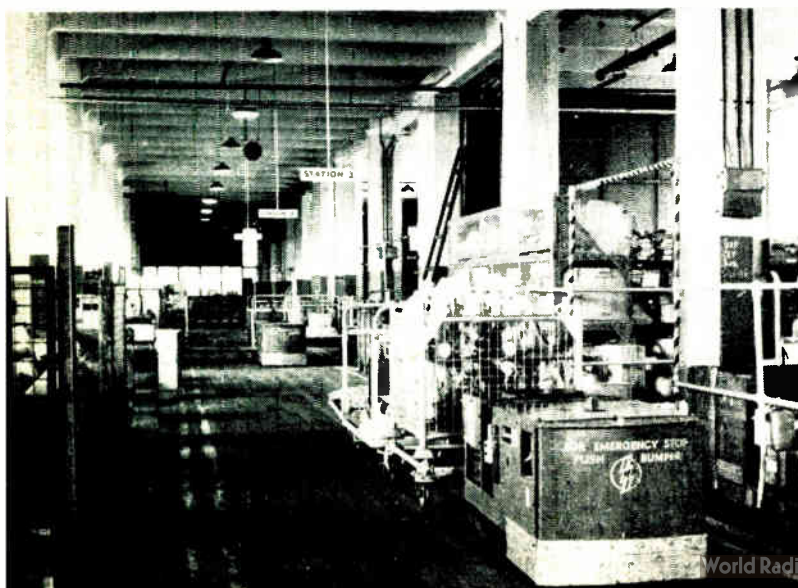

C

(A) Shown here at the Greenford factory of J. Lyons & Co. is part of a Robotug system which has eliminated the need for staff to work outdoors. A covered tug is used to transport 1½-ton loads of tinned coffee from the packing factories to the despatch warehouse 100 yards away. As the Robotug's route crosses a road frequently used by lorries, a system of traffic lights is controlled by the tug

(B) This is part of the main warehouse of Rootes Motors (Parts) Ltd., which is equipped with an extensive track layout and two Robotugs. The picture shows four checking stations in the Goods Inwards Department, where tugs collect trailers for transportation to stores areas on upper floors

(C) Here again part of the Rootes Motors' installation is shown. Illustrated is a tug passing over a contact point in the track which automatically raises sliding doors

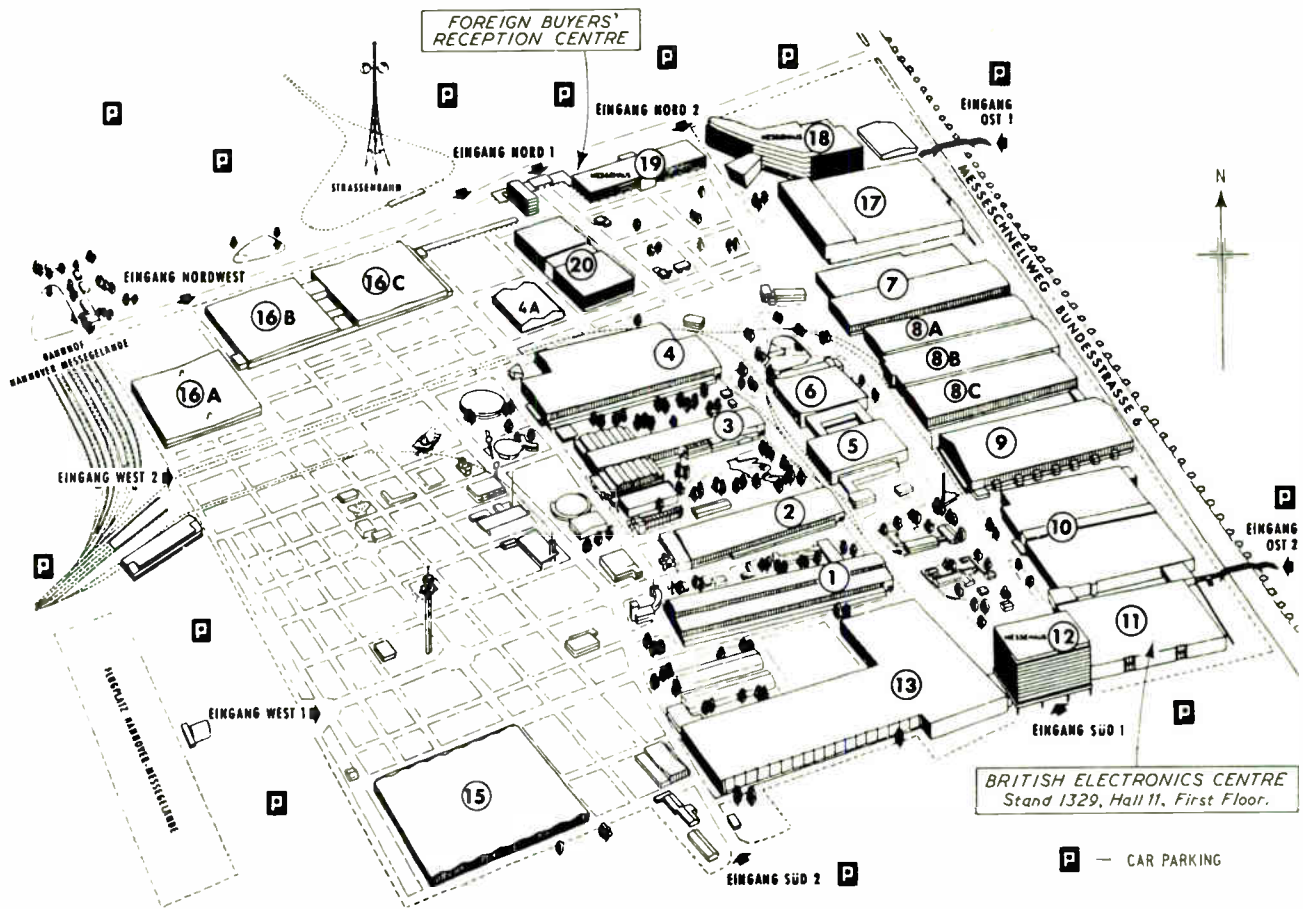

DESCRIBED as an ideal means of international integration in industry, the Hanover Fair is certainly now established as one of the leading shows for the technical trades, capital and consumer goods industries.

This year the Fair will open its doors at Hanover on Sunday, 28th April, at 9 a.m. It will be open every day from 9 a.m. to 6 p.m. up to and including Tuesday, 7th May. Season tickets can be obtained from Schenkers Ltd., 13 Finsbury Square, London, E.C.2, at a cost of 11s. 6d. If purchased in Hanover they would cost the equivalent of 17s. 6d.

Among the 4,400 exhibitors from Germany and some 1,100 from twenty-five other industrial nations of Europe and North America there will be a British contingent representing part of the U.K. electronics industry.

A group of British manufacturers will once again provide a combined display known as the British Electronic Centre on stand 1329 in hall 11 (first floor). Other British manufacturers will be showing products on their agents' and representatives' stands.

The British Electronic Centre will include some of the latest electronic products. A.B. Metal Products Ltd., for example, are adding television aerials and ancillary equipment to their range of components on display. Cosmocord Ltd. are exhibiting two new microphones, the MIC52 and MIC60, which are adjusted to give a linear response from 20 c/s to 10 kc/s by control of the damping of the diaphragm main resonance. British Electric Resistance Co. Ltd. are showing a range of packaged control circuits, using silicon devices, which can be assembled to form complete control systems. The Derritron Electronics Group are featuring their largest vibration equipment, which has a thrust of 340 kg. Electrolube Ltd. are contributing with their range of special lubricants. The English Electric Company's Fuse Division are taking to the Fair a range of electrical protective devices. A special highlight will be their high rupturing capacity fuses for the protection of semiconductor rectifiers. Along with their range of tantalum electrolytics A. H. Hunt (Capacitors) Ltd. are exhibiting three newly-developed capacitors in which the insulation and operating temperature range have both been improved. Painton and Co. Ltd. are showing some additions to their 159 series of multiple plugs and sockets. A newcomer to the Centre, British Physical Laboratories, will be displaying a range of instruments for fundamental electrical measurements. Also London Electric Wire Company and Smiths Ltd., the well-known manufacturers of winding wires, and Insuloid Manufacturing Co. Ltd., the specialists in cable fixing devices, are showing again in the British Electronic Centre at Hanover.

1963



**Hanover
Fair**

EQUIPMENT

review

1. Multi-Channel Recording System

A penless recording system with up to sixty channels available on a single chart has been developed by Vacuum Reflex. Amplifiers are available which will accept signals from most sensing elements used in environmental testing, process control, telemetry, etc.

This recorder operates on the principle of voltage/time conversion; i.e., the signal voltage is converted into a delayed pulse with the delay proportional to voltage. The main advantages of this system are that it permits the simultaneous recording of as many channels as can conveniently be interpreted and that each channel can utilize the full paper width. Channel identification is by a superimposed code.

Each input channel is sampled every 0.5 sec and any single channel can be simultaneously monitored by means of a digital read-out facility.

If an immediate visible record is not needed, signals can be stored on magnetic tape to be played back and recorded on chart paper when required.—*Vacuum Reflex Ltd., 6 Soho Street, London, W.1.*

For further information circle 1 on Service Card

2. Miniature Potentiometer

Ancillary Developments have announced a new type of miniature trimmer potentiometer with an oxide film as the resistive element which has applications in high-frequency equipment and as a replacement for conventional wire-wound trimmers. With the existing size of unit (1.25 by 0.275 by 0.4 in.) elements can be made with values up to 3 M Ω .

Manufacture is by firing a metal oxide on to a high-temperature glass substrate which is, in turn, cemented to a mica-glass moulding to provide distortion-free support. Adjustment is by means of a 32-turn lead screw sealed by two silicone rubber 'O' rings.

The A.D.O. series potentiometer,

which weighs less than 5½ gm, will function under severe environmental conditions and is stable over an ambient temperature range from -50 °C to +150 °C. Power rating is 0.1 W and the overall resistance tolerance is 20%.—*Ancillary Developments Ltd., Ancilco Works, Surrey Avenue, Camberley, Surrey.*

For further information circle 2 on Service Card

3. Packaged Circuit Amplifiers

Newmarket Transistors are offering a range of pre-assembled, miniature packaged circuit amplifiers, intended primarily for use as standard production components. By selective assembly, the tolerances on the transistors and other components in the circuit are so arranged as to provide a very narrow performance spread in respect of the completed units.

The PC.1 is a general purpose

125-mW output audio amplifier with complementary symmetry p-n-p/n-p-n circuits. PC.2, 3 and 4 are 330-mW amplifiers similar in design to the PC.1 with different input impedances and sensitivities.

All the units are intended for 9-V operation and the approximate size is 2 to 3 cu in.—*Newmarket Transistors Ltd., Exning Road, Newmarket, Suffolk.*

For further information circle 3 on Service Card

4. High Vacuum Pumps

Ferranti have developed a range of vacuum pumps capable of reducing pressures to less than 10⁻¹² atm. This degree of vacuum is now frequently required for work in electronics, nucleonics, space research, etc.

In the first of two stages, a rough vacuum of about 10⁻⁵ atm is obtained by means of an absorption type pump which employs the cooling effect of liquid nitrogen on a complex aluminosilicate compound. The second stage of the evacuation is carried out by an electronic titanium getter pump: this consists of an anode shaped like an open-ended box with two titanium cathodes opposite the ends. An electrical discharge ionizes the gas and the positive ions which bombard the cathodes cause them to sputter chemically active titanium on to the anode, the constantly recoated surface of which absorbs the gas in the system.

One important advantage of this type of pump is that, as it is isolated from the rough vacuum pump, it may

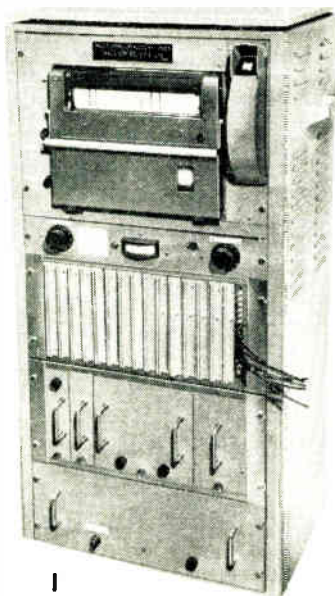

1



2

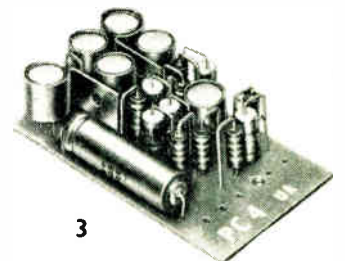

3

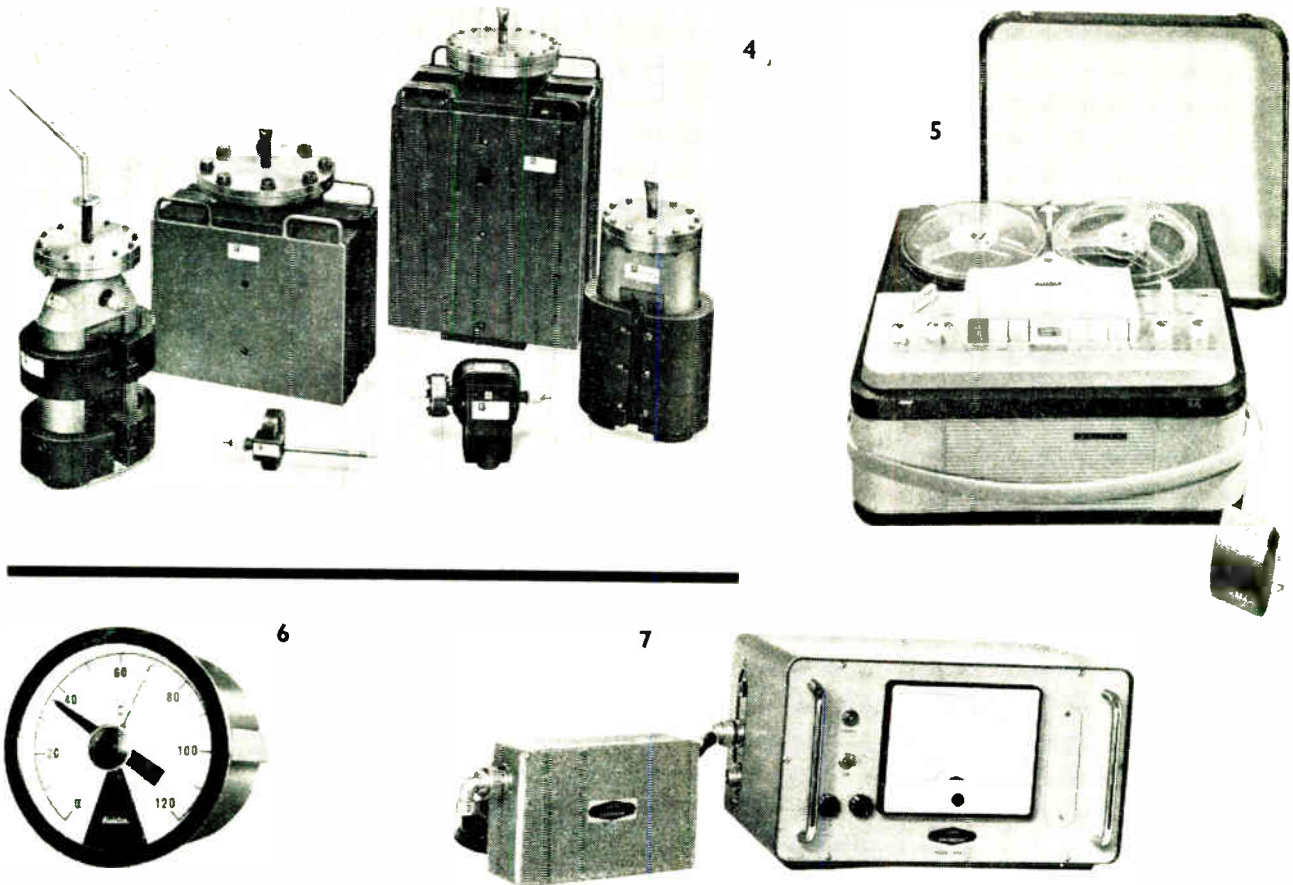

be left to operate unattended without fear of an ingress of gas in the event of a power failure. In addition, it provides a uniform pumping speed without any fluid or heat being involved and normally has a maintenance-free long life.

The series FJD Titanium Getter pumps are available with pumping speeds ranging from 1 to 400 litres/sec and can be supplied with power supply units, control units and other ancillary equipment.— *Ferranti Ltd., Hollinwood, Lancs.*

For further information circle 4 on Service Card

5. Four-Speed Tape Recorder

Philips have recently introduced a low-priced (62 gns), all-transistor tape recorder, Model EL3459.

Although this four-speed, four-track machine is primarily intended for domestic use, it may find professional applications by virtue of its quality.

Parallel-track replay is provided in place of the super-imposition facility on earlier models. Tape speeds are $\frac{1}{8}$, $1\frac{1}{8}$, $3\frac{1}{2}$ and $7\frac{1}{2}$ in./sec with a frequency range of 60 c/s to 4.5 kc/s at

$\frac{1}{8}$ in./sec and 60 c/s to 16 kc/s at $7\frac{1}{2}$ in./sec.

Inputs: microphone, 1 mV into 1 k Ω ; diode, 3 mV into 20 k Ω ; pick-up, 150 mV into 500 k Ω . — *Philips Electrical Ltd., Century House, Shaftesbury Avenue, London, W.C.2.*

For further information circle 5 on Service Card

6. Improved Temperature Indicator/Controller

Fielden Electronics have introduced a new version of their Bikini electronic temperature indicator/controller with the accent on high precision at low cost. While this model is of the same basic construction as the previous versions, a number of modifications have been made to the circuitry. The use of a transistorized switching circuit to actuate the external control relay has improved reproducibility and reduced the switching differential to 0.2 °C. Temperatures can be controlled to better than 1 °C.

The instrument, which is servo-operated, can be situated several hundred feet from the platinum resistance elements with which it is

designed to be used. It is available in a wide variety of ranges from -200 °C to +850 °C (and Fahrenheit equivalents). — *Fielden Electronics Ltd., Wythenshawe, Manchester 22.*

For further information circle 6 on Service Card

7. Continuous Moisture Meter

The Kappa model AB80 continuous moisture meter, although primarily designed for continuous flow applications, can also be used on individual samples and for monitoring the moisture content of bulk-stored material.

The equipment measures the effect of the substance concerned upon the capacitance of an appropriate cell or probe. A measuring head operating at a nominal frequency of 13.0 Mc/s is mounted adjacent to the cell and a remotely connected monitor unit (up to 300 ft away) gives a direct reading of the relative moisture content. An external output signal of 1 mA into 140 Ω is available for recording and control purposes.

The measuring range of moisture content is from 0.1% to more than

60% depending on the material and the cell design. Maximum sensitivity is 0.5 pF f.s.d. and temperature stability better than 2%, f.s.d. per 10 °C with a maximum ambient temperature of 60 °C.—*Kappa Electronics, 159 Hammersmith Road, London, W.6.*

For further information circle 7 on Service Card



9

8. Electronic Transmission System

Evershed and Vignoles announce the introduction of a series of measurement transmitters, designated series 300, together with a transistorized power unit for use with any of the transmitters.

The sensing system of the transmitters retains the principle of force balance used in the Evershed electronic repeater system, but makes use of a capacitance sensing device giving improved accuracy and sensitivity. The moving vane of the capacitor is connected to a transistor oscillator, the fixed vanes being connected to a differential rectifier and transistor amplifier. The oscillator and amplifier circuits are encapsulated in a block of epoxy resin mounted within the transmitter.—*Evershed and Vignoles Ltd., Instrumentation and Controls Division, Acton Lane Works, Chiswick, London, W.4.*

For further information circle 8 on Service Card

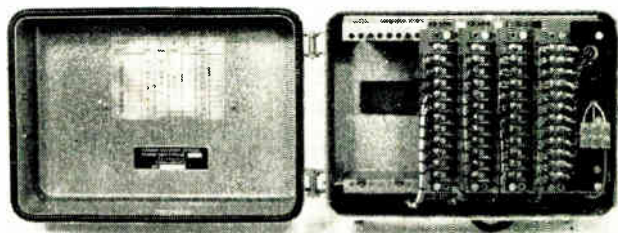

8

9. Crypton Electronic Rev-Counters

Continuous development has resulted in several important improvements in the Crypton electronic rev-counter.

By use of a new transistorized circuit, a steady reading at all speeds on all engines is assured. Connections (only three are necessary) are taken to the low tension system, and there is no interference with ignition performance.

Readability has also been improved by a new dial design, an important advantage when driving at speed. Glare-proof indirect lighting is provided for night use.

All models are now available for use on both positive and negative earth systems. If a motorist changes from a 4-cylinder, 12-volt car to a 6-cylinder, 12-volt model, an inexpensive conversion unit is available.

A protective shield is fitted to prevent the ingress of dirt and dust and protection is also built into the circuit to prevent damage should incorrect connections be made. Standard versions cost £10 10s each.—*Crypton Equipment Ltd., Bridgwater, Somerset.*

For further information circle 9 on Service Card

10. Instrumentation Recorder

A 1.5-Mc/s instrumentation recorder with up to 14 tracks has been introduced by Ampex.

The FR-1400 all solid-state recorder is designed to provide predetection recording of telemetry information and incorporates linear phase response and low intermodulation distortion. It is available with wideband f.m. response from d.c. to 500 kc/s.

The FR-1400 transport, with both dynamic and mechanical braking, features built-in tape shuttle and search, retractable heads and air guiding for increased head and tape life. It has four tape speeds, 120 to 15 i.p.s., and is quickly converted from ½ in. to 1 in. operation, and vice versa. Transport speeds and electronics are switched from a front panel control with no adjustments needed.

Introduced for use with the FR-1400 and other short wavelength applications, is an Ampex instrumentation tape, type 9101, with improved response and high-frequency resolution, available in 7,200-ft lengths.—*Ampex Great Britain Ltd., 72 Berkeley Avenue, Reading, Berks.*

For further information circle 10 on Service Card

11. Sub-Miniature Lampholder

A sub-miniature indicator lampholder for general electronic applications recently announced by Thorn measures only 0.900 in. in length and 0.394 in. in diameter (including tags).

This holder is intended for use with the L1015 sub-miniature lamp which, when operated at 5 V, has a light output of 0.25 lumen and an average life expectancy of 60,000 hr, the corresponding figures for 6-V operation being 1 lumen and 10,000 hr.

Lenses are available in red, green, amber and blue; a clear lens can also be supplied. The operating temperature range is from -40 °C to +70 °C.—*Thorn Electrical Industries Ltd. (Special Products Division), Great Cambridge Road, Enfield, Middlesex.*

For further information circle 11 on Service Card

12. Radar C.R.T.s.

Two cathode-ray tubes intended for use in transistorized radar equipments are now available from Mullard. The first is an 8½-in. diameter tube (type number F21-10LD) and the second a 12-in. diameter tube (type number F31-10LC). Both tubes have a long persistence metal-backed screen with an orange after-glow. Low-voltage electrostatic focusing and double magnetic deflection are common to both types.

The F21-10LD has a 41° deflection angle and under typical operating conditions requires a final anode voltage of 14 kV. The focusing electrode control range is from 0 to 400 V. For visual extinction of a focused spot the grid voltage varies from -32 V to -48 V and the cathode voltage from 30 V to 45 V. Maximum overall dimensions are 460 mm length by 216.5 mm

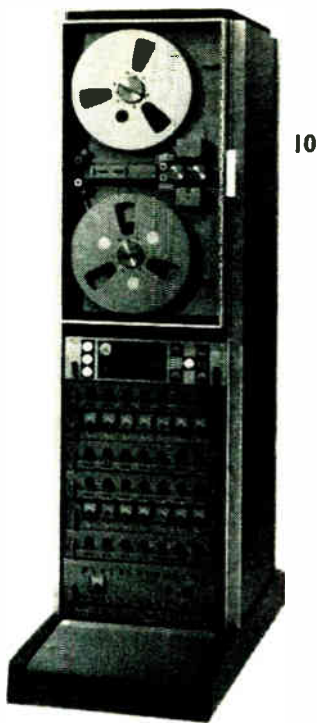

10



11

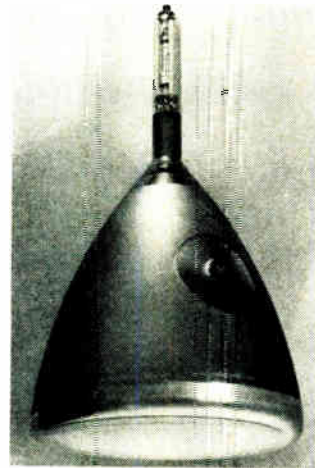

12

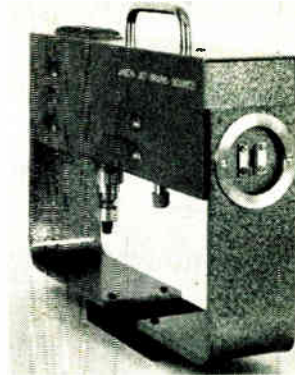

13



14

diameter. The maximum neck diameter is 35 mm and the weight approximately 5½ lb.

The deflection angle of the F31-10LC is 40° and under typical operating conditions the tube requires a final anode voltage of 15 kV. The focusing electrode control range is from -100 V to +300 V and the grid and cathode voltage required for visual extinction of a focused spot is as stated for the F21-10LD. Maximum overall dimensions are 572 mm length by 307 mm diameter. The maximum neck diameter is 35 mm and the weight approximately 15 lb 8 oz.

The heater voltage of both tubes is 6.3 V.—Mullard Ltd., Mullard House, Torrington Place, London, W.C.1.

For further information circle 12 on Service Card

13. Argon Jet Spark Light Source

This light source by Lunartron, based on a design by the National Physical Laboratory, utilizes a jet of argon pumped through the spark gap to stabilize the position of the arc, thus enabling the spark to be focused accurately. A novel feature is the inclusion of a filament lamp to permit adjustment of the optical system prior to use by means of an internally-mounted lens. A variable width optical slit is provided at the front of the unit, which is arranged in two portions:— (a) the spark gap with storage capacitors and trigger transformer, as illustrated, and (b) the power supplies

and trigger circuits, the latter constructed in a standard 19 in. rack-mounting panel, with all controls forward mounted. A remote tripping box is available to permit the operation of the spark gap at a distance of up to 50 yards from the operator.

The illumination time is 0.2 μsec and peak intensity is achieved in 0.04 μsec. The input to the spark gap is approximately 3 joules.

Applications include Schlieren and other high-speed photographic techniques.—Lunartron Electronics Ltd., 42 Langley Street, Luton, Beds.

For further information circle 13 on Service Card

14. Tri-Axis Strain Gauge Accelerometer

A tri-axis strain gauge accelerometer, Type 4-204, which measures acceleration along three mutually perpendicular axes, is now marketed in the U.K. by Consolidated Electro-dynamics.

Dimensions of the tri-axis strain gauge are 2.21 by 2.25 by 1.78 in., and its weight is approximately 7 oz.

Acceleration ranges are available from ±5 g to ±500 g. Cross axis response is less than 0.01 g per g for ranges through ±100 g. The operating temperature range is -70 °F to +300 °F. The combined effects of linearity and hysteresis do not exceed ±0.75 per cent of the full range output for each axis.

The mounting structure of the instrument is fitted with three

factory-interchangeable accelerometer modules. Each module consists of a four-active-arm, spring-type unbonded strain gauge element and a seismic mass damped by a viscous fluid.

Since all the three accelerometer modules are self-contained, sealed units, the type 4-204 can be supplied with any available acceleration range for any of its three axes.—The Consolidated Electro-dynamics Corporation (U.K.) Ltd., 14 Commercial Road, Woking, Surrey.

For further information circle 14 on Service Card

15. Transistor Analyser

Philips have introduced the transistor analyser type PM6505 with which a comprehensive range of measurements can be made on p-n-p and n-p-n transistors and semiconductor diodes. It provides for the simultaneous connection of two transistors and for rapid switching between them for purposes of comparison, thus simplifying selection and matching.

This instrument, which is mains operated and weighs 41½ lb, contains four stabilized power-supply units, the collector supply being rated at 10 W. The characteristics of the component under test are displayed on three moving-coil meters and an output is available for displaying diode and junction curves on an oscilloscope.

The measurements which can be made are as follows: collector-emitter short-circuit test; collector-emitter,

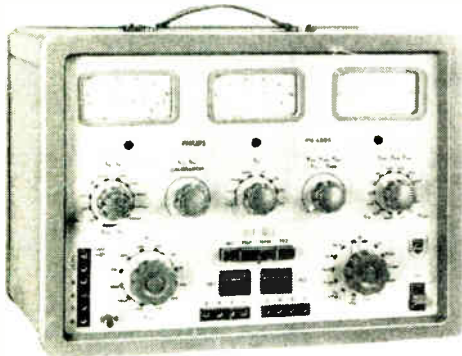

15

16



17

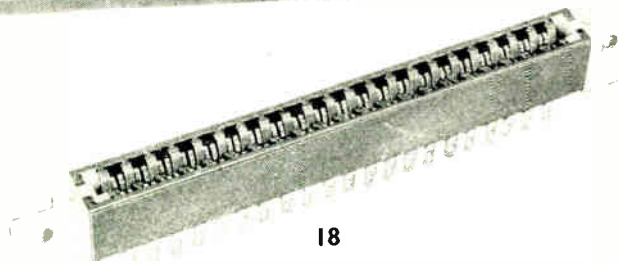
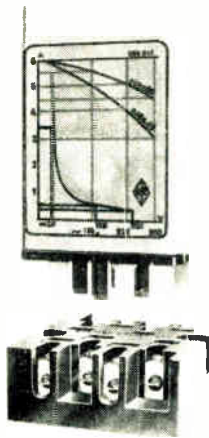

18

emitter-base and collector-base leakage currents; collector current as a function of base current and as a function of base-emitter voltage; and knee voltage. Collector voltage is adjustable from 0 to 60 V in six ranges, and collector current from 0 to 3 A in eight ranges. Dynamic impedance h_{11c} can be measured from 0 to 30 k Ω , and current gain h_{21c} from 0 to 1,000, with an accuracy of 5%. — *Research and Control Instruments Ltd., Instrument House, 207 King's Cross Road, London, W.C.1.*

For further information circle 15 on Service Card

16. Stepping Motor

The Aviation Division of Smiths have added a size 11 stepping motor to their range of servo components. In outline this motor conforms to the international size 11 servomotor. It is designed for use with any type of transmitter including transistor circuitry and has six flying leads, two from each winding. Switching sequences giving either 3, 6 or 12 steps per shaft revolution are possible.

Versions are available having normal voltage ratings of 18 V and 28 V. The displacement torque is 120 gm/cm and at 600 r.p.m. the torque is 75 gm/cm.—*The Aviation Division, S. Smith & Sons (England) Ltd., Kelvin House, Wembley Park Drive, Wembley, Middlesex.*

For further information circle 16 on Service Card

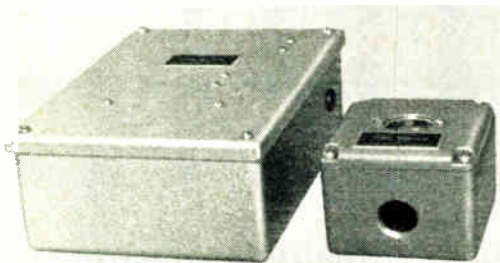

19

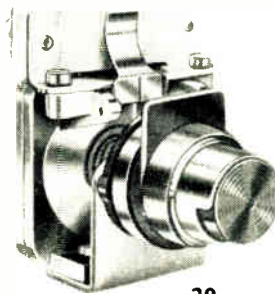

20

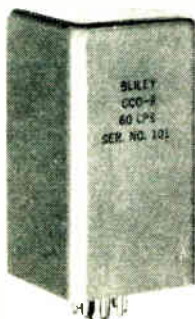

21

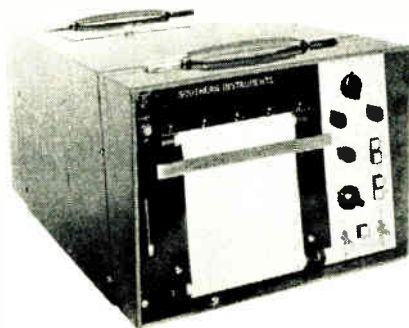

22

17. Heavy Duty Relay

Herga Electric have announced the RVI heavy duty plug-in relay which features two changeover contacts rated at 6 A, 415 V a.c. with a resistive load or 3.8 A, 240 V a.c. with a power factor of 0.3.

The plug and socket have been designed to meet I.E.C. and V.D.E. recommendations to provide maximum creepage distances between the connections and tests have shown that this unit can perform more than ten million trouble-free operations.

Coils can be supplied for most a.c. and d.c. voltages. Dimensions of the relay complete with socket are approximately 3½ by 2½ by 2¼ in. A panel-mounting version is available.—*Herga Electric Ltd., Wallingford Road, Uxbridge, Middlesex.*

For further information circle 17 on Service Card

18. Edge Connectors

A new series of moulded edge connectors for ⅜ in. printed circuits can be supplied by Carr Fastener with any number of ways from 5 to 38

inclusive with a contact pitch of 0.150 in.

The new range is an addition to the standard series of 4, 8, 12, 16, 24, 32 and 40 ways. The snap-in end fix mouldings allow a complete range of connectors with any 'odd' number of ways from 5 to 38 inclusive.

The mouldings house bifurcated phosphor-bronze ribbon contacts, providing low insertion forces with minimum wear. A feature of the contact design is that positive contact with the printed circuit board is maintained at all times. All contacting edges are chamfered to avoid scoring the circuit pads. Contact terminations for solder slot, printed circuit and wire-wrap techniques are available in a variety of finishes. Polarization is by a moulded key which can be inserted in any contact position without affecting the contact.—*Carr Fastener Co. Ltd., Stapleford, Nottingham.*

For further information circle 18 on Service Card

19. Automatic Lighting Controller

One of a number of types of automatic lighting controller now being produced by Hird-Brown is the N4CS, consisting of a photocell unit and a control unit, which will switch a load of up to 20 A.

A solid-state photocell is housed in a watertight case 4 by 3½ by 3 in. and can be mounted indoors or outdoors at any reasonable distance from the steel-encased control unit (9 by 6 by 3 in.) to which the mains supply and the load are connected.

As the natural light level rises the controller operates a 20 A mercury relay to switch off the lights. A time delay is built in to prevent unnecessary switching, e.g. as clouds pass. Price: £24 15s.—*Hird-Brown Ltd., Flash Street, Bolton, Lancs.*

For further information circle 19 on Service Card

20. Time Delay Push-Button

Just announced by Shawford Control Gear Co. Ltd. is a time delay push-button unit. The unit comprises a push-button actuator (standard or mushroom head) operating a snap-action microswitch and a closed-circuit pneumatic system with an adjustable bleed.

Operation of the push-button actuates the microswitch, and original conditions are restored by the pneumatic system after a delay which is adjustable from 0.1 to 60 seconds.

Push-buttons in seven different colours are available, and the units are designed for currents up to 15 A at 115 V a.c., or 5 A at 600 V a.c. These compact units are particularly suitable

for star-delta starters. Prices range from 98s to 106s 2d according to the type of actuator required.—*Shawford Control Gear Co. Ltd., 715 Tudor Estate, Abbey Road, Park Royal, London, N.W.10.*

For further information circle 20 on Service Card

21. Precision Timing Source

Biley have developed the series CCO-9 packaged crystal oscillator; these transistorized units are highly stable without temperature control and provide a timing source for close-tolerance low-frequency synchronization.

The 1.6 to 1.9 kc/s B49 crystal unit will perform reliably under shock and vibration even when the latter is in the region of the output frequency and will maintain tolerance regardless of its orientation. In these respects the crystal-controlled CCO-9 series oscillators are superior to equivalent units with tuning-fork control.

Standard versions are available for 60 c/s and 400 c/s systems, and individual requirements can be met over the range 30 c/s to 2 kc/s.—*Ad. Aurisma Ltd., 414 Chiswick High Road, London, W.4.*

For further information circle 21 on Service Card

22. Ultra-Violet Oscilloscope

The U/V oscilloscope series M.1250 features direct recording of up to 18 data channels, d.c. to 10,000 c/s, at a maximum amplitude of 6 in. Two reference or data lines, timing lines and grid lines may be added to the record. Whenever overlapping traces are recorded, an optional automatic trace identification system momen-

tarily interrupts each in sequence every 8 inches. A manually operated event marker is also incorporated.

To save paper, especially at high recording speeds, the length of record may be pre-set: optional re-spooling is automatic at recording speeds from 0.02 to 100 inches per second. The traces become visible when the completed record is exposed to light: this image is permanent if it is not unnecessarily exposed to bright sunlight. Alternatively, the record may be wet processed.—*Southern Instruments Ltd., Frimley Road, Camberley, Surrey.*

For further information circle 22 on Service Card

23. Angular Divider

Theta Instrument Corporation have developed the Model D4M angular divider which will measure the electrical error, null, and axis error of synchros and resolvers over a temperature range from -55 °C to +130 °C.

The instrument is normally accurate to 20 sec of arc, but accuracy to 3 sec can be obtained if required. The range is from 0° to 360° with continuous motion. Overall dimensions: diameter 11½ in., height 5½ in. Weight: 20 lb.—*Theta Instrument Corporation, 520 Victor Street, Saddle Brook, New Jersey, U.S.A.*

For further information circle 23 on Service Card

24. Waterproof Loudspeaking Telephone

T.M.C. are manufacturing a waterproof transistorized loudspeaking telephone to a design prepared by the G.P.O.

Intended primarily for locations



where both equipment and premises have to be frequently washed down, e.g. hospitals, laboratories, dairies, etc., this instrument connects to a 50 V (+4 V) PBX and operates from the exchange battery.

The type 103 has no dial or handset—merely four pushbutton controls, thus minimizing the risk of contamination by handling. Speech volume can be adjusted according to the background noise level and the distance between user and instrument. The speech circuits are not voice-switched and allow continuous conversations in which any number of people may participate.—*Telephone Manufacturing Co. Ltd., Martell Road, West Dulwich, London, S.E.21.*

For further information circle 24 on Service Card

25. Large-Signal Silicon Transistors

The Mullard range of p-n-p silicon transistors has been extended by the addition of three new types (BCY38, BCY39 and BCY40) all made to an internationally standard size (TO-5 encapsulation).

Because of their high peak-current rating and good linearity these transistors are particularly suitable for use in class 'B' audio output stages and other applications involving the amplification of large signals. Good bottoming characteristics and efficient heat dissipation (420 mW at a case temperature of 45 °C) further extends their use to pulse oscillators and d.c. converters, switching, and servo process control circuits.

All three types have a maximum V_{EB} of 12 V, and a maximum I_C of 500 mA. The h_{FE} at an I_C of 150 mA is 10–30, 10–50 and 16–120 for the BCY 38, 39 and 40 respectively.—*Mullard Ltd., Mullard House, Torrington Place, London, W.C.1.*

For further information circle 25 on Service Card

26. Miniature Plug-in Relay

P.A.R. have produced a plug-in version of their P.3 sub-miniature relay, measuring approximately $1\frac{1}{4}$ by $1\frac{1}{8}$ by $\frac{1}{16}$ in. complete with socket.

Features include twin contacts; buffered contact blades; a knife-edged armature with residual screw, and a wide choice of coil, contact and adjustment specifications. The coils are wound on a one-piece moulded bobbin and the contact insulation is ceramic.

The maximum contact arrangement at present is four change-over and the maximum coil resistance is 10 k Ω .—*D. Robinson & Co. Ltd., 5/7 Church Road, Richmond, Surrey.*

For further information circle 26 on Service Card

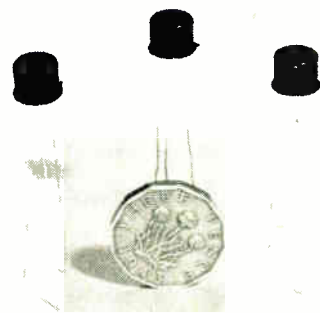
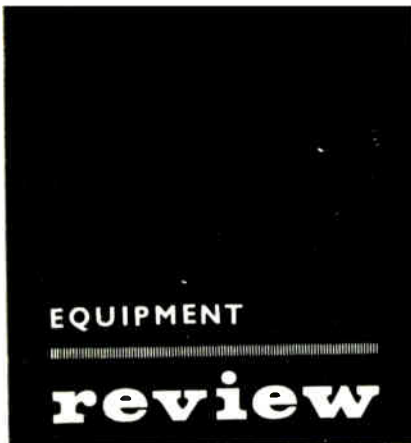

25

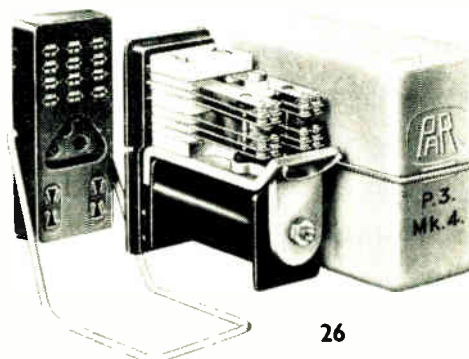

26



27

27. 'Circuitape'

B. & T. Designs are producing a range of ready-made symbols intended to help speed up the preparation of circuit diagrams. The initial 'Circuitape' range consists of symbols for resistors, capacitors, coils, diodes and transistors printed correct to B.S. 530 on transparent self-adhesive labels.

The labels are attached to a continuous wax-paper backing tape, each roll of 500 identical symbols being contained in a 3 in. square cardboard dispenser which delivers the symbols, conveniently, one at a time. Additions to the present range are under development.—*B. & T. Designs (Richmond) Ltd., 70 High Street, Tring, Herts.*

For further information circle 27 on Service Card

28. Add or Subtract Decade Counter

A reversible decade counter tube designed to add or subtract up to 100,000 items a second has been announced by Raytheon.

The self-indicating CK8262 is a cold-cathode, gas-filled, bi-directional stepping device featuring small size, low current drain and long life. The 13-pin tube is only $2\frac{1}{16}$ in. high. Applications

include measuring equipment, timers, programmable counters and scalars, and sorting systems.

Absolute ratings include 0.6 to 0.8 mA at 400 to 800 V d.c. for the anode; 35 V to 140 V d.c. transfer voltage, and a temperature range of -55 °C to $+60$ °C.—*Raytheon-ELSI, 1 Alpenstrasse, Zug, Switzerland.*

For further information circle 28 on Service Card

29. 'Add-On' Alarm Unit

Thomas Industrial Automation has introduced a range of alarm units which can be added together to form a complete indicating system. They are suitable for use with any form of instrumentation capable of closing a pair of relay contacts when the danger condition is reached.

In the single-point system a danger signal causes a 'safe' light to go out and a 'danger' light to come on; in the two-point system the 'safe' light goes out if either 'danger' light comes on.

A flasher unit and/or an audible alarm can be incorporated; a cancellation button will silence the audible alarm and cause the flashing signal to change to a steady illumination. Only one audible alarm and one cancella-

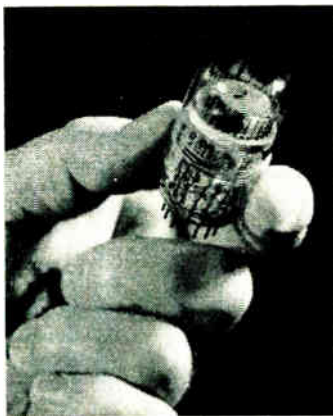

28

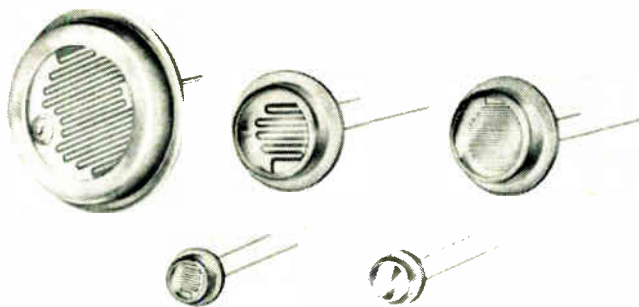

30

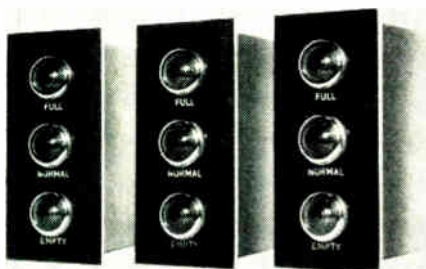

29

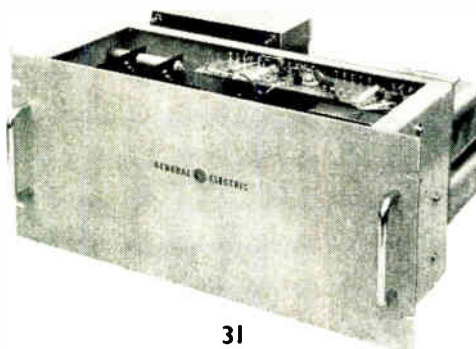

31



32

tion button are required regardless of the number of units in the system.

There is a single plug at the rear of each unit for connection to adjacent units and to the mains supply and external control circuits. — *Thomas Industrial Automation Ltd., Station Buildings, Altrincham, Cheshire.*

For further information circle 29 on Service Card

30. Photocells

Fifteen new types of cadmium sulphide photocell with a wide range of resistance values are available from Hird-Brown, some with very low resistance at moderate light levels for transistor circuit operation. The manufacturer is National Semiconductors Ltd. of Canada.

These units are hermetically sealed in robust head-on metal cases in three styles with body diameters of 0.25, 0.5 and 1.1 in. The photograph shows one of each series of cell. — *Hird-Brown Ltd., Flash Street, Bolton, Lancs.*

For further information circle 30 on Service Card

31. A.C. Voltage Stabilizers

A range of a.c. voltage stabilizers consisting entirely of static components is

available from International General Electric.

The 'Stabiltron' detects deviations from a predetermined output voltage level and provides an almost instantaneous correction through a silicon controlled rectifier circuit. Applications include computers, radar and communications equipment, industrial process control, and X-ray equipment.

Output voltage bandwidth varies from 0.02 to 0.2%, for a variation in line voltage from 95 to 130 V, and the operating temperature range is from -25°C to $+40^{\circ}\text{C}$ with output voltage varying 0.01% per $^{\circ}\text{C}$.

I.G.E. is offering Stabiltrons in ratings of 0.5, 1.0 and 2.0 kVA, in styles to suit various mounting requirements. — *International General Electric Co. of New York Ltd., 296 High Holborn, London, W.C.1.*

For further information circle 31 on Service Card

32. Illuminated Fused Panel Switches

The Rowan type F-C is a compact device which combines the functions of a fuseholder, a switch and a pilot light, thus making possible considerable savings in panel space and installation time.

The FCA version has separate lamp and main circuits, the latter rated at 6 A, 110 V or 3 A, 220 V. In the FCB the two circuits have one terminal in common; ratings are as for the FCA.

The overall life expectancy of the unit, which is designed for operation between 25°C and 55°C , is 50,000 cycles at 6 c/min. Standard industrial fuses are recommended and mounting is through a $\frac{1}{2}$ in. diameter hole. Price: 12s.—*G. S. Westbrook Ltd., Hershaw Factory Estate, Lyon Road, Walton-on-Thames, Surrey.*

For further information circle 32 on Service Card

33. Storage Numerical Display Units

Senior Electronic Equipment claim that by using the latest type of sub-miniature gas tube, they have developed a storage display unit smaller than would be possible using transistors.

A variable length decade display can be built up using a number of the basic units. A standard power supply unit provides for up to six decades, and only mains input is required.

Sensitivity of the units is 5 V on one out of ten lines, each having a very

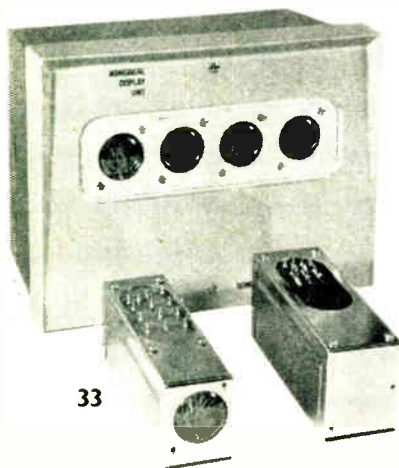

33

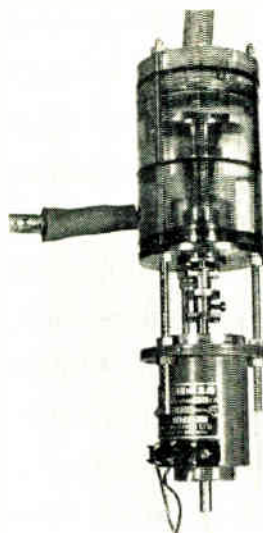

34

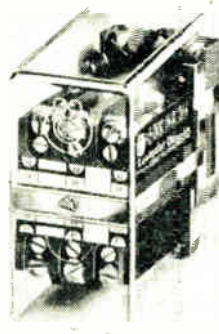

35

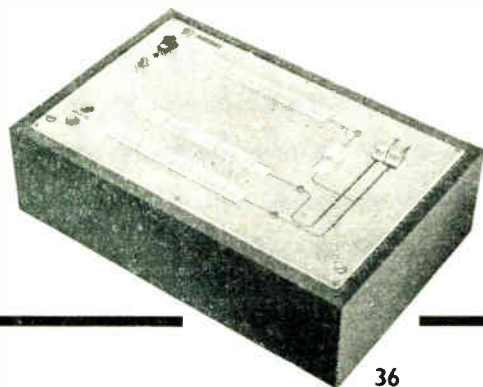

36



37



38



high input impedance. Sampling and storage may be synchronized by a positive pulse, or the units may be set to sample automatically at any rate between two per second and once every ten seconds.

Specifically designed to occupy a front panel area of only 2.8 sq in. and having a long life neon display, the inputs may be referenced to any potential within ± 500 V, so that they may be used with either valve or transistor circuitry. — *Senior Electronic Equipment, 84 Sumner Road, Croydon, Surrey.*

For further information circle 33 on Service Card

34. New Density Meter

A small instrument for measuring the density of liquids, which, unlike a normal float chamber, is insensitive to acceleration in any attitude has been developed by Ultra Electronics.

An impellor, driven by a synchronous motor at constant speed, causes a vortex, which produces a pressure on a thin plate diaphragm. The diaphragm is a variable capacitance pick-off of tandem design, with two fixed plates, one on either side of the centre plate; as it deflects, capacitance is varied between two points with reference to the centre plate.

Small and accurate for measuring mass flow, and envisaged for use in jet engines, this unit can be adapted for industrial use in any process where density measurement is required.— *Ultra Electronics Ltd., Western Avenue, London, W.3.*

For further information circle 34 on Service Card

35. Heavy Duty Miniature Contactors

Electrical Remote Control have announced a series of heavy duty miniature contactors with a number of standard contact arrangements.

The continuous current rating at 380 V is 6 A. Contact and mechanical life: 3 million and 10 million operations, respectively. Standard coil voltages are 110, 240, 380 and 415 V a.c., 50 c/s single phase.

Clear Perspex covers are available. The unit illustrated costs 28s.— *Electrical Remote Control Co. Ltd., The Fairway, Bush Fair, Harlow, Essex.*

For further information circle 35 on Service Card

36. Video Mixer

The Philips EL 8255 video mixer is a fully transistorized unit operating on 625 lines, 50 c/s (C.C.I.R.) for use in television studios and closed circuit television systems.

Up to eight composite video signals of 1.4 V p.p. or eight non-composite video signals of 1 V p.p. can be fed to the mixer inputs which are terminated with 75 Ω impedance. Frequency response is flat within ± 0.5 dB up to 10 Mc/s.

Three rows of eight pushbuttons, two sliding faders and a programme transfer switch are provided for selection, fading, mixing and switching. A built-in intercom. system permits simultaneous communication between the mixer and up to eight cameras and their control units, with priority over local conversations.—*J. Frank Brockliss Ltd., 167-9, Wardour Street, London W.1.*

For further information circle 36 on Service Card

37. Varactor Diodes

The MSI Electronics 361 series point-contact gallium arsenide varactor diodes have a minimum working voltage of 6 V and reverse characteristics extending from 9 V to 15 V before avalanche, making them suitable for such applications as fast microwave switching and harmonic generation.

Packaged in miniature prong configuration with a diameter of 0.100 in. and an overall length of 0.205 in., they are ideal for use in coaxial and stripline circuitry. These varactors can be supplied with a junction capacitance ranging from 0.1 pF to 0.9 μ F. Package capacitance is less than 0.2 pF and frequency cut-off values from 40 Gc/s to 180 Gc/s are available.—*MSI Electronics Inc., 116-06 Myrtle Avenue, Richmond Hill 18, New York, U.S.A.*

For further information circle 37 on Service Card

38. Edgewise Meters

Hoyt are marketing three new meters in edgewise configuration: horizontal and vertical-reading models of 2% accuracy d.c. meters, 2% a.c. meters and 5% d.c. indicators are available in various ranges.

These instruments feature cross-arm balance and jewelled bearings, fade-proof lithographed dials and high overload capacity.—*Hoyt Electrical Instrument Works Inc., Burton Rogers Co., Sales Division, 42 Carleton Street, Massachusetts, U.S.A.*

For further information circle 38 on Service Card

39. Rotary Cable Stripper

The Hellerman rotary electric wire stripper will remove $\frac{1}{4}$ in. to $1\frac{1}{2}$ in. insulation from solid and stranded conductors up to $\frac{1}{8}$ in. in diameter.

This machine is designed for use

where stripped cables are required in quantity; foot-operation leaves the operator with both hands free to feed in the cable ends.

Interchangeable cutting blades can be supplied to give either a 45° or 90° insulation cut. The single-phase $\frac{1}{2}$ h.p. motor operates from a 230/250 V, 50 c/s a.c. supply.—*Hellerman Electric Ltd., Gatwick Road, Crawley, Sussex.*

For further information circle 39 on Service Card

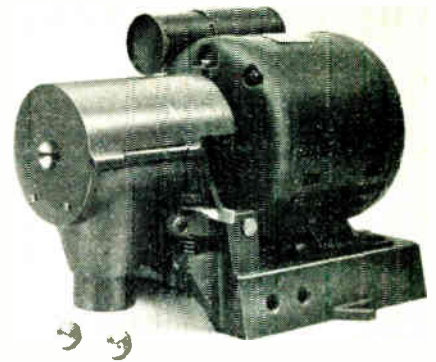

39

40. Transistorized Temperature Controller

Lancashire Dynamo are manufacturing a compact transistorized temperature controller known as the series TCT.1 which, in conjunction with resistance thermometers, will control the temperature of heating elements to within 0.5 °C.

It is available in forms ranging from the fixed differential single switch unit to variable differential units incorporating two relays for three-zone control. 'Wait and see' timers can be included if required, e.g. for use where heat flow is controlled through a motorized valve in a steam line.

The unit is suitable for panel mounting and is housed in a metal case measuring approximately 5½ by 5½ by 8½ in.—*Lancashire Dynamo Electronic Products Ltd., Rugeley, Staffs.*

For further information circle 40 on Service Card



40

41. Magnetic Recording Tape

Ilford are marketing a high quality, long play magnetic recording tape suitable for all conventional recorders. Known as 'Ilfotape', it employs a high flexibility p.v.c. base $\frac{1}{4}$ in. wide and 0.001 in. thick and provides 50% longer playing time than standard tape on the same size spools. Wound on standard polystyrene spools, each tape is provided with a coloured leader and trailer incorporating metal contact foils for the operation of an automatic stop device.

Coating thickness is 13 microns and breakage load 4.4 lb. Acceptable temperature limits: -50 °C to +50 °C. Print through is better than -50 dB and play-back uniformity ± 0.5 dB. Prices: 900 ft (5 in. spool) £1 8s., 1,200 ft (5½ in. spool) £1 15s., 1,800 ft (7 in. spool) £2 10s.—*Ilford Ltd., Ilford, Essex.*

For further information circle 41 on Service Card



41

42. Easy-Entrance Test Jack

Seaelectro have introduced the SKT-0930 test jack designed to facilitate insertion of test probes in

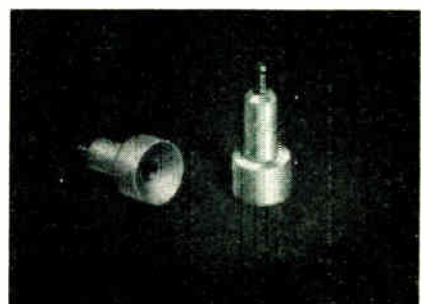

42

awkward chassis locations and blind spots. It is intended for use with 0.093-in. diameter, 0.500-in. long probes, and features a funnelled entrance flaring out at 45°. The lug is in beryllium-copper, plated with gold over silver for low contact resistance.

This 'Press-Fit' jack, which has a Teflon body terminating in a turreted stud below the chassis, has major and minor diameters of 0.375 in. and 0.200 in. respectively, and an overall length of 0.834 in. It is intended for installation in metal chassis from 0.040 to 0.060 in. in thickness.—*Sealectro Corporation, Hershaw Factory Estate, Walton-on-Thames, Surrey.*

For further information circle 42 on Service Card

43. Emergency Lamp

The 'Dominit' emergency lamp type W.207, marketed by G. A. Stanley Palmer, consists of a searchlight with battery case, which can be placed on top of a charger to form an emergency lighting system. In an emergency, such as a power cut, the lamp is automatically switched on and, if necessary, may be removed from its battery case and used as a portable source of light.

The battery consists of four gas-tight nickel cadmium cells having a nominal capacity of 4.5 A-hr. The charging device, equipped with no-voltage relay and voltage stabilizer, is designed for connection to 220 V a.c. (tolerance +20% to -20%). The relay switches the lamp on in the event of a power failure and switches it off on restoration of the supply. In addition to the 8-W main bulb which will give 2½ hr continuous lighting, there is a 1.5-W auxiliary bulb which will provide 15 hr continuous lighting.—*G. A. Stanley Palmer & Co. Ltd., Maxwell House, Arundel Street, London, W.C.2.*

For further information circle 43 on Service Card

44. Timing Relays

Two timing relays developed by B. & R. Relays are now in production. Both are fitted with a high quality jewelled escapement time delay movement.

The first of the timers, type T01 for d.c. operation and T51 for a.c. operation, has a maximum delay of 5 min. The time delay movement incorporates one changeover microswitch which is actuated on energization of the relay after a predetermined time period. The following delays are available on the T01/T51: 0-1, 0-2, 0-10, 0-30, 0-60, 0-120 and 0-300 sec. The 20 VA

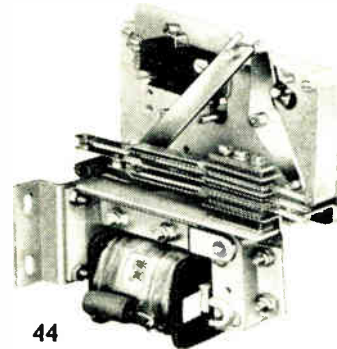
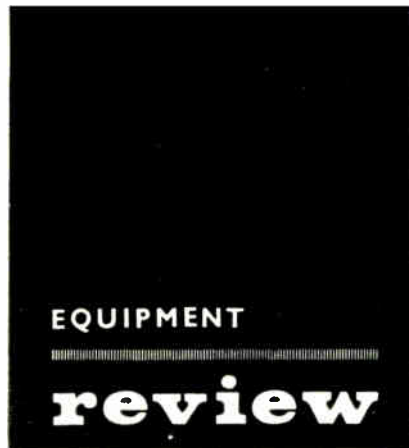

44



45

coils can be supplied for voltages up to 650 V a.c. or 400 V d.c. A maximum of six make, break or changeover contacts can be supplied. These are rated at 5 A 250 V a.c. or 30 V d.c. non-inductive.

The second timing relay styled T02 for the d.c. version and T52 for its a.c. counterpart has a maximum delay of 10 min. The time delay movement here incorporates a changeover microswitch which is actuated on de-energization of the relay after a predetermined time period. Delays available are as follows: 0-10, 0-60, 0-600 sec. Coils and contact ratings are as for the T01 and T51.

All the relays have an accuracy of 2% maximum time setting and will operate in an ambient temperature range of -60°C to +60°C. Applications include the preheating of equipment, motor starting and industrial control circuitry.—*B. & R. Relays Ltd., Temple Fields, Harlow, Essex.*

For further information circle 44 on Service Card

45. Colorimeter

The Unicam SP.1300 colorimeter is a compact and robust unit suitable for a wide range of colorimetric analyses. Outstanding features include an auto-

matic system of filling and emptying cells to save time and avoid spillage (minimum volume of 10 mm glass sample cell: 2 ml), single lever control for the three stages of analysis, and instant selection of filters by rotation of the filter disc.

The instrument, complete with the full range of accessories costs £67 10s. ex-works.—*Unicam Instruments Ltd., York Street, Cambridge.*

For further information circle 45 on Service Card

46. Comparator/Flaw Detector

An improved model of their portable electronic comparator and flaw detector, introduced by Teledictor, is used in conjunction with a plug-in search coil, a range of coils from ¼ in. up to 6 in. internal diameter being available to suit a variety of applications.

The search coil provides the inductance in an oscillatory circuit, the output of which is fed to a valve voltmeter. When the circuit is tuned with a reference standard in the search coil, the comparator is set for the checking of a production run. Because the oscillatory circuit has a narrow bandwidth, very small deviations from the standard are indicated on the

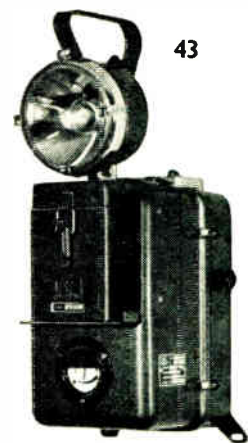

43



46

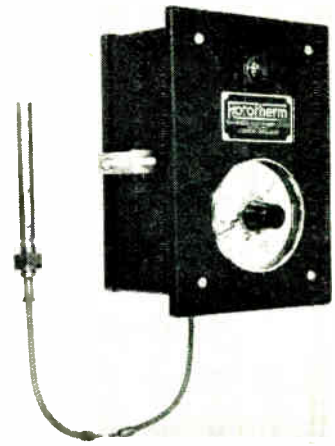

48

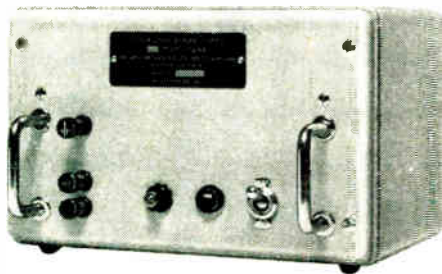

47

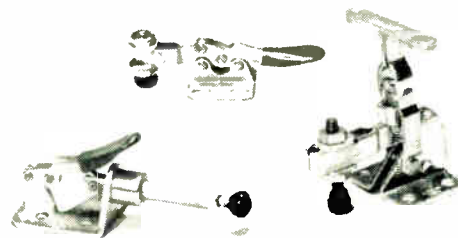

49

meter. Cracks, flaws, occluded impurities, work hardening, differences in alloy constituents and dimensional inaccuracies can all be detected.

Either ferrous or non-ferrous metals may be checked. The range of the tuning allows for either magnetic or eddy-current effects on the inductive circuit. In addition to the inspection of machined or finished parts, the comparator is suitable for the examination of bar stock, e.g. sorting materials into grades.

Measuring 12 by 8 by 9 in. and weighing 17 lb, models are available for all standard voltages and frequencies, complete with mains lead. For permanent installations, a larger version is available.—*Teledictor Ltd., Groveland Road, Tipton, Staffs.*

For further information circle 46 on Service Card

47. Regulated Power Supply

These low cost units by Wilmot Packaging provide a maximum output of 100 mA at preset voltages between 4.5 V and 28 V, either as a two- or three-terminal output, supplying both positive and negative voltages.

Designed primarily to replace batteries when working on transistor circuits, they will be useful where a

large number of individual units are required, as in educational laboratories, etc. They are contained in robust cases 8 by 7 by 5½ in. overall, and operate from a normal 50 c/s, 200 to 250 V supply. A sub-chassis version is available.—*Wilmot Packaging Ltd., Electronics Division, Salisbury Road, Totton, Southampton.*

For further information circle 47 on Service Card

48. Vapour Pressure Temperature Controller

British Rotothem have produced a vapour-pressure temperature controller which costs from £21—approximately 25% less than the equivalent mercury-in-steel models. The vapour-pressure system consists of a phosphor-bronze Bourdon tube, a copper capillary and a temperature-sensitive bulb.

With standard ranges from -30 °F to +500 °F and -35 °F to +260 °F, the instrument can be supplied either to make or break contact on rise or fall of temperature or, with an additional contact pointer, to operate at maximum and minimum levels.

The controller which has a 4-in. dial is accurate to within 2% of the maximum scale reading and has a

switching capacity of 30 A.—*British Rotothem Co. Ltd., Merton Abbey, London, S.W.19.*

For further information circle 48 on Service Card

49. Miniature Toggle Clamps

Destaco miniature toggle clamps provide positive pressure which may be pre-set to avoid damage to delicate work.

They can be readily adapted to a wide variety of applications, from simple holding of parts during drilling, tapping, glueing and soldering, to the positioning of units in bench-assembly work.

The nineteen types in the range include several types of miniature toggle-action pliers intended for awkward jobs where fixed clamps are impracticable. They are self-locking but instantly removable by light finger pressure.

All models are plated to prevent rust and are supplied with neoprene tipped adjustment spindles which prevent damage to work. The smallest weighs 1 oz and can exert a maximum holding force of 42 lb.—*Insley Industrial Ltd., Insley House, 5 Windmill Street, London, W.1.*

For further information circle 49 on Service Card

The need for analogue-to-digital conversion in on-line data handling and computer-control systems is discussed. The basic techniques are considered and a practical converter is described.

Analogue-to-Digital Conversion in On-Line Data Handling Systems

By W. E. WILLISON, A.M.I.E.E., A.M.Brit.I.R.E.*

IN the application of digital techniques to industrial on-line data handling and computer-control systems, analogue signals are usually required to be accepted as input data—hence the need for analogue-to-digital conversion equipment. At the present time, the majority of primary measurement instruments for the determination of temperature, pressure, mass-flow, etc., transduce the physical quantities into a convenient analogue form such as a voltage or shaft rotation. The development of transducers with digital outputs is gaining impetus due to the increasing use of on-line digital computers, but in general these devices rely on some form of built-in analogue-to-digital converter.

In a recent article (March 1963 issue), a description was given of the methods used to monitor the soaking-pit temperatures at Richard Thomas and Baldwins new strip-steel production line at their Spencer Works. In this application, analogue-to-digital conversion is required and a brief description of the method was given. This conversion is constantly required in process control applications, and this article explains the techniques in rather more detail.

Basic Techniques

There are many possible methods of analogue-to-digital conversion and it is convenient to classify them in two major groups, namely: (1) Electro-mechanical converters and (2) Electronic converters. This method of classification has been chosen on the basis of operating principles; Group (1) devices involve mechanical motion and are limited to relatively low speed operation by the inertia and friction of the moving parts, whereas Group (2) devices are potentially capable of very high speed operation.

All converters depend upon an encoding process whereby the magnitude of the analogue signal is represented by a

pattern of digits. The simplest form of digital representation is the well-known binary code, where the position of a digit corresponds to a particular power of two. The binary digit can be either one or zero, so that binary numbers can be represented by simple on-off devices such as transistors or ferrite cores; hence the almost universal use of the binary code in digital computers.

The pure binary code suffers from a serious disadvantage as far as analogue-to-digital conversion is concerned. This is the fact that the binary representation of a decimal number changes by more than one digit for a change of only one decimal digit. In certain forms of analogue-to-digital conversion (a.d.c.) this can cause ambiguity errors and several ingenious codes have been devised to overcome this disadvantage, of which the best known is the Gray Code. Table 1 compares the pure binary and the Gray codes; as an example of the problem of ambiguity consider the transition from 7 to 8. All four digits of the binary number change at this point, whereas only one digit changes in the

TABLE 1

Decimal	Pure Binary				Gray Code			
	2 ³	2 ²	2 ¹	2 ⁰	2 ³	2 ²	2 ¹	2 ⁰
0	0	0	0	0	0	0	0	0
1	0	0	0	1	0	0	0	1
2	0	0	1	0	0	0	1	1
3	0	0	1	1	0	0	1	0
4	0	1	0	0	0	1	1	0
5	0	1	0	1	0	1	1	1
6	0	1	1	0	0	1	0	1
7	0	1	1	1	0	1	0	0
8	1	0	0	0	1	1	0	0
9	1	0	0	1	1	1	0	1

* Process Computing Division, Elliott Bros. (London) Ltd.

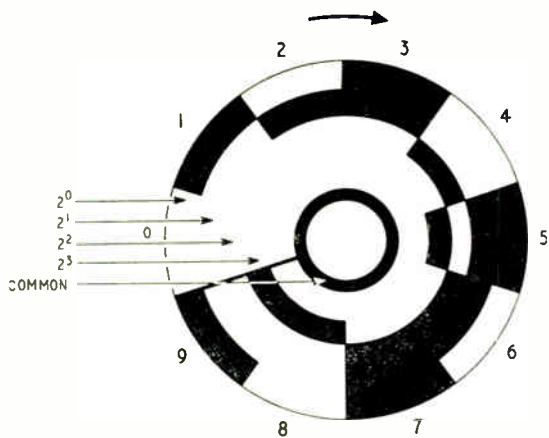

Fig. 1. Elementary coded disc

Gray format. In applications such as data logging, where a computer is not part of the system, it is convenient to use a binary-coded decimal form of digital representation. This form of coding simplifies the translation to the decimal format required for the presentation of output data to the process operators. In this code, each decimal digit is represented by a four-digit binary number, so that a 12-bit converter is required to represent decimals in the range 0 to 999.

The performance of an a.d.c. system is expressed by a number of standard terms such as accuracy, resolution, etc. These terms can be classified as Quantity Factors and Quality Factors.

Quantity Factors

Code: The relationship between the digitized output and the value of the analogue input; i.e., binary, Gray, binary-coded decimal, etc.

Total Count: The full-scale reading of the a.d.c.; i.e., the maximum number of discrete increments available from the converter. For a binary converter having *N* bits, the total count is given by $2^N - 1$.

Quality Factors

Resolution: A measure of the smallest input change which can be detected at the output of the converter. The resolution, which is sometimes called the 'discrimination' can never be better than the value of the least-significant-digit.

Repeatability: A measure of the reproducibility of an invariant input signal when several independent conversions are made under constant environmental conditions. This is sometimes called the 'precision' of the converter.

Zero-Offset: The magnitude of the converter output with zero input.

Drift: The change in zero-offset with time and/or temperature or supply-voltage variations.

Accuracy: The difference between the output and the true digital representation of the input signal, expressed as a percentage of the full-scale output after correction for the zero-offset.

Linearity: A measure of the constancy of the ratio of the output to the input signal magnitude. Usually expressed as a percentage of the full-scale output.

Conversion Speed: The time required for one complete full-scale conversion.

Sampling Rate: The number of complete conversions per second which can be made in a repetitive mode of operation.

Electro-Mechanical Digitizers

This class of converter includes devices which rely upon shaft-position encoders, the analogue signal being first

Fig. 2. Voltage-time converter

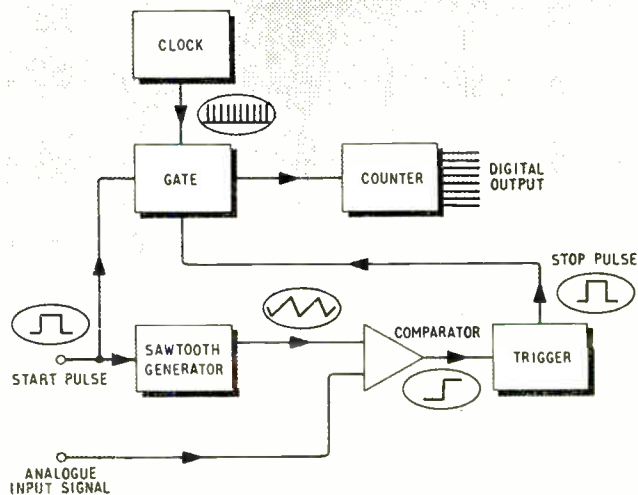

converted to a shaft rotation by means of a suitable servo-mechanism. The class also covers voltage digitizers which use stepping-switches to scan a voltage-divider network which is connected to a constant-voltage reference supply. The input signal is compared with the output of the divider network the switches stepping until a balance is reached. The position of the switches then give the digital representation of the analogue input signal.

Shaft Digitizers

Many different methods of digitizing the position of a rotating shaft have been used or proposed, but the best known is undoubtedly the space, or geometric-pattern coded disc. A simple disc is shown in Fig. 1 which illustrates the principle of operation. The surface of the disc is covered with a pattern of electrically conductive and non-conductive areas, arranged in concentric rings, each ring having a contact brush. One ring is a continuous conductive track which is connected to all the conductive areas and forms a common return path. The whole surface is divided into a number of sectors, one for each decimal digit, such that for any position of the disc a unique pattern will exist at the brushes, the conducting areas representing a '1' and the non-conducting areas a '0'. A practical disc will of course be divided into many more sectors in order to provide a high resolution. The size of the disc will be determined by the conflicting requirements of low inertia and high resolution.

The resolution is restricted for a given disc diameter by accuracy limitations in preparing the coded pattern and etching the copper-clad material to the pattern. A disc encoded into 1,024 parts for 300 degrees of rotation will result in a digit length of approximately 0.005 in. per inch of radius, so that most commercially available discs have a minimum radius of about 1½ in. which is the smallest size for reasonable accuracy. Discs can be obtained with resolutions of one part in 2^{12} . Higher resolutions can be obtained by the use of an optical disc, the pattern consisting

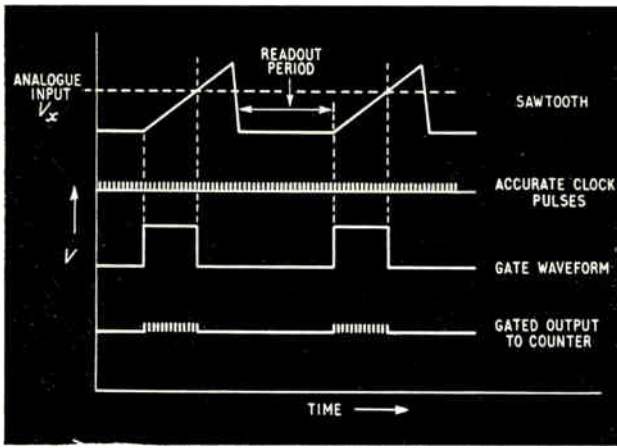

Fig. 3. Voltage-time converter waveforms

of transparent and opaque areas and a light source being placed on one side of the disc and a number of photocells on the other side to read the pattern of digits. Shaft digitizers are extremely useful in cases where the analogue inputs to the data-handling system are in the form of shaft rotations. In some instances self-balancing potentiometric recorders will be installed as part of the general plant instrumentation and shaft digitizers can be incorporated to provide a re-transmission signal in digital form. The speed of response will, however, be limited to about one conversion per second, so that it is seldom possible to use such an a.d.c. on a time-shared basis.

Electronic Digitizers

Electronic a.d.c. systems, in general, can be classified in two main groups, namely: (a) Time-division and counting, (b) Potentiometric methods. There are many variants in each group, so that this section will be confined to one example from each group.

Voltage-Time Conversion

This type of converter operates by producing a pulse, the time duration of which is accurately proportional to the magnitude of the analogue input signal. The pulse is used to gate clock pulses to a counter, the trailing edge

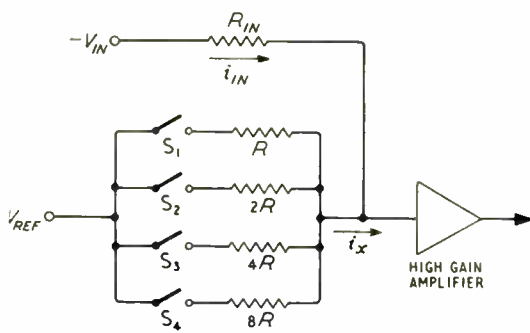

Fig. 4. Four-bit binary comparator

closing the gate so that the accumulated count is a measure of the magnitude of the analogue signal. A practical version of this type of converter is shown in Fig. 2. The magnitude of the input signal is compared with a linear sawtooth which is started by a trigger pulse which also opens the gate to let the clock pulses through to the counter. When the amplitude of the sawtooth is equal to the input signal a stop-pulse is generated which closes the gate; the count accumulated is then proportional to the analogue input signal. Fig. 3 shows typical waveforms. The accuracy will depend upon the linearity of the sawtooth and the stability of the clock-pulse generator, while the resolution will be determined mainly by the sensitivity of the comparator.

Potentiometric Converters

The a.d.c. used in the Richard Thomas and Baldwins data-handling system operates on the potentiometric-comparison principle. The analogue input signal is measured by successively comparing its magnitude with accurate reference potentials in a number of discrete steps, each step corresponding to a digit of a fixed significance. In a binary converter the reference potentials are arranged in a binary progression, each successive reference being one-half of its predecessor; i.e., one-half full-scale, one-quarter full-scale, etc.

The basic principle is illustrated in Fig. 4 which shows a simple four-bit binary comparator. A precision stable reference voltage is applied to a chain of accurate resistors whose values are chosen in geometric progression, so that each resistor, when switched into the circuit, causes a current to flow which is exactly one half of the current due to the preceding resistor. The unknown input signal $-V_{IN}$ is applied to a standard resistor R_{IN} and produces a negative current i_{IN} which is compared with the sum of the positive reference currents by means of a very-high-gain amplifier. The sign of the amplifier output voltage is determined by the direction of flow of the net input current, and thus indicates whether the sum of the reference currents i_x is greater or less than i_{IN} . The sensitivity of the amplifier is such that a current representing one least-significant-digit can 'switch' the amplifier from positive-output-saturation to negative-output-saturation. To perform a conversion, the switches are closed one at a time, in sequence, in an attempt to satisfy the null-condition, $i_x + i_{IN} = 0$. The sequence is as follows:

1. S_1 is closed and left closed if i_x is less than i_{IN} ; otherwise it is opened again.
2. S_2 is closed and left closed if i_x is less than i_{IN} ; otherwise it is opened again.

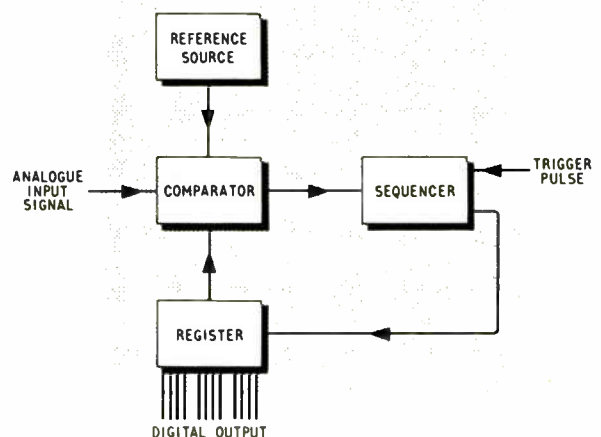

Fig. 5. Block diagram of the analogue-to-digital converter

3. This procedure is repeated for the remaining switches until the null-condition is as closely satisfied as possible.
4. The final state of the switches gives a binary number which is proportional to the unknown analogue input signal, each closed switch representing a '1' and each open switch a '0'. Switch S_1 is the most-significant-digit and S_n is the least-significant-digit.

A block diagram of the complete a.d.c. system is shown in Fig. 5. The 'switches' in the comparator are transistorized switching circuits controlled by a register which consists of a number of bistables (single-bit memories), one per digit. The bistables are controlled by a sequencer. A

trigger pulse initiates the operation, which is started by resetting the register to remove the previous contents. The most-significant-digit switch is then closed and the comparator instructs the sequencer whether or not this digit is required. If it is not required the most-significant-digit bistable is reset; otherwise it is left set. This procedure is repeated until the least-significant-digit has been determined. The register then contains a digital number proportional to the magnitude of the analogue input signal.

The actual converter has 12 binary digits, arranged as three decades of binary-coded decimals and covers the range 0 to 999. The conversion speed is approximately 200 complete readings per second and the accuracy is $\pm 0.1\%$ of full-scale.

COMPUTER AIDS ROUNDNESS MEASUREMENT

THE Rank Taylor Hobson 'Talyrond' roundness measuring instrument employs a spindle-mounted stylus which is rotated round the surface of the component under test; the photograph shows a metal tube in position on the Talyrond table. Roundness errors down to $1 \mu\text{in.}$ are indicated on a polar graph [Fig. 1 (a)] with a scale of up to $10^3:1$.

Until now this graph has had to be assessed manually by floating a transparent template over its surface to find the best fitting circles, their separation being the radial deviation of the component. In order to eliminate this time-consuming process, subject as it is to human error, the manufacturers have developed a small computer which automatically draws on the graph a mean reference circle related to the roundness profile of the component and, in addition, provides meter readings.

Fig. 1. Talyrond traces

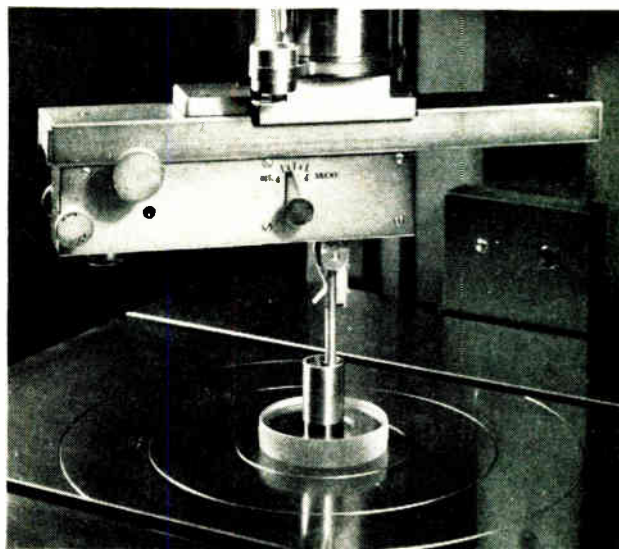

A metal tube in position on the Talyrond table

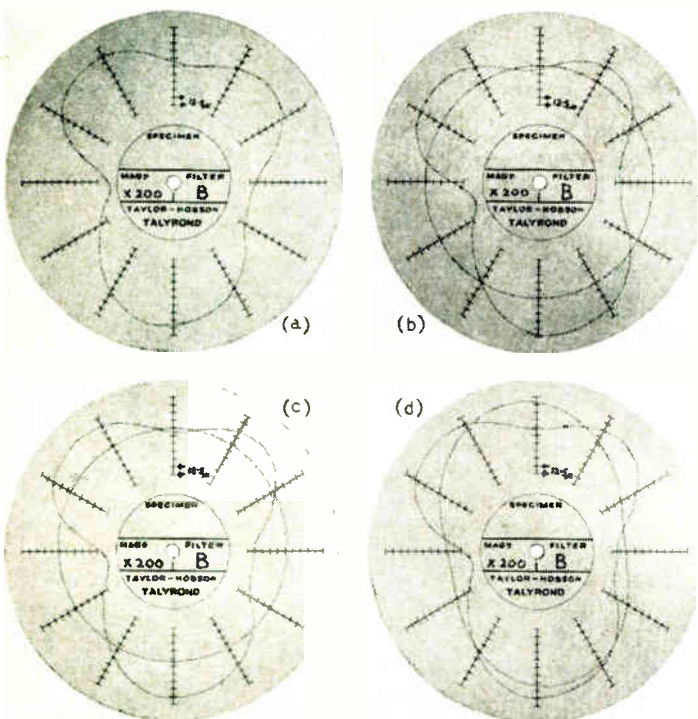

There are two alternative procedures: either the component is centred, its roundness profile drawn, and the reference circle superimposed during the next revolution of the spindle; or the reference circle is drawn first, automatically centred, and then the roundness profile traced around it.

If required, a reference ellipse can be drawn to determine ovality. The readings, which can refer either to the circle or to the ellipse, are displayed on four separate meters indicating: (a) average deviation from the mean reference circle, (b) maximum outward deviation, (c) maximum inward deviation, and (d) maximum peak-to-peak value; i.e., the sum of (b) and (c).

Fig. 1(b) shows a Talyrond trace drawn concentric with the paper with a mean circle inserted by the reference computer. Fig. 1(c) shows the same trace drawn slightly eccentric to the paper. Concentricity is achieved not by mechanical adjustment but by a change in the switching of the computer. Fig. 1(d) shows the same trace with a mean reference ellipse.

For further information circle 53 on Service Card

The principles of eddy-current testing were discussed last month. In this article they are applied to automatic equipment which can sort good and bad specimens as they come off a production line.

AUTOMATIC EDDY-CURRENT TESTER

By W. E. SCHALL, B.Sc., F.Inst.P.

BY observing the feedback effect of eddy currents on the impedance of a test coil which is placed on, or surrounds, a specimen in which these currents are generated, we can watch the behaviour of one of three parameters—conductivity, permeability or diameter when the other two and also the frequency of the exciting current are kept constant. Variations in conductivity and permeability can be related to hardness, case depth, heat treatment, tensile strength, alloy composition, etc., and variations in diameter arise from actual changes in dimension or from defects such as cracks, shrinkages, porosities, etc.

Thus eddy currents can provide much information to interest the metallurgist but non-ferrous metals with a permeability of unity call for high-frequency exciting current when signals from the diameter effect are to be separated from those due to conductivity. On the other hand, ferrous metals where the permeability is a large multiple of unity call for low-frequency current. Hence up to the present two different types of instrument have been in use. They were described in the first article.

Recently a new apparatus—the Defectograph—has appeared in which the frequency of the exciting current is variable between 1 kc/s and 1 Mc/s. This is achieved with the help of four insert sections (modules) which are easily interchangeable in the apparatus and cover the 'spectrum' of frequencies just mentioned.

The Defectograph consists of five sections or modules, of which the top one is a display unit. It contains a cathode-ray tube showing the impedance plane on its fluorescent screen. Below this is the frequency section which is one of the four modules—easily interchangeable—to cover the frequency range.

The third section from the top contains the electronic circuitry to activate a signal when the preset permissible flaw level has been exceeded. This signal is stored until the specimen has left the transit coil. It is then passed on to the mechanism which operates the sorting gates and directs the specimen into the 'accept' or 'reject' bins. The electronic circuitry also contains a delaying relay to control the movement of the paint spray which marks the specimen (if it is bar or tube material) at the exact spot where there is a defect. And, finally, there is on the electronic control a switch to select the appropriate frequency from the frequency insert.

The fourth section from the top is a pen recorder to prepare a graph of the defects, if any are present, which have been detected in the bar or tube. This is of particular importance when reactor material is being tested because a document of this kind is often required before acceptance.

Before discussing the automation of electromagnetic testing there is one further characteristic of material to be considered, namely, the coercive force or coercivity which is required to cancel remanent magnetism. In the hysteresis loop shown in Fig. 1 the remanent magnetism is given by the value of the ordinate RO. When the magnetizing field H_s which magnetized the specimen to saturation at S is reduced to zero and then reversed, a field strength H_c will cancel the remanent flux and reduce it also to zero. H_c is called the coercive force or coercivity. It, or rather the remanent flux of which it is a measurement, is related to hardness, tensile strength, case depth, alloy composition. With suitable automatic sorting equipment it then becomes possible to examine every single unit of mass produced parts like ball-bearing pins, rollers, rings and the balls themselves for hardness.

One large difference which may be noted between eddy-current and remanent magnetic-field tests is that skin effect enters into the former whereas in the latter a constant field magnetization is used. The result is that the eddy-current effect rapidly grows less as the depth below the surface increases and this decline is closely related to the frequency of the exciting current whereas magnetization throughout the specimen is uniform in the remanent field method.

The growing need for 100% test calls for a speed which is altogether beyond the scope of manual operation. It has to be made automatic and moreover it has to be suited to the product. Thus the equipment for mass produced articles like ball-bearing parts differs from that for raw material like bar or tube stock.

The testing and sorting devices (Fig. 2) which are used for coercivity may serve as example of the first group. In Fig. 2 the specimens are fed on to a conveyor belt from a hopper. They then pass through a coil which magnetizes them to saturation. The saturated part then passes over an electronic device (marked 'Cancel') which resets the 'gates' described below after the preceding specimen has been passed, so that they are in a neutral position to receive the newcomer. The value of the remanence is a measure of the coercivity and is read on the 'measuring unit' (an

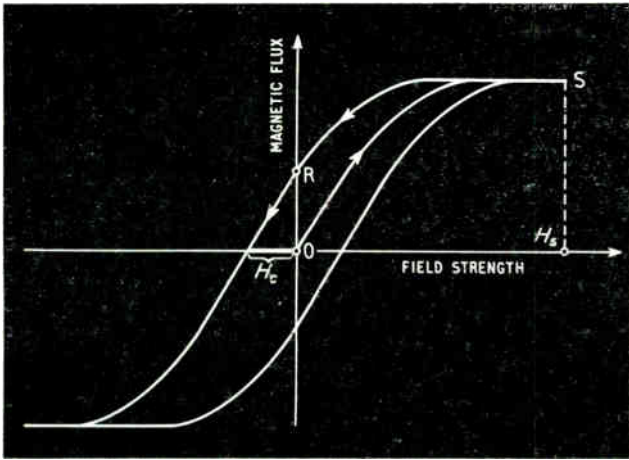
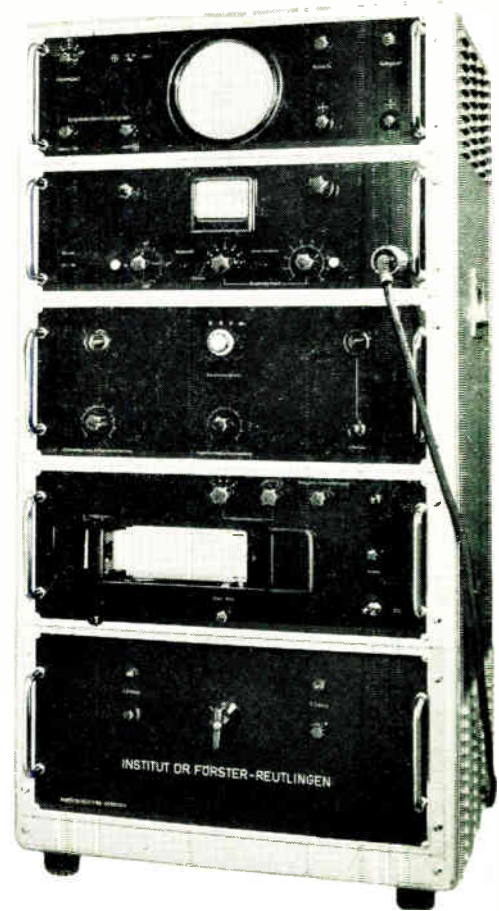

Fig. 1. Hysteresis loop of a ferrous material



Defectograph for measurements on both ferrous and non-ferrous metals

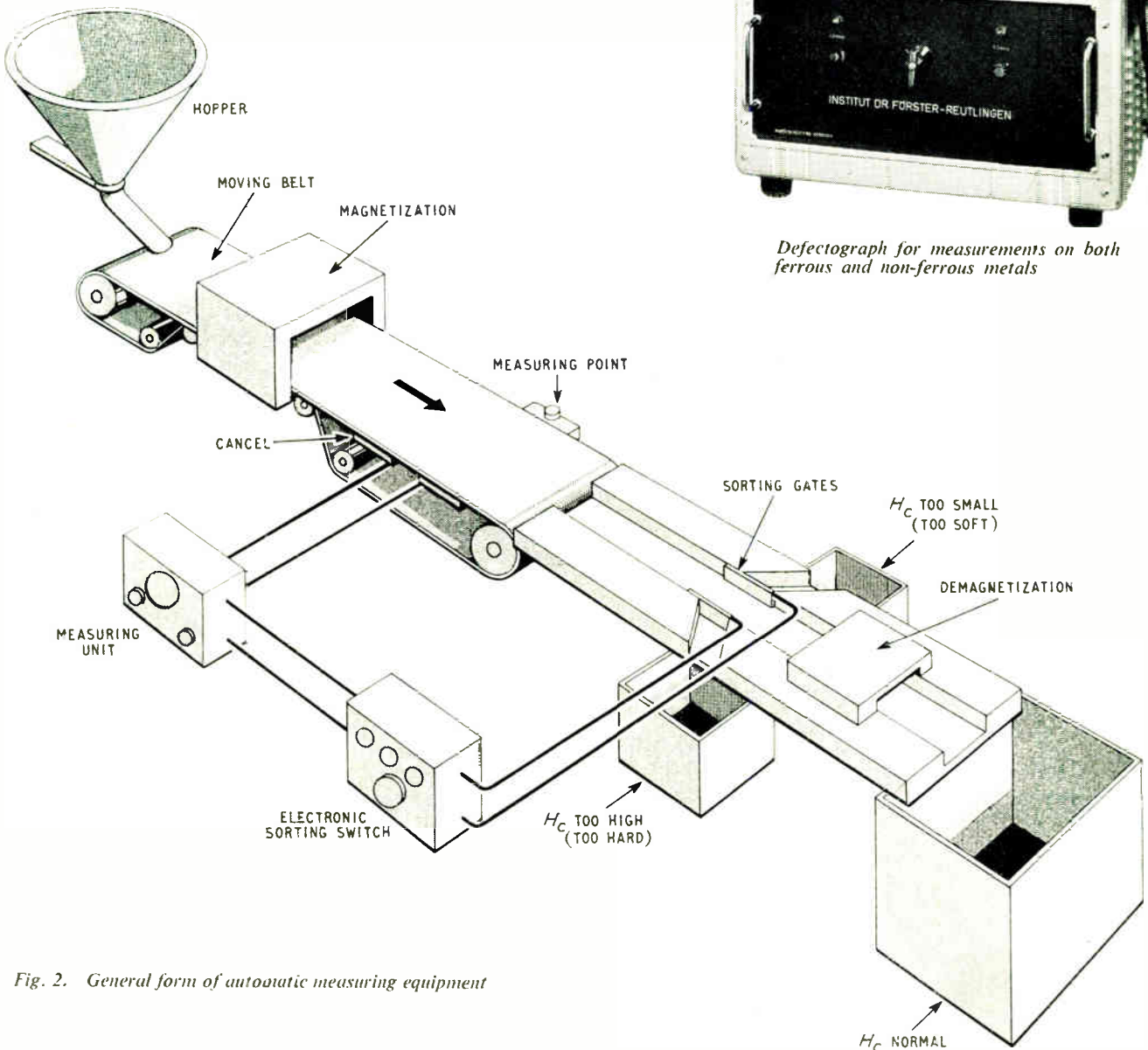
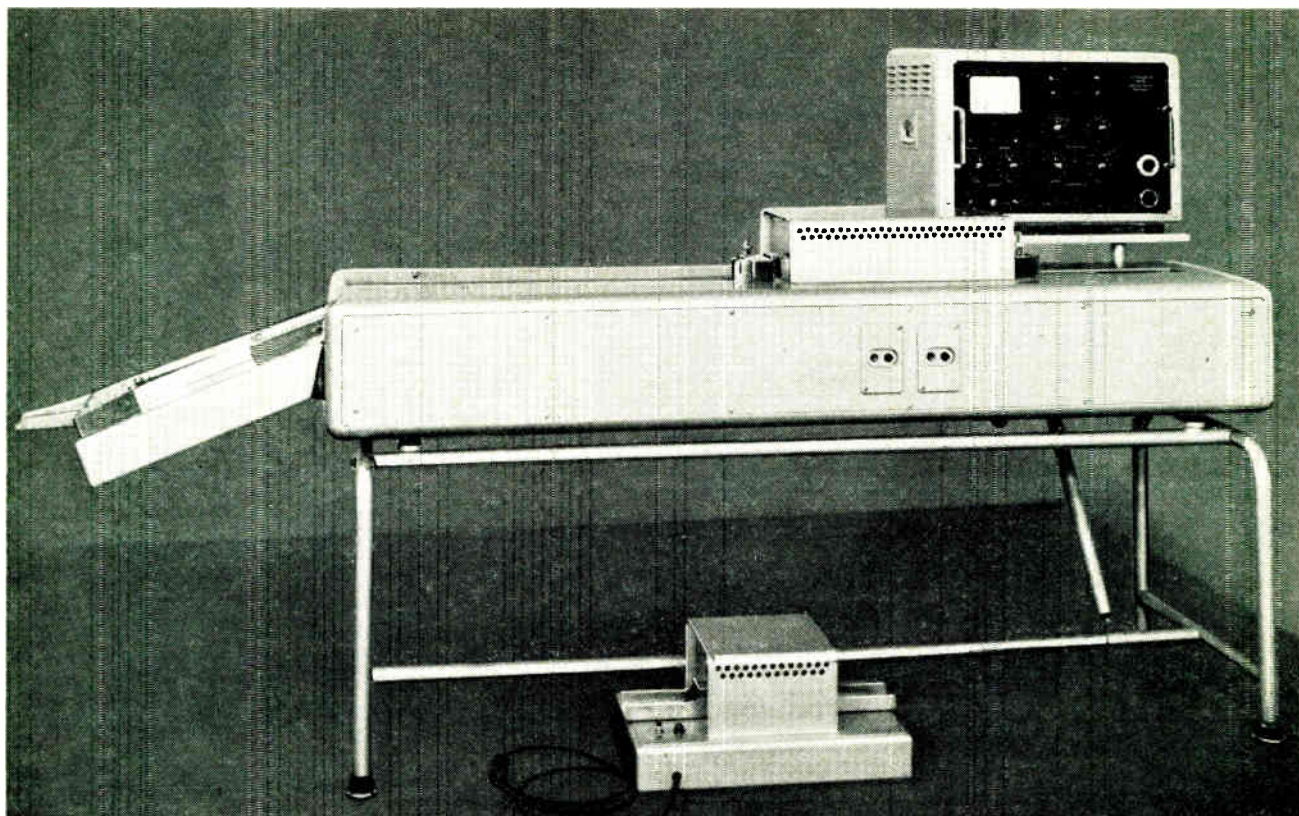

Fig. 2. General form of automatic measuring equipment



Simple sorting apparatus

Oerstedmeter) when the specimen passes between Förster probes at the 'measuring point'. The value thus obtained operates the sorting gates through the electronic sorting device. These gates will either allow the specimen to move straight on to the acceptance bin (H_c normal) or else cause it to move to right or left into rejection bins because H_c is too small or too large. The specimens in this particular case are being tested for hardness and the sorting gate controls are set with the help of two specimens whose hardness is known to be at the upper and lower permissible limits.

A test and sorting unit of this kind can be set up in the production line where the mass produced articles leave the final machining operation. They can be tested and sorted at a speed of 50 specimens per minute.

The set up for bar or tube material is somewhat different. Here the specimens pass through a transit coil and again a 'close-loop-system' is employed. By this is meant a system in which the movement of the specimen rather than a preset timing system determines progress of the test cycle.

Thus the specimen is released by a press button on to a roller bed and moves towards the transit coil. On its way it covers or uncovers photoelectric cells, thereby arranging for the release of a succeeding specimen at a suitable moment and causing itself to be tested, paint marked and numerically recorded for statistical purposes. After passing the transit coil the specimen signals its continued presence on the roller bed till it reaches a limit switch. The latter has received a stored signal and operates the ejection rocker accordingly, so that the bar goes to the 'accept' or 'reject' store.

A test and sorting equipment like this is fitted with safety devices to protect the apparatus from damage arising from (a) failure of pressure of cooling water in the test coil, (b) excessive temperature of test coil, (c) irregularities in test coil primary current.

The electromagnetic methods described thus far are devoted to flaw detection and quality control in materials. Space forbids the detailed discussion of successful applications of these same feedback methods to other problems of which there are many. The most exciting one at the present time is probably the thickness measurement of covering layers—both metallic and non-metallic on metallic or non-metallic bases.

This embraces such important examples as:

1. Non-magnetic or non-metallic layer on steel (e.g., copper on steel before plating or bitumen on steel in pipelines).
2. Insulation of metal (e.g., colour, plastic, paper on any electrically conducting base).
3. Non-ferrous layer on non-ferrous base (e.g., silver, copper, chromium on the same metals but with layer and base differing from each other).
4. Non-ferrous layer on insulating base (e.g., copper in printed circuits, evaporation deposits on capacitor paper, metal deposits on ceramics).
5. Nickel on non-ferrous base (e.g., nickel on aluminium, copper, austenitic steel).

★ FOR THE BUYER

You must have read about a number of products and processes in this issue of which you would like further details. You can obtain this information very easily by filling in and posting one or more of the enquiry cards to be found inset in the front and back of the journal.

This article shows how a resistance mesh may be used to simulate a Hall plate and then how a computer can be programmed to solve the equations of the mesh. In this way the current distribution can readily be computed.

Current Distribution in a Hall Plate

By D. MIDGLEY, B.Sc.(Eng.), Ph.D.*

INTEREST is growing in possible applications of the Hall effect to amplifiers, rectifiers, binary stores and trigger circuits.^{1,2} Semiconducting material in rectangular plate form is usually chosen and an output current I_o is drawn at the Hall terminals (c, d, Fig. 1). The source of energy is a supply current I_s flowing between terminals a and b. For purposes of measurement, the length ab is at least four times greater than the breadth cd, in order to minimize errors due to the short-circuits placed upon the Hall currents by the input leads. It may be argued that this extra length is of no service in a practical design, since it wastes power in the high resistance surplus material of the plate.

On the other hand, a short plate would suffer a great reduction in output from the diversion of current into the input leads. The design of efficient Hall plates thus depends upon knowledge of the distribution of the short-circuit currents for aspect ratios ab/cd probably of the order 2/1. Analytical solutions³ are available when assumptions are made about the small size of second-order Hall effects. An exact solution would need to take account of the fact that transverse currents are the source of e.m.f.s which modify the longitudinal currents. The transverse e.m.f.s and currents are again modified and so on. Add to this the effect that all the currents have in re-shaping the magnetic field and the problem is as unwieldy as any in magnetohydrodynamics.

Existing solutions are adequate for most materials at room temperatures. These solutions are characterized by symmetry of the current flow lines in each quadrant. However, at cryogenic temperatures near absolute zero, it has recently become possible to sustain very strong magnetic fields. In addition, high electron mobilities are reported at these temperatures, notably in bismuth with a mean free path as large as 0.18 cm.

In these conditions, it is no longer satisfactory to neglect second-order Hall effects. In particular the symmetry of previous solutions is brought into question.

An Equivalent Resistance Network

Particular numerical solutions of any desired accuracy are more readily found by a resistance network simulation of the problem than by attempts at direct solution of the field equations. The conductivity of the plate is repre-

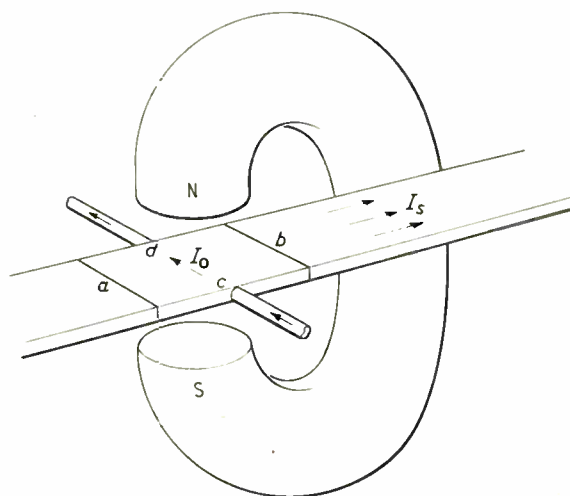
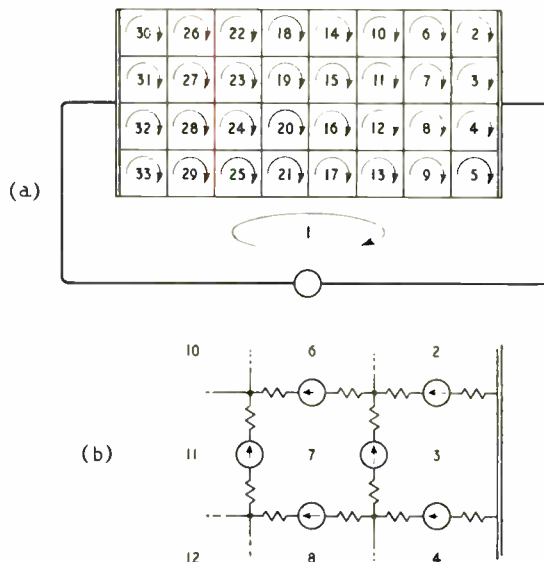

Fig. 1. Hall plate with supply and output terminals and magnetic field

Fig. 2. Location of resistance network meshes in the Hall plate (a) and detail of the meshwork showing e.m.f.s and resistances (b)



* Reader in Electrical Engineering, Bradford Institute of Technology.

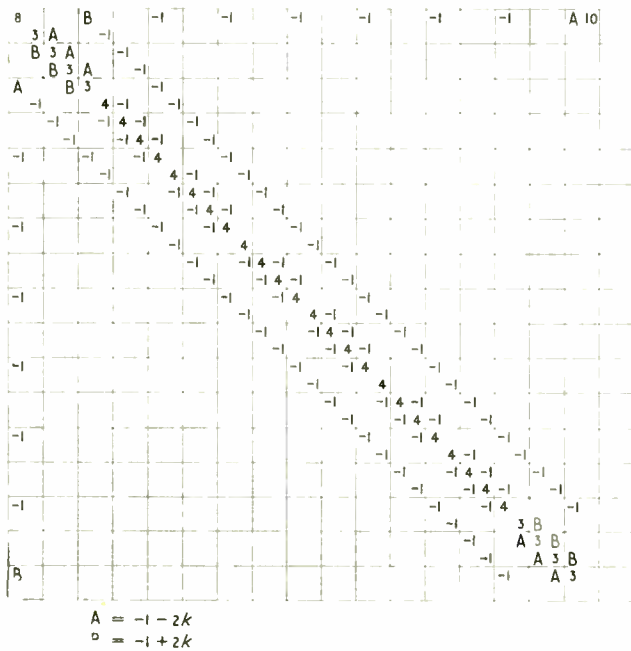

Fig. 3. Matrix of coefficients in the equations to the meshes

Fig. 4. Facsimile of computer teleprinter output, listing mesh currents in the order of Fig. 2(a). +0.624, etc., +1 means +6.24, etc.

$k=0.000025$		$k=0.1$	
+0.624999980	+ I	+0.442876817	+ I
+0.125046326	+ I	+0.256006628	+ I
+0.250065834	+ I	+0.338035249	+ I
+0.375065825	+ I	+0.388708985	+ I
+0.500046303	+ I	+0.423097525	+ I
+0.125023131	+ I	+0.159556437	+ I
+0.250035348	+ I	+0.263228249	+ I
+0.375035343	+ I	+0.336944362	+ I
+0.500023115	+ I	+0.394372506	+ I
+0.125010849	+ I	+0.118990870	+ I
+0.250017085	+ I	+0.218376948	+ I
+0.375017081	+ I	+0.301467707	+ I
+0.500010836	+ I	+0.374571322	+ I
+0.125003181	+ I	+0.980300969	+ 0
+0.250005062	+ I	+0.189820965	+ I
+0.375005058	+ I	+0.275978196	+ I
+0.500003169	+ I	+0.359568263	+ I
+0.124996813	+ I	+0.833085522	+ 0
+0.249994924	+ I	+0.166898619	+ I
+0.374994921	+ I	+0.253055850	+ I
+0.499996801	+ I	+0.344846719	+ I
+0.124989145	+ I	+0.683054926	+ 0
+0.249982901	+ I	+0.141409103	+ I
+0.374982896	+ I	+0.224499368	+ I
+0.499989133	+ I	+0.323885945	+ I
+0.124976865	+ I	+0.485043097	+ 0
+0.249964639	+ I	+0.105932454	+ I
+0.374964633	+ I	+0.179648567	+ I
+0.499976850	+ I	+0.283320379	+ I
+0.124953678	+ I	+0.197792919	+ 0
+0.249934156	+ I	+0.541678309	+ 0
+0.374934147	+ I	+0.104841567	+ I
+0.499953655	+ I	+0.186870188	+ I

(a)

(b)

represented by a rectangular grid of equal resistances, bounded by short-circuits where the supply current is introduced. The Hall effect is represented by placing in each branch an e.m.f. which is proportional to the adjacent perpendicular currents. Thus in Fig. 2 the horizontal e.m.f. in branch 6.7 is proportional to the mean of the vertical currents in branches 2.6 3.7 6.10 and 7.11. The constant of proportionality k is $\frac{1}{4}R_H B$ where R_H is the Hall coefficient of the material (metres per coulomb) and B is the transverse magnetic field intensity (webers per square meter). The solution of the network mesh equations for different values of k is in principle a simple if laborious problem. The only sensible way to write the coefficients of the currents and the constants is as a matrix like that of Fig. 3, where an e.m.f. of 10 volts is applied in mesh 1 and each branch is taken to have a nominal resistance of 1 ohm.

A digital computer solves the equations and lists the mesh currents, as in Fig. 4, which compares results for two widely different values of k . With the smaller value there is regularity in every fourth current in the early digits, ignoring the first result which applies to the large outer mesh. With the larger value of k , there is marked loss of symmetry in adjacent quadrants, but skew symmetry remains in regard to opposite corners. This is shown more clearly by a sketch in Fig. 5 of the flow lines associated with the currents caused by the short-circuits at the ends of the plate. The problem is virtually completed by the solution to the mesh equations, and the few remaining steps to convert from these to flow lines depend upon the introduction of a vector potential A , with $J = \text{curl } A$. Of more general interest is the method of programming the digital computer to handle large sets of equations of the kind represented by Fig. 3 with the minimum of effort in preparation of the input data. Some such pattern around the leading diagonal of the matrix must arise in any problem where a resistance network simulates a field problem.

Automatic Preparation of Input Paper Tapes

A computer programme may easily be written with the object of making the computer prepare its own input data. There is a considerable saving in the labour of operating manual paper tape perforators, especially when similar sets of many simultaneous equations are to be solved for a changing parameter like k . For instance, an existing Simple Code library programme of the Stantec Zebra computer⁶ for the solution of simultaneous equations by elimination* requires each line of the matrix to be prepared as follows:

The equation

$$8.i_1 + 2.i_5 - i_9 - i_{13} \dots \dots \dots = 10$$

is typed on the perforator to allow for those coefficients that are zero, in the form:

$$+8+0+0+0+2+0+0+0-1+0+0+0-1 \dots \dots \dots +10Y$$

where the symbol Y indicates the end of one line.

The computer can be instructed, in a manner of speaking, to take note of the facts that the central area of the matrix has the same pattern of non-zero coefficients in every fourth line, that the number of zeros to the left of these increases by one from line to line and that the zeros to the right decrease similarly. In fact, the hand-produced input data can be reduced to the designation of the parameter k for each run of the programme.

The action that is required of the computer is first made

* Trials confirm that the form of the present equations is such that elimination is quicker and more accurate than an iterative process of the Gauss-Seidel type.

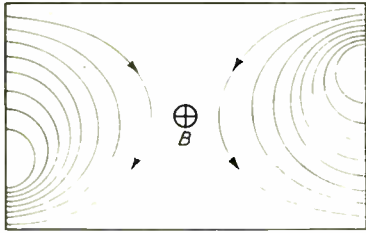

Fig. 5. Derived current flow pattern from the results of Fig. 4(b) with $k = 0.1$. The derivation involves (a) subtraction of the unperturbed current (one fifth of mesh 1 current) from horizontal branch currents, (b) integration to find the vector potential, (c) plotting of lines of constant vector potential as in ref. 4

Fig. 6. Flow diagram

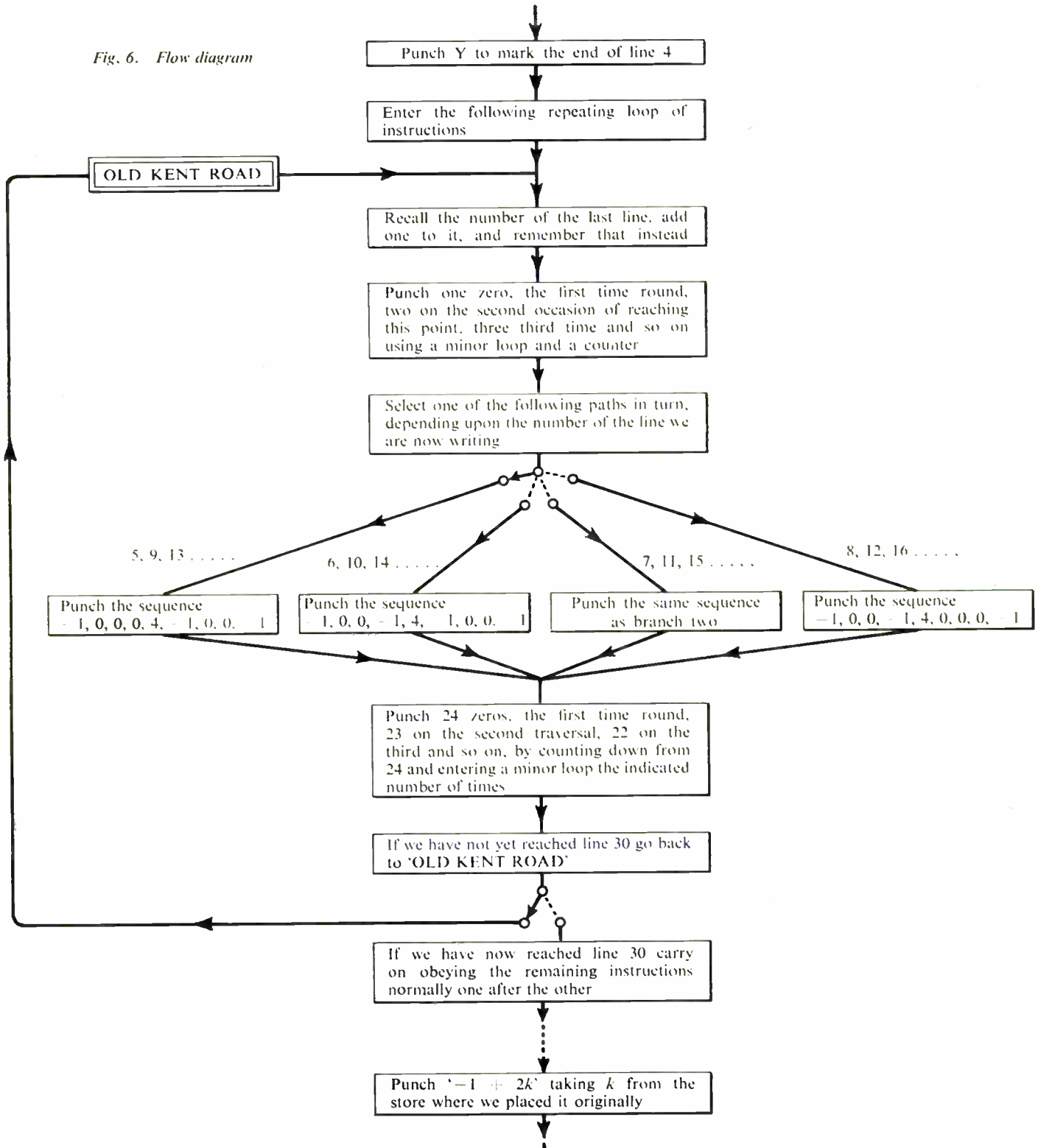

TABLE I. MEANINGS OF THE CODE SYMBOLS OF THE PROGRAMME

Symbol	Its approximate meaning to the computer	Symbol	Its approximate meaning to the computer
Z	Stop, wait for a data tape to be put in and the Start key to be pressed again.	U09	Remember how far we have counted in this loop and do the remembering in store 9 so that I can use the fast registers for something else. (Count to safety.)
L01	Read from this paper tape as many numbers as there are and put them in consecutive stores starting at store number one.	-002	Set up teleprinter character from store number two (see Table 2 for list of these) in a fast register.
T	Transfer whatever you have in the accumulator* to store number zero, which we will treat as a rubbish bin.	Z39	Sub-routine to operate output punch in teleprinter code from the fast register. Punch 'plus zero'.
Z22	Go through the sub-routine that prepares paper tape output punch for action.	H09	Bring back the remembered count ready to have it advanced one place.
Z	Stop again to let me run out a bit of clean tape from the output punch.	S4	Subtract the contents of store 4 from whatever is in the accumulator.
T8T8	Empty the empty accumulator twice into store number 8 to make doubly sure that it, too, is empty.	E2	If the accumulator now has a negative number in it, jump to that instruction labelled Q2; otherwise carry on obeying instructions in the normal sequence. (Conditional jump.)
Q1	Stick this label Q1 in front of this instruction because we might want to jump back to it.	XR3	The most sophisticated instruction in this programme. It selects the flow diagram branches by insisting on an unconditional jump to one or other of the places immediately following label Q3. Which of these places is chosen depends on the content of a fast register that has been made to count 12341234 by instructions 18 to 23.
H8	Bring the contents of store 8 back into the accumulator.	X4 57	Jump again unconditionally and indubitably to label Q4 which might be anywhere, but is in fact at line 57 below.
A1	Add the contents of store 1 to what is already in the accumulator.	X	Jump back to the first instruction Z. Stop and wait for a repetition of this whole programme with fresh data.
T8 (U8)	Transfer what is now in the accumulator to store 8, leaving accumulator clear. (U8 ditto but accumulator not cleared.)		
-08	Note the number in store 8 and for that number of times go through the instructions that lie between these two symbols.		
-1			

*(the accumulator is a fast store where arithmetic is usually done)

Acknowledgment

Thanks are due to present and former colleagues at the Bradford Institute of Technology for providing interest, instruction and inspiration.

References

- ¹ Von H. Weiss, 'Der Ruckgekoppelte Hall-Generator', *Zeitschrift fur Naturforschung*, September 1956, Vol. 9, pp. 674-8.
- ² D. A. Kleinman and A. L. Schawlow, *Journal of Applied Physics*, Vol. 31, No. 12, p. 2176, December 1960.
- ³ I. Isenberg, B. R. Russell and R. F. Greene, 'Improved Method for Measuring Hall Coefficients', *Review of Scientific Instruments*, Vol. 19, No. 10, October 1948.
- ⁴ D. Midgley, *Electronic and Radio Engineer*, Vol. 34, p. 194, May 1957.
- ⁵ H. H. Johnson and D. Midgley, 'The Corbino Disk and its Self-Magnetic Field', *Proc. I.E.E.*, Pt. B., Vol. 109, No. 45, p. 283, 1962.
- ⁶ R. J. Ord-Smith, 'The Stantec-Zebra Simple Code and its Interpretation', p. 146, *Annual Review in Automatic Programming*, Vol. 1 (Pergamon Press 1960).

TABLE 2. CONTENTS AND MEANINGS OF QUANTITIES HELD IN THE NUMBER STORES

Store Number	Its Numerical Content	Teleprinter character of that number
1	1	1
2	26	Plus sign
3	27	Minus sign
4	4	Figure four
5	28	Letter Y
6	0	Figure zero
7	24	(not used as output)
8	Holds the line number which increases by one each time round	(not used as output)
9	Keeps note of state of count	(not used as output)
10	Stores in turn 1, 2, 3, 4, 1, 2, 3	(not used as output)

Electronically Controlled Jig-Borer

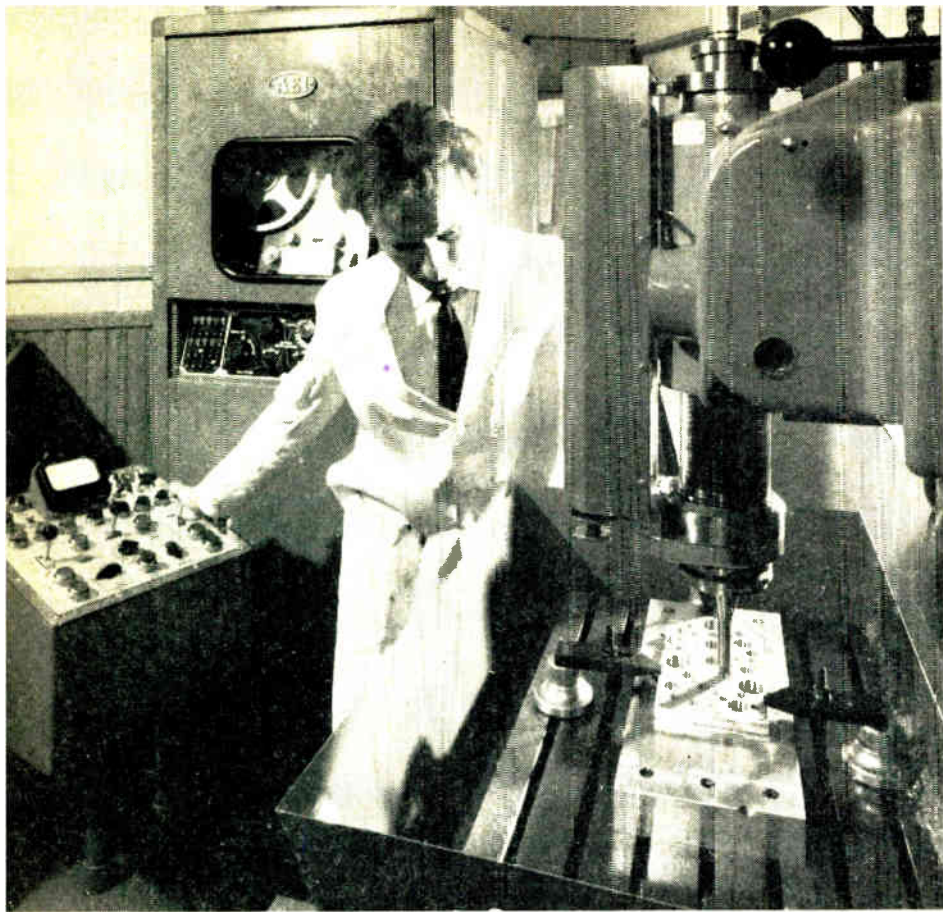

A NEWALL 1520CC jig-borer automatically controlled in three dimensions by an A.E.I. continuous numerical control system is now in use at the Basingstoke factory of Smiths Aviation Division. It is primarily engaged in small batch production, to very fine machining tolerances, of aluminium alloy plates.

The equipment is being used on a two-shift basis for 16½ hours a day, and is producing plates with nil wastage, 3-5 times more quickly than by non-automatic methods.

Eighteen different plates, each calling for a complex operation involving drilling, boring and counterboring, reaming and profile cutting, are now produced completely automatically except for essential manual activities such as

tool changing. Each plate is finished, ready for anodizing, except for tapping threads and other minor operations. Previously, gearbox plates have been produced for Smiths by sub-contractors on conventional manually-operated jig-borers. With the new A.E.I.-Newall numerical control equipment, workpieces are produced on a repetition basis inside the tolerance zone of 0.0002 in. per axis.

The control information for the numerical system is carried on ¼ in. wide magnetic tape and is read and processed in a numerical controller which in turn feeds the servo-mechanisms operating the machine tool.

The magnetic tape takes the place of a dimensioned working drawing and carries in numerical form all the data required to describe accurately a workpiece of complex shape. This information is derived basically by the user's planning engineer from the drawing of the piece to be machined. The planning engineer enters on a 'planning sheet' a step-by-step account of the machining operation, specifying by a code the point at which changes in the programme are to occur, and setting out the appropriate co-ordinates in the vertical and horizontal planes which govern the subsequent machine movements, cutter nominal size, maximum feed rate at which the workpiece and tool should be moved relative to each other, an acceleration limit for the control of profile accuracy, and any other relevant instructions. All the operations on the range of gearbox plates are covered by only 13 code instructions.

The information on the completed planning sheet is transferred to punched tape at the A.E.I. Tape Service Centre at Leicester and is then converted into the continuous information needed on the magnetic tape for accurate control of the machine tool. The planning sheet contains only a relatively small number of co-ordinates and other movement orders, and a computer fills in the detail and transfers the complete continuous control information in numerical form on to magnetic tape.

Because of the high precision demanded in the work, the machine is fitted in all three planes of movement with the A.E.I. Helixyn, an electrical position-measuring system which enables positioning the workpiece to an accuracy

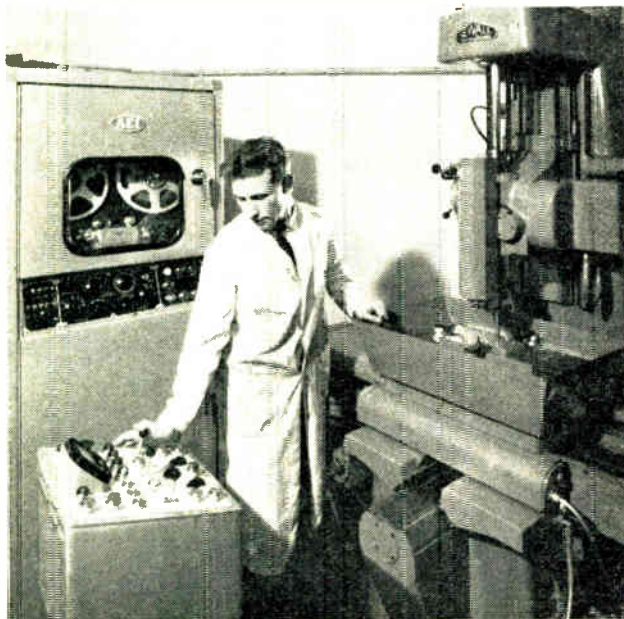

General view of automatically controlled jig-borer in use by Smiths Aviation Division

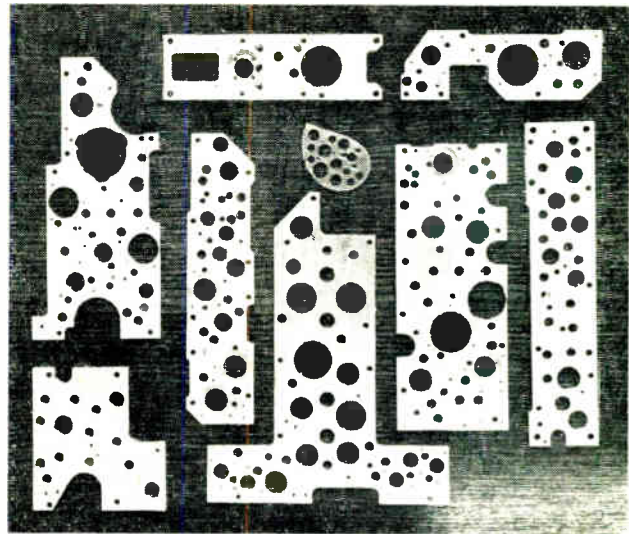
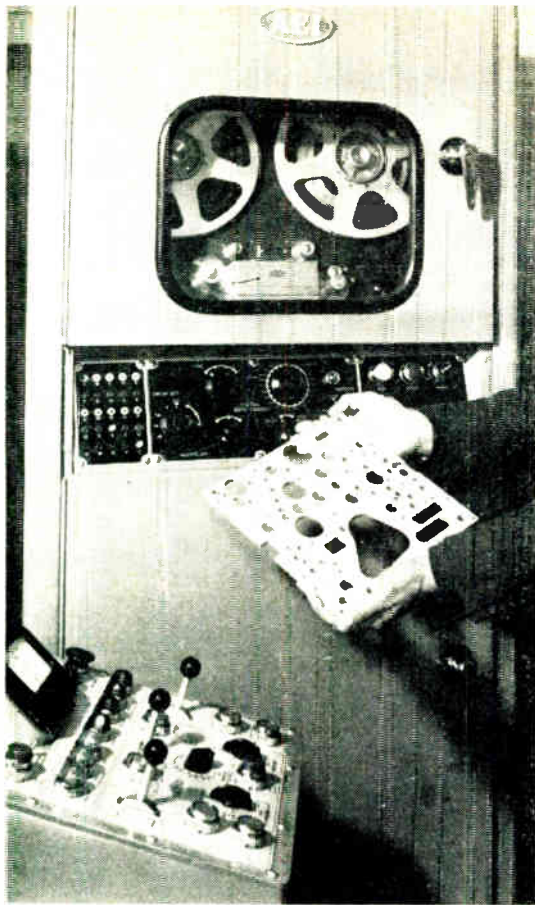

(Above) Selection from range of air data computer gearbox plates produced

(Left) Master plate of air data computer gearbox, the most complex workpiece produced

better than 0.0001 in. for the beginning of the machining cycle, and checking its position throughout. The Helixyn consists of a fibreglass covered steel tube fitted to the body of the machine tool and wound with a system of interlaced helical conductors, and a similarly wound concentric sleeve mounted on the moving member of the machine. The sleeve winding is fed with information from the control tape, and the fixed bar, which picks up the information from its sleeve by capacitive coupling, can be used to detect the exact position of the sleeve's electric field and hence the position of the workpiece at any time.

A number of advantages have been derived at Smiths from the adoption of automatic machine tool control. Much greater use is made of the actual machine tool as a result of reducing, or in some cases eliminating, setting-up and 'thinking' time. A single machine is used to carry out a wide variety of operations which would otherwise mean transferring the work to other machines in succession. Repeated setting-up, and the consequent possibility of errors, is avoided. Machining operations can be closely related in time to shift and break times.

For further information circle 54 on Service Card

Automatic Car Park Control Barriers

A system of fully automatic car park control which utilizes a Westool Sonac ultrasonic sensing unit for controlling the entrance barrier, has been developed by Godwin Warren Ltd. This system automatically operates any fee-paying car park without the need for attendants.

The car park has two barriers, one at the entrance and one at the exit. To enter the car park the motorist drives up to the entrance barrier thereby breaking an ultrasonic beam and automatically operating a switching system to raise the barrier.

The heads of the ultrasonic sensors are so angled and positioned as to give a tolerance on the vehicle positioning up to some 2 ft. Further, the path of the beam is directed downwards and this combination eliminates possible accidental operation by a pedestrian, even if he is carrying a suitcase or similar flat-sided container.

As soon as the car passes through the barrier it crosses over a pad set in the ground. This is part of a pre-set counting mechanism which records the number of cars in the park. There is a similar pad by the exit barrier and together these two pads count by adding and subtracting on a pulse principle.

When the counting mechanism records that the park has reached its pre-set capacity, an illuminated 'FULL' sign lights up by the entrance barrier. At the same time the barrier is automatically locked and the operation of the system temporarily suspended. The barrier remains locked until one car leaves the park. This frees the entrance barrier and brings the system back into operation to allow one more car to enter the park.

Once through the entrance barrier the motorist is free to take any parking space he chooses.

To leave the park the motorist drives up to the exit barrier and stops by the parking fee collecting machine placed just before the barrier. He puts in his coin and this automatically raises the exit barrier for sufficient time for him to drive out.

This type of installation is based on single daily charges and provision is made to cater for season ticket holders.

A further development to the above equipment is the addition of control units which will enable fully automatic operation based on graduated charges. These units will perform the function of recording time of vehicle entrance and, on leaving the park, the amount of charge due. By this method 200 cars an hour can be accommodated in either direction.

For further information circle 55 on Service Card

INDEX TO ABSTRACTS AND REFERENCES

The annual Index to Abstracts and References published during 1962 in *Electronic Technology* (January-September) and with *Industrial Electronics* (October-December) has now been published. It was despatched to subscribers with the March issue of *Industrial Electronics*.

Copies are available at 5s. (postage 6d.).

DUALITY AND TUNNEL DIODES

(Continued from p. 334 of March issue)

In this part of the article tunnel-diode multivibrators with one and two inductances are designed and appropriate circuit values obtained.

By P. J. LANGLOIS, M.Sc.

THE relative inefficiency of the tunnel diode characteristic is illustrated in Fig. 12. Analysis of tunnel diode circuits must account for these departures from the ideal switch. Fig. 21 shows a typical tunnel diode characteristic (JK20A, $I_p = 5$ mA) with the equivalent circuit characteristic chosen. Figs. 22 and 23 show two types of equivalent circuit. They are used respectively when the operating point of the tunnel diode works above or below the elbow 'e' in Fig. 21. Stray reactive effects in the tunnel diode and associated circuitry will be ignored in the a.c. treatment of the multivibrator.

The two multivibrator circuits characterize these types of operation. In the single inductance case, the circuit allows high voltages to be developed across the tunnel diode, and the operating point goes above the elbow 'e'. In the double-inductance case, the voltage across the tunnel diode is limited to approximately the supply voltage, which will be held below the elbow 'e' for efficiency.

Single-Inductance Multivibrator

The astable multivibrator, which is the most general case, will be considered. Monostable and bistable circuits can be derived from astable results. There are two operations to be investigated. First, the conditions of steady-state oscillation, and secondly, the condition for ensuring effective cross-coupling between two tunnel diodes. Qualitative descriptions of these multivibrators have already been given (March).

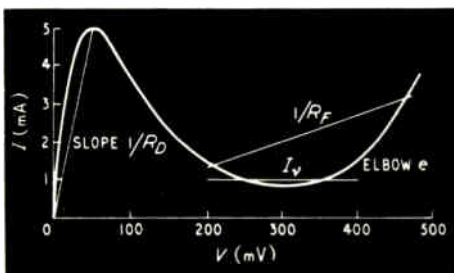

Fig. 21. JK20A tunnel diode characteristic and linear approximations

(i) Conditions in steady-state oscillation

It will be assumed that the multivibrator has reached steady-state oscillation. Figs. 24 and 25 show the equivalent circuit just before and after TD_A has switched to the 'I' condition, where I is the supply current generator. Suppose I_x is the current flowing in R_F at the point of switching. Laplace analysis of the subsequent action of the circuit gives the current I_R , through R_D as follows:

$$I_R = \frac{IR}{R + R_D} (1 - e^{-t/\tau}) + \frac{2IR}{2R + R_F + R_D} e^{-t/\tau} - (I_p - I_x) \frac{R + R_F}{2R + R_F + R_D} e^{-t/\tau} \quad (9)$$

Where I is the supply current,

$$\tau = L/R' \\ R' = (R + R_F) \text{ in parallel with } (R + R_D)$$

The current I_F , through R_F is given by

$$I_F = \frac{IR}{R + R_F} (1 - e^{-t/\tau}) + \frac{2IR}{2R + R_F + R_D} e^{-t/\tau} + (I_p - I_x) \frac{R + R_D}{2R + R_F + R_D} e^{-t/\tau} \quad (10)$$

At the end of the half-period, where $t = t_1$, the current in R_F must be I_x by definition; i.e.,

$$I_F(t_1) = I_x$$

Substituting this in equation (10), and simplifying,

$$I_x = \frac{\frac{IR}{R + R_F} + \left(I \frac{2R}{2R + R_F + R_D} - I \frac{R}{R + R_F} + I_p \frac{R + R_D}{2R + R_F + R_D} \right) e^{-t_1/\tau}}{1 + \frac{R + R_D}{2R + R_F + R_D} e^{-t_1/\tau}} \quad (11)$$

Also, when $t = t_1$, the current through R_D has reached I_p , so that

$$I_R(t_1) = I_p \quad (12)$$

By substituting equations (11) and (12) in equation (9), t_1 can be found in terms of the parameters of the circuit.

(ii) Condition for Cross-Coupling

So far it has been assumed that if one tunnel diode switches, the other will automatically switch back. It is possible, as discussed previously, to have both in the '0' or '1' condition, depending on the biasing arrangements. In the astable case, it is possible to have both in the '1' condition, so that the reactive components and biasing must be arranged to prevent this happening.

Fig. 24 shows the condition just before TD_A switches. Fig. 26 shows the equivalent circuit should TD_B not switch when TD_A switches.

The net current, I_B , in TD_B is

$$I_B = I \frac{R}{R + R_F} - \frac{I_p - I_x}{2} \quad (13)$$

To ensure that TD_B switches to the '0' condition, I_B must be below a certain minimum value, approximately I_v , i.e.,

$$I_B < I_v \quad (14)$$

If this is true, TD_B will start switching before TD_A has finished switching.

Practical Example

The tunnel diode used in this example is the STC JK20A. It has the parameters shown in Figs. 21, 22 and 23:

$$I_p = 5 \text{ mA}, I_v = 1 \text{ mA}, R_D = 10 \text{ ohms}, R_F = 150 \text{ ohms}.$$

Choice of Load Resistance

To ensure that the inequality in expression (14) holds, and since I is usually of the same order of magnitude as $(I_p - I_x)$, then from equation (13)

$$R \ll R_F$$

Now the period of oscillation should be controlled by the load resistance rather than by the parameters of the tunnel diode. From equation (9), this means that

$$R_D \ll R \ll R_F$$

The chosen load resistance R was 47 ohms. It will be seen later that I_x is approximately equal to I_v , so that from expressions (13) and (12)

$$I < 12 \text{ mA} \quad (15)$$

Choice of Current Drive

In order to reduce the deleterious effects of exceeding the elbow 'e' in Fig. 21, the value of I is kept as low as possible. From Fig. 35, which gives the overall $V-I$ characteristic of the actual multivibrator, a value for I of 6.4 mA will keep both diodes in the '1' state under d.c. conditions, which is necessary for oscillation, and is well below the limit in expression (15).

Period of Oscillation

Fig. 27 shows the circuit examined, where I is 6.4 mA and R is 47 ohms as selected above. L is chosen as 10 μ H. From equation (11):

$$I_x = 1.5 + 1.9 e^{-t_1/0.21} \text{ mA}$$

where t_1 is the half-period of oscillation.

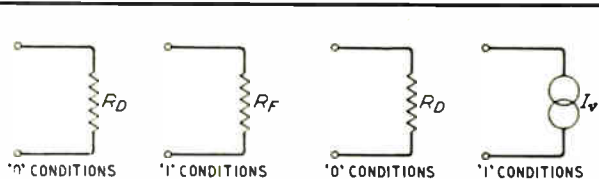

Fig. 22. Equivalent circuit of tunnel diode for unlimited voltage working

Fig. 23. Equivalent circuit of tunnel diode for limited voltage working

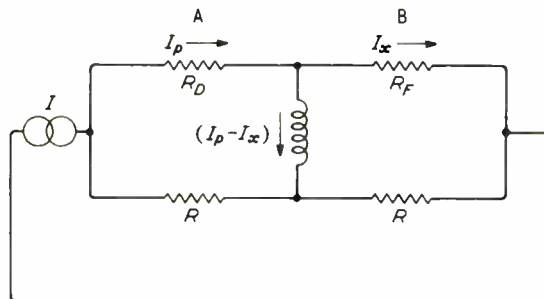

Fig. 24. Equivalent circuit just before tunnel diode A switches

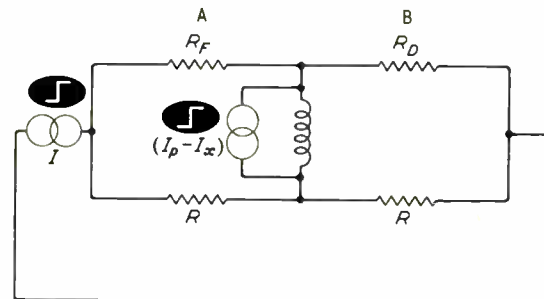

Fig. 25. Equivalent circuit just after tunnel diodes have switched. Note current generators are step functions

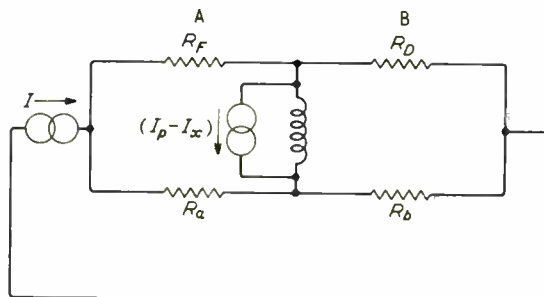

Fig. 26. Equivalent circuit after tunnel diode A has switched if tunnel diode B does not switch

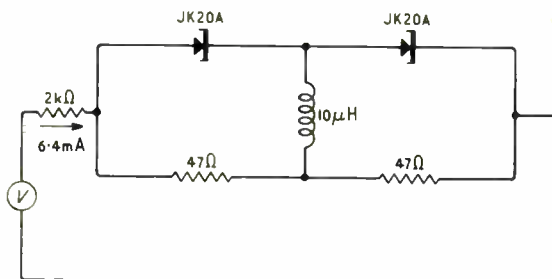

Fig. 27. Practical circuit tested

From equations (9) and (12), and assuming $t_1 \geq 3\tau$ then
 $5 \approx 5.3(1 - e^{-t_1/0.21})$
 and
 $t_1 \approx 3 \times 0.21$, or $0.63 \mu\text{sec}$

Putting this value of t_1 into equations (9) and (10), the curves of Fig. 28 can be plotted. Fig. 54 (included in the fourth and final part of this article) shows the curve trace of the current through the tunnel diode, and is reproduced in Fig. 28 in broken lines.

It can be seen that the theoretical and practical curves are well correlated, and demonstrate the validity of the tunnel-diode equivalent in Fig. 22 for this type of circuit.

Double-Inductance Multivibrator

(i) Conditions in steady-state oscillation

Again, it is assumed that the multivibrator has reached a steady-state oscillation. In this circuit, the transient voltages across the tunnel diode can never substantially exceed the supply voltage due to the low impedances of the supply and R_D . The operating point can therefore be kept below the elbow 'e' in Fig. 21. This is desirable, because the current through the tunnel diode when in the '1' condition is then kept to a minimum. The equivalent circuit for this type of operation is shown in Fig. 23, where R_F in Fig. 22 is replaced by a passive constant-current device passing a current I_v .

Figs. 29 and 30 show the multivibrator equivalent circuits immediately before and after TDA has switched to the '1' condition. I_y is the current through R_a immediately before switching. Laplace analysis gives the current I_r in R_D as

$$I_r = \left(\frac{V}{R + 2R_D} + I_v \frac{R}{R + 2R_D} \right) (1 - e^{-t/\tau}) - (I_D - I_v)e^{-t/\tau} \quad (16)$$

where

$$\tau = \frac{L}{R + 2R_D}$$

At the end of the half-period, when $t = t_1$, I_r reaches the value I_p , when the tunnel diode will switch. Putting $I_r = I_p$,

$$t_1 = \frac{L}{R + 2R_D} \log_e \frac{\frac{V}{2R_D + R} + I_v \frac{R}{2R_D + R} + (I_p - I_D)}{\frac{V}{2R_D + R} + I_v \frac{R}{2R_D + R} - I_p} \quad (17)$$

(ii) Condition for cross-coupling

As discussed in the single inductance multivibrator, it is possible to have both tunnel diodes in the '1' condition in the astable multivibrator. Sufficient cross-coupling must exist to keep steady-state oscillation. Fig. 31 shows the equivalent circuit if TDB were not to switch when TDA switches. TDB has been changed to an unknown. In the equivalent circuit in Fig. 23 for the '1' condition, I_v is not a true current generator. If I_v cannot be maintained, the tunnel diode will switch. In the equivalent circuit of Fig. 31, this will occur when

$$(I_r + I_x) - (I_p - I_r - I_D) < I_r$$

or

$$I_p > I_r$$

It should be noted that since the maximum voltage swing is limited to approximately the supply-voltage swing, the output waveform across the tunnel diode is substantially square, which is often desirable. In the single inductance case, where there are no voltage limits across the tunnel diode except by virtue of the characteristic, the waveform across the tunnel diode is comparatively curved.

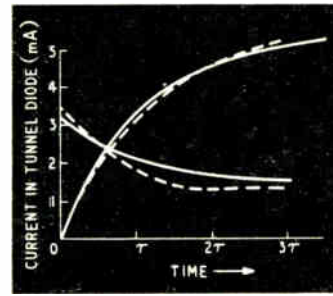

Fig. 28. Theoretical and practical waveforms of current through a tunnel diode in a single-inductance multivibrator. (Broken lines indicate practical waveform.) τ — time constant — $0.21 \mu\text{sec}$

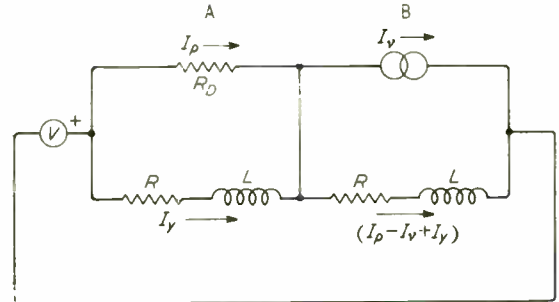

Fig. 29. Equivalent circuit just before tunnel diode A switches

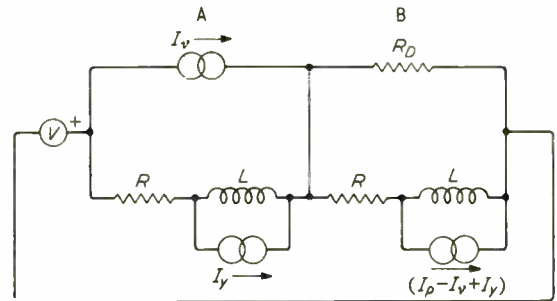

Fig. 30. Equivalent circuit just after tunnel diodes have switched. Generators are step functions

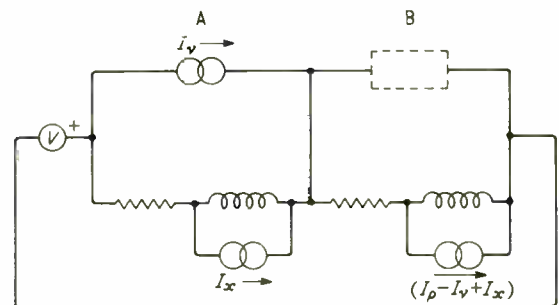

Fig. 31. Equivalent circuit after tunnel diode A has switched if tunnel diode B does not switch

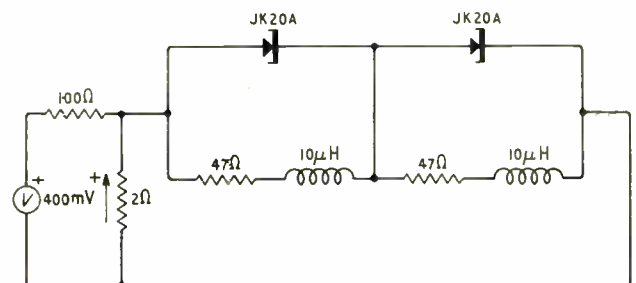

Fig. 32. Practical circuit tested

Practical Example

Choice of load resistance R and supply voltage:

The analysis assumes that the operating point lies below the elbow 'e' in Fig. 21. In the multivibrator, while one tunnel diode is in the '0' condition, the other tunnel diode has virtually the whole of the supply voltage across it. From Fig. 21, the supply voltage must therefore be less than 400 mV. Now for astability the d.c. supply must be capable of keeping both tunnel diodes in the '1' condition. Fig. 35 (Part 4) shows that the supply voltage required for this condition is reduced as the load resistance is reduced. However, to control the timing of the multivibrator by the load rather than by the tunnel diode parameters, from equation (17)

$$R > R_{II}$$

R was chosen as 47 ohms, which gives the overall characteristic of the multivibrator shown in Fig. 35. The supply voltage can then be 400 mV.

Period of Oscillation

Fig. 32 shows the circuit examined, where $V = 400$ mV and $R = 47$ ohms as selected above, and L is selected as $10 \mu\text{H}$. From equation (17), the half-period of oscillation t_1 is

$$t_1 = 0.15 \log_e \frac{6 + 0.7 + 4}{6 + 0.7 - 5} \\ = 0.28 \mu\text{sec}$$

From equation (16) and the '1' condition equivalent circuit, the curves in Fig. 33 can be plotted. Fig. 55 (included

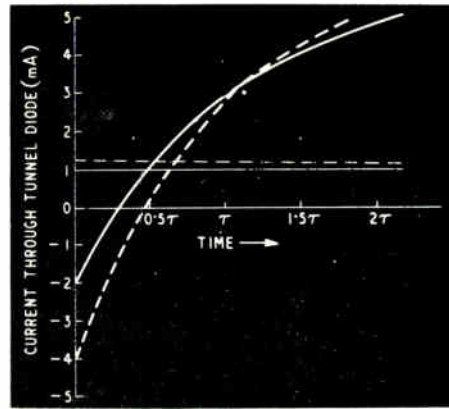

Fig. 33. Theoretical and practical waveforms of current through diode in double-inductance multivibrator. (Broken lines indicate practical waveform.) $\tau =$ circuit time constant $= 0.15 \mu\text{sec}$

in the fourth and final part of the article) shows the current waveform through the tunnel diode and is reproduced as broken lines in Fig. 33. The correlation between theoretical and practical curve traces demonstrates the validity of the tunnel-diode circuit in Fig. 23 for this type of circuit. In practice, due to the more efficient operation of this circuit (keeping the operating point below the elbow), the maximum frequency of this type of multivibrator is higher than that of the single inductance multivibrator.

(To be concluded)

New High-Speed Memory Device

A promising device which may replace ferrite-core and thin-film memory assemblies in computers and switching systems has been announced by Bell Telephone Laboratories.

This is a magnetic memory device that looks somewhat like a miniature waffle iron and operates at read-write cycle times of $1 \mu\text{sec}$. It consists of a base plate made of high-permeability ferrite in which a grid of slots is cut, leaving a regular array of rectangular posts. Hence its name, the waffle-iron memory.

Preprinted wiring patterns, a set for the read-write and a set for the digit-sense wires, are placed in the slots. An overlay of square-loop magnetic material, such as a type of permalloy, is laid across the tops of the posts.

Information is stored in the overlay material between the posts in the direction of magnetization of the magnetic flux. The width of the slot is the effective length of the magnetic path in the storage material. The ferrite base and the overlay material connecting a pair of posts form a closed magnetic flux path. One type of waffle-iron memory has posts 100 mils long and 30 mils wide and slot width of 30 mils.

Both destructive and non-destructive memories have been built. Destructive memories use an overlay of a single magnetic material. Non-destructive memories use an overlay of two magnetic materials, one for storage and the other for sensing. When a non-destructive memory is read, only the sensing material is switched; thus the memory can be interrogated indefinitely without affecting the stored information. Also another form of waffle-iron memory, called the cubic, has been developed. In the cubic structure both the selection and sense wires follow straight paths, instead of weaving around the posts as in the other waffle-iron memory. Since these wires cross each other at right angles, a pulse travelling down one wire will not induce appreciable current in the other, thus the signal-to-noise ratio is improved.

One experimental memory matrix of the cubic type has a capacity of 128 words of 30 bits per word. It has a read-write cycle time as fast as $200 \text{ m}\mu\text{sec}$.

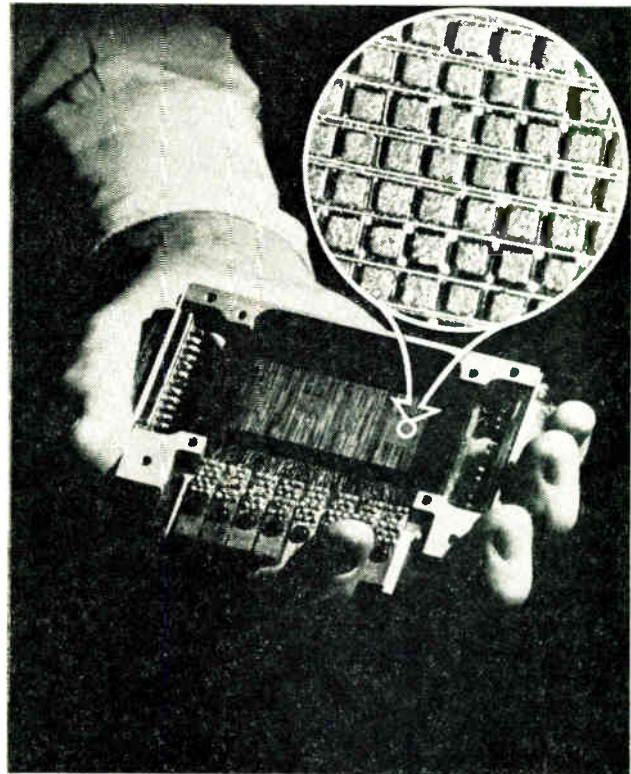

This experimental waffle-iron memory can store 64 words of 30 bits per word



Personal and Company News

Associated Electrical Industries Ltd. announce that it is reducing the number of its research establishments from four to two. The Aldermaston Court Laboratory is to be closed down, but laboratories at Manchester and Rugby are to be extended. Dr. T. E. Allibone, F.R.S., is Scientific Adviser, Dr. J. E. Stanworth and Dr. J. M. Dodds are Associate Directors of Research in charge of Rugby and Manchester laboratories respectively.

Sebastian de Ferranti has been appointed chairman of Ferranti Ltd. He continues as managing director.

A. E. Robertson, B.Sc.(Hons.), A.M.I.E.E., has been appointed head of the B.B.C. Engineering Training Department in succession to K. R. Sturley, Ph.D., B.Sc., M.I.E.E., who has become chief engineer, External Broadcasting. D. H. Cummings, B.Sc.(Eng.), A.C.G.I., A.M.I.E.E., has been appointed superintendent engineer, Sound Broadcasting (Operations).

John H. Powell, M.B.E., A.M.I.E.E., has joined the board of Cannon Electric (Great Britain) Ltd. as deputy managing director.

E. A. J. Hall, B.Sc.(Lond.), Ph.D.(Cantab.), M.I.E.E., has been appointed technical manager avionics of Rank Cintel. G. J. Williams, B.Sc.(Hons.), A.Inst.P., M.Inst.M.S.M., has joined Rank Cintel as general manager, electronic tubes division.

W. H. D. Gregson (Ferranti Ltd.) and W. C. Morgan (E.M.I. Electronics Ltd.) have been elected chairman and vice-chairman respectively of the Electronic Engineering Association.

Marconi's Wireless Telegraph Co. Ltd. has formed an International Division under the management of H. Baker, with E. R. Burroughes as deputy manager.

A broad licensing agreement between Ultra Electronics Ltd. and Avco Corporation of New York has been signed. It enables Ultra to employ certain Avco patents.

Perdio Electronics Ltd. has acquired Electric Audio Reproducers Ltd.

Evershed and Vignoles Ltd. has established a French company, Evershed-Enraf-France S.A., 11, Faubourg Poissonniere, Paris IXe. Megger instruments will continue to be handled by Promesur S.A., 19 Rue-Eugene-Carriere, Paris 18e.

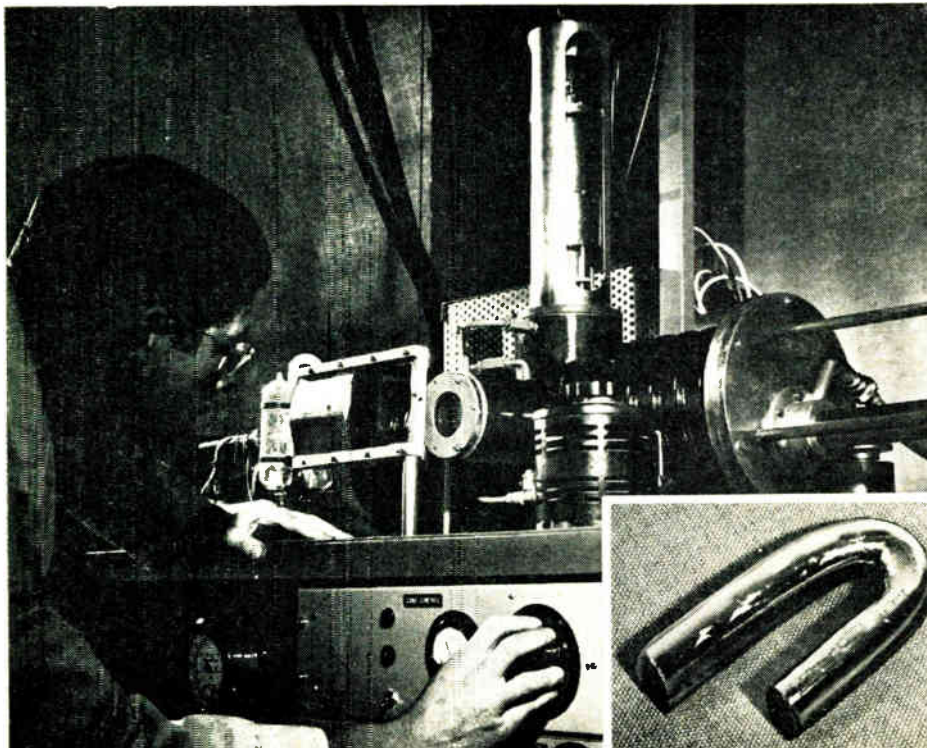

An experimental furnace in the G.E.C. Hirst Research Centre uses an electron beam to melt refractory materials. A power of 4 kW at 8 kV is available in the beam. Inset is a cast bar of molybdenum; after treatment in the furnace it becomes very ductile



▲
Transistor production demands that certain operations be carried out in a dry atmosphere. The photograph shows 'dry boxes' in part of the Hughes International production line for mesa high-speed switching transistors. The operatives wear arm length gloves which are sealed to the boxes

This Geo. Vokes (Infra-Red) Ltd. infra-red dryer with slotted moving belt has a through-put of 1,100 18-in. boards an hour. The oven is 10 ft by 2 ft and consumes 12 kW

For further information circle 56 on Service Card

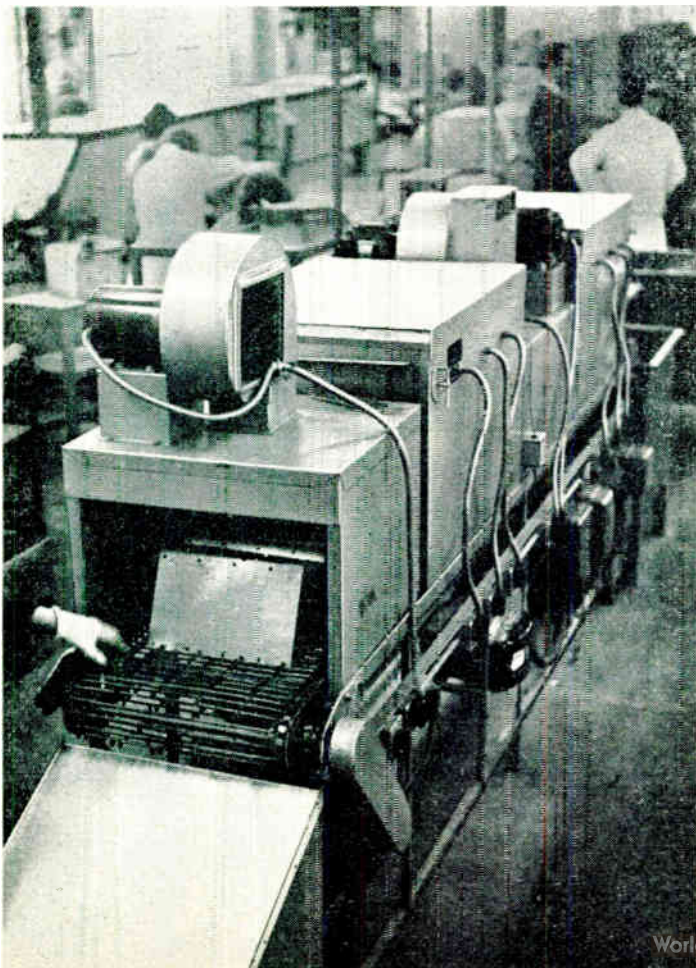

A. C. Cossor Ltd. has opened a London office in Wing 6, 5th Floor, Berkeley Square House, Berkeley Square, London, W.1. (Telephone: Mayfair 1429).

C. D. C. Dickens has been appointed public relations controller of **International Computers and Tabulators Ltd.**

Experitron has merged with **Brayhead Electronic Components Ltd.**

R.C.A. Great Britain Ltd. is marketing in the U.K. and in Eire the language laboratory equipment manufactured by Cedamel of Paris.

A technical data service for Fairchild semiconductor devices is available to circuit and equipment designers from **SGA-Fairchild Ltd.**, Stonefield Way, Victoria Road, South Ruislip, Middlesex.

R. W. Stevens, B.Sc., F.I.E.S., F.S.I.A., has been appointed company industrial designer to **Standard Telephones and Cables Ltd.**

Terence O'Neill, public relations officer of The Solartron Electronic Group Ltd., died on 20th February after a brief illness.

Production Technology

The April issue of this journal contains an article on 'Tape-Controlled Routing', in which the economic advantages of numerically-controlled machining over conventional methods for hogging-out operations on light alloy parts are explained. Another article describes a new approach to die-making by spark erosion methods. Other articles deal with value engineering, plastic protective coatings and the prediction of cutting-tool performance.

Production Technology incorporates *Aircraft Production* and is published by Iliffe Production Publications Ltd.



C.I.C. Engineering, manufacturers of shoe moulds, are using a Cincinnati No. 3 milling machine with an E.M.I. Electronics control system. Punched paper tape is used and left and right foot moulds can be cut from the same tape merely by turning a switch

Exhibitions, Conferences and Symposia

The 1963 Brit. I.R.E. Convention on Electronics and Productivity will be held at the University of Southampton from 16th to 20th April 1963.

The Scientific Instrument Manufacturers' Association of Great Britain is arranging an exhibit of the products of member firms at the Polytechnic Museum, Moscow, from 16th to 26th May 1963.

The Institute of Physics and the Physical Society is holding a conference on Low and Medium Energy Nuclear Physics at the University of Manchester from 4th to 6th September 1963.

An International Telemetering Conference will be held at the headquarters of the Institution of Electrical Engineers from 23rd to 27th September 1963. It is sponsored by the American Institute of Aeronautics and Astronautics, the British Institute of Radio Engineers, the Institution of Electrical Engineers, the Institute of Electrical and Electronic Engineers and the Instrument Society of America.

The Institution of Electrical Engineers is organizing a Conference on the Design and Use of Microwave Valves, which will be held at its headquarters from 16th to 18th October 1963.

A Symposium on Automatic Production in Electrical and Electronic Engineering will be held at the Institution of Electrical Engineers' headquarters from 24th to 25th October 1963.

The Industrial Photographic and Television Exhibition will be held at Earls Court, London, from 11th to 16th November 1963.

The Institute of Physics and the Physical Society is arranging a conference on Solid-State Physics at the H. H. Wills Laboratory, University of Bristol, from 1st to 4th January 1964.

The Institute of Physics and the Physical Society is arranging an international conference on Magnetism on behalf of the International Union of Pure and Applied Physics and the British National Committee for Physics. It will be held at the University of Nottingham from 7th to 11th September 1964.

Obituary

Peter Pendleton Eckersley died on March 17th at the age of 71.

In 1922 'P.P.' was largely responsible for the weekly transmissions from 2MT Writtle, an experimental station of Marconi's Wireless Telegraph Co. Ltd. As all old-hands well remember, he was known and liked as much for his inimitable contributions to the programmes as for his technical achievements. In those pre-broadcasting days 2MT and P.P. were the high spot of the week.

In 1923 he joined the B.B.C. as their first chief engineer, a position which he held until 1929. He was largely responsible for the B.B.C. regional transmitting scheme whereby coverage of the country and alternative programmes were achieved by pairs of high-power co-sited transmitters.

On leaving the B.B.C. in 1929 he became a consulting engineer and in 1946 he joined the Telephone Manufacturing Co. Ltd. He retired in 1962.

De Havilland TRACE is a tape-controlled automatic checkout equipment which is designed to test electronic installations automatically under the control of punched tape. It cuts testing time to one-sixteenth

For further information circle 57 on Service Card

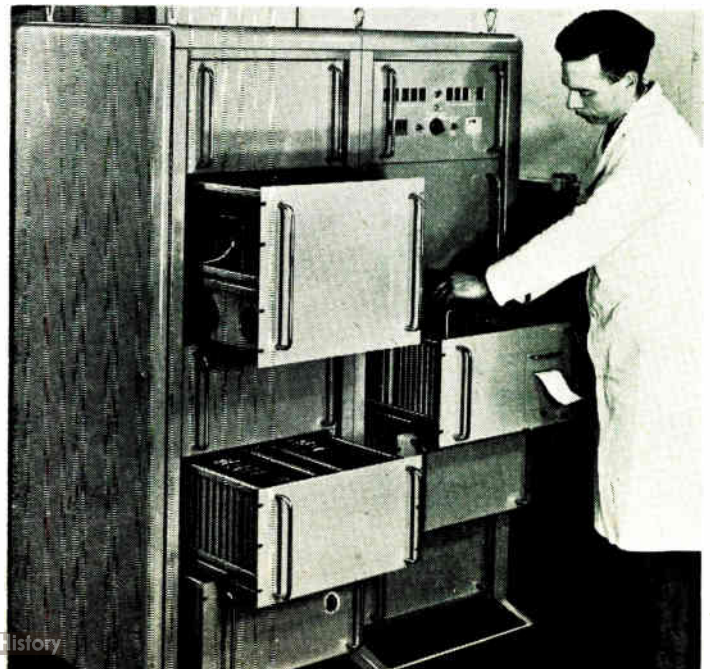



Inertial Navigation

By RICHARD H. PARVIN and others. Pp. 370 + xxi. D. Van Nostrand Co. Ltd., 358 Kensington High Street, London, W.14. Price 93s.

Another volume in the series 'Principles of Guided Missile Design', this book deals with inertial guidance. The reader is supposed to be familiar with the systems requirements of a guided missile. There are seventeen chapters, covering characteristics, the Laplace transform, transfer functions, closed-loop systems, vectors, matrices and co-ordinate transformation, gyros, accelerometers, measuring units, the earth in inertial space, basic system mechanization, pre-launch trim and alignment, classes and sources of errors, space stabilized and base point systems, the computer, space ballistics and guidance equations.

For the complexity of the subject the treatment is a fairly elementary one. Even so, it demands familiarity with a good deal of mathematics on the part of the reader, especially with co-ordinate transformation.

A good deal of laboratory slang has crept into the book; for example, '... the drift rates for each succeeding interval are *root-mean-squared* to come up with a standard deviation ...', and '... the platform is *torqued* out of level'. '... the erroneous velocity computation *torques* the level stabilization gyro ...'. The italics are ours. People do say these things when talking in the laboratory, but this wholesale turning of nouns into verbs is rather much in a serious book.

Digital Computer Principles

By BURROUGHS CORPORATION. Pp. 507 + ix. McGraw-Hill Publishing Co. Ltd., 95 Farringdon Street, London, E.C.4. Price 58s.

This book was originally written for the general computer fundamentals course which is conducted by the Military Field Service Division of the Burroughs Corporation. It is intended for preparing prospective computer technicians, engineers and programmers for the more advanced concepts which they will encounter when they study actual systems.

The book is thus intended primarily for the beginner in the computer field. It meets its purpose excellently; it is man-size and detailed in treatment, and yet it can be understood without difficulty by the newcomer to the subject. It gives the impression of having been written by people who understand beginners' difficulties and who have in consequence really tried to smooth their path (and succeeded in doing so).

The treatment is essentially non-mathematical. In spite of this the book includes one of the clearest explanations of binary arithmetic that we have yet seen. Binary-decimal and decimal-binary conversion are made very clear, as well as addition and subtraction. The octal system, the excess-3 code, the Gray code, the biquinary code and the ternary code are all clearly explained. There is also a chapter on Boolean algebra.

The concepts so well explained here are used in later sections of the book, but not extensively. The bulk of the

book can be understood without knowing anything about Boolean algebra; where this it introduced it is more to show the reader how it lends itself to the compact expression of requirements than as a necessary thing for the proper understanding of the point at issue. The binary system comes up much more often, however, and some familiarity with it is frequently necessary for proper understanding.

This is reasonable enough. Since computers work in terms of binary arithmetic, it would not be very sensible to expect to be able to understand how they work without knowing at least something about this type of arithmetic.

The book is divided into three sections. The first includes the mathematical chapters and covers also magnetic devices, an introduction to semiconductors, and transistor switching characteristics. Section II deals with computer circuits, viz., transistor gate logic, multivibrators and other equivalents, timing oscillators, amplifiers and ferromagnetic cores. Section III covers computer units. Here there are chapters on binary counters and decoders, storage and shift registers, diode and transistor matrices, adders and subtractors, and so on, ending with a chapter on programming.

The book is one which can be thoroughly recommended to any engineer who wishes to study how computers work and the broad details of their circuitry, without going into the finer points of design.

Technical Television

By A. V. J. MARTIN. Pp. 557 + xv. Prentice-Hall International, 28 Welbeck Street, London, W.1. Price 88s.

Although the author is editor of *Electronique et Automatismes* and of *Electronique Medicale*, this book is written in English and has been printed in the U.S.A. The book was written when he was Assistant Professor of Electrical Engineering at the Carnegie Institute of Technology. As might be expected, therefore, there is an American flavour about it especially in so far as examples are mainly drawn from American practice. The only standards considered are the N.T.S.C. 525-line.

In view of this it is quite surprising to find that in matters of circuit detail British practice is by no means ignored. The Blumlein frame timebase linearity circuit is given and attributed to him; also the Miller integrator is described.

The treatment is mainly descriptive. Design formulae (e.g. for i.f. circuits) are quoted, but there are no complete analyses. There is a chapter on the transmitter, another on aerials, and two on colour television. The rest of the book deals with monochrome receivers in considerable detail. The book is a good one and reasonably up to date.

Radio Wave Propagation and the Ionosphere

By YA. I. AL'PERT. Pp. 394 + x. Consultant Bureau Enterprises Inc., 227 West 17th Street, New York 11, U.S.A. Price \$22.50.

This is a translation from the Russian, the original text being published in 1960 in Moscow for the Institute of Terrestrial Magnetism, the Ionosphere, and Propagation of Radio Waves. The book deals with the propagation of electromagnetic waves from millimetre wavelengths upwards to tens of kilometres.

Introduction to Electron Beam Technology

Edited by ROBERT BAKISH. Pp. 452 + xi. John Wiley & Sons Ltd., Gordon House, Greencoat Place, London, S.W.1. Price 105s.

Although accurate enough, the title of this book may be a little misleading in that it may convey the impression that the book is about electronic devices embodying electron beams, such as travelling-wave tubes, cathode-ray tubes,

etc. The book actually deals with the use of electron beams for melting, refining, welding, machining and so on.

The early chapters treat the physics of electron beams, electron-gun design, and design considerations for electron-beam systems. There is a chapter on radiation hazards associated with the processes. Then there are separate chapters for each of the various applications. The early chapters are fairly mathematical, the later ones hardly at all. Extensive bibliographies are included and the book should form a very useful introduction to this rather specialized subject.

An Introduction to Electronic Analogue Computers

By M. G. HARTLEY, M.Sc.Tech. Pp. 155 + vii. Methuen & Co. Ltd., 36 Essex Street, London, W.C.2. Prices 21s.

This is one of the well-known Monographs on Physical Subjects. After giving some historical background, there is a comparison of analogue and digital computers. Then comes a chapter on the role of the operational amplifier, followed by one dealing with the electronic analogue machine. The three remaining chapters cover practical d.c. amplifiers, transistor computing amplifiers, and computer auxiliary equipment.

The book forms a useful introduction to the subject at a serious, but by no means highbrow, level.

Manufacturers' Literature

T.M.C. 10-Line Private Automatic Exchange. An illustrated 4-page leaflet describing the new T.M.C. 10-line private automatic telephone exchange. This gives details of the operation and construction of the equipment as well as outlining power supply and dimensional requirements.

Telephone Manufacturing Co. Ltd., Martell Road, London, S.E.21.

For further information circle 58 on Service Card

Pulse Height Analyser 100 Channel Model 1363D. This 10-page booklet describes the Model 1363D analyser which has 100 channels and is particularly suitable for whole body counting, beta and gamma scintillation counting and time of flight neutron detection.

20th Century Electronics Ltd., Centronics Works, King Henry's Drive, New Addington, Croydon, Surrey.

For further information circle 59 on Service Card

E.M.I. Electronics 'Prestige' Publication. This 52-page profusely illustrated brochure gives details of the development of E.M.I. Electronics and describes some products and services of their various divisions.

E.M.I. Electronics Ltd., Hayes, Middlesex.

For further information circle 60 on Service Card

English Electric Equivalents Index. A 12-page pocket-sized booklet which lists communications, industrial and Services type valves of various manufacturers for which E.E.V. valves may be used as replacements.

English Electric Valve Co. Ltd., Chelmsford, Essex.

For further information circle 61 on Service Card

Precision Vernier Potentiometer Type P10. In this single-sheet leaflet details are given of the latest Croydon d.c. potentiometer. It covers the range $-1 \mu\text{V}$ to 1.8 V and has an accuracy of 1 part in 10^5 of the 1-V setting.

Croydon Precision Instrument Co., Hampton Road, Croydon, Surrey.

For further information circle 62 on Service Card

Solion Devices. Texas Research and Electronic Corporation have published a 12-page brochure 'An Introduction to Solions' and nine separate leaflets describing various types of Solion, their applications and devices using them. Solion is the name given to a family of electronic devices which function by controlling and monitoring reversible electrochemical reaction. The Solion is a very low frequency device which is analogous to a thermionic valve or transistor with an upper cut-off frequency of about 1 c/s. Distributed in the U.K. by *S.A.S.C.O., Stewart Aeronautical Supply Co. Ltd., Adastral House, Nutfield, Redhill, Surrey.*

For further information circle 63 on Service Card

Moving Coil Indicating Relays. The 4-page publication covers the White types AP/1 and AP/2 moving-coil indicating relays which are designed to give both an indication of a particular physical variation and warning or control signal should the signal being measured stray outside certain limits.

White Electrical Instrument Co. Ltd., 10 Amwell Street, London, E.C.1.

For further information circle 64 on Service Card

Miniature Heavy Duty Contactors Series 'ST'. This single-sheet leaflet gives details of the SBK series 'ST' contactors. Each unit in this series is rated at 6 A (continuous) and is designed with a mechanical life of 10 million operations. The series comprises 28 standard types with various coil voltage (110, 240 and 415 V) and contact arrangements.

Elreenco Sales Ltd., Bush Fair, Harlow, Essex.

For further information circle 65 on Service Card

Transistorized Portable Transfer Function Analyser Type 120. In this 8-page leaflet a self-contained servo test equipment giving direct indication of phase angle and amplitude is described.

Servo Consultants Ltd., 162 Kensal Road, London, W.10.

For further information circle 66 on Service Card

Lie Belin Abridged Catalogue. A 20-page catalogue which describes and gives brief specifications for Lie Belin products. These include professional type equipment such as a.f. tape recorders; a.f., nuclear and recording instruments and facsimile equipment.

Lie Belin, 296 Avenue Napoléon-Bonaparte, Rueil-Malmaison (S.-&-O.) B.P. 69, France.

For further information circle 67 on Service Card

Automat Transformers and D.C. Equipment. This 8-page brochure illustrates a range of transformers from 25 VA to 10 kVA single-phase and 100 VA to 20 kVA three-phase. Also described are complete d.c. distribution, battery charging and battery control equipment.

Electro-Automat Ltd., Moorside Works, Swinton, Manchester.

For further information circle 68 on Service Card

Simrad Echo Sounders and Sonar. In this 8-page fold-out leaflet some details are given of the echo sounders and sonar equipments which are manufactured by Simonsen Radio, A.S., of Oslo and are now distributed in the U.K. by

Decca Radar Ltd., Albert Embankment, London, S.E.1.

For further information circle 69 on Service Card

Westinghouse Selenium Rectifiers. This 8-page publication allows the user to select a selenium rectifier to suit his electrical conditions, to choose the most convenient size and to specify his transformer. Eleven basic types of rectifier are listed each of which have many variants.

Westinghouse Brake and Signal Co. Ltd., 82 York Way, London, N.1.

For further information circle 70 on Service Card

Vibrashock Isolation. In this 8-page leaflet various types of shock absorbing mountings are described. All of these are based on an all-metal construction using knitted stainless-steel wire as the damping medium.

Delaney Gally Ltd., Vulcan Works, Edgware Road, London, N.W.2.

For further information circle 71 on Service Card

IT'S EASY
TO CHOOSE
THE RIGHT
TRANSMITTING
VALVE

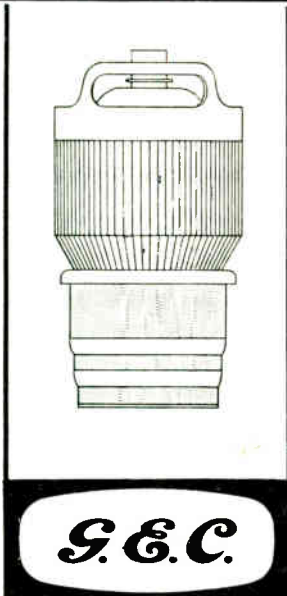
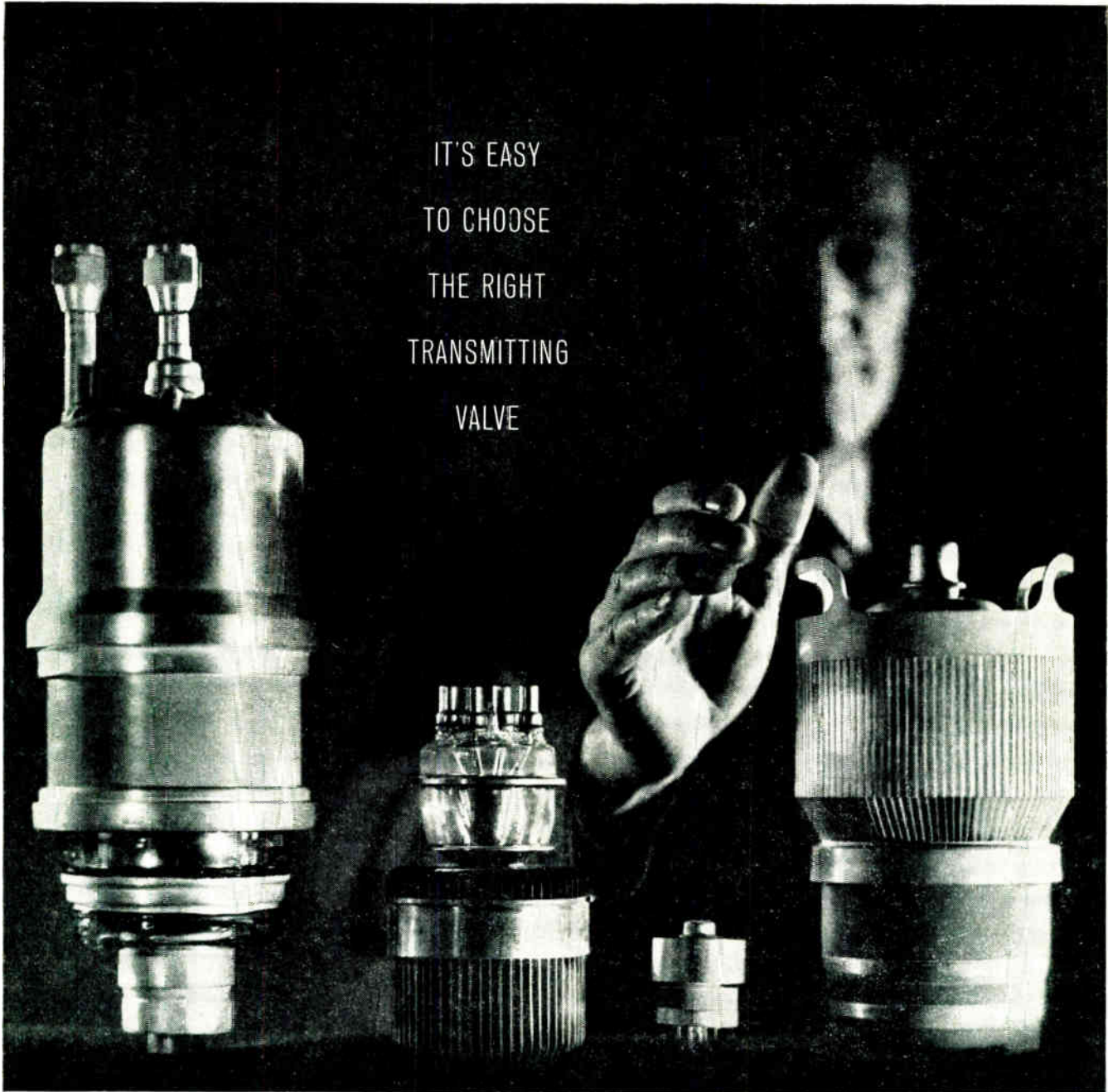

TAKE THE ACS 5

This is a new ceramic tetrode for Single Sideband Transmitters with the following specifications:

- 10 kW output per valve in Class AB1 □ Full ratings up to 30 Mc/s — reduced ratings to 110 Mc/s
- Low inter-modulation distortion — 36dB relative to peak envelope power
- Forced air cooled — 400 c.f.m. at 5" WG for $p_a=6$ kW.

	V_a (kV)	I_a (A)	V_{g2} (V)	I_{g2} (mA)	P_{gr} (W)	P_{out} (kW)
Class C Telegraphy	7.5	2.8	500	500	150	16
Class AB1—S.S.B.	7.5	1.9	1250	200	0	10
Class AB1—audio (2 valves)	7.0	3.65	1250	240	0	17.5

Our 300 engineers are ready to help with your problems. Just ring RIVERSIDE 3431 and ask for the Technical Information Centre, or write to the address below.

THE M-O VALVE CO LTD

BROOK GREEN · HAMMERSMITH · LONDON W6 · RIVERSIDE 3431

A high quality
versatile
OSCILLOSCOPE
that you can
build at low cost!

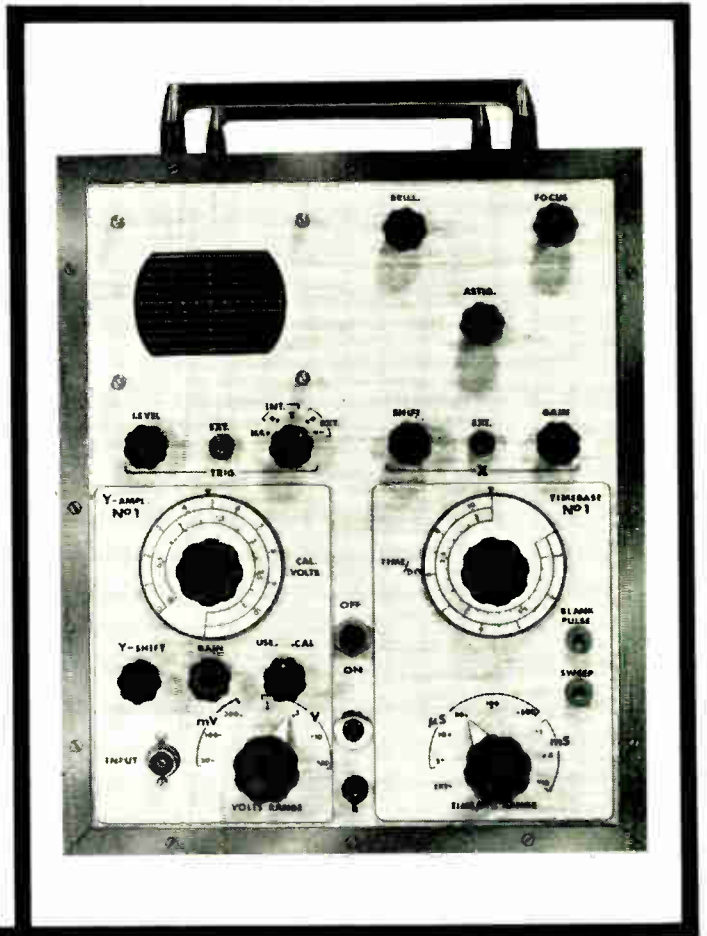

**UNIQUE OPPORTUNITY
—BY BRITAIN'S
TOP ELECTRONICS JOURNAL**

Wireless World

With this oscilloscope WIRELESS WORLD begins a new series of articles on construction and use of electronic apparatus. Intended for readers with limited facilities, it will build up a range of equipment with which many interesting projects can be tackled. Prices are kept down without compromising quality. Start now on this unique course in electronics.

Make sure of APRIL

and place a regular order

This oscilloscope—designed in WIRELESS WORLD's own laboratories—is the basis of a complete set of test equipment. It has a flat-faced, 3 inch, 3 kV. tube, calibrated "x" and "y" controls, and can be adapted by means of plug-in units for varied uses including television testing. Plug-in time bases will range from the free-running type to triggered, delayed versions. Plug-in y-amplifiers cover from the audio range to 10 Mc's.

CONSTRUCTIONAL DETAILS—APRIL

(General design considerations appeared in MARCH)

Wireless World

Newsagents 2s. 6d

(out 25 March)

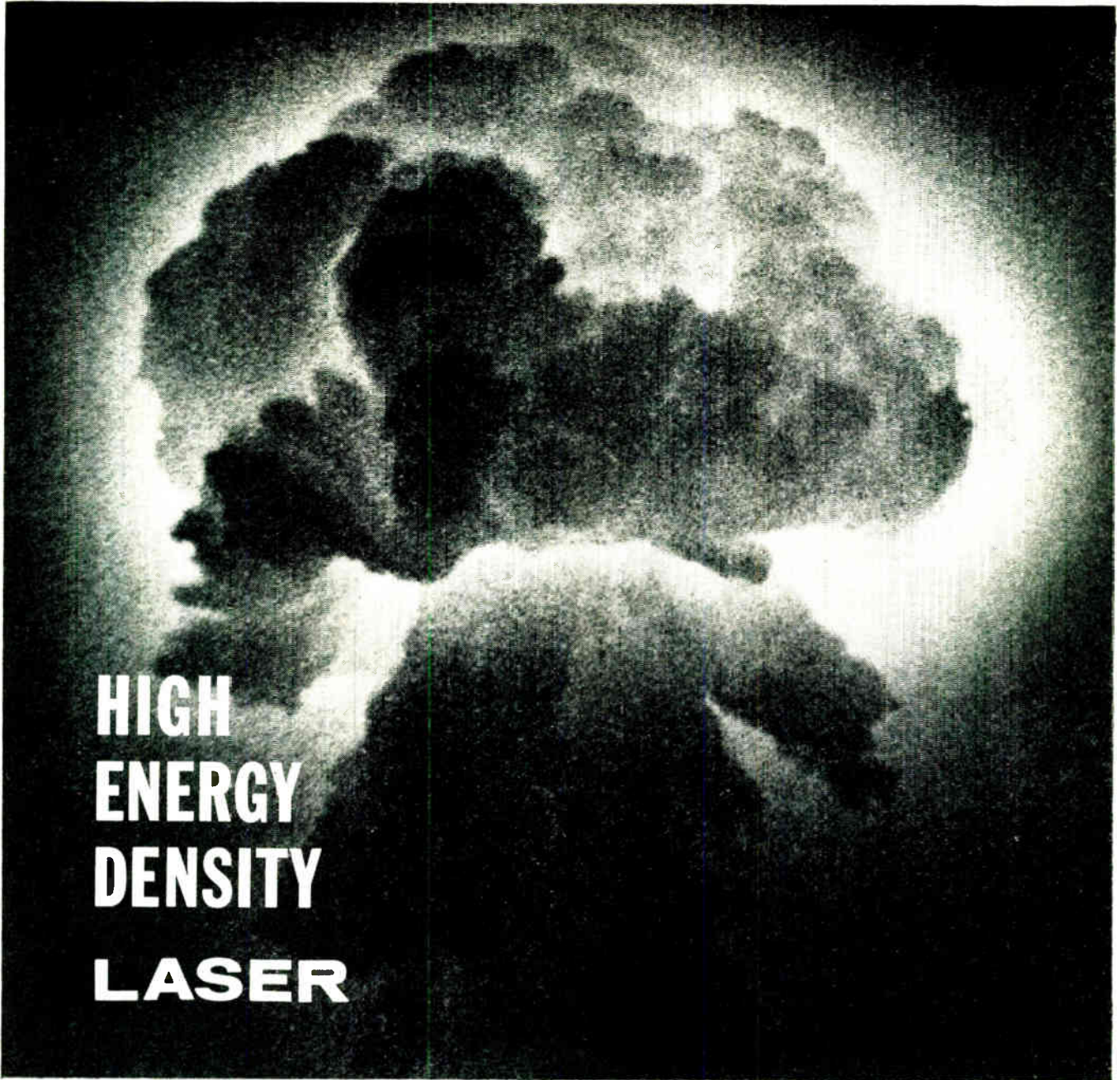

HIGH ENERGY DENSITY LASER



Energy density approaching that to be found within an atomic explosion can be yours with a **Bradley Laser**.

The type 301, a compact, portable unit, produces single pulses of coherent light in the red region of the visible spectrum with high directivity. The active element is a 2 inch ruby rod having an output energy of 2 Joules, at 6943A. Concentrating this beam can produce an energy density of 10^{16} Watts cc.

Our models of greater power and other wavelengths, including the recently introduced 30 Joule model (Type 330), have excited the interest of forward-looking scientists everywhere, while Industrialists readily appreciate the economic potential of this new production tool for cutting, welding, piercing etc.

The LASER Type 330 will be demonstrated at the International Engineering Exhibition Stand 56, Ground Floor, Grand Hall, Olympia.

G. & E. BRADLEY, LTD., Electral House, Neasden Lane, London, N.W.10. Tel. Dollis Hill 7811



For further information circle 228 on Service Card



Soldering Instruments and Equipment

Illustrated

$\frac{3}{16}$ " BIT INSTRUMENT (List No. L64) IN PROTECTIVE UNIT (List No. 700)

ALL VOLT RANGES
6/7 to 230/50 VOLTS

BRITISH & FOREIGN PATS. & REG. DESIGNS, ETC.

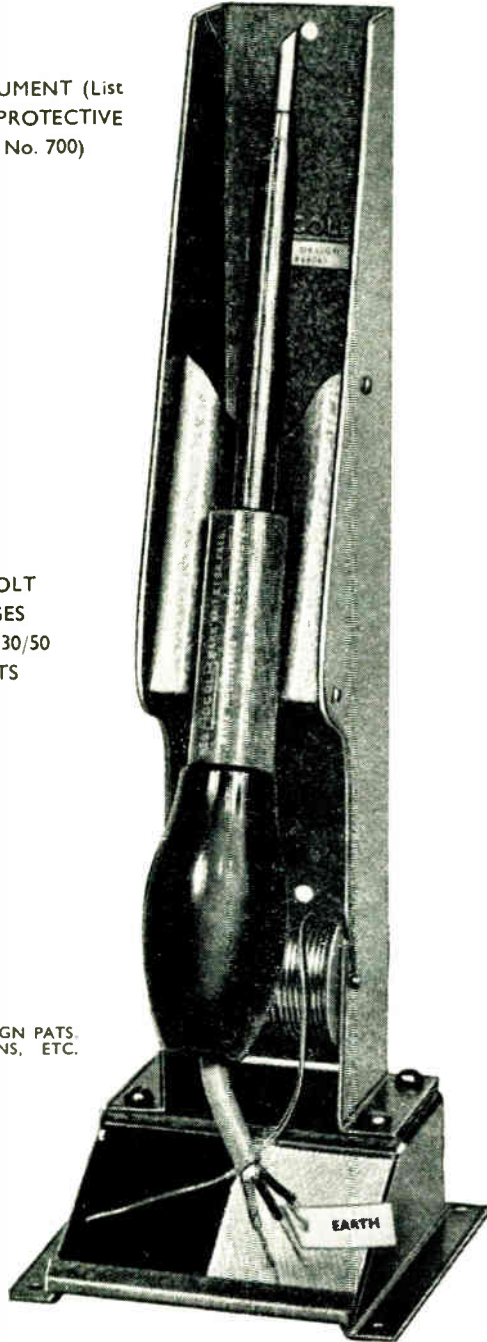

Traditional British Quality and Workmanship
ADCOLA PRODUCTS LIMITED

Head Office, Sales and Service

ADCOLA HOUSE, GAUDEN ROAD, LONDON, S.W.4

Telephones MACAULAY 3101 & 4272

Telegrams SOLJOINT LONDON S.W.4

AUSTRALIAN OFFICE: 420 ST. KILDA ROAD, MELBOURNE, S.C.2

For further information circle 229 on Service Card

Magnetic Amplifier Analyser

DAVID L. LAFUZE, *Department of Specialty Control,*
General Electric Company

Presents and develops a systematic procedure for analyzing amplifier circuits in general. The basis of the presentation is the use of an equivalent circuit to represent the magnetic core; the second major technique used in the block diagram of basic servo theory. Results are tied to basic core properties, especially those found by the AIEE Constant Current Flux Reset Test. The general technique covers both half-wave and full-wave magnetic amplifiers. 262 pages, 74s.

Fundamentals of Semiconductor and Tube Electronics

H. ALEX ROMANOWITZ, *Department of Electrical Engineering, University of Kentucky*

The subject matter of this book is presented from an engineering viewpoint and draws extensively upon background theory in physics in order to clarify fundamental concepts and principles. Wherever possible, a quantitative treatment is emphasized in which lucid qualitative description is combined with the mathematical derivations, proofs and illustrations that lead to greater confidence and efficiency in working with circuits. 584 pages, 62s.

John Wiley • Interscience

Glen House • Stag Place • London SW1

For further information circle 230 on Service Card

OXLEY DEVELOPMENTS CO. LTD.



OXLEY

SOLDERLESS WRAPPED JOINTS

CHARACTERISTICS

Chassis thickness ... 16-18 SWG - 048 064" - 1.2/1.6 mm
Capacity ... 1.5 pF
Operating temperature ... 55°C - + 200°C

The Oxley "Barb" solderless wrapped connector is a speedily assembled lead through, of outstanding electrical and mechanical characteristics.

The spill is nickel flashed and solder dipped and spun to British P.O. Specification No. M38. Insert the bush in a .156 dia. plain hole in the chassis, and press the barbed spill firmly but slowly through the bush; the latter expands, particularly on the far side of the chassis, and results in the insulator becoming an integral part of it.

In addition to its excellent qualities, a considerable saving of time is effected in assembly. Supplied in sealed packets of 100 and 1000.

ACTUAL SIZE



BRITISH & FOREIGN PATENTS

OXLEY DEVELOPMENTS CO. LTD., ULVERSTON, LANCs.

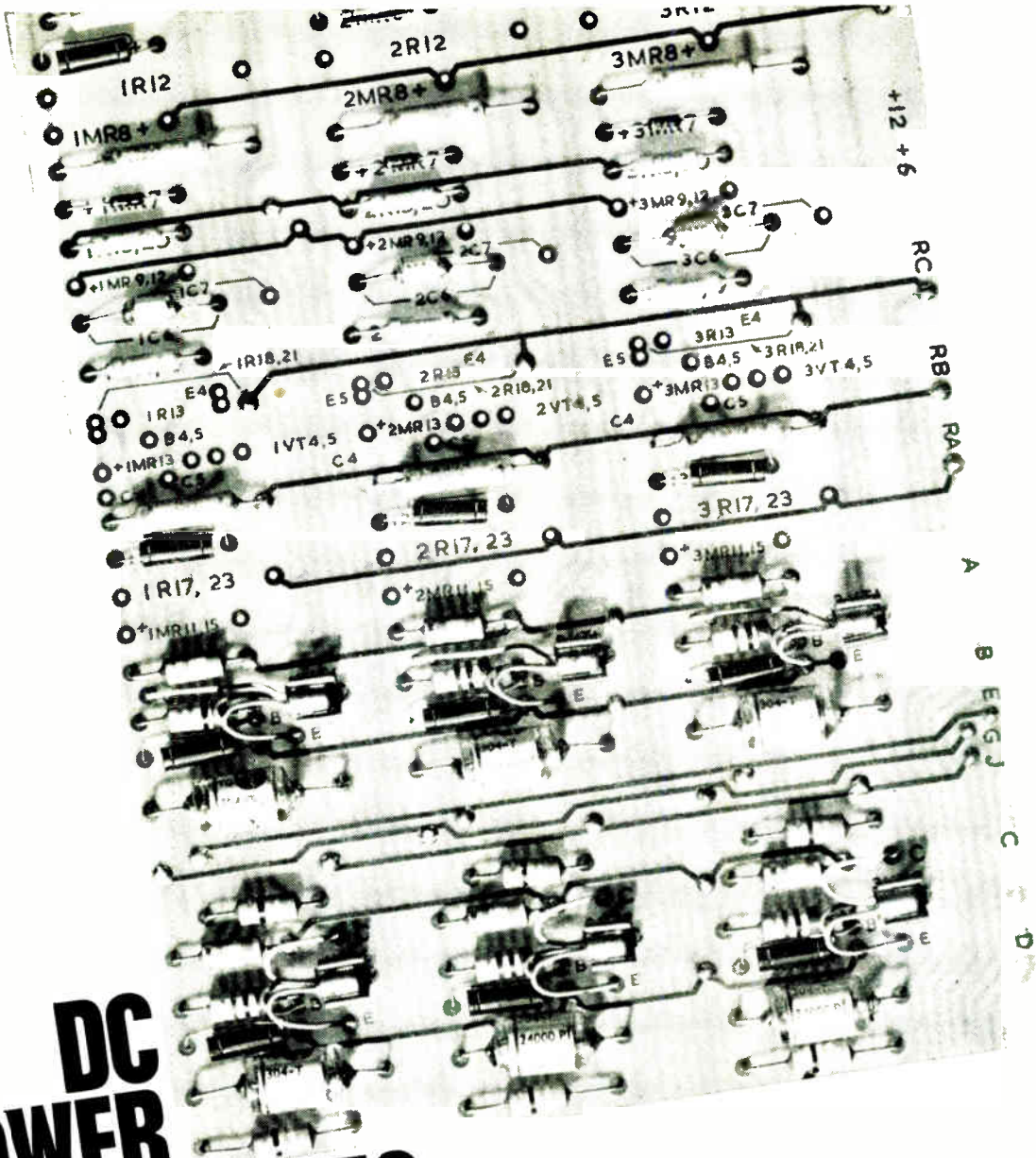

DC POWER SUPPLIES FOR ELECTRONICS

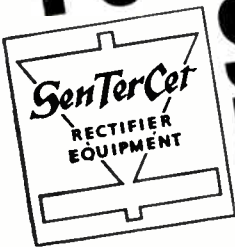

RECTIFIER EQUIPMENT FOR
INDUSTRIAL ELECTRONICS
TELECOMMUNICATIONS
DATA PROCESSING
RADAR
INSTRUMENTATION AND CONTROL

STC Engineers are available to
advise on all rectification problems.



RECTIFIER DIVISION
Standard Telephones and Cables Limited
EDINBURGH WAY · HARLOW · ESSEX
Telephone: HARLOW 26811 · Telex: 81146

NEW MINIATURISED EQUIPMENT



PHILIPS

THREE-TERM CONTROLLER

for proportional, integral, and differential control

Philips Three-Term Controller PR7201 is the latest addition to Philips range of miniaturised equipment. Built to the same dimensions as the well-known Philips Miniature Recorder, its modular construction enables almost any control conditions to be met. Write (or 'phone Tulse Hill 4652) and ask for leaflet IM8-Q1.

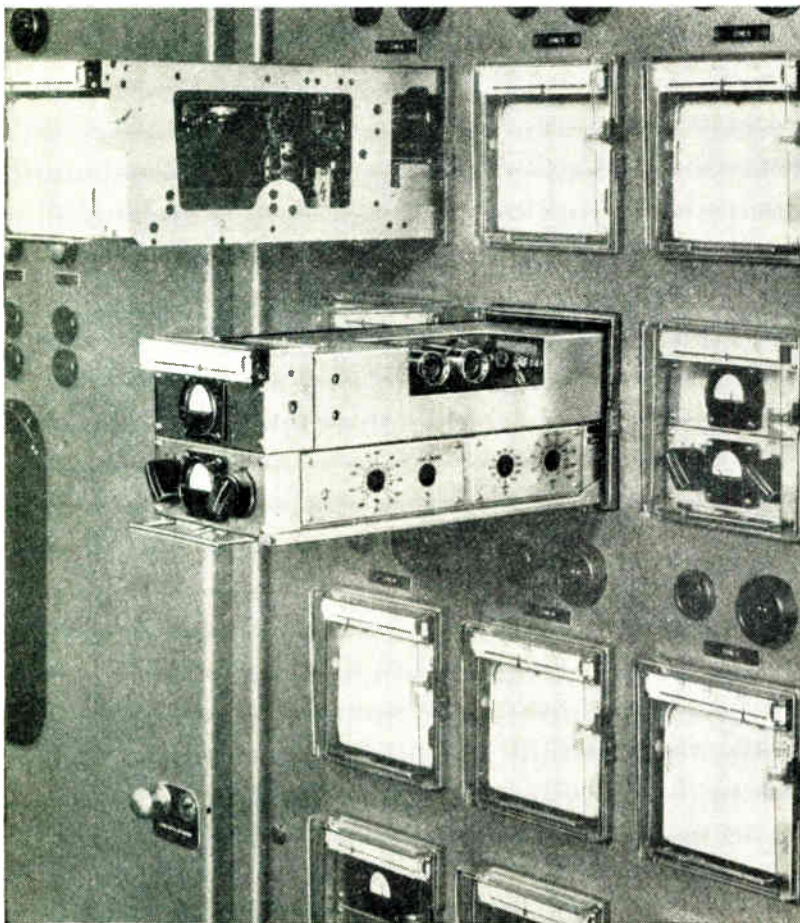

Philips Three-Term Controllers and Miniature Recorders in a process control panel at a ceramic works.

SPECIFICATION

Input Signal 0.....8 volts DC; 2.....10 volts DC; 0.....5 mA DC; 0.....20 mA DC; 0.....50 mA DC; 1.....5 mA DC; 4.....20 mA DC; 10.....50 mA Dc.

Input Load Depends on input signal; maximum input load 5000 ohms.

Accuracy of Input Deviation Meter $\pm 5\%$ of measuring range.

Output Signal For standard version 1.....5 mA DC direct or reverse acting.

Output Load For standard version 3000 ohms.

Accuracy of Output Meter $\pm 5\%$ of output range.

Set Point Setting accurate within $\pm 0.5\%$ of set point range.

P-action 3.....300%, continuously adjustable.

I-action 2.....1800 seconds in 20 logarithmic steps. Also infinite reset time (i.e. no integral action).

D-action 2.....600 seconds in 11 logarithmic steps. Also zero rate time (i.e. no derivative action). At higher frequencies D-action does not exceed 10 x P-action (time derivative).

Zero Frequency Gain Higher than 200 at 100%, P-action setting (i.e. Initial Proportional Band under $\frac{1}{3}\%$).

Max. Output Current (output terminals short circuited) 12 mA DC.

Maximum Output Voltage at Infinite Output Load 16 volts DC.

Manual Automatic Switching Bumpless transfer: manual to automatic direct, automatic to manual via balance position.

Power Supply 110-240 volts AC $\pm 10\%$, 40.....60 c/s, 30 VA.

Maximum Permissible Ambient Temperature 45°C (113°F).

Net Weight 15 kg (33 lbs.).

RESEARCH & CONTROL INSTRUMENTS LTD

Instrument House, 207 King's Cross Road, London, W.C.1. Telephone: TERminus 2877

(RCL0153)

GETTING THE MEASURE OF CLEANING . . .

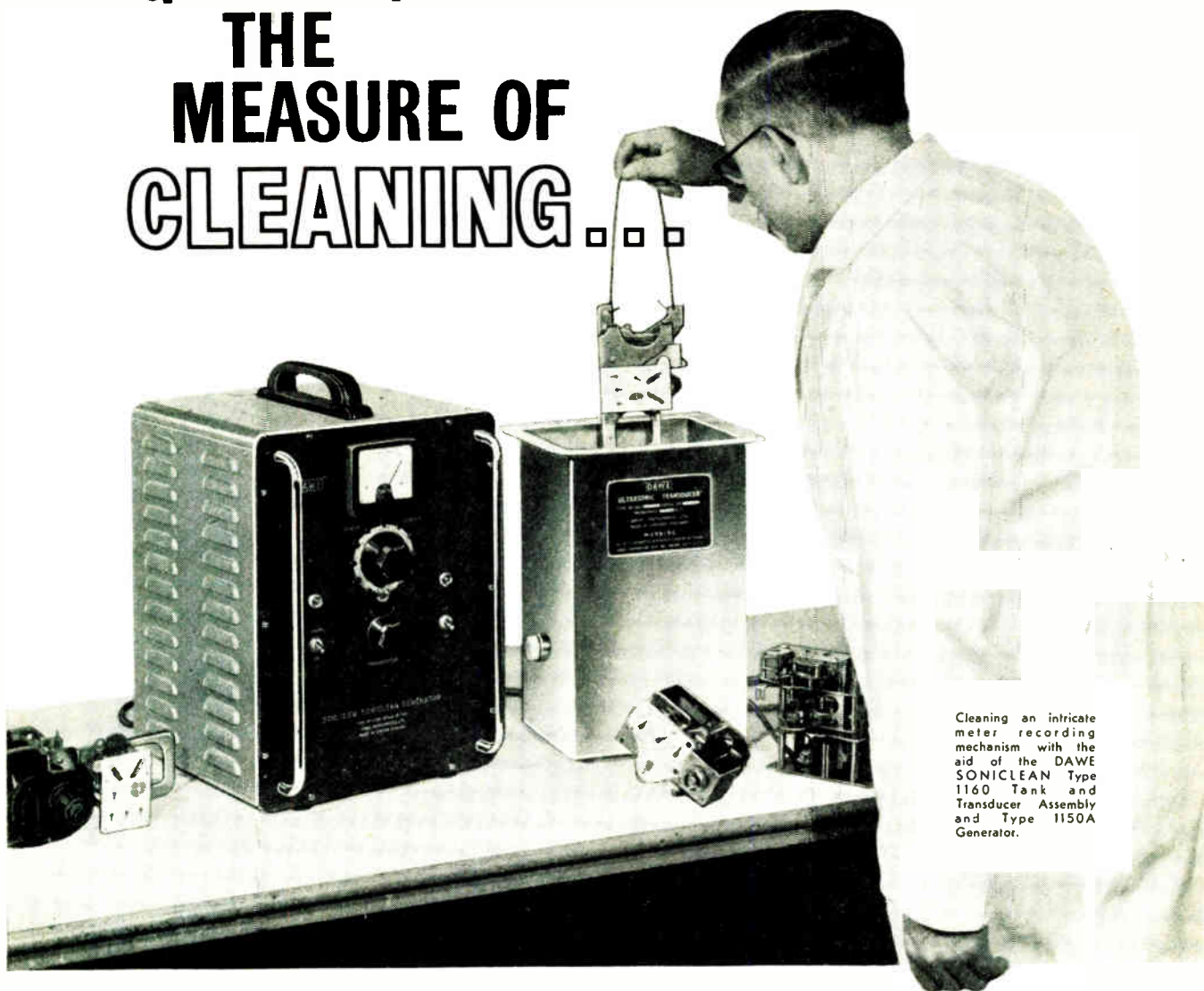

Cleaning an intricate meter recording mechanism with the aid of the DAWE SONICLEAN Type 1160 Tank and Transducer Assembly and Type 1150A Generator.

by Ultrasonic action

Ultrasonics are not the answer to every cleaning problem, but they do give outstanding results in both speed and thoroughness when cleaning metal parts prior to electroplating, protective coating, and other finishing processes. The ultrasonic action not only works simultaneously on all surfaces of the object being cleaned but reaches into all crevices, indentations, holes, pores and complex contours that are inaccessible in the normal way. Dawe produce a wide range of ultrasonic cleaning tanks (from 5 pints to 22 gallons capacity) and an associated range of ultrasonic generators. The technical sales department is always ready to advise you on your exact power and capacity requirements.



Full technical data from:—

DAWE INSTRUMENTS LTD., WESTERN AVENUE, ACTON, LONDON, W.3 Tel: ACOrn 6751

A member of the *Simms* group of companies

DEPENDABLE *Delanco* COPPER CLAD LAMINATES

*the + material
for*

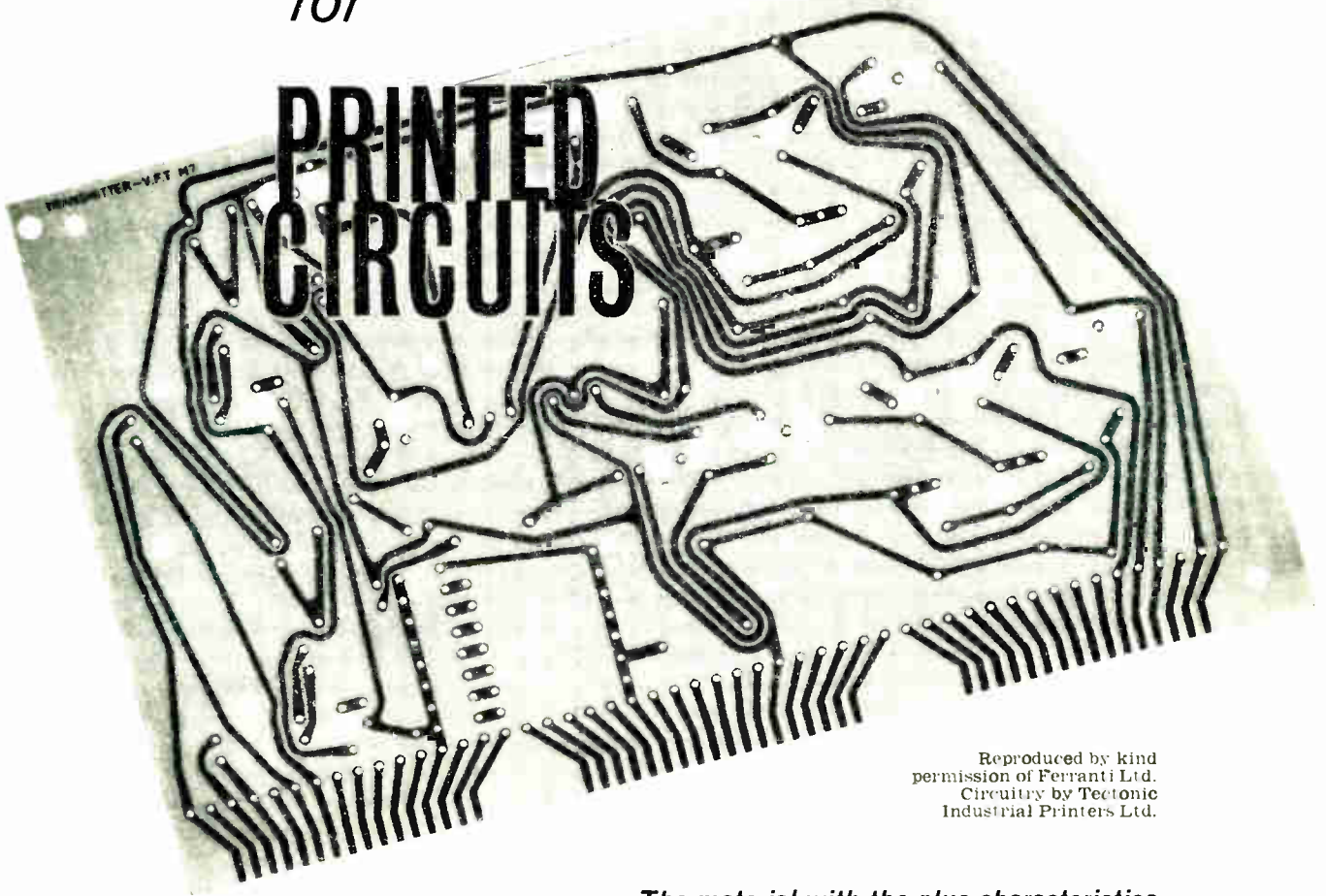

Reproduced by kind permission of Ferranti Ltd. Circuitry by Teetonic Industrial Printers Ltd.

The material with the plus characteristics

For applications where ministry specifications and others demand a material with characteristics far above the commercial range of copper clad laminates for printed circuitry, Delanco epoxy-glass base, and Teflon base, the materials with the "Plus" characteristics will fill the need. Demand for

this material is growing, but production is keeping in step, and most requirements can be executed ex stock, and price is competitive. It will pay you to investigate our claims, so send for sample, with grade details and test report. Both single and double sided are available. In sheet, or cut panels.

WRITE NOW FOR DELANCO TECHNICAL BULLETIN OF



Delanco

COPPER CLAD LAMINATES

ANGLO-AMERICAN VULCANIZED FIBRE CO. LTD • Cayton Works • Bath Street • London • E.C.1
CLE 8484 • Grams: PROMPSERV CENT, LONDON • Delanco Works • Leonard Street • London • E.C.2

Let the

INDUSTRIAL ELECTRONICS

READER ENQUIRY SERVICE

help you to obtain more information

Circle the code numbers of the items in which you are interested. Insert your name and address, etc., in block capitals and post the card to us.

We will communicate with the manufacturers concerned and arrange for the information you require to be sent to you without obligation.

(No postage stamp is required if posted in Great Britain or Northern Ireland)

Is this your own copy ?

Each month INDUSTRIAL ELECTRONICS will bring you news of the latest applications, the most recently announced equipment, produced by the rapidly expanding electronics industries of the world.

It is invaluable to all management and production executives, and engineers, in industry generally, who need to be informed of the latest developments in electronic aids to industry.

**MAKE SURE OF YOUR COPIES
USE THE ORDER CARD NOW**

INDUSTRIAL ELECTRONICS

READER ENQUIRY SERVICE

APRIL 1963 — For further information circle appropriate number

Editorial code number—		1	2	3	4	5	6	7	8	9	10	11	12	13	14	15	
16	17	18	19	20	21	22	23	24	25	26	27	28	29	30	31	32	33
34	35	36	37	38	39	40	41	42	43	44	45	46	47	48	49	50	51
52	53	54	55	56	57	58	59	60	61	62	63	64	65	66	67	68	69
70	71	72	73	74	75	76	77	78	79	80	81	82	83	84	85	86	87
Advertisement code number—		200	201	202	203	204	205	206	207	208	209	210	211	212	213		
214	215	216	217	218	219	220	221	222	223	224	225	226	227	228	229	230	231
232	233	234	235	236	237	238	239	240	241	242	243	244	245	246	247	248	249
250	251	252	253	254	255	256	257	258	259	260	261	262	263	264	265	266	267

I would also like details of.....

Your Name..... Position held.....

Name of Firm.....

Address.....

Nature of Business.....

PLEASE USE BLOCK CAPITALS

Postage will be paid by Associated Iliffe Press

No Postage Stamp necessary if posted in Great Britain or Northern Ireland

BUSINESS REPLY CARD
Licence No. SE 591

**"INDUSTRIAL ELECTRONICS",
DORSET HOUSE,
STAMFORD STREET,
LONDON, S.E.1**

APRIL 1963

INDUSTRIAL ELECTRONICS

SUBSCRIBER'S ORDER FORM

Subscription Rates

Home and Overseas £3. 0s. 0d.

USA and Canada \$8.50

Please supply

INDUSTRIAL ELECTRONICS monthly for the next 12 months

I will remit on receipt of invoice

NAME.....

ADDRESS.....

Postage will be paid by Associated Iliffe Press

No Postage Stamp necessary if posted in Great Britain or Northern Ireland

BUSINESS REPLY CARD
Licence No. SE 591

**"INDUSTRIAL ELECTRONICS",
DORSET HOUSE,
STAMFORD STREET,
LONDON, S.E.1**

Let the

INDUSTRIAL ELECTRONICS

READER ENQUIRY SERVICE

help you to obtain more information

INDUSTRIAL ELECTRONICS

READER ENQUIRY SERVICE

APRIL 1963 — For further information circle appropriate number

Editorial code number—	1	2	3	4	5	6	7	8	9	10	11	12	13	14	15
	16	17	18	19	20	21	22	23	24	25	26	27	28	29	30
	31	32	33	34	35	36	37	38	39	40	41	42	43	44	45
	46	47	48	49	50	51	52	53	54	55	56	57	58	59	60
	61	62	63	64	65	66	67	68	69	70	71	72	73	74	75
	76	77	78	79	80	81	82	83	84	85	86	87			
Advertisement code number—	200	201	202	203	204	205	206	207	208	209	210	211	212	213	
	214	215	216	217	218	219	220	221	222	223	224	225	226	227	
	228	229	230	231	232	233	234	235	236	237	238	239	240	241	
	242	243	244	245	246	247	248	249	250	251	252	253	254	255	
	256	257	258	259	260	261	262	263	264	265	266	267			

I would also like details of.....

Your Name..... Position held.....

Name of Firm.....

Address.....

Nature of Business.....

PLEASE USE BLOCK CAPITALS

Circle the code numbers of the items in which you are interested. Insert your name and address, etc., in block capitals and post the card to us. We will communicate with the manufacturers concerned and arrange for the information you require to be sent to you without obligation.

(No postage stamp is required if posted in Great Britain or Northern Ireland)

Is this your own copy ?

Each month INDUSTRIAL ELECTRONICS will bring you news of the latest applications, the most recently announced equipment, produced by the rapidly expanding electronics industries of the world.

It is invaluable to all management and production executives, and engineers, in industry generally, who need to be informed of the latest developments in electronic aids to industry.

**MAKE SURE OF YOUR COPIES
USE THE ORDER CARD NOW**

Postage will be paid by Associated Iliffe Press

No Postage Stamp necessary if posted in Great Britain or Northern Ireland

BUSINESS REPLY CARD
Licence No. SE 591

**"INDUSTRIAL ELECTRONICS",
DORSET HOUSE,
STAMFORD STREET,
LONDON, S.E.1**



A.C. MAGNETIC VOLTAGE REGULATORS

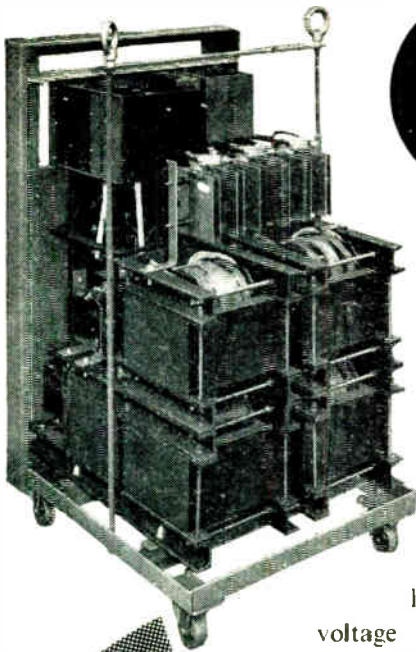

The HED range of regulators are designed to provide voltage or current, stabilised at any desired level by manual control, or in response to an input signal from a temperature controller, radiation pyrometer, photo-electric cell, etc. Regulation is achieved by standard HED transistorised amplifier and reference units in conjunction with saturable reactors.

The highest degree of reliability is ensured by the use of these static devices.

APPLICATIONS: Furnace Control, Arc Welding Control, Light Dimming, Motor Speed Control, etc.

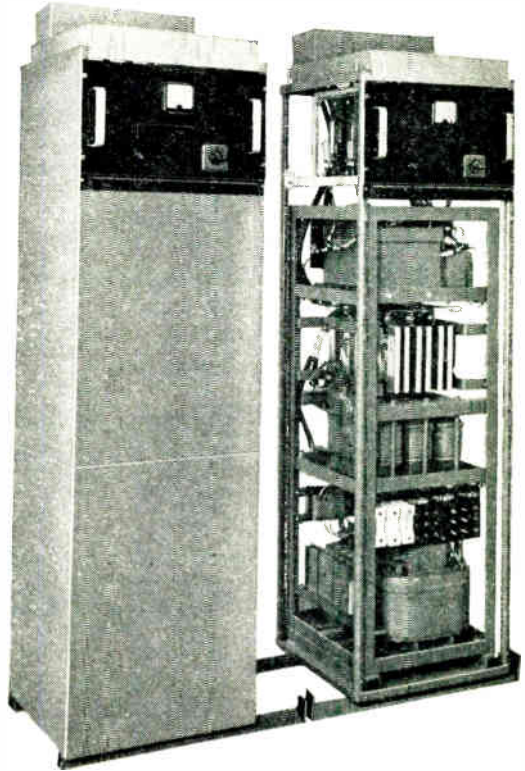

STABILISED RECTIFIER POWER PACKS

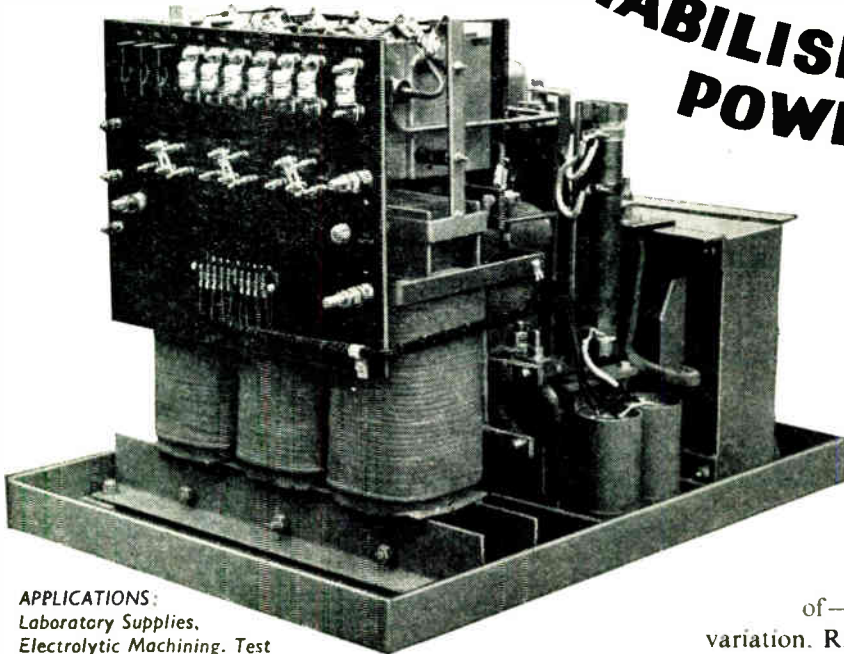

APPLICATIONS: Laboratory Supplies, Electrolytic Machining, Test Supplies, Aircraft Supplies, Linear Accelerator Magnet Supplies, Motor Speed Control Supplies, etc.

HED Stabilised Rectifier Power Packs utilise a saturable reactor, transformer, semi-conductor amplifiers and reference system, the A.C. output being rectified and smoothed to give a D.C. output.

High speed response and high accuracy is a major feature of this system. Both single or three phase inputs can be utilised up to 300 KW, the regulation being $\pm 1\%$ from no load to full load with mains voltage variations of -12% to $+6\%$, and with $\pm 2\%$ frequency variation. Ripple is 4% or to specification.

Unstabilised rectifier power packs can also be built to customer specification.

HIRST ELECTRONIC LTD.

GATWICK ROAD • CRAWLEY • SUSSEX • Crawley 25721-2-3-4

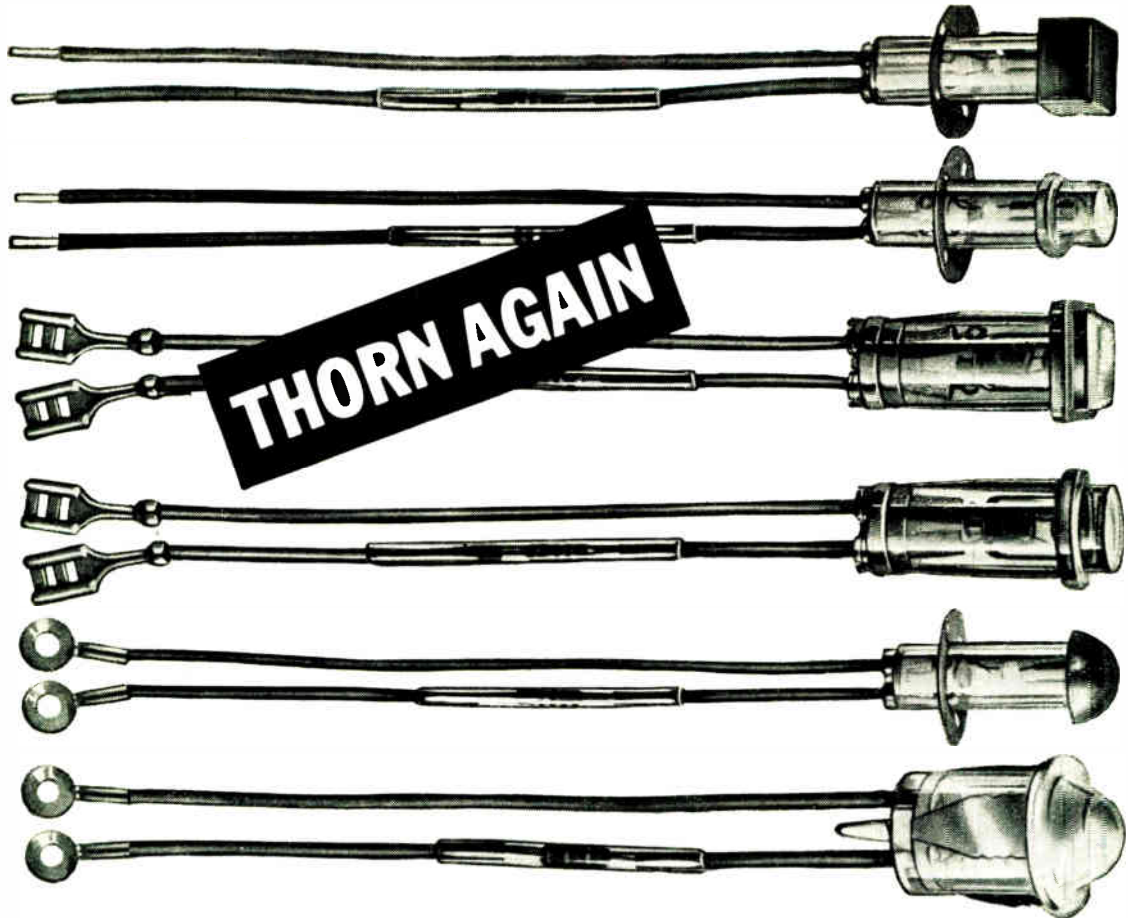

additions to the neon and incandescent lampholder range

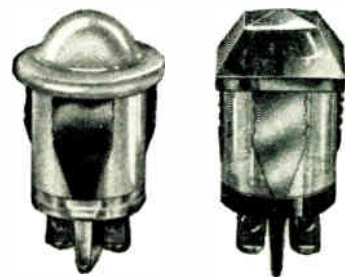

illustrations actual size

Thorn have now extended their already wide range of SGF lampholders even further. This remarkable range of lamps covers a variety of electric, electronic, industrial and domestic applications. The component is an integral unit, with a neon or incandescent lamp built into a plastic holder. No retaining nuts or screws, simply push into close fitting recess. The neon lampholders are available in a voltage range from 70—400. Colours red, yellow, clear or green—even green neon! Incandescent versions from 4—60 volts can be supplied in a variety of coloured caps. Full details will be sent on request. Please write to:



THORN ELECTRICAL INDUSTRIES LIMITED

SPECIAL PRODUCTS DIVISION, GREAT CAMBRIDGE ROAD, ENFIELD, MIDDLESEX. TELEPHONE: ENFIELD 5353

DRV/10

Electro-Magnetic COUNTERS

MODEL 442

6 figures — adds or subtracts

Resettable by hand — or non-resettable

Standard Model — up to 500 counts per min

High Speed Model — up to 1000 counts per min

Standard Voltages

DC	12v	24v	48v	110v
AC	115v	230v	50c/s	115v 60c/s

Base or Panel Mounted

Panel size — 1.781 in (45.3 mm) × 1.250 in (31.8 mm)

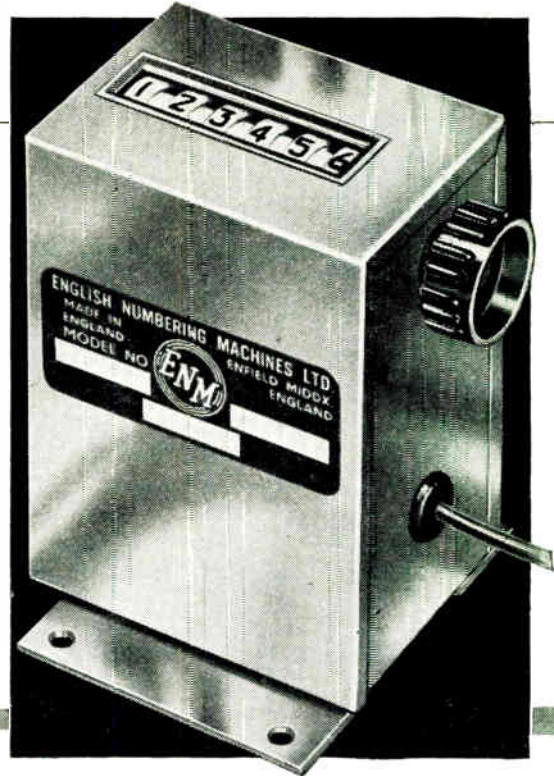

VISUAL OR PRINTING
ADDING AND SUBTRACTING

MODEL 443

Adds or subtracts — or adds and subtracts

Manual or Electric Reset, or non-reset

Standard Models — up to 2100 counts per min

High Speed Models up to 3000 counts per min

Standard Voltages

DC	12v	24v	48v	60v	110v
AC	115v	250v	50c/s	115v	60c/s

Panel mounted only

Panel size — 1.812 in (46.0 mm) × 2.75 in (69.0 mm)

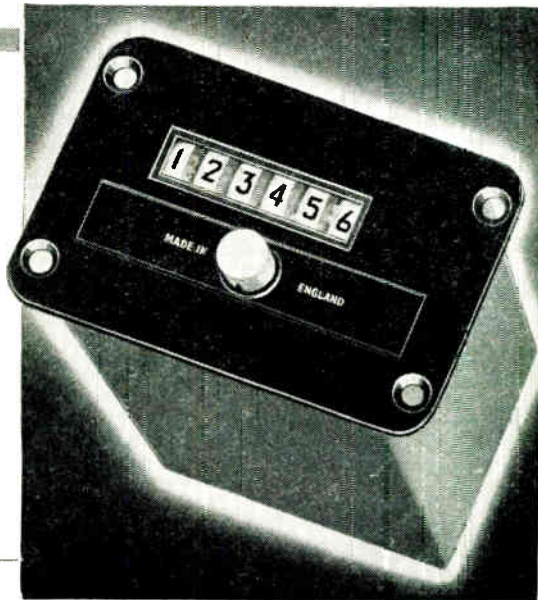

Write or telephone HOWard 2611 for fully descriptive literature

English Numbering Machines Ltd

DEPT E10 QUEENSWAY ENFIELD MIDDLESEX

Tel HOWard 2611

Grams Numgravco Enfield

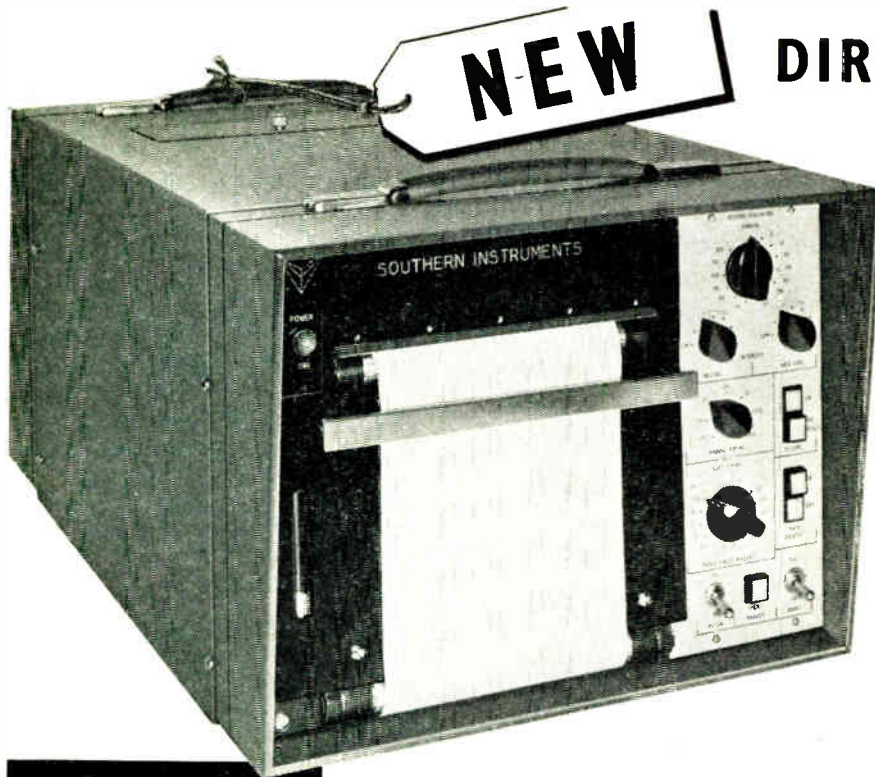

DIRECT RECORDING ULTRA-VIOLET OSCILLOGRAPH Series MI250

- ★ direct recording—no chemicals
- ★ d.e. up to 10,000 cycles per second
- ★ up to 18 channels
- ★ trace amplitude 6 inches
- ★ automatic trace identification
- ★ event marker
- ★ datum traces
- ★ crystal controlled timing lines
- ★ adjustable intensity grid lines
- ★ paper supply indicator
- ★ pre-set record length
- ★ automatic re-spooling
- ★ 12 speeds 0.02 to 100 inches per sec.
- ★ remote control facilities



Telephone or write for a demonstration to
SOUTHERN INSTRUMENTS LTD
INSTRUMENTATION DIVISION
FRIMLEY ROAD CAMBERLEY SURREY. Tel. CAMBERLEY 3401

For further information circle 239 on Service Card



BLACK • SMOOTH • LONG WEARING
EXCELLENT FOR BLUE PRINTS
10H TO 8B • FROM DRAWING OFFICE
SUPPLIERS AND STATIONERS

10½ d
EACH

FABER-CASTELL

Faber-Castell are also famous for slide rules and offer a wide range including student models from 27/6. Ask for literature.

Sole agent U.K.:

Made in Bavaria

BERRICK BROS. LTD., 20-24 Kirby Street, London, E.C.1



For further information circle 240 on Service Card

An essential book for
research workers and
designers . . .

MICROWAVE DATA TABLES

by A. E. Booth, M.I.R.E., GRADUATE I.E.E.

This book forms an accurate and labour-saving aid for computations involving basic microwave quantities which occur continually in design and development work on waveguides and similar transmission lines, such as decibel relationships, guide and free-space wavelengths, voltage standing-wave ratio, and voltage or power reflection coefficients. Printed on stout paper and strongly bound to withstand constant usage in design office or laboratory, it contains 26 tables comprising over 23,000 separate computations. The figures in the tables have been computed on a Pegasus electronic digital computer to the limit of practical measuring accuracy.

27s. 6d. net
by post 28s. 8d.

Over 23,000 separate computations
from leading booksellers

Published by

ILIFFE Books Ltd.,

Dorset House, Stamford Street, London, S.E.1

EFFECTIVE USE

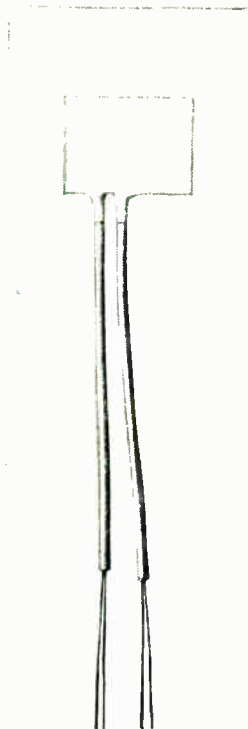

**OF THE
HALL EFFECT**

The Hall-effect (to recap.) is that which results when a conducting material—in this case indium arsenide—is placed in a magnetic field. The voltage developed across the plate is then proportional to the product of the magnetic field and the current passing through the plate.

A Multiplier, incorporating this principle and mounted on an octal valve base, has already been introduced. AEI now present the Hall Effect Field Probe in which the semiconductor plate is encapsulated between ceramic backing and cover plates, sleeved leads being brought out from the edge. The probe, with dimensions of only 0.5" x .625" x 0.055" can be incorporated into a variety of control

systems including parcel sorting and lift control. It can be used for direct measurement of magnetic fields, for instance, in a fluxmeter or a magnetometer. It can also be used in a wattmeter or power factor indicator. New applications are constantly being found. By sending for complete details and ordering a sample probe, you can take the first step towards developing simpler systems and new measuring methods.

For further information contact your local AEI district office or:

**AEI Instrumentation Division
Instrument & Meter Department
Trafford Park, Manchester 17.**



**Associated Electrical Industries Limited
Instrumentation Division**

The amazing variety of applications

MUREX MAGNETS

*HIGH MAGNETIC STABILITY
SMALL INTRICATE SHAPES
FOR ALL APPLICATIONS*

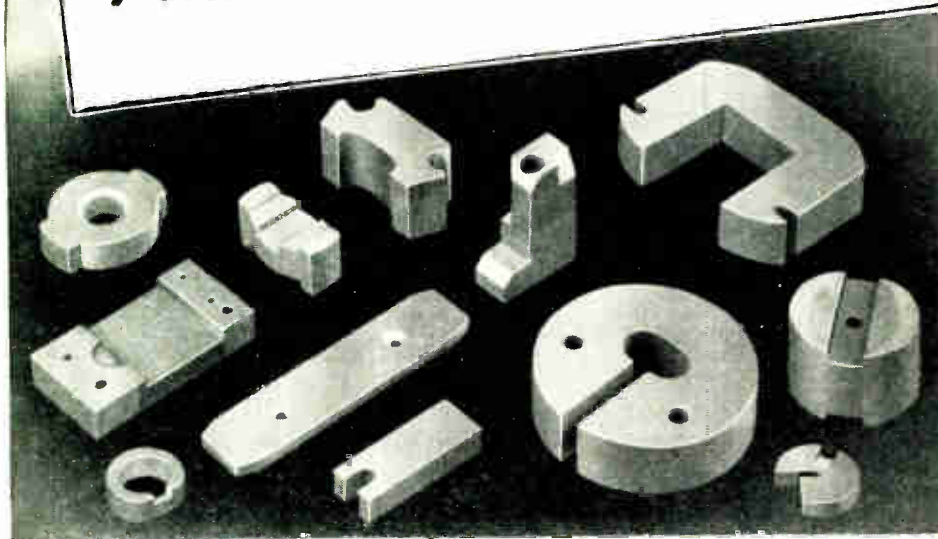

Loudspeakers
Moving Coil relays
Kilowatt hour meters
Polarised relays
Protective switchgear
High speed generators
Alternators
Voltmeters
Ampere meters
Exposure meters
Microphones
Earphones
Hearing aids
Gramophone pick-ups
Thermostats
Timer switches
Level indicators
Water meters
Electric motors
Gyroscopes
Torque motors
Synchronous motors
Hysteresis motors
Flowmeters
Valves (magnetic)
Magnetometers
Filters
Pressure gauges
Calendars
Toys
Telephone call timers
Vibrating reedconverters
Jewellery
Radar equipment
Guided missiles
Ohm-meters
Sump plugs
Automatic lens control
Trigger switch
Flux meters
Automatic transmission
Galvanometers
Fuel gauges
Speedometers
Laboratory stirrers
Electric clocks
Vibrators high speed
Automatic train signals
Aircraft engine Taco
generators
Aircraft engine speed
indicators
Aircraft navigation equipment
Aircraft homing indicators
Temperature controllers
Micro switches
Pneumatic valves
Conveyor systems
Crack detectors

MUREX LIMITED (Powder Metallurgy Division) RAINHAM · ESSEX

Telephone: Rainham, Essex, 3322. Telex 28632. Telegrams: Murex, Rainham-Dagenham Telex

London Sales Office: CENTRAL HOUSE, UPPER WOBURN PLACE, W.C.1. Tel.: EUSton 8265

INDUSTRIAL ELECTRONICS

Press date for the May 1963 issue is
first post 24th April 1963

CLASSIFIED ADVERTISEMENTS

Advertisement Rates. 6d. per word, minimum charge 6/-, each paragraph charged separately. Remittances payable to "Industrial Electronics", Dorset House, Stamford St., S.E.1. Series discount of 15% is allowed for 12 consecutive insertions.

Box Numbers are available at an additional charge of 2/- to defray cost of registration and postage. Replies should be addressed Box No. 0000, c/o "Industrial Electronics", Dorset House, Stamford Street, London, S.E.1.

Semi-Display advertisements with centralized lines £1/15/- per single column inch, Display advertisements £2/10/- per single column inch—no additional charge for Box Numbers. The Publishers are not responsible for clerical or printers' errors although every care is taken to avoid mistakes.

SITUATIONS VACANT

Designer Draughtsman for Electronic equipment, preferably with artistic ability. S.E. London area. Reply stating age, experience, and salary required to Box No. 5204. [2021]

LABORATORY ASSISTANT

Westland Aircraft have a vacancy in the Materials Laboratory for a Laboratory Assistant for Aircraft and Production Instrument Maintenance. Minimum educational requirements City and Guilds Final.

Conditions of employment are good and include a non-contributory pension scheme.

Apply giving details of experience to the

PERSONNEL MANAGER,
WESTLAND AIRCRAFT LTD.,
YEOVIL, SOMERSET. [2020]

BOOKS, ETC.

"RADIO Designer's Handbook." (4th Edition.) Editor: F. Langford-Smith, B.Sc., B.E., Senior Member I.R.E.(U.S.A.), A.M.I.E.E.(Aust.). A comprehensive reference book, the work of ten authors and twenty-three collaborating engineers containing a vast amount of data in a readily accessible form. The book is intended especially for those interested in the design and application of radio receivers or audio amplifiers. 55s net from all booksellers. By post 57s 9d from Iliffe Books Ltd., Dorset House, Stamford Street, S.E.1.

"RADIO Circuits: A step-by-step Survey." By W. E. Miller, M.A.(Cantab.), M.Brit.I.R.E. Revised by E. A. W. Spreadbury, M.Brit.I.R.E. associate editor of WIRELESS & ELECTRICAL TRADER. This established introduction to super-heterodyne receiver circuits has been greatly enlarged and brought completely up to date with the inclusion of transistor and f.m. receivers; there are new chapters covering battery receivers and car radio sets, while the modern a.m./f.m. receiver is fully described. Mathematics and obscure theoretical considerations are entirely omitted, and over 80 easy-to-follow circuit diagrams are explained in a simple but practical manner, splitting up the circuit into sections and working from the aerial terminal through to the loudspeakers. 15s net from all booksellers. By post 15s 10d from Iliffe Books Ltd., Dorset House, Stamford Street, London, S.E.1.

"TELEVISION Engineering: Principles and Practice." Vol. III: Waveform Generation. By S. W. Amos, B.Sc.(Hons.), A.M.I.E.E., and D. C. Birkinshaw, M.B.E., M.A., M.I.E.E. The third volume of a comprehensive work on the fundamentals of television theory and practice, written primarily for the instruction of B.B.C. Engineering Staff. This volume gives the application in television of sinusoidal, rectangular, sawtooth and parabolic waves and shows the mathematical relationship between them. The main body of the text is devoted to the fundamental principles of the circuits commonly used to generate such signals, the treatment being largely descriptive in nature and therefore less mathematical than that of the previous volume. The work is intended to provide a comprehensive survey of modern television principles and practice. 30s net from all booksellers. By post 31s from Iliffe Books Ltd., Dorset House, Stamford Street, London, S.E.1.

"RADIO Interference Suppression: As Applied to Radio and Television Reception." By G. L. Stephens, A.M.I.E.E. 2nd Ed. An up-to-date guide to the various methods of suppressing electrical interference with radio and television reception. Many practical applications are given, particular attention being paid to the problem of interference at television frequencies. Other chapters deal with the design and choice of suppressor components, methods of locating the source of interference, and suppression at the receiver itself. 10s 6d net from all booksellers. By post 11s 2d from Iliffe Books Ltd., Dorset House, Stamford Street, S.E.1.

"ADVANCED Theory of Waveguides." By L. Lewin. Sets out various methods of treating problems arising in work on this complex subject. The author has selected for discussion a number of topics as representative of the field in which the centimetre-wave engineer is engaged, many of the examples being concerned with the rectangular waveguide. 30s net from all booksellers. By post 31s from Iliffe Books Ltd., Dorset House, Stamford Street, London, S.E.1.

"LONG-WAVE and Medium-wave Propagation." by H. E. Farrow, Grad.I.E.E., B.B.C. Engineer-

ing Training Department. The main features of propagation at low and medium frequencies, 30-3,000kc/s, and in particular the broadcasting bands 150-285kc/s and 525-1,650kc/s, are explained. There are sections on aerials, ground and sky-waves attenuation due to earth losses, recovery effects, mixed path propagation, synchronized group working, ionospheric reflection, fading and low-power installations. 4s 6d net from all booksellers. By post 4s 10d from Iliffe Books Ltd., Dorset House, Stamford Street, London, S.E.1.

EDITORIAL ASSISTANTS, male, age 23-35, required by a leading firm of technical book publishers. Minimum qualifications Inter-B.Sc., H.N.C. or equivalent, and experience in one of the following: electronics, electrical engineering, physics, metallurgy, plastics, chemistry or mathematics. Experience in technical publishing, covering sub-editing, technical writing and preparation of make-up desirable. Interesting and well-salaried pensionable positions for applicants with the necessary qualifications and experience. Apply in writing marked "Confidential" giving full particulars of experience and qualifications to Editorial Department, Iliffe Books Ltd., Dorset House, Stamford Street, London, S.E.1.



The Steel Company of Wales invites applications for two vacancies recently created following re-organisation of the Electrical Engineering Department of the Steel Division.

ELECTRICAL MAINTENANCE PLANNING ENGINEER

He will be responsible for the analysis of electrical maintenance reports and records of automation equipment and the co-ordination of maintenance planning. He will also be responsible for the preparation and issue of inspection schedules.

SITE ENGINEER (Automation)

He will be responsible for the supervision of installation and commissioning of all electronic instrumentation and control equipment.

Applicants should have several years' experience of Industrial Electronics, a comprehensive knowledge of Electrical Engineering and preferably some Steel Plant experience. The minimum technical qualification acceptable is H.N.C.

The Company assists with house removal expenses, and operates its own contributory pension scheme.

Completed application forms should be returned not later than May 6th, 1963, and may be obtained from:—

Superintendent, Personnel Services
THE STEEL COMPANY OF WALES LIMITED
Steel Division, Abbey Works, Port Talbot, Glam.

THE STEEL COMPANY OF WALES LIMITED

For further information circle 243 on Service Card

REDUCE DEVELOPMENT COSTS OF SEMI-CONDUCTOR CIRCUITRY



The extensive use of temperature sensitive semi-conductor devices in modern electronic circuitry has demanded the testing in the development stage of these circuits under elevated temperature conditions.

The LAB-OVEN allows a unit under test to remain undisturbed on the base while its temperature is raised to the controlled level or dropped to room ambient. Furthermore, wires for power supplies, test instruments, etc., may extend from the unit, and although these may prevent the oven closing down completely, this will not affect the working temperature, since the unit under test is raised by the thermally insulated platform inside the oven, and the hot air level will be brought down to cover the unit. Moreover, quick changes of components may be effected with a soldering iron without the necessity of removing the test unit, since the hot air trapped inside the oven may be immediately lowered over the test unit.

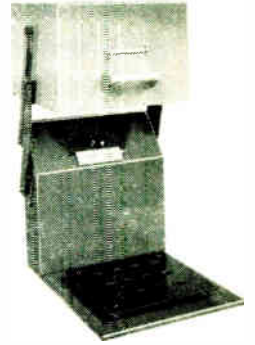

WITH CONTRONICS LAB-OVEN

SPECIFICATION OF STANDARD MODEL

Overall size: 19½" deep × 16" wide × 16" high.
 Oven Cubic Capacity: 1 ft. Cube approx.
 Temperature Control: Transistorised Thermostatic regulator 25°C.-100°C. plus or minus 1°C.
 Temperature Gradient: Approximately 2°C.
 Thermometer: Side fitting mercury thermometer.
 Heating Element: 275 watt element.

We shall be glad to advise on your own Control problems, for we design and manufacture Electronic Equipment to customers' specialised requirements. Standard units include:—Photo-electric relays, High-speed Batching Counters, Mis-feed protection Controls, Infra-red alarms, Daylight Intensity Switches, Electronic Tachometers, Proximity relays, Time Delay relays, Sequential Timers.



CONTRONICS

LIMITED

Blackdown, Nr. Aldershot, Hants. Tel. Deepcut 236

For further information circle 244 on Service Card

LAPLACE TRANSFORMS FOR ELECTRICAL ENGINEERS

By *B. J. Starkey, Dipl.Eng., A.M.I.E.E.* A presentation of the theory of Laplace transformation in which a physical vocabulary rather than a purely mathematical one is used as far as possible. This method of analysis has become

of increasing importance to electrical engineers in many fields, and the work is designed to provide them with a thorough treatment of the subject in a language with which they will be familiar.

30s. net BY POST 31s. 2d.

From leading booksellers, published by **ILIFFE Books Ltd.**, Dorset House, Stamford Street, London, S.E.1

Index to Advertisers

Adeola Products Ltd.	26	English Numbering Machines Ltd.	33	Research & Control Instruments Ltd.	28
Anglo-American Vulcanised Fibre Co. Ltd.	30	Ericsson Telephones Ltd.	2	Rist's Wires & Cables Ltd.	3
Appointments Vacant	37	Eric Resistor Ltd.	<i>Cover iv</i>		
Associated Electrical Industries Ltd.	35	Ferranti Ltd.	21	Silentbloc Ltd.	6
Berrick Bros. Ltd.	34	Harwin Engineers Ltd.	12	Solartron Electronic Group Ltd.	16, 17
Bradley, G. & E., Ltd.	25	Hirst Electronic Ltd.	31	Southern Instruments Ltd.	34
Brush Crystal Ltd.	10	Hughes International (U.K.) Ltd.	13	Standard Telephones & Cables Ltd.	1, 7, 8, 9, 27
Cannon Electric Co. Ltd.	22	Iliffe Books Ltd.	24, 34, 38	Telegraph Condenser Co. Ltd.	<i>Cover iii</i>
CIBA (A.R.L.) Ltd.	5	Marconi Instruments Ltd.	14	Thorn Special Products Ltd.	32
Contronics Ltd.	38	Midland Silicones Ltd.	4		
Dawe Instruments Ltd.	29	M.O. Valve Ltd.	23	Vitramon Incorporated Ltd.	20
E-A Data Processing Ltd.	18, 19	Mullard Equipment Ltd.	<i>Cover ii</i>	Westinghouse Brake & Signal Co. Ltd.	15
Electrosil Ltd.	11	Murex Ltd.	36	Wiley John & Sons Ltd.	26
		Oxley Developments Co. Ltd.	26		

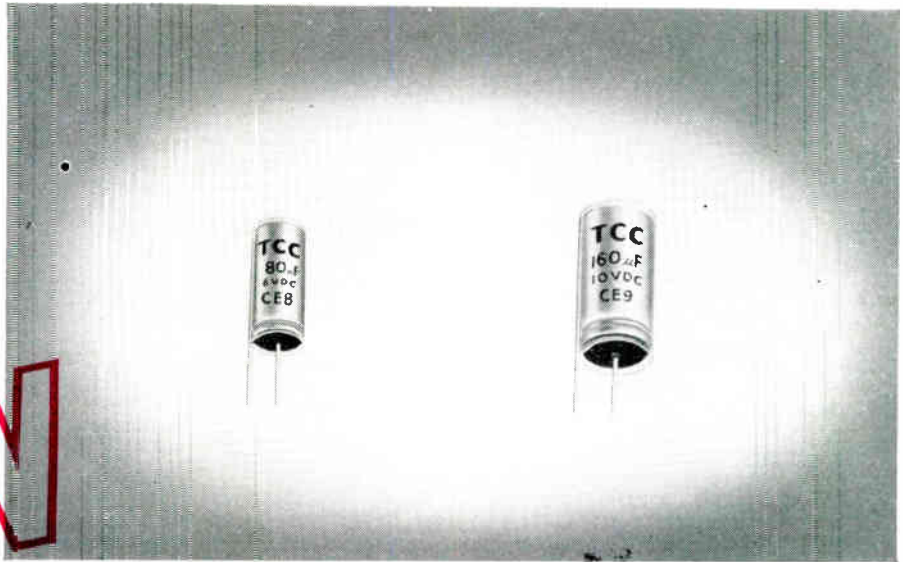

NEW

SUB-MINIATURE ELECTROLYTICS FOR TRANSISTOR CIRCUITS

These Capacitors are shorter than those in our standard range and are ideal for miniaturised transistor circuits such as in pocket radios. The six sizes already announced and the two listed below, are introduced to fill this need, and each is available with wires at opposite ends for horizontal mounting ("H"), or at one end for verticle mounting ("V").

Connection wires are welded for low resistance contact and solder coated for ease of assembly. The standard length is 1½" for the horizontal range, cropped

to ¾" for the vertical range.

The capacitors are in insulated seamless aluminium cases and sealed with a synthetic rubber bung.

Capacitance Tolerance Standard tolerance is -20% +100% of the rated capacitance.

Operating Temperature Range : -20°C to +60°C.

Leakage Current. This may be determined from the following : $I(\mu A) = \cdot 20C.V. + 20$ at applied working voltage and at 20°C.

T.C.C. TYPE No.	CASE SIZE IN INCHES			MAXIMUM D.C. WKG. VOLTAGES AND CAPACITANCE (µF)					
	D	L	C	3V.	6V.	10V.	15V.	25V.	50V.
CE.8	¼	¾	0.14	100	80	60	40	25	8
CE.9	⅜	¾	0.2	250	200	160	100	60	20

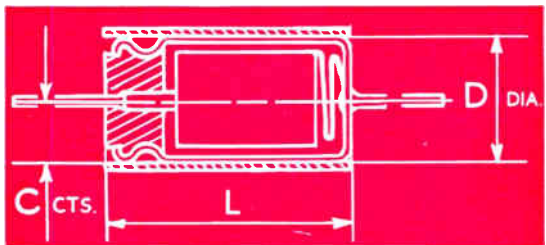

THE TELEGRAPH CONDENSER CO. LTD.

RADIO DIVISION · NORTH ACTON · LONDON · W.3 · Tel: ACOrn 0061

For further information circle 202 on Service Card



THE ERIE STYLE

390

NEW sub-miniature moulded capacitors

DIMENSIONS IN INCHES

TINNED COPPER LEADS
0.025 DIA.

0.095 ±0.003 DIA.

SPECIFICATION

Capacitance Range:
5.6 to 1200pF at 1kc/s, 0.5 to 5V r.m.s., +25°C.

Capacitance Tolerance:
5.6 to 330pF ±10%, ±20%
390 to 680pF ±20%, +100% -0% (GMV)
820 to 1200pF +100% -0% (GMV)

Dissipation Factor:
5.6 to 680pF: 1.5% max. at 1kc/s, 0.5 to 5V r.m.s.
820 to 1200pF: 2.5% max. at 1kc/s, 0.5 to 5V r.m.s.

Working Voltage:
100V d.c. at 85°C. Derate to 50V at 125°C.

Life Test:
200V d.c. at 85°C for 1000 hours; 100V d.c. at 125°C for 1000 hours

Flash Test:
500V a.c. for 1 sec. with 50mA max. charging current

Insulation Resistance:
100kMahms min. after 1 minute at 500V d.c. over temperature range of -55°C to +85°C.

Temperature Characteristic:
5.6 to 200pF: ±10%
220 to 330pF: +22% -33%
360 to 680pF: +22% -56%
750 to 1200pF: +22% -82%
Closer temperature characteristic ranges and temperature compensating units in the lower capacitance values are available upon request

Marking:
Colour coded three capacitance bands and one tolerance band

Case:
High quality moisture resistant moulding

Packing:
Normally supplied bulk packed. Available lead-taped in reel pack or ribbon packed for automatic insertion

MIL Specification:
Meets or exceeds the applicable requirements of MIL-C-11015

The Erie style 390 sub-miniature moulded capacitor embodies revolutionary features of design and construction to attain a wide range of capacitance in a moisture resistant moulding of sub-miniature dimensions. Very definitely the ideal capacitor for packages in which sub-miniature dimensions and lightness of weight are a necessity. Style 390 meets or exceeds the applicable requirements of MIL-C-11015.

ERIE★

**R E S I S T O R
L I M I T E D**

SOUTH DENES, GT YARMOUTH, NORFOLK
Telephone: Great Yarmouth: 4911
Factories
Gt Yarmouth and Tunbridge Wells, England;
Toronto, Ont., Canada; Erie, Pa., U.S.A.

*Registered Trade Mark