

# Hobby Electronics

ISSN 0142-6192

April '80  
50p



## TROUBLE STARTING?

**Don't Keep  
The Lady Waiting...  
Build HE's  
Electronic Ignition**

**Digital Frequency Meter**  
You Can Count On It



**Narrow Bandwidth Television**  
Do-It-Yourself TV

**Hobbycom**  
Wired For Sound

**RC Speed Controller**  
A Model Design

**Solar Cells**  
Sunny Side Up

# BEWARE! RADIO ACTIVITY



The new MK III FM tuner sitting under the Dorchester multiband AM/FM tuner

Revisions to the Mark III include a centre zero tuning indicator meter and silent preset switching

New 944378-2, the last word in stereo decoders with the KB4437/4438.

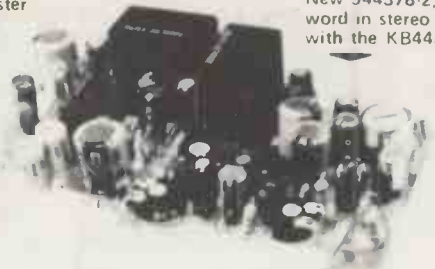

Choosing the products to advertise each month can be quite a task at AMBIT, since we tend to introduce at least one new line per week. So it is nearly impossible to say all we would like in this space - other than to bring you as far up to date as possible with current events. The major medium for finding out about what we have to offer is our unique catalogue system, and we ask that you invest in a copy of parts 1, 2 & 3 since many questions we are asked can be readily answered by reference to these.

Each part costs 60p, or £1.60 for all three current editions. We are also launching a new and greatly elongated version of our PRICE LIST, which now includes a large number of quantity listings, and many items not previously listed. The new style price list is a quick reference short form to our general catalogues - available FOC with a large (A4) SAE please.

As a result of the soaring price of oil - and the subsequent huge increases in the cost of wax for Mr Tom Jackson's famous moustache, the Post Office have increased their charges (Feb. 4th). Accordingly, our standard cover charge has been increased to 35p per order (CWO).

## COMPONENTS

### DIGITAL FREQUENCY READOUTS / SYNTHESISER SYSTEMS

Ambit has the biggest range of digital frequency readout systems for various applications in Broadcast and Communications. Prices range from £18.50 for a complete AM/FM broadcast frequency display (kit of DFM2). Most are detailed in the latest catalogue.

TUNING SYNTHESIZERS are also heavily featured, and we offer our first complete system covering MW/LW/ SW2 and FM based on Hitachi parts. The unit is retrofittable to voltage tuned radio systems - and will shortly be incorporated in a complete tuner project. Cost for the synthesiser will be circa £40. A versatile communications system based on the new Mullard 2 IC system is nearing completion, together with 16 station CMOS memory and optical shaft encoder system with fast tune facility. Synthesiser circa £70, memory £50.

### Latest semiconductor news:

CMOS, TTL and LPSN TTL are in stock (ask for our OSTs price leaflet). Some of the very popular types are still "difficult" but we have things like 4011s, 4017s at the time of writing.

RADIO ICs - interesting developments here, we now have the Hitachi HA11225 and the HA12412 ultra high specification members of the CA3089E family. The PLESSEY SL1600 range now includes the SL6600 high performance PLL NBFM IF and detector.

CA3089E	2.11	HA1197	1.61	SD6000	4.31	SL1610	1.84	SL1626	2.80
CA3189E	2.53	CA3123E	1.61	TOA4420	2.59	SL1611	1.84	SL1630	1.86
HA1137W	1.95	TDA1072	3.09	MC1330P	1.38	SL1612	1.84	SL1640	2.17
HA11225	2.47	TBA651	2.53	MC1350P	1.38	SL1613	2.17	SL1641	2.17
HA12412	2.81	TDA1090	3.51	K8412	2.24	SL1620	2.50	SL6600	4.31
KB4420	1.95	TDA1220	1.61	K8413	2.24	SL1623	2.80	SL6640	3.16
TBA1205	1.15	TDA1083	2.24	K8417	2.53	SL1624	3.77	SL6690	3.68
KB4406	0.80	TDA1062	2.24	MC3357P	3.16	SL1625	2.50	MC1496	1.44

TRANSISTORS - New lower prices, wider range, large stocks. Also the world's lowest noise audio devices (2SC2546E and 2SA1084E) first from AMBIT of course. Power MOSFETs & all sorts of other devices. Our 3SK51 MOSFET replaces the 408XK and 40673 families.

BC237-8-9	0.092	2SC1775	0.207	2SA1084E	0.368	BF256	0.437	BFY90	1.03
BC307-8-9	0.092	2SA872A	0.207	2SC2547E	0.391	2SK55	0.368	BF224	0.253
BC413-5	0.115	2SD666A	0.345	2SA1085E	0.391	2SK168	0.402	BF274	0.207
BD414-6	0.126	2SB646A	0.345	2SK133	6.32	3SK51	0.62	BFT95	1.138
BC546-556	0.138	2SD760	0.52	2SJ48	6.32	3SK60	0.667	VN66AF	1.092
BC550-560	0.138	2SB720	0.52	2SK135	7.29	BF960	1.426	2N4427	0.977
BC639-640	0.265	2SC2546E	0.368	2SJ50	7.29	3SK48	1.426	J176	0.747

RADIO CONTROL: A special section for all RC fans. New and exciting stuff: KB4445/KB4446 - complete 4 channel RX/TX dig.prop IC pair. RF&control in one 4.75p

MSL9362/MSL9363 - logic section of a four channel dig.prop link, with switch opt. 3.75p

NE5044 - Signetics versatile 7 channel encoder, suitable for mixing etc. £2.14 ea

NE544 Signetics famous servo driver IC £2.07 MC3357P as used in RCME design £3.16 ea

AMBIT RCRX4 - RCME FM system compatible, complete RX kit with box/connector and AMBIT design screened front end with 27MHz ceramic filter £16.10 (kit)

XTALS: FM pairs £3.74 (no splits) TX is fund. 1/2 op frequency. RX 3rd OT - 455kHz AM pairs £3.57 (no splits). Both 3rd OT types, again RX IF at 455kHz

### MODULE NEWS

We are at last able to quote for quantities of our modules, following a program of standardization and revision to speed manufacture and test. The following types are the results of the standardization program:

UM1181	5 varicap MOSFET input VHF band 2 tuner/tuner	£12.00 inc
911225 A	High Performance FM IF system, with switched BW	£23.95 inc
911225 B	Single BW filters, single tuned detector	£14.95 inc
91072 A	DC tuned and single pole switched MW LW tuner	£14.43 inc
91072 B	As type 'A' but with either SW1 or SW2 band	£15.90 inc
92242 A	Combined LW/MW tuner, with FM IF detector section	£29.00 inc
92242 B	As 92242A but with 5-10MHz SW section	£34.00 inc

All are supplied housed in screened metal cases 97x56x24mm, with all connections along a single edge, suitable for vertical or horizontal mounting.

Previously advertised units are still available - although there may have been some price changes in the latest edition of the Price List (Date Feb.80). A separate leaflet covering the new range of modules is available from April 80, with an A4 SAE please

NEW LINE: ALPS switches and rotary potentiometers. With a general catalogue that's over 3 inches thick, we cannot begin to offer a comprehensive list of what we can offer - but we are already stocking the keyboard switches, keyswitches, pushbutton switches etc. In particular, the pushbutton switches really put all others in the shade (shadow?) when it comes to quality and price. A special new shortform is being prepared (and may be ready when you read this). All the potentiometers and switches you could ever need from a single source. Keypad switches cost as little as 15p ea (1 off), with a range of two part caps for easy legending. You must see the shortform catalogue (30p) and our new pricelist for full details of this huge range of components



### AMBIT SHOP NOW OPEN

We are gradually getting our caller sales area sorted out, with displays of the products on offer and a browsers corner to sit and study data/catalogues. Call in next time you are in the area - parking outside the door.

### COMPUTER CAPABILITIES

Ambit has been keeping a low profile on the subject of the MPU and its applications. Interestingly enough, the first project we offer with MPU content does rather more in the way of processing than simply playing a daft game, or looking like an enormous calculator. Our MPU facility and expertise is now for hire on a fully commercial basis. 280, 6800, 6809, 2650 etc.

NEW LINE: DC/DC-AC converters for fluorescent displays. TOKO CPS series 12v IN, -20 and 3v AC out at 65mA. Thick film design £2.34 ea Qty. prices OA



### GENERAL INFORMATION

Ambit stocks the following ranges of components for ex-stock volume delivery: SIGNAL COILS, CERAMIC, MECHANICAL and CRYSTAL FILTERS, RADIO ICs for AM/FM/SSB, TOROID CORES FOR RADIO and EMI FILTER CIRCUITS, INDICATING AND PANEL METERS, AUDIO ICs, RF TRANSISTORS, FETS, MOSFETS, DIODES (PIN, VARICAP, SCHOTTKY), PASSIVE DBMs (like MD108 etc), IC SOCKETS, LEDs, TRIMMER CAPS, SWITCHES, KEYBOARD SWITCHES, TUNER HEADS, IF AMPS, AM RADIO MODULES, etc etc

NEW LINE: DVM176 - the definitive ICM7106 LCD DVM module. 3 1/2 digit £22.37 ea.

CM161: LCD 12/24hr alarm clock/day/date/backlight (eq. RS308-499) 7mm digits £11.44 each  
CM174: LCD 12hr alarm clock/stopwatch/backlight with 30mm height digits £14.32 each

CATALOGUES 60p ea., all three for £1.60  
PRICES SHOWN HERE INCLUDE VAT  
POST/PACKAGE CHARGE NOW 35p

**ambit**  
INTERNATIONAL

CWO PLEASE: Commercial MA terms on application  
Goods are offered subject to availability, prices subject to change - so please phone and check if you doubt.

**200 North Service Road, Brentwood, Essex**

TELEPHONE (STD 0277) 230909 TELEX 995194 AMBIT G. POSTCODE CM14 4SG



# Hobby Electronics

APRIL 1980 VOL 2 No. 6

Editor: Steve Braidwood, G3WKE.  
Assistant Editor: Rick Maybury.



See Page 40



See Page 49



See Page 61

## PROJECTS

- ELECTRONIC IGNITION** ..... 11  
*Capacitor-Discharge Unit For 4 or 6 Cylinder Cars With Negative Earth. Status & Timing Lights, Pre-Set Rev Limit, Auto Fail-Safe, Remote Change-Over.*
- HOBBYCOM: TWO-WIRE INTERCOM** ..... 17  
*Multi-Station System For Office Or Home.*
- DIGITAL FREQUENCY METER** ..... 33  
*Battery-Powered, 5-Digit, 20 Hz-2MHz, Portable DFM.*
- SPEED CONTROLLER FOR R/C** ..... 49  
*Controls Speed And Direction Of Electric Motors Rated Up To 15A.*

## FEATURES

- SHORT CIRCUITS** ..... 23, 48  
*Class 'A' Amplifier, 10 to 30 MHz Preselector, Supply Splitter, LED VU Meter.*
- SOLAR CELLS: THE INSIDE STORY** ..... 27  
*Realise The Potential When We Throw Light On Them.*
- NBTV: NARROW BANDWIDTH TELEVISION** . 40  
*First Half Of Our Do-It-Yourself Television Course.*
- CHIT-CHAT** ..... 55  
*Ten One-Transistor Projects, Turn To Pages 55-57 And See.*
- BREAKER ONE-FOUR** ..... 61  
*Lovely Photos Of CB Demonstration In London.*
- INTO ELECTRONICS CONSTRUCTION** ..... 67  
*How To Understand The Markings On Components And Circuit Diagrams.*

## NEWS & INFO

- MONITOR, HE's News Pages** ..... 6
- CLEVER DICK, Bike Speedo, Russian Spare Parts, Translation Contest Results** ..... 15
- HE BOOK SERVICE, Brush Up On Oscilloscopes, Triacs, CMOS, Business, Radio Control, Circuits, Etc** ..... 22, 45
- BACK COPIES OF HE, Hurry While Stocks Last** ..... 25
- SUBSCRIPTIONS, Make Sure You Get Your Copies** ..... 25
- NEXT MONTH'S HE, Contest, Projects, Radio Controlled Cars** 31
- HE MARKETPLACE, Watches And Clocks Going Cheap** .... 52
- SPECIAL PUBLICATIONS FROM HE, Project Books, Circuit Books, Design Books, Into Electronics, Electronics It's Easy** ... 54
- ETI NEXT MONTH, Chorus Machine, Kit Survey, Antimatter** . 58
- HOBBYPRINTS, Make PCBs The Easy Way** ..... 66
- HE PROJECTS SPECIAL NUMBER ONE, Now You Can Build Those Projects From Unavailable Back Issues** ..... 74

**Project Team:** Ray Marston (Manager), Steve Ramsahadeo, John FitzGerald, Keith Brindley.  
**Art Department:** Diego Rincon (Art Director), Dee Camilleri, Lorraine Stout, Lorraine Radmore.  
**Technical Artists:** Paul Edwards, Tony Strakas, Joanne Barseghian.  
**Advertising Department:** Group Advertisement Manager: Christopher Surgenor; Advertisement Representatives: Steve Rowe, Bill Delaney, Margaret Hewitt; Advertising Production Controller: Sandie Neville.  
**Editorial Secretary:** Halina Di-Lallo.  
**Reader Services:** Bren Goodwin, Tim Salmon, Tracey Campbell, Joan Brimm.  
**Managing Director:** T. J. Connell.

Hobby Electronics is normally published on the second Friday of the month prior to the cover date.

**Hobby Electronics,**  
145 Charing Cross Road,  
London, WC2H 0EE.  
01-437 1002 (4 lines).  
**Published by** Modmags Ltd.  
**Distributed by** Argus Distribution Ltd.  
**Printed by** QB Ltd, Colchester.

**Copyright:** All material in this publication is subject to world-wide copyright protection. Permission to reproduce printed circuit board patterns commercially or marketing kits of the projects must be sought from the Editor. All reasonable care is taken in the preparation of the magazine to ensure accuracy but Modmags cannot be held responsible for it legally.

© 1980.

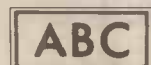

# Simply ahead . .

## ILP'S NEW GENERATION OF HIGH



I.L.P. modular units comprise five power amplifiers, pre-amp which is compatible with the whole range, and the necessary power supply units. The amplifiers are housed and sealed within heatsinks all of which will stand up to prolonged working under maximum operating conditions.

With I.L.P. performance standards and quality already so well established, any advances in I.L.P. design are bound to be of outstanding importance — and this is exactly what we have achieved in our new generation of modular units. I.L.P. professional design principles remain — the completely adequate heatsinks, protected sealed circuitry, rugged construction and excellent performance. These have stood the test of time far longer than normally expected from ordinary commercial modules. So we have concentrated on improvements whereby our products will meet even more stringent demands such, for example, as those revealed by vastly improved pick-ups, tuners, loudspeakers, etc., all of which can prove merciless to an indifferent amplifier system. I.L.P. modules are for laboratory and other specialised applications too.

**PRODUCTS OF THE WORLD'S FOREMOST SPECIALISTS  
IN ELECTRONIC MODULAR DESIGN**

ALSO AVAILABLE FROM A NUMBER OF SELECTED APPOINTED STOCKISTS

# and staying there

## PERFORMANCE MODULAR UNITS

### HY5 PRE-AMPLIFIER

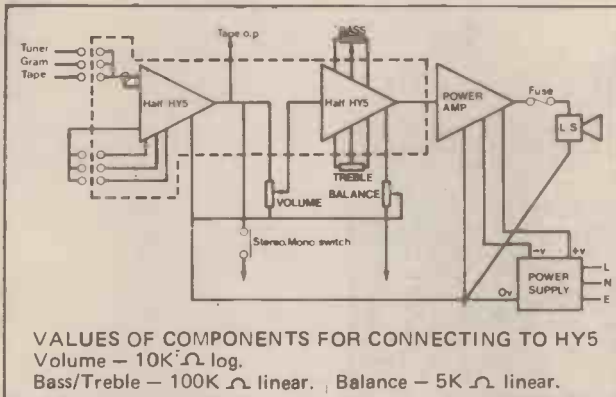
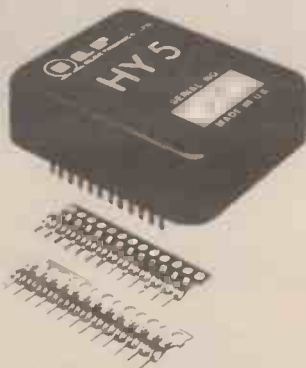

VALUES OF COMPONENTS FOR CONNECTING TO HY5  
 Volume — 10K $\Omega$  log.  
 Bass/Treble — 100K $\Omega$  linear. Balance — 5K $\Omega$  linear.

The HY5 pre-amp is compatible with all I.L.P. amplifiers and P.S.U.'s. It is contained within a single pack 50 x 40 x 15 mm. and provides multi-function equalisation for Magnetic/Ceramic/Tuner/Mic and Aux (Tape) inputs, all with high overload margins. Active tone control circuits; 500 mV out. Distortion at 1KHz—0.01%. Special strips are provided for connecting external pots and switching systems as required. Two HY5's connect easily in stereo. With easy to follow instructions.

£4.64 + 74p VAT

### THE POWER AMPLIFIERS

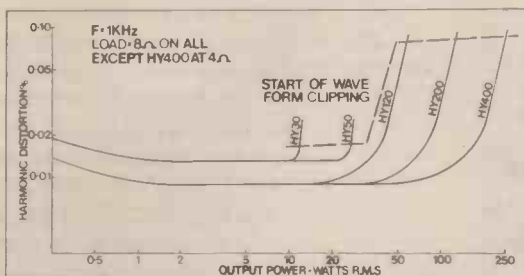

Model	Output Power R.M.S.	Distortion Typical at 1KHz	Minimum Signal/Noise Ratio	Power Supply Voltage	Size in mm	Weight in gms	Price + V.A.T.
HY30	15 W into 8 $\Omega$	0.02%	80dB	-20 -0 +20	105x50x25	155	£6.34 + 95p
HY50	30 W into 8 $\Omega$	0.02%	90dB	-25 -0 +25	105x50x25	155	£7.24 + £1.09
HY120	60 W into 8 $\Omega$	0.01%	100dB	-35 -0 +35	114x50x85	575	£15.20 + £2.28
HY200	120 W into 8 $\Omega$	0.01%	100dB	-45 -0 +45	114x50x85	575	£18.44 + £2.77
HY400	240 W into 4 $\Omega$	0.01%	100dB	-45 -0 +45	114x100x85	1.15Kg	£27.68 + £4.15

Load impedance — all models 4 - 16 $\Omega$   
 Input sensitivity — all models 500 mV  
 Input impedance — all models 100K $\Omega$   
 Frequency response — all models 10Hz - 45KHz - 3dB

### THE POWER SUPPLY UNITS

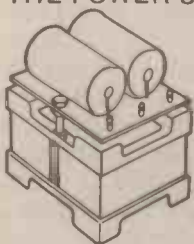

I.L.P. Power Supply Units are designed specifically for use with our power amplifiers and are in two basic forms — one with circuit panel mounted on conventionally styled transformer, the other with toroidal transformer, having half the weight and height of conventional laminated types.

PSU 30	$\pm 15V$ at 100ma to drive up to five HY5 pre-amps	£4.50 + £0.68 VAT
PSU 36	for 1 or 2 HY30's	£8.10 + £1.22 VAT
PSU 50	for 1 or 2 HY50's	£8.10 + £1.22 VAT
PSU 70	with toroidal transformer for 1 or 2 HY120's	£13.61 + £2.04 VAT
PSU 90	with toroidal transformer for 1 HY200	£13.61 + £2.04 VAT
PSU180	with toroidal transformer for 1 HY400 or 2 x HY200	£23.02 + £3.45 VAT

**NO QUIBBLE  
 5 YEAR GUARANTEE  
 7-DAY DESPATCH ON ALL ORDERS  
 INTEGRAL HEATSINKS  
 BRITISH DESIGN AND MANUFACTURE  
 FREEPOST SERVICE  
 —see below**

### ★ ALL U.K. ORDERS DESPATCHED POST PAID

#### HOW TO ORDER, USING FREEPOST SYSTEM

Simply fill in order coupon with payment or credit card instructions. Post to address as below but do not stamp envelope — we pay postage on all letters sent to us by readers of this journal.



**I.L.P.**  
**ELECTRONICS LTD.**  
 FREEPOST 6, Graham Bell House, Roper Close  
 Canterbury, Kent CT2 7EP.  
 Telephone (0227) 54778 Telex 965780

Please supply .....

..... Total purchase price £ .....

I enclose Cheque  Postal Orders  International Money Order

Please debit my Account/Barclaycard Account No. ....

NAME .....

ADDRESS .....

Signature .....



# Monitor

## LIQUID CHESS DEPARTMENT

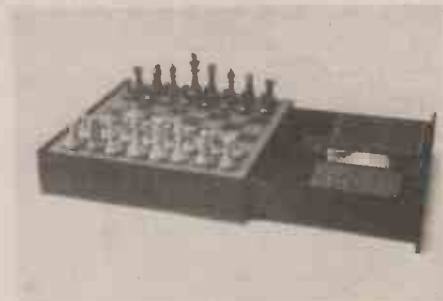

Far left. The complete Chess Master system in its smart attache case.

Centre. Close up of the Chess Master board. The world's first LCD chess display.

Right. The Sargon modulator games system open for use.

If you thought that the recent flood of chessgames had finally subsided then we have some bad/good news for you. Latest contenders for the race have just arrived in this country and as far as we know, we have the only ones in the country at the moment.

In common with other recent chess-playing micros these two are just bristling with gimmicks not directly related to the game of chess. Number one is called the Chess Master Super System III. It is a modular system, expandable according to the depth of your pocket. The basic chess-playing console will set you back around £150. When your next birthday comes round you can now add to your list an impressive range of accessories designed to connect up to the Master. The most novel one, and top of our list has to be the LCD board,

Chessmen are now redundant, this board will display the whole board, complete with pieces during the game. This will set you back £107. The neat little printer comes next. This gives a hard copy of every move and will print out a good graphic representation of the board at the end of every move if instructed to do so. The last couple of add-ons are a bit mundane but nevertheless worth mentioning. A plug-in memory module that will retain all the moves made during a particular game (for up to one year!) will set you back £24 and a rechargeable battery pack for portable use comes to you for just £25. By the way if you're still fluid, a smart looking attache case is available for another £43.

The second game is a little light on the gimmicks, it just claims to have the strongest

chess programme ever put inside a little box. And strong it is, we can vouch for that. The other little thing to mention about the Sargon is that it can be loaded up with a variety of optional game cartridges to make it adept at Backgammon and various other board games. It comes in a rather neat little draw box which holds all the bits. The nasty little plastic men are a little disappointing, especially considering the price tag of around £260 but then it's not worth arguing, given a couple of months they'll end up like all the others and settle down to a realistic price. If you really can't wait and several hundred pounds is burning its way through your pockets then get in touch with Kramer Ltd who may be able to relieve you of some of it. Find them at 9 October Place, London NW4 (203 2473).

## HEBOT ON TV



Did you see HEBOT on Nationwide last month? HEBOT has finally made its long awaited bid for stardom. In the picture we have Luke Casey (one of the Nationwide reporters) describing some of HEBOT's features. The filming was quite an ordeal, taking some three hours to complete. HEBOT actually behaved itself (much to everyone's surprise) and performed its tricks on cue (well, almost). The resultant clip of film was used to illustrate a report on robots, HE and Remcon being only one of two robot manufacturers in the UK.

You may be interested to know that one of the country's leading computer magazines is actually specifying a slightly modified version of HEBOT for the basis of a micro-processor controlled 'Mouse'. The idea is to design a mobile system that can negotiate a complex maze. The winner being the machine that covers the maze in the shortest time and making the least mistakes. HEBOT is the ideal basis for such a competition, the mechanics and drive circuitry could have been designed for the job. The only doubt we have is, why does the chassis have to be cut down for the maze, surely it would have been more sensible to increase the dimensions of the maze? We'll try and get some pix and information on the competition which we believe is due to be held around September.

## MOLTEN MONITOR



These rather gruesome looking objects are the remains (though still working) of a pair of Tann Synchronome Series 3000 Heat detectors. Why you may ask, are they in this condition. Well, they were involved in a rather suspicious fire at a popular nightclub in Chester.

The swift activation of the alarm system by the detectors prevented extensive damage. Fire damage was contained within a relatively small area and smoke damage to two thirds of the ground floor. If you would like to protect your nightclub (or any other building for that matter) with these detectors then you can find Tann at: Station Road, Westbury, Wiltshire BA13 3JT.

# WATFORD ELECTRONICS

35 CARDIFF ROAD, WATFORD, HERTS., ENGLAND  
MAIL ORDER, CALLERS WELCOME. Tel. Watford 40588/9

ALL DEVICES BRAND NEW, FULL SPEC. AND FULLY GUARANTEED. ORDERS DESPATCHED BY RETURN OF POST. TERMS OF BUSINESS: CASH/CHEQUE/P.O. OR BANKERS DRAFT WITH ORDER. GOVERNMENT AND EDUCATIONAL INSTITUTIONS' OFFICIAL ORDERS ACCEPTED. TRADE AND EXPORT INQUIRY WELCOME. P&P ADD 30p TO ALL ORDERS UNDER £10. OVERSEAS ORDERS POSTAGE AT COST. AIR/SURFACE. ACCESS ORDERS WELCOME.

VAT Export orders no VAT. Applicable to U.K. Customers only. Unless stated otherwise, all prices are exclusive of VAT. Please add 15% to all prices.

We stock thousands more items. It pays to visit us. We are situated behind Watford Football Ground. Nearest Underground/BR Station: Watford High Street. Open Monday to Saturday. Ample Free Car Parking space available.

**POLYESTER CAPACITORS:** Axial lead type.  
400V: 1F, 1.5F, 2.2F, 3.3F, 4.7F, 6.8F, 10F, 15F, 9p; 18p 10p; 22n, 33n 11p; 47n, 68n 14p; 100n 17p; 150n, 220n 24p; 330n, 470n 41p; 680n 52p; 1µF 64p; 2µF 82p.  
160V: 33pF, 100n, 150n, 220n 11p; 330n, 470n 18p; 680n, 1µF 22p; 1.5µ, 2µ 32p; 4.7µ 36p.  
100V: 10nF, 15n 20p; 22n 22p; 47n 26p; 100n 38p; 470n 53p; 1µF 175p.

**POLYESTER RADIAL LEAD CAPACITORS: 250V:**  
10n, 15n, 22n, 27n 9p; 33n, 47n, 68n, 100n 7p; 150n 10p; 220n, 330n 13p; 470n 17p; 680n 19p; 1µ 22p; 1.5µ 30p; 2µ 34p.

**ELECTROLYTIC CAPACITORS:** Axial lead type (Values are in µF). 500V: 10 40p; 47 7p; 250V: 100 85p; 63 9p; 0.47, 1.0, 1.5, 2.2, 2.5, 3.3, 4.7, 6.8, 8, 10, 8p; 15, 22, 47, 32, 50 12p; 63, 100, 27p; 50V: 50, 100, 220, 25p; 470, 32p; 1000, 50p; 40V: 22, 33, 10p; 100, 12p; 2200, 3300, 85p; 4700, 98p; 35V: 33, 100p; 330, 47p; 32p; 1000, 49p; 25V: 10, 22, 47, 6p; 80, 100, 160, 8p; 220, 250, 13p; 470, 640, 25p; 1000, 33p; 1500, 35p; 2200, 45p; 3300, 62p; 4700 85p; 16V: 10, 40, 47, 68, 7p; 100, 12p; 8p; 220, 330, 14p; 470, 18p; 1000, 1500, 20p; 2200, 34p; 10V: 100, 6p; 640, 12p; 1000, 14p.  
**TAG-END TYPE:** 450V: 100µF 180p; 70V: 470p, 165p; 64V: 3300 130p; 2500 98p; 50V: 3300 105p; 2200 99p; 40V: 15000 39p; 4700 120p; 4000 92p; 3300 93p; 2500 85p; 2200 85p; 2000+2000 120p; 30V: 4700 90p; 25V: 6400 105p; 4700 85p; 3300 80p; 2200 60p.

**TANTALUM BEAD CAPACITORS**  
35V: 0.1µF, 0.22, 0.33, 0.47, 0.68, 1.0, 2.2µF, 3.3, 4.7, 6.8, 8, 10, 25V: 1.5, 1.0, 20V: 1.5, 1.6V: 10µF 13p each; 47, 100, 40p; 10V: 22, 33, 20p; 6V: 47, 68, 100, 30p; 3V: 68, 100, 20p.

**MYLAR FILM CAPACITORS**  
100V: 0.001, 0.002, 0.005, 0.01µF 6p  
0.015, 0.02, 0.04, 0.05, 0.056µF 7p  
0.1, 0.15, 0.2, 0.25, 0.47µF 12p  
100V: 0.01, 0.02, 0.05, 0.1µF 12p

**MINIATURE TYPE TRIMMERS**  
2.5-6pF, 3-10pF, 10-40pF  
5-25pF, 5-45pF, 60pF, 80pF 22p 30p

**COMPRESSION TRIMMERS**  
3-40pF, 10-80pF, 25-190pF 33p  
100-500pF 45p 1280pF 58p

**POLYSTYRENE CAPACITORS:**  
10pF to 1nF 8p; 1.5nF to 10nF 10p

**SILVER MICA (Values in pF) 3-3, 4.7, 6.8, 10, 12, 15, 22, 33, 47, 56, 75, 82, 85, 100, 120, 150, 180 11p each; 220, 250, 270, 300, 330, 360, 390, 600, 820 16p each; 1000, 1200, 1800, 2200 26p each.**

**CERAMIC CAPACITORS 50V, 0.5pF to 10nF 4p; 22n to 47n 6p, 100n.**

**EURO BREADBOARD £5.80.**

**VOLTAGE REGULATORS**  
1A T03 +ve -ve 7805 145p 7905 220p  
12V 7812 145p 7912 220p  
15V 7815 145p 7915 220p  
18V 7818 145p 7918 220p

1A T0220 Plastic Casing 7805 75p 7915 75p  
12V 7812 85p 7912 75p  
15V 7815 85p 7915 75p  
18V 7818 85p 7918 75p  
24V 7824 85p 7924 75p

100mA T092 Plastic Casing 78L05 65p 79L05 65p  
5V 78L02 30p 79L02 65p  
6V 78L02 30p 79L02 65p  
12V 78L12 30p 79L12 65p  
15V 78L15 30p 79L15 65p

CA3085 95p LM323K 62p TAAS50 50p  
LM300H 170p LM325N 24p TBAS25B 50p  
LM305H 140p LM326N 24p TDA1412 150p  
LM309K 135p LM327 27p 78H05 595p  
LM317K 350p LM723 39p

**JACKSONS VARIABLE CAPACITORS**  
Dielectric 0.2 365pF with slow motion Drive 370p  
100/300pF 175p 0.0208/176 330p  
500pF 205p 0.0208/176 330p  
6.1 Ball Drive 0.0208/176 with wick  
451/DAF 125p slow motion Drive 370p  
Dial Drive 410p  
6.1/36.1 650p CB04-5pF 10 15  
Drum 54mm 40p 25 50pF 185p  
0.1-365pF 245p 100 150pF 275p  
0.02-365pF 295p L 3.310pF 550p  
0.00325pF 430p

**DIODES**  
AA119 25  
AA129 20  
BA100 10  
BY126 12  
BY127 12  
CR033 148  
OA9 75  
OA47 12  
OA70 12  
OA79 15  
OA81 15  
OA85 14  
OA90 7  
OA91 8  
OA95 8  
OA200 8  
QA202 8  
IN54 4  
IN16 4  
IN41/2 5  
IN400/3 6  
IN400/4 6  
IN400/5 6  
IN400/6 7  
IN414B 4  
IS4 26  
3A 100V 18  
3A 200V 27  
3A 400V 27  
3A 1000V 30

**ZENERS**  
Range: 2V7 to 39V 400mW  
Range: 3V3 to 33V 1.3W  
SPDT c/over 79p  
DPDT Biased 115p

**NOISE**  
25J 180p

**BRIDGE RECTIFIERS**  
(plastic case) p  
1A/50V 20  
1A/100V 22  
1A/200V 25  
1A/400V 29  
1A/600V 34  
2A/50V 35  
2A/100V 44  
2A/200V 46  
2A/400V 53  
2A/600V 55  
4A/800V 120  
6A/100V 73  
6A/200V 78  
6A/400V 85  
BY164 56  
VM18 DIL 40

**SCRs Thyristors**  
0.6A/200V 30  
D 8A100V 30  
0.8A200A 35  
1A600V 70  
5A300V 35  
5A600V 43  
8A300V 48  
8A500V 58  
8A600V 58  
1A2300V 92  
1A2500V 92  
1A2700V 92  
1A4444 140  
2N5602 29  
2N5604 35  
1A/100V 22  
C106D 38  
1A/200V 25  
1A/400V 29  
1A/600V 34  
2A/50V 35  
2A/100V 44  
2A/200V 46  
2A/400V 53  
2A/600V 55  
4A/800V 120  
6A/100V 73  
6A/200V 78  
6A/400V 85  
BY164 56  
VM18 DIL 40

**TRIACS**  
1A100V 48  
1A2300V 92  
3A200V 49  
3A400V 50  
8A100V 54  
8A400V 64  
8A600V 64  
8A800V 108  
12A100V 60  
12A400V 70  
12A600V 80  
12A800V 108  
16A100V 95  
16A500V 150  
26A800V 295  
2.5A 100V 48  
2.5A 200V 48  
T28000 120

**DIAC**  
5T2 25

TTL 74	74126 57	74LS42 98	74LS324 240	4073 21	CA3085 85
	74128 74	74LS47 63	74LS365 66	4075 23	CA3089E 215
	74132 73	74LS51 24	74LS366 65	4076 85	CA3090AQ 375
	74136 65	74LS54 28	74LS367 65	4077 85	CA3123E 150
	74141 30	74LS59 30	74LS368 66	4078 21	CA3130 48
	74142 209	74LS63 150	74LS369 66	4079 20	CA3140 48
	74143 314	74LS73 46	74LS374 155	4082 21	ICL7106E 795
	74144 314	74LS74 41	74LS375 160	4085 74	ICL7107 975
	74145 65	74LS75 48	74LS378 184	4086 73	ICM7205 1189
	74147 178	74LS76 40	74LS870 248	4089 150	ICM7217A 790
	74148 109	74LS78 40	7 4 L S 6 7 3	4093 85	ICM7555 89
	74149 99	74LS83 115	7 4 L S 6 7 4	4094 190	LD130 452
	74151 64	74LS85 118	1450	4095 105	LM300H 170
	74152 64	74LS86 43		4096 105	LM301A 23
	74154 96	74LS90 38		4097 372	LM308 70
	74155 53	74LS91 104		4098 110	LM318 205
	74156 80	74LS92 89		4099 145	LM324 45
	74157 85	74LS93 89	CMOS*	4180 109	LM339 70
	74159 185	74LS95 116	4001 13	4161 109	LM348 90
	74160 82	74LS96 116	4002 15	4162 109	LM379 375
	74161 92	74LS107 44	4006 67	4163 110	LM380 80
	74162 92	74LS109 85	4007 18	4174 109	LM381 100
	74163 92	74LS112 85	4008 82	4175 89	LM382 125
	74164 108	74LS113 50	4009 33	4178 99	LM384 108
	74165 105	74LS114 50	4010 33	4180 99	LM3900 60
	74166 140	74LS123 70	4011 28	4409 720	LM3909N 70
	74167 200	74LS124 180	4012 18	4410 720	LM3911 125
	74168 185	74LS125 60	4013 45	4411 158	LM3914 240
	74172 628	74LS126 80	4014 80	4412V 330	MC1553AA 95
	74173 120	74LS127 85	4015 82	4413 75	MC1304P 260
	74174 87	74LS136 85	4016 45	4415V 290	MC1310 149
	74175 87	74LS138 85	4017 82	4419 785	MC1312P 185
	74176 75	74LS139 88	4018 87	4422 545	MC1488 85
	74177 78	74LS151 98	4019 48	4433 995	MC1489 90
	74178 153	74LS153 78	4020 98	4435 825	MC1495 350
	74179 85	74LS155 96	4021 95	4436 1275	MC1496 92
	74181 165	74LS156 96	4022 85	4450 295	MC1710 79
	74182 88	74LS157 76	4023 22	4451 295	MC3340P 120
	74184 135	74LS158 96	4024 66	4490F 695	MC3360P 120
	74185 135	74LS160 128	4025 19	4490V 525	MC3401 82
	74188 278	74LS161 98	4026 180	4500 180	MC3403 95
	74190 95	74LS162 138	4027 45	4502 120	MCFC040 92
	74191 95	74LS163 102	4028 81	4503 69	MK50362 670
	74192 98	74LS164 114	4029 99	4506 51	MKS0398 635
	74193 98	74LS165 75	4030 58	4507 55	MM5303 635
	74194 98	74LS168 115	4031 205	4508 288	MM5307 1275
	74195 98	74LS169 150	4032 100	4510 89	NE518 210
	74196 98	74LS170 283	4033 145	4511 89	NE519 210
	74197 80	74LS173 105	4034 216	4512 98	NE544 185
	74198 150	74LS174 106	4035 111	4520 108	NE555 20
	74199 175	74LS175 110	4036 325	4520 108	NE556 55
	75491 92	74LS181 398	4037 100	4521 108	NE560 325
	75492 92	74LS183 298	4038 108	4522 108	NE561 325

74LS*	74LS00 13	74LS192 132	4042 75	741C 8 pin 17	NE566 160
	74LS01 14	74LS193 130	4043 94	741C 7 pin 78	NE567 170
	74LS02 14	74LS194 166	4044 95	748C 36	NE568 160
	74LS03 14	74LS195 136	4045 145	100 159	RC136 10
	74LS04 14	74LS196 100	4046 128	100 159	S556 225
	74LS05 23	74LS197 140	4047 87	8038CC 340	SN76003 210
	74LS06 22	74LS221 96	4048 58	AV-1-0212 580	SN76013 140
	74LS07 22	74LS240 236	4049 48	AV-1-1313A 660	SN76023 140
	74LS08 22	74LS241 236	4050 48	AV-1-1320 315	SN76024 140
	74LS10 20	74LS242 232	4051 72	AV-1-5050 110	SN76025 200
	74LS11 22	74LS243 232	4052 72	AV-1-5051 145	TA6621 250
	74LS12 23	74LS244 155	4053 72	AV-1-6721-6 195	TBA120F 70
	74LS13 38	74LS245 270	4054 110	AY-3-8500 390	TBA641 250
	74LS14 76	74LS247 190	4055 123	AY-5-122A 260	TC9485 120
	74LS15 34	74LS251 34	4056 134	AY-5-1230 450	TC9486 120
	74LS16 142	74LS252 110	4059 480	CA3010 110	TDA1022 575
	74LS17 110	74LS257 110	4060 115	CA3018 68	TDA1024 105
	74LS18 22	74LS258 110	4061 1425	CA3020 186	TDA2020 320
	74LS19 68	74LS259 160	4062 999	CA3023 191	TLO61 54
	74LS20 28	74LS261 450	4063 110	CA3028A 80	TLO74 140
	74LS21 28	74LS262 450	4064 28	CA3035 25	TN601 140
	74LS22 22	74LS273 244	4067 380	CA3039 275	TLO82 70
	74LS23 27	74LS275 250	4068 22	CA3046 71	TLO83 95
	74LS24 19	74LS279 66	4069B 20	CA3048 214	TLO84 120
	74LS25 25	74LS280 250	4070 32	CA3059 176	UAA170 150
	74LS26 39	74LS289 468	4071 21	CA3080E 85	UAA180 150
	74LS40 28	74LS323 488	4072 21	CA3081 190	ZN414 80

LINEAR ICs	709C 8 pin 35	NE562 410	710 67	NE564 425	716 150
	710 67	NE565 120	716 150	NE566 160	716 150
	716 150	NE567 170	748C 36	NE568 160	748C 36
	748C 36	RC136 10	100 159	S556 225	SN76003 210
	100 159	S556 225	SN76013 140	SN76023 140	SN76024 140
	SN76023 140	SN76024 140	SN76025 200	TA6621 250	TBA120F 70
	SN76025 200	TBA641 250	TC9485 120	TC9486 120	TDA1022 575
	TC9485 120	TC9486 120	TDA1022 575	TDA1024 105	TDA2020 320
	TDA1022 575	TDA1024 105	TDA2020 320	TLO61 54	TLO74 140
	TDA2020 320	TLO61 54	TLO74 140	TC9485 120	TC9486 120
	TLO74 140	TC9485 120	TC9486 120	TDA1022 575	TDA1024 105
	TC9486 120	TDA1022 575	TDA1024 105	TDA2020 320	TLO61 54
	TDA1024 105	TDA2020 320	TLO61 54		



## News from the Electronics World

### RING MY BELL



Yes folks, these are the happy, smiling girls that put your phones together. This young lady is responsible for putting the finishing touches to one of the Post Offices latest offerings — called the Compact. As you can see these girls (at the Plessey factory) are having a whale of a time assembling these ultra-slim 'window-sill' or shelf compatible instruments with their three metres of cable making them truly mobile.

Now for the good bit. If you can think up a caption for this picture or suggest what the young lady may be saying, we'll send the best five a Tee-Shirt. Only clean(ish) suggestions please, dirty ones will not be printed (but may well win a prize if they're funny enough). Send your effort to: Caption Competition, Hobby Electronics Magazine, 145 Charing Cross Road, London WC2H 0EE. To arrive no later than April 1st.

### BOOK REVIEW

Not much in the way of new books lately, in fact there is only one this month. It is called Electrical Drawing and comes from Firth and Lowe (they wrote it) and is published by McGraw-Hill price £3.95.

We managed to persuade our drawing office to do the review so it's over to you Joanne for your verdict.

"This book is a very simplified and readable approach to Technical Drawing, ranging from the basics of geometry and techniques to the drawing of circuit diagrams. It contains exercises and self-assessment questions, these enable the reader to learn the necessary steps to achieving a reasonable standard of electrical drawing. There is a detailed list of abbreviations and terms used so that the reader can familiarise himself (or herself) more easily with the subject matter. The drawings are not over technical and are designed to be easily understood, useful both for the amateur who has some basic knowledge and also helpful to the beginner. Altogether a worthwhile companion for the technical artist."

### STAMP THIS OUT

Contrary to popular belief we are not millionaires, we are still getting loads of 'Technical Enquiry' letters without a SAE for reply. So, if you have a genuine problem concerning one of our projects (not for any other magazine please, they can sort out their own problems) then by all means write to us about it but please include an SAE. We cannot promise an immediate reply so you should allow at least three weeks before complaining.

### IT'S IN THE BAG

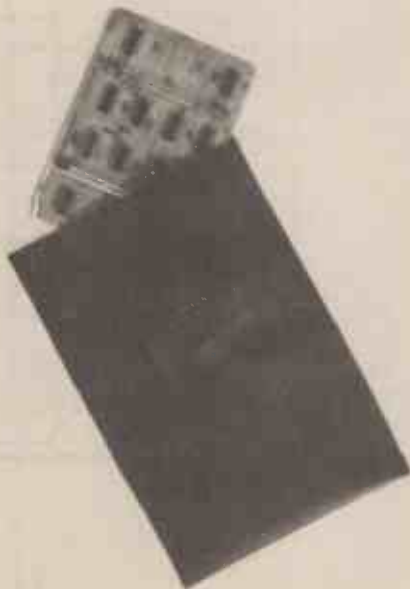

### NEGATIVE ION GENERATOR KIT

As you will see there is a distinct lack of Negative Ion Generator Kits being reviewed this month. This is not actually our fault (believe it or not). The manufacturers have informed us that due to unforeseen problems with the transformer supplied with the kit they cannot market them just yet. However, all being well they should have a new batch in a few weeks so we will be bringing you the review in the next month or so.

If you're in the habit of carrying large quantities of CMOS, MOSFET or similarly delicate components around with you, then pin your ears back. Henri Picard and Frere are proud to announce the introduction of their new conductive bags. Called the 'Statfee' (isn't that better than some boring number?) they claim the strength of the new fabric used in these bags offer a 30% higher tear resistance than their old bags.

The bags are available in five sizes between 5 in by 8 in to 10 in by 18 in. Bags can also be supplied in custom sizes. If you want to keep your valuables free from the ravages of static electricity (and who doesn't) then get in touch with H P & F at: 357-359 Kennington Lane, London SE11 5HY.

### SHOP SHAPE

Just a quick word for those of you living around the London area and particularly in Tottenham. Just around the corner from the 'Spurs' ground you will find NIC Models little shop. If you get a chance why not drop in and have a look round. His stocks of electronic games, 'scopes, computers, models and books just has to be seen to be believed. If you talk to him nicely (Nick Nicholls that is) he may just make you a cup of his diabolical coffee. You can find him hiding in Broad Lane N15 at number 61.

### CATALOGUES

Some catalogues are destined to become tatty. This is not usually a reflection of the quality of goods within, quite the opposite in fact. The West Hyde catalogue is certainly doomed, rarely have we seen so many interesting cases just crying out to have projects inside them. Apart from the cases (which must be the largest range anywhere!) they also offer a very creditable range of tools and hardware as well as testgear and components. Certainly with a range this specialised you could be excused in thinking that they would be expensive, happily this is not so. Nothing in the catalogue struck us as being overpriced, indeed many items seemed a bit too cheap to be true. Worry not though, we can vouch for West Hyde's service and have no hesitation in recommending this catalogue. After all, a really good looking case can turn a quite mundane project into a really professional piece of equipment.

West Hyde can be reached at: Unit 9, Park Street Industrial Estate, Aylesbury, Bucks HP20 1ET.

Whilst we are on the subject of catalogues, look out for our annual catalogue survey in the next month or two.

### PHOTOSTATS

Due to the shortage of certain issues of HE we are now offering a photostating service for articles and projects. Each article or project will cost just 50 pence including postage (irrespective of length etc) with the exception of HEBOT which costs 75 pence (all three parts). Please specify the month, year and title of the article or project you require and address your envelope to: Photostats, Hobby Electronics, 145 Charing Cross Road, London WC2H 0EE.

### ERRATA

Did you spot the mystery components in last month's batch of Short Circuits? Well for those of you that missed them the answers are: Page 33 Sound Operated Switch, the unmarked resistor above C3 and C4 is R2-47 k. Page 52, the Thermostat. Capacitor C1 is 1000  $\mu$ F, the resistor next to C2 is called R3 and is a 1k2 and the capacitor next to it is C3 and is 2  $\mu$ 2. The last mistake (courtesy of our Mr Corbett) concerns a couple of connections around IC1. Pin 9 is connected to the 0 V rail and pin 11 isn't. Sorry about that. We'll all write out 100 times 'we must not make mistakes', trouble is nobody knows how to spell the long words and we can only count up to 50 anyway.





# VERO Metal Cases

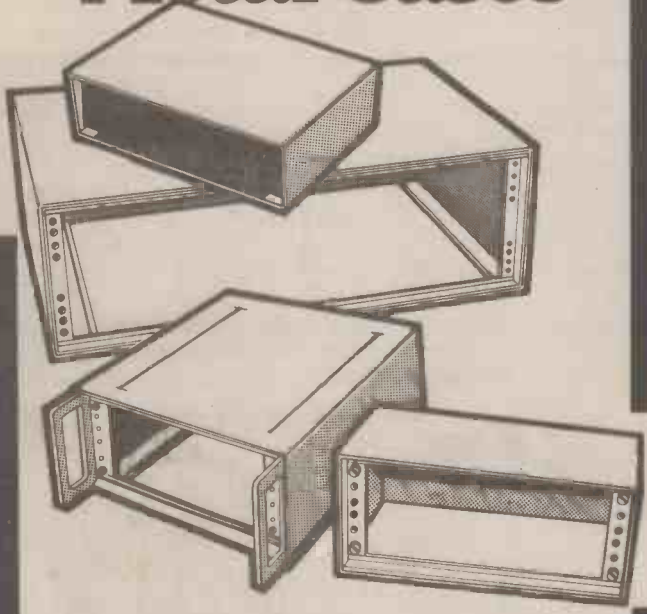

Our catalogue contains small metal enclosures for every application including the attractive new G range cases, with unique integrated chassis and sloping visor front and the inexpensive kit-form Veropak. We've also got circuit boards, accessories, module frames and plastic boxes — all to the highest standard to give your equipment the quality you demand. Send 40p to cover post and packing and the catalogue's yours.



**VERO ELECTRONICS LTD RETAIL DEPT.**  
Industrial Estate, Chandler's Ford,  
Hampshire SO5 3ZR  
Tel: (04215) 62829

# GREENWELD

443F Millbrook Road, Southampton SO1 0HX  
All prices include VAT at 15% — Just add 40p post



## COMPONENT CABINET IDEAL FOR THE NEWCOMER TO ELECTRONICS

Contains hundreds of brand new resistors, capacitors, transistors, diodes and i.c.s. All useful values, carefully chosen to help the new constructor pursue his hobby without finding himself short of some vital parts!

All parts contained in clearly marked bags in a plastic storage cabinet 232 x 121 x 185mm with 9 drawers into which all parts can be neatly located.

If bought individually parts plus case would cost over £45 but we are offering this for **ONLY £31.95 + £1 P&P**. Simply send a cheque or PO for **£32.95** for immediate despatch.

- CONTENTS**
- 200 1/4 watt resistors
  - 20 Wire wound resistors
  - 70 Ceramic Capacitors
  - 70 Mylar Capacitors
  - 50 Polyester Capacitors
  - 56 Electrolytic Capacitors
  - 61 Transistors
  - 12 I.C.s
  - 20 L.E.D.s
  - 55 Diodes and rectifiers

Altogether 614 components

Price includes current catalogue and Greenweld pen for reordering supplies. Plus free surprise gift.

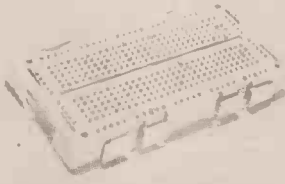

## VEROBLOC BREADBOARD

New from Vero, this versatile aid for building and testing circuits can accommodate any size of IC. Blocks can be joined together. Bus strips on X & Y axis — total 360 connection points for just **£3.70**.

## 3W Amp Module

Ready built and tested, this handy amplifier will prove very useful around the workshop. Just requires 17V ac source (and BR spkr) as bridge rect and smoothing cap are mounted on the PCB. The 4 transistor circuit provides enough sensitivity for most applications. Supplied complete with circuit diagram and wiring details.

Only **£1.75**. Suitable transformer, **£2.20**

## DISC CERAMIC PACK

Amazing variety of values and voltages from a few pF to 2.2uF1; 3V to 3kV1; 200 £1, 500 **£2.25** 1000 **£4.00**.

## DIODE SCOOP!!!

We have been fortunate to obtain a large quantity of untested, mostly unmarked glass silicon diodes. Testing a sample batch revealed about 70% useable devices — signal diodes, high voltage rectis and zeners may all be included. These are being offered at the incredibly low price of **£1.25/1,000** — or a bag of 2,500 for **£2.25**. Bag of 10,000 **£8**. Box of 25,000 **£17.50**.

## AERIALS

- X901 Telescopic 8 section 970mm long extended. 175mm collapsed. Swivel joint. 28A fixing hole in base. **75p**.
- X904 Ferrite rod 140mm x 9mm LW/MW/coupling coils, each independently moveable **64p**.
- X905 As above, but LW/coupling coil together on moveable former **65p**.

## THE NEW 1980 GREENWELD CATALOGUE

### FEATURES INCLUDE

- 60p Discount Vouchers
- Quantity prices for bulk buyers
- Bargain List Supplement
- Reply Paid Envelope
- Priority Order Form
- VAT inclusive prices

All for only 40p + 20p post

### 1000 RESISTORS £2.50!!

New stock just arrived — Carbon Film 2% & 5%, 1/4 & 1/2W, all brand new, but have pre-formed leads, ideal for PC mntg. Enormous range of popular mixed values for just **£2.50/1,000; £11/5,000; £50/25,000**

### INVERTER

Prepare for the Power Cuts! Ready built inverter, 290x55x37mm 24V DC in, will power 6 x 8W fluorescent tubes. Circuit supplied. Only **£2.90**

### SCR PANEL & REED PANELS

Z525 Contains 11 800mA 60V 2N5061 SCR's, 11 6V8 zeners, 11 1N4004 diodes + Rs, Cs etc. Only **£1.00**.

Z527 2 x 6V reed relays, 6x2S030 or 2S230 6x400V rectis. + Rs. Only **50p**.

### WIRE AND FLEX

Solid core — ideal for breadboards etc 50 x 2m lengths many assorted colours, total 100m for **£1.30**.

Flex packs — 5 x 5m lengths of multi-strand thin flex, ideal for wiring up circuits. Only **35p**.

### EX-COMPUTER PANELS

Z528 Pack of boards containing 100s Rs, Cs diodes, including at least 50 transistors. Only **£1.20**.

Z529 TTL pack — Panels with 74 series on, together with code sheet. From simple gates to complex counters. 20 ICs **£1**. 100 ICs **£4**.

### VERO OFFCUTS

Packs of 100 sq ins of good size pieces about 4x2in. in the following types:

- K5410 0.1in. copper clad **£1.80**
- K544 0.1in. plain **£1.80**

Also pieces 2 1/2x1in. — 10/£1.20 100/£9. 17x3 3/4in.x0.1in. sheets, 10/£16.50

Large range of Standard Veroboard and boxes/cases in stock. Details in Catalogue.

**SCOOP!!!** Verobox type 2522, unused but has 3 1/2in. holes in one end and 1 1/2in. hole in the other, so instead of £3.96, we are selling these at **£1.85**.

### BUZZERS, MOTORS & RELAYS

- Z401 Powerful 6V/DC Buzzer, all metal construction, 50mm dia, x 20mm **70p**.
- Z402. Miniature type, Buzzer, 6, 9 or 12V, only 22x15x16mm. Very neat. **53p**.
- Z450 Miniature 6V DC motor, high quality type, 32mm dia x 25mm high, with 12mm spindle. Only **£1**.
- W892 Heavy duty 12V relay, ideal for car use — single 15A make contact. Coil 25R **85p**.
- W890 DIL reed relay SPCO 2.4-10V 200R coil. Only **£2.20**.

### VU METERS

- V002 Twin type. 2 metres 40x40mm and driver board, supplied with circuit and connexion data **£3.50**.
- V003 New type, just in. Twin type moulded in one piece, 80x40mm (no driver board but suitable circuit supplied) **£2.50**.

### COMPONENT TRAY

Attractive yellow tray 285x165x42mm with clear hinged lid and moveable compartments. Up to 15 can be made from dividers supplied. As an added bonus, a selection of new surplus components are included, all for the special low price of **£3.95**.



# Electronic Ignition

***A first-class capacitor-discharge ignition unit that can be easily fitted to any 4- or 6-cylinder negative ground car engine. The unit has built-in goodies like status and timing lights, pre-settable RPM limiting, automatic fail-safe circuitry and remote change-over switching.***

CONVENTIONAL IGNITION SYSTEMS work by inductively storing energy in the ignition coil when the contact breaker (CB) points are closed and then releasing this energy (at a high voltage level) to the spark plug when the CB points open. These simple 'inductive discharge' systems suffer from a number of disadvantages. The available spark energy and voltage falls to low (and sometimes inadequate) levels and under cold-start conditions. The high inductor charge currents and heavy kick-back voltages cause excessive CB points burning and wear. Most important, the relatively long rise times of the ignition waveform (typically 100  $\mu$ S) make the system very susceptible to total energy loss under fouled-plug and damp-weather starting conditions.

Capacitor-discharge electronic ignition systems, by contrast, work by storing energy in a capacitor (charged to 300 volts or so) between ignition cycles. This energy is then released to the spark plugs via a 100:1 step-up transformer (the existing, conventional ignition coil) each

time the CB points open. The energy is released via a fast-acting silicon controlled rectifier (SCR), which in turn is triggered via the CB points at a 12 volt, 250mA level.

CD ignition systems offer several practical advantages over conventional systems. CB points burning is eliminated and wear reduced. Available spark energy and voltage do not degrade significantly under cold starting conditions, so cold-start performance is improved. Most important, the very fast rise time of the ignition waveform (about 5  $\mu$ S) ensures that the spark does not degrade significantly under fouled-plug and damp-weather starting conditions. The system also gives improved ignition or 'firing' characteristics and consequently gives a slight improvement (2-5%) in fuel economy.

The HE CD ignition system described here can be used on all 4- and 6-cylinder 4-stroke engines fitted with 12 volt negative-ground electrical systems. Our unit is



*The CD ignition installed and ready for use. This system has already given many thousands of miles of trouble-free motoring.*

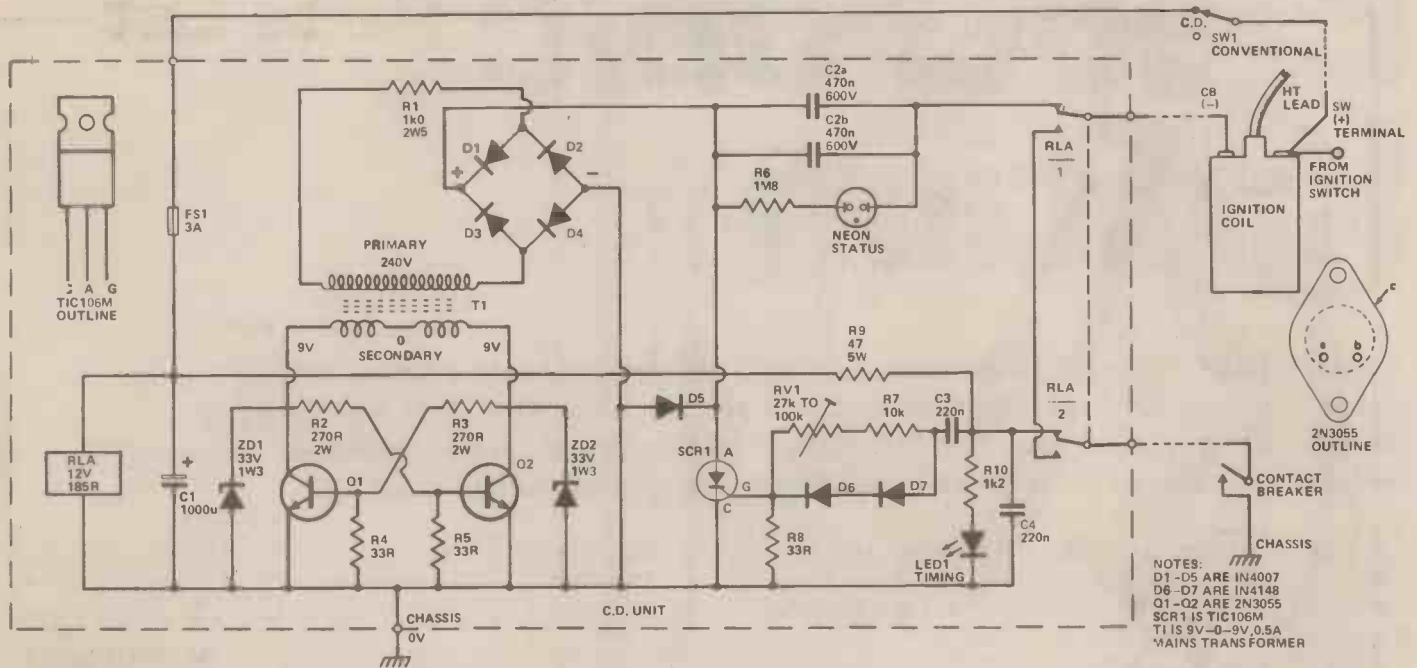

Fig. 1. Circuit diagram of the HE CD ignition system.

## How it Works

The circuit can be broken down into four basic sections, a low-voltage (14 volts) to high-voltage (about 350 volts) DC-to-DC converter, an energy-storage section, a trigger/discharge section and a relay fail-safe/mode-selector section. The DC-to DC converter is used to charge the energy storage capacitor to about 250-350 volts and the trigger/discharge section is used to direct this energy to the spark plugs via the ignition coil (which is used as a simple step-up transformer) as the contact breaker (CB) points open in each cycle.

The converter section is designed around T1-Q1-Q2 and the associated components. T1 is a standard 9 V-O-9 V 0.5 amp mains transformer. Q1 and Q2 are connected to the T1 primary terminals and cross coupled via R2 and R3 so that they act as a high power astable multivibrator which feeds anti-phase square waves to T1 primary. The primary circuit is powered from the vehicles battery supply (typically 14 volts under running conditions) and the astable action is such that double this voltage appears alternately on the collectors of Q1 and Q2 during the astable action. The astable waveform has considerable leading-edge overshoot and zener diodes ZD1 and ZD2 are used to limit this overshoot to safe values.

The astable voltage is stepped up to about 350 volts at D1-D4 bridge. The resulting dc is used to charge energy storage capacitors C2a-C2b, which have one side effectively taken to the battery positive line via the ignition coil. Resistor R1 and the output impedance of T1 limit the peak charging currents to safe values. The neon lamp wired across the energy storage capacitors is used to indicate their status and also to slowly discharge them when the ignition unit is switched off. Note that, because of the overshoot characteristics of

the Q1-Q2 astable, the circuit is capable of producing a considerable capacitor charge even under low-voltage 'cold start' conditions.

Silicon controlled rectifier SCR1 is used to discharge the storage capacitors as the CB points open. A current of about 250mA is fed through the CB points when they are closed. As the points open a brief trigger pulse is fed to the SCR gate via C3-D6-D7 and causes the SCR to turn on and discharge C2 into the ignition coil primary. Under this condition C2 and the ignition coil form a resonant circuit and the resulting backswing is 'captured' by D5 and automatically turns the SCR off after 100 uS or so, thereby completing the operating cycle: the total ignition cycle lasts for about 200 uS.

Returning to the CB 'trigger' action, assume that C3 is fully discharged just prior to the CB points opening. As the points open C3 charges rapidly via R9-D6-D7 and feeds a trigger pulse to the SCR gate. When the CB points close again C3 starts to discharge via RV1 and R7 and R8. If C3 has not discharged by the time the CB points re-open, a new trigger pulse will not be fed to the SCR gate. Thus, RV1-R7 act as a bounce-suppression network and can also be adjusted to prevent triggering beyond a certain CB operating frequency: they thus act as an RPM limiter. Light-emitting diode LED1 illuminates when the CB points are open and can thus be used as a static timing light.

Final points to note about the circuit are that its converter section is designed to give adequate operation up to 6000RPM on a 6-cylinder (9000RPM on a 4-cylinder) 4-stroke engine and its trigger/discharge section is designed to give cold-start triggering at battery voltages down to 6 volts.



# Electronic Ignition

## Parts List

### RESISTORS:

R1, 1k $\Omega$  2W5  
 R2, 3, 270R 2w  
 R4, 5, 8, 33R  
 R6, 1M8  
 R7, 10k  
 R9, 47R 5W  
 R10, 1k2

### POTENTIOMETERS:

RV1, 10k horizontal preset

### CAPACITORS:

C1, 1000u 25v electrolytic  
 C2a+b, 470n 600V dubilier  
 C3, 4, 220n polyester

### SEMICONDUCTORS:

Q1,2, 2N3055  
 SCR1, T1C106M  
 D1-5, IN4007  
 D6-D7, IN4148  
 ZD1, 2, 33V 1W3  
 Led 1, 0.2" dia. red led.

### MISCELLANEOUS

T1, 9-0-9 600mA  
 2 off heatsinks drilled for to3  
 Neon  
 SW1 SPDT toggle  
 FS1 3A +holder  
 Relay DPCO coil 185R (continental style)  
 Case aluminium box, size 8½" x 5½" x 2"



Fig. 2. Above. PCB layout for CD ignition.

Fig. 3. Below. Overlay diagram — ensure the relay is connected the right way round.

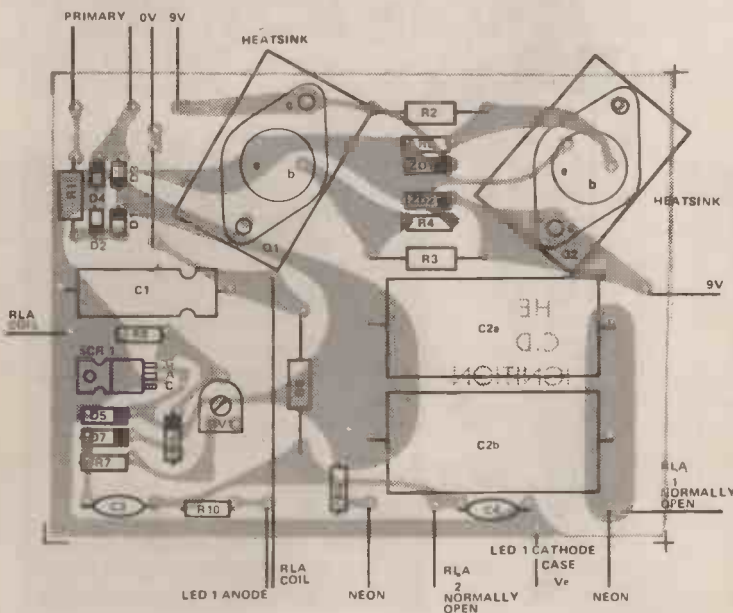

## Buylines

The transformer was obtained from Electrovalue, order as GP909.

A selection of aluminium boxes are available from H. L. Smith & Co. Ltd, Edgware Road. All other components are common types and should present no problems.

designed for easy fitting and uses only four external connections. The design, which has been subjected to several thousand miles of actual and simulated road testing, incorporates a number of unusual 'goodies'. It has a built-in 'status' light to indicate correct functioning and a LED indicator that can be used as an ignition timing aid (the LED illuminates when the CB points open).

Our unit also incorporates a pre-settable RPM limiter. A relay is used to change the circuit connections from 'conventional' to 'capacitor-discharge' ignition and can be activated via a remotely mounted panel switch. The CD unit is fuse-protected and the relay automatically reverts to the 'conventional ignition' mode in the event of fuse failure, thus giving fail-safe operation.

These features should ensure many thousands of trouble free miles.

# Electronic Ignition

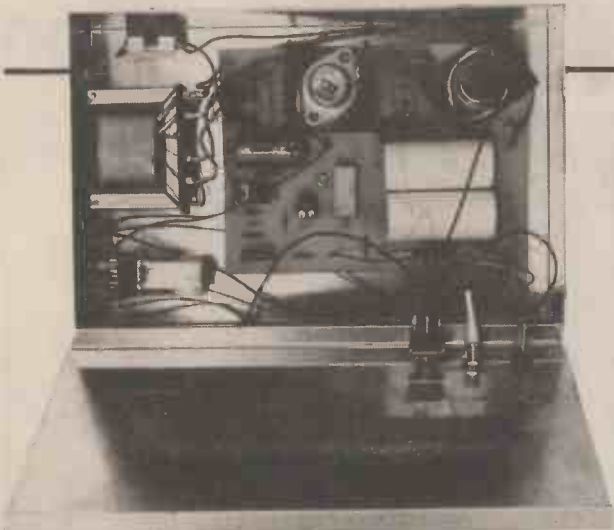

We recommend that the PCB be covered in wax or varnish to reduce the vibration damage.

## CONSTRUCTION AND USE

This project has been designed with ease of construction in mind and no attempt has been made to miniaturise the unit. All components except the relay and transformer are mounted on a single PCB as shown in the overlay. Use only the specified components (see Buylines) and take care to observe the polarities of all semiconductor devices and electrolytic capacitor C1. Gives RV1 an initial value of 100k.

When the PCB construction is complete fit the PCB, relay and transformer into a suitable metal box and complete the interconnections, taking special care to see that no short circuits occur between the circuitry and the

case. You can then give the unit a functional check as follows, after first setting RV1 to the minimum resistance position.

Place the unit loosely in the vehicles engine compartment, remove the existing CB-to-coil connections and then connect the unit's four output leads as shown in the diagram. One lead goes to chassis, one to the ignition coil's 'SW' or '+' terminal, one to the CB points and one to the coil's 'CB' or '-' terminal. When the connections are complete, switch on the ignition. If all is well the neon will light and the unit will emit a whistle sound. Operate the vehicles starter switch. The engine should start easily and run smoothly. Check that the ignition reverts to 'conventional' operation when the connection to the coil's 'SW' terminal is broken.

If everything is OK, bolt the unit into place in the engine compartment, as close to the coil as possible. Switch SW1, used to connect the unit to the coil's 'SW' terminal, can be mounted on the vehicle's instrument panel. If you wish to use the unit's 'RPM LIMIT' facility, raise the engine revs to the desired limit value and then adjust RV1 so that misfiring just starts to occur: if necessary, change the value of RV1 so that limiting occurs with RV1 at approximately mid value.

If your vehicle is fitted with a CB-activated tachometer, the tachometer will probably work perfectly well with the CD unit. If you have a Smiths or similar 'impulse' tachometer, you may have to wind a few turns of wire around the ignition HT lead to form a suitable impulse pick-up point. One side of this pick-up goes to ground and the other to the tach input. **HE**

**OHIO SCIENTIFIC** Superboard 2. Assembled 50Hz model £188 + 15% VAT, post free.

★ ★ ★ ★ ★  
 ★ Special offer: — If bought with superboard these items are at the reduced price shown first. Also sold separately at the bracketed prices. Add 15% VAT. Modulator and power supply kit £4.95 (£7.98). 4K extra ram £18.40 (£24). Cassette £19 (£21). Cassette recorder £12.13 (£14.74).  
 ★ ★ ★ ★ ★

**SINCLAIR PRODUCTS** New 10MHz scope £145, pm200 £51.95, case £2.07. adaptor £4.03. connector kit £11.27. Microvision tv £91. adaptor £6.88. pdm35 £34.23. adaptor £4.03. case £2.07. dm350 £76.70. dm450 £102.17. dm235 £55.55. rechargeable batta £7.99. adaptor £4.03. case £9. enterprise prog calculator + accessories £19.95.

**COMPUTER GAMES** chess champion 6 £49.95. Chess challenger 7 £84. Philips G700 home computer £149. Videopaks £12.95. Atari videocomputer £147. cartridges £14.95.

**COMPONENTS** 1N4148 0.9p. 1N4002 2.9p. 741 18p. bc182, bc184, bc212, bc214, bc548 5.5p. Resistors 1/4W 5% E12 10R to 10M 1p. 0.8p for 50¢ of one value. 16V electrolytics 5, 1, 2, 5, 10, 22mf 5p, 100mf 5p, 1000mf 11p, 1 1/2 Fc1 £1.30. Dalco pen 84p. 40 sq. ins. pcb 4.5p. Polystyrene capacitors E12 63V 10 to 100pf 3p, 1n2 to 10n 4p. Ceramic capacitors 50V E6 22pf to 47n 2p. Zeners 400mW E24 2v7 to 33v 7p.

**TV GAMES** AY-3-8500 + kit £7.26, rifle kit £5.27. AY-3-8600 + kit £17.28. stunt cycle chip + kit £18.66. AY-3-8603 chip £13.63.

**TRANSFORMERS** 6-0-6V 100ma 76p, 1 1/2 £2.60. 9-0-9V 75ma 76p, 1a £2.22. 2a £3.94. 12-0-12V 100ma 82p, 1a £2.80. **IC AUDIO AMPS** with pcb JCT2 6W £2.08. JC20 10W £3.14.

**BATTERY ELIMINATORS** 3-way type 6/7 1/2 / 9v 300ma £3.14. 100ma radio type with press-studs 9v £3.57. 9+9v £4.79. car converter 12v input, output 4 1/2 / 6 / 7 1/2 / 9v 800ma £2.66.

**BATTERY ELIMINATOR KITS** 100ma radio types with press-studs 4 1/2 v £1.49, 6v £1.49, 9v £1.49, 4 1/2 + 4 1/2 v £1.92, 6+6v £1.92, 9+9v £1.92. stabilized 8-way types 3/4 1/2 / 6 / 7 1/2 / 9 / 12 / 15 / 18v 100ma £2.60. 1 Amp £5.30. stabilized power kits 2-18v 100ma £2.98, 1.30v 1A £6.20, 1-30v 2A £11.24. 12v car converter 6/7 1/2 / 9v 1A £1.35.

**T-DEC AND CSC BREADBOARDS** t-dec £3.79. t-dec £4.59. u-deca £4.69. u-decb £7.16. exp4b £2.64. exp300 £6.61. exp350 £3.62. exp325 £1.84.

**BIPAK AUDIO MODULES** s450 £25.06. AL60 £5.06. pa100 £17.23. spm80 £4.74. bmi80 £6.08. stereo 30 £21.57. AL30A £4.08. pa12 £8.38. ps12 £1.59. ma60 £38.27.

### SWANLEY ELECTRONICS

Dept. HE, 32 Goldseal Rd., Swanley, Kent. Post 30p extra, prices include VAT unless stated. Official and overseas orders welcome. Lists 24p post free. Mail order only.

## VMOS POWERFETS

VMP4 (25W, 10dB at 200MHz, min.) £12.50  
 VN67AF (15W, 2A, TO202) 75p, 10 + 70p  
 VN10KM (1W, 1/2 A, TO92) 55p, 10 + 50p  
 BD512 (P-chan, 10W, 1 1/2 A, TO202/3) 85p 10 + 80p  
 Heat clips, TO202 12p, TO92 8p. VN/VM Design Cat. 20p

TL081CP 29p, 10 27p, 25 25p, TL082CP 55p, 10 50p, 25 25p.

CA3026	70p	709C	15p
CA3080E	70p	710N	25p
CA3140E	38p	733N	50p
2102	80p	741	18p
CD4011B	17p	78L05	29p
555	25p	78L12	29p

Mini mains transformer 6v-0-6v, 100mA 75p

**6 WATT SIREN**  
 Modified design with touch control option and improved tone. Circuit, VN67AF and all components (excluding switch, board and speaker) 140p

**VOLTAGE CONTROLLED AMP**  
 OdB to more than 80dB attenuation. Fast slewing, very low distortion. All components and circuit 225p

Brief data on everything in new lists. S.A.E. P&P30p. Mail order only. Prices inc. Tel. 01-800 6667  
**J. W. RIMMER** 367 GREEN LANES LONDON N4 1YD



## The MIGHTY MIDGETS SOLDERING IRONS AND ACCESSORIES

	RETAIL PRICE EACH INC V.A.T.	POSTAGE EXTRA
<b>18 WATT IRON</b> FITTED WITH NO. 20 BIT AVAILABLE IN 12V, 110V, or 240V	£4.43	26p
<b>SPARE BITS</b>	52p	—
<b>STANDS</b>	£4.23	75p
<b>SOLDER: SAVBIT 20'</b>	61p	10p
" " 10'	32p	6p
<b>LOWMELT 10'</b>	76p	12p
<b>I.C. DESOLDERING BIT</b>	£1.04	12p
<b>BIT SIZES:</b>	NO. 19 (1.5mm) NO. 20 (3mm) NO. 21 (4.5mm) NO. 22 (6mm)	

From your Local Dealer or Direct from Manufacturers

**S & R BREWSTER LIMITED**

86-88 UNION ST. PLYMOUTH PL1 3HG  
 Tel: 0752 65011 TRADE ENQUIRIES WELCOME



PLEASE QUOTE YOUR NUMBER WHEN ORDERING



# Clever Dick

**Thanks for all the translations, we continue in this foreign theme with a query on Russian transistors. Plus some more comments on 'medical' circuits**



WE RECEIVED literally dozens of replies to our request for a translation of the article we printed last month. As promised the first reply (from Holger Hasenstrauch, surprise, surprise) has won a genuine HE Binder. The standard was extremely high, this we determined by the similarity between different submissions. Now for the bad news, the article was so boring that we are both to waste space in printing the correct translation. Suffice to say that according to the 'Luxemburger Wort' Negative Ions are actually dangerous, to the extent of causing certain bronchial ailments. The article goes on to quote a couple of impressive sounding sources and leaves little doubt as to the nature of Negative Ions. Who do we believe? Ah well, thanks to everyone who took the trouble to write in, we'll try and find something a bit more interesting next time.

Now back to more pressing matters.

A couple of months ago Dr R N C Douglas wrote to us about the possibility of publishing some 'medically' orientated circuits. If you can remember back that far you may recall our doubts regarding the legality of these circuits. Well, to cut a long story short we're still no wiser. However, it was apparent from the letters we received that circuits in this vein would be most welcome. Here are a couple of extracts from these letters. The first is from Richard Marengo.

*Dear Dick,*

*I share Dr R N C Douglas's interest in physiological measurement but not your concern for safety. According to a text book on psychophysiology (Masset J, a Primer of Psychophysiology, San Francisco, W M Freeman and Co, 1978), which my class was recommended at undergraduate level, there is an enormous change in voltage ( $\approx 1$  mV) from one side of the body to the other on each beat of the heart. It would not be at all dangerous to measure this change at any two of the three points on 'Einhovens Triangle'!*

*Richard Marengo  
Birmingham*

Richard does go on to explain a couple of other interesting phenomena but space is sadly limited. From what he says though this Masset book looks like required reading, we'll try and get hold of a copy.

By the way Richard does explain Einhovens Triangle, it is an imaginary triangle drawn across the body from wrist to wrist and meeting at one of the two legs. These are the optimum positions for such measurements.

Our second letter comes from Brian Audley, he writes:

*Dear Dick,*

*How about producing a pulse rate monitor. There are so many people these days to keep fit by various methods, many of which require one keeping an eye on one's pulse rate. I'm sure such a circuit would create a lot of interest.*

*Brian Audley  
Portstewart  
Northern Ireland*

These two letters, and the many others we received all agreed, circuits that monitor bodily functions are popular. We are forced to conclude that a design or two along these lines would not come amiss. Look out for them in the coming months.

Now to more down-to-earth matters. Peter Boyle has had some problems with transistors.

*Dear Dick,*

*I have a Russian Radio ("Astrad" model) which is unserviceable due to some faulty transistors. They are marked r T 322A 3 71 (equivalent to GT 322A 3 71).*

*I have asked many people — including exhibitors at the recent Breadboard Exhibition — what the present day equivalent transistor is and where it might be obtained, without success.*

*I would be grateful if your experts could help with any information.*

*Peter Boyle  
Windsor*

This one did cause a little bit of trouble. None of our reference books could shed any light (although we did get close to it and have a good idea of the specs). Our second recourse was to try the Russian Embassy. They referred us to their Trade Legation who referred us to a very helpful lady at a company called Technical and Optical. It appears that they carry large stocks of spare parts for Russian equipment and are only too happy to help anyone out with this sort of problem. Although we were still unable to sort out a direct European or American equivalent for this transistor they did tell us that they stock a Russian equivalent at their shop, this is the RT322B. Technical and Optical can be found at Zenith House, The Hyde, Edgware Road, in London. Don't all go Russian over there at once, you can give them a tinkle on 01-200 6505.

Jon Thompson writes to us after having an unfortunate experience with his car and some light fingered gentlemen.

*Dear Clever Dick,*

*After having an expensive radio and large portion of the*

dashboard ripped from my car I have just finished constructing and installing an incredibly devious, totally unbeatable (I hope) alarm system. However, the 100,000 dB siren that I invested in is somewhat inaudible above the din of the juke-box in my local Ale-house.

I would like to add on to the alarm system a radio with pocket receiver of the type currently being advertised for the extortionate price of £70-£80. Can you provide constructional details of a simple R/C transmitter and receiver, I know I need a licence.

Jon Thompson,  
South Yorkshire.

Some time ago we were approached by a gentleman with a similar idea. He had even gone to the Home Office with his prototype to enquire if there would be any problems licensing his system. He was using the 27 MHz R/C band so there should have been no problems on that score, or so he thought! It turned out that his idea was fine, trouble was, as he was using the radio control band, the TX/RX combination may not be used for the transmission of messages, only the control of models. The helpful gentleman at the Home Office did have one suggestion to get round the regs. His modification to the receiver included a small motor with a miniature aircraft attached to a little wire. If the thief activated the alarm the little aeroplane would start to whizz around on top of the receiver. This had another bonus, the thief probably wouldn't have a R/C licence and they could 'do' him for unauthorised transmitting as well as car theft.

But that doesn't help you, all we can say is have a look at our R/C system that will be making an appearance (hopefully in the June issue), maybe you could modify that.

Last but not least we have a request from Shaun Donelly for a speedometer design. Can we help? Of course we can!

Dear Dick,

I am now studying for my 'O' level course in Technology. I am designing an electronic speedometer for a bicycle. Do you think you could give me the address of any firms that manufacture such devices?

Shaun Donelly,  
Bedford.

CD to the rescue. We have a couple of ideas for you. Why not modify the LED Tachometer in the August '79 issue? You will need to employ a sensor system on one of the wheels to act as a trigger input. The only real problem is likely to be calibration. You will need to know how far you travel for each revolution of the wheel and adjust the timing period of the range capacitors C2 and C3 accordingly. If you despair why not have a word with the British Cycling Bureau who organised a 'Bike of the Future' competition last year. The winning entry was an electronic speedometer. By the way, the August issue is now unavailable but the LED Tacho, along with 24 of our best projects are now available in the new Hobby Electronics Projects Special. See the ad in this issue for more details.

We've run out of space and time again so, keep the letters coming (and please try to keep them short). See you next month.

HE

## CAMBRIDGE LEARNING ENTERPRISES

## Self Instruction Courses

### Microcomputers are coming - ride the wave! Learn to program.

Millions of jobs are threatened but millions more will be created. Learn BASIC- the language of the small computer and the most easy-to-learn computer language in widespread use. Teach yourself with a course which takes you from complete ignorance step-by-step to real proficiency with a unique style of graded hints. In 60 straightforward lessons you will learn the five essentials of programming: problem definition, flowcharting, coding the program, debugging, clear documentation.



Book 1 Computers and what they do well; READ, DATA, PRINT, powers, brackets, variable names; LET; errors; coding simple programs.

Book 2 High and low level languages; flowcharting; functions; REM and documentation; INPUT, IF...THEN, GO TO; limitations of computers, problem definition.

Book 3 Compilers and interpreters; loops, FOR...NEXT, RESTORE; debugging; arrays; bubble sorting; TAB.

Book 4 Advanced BASIC; subroutines; string variables; files; complex programming; examples; glossary.

### Understand Digital Electronics

Written for the student or enthusiast, this course is packed with information, diagrams and questions designed to lead you step-by-step through number systems and Boolean algebra to memories, counters and simple arithmetic circuits and finally to an understanding of the design and operation of calculators and computers.

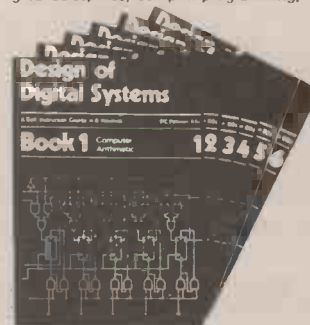

Book 1 Octal, hexadecimal and binary number systems; conversion between number systems; representation of negative numbers; complementary systems.

Book 2 OR and AND functions; logic gates; NOT, exclusive-OR, NAND, NOR and exclusive-NOR functions; multiple input gates; truth tables; De Morgans Laws; canonical forms; logic conventions; karnaugh mapping; three state and wired logic.

Book 3 Half adders and full adders; subtractors; serial and parallel adders; processors and ALU's; multiplication and division systems.

Book 4 Flip flops; shift registers; asynchronous and synchronous counters; ring, Johnson and exclusive-OR feedback counters; ROMs and RAMS.

Book 5 Structure of calculators; keyboard encoding; decoding display data; register systems; control unit; program ROM; address decoding.

Book 6 CPU; memory organisation; character representation; program storage; address modes; input/output systems; program interrupts; interrupt priorities; programming, assemblers; computers; executive programs; operating systems.

### GUARANTEE - No risk to you

If you are not completely satisfied your money will be refunded, without question, on return of the books in good condition.

Please send me:-

....Computer Programming in BASIC (4 books) @ £7.50

....Design of Digital Systems (6 books) @ £11.50

All prices include worldwide surface mailing costs (airmail extra) IF YOUR ORDER EXCEEDS £15, DEDUCT £2

I enclose a cheque/PO payable to Cambridge Learning Enterprises for £.....

or please charge my Access/Barclaycard/Diners Club etc.

account no. ....

Telephone orders from credit card holders accepted on 0480-67446 (Ansafone). Overseas customers (inc Eire) send a bank draft in sterling drawn on a London bank, or quote credit card and number.

Name .....

Address .....

Cambridge Learning Enterprises, Unit 79, Rivermill Site,  
FREEPOST, St. Ives, Huntingdon, Cambs PE17 4BR England.



# Hobbycom

**HE proudly presents HOBBYCOM, a multiple station, two-wire intercom with call facility — a project to talk yourself into.**

THE BASIC HOBBYCOM is a master station intercom which is a completely self-contained mains powered unit. This saves the necessary and costly replacement of batteries which seems to come round with sickening regularity in battery powered equipment.

Hobbycom is a four sub-station intercom although constructional hints are given later to adapt the intercom system to more than four channel ie. 8, 12 or more. Each sub-station consists only of one loudspeaker, one push-button switch and one capacitor and is connected by cable to the master unit.

In our efforts to keep down the cost of the intercom we hit upon a design which allows the use of two-wire connections. A lot of other designs use three wire (mains cable) connecting wire but as the price of such cable is more than three times the price of the two-wire variety, our Hobbycom is obviously superior to these designs, remembering that in a typical installation of Hobbycom about 100 metres of wire will probably be used.

The call facility allows the user of any one of the substations to call the master station user, or vice versa, quite a useful addition to the plain intercom.

## CONSTRUCTION

Construction is, as usual in HE, straightforward if our PCB designs are used. There are of course, two boards — one for the main circuit and one for the switch circuitry (shown inside the broken lines on the circuit diagram). Neither should present problems.

Ensure that all semiconductors are inserted correctly. It is perhaps advisable to use IC sockets for the DIL integrated circuits. Electrolytic capacitors should also be checked for correct insertion before switch on.

Always, when dealing with mains powered equipment be extra careful. It only takes one mistake! You might not live to make another.

If you follow the overlay diagrams when wiring up the two boards no difficulties should arise as all connections are adequately shown. Connections to the remote stations can be made using any suitable plug and socket arrangement eg. banana type, or possibly the clip-on-type speaker connections which are available. As the lead to the remote station does have to be polarised then



*Our receptionist Tracy Cambell using the Hobbycom. Will it ever replace the telephone?*





## How it Works

The amplifier is formed around a standard LM380 two watt power amp IC. This device should be easily recognisable to our regular readers. A speaker of the type used in this circuit has a low O/P whilst the I/P to the IC needs to be quite high. To match the two the circuitry around Q1 is needed.

Relay RLA is in the circuit simply to alleviate the normal wiring problems encountered with changeover between I/P and O/P speakers. All of the complicated interwiring is on the copper track of the circuit board and changeover is now performed by activating the relay with the use of a simple push button switch PB1.

The bank of switches which make up SW1 connect the master station to one of four remote sub-stations. Simultaneously, SW1 also connects the remaining three sub-stations to the correspon-

ding three remaining I/Ps of the LED generator formed around Q2 — 6 and circuitry. These I/Ps are also paralleled to the I/P of the call generator. At any time, these two parts of the circuit allow a sub-station to call the master by means of a push-button switch. In the diagram, station A is shown connected to the intercom whilst stations B, C and D are not. If sub-stations B, C or D contact the master by pushing one of the switches PBB, PBC or PBD then the call generator is enabled, emitting a tone to the master thus attracting his attention. The corresponding LED 2, 3 or 4 will also light, telling the master which sub-station is calling. The LED will stay lit for a few seconds before going out.

The power supply is mains to DC and makes use of a 15 V voltage regulator IC to give a steady voltage to the rest of the circuit.

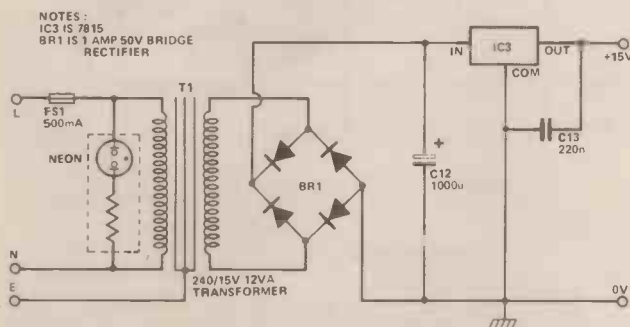

Fig. 2. PSU circuit diagram for the Hobbycom. Battery operation is not advisable.

whatever connecting arrangement you use will need to be coloured to differentiate between the two leads.

When you are ready to test, do so without IC1 and 2 in place. The only reason for this is their cost of replacement if you have a serious fault. Turn on the power and carefully measure the voltage between the power supply output pins from the main board, it should be 15 V DC  $\pm$  0.5 V. If you find anything else then check the circuit again. If all is well, however, then insert the remaining parts and test the whole circuit. Remember that with both master and a remote station in the same room you will almost certainly get loud feedback. The only way to eliminate this is to separate them completely.

Some of our quicker readers will no doubt have noticed that as the I/Ps and O/Ps to and from the switches on the switch board are paralleled then more than one switch board can be used. ie. two switch boards give eight stations, three give twelve etc. This is perfectly true and more than one can be used, with one constraint. The banks of switches between separate switch boards will not be interlocking, meaning that the master can be connected to more than one remote station simultaneously. Apart from heavily loading the amplifier this also means that a supposedly private conversation between master and a particular sub-station may not be quite as private as you thought.

Alternatively, the Hobbycom can be adapted to a 1, 2 or 3 sub-station intercom by omitting 3, 2 or 1 of the switches on the switch board.

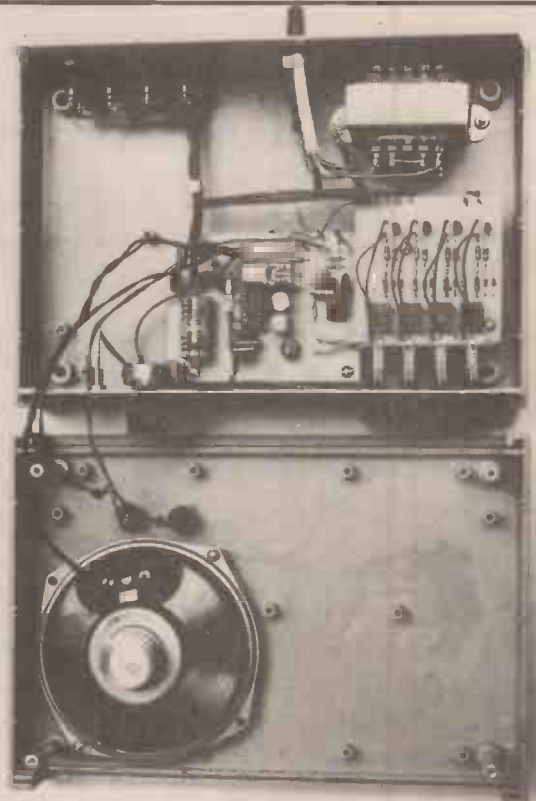

The Hobbycom opened up for inspection. If required a small box could easily be used.

## Buylines

We obtained our relay and bank of switches SW1, from Watford Electronics, but no doubt readers will probably be able to find alternative suppliers if they wish.

The case we used for the master station is type CTB 1, which is available from Continental Specialties. Our sub-station cases were also from Continental Specialties, type DMC-2.

All other components should be easily found at your local stockist.

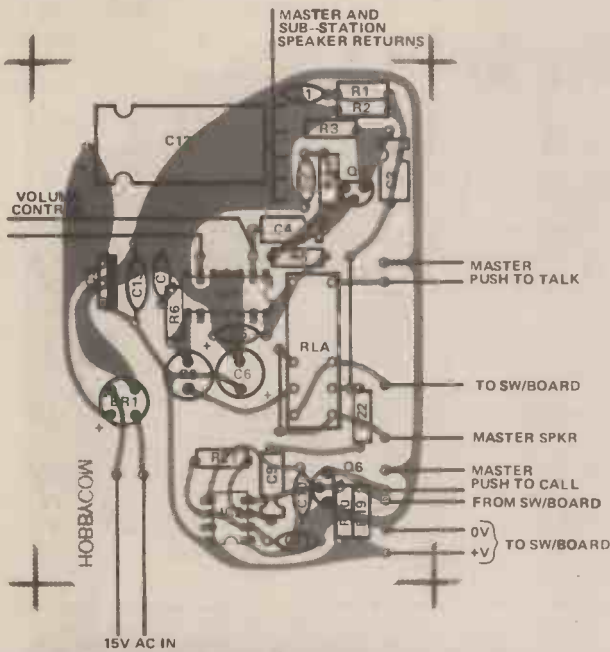

Fig. 3. Overlay for main board.

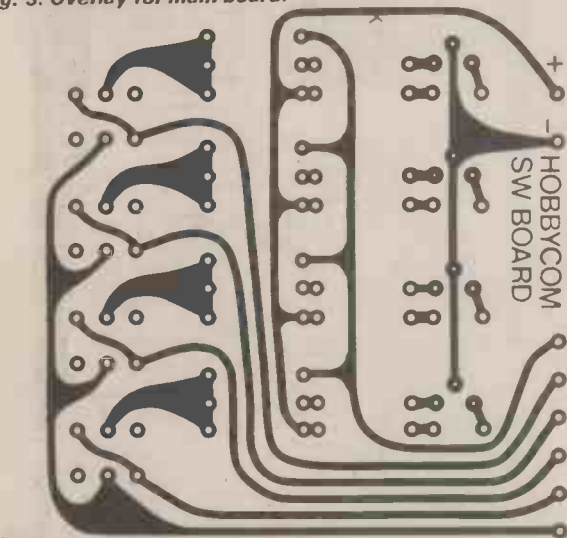

Fig. 4. PCB for the switch board.

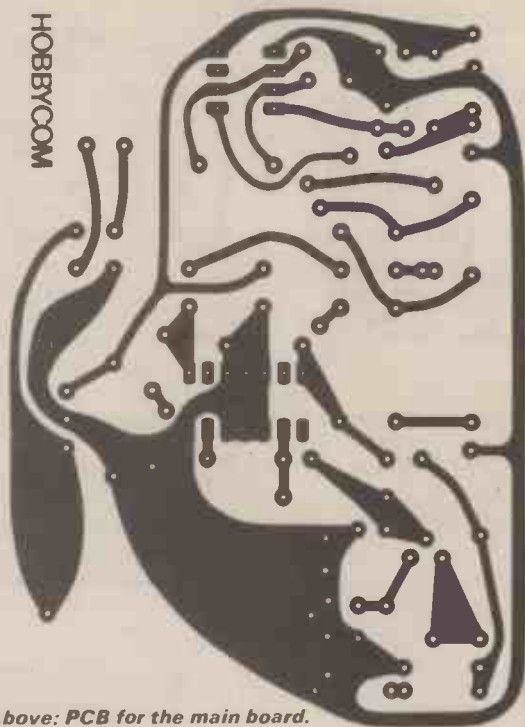
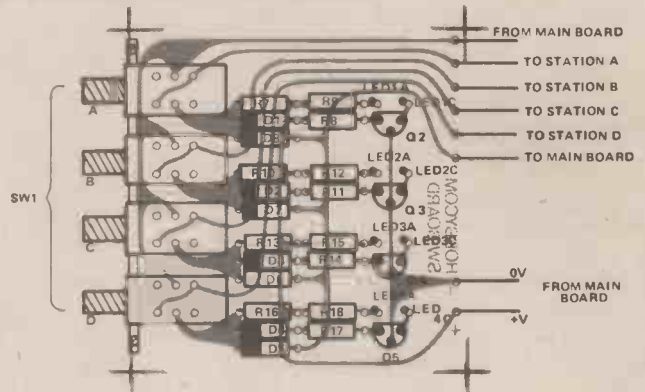

Fig. 4. Above: PCB for the main board.

Fig. 6. Below: Overlay for switch board.



## Parts List

### RESISTORS (All 1/4 Watt, 5%)

R1	10R
R2	150R
R3	10k
R4	1M2
R5, 19	100k
R6	2R7
R7, 10, 13, 16	2k2
R8, 11, 14, 17	1k
R9, 12, 15, 18	390R
R20	4k7
R21	12k
R22	68k

### CAPACITORS

C1, 3, 5, 7, 10, 11	100n Polyester
C2, 4, 9	1u 16 V Elect.
C6, 8	220u 16 V PCB Elect
C12	1000u 25 V Elect.
C13	220n Polyester
CA, B, C, D	220u 16 V Elect.

### POTENTIOMETERS

RV1	1M Log
-----	--------

### SEMICONDUCTORS

IC1	LM380
IC2	555
IC3	7815
Q1, 6	BC182L
Q2, 3, 4, 5	BC212L
D1-8	1N4148
BR1	1A 50 V Bridge Rectifier

### MISCELLANEOUS

2 x 8R greater than 2 watt speakers  
 RLA 12 V 200R P.C. mounting relay  
 PB1, 2, A, B, C, D momentary action push button  
 SW1 bank of four, interlocking, 2 pole C(O) signal switches + knobs  
 T1 Mains to 15 V 12 VA transformer  
 FSI + panel mounting holder  
 Neon, case and knob to suite



# MAPLIN

## ELECTRONIC SUPPLIES



**PRINTED CIRCUIT DRILLS**  
Miniature 12V DC drills designed for drilling pcb's. Small drill. Order as BW03D Price £8.75  
Large drill. Order as BW02C Price £10.63



**ANTI-STATIC MAT & GUN**  
Turntable mat removes static from discs while they are playing.  
Order as LX10L Price £3.19  
Gun removes static charge from discs. After use dust no longer clings and may be easily brushed off.  
Order as LX04E Price £6.90

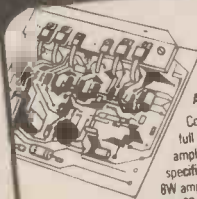

**AMP KITS**  
Complete kits of parts with full instructions to make hi-fi amplifiers with excellent specifications.  
6W amp kit: Order as LW36P Price £3.83  
50W amp kit: Order as LW35Q Price £13.73  
150W amp kit: Order as LW32K Price £14.89



**HEADPHONES**  
High quality stereo headphone with large padded headband and slider volume controls.  
Order as WF14Q Price £8.17



**CONDUCTIVE PAINT**  
Repair pcb's, car demisters, etc., with this silver paint. Phial contains 30g.  
Order as FY72P Price £2.12.



**McKENZIE POWER SPEAKERS**  
High quality, high power speakers.  
12in. 50W 8Ω Order as XQ79L Price £18.20  
12in. 50W 16Ω Order as XQ80B Price £18.20  
12in. 80W 8Ω Order as XQ81C Price £26.92  
12in. 80W 16Ω Order as XQ82D Price £26.92  
15in. 150W 8Ω Order as XQ83E Price £56.00  
15in. 150W 16Ω Order as XQ84F Price £56.00



**MINIATURE VICE**  
Small modellers vice in tough plastic with metal faced jaws. Clamps to bench. Jaws width 41mm, maximum opening 30mm.  
Order as FY53H Price £2.45



**20,000 OHM/VOLT MULTIMETER**  
A 20,000 ohms per volt multimeter at an incredibly low price. DC volts 5, 25, 125, 500, 2,500; AC volts 10, 50, 250, 1,000; DC amps 0 to 0.05mA, 0 to 250mA, 5mA ohms; Resistance 0 to 50k, 0 to 5M ohms; Decibels -20 to +22dB. Complete with test leads, battery and instruction leaflet.  
Order as YB83E Price £14.68



**ELECTRET MICROPHONES**  
Super quality genuine electret microphones operating on 1.5V battery (HP7 type) supplied. Cassette type with miniature jack plugs.  
Order as YB33L Price £3.84  
Omnidirectional low cost with standard jack plug.  
Order as YB34M Price £3.54  
Unidirectional 600Ω with standard jack plug.  
Order as YB35Q Price £9.45  
Unidirectional 600Ω/50kΩ dual with standard jack plug (pictured).  
Order as WF34M Price £16.77

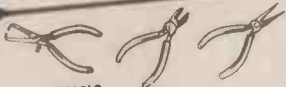

**WIRING TOOLS**  
Miniature box-jointed wiring pliers with insulated handles and return spring.  
Order as BR65A Price £4.52  
Miniature box-jointed side-cutters with insulated handles, return spring and precision cutting edges.  
Order as BR70M Price £4.45  
End action wire strippers, fully adjustable, insulated handles.  
Order as BR76H Price £5.85



**CLOCK MODULE**  
Module requires only transformer and two push switches to operate 4-digit, 0.7in red LED display. Alarm and radio outputs. Battery back-up when mains fail. Sleep and snooze timer. Seconds display. Just add speaker for alarm tone. Full details on page 267 of our catalogue.  
Order as XL14Q Price £8.41



**MEGAPHONE**  
High quality megaphone with differential microphone. Requires eight HP11 batteries (not supplied). Shoulder strap for portable operation.  
Order as XQ72P Price £49.50



**DEMAGNETISER**  
Tape head demagnetiser with curved probe ideal for cassette tape heads. Cures hiss due to permanently magnetised heads. Amazing low price.  
Order as F062S Price £4.15



**CAR AERIAL BOOSTER**  
High gain car aerial booster for long, medium, short and VHF bands. Negative earth cars only. Very easy to fit - just plugs in plus one wire to +12V. We have measured gains of 20dB at 30MHz!  
Order as XK37S Price £5.49



**TEACH YOURSELF ELECTRONICS**  
There is no better way of learning basic electronics than by practical experience and this set of books is undoubtedly the very best basic course for doing just that. Set of five Basic Electronics books.  
Order as XX10L Price £8.30



**MULTIMETER & TRANSISTOR TESTER**  
Superb high sensitivity multimeter and transistor tester in one. Sensitivity 100,000 ohms per volt. DC Ranges DC volts 0.5, 2.5, 10, 50, 250, 1,000; AC volts 5, 10, 50, 250, 1,000; DC current 0.01, 0.025, 0.5, 5, 50, 500mA, 10A; AC current 10A; Resistance 5k, 50k, 5M, 50M ohms; Decibels -10dB to +62dB. Complete with test leads, three leads for transistor tester batteries and instruction leaflet.  
Order as YB87U Price £39.30



**TURNTABLES**  
Autochanger complete with stereo ceramic cartridge and circuit to make a complete low-cost record player ideal for the young pop fan.  
Order as XQ00A Price £18.48  
Single play rim-drive turntable with stereo ceramic cartridge.  
Order as XB23A Price £23.49  
Single play belt-drive turntable 'S'-shaped tone arm.  
Order as XB25C Price £30.63



**TRANSISTOR TESTER**  
Accurate transistor tester measures dynamic gain, identifies unknown transistors, also ideal for matching transistors into pairs.  
Order as LH05F Price £11.86



**QUICKTEST**  
A safe and quick way to connect to the mains. Just snap the wires under the sprung keys and close the lid. Completely safe both open and closed.  
Order as YB21X Price £6.54

All prices include VAT and postage and packing, but if total under £4 please add 30p handling charge. Prices guaranteed until May 8th, 1980. Export customers deduct 13% and export postage will be charged extra at cost.

Please use order code. All items in stock at time of going to press.

FOR FULL CATALOGUE DETAILS SEE BACK COVER.



**ELECTRONIC SUPPLIES LIMITED**

All mail to (ET1380), PO Box 3, Rayleigh, Essex SS6 8LR. Telephone: Southend (0702) 554155.  
Shop: 284 London Road, Westcliff-on-Sea, Essex (closed on Monday). Telephone: Southend (0702) 554000

# Hobby Electronics Book Service



## POPULAR ELECTRONICS BOOKS

Sinclair, I. R., <i>Introducing Electronic Systems</i> .....	£1.95
Sinclair, I. R., <i>Introducing Amateur Electronics</i> .....	£1.65
Sinclair, I. R., <i>Electronic Fault Diagnosis</i> .....	£3.55
Sinclair, I. R., <i>Repairing Pocket Transistor Radios</i> .....	£2.60
Sinclair, I. R., <i>Oscilloscope In Use</i> .....	£3.10
Sinclair, I. R., <i>Understanding Electronic Components</i> .....	£4.20
Sinclair, I. R., <i>Understanding Electronic Circuits</i> .....	£4.20
Kitchen, H. T., <i>Handtools For Electronic Workshop</i> .....	£2.95
Kitchen, H. T., <i>Electronic Test Equipment</i> .....	£5.20
Capel, V., <i>How To Build Electronic Kits</i> .....	£2.35
Darr, J., <i>How to test almost everything electronic</i> .....	£3.70
Brown, R. M., <i>How to read electronic circuit diagrams</i> .....	£5.60

## AUDIO

Earl, J., <i>Audio Technicians Bench Manual</i> .....	£3.70
Earl, J., <i>Pickups and Loud Speakers</i> .....	£3.70
Earl, J., <i>Tuners and Amplifiers</i> .....	£3.20
Earl, J., <i>Cassette Tape Recorders</i> .....	£5.40
Earl, J., <i>ABC of Hi-Fi</i> .....	£4.35
Capel, V., <i>Microphones In Action</i> .....	£3.15
Capel, V., <i>Improving Your Hi-Fi</i> .....	£3.65
Capel, V., <i>Creative Tape Recording</i> .....	£4.20
Hellyer, H. W., <i>Tape Recorders</i> .....	£4.45
Sinclair, I. R., <i>Audio Amplifiers For Home Construction</i> .....	£2.85

## RADIO CONTROL

Drake, J., <i>Radio Controlled Helicopter Models</i> .....	£4.20
Jeffries, C. R., <i>Radio Control For Model Yachts</i> .....	£3.85
Salford, E. L., <i>Radio Control Manual</i> .....	£2.60

## COOKBOOKS

Tracton, K., <i>BASIC Cookbook</i> .....	£4.10
Lancaster, D., <i>TTL Cookbook</i> .....	£7.00
Lancaster, D., <i>RTL Cookbook</i> .....	£4.65
Lancaster, D., <i>CMOS Cookbook</i> .....	£8.20
Jong, W., <i>IC Op Amp Cookbook</i> .....	£10.00
Lancaster, D., <i>T.V. Typewriter Cookbook</i> .....	£7.75
Lancaster, D., <i>Cheap Video Cookbook</i> .....	£7.00
Jong, W., <i>IC Timer Cookbook</i> .....	£7.50
Lancaster, D., <i>Incredible Secret Money Machine (a how to cook book for setting up your computer or technical business)</i> .....	£4.95

## QUESTIONS AND ANSWERS

SIMPLE AND CONCISE ANSWERS TO MANY QUESTIONS WHICH PUZZLE THE BEGINNER.

Coker, A. J., <i>Q &amp; A On Electric Motors</i> .....	£1.90
Hellyer, H., <i>Q &amp; A On Radios and T.V.</i> .....	£1.90
Hibberd, R., <i>Q &amp; A On Integrated Circuits</i> .....	£1.90
Jackson, K., <i>Q &amp; A On Electricity</i> .....	£1.90
Brown, C., <i>Q &amp; A On Hi-Fi</i> .....	£1.90
Brown, C., <i>Q &amp; A On Transistors</i> .....	£1.90
Brown, C., <i>Q &amp; A On Electronics</i> .....	£1.90
Reddihough, J., <i>Q &amp; A On Colour T.V.</i> .....	£1.90
Miller, H., <i>Q &amp; A On Electric Wiring</i> .....	£1.90

## CONSTRUCTOR GUIDES

Graham, P., <i>Simple Circuit Building</i> .....	£2.70
Colwell, M., <i>Electronic Diagrams</i> .....	£2.70
Colwell, M., <i>Electronic Components</i> .....	£2.70
Colwell, M., <i>Printed Circuit Assembly</i> .....	£2.70
Ainslie, A., <i>Practical Electronic Project Building</i> .....	£2.70
Colwell, M., <i>Project Planning and Building</i> .....	£2.70

## BEGINNER'S GUIDE

Sinclair, I. R., <i>Beginner's Guide To Tape Recording</i> .....	£3.45
Sinclair, I. R., <i>Beginner's Guide To Integrated Circuits</i> .....	£3.45
Sinclair, I. R., <i>Beginner's Guide To Audio</i> .....	£3.45
King, G. J., <i>Beginner's Guide To Radio</i> .....	£3.45
King, G. J., <i>Beginner's Guide To Television</i> .....	£3.45
King, G. J., <i>Beginner's Guide To Colour T.V.</i> .....	£3.45
Gilou, F., <i>Beginner's Guide To Electric Wiring</i> .....	£3.45

## PROJECT BOOKS

Marston, R. M., <i>110 Cosmos Digital IC Projects For The Home Constructor</i> .....	£3.95
Marston, R. M., <i>110 Wave Form Projects For The Home Constructor</i> .....	£3.95
Marston, R. M., <i>110 Op Amp Projects For The Home Constructor</i> ..	£3.95
Marston, R. M., <i>110 Semiconductor Projects For The Home Constructor</i> .....	£3.95
Marston, R. M., <i>110 Thyristor/SCR Projects For The Home Constructor</i> .....	£3.95
Marston, R. M., <i>110 Electronic Alarm Projects for The Home Constructor</i> .....	£3.95
Marston, R. M., <i>110 Integrated Circuits Projects For The Home Constructor</i> .....	£3.95
Marston, R. M., <i>20 Solid State Projects For The Car and Garage</i> ..	£3.20
Marston, R. M., <i>20 Solid State Projects For The Home</i> .....	£3.20

Note that all prices include postage and packing. Please make cheques, etc. payable to Hobby Electronics Book Service (in sterling only please) and send to:

Hobby Electronics Book Service,  
P.O. Box 79,  
Maidenhead, Berks.

★ Prices may be subject to change without notice.



# Short Circuits

## CLASS A AMPLIFIER

One problem with conventional (class B) audio power amplifiers is that they produce increased distortion at low output powers. The type of distortion produced is a particularly noticeable type known as crossover distortion. One way of totally overcoming this problem is to use a class A amplifier, and designs of this type produce no crossover distortion whatever. Unfortunately, the efficiency of Class A designs is considerably less than that of Class B designs, which is probably the main reason that Class A designs are a rarity these days. This design gives an output power of about 4.1 watts RMS into an 8 ohm load, but requires a supply of about 22 to 24 volts at 1 amp. (some 22 to 24 watts). This gives an efficiency of only about 19% at best, which is less than a third of the efficiency of many Class B designs.

However, this circuit does give good quality despite its simplicity, and is an interesting design for those who like to experiment with unusual circuits. Q1 is used in the common emitter input stage, and it is direct coupled to the output stage via emitter follower buffer transistor, Q2.

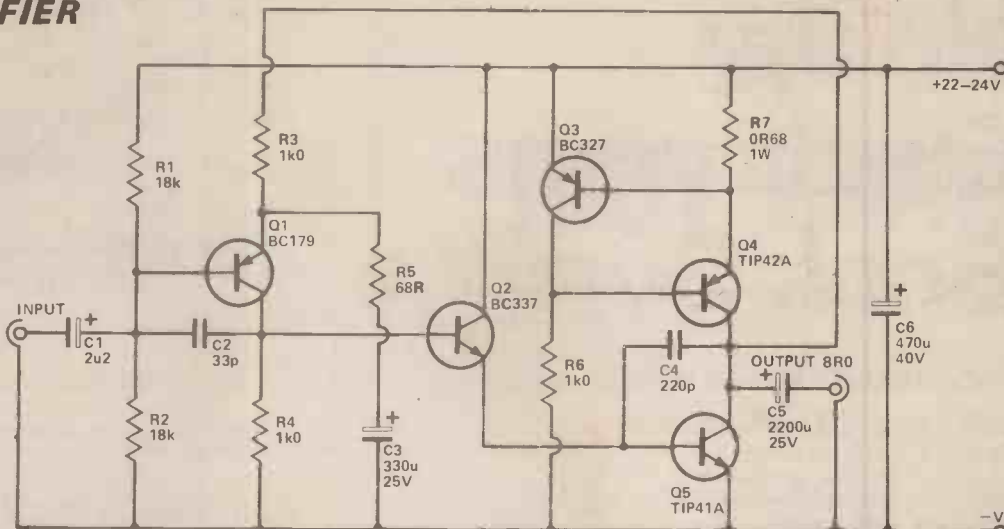

The latter is needed because of the fairly high drive current required by the output stage. Q5 is the output transistor, and it is employed in the common emitter mode. It has a constant current source as its collector load, and this is formed by Q3, Q4, and R7. The latter sets the output current of the circuit at nominally just under 1 amp. The constant cur-

rent generator load gives better efficiency than simply using a load resistor, and also gives good linearity.

R3 gives virtually 100% negative feedback over the amplifier at DC, giving unity voltage gain. By biasing the input to half the supply voltage using R1 and R2, the output is also biased to the required level of half the

supply voltage. R5 and C3 decouple some of the feedback at audio frequencies, giving the circuit a sensitivity of about 380 mA. RMS for maximum output. C2 and C4 aid stability, while C1 and C5 provide DC blocking at the input and output respectively.

Q4 and Q5 must be mounted on a substantial heatsink.

T1 = DENCO TRANSISTOR USAGE, BLUE AERIAL COIL, RANGE 5T

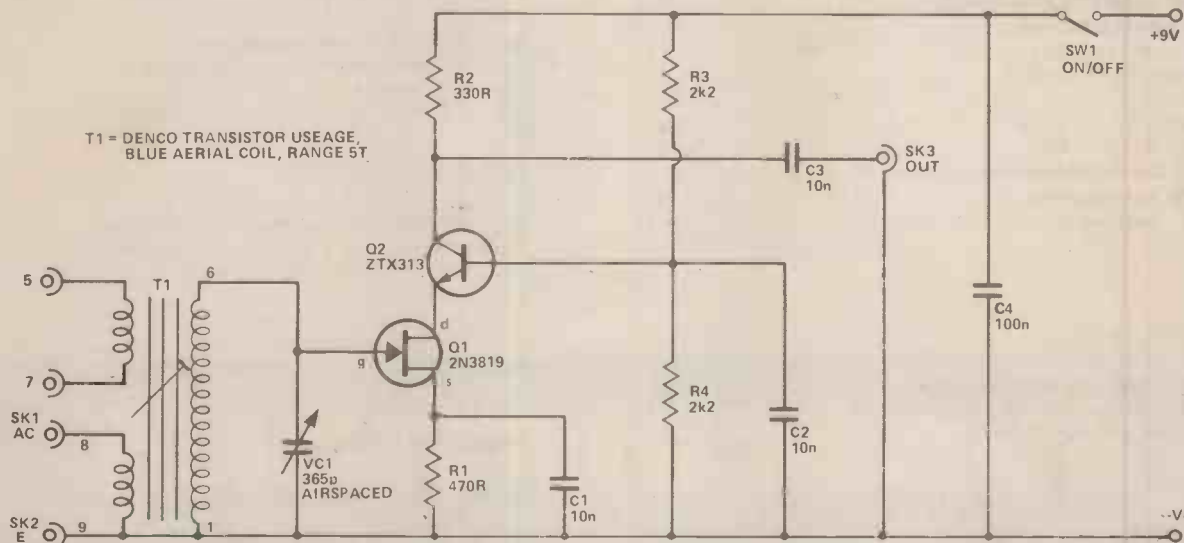

## 10 TO 30MHz PRESELECTOR

Many older or less expensive SW receivers give a relatively poor level of performance on the high frequency bands where their sensitivity falls away somewhat. One way of improving the high frequency performance of such a set is to add a preselector at the input. A preselector is a tuned RF amplifier which boosts the aerial signal before it is fed to the receiver. Apart from giving improved sensitivity, the de-

creased RF bandwidth provided by the unit also helps to attenuate any spurious responses of the receiver.

The aerial signal is taken to the low impedance primary winding of T1, and from here it is induced into the main, tuned winding. VC1 can be used to resonate the tuned circuit at any frequency between about 10 and 30MHz, and all the HF bands fall within the coverage of the unit. Of course, in practice VC1 is simply adjusted to peak received signals, and is the tuning control of the unit.

Q1 is a JFET which is used in the common source mode, and

has R1 and C1 as its source bias resistor and bypass capacitor respectively. It directly drives the input of Q2, which is an ordinary bipolar device which is used in the common base mode. This has R2 as its collector load, R3 and R4 to provide base biasing, and C2 as the base decoupling capacitor. This two stage amplifier is a form of "cascode" circuit, and gives good performance at the fairly high frequencies involved here. The voltage gain of the circuit is well over 20dB. C3 provides DC blocking at the output of the unit.

Construction of the unit is not critical, but try to keep all the

wiring reasonably short. As supplied, the core of T1 is fully screwed into the former, and in order to obtain the correct frequency coverage the core must be unscrewed so that approximately 10 mm of metal screwthread protrudes from the top of the coil. T1 can be mounted in a B9A valveholder incidentally. The twin lead connecting the output of the preselector to the aerial and earth sockets of the receiver should be reasonably short (no more than about 1 metre) in order to minimise losses.

The current consumption of the circuit is approximately 5 mA.

# WE DID WARN YOU!

Nobody likes to gloat, but nearly six months ago we warned you about our diminishing stocks of backnumbers. The ones shown here are all that are left! Hobbyprints are *still* available.



## JUNE 79 (Hobbyprint H)

**Projects:** GSR Monitor, Envelope Generator, Drill Speed Controller  
**Features:** Citizen Banned, Display Techniques, Moving Coil Meter, Electronics in Music Pt 2, etc.



## JULY 79 (Hobbyprint I)

**Projects:** Shark, Baby Alarm, Point Controller, Linear Scale Ohmmeter.  
**Features:** Cassette Decks and Tapes, Binary Numbers, Fixed Resistors, Short Circuits Special, etc.



## AUGUST 79 (Hobbyprint J)

**Projects:** Home Security Sound System, LED Tachometer, Injector/Tracer, Constant Volume Amplifier.  
**Features:** Security Installation, Variable Resistors, Tools, Satellite Power etc.



## SEPTEMBER 79 (Hobbyprint K)

**Projects:** Combination lock, Light dimmer, Starburst, Ultrasonic Switch.  
**Features:** Electronic Timekeeping, Thyristors, Radio Control, FET Special.

Shown here are all of the backnumbers still available. They are **£1.00 each** inc. P&P. When ordering please quote the issue number, i.e. Nov. 78 is issue 1 Vol. 1. Next to each issue is the relevant Hobbyprint code letter, please note that Hobbyprints are still available for every issue.

Please send me the following back issues Nos .....

Cheque/P.O. enclosed £ .....

**Hobby Electronics Backnumbers Dept.**  
**145 Charing Cross Road, London WC2H 0EE**

Name .....

Address .....



## OCTOBER 79 (Hobbyprint L see Hobbyprint Ad)

**Projects:** Tantrum, Hobbytune, Analogue Frequency Meter, Multi Siren.  
**Features:** Home Computing, Electronic Games, Microwave Cooking, Breaker One-Four.



## DECEMBER 79 (Hobbyprint N)

**Projects:** Scalextric Controller, Ring Modulator, Bargraph Voltmeter, Hebot II.  
**Features:** TV Receivers, Project Fault Finding, Data Supplement.



## JANUARY 80 (Hobbyprint O)

**Projects:** Hebot III, La/p Counter, Crosshatch Generator, Digi-Die.  
**Features:** Mini TV Survey, CMOS Spread, Spacelab.



## FEBRUARY 80 (Hobbyprint P)

**Projects:** Passionmeter, Infra-Red Control, Win Indicator.  
**Features:** Short Circuit Special, Kezy Does It, Power to the People.

# SUBSCRIPTIONS

## WHY MISS OUT?

To: Subscriptions  
Hobby Electronics  
P.O. Box 35  
Bridge Street  
Hemel Hempstead  
Herts

I would like a postal subscription to HE starting with the ..... issue. I enclose payment of £9.00 UK and overseas — (airmail rate on request).

Name .....

Address .....



# MIDLAND TRADING CO.

## GENT'S MEMORY CALENDAR ALARM CHRONOGRAPH



"Latest technology" constant display of hours, minutes, seconds; weekday and snooze alarm indication. A further two optional display modes are available, one being the calendar and month, which can be increased or decreased to give the appropriate month of the year. A 1/100th second chronograph with split and lap mode facilities is built into the watch, with a 12-hour capacity. A 24-hour alarm with a 10-minute snooze function is also standard to this watch. A further feature is the backlight and fully adjustable stainless steel bracelet strap.

**£19.95**

## GENT'S MULTI-MELODY CHIME ALARM CHRONOGRAPH



"Latest technology" constant display of hours, minutes and seconds; weekday date and month, with mode and chime indication display. A musical alarm is built in and can be set to any time within 24 hours; once activated playing the tune "Oh Suzanna". Two further alarm systems are incorporated in this outstanding watch: (i) 24-hour alarm; (ii) count down alarm. The watch can be set to chime on every full hour. A 1/100th second chronograph with split and lap mode facilities is standard, the watch function may also be switched off. An excellent feature is the mineral glass face. This watch also has a battery hatch, backlight and infinitely adjustable stainless steel strap.

Value at **£19.95**

## GENT'S FRONT BUTTON ALARM

"Latest style" constant display of hours, minutes, seconds, am/pm; weekday and alarm indication. A further two optional display modes are available. The watch comprises 7 digits, 12 functions and is programmed to the year 2009. The alarm can be set to any time within 24 hours and operates for 30 seconds. A backlight and closely woven adjustable stainless steel strap highlight this extremely sleek-looking watch — only 8mm thick



Only **£13.25**

## GENT'S CHRONOGRAPH



Probably the best-looking chrono on the market. Constant display of hours, minutes, and seconds, with am/pm indication, also month, date and weekday indication.

1/100th and 1/10th second, with split and lap mode facilities. A backlight and closely woven fully adjustable stainless steel strap, again highlight this style of quartz LCD.

Special price: **£8.95**

## LADY'S SUGAR-COATED QUARTZ LCD



Another superb lady's watch with that extremely popular "sugar frost finish" (gold or silver finish). Links can easily be removed from the strap and the clasp has a spring mechanism incorporated to ensure a comfortable fitting. Constant display of hours and minutes, with month, date and seconds mode are features, also auto calendar and backlight amount to a very nice lady's LCD.

Exc. Value **£10.50**

## LADY'S COCKTAIL LCD

"Elegance and style" for the lady with a discerning taste. In gold or silver finish, with matching adjustable bracelet. Constant display of hours and minutes, with month, date and seconds, auto calendar and backlight.

Very special price: **£10.50**



## "ZETRON" WHERE RELIABILITY, STYLE AND ELEGANCE REALLY COUNT "ZETRON"

Before buying a digital watch, consider the following. We offer:

- (i) 48-hour dispatch guarantee
- (ii) Full instructions and 12-month Guarantee
- (iii) 10-day money back guarantee if not completely satisfied
- (iv) Felt presentation case with each watch

Phone or write for full comprehensive catalogue on the complete range of watches we carry. Huge discounts available for bulk buyers, trade lists on application. P&P per item 75p. Cheques or P.O.s should be made payable to Midland Trading Co. and sent to:—

**DEPT HE, 58a WINDMILL AVENUE, KETTERING  
NORTHANTS NN16 8PA  
Tel: Kettering 522024 (STD) 0536**





# Sunny Side Up

***Rick Maybury has some bright ideas and illuminating facts on solar cells. They may be just the thing to give this energy-starved world a sunnier outlook.***

FREE ELECTRICITY! Have you just received a large electricity bill? Then read on because we are about to tell you know, for just a few thousand pounds, you can 'cock your snoot' at your local purveyor of electricity.

On a sunny day (even in this country) the old 'currant bun' up in the sky, deposits something like 1 kilowatt of energy on every square metre of ground. Given that a pretty average Solar Cell is about 10% efficient you could expect to collect something like 4.5kW of electricity from a surface area of just 80 square metres, even on a cloudy day. (That is roughly the roof area of a smallish house.) Providing you have some sort of storage system for those dark nights, Lead-acid accumulators would do nicely, you might never receive another electricity bill.

It all sounds so simple doesn't it? Actually it can be, trouble is you would need to have an income approaching the average oil Sheik to afford it. It seems ironic that most solar cells are made from Silicon, one of the Earth's most abundant elements. Unfortunately, to be of any use in solar cells it must be incredibly pure. And that costs money.

## RISE AND SHINE

Solar Cells, or to be more precise, Photovoltaic Cells have been around for quite a few years now. The first successful cells were developed in the early 1800s. The material used was based on an element called Selenium, conversion efficiency in those days was pretty dire, in the order of 0.025% on a very sunny day.

Since then things have improved dramatically. Modern cells have managed something like 25% efficiency although they are seldom seen outside research labs at the moment. Most commercial cells can convert at about 15% efficiency and this figure is unlikely to change for a few years, or at least, if they do improve they are going to be horribly expensive.

## LIGHT WORK

Extracting your 15% of free energy is quite a complicated process. Without going too deeply into the details, (you don't really want to read a long boring story all about minority carriers and other molecular phenomenon do you?) the silicon solar cell is best described as a kind of semiconductor diode.

The cell is made up from two semiconductor layers. If you've been paying attention over the last few months you may recall that these semiconductor materials are made by 'doping' or adding certain impurities to the purified silicon. (This applies to other semiconductor materials too, like Germanium, selenium and Gallium Arsenide. These can be used for making Solar cells but are even less efficient!) According to the impurities added the silicon will be called either N type or P type. N type means that the Silicon now has an abundance of electrons within its structure. The P type is the exact opposite, it has a distinct lack of electrons, in fact lots of little 'holes' where they used to be. If you take two thin slices of P type and N type silicon and put one on top of the other the point at which they meet exhibits some very unusual properties. This area is called the junction and forms a region called the 'depletion layer.' Should a photon (a particle of light) enter this layer it will break down the bond that exists between the molecules and send an electron scuttling towards the N type layer and a 'hole' to the P layer. If the two slices are connected to an external load a circuit will exist and a current will flow.

In practice one layer has to be transparent. This is achieved by either depositing a very thin P type layer on a much thicker N type substrate or a thin N type on a P type substrate.

In order to extract the maximum amount of power possible from the cell certain construction techniques have been evolved. Connections to the substrate are relatively easy, this is usually made on the underside of the cell. The topside is a little more difficult. One method



***This is the Ferranti ESC-3 Silicon Solar cell module. It is primarily intended for experimental use and will deliver 0.5 V at 0.8 A in bright sunlight***

is to deposit a thin conductive layer onto the rim of the cell. A great deal of care has to be taken to ensure that this does not form a semiconductor junction (remember the solar cell is basically a diode) otherwise the cell could be reverse biased. This connection has to be as small as possible as it will reduce the effective area of the cell. The second method works by depositing a thin grid of

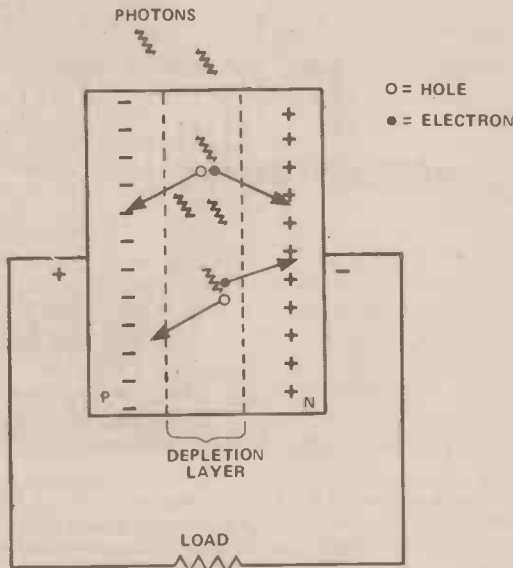

Fig. 1. General construction of a photovoltaic cell

conductive fingers on the topside, again precautions are taken to prevent any undue 'masking' or undesirable reverse bias.

As it stands the cell would be physically fragile so they are usually mounted on some kind of rigid base. In the case of a large array of cells this can be an aluminium sheet. This also helps in dissipating the other 80 or so percent of lost energy as heat.

As with batteries cells connected in series will produce a voltage equal to the sum of the voltage of all the

individual cells. Parallel connections will yield current in a similar proportion.

That of course is an almost wickedly simplistic explanation of solar cells but as you will doubtless appreciate several books have been written on the subject. To explain it in just a couple of paragraphs is a hopeless task. If you really want to know how they work then take a trip down your local library, but don't forget your degree in molecular physics — you'll need it.

## BRIGHT IDEAS

But now, back to the land of the living and a few ideas on how solar cells can improve your life.

The most publicised use for solar cells has got to be in powering satellites. Unfettered by the Earth's atmosphere, gravity (and lack of money) they can provide a reliable source of electricity. The cells are usually arranged on 'winged' arrays that deploy from the satellite once it has reached its orbit. Under these fairly harsh conditions the cells should supply power to the satellite for a good few years. If you can remember back to our August 79 issue you may recall our feature on 'Satellite Power'. Vast arrays of solar cells on orbiting 'solar power stations' would collect sunlight, convert it into high intensity microwaves and beam it to Earth. This would then be re-converted back into electricity, suitable for connection to a grid supply.

This idea is receiving some serious investigation at the moment but any practical development would take many years to come to fruition, so let's look at how solar cells are getting on down here, today.

## MOONSHINE

Many of you will have a solar cell or two hiding in bits of equipment around the house. Some older light meters used for photography sported solar cells. It's easy to identify them, they don't need batteries! Several older types of cameras had solar cells built in. This is an extremely elegant way of measuring light intensity. Most cells exhibit a fairly linear voltage output under a constant load. Coupled up to a moving coil microammeter with an appropriately calibrated scale it will never wear out. The only problem is that, because the currents involved are extremely small, (especially in near-dark conditions) the meter movement has to be extremely sensitive. Consequently, they are extremely fragile, both mechanically and electrically. Today they have been largely superseded by the photoconductive cell or LDR (Light Dependant Resistor) type lightmeter which, although it needs a battery is considerably cheaper and much more robust.

In the past year or so solar cells have been turning up on digital watches. Most, if not all of the current batch use the cell to 'back up' a conventional mercury cell. Exposing the cell to a bright light stretches the life of the internal battery. Some manufacturers are making some rather dubious claims for longevity, we would suspect that doubling the life from one to two years is not unreasonable. As with any kind of LCD watch the battery life usually depends on how much use the backlight gets, or in the case of an alarm model, how long you let it sound. At the moment these solar cells are a bit of a gimmick but given the current trends in lower current consumption etc we can see no reason why they should not be worthwhile in a year or two as a primary power source.

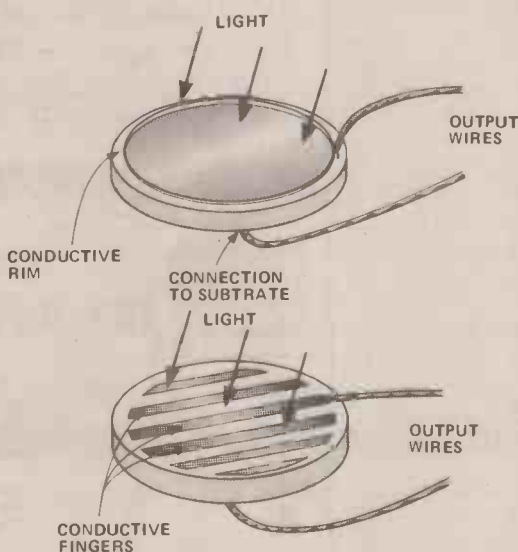

Fig. 2. (A) connection by conductive rim. (B) connection by conductive fingers.



## LIGHTING THE WAY

So much for domestic applications. In the big, wide world solar cells are finding themselves in all sorts of places. Remote, emergency radio telephones are already in use in isolated areas. Buoys at sea are using solar cells to power lights and audible warning devices. One enterprising gentleman in America actually powered his car with a solar panel. Truth be told though, he could only get up to about five miles an hour in very bright sunlight and weight being at a premium he couldn't carry any batteries. What is even more surprising is that this was some seventy years ago. There really is nothing new under the sun!

## A SUNNY OUTLOOK?

Doubtless, improvements in production techniques and development of new materials will result in an even greater efficiency. We can expect to see solar cells popping up all over the place in the coming years. But will they ever be cheap/efficient enough to really solve our current or future energy problem? We would like to think so, solar electricity is clean enough not to upset anyone. However, one intriguing problem remains. If you consider how much energy is required to manufacture a solar cell, will we have enough energy left in the ground to develop a new power source? The energy needed to create the ultra-pure crystals for one single solar cell a couple of inches across is more than one person would normally use in a whole lifetime. Cheap they are not!

HE

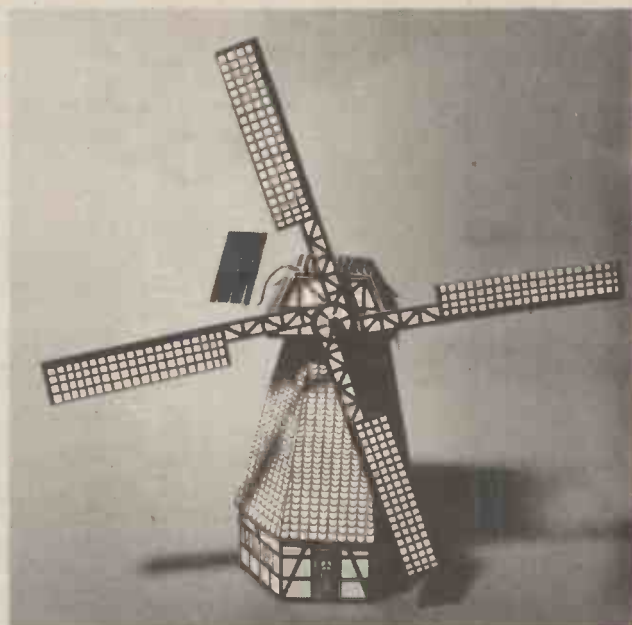

*A mixture of alternative technologies. This cardboard windmill is proving very popular in Germany at the moment. It conceals a small electric motor that is powered by a small solar panel. (between the two sails on the left hand side). In Germany (and many other European countries) this kind of solar powered toy symbolises the strong anti-nuclear movement. In almost every shop they have some kind of animated display powered by a solar panel. We wonder if they realise how much energy (much of it nuclear) went into producing the solar cells.*

<h3>DISPLAY LIGHTING KITS</h3> <p>Each unit has 4 channels (rated at 1KW at 240V per channel) which switch lamps to provide sequencing effects, controlled manually or by an optional opto isolated audio input.</p> <p><b>DL1000K</b> This kit features a bi-directional sequence, speed of sequence and frequency of direction change being variable by means of potentiometers. Incorporates master dimming control. £14.60</p> <p><b>DL21000K</b> A lower cost version of the above, featuring unidirectional channel sequence with speed variable by means of a preset pot. Outputs switched only at mains zero crossing points to reduce radio interference to minimum. £8.00</p> <p>Optional Opto Input DLA1 60p</p>	<h3>DIGITAL VOLTMETER/THERMOMETER KIT</h3> <p>Based on the ICL7106. This kit contains a PCB, resistors, presets, capacitors, diodes, IC and 0.5" liquid crystal display. Components are also included to enable the basic DVM kit to be modified to a Digital Thermometer, using a single diode as the sensor. Requires a 3mA 9V supply (PP3 battery) £20.75</p>	<h3>24 HOUR CLOCK/APPLIANCE TIMER KIT</h3> <p>Switches any appliance up to 1kW on and off at preset times once per day. Kit contains AY-5-1230 IC, 0.5" LED display, mains supply, display drivers, switches, LEDs, trac, PCBs &amp; full instructions. £14.90</p> <p><b>CT1000K Basic Kit</b> CT1000KB with white box (56 x 131 x 71mm) Ready Built £17.40 £22.80</p>	<h3>MINI KITS</h3> <p>These KITS form useful subsystems which may be incorporated into larger designs or used alone. Kits include PCB short instructions and all components.</p> <p><b>TEMPERATURE CONTROLLER/THERMOSTAT</b> Uses LM3911 IC to sense temperature (80 C max.) and trac to switch heater. PCB (4 cm sq.) potentiometer, plus all other components included with instructions. 500W £3.20 1KW £3.60</p> <p><b>SOLID STATE RELAY</b> Ideal for switching motors, lights, heaters etc. from logic. Opto isolated with zero voltage switching. Supplied without trac. Select the required trac from our range. £2.80</p> <p><b>BAR/BOT DISPLAY</b> Displays an analogue voltage on a linear 10-element LED display as a bar or single dot. Ideal for thermometers, level indicators etc. May be stacked to obtain 20 to 100 element displays. Requires 5-20V supply. £4.76</p> <p><b>BURST FIRE/PROPORTIONAL TEMPERATURE CONTROLLER</b> Based on the TDA1024 Zero Voltage Switch this kit contains all the components required to make a "burst fire" power controller or a "proportional temperature" controller enabling the temperature of an enclosure to be maintained to within 0.5 C. 1.5KW £6.26 3KW £8.86</p>																																																																																																																																																																			
<h3>INTEGRATED CIRCUITS</h3> <p>555 Timer 21p 741 Op Amp 18p AY-5-1224 Clock £2.80</p> <p>AY-5-1230/2 Clock/Timer £4.20 AY-3-1270 Thermometer £8.20 ICL7106 DVM (LCD drive) £7.00 LM377 Dual 2W Amp £1.45 LM3795 Dual 6W Amp £3.50 LM380 2W Audio Amp 80p LM382 Dual low noise pre-amp £1.00 LM386 250mW low voltage amp 75p LM11830 Fluid Level Detector £1.50 LM2907 1v Converter £1.40 LM3909 LED Flasher/Oscillator 55p LM3911 Thermometer £1.20 LM3914 Out/Bar Driver £2.10 MM57160 (stac) Timer £5.90 MM74C911 4-digit display controller £8.50 MM74C915 7-segment-BCD converter 96p MM74C926 4-digit counter with 7-seg outputs £6.50 S5668 Touchdimmer £2.50 S9263 Touchswitch 16-way £4.85 TBA800 5W Audio Amp 58p TBA810AS 7W Audio Amp 85p TDA1024 Zero Voltage Switch £1.00 TDA2020 20W Audio Amp £2.85 ZN1034E Timer £1.80</p> <p>All ICs supplied with data and circuits. Data sheets only 5p</p>	<h3>LEDs</h3> <table border="1"> <tr><td>0.1" Red</td><td>9p</td></tr> <tr><td>0.1" Green</td><td>12p</td></tr> <tr><td>0.1" Yellow</td><td>12p</td></tr> <tr><td>0.2" Red</td><td>9p</td></tr> <tr><td>0.2" Green</td><td>12p</td></tr> <tr><td>0.2" Yellow</td><td>12p</td></tr> <tr><td>0.2" clips</td><td>3p</td></tr> <tr><td>Rectangular Red</td><td>18p</td></tr> <tr><td>Rectangular Green</td><td>20p</td></tr> <tr><td>Rectangular Yellow</td><td>21p</td></tr> </table>	0.1" Red	9p	0.1" Green	12p	0.1" Yellow	12p	0.2" Red	9p	0.2" Green	12p	0.2" Yellow	12p	0.2" clips	3p	Rectangular Red	18p	Rectangular Green	20p	Rectangular Yellow	21p	<h3>CAPACITORS</h3> <p><b>Polyester 250V</b></p> <table border="1"> <tr><td>0.01</td><td>6p</td><td>0.22</td><td>12p</td></tr> <tr><td>0.002</td><td>6p</td><td>0.33</td><td>12p</td></tr> <tr><td>0.033</td><td>7p</td><td>0.47</td><td>15p</td></tr> <tr><td>0.047</td><td>7p</td><td>0.68</td><td>18p</td></tr> <tr><td>0.068</td><td>7p</td><td>1.0</td><td>24p</td></tr> <tr><td>0.1</td><td>7p</td><td>1.5</td><td>27p</td></tr> <tr><td>0.15</td><td>11p</td><td>2.2</td><td>31p</td></tr> </table> <p><b>Electrolytics A Axial R Radial</b></p> <table border="1"> <tr><td>63V</td><td>1.0 R</td><td>3p</td><td>16V</td><td>10 R</td><td>3p</td></tr> <tr><td></td><td>2.2 R</td><td>3p</td><td></td><td>22 R</td><td>3p</td></tr> <tr><td></td><td>4.7 R</td><td>4p</td><td></td><td>33 R</td><td>3p</td></tr> <tr><td></td><td>10 R</td><td>5p</td><td></td><td>47 R</td><td>4p</td></tr> <tr><td></td><td>47 R</td><td>8p</td><td></td><td>100 R</td><td>5p</td></tr> <tr><td></td><td>100 A</td><td>6p</td><td></td><td>220 R</td><td>8p</td></tr> <tr><td></td><td>110 A</td><td>6p</td><td></td><td>470 R</td><td>9p</td></tr> <tr><td></td><td>470 A</td><td>16p</td><td></td><td>1000 R</td><td>15p</td></tr> <tr><td></td><td>1000 A</td><td>20p</td><td></td><td>10V</td><td>47 A</td><td>6p</td></tr> <tr><td></td><td></td><td></td><td></td><td>100 A</td><td>4 A</td><td>6p</td></tr> <tr><td></td><td></td><td></td><td></td><td>220 A</td><td>20 A</td><td>6p</td></tr> </table> <p><b>Tantalum (bead)</b></p> <table border="1"> <tr><td>35V</td><td>0.1</td><td>7p</td><td>10V</td><td>22</td><td>12p</td></tr> <tr><td></td><td>0.22</td><td>7p</td><td>6.3V</td><td>33</td><td>12p</td></tr> <tr><td></td><td>0.47</td><td>7p</td><td></td><td>47</td><td>14p</td></tr> <tr><td></td><td>1.0</td><td>7p</td><td>3V</td><td>100</td><td>14p</td></tr> <tr><td>25V</td><td>2.2</td><td>8p</td><td></td><td></td><td></td></tr> <tr><td></td><td>4.7</td><td>9p</td><td></td><td></td><td></td></tr> <tr><td></td><td>10</td><td>12p</td><td></td><td></td><td></td></tr> </table>	0.01	6p	0.22	12p	0.002	6p	0.33	12p	0.033	7p	0.47	15p	0.047	7p	0.68	18p	0.068	7p	1.0	24p	0.1	7p	1.5	27p	0.15	11p	2.2	31p	63V	1.0 R	3p	16V	10 R	3p		2.2 R	3p		22 R	3p		4.7 R	4p		33 R	3p		10 R	5p		47 R	4p		47 R	8p		100 R	5p		100 A	6p		220 R	8p		110 A	6p		470 R	9p		470 A	16p		1000 R	15p		1000 A	20p		10V	47 A	6p					100 A	4 A	6p					220 A	20 A	6p	35V	0.1	7p	10V	22	12p		0.22	7p	6.3V	33	12p		0.47	7p		47	14p		1.0	7p	3V	100	14p	25V	2.2	8p					4.7	9p					10	12p				<h3>BOXES</h3> <p>Moulded in high impact ABS. Supplied with lids and screws. Black or white.</p> <table border="1"> <tr><td>82 95 x 71 x 35mm</td><td>65p</td></tr> <tr><td>83 115 x 95 x 37mm</td><td>78p</td></tr> </table>	82 95 x 71 x 35mm	65p	83 115 x 95 x 37mm	78p
0.1" Red	9p																																																																																																																																																																					
0.1" Green	12p																																																																																																																																																																					
0.1" Yellow	12p																																																																																																																																																																					
0.2" Red	9p																																																																																																																																																																					
0.2" Green	12p																																																																																																																																																																					
0.2" Yellow	12p																																																																																																																																																																					
0.2" clips	3p																																																																																																																																																																					
Rectangular Red	18p																																																																																																																																																																					
Rectangular Green	20p																																																																																																																																																																					
Rectangular Yellow	21p																																																																																																																																																																					
0.01	6p	0.22	12p																																																																																																																																																																			
0.002	6p	0.33	12p																																																																																																																																																																			
0.033	7p	0.47	15p																																																																																																																																																																			
0.047	7p	0.68	18p																																																																																																																																																																			
0.068	7p	1.0	24p																																																																																																																																																																			
0.1	7p	1.5	27p																																																																																																																																																																			
0.15	11p	2.2	31p																																																																																																																																																																			
63V	1.0 R	3p	16V	10 R	3p																																																																																																																																																																	
	2.2 R	3p		22 R	3p																																																																																																																																																																	
	4.7 R	4p		33 R	3p																																																																																																																																																																	
	10 R	5p		47 R	4p																																																																																																																																																																	
	47 R	8p		100 R	5p																																																																																																																																																																	
	100 A	6p		220 R	8p																																																																																																																																																																	
	110 A	6p		470 R	9p																																																																																																																																																																	
	470 A	16p		1000 R	15p																																																																																																																																																																	
	1000 A	20p		10V	47 A	6p																																																																																																																																																																
				100 A	4 A	6p																																																																																																																																																																
				220 A	20 A	6p																																																																																																																																																																
35V	0.1	7p	10V	22	12p																																																																																																																																																																	
	0.22	7p	6.3V	33	12p																																																																																																																																																																	
	0.47	7p		47	14p																																																																																																																																																																	
	1.0	7p	3V	100	14p																																																																																																																																																																	
25V	2.2	8p																																																																																																																																																																				
	4.7	9p																																																																																																																																																																				
	10	12p																																																																																																																																																																				
82 95 x 71 x 35mm	65p																																																																																																																																																																					
83 115 x 95 x 37mm	78p																																																																																																																																																																					
<h3>RESISTORS</h3> <p>1/4W 220hm-10M Pack of 10 (one value) 10p 10 Packs (10 values) 80p</p>	<h3>DISPLAYS</h3> <p>DL304 Red 0.3" c.c. pin compatible with DL704 70p DL3D7 Red 0.3" c.c. pin comp. DL7D7 70p</p> <p>DL847 Red 0.8" (pin comp. DL747) c.c. £1.80 DL850 Red 0.8" c.c. (pin comp. DL750) £1.80 DL727 Dual 0.5" c.c. Red £1.50</p> <h3>MINI TRANSFORMERS</h3> <p>Standard mains primaries 240V a.c. 100mA secondaries</p> <table border="1"> <tr><td>6-0-6V</td><td>80p</td></tr> <tr><td>9-0-9V</td><td>85p</td></tr> <tr><td>12-0-12V</td><td>90p</td></tr> </table>	6-0-6V	80p	9-0-9V	85p	12-0-12V	90p	<h3>VOIAGE REGULATORS</h3> <p>Available in 5V, 12V &amp; 15V versions.</p> <table border="1"> <tr><td>78L series 100mA pos.</td><td>26p</td></tr> <tr><td>79L series 100mA neg.</td><td>60p</td></tr> <tr><td>78 series 1A pos.</td><td>52p</td></tr> </table> <p>LM317T adjustable 1.2V-37V 1.5A £1.80</p>	78L series 100mA pos.	26p	79L series 100mA neg.	60p	78 series 1A pos.	52p	<h3>ZENER DIODES</h3> <p>400mW 3.3V-30V 8p 1.3W 7.5-27V 15p</p> <h3>TRIACS</h3> <p>400V Plastic Case (Texas)</p> <table border="1"> <tr><td>3A</td><td>49p</td><td>16A</td><td>90p</td></tr> <tr><td>8A</td><td>58p</td><td>20A</td><td>165p</td></tr> <tr><td>12A</td><td>70p</td><td>25A</td><td>190p</td></tr> <tr><td>6A with trigger</td><td></td><td></td><td>80p</td></tr> <tr><td>8A isolated tab</td><td></td><td></td><td>65p</td></tr> <tr><td>Diac</td><td></td><td></td><td>18p</td></tr> </table>	3A	49p	16A	90p	8A	58p	20A	165p	12A	70p	25A	190p	6A with trigger			80p	8A isolated tab			65p	Diac			18p																																																																																																																															
6-0-6V	80p																																																																																																																																																																					
9-0-9V	85p																																																																																																																																																																					
12-0-12V	90p																																																																																																																																																																					
78L series 100mA pos.	26p																																																																																																																																																																					
79L series 100mA neg.	60p																																																																																																																																																																					
78 series 1A pos.	52p																																																																																																																																																																					
3A	49p	16A	90p																																																																																																																																																																			
8A	58p	20A	165p																																																																																																																																																																			
12A	70p	25A	190p																																																																																																																																																																			
6A with trigger			80p																																																																																																																																																																			
8A isolated tab			65p																																																																																																																																																																			
Diac			18p																																																																																																																																																																			

TTLs by TEXAS			93 SERIES			VEROBOARDS			TRANSISTORS			TIPO30A			40408			10A 400V		
7400	11p	74278	250p	4019	45p	9301	160p	0.1	AC126	25p	BF259	36p	2N3442	140p	40408	70p	10A 400V	200p		
7400	11p	74278	200p	4020	100p	9302	175p	0.15	AC127/8	20p	BF39	25p	2N3553	240p	40409	85p	25A 400V	400p		
7400	12p	74283	160p	4022	100p	9308	318p	(copper clad)	AC176	25p	BF40	25p	2N3554	30p	40411	300p	ZENERS			
7402	12p	74290	160p	4024	100p	9310	278p	2.5x3.75"	AC177/8	25p	BF79	25p	2N3584	250p	40594	110p	2.7V-33V			
7403	14p	74293	160p	4023	25p	9311	278p	57p	AC178	25p	BF80	25p	2N3702/3	12p	40595	120p	40kV	8p		
7404	14p	74298	200p	4025	27p	9312	160p	57p	AF116	50p	BF81	25p	2N3704/5	12p	40673	75p	400mW	9p		
74504	90p	74365	100p	4026	130p	9314	185p	4.75x11.9"	AD149	45p	BF29	30p	2N3706/7	14p	40871	90p	1W	15p		
7405	18p	74366	100p	4027	50p	9316	225p	290p	AD161/2	45p	BF30	34p	2N3733	200p						
7406	32p	74367	100p	4028	85p	9321	225p	50p	AU107	200p	BF33	34p	2N3819	25p						
7407	32p	74368	100p	4029	100p	9322	150p	50p	BC107/8	11p	BF34	34p	2N3820	50p						
7408	17p	74370	200p	4030	55p	9334	360p	118p	BC109	11p	BF35	34p	2N3821	50p						
7409	19p	74393	200p	4031	200p	9368	200p	370p	BC117	20p	BF36	34p	2N3822	50p						
7410	15p	74490	225p	4033	180p	9370	200p		BC147/8	9p	BF37	34p	2N3823	50p						
7411	24p	74LS SERIES		4034	200p	9374	200p		BC159	12p	BF50	50p	2N3824	50p						
7412	20p	74LS00	14p	4035	110p				BC159	12p	BF51/2	30p	2N3825	50p						
7413	20p	74LS02	16p	4036	110p				BC172	12p	BF52	30p	2N3826	50p						
7414	50p	74LS10	18p	4037	115p				BC177/8	17p	BF53	30p	2N3827	50p						
7414	50p	74LS10	16p	4038	120p				BC179	18p	BF54	30p	2N3828	50p						
7416	27p	74LS05	25p	4039	285p				BC182/3	10p	BF55	30p	2N3829	50p						
7417	27p	74LS08	22p	4040	100p				BC183	10p	BF56	30p	2N3830	50p						
7420	17p	74LS10	20p	4041	100p				BC184	11p	BF57	30p	2N3831	50p						
7421	40p	74LS11	40p	4042	80p				BC187	10p	BF58	30p	2N3832	50p						
7422	22p	74LS13	40p	4043	90p				BC212/3	11p	BF59	30p	2N3833	50p						
7423	34p	74LS14	72p	4044	90p				BC214	12p	BF60	30p	2N3834	50p						
7425	30p	74LS15	45p	4046	110p				BC237	15p	BF61	30p	2N3835	50p						
7426	40p	74LS20	20p	4047	100p				BC337	16p	BF62	30p	2N3836	50p						
7427	34p	74LS21	40p	4048	120p				BC358	16p	BF63	30p	2N3837	50p						
7428	17p	74LS27	36p	4049	45p				BC461	36p	BF64	30p	2N3838	50p						
7430	17p	74LS30	30p	4050	49p				BC477/8	50p	BF65	30p	2N3839	50p						
7432	30p	74LS32	27p	4051	80p				BC517/7	50p	BF66	30p	2N3840	50p						
7433	40p	74LS42	70p	4052	80p				BC530	50p	BF67	30p	2N3841	50p						
7437	35p	74LS47	90p	4053	80p				BC547	50p	BF68	30p	2N3842	50p						
7438	35p	74LS51	24p	4054	80p				BC548C	9p	BF69	30p	2N3843	50p						
7440	17p	74LS55	30p	4055	125p				BC549C	9p	BF70	30p	2N3844	50p						
7441	70p	74LS73	50p	4056	135p				BC557B	18p	BF71	30p	2N3845	50p						
7442A	60p	74LS74	35p	4059	600p				BC559C	18p	BF72	30p	2N3846	50p						
7443	112p	74LS75	40p	4060	115p				BC570	18p	BF73	30p	2N3847	50p						
7444	112p	74LS76	45p	4063	120p				BC571/2	22p	BF74	30p	2N3848	50p						
7445	100p	74LS83	110p	4064	45p				BD131/2	50p	BF75	30p	2N3849	50p						
7446	93p	74LS85	100p	4068	27p				BD135/6	50p	BF76	30p	2N3850	50p						
7447A	50p	74LS86	40p	4069	27p				BD139	50p	BF77	30p	2N3851	50p						
7448	80p	74LS90	40p	4069	27p				BD140	60p	BF78	30p	2N3852	50p						
7450	17p	74LS92	70p	4070	30p				BD189	60p	BF79	30p	2N3853	50p						
7451	17p	74LS93	60p	4071	25p				BD232	95p	BF80	30p	2N3854	50p						
7453	17p	74LS96	110p	4073	25p				BD233	75p	BF81	30p	2N3855	50p						
7454	17p	74LS107	40p	4075	25p				BD235	95p	BF82	30p	2N3856	50p						
7460	19p	74LS109	40p	4076	107p				BD241	70p	BF83	30p	2N3857	50p						
7470	36p	74LS112	100p	4076	107p				BD242	70p	BF84	30p	2N3858	50p						
7472	30p	74LS113	90p	4081	27p				BD255	200p	BF85	30p	2N3859	50p						
7473	34p	74LS114	45p	4082	27p				BF200	32p	BF86	30p	2N3860	50p						
7474	30p	74LS122	80p	4083	27p				BF201	35p	BF87	30p	2N3861	50p						
7475	30p	74LS123	70p	4089	13p				BF202	35p	BF88	30p	2N3862	50p						
7476	35p	74LS124	180p	4093	80p				BF203	35p	BF89	30p	2N3863	50p						
7480	50p	74LS125	60p	4094	250p				BF204	35p	BF90	30p	2N3864	50p						
7481	100p	74LS126	60p	4095	36p				BF205	35p	BF91	30p	2N3865	50p						
7482	84p	74LS132	95p	4096	95p				BF206	35p	BF92	30p	2N3866	50p						
7483a	90p	74LS133	30p	4097	95p				BF207	35p	BF93	30p	2N3867	50p						
7484	100p	74LS136	55p	4098	200p				BF208	35p	BF94	30p	2N3868	50p						
7485	110p	74LS139	75p	4099	200p				BF209	35p	BF95	30p	2N3869	50p						
7486	34p	74LS139	75p	4100	220p				BF210	35p	BF96	30p	2N3870	50p						
7489	175p	74LS145	120p	4101	132p				BF211	35p	BF97	30p	2N3871	50p						
7490A	30p	74LS147	220p	4102	180p				BF212	35p	BF98	30p	2N3872	50p						
7491	80p	74LS148	175p	4103	180p				BF213	35p	BF99	30p	2N3873	50p						
7492A	46p	74LS151	100p	4104	99p				BF214	35p	BF100	30p	2N3874	50p						
7493A	30p	74LS153	60p	4105	99p				BF215	35p	BF101	30p	2N3875	50p						
7494	84p	74LS154	200p	4106	90p				BF216	35p	BF102	30p	2N3876	50p						
7495A	70p	74LS155	90p	4107	60p				BF217	35p	BF103	30p	2N3877	50p						
7496	65p	74LS156	90p	4108	470p				BF218	35p	BF104	30p	2N3878	50p						
7497	180p	74LS157	60p	4109	470p				BF219	35p	BF105	30p	2N3879	50p						
74100	100p	74LS158	100p	4110	30p				BF220	35p	BF106	30p	2N3880	50p						
74104	65p	74LS160	130p	4111	250p				BF221	35p	BF107	30p	2N3881	50p						
74105	65p	74LS161	100p	4111	110p				BF222	35p	BF108	30p	2N3882	50p						
74107	34p	74LS162	140p	4502	120p				BF223	35p	BF109	30p	2N3883	50p						
74109	55p	74LS163	100p	4503	70p				BF224	35p	BF110	30p	2N3884	50p						
74110	55p	74LS164	120p	4507	55p				BF225	35p	BF111	30p	2N3885	50p						
74111	70p	74LS165	180p	4508	290p				BF226	35p	BF112	30p	2N3886	50p						
74116	200p	74LS168	180p	4510	99p				BF227	35p	BF113	30p	2N3887	50p						
74118	130p	74LS173	110p	4511	150p				BF228	35p	BF114	30p	2N3888	50p						
74119	210p	74LS174	110p	4512	80p				BF229	35p	BF115	30p	2N3889	50p						
74120	110p	74LS175	110p	4514	285p				BF230	35p	BF116	30p	2N3890	50p						
74121	28p	74LS181	320p	4515	300p				BF231	35p	BF117	30p	2N3891	50p						
74122	40p	74LS190	250p	4516	110p				BF232	35p	BF118	30p	2N3892	50p						
74123	48p	74LS203	40p	4518	100p				BF233	35p	BF119	30p	2N3893	50p						



**Next  
Month**

# Hobby Electronics

## RADIO CONTROL MODEL SURVEY

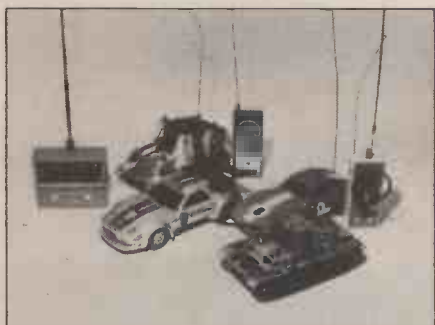

It's been quite some time since we had a 'toy' feature, so we thought it was a good excuse to look at the latest crop of remote control cars, tanks, boats and other vehicles that have been flooding into the toy shops in the last few months.

Many of these so-called 'toys' are quite sophisticated, in fact a couple of them are far too good for youngsters. We reckon any kid getting one of these for a present hasn't a chance of playing with it if there is an adult around. This was more than borne out by the HE staff, literally queuing up to play with them. Find out how we got on in next month's exciting feature (providing we can tear them away from tearful office staff).

## CONTEST

Yes, another of our famous devil-may-care contests. Prizes galore, instant stardom, just some of the things that happen in our competitions. We can't reveal the details yet (we're not too sure of them ourselves). What we can say is that the first prize will be a superb Heathkit type build-it-yourself goodie and that if you miss it you will never forgive yourself.

## CROSSEVERS

Now for the first time anywhere. The complicated bits in loudspeakers, the Crossover Networks, will be explained as never before. Learn the intimate secrets of these cunning little circuits. Now you will be able to look any 'Audiophile' in the eye and know what he's talking about, you may even be able to tell him a thing or two.

## MINICLOCK

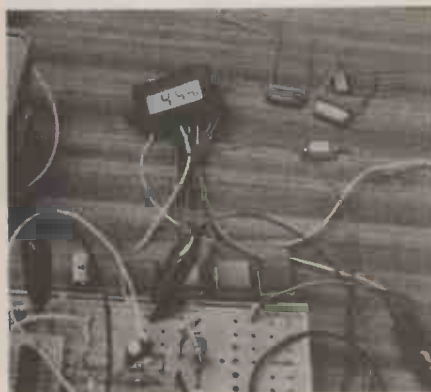

Time for a really alarming project. We promise no 'wind-ups' with this crystal controlled, battery powered, LCD display travelling alarm. It will fit snugly into the palm of your hand. Ideal for the 'travelling man', this neat little timepiece will reliably inform you of the correct time anywhere in the world. (Yes folks, a truly international clock, we absolutely guarantee it will work anywhere in the world.)

The built-in alarm will remind you of that all-important business lunch or just tell you it's time to get up. Never be late again, never be at a loss at parties, impress your friends . . . . .

The copywriter for this project has just been retired due to an overdose of corny cliches. Seriously though, don't miss next month's HE, or you'll live to regret it.

## SYSTEM 5080



To conclude the fabulously popular 5080 modular Hi-Fi system we are presenting the last word in Pre-Amplifier designs PLUS an amazing speaker system that will really complement the PA and PSU modules. For less than the price of a half decent ready built amplifier the 5080 system will bring the world of true Hi-Fi into your living room. (And if that sounds a bit schmalzy just wait till your hear the amp at full tilt . . . . .)

## TRACK CLEANER

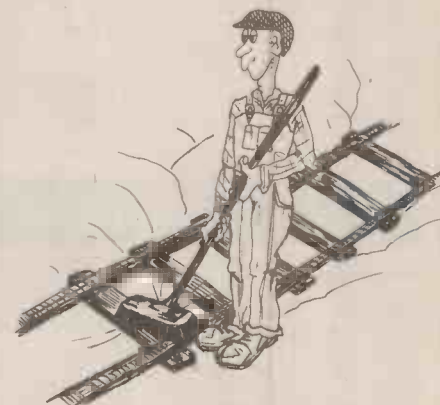

Troubled by tarnished tracks? Confounded by corroded connections? HE to the rescue, our supersonic, high-voltage grime-beater will get rid of those bits that clog your contacts and leave your model railway running so smoothly you'll wonder how you ever shunted your steamer without it.

**The May issue will be on sale April 11th**

The items mentioned here are those planned but circumstances may affect the actual contents

# BI-PAK SEMICONDUCTORS SEND YOUR ORDERS TO DEPT. HE4, PO BOX 6, WARE, HERTS. VISIT OUR SHOP AT: 3 BALDOCK ST., WARE, HERTS. TEL: 0920 3182. TELEX: 817861

## TRANSISTORS

AC126	£0.21	BC148	£0.08	BC549	£0.12	BU105	£1.84
AC127	£0.21	DC149	£0.08	BC550	£0.16	BU105/02	£2.24
AC128	£0.18	BC157	£0.12	BC556	£0.16	BU204	£1.81
AC128K	£0.30	BC158	£0.12	BC557	£0.16	BU205	£1.61
AC132	£0.23	BC159	£0.12	BC558	£0.14	BU208/02	£2.58
AC134	£0.23	BC167	£0.14	BC559	£0.16	MJE2955	£1.04
AC137	£0.23	BC168	£0.14	BD115	£0.58	MJE3055	£0.69
AC141	£0.25	BC169	£0.10	BD116	£0.92	MJE3440	£0.60
AC142	£0.35	BC169C	£0.12	BF121	£0.75	MFF102	£0.32
AC142K	£0.23	BC170	£0.10	BD124	£0.81	MFF104	£0.40
AC176	£0.21	BC171	£0.10	BD131	£0.40	MFF105	£0.40
AC176K	£0.30	BC172	£0.10	BD132	£0.40	MPSA05	£0.23
AC178	£0.29	BC173	£0.10	BD133	£0.46	MPSA06	£0.23
AC179	£0.29	BC177	£0.18	BD136	£0.44	MPSA55	£0.23
AC180	£0.23	BC178	£0.18	BD136	£0.40	MPSA56	£0.23
AC180K	£0.32	BC179	£0.18	BD137	£0.40	OC22	£1.73
AC181	£0.23	BC180	£0.29	BD138	£0.41	OC23	£1.73
AC181K	£0.32	BC181	£0.10	BD138	£0.41	OC24	£1.55
AC187	£0.21	BC182L	£0.10	BD140	£0.41	OC26	£1.15
AC187K	£0.32	BC183	£0.10	BD155	£0.92	OC26	£1.15
AC188	£0.21	BC183L	£0.10	BD175	£0.69	OC29	£0.92
AC188K	£0.32	BC184	£0.10	BD176	£0.69	OC29	£1.09
AD140	£0.69	BC207	£0.13	BD177	£0.78	OC35	£1.03
AD142	£0.98	BC208	£0.13	BD178	£0.78	OC36	£1.03
AD143	£0.86	BC209	£0.14	BD179	£0.86	OC70	£0.27
AD149	£0.69	BC212	£0.10	BD203	£0.92	OC71	£0.17
AD161	£0.40	BC212L	£0.10	BF594	£0.35	TC44	£0.33
AD162	£0.40	BC213	£0.10	BDY20	£0.92	TC45	£0.40
AD161	162MP	BC213L	£0.10	BF457	£0.43	TIP29A	£0.46
AF124	£0.38	BC214	£0.10	BF458	£0.43	TIP29B	£0.46
AF125	£0.35	BC214L	£0.10	BF594	£0.35	TIP29C	£0.51
AF126	£0.35	BC215	£0.18	BF596	£0.32	TIP30B	£0.48
AF127	£0.37	BC251	£0.17	BF839	£0.28	TIP30C	£0.50
AF139	£0.40	BC251A	£10.18	BF840	£0.29	TIP31A	£0.46
AF186	£0.58	BC301	£0.32	BF879	£0.32	TIP31B	£0.48
AF239	£0.47	BC302	£0.33	BF880	£0.32	TIP31C	£0.50
AL102	£1.38	BC303	£0.32	BF881	£0.25	TIP32A	£0.48
AL103	£1.36	BC304	£0.34	BF882	£0.35	TIP32B	£0.48
AU104	£1.61	BC327	£0.18	BF884	£0.25	TIP32C	£0.50
AU110	£1.61	BC328	£0.17	BF885	£0.28	TIP41A	£0.50
AU113	£1.61	BC337	£0.17	BF886	£0.29	TIP41B	£0.52
BC107A	£0.09	BC338	£0.17	BF887	£0.25	TIP41C	£0.55
BC107B	£0.09	BC340	£0.35	BF888	£0.25	TIP42A	£0.50
BC107C	£0.12	BC441	£0.35	BFY50	£0.20	TIP42B	£0.52
BC108A	£0.09	BC460	£0.44	BFY51	£0.20	TIP42C	£0.55
BC108B	£0.11	BC461	£0.44	BFY52	£0.20	TIP2955	£0.69
BC108C	£0.12	BC477	£0.23	BF119	£0.44	TI543	£0.28
BC109A	£0.09	BC478	£0.23	BF120	£0.44	TI590	£0.20
BC109B	£0.10	BC479	£0.23	BF119	£0.44	UT46	£0.23
BC109C	£0.12	BC547	£0.12	20MP	£0.92	ZTK107	£0.11
BC147	£0.08	BC548	£0.12	BRY39	£0.51	ZTK108	£0.11

## 74 SERIES TTL

Type	Price	Type	Price	Type	Price	Type	Price
7400	£0.10	7427	£0.27	7472	£0.27	7415	£0.43
7401	£0.12	7428	£0.29	7473	£0.28	7416	£0.43
7402	£0.12	7430	£0.12	7474	£0.28	7417	£0.43
7403	£0.12	7432	£0.25	7475	£0.33	7418	£0.43
7404	£0.12	7433	£0.34	7476	£0.28	7419	£0.43
7405	£0.12	7437	£0.25	7480	£0.50	7420	£0.43
7406	£0.25	7438	£0.24	7481	£0.97	7421	£0.43
7407	£0.25	7440	£0.13	7482	£0.78	7422	£0.44
7408	£0.14	7441	£0.57	7483	£0.66	7423	£0.44
7409	£0.14	7442	£0.48	7484	£1.01	7424	£0.44
7410	£0.12	7443	£0.80	7485	£0.78	7425	£0.44
7411	£0.18	7444	£0.80	7486	£0.25	7426	£0.44
7412	£0.17	7445	£0.74	7489	£1.95	7427	£0.44
7413	£0.27	7446	£0.69	7490	£0.36	7428	£0.44
7414	£0.57	7447	£0.55	7491	£0.73	7429	£0.44
7416	£0.26	7448	£0.64	7492	£0.40	7430	£0.44
7417	£0.26	7450	£0.12	7493	£0.34	7431	£0.44
7420	£0.12	7451	£0.12	7494	£0.86	7432	£0.44
7421	£0.23	7453	£0.12	7495	£0.57	7433	£0.44
7422	£0.18	7454	£0.12	7496	£0.57	7434	£0.44
7423	£0.24	7460	£0.12	74100	£0.97	7435	£0.44
7425	£0.21	7470	£0.28	74104	£0.44	7436	£0.44
7426	£0.26					7437	£0.44

## CMOS ICs

Type	Price	Type	Price	Type	Price	Type	Price
CD4000	£0.16	CD4015	£0.87	CD4026	£1.38	CD4043	£1.01
CD4001	£0.22	CD4016	£0.48	CD4027	£0.57	CD4044	£0.94
CD4002	£0.18	CD4017	£0.86	CD4028	£0.78	CD4045	£1.61
CD4006	£1.05	CD4018	£0.97	CD4029	£0.97	CD4046	£1.40
CD4007	£0.19	CD4019	£0.48	CD4030	£0.95	CD4047	£1.00
CD4008	£1.05	CD4020	£1.03	CD4031	£2.30	CD4049	£0.48
CD4009	£0.51	CD4021	£0.94	CD4035	£1.15	CD4050	£0.48
CD4010	£0.55	CD4022	£0.94	CD4037	£1.09	CD4054	£1.26
CD4011	£0.22	CD4023	£0.17	CD4040	£1.01	CD4055	£1.15
CD4012	£0.18	CD4024	£0.74	CD4041	£0.87	CD4056	£1.15
CD4013	£0.48	CD4025	£0.17	CD4042	£0.82	CD4059	£0.19

## LINEAR

Type	Price	Type	Price	Type	Price	Type	Price
CA3011	£0.92	CA3130	£1.06	MC1350	£1.38	UA710C	£0.46
CA3014	£1.55	CA3140	£0.80	MC1352	£1.61	72710	£0.34
CA3018	£0.74	LM301	£0.33	MC1469	£3.59	UA711C	£0.36
CA3020	£1.95	LM304	£1.84	MC1496	£1.03	72711	£0.36
CA3028	£0.98	LM308	£1.15	NE536	£0.05	UA723C	£0.52
CA3035	£1.15	LM309	£1.72	NE550	£0.09	72723	£0.52
CA3036	£1.15	LM320 5V	£1.72	NE555	£0.27	UA731C	£0.27
CA3042	£1.72	LM320 12V	£1.72	NE556	£0.69	72741	£0.27
CA3043	£2.12	LM320 15V	£1.72	NE565	£1.38	7419	£0.23
CA3046	£0.80	LM320 24V	£1.72	NE566	£1.38	UA747C	£0.69
CA3052	£1.84	LM380	£0.97	NE567	£1.95	72747	£0.69
CA3054	£1.26	LM381	£1.56	UA702C	£0.52	UA748	£0.40
CA3075	£1.72	LM3900	£0.66	72748	£0.52	72748	£0.40
CA3081	£1.72	MC1303L	£0.97	UA703	£0.28	72749	£0.40
CA3089	£2.30	MC1304	£0.79	UA709	£0.28	SN7613N	£2.01
CA3090	£4.14	MC1310	£1.09	72709	£0.52	SN76023	£2.01
CA3123	£2.18	MC1312	£1.18	709P	£0.28	SN76110	£1.72

## THYRISTORS

Volts No	Price	Volts No	Price
50 THY1A/50	£0.29	50 THY7A/50	£0.55
100 THY1A/100	£0.32	100 THY7A/100	£0.58
200 THY1A/200	£0.36	200 THY7A/200	£0.65
400 THY1A/400	£0.43	400 THY7A/400	£0.71
600 THY1A/600	£0.51	600 THY7A/600	£0.89
800 THY1A/800	£0.66	800 THY7A/800	£1.05

## LEDs

O/no	Size	Colour	Price
1501	125	RED	£0.10
1502	125	GREEN	£0.16
1503	125	YELLOW	£0.16
1504	2	RED	£0.11
1505	2	GREEN	£0.16
1506	2	YELLOW	£0.16
1509	2	CLEAR	£0.12

(All Red)

## CLIPS

1508 / 125 pack of 5	125 clips	£0.17
1508 / 2 pack of 5	2 clips	£0.20

## DISPLAYS

DL703	7 segment D.P. left (30" height) common anode single digit	£0.80
DL707	RED 7 segment D.P. left (50" height) common anode single digit	£0.82
DL527	RED 7 segment D.P. left (50" height) common anode Two-digit reflector	£0.92
DL727	RED 7 segment D.P. right (50" height) common anode Two-digit light pipe	£1.95
DL747	RED 7 segment D.P. left (630" height) common anode Single-digit light pipe	£2.53

## SILICON RECTIFIERS

200MA	IS920 50v	£0.07	10 Amp	IS10/50 50v	£0.21
	IS921 100v	£0.08		IS10/100 100v	£0.24
	IS922 150v	£0.09		IS10/200 200v	£0.26
	IS923 200v	£0.10		IS10/400 400v	£0.40
	IS924 300v	£0.11		IS10/600 600v	£0.48
1 Amp	IN4001 50v	£0.05		IS10/800 800v	£0.58
	IN4002 100v	£0.05		IS10/1000 1000v	£0.69
	IN4003 200v	£0.07		IS10/1200 1200v	£0.79
	IN4004 400v	£0.08	30 Amp	IS30/50 50v	£0.64
	IN4005 600v	£0.10		IS30/100 100v	£0.79
	IN4007 1000v	£0.11		IS30/200 200v	£1.06
1.5 Amp	IS105 50v	£0.10		IS30/400 400v	£1.43
	IS020 100v	£0.11		IS30/600 600v	£2.02
	IS021 200v	£0.12		IS30/800 800v	£2.23
	IS023 400v	£0.14		IS30/1000 1000v	£2.65
	IS025 600v	£0.16		IS30/1200 1200v	£3.31
	IS027 800v	£0.18	60 Amp	IS10/50 50v	£0.86
	IS029 1000v	£0.23		IS10/100 100v	£0.96
	IS031 1200v	£0.28		IS10/200 200v	



# Digital Frequency Meter

*Living by numbers? . . . do it digitally with this easy to build DFM.*

WITH JUST A COUPLE of simple-to-operate controls, this project will enable you to measure and display frequencies from 20 Hz to about 2 MHz. The upper frequency limit is determined by the waveform of the input signal, the input amplifier and the performance of the particular chip used for IC3. As the CMOS chips used in this design have a better high-frequency performance with increasing supply voltage, a twelve volt supply was chosen and this can be simply provided with eight AA size cells; HP 7s for example.

## 99999 = 1

Even a few years ago, a DFM like this unit would have been mains-powered with numerous boards and in-

numerable interconnections. Large scale integration, the same technology that has put microprocessors in almost everything, has changed all that and this project features a five digit readout with input amplifier, logic gating and counter all on one board. This saves you from having to worry about connecting displays and cascading discrete counter chips.

Most of the work is done by one chip which counts the input pulses and organises the display. Another chip takes the display data and drives the light-emitting-diode display while the remaining ICs provide an accurate counter "window" and gate the input signal.

The advantage of CMOS over conventional bipolar technology is low current drain and the whole unit uses less power than an ordinary torch bulb. Many more



*The HE Digital Frequency Meter hooked up to our workshop signal generator and oscilloscope for calibration*

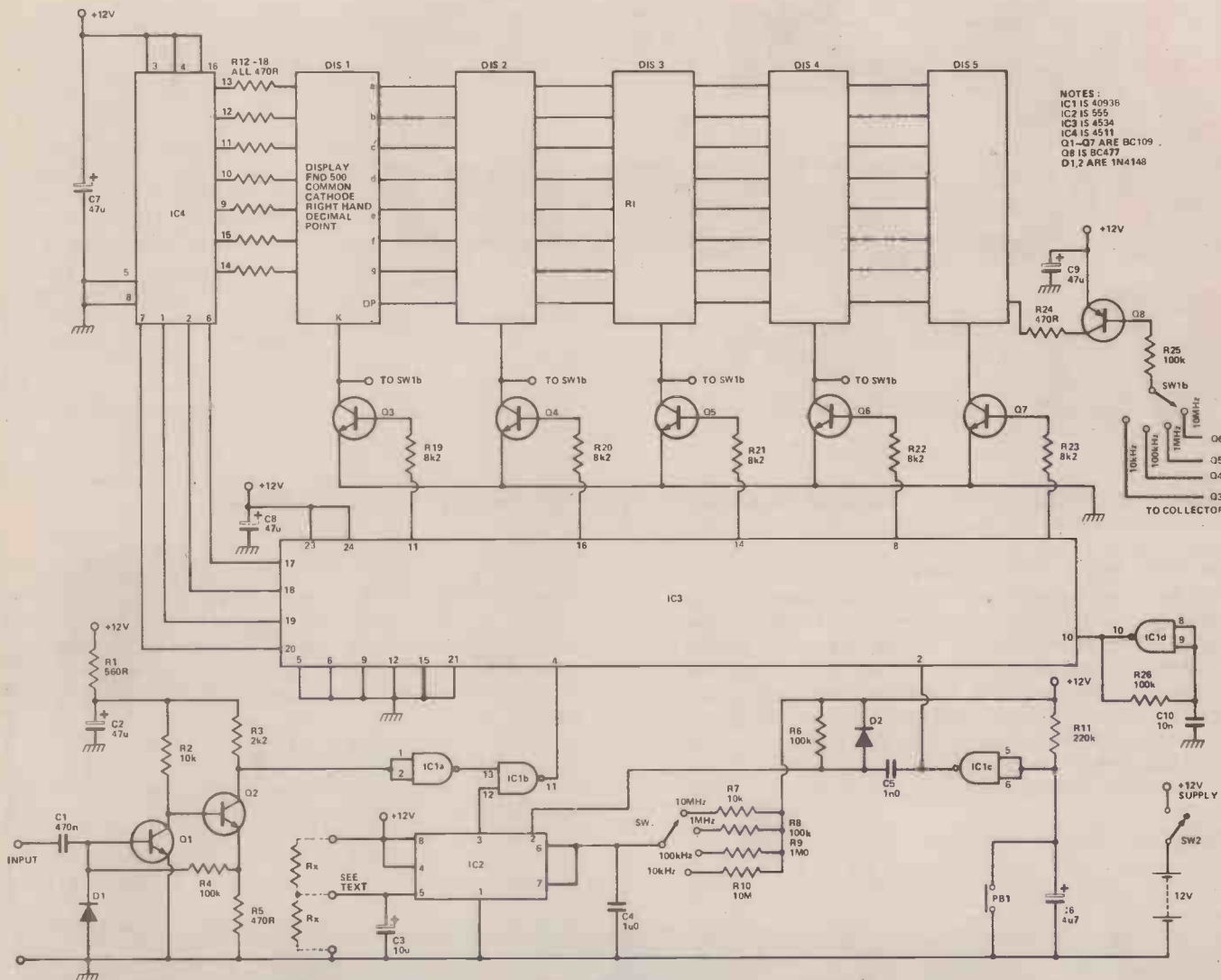

Fig. 1. Circuit diagram of the HE DFM. By using close tolerance components for C4 and R7 to R10 accuracy should be assured.

## How It Works

Circuit operation is most easily understood by considering each section separately. This approach makes troubleshooting much simpler too.

### THE AMPLIFIER

Transistors Q1, 2 form a simple direct-coupled amplifier. The DC operating point is set by negative feedback via R4. Input signals are capacitively coupled via C1. The value chosen gives good results between 20 Hz and 2 MHz. The amplified signal appears at Q2 collector where it is 'squared-up' by Schmitt trigger gate IC1a whose output drives one input of IC1b. Components R1, C2 provide a smooth 'decoupled' supply for the amplifier.

### THE COUNTER WINDOW GENERATOR

Input pulses are only allowed to reach the counter (pin 4, IC3) when the other input of IC1b is 'high'; ie at about twelve volts. The input is driven from a 555 counter, IC2, connected as a monostable multivibrator. This means that upon being triggered when the voltage at pin 2 drops below about one-third of the supply voltage, the chip will

generate a pulse whose length is determined by the values of C4 and one of the switch-selectable resistors R7, 8, 9, 10. This pulse provides a 'window' during which time signal transitions at the amplifier input are counted. The number of transitions (that is just another way of saying changes from one level to another) in a certain period; say a second, is expressed as the frequency of the input waveform. This means that a frequency of 50 Hz is just a way of saying that there are fifty cycles of change in one second of time. A cycle is a change from positive to negative and back again. By changing the counter window length, we can provide our frequency meter with different ranges. This circuit generates a window of ten secs., one sec., one tenth sec., or one hundredth sec. depending on the choice of resistor R10 to R7; giving a full scale measurement from 9.9999 kHz to 9.9999 MHz.

A novel feature of the 555 chip used in this design is its ability to provide a large range of output timing periods with good accuracy. Using a polyester capacitor for C4 and close tolerance resistors



# Frequency Meter

## How it Works

for R7 to R10, the timing intervals obtained will be very close to ten times multiples of each other. This means that if the circuit can be accurately set up on one range then the other ranges will fall into line automatically. Fortunately the 555 has another trick up its sleeve as the timing period, even with fixed values of R and C, can be varied considerably by use of the control input, pin 5.

With the unit set to the lowest range, a 50 Hz signal from the low voltage output of a transformer (say 6 or 9 volts) may be applied to the input via a resistor (about 1 M $\Omega$  should do). After depressing and releasing PB1, the display should flicker as the unit counts until a steady number is displayed. The mains frequency is 50 Hz but the display will probably read 55 Hz or so. A resistor 'Rx' should now be connected between 'C' and 'N' and a new reading taken. Different values of resistance should be tried until the display indicates 50 Hz (0.0500) or at least something close. Don't be surprised if a slightly different reading is obtained even with the same value of resistance for Rx. We found a value of 56 k was about right. If a value less than 10 k is required then C4 should be replaced. In the unlikely event that the display reads less than 50 Hz then the resistor should be connected between 'C' and 'P'. Any value down to 4 k7 may be used. Once one range is calibrated, the accuracy of the other ranges will depend on the tolerance of resistors R7, 8, 9, 10. Capacitor C3 prevents noise from upsetting things at the control input.

### COUNTER AND TRIGGER

Depressing PB1 causes the output of IC1c to go high to a logic '1' resetting the counters in IC3.

When PB1 is released, C6 charges via R11 and IC1c output goes low removing the reset signal from IC3 and triggering the monostable IC2 which enables gate IC1b to pass signals to the counter input (pin 4, IC3). IC3 contains five decade counters which means that it can count up to 99,999 before 'overflowing' and starting again from zero. The output of each stage is presented in binary-coded-decimal form on pins 17, 18, 19, 20. Each stage uses all four pins but only one stage at a time is connected to them. Simultaneously, one of the digit driver outputs goes high corresponding to the stage whose value is being output. The binary-coded-decimal signals are converted to drive a seven-segment display by IC4 and the appropriate digit is enabled by Q3 to Q7 driven from the digit driver outputs pins 11, 16, 14, 8, 7. The decimal point is driven from Q8 which is turned on at the appropriate time by controlling it from the digit driver transistors via SW1b. The technique of using a few pins to carry many signals at different times is known as multiplexing. The multiplexer circuitry inside IC3 needs to be driven by an external clock and this is provided by IC1d which, with R26 and C10, oscillates at about 700 Hz. (Try using the meter to check this after you have built it!) The exact frequency is not important. Resistors R12 to R18 and R24 serve to limit current flow in the display driver and the LED displays. Do not be surprised if the resistors feel a little warm. They dissipate about 200 mW and this is quite normal.

The 47 $\mu$  capacitors dotted around the circuit help to prevent interaction between different stages and are deliberately sited close to individual chips and transistors.

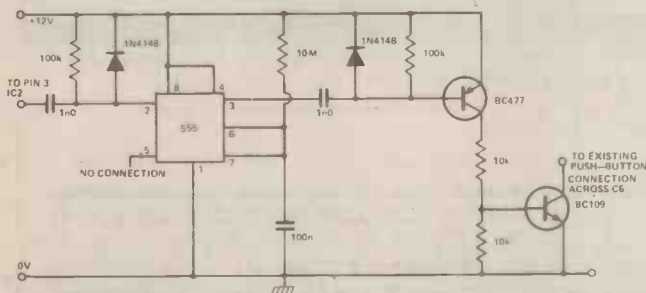

Fig. 2. Suggested additional circuitry to perform "auto update" on DFM.

sophisticated units of this type use a crystal oscillator and divider chain to provide accurate timing (just like in your digital watch). As this would have added considerably to the cost of the project an analogue technique based on the ubiquitous 555 timer chip has been used. This is not too much of a problem as the 555 is capable of providing accurate and repeatable time delays set by choice of just one resistor and capacitor and a simple technique is outlined in "how it works" for calibrating all four ranges.

### CONSTRUCTION AND USE

If you are confident of your ability to handle CMOS and make the many interconnections required then almost any constructional technique may be used. However, we



Above. Side view of the DFM. By keeping a low profile it's easier to mount the unit in its box.

Below. Although the layout is not critical we strongly recommend you follow ours.

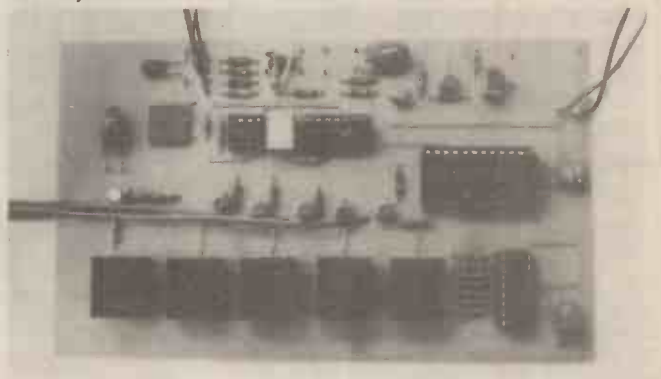





# Frequency Meter

strongly recommend that our PCB design is used as this will cut down the chance of any error creeping in.

If you do use a PCB then construction is quite straightforward. There are sixteen wire links to make and these should be inserted first as they pass beneath many of the other components. Use an insulated link for the connection between IC2, pin 3 and IC1, pin 12 to avoid a possible short circuit to C4. The other components may be inserted almost as they come to hand although it helps to have some kind of system to facilitate checking. The best course is to follow the parts list; resistors first followed by capacitors and finally the semiconductors. This technique minimises the chance of overheating the semiconductors though modern silicon devices are fairly hardy anyway. We usually use IC sockets; avoiding handling problems and enabling the chips to be re-used or replaced if they fail. The LED displays may be soldered to the PCB or "soldercon" pins can be used. These are do-it-yourself IC sockets which are supplied in strip-form. You just break off as many as you need; in this case five, solder them into the board then break off the unwanted metal carrier strip at the top of the pins by grasping it with a pair of pliers and repeatedly flexing it back and forth. The displays should be mounted so that the decimal point is facing away from the nearby edge of the board. In fact the displays will still work if you put them in back to front but you will see some pretty funny numbers!

There are few connections to make to the board and the only ones which need special care are those to SW1. These should be arranged so that when one section is connected to R7, the other section connects with the collector of Q6 and so on as the ranges are selected. This gives a display reading directly in kilo-Hertz with a moving decimal point so each range is selected and facilitates reading the display.

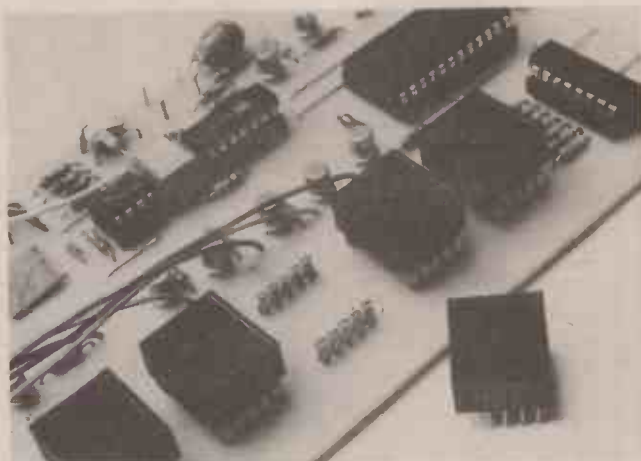

One of the display units removed from its socket. Note C2 and C6 are mounted flush to the board.

In use, the highest range should be used first and then lower ranges selected as required. This avoids false readings as the counter overflows. The unit is quite sensitive and will tolerate many waveforms though it becomes fussier on the highest range, preferring a sinusoidal waveform. The basic design will only update the display following a depression of PB1. Included here is a simple update circuit which you can add if you like. It works by imitating the action of depressing PB1 electronically about one second after the display has settled. Any method of construction may be used for this little circuit and there shouldn't be much difficulty in making the required connections to the main board.

Whichever way you build it, this project will provide you with an economical piece of test gear — off the shelf and made to measure.

HE

## TRANSFORMER OFFER (PSU)

If you are contemplating building the 25 watt amplifier and PSU modules in last month's HE (page 19) then you may be interested in our special Readers Offer. We have a fairly limited supply of transformers suitable for the PSU module. These are the same types as used on our prototype. We have two types on offer, the larger of the two is a 100 VA device, it has two 12V windings and one 40V winding. The primaries are both rated at 240V AC. (The smaller models also has a 220V tapping on the primary).

Both types are available for just £6, that includes VAT and postage and packing. (Postage on the larger one is nearly £1.50!) so as you can see it is a very good deal indeed.

When ordering please specify which type you need (S or L). As stocks may be limited we reserve the right to send you the alternative model, so order early.

**Send cheques, postal orders or gold (not less than 1oz please) to:**

**HE TRANSFORMER OFFER.**

**Hobby Electronics,  
145 Charing Cross Road,  
London WC2H 0EE.**

Few only



Personal callers to the HE offices can purchase the transformers for just £4.50 (inc VAT)

### QUARTZ LCD 11 Function Slim Chronograph

12:30<sup>pm</sup>  
Hours mins secs

8 14<sup>TH</sup>  
Month date day

0:00<sup>00</sup>  
Min secs 1/10 1/100



Price only  
**£9.95**

Also available:  
SOLAR CHRONOGRAPH  
M9 Price £11.95

6 digit, 11 functions,  
Hours, mins., secs., day,  
date, day of week,  
1/100th, 1/10th, secs.,  
10X secs., mins.  
Split and lap modes.  
Back-light, auto calendar.  
Only 8mm thick.  
Stainless steel bracelet  
and back.  
Adjustable bracelet.

SAME DAY DESPATCH.  
**M3** Price includes POST & PACKING

### QUARTZ LCD ALARM with Snooze Alarm

12:30<sup>pm</sup>  
Hours mins secs

8 14<sup>TH</sup>  
Month date day

7:30<sup>A</sup>  
Alarm



Price only  
**£9.95**

6 functions plus Alarm.  
Conference signal,  
5 minute snooze alarm,  
Conference signal sounds  
4 secs. before main alarm  
to give advance warning  
and an option to cancel.  
Snooze sounds 5 mins.  
after main alarm and is  
always preceded by the  
conference signal.

SAME DAY DESPATCH.  
**M4** Price includes POST & PACKING

### QUARTZ LCD ALARM CHRONOGRAPH with 12/24 display

12:30<sup>pm</sup>  
Hours mins secs

8 14<sup>TH</sup>  
Month date day

0:00<sup>0</sup>  
Min sec 1/10th



Price only  
**£13.95**

Also available:  
SOLAR ALARM CHRONO  
M7 Price £17.95

Alarm  
Hours, mins, secs, day  
of week. Month, date,  
day of week, alarm,  
hour, mins., a.m./p.m.  
24 or 12 hour display  
mode. Alarm test.  
Chronograph, lap  
time, stop watch 1/10  
secs.

**M16** Price includes POST & PACKING

### QUARTZ LCD Ladies Day Watch

Hours, mins., secs., day,  
date, back light, auto  
calendar.

12:30  
Hours mins

8 14  
Month date

:45  
Secs



Price only  
**£7.95**

Fully adjustable bracelet.  
Only 25 x 20mm and  
6mm thick.  
Silver or Gold.

**M15** SAME DAY DESPATCH. P.&P. included

### QUARTZ LCD Ladies Cocktail Watch

Beautifully designed with a very thin bracelet.

12:30  
Hours mins

8 14  
Month date

:45  
Secs



Price only  
**£14.95**

Hours., mins., secs., day, date,  
backlight and autocalendar.  
Bracelet fully adjustable to  
suit slim wrists.  
State Gold or Silver finish.  
Only 25 x 20 x 6mm.

**M18** SAME DAY DESPATCH. P.&P. included

### HANIMEX Electronic LED Alarm Clock

Features and Specification:

Hour, minute display. Large LED display with  
p.m. and alarm on indicator. 24 Hours alarm  
with on/off control. Display flashing for power  
loss indication. Repeatable 9-minute snooze.  
Display bright/dim modes control. Size: 5.15"  
x 3.93" x 2.36" (131mm x 11mm x 60mm).  
Weight: 1.43 lbs (0.65 kg).

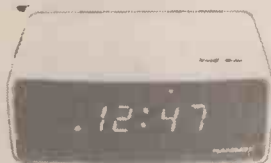

**M13**

Price only Mains operated.  
**£10.20** Thousands sold!

### QUARTZ LCD 5 Function

Hours, mins., secs.,  
month, date, auto  
calendar, back light,  
quality metal  
bracelet. 6mm thick.

12:30  
Hours mins

8 14  
Month date

:45  
Secs



Price only  
**£6.95** P.&P. included

**M1** SAME DAY DESPATCH. P.&P. included

### METAC GUARANTEE

All METAC products carry 12 months guarantee and we also refund your money if not satisfied with our goods or service in the first 10 days.

METAC's well equipped service centre minimises service delays. Please note, we do not delay your order to clear cheques.

Telephone your order using

Barclaycard/Access

Number on on

**03272 -  
76545**

OR

**01-723 4753**



24 hour answering service  
OR COMPLETE THE  
COUPON

### WHOLESALE MAIL ORDER

Send for our trade price list and order details. Sell our products to your friends and earn yourself

**£££'s**



**NEW 24 HOUR  
DESPATCH SERVICE**

METAC have opened a new even faster Mail Order and Service Centre at **DAVENTRY**. Orders received before 3.30 p.m. will be despatched same day.

**VISIT OUR ELECTRONIC TIME CENTRES  
AND SEE ONE OF THE MOST IMPRESSIVE QUARTZ WATCH  
RANGES IN BRITAIN**

**LONDON**  
327 EDGWARE ROAD,  
LONDON W.2  
Telephone: 01-723 4753

**DAVENTRY**  
67 HIGH STREET,  
DAVENTRY, NORTHANTS.  
Tel: 03272 76545/77659

**NORTHAMPTON**  
ST. GILES SQUARE,  
NORTHAMPTON  
(Opens 1st February, 1980)

**QUARTZ MELODY  
Alarm Chronograph**

**INCREDIBLE WATCH 34 Functions**

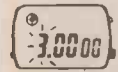

Count-down Timer

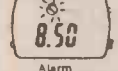

Alarm

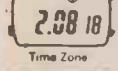

Time Zone

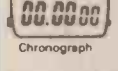

Chronograph



5 independent working modes, day of week in English, French or German. (Just select the one you like). Hours, mins., secs., day, date, countdown alarm, dual time zone, 1/100th sec., stopwatch. Lap/split time, 1st and 2nd place times. Melody test function.

Price only  
**£19.95**

Price includes  
POST &  
PACKING

**M30 SAME DAY DESPATCH.**

**CASIO CHRONO  
950S - 32B**

Stainless steel case, water resistant to 66 feet. Hours, mins., secs., am/pm, year, month, date, day. Auto calendar. Pre-programmed until the year 2029. 12/24 hour. Stopwatch function. Range 7 hours, 1/100 sec. (Mode) Net time/lap-time/1st - 2nd place times. Dual time function. Accuracy 15 secs. per month. Battery life approx. 4 years.



Price only  
**£23.95**

**M22 SAME DAY DESPATCH.**

**CASIO ALARM  
CHRONO**

**81CS - 36B**  
Hours, mins, secs., day, and also day, month and year perpetual automatic calendar. 100th sec. chronograph to 7 hours. Net time/lap/time/1st and 2nd place times. User optional 12/24 hr. display. 24 Alarm. User optional, hourly chime. Backlight, mineral glass, stainless steel. Water resistant to 100 ft. Battery life approx. 4 years.



Price only  
**£35.95**

**M25 SAME DAY DESPATCH.**

**CASIO F-200  
Sports Chrono**

Attractive Mans watch in black resin with mineral glass. Hours, mins., secs., am/pm. Month, date, alpha-numeric day. Auto-calendar set 28th Feb. Stopwatch working range 1 hour, units 1/100 sec. Mode, Net Time/lap/time/1st - 2nd place times. Accuracy approx. 15 secs. per month. Battery 12 months.



Price only  
**£15.95**

**M24 SAME DAY DESPATCH.**

**CASIO F-8C  
3 year battery life**

Hours, mins., secs., am/pm, date, day. Auto calendar set 28th February.

Accuracy 15 secs. per month.

Battery life approx. 3 years.



Price only  
**£10.95**

**M36 SAME DAY DESPATCH.**

**SEIKO  
CHRONOGRAPH**

Hours, mins., secs., and day of the week. Month date and day of the week. Stopwatch display - Hours., mins., secs., up to 12 hours (mins., secs., 1/100 secs. up to 20 minutes). Lap timing. Continuous time measurement of two competitors. Stainless steel, mineral glass.



Price only  
**£39.95**

**M33** SAME DAY DESPATCH.  
including POST & PACKING

**SEIKO ALARM  
CHRONOGRAPH**

With WEEKLY Alarm, Hours, mins., secs., month, date, day, am/pm. Weekly alarm - can be set for every day at designated time, e.g. 6.30 am on Monday, Wednesday and Friday. Alarm set time displayed above time of day. Full stopwatch functions, laptime, split etc.



Price only  
**£79.95**

**M10** SAME DAY DESPATCH.  
including POST & PACKING

**SEIKO DIGI-ANA  
CHRONOGRAPH**

TIME AND CALENDAR FUNCTION

Analog part display Hour, mins., secs. Digital part display; Hour, mins., secs., date, day and colon. Calendar-month, date, day, stopwatch - Hour, mins., secs., 1/100 secs. LAP/STOP and stop marks. Counter-function. Time and calendar setting function.



Price only  
**£79.95**

**M62** SAME DAY DESPATCH.  
including POST & PACKING

POST COUPON TO: METAC (24 hour despatch centre), FREEPOST, 47a High Street, Daventry, Northants.

PLEASE COMPLETE BOTH COUPONS

Please send me .....

I enclose P.O./Cheque value .....

Barclaycard/Access No. ....

Name .....

Address .....

FROM:

**METAC ELECTRONICS & TIME CENTRE, (ETI),  
67 HIGH STREET, DAVENTRY, NORTHANTS.**

Name .....

Address .....

POST, PACKING AND VAT INCLUDED IN PRICE.

# Narrow Bandwidth Television

## PART 1

*How do you fancy building your own closed circuit TV system for around a fiver? How about making video recording on an ordinary domestic tape-recorder? Sounds too good to be true, but it is as Doug Pitt of the Narrow Bandwidth TV Association explains in this major two part feature.*

READERS of popular radio and electronics magazines may have noticed references, over the past few years, to NBTV (or LDTV as it is sometimes called).

Quite simply, this indicates a resurgence of interest in the old 'Baird' system of mechanical TV, called 'Narrow Bandwidth' because the signals generated in the formation of the pictures occupy roughly the same range as audible sound, that is, up to about 12 KHz only.

The alternative label, 'Low Definition', refers to the relatively coarse picture structure, of roughly 24 to 64 parallel lines, compared to the Modern European standard of 625 lines which is 'high' definition.

Television since 1946 is almost wholly linked to the cathode-ray tube display (perfected as a mass-produced component during World War II) and to the high definition picture of many hundreds of lines. It is not generally appreciated that the mechanical systems maintained their superiority, even with 405 line signals, right up to 1939.

Familiarity with the mechanical systems is now rarely encountered. It is confined to an older generation who experienced the excitement of the pre-war television broadcasts or the more thoughtful readers of technical encyclopedias who may have been stimulated by such odd entries as 'Nipkov Disc', to seek further knowledge.

### THE THIRTY LINE BROADCASTS

Broadcasting of TV entertainment programmes were started by the British pioneer, John Logie Baird, in 1929 and continued under joint Baird/BBC direction until late 1935.

Broadcasts were confined to the early morning and late evening to avoid 'contact' with normal sound broadcasting, and used two medium waveband frequencies, the second for the accompanying sound. Naturally, two receivers were needed, as with early stereo-sound broadcasts.

The pictures were both transmitted and displayed by mechanical devices and used thirty (vertical) lines, with 12½ pictures per second. To the modern TV viewer, a thirty line picture is mind-boggling, accustomed as it is to the luxury of 625 horizontal lines for picture composition.



*Photograph from a CRT screen of a 48 line picture. Pictures of this quality are easy to duplicate on relatively simple equipment. (The use of a CRT for display is simply to produce a better photograph.)*

Suffice it to say that for single-person acts (singers, instrumentalists, ventriloquists, magicians, and the like), it proved both adequate and exciting and attracted all the top-flight cabaret entertainers of the period to the 'little screen'. Some, like Arthur Askey, are still around to talk about it.

Like all medium-wave transmissions, especially at the higher frequency end of the band, they were receivable, after dark, over a wide area, so that BBC/Baird TV became a talking point from Iceland to Morocco, and from the Azores to Warsaw.

The receivers (mainly home-built from kits of parts) consisted, in their simplest form, of a rotating disc of aluminium, a driving motor, a neon lamp, and some sort of synchronising device — if only in the form of a well-trained finger!

### MODERN NBTV

The revival of activity in this field, with which the author is associated, takes the 1930-35 experience merely as a starting point. Since it is a practical rather than a nostalgic movement, all modern devices, components, and materials, are employed and at the receiving end of



the process, old TV's and oscilloscopes are unhesitatingly pressed into service. The domestic tape-recorder, quite adequate for the frequency range of NBTV signals, provides a storehouse for programmes and for their transmission through the post. Stereo recorders enable instant synchronised sound to be added.

## WHAT DOES NBTV OFFER?

It is important neither to exaggerate nor under-estimate the possibilities of the system. The moving pictures produced are inferior in detail to those of, say 8 mm home movies and do not (as yet) provide colour. On the other hand, their cost of production is virtually zero, as tapes can be continually re-used.

They are clearly inferior to the familiar high definition TV pictures, but the wide bandwidth required for these, (several megahertz) inhibits their use by radio amateurs and restricts storage to those who can afford a highly expensive VTR machine.

Compared to the Slow Scan branch of amateur TV, NBTV requires a bandwidth some four times as wide, but as a compensation, provides the vital quality of *movement* which no amount of stationary perfection can match in terms of human interest.

Above all, NBTV is *very inexpensive*, opening up TV experimentation to all with the patience and determination to build the required apparatus themselves. Its circuitry is relatively simple and its mechanics offer unlimited scope for ingenuity. It is perfectly adequate for 'personal' and 'close-up' subjects.

If you examine the printed examples of photos taken from NBTV displays, making allowance for picture degradation caused by the necessary 'screening' for magazine printing, then imagine these pictures *in motion*, you should get a fair idea of NBTV's potentialities and limitations.

On the other hand, if you are thinking of using the system to produce a new version of 'War and Peace', with a cast of two thousand Cossacks — forget about it!

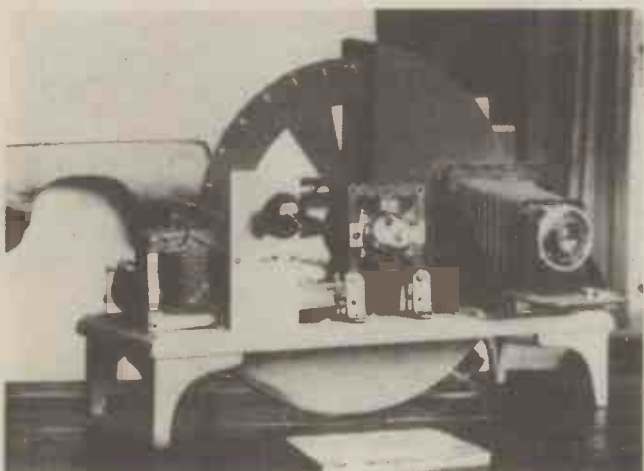

A simple NBTV camera with a photomultiplier for superior definition at low light levels.

## THE START

No attempt is made in this article to describe a complete NBTV system. That would be far too complicated and likely to put you right off the subject. Instead, the

principal techniques and terms will first be explained, and secondly, some simple experiments, involving few special components and relying heavily on the 'junk box', will be described. If, after pursuing these, sufficient interest has been aroused, you can seek (easily obtained) further information.

## PICTURE ANALYSIS AND SYNTHESIS

In all conventional TV systems the picture is 'analysed' into a steady stream of electrical information about its gradations of brightness, and then re-synthesized into a semblance of the original form in two-dimensional space, using the stream of information (video signal) as building material.

The direction and sequence of the analytical 'passes' is of trivial importance, provided they match the corresponding movements at the receiving end *precisely* and in *perfect synchronism*. Usually, and following P. Nipkov and J. L. Baird, they are of *parallel lines in ordinary sequence and in the same direction*. The simplest method of achieving this is by means of a Nipkov Disc, as shown in Figure 1.

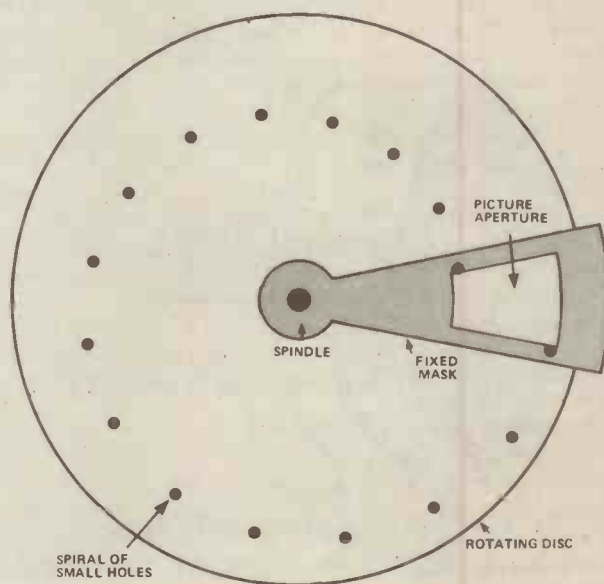

Fig. 1. Nipkov Disc

A large disc of some thin, opaque material (aluminium, blackened card, plastic etc) is rotated behind a fixed mask. The disc has a spiral of small holes drilled in it, fairly near the rim. Each hole lies exactly on an equal sector of the circle and the aperture in the mask is exactly one sector high. In this way only one hole can ever appear in the aperture at any given moment. The width of the aperture is less important but must not, of course, be less than the complete 'throw' of the spiral.

If a diffused light is placed *behind* in the disc at the aperture position and the disc rotated rapidly, an evenly illuminated 'raster' of parallel curved lines will appear in the aperture, the individual holes vanishing through 'persistence of vision'. Each revolution of the disc completes one exploration of the whole area of the picture aperture.

If the light behind the disc fluctuates, lighter or darker patches will appear within the area, these building up the picture in a receiver. In the case of a camera, a convex lens is arranged in front of the mask at such a distance as to focus a sharp image of the subject onto the disc. The light behind the disc is replaced by a photosensing device to convert the analysed picture into electrical signals. Two such discs, mechanically and electrically coupled, constitute a complete NBTV closed-circuit system.

If the principal is not clear from the fore-going description, a model made of two pieces of card and a 'butterfly' paper-fastener should enable the basic notion of *scanning* to be grasped.

A variant of the Nipkov (or perforated) disc is the perforated drum shown in Fig. 2. It works in just the same way and can be made from a round biscuit tin or similar. The raster lines are straight instead of slightly curved as in the disc. It is very easy to mark out the helix of holes on the curved surface because a helix, when straightened out, becomes a *slanting straight line*. For this reason, a strip of paper wrapped round the drum to measure the circumference then removed and creased into equal parts, can quickly determine the hole positions when used as a template. Oddly, the drum has never been as popular as the disc.

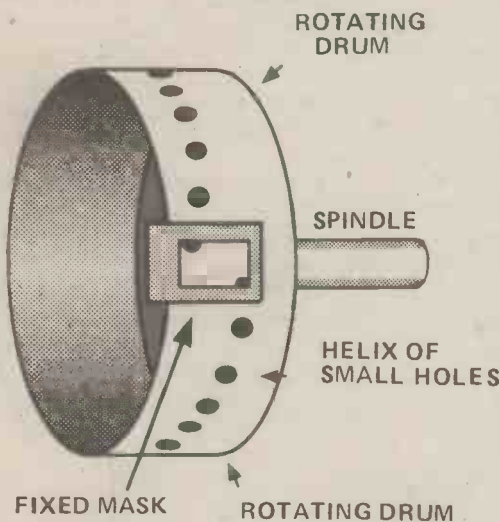

Fig.2. Perforated drum

Both disc and drum are examples of *moving point* devices and cameras using them depend on *ambient light* i.e. the light natural or artificial, that happens to be shining on the subject and gets reflected from it into the camera lens. This light is often rather low in intensity and the camera needs a sensitive photosensor to detect it. Increasing the ambient light may dazzle a living subject or make it uncomfortably warm. The device shown in Fig. 3, called the mirror-drum gets over this difficulty by using a blacked-out room and projecting a moving spot of intense light onto the subject in the form of a raster of parallel lines. Because of the rapid movement, the subject sees and feels the projected spot as dim and cool, while the photosensor records a high level of reflected light.

The raster is produced, because the flat mirrors arranged around the curved surface of the drum form a perfectly regular polygon when viewed *parallel* to the

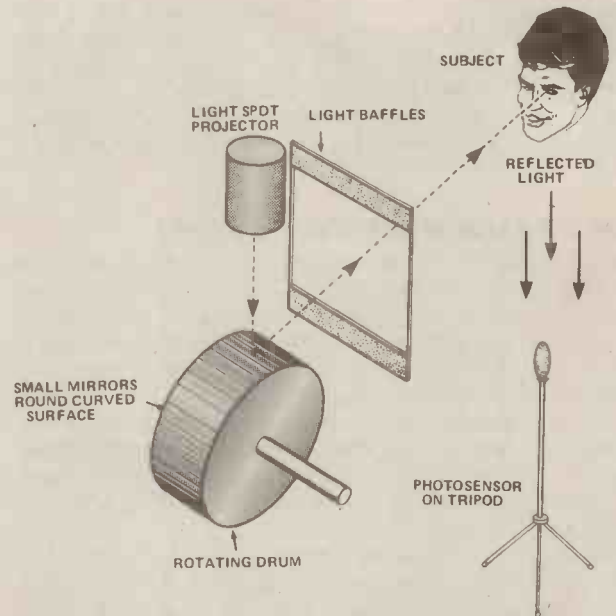

Fig.3. Mirror Drum 'Flying Spot' camera

axle, but are each tilted at a slightly different angle when viewed *at right angles* to the axle. The light baffles are needed to prevent more than one spot of light reaching the subject at any moment and are just a larger version of the mask used on a disc. The whole process is called 'Flying Spot'.

### MOVING IMAGE SCANNERS

Moving point devices, like all those described so far, favour photosensors with a fairly large sensitive area, small detectors such as phototransistors, with only a tiny sensitive area, are difficult to employ. For these, *'moving image'* scanners can be used. Two examples are illustrated.

The first, (Fig. 4) uses a disc with lenses instead of holes. It is called a Lens Disc and there is the familiar spiral arrangement. Because of weight and expense, plastic lenses are preferred. Each lens focuses a sharp picture of the subject onto the centre of which is a small hole. Immediately behind the hole in the screen is a photosensor of small size. When the disc rotates, a succession of images, each in a slightly different position, sweeps across the screen. The analysing effect is just the same as though the hole were moving and the image were stationary.

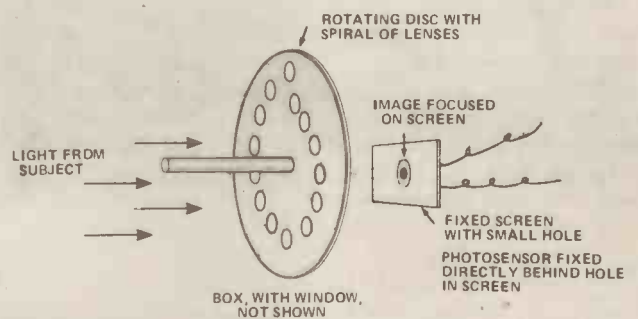

Fig.4. Lens Disc Camera



# Narrow Bandwidth Television

Another moving image type of scanner is shown in Fig. 5. It employs the mirror-drum shown in Fig. 3 in combination with one good quality lens. Again, a succession of images moves across the screen with one small hole in it. In both moving image devices shown, the screen and photosensor are arranged to have a small 'fore-and-aft' freedom of movement for the purpose of focusing.

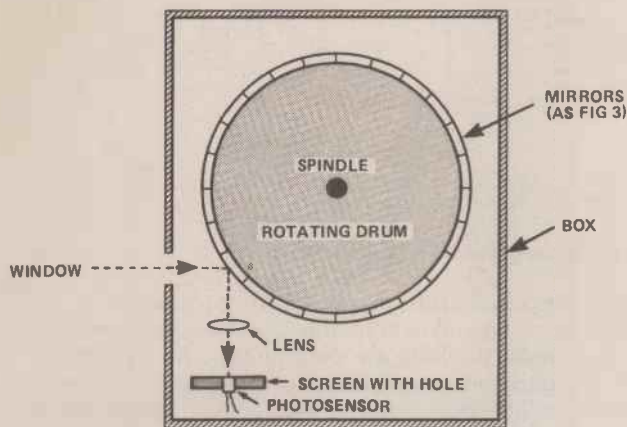

Fig.5. Mirror Drum Camera

## AN EXPERIMENTAL NIPKOV DISC

Before constructing your first disc, it is necessary to decide how many holes the spiral is to have, that is, how many lines the picture is to be built up of. You will also have to decide what aspect ratio the picture is to be and how big.

A useful size of disc to start with is 1ft diameter because a ready-made black plastic disc of this size is easily obtainable in the form of a discarded LP record. However, make sure it has been discarded because of scratches, not because of warping.

It is best to select the number of holes (n) in the spiral either from the series 12, 24, 48 etc, or the series 16, 32, 64 etc. These two series, interwoven, ie 12, 16, 24, 32, 48 etc are often called 'Pythagorean Numbers' and a circle can be divided into such numbers using only a ruler and a pair of compasses (or dividers) so you don't need a large protractor.

The aspect ratio (a) of a picture means its length (direction of scanning or spot movement), divided by its width (at right angles to scan) and for a square this is of course 1, the easiest figure.

The step(s) of the spiral is the small amount of inward (or outward) movement per sector, so 'ns' is the width of the picture area. Choose 's' as any amount eg 1/16" or 0.5 mm, to make measurements simpler. As an example, we could choose a 32 hole spiral (so n=32), a 3 by 2 picture so a = 3/2 or 1.5, steps of 0.5 mm each, making s = 5 mm. The outermost hole of the spiral will then be R<sub>(o)</sub> mm from the centre of the disc, according to the formula:—

$$R_{(o)} = \frac{n^2sa}{2\pi} + \frac{(n-1)s}{2}$$

Substituting figures this becomes:—

$$R_{(o)} = \frac{32^2 \times .5 \times 1.5}{2 \times 3.14} + \frac{31 \times .5}{2}$$

The first fraction works out at 122.3 mm and this, incidentally, gives R<sub>(m)</sub>, the radius to the middle of the picture area. The second fraction works out at 7.75 mm and these, added together, give about 130 mm. Since an LP record has a radius of 150 mm, this fits rather nicely. So, after drawing 32 sectors on the record, you mark a point 130 mm from the centre and work inwards 1/2 mm each sector.

## MARKING THE SECTORS

Clean off the grooves (strictly, 'one' groove!) on one side of the record with rough glass-paper, then polish smooth with fine glass-paper. Stick a small disc of plastic etc, over the central hole and mark on this, a deep pin-prick exactly at the centre of the record.

Since 32 is a number in the second series mentioned, we start with a true diameter scratched across the centre, using a good steel rule. Using dividers, we bisect these 180° angles to give four sectors of 90° each, then bisect again to give eight of 45° each, and so on until we have scratched 32 sectors of 11.25° each.

The method is simple and enables us to disregard the actual number of degrees altogether. If the number has been in the first series, say 24, we should have started by drawing a large circle and stepping off the radius round the circumference (exactly six times) to give a basic six sectors. Bisecting these gives 12 sectors, and again gives the required 24.

Marking the points of the spiral requires a sharp steel point, a good eye, and an accurate ruler. Finish off with a 0.5 mm drill to give clean holes. The fact that the steps(s) have been chosen as 0.5 mm each does not necessitate the choice of a 0.5 mm drill; in practice a larger drill size is preferable, say 50% larger than the step size.

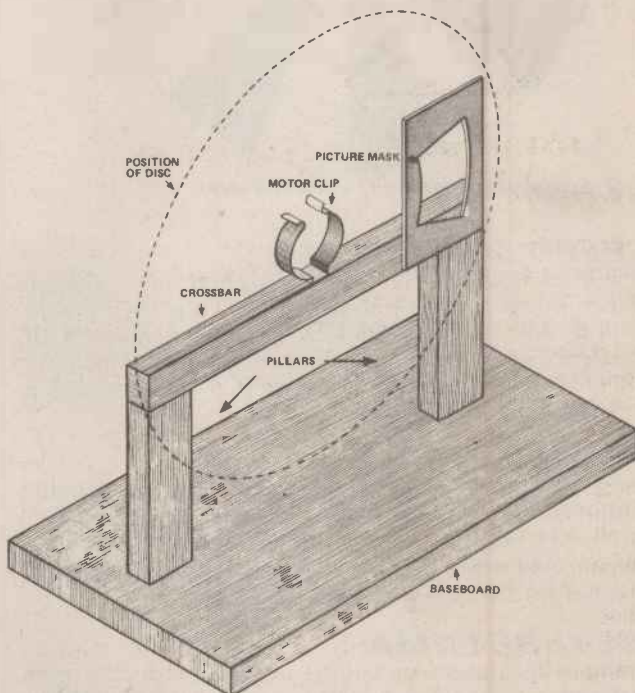

Fig.6. Wooden 'Goal Post' mounting



# Narrow Bandwidth Television

## MOUNTING THE DISC

The simplest mounting is shown in Fig. 6 and is referred to as a 'goal-post'. It consists of a wooden baseboard and three strips of wood. Two of these match the disc's radius and the third matches its diameter. A Terry-clip or similar holds the drive motor or a separate bearing for the disc, if indirect drive is preferred.

## CHOICE OF MOTOR

A powerful motor is not needed, provided that the disc has been well balanced and does not wobble. (Sticking on small pieces of card, washers, etc, will effectively cure wobble if carefully done).

Avoid very flimsy motors, such as these used in toys. They produce noise and sparks and 'gobble' up current. Cassette-recorder type motors are much better and justify the extra cost. Before drilling, the centre of the disc to fit the motor-spindle or other axle, stick a paper stroboscope as in Fig. 7 onto one side of the disc.

Indirect drive is preferable to direct, when using a small motor. For this, arrange some sort of bearing for the disc centrally on the crossbar with a pulley-wheel on the axle, and position the motor, with a *smaller* pulley, in a clip directly below on the baseboard. A rubber band completes the drive arrangement.

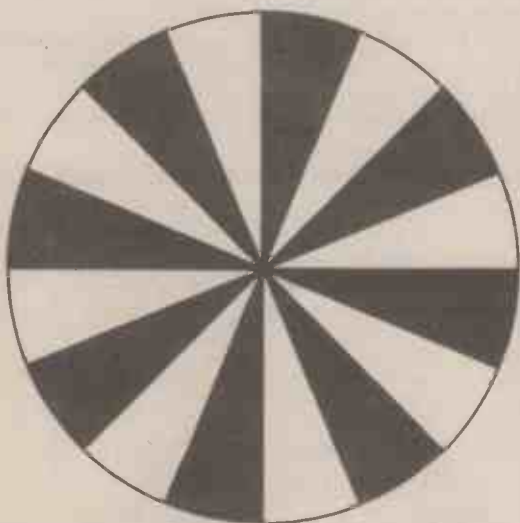

Fig. 7. Stroboscope pattern (approx half size)

## SPEED CONTROL

Speed controls used in NBTV are often quite sophisticated, but a simple potentiometer, preferably wire-wound, will do for a start. Measure the motor's DC resistance with a multimeter and choose a potentiometer with roughly the same resistance. Connect the potentiometer in series with the power supply (Fig. 8a).

## POWER SUPPLY

Because a very constant speed is needed, dry batteries should be avoided. (They are also expensive and have a short life when used to drive motors). Use a transformed-mains supply, as for model trains or cars, or a rechargeable battery such as a lead-acid type.

## PICTURE LAMP

Ordinary incandescent lamps are useless as TV light sources because of thermal lag in the filament. Mains

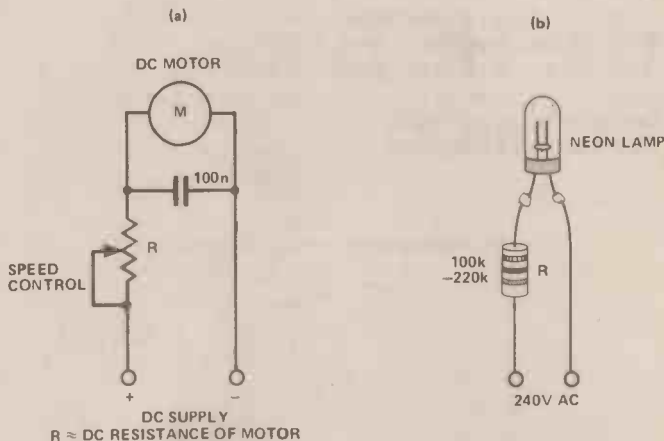
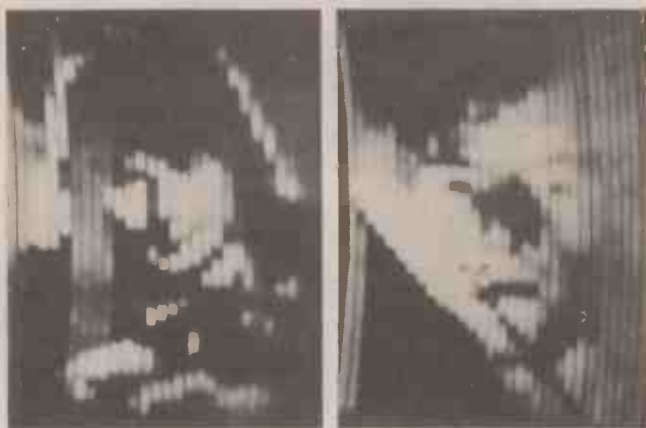

Fig. 8. Connections for motor and lamp

neons are ideal, but manufacture of suitable types ceased years ago (except on the Continent) and you may have to make do with the very cheap wire-ended sort that are generally available. However, these have no limiting resistor built into them so *when used on mains, they must have resistor minimum 100 KΩ, connected in series.* For non-mains usage, this resistor is unnecessary.

Some of the old mains-type neons are still to be discovered and are well worth searching for. In addition, many surplus alpha-numeric tubes are of the neon type and, with their segment pins strapped together, work well as light sources. Small fluorescent 'strip' tubes and mercury vapour lamps have also been successfully substituted for neons, but the latter give off ultra violet light and should not be looked at except through a diffusing screen of some sort.

HE



Two examples of NBTV pictures taken directly from the screen. The quality looks a bit rough but this is mostly due to the inherent difficulties with photographing this system. In practice the quality is quite acceptable.

Next month in part 2 Doug Pitt explains how to make a camera for your Televisor. With the aid of some simple experiments you can actually start to record your own programmes on an ordinary domestic tape recorder. This could start a new craze, watch out Philips, JVC and Sony, the HEVCR is coming . . . .



# Books from the HE Book Service

**28 Tested Transistor Project** ..... £1.55  
Richard Torrens. The projects can be split down into simple building blocks which can be recombined for ideas of your own.

**Electronic Projects for Beginners** ..... £1.65  
F. G. Rayer. Divided into 'No Soldering Projects,' Radio and Audio Frequency, Power Supplies and Miscellaneous.

**Practical Electronic Calculations and Formulae** . £2.55  
F. A. Wilson. A valuable reference for the home and laboratory, containing all the most frequently used, and some of the less well known electronic formulae and calculations.

**Popular Electronic Projects** ..... £1.75  
R. A. Penfold. A collection of the most popular types of circuits and projects using modern, inexpensive and freely available components.



**Digital IC Equivalents and Pin Connections** .... £2.85  
Adrian Michaels. Covers most popular types and gives details of packaging, families, functions, country of origin and manufacturer.

**Radio Stations Guide** £1.75  
B. Babani and M. Jay. An invaluable aid to everyone with a radio receiver helping them to obtain maximum entertainment, value and enjoyment from their set.

**Linear IC Equivalents and Pin Connections** ... £3.10  
Adrian Michaels. Gives most essential data for popular devices.

**Electronic Security Devices** ..... £1.75  
R. A. Penfold. Full of constructional circuits covering the most basic security systems to the Ultrasonic and Doppler Shift systems.

**How To Build Your Own Solid State Oscilloscope** ..... £1.80  
F. G. Rayer. The book contains concise practical instructions so that even an inexperienced hobbyist can construct a fairly sophisticated instrument with the minimum of difficulty and expense.

**50 FET (Field Effect Transistor) Project** ..... £1.55  
F. G. Rayer. Contains something of interest for every class of enthusiast. Short Wave Listener, Radio Amateur, Experimenter or audio devotee.

**50 Circuits Using 7400 Series ICs** ..... £1.65  
R. N. Soar. The author has managed to compile no less than 50 interesting and useful circuits using this range of devices, covering many different aspects of electronics.

Note that all prices include postage and packing. Please make cheques etc. payable to Hobby Electronics Book Service (in Sterling only please) and send to:

**Hobby Electronics Book Service, P.O. Box 79  
Maidenhead, Berks.**

**Essential Theory for the Electronics Hobbyist** £1.55  
G. T. Rubaroe gives the hobbyist a background knowledge tailored to meet his specific needs.

**Beginners Guide to Building Electronic Projects** . £1.55  
R. A. Penfold. Covers component identification, tools, soldering, constructional methods and examples of simple projects are given.

**50 Projects using IC CA3130** ..... £1.25  
R. A. Penfold. Describes audio projects, RF project, Test Equipment, Household and miscellaneous circuits.

**IC 555 Project** ..... £2.05  
E. A. Parr. Circuits are given for the car, model railways, alarms and noise makers. Also covers the related devices 556, 558 and 559.

**Second Book of CMOS IC Projects** ..... £1.80  
R. A. Penfold. Following in the success of the original CMOS projects book we present the second volume covering all aspects of CMOS technology from multivibrators to triggering devices.

## WEST HYDE CASES FOR H.E. PROJECTS

- Power Supply Unit (May 1979) Order Code SWF 222L
- Parking Meter Timer (May 1979) Order Code BOC 410
- Digibell Project (May 1979) Order Code MIN 020 + 020A
- Baby Alarm (July 1979) Order Code BOC 440
- Scalextric Lap Counter (January 1980) Order Code BOC 670
- Crosshatch Generator (January 1980) Order Code SAM 003
- System 5080A Amplifier Module (March 1980) Order Code ACE 100K
- System 5080A Power Supply (March 1980) Order Code MD4 01K

PLEASE SEND FOR OUR FREE  
80-PAGE CATALOGUE & PRICE LIST

THE BIGGEST SELECTION OF CASES IN EUROPE



# WEST HYDE

WEST HYDE DEVELOPMENTS LIMITED, UNIT 9, PARK STREET INDUSTRIAL ESTATE, AYLESBURY, BUCKS. TEL: 0296 20441

# ANOTHER STEP FORWARD IN TIME

## NEW CASIO WATCHES

### 81QS-35B Alarm Chronograph

Stainless steel, mineral glass. Water resistant. 5 YEAR BATTERY. Hours, minutes, seconds, day, and day, date, month and year. 12 or 24 hour display. 24 hour alarm, hourly chimes. Stopwatch from 1/100 second to 7 hours; net, lap and 1st and 2nd place times.



(£34.95) **£29.95**  
Similar to illustration

### F-80 Alarm Chronograph



Black resin case, mineral glass. Water resistant. 3 YEAR BATTERY. Hours, minutes, seconds, date, am/pm; or hours, minutes, alpha day, date am/pm. 24 hour alarm, hourly chimes. Stopwatch from 1/10 second to 12 hours; net, lap and 1st and 2nd place. Nightlight.

**£19.95** (£24.95)

### 95QS-36B Chronograph

Stainless steel, mineral glass. Water resistant. 5 YEAR BATTERY. Hours, minutes, seconds am/pm and day (12 or 24 hours). Dual time (12 or 24 hour). Day, date, month and year calendar. Stopwatch from 1/100 second to 7 hours; net, lap and 1st & 2nd place times.



(£24.95) **£19.95**

### 111QS-34B



Superbly finished chrome plated case, mineral glass. Water resistant. Comprehensive display, hours, minutes, seconds, am/pm, day and date. Button for nightlight.

**£14.95** (£17.95)  
F-8C Black resin cased version. **£10.95**

## BARGAIN BASEMENT

Clearance offers while stocks last.

95QS-32B. Chrome plated version of 95QS-32B above.	<b>£16.95</b>
CQ-82 Clock, 4 alarms (one with snooze), calculator	<b>£13.95</b>
HQ-21 Clock, calculator	<b>£8.95</b>
UFO Master Blaster Station (RRP £24.95) Was £22.50	<b>£16.95</b>
Grandstand Adam. 4 games, one as "Simon says". Was £22.50	<b>£16.95</b>
Grandstand 4-in-1. Was £22.50	<b>£16.95</b>

Send 25p for our illustrated catalogue of Casio and Seiko products. (Refundable on purchase) to TEMPUS. Information and Service Centre, 19-21 Fitzroy Street, Cambridge CB1 1EH. 12 months guarantee on all products. Wholesale prices on application.

## RETURN OF POST SERVICE

Postal and telephone orders received before 4.00 p.m. will normally be despatched the same day by FIRST CLASS POST.

Send your order by FREEPOST (Second class post — no stamp required). Please telephone urgent orders or use first class mail. (NB Postcode CB1 1DB).

You may use the order form opposite

PRICE includes VAT, P&P. Send your Company Order, Cheque or P.O. or phone your ACCESS or B'CARD number to.

# TEMPUS

Tempus (Dept. HE)  
FREEPOST, 164-167 East Road  
Cambridge CB1 1BR. Tel. 0223 312866

Our retail shop will be moving soon. Personal callers, please telephone first for details.

## NEW CASIO CALCULATORS

### MELODY 81

(ML-81)  
(RRP £24.95)

**£22.95**

More musical than the Melody 80



### ML-81. 11 Note Melody Maker

Clock. 200 year auto calendar. Two musical alarms, countdown timer and hourly chimes. 1/10 second stopwatch measuring net, lap, and 1st & 2nd place times to 24 hours. Calculator with full memory, %, square roots. 1 year battery life from two RW42 batteries. 5/16"x4 1/2"x2 1/4".

### ML-71

(£24.95)

**£22.95**

As ML-81 but 1 alarm 3/16"x3 3/4"x2 1/4".



### AQ-2200

**£19.95** (£21.95)

Permanent display of full month calendar. Clock, alarm, hourly chimes. Stopwatch from 1/10 second to 12 hours; net, lap, 1st & 2nd place times. Calculator with full memory, %, √. 1 year batteries. 9/32x2 5/8x4 1/2".



### MQ-12

(RRP £21.95)

**£19.95**

Card version of AQ2200. 3/16"x3 3/4"x2 1/4".

### MQ-6 Micro Card

Pocket watch, calendar, 1/10 second stopwatch (net, lap, 1st & 2nd pl.) 8 digit calculator. % GT memory. Fob chain. 3/16x1 1/4x2 1/4".

(£21.95) **£19.95**

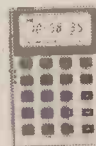

### New Scientific FX-81

30 scientific functions. Pi, cube roots, 6 levels ∫, 4,000 hours battery life from 2xAA size 3/4x3x5 1/4".

**£12.95** (£14.95)

### MINI PRINTER HR-10

Many office functions. Prints full month calendar. 3 way powered. 1 1/2x3 1/2x6 1/4".

**£29.95**



FX-80 £15.95. FX-310 £17.95. FX-510 £19.95. FA-1 £19.95. FX-501P £54.95. FX-502P £74.95 + M.P. £5.

# SEIKO

## LATEST 1980 MODELS AROUND 30% OFF!

### SEIKO'S STAR BUY FOR 1980

#### TS2 Alarm Chronograph

Comprehensive display of hours, minutes, seconds, day, date and month. 24 hour alarm and hourly chimes. Stopwatch from 1/100 second to 20 minutes, then seconds to 20 hours. Upper display — lap times. Lower display — total time. Stainless steel encased. Only 8mm thick-8.8mm including front buttons.

**ONLY £47.50**



#### TSi Alarm Chronograph



With countdown alarm. Hours, minutes, seconds, alpha day and date on upper display; and day, date, month, alarm and hourly chimes. Countdown alarm (upper display). Stopwatch from 1/100 sec to 12 hours; net, lap, and 1st & 2nd place times. Stainless steel. Glass.

**Only £57.50**

#### TS7 Alarm Chronograph

100M Water Resistant. Suitable for swimming, water skiing etc. Hours, minutes, seconds, day, date and month. Programmable weekly alarm. Interval alarm timer up to 16 hours. Hourly chimes. Stopwatch, 1/100 second to 20 minutes, then seconds to 12 hours. Upper display — lap times. Lower display — Total time.

**Only £74.95**



#### TS5 World Time / Alarm



Two Alarms, local and world time (dual tones). Hourly chimes. Normally displays hours, minutes, seconds, day; or optionally hours, minutes, day, date, month. World time mode displays an atlas with each of the 19 time zones highlighted when selected. Date and summer time functions.

**Stainless £79.95**

**Gold Pl £99.95**

#### H127 Analogue / Digital

Independent analogue display. Digital hours, minutes, seconds, day; and day, date, month, 1/100 second stopwatch to 20 minutes, then seconds to 12 hours; net lap and 1st & 2nd place. Single counter to 9,999 or dual counter to 99.

(£95) **£69.95**



**SEIKO.** The world's largest manufacturer of high quality watches.

Solid stainless steel cases and bracelets, unless otherwise stated. Scratch resistant glass. Splash resistant. Typically 2 year + battery life. Accuracy: ± 15 seconds per month or better.



Now Casio give you

# TIME TO SOLVE YOUR PROBLEMS

- Super-accurate watch
- Calculator
- Stopwatch
- Lap times
- Dual time

All this for

## ONLY £24.95

Available late Feb./March

SAME DAY DESPATCH



"You can count on Casio"

IT HAD TO HAPPEN! Casio, world leaders in high quality calculators and watches, combine their talents to bring you the incredible

## C-80 CALCULATOR WATCH

(With finger-touch keyboard)

- Hours, minutes, seconds, day, am/pm; And day, date, month, auto calendar pre-programmed to July 16, 2003.
- 8 digit calculator function. 6 digits + 2 digits (double display).
- Professional 24-hour stopwatch function. 1/100 second timing of net, lap and first and second place times.
- **Dual time function** (24-hour system).
- Super-accuracy:  $\pm 15$  seconds per month.
- Micro-light for night viewing.
- **Water resistant** black resin case and matching strap.
- **Mineral glass** scratch resistant face.
- 12 months' battery life from two UCC 391 silver oxide batteries. Includes an average of 3 one-second pushes of the light button and calculating for 1 hour per day.
- Dimensions: 44.9 mm x 35.8mm x 10.2mm (thickness).

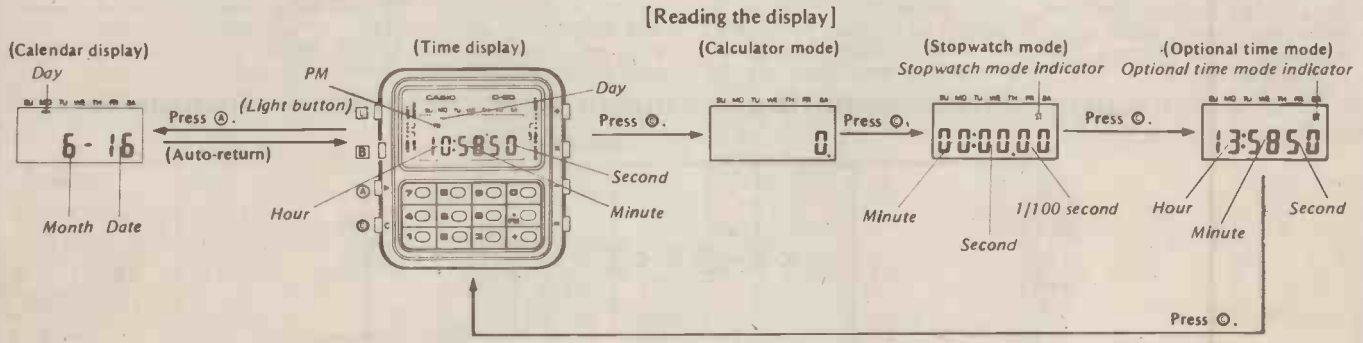

(Auto-retrieve function) The calculator, stopwatch or optional time display will automatically return to the time display in 3 or 4 minutes.

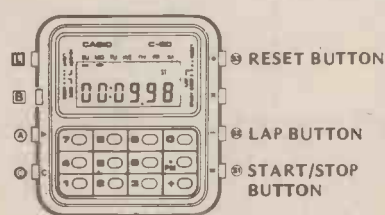

**[Stopwatch operation]**  
 (Working range)  
 The stopwatch display is limited to 23 hours 59 minutes 59 seconds 99. Thereafter it can be reset and started again. The hour digits can be shown by pressing the L button.

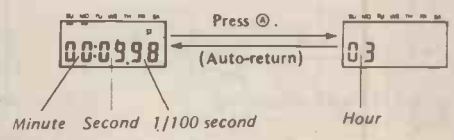

### [Calculator operation]

Appears when a number is set as a constant. Indicates that the last 2 digits can be shown.  
 8-digit entry (7-digit for negatives) can be made.  
 Shows the last 2 digits when the content of the display becomes 7 or 8 digits.  
 Clears entry for correction. Releases overflow or error check. Overflow is indicated by an "E" sign and stops the calculation. Overflow occurs when the integer part of an answer, whether intermediate or final, exceeds 8 digits (7 digits for negatives).

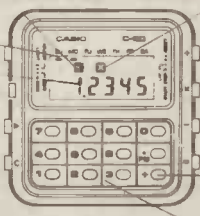

A function command sign.  
 Perform the four basic calculations. An incorrect function command is corrected by pressing the correct button.  
 Obtains answer.  
 Enter numerals. For decimal places, use the . key in its logical sequence.

Please send cheques, postal orders, company orders or phone your ACCESS or BARCLAYCARD number to: (Male order only)

## TEMPUS

Tempus (Dept. HE) FREEPOST 164-167 East Road Cambridge

(Catalogues, information and service centre) Tempus 19-21 Fitzroy Street Cambridge CB1 1EH

Telephone: 0223 312866

Prices include VAT and Post and Packing

To: Tempus (Dept. HE), FREEPOST, 164-167 East Road Cambridge CB1 1BR HE4

Please send me .....

Remittance enclosed £ .....

Access or Barclaycard number .....

Name .....

Address .....

Post code .....





# R/C Speed Controller



***A state-of-the-art unit that allows precision control of model electric motor speed and direction via a single radio control 'proportional' channel. The unit can supply motor currents up to 15 amps.***

THIS DEVICE lets you use a single channel of your proportional radio control system to control both the speed and direction of an electric model motor. The unit has been designed specifically to control the Mabuchi RS-540 racing motor fitted to our Timaya 1/12th scale Countach LP500S Competition Special but can in fact be used to control any 4 V5 to 12 V DC electric motor that draws peak currents below 15 amps (a 15 amp protection fuse must be wired in series with the motor's supply battery).

The unit incorporates two parallel-connected power output transistors, which must be bolted to a decent heat sink: we use the car's metal chassis as the heat sink on our prototype, but other arrangements are, of course, possible. The unit is ideal for use in model boats and

large-scale land vehicles. It costs only a fraction of the price of equivalent commercial units.

In 'conventional' radio-controlled motor-speed controllers a special heavy-duty rheostat assembly is wired in series with the motor and it's supply battery and has it's moving arm controlled via a conventional rotary-action servo unit which is driven from one of the proportional radio control decoder channels. This system is cumbersome and expensive and, worst of all, gives very poor low-speed motor control characteristics.

Our unit can be used to directly replace an existing servo/rheostat control assembly and gives excellent motor control characteristics right down to 'crawl' speeds. The logic section of the unit is fed (like a conventional servo) directly from one of the receivers

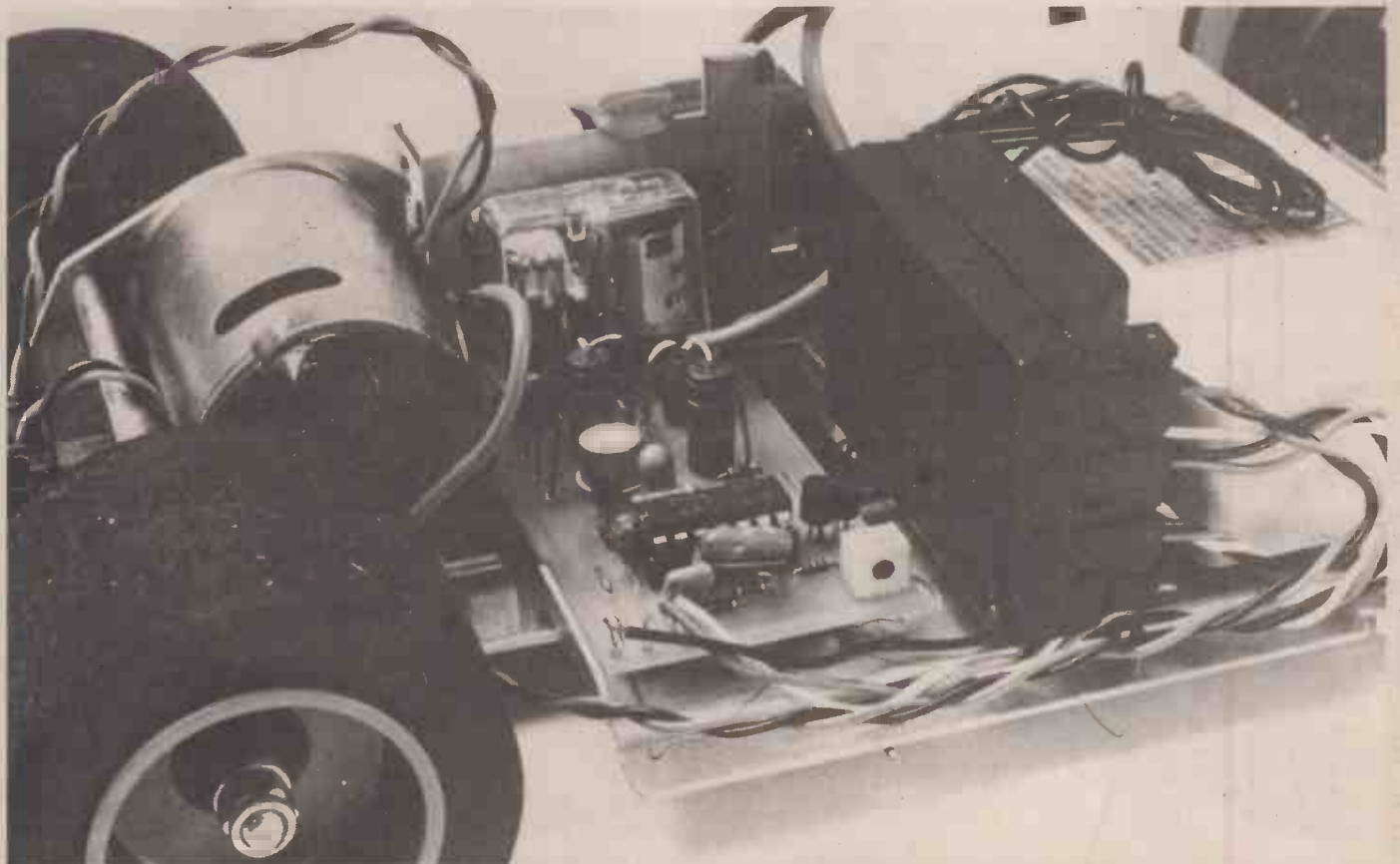

***With the Countach's body removed you can see how neatly the controller fits into the chassis pan. Unless space is really at a premium we suggest you stick to our layout.***

**Fig. 1. Circuit diagram of the Motor Speed Controller. The thick connections are for the high-current carrying motor wires.**

NOTES:  
 D1-D2 ARE 1N4148  
 D3 IS 1N4001  
 D4-D5 ARE 1N5401  
 Q1 IS BC212L  
 Q2-Q3 ARE BC182L  
 Q4 IS 2N3053  
 Q5-Q6 ARE TIP3055  
 IC1 IS ZN419CE

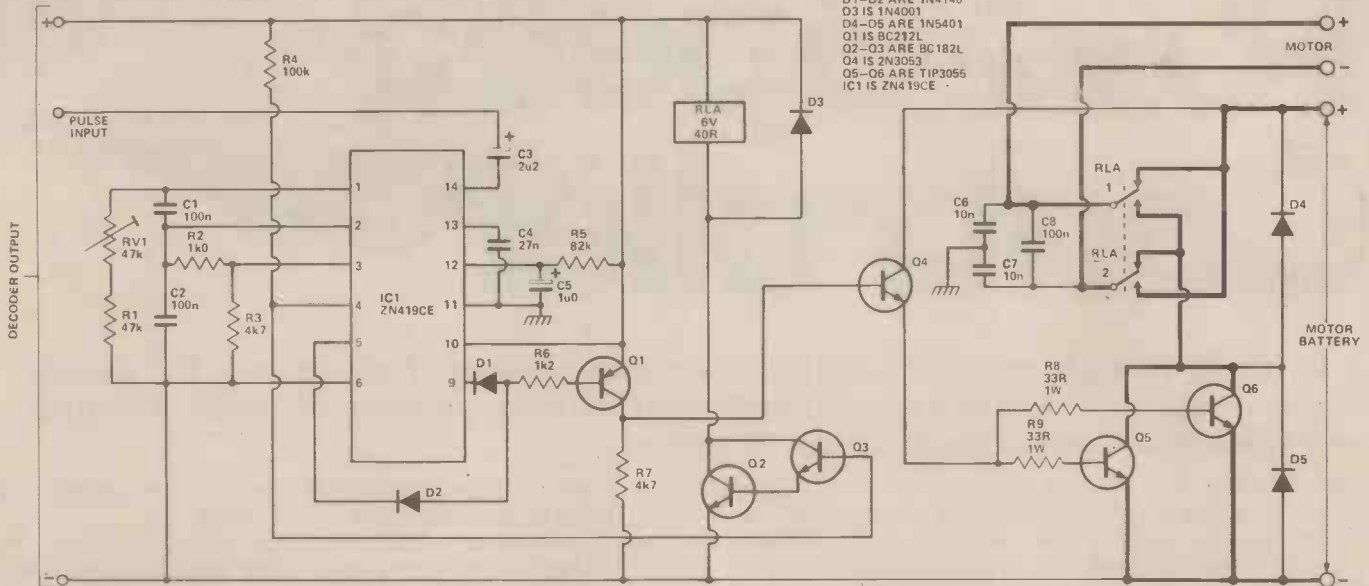

## How it Works

A normal proportional radio control 'channel' signal consists of a positive pulse with a width that is variable between approximately 1 mS and 2 mS via the transmitter joystick. The pulse has a nominal width of 1.5 mS with the joystick centred and is repeated at a 'frame' rate of 50 Hz, or once every 20 mS. The 'centred' pulse width can be varied over a limited range by a 'trim' control associated with the transmitter joystick.

All of the 'logic' of our motor speed controller is carried out by IC1 and its associated components. Each time an input pulse is received via C3 the IC generates a 1.5 mS (nominal) reference pulse (via C1-RV1-R1) which it compares with the incoming pulse width. If the input pulse is less than the reference the IC generates a high output at pin 4 and turns direction-control relay RLA on via Q2-Q3: if the input pulse is wider than the reference, pin 4 goes low and the relay is turned off.

Simultaneously, the pulse-comparator circuitry generates an internal pulse with a width equal to the difference between the two pulses and this

pulse is then expanded by a factor of about 20 (via R5-C5) and is presented to pin 5 or 9, depending on the relative 'phase' of the incoming pulse. The pin 5 and 9 signals are then 0RED via D1-D2-Q1 and fed to the power driver circuitry via Q4.

The net result of the above action is that the signal reaching Q4 takes the form of a 50 Hz (nominal) square wave with a mark/space or on/off ratio that is infinitely variable via the transmitter joystick. This waveform is used to switch power transistors Q5-Q6 via Q4 and so control the power feed to the motor via the contacts of the direction-control relay. When the joystick is moved to the extreme position in either direction, full power is fed to the motor. The motor receives zero power when the joystick is centred. IC1 incorporates 'deadband' circuitry (controlled via C4) which ensures that there is a narrow band around the joystick 'centred' position in which zero power is fed to the motor, thus enabling the motor to be easily 'neutralled' via the joystick.

decoder channels via a 3-wire servo harness. The power feed is taken to the motor and its supply battery via four heavy-gauge leads.

The unit can be used in conjunction with any modern fixed-frame multi-channel proportional radio control system that gives positive decoder output pulses with widths variable over the approximate range 1 mS to 2mS (these are the 'standard' parameters of virtually all modern systems). The unit incorporates only one pre-set pot, which is used to set the motor drive to 'off' or 'neutral' when the transmitter joystick and trim controls are centred. The motor direction is controlled (via the joystick) by a heavy-duty relay mounted on the unit's PCB.

## CONSTRUCTION AND USE

Before starting construction, check that your model has sufficient space to accommodate the unit and that



*Installed and ready to go in our workshop Countach.*



# R/C Speed Controller

## Parts List

RESISTORS (All 1/8 watt 5% unless specified)

R1	47k
R2	1k0
R3, 7	4k7
R4	100k
R5	82k
R6	1k2
R8, 9	33R 1 watt

CAPACITORS

C1, 8	100µ resin dipped ceramic
C2	100µ polyester
C3	2µ 2 10 V tant
C4	27n polycarbonate
C5	1µ 0 10 V tant
C6, 7	10n resin dipped ceramic

POTENTIOMETERS

RV1	47k side adjusting sub-min trimming pot
-----	--

SEMICONDUCTORS

IC1	ZN 419CE
Q1	BC 212L
Q2, 3	BC 182L
Q4	2N 3053
Q5, 6	TIP 3055
D1, 2	IN 4148
D3	IN 4001
D4, 5	IN5401

MISCELLANEOUS

RLA	6 V 40R relay PC mounting 2-pole changeover
-----	--

adequate heat-sinking arrangements are possible. If your model does not have a metal chassis that can be used as a heat sink, a suitable sink (capable of dissipating about 15 watts) will have to be constructed.

All components, including the heavy-duty direction-control relay (see Buylines), are mounted directly on the PCB. Note that sub-miniature components are used where possible and that IC1 is mounted in a 14-pin socket. Take particular care in the construction to observe the polarities of all semiconductor devices, etc. When construction is complete check that there are no shorts between tracks and then give the unit a function check as follows.

Make three connections between the unit's input and one of the receiver decoder outputs, as shown in the circuit diagram and the overlay, using a standard 3-wire servo harness and socket. Switch on the receiver and transmitter and check that relay RLA can be turned on and off via the transmitter joy stick.

If all is well, make two connections from the unit's output to the motor, using heavy gauge wire, and two connections to the motor battery, taking care to wire a 15 amp fuse in series with the battery positive lead. Now operate the transmitter again and check that the motor speed and direction can be controlled via the joystick. If necessary, reverse the motor lead connections to obtain the desired direction of motor rotation.

Centre the joystick and it's associated 'trim' control and adjust RV1 so that the motor goes into the 'off' or 'neutral' mode under this condition. Advance the joystick and check that the motor reaches full speed with the stick slightly short of the 'full' position. If full speed is not obtained, increase the value of pulse expansion resistor R5. Alternatively, you can limit the maximum speed by reducing the R5 value.

When the above checks are complete, fix the unit into place in the model via the two power transistors. If you are using the chassis as a heat sink, note that it must either be electrically insulated from all other circuitry or the two power transistors must be mounted via suitable insulation washers. Also note that the unit's output-to-battery connections do not need to be provided with an on/off switch. **HE**

## Buylines

IC1 should be obtainable from most of the larger mail order companies, e.g. Technomatic.

The printed circuit mounting relay is available from Watford.

Resistors R1-7 are all 1/8 watt types which you can get from Electrovalue.

All other components are fairly common types which should present no difficulties regarding availability.

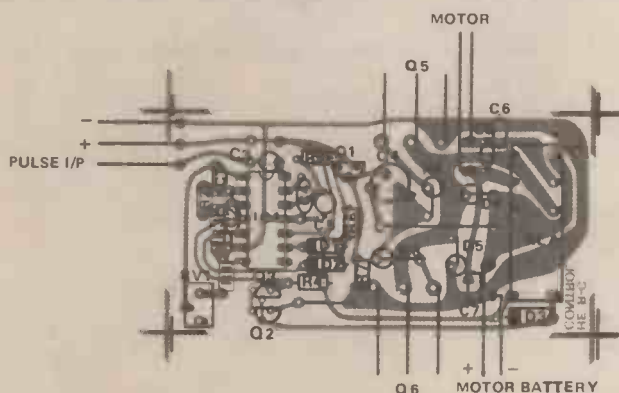

Fig. 2 (left) Overlay diagram for the R/C Motor Speed Controller.

Fig. 3 (right) PCB foil pattern. Ensure the relay tags are securely soldered.

# HE MARKET

## LCD CHRONO



We feel we've got to tell you carefully about this offer. Why? Because our price is so enormously lower than anywhere else you may suspect the quality.

The display is LCD and shows the seconds as well as the hours — and minutes — press a button and you'll get the date and the day of the week.

Press another button for a couple of seconds and you have a highly accurate stopwatch and hundredths of a second displayed and giving the time up to an hour. There is a lap time facility as well — and of course a back light.

Our Chrono comes complete with a high grade adjustable metal strap and is fully guaranteed.

**£11.95**

## ALARM-CHRONO LCD



This new addition to our unbeatable selection of bargains is no ordinary LCD watch. It's a slim, multi-function, dual time chronograph alarm watch, no less.

This model will show hours, minutes, seconds, date, day of the week, stop watch, split time, alarm and alternate dual time zone — not all at once, of course. There is also a night light.

Hours, minutes, seconds and day of the week are displayed continuously, while the date will appear at the touch of a button. The day of the week is indicated by a flag. When used as a stopwatch, the maximum count is 0.1 secs. short of thirteen hours.

**£19.95**

To: Sales Office,  
(LCD Watch Offer),  
HE Magazine,  
145 Charing Cross Road,  
London WC2H 0EE.

Please find enclosed my cheque / PO for £11.95 (payable to HE Magazine) for my LCD Chrono.

Name .....

Address .....

.....

.....

To: Sales Office,  
(ALARM / CHRONO LCD WATCH Offer),  
HE Magazine,  
145 Charing Cross Road,  
London WC2H 0EE.

Please find enclosed my cheque / PO for £19.95 (payable to HE Magazine) for my Alarm / Chrono LCD watch.

Name .....

Address .....

.....

.....

Please allow 28 days for delivery



# PLACE

## DIGITAL ALARM

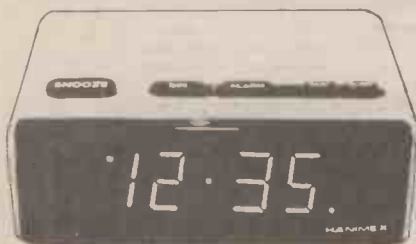

THIS IS THE THIRD digital alarm clock that we are offering (we regret the earlier versions are no longer available). We have sold thousands and thousands of these and our buying power enables us to offer a first rate branded product at a really excellent price.

The Hanimex HC-1100 is designed for mains operation only (240V/50Hz) with a 12 hour display, AM/PM and Alarm Set indicators incorporated in the large display. A switch on the top controls a Dim-Bright display function.

Setting up both the time and alarm is simplicity itself as buttons are provided for both fast and slow setting and there's no problem about knocking these accidentally as a 'locking' switch is provided under the clock. A 9-minute 'snooze' switch is located at the top.

An example of this clock can be seen and examined at our Charing Cross Road offices.

**£10.60**

## CLOCK RADIO



You probably won't believe us as we're selling the goods but we're going to tell you anyway! We have *rejected* eight clock radios for Marketplace, they were all cheap enough but the quality was so poor that we couldn't have lent our name to them. However, we are now able to offer another portable LCD Clock Radio to you which meets our standards.

The clock is a 12-hour one with AM/PM indicated and a back light. The radio is Medium Wave with very nice quality for a small speaker. The alarm can be either a beep-beep type or the radio, there's also a snooze facility.

The cylindrical construction is in keeping with the very modern styling. The tuning dial is actually incorporated into one of the end caps!

We won't even mention the RRP — but just check on comparable prices — you'll find ours a bargain.

An example of this Clock Radio can be seen and examined at our Charing Cross Road offices.

**£17.95**

To: Sales Office,  
(Hanimex Alarm Offer),  
HE Magazine,  
145 Charing Cross Road,  
London WC2H 0EE.

Please find enclosed my cheque/PO for £10.60 (payable to HE Magazine) for a Hanimex Digital Alarm Clock.

Name .....

Address .....

To: Sales Office,  
(CLOCK RADIO Offer),  
HE Magazine,  
145 Charing Cross Road,  
London WC2H 0EE.

Please find enclosed my cheque/PO for £17.95 (payable to HE Magazine) for my Clock Radio.

Name .....

Address .....

All offers inclusive of 15% VAT and Postage

## RANDOM ELECTRONIC EASY DICE

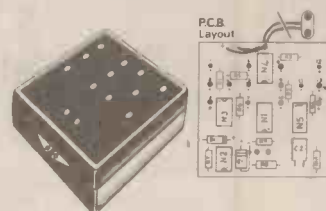

Self Assemble **£4.50**  
Ready Built **£5.45**  
Roll Out Model **£5.95**

INCLUSIVE VAT.

ADD 25p. POSTAGE PER DICE

**SUPER VALUE!**

## 5 FUNCTION RADIO CONTROLLED CORVETTE FULLY ASSEMBLED

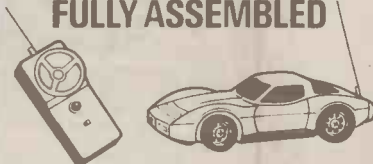

**£22.50 + 60p.p+p**

## CLOCK ALARM KIT FULL INSTRUCTIONS



**£12.95 + 25p.p+p**

T.V. GAMES B/WHITE  
**£8.95 + 25p.p+p**

24 TUNE ELECTRONIC  
DOOR CHIMES  
**£14.50 + 25p.p+p**

CALCHEC EDUCATIONAL  
CALCULATOR  
**£2.25 + 25p.p+p**

ORDER FROM

Menorcrest Electronics Ltd.  
1 Hatton Court  
Ipswich Suffolk  
Tel: 0473-210151/2

# All these advantages...

- Instant all-weather starting
- Smoother running
- Continual peak performance
- Longer battery & plug life
- Improved fuel consumption
- Improved acceleration/top speed
- Extended energy storage

## ..in kit form

SPARKRITE X5 is a high performance, top quality inductive discharge electronic ignition system designed for the electronics D.I.Y. world. It has been tried, tested and proven to be utterly reliable. Assembly only takes 1-2 hours and installation even less due to the patented 'clip on' easy fitting.

The superb technical design of the Sparkrite circuit eliminates problems of the contact breaker. There is no misfire due to contact breaker bounce which is eliminated electronically by a pulse suppression circuit which prevents the unit firing if the points bounce open at high R.P.M. Contact breaker burn is eliminated by reducing the current by 95% of the norm.

There is also a unique extended dwell circuit which allows the coil a longer period of time to store its energy before discharging to the plugs. The unit includes built in static timing light, systems function light, and security changeover switch. Will work all rev counters.



**Fits all 12v negative-earth vehicles with coil/distributor ignition up to 8 cylinders.**

### THE KIT COMPRISES EVERYTHING NEEDED

Die pressed case. Ready drilled, aluminium extruded base and heat sink, coil mounting clips and accessories. All kit components are guaranteed for a period of 2 years from date of purchase. Fully illustrated assembly and installation instructions are included.



Roger Clark the world famous rally driver says "Sparkrite electronic ignition systems are the best you can buy."

# Sparkrite

HIGH PERFORMANCE  
ELECTRONIC IGNITION

Electronics Design Associates, Dept. HE/4  
82 Bath Street, Walsall, WS1 3DE. Phone: (0922) 614791

Name \_\_\_\_\_

Address \_\_\_\_\_

Phone your order with Access or Barclaycard

inc V.A.T. and P.P.

QUANTITY REQ'D

X5KIT £16.95

ACCESS OR BARCLAY CARD No. \_\_\_\_\_

I enclose cheque/PO's for

£

Cheque No. \_\_\_\_\_

Send SAE if brochure only required

# SPECIALS FROM MODMAGS

Mark your envelopes Specials, and send them to Sales Office (Specials), Modmags Ltd, 145 Charing Cross Road, London, WC2H 0EE.

### ETI CIRCUITS

Books 1 & 2.

Each volume contains over 150 circuits, mainly drawn from the best of our Tech-Tips. The circuits are indexed for rapid selection and an additional section is included which gives transistor specs, and plenty of other useful data. Sales of this publication have been phenomenal — hardly surprising when the circuits cost under 1p each!

£1.50 + 30p P&P each.



### electronics tomorrow



### ELECTRONICS TOMORROW

Comprised entirely of new material, the edition covers such diverse topics as Star Wars and HI-FI! The magazine contains projects for everyone — none of which have appeared in ETI — and a look at the future of MPUs, audio, calculators and video. How can you not read it?

75p + 30p P&P

### TOP PROJECTS

Book 1 + 2: £2.50 + 25p P&P.

Master mixer, 100W guitar amp, low power laser, printmeter, transistor tester, mixer preamp., logic probe, Ni-Cad charger, loudhailer, 'scope calibrator, electronic ignition, car theft alarm, turn indicator cancellor, brake light warning, LM3800 circuits, temperature alarm, aerial matcher, UHF-TV preamp., metal locator, four input mixer, IC power supply, rumble filter, IC tester, ignition timing light, 50W stereo amp. and many more.

Book 3: **SOLD OUT!** Book 4: £1.00 + 30p

P&P. Book 5: £1.00 + 30p P&P. Book 6:

£1.00 + 30p P&P.



### TOP PROJECTS

Book 7: £1.25 + 30p P&P.

ER II loudspeaker, CCD phaser, 3-channel tone control, bass enhancer, continuity tester, bench supply, LCD digital multimeter, digital frequency meter, wide range oscillator, ETI wet, egg timer, house alarm, porch light, torch finder, light dimmer, IB metal locator, electronic bongos, puzzle of the drunken sailor, race track, ultrasonic switch, tic-tac radio, rev counter, Transcendent 2000, spirit level.

### ELECTRONICS — IT'S EASY

This very successful beginners' series has now been reprinted in one volume. The book covers just about every aspect of electronic theory and is ideal for anyone just starting out in this fascinating hobby.

£3.30 + 30p P&P each



### INTO ELECTRONICS PLUS

The complete series of Ian Sinclair's series Into Electronics Plus a selection of some of the most popular and informative articles from HE. Everything from Home Computing to making your own PCBs. £1 + 30p P&P.



# Hobby Chit~Chat

**HE project editor and chief designer Ray Marston presents ten simple transistor projects to help while away your evenings.**

REGULAR READERS of HE will no doubt have noticed (and possibly regretted) the almost total absence of simple transistor circuits from the 'projects' sections of the magazine. The truth is, of course, that one- and two-transistor circuits are usually regarded as a bit 'old hat' these days, when inexpensive ICs such as the 741 Op-Amp and the 555 timer can so easily outstrip them in most applications in terms of performance sophistication and cost effectiveness.

Still, one of the greatest pleasures of hobby electronics comes from actually 'messing about' with circuits and thereby 'learning things'. In these terms, transistor circuits can be as much fun as any other type, so, with these points in mind, we devote this month's 'Chit-Chat' feature to describing ten simple little transistor circuits that you can fiddle with when you have a few spare evenings.

## LINEAR AMPLIFIER CIRCUITS

Our first circuit (Fig 1) is a simple common-emitter pre-amplifier that you can use for boosting weak audio input signals to a more useful level. For a simple demonstration of its effectiveness, feed its input from the output socket of a radio and then alternately connect a crystal earpiece between the circuit's input and output. The circuit gives a voltage gain of about 50, so you'll notice a great difference between the input and output signal levels.

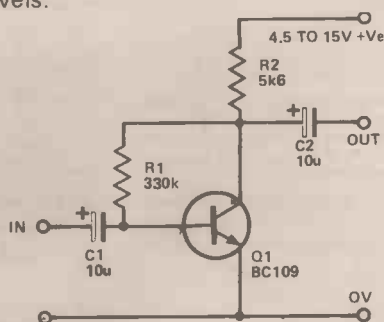

**Fig. 1. Simple Pre-Amplifier circuit gives a voltage gain of about 50 and has a frequency response extending from 25 Hz to 120 kHz.**

The Fig 2 circuit is a simple emitter follower stage. The main purpose of this circuit is to convert the signal from a high-impedance source (such as a crystal pick-up) into a low-impedance output. The circuit gives unity

voltage gain. This particular design has an input impedance of about 180k.

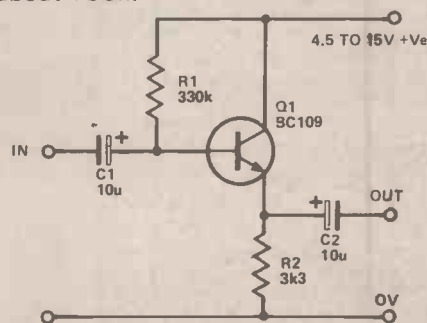

**Fig. 2. This simple Emitter-Follower circuit gives unity voltage gain but has an input impedance of about 180 k.**

The Fig 3 circuit is a 'tarted up' emitter follower. It uses two transistors and lots of feedback (via C2) to boost the input impedance to about 4MO. The two transistors are wired as a 'Super-Alpha' pair and act like a single transistor with a current gain equal to the product of the two individual gains, about 10 000 in this case.

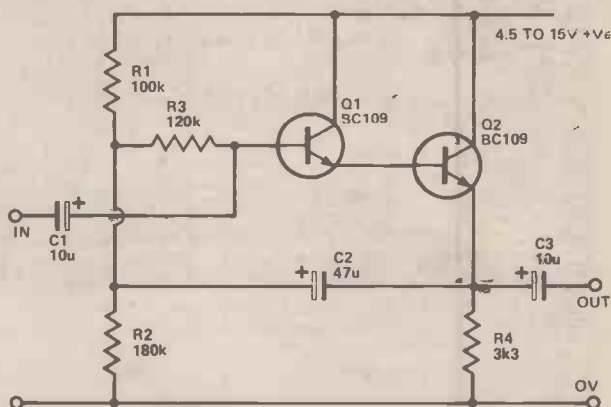
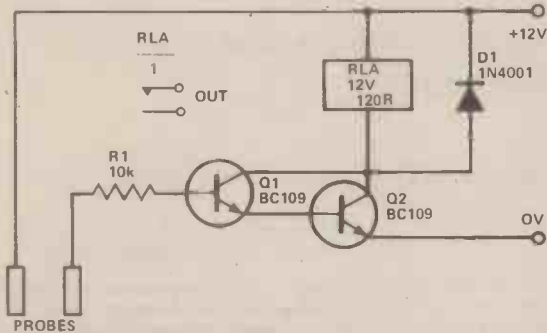

**Fig. 3. This 'Bootstrapped' Emitter Follower has an input impedance of about 4MO and can be used to convert a High-Impedance Pick Up to a low-Impedance signal.**

Fig 4 shows another application of the 'Super-Alpha' principle, in which Q1-Q2 can be regarded as a single transistor with a gain of about 10 000. In this case the 'transistor' is used in the common emitter mode and uses relay RLA as a collector load. If we assume that the

relay turns on at about 100 mA, you'll see that this current can be obtained with a Q1 base current of only 10  $\mu$ A (= 100 mA / 10 000). This current can in turn be obtained via the positive supply line by wiring a resistor of 1M $\Omega$  or so across the probes.

In practice, the relay will turn on at less than 100 mA and the Super-Alpha gain of Q1-Q2 will probably be greater than 10 000, so you'll find that the relay will turn on if any resistance less than a couple of megohms is placed across the probes. Water, steam and skin resistance have resistances below this value, so this simple little circuit can be used as a water, steam or touch-operated relay switch.

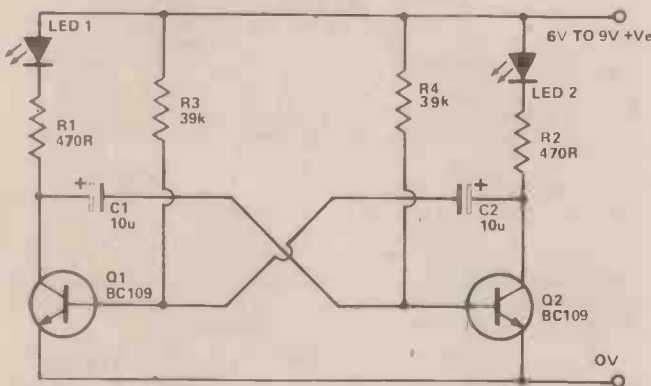

**Fig. 4.** Touch, water or steam operated relay turns on when a resistance less than a couple of Megohms is placed across the probes.

## OSCILLATOR CIRCUITS

Oscillator circuits often make amusing and/or useful projects. One of the simplest oscillators is the 2-transistor astable multivibrator or square wave generator, an example of which is shown in Fig 5. Here, the two transistors are cross-coupled via R-C networks (C1-R4 and C2-R3) in such a way that the transistors alternately switch on and off in opposition to one another. If the R-C networks have equal values, as in Fig 5, symmetrical but anti-phase signals are produced at the collectors of Q1 and Q2, with one transistor turning on when the other is off, and vice versa.

In the Fig 5 circuit LEDs are wired in series with the transistor collectors and flash on and off in opposition to one another at a rate of about 1 flash per second. The



**Fig. 5.** This LED flasher operates at about 1 flash/second. The rate can be increased by reducing the C1/C2 values or vice-versa.

flash rate can be changed by altering the values of either C1/C2 or R3/R4. This simple 'flasher' circuit provides about 10 seconds of interest to the casual onlooker but hours of pleasure to the avid electronics experimenter.

A simple variation of the astable circuit is shown in Fig 6. Here, a non-symmetrical waveform is generated and is fed to a speaker and limiting resistor in the collector of Q1. The unit can be used either as a 'sound generator' or as a 'morse code practice oscillator'. The tone frequency can be changed by altering the C1 and/or C2 values.

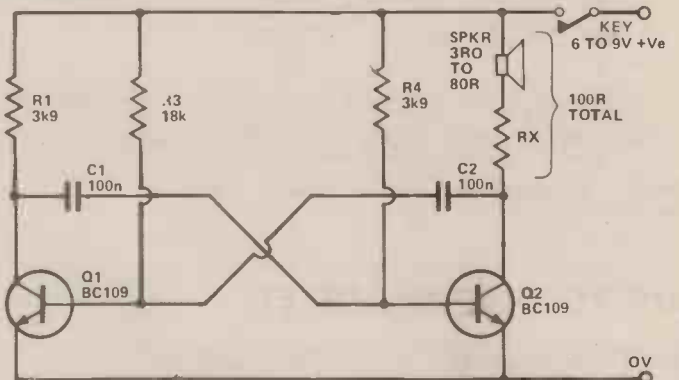

**Fig. 6.** This Morse-Code oscillator is a simple modification of the Fig. 5. circuit.

Fig 7 is a simple crystal oscillator circuit which can be used to calibrate the dial of a radio or the timebase of a scope. If, for example, you use a 100 kHz crystal, the circuit will give 10  $\mu$ s markers on a 'scope waveform or 100 kHz harmonic calibration points (100, 200, 300 kHz, etc) on a radio dial. To calibrate a 'scope you need to feed the circuit's output directly to the 'scope's 'Y' terminals. To calibrate a radio, no physical contact is required and it is sufficient to simply place the oscillator close to the radio antenna.

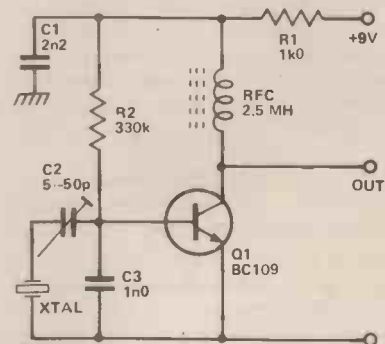

**Fig. 7.** This simple crystal-controlled oscillator can be used with any good 100 kHz to 5 MHz crystal. C2 can be used to set the crystal against a standard.

The Fig 7 crystal oscillator circuit will only work well with good quality crystals. The 2-transistor Fig 8 circuit, on the other hand, will work with just about any 50 kHz to 10 MHz series-resonant crystal that shows the slightest signs of life. Q1 is wired as a common base amplifier and Q2 is an emitter follower and the circuit acts as a strong oscillator that generates a large-amplitude output. An excellent circuit.



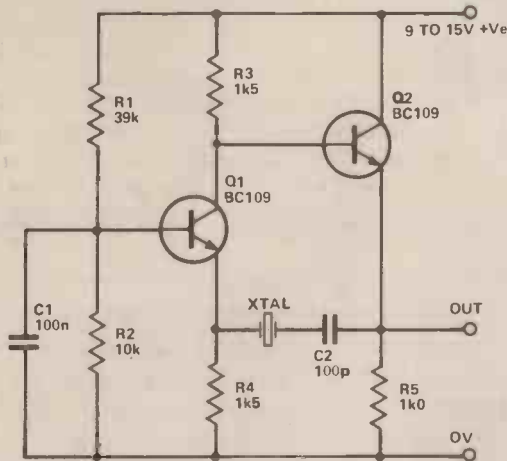

Fig. 8. This wide-range oscillator can be used with virtually any 50 kHz to 10 MHz crystal.

## DC-TO-DC CONVERTER

The Fig 9 circuit is a simple design that converts an innocent 9 volt battery supply into a shocking 300 volts DC output. What you do with such an output in the privacy of your own home is your own affair: the mind boggles. The circuit is, however, an absolute MUST for the experimenter.

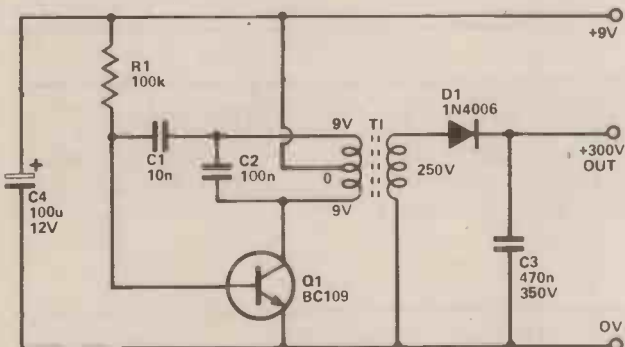

Fig. 9. This simple 9 V to 300 V 'converter uses a 9 V-0 V-9 V mains transformer in the oscillator / inverter mode. Output current is limited to a few mA.

Circuit operation is quite elementary. Q1 is configured as an L-C oscillator, with the primary of any low-power 9 V-0-9 V mains transformer acting as its 'L' load. This voltage is stepped up to about 350 volts peak at T1 secondary and is half-wave rectified by D1 and used to charge C3. With no permanent load on C3, the capacitor can deliver a healthy but non-lethal 'belt'. With a permanent load on the output, the output fall to about 300 volts at a load current of a few milliamps. A neon 'mains' indicator can be wired across C3 to indicate the presence of the high output voltage.

## A LIE DETECTOR

Our final circuit (the lie detector of Fig 10) is most emphatically an 'experimenters' circuit. Here, the 'victim' is connected, via a pair of substantial metal probes, into a Wheatstone bridge circuit formed by R1-RV1-Q1 and R3-R4. The meter, which should be a centre-zero

type, is used as a bridge-balance detector. In use, the victim makes firm contact with the probes and, once he or she has attained a relaxed state (in which the skin resistance attains a stable value), RV1 is adjusted to obtain a null on the meter. The victim is then cross-questioned.

The theory of operation is that the victim's skin resistance will change and the bridge will go out of balance if he or she lies or shows signs of emotional

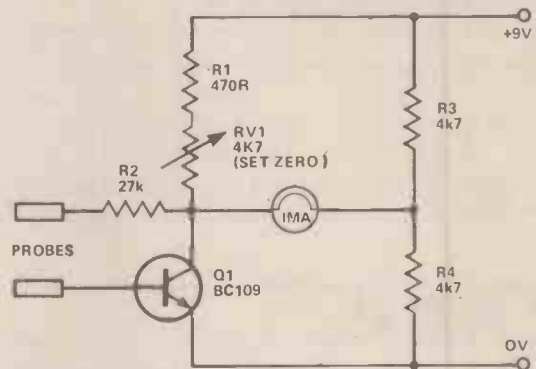

Fig. 10. A simple 'Lie Detector'. The two probes are held in both hands and RV1 is then adjusted for a meter 'null'. Any change in skin resistance (due to embarrassment, etc) causes the meter reading to change.

upset, (embarrassment, etc) when being questioned. Some people claim wonderful results from this circuit. Personally, I find that it gives not the slightest flutter when I lie but goes absolutely berserk when I think about 'thingy' (you know). Maybe you'll find the same. HE

## TEE SHIRTS

We won't guarantee HE Tee-Shirts will make your soldering any better, we won't even claim it will make your projects work first time. What we will say is that it will protect your body from harmful Ultra-Violet radiation from the sun, embarrassing Tomato Ketchup stains on your hairy chest and overweight wallets (if bought as directed in sufficient quantity).

Yes folks, for just £2 all inclusive you can be the first kid on your block to own a brand new HE Tee-Shirt. If you buy more than one your torso need never be left unprotected whilst your other one is in the wash.

Send your cheque, PO or anything negotiable to:  
HE TEE SHIRTS, 145 Charing Cross Rd, London WC2H 0EE.



---

---

# ETI MAY 1980

---

## THE BLACK HOLE

---

We proudly present the latest offering from Tim Orr, the prolific producer of music machines — the Black Hole Chorus Machine. It's capable of processing the output of both natural instruments and synthesisers.

In addition to the chorus effect you can also choose genuine vibrato. That's not all — you can select a 'double' chorus option. The speed of both effects can be controlled manually. If you're not into knob-twiddling or you don't have a free hand or two, the Black Hole can be controlled by footswitch. Keep up with what's happening in music machines and much, much more in the next audio special issue of ETI.

---

## KIT SURVEY

---

Across the length and breadth of this sceptred isle, there are companies producing kits of everything from power supplies and pin ball games to amplifiers and ignition systems. Want to buy a kit? How do you know who the supplier is, where he is, how reliable his product is and how much it costs? You could search through a dozen or so electronics magazines and spend a small fortune on postage to collect a library of catalogues.

Why don't you do it the easy way? Let ETI's fingers do the walking for you. Next month we get it all together — kits, suppliers, prices, quality — in an easy to compare format.

---

## IMAGE CO-ORDINATOR

---

How to throw your voice without straining your vitals — build the ETI Image Co-ordinator. The clever co-ordinator takes your single vocal (or guitar, etc.) input and splits it in two. What can you do with two half voices? You can recreate a single sound image and make it move around, suggesting a few interesting stage and studio effects. The Image Co-ordinator uses two of the 1537A VCA chips introduced by Keith Brindley in March.

---

## LED VU

---

Banish the bearings from your VU meters. Change over to a stylish LED display. Our LED VU meter is based on the LM3915, a chip which gives you VU or peak programme (PPM) options with bar or dot display. Look in next month to see the VU from ETI.

---

## SERVO TESTER

---

Last month's Radio Control Fail-Safe stops your plane or boat disappearing into the sunset if you lose control of a channel, for whatever reason. When you get your plane or boat back onto dry land, a thorough systems check is number one on the list of things to do. A servo fails to operate. Is it the servo or the receiver? You can eliminate the servo by using our servo tester — an unusual and useful little piece of test gear.

---

## SYNTHESISER

---

The Project 80 Modular Synthesiser returns with designs for the four filters most widely used in music synthesis — low pass, high pass, band pass and phase shift. They are four pole filters with one volt per octave control of their cut-off, or centre, frequency. Voltage control of signal regeneration is also included.



# The Proto-Board®

Now circuit designing is as easy as pushing a lead into a hole . . .  
 No soldering  
 No de-soldering  
 No heat-spoilt components  
 No manual labour  
 No wasted time



For quick signal tracing and circuit modification  
 For quick circuit analysis and diagramming  
 With or without built-in regulated power supplies  
 Use with virtually all parts — most plug in directly, in seconds.  
 Ideal for design, prototype and hobby

NO	MODEL NO.	NO. OF SOLDERLESS TIE POINTS	CAPACITY (sq. in.)	UNIT PRICE	PRICE NO. VAT	FEATURES
1	PB 6	630	6	9.20	11.73	Kit
2	PB 100	760	10	11.80	14.72	Kit
3	PB 101	940	10	17.20	21.21	
4	PB 102	1240	12	22.95	27.83	
5	PB 103	2250	24	34.45	41.34	
6	PB 104	3060	32	45.95	54.56	
7	PB 203	2250	24	55.15	65.14	5V @ 1A
8	PB 203A	2250	24	74.70	87.63	5V ± 15V
9	PB 203AK	2250	24	59.00	69.57	5V ± 15V & Kit

## Tomorrows tools for todays problems

CONTINENTAL SPECIALTIES CORPORATION



**C.S.C. (UK) Limited,**  
 Dept. 14U Unit 1, Shire Hill Industrial Estate,  
 Saffron Walden, Essex. CB11 3AQ.  
 Telephone: Saffron Walden (0799) 21682  
 Telex: 817477.

C.S.C. (UK) Ltd., Dept 14U Shire Hill Industrial Estate, Unit 1, Saffron Walden Essex, CB11 3AQ

1 Qty Req 2 Qty Req 3 Qty Req 4 Qty Req 5 Qty Req 6 Qty Req 7 Qty Req 8 Qty Req 9 Qty Req

Name \_\_\_\_\_ Address \_\_\_\_\_

I enclose Cheque/P.O. for £ \_\_\_\_\_ or debit my Barclaycard, Access.

American Express card no. \_\_\_\_\_ exp. date \_\_\_\_\_

FOR IMMEDIATE ACTION — The C.S.C. 24 hour 5 day a week service Telephone (0799) 21682 and give us your Barclaycard, Access, American Express number and your order will be in the post immediately For FREE catalogue tick box

# K40

SUPEREX CB  
 ALBRECHT CB  
 TURNER CB  
 HYGAIN

# CB

# ACCESSORIES

HAM  
 INTERNATIONAL CB

# K40

WILSONS  
 ANTENNAS  
 TELEX CB

SPEECH PROCESSORS  
 (inc. K40, TELEX)  
 POWER MIKES  
 TELEPHONE STYLE  
 MIKES  
 SPEECH COMPRESSORS  
 VOICE OPERATED MIKES  
 BASE STATION MIKES  
 (amplified & standard)  
 BASE STATION HEADSETS  
 (inc. VOXes)

MIKE-PLUGS  
 FOR MOST RIGS

EXTENSION SPEAKERS  
 P.A. SPEAKERS

EXTENSIVE RANGE  
 OF

SWR METERS

inc.  
 BASE MONITORING  
 SYSTEMS

METER/MATCHER  
 UNITS

TRANSCEIVER  
 TEST MASTER

BASE ANTENNAS  
 (inc. Beam, Omnidirectional,  
 Balcony, Loft & Indoor)

DISGUISED ANTENNAS  
 with or without  
 Splitters

ELECTRIC AM/FM/CB  
 hidden loading  
 coil

WINDSCREEN ANTENNAS

K40 BASE LOAD

DV27- all types

DX27- inc. 'S' type\*

5/8 & 3/4 HELICALS\*

RUBBER DUCK\*

(\* DV BASE)

EXTENSIVE RANGE OF  
 WHIPS FOR DV BASES

ANTENNA ACCESSORIES  
 DV BASE SPARES  
 (inc. cable with plug,  
 bolts etc)

SPLITTER BOXES  
 PROTECTED SWITCHES  
 (with dummy load)

100W MATCHERS

PL 259s

REDUCERS

ETC. ETC. ETC. ETC.

SLIDE MOUNTS

POWER SUPPLIES

LINEAR AMPLIFIERS  
 25W-1000W

MOTORCYCLE CB  
 ACCESSORIES  
 inc. HELMET  
 MIKE/SPEAKER SETS

★ UNTIL RIGS BECOME  
 LEGAL WE WILL BE UNABLE  
 TO SUPPLY THEM

★  
 Send £1.00 for our  
 comprehensive  
 catalogue  
 ★

## WINTJOY

Ltd.

COMMUNICATIONS EQUIPMENT DISTRIBUTORS

103 High Street,  
 Shepperton, Middlesex

Tel: Walton-on-Thames 48145  
 (STD 09322)

UK RETAIL OUTLETS SOUGHT

JRA

# Station Garage

Station Approach, Shepperton, Middlesex, TW17 8AN.

Tel: Walton-on-Thames 44742 (STD 09322)

Wintjoys range of CB accessories available  
 from our shop



SALES

SERVICE

FORD RENT-A-CAR

MOTORCRAFT PARTS CENTRE

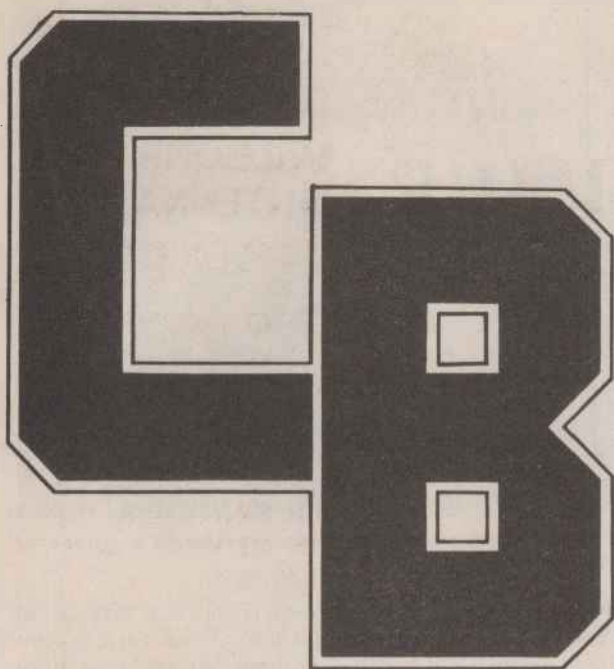

# Breaker One Four

Send any news, comments or information you may have to:  
Breaker One Four, Hobby Electronics, 145 Charing Cross  
Road, London WC2H 0EE.

***Breaker One Four goes up to three pages this month. Now we can bring you even more of the latest news and information. Look out for the pictures of the demonstration and in the coming months equipment reviews***

WELCOME to the new style Breaker One Four. We've decided to increase our coverage of the CB scene to nearly three pages (our regular readers need not worry, though, we haven't sacrificed any of our other features or projects).

As you will have doubtless noticed, the number of companies advertising CB accessories has also increased dramatically, a CB magazine can't be far away! This trend reflects the healthy growth in CB over the last few months (it is less than a year since we first published 'Citizens Banned'), and we hope that we have brought legalisation that little bit nearer. Already there have been reports in some national papers taking the view that CB will be legalised in the next few months. We've had our fingers burnt in the past making predictions so we will just continue to bring you the latest news until we have something more definite. Suffice it to say, don't believe everything you read, it's so easy to check these things out, but more of that later. Now to this month's news.

Yes, even BOF makes mistakes, although nobody spotted it, last month we said that the amateur band next door to CB was on 11 metres and CB was on 10. Actually it's the other way round.

## **CB SOUND EFFECTS**

Some of you seem hell-bent on making a name for yourself, why anyone should want to intersperse their conversation with an assortment of squeeks and other outlandish noises, we'll never know. But you're the bosses and in response to the dozens of phone calls here is the address of a company that is willing to sell you one of the famous 'Tweety Boxes' so popular with our American cousins. They are: Frontcrest Ltd, 79 Church Road, Hendon. And may God have mercy on your wallets because they cost something like 40 quid each. Purely in the interests of journalism we'll try and get hold

of one of them and tell you exactly what you're letting yourselves in for.

One last note for those of you in the Harrow area, The Harrow and Wembley group that meet at the Queens Arms would like to point out that the High Street in question is in Wealdstone. It appears that there are several High Streets, doubtless with more than one Queens Arms.

## **NEW CLUBS**

A selection of the latest clubs to open their doors for your notebooks.

Don Valley Breakers (HE)  
c/o 282 Ecclesall Road,  
Sheffield S11 8PE.

Please note this is also the new address of the Steel City Club mentioned in the December BOF.

G B A (We don't know what it stands for either)  
c/o Coronation Service Station,  
Middleton Road,  
Heywood,  
Lancs.

Secretary Bob

## **DEMO 2**

### **(23rd FEBRUARY SPEAKERS CORNER)**

This was much more like it, the rain held off, nearly 1,000 people turned up and a good time was had by all.

BOF arrived at Speakers Corner at the appointed hour (11 am) to find about fifty stalwart CB campaigners collected around the tea hut. (They must have taken our comments on the last demo to heart.) We later discovered that the march had been postponed until midday so it gave us a chance to meet a few of the organisers. In





*It was a friendly march, CB is for everyone.*



*It must have been the tea or the promise of a troupe of majorettes.*

attendance were Richard Towne (Technical adviser to the Government Committee on CB), Theo Yard (Councillor for Lewisham), Andy Donovan (we all know him) and the ever-ready Keith Townsend of the Midlands CB club. (Incidentally, next time Keith, have something to eat before you travel all the way from Birmingham.)

Things really started to happen about 11.30, rumours that there was to be a troupe of Majorettes to lead the march were soon confirmed by the arrival of said young ladies. Hopes were dashed equally rapidly when it became apparent that the oldest majorette was

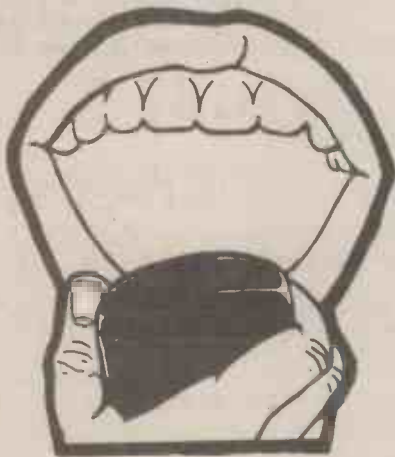

## CB Equipment Specialists

the U.K.'s leading CB equipment supplier..!

All types of antennae — disguise, tri-band, DV27, DX27, B27, T27, dipoles, twins — every possible type/position of mount. We're approved distributors for antenna specialists. We also sell burners (50-1000 watts), pre-amps, SWR meters, mikes, test equipment, suppression gear, plus, connectors, books, etc. In fact, anything to do with CB EXCEPT RIGS. Special pledge — we will match or beat any genuine price anywhere in the UK.

Mail order expressed by Red Star, all goods returnable if not satisfied.

Phone your requirements, quoting your Access or Barclaycard number for immediate despatch. We'll help with any problems, by phone if at all possible.

*10-21 breakers*

*Woking (04862) 67944 Mon-Sat.*

# Breaker One Four



Richard Towne signs the latest petition. This one is aimed specifically at Londoners. Andy Donovan (right) awaits his turn.

approaching 9. Actually the young ladies put on a splendid show and were gallant enough to cover the entire march in a quite strong wind without so much as a murmur. We would like to thank the girls from Kilburn for really livening up the proceedings. Next time girls, how about bringing along your big sisters?

At about 12.00 Richard Towne and Theo Yard had a few words to say to the assembled masses, they sent round some petition forms for everyone to sign. They hope to exceed ours, more power to their collective elbows.



The ever-hungry Keith Townsend (left) discussing the march with Richard Towne.

The speeches over, the march finally got underway. The gentlemen in blue provided an escort and assisted in negotiating the Saturday traffic. Keith Townsend provided the entertainment by encouraging everyone to chant as they marched. We think you need some new batteries for that megaphone Keith.

The procession arrived at Waterloo Bridge House (The Home Office) at around 3.00 and after handing over some letters to the gentleman on the door (for the attention of the Home Secretary, the contents of which you can doubtless guess) the demonstrators then pro-

## C.B - C.B - C.B

### AERIALS AND ACCESSORIES

Cutter mount	£16.95
Boot/Roof/Wing mount	£19.95
Traditional Fibreglass Whip	£14.95
AM/FM/CB Retractable	£25.95
CB Electric Retractable	£29.95
AM/FM/CB Electric Ret	£39.90
Roof mount 20" Glass Whip	£19.95
SWR/Power/F.S. Meter	£24.95
SWR/Power Meter	£12.95
Pre-Amp 20db gain	£19.95
Splitter Box	£9.95
Linear Amps from	£59.95
27 MHz Monitor + AM/FM	£18.65

\*These are a few of the items available\*

## The latest from the U.S.A. PINBALL WIZARD

\*Still available\*  
Featured in Nov. issue of E.T.I.  
Home TV Game — B/W Kit

Basic Kit **£28.90**

Contains everything except box and controls	
Box & Controls	£6.50, P.S.U. £3.90
CEH Car Alarm Kit	£18.90
Chroma Chime 24 tune door chimes kit	£10.50, Built £15.95
SINCLAIR SC110 10MHz scope	£145.25
PFM 200 Digital Frequency Meter	£52.00
3" 5 MHz Oscilloscope	£113.85
4" 5 MHz Oscilloscope	£139.90
5" 10 MHz Oscilloscope	£169.90

**ATARI £145**

## ELECTRONIC GAMES

Star Chess T/V game	£63.35
Database Prog T/V game	£89.95
Chess Challenger 7	£99.00
Chess Challenger 10	£160.00
Voice Challenger	£230.00
Chessmate 8 level	£59.95
Zodiac Astrology Computer	£29.95
Electronic Mastermind	£14.90
Supersonic Mastermind. New	£19.90
Mattel Subchase. New	£17.90
Mattel Armor Battle. New	£17.90
Enterprise 4 in 1	£22.90
Galaxy Invaders. New	£29.90
Radio Control Models—Various	

## COMPUTERS—HOME BUSINESS, ETC

Pet 8k	£550.00
Pet 16K	£670.00
Pet 32K	£790.00
Superboard 11 4K	£216.20
UK101 kit 4K	£228.85
UK 101 Built 4K	£286.35
Superboard/UK101 case	£33.80
Nascom 2 kit	£339.25
Nascom 2 built	£420.00
TRS80 16K Level II	£440.00
H14 line printer kit	£410.00
5 1/4" disc drive for TRS80	£287.50
Computer Books	S.a.e.
Software - Pet/TRS80/Superboard, etc.	

FREE—ADVICE/DEMONSTRATIONS/  
COFFEE

S.a.e Enquiries. Please allow up to 21 days for delivery. All prices inclusive

# CITIZEN BAND AERIALS

## SPECIAL OFFERS!

Black base loaded aerial 27MHZ (looks like radio telephone aerial!) Works well, good reports! Roof or boot mount, complete with cable/PL259. ONLY £17.00 inc P&P.

**ALSO** gutter mount, new design from Japan, only 22" long, centre loaded coil, mounts easily on gutter with mounting bolts, just tighten up! With cable/PL259 plug, ONLY £13.00.

**QUANTITY DISCOUNT** available on both these models. Prices on application DV27, Electric aerials, SWR meters, connectors, mikes, etc. P.O.A.

Trade enquiries welcome

Send cheque/PO to:

**UNIFAX**  
74 AMHURST PARK  
LONDON N16 5AP



**N.I.C.**  
61 BROAD LANE, LONDON N.15 4DJ  
Day 01-808 0377; Eve 01-889 9736







The march with its police escort just before it left Hyde Park. Who is the suspicious character on the left, someone from the Home Office perhaps?

ceeded to the adjacent park for a few more words from the organisers.

The big question is, did it do any good? We are sure it did, but demonstrations are like medicine, they must be taken regularly. The show on Saturday was impressive and it has certainly made a few people take note. The next one on April 27 MUST be bigger, we have shown we mean business now we must convince them that we intend to keep demonstrating for CB until it is legalised. See you at the next one and thanks to everyone who turned up.



The march getting underway, the column stretched for nearly a quarter of a mile.

## OVERSEAS CB

We had quite a bit of response to our plea for QSL cards from overseas CBers and we'll be publishing a selection soon. The furthest (distance wise) reply so far has come from Australia, (actually it would be quite difficult to be any further away, interstella CB perhaps?). It comes from a lady called Ma Baker (miss) who lives in Perth, she runs a base station with a half wave antenna at 12 Watts sideband on 27.450. Thanks for the contact. Our second furthest letter comes from John Tennant in Canada, he would like to get in touch with any English CBers. Unfortunately the 4 watts he pushes out might not reach this far so if you would like to have a penfriend

# ARE YOU INTO THE C.B. SCENE?

If so, a 9" x 4" s.a.e. will bring you free details of our carefully selected range of C.B. Accessories.

MAIL-ORDER ONLY

Post today to:

**POLAR ENTERPRISES**  
**2 SWORDS HOUSE**  
**HIGH STREET**  
**CROWTHORNE, BERKSHIRE**  
**Tel. 03446-71714**  
**(24-hr. Answering Service)**

**REMEMBER! UNTIL CB BECOMES LEGAL WE DO NOT SELL RIGS**

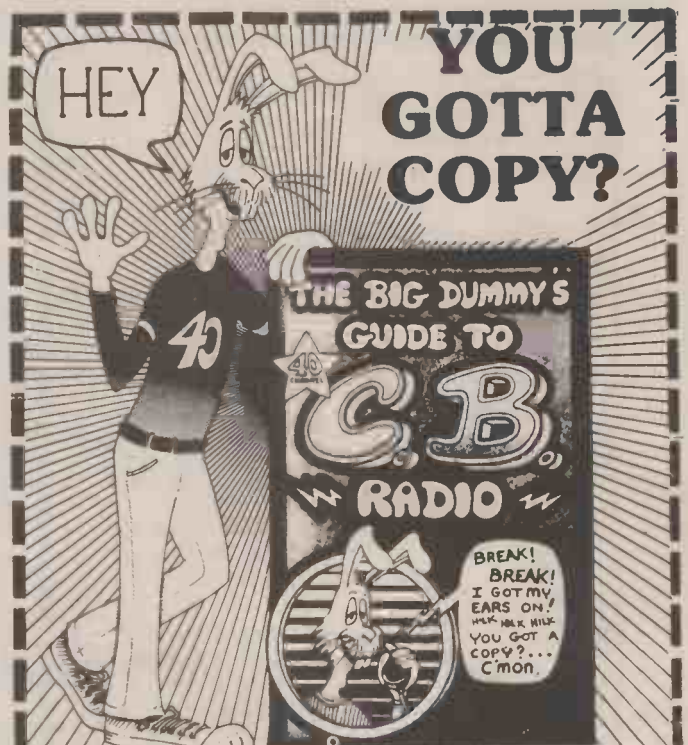

Also for the more technically minded - "THE BEST ON C.B. RADIO" and "GOOD BUDDIES" ... Car sticker.  
 Also: THE C.B. BIBLE - Discusses social aspects of C.B. £3.75 + 70p P&P.  
 send me ... copies of "BIG DUMMYS GUIDE" at £2.50 each + 45p P. + P.  
 And/or ... copies of "THE C.B. BIBLE" at £3.75 each + 70p P. & P.  
 And/or ... copies of "THE BEST BOOK" at £3.95 each + 70p P. + P.  
 And/or ... car stickers at 75p each + 15p P. + P.

I enclose £..... Cheques or postal orders only.  
 Name, Mr./Miss/Mrs. ....

Address .....

Wide range of C.B. Accessories available. Send for catalogue.

**KONA PUBLICATIONS LTD. CITY RD., LONDON EC1**



# Breaker One Four

with similar interests then you can write to John at: 508 Village, Morin Heights, Province of Quebec, Canada, JOR 1H0.

## GERMAN GEAR

A couple of weeks ago BOF was in Germany to look around one of the largest electronics shows outside the 'States. There wasn't much in the way of really new equipment but a couple of interesting odds and ends were to be found if you looked hard enough.

One of the first things that caught our eye was a pedal bike CB. Obviously with power supply limitations (and remember German CB is limited to 0.5 Watt PEP) the performance wouldn't be up to much but it is a real CB rig and as such might just help someone out one day.

Some unusual looking mikes were on one stand. They looked so strange we were prompted to find out more. They were called Revolver Mike and came in two styles. Both looked something like the butt of a pistol with the barrel removed. The design was so comfortable and the trigger mike key so easy to use we wonder why this type of mike hasn't been tried out before. Both had a simple speech processor circuit built in, similar in concept to the K40 although they required a battery to drive the circuitry.

Antennas were also in considerable abundance. Most interesting were the glass mounted aerials that have been around for a year or so. The base of the antenna actually sticks to the car windscreen (or any other window) and the RF is coupled capacitively through the glass, to a plate stuck on the interior of the car wind-

screen. Actual performance is difficult to gauge but it does do away with holes in your lovely new car (and it can be removed very quickly indeed). Hopefully we'll have some pix of these new bits and pieces next month.

## NEWSLETTERS

Some of the better organised clubs have started sending out newsletters to their members (and to us we hope). The latest example to come into the BOF office is from the MCBRC and makes very interesting reading. If any of the newer clubs are planning to, or have already produced a newsletter we would like to see it. This will enable us to keep in touch with local events and the interesting bits we'll publish for the benefit of everyone.

## DEALERS

As you can see from all the ads in this month's issue CB accessories have become big business. Unifax Ltd are currently offering a discount to all BOF readers on antennas if you mention their ad. The Base loader can be yours for just £17 and the screw-on gutter aerial is just £13, sounds OK to us.

## LATE NEWS

We heard hours (literally) before we went to press that the Southern Irish Government are likely to legalise CB in the next few months. We hasten to say we couldn't check it up in time and if this proves to be a rumour Keith Townsend will be speaking in a considerably higher voice. We are still against rumour-mongering but we felt this was too important to ignore.

Stay lucky . . . .

HE



Radios for all frequencies and 400 accessory parts available from the Europe-specialist.

**LOTHAR ALBRECHT**

Dovenkamp 11  
D-2073 Lütjensee  
Tel: 04154/7274  
Telex: 2 189 406 agru d

Registered dealers will be submitted special offers by request.  
Until rigs become legal we will be unable to supply them.

# Hobbyprints



Each HOBBYPRINT costs 95 pence but see note for exceptions.

To order your HOBBYPRINT you must know the code letter of the sheet (sheets required). Volume one of HE was coded from November 78 (A) to November 79 (M). Volume two starts with December 79 (N) and runs to November 80 with HOBBYPRINT (X). If that is all clear then send your cheque or postal order to

Sales Office (Hobbyprints), Hobby Electronics, 145 Charing Cross Road, London WC2H 0EE.

HOBBYPRINTS are the easiest way to produce perfect, accurate PCBs every time.

Just place the appropriate HOBBYPRINT over a clean piece of copper-clad PCB material and gently rub it down with a soft pencil.

Once the design has been transferred the board can be immersed in a solution of Ferric Chloride.

A few minutes later you will be rewarded with a perfect PCB ready for drilling.

HOBBYPRINTS are so good we've patented the idea 1445171 and 1445172 so beware of imitations.

HOBBYPRINT L is £1.20. Print N is in two parts.

Print(a) has all of the boards except HEBOT and costs 95 pence. Print (b) has the HEBOT design and costs 40 pence. Print O (Jan HE) is also in two parts. Part (a) has the Lap Counter and PSU, (b) has Digi-Die, HEBOT Loop Drive and Crosshatch Generator.

Both cost 95 pence. Print (a) has all of the boards

## The NEW Marshall's 79/80 catalogue is just full of components

*and that's not all...*

... our new catalogue is bigger and better than ever. Within its 60 pages are details and prices of the complete range of components and accessories available from Marshall's.

These include Audio Amps, Connectors, Boxes, Cases, Bridge Rectifiers, Cables, Capacitors, Crystals, Diacs, Diodes, Displays, Heatsinks, I.Cs, Knobs, LEDs, Multimeters, Plugs, Sockets, Pots, Publications, Relays, Resistors, Soldering Equipment, Thyristors, Transistors, Transformers, Voltage Regulators, etc., etc.

Plus details of the NEW Marshall's 'budget' Credit Card. We are the first UK component retailer to offer our customers our own credit card facility.

Plus — Twin postage paid order forms to facilitate speedy ordering.

Plus — Many new products and data.

Plus 100s of prices cut on our popular lines including I.Cs, Transistors, Resistors and many more.

If you need components you need the new Marshall's Catalogue.

Available by post 65p post paid from **Marshall's, Kingsgate House, Kingsgate Place, London NW6 4TA**. Also available from any branch to callers 50p.



Retail Sales: London: 40 Cricklewood Broadway, NW2 3ET. Tel: 01-452 0161/2. Also 325 Edgware Road, W2. Tel: 01-723 4242. Glasgow: 85 West Regent Street, G2 2QD. Tel: 041-332 4133. And Bristol: 108A Stokes Croft, Bristol. Tel: 0272 426801/2.



# Into Electronics

# Construction

## PART 3 BY IAN SINCLAIR

*Down to the nitty-gritty this month. We take a look at circuit symbols and how we can connect them up to form circuit diagrams. As usual some more new circuits for you to build*

SO FAR, it's been a bit like your first Meccano set, just assembling circuits to a set of detailed instructions. This month, we're going to make the breakthrough to the big world outside, so that you can build any circuit from a circuit diagram. As usual, though, we've a bit to learn on the way.

Let's start with some of these components again. Up until now, we've used values of resistors and capacitors without knowing much about these units of measurements, and it's time to set that right. Resistors have their values of resistance measured in units called ohms, and indicated on lists by the letter R after the number. If you see 47R, then, it means a 47 ohm resistor. It's written this way round, because on a circuit diagram, each resistor is given a reference number, which consists of the letter R and then a number. When you see R9 in a circuit, then, it means the 9th resistor in the circuit, not a 9 ohm resistor. A list of values of components might contain an entry:

R9 . . . . . 47R meaning that resistor number 9 should be a 47 ohm resistor.

We don't use many resistors whose values are only a few ohms. Most of the resistors we use have resistance values of several thousands of ohms, and to save writing all these zeros we use the letter 'k' to mean thousand. At one time, the k was placed after the value, so that 2.2k meant 2.2 thousand, which is 2 200. Nowadays, the k is often used in place of the decimal point, so that the same value would read 2k2, two thousand two hundred. This avoids having to use decimal points (they're small and easily lost), and makes the values a bit clearer. For a few purposes, we need very large values of resistance, so that we also use units of millions of ohms, called Megohms, and indicated as M on a diagram. Don't get this capital M confused with the small m we use for some other quantities.

### COLOURED BANDS

Resistance values aren't usually printed on to resistors, they're coded on, using coloured bands. Fig. 3.1 shows how these colours are used to indicate number values, and how these numbers are translated into values of resistance. This three-colour system works because we

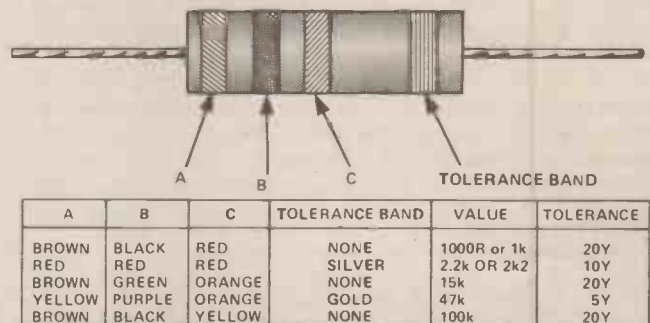

Fig. 3.1 Colour codes and resistor values.

use a set of standard values of resistors, with only two figures apart from zeros. This way we can use a colour band for each figure (called the significant figures), and another for the number of zeros after these two figures. One of the 'significant' figures can be a zero as well.

The values of capacitors are usually printed on to the capacitors. The unit that's used for measuring capacitance is called the Farad, but it's much bigger than we need, so that we use smaller units as the microfarad (written as  $\mu$ F and pF. Japanese manufacturers like to mark values in pF or in nF, but write K in place of nF, some use the colour code, with the number representing the size of the capacitor in pF. Table 3.1 shows some common values in various units.

VALUE IN $\mu$ F	VALUE IN nF	VALUE IN pF
0.0001	0.1	100
0.001	1	1,000
0.0022	2.2 (or 2n2)	2,200
0.01	10	10,000
0.047	47	47,000
0.1	100	100,000
0.47	470	470,000
1.0	1,000	1,000,000

It is most convenient to use pF for amounts less than one nanofarad (1nF). Similarly we use nF for quantities between 1nF and 999nF, and  $\mu$ F for amounts of 1 $\mu$ F and more. This way, we never have to print decimal points.



## WORKING VOLTAGE

As well as the value of capacitance, capacitors need to have their working voltage printed on. This is the greatest voltage that you're allowed to have across the capacitor while its working; you can, of course, have a lower voltage. When you choose a capacitor for a circuit, you must make sure that its printed working voltage is higher than the voltage which it will have to stand in the circuit. For example, if you're using a 9 V battery supply, then most of your capacitors will need to have a working voltage of 12 V or more. The exceptions are capacitors which are used in parts of the circuit where only a low voltage ever exists. For example, if you had a capacitor connected between the base and the emitter of a transistor, the working voltage could be the lowest you can find, 3 V, because the voltage between the base and the emitter of any transistor is usually around 0.6 V never much more.

The larger capacitors, 1  $\mu$ F and more, are of a type that we call electrolytic. In practical terms, that means that they must always be connected the right way round in a circuit, and the connecting wires or tabs are marked + (red) and - (black) to show you which way round is correct.

Now for the most important item of the day — circuit diagrams. As you will have noticed reading through HE, it's only in this series that your circuits have been given in the form of a table of connections on to a Eurobreadboard. The other circuits in your favourite mag are in the form of circuit diagrams, and until you

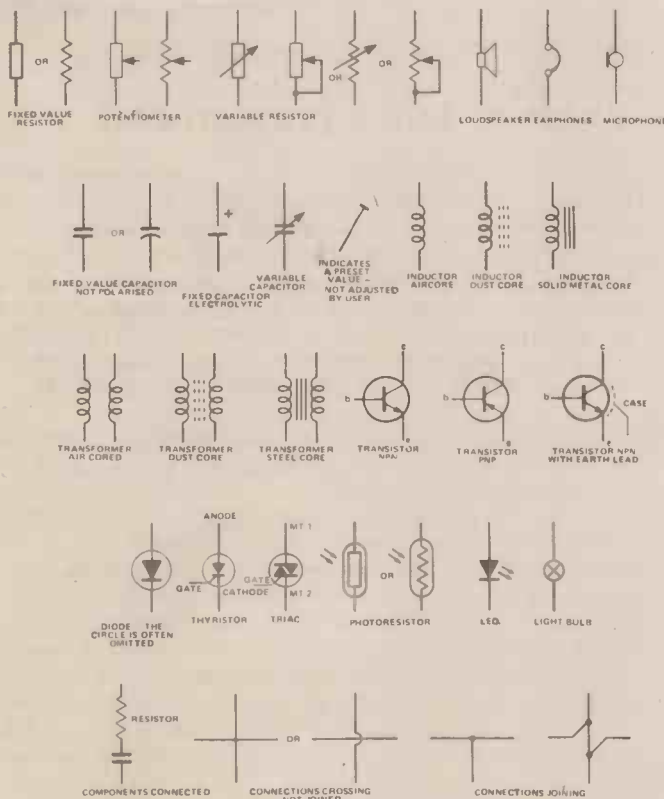

Table 3.2. Circuit symbols in common use. The zig-zag symbol for resistors etc has ceased to be the international standard although it is still in common use. Transistor symbols are shown although you may see similar symbols for FETs etc these will be dealt with at a later date.

learn to read and understand these circuit diagrams you can't really get much further into practical electronics. In a circuit diagram each component is shown as a symbol. It's a darn sight easier to draw a symbol (and to read the drawing) than it is to draw or understand the drawing of the actual component, and the symbol helps to remind you that it doesn't matter what size or shape a component is — it's the connections that count. Some of the standard symbols we use are shown in Table 3.2. The zig-zag symbol for resistors is a bit out of date these days, but you will still see it around, so we've included it.

Symbols for specialised devices, ie, FETs etc have been omitted. These devices will be dealt with in more detail at a later date. To avoid confusion we have also left out some obsolete devices although some components, ie, valves are still to be found they are best explained in a separate article.

## CIRCUIT DIAGRAMS

Now a circuit diagram doesn't show you where to plug the component into a Eurobreadboard, nor does it show you where to solder the components into a printed circuit board. What it does show you is how the components are connected together. Take a look at the circuit diagram in Fig. 3.2. This is a circuit which you've already built (Part 2), and its Eurobreadboard connections are shown on the actual diagram. Let's trace through it.

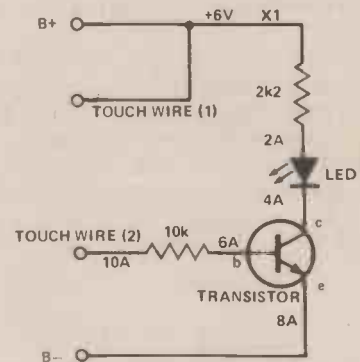

TABLE OF CONNECTIONS:	
X1	IS TOUCH WIRE (1); B+; 2k2 TO 2A
2A	IS 2k2 FROM X1, ANODE OF LED
4A	IS CATHODE OF LED; COLLECTOR OF TRANSISTOR
6A	IS BASE OF TRANSISTOR; 10k TO 10A
8A	IS EMITTER OF TRANSISTOR; B-
10A	IS 10k FROM 6A; TOUCH WIRE (2)

Fig. 3.2 The circuit diagram for the touch-wire circuit.

Start with the +6 V wire from the battery, represented by the line at the top of the diagram marked + 6 V. This shows a connection from the battery to one end of the 2k2 resistor, and to the bit of wire which is labelled 'touch-wire.' It doesn't connect anywhere else, and on the Eurobreadboard this part of the circuit is simply line number X1, with one wire plugged in and connected to battery +, one leadwire of the 2k2 resistor plugged into another hole on the same line, and a third bit of wire plugged into another hole on the same line,

# Into Electronics Construction

and left bare for you to touch, because this is the circuit which lights a LED when you touch two wires.

What about the other end of the 2k2 resistor? It makes only one connection, to the anode of the LED and nowhere else. The circuit shows, incidentally, that this connection is to the *anode* of the LED, something that is very difficult to show on any other kind of diagram. The connections here need only two holes on another line of Eurobreadboard. We have to use a line of the Eurobreadboard which is not used for anything else, because the circuit shows quite clearly that no other connections are made here.

Next step is where the cathode of the LED connects to the collector of the transistor. The collector is always shown as a plain thin line with no arrow, and there's only one connection here, so that we have two holes along one line of Eurobreadboard used. These places where components join each other are called circuit junctions, and there has to be one Eurobreadboard line used for each circuit junction that we have.

Now we've arrived at the transistor, and it has two other connections. The base, represented on the diagram by a thick line, or a hollow flat box, is connected to the other touch wire, so that this is another circuit junction which needs a separate Eurobreadboard line with no other connections made to it. We would have to be careful, incidentally, if we were building this all over again, that the two 'touch' wires never touched each other, or to any other part of the circuit, because this could mean instant death for the transistor. Just as a protection, the 10k resistor has been added between 6A and 10A.

Finally, there's the emitter lead of the transistor. This is the one shown on the circuit diagram with the arrow on it, and it makes a connection to the battery negative (-). Once again, there are no other connections, so that a fresh Eurobreadboard line has to be used — it's a good thing there are a hundred separate lines to choose from!

## SIMPLE SYMBOLS

The circuit diagram, then, shows you at a glance how the components are connected together, and when you get used to them, they also give you a pretty good idea about how the circuit works. Just looking at this one for the last time, you can see how, using your fingers to touch the two 'touch-wires' will cause a current to flow from the battery + to the base of the transistor; and why the LED lights, because current which flows between the collector and the emitter has to pass from the battery + through the LED and the 2k2 resistor to get to the transistor.

Now take a look at two more circuits, both of which you've already built. Fig. 3.3 shows the flashing LED circuit which was the last item in Part 1, and Fig. 3.4 shows the moisture detector which was the pride-and-joy of Part 2. Trace through these circuits, just as we've done in detail for the touch-wire circuit, and make sure you understand what connections are made and how the Eurobreadboard lines are used. That way you get used to reading the circuit diagrams and recognising what components are connected together. Now comes the crunch. You can read a circuit diagram, but how do you build a circuit on to the Eurobreadboard when all you have is a circuit diagram, but no table of connections? It's easy, really, if you just use 'Sinclair's Instant Layout System' (SILS), which goes something like this:—

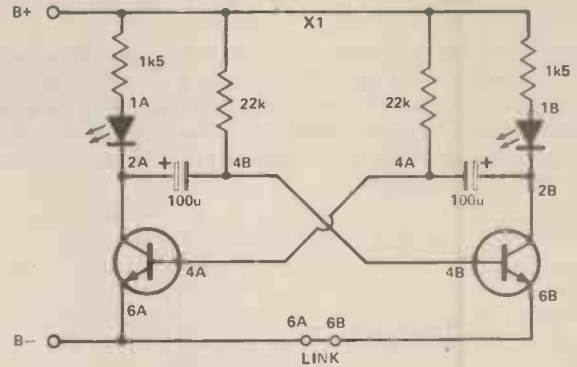

Fig. 3.3 The circuit diagram for the LED flasher.

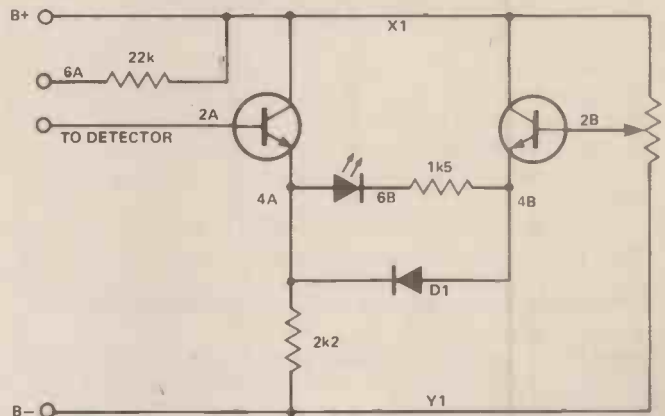



Fig. 3.4 The circuit diagram for the wet/dry indicator.

## BACK TO THE BREADBOARD

Circuits consist of circuit junctions (remember) connected by components. At a circuit junction you can expect to find one lead of a component which connects into the junction, plus any other wire leading to battery + or -, or for signals coming into the circuit or going out from it. Just take a look through the circuit diagrams we've shown so far, and pick out these circuit junctions. There are 6 of them in the circuit of Fig. 3.2, 9 of them in the circuit of Fig. 3.3, and 8 of them in the circuit of Fig. 3.4.

For each circuit junction, we use a separate line on the Eurobreadboard. This doesn't just apply to Eurobreadboard construction; as you'll find out later, it also applies when you build on solderboards. What makes the use of the Eurobreadboard special is that the lines are numbered and the columns lettered, which is what makes the circuits so simple to build. In addition, though, it makes the job of construction from a circuit diagram much easier. Here's how. Because each circuit junction needs to use a separate line on the Eurobreadboard we can label each circuit junction on the diagram with a Eurobreadboard line number and letter. Take a look at the simple circuit of Fig. 3.5 — it's the emitter-follower, one of the circuits you build in Part 2. There are five circuit junctions here, so that we need five Eurobreadboard lines for the circuit. We could simply take 1A, 2A, 3A, 4A, 5A if we liked, but this would make the circuit a bit cramped, though there's no other reason for not using these numbers. Life is easier if you give yourself a bit of room, so we can use every other line for this circuit, 

labelling the battery + circuit junction as 1A, and the others as 3A, 5A, 7A, 9A as shown in Fig. 3.5.

Looks almost too easy, doesn't it? The technique is to pencil a loop around each junction in a circuit, and then simply fill in the Eurobreadboard line numbers, leaving yourself a bit of room. With the components we're using, there's no need to try to build the whole circuit in

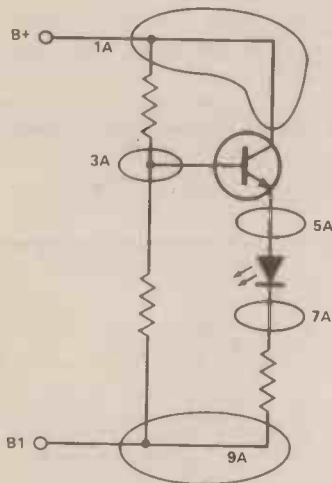

Fig. 3.5 Marking in circuit junctions for Eurobread numbers.

a small corner and there's plenty of space on this board (unlike some others) to play with. Some transistor types have very short leads which are set at only 0.1" apart, and these would have to be placed on three consecutive Eurobreadboard lines, like 2A, 3A, 4A, for example, but we're not using such components. One very useful tip is to use line X1 for battery + and Y1 for battery -.

So far, so good. Now give yourself a bit of practice — design a Eurobreadboard layout for the circuit which is shown in Fig. 3.6. Pencil in loops at each circuit junction, write in the Eurobreadboard numbers, and then construct the circuit. If you get completely stuck, then one possible layout is given at the end of this part (Fig. 3.9). Remember that it's just one of many possible layouts, so that if yours is different it's not necessarily wrong. What *is* wrong is having two junctions on the same Eurobreadboard line, or lines with just one connection.

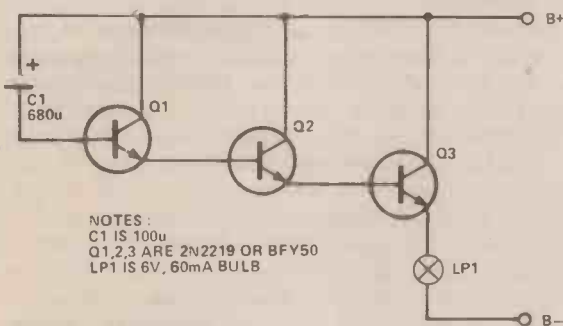

Fig. 3.6 The slow-fade circuit.

Check over your connections carefully, and when you're sure that the layout is correct, connect the battery. Watch the light over a time of a minute or so. Now unplug the capacitor, and plug in another one, any

of the values which you have, remembering that these capacitors must plug in the correct way round, with the red (+) end connecting to the + voltage line. What happens?

## CONNECTIONS

Looking at the circuit, we can now follow what happens. When the battery is connected, one terminal of the capacitor suddenly has its voltage jacked up to +6 V. Now the important feature of a capacitor is that when you suddenly change the voltage on one terminal, the voltage on the other terminal changes by the same amount, and then goes back to the voltage it had before. The time this takes depends on how large (how many  $\mu\text{F}$ ) the capacitance is, and how much resistance is connected to the second terminal. In our circuit, the second terminal connects to the base of a transistor, Q1, which doesn't need to pass much current, and which therefore behaves like a large resistance. When the circuit is switched on, the terminal of the capacitor which is connected to the +6 V line suddenly has its voltage changed from zero to +6 V. Because of this, the base of Q1 also has its voltage suddenly changed to +6 V, and the voltage on the base will then start to drop slowly as the capacitor goes back to normal, a process which is called charging.

When the base of Q1 suddenly gets switched to +6 V, through, the emitter voltage also must change. The emitter voltage will change to about +5.5 V when the base goes to +6 V, because there's always about 0.5 V between the base and the emitter voltage of a transistor when it's conducting. This 5.5 V at the emitter of Q1 is connected into the base of Q2, so that the base of Q2, is at a voltage of 5.5 V as well. That, in turn, means that the emitter of Q2 is at 5.0 V, another half-volt down as usual. Now there's 5.0 V on the base of Q3, and 4.5 V on its emitter, and that's the voltage we're using to light the bulb LP1. Since it's a 6 V bulb, the light isn't exactly going to be brilliant.

The light gradually dims and goes out, though, and this happens because the voltage across the capacitor C1 is gradually going back to normal — and normal is zero. What's happening is this. When we made the voltage at the + terminal of the capacitor equal to +6 V by connecting the battery, this automatically made the voltage at the other terminal equal to +6 V. Now this other terminal is connected to the base of Q1, and the capacitor terminal is going to act like a little battery, supplying current to the base of Q1. When a capacitor supplies current like this, though, the voltage of the terminal which is supplying the current will drop. We say that the capacitor is charging — there is an increasing voltage between the terminals (one held at +6 V, one at a lower voltage). We can do this either by keeping one terminal at a constant voltage and passing electric current into the other terminal, causing its voltage to rise, or by letting the current flow in the opposite direction so that the voltage drops. Connecting the terminals together so that they both reach the same voltage is called discharging.

How much current do we take out of C1 as it charges? We can't measure this exactly, but we can get a fair idea of how little it is at the time when the circuit is switched on. Suppose the lamp takes a current of 50 mA (milliamps). If Q3 has a current gain of 50 times, then a



# Into Electronics Construction

base current of 1 mA is needed at the base of Q3 to provide that much collector current. Now this 1 mA to the base of Q3 is provided from the emitter of Q2, and if this transistor also has a current gain of 50 times, then the base current of Q2 needs to be only  $1/50$  mA, 0.02 mA. This current, in turn, comes from Q1, and its base current, assuming it also has a current gain of 50 times, needs to be only  $1/50$  of  $1/50$  mA, which is  $1/2500$  mA, 0.0004 mA. This is a very small current, so that the capacitor C1 takes quite a long time to charge. If we plug in a smaller capacitor value, charging takes less time, so that the light from the lamp fades much more quickly. It's a useful way of making the light from a small bulb fade slowly over a long period. Incidentally, if the light refuses to fade, it's usually because of a "leaky" capacitor. A leaky capacitor will pass enough DC from the 6 V supply to keep current flowing into Q1, so that the fading action doesn't take place. You can't, of course, use this circuit for a mains voltage lamp, but the same principle can be used, in a rather different circuit, for automatic faders.

## MODIFICATIONS

Let's come back to the circuit layout theme for a moment, because there's one type of circuit which can benefit from a slight modification to our technique. Fig. 3.7 shows, once again, the circuit which was featured in Part 1 of this series. There are two ways of building this on a Eurobreadboard both with practical advantages compared to the standard method which we've just described. The point here is that if we pencil in the loops and number them in the usual way, we find that there are some awkward connections — usually one emitter has to be connected to a line which is a bit far away from its base or collector. Now we can get round this in two ways which are particularly useful if transistors with short leads are being used.

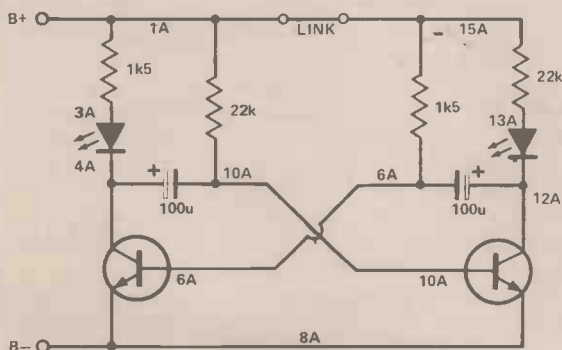

Fig. 3.7 Another way of laying out the LED flasher circuit.

One method is the scheme shown in Fig. 3.7. This method uses the second transistor connected as the "mirror image" of the first one, with both emitter leads in the same line of the Eurobreadboard, and the resistor R bridging the gap back to the + battery line. If we've spaced the circuit out too much for the resistor's leads to stretch, we can use a separate + line to connect R to, and we can connect this to the main + line with a wire link. Either way, it's a lot easier to build and check than the straightforward layout.

The other possible method, Fig. 3.3, makes use of the way that the Eurobreadboard is laid out. We built one

half of the circuit on column A and the other half on column B, keeping the transistors at the ends of the lines so that the connections between the A and B columns can cross over easily. We have to use wire links to connect 6A to 6B, but this is a small price to pay for such a simple method of construction. It's usually easier to plan out than the "mirror-image" method, and it's particularly well suited to the Eurobreadboard.

Now it's have-a-go time. The circuit is shown in Fig. 3.8, so that you have to design a Eurobreadboard layout for yourself. There are two transistors, two capacitors, five resistors, and an LED used, along with a push-button switch. You can just touch two wires together instead of using a push-button switch, but it looks a bit more interesting when the switch is used!

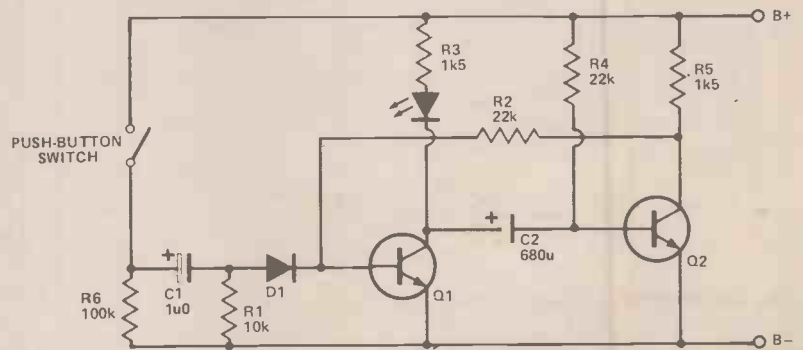

Fig. 3.8 This month's new circuit — a time delay.

Be careful to get the transistors the right way round, and remember that the capacitors are electrolytic types, which have to be connected the right way round. The LED must also be connected right way round if the circuit is to indicate that it's operating correctly. Once you're sure that all is well, connect up to the battery. Is the LED lit? Now press the push-button, and watch the LED. Does it light? How long does it stay lit after you release the push-button?

If you had difficulty with the layout, Fig. 3.6 shows connections, using the A-B column method, but you should try with your own layout first. The way the circuit works is like this.

## BOTTOMED

When you switch on first, current flows through R4 into the base of Q2, making this transistor conduct. Because Q2 is conducting well, much better than R5, the voltage at the collector of Q2 is low, about 0.2 V. This is the state we call "bottomed" — the voltage has reached rock bottom. The same voltage appears at the base of Q1, because R2 connects the collector of Q2 to the base of Q1, but 0.2 V is too small to start current flowing into the base of Q1. Since Q1 doesn't pass current, its collector voltage stays high, about the voltage of the battery supply. One terminal of C1 is at zero volts, because of R1, the other is at about 0.2 V. The circuit can remain with the voltages for as long as you like, it's the sort of condition we call stable. Now when the button is pressed, one terminal of C1 is hoisted up to +6 V, and the other one tries to follow. This makes current flow into the base of Q1, so that Q1 conducts well, and the voltage at its collector drops to about 0.2 V. That's because there's a much lower resistance through Q1 to

zero volts than there is through to the +6 V of the battery.

The drop of voltage at the collector of Q1 is applied to one terminal of C2, so that the other terminal of C2 also suffers a drop of voltage. The effect of that drop is to stop Q2 conducting, so that its collector voltage rises. There's now enough voltage on one end of R2 to keep Q1 conducting, and the circuit will stay that way for a time. Because Q1 is conducting, with current flowing through R3, the LED is lit.

It doesn't stay like that. C2 is being fed with current from R4, so that it charges up, and eventually the voltage of the base of Q2 reaches 0.5 V, and Q2 turns on again. When that happens, Q2 becomes a good conductor, its collector voltage drops again to a low voltage, and there isn't enough voltage on R2 to keep Q1 switched on. Q1 stops conducting, and the LED goes out. It doesn't matter how long or for how short a time you hold the push button switch down, the LED spends the same amount of time switched on. The diode D1 prevents the circuit from switching back when the push-button is released, so that the timing always depends on R4 and C2.

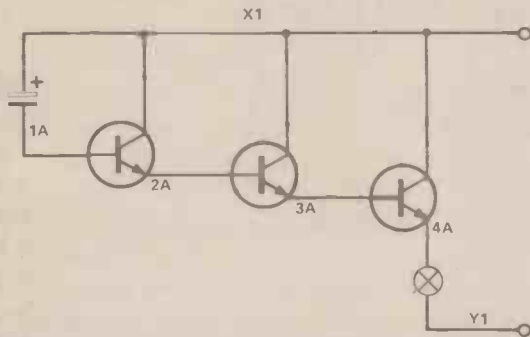

Fig. 3.9 One possible connection diagram for the circuit of Fig. 3.6.

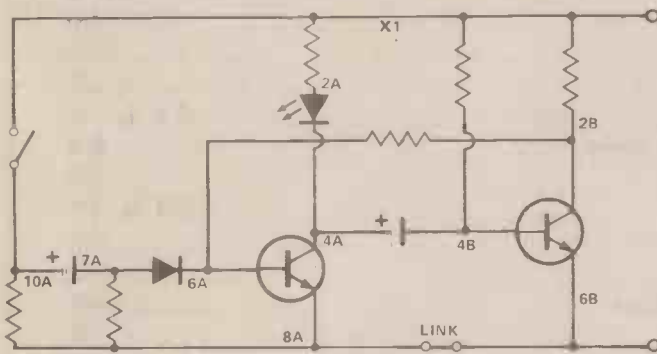

Fig. 3.10 One possible connection diagram for the circuit of Fig. 3.8.

Next month — how to generate sounds from a loudspeaker. **HE**

Ian Sinclair's first series, 'Into Electronics' is still available from our specials department. See ad in this issue

## SOUTH WALES FOR TTL, CMOS, LINEARS, DIS- CRETES, PASSIVES, HARDWARE, TOOLS, CASES, TRANSFORMERS, ETC. CLOCKS, LEKTROKIT, BREAD- BOARDING AND VERO DEALERS

BOOKS BY NATIONAL, IOR, BABANI

SPECIAL OFFER LIST. ALL BRAND NEW. FULL SPEC.

### DIL SOCKETS—GOLD PLATE

8 pin	9p	28 pin	27p
14 pin	11p	40 pin	32p
16 pin	12p	4013 CMOS	24p
18 pin	15.5p	7401 TTL	7.5p
22 pin	21p	4017 CMOS	70p
24 pin	24p	7447 TTL	75p

THYRISTOR 1A, 200V MADE BY ITT, TYPE CRS1 / 20AF 30p.

BRIDGE RECTIFIER BY MOTOROLA 1.5a, 50v 28p.

20k LIN-POT BY AB (+1) 20p, (+10) 19p.

100k LIN MOULDED TRACK (+1) 55p, (+10) 50p.

RELAY 4 POLE C/O, 12v COIL, £1.00.

20mm Q/B FUSES 150mA, 500mA, 4a, 5a, 50p for 10.

GLASS ENCAPSULATED REED SWITCHES £1 for 10.

DIGITAL METERS TYPE DM235 SINCLAIR MULTIMETER £58.

PDM 35 SINCLAIR MULTIMETER £34.99.

TFM 200 SINCLAIR FREQUENCY METER £53.

TMK 500 £33 LT22 £15.10

TMK 500 TUB £41 KRT 101 £7

CASE FOR ABOVE £8

ALL PRICES VAT INCLUSIVE : PLEASE ADD 25p PACKAGE AND POST

SEND YOUR ORDERS TO:

**STEVE'S ELECTRONICS**

15/17 THE BALCONY, CASTLE ARCADE

CARDIFF, CF1 2BU TEL: (0222) 41905

OR VISIT US AT THE SHOP—

OPEN TUESDAY TO SATURDAY 9-5.30 FRIDAY 12.30-7

Mail and Official Orders Accepted

### NEW FROM MAGNUM

DIGITAL INDICATION of RADIO FREQUENCY using a unique combination of FUTABA FLUORESCENT DISPLAY (the 'Green One') and OKI COUNTER/DRIVER.

#### Combination 1

OKI MSM 5524RS  
OLI MSL 2318  
FUTABA 6-LT-09  
Crystal

Special Price Offer £21.38

AM, FM, SW  
Pre-Scaler  
5 digits + MHz, KHz  
3.2768 MHz

#### Combination 2

OKI MSM 5525RS  
OKI MSL 2318  
FUTABA 6-LT-06

Special Price Offer £18.32

AM, FM  
Pre-Scaler  
3½ digits + MHz, KHz + AM,  
FM  
6.5536 MHz

Crystal

#### Combination 3

OKI MSM 55271  
OKI MSL 2318  
FUTABA 7-LT-02

Special Price Offer £24.57

AM, FM, SW  
Pre-Scaler  
5 digits + MHz, KHz + AM,  
FM  
6.5536 MHz

Crystal

Send today for your Combination (suggested circuit details and FREE I/C Socket are included) and enjoy "spot on" visual tuning.

OUR NEW CATALOGUE IS NOW READY. Send S.A.E.

**MAGNUM AUDIO Ltd.**

DEPT. HE4, 13 HAZELBURY CRESCENT  
LUTON, BEDS. LU1 1DF  
TEL: 0582 28887

## PRINTED CIRCUITS and HARDWARE

Comprehensive range Constructors Hardware and accessories.

Selected range of popular components  
Full range of HE printed circuit boards normally ex-stock, same day despatch at competitive prices  
P.C Boards to individual designs  
Resist-coated epoxy glass laminate for the d.i.y man with full processing instructions (no unusual chemicals required)

Affac range of etch resist transfers, and other drawing materials for p.c. boards.

Send 15p for catalogue.

**RAMAR CONSTRUCTOR  
SERVICES**  
MASON'S ROAD  
STRATFORD-ON-AVON  
WARWICKS, Tel. 4879

## CLASSIFIED INFORMATION

### Semi-Display

1-3 insertions—£4.00 per single column centimetre.

4-11 insertions—£3.50 per s.c.c.

12 insertions—£3.00 per s.c.c.

### Classified:

15 pence per word (minimum 25 words).

Box number on application (Personal ads. only)

£1.00 extra to cover 5 replies.

**ALL ADVERTISEMENTS IN THIS SECTION MUST BE PRE-PAID**

Closing date: 2nd Friday in month preceding publication.

Advertisements are accepted subject to the terms and conditions printed on the advertisement rate card (available on request).

Cheques and postal orders should be crossed and made payable to "Hobby Electronics."

### CLASSIFIED ADS, HOBBY ELECTRONICS

145 Charing Cross Road,  
London WC2H 0EE  
(Telephone: 01-437 1002)

## CB HANDLES

Book to be published this year. To enter your handle send details: Handle, Town, Rig. Enclosing £2.

### BLEWITT & CO.

133 Grafton Road  
Warley, W. Midlands

**£5 OSCILLOSCOPE.** Standard junk box components plus approximately another £5. (Total components approximately £12). This converter unit plugs into TV aerial socket and converts to large screen oscilloscope. Circuit and Plans £3. — Kerr, 27 Coles Road, Milton, Cambridge CB4 4BL.

**INGENIOUS GAMES** to distract and tantalize — and to construct. Three original designs by me in kit form, pocket sized with a top quality finish to grace your coffee table and deceive your friends. From £4.25 to £5.25. Send SAE for details of all three to H. S. Houston, 12 Harlech Avenue, Leeds 11, Yorkshire.

**OSCILLOSCOPE FOR £12.** Easy build converter plugs into TV aerial socket and converts to large screen oscilloscope. Components cost approximately £12. Circuit and plans £3. — Kerr, 27 Coles Road, Milton, Cambridge CB4 4BL.

**GAMBLER, N. LONDON,** seeks electronics enthusiast within travelling distance to make special electronic counter. — Box No. 20, Hobby Electronics, 145 Charing Cross Road, London WC2H 0EE.

**INTRODUCTION TO MICROPROCESSORS.** A beginners book £2.30. Popular Electronic Projects £1.45. Single IC Projects £1.50. 28 Tested Transistor Projects £1.25. Add 35p p&p. — Educational Data & Technical Services, 59 Station Road, Cogenhoe, Northampton NN7 1LU.

**100 MIXED** components £2.50. 100 mixed diodes 85p. Leds, 10 mixed colours/sizes, £1.15. Lists 15p. Sole Electronics, H/E 37 Stanley Street, Ormskirk, Lancs L39 2DH.

If it's a case of making your project look good, then use one of ours.

Simply send a S.A.E. for Details and prices.

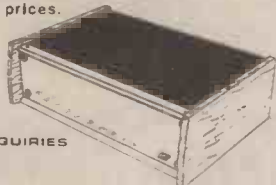

TRADE ENQUIRIES  
INVITED.

**H. M. ELECTRONICS**

271a/275a Fulwood Road,  
Broomhill  
Sheffield S10 3BD

## AD. INDEX

Ambit International	2
Bi-Pak Semiconductors	32
Boss Industrial	9
S. & R. Brewster	14
Cambridge Learning Enterprises	16
C.S.C.	59
E.D.A.	54
GMT Electronics	75
Greenweld	10
I.L.P.	4 & 5
Kona Publications	64
Lothar Albrecht	65
Magnum Audio	72
Maplin	21 & 76
A. Marshall & Son	66
Menorcrest	53
Metac	38 & 39
Midland Trading Co.	25
NIC Models	63
Polar Enterprises	64
J. W. Rimmer	14
C. N. Stevenson	26
Steve's Electronics	72
Swanley Electronics	14
Symbolyka	62
Technomatic	30
Tempus	46 & 47
TK Electronics	29
Unifax	63
Vero	10
Watford Electronics	7
West Hyde Developments	45
Wintjoy	60



# Touch Switch

For turning on equipment sensitive to vibration — photographic enlargers for example — or even just for a doorbell, this circuit is a boon



# Photon Phone

The PHOTON is a light talker: a communications system which requires no licence.

THIS IS NOT a normal light talker... All a valid transmitter frequency signals and receiver... This project should be... in photometrics but... and our first... component only an amp is

### USING IT

The device is almost... and our first... component only an amp is

# Starburst

Expand your universe with HE's pulsating photonic display

LOOKING FOR a novel... display device...

# Audio Mixer

This project should prove invaluable to anyone who is into live music. The... unless they've just spent five times as much on a commercial one!



# Ultrasonic Switch

# Multi Option Siren

# Shark!

H.E. Shark game brings you absolutely no water!

DEFINITE! HE'S... the game... absolutely no water!

# White Noise Effects Unit

Simulate the soothing sounds of wind, waves and surf on the beach, or the roar of jet aircraft and steam trains, with this HE White Noise Effects Unit.

# Constant Volume Amplifier

# Graphic Equaliser

# Getting Started

Before you jump in at the words of advice for be...

# Digital Clock

Pass some time with this time project! Using only the minimum components you can construct a multipurpose digital...

# PROJECTS SPECIAL VOL 1 FROM HOBBY ELECTRONICS

For your book of HE Project Reprints send £1.25 + 25p (P&P) to Sales Office (Specials), Hobby Electronics, 145 Charing Cross Road, London, WC2H 0EE.

# Ohmmeter

HE'S late... accuracy... of test gear. An inexpensive unit that gives rapid and... of resistance from a few tens of ohms to one megohm.

# Gain Tester

Factor is somewhat unusual in that it does not use a... visual indication of the transistor's...

### TRANSISTOR GAIN MEASUREMENT

### CONSTRUC

# Digibell Project

...ing door bells with the... will never be ignom...

# LED Tachometer

The HE Tacho uses 21 LEDs to give a solid-state analogue RPM display. It's an ideal project for the motoring or motor-cycling enthusiasts.

# Envelope Generator

Here's a project that you can use to... simulate the sound of... Generator to produ...

# Push-Button Dice

We think...

# Tantrum

Want a first rate 25 watt stereo amplifier? Look no fu... project, turn up the volume and watch the neighbours fly

# Analogue Audio Frequency Meter

Get in tune with the modern age... economical... made to measure

# Drill Speed Controller

An elegant build project that lets you vary the speed of your... any other domestic appliance that is powered by a mains...

# Parking Meter

Avoid expensive parking fines... our pocket-sized warning bell.

# Hobbytune

Build a full feature monophonic organ for less than ten pounds

# Photographic Timer

This project should appeal to the photo enthusiast. Use it to do your enlarging timing.

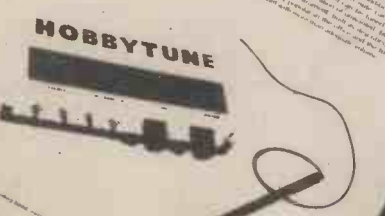
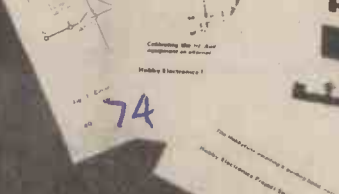
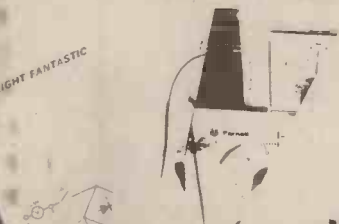

POWER SAVING

CONSTRUCTION



**Freepost Birmingham B19 1BR**  
**021-233-2400**

- FREEPOST ON ORDERS
- VAT INCLUSIVE PRICES
- ADD 30p P&P
- ACCESS
- VISA
- CASH
- CHEQUE
- 24 HR PHONE ANSWERING SERVICE

ALL PRICES IN PENCE EACH UNLESS OTHERWISE STATED

CAPACITORS				Electrolytic Radial Leads				Miniature Low Value				Polyester Radial Leads			
Electrolytic Axial Leads -10% to +50% Tol.				-10% to +50% Tol.				Polyester, Axial, ±1% Tol., >63V DC Wkg.				Dipped Type, C260/352 Svw			
Order Code	Order Code	Order Code	Order Code	Order Code	Order Code	Order Code	Order Code	Order Code	Order Code	Order Code	Order Code	Order Code	Order Code	Order Code	Order Code
Cap 015 + μF + V.d.c.	Cap 034 + μF + Volts	Cap 424	Cap 632	Cap 424	Cap 632	Cap 424	Cap 632	Cap 424	Cap 632	Cap 424	Cap 632	Cap 424	Cap 632	Cap 424	Cap 632
1.0	0.47	1.0	1.0	0.1	0.1	0.1	0.1	0.001	0.001	0.001	0.001	0.001	0.001	0.001	0.001
1.5	0.8	1.5	1.5	0.01	0.01	0.01	0.01	0.01	0.01	0.01	0.01	0.01	0.01	0.01	0.01
2.2	1.5	2.2	2.2	0.02	0.02	0.02	0.02	0.02	0.02	0.02	0.02	0.02	0.02	0.02	0.02
3.3	2.2	3.3	3.3	0.05	0.05	0.05	0.05	0.05	0.05	0.05	0.05	0.05	0.05	0.05	0.05
4.7	3.3	4.7	4.7	0.1	0.1	0.1	0.1	0.1	0.1	0.1	0.1	0.1	0.1	0.1	0.1
6.8	4.7	6.8	6.8	0.2	0.2	0.2	0.2	0.2	0.2	0.2	0.2	0.2	0.2	0.2	0.2
10	6.8	10	10	0.5	0.5	0.5	0.5	0.5	0.5	0.5	0.5	0.5	0.5	0.5	0.5
15	10	15	15	1.0	1.0	1.0	1.0	1.0	1.0	1.0	1.0	1.0	1.0	1.0	1.0
22	15	22	22	2.2	2.2	2.2	2.2	2.2	2.2	2.2	2.2	2.2	2.2	2.2	2.2
33	22	33	33	5.0	5.0	5.0	5.0	5.0	5.0	5.0	5.0	5.0	5.0	5.0	5.0
47	33	47	47	10	10	10	10	10	10	10	10	10	10	10	10
68	47	68	68	20	20	20	20	20	20	20	20	20	20	20	20
100	68	100	100	50	50	50	50	50	50	50	50	50	50	50	50
150	100	150	150	100	100	100	100	100	100	100	100	100	100	100	100
220	150	220	220	200	200	200	200	200	200	200	200	200	200	200	200
330	220	330	330	500	500	500	500	500	500	500	500	500	500	500	500
470	330	470	470	1000	1000	1000	1000	1000	1000	1000	1000	1000	1000	1000	1000
680	470	680	680	2000	2000	2000	2000	2000	2000	2000	2000	2000	2000	2000	2000
1000	680	1000	1000	5000	5000	5000	5000	5000	5000	5000	5000	5000	5000	5000	5000
1500	1000	1500	1500	10000	10000	10000	10000	10000	10000	10000	10000	10000	10000	10000	10000
2200	1500	2200	2200												

TRIMMERS				ELECTROLYTIC CAN TYPE				INTEGRATED CIRCUITS				LINEAR																					
250V D.C. Wkg. Film Dielectric, Miniature				High Ripple, IEC Grade 1, Low E.S.R., Cap HR - μF + Volts				4000 Buffered C-MOS - High Speed				Voltage Regulators																					
Order Code	Order Code	Order Code	Order Code	Order Code	Order Code	Order Code	Order Code	Order Code	Order Code	Order Code	Order Code	Order Code	Order Code	Order Code	Order Code																		
1.4 - 4.1pF	Cap B0B A	2 - 5pF	Cap B0B B	10000 μF ±50V	Ripple 5.8A @ 85 C	8.1A @ 50 C	238	HEF4000	22	HEF4044	1.05	HEF4512	138	N7400N	13	N7444N	92	N74122N	40	N74192N	91	N74LS28N	35	N74LS138N	99	N74LS253N	117	CA3046	84	LM3090A/K1	119		
7 - 50pF	Cap B0B C	2 - 200pF	Cap B0B C	47000 μF 25V	4.6A	6.4A	215	HEF4001	22	HEF4046	1.33	HEF4514	313	N7401N	14	N7445N	85	N74123N	77	N74194N	77	N74LS30N	19	N74LS139N	99	N74LS257N	117	CA3300E	77	LM3090A/K1	119		
5.5 - 59.5pF	Cap B0B D			10000 μF 25V	8.0A	41.2A	282	HEF4002	22	HEF4047	1.09	HEF4515	374	N7402N	14	N7446AN	85	N74125N	37	N74195N	57	N74LS32N	27	N74LS142N	117	CA3100E	99	LM3090A/K1	119	CA3100E	99	LM3090A/K1	119
				47000 μF 25V	12.8A	17.9A	469	HEF4003	22	HEF4048	0.57	HEF4516	127	N7403N	14	N7447AN	71	N74126N	37	N74196N	135	N74LS33N	35	N74LS154N	98	CA3189E	293	LM3090A/K1	119	CA3189E	293	LM3090A/K1	119
				10000 μF 40V	9.2A	12.8A	393	HEF4004	22	HEF4049	0.7	HEF4517	478	N7404N	16	N7448AN	92	N74128N	38	N74197N	122	N74LS37N	35	N74LS155N	93	N74LS261N	321	LM339N	78	LM339N	78	LM339N	78
				47000 μF 70V	7.5A	10.5A	403	HEF4005	22	HEF4050	0.87	HEF4518	118	N7405N	16	N7449N	16	N74129N	38	N74198N	135	N74LS37N	35	N74LS156N	93	N74LS262N	321	LM339N	78	LM339N	78	LM339N	78

CASES				OPTO ELECTRONICS				SWITCHES				SEMICONDUCTORS			
Small Desk Console - Boss Industrial Mouldings				Light Emitting Diodes, Individual				Miniature Toggle - Honeywell				INS14			
Order Code	Order Code	Order Code	Order Code	Order Code	Order Code	Order Code	Order Code	Order Code	Order Code	Order Code	Order Code	Order Code	Order Code	Order Code	Order Code
W161, D96, H39 (571)	214	Case BIM1005 OR		1251 (3mm)	Ref	16	COY54	SPDT	67	SW BA1011	5	IN4001	5	BC182L	12
W215, D130, H47 (731)	308	Case BIM1006 OR		1251 (3mm)	Ref	16	COY95	SPDT	81	SW BA1021	5	IN4002	5	BC184L	12
				Panel Mounting Clip to suit.		20	COY97	SPDT	90	SW BA1051	5	IN4003	5	BC212L	12
				2" (50mm)	Ref	16	COY98	SPDT	90	SW BA1051	5	IN4004	5	BC217L	12
				Panel Mounting Clip to suit		20	COY96	SPDT	116	SW BA2061	5	IN4005	5	BC219L	12
				Photoresistors		95	ORP12	DPDT	111	SW BA2021	5	IN4006	5	BC247L	12
				ORP12		95	ORP12	DPDT	123	SW BA2051	5	IN4007	5	BC254L	12
				ORP61		95	ORP61	DPDT	123	SW BA2021	5	IN4008	5	BC259L	12
				Photoresistors		95	ORP61	DPDT	123	SW BA2051	5	IN4009	5	BC267L	12
				OCPT71		220	OCPT71	DPDT	116	SW BA2061	5	IN4010	5	BC268L	12
				BPX25		195	BPX25	DPDT	116	SW BA2061	5	IN4011	5	BC271L	12
				BPX29		195	BPX29	DPDT	116	SW BA2061	5	IN4012	5	BC274L	12
				Photocoupler		165	FCDB20	DPDT	116	SW BA2061	5	IN4013	5	BC279L	12
				FCDB20		165	FCDB20	DPDT	116	SW BA2061	5	IN4014	5	BC284L	12
				HARDWARE				DPDT	116	SW BA2061	5	IN4015	5	BC289L	12
				D.I.L. Sockets				DPDT	116	SW BA2061	5	IN4016	5	BC294L	12
				8 Pin Low Profile Socket Tin		12	DIL SKT B	DPDT	116	SW BA2061	5	IN4017	5	BC299L	12
				14 Pin Low Profile Socket Tin		14	DIL SKT L	DPDT	116	SW BA2061	5	IN4018	5	BC304L	12
				16 Pin Low Profile Socket Tin		16	DIL SKT L	DPDT	116	SW BA2061	5	IN4019	5	BC309L	12
				Heatinks				DPDT	116	SW BA2061	5	IN4020	5	BC314L	12
				Individual Type for 1 x T05 50°C/W		12	Sink 5	DPDT	116	SW BA2061	5	IN4021	5	BC319L	12
				Individual Type for 1 x T06 60°C/W		28	Sink TV2	DPDT	116	SW BA2061	5	IN4022	5	BC324L	12
				Individual Type for 1 x T03 7°C/W		26	Sink TV3	DPDT	116	SW BA2061	5	IN4023	5	BC329L	12
				Individual Type for 1 x T01 26 17°C/W		26	Sink TV4	DPDT	116	SW BA2061	5	IN4024	5	BC334L	12
				Individual Type for 1 x T02 21 17°C/W		26	Sink TV5	DPDT	116	SW BA2061	5	IN4025	5	BC339L	12
				P.C.B. Components				DPDT	116	SW BA2061	5	IN4026	5	BC344L	12
				Dalo Pen, Blue Ink, Slow Drying		813	Pen 33PC	DPDT	116	SW BA2061	5	IN4027	5	BC349L	12

RESISTORS				VERO ELECTRONICS PRODUCTS				Skeleton Presets, Miniature					
Carbon Film, Fixed				2.5" x 5", 1" pitch Veroboard				0.1W, E3 Values, 1000R/L, Lin. Vertical Mounting					
Order Code	Order Code	Order Code	Order Code	Order Code	Order Code	Order Code	Order Code	Order Code	Order Code	Order Code	Order Code	Order Code	Order Code
0.25W, E24 Values, 10R-10M, 5% Tol.	2 each	100/100 (Multi 10/Value)	Res RD%	3.75" x 5", 1" pitch Veroboard	71	200-21069J	0.1W, E3 Values, 100R/H, Lin. Horizontal Mounting	8	BC186L	11	Min. Preset H		
0.5W, E12 Values, 10R-4M7, 10% Tol.	3 each	150/100 (Multi 10/Value)	Res RD% + Value	2.5" x 1", 1" pitch Veroboard (5)	85/Pack	200-21072D	0.3W, E3 Values, 100R/H, Lin. Vertical Mounting	11	Sid. Preset H				
				3.75" x 5", 1" pitch Plain Board	68	200-21078H	0.3W, E3 Values, 100R/H, Lin. Horizontal Mounting	11	Sid. Preset V				
				5.8" x 2.9", 1" pitch V-Q DIP Board	135	200-21084E							
				Spot Face Cutter	107	203-21013A							
				Pin Insertion Tool for 040 type pin	147	203-21015F							
				DS Pins, 040 (100)	44/Pack	200-21087G							
				SS Pins, 040 (100)	44/Pack	200-21017B							
				Wirewrap Kit (1-pin, 2-wire, 75-omb)	454/Kit	200-21314D							
				Wirewrap Combs (26)	109/Pack	200-21339F							
				Wirewrap Wire (2)	109/Pack	200-21340G							



# STEP INTO A NEW WORLD WHEN YOU DISCOVER **MAPLIN**

For beginners or professionals, the Maplin catalogue will help you find just about everything you need for your project.

Over 5,000 of the most useful components — from resistors to microprocessors — clearly described and illustrated.

Send the coupon for your copy  
and **STEP UP TO  
MAPLIN SERVICE  
NOW**



Post this coupon now for your copy of our 1979-80 catalogue price 70p.

Please send me a copy of your 280 page catalogue. I enclose 70p (plus 46p p&p). If I am not completely satisfied I may return the catalogue to you and have my money refunded. If you live outside the U.K. send £1.35 or ten International Reply Coupons. I enclose £1.16.

NAME \_\_\_\_\_

ADDRESS \_\_\_\_\_



# MAPLIN

ELECTRONIC SUPPLIES LTD

All mail to:

P.O. Box 3, Rayleigh, Essex SS6 8LR.

Telephone: Southend (0702) 554155.

Shop: 284 London Road, Westcliff-on-Sea, Essex. (Closed on Monday).

Telephone: Southend (0702) 554000.

HE 4 80