

7th FEBRUARY 1962

VOL. 133

NUMBER 3452

THE ORIGINAL
'DO-IT-YOURSELF'
MAGAZINE

HOBBIES *weekly*

FOR ALL
HOME CRAFTSMEN

FREE Design

Also in this issue:

DISC BREAK —
THE HIGHWAYMEN

COLLECTORS' CLUB
— LATEST STAMPS

CONTINUATION OF
THE GARAGE

MODEL TRACTOR
WITH IMPLEMENTS

TUNNEL 'MOUTHS'
FOR RAILWAYS

FRETWORK — A
PLANT HOLDER

ETC. ETC.



TABLE MATS

Up-to-the-minute ideas

Practical designs

Pleasing and profitable things to make



5^D

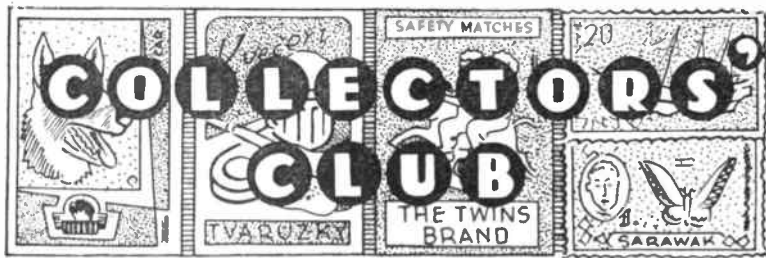

★★★★★★★★★★★★★★★★★★★★★★★★★★★
 ★ NOTE TO CORRESPONDENTS ★
 ★ All correspondence on any subject covered in this magazine ★
 ★ must be addressed to: The Editor, ★
 ★ Hobbies Weekly, Dereham, Norfolk. ★
 ★ If a reply is required, queries ★
 ★ should be accompanied by a ★
 ★ stamped addressed envelope and ★
 ★ reply coupon inside back cover. ★
 ★★★★★★★★★★★★★★★★★★★★★★★★

PRINCE ANDREW APPEARS ON A NEW STAMP



THIS full-size reproduction of the £1 stamp from the new definitive issue of St. Helena shows the Queen and Prince Andrew. In sepia and blue, the stamp is the first to include the new Prince. Details of designs and illustrations of the thirteen other stamps in the issue, which were released on December 12th, will be given next week.

TWICE in its history, Pitcairn has been abandoned by its inhabitants. On both occasions the reason was the same; a fear that the island was about to become overpopulated.

FROM THE PITCAIRN ISLANDS



The first migration in 1831 was not a serious affair, for the islanders all returned after a few month's absence.

The second desertion in 1856 was far more serious. Plagued by famine and disease, the entire population of 187 was taken to Norfolk Island, but a number of them became so homesick for their beautiful island that between 1859 and 1864 they returned. It is from these 43

that the present population of Pitcairn is descended, and with their return commences the modern history of the island.

* * *



This Post Office centenary issue appeared from the Seychelles on December 11th

To commemorate this uninterrupted and peaceful resettlement of a hundred years, the Pitcairn administration issued a series of three stamps, 3d., 6d., and 1/-, on the 15th November 1961. Colours are: 3d. yellow and grey; 6d. blue and brown; 1/- blue-green and orange-red.

RUSSIA

LATEST stamps from Russia celebrate the 250th Anniversary of M. V. LOMONSOV's birth (1711-1765). They are:

- 4 Kopeks, multi-coloured — 'LOMONSOV Sculpture'.
- 6 Kopeks, multi-coloured — 'LOMONSOV's Portrait'.
- 10 Kopeks, multi-coloured (illustrated) — 'LOMONSOV's Portrait with Lenin'



grad Academy of Science in background.

A 2 Kopeks value depicting workers appeared on 1st December 1961.

Other new issues from Russia during December were a 4K stamp commemorating the 25th Anniversary of the U.S.S.R. Constitution, and two values of 2K and 6K commemorating the abolition of Colonialism. The latter stamps depicted a negro with hand shackles broken.

Advertisers' Announcements

32 PAGE ILLUSTRATED 'STAMP FINDER' BOOKLET
 FREE to all requesting our PRIORITY APPROVALS. World-wide selections and sets.
 Please send 3d. postage
THE PRIORY STAMP COMPANY
 (Dept. H/4) 86 Pauntley Road, Muford, Christchurch, Hants.

FOR SALE — NEWFOUNDLAND STAMPS! 100 fine NFLD stamps \$1.00 — 1,000 \$9.00 — 2,000 \$15.00 — 50 all different \$2.00 — 100 all different \$6.00 order now from HARRY PHILLIPS SALES, BONA-VISTA-2K, NEWFOUNDLAND, CANADA.

ON APPROVAL collections of Austria, Germany, Russia, Belgium, France, Scandinavia and other countries. References please. — Strads, 47 Abbey Road, Aylesbury.

BRITISH QUEENS, current, 2/6, 5/-, 10/- Superb used, 1/6 posted. — Lovel, 3 Tollgate Gardens, Eastbourne.

100 DIFFERENT stamps free! Request 4d. upwards discount approvals. — Bush, 53 Newlyn Way, Parkstone, Dorset.



Stamp Collector's Corner

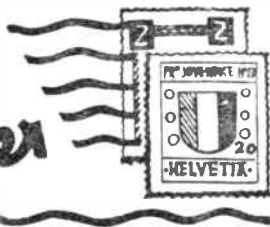

THOSE of you who have a reasonably large collection of stamps will doubtless have noticed that there are more animals depicted on the stamps of the British Empire than on the foreign ones. It is true, however, that when a foreign country does show animals then it does so very thoroughly.

For example Angola, the Portuguese colony, issued a set in 1951 consisting of twenty-four stamps with pictures of different birds. When Chile issued a sheet of twenty-five stamps, nineteen of these designs were animals (five birds), and the other six were plants. Quite possibly the increased number of bird designs on stamps is due to the great development of bird watching as a hobby, not only in this country, but all over the world. Incidentally, very few stamps show pictures of eggs!

Non-flying birds

There are, of course, some birds that cannot fly. The kiwi, which appears on many of the New Zealand stamps, is an example. It is fairly evident what it feeds on from its long beak, which is ideal for searching in the mud for worms. Not quite so well known is the fact that it hides away during the day and that it only lays one or two very large eggs which are incubated by the male.

The same remark about incubation may be made with regard to the ostrich, except that he will have to incubate between twenty and thirty eggs — and you know what size they are! Although it cannot fly the ostrich can run very fast indeed, faster in fact than a horse. Its feet are especially adapted for running having only two toes. Ostrich tail feathers have, of course commercial value. Ethiopia in 1919 showed a group of three.

The other two birds that cannot fly are the emu seen on the 5½d. stamp of Australia issued in 1938 and the cassowary which is seen on the 24c value of the North Borneo stamps of 1909. Still another is the penguin, whose wings are so well developed for swimming that one almost forgets that it is a bird at all. It appears several times on the stamps of Falkland Islands.

The domestic hen is shown on the

Bulgarian stamp, which is one of the few stamps showing eggs. It was issued in 1938 as one of a set of trade propaganda stamps. Cuba has produced the Christmas bird — the turkey. In South Africa the secretary bird is protected by law and well it may be because its main food consists of snakes. In attacking these creatures the feet alone are used, the bird striking forwards and downwards with great force. The wings are outspread and used as a shield so that if the blow fails and the snake strikes it expends its venom on the quill feathers. The name 'secretary' would appear to come from the long feathers which stand out from the head, looking like a bunch of quill pens sticking out from the ears. The bird is shown on the 20c of the new set from the Republic of South Africa.

Another useful bird is the cormorant shown on the Japanese stamp. A fisherman in his boat holds ten strings in his hands, each one leading to a cormorant swimming close by. The string is tied to a ring round the neck of the bird. The cormorant dives down for a fish which it catches in its beak, but the ring prevents it from swallowing the fish which is retrieved by the fisherman. Cormorants also appear on the stamps of Peru, the 2c of the 1936 issue. Peru obtains a lot of revenue from the guano industry. Guano is the dropping of birds accumulated over thousands of years, which is sold as fertilizers.

Many birds appear on stamps as illustrations because of their beauty; the



See text for stories

lyre bird on the 1/- value of the 1937 set from Australia is an example. And in so many other birds the male develops its beautiful plumage as a courtship display. In this case the frame of the instrument is formed by the outermost tail feathers, which are curiously notched, while the upper tail coverts form the strings of the musical instrument. In the breeding season each cock makes himself a playground where he goes through his antics, showing off his tail. Another very beautiful bird is shown on the 2d. stamp from Papua issued in 1932. This is a bird of Paradise. Another is the Argus Pheasant shown on the 5c stamp from North Borneo in 1894. It seems to have a plumage of the softest painted velvet.

BIRDS IN YOUR ALBUM By L. P. V. Veale

surpassing in beauty even the peacock. Some of the cockatoos, macaws and parrots are also very beautiful but there just is not space to describe them all.

Curiosities

There are a few curious looking birds worth considering; the shoe-bill shown on the 2m Sudan of 1951 is a case in point. The bird is found only in the swamps of the White Nile. It stands about 5 ft. high and has an enormous bill. Another curious bill is that possessed by the flamingo, shown on the 8d value from Bahamas issued in 1938. The bill bends at right angles about half way along so that when searching in the water for plant, part of the bill at least is horizontal. As is shown on the stamp the bird flies with the neck fully extended. It has webbed feet and although it spends most of its time in shallow water it is able to swim.

Another bird with a curious bill is the toucan, seen on the 90c stamp from Bolivia issued in 1939. The enormous bill is about a quarter of the length of the bird.

Game birds have not been forgotten. The ptarmigan is on the 12 c of the 1897 set of Newfoundland, the game-cock on the 30r of the 1950 set from Liechtenstein and the gerfalcon on the 1938 50h from Czechoslovakia.

One could quite easily write a book about all the birds that appear in the stamp album, and it should prove a very attractive subject. Look through your own collection and see how many birds you can name as they appear.

BUILDING A GARAGE

LAST week we gave a complete cutting list of materials, and the first stages for building a strong and handy garage. Now we can continue with the roof.

The roof is divided into four sections, each section being made of 2 in. by 1½ in. scantling, as shown in Fig. 9. Half joints are used throughout these sections. Three 2 in. nails are used at each corner and joint, these being clenched over. When the roof sections are completed, the entire framework is ready for covering.

The most popular sizes in asbestos are 6 ft. by 4 ft. and 6 ft. by 3 ft. With this in mind, the framework has been designed to meet these sizes. The necessity for cutting some of the sheets is unavoidable, but this need not offer any great difficulty if the instructions are carefully followed. The best tool for cutting the asbestos is an old rip saw.

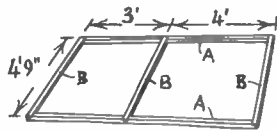

FIG 9

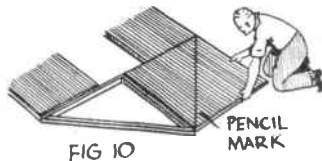

FIG 10

Although the expert can cut asbestos by nicking it with a file, this method is not to be recommended when the stock of asbestos is limited. Also it is possible to drive nails straight through the asbestos without first drilling, but this should not be done, as there is always the danger of cracking the sheeting.

It is best to cover the side sections first, these being the most straightforward job. Lay a side frame on the floor, and place in position two 6 ft. by 4 ft. sheets, one at each end of the frame. Position them to extend just half way across the two pieces D. Next place in position a 6 ft. by 3 ft. piece with its upper edge extending half way across the middle rail.

With the three pieces in correct position, mark off and drill for the nails. Round the outside of the frame, holes should be drilled 1 in. from the edge of

the asbestos, but where the sheets meet, and under the windows, the holes should be drilled ½ in. from the edge.

Round nails 1½ in. long should be used, and they should be spaced approximately 6 in. apart. The side will now be covered with the exception of the strip above the window frame; this can be covered later with strips left over from the roof.

Covering the rear section

Lay the rear section on the floor, and place in position the two 6 ft. by 3 ft. sheets, one each side of the doorway. Take up a 6 ft. by 4 ft. sheet, and place on two trestles or tea boxes of equal height. Mark off and saw the piece into two equal pieces 4 ft. by 3 ft. It is a good plan to saw 2 in. or 3 in. from one side, then start at the other side and saw right through. This will avoid breaking the corner off when finishing. Take one of these pieces, and draw a pencil line across the diagonal.

Now try the sheet in position (see Fig. 10). If the frame has been built correctly, there will be a strip of asbestos about ½ in. to spare. If necessary, mark to fit the frame, and carefully saw. The piece left over should be sawn to fit the opposite triangular space. With the four pieces in position, mark out and drill for nails. While the section is still on the floor, after the asbestos has been nailed in position, drill the four ½ in. holes to take the ¾ in. bolts which are to hold the sections together.

It is important that the holes in each section are drilled to a convenient set dimension, noting that the front section bottom rail lies 2 in. lower than those of the other sections when assembled. This is to give a clean run in, the front section bottom rail being sunk in the floor.

Covering the roof sections

The four roof sections are identical in size, and so is the covering, but care must be taken when fixing, due to the over-

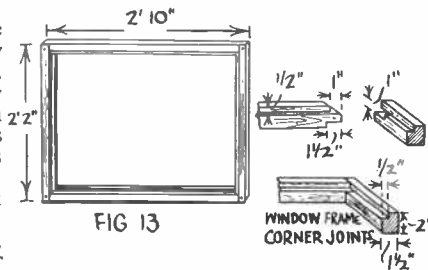

FIG 13

hang. The first thing to do is to saw the sheets ready for fitting. It should be noted that although the roof frames are 4 ft. 9 in. long, the asbestos is sawn 5 ft. This gives a 3 in. overhang, which is just right for the 3 in. guttering, after allowing for the thickness of roof board and the gutter bracket.

Each of the four sections will require one sheet 5 ft. by 4 ft. and one sheet

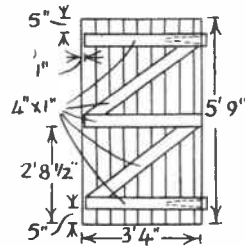

FIG 11

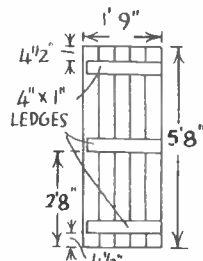

FIG 12

5 ft. by 3 ft. This means that a 12 in. strip will have to be cut from four sheets of 6 ft. by 4 ft., and from four sheets 6 ft. by 3 ft. Take each sheet in turn and support it on trestles, and saw off the spare strips, taking care not to break them, as they will be wanted later.

Asbestos sections

As already mentioned, care must be taken when fixing the asbestos. The four sections must form a set. To make sure that everything is right, lay the four sections out on the floor just as they will fit when in position on the roof. This means that the 3 ft. and 4 ft. spaces line up with those in the side sections. Next place the asbestos in position with the overhangs to the outside. The asbestos can then be marked out, drilled, and nailed in correct position.

Before drilling for the nails, it should be remembered that as the weather strips which cover the sheeting joints are only

2 in. wide, it is important that the nail heads come well under the strips to prevent wet entering down the nails. With this in view, nails should be placed not more than $\frac{1}{2}$ in. from the edges where the sheets meet. The nails used along the top and bottom of the sections should be special roof nails, having large flat heads. They should be galvanized, and 1 in. to $1\frac{1}{2}$ in. long.

The front section being chiefly doors, requires very little asbestos for covering. The 4 ft. by 3 ft. piece left over from the rear section, should be sawn down the diagonal after it has been tried in position on the frame. Fit the two triangular pieces in position, mark out, and drill for the nails. Make secure, using $1\frac{1}{2}$ in. round nails. The pieces left over from the roof can be used to fill in the $7\frac{1}{2}$ in. spaces each side of the door frame. If 3 ft. strips are used, these will make a joint half way up the frame, which can later be covered with weather stripping.

Finally, drill the four $\frac{1}{2}$ in. holes for the bolts which hold the sections together, drilling them to match the holes in the side sections, and not forgetting that the bottom rail of the front section is 2 in. lower than the side sections.

All that remains to finish covering, is to finish the side sections by covering the spaces over the windows. Four pieces will be required for the two sides, all

3 ft. by $8\frac{1}{2}$ in. These can be cut from the remaining strips left over from the roof. The asbestos covering is now complete, and everything dealing with it can be cleared away.

The front doors are made of $\frac{5}{8}$ in. tongued and grooved matching, 5 in. wide. Asbestos panel doors can be made, but these soon get cracked if caught out in a gale. The bracing pieces are 4 in. by 1 in., planed battens. The layout and dimensions are shown in Fig. 11. A 6 ft. length of matching should be marked out for the rails or ledges. Nail the three ledges in position and perfectly square with the matching, using $1\frac{1}{2}$ in. nails (oval) two in each ledge.

When it is assured that the ledges are perfectly square, drill each ledge to take $1\frac{1}{2}$ in. screws. Fit the screws and pull them dead tight, so there is no chance of the ledges getting out of square. Nail the other matchings in position, using two $1\frac{1}{2}$ in. oval nails in each end. The matchings should be held together with a clamp before nailing, or knocked together with a wooden block.

Trim the ends to give each door an overall length of 5 ft. 9 in., making the bottom ledge 5 in. from the bottom of the door. Add two screws to each end of the last matching to prevent the boards opening when exposed to the weather. Place the bracing pieces in position, and mark for sawing. The braces should be

fitted to the doors to form a pair, that is in each case they should point down from the hinges.

Making the rear door is a very simple matter. The layout and dimensions are given in Fig. 12. Mark the first piece of matching, and screw on the ledges 1 in. away from the edge of the matching. Fit the other four pieces, and secure with $1\frac{1}{2}$ in. nails. If it is necessary to saw a strip off the last piece of matching to give the correct door width, this is best done before the matching is nailed in position. Trim the door to length, leaving the ledges equally spaced from each end.

The four window frames are made from 2 in. by $1\frac{1}{2}$ in. planed and rabbeted, as shown in Fig. 13. To make a good sound job, all the corners should be mortised and tenoned. Mark the corners for sawing, and re-check. It is very easy to saw in mistake when making this kind of joint.

The points to watch are to see that the rabbet in each piece will come in the right place when the joints are cut, and when cutting not to saw off the overlapping piece which fills the rabbet at the corners when the frames are assembled. It is also advisable to check the frames in their respective positions before fixing the corners with pegs or wedges.

Concluding article next week

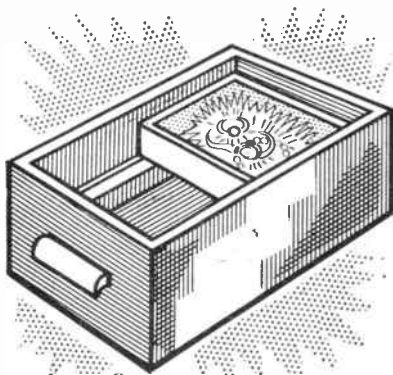

IN some modern designs of ladies' dressing tables provision is often made for one or two small drawers in which to keep trinkets and others items of jewellery. Where there is no such provision and the drawers are deep ones, simple fittings can be made as shown.

No measurements are given for the tray because this will depend on the size of the drawer. The construction need not be elaborate. Use $\frac{1}{2}$ in. thick wood planed smooth on all four sides. Cut the four members to the required lengths and then joint them to form a rectangular frame. Ordinary housing joints will be

A TRAY FOR JEWELLERY

quite satisfactory. Assemble together and then glue and nail on a plywood or hard-board base. Complete the tray by lining the inside with felt or green baize. Attach two narrow strips of wood to the sides

of the drawer to serve as runners.

In use the large drawer is pulled out and the tray brought forward to the front so that the contents are fully displayed. (F.K.)

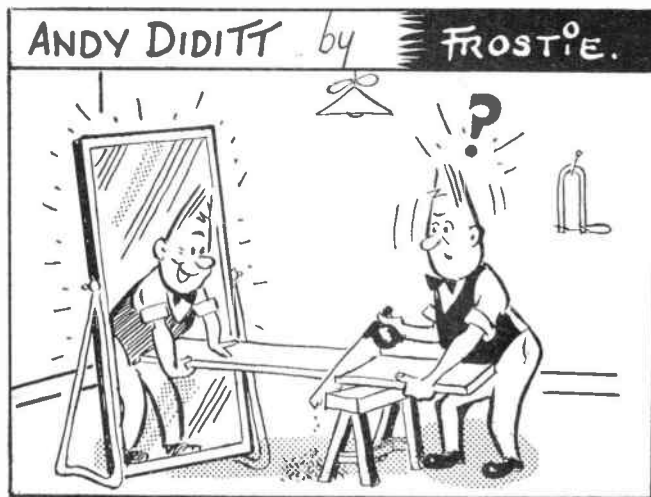

A Model Tractor with Implements

HERE is an easy-to-make tractor and four attachments for it to draw. They are a trailer, plough, disc harrow, and seed hopper.

The body of the tractor is made from a block of 1 in. thick wood, $7\frac{1}{2}$ in. long and 2 in. wide (Fig. 1). The cut-out section A is $3\frac{1}{2}$ in. by 1 in., B is 2 in. by $\frac{1}{2}$ in., C is $\frac{3}{4}$ in. wide and $\frac{1}{2}$ in. deep, and D is $\frac{1}{2}$ in. wide and 1 in. deep.

The front and top of the bonnet are rounded off, and a $\frac{1}{2}$ in. diameter hole is drilled vertically through the projections at the rear to take a cotter pin for towing. The rear end should also be rounded off.

The front axle is a $2\frac{1}{2}$ in. length of $\frac{3}{8}$ in. by $\frac{1}{2}$ in. wood, cut away on the underside as shown in Fig. 2. It is screwed in place $\frac{1}{2}$ in. from the front end, and a pair of 2 in. diameter wheels screwed or pinned in place.

By
A. Liston

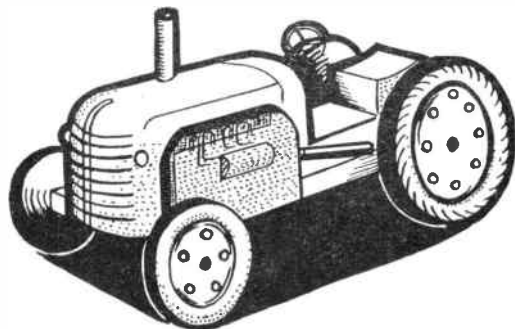

length of $\frac{3}{8}$ in. dowelling tapered at the top and glued in a hole half way along the bonnet top on the right side. A $\frac{3}{8}$ in. long piece of dowel, split lengthwise, forms the half round projections glued on each side of the body, which represent the generator and starter motor. The steering wheel is a $\frac{3}{4}$ in. circle of

leads can also be painted in black.

The trailer E has a T-shaped chassis of $\frac{3}{4}$ in. by $\frac{3}{4}$ in. wood, the 'backbone' being 5 in. long, and the axle 3 in. long. On this is mounted a shallow box, 3 in. wide, 6 in. long, and 1 in. high. This can be made of plywood, or an existing wood or metal box can be used. The box is

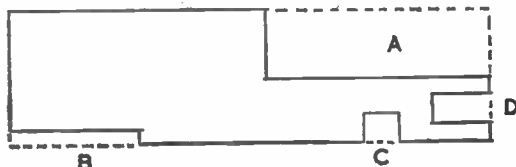

Fig. 1

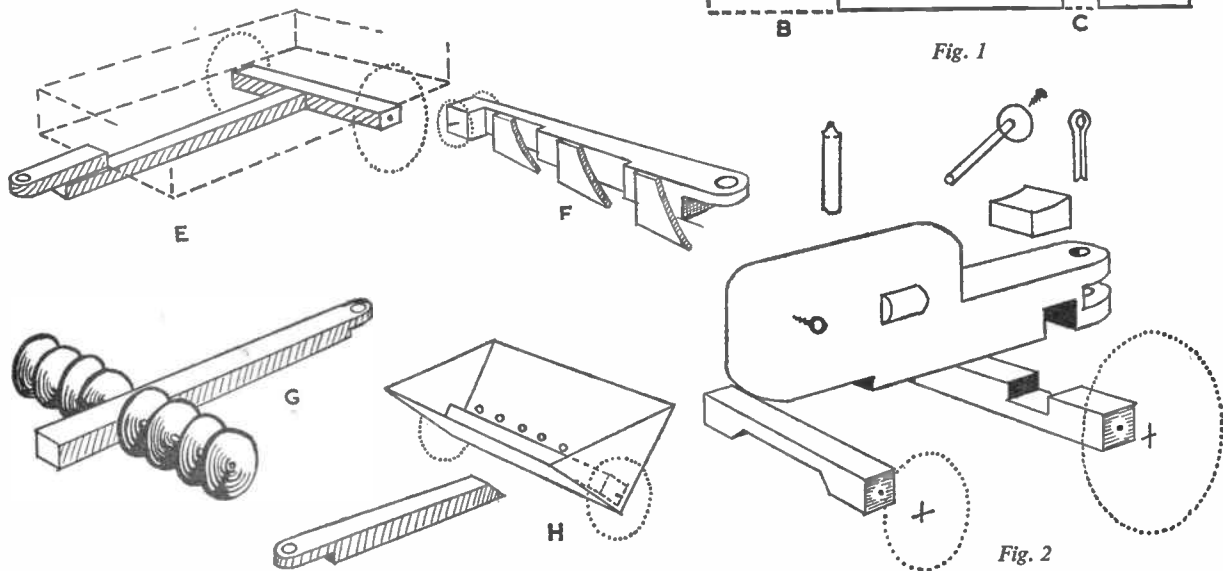

Fig. 2

The rear axle is similar in size to the front one, but a 1 in. wide and $\frac{1}{2}$ in. deep cut is made in the centre of its upper surface; this fits in the recess under the tractor body, where it is screwed in place (Fig. 2). The rear axle is fitted with 3 in. diameter wheels. Saw cuts at an angle round the rim of each wheel represent the tread of the rear tyres.

The seat is a 1 in. cube made slightly concave on the top, and is glued in place. The exhaust pipe is a $1\frac{1}{4}$ in.

hardboard mounted on a 1 in. length of thin dowel inserted in a hole made at an angle in the rear of the bonnet. Headlamps are metal eyes screwed on each side of the bonnet and filled with plastic wood.

The tractor should be painted bright red, with grey tyres, engine block, and exhaust pipe. The part between the engine block and the red bonnet top should be painted in black. Engine details such as fuel lines and electric

positioned so that the chassis member projects forward 1 in. beyond it, and on top of the projecting piece a $2\frac{1}{2}$ in. long strip of wood, $\frac{1}{2}$ in. thick, is screwed. A $\frac{1}{2}$ in. hole is drilled in this to take the cotter pin when the trailer is fitted behind the tractor. A pair of 2 in. diameter wheels are fitted to the trailer.

The three-bladed plough F is made from a 7 in. length of $\frac{3}{4}$ in. by $\frac{3}{4}$ in. wood. It is stepped on one side as shown, and

● Continued on page 303

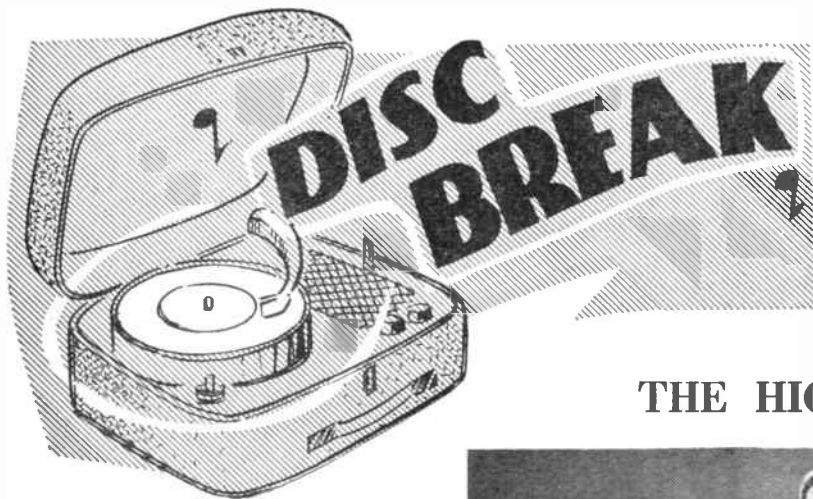

to preserve as much authenticity of the music as possible while still making it commercially acceptable.

The boys are all guitarists — but they often feature also other folk instruments such as the five-string banjo, bongo drums and recorders. Since they are all potential folk soloists they are all featured at one time or another. Solos, duets and trios are not uncommon at 'Highwaymen' concerts, in addition to numbers for the entire group.

STEVE BUTTS, guitarist and bass, hails from New York City. He has travelled to India, Arabia, Ceylon, Egypt and Australia, amongst other places.

THE HIGHWAYMEN

SHEER coincidence — that's what brought 'The Highwaymen' together. They met while attending Wesleyan University in Middletown, Connecticut, USA and joined forces to prepare some entertainment for a party. They were such a great success that they decided there and then to continue with the act.

From that beginning they now have the satisfaction of seeing 'The Highwaymen' at the very top of the American Hit Parade with their tremendously popular recording of *Michael* — released in this country on H.M.V. 45-POP910.

It was in the winter of 1960 that the boys found their way to New York and met up with Ken Greengrass, who became their manager. Soon afterwards they were signed to a United Artists contract.

The music that The Highwaymen sing is strictly folk music. It is said that in these very commercial days their aim is



● Continued from page 302

A MODEL TRACTOR

the towing bar is cut to $\frac{1}{4}$ in. thick at the front, drilled for the cotter pin, and rounded. A pair of 1 in. wheels are fitted at the rear. The plough should be attached to the tractor before the three plywood plough-shares are fitted, for the strip on which they are mounted slopes down towards the rear. Each plough-share should be placed so that it just clears the ground.

The disc harrow G needs only a 6 in. length of $\frac{3}{4}$ in. by $\frac{3}{4}$ in. strip with a towing attachment at the front end. Eight $1\frac{1}{2}$ in. plywood or hardboard discs are glued to a thin dowel rod axle, 6 in. long, which passes through the wooden strip. Hardboard or plywood washers act as

distance pieces between the discs.

The seed hopper H has front and back pieces, each 4 in. wide and 3 in. deep, pinned and glued as shown to a 4 in. piece of $\frac{3}{4}$ in. by $\frac{3}{4}$ in. strip. The two sides, made by cutting a 3 in. square of plywood diagonally, are glued in place, 2 in. diameter wheels are fitted, and a 4 in. long shaft of wood strip is screwed in place. This shaft has the usual towing attachment at the front end, and the rear end is cut at 45 degrees. A row of small holes can be drilled in the rear side of the hopper.

All the attachments look best painted in bright colours such as blue, red or yellow, with details in black.

CHAN DANIELS, plays the guitar, the charango, and sings baritone. He was born in Buenos Aires and lived there before moving to Wesleyan.

BOBBY BURNETT, a tenor who plays guitar, bongos and maracas. He lives in Mystic, Conn., where he spends his summers giving sailing lessons to tourists and hometown enthusiasts.

STEVE TROTT, guitarist and tenor, was raised in Mexico City. He has studied in Europe and is fluent in three languages.

DAVE FISHER, plays guitar, banjo, recorder, bongos — and is lead tenor. He lives in New Haven, Conn., and is the musical arranger and organiser of The Highwaymen.

**THERE'S MORE
THAN A TOOL CHEST
IN THIS TIN**

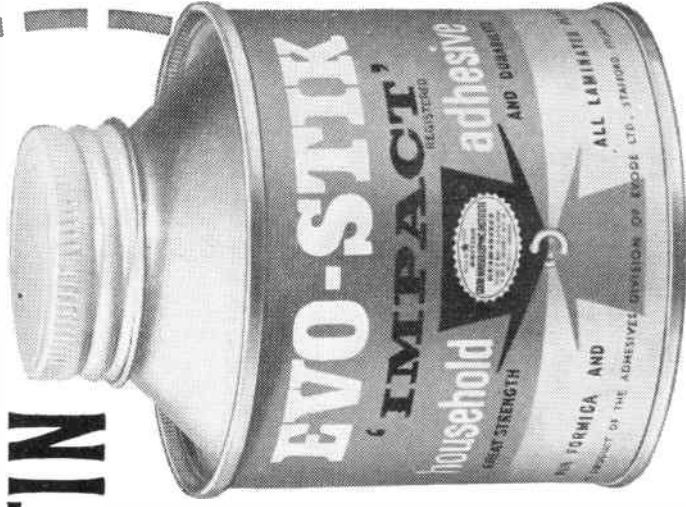

**... THERE'S THE STRENGTH
OF A HERD OF WILD ELEPHANTS**

with an invisible ease and economy which makes most tools and fixing methods "old-fashioned"

You can say "thanks" to modern research and scientists for Evo-Stik 'Impact' Adhesive. The amazing new "toolchest in a tin" which permanently fixes almost anything to anything. And with a power which wild elephants couldn't separate.

Demand for this new scientific method of fixing means that hundreds of thousands of gallons of Evo-Stik 'Impact' Adhesive go to important British industries. And millions of gallons go to industries throughout the world.

Now, demands from home-users just like you mean that all this fixing power; all this "know-how", powering international industry is available to you. Here are some examples . . .



SURFACES THAT SHINE

Decorative wall-boards and laminated plastics fix to almost any surface, be it plaster, metal or wood. And although they can be screwed, nailed or pinned, few builders would care to spoil such fine surfaces. Instead, manufacturers invariably recommend fixing with Evo-Stik 'Impact' Adhesive. And it is mainly due to the speed, economy and amazing strength of Evo-Stik that 75 million square feet of these materials are fixed each year.

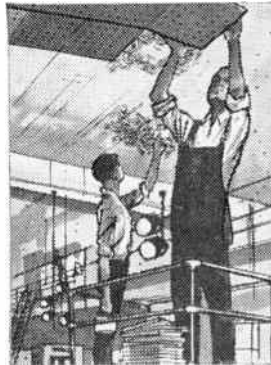

Ceilings That Seal Sound

Only a few years ago industrial installations of Acoustic Tiles were laboriously and expensively fixed with screws and bolts. Often with a maximum speed of around 30 tiles an hour. Demand was low due to high installation cost. But to-day, two workers using Evo-Stik 'Impact' Adhesive install up to 300 tiles an hour. Result; new ceilings that silence sound; and new acoustic materials, shapes and decorative effects: through the speed of Evo-Stik.

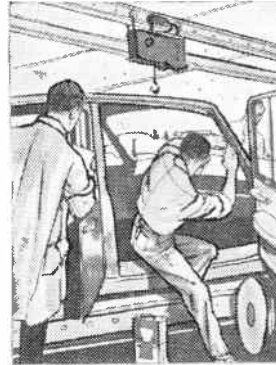

CARS THAT LAST LONGER

Many of the component parts of motor vehicles such as draught excluders, foam rubber weather seals, etc., are under permanent atmospheric attack. Metal fixings used to hold these parts in position were constantly attacked by rust and corrosion. New fixing methods, resistant to atmospheric attack yet with all the strength of steel rivets and bolts were needed. Evo-Stik 'Impact' Adhesive answered this vital problem, throughout the motor industry.



DO THAT JOB YOURSELF

Because Evo-Stik is in your Ironmongers right now all these latest industrial joining techniques are being applied in the home. No wonder people say it's taken the "do" out of "do-it-yourself". Within seconds of applying Evo-Stik 'Impact' Adhesive you have a permanent, waterproof, and heat resistant bond. And Evo-Stik is efficient with practically every material you can think of. It's a toolchest in itself. Keep a tin handy.



TINS 7/- AND 4/3. TUBES 1/9



'IMPACT' EVO-STIK ADHESIVE

is a Registered Trade Mark

Remember . . . a small deposit secures any article.

LONDON OFFICE: 450/52 EDGWARE ROAD, W.2. AMB 2425 (5 lines). Associated Company in **Elze**: Evode Industries Limited, Swords, Co. Dublin. Swords 331

Mainly for Modellers

LET us now consider those vessels of the merchant navies of the East India Co., and other British and European trading concerns.

The East India Co. were famous for the quality of their ships. Built on similar lines to the large naval frigates, they differed mainly in being fuller bodied, being built to carry cargo. At a time

small arms and well disciplined.

Because of the high price of building this type of vessel the Company started to build their own vessels, founding a large shipbuilding yard at Deptford where over 500 men were employed. Some of their vessels were built in India from teak.

The first East Indiamen were clumsy to handle and made slow passages. This was during the Stuart period, and they usually carried four masts, three square rigged, the mizzen fore and aft. They were low and wide with low bows and high sterns.

During the middle of the eighteenth century the company reached peak power and prosperity. Their records date back to about 1708 and thus our knowledge of their ships is greater than of the average merchantman. Although some of their vessels were as low as 200 ton burden, the average was 400 to 500 tons. But after about 1700 they concentrated on larger ships and began to have them built by other shipbuilders, so that eventually the vessels were from 750 tons mainly and up to some 1,500 tons. They

WOODEN SHIP BUILDING—17 By 'Whipstaff'

when the majority of crews were made up of all sorts and conditions of men, they nevertheless were fine seamen.

The building of large ships for carrying cargo and passengers and to enable them to hold off pirate attacks was favoured. They were in appearance war vessels, their crews trained in gunnery and

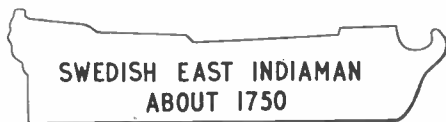
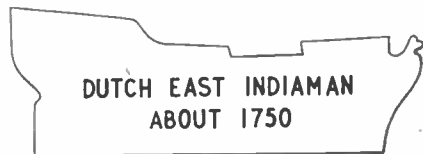

were frigate built and their armament was usually about twenty-eight guns, six of which were on the quarter deck.

In 1791 one of their surveyors was responsible for an important advance in shipbuilding. This was the introduction of iron knees (brackets) to connect the beams with the side timbers and the use of iron spikes and bolts in the place of wooden treenails. Their first successful use was in the teak-built vessels of the company.

It is of interest here to note that the famous Blackwall frigates were the type to succeed the Indiamen and they not only took part in the Australian service but actually became the heirs to the East India Co. on the far Eastern trade runs. They also carried a superior type of crew and officer in the same manner as the East India Co.

The larger vessels of the company had in the main dimensions similar to a two decked warship of sixty-four guns of the late eighteenth century, although as mentioned previously they were fuller in the body and with flatter floor timbers to accommodate cargo. They carried no guns on the lower deck, and in place of portholes on the lower deck a row of dummy ports were usually painted to give the appearance of a heavily armed vessel.

The most important internal difference between these vessels and the navy type was in the arrangement of the decks. In the Navy ships the quarter deck and forecastle were still only connected with wide gangways, while in the Indiamen the waist was decked in so that the forecastle and quarter deck merged in one continuous deck called the upper deck. Above the foreward end of this deck was erected a small deck, known as a top-gallant forecastle.

What was termed the upper gun deck on the man-of-war was known as the middle deck on the Indiaman and it was here the main armament of guns was carried.

The high bulwarks and dummy ports gave these vessels the appearance of being of greater depth than the Navy vessels and showed less sheer. Another difference was the shape of the stern post and provision of ample cabin accommodation.

The Dutch East Indiaman followed the same pattern of being built on the lines of the contemporary man-of-war and this practice was continued even longer than by the British.

Although not so well known as the rest of the Indiamen (including the French), the Swedish merchants produced East Indiamen that were much more satisfactory as merchant vessels.

In our sketches the hull shapes of the various types can be seen and their close affinity with existing Navy types noticed.

'CRINOLINE' TABLE MATS

INTARSIA



Fig. 1

A DESIGN MARKED ON WOOD

B CUT SHALLOW GROOVES ALONG ALL LINES AS SECTION

C PAINT AREAS TO COLOURS INDICATED WITH WATER COLOURS & ARTISTS SMALL BRUSH

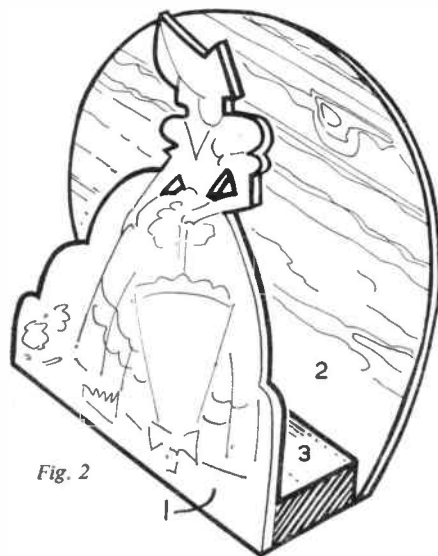

Fig. 2

A SET of table mats is a very welcome gift at any time of the year and can be quite expensive in the shops. Our design is for a very practical set of mats with plastic surfaces, contained in an attractive stand with a crinoline lady motif. This is executed in intarsia work, which will be explained in detail later. It is quite a simple application even for the beginner and when finished gives a very similar result to marquetry work using coloured veneers.

The set of mats consists of four which are 5½ in. square, two others 6 in. square and a large one 7½ in. square. As shown in the illustration, together they fit nicely into the wood stand.

On the design sheet, the three pieces which make up the stand are shown full size. Also shown is the size of the various mats and the positioning of all pieces on the Hobbies panels of plywood, which are 18 in. by 12 in. by ⅜ in. Piece 3 is cut from a ½ in. thick panel of wood. Also in the Hobbies kit is sufficient laminated plastic to cover the mats.

Trace and transfer the full size pieces by means of carbon paper on to the wood and measure off the other parts as indicated. Cut out neatly with a fretsaw, noting that there are two interior cuts in the crinoline lady figure inside the arms.

The plastic surface is cut to the shape of each mat and fixed in the normal way by gluing with the appropriate adhesive. Allow plenty of time for setting, with the

mats placed under weights such as heavy books. The plastic finish is, of course, only applied to one side of each mat. The edges should be smoothed off neatly and the corners rounded.

KIT FOR 15s. 6d.

All the materials for making the set of Crinoline Lady Table Mats complete with holder are contained in Hobbies Kit No. 3452, price 15s. 6d. from branches etc, or direct from Hobbies Ltd, Dereham, Norfolk (post 3/- extra)

Dealing next with the crinoline lady figure, the application of intarsia work is shown in Fig. 1. From the design sheet, mark out the details of the crinoline lady on to piece 1. Then along each line cut a shallow groove with a sharp modelling knife. This groove will prevent the colours, which will be applied later, from running into the neighbouring areas by way of the grain. It is not necessary to cut these grooves too deeply as they will be filled later with the wax finish.

Clean up the surface thoroughly with glasspaper and then apply the colours as indicated on the design sheet. Ordinary water-colours are ideal for this purpose. Wood stains can be used, but obviously here the range of colours is

limited. The colour will soak into the wood quickly, but one application of each should be sufficient.

Before assembling the stand, it is advisable to finish the three pieces which complete its make-up. Give the picture several applications of white furniture wax polish, filling the grooves with the first application. Work the polish in well with the finger tips. After three or four applications, smooth down lightly with fine glasspaper and after two or three more applications of wax, finish off with a clean duster.

Pieces 2 and 3 of the stand can be finished with stain and polish or by painting, as desired. The assembly is shown in Fig. 2, piece 3 being glued between the back and front.

The edges of the stand and the mats would look attractive in a contrasting paint.

Next week's issue will show how to make a photo enlarger from an old camera — cheap and efficient. Make sure of your copy of Hobbies Weekly by placing a firm order with your newsagent

NEW Thoughts on

RAILWAY MODELLING



THIS week I will give you some instruction on the making and fitting of tunnel mouths. I give a couple of designs for a typical type of mouth. One you will see is made to represent stone blocks, and the other in the more recent type of concrete construction. One is for a single road, and the other for a double road.

I know that there are tunnel mouths on the market that one can purchase ready made, and some of them, or rather most of them, are very good models indeed. But the purpose of my writing is to show you how to do-it-yourself, and I am sure you will agree that you can take more pride in an article if you have made it yourself.

Well, let us first consider the double road tunnel mouth. You will see that this is only a front, as it were, to put against your tunnel that was described some weeks ago. I should make this up in wood, or very thick cardboard, with card overlays for the top stone copings, etc. It is very difficult to give actual dimensions, which will differ according to the type of track you are using. But I will list the dimensions, and you should be able to work from that to make it to fit your own layout.

There are various ways in which you can simulate the stone blocks on the surface of the construction. You can use a printed paper, either Modelcraft or Merco, both of which can be obtained

from your local model shop. Or you can score the lines on the surface of the material used with a dry ball point pen, and then you will have a wonderful effect of the blocks when the whole thing is given a coat or two of stone paint.

'MOUTHS' FOR YOUR TUNNELS

By F. A. Barrett

Now as to the size of the thing. The width of the actual opening at track level should be about 22 scale feet. The height of the opening should be about 18 or 20 scale feet. The size of the structure will depend on the tunnel, and remember that it should come a little lower than the tunnel. That is to say, it should be used as a retaining wall for the rocky hill that serves as the tunnel.

I have shown on one side of the tunnel a wing wall. Now this can be placed in any direction, to suit the surroundings, and, of course, you can put one on each side of the mouth if you wish. Some of them are at right angles to the tunnel mouth, others are put at an angle of, say, 45 degrees. It is largely a matter of the amount of rock or earth that has to be held in place by the tunnel mouth.

Now to the fixing of the tunnel mouth to the tunnel framework. I did point out in a previous article that we should be able to get into the tunnel for cleaning purposes, and we must still keep that in our minds. If you are making the mouth with wing walls that are fixed at an angle to the tunnel mouth I would suggest that you drill a few holes in the bottom of the tunnel mouth and the wing walls, and in these fix some pieces of dowel, say, $\frac{1}{8}$ in. or $\frac{3}{16}$ in., and then drill into your base-board holes to take these dowel pins. This will make sure that the structure is well supported. This method could also be used with a straight mouth as I have shown. But I would suggest that a little

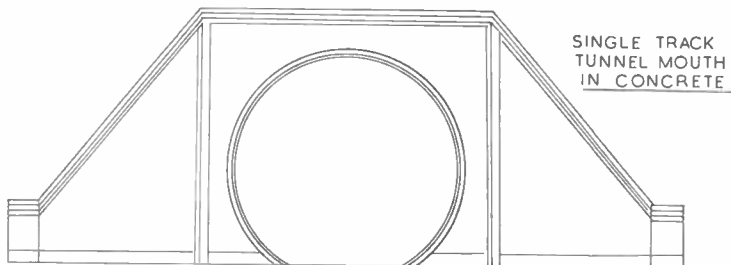

DOUBLE TRACK TUNNEL MOUTH IN STONE BLOCKS

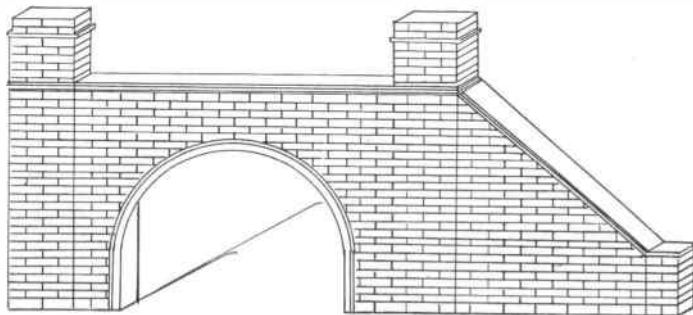

more is needed, and would put three strips of wood, say, $\frac{3}{8}$ in. square, at the back of the tunnel mouth, one at the top and one each side, to be a tight fit inside the tunnel structure. Of course, you could drill the back of the tunnel mouth about half the depth of the thing, and put dowels into these holes to line up with holes in the tunnel structure. But in any case I am sure you will see that what we are doing is to make the tunnel mouth removable should we want to get inside for cleaning or other purposes.

Now, with regard to the single tunnel mouth, here we work in exactly the

same way, and the height of the opening should be about the same as for the double track version, but we can, of course, alter the width of the opening to suit single track conditions. The best way to ascertain the actual width is to measure your track and allow about $\frac{1}{4}$ in. or $\frac{3}{16}$ in. each side of the sleepers, that should give you sufficient space for trains to get through, but don't make the actual portal too small. One must remember that small trains when they are running tend to sway from side to side. And a word of warning here, if your tunnel is on a curve, then you must allow room for engines to clear the front of the tunnel. This is more apparent on small radius curves. But you will have seen on some model railways the swing of the leading bogies on the engines, and where they have couplings in the front this could lead to trouble. So always make sure you have plenty of room to let a train through.

The same rules apply to the single road mouth as for the other one. The wing walls can be put in any direction, and the fixing would be the same.

Well, this should start you thinking along the right lines, and I am sure that you will be designing some tunnel mouths for yourselves. This is a very interesting subject, and if one looks at some of the actual tunnel mouths to be seen on British Railways, and, indeed, in any part of the world, some beautiful examples may be seen. Tunnels are not the austere things that some people seem to think. Some are wonderful examples of the architect's art. I would suggest that you try to obtain from your local library, or else buy, a book about railway architecture where you will see some typical examples. Some have towers and look like fortresses, some are plain, made of concrete, and in between these are all sorts of shapes and sizes. Many of these are easily modelled, the ones with the towers, for example, could be made using cardboard postal tube for the towers. These could be covered with brick paper, or else scored and painted. And speaking of painting, there is one point that is most often overlooked in tunnel mouths, and that is the smoky appearance over the tracks. This should

be applied directly over the centre of the tracks where the chimney of a passing engine would deposit the soot and smoke. But do not just paint a blob of black and let it go at that. The best method is to use a small piece of candle. Place this on one of your open wagons, light it, and then push the wagon through your tunnel with your finger, or you could couple it on to an engine. But make sure that it is kept moving, and that the candle is of the correct height, so as not to burn the tunnel top. It is such little touches that make a model railway worth while.

Whilst on the subject of tunnels let us consider the places where one can use them. It is advisable not to use them on straight track. It is nice to see trains running along the track, and if they are lost to sight under a tunnel it spoils the effect. The best place for tunnel work is at the corners of the layout. Here one can use a tunnel to hide an ugly corner, and in any case, with small radius curves it would tend to hide the ugly effect of a train going round a very tight corner. But when putting tunnels in corners remember my foregoing remarks, and do leave plenty of room for the trains to traverse the curve when making the tunnel mouth.

With so many transcontinental trains on the market these days, I should mention that there are one or two points where their tunnels differ from ours. The locomotives are larger, so that tunnel mouths are bigger, and always at some distance from the tunnel they have what they call a 'tell-tale'. This is a structure in many ways similar to our loading gauges, but it takes the form of a bar with a row of lengths of chain hanging from it. Its purpose is to warn the conductor and trainman on the freight trains that a tunnel is imminent, and to get down from the top of the cars, it being the custom of the train crews to walk along the top of the cars to see if everything is O.K., and also to get to the driver of the train in case of emergency.

It is a good thing to have a loading gauge on your layout. These are usually to be seen on sidings where there is a goods shed or near factory sites. The idea of this is so that the train or station officials can check that a load can go through the smallest tunnel it is likely to come to on its journey.

Well, I hope that I have given you a little interest in tunnels and their portals or mouths. They are not just lumps of stone put up to suit the occasion. They have a function, and no two are alike on the railways of Britain. In many cases they do not even match on each end of a tunnel, so you can use your imagination.

In my next article I shall be dealing with some aspects of track work, the most important part of railway modelling.

ITOLD you recently about the very excellent Tri-ang Motorways system, and I have now received some very exciting new additions to this range, writes F.A.B. Firstly, a model of a London Transport Routemaster bus is complete in every way with seats, route indicators, and everything one could wish for. This is a gem, and a perfect little model. Of course, it is fitted with a motor, and it will run on the motorway roads. This is something that should appeal to all my readers. Buses on a layout do add an authentic touch, and when they are also capable of working, the interest is even greater.

Another new feature is a complete

ADDITIONS TO TRIANG MOTOR- WAYS

flyover bridge, and this makes up into a model that is ideal in every way. It will take your road up an incline and over the top of your railway, and then down the other side. It is made in plastic, and is easily put together. There are also available pavements and walls.

The Tri-ang Motorway series is perfect in every way, and a lot of fun and interest can be had from adding its components to your own layout. As I have

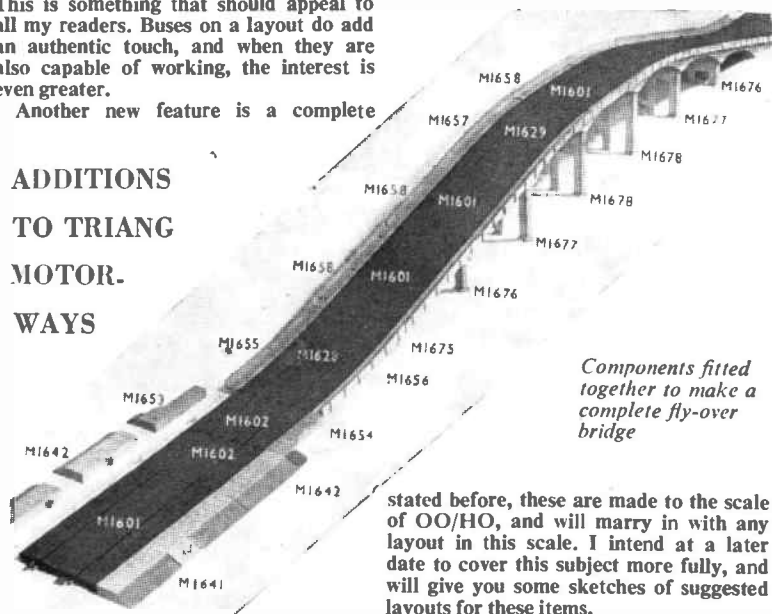

Components fitted together to make a complete fly-over bridge

stated before, these are made to the scale of OO/HO, and will marry in with any layout in this scale. I intend at a later date to cover this subject more fully, and will give you some sketches of suggested layouts for these items.

HEAR ALL CONTINENTS With H.A.C. Short-Wave Receivers

Suppliers for over 18 years of radio S-W Receivers of quality.

One-Valve Kit, Price 25/- Two-Valve Kit, Price 50/-
Improved designs with Denco coils. All kits complete with all components, accessories and full instructions. Before ordering, call and inspect a demonstration receiver, or send stamped addressed envelope for descriptive catalogue.

(H.A.C.) Short-Wave Products (Dept. 22), 11 Old Bond Street, London, W.1.

No. 1 MITRE-CUTTING TOOL AND CORNER CRAMP

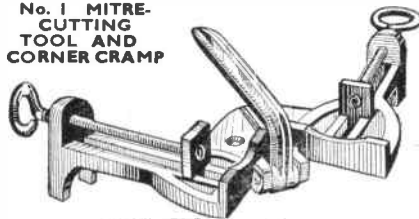

Will cut mitres on moulding and similar work up to 4 ins. wide. (post free) **55/-**

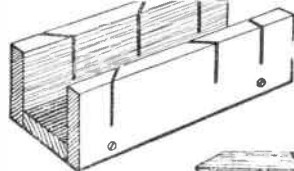

WOOD MITRE BOX

Made of selected hardwood. Size 9 ins. long. (postage 1/6) **5/6**

MITRE BLOCK
Made of selected hardwood. Size 9 ins. long. (postage 1/-) **3/-**

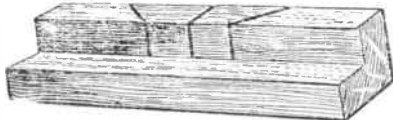

HOBBIES LTD (DEPT. 99), DEREHAM, NORFOLK

LEARN

RADIO & T/V SERVICING

for your OWN BUSINESS/HOBBY

● by a new exciting no-maths system, using practical equipment recently introduced to this country
FREE Brochure from:—

RADIOSTRUCTOR

DEPT. 681, READING, BERKS.

7/2/62

STOP SMOKING

You can overcome the Smoking habit in 3 days, or money back. Safe, pleasant, permanent. The only scientific way. No Will Power necessary. 'Conquered the habit in 2½ days.'—F.C. 'Within 2 days I was free.'—W.G. Complete Course 7/6 Details 2d. Sent under plain cover.

NATURE REMEDIES, (H165), 28 Dean Road, London, N.W.2. Established 1928

IT'S EXCITING. IT'S PROFITABLE. Paint designs. Flowers. Anything. Even beginners' ideas can sell for £25/£60. Inexhaustible demand. Details free. **POPULAR ART SERVICES (HW), CLUN, SALOP.**

ENJOY WRITING? Then write for Profit. Send for 'Writers' Handbook' (free) detailing countless 'opportunities for beginner or experienced. — Writers' Ring (HW), 5 Edmund Street, Birmingham.

PERSONAL COLUMN LTD, Falcon House, Burnley, Lancs. Pen Friend — all hobbies. Correspondents in almost every Country. All ages. S.A.E. for details.

BARGAIN — Set of 4 Sheffield Wood Chisels. Firmer 10/-; Bevel Edge 12/6. In Presentation Box. Ideal Gift. Post 2/- Davy & Son, 1 Prince of Wales Crescent, London, N.W.1.

FRIENDS' WORLD, International Penpals' Association (HB), Postbox 708, Calcutta, India, offers world-wide congenial pen friends.

LEARN CONJURING for pleasure or profit; details S.A.E. — **MAGICIAN, 63 Withington Road, Fegg Hayes, S.-O.-T., Staffs**

'ORIENTAL' PLANT HOLDER



FULL-SIZE PATTERNS FOR MAKING THIS NOVELTY SUITABLE AS A GIFT ARE GIVEN ON PAGE 311

Trace the parts first of all, then transfer them to the wood by means of carbon paper. You will need two of A, three of B, two of C, and two of D. The figures O can face in opposite directions if you wish.

Assemble the pieces in the following order. Glue the three pieces B together to form the sides and bottom as seen by the dotted lines on piece A. Now glue the front and back, pieces A in position.

The brackets C are glued in the position shown by the dotted lines, and the figures are glued in the slots. Clean up with glasspaper, and paint in attractive colours. The holder should be black, with touches of gold around the edges to give an oriental effect. The figures should be a combination of black, gold, and red. A tin lid may be inserted in the bottom of the holder to catch surplus water. (M.p.)

MAKE this little novelty from ¼ in. wood. The parts shown full size on page 311 are easily cut out with a fretsaw.

for holding
POWER

SECCOTINE

REGD

There's nothing like real SECCOTINE! For over sixty years Seccotine has been indispensable to every handyman. For sheer adhesive power buy Seccotine with the efficient new "pop-on" seal and open-nozzle tube ready for use.

STILL ONLY 1/3 PER TUBE

Sole Manufacturers — **McCAW, STEVENSON & ORR LTD., BELFAST**

Use these full-size patterns

ORIENTAL PLANT HOLDER



CUT ALL
PARTS
FROM
1/4 in.
WOOD

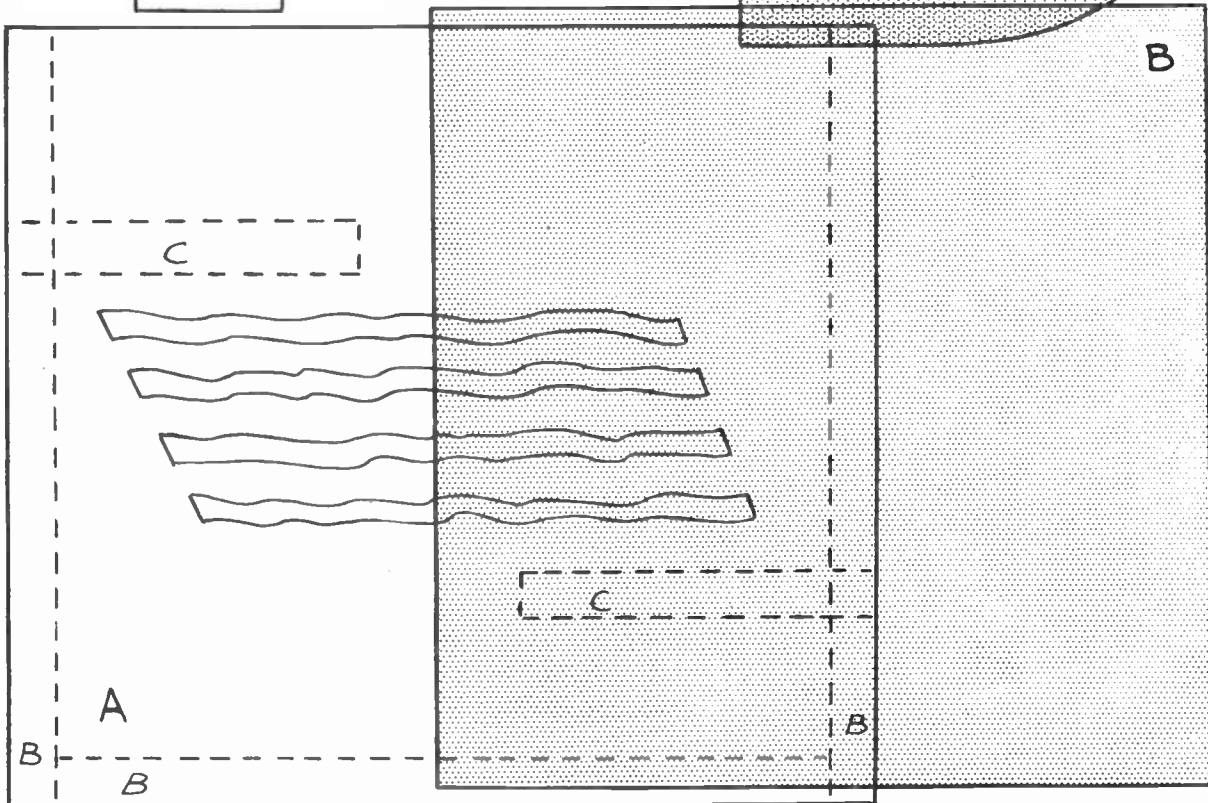
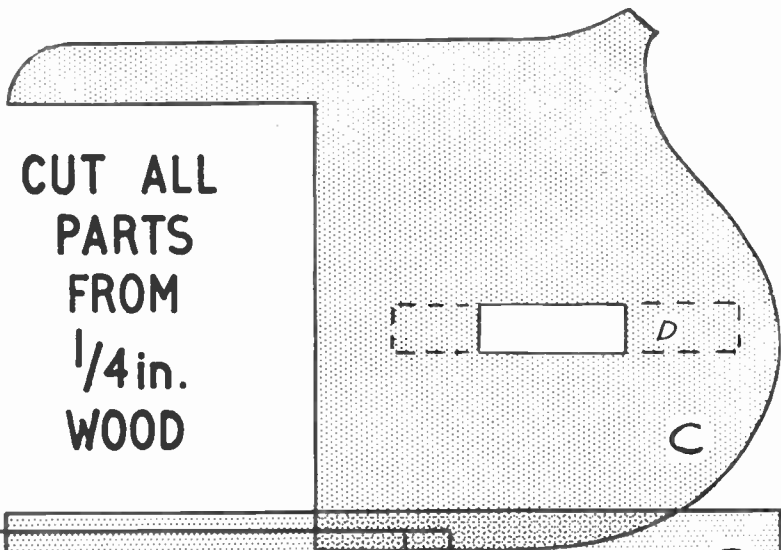

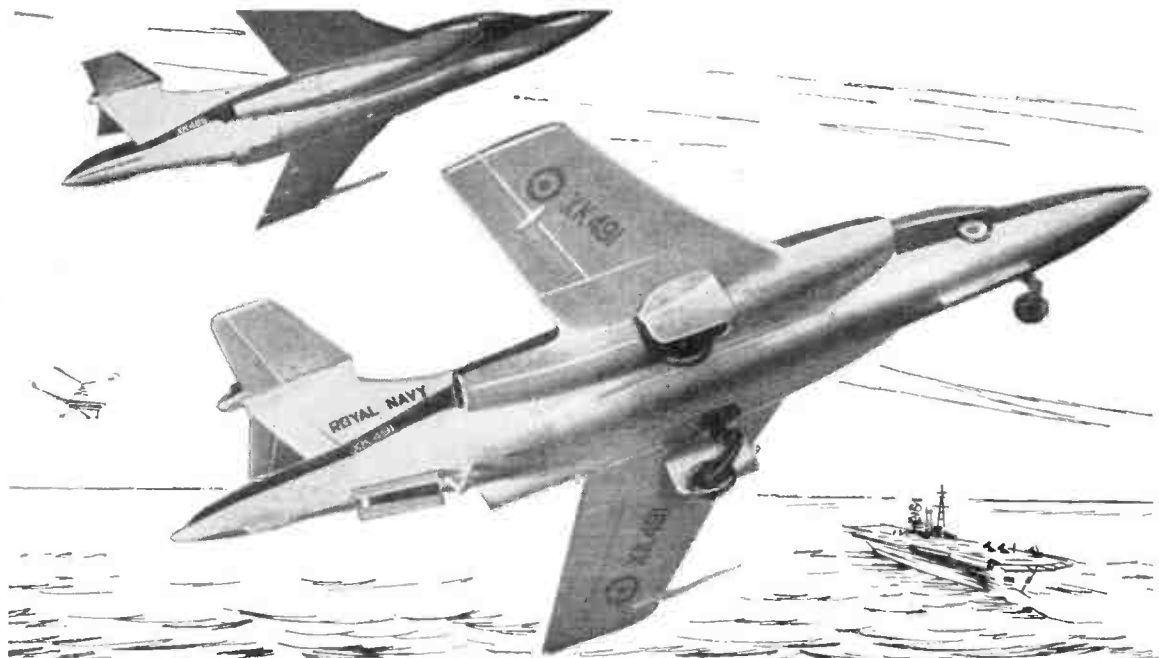

Just like the real thing!

Believe it or not, the nearer one is the Airfix model of the Blackburn Buccaneer (N.A. 39), 1/72nd scale (Kit 4/6). Behind it is a picture of the real thing.

That's how wonderfully realistic Airfix models are. Close attention to every detail gives them their faithful-to-the-original look—makes them true collector's pieces. And every Airfix series is to a constant scale. This means Airfix models look proportionally right, one against another, because *they are right!* You can't beat Airfix for realism—or value.

AIRFIX

Constant Scale Construction Kits

From Model & Hobby Shops, Toy Shops and F. W. Woolworth

There are over 140 Airfix models from 2/- to 10/6.

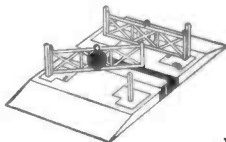

TRACKSIDE SERIES
Level Crossing 2/-

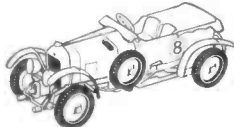

VINTAGE CARS
1930 Bentley 2/-



MODEL FIGURES
Lifeguard 2/-

BRITISH WARSHIPS
H.M.S. Cossack 2/-

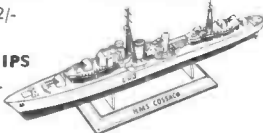

A.160

STOP PRESS!

Latest Airfix Production

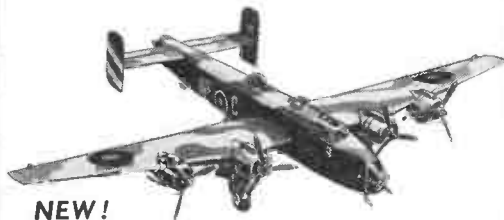

NEW!

HALIFAX Mk III

This magnificent 1/72 scale model of the Handley-Page 'Halifax' has a 16½" wingspan, retractable undercarriage, rotating turrets, movable control surfaces and a complete set of transfers.

110 part kit . . . 7/6

ALSO NEW H.M.S. 'NELSON' Another in the Airfix Warship Series. This famous ship is reproduced in magnificent detail, overall length 14"

134 part kit . . . 6/-

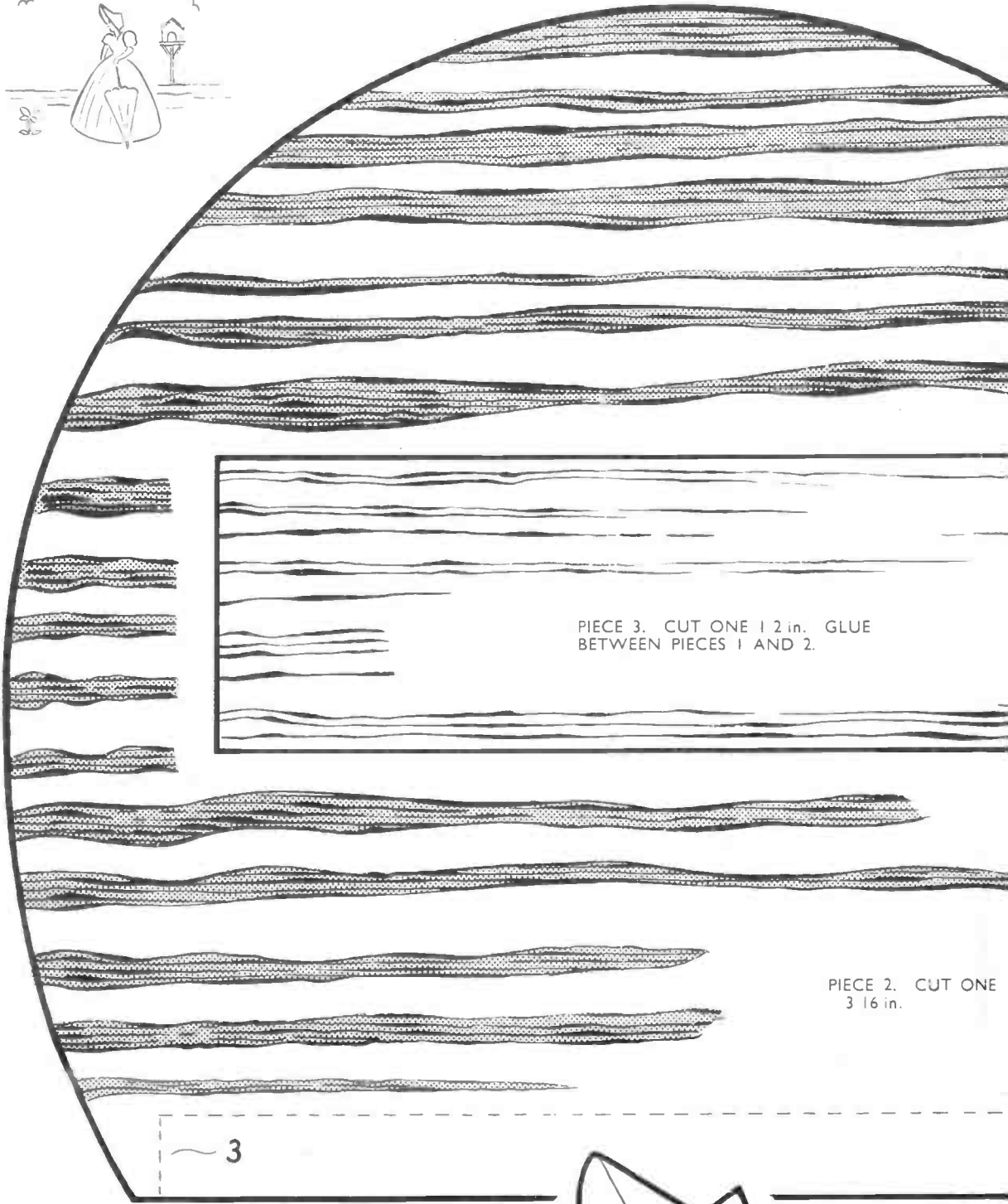

PIECE 3. CUT ONE 1 2 in. GLUE BETWEEN PIECES 1 AND 2.

PIECE 2. CUT ONE 3 16 in.





“CRINOLINE LADY” TABLE MATS & HOLDER

FOUR MATS 5½ in. sq., TWO 6 in. sq.,
and ONE 7½ in. by 7½ in.

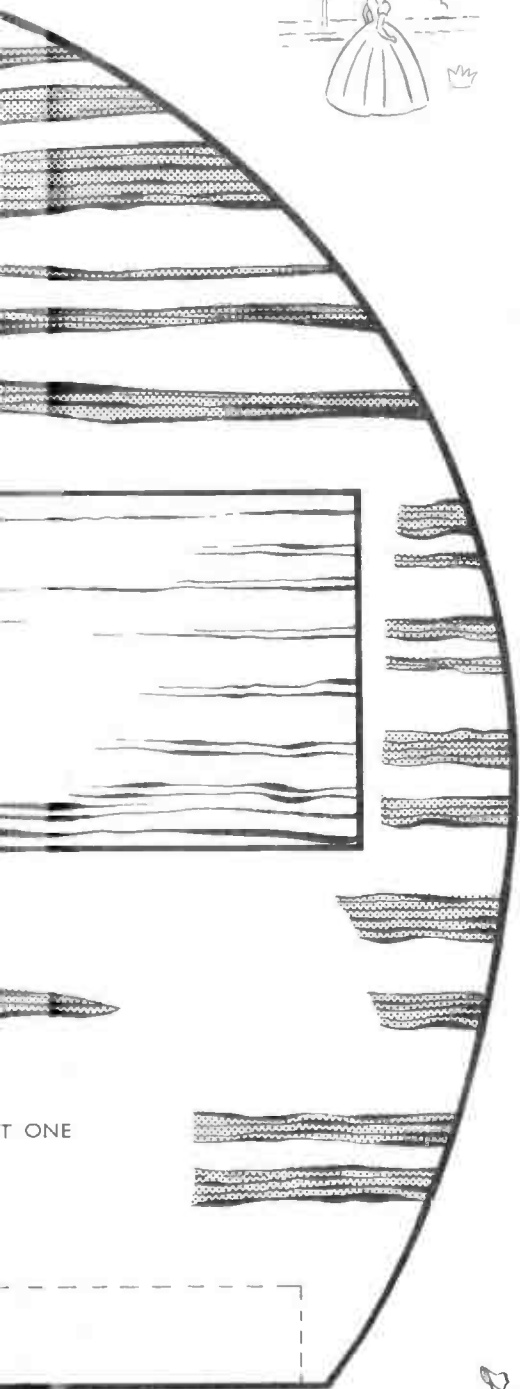

use **CASCAMITE**
‘One Shot’
Resin Glue
for bonding · Decorative
Plastic Laminates
and all Wood Gluing



- Mixed & use cold • Waterproof type
- Gap-filling and non-staining

Manufactured by:
LEICESTER, LOVELL & CO. LTD. North Baddesley, Southampton

Obtainable in:
3½-oz.; 7-oz.
and 18-oz. tins.
Stocked by: Iron-
mongers, Builders’
Merchants, etc.

PIECE 2. CUT ONE
3/16 in.

3



YELLOW
DK. BLUE
BROWN
PINK
LT. BLUE
PINK

PINK
GREEN

PIECE 1. CUT ONE
3/16 in. THE
METHOD OF
"INTARSIA"
WORK IS
SHOWN
IN
DETAILS.

LT. BLUE

RED

WHITE

DK. BLUE

YELLOW

BLUE

YELLOW

RED

GREEN

GREEN

3

T ONE

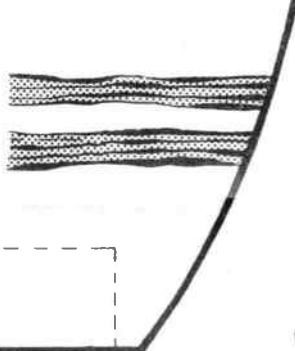

use **CASCAMITE** **'One Shot'** **Resin Glue**

for bonding **Decorative
Plastic Laminates**
and all **Wood Gluing**



Obtainable in:
3½-oz.; 7-oz.
and 18-oz. tins.
Stocked by: Iron-
mongers, Builders'
Merchants, etc.

- Mixed & use cold
- Waterproof type
- Gap-filling and non-staining

Manufactured by:

LEICESTER, LOVELL & CO. LTD. North Baddesley, Southampton

A KIT OF MATERIALS FOR MAKING
THIS DESIGN IS SUPPLIED BY
HOBBIES LIMITED
DEREHAM, NORFOLK.
PRICE ON APPLICATION.

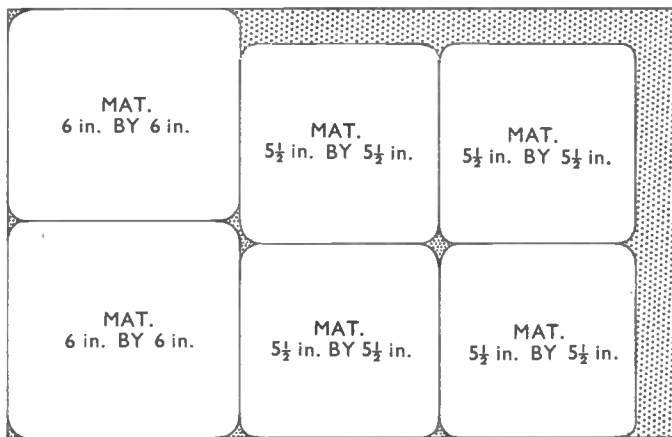

SHOWING ALL
THE 3/16 in.
PIECES ON
THE TWO
18 in. BY 12 in.
PANELS.

