

HOBBIES *weekly*

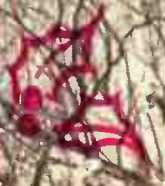

World Radio History

20th DECEMBER 1961

VOL. 133

NUMBER 3445

5°

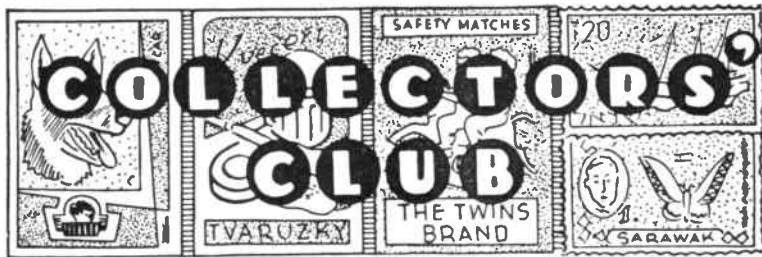

FROM Russia comes this 'Gagarin' commemorative set of match labels. We suggest that philumenists open

a special album entitled — 'Men In Space'. There will, obviously, be many more issues on a similar theme.



LIECHTENSTEIN 'DEFINITIVE' STAMPS

THE current definitive series are to be continued until further notice. This set is worth consideration. Designs (illustrated) show: 'Haymaker in Alps' — 80 Rappen green.

'Work in the Vineyard' — 90 Rappen violet.
'Mother in her Kitchen' — 1 Franc red.
A С.Е.Р.Т. commemorative has also been issued.



FINLAND CHARITY STAMPS

The 1961 charity stamps appeared on 4th September. Designs include the following animals: Muskrat — 10+2 mk. Otter — 20+3 mk. Seal — 30+5 mk.

A special commemorative marking the centenary of the birth of the Finnish writer Juhani Aho (1861-1921) was released on 11th September.



I collect thematic stamps from the whole world,' says PAUL MILLERS, Latvian SSR, Tukums, Lenin Street 2-3A, Russia (see photo). Paul is also keen on records. He will answer all letters and will send Russian stamps in exchange for those sent to him.



Paul Millers

SURENDRA G. PANDIT, P.O. Box 3653, Nairobi, Br. East Africa, (see photo) collects coins, stamps, postcards and is keen on all sports.

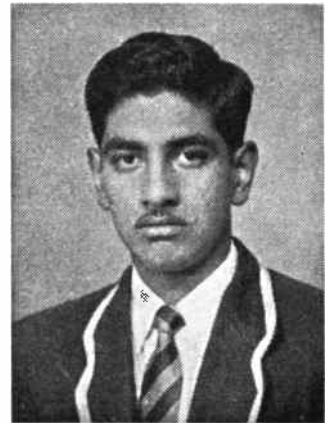

Surendra G. Pandit

You still need pen friends? Then write to any of the following:

UBAH AHGPEEBUZ, Oaeca, Normamn, 40 Bocmpedobahua, Cemupuk, Russia. Stamps. Postcards.

VICTOR CHERNOV, Schmidt St. 6-5, Rostorsk Obl., Shakhti — 10, Russia. Postcards. Stamps.

Dr TAKACS TAMAS, Gyor, Revai U.5. Hungary. Match labels.

HAAYE A. GREYDANUS, 5 Barrewier, Sneek, Holland. Match labels.

IVAN A. SEMIRIK, Poste Restante, Odessa, Russia. Postcards.



Stamp Collector's Corner

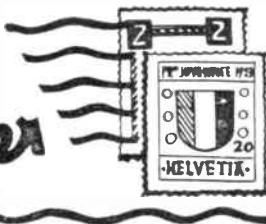

MAPS on stamps from foreign countries will be dealt with in this article. Surely one of the most unusual stamps in this category would be an issue with a map on the back.

'MAP' ISSUES

By L. P. V. Veale

Latvia can boast of that, or perhaps one should say a map with stamps on the back. In 1918 they were very short of paper so they printed the stamps on the backs of German military maps. The first illustration shows the stamp and beside it the back of another stamp

showing the map. These stamps are not very expensive.

Last time we started with the stamp showing the map of Australia and we mentioned how useless it was as a map. Well, the same remark applies to the map of Eire. There is no scale, no north point therefore no use. Another stamp the design of which is not much use now, but which years ago was probably quite valuable, is the Spanish stamp showing a very large part of the country of Brazil with the river Amazon mapped as of old. The stamp was issued in connection with the Iglesias Amazon Expedition.

Spain also issued an Air Stamp in 1926 to commemorate the Madrid to Manila flight. This was by no means an old map but is a very clear map of the east showing the route followed during the journey. Note that there are 16 towns marked. How many can you name without first looking at an atlas?

Rather a nice map is found on the 1949 stamp from Egypt to commemorate the anniversary of the death of Mohammed Aly. It shows the River Nile and the eastern end of the Mediterranean. Probably it is rather attractive because of its unusual shape. Egypt has issued other stamps of the same shape but most of them have been horizontal.

Quite a number of the foreign stamps with maps on them have a history to relate. Illustrated is a stamp with a map of an island, and if you look carefully you will see that the western side is marked 'Haiti' and all the rest is marked 'Dominica'. This stamp was almost the cause of a war between the two republics because Haiti accused Dominica of claiming far too much of the island. The stamp was issued in 1900 and diplomatic pressure led to the withdrawal of the stamp and the destruction of unsold stocks. It was not until nearly thirty years later that the controversy was settled. The republics signed their treaty of frontiers and to show that the whole matter was settled Dominica issued a stamp bearing a portrait of the President of Haiti and Haiti issued one showing the President of Dominica — rather a neat way of showing the whole world that all was well between them.

Other countries have also shown their thoughts or wishes concerning the lands that they would like to own. Argentina for instance, has for a long time cast envious eyes on the Falkland Isles and has issued two or three stamps showing these islands as though they belonged to her. First in 1936 there were stamps showing the map of South America — Argentina shaded in, also the Falkland Isles. Then in 1951 they issued the stamp showing Argentina and also the South Pole with the arc marked out, which the Argentine Republic assumed was hers. The area marked was from 25 degrees West to 74 degrees West. But Chile in 1947 had issued a couple of stamps and both of these were maps of the Antarctic showing Chile with her claims as from 53 degrees West to 90 degrees West. So there would appear to be some overlap in the wants of these two countries and our rights to the area.

The United States of America must certainly have a paragraph when discussing map stamps, although one always feels that they are rather overdoing the issue of stamps. Collectors are finding it too expensive to keep up with the tremendous number that appear. One of the most interesting of their many maps is the one which appeared in 1904 to commemorate the International Exposition held in St. Louis and also the purchase of Louisiana from France for £3,000,000 in 1803. The stamp shows a



● Continued on page 195

Out with a camera

SNOW PHOTOGRAPHY

IF you usually store your camera away at this time of year you are missing glorious opportunities of taking snow pictures. Snow gives an entirely new appearance to even commonplace subjects and pictures may even abound in your own garden, just around the corner or in the parks.

By S. H. Longbottom

When grasses become frozen they take on an unexpected gleam in the sunlight and we cannot overlook the many activities associated with this time of the year such as the building of a snowman, skating or tobogganing. But you have to be prepared, working quickly before the pleasant looking snow has turned into a grey, dirty slush and there are some advantages in the low, subdued sunlight.

If there is any secret at all about snow photography it is that we should favour short exposures with cross sunlight as much as possible, but let us expand on these two points. The main difference between photography with snow on the ground and summer photography is that a white carpet of snow combined with that on the trees or buildings brings with it an increased range of brightness. In summer, although the light is brighter, much of this is absorbed and the subjects are virtually darker in terms of reflected light. So where we normally expose for 1/50 sec. at *f*/11 for summer pictures we should reduce this by half to 1/100 sec. at the same aperture or 1/50 sec. with the aperture reduced to *f*/16.

When we refer to cross lighting we mean that we should select a viewpoint where the sun will be shining at right angles to the camera position. Not only are interesting shadows thus thrown across the picture but we also capture the texture of the snow, emphasizing all the tiny undulations of the surface. Remember that winter sunlight is much weaker and failure to make use of cross lighting as much as possible will only produce dead, white foregrounds with little form or detail. And this is the usual reason for disappointment. Be patient and wait for the sun to create the right conditions and shadows, then carefully position the camera so that the sun is either to the right or the left.

When is the best time for snow pictures? You will find that the longest shadows are cast early in the morning or



Happy moments captured on film

late in the afternoon. Incidentally, you are recommended to use a lens hood to counteract the glare of low sunlight.

So far as processing is concerned we must mention that it is detrimental to overdevelop, as the fine shadows composing the texture will become clogged, making a correct rendering difficult.

Some will say that a filter is advisable while others specify a special kind of film. Let us examine these two factors. The shadows in the snow incline towards blue — and this is most apparent in colour photography. If you use a yellow filter you will only make them much darker with consequent increase in contrast and loss of texture. So you will be well advised to reject the use of a filter. Nor do you need a fast film for this type of work. In practice you will find that Selochrome films are quite suitable.

There are some other remarkable features of snow photography worthy of attention due to the fact that the scenes are constantly changing. This may be due to the winds and heavy drifting. You

will discover trees assuming an outline of snow on different sides, depending on wind direction at the time of the fall. Even the little bird sanctuary in your own garden will look attractive when snow covered, cracks and deficiencies having disappeared.

Falling snow 'trick'

When the snow is actually falling things become a little trickier for there is usually no sunlight at all and the skies are leaden. At the same time there is no reason why we should not make an attempt and if we fail we can always resort to a little trickery.

A 'snow' negative can be made on a piece of clear celluloid, equal in size to the genuine one to be used, probably of a straight snow scene. This celluloid is sprayed with an opaque colour such as Indian ink or it can be spattered to produce a covering of small dots. Damp a toothbrush with the colour, releasing the surplus on an old newspaper and then draw a nail across the bristles towards

you. This will discharge a fine spray of ink which if applied to the celluloid will make a spotted negative. When printing the picture the two are placed together in the enlarger carrier to produce a picture of falling snow, since the black dots are represented by white.

It is an advantage to sandwich one or two more pieces of clear celluloid between the genuine and the snow negative — the latter being on top — to produce a natural, blurred effect. Printing is otherwise quite normal but the results are usually fascinating and well worth the experiment.

The next time there is a snowfall make some careful observations of your own garden and then try a few exposures on the lines indicated. Or take a few shots of your friends. The latter should be real winners, providing glimpses of happy scenes.

There is one other thing that we may mention about snow photography and that is the advantage of toning. Admitted, this is entirely another subject but nearly all snow pictures may be toned blue with every certainty of success to give most pleasing effects. And that gives you a further opportunity for experimenting with snow photography.

The photographs accompanying this feature, including that of Willingdon Church, Sussex on the front, are on Ilford Film.



In the Surrey hills



"THAT'S WHAT I LIKE ABOUT ANDY — HE'S A GOOD MIXER."

A Sincere
Christmas
Greeting
with
Best Wishes
to all
Hobbyists

Tiny Tots'



PUZZ

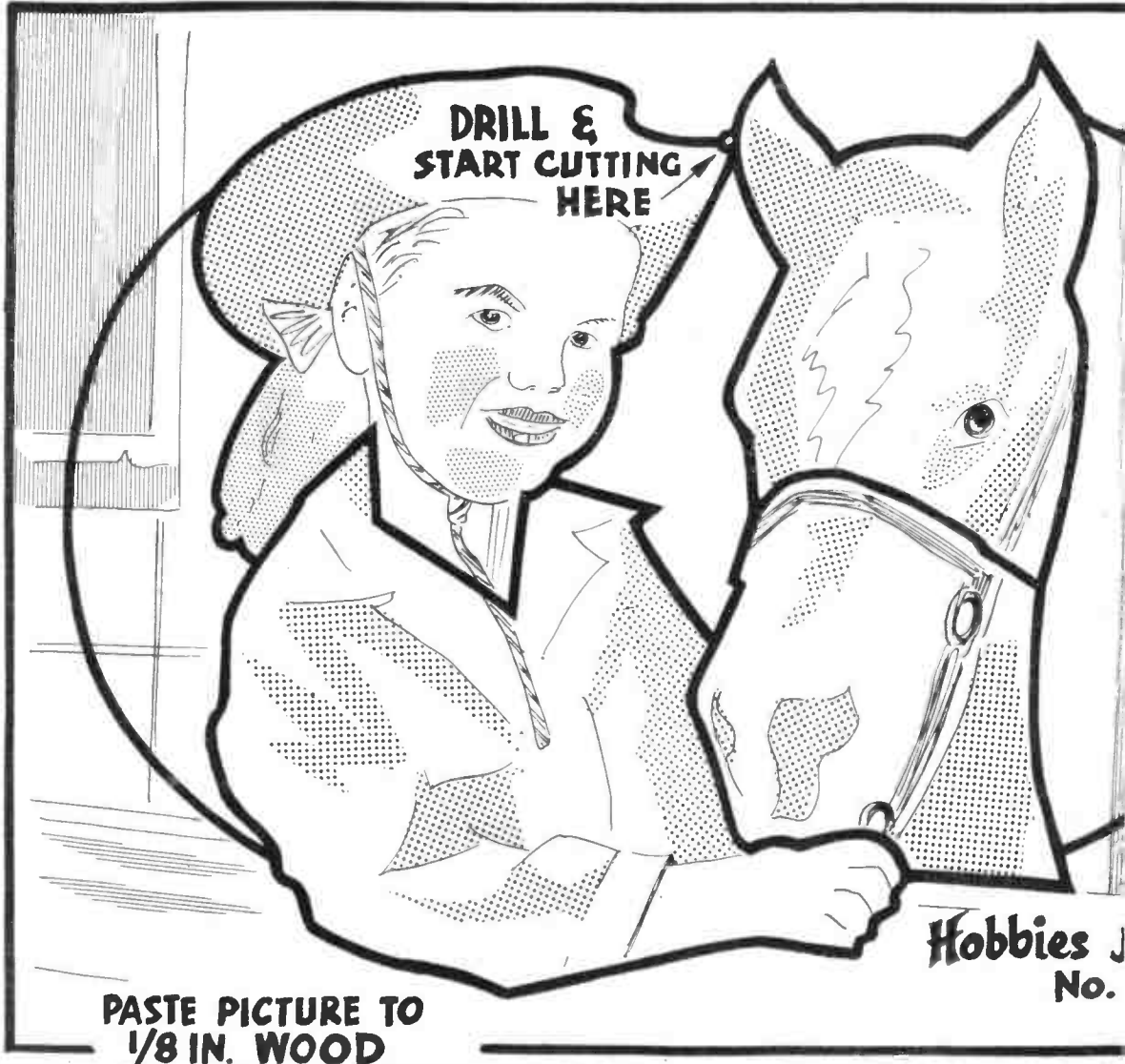

DRILL &
START CUTTING
HERE

PASTE PICTURE TO
1/8 IN. WOOD

Hobbies J
No.

PUZZLE

CUT OUT PORTIONS OF A

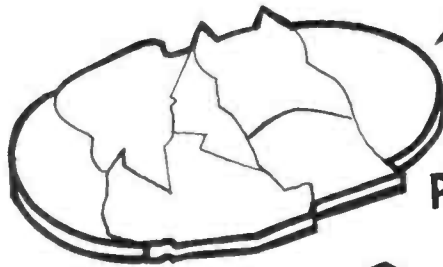

PIECE A 1/8"

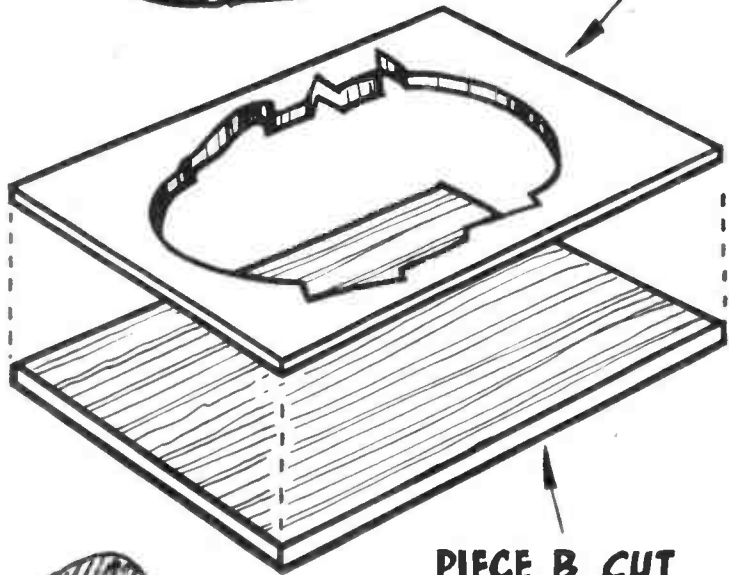

PIECE B. CUT ONE 1/4" TO OUTLINE OF PICTURE

CUT OUT ALONG HEAVY LINES

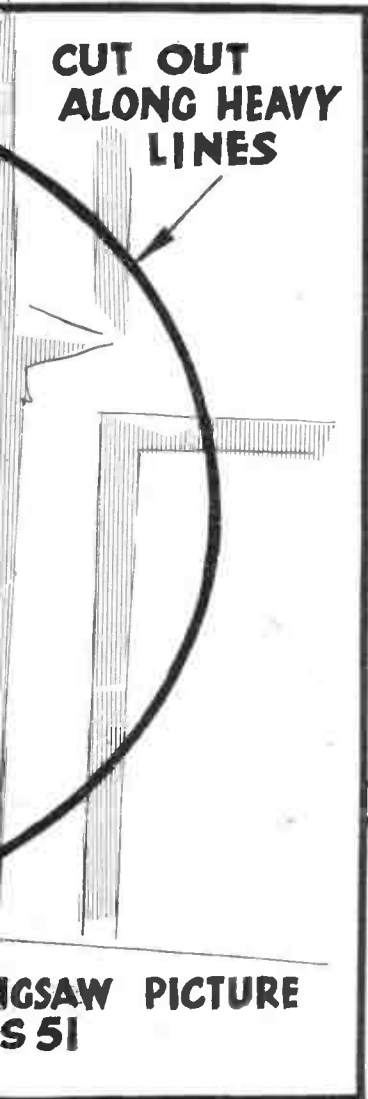

SAWSAW PICTURE
S 51



* GLUE A TO B AS SHOWN. LEAVING CUT OUTS FREE FOR JUNIOR TO ASSEMBLE

NOVEL METHOD IN MARQUETRY

By H. Stewart

★★★★★★★★★★★★★★★★★★★★
 ★ Fretsaw workers, particularly ★
 ★ those with jigsaw cutting ex- ★
 ★ perience, will be keen to try ★
 ★ their hand at this method of ★
 ★ picture and map making. At the ★
 ★ end of the 3-part series the ★
 ★ author will describe how to cut ★
 ★ with a slight tilt on the saw- ★
 ★ blade, thus giving a 'wedge' fit ★
 ★ to the various pieces. ★
 ★★★★★★★★★★★★★★★★★★★★★★

VERY often we will find the ornaments in our homes quite straightforward and ordinary — such things as paintings, photographs, models, etc. — where, though the theme may be unusual, the medium used is perfectly orthodox. Why not have it the other way round? Treat an ordinary

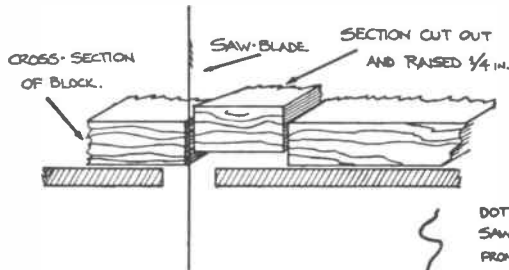

Fig. 1—Illustrating the raised section

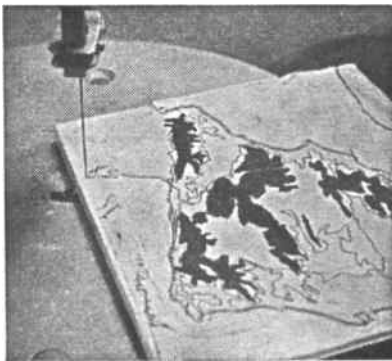
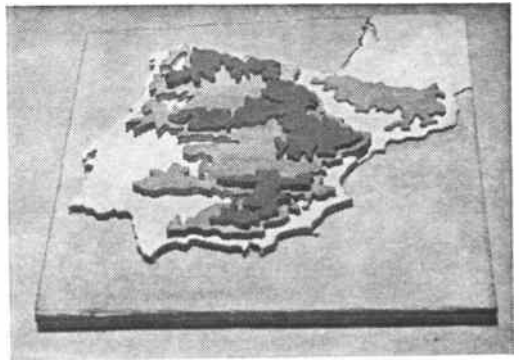

Fig. 2—A map of Spain in the preliminary stages, cutting from the outside inwards

The finished article, showing the effect of high land represented. The colouring of the outline must be such that it stands out clearly against the background, and the design should be easily recognizable. Notice the $\frac{1}{4}$ in. steps.



subject in an unusual way and the result will often be striking.

Here then, is a method of transforming a map, picture, portrait or anything into something a little out of the ordinary. And since the map is the easiest form in which it can be grasped, I will proceed to apply this principle to the map.

The intention is to raise the high ground of a map above the lowland, and to do this you simply cut along the contours which are pasted on to a block of wood and push the highlights through so that they are literally raised above the rest. The effect as used on a map of Spain can be seen in the main illustration where the three steps — lowland, medium height and highland — are shown in rises of $\frac{1}{4}$ in. The method is further shown in Fig. 1.

First, you must choose your design. It should be

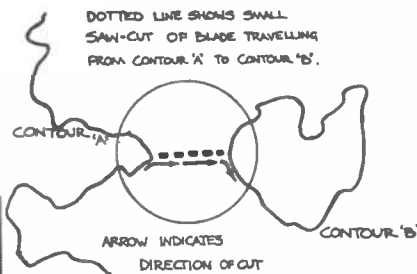

Fig. 4—The invisible saw cut—simply a convenience.

clearly recognizable, and it is as well to choose one that is of an island or a peninsula, so that the land will stand out distinctly from the background. In this article, I have used the peninsula of Spain and Portugal as being particularly illustrative, but the British Isles would do just as well. The size should not be much over 60 sq. in. in all, or else it becomes too large to manage and much of the effect is lost by spoiled work.

Now, having chosen a map, trace it on

to some paper, being particularly careful to add only the essential contours so that there are no more than 5 steps of land from the lowest to the highest — any more will complicate the issue. Then you must select a piece of wood the same size and about a centimetre thick of a sort that is practically grainless. Plywood will be found to break apart in the more

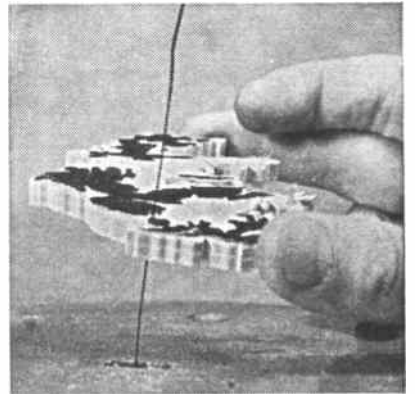

Fig. 3—Threading the saw-blade through the hole. Here we are about to cut out the highest land from the middle-height. The black on the glued-on paper represents the highest land

intricate cuts. Boxwood is the ideal wood for the purpose, but I use obeche as the next best thing. Stick the paper with gum arabic or any soluble glue to the block as flat as possible, and allow to dry thoroughly.

The question of tools now arises. You merely need a treadle fretsaw, infinitely preferable to a hand-operated one; a sharp knife for touching up at the end, some powder paints or lacquers, and a tube of balsa cement. Then you are all set for the cutting, which can be tackled in one of the two ways — working from the outside inwards as shown in Fig. 2 or the inside outwards.

Each presents an individual problem. Even so, there are certain cardinal 'musts' in both.

The saw-cut must be exactly perpendicular to the plane of the saw-table; great care in the composition of the picture must be taken, so that not only are all irrelevant lines excluded but also that no lines come so close together for a break to occur; the blade should be a Hobbies' OO, the finer the better.

Both ways present the problem of how to get the blade from one contour-line to another. Obviously contours do not join; so there are two methods of doing this. Either you drill a hole or cut across. In the first instance, you drill a small hole in the wood, about $\frac{1}{32}$ in. on the contour along which you are next going to cut. Place the hole carefully in as unobtrusive a place as possible, and it must be filled in with plastic wood afterwards. The snag which immediately arises is how to get the blade to run vertically when threaded through the hole and fastened up again. The answer is, by trial and error. But, if before detaching the blade you note exactly where on the clip the tip enters, you can

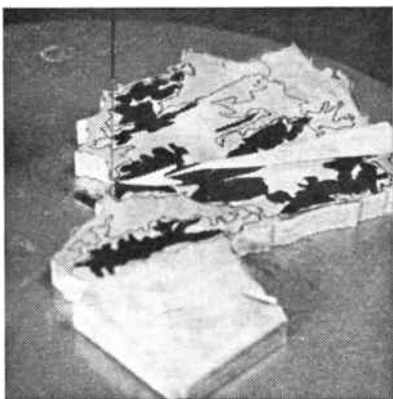

Fig. 5—Arrow indicates the small saw-cut from the edge of one piece to the contour line of the next. If carefully placed, it should not be noticed.

replace it in the same position and it should run true. Fig. 3 illustrates how to

thread the blade through: note the position of the hole.

The second way, we have seen, is to cut across. The magnified portion in Fig. 4 shows clearly how you can get from one contour to the next. Choose a place to cut across that is very small and unobtrusive, as Fig. 5 shows, and you will not have to touch it up afterwards. This is perhaps the easier way of the two.

To return to the question of how to cut. I prefer to cut from the inside outwards if the block of wood is quite small, and vice versa with the larger block. The reason is simple — it is easier with the smaller sized block to work outwards because then you can really get a hold and purchase on the block when holding it by its four square sides. Otherwise, it is not easy to grip an edge which has been intricately cut without breaking it, which is the case when you work inwards. However, this will become more obvious when you actually start your own cutting.

Assembling the pieces and finishing will be dealt with in the next article.

● Continued from page 187

'MAP' ISSUES

map of the U.S. with the purchased territory shaded.

Then of course there is the American stamp commemorating the opening of the St. Lawrence Seaway — a similar design to the Canadian stamp showing the five Great Lakes, having 'U.S. Postage' instead of 'Canada'. The U.S. Air mail stamps of 1926 and 1927, the latter commemorating Lindbergh's Transatlantic flight in 'The Spirit of St. Louis' both have maps on them. Then the later issues for the North West Territory, the Everglades National Park, Alaska, Wisconsin and so on all have maps which are necessarily so small that they cannot tell anyone very much.

On the occasion of the hundredth anniversary of the founding of the Commonwealth of Liberia there was issued a relief map, really a view of what one might like to be able to see from an aeroplane. As the distance along the coast is some 350 miles that is why we say 'might like to see'. Another relief map is on a stamp from Panama. It shows the Canal. The only thing to remember with this stamp is that Colon is on the Atlantic side and Panama on the Pacific. Looking at the stamp one might easily be confused.

Now these two articles have not by any means exhausted the supply of map stamps. We have only tried to show that these designs are particularly interesting. Have a look through your own collection and see how many maps you have.

Below: Dinky Toys 'Rambler'. Meccano Ltd. 6/3

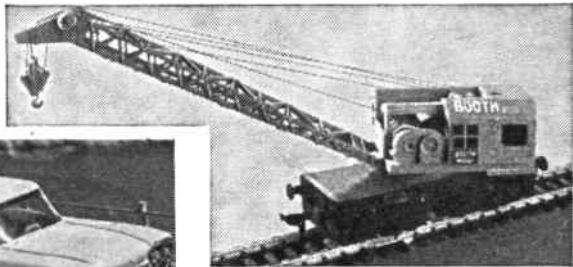

Above: British Railways 15 ton diesel locomotive crane. Fully working in 'OO' and 'HO' scale. Airfix construction kit 3/4-

KITS AND MODELS IN THE SHOPS



BEA Comet in the new 1/144 scale. Airfix kit, Skyking Series, 4/6

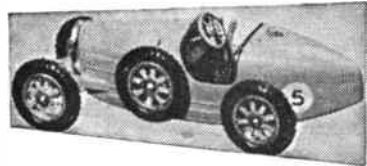

'Model of Yesteryear' Type 35 Bugatti. 'Matchbox' model 2/11

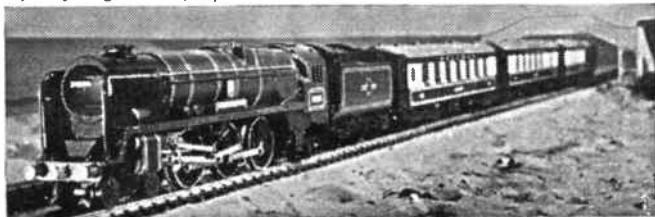

Hornby-Dublo Pullman Train Set. Three super detail Pullman cars hauled by West Country class 'Barnstaple' loco and tender. Meccano Ltd, £9.18.1. 'Barnstaple' loco also available separately £5.16.5.

AN EVER-WELCOME GIFT

Making toys, models and novelties is a paying pastime, and with a machine you can double your output right from the start. In fact you have a factory in the home.

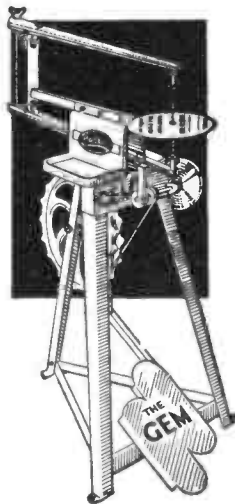
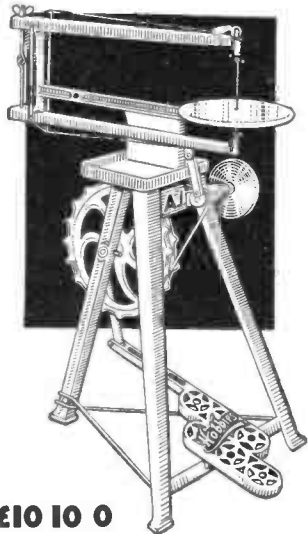

£10 10 0

'A.1' TREADLE SAW

A sturdy machine with cast metal legs, metal table, wooden arms, special saw tension action, etc. Easy to treadle, smooth running and rigid. Provides a factory at home for the handyman — a machine for profit and pleasure.

THE 'GEM'

£6 12 6

A lighter machine with pressed metal legs, but easy running and a reliable worker. Sound value and a machine for all kinds of work. Spare blades, instructions, and designs are included with each.

THE 'MARVEL' BENCH MOTOR-DRIVEN SAW

To meet modern needs. Just plug in and switch on from any house lighting point. For either A.C. or D.C. mains, with 230/250 volt motor, flex, switch etc.

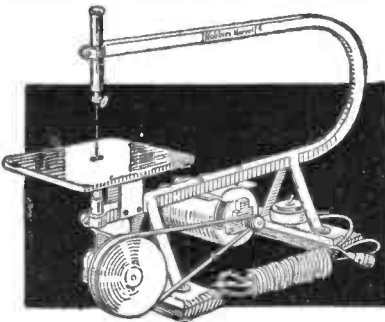

£13 10 0

Also a Bench Machine without motor for £5 10 0.

EASY PAYMENTS

A system is now in operation whereby a machine can be despatched carriage paid after the initial down payment and subject to the completion of a simple form of Agreement. The slight additional cost over cash price is to cover extra clerical work, books, interest charges, etc. It is impossible for us to allow this system to apply in any part of Ireland, or anywhere outside Great Britain.

Agreement Forms are obtainable at any Hobbies Branch, where machines may be seen, and money paid each month. Or, you can do the business through Hobbies Head Office, at Dereham, Norfolk, sending your instalments there.

Hobbies Ltd (Dept. 993) DEREHAM NORFOLK



HUMBROL'S HANDY IN THE HOME...TOO!

Handy tinlets by Humbrol give you an attractive range of 34 intermixable colours. No undercoat needed, dries in an hour without brushmarks. Also available is Humbrol radiant Décor, the luxury paint to give your home the daring, different '61 look. Décor comes to you in 22 wonderful colours. Use Humbrol paints for every household and handicraft purpose.

Humbrol is available in handy tinlets price 9d. each and 2oz. tins at 1/6 each at all Hobbies Ltd., Branches

HUMBROL ONE-HOUR ENAMEL in the Décor range of colours



Humbrol One Hour Enamel, in a range of glorious Décor colours, is the ideal paint for those round-the-house jobs. It's so easy-flowing and it withstands the worst the weather can do. Décor colours at your local paintshop ¼ pt. 3/-; ½ pt. 5/3.

KEEP HUMBROL HANDY
THE HUMBROL OIL COMPANY LTD, MARFLEET, HULL



HELEN SHAPIRO



NEATLY dressed in her Clapton Girls' School uniform 15-year-old Helen Shapiro collected up her satchel and school books, met her father at the school gates, took a bus to recording manager Norrie Paramor's office in E.M.I. House . . . and signed her name to a recording contract with Columbia Records.

This pretty, wide-eyed teenager has a rich, earthy singing voice which has soon become the object of much admiration and amazement. As Helen swings and bounces along each phrase it is difficult to picture a 'slight young thing' of school age behind the 'mike' in the studios.

Born September, 1946, in Bethnal Green General Hospital, Helen Shapiro is an attractive 5 ft. 2 in., with short black hair, dark brown eyes, an alert friendly nature and a strong will.

'My family loves music', says Helen proudly. 'Ronnie my brother has a jazz band of his own, my mother plays the violin and my father fondly encourages us all.'

Helen was coached by Maurice Burman. John Schroeder of Columbia Records was invited along to Burman's studios to hear several hopeful singers one afternoon and it was then that he heard Helen. Immediately interested, John arranged for her to make a test recording of a few numbers.

'I was very pleased with the result,' says John, 'and took the disc to Norrie Paramor. He was so impressed with Helen that, then and there, he decided to contract her.'

The next step was to find a song for Helen to record as her debut disc. Most of the current 'pop' lyrics were quite unsuitable for someone so young, and it was suggested that John Schroeder should write two numbers for her — swinging, up-tempo numbers with lyrics to match Helen's youth. John came up

with two really first class numbers, *Don't Treat Me Like a Child*, of which he wrote both music and lyrics himself, and *When I'm With You*, written by John and Maurice Burman and Mike Hawker (Columbia 45-DB4589).

All Helen's young life she has been surrounded by a family of music enthusiasts, all striving to develop and encourage her ambition 'to be a blues singer'. Her own taste in music includes rock 'n' roll and the more popular classical pieces, and her favourite artists are Perry Como, Elvis Presley and Bobby Rydell.

The popular Joe Loss

JOE's interest in music started when he was a small boy and his musical education was fostered on a cheap secondhand violin. He took it seriously and vowed to his school chums that he would one day be a big name in music. His friends never took him seriously

and in fact buttered his strings one day. Joe remembers how he placed his bow to his violin — and nothing came out! He stopped boasting and studied all the harder.

Since he became a bandleader in his own right, some 29 years ago, Joe has always been in the news and has, since the beginning, had a 'star' band whose popularity has never declined. Joe insists on melody and rhythm but his instrumentation allows colourful arrangements and interpretations.

While resident at London's Kit Kat Club in December, 1933, the band made its first broadcast in a programme called 'First Time Here'. From that day to this they have enjoyed record-breaking ballroom and theatre engagements.

Where dancing is of first importance you'll find the Joe Loss band. Dancers know what to expect when his band takes the stand for it is music for dancing, and as Joe says — 'the customer is always right'. Joe Loss, who consistently records for the H.M.V. label, has been doing so for some 25 years. Besides his normal 'single' releases he has several 'Dancing Time for Dancers' LP discs to his credit.



**There's always a big demand
Make sure of your copy
NOW!**

**STILL ONLY
2/-**

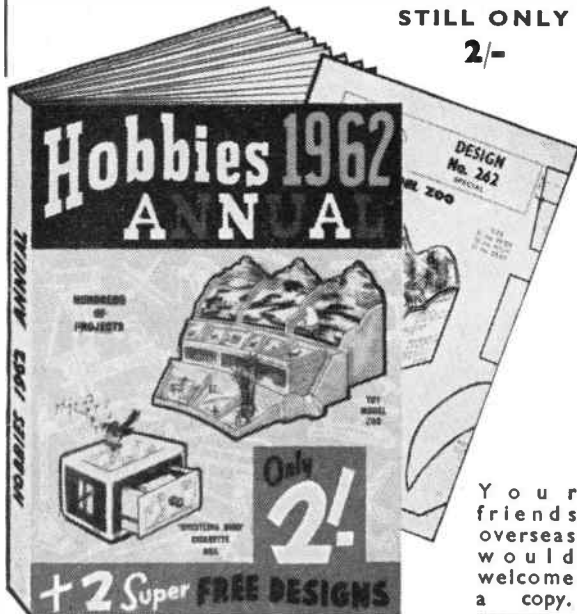

Your friends overseas would welcome a copy.

HOBBIES 1962 ANNUAL

180 pages packed with hundreds of exciting projects and interesting information for the handyman, hobbyist modeller and home craftsman.

GIVEN FREE WITH EACH COPY

Large designs for making a sensational novelty — the 'WHISTLING BIRD' CIGARETTE BOX, and a grand TOY MODEL ZOO. Each worth the price of the Annual.

Obtainable now from Hobbies branches, stockists, news-agents, bookstalls, etc, or by post direct (6d. extra for postage).

To Hobbies Ltd., Dept. 993, Dereham, Norfolk

Please sendcopy/copies Hobbies 1962 Annual containing two free plans

Name

Address

P.O. for.....enclosed

54 page Edition WHERE'S THAT CAR FROM?

Price 1/- (Postage 4d.)

Entirely new! Brief Guide to
INN SIGNS

Price 1/6 (Postage 4d.)

Of all Booksellers

or

RALEIGH PRESS, Exmouth, Devon

IT'S EXCITING. IT'S PROFITABLE.
Flower painting can bring extra income. Previous experience unnecessary. Waiting markets. Inexhaustible demand. Details free. Popular Art Services (HW), Clun, Salop.

PERSONAL COLUMN LTD, Falcon House, Burnley, Lancs. Pen Friend — all hobbies. Correspondents in almost every Country. All ages. S.A.E. for details.

HOMEWORKERS required to make up and machine simple household goods. Experience unnecessary. Good pay. Regular work. S.A.E. for details to Dept. 28, Arnold, 10 Shelley Road, Worthing, Sussex.

100 DIFFERENT stamps free! Request 4d. upwards discount approvals. — Bush, 53 Newlyn Way, Parkstone, Dorset.

ENJOY WRITING? Then write for Profit. Send for 'Writers' Handbook' (free) detailing countless opportunities for beginner or experienced. — Writers' Ring (HW), 5 Edmund Street, Birmingham.

LEARN

RADIO & T/V SERVICING for your OWN BUSINESS/HOBBY

● by a new exciting no-maths system, using practical equipment recently introduced to this country
FREE Brochure from:—

RADIOSTRUCTOR

DEPT. G81, READING, BERKS.

20/12/61

MAKING YOUR HOBBY MAKE MONEY

HOW, WHY any handicraft can make money for you — everything you should know.

40 pages of experience — 5/6 from

G. SEALE
Regent House, 26 Queen's Rd., Coventry

NYLON · P.T.F.E

BRASS · COPPER · BRONZE
ALUMINIUM · LIGHT ALLOYS
ROD, BAR, SHEET, TUBE, STRIP, WIRE
No Quantity too Small List on Application
H. ROLLET & Co. Ltd.
6 Chesham Place, S.W.1 BELGRAVIA 4300
ALSO AT LIVERPOOL, BIRMINGHAM
MANCHESTER, LEEDS

HULL

DO YOU KNOW?

HOBBIES LTD. have a branch at

42 SAVILE STREET

(Removed from Ferensway)

where the manager and staff are always willing to give you the benefit of their experience with any of your handicraft problems. Why not pay a visit?

FREE Money Making Magazine. Send 6d. stamp. — TEM, 124-H Newport St, Bolton.

MAKE YOUR OWN table tennis table. We can supply all the materials required to make a really first-class job. In fact, everything down to the last screw. Complete kit including plans sent carriage paid for £12/10/0. Plans sold separately 10/-. — Edrank Trading Co. Ltd, 66A Susans Road, Eastbourne, Sussex.

'HORSE-SHOE' WATCH STAND

THIS stand is intended to be used for a wrist watch which should be hung across the bar at the top.

Cut one of each piece from $\frac{1}{4}$ in. wood with a fretsaw. The pieces are glued together as shown in the small sketch and are cleaned up ready for finishing.

Fill the grain and give one undercoat and two finishing coats of high gloss-enamel. (M.p).

**CUT OUT THESE
FULL SIZE
PATTERNS WITH
A FRETSAW**

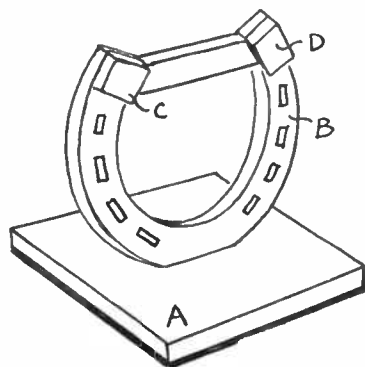
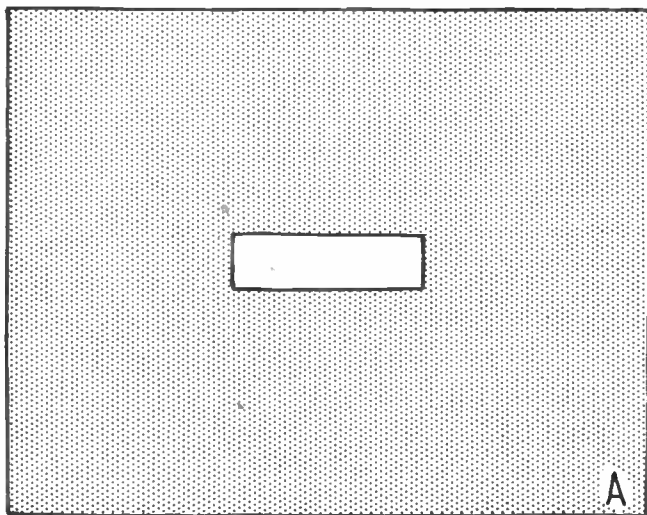
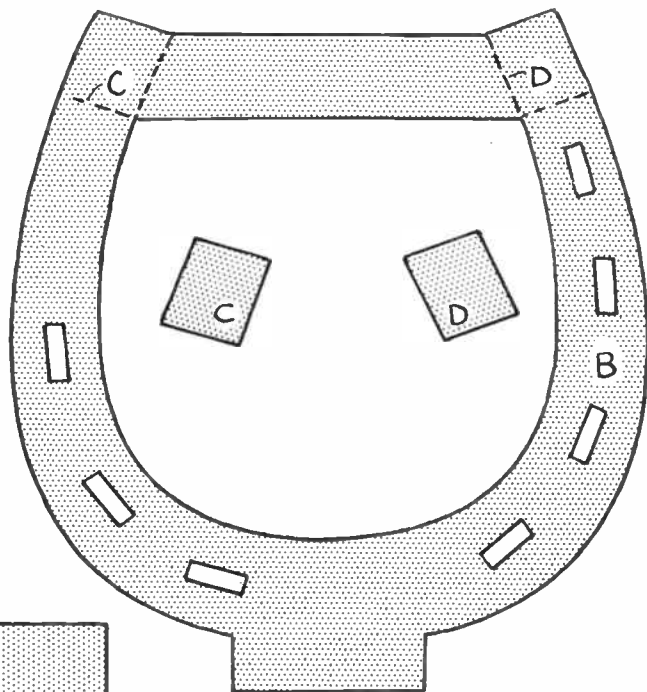

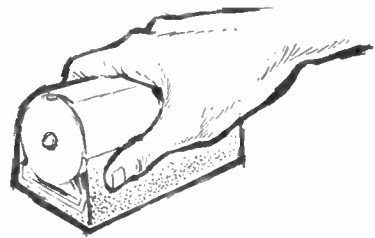
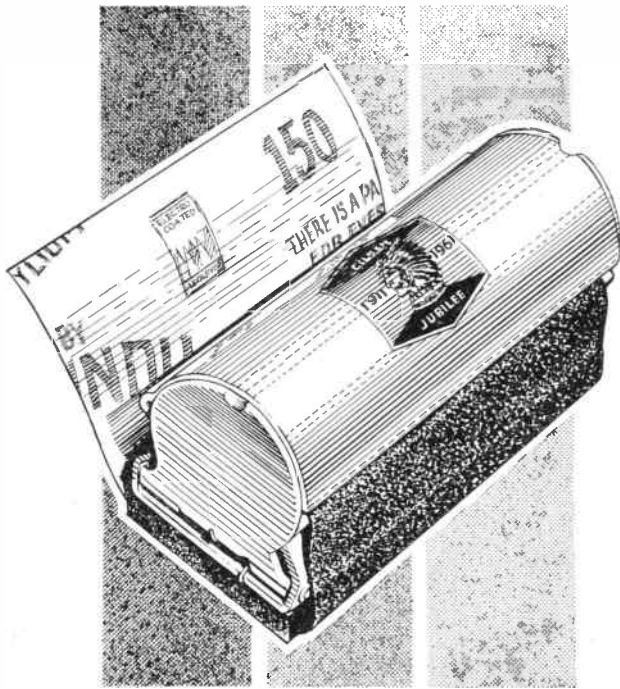

For the professional or amateur handyman here is a device that was really needed. It makes sand papering easier, quicker, more economical and gives a better result too—it uses all the abrasive paper uniformly. A steel cylindrical container holds a roll of abrasive paper which is withdrawn through a slot and folds round the resilient rubber base where it is firmly held by fingers and thumb—the rubber base enables the abrasive to make a better all-over contact.

As each portion is used to the limit, the roll is pulled out just the width of the base again—no waste in time or material.

the new **SLIK** sander

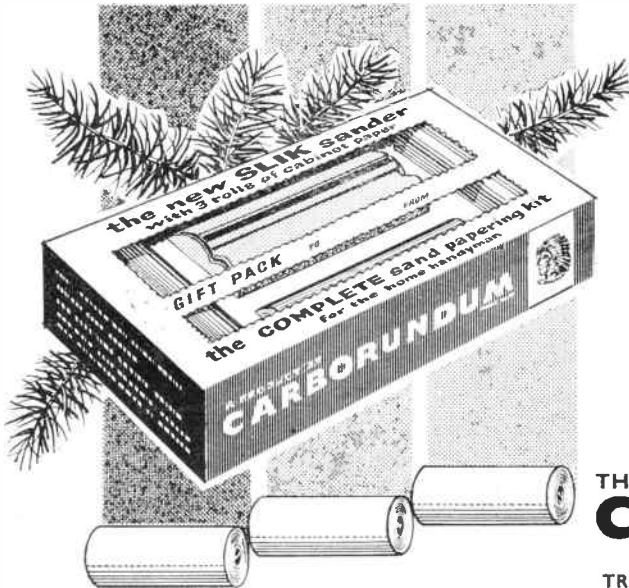

**GIVE IT, IN THE NEW
ATTRACTIVE
GIFT PACK
THIS CHRISTMAS**

From Ironmongers, Hardware
and Do-it-Yourself Shops.



THE
CARBORUNDUM
COMPANY LTD
TRAFFORD PARK
MANCHESTER 17