

5th APRIL 1961

VOL. 132

NUMBER 3408

THE ORIGINAL
'DO-IT-YOURSELF'
MAGAZINE

HOBBIES *weekly*

FOR ALL
HOME CRAFTSMEN

*FREE plan
to make . . .*

Also in this issue:

PHOTOGRAPHS
WITH FLASH

COLLECTORS' CLUB

A 'SHIELD'
PIPE RACK

MAKE A THRILLING
ELECTRIC GAME

A DIM/BRIGHT
LIGHT FITTING

FRETWORK PROJECT

ETC. ETC.

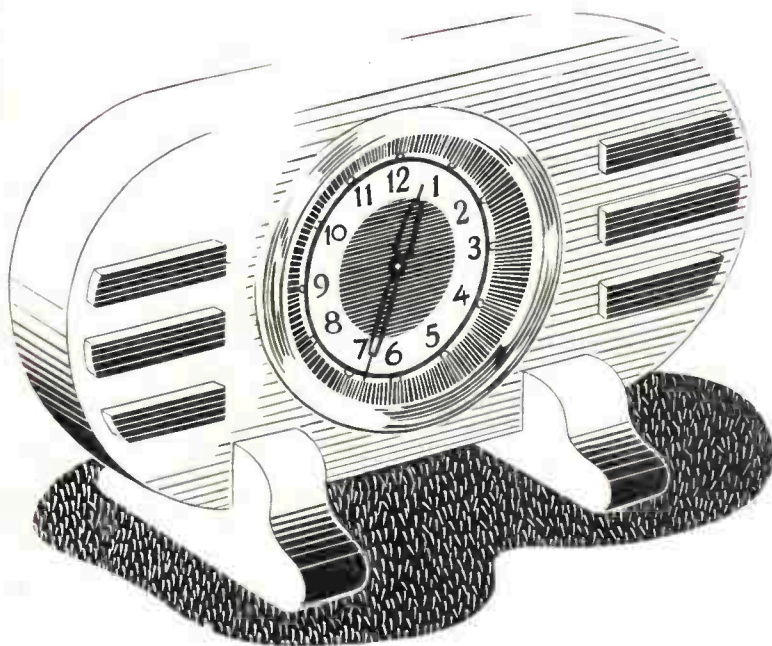

A MODERN CLOCK



Up-to-the-minute ideas

Practical designs

Pleasing and profitable things to make

World Radio History

5^D



THE Government of the Federation of Malaya released a special 10-cent stamp to commemorate the Installation (*Pertabalan* in Malay) of His Majesty Tuanku Syed Putra ibni Almarhum Syed Hassan Jamalullail, D.M.N., D.K. (Brunei) as the Yang di-Pertuan Agong (Supreme Head) on the 4th January.

The stamps are printed by Messrs. Harrison & Sons Ltd, by the photo-gravure process in blue and black in vertical format, size 1.386 in. by 1 in., perforation to perforation on C.A. (block capitals) watermarked paper. The design features a portrait of His Majesty, and the stamps will remain on sale for three months or until stocks are exhausted, whichever is the earlier.

When the Federation of Malaya attained its Independence on the 31st August 1957, the Constitution provided for a Supreme Head of State who is called the Yang di-Pertuan Agong.



As the Federation of Malaya is composed of eleven States, of which nine have their own Rulers, the Constitution also provided for the election of the Yang di-Pertuan Agong from among their own number. On election a Yang di-Pertuan Agong holds office for five years. The first Yang di-Pertuan Agong was His late Majesty Tuanku Abdul Rahman ibni Almarhum Tuanku Muhammad. He was installed on the 2nd September 1957. On his demise on 1st April 1960, His late Majesty Tuanku Hisamuddin Alam Shah Al-Haj ibni Almarhum Sultan Ala-iddin Suleiman Shah was elected Yang di-Pertuan Agong on 14th April 1960, but, unfortunately, he passed away on 1st

September 1960, before he was installed as the Yang di-Pertuan Agong.

On the 21st September 1960, Tuanku Syed Putra ibni Almarhum Syed Hassan Jamalullail, D.M.N., D.K. (Brunei) was elected by Their Highnesses the Rulers as the third Yang di-Pertuan Agong.

His Majesty was born in the Royal town of Arau in Perlis on 25th November 1920. Incidentally, Perlis is the smallest State in the Federation, covering 310 sq. miles, and with a population of 90,800. He had his early education in a Malay School, and later studied at the

A MALAYAN COMMEMORATIVE

Penang Free School — one of the leading schools in Malaya. His father Tuan Syed Hassan Jamalullail, the brother of the Ruler of Perlis, died in 1935. In 1938 Tuanku Syed Putra was chosen by the State Council of Perlis as the 'Bakal Raja' (heir presumptive), as the Ruler had no male heir. Since 1940 he worked in the courts in Kangar, Perlis, and in the Land Office and Magistrate's Court in Kuala Lumpur. During the Japanese occupation of Malaya he went into business.

On 1st February 1943, his uncle the Raja of Perlis, died after a reign of thirty-eight years. The Japanese, however, disregarded Tuan Syed Putra's legitimate claims to the throne.

On the return of the British he acceded to the throne of Perlis on the 4th December 1945. It may be of interest to note that Perlis is the only State in Malaya whose Ruler has the title of Raja. The other Rulers are called 'Sultans' with the exception of Negeri Sembilan, whose Ruler is called the Yang di-Pertuan Besar, because he himself is elected by the major chiefs (Undangs) of his State. The term Yang di-Pertuan *Besar* must be distinguished from the Yang di-Pertuan Agong, who is the Supreme Head of State.

He was elected as Timbalan Yang di-Pertuan Agong (Deputy Supreme Head) of the Federation of Malaya on 14th April 1960.

As Raja of Perlis he concentrated on developing the State and providing better facilities and opportunities for his subjects. One of his outstanding contributions was towards improving Malay and English education in his State.

His Majesty is widely travelled. In 1951 he visited the United Kingdom during the Festival of Britain, in 1954 he went to Hong Kong and Japan, and in 1956 he went to Australia and attended the Olympic Games in Melbourne. After his Australian trip he also visited Indonesia and New Zealand.

Head choir-boy

BRIAN ALLMOND aged thirteen, is head choir-boy at St. Francis's Church, Oxford. 'I like singing very much', he tells me. 'I have been in the choir now for three years. When I leave school I would like to be a carpenter.'

Brian has three brothers and four sisters. His hobbies are stamps, labels, all sports, and woodwork. 'I have made a model yacht and a boat carved from a block of wood', he says.

I have at long last persuaded regular reader GEORGE PENTELOW to send his photograph for our pen friend page.

George has one of the largest collections of beer labels in the world. Write to: Tydd Manor, Tydd St. Giles, Wisbech, Cambridgeshire.

'I would like a pen friend aged about seven or eight years', says IVAN POWIS of 85 Walsall Road, near Oldchurch, West Bromwich, Staffs.

ROGER TAYLOR of Greenways Nursery, Wick Road, Egham, Surrey, writes: 'I am keen on boats and cars, especially on R.N. launches and sports cars. I would like other readers to write to me.'



George Pentelow

VARIETY OF BULBS FOR USE

BEFORE the advent of flash photography and photoflood lamps I regularly used magnesium powder or ribbon for my indoor photography. Some of you may never have experienced this particular method. Sometimes it would fail to ignite, usually on the most important occasions, and when it did, large volumes of white smoke followed the flash, and more often than not the human subjects of my pictures were shown with staring eyes sticking out like pinheads!

Flash photography has altered all this — just fit a tiny bulb into the flashgun and shoot as though it was in bright sunlight. The majority of modern cameras are now synchronized to take a flash lead. Handy flash outfits have become cheaper, the bulbs are inexpensive, and there is no reason why anyone should not be able to take some happy

By
S. H. L.



All jammed-up and sticky. A typical homely flash subject. Gun fired from the left. Photograph on Ilford film.

shots of family life in the home. Moreover, flashbulbs can be used to bolster up failing daylight, in caves, or at night,

thereby making some difficult camera work so very easy.

This applies to even the box camera costing only two or three pounds. A flashgun which plugs into the camera will not cost more than about 30/-, while bulbs are 8d. or 9d. each. The shutter is adjusted for instantaneous exposures, a bulb inserted in the gun, the camera pointed at the subject, and the shutter released. When this operation is made, the flash bulb is fired by an electrical contact on the shutter blades, and it is so rapid that it is almost true to say that the box camera can give results nearly the equal of more expensive instruments.

Here we propose to examine some details of flash photography, using miniature bulbs which are more convenient for the amateur than the expensive electronic equipment, so we must first explain the variety of bulbs at our disposal.

Class F bulbs are intended for use with X or F type synchronized shutters found in most inexpensive cameras. The bulb is actually fired about 4-5 milliseconds before the shutter is fully opened.

Class M bulbs have a medium time to reach peak intensity, and are for use with M type shutters. These incorporate a delay action. These bulbs can only be used where a speed synchronizer is built in the camera.

Class S bulbs are the largest and take

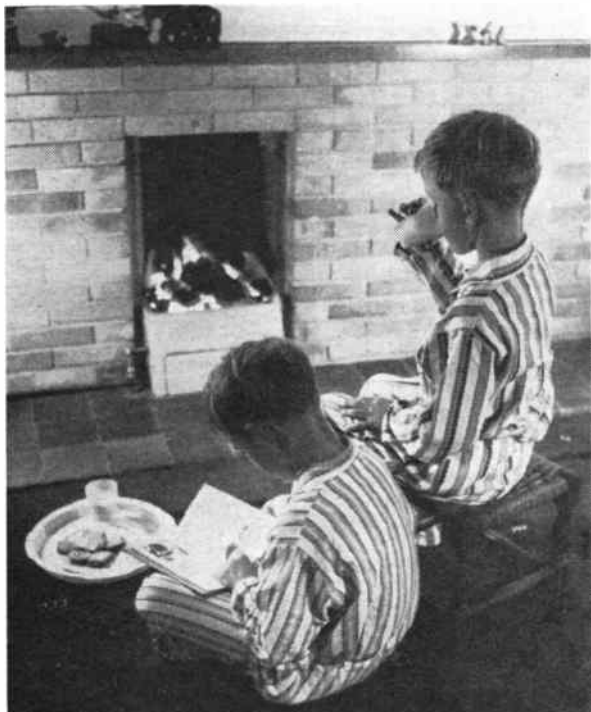

Another homely scene. Photograph on Ilford film.

longer to light up than the others. These should not be used at a shutter speed faster than 1/25 second.

Class FP bulbs are only for use with focal plane shutters, and the majority of amateurs need not trouble about these.

There is a variety of intensities to suit all types of subjects, the smaller being for home shots, while the larger will be suitable for large halls. Daylight reversal colour films demand the use of blue flash bulbs, and this is rather important if you wish to take successful colour pictures indoors.

On the average it will be safe to say that Class F bulbs are most widely used, and all these are what we term expendable, that is, they will fire only once. The electronic flash bulbs contain a gas charge and require batteries or accumulators to build up a high voltage. These make an intense, rapid flash, and will, perhaps, produce 10,000 flashes before becoming exhausted. Good electronic equipment is expensive and heavy, while the cheapest does not produce better results than the small flashbulb.

Some confusion often arises about what we term the 'guide numbers' for determining the actual exposure, so we will endeavour to clarify. The makers allocate guide numbers to each class and size of flashbulb. All you have to do is to divide this particular number by the distance in feet between the camera and the subject. The answer gives the lens aperture to use with the speed indicated. Note that this guide number is different for each film speed and shutter speed. Here is an example.

Using a No. 1 bulb the guide number for a film of 28° speed is 150. Our subject is 15 ft. from the camera, therefore 150 divided by 15 produces an answer of 10. In theory we should use an aperture of f10 at a speed of 1/25 second — but there is no such aperture. Here we have to use a little discretion and use the aperture of f11. Where the aperture is fixed, as with some box cameras, the distance to be used is quoted on the bulb container. It is essential to note that the tungsten speed of the film should be used and not the daylight speed.

We now come to the more detailed description of synchronization. Most of the cameras made in the last ten years have a socket incorporated with the shutter mechanism, and it is actually an integral part of the camera. This is what happens. When the shutter blades start to open, an electrical contact is made. The bulb is fired, and although there may be a short time lag it is not sufficient to be detrimental, and the fact is that the bulb has reached its peak intensity before the shutter closes. This will be clear when we say that the actual time for the flash to reach its peak is only 18 milli-

seconds. More often than not the gun can be attached to the camera by means of an accessory shoe or a bar fitted to the tripod screw, and we are free to observe our subjects through the viewfinder as with any other normal snapshot. There are, however, three forms of synchronization we should tell you about if you are to match your bulbs correctly.

The simplest is known as F synchronization, and the form used for most box cameras. As mentioned we use small bulbs which have a flash lasting about 1/100 second. Class M bulbs can be used, but the flash is of longer duration. In practice, and using a box camera, correct exposure is assured if you use a Phillips PF1 or GEC No. 1 at 1/25 second, with the shutter at the '1' position.

We then have 'X' synchronization, when the current fires the bulb when the shutter blades are fully open. Use 1/25 second with class M bulbs, or even slower speeds. This particular form is now popular on most simple cameras, but is more often found on cameras allowing a variety of shutter speeds and lens apertures opening to f4.5. The adjustment of the aperture is also an important factor, since it allows us to control the exposure. At times, and particularly when taking close-ups or light toned subjects, it is often necessary to place a white handkerchief over the bulb, but we will deal with these practical points later.

Finally, we have the speed synchronized cameras which bear settings

marked X and M. The X form has just been described, but note the difference with the M type. When the lever is adjusted to M we have prepared for a delayed action, which is sufficient to compensate for the time it takes to light the class M bulb to greatest intensity. In practice we find that while you can use class M bulbs at any shutter speed, you cannot use Speed Midget bulbs or even electronic flash equipment. This particular form permits the use of fastest shutter speeds, stopping movement, but as stated the use is limited to certain cameras only.

There is a wide variety of compact flashguns on the market at the present time many of which have folding reflectors and fit into small cases. They work by means of a small torch battery and it is wise to make a regular inspection of same to prevent not only disappointment but corrosion of the contacts. This difficulty has been overcome in the capacitor type of gun where the battery charges a capacitor before firing, so when the battery itself is in the last stages of usefulness it will charge the capacitor to a full voltage ensuring that the bulb is discharged.

We should also mention that it is possible to buy small adaptors whereby one flashgun may be used with different cameras if the sockets happen to be different on each instrument.

In another article we hope to show some different methods of using the gun for both indoor and outdoor photography.

A FAITHFUL REPRODUCTION

THE new kit of H.M.S. 'Hood', is the first battleship ever made by Airfix in their 1/600th scale Famous Warships series. The kit costs only 6s. Od. yet has a record 133 parts, plus cement, measures 17½ in. long and actually floats without modification.

The 'Hood' embodies a degree of detail. For example, the mouldings include each individual deck plank and each link in the anchor chains; individual flights of nine stairs are faithfully portrayed in the

space of ¼ in. and the eight separate guns of a pom-pom battery are contained within a ¼ in. square.

The four main turrets of the model all swivel and there are 18 other gun units as well; on the decks and davits are a total of 15 lifeboats, cutters and barges, and below the waterline four propellers and shafts.

On May 24, 1941 H.M.S. 'Hood' was sunk by the 'Prinz Eugen' following a direct shell hit on her magazine; this was during the famous 'Bismark' action.



A 'SHIELD' PIPE RACK

THIS useful pipe rack in the novel form of a shield is an attractive piece of fretwork. It has two shelves instead of the usual single rack, so that the bowls of the pipes may rest on the lower shelf, and the stems pass through holes in the upper. This prevents the nicotine running into the mouthpiece.

Fretwood such as of walnut, mahogany or oak will work up splendidly, if available, but the article could also be made of plywood, which may be suitably stained and varnished, and will have greater strength.

The cutting list is as follows: plaque, 10 in. by 9 in. by $\frac{1}{4}$ in. thick; upper shelf U, 7 in. by $1\frac{1}{2}$ in. by $\frac{1}{4}$ in.; lower shelf L, 7 in. by 2 in.; bracket B, $1\frac{1}{2}$ in. by $1\frac{1}{2}$ in. by $\frac{1}{4}$ in.; pipe overlay, 5 in. by 2 in. of $\frac{1}{8}$ in. or $\frac{1}{16}$ in. contrasting wood for overlay or inlay decoration.

The design of the shield for the back of the rack is shown in Fig. 1. Mark off the 1 in. squares on a piece of paper, and copy the outline to the full scale. Mark in the positions of the shelves, including the two mortises for each. These slots are 1 in. long by $\frac{1}{4}$ in. wide.

Fig. 2 gives all dimensions for shelves

By
T. S. Richmond



and the bracket. The top shelf has a row of $\frac{3}{8}$ in. diameter holes, evenly spaced and drilled with brace and bit, or cut with a fretsaw.

When the parts are all cut and have been cleaned up with glasspaper, the two shelves are glued in place. The tenons should be a tight fit into the mortises. The supporting bracket is simply glued centrally beneath the lower shelf and $\frac{1}{2}$ in. nails or screws may be inserted through the back, wherever needed, to give extra strength.

Draft out the outline of the pipe overlay over $\frac{1}{2}$ in. squares. Transfer either the complete design on to one

piece of wood, or make separate tracings on contrasting pieces. The overlays can be tacked together, the one cutting then giving you both pipes. The waste portion (dotted lines) is cut away where the pipes intersect. The overlay is glued centrally above the top shelf, as illustrated.

The experienced worker may wish to fretwork the design in the area between the two shelves; or work in a marquetry emblem with attractive coloured veneers. The edge of the shield would look effective if chamfered. Two wall hangers through the holes in the rack make a secure fitting.

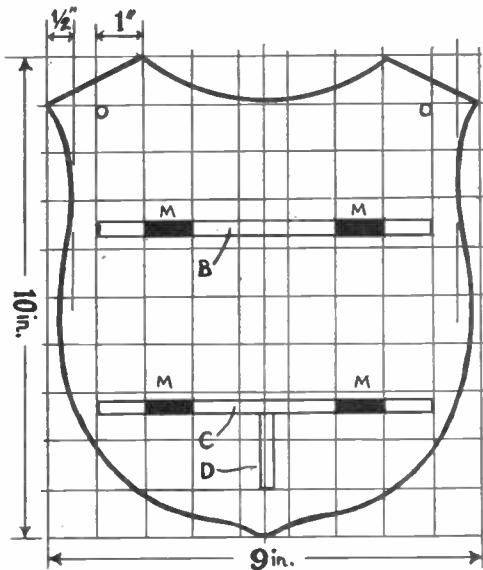

Fig. 1

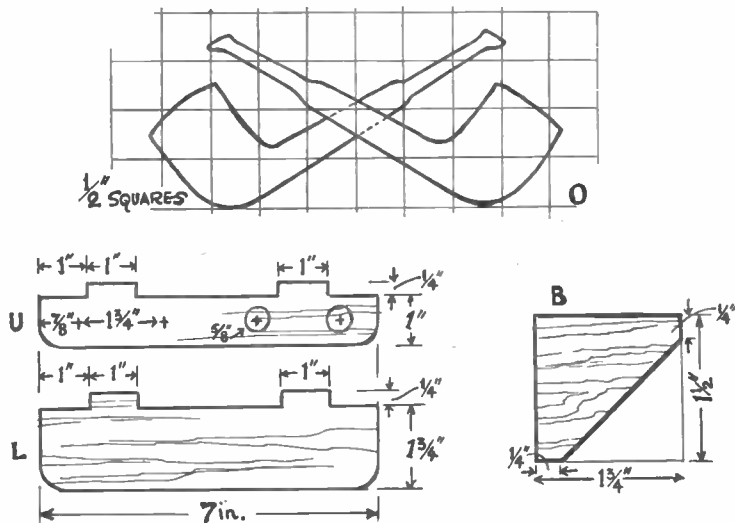

Fig. 2

MAKE A THRILLING ELECTRIC GAME

THE thrills and excitement of playing electrical games in amusement arcades can be brought into your home if you make this intriguing number game. When you spin the large wheel on the front of the cabinet, five electric eyes will 'wink' in a fascinating sequence, and your score will be indicated by a single glaring lamp when the wheel ceases to turn. Building the game will not be a difficult project, and only slight electrical knowledge will be necessary, but

By A. E. Ward

you will need to exercise care and patience when you connect the numerous short wires to form the twelve possible circuits which are incorporated in the apparatus.

Your main requirements will include five flashlamp bulbs and bulb holders, and a 4½ volt flat battery. Also you will need a dozen paper fasteners, a few yards of thin insulated copper wire, and a box measuring 20 in. by 15 in. by 5 in. The box may be a shirt box or a specially constructed 'cabinet' made of strong manilla cardboard or plywood, which will be minus a 'back' during the manufacture of your game. Also supply yourself with some corks, a piece of thin glass tubing, scraps of stout cardboard, a steel knitting needle, and a coffee tin lid. The use of a small switch is optional.

Bore a graceful 'arc' of five holes across the top of the box front, into which the flashlamp bulbs can be tightly inserted. Obtain a 1 in. length of thin glass tubing and find a steel knitting needle which will fit loosely into the tube, to serve as a spindle later on. The ends of the glass tube should be heated in a hot Bunsen flame until the glass softens a little, and the jagged ends are rendered smooth. Bore a hole through a large ¾ in. thick slice of cork, and press the glass tube right through it. Make a hole in the middle of the box front through which the glass tube will easily pass. Glue the cork to the back of the box front, in such a manner that the glass tube will just project beyond the box front. (See the centre of Fig. 2.)

Next, prepare a 3 in. diameter cardboard 'contact disc' by inserting twelve paper fasteners equidistantly around the edge. Bore the ends of twelve 9 in. lengths of thin insulated copper wire, and connect one wire to the back of each paper fastener. When you have done this, bore a small hole in the centre of the contact disc, and glue the disc over the glass-bearing slice of cork. The hole in the contact disc A should be exactly in line with the middle of the glass tube. (See Figs. 1 and 2.)

A small round flat toffee tin may be utilized as a 'wheel' for the front of your apparatus. Bore a hole in the bottom of the tin, to take the knitting needle. Nail a large cork inside the tin, in the middle.

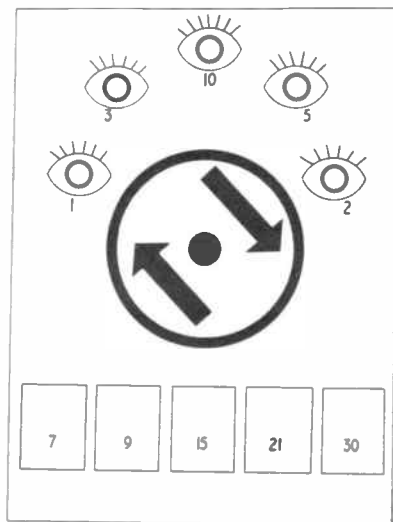
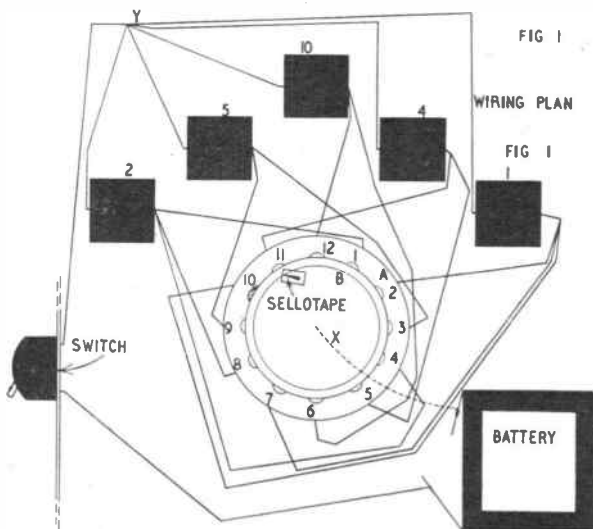

Mount the wheel upon the end of the knitting needle spindle, as illustrated in Fig. 2, then place the lid upon the tin. Insert the knitting needle through the glass spindle mounting.

Use the coffee tin lid to make the

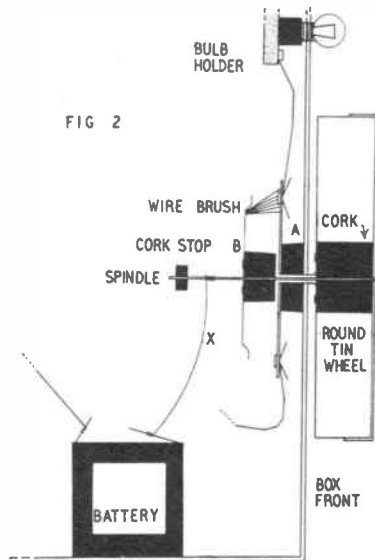

'selector disc' B. Bore a little hole in the centre, into which the knitting needle spindle will be able to fit tightly. Nail a small cork to the middle of the tin lid, as shown in Fig. 2. Bore a small hole near the edge of the lid. Obtain a short piece of 'flex' wire, and strip away the insulation from the tight bundle of wire strands. Thread the bundle through the little hole in the edge of the lid, and hold

• Continued on page 7

Mainly for Modellers

DEAD EYES AND BLOCKS. — In the building of ship models we find that dead-eyes and blocks on models are inclined to be oversized. If buying the commercial components we cannot always obtain those of correct size to our scale. That is why I prefer to make my own by methods already outlined in earlier articles.

- 50 guns to 36 guns
blocks ranging from 5 in. to 20 in.
- 32 guns to 28 guns
blocks ranging from 5 in. to 20 in.
- 28 guns to 24 guns
blocks ranging from 5 in. to 18 in.
- 28 guns to 22 guns
blocks ranging from 5 in. to 16 in.
- 18 guns to 14 guns
blocks ranging from 5 in. to 14 in.

These sizes are the diameter of the individual dead-eyes and blocks, and the separate sizes in the range being governed by the purpose for which they are used, the larger sizes will come in the standing rigging.

Details of blocks for any particular model if being rigged to scale will be supplied upon request.

TYPES OF BLOCKS. — During the above period the following types of blocks were used; single and double blocks, winding blocks (for heavy weights), double long blocks, ram-heads, dead-eyes, euphroes, snatch blocks (these brought the ropes to the capstan).

THE GOLDEN HIND. — For long one of our popular kits, this vessel is one of those about which details are difficult to obtain. According to notes taken from a work by Wycherley she was sheathed to protect sides and bottom, had seven port-holes each side, and out of a total of eighteen guns carried four guns in the bow. Her guns are given as thirteen made of bronze and five of cast iron. He also gives her a pinnace armed with a small bronze cannon.

SCROLL DESIGNS. — In many of our models of sailing ships we find that the gilded scroll work is difficult to add

in the decorations, and yet in models of clipper ships especially we find them appearing at a size that is easy to show on the actual model. Most gold paints or enamels are inclined to spread when applied with a brush, and the fine effect is blurred. By far the best method for simplicity of application and also for the finished appearance is the use of gold thread made by yourself. I use fine nylon thread, using an appropriate thickness for the scroll required. It is hung with a weight on the end to keep it taut, and is then painted with gold enamel, and left to dry.

To apply, coat the surface where the scroll is to appear with a slow-drying liquid glue, cut the gilded thread to suitable lengths, and work into the finished design with a gramophone needle mounted in a length of dowel to form a handle (Fig. 1).

CABLES AND ROPES. — To those of us who make scale models, the correct scale size of ropes and cables is of equal importance to accurate scale in the other items of ship's gear and furniture. These notes will help readers to follow the correct procedure in ropes for their models.

Cables and ropes are never measured by diameter — any measurement given refers to the circumference.

Some of the ropes are wound right-hand, some left-hand, and some with a 'heart', that is they are wound around a centre strand forming a core.

Suitable materials for your own ropes are artificial silk, fly silk from anglers' supply stores, surgical silk, nylon thread, and even fine sewing thread for larger ropes.

GUN POSITIONS. — When modelling your own guns for such models as our *Ark Royal*, *Golden Hind*, and other galleons, greater realism can be obtained by making them in three sizes to represent the main sizes of gun used. On the *Ark Royal* swivel guns can be added on the bulwarks. I added these to my model some years ago, and they were included in my series of articles on building this ship.

Having made your guns in the three sizes to represent the saker, demi-culverin, and culverin they are situated as in Fig. 2.

MOORING CHOCKS. — These were large pieces of hardwood, with an iron rimmed hole for use as a fairlead, and were let into the bulwarks. When modelling these they are situated usually one on either side of the bow, and one on either side of the quarters. The mooring rope was passed through the fairlead (known as the 'mooring pipe'), and belayed to the projections provided on each side of the block (Fig. 3).

PAGES FROM MY NOTEBOOK

By 'Whipstaff'

To assist our modellers here is a list of the sizes of the actual blocks, etc, used on the wooden warships in the Establishment during the period from about A.D. 1600 to 1800, the ships being rated by the number of guns carried.

- 110 guns to 74 guns
blocks ranging from 5 in. to 26 in.
- 74 guns to 64 guns
blocks ranging from 5 in. to 24 in.

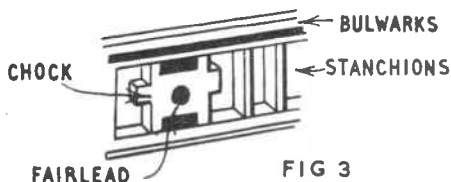
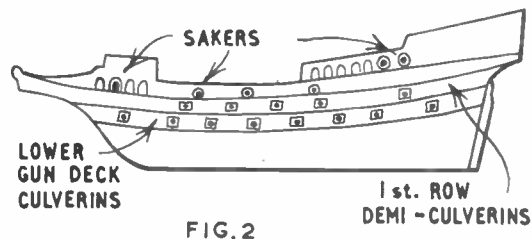

A DIM/BRIGHT LIGHT FITTING

A circuit which will provide bright/dim running with a single household lamp is shown in Fig. 1. The on/off switch will put the lamp on at full or reduced brilliance, according to the position of the bright/dim switch.

the lamp base, to avoid any chance of shocks to the user. If connections are checked, or any changes made after trying the circuit, momentarily short circuit the condenser with a tool with an insulated handle, to discharge it. Do not touch any connections whatever unless the lamp has been disconnected from the mains by withdrawing its supply plug or adaptor.

Circuit for low power bulb

Fig. 2 shows an arrangement which will allow a 200/250V. lamp of any required wattage to be used, with a small 6.3V. torch type bulb for subdued lighting. This is a very good arrangement for a night-light, as the illumination from the small bulb is about right for this purpose.

A small bell transformer giving about 5V. to 6V. or so will do for the bulb circuit. A satisfactory bulb will be the 6.3V. .3 amp, or 6.3V. .15 amp dial-light type sold for mains radio sets, or the similar type of bulb used in the head-lamp with some cycle dynamo fittings.

It will probably be necessary to make a table lamp to suit, with a base large

By 'Modeller'

The 1mfd. condenser will be found generally satisfactory for a 25 watt lamp, and provides fairly subdued lighting. If a lamp of larger wattage were used (such as 40 watt or 60 watt) it would be necessary to increase the capacity of the condenser, as the 'dim' position on the switch would then give almost no light at all. A high quality, high voltage paper type condenser is most satisfactory.

All joints and connections should, of course, be concealed and protected by

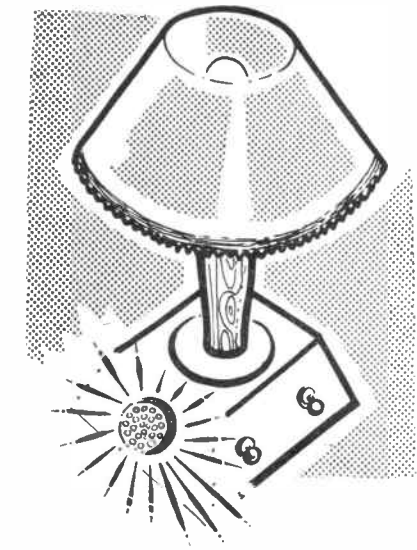

A STANDARD or table lamp which can be lit at full or reduced brilliance is useful for a number of purposes, such as for a bedside light or night-light, or to provide reduced illumination when watching television programmes. If an existing lamp has enough space to take the extra parts, this may be converted. If not, a table lamp can be made with a slightly enlarged base, to accommodate the items used in the dimming circuit.

Both the methods described here will work from A.C. mains, but cannot be used with D.C. mains. It is important that mains voltage switches should be fitted, and small, insulated toggle or push-button switches are satisfactory. Actual connections throughout the circuit can be made with good quality insulated flex. Twin flex will be most convenient to run to switches, lamp-holders, etc.

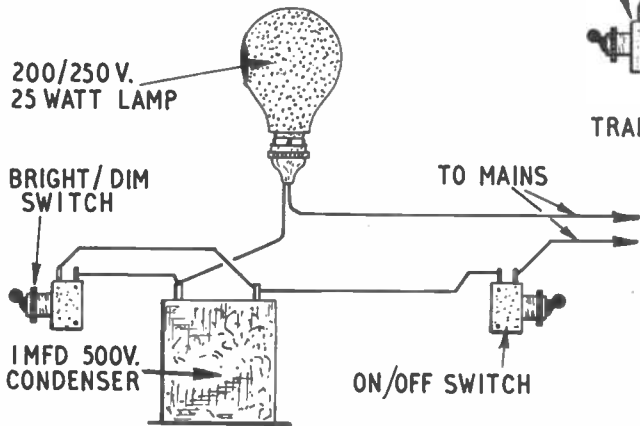
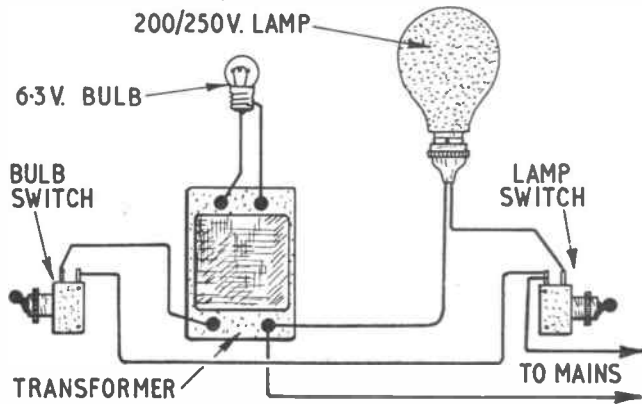

Fig. 1—Circuit for dimming a 25 watt lamp.

Fig. 2—Using a separate low power bulb.



enough to accept the transformer. The 200/250V. lamp will occupy its usual position, with shade. Both the small switches can be fitted to one side of the base. The 6.3V. or similar bulb should be in an insulated holder, or it should be placed behind a piece of glass. Insulated, fully enclosed 'signal lamp' holders can be obtained, and will be very satisfactory. Many shapes and sizes are made, but it is best to avoid one with a coloured glass.

...ab evenly on the paper in... to know if you could... wish to make some play... mitter? (R.P.—Wolverhampton.)...
 ...ht and hang to dry under... it to go over the wallpou... on the same... Channel 10...
Replies to Readers
 ...V. and 15V... more.)... to charge a 12V. battery, as c... was made by fixing... should over a stu...

Fading on Luxembourg

I HAVE made the crystal and 1-transistor set ('Hobbies Weekly', 26 June 1957) using a speaker, not phones. I get very good volume on Third Programme, reasonable on Light and Home. Is it possible to increase the latter two and cut down on Third. Also I would like to put a volume control on. Would this increase volume in any way? Would also like to know if it is possible to get Luxembourg clearly, as fading occurs. (D.F.—Huntingdon.)

THE relative volume of the stations depends on how near they are, their power, and the direction your aerial points. Luxembourg fades due to changes in the radio path. A large receiver, with automatic volume control, will compensate for this to some extent. In some localities, a vertical aerial will result in less fading. A volume control will reduce volume, but not increase it. To increase volume, an extra amplifier stage is needed. Circuits for two transistors have appeared in various past issues. A $\frac{1}{2}$ megohm or similar potentiometer can be used as volume control. Wire its outer tags to diode detector and earth line, and feed the transistor from the slider, instead of directly from the diode.

Painting over Stained Work

I HAVE a room, the woodwork of which has been stained dark oak, and over which numerous coats of varnish have been applied. I now wish to paint this room with a gloss paint. Is it necessary to remove the old stain and varnish? If so, could you inform me how to set about it, and if not, how to prepare the surface? (T.H.—Gloucester.)

IT is not strictly essential to remove the old varnish from previously coated paintwork, but, obviously, the dark colour will have to be obliterated by the application of two undercoats, the colour of which will depend upon the final gloss paint finish. For instance, if you wish to finish in cream, then your undercoats will be white. Old varnish should, however, be removed if the surface is cracked. This can be done with a blowlamp and scrapers, or by means of one of the chemical strippers now on the market, of which you can obtain guidance from your local supplier. Either process will not entirely remove the stain which has, obviously, pene-

trated into the woodwork, but in any case an undercoat should be used.

Painting Concrete

I HAVE a concrete step which has considerable wear. In its present state I have tried painting it with liquid lino floor paint and with Syres floor covering both without success. I believe it is necessary to first fill the pores in the concrete. Could you tell me the best way of doing this, and what is best to paint it with (either matt or gloss)? (H.T.—Bideford.)

AS your concrete step is porous you should thin down the paint with which you wish to cover it, so that it will penetrate deeply and thus have a more lasting effect. Thin with turpentine for the first coat or two, and then finish with the unthinned top coat. If, however, you wish to seal the cement pores, this can be done with a coating of hot size allowed to cool, and then painted over, but this we think would not give the same lasting effect as a deeper penetration.

Engraving on Brass

MANY years ago I saw my father write names on a piece of brass for a dog collar. Can you tell me the name of the acid and how to do the job? (J.A.—Co. Armagh.)

THE acid is nitric acid. To engrave on brass, dilute the acid with its own volume of water. Coat the brass with a thin film of candle wax, scratch out the characters it is wished to engrave, and apply the acid a few drops at a time. A greenish effervescence will be seen at the exposed places. When the effervescence ceases more acid may be applied until the engraving is deep enough. Then rinse with water and remove the wax. The acid is, of course, corrosive to the skin. Treat any on the skin by flushing with water and applying wet sodium bicarbonate. The fumes arising from the brass while under treatment are also harmful; hence the operation should be conducted in the open air. To apply the acid, use a glass rod or a sharpened stick.

This is the first issue of a new volume. Why not make a permanent book of your copies of 'Hobbies Weekly' by using an Easibinder? See details on page 14.

Treating a Wooden Ceiling

WILL you tell me how to treat a wooden ceiling which is affected with soot, so that oil paint will dry on it? No matter how I wash it, the paint will not harden. (A.J.—Newtownhamilton.)

OBVIOUSLY your ceiling is affected with a grease which prevents proper adhesion of the oil paint. It is suggested that you should remove this grimy surface with a scraper, and then rub down thoroughly with glasspaper. This would also have the effect of giving a 'key' for the addition of paint. It might help, too, if a suitable flat undercoat were used before adding the glossy finish.

Curing a Cow's Horn

I SHOULD be glad of some information on how to cure a cow's horn. I want to polish it and hollow it to make a vase if possible. (V.B.—Wrexham.)

CLEAN the horn thoroughly by washing in warm water, scrubbing, and scraping out every trace of fleshy matter in the interior of the horn or around the base. Allow to dry thoroughly then polish by rubbing with Florence oil (if obtainable) or alternatively with salad oil or olive oil; no other preservative is needed.

Wadding Proofing

I HAVE a feather-filled sleeping bag, and although I have put dry soap down the seams, the feathers come out through the material as well. Can you tell me of a way to prevent this? (W.B.—Dundee.)

FEATHERS working through their covering are a great nuisance and hard to cure. An application of soap or beeswax over the whole of the inner surface is the only real palliative. For soaping, the area is well dampened and then rubbed uniformly with any ordinary cake soap. Soap applied on the outside of material is always visible and not desirable, but a certain amount of 'wadding proofness' can be secured by applying soap lightly to the outside and continuing rubbing with, say, a cloth pad until it has almost passed through the fibres. The thorough rubbing makes the dressing less obvious. Soaping the outside would be excellent if it were possible to fit the bag with an extra cover which need only be of the thinnest and lightest fabric. When buying a sleeping bag make sure the material is 'wadding proof' — the salesman will know exactly what you mean by this term.



SENTINEL OF THE DARK ...

NIGHT-HUNTER

by Ed Capper

IN a single night a barn owl catches an average of twelve rats. In each square mile owls will catch 24,000 rodents per year. Easy to imagine how over-run we would become with disease-carrying rats and mice, were it not for the owl. No wonder he is called the Night-Hunter.

Just how does he do it? It is a combination of sight and sound. Human eyes contain both cone cells (to distinguishing colour), and rod cells for light gathering. Owls only have lots of rod cells in their eyes.

Their eyes are much larger proportionately than human eyes. Yet they have one disadvantage. The eyeballs are fixed, and the bird sees in all directions only by swivelling its head. It is able to rotate its head three-quarter the way round in one direction, return, and swivel it around the other way.

It is able to capture prey in light equal to only one candle power, 750 yards away, a most astonishing feat. Experiments were made in America in a completely darkened-out barn. When the prey was released, the owl swooped to catch it without any difficulty.

The owl's face is ringed by stiff curved feathers. These collect and bounce sound waves into the ear drums. It could be likened to a form of animal radar.

There are a total of 136 species of owls doing their good work throughout the world. Britain has five varieties, the most common being the barn and the tawny types. It is a fallacy to say that owls inhabit empty houses, and will attack anyone entering. They enter empty houses only to catch their prey, and seldom spend a whole night in one house. Mostly they nest in large barns, whilst their natural habitat are holes in trees.

They are comparatively large birds with a huge wing span, although some foreign species are no larger than our sparrow. Owls attain a ripe old age, the oldest known living to seventy.

Nature has again equipped the owl with a perfect camouflage to help it in its work. The feathers are similar to sunlight against a tree bark.

It is the bird that is most rarely seen by the average human being. If you have seen one during the hours of daylight you were probably struck by its stillness, and imagined it to be asleep. This immobility is again provided by Nature to help the bird catch its prey. It can sit perfectly still by controlling its breathing in such a way that not a rustle of its plumage can be seen. Further, its body is completely covered with a fine down, so that no tell-tale, whirring noise is made when the bird is in flight.

Whilst such a daring marauder by night, the owl is quite helpless during the day, and will be attacked by rooks, crows, or jays if seen. He is wise enough, therefore, to keep well out of sight during daylight.

Not too much attention should be paid to those tales of owls carrying off

really large prey, although they will attack and kill cats, rabbits, and even turkeys. The North American Owl, no larger than our sparrow, is quite used to catching the much larger squirrel.

The owl's talons are made for grabbing. There is a strong back-heel, fronted with four sharp and long talons. Owls will not hesitate to use these talons on anyone foolish enough to go near a nest when the young are about. They are proud defenders of their family.

Another trick of defence is to lure any trespassers away by imitating bird calls or the sounds of animals in distress, hoping the interloper will turn away from the nest just long enough for the owl to reach it unseen. If this happens, woe betide anyone too near the nest.

As can be expected, the owl is a protected bird coming under the care of the Royal Society for the Protection of Birds. No other bird deserves more protection than the owl — a friend, indeed, to mankind.

Peeps at Nature

STARFISH AND SEA URCHINS

STARFISH and sea urchins are closely related, belonging to the Echinoderms or 'spiny skinned' creatures. There are several British species, the 'common starfish' being most widespread.

The one shown is the Purple Sun Star, most often seen on northern coasts. If a starfish suffers injury to one of its arms, it can shed it and grow another.

Starfish have many sucker-like 'feet' on the underside, and are able to force open oysters and other bivalves by pulling the valves apart with a slow continual pull until the victim is forced to give way. The starfish then protrudes its stomach through its mouth and devours the flesh of the mollusc. Starfish are, therefore, considered a pest in oyster beds.

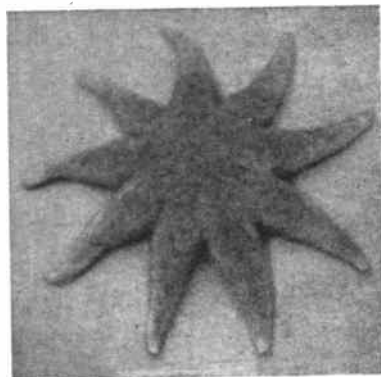

PAINTING?

A GOOD JOB needs
A CLEAN START!

STRIP YOUR OLD PAINT WITH

NON-
INFLAMMABLE



PAINT REMOVER
TYPE 'C'

NO NEUTRALISER WASHING OR CLEANING REQUIRED
AFTER USE — BRUSH IT ON, LEAVE FOR 5 TO 15 MINUTES,
THEN STRIP OFF, PRIME AND REPAINT.

REMOVES Varnish, Emulsion Paints, Stoving Enamels,
Lacquer, Cellulose, Epoxide Coatings, Chlorinated
Rubber Paints, Poly-Urethane Coatings, etc. etc.

1 gallon ...	45/-	} Carriage & Packing 2/6 extra
1 " " ...	24/-	
1 quart ...	12/6	
1 pint ...	7/-	

GET 'PITAN' FROM YOUR LOCAL STOCKIST
or in event of difficulty, send a covering remittance
to the manufacturers:—

ALLWEATHER PAINTS LTD

36 GT. QUEEN STREET, LONDON W.C.2

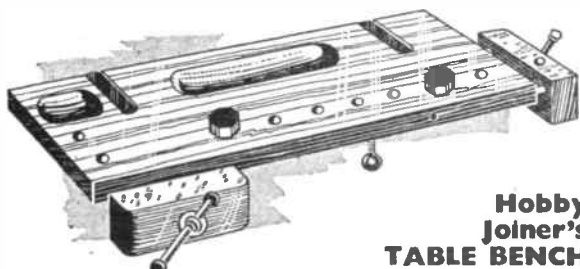

**Hobby
Joiner's
TABLE BENCH**

Cramps to kitchen table to provide an ideal working surface for cutting,
shaping and assembling small parts. The spaced holes and pegs permit work
to be held for planing. Two sturdy vices, two metal cramps. Size 37/6
20 in. long. Made of seasoned hardwood for years of service.

HOBBIES LTD., Dept. 99, Dereham, Norfolk

$$X = \frac{-b \pm \sqrt{b^2 - 4ac}}{2a}$$

**1st lesson and
details FREE**
from →

DON'T FUMBLE with Formulae.
Master Mathematics Quickly and
Easily the Understandable Way.

UNDERSTANDABLE MATHEMATICS
11H, Dryden Chambers, Oxford Street,
London, W.1.

Name

Address

MANY MODELS from ONE TIN!



Pyruma, plastic and ready to use from its tin, can be fashioned into the
widest variety of models imaginable. Buildings for your model railway
set, houses, ship models, animals and figures, ashtrays and plaques — all
of which when set or baked to stone-hardness can be finished in
natural colours. Get the Pyruma Model Instruction book — see Coupon
and start making things like those shown below

SANKEY'S PYRUMA PLASTIC CEMENT

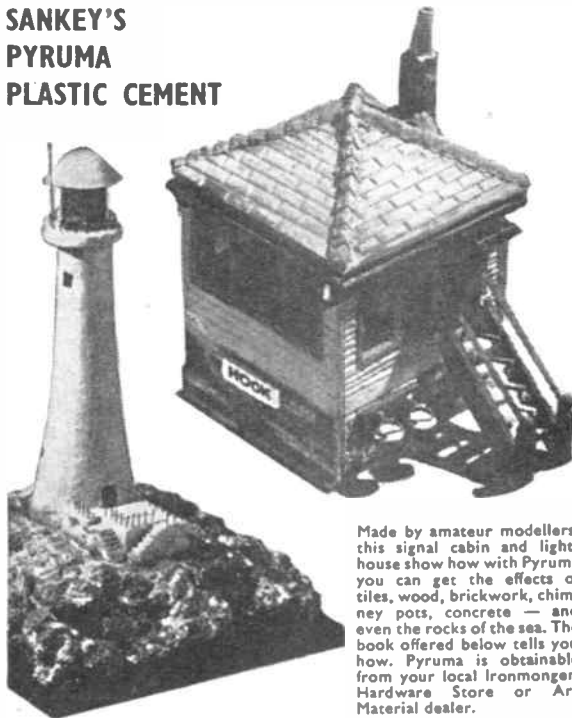

Made by amateur modellers,
this signal cabin and light-
house show how with Pyruma
you can get the effects of
tiles, wood, brickwork, chim-
ney pots, concrete — and
even the rocks of the sea. The
book offered below tells you
how. Pyruma is obtainable
from your local Ironmonger,
Hardware Store or Art
Material dealer.

POST THIS BOOKLET COUPON TO-DAY

To J. H. SANKEY & SON, LTD (Dept. HW),
ILFORD, ESSEX

I enclose P.O. 6d. (not stamps) for a copy of Pyruma
Modelling Instruction Booklet, post free to:

NAME

ADDRESS

(BLOCK LETTERS PLEASE)

Yours
for
only
8/6d.
(Post 1/3)

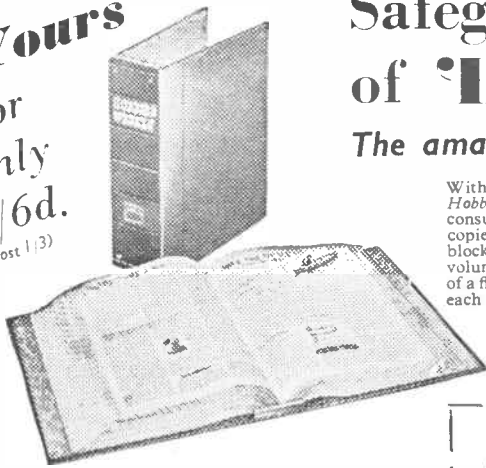

Safeguard your copies of 'HOBBIES WEEKLY'

The amazing 'EASIBINDER' (Pat.) makes it simple

With the new *EASIBINDER*, specially prepared for Hobbies, you can bind each copy of *Hobbies Weekly* as you get it, turning your favourite magazine into a permanent, easily-consulted library of immense value, and avoiding the delay and despair occasioned when copies are accidentally mislaid or destroyed. Carefully finished in black leather-cloth and gold-blocked on the spine, each binder is strong, serviceable and neat. It will hold two complete volumes (52 copies) and costs only 8 6. Each copy of the magazine is quickly inserted by means of a flexible steel wire, and can easily be removed if necessary. Easy-to-follow instructions with each *EASIBINDER*. Get one today and take care of your copies of *Hobbies Weekly*.

NOTE From the issue April 10th, 1957, there is a slight difference in the size of the magazine, and two sizes of Easibinders are available. Type A is for binding issues published before April 10th and Type B is for those printed subsequently. To avoid confusion, when ordering, please indicate clearly the type of Easibinder required. Indices for each completed volume 1, - each post free.

☆ One 'EASIBINDER' holds two volumes (52 copies)

☆ Easy to use

Post today

100 DIFFERENT stamps free! Request 1d. upwards discount approvals. — Bush, 53 Newlyn Way, Parkstone, Dorset.

PROFIT AND PLEASURE is obtainable from WRITING (typewriter unnecessary) or ARTISTRY. Send for free fascinating bumper package 'PROFITABLE LEISURE'. — Writers' & Artists' Ring (HW), 5 Edmund Street, Birmingham.

WORKERS with sewing machines required for making cushion covers. Regular work guaranteed. Apply Dept. 28, Arnold Trading, 92 Shelley Road, Worthing, Sussex.

50 MIXED stamps 5/-. Try our 6d. in 3/- discount approvals. — E. C. F. Townsend, 25 Tenby Road, Edgware, Middx.

LEARN RADIO & ELECTRONICS the NEW Practical Way! Very latest system of experimenting with and building radio apparatus — 'as you learn'. FREE Brochure from: Dept. H.W.10, Radiostructor, 40 Russell Street, Reading, Berks.

PERSONS (either sex) Soft toy assembling in spare-time. The ideal profitable pastime. Everything supplied. Details s.a.e. Dept. H.W.. Cuddycraft Supplies, East Road, London. N.1.



To: HOBBIES LTD., Dept. 99 Dereham, Norfolk.

PLEASE SUPPLY EASIBINDERS
(Type) at 8 6 each (post each 1/3).

NAME
ADDRESS
P.O. for
enclosed

LEARN

RADIO & T/V SERVICING

for your OWN BUSINESS/HOBBY

● by a new exciting no-maths system, using practical equipment recently introduced to this country
FREE Brochure from:—

RADIOSTRUCTOR
DEPT. G81, READING, BERKS. 5/4/61

25 SOUTH AFRICAN STAMPS. This interesting, valuable packet offered as Free Gift to all approval applicants enclosing postage. — Yulwontmor Stamps (Dept. H.), 54 Compton Avenue, Leagrave, Luton.

MATCHBOXES/LABELS/BOOKLETS re-acquired by collector. Discarded collections welcome. — Box No. 40, Hobbies Weekly, Dereham, Norfolk.

BUYING OR SELLING?

Classified advertisements on this page are accepted at a cost of 6d. per word prepaid. Use of a Box No. is 1/- extra. Send P.O. with advertisement to *Hobbies Weekly*, Advert. Dept., Dereham, Norfolk. Rates for display advertising on application

Got your copy yet?

HOBBIES 1961 ANNUAL

180 pages — crammed with ideas
There may be a copy available at your newsagents
price only 2/-

If in difficulty send 2/6 (including postage) to:
HOBBIES LTD, DEREHAM, NORFOLK

EXETER

DO YOU KNOW?

HOBBIES LTD. have a branch at

No. 9 NORTH STREET

where the manager and staff are always willing to give you the benefit of their experience with any of your handicraft problems. Why not pay a visit?

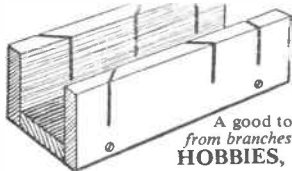

WOOD MITRE BOX

Made with selected hardwood with slots for 45° and right-angle cutting. Size 9ins. long. 5/6

A good tool at a modest price (post 1/6)
HOBBIES, DEREHAM, NORFOLK

HEAR ALL CONTINENTS With H.A.C. Short-Wave Receivers

Suppliers for over 18 years of radio S-W Receivers of quality.
One-Valve Kit, Price 25/- Two-Valve Kit, Price 50/-
Improved designs with Denco coils. All kits complete with all components, accessories and full instructions. Before ordering call and inspect a demonstration receiver, or send stamped addressed envelope for descriptive catalogue.
"H.A.C." Short-Wave Products (Dept. 22), 11 Old Bond Street, London, W.1.

THE 'POLLY' PINCUSHION

CUT 'Polly' A and the base B from $\frac{1}{4}$ in. wood, with a fretsaw. Clean up the two pieces, and paint in bright colours. Glue Polly into the base B.

The pincushion consists of two pieces of sponge glued in the position shown by the dotted lines, one piece on each side of Polly. (M.p.)

USE YOUR
FRETSAW

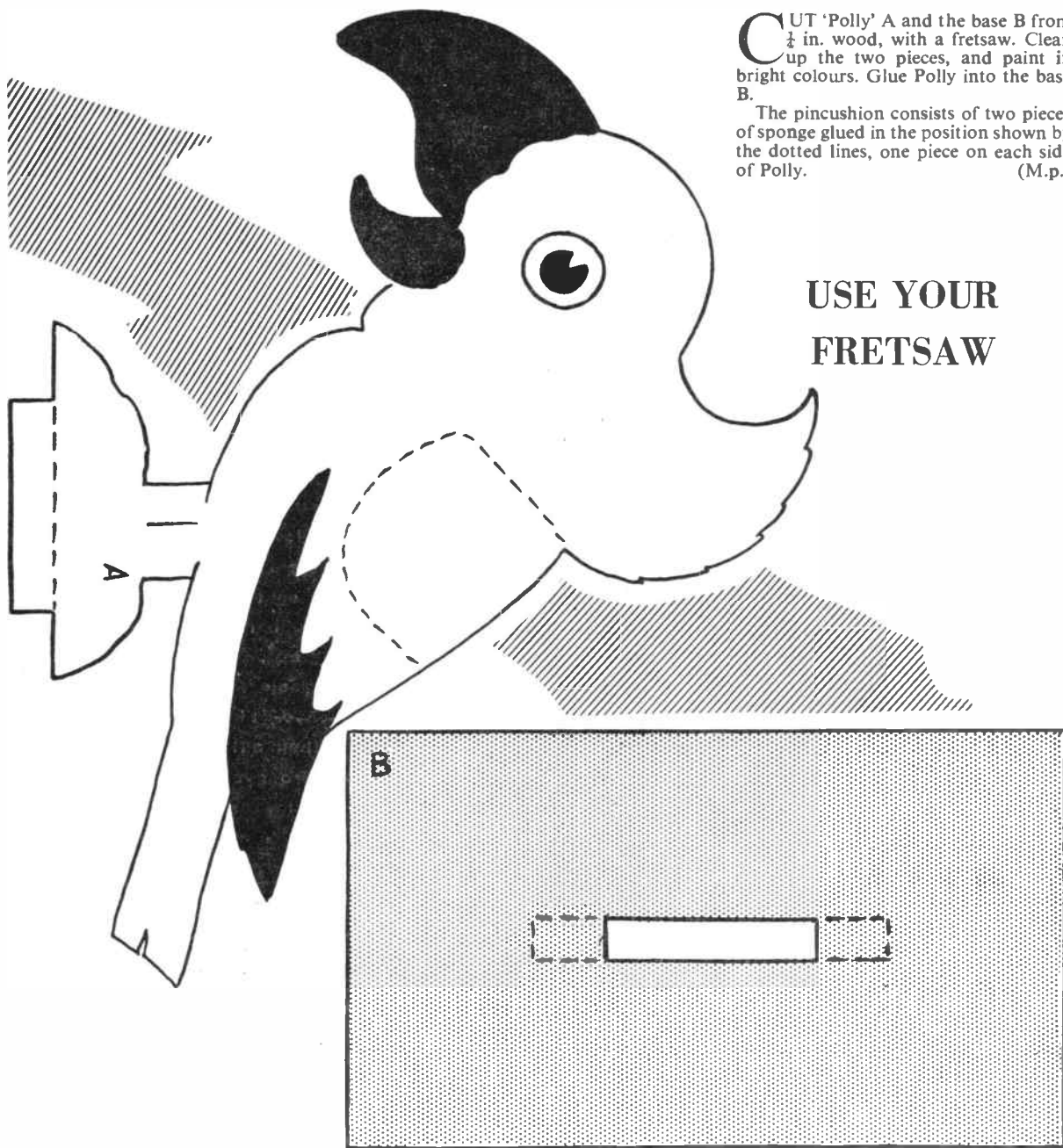

A tube or tin of Evo-Stik is a tool chest in itself

Available from
stockists
everywhere



Scientific Evo-Stik 'Impact' adhesive works miracles in the modern home today. Just spread the adhesive on both surfaces to be joined, allow a few minutes for them *both* to dry, and place them together, that's all! Rubber, metal, plastic, glass, pottery, fabrics, plaster board and wood... Evo-Stik 'Impact' *joins* them all! Let the fastest, strongest adhesive known to modern man save you time and money.

Tin 7/- and 4/3
Handy Tubes 1/9

EVO STIK 'Impact' Adhesive

Evo-Stik 'Impact' adhesive is a Registered Trademark



**CUT THE
SHAPES WITH
A FRETS**

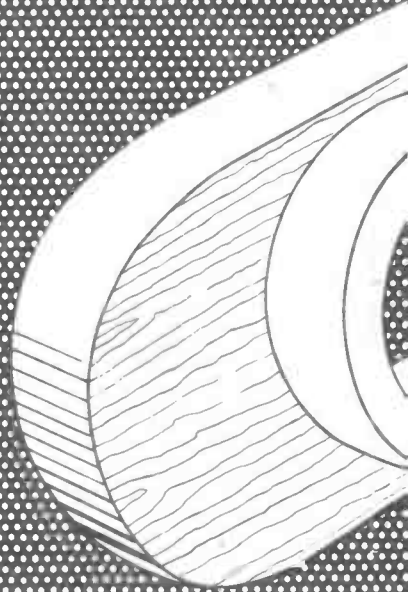
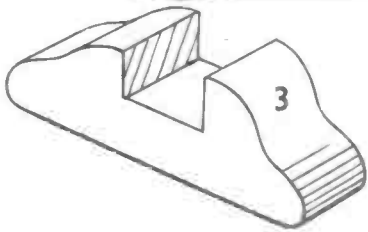
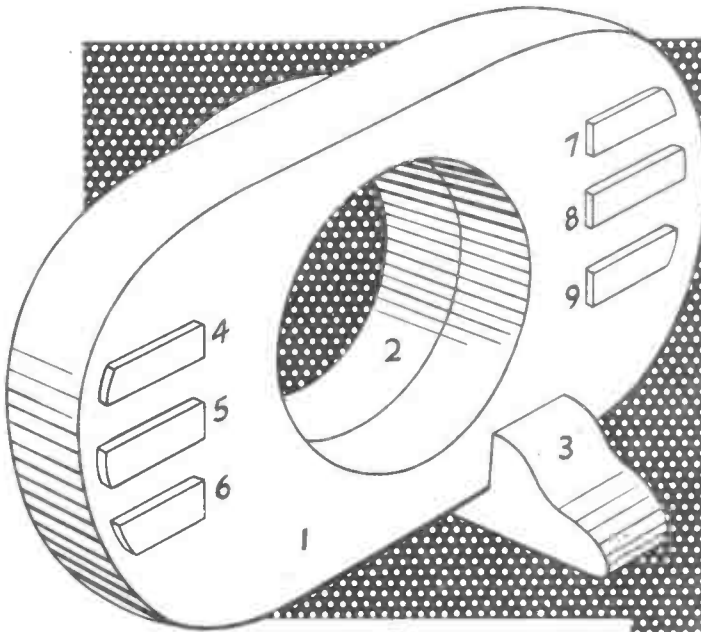

PIECE 1. CUT ONE 3/4 in.

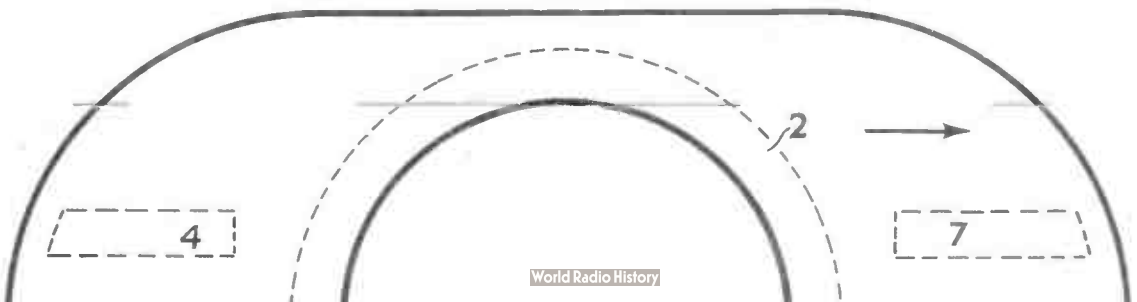

**THESE
WITH
TSAW**

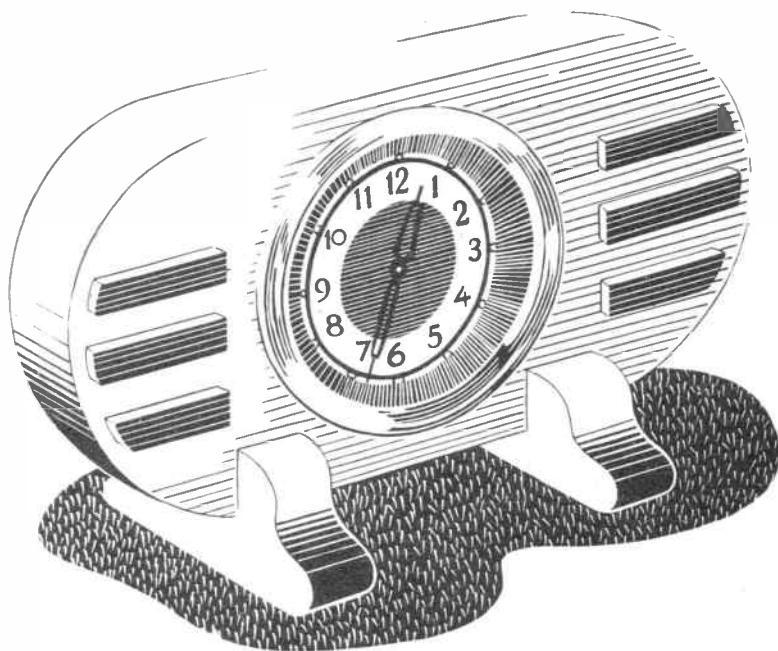
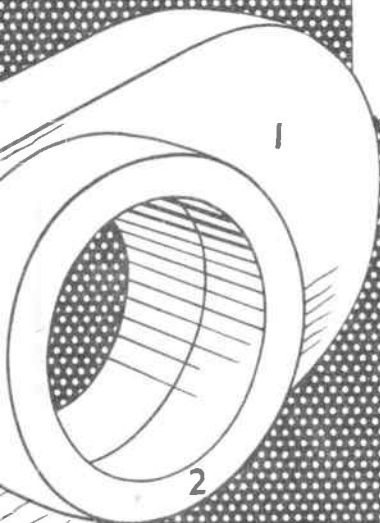

SIZE: 6 in. WIDE. $3\frac{3}{4}$ in. HIGH.

A KIT OF MATERIALS FOR MAKING THIS DESIGN IS SUPPLIED BY HOBBIES LIMITED, DEREHAM, NORFOLK. PRICE ON APPLICATION.

Use **CASCAMITE**
‘One Shot’
Resin Glue
for all Wood Gluing



- Mixed & use cold
- Waterproof type
- Gap-filling and non-staining

Obtainable in:
3½-oz.; 7-oz.
and 18-oz tins.

Stocked by: Ironmongers, Builders' Merchants, etc.

Manufactured by:

LEICESTER, LOVELL & CO. LTD. North Baddesley, Southampton

PIECE 1. CUT ONE 3/4 in.

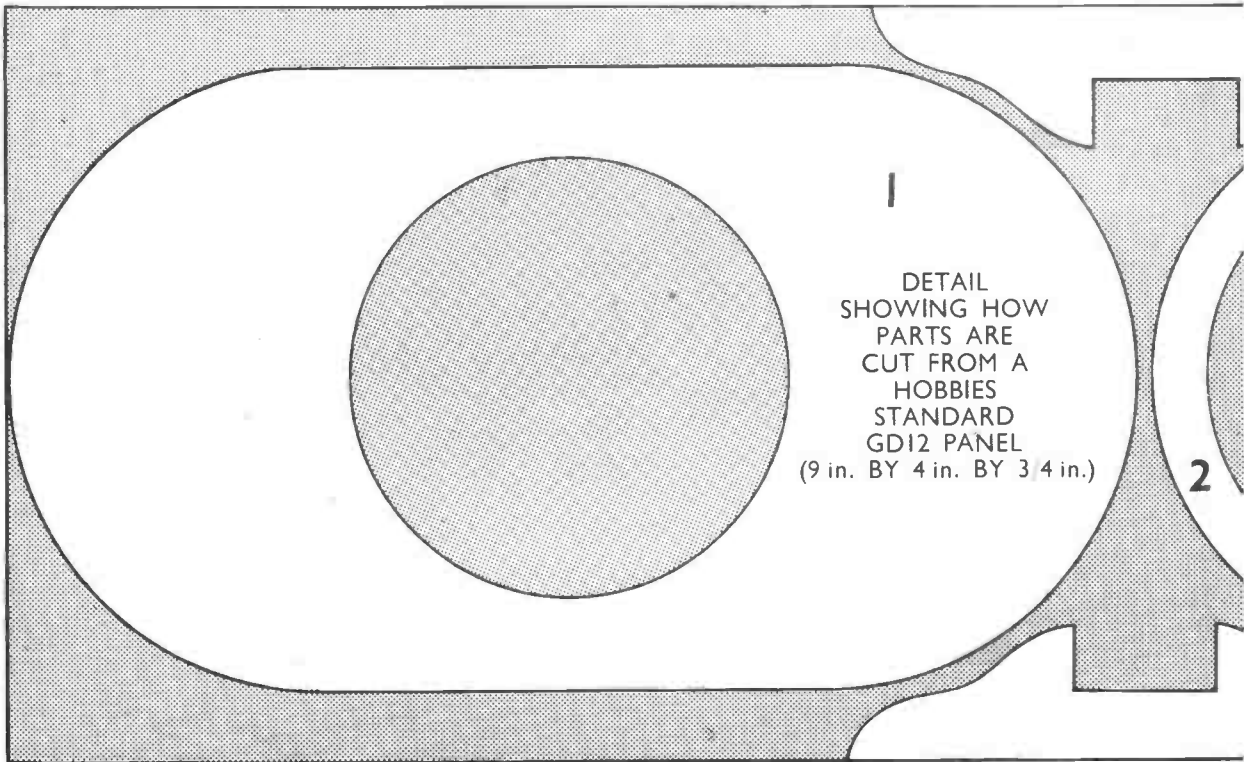
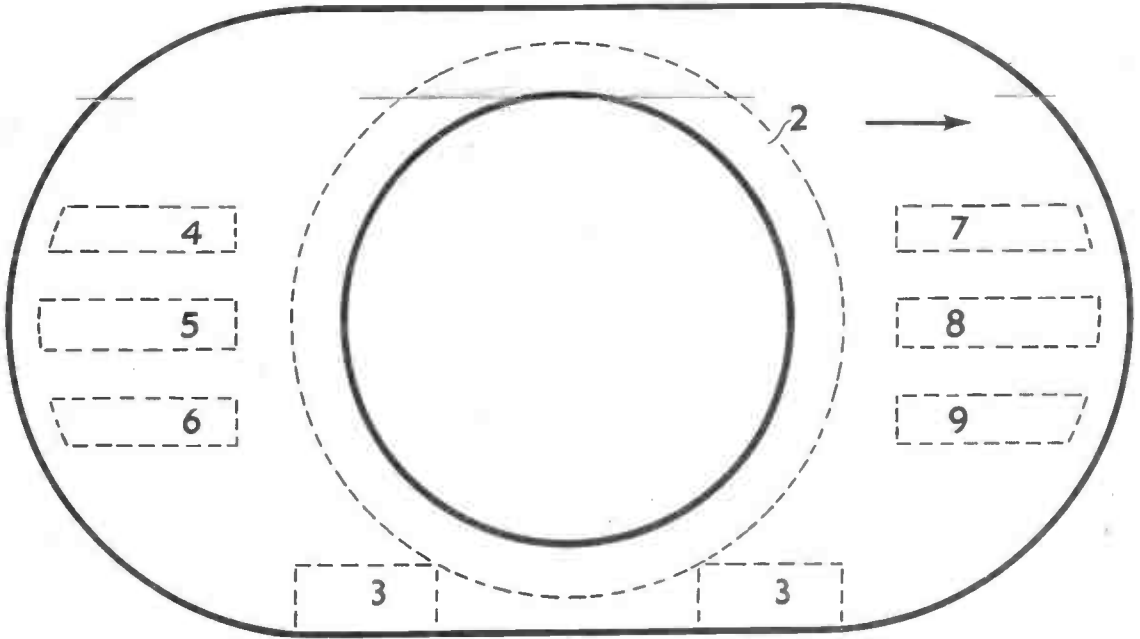

Use **CASCAMITE**
'One Shot'
Resin Glue
for all Wood Gluing



- Mixed & use cold
- Waterproof type
- Gap-filling and non-staining

Obtainable in:
 3½-oz; 7-oz.
 and 18-oz tins.

Stocked by: Ironmongers, Builders' Merchants, etc.

Manufactured by:

LEICESTER, LOVELL & CO. LTD., North Baddesley, Southampton

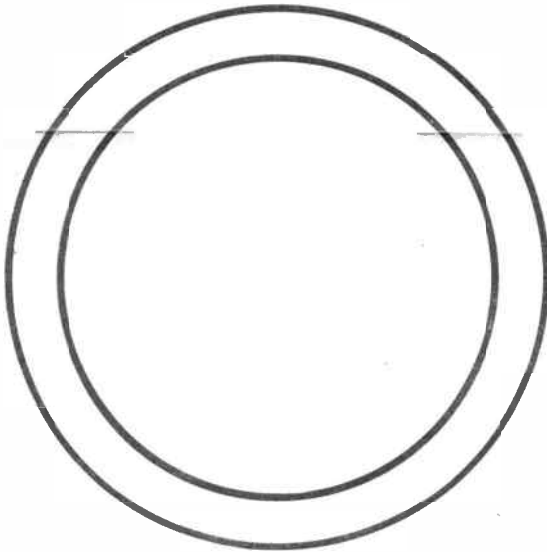

PIECE 2. CUT ONE
 3/4 in. GLUE BEHIND
 PIECE 1.

THE ARROWS INDICATE
 DIRECTION OF GRAIN
 OF WOOD.

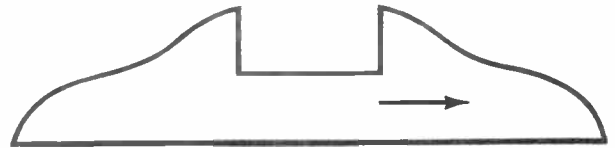
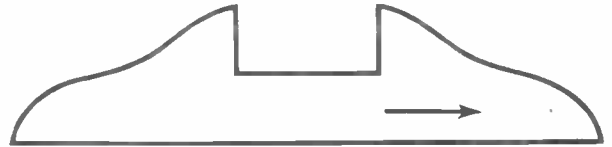

PIECE 3. CUT ONE OF EACH 3/4 in.

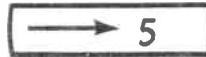
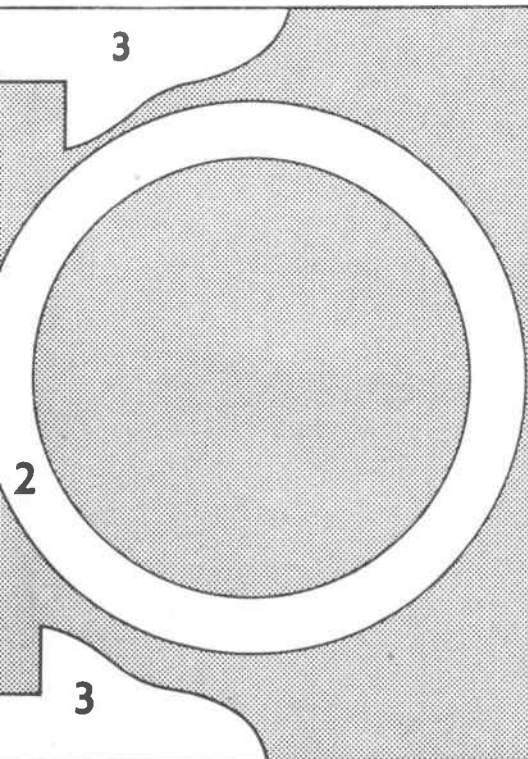

DECORATIVE OVERLAYS.
 CUT ONE OF EACH FROM
 1/4 in. BY 1/8 in. STRIPWOOD.

PRINTED IN ENGLAND.