

4th JANUARY 1961

VOL. 131

NUMBER 3395

THE ORIGINAL
'DO-IT-YOURSELF'
MAGAZINE

HOBBIES *weekly*

FOR ALL
HOME CRAFTSMEN

Also in this issue:

NOVELTY TOYS
FOR CHILDREN

COLLECTORS' CLUB

WHITTLING A
WHALE IN WOOD

A PRE-AMPLIFIER
SIGNAL BOOSTER

RECIPES FOR
DELICIOUS SWEETS

PATTERN FOR
FRETWORKERS

ETC. ETC.



INSTRUCTIONS
TO BUILD...



HOBBIES 'ZIP' RUNABOUT

Up-to-the-minute ideas

Practical designs

Pleasant and profitable things to make



5^p



HOW would you like a pie not only sweetened and spiced, but made hot with a sprinkling of pepper, or a cake full of fruit, and also strongly peppered?

These queries are posed by Bessie S. Dean of Falls Village, Conn., U.S. America. 'I got interested in pepper when a boy showed me his label collection', she says. 'He had fifteen coloured pepper labels. Now I am collecting them, too.'

SOME NOTES ON PEPPER

About 500 years ago no dish was complete without pepper. When the Northern conqueror Alaric the Visigoth besieged Rome he demanded a ransom of 3,000 lb. of pepper. Later on, taxes were paid in pepper instead of money.

In the twelfth century, according to an old law, the Jews paid to the Pope a tribute of 1 lb. of pepper and 2 lb. of cinnamon. In 1385 the King of Provence imposed on the Jews in his dominions a tax of 60 lb. of pepper.

So much traffic in this spice came to the city of Alexandria that one of its streets and a gate were so named.

People used to make presents of pepper. Even kings and ambassadors gave and received it. When the people of Venice wished to show special gratitude to the Emperor Henry V, they gave him 50 lb. of pepper. After a victory gained by the people of Genoa in 1101, each soldier was awarded 2 lb. of pepper.

In many countries there prevailed a curious system which obliged certain persons to furnish, at stated times, pepper in small quantities, usually about 2 lb. These payments were called 'peppercorn rents'.

In England the tax on pepper in 1623 was 5/- a lb. In those days people did not say 'I haven't enough sugar in my pudding or enough salt in my soup', but, 'There isn't enough pepper.'

Cingalese student

An eighteen-year-old student from Ceylon writes: 'I collect stamps, labels, and picture postcards. I like to have pen friends from any part of the world. I read your magazine regularly, and find

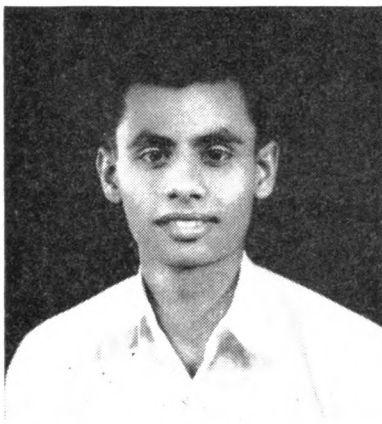

it very interesting. My address is W. D. A. Samarasinghe, No. 141 Banapawela, Ceylon.'

Mr T. Jones of 44 Holyrood Gardens, Edgware, Middlesex, is a keen stamp collector. He is interested in people from overseas.

Mr C. H. Stewart says: 'Several of my pen pals whom I have had through you are collectors of beer labels. I must congratulate you on your pen friend service. It is a wonderful pastime, and lets one see how the other half of the world lives.' Write to 554 Rutherglen Road, Glasgow, C.5.

'I wonder if you would put a note in 'Collectors' Club' asking if any readers are interested in a Rhodesian friend?' says Mr C. H. Davies, P.O. Box 8050, Woodlands, Lusaka, N. Rhodesia, who collects match labels and beer, wine, and spirit covers. Mr Davies would like to know of any readers interested in corresponding through the medium of tape recordings.

'Both my father and myself are regular readers of *Hobbies Weekly*; we have a copy which is eleven years old', writes Stuart Massey, 25 Dudley Road,

Sale, Cheshire. Stuart is fourteen years old. His hobbies include animals, making model boats, and woodwork.

'I would like a pen friend from overseas', says J. Leisham of 4 Kirkland Gardens, Methil, Fife, Scotland. 'My hobbies include tennis, skating, swimming, and model making. My age is fourteen.'

Raymond's ambition

Raymond Lee of 395 Crumlin Road, Belfast 14, would like friends from America or Germany. 'But I will answer all letters', he writes. 'My hobbies are reading and chemistry. And my ambition is to help man conquer space.'

'I collect used stamps of the world, by exchanging with collectors in other countries', says M. Akhtar Ali Khan of Karachi 29, Pakistan. 'I would like friends throughout the world.'

Mushrooms

NOW Czechoslovakia has put mushrooms and toadstools on stamps.

Some mushrooms are good to eat. But those who do not know mushrooms well should not gather them, as there are many poisonous kinds.

Thousands of mushrooms are grown for market in caves near Paris in France. Some of the beds are 7 miles long.

In Italy mushrooms are valuable. The beds are guarded carefully. But the poachers train their dogs to go among the beds and dig up the mushrooms.

Cows, sheep, squirrels, and many kinds of birds eat mushrooms. In many places mushrooms are dried just as our grandmothers once dried apples, strung on strings, and hung from the ceiling for winter use.

In Bohemia a large round toadstool is dried and the inside removed. It is turned bottom upward, fastened to the wall, and used as a flower vase.

A strange mushroom grows beneath the ground in India. It looks like an orchid bulb. They call it 'little man's head', in memory of a race of dwarfs who once lived in India.

A mushroom which grew beneath a pavement in Rome, Italy, was so strong that it lifted an 83 lb. flagstone a half inch out of its bed.

Many match labels and cards also depict mushrooms.



HOBBIES RUNABOUT 'ZIP'

At the 'Do-it-Yourself' exhibition at Olympia, London, last September, considerable interest was shown in Hobbies hardboard runabout 'Zip'. In view of the tremendous enthusiasm nowadays for boats of all kinds, we have pleasure in detailing instructions for building this hard chine craft, which is 7 ft. 8½ in. long, has a beam of 2 ft. 10½ in., and is intended to be powered by an outboard motor of from ¾ to 5 h.p.

Building this craft is comparatively simple for anyone who is at all handy with tools, of which only the ordinary kinds are necessary, and the project can be undertaken with confidence by anyone who is at all interested and enthusiastic. For a low cost it will provide a grand means of initiation into the pastime. Extra high speeds on the water must not be anticipated, depending on the load carried (see front page). But it will provide pleasurable cruising for an adult (in front) and one or two children in the back, where available leg room is more suitable.

The original was designed and made by a member of our staff with the intention of keeping costs down to a minimum. He had in view a holiday boat for the use of himself and his son, and after extensive trials it has come fully up to expectations, giving many pleasurable hours on inland waterways and in some instances on calm stretches of the sea.

Naturally, in such a small boat care has to be exercised in maintaining an even balance, and normal precautions for craft of this nature should be taken. Distribution of weight is an important factor, and if, say, an adult and two

FOR AN
ADULT
AND ONE
OR TWO
CHILDREN

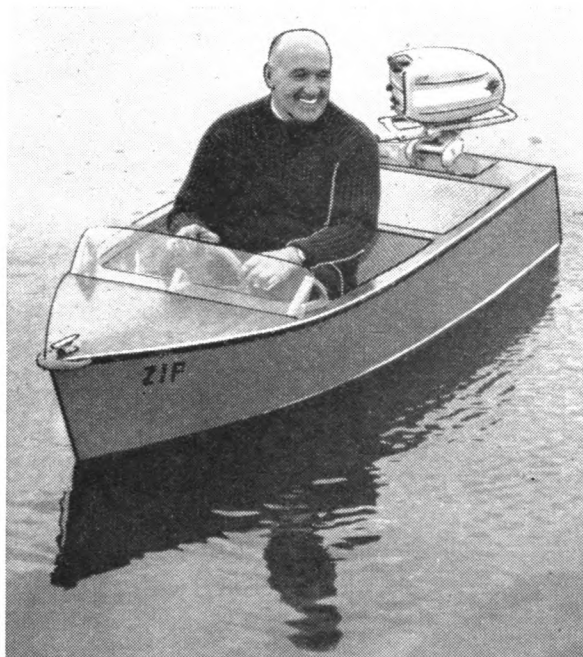

Steering is by a wheel or the handle on the engine

children are to be carried, then the weight should be distributed proportionately. There are two seats and provision is made for steering from the front seat by means of a wheel, although this can be also carried out by the person in the rear seat by means of the handle on the motor. When boating solo, the

driver can steer from the wheel and lean back to make any necessary adjustments to the engine, such as throttle speed, etc.

Marine plywood is the normally accepted material for skinning boats of this nature, because of its waterproof qualities. To keep down the cost, however, and thus encourage as many as possible to venture into the craft of making their own boat, oil-tempered hardboard has been utilized with marine plywood for decking, etc. To help the waterproof qualities of the hardboard, the craft should also be well painted, but care will obviously have to be taken when launching and taking from the water to avoid puncturing or otherwise damaging the skin.

Wooden strakes are provided along the bottom of the boat for launching and drawing out of the water on a reasonable surface, but it will be appreciated that the boat should not come into violent contact with any obstructions such as large and sharp stones, etc. (This, of course, also applies to boats of plywood construction.) Wooden battens have been incorporated at very short intervals along the hull so as to ensure maximum strengthening for the hardboard.

Weighing only 80 lb., 'Zip' can be carried quite easily by two persons, and in view of the nature of its makeup,

MATERIALS LIST FOR BUILDING 'ZIP'

Transom — one piece parana 36 in. × 12 in. × 1 in.

Hog — one piece parana 8 ft. × 2 in. × 1 in.

Stem — one piece parana 24 in. × 8 in. × 1 in.

Screen and seat supports and pulley — one piece parana 3 ft. 6 in. × 6 in. × ¾ in.

Transom plate — one piece parana 11 in. × 5 in. × 1 in.

Chines, gunwales, seat and deck supports, battens, etc.—1 in. × ½ in. stripwood, thirteen pieces 6 ft. long, seven pieces 8 ft. long.

Deck support — one piece 26 in. × ¾ in. square stripwood.

Sides and bottom skin — two sheets oil-tempered hardboard 8 ft. × 3 ft. × ½ in.

Deck, seat backs, floor etc. — one sheet mahogany, faced plywood (marine grade) 8 ft. × 3 ft. × ¼ in.

Skin laminate — one piece of ½ in. plywood 6 ft. × 2 ft.

Wheel, seats and pulley — one piece plywood 4 ft. × 3 ft. × ¾ in.

Dashboard — one piece plywood 2 ft. 6 in. × 12 in. × ¾ in.

Blocks — one piece 1 in. square stripwood 4 ft. long.

Rubbing strips — ¾ in. half-round beading, four pieces 8 ft. long, one piece 6 ft. long, one piece 4 ft. long.

Screen — one piece Perspex 27 in. × 6 in. × ½ in.

Bowden cable — (as for motor cycle brakes) — outer, two pieces 6 ft. 6 in.; inner, one piece 15 ft.

Eight 1 in. × 4 brass screw eyes.

One box ¾ in. panel pins.

Glue — 18 oz. Cascamite — One Shot.

One gross ¼ in. × 4 gauge countersunk brass screws.

One gross ¼ in. × 4 gauge countersunk brass screws.

One doz. 1½ in. × 8 gauge countersunk brass screws.

Three 2½ in. × 8 gauge countersunk brass screws.

One ⅝ in. diameter bolt 5 in. long.

One piece ¾ in. metal tube 1½ in. long

Two nuts.

One locknut.

transom as shown in Fig. 3. Note that the width of the hog is tapered to 1 in. to fit the stem and projects at the front as shown. It is shaped to conform to the stem when the boat is turned over. The stem is also shaped to conform to the chines and gunwales.

Shape the ends of the chines (1 in. by $\frac{1}{2}$ in.); screw and glue to the stem and bend gently before fixing to the transom. Two temporary supports will hold them to their correct width. Similarly fix the

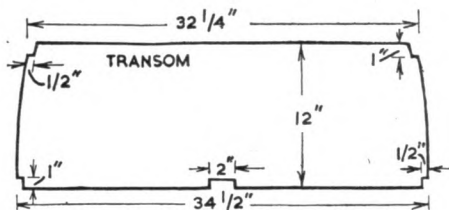

gunwales (1 in. by $\frac{1}{2}$ in.) to stem and transom. Now screw and glue the deck support and seat supports which are butted to the gunwales, using $\frac{3}{8}$ in. countersunk screws. The position of the deck support is seen in Fig. 3 and the seat supports in the general layout sheet 1, pages 242 and 243.

Turn the boat upside down and, taking your measurements from sheet 1, fix the

floor battens (1 in. by $\frac{1}{2}$ in.) to the chines and hog. They are let into the hog and screwed in position as shown in Fig. 4. The section and detail show how the hog is cut away to receive the battens. The angle of the joint will, of course, vary according to the angle of the floor battens. They will be almost flat at the transom end and will slope considerably towards the stem. Use glue liberally when fixing the battens. The hog is now chamfered along its length to conform to

the slope of the battens. Remove the temporary supports.

With the boat the right way up, the side battens (1 in. by $\frac{1}{2}$ in.) are now butted and glued in place as indicated in Fig. 5. Pins are driven in at an angle as shown. These pins will be sufficient to hold the battens securely until the glue is dry. At this stage the remaining two deck supports are fixed. The wedge-shaped piece is cut from a piece of $\frac{3}{4}$ in. square stripwood. It is shaped to a

Fig. 2

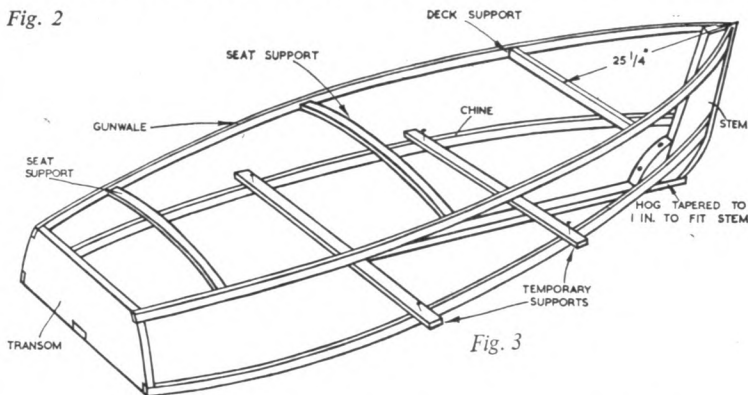

Fig. 3

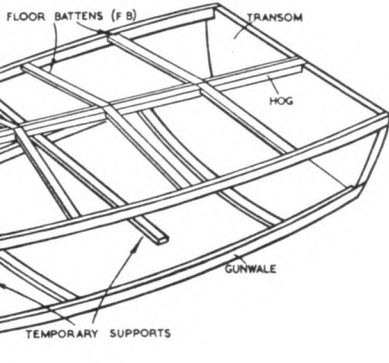
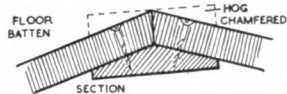

Fig. 4

feather edge at the stem (Fig. 5).

The floor supports (1 in. by $\frac{1}{2}$ in.) are screwed and glued to the chines and are strengthened at the centre by uprights (1 in. by $\frac{1}{2}$ in.). The forward upright extends right up to the wedge-shaped deck support, and is secured there by a screw and glue. The exact position is not critical. The remaining two floor supports have short stubby uprights cut off flush with the supports (Fig. 5). Screw the wooden plate (which supports the motor) to the transom in the position shown.

Next week we shall deal with the skinning of 'Zip' with hardboard and completing the hull.

Visitors to the National Boat Show at Earls Court, London from Jan. 4th-14th will be able to inspect 'Zip' on Hobbies Stand UK15 (1st floor). Also featured will be Hobbies 'Flying Cat' catamaran, a 9' 8" plywood runabout, and Hobbies canoes. (see back page)

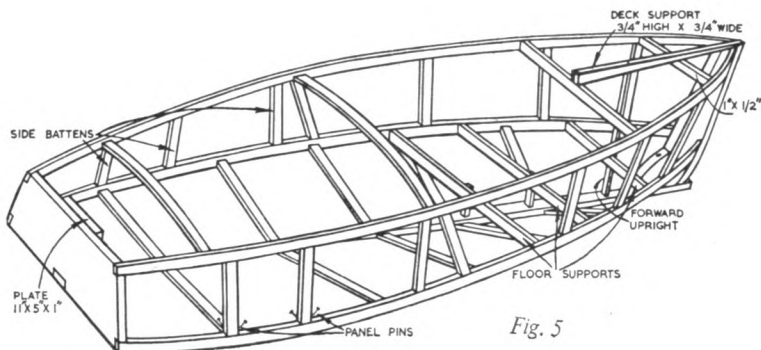

Fig. 5

Designs Designing

IN the previous article we indicated how it is possible to construct a skeleton design by making geometric figures. The main reason we use

and reference should be made to Fig. 6. Here you will see that we have returned to the skeleton shapes of the square and the circle. The former has been sub-

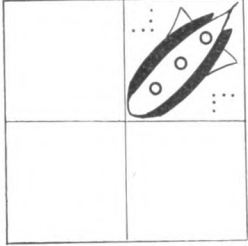

FIG 6



FIG 8

such a basis is that we are able to calculate the space at our disposal, and arrange our skeleton accordingly.

Free designs are only suitable where they stand alone, and do not have to fit within a limited space. A good example is a border. This may be for a tile, a table top, a wall or some other object, and where the pattern must fit, repeating within the space available. A table top can be measured, the length measured, and this divided up into convenient squares or circles which will then enable us to decide the proportions of a repeating pattern.

We can now proceed to demonstrate our process of designing a stage further,

divided into quarters, and a motif designed on the diagonal. To achieve perfect balance we only design one half of such a motif, take a tracing, and reverse this to balance the other half. When the

full motif has been traced it can be applied to the remaining three corners, and the whole is complete. It would be far too tedious to make a complete border by these methods, so the ultimate procedure is to make a stencil of a complete motif, but we will refer to this process later.

By S. H. Longbottom

(PART II)

A similar method is used to clothe the skeleton of the five-pointed star, details of which have already been given, and by now you should be able to appreciate how designs are transformed from the basic shapes.

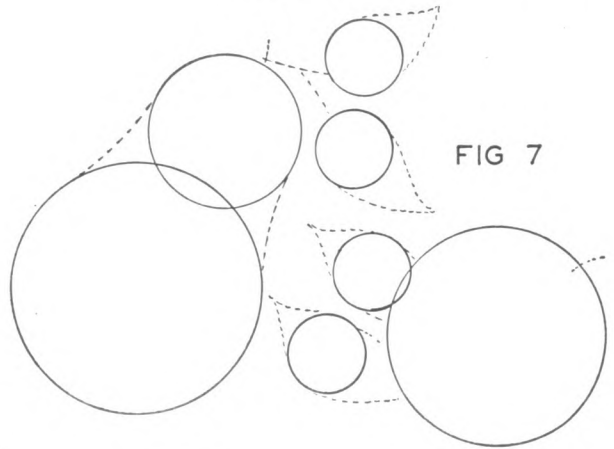

FIG 7

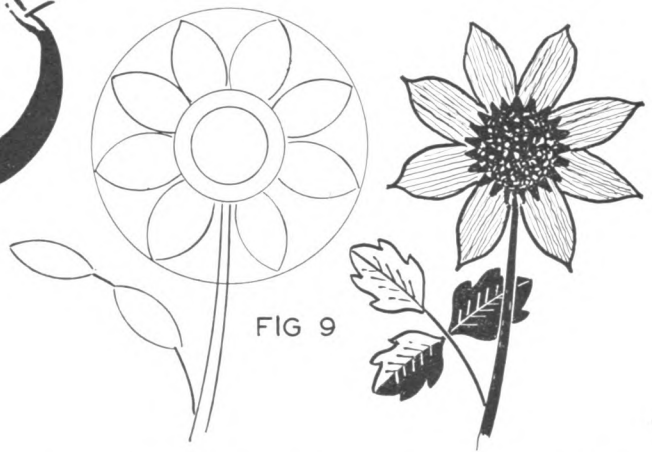

FIG 9

When we proceed a stage further to the production of active, free designs, we would first introduce the example of the pear and the apple. If you will endeavour to visualize objects in terms of

their basic shapes, it is a simple matter to sketch a picture.

The pear apparently consists of a large and a small circle, while the leaves have circular bodies. The shape of the apple is obvious. The two circles are prepared, and the 'bumps' joined with the aid of a flexible curve, and there you are. Fig. 7 indicates the basis of these two fruits, while Fig. 8 shows the final drawing. In the process of completing the drawing we use the compass as far as possible, and the curves for the remainder, i.e. stalks, leaves, and all gentle curves.

We can adopt the same process for a flower, and Fig. 9 shows how once again we take the circle as the basic shape for the centre and outside of the petals. The skeleton for the latter is produced by describing quarter circles within the outer circle, and subsequent treatment may be free.

The pigeon in Fig. 10 may be rather a fantastic version of the bird, but it is intended once again to show how we use the basic shape of a circle, segments, and semi-circles for designing. Incidentally, we would emphasize that the designer is entitled to all the freedom of pattern making he chooses, and frequently allows himself many liberties in completing his patterns. This is true of both the line and colouring. It only requires a brief examination of many striking designs to support this contention, and the pigeon is but one example.

You may be assured that there is no

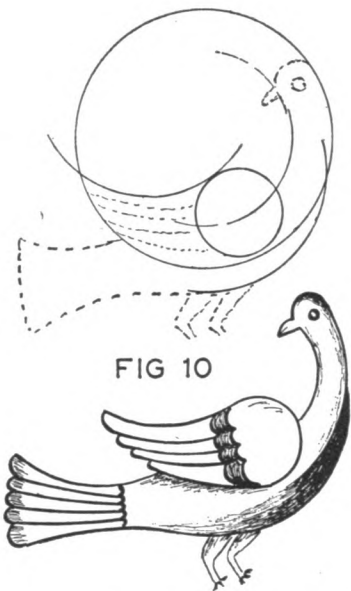

FIG 10

need whatever to try to make exact copies of living things or objects. The aim is to produce a clear, simple yet interesting pattern. A more detailed study of traditional patterns used by different races in the world for decorating their clothes, objects, or living quarters will indicate distinct tendencies to evolve patterns with definite charac-

teristics. Consequently, we can quickly recognize some designs as being the product of some tribe or other, and the period in which they were made. Good examples of this are relics recovered from the pyramids of Egypt, cities of ancient Peru, and the North American Indians.

A rose, tulip, daisy, and other flowers are often the subject of many designs. They produce graceful curves and patterns, but the designer can modify them as he desires, adding spots or lines if necessary, and you are recommended to experiment with these particular blooms. In time you will discover that a characteristic style will develop in exactly the same way as your own handwriting.

You should endeavour to copy the apple and pear, then proceed to a strawberry, orange, or something similar. You may also obtain some more practice by preparing a design for an eagle, or perhaps a flower, and very soon we will come to the important question of colouring.

So far we have examined some of the actual processes involved in simple designing, but further explanation is required with regard to procedure for specific subjects. For example, it is impracticable to attempt a design for a small area on exactly the same scale. The method is to prepare a much larger design, scaling down to the required size. We shall deal with this aspect in our next issue along with the method of preparing stencils for flat and round objects.

TWO-MINUTE QUIZ ^{by} Ed. Capper

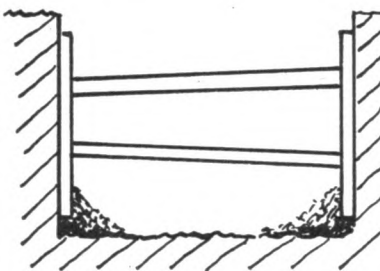
1. 

NAME WOOD SUPPORTS HOLDING HOLE SIDES.

2. 

WHAT TOOL?

3. 

NAME THIS BRICK-WORK

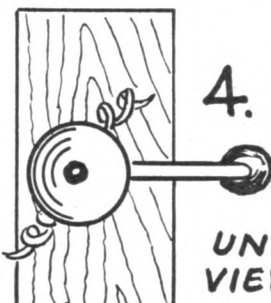
4. 

UNUSUAL VIEW OF - WHAT?

5. WHAT DO THE FOLLOWING INITIALS MEAN - S.W.G and B.G

A BALANCING PEG-MAN . . .

FOR generations old fashioned 'dolly' pegs have been used by toymakers to create a wide range of charming playthings based upon the peg's rough resemblance to the human figure. You can employ a clothes peg to construct a thrilling balancing toy which will be both decorative and instructive. The toy is made in the form of a little puppet man who will sway precariously on top of a pole without falling off. You will also need two 1 in. diameter wooden beads, a length of broom pole, a large tin lid, some balsa wood and a 9 in. length of stout wire.

Saw 1 in. off the 'legs' of the peg and round off the stubs using a sharp pen-knife and fine grade glasspaper. Bore a small hole right through the 'body' of the peg just above the legs, through which the wire can be passed. Make a pair of arms out of $\frac{1}{8}$ in. thick sheet balsa wood, and let them be 2 in. long and $\frac{1}{4}$ in. wide. Fix these to the 'shoulder' of the figure with nails in such a manner that they may be set at any desired angle. Pass the stout wire through the hole in the puppet's body and bend each end of the wire downwards to form an evenly balanced horseshoe shape. Fit the beads

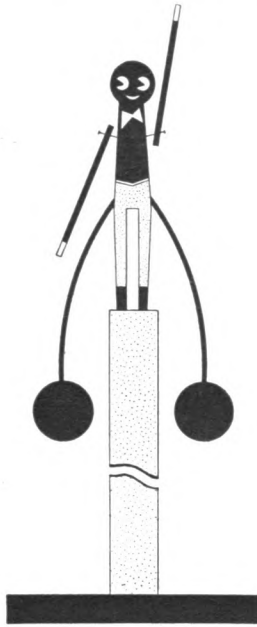

on to the ends of the wire. Strips of Sellotape bound round the wire ends will help to effect a tight fit.

A 9 in. length cut off an old broom handle will serve as a 'pole' upon which the peg man will be able to perform his amusing antics. Fasten the pole to the middle of a large tin lid with two small screws. Now it will be possible to stand the pole upright upon its secure metal base. Place your puppet upon the top of the pole and give it a gentle push. The figure should swing around and sway about in the seemingly dangerous manner, but it will not fall down because the heavy beads will keep the toy's centre of gravity well below the point of support on the pole. You may need to adjust the balance of your figure by shortening the legs a trifle, or by increasing the size (or weight) of the beads.

Paint the toy gaily. Give the figure a coat with tails and a big bow tie. Try balancing your puppet upon a 'tight-rope' tied between two chairs. The balancing peg man on a pole has been popular for centuries as a folk toy, and many versions of this basic idea have been made by peasant craftsmen in all parts of the world. (A.E.W.)

. . . and a Picture Making Toy

TOYS which provide plenty of scope for creative self-expression are much appreciated by young children, and they also have much educational value. An endless variety of colourful pictures is possible with a simply made 'feltograph', and the fun is enhanced when the young owner of the toy discovers that he can change the arrangement of his pictures at will, and alter the facial expressions of his portrait characters by merely shifting about the little felt fragments. The only materials needed to construct the toy are felt remnants, stout cardboard, Sellotape, and strips of brightly coloured plastic insulating materials. Felt may be bought at handicraft shops, and it is sometimes possible to buy bundles of 'off-cut' remnants, in assorted colours, at bargain prices.

Cut out two rectangular pieces of stout cardboard measuring 12 in. by 8 in. Obtain a single piece of pale coloured felt measuring $13\frac{1}{2}$ in. by $9\frac{1}{2}$ in., and fix this tightly over one of the cardboard rectangles, using strips of Sellotape. Neatly fix the remaining sheet of cardboard to the 'back' of the felt-board by means of Sellotape strips.

Ordinary lint may be used instead of felt to make the board, and this may be dyed an attractive colour before use. Finally, 'frame' your board with strips



of coloured insulating tape, and your feltograph will be complete. Of course, the actual dimensions of your apparatus can be any size you please, and you may prefer to make a de luxe model, using plywood and picture frame beading.

Cut up pieces of brightly coloured felt into simple geometrical shapes. Strips, oblongs, squares, ovals, circles, semi-circles, triangles, and crescents must all be provided in order to stimulate the imagination of the young artist who will use the toy. These shapes should be of differing sizes. Provide a strong little box painted gaily or covered with wallpaper, in which the felt fragments can be stored, and which may serve to remind its young owner that tidying up afterwards should always be part of the game. The pictures are made by pressing the felt shapes against the board, to which they will adhere owing to the coarseness of the rough cloth fibres. If necessary the shapes can be superimposed one over another.

With a feltograph a youngster can be happily engaged for hours creating houses, aeroplanes, seascapes, and quaint figures of little men and animals.

(A.E.W.)

WHITTLING A WHALE

THIS whale is an ideal subject for anyone who has not tried his hand at woodcarving before. And it makes an ornament which never loses its charm.

Purple-heart was used to make the carving illustrated, but beech or sycamore make suitable alternatives, while softwood, if of good quality, may be tried with success. A piece about $2\frac{1}{2}$ in. thick is required.

Divide a piece of paper into $\frac{1}{4}$ in. squares, as shown in Fig. 1, and draw the side view on to this. Glue this to the side of the wood in such a way that the grain of the wood runs in the direction indicated by the double arrow. Saw through the wood just clear of the base line A-A with a tenon saw and finish with a smoothing plane to make a flat base. Now saw round the outline with a bow-saw or coping saw, keeping $\frac{1}{16}$ in. or so outside the line. Finish off to the line by putting the wood on a flat surface, and cutting vertically downwards with a chisel. A scribing gouge must be used to finish the hollow curves. Fig. 2 shows the work at this stage.

The next job is to draw the top view on to the wood (Fig. 3). Continue the vertical $\frac{1}{4}$ in. division lines of the side view

By
K.
Blackburn

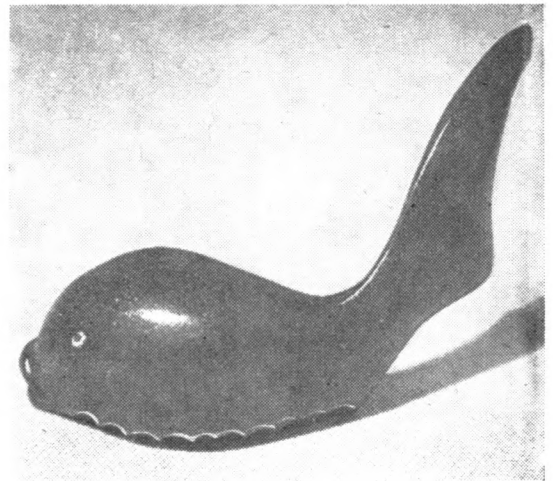

across the top of the wood with a try-square. Also draw in $\frac{1}{4}$ in. spaced lines parallel with the face of the wood; this can be easily done with a marking gauge. Draw in the top view, referring to Fig. 3. Saw round the outline again, keeping the blade of the saw perpendicular to the flat base of the wood. This is most important if the finished shape is to be true to the drawing. Finish to the line with chisel and gouge, this time fixing the wood in the vice and cutting horizontally.

Use a sharp penknife to remove all sharp corners to give a nice rounded outline. The end view in Fig. 4 will give

an idea of the shape required. The mouth and the tail need further shaping with the knife. A number of rounded cuts are made round the base to give the effect of waves lapping round the body. These may be seen in the photograph.

Make the surface as smooth as possible with the penknife, and then rub in the direction of the grain with medium glass-paper. Finish off with fine grade, making sure that all knife marks are removed. Make marks for the eyes by pressing in a nail punch. Finish off with wax polish, or with several coats of French polish applied with a brush.

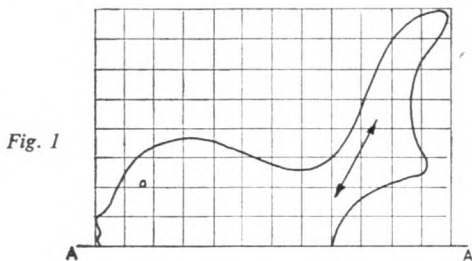

Fig. 1

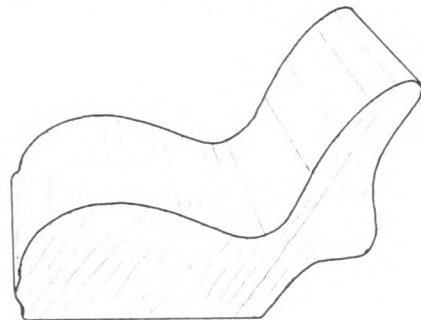

Fig. 2

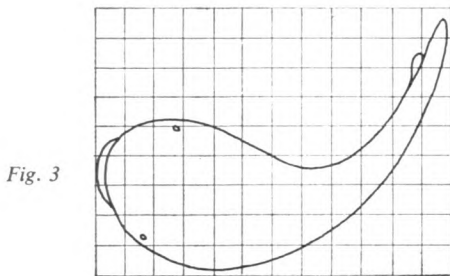

Fig. 3

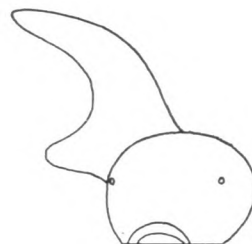
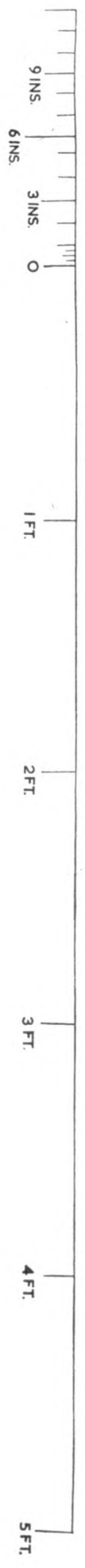
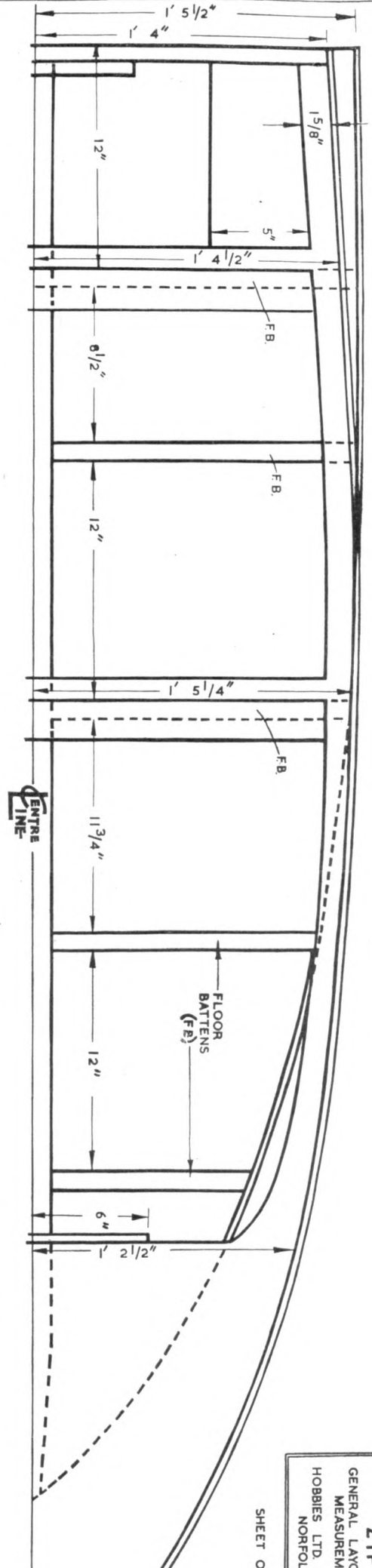
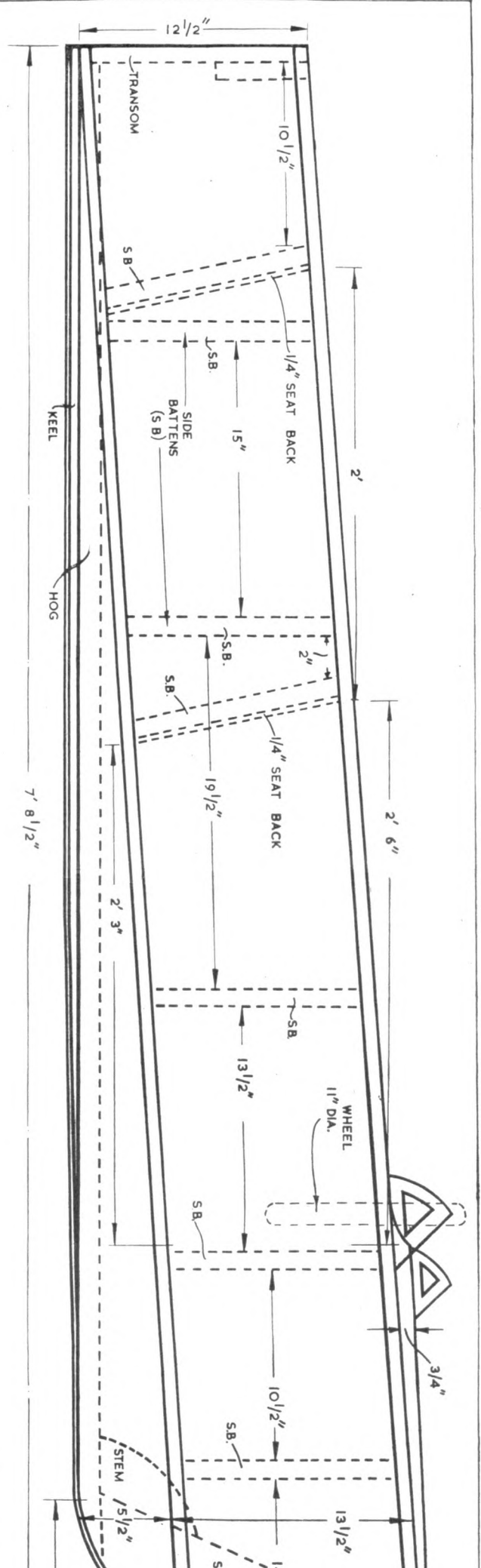
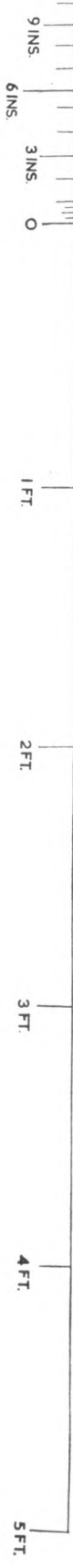
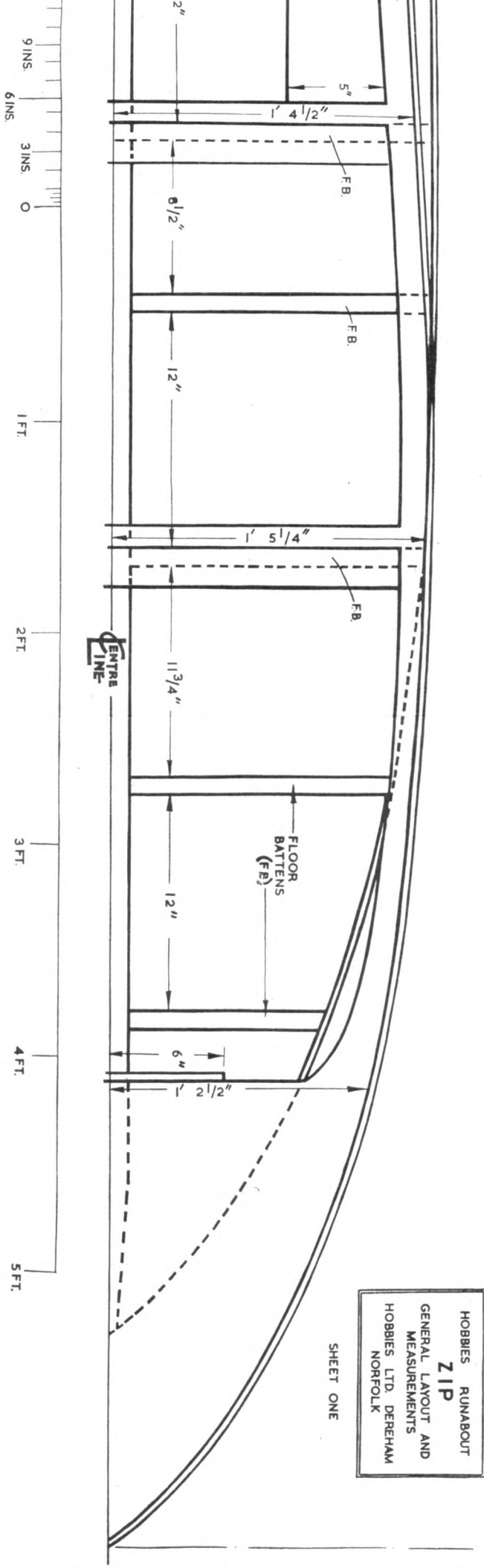
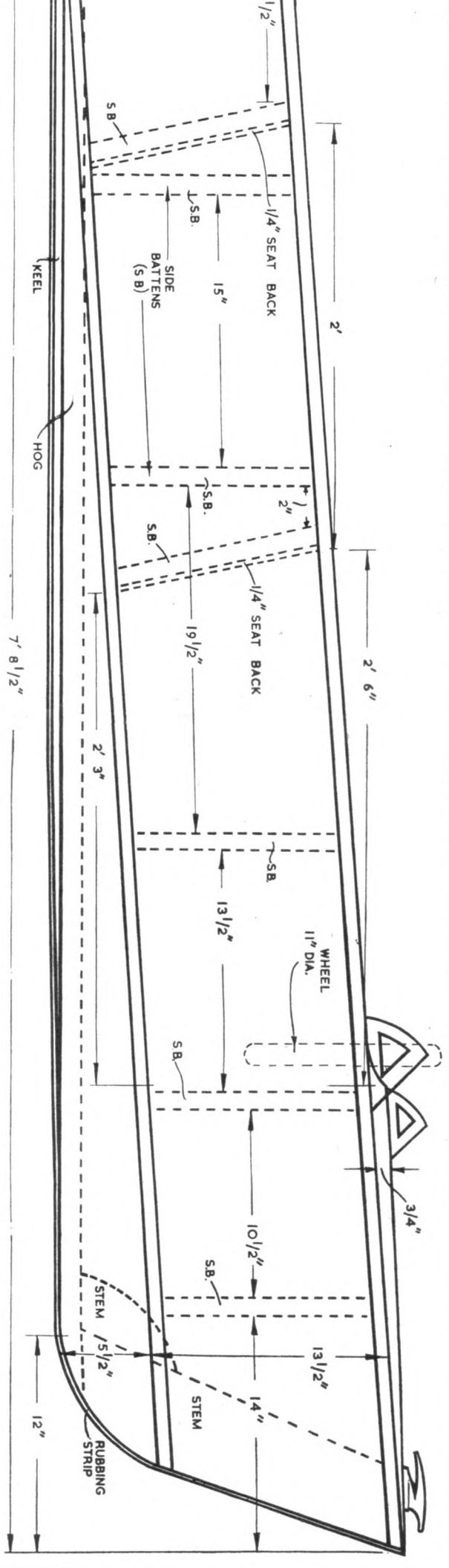

Fig. 4



HOBBIES RUN
GENERAL LAYOUT
MEASUREMENTS
HOBBIES LTD. E
NORFOLK

SHEET ON



HOBBIES RUNABOUT
ZIP
 GENERAL LAYOUT AND
 MEASUREMENTS
 HOBBIES LTD. DEREHAM
 NORFOLK

SHEET ONE

A PRE-AMPLIFIER TO BOOST SIGNAL

MANY simple and low priced amplifiers do not give very loud results when the signal input to them is small. With a good input signal, such amplifiers can provide plenty of volume. It may, for example, be possible to play records with complete success, especially the 78 r.p.m. type, with a 78 r.p.m. pick-up. But if a microphone is used, or a lightweight pick-up for long playing records, the volume may be too small.

When this happens, the amplifier does not provide enough gain, or amplification. This does not mean that there is any defect in the amplifier, but merely shows that it was designed to work with a fairly large input signal. With a much smaller signal, such as would be obtained from a microphone, the amplifier can only give a correspondingly smaller output.

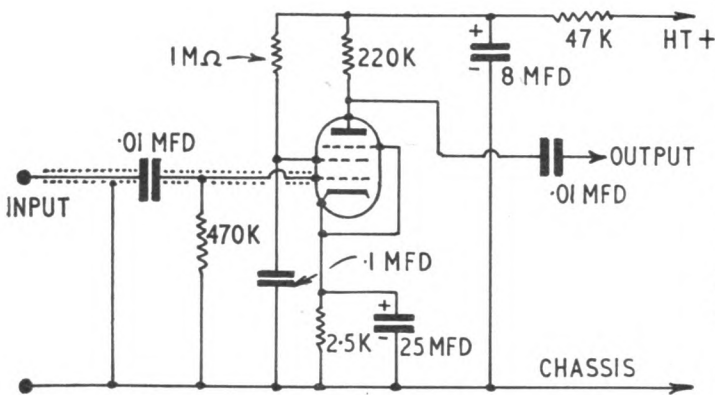

Fig. 1—The pre-amplifier circuit

This trouble can arise with any amplifier designed to work with a large input, and it is usually overcome by adding a pre-amplifier. The pre-amplifier frequently has one valve, and it is connected between the microphone and the main amplifier. The small signal from the microphone is thus increased in strength, and fed into the main amplifier, so that the latter can give full volume.

With a 1-valve pre-amplifier it is usually possible to draw the heater and

By
'Radio Mech'

H.T. current from the main amplifier, so that no extra power supply circuits are needed for the pre-amplifier itself. The unit described here works in this way. It is intended to add to A.C. mains type amplifiers which draw both H.T. current and heater current from a mains transformer, and which has valves with 6.3V. heaters. It may be

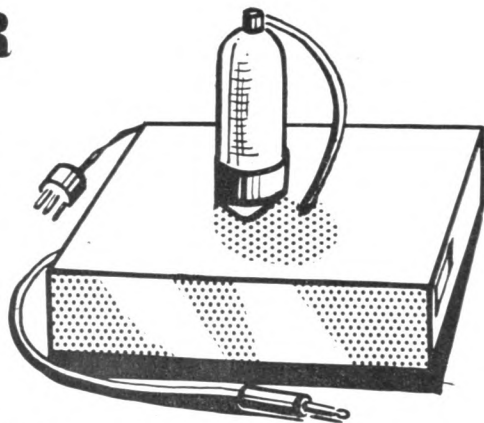

The lead marked 'Chassis' is taken to the chassis of the main amplifier, and acts as H.T. negative connection, and a return for the heater circuit. The H.T. positive lead is taken to a H.T. point in the main amplifier, 250V. to 350V. being satisfactory. The current drawn is extremely small. For the valve heater, the

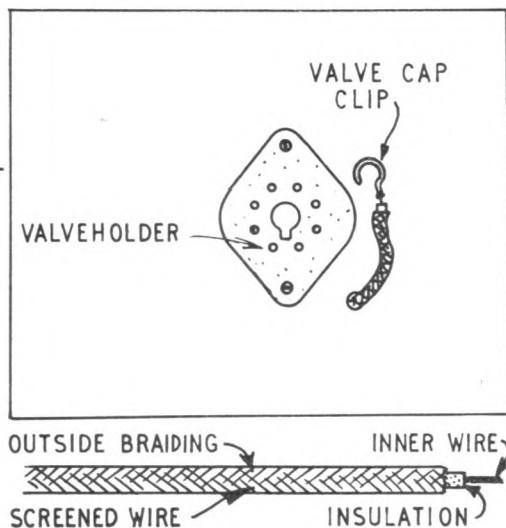

Fig. 2—Chassis and screened wire

used with crystal microphones, lightweight record pick-ups, guitar pick-ups, and any similar units which give a small output.

The circuit is shown in Fig. 1, and is intended for a 6J7 valve. A 6J7/G or 6J7/GT, or equivalents such as the CV1935, CV1937, or Z63, may be inserted in the holder instead, without any changes to components and wiring. A single valve, used in this way, gives a high degree of extra amplification.

6.3V. lead (Fig. 3) is taken to the main amplifier heater circuit. If the pre-amplifier will not be used permanently with the main amplifier, it is convenient to fit a 3-socket holder to the main amplifier, and to wire the sockets to chassis, H.T. positive, and heater circuit. A 3-pin plug to match is then connected to the pre-amplifier, so that it can be brought into use in a few seconds, when necessary.

In a few cases the main amplifier

heater circuit may have both connections isolated from the chassis, and fed from a centre-tapped heater winding. If so, do not wire the pre-amplifier valveholder pin 2 to the chassis, but instead take it to a further flexible lead. This lead, and the 6.3V. lead, then form the heater connections, and are taken to the main amplifier heater circuit. A 4-pin plug and socket will then be needed, instead of the 3-pin arrangement described. The base from a broken valve, with holder to suit, will make a convenient power-supply connector, unused pins being left disconnected.

The pre-amplifier does not have a switch, because it only runs when the main amplifier is switched on. Nor is there a volume control in the pre-amplifier, since this will be present in the record player or guitar, or on the main amplifier.

Chassis and screening

A small aluminium chassis, about 4 in. by 5 in., and 1½ in. deep, is most satisfactory. A clearance hole for the valveholder is located as in Fig. 2. If a large hole cutter is not to hand, this hole can be made by drilling a ring of small holes close together. Rough edges are afterwards cleared up with a half-round file.

To avoid picking up hum, the input leads to the amplifier, and connection to the valve cap, are made with screened wire. If the output lead from pre-amplifier to main amplifier is at all long, this should also be of screened wire. But if this lead is very short, screening is often unnecessary.

One end of a length of screened wire is shown in Fig. 2. The outside braiding

is carefully cut away about ¼ in. from the end of the wire. About ¼ in. of insulation is then left, so that about ¼ in. of the inner wire will project, as shown. This inner wire is soldered to the valve cap clip. This lead passes through a hole in the chassis. Here, the outside braiding is connected to the chassis. This can most easily be done by unwinding the braiding for a short distance, then twisting all the strands of fine wire together, and soldering them to a short length of connecting wire. The inner lead goes to the junction of .01mfd condenser and 470K resistor.

No difficulty will arise in making any of the screened connections if care is taken that the outside braiding cannot touch the inner wire at either end. In each case the outside braiding is connected to the pre-amplifier chassis. If these connections are made with ordinary wire, instead of being screened, mains hum will almost certainly be present with the signal, especially if mains leads pass near the pre-amplifier or input circuit. As screened wire costs only a few pence for several feet, it is thus wise to use it to avoid such trouble.

Underneath connections

Fig. 3 shows wiring under the chassis. Three points are marked 'C', and these are connections to the chassis. Such connections are best made by fitting soldering tags on the bolts holding the valveholder and socket strip. Wires are then soldered to these tags.

The two largest condensers have positive and negative markings, and these must be observed, negative going to chassis. The resistors and small condensers can be wired in either way

round. All leads should be short and direct, and insulating sleeving can be placed on the wire ends of resistors, etc. to avoid any possible short circuit.

Keep the 6.3V. lead close to the chassis, well clear of the connection to the .01mfd condenser. The H.T. positive, chassis, and 6.3V. leads all pass out through the rubber grommet at the back of the pre-amplifier chassis. These three leads can all be twisted together, but the input and output leads must be kept separate from them, and from each other.

A screened lead is usually provided on a crystal microphone, or gram pick-up. It may already be fitted with a jack plug, or co-axial plug. If so, it is best to fit a jack socket, or co-axial socket, instead of the 2-socket strip shown in Fig. 3. The microphone or pick-up lead can then be plugged directly into the pre-amplifier.

When using separate plugs, as in Fig. 3, remember that the screened braiding must always be taken to the socket wired to the pre-amplifier chassis. If connections are reversed, a loud hum will be present with the signal, and loud howling may also arise.

When the pre-amplifier is very near the main amplifier, the output lead may not need screening, as mentioned. But if this lead is long, or near mains wiring, it should be screened. If so, the braiding should be connected to the earthed side of the main amplifier input. This is most easily arranged by using a jack plug, co-axial plug, or two separate plugs, to fit the amplifier input sockets. The pre-amplifier output lead is then merely plugged into the main amplifier input point.

Using the pre-amplifier

The microphone or pick-up is plugged into the pre-amplifier, and the pre-amplifier output lead is taken to the main amplifier input sockets. The power supply circuits are connected up as described.

If the pre-amplifier valve heater can be seen, this should light up with the main amplifier heaters. Signals should then be heard as before, but very much amplified. It will usually be necessary to turn the record player or main amplifier volume control down considerably after adding the pre-amplifier.

If a microphone is used, sounds from the loudspeaker must not reach this strongly, or continuous howling will begin. Should this happen, it can be prevented by moving the mike away from the loudspeaker, or shielding it from direct sound waves coming from the loudspeaker. The trouble is most likely if the volume control is near maximum, but can easily be prevented by a little rearrangement of the position of the

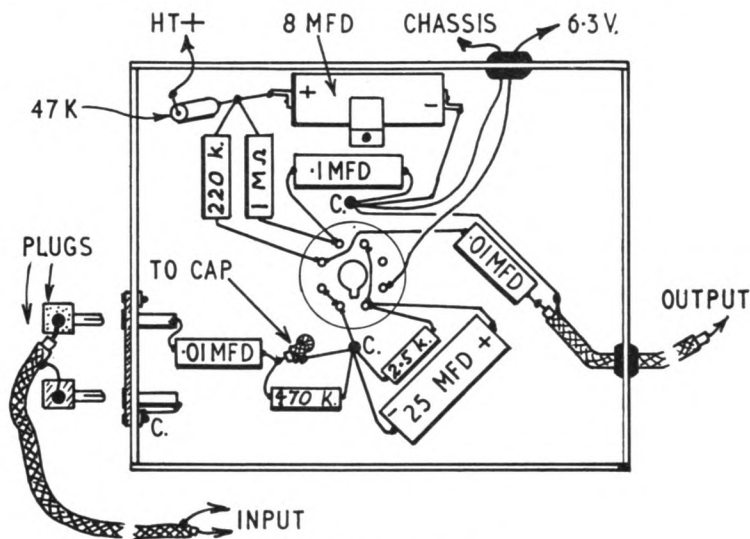

Fig. 3—Under the chassis

Sharpening Planes and Chisels

MOST home handymen will agree that in order to produce a good standard of workmanship it is necessary to use good quality tools. It is equally important, too, that the tools are kept in a good serviceable condition at all times, particularly edge tools.

The two most common edge tools found in the handyman's kit are planes and chisels, and every handyman should be familiar with the proper sharpening procedure. The sharpening of a plane iron and chisel is somewhat similar, the only difference being that the cutting edge of a chisel is always sharpened square, whereas a slight curve is usually formed on the cutting edge of plane irons. This is achieved by applying a little more pressure on the extreme corners; the function of the curved edge

being to prevent the corners digging into the wood.

A close examination of the cutting edge of a plane iron or chisel will show that there are two distinct bevels: a grinding bevel and a sharpening bevel, as shown in Fig. 1. Generally speaking these bevels are approximately 25 degrees and 35 degrees respectively. Repeated sharpening eventually causes the

remove the burr, but remember to keep pressing the tool hard against the oil-stone. These two processes should be repeated several times, the amount of pressure being reduced each time. The more gradually this process is carried out, the keener the cutting edge will be.

Patented sharpening jigs can be purchased to clamp plane irons and chisels at the proper angle whilst they are being sharpened. These can be obtained from any tool store for a shilling or two.

To ensure a really keen edge on tools, an oil-stone must have perfectly flat surfaces. Sometimes the constant sharpening of narrow tools causes stones to get worn hollow, and if such is used to remove the back burr from a tool which is being sharpened, a bevel will be formed on the wrong side. This will make it impossible to get a keen cutting edge. A stone which has been worn hollow can be made true again by rubbing it on a sheet of emery cloth placed on a flat surface.

Finally, once the tools have been sharpened, remember to wipe away any oil from the oil-stone. This will remove the tiny steel particles which are always present, and will also prevent the oil soaking into the stone and clogging it up.

By Finlay Kerr

sharpening bevel to merge with the grinding bevel, and this results in the cutting edge becoming 'stubby'. When this happens the tools must be re-ground.

Grinding is best done on a power-driven grindstone, which must revolve away from the operator. The plane iron or chisel should be firmly held at the proper angle, and moved slowly across the revolving stone in a horizontal manner. When a tool is being ground, a great deal of heat is produced by friction, and it is essential that it is not allowed to become overheated and burn. When this happens, the cutting edge turns brown, and the steel loses its temper. To prevent this, the tool should be frequently dipped into cold water to keep the steel cool. A little experience is usually all that is necessary to enable the handyman to hold the tool at the proper angle, and to obtain an even bevel. If, however, any difficulty is encountered, a simple jig can be made to keep the tool at a constant angle, as shown in Fig. 2.

Once a tool has been ground, the next step is to sharpen it on an oil-stone. Before using this the surface should be lubricated with a little light oil, so that tiny particles of steel are kept in suspension, and not rubbed into the pores to glaze the surface. Place the tool to be sharpened on the stone at an angle of approximately 35 degrees, and move it backwards and forwards several times, maintaining the same angle throughout each stroke. This action will ultimately cause the extreme edge of the tool to bend over and form a burr, as shown exaggerated in Fig. 3. This burr is essential, because without it, the tool cannot become really sharp.

Having now obtained a burr on the edge of the tool, the blade should be turned over and laid flat on the oil-stone, the bevelled part facing uppermost. A few rubs across the surface will

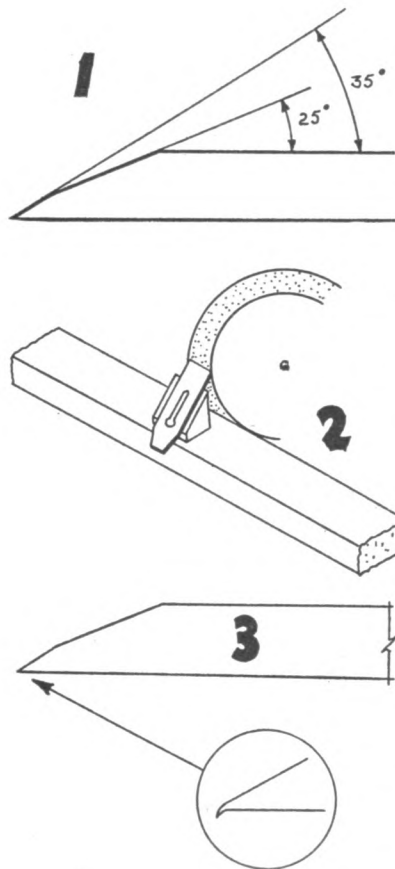

● Continued from page 245

Pre-Amplifier Unit

microphone, or the direction in which it faces.

The pre-amplifier can also be used with a radio set having pick-up sockets, but which does not give enough gain for a microphone. The pre-amplifier input circuit is particularly intended for a high impedance unit such as a crystal microphone or crystal lightweight pick-up, and will usually allow more than ample volume to be obtained. With some microphone or pick-up units results may be better if the .01mfd condenser connected to the input socket in Fig. 3 is omitted, the valve cap lead being taken directly to this socket instead. This modification is thus worth trying, when first testing the pre-amplifier.

ANSWERS TO QUIZ (see page 239)

1. Shoring. 2. Turfing Iron. For cutting and lifting curves of grass. 3. Footings. 4. Brace and bit drilling hole in wood. 5. They are Wire Gauges, viz. Standard Wire Gauge and Birmingham Gauge.

A tube or tin of Evo-Stik is a tool chest in itself

Available from
stockists
everywhere



Scientific Evo-Stik 'Impact' adhesive works miracles in the modern home today. Just spread the adhesive on both surfaces to be joined, allow a few minutes for them *both* to dry, and place them together, that's all! Rubber, metal, plastic, glass, pottery, fabrics, plaster board and wood... Evo-Stik 'Impact' *joins* them all! Let the fastest, strongest adhesive known to modern man save you time and money.

Tins 7/- and 4/3
Handy Tubes 1/9

EVO-STIK 'Impact' Adhesive

Evo-Stik 'Impact' adhesive is a Registered Trademark



Sweets for Special Occasions

NO party would be complete without a dish of sweets and when these are home-made the pleasure is even greater.

Let's start off with sweets that can be made without cooking any of the ingredients.

Orange dreams

- 1 lb. icing sugar
- 2 teaspoonfuls lemon juice
- 2 tablespoonfuls orange juice
- 1 egg white
- grated rind of 1 orange
- angelica and orange colour

Thinly grate the rind of the orange and mix it with the orange and lemon juices. Pass the icing sugar through a fine sieve and add the juice and rind together with just enough of the egg white to form a firm mixture. Add the liquid gradually to the sugar and thoroughly mix, but be careful not to add too much and make it sticky.

While mixing the ingredients add a few drops of orange colouring and see that it is evenly distributed throughout the whole mass. Mould into small balls and put a small piece of angelica in each to represent a stalk. Allow at least 24 hours for the sweets to set.

Chocolate crispies

- 2 oz. bar plain chocolate
- 1 tablespoonful (heaped) cereal

Break up the chocolate into small pieces and put them in a small basin. Stand this in a saucepan of hot water and stir until the chocolate is melted. The water should not boil and a temperature of about 100° is usually sufficient.

Take the basin out of the saucepan and stir in the cereal. Before it cools too much spoon out on to a sheet of waxed paper in small rounds and allow to set till next day. There are many varieties of cereal which are suitable. Desiccated cocoanut and chopped up nuts can also be tried.

Chocolate truffles

- 2 oz. butter
- 2 oz. icing sugar
- 2 egg yolks
- 3 teaspoonfuls milk
- 4 oz. powdered chocolate or cocoa coffee essence

Well beat the egg yolks, then cream the butter and mix these with the other ingredients. It is necessary to stir thoroughly until it forms a thick creamy texture. The coffee essence is added according to taste but the flavouring should not be overdone.

Shape the mixture into balls or small

pyramids and roll in some of the chocolate powder. Lay aside until next day to set in a cool room.

Now let us have a look at some recipes which need cooking. Fondant forms the basis of so many sweets, and when you can make a good batch of fondant you have solved a lot of sweet problems.

De luxe satin fondant

- 1½ lb. granulated sugar
- ½ pint cream
- 1½ teaspoonfuls glycerine
- ½ teaspoonful vanilla essence
- pinch salt

It is very important that a large saucepan is used for this fondant, and one that is three times the size of the batch will not be too large. With the exception of the vanilla all the ingredients are placed in the saucepan and boiled over a medium heat.

Unlike the usual method of making fondant this mixture must be stirred all the time, but it should be done gently. When the temperature of 238° is reached remove the saucepan from the stove and leave it undisturbed for a few minutes. Pour out on to a large meat dish which has been damped with cold water and allow to become lukewarm, then cream in the following way.

With the aid of a spatula keep turning the edges of the batch into the centre until it appears cloudy and then finally sets in a lump of firm white cream. The vanilla essence is gradually added to the batch as the creaming process is carried out. Cover with a damp cloth and leave for an hour or so to mellow, after which it should be kneaded with the hands until it becomes soft and creamy. Store in a stone jar covered with a damp cloth or piece of waxed paper until needed.

Bonbons

A bonbon is a confection that has a fondant centre and an outside coating of a slightly harder fondant. The centre can be plain fondant flavoured and coloured in various ways or it may contain nuts and fruit. Here are a few suggestions you may like to try.

The nuts or fruit are usually cut into small pieces and well mixed into the fondant. Most kinds of nuts can be used, such as almonds, brazils, walnuts and desiccated cocoanut, or you may like to try whole pea nuts, either plain or salted.

The fruits may be dates, cherries, figs, raisins, pineapple and crystallized ginger all chopped up into small pieces. It is a good idea to use both fruit and nuts in the same bonbon, and there are endless

varieties for you to experiment with.

The nuts and fruit can be mixed in the fondant in bulk or it may be moulded into small balls or pyramids and then added as the shaping proceeds. Place the bonbons on waxed paper and leave until next day to set firm.

If they are not needed at once it is advisable to dip the bonbons in a fondant that has been boiled to 245°. After it has been creamed and allowed to mellow place in a basin and stand in hot water to melt it. Then dip each bonbon and place on waxed paper to set.

The tops of the bonbons may be decorated with pieces of nut or fruit and these have to be put on before the dipped bonbon has had time to set.

Chocolates

The production of chocolates is a most fascinating part of sweet making. Some amount of care is needed however in their preparation.

Firstly the room should have a temperature of 65° and they should be hardened off in slightly lower conditions. The chocolate used for coating must never be melted over direct heat, but should be put into a basin; this is stood in water having a temperature of about 110°. The temperature of the actual chocolate during the dipping process should be between 86° and 88°, according to the type of covering used.

Either chocolate couverture or plain bar chocolate is grated into a basin placed over hot water to speed up the melting and when the correct temperature is reached the sweets can be dipped into the mixture. Each sweet in turn is dropped into the basin and immediately removed with a two prong wire fork. Scrape off the superfluous chocolate on the edge of the basin and place on waxed paper to harden.

Almost any type of centre is suitable for covering with chocolate and can include plain and nut fondant, fudge, nougat, caramel, marzipan, turkish delight and many others.

Decorating the top of the chocolate after it has been dipped can take many forms. Whirls made with the dipping fork or pieces of nuts and crystallized cherries and ginger are some of the many types available.

Chocolates that are dipped at too high a temperature will be dull and not glossy. Too much heat also produces a spotted or grey coating. Damp or foggy weather are not good conditions for chocolate making and the centres should be perfectly dry before dipping.

(A.F.T.)



It won't move!

CERTOFIX liquid glue can cope with all general repairs. It unites wood, glass, metal and almost all substances. It is clean in use; its joints are stronger than the materials it unites.

Sold at all Woolworth Stores

CERTOFIX

Will Really FIX IT!



COT FITTINGS (full size)

The fellow handy with tools can make quite easily a drop-side Cot using these fittings. The set comprises two bright steel rods 36in. long, six heavy-duty screweyes (four plain and two threaded for rods) and two catches. Price 7/9 Set.

From branches or: **HOBBIES LTD., Dept. 99, Dereham, Norfolk**

APPARATUS & CHEMICALS

For your experiments. Let us help you equip a **HOME LABORATORY**

Beakers, Crucibles, Flasks, Funnels, Gas Jars, Test Tubes, etc.

Booklets:
(including postage)

'Experiments'	1/3
'Formulae'	1/3
'Home Chemistry'	2/11
New edition	

Send 4d. Stamp for latest **PRICE LIST**

A. N. BECK & SONS (Dept. H.W.)
60 Stoke Newington High Street, London, N.16



MANY MODELS from ONE TIN!



Pyruma, plastic and ready to use from its tin, can be fashioned into the widest variety of models imaginable. Buildings for your model railway set, houses, ship models, animals and figures, ashtrays and plaques — all of which when set or baked to stone-hardness can be finished in natural colours. Get the Pyruma Model Instruction book — see Coupon, and start making things like those shown below.

SANKEY'S PYRUMA PLASTIC CEMENT

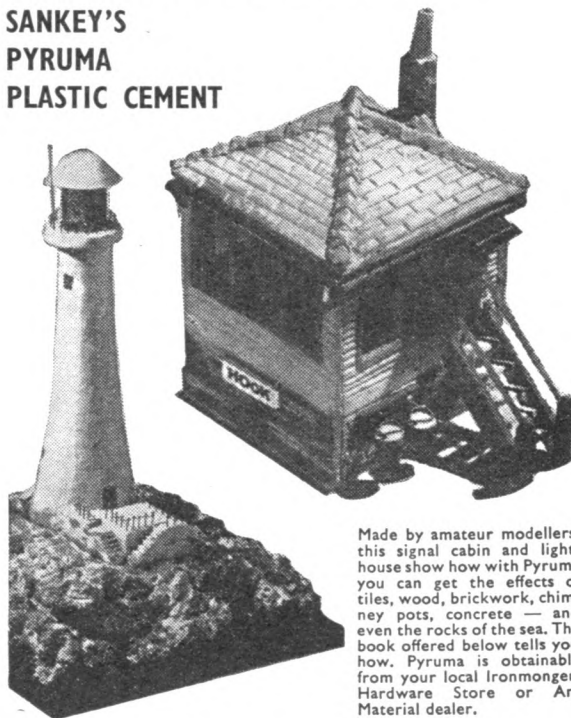

Made by amateur modellers, this signal cabin and lighthouse show how with Pyruma you can get the effects of tiles, wood, brickwork, chimney pots, concrete — and even the rocks of the sea. The book offered below tells you how. Pyruma is obtainable from your local Ironmonger, Hardware Store or Art Material dealer.

POST THIS BOOKLET COUPON TO-DAY

To **J. H. SANKEY & SON, LTD (Dept. HW),**
ILFORD, ESSEX

I enclose P.O. 6d. (not stamps) for a copy of Pyruma Modelling Instruction Booklet, post free to:

NAME _____
ADDRESS _____

(BLOCK LETTERS PLEASE)

"GLOBE-KING"

WORLD-FAMOUS KITS AND RECEIVERS

for the Radio Amateur and S.W. Listener. Catalogue Free, enclose stamp for postage. Kits from 79/6 obtainable at your dealers or direct from the sole manufacturers

JOHNSONS (Radio)
ST. MARTINS GATE — WORCESTER

MUSICAL MOVEMENTS CHEAPER THAN EVER

Ballerina movements only 19/11 post free. Send for illustrated catalogue of movements and kit.

SWISSCROSS LTD (Dept. HW2)
202 TULSE HILL, LONDON, S.W.2

PROFITABLE PLEASURE from Popular Art. Easier to Learn and Earn than you think. Send for free copy 'SOMETHING NEW' Popular Art Services (HW), Clun, Salop.

100 DIFFERENT stamps free! Request 1d. upwards discount approvals. — Bush, 33 Newlyn Way, Parkstone, Dorset.

50 mixed stamps 5/-. Try our 6d. in 3/- discount approvals — E. C. F. Townsend, 92, Tenby Road, Edgware, Middx.

I went to a dance to find a girl friend— —but my dancing didn't make girls 'friendly'!

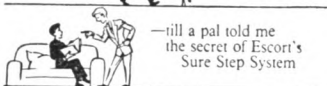

Now I'm no longer lonely— —the girls know my steps are sure!



Can't afford private lessons? Learn ballroom dancing at home! Send for exciting booklet "Dance Escort" — FREE to readers of 'Hobbies Weekly' — which explains the dynamic SURE STEP system.

Just send name and address to:
ESCORT DANCE INSTRUCTORS

Studio H31 Harrogate
(or Rock'n'Roll Course — send 4/6 P.O.)
or Old Time Course 8/6 or Cha-Cha Course 5/6
or Escort's complete Ceili Course 6/6.

PROFIT AND PLEASURE is obtainable from **WRITING** (typewriter unnecessary) or **ARTISTRY**. Send for free fascinating bumper package 'PROFITABLE LEISURE'. — Writers' & Artists' Ring (HW), 5 Edmund Street, Birmingham.

LEARN RADIO & ELECTRONICS the NEW Practical Way! Very latest system of experimenting with and building radio apparatus — 'as you learn'. FREE Brochure from: Dept. H.W.10, Radiostructor, 40 Russell Street, Reading, Berks.

LEARN

RADIO & T/V SERVICING
for your OWN BUSINESS/HOBBY

● by a new exciting no-maths system, using practical equipment recently introduced to this country. FREE Brochure from:—

RADIOSTRUCTOR
DEPT. G81, READING, BERKS. 4/1/61

Completely new 54 page Edition
WHERE'S THAT CAR FROM?

Price 1/- (Postage 4d.)

Of all Booksellers
or
RALEIGH PRESS, Exmouth, Devon

WORKERS with sewing machines required for making cushion covers. Regular work guaranteed. Apply enclosing s.a.e., Dept. 28, Arnold Trading, 10 Shelley Road, Worthing, Sussex.

125 STAMPS FREE to approval applicants. — Read, 19 Kelstern Close, Cinderhill, Nottingham.

IF you have taken a lot of care in making a musical box, be sure to make it worthy by including the best Swiss movement — a **REUGE**. Prices from 13/9. Wide range includes a charming Dancing Ballerina. Many tunes to choose from. Send for details in free booklet 'Profitable Leisure'. **HOBBIES LTD. DEREHAM, NORFOLK.**

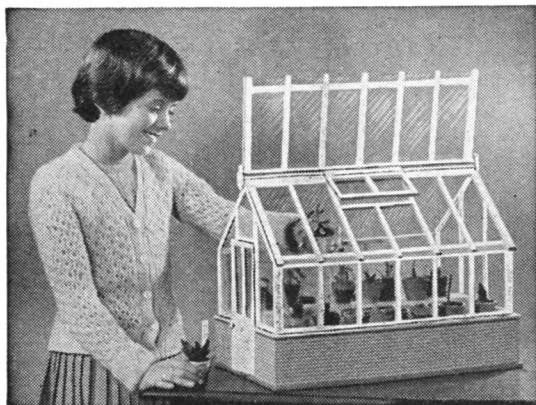

JUST LIKE DAD'S!

You can make this ideal showpiece from Hobbies Kit No. 3300, which contains all wood, materials, etc., and 12 sets of pots and saucers. Hinged roof, window, door. 18 in. x 12 in. x 13 in. high. Only a few simple tools needed in construction.

Kits from Hobbies branches, stockists or post free (see coupon). **39/6**

ALL-THE-YEAR-ROUND INTEREST



MINIATURE GREENHOUSE

*A really practical
model for the home*

For growing cacti, succulents, miniature trees, seedlings, etc., and can be used as a propagating frame.

To **HOBBIES LTD.**, Dept. 99, Dereham, Norfolk

Please send Kit No. 3300 for making Miniature Greenhouse
I enclose P.O. for 39/6

Name

Address.....

.....
.....
.....

ATTRACTIVE NEEDLE BOX

MAKE this attractive needle-tidy specially for Mum. She will surely appreciate your thoughtfulness. Cut two of A, two of B, and one each of C, D, and E from $\frac{1}{4}$ in. wood, using a fine-grade fretsaw. Glue the sides A and the bottom C to the back B. Glue E to D to form the lid. Hinge the front B and the completed lid in place.

Cut two of the overlay 'NEEDLES' from $\frac{1}{8}$ in. wood (F) and glue one on each side of the box. Clean up and paint.

Finally make a pad of cotton wool covered with a piece of material and glue it inside the box. (M.p.)

MAKE IT FOR MUM WITH A FRETSAW

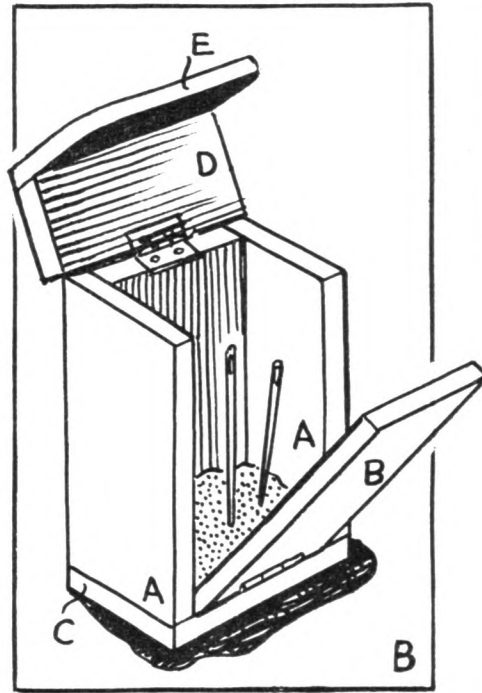
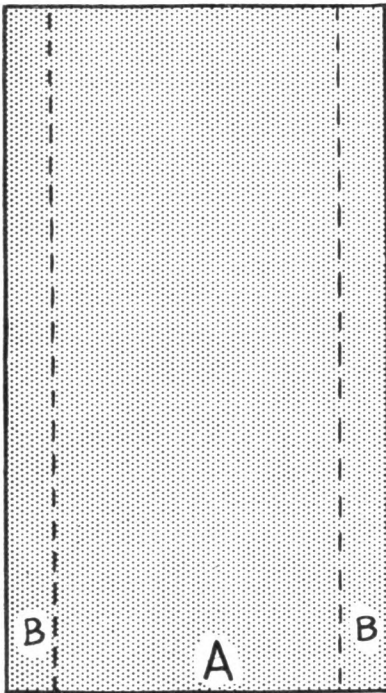
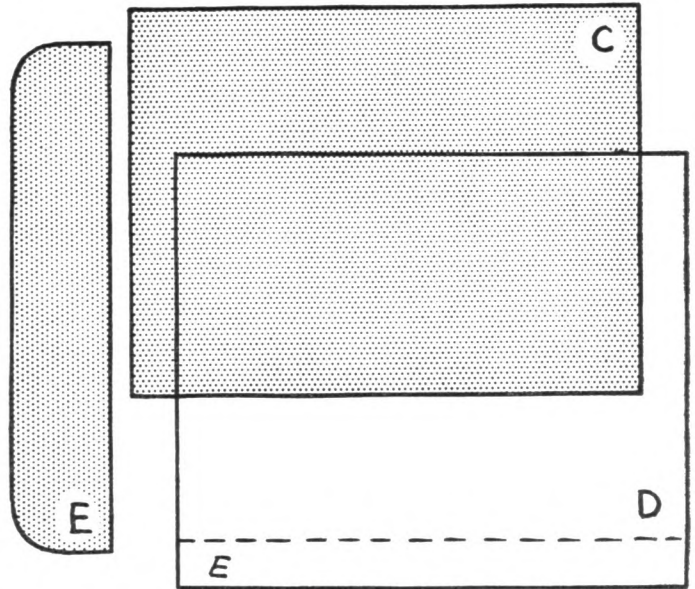

Before you decide . . .

. . . you must consider these

EXCITING NEW CRAFT by

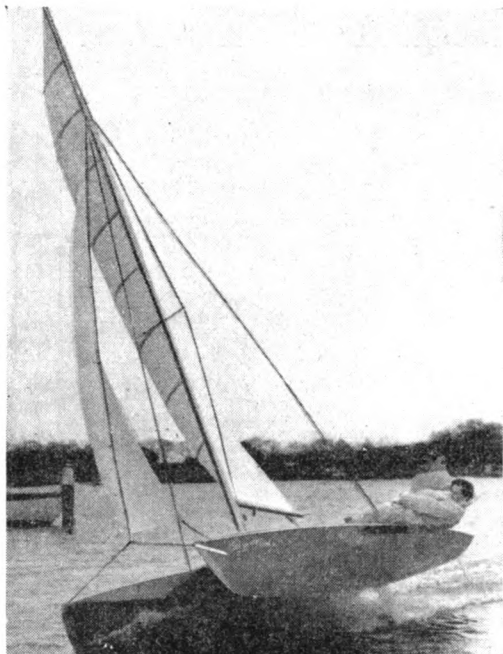

'FLYING CAT' CATAMARAN (Designed by F. M. & J. A. Montgomery)

For high quality and outstanding performance the 'Flying Cat' is one of the best 'buys' in its class.

Its twin hulls are 16 ft. long and it has a beam of 7 ft. 6 in. The draught is 6 in. with plates up and 2 ft. with them down. Carries about 200 sq. ft. of sail on metal mast.

Incorporating many advanced ideas, its most striking feature is the way the hulls are splayed outwards to give an efficient underwater hull shape with one float lifted.

Available complete, or in various kit forms.



HOBBIES RUNABOUT 'ZIP'

Designed especially for the beginner, as an inexpensive introduction to the water. Skinned with oil-tempered hardboard and suitable for a small h.p. outboard engine. Will carry an adult and one or two children. Length 7 ft. 8½ in., beam 2 ft. 10½ in. Weight (without motor) 80 lb.

Available as a kit, or full size plans.



HOBBIES RUNABOUT 'ROAMER'

An ideal craft for the family, designed for all waters. Best marine plywood and quality materials. Length 9 ft. 8 in., beam 4 ft. 2 in. Weight (without motor) 130 lb. Car rack transportation.

Available complete, or as a kit.

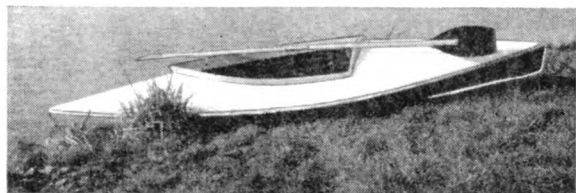

PBK 10 AND PBK 20 CANOES

These famous single-seater and two-seater craft are supplied complete, in kit form, or as full-size plans to build your own.

PBK 10 (single-seater) 11 ft. long, 28 in. beam, load 300 lb.

PBK 20 (two-seater) 15 ft. long, 32 in. beam, load 700 lb.

Ideal for young enthusiasts.

Full details of these craft at the National Boat Show, Earls Court (Stand UK15, 1st floor), from Hobbies branches, or from Head Office

HOBBIES LTD, Dereham, Norfolk

11th JANUARY 1961

VOL. 131

NUMBER 3396

THE ORIGINAL
'DO-IT-YOURSELF'
MAGAZINE

HOBBIES *weekly*

FOR ALL
HOME CRAFTSMEN

THE OLD RUSTIC BRIDGE POSY RING

FREE
plan
inside
for
this
novelty



Also in this issue :

- ATTRACTIVE 'DICE' TABLE LAMP
- COLLECTORS' CLUB
- CONTACT PRINTER FOR PHOTOGRAPHERS
- DECORATING WITH PASTE PAPERS
- 'GOOD LUCK' FRETWORK BRACKET
- ETC. ETC.

**HOW
TO MAKE**

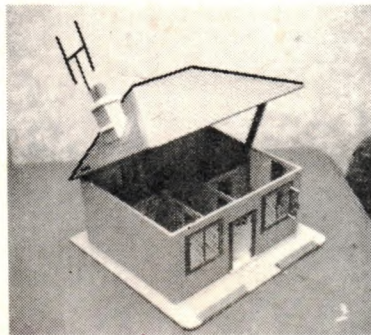

**DOLL'S MODEL
BUNGALOW**



Up-to-the-minute ideas
Practical designs
Pleasing and profitable things to make

5^D



NEW Guinea is a large island to the north of Australia. Half of it is under Australian control, the other half is Dutch.

The Australian section is divided into two parts, called Papua and the Territory of New Guinea. Many of the natives still use bows and arrows. Some still use stone implements like those which were used in England about 2,000 years ago.

Why 'New Guinea'? In English shops some goods are still priced in guineas. The value of a guinea is 21s. 0d. At one time golden coins of this value were minted and the gold for them was brought from the 'Guinea Coast'.

'Guinea' comes from a Berber word meaning 'land of the black men'. 'Papua' is a Malayan word. It is derived from 'Papuwah' meaning 'frizzled'. This refers to the hair style of the Papuan people, who are often called 'fuzzy-wuzzies'.

New Guinea is the place for adventure. When the natives dress for a festival they wear fantastic outfits. Through the nose they have a wild pig's tusk. Around the forehead and neck they have a string of teeth — probably also from the pig — while their headgear is made from the gorgeously coloured feathers of the bird of paradise.

Stamps: 1932. 2d. red — Bird of Paradise — 6d. used. 1952. 1d. brown — Buka Head-Dresses — 3d. mint. 2d. blue — Native Youth — 4d. mint. 3½d. red — Papuan Head-dress — 9d. mint.

The cacao plant appears on the present 4d. stamp. The cacao tree is an evergreen

and grows three or four times as high as a man. It bears a fruit shaped like a thick, short cucumber, from six to nine inches long and about half as wide. The skin is rough and warty; the inside is a sweet pinkish-white pulp, used for food, which contains from twenty to sixty seeds, about as large as almonds. These seeds, which are called cocoa beans, have a thin, brittle, reddish-brown husk and a dark-brown oily inside.

New Guinea—An Amazing Country

In preparing cocoa beans for use they are first roasted like coffee beans, and afterwards bruised and winnowed or cleaned of the husks. The husks, which are thus parted are the 'cocoa shells' of commerce, and the beans, broken into pieces, are called 'cocoa nibs'. This is the purest form in which cocoa comes. The paste obtained by grinding the nibs alone is properly called cocoa, and that made by grinding them with other substances and flavours, chocolate.

Coffee beans are depicted on the 5s. 0d. stamp.

Here again, the coffee tree often grows three or four times as high as a man. But

it is usually kept down by cutting it to a height of about five feet, so that the berries can be easily picked.

The plant is raised from the seed in nurseries, and when one year old is set out in the plantations. It begins to bear when three years old, and will yield for more than twenty years. The leaves are evergreen and never change, and the tree blossoms and bears fruit nearly always, flowers and ripe fruit being seen on the tree at the same time. But the seeds are gathered usually only two or three times a year.

The fruit looks like a cherry, and is red when ripe, but finally turns dark purple. It is sweet and good to eat. Each one contains two seeds, or coffee beans, which lie with their flat sides to each other and are held together by a tough skin which covers them.

When ripe, the fruit is gathered and dried, and the outer part is easily removed by hand or by being rolled under woollen rollers. The seeds are then dried again, the tough skin around them is broken by other rollers, and after the chaff and light husks have been cleaned from them the coffee beans are ready for market.

Coffee is said to have been used in Persia about a thousand years ago. But it has been known in Europe only about three hundred years. The first coffee-house in London was opened in 1652.

Exchanges wanted

'Stamps and match labels are my main interest', writes Mr C. A. Strike of Dymesbury Park, King River, Via Albany, West Australia. 'But I am now on to beer labels. I would like to exchange these items with other readers. I have been taking *Hobbies Weekly* for three years, and think it a very good paper'.

Stanley J. Serxner of Apartado Postal 967, Guatemala City, Guatemala, Central America, would like English friends.

Helmut Henry Flamm of Strandhotel Gerken, Nordseebad Wangerooze, Western Germany, collects hotel, airline, and steamship labels. He will answer all letters.

CAN WE HELP?

WE have received a request from an Irish reader to help him in obtaining three Hobbies designs which were produced during the war years. They are: Lancaster Bomber (No. 2504), Douglas Dakota (No. 2572), and H.M.S. 'Warspite' (No. 2578). Any reader who can help should write to D. O'Neill, 109 Thomas Moore Road, Walkinstown, Co. Dublin.



DOLL'S MODEL BUNGALOW

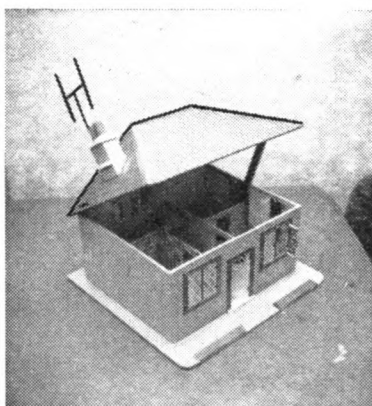

LITTLE material is needed to build this compact model bungalow, and as the walls and roof will be covered with appropriate doll's house papers, there is no need to use first-quality stuff for these parts, if odd pieces of plywood are to hand.

Cut all units from $\frac{3}{8}$ in. ply, glass-paper smooth, and assemble as shown in the diagrams. Glue walls around the floor piece. Make larger base surround of one piece with a centre cut-out of approximately 9 in. by 7 in., or of four separate pieces glued and nailed to the underside edges of the floor panel.

Cover the outside walls with red brick paper and then nail on the fittings over the pre-cut door and window openings. Fit dividing walls inside and decorate with colour pattern reproductions from women's magazines to make up a hall, living-room, bedroom, kitchen, and bathroom.

Cut two each of pieces A and B and one of C. Glue these together to form the roof, binding the edges securely with gumstrip paper. When set, add cardboard strips along the roof ridges, then paste pieces of green tile paper to the four sections.

Make the chimney from 1 in. thick wood as shown, adding the dowel rod chimney pots and strips around the stack into which fit the wire TV. aerial.

Glue the chimney in position and cover with one piece of brick paper. Paint the strips white and pots red. The aerial should be removable for compactness in the toy cupboard.

The roof may be hinged, and a strip of wood pivoted on a small screw fixed to one side of the house will keep it propped up for easy access to the interior. Finish off the model with a grass-green surround, crazy-pavement, and moulding or strip-wood 'garden walls', painted red.

The door, windows, paper, etc. can be obtained from all Hobbies branches, or by post from Hobbies Ltd, Dereham, Norfolk. (T.S.R.)

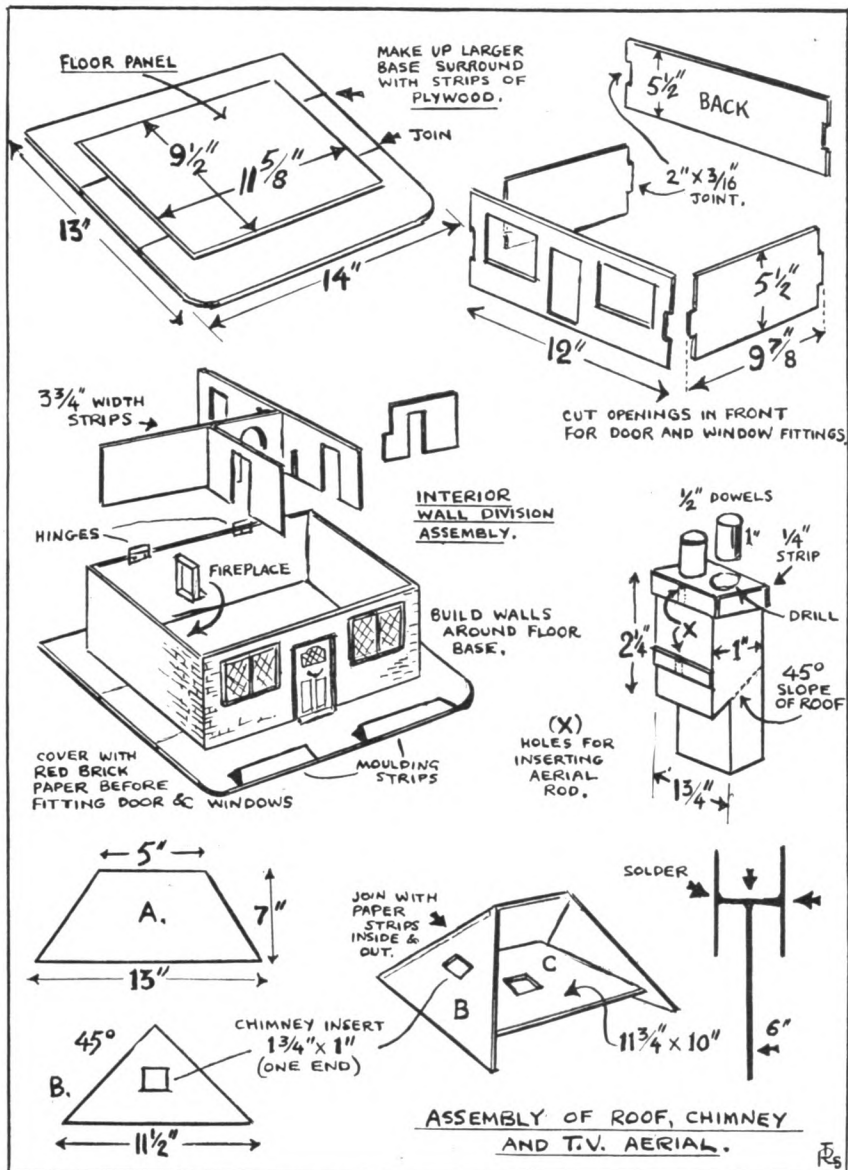

CONTINUING HOBBIES 'ZIP'



Because of restricted leg room the back seat of 'Zip' is more suitable for children

NOW that the frame is fairly rigid the boat can be turned upside-down again, and the end of the hog shaped. This can be done with a plane, rasp, file, or Surform tool. The hog should blend nicely with the curve of the stem.

The framework is now almost complete and a start can be made with skinning, using $\frac{1}{8}$ in. oil-tempered hardboard. Lay the board along the gunwale and mark off the lower edge of the chine. Do not commence cutting until you are quite sure that the cut will enable you to leave enough for the other side. The hardboard is quite easy to cut with a tenon saw or handsaw. A cleaner edge is usually obtained by using a tenon saw. Leave a slight amount of hardboard overlapping so that it can be planed or glasspapered flush.

The easiest way to work is to turn the boat on its side and pack up with boxes or books. Coat the gunwale, chine and side battens with glue (fairly stiff) and lay the skin in position. Screw at intervals of about 6 in., using $\frac{1}{2}$ in. brass

screws and countersinking slightly. Turn the boat on the other side and repeat the procedure.

Before applying the bottom skin, the boat is turned upside-down and the chines planed to conform to the slope of the bottom battens as seen in the section (Fig. 6). The skin is then glued and screwed in position in the same manner as the sides, but stopping short on the centre of the floor batten nearest the stem. This diagram is broken away to show the blocks of $\frac{3}{4}$ in. wood which support the two seats and the rear floorboard.

For the back seat, five blocks are required. The four blocks, two on each side, are $1\frac{1}{2}$ in. deep and are glued to the chine and side. The centre piece is $11\frac{1}{2}$ in. long and just under 3 in. deep. These measurements may not be the same for your particular boat and should be checked carefully. The seat will, of course, be flat, and the blocks should therefore be adjusted accordingly.

The block immediately behind the front seat is 11 in. by $1\frac{3}{4}$ in. It supports

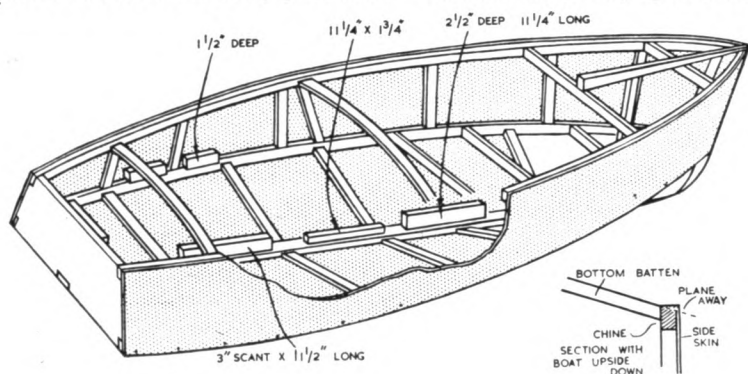

Fig. 6

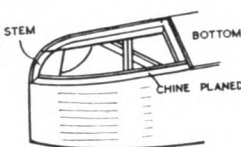

Fig. 7

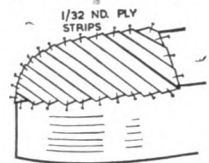

Fig. 8

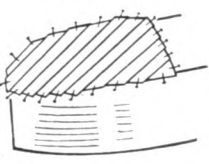
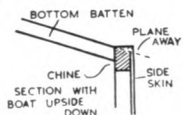

Fig. 9

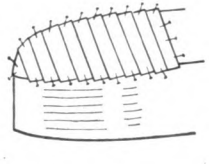

Fig. 10

 ★ Hobbies Ltd. supply a complete ★
 ★ kit of materials for building 'Zip' ★
 ★ as detailed in the materials list. ★
 ★ Also included is a set of full-size ★
 ★ plans at an inclusive cost of ★
 ★ £19. 19. 0. Kits are obtainable ★
 ★ from branches, etc., or from Hobbies ★
 ★ Ltd., Dereham, Norfolk. ★
 ★ 'ZIP' BOAT KIT ★
 ★ Cash price £19. 19. 0 (plus 30/- ★
 ★ part carriage and packing) ★
 ★ EASY PAYMENT TERMS. ★
 ★ £5 down (plus 30/- part carriage ★
 ★ and packing) and 6 monthly pay- ★
 ★ ments of £2. 13. 0. ★
 ★ Total E.P. price £20. 18. 0 (plus ★
 ★ 30/- part carriage and packing). ★
 ★ Full-size plans separately 16/6 ★
 ★ (post 9d. extra) ★
 ★ *****

the floorboard which also rests upon the chines. The remaining block supports the front seat and is $11\frac{1}{4}$ in. long by $2\frac{1}{2}$ in. deep. Construction of boards and seats is dealt with later.

As with most hard chine boats it is not easy to get a good shape at the stem, and the skin is sometimes broken in the effort to twist it to a good shape. This difficulty is overcome by using narrow strips of $\frac{1}{32}$ in. plywood laminated to shape and trimmed when the glue has set. This gives an excellent shape which would be almost impossible to obtain by conventional methods. The portion to be filled in is seen in Fig. 7.

Cut the $\frac{1}{32}$ in. plywood into strips about $\frac{1}{2}$ in. to $\frac{3}{4}$ in. wide and pin over the opening as seen in Fig. 8. They should be pinned quite lightly to chines or hog. These pieces are not glued in place since the whole panel will be removed later.

Spread glue liberally over this layer and put the next layer in position (Fig. 9). Remove pins as work proceeds, putting them back to hold subsequent strips in position. The last layer which is also glued is shown in Fig. 10, and goes approximately in the direction shown. It will be found that the strips are easily moulded into shape if glue is liberally applied. The important thing to remember is that

'Zip' is on show at Hobbies stand (UK15, first floor) at the National Boat Show, Earls Court, London, which ends on Saturday

for strength the three layers should all run in different directions.

Leave the glue to harden for at least 24 hours and remove the pins. Lift the panel off and it will be found to be quite hard and set to shape. Trim up, chamfer where necessary, and glue the panel back in place. Add screws wherever practicable. The second panel for the opposite side is of course formed in the same way.

The seating and floors should next be dealt with and a suitable arrangement is sketched in Fig. 11. The two shaped pieces at the extreme front are cut from $\frac{1}{4}$ in. marine grade plywood and are shaped to fit the curve of the bow. The easiest way to get the correct shape is to cut card templates to fit exactly. They can then be laid on the wood and marked round. Notch the pieces to fit round the

side battens, centre upright, and stem. They should extend to the centre of the middle floor support. They should be screwed but not glued in place.

Next make templates for the seat backs and cut them from $\frac{1}{4}$ in. plywood. Notch the corners and bottom to fit the gunwales, chine and hog. The tops of the seat backs should curve slightly to give a better appearance. The curve should rise about $\frac{3}{8}$ in. from the horizontal to coincide with the rise of the wedge-shaped deck support. Glue and screw the seat backs in position, fixing them to the side battens, floor battens, and seat supports.

The front seat consists of a piece of $\frac{3}{8}$ in. plywood supported by a frame of 1 in. by $\frac{1}{4}$ in. stripwood. It is not essential that plywood for seats and floorboards should be marine grade, provided that

it is kept well varnished. No measurements are given for any of these pieces because they should be made to fit, taking measurements from the actual boat.

The rear seat has no framework and is a plain piece of $\frac{3}{8}$ in. plywood supported by the blocks already described in Fig. 6.

The front floorboard is cut to fit and rests on the chines and floor supports. It is cut from $\frac{1}{4}$ in. plywood. The rear floorboard is of $\frac{3}{8}$ in. plywood and rests upon the floor support (Fig. 6) and the chines. Seats and floorboards need not be screwed or glued in position.

How to make up the steering gear, windscreen and other accessories will be described in the concluding article next week.

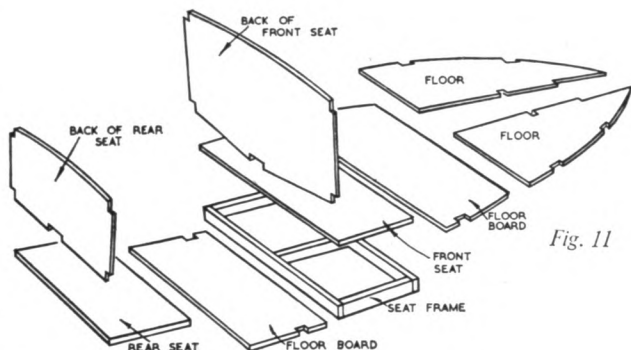

Fig. 11

NEW KITS BY AIRFIX

THREE additional 1:72nd scale aircraft plastic construction kits have been introduced by Airfix Products Ltd. They are of the Boulton Paul Defiant 1940 night fighter at 2s. 0d., the 700-mph. Hawker Hunter F.6 jet interceptor at 3s. 0d., and the famous Douglas Dakota military transport and

civil airliner at 6s. 0d.

The new introductions increase to fifty the number of aircraft modelled by Airfix. They are all to the same 1:72nd scale and range from the fighters of World War I to some of the latest aircraft of today.

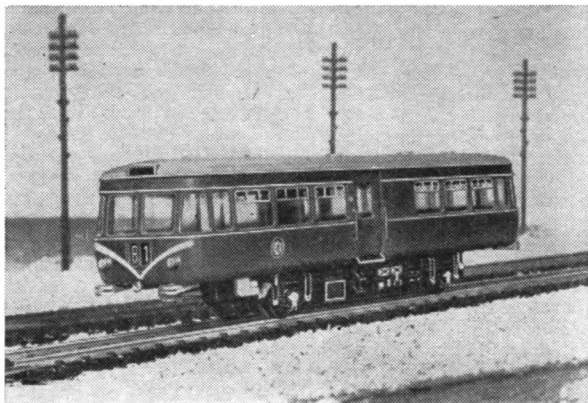

Airfix have also introduced a kit for a British Railways 50-seater Railbus, seen here. It has 67 parts, costs only 3s. 0d. and is to the same OO and HO scale as the majority of model electric railway layouts.

Railway Enthusiast's Guide

by P. M. E. Erwood

RAILWAY enthusiasts will find this publication a ready means of improving their knowledge of the hobby and increasing contacts with other enthusiasts.

Essentially this is a directory covering some fifty countries, detailing the activities, etc., of railway clubs, museums, relics, associations, model railways, periodicals, and many items of interest to railway fans throughout the world. The publication of this book is a tribute to the co-operative nature and good will of all railway enthusiasts, and opportunity is taken to include some excellent photographs of 'collectors' pieces'.

Published by George Ronald, London. Price 10s. 0d.

Details for making an electric poker machine for poker work will be among the features in next week's issue. Make sure of your copy.

Experiments with Balloons

THE use of balloons is an ideal expedient for the colourful and dramatic demonstration of a variety of important scientific principles. Half-a-dozen penny balloons in addition to a few easily obtained accessories will provide enough apparatus for an instructive evening's entertainment. Begin by trying to push a fully inflated balloon beneath the surface of a half filled bucket of water. If the balloon does not burst in the process you will be amazed to discover how much effort is required.

However, the result of your experiment will not be surprising if you remember the principle of Archimedes which states that, when an object is immersed

balance. Bore a $\frac{1}{4}$ in. diameter hole through a second cork into which a pair of similar pencils or a 15 in. length of dowel rod can be firmly inserted to form a beam. Fit the pencils or dowel

By A. E. Ward

into the cork, then press two pins into opposite sides of the cork to make spindle ends which will enable you to mount the beam upon the wire stirrup. Fit a small cork upon one end of the

balloon between them. Hold the cups steady and blow into the balloon. As the balloon expands the rubber will press against the rims of the cups, and as you blow more air into the balloon the convex curvature of the rubber surfaces stretching across the cups will flatten and thus reduce the air pressure within the cups. Lift up the balloon (Fig. 2). Atmospheric pressure, being greater than the air pressure inside the teacups, will press the cups against the balloon so that they will easily be lifted. This effect can be very amusing. A limpet clinging to a rock contrives to reduce the pressure of the air beneath its shell, thus letting atmospheric pressure push it hard against the rock.

in water, the water will press the object upwards with a force equal to the weight of water displaced by the object. Your lightweight balloon will displace several pounds of water and this force must be overcome in order to submerge the balloon. Archimedes' principle may also be applied to gases. When you release a hydrogen-filled balloon in a summer balloon race it will rise into the sky because the weight of the balloon and the gas together will be much less than the upward pressing force of the displaced air, which is considerably heavier.

Invisible air is a material substance which possesses weight. This fact, which is not always easily apparent, may be elegantly demonstrated with the aid of a specially constructed balance (see Fig. 1). Use a corked squash bottle for the base and pillar of the balance. Fashion a stout wire stirrup with loops at the ends and fix this, pointing upwards, into the cork in the bottle. The stirrup should be wide and 'deep' enough to serve as a convenient support for the beam of the

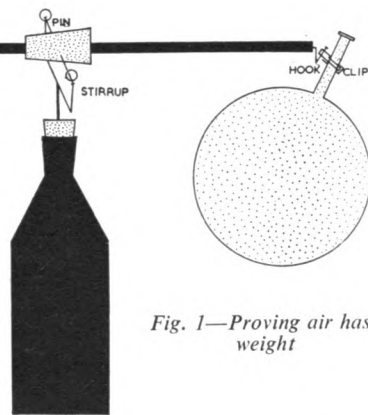

Fig. 1—Proving air has weight

beam and fix a bent pin on to the opposite end.

Now proceed with your experiment to prove that air has weight. Inflate a balloon with air, using a bicycle pump or a cardboard balloon pump, and seal the neck by means of a wire paper clip. It would be unscientific to use your breath to inflate the balloon because expired 'air' contains an appreciable proportion of heavy carbon dioxide gas. Suspend the balloon, by the paper clip, on the bent pin hook on the beam of the balance, then bring the beam into equilibrium by pressing pins into the small cork until the beam is horizontal. Remove the balloon and deflate it by releasing the clip. When you hang the balloon and clip upon the beam again, the loss in weight due to the released air will be obvious owing to the marked 'dipping' of the counterweight of clustered pins.

You can use a balloon to lift two teacups and demonstrate the subtle means by which a limpet clings to a rock at the seashore. Use plastic cups to avoid accidents. Place the cups with their openings half an inch apart and dangle a

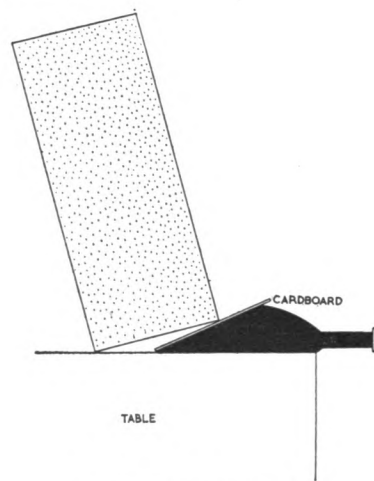

Fig. 3—Toppling a brick

Pascal's Law states that water and air pressure are transmitted equally and undiminished in all directions, a principle of great importance in the design of hydraulic lifts and high power presses. If you try to blow over a house brick stood on end upon a table you will surely fail unless the force of your breath is equal to that of a gale. However, Pascal's Law may be neatly applied to make this feat possible. Place a balloon flat upon the table with its neck protruding over the edge. Rest a 3 in. by 4 in. piece of cardboard upon the balloon and stand a brick on end so that it half covers the cardboard (Fig. 3). Blow hard into the balloon. The pressure of your breath will be transmitted undiminished in force over the whole surface of the balloon and the brick will crash over as the balloon is blown up.

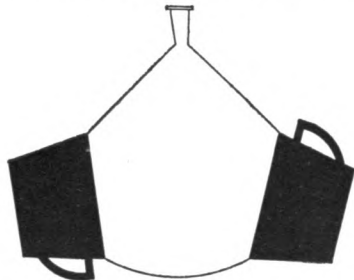

Fig. 2—Lifting the cups

● Continued on page 259

Make an attractive 'Dice' Table Lamp

A DICE-SHAPED table lamp looks very attractive in almost any setting, and is fairly simple

soldered to the corners of one of the squares (B). The upper wire square is then soldered to the tops of the up-

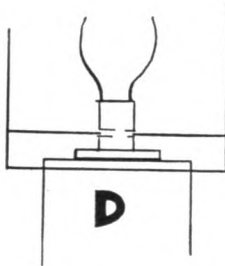
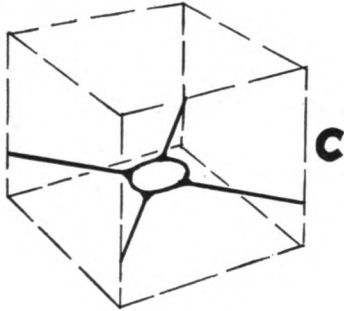
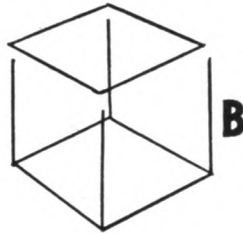
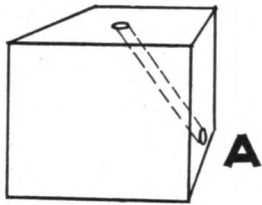
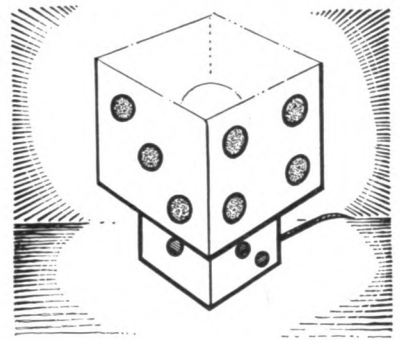

rights. The supports for the shade are made by laying two lengths of wire diagonally inside the frame from corner to corner. A ring of wire, large enough to fit over the lampholder, is placed where the ring crosses them and soldered to it to give the shape shown at C. This is soldered to the uprights, 1 in. above the lower wire square (D). The complete frame is washed and given a coat of white paint.

The shade sides are covered with four 8 in. squares of plain plastic or acetate sheeting, preferably white or a pale colour. The spots on each of these sides are penny-sized circles of red plastic or felt, which are glued in place. If they are painted, the light shining through the shade may show the brush marks.

The covering material can be bound to the frame with plastic thonging or silk braid, but to emphasize the square lines of the shade and its resemblance to a dice, thin white cotton or linen thread, which is unobtrusive if neatly done, should be used. (A.L.)

and inexpensive to make.

The base of the lamp is a 4 in. cube of wood, which must be glass-papered to a very smooth finish. A hole for the flex is drilled from the top at an angle, coming out at the bottom of the rear face (A).

A white plastic lampholder, with flex attached, is screwed to the top of the cube after the flex has been led through the hole.

The base is then painted. After the undercoats have been applied, it is given a coat of white enamel. When this is dry, the spots are put on. Use a sixpence as a guide, drawing the circles round it in pencil, and painting them in red enamel with a small water-colour brush.

The shade is also made in the form of a cube. First, two squares with 8 in. sides are made from lampshade wire, and four 8 in. long wire uprights are

● **Continued from page 258**

EXPERIMENTS WITH BALLOONS

At Christmas time, when you hang up balloons as decorations, they will sometimes burst unexpectedly as the warmth of the room causes the air inside them to expand and increase the tension upon the rubber. Fit a balloon over the neck of a large bottle and hold the bottle in both hands for a few moments. The heat of your body will cause the air inside the bottle to expand and cause the balloon to pop up suddenly. Show that air will contract when cooled by holding the bottle beneath running cold water. The air contracts and causes the balloon to flop down again.

The rubber molecules in an inflated balloon are in a greater state of activity

than when the balloon is not blown up. Moisten your lips with your tongue then hold a rubber balloon against them. The balloon feels cool. Now stretch the balloon and hold it, still pulled taut, against your moist lips. The balloon feels warm. Relax the tension on the balloon and the rubber will feel cool again. As molecular activity increases, heat energy is liberated. Dozens of other entertaining experiments are possible with balloons. Devise some experiments yourself to investigate the force of reaction which drives jet engines and rockets, and to study the uncanny phenomena produced by static electricity.

MAKE THIS HANDY CONTACT PRINTER

THE amateur photographer who does a considerable amount of contact printing will find the printer illustrated very useful. The bulb is always the same distance from the printing frame and if the same bulb is used every time, it is easy to estimate the exposure required by referring to past results.

The printer consists of a 40-watt opal bulb. Above it is a mirror to reflect the maximum amount of light. Below is a piece of ground glass to diffuse the light and the printing frame stands on the base as shown in the photograph.

Commence by making the base from a

piece of solid wood, 8 in. by 5 in., and as thick as possible. This forms a firm base, unlikely to shake during exposure.

By N. E. Jenkinson

From a piece of quarter-inch wood, cut out the rear column, 14 in. by 2 in., and cut out a hole to accommodate the bulb holder, 11 in. from the bottom. From half-inch wood, cut out the piece marked

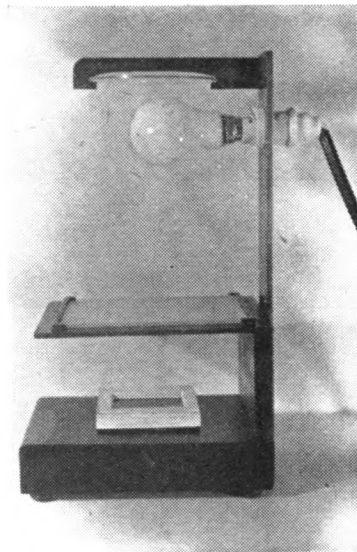
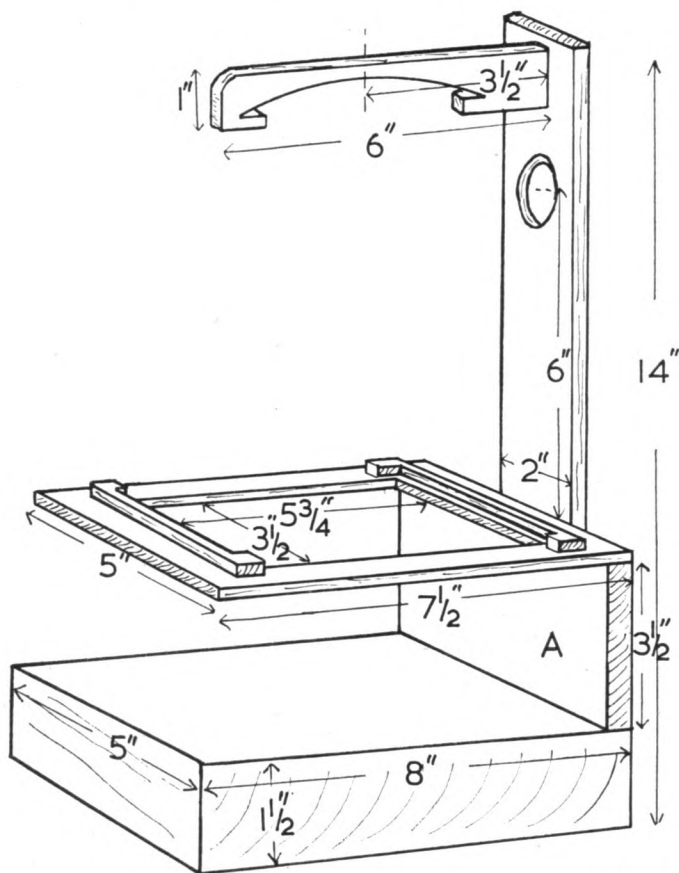

'A' in the diagram, 5 in. by 3 1/2 in. Secure the rear column to the centre of the base by means of screws and then screw part 'A' to the column.

Now make the piece holding the ground glass. This is made from quarter-inch wood, and is 7 1/2 in. by 5 in. Cut out a section 5 3/4 in. by 3 1/2 in., and then obtain a piece of frosted glass 6 in. by 4 in. to place over the cut-out. This glass is held in place by two narrow strips of wood which can easily be removed for cleaning. Secure the finished part to the top of part 'A' by means of screws.

The size of the part holding the mirror will depend on the mirror available. A flat piece of mirror, either circular or rectangular will suffice, although the one used in the illustration was a slightly concave circular one, as used in cheap shaving mirrors. This gives a good beam of light. If such a mirror is used, ensure that the centre of the mirror is directly over the centre of the bulb, in the case of a 40-watt bulb, approximately 3 1/2 in. from the column. Cut the piece of wood and the slot to hold the mirror. This should be a tight fit. Secure the piece to the rear column.

A lampholder incorporating a switch, as for table lamps, should be used, and the printer can thus be switched on and off for the required exposure.

Give the finished printer a coat of dark stain or black paint. Screw four rubber feet to the base to prevent it slipping.

Fix the mirror and the ground glass in place, plug in the bulb and the printer is ready for use.

Instructions to make

The Old Rustic Bridge Posy Ring



THIS charming bowl of flowers incorporated in an old rustic bridge setting makes an ideal centre piece for standing on a table or sideboard where the gay flowers will contrast delightfully with the 'weathered' look of the overhanging bridge. The overall width is $9\frac{1}{2}$ in., and apart from its novelty and charm, the design is an excellent piece of work for the fret-worker. Construction is quite simple and with care in cutting this will make a very attractive project, and an unusual gift.

The plastic circular container has a well to hold short-stemmed flowers, and is surmounted by the bridge in wood. The bowl is slipped under the bridge on a base, then filled with water and set out with flowers. The whole assembly can be moved around quite easily by lifting.

Steps lead up from the sides to the span of the bridge which is planked in half-round beading to give a log effect. The handrails are cut out from the solid

with a fretsaw and rounded off to represent rustic work. Small plastic or plaster figures can be incorporated into this layout, and a small gnome with fishing rod would look particularly attractive in such a setting.

The plastic ring is included in Hobbies Kit No. 3396. All the parts needed for making the bridge are shown full size on the design sheet. They should be carefully traced, transferred to wood by means of carbon paper and cut out neatly with the fretsaw, and finally cleaned up with glasspaper.

Make a start on construction with the two ends of the bridge shown in Fig. 1 on the design sheet. Piece 3 is glued between the two pieces 2 and the individual steps (pieces 5) are then glued on one by one as shown in Fig. 2. Next glue the completed ends on to the base (piece 4) as seen in Fig. 3 and also indi-

cated by dotted lines on the base. Note that the positioning of the ends allows for the addition of the last step on the base.

Hobbies Kit No. 3396 for making this delightful novelty includes planed wood, beading, and plastic posy ring. Kits from branches, &c., price 5/3 or from Hobbies Ltd, Dereham, Norfolk (post 1/6 extra).

Bridge the gap between the ends by adding piece 1 on to which are glued the short lengths of half-round beading. The handrails (pieces 6) are glued centrally on either side of the bridge.

Give the woodwork a weathered-looking finish with various shades of brown stain.

TWO-MINUTE QUIZ ^{by} Ed. Capper



WHAT IS A COOMB ?

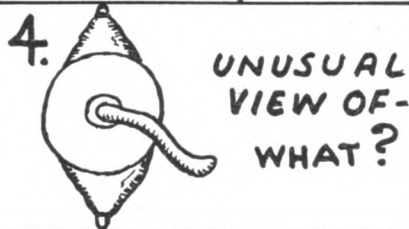

Answers on page 264

CHEMISTRY AT HOME

THE popular use of glucose as an energy producer naturally may make the home chemist curious to know something of its chemical properties.

Before we give its formula let us first see what elements it contains. Mix a little glucose with about ten times its bulk of powdered copper oxide, CuO , which has first been heated and allowed to cool so as to remove moisture. Place the mixture in the horizontally clamped test tube shown in Fig. 1. A little before it place some anhydrous copper sulphate, CuSO_4 . Let the delivery tube dip under lime water, Ca(OH)_2 .

Now heat the tube gently. The anhydrous copper sulphate turns blue owing to formation of water, H_2O , and production of the hydrate, $\text{CuSO}_4 \cdot 5\text{H}_2\text{O}$:

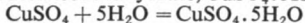

Since copper oxide contains no hydrogen, H, the latter must have been supplied by the decomposing glucose.

The lime water turns milky owing to carbon dioxide, CO_2 , forming insoluble calcium carbonate, (chalk), CaCO_3 :

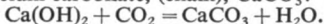

The carbon, C, can only have come from the glucose.

water of crystallization. Chemists prefer to call glucose dextrose, on account of its property of turning a ray of polarized light to the right. You already know that it is a sweet tasting substance. Taste is one factor which chemists have not been able to reproduce in instruments, and we still have to rely on our tongues. Careful

EXPERIMENTS WITH GLUCOSE

tests have shown that glucose is only about one-third as sweet as sugar, $\text{C}_{12}\text{H}_{22}\text{O}_{11}$.

Its solubility, too, is less than that of sugar, needing about four and a half times more water for solution.

The term sugar is a loose one. What we know as sugar is more precisely termed sucrose, for it is only one of many sugars. Glucose is another. The sweet

grape skins:



Dissolve 2.5 grams of glucose in 10 c.c. of water in a test tube, add a little yeast, and fit a cork and delivery tube, the latter dipping under lime water in a second test tube, Fig. 2. Pour a thin layer of benzene, C_6H_6 , on to the lime water, so as to prevent its being acted upon by atmospheric carbon dioxide. Put the apparatus in a warm room. Very soon gas bubbles appear in the lime water, turning it cloudy and thus showing the formation of calcium carbonate from carbon dioxide released from the fermenting glucose.

When the action in the glucose solution ceases, let the yeast settle, and carefully pour off the upper solution into a small flask fitted with a cork and drawn out tube. You will note the solution has a winy odour. Heat the flask until the liquid just begins to boil. Now apply a flame to the tip of the drawn out tube. The issuing vapour takes fire and burns with the typical blue flame of ethyl alcohol.

This illustrates also the manufacture of spirits from fermented liquids. By condensing instead of burning the alcohol vapour, brandy, rum, whisky, vodka, and other potent drinks are produced, according to the raw materials used for the primary fermentation.

Just as sucrose forms caramel (formula indefinite, since mixtures are formed) on heating, so does glucose. Caramel is the basis of gravy browning and is also used for colouring wines and other liquids

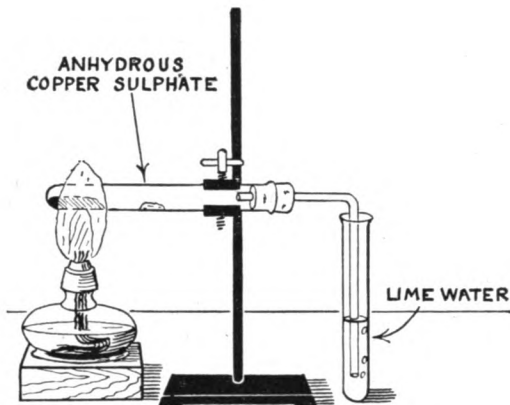

Fig. 1—Finding the elements in glucose

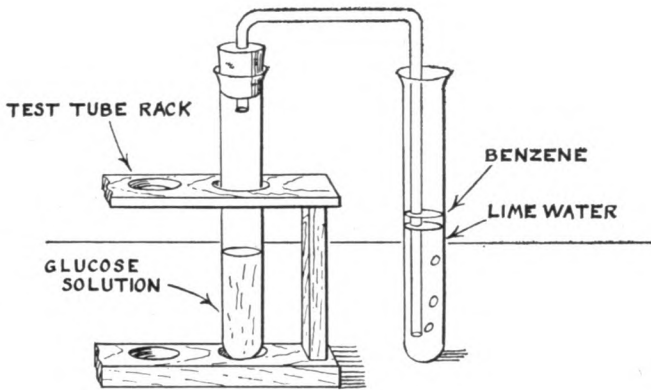

Fig. 2—Acting on glucose with yeast

We know, then, that glucose contains carbon and hydrogen. It also contains oxygen, but this cannot be tested for by simple means in the home laboratory. The formula of the glucose we meet in everyday life is $\text{C}_6\text{H}_{12}\text{O}_6 \cdot \text{H}_2\text{O}$, which shows it to contain one molecule of

grains in raisins consist of glucose, as does the solid part of crystallized honey.

It is the presence of glucose in grapes which permits the making of wine, for glucose is converted mainly into ethyl alcohol, $\text{C}_2\text{H}_5\text{OH}$, and carbon dioxide, by the action of the yeast present on the

The heating must be carefully done, as we shall see.

Put a little glucose into a dry test tube and clamp it upright in an oil bath (use medicinal liquid paraffin). Heat up the bath and hang a thermometer with its bulb in the oil. When the temperature

rises somewhat beyond 80°C. the glucose melts. At 200° and slightly beyond the glucose turns brown. Continue heating for a short time until no further change appears to be taking place, remove the test tube, and let it cool. The contents remain liquid. This is caramel. Dissolve a drop in water and note the familiar coloration of gravy browning.

Now wipe the tube and heat it in a flame. The caramel undergoes further change, gives off a smell of burnt sugar, and finally remains as a black mass of carbon.

To distinguish glucose from sucrose there are several interesting tests. In separate dry test tubes put a little

sucrose and glucose. To each add a few drops of strong sulphuric acid, H_2SO_4 , (caution, corrosive; treat any on the fingers by water flushing and then by dabbing on wet sodium bicarbonate). The sucrose blackens; the glucose does not. The sulphuric acid abstracts water from the sucrose and leaves carbon:

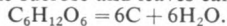

In separate test tubes warm a little sucrose and glucose with sodium hydroxide solution, NaOH. That containing the sucrose undergoes no change, whereas in the case of glucose the liquid turns yellow and then red-brown.

Another interesting test is to add lead acetate solution, $(CH_3.COO)_2Pb$, to a

solution of glucose. Boil for a few seconds, allow it to cool somewhat, and add ammonium hydroxide, NH_4OH , until a white precipitate just appears. Boil up again. The precipitate turns a salmon-pink colour. Repeat the experiment with sucrose solution. In this case the white precipitate undergoes no colour change.

Perhaps the most striking tests depend on the reducing properties of glucose. An alkaline copper solution, for instance, is quickly reduced to cuprous oxide, Cu_2O . Add some Fehling's solution to glucose solution and boil. Red cuprous oxide is thrown down. Sucrose does not give this reaction. (L.A.F.)

Interesting Locos—No. 30

THE CHURCHWARD 'SAINTS'

THE G.W.R. 4-6-0 'Saint' class were probably the swiftest running engines in this country. The type developed from the big 4-6-0 engine which William Dean first put on the line in February 1902.

March 1903. This was later named 'Ernest Cunard', and was later re-numbered 2998, whilst No. 100 was altered to 2900. The third 4-6-0 engine came out in December 1903. This was No. 171 (later 2971) 'Albion', which

on the fastest and heaviest trains of the G.W.R., where some remarkable instances of high speed running have been recorded. As shown, the class carried the following leading features: cylinders $18\frac{1}{2}$ in. diameter by 30 in. stroke, wheels,

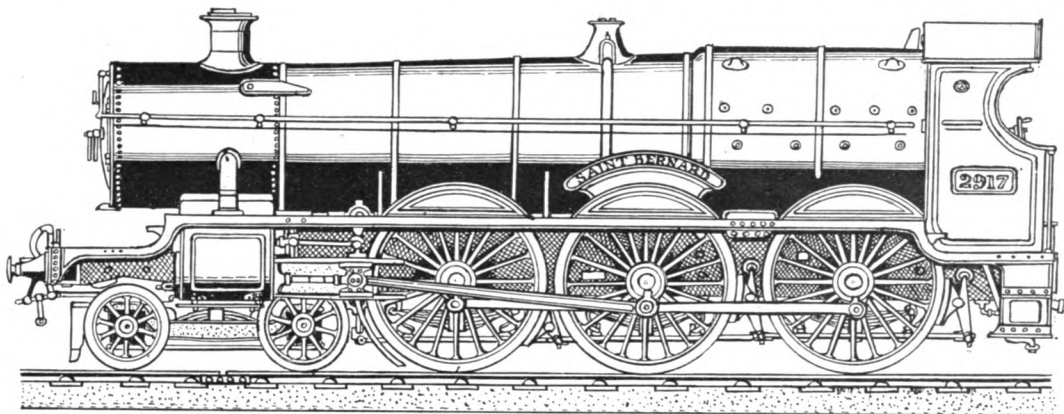

This excellent engine, which carried the running number 100, was the first 4-6-0 Express type for the G.W.R., and at the time was a worthy product of the Swindon Works. Mr G. J. Churchward, who was at the time Mr Dean's premier assistant, later named the engine 'William Dean' as a compliment to his former chief when he succeeded him as chief mechanical engineer at Swindon in 1903.

It may be said that No. 100 marked the commencement of the Churchward era with regard to the G.W.R. 4-6-0 type for express work. The 2-cylinder type ended in 1913 with the completion of the 2931 'Court' class. The second 4-6-0 engine, No. 98, was built in

was later altered to the 4-4-2 'Atlantic' type in order to compete in trials with the French De-Glehn 4-cylinder Compound 'Atlantic', 'La France', No. 102 (as detailed in No. 11 of our series).

The engine shown in the drawing, No. 2917 'Saint Bernard', was one of the twenty, Nos. 2911 to 2930, built from August-September 1907, and named after patron and historical saints. With the completion of No. 2955 'Tort-Worth Court' in April 1913, the class eventually totalled seventy-seven engines, Nos. 2900 to 2955, 2971 to 2990, and No. 2998. For many years, up to the introduction of the 4-cylinder 'Star' class, the Saints were employed

bogie, 3 ft. 2 in. diameter, coupled 6 ft. $8\frac{1}{2}$ in. diameter, boiler, standard No. 1, containing 176 tubes of 2 in. diameter, and fourteen superheater flues of $5\frac{1}{2}$ in. diameter, the elements being 1 in. diameter. The heating surface of the tubes was 1,686 sq. ft., and the fire-box 262.62 sq. ft. Boiler water pressure, 225 lb. p.s.i.-Weight of engine in working order $69\frac{1}{2}$ tons, 41 tons 18 cwts. being carried on the six coupled wheels. At 85 per cent water pressure the tractive effort was 20,530 lb.

September 1953 saw the final withdrawal of the last engine of the class, 'Saint David', No. 2920, stationed at Hereford.

(A.J.R.)

DECORATIVE PASTE PAPERS

HERE is an interesting method of making your own distinctive fancy papers for covering boxes, folders, files, or books, and you will quickly realize that there are many other useful possibilities.

The main item is good quality, strong white paper. This must have a smooth surface, and be non-absorbent. Most good stationers sell first quality drawing papers, measuring 20 in. by 25 in., and this size will be adequate for most purposes. The medium is nothing more than starch as used for laundering, and the mixture is four dessertspoons of starch to 1½ pints of water.

Make a smooth paste

Use a basin large enough to hold this volume, adding the prescribed quantity of starch. Add a little water, stirring continuously until you have a smooth paste. Note that only a minimum of water is used for this preliminary, for we only require to dissolve the starch. The remainder of the water is boiled and poured over the mixture to make a

starch paste while at boiling point. Once again the mixture should be stirred continuously while the boiling water is being slowly added. If you follow these

may be in different widths, and you will see that there are limitless possibilities at your command. A stiff brush will add a grain to your design, changing streakiness into lines, and again evening out the colour and paste.

A crumpled piece of paper will make a stippled effect where the colour is applied in patches, while a comb will make a more pronounced effect than the stiff brush. If the comb is held with one end stationary on the paper and given a quarter turn, you will be able to introduce semi-circles into the pattern.

By S. H. Longbottom

simple instructions you will produce a smooth paste of correct consistency entirely free from lumps. Allow to cool before using. You will also require a few cold-water dyes in various colours.

Since the process is inclined to be a little messy, it is advisable to cover the working area with old newspapers, having all the equipment at hand, since the colouring and patterning must proceed and be finished before the paste dries.

Lay a sheet of new white paper before you, dip a distemper brush into the paste, and apply to the paper. It will be found best to brush the paper in the vertical direction and then horizontally to produce an even coating of the paste foundation.

Different patterns

Now dip the paint brush into the colour dye and apply to the paper. If only one colour is to be used you may quickly cover the entire sheet, when it will spread; you may stripe the paper in different colours; you may make a check pattern by crossing the stripes, or you may apply patches of colour. The stripes

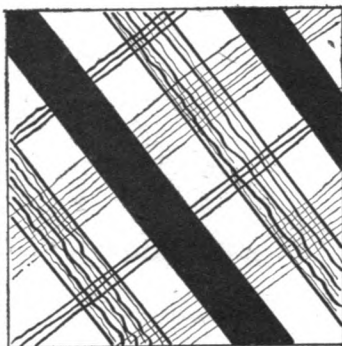
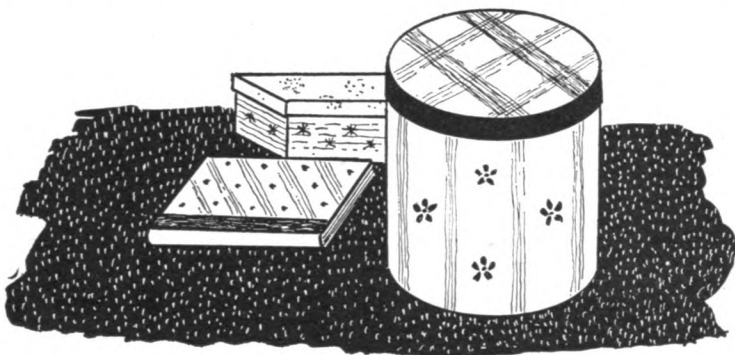

Fig. 1

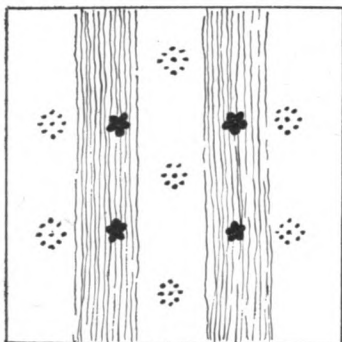

Fig. 2

Check effects

Different coloured check effects are most attractive if pale colours are employed. An example of such a check pattern is shown in Fig. 1. You can also colour the paste itself, and then add all kinds of patterns by means of potato blocks or shaped wooden sticks, as shown in Fig. 2. When using the latter method the paper must be allowed to dry, when it can be overprinted with the block in any desired colour.

When the paper has been treated, and the design is complete, it should be laid aside to dry on another sheet of old newspaper. To restore its original gloss and flatness, iron with a moderately heated iron. Finally, you may also apply a coat of white wax polish, which will protect the paper, and give a nice gloss on polishing. You may also apply a coating of thin, clear spirit varnish, although this is sometimes best if left until the particular craftwork has been covered.

ANSWERS TO QUIZ (see page 261)

1. Flat-Blade Spud Hoe. 2. It is called a 'half-bat'. 3. Four bushels. 4. Glue emerging from a tube. 5. Rusticated.

Make sure of your copy

HOBBIES 1961 ANNUAL

Enlarged to 180 pages—and still only 2/-

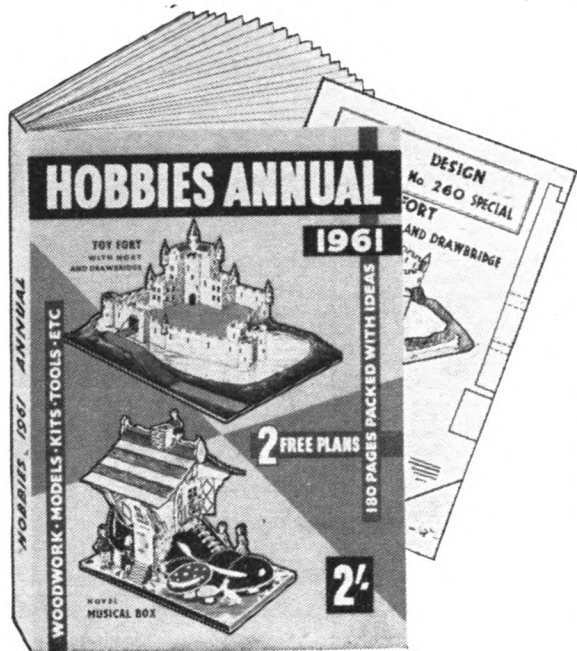

Two free plans with each copy, for making

TOY FORT (with moat and drawbridge)

MUSICAL BOX (The Old Woman who lived in a Shoe)

Hundreds of exciting projects for all ages

From Hobbies branches, stockists, newsagents, bookstalls, etc, or send NOW for your copy by post (6d. extra)

To Hobbies Ltd., Dept. 99, Dereham, Norfolk

Please send.....copy/copies Hobbies 1961 Annual containing two free plans

Name.....

Address.....

P.O. for.....enclosed

Yours
for
only
8/6d.
(Post 1/3)

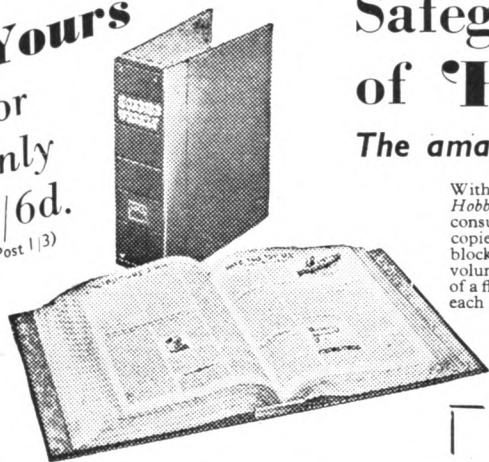

Safeguard your copies of 'HOBBIES WEEKLY' The amazing 'EASIBINDER' (Pat.) makes it simple

With the new *EASIBINDER*, specially prepared for Hobbies, you can bind each copy of *Hobbies Weekly* as you get it, turning your favourite magazine into a permanent, easily-consulted library of immense value, and avoiding the delay and despair occasioned when copies are accidentally mislaid or destroyed. Carefully finished in black leather-cloth and gold-blocked on the spine, each binder is strong, serviceable and neat. It will hold two complete volumes (52 copies) and costs only 8/6. Each copy of the magazine is quickly inserted by means of a flexible steel wire, and can easily be removed if necessary. Easy-to-follow instructions with each *EASIBINDER*. Get one today and take care of your copies of *Hobbies Weekly*.

NOTE From the issue April 10th, 1957, there is a slight difference in the size of the magazine, and two sizes of Easibinders are available. Type A is for binding issues published before April 10th and Type B is for those printed subsequently. To avoid confusion, when ordering, please indicate clearly the type of Easibinder required. Indices for each completed volume 1/- each post free.

☆ One 'EASIBINDER' holds two volumes (52 copies)

☆ Easy to use

Post today



To: HOBBIES LTD., Dept. 99 Dereham, Norfolk.

PLEASE SUPPLY EASIBINDERS (Type) at 8/6 each (post each 1/3).

NAME.....

ADDRESS.....

P.O. for.....

enclosed

HULL

DO YOU KNOW?

HOBBIES LTD. have a branch at

179 FERENSWAY

where the manager and staff are always willing to give you the benefit of their experience with any of your handicraft problems. Why not pay a visit?

PROFITABLE PLEASURE from Popular Art. Easier to Learn and Earn than you think. Send for free copy 'SOMETHING NEW' Popular Art Services (HW), Clun, Salop.

'THE MATCHBOX LABEL' CLUB. 105 Sunnyside Gardens, Upminster. Membership free. Send postcard

100 DIFFERENT stamps free! Request 1/4d. upwards discount approvals. — Bush, 53 Newlyn Way, Parkstone, Dorset.

WHEELS (Hardwood and Rubber Tyred Metal). Cot, Pram, and Doll's House Fittings and Papers, Beads, Transfers, Prints and other accessories. Stamp for new lists. (Trade supplied.) New address — JOYDEN CO., 91 Peplins Way, Brookmans Park, Herts.

LEARN

RADIO & T/V SERVICING for your OWN BUSINESS/HOBBY

● by a new exciting no-maths system, using practical equipment recently introduced to this country
FREE Brochure from:—

RADIOSTRUCTOR

DEPT. G81, READING, BERKS.

11/1/61

BUYING OR SELLING?

Classified advertisements on this page are accepted at a cost of 6d. per word prepaid. Use of a Box No. is 1/- extra. Send P.O. with advertisement to *Hobbies Weekly*, Advert. Dept., Dereham, Norfolk. Rates for display advertising on application.

LEARN RADIO & ELECTRONICS the NEW Practical Way! Very latest system of experimenting with and building radio apparatus — 'as you learn'. FREE Brochure from: Dept. H.W.10, Radiostructor, 40 Russell Street, Reading, Berks.

KUKLOS ANNUAL. Indispensable cyclists' handbook. Tours, resthouses, money-saving hints. 3/- post free. — Burrow, Publishers, 2 Imperial House, Cheltenham.

WORKERS with sewing machines required for making cushion covers. Regular work guaranteed. Apply enclosing s.a.e., Dept. 28, Arnold Trading, 10 Shelley Road, Worthing, Sussex.

GRIMSBY

DO YOU KNOW?

HOBBIES LTD. have a branch at

88 VICTORIA STREET

where the manager and staff are always willing to give you the benefit of their experience with any of your handicraft problems. Why not pay a visit?

PROFIT AND PLEASURE are obtainable from WRITING (typewriter unnecessary) or ARTISTRY. Send for free fascinating bumper package 'PROFITABLE LEISURE'. — Writers' & Artists' Ring (HW), 5 Edmund Street Birmingham.

50 MIXED stamps 5/-. Try our 6d. in 3/- discount approvals. — E. C. F. Townsend, 92 Tenby Road, Edgware, Middx.

EARN EXTRA CASH doing Invisible Repairs. We teach you to restore tears, burns, etc., to like-new perfection. Your own business in your own home. Send for details of our home course to — Invisible Reweaving Industry, Keswick, Cumberland.

PICTURESQUE GALLEON ELECTRIC LAMP

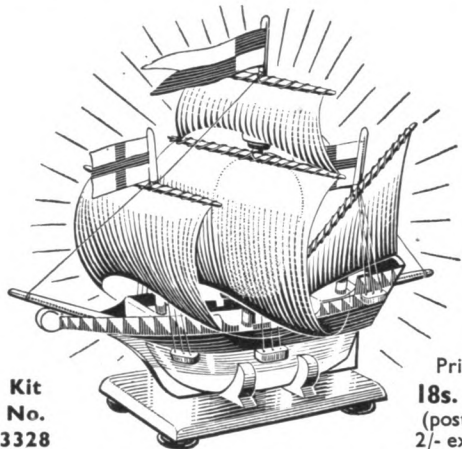

Kit
No.
3328

Price
18s. 6d.
(postage
2/- extra)

A really worthwhile project which will add distinction to any home, and can easily be built with a fretsaw and a few simple tools. Kit No. 3328 contains all necessary wood, materials, and fittings.

HOBBIES LTD (DEPT. 99), DEREHAM, NORFOLK



HOBBIES BRITISH FRETSAW BLADES

THE BEST YOU CAN BUY

YELLOW LABEL 1/2 per doz. 13/6 gross

BLUE LABEL 8d. per doz. 7/6 gross

From Hobbies Branches or by post (3d. extra)
from Hobbies Ltd., Dereham, Norfolk

HEAR ALL CONTINENTS With H.A.C. Short-Wave Receivers

Suppliers for over 18 years of radio S-W Receivers of quality.

One-Valve Kit, Price 25/- Two-Valve Kit, Price 50/-

Improved designs with Denco coils. All kits complete with all components, accessories and full instructions. Before ordering call and inspect a demonstration receiver, or send stamped addressed envelope for descriptive catalogue.

'H.A.C.' Short-Wave Products (Dept. 22), 11 Old Bond Street, London, W.1.

THE 'MARVEL' BENCH MOTOR- DRIVEN SAW

To meet modern needs. Just plug in and switch on from any house lighting point. For either A.C. or D.C. mains. With 230/250 volt motor, flex, switch, etc.

£12 5 0

Easy Payments
Available

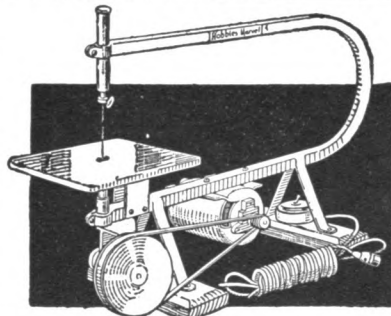

HOBBIES LTD (Dept. 99), DEREHAM, NORFOLK

'Good Luck' Bracket

CUT one each of A and B from $\frac{1}{4}$ in. wood. Use your fretsaw for cutting and make sure that it is held upright.

Glue piece B into piece A and clean up before painting. Fix to the wall through the hole at the top (M.p.)

**A JOB
FOR THE
FRETSAW**

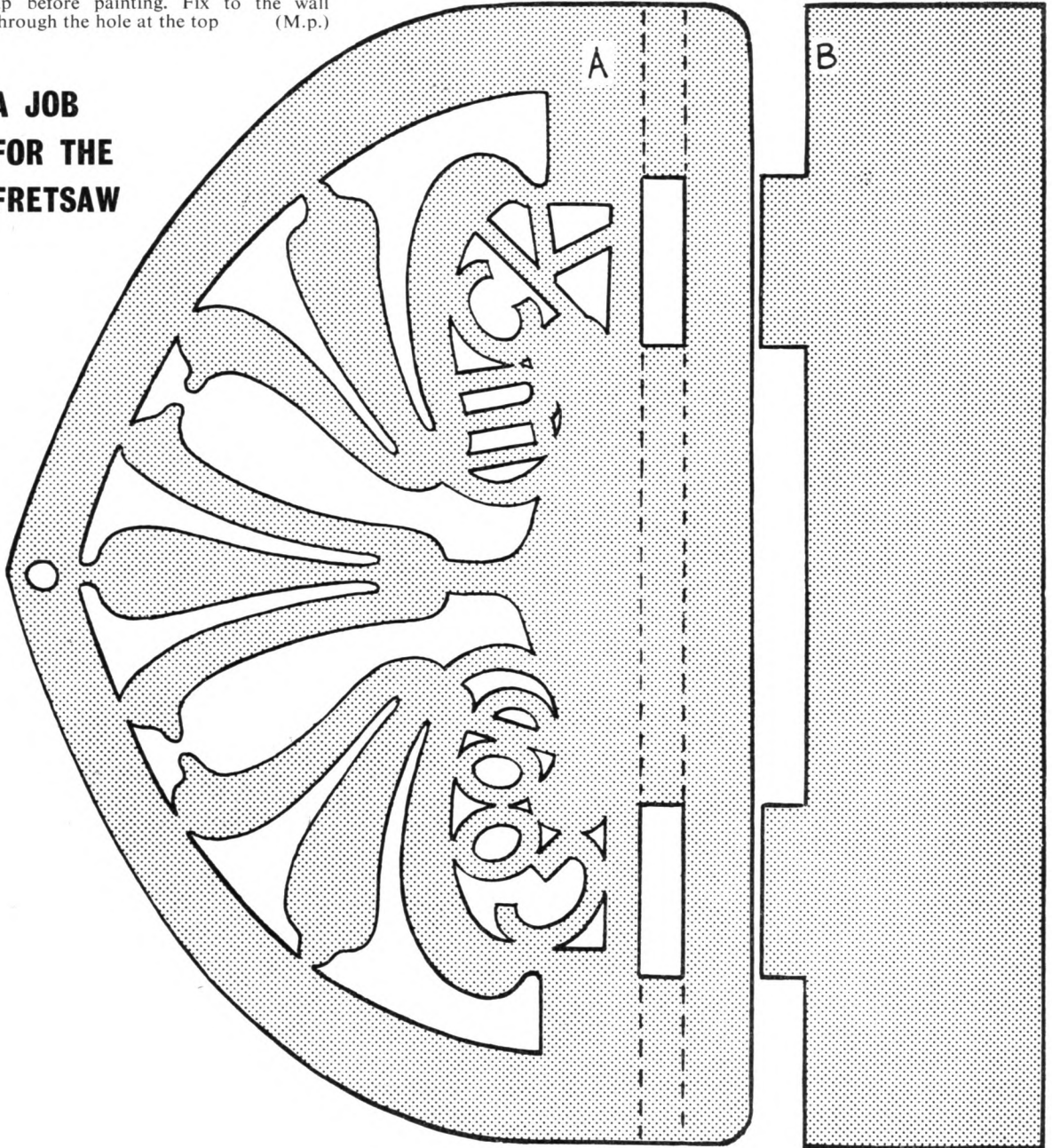

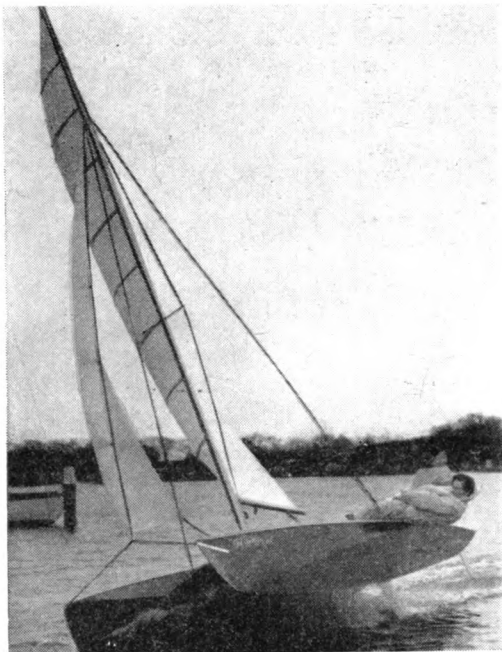

'FLYING CAT' CATAMARAN (Designed by F. M. & J. A. Montgomery)

For high quality and outstanding performance the 'Flying Cat' is one of the best 'buys' in its class.

Its twin hulls are 16 ft. long and it has a beam of 7 ft. 6 in. The draught is 6 in. with plates up and 2 ft. with them down. Carries about 200 sq. ft. of sail on metal mast.

Incorporating many advanced ideas, its most striking feature is the way the hulls are splayed outwards to give an efficient underwater hull shape with one float lifted.

In kit form from **£115** Complete with mast (less sails) **£254 10s.**

Before you decide . . .

. . . you must consider these

**EXCITING
NEW CRAFT** by



HOBBIES RUNABOUT 'ROAMER'

An ideal craft for the family, designed for all waters. Best marine plywood and quality materials. Length 9 ft. 8 in., beam 4 ft. 2 in. Weight (without motor) 130 lb. Car rack transportation.

Complete (without motor) **£88 10s.** Kit (with plans, etc.) **£52 10s.**



HOBBIES RUNABOUT 'ZIP'

Designed especially for the beginner, as an inexpensive introduction to the water. Skinned with oil-tempered hardboard and suitable for a small h.p. outboard engine. Will carry an adult and one or two children. Length 7 ft. 8½ in., beam 2 ft. 10½ in. Weight (without motor) 80 lb.

Complete kit **£19 19s.** Full size plans **16s. 6d.**

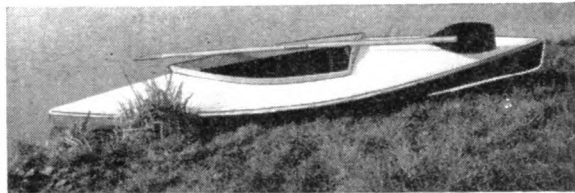

PBK 10 AND PBK 20 CANOES

These famous single-seater and two-seater craft are supplied complete, in kit form, or as full-size plans to build your own.

PBK 10 (single-seater) 11 ft. long, 28 in. beam, load 300 lb. Complete **£24 5s.** Kit **£15 10s.**

PBK 20 (two-seater) 15 ft. long, 32 in. beam, load 700 lb. Complete **£32 10s.** Kit **£22 5s.**

Full details of these craft from Hobbies branches, or from Head Office.

All prices ex-works.

HOBBIES LTD, Dereham, Norfolk

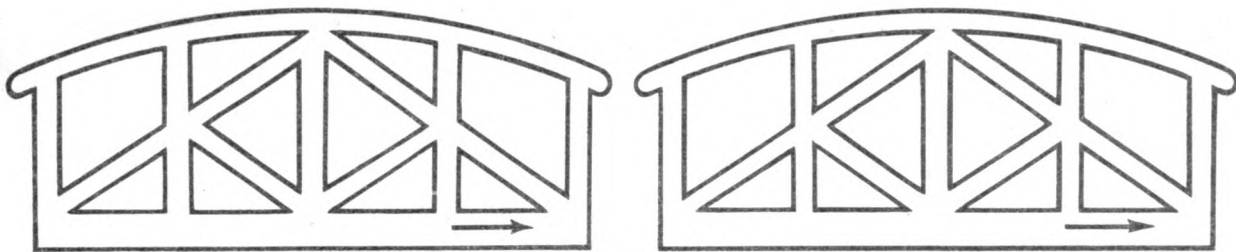
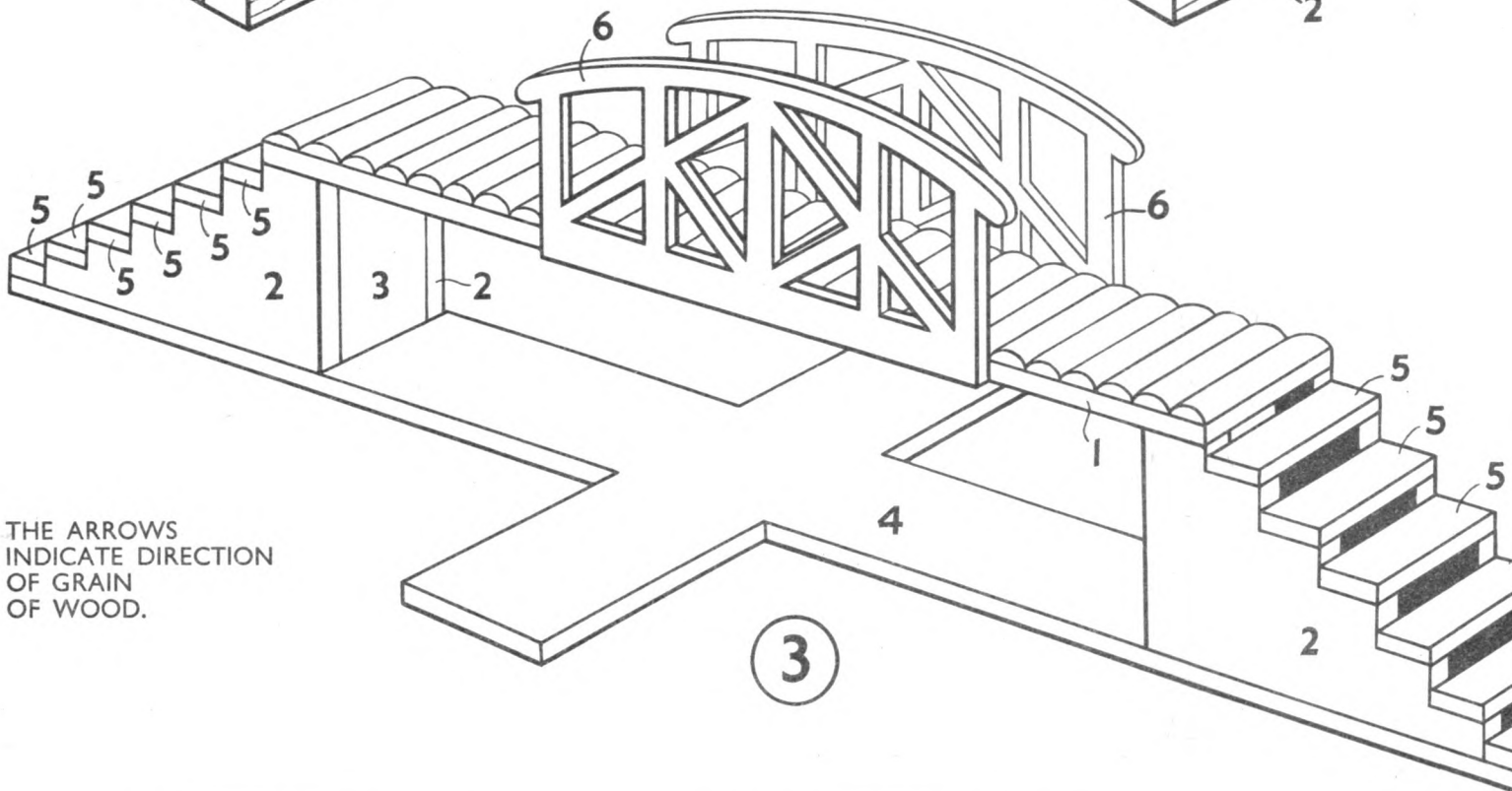
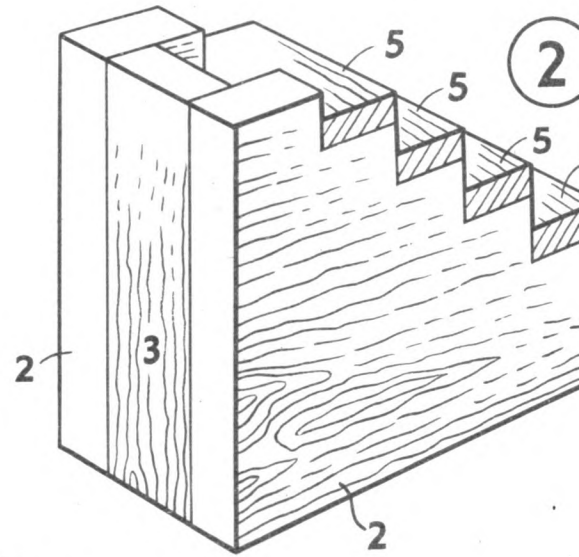
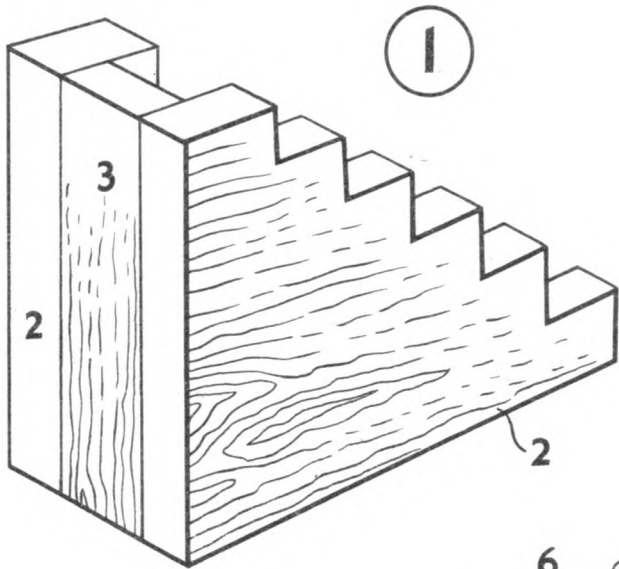

PIECES 6. CUT ONE OF EACH 1/8 in.

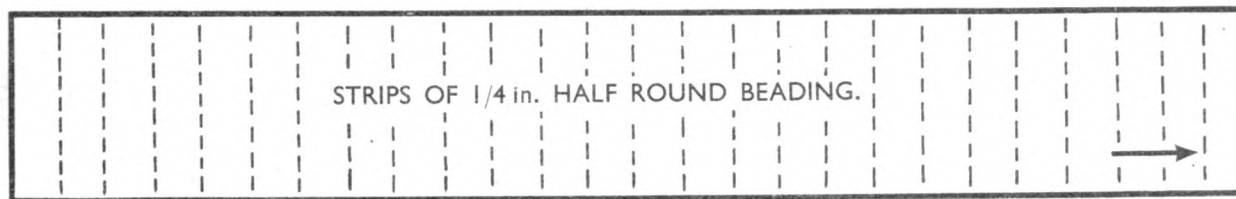

PIECE 1. CUT ONE 1/8 in.

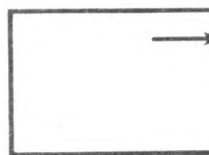
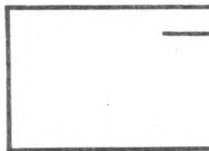

PIECES 3. CUT ONE OF EACH 1/8 in.



THE 'OLD RUSTIC BRIDGE' POSY RING

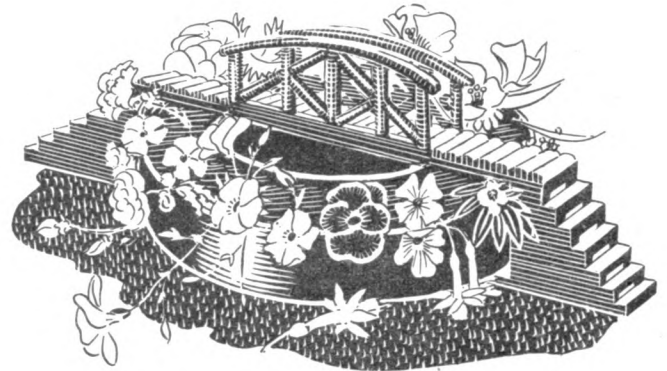

SIZE 9½ ins. WIDE.

A KIT OF MATERIALS FOR MAKING THIS DESIGN IS SUPPLIED BY HOBBIES LIMITED, DEREHAM, NORFOLK. PRICE ON APPLICATION.

THE WORLD'S STRONGEST GLUES

Stick it with-

Croid POLYSTIK

A white P.V.A. adhesive, clean to use, non-staining, fast-drying and strong. For joinery and cabinet work. In easy-spread polythene bottle: 2/6d and 5/-.

BUY CROID FROM YOUR LOCAL HOBBIES BRANCH

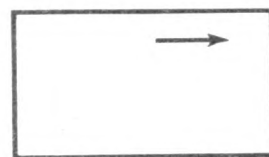
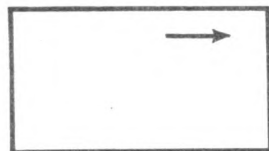
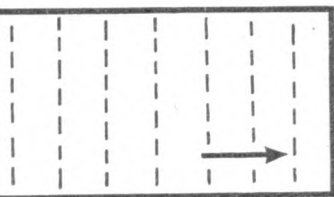
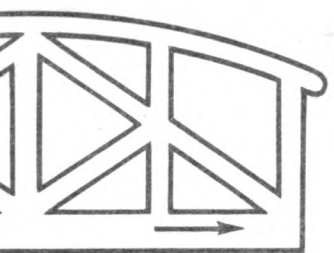
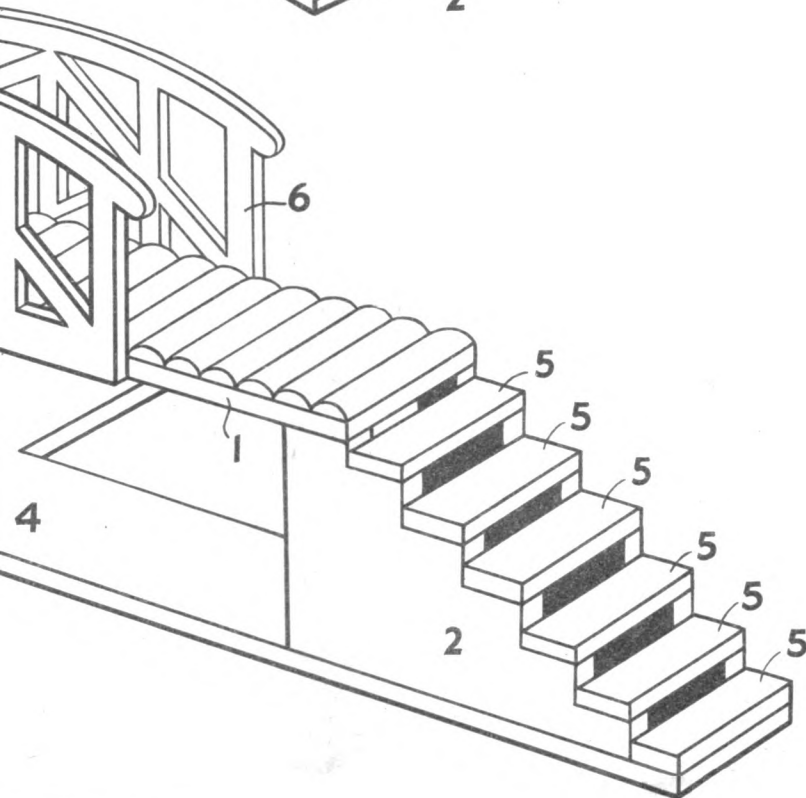
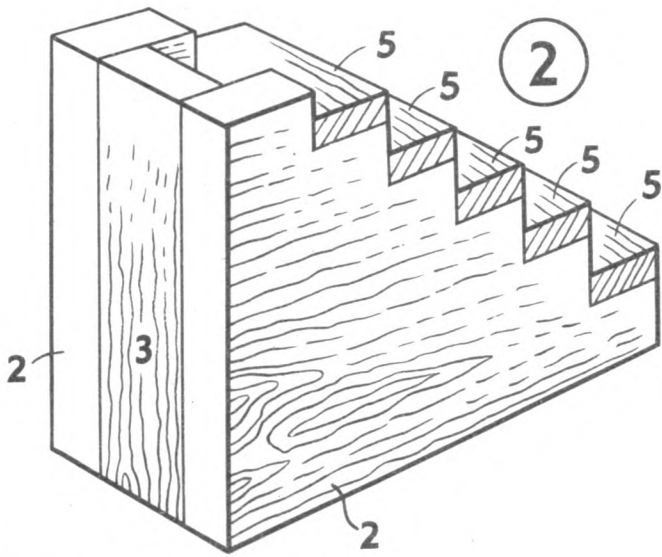

PIECES 3.
CUT ONE OF EACH
1/8 in.

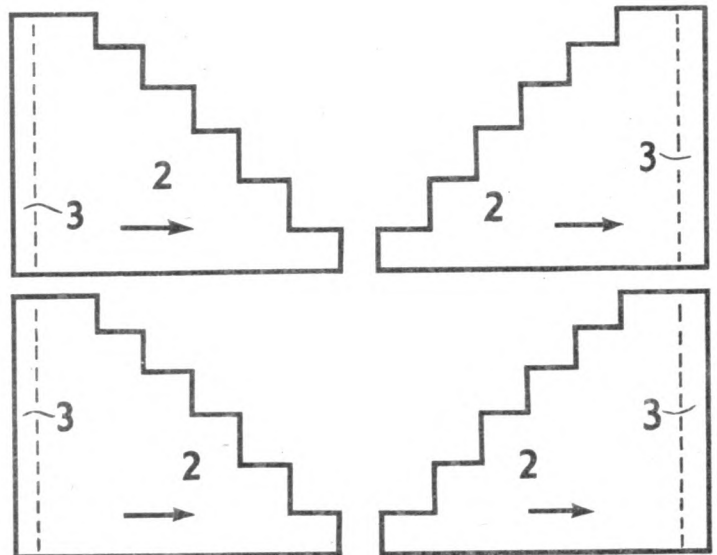

SIDES OF STEP 2. CUT ONE OF EACH 1/8 in.

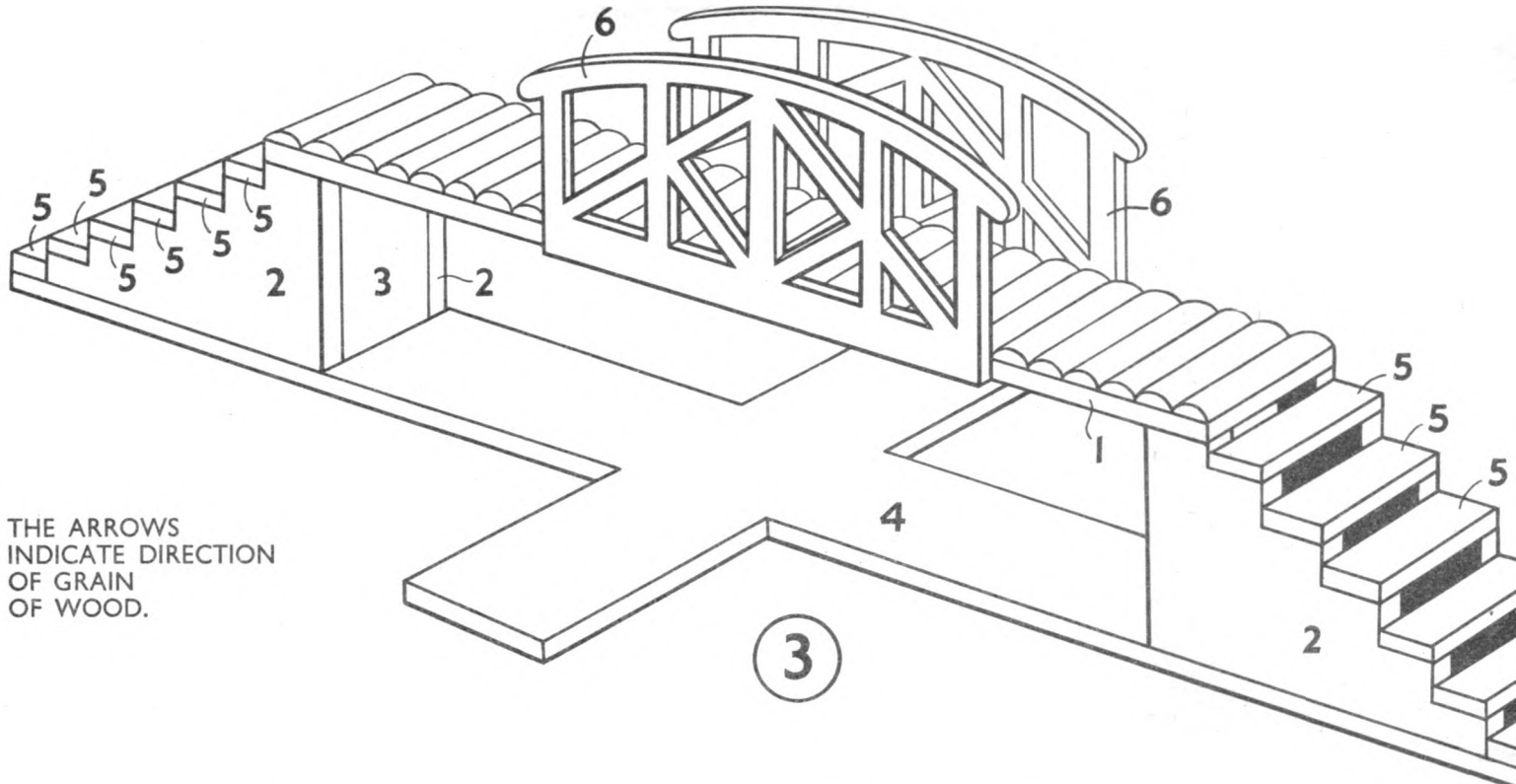

THE ARROWS INDICATE DIRECTION OF GRAIN OF WOOD.

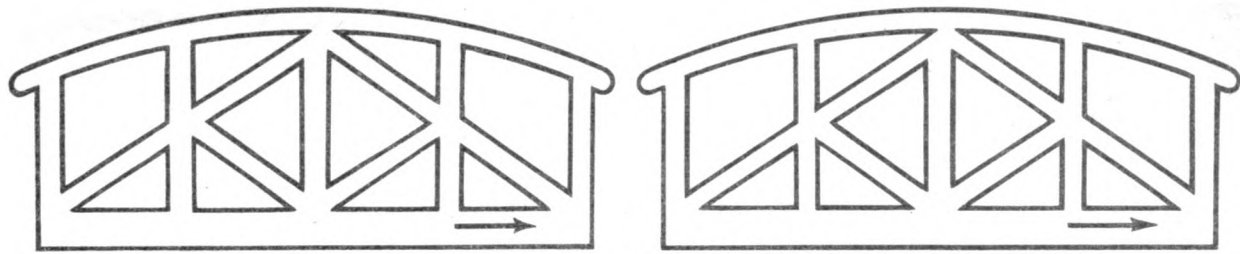

PIECES 6. CUT ONE OF EACH 1/8 in.

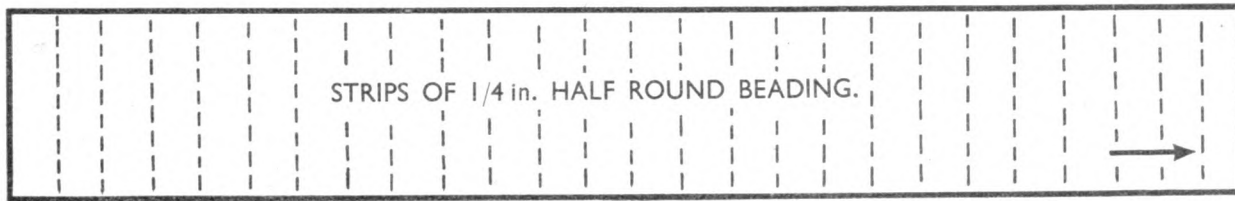

STRIPS OF 1/4 in. HALF ROUND BEADING.

PIECE 1. CUT ONE 1/8 in.

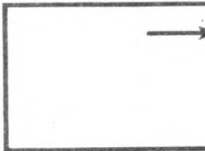
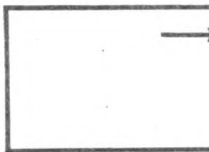

PIECES 3. CUT ONE OF EACH 1/8 in.

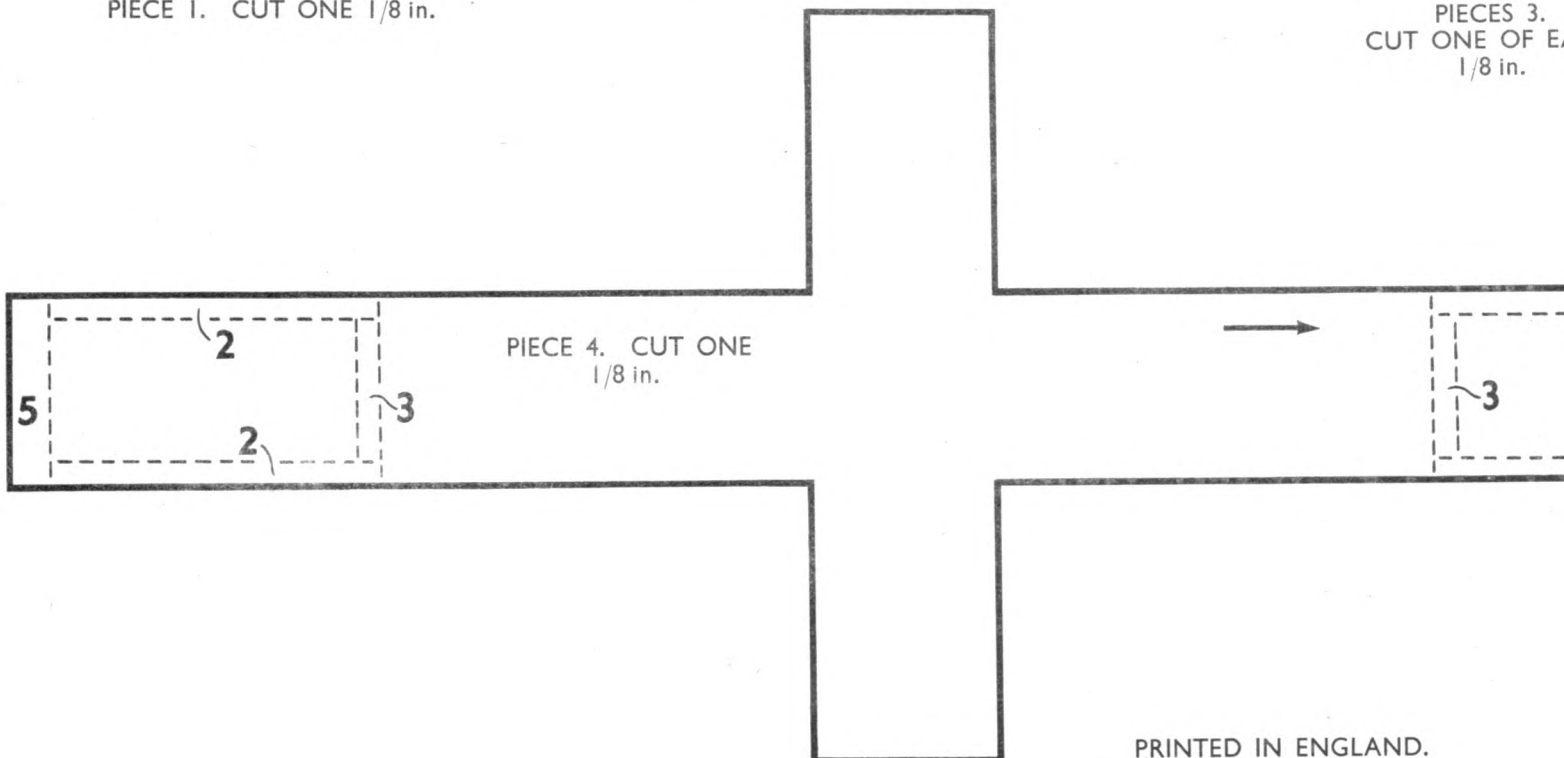

PIECE 4. CUT ONE 1/8 in.

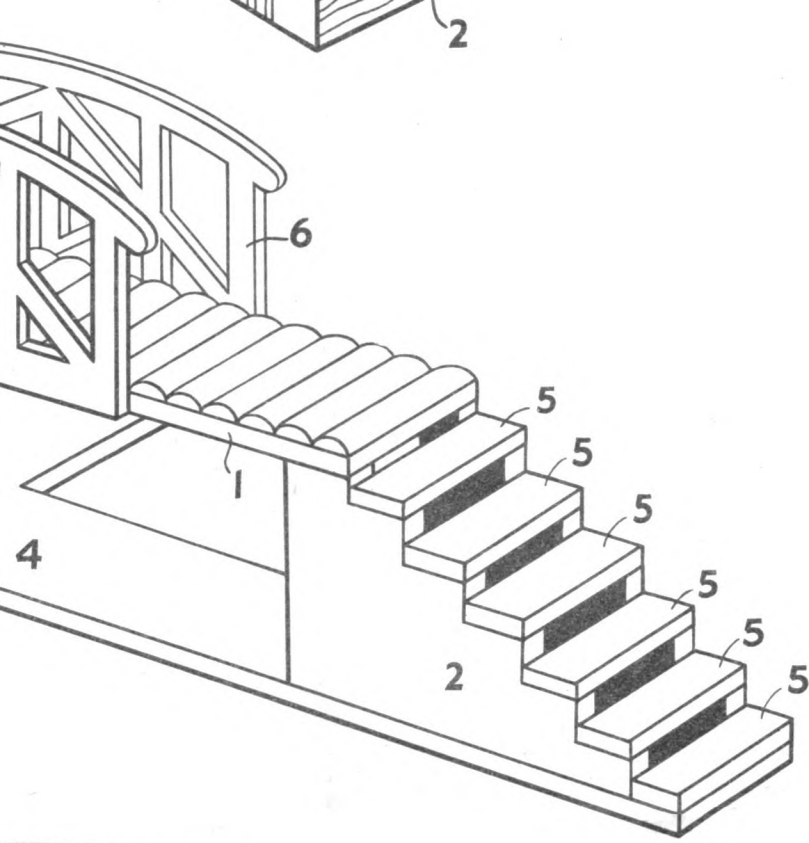

SIZE 9½ ins. WIDE.

A KIT OF MATERIALS FOR MAKING THIS DESIGN IS SUPPLIED BY HOBBIES LIMITED, DEREHAM, NORFOLK. PRICE ON APPLICATION.

THE WORLD'S STRONGEST GLUES



A white P.V.A. adhesive, clean to use, non-staining, fast-drying and strong. For joinery and cabinet work. In easy-spread polythene bottle: 2/6d and 5/-.

BUY CROID FROM YOUR LOCAL HOBBIES BRANCH

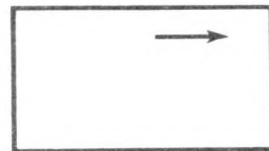
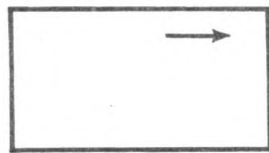
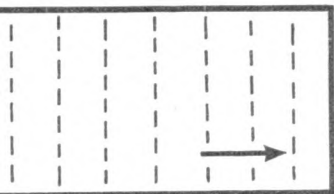
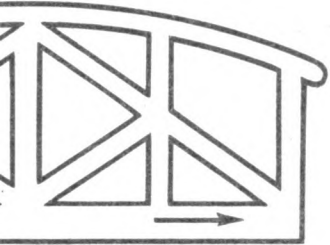

PIECES 3.
CUT ONE OF EACH
1/8 in.

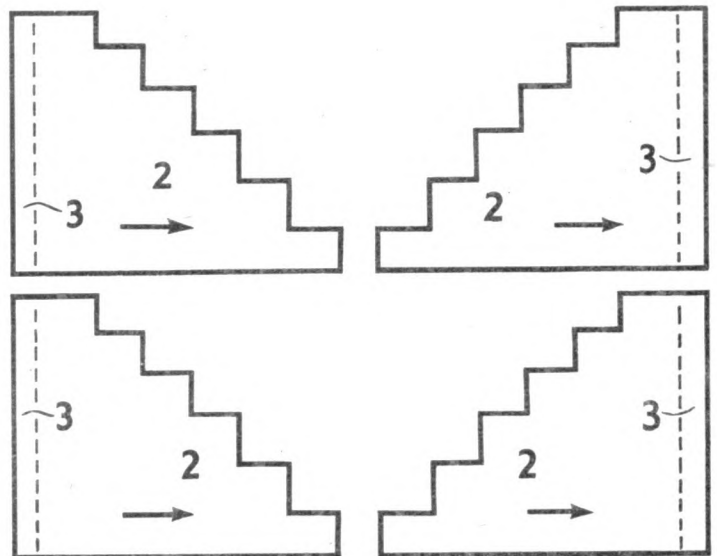

SIDES OF STEP 2. CUT ONE OF EACH 1/8 in.

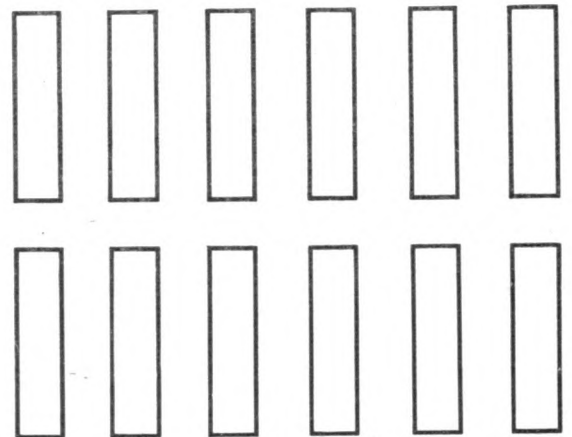
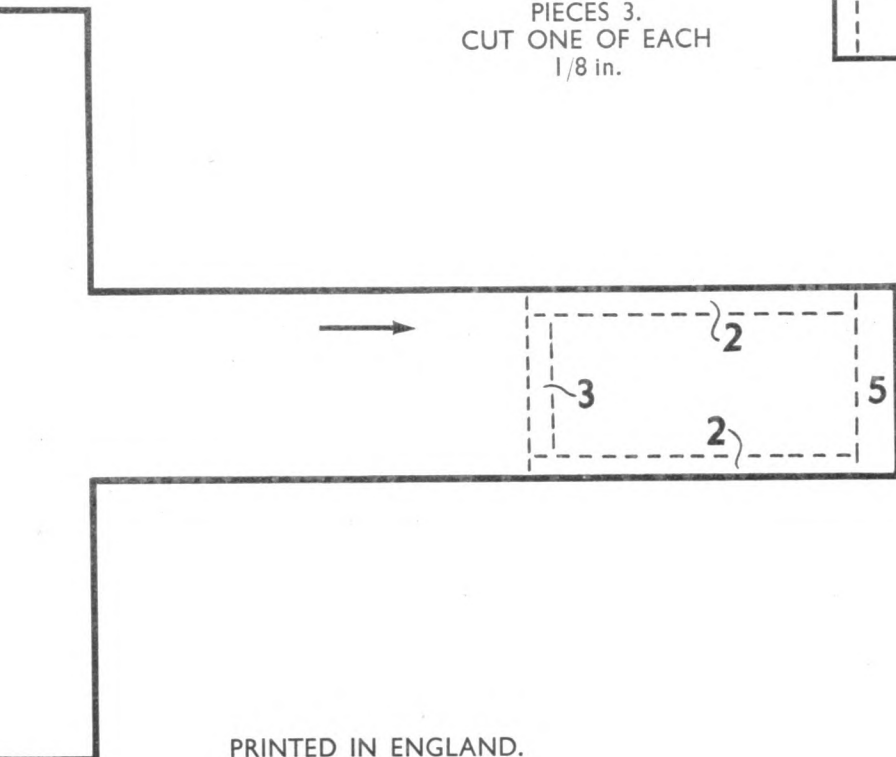

PIECES 5. CUT ONE OF EACH 1/8 in.

18th JANUARY 1961

VOL. 131

NUMBER 3397

THE ORIGINAL
'DO-IT-YOURSELF'
MAGAZINE

HOBBIES *weekly*

FOR ALL
HOME CRAFTSMEN

DETAILS FOR MAKING **ELECTRIC POKER MACHINE**

Also in this issue:

PATTERNS FOR A
FLORAL FANTASY

COLLECTORS' CLUB

A 'WISHING WELL'
ROCK GARDEN

A DARKROOM
FOR PHOTOGRAPHY

CANAL FOR
MODEL LAYOUTS

RECIPES FOR QUICK-
MATURING WINES

READERS' REPLIES

ETC. ETC.

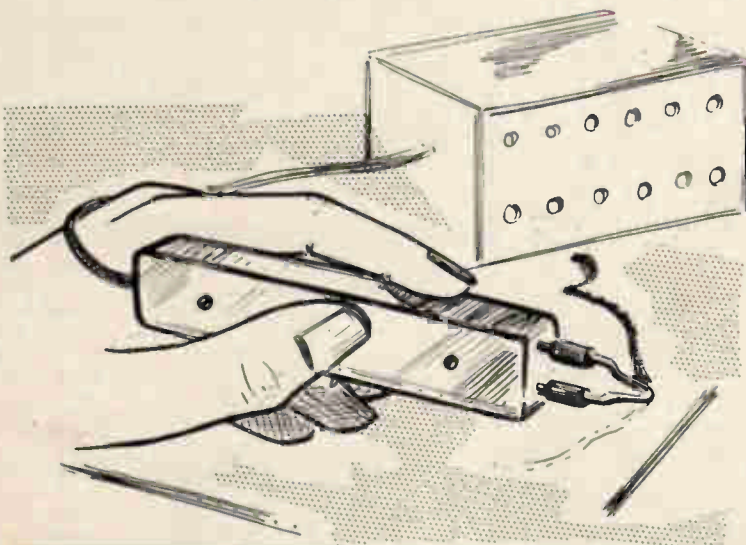

COMPLETING HOBBIES 'ZIP'



Up-to-the-minute Ideas

Practical designs

Pleasant and profitable things to make

5^D



ABOUT a month after the first Zeppelin dropped bombs on London, Mauritius issued a match label depicting one of these cigar-shaped airships. That was in 1915, during World War I, when the cry 'The Zepps are here!' made people tremble with fear.

ing that in 1490 da Vinci made designs for a helicopter. He appears on 1938 Italy issues, and on the 1952 commemorative on the 500th anniversary of his birth. In 1951, Italy issued a 20 lire stamp showing a helicopter over the da Vinci Heliport.

In 1935, Spain issued a 2 peseta stamp

'Correo Español Tanger' for use in the International City of Tangier.

In March 1936, a set issued by Spain for its national press association used the autogiro over the Casa de Nazareth home for disabled newspapermen.

In observance of the 75th anniversary of the Universal Postal Union, Lebanon issued two stamps on August 16th 1949, which show a helicopter over the Cedars of Lebanon.

Belgium issued a semi-postal in 1950 which shows a helicopter leaving the airport; the surtax for the national aeronautical committee.

Monaco joined the parade in 1954 with a 1 franc triangular postage due stamp showing a U.S. Navy Sikorsky helicopter.

Hurricane Hazel, in its sweep across

HELICOPTERS AND AUTOGIROS

Count Von Zeppelin, who designed these airships, had many disappointments. War Zeppelins could fly long distances but were defenceless. They proved of little military value.

In the past few years there has developed a great deal of interest in autogiro and helicopter flight stamps and covers. Most of these flights are of recent origin. And since transportation of mail by helicopter is in its infancy, there is opportunity to specialize.

Even Leonardo da Vinci is associated with the helicopter, his original manuscript 'Codex Atlanticus' preserved in the Ambrosian Library in Milan, show-



to commemorate the invention of the autogiro by Juan de la Cierva. The design shows an autogiro over Seville. Several perforation varieties are known, and in 1938 it was re-engraved. On several occasions it was overprinted



Haiti, caused considerable damage. And helicopters were used extensively for rescue work. In 1955, ten postal tax stamps were issued by that country. One of the designs depicted a helicopter inspecting the hurricane damage.

Obsolete

THE term 'obsolete' applies to a stamp or label which is no longer in use. For example, the illustration shows the Cape triangular of 1853. This stamp is no longer sold by the post office, therefore, it is obsolete — its present value is £25.



This cover was issued to mark the centenary of Westland Province, New Zealand. The stamps pay tribute to the founders of Westland — the Explorer (2d), the Gold Digger (3d), and the Pioneer Woman (8d). It was received from Mr Murray Scott.



Jubilee points

AUSTRALIAN Silver Jubilee stamps of 1935 did not show Windsor Castle. The design chosen depicted King George V on horseback. Aden did not issue stamps until 1937. So there were no Jubilee issues.

COMPLETING HOBBIES 'ZIP'

TO prepare for the decking, rails of 1 in. by $\frac{1}{2}$ in. strip are fixed round inside the gunwales. They should be 1 in. from the gunwales and fixed by means of 2 in. blocks of 1 in. square stripwood as seen in the broken-away diagram in Fig. 12. Note the arrangement too, of the covers at the stern. Supports are made from 1 in. by $\frac{1}{2}$ in. strip and 1 in. square blocks.

Commence skinning at the bow, then the side strips, and finally the stern. Use glue throughout and screw down to the gunwales, rails, deck supports, etc, using $\frac{3}{8}$ in. countersunk brass screws. Narrow strips should also be fixed across the top of the seat backs and supports to make a neat finish.

The small well at the back may be used for a buoyancy bag. A cover plate could be made from waste plywood to fit over the well opening. It should, of course, be made to suit the particular motor used.

The motor can be reached from the front seat to operate controls, but it is recommended that steering should be by means of a wheel at the front. This gives a comfortable driving position and a much better balance to the boat.

The steering arrangement is by means of a wheel, which, when turned, operates a length of Bowden cable running along the sides of the boat to the motor at the stern. The wheel works on a bolt which runs through a length of metal tubing

When launching in shallow water, ensure that the propeller does not foul the bottom



inserted into the dashboard. The dashboard, wheel, bolt, tube, and general arrangement are shown in Fig. 13. The section in Fig. 14 also helps to show the assembly.

The wheel is made from three pieces of $\frac{3}{8}$ in. plywood glued together and shaped. It will be found more convenient if the two rims are rounded before gluing in place. The large pulley which controls the cable is made up from four pieces.

SOME GENERAL SAFETY PRECAUTIONS

We have indicated some of the precautions to take when using this craft, particularly about keeping to safe waters and providing buoyancy by way of sealed tanks or bags.

It is always also advisable to take with you some means of propulsion in case the motor should give up, and paddles are recommended.

Obviously you should keep your motor in good running order at all times, to limit the possibilities of any trouble in that direction.

When boarding the boat or changing seats, keep low and in the centre — do not fool about. Know your boat and its limitations. Do not overload it.

When fixing the motor make sure you are in deep enough water so that the propeller does not ground.

Avoid abrupt, sharp turns that put a strain on the boat, its engine, and the passengers. With a shifting 'load' the balance of the boat is easily upset.

If you are on the sea and it gets rough, head into the waves to avoid swamping.

At all times be on the lookout for swimmers. When coming into the bank, draw gently alongside and avoid unnecessary bumping.

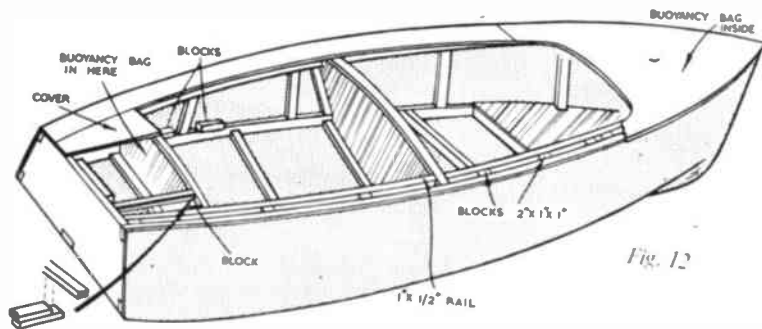

Fig. 12

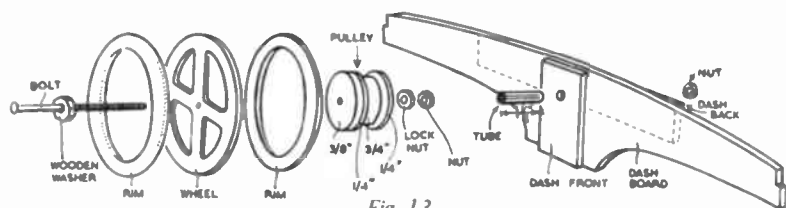

Fig. 13

Two are $\frac{1}{2}$ in. thick (plywood), one $\frac{3}{8}$ in. (plywood), and one $\frac{3}{4}$ in. glued together as shown. All are shown with measurements in Fig. 15.

The dashboard is formed of three pieces (Fig. 16), of $\frac{3}{8}$ in. wood glued together to give extra strength. They are drilled to take a $1\frac{1}{2}$ in. length of $\frac{3}{8}$ in. metal tubing. The 5 in. bolt is inserted through the wheel and dashboard as shown in Fig. 13. Fix the wheel to the pulley by means of glue and screws. The washer shown in Fig. 15. is cut from $\frac{3}{8}$ in. plywood.

The inner cable is looped round the

pulley and fixed at the sides with two small staples or nails bent over (Fig. 17). The pieces of outer cable are now threaded on and are supported at convenient positions by screw eyes to which the cable is bound and glued to prevent movement. The cable passes along the sides, through the seat backs, to the stern of the boat. The method of fixing to the motor will of course be a matter of improvisation, depending upon the type of motor employed.

The screen is cut from $\frac{1}{2}$ in. clear Perspex, using a fretsaw, to the size shown in Fig. 15. Keep the saw and Perspex well lubricated with oil when cutting. Holes should be drilled and

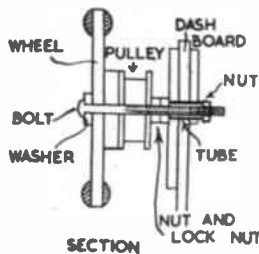

Fig. 14

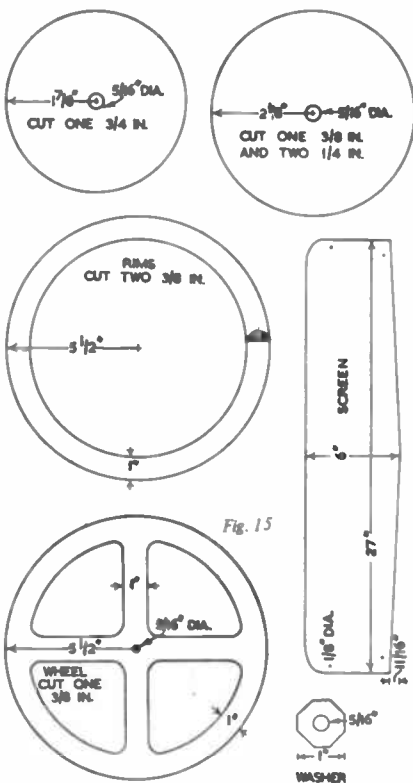

Fig. 15

countersunk ready for fixing to the screen supports. These are cut from $\frac{3}{4}$ in. wood to the sizes indicated in Fig. 18. Note that the smallest support goes in the centre and the large ones on the outside. The latter are chamfered to the section shown and should conform to the slope of the screen which is bent round in a gentle curve. Supports are screwed to the deck to facilitate removal if necessary.

Finish off the boat by adding the keel and rubbing strips. The keel consists of two pieces of 1 in. by $\frac{1}{2}$ in. stripwood laid side by side with a rubbing strip of $\frac{3}{8}$ in. diameter half-round beading pinned and glued over the top as shown by the section in Fig. 19. The keel pieces should be about 6 ft. long and taper off to a feather edge towards the stem. The keel stops short about level with the first pair of floor battens. The rubbing strip, which should be made from two pieces, is bent carefully round the stem. It may be

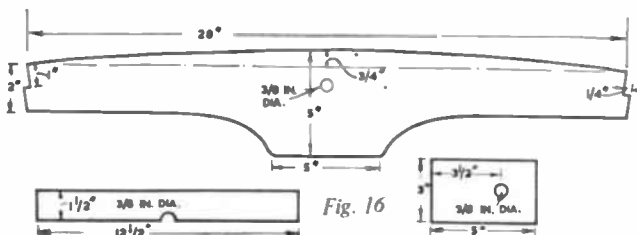

Fig. 16

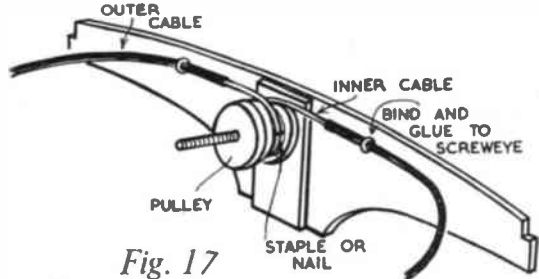

Fig. 17

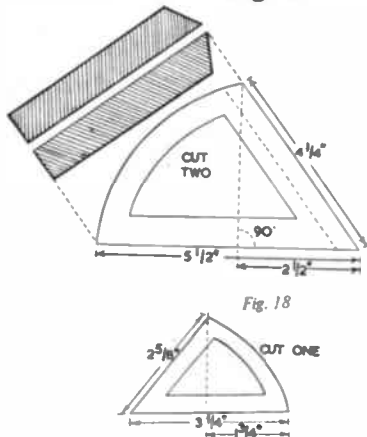

Fig. 18

★★★★★★★★★★★★★★★★★★★★
 ★ Hobbies Ltd. supply a complete kit ★
 ★ of materials for building 'Zip' as ★
 ★ detailed in the materials list. Also ★
 ★ included is a set of full-size plans ★
 ★ at an inclusive cost of £19. 19. 0. ★
 ★ Kits are obtainable from branches, ★
 ★ etc., or from Hobbies Ltd., ★
 ★ Dereham, Norfolk. ★
 ★ 'ZIP' BOAT KIT ★
 ★ Cash price £19. 19. 0 (plus 30/- ★
 ★ part carriage and packing) ★
 ★ EASY PAYMENT TERMS. ★
 ★ £5 down (plus 30/- part carriage ★
 ★ and packing) and 6 monthly pay- ★
 ★ ments of £2. 13. 0. ★
 ★ Total E.P. price £20. 18. 0 (plus ★
 ★ 30/- part carriage and packing). ★
 ★ ★
 ★ Full-size plans separately 16/6 ★
 ★ (post 9d. extra) ★
 ★ ★★★★★★★★★★★★★★★★★★★★★★

helped by the use of cloths soaked in hot water. It can be helped further by making transverse cuts on the underside with a tenon saw to a depth of about $\frac{1}{4}$ in. or even $\frac{1}{2}$ in.

The bottom rubbing strips are of 1 in. by $\frac{1}{2}$ in. stripwood and are about the same length as the keel. They also taper off at the front and are curved to conform to the shape of the sides. The rubbing strips on the sides are of $\frac{3}{8}$ in. half-round beading glued and screwed in place. The section in Fig. 19 shows rubbing strips and keel.

All parts are now thoroughly cleaned up with coarse and then fine glasspaper. All joints are carefully inspected and filled with waterproof glue where they appear weak. All holes are filled with

waterproof stopping and any open grain similarly filled.

Parts to be painted, such as interior, and exterior hardboard parts, keel, rubbing strips, etc, should be given two flat undercoats of good quality paint and lightly rubbed down with silicon carbide paper, used wet. Wipe down carefully and apply one finishing coat of high-gloss enamel. Leave to dry for 48 hours and lightly rub down with silicon carbide paper, again used wet.

A final top coat in dust-free conditions will give an excellent finish. Of course it must be remembered that the hardboard surface inside the boat is rough and will

not give a perfectly smooth appearance. It need not, therefore, be rubbed down before painting.

All the plywood parts should be varnished to give a pleasing high-gloss finish. They will need two or three coats and each coat should be allowed to harden, and should be rubbed down before applying the next coat. Silicon carbide should, of course, be used for rubbing down.

It will be best to use marine grade paint and varnish, but since the boat is intended to be removed from the water immediately after use, any good quality exterior paint may be used. (M.h.)

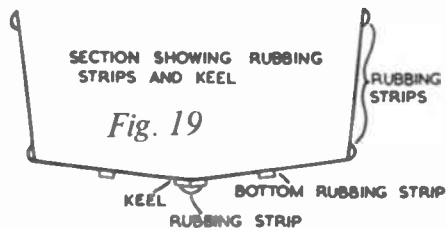

Engine control can be maintained while steering from the front seat

How to make Changeable Portraits

A POPULAR children's pastime of the last century was the composition of grotesque and fantastic portraits made up of unrelated heads, bodies, and feet. One such game was called 'Changeable Portraits of Ladies' and this comprised a set of delicately coloured caricatures of splendidly attired aristocratic ladies. Each picture was cut into three pieces and the drawings were so arranged that, when any series of head, body, and legs was placed together, a different and highly enter-

taining portrait resulted. A similar game, of continental origin, can be seen in a cabinet of Victorian toys at Blaise Castle Folk Museum, near Bristol. This example bears the imposing title of 'Metamorphenspiel'.

By A. E. Ward

It is great fun and not at all difficult to make up a modern version of the toy, in the form of a little book, which will give much pleasure and entertainment to a youngster. You will need half a dozen sheets of good quality drawing paper, measuring 6 in. by 3 in., together with a folder type cardboard 'cover' of slightly greater dimensions. Staple the papers on to the 'lower' half of the cover, using three staples placed regularly, to form a book. Cut 2½ in. slits across the drawing paper pages, so that each page is evenly divided into three 2 in. tall rectangular flaps.

Commence to draw full-length portraits of people, birds, or imaginary beasts upon the respective sets of page flaps. You must plan your pictures in such a manner that, when the page flaps are turned to bring together any given selection of head, body, and feet, the various parts will combine neatly to form a weirdly funny character. Artistic

skill is not necessarily an advantage, as badly sketched drawings will often be funnier than more carefully drawn pictures.

The idea has also been applied as a family or party game resembling 'Consequences'. Three or more players are provided with strips of paper which are folded into three equal parts. Each player secretly draws a head before bending over his work and passing on the paper to a neighbour. Next, the players draw bodies upon the papers and, finally, pairs of legs are drawn. At the end of the game, when the papers are opened out, the resulting portraits are sure to be greeted by laughter.

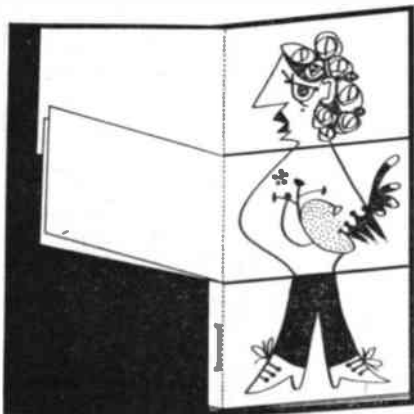

Next week's free plan will be for making a Toy Crossbow. This has been requested by many readers and there is bound to be a big demand for this issue, so—make sure you have a firm order with your newsagent.

ELECTRIC POKER MACHINE

A SPECIAL form of electrically-heated tool can be used for poker-work, or writing and burning designs on white wood. Current may be drawn from A.C. mains, so the machine is very easy to use, once it has been constructed.

By 'Modeller'

The way in which it operates will be clear from Fig. 1, which shows the circuit. The transformer primary is run from the usual 200/250V. mains, and may be wired to a 2-pin or 3-pin plug, to suit the type of socket available in the house. The secondary delivers a high current, at very low voltage, and this is carried by means of a twin flexible lead to the poker. The latter has a shaped wire element, which becomes red hot, and this is employed to burn designs, or write, upon the wood being decorated.

If a 3-pin plug is used, one side of the secondary can be earthed, as in Fig. 1. This prevents mains voltages arising in the poker circuit, even if a short should happen between primary and secondary in the transformer. Such a defect is, however, unlikely, and the poker machine may run without an earth.

Transformer windings

The transformer has a standard 200/250V. primary, but a very low voltage, high current, secondary. This means that some types of ready-made transformers can be used, the secondary being unwound, so that the low voltage secondary can occupy the space thus made available. It is also fairly easy to wind a transformer especially for the job.

When using a ready-made transformer which may be to hand, the output which will be available for the poker may be found by multiplying the existing

watts, and this would be too small.

If an existing transformer is used in this way, the bobbin, stampings, and primary will all be ready. The stampings, which make up the core, should be withdrawn, and the secondary can then be unwound. The primary, and insulation wound upon it, should not be disturbed.

If a transformer is to be wound, it can best be of fairly generous size. It will then need less turns, and there will be plenty of output for the poker. The core is most cheaply obtained by purchasing a surplus transformer or choke. The centre limb of the core should for preference be at least 1 sq. in. in cross-sectional area. That is, the pile of stampings should be about 1 in. thick, and the centre limb of the 'T' stamping should be about 1 in. wide.

When the core is of 1 sq. in. cross-sectional area, the primary can have 1,600 turns for 200/210V., or 1,760 turns for 220/230V., or 1,920 turns for 240/250V. The exact number of turns is not very important, but should lie around these figures. The turns are wound on evenly, side by side. After each layer is completed across the bobbin, a strip of thin paper is put on before beginning the next layer. When the primary is completed, several layers of good quality insulation are put on. The ends of the

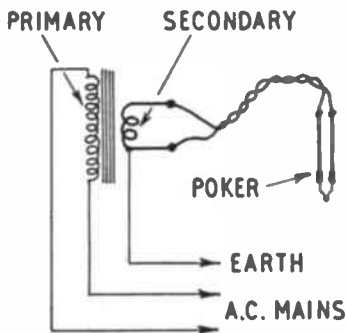

Fig. 1—The Electric Poker circuit

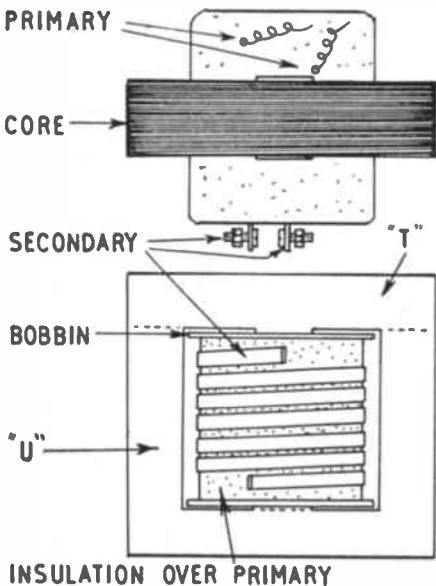

Fig. 2—How the transformer is wound

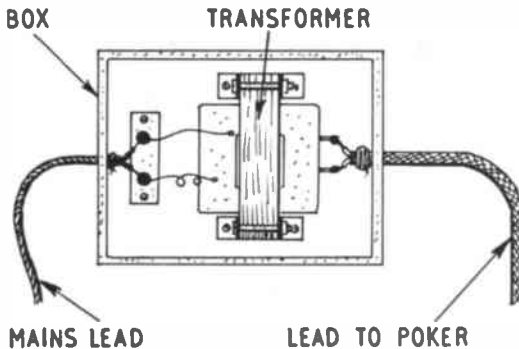

Fig. 3—Box housing and connections

secondary voltage and current together. For example, a 12V. 2 amp transformer would have a secondary output of 12 by 2, or 24 watts. It is wise to allow at least 12 watts for a reasonably large poker, so the transformer could be used. On the other hand, a bell transformer rated at, say, 8V. $\frac{1}{2}$ amp would only have a secondary output of 8 by $\frac{1}{2}$, or 4

primary issue through small holes in one end of the ribbon, as in Fig. 2. Wire of about 30 S.W.G. will be satisfactory.

If the cross-sectional area of the core is not 1 sq. in., find its actual area by measuring the thickness of the pile of stampings and the width of the centre limb of one 'T' piece, and multiplying these figures together. Then divide the number of turns quoted above by the actual cross-sectional area. This gives

the number of turns to use. E.g., if the core is twice as big, there will be only one-half the number of turns. But if the core is smaller than 1 sq. in., there will be more turns.

The secondary should deliver 1 to 2 volts, at 5 to 15 amperes, or thereabouts. The heavier the current available, the hotter and more robust will the poker element be. To obtain a heavy current, without taking up too much space, the secondary is best wound with copper strip. If this is not available, heavy insulated cable can be used, for example, a piece of 15 amp or 30 amp cable such as is employed for mains power wiring in a house.

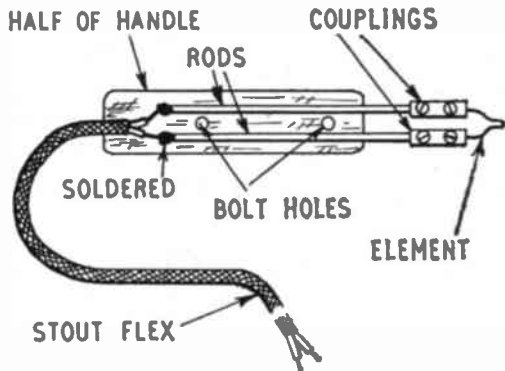

Fig. 4—How the poker is made

Fig. 2 shows the secondary wound with copper strip, with the ends bent out, and fitted with two bolts, for the flexible leads going to the poker.

The number of turns on the secondary again depends on the core size, but some 6 to 8 turns will usually do for a large transformer. If the core is small, 8 to 12 turns may be used.

Stout single strand copper wire may also be used for the secondary, when available. For up to 16 amperes, 9 S.W.G. is suitable. For up to 9 amperes, 12 S.W.G. may be used.

The secondary must be so wound that turns cannot touch each other, or the core. The ends can be secured by binding with thread. When the windings are completed, the stampings are inserted into the bobbin. If an old choke or transformer has been used, the original clamps or bolts may be used to hold the stampings tightly together. Failing this, cut metal brackets a little longer than the height of the transformer, so that they can be used as clamps, as shown in Fig. 3.

The poker

The handle of the poker is made from two similar pieces of wood, clamped to-

gether by means of a pair of nuts and bolts. The wood is grooved to take two rods, positioned as shown in Fig. 4. Two $\frac{1}{4}$ in. thick strips 1 in. wide and about 3 in. long will be convenient.

The flexible lead should be fairly short, and its conductors must be able to carry the necessary current without overheating. A piece of flexible cord of the type used for a 3 kW domestic electrical appliance (e.g., 3-bar fire, boiler, etc) will be satisfactory for currents of 15 amperes or so. After baring the wires, they are soldered to the ends of the rods, as in Fig. 4. The wooden parts of the handle will need to be cut away slightly, to accommodate the soldered joints, and

lead, where it joins the transformer primary connections.

The poker lead is similarly bound to prevent it being pulled away. It is soldered or bolted to the ends of the secondary winding. In use, the transformer box is placed on the work-table, so that a long lead is not required for the poker. This is important, because of the high current, but low voltage, of the secondary circuit. For the same reason it is essential that the joints from secondary to lead, and lead to poker, should be really sound, and of low resistance.

Rows of $\frac{1}{4}$ in. or $\frac{3}{8}$ in. holes in the sides of the box allow ventilation. No switch is fitted, as the machine is plugged into the mains when required.

Poker element

The gauge and length of wire used for the element will largely determine the temperature it reaches. If the element is too thin for the current and voltage actually obtained, it will become extremely red, and soon melt through. But if it is of too stout wire, or too long (so that it is of high resistance) it will not be hot enough to char the wood.

A few experiments should thus be made, to find what length of element suits the transformer output. Resistance wire, of high melting point and about 18 to 22 S.W.G., will be required. The usual 1kW single bar, or fire element, as used in a domestic electric fire, will normally glow red at about 5 amperes, and this wire may be used at about 7 to 9 amperes, in the poker.

With a given gauge of wire, the temperature may be adjusted by varying the length of the element. As the element is made longer, its resistance rises. The current therefore drops, and this results in a lower temperature. Because of this it is not necessary that any exact or particular voltage should be obtained from the transformer.

The tip of the element will normally be at highest temperature, because the couplings conduct heat away. An even higher point temperature can be obtained, if wanted, by slightly filing the element wire here, to make it thinner. Provided the secondary circuit is completely isolated from the primary, as explained, the voltage at the element and couplings will always be so very low that no shock whatever can be experienced by handling them.

The element must operate at high temperature, as it will not stand up to much pressure. As a guide, a slip of paper placed on the tip should ignite.

Small, simple design features, such as a semi-circle, may be repeated by making an element with a small loop at its end. In the same way elements with pointed or flat ends, etc, may be made, so that other decorative work is simplified.

to allow the flexible lead to issue near the top of the handle. The rods themselves can be made from 6 BA screwed rod, or anything similar. The length, size, and kind of metal are not very important.

The two halves of the handle are then bolted together, so as to grip the rods securely. Couplings to hold the element may be taken from a 2-wire connector, such as may be used for joining mains circuits. It is then possible to remove the element by loosening the lower pair of setscrews.

It is also possible to solder the element to the rods. Though the element will become red hot, this will not unsolder the connections, as the rods conduct the heat away. However, it will be necessary to have the element fairly long (so that heat is lost before the solder is reached), and this is less easy to handle.

The transformer should be mounted in a box, as shown in Fig. 3, so that the mains voltage (primary) connections cannot be touched. For the mains lead, ordinary 5 amp twin or 3-core flex can be used. This lead may be of any length, as the current is small. If the lead is taken to a 13 amp plug, a 3 amp fuse may be inserted in the plug. Bind the flex with glued string, to avoid it being pulled loose. Two terminals, on a strip of Paxolin, form anchor points for the mains

Designs Designing

HAVING explained the basic details of designing and the tools required, along with some descriptions of the basic shapes, we are now concerned with the practical application.

When it has been decided that some object requires additional decorative treatment by means of a picture or pattern we first consider whether the ornament should be round, oblong, or square. Very often this is decided by the object itself, when we can proceed to sketch something suitable.

By S. H. Longbottom
(PART III)

It will be found advisable to measure the object and prepare a basic plan, dividing the shape into squares after doubling the measurements. This permits greater latitude and less strain on the eyes. Reduction for the actual object is achieved by scaling down the size of the squares and tracing on to the object after completion.

This method of squaring is exceptionally useful for either reduction or enlarging and your squares may be made to fit any convenient size. For example, one design may be used for different objects unequal in size, if the squares are adjusted to meet the requirements one way or the other. In Fig. 11 we show how we square off the original drawing of a horse's head. By copying the design on reduced sizes of squares it will be correspondingly reduced. All you have to do is to copy the curve and position of the head in, say, square 2 of the original to square 2 of the copy and so on. On completing the copy you will have an exact but smaller replica of the original.

Transferring your designs to the work is another matter but do not worry for we have several simple ways at our disposal, each suitable for different types of work.

A familiar method is to make a tracing on transparent paper rubbing the back with pencil. The tracing is then laid on the object and the outline retraced with a pencil, leaving an impression on the

object underneath. This method has the advantage that you can see the correct position of the transfer. A very similar method is to place a piece of carbon paper between the design and the object, tracing the outline as before, but this sometimes smudges other parts of the work unless care is taken.

Another easy method is to perforate the original design with a needle or pin. The tracing is then attached to the work and powder of some kind rubbed through the perforations with a cloth. The advantages of this method will be best appreciated when dealing with a dark object, for example, black painted tinware. Powdered lead pencil is suitable for light objects but some care is needed to protect the design while working and after preliminary application it is sometimes advisable to strengthen the outline with a lead or white pencil.

We also have the advantage of being

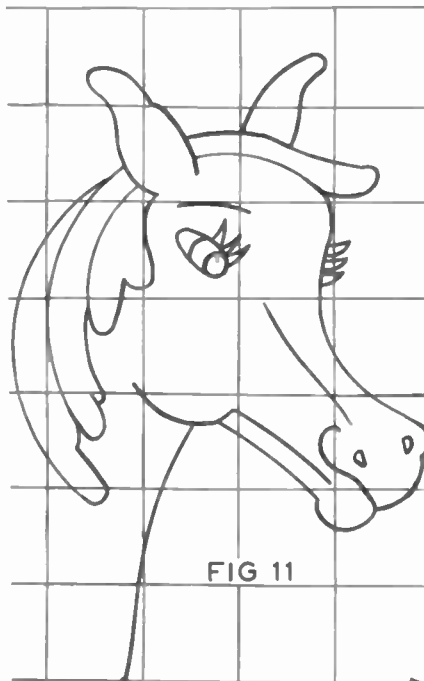

FIG 11

able to prepare stencils which are more useful when dealing with repetition work or repeating designs on borders. The necessity also arises when decorating walls, fabrics, furniture, and other novelties. Some simple examples of border treatment are shown in Fig. 12 where it will be seen that in some cases the basic motif is reversible.

The prepared design is transferred on to oiled stencil paper by one of the aforementioned methods, before cutting. It is advisable to work on a hard surface — glass is ideal — with a hard pencil to produce clean lines. Cut along the lines with a sharp stencil knife or razor blade,

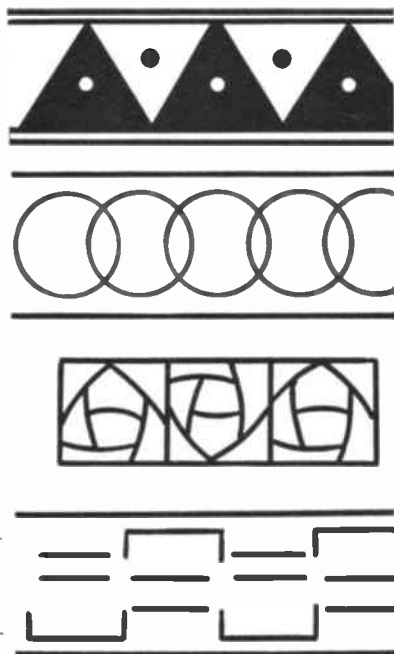

FIG 12

remove the centre, and the stencil is ready. We must mention however, that whenever more than one colour is involved in the final stages of painting it is necessary to prepare a separate stencil for each colour.

Again, we have to consider the material and the shape of the object being decorated, and we must make our stencils accordingly. Oiled stencil paper is suitable for all flat objects but when confronted with a round object, like a vase or canister, it is advisable to work with a good quality linen as used by architects for making plans, or aluminium foil as used for cooking.

The preparation of masks is also a suitable method of transferring patterns.

● **Continued on page 277**

'WISHING WELL' ROCK GARDEN

A ROCK garden in the form of an old well makes an attractive feature.

If the well is to be placed on a hard surface, such as a concrete path, no foundation is needed, but if the ground is soft, make a foundation as follows.

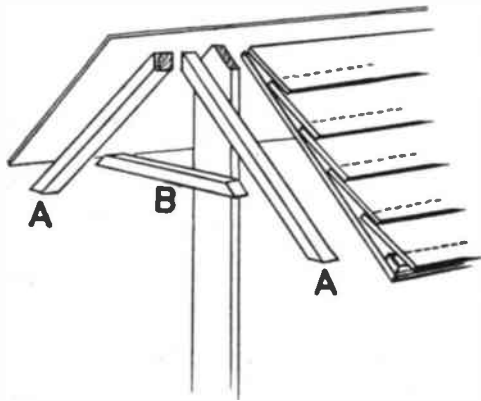
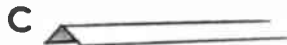

Mark out a 3 ft. diameter circle, and dig out a trench 6 in. wide and 6 in. deep inside the marked circle. Fill this with concrete. A 3:1 sand and cement mixture with an equal volume of small stones will do for this, or a mix can be bought ready for use.

The next step is the building of the wall. This is made of random stone of any kind; the stones may be rounded, or have sharp edges, but the two kinds should not be mixed. The stones should vary in size, but it is best to avoid ones smaller than a half-brick.

The stones are laid with a generous layer of concrete, about 1/2 in. to 1 in. thick, between each stone. Use a fairly stiff concrete mixture made of 2 parts sand to 1 of cement, and wipe the joints with a ball of rag to get a rounded recessed finish which throws the stones into relief. An 18 in. wall will generally be high enough for most gardens. Drainage gaps should be left at the bottom of the wall if it is built on an impervious surface such as concrete.

The uprights for the roof are made from two 4 ft. lengths of 2 in. by 1 in. wood. These are first placed in position inside the wall and the distance between them noted. Next, the triangular end supports are made from 1 in. by 1 in. wood. The two side pieces at each end (A) are 12 in. long, and the cross piece (B) 10 in. long. The ends of the uprights and supports are cut as shown at 45°, and they are then screwed together.

Two pieces of hardboard or 3-ply wood, 3 ft. by 1 foot, form the sides of the roof. They are screwed to the A-shaped supports at the top of the uprights. These should be the correct distance apart (previously measured) to fit inside the wall.

The roof is covered on each side by six 3 ft. long strips of hardboard or plywood. Five of the strips are 2 1/4 in. wide, and the top one is 2 in. wide. Before they are put in place, a 1/2 in. wide strip is tacked along the lower edge of the roof. The strips are then tacked in place at the bottom, overlapping each

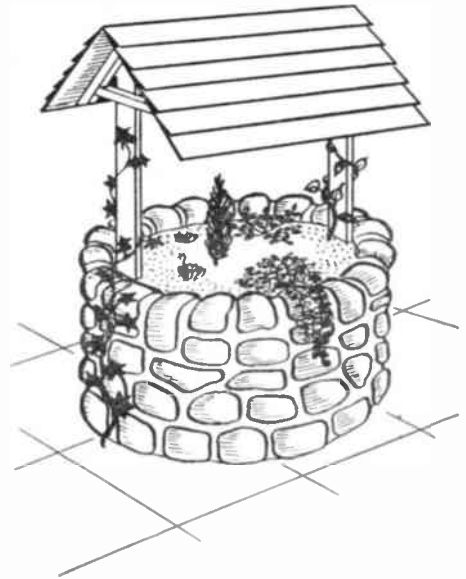

strip by 1/4 in., and finishing off with the 2 in. wide top strip at the apex. A 3 ft. length of angled plastic edging strip (C) is fixed along the ridge of the roof with waterproof adhesive.

Lastly, the wooden parts are painted. Avoid bright colours, which will spoil the whole effect. Paint the woodwork grey or white, and the roof a chocolate colour. Place the roof assembly in position, and fill the bottom 6 in. of the well with stones for drainage, and also to hold the uprights in position until the soil is filled in. As well as plants, an opaque plastic bowl may be sunk in the earth and filled with water, its edges hidden by trailing plants. (A.L.)

● Continued from page 276

DESIGNS AND DESIGNING

A shape is cut out to size from durable material, when it can be laid on the work and a pencil traced round the outline.

While the preparation of stencil or design is proceeding there is nothing to prevent progress with the other processes. Basic coats of paint can be applied and allowed to dry and in most cases at least 24 hours must be allowed for each coat of flat paint. During this time you may be preparing masks or stencils.

On occasion you may decide to incorporate a border consisting of motifs — already designed — between striped lines. This can be a tedious job and presents quite a problem for the amateur. A much easier way is to first apply lengths of decorator's masking tape, leaving a suitable space between for the lines. Apply the paint between the strips

and when dry the tape is peeled away and the remainder of the design added.

We have endeavoured to illustrate the easiest methods of designing motifs and free sketches for every type of craftwork. These methods are suitable for every type of decorative handicraft, such as fretwork, furniture, toys, glassware, textile painting, wall decoration, tiles, pottery, and so forth. We would repeat that the basic shapes we mentioned in an earlier article can be adapted to meet any eventuality if only a little thought is applied. A few experiments will quickly reveal the truth of these contentions and give you added pleasure with your hobby.

There remains one other aspect of designing and that is the effect of colour. In our next article we will show different methods of applying colour to your designs.

"WOODLAND FANTASY"

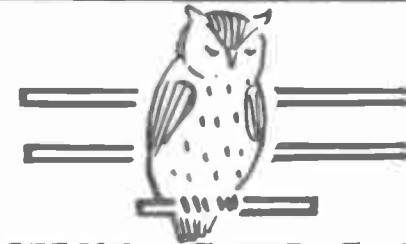

THE STEMS OF THE FLOWERS CAN BE PUSHED INTO BALSAM AT ANY ANGLE

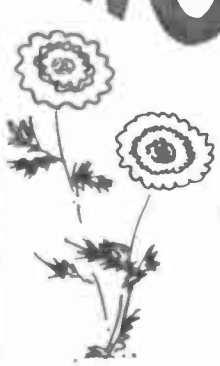

FOR DISPLAYING ARTIFICIAL FLOWERS

PIECE C CUT ONE 1/8 IN

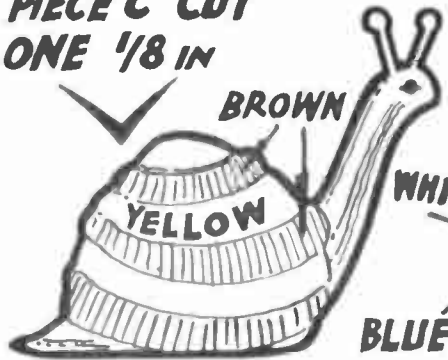

PIECE D CUT ONE 1/8 IN.



PIECE B. CUT ONE 1/8 IN.

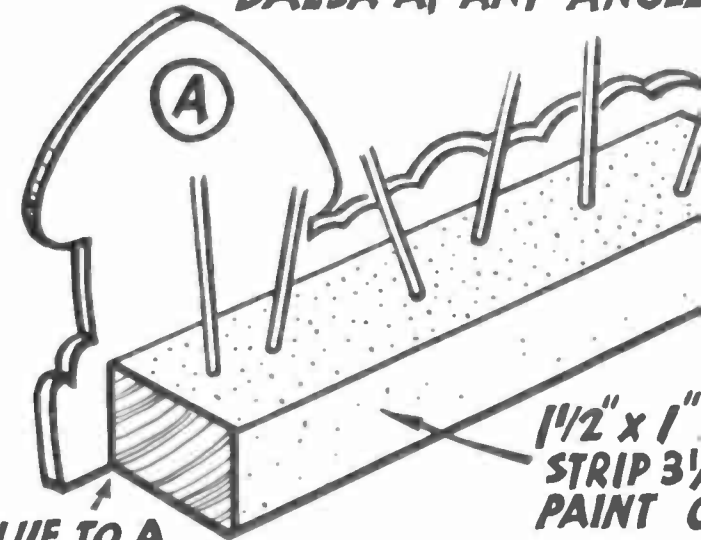
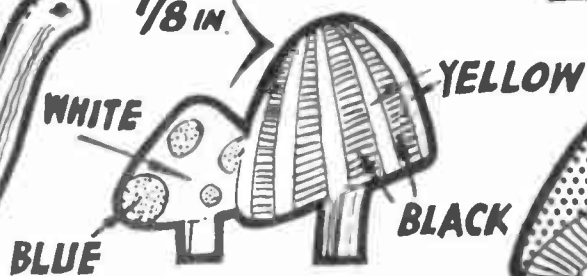

1 1/2" x 1" STRIP 3/4" PAINT C

GLUE TO A PAINT GAILY AS SUGO

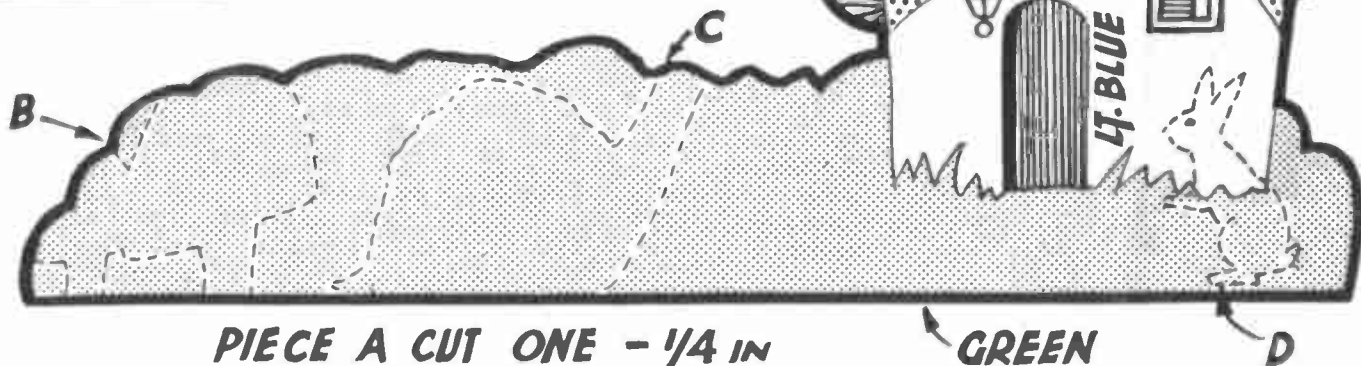

PIECE A CUT ONE - 1/4 IN

GREEN

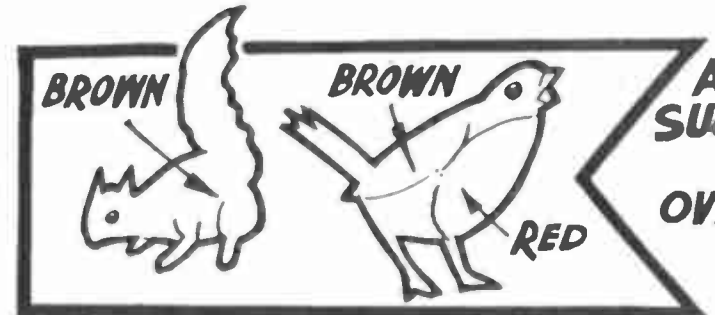

WOODLAND FANTASY

FOR DISPLAYING ARTIFICIAL FLOWERS



THE STEMS OF THE FLOWERS
CAN BE PUSHED INTO THE
BALSA AT ANY ANGLE

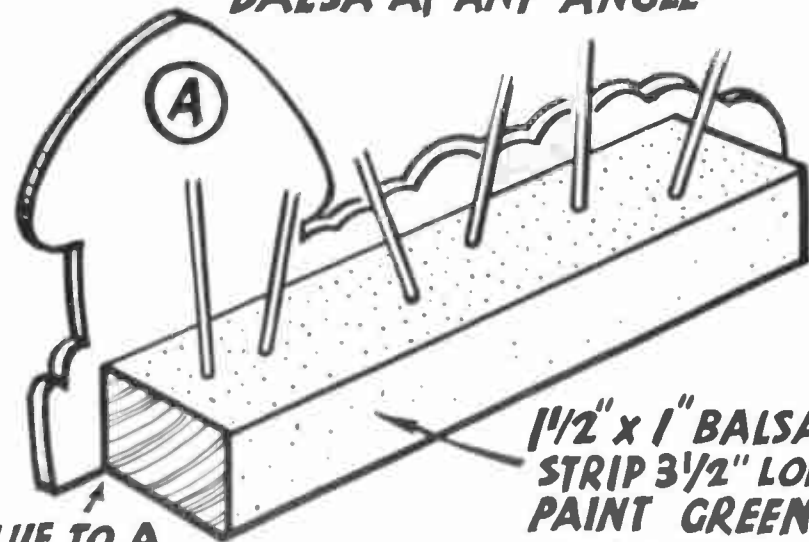
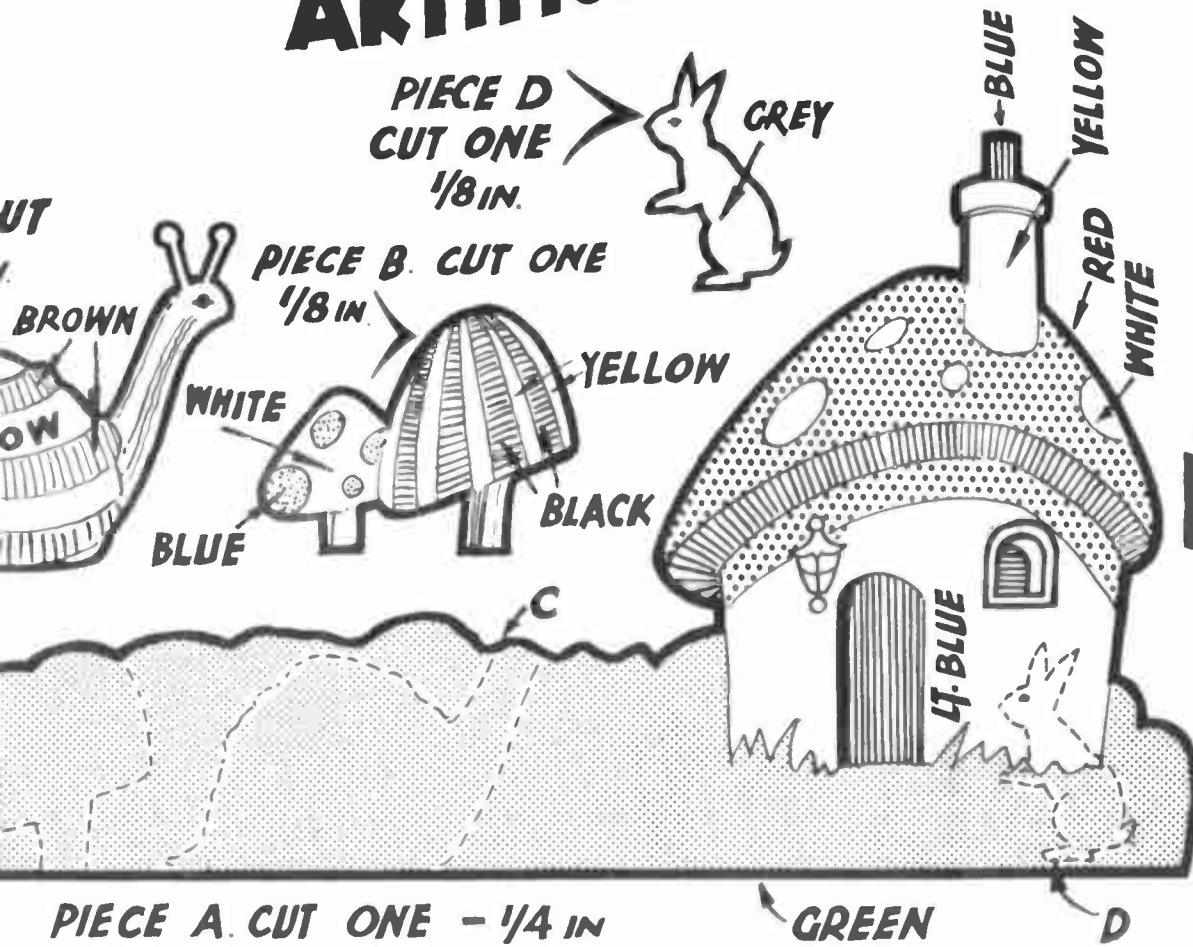

GLUE TO A
PAINTE GAILY AS SUGGESTED

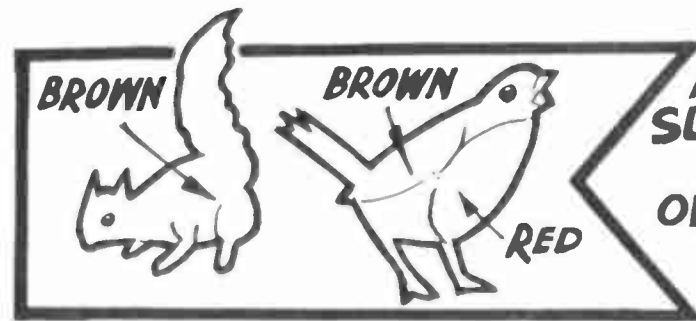

ALTERNATIVE
SUGGESTIONS
AS
OVERLAYS

Fit Out Your Own Darkroom

TO get the most enjoyment and maximum benefits from your photographic activities a darkroom is a 'must'. Such a room, either temporary or permanent, will enable you to develop and print your own films. This, in turn, with practice and experience will give your work that polished, professional look.

An ideal size for a darkroom is 10 ft. by 6 ft.; the ceiling height is immaterial.

By K. Baxter

If you have set up your own studio (as described in earlier issues of *Hobbies Weekly*) a section of this can be utilized as a darkroom. Alternatively, any spare room in the house, or the garden shed or the garage can readily be converted.

Wherever and in whatever sized room you decide to set up shop, try and keep to a working area of 10 ft. by 6 ft. This ensures all equipment and materials being easily to hand without cramping your actual working space.

A darkroom need not be black or even decorated in sombre colours, but it must be completely light-proof. Any illumination in the room must come from safelights or by reflection from the walls and ceiling. To this end, white is the best colour.

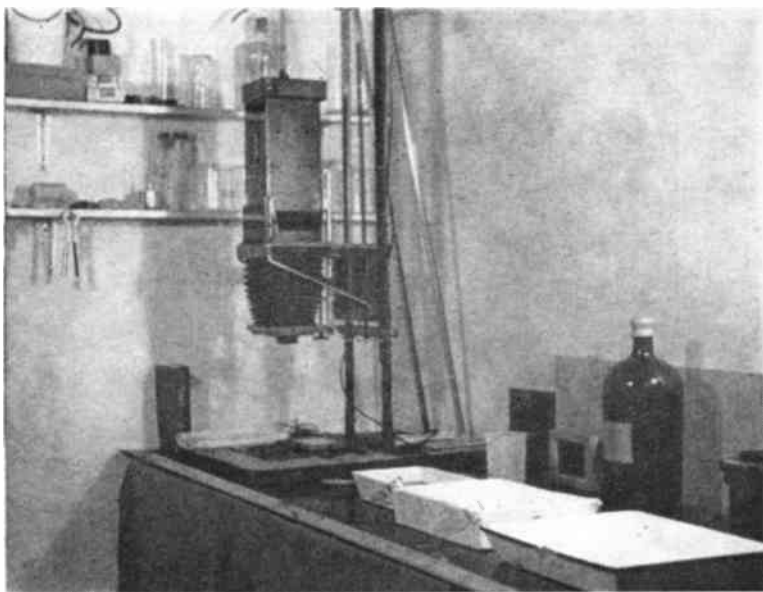

General view.—Wet and dry partition has been removed to show section of the workbench with some of the equipment used in the darkroom

The walls and ceiling can be either papered with white lining-paper or painted. If the latter, use oil-bound paint; use it also on all woodwork.

Black out the window with a close-fitting cardboard or hardboard screen, or a piece of material of suitable density. Lightproof the door with draught-excluding strip — preferably the rubber type.

Test that the room is really light-tight by standing in it for not less than five minutes. At the end of this time the original, intense gloom will have lessened and any chinks of light, however small, will be readily observed.

With your darkroom satisfactory you can go ahead with installing the necessary equipment. Essential items are a

workbench or working surface, and two wall shelves, one at shoulder height, the other 9 in. lower.

For a solid working top the most suitable wood is beech. If softwood is used it should be covered with fibre-board, heavy linoleum or one of the laminated plastics.

Divide the working surface into two parts: the right half for carrying out wet work, the left for dry work. It is essential that no water or chemical solution, such as is used for developing, be allowed to come in contact with any of the dry materials, so the division should be in the form of a movable screen.

For this you require a piece of plywood 9 in. high when in position, and the same width as the work-top, and two lengths of 2 in. by 2 in. softwood with which to hold the screen in place.

Cover the two strips of wood and one side of the plywood with stain-resistant plastic material. Screw the strips across the width in the centre of the working top, keeping the distance between them slightly more than the thickness of the covered plywood partition. Slot the partition into place with the covered side facing to the right.

It is a good plan to finish off the 'wet' side of your working surface by tacking $\frac{1}{4}$ in. moulding, or other suitable strips of wood, round three sides of the top. This will prevent any chemical solutions that might be accidentally spilt from running down to the floor or coming in direct contact with your clothes.

Fix the completed work-top to the

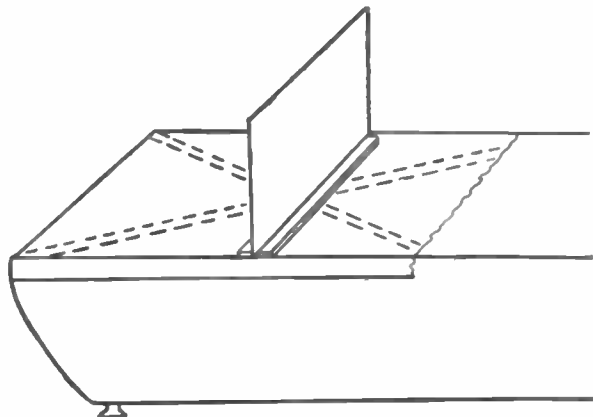

Bathroom arrangement showing worktop and wet and dry partition

wall, using angle brackets. Three or four will make a solid structure, unless your work-top is extra long. The height from the floor will, of course, depend upon your own height, but as a general rule 32 in. will be found to be about right.

Divide the space under the work-top into two halves, either with a partition or by fitting a full-length shelf. Use one half for sensitive materials — printing paper, films, etc., and the other for your reserve stock of chemicals. Seal out light and dust from this storage space with a curtain of heavy plastic or similar material.

Another way of constructing a work-bench is to mount a piece of plywood on a wooden frame and fix this over the tops of two cupboards, each measuring approximately 32 in. high by 18 in.

square. Cover the entire surface on which you will work with a suitable plastic material. Fit a movable partition to separate the wet from the dry side. Finish off with moulding tacked all round the top.

An alternative darkroom can be set up in the bathroom. Again the first requirement is that the room be made light-tight. A close-fitting black blind will be the most suitable method of sealing off the window in this room. It should preferably be fixed to a wooden frame the exact size of the window to ensure flush fitting.

If a roller blind is used it should be held securely to the window frame by suitable clips fitted at frequent intervals down each side. Light-proof the door with rubber or metal draught excluder.

Next, arrange your working surface directly over the bath. A piece of plywood 1 in. wider than the bath and about two-thirds its length will be satisfactory.

For extra strength brace the plywood with cross strips of 1 in. by ½ in. softwood. Underneath the front edge fix a 2 in. by 1 in. wooden lip. This will keep the work-top securely in position. Cover the complete surface with stain-proof plastic material and divide into a wet and dry side, as described for the permanent workbench.

Certain of the work in a darkroom can be carried out by safe-light. The construction, placing, and general use of safe-lights will be dealt with in the next article.

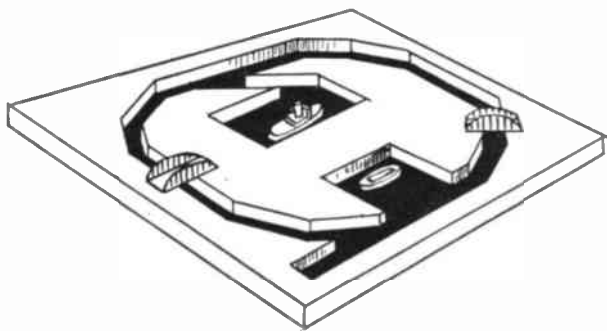

A Miniature Canal System for Outdoors

A MINATURE canal system in the garden is a fascinating model which can be operated by itself, or in conjunction with a model railway. The size of the lay-out, and the width of the canals depends on the space available, but the method of construction given here remains the same.

First, the area is marked out and the soil removed to a depth of 4 in., and a border of 2 in. high edging is put in position, with the pegs holding it in place on the outside of the square. (A)

A 3 in. layer of bottoming is put in place and cemented over to ground level. Use a spirit level to ensure that the cement surface is perfectly level.

After three or four hours, while the cement is still wet, the plan of the canal network is laid out in pieces of 2 in. by 2 in. wood. The ends are cut at an angle to form corners. These angles should be as wide as possible to allow model ships to easily negotiate the resultant channels. Blocks of wood, at least 2 in. high, can be

used to form basins (B).

Cement is filled in between the wood to the depth of 2 in., level with the top of the wooden edging. A 2:1 sand and cement mixture should be used throughout.

Leave the cement to set for at least 24 hours, then carefully remove the wooden strips and blocks. If the wood has been given a light rub with grease before being put in place, it will come away more easily. The cement should then be left for a few days to dry out thoroughly before the canals are filled with water.

Various refinements can be added when the system is being made. A drain plug, for example, is made by bending a length of piping to a right-angle and sinking it in the foundation layer of cement with its top flush with the surface. The other end can lead to a stone-filled soakaway. The top end of the pipe must be positioned so that one of the wooden moulds for the canal is laid on top of it, and it becomes incorpor-

ated in the bed of the canal. A cork serves as a plug (C).

Four-inch long wooden plugs, sunk in the cement with their tops level with the surface, will take screws on which simple bridges spanning the canals can pivot. (D). These bridges can be made from single pieces of tinplate with the edges bent up to form sides as shown. (A.L.)

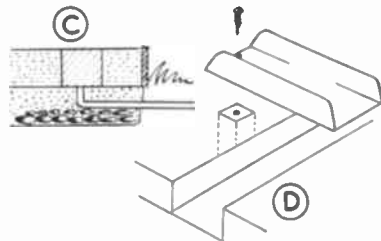
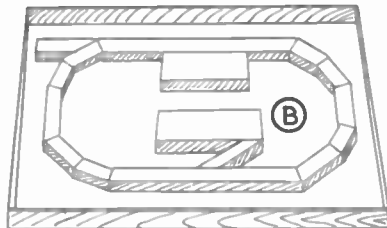

QUICK-MATURING WINES

THE period that wine takes to mature is an anxious time for most enthusiasts. There is always a desire to taste a new wine directly it has finished fermenting and before it has had time to mature.

Different kinds of wine mature and become fit to drink at varying periods: some taking as much as two or more years while others need only a month or so. Many new wines taste very unpleasant but quickly improve after a month or two.

For those wine makers who cannot resist the temptation of sampling a brew directly it is made we have selected a few well tried recipes that will mature and can be drunk almost at once.

Cottage cider

- 3 lb. apples
- 1 gal. water
- 1½ lb. sugar
- 1 oz. ginger root
- 10 cloves
- ½ teaspoonful cinnamon
- ½ oz. yeast

Thoroughly wash the apples and grate them into a jar of cold water without removing the peel but avoiding the cores. Dissolve the yeast in a little warm water (98° or blood heat), add it to the liquid, cover with a cloth and leave for 7 days. Give it a stir each day.

Strain through butter muslin or a similar cloth, add the sugar and stir until dissolved. Bruise the ginger root and together with the cinnamon and cloves, add to the partly fermented juice. Cover again and leave for a further 7 days after which time it may be bottled and is ready to be drunk in another 7 days.

Pears may be used instead of apples in this recipe and made into a kind of perry. Made in this way both cider and perry are somewhat low in alcoholic content, and once the bottle is opened it will not keep good for long. Stored in a cool place, it should be consumed within two weeks.

Parsnip wine

- 5 lb. parsnips
- 1 gal. water
- 1 oz. root ginger
- 3½ lb. sugar
- ½ oz. yeast

Well wash the parsnips, cut them into medium size pieces and boil gently with the bruised ginger until tender. About half an hour should be sufficient. Strain through muslin, dissolve the sugar in, and when the temperature has dropped to 98° add the yeast.

Allow to ferment at room temperature for 15 days, then strain and bottle, corking lightly at first. It will be fit to drink in a month, but will improve by being kept for a longer period.

Dandelion wine

- 1 gal. dandelion flowers
- 1 gal. water
- ½ lemon
- 4 lb. sugar
- ½ oz. yeast

For best results the flowers should be freshly gathered, but quite good wine

dissolved. Mix the yeast with a little of the warm liquid, add to the remainder and allow to ferment for 15 days. Bottle after straining and keep undisturbed for 2 months, when it should be fit to drink.

Although it cannot be classed as a true wine, the great popularity and many requests for Ginger Beer has induced us to include a recipe here.

Ginger beer

- 1 oz. whole ginger
- 1 lemon
- 1 lb. sugar
- ½ oz. cream of tartar
- ½ oz. yeast
- 1 gal. water

Well bruise the ginger root and place in an earthenware jar together with the thinly cut peel of the lemon, cream of tartar and sugar and pour in the boiling water. Cover with a thick cloth and when the temperature has dropped to blood heat (98°) add the yeast. Leave this in a warm place for 24 hours. Carefully siphon off the liquid without disturbing the sediment, strain and put into strong bottles, tying down the corks. This will be ready to drink in 2 days and should not be kept too long. It is better to make it in small quantities and frequently.

For a health giving drink both dandelion and nettle beers are excellent and both are ready to drink in about a week.

Dandelion beer

- 1 lb. young dandelion plants
- 1 lemon
- 1 oz. cream of tartar
- 1 lb. demerara sugar
- ½ oz. root ginger
- ½ oz. yeast
- 1 gal. water

The whole plant is used for this and the roots should be well washed to remove all traces of earth. Young plants are best, but older ones may be used. Place them in a large saucepan and boil in the water together with the bruised ginger and thinly sliced lemon peel for 15 minutes.

Strain, add the sugar and cream of tartar and stir until dissolved. Allow to cool, then add the lemon juice and yeast and keep the jar covered in a warm temperature for about 3 days. Strain again and put into strong bottles with either screw stoppers or corks, which must be tied down.

The same recipe can be used for nettles. Only the tops are needed and no roots should be included. The ginger may be omitted in each case, using another lemon instead.

By A. F. Taylor

can be made with dried petals. This also applies to most of the wines made from flower petals and herbs. The material needs careful drying to eliminate every particle of moisture in order to prevent mould.

Freshly gathered petals should be washed in cold water, then pour boiling water on the petals and the grated rind of the half lemon and let it stand for 10 days, stirring each day. Strain through muslin or similar material, add the sugar and yeast and allow to ferment for 7 days. Strain again and bottle, but do not cork tightly, and in a month it will be fit to drink.

The same recipe and method may be used for clover wine, while another recipe includes 2 lemons and 2 oranges besides the other ingredients as quoted. The grated rinds and also the juice is used in this recipe.

Ginger wine

- 1 gal. water
- 3 lb. sugar
- ½ lb. raisins
- ½ lemon
- 1 oz. root ginger
- ½ oz. yeast

Cut up the raisins into small pieces and put in a saucepan with the water. Add the bruised ginger root and the thinly sliced peel of the lemons, and boil gently for about an hour.

Skim and strain through muslin, then add the sugar and stir until thoroughly

Before you decide . . .

. . . you must consider these

EXCITING NEW CRAFT *by*



'FLYING CAT' CATAMARAN (Designed by F. M. & J. A. Montgomery)

For high quality and outstanding performance the 'Flying Cat' is one of the best 'buys' in its class.

Its twin hulls are 16 ft. long and it has a beam of 7 ft. 6 in. The draught is 6 in. with plates up and 2 ft. with them down. Carries about 200 sq. ft. of sail on metal mast.

Incorporating many advanced ideas, its most striking feature is the way the hulls are splayed outwards to give an efficient underwater hull shape with one float lifted.

In kit form from £115 Complete with mast (less sails) £254 10s.



HOBBIES RUNABOUT 'ROAMER'

An ideal craft for the family, designed for all waters. Best marine plywood and quality materials. Length 9 ft. 8 in., beam 4 ft. 2 in. Weight (without motor) 130 lb. Car rack transportation.

Complete (without motor) £88 10s. Kit (with plans, etc.) £52 10s.



HOBBIES RUNABOUT 'ZIP'

Designed especially for the beginner, as an inexpensive introduction to the water. Skinned with oil-tempered hardboard and suitable for a small h.p. outboard engine. Will carry an adult and one or two children. Length 7 ft. 8½ in., beam 2 ft. 10½ in. Weight (without motor) 80 lb.

Complete kit £19 19s. Full size plans 16s. 6d.

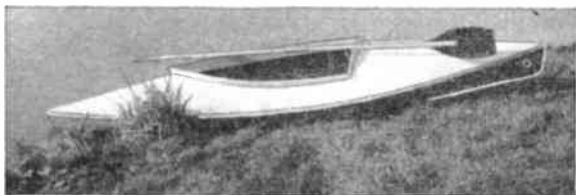

PBK 10 AND PBK 20 CANOES

These famous single-seater and two-seater craft are supplied complete, in kit form, or as full-size plans to build your own.

PBK 10 (single-seater) 11 ft. long, 28 in. beam, load 300 lb.
Complete £24 5s. Kit £15 10s.

PBK 20 (two-seater) 15 ft. long, 32 in. beam, load 700 lb.
Complete £32 10s. Kit £22 5s.

Full details of these craft from Hobbies branches, or from Head Office.

All prices ex-works.

HOBBIES LTD, Dereham, Norfolk

...ab evenly on the paper... to know if you could... wish to make some pl... mitter? (R.P. — Wolverhampton.)
 ...ht and hang to dry under... in go over the wallp... on the same pl... Channel 10 would...
Replies to Readers
 ...to charge a 12V. battery, as... was made by fixing... Board over a 150...
 ...is a brush point...
 ...157... (memory.)

Leather Cigarette Case

I HAVE a leather cigarette case, and when I have cigarettes in it, it makes them taste of leather. Could you tell me how I can remove this? (D.B.—Brighton.)

THE taste is most probably due to nitrobenzene having been used in the leather finish. This gradually disappears, but it takes a very long time. Steeping the case in benzene is the most likely quick cure, although there is a risk of dye removal if the leather is coloured, and it may also stiffen the leather by removal of softening oils. The latter can, however, be rectified by sparingly rubbing in neatsfoot oil and working the leather about between the hands.

the shavings spread out to dry and then crushing and sieving.

Restoring a Pistol

COULD you please advise me on a suitable method of cleaning and preserving an 1855 Tower percussion pistol and an 1871 bayonet with scabbard? The metal on the pistol is slightly rusty; the wooden handle appears to be sound. The blade of the bayonet is only tarnished and the scabbard is slightly rusty. Could you also tell me any method of distinguishing genuine pewter ware from other similar articles? (K.B. — Mansfield.)

A TOOL shop can sell you rust-removing fluid. Alternatively use penetrating oil. Rubbing this on the bare steel will remove corrosion. Careful use of 'Duraglit' will brighten the metal. If the wood is not varnished, it may be brightened with linseed oil, put on and left for a few hours, then rubbed with sacking. Preservation is best done by storing in the dry and occasionally rubbing with an oily cloth.

Unfortunately the name 'pewter' has been given to several alloys. The oldest pewter is a mixture of lead and tin, and is very soft and normally a dull lead colour, although it can be brightened to a limited extent. More recent alloys are much harder. If the metal can be dented with a screwdriver and light pressure, it is the lead/tin alloy.

Cleaning Formulas

WOULD you please send me formulas for making my own black shoe polish, washing powder for hard water, and whitening for white plimsolls? (P.M. — Dumfries.)

A VERY fine black cream polish may be made as follows: Boil 55 c.c. of soft water (rain water will serve). Dissolve in this 1 gram of soap shavings and 1 gram of potassium carbonate. Now dissolve in this 3 grams of powdered rosin and 2 grams of water-soluble Nigrosine. Next heat 25 c.c. of genuine turpentine oil and 15 grams of beeswax in a water bath until the wax has dissolved and the solution stands at 85 to 90°C. Remove the first solution from the flame and run it into the turpentine-wax solution in a thin stream, stirring rapidly until the mixture has cooled considerably and an even emulsion has formed (the turpentine-wax solution should, of course, have been removed from the bath). This polish is smeared thinly on the leather with a rag and then buffed up.

A washing powder for hard water may be made by thoroughly mixing 3 ounces powdered soap, 8 ounces soda ash, 4 ounces washing soda and 1 ounce of borax. After mixing, spread out and leave in a dry room for a few days and then pass through a sieve.

Whitening for plimsolls: mix 1 ounce powdered gum arabic, ½ ounce powdered soap, 15 ounces zinc oxide, 9 ounces kaolin, then work in 6 fluid ounces soft water. Soap may be powdered by shaving a bar on the sole of a plane, leaving

until a clear solution is obtained. Remove the vessel from the double boiler and let the solution cool but not set. Stir in 1 ounce of ultra-marine powder and keep on stirring until the mixture thickens to a paste. It is then ready for use and should be kept in well-closed tins to prevent evaporation of the white spirit.

Enclosing a Bath

I WANT to enclose a bath with hard-board and retain the curve at the end. Can you give any advice? (F.B.B. — London.)

TO box a round end bath, first prepare a suitable wood framework of 2 in. by 1 in. battens. Fix these securely to the floor and walls at each end of the bath with uprights at the ends and at intervals of about 12 inches on the long side and on the round end. Keep the whole framework back about ¼ in. from the outer edge of the bath.

Thoroughly damp the reverse side of the hardboard with water as recommended by the manufacturers, as this will permit it to bend readily. Commence securing the hardboard where the rounded end of the bath meets the wall and work round the curve, fixing to uprights and finishing to an upright placed to coincide with the end of the length of the board. An 8 ft. length will provide sufficient to cover the round end and full length of the bath.

Remember to use non-rusting screws or pins to fix the hardboard, otherwise the painted work will be disfigured after a time, with rust stains.

Constructing a Quartz Lamp

I WOULD like to know how to construct a quartz lamp or some other efficient watermark detector for postage stamps, especially the early Americans. (W.F. — Ruislip.)

METHODS of observing and detecting watermarks vary very much, and depend so much on the purpose in view, that it is suggested you refer to books on philately. Simple illumination from behind shows some marks. Polarized light, obtainable from a quartz lamp or other source, may be used when paper or other factors are such that the watermark is then increasingly visible. Ultra-violet rays are also used, in conjunction with a fluorescing material, in the detection of difficult watermarks. In some cases the results cannot be observed direct, but may be observed clearly on photographs taken with special filters. In view of these facts, some special knowledge is required in selecting and using methods for detecting difficult watermarks.

Cement Floor Stain

WE have a cement floor painted with liquid lino floor paint in Dutch blue, but find it is now wearing off in places. The problem is, we cannot obtain a blue stain polish in the shops. Is such a polish procurable, or can you suggest a formula for making up a blue polish after the style of the Cardinal we use on a red floor? (K.L.—Reading.)

WE know of no proprietary polish in Dutch blue. One can be easily made, however, by melting 3½ ounces of paraffin wax (candles will do) in a double boiler. Remove the flame and stir in 6 fluid ounces of white spirit (turpentine substitute) and leave to warm up

at last...

A FAMILY OF DO-IT-YOURSELF PRODUCTS



Specially formulated for professionals, the new matched Humbrol & Britfix products give a finer finish to models and handicrafts. There is a Humbrol enamel or adhesive for every job — effective for plastics, wood, metal, paper, etc. Humbrol gives that essential touch of realism to every replica while Britfix adhesives hold firm and strong. Use Humbrol and Britfix always for model making and general purpose. Obtainable from all HOBBIES BRANCHES.

Manufactured by:

THE HUMBER OIL COMPANY LTD.
MARFLEET, HULL. Telephone: 74121

HUMBROL. One hour PLASTIC ENAMEL. Dries in one hour leaving no brush marks. Dries with porcelain finish. Tinlets 8d. each.



BRITFIX 55. The P.V.A. type adhesive that sticks almost anything. Supplied in handy "squeeze" bottle. 1/9d. each.

BRITFIX 99. Specially prepared for general purpose adhesion of laminated plastics, leather, rubber etc. 1/9d. per tube.



HUMBROL clear VARNISH. Super clear varnish, dries without brush marks. Resistant to water "bloom" 1/2 oz. tins. 8d. each.

BRITFIX 77. A polystyrene cement prepared for use with plastics. Quick drying and non-stringing. 1/2 oz. tube. 6d. each.



**The Pistol all your
chums will envy!**



- ★ High Accuracy and Hitting Power
- ★ Perfect Balance
- ★ Robust Construction

Send for catalogue

WEBLEY & SCOTT LTD

34 PARK LANE, HANDSWORTH, BIRMINGHAM 21. West Bromwich 2821

One of the Windsor Group of Companies

APPARATUS & CHEMICALS

For your experiments. Let us help you equip a
HOME LABORATORY

Beakers, Crucibles, Flasks, Funnels,
Gas Jars, Test Tubes, etc.

Booklets:
(including postage)

- 'Experiments' 1/3
- 'Formulae' 1/3
- 'Home Chemistry' 2/11

New edition

Send 4d. Stamp for latest PRICE LIST

A. N. BECK & SONS (Dept. H.W.)

68 Stoke Newington High Street, London, N.16



**The
STRONGEST
handy glue**

STILL ONLY

1/2 a large tube

"GLOBE-KING"

WORLD-FAMOUS KITS AND RECEIVERS

for the Radio Amateur and S.W. Listener. Catalogue Free, enclose stamp for postage. Kits from 79/6 obtainable at your dealers or direct from the sole manufacturers

JOHNSONS (Radio)

ST. MARTINS GATE — WORCESTER

STOP SMOKING

You can overcome the smoking habit in 3 days, or money back. Safe, pleasant, permanent. The only scientific way. No Will Power necessary. 'Conquered the habit in 2 1/2 days.'—F.C. 'Within 2 days I was free.'—W.G. Complete Course 7/6 Details 2d. Sent under plain cover:—**NATURE REMEDIES, (H.150), 28 Dean Rd., London, N.W.2.** Established 1928

FOR MODEL MAKERS

THE 'MIGHTY MIDGET' electric motor, only 1 1/4 in. high. Runs at 10,000 R.P.M. from a 4 1/2 V. torch battery. Minute current consumption. Complete with pulley, price 10/6 postage 6d. **MODEL BOAT PROPELLER.** 3 blades, shaft, pulley, and 5 1/2 in. long stern tube, to run off above 'Mighty Midget'. Price 7/3, plus 6d. postage. **HOBBIES LTD. (Dept. 99), DEREHAM, NORFOLK.**

PROFIT AND PLEASURE is obtainable from **WRITING** (typewriter unnecessary) or **ARTISTRY.** Send for free fascinating bumper package '**PROFITABLE LEISURE.**'—Writers' & Artists' Ring (HW), 5 Edmund Street, Birmingham.

LEARN RADIO & ELECTRONICS the NEW Practical Way! Very latest system of experimenting with and building radio apparatus — 'as you learn', FREE Brochure from: Dept. H.W.10, Radiostructor, 40 Russell Street, Reading, Berks.

'THE MATCHBOX LABEL' CLUB. 105 Sunnyside Gardens, Upminster. Membership free. Send postcard

LEARN

RADIO & T/V SERVICING
for your OWN BUSINESS/HOBBY

by a new exciting no-maths system, using practical equipment recently introduced to this country. FREE Brochure from:—

RADIOSTRUCTOR

DEPT. G81, READING, BERKS.

18/1/61

**BRASS, COPPER, DURAL,
ALUMINIUM, BRONZE**

ROD, BAR, SHEET, TUBE, STRIP, WIRE
3,000 STANDARD STOCK SIZES

No Quantity too small List on Application

H. ROLLET & Co. Ltd.

6 CHESHAM PLACE, LONDON, S.W.1

Also at

Liverpool, Manchester, Leeds, Birmingham

50 MIXED stamps 5/-. Try our 6d. in 3/- discount approvals. — E. C. F. Townsend, 92 Tenby Road, Edgware, Middx.

PROFITABLE PLEASURE from Popular Art. Easier to Learn and Earn than you think. Send for free copy '**SOMETHING NEW!**' Popular Art Services (HW), Clun, Salop.

100 DIFFERENT stamps free! Request 1/6 upwards discount approvals. — Bush, 3 Newlyn Way, Parkstone, Dorset.

Completely new 54 page Edition
WHERE'S THAT CAR FROM?

Price 1/- (Postage 4d.)

Of all Booksellers
or

RALEIGH PRESS, Exmouth, Devon

WORKERS with sewing machines required for making cushion covers. Regular work guaranteed. Apply enclosing s.a.c., Dept. 28, Arnold Trading, 10 Shelley Road, Worthing, Sussex.

BUYING OR SELLING?

Classified advertisements on this page are accepted at a cost of 6d. per word prepaid. Use of a Box No. is 1/- extra. Send P.O. with advertisement to **Hobbies Weekly, Advert. Dept., Dereham, Norfolk.** Rates for display advertising on application.

SOME DECORATIVE OVERLAYS

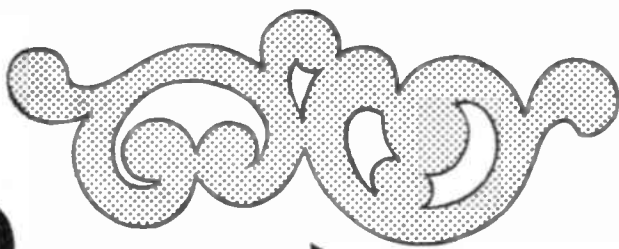
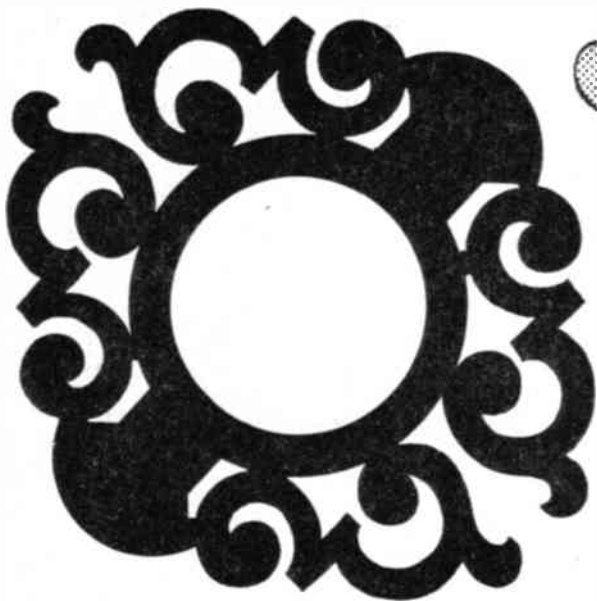

**TRACE, TRANSFER
AND CUT OUT
WITH A FRETSAW**

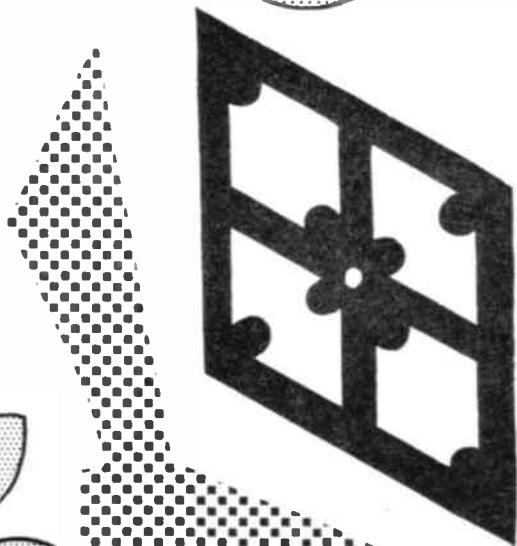
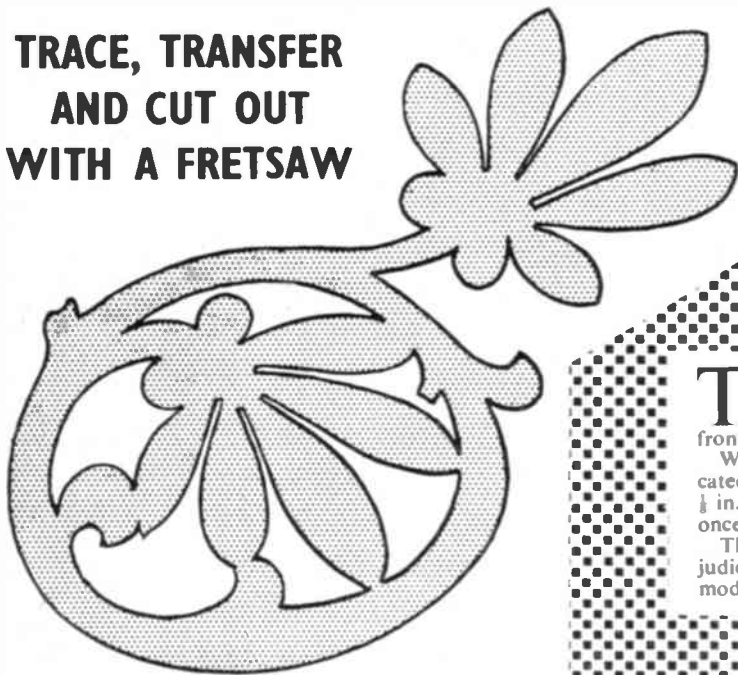

THESSE decorations should be used as overlays, to be stuck in position on boxes, cabinets, drawer fronts, etc.

Where the overlays are to be duplicated it is possible to pin four pieces of $\frac{1}{8}$ in. wood together and cut them all at once.

They may be further enhanced by the judicious use of carving tools or a modelling knife. (M.p.)



Just like the real thing!

Believe it or not, the nearer one is the Airfix model of the Railbus, 00 gauge (Kit 3/-). Behind it is a picture of the real thing.

That's how wonderfully realistic Airfix models are. Close attention to every detail gives them their faithful-to-the-original look—makes them true collector's pieces. And every Airfix series is to a constant scale. This means Airfix models look proportionally right, one against another, because they *are* right! You can't beat Airfix for realism—or value.

AIRFIX

Constant Scale Construction Kits

From Model & Hobby Shops, Toy Shops, and F. W. Woolworth

There are over 100 Airfix models from 2/- to 10/6.

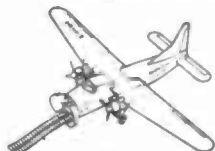

AIRCRAFT

Bristol Superfreighter 716

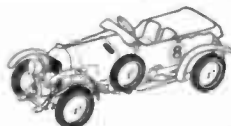

VINTAGE CARS

1930 Bentley 21-



MODEL FIGURES

Lifeguard 2/-

BRITISH WARSHIPS

H.M.S. Cossack 71.



STOP PRESS!

Latest Airfix Production



Douglas-C47 DAKOTA

A magnificent 1/72nd scale model of the world-famous transport aircraft. Realistic in every detail, it has a 16-inch wing span, many moving parts, and is boxed complete with alternative U.S.A. F. and Silver City Airways marking transfers. Including adhesive and display stand. 6/-

Also new: HAWKER HUNTER, the standard R.A.F. day fighter, 3/- and DEFIANT night fighter, 2/- Both 1/72nd scale

PIECES 13.
CUT TWO
3/8 in.

PIECE 12.
CUT ONE
3/8 in.

PIECE 5.
CUT ONE
3/8 in.

PIECE 14. CUT ONE 3/8 in.

PIECE 6.
CUT ONE
3/8 in.

PIECES 10.
CUT TWO
1/8 in.

TRIGGER 11.
CUT ONE
3/8 in.

THE ARROWS INDICATE
THE DIRECTION OF
GRAIN OF WOOD.

Note—CUT
TO THE OUTSIDE
OF
THICK LINES.

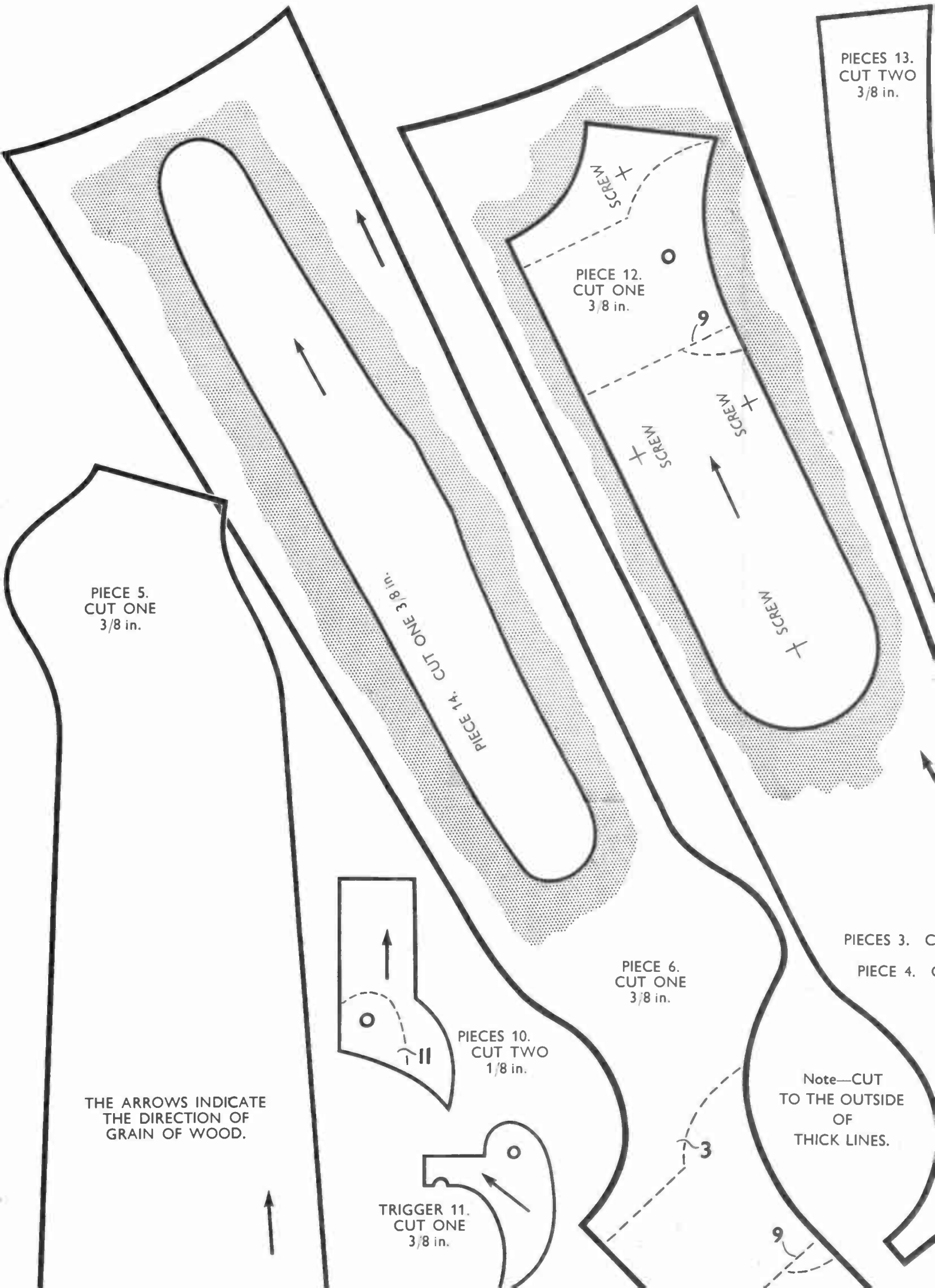



DESIGN

No. 3398

TOY CROSSBOW

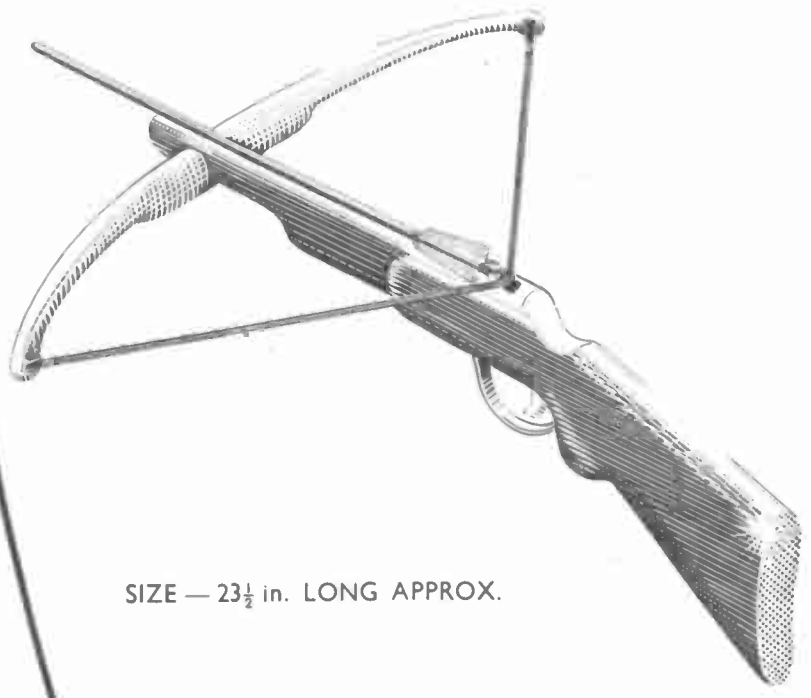

SIZE — 23½ in. LONG APPROX.

A KIT OF MATERIALS FOR MAKING THIS DESIGN IS SUPPLIED BY HOBBIES LIMITED, DEREHAM, NORFOLK. PRICE ON APPLICATION.



PIECES 13. CUT TWO 3/8 in.

PIECE 12. CUT ONE 3/8 in.

PIECE 6. CUT ONE 3/8 in.

PIECES 3. CUT TWO 3/8 in.

PIECE 4. CUT ONE 1/8 in.

Note—CUT TO THE OUTSIDE OF THICK LINES.

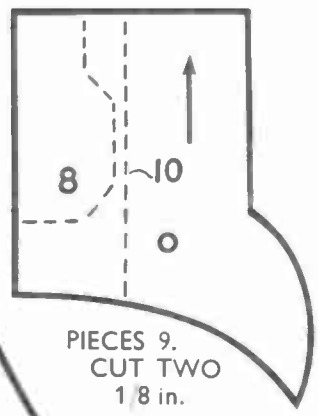

PIECES 9. CUT TWO 1/8 in.



PIECES 8. CUT TWO 1/8 in.

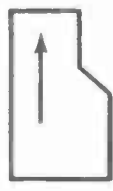

PIECE 7. CUT ONE 3/8 in.

Use **CASCAMITE** 'One Shot' Resin Glue for all Model Making



- Mixed & use cold
- Waterproof type
- Gap-filling and non-staining

Obtainable in 3½-oz., 7-oz., and 18-oz. tins.

Sold by: Ironmongers, Builders' Merchants, etc.

Manufactured by LEICESTER, LOVELL & CO. LTD. North Baddesley, Southampton

PIECE 5.
CUT ONE
3/8 in.

PIECE 14. CUT ONE 3/8 in.

3/8 in.

PIECE 6.
CUT ONE
3/8 in.

PIECES 10.
CUT TWO
1/8 in.

TRIGGER 11.
CUT ONE
3/8 in.

THE ARROWS INDICATE
THE DIRECTION OF
GRAIN OF WOOD.

Note—CUT
TO THE OUTSIDE
OF
THICK LINES.

PIECES 3. C
PIECE 4. C

SCREW
SCREW

SCREW
SCREW

SCREW

3

9

13

2

SECTION

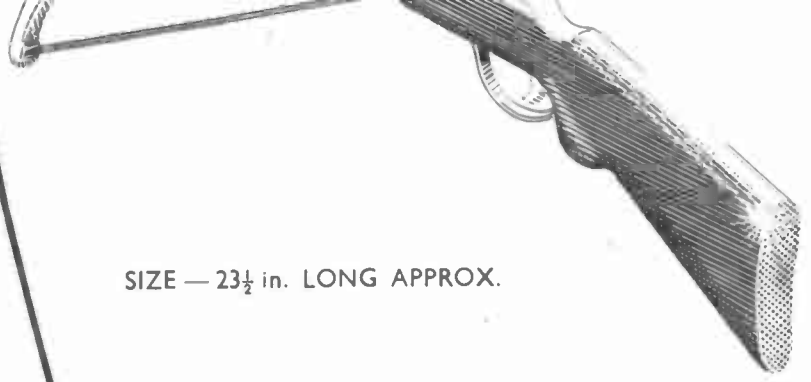
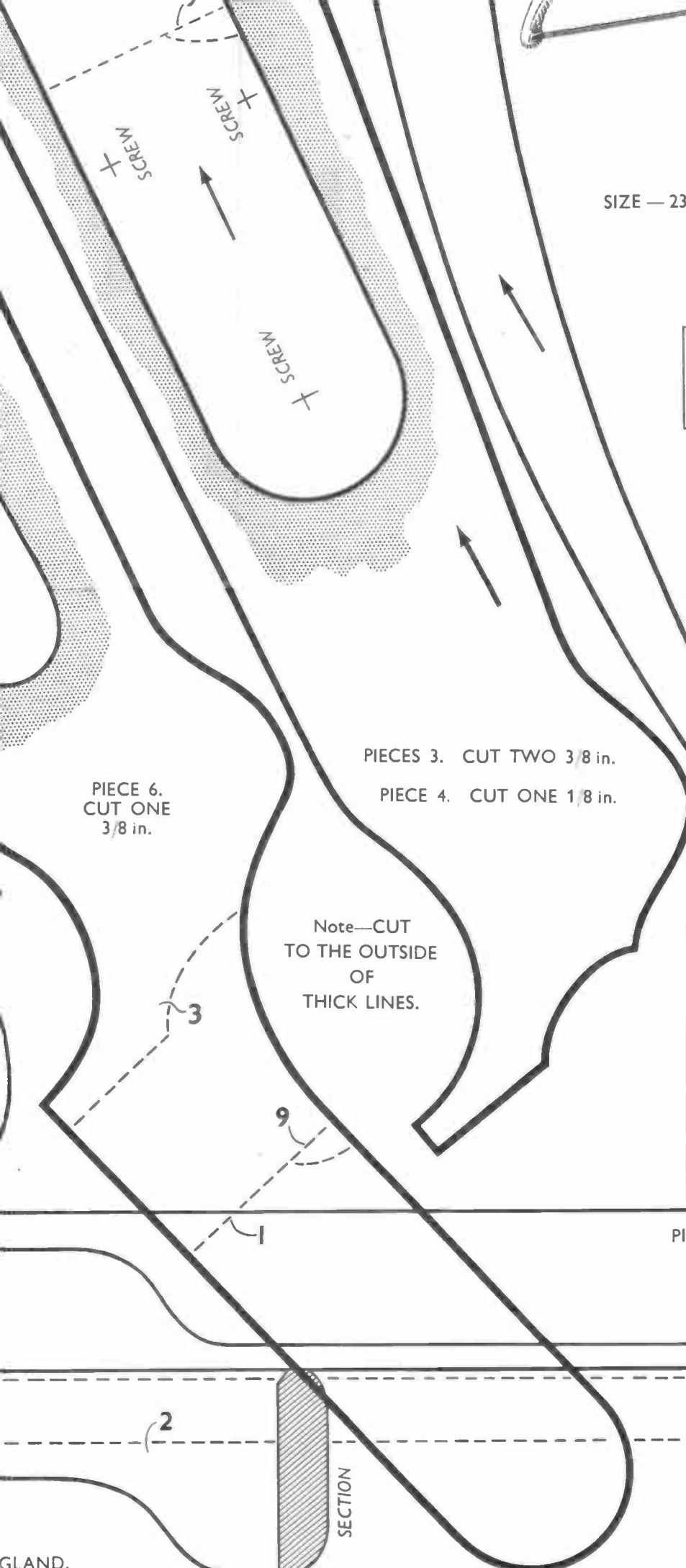

SIZE — 23½ in. LONG APPROX.

A KIT OF MATERIALS FOR MAKING THIS DESIGN IS SUPPLIED BY HOBBIES LIMITED, DEREHAM, NORFOLK. PRICE ON APPLICATION.

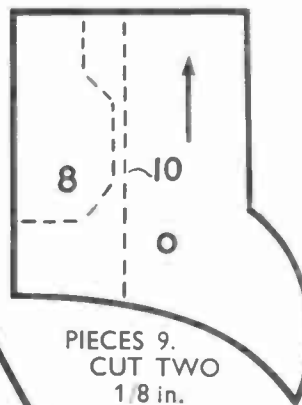

PIECES 9. CUT TWO 1/8 in.

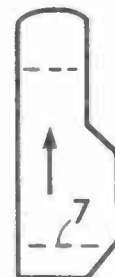

PIECES 8. CUT TWO 1/8 in.



PIECE 7. CUT ONE 3/8 in.

PIECES 3. CUT TWO 3/8 in.

PIECE 4. CUT ONE 1/8 in.

PIECE 6. CUT ONE 3/8 in.

Note—CUT TO THE OUTSIDE OF THICK LINES.

Use **CASCAMITE**
'One Shot'
Resin Glue
for all Model Making



- Mixed & use cold
- Waterproof type
- Gap-filling and non-staining

Obtainable in 3½-oz; 7-oz. and 18-oz tins.

Stocked by Ironmongers, Builders' Merchants, etc.

Manufactured by **LEICESTER, LOVELL & CO. LTD.** North Baddesley, Southampton

PIECE 2. CUT ONE 1/8 in.

PIECES 1. CUT TWO 3/8 in. CHAMFER TO SECTION.

25th JANUARY 1961

VOL. 131

NUMBER 3398

THE ORIGINAL
'DO-IT-YOURSELF'
MAGAZINE

HOBBIES *weekly*

FOR ALL
HOME CRAFTSMEN

Also in this issue:

PHOTOGRAPHIC
SAFELIGHTS AND
SCREENS

COLLECTORS' CLUB

PAINTING DESIGNS
ON GLASSWARE

KITCHEN RACK

BOWL TIDY

ROLLER-SKELTER
GAME

ETC. ETC.



**MODERN
VERSION
OF THE
'WILLIAM
TELL'
WEAPON**

*FREE plan inside
to make this*

TOY CROSSBOW



Up-to-the-minute ideas

Practical designs

Pleasant and profitable things to make

5^p



BOXING is easily the favourite sport of stamp and label designers. Who was the world's all-time boxing champion? Joe Louis? Ezzard Charles? Rocky Marciano?

You're nowhere near it. It was a Greek named Theagenes who did his campaigning sometime in the ninth century B.C.

And Theagenes really deserves the title. For he won no less than 1,452 bouts — every one by permanent knockout. When Theagenes was slugging it out, referees and judges were thought unnecessary. Nothing was left to chance — or human fallability. Boxers' fists were encased in spiked thongs — and death was the only arbiter.

The earliest facts on boxing come from some painted slates recently found in a temple at Khafaje, in Mesopotamia, and possibly dating from between 3,000 and 2,000 B.C. It was known, too, on the island of Crete where a high civilization flourished 3,500 years ago.

The Romans helped to put the game on its feet — literally. Until the conquering legions took the game home to Rome, the Greek boxers had fought seated, brow touching brow.

Modern boxing obviously evolved from the bloody sport of the ancient Greeks. The link between the ancient fist-killing and the noble art of self-defence defined by the Marquis of Queensberry was the rough-and-tumble bout popular in seventeenth-century

England. By 1719, interest in the game had grown to such an extent that a fighter named James Figg won recognition as the first champion of England.

THE BIG FIGHT

But Figg, according to sketchy surviving records, defended his title only twice during the fifteen years he reigned as champion. This was due to the fact that boxers then fought without gloves and it took months for a fighter's hands to heal after a contest. The winner usually finished in worse shape than the loser, for his hands had taken the heavier beating. Broken noses and battered ears healed quickly. Broken knuckles and torn tendons did not.

Jack Broughton became champion boxer of England in 1734. He held the title for six years. When he won the title it was the fashion for boxers to stand toe-to-toe slugging it out. Wrestling was encouraged. A boxer's aim was to catch hold of his opponent and toss him to the ground in an effort to bounce all the fight out of him. It was good tactics to kick a man when he was down. Eye-gouging was common, the fist was relatively incidental.

Broughton, as skilled in the art of throwing, kicking, and gouging as the

next man, found by experience that his fists were his most effective weapons. He introduced into boxing the science of deception. His skill and mastery of boxing technique won him the admiration of the nation — and a reputation as the major authority on the sport.

So when, in 1743, he wrote a code of rules laying down the conditions of a prize fight and the conduct of fighters, it was accepted, and with minor modifications Broughton's Rules governed for nearly a hundred years. Broughton lifted boxing from the gutter. He was the true father of boxing. He believed in fair play. But he lost his title to a man who was the exact opposite of everything he stood for — an unsavoury character called Jack Slack, the 'Norwich Butcher'.

But Slack was not just a dirty fighter. He was boxing's first crooked promoter as well. He fought infrequently himself. But he staged a series of shady bouts that dragged boxing back to the gutter. During the ten years he wore the crown, boxing sank rapidly in public esteem.

The rise of a brilliant new fighter, a man who did as much for boxing in the 1790's as Broughton had done half a century earlier, marks the rescue of boxing from disrepute. His name was Daniel Mendoza, an English Jew of Portuguese extraction, reared in the squalid, vicious East End of London.

Mendoza stood barely 5 ft. 7 in. But his superiority in the science of boxing made him a giant among men. He made up for his small stature by employing skill and a sort of footwork unknown previously. He was also the first man to demonstrate the power of the light jab landed frequently.

By the time Mendoza lost his title to John Jackson in 1795, boxing had begun to spread all over the world. Italy, France, and Ireland had already started staging their own championships. As the fight game became international it was inevitable that someone should reshape and codify it. That person was the Marquis of Queensberry, patron of boxing, who in 1867 undertook the task.

With the introduction of the Queensberry Rules, boxing as we know it today was born. The new laws shifted the emphasis from brute force to scientific boxing. Wrestling was completely outlawed. Padded gloves replaced the skin-tight 'muffers' of Broughton's day. The three-minute rounds replaced the custom which allowed boxers a rest only after a knockdown.

Other fighters were to introduce finesse into the sport. Men like Jim Corbett, whose science ended the era of the sluggers. But to all intents the noble art had been cast in its final mould.

Almost every week there's a new set of stamps or labels issued depicting sports. Boxing is invariably featured.



SAFELIGHTS AND SCREENS

WHEN handling sensitized materials the only direct illumination in a darkroom must come from safelights. One of these may be allowed to shine on your working area from a distance of not less than 4 ft. But it is essential that the coloured screen through which the light filters is the correct one for the type of material on which you are working.

For other than contact material the following screens are recommended:

Orthochromatic film may be developed and inspected at intervals by dark red safelight. Panchromatic film, if circumstances particularly require it, may be inspected once or twice for a few seconds while developing by dark green safelight, but this is not recommended. In both cases it is vital that inspection of the film is completed in under five seconds.

For general darkroom illumination, other than by reflected light, a second safelight may be used. This should be situated about 10 ft. from your workbench. Because of its distant position, the light emanating from it will, naturally, be isolated. At the same time it will relieve the sense of heavy darkness in the room, and can be used to pick out the face of your timing clock.

Safelight screens are made in various materials, including celluloid, plastic, and glass. The last mentioned is the best type, having greater colour accuracy. It consists of two sheets of glass with a layer of coloured gelatine between them.

When working with contact printing material a yellow screen is the most satisfactory. It can be used throughout the entire operation of processing con-

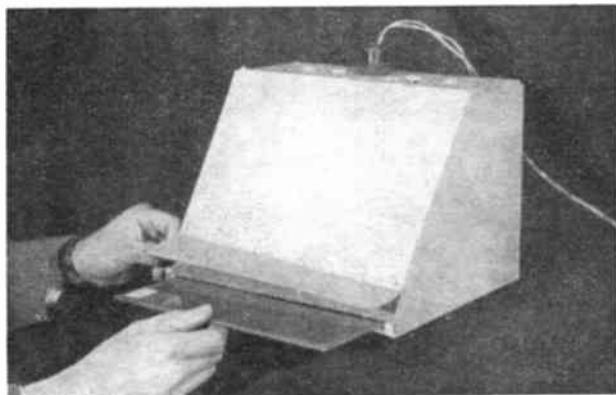

Fitting the coloured screen into the completed safelight

tact prints, and will provide plenty of light for comfortable working.

A safelight is quite simple to make. The main structure is hardboard or plywood, reinforced with strips of softwood. There is no appreciable difference in the suitability of these materials, only in the cost. The safelight illustrated was made from hardboard and $\frac{1}{2}$ in. square softwood for 2s. 3d., the lamp and light fitting being extra.

Two equal sides, each measuring 8 in. by 9 in. by 4 in. are first cut out. Suitable lengths of the $\frac{1}{2}$ in. square softwood are then glued and pinned across the width of the sides. The top strengthening piece is fitted flush with the top edge; the lower strut is located $\frac{1}{2}$ in. up from the bottom edge. Then the back is glued and pinned in position (Fig. 1).

At this stage, run a plane lightly along each of the edges where they meet to

remove any undue sharpness.

The safelight is painted inside and out with a light grey matt finish. Emulsion paint is suitable and has the advantage of being very quick drying. Apply a generous coat to the completed section of the safelight and to the inside of the front panel.

While waiting for this to dry, the top of the safelight can be cut out and prepared.

Adequate ventilation is all-important. At the same time no light that is not filtered must be allowed to escape. To ensure this a light-trap is built into the top.

Cut out a piece of hardboard 11 $\frac{1}{2}$ in. by 4 in. and in the centre drill out a 1 in. hole to receive the bulb holder. On each side of this drill two equally spaced $\frac{1}{2}$ in. ventilation holes (Fig. 2). Then, centrally, 1 $\frac{1}{2}$ in. in from each end a $\frac{1}{2}$ in.

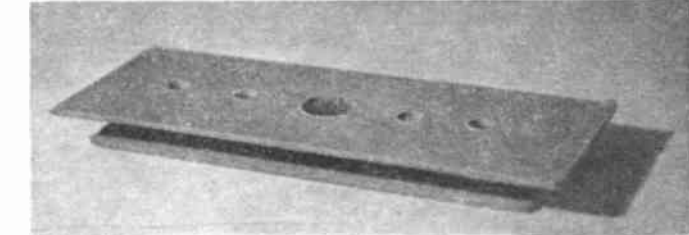
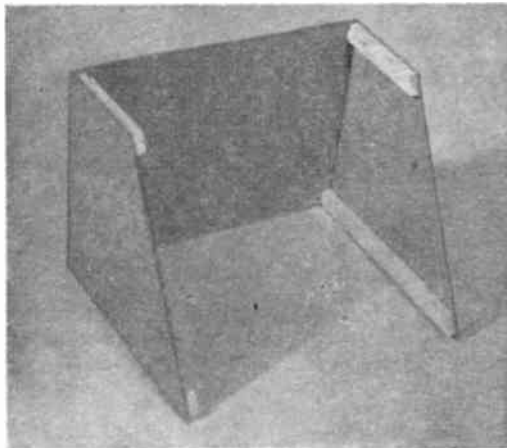

Fig. 2— Top of safelight showing light-trap panel, recess for bulb holder, and ventilation holes

Fig. 1—Section of safelight, showing side struts in position to receive top, base and front

length of dowelling is attached, preferably by screws.

For the light-trap a second piece of hardboard, 9 $\frac{1}{2}$ in. by 3 in. is used. A 1 in. hole is drilled in the centre of this. The

● Continued on page 292

A Useful Rack for Kitchen Oddments

THESE shelves can be made in two hours at a cost of approximately 3/-. When fixed to the kitchen wall or the bathroom, they are very useful for holding small jars, cups, soap, and cleaning powder, etc.

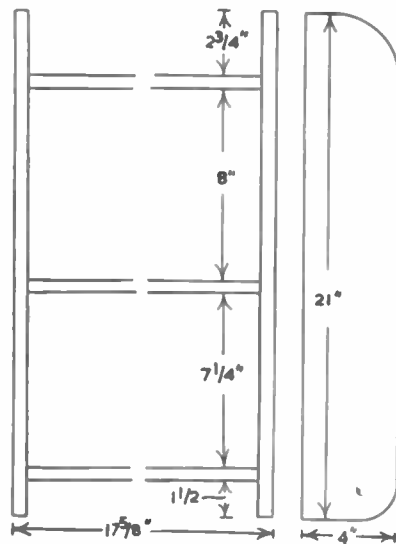

Fig. 1

A stopped housing joint (Fig. 2) is made at the end of each shelf. This is a simple joint, and looks better when finished than a through housing joint. When cutting the grooved part in the upright to a depth of $\frac{1}{8}$ in., one method is to chop out a square mortise first, as shown in Fig. 3, and then to saw down the remainder with very short saw cuts, chiselling out the waste afterwards. An alternative method is to make two sloping saw cuts, and then to chisel out the waste carefully. The front corners of the uprights are radiused as shown in Fig. 1, where dimensions are also given.

Clean up both sides of the shelves and the insides of the uprights. Glue the joints and strengthen with $1\frac{1}{2}$ in. oval nails. Give the glue time to set (overnight is safest), and then chisel off any surplus. Should the edges of the shelves or uprights protrude, these discrepancies can be rectified with a smoothing plane. Remove all sharp edges with glasspaper, and then clean up all the surfaces perfectly smooth with fine glasspaper. Painting is a matter of personal choice,

but at least two coats are necessary, rubbing down when the first coat is dry.

Two metal plates each drilled with two holes which are countersunk on

By K. John

opposite sides are the easiest method of securing to the wall. Screw through the top hole of each plate into the back edge of the top shelf, and then screw through the lower hole from the front into a plugged wall.



CUTTING LIST

2 at 21 in. by 4 in. by $\frac{3}{8}$ in. Softwood.
3 at 17 in. by 4 in. by $\frac{1}{2}$ in. Softwood.

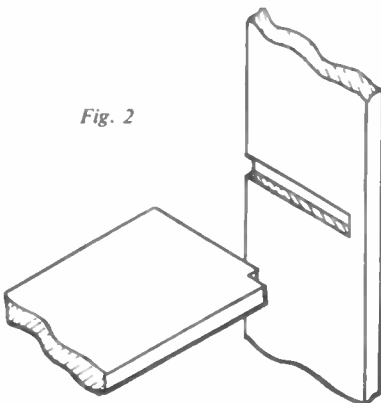

Fig. 2

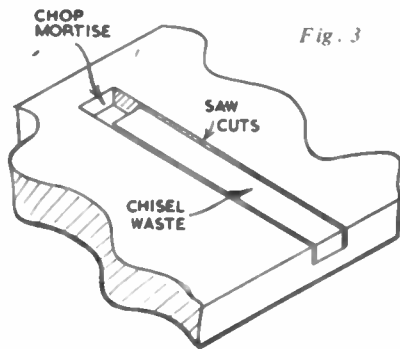

Fig. 3

● Continued from page 291

SAFELIGHTS AND SCREENS

two sections are then joined together, the larger one on top, ensuring that the 1 in. centre holes are located immediately opposite each other. Smooth off any sharp or rough edges and paint.

By this time the first completed section of the safelight will be dry and the front panel can now be fitted. Glue and pin it into position, leaving a gap of $\frac{1}{2}$ in. between the bottom edge of this panel and the base of the safelight.

Next, light-proof all joints from the inside with a suitable sealing compound. The runners for the coloured screen can then be fixed. For these you require two lengths of hardboard $11\frac{1}{2}$ in. by $\frac{3}{4}$ in., and two $7\frac{1}{2}$ in. by $\frac{3}{4}$ in. These are attached to the lower side-struts to form an open rectangular base.

A 1 in. deep hardboard flap is hinged

in position across the bottom edge of the front panel. Adhesive tape, the first-aid type, will hold it securely in place while allowing free movement, the flap being raised for the coloured safelight screen to be slid into position, and then lowered to form a light-trap.

Assembly is completed by fitting a bayonet-cap bulb holder through the 1 in. holes in the top section, which is then glued and pinned into place. A suitable safelight bulb is inserted and a 10 in. by 8 in. coloured screen is slid home.

For direct illumination the safelight bulb should have a maximum strength of 15 watts.

The subject of developing will be covered in the next article in this series.

AN EXTRA STORAGE BIN . . .

GO to any garage and ask for a 5-gallon oil drum. You will be welcomed with open arms, as garage proprietors just don't know what to do with these empty drums. The wise handyman, however, will always find a use for one.

The bin shown in the sketch has been made from such a drum. Its use? — as an extra coal bin. How often have you wanted such a spare container to keep the coke or small coal separate from the house coal — or for use as a kitchen waste bin, a bin for the workshop, or even a waste-paper bin.

You will not be able to use the drum in its entirety. For one thing it is sealed at both ends, the top end having also a hole to pour out the oil. So with metal shears cut it to reduce it to two-thirds its height.

Now, thoroughly clean the drum. Paraffin is best, and you will find when you have finished, that the metal inside is as brand new — the oil having preserved it.

The cut edge can be sharp and, there-

fore, dangerous. File it to remove most of the sharpness. The cut edge will also need some reinforcement to stop it buckling. This is done by cutting a 1 in. wide length of 3-plywood, and fitting inside the cut edge to form a thicker rim, as shown. A continuous length of plywood is obviously best, but you can manage with two joined lengths. Hold it with rivets or screws, through drilled holes around the metal rim.

The three stub legs are made from broom handles. They should be shaped to include a step which fits under the lower rim of the drum. The legs are held to the drum with two $\frac{1}{2}$ in. nuts and bolts to each leg, as shown.

You may not, of course, require a lid to the bin, but one can be made quite easily. A circle is cut from 3-plywood of the same diameter as the drum. Two cross supports of 1 in. square timber, intersecting with halved joints, are screwed to the underside of the lid. They are cut in length to fit between the fitted rim. A lifting knob completes the job.

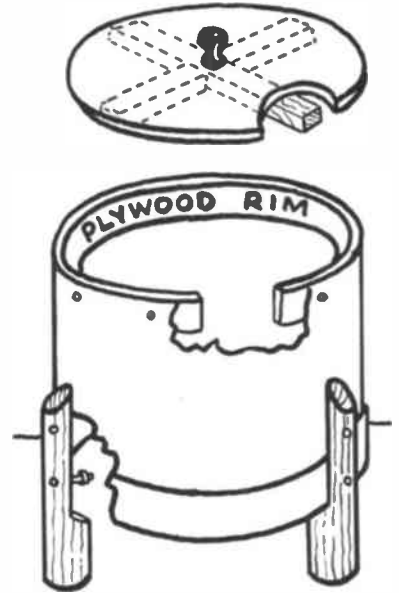

A KITCHEN sink bowl can become an annoying spacewaster when not in use, especially in the small modern home. Make a slide-away fitting, as shown, and then, besides being a useful stow-away unit, the bowl in its swung-out position is a ready-at-hand receptacle for vegetable cuttings and kitchen waste.

Cut a square piece of $\frac{1}{2}$ in. plywood, with sides 2 in. longer than the diameter of the bowl. Cut out a circle with a fret-saw so that the bowl, when at rest in the circular hole, rides proud of the surface by approximately 1 in. This allows for easy removal of the bowl for emptying.

To hinge the fitting, first nail a block of wood to the top right-hand corner of the plywood to give the bowl sufficient clearance under the table top as it is swung to its stow-away position.

Drill a hole centrally through the block and the plywood to take a $\frac{1}{2}$ in. carriage bolt. Use a washer between the block and the underside of the table. Prevent the nut of the carriage bolt becoming loose with movement by either fitting an extra nut as a locknut or burring over the end of the bolt.

For metal workers, a length of $\frac{3}{4}$ in. round bar can be shaped to a circle to carry the bowl. Part of the circle circumference is pinched into a small circle, through which a bolt passes to act as an axle. The bolt is then fixed

. . . AND BOWL TIDY

through the table top and held with the necessary nuts, washers, and spacers to allow the bowl to swing in and out for

use. Do not at any time strain the fixing by putting too much weight in the bowl. (E.C.)

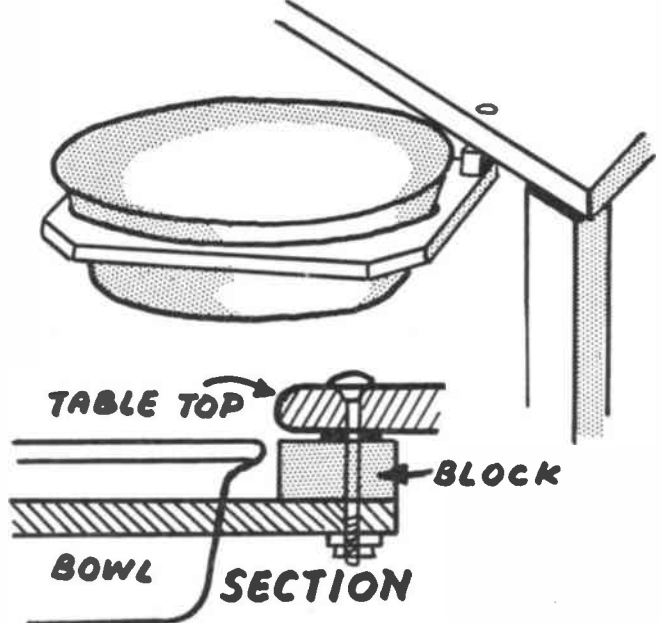

PAINING DESIGNS ON GLASSWARE



varnish over the design. The latter fixes and preserves the paint. Oil paints will give a more durable finish of course, and small tubes of artists' colours may be purchased very cheaply. You will require brushes, but you will need very few, and these may be of squirrel hair, sizes 2, 3, and 4, or sable hair brushes, which are rather more expensive.

We will assume that we are to decorate a small tumbler as a gift for a child. First of all we prepare a design.

By H. Mann

This may consist of a floral pattern, an animal pattern or other motif, which can include a label for the child's name. Determine the circumference of the tumbler with a tape measure, cutting a suitable strip of paper, and which is equal to the depth. Trace your design so that the strip can be inserted inside the

glass, completely fill in the shape with colour, or fill in some portions, adding details as required. Fig. 3 shows a floral design suitable for a tumbler, and a border has been incorporated. Note that if the latter is to be added at the top it must be reversed, and placed not too near the top rim.

The outside of the tumbler is now thoroughly cleaned with methylated spirit to remove all traces of grease from the fingers, handling with a duster to avoid any further impressions while painting. It is essential that any greasiness be removed, otherwise the paint would not 'take'. It is not sufficient to wash in soap and water, for there is always a danger that traces of soap will remain.

To hold tumblers steady while painting, partly fill a small box with sand, which can be moulded into shape for the object. This will leave both hands free for painting. Otherwise you may hold one hand inside the tumbler, which is rested on a table while painting with the other, but you must endeavour to keep

THERE are several ways of applying painted designs to glassware to achieve some really striking results, thus providing an opportunity for your creative skill. You may treat tumblers, bottles, vases, glass soup bowls and the like, transforming them into attractive novelties.

In our illustration we show an old fruit juice bottle which has been treated,

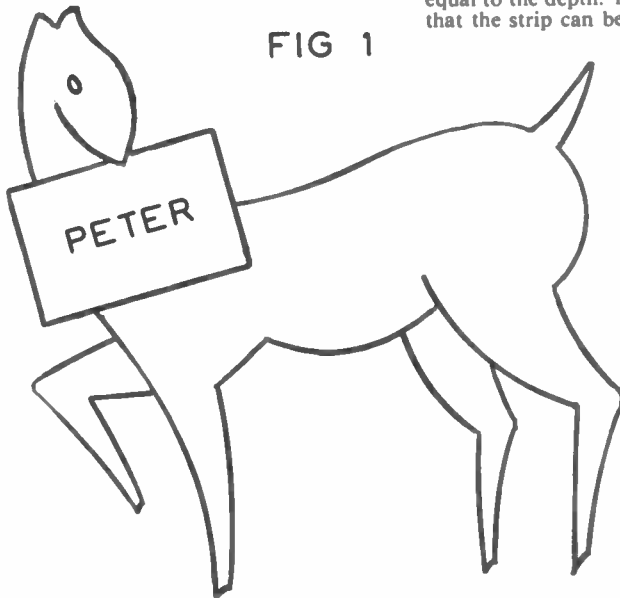

FIG 1

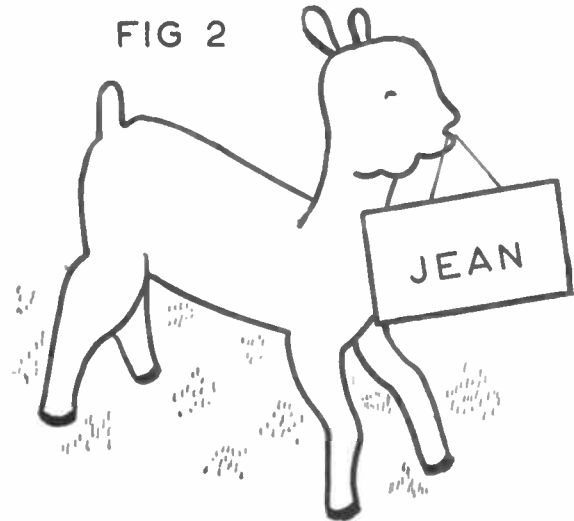

FIG 2

and is to be converted into a table lamp base; a bowl has been painted black on the outside, spots applied by means of the ends of a matchstick, and varnished; and a small perfume bottle decorated with a floral design.

The easiest way is to apply ordinary water colours on the outside of the glass, finally applying a coat of colourless nail

tumbler so that the pattern shows clearly on the outside and temporarily fasten it in position with Sellotape.

Fig. 1 and Fig. 2 show suitable designs for such novelties and these may be reduced to any size you may require by copying on squared paper of appropriate size. It will be realized that you may either paint outline drawings on the

it perfectly steady. Other objects do not present the same difficulty but you may still use a sandbox where desirable.

When painting it is advisable to deal with the largest areas first if filling in. Apply the paint sparingly, otherwise you will find it trickles down the tumbler. You can apply two coats if necessary, and then any details or overtones. Water-

colours dry quickly, when a finishing coat of nail varnish can be applied. Oil colours are much slower, and may not dry for two weeks, so always examine carefully before finishing.

Another effective method of glass painting — especially flat glass for decorative table tops or trays — is to prepare your drawing on tracing paper, and then outline with Indian ink on the reverse side. This drawing is then attached to the upper side of the glass, with the inked side in contact with the glass, and the painting done on the reverse side of the glass. You will see the reason for inking in on the reverse side of the drawing, when you realize that we have to see a distinct outline. This method of reverse painting is tricky but fascinating, and you have to remember that you are actually working in reverse. Any outlines and details are first painted in the desired colours. Use one colour at a time, and allow ample drying time. Then apply the background colours. For example, in painting a leaf, prepare the outline and the veins, next any overtones, and lastly the leaf green. When seen from the correct side of the glass the green is behind the details and overtones. Finally, apply a coating to the whole of the back of the glass in flat white — or a pale colour — thinned if desired with turpentine. Give a further

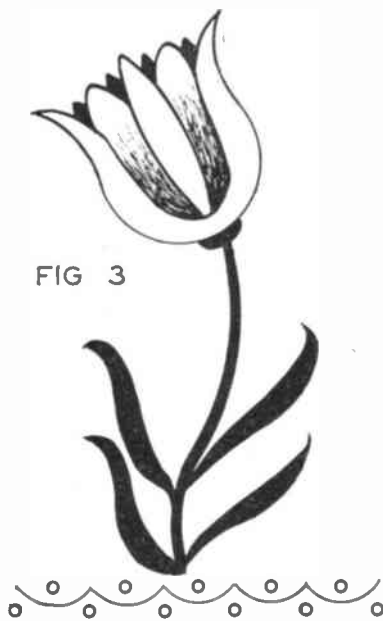

coat about two or three days later. This backing coat must be oil paint, and the resulting painting indicates a design

backed with a ground coat. Glass is not always the best medium to paint and you may find that normal brushing becomes patchy. This can be overcome by applying the paint with a dabbing action, with the brush held vertically, until the surface has been treated.

Apart from water-colours and oil paints I have discovered another satisfactory method in glass painting with sealing wax. The latter is the same kind normally used for sealing letters and can be bought in many colours. If a piece is broken from a stick, crushed, and placed in a small bottle and covered with methylated spirit you will find it dissolves into a waterproof paint, and is quite suitable for use on glass. Moreover, it does not wash off in hot water. Note that the sealing wax has only to be covered with spirit, for too much of the latter will make the paint too thin for use.

Old wine bottles in dark colours look most attractive when painted, while much of the popular heatproof glassware now available for domestic purposes is ideal. Small soup bowls, complete with lid, are transformed into powder bowls while small dishes will make bulb bowls. No doubt you will find many odd pieces of glassware in your home which could be brightened with a painted design.

HOW TO BE A TRICKSTER

CAN you light a match under water, push a teapot through a sheet of paper, or make a Maltese cross with two matches? Stunts and catches such as these can be used by the young conjurer in interludes between his more serious magic tricks.

Quickly write down the number twelve thousand, twelve hundred and twelve. Have you written, '121212', as most people will when they are not given time to think? Of course, a more careful person would write the correct version, which is 13,212.

Try to make a square with four pennies. This is possible if you begin by turning the pennies 'tails up', and then place them together so that the straight lines at the bases of the four Britannias form a four-sided figure. Now make a cross with two pennies. No, it is not impossible. Pick up a penny and mark a straight scratch upon a sheet of paper, then, use the other penny to make a second scratch across the first. You will have drawn a cross.

Tear a strip of paper into five little pieces, and number the fragments from

one to five. Place them upon a tray. Decide upon one of the numbers. Can you now blow hard on the tray and cause all the pieces to flutter away, except the one you chose? If this stunt baffles you, try blowing whilst you press a finger against the selected number.

By A. E. Ward

There was no rule against doing this. How about pushing a teapot through a sheet of paper the size of a pound note? Can you do this? When you know the catch it is really very easy. Stand the teapot on the table, and rest the paper against it, then press the sharp point of a pencil through the paper, and let the pencil push the teapot — through the paper!

Who would have thought it possible to immerse a handkerchief in a bowl of water without wetting the handkerchief? Merely push the handkerchief into the bottom of a dry drinking glass, turn the glass upside down, and push it under the water. The air inside your miniature diving bell will not let the water rise up and give the handkerchief a soaking. Be careful how you lift out the glass, and dry the rim before removing the handkerchief. You can stay under water for a hundred seconds — if you hold a glass of water above your head! Give a jug of water to an assistant, and say that your science teacher has recently shown you how to light a match under water. Your audience will be very interested until you proceed to strike a match held just underneath the jug.

Have you succeeded in making a Maltese cross with two matches? The matches must not be broken. You will need a genuine Maltese citizen to do this. Strike one of the matches, and put it inside his shirt. If this fails to make him cross, a second lighted match down his neck will be sure to do the trick!

A TOY CROSSBOW

THIS toy crossbow is an ideal piece of equipment for boys playing at 'William Tell' and other characters from the Middle Ages. Although in the main the shape of the crossbow conforms to the original weapon, our version has been streamlined on modern lines.

Arrows are released by a trigger action and travel in a groove along the stock. The motive force is obtained from a length of elastic stretched from the ends of the bow.

Although the makeup described here is not powerful enough to do any serious damage, the usual precautions

should be taken when using the crossbow. It should be fired out of doors, as with any other toy bow and arrow, and not pointed directly at any other person. Nevertheless, good fun can be obtained by aiming at trees or other targets. Parents should note that power can be controlled by the tension of the elastic, which should be adjusted accordingly. The tips of the wooden arrows should also be rounded as an additional safety precaution.

The makeup of the crossbow is on the sandwich or bread-and-butter principle. All the parts necessary are shown full size on the design sheet. Because of

space limitations, some have been overlapped, but the shapes are clearly defined. They should be traced and transferred to their appropriate thicknesses of wood, and cut out with the fretsaw.

Chamfer one edge of each piece 1, and glue them to piece 2, as shown in Fig. 1, noting that the chamfered edges face each other. This will form the groove along which the arrow and flight travel. Next glue together pieces 3 and 4 as seen in Fig. 2, and continue by adding pieces 5 and 6 as shown in Fig. 3.

The trigger assembly is shown in Fig. 4 and an exploded version in Fig. 5. First

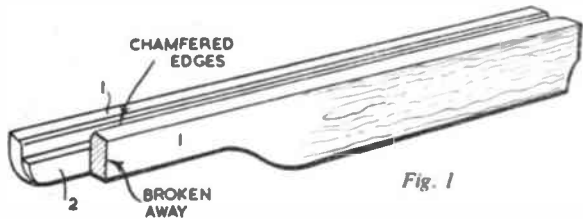

Fig. 1

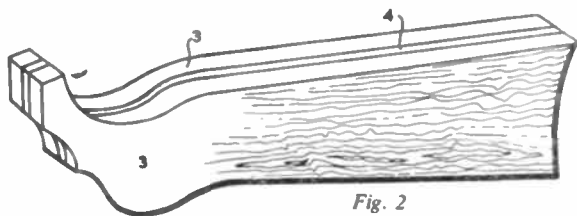

Fig. 2

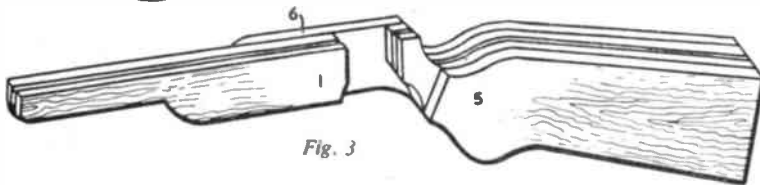

Fig. 3

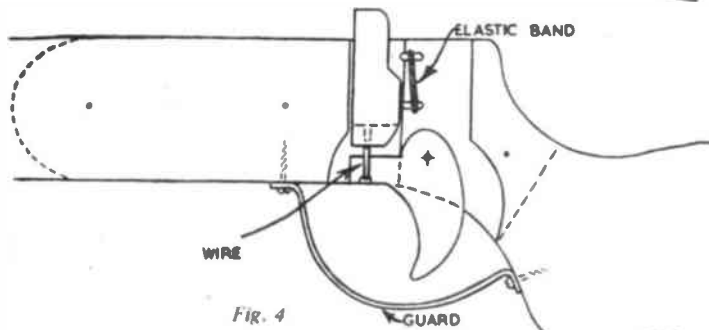

Fig. 4

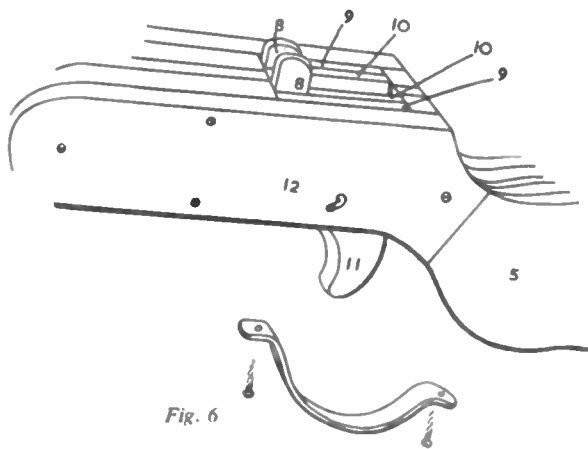

Fig. 6

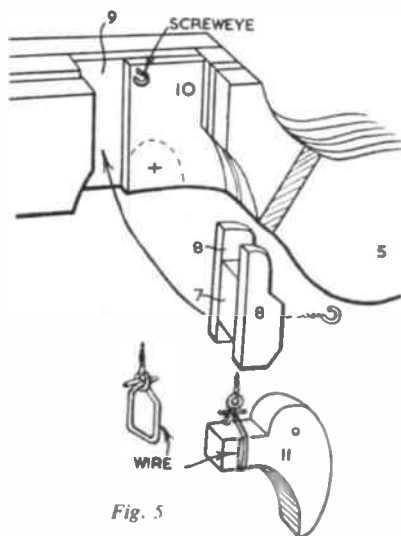

Fig. 5

pivoted to the piece 10 already in position, and an elastic band wound round the two screweyes as shown in Fig. 4 to give a strong tension. Test the mechanism for smooth working, ensuring that the firing pin comes up as the trigger is released after firing.

The cover plate (12) is made up as

shown in Fig. 6 by gluing piece 9 and the other piece 10 in position on the inside, so as to match their counterparts seen in Fig. 5. The completed cover plate is screwed in position to facilitate removal for renewals, etc. The trigger is now pivoted by a piece of wire put right through from one side to the other.

Continue by adding the bow (pieces 13 and 14) glued together, and then glued in position as shown in Fig. 7.

Next round off all corners and sharp edges as suggested in Fig. 8. The stock and bow can be cleaned up and stained and varnished, or painted, as desired. Add $\frac{1}{2}$ in. flat elastic, binding at the ends, as shown in Fig. 8, and stretched across, not too tightly. Add a trigger guard made from $\frac{1}{2}$ in. flat brass or copper strip (Figs. 4 and 6).

Arrows should be made from $\frac{1}{4}$ in. diameter round rod about 12 to 15 in. long. Flights are made from card, as indicated at Fig. 9. Make two right-angle cuts in the end of the shaft with a fretsaw. Insert the flights, and then bind the shaft at the end. Alternatively, flights can be made from chicken

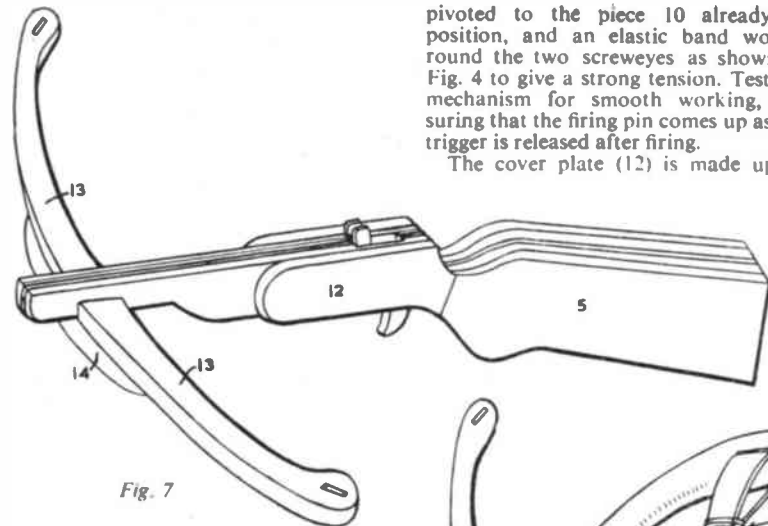

Fig. 7

glue piece 9 in position (Fig. 5); into this add a shaped piece 10. Note the screw-eye (slightly opened) in position at the top of piece 10.

Next glue together the three pieces which form the firing pin (two pieces 8 and one piece 7), and insert another slightly open screw-eye at the back. These screweyes are slightly opened, incidentally, in order to allow an elastic band to pass through.

The trigger (piece 11) is linked to the underside of piece 7 by means of a shaped piece of wire and screw-eye. Insert the screw-eye into piece 7 first, then add the wire stirrup as shown in Figs. 4 and 5. The trigger is temporarily

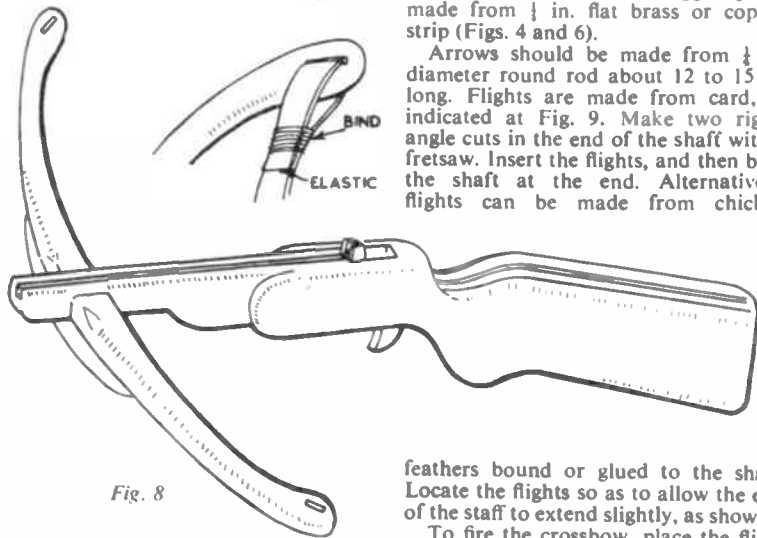

Fig. 8

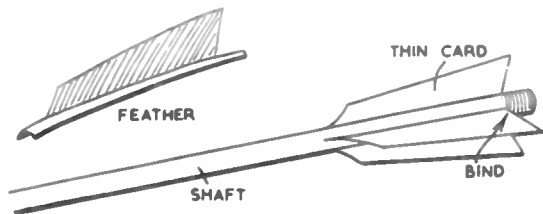
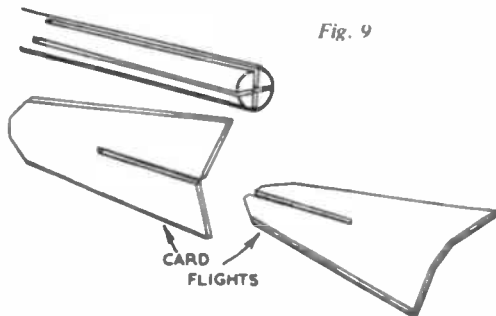

Fig. 9



feathers bound or glued to the shaft. Locate the flights so as to allow the end of the shaft to extend slightly, as shown.

To fire the crossbow, place the flight end of the shaft in the firing pin with one flight lying in the groove. The arrow should lie snugly along the chamfered edges of pieces 1. Draw the elastic back to behind the firing pin. The weapon is now set. When the trigger is pulled the pin is depressed and the elastic freed to contact and fire the shaft.

A KIT FOR 10/9

Hobbies Kit No. 3398 for making the Crossbow contains all wood, wire, copper strip, rubber, etc. Kits price 10/9 from branches or from Hobbies Ltd, Dereham, Norfolk (post 1/6 extra).

A HANDY HOME LETTERBOX

THE home handyman will want to make this useful 'letter-box' which not only saves stooping to pick up the correspondence from the hall floor — but also keeps out the draught. Quite ingenious too, with its self-drop flap at the front, allowing newspapers and long envelopes to pass through without damage.

lid and base pieces are glued and nailed first to the end pieces, then the front strengthening strip (O) added. No back piece is required, but a metal wall hanger is screwed to both end members for mounting the finished job on to the door.

Next make up the flap assembly. Drill vertical holes for the pivot screws

front edges of the box when screwing the flap in position. There should be just enough clearance under the lid for the flap to be lifted and to drop back to the closed position smoothly.

Finish the cabinet with gloss paint of a colour to match the door or hall décor before fixing to the door.

By T. Richmond

The ends of the cabinet are cut from soft wood of about $\frac{3}{8}$ in. thickness. The pivot bar which carries the flap is also of this thickness, though preferably timber of the harder variety. The rest of the parts — all detailed in the diagram — are of $\frac{1}{8}$ in. plywood or hard-board cut out with the fretsaw, with the addition of a strengthening strip (O) of $\frac{1}{2}$ in. or $\frac{3}{8}$ in. thickness.

Clean away rough edges of each section with glass paper before assembling. The

in the ends of the pivot bar. Drill corresponding holes in the end members and insert wood screws so that the bar may pivot freely just under the lid. A packing strip of plywood (at X) may be necessary to bring the flap flush with the

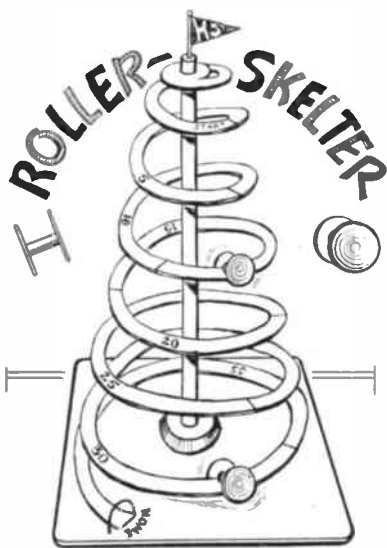
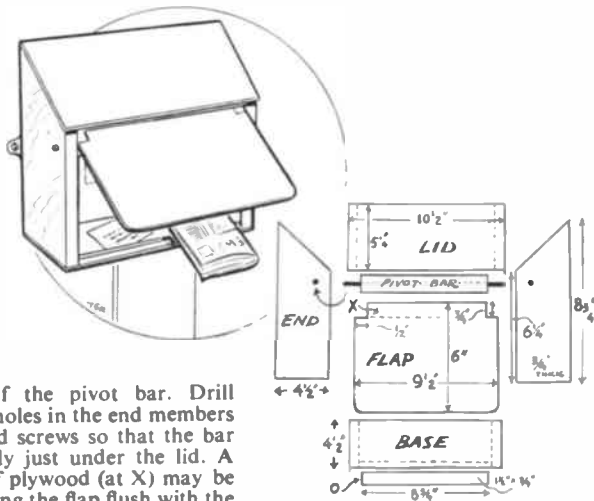

ONE small plywood panel, fret-sawn to the pattern given opposite, is quickly transformed into a 16 in. 'helter-skelter' spiral track on

which roller-coaster games can be played.

Two or more players take turns, orbiting their rollers down the spiral track. Each player obtains a score from the numbered section of track at which the roller sticks or falls from the track.

A 12 in. square panel of $\frac{3}{8}$ in. hard-board or plywood provides the base with its four corners rounded. In the centre is firmly fixed the disc of $\frac{1}{2}$ in. or $\frac{3}{4}$ in. thickness. As shown in the diagram, it has a hole drilled to accept a friction-tight fit of the end of the vertical round-rod column. This rod may be of between $\frac{1}{8}$ in. to $\frac{3}{8}$ in. diameter and the hole bored accordingly. A pennant is made for the top with a card, plastic or metal flag and a wire or 'lolly-stick' mast (X).

An 11 in. square panel of $\frac{3}{8}$ in. plywood is required for the spiral track cut-out. With a pair of compasses mark-out circles, $\frac{1}{2}$ in. apart, with the compass point in the centre of the panel (see plan of track). Now move the point from A to B and intersect the rings as shown at D. Drill the centre hole for a loose fit of the column and cut out the 10 in. diam. disc away from the

outside waste wood (W). Next cut out the middle portion shown black on the pattern.

Cut around the spiral lines with a fretsaw to complete a continuous track which can be opened out to fit on to the column. Trim off the end of the track and fix a wood block or wire roller-stopper. Glasspaper before painting in contrasting colours and add score numbers to sections of the track. The column and base can be painted or varnished as desired.

Assemble the finished units as in the illustration of the finished toy, which also shows rollers used for play. These are assembled from a pair of $1\frac{1}{2}$ in. diameter ply discs, spaced approximately $\frac{3}{4}$ in. apart on a centre axle of $\frac{1}{2}$ in. or $\frac{3}{8}$ in. round rod. Test them on the track and make any adjustments necessary, before finally gluing together. Paint each roller a different colour, adding a spiral or other spinning-top, design.

The game is designed for dismantling and presentation in a cardboard or specially-made wooden box, which would make an attractive gift for a young boy or girl. (T.S.R.)

BASE

PENNANT

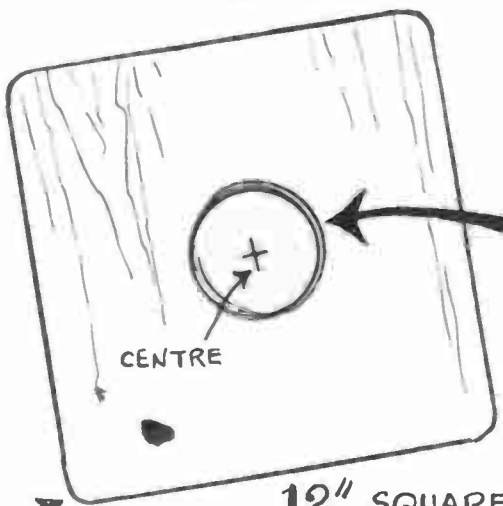

2" DIAMETER

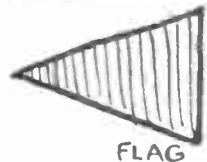
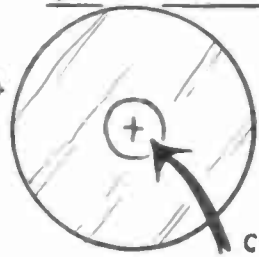

FLAG

MAST

X

WIRE



16"

ROD
 $\frac{1}{2}$ " DIA.

ROUND
CORNERS

12" SQUARE

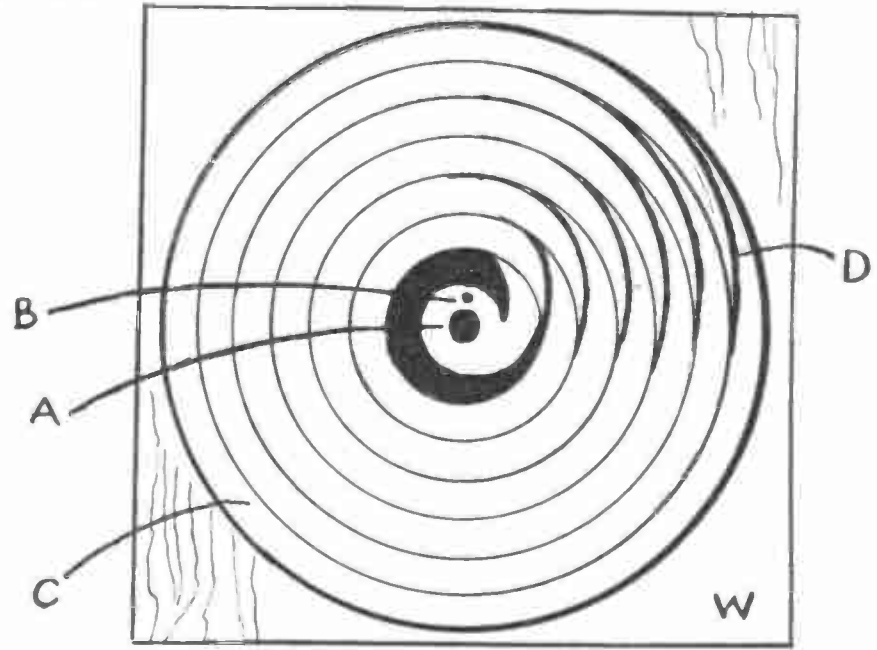

PLAN OF SPIRAL TRACK (SEE TEXT)

Watch for these Winter Visitors

THE bird-watcher in winter cannot fail to be interested in looking for the many species that visit Britain's woods, marshes, and hedgerows.

The Bramblings or Bramble-finches in the young trees in the plantations are worth noting. They come from Norway to enjoy the ripe beech-nuts and other food, so if you live near a beech wood that is a likely spot to see them. The Brambling often mixes with the flocks of bachelor finches, such as the Chaffinch. You may easily distinguish between the two. The Brambling is recognized by the white patch just above the tail, displayed when the bird is flying.

Foreign Goldcrests journey across the North Sea to spend winter here, travelling 300 miles or more. If you live within reach of fir woods you may see the wee bird. It is recognized by its small size and the crest or crown of golden-yellow on the head bounded on either side by a black streak. There are white bars on the wings, plainly visible in flight. A flock of Goldcrests fill the winter copse with eager shrill call-notes as they quest for food; 'tsit, tsit' echoes their needle-like efforts. Most of them return overseas in spring, but some will stay and breed here.

'Gipsy migrants'

Also, while among the firs and conifers look out for the Crossbills, members of the finch family. These handsome, 'parrot-like' birds come to Britain from parts of Scandinavia during winter months. Keep a special watch for them as they are worth seeing. Crossbills have beak-tips that overlap, enabling them to extract seeds from the pine cones, their special diet, to obtain which they often hang upside-down like tits. The male is handsome, with bright red plumage, and the female has greenish-yellow feathers.

They wander about the countryside a lot, 'here today, gone tomorrow'. Some people refer to them as 'gipsy migrants' owing to their wandering habits.

The pretty Redwing is another winter visitor — a lovely bird with a ruddy patch of feathers on the flanks — a notable feature as the bird expands its wings to fly up from the ground. The wings are not red, as one might surmise from its name. Sometimes, on a mild day, the Redwing warbles a sweet, low song.

Then we have the Fieldfares from Norway. These are the biggest members of the thrush family, very handsome, with auburn mantle and general plumage of grey and buff, black and white, in contrasting shades. You may watch for these fine birds and hear their characteristic 'chak-chak-chak' as they flit

about the winter meadows in flocks, or see them resting on the grass, with pickets posted.

Still another interesting winter bird is the Snow-bunting, which, on arrival in this country, is of sober, mottled plumage, but as winter develops changes its feathering to a much lighter colour, often pure white. But you have to visit the moors and hilly countryside to come across these pretty creatures.

A further visitor to our hedgerows and coppices is the pretty little Siskin, a bird which roams about in small flocks, haunting the alders by the riverside, where they feed on the kernels of the catkins. It is a pleasure, indeed, to watch a party flickering about the black boughs and naked twigs like bright greeny-olive and yellow canaries, their gay colouring showing up in contrast. The cocks are very striking with their gold-banded wings, yellow rumps, and greenish backs. As they flutter about the trees, they utter snatches of linnet-like notes ending in a rather drawn-out 'tsy-e-e'. Siskins are erratic visitors, some years fairly plentiful, other seasons scarce. It is a red-letter entry for your diary when you see a party of these gay-hued birds on a winter day.

Although the number of birds that indulge in winter song can be counted on your fingers, they are worth notice. The

warbling of a bird at such a time is one of the most delightful sounds that fall upon the ear of a bird-lover. Here are the most noticeable winter singers: Misselthrush, Song thrush, Starling, Robin, Wren, Dipper or Water Ouzel (a bird of the stream-side), and occasionally the Hedge-sparrow. Of course, many other birds utter their call-notes, and Goldfinches twitter sweetly as they wander about the banks where seeded heads of weeds provide food. There are the calls of tits in the garden and orchard, where they inspect every tree and fruit bush for scraps to eat.

But real song is scarce during winter. The Robin will give good measure, and so will the Dipper, but you will need to go to the hillside stream to hear him, for he is a bird of the wilderness. The Dipper tunes in to the metallic flow of the rock-strewn beck, raising his notes above the gurgle and splash of the fretting water.

In mid-winter, too, you will at times hear the Misselthrush, or Stormcock, singing from the uppermost boughs of the tall elm tree, defying the wintry wind. It takes a lot to dishearten him from throwing forth his clarion notes, just as the Starling on the chimney-pot defies the blast and chitters and whistles in rain and sleet, frost, and snow. The little Wren, too, is a persistent winter songster and will sing undismayed. (E.)

Hobby or Hobo!

Whether you're interested in a particular hobby such as photography, sketching, botany or bird watching, or whether you just enjoy the freedom of wandering at will where the fancy takes you, you'll be glad to know about youth hostels. Nearly 300 in England and Wales provide simple but friendly accommodation for walkers or cyclists at only 3s. a night (1s. 6d. if under sixteen). There are also available three-course suppers at 3s. each, and breakfasts at 2s. 6d. each, or you can cook your own food in the members' kitchen for 3d.



**Don't
delay
Post
today**

To Y.H.A., Trevelyan House, St. Albans, Herts. HW61/1
Please send me "Going Places" and details of Y.H.A. membership

Name

Address

NEW Angles

on OLD favourites

from these Books bulging with BRIGHT IDEAS

Any volume in this most interesting range of books, each dealing with a different aspect of gummed paper-craft, will show you a wealth of ideas, the way to carry them out, and give hours of intense enjoyment.

Each is the key to an economical hobby that is rich in variety, ranging from the making of a charming picture to framing it delightfully — from three dimensional models to wall decorations, from paper sculpture to charming flower studies.



Other books by FREDERICK T. DAY

Coloured Paper Decoration	7/6
Coloured Papercraft for Schools ..	7/6
Coloured Papercraft for Infants' Schools ..	6/-
Lampshade and Parchment Craft ..	8/6
Decorative Flower and Leafmaking ..	8/6
Gummed Strip and Paper Modelling ..	7/6
Paper Sculpture for Schools	7/6



8/6

All books obtainable from:
Newnes & Pearson Ltd.
Tower House, Southampton St., Strand, W.C.1.
Ask your stationer to show you the Butterfly range of handcraft materials.

SAMUEL JONES & CO., LTD.

STATIONERY MILL, CAMBERWELL, LONDON, S.E.5. RODNEY: 5064



A NEW RANGE OF JOHNSON DO-IT-YOURSELF OUTFITS

Here's excitement! The new Johnson range of "Do-it-yourself" outfits makes it so easy to develop and print your films at home.

These outfits contain everything you need. They range from sets for the beginner, to outfits for the more advanced enthusiast. And full instructions go with every outfit.

Prices from £1-17-6 to £5-12-6.

JOHNSONS
OF WENDON LTD

FOR CONFIDENCE
IN PHOTOGRAPHY

KITS for OLD TIME SHIPS

Hobbies range of Ship Models includes Elizabeth Jonas, Cutty Sark, Victory, Mayflower, etc. Complete kits, of wood, sail material, guns, pulleys, cord, etc., with full-size patterns of parts and planned wood ready to cut out, shape and construct. A fascinating pastime.

Ask for free illustrated list at Hobbies Branches or from Hobbies Limited, Dept. 99, Dereham, Norfolk.

HEAR ALL CONTINENTS With H.A.C. Short-Wave Receivers

Suppliers for over 18 years of radio S-W Receivers of quality.

One-Valve Kit, Price 25/- Two-Valve Kit, price 50/-

Improved designs with Denco coils. All kits complete with all components, accessories and full instructions. Before ordering, call and inspect a demonstration receiver, or send stamped addressed envelope for descriptive catalogue.

H.A.C. Short-Wave Products (Dept. 22), 11 Old Bond Street, London, W.1

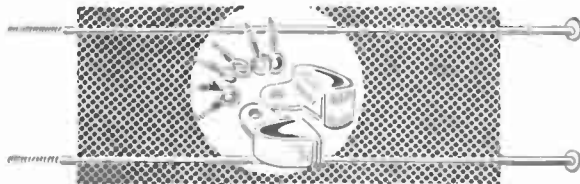

COT FITTINGS (full size)

The fellow handy with tools can make quite easily a drop-side Cot using these fittings. The set comprises two bright steel rods 36in. long, six heavy-duty screweyes (four plain and two threaded for rods) and two catches. Price 7/9 Set.

From branches or
Post 1/6
HOBBIES LTD., Dept. 99, Dereham, Norfolk

BUYING OR SELLING?

Classified advertisements on this page are accepted at a cost of 6d. per word prepaid. Use of a Box No. is 1/- extra. Send P.O. with advertisement to *Hobbies Weekly*, Advert. Dept., Dereham, Norfolk. Rates for display advertising on application.

Starline

CHINESE LACQUER

THE SAFE PAINT FOR HOUSE & NURSERY FURNITURE

PROFITABLE LEISURE. Learn to draw/ paint flowers, birds, doodles, etc. Waiting markets. Profitable. Fascinating. Exciting. Beginner's work can sell. Booklet free. — Popular Designs (H W), Clun, Shropshire.

100 DIFFERENT stamps free! Request 4d. upwards discount approvals. — Bush, 53 Newlyn Way, Parkstone, Dorset.

WHEELS (Hardwood and Rubber Tyred Metal). Cot, Pram, and Doll's House Fittings and Papers, Beads, Transfers, Prints and other accessories. Stamp for new lists. (Trade supplied.) New Address — **JOYDEN CO.**, 91 Pepins Way, Brookmans Park, Herts.

LEARN RADIO & ELECTRONICS the NEW Practical Way! Very latest system of experimenting with and building radio apparatus — 'as you learn'. FREE Brochure from: Dept. H.W.10, Radiostructor, 40 Russell Street, Reading, Berks.

PROFIT AND PLEASURE are obtainable from **WRITING** (typewriter unnecessary) or **ARTISTRY**. Send for free fascinating bumper package 'PROFITABLE LEISURE'. — Writers' & Artists' Ring (HW), 5 Edmund Street, Birmingham.

50 MIXED stamps 5/-. Try our 6d. in 3/- discount approvals. — E. C. F. Townsend, 92 Tenby Road, Edgware, Middx.

THE MATCHBOX LABEL' CLUB. 105 Sunnyside Gardens, Upminster. Membership free. Send postcard.

25 CHEESE LABELS 1/9. British Colonials, — stamps on approval. Daniels, 66 St. John's Road, Romford, Essex.

SAN MARINO and Airmail stamps. Packets 25 and 50 different (all countries). Tweezers, magnifiers and other accessories. Order now. All enquiries dealt with. — Ronald F. and Freda Alborough, 125 Beehive Lane, Eastern Avenue, Ilford, Essex.

LEARN RADIO & T/V SERVICING for your OWN BUSINESS/HOBBY ● by a new exciting no-maths system, using practical equipment recently introduced to this country FREE Brochure from: — **RADIOSTRUCTOR** DEPT. G81, READING, BERKS. 25/1/61

KUKLOS ANNUAL. Indispensable cyclists' handbook. Tours, resthouses, money-saving hints. 3/- post free. — Burrow, Publishers, 2 Imperial House, Cheltenham

WORKERS with sewing machines required for making cushion covers. Regular work guaranteed. Apply enclosing s.a.e., Dept. 28, Arnold Trading, 10 Shelley Road, Worthing, Sussex.



RUNABOUT 'ZIP'

Length 7ft. 8½in. Beam 2ft. 10½in.
Weight 80 lb. (without motor)

A kit designed especially for the beginner to make as an inexpensive introduction to water craft. Skinned with oil-tempered hardboard and suitable for a small h.p. outboard engine. Will carry an adult and one or two children. Steering by wheel and/or motor.

COMPLETE KIT OF MATERIALS FOR BUILDING 'ZIP'

includes PARANA PINE, MAHOGANY MARINE PLYWOOD, OIL-TEMPERED HARDBOARD, STRIPWOOD, BEADING, PERSPEX, BOWDEN CABLE, SCREWS, GLUE, FULL-SIZE PLAN, etc. (not paint and varnish).

CASH PRICE

£19. 19. 0

(plus 30/- part carriage & pkg.)

KIT EASY PAYMENT TERMS—£5 down (plus 30/- part carriage and packing) and 6 monthly payments of **£2/13/0**. Total E.P. price **£20/18/0** (plus 30/- part carriage and packing).

FULL-SIZE PLANS AVAILABLE SEPARATELY, 16/6 (post 9d. extra)

Kits from branches, etc., or direct from the factory

HOBBIES LTD., (DEPT. 99), DEREHAM, NORFOLK

A DECORATIVE VASE STAND

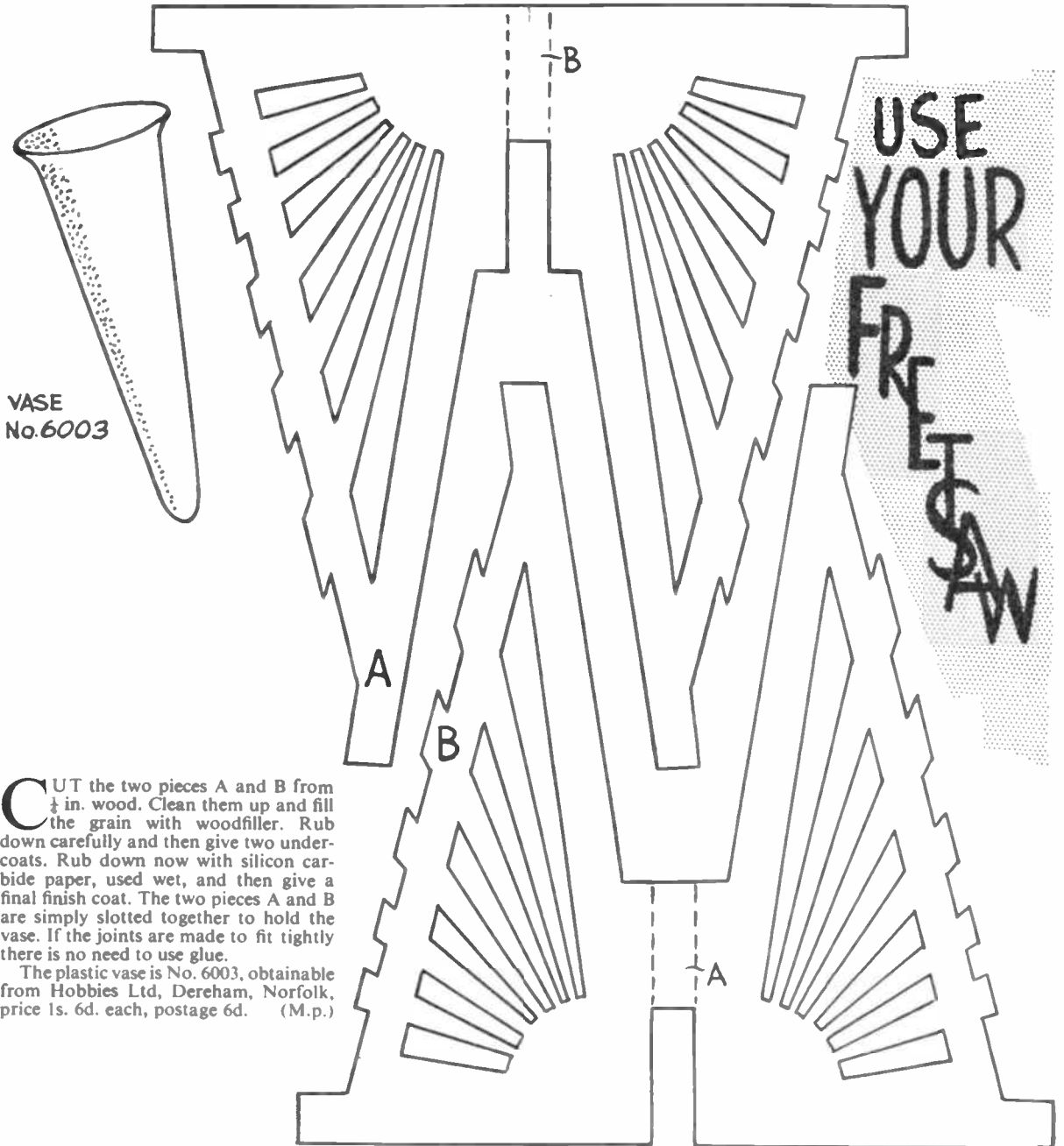

VASE
No. 6003

CUT the two pieces A and B from $\frac{1}{4}$ in. wood. Clean them up and fill the grain with woodfiller. Rub down carefully and then give two undercoats. Rub down now with silicon carbide paper, used wet, and then give a final finish coat. The two pieces A and B are simply slotted together to hold the vase. If the joints are made to fit tightly there is no need to use glue.

The plastic vase is No. 6003, obtainable from Hobbies Ltd, Dereham, Norfolk, price 1s. 6d. each, postage 6d. (M.p.)

ARCOY PRODUCTS



make ideal
tools for
the handyman



ARCOY RABBETTER

For use with any Portable Drill.
A boon for all workers in wood.
It rebates for panelling, etc.
It slots for drawers. It
strips for laths. It tongues,
grooves and fillets.

PRICE £2.2.6

Moulding cutters for use
with rabbetter £1.3.6 each.



ARCOY POWER PLANE

Combines the handiness of the
normal smoothing plane with the
efficiency of the planing machine.
Will never split wood, lift fibres
or tear. Depth of cut
adjustable from 0- $\frac{1}{8}$ in.

PRICE £14.15.9

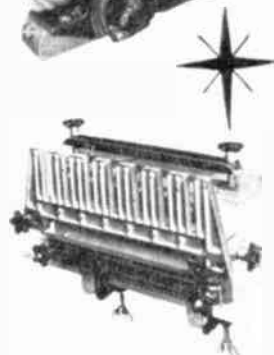

ARCOY DOVETAILER

With the aid of any $\frac{1}{2}$ in.
capacity power tool you can
produce joints at $\frac{3}{4}$ in.
pitch in timber up to 9 in. in
width in any combination
of thicknesses from $\frac{1}{2}$ in.
to 1 in. in five minutes!

PRICE £6.6.3

Heuristic Joint Attachment

PRICE £1.11.9

Multi-Pitch Attachment

PRICE £2.16.9

If you have any difficulty in obtaining Arcoy Products write for the name
of your nearest stockist to:
ARCOY PRODUCTS, KNOWSLY RD, BOOTH, LIVERPOOL, 20

NAME

ADDRESS

TOWN

COUNTY

PLEASE COMPLETE IN BLOCK CAPITALS

If you want sound soldering



you've only



to say the word



Say **FLUXITE** and you show yourself to
be someone who *knows* about soldering
—knows that nothing *but* **FLUXITE** will
give the selfsame high standard results,
whatever the type of soldering job you're
doing. It's the one flux that simplifies
all soldering.

FLUXITE SIMPLIFIES ALL SOLDERING



FLUXITE LTD., Bermondsey St., London, S.E.1

GMB6