

21st OCTOBER 1959

VOL. 129

NUMBER 3332

THE ORIGINAL
'DO-IT-YOURSELF'
MAGAZINE

HOBBIES *weekly*

FOR ALL
HOME CRAFTSMEN

★ *FREE Design Supplement*

Also in this Issue

MAKE A CAR
PLAY PEN

PLANTS FOR
GARDEN POOLS

NEW LOOK FOR
PHOTO ALBUMS

COLLECTORS' CLUB

PLASTER GARDENS
IN MINIATURE

MODEL AND
TOY MAKING

ETC. ETC.



TEA TROLLEY

(FOR GARDEN OR INDOOR USE)



Up-to-the-minute ideas

Practical designs

Pleasing and profitable things to make

5^p

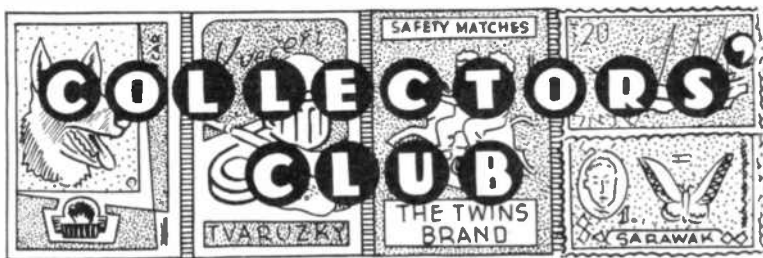

OCTOBER has preserved its name ever since the time when it was the eighth month of the year, as its etymology denotes. The Saxon names for it were Wyn-Monath or wine-month, and Winter Fylleth.

The month was usually represented as a husbandman carrying a sack over his shoulders, and sowing the winter grain.

A Sower is depicted on a 2½d. Irish stamp of 1945 — 1d. used.

OCTOBER

Hallowe'en, or All Hallow's Eve, (31st Oct.) sometimes called Nutcrack Night, from the custom of cracking and eating nuts on that evening, was a season of great enjoyment to young people. They 'dived for apples', and flung nuts into the fire; used divinations to discover whom they were to marry, and passed the evening in laughter and merriment, consuming enormous quantities of ale, apples and nuts.

Other October anniversaries, etc., 1st, 1881, Red Cross founded.

*Stamps: Switzerland 1928, 30 cent blue and red — J. H. Dunant, who founded the Red Cross — 1/3 mint.

Match Labels: Czechoslovakia 1956, set of 12 Red Cross designs — 2/6 mint.*

10th, 1913, Panama Canal completed — 1939 2 cent stamp of Panama depicts Allegory of Canal Construction — 6d. mint.

20th, 1632, Sir Christopher Wren born — 1946 New Zealand stamp depicting St. Paul's Cathedral — 3d. mint.

21st, Trafalgar Day — 2/6 stamp of Gt. Britain 1951 — H.M.S. Victory — 9d. used.

29th, 1950, King Gustav V of Sweden died — the King appears on Swedish stamps of 1920.

October is a good month for transplanting evergreen shrubs.

Stamps: Yugoslavia 1951, 3 dinar magenta — Evergreens and Winter Landscape — 1/3 mint. Ditto: 1956 Match Labels — set of 12 depicting Evergreens — 2/6 mint.

The Mop Fair at Stratford and the



Tavistock Goose Fair are October occasions.

Pheasant shooting begins; many angling contests are staged.

The Flat season draws to a close with the autumn double, the Cesarewitch and the Cambridgeshire.

'If the oak bear much mast, it fore-shows a long and hard winter'.

An oak tree is depicted on American stamps of 1935.

Peeps at nature THE MUTE SWAN

THE 'Mute Swan' is the swan commonly seen on park lakes and rivers in most parts of this country, and must surely be familiar to everybody. It is characterized by its orange bill with a black knob at the base, larger in the male (cob) than the female (pen). In spring, a nest is constructed of twigs by both birds on the bank and three to four eggs are laid, more by an old bird. Both birds take turns on the nest, which is guarded savagely by the male.

Swans feed mostly upon water plants and grass, and if fed on bread, they like it wet and soft. The mute swan is not a native of this country, being introduced about the 12th century. (P.R.C.)



Instructions for making

WHEELED TEA TROLLEY

(ILLUSTRATED ON FRONT PAGE)

A TEA trolley which is equally useful in the home or garden is a desirable project for the handyman, to whom it should offer no difficulties in making. The one illustrated on the front page has been designed for easy construction and can be made collapsible if desired. This amendment will be detailed later.

It is intended to be used as a wheeled trolley for taking out refreshments for a picnic on the lawn or from the kitchen to, say, the TV lounge. Besides the tray for the crockery and eats, etc., there is a handy compartment in which glasses and bottles can safely be carried without fear of spilling.

The height of the trolley is approximately 29 in. and it is 35 in. long with a width of 20 in., the tray section measuring 18 in. by 19 in. Plywood, stripwood and round rod are used in its construction.

Obviously the parts are too large to be shown full size on the design sheet, but all relevant measurements are given there for easy marking off and cutting out. Each part is numbered on the design sheet and in Fig. 1 for quick cross reference when following these instructions.

Preventing Waste

All the necessary wood and materials are contained in Hobbies kit for making the trolley as a fixture. When working with 36 in. lengths of stripwood, care should be exercised in marking out the various pieces. For instance, it is necessary to cut one piece 12 (measuring 19½ in.) and piece 2 from the same 36 in. length of stripwood, thereby leaving no waste. Similarly, piece 9 and the other piece 12 can be cut from one length of stripwood. Before cutting out, therefore, study the measurements carefully and mark them all out on the wood, making sure that every piece is allowed for before cutting. It will be seen that the 24 in. by 18 in. panel of plywood will provide the two pieces required for the tray and bottle compartment.

The trolley is made up in three separate portions, diagrams of which are shown on the design sheet. They are numbered separately for easy reference to the side view.

Start by making up the tray and handle (section 1) by pinning and gluing. Pieces 1 and 2 are cut from 1½ in. by ¾ in. stripwood, pieces 3 from ¾ in. thick wood,

pieces 4 and 5 from ¼ in., plywood and piece 6 from ½ in. round rod. The ends of the side pieces are drilled to take the dowel handle. Section 2 is similarly assembled from stripwood and dowelling to the measurements shown.

A halving joint is used for joining the cross braces (13) in section 3 and the construction is clearly explained in the diagram on the design sheet on which is also shown the type of joint to use.

Pieces 14 and 15 are glued underneath the tray as shown in the side view. Piece 14 measures 16½ in. by 1½ in. by ¾ in. and piece 15 is 16½ in. by 1 in. by 1 in.

The three sections are assembled by screwing the ends of pieces 7 and 11 to the tray, section 2 going inside section 3. Where these two sections cross, secure with countersunk or round-head screws.

If a folding trolley is required, the width of the tray and the lengths of pieces 14 and 15 should be cut scant or later planed. Similarly the width of section 2 should be scant. Pivot at points P shown on the side view with round-head screws and washers, and use wing nuts and bolts where indicated.

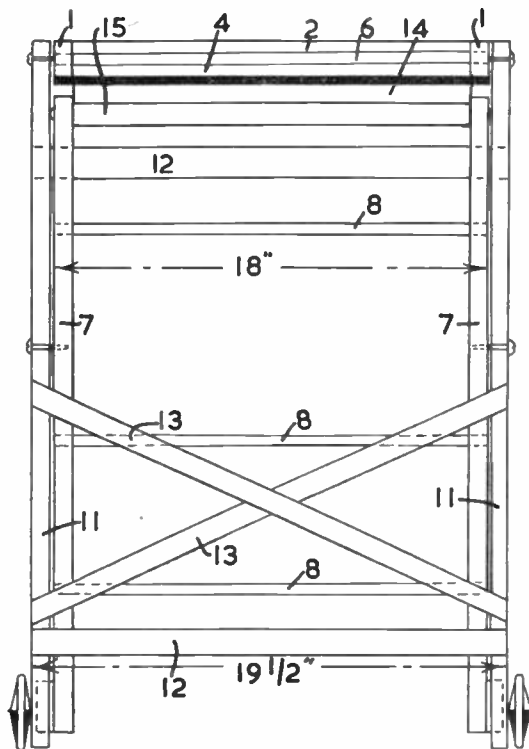

Fig. 1

For finish, paint is recommended for an article of this type. It will stand up to the weather better and can also be more easily renovated. If desired, one of the many available plastic coverings can be used for the tray. When the finish has been completed, add the two wheels as shown in the detail on the design sheet.

KIT FOR 33/-

Hobbies Kit No. 3332 for making the Tea Trolley contains all the necessary wood, rubber-tired wheels, etc. Kits from branches or by post from Hobbies Limited, Dereham, Norfolk. Price 33/- (post free).

Making a Multimeter

OHMMETER & MILLIAMMETER

WE can now deal with the ohmmeter section. For this we need a 4-pole 2-way switch, a potentiometer, a resistor and a battery. The resistance range we can measure depends on the voltage of the battery.

With the voltmeter, voltage values rise from left to right of the scale, but with an ohmmeter the reverse is the case. The higher the resistance to be measured, the lower the needle falls to

reader can make his own choice, and need not accept our choice of a 4.5 volt battery. This can be a flashlamp type, or made up of U2 cells in series.

With a 4.5 volt battery, the resistor R5 (Fig. 3) should be 3.9K and the potentiometer (V.R.) should be 1K ohms. This

selector panel of the voltmeter section.

Take centre tag A to the negative socket on this same panel.

This completes the ohmmeter.

The milliammeter

The milliammeter section can now be made. The purpose of such a section is

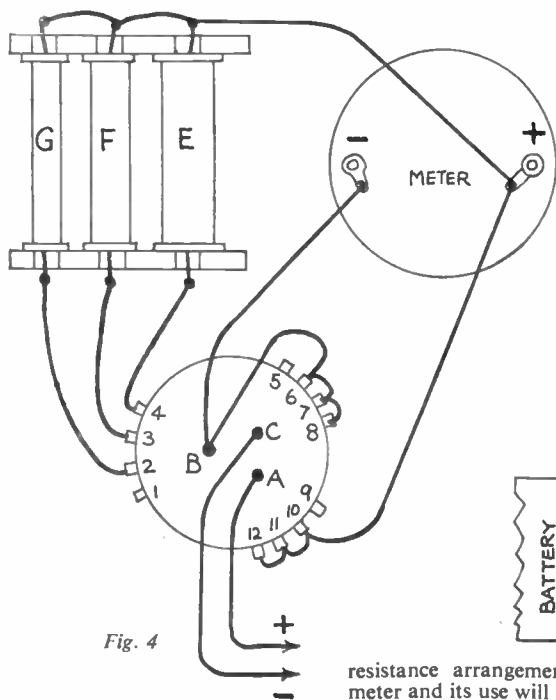

Fig. 4

the left of the scale. At this end the readings are very crowded and so readings are best avoided on the extreme left. Fairly easy reading is possible down to .2 or .1 on the scale but no further.

Taking this limit (.1 on the scale), the use of a 1.5 volt battery would allow us to read to 13,500 ohms. A 3 volt battery would take us to 27K ohms. A 4.5 volt to 40.5K ohms, a 9 volt to 81K ohms. A 36 volt battery would read 324K ohms at .1 on the scale.

The choice is a compromise between resistance range and the size of the battery the cabinet can hold. A larger case will allow the use of a bigger battery and therefore allow bigger resistance values to be measured. The

resistance arrangement is to 'set' the meter and its use will be explained later. (The valves must match the voltage of the battery.)

The battery can be fixed to the bottom of the case by means of a metal strip and two screws to secure it.

First fix in the 4-pole 2-way switch as shown in Fig. 3, then the potentiometer V.R.

Join centre tag B to negative terminal of meter, using soldering tag on to the meter. Join centre tag C to the meter positive terminal. Join outside tags 2 and 4. Join R5 from tag 6 to tag P on the potentiometer.

Join tags Q and R on potentiometer and take to positive (+) of the battery. Take the negative (-) pole of the battery to tag 8 on the switch.

Take centre tag D on switch to the positive (plus) socket on the voltage

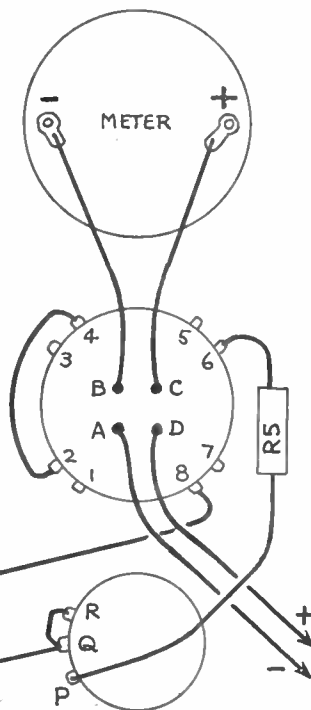

Fig. 3

to increase the range of the milli-amp meter so that it can read up to 10 mA, or up to 50 mA, or up to 100 mA. These ranges will be found very useful in ordinary radio work, and were chosen for that reason. The range of the meter is increased by means of shunts, but before making these, fit in the 3-pole 4-way switch as shown in Fig. 4.

For making the shunts, 28 gauge Eureka wire (enamelled) is needed. One ounce will be much more than is needed. The wire is wound on pieces of dowel or Paxolin tubing about $\frac{3}{8}$ in. diameter and about $2\frac{1}{2}$ in. long. Paxolin or cardboard or plywood washers or cheeks are glued on to these, about $\frac{1}{4}$ in. from each end. Two small holes are made in each cheek (at the edge) through which the ends of the wire are threaded. See Fig. 5(a).

For shunt E (10 mA), wind on to one of the formers $2\frac{3}{4}$ yd. of the Eureka wire.

Arrange it so that only $\frac{1}{4}$ in. of wire is projecting from the holes at either end. Scrape the enamel from these ends.

The shunt F (50 mA), has $18\frac{1}{2}$ in. of wire. Bare $\frac{1}{4}$ in. at each end as above.

The shunt G (100 mA), has $9\frac{1}{2}$ in.

The shunts are fixed by glue into a wooden cradle (Fig. 6), made by boring three holes in a piece of wood and sawing down the middle along the dotted line, as in 5(b). The cradle itself can be glued or nailed to the base, in the position shown in Fig. 4.

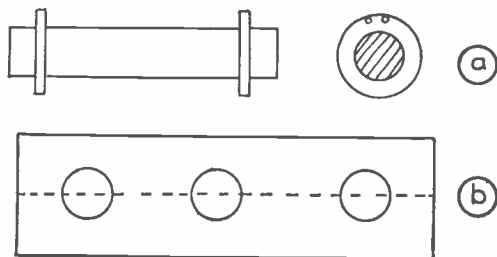

Fig. 5

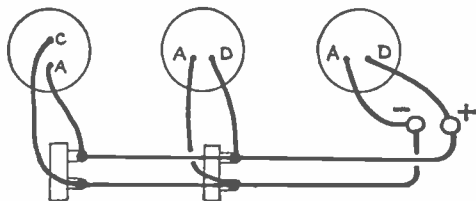

Fig. 7

The wiring is as follows, consulting Fig. 4. Join the top ends of E, F, G, together and take to the positive terminal of the meter. Join the lower end of G shunt to tag 2 on the switch. Join F to tag 3. Join E to tag 4.

Join negative terminal of meter to centre tag B of switch and join B in turn to tag 6 of switch. Join tags 6, 7 and 8.

Join tags 10, 11, 12, and take to the positive terminal of the meter.

Join centre tag C to the negative socket of the voltage selector panel of the voltmeter section.

Join centre tag A to the positive socket on this same panel.

Incidentally, a couple of tag strips would be useful in making connection with the voltmeter section sockets. Fig. 7 shows how they could be used as intermediate tie-posts. Keep the positive leads red and the negative black, to avoid mistakes.

The case of the multi-meter can next be completed, using $\frac{1}{2}$ in. plywood and fixing with glue and panel pins. The sides can be about 3 in. deep. The back, or bottom, can be of thinner plywood and must be detachable, so use screws to fix it.

The test prods must be made now. These consist of thick stranded wire, with thick insulation (red for the positive lead and black for the negative). The red lead should have a red wander plug attached to one end, while the negative must have a black plug.

The other end of each lead is passed down some Paxolin or ebonite tubing. The end of the wire is soldered to a $\frac{1}{2}$ in. length of 16 gauge tinned copper wire. Insulating tape is used to cover the joint, then the ebonite tube is pushed

down into position, leaving $\frac{1}{4}$ in. of the 16 gauge wire projecting. The ebonite tubing is bound round at both ends with insulating tape to secure it firmly to the lead.

The test prods, in full length, can be 2 ft. to 3 ft. long. To avoid mistakes, the ebonite tubing of the positive lead should have a red Sellotape (or red rubber) band at its bottom end.

The black test prod is plugged into the black (negative) socket on the front panel of the test meter and always

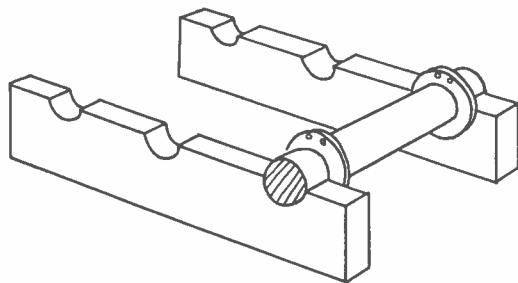

Fig. 6

occupies this position. The red prod, initially, occupies the red (positive) socket. (A.F.)

The concluding article will describe the setting up of the scales and the operation of the multimeter.

An excellent Paste Bait

ALL anglers should be interested in how to make a very good paste bait. This one has the advantage that it stays on the hook and does not go hard in the water.

That it will take fish, and good ones, too, I have ample proof from my own experience. It is an ordinary cheese paste, but with a difference in the way it is made. This is it.

For three slices of bread you will require one of the small triangular sections of cream cheese (any 'brand'). Spread this on one slice of bread, and then put a further slice on each side after first cutting off all the crust. On no account must you add water. Knead together until the cheese has worked its way into all the bread. You will know when this stage has been reached when there are no crumbly pieces of bread.

For the next operation you will need a small saucepan and a basin which will go inside. Put sufficient water in the pan so that there is enough to ensure that your basin does not float. Bring to the boil on the gas-ring and then simmer. Now tie the ball of paste in a clean piece of cloth

and place in the basin. For a quantity as stated you should simmer, with the lid on, of course, for fifteen minutes, when the paste will be in the form of a glutinous mass right through.

It retains this consistency of softness, and you will be surprised how it really stays on the hook. It will stand up to really long casting without falling off halfway across the water or on hitting the water.

I have taken carp, roach, bream, rudd, tench and dace on this bait, and once had the surprise of my life when a companion began catching large eels on it! The paste is white, of course, but it can be coloured by kneading into it a little maggot dye before it is steamed. Very often when sport falls off I have found that the same paste, but of a different colour, attracts the fish back again. In conjunction with this use the ordinary groundbait, but from time to time throw in a small pellet of the paste. This should be done sparingly, as you don't want the fish to get full on free samples!

'Kingfisher'

Ideal as gifts

MINIATURE PLASTER GARDENS

DELIGHTFUL miniature gardens as shown in our illustration make attractive gifts and are easily made from simple materials, much of the modelling being done by hand.

All you need for the base is a piece of hardboard or $\frac{3}{4}$ in. plywood measuring approximately 8 in. by 5 in. and cut to an irregular shape by means of a fretsaw as shown in Fig. 1. There is no hard and fast rule about this size and any scrap piece of similar dimensions may be used provided it is large enough to make a garden. Four wooden buttons, or beads, are attached with glue to the underside, to form feet.

The material used for shaping the crazy paving and the walls can be fillers such as Alabastine or Polyfilla, mixed to a stiff, putty-like consistency. Pour a table-spoonful of water into a dish, adding the filler a little at a time and stir until thoroughly mixed. Do not put too much powder in at first, but add gradually until the mixture is very similar to putty and can be handled as such. You may find it an advantage to smear your hands

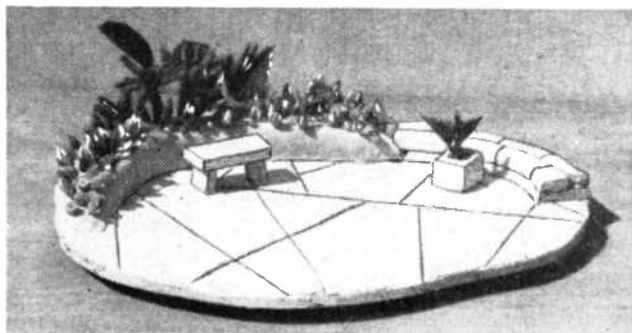

Described by S. H. Longbottom

With any surplus mixture remaining make a seat or a shrub box. Take a portion of the mixture and flatten out on newspaper with the aid of a knife blade until it is about $\frac{1}{8}$ or $\frac{3}{16}$ in. thick. The purpose is to make strips of the material. A strip is prepared by

a little of the filler itself if of a thinner consistency. The shrub box can be similarly finished.

The flowers have to be planted on a 'mound' shown on the left of the garden in the illustration, while on the right we have endeavoured to show the effect of

FIG 1

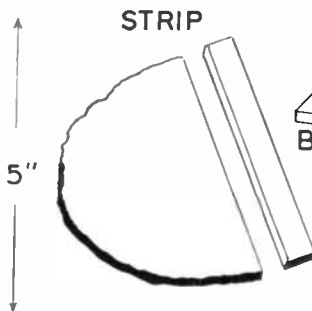
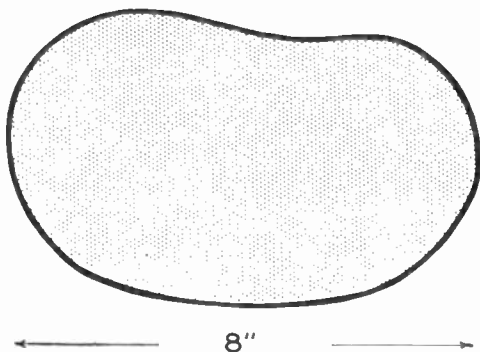

FIG 2

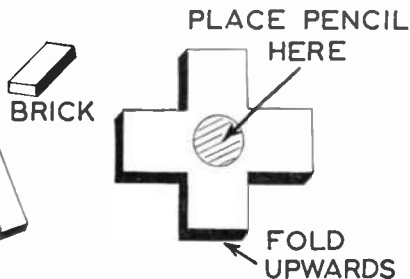

FIG 3

with a little Vaseline to prevent the mixture from sticking to the fingers.

Our first task is the laying of the crazy paving on the base. First dampen the whole of the top side of the base — but be careful not to apply too much moisture. Lay the mixture on to the base with any convenient tool such as an old table knife or even a celluloid set square. Press the material firmly on to the base, smoothing out until a layer about $\frac{1}{8}$ in. thick has been formed. After about 20 minutes, and before the material has set, the seams in the crazy paving must be impressed. Press a suitable tool into the material to divide it up appropriately. Do not attempt a cutting action, for this will spoil the lines.

pressing the knife edge into the mixture to form the top of the seat, and two smaller pieces are required for the legs. (Fig. 2) Lay these pieces aside until dry and hard. A box is formed by cutting out the material as shown in Fig. 3. Hold a pencil vertically on the centre, but without pressure, fold up the sides while still plastic and smooth off at the corners with the fingers, laying aside until dry.

When the base has thoroughly dried the edges should be smoothed off with rasp, file or glasspaper. This will not only remove any loose particles but improve the finish. The top and legs of the seat can also be squared up by rubbing the edges on glasspaper. The legs may be fastened to the top by means of glue or

making a wall with individual bricks. You may either make a mound or build a wall for the display of flowers which are artificial and made with 'stamens'. The latter can be bought quite cheaply in small bundles at any crafts shop. Alternatively, you may be able to find some discarded, artificial flower trimmings which would be very suitable for this purpose.

Once again filler is mixed to a putty-like consistency and the area of the mound is dampened to ensure adhesion of the two parts. The mound is gradually built up to a height of about $\frac{1}{8}$ in. by applying portions of the mixture, trowel-

● Continued on page 43

MAKE A BALLOON PUMP

CARDBOARD and paper are the main materials required to make this simple pump which can be used at party time when large numbers of rubber balloons have to be inflated.

The body of the pump is made from a 9in. length of mailing tube, the outside of which is rendered smooth by the complete removal of paper labels and postage stamps. From fairly stout cardboard prepare a neat cylinder 10ins. long to fit firmly, but not too tightly, over the mailing tube. Do this by rolling the cardboard on to the mailing tube and securing the edges together with a quick acting adhesive. Hold the seam in place while the adhesive sets.

By A. E. Ward

Make the air exit valve from a 1in. length of the same diameter mailing tube. Cut two discs from very stout cardboard, making their diameters the same as the external diameter of the mailing tube. In the centre of one disc bore a hole $\frac{1}{4}$ in. in diameter. Holes can conveniently be bored in cardboard with sharp cork borers. Glue this disc on to one end of the 1in. length of mailing tube. Bore two smaller holes in the other disc (A), about $\frac{1}{8}$ in. from the centre of the disc and opposite one another.

Cut a strip of greaseproof paper (B) big enough to cover both holes, with a good margin all round, but not so big that it overlaps the edges of the disc. Place the paper strip so that it covers both holes evenly and then secure it in position by pressing a narrow strip of Sellotape (C) across the middle in such a manner that each hole will be covered by a loose flap of paper. Glue this disc on to the other end of the short length of mailing tube, with the paper flaps facing inside the tube.

Glue the air exit valve just inside the 10in. long cardboard cylinder, with the single hole side level with the cylinder end.

Cut out another stout cardboard disc with the same diameter as the mailing tube and make it into another two-holed paper flap valve in the manner already described. This will be the air entry valve and must be glued on to one end of the mailing tube with the paper flaps facing inside.

Put the pump together by telescoping the cardboard cylinder over the open end of the mailing tube. As you do this the air inside the apparatus should be forced out of the air exit valve, while the air entry valve remains closed. When you

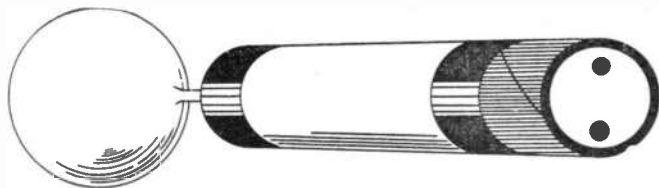

draw the two tubes apart the exit valve should close and the entry valve open to admit air into the lower part of the pump.

Insert the neck of a balloon into the $\frac{1}{4}$ in. diameter hole above the air exit valve and let the balloon be supported in position by the rim of its neck pressing against the cardboard. Inflate the balloon by lengthening and shortening the pump so that air is forced through the exit valve. It will not matter if the pump is not a hundred per cent efficient as long as the pumping action is carried out fairly quickly. When the balloon has been fully inflated it is an easy matter to pinch its neck and disconnect it from the pump.

You will probably wish to decorate

your pump in attractive colours. This can be done by covering the outside with white paper and then painting all over with poster colours. An alternative is to paste on brightly coloured papers.

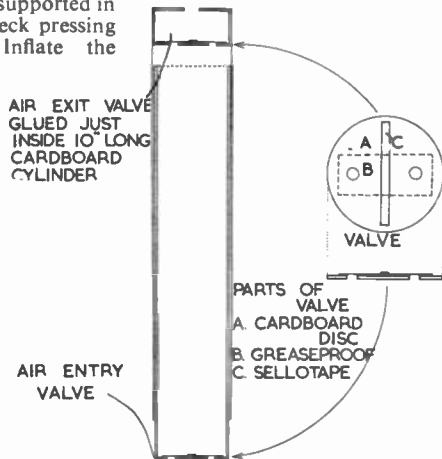

● **Continued from page 42**

Miniature Plaster Gardens

ling smooth the inside, outside and top. Note that this mound slopes gradually to the crazy paving at both ends.

It is best to have a variety of colours, planting in clusters to give splashes of colour, with an odd 'shrub' or two.

If you prefer to build a tiny wall it is necessary to flatten out the material to a thickness of $\frac{1}{8}$ in., cutting off strips $\frac{1}{2}$ in. wide, and making the individual bricks 1 in. long. These bricks can easily be shaped to the curve of the base while in their plastic condition and are built up brick by brick. There is no need to apply any 'cement' between the courses, as the bricks will adhere quite firmly if laid while the mixture is still damp.

For finish, you may use water or poster colours so long as they are not too vivid. For the model shown emulsion paint was used. The wall and mound are in ivory, while the crazy paving is treated

with a coating of pale blue. The seat and box are in their natural colour, but these could be finished in brown to give the impression of wood.

These miniature gardens can be made in any shape or form and you will realize that with a little ingenuity you may modify to your own ideas. For example a pond can be introduced in the centre of the crazy paving.

A small round mirror should be laid in the desired position after preparing the base with the mixture and after marking out the crazy paving. The filler should then adhere to the back of the mirror, keeping it in position. Afterwards, strips of the mixture should be laid round the edge to provide a wall, the seams being pressed all the way round the circumference. With a little patience you may be able to shape a sundial or birdbath.

'SPIN IN SPACE' GAME

By T.S.R.

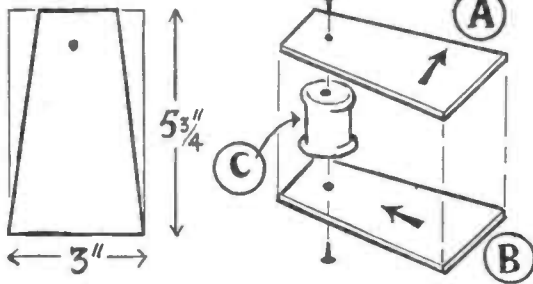

Cut (A) and (B) members from $\frac{1}{2}$ in. plywood to pattern. Arrows indicate direction of outside layers of wood grain. (Grain across width for (A).) When both pieces are mounted to large cotton-reel (C), the top 'spring-board' may be flicked at open end.

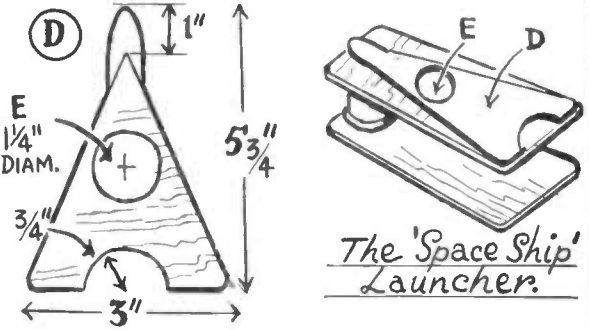

Mark out 'Delta Wing' shape (D). Cut out from $\frac{1}{2}$ in. wood or cardboard, including centre hole (E). Glue to (A). Smooth round edges of 'launcher'. Brightly paint. Silver the 'space ship' or cover with metallic paper.

The 'Space Ship' Launcher.

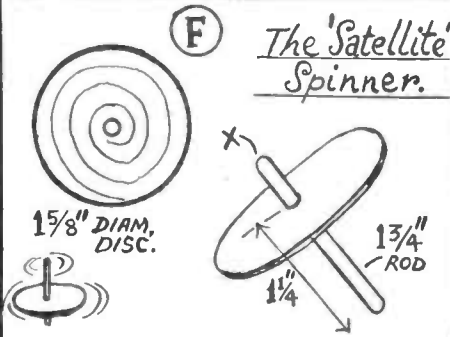

Cut spinner tops for each player from thin wood. Secure 'lolly stick' or $\frac{1}{4}$ in. round rod spindle through centre hole. Paint top in spiral or other gay-colour designs. Round spindle end at (X).

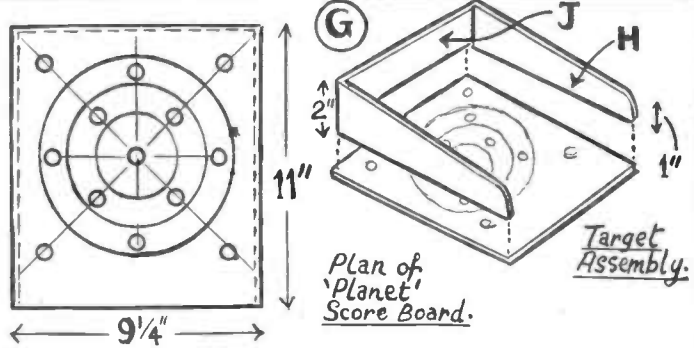

Cut $\frac{3}{8}$ in. ply panel (G). Mark out 'orbit' rings with pair of compasses and drill nine 'planet' score holes to accept spindle end of spinner top. Make up sides (H) and end member (J) with thin plywood and glue and nail to the score board. Paint target sides dark blue enamel.

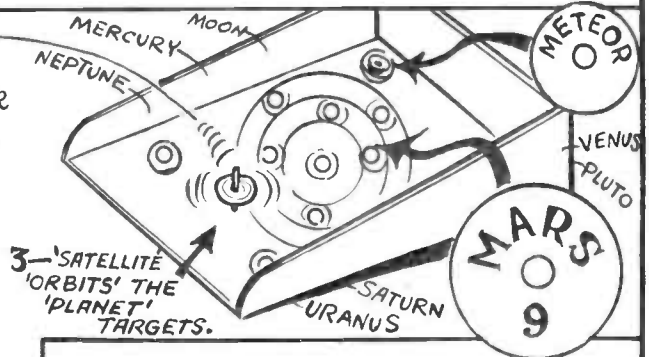
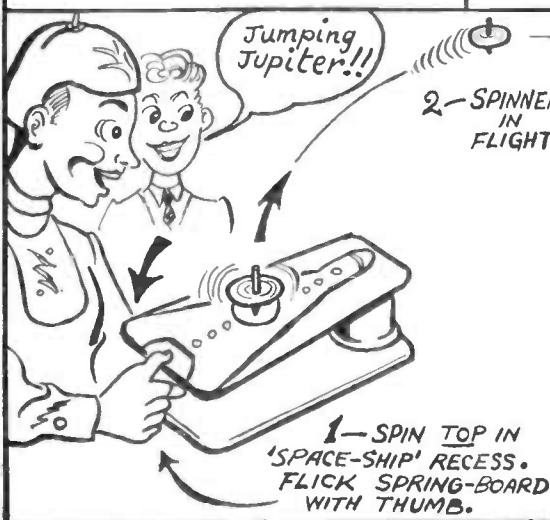

Paint score board pale blue. Colour in the 'orbit' circles and paint 'planet' rings direct or on applied paper around score holes. Add numbers to score rings. Indicate corner holes with 'Comet', 'Satellite', 'Shooting Star' and 'Meteor'. Competitors try their skill at spinning satellite tops into numbered planets to obtain highest scores.



Car PLAY PEN

TAKING a young baby on a long trip in the car is no problem when a playpen or bed is used. It may be fitted in a few moments and can be used for playing or sleeping. Since it is hinged it will take up the slope of your car seats and at the same time will be easy to fix and remove.

Overall sizes will of course depend upon the actual pattern and shape of car and it will only be necessary to mention thicknesses. Fig. 1 shows how the playpen should fit nicely between front and back seats. The back and front should be cut from $\frac{1}{2}$ in. or $\frac{3}{4}$ in. plywood and the bottom from $\frac{1}{2}$ in. plywood.

The side bars are cut from strips of $1\frac{1}{2}$ in. by $\frac{3}{4}$ in. deal and are pivoted to the plywood as shown in Fig. 2. Use round-head screws for pivoting and slip a washer under the screw head to save wear on the wood.

The diagram in Fig. 2 also shows how the bottom is hinged to the ends to allow the playpen to be folded. Light brass butt hinges will be heavy enough for this purpose. They should be about $1\frac{1}{2}$ in. wide.

The pen is held in place by means of

Fig. 1

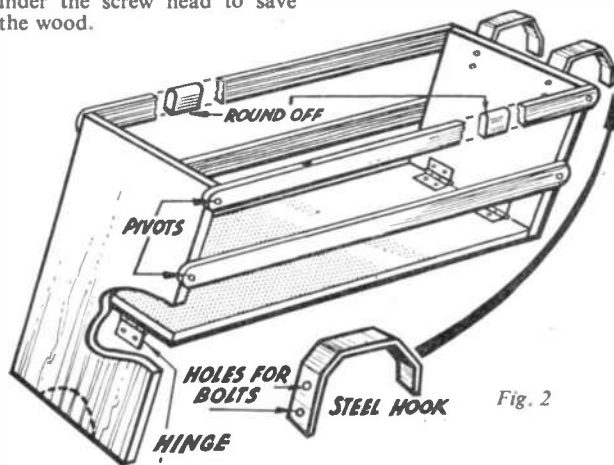
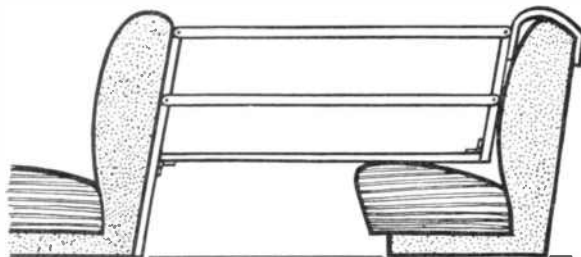

Fig. 2

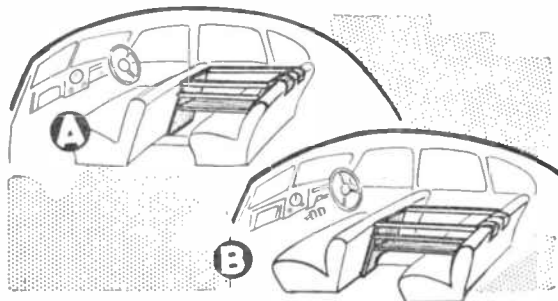

Fig. 3

two hooks made from mild steel. The hooks are bent roughly to the shape of the back seat. They are drilled and bolted or screwed to the plywood back of the pen. The hooks should not be fixed until after the pen has been painted.

If the car has a floor which is not level, owing to the transmission, a semi-circle of wood must be cut from the front as indicated by the dotted lines in Fig. 2. The pen can then be placed to one side as in A (Fig. 3) or centrally as in B.

To finish off the playpen, round off all sharp edges and give one undercoat and two top coats of lead-free paint. It is important to use lead-free paint where young children are concerned.

For sleeping purposes a small mattress may be made from foam rubber and the sides could be lined with material. (M.h.)

A BRAND-new appliance from Arcoy Products, Knowsley Road, Bootle, Liverpool, 20, is the **ARCOY RABBETTER**, for use with any standard portable drill, and costing only £1.19.6. The Arcoy Rabbetter is a boon to all home handymen. It rebates for picture frames, greenhouses, paneling etc., in a matter of minutes; it slots drawer bottoms, sliding glass doors; it strips for laths, garden sticks, fillets, and strips wood; it tongues and grooves for floors, table tops and outbuildings; it fillets for floors, etc., all very professionally and very quickly.

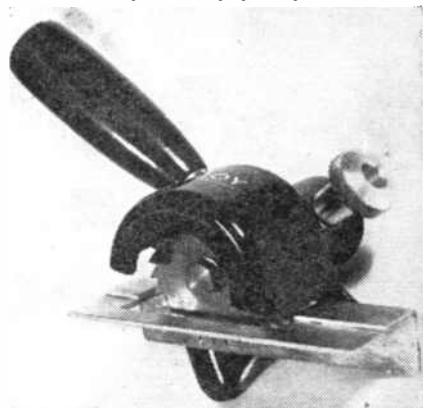

MARGINAL PLANTS



Acorus Calamus. Sweet Flag. A reed-like plant with aromatic sword shaped green foliage. 2 to 3 ft.

Alisma Plantago. The Water Plantain has large, dark green leaves and tall spikes of small pink and white single flowers. Water up to 12 in. deep.

Butomus Umbellatus. The Flowering Rush has been described as the most beautiful of our native plants. It has bold stems bearing large clusters of rose pink flowers. Up to 12 in. deep.

Caltha Palustris. The dainty white flowers of the Bog Arum are not conspicuous, but are followed on in the autumn by pods of showy scarlet seeds. Plant June and July. 9-12 in.

Cyperus Longus. The Sweet Galingale is a charming Sedge with graceful slender stems that terminate in feathery chestnut plumes. 3 ft.

Glyceria Aquatic Variegata. A very pretty and conspicuous plant and considered the most showy of the marginals. Strap shaped leaves, striped with green, white and yellow, and suffused with pink in the spring and autumn. 1½-12 ft.

Iris Laevigata. A glorious blue, almost violet, flower, faintly lined with gold makes this one of the treasures of the water garden. June-September. 2 ft.

Juncus Effusus Spiralis. This quaint contorted rush has the picturesque character found in Japanese garden plants. The stems, growing corkscrew fashion in a wide spiral, certainly make a change from the conventional types.

Lobelia Cardinalis Queen Victoria. Although normally regarded as a 'damp soil' border plant, the brilliantly scarlet flowered Lobelia is included here because it has proved hardy when grown in 2 or 3 in. of water. August-October. 3 ft.

Mentha Aquatic. The Water Mint, in addition to aromatic foliage and whorls of lavender flowers, has a reputation for helping to keep the pool clear and pure. August-September. 9-12 in.

Pontederia Cordata. A first class marginal with shining dark green

luxuriant foliage and clustered light blue flowers similar to Delphinium spikes. 2 ft.

Sagittaria Japonica Plena. The very double flowers, reminiscent of white Stocks and the bold arrow shaped leaves, make this one of the most desirable marginals for tubs or pools. July-September. 2 ft.

Sagittaria Sagittifolia. The Common Arrowhead, with its lush profusion of long-pointed arrow leaves, has all the characteristics we expect of a pond plant, plus an exuberant rate of growth that may need to be curbed occasionally. It produces spikes of three petalled white flowers and will flourish in water up to 18 in. deep. July-September. 2½ ft.



Scirpus Zebrinus. A particularly striking and attractive plant. The quill-like stems are brightly marked with alternative bands of white and green. 3-4 ft.

Typha. These are the plants that are so often referred to as Bulrushes, although the name correctly belongs to the *Scirpus* family. The correct common names for *Typha* are Reed Mace or Cat-Tail.

Veronica Beccabunga. An attractive little marginal of creeping habit, particularly useful for tubs and sunken sinks and for softening the hard outline of a concrete pool. It has shiny dark green foliage and light blue flowers. 6 in.

Only a small selection of plants have been detailed above. Many of them are family groups containing many varieties within the group. Among these are the *Caltha*, *Acorus*, *Iris*, *Mimulus*, *Scirpa* and *Typha* families, all of which will be familiar with plant stockists.

NO pool is complete without a fringe of the attractive rushes, Iris, and other marginals, which make a graceful and natural setting for the serene beauty of the water lilies. The marginals flourish either in shallow water or in soil which, although above water level, is permanently moist. In this sense, the marginals can be described as amphibious, and are well adapted to cope with the fluctuating water level often found in natural ponds and lakes.

In artificial pools provision can be made for the marginals by having shallow sloping sides or by constructing a shelf a few inches below the surface. 2 in. or 3 in. of loam is sufficient, and no manure of any kind is needed. Over the soil there may be any depth of water up to 6 in. Marginals will grow equally well in boxes, pots or chip baskets. If there is no shelf or shallow margin, these can be stood on bricks to bring their tops to the necessary level. As another alternative to the shelf, 4- or 5-inch. pots can be cemented to the side of the pool with their rims not more than 6 in. from the surface.

All marginal plants are perennial, dying down in the autumn and re-appearing with renewed vigour in the spring. The planting season extends from April until July. Once planted, they need no attention apart from thinning of any vigorous growth.

Here are detailed some of the more popular varieties. All the plants named will flourish

- (1) above water level provided their roots can reach plenty of moisture and
- (2) in shallow water.

Unless a greater depth is mentioned in the description, 6 in. of water is the limit.

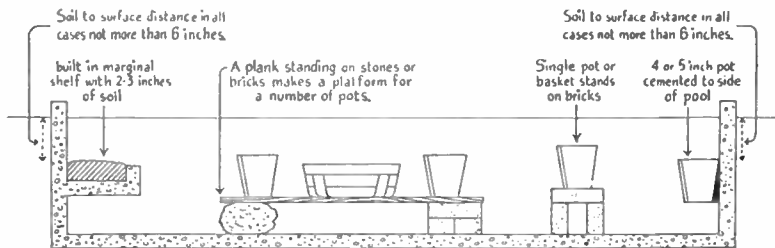

PLANTING MARGINALS IN A STRAIGHT-SIDED POOL



MAKING ITS MARK . . .

More and more, woodworkers—both amateur and professional—are acclaiming CASCAMITE "One Shot" as the *smash* hit in glues. And for top performance, combined with simplicity of use, there's nothing like it! Made by a patented process, this unique resin glue is a "two-in-one" powder (resin and hardener, blended together in exactly the right proportions) which merely requires mixing with cold water—one simple operation only. Using CASCAMITE "One Shot" could hardly be easier; and the results are *outstanding*! Joints are as strong as the wood itself, heat resistant and waterproof . . . the glue line is colourless and stain-free . . . and furthermore, joints can be successfully glued even when there are gaps between the surfaces of up to $\frac{1}{8}$ ". CASCAMITE "One Shot" is specially recommended for furniture making and repairs, joinery, boat building, etc. Packed in 3½, 7 & 18 oz. tins (2/6d., 4/-d. & 8/6d. respectively). Also in larger sizes.



111

Other products in the CASCO range include:—

CASCO Cold Water Casein Glue,

CASCO P.V.A. Glue,

CASCO "CONTACT" Instant Adhesive,

CASCO Wood Stopper.



SYNTHETIC RESIN & CASEIN GLUES

Manufactured by: LEICESTER, LOVELL & CO. LTD · NORTH BADDESLEY · SOUTHAMPTON

APPARATUS & CHEMICALS

For your experiments. Let us help you equip a **HOME LABORATORY**

Beakers, Crucibles, Flasks, Funnels
Gas Jars, Test Tubes, etc.

Booklets:

(including postage)

'Experiments' 1/2

'Formulas' 1/2

'Home Chemistry' 2/10

New edition

Send 3d. Stamp for latest **PRICE LIST**



A. N. BECK & SONS (Dept. H.W.)

60 Stoke Newington High Street, London, N.16



BRANCHES: LONDON

78a New Oxford St., W.C.1

87 Old Broad Street, E.C.2

81 Streatham Hill, S.W.2

151 High St., Walthamstow E.17

GLASGOW

326 Argyle Street

MANCHESTER

10 Piccadilly

Head Office & Factories—**HOBBIES LTD, DEREHAM, Norfolk**

BIRMINGHAM

100a Dale End, Birmingham 4

SHEFFIELD

4 St. Paul's Parade

LEEDS

10 Queen Victoria Street

HULL

179 Ferenway

SOUTHAMPTON

134 High St. (Below Bar)

BRISTOL

65 Fairfax Street

NEWCASTLE

42 Dean Street

GRIMSBY

88 Victoria Street

HEAR ALL CONTINENTS With H.A.C. Short-Wave Receivers

Suppliers for over 18 years of Radio S-W Receivers of quality.

One-Valve Kit, Price 25/- Two-Valve Kit, Price 50/-

Improved designs with Denco coils. All kits complete with all components, accessories and full instructions. Before ordering, call and inspect a demonstration receiver, or send stamped addressed envelope for descriptive catalogue.

"H.A.C." Short-Wave Products (Dept. 22), 11 Old Bond Street, London, W.1

TELEPLASTIC

Casting and moulding mixture for plaques, figures, etc. Simplicity itself. A beautiful white material. Heat it up on your stove in a tin can, and pour into a mould. Sets hard in a few minutes. No extras needed. May be coloured in lovely pastel shades. Re-melt and use again and again. Light in weight. Will make many casts. 4/6 per ½ lb., plus 1/2 post.

FOSTER, 28 PARKER ROAD, WEDNESFIELD, STAFFS.

STICK TO SECCOTINE

it sticks everything



1'3
PER TUBE

Sole Manufacturers—

MCGAW, STEVENSON & ORR LTD., BELFAST

NEW LOOK FOR ALBUMS



The print will now turn deep yellow in colour, and the image will begin to fade away. Rinse in clean water and transfer quickly to a solution of ACID hypo fixer.

By M. Bowyer

The image will now disappear completely, leaving only the drawing on a whiter than white background. Leave the print to fix for 10-15 minutes, and finally wash in running water for about half an hour.

Final hints

The whole operation can be carried out in normal room light, and the finished picture will be the same, whether the original was taken with a simple box camera or the most expensive reflex. Although the sketches illustrated were made on glossy paper, by far the best results will be obtained by using a paper with a matt surface.

NEXT time you visit a friend who shares the same photographic interests as yourself, get him to show you his album. The odds are that it will be no different to any other; full of photographs and, unless the standard is very high, rather monotonous.

The solution to this problem is to break up the various sections of the album with something really unusual.

Have you ever tried making pen-and-ink sketches from *your* pictures by using the bleaching out process?

You don't have to be an artist to get first class results. Simply take the selected picture, enlarged to a workable size (no smaller than half plate), and with a pen and waterproof indian ink draw over the outlines of the photograph, using a ruler where straight edges are required.

Keep an eye on sunlight and shadows, shading in the shadowed areas exactly as in the actual picture. Large areas of black should be marked lightly and left until the end of the process to be painted in with a brush.

Bleaching out

Once the pen work is dry, the next stage is to bleach away the photographic image, in order to leave a straight black and white drawing.

There are several ways of doing this, but the most convenient is to rub over the complete picture with ordinary tincture of iodine, obtainable from any chemist. This should be applied either with a brush or a pad of cotton wool.

Old Inns make attractive pen sketches and would make an interesting addition to an album devoted to a collection of beer labels.



Country scenes come out equally well and a few drawings will add considerably to the interest of your holiday album.

BUYING OR SELLING?

Classified advertisements on this page are accepted at a cost of 6d. per word prepaid. Use of a Box No. is 1/- extra. Send P.O. with advertisement to *Hobbies Weekly*, Advert. Dept., Dereham, Norfolk. Rates for display advertising on application.

EXTRA cheques from writing. Send for 'Ideas for Writers' (free). Scores of suggestions for beginners and others. Typewriter unnecessary. — Writer's Ring (H.W.), 5 Edmund Street, Birmingham 3.

TRANSISTORS, Germanium Crystals, Headphones, etc. Lists and diagrams free. Germanium Diodes with three crystal set circuits 1/-. Postage 3d. — P.R.S. (H), 33 Bourne Gardens, London, E.4.

WHEELS (Hardwood and Rubber Tyred Metal). Cot, Pram and Doll's House Fittings and Papers. Beads, Transfers, Prints and other accessories. Stamp for new lists. (Trade supplied.) New address — **JOYDEN CO.**, 91 Peplins Way, Brookmans Park, Herts.

KUKLOS ANNUAL. Indispensable cyclist's handbook. Tours, resthouses, money-saving hints, 3/-, post free. — Burrow, Publishers, 2 Imperial House, Cheltenham.

MODELS. You can make lasting stone-hard models with Sankey's Pyruma Plastic Cement. Supplied in tins by Ironmongers, Hardwaremen and Builders Merchants. Ask for instruction leaflet.

LEARN RADIO AND ELECTRONICS the NEW practical way! Very latest system of experimenting with and building radio apparatus — 'as you learn'. FREE brochure from — Dept. HW 10, Radiostructor, 46 Market Place, Reading, Berks.

Refund if not worth double !



TV TABLE & EXTRA LARGE RECORD CABINET

Not only sand polished but also sprayed light or medium WAL-

NUT tone. NOTE—ROOMY BOOK CASES AT BOTH ENDS — one converts to Magazine Rack by insertion of sloping panel provided, as illustrated. Amazing offer — 59/6, carr. 6/6 or sent for £1. Balance 6 monthly payments 8/-, plus carr. A well-built contemporary piece of furniture to solve your record problem and also ideal as stand for TV, Radio or Record Player. 30" x 15" x 24" high. Modern sliding doors. Roomy interior, partitioned for classifications, holds up to 200 records (upright for perfect condition). Entirely of seasoned timber. Detachable legs. SEND quickly. **LISTS, FURNITURE.**

SEND FOR OUR FREE ILLUSTRATED CATALOGUE OF BINOCULARS (EVERY KNOWN MAGNIFICATION), RINGS, WATCHES, FURNITURE, ETC. ALL AVAILABLE ON THE EASIEST OF TERMS

HEADQUARTER & GENERAL SUPPLIES LTD.
(HOBW/85) 196-200 Coldharbour Lane, Loughboro Junc., London, S.E.5. Open Sat.

BUILD YOUR OWN HI-FI at home! At last, for reasonable cost — the chance to make your own quality HI-FI audio equipment and to gain the knowledge to service and maintain it. FREE brochure from — Dept. HW 20, Radiostructor, 46 Market Place, Reading, Berks.

NYLON · P.T.F.E
ROD, BAR, SHEET, TUBE, STRIP, WIRE
No Quantity too Small. List on Application.
BRASS · COPPER · BRONZE
ALUMINIUM · LIGHT ALLOYS
H. ROLLET & Co. Ltd.
6 Chesham Place, S.W.1 SL Oane 3463
ALSO AT LIVERPOOL, BIRMINGHAM
MANCHESTER, LEEDS

STAMPS FREE — Empire Packet including SPictorials and Victorians with approvals. — Robert J. Peck, 7A Kemp Road, Bournemouth.

INTRODUCTIONS to new friends; home and Overseas. — V.C.C., 34 Honeywell Road, S.W.11.

MAKE A MUSICAL BOX for as little as M21/-. New kits and tunes available. Movements 13/-, post free. Please send 3d. stamp for free illustrated catalogue. — The Swisscross Co., Dept. B, 202 Tulse Hill, London, S.W.2.

100 DIFFERENT stamps free! Request 4d. upwards discount approvals. — Bush, 53 Newlyn Way, Parkstone, Dorset.

GIANTS, Triangles, Pictorials, etc. — 100 Free. Request Approvals. Postage. — Salter, 42 North Rd., Rotherham.

BUILD AN EFFICIENT Crystal Receiver with our quality complete kit. Easy instructions. Soldering unnecessary. Good reception anywhere. Reduced price for short period, 14/6 post free. Send P.O. NOW — Radio Components, Accessories, wonderful new Transistor Receiver Kits supplied. Send 3d. stamp for Bargain List. — **RADIOMATIC**, 26 Blackburne Drive, Hunts Cross, Liverpool.



Another "Musical" Winner!
BALLERINA CIGARETTE BOX
Make it yourself

When the lid is lifted the gay Ballerina appears and "dances" to tuneful music in a ballet setting complete with a background of mirrors. Box holds 50 cigarettes. Hobbies Kit No. 257 Special contains all materials for making the box, including paint, glue, mirrors, veneers, etc., and costs only 21/- (post 1/9 extra).

Post coupon for free booklet

Fit it with a musical movement, which incorporates the exquisitely dressed ballerina. Two tunes are available. Choose from:

- B1 Swan Lake
 - B2 I could have danced all night
- Price each 24/3 (post 9d. extra)

Many other outstanding novelties in Hobbies 1960 Annual. 168 pages, price only 2/- from newagents, etc., or by post (6d. extra)



To **HOBBIES LTD.**, Dept. 991, Dereham, Norfolk
Please send free 20-page booklet of kit details and items indicated.

- Ballerina Kit (21/- plus 1/9 post)
- 1960 Annual (2/6 post free)
- Musical Movement, state choice (24/3 plus 9d. post)

Name.....
Address.....
.....
.....

(Orders 30/- and over post free)

Mainly for Modellers

LET us now consider the basic development of ship design from medieval times to the 19th century.

The medieval ship was mostly the carrack-type of vessel, the design of such vessels being based on the circle, and in examining contemporary pictures and sketches of these ships we see this in the

large castles, one forward and one aft, see Fig. 1.

The southern type (Fig. 2) carried a mast raked forward, with a lateen sail and a square top set at the top of the mast.

Another point of difference was in the method of planking, the northern type

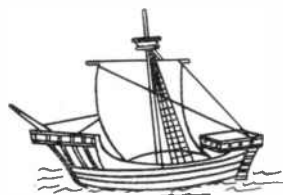

① NORTHERN TYPE

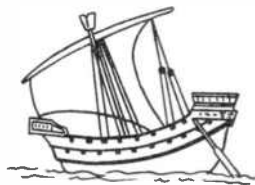

② SOUTHERN TYPE

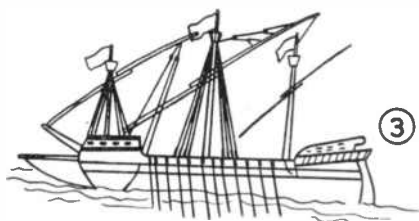

③ GALLEASS



④ CARAVEL

generous curves given to the sheer line, amidship section, etc.

The topsides had the 'Tumble Home' I have shown in earlier articles. In some drawings they are shown as curving inwards to the gunwale. The usual proportions overall were approximately breadth (or beam) one quarter the length.

The Carrack originated in the Mediterranean, and was developed mainly by the Genoese. The first to reach the Northern seas came at the end of the 14th century and had a single mast. In the northern type the ship carried one square sail, with a circular mast top placed just over the top of the shrouds, the stem raked forward sharply, and the vessel had two

being clinker built, while the southern was carvel built. As seen in the illustrations, the northern carried a bowsprit while the southern type was without a bowsprit. Note also a difference in steering methods. The northern types already had a rudder fitted to the sternpost, the southern still using the adaptation of the steering oar hung on the quarter.

We can trace no actual building of the carrack type of vessel by the English, and those in service with the Navy of the time (early 15th century) were prizes, being captured vessels.

The next development came with introduction of the Galleass and the

Caravel. The Galleass was the development of the Galley, having the lateen sails and also using oars for propulsion (Fig. 3).

The Caravel was a development from the carrack type. The Caravel was at first lateen rigged on all masts, later the foremost mast being square rigged and the remaining masts lateen rigged (see Fig. 4).

With the development into the Galleon we enter on rather better ground in regard to available information. Although details of individual ships are not available we do have plans and details of the type that were contemporary and as we progress into the 17th century, draughts and drawings began to be kept of all ships built for the service of the British Navy.

WOODEN SHIP BUILDING — 3

By 'Whipstaff'

We now turn to the early writers for details of the methods of building ships of this period, 16th to 18th centuries, and make a start with writers on the building of the Galleon type.

The materials used in shipbuilding as already outlined are timber, tree-nails and ironwork.

The timber consists of straight timber, compass (curved) timber knee timber, and planks, 4 in., 3 in., 2 in., and 1½ in. thick. Treenails were in reality wood dowels or cylinders in five lengths, 1 ft., 1½ ft., 2 ft., 2½ ft., and 3 ft. long. By ironwork is meant mainly the bolts used for fastening the timbers to give added strength.

In part 4 of this series we will follow out the progress of the actual building in order from laying of the keel.

Worthwhile projects for readers of all ages will be described in next week's issue. Table construction will be explained and among the interesting toy novelties will be a climbing monkey — ideal for making as a Christmas present.

MAKE SURE OF YOUR COPY

DUCK TRAIN FOR BABY

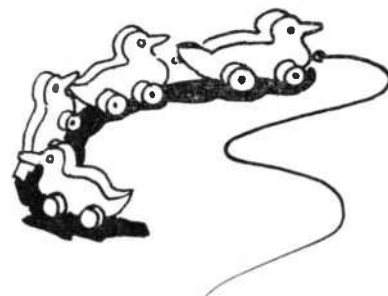
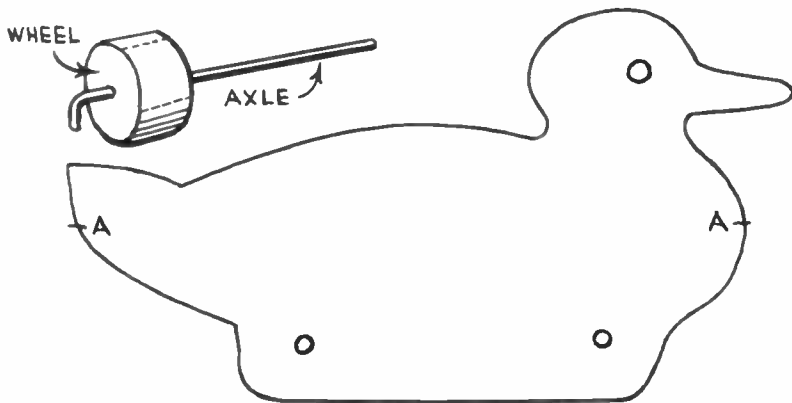

CUT one each of the ducks from $\frac{1}{2}$ in. wood. Insert small screw-eyes at the spots marked A. The wheels, four to each duck, consist of $\frac{3}{8}$ in. lengths of $\frac{1}{2}$ in. diameter round rod, and the axles are bent from medium gauge wire as shown in the small detail. Paint bright yellow, and connect up the ducks with pieces of thin cord. (M.p.)

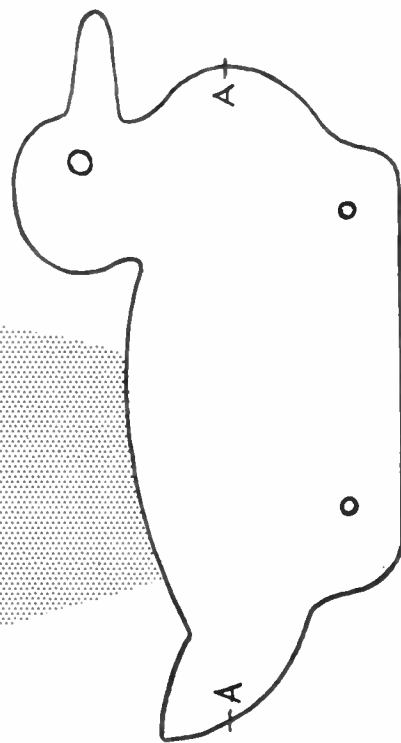
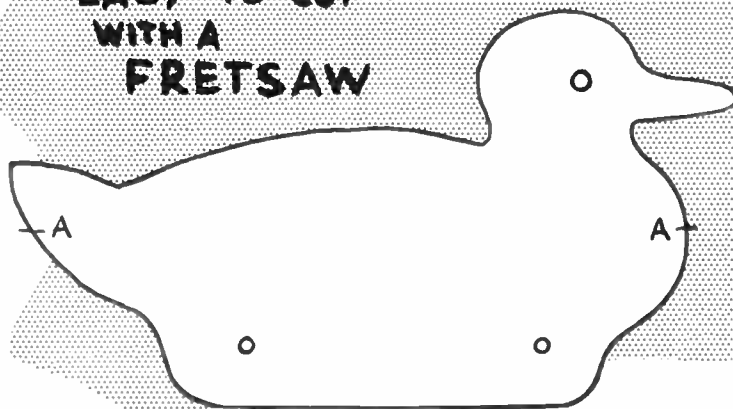
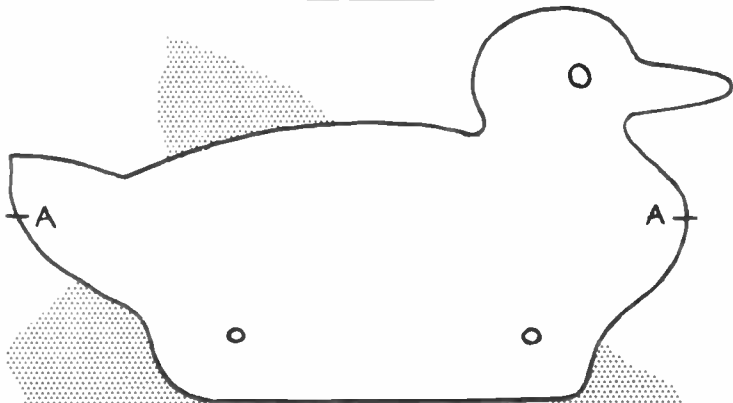

**EASY TO CUT
WITH A
FRETSAW**



Sculptorcraft

people present!

'MODULO'

Here's a fabulous new modelling hobby for children of every age. Even adults will find this fascinating, as with small pieces of wire life-like flowers can be made. There are three colours which will mould into all the colours of the spectrum.

'Rubbacraft'

These delightful figures are designed as squeaky toys for younger children. But they have sufficient merit to be hung as mascots.

1. Dulcie Doll.
2. Christopher Choirboy.
3. Clarence Clown.
4. Monty Monkey (illus.)
5. Pete the Pied Piper.
6. Terry Teddy Bear.
7. Gordon Golliwog.

see us on T.V.

Yes! See us on the 'Send for Saunders' show, October 25th, at 4.45 p.m. approx. A.T.V. London.



SEAMER PRODUCTS (SCULPTORCRAFT) LTD
23/27 EASTBOURNE STREET, HULL

QUALITY TOOL CHESTS

FOR
THE
LAD



AND
HIS
DAD

These fine presentation sets introduced by Hobbies will prove ideal gifts throughout the year for any lad or adult interested in woodworking, modelling, etc.

They contain a useful range of carefully selected tools of highest quality — guaranteed to give every satisfaction.

Available from all Hobbies branches, stockists, etc., or send coupon today for immediate post-free delivery.

Hobbies have other outfits ranging in price from 13/6 to 65/-, suitable for all occasions and all pockets.

You must have

HOBBIES 1960 ANNUAL

168 pages crammed with wood-working projects, toys, novelties, furniture, etc. Free designs for making Ballerina Musical Cigarette Box and Model Garage with each issue. Only 2/- from news-agents, etc., or by post 6d. extra.

FREE Ask for 20-page booklet, Profitable Leisure

To Hobbies Ltd., Dept. 991, Dereham, Norfolk.
Please send free 20-page booklet, name of stockist and items indicated.

- Hobbies Annual (2/6 post free)
 Craft Tool Pack (42/6)
 Handikit (45/-)

Name

Address

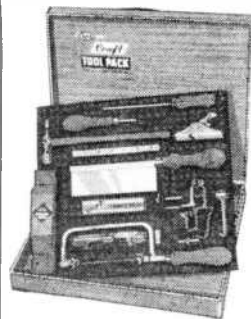

CRAFT TOOL PACK

Three sets in one!
Includes backsaw, fretsaw and accessories, vice, craft knife, hammer, plane, etc. **42/6**

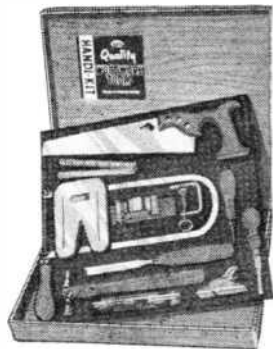
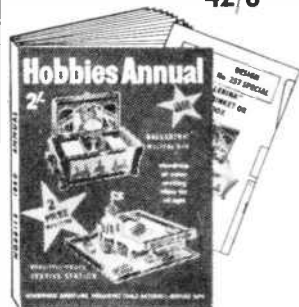

HANDIKIT

For carpentry and fretwork. Includes handsaw, fretsaw and accessories, chisel, plane, hammer, screwdriver, etc. **45/-**