

8th JULY 1959

VOL. 128

NUMBER 3323

THE ORIGINAL  
'DO-IT-YOURSELF'  
MAGAZINE

# HOBBIES *weekly*

FOR ALL  
HOME CRAFTSMEN

## FULL INSTRUCTIONS FOR MAKING

*Also in this issue :*

**HOW TO LAY  
GARDEN PATHS**

**MAKING MODEL  
RAILWAY FITTINGS**

**OPTICAL ILLUSIONS**

**PATTERNS FOR  
TWO TOYS**

**EXPERIMENTS IN  
CHEMISTRY**

**REPLIES TO  
YOUR QUERIES**

**COLLECTORS' CLUB**

**ETC. ETC**



## A LABOUR-SAVING GARDEN CART



*Up-to-the-minute ideas*

*Practical designs*

*Pleasing and profitable things to make*

**5<sup>p</sup>**

**T**HERE is a great interest in rock collecting today. Many other hobbies claim to be older, but even the ancient cave men were rock collectors.

## HE COLLECTS ROCKS AND FOSSILS

'Rockhounds' have a wide variety of interests in rocks. Some want only polished gems, others like to do the polishing, most collectors prefer to do the gathering. Some collect only fossils, ores, crystals or fluorescents, while many are interested in all kinds of rocks.

Even though few can travel the world to do their collecting, there are many dealers who handle foreign rocks for

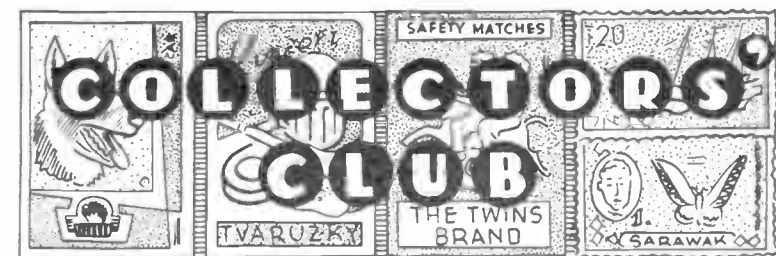

collectors. Most enthusiasts collect agate of one kind or another. Agate is a form of quartz. It is a semi-precious stone.

Crystals are the most beautiful of all types of rocks. Although some are so tiny that a microscope is needed to see them, others are several feet across.

There are a good number of fluorescent rocks, and even some phosphorescent. It is amazing the number of vivid colours that some rocks glow.

Although most rockhounds are folks with other occupations, some have work that is directly related to rocks, such as geologists, miners, students, etc.

Regular readers throughout the world should not overlook the possibilities of exchanging their specimens with other collectors.

Geoffrey R. Scott, of Thursday Island, Box 117, Queensland, Australia, would like to exchange rocks, fossils and shells.

'In fact', he writes, 'anything that you want, ask, and if in my power I will get it.'

In future articles we hope to introduce other overseas collectors. Meantime, all enquiries, please, to the Editor, *Hobbies Weekly*, Dereham, Norfolk, England. And do remember to send reply coupon on page 251. (R.L.C.)

## Stamps on a 'Keep Fit' Theme



**B**OYS and girls who take plenty of open air exercise grow strong and healthy. Games like football and cricket are good for boys. There are also plenty of pleasant outdoor games for girls.

Children who join the Scouts or Guides are taught how to keep fit. Sports and outdoor pastimes are an important part of their training.

The Queen, as Princess Elizabeth, and Princess Margaret, are depicted together in their Guide uniforms on New Zealand's 1944 Health stamp (5d. mint).

It is interesting to note that Princess Anne has recently joined the Buckingham Palace Brownie Pack.

Scouts and Guides, athletes, outdoor sports, etc., are illustrated on hundreds of stamps. These provide authentic pictorial facts on which many interesting themes may be based.

### New Match Labels

Our illustrations on the right show the latest match label issues from Yugoslavia, which are well worth securing.





# PATHWAYS TO SUCCESS

THE worth of a concrete path is to have a solid walk that will last virtually a lifetime. That is what makes people want to tackle the job. Yet, how many paths are laid properly, compared to those that are rushed down and begin to crumble within a few years? Remember, Rome wasn't built in a day, so if you want a good path, you will have to take your time on it, and do it correctly.

Similarly, crazy paving paths are not meant to drive you crazy with their inadequacies. They are just a novel form of a good solid path. Therefore, there is a right and wrong way of laying such a path.

The solid path consisting of a length of set concrete is, of course, the easiest to lay. First, dig out a foundation to a depth of at least 4ins., and making it 6ins. wider than the finished path width will be.

Now, set out the shuttering (or retaining side pieces) using timber of 4in. depth, and around 1in. thick. Keep the

shuttering in place with 1in. square stakes driven into the ground for a depth of at least 10ins. (see Fig. 1).

The level of the top edges of the shuttering is very important. Use a

of the last-named as you require. Ram it all well down with the end of a heavy piece of timber.

The length of wood used to tamp over and draw level the concrete as it is filled in, is called a screed. Cut it from a length of scrap wood, 4ins. wide and 6ins. longer than your finished path width.

The finished surface of the path should be slightly convex. This allows surplus rainwater to run off easily and quickly. In Fig. 1, the convex is shown exaggerated. It is not necessary to have such an acute arc; in fact, hollowing out a slight convex in your screed with a rasp will be found sufficient.

Make the concrete mixture, 1 part of cement, 3 parts of sharp sand, 1 part of chippings (granite is best if obtainable, although rather more expensive) and 1 part of water. Mix the dry components thoroughly by turning them over at least four times before adding the water. Do not make too sloppy a mixture — it will get sloppy enough whilst you are tamping it down with the screed.

Don't be tempted to simply draw the screed over the surface of the wet concrete. Really tamp it down — you can't do it too hard for a good path.

Finish off the surface with a plasterer's trowel only when the path looks as though it is really set. Hard trowelling will bring the water to the surface, and this also ensures a really good smooth surface to the path.

---

By E. Capper

---

spirit level to keep them level with one another. If you do not possess a spirit level and cannot borrow one, make up a temporary job by filling a pint bottle almost full with water, so that when the bottle is corked securely, a solitary bubble is left inside. Lay the bottle on something you know is perfectly level, mark a point where the bubble comes to rest in the centre of the bottle, and the makeshift spirit level is ready for use.

When the shuttering is complete, add to the enclosed part a 2in. layer of hard core, clinkers or heavy ashes. Your local gas works will gladly give you as much

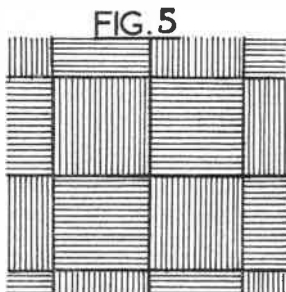
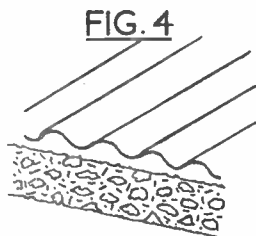
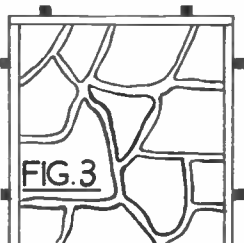
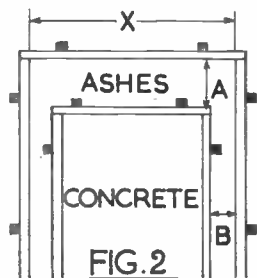
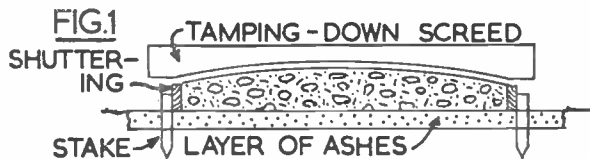

## Crazy paving

The popular way of making a crazy paving path is to buy the flat stones and to lay them in a bed of sand and cement. It does not follow that it is the best way. For one thing, most of the time on the job will be spent in sorting out the various shaped pieces, so that they fit to one another without too much gap. Even then the edges of the path are almost sure to be ragged and not in a nice straight line. And it's an even bet you will have lots of stones left over that just won't fit in.

The perfect crazy paving path is constructed as shown in Figs. 2 and 3. There is no waste, and the edges are straight and even. First, dig out and erect the shuttering as described for a solid path. It should be set out so that your desired width of the path is as shown at measurement (X).

Inside this shuttering build an inner shuttering. Fill up this inner shuttering with the same concrete mix as for a solid path. If you wish, make three or four mixes, adding a different colour

additive. Fill in the mixes, a bit here and a bit there, so that you get a jigsaw puzzle kind of surface to the laid concrete.

Before filling in the mixtures, lay sheets of newspaper inside the inner shuttering. This will prevent the mix from adhering to the clinker foundation, which for this method is important.

Leave it for 2-3 days until the concrete is set really hard. If the weather is hot, constant sprinkling of water to the concrete surface will hasten the hardening process. Now break up the concrete with a heavy hammer, and remove the inner shuttering. Relay the broken pieces into the framework of the outer shuttering (see Fig. 3), bedding them in with a mixture of 6 parts of sharp sand to 1 of cement. Finally, fill in the gaps and trowel off level, with a stronger mixture of 4 parts of sand to 1 of cement.

These calculations will help you; for paths of 2ft. wide or under, make the

difference shown at (B) in Fig. 2, approximately 2ins. Extend it by 1in. for every foot of extra width the path may be. To calculate distance (A) (see Fig. 2), on every 4ft. of path run, allow 1ft.

#### Patterned paths

A ribbed path has the advantage of providing channels down which excess rain water can be made to run away more quickly. Corrugated cardboard is all that is needed to provide this surface (see Fig. 4). After trowelling off the concrete surface as smooth as possible whilst still semi-wet, lay the corrugated cardboard on the surface and press it in gently and evenly. Leave it there until the concrete has set really hard. You will then find that the corrugated cardboard will peel off quite easily.

Square sets are very attractive. Make up a hollow framework of 2in. by  $\frac{1}{2}$ in. timber. If possible make up to about a dozen. Starting on a level piece of

ground, first lay newspaper on to it, over it place the frame, fill it with the concrete mixture, lay newspaper on the surface, place another frame over the first, fill in with concrete, and so on until you have a stack. Do not make the concrete mixture soggy; on the contrary make it very stiff.

For those with an artistic bent, make a design on the surface of your path whilst it is still semi-dry. A pleasing pattern is shown in Fig. 5, and is done quite easily with a nail point and ruler.

Circular patterns can be obtained by pressing a tin lid on the surface, a stippled effect can be obtained with the prongs of a rake, or you can go really contemporary and mark on a design that is really something. Remember, however, all these fancy touches are only possible once you have made a good level surface. Footprints are all right in Hollywood; on your path they will only leave water-laden hollows.

## SHIFTING SAND TRICK

**S**AND which mysteriously jumps from one place to another forms the basis of this interesting piece of deception.

For the presentation you will require two small cups and a matching saucer of the popular plastic variety now sold in most stores. They need only be small and inexpensive, but it is essential that they are plastic. You will also need a large sugar bowl or basin for holding a quantity of fine sand, and the bowl must be of such a size that it will adequately conceal a small pile of sand placed at the ready on your conjuring table.

A cup is taken up in the right hand and revealed to the audience, but not offered for examination as in some tricks, then turned upside down and replaced on the table to cover up the pile of sand concealed by the sugar bowl. The latter is moved aside at almost the same time by the free hand, so that the audience apparently sees the action of placing cup upside down on the table.

The other cup — on the saucer this time — is now taken up by the left hand, and after running some sand through the fingers to show the audience, you may remark that the trick should be performed with sugar, but it is too expensive to waste. You then proceed to transfer some sand to the cup from the bowl, and this is done rather carelessly, when it will be obvious that some is falling into the saucer. Here you may remark that your hands are cold and shaky, or some similar patter to cover the device. Having completed the operation of placing a supply of sand in the cup, you may admit that there is almost

as much in the saucer as in the cup. This allows you the opportunity of removing the sand from both the cup and saucer.

Hold the cup and saucer over the sugar bowl, moving the saucer outwards in a hinge fashion, with the back facing the audience, so that the spilt sand will trickle back into the bowl, after which the cup is returned to one end of the table with the saucer on top.

Here we must now reveal the secret of the trick. The cup you have just used

has had the bottom neatly cut out with a fretsaw, so when the saucer is taken away, the sand immediately trickles out of the cup! Sand is specified for this trick since it is more or less noiseless, and any swishing sound can be drowned by a little patter. You may use tea with similar effect, but it is not as well seen as the lighter coloured sand, and you will notice that when the saucer is held in front of the cup, as shown in our diagram, it conceals the sand dropping from the bottomless cup — a piece of deception that the audience will not expect. Perhaps you will also appreciate that the careless filling of the cup gives an excuse for emptying the saucer.

A few more magic words may be uttered, or the second cup tapped with the wand, directing the sand to disappear, and we are ready for the climax of our trick.

The saucer is removed from the top of the cup, placed in its usual position underneath the cup and the pair, held by both hands, tilted forwards, when the cup will be seen to be empty. The hole in the bottom of the cup will be unseen if cup and saucer match in colour.

You may now turn your attention to the first cup handled, and on lifting this, the pile of sand will be revealed, giving the illusion of a magical transfer!

The only preparation required is the making of the hole in the bottom of one cup, and this should not prove an awkward job if you use a fretsaw. The sand to use is known as silver sand, often used by gardeners for their seedbed mixtures, and which will be found quite light coloured. ('Mystifier')

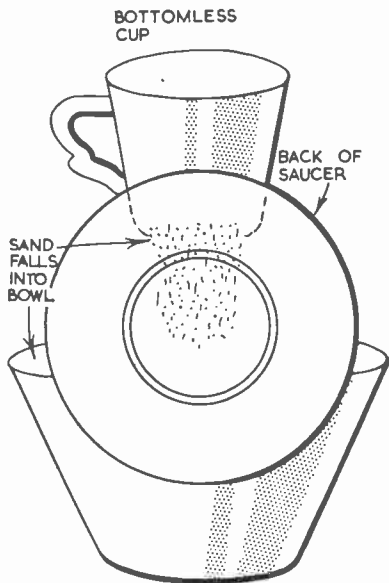

# Miniature Railway Accessories

**S**MALL accessories for your miniature railway layout are easily made from scraps of plywood, hardboard, dowel rod and tin salvaged from old containers, while a painted finish will both preserve the models and make them look very realistic.

No railway system is complete without gradient posts to assist the drivers and these should present no difficulties. All you need is a baseboard measuring  $1\frac{1}{2}$  in. by  $\frac{3}{4}$  in. made from  $\frac{1}{4}$  in. plywood or hardboard and some  $\frac{1}{4}$  in. square section for the posts. The latter are made  $1\frac{1}{2}$  in. long and fastened to the base by means of a fine screw from the underside. The arms indicating the gradient are made from pieces cut from an old cocoa tin and fitted into a fine slot made by drill and fretsaw. Finally, the whole is painted white with the required data in black as shown in Fig. 1.

Again, we must have telegraph poles, and these also are easy to construct. They are made from  $\frac{1}{4}$  in. dowel rod

fitted into a plywood base  $1\frac{1}{2}$  in. square. The latter is bored to accept the rod and it is essential that the drilling is perfectly vertical or the pole will slant. The top of the rod is shaped at each side to allow for a weather cap made from tin as shown in Fig. 2. A little strong glue will hold it in position. Insulator crossbars are made from  $\frac{3}{16}$  in. stripwood glued into the notches. The insulators are small white beads or small wooden beads cut in half and painted white. The post and crossbars are stained dark brown.

Another simple accessory for you to make is the advertising board for the station platform, using plywood for a base with two upright posts, each  $2\frac{1}{2}$  ins. high secured by screws through the baseboard. The advertisement board can be made from tin slotted into the posts as shown in Fig. 3 or from  $\frac{1}{4}$  in. plywood, the whole being finished in white paint and lettered as desired. The same kind of accessory can be made for indicating the station name.

The foregoing concerns simple accessories which can be made very quickly

and cheaply from oddments, but we will now describe two small buildings more often seen in the goods yard. One is the coal merchant's cabin, as shown in Fig. 4, bearing a sign over the roof to indicate the name of the dealer. Here again we require a baseboard of either  $\frac{1}{4}$  in. or  $\frac{3}{8}$  in. plywood, the walls being made from  $\frac{1}{8}$  in. material or even cardboard of stout quality. You may con-

By H. Mann

struct this type of building like a box but you will find it easier to first cut out the parts, that is, the front and sides, then fastening them to square section glued to the baseboard on the inside. If quarter round, or triangular section is also glued to the inside corners of the building before fitting the roof you will find it makes the job much stronger.

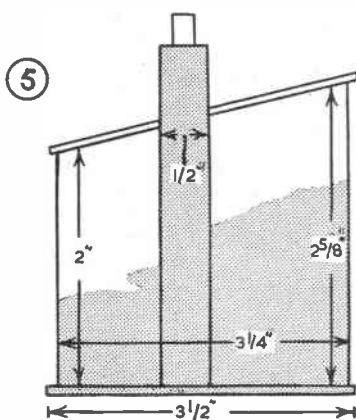
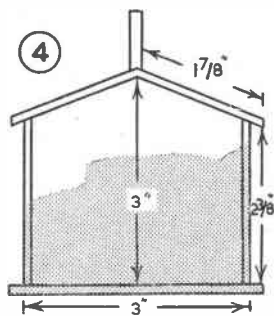
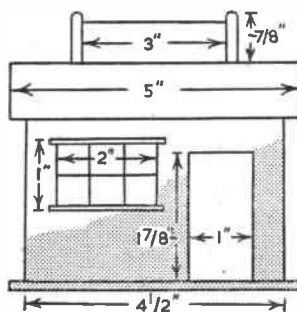
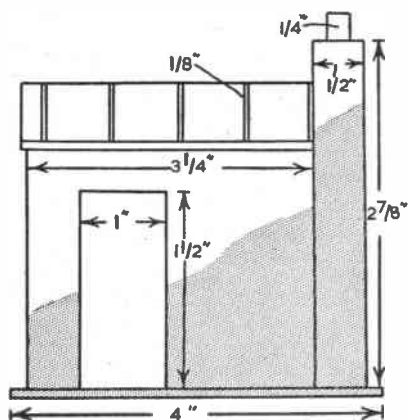
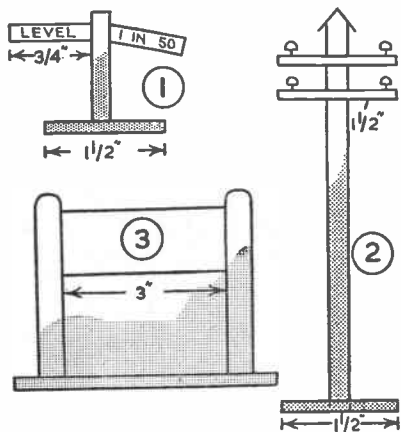

First prepare the two ends, back and front of the cabin, cutting out apertures for the window and doorway. The portion which is removed for the door should be retained and hinged to the building by means of a strip of adhesive tape on the inside. The window has thin pieces of stripwood across the top, bottom and sides, with cross-pieces as shown to make the panes. A piece of celluloid fixed on the inside will give the appearance of a real window.

Next comes the roof, and this can be made from stout cardboard, scored down the centre and attached with glue and panel pins, but before so doing we must provide for the sign on top of the cabin. Two short posts of square section are prepared and slotted for the signboard

● Continued on page 240

# Tortoises and other Reptiles

**R**EPTILES as a class are not popular animals, and yet one of the most commonly kept pets belongs to this group, namely the tortoise. The tortoise is a long-suffering creature, not only before it arrives in the pet-shop, but often also when it is kept as a pet, owing to the misguided attentions of its owner.

The common or 'Greek' tortoise is a native of the Mediterranean area, mostly Tunisia and Morocco, and is not common in Greece. It is exported to this country often under appalling conditions, sometimes being tightly packed in crates or boxes. There is thus a high

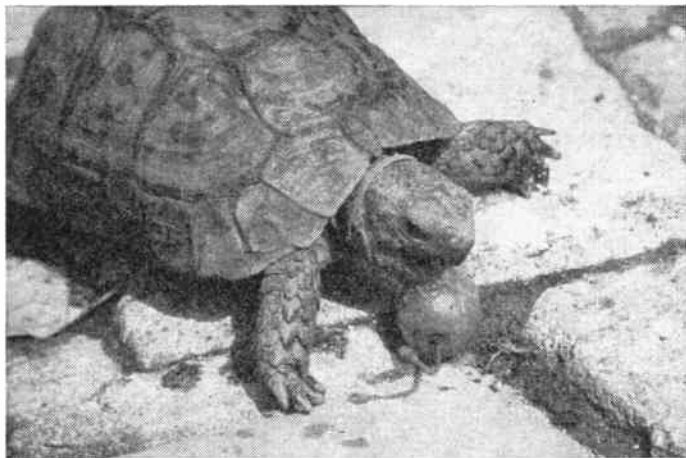

*The common tortoise enjoying a grape*

mortality rate en route, and some of the survivors are doomed to die later, often after they have been purchased by the unsuspecting buyer. It is, therefore, of the utmost importance to choose a healthy animal, and to know what to look for oneself, not relying on the assurances of the dealer.

tortoise is purely vegetarian, and any suggestion that it will rid your garden of slugs should be treated with the contempt it deserves. A tortoise will certainly not do 'good' in the garden; indeed, it will wreak havoc with young shoots and lettuce seedlings if allowed access to them. For this reason, if you wish to preserve your garden, it is desirable to have a special pen for your pet. In any case this is a good idea, since few gardens are tortoise-proof.

This pen should be as large as possible and can be constructed from firmly fixed wire mesh about 1ft. high. In some cases it may only be necessary to fence in valuable seedlings and plants, and allow the tortoise the run of the rest of the garden. The part available to the reptile should be varied; that is, it should contain grass, earth and rockery, and particularly important is some method of escaping from fierce midday sun, since, although tortoises inhabit hotter lands than this, they still like a little shade.

A waterproof box for the night into which the tortoise can easily crawl is necessary, and some straw or dry grass should be provided. It is sometimes suggested that a tortoise may be tethered by drilling a hole in the shell and attaching a string to it. This is a cruel practice which should never be considered. There is, however, no harm in writing your name and address on the underside of the shell, using Indian ink, if you do fear your pet should wander. This will of course need renewing from time to time.

## Feeding

Apart from any choice seedlings, which the tortoise will naturally prefer to any other food, a good basic diet is lettuce. Most tortoises like this, although like ours, their tastes vary and you may have to experiment to discover the most

readily accepted food. Dandelions are often popular, also watercress and indeed any greenstuff may be tried. Some like a little tomato or other fruit from time to time. It is a good idea to feed in the morning and again in the afternoon. Water should always be available, and to avoid the container being tipped over, a small sunken saucer is most suitable.

## In the winter

The winter does present a difficult time for the reptile, and it is during this period, or soon after, that many pets are lost. However, if attention is paid to several details, all should be well. An active healthy animal should eat plenty during the early autumn in order to be ready for its winter rest. The chief difficulty here is the weather, since, if it should be cold and damp, the tortoise will be less inclined to feed well, and it may need a little tempting with its favourite food.

With the onset of the colder weather your pet will become sluggish and sleepy and, although if left alone it would probably dig itself in somewhere in the garden, the procedure is rather risky. It is better to place it in a box with hay or straw, and keep it as cool as possible. The best place is a dry outdoor shed. It is very desirable that the tortoise should not wake up during the winter, but if it does, due to a sudden warm spell in our fickle climate, and shows no signs of returning to sleep, it is better to bring the animal indoors and try to feed it before putting it outside again when the temperature has returned to normal. Tortoises can be kept warm and active throughout the winter indoors, but they usually suffer the following year. (This, of course, does not apply to the tropical tortoises sometimes kept, with which we are not concerned here.)

---

*By P. R. Chapman*

---

mortality rate en route, and some of the survivors are doomed to die later, often after they have been purchased by the unsuspecting buyer. It is, therefore, of the utmost importance to choose a healthy animal, and to know what to look for oneself, not relying on the assurances of the dealer.

## Choosing your tortoise

Tortoises should always be purchased in spring or summer, when they have fully awakened from their winter hibernation, and the animal chosen should be of alert appearance and lively. The fact that it withdraws rapidly into its shell when touched is a good sign rather than a bad one. It will get used to being handled later on. If you push upon its back legs it should push back; if it allows you to press them in easily it is probably ill. The tortoise should have clear bright eyes and a clean-looking mouth. If several equally suitable-looking animals are available, it is a good point to choose the heaviest, assuming that they are of the same size. A good size is about 4-5ins.; very small ones are more difficult to rear. Examine the shell carefully; it should be clean-looking and free from damage. Any tortoise with a sign of a crack in its shell is better rejected. If these points are kept in mind there is no more advantage in buying your pet in a large store than from a small trader, from whom it will probably be much cheaper.

As everybody should know, the land

When your tortoise awakens in the spring, you may have to bathe its eyes with a dilute boric acid solution, if they are gummed up or watery. It may not want to eat at first, but do not forget to provide water, and if the weather is inclined to be cold at nights, bring your pet indoors.

In addition to the land tortoises, the European Pond Tortoise is sometimes kept as a pet. This creature requires a pond in the garden, and if the prospective owner is prepared to construct a shallow concrete pond and to keep it clean, they make attractive pets. These reptiles are carnivorous and will eat earthworms readily. Other live food and sometimes pieces of meat are usually taken, preferably in the water. Hibernation should be in a dry box as for the land tortoises.

#### Other reptiles

Although tortoises are, undoubtedly, the most popular reptiles kept as pets, they are by no means the only ones available. The others most easily kept are lizards and the smaller snakes. These have at least one advantage over tortoises, in that they are usually kept in indoor vivariums, and can thus be more constantly with the owner. There are many lizards and snakes that can be obtained, but the tropical ones need considerable heat and care, and here we will only deal with the temperate types.

These reptiles may quite easily be kept in an aquarium, which, of course, does not even need to be watertight, although a proper vivarium can quite easily be constructed.

#### Types to keep

Of the lizards we may mention the Green Lizard and the Sand Lizard. The latter is a native of this country, whilst the former, larger and brighter, comes from Central and S. Europe. Both, in common with most lizards, are carnivorous, and may be fed on small earthworms, slugs, flies and mealworms. The last mentioned is a convenient food stocked by most pet-shops, but is expensive to use continuously. The vivarium should be provided with sand and large pieces of stone under which the animal may crawl. Although lizards are fond of sunning themselves, care should be exercised when placing their container in direct summer sunlight, since in an enclosed space the temperature may easily rise to a dangerous level for them. In winter they will hibernate under a convenient piece of stone, and like tortoises, should be kept cool. The snake-like Slow Worm, which is a legless lizard, is a most interesting pet, which should be treated just as the other lizards. It is very partial to small slugs.

There are many interesting harmless snakes, but the one most likely to be kept as a pet is the common Grass Snake. The main difficulty with snakes is the feeding, and this one really prefers young frogs, which may not be easy to provide. It will also take small fish, such as sticklebacks. Earthworms may sometimes be accepted, but are not nearly as popular. Otherwise the treatment is much the same as for the lizards. Grass snakes become quite tame and friendly, although at first, when alarmed, they may exude an objectionable-smelling liquid. They soon get over this unpleasant habit!

*The alligator, although tame, is not everybody's idea of a pet!*



● Continued from page 238

## Railway Accessories

and trimmed at the base to fit the apex of the roof. Apply a coating of glue to the bottom of the posts and a screw from the inside will hold them secure. The board for the name can be made from a piece of tin or thin plywood in the same manner as the advertisement boards.

With the parts prepared all we need is a base provided with strips of square section made to fit and glued. Attach the ends first, then the front and back, gluing and pinning as necessary, and finally add the roof complete with sign. Paint the roof slate grey, the walls brick red, the sign white with lettering as required, and the baseboard grey.

Fig. 5 shows a platelayer's hut which is constructed on similar lines to the coal merchant's cabin with the exception of the lean-to roof and the chimney stack. You will have seen this type of hut alongside the track when travelling by train and know that they are mostly tarred. They have the distinctive wooden laths nailed to the roof for the protection of the waterproof felt, and for safety against fire the chimney stack is brick built on the outside. The diagram gives clear dimensions for this hut, again using thin plywood, while you will require

$\frac{1}{2}$  in. square section for the stack, which has a short piece of  $\frac{1}{4}$  in. dowelling fitted as a chimney pot. The stack is glued to the outside of the hut but it is also wise to take the precaution of screwing from the inside. The whole accessory is painted in black but the base may be grey, the stack and the chimney pot being finished in red. Note that the top of the pot should be painted black to represent a deposit of soot on the inside.

In the two latter models the roof overhangs the walls in each case by about  $\frac{1}{2}$  in. You may use thin stripwood laths of, say,  $\frac{1}{8}$  in. or  $\frac{1}{4}$  in. square section for the roof of the platelayer's hut and the window frame of the coal merchant's cabin. The most important thing to remember is that the joints are well glued and reinforced, while some care in the final painting will make all the difference to the finished article.

A stack of coal for either the coal yard or shed can be made from a cube of wood about 5 ins. by 3 ins. by 2  $\frac{1}{2}$  ins. Round off the top edges, brush on glue on all sides excepting the bottom, then sprinkle with coal dust. When this has dried a further coating of glue is applied and small pieces of coal, about  $\frac{1}{4}$  in. square, are stuck on.



# ENTERTAINING ILLUSIONS

**T**HERE are dozens of curious optical illusions which seem very mysterious to the uninitiated. For the scientific amateur who enjoys performing 'natural magic' for the entertainment of his friends here is a selection of optical experiments involving the use of quickly constructed pieces of apparatus.

Draw a pin man no more than one inch high to the left of the plain side of a postcard and mark a little cross about 3 ins. to the right of the figure. With this diagram you will be able to demonstrate the existence of the blind spot of the eye.

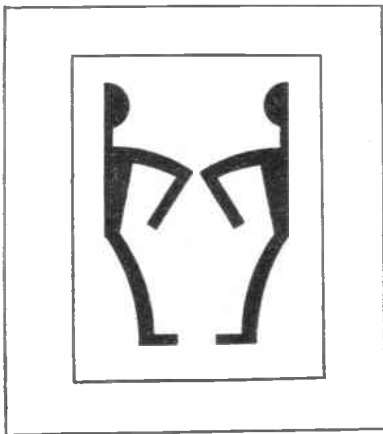

Fig. 1—Man in Space

Hold the postcard in front of you and close your right eye. Now focus your left eye upon the cross and bring the diagram nearer your face. At a certain distance the pin man will completely disappear owing to the fact that its image will be falling upon the blind spot of your eye. The blind spot is that part of the retina where the optic nerve enters the eyeball and there are no nerve endings sensitive to light.

As is well known, the forward looking pair of eyes possessed by human beings is especially suited for the judgment of distance and consequently this is the reason for our being aware of depth in the world of space around us. You can exploit this 'three dimensional sense' by making it appear that you have a round hole clean through the palm of one hand. Make a 6 in. tube  $\frac{3}{4}$  in. in diameter by rolling up a sheet of notepaper. Hold out the palm of your left hand in front of you and at the same time support the tube in your right hand. Look at the palm of your left hand with one eye while you gaze into the tube with your other eye. Owing to the superimposition

of the two images as seen by your brain you will seem to see a neat round hole in the centre of your hand.

An optical illusion which always causes amusement has been described as 'the sausage in space'. Hold your fore-fingers about  $\frac{1}{2}$  in. apart and focus your eyes on a point somewhere beyond them. If you persevere you will soon be surprised to observe a tiny elongated form apparently suspended in the air between your fingers. This happens because each eye receives out of focus impressions of both finger tips and when these slightly conflicting images are registered by your brain they are blended to produce the comic illusion which you see.

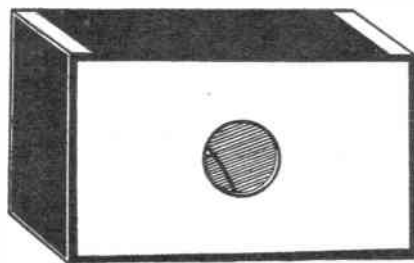

Fig. 2—X-Ray Matchbox

If you wish to see a 'man in space' cut out the shape of a miniature paper man, which must be symmetrical, and cut the figure in half down the middle (Fig. 1). Stick the two pieces to a window or small piece of glass in such a manner that the arms and legs of the two pieces are separated by a small space. The straight cuts, which will be on the outside, should be parallel. Stare at the two halves in the same way that you viewed your fingertips and you will see a complete little man 'in space'.

Using a matchbox and a feather it is possible to make an interesting device which will apparently enable you to see an X-ray view of your hand. Make neat round  $\frac{1}{2}$  in. diameter holes right through the centres of the top, bottom and tray of a matchbox. Obtain a piece of the vane of a big quill feather large enough completely to cover one of the holes. Glue the piece of feather over the hole in the tray and slide the tray into the cover so that the holes in the cover are in line with the hole in the tray (Fig. 2). Before your X-ray viewer is complete you may care to enlarge the hole in the cover opposite the feather so that more light can be admitted. If you now hold up a hand to the daylight and look at it through your apparatus with the feather close to your eye you will see what

appear to be the bones in your hand surrounded by a vague fleshy outline. The illusion is due to the distortion of light rays by the feather.

Not everybody believes in ghosts, but you can cause a grey phantom to appear in your own home with the aid of a white card upon which the spectre-to-be is outlined and shaded in black Indian ink. Use a piece of pure white card

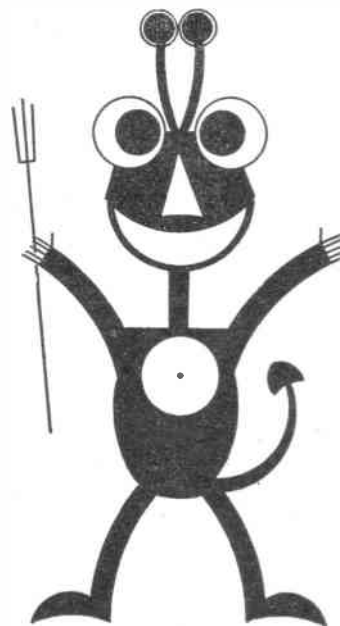

Fig. 3—The Phantom

measuring 6 ins. by 8 ins. and carefully draw a weird black mask with facial features left in white (Fig. 3). If you like you can draw on a body, but make your figure as simple as possible. Make a tiny dot in a white area near the middle of your drawing. Hold the drawing under a bright light for two or three minutes while you stare steadfastly at the dot. Then look away into a shadowy corner of the room where you will see a deathly grey after-image of your phantom. As the apparition fades, blink your eyes, and it might momentarily reappear. When you gazed at your drawing the bright white part of your picture tired the retinas of your eyes. As you stared into the dim corner, the tired parts of your eyes did not function very well, while the understimulated parts which had rested upon the black drawing still received some light.

(A.E.W.)

# CONSTRUCTIONAL C

\* FOR JUNIOR TO BUILD AND DISMANTLE

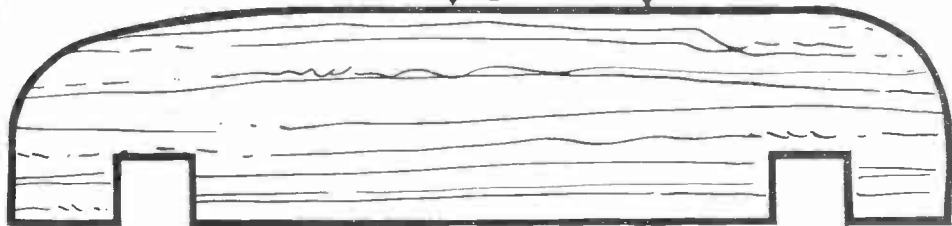

PIECES A CUT ONE OF EACH 1/2 IN.

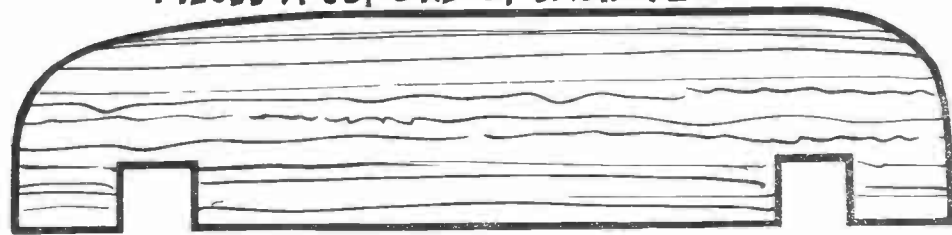

PIECES B. CUT ONE OF EACH 1/2 IN.

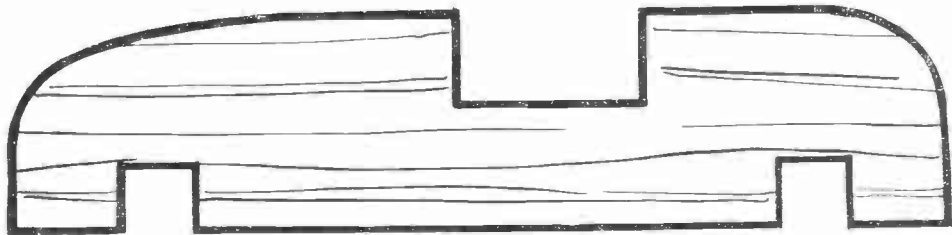

PIECES C. CUT ONE



PIECE D. CUT ONE 1/2 IN.



PIECE D. CUT ONE 1/2 IN.

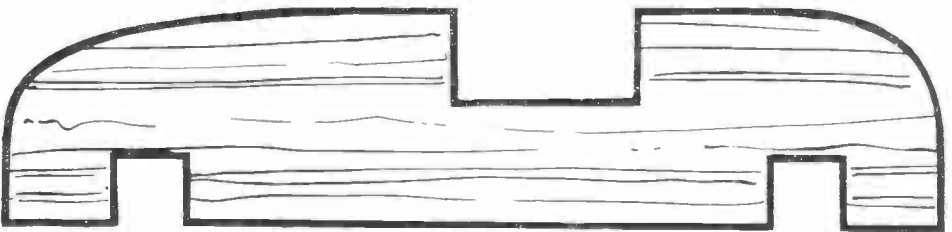
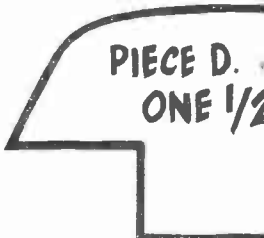

AXLES E. CUT ONE



# CAR

NTLE

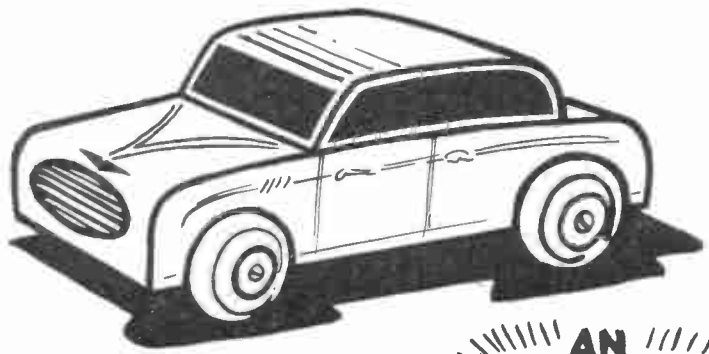

AN EDUCATIONAL TOY



CUT ONE OF EACH 1/2 IN.

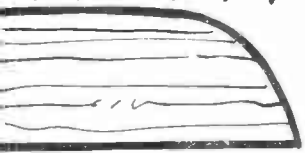

D. CUT ONE 1/2 IN.

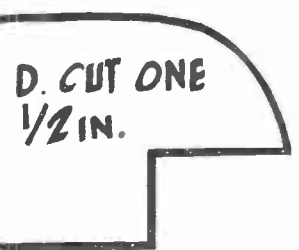

E. D. CUT ONE 1/2 IN



CUT ONE OF EACH 3/8 IN. SQ

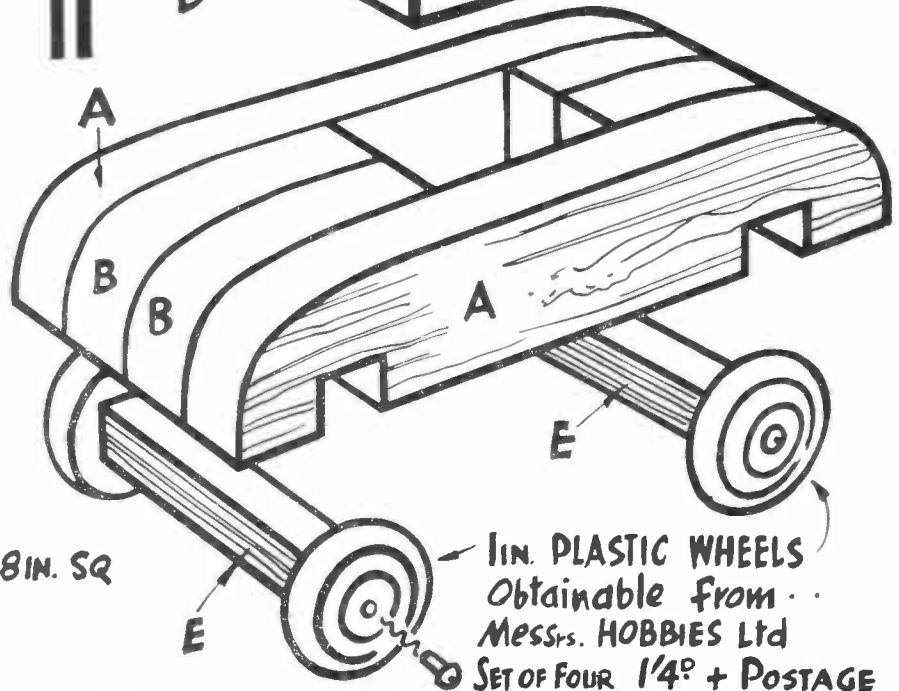
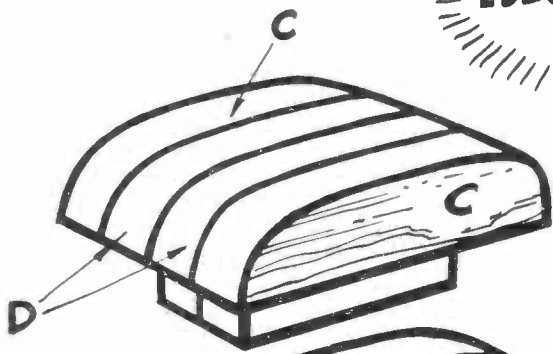

1 IN. PLASTIC WHEELS  
Obtainable from  
Messrs. HOBBIES Ltd  
SET OF FOUR 1/4<sup>p</sup> + POSTAGE

# CHEMISTRY AT HOME

IT is an intriguing fact that egg and sea shells, limestone, marble, stalactites and stalagmites, coral, whiting and the chalk of the white cliffs of Dover are essentially the same. Apart from small variable amounts of impurities they all consist of calcium carbonate.

In the laboratory we meet calcium carbonate as marble chips and precipitated chalk. It is the latter which we can use for some interesting experiments.

You may recall sometimes having seen a crystalline efflorescence on the wall of a stable or manure dump. This is calcium nitrate. It arises from the action of the decomposing organic matter on the lime in the mortar. In some countries use is made of this fact to manufacture saltpetre or potassium nitrate. Crude calcium nitrate is first produced by mixing vegetable and animal refuse with chalk and the mass wetted with liquid stable manure during two or three years. The calcium nitrate is then extracted with water.

No such lengthy and unpleasant process is necessary in the home laboratory to prepare calcium nitrate. Simply add precipitated chalk a little at a time to dilute nitric acid. The chalk dissolves with brisk effervescence, therefore use a big beaker or jam jar so as to prevent the liquid foaming over. When one addition of chalk refuses to dissolve the process is finished. On filtering, you will have a solution of calcium nitrate.

## Seal bottle

Evaporate half of this to small bulk on wire gauze then transfer the basin to a water bath and continue the evaporation to dryness. As calcium nitrate is deliquescent, bottle the salt while it is still warm, using a screw top bottle with a rubber disc inserted in the cap to provide a hermetic seal.

The other half of the solution can represent the solution of calcium nitrate obtained by the extraction of the refuse. By adding a solution of potassium carbonate to this, double decomposition takes place, calcium carbonate being precipitated and potassium nitrate remaining in solution.

Add the potassium carbonate solution a little at a time, stirring well, and testing after each addition by putting a drop of the mixture on red litmus paper. When the litmus paper turns purple the double

decomposition is complete. Filter off the calcium carbonate, and after washing it thoroughly with water dry, it and return it to your stock bottle.

Evaporate the filtrate to low bulk, occasionally taking up a drop on a cold glass rod. When a drop crystallises almost at once, you will have reached the crystallisation point and the solution should then be allowed to cool and stand overnight. White crystals of potassium nitrate separate and may be removed and drained dry on a porous brick for your specimen collection.

This experiment illustrates the simple saltpetre manufacturing process used in some countries.

The all important lime is, as we all know, made from limestone. Since calcium carbonate is the basis of other naturally occurring substances they could

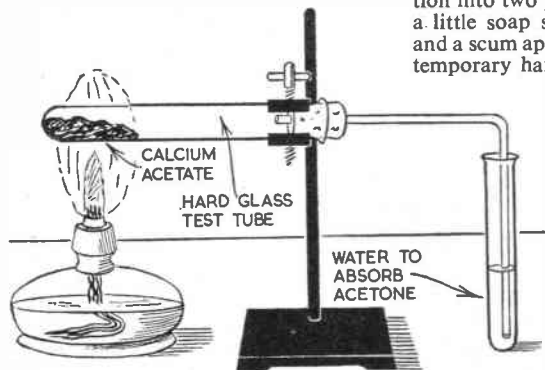

equally well be used, and indeed are in places where limestone is scarce. Precipitated chalk will likewise serve to show how lime is made.

Half fill a crucible with chalk and set it without its lid in the hottest part of the fire so that the crucible and contents become red hot. Maintain the heat for about half an hour. During the heating the calcium carbonate loses carbon dioxide; calcium oxide or quicklime is left. Let the crucible cool. Weigh the quicklime and then add one-third of its weight of water. For instance, if the lime weighs three grams, 1 c.c. of water may be added, since 1 c.c. of water weighs 1 gram. The lime grows very hot. The water disappears having combined with the lime to produce slaked lime.

Slaked lime is slightly soluble in water and constitutes a useful test for carbon dioxide. Put the lime in a closed bottle with water and shake occasionally during the next day or two. When the lime has settled decant off the clear upper liquid into a well closed bottle. This is lime water.

An easy demonstration of its use as a carbon dioxide test is to put some in a test tube and bubble your breath through it. The lime water soon becomes cloudy owing to the carbon dioxide in your expired breath combining with it to form insoluble calcium carbonate once more.

## EXPERIMENTS WITH CHALK

Continue bubbling your breath through it. The calcium carbonate disappears and the solution becomes clear once again. The calcium carbonate has combined with more carbon dioxide to form soluble calcium bicarbonate. Calcium bicarbonate is the main cause of temporary hard water. Divide the solution into two parts. Shake one half with a little soap solution. No lather forms and a scum appears, just as happens with temporary hard water. Only by adding

a good deal more soap will you succeed in obtaining a lather.

Now boil the other half. The solution grows turbid, insoluble calcium carbonate being precipitated and carbon dioxide escaping. Shake this liquid with some soap solution. A lather is obtained at once. This is why the hard water of some districts is softened by boiling. Permanently hard water, on the other hand, is caused by dissolved calcium sulphate and boiling will not soften it.

In both temporary and permanently hard water the dissolved calcium salts combine with the soap until they are completely precipitated and removed from the solution as insoluble calcium soaps which make up the scum. Only

● Continued on page 245

# CONTAINER FOR WASTE PAPER

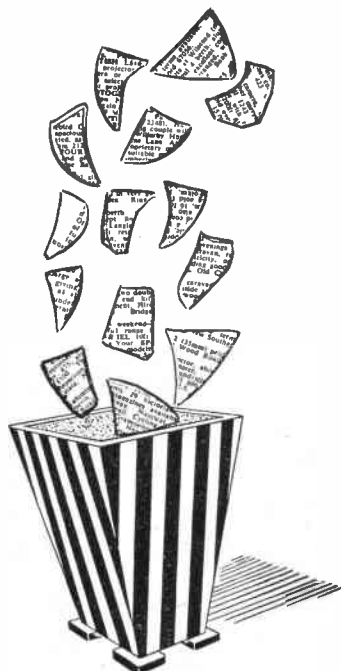

By H. Mills

**T**HIS handy and attractive waste paper container is modern in design. To make it you will need a piece of  $\frac{1}{2}$  in. plywood,  $12\frac{1}{2}$  ins. by about 30 ins., and a small  $4\frac{1}{2}$  ins. square of white pine or other suitable wood at least  $\frac{3}{4}$  in. thick.

The four sides of the container are sawn from the plywood. Each side is to measure  $9\frac{3}{4}$  ins. along the top and  $4\frac{1}{2}$  ins. along the bottom, as in Fig. 1, ignoring the dotted line on the right. The height will be  $12\frac{1}{2}$  ins. and therefore the width of the wood will just take the height of the sides. These four sides should be cut alternately, or the first one right way up

and the second one upside down. The third is cut right way up and the fourth upside down. This is a saving in wood as you will find the sides fit against each other. It is, however, advisable to allow ample measurement to take in the saw cuts.

Use 1 in. panel pins to nail the sides together. Nail the second side on to the edge of the first side. Number three is nailed on to the edge of number two. Number four is nailed on to the edge of number three and number one is nailed on to the edge of number four, as shown in Fig. 2.

Taking the  $4\frac{1}{2}$  in. square of white pine, chamfer the edges so that the bottom becomes  $4\frac{1}{2}$  ins. Insert from inside the cylinder until flush and nail to the sides.

It is wise to paint the container at this stage. To prepare for this, first rule off the 1 in. stripes on each of the four sides as in Fig. 1. This is done by measuring along the top edge. Next measure along the bottom. Commencing at the left, mark  $\frac{1}{2}$  in., then make four 1 in. marks and end with  $\frac{1}{2}$  in. at the right.

The stripes are painted alternate colours, continuing all around the four sides. The prototype was enamelled in black and gold, but any two colours could be chosen. The inside and the top edge are painted the lighter colour. All the wood should be given two coats.

Four blocks, as shown in Fig. 3, are sawn from the plywood to form legs. These are 2 ins. square. Measure in  $\frac{1}{2}$  in. on two adjoining edges of each leg. When the container is thoroughly dry, turn it upside down and nail one of the legs flat on each corner so that it protrudes the  $\frac{1}{2}$  in. on the two sides. Paint the tops of the legs the lighter colour

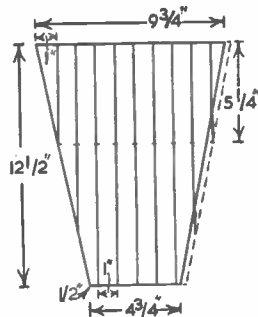

FIG. 1.

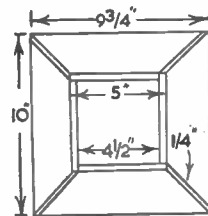

FIG 2



FIG. 3.

chosen and the edges of the legs the darker colour.

The finished container is very useful and makes a decorative addition to the furnishings of a room.

● Continued from page 244

## Experiments with Chalk

when this has happened is the soap able to form a lather.

Calcium acetate is a salt which has importance in one industrial method for making acetone, the solvent so much used in dopes and lacquers. When wood is distilled a liquid is obtained which is rich in acetic acid. This acid is separated from the other products by converting it into calcium acetate by means of chalk or lime.

To prepare calcium acetate and then to see how acetone is made from it, add dilute acetic acid to some precipitated chalk little by little until a small amount

of chalk remains undissolved. As effervescence occurs owing to evolution of carbon dioxide, use a capacious beaker or jam jar. Filter the solution and evaporate it to low bulk over wire gauze and then to dryness on the water bath or in the oven. White calcium acetate remains.

Dehydrate some of this by heating it gently in an evaporating basin, stirring constantly to avoid charring, and testing occasionally by holding a cold watch glass close to it. When the watch glass no longer mists over the salt is dry.

Rig up the apparatus shown and

heat the calcium acetate. When tarry matter ceases to appear in the water in the test tube stop the heating.

The liquid in the test tube now has the sweet smell of acetone. The presence of acetone may be proved by means of the iodoform reaction. To do this add some of the filtered liquid to a little solution of iodine in potassium iodide and then add either sodium hydroxide or sodium carbonate solution dropwise until the liquid is just decolourised. Now warm the liquid gently and let it cool. Small golden yellow crystals of iodoform appear and are readily recognized by their strong smell, which is a cross between that of iodine and apples. (L.A.F.)

# Easily-Made Window Pelmets

THE enhanced appearance and homeliness which well-designed pelmets can give to your windows makes the small amount of labour and cost well worth while. The most important point to consider is to ensure that the designs will suit the rooms in which pelmets are fitted. A simply designed pelmet suitable for a small bedroom could 'look out of place' in a spacious lounge.

Probably the simplest design of all is the box pelmet illustrated in Fig. 1. The top and ends are made from  $\frac{3}{4}$ in. thick timber, butt jointed at the corners and faced with a rectangular piece of hardboard or plywood. The appearance is rather plain and should be confined to small bedrooms. If desired, the front board may be made from reeded or fluted hardboard to reduce some of the plainness.

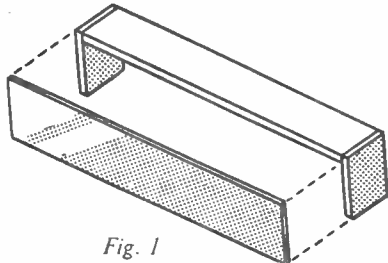

Fig. 1

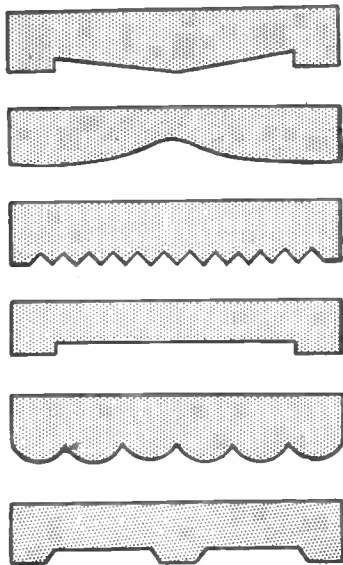

Fig. 2

Its appearance can also be greatly improved by cutting the front board to a pleasing shape, suggested in Fig. 2.

A more elaborate design of pelmet suitable for living rooms, lounges and other main rooms is illustrated at Fig. 3. This type is called the 'built-up' pelmet and basically consists of a simple box pelmet with overlays on the front. These overlays are small pieces of shaped hardboard or plywood and they produce an effect of solidity.

Having chosen the design, the size has to be considered. In determining the

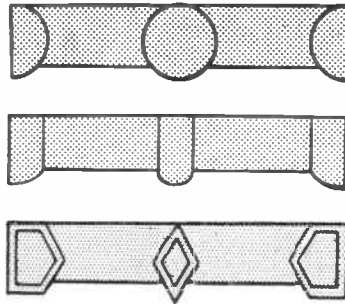

Fig. 3

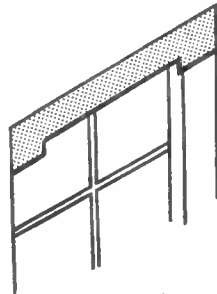

Fig. 4

length it is normal to measure the window opening and add 8 inches. This will give a projection of 4ins. on either side to allow the curtains to clear the window opening when they are apart. If it is intended to use a heavy type of curtain material then it would be safer to allow for a 6in. projection on either side.

Some people have fitted pelmets inside window openings as shown in Fig. 4, but this means that your hanging curtains will reduce the amount of light entering the room.

The depth of a pelmet is usually governed by its length. A shallow pelmet would look rather queer on a long window and conversely a deep one would be unsuitable for a narrow win-

dow. Before deciding on the final depth it is a good plan to draw out a paper pattern and fold back the paper to judge various depths.

The width of pelmets should be sufficient to give adequate sliding room for the curtains. A normal width is 4ins.

The methods of fixing vary. If the top of the window is positioned near the ceiling then the pelmets may be screwed into the first-floor joists or ceiling joists above. Always use wood screws for fixing so as to facilitate removal.

If the windows are the up-and-down sliding sash type and finished off by architraves on the face of the walls, the pelmets can be fixed by metal brackets screwed to the top members of the pelmets and the architraves.

If neither of the above methods is suitable then a 2in. by  $\frac{3}{4}$ in. timber fillet can be plugged and screwed to the wall

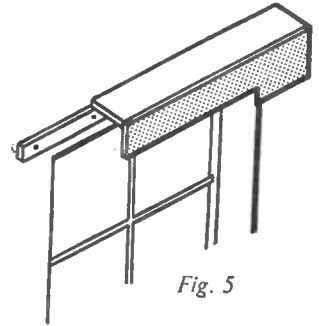

Fig. 5



Fig. 6

immediately above the opening as shown in Fig. 5. The pelmet can then be hung on this fillet and screws inserted from above or through the ends.

Always try and position pelmets so that the bottom edges do not project a great distance below the top of the window opening. This reduces the amount of light entering the rooms and places the backs of the pelmets in full view of people outside.

Finally, before fixing the pelmets in position remember to screw on the curtain runners and if the curtains are required to overlap at the centre then the rails should be fixed in two parts and cranked at the centre as shown in Fig. 6.

Complete by painting the pelmets to match the existing woodwork or cover with wallpaper. (F.K.)

# LADY'S SEWING 'COMPANION'

ALSO FOR  
USE AS  
A SMALL  
TABLE



MAKE IT FROM  
DESIGN No. 3278

A well-designed piece of furniture in contemporary style to hold all sewing and mending materials, etc. When closed it serves as a handy occasional table.

Today's value is in the region of £9 but a big saving can be made by working with Hobbies Kit No. 3278, price 65/-. This contains all planed wood panels, contemporary legs which are simple to fit, hinges, etc. Kits from all Hobbies branches, etc., or post free (see coupon).

Send for details of other furniture kits which will save you pounds.

To HOBBIES LTD., Dept. 99, DEREHAM, Norfolk

Please send details of furniture kits and Kit No. 3278 for Lady's Sewing Companion, price 65/-.

Name .....

Address .....

## This model farm cost less than 2/6

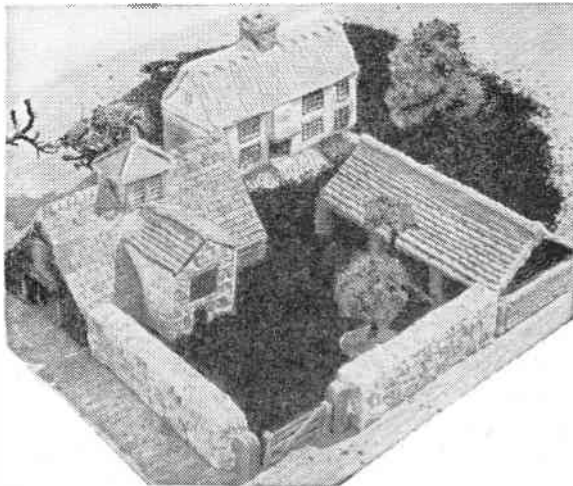

It was made from a half-crown tin of Sankey's PYRUMA — farmhouse, barn, implement shed, walls and gate — and there was still plenty of this grand modelling material left to build many more farm features, by simple methods described in the Instruction Book (see Coupon below). PYRUMA, plastic and ready-for-use, becomes stone hard after drying or baking, and can be painted in natural colours. For permanent modelling —

MAKE IT AND BAKE IT IN



Obtainable from your local Ironmonger or Hardwareman and many Art Material dealers. Ideal for making —

**Model Railway Buildings and Accessories,  
Harbours, Ship Models, Airport Buildings  
and Features, Houses, Bookends, Ashtrays,  
Animals and Figures, Plaques, etc.**

Post this Coupon today for your Instruction Book

**J.H. SANKEY & SON, L<sup>TD</sup>**

Established over a century  
Dept. H, ILFORD, ESSEX

Please send ILLUSTRATED INSTRUCTION BOOK with full colour pages on Pyruma Modelling.

Enclosed Postal Order value 6d. (not stamps)

NAME (Block letters) .....

ADDRESS .....

...ab evenly on the paper in... to know if you could... wish to make some plan... mitter? (R.P.—Wolverhampton.)  
 ...ght and hang to dry under... to go over the wallpan... on the same plan... EV... Channel 10 would

# Replies to Readers

...replied... directly is a brush polish... —... to charge a 12V. battery, as... was made by fixing... (Inmore.)

## Radio Interference from TV

**I** LIVE in a cul-de-sac comprised of fourteen houses, and of these, twelve have TV. aeriols. I have a 5-valve radio set which gives excellent reception except when the TV programmes are on, and then it is just impossible for us to listen-in because of interference and a continuous high-pitched whine. Our radio dealer suggested moving the set to the other side of the room, but this was no improvement. Can you suggest a remedy, please? (I.A.—Saltcoats.)

**SCANNING** oscillators in nearby STV sets are probably responsible for the interference. The trouble may be intensified by a fault in this part of a TV receiver. The G.P.O. will normally make an investigation and give advice if requested. If the noise is carried on the mains, a mains suppressor will help. Belling & Lea produce suppressors for this, available through dealers. Or try wiring a .05μF 750V. condenser from each mains lead to earth, or across the mains. In bad cases a suppressor choke may also be needed in each lead to the receiver. If, however, the noise is picked up direct, mains suppressors will not help. The cure then lies in positioning the set clear of interference, or screening it and having an aerial of anti-interference type situated away from the source of interference. The way in which the noise reaches your set can only be found by actual experiment.

## Miniature Spotlight

**CAN** you please describe to me how to construct a miniature spotlight on a swivelling stand, which will concentrate a beam of light about 2ins. in diameter on the subject, at about 5ft. away from it? It must have a voltage of about 3 volt A.C. or 6 volt D.C. (R.H.—Johannesburg.)

**TO** throw a more or less parallel beam of light, you will require a condenser lens or magnifying lens. This should be spaced from the bulb by a distance equal to its focal length, e.g. — say, 2½ins. away, with a lens of 2½ins. focus. The exact position can best be found by trial. To obtain a fairly bright light, the lens should not be too small in diameter. About 1½ins. to 2½ins. should do. Surplus lenses can be obtained from H. W. English, Rayleigh Road, Hutton, Essex. Two lenses can also be used together. A reflector behind the bulb

would give a brighter light. For 3V., a 2½V. or 3½V. torch bulb should do. For a stronger light, a 6V. 6 watt car type bulb, with 6V. accumulator would do. The spotlight body could be made from metal, wood, or stout card, as you wish. You might find a reflector and lens in an old torch.

## Hardboard for outside jobs

**I** AM building a small workshop, using sheets of Royal hardboard on the outside, and lining the inside with plywood. I would be grateful if you could inform me if the hardboard need be felted round, or would a good coat of paint with covering strips on the joints be sufficient? (T.P.—Bristol.)

**I** T is suggested you utilize oil tempered grade for the purpose, since this is denser and more suitable than the

★★★★★★★★★★★★★★  
 ★ Readers are reminded that all ★  
 ★ requests for information should be ★  
 ★ accompanied by a stamp for return ★  
 ★ postage. Otherwise they may have ★  
 ★ to wait weeks for a printed reply ★  
 ★ in this column. The coupon printed ★  
 ★ on page 251 must also be included. ★  
 ★★★★★★★★★★★★★★★

standard quality. For vertical surfaces, oil tempered board carefully painted on the surface, edges and over the edges on to the first few inches of the screen side should keep out moisture. Paint should also be applied under any cover strip. Your local supplier may not stock oil tempered quality Royal, but will be able to obtain this to order.

## Durability of Plating

**CAN** you please tell me how long nickel-plating lasts, as described in an article 'Chemistry in the Home'? ('Hobbies Weekly' dated 17-9-58). How long would it last if the object was rubbed with the powder and the immersion method? Can you plate on top of chrome? (B.D.—Belfast.)

**THE** durability of the nickel-plating naturally depends on the handling conditions, the care with which it has been applied and whether exposed outdoors or not. On an outside brass door handle the powder method gave a

coating which lasted for five months. By the immersion method the thickness of the coating is not controllable within narrow limits. Hence a durability period is not easy to define with any precision, but it is much superior to the powder method if the process has been repeated so as to give a thicker layer. We have not found either of these methods applicable over existing chrome. Electrodeposition is required in this case.

## Renovating Red Bricks

**OUR** bungalow is roughcast at the top, but at the bottom there are about eight rows of red bricks. These have become very dull red — is there a way of brightening them, please? (B.B.—Hols-worthy.)

**YOUR** best plan is probably to buy dry colour and petrifying liquid from a paint shop. The powder is mixed with the liquid and used like paint. It stands up to the weather well and keeps its colour. You could do the bricks red, and line the joints black.

## Stocking a Fishbowl

**I** HAVE heard that the size of a goldfish is controlled by the size of the tank or bowl; could you tell me if it is true? (T.A.—Lincoln.)

**GOLDFISH** which have plenty of space in which to move about and exercise, are naturally more healthy and consequently grow to more mature size than those in a restricted container. Oxygen availability plays a big part in the health of a fish, a general rule being 1in. of fish (in length) needs 24 square ins. of water surface.

## 2-Transistor Radio

**I** AM interested in the 2-Transistor Receiver ('Hobbies Weekly' dated 8-10-58). Before commencing to build it, however, would you advise me as to whether I would be likely to get any reception down here in East Cornwall? We are quite close to Hessorry Tor television transmitter, but I understand that this only transmits radio programmes on V.H.F. (C.L.—Nr. Liskeard.)

**THE** receiver is intended to tune in the usual medium wave transmitters, not V.H.F. programmes. In most parts of the country, some medium wave stations are satisfactorily received, and this should be so in your locality as far as is known. Receivers of this kind cannot be adapted for V.H.F. reception, but one or more BBC medium wave stations should be within range.



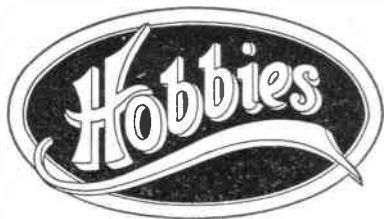

# KITS WHICH WILL MAKE GRAND GIFTS FOR ALL MEMBERS OF THE FAMILY

Gifts made by yourself have that 'personal' touch which make them all the more appreciated. Here are a few kit suggestions from Hobbies which will delight both giver and receiver. Many more ideas in Hobbies free 20-page booklet. Send for one today and save yourself £££'s.

**KITS CONTAIN ALL MATERIALS AND FULL INSTRUCTIONS FOR MAKING WITH A FEW SIMPLE TOOLS.**

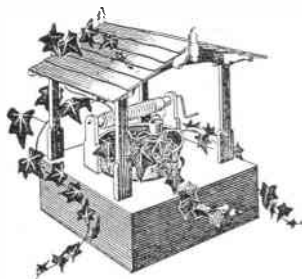

**'OLD WELL' PLANT HOLDER**  
Kit No. 3248  
**10/3** (post 1/6)

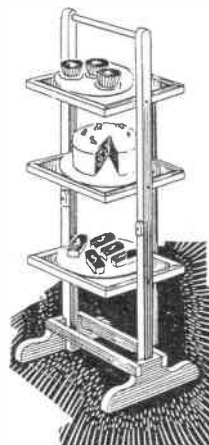

**FOLDING CAKE STAND**  
Kit No. 3226. All wood, hardboard, etc.  
**20/-** (post 1/9)



**'LIGHTHOUSE ELECTRIC LAMP'**  
Kit No. 3252. Lampfittings, printed window material, etc.  
**22/6** (post 1/9)

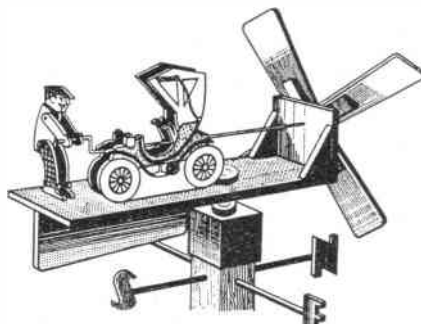

**NOVEL WINDVANE**  
Kit No. 3258. Wood, wire, steel, etc.  
**16/-** (post 2/-)



**GALLEON CALENDAR** **5/9** (Post 1/-)  
Kit No. 3188 Graceful and practical.

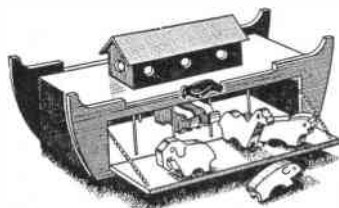

**NOAH'S ARK**  
No. 3270. With animals.  
**13/11** (post 1/6)



**AUTOMATIC CIGARETTE BOX**  
No. 3272. Open the drawer for a cigarette.  
**5/6** (post 1/-)

**GET STARTED ON SOME  
OF THESE RIGHT AWAY!**

To Hobbies Ltd., Dept. 99, Dereham,  
Norfolk.  
Please send free copy of 'Profitable Leisure'  
and

KIT NO.....

Name.....

Address.....

P.O. for.....  
enclosed. *Orders totalling 30/- and  
over, post free U. K.*

**APPARATUS & CHEMICALS** — Gigantic price reductions. Save pounds! Special offers. Catalogue free. New premises and better service. — Scientific and Technical Supplies (Nottm.) Ltd., 286 Alfred Street Central, Nottingham.

**100 DIFFERENT stamps free!** Request 4d. upwards discount approvals. — Bush, 53 Newlyn Way, Parkstone, Dorset.

**PERSONS** required, to make new type fancy cushion covers. Apply, enclosing S.A.E. — Dept. 28, Arnold Trading, 10 Shelley Rd., Worthing, Sx.

**BUILD YOUR OWN HI-FI** at home! At last, for reasonable cost — the chance to make your own quality HI-FI audio equipment and to gain the knowledge to service and maintain it. FREE brochure from — Dept. HW20, Radio-structor, 46 Market Place, Reading, Berks.

**LEARN RADIO and ELECTRONICS** the NEW practical way! Very latest system of experimenting with and building radio apparatus — 'as you learn'. FREE brochure from — Dept. HW10, Radiostructor, 46 Market Place, Reading, Berks.

Completely new 54 page Edition  
**WHERE'S THAT CAR FROM ?**

Price 1/- (Postage 4d.)

Of all Booksellers

or

**RALEIGH PRESS, Exmouth, Devon**

*Genuine* **BRITISH NAVAL** 25%  
*Telescope Gun Sight*

THIS IS THE USEFUL MODEL. Naval telescope: powerful day and night lenses, modern micrometer, automatic non-extending range focus apparatus. Splendid object lens. Approx. 15ins. in length. Picks out object with clarity and precision at many miles' range. Scientific instrument. COST WELL OVER £20 TO MAKE. Buy one! It is a real investment. Made by famous instrumental makers. Only 25/- Post & pack., 2/6. Approx. wgt. 5 lb. FREE LISTS BINOCULARS, TELESCOPES, TENTS, CAMPING EQUIPMENT, SLEEPING BAGS, WATCHES, JEWELLERY.

**TERMS.** Complete transmitting and Receiving apparatus for two persons. From a few yards to a mile. Normal telephone strength. No batteries or electricity — it just works! Send 12/11, post 2/1. Ready for use in 5 minutes. Lists, Binoculars, Watches, Tents, Terms. **Headquarter & General Supplies Ltd. (HOBW/70) 196-200 Coldharbour Lane Loughboro Junc., London, SE.5. Open Sat.**



**INTRODUCTIONS** to new friends; home and overseas. — V.C.C., 34 Honeywell Road, S.W.11.

**HOBBIES BRANCHES**

LONDON

78a New Oxford Street, W.C.1 (Phone MUSEUM 2975)  
87 Old Broad Street, E.C.2 (LONDON Wall 4375)  
81 Streatham Hill, S.W.2 (TULSe Hill 8796)

151 High St., Walthamstow, E.17 (COPermill 3928)

**GLASGOW**—326 Argyle Street (Phone CENTRAL 5042)

**MANCHESTER**—10 Piccadilly (Phone CENTRAL 1787)

**BIRMINGHAM**—100a Dale End  
**SHEFFIELD**—4 St. Paul's Parade (Phone 26071)

**LEEDS**—10 Queen Victoria Street (Phone 28639)

**HULL**—179 Ferensway

**SOUTHAMPTON**—134 High St. (Below Bar)

**BRISTOL**—65 Fairfax Street  
**NEWCASTLE**—42 Dean Street Newcastle-on-Tyne 1

**GRIMSBY**—88 Victoria Street  
**ALSO AT LONDON AIRPORT**

**STOP SMOKING!** Quick guaranteed remedy. Testing sample free! — Triumph Remedies (A16) Exeter.

**STAMPS FREE** — Empire Packet including Pictorials and Victorians with approvals. — Robert J. Peck, 7A Kemp Road, Bournemouth.

**MAKE A MUSICAL BOX** for as little as 12/11. New kits and tunes available. Movements 13/- post free. Please send 3d. stamp for free illustrated catalogue. — The Swisscross Co., Dept. B, 202 Tulse Hill, London, S.W.2.

**The HALTRAC MIDGET HOIST**

Weighs 1 lb. Tested to lift 1,000 lbs.

PRICE 57/6

will pull or lift anything. Self-lubricating solid nylon pulleys. — 72 ft. nylon rope — rustless aluminium construction throughout. Standard equipment for the Motorist, Caravaner, Gardener, Workshop, etc. etc.

Available from all good Stores, Ironmongers, Halford Branches, Yacht Chandlers, etc., or from:

**HALTRAC LTD. (Dept. HW. 4)**  
**BOURNE WORKS, WEIMAR STREET, LONDON, S.W.15**

Trade enquiries also invited



**WOOD BENCH VICE**

A strong hardwood vice which can be screwed to the work bench. A real serviceable tool, well made, and fitted with hardwood screws. 12ins. long.

From branches or:  
**HOBBIES LTD., Dereham, Norfolk**

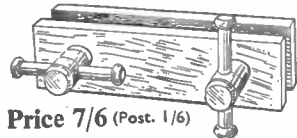

Price 7/6 (Post. 1/6)

LET

**★ 'Plasticine'**

HELP YOU DO-IT-YOURSELF Regd. Trade Mark  
Harbutt's Plasticine Ltd, Bathampton, Bath

**Webley AIR PISTOLS**

High Accuracy  
and Hitting Power  
Perfect Balance  
Robust Construction



Send for Catalogue

**WEBLEY & SCOTT LTD.**

34 PARK LANE, HANSDWORTH, BIRMINGHAM 21

**Is This Saw in Your Kit?**

You can cut almost anything in wood with this Coping Saw. The blade is 6½ins. long and can be turned to cut at any angle. No tool-kit complete without one. Get yours NOW.

Buy from any Hobbies Branch or by post from Hobbies Ltd., Dept. 99, Dereham, Norfolk

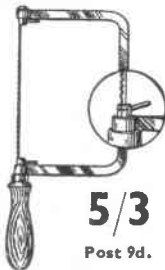

5/3  
Post 9d.

# 'PIXIE HOUSE' MONEY BOX

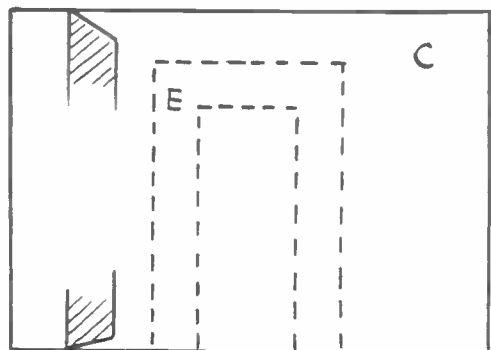
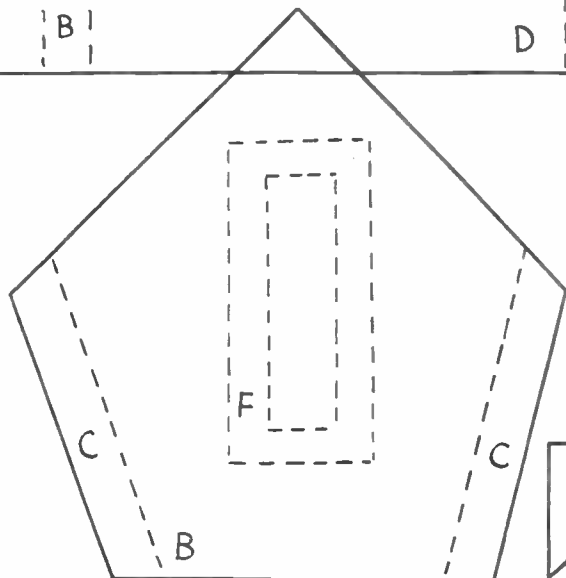
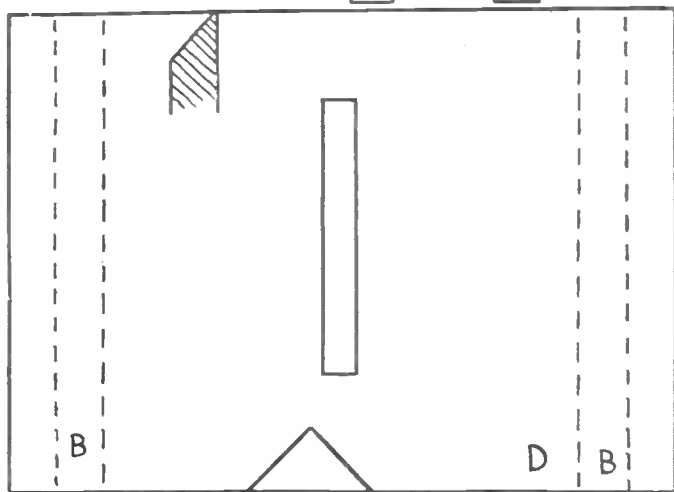
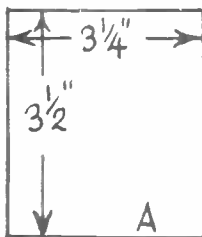
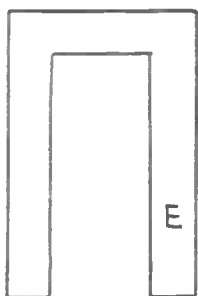
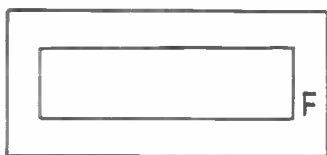

ALL parts are shown full size and are cut by means of a fretsaw from fretwood or plywood. Cut the base (A), ends (B), sides (C) and roof slopes (D) from  $\frac{1}{4}$  in. wood and pieces (E) and (F) from  $\frac{3}{8}$  in. The chimney is cut from  $\frac{3}{8}$  in. wood.

Cut a circle of wood from the base and push it back in place, pasting over it two or three thicknesses of brown paper. It can then be easily removed to get out the money.

Glue ends (B) to sides (C), then glue these to the base. Now glue roof slopes, windows and door in place. Glue chimney to roof.

Finish off by painting in bright colours. (M.p.)

# 2

## fine NEW models in the shops in July

Dinky Toys No. 165 HUMBER HAWK, with windows and independent suspension. Length 4 in. Price 3 9 (inc. tax)

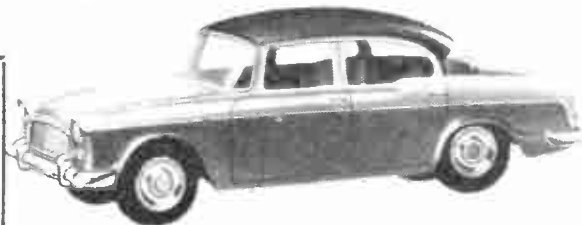

Dinky Supertoys No. 967 B.B.C. TV MOBILE CONTROL ROOM. One of a fleet of B.B.C. Mobile TV telecasting units, with windows. Length 5 <sup>5</sup>/<sub>16</sub> in. Price 8 3 (inc. tax)



INSIST ON  
**DINKY TOYS**  
TRADE MARK REGISTERED

MADE BY MECCANO LTD, BINNS ROAD, LIVERPOOL 13.



BUTTERFLY BRAND

**Introducing YOU to an ABSORBING HOBBY with beautiful really worthwhile RESULTS**

Some of the beautiful, interesting and useful items include fish tank models, sea shells and starfish; butterflies and moths; seasonal display flowers; model gardens and floating water lilies, etc.

All the models can be made from coloured paper and easily obtained materials of exceptionally low cost. The book is illustrated throughout with colour and monochrome photographs as well as many 'step-by-step' line diagrams.

An essentially practical book which will be tremendously useful for educational and therapy work.

*Other works*  
by **FREDERICK T. DAY**

- COLOURED PAPER DECORATION . . . . . 7 6d.
- COLOURED PAPER-CRAFT FOR SCHOOLS . . . . . 7 6d.
- COLOURED PAPER-CRAFT FOR INFANT SCHOOLS . . . . . 6 0d.
- LAMP SHADE AND PARCHMENT CRAFT . . . . . 8 6d.
- PASSE PARTOUT FOR SCHOOL AND HOME . . . . . 8 6d.
- GUMMED STRIP AND PAPER MODELLING . . . . . 7 6d.
- PAPER SCULPTURE FOR SCHOOLS . . . . . 7 6d.



8/6

All books obtainable from:  
**Newnes & Pearson Ltd.**  
Tower House, Southampton  
Street, Strand, W.C.1  
Ask your stationer to show you the  
Butterfly range of handicraft  
materials

**SAMUEL JONES & CO., LTD.**  
STATIONERY MILL, CAMBERWELL, LONDON, S.E. RODNEY 5064