



It won't move!

CERTOFIX liquid glue can cope with all general repairs. It unites wood, glass, metal and almost all substances. It is clean in use; its joints are stronger than the materials it unites.

Sold at all
Woolworth Stores

CERTOFIX

WILL Really FIX IT!

PHOTOGRAPHERS!

DO YOUR OWN DEVELOPING



Here's a quick way to the mastery of developing photographic films. The Roto One tank is designed for easy loading. You have everything under control from the outset. Adjustable to take 120, 127 and 88 roll films or 20 exposure 35 mm. films. From Photographic Dealers with full instructions £1 10s. 0d.

IT'S EASY AND EXCITING WITH
JOHNSON *Koto* ONE

DEVELOPING TANK

JOHNSONS
OF HENON LTD

HOBBIES BRANCHES

LONDON
78a New Oxford Street, W.C.1
(Phone MUSeum 2975)
87 Old Broad Street, E.C.2
(LONdon Wall 4375)
81 Streatham Hill, S.W.2
(TULae Hill 8796)
151 High St., Walthamstow, E.17
GLASGOW—326 Argyle Street
(Phone CENTral 5042)
MANCHESTER—10 Piccadilly
(Phone CENTral 1787)
BIRMINGHAM—100a Dale End
SHEFFIELD—4 St. Paul's Parade
(Phone 26071)
LEEDS—10 Queen Victoria Street
(Phone 28639)
HULL—179 Fereensway
SOUTHAMPTON—134 High St.
(Below Bar)
BRISTOL—65 Fairfax Street
NEWCASTLE—42 Dean Street
Newcastle-on-Tyne 1
GRIMSBY—88 Victoria Street

STOP SMOKING

in 3 days or money back. Safe, pleasant, permanent. The only scientific way. No Will Power necessary. 'Conquered the habit in 2½ days'.—F.C. 'Within 2 days I was free from the tobacco habit'.—W.G. 'Was a smoker for 2 years and broke the habit in 2 days'.—F.N. 'I used to smoke 2 a day... now I have no desire to smoke'.—J.M. Recommended by 'Health and Efficiency Magazine'. Complete course 7/6 (or \$1.00 bill). Details 3d. stamp. Sent under plain cover. **NATURE REMEDIES**, 28 (H/189) Dean Road, London, N.W.2. Established 1928

Completely new 54 page Edition

WHERE'S THAT CAR FROM?

Price 1/- (Postage 4d.)

Of all Booksellers

or

RALEIGH PRESS, Exmouth, Devon

BUYING OR SELLING?

Classified advertisements on this page are accepted at a cost of 6d. per word prepaid. Use of a Box No. is 1/- extra. Send P.O. with advertisement to **Hobbies Weekly**, Advert. Dept., Dereham, Norfolk. Rates for display advertising on application.

HOME-MADE WINE. Complete equipment. HBooks, etc. Lists free. — Leigh-Williams, (Dept. C.), 5 Western Drive, Liverpool 19.

PHOTO-CARDS SHIPPING. Famous liners, etc. Send 1/6 list; specimen. — Elder, 38 Westview Rd., Barrow-in-Furness.

Sent for 10/- bal. 18 fortnightly payments 7/6. Water-proof 1958 Tents of real 8 oz. WHITE Duck. Galeproof Brand new, surplus to export order. DON'T CONFUSE with Tents made from drab material never meant for tentage. This is real thing, withstands anything even in our climate. Approx. 7ft. 6in. x 6ft. x 6ft., 3ft. walls. Cash £5/17/6, carr 6/- complete ready to erect, incl. valise. Willesden Green 42/- extra. Ridge pole if required 7/6. Fly-sheet 37/6. Rubberised Ground Sheet 19/6. LISTS, TENTS, MARQUEES, ETC. TERMS.

GREAT HALF PRICE OFFER!
"Matahari"
FOLDING
CAMP BEDS
CASH PRICE 27/6

**Makes Camping
Holidays a Joy!**

BRAND NEW, famous lightweight, tremendously strong beds fold to practically nothing in size for easy transport. Full 6 ft. length, normal width. This represents the finest camping bargain. Half price of other types. Lightweight rustless sprung steel. Lasts years. Ideal as occasional bed for visitors. Makes up like divan. 27/6, post 3/6. Three for 89/6, including post. **Headquarter & General Supplies Ltd.** (HOBW/52) 196-200 Coldharbour Lane Loughboro Junc., London, S.E.5 Open Sat.

125 DIFFERENT STAMPS free to applicants for my 3d. upwards approvals. — Read, 19 Kelstern Close, Cinderhill, Nottingham.

MAKE A MUSICAL BOX for as little as 21/- . New kits and tunes available. Movements 13/- post free. Please send 3d. stamp for free illustrated catalogue. — The Swisscross Co., Dept. B, 202 Tulse Hill, London, S.W.2.

STAMPS FREE — Empire Packet including Pictorials and Victorians with approvals. — Robert J. Peck, 7a Kemp Road, Bournemouth.

100 DIFFERENT stamps free! Request 3d. upwards discount approvals. — Bush, 53 Newlyn Way, Parkstone, Dorset.

100 FREE including Giants, Triangles. Request Approvals. Postage. — Salter, 42 North Road, Rotherham.

HOBBIES WEEKLY

MARCH 4th 1959

VOL. 127

NUMBER 3305

IN THIS ISSUE

	Page
A Four-Poster Fitment	353
Child's Aptitude Toy	355
Completing the Midget Receiver	356
Attractive Cigarette Dispenser	357
A Cold Water Aquarium	358
Make this Model Glider	359
Patterns for Doll's House Furniture	360
Make a Graphoscope	362
Collectors' Club	364
Is this Your Problem?	366
Patterns for a 'Puzzle' Money Box	367



All correspondence should be addressed to the Editor, Hobbies Weekly, Dereham, Norfolk

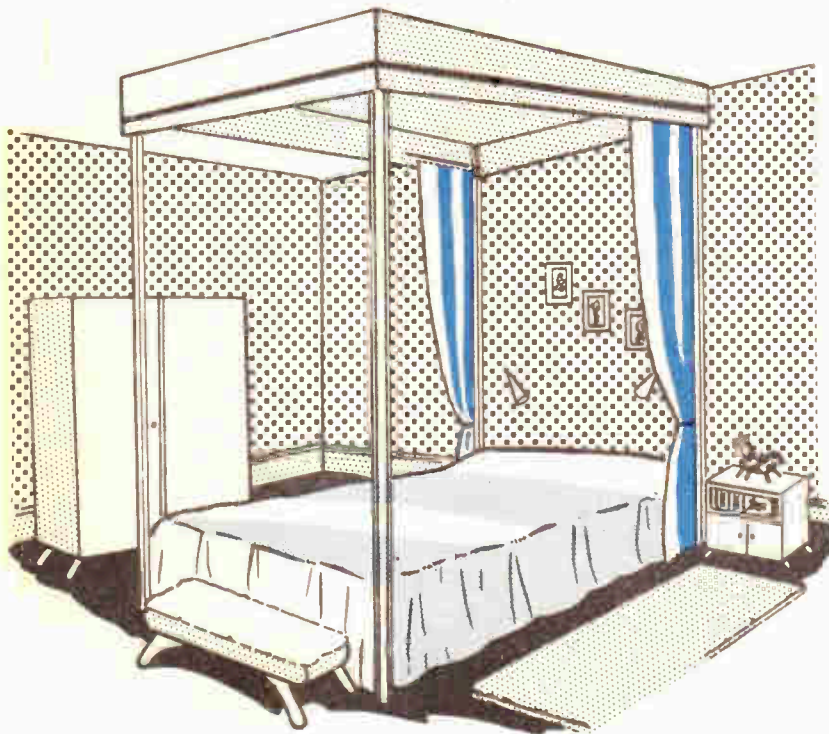

*A popular new
version of
an old favourite*

A FOUR- POSTER FITMENT

*Afternoon's job
for a
handyman —
see inside*

353

FOR ALL HOME CRAFTSMEN
Over 60 years of 'Do-it-Yourself' World Radio History

4¹/₂

FOUR-POSTER FITMENT

THEY'RE coming back with a rush. Soon you will hesitate to 'show-off' your bedroom unless it contains a four-poster bed. Obviously, the heavy, Victorian type is out; the new version has to be light and airy, with simple lines in keeping with the modern trend. Because of this, its construction is well within the scope of the average handyman. Don't let the cost put you off — two pounds will cover a simple model. The time factor? — an afternoon should see it completed.

The simplest and firmest construction is a floor-to-ceiling fitting. By a nut and bolt adjustment, easily included in the feet of the upright corner posts, the fitting is kept quite rigid, even with boisterous children. By the same mechanism, the structure is easily removable if needed.

If you live in a house where bedroom height does not exceed, say, 8ft. 6ins., the floor-to-ceiling fitting does not look 'leggy' or out of place, even with the modern low, divan bed. In rooms over this height, unless you have a high-from-the-floor bed, the structure can look much too tall.

In the latter case the solution is to reduce the canopy height to say, 7ft. This however, has two disadvantages (1) a false ceiling must be built over the canopy framing with hardboard and (2) the whole construction must be built much stronger and affixed solidly to the floor in some way to prevent the whole structure swaying drunkenly, when touched.

Therefore, wherever possible, fit a floor-to-ceiling structure incorporating adjustable feet. Remember, if you fit a good, deep pelmet around the canopy framing, the effect of height and legginess is minimised considerably.

Floor to ceiling fitting

The ideal uprights for the corner posts would be that of 3in. round timber. However, unless your local timber merchants have specialised forming machinery, this will probably be difficult to obtain. What he will be able to supply is 3in. square timber and to cut off the corners to form a hexagon or an octagonal shape, whichever you desire. This will be quite suitable — in fact, this shape may be preferred by many.

The four uprights should be cut 1½ins. less in length than that of the floor to ceiling height. At the top end of the upright, mark out a square, with sides of a maximum dimension that will just clear the profile of the wood. Then cut out a

square stump to these markings and to a depth of 2ins.

As shown in Fig. 1, the square stump fits inside the corner of the canopy frame where it is finally held in place with countersunk head, wood screws.

This canopy frame is a simple rectangle made of 2in. by ¾in. deal. Its area should be 6ins. more on each side than that of the bed over which it is to fit.

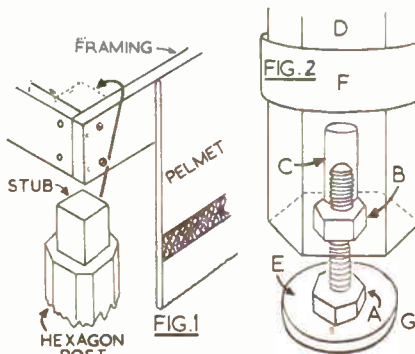

KEY
 A - ADJUSTING BOLT
 B - FITTED NUT
 C - CLEARING HOLE
 D - HEXAGON POST
 E - PLY CUSHION
 F - METAL RING
 G - FLOOR

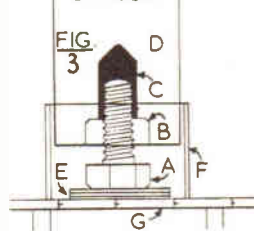

The bottoms of the posts or feet, are to enclose the simple adjusting mechanism. Fig. 2 and the section shown in Fig. 3 describe the procedure adopted.

First, drill centrally a ¾in. hole to a depth of approximately 2ins. (see 'C'). Now, taking a ¾in. Whitworth nut, place it centrally over the drilled hole, mark out its hexagon shape and with a small chisel, gouge out the shape so that the nut can be driven into this shaped seating and to rest with its face level with the bottom of the post (see 'B').

The adjusting ¾in. Whitworth bolt (see 'A') that is to locate into the held nut, should be approximately 1½ins. in length and should be a bolt whose

threaded portion reaches almost to the shoulder of the bolt.

Finally, cut a round piece of plywood, 1½ins. in diameter to act as a 'cushion' piece on which the bolt head will rest (see 'E').

It now follows, that by turning the bolt head with a spanner, tension is made which tightens the upright post between floor and ceiling, making the whole structure rigid and immovable. No damage occurs to the ceiling, owing to the large area of contact made by the area of the framing to which the corner posts are attached.

Whilst not strictly necessary, for the adjusting mechanism is hardly visible under the post feet, you may wish to incorporate a metal collar (see 'F') of a diameter that fits easily over the corner posts. This is, of course, placed on the posts before they are finally adjusted between the floor and ceiling and is then allowed to drop down to the foot of the upright.

The pelmet

Do not fit a pelmet of less than 12ins. in depth. The present trend is for the plain, straight pelmet but if you prefer a feminine, frilly type they can be easily fitted around the 2in. by ¾in. framing of

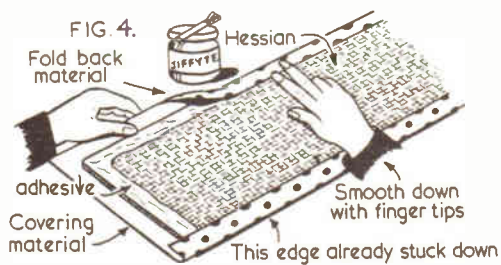

the canopy with the usual expanding wire between hooks. You may prefer to make the pelmet in one continuous length. In this case, thread it with elastic of a tight tension. This will keep it easily in place.

The modern plain pelmets are even simpler to make and fit. First, cut hessian strips to the required length and depth. Next, cut the pelmet material 2ins. larger all round. Lay the hessian over the material, paint on an inch wide strip of fabric adhesive along the leading edges of the hessian, fold back the material and stick down (Fig. 4).

● Continued on page 355

CHILD'S APTITUDE TOY

You will need

- Base 2½ins. by ¾in. 1 piece 10ins. long.
- Dowelling ¼in. diam. 1 piece 3ins. long.
- 5/16in. diam. 1 piece 3ins. long.
- ¾in. diam. 1 piece 3ins. long.
- Cut-outs Enough ¾in. thick plywood as desired.

PARENTS of small children should make full use of aptitude toys which are designed to develop young minds and make them more alert and intelligent.

Such a toy is the one described here. It consists of a small wooden stand having three round pegs of slightly varying diameters. In addition to this there are three sets of nine wooden shapes, each having a hole bored through its centre to correspond with the diameter of one of the pegs.

The object of the toy is to scatter the

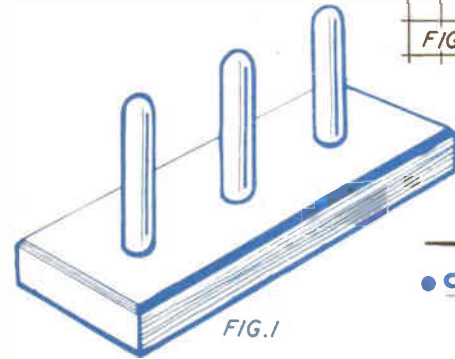

FIG. 1

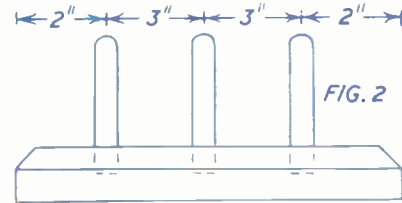

FIG. 2

twenty-seven shapes on the table and allow the child to arrange them on the stand in their respective sets. When done correctly nine shapes should be on each peg. The making of the toy is quite simple and should present no difficulty to readers who are handy with their hands at making woodwork projects.

The base of the stand consists of a piece of 2½in. by ¾in. planed timber cut 10ins. long. To give a neater finish to the stand, chamfer off the top corners as shown in Fig. 1. Obtain three pieces of

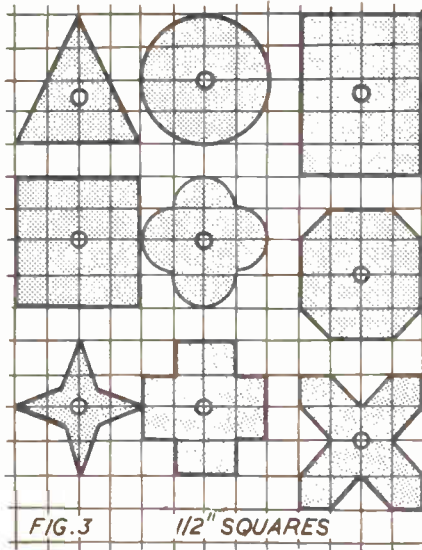

FIG. 3

112" SQUARES

dowelling 3ins. long, having diameters of ¼in., 5/16 in. and ¾in. respectively. These are housed half-way into the base in the positions shown in Fig. 2. Secure with a touch of glue, and round off the tops.

The shaped pieces are made from ¾in. thick plywood. Fig. 3 shows a set of nine suitable shapes for the cut-outs but, of course, you can incorporate other shapes of your own choice if desired.

By Finlay Kerr

Use a fretsaw to cut out the shapes. Each set of cut-outs should have a central hole bored to correspond with the diameter of one of the pegs on the stand.

When boring these holes use a brace and a sharp bit. You will find it much easier if you bore the necessary holes *before* the shapes are cut. This avoids the awkwardness of boring small pieces of plywood.

Once the twenty-seven shaped pieces are cut, complete with central holes, give the sawn edges a light rub over with glasspaper. Check each set of cut-outs on its respective peg to ensure that they slide on properly. It is essential that the cut-outs slide on to the pegs accurately without any clearance.

To complete, apply a coat of lacquer to all parts. If desired, the shaped pieces may be painted different colours.

● Continued from page 354

Four-Poster Fitment

Whilst not strictly necessary, the finished pelmet can be backed with a cheaper material. It does finish off the job in a neat and tidy way for it must be remembered that because of the height of the four-poster fitting, the inside of the pelmet will be on show. To fit a backing, cut the material ¼in. less in depth than the pelmet and again fix it with adhesive.

Most people prefer a fringe to their pelmet and shops now stock contemporary designs. Fix it again with adhesive. Adhesive can also be used to hold the finished pelmet to the framing. If however, you would prefer it not to be a permanent fixture hold it in position with small-head, brass tacks.

Side curtains

Side draperies, skirting each side of the bed head, are again, optional. It is almost certain the lady of the house will insist on them and they do certainly give charm to the structure. They are easily

fitted with the usual rail and runner mechanism or expanding wire, screwed into the inside edge of the canopy framing. A modern net curtaining is to be preferred although some may prefer to fit curtains that match those already being used in the room. Heavy, plain curtains of the chenille variety obviously look very much out of place.

As will be seen, only the posts themselves need finishing although it is an advantage to paint the 2in. by ¾in. canopy framing, white or whatever colour matches your ceiling. Probably the best finish for the posts is that of stain and varnish. Or if you are able to french polish them, so much the better.

Next week E. Capper will describe a free-standing fitment for a four-poster.

Final instructions

Completing the Midget Receiver

FIRST, add to the frame aerial a coupling winding, so that we can add house aerial when wanted. This can consist of six turns or so of enamelled or cotton-covered wire of 24 to 30 gauge. Wind it side by side on top of the frame aerial and secure it with Sellotape, etc. Bare the ends. Join one end of the frame aerial to one end of the coupling winding and form into a loop to hold a 6BA nut and bolt.

Fix the frame aerial to the back cover of the cabinet with Sellotape (or similar), so that the loop is within easy reach of the chassis (when the back is in position). See Fig. 6.

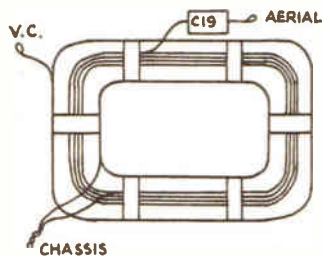

Fig. 6

The other end of the coupling winding is joined to C19 (.001), preferably a flat mica type, which is fixed to the cabinet back cover with Sellotape. The free end of the condenser is looped to hold the end of the house aerial, when used.

The other end of the frame aerial itself is also looped and has a 6BA nut and bolt attached. This is to secure the lead (H) which joins the frame aerial to the tag on the back section of the tuning condenser. This lead (H) should be taken along the edge of the chassis.

The other loop joining the frame aerial and coupling winding, is fastened to a lead joined to any near point on the chassis.

For testing the set, before the cabinet back has been made, one can stand the frame aerial up against any non-metallic object.

For the dial, white cartridge paper is pasted on to a strip of plywood $4\frac{1}{2}$ ins. by 1 in. A line 3 ins. long is drawn down the centre of this, and divided as shown in Fig. 7. The figures represent the wavelength in metres, for medium wave. Indian or coloured ink can be used.

Attach the dial by bolts (6BA) to the centre of the chassis front, then add the guides (A, B, C, D) for the nylon cord drive. These are simply bolts, pieces of tubing (metal or Paxolin), washers and

nuts to hold, assembled as in Fig. 8(a). Pulley wheels are not required.

A pointer is made of thin tin or aluminium (Fig. 8b). Fix the nylon cord as shown, looping it round the drive shaft F. Crimp the pointer to the cord between A and B with pliers. When the tuning condenser vanes are right out, the pointer should be to the left of 200, and when fully in, it should be to the right of 550.

Then shift the pointer to 247 metres and adjust the oscillator trimming condenser on the front section of the tuning condenser, until the Light Programme is heard. Repeat both these operations until there is no further improvement. Finally turn the pointer to 247, or 208 (Luxembourg), and adjust the trimmer on the back section of the tuning condenser for maximum reception.

The set is now aligned. Reception on

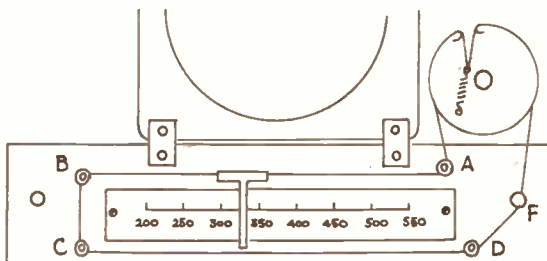

Fig. 7

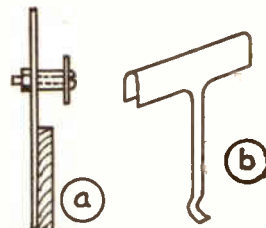

Fig. 8

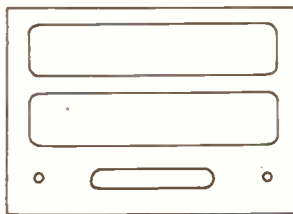

Fig. 9

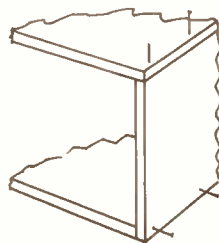

Fig. 10

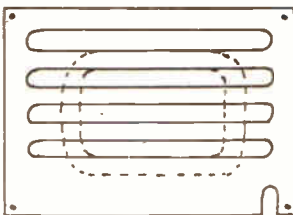

Fig. 11

One should check and re-check the whole wiring of the set now. If satisfied, plug in the valves, add the frame aerial, and switch on the mains supply. The alignment of the set can now be effected.

If the I.F.T.'s were pre-aligned, do not touch them. Turn the dial pointer to 464 metres, then with a wooden or plastic tool, adjust the slug in coil L2 (oscillator, under the chassis) until the Third Programme is heard at maximum.

distant stations is improved by the addition of an external aerial to the free end of C19.

Note that the chassis must not have an earth attached, as it is joined directly to the mains. For this latter reason, the chassis could be 'live' and no metal part should be touched while the set is plugged to the mains.

A simple but effective cabinet can easily be built for the set. Ordinary $\frac{1}{2}$ in. plywood is used for the top, bottom and sides, with $\frac{1}{4}$ in. plywood for the front and back. The exact dimensions should be taken from the built chassis, but will not be far from the following; if built as directed. Base to be 7.8 ins. by 5 ins. Sides to be 5 $\frac{1}{2}$ ins. by 5 ins. Top to be 8.3 ins. by 5 ins. Front should be 8.3 ins. by 5 $\frac{1}{2}$ ins. The back should be the same, or less, if it is to fit inside.

The front is shown in Fig. 9 and can easily be sawn out of $\frac{1}{2}$ in. plywood with a fretsaw. The dial aperture, of course,

• Continued on page 357

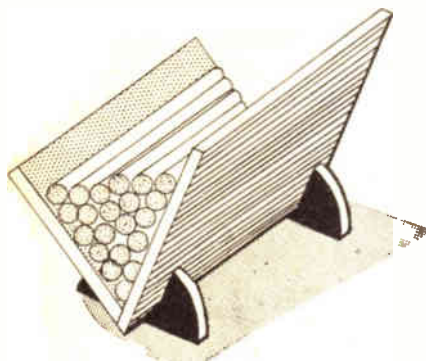

ATTRACTIVE CIGARETTE DISPENSER

that it is necessary to splay the bottom end of one of the sides. This will give the necessary bevel which should be approximately 60 degrees.

Next, two small 'feet' should be cut to

the desired design with V-shaped cut-outs to suit the bevel of the sides.

Once the four parts are prepared, file and polish the sawn edges and assemble, using plastic cement. (F.K.)

HERE is an attractive cigarette dispenser which can be easily made, using only a few off-cuts of plastic or perspex. The measurements given in the accompanying sketches will make a handy dispenser but, of course, they can be altered to suit your own requirements.

The two pieces forming the sides should be joined at the bottom and note

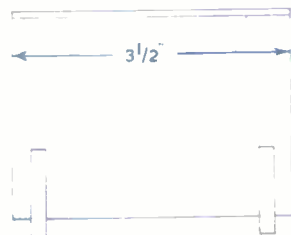
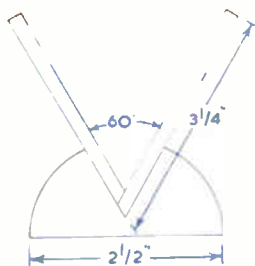

A Hardwood Paper Knife

NO expert knowledge is required to make this paper knife. Accurate marking out and some patience in acquiring a good finish are, however, essential. The knife is sawn out of the solid, the best method of marking out being to use a mortise gauge with

CUTTING LIST
1 piece hardwood 7 1/4 ins. by 1 1/4 ins. by 1/8 in.
Finished size.

the spurs as close together as possible for the blade and to reset the spurs to 1/4 in. apart for the handle. Having removed as much waste as possible with a saw, the remaining shaping must be done with a file and glasspaper. The curve to the blade can be done with a fretsaw.

The hilt is rounded over as shown. The blade is tapered towards the edges and the corners of the handle are slightly rounded. Fine cut files should be used, following up with various grades of glasspaper until a smooth finish is obtained. Finally, rub in linseed oil and polish with a clean dry cloth until a sheen appears.

Other shapes may suggest themselves but it should be remembered that the simpler the shape, the easier it is to obtain a good finish. (K.J.)

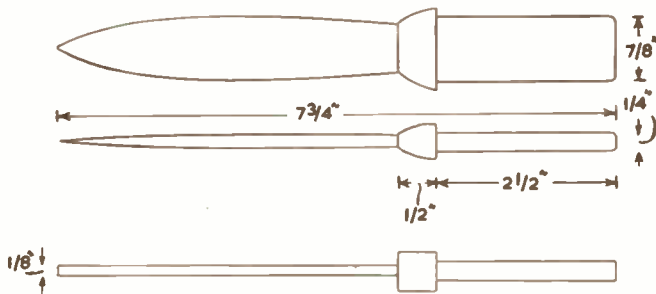

• Continued from page 356

The Midget Receiver

should come right opposite the dial position on chassis. Clean and smooth the cut out edges with glasspaper.

The top, bottom and sides of the cabinet should be fixed together as shown in Fig. 10, using 1/4 in. panel pins and glue. The front of the cabinet is fixed in a similar manner.

The back is shown in Fig. 11. Use a fretsaw again for cutting out and a drill for the screw holes at the corners. The position of the frame aerial is shown in dotted lines.

When the glue is set, paint the edges of

cut-outs in the front with suitable paint to conceal the laminations of the plywood. When dry, veneer the top, sides and front of the cabinet with the modern paper — thin 'Aga' veneer, of the type of wood you fancy. Trim the veneer off with a razor blade.

Glue the speaker fabric over the inside of the front to tone with the veneer. Glue also a piece of transparent plastic sheeting over the inside of the dial aperture, add four rubber feet and the cabinet is finished and should be highly presentable. (A.F.)

A COLD WATER AQUARIUM

A TANK of cold water fish can make an attractive addition to the living room, or a child's room, where it will provide much instructive entertainment. For those who do not wish to purchase the more expensive tropical fish and to bother with heating arrangements such as a tank with a few goldfish or similar types is ideal.

Unfortunately, many fish are doomed to a speedy end owing to ignorance of their requirements. Let us emphasize at the start that 'goldfish bowls' should not be used; they are quite unsuitable for serious fish keeping. An aquarium is essential. This can either be an all glass

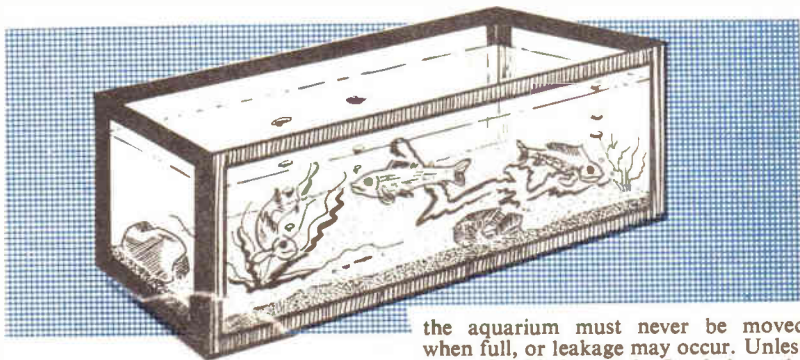

with a hacksaw. The pieces must be welded together, and a local garage will usually undertake this if provided with the pieces of correct length and a sketch.

When the frame is complete it should be painted with good enamel paint (preferably with an undercoating of aluminium paint), and can be measured for the glass. The bottom piece should be measured first, and this is preferably $\frac{1}{2}$ plate. The thickness of this must be taken into consideration when measuring the sides and the latter also when measuring the ends. The sides and ends should be of 21 ozs. or 26 ozs. glass (this specifies the thickness, and will be understood by a glazier).

To fasten the glass into the frame, ordinary putty may be used, but specially prepared aquarium cements may be purchased from most shops supplying fish requirements. These do not set quite hard as putty eventually does, and are thus less likely to leak after prolonged use. The cement is spread on the inside of the frame and the glass firmly pressed into position. First the bottom and then front and back, and finally the ends should be fitted. Clean the glass whilst fitting, and finally place weights on the bottom and wooden struts across between the sides and ends to hold the glass firmly in place.

About three days should be allowed for setting after which the tank must be filled with water for about twenty-four hours. It is then ready for use and may be refilled with fresh water. A layer of aquarium sand about 1 in. to 1½ ins. thick should be placed on the bottom. This sand can be bought at most pet shops that sell fish, and must be well washed before use.

It must be remembered that a tank of water and sand is quite heavy and a firm table or other support is essential, and

the aquarium must never be moved when full, or leakage may occur. Unless an artificial light is to be fitted above the tank, the aquarium should be situated near a window, preferably facing North, where it will not receive the full strength of a midday summer sun.

A few small pieces of stone, well scrubbed, may be placed on the bottom, and the tank is ready for planting. It is necessary to have growing plants in an aquarium for these, in light, absorb carbon dioxide from the water and evolve oxygen, essential for the fish. Suitable water plants may be bought

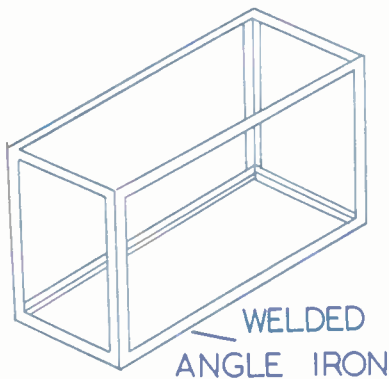

affair, or one constructed from angle iron and glass sides and bottom. As far as the fish are concerned, one type is as good as another. However, the former, although quite leak-proof unless cracked, does not give such clear vision of the fish since the glass is usually uneven. It cannot, of course, be constructed by the amateur, since it is cast, but the second type can be made at a fraction of the cost of buying a ready-made one.

The actual size of tank depends upon the space available and the number of fish it is desired to keep. Very small ones are not satisfactory since a goldfish will quickly outgrow it and will not thrive well in too confined a space. Overcrowding must be avoided if fish are to be kept successfully. A good average size is 12 ins. by 18 ins. by 12 ins. deep, and although a good quality tank of this size would be rather expensive to buy, the average handyman should have no difficulty in constructing one himself.

The tank

The framework should be of $\frac{3}{8}$ in. or 1 in. angle iron, as shown in Fig. 1. This is quite cheap to buy, and can be cut



A healthy goldfish



A sick fish

from the shop, and, given the right conditions, they will quickly spread and increase, so that you will soon be giving pieces to your friends. The best plants to ask for are *Vallisneria* and *Elodea*, the Canadian waterweed. There are many others, but these will be suitable to start with.

About five or six pieces will be sufficient for an average sized tank. They should be planted in the sand, using the stones to hold them down if necessary. The *Vallisneria* will probably have roots and must not be planted too deeply; the top of the roots should just show. The

● Continued on page 359

MAKE THIS MODEL GLIDER

MODEL gliders are easy to make and by varying the size and shape of the wings, they can form the basis of experiments for making larger types. The one described is made from balsa wood and suitable for outdoor use but if you wish, smaller models can be made for indoors if the measurements are reduced proportionately.

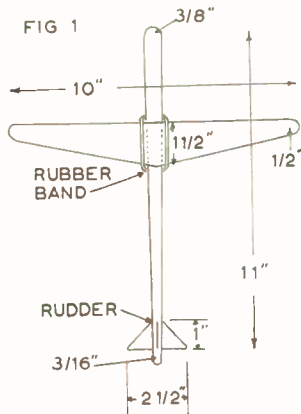

The main dimensions are shown in Fig. 1 where it will be seen that the wings are in one piece and made from a strip of thin wood measuring 10 ins. by $1\frac{1}{8}$ ins., tapered to $\frac{1}{8}$ in. at each end. The fuselage is a strip 11 ins. by $\frac{1}{8}$ in., tapering from $\frac{3}{8}$ in. at the front to $\frac{1}{8}$ in. at the tail. The

rudder and tailpiece are also made from balsa wood of the same thickness as the wing, but these will be mentioned later.

The wing is prepared after careful marking out of the wood from a centre line, cutting out with a sharp knife. When this has been done, place the wing on the edge of a ruler and test for balance. Should either side of the wing fall a little due to any unevenness in weight, a little wood can be removed from the heavier side by means of careful glass-papering. An endeavour should be made to see that the wing is reasonably

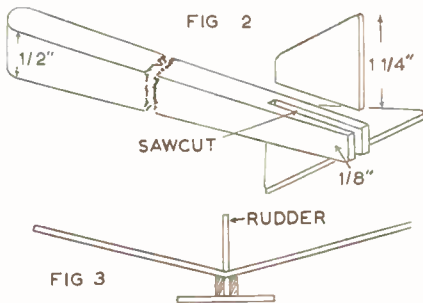

balanced and afterwards the centre is steamed to help shaping.

Boil some water in a kettle, hold the centre of the wing in a jet of steam emerging from the spout, place the marked centre in line with the table edge, and by pressing one side downwards a

little you will achieve a shallow V shape as shown in Fig. 3.

Fig. 2 shows how the rudder is fitted. First cut the triangular piece from balsa wood measuring $1\frac{1}{8}$ ins. by 1 in., again using a knife, and fitting into a fine slot in the end of the fuselage cut with a fretsaw. A little balsa cement will keep the rudder firmly in position. In this diagram you will also see the elevator, or tailpiece, made from similar material measuring $2\frac{1}{8}$ ins. by 1 in. shaped like a triangle and attached by glue to the underside of the fuselage as shown.

The fuselage itself is merely a length of $\frac{3}{8}$ in. by $\frac{1}{8}$ in. material tapered towards the end. The width is tapered to $\frac{1}{8}$ in. and the thickness to $\frac{1}{8}$ in. as shown in Fig. 2. It is advisable to mark in a centre line for this reduction, easily accomplished with a small plane. A saw cut in the tail end completes the preparation of this part of the glider.

The wings are in one piece as mentioned and fastened to the fuselage by means of a rubber band crossed on the underside. This method is preferable to permanent fixing by glue because it is more flexible, allowing some elasticity against impact when the glider grounds. Moreover, it permits easy assembly and carriage of the glider.

This basic shape may be modified as desired and you may like to experiment with delta or other types of wings, or different rudders and elevators.

(S.H.L.)

Continued from page 358

Stocking the Cold Water Aquarium

Elodea will almost certainly be a cutting and should be just pushed into the sand and left to root, which it will do very quickly.

Buying the fish

Assuming that the fish are to be bought at an ordinary pet shop, one or two points should be kept in mind. Goldfish are quite cheap but, nevertheless, one wants to obtain a good specimen. The difference between a good and a sick fish may be seen in Fig. 2. Briefly, the fish should have its fins upright and stiff and should have no signs of white spots anywhere on the body or fins. Since there will be many fish in the dealer's tank, insist on having those that appeal to you. There are many fancy goldfish, but the ordinary pet shop will probably not have them, and anyway you will be wise to keep to the common

ones first.

Most fish suffer from either too much food or the wrong type. Goldfish will eat a varied diet but the most suitable foods are proprietary dried foods and live food. The former must be given in small quantities only, otherwise it will go bad and pollute the water. A pinch a day is sufficient; a fish can go quite long periods without food, and will not suffer if a feed is omitted. The most convenient live food is Tubifex. This is a small river worm occurring in clumps, and may be bought for sixpence a portion at most pet shops. The clump should be kept in a little water in a jam jar, and the water changed daily. Small portions may be removed for the fish, and since the food is alive, there is less risk of pollution.

It is better for the stable diet to be Tubifex with an occasional feed of dried

food. In addition, very small amounts of cold potato, crumbs or porridge scraps may be given, but do not continue to do so unless the fish appear to like the food and eat it in a few minutes.

Overcrowding is another common trouble in tanks. A safe rule is 24 square inches of water surface to 1 in. of fish, excluding tail. Thus for the size suggested, the inches of fish would be 12 by 18 divided by 24, which comes to 9. This would mean two fish of $4\frac{1}{2}$ ins. or three 3 ins.

Keeping clean

A well planted tank will not need cleaning out often, but when green algae are troublesome and the water becomes foggy, it should be changed. A part may be siphoned out and fresh added. A few water snails will help to keep the water clean.

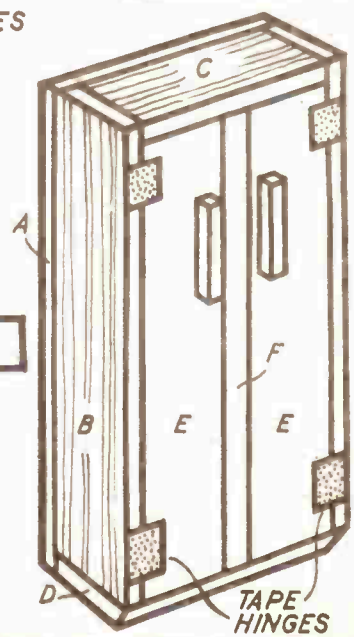
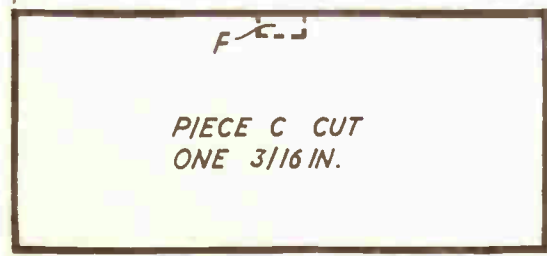
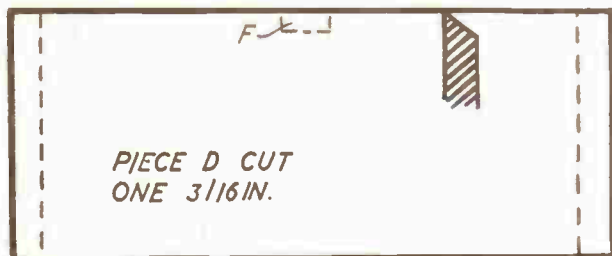
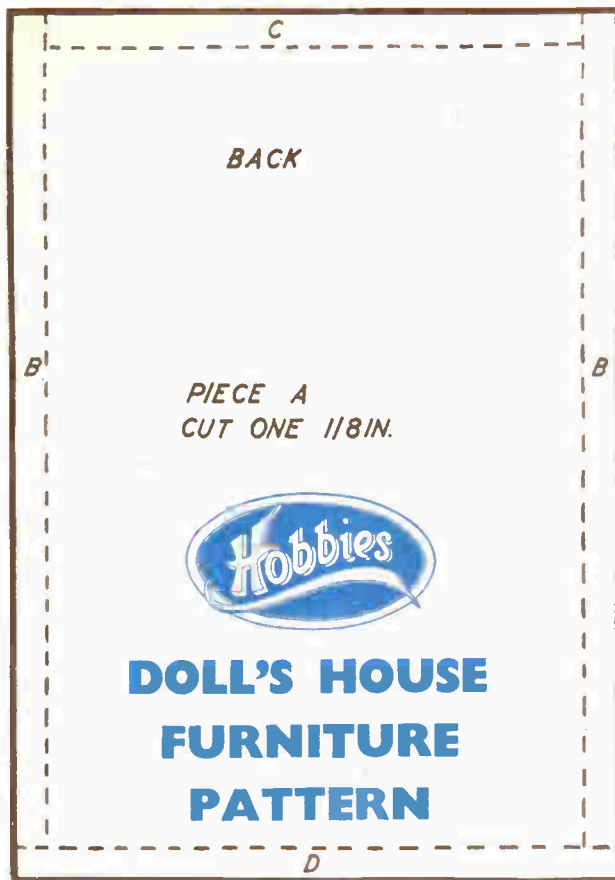

WARDROBE AND DRESSING TABLE

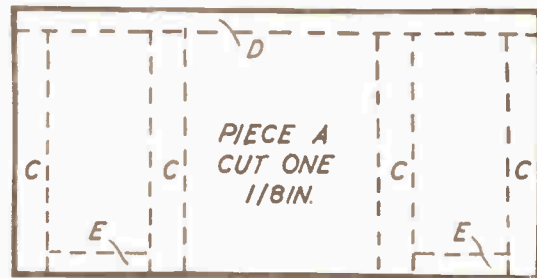
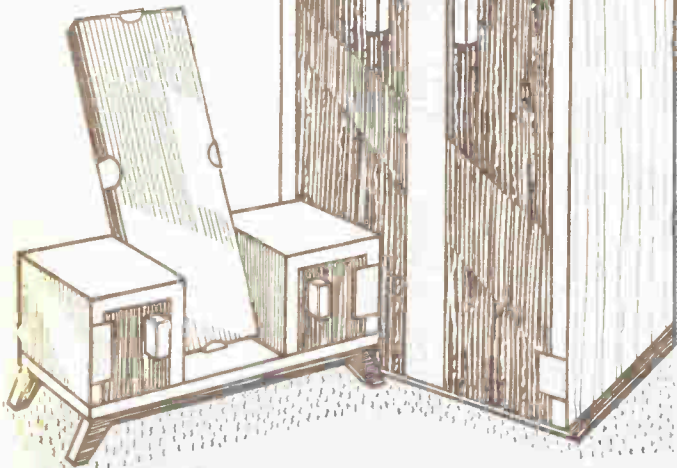

PIECES E CUT
TWO 1/8 IN.

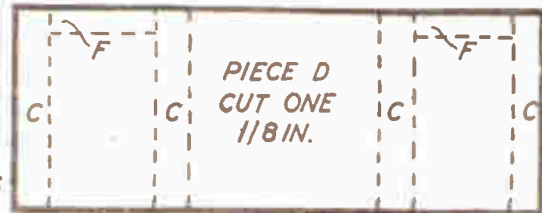

MIRROR SIZE
2 1/16" X 1"



PANELS OF WOOD REQUIRED
ONE G3 TWO G2

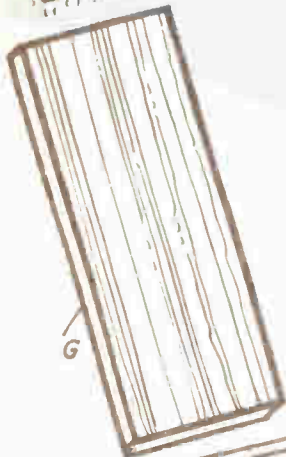

MIRROR CLIPPED
ON TO PIECE G
WITH SMALL
PIECES
OF BRASS

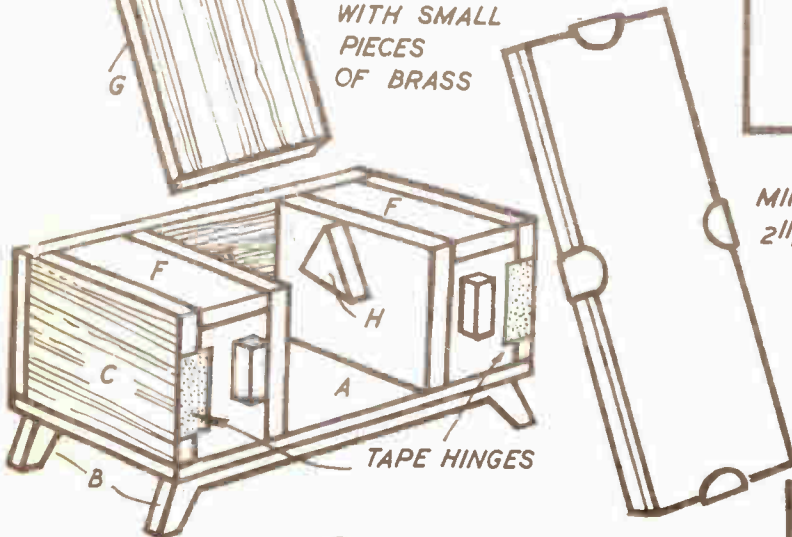

PRINTED IN ENGLAND

MAKING A GRAPHOSCOPE

A SIMPLE form of graphoscope, or copying apparatus, by means of which copies of maps, pictures, diagrams, etc., can be quickly and accurately made is shown in Fig. 1.

Apparatus required:—pieces of wood 9ins. by 14ins. by $\frac{1}{2}$ in. and 10ins. by 1 $\frac{1}{2}$ ins. by $\frac{1}{2}$ in. Piece of glass 10ins. by 9ins. Piece of plywood 8ins. by 10ins.

An upright piece of wood (A) is fixed with two screws to the wooden base. Narrow grooves about $\frac{1}{2}$ in. deep have previously been cut in the base and the

drawing will be found on the under surface of the paper.

A daylight sign

A simple daylight sign is shown in Fig. 2. It consists of a wooden box about 12ins. by 4 $\frac{1}{2}$ ins. by 4 $\frac{1}{2}$ ins. A rectangular hole is cut in one side and over this a piece of plain glass may be fitted.

A rectangular piece of mirror is fitted inside the box as indicated by the dotted lines, and the whole of the inside of the box should be painted dead black.

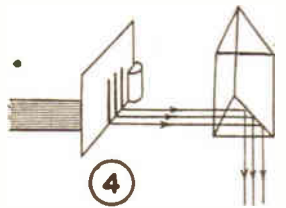
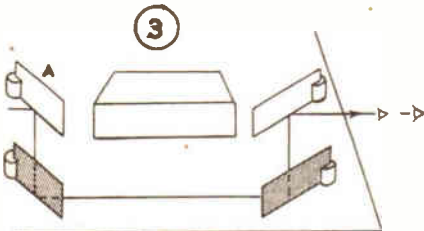
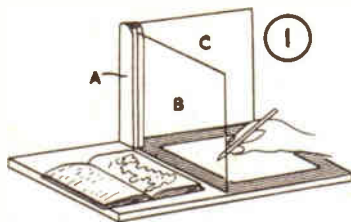

article, using a cigarette tin, a cylindrical convex lens and a narrow slit in a piece of cardboard. This beam of light is directed on to the mirror (A) and the other mirrors are arranged as shown.

The eye receives the light as though it had passed straight through the brick.

The actual course of the light can be seen on the surface of the paper.

Glass prisms as reflectors

The apparatus for producing a narrow parallel beam of light is required again for this experiment. The parallel beam is broken up into three very narrow parallel beams by means of three parallel vertical cuts in a piece of cardboard, and these are allowed to fall into a right-angled glass prism as seen in Fig. 4. The apparatus is placed on a sheet of white paper on the bench. It is a good plan to roughen with emery paper the face of the prism in contact with the paper. This will enable you to follow the paths of the narrow beams of light through the prism.

upright (A). A piece of glass (B) is fixed in these grooves with putty. (C) is a piece of cardboard or plywood. All the wooden surfaces should be painted dead black.

The diagram, picture or object to be copied is placed on the left-hand side, and it should be well illuminated. The paper on which the copy is to be made is placed on the right-hand side, and as little light as possible should fall on this side. When making the copy, look through the glass from the left-hand side.

The image will be seen on the paper, and can be traced out with a pencil, which can also be seen quite clearly.

It is important to notice that copies of diagrams and pictures which are not bilaterally symmetrical are rendered useless by lateral inversion. This can be overcome by placing under the paper on which the copy is being made, a piece of carbon paper with the carbon surface next to the underside of the paper. When the copy is completed, the correct

Pieces of plywood are cut so as to slide in grooves made in the sides of the box; and different words can be cut from each piece of plywood with a fretsaw.

Colour effects can be produced by placing under the letters and in the grooves pieces of colour filters.

Looking through a brick

This experiment provides much amusement and demonstrates an interesting use of plane mirrors.

As shown in Fig. 3, place a large sheet of white paper near the edge of a table, and place the brick in the centre of the paper. A narrow parallel beam of light is produced, as described in a previous

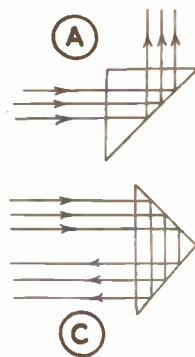

The diagrams show (a) how a prism can be used as a mirror to deflect light through 90°, (b) to erect an image which is upside down, and (c) to deflect light through 180° as in prismatic binoculars.

Next week's free design will be for making a pair of attractive Candlesticks, on each of which will be incorporated a miniature model galleon. These should make a pleasing gift novelty and readers are recommended to make sure of their copy of the magazine from their newsagent.

LADY'S SEWING 'COMPANION'

ALSO FOR
USE AS
A SMALL
TABLE

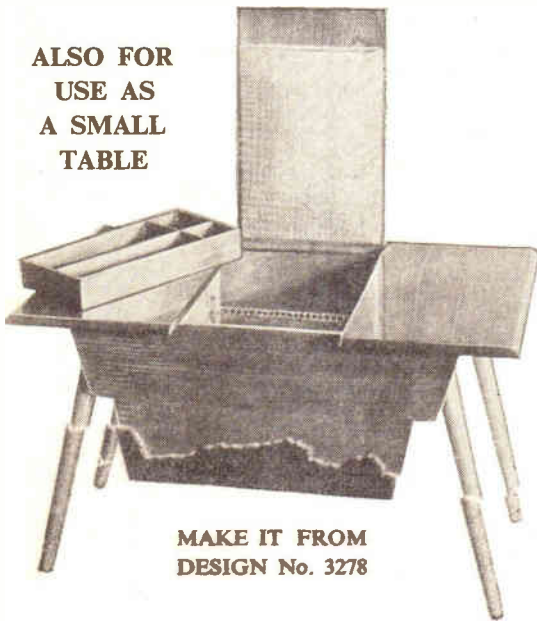

MAKE IT FROM
DESIGN No. 3278

A well-designed piece of furniture in contemporary style, to hold all sewing and mending materials, etc. When closed it serves as a handy occasional table.

Today's value is in the region of £9 but a big saving can be made by working with Hobbies Kit No. 3278, price 65/-. This contains all planed wood panels, contemporary legs which are simple to fit, hinges, etc. Kits from all Hobbies branches, etc., or post free (see coupon).

Send for details of other furniture kits which will save you pounds.

To HOBBIES LTD., Dept. 99, DEREHAM, Norfolk
Please send details of furniture kits and Kit No. 3278 for Lady's Sewing Companion, price 65/-.

Name.....

Address.....
.....
.....

This model farm cost less than 2/6

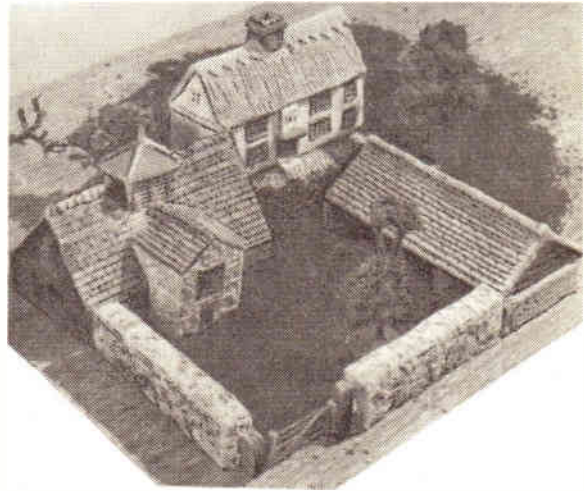

It was made from a half-crown tin of Sankey's PYRUMA — farmhouse, barn, implement shed, walls and gate — and there was still plenty of this grand modelling material left to build many more farm features, by simple methods described in the Instruction Book (see Coupon below). PYRUMA, plastic and ready-for-use, becomes stone hard after drying or baking, and can be painted in natural colours. For permanent modelling —

MAKE IT AND BAKE IT IN



Obtainable from your local Ironmonger or Hardwareman and many Art Material dealers. Ideal for making —

**Model Railway Buildings and Accessories.
Harbours. Ship Models. Airport Buildings
and Features. Houses. Bookends. Ashtrays
Animals and Figures. Plaques, etc.**

Post this Coupon today for your Instruction Book.

J.H. SANKEY & SON, LTD.

Established over a century
Dept. H, ILFORD, ESSEX

Please send ILLUSTRATED INSTRUCTION BOOK with full colour pages on Pyruma Modelling.

Enclosed Postal Order value 6d. (not stamps)

NAME (Block letters).....

ADDRESS.....
.....



THE first attempt at postal organisation in the British Isles was made under the authority of King Edward IV in 1482. A war with Scotland was in progress and the king required a regular system for carrying dispatches between that country and London.

By relays of horses, each covering a distance of twenty miles, it was found possible to convey news for 200 miles within two days. This service was not available to the public and only the King's letters were carried. This event in postal history is well illustrated by the 1949 Australian 3½d. anniversary stamp which pictures a Mounted Postman (cat. 1/- mint).

CARRYING THE MAIL — *By R.L.C.*

London, Edinburgh and Dublin were the first towns in the kingdom to possess a definite organisation for postal collection and delivery. Owing to confusion arising from postmasters in some towns making a charge for delivery the Post Office, in 1774, arranged for free house-to-house delivery within the area of each post town. This entailed employing large numbers of letter carriers.

A uniform was supplied officially to the London General Post letter carriers in 1793. The dress comprised a beaver hat with gold band and cockade, and a scarlet cutaway coat with blue lapels and cuffs. 'Yugoslavia 1940, 50 p. + 50 p. orange and brown — Postman Delivering Letters (1/- mint), 1d. + 1d. green and black — Collecting Letters (1/3 mint).'

Towards the end of the eighteenth century, John Palmer a theatre proprietor of Bath, began an agitation for the establishment of regular mail coach services. The scheme was supported by William Pitt, then Chancellor of the Exchequer. No effective action was taken by the authorities until Pitt himself became Prime Minister when he carried through the plan with his characteristic

efficiency. The first coach ran from Bristol to London on August 2nd, 1784, completing the distance in 17 hours.

All Mail Coach guards were equipped with a long, shiny 'post-horn' to warn traffic in front and to announce the approach of the coach to a turnpike so that the keeper could ensure a clear passage through it. 'Canada 1951, 7 cent blue — Mail Coach (10d. used). Norway 1937, 1 ore olive — Posthorn (1d. mint).'

During the Napoleonic wars coaches not only carried mails and people but were the means of distributing news to all parts of the kingdom.

The first recorded steamship employed in the Mail Service was the *Lightning*, built in 1821, which sailed between Holyhead and Dublin. Soon after this steampacket services were extended to Calais, Ostend, Hamburg and Gothenburg, and later introduced on the Portuguese, Mediterranean and trans-Atlantic routes. 'Canada 1951, 5 cent violet — Mail Boats (1/6 used). Sudan 1950, 4½ piastres black and blue — Nile Post Boat (1/5 mint).'

The first rail-borne mail was carried between Liverpool and Manchester on the 11th of November, 1830, and on the 3rd of July, 1837, a mail was conveyed from London to Liverpool and Manchester in 16½ hours. The mail was taken from London to Birmingham by coach and there placed on the railway which was open northwards.

On the 6th of January, 1838, a sorting carriage consisting of a temporarily fitted horse box, was run as an experiment on the Grand Junction Railway between Birmingham and Liverpool. The journey took 4½ hours and the experiment was considered to be so successful that on the 19th of June, 1838, it was decided to make the 'travelling post office' a permanent feature of the service which has continued to the present day. 'Canada 1951, 4 cent black — Mail Trains, 1851 and 1915 (6d. used).'

The postcard, an idea imported from Austria, was first authorised by Parliament on October 1st, 1870. It was an instant success, and 75 millions of cards passed through the post in the year 1871.

Letters were first carried by air in the United Kingdom as part of the Coronation celebrations of King George V in 1911.

A London-Paris Air Mail service was inaugurated on the 10th of November, 1919, and was soon extended to other continental capitals. Today, letters from this country can be dispatched by air mail to most countries overseas. 'South West Africa 1937, 1½d. brown — Mail Transport (pair: 6d. mint).'

Here is a brief list of some of the hundreds of stamps which may be used to illustrate Postal themes:

'Great Britain 1949, 3d. violet — U.P.U. Monument, Berne (6d. mint). Aden 1946, 1½ anna red — Houses of Parliament, London (3d. mint). Antigua 1949, 2½d. blue — Hermes, Globe and Forms of Transport (8d.). Australia 1950, 2½d. maroon — Reproductions of First Stamps (1d. used). Barbados 1952, 3 cent green and slate — King George VI and stamp of 1852 (4d. mint). Belgium 1950, 1 franc 75 cent sepia — Allegory of Saving (2d. used). Ditto 1948, 11 franc red — "Parcel Post" (1/3d. used). Ditto: 1935, 10 cent red — Diesel Locomotive (2d. used). Denmark 1951, 15 ore violet — Mail Coach (2d. used). Dominican Republic 1941, Air, 10 cent brown — Globe and Winged Envelope (6d. used). Southern Rhodesia 1953, 1/- black and brown — Transport (2/9 mint), etc.'



A 'PUZZLE' MONEY BOX

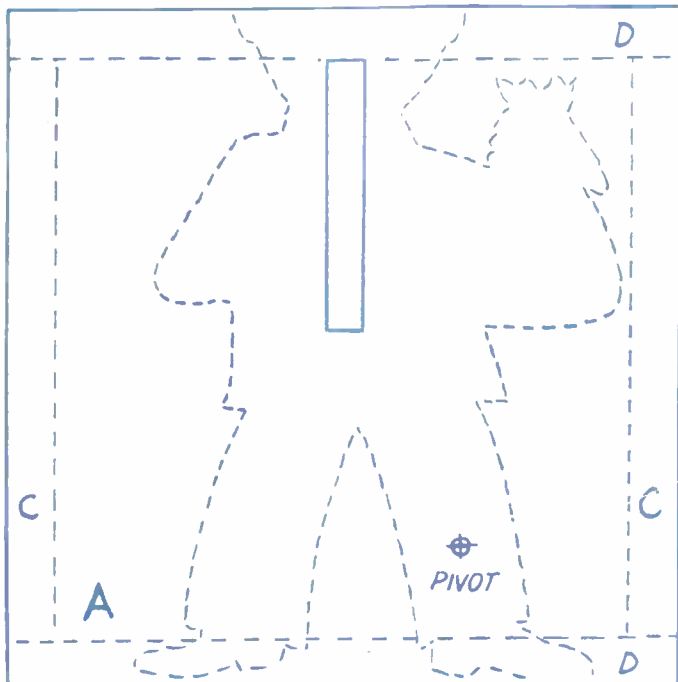

Cut out these shapes with your fretsaw

THIS novel money box, if properly made, will puzzle your friends. The slot is only revealed when the figure is moved sideways as shown in the illustration.

The box should be about 3½ins. square with the sides (C), the top and bottom (D), glued or screwed between the front (A) and the back (B). Take your measurements from the full-size plan of piece (A). All these pieces are cut from ¼in. wood.

The figure is also cut from ¼in. wood, and is pivoted to the front (A) after painting and before the box is assembled. Use a round-head screw for a pivot and make sure that it is fairly tight. Give the box a final touch up with paint to finish. The bottom (D) should be screwed in place to enable the money to be removed. (M.p.)

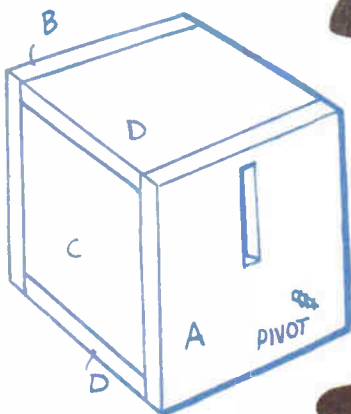

TWO SUPERB DESIGNS

*For those who want
'something different'*

The Swiss Church (right) and Willow Pattern Box (below) are two fine examples of exclusive designs introduced by Hobbies Ltd. They are intended for the worker who requires something more than just a plain 'musical box'.

Authentic in design and detail, the finished models provide ample reward for the care taken in execution, and can be put to a real practical use, such as for holding cigarettes or trinkets.

A list of tunes available which can be incorporated into these designs is given below. Kits and musical movements, which are sold separately, can be obtained from any Hobbies branch or stockist, or by post.



WILLOW PATTERN BOX
Design No. 3284

Scenes from the famous story in fine detail. Music plays when pagoda lid is raised. Kit of wood and materials for making box **9/3** (post 1/6 extra)

Fit with a movement from adjoining list



SWISS CHURCH
Design No. 256 Spl.

Windows light up and music plays when the roof is raised. Kit of all materials and fittings, paint, **25/-** glue, etc. (post 1/9 extra)

Base 9ins. x 6ins.,
12ins. high.

MUSICAL MOVEMENTS

15/6 extra (see below)

CHOOSE FROM THESE TUNES

(A) Auld Lang Syne, (B) Limelight, (C) Swedish Rhapsody, (D) Silent Night, (E) Brahms' Lullaby, (F) Harry Lime Theme, (G) Blue Danube, (H) Parade of the Wooden Soldiers, (I) Bells of St. Mary's, (K) Moulin Rouge, (L) Vienna, City of My Dreams, (M) Jingle Bells, (N) Home Sweet Home, (O) Auf Wiedersehn, (P) Green-sleeves, (Q) O My Papa, (V) Merry Widow, (W) Tales from the Vienna Woods, (X) Irish Eyes are Smiling, (Z) Gounod's Ave Maria, or (I) Church Bells Air (specially for Swiss Church).
Each movement 15/6 (post 6d.).

Ask for details of other musical kits.

To Hobbies Ltd., Dept. 99, Dereham, Norfolk

Please send details of other Musical Box kits and items ticked.

- Swiss Church Kit 256 Spl. 25/- (post 1/9)
- Willow Pattern Box Kit 3284. 9/3 (post 1/6)
- Musical Movement (A, B, C, etc.) 15/6 (post 6d.)

Name

Address

Orders 30/- and over post free