

HOBBIES WEEKLY

JANUARY 21st 1959

VOL. 127

NUMBER 3299

IN THIS ISSUE

	Page
A Tray for your Drinks - - - -	257
Handy Adjustment to a Drawing Pen - - - -	258
'Windmill' Windvane - - - -	259
Moving Picture Toys - - - -	261
A Cover for 'Radio Times' - - - -	263
Patterns for 'Pimpo' the Poodle - - - -	264
Solving a 'Light' Problem - - - -	266
Collectors' Club - - - -	268
The Benefits of Tramping - - - -	270
Watch Stand Patterns - - - -	271



All correspondence should be addressed to the Editor, Hobbies Weekly, Dereham, Norfolk

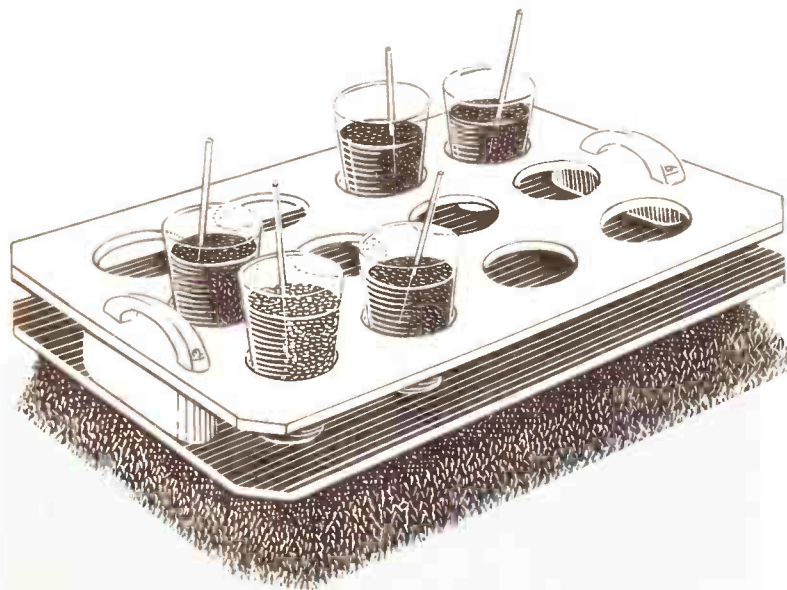

A TRAY FOR YOUR DRINKS

*So simple
to make —
but so
handy in
preventing
'accidents'*

A GLASS of lemonade is so easily knocked over if placed on an ordinary tray, but is quite safe in the special tray illustrated. It is so simple to make, too. All you need are two pieces of plywood, two small blocks and two plastic handles.

Instructions on next page

257

FOR ALL HOME CRAFTSMEN
Over 60 years of 'Do-it-Yourself'

4¹/₂

World Radio History

MAKING UP THE TRAY FOR DRINKS

THE pieces of plywood should be $\frac{1}{4}$ in. thick and measure $17\frac{1}{2}$ ins. by 11 ins. Mark out the centres of the circles as shown in Fig. 1. The circles may now be described with compasses, each circle being $2\frac{3}{8}$ ins. diameter. Check this measurement with the tumblers you are using, remembering that the circle will come about 2 ins. up from the bottom.

Now drill a hole in each circle with a fretwork drill, and cut out with a fretsaw. If using a handframe be sure to keep the saw upright. The holes will, of course, be in one piece of plywood only.

The end blocks are shown in Fig. 2. They serve to keep the two pieces apart and to hold them rigid. They should be of 1 in. thick wood, and at least 4 ins. long. They can be rounded at the ends to improve the appearance. Screw and glue the blocks between the pieces of plywood as indicated in Fig. 3.

Clean up the edges with glasspaper and fill the grain, paying particular attention to the plywood edges. Smooth down all over with fine glasspaper. Give

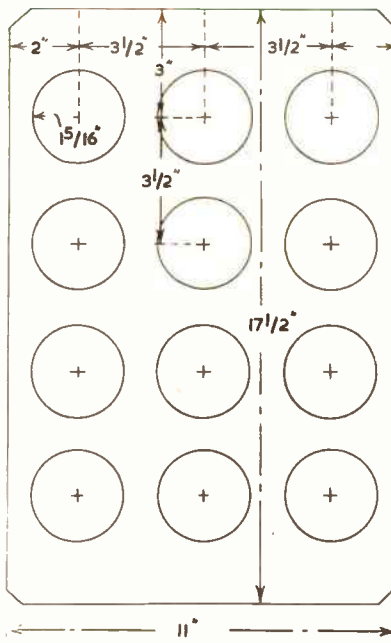

Fig. 1

one undercoat of white paint and two top coats of high gloss enamel. The top coats should be cream or white.

The No. 711 plastic handles may be

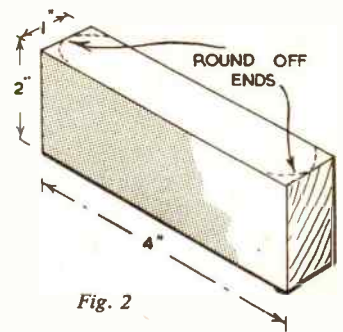

Fig. 2

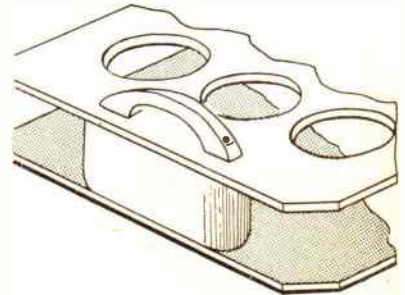

Fig. 3

obtained direct from Hobbies Ltd., Dereham, Norfolk, price 1/- per pair, postage $4\frac{1}{2}$ d. They are screwed in the position shown in Fig. 3. (M.h.)

Handy Adjustment to a Drawing Pen

THIS little gadget will be found extremely useful for the draughtsman or artist who does a lot of work with pen and ink. It enables him to draw both thick and thin lines with the same pen without even taking the pen from the paper, the change being instantaneous.

The width of both the thick and the

a thin line results as at (2). The small adjusting screw on the end of the lever regulates the fineness of the lines. By releasing the pressure on the lever, however, it reverts to its normal position and produces the thick line, the width of which is regulated by the normal adjusting screw of the pen.

A piece of hard sheet brass is suitable

adjusting screw. Any type of screw will do but it is an advantage to procure one with a knurled head if possible. A gramophone soundbox needle screw is excellent for the job and should not cost more than 6d. at the most.

Make the metal nice and smooth with emery paper and bend to shape with fine pliers. The height of the arched part

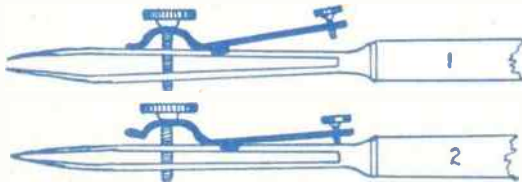

thin lines can be set before starting to use the pen, then they will remain constant until readjusted.

The gadget consists of a small metal lever which is quite easy to make and is attached to the adjusting screw of an ordinary spring drawing pen as shown at (1).

When this lever is depressed by the finger the jaws of the pen are closed and

for making the lever and the shape is shown at (3). The size will, of course, depend on the pen and care should be taken in setting out the lever on to the metal before cutting it out with a metal fretsaw.

The hole for the pen adjusting screw should allow it to move freely without being too loose a fit. The hole on the end of the lever is tapped to take a small

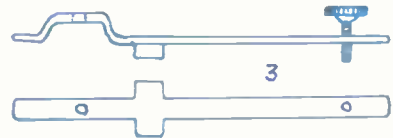

which goes under the adjusting screw will depend on the amount of thread on this screw and can indeed be kept quite shallow. If, however, the screw is very short it may be necessary to get a longer one before the lever can be attached.

The gadget may be left on the pen and in no way affects its ordinary working, nor does it interfere with the cleaning of the pen after use. (A.F.T.)

'WINDMILL' WINDVANE

THE windvane, illustrated, based in design on a windmill, is a working model of a simple kind and, therefore, unlikely to give any mechanical trouble.

The wind turns the sails, which, in turning, cause the flag at the top to wave energetically. It is simple to construct, and interesting to see in action.

Fig. 1 shows a side view of the model. The mill consists of a body part, with a rotating cupola on top, to which the sails are attached. This body part is most easily built solid, but if a piece of wood of sufficiently large section cannot be obtained, then two or more pieces can be glued together to make it up. If, however, it is necessary to glue pieces together, be sure to employ as an adhesive, glue of the waterproof variety.

Trim the wood to 5ins. square at the bottom and 4ins. at the top. As this body part is to be octagonal in shape refer to Fig. 2, as this shows how to mark off the octagons, both large and

MATERIALS REQUIRED

2 — 14in. lengths $\frac{1}{2}$ in. square stripwood.
 7ins. by 14ins. panel $\frac{1}{2}$ in. wood for base and cupola.
 6ins. by 20ins. panel sheet aluminium for sails, fin and cupola.
 3ins. by 6ins. piece of $\frac{1}{8}$ in. sheet brass for bearings, etc.
 $\frac{1}{2}$ in. round-headed brass screws 3 $\frac{1}{2}$ dozen.
 $\frac{1}{2}$ in. flat-headed screws, 1 $\frac{1}{2}$ dozen.
 2 Meccano screw collars. 8 small staples.
 4ft. of stiff tinned iron or brass wire.

small. Measurements are only given for one side, but the remaining three sides are alike. Saw off the corners to make the shape, and smooth the sides with a few strokes of a smoothing plane and glasspaper.

The base is a 7in. square of $\frac{1}{2}$ in. wood, and can now be cut and the body of the mill screwed to it from beneath. Liberally coat the joint with paint before screwing to seal it against water seeping through.

In the centre of the top, bore a hole about 1in. deep, for the pin on which the

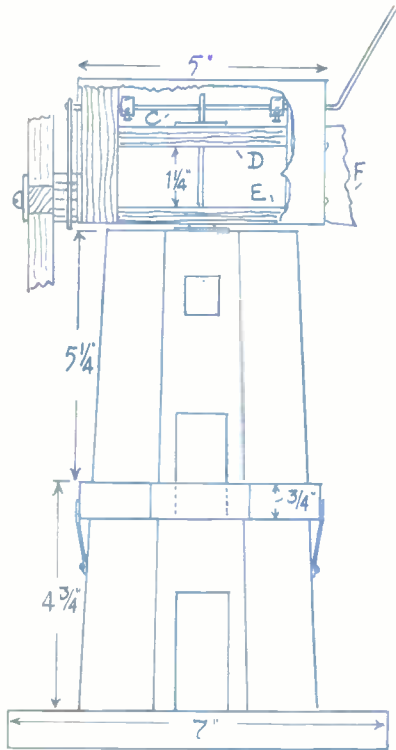
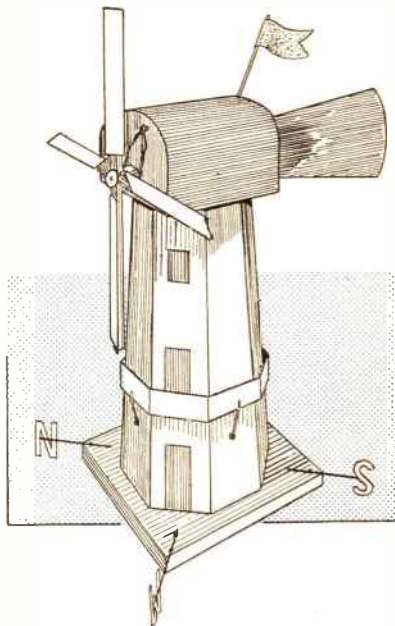

Fig. 1

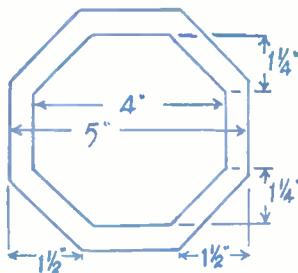

Fig. 2

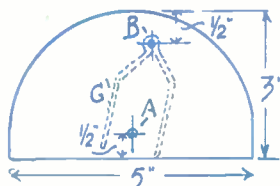

Fig. 3

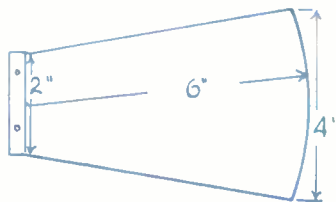

Fig. 4

cupola turns. This should be about 4ins. long and could well be a wire nail. Care must be taken to drive in the pin, which must stand up truly vertical. It should project above the top of the body part 2 $\frac{1}{2}$ ins. From brass sheet, about $\frac{1}{16}$ in. thick, cut a 1in. disc. Drill a hole to fit over the pin at the centre of the disc, and three holes round the central ones, well countersunk, for fixing screws. See the disc is perfectly flat, then pass it over the pin and screw the disc to the wood. The screw heads must on no account project above the discs, but sink slightly below its surface.

The gallery

For the gallery, cut a strip of metal (stout tin would do) $\frac{1}{2}$ in. wide and 17ins. long. Bend this to an octagon the same width as the bottom of the body part of the mill. It would be helpful in fact, to bend it round the body part as a guide. Allow $\frac{1}{2}$ in. overlap and cut off any surplus. A strip $\frac{1}{2}$ in. wide of the gallery should be bent inwards to stiffen the metal. It will be necessary to cut a notch at each angle before bending inwards. Solder the overlap to complete the octagonal shape. For the supports, cut four lengths of wire each about 2ins. long. At one end bend round to make a small eye, through which a fixing screw

can be passed. Solder a support to every alternate side of the gallery, and fix it to the body part, where shown in Fig. 1, with $\frac{3}{16}$ in. round-headed brass screws.

For the cupola cut two end pieces of $\frac{3}{16}$ in. thick wood to the shape shown in Fig. 3, an end view. At point (A) at the middle, bore a hole for the screw on which the sails of the mill will subsequently rotate. This is done on one end only, of course. In both ends bore a hole (B) for a stiff wire rod (C) to swing in. These latter holes are drilled $\frac{3}{16}$ in. away from the centre of the ends to prevent the rod (C) fouling the pivot pin on which the cupola rotates. These holes should really be metal bushed for easy action, but a more simple method is to drill holes in a small piece of metal and screw it inside over the holes in the wooden ends. It is also a good plan to ease the action by slightly enlarging the holes in the wood, leaving the rod to turn in the metal bearings only.

From $\frac{3}{16}$ in. thick wood cut two horizontal pieces to which the ends of the cupola are nailed. These are seen in the cutaway view of the cupola drawn in Fig. 1. The lower one (E) is $3\frac{1}{2}$ ins. long and 5 ins. wide. The upper one (D) $3\frac{3}{4}$ ins. long and 4 ins. wide. The wood ends are grooved $\frac{1}{16}$ in. deep for (D) to enter. Before fixing all together, holes must be bored through both (D) and (E) for the pivot pin.

Cover the cupola

The holes must be exactly central and the metal bushed or covered with drilled metal plates as done for the rod (C). That for the upper one (D) can be a 1 in. disc, similar to the one already fitted over the pin at the top of the body part. That for the lower one (E) is smaller, $\frac{3}{4}$ in. will serve. It is fixed underneath. Now nail (E) to the wooden ends of the cupola. Fit (D) in its grooves, but before nailing it in place, try the whole on its pivot pin and make sure by testing that both holes are in alignment, and the cupola can rotate quite easily.

The cupola is to be covered with thin sheet metal, bent over and secured with round-headed screws driven into the end pieces and also in part (E), but leave the fixing until the rod (C) is finally fitted in. The fin (F) is partly shown in Fig. 1 as a guide to the fixing positions. Fig. 4 shows the complete fins which can be marked out on sheet metal. The inner edge is drilled for fixing screws and bent outwards at right angles. Fix the fin to its end of the cupola with screws, exactly central.

For the rod a length of stiff wire 12 ins. long will be needed. To one end a shaped part, made from similar wire, should be fitted. The shape is shown in dotted outline (G), the two legs should be a

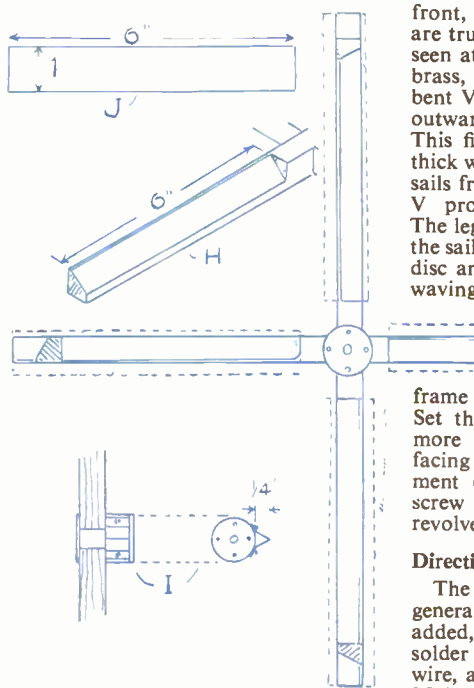

Fig. 5

trifle over $1\frac{1}{2}$ ins. apart. Fix it to the end of the rod with solder. Pass the rod through its bearing holes. Shape (G) should project $\frac{1}{16}$ in., and to allow the rod to keep its position, and not ride left or right, a pair of brass screw collars, such as Meccano sets include, should be passed on to the rod (C) and be fixed as near as possible to the wooden ends of the cupola, without actually touching it. The remainder of the rod, protruding from the opposite ends of the cupola, should be bent upwards. To this a small flag or pennon can finally be fastened.

Fig. 5 shows part of the sails with relative details. The frame is composed of two 14 in. lengths of $\frac{1}{4}$ in. square section stripwood, fixed together at right angles with a halved joint. A portion of each arm is bevelled as at (H), the angle being 30 degrees. Note that the bevels all face in a clockwise direction.

Align correctly

Cut two 1 in. discs of $\frac{1}{16}$ in. sheet brass, drill these central to suit a 2 in. round-headed screw, the pivot on which the sails will revolve. At equal distances apart round the hole drill small holes for fixing screws. From a piece of $\frac{3}{16}$ in. thick wood saw a 1 in. disc. Glue this to the frame at the rear of the centre, and continue the central screw hole through it. Now screw the metal discs back and

front, making sure that the pivot holes are truly in alignment. These details are seen at (I). A piece of rather thin sheet brass, $\frac{1}{16}$ in. wide and 1 in. long should be bent V-shaped, then the ends of it bent outwards and drilled for small screws. This fitment is to be fitted to the $\frac{3}{16}$ in. thick wood disc, glued to the back of the sails frame and is seen in detail (I). The V projection should not exceed $\frac{1}{16}$ in. The legs of fitment (G) should, when the sails are fitted in place, drop over the disc and rock as the sails revolve, thus waving the flag.

The sails are cut from thin sheet metal to the dimensions given at (J) and fixed to their respective arms on the sail frame with small round-headed screws. Set them so that they do not project more than about $\frac{1}{16}$ in. on their edges facing the cupola and do not foul fitment (G). Finally, drive in the pivot screw and test to see that the sails can revolve quite easily.

Directional letters

The directional letters, seen in the general view, are optional. If to be added, cut the letters from tinplate, solder them to short lengths of stout wire, and bend $\frac{1}{16}$ in. of each wire down. Make holes for these bent ends to fit in, and then secure the wires to the baseboard with a couple of small staples.

Painting the windvane can be left to the choice of the reader, but it would be advisable to use a waterproof lacquer as a finish. The completed article could be mounted on a pole or fixed to the roof of a garden shed, or any point high enough to catch the wind in any direction, and, of course, positioning the directional letters to point to their respective points of the compass.

WISDOM OF A WOMAN

MRS. D. MURISON entered seven exhibits in the Handicraft Section of the Willesden Show, and such was the quality of her work, that she won six awards. One of them, a Musical 'Swiss Chalet' Cigarette Box, was the result of much painstaking care over a period of three months.

We are pleased to record that four of Mrs. Murison's successful entries were made from Hobbies designs, and this hobby-minded housewife makes full use of her Hobbies A1 fretmachine.

Mrs. Murison, who has previously won a special award in a Hobbies Fretwork Competition, says 'If you really want happiness in life, create things'.

Simple, yet fascinating

MOVING PICTURE TOYS

BEFORE Peter Roget wrote 'Persistence of Vision in Regard to Moving Objects' in 1824, optical toys involving a static image were already popular, but inventors were dreaming of a device which would make pictures move. Early attempts to do so involved the projection of articulated cardboard picture-figures with the aid of a 'magic lantern'. Two simple solutions to the problem became available and were sold as toys. They were the Phenakistoscope and the Zoetrope.

The explanation depended upon the principle of the persistence of vision. Looking at the pictures through the slots ensured that each picture was seen separately for an instant, with a brief interval of blackness between it and the next picture. Thus the individual pictures were superimposed, one upon the other, on the retina of the eye. Each picture seemed to fade into the next. Since each succeeding picture showed a subsequent phase of a movement, the picture appeared to be really moving.

support for the dowel spindle. Also bore two holes into the ends of the dowel rod to take the two nails.

Making the pictures

Assemble your device by first inserting the spindle into the handle. Drive one of the nails through one of the jar covers and the black side of the slotted disc, then push the nail securely into one end of the dowel spindle so that the disc is held fast. Finally mount the other disc in the same manner upon the opposite end of the dowel.

Make pictures for your toy by drawing sequences of twelve simple diagrams, or figures around stiff paper circles, being careful to space and draw them in such a way that each picture shows a slightly advanced stage of some movement. Take care to ensure that

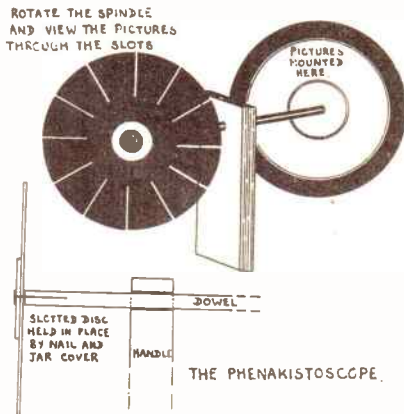
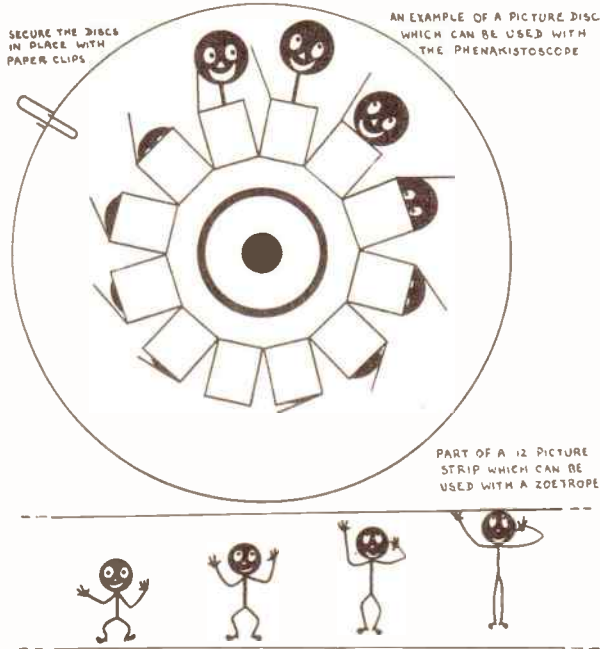

The Phenakistoscope was usually in the form of a disc with its face divided into twelve segments in each of which was drawn a picture. Every successive picture depicted a stage in a simple obvious movement starting and finishing in the same place and position. Around the rim of the disc were twelve narrow slots corresponding with the twelve pictures. The back of the disc was painted black. It was possible to spin the disc upon a pin pushed through its centre. To operate the Phenakistoscope the disc was spun in front of a mirror and the reflected pictures viewed through the rotating slots. The viewer saw a moving image — or rather, a series of moving images — as we do today when we look at a Popeye or Mickey Mouse cartoon film.

Queen Victoria is said to have amused herself with a Phenakistoscope.

You can make an improved Phenakistoscope from two 10in. diameter cardboard discs, two nails about 2in. long, two metal jar covers, a 9in. length of $\frac{1}{2}$ in. diameter dowel and a block of wood 6ins. by 2ins. by 1in.

In the rim of one of the discs cut twelve slots $\frac{1}{2}$ in. wide and 2ins. deep at equal distances apart. This will be easy if you rule six guide lines across the centre of the disc so that they mark out twelve 30° segments of the circle. Make one side of the disc black with indian ink.

Bore a hole with a diameter slightly greater than $\frac{1}{2}$ in. near one end of the wood block. The block will now be ready to serve as a handle and as a

picture number twelve brings the movement naturally and exactly back to its starting place, otherwise the illusion will be jerky.

Classic subjects for the picture discs include serpents which seem to pass from the centre of the rotating disc to the rim, little men coming out of bottles, peas passing into the chewing mouths of grotesque heads and a comic character turning a handle. The writer has had success with simple animated diagrams like turning wheels and a black ball bobbing up and down a string. Other subjects which proved successful were; a woodpecker making a hole in a tree, a man drinking beer from an inexhaustible glass, a small bird being eaten by a monster head, a flying bee and a jack-in-the-box. However, the most satisfying subject of all proved to be a pin man with a large, crudely drawn face, who

A COVER FOR 'RADIO TIMES'

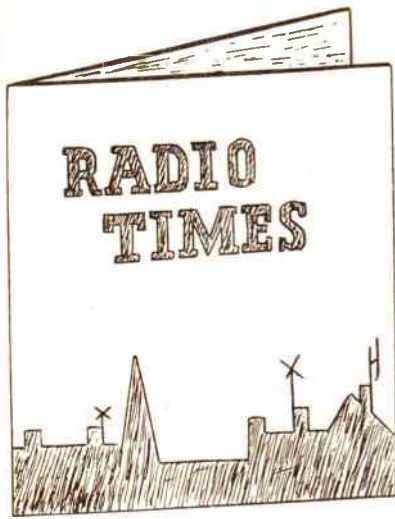

IT is probably correct to state that, of the weekly papers printed, the 'Radio Times' is one of the most widely used, being required daily for perusal of both sound and television programmes. In view of this it is a good plan to provide a stout gay cover, which will not only offer some protection, but will distinguish the magazine from the other periodicals and newspapers you happen to take.

By S. H. Longbottom

Such a cover is quite easy to make, and the binding itself depends partly on the amount you wish to expend and partly on the effect desired. You may use wall-paper remnants, bookbinding paper or cloth, or imitation parchment, but your

choice may have to be guided by the ultimate treatment. There is little doubt that imitation parchment makes a neat job, but the latest plastic self-adhesive coverings can prove very attractive.

Other requirements are simple, being two pieces of cardboard for use as stiffeners — an old carton will do admirably — two thinner pieces of card for making pockets and some strong paper gumstrip for making a hinge. Now let us examine the construction of our binding cover.

Cut out two pieces of cardboard measuring 10ins. by 12 $\frac{3}{4}$ ins. for the backs. See that these are exactly alike in size and are perfectly square at the corners. Lay the two pieces side by side on the table, so that they are $\frac{1}{2}$ in. apart

a piece of lining paper to one side only of the cards, covering the hinge. This lining paper may be plain white or any fancy patterned paper you have available, but we must emphasise that only a thin coating of paste should be applied, otherwise you may cause the boards to buckle when dry. Any surplus paper at the edges must be trimmed away flush with the edge and not allowed to overlap. Even the small thickness of paper taken over the front edges would show on the finished article, and this must be avoided by trimming as mentioned. Care should be taken to avoid paste marks soiling the face of the lining paper.

Outside covering

We now come to the outside covering,

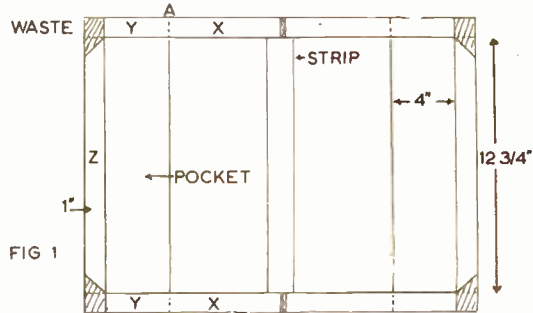

and a length of gumstrip is then applied down the centre. Now reverse the two boards, applying a similar strip on the other side. This should be quite sufficient to make a substantial hinge.

After the gumstrip has dried we apply

cut out with a border 1in: greater than the prepared cardboards which act as stiffeners. This is shown in Fig. 1, and achieved by laying the stiffener on the material selected, marking out accordingly. The outer cover, which is folded on to the inside, requires neat cutting, and you will observe that the waste material at the corners, indicated by the shaded portion, is trimmed and mitred for neatness. Moreover, a narrow section is removed at the centres to both ease the hinging and the task of attaching to the cardboards. It should be noted that when attaching the cover, the top and bottom margins are first folded, and then the sides, leaving the mitred corners.

Before folding over the edges of the outside covering, we need two thinner pieces of cardboard — (it is optional whether you use lining paper for these, providing the card is clean) — each measuring 4ins. by 12 $\frac{3}{4}$ ins. to form the pockets, just like a wallet. When these are prepared, place one on the left-hand

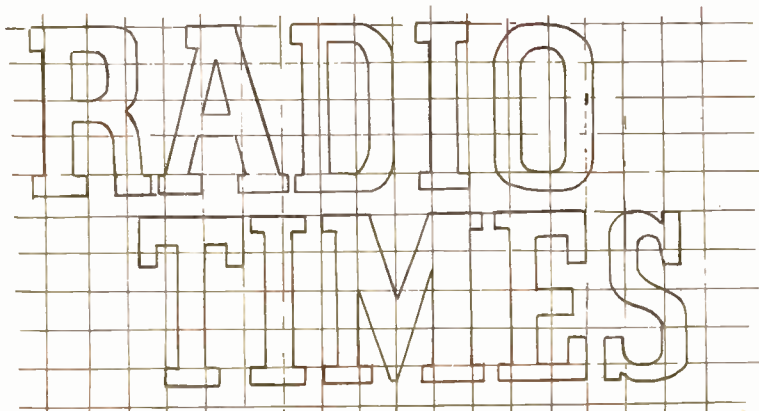
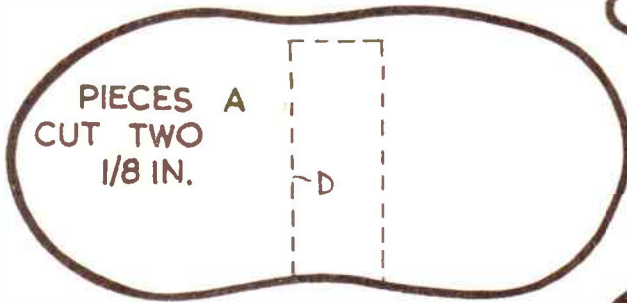

FIG. 2 1/4" SQUARES



The PO



PIECE D CUT ONE 3/16 IN.

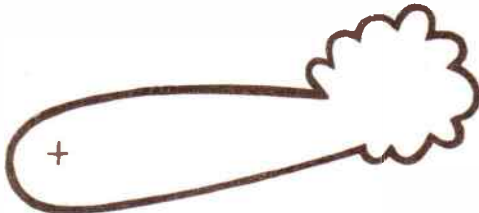
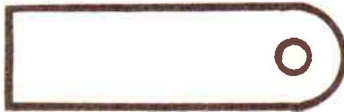

PIECE C CUT ONE 1/8 IN.

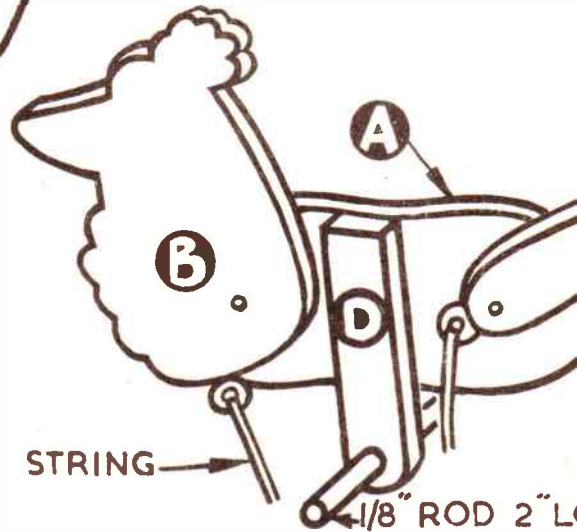

CONSTRUCTION OF PIMPO
ONE SIDE MISSING

ODLE...

HE NODS HIS HEAD
AND WAGS HIS TAIL

UT ONE 1/4 IN.

12" x 1 1/2" x 1/4"

**AN
AMUSING
NOVELTY**



IG

WEIGHT
ON END
OF STRING
APPROX.
1. OZ.

SUGGEST
FISHERMAN'S
PLUMMET
OR
LEDGER
WEIGHT

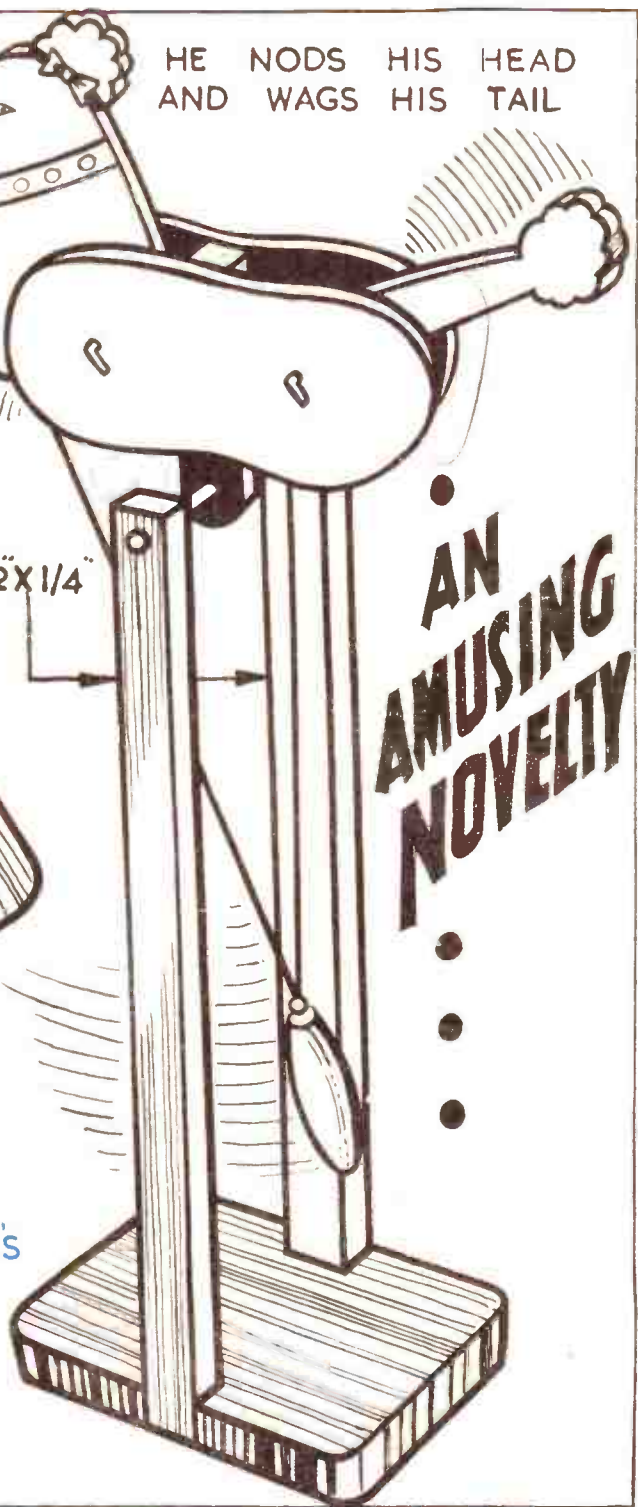
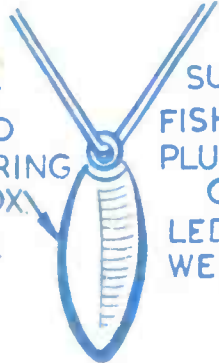

SOLVING A 'LIGHT' PROBLEM

NOT everyone owns a house large enough for each of its occupants to have a bedroom to call his or her own. The opposite is usually the case — two boys or two sisters must share a room. And that is where the trouble starts. . .

One of them wishes to read in bed; the other is tired and would rather sleep. But how can one sleep soundly with the bedroom light full in one's face?

Or, perhaps, one of the sisters has been out on a late date. She creeps into the bedroom, loth to disturb her sleeping sister, but must put on the light in order to see her way around. And so poor sister is awakened. . .

Here is a simple unit that can be made up in an hour or two, and which will

~~~~~  
*By E. Capper*  
~~~~~

prevent black glares between room mates. And besides its functional use, it can be used for a wall piece to house all those pictures of favourite film stars, seaside pennants, holiday snaps and the various mementos that teenagers like to hang on the bedroom wall.

Obtain a sheet of $\frac{3}{8}$ in. thick hardboard, 4ft. long by 2ft. wide. Cut it into three, so that you have three pieces each measuring 2ft. by 16ins. Now surround all the edges of the three pieces with 1in. square, planed battening; you will need to purchase 20ft. Use $\frac{1}{4}$ in. panel pins for nailing it together.

Next, buy four brass butt hinges and connect the three sections together with the hinges, so that you have a folding screen type of construction.

Now, mount the fitting to the wall, with the centre panel exactly in a position between the two beds in the room. Drill holes in the wall, fill them with rawlplugs and screw into the plugs. Fix only the centre panel, leaving the two wings free, so that they will swing backwards and forwards on their hinges. Fit it so that the bottom edge of the panel is approximately 3ins. above the level of the top of the headboards of the beds.

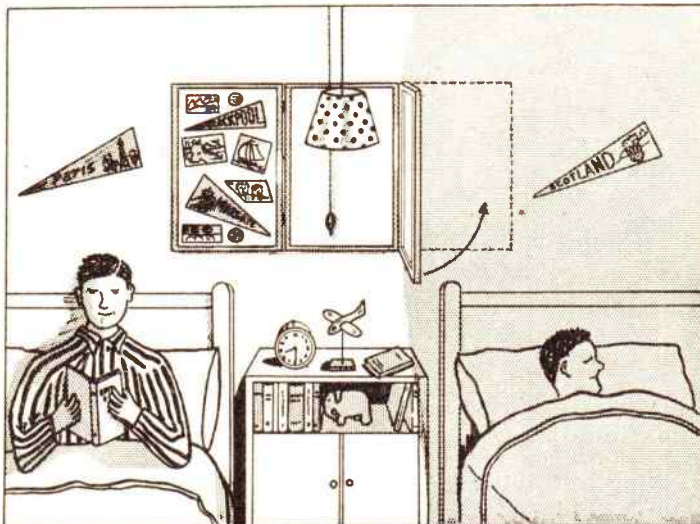

The bedroom light must now be moved so that it occupies a position near the top of the centre panel, as shown in the illustration. This is an operation that most people can tackle successfully, but if you do not possess the necessary knowledge, don't attempt it. It is dangerous to interfere with electric wiring, so enlist the aid of a friend who is conversant with these matters.

Whilst you are moving the light, it is a good idea to incorporate a cord switch to hang near the lampshade, obviously, you will not want to get out of bed in order to switch off the light. Cord switches can be easily purchased, and they are connected to a special rose

in the ceiling. Here again, if the job is above you, get advice before you experiment.

The fitting is now complete except for finishing. Here, you have all sorts of alternatives. The panels can be papered in a gay contrasting contemporary wallpaper, or they can be painted to match the colour scheme of the room. Then again, you may like to try painting a mural on the panels.

The operation of the unit is simplicity itself. When one of the room mates wishes to go to sleep before his or her partner, the panel on his particular side is swung back at right angles to the centre panel, blacking out the light glare on the one side.

A letter from the Queen

AMONG the treasured possessions of Mr. W. I. Easton, 104 East Row, Eston, Middlesbrough, is a letter from H.M. the Queen, thanking our reader for a photograph of some of his models on a Royal theme executed from *Hobbies* designs.

Some of these projects can be seen in the accompanying photograph which was

taken at an exhibition of Mr. Easton's work at a garden fete, in aid of his local hospital's comforts fund, where his work was greatly admired.

Also on show was the Queen's letter together with various awards won by Mr. Easton for his work. Our congratulations go to this very keen worker on his successes.



MODELS FOR BOYS

No. 251 Spl.
TUG 'CLIMAX'
16ins. long

53/6



Make them with a
Hobbies Kit

No. 253 Spl.
TRAWLER
'ANGLIAN'
18ins. long

54/6

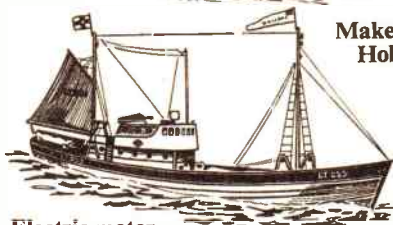

Electric motor
and propeller
included

No. 3206
'EMPRESS
OF
BRITAIN'
24ins. long
56/5

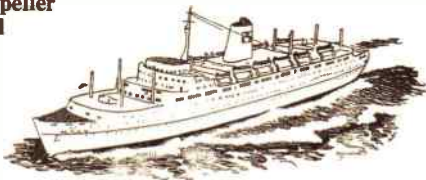

Hobbies Ltd, Dept. 99 Dereham, Norfolk

BARGAIN
FOR Stamp
Collectors

121 DIFFERENT GENUINE STAMPS
INCLUDES 2 SPUTNIK STAMPS
Plus 88 FLAGS OF THE WORLD
and "BOY SCOUT SHEET"

THE GREATEST

BARGAIN EVER OFFERED

1 **GIANT IMPORTED COLLECTION** 121 all different genuine foreign stamps includes: Germany & Czech 'Sputniks' — First 2 space stamps ever issued. Red China — 'Liberation of Canton' complete set of 5 to \$100. Canada — Queen Elizabeth complete set of 5. Viet Nam — First 2 stamps. Nazi Germany — and many other hard-to-get countries and unusual issues from all over the world. Grand total 121 all different genuine stamps.

2 **FLAGS OF THE WORLD.** 88 different stamp size flags in full colour. A spectacular extra to dress up your album pages.

3 **FREE!** **BOY SCOUT JAMBOREE SOUVENIR SHEET.** An unusual 'showpiece' for your collection, that not one collector in 10,000 will ever have!

All 3 items — regular value 5/3 yours for just 1/- to introduce our Bargain Approvals Send 1/- TODAY ask for LOT AB2 Satisfaction guaranteed or refund in full

ALL FOR
1-
WORTH 5/3



BROADWAY APPROVALS · 486 OLD KENT RD · LONDON · SE10

Make Your Own
MUSICAL CIGARETTE BOXES

with

Hobbies
kits & outfits

Hobbies kits for novel musical boxes are extremely popular for making up as gifts and for sale. Kits include materials and full instructions for making with a few simple tools. Musical movements are extra. Make your choice of tune from list below.

GET A KIT NOW!



Kit
No. 3152

7/11
(post 1/3)

SWISS CHALET. Lift the lid to offer a cigarette and it plays a tune.
Fit with Musical Movement No. 1.



Kit
No. 3222

11/6
(post 1/6)

MUSICAL TAVERN. A savings box which plays a tune when you insert a coin.
Fit with Musical Movement No. 2.

Fit your box with one of these tunes

- No. 1 Movement. 15/6 (post 6d.)
- C Swedish Rhapsody
- D Silent Night
- E Brahms' Lullaby
- Y Anniversary Waltz
- No. 2 Movement. 16/9 (post 6d.)
- R Happy Wanderer
- S Teddy Bears' Picnic

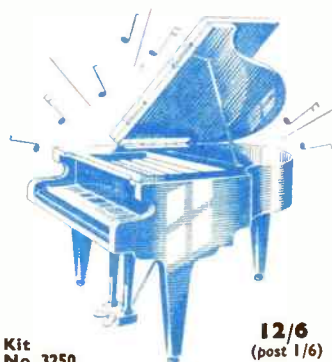

Kit
No. 3250

12/6
(post 1/6)

GRAND PIANO Kit includes printed keyboard.
Fit with Musical Movement No. 1.

Other models detailed in free Booklet

To Hobbies Ltd., Dept. 99, Dereham, Norfolk.

Please send free copy of 'Profitable Leisure' and items detailed.

Kit No.

Musical Movement.

Name

Address

P.O. for enclosed



THERE is little variation in the form and style of modern visiting-cards. But there was a time when such cards were extremely elaborate.

In the reign of Maria Theresa artistic cards were popular. Sometimes a dog held in his mouth a card with the name of the visitor inscribed on it; sometimes a deep, artistic border was used, the name being written on a small white space in the centre. Such cards were sold blank, and the lettering added in elaborate penmanship.

Adam Bartock, a Viennese painter, designed many visiting-cards of an artistic or eccentric description. His own represented a spaniel sitting upon its hind legs, the name issuing from its mouth.

Elaborate forms

Army officers would have in one corner some of the insignia of their profession. Naval officers had their cards decorated with anchors or ships.

Visiting-cards assumed their most elaborate form in the Louis Quinze period, at this time being made to serve a double purpose. They were especially useful when a card was left by a new-comer, or with a letter of introduction. Dots in the ornamentation indicated the amount of the caller's fortune; the colour told the country from which he came; the size, his age; the turns and twists in the border his character and possible intentions; while the stops in the lettering were indicative of his religion.

I have seen a card made with strange glazed and watered paper, gilt borderings were frequent. Tinted card was often used; but colouring was not employed in any other way. Quaint conceits, such as a dove bearing in its mouth a ribbon, on which the name of the owner was printed, were frequently indulged in by ladies.

Small views of the country seats of the owners often figured on the cards at this time. Many people received great praise for their skill in etching a picture of their house.

In Italy pictures of classical ruins were used, the name being printed upon a fallen column or tables in the architecture.

VISITING CARDS

— By R.L.C.

Some of the most noted engravers have turned their attention to designs for visiting-cards. A few specimens exist where the name of the artist is signed, but these are rare.

Foreign visiting-cards have always been elaborate. Coronets and armorial bearings in the corner are common. In England the representation of such emblems is rare.

Regimental visiting-cards are distinct in character. Hospitality is often ex-



DR. & MRS. H. G. COUPLAND
ANNOUNCE THE ARRIVAL
OF
TERENCE GRAHAM
9TH. FEB. 1945

tended to all officers belonging to a regiment. Special cards produced for regimental entertainments were usually kept for sentimental reasons. These are often found tucked away in old books at antique shops — some are valuable. Individual members of a regiment used their own cards of ordinary size and shape.

Men's visiting-cards have not always been smaller in size than those of women. At one time they were much larger. It is suggested that as women gradually asserted their importance in the social scale, so their visiting-cards grew in size. But, whatever the reason, the fact still remains that the usual size of a woman's card is 3½ ins. by 2½ ins., and that of a man 3 ins. by 1½ ins.

Children's cards are amongst the curiosities. The 'return thanks' card of a mother after the birth of a child is not infrequently accompanied by a tiny card on which the name of the babe is engraved. Both cards are usually printed in silver, and the infant's paste-board is attached to one corner of the larger card with a dainty bow of white satin ribbon.

Juvenile Christmas and birthday cards in use about sixty years ago are worth a place in any collection.

There is a humorous side to nearly every aspect of social life, however important, and visiting-cards have not escaped the touch of comedy.

One for 'Towser'

About 100 years or so ago, devoted mistresses were not content with buying elaborate bracelets, collars, travelling, walking and park costumes for their canine pets. When 'Towser' went visiting, his mistress left his card at those houses where a dog acquaintance lived.

I shall be pleased to help any reader interested in this hobby and put him or her in touch with others at home and abroad with the same interests. Address all inquiries to the Editor, Hobbies Weekly, Dereham, Norfolk, enclosing stamp for reply.

DRAUGHT EXCLUDER

CLING, the self-adhesive draught excluder made from a pharmaceutical grade of foam, was successfully introduced to the handyman twelve months ago. Now Cling Minor has been added to the range. In 16½ ft. coils of 3 mm. grey foam, costing 2/6, this works on the same principle of eliminating draughts and dust in the home by the compression of the foam between two surfaces. Its use on doors and windows is obvious, but the motorist and householder will appreciate many other applications which are suggested on the container.

*** GREAT CAMPING OFFER ***



RIDGE TENT SENT FOR 4/-

BRAND NEW de luxe 'Safety' Tent. All colours. Complete. Ideal cyclists, campers. Length 7' 3" sleeping base x 4' 6" wide x 3' 6" high x 12" walls, all approx. Weight 3½ lbs. Cash 55/-. or 4/- deposit and 9 monthly payments 6/-. 1 of 2/6. WITH FLYSHEET 83/6, or 9/3 deposit and 8 monthly payments of 9/9. 1 of 4/9. Both carriage 2/6. **LISTS, TENTS, TERMS.**

GREAT HALF-PRICE OFFER!



Matakari FOLDING CAMP BEDS CASH PRICE **27/6**

Makes Camping Holidays a Joy!

BRAND NEW, famous lightweight, tremendously strong beds fold to practically nothing in size for easy transport. Full 6 ft. length, normal width. This represents the finest camping bargain. Half price of other types. Lightweight rustless sprung steel. Lasts years. Ideal as occasional bed for visitors. Makes up like divan. 27/6, post 3/6. Three for 89/6, including post. **Headquarter & General Supplies Ltd. (HOBW/47) 196-200 Coldharbour Lane Loughboro Junc., London, S.E.6** Open Sat.

10/- 'GOLD MINE' 10/- PARCEL OF STAMPS

Contains sets, Mixed lots, Approval sheets, Album leaves, etc. *Hundreds of satisfied customers.* Rec. — "Please send me a Gold Mine (I have had one and found it excellent value)"—T.R.T., Coventry
BELFIELDS, (Dept. H)
STOUR HILL, QUARRY BANK, STAFFS.
Postal Business Only C.W.O. Post Extra

BRASS, COPPER, DURAL, ALUMINIUM, BRONZE

ROD, BAR, SHEET, TUBE, STRIP, WIRE
3,000 STANDARD STOCK SIZES
No Quantity too small List on Application
H. ROLLET & Co. Ltd.
6 CHESHAM PLACE, LONDON, S.W.1
Also at
Liverpool, Manchester, Leeds, Birmingham

Completely new 54 page Edition
WHERE'S THAT CAR FROM?

Price 1/- (Postage 4d.)

Of all Booksellers

or

RALEIGH PRESS, Exmouth, Devon

15/6 CRYSTAL RADIO KIT. Easy-to-build with only a screwdriver and pliers. Post free, send 15/6 P.O. — Also 1 and 2 valve kits, headphones, etc. Send stamped addressed envelope for complete list to Blanchard's Radio, Dept. HC8, 13 Gainford Gardens, Manchester 10.

The amazing **'ABRAFILE'** ROUND FILES



They bend to any shape you need!

New soft-core, parallel Round Files. Can be used as normal files or bent cold to almost any shape. Made on the 'Abrafile' Tension File patent of non-clogging teeth. Ideal for model making, craftwork, decarbonising engine parts, cleaning concave surfaces, and awkward corners in pipe bends, castings, etc. Fitted into varnished wooden handles and made in diameters 1/8", 1/4", 3/8", 1/2", 5/8", 3/4", 1", 1 1/8", 1 1/4", 1 1/2", 1 3/4", 2", 2 1/2", 3", 3 1/2", 4", 4 1/2", 5", 5 1/2", 6", 6 1/2", 7", 7 1/2", 8", 8 1/2", 9", 9 1/2", 10", 11", 12". Also the 'Mousetail'—ideal for small work. Price 6d. each. From all leading hobby shops and ironmongers, or send 2d. stamp for illustrated leaflet to:



ABRASIVE TOOLS LTD
COLNE ROAD, TWICKENHAM, MIDDLESEX

MAKE A MUSICAL BOX for as little as £21/- New kits and tunes available. Movements 13/- post free. Please send 3d. stamp for free illustrated catalogue. — The Swisscross Co., Dept. B, 202 Tulse Hill, London S.W.2.

MEN/WOMEN with spare time, required for new simple weaving work. For details send S.A.E. — Dept. 4, Weava Products, 10 Shelley Road, Worthing.

STAMPS FREE — Empire Packet including Pictorials and Victorians with approvals. — Robert J. Peck, 7A Kemp Road, Bournemouth.

100 DIFFERENT stamps free! Request 1d. upwards discount approvals. — Bush, 53 Newlyn Way, Parkstone, Dorset.

LET
★ 'Plasticine'
HELP YOU DO-IT-YOURSELF Regd. Trade Mark
Harbutt's Plasticine Ltd, Bathampton, Bath

BE TALLER

in 12 days or money back. New gland and spinal discovery increases height 2 to 5 inches. 'I have gained 4½ inches in height. My weight increased from 9-stone 4-lb. to 10-stone 3½-lb.'—P.D. 'Increased 3 inches.'—H.G. Guaranteed harmless. Full course 10/6 (or £1.50). Air mail 16/3. Details 2d. Sent under plain cover. **J. H. MORLEY, 28 (H/188) Dean Rd., London, N.W.2.** Practical Courses, all subjects. List free.

Hobbies

BIRMINGHAM
100a Dale End, Birmingham 4

SHEFFIELD
4 St. Paul's Parade

LEEDS
10 Queen Victoria Street

HULL
179 Ferensway

SOUTHAMPTON
134 High St. (Below Bar)

BRISTOL
65 Fairfax Street

NEWCASTLE
42 Dean Street

GRIMSBY
88 Victoria Street

BRANCHES: LONDON
78a New Oxford St., W.C.1
(Phone MUSEUM 2975)
87 Old Broad Street, E.C.2
81 Streatham Hill, S.W.2

GLASGOW
326 Argyle Street

MANCHESTER
10 Piccadilly

Head Office & Factories—**HOBBIES LTD, DEREHAM, Norfolk**

HOBBIES
No. 1
MITRE-CUTTING TOOL AND CORNER CRAMP

Price 50/-

Cuts mitres on moulding and similar work up to 4 ins. wide by about 1 in. thick. The wood is held fast on a perfectly flat bed, and the tenon saw is gripped between the blades of the saw guide at an angle of 45 degrees. The guide can be thrown up out of the way when the work can be cramped for gluing. Ease and accuracy ensure perfect results.

HOBBIES LTD, Dept 99, Dereham Norfolk

Pictorial Window Leading and Glass Colouring with
DECRA-LED

Make beautiful stained glass windows with the new Pictorial Kit. Containing lead, cement, 5 colours, paint brush, design (24" x 18") full instructions. Choice of Galleon, Castle, Bridge and Dutch Boy scenes. Ideal for novel firescreens, door panels, landing windows, etc. Price 10/- complete Kit (add 1/6 postage). *Guaranteed by the Good Housekeeping Institute.*

Decra-Led Transparent Glass Stain. The new formula colour for all glass painting, or colouring existing leaded window designs. Red, Green, Blue, Amber, Brown and Frost, in 1/- jars and half pint 9/6 tins.

The Art of Window Leading—a fine new book. 40 illust. Price 2/6 (6d. postage). All Decra-Led Products from local suppliers, or from sole makers.

NORTH WESTERN LEAD CO., LTD., DEPT. 1, HYDE, CHESHIRE TEL.: Hyde 1234
Trade enquiries invited

THE BENEFITS OF TRAMPING

WALKING, if not overdone, is one of the healthiest forms of outdoor exercise. When walking for health's sake it is not at all necessary to endeavour to set up a new record for the mile, or to accomplish a given number of miles per hour, thus converting moderate exercise into something approaching tiring exertion, although many pedestrians, walking solely for health and pleasure, have accomplished some really wonderful performances on foot.

One of the better known advocates of pedestrianism, the one-time Vicar of Filey — frequently spoken of as 'The Walking Parson' — performed remarkable feats on foot. Among them we may mention a tramp from Filey to London, a walk across Ireland, a climb over the Pyrenees, and a walking tour to Rome. Again on his lecturing business he used to tramp sixteen miles back home to Filey, thinking nothing of it. He was confident that the exercise of walking was the best kind of medicine anyone could have. Once, when asked to give the name of his doctor, he replied: 'The man who walks is the man who is well; I myself am proof of the truth of this maxim.'

Eugene Lamb Richards, author of 'Walking as a Pastime', was most enthusiastic about the benefits to be derived from plenty of walking. 'This form of exercise induces sound sleep,

stimulates the appetite, sets the blood circulating freely, and is, in fact, one of Nature's best tonics.' Richards is the person who accomplished the feat of tramping across the State of Connecticut, a distance of fifty-five miles, in a day.

By A. Sharp

John Wilson, better known by his nom-de-plume of 'Christopher North', was a tremendous walker, never happier than when a-foot on the fields, fells and moors. Much, if not all, of his prowess he owed to his love of the open air and long hours spent a-walking over moss and heather, hill and dale. He has been described as a 'king among men', whether fishing on mountain streams, climbing Highland bens, leaping, running and boxing. One day he walked seventy miles to fish a certain Scottish loch!

Mr. A. Alexander, author of 'The Wayfarer's Log' was another example of what walking will do towards keeping an outdoor man fit. When, during his sixties he tramped across England 'enjoying every foot of the way', tramping by road and field path from Scarborough, through Knaresborough and Harrogate to the West Coast.

Charles Kingsley was another advocate of the benefits of walking and the open air. His cure for stupidity and headaches was to tramp across country in a roaring fen wind. He had a passion for the woods and fields, and to this great love for outdoor exercise he owed much of the health and vigour which enabled him to live so vigorous a life, accomplishing all that he attempted to do, with great zest.

Nearly every doctor prescribes walking — within reason that is — for the convalescent person, a little walk is usually the first step towards normal activity. When, following some weeks of inactivity, we can indulge in a long walk, we feel that our feet are planted on the road to health again. For the outdoor lover the great outdoors is the key to vigorous health again.

Don't over-do it

Undoubtedly, the best health to which we can attain, is to be won by a moderate amount of exercise in the sunshine, and fresh air. Tramping is one of the finest and most health giving of recreations. Sunlight, unpolluted air, the incense of tree and flower, will prove the finest tonic that Nature can administer to body and mind. All the same, don't over-do it.

Hilaire Belloc tramped to Rome. George Borrow did much walking throughout Spain — both have left records of their adventures tramping through these countries. They stress the fun of walking alone, without company. But Sterne says in one of his books: 'Give me a companion by the way, if it be only to remark how the shadows lengthen as the sun declines.' Another writer remarks that, with good company, the hours pass swiftly, and fatigue is scarcely felt. Undoubtedly, a good companion, with similar tastes to one's own, is a boon on a long tramp, and the right company adds pleasure to the tour.

There are many routes open to the wayfarer, but it is unwise to suggest any to the trampler on holiday, for much of his pleasure lies in exploring for himself the ways and life of the countryside. Change of scene and freedom of the mind should combine to make a tramping outing a complete success. Pack your rucksack, replace your usual footwear with easy walking boots with thick soles; take your stick, and do not forget a 'mac' in case of rain. Then set out to find pleasure and health by the rucksack way of enjoying the countryside.

Hobby or Hobo!

Whether you're interested in a particular hobby such as photography, sketching, botany or bird watching, or whether you just enjoy the freedom of wandering at will where the fancy takes you, you'll be glad to know about youth hostels. Nearly 300 in England and Wales provide simple but friendly accommodation for walker or cyclists at only 3s. a night (1s. 6d. if under sixteen). There are also three course suppers and breakfasts available at 2s. 6d. each, or you can cook your own food in the members' kitchen for 3d.



**Don't
delay
Post
today**

To Y.H.A., Trevelyan House, St. Albans, Herts. 591/HW
Please send me "Going Places" and details of Y.H.A. membership

Name

Address

A NEAT WATCH STAND

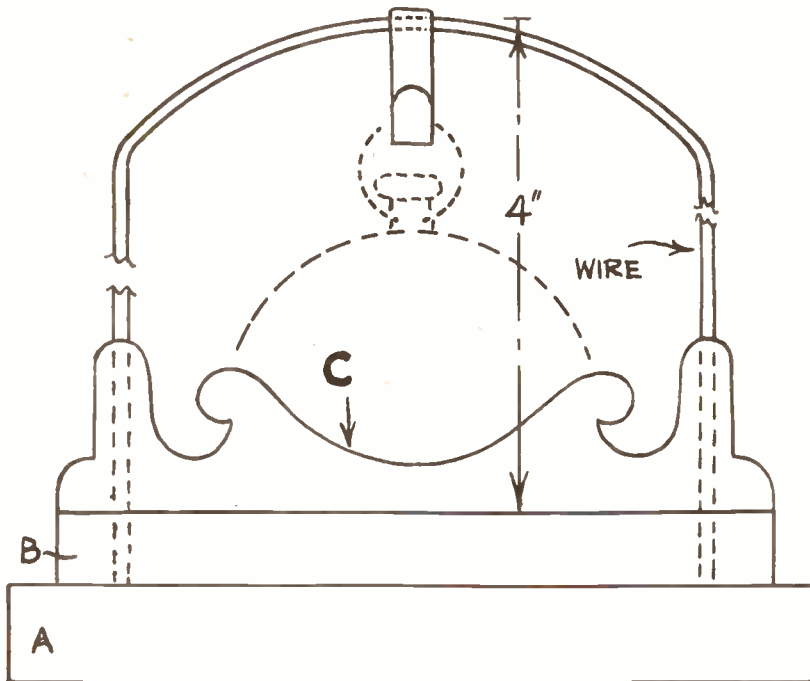
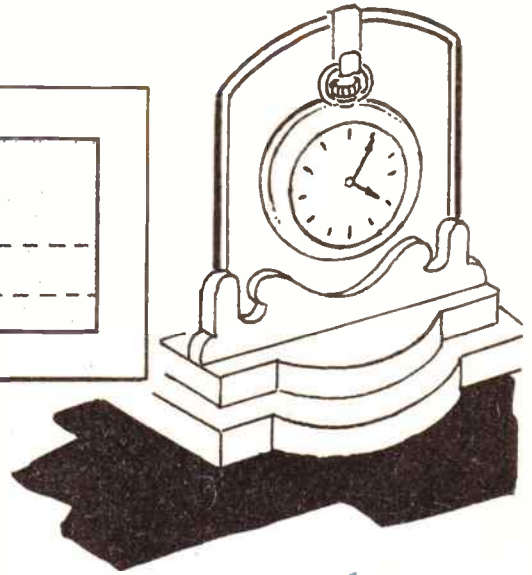
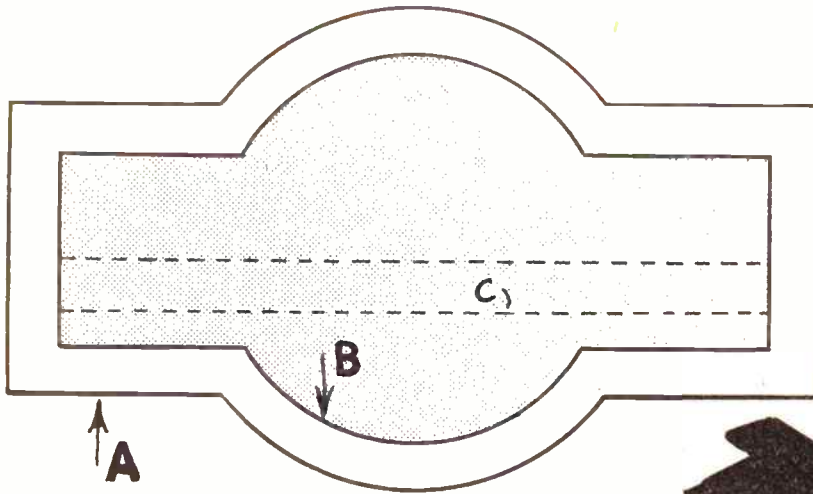

Instructions for making

THE base of the watch stand is made from three pieces of wood. Piece (A) is $\frac{1}{2}$ in. thick, piece (B) $\frac{3}{4}$ in., and piece (C) $\frac{1}{2}$ in. Trace the shapes and transfer them to the wood by means of carbon paper. Cut out each piece with a fretsaw.

Clean up the edges with glasspaper, and glue the three pieces together. Piece (B) is glued to piece (A), and piece (C) to piece (B).

The watch support is made from wire and a small piece of $\frac{1}{4}$ in. wide copper or brass strip. Drill holes in piece (B) to take the wire, and bend the brass strip to form a hook as shown by the small diagram.

The watch stand should be finished by painting with plastic enamel. The base should be painted white and the wire black. (M.P.)



KITS WHICH WILL MAKE GRAND GIFTS FOR ALL MEMBERS OF THE FAMILY

Gifts made by yourself have that 'personal' touch which make them all the more appreciated. Here are a few kit suggestions from Hobbies which will delight both giver and receiver. Many more ideas in Hobbies free 20-page booklet. Send for one today and save yourself £££'s.

KITS CONTAIN ALL MATERIALS AND FULL INSTRUCTIONS FOR MAKING WITH A FEW SIMPLE TOOLS.

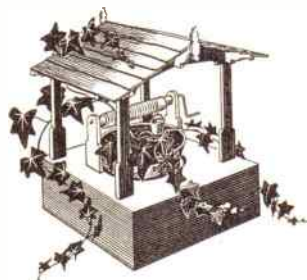

'OLD WELL' PLANT HOLDER

Kit No. 3248

10/3 (post 1/6)

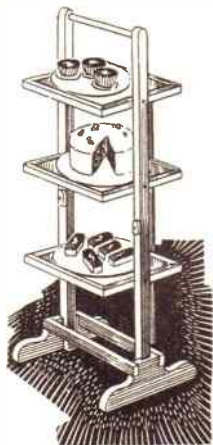

FOLDING CAKE STAND

Kit No. 3226. All wood, hardboard, etc.

20/- (post 1/9)



'LIGHTHOUSE ELECTRIC LAMP'

Kit No. 3252. Lampfittings, printed window material, etc.

22/6 (post 1/9)

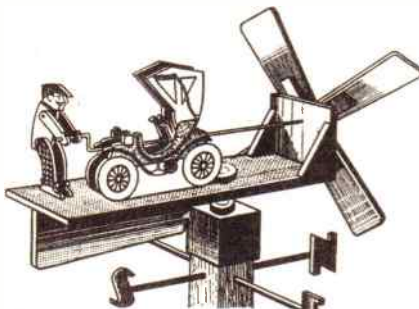

NOVEL WINDVANE

Kit No. 3258. Wood, wire, steel, etc.

16/- (post 2/-)

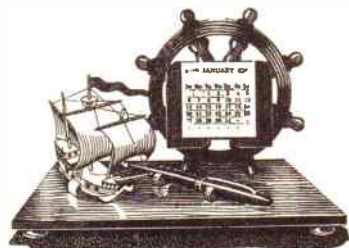

GALLEON CALENDAR **5/9** (Post 1/-)
No. 3188 Graceful and practical.

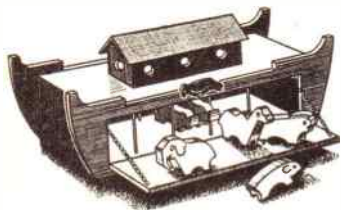

NOAH'S ARK
No. 3270. With animals.

13/11 (post 1/6)



AUTOMATIC
CIGARETTE BOX
No. 3272. Open the
drawer for a cigarette.

5/6 (post 1/-)

**GET STARTED ON SOME
OF THESE RIGHT AWAY!**

To Hobbies Ltd., Dept. 99, Dereham,
Norfolk.
Please send free copy of 'Profitable Leisure'
and

KIT NO.....

Name.....

Address.....

P.O. for..... Orders totalling 30/- and
enclosed. over, post free