

HOBBIES WEEKLY

JANUARY 14th 1959

VOL. 127

NUMBER 3298

IN THIS ISSUE

	Page
A Toy Crane	241
Pictures from Greetings Cards	242
Making the TV Trolley	243
Cot Precautions	244
Smoker's Fireside Companion	245
Mainly for Modellers	246
An Enlarging Easel	247
Fifty Years a Modeller	248
A Simple Steam Engine	250
Make a 'Boomerang' Tin	250
Collectors' Club	252
Patterns for a Handy Tie Rack	255



All correspondence should be addressed to the Editor, Hobbies Weekly, Dereham, Norfolk

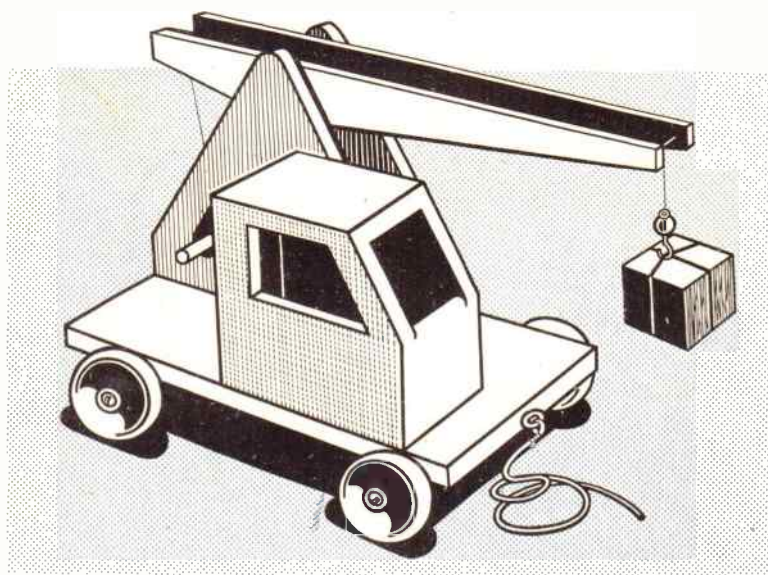

*Make it from
FREE design
in this issue*

HOURS of enjoyment can be had by a child with the type of crane illustrated. With it he can lift cargoes of various shapes and sizes, and transport them about the room. He would have lots of fun picking up and setting down at various places.

This pull-along crane is very easy to construct and simple in operation. It measures 7½ ins. long by 3½ ins. wide by 5½ ins. high, and there is no involved ratchet set-up in the hoisting and lowering mechanism. The hoist is operated by a handle to which is affixed a length of string which runs over wires in the arm of the vehicle, and thence to the hoisting hook. The string winds and unwinds around a length of dowel when the handle is turned.

Instructions on next page

A TOY CRANE
PULL-ALONG MODEL WHICH
WILL DELIGHT ALL YOUNGSTERS

241

FOR ALL HOME CRAFTSMEN
Over 60 years of 'Do-it-Yourself'

World Radio History

4¹/₂^D

INSTRUCTIONS FOR MAKING A TOY CRANE

All parts are shown full size on the design sheet. Trace these on to tracing paper and from this transfer to the various thicknesses of wood by carbon paper. Cut out with a fretsaw and clean up each part thoroughly, noting the shaped sections on pieces 5 and 6.

Kit for 6/11

Hobbies Kit No. 3298 contains all the wood and materials, including wheels, needed for making the Toy Crane. Kits from branches, price 6/11 or from Hobbies Ltd, Dereham, Norfolk (post 1/6 extra).

The cab of the crane can be assembled first, and the make-up of this is shown in Fig. 1, from which it will be seen that pieces 4 and 5 are butted between pieces 2 and 3, and piece 6 is glued on top.

Leave this section to dry while the crane jib and housing are assembled.

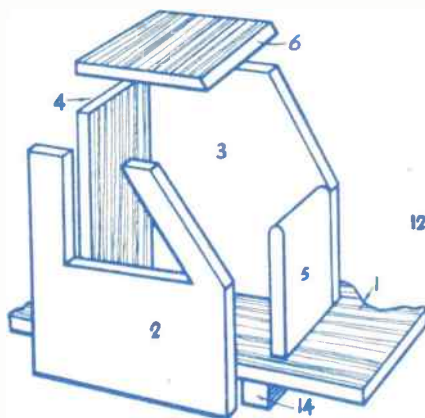

Fig. 1

This is shown in Fig. 2. The two arms (8) are glued in the positions shown by dotted lines on the design sheet to the insides of pieces 7. The winding gear consists of a piece of $\frac{1}{4}$ in. dowel (10) to which are glued two spacing discs (pieces 9) the positions of which are shown on the design sheet.

Now prepare piece 13 and the two pieces of wire, and assemble these together with the winding gear at the same time, between pieces 7. Note that piece 13 is a spacing spar which is glued

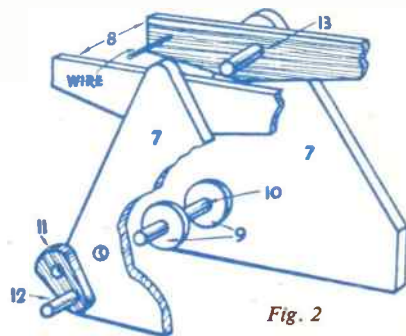

Fig. 2

in the holes provided in the two arms (pieces 8).

Make up the winding handle from pieces 11 and 12, and add to the winding spindle (see Fig. 2).

The two sections assembled can now be glued in their respective positions on the base (piece 1).

The two axles are cut from $\frac{1}{4}$ in. square stripwood and glued to the underside of the base. Wheels are added by screws and a screw-eye is inserted in the front of the vehicle on which to tie a string for pull-along purposes.

Make up the lifting hook from a bead and wire as shown on the design sheet. Cargoes for hoisting, etc., can be fashioned from cubes of wood wrapped with paper and tied with string. Paint the crane in bright colours such as red, yellow, blue and green, to make it most attractive to youngsters.

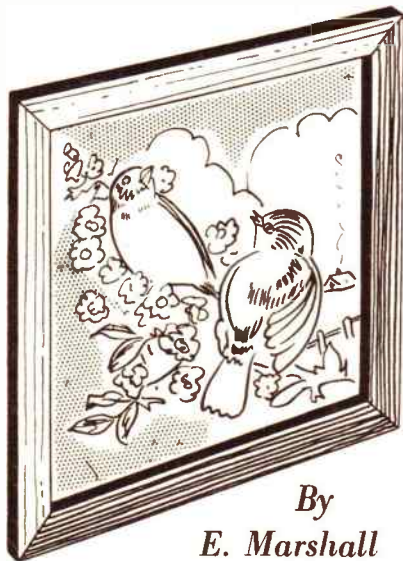

By

E. Marshall

FRAMED pictures may be made quite easily from magazine illustrations, old Christmas cards, and

PICTURES FROM GREETINGS CARDS

calendars or pictures cut from seed catalogues. Just cut the illustration out neatly, using a straight edge and a razor blade, and paste or gum to a piece of hardboard or stiff cardboard, of suitable size. Finish with half-round moulding.

Carefully mitre the corners of the moulding and glue to the edges of the hardboard. A few fine fretpins may be driven through the hardboard into the moulding if desired. Stain the moulding and give it two or three coats of shellac, varnish, enamel, or French polish. The picture, which must be neatly cut to fit inside the moulding, must be carefully pasted or gummied all over. Smooth the picture well down, starting from the centre and working to the edges.

If an old calendar is being used, and is already on a stiff card, the hardboard backing may be dispensed with, the moulding being glued directly to the picture.

Fix two small brass screw-eyes about one third of the way down from the top

of the frame for hanging.

These simple pictures look exceedingly well against a plain wall. A 'glass' may be easily cut from old washed-off photographic film, clear celluloid or perspex sheet and fixed to the picture with a solution of clear gelatine. This can be made by dissolving as much gelatine as possible in a small quantity of hot (not boiling) water. When cold it is ready for use. Again, great care should be taken to remove all air bubbles under the 'glass'.

These framed pictures are ideal for nurseries and bedrooms. They are cheap and easily replaceable. In fact, if one gets tired of any particular picture it may be replaced in a few moments by simply pasting a fresh illustration of suitable size over the old one.

It should be noted that there may be a copyright on some pictures, and if these articles are to be made for sale, inquiries should be made at the source of publication.

Concluded from last week

MAKING THE TV TROLLEY

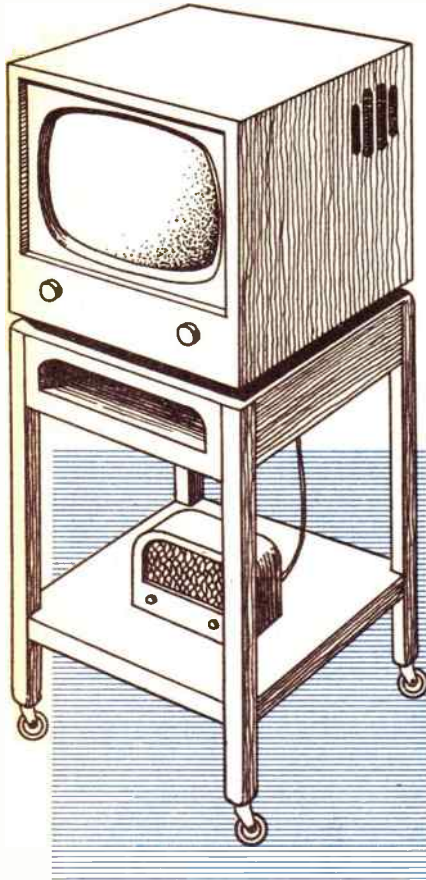

shape shown in Fig. 1(a). $1\frac{1}{2}$ ins. is left at the sides, and 1in. at the top. Smooth out the inside of the cut-out portion with glasspaper.

As stated last week, difficult jointing is avoided, and this is achieved by adopting one or other of the methods shown in Figs. 1(b) and 1(c). In Fig. 1(b), 4in. lengths of sparring are glued and nailed (or screwed) to the inner corners of each leg, at the top. The section of the spar should be $\frac{1}{2}$ in. if the boards are $\frac{1}{2}$ in. thick. This would bring the outer surface of the board flush with the outside of the leg. The board butts up into the ledge so provided and is glued and nailed to the spar.

The other method is to use 4in. lengths of aluminium or brass angle bar, instead of the spar. A plan view is seen in Figure 1(c). Screws are used for fixing legs and boards to the aluminium angle bar, while glue is used where the boards butt up against the legs.

The rail on which the shelf comes should be 16ins. wide, $1\frac{1}{2}$ ins. deep and

shelf can be obtained precisely. It should be $17\frac{1}{2}$ ins. wide by $17\frac{1}{2}$ ins. (if $\frac{1}{2}$ in. boards are used). The thickness need only be $\frac{1}{2}$ in. There will have to be cut-outs in the corners to make way for the legs, etc, to fit in.

By A. Fraser

This shelf is fixed with glue and by nailing from below into the bottoms of the lin. spars. If these are not used, the shelf can be set (and glued) on to $\frac{1}{2}$ in. triangular fillets fixed on to the bottom edges of the side and back boards and the top edge of the front rail below the cut-out. Fig. 2 shows a view from within the trolley, looking upward. The dotted line shows position of the shelf, and how it can be nailed or screwed on to the bottom ends of the lin. spars.

FOR the 17in. set cabinet described in last week's issue, the trolley measures 19ins. wide by $18\frac{1}{2}$ ins. from back to front, and is 30ins. high (including wheels). These measurements, of course, can be altered to suit one's own particular needs, the constructional principles being applicable to any size of trolley.

The legs of the trolley should be of some hard wood, preferably of a kind to match the wood veneer chosen for the cabinet. They should be $1\frac{1}{2}$ in. or $1\frac{1}{4}$ in. square, and should be sawn 27ins. long (for the 17in. TV). With a chisel, chamfer off the lower edges of the legs and round off with a glasspaper block, to improve the appearance (Fig. 1(d)).

Next, saw out the side and back rails for the top end of the trolley. These are of $\frac{1}{2}$ in. (or even $\frac{1}{4}$ in.) thick board, either plain or ply. The sides and back are $4\frac{1}{2}$ ins. deep. The sides will be $15\frac{1}{2}$ ins. wide, while the back will be 16ins. wide. These should be sawn truly rectangular.

The front portion is 16ins. wide and 4ins. deep. It is sawn out to produce the

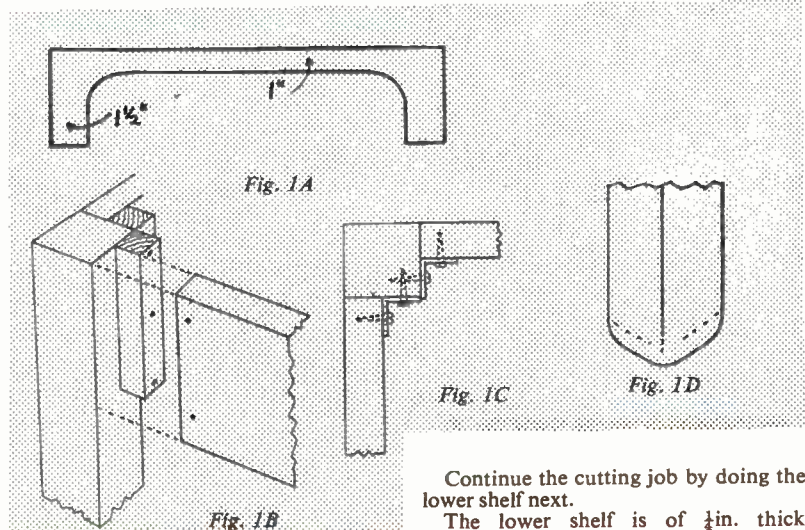

$\frac{1}{2}$ in. thick. This is fixed with a $1\frac{1}{2}$ in. long angle bar, as well as glue where it butts up against the leg and the bottom of the cut-out front portion.

Once these parts, detailed above, have been cut out, they can be assembled temporarily with a nail (or screw) or two, so that the measurements of the inner

Continue the cutting job by doing the lower shelf next.

The lower shelf is of $\frac{1}{2}$ in. thick plywood, glued to rails of $1\frac{1}{2}$ in. deep batten, $\frac{1}{2}$ in. thick. The plywood should be 19ins. wide by $18\frac{1}{2}$ ins. Cut out the corners to allow the legs to sit in. The rails should be fixed with $1\frac{1}{2}$ in. or $1\frac{1}{4}$ in. long angle bar to the legs, with glue to help where they butt up against the legs. The bottom of the rail comes

7½ins. above the end of the leg (excluding the wheel). See Fig. 3.

When satisfied that all the parts are fitted properly, they can be assembled permanently, using glue and nails or screws.

Now saw out the plywood top (this should be 19ins. by 18½ins.), and glue its position on top of the trolley. When fixed, round off the edges, preferably with a plane first, then glasspaper block. Its tops should be ⅜in. or ½in. thick.

Fig. 2

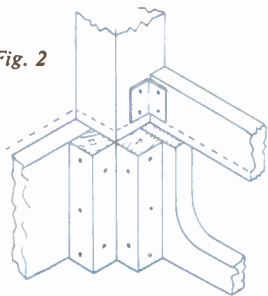

If desired, the outer corner of each leg can be taken down with a plane all the way along and then rounded off with glasspaper. It adds some quality to the design.

The trolley is then glasspapered smooth, all over. The top can be veneered to match the TV cabinet, using the same 'Aga' veneer. Similarly with the sides and front. The legs, if they are of some other kind of wood, can be disguised with the judicious use of stain and varnish.

Finally, holes are bored in the bottoms of each leg and trolley wheels inserted. These are the usual rubber tyred wheels obtainable quite cheaply and very easily fitted.

Fig. 4 shows how the ordinary radio aerial can be dispensed with. A yard of insulated wire (stranded) is more than sufficient. Join a plug at one end, for radio connection, and bare the other end for 1½ins. Pass this bare wire round the metal case of the co-ax lead to the TV set and twist it firmly into a tight loop. In this way the outer braiding of the co-ax lead of the TV aerial acts as the aerial for the radio, with highly satisfactory results.

When there is only one mains socket and a plug each for radio and TV one is obliged to keep changing the plugs over

'OFF' as desired, with a single turn of the switch toggle or knob.

The important thing is that the insulation of the switch must be able to stand the voltage of the mains and the current drain of the TV set. The rating is usually on the switch.

Fig. 5(a) shows the circuit arrangement for a two pole, three-way rotary switch. Where such a switch is not to hand, two two-pole, two-way toggle switches can be pressed into service. (These, again, should be rated to withstand the necessary voltage and current.) The circuit is shown in Fig. 5(b). One toggle is for the

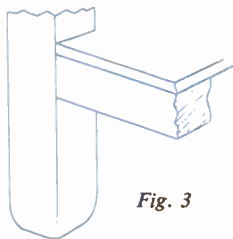

Fig. 3

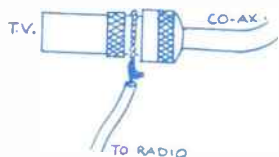

Fig. 4

Fig. 5A

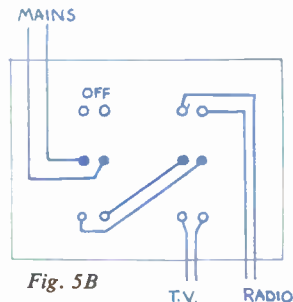
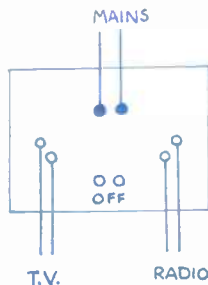

Fig. 5B

every time one wants to change from set — rather a tiresome business. The ideal way to avoid this would be to have a two pole, three-way switch, connecting the mains input to the centre poles and switching in the radio, TV or

mains 'OFF' or 'ON', the other for engaging the TV or radio.

Either switch system should be mounted in a wooden box for insulation, and fixed to the wall within easy reach.

COT PRECAUTIONS

HOBBY enthusiasts often try their hand at making cots, and as all fittings are available, this is quite a good way of saving expense, but there are various safeguards we must take.

One child was trapped by getting its head between the bars, set too far apart. Another died of sucking the rails and being poisoned by the paint.

Standard measurements are adhered to by the official makers. Maximum width between the vertical bars, including space between the corner posts, is recommended at 2¾ins. Any width between mattress frame and the lower horizontal bars should never be more than 3ins. Where the mattress is of the lay-on type, that rests on the bottom end rails of the cot, the sides of the frame should project at least 1in. beyond the

ends: and there should be no more than ½in. play between the end rails of the mattress and the vertical sections of the cot ends. Allowing for a 4in. deep mattress overlay, the cot ends and sides, when raised, should be not less than 23½ins.

Carefully consider the position of fittings to let the side down. Some sturdy youngsters have been known to find out how to let the side down,

unaided. Arrange the fastenings so that two operations at each end of the cot are necessary. Place the fasteners well away from the fingers of the youngster in the cot.

Pay great attention to wood used, and see that all surfaces are perfectly glasspapered down. Rough areas are a danger to any youngster. Insist on getting the special paint now available for this work — it is on sale in all good-class paint stores.



This set of full-size cot fittings costs 7/11 (post 1/6) from Hobbies Ltd, Dereham, Norfolk. Cot design (No. 3202) is 1/3 (post 2d)

Relax at ease

Smoker's Fireside Companion

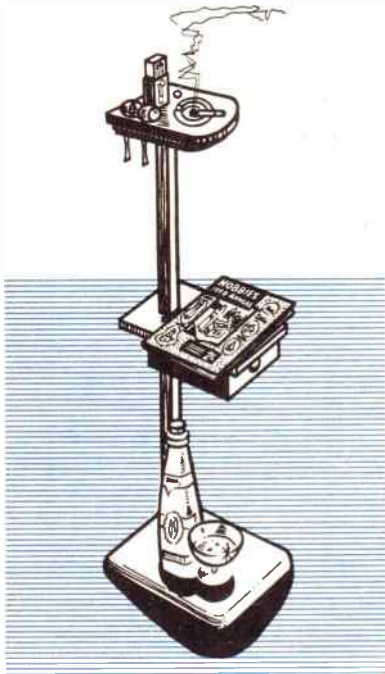

WHEN father is seated in an easy chair beside the fire he usually likes to have his pipe, tobacco and matches or cigarettes nice and handy. Much of the enjoyment is lost if he has to keep getting up or is obliged to search through various pockets for the items needed.

Here is a roomy fireside companion which will solve this problem and hold everything he may require. In the top is a sunken ash tray, holes for four pipes, and a match box stand. The shelf midway down, together with its handy drawer underneath, provides ample space for the remaining items. The base is large enough to hold a pile of books or a bottle of wine with which to complete his pleasure.

Choose a hard wood

One of the well known hard woods, such as oak, walnut or mahogany should be chosen for the job, although there are an increasing number of attractive woods now being used for furniture which would be suitable. Try to match up with the existing room furniture if at all possible.

A substantial base is needed, so that the companion will stand firm, and we have made this 12ins. long, 8ins. wide

and 1in. thick, but this last measurement could be increased to 1½ins. with advantage. Round off or bevel the top edge. Cut a 1in. square hole 2ins. from the back edge to take the upright, and this should go about three-quarters of the way through. Make sure that this is cut perfectly upright, as the appearance of the entire job depends upon accuracy here; if the upright bar is only slightly out of true, it will spoil an otherwise good job.

Make the upright bar 29ins. long and 1in. square. It would be advisable to cut this before making the hole in the base, so that you can make sure it is cut true. When you are satisfied, then it can be glued in and allowed to set.

Adding the drawer

The middle shelf with drawer underneath should be made and fixed next. A piece of ½in. wood 10ins. long and 8ins. wide is needed for the shelf, and has a 1in. square hole cut 1in. from the back. Like the hole in the base, this must also be cut true, and should be a good fit on the upright bar, so that it will only need a spot of glue to secure it in place. There is a distance of 17ins. from the underside of this shelf to the top of the base.

The drawer slides in a simple framework fixed to the underside of the shelf.

Two side pieces 7½ins. long, 3ins. wide and ½in. thick, and the back piece 6½ins. long of the same material, are used. Cut the rebate for the ½in. thick ply bottom before gluing and pinning these pieces on to the shelf. This ply piece is 7½ins. long and 6½ins. wide.

By A. F. Taylor

The actual drawer should not present any difficulty — four strips of ½in. wood 2½ins. wide for the front, sides and back, with rebates cut for the ply bottom ½in. thick. Glue all these together, and fix a knob or strip to the front to serve as a handle.

For the top of the companion three pieces of ½in. wood are glued together, the upper one being 8ins. long and 6ins. wide, with the front cut to a half circle as shown. The middle piece is ½in. smaller all round, i.e., 7½ins. by 5½ins., while the third piece is 7ins. by 5ins.

A circle is cut in the upper piece for the brass ash tray so that it will lie flush with the top. If this is more than ½in. deep you may have to cut out a portion of the middle piece of wood also. By making the tray fit tightly into the wood no other form of fixing will be necessary, but in case of difficulty a small hole can be drilled in the centre and a screw inserted.

Provision for pipes

The match box holder is simply a block of wood which is screwed to the top piece of the three before they are glued together. It is 1½ins. wide, ¾in. thick and 1in. high, and the matchbox is just slipped over it, leaving the box open ready to take a match out.

It only remains now to drill the necessary number of holes for the pipes to fit into. We have put four in our design, but these can be altered to suit your requirements. Perhaps the stock of pipes does not extend to four, but it is always nice to have a spare hole just in case it is wanted.

French polish is a good way of finishing the job, although one of the more modern finishes will be quite satisfactory.

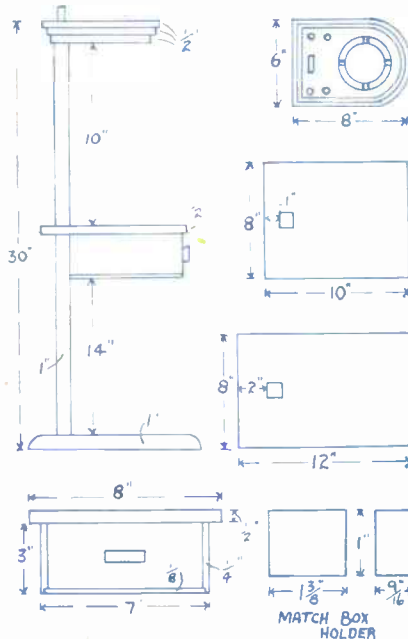

MAINLY *for* MODELLERS

PADDLE steamers have a fascination all their own, and the subject of this kit is one of the premier pleasure steamers in the Thames service.

There have been several *Eagles* in this service, the first was an early type steamboat built at Deptford around 1820, probably one of the first to be powered by engines of the famous Boulton and Watt firm of Birmingham.

The second *Eagle* was purchased for the Company (The General Steam Navigation Co.) in 1856, and then she was followed in 1896 by a third of this name. As this vessel was still in service early in the twentieth century the next in line was called the *Golden Eagle*. This one actually served as a troopship in the First World War.

Another and larger vessel, the *Crested Eagle* was built and added to the fleet in 1925, and finally appeared the subject of our kit, The *Royal Eagle*, built by Cammell Laird in 1932. She was very up-to-date, with a glass enclosed deck saloon.

These few notes will, I hope, add to the interest of building the model. I always like to know as much about the original prototype as possible. It adds to the enjoyment and I feel that she is not just a model but an actual miniature of the original.

In building our model we follow closely the kit instructions in cutting and assembling the parts; my purpose in these notes is to show the methods I used in creating the details on my model.

BUILDING THE 'ROYAL EAGLE'

By 'Whipstaff'

The first detail I added was in the bridge itself (piece 29). Instead of cutting this from $\frac{1}{8}$ in. wood, I assembled it as shown in (1A). A centre piece is cut in $\frac{1}{4}$ in. wood to the shape shown, that is taken from the plan, we cut smaller all round the upper edge, the dotted lines showing the plan shape, the solid lines the shape cut in my assembly. Two pieces exactly to the plan shape are now cut in Bristol Board and glued one on each side of the centre piece giving us the finished bridge as in (1B).

The next items to receive attention were the round type ventilators. In our plan instruction they are assembled



1A



1B

PERSPECTIVE VIEW
OF FINISHED ASSEMBLY



2

TURNING VENTILATORS
IN DRILL CHUCK



BAMBOO



3

FINISHED
VENTILATOR

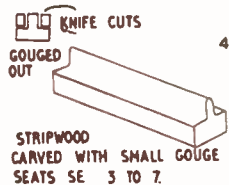

4

STRIPWOOD
CARVED WITH SMALL GOUGE
SEATS SE 3 TO 7.



END VIEW

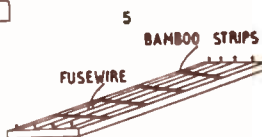

BAMBOO STRIPS

FUSEWIRE

J.C. PLYWOOD AND PANEL PINS

6

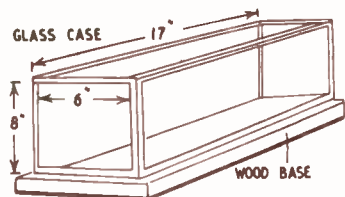

GLASS BOUND WITH PASSE PARTOUTS
17X6X8" TOP TWO ENDS WIDER BY THICKNESS
OF GLASS



TURNED BASE

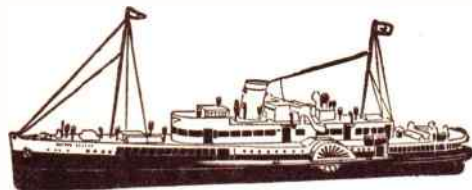

Hobbies Kit No. 2674 for building this striking 14in. replica of the 'Royal Eagle' costs 13/3 from branches or by post from Hobbies Ltd., Dereham, Norfolk (post 1/6 extra).

from wire and paper. These I found much easier to make by utilising white plastic knitting needles, turning the ventilators in the drill chuck of my Hobbies' lathe. Those without a lathe can use an ordinary hand drill held in the bench vice and can shape the ventilators with a file. By turning or filing these from white plastic needles we avoid that ticklish job of painting them. Apart from the difficulty of painting small parts like these, the tendency of a coat of paint over such a small unit is to make it appear out of scale. $\frac{1}{8}$ in. plastic needles only cost a copper or two (see detail 2).

We now come to another item that can be produced more quickly, that is the cowl ventilators detailed in 3. I made mine from bamboo dowel, the cowl being a small blob of plastic wood shaped while pliable. The bamboo dowels are made by cutting strips of bamboo and tapping them through a $\frac{1}{8}$ in. hole drilled in the top of a mustard tin. The tin collects the dowels as they are tapped through. Bamboo, even in small units like these, is very strong and less liable to be damaged when dusting the model.

● Continued on page 247

AN ENLARGING EASEL

THERE are no working parts to get out of order on this useful easel for making enlargements, which is quickly made from hardboard or plywood. The adhesive tape incorporated for holding the paper flat can be renewed as required. The instructions provide for half plate prints measuring $4\frac{1}{2}$ ins. by $6\frac{1}{2}$ ins., but you will be able to modify to any size.

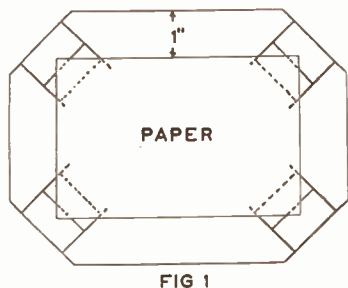

Fig. 1 reveals that a baseboard is cut out 2 ins. larger in both dimensions than the size of the paper to be used, in this case it is $8\frac{1}{2}$ ins. by $6\frac{1}{2}$ ins. We now measure $1\frac{1}{2}$ ins. from each corner, joining the two points and removing the waste by saw, afterwards smoothing with glasspaper. Mark points $\frac{1}{4}$ in. from the edge along this new cut, producing lines at right angles to a depth of $1\frac{1}{2}$ ins. The details of these measurements are clearly shown in the enlarged diagram of Fig. 2.

Printing guide

Before proceeding further, mark out a rectangle in indian ink to the size of the paper and which will be a useful guide during the process of printing. Following this, the prepared lines for the slots are cut by saw to the depth of $1\frac{1}{2}$ ins. as mentioned, treating every corner similarly.

We must provide means of keeping the printing paper firmly attached flat to the easel during the exposure. To obviate the use of pushpins each time a print is made we use strips of Sellotape threaded through the slots.

Reference to Fig. 3 reveals how a strip of this adhesive tape is attached to the back of the easel, taken through one slot and returned through the other slot to the back again. This leaves the adhesive side of the tape uppermost on the upper side of the easel and all that is required when using is to lay the paper in position on the prepared rectangle when it will adhere to the Sellotape. Since the corners

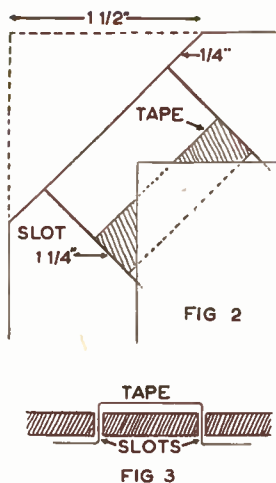

of the paper remain free, removal is quite easy and the tape may be used for many prints before requiring renewal.

You may add small rubber buffers at the corners of the underside if you wish to obviate any possible movement of the

By S. H. Longbottom

easel, and in the case of an easel for larger sized paper it may be advisable to prepare pairs of slots on the longer sides, threading the Sellotape through as before.

It is advisable to store the easel in a box when not in use to prevent too rapid evaporation of the adhesive. Moreover, there is also the possibility of dust settling of this tacky surface thus impairing its adhesive qualities.

Continued from page 246

Building the 'Royal Eagle'

In detail 4 we have the method I used in making the back-to-back seats, SE.3 to 7. By making them all in one strip and cutting each seat off to size we make sure that all are uniform, as even a slight difference occurring in seats made separately is noticeable when on the finished model. Take a piece of $\frac{3}{8}$ in. square stripwood (I used boxwood), and with an X-acto gouge, shape along two sides so that the end view is as shown. Carefully sand with very fine glasspaper and cut off each seat to length. Instead of painting, give each seat a coat of french polish with a small paint brush. With boxwood this gives a nice tone and colour, but is equally successful with other woods. We now have every one of these seats with exactly the same profile shape and quite strong for their size.

The next item is one I have always found to be a problem on small models of this type, and that is the handrails. At first I made my handrails for this model from cotton thread, but I found that, due to various circumstances, sooner or later the rails had a tendency to get out of line, or tilt over, perhaps after an attempt to clean the model, possibly through the action of the atmosphere on the thread. I therefore removed all handrails from the model and replaced with those made in the following manner.

A piece of plywood was prepared as a jig as in (5), and across this were stretched lengths of 5 amp. fuse wire stretched tightly. Uprights of fine slips of bamboo were cemented in position with Balsa cement, the bamboo being $\frac{3}{16}$ in. longer than the height of the finished rails to allow for insertion into holes drilled in the deck. The rails were carefully painted with Reeves model paint in white and then affixed to the hull by cementing into the holes drilled to receive the uprights. Reeves paints for models are thin enough to avoid making small parts overscale and yet have an excellent covering property.

The model was mounted in a glass case made with passe-partout as shown in detail (6), the glass fitting over the upper base firmly.

With detailed models such as this one it is better to house them in a dust-proof case. If left open on a stand the dust will collect and cannot be removed easily with so many tiny details such as seats, ventilators, etc.

The masts, again, were made of bamboo dowel, for strength, and the upright supports for the base were turned in Hobbies' lathe in walnut, to contrast with the base of light oak. A typical turned support is shown in detail (7).

FIFTY YEARS A MODELLER

It is very satisfying to look back fifty years and realise that for all that time I have had an interest in model-making and still continue the craft. I recall all the exhibitions I have been in, finding authentic material for new models, taking part in three television performances, and advise that any keen youngster can enjoy the same thrills and he will never regret it.

All I do say is 'make up your mind and follow a certain line of model-making. By all means have other hobbies and even vary the type of model-making, but if you are keen you will always come back to the section you like best'.

At the age of eight I took to model-making. To me anything was a model, and my first effort was a copy of a nearby factory. I well remember shaping the chimney stack round a cardboard canister. I made my own adhesive from gum arabic purchased at the chemists. This first model won me first prize at a local Band of Hope sale of work and I thus had my first box of paints.

After that, earning money to get the material was quite a nightmare because threepence a week would not buy much and for that I had to blacken shoes, clean the cutlery and slice up the weekly block of salt. I found other means of doing odd jobs and soon had money in hand. I actually bought a shilling bundle of

plaster laths which I stripped down (no mail order stripwood firms about in those days).

I started something which is still with me — a box for all sorts of oddments such as bits of wire, large pins from flag days, cotton reels, anything which I thought would come in useful. Every spare hour went on model-making.

My early days seemed to centre round making buildings and I had quite a range of these. That is probably the reason that I still have 80 ft. of scenery to go with my major fire scene! I developed the

Is there anything more to model-making than the satisfaction of having created something with one's own hands? Victor Sutton thinks there is, and in this retrospective of fifty years he brings his wide experience to bear in giving some useful and heartening advice to all who share this fascinating hobby.



A model for use in schools

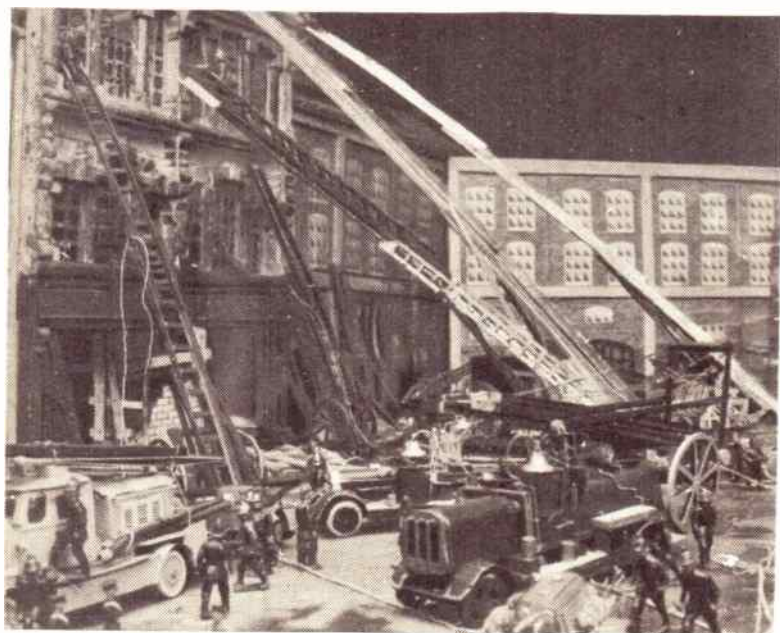

A major fire scene, which can be extended to 80 ft., showing three turntable ladders in use

habit of using any box to make a building and if you get a copy of my latest book, 'The Model Village' you will see that I have featured this quite a bit for beginners.

In the first year my mind turned a little to model vehicles and I made some of the very earliest charabancs which were so built to go up steps at the back so that people in the back seats could view the scenery. There were no manufactured wheels as we know them today. I had to cut up cotton reels, round them off and pack them with stripped paper to make the solid tyres. Steam-rollers, traction-engines and similar ideas developed and often I had ten on hand. I have nothing against having several models on hand, in fact I am all for it provided you finish them. What you like making on Monday night may not appeal to your temperament on Tuesday. Model-making must never be 'work' in that sense.

How far I shot off the beaten track may be interesting because I then made up a fleet of 7 airships. Some of these were 6ft. 6ins. long and three of them had their own hangar built on top of a shed.

From that stage I built a mast which rotated and thus I had the airships in

pairs floating over two gardens because the mast was 28ft. high. It was at this stage that an American journalist saw them from a neighbouring window and had some photographs taken. So actually I was 'in print' at the age of ten, and in America at that. Suffice it to say that my airships cost me little. Stripped laths, some poster paper and the ribs from father's old umbrella were all components of these craft.

Aircraft and ships

Next I went over to aircraft, but somehow this did not altogether appeal and the same applied to ship building, but I must say that there is a great interest in forming up sections, ribs and cut parts to make a good model. Unless you make a model you never know the interest. If one wants to get 'lost' — and by that I mean that those round you are sure that you are getting deaf — then model-making will do it.

My early fire brigade of thirty engines consisted of wood blocks, cotton reels and bent hairpins. My scenery was merely sheets of cardboard boxes stuck together and painted. Nowadays my



A good instance of the practical use of models for serious training purposes — Daily Mirror photograph



Some model vehicles of the R.A.F. which still attract much attention when shown

scenery looks as perfect as that seen in screen workshops. I paint it, I mark it and I slightly burn it with a candle after wetting the surface and I follow pictures of any burnt-out building so that those marks are just right.

On Television

It was in 1938 that a big display of my models was published in the *Daily Mirror* and was spotted by members of the B.B.C. I had a rehearsal and ten days later my fire scene was shown from Alexandra Palace. In 1948 and 1953 I again appeared on television with a cavalcade of fire models.

I have a complete history of the Fire Service from 1666 to 1958, thought to be the only set so complete. In another field I have thirty-five miniature vehicles of all the types used on our 'dromes during the war.

So now if you feel you are interested, set aside a little money, make a model you like, try to get it in an exhibition and set it up nicely. Have suitable boxes for

storage, collect information from catalogues, write to Press Officers of firms making various types of vehicles, seek information and learn from it.

What is there in model-making?

My answer is — a lot. You must be artist, model-maker, carpenter and odd job man. Models are used more and more in shop window displays. Scenic model-making is used in all film studio workshops. Aerial survey covering thousands of square miles means hundreds of thousands of photographs made into contour maps. No bridge, dam or waterway comes into being without the model. Few plants in machinery or factory will ever be tackled without a model. Decorators use models and so do furniture firms.

So if you have a bearing that way, study young, get all the model books you can and it can lead to a very worthwhile career.

The Curlew's Soft Call

THERE is no sound among all the varied bird calls of winter heard in the river valleys like the mellow, musical notes of the curlew, especially if there are several curlews together in the water meadows.

With their brownish-grey heads mottled beautifully, and their long curved bills and long stilts, they love to haunt the quiet flatlands by the riverside.

Their mellifluous notes come floating downwind, reminding one of the upland moors in springtime, of the scent of flowering gorse, the whistling of golden

plower nestling in the heather, and all the charm of the wild open spaces.

It is always pleasant to listen to the curlew on a winter's evening; it reminds us of the lines by Hurdis:

'A gentle curlew calling kind good-night

To the quiet villager.'

Never does the cry sound so lonesome as at such a time — lonesome, yet fascinating and glamorous. A different note to the one we hear from the mountainside on a bright spring morning!

(A.S.)

A SIMPLE STEAM ENGINE

THE model steam engine — be it stationary or mobile — never seems to lose its appeal. Here are details of a simple stationary model which any schoolboy can put together. All requirements are easily obtainable.

Requirements are: 1 empty syrup tin, 1 medium sized cocoa tin, 1 long iron nail or other similar sized metal rod, short length of copper tubing about 1 mm. inside diameter and about 3ins. long, 1 large bottle cork, 1 2 B.A. brass nut and bolt. A pair of tin shears or strong scissors, a soldering iron, a sharp razor blade and a small tack hammer will be required to work with.

Treacle and cocoa tin

A good idea of the general construction will be apparent from Fig. 1. First of all, using the tin shears, remove a square from the side of the treacle tin. The size of this aperture is not critical and can be from two to three inches. It should not be too large, however, or an undue draught will get to the lamp or burner. The cocoa tin acts as the boiler and is placed on top of the treacle tin (or lamp house) from which the lid has been removed.

We are now ready to assemble the mechanism. This consists of a large cork, which is cut with the razor blade so as to take eight pieces of tin (the fins), as indicated in Fig. 2.

The centre of the cork is pierced with a sharp steel skewer, to take the long

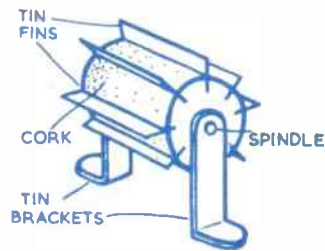
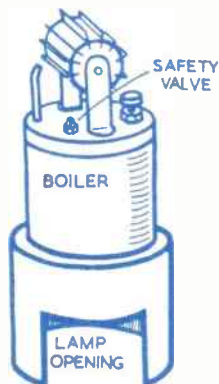

nail or spindle. A couple of tin brackets are then cut and bent, and soldered on to the cocoa tin or 'boiler' lid. These brackets of course are each drilled (as shown in Fig. 2), to take the nail spindle. A short length of the copper tube is bent, being then soldered into the boiler lid, in which a suitably sized hole has first been drilled. A second hole is now made in the lid to take the 2 B.A. bolt. The brass nut is then soldered over this hole, thus acting as a filler vent.

As a safety measure, a further hole must be made in the boiler lid, and a small safety valve fitted (obtainable from most toy stores).

The whole lid is secured finally with solder on to the boiler, and we are ready

to 'fill up'! This can best be done by making and using a small metal funnel. Filling up to about three parts full, then screw back the brass filler bolt into position,

The lamp itself may be just an ordinary domestic candle (cut down to fit snugly inside the treacle tin), or alternatively, a small paraffin burner (of the night light variety) may be used. Whichever method is adopted, care should be exercised to see that nothing inflammable is in close proximity.

The method of operation is simple. As the water heats, steam will emanate from the boiler via the copper tube, thus impinging on the 'fins' of the 'rotor', turning them round at a rapid rate. Although not sufficiently strong to drive external mechanism, a small flywheel could be attached to the centre pinion if desired.

Comparatively easy to make, this little model can give many hours of instructive entertainment. (S.G.W.)

Make a 'Boomerang' Tin

THE 'Boomerang Tin' is an entertaining toy which should keep a small boy amused for a long time. When the gaily decorated tin is rolled along a flat linoleum covered floor, it will return to its young owner in a most uncanny fashion. Here then are instructions for making the toy.

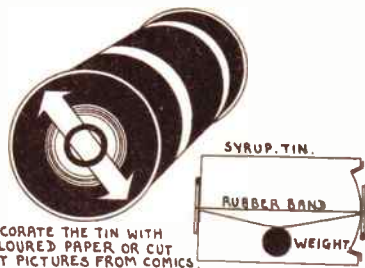

DECORATE THE TIN WITH COLOURED PAPER OR CUT OUT PICTURES FROM COMICS.

A syrup or coffee tin with a press-in lid will be found most suitable. Also required are two used matches, a strong rubber band, a small but heavy weight and a piece of thread or thin string.

Begin construction by tying the weight with thread to one side of the rubber band. Bore neat holes in the centre of the top and bottom of the tin. The holes should be of just the right size to let the ends of the rubber band pass through.

Next thread the ends of the rubber band through the holes in top and bottom of the tin and secure the ends in place with the matches. This procedure can be simplified if the ends of the rubber bands are pushed through the holes, using a thin blunt-ended knitting needle. The weight should hang in the centre of the tin. Finally press on the tin lid and make the toy look attractive by

painting it in bright colours. Cut-out figures of animals or comic characters can be gummed on afterwards if desired.

If the tin is rolled along the floor the hanging weight inside will cause the rubber band to become twisted until the tension is so great that the rubber has to unwind. When this happens the weight remains in place and the tin itself is made to roll back to its owner.

(A.E.W.)

- ★ ★ ★ ★ ★ ★ ★ ★ ★ ★ ★ ★ ★ ★ ★ ★
- ★
- ★ A tray for serving drinks which
- ★ eliminates the danger of spilling
- ★ will be described next week. Also
- ★ a windvane for the garden, various
- ★ toy projects, together with regular
- ★ features; make sure of your copy
- ★
- ★ ★ ★ ★ ★ ★ ★ ★ ★ ★ ★ ★ ★ ★ ★ ★

GET TO KNOW THE NEW R.A.F.

Can you identify this fighter?*

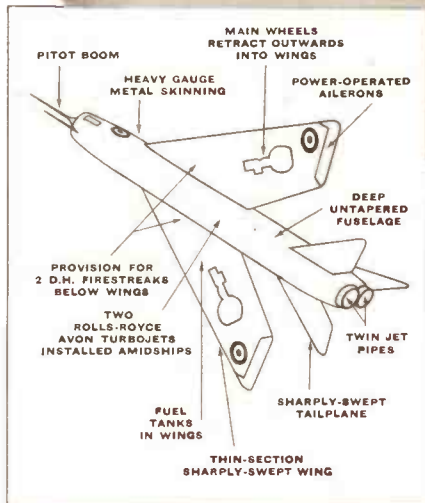
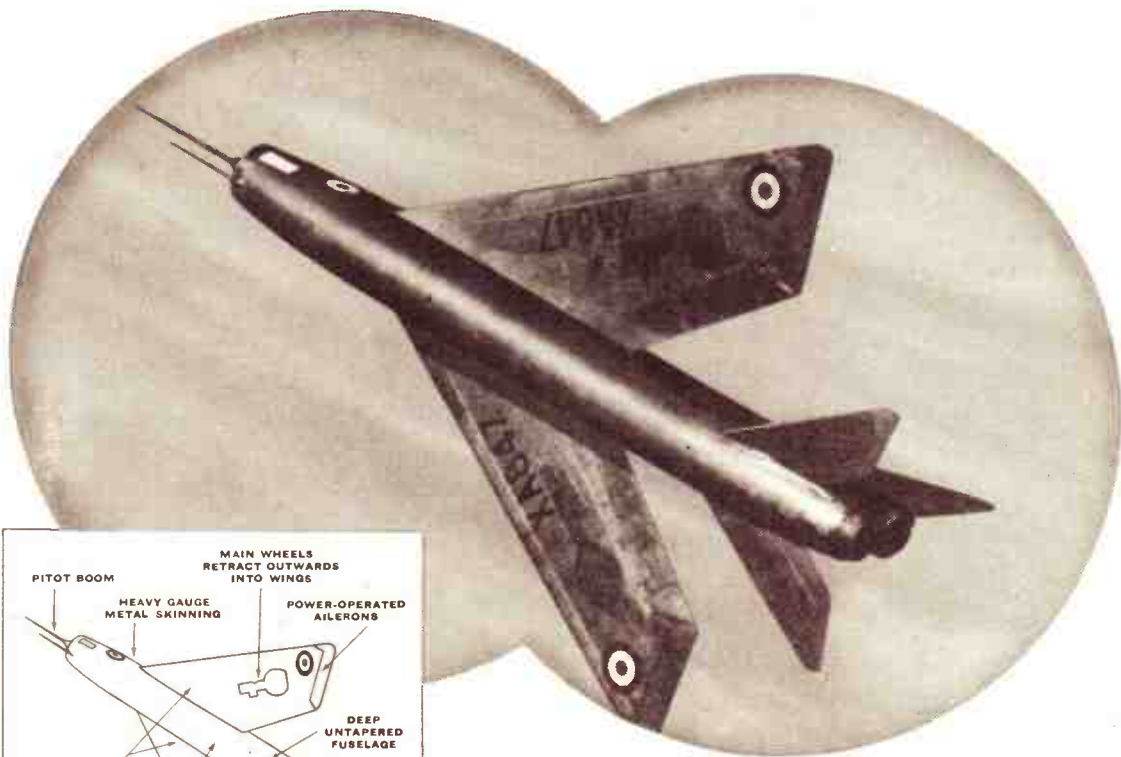

Faster than sound! It's one of the latest aircraft which will go into service with the Royal Air Force. With the terrific developments that are taking place all the time in aircraft and guided missiles, it's a jolly interesting life in the R.A.F. today. And you can join this exciting Service as an Apprentice between 15 and 17. Post the coupon *now* for full details.

There's a career for you in the R.A.F.

To: ROYAL AIR FORCE (H.S. 76), Victory House, London, W.C.2.

I am over 14. Please send me details of entry for R.A.F. Aircraft and Administrative Apprentices.

NAME.....

ADDRESS.....

Date of Birth.....

(Applicants from British Isles only)

If you're too young for the R.A.F.—join the Air Training Corps!

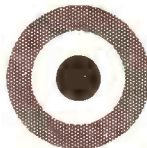

* This is the English Electric Lightning, Britain's superb new single-seat fighter which flies far above the speed of sound. Wing span 36 ft. . . . length 52 ft. The Lightning has provision for Firestreak guided missiles and 30 mm. Aden guns. It is powered by two Rolls-Royce Avon turbojets with reheat.

THE Turks are thorough Orientals. They wear turbans and long robes. They will sit at their shops without moving from morning until night, doing nothing but smoke.

Stamps first appeared in 1863; about 2,200 have been issued to date. Many are valuable, but beware of forgeries.

The Turk is very religious. He carries a carpet about with him, and at the stated five times of prayer, he spreads his carpet, turns towards Mecca, and goes through his devotions, teaching us never to be ashamed of our religion.

'Stamps 1953. 15 k. violet — St. John's Church and Acropolis — 3d. used. 20 k. slate — Statue of Blessed Virgin, Panaya Kapulu — 3d. used.'

The Turkish girl is depicted on stamps of 1941.

From the hills of Pera, the beautiful city of Istanbul presents a glorious sight below, with its mosques and palaces, its domes and minarets, and richly decorated buildings peeping out of groves of cypresses and luxuriant trees.

TURKEY AND THE BALKANS — R.L.C.

Istanbul is noted for its bazaars — a cluster of streets arched over and covered in. Each avenue of the bazaar is entirely given up to the sale of a particular kind of goods. On either side are arranged counters, whereon the goods are displayed, and which form a resting-place for the merchants.

The armoury bazaar is always busy. All around are suits of mail, old swords, rusty maces and battle axes, cumbrous fire-arms of antique make, Damascus swords, saddles and richly decorated pistols.

In the embroiderers' quarter are beautifully worked silks and scarves, shawls and carpets.

English children would love the sweetmeats bazaar where one can buy pre-



served rose-leaves, delicious cakes of sherbet paste, and all kinds of dainties.

'Stamps 1953. 60 k. brown — Map of Constantinople — 2/- used.'

The Balkan mountains include Pindus, the Dinaric Alps, Shar Dag, the Rhodope range, Athos, Ossa, Pelion, and Olympus, famous in olden times. Rivers include the Drin and Voyusa, flowing into the Adriatic; Salambria, Kara, Vardar, Struma, and Maritza, flowing into the Aegean. Principal lakes are Shkodra (formerly Scutari), 150 square miles, Ochrida and Janina.

'Stamps 1929. 7½ k. lake — Gorge and river — 2d. used.'

The soil is fertile. Enormous crops of grain and fruit are raised. Numbers of

wild animals find shelter in the dense forests that skirt the mountain sides. Amongst these are boars, bears, wolves, lynxes, wild cats and deer.

Imports include corn, manufactured goods and colonial produce. Exports are raw materials, carpets, fruits, olive oil, silk, cattle, leather and hides.

'Stamps 1938 — 6 k. brown — Woman Gathering Grapes — 1/3 used. 2½ k. green — Fig Tree — 6d. used. 5 k. olive — Olive Branch — 1/- used.'

The Turkish flag, a star and a crescent on a red field, is illustrated on cigarette cards, issued by John Player and Sons in 1938.

Mehmet Akif Ersoy, who composed the Turkish National Anthem, appears on stamps of 1956.

Valuable American Coins

MANY people think that the only coins that are valuable are old battered pieces that were originally saved for some sentimental reason. But some of the coins of later date may be more valuable from a numismatic standpoint.

A new piece may have been kept because it was the first of a new design, or because it was issued on one's birthday. A trip by someone to the Mint might have encouraged the saving of a whole issue of new coins of that year. There are innumerable reasons why such coins would be saved. They may be black with tarnish now, but still unused, and those are the pieces that are liable to be valuable.

Take American coins for example. An uncirculated set of quarters of any year during World War I would be worth a great deal today.

Recently, a dollar gold piece dated 1926 with a 'D' for Denver Mint directly over the date sold for £40.

Many people kept as a souvenir the Teddy Roosevelt 20 dollar gold piece with the date—1907—in Roman numerals. The coin, with high relief (first of the new St. Gaudens's designed Twenties), is worth about £20, if in fine condition.

Denver Mint dimes of 1916 in uncirculated condition fetch between £20 and £25 at auction. Multiply that by fifty — the number of dimes in a 5 dollar roll — and you have a tidy sum.

The Denver quarter of 1932 is worth about £5.

Old large-sized paper money printed before 1928 is beginning to come into its own.

Speaking about the Mercury dime and its reverse, the fasces upon it: the Fasces of Roman Antiquity consist of an axe tied up with a bundle of rods and borne before the magistrates as a badge of their authority; the emblematical weapons used by the Romans and borne by the lictors before the Consuls, Emperors and Magistrates, both civil and military. They were not always purely ornamental, however, for the switches drawn by the lictor were used for flogging and the axe for decapitation.

Any reader in need of help, U.S.A. pen friends, etc, should write to the Editor, *Hobbies Weekly*, Dereham, Norfolk, enclosing stamp for reply. But do remember that we cannot evaluate coins; addresses of expert numismatic firms where such information is obtainable can, however, be given.



GAPS of 1/16"?

If you can't cut an accurate joint....



if you can see gaps when you fit the joint together . . . then ordinary glue (even with screws or nails as well) will never produce a really sound woodworking job. But use CASCAMITE "One Shot"—the gap-filling powdered resin glue that is easy to use because the hardener is incorporated in the powder—and you can fill gaps of as much as $\frac{1}{16}$ ". This special advantage is one of the reasons why so many professional woodworkers use CASCAMITE "One-Shot"; they play safe, even with machine cut joints. And remember, too, that this outstanding wood glue is also waterproof, non-staining, and heat and mould resistant. Packed in 3½, 7 and 18 oz. tins (2/6d., 4/-, and 8/6d. respectively). Also in larger sizes.



But for a good general-purpose glue, be sure to get CASCO Grade 'A' (Powdered) Casein glue. It glues almost everything, is easy to use and is most economical (2½ oz. of powder make 7½ oz. liquid glue). Packed in 2½, 7½ and 16 oz. tins (2/-, 4/6d., and 7/6d. respectively). Also in larger sizes.

Stocked by Ironmongers, Builders' Merchants, Handicraft Shops etc.



SYNTHETIC RESIN & CASEIN GLUES

Manufactured by: LEICESTER, LOVELL & CO. LTD · NORTH BADDESLEY · SOUTHAMPTON

The Pride of any Boy

'JAPONICA'

A magnificent Sailing Cruiser with Auxiliary Motor

This fine model of a characteristic craft used on the Norfolk Broads is 20 ins. long. Extra mechanical power is provided by a Mighty Midget electric motor and propeller unit.

Make this magnificent craft with Hobbies Kit No. 3254 containing all wood, materials, motor, propeller, metal keel, etc., and easy-to-follow instructions. From branches, stockists, etc., or by post.

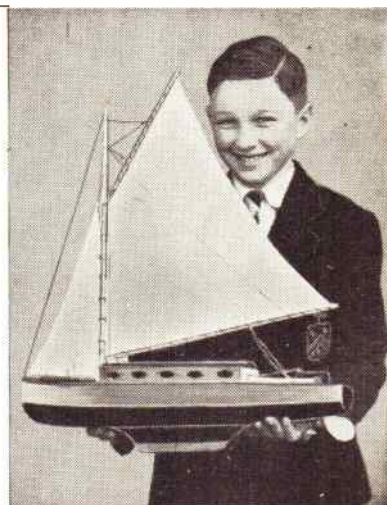

'JAPONICA' Kit No. 3254 65/-

FREE 20-page booklet 'Profitable Leisure' showing kits available for dozens of other exciting models (ships, aircraft, etc.)



GET A KIT TODAY

To HOBBIES LTD,
Dept. 99, Dereham, Norfolk

Please send free copy of 'Profitable Leisure' and 'Japonica' Kit No. 3254.
P.O. for 65/- enclosed.

Name

Address

*** GREAT CAMPING OFFER ***
RIDGE TENT SENT FOR 4/6



BRAND NEW de luxe 'Safety' Tent. All colours. Complete. Ideal cyclists, campers. Length 7' 3" sleeping base x 4' 6" wide x 3' 6" high x 12" walls, all approx. Weight 3 1/2 lb. Cash 55/-, or 4/- deposit and 9 monthly payments 6/-. 1 of 2/6. WITH FLYSHEET 83/6, or 9/3 deposit and 8 monthly payments of 9/9, 1 of 4/9. Both carriage 2/6. LISTS, TENTS, TERMS.

GREAT HALF PRICE OFFER!

"Matahari"

FOLDING CAMP BEDS



CASH PRICE 27/6

Makes Camping Holidays a Joy!

BRAND NEW, famous lightweight, tremendously strong beds fold to practically nothing in size for easy transport. Full 6 ft. length, normal width. This represents the finest camping bargain. Half price of other types. Lightweight rustless sprung steel. Lasts years. Ideal as occasional bed for visitors. Makes up like divan. 27/6, post 3/6. Three for 89/6, including post. Headquarter & General Supplies Ltd. (HOBW/46) 196-200 Coldharbour Lane Loughboro Junc., London, S.E.6 Open Sat.

KUKLOS ANNUAL. Indispensable cyclists' handbook. Tours, resthouses, money-saving hints, 3/- post free. — Burrow, Publishers, 2 Imperial House, Cheltenham.

MODELS. You can make lasting stone-hard models with Sankey's Pyrama Plastic Cement. Supplied in tins by Ironmongers, Hardwaremen and Builders' Merchants. Ask for instruction leaflet.

15/6 CRYSTAL RADIO kit. Easy-to-build with only a screwdriver and pliers. Post free, send 15/6 P.O. — ALSO 1 and 2 valve kits, headphones, etc. Send stamped addressed envelope for complete list to Blanchard's Radio, Dept. HC8, 13 Galford Gardens, Manchester 10.

10,000 FORMULAS. Trade secrets, recipes, processes. Remarkable 900 page book. Only few available. Money back guarantee. 27/6 p. pd. — S. P. Ltd., 28(H.B.) Dean Road, London, N.W.2.

MAKE A MUSICAL BOX for as little as 21/-. New kits and tunes available. Movements 13/- post free. Please send 3d. stamp for free illustrated catalogue. — The Swisscross Co., Dept. B, 202 Tulse Hill, London, S.W.2.

HOW TO STOP SMOKING

and permanently overcome that ceaseless craving for tobacco. Save money, safeguard health. Send stamp for details of the world-famous inexpensive Stanley Treatment for tobacco habit.

THE STANLEY INSTITUTE LTD Dept. 30
12 Bridewell Place, London E.C.4

HOBBIES BRANCHES

LONDON

78a New Oxford Street, W.C.1
(Phone MUSEUM 2975)
87 Old Broad Street, E.C.2
(LONDON Wall 4375)
81 Streatham Hill, S.W.2
(TULSe Hill 8796)

GLASGOW—326 Argyle Street
(Phone CENTRAL 5042)

MANCHESTER—10 Piccadilly
(Phone CENTRAL 1787)

BIRMINGHAM—100a Dale End

SHEFFIELD—4 St. Paul's Parade
(Phone 26071)

LEEDS—10 Queen Victoria Street
(Phone 28639)

HULL—179 Ferensway

SOUTHAMPTON—134 High St.
(Below Bar)

BRISTOL—65 Fairfax Street

NEWCASTLE—42 Dean Street
Newcastle-on-Tyne 1

GRIMSBY—88 Victoria Street

100 DIFFERENT stamps free! Request 4d. upwards discount approvals. — Bush, 53 Newlyn Way, Parkstone, Dorset.

MEN/WOMEN with spare time, required for new simple weaving work. For details send S.A.E. — Dept. 4, Weava Products, 10 Shelley Road, Worthing.

FREE stamp album and 20 stamps. Request approvals, enclosing 6d. Additional gifts given. — Beeze, 8 Langland Villas, Mumbles, Swansea.

STAMPS FREE — Empire Packet including Pictorials and Victorians with approvals. — Robert J. Peck, 7A Kemp Road, Bournemouth.

WHEELS (Hardwood and Rubber Tyred Metal). Cot, Pram and Doll's House Fittings and Papers, Beads, Transfers, Prints and other accessories. Stamp for new lists. (Trade supplied.) New address — JOYDEN CO., 91 Peplins Way, Brookmans Park, Herts.

STICK TO SECCOTINE

it sticks everything

SECCOTINE

1/3 PER TUBE

Sole Manufacturers —

McCAW, STEVENSON & ORR LTD., BELFAST

You simply pour out these
NOVELTIES
with NEW LIQUID PLASTIC

Here's the hobby to make your spare time pay dividends. You simply choose your mould and pour out beautiful castings. We supply everything, including instructions. Wonderful results achieved — wonderfully quickly! Start right away — no training needed. Send 6d. stamp for exciting book and market details. No obligation.

QUALITY PLASTICS LTD.
Dept. H31, Brentwood, Essex



APPARATUS & CHEMICALS

For your experiments. Let us help you equip a HOME LABORATORY

Beakers, Crucibles, Flasks, Funnels, Gas Jars, Test Tubes, etc.

Booklets:
(including postage)

- 'Experiments' 1/2
- 'Formulas' 1/2
- 'Home Chemistry' 2/10

Send 3d. Stamp for latest PRICE LIST

A. N. BECK & SONS (Dept. H.W.)
60 Stoke Newington High Street, London, N.16

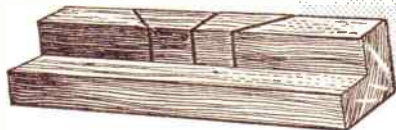

WOOD MITRE BLOCK

Price 3/3 (post 1/-)

This 9in. block is handy for cutting mitres on any small work — moulding, edgings, etc. Made of selected hardwood with right angle and 45° slots for the small tenon saw

From branches or:
HOBBIES LTD., DEREHAM, NORFOLK

HEAR ALL CONTINENTS

With **H.A.C. Short-Wave Receivers**

Suppliers for over 18 years of radio S-W Receivers of quality. One-Valve Kit, Price 25/- Two-Valve Kit, Price 50/- Improved designs with Denco coils. All kits complete with all components, accessories and full instructions. Before ordering, call and inspect a demonstration receiver, or send stamped addressed envelope for descriptive catalogue.

'H.A.C.' Short-Wave Products (Dept. 22), 11 Old Bond Street, London, W.1.

A HANDY TIE RACK

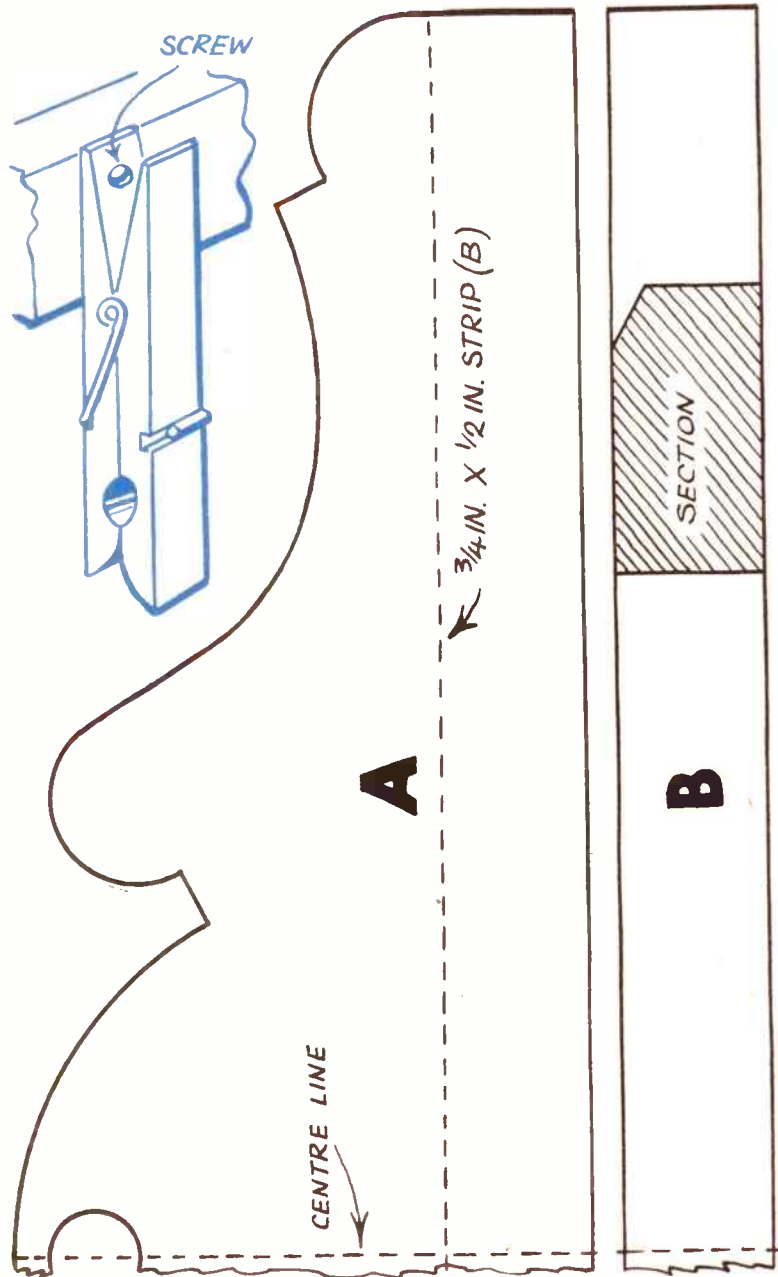

Neat and Tidy

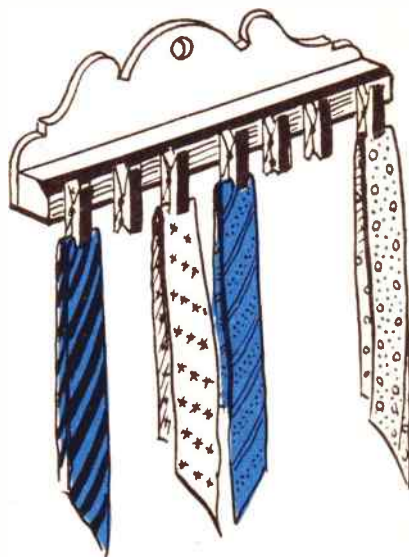

MADE IN AN EVENING

KEEP your ties free from creases. Hang them from a neat and attractive rack which you can make in one evening.

The back (A) is cut out with a fretsaw from $\frac{1}{4}$ in. wood, and the rail (B) is a length of $1\frac{1}{2}$ in. by $\frac{1}{2}$ in. stripwood. Glue the rail (B) to the back (A) in the position shown by the dotted line. Shape the rail to the section shown.

When tracing the back, remember that only half of the shape is shown.

The ties are hung from clothes-pegs which are screwed to the rail as shown in the small diagram. It is a simple matter to twist the two portions of the peg to allow the screw to be inserted.

Paint the back and rail white, and the pegs in different colours. Bright colours, such as red, blue and yellow should be used. (M.p.)

For wood,
card,
plastic,
leather,
metal, etc.

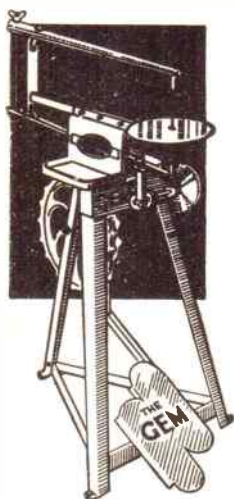

£5 - 17 - 6

HOBBIES LIMITED, DEREHAM, NORFOLK

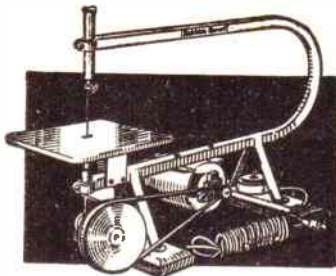

£12 - 5 - 0

TREADLE OR MOTOR FRETSAWS

Whatever the handyman or craftsman is cutting or making, one of Hobbies Fretmachines will help with the job. For toy making, fretwork, model making, it provides easy and speedy cutting in all kinds of material. A pleasure to use, a factory for output, a lifetime of service.

Obtainable at any Hobbies Branch or good class ironmonger or hardware stores. Or carriage paid U.K. from:



SPEED YOUR WORK

with POLYSTIK P.V.A. adhesive

Use Polystik P.V.A. for everything. Polystik is strong. Polystik is reliable. And Polystik will save you time.

READY TO USE No stirring, no heating, you can use Polystik straight out of the bottle or jar.

QUICK SPREADING Flows onto your work from bottle or brush — you get an even film.

FAST DRYING Polystik grips in a few seconds. Cuts down cramping time. Minimises delays.

Croid POLYSTIK
Polythene bottles 2/6, 28 oz. jars 12/6

CROID LTD., IMPERIAL HOUSE, KINGSWAY, LONDON, W.C.2



For
REPAIRING
FIREPLACES

IN THE BLUE
and
WHITE TIN
PRICES

1 lb. 1/9
2 lb. 2/9



PURIMACHOS LTD
ST. PHILIPS · BRISTOL 2

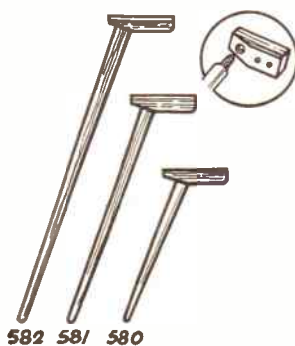

You Can Make
a Modern
Table in
One Evening
with these legs



FOR ALL
CONTEMPORARY
FURNITURE

A coffee table, TV table, footstool, etc. . . . all can be made in quick time with these Contemporary style legs. Beautifully turned in Scandinavian beech, they can be left in their natural colour, or stained. Each leg is threaded at one end to screw into a hardwood block (see inset) which, in turn, is screwed to the underside of a piece of plywood or suitable material which forms the table top. Simple . . . and a perfect job. The legs are obtainable in three sizes:—10 ins. 2/3 each, 15 ins. 2/6 each and 20 ins. 3/- each. Postage on 3 or 4 legs 1/6 extra. Legs from branches or:

HOBBIES LTD, Dept 99, Dereham, Norfolk

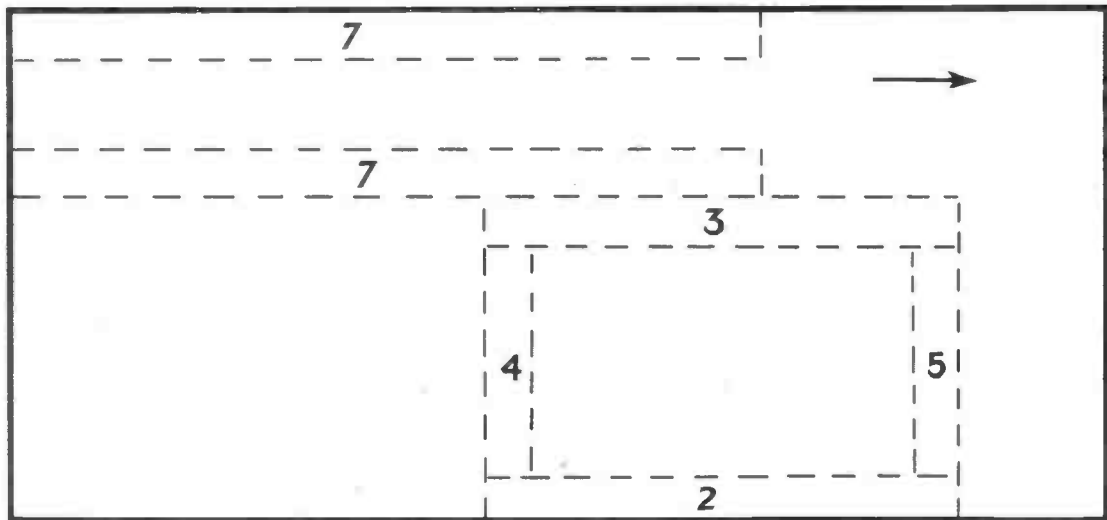

PIECE 1. CUT ONE 1/4 in.

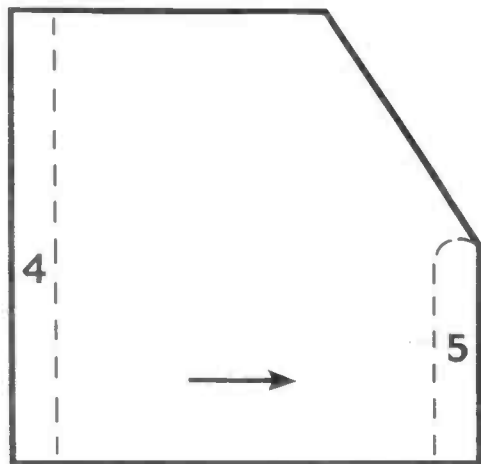

PIECE 3. CUT ONE 1/4 in.

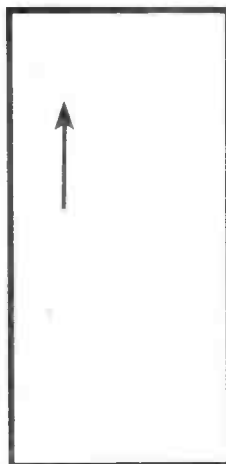

PIECE 4. CUT ONE 1/4 in.

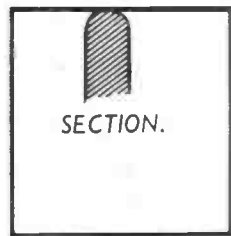

PIECE 5. CUT ONE 1/4 in. SHAPE TO SECTION.

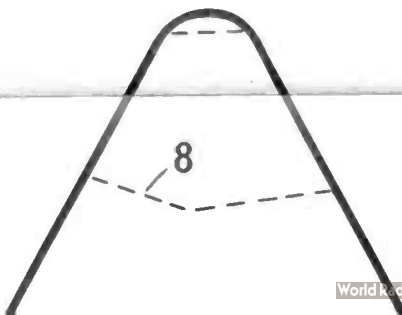

PIECES 7. CUT ONE OF EACH 1/4 in.

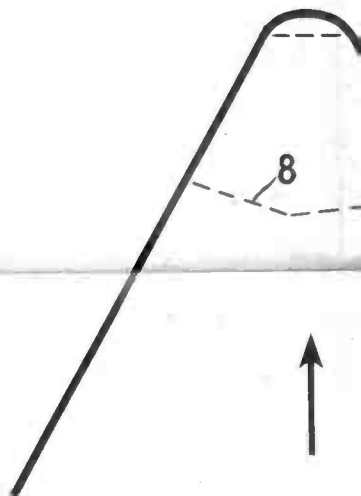



DESIGN

No. 3298

A TOY PULL-ALONG CRANE

SIZE $7\frac{1}{2}$ ins. \times $3\frac{1}{2}$ ins. \times $5\frac{1}{4}$ ins. HIGH

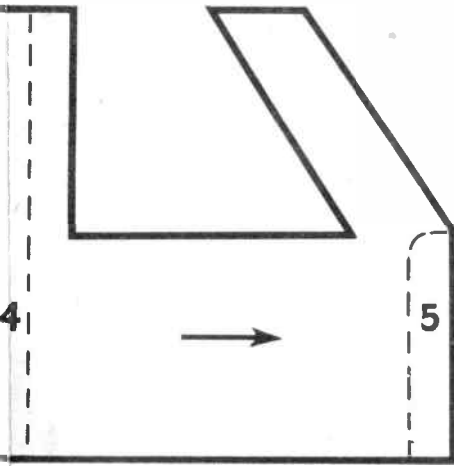

PIECE 2. CUT ONE $\frac{1}{4}$ in.

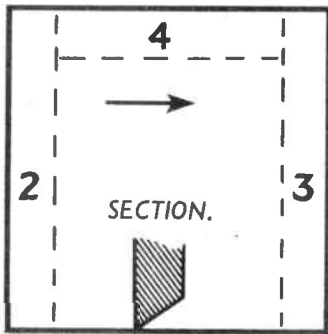

PIECE 6.
CUT ONE $\frac{1}{4}$ in. SHAPE
TO SECTION.

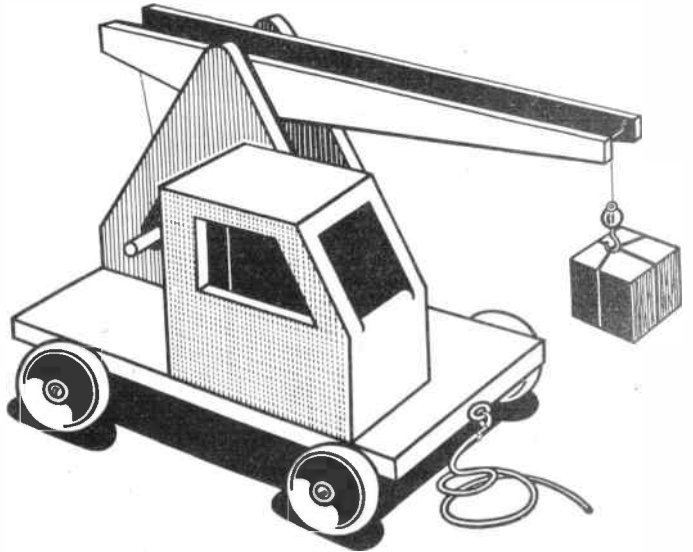

PANELS OF WOOD
REQUIRED FOR THIS DESIGN.

ONE **H4** ONE **G2**

A KIT OF MATERIALS FOR MAKING THIS
DESIGN IS SUPPLIED BY HOBBIES LIMITED
DEREHAM, NORFOLK.
PRICE ON APPLICATION.

BEAD OR
WOODEN BALL.

BENT
WIRE.



PIECE 3. CUT ONE 1/4 in.

PIECE 4. CUT ONE 1/4 in.

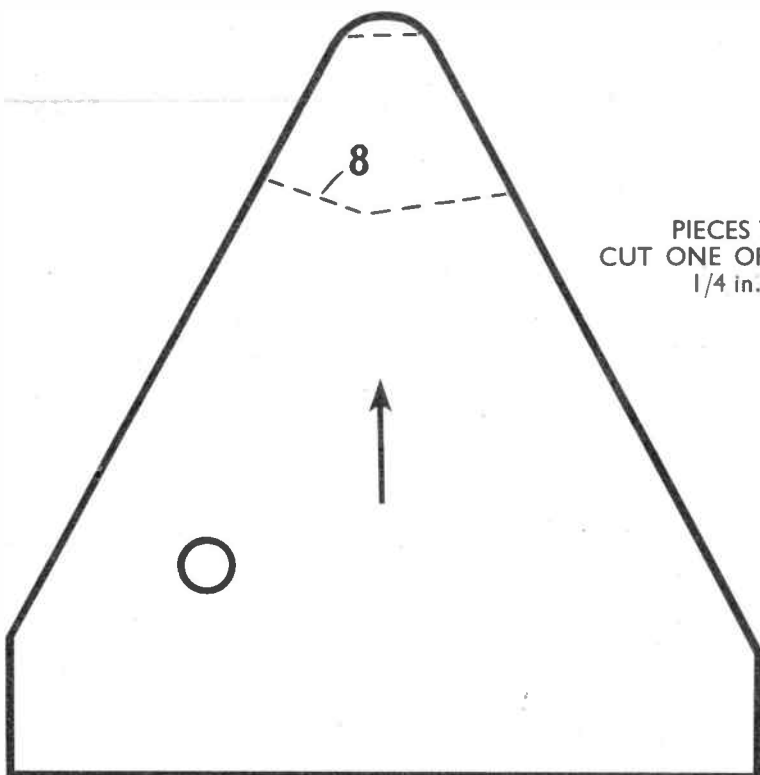

PIECES 7. CUT ONE OF EACH 1/4 in.

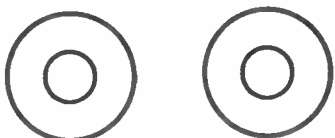
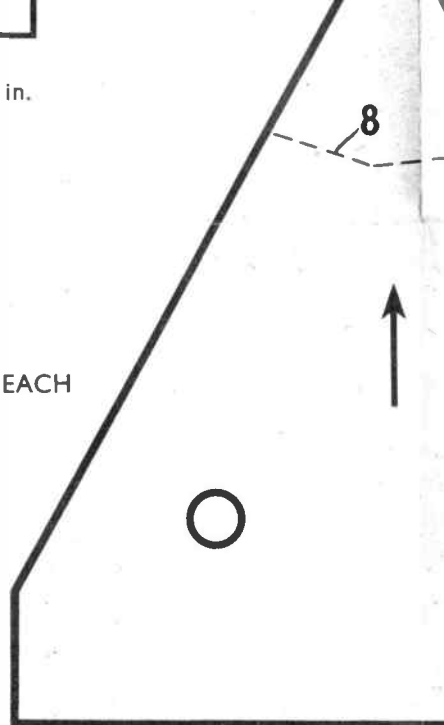

PIECES 9. CUT ONE OF EACH 1/8 in.



PIECE 10. CUT ONE 1/4 in. ROUND ROD.

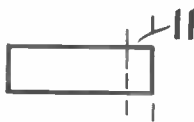

PIECE 12. CUT ONE 1/4 in. ROUND ROD.

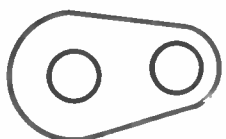

PIECE 11. CUT ONE 1/8 ins.

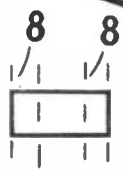
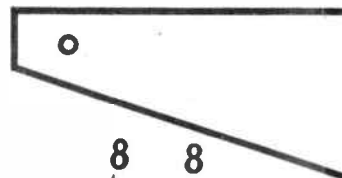
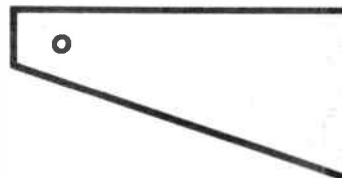

PIECE 13. CUT ONE 1/4 in. ROUND ROD.

A KIT OF MATERIALS FOR MAKING THIS
DESIGN IS SUPPLIED BY HOBBIES LIMITED
DEREHAM, NORFOLK.
PRICE ON APPLICATION.

BEAD OR
WOODEN BALL.

BENT
WIRE.

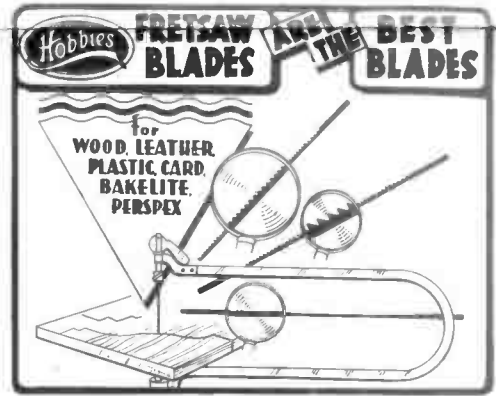

PIECE 14. CUT TWO FROM 1/2 in. SQ.
STRIPWOOD.

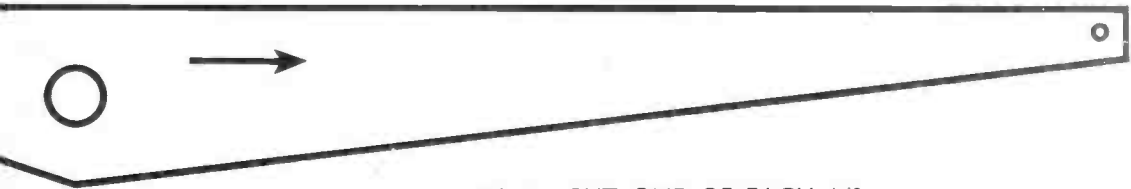

PIECES 8. CUT ONE OF EACH 1/8 in.



THE ARROWS INDICATE
DIRECTION OF GRAIN OF
WOOD.

PRINTED IN ENGLAND.