

HOBBIES WEEKLY

OCTOBER 1st 1958

VOL. 126

NUMBER 3283

IN THIS ISSUE

	Page
Cabinet for Coins - - - - -	401
Cinders? — The answer's a Riddle! - - - - -	402
A Colourful Spill Holder - - - - -	403
Make the Best of Things - - - - -	404
Two Minute Quiz - - - - -	405
Attention to Guttering - - - - -	406
Stool for a Child - - - - -	407
Money Box with Secret Opening - - - - -	408
Collectors' Club - - - - -	410
Naturecraft Ornaments - - - - -	412
Useful Spring Scales - - - - -	415



All correspondence should be addressed to the Editor, Hobbies Weekly, Dereham, Norfolk

Full instructions
for making

CABINET FOR COINS

THE hobby of coin collecting has become increasingly popular in recent years, and there is no doubt that a collection of coins in good condition is a beautiful, instructive and valuable possession. Coins stored in envelopes and small boxes are not displayed to advantage, however, and a few hour's work in constructing a special cabinet would be time well spent.

The cabinet should include a number of shallow trays which are divided into partitions for the coins. Any number of trays may be used, depending, of course, upon the size of the collection. For this reason only approximate measurements are indicated on the diagrams.

The construction of the cabinet is shown in Fig. 1. The sides, top, bottom and back are all cut from $\frac{1}{2}$ in. wood, and are glued and pinned together. They are strengthened by the addition of $\frac{1}{4}$ in.

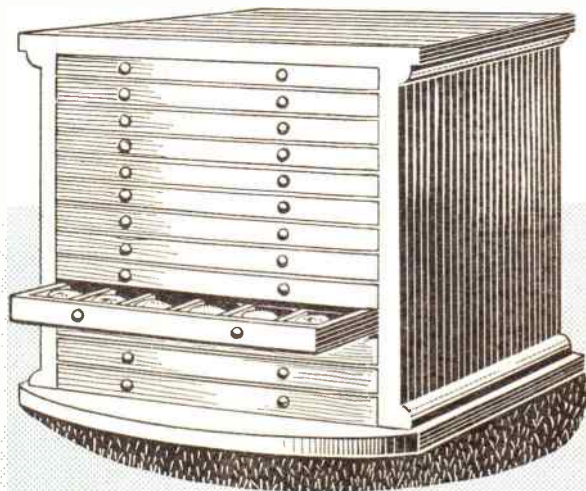

TO HOUSE YOUR VALUABLE COLLECTION

quarter round beading glued in the corners.

The trays are supported by $\frac{1}{4}$ in. square stripwood glued to the sides as shown in Fig. 1. Space the runners so that there is just enough clearance for the trays. Runners should be well smoothed with fine glasspaper before fixing, and should be recessed $\frac{1}{4}$ in. from the front.

Trays are all the same size and must fit nicely into the cabinet. The bottom should be $\frac{1}{4}$ in. thick, and the sides and back are of $\frac{1}{4}$ in. by $\frac{1}{4}$ in. stripwood, the fronts being of $\frac{1}{4}$ in. by $\frac{1}{4}$ in. The sizes are indicated in Fig. 2, and give a depth of $\frac{1}{4}$ in. The drawer front extends $\frac{1}{4}$ in. below the floor to compensate for the thickness of the runners.

401

FOR ALL HOME CRAFTSMEN
Over 60 years of 'Do-it-Yourself'
World Radio History

4¹/₂^D

The tray is divided into a number of partitions according to the size of coins to be displayed. Use $\frac{3}{8}$ in. by $\frac{1}{4}$ in. strip-wood for the divisions and glue direct to the bottom. Divide the tray neatly, keeping the spaces as square as possible.

For small coins up to farthings and sixpences you need about 1 in. square. Halfpennies and shillings need about $1\frac{1}{2}$ ins. square, pennies and half crowns $1\frac{3}{4}$ ins., crowns and twopenny pieces $1\frac{3}{4}$ ins. Old copper coins will, of course, need larger spaces than the modern bronze issues.

For withdrawing the trays, small knobs such as Hobbies No. 80 or No. 49 may be used. The tray fronts are drilled to suit the shanks which are then glued in position. No. 80 knobs, $\frac{1}{4}$ in., cost 6d. per doz. and No. 49, $\frac{3}{8}$ in., 1/- per doz. Postage and packing 6d. extra

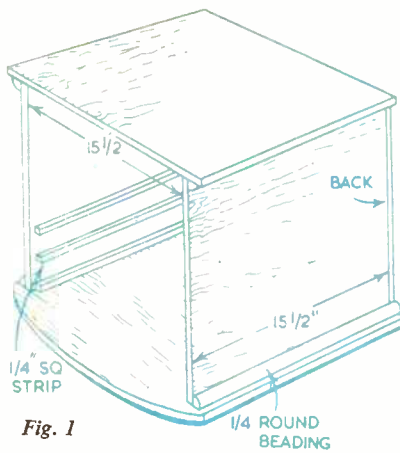

Fig. 1

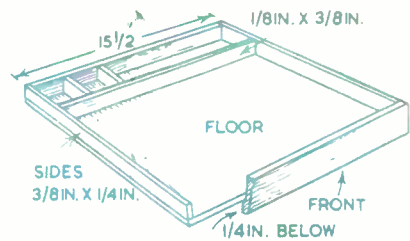

Fig. 2

on any quantity from Hobbies Ltd., Dereham, Norfolk.

To finish, the whole cabinet may be stained and varnished or painted. Small labels, neatly painted can be glued to the fronts of the trays to indicate the contents, while the interior may be lined with flock paper. (M.h.)

CINDERS? – The answer's a Riddle!

IT is no new idea to riddle (or sieve) your fire ash to retrieve the small clinkers for replacing on your next fire. Most people already use this shilling-saving method. However, it can be a very messy job, standing over the dustbin and getting enveloped in choking rising dust as you perform the riddling.

From scraps of old wood or an orange box or two, anyone can make an enclosed riddler as shown in the drawing. It consists of a fitting that encloses a bucket and a top tray, protected by a lid.

In the tray has been cut a circular hole just large enough for the sieve to fit over.

The bottoms of the side pieces are cut in an arc shape. An ordinary coat-hanger makes a useful guide for marking off the arc. When the fitting is rocked, the ashes fall through the sieve into the bucket. The drop lid of the unit prevents the dust from rising, whilst a circular chute made of sacking, nailed to the underside of the top tray, guides the ashes safely into the bucket underneath.

Make the inside square of the top tray

of dimension just a little larger than the circumference of the sieve, so that same does not wander about. Also, make a small flat (approximately 2 ins. long) at the apex of the arcs cut on the side-bottoms, so that the fitting will stand upright when not in use.

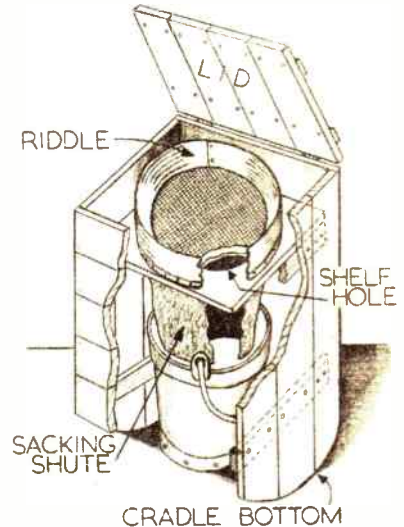

NEXT WEEK'S BUMPER ISSUE

Readers are particularly advised to make sure of their copy of *Hobbies Weekly* next Wednesday, as it will be the Special Birthday Number extending to 32 pages — a double issue.

There will be more than value for money in this edition, which celebrates the start of our 63rd year of publication. For instance, with every copy there will be included a free design and full instructions for making a charming trinket or cigarette box, the theme of which will be the well-known romance of the Willow Pattern Plate. The model, which will incorporate a musical movement, will be in the shape of the Chinese pagoda and scenes from the story are depicted on the side panels of the box.

This design should particularly interest those keen workers who often ask for something 'more difficult', but at the same time the make-up of the model has been so arranged that it can be confidently undertaken by all. In any case, it is a subject which should be a universal favourite for making up as gifts, particularly with Christmas in view.

Also, through the generosity of our printers, Messrs Balding & Mansell of Wisbech, we shall be including in next week's issue a fine colour print with instructions for making it into a jigsaw puzzle.

Radio fans will be catered for with details and circuit for building a two-transistor receiver and full-size patterns will be included for an animated toy, another ideal gift project for children. Many other 'how-to-make' articles are in this bumper issue which for that week only will be priced 9d. so

MAKE SURE OF YOUR COPY

A COLOURFUL SPILL HOLDER

MOST rooms can be much enlivened with a spot of colour, especially in the winter time, when flowers are scarce. Articles, brightly coloured are valuable in this respect and such prosaic things as spills, useful as match savers, can well be employed as they are available, dyed in a variety of gay colours. A suitable holder for these is the subject of this article.

It is quite an attractive ornament in itself, and enhances the colourful effect of the spills. As shown in the drawing a clownish figure is depicted, holding five toy balloons each a different colour, the colour being imparted by the spills

centres of the five holes, which represent the toy balloons. The end ones are centred $\frac{1}{8}$ in. from the sides, and the intermediate ones $\frac{1}{4}$ in. apart, centre to centre. They are staggered, as shown and should be positioned about $1\frac{1}{2}$ in. from the top.

Place the wood on a spare bit of deal, or box wood, and bore the holes with a $\frac{1}{8}$ in. centre bit, clean out the edges of these holes with a scrap of fine glass-paper, wrapped round a finger and rubbed round the holes gently, remembering that the wood is very thin. This part, and that already cut for the plain back should be glued and nailed to strips of $\frac{3}{8}$ in. fretwood at sides and bottom to make a case, as seen in the side view, Fig. 2. The position of these

strips is clearly indicated by the dotted lines in Fig. 1.

The divisional pieces, which separate the coloured spills, keeping each group of colours apart, are 1 in. long pieces of $\frac{1}{8}$ in. fretwood, the same width, of course, as the side and bottom strips, i.e. $\frac{1}{8}$ in. These are spaced $\frac{1}{8}$ in. apart, as the dotted lines show up. Apply a little glue to the side edges of each and slide in position. Allow time for the glue to set hard.

In the meantime cut the base. Any suitable oddment of wood will serve here, even a piece of common deal. The exact thickness is left to individual choice, but $\frac{3}{8}$ in. wood, if available, will suit very well.



Fig. 2

Cut the width given in Fig. 2, and make it 1 in. longer than the case. The edges can be quarter rounded, as in the diagram or just bevelled if preferred. Fix the case to its base with a couple of screws, well countersunk to avoid the risk of scratching a polished furniture surface.

The figure of the clown, is drawn over $\frac{1}{8}$ in. squares in Fig. 1. Draw the squares full size on to thin paper and copy the

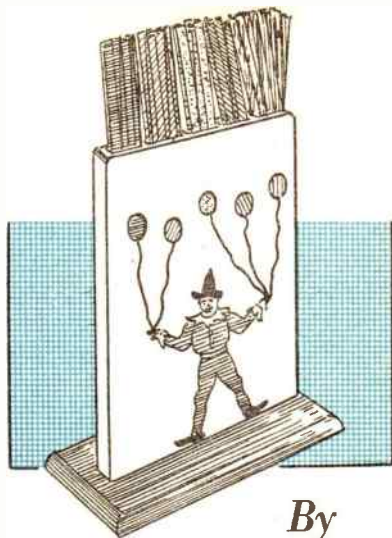

By
W. J. E.

figure, which is quite a simple one. Trace this through carbon paper on to the case. Then give the case a coat of thin size or clear varnish, to fill the grain, preparatory to painting or lacquering the article.

The finish of the spill holder is a matter of individual choice, but for the benefit of those who may prefer some guidance it is suggested that the base and case, except the figure, should be given a coat of black lacquer. This will show the coloured spills to advantage. Paint the face and hands of the clown yellow, his suit green, with brown for his hat and feet. Details of the face and hands and the balloon cords can be added with a fine brush dipped in black or brown enamel.

The final touch is to glue inside the case some lengths of coloured spill to cover the holes. Three short lengths of spill side by side will do this. It is not a difficult job if a little tube glue is applied on the inside of the case around each hole, using a small brush, or a thin shiver of wood. Press the spills flat over each hole and when the glue is hard, cut off any surplus above the case.

This part of the job could be done, of course, directly after the holes are bored and before the case is made up. If this method is adopted, quite short lengths of spill, say about 1 in. long would serve, glued well down. A little of the colour to be used for the painting of the case should be applied to the edges of the holes beforehand.

It is of course intended that the colour of each group of spills should match that of the balloon for each division.

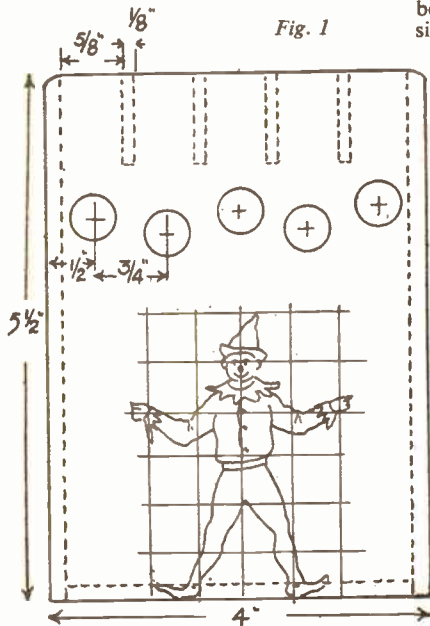

Fig. 1

inside the holder. It is quite a simple article to construct and can be made mostly of spare oddments of fretwood of thicknesses $\frac{1}{8}$ in., $\frac{3}{8}$ in. and thinner material for front and back. These latter parts could be cut from $\frac{1}{8}$ in. wood, or 1 in. wood, the last named being sold as a panel (P.P.M.) measuring 11 ins. by 4 ins. To avoid waste, this panel, cut into two equal pieces, will form both back and front of the holder.

The outside dimensions of the front and back parts are given in Fig. 1. Cut these to size, and on what will subsequently be the front, mark out the

Make the Best of Things

THE beginner at photography soon learns with his first family snaps that intrusive objects not connected with the main scene can be an irritating nuisance — and thereafter avoids placing his subjects so that in the final print they seem to have telephone poles or trees growing from their heads, or avoids positioning them against the background of a strongly lit, heavily patterned, eye-catching wall.

When he branches out from the holiday snap of the family and uses his camera for general views, snaps of buildings and appealing corners, he may easily forget his first lesson on 'irritating nuisances' which steal the eye-interest in the final print — only to find that they lie in wait everywhere for the unwary photographer!

They are usually man-made — gaunt telegraph poles right in the foreground, ornate old fashioned lamp-posts or modern concrete ones, a mass of telephone wires streaking right across the sky on which he used the new filter to bring out the white clouds, or the heavy,

thick curve of overhead electricity power lines. And Nature lends a hand to annoy sometimes — the low overhang of lower tree branches, tall stalks of wild grasses and thistles sticking up and dotting the foreground and looking even more prominent in the print, maybe, because they're waving in the breeze and all blurred or highlighted.

When he eagerly examines his prints he finds to his annoyance that the 'eye interest' is held by some of these nuisances — they were there when he snapped, but we've the habit of seeing and mentally *ignoring* such intrusions on a scene that makes us pause to admire it. But they are not so easily ignored when seen on the small confines of a print or enlargement — they catch the eye. And anything which holds visual interest from the main scene detracts from its impact.

Often such factual nuisances are dealt with in photographic books on the basis that they *should* be avoided — with the implication that one needs either a bulldozer or a magic wand to dispose of

them, or just a complete change of snapping position. Yet every amateur snapper soon finds that in most cases a complete change of taking position is out of the question — and the poles, lamp-posts, heavy road signs, telephone wires and electric cables cannot be wished away! So if a radical change of snapping position won't help, what can be done?

By E. G. Gaze

The answer lies in deliberately choosing one's snapping position, and possibly lighting conditions, to minimise their obtrusive 'eye-interest' slap across the main subject, or in the foreground, or across the sky space. In other words, what cannot be altered must be accepted and made the best of if a snap is wanted of that particular scene.

(1) *Poles of every description, and road signs.* These will stand out most prominently in the print when placed against a contrasting background: a white road sign against a dark patch of building or greenery, a dark telephone pole against the sky or light building, etc. Often road signs and poles can be toned down in eye-interest on the print by a little forethought in snapping position and angle of lighting — so that they tend to merge into the background instead of standing forth in all their nuisance-glory. By a little care, an obtrusive pole or sign may be placed against a broken-contrast patch of background, so that its harsh eye-catching lines are merged, and minimised.

A useful dodge

Sometimes it is possible to turn the 'nuisance' into a planned feature of the scene — such as a lamp-post right in the foreground, and which cannot be avoided. By choice of snapping position it is often possible by placing it to one side of the scene to connect sky and foreground and use it as a detail-lacking lead-in to the main view. This is a useful dodge at any time to give an impression of depth and distance through perspective.

Fig. 1 shows a light coloured lamp standard — on left — minimised and not important in eye-interest, because a slight change in snapping position utilised the broken-contrast pattern of the shop immediately behind it. A snapping position more to the left would show the standard against the

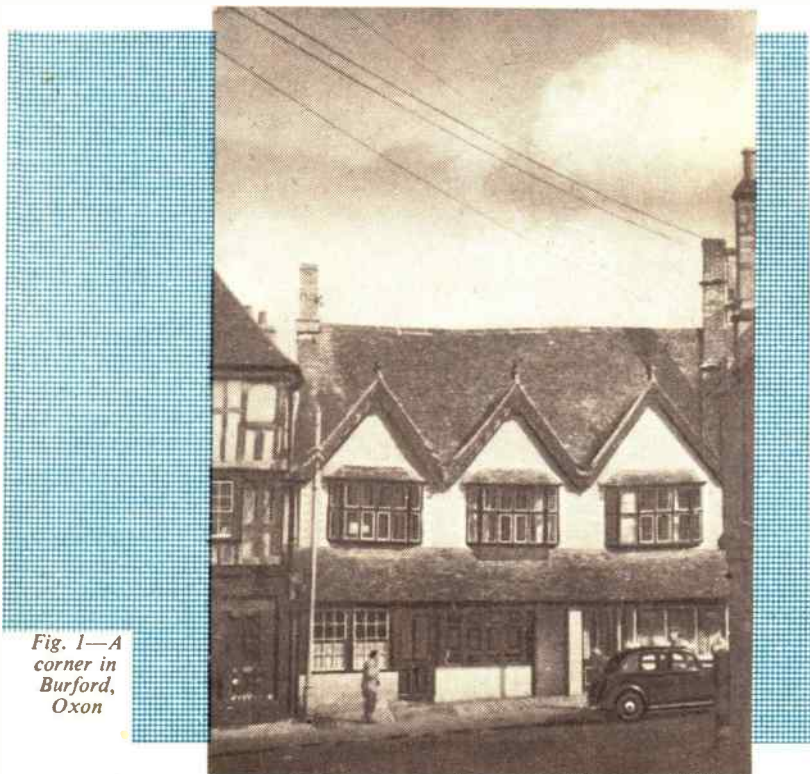

Fig. 1—A corner in Burford, Oxon

near dark window and connected lower dark roofing — making it stand out and catch eye-interest much more than it does in this view.

(2) *Overhead wires and cables.* These are an even greater nuisance to the amateur photographer, as he soon learns — especially in old-time towns and villages where they tend to stretch and curve across the most picturesque points of interest! But they have to be accepted, or the particular scene lost to the album.

Telephone wires tend to run in straight, relatively thin lines, and a slightly adjusted snapping position can often position them against the broken pattern of roofs and tiles instead of clearly against the sky. But sometimes this cannot be done, and they streak as thin black tram-lines across an otherwise nicely photogenic sky: and power cables, much thicker and heavier, tend to curve gracefully too high above ground level to be 'lost' in the print by this dodge.



Fig. 2—A corner in Laycock Village, Wilts.

Thin wires can sometimes be lost in the print by holding back the sky they cross, but it's a pity to rely on bald skies to avoid them.

If, thick or thin, they cannot be avoided, then accept them — and try to make them some part of the scene by turning their obtrusiveness to some account which tends to minimise their eye-catching interest against the main subject. If a change of snapping position will make them run at a more or less graceful angle — not dead across the sky — they may link the corner of the print to some part of the scene and not clash as much as previously with the main subject.

Fig. 1 again shows this point. The overhead power cables are thick and heavy — but they form a pattern,

mainly on a darker background of sky and not glaringly against the white cloud, and link in some small way the darker sky area with the shadowed building to the right. They were there, they're in the print — but they've been minimised to a great extent and made part of the design through necessity.

(3) *Low branches and sprays of leaves against sky-line.* If a new snapping position spoils the view of the main scene as it appeals to you, then sometimes a kneeling position will bring in slightly more foreground and 'lift' them clear of the sky-line. But it may not, and a top sky with patchy fingers of branches sticking down is eye-catching and 'messy'. If, however, that is the scene you want to snap, then turn the intruding branches to some good use, and make them earn their nuisance value and place in the print.

Just as a broken patch of intruding branches can detract from the print, so can a *top* frame sometimes enhance it,

TWO MINUTE

QUIZ

by Ed Capper

1



NAME THIS
GABLE ORNAMENT

2



WHAT TYPE OF JOINT?

3



WHAT STYLE OF BRICKWORK?

4

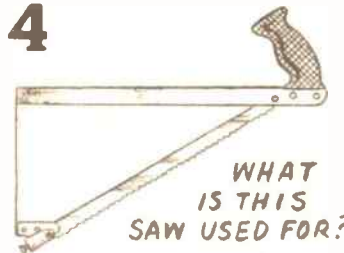

WHAT
IS THIS
SAW USED FOR?

5

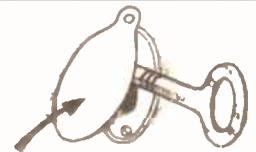

NAME THE COVER

ANSWERS ON PAGE 412

ATTENTION TO GUTTERING

MOST of us can find a little time to attend to jobs around the house during the long summer evenings which will save us considerable expense later on. We need the daylight to do these jobs thoroughly and reasonably good weather. Some of these tasks are really quite elementary but if you have your own property, then they are very essential.

By V. Sutton

To let the gutters fall down is about the last word in false economy. If you carefully study the way your gutters are put up you should have a very good idea of what repairs you can do.

All gutters are supported by brackets and over the years these will tend to bend under weight, putting the gutter out of the normal slight slope which it generally has. It may lead to a sag in the centre and this you will find by repeated dripping of water when there is no rain. A slight dip means a pile up also of sand and residue from the roof. This can mean a rusting of the section and a consequent hole in the gutter. As a very temporary measure you can put in slips of wood between gutter and bracket to hold the gutter in position. There are now several adhesive plasters and a material called 'Sylglas' which will patch up slits in the gutter. New brackets are a great advantage and the modern ones are quite ornate in design and immensely strong. They cost about 1/10 each.

Far too little time is actually spent on the gutter and that is why so many people have this heavy expense from time to time. The secret to saving them is in the painting of them, even if you are not painting the house. Get busy with a wire brush, coarse glasspaper, a putty knife for corners and then the wide brush with a good aluminium basis paint. If you ask for paint for ironwork at the local paint store, you will learn quite a bit from the instructions on the tin.

A new sump

Often I am asked about dampness in the corner of a room and find the explanation very simple. In several cases I have found a rain-water pipe running down into a path and quite near to the wall corner. It is obvious that this may have been run into a sump many years ago but the sump is now clogged up. A simple job this is if you pick up a length

of rainwater pipe and remove the water to a new sump well away from the property. Butts of water are also another source of considerable dampness at all times.

Although it is quite a popular thing to have flower beds near the house, it still can lead to quite a bit of dampness on a wall and more so if the plants are tall and subjected to winds which throw them against the building.

Many people are now dispensing with garden beds near the house, but if you must have them, then be sure that plants are of the shorter type and not so likely to cause splashing.

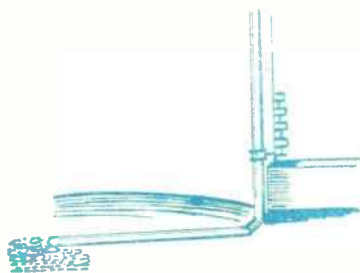

Fig. 1—Fill in old sump, add length of gutter pipe and make new sump.

I have seen the very important air vent grid cluttered up with plants and mould. This is the first start to floor damage if it is allowed. It is far better to make a neat box with three sides (as illustrated) about 6ins. deep and large enough to ensure that nothing gets to the grating. A piece of mesh over the top will save any further trouble but at no time should the flower bed be above the wooden box.

Great strides have been made in the production of special liquids for protecting those lower walls which are so often the cause of much damage to property. If you go to a really good paint store, insist that you see the liquids made for the job. Some of these are coloured and some transparent, but they are all simple to use, of real lasting protective value and reasonable in price.

Saving the pipes

To replace iron pipes on the outside of the property can be an expensive item. One of our main troubles is that we paint the pipes the same time as we paint the house. Few people know that there are very special paints for all pipe painting and that these should be used and not the ordinary woodwork paint.

Where the ventilation pipe turns in under the eaves and over the gutter is a danger point for decay. Often we do not get around the tricky bend and that is why the pipe develops a split. There are brushes today very specially made to get under and round these curves, and if you go to a really large paint store you will find them shown and demonstrated.

Painting behind pipes is something we

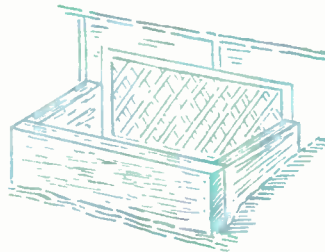

Fig. 2—Make a box to go round vent and protect the air bricks.

would all dodge if we had the chance, but that will not save the property, and splashing that wall with its pleasing cream surface is something we would prefer to avoid. I find that a cheap splash tin panel from the ironmongers can be bent round to a curve and will save all those splashes as you go along.

Pipes need painting — why not have them in aluminium, irrespective of the house shades? It may pay you and it looks smart and modern.

Book to read

The Young Cameraman

by Gordon Catling

THIS is essentially a book for the young beginner in photography. It is written by a professional photographer who is also an experienced lecturer on photography to schools and who is, therefore, one who not only knows his job, but can 'put it across' in such a convincing way that success in picture making and not mere 'snapping' is assured for even the least bright of his readers.

The work just published is a totally revised and enlarged edition of the book first published in 1949 and it includes details of the latest techniques and up-to-the-minute equipment.

Published by Nicholas Kaye Limited, 194-200 Bishopsgate, London, E.C.2—Price 10/6.

A sturdy job

STOOL FOR A CHILD



A STURDY stool for a child can be simply made. With six pieces of wood cut to size and neatly screwed together, and a top covering of a small strip of colourful carpet, one is able to produce a stool that will not easily tip and yet be attractive for children.

White Pine is suitable to use if other wood of the necessary size is not on hand. Three feet of 1in. by 8in. clear wood, without knots, will be required, and also 3ft. 6ins. of 1in. by 2in. Other items needed are 1½ doz. of 1½in. slight screws, some tacks, and about 28 brass, round-headed nails.

The 8in. section of wood is cut into three pieces to make the top and the two legs. The top will be 13½ins. long and the two legs will each be 8½ins. long.

From the 1in. by 2in. section are cut two lengths, each 13½ins. long for the front and back strips along the top. A third piece is cut 9½ins. long. This is for the centre support or spreader.

Next prepare the legs. Make a cut-out in the two top corners of each leg. These should be cut down 2ins. and in 1in. Cut the tops of the legs on a very slight slant so that when attached they will bear outwards. This also applies to the inch cut-in.

A scoop is made in the bottom of each leg. Measure in 2ins. from each side of the leg at the bottom and curve up the scoop to 1in. at the centre as in Fig. 1.

The third narrow piece or spreader, cut 9½ins. long, must be slanted up the 2in. ends, going in ½in. to match the angle of the legs, reducing the top edge measurement to 9½ins. as Fig. 2.

To attach the legs, put screws from the top down into the legs. Countersink these but do not screw down tightly until later. Place the legs 1in. in from the narrow ends of the top. The top will overlap the legs 1in. at the front and back where the cut-ins have been made in the legs. Of course make certain that the legs are placed on the correct side so that they slant outwards. Use three 1½in. screws for each leg, one screw in

the centre and the others 2ins. in from the edge.

Place the support or spreader in position by forcing it between the legs towards the centre of the top until it fits in snugly against the top with the 9½in. side uppermost. Hold firmly by countersinking two screws through the outside of each leg into the spreader.

The six screws holding the top to the legs can now be screwed down tightly.

Take the two strips of 13½ins. by 2ins., as in Fig. 3, for the front and back and lay these into position in the cut-outs in the tops of the legs just below the actual seat. These strips should fit in snugly

from the top of the strip and the second screw 1in. lower. This, again, gives the appearance as in Fig. 4.

It is advisable to rub down all the sawn edges with glasspaper. To stain the stool with an oak finish, take a small portion of black enamel diluted with a very small quantity of turpentine. Spread this on the wood with a brush or a piece of cloth.

When the stain is dry, the seat is covered with a strip of carpet. Any odd piece can be used, the more colourful the better. Red is most appropriate as it blends well with the oak finish. Often small remnants of carpet can be purchased reasonably from furnishing shops.

The piece of carpet should measure approximately 14ins. by 12ins. If this

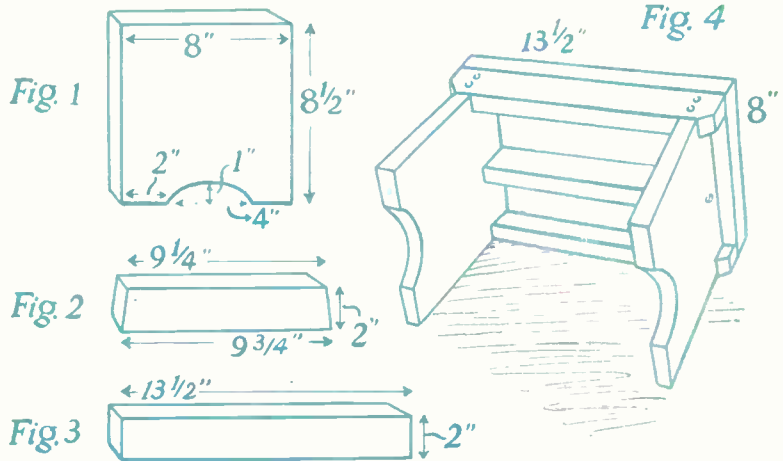

under the top and rest on 1in. niche. Measuring down 1in. from the top at each end of the strip, mark a slanting line from the 1in. point to the outside edge of the opposite leg. Remove the strips and saw along the four short slanting lines which actually removes the corners and the strips will appear as on the completed stool in Fig. 4.

Place the two strips into position again and screw on to the legs by using two countersunk screws at each end of each strip, placing one screw down ½in.

has rough edges, overcast the underwebbing only with thick thread and use a stout needle.

To fix the carpet on the seat, bring it down 2ins. in the front and back covering half the shaped strips. Tack the edge of the carpet along the strips, starting the tacks about ½in. from the end.

A length of braid to blend with the colour of the carpet is nailed over the tacked edges of the carpet with brass round-headed nails at intervals of 1in. commencing at the far edges. (H.M.)

MONEY BOX

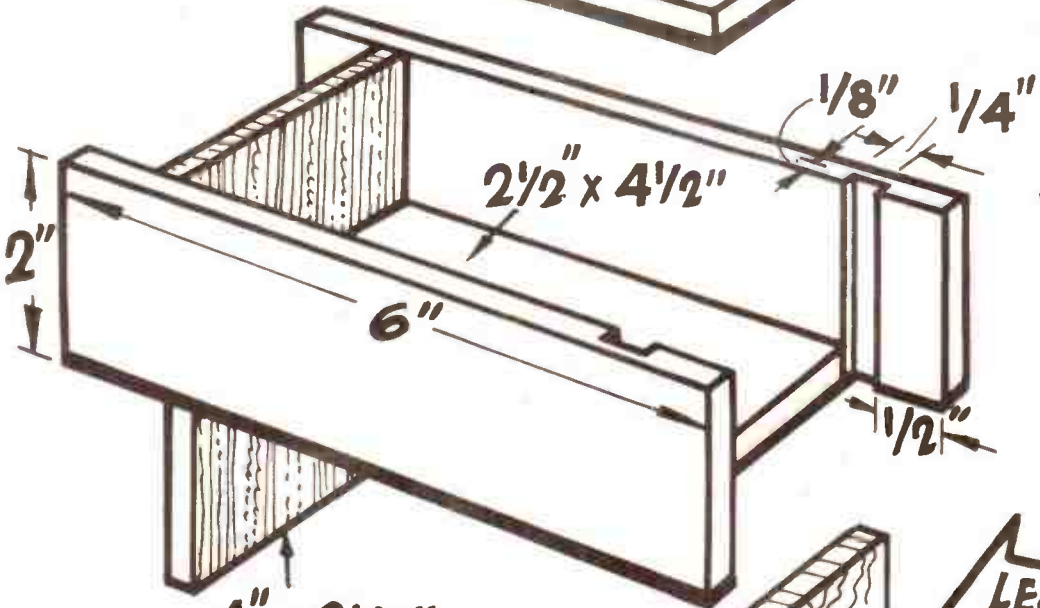
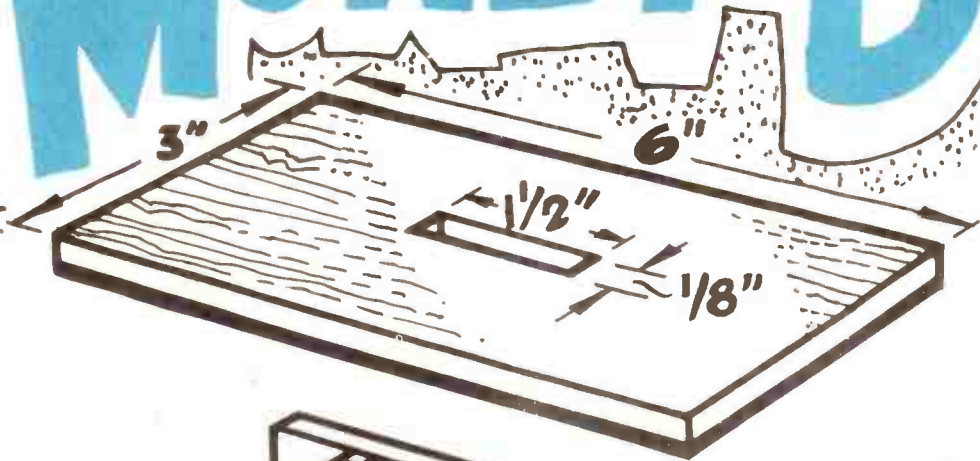

4" x 2 1/2"

ALL PARTS CUT FROM 1/4" WOOD

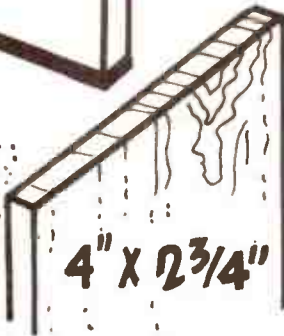
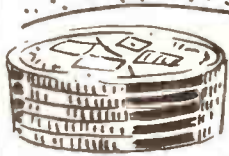

LEG SLIP IN AND OF GROOV

EVERY PR

WITH Secret Opening

SUITABLE OVERLAYS FOR SIDE OF BOX



HING
JECT

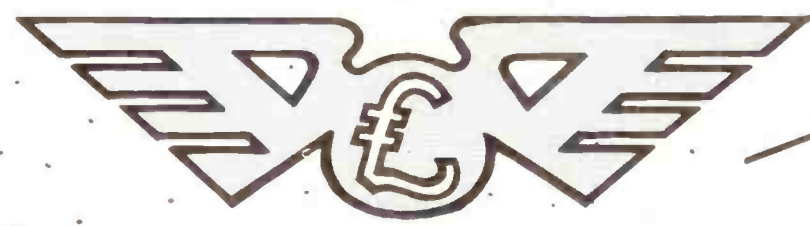

CUT FROM 1/8" WOOD



S
T
S



MANY people seem to want Great Britain to change the style of her postage stamps and have the pictorial stamps that are now so fashionable. They use as an argument that the stamps would serve as an advertisement for this country, and that many would come here to see the places shown on the stamps. It might be nice to have pictorial stamps, but it is not likely that anyone would pay much attention to the stamps as advertisements. They might, if they were in Britain, go there, but it is not likely they would come especially.

GREAT BRITAIN ON STAMPS

It is not generally appreciated how many British scenes appear on stamps, not, it is true, on the stamps of this country, but on those of other regions. Here we have six views. Two of them came out in 1951; they were the 2/6 value which showed a picture of H.M.S. Victory, the ship on which Nelson lost his life, and the 5/-, which showed a picture of the 'White Cliffs of Dover'. Then in 1955 we had the high value stamps with their pictures of castles. The 2/6 has Carrickfergus Castle on it. How many have taken the trouble to look in the atlas to see where Carrickfergus is? It is, of course, in Northern Ireland at the mouth of Belfast Lough. For the 5/- value they chose a castle in North Wales, and that was Caernarvon Castle; then, as anyone would guess, they went to Scotland for the 10/- value and, of course, it was Edinburgh Castle. For the £1 Windsor Castle was the obvious choice. Windsor Castle is probably the best known British pictorial stamp. Not only is it on the present £1 stamp, but it was, of course, the subject of the Silver Jubilee stamp for the Crown Colonies, and, again, it was used by Canada for the 10c. value of their Silver Jubilee

issue. The Houses of Parliament must come quite close to Windsor Castle. They were the subject of the design of the Victory issue of 1946, also for the Crown Colonies and, moreover, they appeared on the stamp issued by France in 1938 for the 1fr. 75c. stamp to commemorate the visit of H.M. King George VI and Queen Elizabeth.

One of London's most famous monuments was used by Australia for the 1935 stamps issued to commemorate the 20th anniversary of the landing of the Australia and New Zealand Army Corps at Gallipoli. There were only two values issued, the 2d. and the 1/-. The latter stamp is quite a nice one to possess, the value having gone up considerably.

New Zealand has shown more scenes from Great Britain than any other country, including the Mother Country. She has given us no less than eight. The two health stamps issued in 1945 used the statue of Peter Pan from the Kensington Gardens as the subject for their design, and then two years later the famous statue of Eros was used, again, for the health stamps, both values having the same design. New Zealand issues stamps for her Government Life Insurance Department, and in 1947, she showed pictures of seven different lighthouses, most of them grouped around her coasts, but one of these designs was of the famous Eddystone lighthouse; it was the 3d. value.

Many of you will have the 1½d. value

of the 1946 Peace issue, and you will see that this shows a picture of St. Pauls Cathedral. It is shown in the angle of the 'V' for the Victory sign, and in very small letters you will see 'St. Pauls London — This was their Finest Hour'. St. Pauls is backed by the Union Jack, and there appears a haze behind, symbolising the burning which went on in those days.

Next we pass to the Coronation set which, of course, came out in 1953. There were five stamps and four of them give us London pictures. On the 8d. value we see Westminster Abbey, and then on the 2d. there is an aerial view of Buckingham Palace. The 4d. and the 1/6 stamps give us pictures which, although they can hardly be called views of London, yet many people went to London to see the originals, the Coronation State Coach on the 4d. and St. Edwards Crown and Royal Sceptre on the other value.

Doubts about some

Another Colony which has populated Great Britain is Newfoundland. In 1933 she issued a set of stamps to commemorate the 350th anniversary of the annexation by Sir Humphrey Gilbert, and the West Country is pictured on three of these. The 2c. has a picture of Compton Castle, from which Sir Humphrey came, the 32c. shows Sir Humphrey's statue which is to be seen in Truro. The 8c is rather imaginative, the caption on the stamp saying 'Fleet leaving Plymouth 1583'. Well the stamp says so, and presumably it must be that, but really it would be very difficult to recognise Plymouth on the stamp. The 4c. takes us a long way from the West Country, going to Eton College — the only English School to appear on a postage stamp.

In 1897 another doubtful item appeared. The stamp is entitled 'Cabot's ship the Matthew leaving the Avon'. As was mentioned above, one cannot contradict this, even if one wanted to do so. It is the 10c. of the set to commemorate the 400th anniversary of the discovery of Newfoundland and also the 60th year of Queen Victoria's reign. (L.P.V.)



Barbados.
Windsor Castle

New Zealand.
'St. Paul's'—
This was their finest
hour.'

Newfoundland.
Cabot's ship
the 'Matthew'
leaving the Avon.

New Zealand.
The
State
Coach.

Photographers!

Here's everything you need to
'PRINT-IT-YOURSELF'



ONLY £1 - 17 - 6

Complete
From Photographic
Dealers Everywhere

This outfit will set you up to print your own pictures. It contains everything you require to embark on an absorbing hobby: printing frame (3½ × 2½), masks, dishes, developer, fixer, thermometer, measure for chemicals and darkroom lamp.

FOR CONFIDENCE IN PHOTOGRAPHY

JOHNSONS
OF HENDON LTD.



The world's
strongest
glue

STILL ONLY

1/2

A LARGE TUBE

This model farm cost less than 2/6

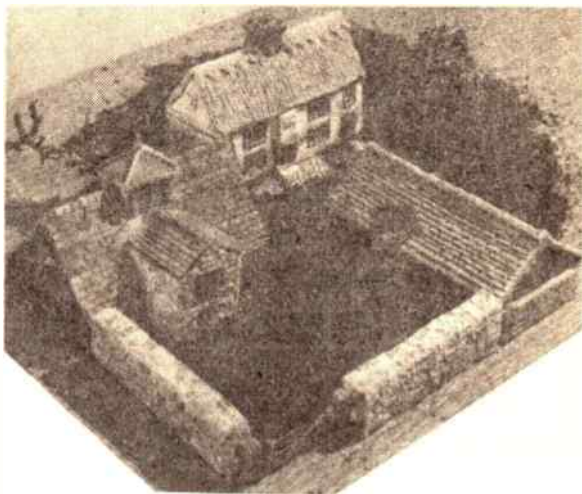

It was made from a half-crown tin of Sankey's PYRUMA — farmhouse, barn, implement shed, walls and gate — and there was still plenty of this grand modelling material left to build many more farm features, by simple methods described in the Instruction Book (see Coupon below). PYRUMA, plastic and ready-for-use, becomes stone hard after drying or baking, and can be painted in natural colours. For permanent modelling —

MAKE IT AND BAKE IT IN



Obtainable from your local Ironmonger or Hardwareman and many Art Material dealers. Ideal for making —

**Model Railway Buildings and Accessories.
Harbours. Ship Models. Airport Buildings
and Features. Houses. Bookends. Ashtrays.
Animals and Figures. Plaques, etc.**

Post this Coupon today for your Instruction Book.

J.H. SANKEY & SON, L^{TD}

Established over a century
Dept. H, ILFORD, ESSEX

Please send ILLUSTRATED INSTRUCTION BOOK with full colour pages on Pyruma Modelling.

Enclosed Postal Order value 6d. (not stamps)

NAME (Block letters) _____

ADDRESS _____

NATURECRAFT ORNAMENTS

DRESS ornaments have become so popular with members of the fair sex, that there are very few who do not wear one in some form or another. Ornaments for the adornment of the person or dress are of great antiquity, and there are many occasions down the ages when they were even worn by the male members of the community.

By A. F. Taylor

Jewellery has played a very important part in the formation of these adornments, and more recently the production of artificial flower ornaments has become a very profitable business. These are made in a vast number of different materials, many of which are very realistic, while others are somewhat futuristic.

Felt and leather have had their full share of usefulness, but little seems to have been done with the materials available from nature's vast storehouse of treasure. The idea, therefore, of this article is to give a brief outline of how such things as acorns, pine cones, beech nuts and their cases may be used for this purpose.

There is no need to travel far for our material, as there is an ample supply in our woodlands and parks, and along our country lanes. All this material is free, and hunting for it is great fun and well worth the time and trouble taken.

Before they can be used it is necessary to thoroughly dry them, and this should not be hurried. Natural drying in a dry atmosphere is to be preferred to placing them in a hot oven and driving off the moisture quickly. Spread them out thinly on a tray or shallow box, and put them where the air can circulate freely and in a sunny position if possible. If gathered when damp and crowded together, they are apt to go mouldy and be useless.

Choose gay colours

Any of the materials can be used in its natural state, but it is much more attractive if painted in gay colours. It can then be made up to wear with certain clothes in matching tones.

Stalks are best fixed on before any colouring is done, and these can be either stiff for upright flowers, etc., or flexible for making up in the form of 'drops'. Both types are fixed in the same manner and should not present any difficulty.

Holes are drilled in the material, so

that the stalk will just fit without being either too loose or too tight. A twist drill will do the job better than the flat type, and is to be preferred. Some will need drilling right through, such as acorn cups and beech cases, while others need only be about $\frac{1}{16}$ in. to $\frac{3}{16}$ in. deep, and these include the various cones, acorns and certain nuts.

For the upright type of ornament a stiffish wire is used for the stalk. Cotton or silk-covered copper wire has been found to be very satisfactory, and if green, is chosen it will not require any further treatment.

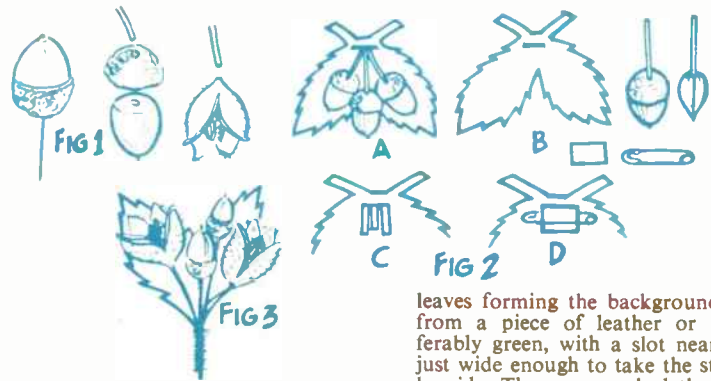

Leather cut into narrow strips is, undoubtedly, the best form of stalk for the hanging or 'drop' type of ornament. Silk or some other similar cord is quite good for some arrangements, but is not so durable as leather. A sharp razor blade and a straight edge will quickly cut off a number of neat strips from a piece of sheepskin or suede.

A dab of glue is sufficient to hold the stalk in place after which it should be put on one side for a few hours to thoroughly dry out. It will save a considerable amount of time if you stalk a number at a time. Fig. 1 shows how the stalks are attached to different objects.

Painting can be quite interesting and much experimenting can be done with colour combinations. Acorn cups, for instance, may be one colour, while the acorn is painted in another or a different shade of the same colour.

There is a wide range of paints now available which are suitable for the job. Any paint used must be waterproof and a glossy rather than a dull finish certainly looks better, besides being less liable to become shabby quickly. Cellulose paints and certain enamels obtainable in small tins are best, and these are easy to apply and dry quickly.

Half open beech cases are very at-

tractive if the inside and outside are coloured in different shades with a tiny alder cone glued in the centre and painted a bright gold or some other gay colour. Paint a pine or larch cone all over in one colour, and when dry, put small dabs of a different colour here and there.

Assembly

Putting all the parts together can be started when they are thoroughly dry. Take a 'drop' dress ornament for instance (Fig. 2) where (B) shows all the separate parts before assembly. The

leaves forming the background are cut from a piece of leather or felt, preferably green, with a slot near the top just wide enough to take the stalks side by side. These are pushed through and glued on the back as at (C). The ornament will generally look more attractive if the various drops are fixed at different levels.

The back is finished off by gluing a small square of leather over the ends of the stalks, and at the same time fixing a gilt safety pin as shown at (D), so that the ornament may be easily attached to the dress.

Arranging and fitting together the upright stems of wire is just as easy, and Fig. 3 gives an example of this. Several stems are wired together or tied with a piece of silk cord or a ribbon with a bow to cover up the join and finish it off. A spray of leaves can be incorporated as in the 'drop' type.

We have described only a few examples of the countless possibilities which exist, and you will, doubtless, have much fun creating others. Besides making them up for presents, a very profitable little business could soon be worked up, especially if you can design something original and outstanding.

ANSWERS TO TWO-MINUTE QUIZ. (See page 405.) 1. Finial. 2. Hous-ing. 3. English Bond — alternates of stretchers and headers. 4. For cutting corrugated sheets. 5. Escutcheon.

The best tools you can lay hands on...

STANLEY VICE

A new portable vice at an amazingly low price. Body of cast aluminium gives lightness combined with great strength. Clamped to table or workbench it holds work rigidly—either horizontally or vertically.

25/-



STANLEY BENCH PLANES

For the hardest and toughest work. Adjustable for coarse or fine work, and thickness and evenness of shaving. 9" long. 2" cutter

41/-



"YANKEE" HANDYMAN SPIRAL RATCHET SCREWDRIVER

A simple push action turns blade automatically and does all the work. Drives or withdraws screws effortlessly. Ask for the 133H.

18/6

Accessory Wallet containing 3 drill points, spare blade and countersink. **9/6**



STANLEY

STANLEY WORKS (G.B.) LTD., RUTLAND ROAD, SHEFFIELD, 3, S.W. 59



BRANCHES: LONDON

78a New Oxford St., W.C.1
(Phone MUSEUM 2975)

87 Old Broad Street, E.C.2

81 Streatham Hill, S.W.2

GLASGOW

326 Argyle Street

MANCHESTER

10 Piccadilly

Head Office & Factories—HOBBIES LTD, DEREHAM, NORFOLK

BIRMINGHAM

100a Dale End, Birmingham 4

SHEFFIELD

4 St. Paul's Parade

LEEDS

10 Queen Victoria Street

HULL

10 Paragon Square

SOUTHAMPTON

134 High St. (Below Bar)

BRISTOL

65 Fairfax Street

NEWCASTLE

42 Dean Street

GRIMSBY

88 Victoria Street

Special offer of STEEL HANDY BOXES

lined and partitioned with felt.

Just the job for the modeller and handyman for small tools, tubes of adhesive, fret blades, drills, etc., to keep your workshop tidy.

Only 7/6 for 3 boxes. Postage & packing 2/6.

W. TABORN & Co. Ltd. (Tools), 66-68 Tooting High Street, London, S.W.17

KITS for OLD TIME SHIPS

Hobbies range of Ship Models includes Elizabeth Jonas, Cutty Sark, Victory, Mayflower, etc. Complete kits of wood, sail material, guns, pulleys, cord, etc., with full-size patterns of parts and planed wood ready to cut out, shape and construct. A fascinating pastime.

Ask for free illustrated list at Hobbies Branches or from Hobbies Limited, Dept. 99, Dereham, Norfolk.



For REPAIRING FIREPLACES

IN THE BLUE and WHITE TIN PRICES

1 lb. 1/9
2 lb. 2/9



PURIMACHOS LTD

ST. PHILIPS · BRISTOL 2



MAKE YOUR OWN

GUITAR

Kit 3209

All wood (including partly shaped neck) full-size plan, six strings, etc.

59/11

(Note reduced prices)

UKULELE

Kit No. 3260

Contains all wood, wire, strings, etc., for full-size instrument

24/6 Post 1/6



Overall Length 36½"

As shown on TV. Thousands of satisfied customers. Make your own first-class instrument.

From branches, etc., or by post



To Hobbies Ltd., Dept 99, Dereham, Norfolk. Please send Kit No.

P.O. for enclosed

Name..... enclosed

Address.....

Yours
for
only
8/6d.
(Post 1/3)

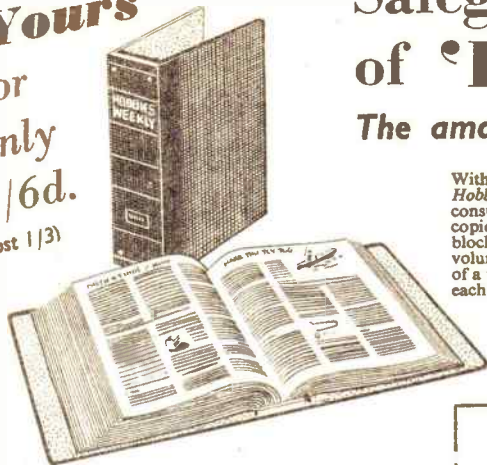

Safeguard your copies of 'HOBBIES WEEKLY'

The amazing 'EASIBINDER' (Pat.) makes it simple

With the new *EASIBINDER*, specially prepared for *Hobbies*, you can bind each copy of *Hobbies Weekly* as you get it, turning your favourite magazine into a permanent, easily-consulted library of immense value, and avoiding the delay and despair occasioned when copies are accidentally mislaid or destroyed. Carefully finished in black leather-cloth and gold-blocked on the spine, each binder is strong, serviceable and neat. It will hold two complete volumes (52 copies) and costs only 8/6. Each copy of the magazine is quickly inserted by means of a flexible steel wire, and can easily be removed if necessary. Easy-to-follow instructions with each *EASIBINDER*. Get one today and take care of your copies of *Hobbies Weekly*.

NOTE From the issue April 10th, 1957, there is a slight difference in the size of the magazine, and two sizes of *Easibinders* are available. Type A is for binding issues published before April 10th and Type B is for those printed subsequently. To avoid confusion, when ordering, please indicate clearly the type of *Easibinder* required. Indices for each completed volume 1/- each post free.

☆ One 'EASIBINDER'
holds two volumes
(52 copies)

☆ Easy to use

Post today



To: **HOBBIES LTD., Dept. 99, Dereham, Norfolk.**

PLEASE SUPPLY EASIBINDERS
(Type) at 8/6 (post each 1/3)

NAME.....
ADDRESS.....
P.O. for.....
enclosed

Completely new 54 page Edition

WHERE'S THAT CAR FROM ?

Price 1/- (Postage 4d.)

Of all Booksellers
or

RALEIGH PRESS, Exmouth, Devon

SAVE THIRTY SHILLINGS !

ELECTRIC DRILL ACCESSORY KITS

Sanding Discs - Backing Pad - Lambswool Bonnet - Grinding, Buffing and Wire Wheels with Arbor - Masonry Drill and Wallplugs - 3 Drills for Wood - 3 Drills for Metal - Postage Paid - 24/6 - (Usually 54/6). - Lists Free.

BARKERS, 70 WEST STREET, LEEDS 1

MAKE A MUSICAL BOX for as little as 21/- . New kits and tunes available. Movements 13/- post free. Please send 3d. stamp for free illustrated catalogue. - The Swisscross Co., Dept. B, 202 Tulse Hill, London, S.W.2.

MUSICAL MOVEMENTS. The largest selection of tunes in England. - Richardson & Forder, 5 Chapel Place, London, N.17.

STAMPS FREE - Empire Packet including Pictorials and Victorians with approvals. - Robert J. Peck, 7A Kemp Road, Bournemouth.

100 DIFFERENT stamps free! Request 4d. upwards, discount approvals. - Bush, 53 Newlyn Way, Parkstone, Dorset.

CARDBOARD OFF-CUTS, various sizes, colours, suitable calendars, mounts, show-cards, etc. Selected sample parcel 5/- post paid. - Hayman, 12 Queen Street, Bridgwater, Somerset.

Superfine POPLIN SHIRTS
FOR ALL BOYS & SMALL MEN

3 for only 8/6
POST ETC. 7/6

Unbelievable Clearance OFFER!

These new ex-Government fawn superfine poplin shirts were produced for the women's Services and have been slightly modified to fit boys and small men. Long sleeves, coat style, with collar. Double thickness cuffs. A fantastic bargain - THREE for less than the price of one. Yes, only 8/6, post, etc., 1/6. Collar sizes 12 to 15. State size. Send quickly.

20000 ALL WOOL
GENUINE **KHAKI ARMY PULLOVERS**
LONG SLEEVES

8/11 POST 2/1

Just try and knit one for the money! Here you have the finished article, soft, supple, magnificently made.

All Wool. V-neck. The Real answer to chill winds and icy dampness. 3 can be supplied for 28/- Post Free, or singly 8/11, post, etc., 2/1. Sizes 34 to 40 only. New stock unissued. LISTS CLOTHING, FOOTWEAR, TENTS, SLEEPING BAGS, WATCHES, ETC. TERMS.

Headquarter & General Supplies Ltd. HOBW/31 196-200 Coldharbour Lane Loughboro Junc., London, S.E.5 Open Sat.

STOP SMOKING in 3 days or money back. Safe, pleasant, permanent. The only scientific way. No Will Power necessary. 'Conquered the habit in 2 1/2 days'. - F.C. 'Within 2 days I was free from the tobacco habit'. - W.G. 'Was a smoker for 2 years and broke the habit in 2 days'. - F.N. 'I used to smoke 20 a day . . . now I have no desire to smoke'. - J.M. Recommended by 'Health and Efficiency Magazine'. Complete course 7/6 (or \$1.00 bill). Details 3d. stamp. Sent under plain cover. **NATURE REMEDIES, 28 (H/184) Dean Road, London, N.W.2.** Established 1928

BUYING OR SELLING?

Classified advertisements on this page accepted at a cost of 6d. per word prepaid. Use of a Box No. is 1/- extra. Send P.O. with advertisement to *Hobbies Weekly*, Advert. Dept., Dereham, Norfolk. Rates for display advertising on application.

BECOME CHIROPODIST (MASSEUR. B) Postal Schools (Dept. 27), 48A Abbey Street, Accrington.

'PAINTSPRAYING' HANDBOOK. Covers Car, Industrial & Flock Spraying. 3/6, post 4d. Catalogue of our Cellulose and Paints and all Allied Sundries 3d. - Leonard Brooks Ltd., 81 Oak Road, Harold Wood, Essex.

CLUB PRINTING AND DUPLICATING. Samples and prices 3d. - Bernard Salmon, 107 Shearer Road, Buckland, Portsmouth.

1000 DOORS - Flush, New, Slight Sub-standard but really excellent quality, all 78ins. high. Sizes 24in. at 22/-, 27in. at 24/-, 30in. at 27/-, 33in. at 35/-. Please add 4/- per door part carriage. - Sanco Ltd., 17 'm' Boundary Road, Hove.

Make these yourself

USEFUL SPRING SCALES

For 'playing shops'
or for use in
the home

THESE simply-constructed spring scales are ideal for playing at 'shops', and they can also be put to good use in the garden. They are quite accurate enough for measuring small quantities of fertilizer, etc.

Make the base (A) and the column (B) from $\frac{1}{2}$ in. wood and glue them together. The spring consists of a piece of piano wire wound round a piece of $\frac{1}{2}$ in. dowel as indicated.

For a pan use a small tin lid suspended from the wire and for the indicator (D) use a piece of tin or card. You will see from the illustrations that it is a straightforward job to fix these up, so that the indicator slides up and down the column.

To mark the scales, borrow some weights and tick off each $\frac{1}{4}$ oz. as it is added to the pan. (M.p.)

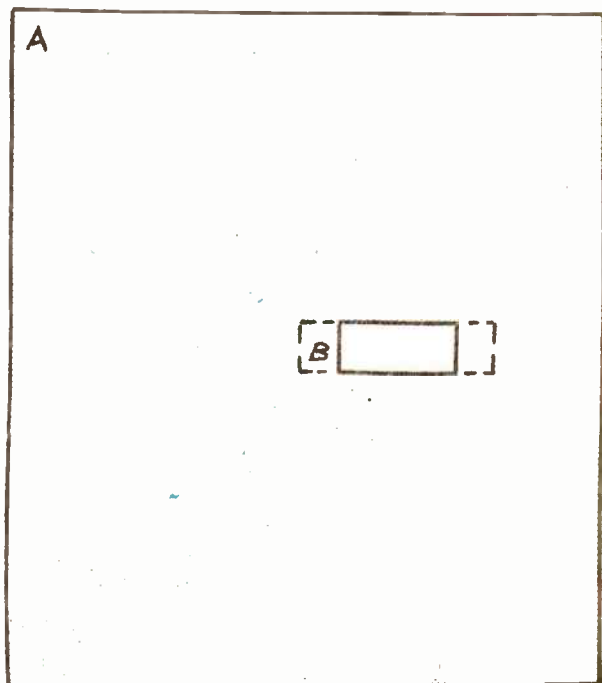
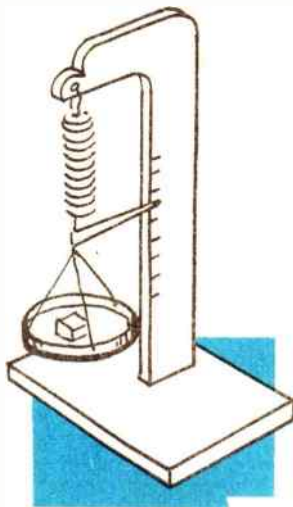
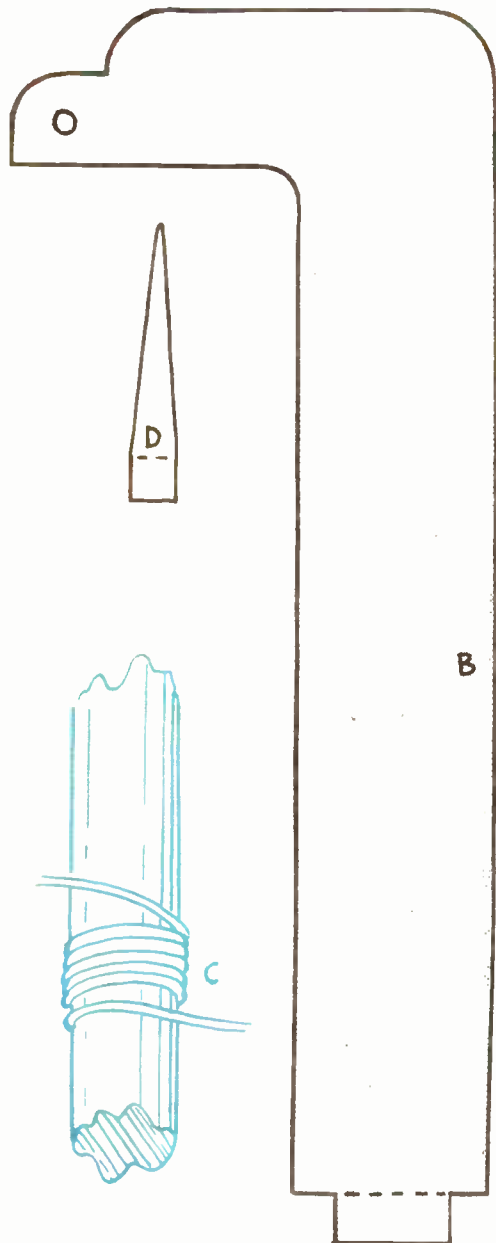



A FASCINATING HOBBY made Simple & Successful by means of this BOOK

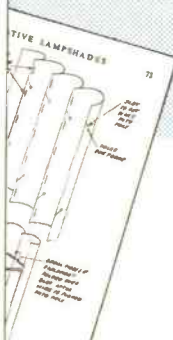
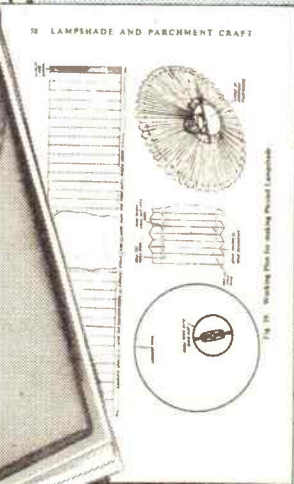

Lampshade making can give endless fun, beautify your home and delight your friends. There are 83 practical and easy-to-follow illustrations and ideas to show you how to do it.

Published by C. Arthur Pearson Ltd, Tower House, Southampton Street, Strand, London or obtainable from

SAMUEL JONES & CO. LTD.

8/6

SAMUEL JONES & CO. LTD.
Obtainable from all Booksellers or by requisition

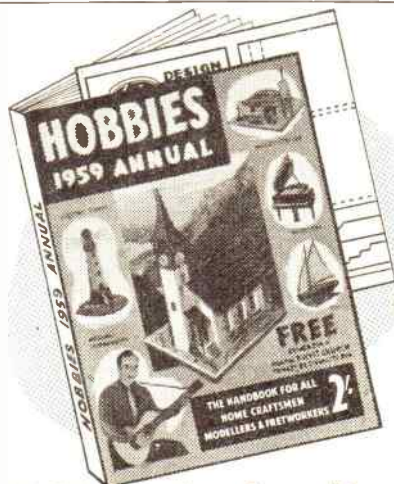

The Handbook of the year! **HOBBIES 1959 ANNUAL**

With Free Design for an illuminated **MUSICAL SWISS CHURCH**, for cigarettes or trinkets, etc.

168 packed pages full of interest for the modeller and home craftsman

GET YOUR COPY TODAY

From Newsagents, Hobbies Stockists or Hobbies Branches price 2/-; or direct price 2/6 post free (see coupon).

Full instructions for making

- ★ Grandmother Clock
- ★ Rocking Horse
- ★ Marquetry Picture
- ★ Canine Cot
- ★ Guitar and Ukulele Case
- ★ Garden Trolley
- ★ Propagating Frame
- ★ Hardboard Projects
- ★ Fretwork and Toy Patterns and a host of other projects

To HOBBIES LTD.

Dept. 991 Dereham, Norfolk

Please send copy/copies of *Hobbies 1959 Annual* (2/6 each post free).

Name

Address