

HOBBIES WEEKLY

JULY 2nd 1958

VOL. 126

NUMBER 3270

IN THIS ISSUE

	Page
A Toy Noah's Ark -	193
Last of the Ten Wheelers -	194
Moth Rearing -	195
Chemistry in the Home -	196
A Trough for your Records -	197
'Flowers' of the Sea -	198
Boot Cleaner for Outdoors -	199
Make a Model 'Cableplane' -	200
Milk Bottle Holder -	201
Mainly for Modellers -	202
Products Noted -	204
Is This Your Problem? -	206
A 'Goose' Thermometer -	207



All correspondence should be addressed to the Editor, Hobbies Weekly, Dereham, Norfolk

★ FREE design inside

THIS design for a toy Noah's Ark complete with animals is an excellent job for the fretworker, and makes an ideal subject as a gift for a youngster.

The ark has a drop-down front which acts as a stage on which to set out the animals. When they are packed away for the night, the animals are stored in

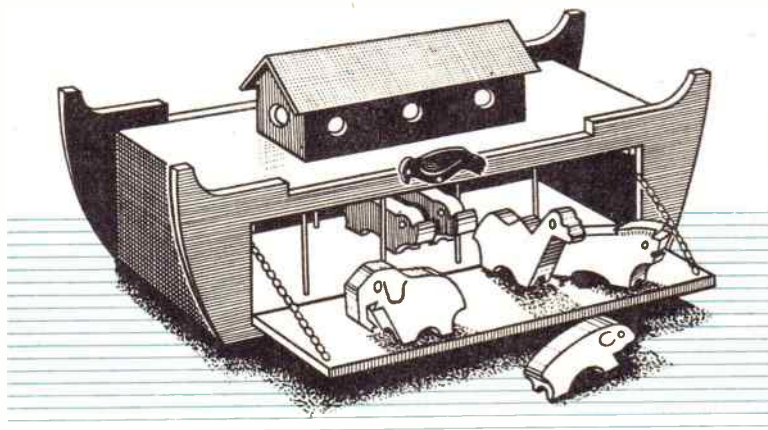

A TOY NOAH'S ARK (with seven animals)

their various pens. Seven different animals are shown on the design sheet, and the dove is also depicted, being used on the front in the form of a turn button with which to keep the ark closed.

All the animal shapes are shown full size on the design sheet. These should be traced and transferred to wood by means of carbon paper, and then cut out with the fretsaw. Some parts of the ark are also shown full size, and these should likewise be traced and cut out. For other parts the dimensions are

given, and these will be measured and marked on the wood for cutting.

Note that the cut-out piece from the front (piece 1) will later be hinged back in place to form a drop-down front. When cutting this piece, as small a hole as possible should be drilled in a corner to start the cutting.

The general assembly of the ark is shown in Fig. 1. The pens for the animals are formed by wires and their number is left to individual choice. Holes are drilled in the bottom (piece 2)

to take the wires, and corresponding holes are drilled half way through the underside of the top (piece 2) to take the other ends of the medium gauge wire.

Pin and glue the ends of the ark (pieces 3) between the back and front (pieces 1) in the positions shown on the design sheet. Then add the bottom (piece 2) between the back, front and two ends, again pinning and gluing. Put the wires in position, adding a dab of glue to secure, at the same time fixing on the top (piece 2).

The structure built on the deck of the ark consists of pieces 4, 5 and 6 pinned and glued together. Pieces 6 are chamfered slightly where they join. This assembly can now be glued centrally on the deck.

The piece cut out from the front (piece 1) can now be hinged back in place as shown in Fig. 2. Note the rebates for the hinges to enable the drop-down front to fit flush. Fig. 2 also shows how small pieces of chain are cut to length and fixed with fret pins. One of the doves is fixed in position at the back (piece 7 on Fig. 1) and the other is pinned centrally on the front to form the turn button.

SHOWING HOW CHAIN SUPPORTS DROPPED SIDE

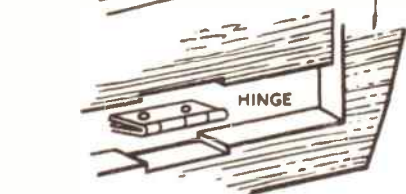
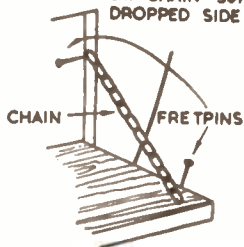

SHOWING HOW CUT OUT PIECE FROM SIDE ① IS HINGED BACK IN POSITION

Fig. 2

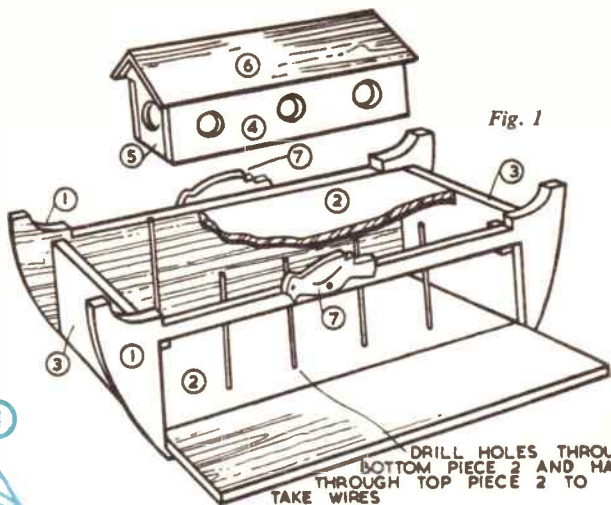

Fig. 1

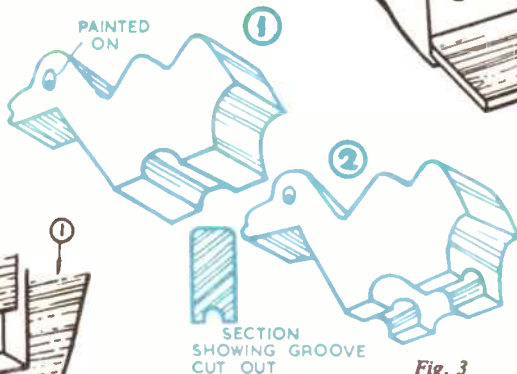

Fig. 3

There is sufficient wood in the Hobbies kit to cut out one of each of the seven animals to go in the ark. These are cut from $\frac{3}{4}$ in. wood and the shapes can be repeated if pairs of animals are required.

Fig. 3 shows how the four legs of the animals are formed for standing, grooves

being cut with the fretsaw, a sharp knife, or formed with a round file.

A toy of this nature looks most attractive if painted in bright enamels. Do not attempt to capture the authentic animal colourings, but concentrate on greens, reds and yellows, etc. The ark can be coloured in different shades of brown.

Hobbies Kit No. 3270 contains wood, wire, hinges, etc. for making the Noah's Ark and animals. Obtainable from branches, etc. or Hobbies Ltd., Dereham, Norfolk, price 13/11 (post free).

Last of the Ten Wheelers

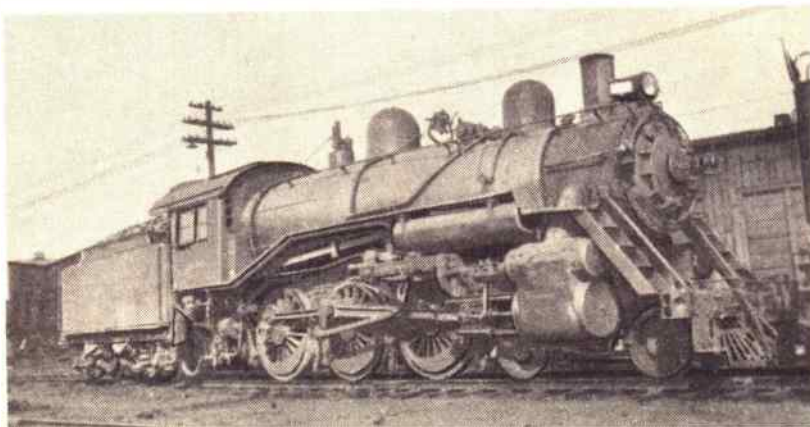

THE last American coal burning 4-6-0 type locomotive has recently been withdrawn from service and has now been reconditioned and put in permanent preservation at the museum at Shelbourne, Vermont. This engine No. 220 of the Central Vermont R.R. was used extensively for hauling Presidential specials over various American railroads and was known as 'the locomotive of the Presidents'. Now preserved as a locomotive of historical interest No. 220 joins the famous old side wheel steam boat, the 'Ticonderoga' both being now part of a permanent transportation exhibition at Shelbourne.

The 4-6-0 type loco in America was known as the 'Ten Wheeler', being a development of the 'Eight Wheeler' (4-4-0 type). Our photograph shows a typical Ten Wheeler, No. 2039 of Class B, 18, CA of the Baltimore and Ohio R.R. taken at Glenwood, Pennsylvania in December 1946. This engine much resembles No. 220 in appearance. (A.J.R.)

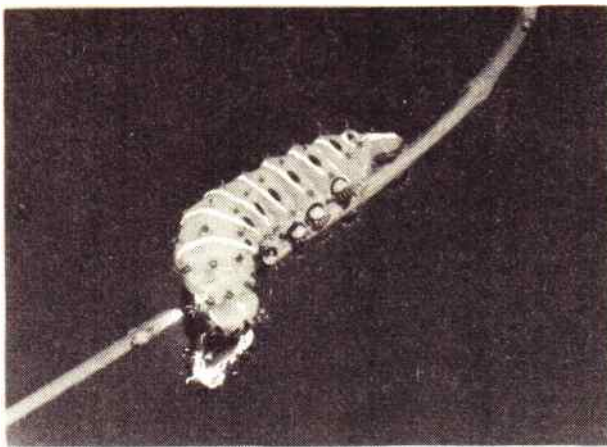

Larva of Rothschild's Atlas Moth

THE best way to make a start with this hobby is to buy a few cocoons of one of the easier species to rear, such as the Eri Silkmoth. While this is more expensive than buying eggs it is more reliable as I often find that eggs that have had to travel through the post fail to hatch. Since a pair of moths will also produce several hundred eggs you do in fact get more value for money in the end with cocoons.

As soon as the cocoons are received they should be kept in a warm place to encourage the moths to emerge. They should also be kept slightly moist and the best way to do this is to place them on slightly damp peat at the bottom of the cage described in an earlier article. On no account should they be kept too moist, as this would encourage the growth of mould, with fatal results.

You will find that when the moths start to emerge several of the same sex will often come out first. It is therefore important to be able to tell the sex of the moths and this can be done by the distinguishing features shown in Fig. 1. Not all moths have all the characteristics shown, but any one present determines the sex. In general the male has more feathery antennae than the female, and in the female the tips of the forewings have a more rounded appearance. Failing either of these, then you will clearly be able to see that the female has a far larger body.

One of the characteristics of the silkmoth group is that the adult moth does not take any food. This is a help to the breeder, as moths that feed are difficult to keep alive. Having now determined the sex of the first moth to emerge, it must be kept available until there is a mate available for it. This is best done by keeping the moth as cool as possible by putting it in a cellar or cool outhouse. A

cardboard box is a convenient container to store the moths in.

As soon as a male and female have emerged, they must be left together to mate. In all silkmoths mating takes place in the dark and lasts from a few minutes to nearly a day, according to



Fig. 1

the species. The cage that has been described for keeping the caterpillars is suitable for use as a mating cage, except for the very largest species such as the Tussor and Atlas moths. For these a larger cage is required, and a very simple one may be made as follows.

Bend two pieces of stiff galvanised wire into two circles 2ft. in diameter, and solder or tie the overlapping ends together. Next obtain a length of netting material and sew it into a tube 6ft. in length and 2ft. in diameter. Now sew the wire rings into position 3ft. apart and

Moth rearing

PAIRING AND EGG-LAYING

18ins. from each end. One end is now drawn together and tied with a length of string, which can now be used to tie the cage up on to a picture rail or hook. The moths are now put in through the bottom end, which is then closed by tying together with string.

After the moths have mated, the male should be removed, as he is the more active partner, and will tend to disturb the female while she is trying to lay her eggs, which she does on the night following, and generally for about a week afterwards, laying fewer eggs each night. For the larger moths, or if there are several laying females, it is best to leave them in the cage for the eggs are readily laid on the muslin, and may be easily removed from this. For small moths, however, a container such as a shoe box is quite adequate for egg-laying purposes.

Whatever the eggs have been laid on, they should be removed when a few days old. Small caterpillars in a large cage will get lost and fail to find the foodplant. Most moths lay eggs in batches, and these can easily be prised off muslin or cage walls with gentle sideways pressure of a finger-nail, a small box being held underneath while this is being done to catch the eggs.

While dealers sell special glass-topped metal tins for keeping eggs in, these are expensive and waxed pillboxes 2ins. in diameter which can be obtained from most chemists for about 3d. are just as good. For large numbers of eggs plastic sandwich boxes are ideal, but when using these, a piece of blotting paper should cover the bottom.

Depending on the species the eggs will hatch in from two to four weeks. (Some eggs, however, will overwinter.) A close watch should be kept on them and as soon as the caterpillars hatch out, a few leaves of the foodplant must be supplied. Finally, always see that they are kept warm and in the shade. Both sun and cold will cause failure to hatch.

(B.G.)

CHEMISTRY IN THE HOME

EXPERIMENTS WITH ZINC — Part 2

IN the first article we found that zinc deposits silver and copper from solutions of their salts and that it will do the same with some other metals, notably cadmium, tin and lead. Cadmium is a metal not often found in the home laboratory, while tin and lead are. Cadmium is often useful for making small quantities of very low melting alloys.

A specimen of cadmium may be prepared with the aid of zinc from a solution of cadmium sulphate, which is a common laboratory reagent. Dissolve 10 grams of cadmium sulphate in 200 c.c. of water and suspend a rod of zinc in the solution as shown in the diagram. A grey deposit of metallic cadmium at once begins to form on the zinc. This will continue until all the cadmium has been thrown out of solution and its place taken by an equivalent amount of zinc which passes into solution. Finally we shall arrive at a solution of zinc sulphate instead of cadmium sulphate.

To ascertain when this is the case we make use of the colours of the sulphides of the two metals. Cadmium sulphide is yellow, zinc sulphide white. Therefore, if we test a few drops of the solution from time to time with ammonium sulphide solution, the yellow precipitate of cadmium sulphide will gradually give place to the white one of zinc sulphide. When the precipitate is white, push off the cadmium from the zinc into the solution, and then filter off the metal. Keep the filtrate for the time being and rinse the cadmium well with water. Dry it partially by draining on a porous brick and then complete the process in a warm room. It is a grey powder, often containing bright spangles of the metal when made by this method.

The filtrate can be worked up for zinc sulphate. Simply boil it down until a drop taken up on a cold glass rod crystallises at once. Then let it cool overnight. White crystals of zinc sulphate are deposited and may be dried on a porous brick for your stock. We shall see later how to make zinc sulphate in quantity for your general laboratory stock.

You may sometimes have wanted to write on zinc, usually for making garden labels. An excellent, very weather resistant ink is easily made for the purpose. The writer has labels in his garden which are perfectly legible after two years.

Two common chemicals only are needed. Namely, copper sulphate and potassium chlorate. Weigh out 1 gram of each, stir them with 36 c.c. of warm water in a beaker until dissolved and allow to cool. The solution is pale blue and will keep indefinitely. To use it simply write with an ordinary steel nib, but wash it after use. The writing, at first invisible, suddenly appears in black.

Zinc is attacked by alkalis and it is interesting to see how. Put a piece of granulated zinc in a test tube and add some potassium hydroxide solution. On warming the tube gas bubbles begin to

cheaply by using accumulator acid (dilute sulphuric acid). Dilute some by mixing it with its own volume of water. About half fill a clean one pound jam jar with the diluted acid and add some zinc. Granulated zinc dissolves quickest, since it offers a larger reaction surface. Put the jar in a safe place in the open air, for inflammable hydrogen is evolved.

Should all the zinc dissolve, add more until some remains when all gas bubbles have stopped. Filter the colourless solution of zinc sulphate and boil it down until a drop taken up on a cold glass rod crystallises at once. Then let it

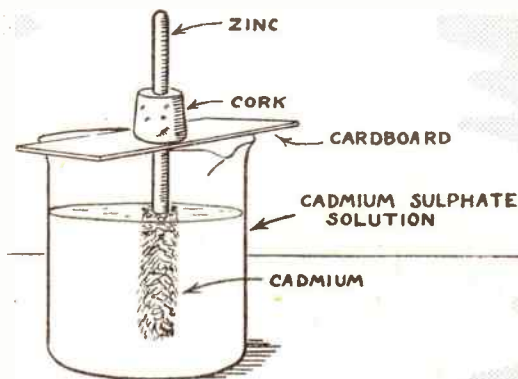

Using zinc to make cadmium

appear and by adding a small piece of iron, such as a small nail, so that it is in contact with the zinc, the gas evolution is much speeded. Hold the mouth of the tube to the flame. A sharp pop will be heard and a momentary blue flame be seen. The gas is hydrogen.

If you replace the potassium hydroxide solution with fresh from time to time the whole of the zinc will dissolve. This is very curious. Zinc being a metal and hence a base is expected to dissolve in acids to form salts. This it, of course, does. We now find it can also dissolve in an alkali and act like an acid. It has formed a solution of potassium zincate.

This reaction can serve at a pinch for making hydrogen. The gas so obtained is also free from the odour of hydrogen made by the usual zinc and acid method.

Now that we have found out a good deal about the metal, let us prepare some zinc compounds for your laboratory shelves. Zinc sulphate can be made

cool overnight. Remove the white crystals of zinc sulphate and dry them on a porous brick.

From zinc sulphate many other zinc compounds can be made. Basic zinc carbonate, for instance, is readily prepared by adding sodium carbonate (washing soda) solution to zinc sulphate solution, when it appears as a white precipitate. Add the sodium carbonate solution a little at a time until a drop of the mixture just turns red litmus paper blue. The experiment is best done with hot solutions, though cold will serve. Filter off the zinc carbonate and wash it well with water — preferably hot — until the wash water running through the funnel stem no longer gives a white precipitate with strontium nitrate solution. Dry the zinc carbonate in a warm room. The well known calamine lotion consists of a suspension of zinc carbonate.

● Continued on page 197

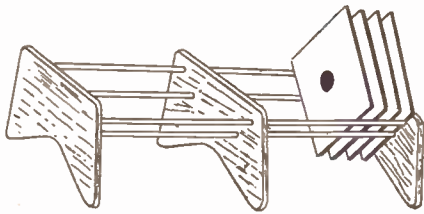

A TROUGH FOR YOUR RECORDS

By S.H.L.

IF you do not possess a gramophone record cabinet the next best thing is probably a trough, constructed, with some modifications, in a similar manner to the familiar book trough.

In order to accommodate the weight of a number of records you will find it advisable to use half-inch dowel rods for the cross members and an additional centre support is recommended if the trough is more than a foot wide. The actual width remains a matter for your own decision and it may be that the ultimate position will determine this. The trough will either stand on a table or radiogram and these must also be considered in relation to the width of the trough. A narrower trough need not have the centre support, but here again you must use your own discretion.

The illustration shows a trough prepared for the popular 10in. records, and is two feet in width, but it will also accommodate the smaller variety if desired.

Marking out

Three pieces of half-inch plywood measuring 1ft. 6ins. by 11ins. are required, being cut to the shape shown in Fig. 1. You will observe that all corners have been rounded and smoothed to prevent scratching of other furniture. The base has been so shaped not only to prevent scratching, but also to prevent any wobble on an uneven surface. The three pieces may be worked and drilled together after marking out as follows:

Prepare a centre line, marking a point 6½ins. down from the top edge and at 45° to the centre line, extensions are made to points approximately ¾in. from the sides as indicated by the dotted lines in the diagram. This leaves a right angle at the centre to fit the record cases. Centres are marked on these two lines for drilling holes for six ½in. dowel rods. Do not place a rod exactly in the centre as this would prevent stacking of the records. The top edge of the plywood measures 1ft. 3ins., and the base 1ft.

6ins., giving a gentle broadening to the feet. Another point, 2½ins. from the centre base is marked and lines joined to the bottom corners which are rounded. It will be found best to drill the holes in the three pieces of plywood while all

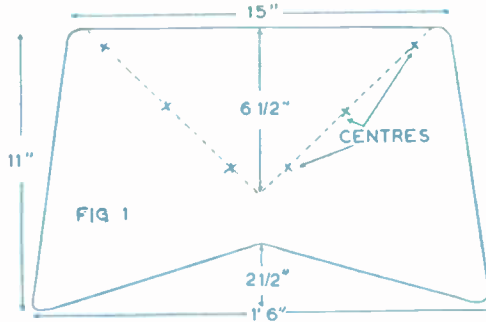

are cramped together and before cutting out the shape. This will also ensure good fitting of the rods. The edges of these sidepieces should be rounded off

with rasp and file, then thoroughly glasspapered to ensure smoothness.

Six equal lengths of dowel rod are prepared, slotted through the centre piece and the ends attached. If the drilling is correct and a tight fit results, nothing further is required, although no harm is done by adding a little glue to these joints. If there is any tendency towards looseness the remedy is to make a saw cut in the ends of the rods, afterwards knocking in thin, taper wedges, removing the waste and smoothing. The addition of a handle, by screwing from the inside, is optional but will make for convenience of handling.

After assembly the trough may be stained and polished or painted to match existing decorations, and ornamented with either a moulded motif or decorative transfers.

● Continued from page 196

Experiments with Zinc

By heating zinc carbonate you can prepare zinc oxide. Carbon dioxide and water are given off in the process. Heat zinc carbonate in a crucible to a near red heat for half an hour. You will note that it is yellow, but as the substance cools it becomes white. This colour change is characteristic of zinc oxide. The compound is used in medicine for making zinc ointment and zinc plasters. It also constitutes the white pigment known as Chinese or Zinc White.

Another compound of zinc used as a pigment is basic zinc chromate. This is a splendid yellow. To make some, stir potassium chromate solution into zinc sulphate solution little by little until no more yellow precipitate of zinc chromate forms. Then filter it off, wash it well with water until one wash water no longer gives a white precipitate with strontium nitrate solution and then dry it in the

oven or in a warm room. This yellow pigment is also known as Zinc Chrome or Citron Yellow.

In common with other zinc based pigments it has the advantage over lead based pigments of not darkening in the sulphur-laden air of towns. The reason for this will be clear if to zinc sulphate and lead acetate solutions in separate test tubes you add a few drops of ammonium sulphide solution. A precipitate appears in both tubes, white zinc sulphide in the first and black lead sulphide in the second. Town air contains enough hydrogen sulphide to produce a little of these sulphides in paints based on these two metals. Consequently, while the lead paint becomes very dingy, the zinc paint is unaffected in the case of a white zinc pigment, and in the case of a coloured one becomes only a little paler. (L.A.F.)

★★★★★★★★★★★★★★★★★★
 ★ Next week's issue will contain ★
 ★ articles of interest to all hobbyists, ★
 ★ and will describe how to make a ★
 ★ bed ideally suitable for a boy's ★
 ★ room. ★
 ★★★★★★★★★★★★★★★★★★★

'FLOWERS' OF THE SEA . . .

HAVE you ever thought what it is like in the wonder world beneath the waves, where the flat fish and the congers play? There are jungles and forest; mountains and valleys; watery meadows with waving seaweed and flowers of the sea. A study of marine flora, algae, variegated mosses and sea weed will well repay your interest.

If you examine them closely you will marvel at their beauty and intricate design, and as you learn their names, habits and history, it will lend an added charm and excitement to those sunny days spent at the seaside.

As you visit different shores year after year, you will seek out old friends among the algae and make new acquaintances, until after visits to various places by the sea, you will have amassed quite a collection of authentic information about the inhabitants of this watery world, mostly unexplored.

So be sure to take a note book with you to jot down the curious things you will find among the marine fauna and flora. The names of the different kinds are easily learned, and the collecting needs no special apparatus, nothing more than a few pieces of white paper or cardboard and a pin.

Slip the paper or cardboard under the bit of algae as it floats in that quiet pool among the rocks at low tide. Lift it horizontally almost to the surface. Arrange the delicate filaments with the pin and lift the paper or card out of the water. The specimens may now be laid on a sloping bank to dry in the sun, which will not take very long. Afterwards press them smooth and flat between the folds of old newspapers.

Use a skimmer

It will, however, be found much more convenient and easier to collect by means of a long-handled skimmer, that is, a net or other simple gadget by which you can reach into the water and gather the specimens as they float by.

The skimmer is best and may be purchased from any ironmonger. It should be lashed with stout string to the end of a pole 4ft. or 5ft. long. You will find it useful not only for catching the floating algae, but for detaching the plants from their anchorage near the low-water line.

Specimens thus obtained may be placed in tins, wide-mouthed bottles or pails partly filled with sea-water and kept a day or two for mounting indoors at leisure; perhaps in the evening or on a stormy day.

Now to mount the catches. Fill a large white bowl nearly full of sea-

water and place a few specimens in it to 'float out' on white cards of the same dimensions, that is, 4½ ins. by 6½ ins., or any convenient size. Hold the card in the left hand a little under the water; arrange those delicate filaments by means of sharp pointed forceps or a pointed instrument. A camel-hair brush is fine for this job. Scissors may be used for trimming off the larger branches and unwanted parts.

The specimens may be floated out from this bowl, but it will be best to do the shaking out, trimming, cleaning etc., in a separate bowl, and then transfer to one with clean water, especially for the final work. You may need a bit of practice to get the knack.

. . . and weed collecting

ONLY fresh pieces of seaweed should be collected. They should be first soaked in a basin of fresh water, to clean them from sand and salt. Then select a good piece, lay it in a soup-plate filled with fresh water, and slip under it a sheet of white paper. While in the water the seaweed may be easily spread out evenly on the paper by means of a camel's-hair pencil or brush. When this has been done, the paper may be raised gently from the water, and the seaweed will keep its form. Let the water drain off and then lay the paper on a sheet of blotting paper; over the seaweed lay a piece of linen cloth, and over that another sheet of blotting paper. The linen cloth is put in to keep the blotting paper from sticking to the seaweed.

After arranging all the pieces of seaweed in this way, pile them up between two boards and put some weights on them, and leave them for three or four days to dry. When dry, take off the blotting paper and rag from each carefully, so as not to pull up the seaweed.

Most seaweeds are gummy and stick to the paper, but some hard ones need a little mucilage. When well dried, the papers may be neatly arranged, according to their sizes, on the pages of an album. If the specimens are large, only one can be put on a page, but if they are small, they may be placed in many pretty ways. A little mucilage under the corners of each paper will hold them securely.

Seaweeds have no roots and, therefore, do not get any of their food from the earth, but live entirely from the

Put the cards for a few minutes on a slanting board to drain away the water, then lay them on sheets of blotting paper or botanists' drying paper. Get as many as you can on each sheet and cover all with a piece of muslin. Continue like this, drying-paper, cards with specimens on, cloth, drying-paper and so on, till you have all in the pile. Then put a board on top with a heavy weight on it. Change the drying-papers in about six hours, and again the next day.

With these 'flowers of the sea' you can devise many original ways of decorating various articles for household ornaments, making gifts to friends, articles for sale at church fetes and so on. They are almost certain to attract attention.

water. Many float about in the water, and many are fastened to rocks and other objects at the bottom of the sea, to which they are made fast by a kind of stem with a sticky surface. They have no real leaves, but have parts which answer for leaves. Sometimes these are like wavy thongs, sometimes like crumpled threads; others resemble fans, balloons, leather belts, delicate ribbons, or shreds of jelly. Some are thick and tough, others thin and tender; and they are of many colours, such as fawn, yellow, brown, olive, green, pink, and carmine. Those in deep waters are generally brown of different shades; those nearer the surface and often floating are mostly green; the pinks and reds are chiefly found in shallow water near the shore.

The uses of seaweed

Many seaweeds are useful to man. In Eastern Europe they are dried for fuel and put on land for manure.

The seaweeds called bladder-wrack and knobbed-wrack were once much used for making kelp. In Northern Europe these are used for feeding pigs, and when food is scarce even horses and cattle thrive on them.

In Holland a kind of seaweed is employed in building dykes, and the same is also used for stuffing mattresses and cushions, and for packing goods.

The Sandwich Islanders, the Chinese and Japanese, the Icelanders, and many other peoples eat various kinds of seaweeds. (R.L.C.)



Wipe your feet!

BOOT CLEANER FOR OUTDOORS

A front view and a vertical side section are given, from which the general construction can be gathered.

Cut the sides from 8in. wide boards, and note the slope of the top ends. These sides are joined together with the cross-bars (A) and (B), seen in the sectional view. The top edges of these might be bevelled off to the slope of the roof with some advantage to secure nailing of the roof board. At point (C), a third cross-bar is nailed across.

A batten (D), is screwed to each side,

MATERIALS REQUIRED

Sides (2), 2ft. by 8ins. by 1in.
 Battens A, B and C, 8ins. by 2 ins. by 1 in.
 Batten D (2), 11ins. by 2ins. by 1in.
 Roof, 12ins. by 9½ins. by ½in.

FITTINGS

Mild steel or iron scraper, 11ins. by 2ins.
 1 pair iron wall plates.
 1 pair laundry scrubbing brushes.

ALL thoughtful gardeners like to remove from their boots as much of the clinging soil as possible before entering the house, and, although the ordinary scraper may help, it is by no means the complete answer to the problem facing the keen gardener who is anxious to enter his house after a long session on sticky ground without incurring the just wrath of a house-proud mother or wife.

The boot cleaner described here provides the solution as not only is a scraper incorporated but two brushes are also available to reach the boot uppers and to clear away the mould from the welt seam and the heels.

It is simple to make and quite inexpensive. Built to stand flat up against the wall of the house, as near to the garden door as convenient, it occupies little space. As to the material, 1in. thick wood is suggested, with thinner stuff for the sloping top, the latter being covered with a piece of roofing felt, should a suitably small piece be at hand.

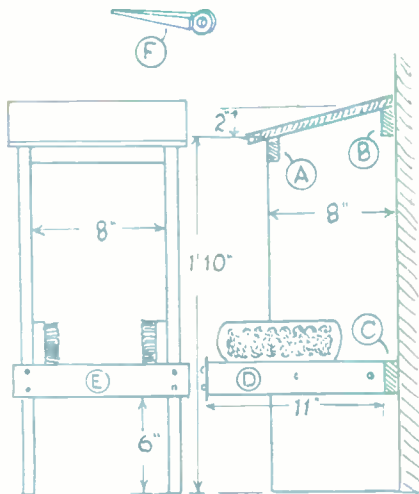

as shown. This will project in front of the construction some 4ins. and across it a scraper, made of stout sheet iron, is firmly attached with two round-headed screws each side. The actual width of the scraper, (E), is not very important, say about 2 ins. As a suitable strip of metal may be found in the household junk box, the width of the batten (D), should be made the same.

The roof board can be cut from ½in. stuff, or thereabouts. If it is intended to cover this afterwards with roofing felt, ¾in. plywood would serve quite well. If not, it might be as well, should the timber be handy, to employ two or more pieces of weatherboard.

Finally to complete the work of construction, screw to each side a common laundry scrubbing brush. The cheap kind, with stiff bristles is the best choice for the rough work they will have to perform. Give the whole a coat or two of creosote and fix to the wall with a pair of wall plates as detailed at (F), and obtainable at any ironmonger's shop.

SOLUTION TO LAST WEEK'S JIG-QUIZ No. 9

THE aeroplane puzzle last week highlighted the Avro 504 K. Many variants of the 504 were built, but the K was undoubtedly the one to create the biggest impression. Those of you who saw the film 'Reach for the Sky' would have noticed a shot of the 504 K. This was in fact the actual model rebuilt by Avro apprentices and now kept on display to remind us of the early days in aviation.

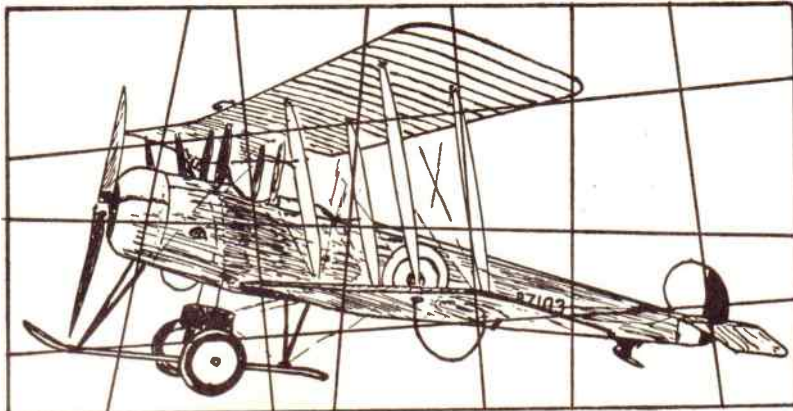

Make a model

'CABLEPLANE'

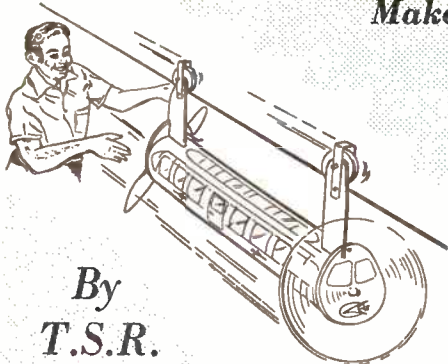

By
T.S.R.

AERIAL and cable railways are not a new form of transport, but recent designs with passenger-carrying compartments such as Monorail Trains running on overhead rails are gaining much popularity in Germany and other countries. Here then is a topical project for toy and model-making enthusiasts — an easy-to-build model

'Cablecar' or 'Cableplane'.

As will be seen from the illustration, the writer's prototype model consists of a cylindrical body with twin propellers, and suspended by bogies with wheels from an overhead cable. The model is propelled by the simple 'rubber motor' as used in model aeroplanes.

Referring to the illustrations, the first thing required is the tube for the body of the car. This is a cardboard postal tube measuring 9ins. in length by 2ins. diameter. If a tube is not readily to hand one can be made to the required size from thin cardboard. Alternatively the tube could be of transparent material

as used for the windows of doll's houses. In this case, windows, doors, etc. could be realistically painted onto the material before forming into a tube. In addition to odds of wood for parts (A), (B) and (C), and bits of wire and metal strip for propeller shafts and pulley brackets, the only other components required are the two 8in. diameter propellers and two suitable pulley wheels. The latter can be purchased or be made up from wood sandwiched together and drilled to slot on dowel-rod spindles. Meccano outfit pulleys could well be utilised.

Note that if a larger than 1½in. diameter pulley is used, the support arms (C) will have to be lengthened, or the U-shaped wheel bracket raised so that

Continued on page 201

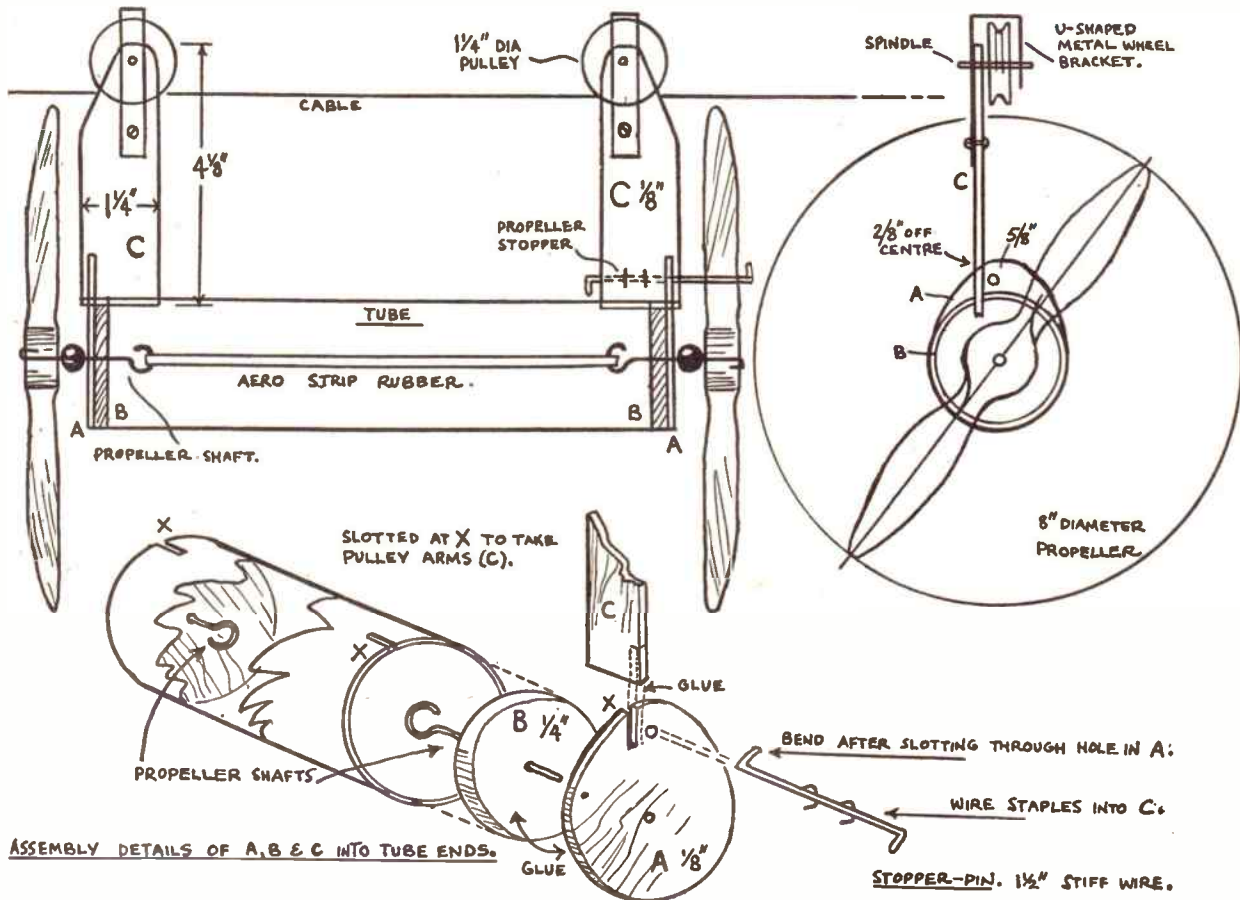

ASSEMBLY DETAILS OF A, B & C INTO TUBE ENDS.

Hygienic and safe

MILK BOTTLE HOLDER

HERE is a handy milk bottle holder which should have an immediate appeal. It not only keeps the bottles from getting accidentally knocked over, but the hygienic cap keeps the tops clean and also prevents that little thief, the blue tit, from piercing the metal tops and stealing the cream.

This holder has been designed to hold two pint bottles, but it would be quite easy to alter this, and using the same idea, to make it hold three, four or even more bottles.

Almost any kind of wood can be used, a hardwood of course making a stronger and more lasting job. Cut the base 8ins. long, 4ins. wide and $\frac{1}{2}$ in. thick to the shape shown at (A). Increasing the thickness to say $\frac{3}{4}$ in. would also increase its stability and this would certainly be an advantage. A hole $\frac{1}{2}$ in. diameter is drilled in the centre to take the dowel rod handle, and this should be a tight fit, even though it is also glued in position. The length of the $\frac{1}{2}$ in. dowel is 13ins.

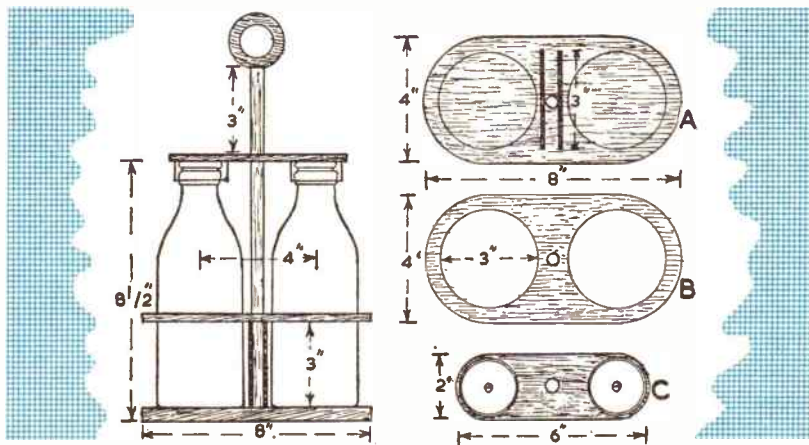

A piece of wood similar in size to the base but only $\frac{1}{2}$ in. thick is fixed 3ins. above it and holds the bottles in

place. Plywood is more suitable for this guard piece as it will give more strength when the 3in. holes have been cut out for the bottles to slide through.

Most pint-size milk bottles are this size but it would be advisable to measure them before cutting out the parts. If there is much variation then this piece and also the base can be amended to suit.

Drill a hole in the centre for the handle to pass through and the plan of this piece is given at (B). Two 3in. squares of $\frac{1}{2}$ in. ply will secure this guard in its correct position. Glue to the base, the centre dowel handle and lastly place the guard piece on top.

Now cut out piece (C) which covers and protects the milk bottle caps. This is 6ins. long, 2ins. wide and $\frac{1}{2}$ in. thick. Drill the centre hole a little larger than $\frac{1}{2}$ in. so that it slides easily over the dowel handle enabling it to be lifted and given a half turn when bottles are put in or taken out of the holder.

At each end of the piece (C) and at a distance of 4ins. measured from their centres, fix a metal screw cap from an old jar. This should have a diameter of about 2ins. so that it will fit fairly closely over the milk bottle and keep the birds from pecking off the top. Try to find lids with a deep rim to well cover the bottles. A small screw in the centre will hold these in place but remember not to let them protrude, and if a slight dome is made with a punch this will be avoided.

To facilitate carrying the holder and to enable it to be hung up on a peg out of harms way fix into the top of the dowel rod either a large screw-eye or a wooden ring as shown in the sketch.

(A.F.T.)

● Continued from page 200

Model 'Cableplane'

the propeller runs clear of the cable line. In order to obtain driving power, you will of course need rubber strip or band, and it is well worth purchasing a yard of catapult rubber or aero strip and cut the required length for hooking on to the two propeller shafts.

Draw out two 2in. circles on $\frac{1}{2}$ in. thick wood. Do the same on to wood of $\frac{1}{2}$ in. thickness. On the latter extend the height by $\frac{1}{2}$ in., turning it into an oval shape. Cut these out so that you have two of (A) and of (B). Disc (A) should fit smoothly and hold firmly into the end of the tube. Glue (A) and (B) together, and drill the centre shaft hole through both pieces.

The arms (C) are next cut out of $\frac{1}{2}$ in. wood to the dimensions in diagram and drilled at top to take the pulley spindles. Draw a line along the tube, and at each end cut slots to accept the arms (C). Bend two pulley brackets from metal strip or Meccano strip, fixing in the pulleys so that they revolve smoothly. The front view sketch shows how the U-shaped bracket carrying the wheel is secured to support arm (C). If both sides of the bracket were fixed to the arm member, the cable line would have to be threaded through the bracket.

The end members (A) have to be slotted as shown to receive the end of the uprights which are glued in position,

and it should be noted that to obtain correct balance when suspended from the cable, these slots should be cut off centre according to the width of pulley used. Staples are driven in to hold the stopper wire, and then the complete 'bogies' are glued securely into the slotted tube ends.

The arms should not be glued, however, to the tube, but slide into the slots in the tube when disc (B) is fitted, so that the two units may be removable for fixing and adjusting the rubber motor. Finally fashion the two propeller shafts from stiff wire, slot through, and fix on the propellers, adding a wood or glass bead. Fix on the rubber strip or band, and replace the end members into the tube.

Rig up a 'cable' securing a length of string, cord or plastic covered wire between two hooks from one wall to the other. The line should be quite taut and should not sag if the model has been built with fairly light materials. To help the 'plane' along, it may be found necessary to slope the line slightly, so that it propels on an incline. The stopper pins allow the propellers to be revolved alternately for forward or backward drive. Paint the model with bright enamels, adding authentic details to the coach, such as windows for passengers, etc.

MAINLY *for* MODELLERS

FITTINGS Part 2

By 'Whipstaff'

WE now come to one of the most interesting periods, from the rigging aspect, the days of the 'Sovereign of the Seas' and other famous ships, the days of the spritsail topmast.

For this period our model makers should use three-hole round deadeyes for setting up the shrouds. The metal stopping shown in Fig. 1 is the correct procedure and can be modelled in several ways. For small models they can be stropped with rigging cord, stiffened with glue or cement, but for the scale model in which we try to copy full scale practice, we will make them of metal wire.

A fine gauge wire is needed, of a rust proof type. I have used fine galvanised wire, jewellery wire and brass wire stained black.

First we must convert the wire into wire rings, of a diameter suitable for our purpose, that is, if we are fitting 'chains', the loop will form the first link and must reach well below the channels. If we are fitting chain-plates, we make them smaller in order that the loop should merely be large enough to hook on the chain-plate.

As far as we can ascertain, the chains were used on English vessels from about 1640 to 1655. From 1600 to 1640 and from 1655 to about halfway through the next century, chain-plates were used, but more about these later.

To make our rings, having decided the size of the loop we require, we obtain a piece of dowel of this diameter. It will be that much larger than your deadeye by the size of the loop. Thus, if your dead-eye is $\frac{1}{4}$ in. and your loop is for chain-plate, a dowel of $\frac{3}{4}$ in. in diameter will suffice.

Wrap the wire around the dowel as in Fig. 2A for sufficient turns to supply the number of rings required. These can be now cut straight along the dowel. For cord rings use a razor blade, for wire a fine hacksaw blade, or if this is not available, a flat jeweller's swiss file.

All rings are now mounted in a bar of soap (Fig. 2B) and a spot of solder paste is put on each joint (a pointed match-stick is ideal for this). A touch with your blow lamp will complete your rings. If you put too much paste on, the surplus can be filed off.

Our next piece of work is to attach the rings to the deadeyes. This is a simple operation. Just slip the ring over the deadeye and pinch together to form the loop, with a pair of small pointed pliers,

making sure the loop is directly opposite the single hole, as in Fig. 1.

To make chain-plates is another simple job. The one shown in Fig. 3 was made from soft wire, flattened with a hammer, on a small anvil made from an old fashioned domestic iron. It was then

separate link, the mild steel rod was put in the vice and pressed to shape as shown in Fig. 5.

To solder these is a more difficult job than the rings. For this we require a piece of steel or other hard metal of a thickness equal to the length of the link.

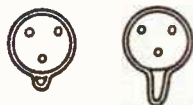
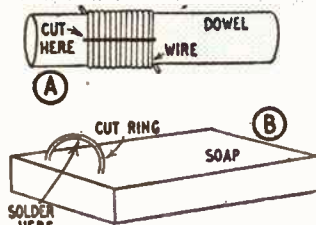
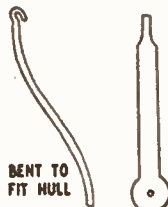

FIG. 1.



RING MOUNTED FOR SOLDERING

FIG. 2.



CHAIN PLATE

FIG. 3.



FIG. 5.

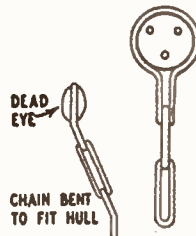
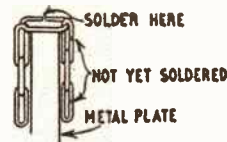

FIG. 4.



SOLDERING CHAIN LINKS

FIG. 6.

filed to shape and drilled for the bottom hole with a No. 74 twist drill, and then bent to fit the tumble home curve of the hull.

To make the chains of the middle period as shown in Fig. 4, proceed as follows. Obtain a piece of metal rod of suitable diameter to form the rings required for your particular scale, and again wind the fine cord or wire around the rod and separate to form the rings. The correct shape of the links is shown in the sketch and to save shaping each

Having soldered the first few links, say, half a dozen by the soap method, we can then speed up the work by using our piece of metal as a jig, resting each link in turn on the edge of the metal while soldering (Fig. 6).

It is worth noting that in some cases small jewellery chain can be obtained in correct scale size and shape.

In our next article we shall show an alternate method of making chain-plates and follow on our study of this branch of modelling.

FREE PICTORIAL packet with approvals. 3d. postage. — Allcock, 74 Tynyparc, Rhiwbina, Cardiff.

ROY'S STAMP SERVICE — Beginners and Juniors specially catered for. Send 3d. stamp requesting details and trial. — 23 Adria Road, Birmingham 11.

MATCHBOX crystal receiver parts and instructions. Reception guaranteed, 3/6. Write BCM/ALEXSTONE, London, W.C.1.

RUSSIA 1946 RECONSTRUCTION PLAN. This fine complete set priced 2/10 offered FREE to approval applicants enclosing 3d. postage. — Yulwontmor Stamps (Dept. H7), 29 Layton Avenue, Mansfield, Notts.

STAMPS — First Day Covers, 1958 Health, 1/3 each. Order Now. — Jackson, Awara Road, Henderson, Auckland, New Zealand.

100 DIFFERENT stamps free! Request 4d. upwards discount approvals. — Bush, 53 Newlyn Way, Parkstone, Dorset.

WHEELS (Hardwood and Rubber Tyred Metal), Cot, Pram and Doll's House Fittings and Papers, Beads, Transfers, Prints and other accessories. Stamp for new lists. (Trade supplied.) New address — JOYDEN CO., 91 Peplins Way, Brookmans Park, Herts.

MAGNIFIER PLUS 50 STAMPS Absolutely FREE!

To obtain these 2 Gifts, send 4½d. stamp to cover return postage, and Request Approvals, together with details of other Gifts available.
MYERS & Co. (Dept. HA2)
42 Castleview Gardens, ILFORD, Essex.

* GREAT CAMPING OFFER * RIDGE TENT SENT FOR 4/-

Complete. Ideal cyclists, campers. Length 7' 3" sleeping base x 4' 6" wide x 3' 6" high x 12" walls, all approx. Weight 3½ lb. Cash 55/6, or 4/- deposit and 9 monthly payments 6/6, 1 of 2/6. WITH FLYSHEET 83/6, or 9/3 deposit and 8 monthly payments of 9/9, 1 of 4/9. Both carriage 2/6. **LISTS, TENTS, TERMS.**

GREAT FURNITURE SALE! THREE-IN-ONE ★ WRITING BUREAU ★ BOOKCASE ★ RECORD CABINET

Magnificent ultra-modern space saving item of furniture designed for 3 essential purposes. Holds 200/300 Records (upright in perfect condition). Incorporates a spacious Bookcase. Drop-front desk closes when not in use. Numerous compartments provided to contain papers, etc. Superbly made, beautifully sand-polished 100% hard wood. Doors Compo read. 42" x 24". Don't miss. Flat top takes Radio or Gram.

Headquarter & General Supplies Ltd.
(HOBW/18) 196-200 Coldharbour Lane
Loughboro Junc., London, S.E.5 Open Sat

ONLY £3196 COMES WITH 100 RECORDS

BECOME CHIROPODIST MASSEUR. Postal Schools (Dept. 27), 48a Abbey Street, Accrington.

'PAINTSPRAYING' HANDBOOK. Covers Car, Industrial & Flock Spraying, 3/6, post 4d. Catalogue of our Cellulose and Paints and all Allied Sundries 3d. — Leonard Brooks Ltd., 81 Oak Road, Harold Wood, Essex.

MODELS. You can make lasting stone-hard Models with Sankey's Pyruma Plastic Cement. Supplied in tins by Ironmongers, Hardwaremen and Builders' Merchants. Ask for instruction leaflet.

MAKE A MUSICAL BOX for as little as 21/6. New kits and tunes available. Movements 14/9 post free. Please send 3d. stamp for free illustrated catalogue. — The Swissross Co., Dept. B, 202 Tulse Hill, London, S.W.2.

KUKLOS ANNUAL. Indispensable cyclist's handbook. Tours, resthouses, money-saving hints, 3/- post free. — Burrow, Publishers, 2 Imperial House, Cheltenham.

STAMPS FREE — Empire Packet including Pictorials and Victorians with approvals. — Robert J. Peck, 7a Kemp Road, Bournemouth.

CHEMICALS AND APPARATUS. Free Cbooklet of 100 experiments with orders over 15/6. Send 3d. stamp for catalogue and details of special offers. — Scientific & Technical Supplies (Nottm.) Ltd., Dept. H, 9 Wellington Circus, Nottingham.

STOP SMOKING in 3 days or money back. Safe, pleasant, permanent. The only scientific way. No Will Power necessary. 'Conquered the habit in 2½ days'.—F.C. 'Within 2 days I was free from the tobacco habit'.—W.G. 'Was a smoker for 2 years and broke the habit in 2 days'.—F.N. 'I used to smoke 20 a day . . . now I have no desire to smoke'.—J.M. Recommended by 'Health and Efficiency Magazine'. Complete course 7/6 (or \$1.00 bill). Details 3d. stamp. Sent under plain cover. **NATURE REMEDIES**, 28 (H/181) Dean Road, London, N.W.2. Established 1928

APPARATUS & CHEMICALS For your experiments. Let us help you equip a HOME LABORATORY

Beakers, Crucibles, Flasks, Funnels, Gas Jars, Test Tubes, etc.

Booklets:
(including postage)

'Experiments' 1/2
'Formulas' 1/2
'Home Chemistry' 2/10
New edition



Send 3d. Stamp for latest PRICE LIST

A. N. BECK & SONS (Dept. H.W.)
60 Stoke Newington High Street, London, N.16

HEAR ALL CONTINENTS With H.A.C. Short-Wave Receivers

Suppliers for over 18 years of Radio S-W Receivers of quality.

One-Valve Kit, Price 25/- Two-Valve Kit, Price 50/-

Improved designs with Denco coils. All kits complete with all components, accessories and full instructions. Before ordering, call and inspect a demonstration receiver, or send stamped addressed envelope for descriptive catalogue.

'H.A.C.' Short-Wave Products (Dept. 22), 11 Old Bond Street, London, W.1

HARDHITTING ACCURATE

Webley AIR PISTOLS

AIR RIFLES · ACCESSORIES

Write for Catalogue

WEBLEY & SCOTT Ltd., 166 WEAMAN ST., BIRMINGHAM, ENGLAND

BETTER CUTTING

With the NEW
**Steadfast
Hacksaw
Frame**

STEAD



**WITH FREE BOOKLET
SOLVING YOUR
HACKSAW PROBLEMS**

An entirely new type of Hacksaw Frame embodying a shatterproof plastic handle giving a better grip. Adjustable oval tube frame. Packed in an attractive plastic wallet with an extra blade.

RETAIL PRICE **19/6**



J. STEAD & CO. LTD. SHEFFIELD 2 · ENGLAND

PRODUCTS NOTED

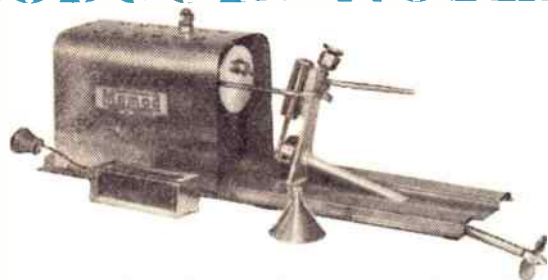

Mamod Marine Steam Engine Unit

THIS entirely new model steam marine engine unit has just been marketed by Messrs. Malins (Engineers) Ltd. of Summer Road, Edgbaston, Birmingham. The complete unit which weighs 21 ozs. is mounted on a base plate of light and rigid construction designed to give heat insulation and provide adequate protection to the boat. The base plate measures 12ins. by 3½ ins. and the overall length of the unit, including the propeller, is 13½ ins. with an overall height of 3½ ins.

The boiler is made from seamless brass tube and is fitted with safety valve and water level plug to ensure dry running

throughout and is protected by a detachable chromium-plated windscreen. The unit, which is mounted on a cast brass frame, includes a complete lubricating system to ensure sustained maximum output. The two-blade propeller is connected direct to the flywheel through a stern tube. The boiler is fired by an efficient spirit vaporising lamp, a tundish being fitted for boiler filling.

This is claimed to be a very lively engine unit of highest quality, designed for easy installation in flat or 'V' bottom hulls. It costs 45/- (including purchase tax).

POLYCELL Products have introduced a new paint stripper called Polystrippa. This new member of the Poly-family will act on all types of paint, including cellulose paints, varnishes, enamels, lacquers, and all types of oil-bound distempers. Generously applied with a smooth bristle brush, only washing down with water is necessary after the paint has been taken off with a stripping knife. Because of its viscosity, Polystrippa does not run on vertical surfaces.

Polystrippa, it is claimed, remains penetrative for three to fifteen minutes after application and will remove from one to six coats of paint according to the surface to be acted upon.

MESSRS. SPEAR & JACKSON LIMITED of Sheffield have been making good tools for close on two hundred years. They have now made a careful selection and grouping of just those tools the householder needs to function adequately as a handyman.

Our photograph shows the Handyman Kit No. 2, containing Pin Hammer, Tenon Saw, Wood Chisel, Tri-Square, Electrician's Screwdriver, Pincers, Putty Knife, Bradawl and Nail Punch. It sells at 62/6 and Kit No. 1, with a different assortment of tools, costs 59/6.

MADE of imperishable plastic, with a knitted fabric lining, Northands gloves will prove invaluable when gardening, painting, etc. or doing other messy jobs about the house. To clean, they require only a quick rub in sudsy water.—James North Distributors Ltd., 54A Tottenham Court Road, W.1.

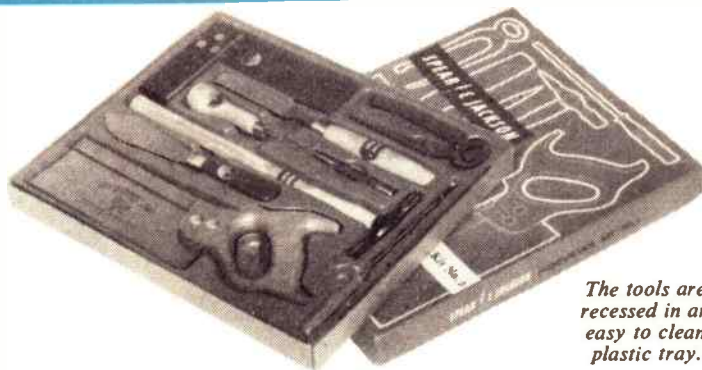

The tools are recessed in an easy to clean plastic tray.



These jolly sailors make a pair of attractive models and have recently been introduced into the Sculptorcraft flexible rubber mould range. The pack of two moulds costs 7/.



A plastic cap which also acts as the handle of a brush for applying adhesive from its collapsible metal tube has been developed by Copydex Limited, in collaboration with Venesta Limited, tube manufacturers.

SOMETHING FOR THE HOME?

Kits of materials with full details of construction

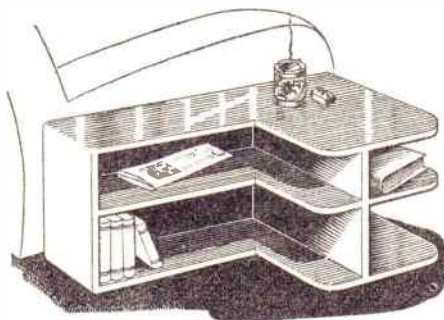

FIRE-SIDE TABLE/BOOKCASE No. 3200 68/9
Selected wood panels, etc.

Make it with a Kit from

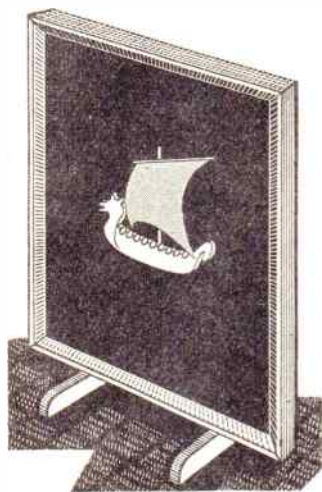

VIKING FIRE-SCREEN No. 3208 13/6
With ship in semi-relief.

Hobbies Kits make it easy for the average handyman to complete a fine piece of furniture for the home. They have that individual touch which gives the maker a pride of achievement.

Kits obtainable from branches or direct (post free).

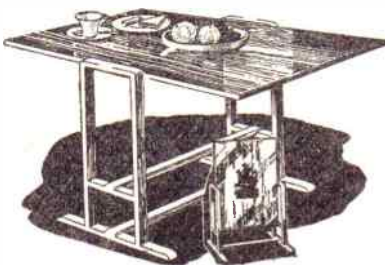
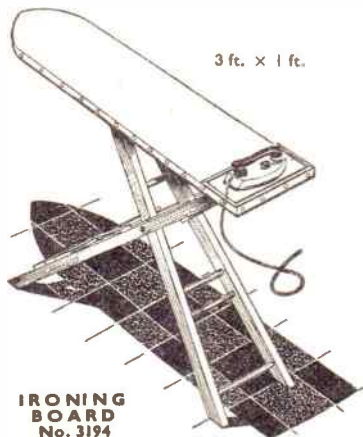

TABLE AND FIRE-SCREEN No. 3050 37/6
A dual-purpose kit.



BRUSH SET No. 3080 10/6
With mirror, brush, etc.



3 ft. x 1 ft.

IRONING BOARD No. 3194 27/6
Folds into small space. A worthwhile project for the handy man



CONTEMPORARY TABLE No. 3212 29/6
With special screw-in legs. Made in an evening.

To Hobbies Ltd., Dept 99, Dereham, Norfolk.

Please send free 20-page booklet showing kits available and kit marked below

Kit No.

P.O. for enclosed.

Name

Address

Replies to Readers

Is this YOUR Problem?

Lift-up Door Hinges

CAN you explain to me the fixing of the lift-up hinges used for lifting doors over carpets, etc.? Would it be necessary to bevel off the top of the door to allow for the hinge rising as the door opens? If so, how much should be planed off? It occurs to me that the hinges in question would be no good at all where there were fitted carpets right up to the skirting board. Will you tell me how this difficulty is overcome in the case of a fitted carpet? (W.H. — Stoke-on-Trent.)

WE would say that from a practical point of view there seems no need to fit rising hinges when the carpet comes up to the skirting board, as there is nothing left for the door to clear. The only advantages are less risk of scraping the carpet every time the door is opened

and the hinges being self-closing. If this is good enough, it will be necessary to remove by planing, enough of the bottom edges to allow the door to open with ordinary hinges. The hinges of self-rising pattern can then be fixed as ordinary hinges with the exception that the knuckles must project at least $\frac{1}{8}$ in. beyond the door faces. Closing the door will then show how much, if any, must be planed off the top edge to avoid jamming. This planing should be of bevelled form from behind, then it will not be seen when the door is closed.

* * *

Photographic 'Magic'

I ONCE read an article on how to perform a photographic 'magical' trick. After taking a person's portrait, a print is made from the negative, but instead of developing, it is soaked in a solution to hold it back. It is then dried in the usual way. Next a piece of blotting paper is soaked in a strong solution of either developer or fixer and allowed to dry. The blank sheet of bromide and the piece of blotting paper is then given to the person whose portrait it is, with instructions to wet the blotting paper and rub it over the sheet of bromide. In a minute or two he is looking at a portrait of himself. Have you any knowledge of this process, and if so, could you please give me full details on how to perform the trick. (C.F. — Runcorn.)

I THINK you will appreciate that it would be impossible to 'hold back' the image, for on second exposure to light the entire paper would go black. You are quite right about the possibility of performing this apparent miracle which has appeared in many forms from time to time, and the solution requires an additional operation to the one you mention. The picture is prepared in the normal way, and you may either use bromide paper or contact paper, that is, by normal exposure, development and fixing. The photograph is then in the usual state, but we make it disappear by bleaching out. In actual practice an intensifying agent is used for the bleaching process, e.g., potassium bichromate and you would be recommended to buy a small bottle of tablets. These are sold under the trade name of 'Tabloids' and known as Potassium Bichromate Intensifier. After washing, the print is bleached and the picture

re-appears on placing in the usual print developer — in this case, blotting paper saturated with the solution and allowed to dry. There are one or two difficulties to watch. First of all the print should be a little lighter than usual, for the process tends to intensify. Secondly, the print *must* be well washed after processing to remove all yellow traces of the bichromate, but this can be eliminated in a bath of potassium metabisulphite. After removal of the yellow traces, contact with developer or the treated blotting paper will bring up the picture. You must also realise that the prepared blotting paper will not last indefinitely for developers oxidize rapidly, 24 hours usually being the length of practical life. If you propose experimenting with this trick it will be better to prepare the blotting paper a short while before required. Allow the paper to dry naturally or the ultimate result may be a little patchy.

LABELS FROM TUBES

CUT AWAY NOZZLE



COXS ORANGE PIPPIN

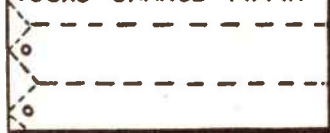

FOIL SHEET OPENED OUT

ANY number of unperishable garden labels may be made from discarded toothpaste or hair-cream tubes. Cut off the nozzle end of each tube open the foil out flat, and thoroughly wipe off any residue.

Cut the labels, about 4ins. long and $\frac{1}{2}$ in. wide, with a pair of scissors, punching a hole in one end to take string or raffia tape for attaching to the trees or plants.

Write the names of the various plants or trees using linen marking-ink. These labels will last indefinitely, and the writing on them remains legible for years.

(G.H.H.)

GARDEN STAKES

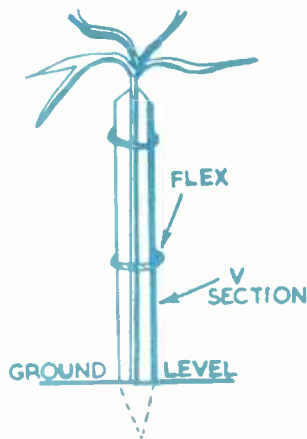

IF you are tired of having to stake fruit and other trees every few years because the wooden stakes rot or split, visit a junk yard and buy a number of angle iron lengths from old metal bedsteads.

Taper each 'stake' at one end to drive into the ground. The trunk of each tree should neatly fit in to the V shaped stake and will only need pieces of old sacking as a packing.¹ Lash the tree and stake together with old flex wire.

Although there will be a certain amount of black or other coloured enamel on the iron when bought, it is advisable to give each stake another coating of weather-resisting paint.

(G.H.H.)

Easy-to-make gift

A 'GOOSE' THERMOMETER

THE backing piece (A) is cut from $\frac{1}{2}$ in. wood and the two geese from $\frac{1}{2}$ in. The strut (C) is also cut from $\frac{1}{2}$ in. wood, and should be about 2ins. high, and shaped to allow the stand to tilt back slightly. If sending by post, the strut should be made to hinge with small pieces of tape or metal hinges.

Glue the geese to the backing piece, and glue the small thermometer (E) in the position shown by the dotted lines. Paint the background dark grey and the geese white. Markings on the geese should be black or dark brown.

Suitable thermometers may be obtained from Hobbies Ltd., Dereham, Norfolk, price 1/6 (post and packing 4d. extra). (M.p.)

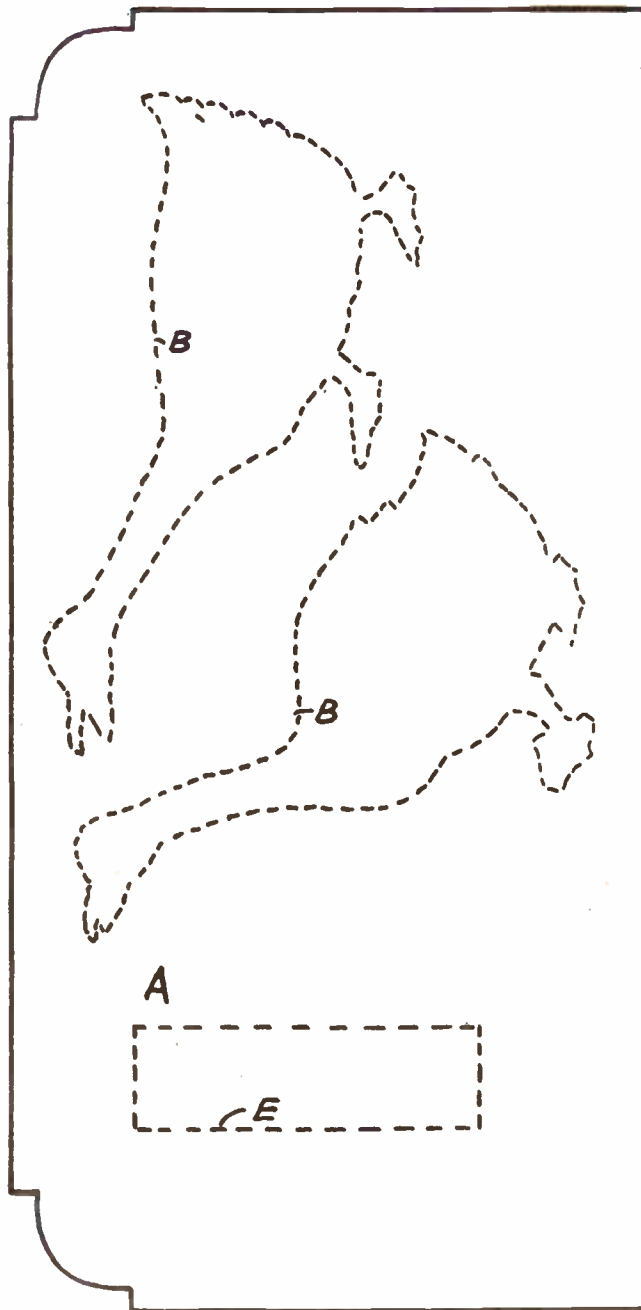
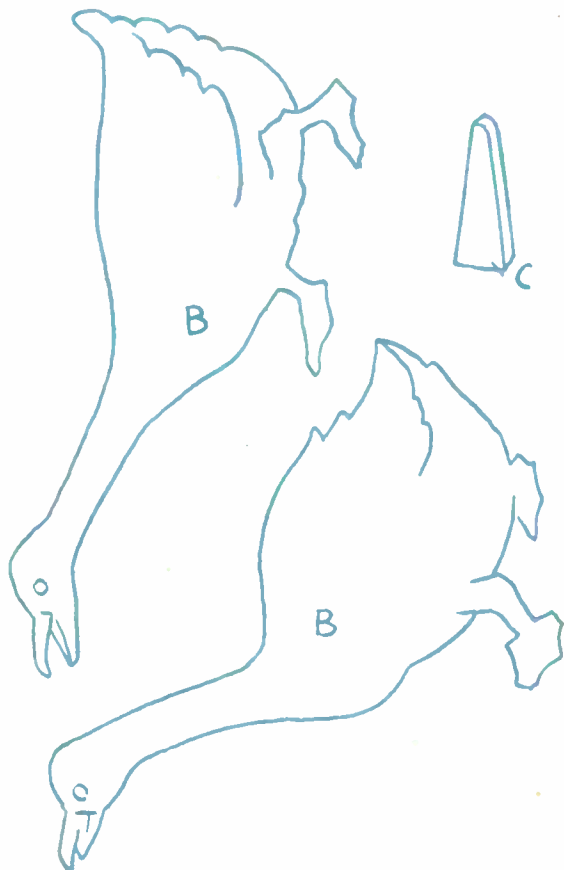

OUT of the BLUE

SUPER AIRCRAFT KITS

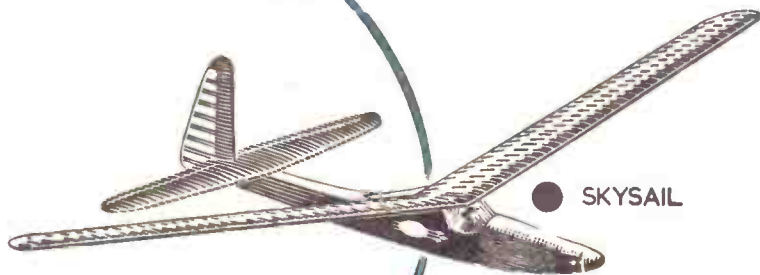

● SKYSAIL

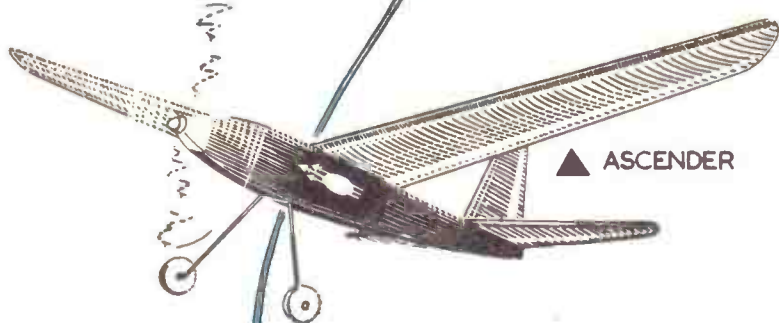

▲ ASCENDER

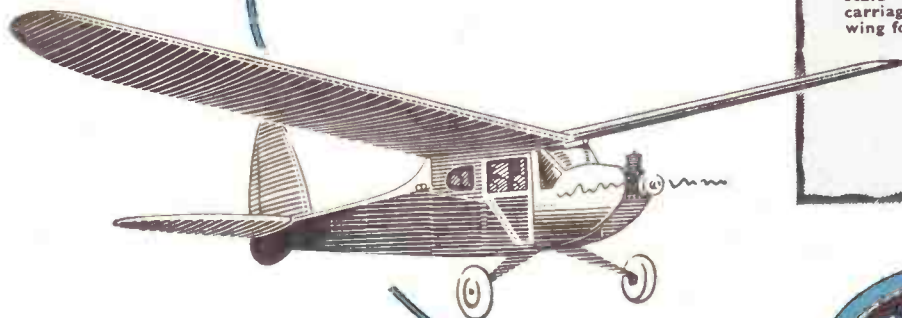

★ CHAMPION

EXCLUSIVE FEATURES

These kits introduced by Hobbies have many important exclusive features. Designed to give top performance in their various classes. All sheet parts are die cut and there are super detail plans. Easy to build and fly.

● SKYSAIL — A 36in. wing span glider for tow launching. 'Wing-saver' tow hook—printed dummy pilot — anti-warp wing bracing — jig-lock fuselage alignment.

6/6

▲ ASCENDER — A 30in. wing span rubber band model. Adjustable pitch propeller with replaceable blades — fixed tail surfaces for positive trimming — anti-torque automatic-action rudder.

10/11

★ CHAMPION — A 36in. wing span free flight power model. Suitable for .5, .75, .8 and 1 c.c. motors. Opening cabin door and complete cabin details — scale type light alloy undercarriage — optional polyhedral wing for high power.

18/6

DESIGNED FOR
THE NOVICE
AND EXPERT



From all Hobbies branches and model shops, or

HOBBIES LTD. (Dept. 99), DEREHAM, NORFOLK

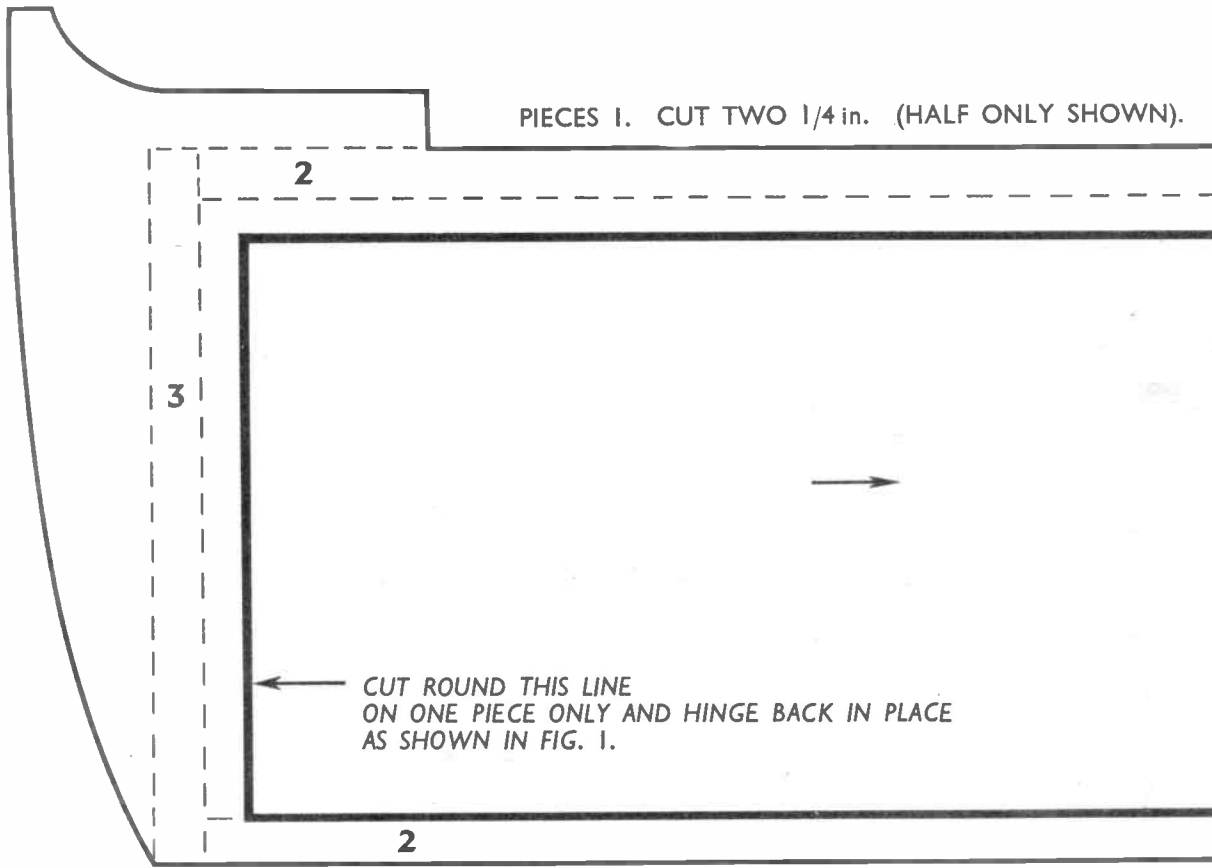

PIECES 1. CUT TWO 1/4 in. (HALF ONLY SHOWN).

CUT ROUND THIS LINE ON ONE PIECE ONLY AND HINGE BACK IN PLACE AS SHOWN IN FIG. 1.

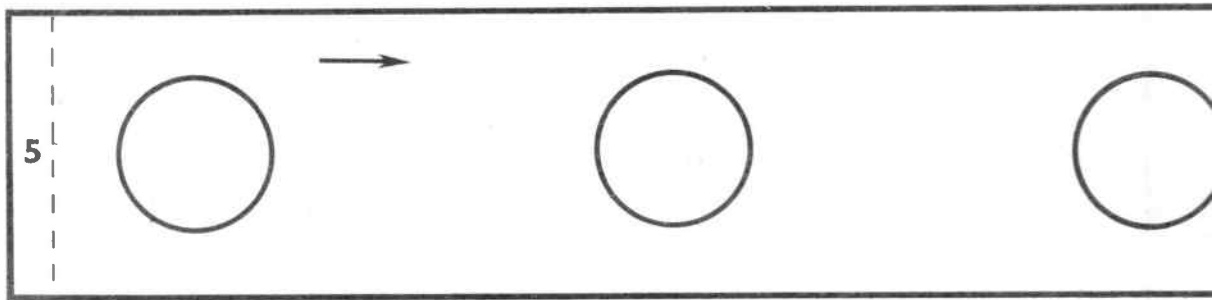

PIECES 4. CUT TWO 1/4 in.



3 1/2"



DESIGN

No. 3270

TOY NOAH'S ARK WITH ANIMALS

SIZE: 13½ INS. x 4 INS. x 6 INS. HIGH

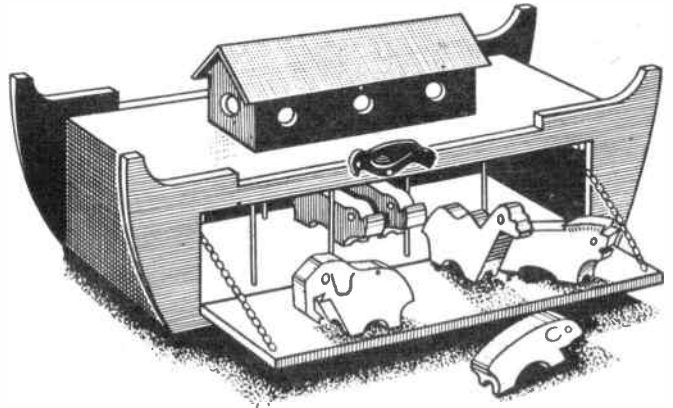

THE ARROWS INDICATE THE DIRECTION OF GRAIN OF WOOD.

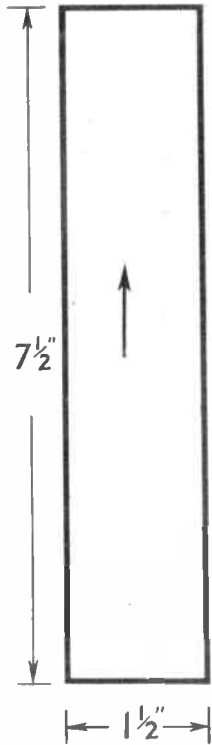
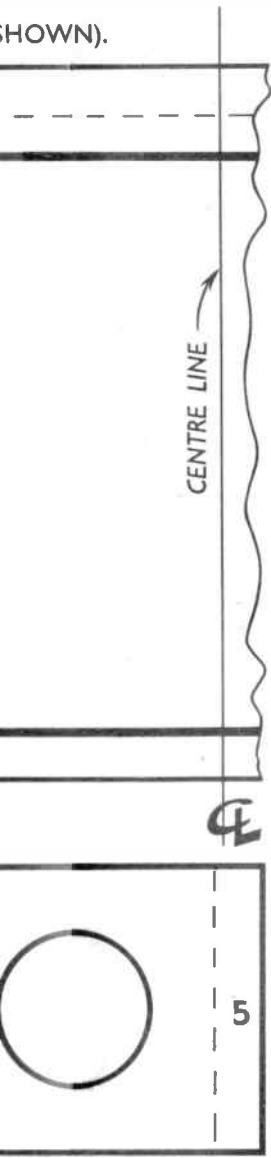

PIECES 6. CUT TWO 1/8 in.

HERE'S THE IDEAL PAINT PACK

6 intermixable colours in capsule form — just enough to do a small job and so economical. The Humbrol Art Oil Enamel Intermixable Paint Pack costs only 1/3 from "Hobbies" and Handicraft Shops everywhere.



"intermixable"
PAINT PACK
THE HUMBER OIL CO. LTD., MARFLEET, HULL

A KIT OF MATERIALS FOR MAKING THIS DESIGN IS SUPPLIED BY HOBBIES LIMITED, DEREHAM, NORFOLK. PRICE ON APPLICATION.

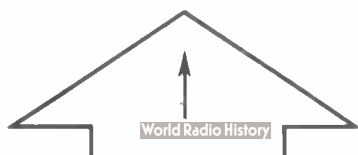



PIECES 4. CUT TWO 1/4 in.

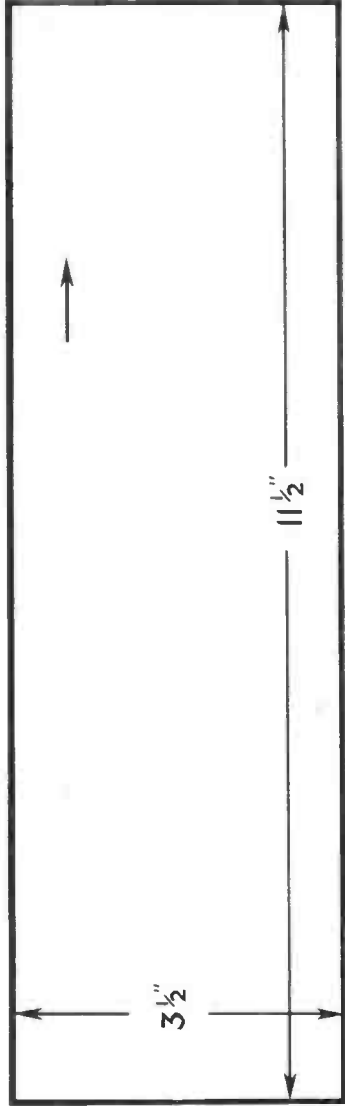

PIECES 2. CUT TWO TO MEASUREMENTS SHOWN 1/4 in.

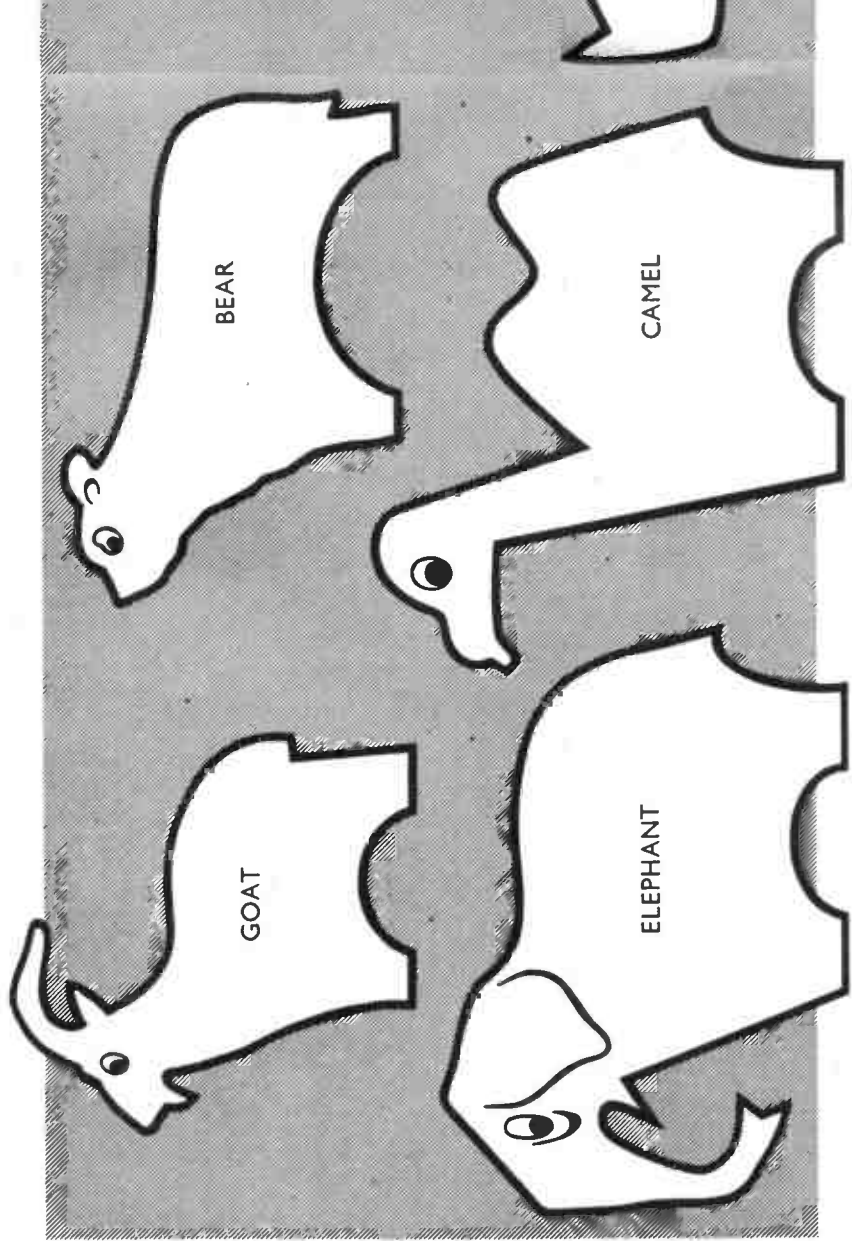



1 1/2"

PIECES 6. CUT TWO 1/8 in.

A KIT OF MATERIALS FOR MAKING THIS DESIGN IS SUPPLIED BY HOBBIES LIMITED, DEREHAM, NORFOLK. PRICE ON APPLICATION.



PIECES 7. CUT TWO 1/8 in.

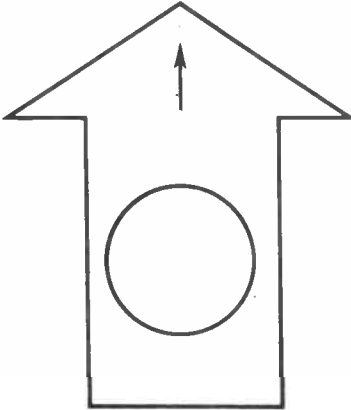

PIECES 5. CUT TWO 1/4 in.

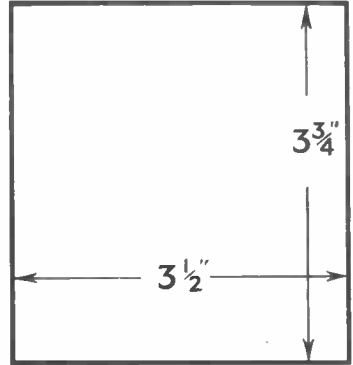

PIECES 3. CUT TWO 1/4 in.

ALL ANIMALS CUT FROM 3/4 in. WOOD.

