

# HOBBIES WEEKLY

JUNE 5th 1957

VOL. 124

NUMBER 3214

## IN THIS ISSUE

|                                    | Page |
|------------------------------------|------|
| Engine Shed - - - - -              | 129  |
| Comfort in the Saddle - - - - -    | 130  |
| A Word in your Ear - - - - -       | 131  |
| A Massive Fort - - - - -           | 131  |
| Winding your own Coils - - - - -   | 132  |
| 'Souvenir' Photographs - - - - -   | 134  |
| Chemistry in the Home - - - - -    | 136  |
| Tunnel Portals - - - - -           | 137  |
| Trinket Box Watch Stand - - - - -  | 137  |
| Maze Puzzle - - - - -              | 138  |
| A Punching Tool - - - - -          | 138  |
| Seashell Creations - - - - -       | 140  |
| Clover Root Chemists - - - - -     | 140  |
| Patterns for Trinket Box - - - - - | 143  |



All correspondence should be addressed to the Editor, Hobbies Weekly, Dereham, Norfolk

## ★ FREE design inside

**T**HIS sturdy engine shed is ideal for adding to an 'OO'-gauge model railway layout. With such a solid construction it can thus be handled without fear of damage and positioned around to suit alterations in the layout and theme of your railway. With a length of 12ins. and width of 5½ins., the shed will take a double track and house two locomotives.



# ENGINE SHED

(FOR 'OO'-GAUGE LAYOUTS)

Before beginning construction, make sure that there will be sufficient clearance in the shed to take the combined height of your locomotive and track. There are differences in height in various proprietary locomotives and tracks, and if the measurements given do not give due allowance for clearance, adjustment must, obviously, be made. For some tracks it may be found that the overall height of the shed must be increased by up to ¼in. While working to the figures given, however, it should be noted that the height of the shed can also be increased by standing it on ballast.

Make a start by tracing the various

parts of the shed from the design sheet and transferring them to the indicated thicknesses of wood. Then cut out all the parts cleanly with the fretsaw and glasspaper ready for assembling.

### How to construct

Commence construction by gluing the end (2) to the sides (1). If you are using a Hobbies kit the end (2) must be made up in two pieces and strengthened by gluing waste pieces of wood behind the joint. If using your own materials, the end can be made from a single piece of ½in. wood.

Now glue the front portion (3) in position (see Fig. 1B), and continue by

adding the piers (9) and plinth pieces (10) all round. Note that the piers must be chamfered at the top to conform with the slope of the roof.

The decorative pieces (4) at either end and the strengthening pieces (13) at the front (Fig. 1B) can now be added. The next step is to fix the two roof pieces (5) which should be chamfered to fit at the ridge.

The smoke vents, of which four are required, are made up from pieces 6, 7, 8 and 14, the latter pieces being the roof slopes of the vents.

It is suggested that the building be

● Continued on page 130

129

FOR ALL HOME CRAFTSMEN  
Over 60 years of 'Do-it-Yourself'

WorldRadioHistory

4<sup>1</sup>/<sub>2</sub><sup>D</sup>

# Comfort in the Saddle

**T**HERE are many ways in which you can add to your comfort when cycling. The machine you hope to ride, for instance, is of the first importance. It is very essential that you choose one that is 'just your fit'; not a heavy bike, but rather a lightweight with the latest improvements in accessories and the best type of wheels and tyres, etc.

## Selecting the right bicycle

Nothing is worse than a really hefty machine built to carry a giant if you are only medium sized. Yet we frequently see on the road younger cyclists on tour riding bicycles intended for riders twice their weight, and hefty enough to be very fatiguing indeed.

Having selected a bicycle that is as near right for you in weight and height as is possible — a low-framed machine is the better — see to it that your riding position is comfortable. It requires only a little experimenting and adjustment of the saddle and handlebars, for correct height and position.

You will ride all the easier for such an adjustment. Borrow a friend's machine, for instance, and ride it for a mile or two; you will probably find the seat

uncomfortable, yet, no doubt, it suits your chum all right. Do not be satisfied until you have acquired a nice easy seat when in the saddle, just the correct height from frame to allow you to pedal easily and without any strain. When at length you have fixed handlebars, brakes, and saddle to your entire satisfaction, maintain that position if it is 'just right', but remember that it will require a few outings to get settled down to a good riding position.

You will be surprised to note how much easier you can travel and how much farther you can go when you have found the correct riding position. Some cyclists have short legs, others long legs; some have long arms, others short ones; all this makes a difference, so that, one cyclist's riding position is seldom the same as another's.

Correct saddle position is largely at the rider's fancy, but for height a good enough rule is that when in your riding position it should be possible to place the heel on the pedal at its lowest point without stretching your leg unduly. Do not have your saddle too low, or your pedalling will be harder, and the efforts required will be tiring and a waste of energy.

The position of the saddle is not easy to determine, much depends on one's style of riding. For those who prefer fast pedalling a forward position is the better, while for slower and steadier riding a position more to the rear is to be recommended.

There are many different types of saddles, such as touring, racing, broad and narrow. Giving a tilt to the saddle, either fore or aft, is also helpful, or a horizontal may be 'just the thing'. A saddle with a peak too broad may be the cause of chafing. Breaking in a saddle will help you to find its qualities.

A correct position in riding a bicycle is helpful in more ways than one, for a perfect position assists the rider to concentrate upon the actual act of riding, by making for a greater degree of confidence, with resulting safety and greater expertness.

## Touring preparation

It is essential to prepare yourself if you decide to become a touring cyclist. Commence with short leisurely spins, gradually increasing the distance, but not the speed. Remember, it is the pace, and not the distance that kills.

Take care of your saddle. It is usually the most neglected item on the bicycle. Colza oil or castor oil should be applied to the underside of the saddle from time to time, to prevent the leather from cracking or perishing. Never ride on a wet saddle without rubbing over with a dry cloth. Waterproof covers can be obtained. When a saddle squeaks take it off the machine, turn it upside down and run a little oil sparingly round the steel and the leather. Do not let the saddle sink and stretch too much, until you have no proper seat to sit on. Tighten it up by the nut on the tensioning screw. (A.S.)

● Continued from page 129

## '00' Engine Shed

painted a stone colour, with the roof a slate grey. Markings to indicate slates or stonework can be made with a lead pencil. Some workers, of course, may prefer to use modelling paper on the outside of the shed.

Now glue the vents in position. The windows are prepared from transparent material which is provided in the Hobbies kit. Cut it to shape and paint to choice before pinning the windows in position behind the openings.

### KIT FOR 7/11

Kit No. 3214 contains all the various thicknesses of wood, transparent material etc., for making the Engine Shed. Price 7/11 from branches or Hobbies Ltd., Dereham, Norfolk (post free).

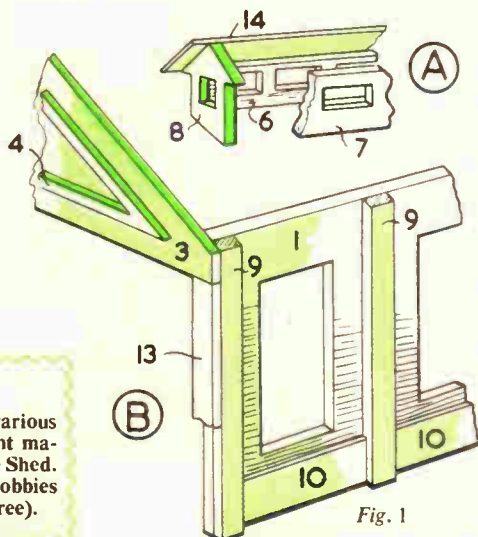

Fig. 1

## REMOVE THOSE STAINS

**U**NSIGHTLY stains (other than heat spots) on polished furniture may be removed by the following method.

Slightly dampen a cloth with methylated spirits and have a second one ready with furniture polish on it. Put a little salt on the stain and rub the first cloth briskly over it. Polish immediately with the second cloth.

Be careful with the methylated spirit. If left too long or the application too strong, it will seriously damage the original polish. (R.L.C.)

# A Word in your Ear

From the Editor . . . . .

**I**FREQUENTLY receive requests for Hobbies designs which have long gone out of print, and reluctantly have to regret being unable to help, as, obviously, with new designs regularly coming along, we cannot hope to keep stocks of all. The old, in fact, have to give way to the new.

One such request has been for No. 5 Special design issued in the very early days of Hobbies, and the subject of which was a Lord's Prayer Tablet with some delightful figurework. This subject has since been modified to our No. 2904 which is, incidentally, still in print. However, such was the appeal of the person who so dearly wanted a copy of our No. 5 Special that I invite my readers to co-operate by looking through their piles of designs. If No. 5 Special comes to light, would you send it to me for onward transmission? Or if the design is wanted back, I could have a tracing made first.

I do hope we can help this reader — a woman, incidentally — who wants to surprise her husband. He has expressed a wish to cut this design as a memorial to some loved ones — truly a labour of love on which his wife will heartily co-operate by acting as the 'general labourer' with glasspaper and paint.

## CHANNEL WARFARE

**O**VER 50 ship models were incorporated in a layout evolved by boys of the Margate Walpole Bay Ship Spotters' Club, and shown at the local Trades Exhibition with a view to persuading some grown-ups to sacrifice a little of their spare time for the Royal Naval Mine Watching Service.

Aged between 11 and 15, the fourteen schoolboys, provided with authentic details by the club organiser, Mr. F. C. Shelley, reconstructed the kind of sea battles fought in the English Channel during the 1939-45 war.

The boys obtained photographs and drawings of enemy aircraft dropping parachute mines in the path of merchant ships and their escorts. They made the ship models, the biggest of which is less than 3ins. in length, from odd pieces of wood, pins and needles. And from a photograph which I have seen, it made quite an impressive scene.

## PICTURESQUE STAMPS

**J**UDGING for our February competition (Picturesque Stamps) was not easy, as most of the competitors had well interpreted our wishes for a design

based on a highlight or features of their own neighbourhood. Some of the ideas, however, although lending themselves to much colour, were not suitable for application to such a small area as a stamp. The winner of the Senior watch awarded — F. A. Frost of Dudley — sent in a very practical suggestion finely executed, incorporating Dudley Castle and the Coat of Arms. Incidentally, draughtsmanship was not the final test — it was ideas and originality we were looking for.

Mr. E. Howard of Bishops Frome, one of the runners-up, chose Hereford cattle as his theme, and others who were awarded ball pens for their efforts were:—J. Griffiths, Bootle; P. R. B. Paterson, Renfrew; R. Martin, Peas-

lake; E. Deacon, Plymouth.

The Juniors (15 and under) were headed by John Rawnsley of Guiseley, aged 15, who incorporated four subjects for which his county of Yorkshire is noted. The tall chimneys of Sheffield industry were featured in the entry of Michael Batty (12) and another 12-year-old, R. Cragg of Horsham, submitted a peaceful layout of agricultural Sussex, with a sheaf of corn and sickle as the main motifs. Two of the runners-up in this section were aged only 10 and other winners of pens were Barry Isaac, Bentley; P. W. Morris, Rotherham; D. M. Dent, Ramsgate; Robert Clarke, Crewe.

## A Massive Fort

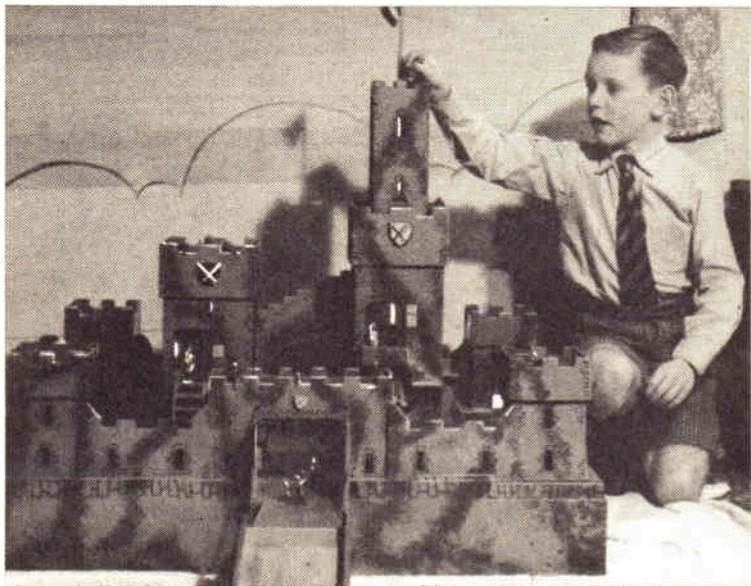

Having made several of the smaller forts from Hobbies designs, Mr. D. H. Bates of 2 Grange Terrace, Pettinain, By Lanark, decided to use ideas from all three and produced the magnificent result pictured above. As will be seen, it is quite a large toy giving the fortunate recipient great scope for play and imagination. All towers have rooms complete with doors and windows etc. The centre towers have lift-off tops to facilitate easy storage and housed beneath the main centre tower there is a dungeon complete with barred window.

Other offices include officers' and sergeants' messes, an armoury, cookhouse, and C.O.'s headquarters. Provision has also been made for a tank park.

The whole construction is made from 1/4in. plywood on a base 39ins. long by 30ins. wide. It is painted in light grey with black brickwork and green mottling.

# Winding your own Coils

THE tuning coil, which is the indispensable element to all radio sets, is, undoubtedly, expensive when bought as a commercial product. Three shillings for air-cored coils and four shillings for dust-cored coils is the normal price.

Considerable saving results, therefore, if one makes one's own coils. It is possible to make air-cored coils for twopence or so, while dust-cored coils can cost no more than sixpence. The performance, in either case, is excellent and will stand comparison with the commercial products.

There are no difficulties in making these home-made coils. Indeed, they are easy to make. Although some people use mechanical aids to speed up wind-

ing, these are unnecessary where only a few coils are needed. Winding by hand is quite simple and sufficient.

When the varnish is quite dry, shape a tube is ready, warm in the oven or beside the fire to drive out any moisture completely. Then varnish or shellac it inside and out, giving a second coat when dry. Polystyrene varnish is best, but any fast drying varnish will do. It must dry hard and not sticky.

When the varnish is quite dry, shape a

By A. Fraser

piece of wood to fit across the bottom of the tube, and fix with glue and pins or screws. The wood can be  $\frac{1}{2}$  in. by  $\frac{1}{4}$  in. section. Its length will be the inside diameter of the tube. Drill a small hole through it to take the fixing screw

and this limits the size of coils. A former of 1 in. diameter is a suitable compromise and is recommended. Larger coils will be more efficient, but rather bulky to fit into modern sets. Smaller coils will be less efficient.

An average medium-wave coil has an inductance of 170 or 175 microhenries. A coil for this can be made by winding one hundred turns of 34 gauge enamelled wire on a 1 in. diameter former. The winding will extend to a depth of slightly over 1 in., so the two sets of anchoring holes can be pricked preparatory to the winding.

Thread in the beginning of the winding as previously described, and start

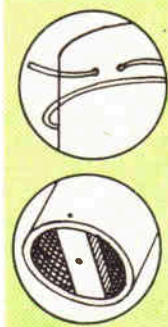

Fig. 1

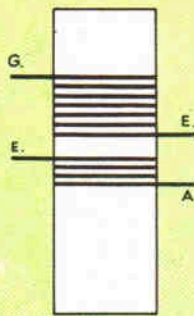
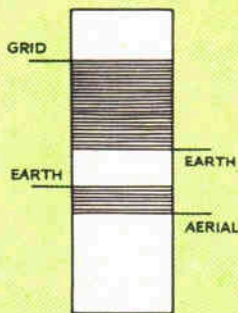

Fig. 2

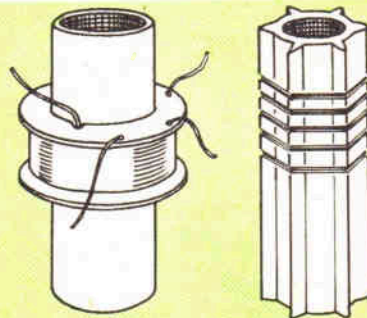

Fig. 3

ing, these are unnecessary where only a few coils are needed. Winding by hand is quite simple and sufficient.

We will deal first with air-cored coils and then afterwards with the dust-cored type.

With the air-cored type, the coil former on which the wire is wound must have good insulating qualities. Materials used are Paxolin, Bakelite, ebonite and so on. These formers are obtainable in plain cylindrical form or in ribbed types. Both kinds are procurable in various diameters and lengths from Post Radio Supplies, 33 Bourne Gardens, London, E.4, and the reader is advised to send for their complete list.

## Make your own formers

However, the reader can make his own coil formers for practically nothing. Cardboard tubing is usually at hand somewhere, and this is ideal. Alternatively, one can roll a tube from paper or card, using glue to fix it (or gum strip). Use a length of dowel or something similar to roll the paper round. The wall of the tube can be  $\frac{1}{8}$  in. thick. When the

coming through the chassis. This is the simplest way of securing the coil to the chassis.

## Winding the coil

For the start of the winding, two small holes are drilled or pricked through the wall of the former. The end of the wire is threaded through one hole and out again through the other, 1 in. or so of wire is left loose. This method securely anchors the end of the wire. The finish of the winding is treated similarly — a further couple of holes being pricked for the purpose.

The exact location of these anchoring holes will depend on the size of the particular winding. This will be discussed later.

The wire used for winding is copper, either enamelled, or double-silk, or double-cotton covered. The gauge or thickness required will again depend on the particular winding, and will be considered in a moment.

The coil using the widest diameter former and the thickest wire is the most efficient. However, sets today are small

winding the wire round the former. Keep the wire stretched firmly all the time, never slacking off, and wind the turns side by side close together. When the hundred turns (or just over 1 in.) have been wound, thread through the two anchoring holes and cut the wire, leaving about 1 in. free. The leads from the winding can then be scraped free of enamel, ready for soldering. Use a safety razor blade for this, or emery paper, and be careful not to damage the rest of the winding.

If the coil is an aerial one, a coupling winding is probably needed. This can be wound of twenty turns, and should be  $\frac{1}{2}$  in. distant from the bottom of the main winding. The coil can be seen in Fig. 1, together with the connections.

## Reaction

For those who need a reaction winding for T.R.F. circuits, there are two alternatives. Either stick a layer of insulating tape round the lower half of the main winding, and wind the reaction coil over this (fixing the ends with Uhu or Durofix glue, or tape), or wind it at

the other end of main winding. There should be no space left between the two windings, as was the case with the aerial coupling coil. The reaction winding should consist of about forty turns.

The ends of the coupling coil (and reaction coil, if used) should have the enamel scraped off, as was done with the main winding.

Some people coat the windings (once they are wound), with shellac or other varnish, in order to fix them and prevent the turns loosening. This should be done very sparingly, as it increases capacity losses. Gluing a turn or two at the start and finish of the winding is quite sufficient in most cases.

### Long- and short-wave coils

Short-wave coils are wound similarly to medium, except that the turns are spaced to lessen losses. The best way to do this is to wind two wires together tightly, side by side, and after fixing with Uhu, etc., remove one of the wires, leaving the other winding intact and spaced as was desired.

Short-wave coils tuning from 15 to 50 metres need an inductance of about 1.2 microhenries. Such a coil can be made by winding six turns of 24 gauge enamelled wire on a 1in. former. The wire should be spaced its own diameter apart, as just described.

The aerial coupling coil should be three turns,  $\frac{1}{2}$ in. distant from the bottom of the main winding (see Fig. 2).

Reaction winding is easily wound between the turns of the main coil, using thinner wire, say, three turns of 34 gauge, in the lower half of the main coil.

Long-wave coils can be wound in two ways. The first method is as follows. Make two washers to fit on the 1in. coil former. These can be of Paxolin, etc., or cardboard or plywood varnished. These washers should have an outer diameter of 1 $\frac{1}{2}$ ins. or 1 $\frac{3}{4}$ ins. They should be placed .2in. apart half way up the coil former and fixed there with glue. A small hole should be drilled in the inner margin of one washer and another at the outer margin of the other washer (see Fig. 3). These are for winding leads to go through.

The wire is wound side by side, layer upon layer. Two hundred and thirty turns of 34 gauge enamelled wire will give the required 2,000 microhenries.

For the aerial coupling, fifty turns laid over the main winding will do, with a layer of insulating tape to separate the two windings. This could also serve as a reaction winding, with the aerial coupling wound beside the main winding, using another washer to hold it.

The other method is to use a ribbed former, either purchased or made. With a file, slots are made in the ribs to hold

the windings. These slots should be  $\frac{1}{16}$ in. wide,  $\frac{1}{8}$ in. deep and  $\frac{1}{4}$ in. apart. Four of these are cut in each rib. The former should be 1in. diameter, and, using 36 gauge enamelled wire, ninety turns should be wound in each slot, making three hundred and sixty altogether.

Further slots, above and below the main coil, should be used for aerial coupling and reaction. In this case, the turns should be about ninety each.

### Dust-cored coils

We can now turn to the dust-cored coils. These are extremely convenient for small modern sets, as they take up very little room. Moreover, the dust cores allow variation of the inductance, which is advantageous for alignment.

The formers used are Aladdin dust-cored formers of .4in. diameter. These are obtainable at most places for ninepence, but can often be obtained for fourpence from J. E. Annakin, 25 Ashfield Place, Otley, Yorks., complete with dust cores.

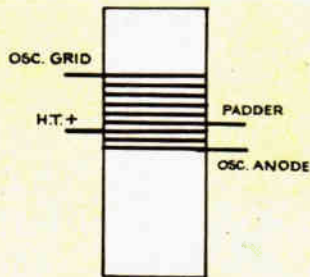

Fig. 4—Oscillator coil connections

For these formers, washers will again be needed to hold the windings in place. Again, Paxolin, or plastic sheet, or cardboard or plywood (varnished) will do. For the medium wave, the washers should be  $\frac{1}{2}$ in. diameter (the inner hole is approximately .4in.). They should be placed .2in. apart, half way up the former and fixed with Uhu or Durofix, etc. Holes should be drilled previously, to allow entry and exit of the winding wires.

For the medium waves, wind ninety-five turns of 28 enamelled wire. Lay the wires side by side and layer upon layer. Seal with a layer of insulating tape, or two layers of Sellotape. On this, wind twenty to twenty-five turns of some thinner wire, preferably, say, 32 to 43 gauge. This will do for the aerial coupling. The aerial coupling can also be wound alongside the main winding — another washer  $\frac{1}{2}$ in. away will hold the winding. In this case, the winding on top of the main coil can be used as reaction, if necessary.

Long-wave coils are wound similarly, only the washers should be larger — a

1in. diameter will be quite sufficient. They should still, however, be only .2in. apart. Use 34 gauge enamelled wire and wind in three hundred and sixty turns. Seal as before, with insulating or Sellotape, and wind on ninety turns for the aerial coupling.

For the short waves, no washers are needed, for the wire is wound straight round the former. Use 20, 22 or 24 gauge enamelled wire and wind on eight and a half turns, spacing the turns to occupy a space of .6in. from top to bottom of the winding. Fix with Uhu, Durofix, etc. A coupling winding can be wound on as in the manner of the air-cored short-wave coils — that is, use finer wire wound in between the bottom turns of the main winding. Three or four turns will do. Fix with the adhesive again.

For those who build H.F./Detector type of sets, two coils of similar characteristics will be needed, one for each stage. Two coils made exactly as the aerial coils we have described will do perfectly. In the H.F. stage the small coupling coil is connected to aerial,

while in the detector stage coil the small coupling is wired between H.T.+ and anode of the H.F. valve.

For superhet sets, oscillator coils are just as easily made. Taking air-cored coils first, and using 1in. formers, a

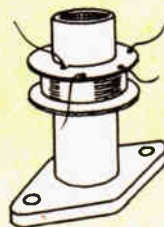

Fig. 5—Dust-cored coil

medium-wave oscillator would consist of sixty-five turns of 34 gauge enamelled wire side by side, with twenty-five turns of feedback winding wound close to the first winding.

A short-wave oscillator needs five and a half turns (spaced its own diameter) of 24 gauge enamelled wire, with two and a half turns feedback.

A long-wave oscillator needs one hundred turns of 28 enamelled wire wound between washers .2in. apart. Feedback is thirty turns of 34 gauge on top of the first winding.

With dust cores, the following are necessary for oscillators. Medium wave: Eighty turns of 28 gauge enamelled wire between washers .2in. apart. Feedback is twenty turns of 34 gauge on top of first winding. Short waves: Seven and a half turns of 22 or 24 gauge spaced to .6in. Feedback is three turns of 34 gauge wound between the bottom turns of the first coil. Long waves: One hundred and eighty turns of 28 gauge enamelled wire between washers .2in. apart. Feedback is sixty turns of 34 gauge on top of the first winding.

# 'SOUVENIR' PHOTOGRAPHS

**A**N interesting contribution to the photographic album is a collection of shots covering any place visited. The beginner, just commencing photography, will find it an excellent idea to adopt, while the more advanced will

As one cycles, drives or walks through town or countryside, one sees a continuously changing view of the scene, and immediately something strikes one as attractive or interesting, it is time to take a shot.

When at the seaside, pictures offer themselves so frequently that it is usually a matter of deciding how much film can be used. Waves, rocks and sea. The pier and amusements. Perhaps, a donkey, or boats, ships, and promenade. Inland, the character of the scene changes, of course, but it can, nevertheless, be variable, worth taking, and able to recall memories.

By 'Photographer'



*The value of an outstanding feature*

have every chance of obtaining some useful pictures. All too often souvenirs take the form of some ashtray or other 'novelty' which has been mass-produced by the thousand. Souvenir photographs cost less, have more interest and originality, and help to bring back the scene more vividly.

A collection of ready-made picture postcards of a place can never be as interesting as shots taken by the person himself. The latter recall some place or spot actually visited. But postcards may have been taken from viewpoints the collector never reached, and portray scenes he thus never witnessed. A person who purchases such postcards has the choice of, perhaps, a dozen or so conventional scenes. But the person who takes his own shots is faced with many possible pictures on every journey he makes, and can make a personal choice.

It is wise to learn at once that remote scenes covering a great distance do not normally make good pictures. If they are taken, there should be some prominent object which will stand out in the mass of detail — a nearby church or building, or, perhaps, a pier or bridge. Without something of this kind, the shot will prove a great disappointment.

The accompanying pictures are three of a score which are souvenirs of a little Midland town — Malvern, in Worcestershire. There is the winding road along the side of the hills, with its view extending over far country. A picture helps to recall this road, and the tree on the left helps to make the picture worthwhile. Cover up the tree, imagining that the shot was taken a few yards farther on along the road, and the importance of some outstanding feature is clear.

Continuing along the road offers scores of shots, and the next was chosen because of the interesting building in the centre, and the characteristic way in which the houses crowd along the road and stand on the hillside.

Passing down through the town gives pictures in plenty, and the shot of the



*Houses on the hillside*

gatehouse, under which a bus can just pass, is very characteristic.

Any such photographs must always be more interesting, as souvenirs, than a ready-made, mass-produced article, and it would be difficult to find a city, town or village anywhere throughout the country which would not furnish a handful of equally variable pictures, each one individual, personally chosen by the photographer.

From the technical viewpoint, such shots are probably the easiest to take. They are all middle-distance subjects. The box camera will be at its best, here, and the better-class camera will not be critical to focus, as with near objects. Nor will there usually be much movement. As a result, it is only necessary to set the aperture at  $f/11$ , and the distance scale at about 30ft., and everything from about 14ft. to infinity will be reasonably sharp. Using this aperture, and a medium-speed film such as FP3, a  $1/25$ th second will do splendidly for weak sun or bright daylight. As the sun appears more clearly, the shutter may be moved to  $1/50$ th second. Shots in dull weather are best avoided, as they will be flat.

About  $1/25$ th second at  $f/11$  or thereabouts is the setting and aperture provided by the maker on any simple box or folding camera. This explains why such shots can be taken with maximum



*The Gatehouse, Malvern*

chance of success — they are the type for which such cameras are, above all, intended. Indeed, if such scenes do not give sharp negatives, trouble must be present somewhere. If the camera lens

is clean, the photographer should note whether he jerks the camera when shooting. This is fatal to definition. Instead, the pressure should be gently increased until the shutter is released.

● Continued from page 136

## Experiments with Dimethylaniline

litmus paper. When one test causes the litmus paper to become blue, stop adding sodium hydroxide.

Remove the beaker from the ice and stir in 10 grams of sodium chloride (table salt). Methyl Orange will be precipitated. After standing about fifteen minutes, filter off the dye, preferably with a filter pump. Then dry it in a warm room.

Dissolve a few specks of it in a few c.c. of water in a test tube — enough to give a yellow colour. Add a few drops of dilute hydrochloric acid. The colour changes at once to pink.

By making a slightly stronger solution of the dye, so as to simulate orangeade, you have the basis of a conjuring trick — turning 'orangeade' into 'raspberry juice' (both undrinkable, of course). The party guest who says he can change one fruit juice into another simply by adding water — and proves it — is always sure of respect! Take along a bottle of Methyl Orange solution and a bottle of very dilute hydrochloric acid (1 volume of the strong acid to 50 volumes of water). Retire to another room. Pour the Methyl Orange solution into a tumbler and the acid into a water jug.

Bring the two into the party room and watch the astonishment as you pour the 'water' (dilute hydrochloric acid) into the 'orangeade' (Methyl Orange).

An interesting reaction of Methyl Orange takes place when it is heated with an acid solution of stannous chloride. In a small flask dissolve 4 grams of stannous chloride in 10 c.c. of strong hydrochloric acid. Add a solution of 1 gram of Methyl Orange in a few drops of hot water and boil the mixture for a few minutes. The colour of the mixture disappears. Let the mixture cool. A crystalline mass of sulphanic acid and a substance called dimethylparaphenylenediamine (usually written dimethyl-p-phenylenediamine) separates. Dilute with water and add sodium hydroxide solution little by little until the white precipitate which first appears redissolves.

The dimethyl-p-phenylenediamine can now be separated by shaking the mixture with ether in a stoppered separating funnel (Fig. 3). The ether rises as a separate layer to the surface on standing a short time and the lower waste solution may be run off by opening the tap. Pour the ethereal solution of

dimethyl-p-phenylenediamine from the neck (A) of the funnel into a bottle containing a little potassium carbonate to absorb any water present in the ether. After standing about half an hour, decant off the ether into an evaporating basin and let the ether evaporate spontaneously in the open air.

The white solid left is dimethyl-p-phenylenediamine. It is the parent substance of the well known dye Methylene Blue. As ether is very inflammable, no flames should be allowed in the laboratory while working with it or near it when the evaporation is proceeding in the open air. A brilliant colour reaction can be seen with this substance. Dissolve a little of it in water, add some acetic acid and then a little lead dioxide. A beautiful magenta red colour appears. In a few moments another spectacular change occurs, for the magenta shade changes to an intense purple.

For the preparation of Methylene Blue, the necessary dimethyl-p-phenylenediamine is not made from Methyl Orange, but by a more direct and cheaper method. Details will be given in a later article.

# CHEMISTRY IN THE HOME

## EXPERIMENTS WITH DIMETHYLANILINE

### Part 2

**M**ANUFACTURED edible fats, such as margarine, are coloured with oil soluble dyes to make them look more attractive. A dimethylaniline dye was used formerly in America for this purpose. It was given

until the melted lard is a full yellow colour. Let it cool. The solidified lard will now have the attractive yellow colour of butter.

Malachite Green, another important dyestuff, is prepared from dimethylaniline. As its preparation and isolation is a lengthy and involved operation for the home laboratory, we will just demonstrate its formation without isolating it.

zinc chloride and partially sink the crucible in hot sand on a sand-bath, as shown sectionally in Fig. 2. Heat gently for about five minutes, taking care that the heat is not enough to make the mixture boil. Remove the crucible, let it cool, put it into a beaker and pour in enough dilute hydrochloric acid to cover it. Stir in about 0.5 gram of lead dioxide and warm the whole. Soon there appears an intense and beautiful green colour in the liquid, due to the production of Malachite Green.

Dyes are much used for detecting acids and alkalis. An example which immediately springs to mind is the case of litmus, which changes to red in acid solutions and to blue in alkaline. A dye which is much used for this purpose in volumetric analysis is Methyl Orange. The orange colour of its solution changes to red in the presence of an acid.

This dye is simple to prepare from dimethylaniline. Dissolve 1.25 grams of anhydrous sodium carbonate in a beaker in 50 c.c. of water. In this dissolve 5 grams of sulphanic acid. Add to it a solution of 1.75 grams of sodium nitrite in 10 c.c. of water and surround the beaker with ice in a dish (a friend who owns a refrigerator can make you some ice). Stir well to cool the solution and then add, a few drops at a time, a mixture of 3 c.c. of strong hydrochloric acid and 5 c.c. of water.

Dissolve 3 c.c. of dimethylaniline in a mixture of 3 c.c. of strong hydrochloric

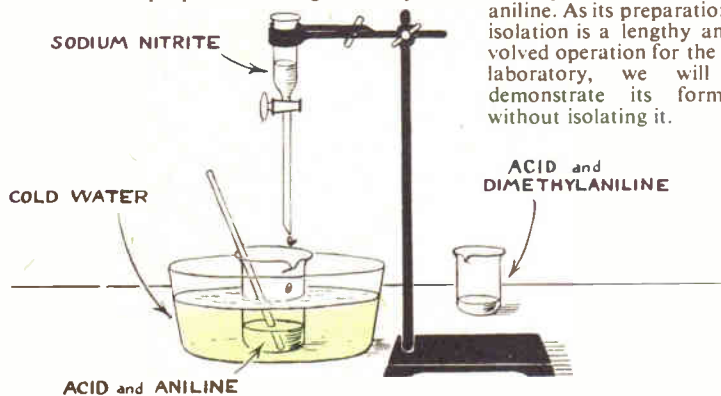

Fig. 1—Making Butter Yellow

the appropriate name of 'Butter Yellow', though its chemical name is benzeneazodimethylaniline.

To prepare a specimen of it, first mix 2 c.c. of dimethylaniline with 2 c.c. of strong sulphuric acid and pour the mixture into 10 c.c. of cold water in a beaker. Into another beaker pour 15 c.c. of 40 per cent sulphuric acid (as accumulator acid is about this strength, it may be used here), stir in 1.5 c.c. of aniline and then place the beaker in very cold water — better in ice.

From a dropping funnel, as shown in Fig. 1, add a 10 per cent solution of sodium nitrite a few drops at a time, stirring well after each addition, and then bringing a drop of the mixture on to starch-potassium iodide paper. When an immediate deep blue or brown colour is produced on the latter, stop adding sodium nitrite and pour the mixture into the dimethylaniline solution. A pink colour develops.

Now add sodium hydroxide solution until a drop of the mixture turns red litmus paper blue. A dingy yellowish precipitate will have formed in the mixed solutions. This is the dye we are out to prepare. Filter it off, wash it with water and then dry it in a warm room.

Melt a little lard in a test tube. A few specks at a time, add Butter Yellow

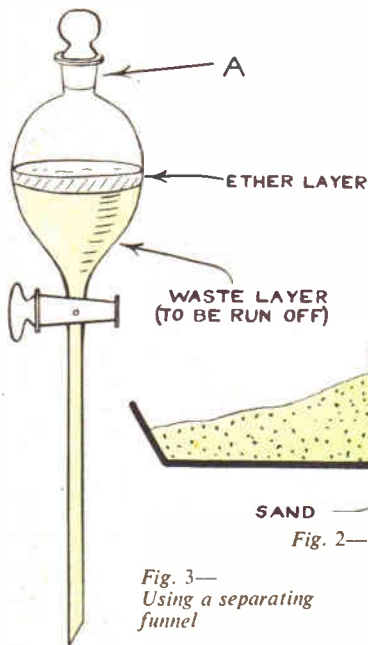

Fig. 3—Using a separating funnel

In a small crucible mix 1 c.c. of benzaldehyde with 2 c.c. of dimethylaniline. Add a small piece of anhydrous

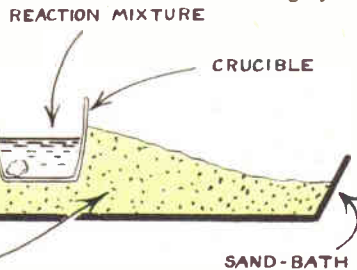

Fig. 2—Forming Malachite Green

acid and 10 c.c. of water. Stir this into the mixture in the ice-cooled beaker. Now stir in sodium hydroxide solution a little at a time. After each addition, spot a little of the mixture on to red

● Continued on page 135



Make your own

# Tunnel Portals

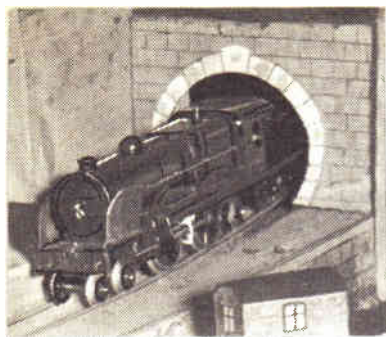

**C**ERTAIN model railway items can quite well be in broad effect rather than fine detail. Thus finished, they can be quickly made and more of the item, whatever it is, put on the line. Many tunnel portals come in this category.

The locomotives, rolling stock and track form the 'machine', which in effect a model railway is; everything else comes into the category of line-side effects that are really only seen in their broad aspect by the onlooker.

A single scale-model tunnel portal constructed in the correct materials could be a couple of months' work in itself; the portal in the photograph, which is quite effective in a general way, was made in an evening.

Materials used were, stone paper, thin plywood, thick white paper, indian ink and a good gum.

To make portals of this kind, the desired outline is first traced on to the 3-ply and then cut out. There are numerous outlines to choose from, but at the time of making the one shown, I was rather keen on the almost complete circle which, though not often seen,

seems to have a rather intriguing look for a single set of rails. Other shapes that can be copied are given in Fig. 1. A fretsaw is best for the cutting.

Unless the portal is to go against any ready-made partition, it should be self-supporting, or, in other words, able to stand by itself before any hill-like camouflage is added. The support is provided by the simple card frame (a) fastened to the back with strong glue by the flaps (b) (see Fig. 2).

Before putting on the frame, however, complete the portal. Laid flat this

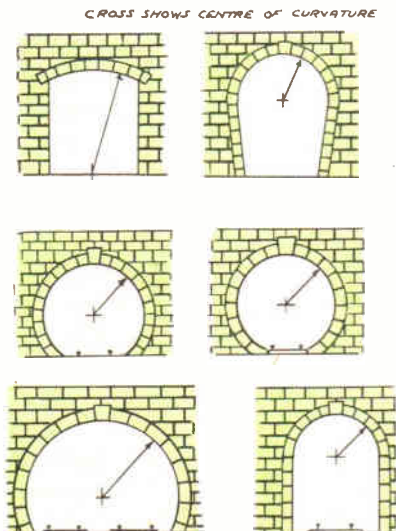

FIG 1

is covered with stone paper, using a suitable paste or gum.

Take a piece of the white paper and on it lightly draw the outline of the arch. Go further out for  $\frac{1}{8}$  in. (for gauge O) and repeat the outline. Divide the curved strip so obtained into blocks and draw in a keystone at the top.

Now with the Indian ink, go over the lines heavily, and glue the finished piece round the outline of the opening, trimming away any unwanted brick paper on the under side. Place the whole frontage under pressure while it dries completely out.

Attach the back frame and all is complete.

It is a good plan to secure this frame, and so the portal, to the baseboard by screws (or even drawing pins) through the lip (a) which prevents any displacement relative to the track. (H.A.R.)

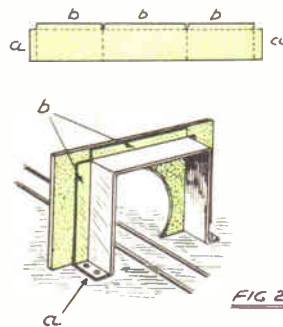
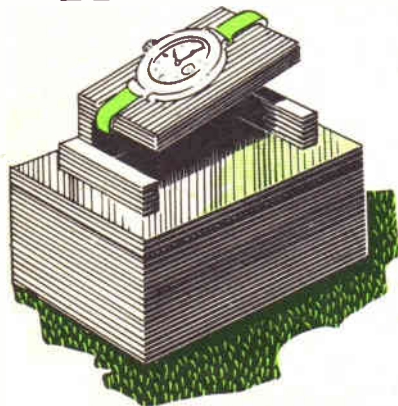

FIG 2

BACK FRAME

## Trinket Box Watch Stand



**M**AKE up this useful gift from odd pieces of  $\frac{1}{4}$  in. fretwood. Colour with enamel or stain and finish with wax polish. It can be used for trinkets or studs and cuff links and, therefore, makes an excellent present for mother or father.

### Patterns on page 143

Make up the box portion first, using (E) as the base with two pieces (G) and two pieces (F) as the ends and sides. Glue these pieces together and hinge the lid (A) in place.

The watch-stand portion is built up on top of the lid and the dotted lines show

the positions of the various pieces. Actual assembly is shown in Fig. 1. It will be seen that the watch is simply slipped over piece (D).

Pay attention to details such as cleaning up, and make sure that all joints are true. To ensure this, hold your fretsaw upright when cutting. If you decide to use paint for finishing, give only thin applications, and rub down with glass-paper between coats. (M.p.)

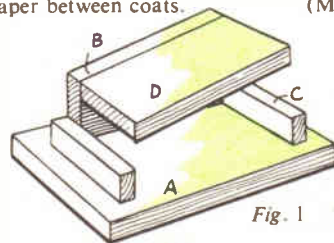
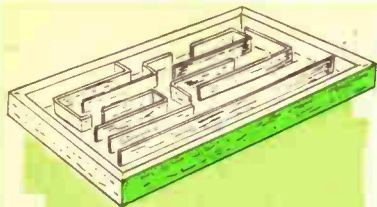

Fig. 1

# MAZE PUZZLE



By S. H. Longbottom

THOSE who have been to Hampton Court, near London, will probably have seen the maze, spending a happy time trying to find the right way out. Others may only have read of this giant puzzle garden which is a labyrinth of growing shrubs. There are other famous mazes in existence, but by using the same principle here is one to make for yourself, having an imprisoned ball-bearing which has to find the correct route to the centre and back again.

We require a piece of stout cardboard for the base measuring  $9\frac{5}{8}$  ins. by  $5\frac{1}{2}$  ins., a piece of picture glass of the same size, some  $\frac{1}{4}$  in. square section, some thinner cardboard and a sheet of coloured gummed paper. A  $\frac{1}{4}$  in. ball-bearing, or a bead of similar size is also required.

Cut out the cardboard to the above dimensions, covering one side with a piece of the coloured paper, then marking out as shown in Fig. 1. First of all, rule a  $\frac{1}{4}$  in. border all the way round, then lines  $\frac{3}{8}$  in. apart to form the squares. You may thicken the lines according to the pattern shown, for this is where we place strips of card to form channels for the ball bearing. It is far easier to construct the puzzle if you take the trouble to plan out properly.

Now take the thinner card, covering on both sides with the coloured paper, and cutting into strips exactly  $\frac{1}{4}$  in. wide. Measure these strips very carefully, using a good straight edge and sharp knife for cutting, for they must all be equal in width. Moreover, try to keep the knife perfectly vertical in order to produce a clean square cut.

With the strips prepared and the base ruled out, we may begin to assemble the puzzle. First of all, prepare two strips of the  $\frac{1}{4}$  in. square section, each  $9\frac{5}{8}$  ins. long, and two more each  $4\frac{1}{2}$  ins. long. Glue and pin these to the base, with the coloured side of the cardboard inside. Take a strip of the prepared card, measure off the required length on a thickened line, cutting accordingly. In some cases these walls may be folded at right angles and you must allow for the additional length in such cases, scoring lightly at the angle.

Reference to Fig. 2 will show how these walls are held in position on the

baseboard. Take a strip of the coloured paper measuring  $1\frac{1}{2}$  ins. by  $\frac{1}{2}$  in. that is long enough to stick to both sides of the strip with overlaps for sticking to the baseboard. Since you will need a small supply of these, it is advisable to prepare them in advance. Attach a small gummed strip of this type to each end of the piece of 'walling', perhaps using a further one in the middle where there is too much play. A coating of glue on the lower edge of the card strip will also be helpful.

The same procedure is followed until all the walls for the channels have been made. Make quite sure that they are firmly held in position, particularly at the corners, reinforcing with the small gummed strips if necessary.

You should now have the maze part fully completed with the base and channel walls of the same colour. All that remains is the glazing.

If the cardboard strips have been cut according to the previous directions, they should lie just below the inner surface of the glass, now to be laid on top of the frame. You may use a piece of picture glass cut to  $9\frac{5}{8}$  ins. by  $5\frac{1}{2}$  ins., that is, the exact size of the frame given. If you have used square section of a different thickness than quoted, measure up the frame, cutting the glass accordingly. Clean and polish the surface of the glass which will be inside the puzzle. Fig. 3 shows how the glass is easily fastened to the frame by means of strips of passe partout or the popular gumstrip.

Do not forget, of course, to place the ball bearing or bead into the puzzle before this final sealing with the passe partout.

The starting point is shown in Fig. 1 by a black dot, and the object is to find the correct path, by twisting and turning the frame to propel the ball along the various channels.

You will find it is not quite so easy to find the correct way to the centre as would appear, and once there, you have to find your way back. The puzzle will be found to be almost as entertaining as a visit to a real maze.

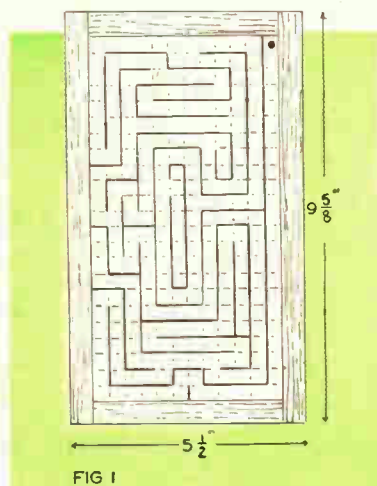

FIG 1



FIG 2



FIG 3

## A Punching Tool

FOR LEATHER WORKERS

A TOOL for punching holes in leather and other thin material or for marking off eyelets is easily formed from a pair of pliers.

Drill through both the jaws, as shown. In one jaw either force a short length of steel tube to make a hole punch, or tap and fit a steel screw to make a riveter. (R.W.)

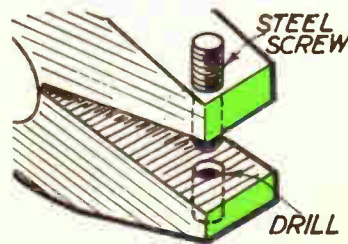

## Make model buildings—

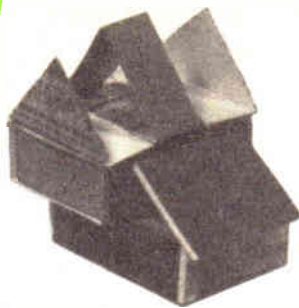

as simply  
as this!

A new method—described in a new book on Pyruma Modelling. This shows how to turn empty match boxes into model buildings, by Pyruma 'Plasticraft'. It is one of the many methods of modelling in plastic Pyruma, shown in black and white and full colour pages, which enable you to build and finish in natural colours:—

MODEL FARMS, RAILWAY STATIONS, SIGNAL CABINS, AIRPORT BUILDINGS, DOCKS, SHIPS, FIGURES, ANIMALS, ASHTRAYS, BOOKENDS, DOLL'S FURNITURE, PLAQUES, RELIEF MAPS, ETC.



is a ready-to-use material, cheap to buy locally, and easy to work by following the Instruction Book offered below. Pyruma dries or can be baked to stone-hard permanence, then painted in natural colours. Sold by local Ironmongers and Hardwaremen, Hobbies shops and Art material Dealers, in airtight tins from 1/6 upwards.

Send Coupon and 6d. P.O. (not stamps) for this NEW Book of Instructions to:—

**J.H. SANKEY & SON.L<sup>TD</sup>**

1857-1957

Dept. H. ILFORD, ESSEX

Enclosed 6d. P.O. (not stamps) for PYRUMA MODELLING INSTRUCTION BOOK addressed to:—

NAME (Block letters) \_\_\_\_\_

ADDRESS \_\_\_\_\_



TOP CLASS  
MODELMAKERS

invariably choose

# VALSPAR

REG. NO. 405960

2-4 Hour

LACQUER • VARNISH • WOOD STAIN

it's easy to see the reason why

★ PROOF AGAINST BOILING WATER, PETROL, OIL, ALCOHOL, ETC.

★ DRIES IN 2-4 HOURS

★ UNMATCHED HARDNESS AND ELASTICITY

★ FOR ALL SURFACES



GOODLASS, WALL & CO. LTD. 179/185 (AC6) Gt. Portland St. London W.1

Please send me a free copy of the Valspar Handbook giving full details of how to use Valspar paints

NAME .....  
BLOCK CAPITALS

ADDRESS .....



## FOR PLEASURE AND PROFIT

WITH a little practice, creations from seashells can be profitable. Organisers of bazaars and similar functions will be only too pleased to buy your home-made gifts once you become known for your attractive little seashell ornaments. You will find pleasure in making them, and your relatives and friends will be pleased with your shell gifts.

In addition to recalling happy days on the beach, once you begin to make these charming little whimsies, you will find yourself in a fascinating world.

Your creations can be used as ash-trays, paper-weights, etc., as well as most attractive ornaments.

Miniature shells can be used to make snails, owls and rabbits, which give an added charm to small cactus gardens and indoor plate gardens. If for any reason you are unable to reach the seashore, parcels of small shells can be obtained from handicraft shops.

You will never be bored when juggling with this infinite variety of seashore treasures. The illustrations show only a few of the many pixie-like creatures.

Scallop, cockle and mussel shells all find a place in this hobby of shellcraft, as well as smaller varieties. Make use of any odd beads you may have, gluing them in position for use as eyes. Coloured glass marbles are also used in the Japanese lady arrangement (illustration 5). Use a good make of glue for fixing. Small seaside stones may also be used as a base.

### Practice essential

Leave the shells until the glue is firm. Paint in any necessary features and allow the paint to dry thoroughly, then apply a light coat of varnish. Bottles of colourless varnish can be obtained from artists' supply shops.

If at first you are dissatisfied with what you have made, don't be discouraged. Practice and patience will effect a wonderful improvement in your work.

In illustration No. 2, a tiny dried flower is placed near the bee.

Arrangement No. 5 is fixed on to a tin or plastic base. Plaster of paris is used to fix the shells in position. The scallop shell is fixed as though partly open.

Your ornaments will make charming little photographic studies and on many a wet afternoon your shellcraft hobby will bring both pleasure and profit, as well as helping you to re-live your adventures on the beach. (G.S.)

## Seashell Creations

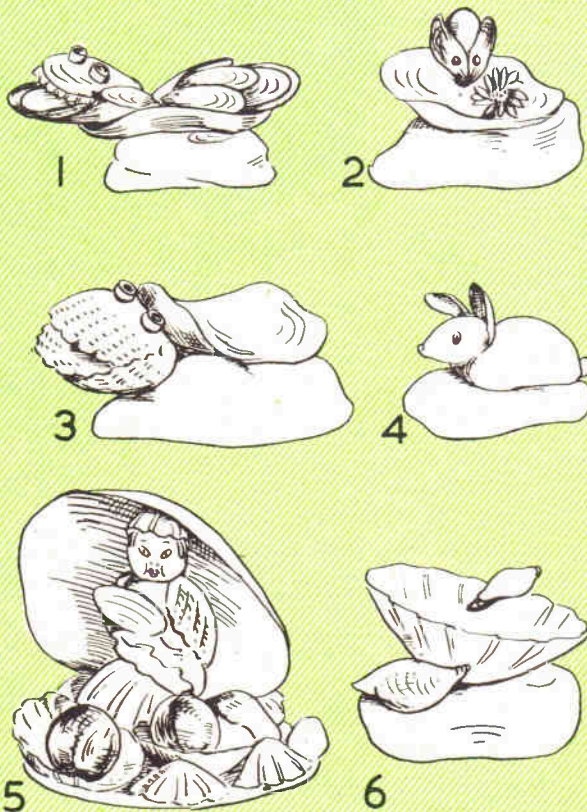

## Clover Root Chemists

PULL up a root of clover, shake off the soil and note those little white bunches attached to the roots, almost like tiny potatoes, each no bigger than a pin head.

Scientists call them 'root tubercles'; and each is a laboratory where armies of microscopic organisms are constantly at work.

These tiny bacteria take nitrogen from the air in the soil around the roots, and change it into plant food.

It is not known just how they do this, but it is clear that the clover provides a home for millions of minute one-celled organisms whose activities produce nourishment for the plant.

This fact is useful to the farmer, who can harvest a good crop of clover, rich in nitrogen, and leave the ground more fertile than it was before, thanks to the

little chemists who have left nitrogen in the decaying clover roots.

Of course, if he ploughs in the entire clover plants, the ground will be much richer than if he leaves only the roots to decay. He can plant corn or sow wheat on the field and it will get the benefit not only of the roots and stems (humus) but also a good supply of needed nitrogen manufactured by the clover chemists. Scientists call it 'bacterial action'.

Other plants, too, such as peas and beans, have similar root tubercles containing bacteria with the power of gathering food from the air. That is why the sensible gardener will not burn the pea and bean haulms but will make sure they go back into the good earth as compost or manure, because they contain one of the most valuable plant foods — nitrogen. (R.L.C.)

# A WELCOME ADDITION TO EVERY HORNBY-DUBLO RAILWAY

*Real in everything but size*

With this attractive T.P.O. Mail Van set, Hornby-Dublo owners can run trains that pick up mail and set it down without stopping, just as is done on real railways. The Set comprises the Mail Van, the lineside apparatus, two mail bags, and a push button switch to operate the mechanism.

Price 38/6 (inc. Tax)

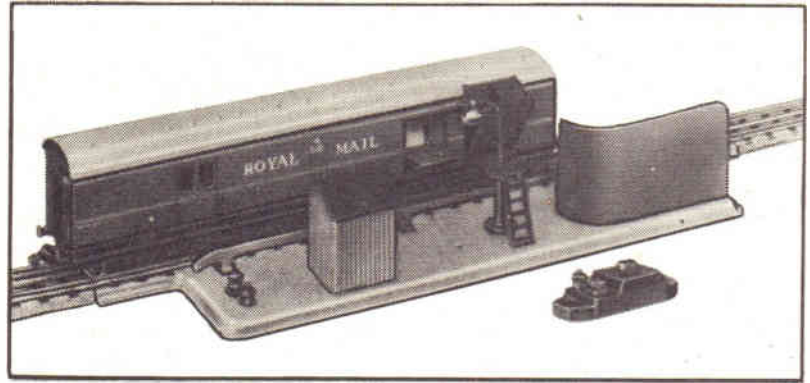

★ It is important to note that the source of current supply must be separate from that used for driving the train, of which the T.P.O. Mail Van forms part.

**AS DEMONSTRATED ON TELEVISION**

MADE AND GUARANTEED BY MECCANO LTD.



When you want it  
to stay put



## USE CERTOFIX

**CERTOFIX really fixes**  
This super liquid glue copes with all general repairs. With wood, glass, metal and most other materials. CERTOFIX makes a joint stronger than the substances it unites.

**make it immovable with Certofix**

Sold at all Woolworth Stores

**NEW! THE PRACTICAL WAY**  
of learning **RADIO · TELEVISION · ELECTRONICS**  
AMATEUR S.W. RADIO · MECHANICS · PHOTOGRAPHY · CARPENTRY, etc., etc.

**NEW**—Experimental outfits and lesson manuals sent on enrolment remain the student's property. Tutor allotted to each student for personal tuition throughout the course.

In radio and television courses, specially prepared components are supplied which teach the basic electronic circuits (amplifiers, oscillators, detectors, etc.) and lead by easy stages, to the complete design and servicing of modern radio and T/V equipment.

THESE PRACTICAL COURSES  
ARE IDEAL AND MAY BE YOURS  
FOR MODERATE COST

Fill in the coupon to-day  
for a free Brochure. There is  
no obligation whatsoever.

Courses with equipment enable  
you to design, construct and service

2-stage radio equipment  
3-stage T.R.F. circuits · Television  
equipment · Workshop Test Panel  
Oscilloscope · 5 valve 3-waveband superhet circuit

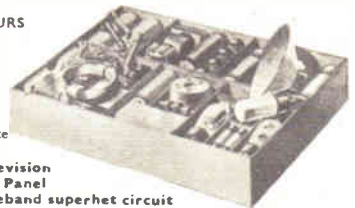

**SUBJECTS INCLUDE:—** Radio · Electronics · Television Equipment  
Mechanics · Chemistry · Photography · Electricity · Woodwork  
Electrical Wiring · Draughtsmanship · Art · Short Wave Radio  
Oscilloscope · also many other Home Study Courses without equipment.

|   |  |                              |
|---|--|------------------------------|
| <b>EMI<br/>INSTITUTES</b><br><small>Associated with H.M.V.,<br/>Morconiphone, etc., etc.<br/>The only Home Study<br/>College run by a<br/>World-wide industrial<br/>organisation.</small> | <b>COURSES FROM 15/- PER MONTH</b>       |                              |
|   | E.M.I. INSTITUTES, Dept. 31.X London W.4 |                              |
|   | NAME .....                               |                              |
|   | ADDRESS .....                            |                              |
| Subject of interest .....   | AGE .....                                |                              |
| (We shall not worry you with collers)   |  | (if under 21)<br>5/6/57 1CAS |

**WHEELS** (Hardwood and Rubber Tyred Metal). Cot, Pram and Doll's House Fittings and Papers. Beads, Transfers, Prints and other accessories. Stamp for new lists. (Trade supplied.) New address. — **JOYDEN CO.**, 91 Peplins Way, Brookmans Park, Herts.

**SWISS MUSICAL MOVEMENTS.** Before you buy send 2d. stamp for our illustrated brochure. — **Metwold Accessories** (Dept. HW), Church St., Wolverton, Bucks. (Trade enquiries invited.)

**STOP SMOKING** in 3 days or money back. Safe, pleasant, permanent. The only scientific way. **No Will Power necessary.** 'Conquered the habit in 2½ days'.—F.C. 'Within 2 days I was free from the tobacco habit'.—W.G. 'Was a smoker for 2 years and broke the habit in 2 days'.—F.N. 'I used to smoke 20 a day . . . now I have no desire to smoke'.—J.M. Recommended by 'Health and Efficiency Magazine'. Complete course 6/6 (or \$1.00 bill). Details 2d. stamp. Sent under plain cover. **NATURE REMEDIES, 28 (H/168) Dean Road, London, N.W.2.** Established 1928

**STAMPS FREE** — Empire Packet including Pictorials and Victorians with approvals. — **Robert J. Peck, 7A Kemp Road, Bournemouth.**

**EARN** it as you do it — we provide practical equipment combined with instruction in Radio, Television, Electricity, Mechanics, Chemistry, Photography, etc. — Write for full details to **E.M.I. Institutes, Dept. HW47, London, W.4.**

**STOP SMOKING!!** Quick guaranteed remedy. Free testing sample!! — **Triumph Remedies (H), Exeter.**

**KUKLOS ANNUAL.** Indispensable cyclist's handbook. Tours, resthouses, money-saving hints, 2/10, post free. — **Burrow, Publishers, 2 Imperial House, Cheltenham.**

**MODELS.** You can make lasting stone-hard models with Sankey's Pyruma Plastic Cement. Supplied in tins by Ironmongers, Hardwaremen and Builders' Merchants. Ask for instruction leaflet.

**100 DIFFERENT stamps free!** Request ½d. upwards discount approvals. — **Bush, 53 Newlyn Way, Parkstone, Dorset.**

**\* GREAT CAMPING OFFER \***



**RIDGE TENT** SENT FOR 4/-

**BRAND NEW de luxe 'Safety' Tent.** All colours. Complete. Ideal cyclists, campers. Length 7' 3" sleeping base x 4' 6" wide x 3' 6" high x 12" walls, all approx. Weight 3½ lb. Cash 55/-, or 4/- deposit and 6/- monthly. WITH FLYSHEET 83/6, or 9/3 deposit and 9/9 monthly. Both carriage 2/6. **LISTS OTHER EQUIPMENT, TENTS, CLOTHING, WATCHES, ETC., TERMS.**

**\* R.A.F. NEW WATERPROOF BACK PACKS \***



One large **FULLY ZIPPED** Compartment. One ditto same size back to back. 4 Buttoned off separate side by side super imposed Pockets. 2 strong adjustable webbing back straps with easy release press studs. Made of genuine **R.A.F. 100** per cent. waterproof material, all brand new. Ideal for Motor Cyclists, Hikers, Fishermen and 100 other uses. 4/11 only, post etc. 1/1. A fraction of original cost. Send immediately.

**HEADQUARTERS & GENERAL SUPPLIES LTD.**

(HOBW/62), 196-200 Coldharbour Lane Loughboro Junction, London, S.E.3 Open all day Saturday. 1 p.m. Wednesday.

**'PAINTSPRAYING' HANDBOOK.** Covers Car, Industrial & Flock Spraying. 3/6, post 4d. Catalogue of our Cellulose and Paints and all Allied Sundries 2½d. — **Leonard Brooks Ltd., 81 Oak Road, Harold Wood, Essex.**

**GENUINE Swiss Musical Movements.** The best and largest selection of tunes in the country, lowest prices 16/3 each. Genuine Thorens Movements, 22/9 each. All guaranteed. P. & P. 9d. extra on all orders. — **Richardson & Forder, HW, 5 Chapel Place, White Hart Lane, London, N.17.**

**LEARN** to be a watch and clock repairer in your spare time and earn extra money at home. We can supply everything you need at unbeatable prices. Including instructional books, Swiss watchmakers' tools, watches, watch and clock movements, lathes, cleaning machines, all spare parts for watches and clocks, etc. We also have a fine selection of musical box movements and kits. Send 9d. P.O. for Bumper Bargain Catalogue. — **The Watchmakers' Supply Company (Dept. H), Carterton, Oxford.**

**GOVERNMENT SURPLUS BARGAINS.** Inter-room Telephones, comprising 2 self-energised microphone/receivers and approx. 6yds. flex (may be extended if desired). No Batteries needed. Nothing to wear out. Complete 9/6, post 6d. Motors, Transformers, Switches, etc. 3d. stamps for illustrated list. **Milligan's, 24 Harford Street, Liverpool, 3. Money Back Guarantee.**

**STAMPS** — Wonderful offer. New Great Britain Queen Elizabeth 2/6, 5/- and 10/- values entirely **FREE** to genuine applicants requesting to see my bargain approvals, and enclosing 3d. postage. — **R. A. White, Dept. 20, 4 Twyford Road, Eastleigh, Hants.**

**FOR** fine, cheap approvals, write including postage to — **H. Westlake, West Park, Clawton, Holsworthy, Devon.**

**UNPAINTED** plaster casts from 1/- per dozen. — **Lancaster, Hopwood House, Bracewell, Skipton, Yorks.**

**ATTENTION!** Attractive selection 100 stamps approvals. Free gift stamps for all customers. — 2½d. stamp. — **Andrewes, Innisfree, Hammerfield, Hemel Hempstead, Herts.**

**EVERY CAR THAT PASSES—YOU WILL FIND THE INDEX MARK ALPHABETICALLY ARRANGED IN WHERE'S THAT CAR FROM?**

Price 9d.  
from all Booksellers or from the Publishers  
(2d. postage)  
**RALEIGH PRESS, EXMOUTH**

**Hobbies**

**MANCHESTER**  
10 Piccadilly  
(Phone CENTRAL 1787)  
**BIRMINGHAM**  
100a Dale End, Birmingham 4  
**SHEFFIELD**  
4 St. Paul's Parade  
**LEEDS**  
10 Queen Victoria Street  
**HULL**  
10 Paragon Square  
(Phone 32959)  
**SOUTHAMPTON**  
134 High St. (Below Bar)  
**BRISTOL**  
30 Narrow Wine Street  
**NEWCASTLE**  
42 Dean Street

**BRANCHES: LONDON**  
78a New Oxford St., W.C.1  
(Phone MUSEum 2975)  
87 Old Broad Street, E.C.2  
(LONDON Wall 4375)  
81 Streatham Hill, S.W.2  
(TULse Hill 8796)

**GLASGOW**  
326 Argyle Street  
(Phone CENTral 5042)

Head Office & Factories—**HOBBIES LTD, DEREHAM, NORFOLK**

**Chemistry Experiments in your own laboratory**

**WE CAN SUPPLY A WIDE RANGE OF APPARATUS AND CHEMICALS**

Send 3d. Stamp for **PRICE LIST**

'EXPERIMENTS IN CHEMISTRY' 1/2 (post free)  
**A. N. BECK & SONS (Dept. H),**  
60 STOKES NEWINGTON HIGH STREET, LONDON, N.16

**HEAR ALL CONTINENTS With H.A.C. Short-Wave Receivers**

Suppliers for over 18 years of Radio S-W Receivers of quality.

**One-Valve Kit, Price 25/-** — **Two-Valve Kit, Price 50/-**  
Improved designs with Denco coils. All kits complete with all components, accessories and full instructions. Before ordering, call and inspect a demonstration receiver, or send stamped addressed envelope for descriptive catalogue.

'H.A.C.' Short-Wave Products (Dept. 22), 11 Old Bond Street, London, W.1.

**KITS for OLD TIME SHIPS**

Hobbies range of Ship Models includes Elizabeth Jonas, Cutty Sark, Victory, Mayflower, etc. Complete kits of wood, sail material, guns, pulleys, cord, etc., with full-size patterns of parts and planed wood ready to cut out, shape and construct. A fascinating pastime.

Ask for free illustrated list at **Hobbies Branches or from Hobbies Limited, Dept. 99, Dereham, Norfolk.**

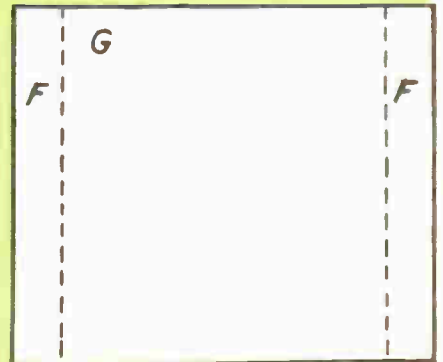
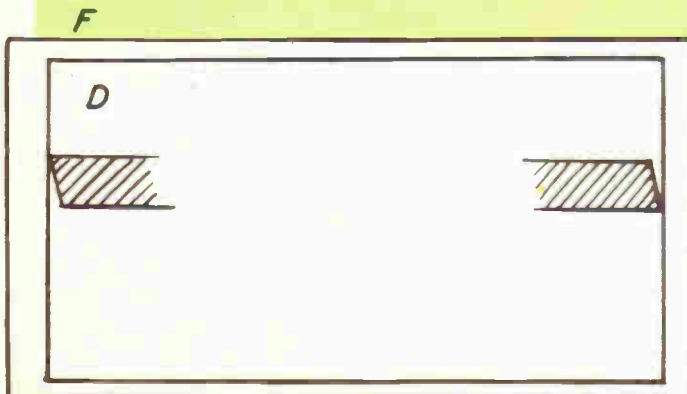
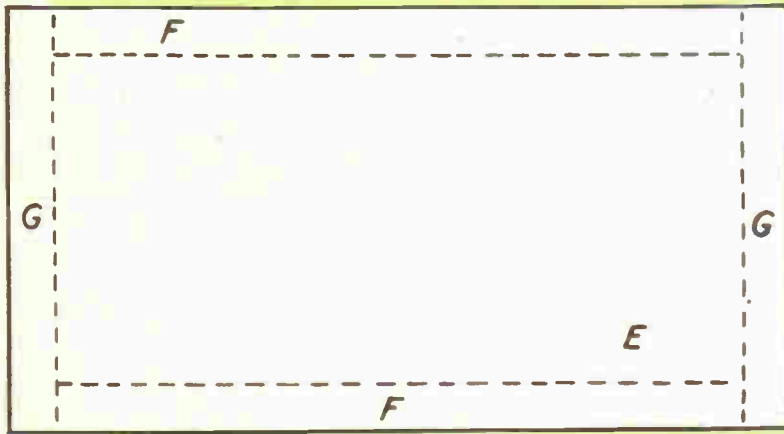
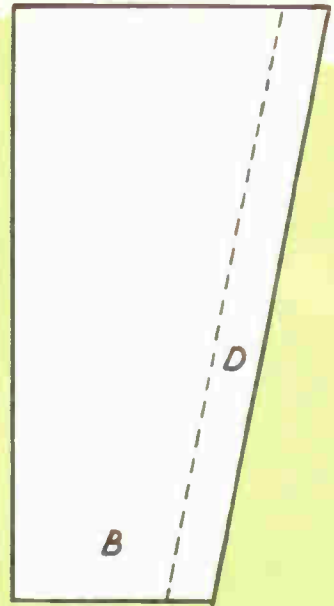
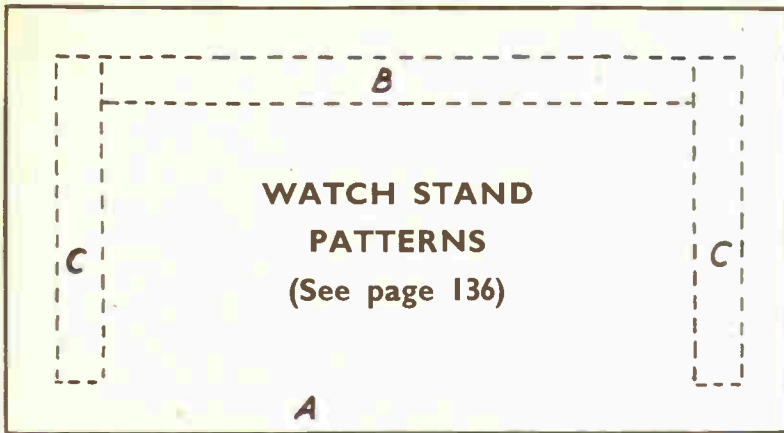



Whitby, Yorks

# ILFORD FILMS *for faces and places*

ILFORD FILMS IN BLACK-AND-WHITE IN ALL POPULAR SIZES. IN 35mm. COLOUR, TOO!

**STICK  
TO**



**-it sticks  
everything!**



PER TUBE

*Keep a tube  
in the home*

Sole Manufacturers :  
McCaw, Stevenson & Orr Ltd., Belfast

Exhibit YOUR Work  
AT THE

## *Model Engineer Exhibition*

NEW HORTICULTURAL HALL  
WESTMINSTER, S.W.1

**AUG 21st-31st**



Every kind of land, sea and air model can be seen at this fascinating Exhibition as well as many kinds of amateur craftsmanship. The Competition Section is open to all, and there are a number of cups and medals to be competed for, in addition to diplomas, cash vouchers and workshop equipment.

*Entry forms and information from Exhibition  
Manager, 19-20 Noel Street, London, W.1*

THE FINAL DATE FOR ENTRIES IS:  
**Monday July 15th**



SCALE—  
4 mm.

SIZE:—  
12 ins. LC  
5 3/4 ins. W

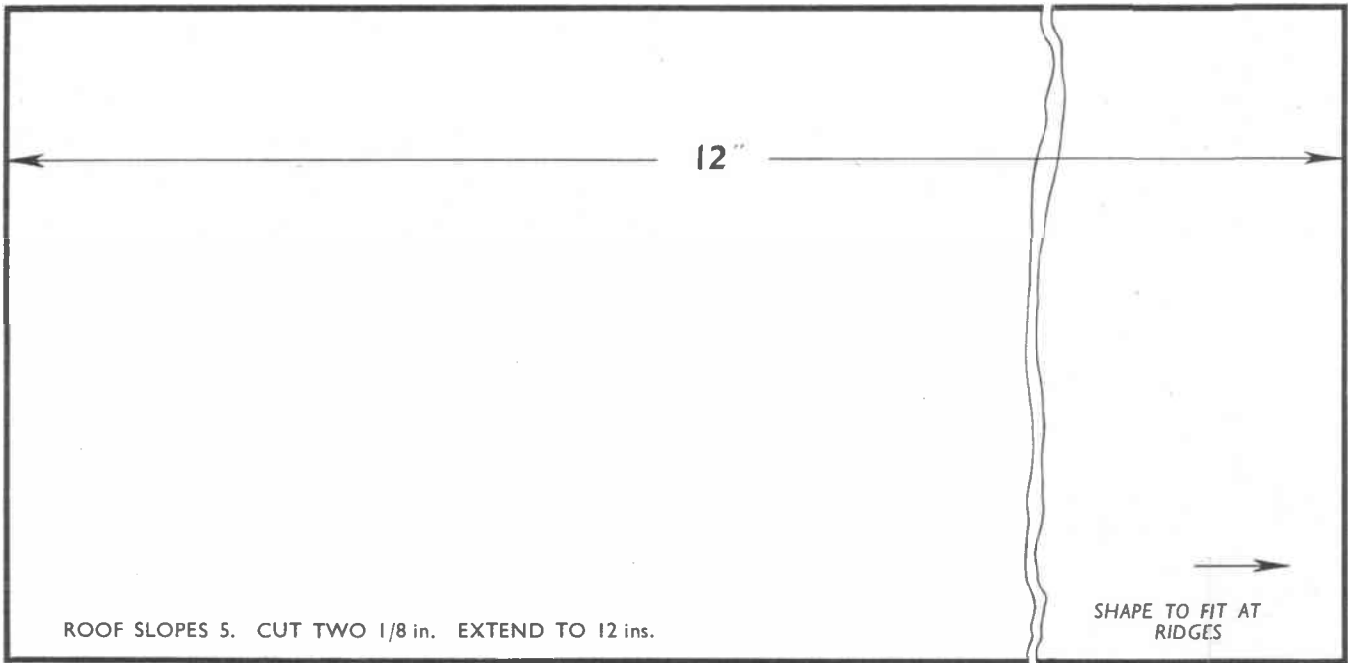

PIECES 9. CUT EIGHTEEN 1/8 in. AND GLUE IN POSITIONS SHOWN. CHAMFER WHERE NEEDED, TO FIT UNDER ROOF SLOPE.

PIECES 6. CUT FOUR 1/8 in. CHAMFER TO SECTION.



PIECES 10. CUT TWELVE 1/16 in.

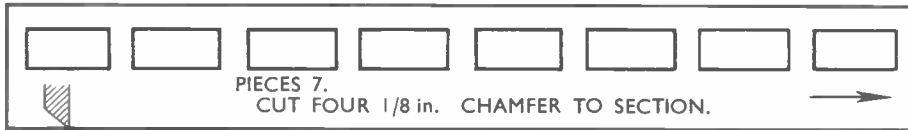

PIECE 12. CUT ONE 1/16 in.

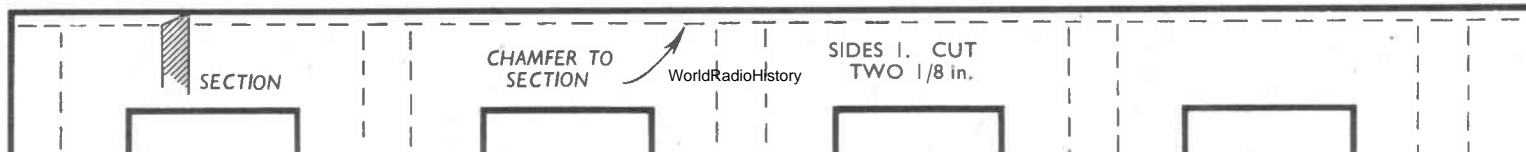
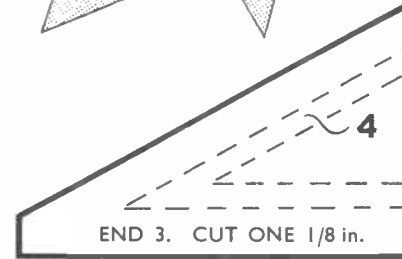
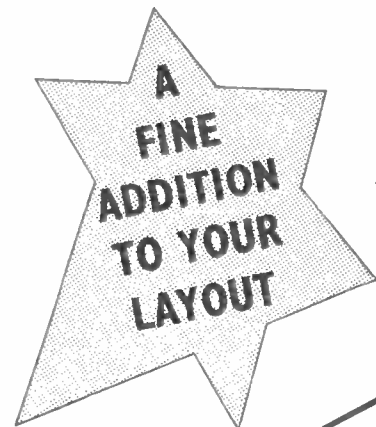
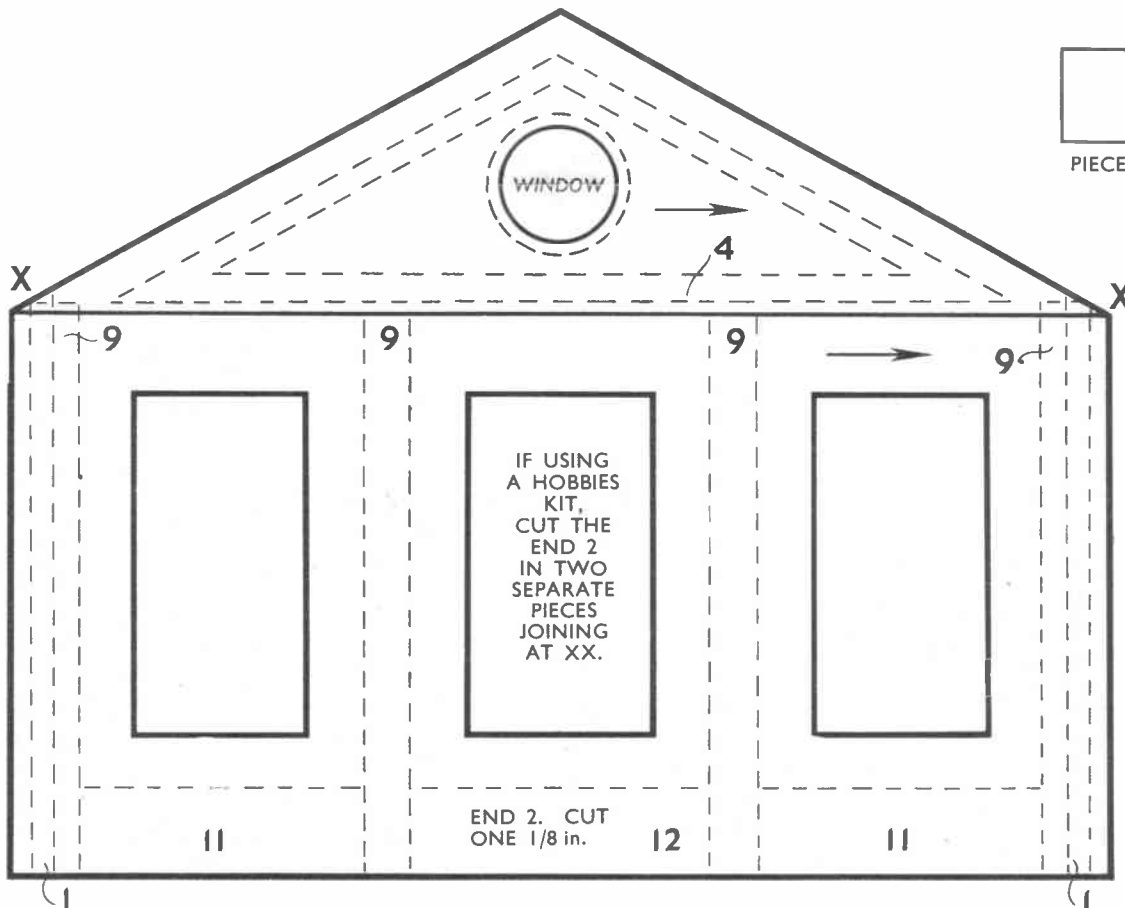



DESIGN

No. 3214

# OO GAUGE ENGINE SHED

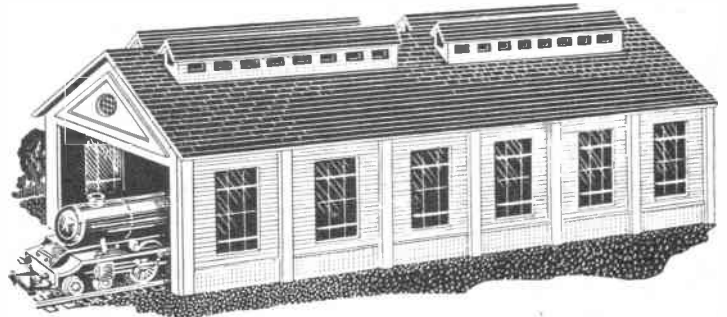

SCALE —  
4 mm. : 1 ft.

SIZE:—  
12 ins. LONG  
5 3/4 ins. WIDE

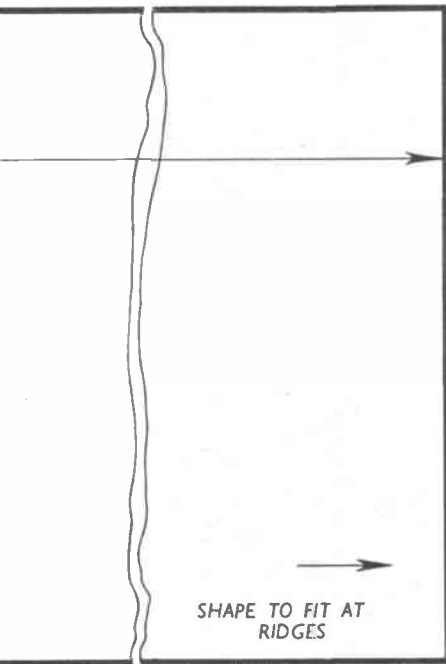

A KIT OF MATERIALS FOR MAKING THIS DESIGN IS SUPPLIED BY HOBBIES LIMITED, DEREHAM, NORFOLK. PRICE ON APPLICATION.



PIECES 9. CUT EIGHTEEN 1/8 in. AND GLUE IN POSITIONS SHOWN. CHAMFER WHERE NEEDED, TO FIT UNDER ROOF SLOPE.



PIECES 10. CUT TWELVE 1/16 in.



PIECES 11. CUT TWO 1/16 in.



PIECE 12. CUT ONE 1/16 in.



PIECES 8. CUT EIGHT 1/8 in.



## Use Croid POLYSTIK

IT'S DESIGNED FOR THE JOB

A cold liquid PVA adhesive combining instant grip with immense and lasting strength. Clean to use, non-staining. In polythene bottle with spreader 2/6.

AVAILABLE FROM ALL BRANCHES OF HOBBIES LTD.



THE ARROWS INDICATE DIRECTION OF GRAIN OF WOOD.

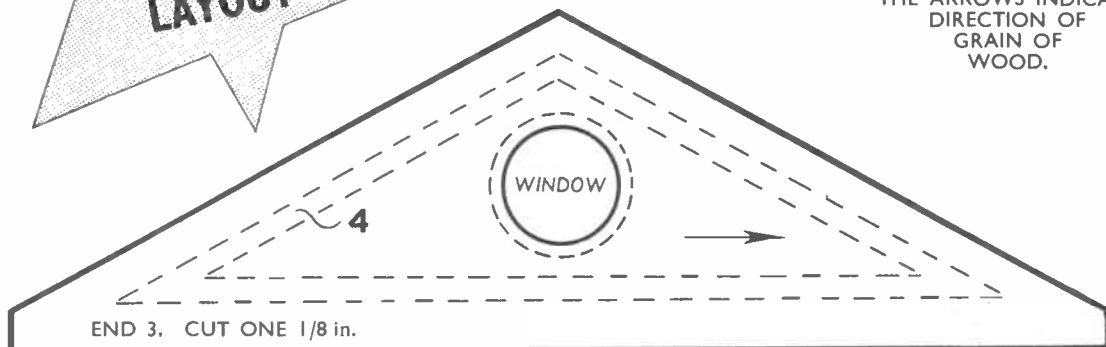

PIECES 13. CUT TWO 1/8 in

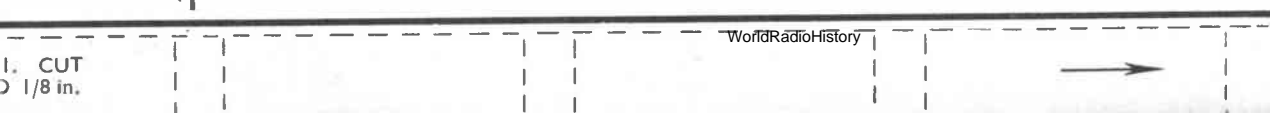

ROOF SLOPES 5. CUT TWO 1/8 in. EXTEND TO 12 ins.

SHAPE TO FIT AT RIDGES

ROOF SLOPES 14. CUT EIGHT 1/16 in.

SHAPE ONE EDGE OF EACH TO FIT AT RIDGE

PIECES 6. CUT FOUR 1/8 in. CHAMFER TO SECTION.



PIECES 7. CUT FOUR 1/8 in. CHAMFER TO SECTION.

PIECES 9. CUT EIGHTEEN 1/8 in. AND GLUE IN POSITIONS SHOWN. CHAMFER WHERE NEEDED, TO FIT UNDER ROOF SLOPE.



PIECES 10. CUT TWELVE 1/16 in.



PIECE 12. CUT ONE 1/16 in.

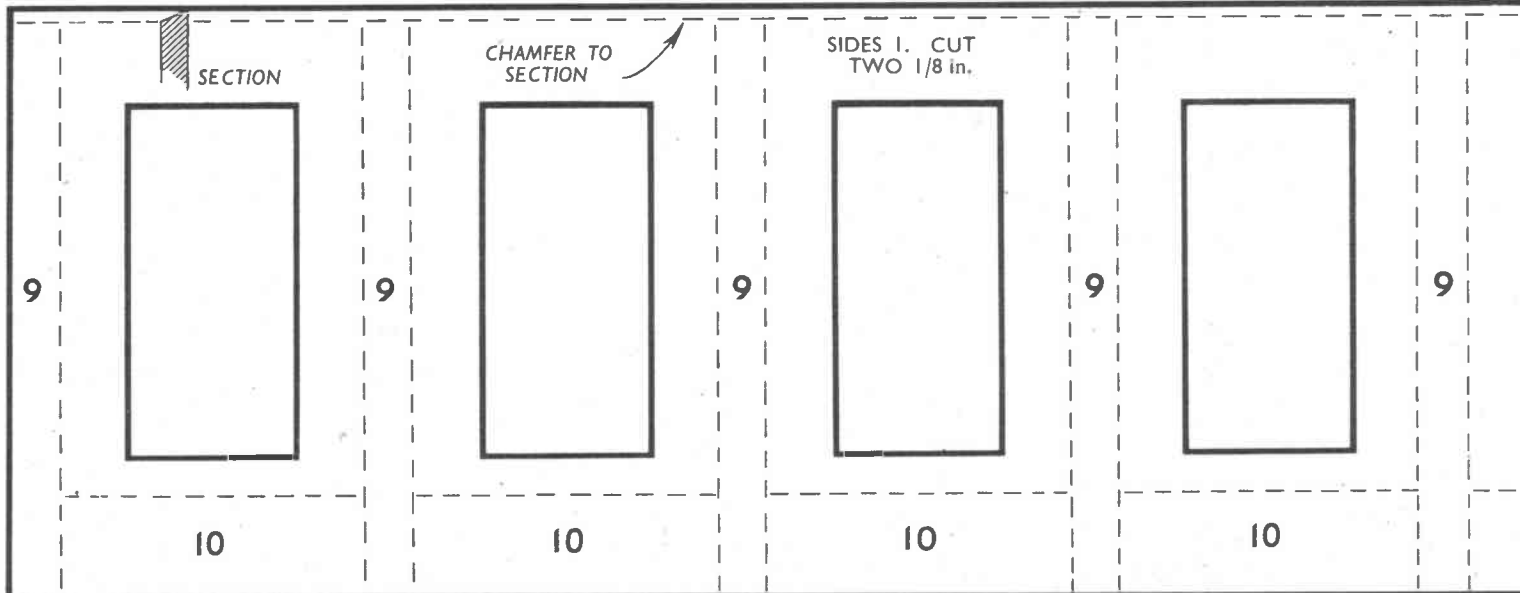
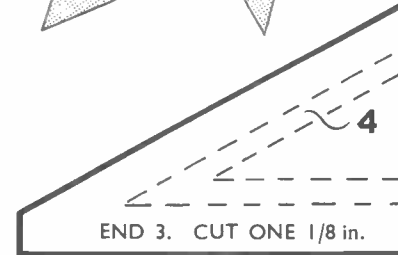
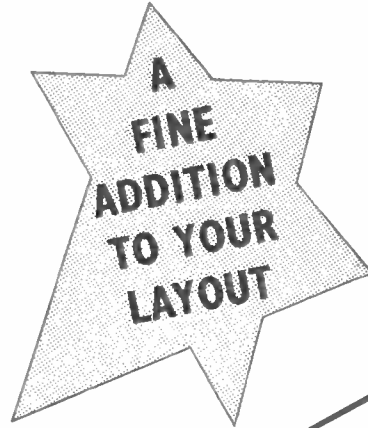
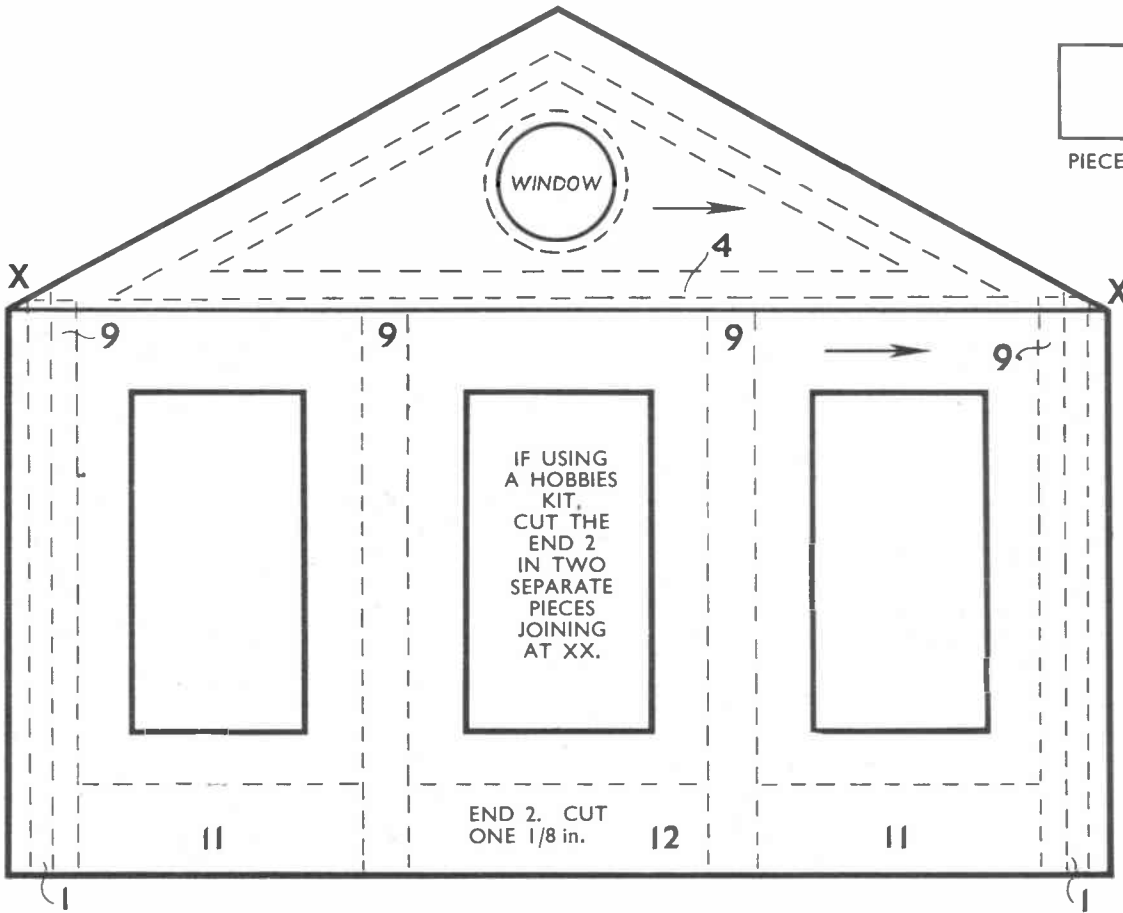

SIZE:  
12 ins. LONG  
5 3/4 ins. WIDE

SHAPE TO FIT AT  
RIDGES



A KIT OF MATERIALS FOR MAKING THIS DESIGN IS SUPPLIED BY  
HOBBIES LIMITED, DEREHAM, NORFOLK.  
PRICE ON APPLICATION.

PIECES 9. CUT EIGHTEEN 1/8 in.  
AND GLUE IN POSITIONS SHOWN.  
CHAMFER WHERE NEEDED, TO FIT  
UNDER ROOF SLOPE.



PIECES 10. CUT  
TWELVE 1/16 in.

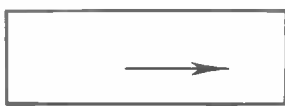

PIECES 11. CUT TWO  
1/16 in.



PIECE 12. CUT ONE  
1/16 in.



PIECES 8.  
CUT EIGHT  
1/8 in.

**Use  
Croid POLYSTIK**

**IT'S DESIGNED FOR THE JOB**

A cold liquid PVA adhesive combining instant grip with immense and lasting strength. Clean to use, non-staining. In polythene bottle with spreader 2/6.

AVAILABLE FROM ALL BRANCHES OF HOBBIES LTD.

**A  
FINE  
ADDITION  
TO YOUR  
LAYOUT**



PIECES 4.  
CUT TWO 1/16 in.

THE ARROWS INDICATE  
DIRECTION OF  
GRAIN OF  
WOOD.

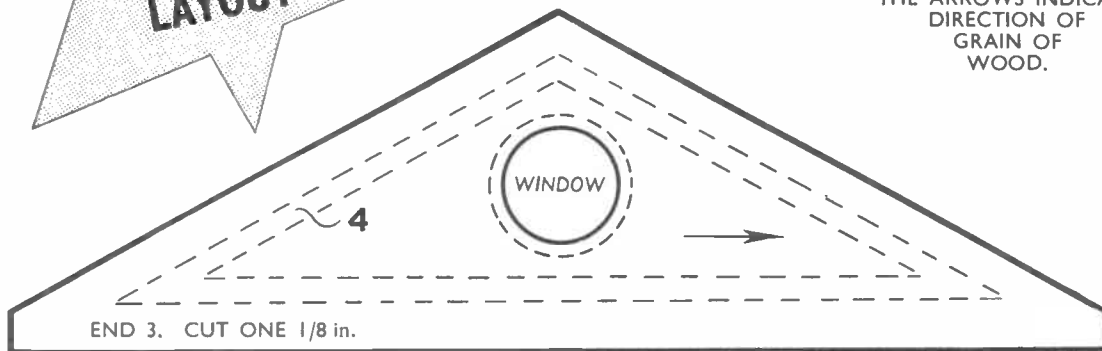

END 3. CUT ONE 1/8 in.

PIECES 13.  
CUT  
TWO  
1/8 in

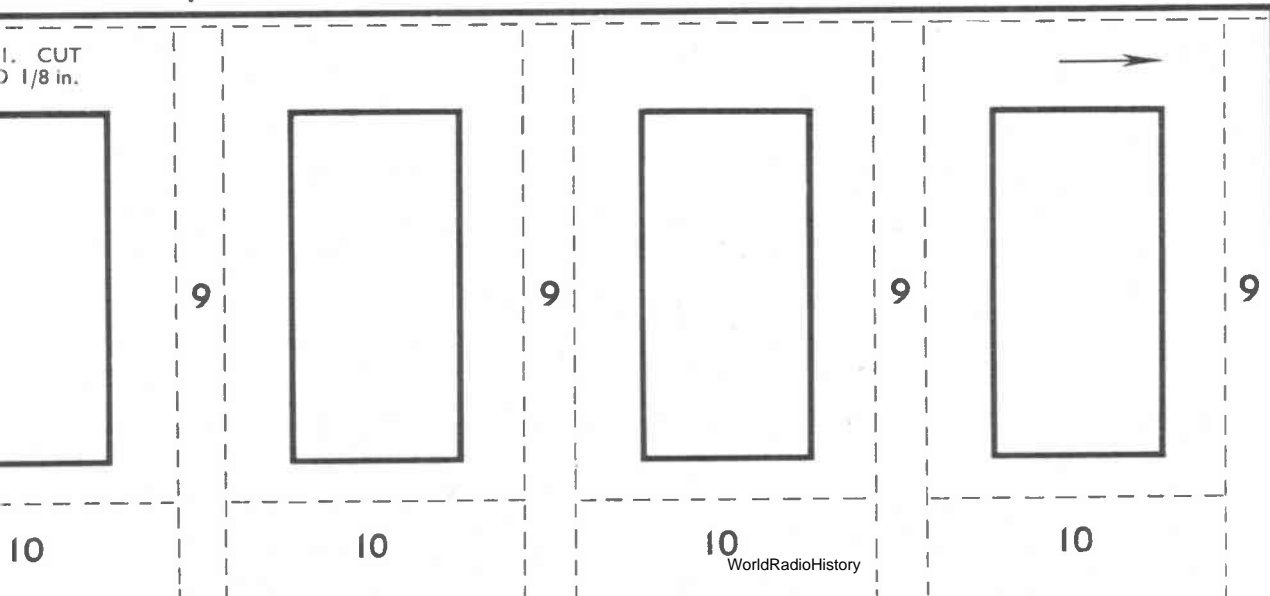

1. CUT  
1/8 in.

9

9

9

9

10

10

10

10