

HOBBIES WEEKLY

IN THIS ISSUE

	Page
'Stand' One-Valver - - - -	369
A Modern Table in Plain Style - - - -	371
Fun with Photographs - - - -	372
A Word in your Ear - - - -	373
A Simple TV Lamp - - - -	374
The Button and String Puzzle - - - -	374
Chemistry in the Home - - - -	375
Unit for Books and Magazines - - - -	376
Can You Read This? - - - -	377
Stamp Collector's Corner - - - -	378
Aid for Film Development - - - -	380
Patterns for An Absorbing Puzzle Game - - - -	383



MARCH 6th 1957

VOL. 123

NUMBER 3201

AN EFFICIENT RADIO OF SIMPLE CONSTRUCTION



1S4. It is also desirable to increase the H.T. to 45 V by using two 22½ V batteries in series.

The circuit is shown in Fig. 1, and uses the valve as a triode, this being simplest. If it is subsequently wished to try the valves as a tetrode, this can be done by wiring the screen grid separately to H.T. positive.

It is possible to use a ready-made tuning coil, instead of that to be described, but an additional aerial will then be necessary in all circumstances. With the coil shown, the winding is of large diameter, and thus acts as a small frame aerial. This will give moderate phone volume, with no external aerial or earth, when the set is used fairly near the local station. With an additional aerial wire, range and volume is much increased.

A B7G holder is necessary for the valve. A small toggle or push-pull

'STAND' ONE-VALVER

A NOVEL form of construction is employed in this set, and it greatly simplifies both building and wiring. A single flat panel is used, holding all the components. This means that all the wiring is on one plane, which cannot be so with the conventional panel, chassis (or baseboard) and rear socket or terminal strip. The completed set, which is thus exceedingly easy to make, stands upright on two small feet. Controls, and also Aerial, Earth, and Phone terminals come on the front.

So that the required batteries may be included, an 'all-dry' circuit is used, with a 1S4 valve, which will operate well with only 22½ V H.T. A small deaf-aid battery is satisfactory. This costs little, and has a useful life, as there is only one valve. A single dry cell provides filament current.

If other miniature valves such as the 1T4 or 1S5 happen to be to hand, they can be used. If so, it is essential to wire the valveholder to suit, as electrode connections are not the same as with the

switch is used for on/off purposes. A .0005µF variable condenser with dial or a fairly large knob is used for tuning, with a .0003µF condenser with knob for reaction. The other parts are not critical, the fixed condenser being about .0001µF to .0003µF, and the leak about 2 to 4 megohms.

The valve has been mentioned, and an unused surplus valve will only cost about 7/6, compared with the 16/- or so charged for a valve of named manufacture.

All correspondence should be addressed to The Editor, Hobbies Weekly, Dereham, Norfolk

For Modellers, Fretworkers
and Home Craftsmen

4½^D

PAGE 369

Try this unusual treatment

A Modern Table in Plain Style

THIS is a modern table in 'plain' style with unusual edge treatment.

The top is a panel of resin-bonded faced plywood, rather more expensive than ordinary ply, but the veneer face is more than worth the additional cost, as far as finished appearance goes. Edges are well rounded off and to cover the 'raw' edges thus exposed, the top is 'framed' with a painted edge in white enamel. Provided the edges are glass-papered perfectly smooth and the grain of the wood treated with filler, this treatment is most effective.

The top is a 30ins. by 15ins. panel of $\frac{3}{8}$ in. or $\frac{1}{2}$ in. faced ply cut dead square. It is best to work on the rounded edges with the panel in this state, i.e., before fitting the legs, etc. This is readily done with a power sander. Avoid planing as you are liable to split or tear the edge plies. Glasspapering will give equal results, even if a little laborious. In any case the final smoothing should be done by hand. A power sander is a little too vicious in cutting action.

Protect the veneer

Having finished the top, the remainder of the work on this piece is on the underside. To protect the face veneer lay the top face down on a piece of cloth or soft material and be sure that there are no hard pieces under the cloth which could be driven into the wood and so mark the surface.

Draw diagonals on the underside and mark the leg positions, as shown. $\frac{1}{2}$ in. diameter holes should be blind drilled at these points to a depth of $\frac{1}{4}$ in. (in $\frac{3}{8}$ in. ply) or $\frac{3}{8}$ in. (in $\frac{1}{2}$ in. ply), taking extreme care not to break through into the face veneer. These holes are then plugged with hardwood dowels, which should protrude approximately 1in. from the bottom surface. Glue these dowels in place.

The legs are cut from 1in. square stock, straight tapered to $\frac{1}{2}$ in. square at the bottom end as shown. All of this wood can be removed by planing, finishing smooth with glasspaper. Choose hard, straight grained stock for the legs free from warps or other imperfections. If you have some really hard wood available, the leg section can be thinned down from the dimensions given still further to improve appearance. The top end of each leg is

drilled to fit the dowels, e.g., to a depth of just over 1in., drill size as per dowel diameter.

The triangular braces are cut from $\frac{1}{4}$ in. ply. Four are required which can be

any overlapping polish removed or flattened with garnet paper and enamelled white. With modern enamels

By R. H. Warring

it should be possible to brush on a perfect coating. Alternatively you may care to try your hand with one of the inexpensive miniature spray guns now available, but if you do, be sure to cover all the polished woodwork as a precaution against 'overspray' getting on to these surfaces.

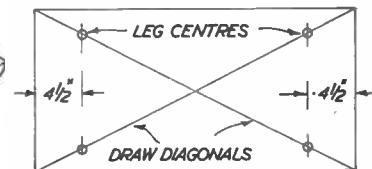
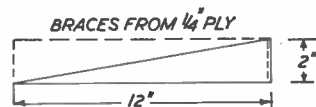
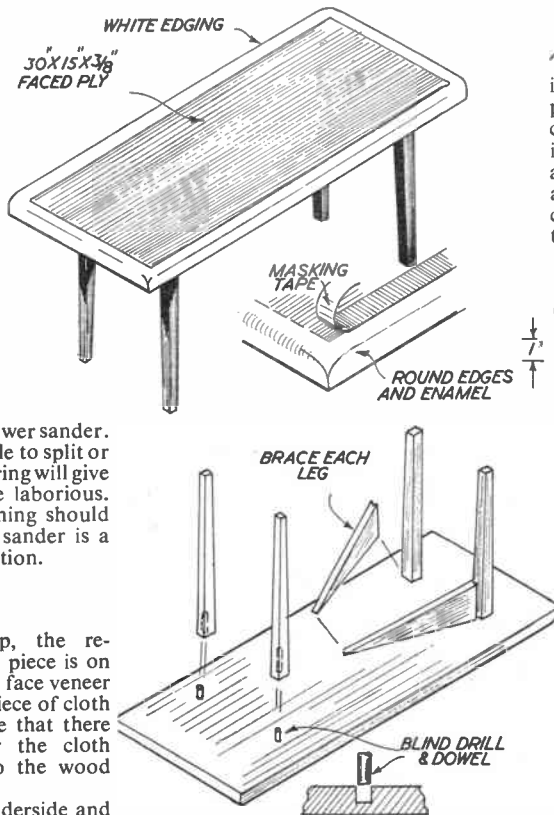

Continued from page 370

ONE-VALVER

and winding about 500 turns of thin wire in each space, as shown in Fig. 4.

A run down battery will also prevent reaction. If the reaction control has no effect whatever, joints to it should be checked.

When the self-contained winding is used as aerial, it is directive, and turning the set one way or the other may be necessary for best volume from any particular station. With an external aerial added this directional effect ceases.

Care should be taken that the corner brackets are really secure, before winding, or the tension of the wire may bring them adrift. A small screw driven through the panel into each, if necessary, will prevent this trouble.

No camera needed

FUN WITH PHOTOGRAMS

YOU don't have to be an expert with the camera to make photograms. All you need is some photographic printing paper, a few bits and pieces, plus your own ingenuity.

The work is done with the aid of the usual darkroom safelight, and the only other apparatus needed is some form of electric lamp you can control by a switch.

~~~~~  
*By S. H. Longbottom*  
~~~~~

Actually, photograms are like silhouettes in reverse. You lay an object on to a sheet of paper, allow a light to shine on this, and after developing, you have your picture. The interesting part about it all is that you are never certain what the result will be, yet no camera is required.

You may take a few nails, varying in size, scatter them over the paper, mixing them up until you have made a design. If you prefer, you may make a 'Nail Man' profile, as shown in Fig. 1, by using pins and nails of all sizes.

Paper clips are very useful for this process, for you may use them in their normal state, or manipulate them with a



Fig. 2

pair of pliers to take the shape of twists or curls. This enables you to make original caricatures of all kinds. Look at Fig. 2. Here paper clips have been bent into various shapes to form the features. A safety pin was used for the chin, and a length of thin fuse wire, formed into a spring by winding round a knitting needle, helped to produce the 'curly' hair.

You may use any humorous cartoon as a basis for such cartoon photograms, using twisted wire for the outlines, plus any available odds and ends for other details. Perhaps it should also be mentioned that in the case of Fig. 2, the collar and tie was made from a piece of cardboard cut to shape, then laid in position on the paper.

An entirely different effect has been produced in Fig. 3 where a pair of pliers forms the basis of the picture. Beads have been used for the eyes, pins for the 'beard' and paper clips for the hair.

You will now see that all types of materials can be used for making humorous cartoon-photograms.



Fig. 3

There is no end to the many modifications of this idea, for instead of making faces, you may like to produce pattern pictures of familiar objects. You may use pressed flowers or leaves, fine net, buttons, ferns, hinges, nuts and bolts, or what you will. With the addition of other little properties, cut from card, you may make some really original prints.

Processing

Having given some idea of the materials to be used, a few words on processing will not be out of place.

Any size of paper may be used, but no doubt it will be appreciated that it is more convenient to work on larger sizes of paper. Half plate is quite suitable, but you may use quarter plate size. It makes

no difference whether you use contact printing paper or bromide paper, although the latter demands an efficient safelight or the paper will fog. Moreover, a contrasting grade of paper is preferable to produce good blacks and whites.

Exposure

If you are working to a sketch, you may prepare the design and necessary materials in the ordinary roomlight before proceeding to the 'darkroom' for processing. In the darkroom, the paper should be opened out and a sheet placed in a printing frame, or fastened to a board with push pins, since it is essential that it lies flat or nails and the like may roll.

When the bits and pieces have been positioned to your satisfaction, a white electric light, say, 100 watts, is exposed to the paper for approximately 15 to 30

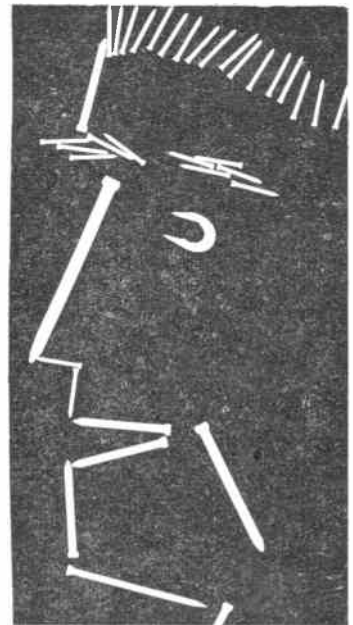

Fig. 1

seconds while held at a distance of 18 ins. The materials are then removed and the paper developed, rinsed and fixed in the normal manner.

Following the production of your photograms, it is possible that traces of dust may show as white specks on the black background. Take a fine pen, charge with a little indian ink, touching the spots lightly when they will quickly be spotted out to make a perfect print.

A Word in your Ear

From the Editor

MY post bag during the last few weeks has contained letters which really gladden the heart. From young and old, they tell of the great amount of satisfaction gained from the hobby of fretwork, and of the many successful models made from Hobbies designs and kits.

It is encouraging to know that despite counter-attractions such as TV and other entertainment, there is still apparent a pride of workmanship and a strong urge to make things with one's own hands.

This urge is, of course, inherent in every child, who is never so happy as when playing with wood and nails. And there is no doubt that if you want your son to be 'handy', then a Hobbies outfit will put him on the right road. He will need encouragement, though, and an interested parent can do much in this respect. Even a poorly executed piece of work deserves a measure of praise — if only for the effort.

As an instance of this encouragement, I quote from a letter sent by M. J. Hodgson of Wainfleet, Lincs. He says 'I purchased your kit for a Swiss Chalet Musical Cigarette Box (No. 3152) and when I wanted to give the model away to a close friend, my mother would not part with it. I am afraid the model has been so much a success that I wish to purchase three more kits'. This is obviously a case where the parent's attitude has helped a lot. Mother is pleased, her son is encouraged, and three more Swiss Chalets will be gratefully received.

FOR BABY SISTER

I PARTICULARLY liked the letter from a 10-year-old boy who sent for a kit of the TV Roundabout (No. 3179) in order to make it up for his little sister — a bare 18 months old. It is easy to get sentimental over instances like this, but surely this is an attitude which deserves to be fostered. Perhaps 'big brother' was not very accurate in his cutting . . . perhaps the finished job was not much to look at by adult standards. But I bet that for baby this was the finest present ever, and that the young worker glowed with immense satisfaction. Criticisms of the finished work do not enter into the question at all — I applaud the thought behind it.

It is not suggested that galleons are easy to make, especially for youngsters. Readers who have tried them will appreciate that much care and long hours are involved — and given this, a delightful model will result. One lad who

is enthusiastic about his efforts at galleon-making is M. Smith of South Woodford, E.18. His 'Ark Royal' (Hobbies No. 211 Sp.) took him two months to complete, but he says 'all the boys down my road are very jealous, and all are saying how lucky I am. Already three of them have bought the kit and are pleased with it'. The enthusiasm of youngsters is obviously catching.

ADJUSTMENT TO A FORT

TOY forts will, of course, always be associated with fighting on foot and horseback, with rifle and sword. So what happens when a five-year-old with modern ideas and equipment finds it necessary to move his lorries and other wheeled vehicles into an interior courtyard?

The answer to this problem was pro-



A 'super model'

vided by Grandad W. Baxter of Canvey Island, Essex. He cut gates into the back walls of the model, which was made from Hobbies Design No. 248 Special.

Thus do grownups have to bow to the whims and ideas of the up-and-coming generation. Incidentally Mr. Baxter praises this design as a 'super model', a description with which his young grandson quite obviously agrees. He is very lucky to have such a handy grandad, who wrote to tell me that his next job was to make Hobbies Model Farm, No. 249 Special.

POKERWORK

FROM time to time we have described projects which included the use of pokerwork. This, as many readers know, involves the burning on

★★★★★★★★★★★★★★
 ★ Next week's free design will be for ★
 ★ a child's cot. It has drop sides, is ★
 ★ full-size and folds for easy storage. ★
 ★ Also fretwork pattern and inter- ★
 ★ esting projects for the handyman, ★
 ★ hobbyist and fretworker. ★

★★★★★★★★★★★★★★
 ★ to wood of lettering and designs, etc.,
 ★ carried out originally with a hot poker.

The work can well, of course, be carried out in this way, but there have been on the market poker points electrically heated, which obviate mechanical heating and is more speedy. It appears, however, that these tools were not satisfactory in all respects, and the firm to which we have often directed our readers to apply for one of these tools, informs me that their instrument is temporarily out of production, so that modifications can be carried out to make it a more adaptable tool.

When these modifications have been carried out, I shall be pleased to give this information to interested readers.

HELPING HANDS

I RECEIVE many letters commenting on various designs and articles which appear in our magazine, and one which gave me great pleasure was from a Liverpool reader, T. E. Youds.

In our issue of October 28th, 1953 we described a handy bookrest which could easily be cut out with a fretsaw. It was only a small illustrated article, but apparently it attracted the attention of Mr. Youds who made up three of the bookrests for bed patients in a local hospital, to whom they proved of great value. He learned subsequently that one of these rests was passed to a polio patient, with the result that the hospital management committee have had a number of these articles made and one is supplied to every patient in that particular ward.

Mr. Youds says: 'I leave to your imagination the godsend this must prove to those who have not the ability to hold a book.' In praising the contributor of the article for the original idea, Mr. Youds adds 'He is far more entitled to the great feeling of satisfaction that I myself enjoy.' And as a final word from me I must say that Mr. Youds also deserves the greatest credit for his initial good thought and deed.

INSPIRATION — My final paragraph this week concerns a reader living in Tolworth, Surbiton, Surrey, whose first Hobbies set was purchased about 55 years ago at Messrs Osborne's tool shop, Below Bar, Southampton. He says 'I am an old age pensioner with both legs amputated above the knees and most of my fretwork is done in bed with a good bed table'. Certainly an inspiration — but readers may think 'GUTS' would have been a more appropriate heading.

Gives diffused lighting

A SIMPLE TV LAMP

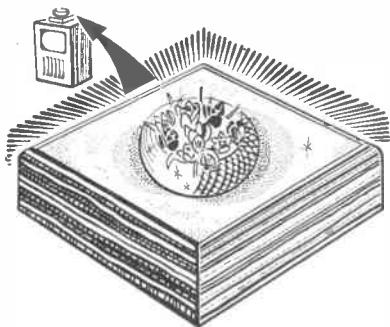

TO thoroughly enjoy a TV programme the room must be almost dark and yet there must be sufficient light to be able to see all around the room. This TV lamp is very simple and easy to make. It also has the advantage that in cases of sickness it may be used as a night-light, because it gives a nice diffused light. If a coloured lamp is used the light may be made to tone in with the general

colouring of the room, as most of the light is reflected from the ceiling. The lamp can also be used as a stand for a fancy ornament or a vase of flowers. Its total cost should not exceed 5/-.

To make you will require:—

- 1 piece obscured glass, 6ins. by 6ins.
- 4 pieces of suitable wood, 2½ins. by ½in. by 7ins. long.
- 1 length of ½in. by ½in. triangular corner moulding 10ins. long.
- 1 piece plywood 6½ins. by 6½ins. by ½in.
- 1 bayonet cap holder, wire and switch.
- 1 single cap tubular bulb, 25 or 40 watt.

To make, mitre the ends of the four 2½in. by ½in. pieces of wood and round off the top edge, and glue all together. Then glue into the four inside corners, stiffeners, made from pieces of the triangular moulding each just long enough to leave room for the glass to sit on top and allow the upper surface of the glass to lie level with the top of the frame. The glass is left loose for easy cleaning or bulb cleaning.

The obscured glass may be of any suitable pattern, even a piece of ground glass will do, but it should have one face flat or the lamp will not be suitable for use as a plant or vase stand.

If it is not possible to mitre the ends of the frame side-members, then butt joints will have to do, but two side pieces will have to be cut to 6ins. long, the whole being glued, complete with corner pieces, as before.

The plywood is glued and pinned to the base and a square of felt or small pads of soft rubber are glued to the underside to prevent possible scratching of a polished table. The lamp holder is fitted in place with ½in. wood screws after a ½in. diameter hole has been drilled in the frame for the cord. Insert an 'on and off' switch in the cord about 1ft. or so from the lamp, and all is ready for finishing.

Stain and French polish, cellulose lacquer, or any other suitable or desirable finishing may be used, but a thorough glasspapering first is absolutely essential to a good finish. (T.H.M.)

The Button and String Puzzle

YOU can easily make this puzzle from a piece of stiff white paper 6ins. square, a length of thin string and two buttons.

Take a piece of paper and square out as shown in the diagram by drawing lines ½in. apart in both directions. Cut two long slots at the top of the paper, each 4ins. long and ½in. wide. At the bottom two small vertical slots are made ½in. deep and ½in. wide. This completes the basic part of the puzzle, and while you are doing it, perhaps it would be an advantage to cut out one or two extra pieces at the same time.

The piece of string is threaded as shown through the upper slots, passing through the small vertical slot on the left to the back of the paper, then emerging to the surface again through the right slot. Fasten a large button — too large to pass through the slots — to each end of the string. The puzzle is to remove the string and buttons from the paper without untying, and without damaging the paper.

No matter how your friends may try, they will be unable to solve the puzzle until you show them, and like many other puzzles, the solution is quite easy once you know it.

You will notice that the diagram bears small letters (a) and (b). To release the buttons first fold the paper in half along a line made between the two

small (a's). This has the effect of making that portion between the two long slots take the form of a tongue. Now fold the paper again between (b) and (b), so that the ends of the string emerge *outside* the paper, and it will be noticed that the tongue is in line with the small vertical slot. Now push the tongue through the slot along with the string. All you have to do to release the buttons and string is to pass one through the folded part

resembling a tongue, unfolding the paper to its original position and showing that both paper and string are still intact.

Earlier it was mentioned that it would be a good plan to cut out one or two pieces of paper at the same operation. No doubt you will appreciate that the folds in the paper used once or twice may give a clue, so it is better to discard if the crease becomes too apparent. (S.H.L.)

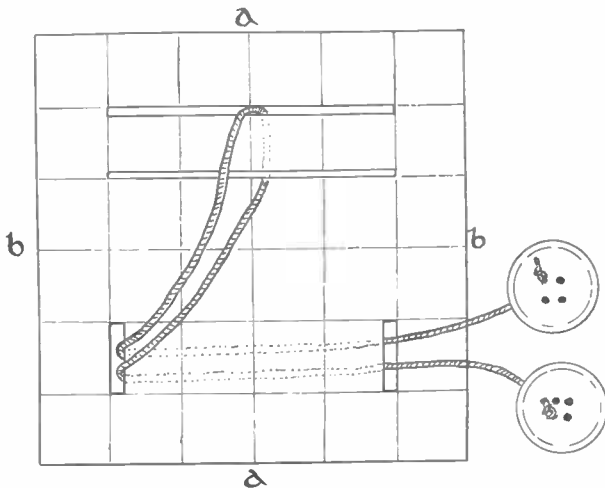

CHEMISTRY IN THE HOME

Making Acids Part 3

IF you have ever seen wood sorrel — the pretty shamrock-like plant with the delicate flowers — you have, perhaps, wondered if there is any connection between this and the salt of sorrel used to remove iron mould from cloth. There is. Wood sorrel contains a salt of oxalic acid which is used for this purpose — potassium hydrogen oxalate. Hence the name salt of sorrel. Rhubarb also contains a small quantity of this salt.

Though oxalic acid itself could be prepared from wood sorrel, it is not productive enough on a laboratory scale. So we will prepare it from an easily available chemical. Namely, sodium formate. When this is heated, hydrogen is given off and a residue of sodium oxalate remains. By converting this into calcium oxalate and acting on this with an acid we can set free the oxalic acid.

As hydrogen is inflammable it must be conducted away from the flame area,

the glass plate and put another jar on the shelf. The filled jar can be left in the trough until the experiment is completed, or taken outside for emptying straight away. To empty it, simply turn the jar right side up and slide off the glass plate, when the gas, being lighter than air, will rise out.

When the flask is cold, add water to the contents and boil, so as to dissolve out the sodium oxalate. Filter the solution and add calcium chloride solution

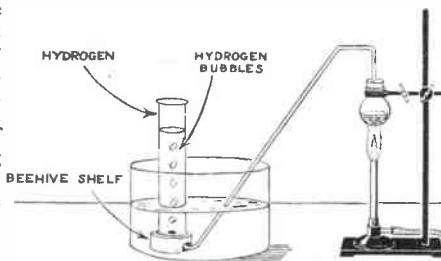

Fig. 1—Pneumatic trough

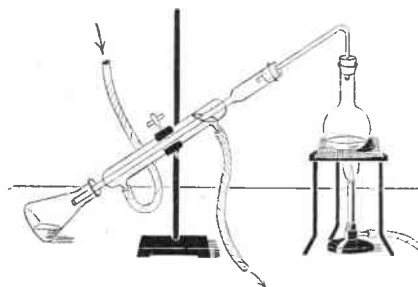

Fig. 2—Distilling hypochlorous acid

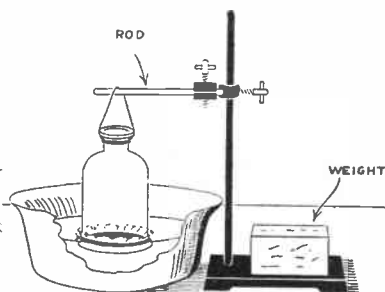

Fig. 3—Separating a colloidal solution

either by a long rubber tube running from the heating vessel and out of a window, or by collecting it in gas jars in a pneumatic trough, as shown in Fig. 1, the jars being closed with glass plates, taken away and emptied in the open air.

Place some sodium formate in the flask and heat it gently until it blackens slightly and the effervescence due to evolved hydrogen slackens. To collect the hydrogen, fill each jar with water, slide a greased glass plate over the mouth, invert it and dip it under the water in the trough (for which a wash bowl will serve). Slide off the glass plate and bring the jar on to the beehive shelf.

The hydrogen bubbles issuing from the delivery tube will displace the water in the jar. When the jar is full, replace

to the filtrate until no more white precipitate of calcium oxalate appears. Filter this off and wash on the filter until one wash water gives no white turbidity with silver nitrate solution. Then dry the filter paper and precipitate in the oven.

Now weigh the calcium oxalate. Each 10 grams of calcium oxalate requires 6.7 grams (or 3.6 c.c.) of strong sulphuric acid to free the oxalic acid. Stir the sulphuric acid into about ten times its bulk of cold water, pausing if the water becomes warm, and continuing when it is cold.

Add the calcium oxalate to the diluted sulphuric acid and heat the mixture in a water-bath for about half an hour. Insoluble calcium sulphate is formed and soluble oxalic acid set free.

By filtering off the calcium sulphate, running two or three lots of water through the filter, boiling down the filtrate to the crystallisation point and letting it cool, you will obtain white crystals of oxalic acid. Dry these on a porous tile.

Chromic acid is an important chemical in the chromium plating industry, besides having many other uses. An easy way to make a solution of it is to decompose lead chromate with sulphuric acid.

First prepare your lead chromate by adding potassium chromate or dichromate solution to lead acetate solution until no more yellow precipitate of lead chromate forms. Wash the precipitate of lead chromate by decantation or on a filter until one wash water is colourless. Dry the lead chromate in the oven and then weigh it.

Each 10 grams of lead chromate require 3 grams (1.6 c.c.) of strong sulphuric acid to free the chromic acid. Stir each 3 grams or 1.6 c.c. of the acid into about 20 c.c. of cold water, add the lead chromate and heat in a water-bath for half an hour. Lead sulphate is formed, which is insoluble, and a solution of chromic acid. By filtering off the lead sulphate and running several lots of water through the filter you will obtain a filtrate of chromic acid solution.

When 'chloride of lime' is stirred up with water, the mixture contains dissolved calcium hypochlorite. This, as we all know, is a good bleaching and disinfecting agent. The same is true of the parent acid — hypochlorous acid. The acid is unstable and is known only in solution.

The easiest way to prepare a solution of it is to act on chlorine water with precipitated mercuric oxide and to distil the filtrate.

First prepare the mercuric oxide by adding potassium or sodium hydroxide solution to mercuric chloride solution, bearing in mind that mercuric chloride is poisonous and that you should wash your hands before eating anything. The precipitate which first forms is brown, but as you continue to add the hydroxide it passes to yellow. Filter this off and wash it well on the filter.

By means of a spatula, add portions of the wet oxide to chlorine water contained in a glass stoppered bottle and shake the mixture. The oxide dissolves. When one portion refuses to dissolve, the reaction is complete, hypochlorous acid and mercuric chloride being present in the solution.

● Continued on page 377

UNIT FOR BOOKS AND MAGAZINES

Woodwork
Project
described
by
*Gordon
Allen*

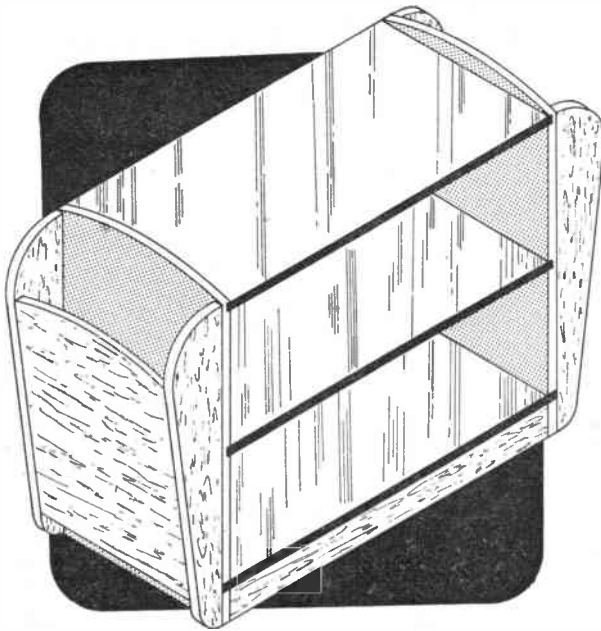

THIS unit, which combines shelves for books, and racks for magazines and newspapers, is a particularly suitable woodwork project for the young handyman.

Plywood can be used throughout and is specified in this article, but other hard straight-grained timber can be used with equal success.

Make the two uprights — items (A) and (B) — first. Mark their shapes as shown in Fig. 1 directly on to the $\frac{1}{2}$ in. plywood but make sure that they are *handed*. That is, in item (B) the $\frac{1}{2}$ in. wide slot will be cut in from the *right-hand*

edge instead of from the left as in item (A). Before cutting them out mark in pencil the positions of the $\frac{1}{2}$ in. shelves on the inside faces.

When the uprights are cut out trim up the edges and the slot and form the $\frac{1}{2}$ in. deep grooves at the shelf positions with a 1 in. chisel. First cut along the pencil lines to a depth of $\frac{1}{4}$ in. and remove, piece by piece, the surplus between the lines. If ply is used this will be a very simple job because the laminations will break away quite easily. Clean up the grooves with glasspaper wrapped round a square stick and see that they provide

CUTTING LIST	
(Sized bigger for trimming)	
$\frac{1}{2}$ in. plywood:	
2 pieces 24 ins. by 12 ins.	(uprights)
2 pieces 26 ins. by 12 ins.	(top and middle shelves)
1 piece 28 ins. by 12 ins.	(base)
1 piece 20 ins. by 12 ins.	(rack sides)
$\frac{1}{2}$ in. plywood:	
1 piece 30 ins. by 12 ins.	(rack fronts)
Hardboard — if required:	
1 piece 24 ins. by 20 ins.	(backing)
Glue, panel pins, filler, stain, varnish, etc.	

a snug fit for the $\frac{1}{2}$ in. plywood to be used for the shelves.

Cut the top and middle shelves each measuring $23\frac{1}{2}$ ins. by 12 ins. and make sure their ends are square and true.

The shape of the base, item (C), is given in Fig. 2. Cut this out next from $\frac{1}{2}$ in. plywood and again make sure that the slots are true, square and accurately positioned. They must provide a neat sliding fit in conjunction with those in the uprights. The ends of the base are chamfered so that they will butt-joint neatly with the angled fronts of the magazine racks. Do this with a chisel, with the base held in the vice, and glasspaper smooth.

● Continued on page 377

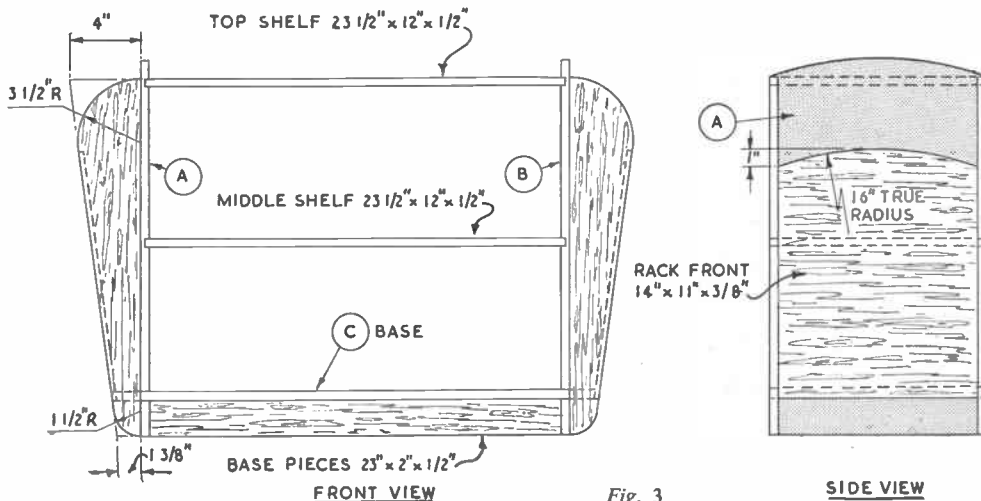

Fig. 3

Assemble the shelves by first gluing in place the top and middle shelves and then fixing the base which makes a 'half-and-half' joint with the uprights.

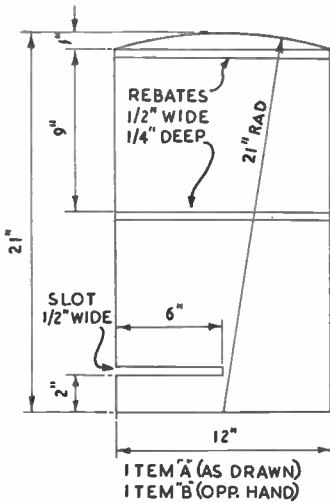

Fig. 1

Make sure that the assembly is square and correct any tendency to 'lean' before the glue sets. Then drive panel pins into the edges of the shelves through the uprights and see that the heads are below the surface of the wood.

Next cut and glue in place the two base pieces which are $\frac{1}{2}$ in. plywood. Reinforce the joints with panel pins driven through the base.

Four end pieces are now required to form the sides of the magazine racks. Their shapes and dimensions are given in Fig. 3. Cut them from $\frac{1}{4}$ in. plywood,

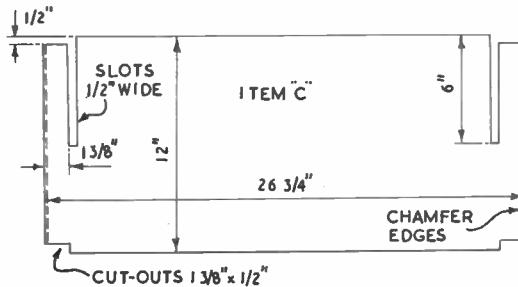

Fig. 2

glue and pin them to the edges of the uprights and see that they are level with the bottom edges of the base extensions, to which they are also glued. Finally, cut the rack fronts (detailed in Fig. 3) from $\frac{3}{8}$ in. plywood and glue and pin them flush with the edges of the racks. Glue and pin the bottom edges flush with the beveled base extensions.

Fill all pin holes with wood filler or Alabastine and glasspaper the whole unit. It can be stained and wax-polished. If you intend to use enamel give the assembly a preliminary coat of aluminium paint, which serves the dual purpose of primer and undercoat. The tops of the shelves and base can, of course, be faced with a laminated plastic applied as recommended by the manufacturers.

If you wish to back the shelves use a piece of $\frac{1}{4}$ in. hardboard measuring 24 ins. by 20 ins. Pin this at about 2 in. intervals along the rear edges of the shelves and uprights.

CAN YOU READ THIS?

CAN you solve this jumbled puzzle? If not, take the paper, holding it at eye level, when you will see two familiar words quite clearly. Now turn the page round, looking at it from a similar angle until you find the other two words.

You can make puzzles like this quite easily, using your own name. All you have to do is to draw parallel lines on the paper about $\frac{1}{4}$ in. apart. Pencil in long, thin letters, using only short lines for the horizontals. This part should be inked in before the paper is turned round for more words to be added.

The paper is turned round one quarter, and the same technique applied, preparing the pencil letters across those already inked. When two words are used, it is best to mark out the first, starting from the left, then start with the last letter of the second word on the

extreme right, working backwards to the centre. This method will then produce the square shape. Finally, complete the letters with pen and ruler.

● Continued from page 375

Making Acids—Part 3

Filter the solution into a flask connected to a condenser (Fig. 2) and distil until most of the liquid has passed over into the conical flask. The distillate is a strangely smelling colourless solution of hypochlorous acid. If you drop in a slip of litmus paper, you will note it is soon bleached.

An essential part of clay and many other minerals is silicic acid, ordinary clay being aluminium silicate. Water glass is a mixture of sodium silicates and silicic acid can be prepared from this.

Dilute a little water glass with several times its bulk of hot water and let it cool. Add this gradually to several times its bulk of dilute hydrochloric acid. The mixture appears to have undergone no change. Actually, the silicic acid is present as a colloidal solution. Colloidal solutions will not pass through parchment paper. By using this fact, we can separate the silicic acid from the sodium chloride which is also formed in the reaction.

Tie a sheet of parchment paper over

When the page is held at eye level, the letters appear as normal, being shortened by the different viewing angle. You may draw your Christian names one way, with your surname at right angles, and remember that it makes the puzzle more difficult when the letters are as thin as possible. (S.H.L.)

the mouth of an open topped bell jar, or over the mouth of a jam jar whose bottom has been cut off. Suspend the jar mouth down in a bowl of water and pour the silicic acid solution into the jar, as shown in Fig. 3. Weight the retort stand with a piece of brick to prevent it overbalancing. The sodium chloride will now start to pass through the parchment paper. You can prove this in an hour or so by adding a few drops of silver nitrate solution to a sample of the water, when a white precipitate of silver chloride will form.

Change the water every few hours until a sample no longer gives a precipitate with silver nitrate solution. The liquid left in the bell jar is silicic acid. If you pour this into a bottle and keep it a few days, a strange modification takes place. The thin colloidal solution thickens and becomes a jelly. It is still silicic acid, but in another form. This curious double form distinguishes silicic acid from all other common acids.

A.F.)



CHARITY ISSUES

By L. P. V. Veale

which have in the past been helped by the post office. Again it is the collection of small sums rather than one large one.

A LITTLE while ago we dealt with some of the commemorative stamps that have been issued, and on that occasion we showed that there are many stamps, some justified as commemorative and some which are not. The same remark must apply to these charity stamps. There are some which are eagerly awaited and others which do not cause the slightest excitement when they come out.

When charity stamps are mentioned most collectors will immediately think of the two countries New Zealand and Switzerland. Both of these countries have an annual issue, just before Christmas. Obviously this season is chosen because at this time of the year more people are ready to part with money than at any other.

Very popular

New Zealand has issued her charity stamps since 1929. Actually on that date she only issued one stamp, a 1d. stamp, for which people had to pay 2d., 1d. going to defray the cost of the letter being carried and the other 1d. going, as the stamp states, to 'Help stamp out tuberculosis'. The next year the same design was used, but the wording on the stamp was altered to 'Help promote Health'. Then followed in 1931 the most celebrated of the New Zealand Health stamps, the 'Smiling Boy'. There were two stamps, one the 1d. red and the other the 2d. blue, two stamps which today are worth far more than their weight in gold. From then to 1938 they issued one stamp per year, but since then they have had two stamps until last Christmas, when they had three. These are very popular stamps, indeed, and so are, though to a somewhat lesser extent, the stamps from Switzerland, known as 'Pro Juventute' issues. These date from 1913, but unlike the stamps from New Zealand, they do not indicate the extra that had to be paid for them, which should go to charity. The 3c. stamp cost an extra 2c., the 5c. to 20c. was an extra 5c., and the 30c. and 40c. cost an extra 10c. These rates held until 1945 and then they were raised somewhat. The earlier issues had as the design the arms of the various cantons (similar to our counties) and some of these arms or rather their

background are quite instructive. For example, if one looks closely at the 20c. of the 1923 issue, which shows the arms of Neuchatel, one notices a background of watches, so from this one can judge from which part of Switzerland watches come. The 7½c. of the 1920 set shows the arms of Schwyz the background is made up of a lot of hands and from this canton we get gloves.



Switzerland - Neuchatel - watches as a background

Peru - for unemployed

Norway - Norwegian Tourist Association

Russia - Volga famine relief

France in particular has issued all kinds of charity stamps, starting in 1914 with a 10c. plus 5c. for the French Red Cross. In 1917 the War Orphans Fund benefited by the premiums varying from 3c. to 5frs., and in 1935 the Unemployed Intellectuals Fund was aided by premiums on two stamps, whilst the next year, the children of the unemployed were helped. In following years many additional charity issues were made including aid to the Resistance Movement in 1943, so there can be no doubt that France uses its postal service to produce money for charity.

No value

It is not out of place to mention here that the Christmas seals which are sold in this country at the festive season have absolutely no postal value. Although they look like stamps and are bought in the same way, they can have no place in the stamp album. The stamps of France, however, sold for the benefit of the same kind of society, since they also represent the postal charge, will have a rightful place in the album.

It is during a period of distress that one finds many charity stamps issued, and one of the British Colonies gives us an example of three kinds of charity

Issue delayed

The Colony referred to is the Bahamas. The 1d. value of the Queen's Staircase design was overprinted in red with a red cross and the date 1.1.17. This stamp was to have been issued on January 1st, 1917, but due to a delay in shipping, the stamps were not issued until May, 1917. There was a war tax stamp and on the 3rd June, 1918, a war charity stamp was

issued. The war tax helped to pay for the war, the war charity helping some of the various societies which were doing work for those engaged in some way in the war effort.

There are one or two rather curious objects for which money has been raised through the post office. For example, Peru had a stamp issue in aid of the unemployed. This came out in 1934-1936. On one of the normal stamps the words 'Pro-Desocupados' were overprinted. A serious disaster is depicted on the stamp from Dominica. It shows the devastation on the river due to the cyclone of 3rd September, 1930. In 1921 Russia issued stamps to aid the victims of the Volga famine. The stamp illustrated as you can see, cost 2250 roubles. The postal value was only 250 roubles, the amount going to charity being 2000 roubles.

Sports have their pickings in some countries. Hungary in 1925 issued a set of eight stamps, the design of each being a sporting scene such as a goal-keeper saving, a man diving, etc., the values varying from 100k. to 2500k. These stamps do not on the face show any premium for charity, but on the back there is an inscription which states

● Continued on page 380

STICK TO SECCOTINE

Regd.
-it sticks everything!

Keep a tube
in the home



PER TUBE

Sole Manufacturers: McCaw, Stevenson & Orr Ltd., Belfast

Follow the **FLUXITE** way to Easy Soldering

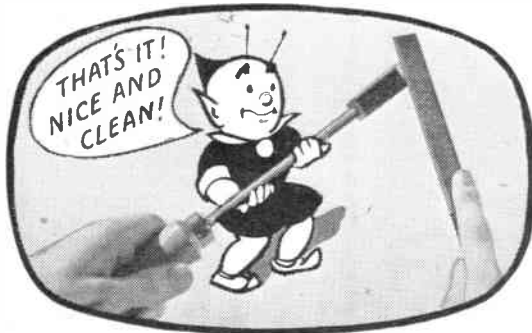

No. 2. Cleaning the bit

Solder will not adhere to a dirty or greasy bit so whether the iron is new or old it **MUST** be filed clean and bright on all its four faces for a distance of about $\frac{1}{16}$ in. It is now ready for tinning.

FLUXITE is the household word for a flux that is famous throughout the world for its absolute reliability. In factory, workshop and in the home FLUXITE has become indispensable. It has no equal. It has been the choice of Government works, leading manufacturers, engineers and mechanics for over 40 years.

FLUXITE

SIMPLIFIES ALL SOLDERING

FLUXITE Limited, Bermondsey St., London, S.E.1
H.2

YOU can make - and give

wonderful WREN CRAFT FURNITURE

Save pounds
on presents
with these easy
to-assemble outfits

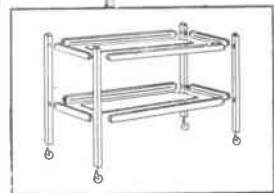

Here's the best money-saving idea for years — beautiful WREN CRAFT Furniture. It's so simple, satin-smooth parts, step-by-step instructions, pins, glue — everything supplied. Fit the parts together and you have lovely furniture at a fraction of shop prices. Choose from OAK, WALNUT, MAHOGANY or BEECH — all top quality timber and with a money back guarantee of workmanship.

Here are just a few of the wonderful things you can make with WREN CRAFT outfits: COT, PLAY PEN, CHILD'S DESK AND CHAIR, COFFEE TABLES AND TROLLEYS, BOOKCASES, COMPLETE BED-ROOM SUITE, BATHROOM AND NEEDLEWORK CABINETS. In fact 53 ARTICLES.

ACT NOW!



Get the exciting **FREE**
WREN CRAFT CATALOGUE
Post the coupon **NOW**

Please send me **FREE COPY** of the
WREN CRAFT CATALOGUE

NAME

ADDRESS

WREN CRAFT FURNITURE LTD.
Wellington Cr., New Malden, Surrey
H15.

Aid for Film Development

IF you have ever suffered the misfortune of overrunning development time of a film, you will appreciate the value of this simple device, particularly if you do not possess an expensive timer or special clock. Using the family alarm clock for timing, it is quite easy to forget that actual starting time, or you may be interrupted by a caller.

coincide with the 12 o'clock position — to the present position of the minute hand.

To operate, the aperture is set to the required time and adjusted so that the minute hand of the clock coincides with the left-hand side of the aperture at the start of processing. The time has expired when the hand reaches the other rim of the aperture.

method, the agitation is constant and recommended development times may be reduced by about one third. This will produce a nice negative — providing the exposure is correct — of medium density, suitable for contact printing and enlarging, and giving full details of the sky.

Try experimenting

There are varying schools of thought on this subject, some maintaining that the exposure should be generous and the development made short. Others have

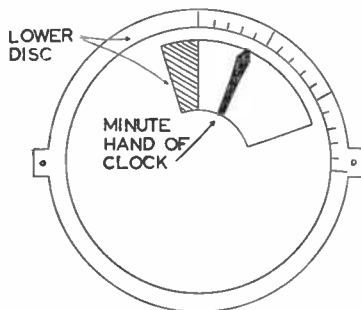

Fig. 1

The device shown can be made to fit on any size of clock without disturbing the hands in any way, is adjustable to any desired timing and made from only two pieces of cardboard.

Prepare a piece of pliable white card to the size of your own clock face as shown in Fig. 2, cutting out the aperture to allow for a period of twenty minutes or more. Note the small projections on both sides of this part, and making an allowance for same when cutting out.

With the aperture made, place the card over the clock face, marking off the minutes from 12 o'clock onwards with a pencil. Remove the disc, inking in the marks, but making longer strokes at the five minute points.

Second disc

A second disc is prepared with the same size of aperture marked from the first piece, but this disc is $\frac{1}{2}$ in. less in diameter, so that when the two are combined, the minute marks are quite visible.

The two discs are fastened together by means of a brass paper fastener, taking care that the fit is reasonably tight or the discs may slip. The two projections are pierced to take an elastic band. Cut a band, knot at one end, pass through one hole from the face side, take round the back of the discs and through the other hole where another knot is made on the band. It will be seen that the device will now slip over the face of your alarm clock in any desired position.

There is no need to move the hands of the clock, for all that is required is to fit the left side of the aperture — made to

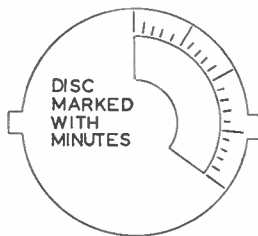

Fig. 2

While dealing with the subject of film development it may be as well to mention one or two rather important points. When a film is fully developed a contrasty negative will be produced, often calling for soft paper to make a suitable print. Moreover, the sky areas are made so dense that it becomes almost impossible to print the clouds. And the dense negative increases printing time for both contact prints and enlargements.

Tendency to over-develop

Another factor to be considered when developing a film is the amount of agitation given. Time increases with a decrease of agitation and this must be compensated when observing the instructions given by the film maker or the developer maker.

Usually, the average amateur has a tendency to overdevelop his films, producing dense contrasty negatives. It should be remembered that when a film is developed in a dish by the see-saw



Fig. 3

the opposing view of a minimum exposure and full development of the film.

It is well worth trying the latter method of minimum exposure and full development as an experiment, since from a practical point of view, the negatives are much easier to enlarge and their tones are improved. A more brilliant print, with luminous tones, is obtained with less effort on normal grade papers.

The best thing to do is to make the experiment carefully, noting the development times, and developer used, making the two standards for future practice.

You gain nothing whatever by constantly changing from film to film or developer to developer. When necessary you may reduce the development time to make your type of negatives, but don't forget to keep your temperatures also to a standard. (S.H.L.)

● Continued from page 378

Charity Stamp Issues

that the stamps are sold at a premium of 100%, the extra going to the various sporting associations.

Roumania is another country which has allowed sports to benefit through the post office. Up to 1930 her charity stamps were for Red Cross work, refugees, and so on, but after that date there was an aviation fund set, two or three for scouts and in 1937 two issues for sports.

Lastly, as a form of charity stamp, Norway has produced some items of beauty, both in 1938 and in 1930. These

were in aid of the Norwegian Tourist Association Fund. The 1930 stamps showed a picture of the North Cape, whilst the 1938 had some general views.

The fact that a stamp has been produced to aid some form of charity must add an interest to a stamp, yet at the same time it must add to the price of the stamp, but not always to the value. In one case in France, the authorities added too high a premium, with the result that the stamp did not sell, and they had to reduce it.

Make no mistake about it . . .

When it's a wood gluing job, there's only one way to get really first class results — use a glue manufactured specifically for use with wood. And for this type of gluing, CASCAMITE "One Shot" Resin Glue is unsurpassed both in performance and in its simplicity of use. Supplied in powder form, this resin glue is easily mixed in cold water, is used cold, and is unique in that it requires *no hardener additions* — the hardening agent is incorporated in the powder during manufacture. The glue is gap-filling (to the British Standard Specification requirement), is non-staining and makes joints which, in addition to having tremendous strength, are water-proof and heat and mould-resistant.



Remember, too . . .

When you want a good general-purpose glue, be sure to choose CASCO Grade "A" Powdered Casein Glue. It is mixed and used cold, heat and moisture resistant, very economical in use (1-oz. of powder makes 3-oz. of liquid glue) and will glue a wide variety of materials. Packed in 2½, 7½ & 16-oz. tins (2/-, 4/6 & 7/6 respectively). Ask your local stockist for free descriptive leaflet.

Available from ironmongers, hobbies shops, builders' merchants, etc., in 3½-oz., 7-oz. and 18-oz. tins (prices 2/6d., 4/- and 8/6d. respectively).

... for wood gluing, choose **CASCAMITE "One Shot"**

One of the range of



SYNTHETIC RESIN AND CASEIN GLUES

73a

Manufactured by: LEICESTER, LOVELL & CO. LTD. NORTH BADDESLEY, SOUTHAMPTON

CASCO GLUES
are recommended for
"Build-it-Yourself"

with **Easi-Bild** Patterns



BRANCHES: LONDON

- 78a New Oxford St., W.C.1
(Phone MUSEum 2975)
- 87 Old Broad Street, E.C.2
(LONDOn Wall 4375)
- 81 Streatam Hill, S.W.2
(TULse Hill 8796)

GLASGOW

- 326 Argyle Street
(Phone CENTral 5042)

Head Office & Factories—HOBBIES LTD, DEREHAM, NORFOLK

MANCHESTER

- 10 Piccadilly
(Phone CENTral 1787)

BIRMINGHAM

- 100a Dale End, Birmingham 4

SHEFFIELD

- 4 St. Paul's Parade

LEEDS

- 10 Queen Victoria Street

HULL

- 10 Paragon Square
(Phone 32959)

SOUTHAMPTON

- 134 High St. (Below Bar)

BRISTOL

- 30 Narrow Wine Street

NEWCASTLE

- 42 Dean Street

NEW! THE PRACTICAL WAY of learning RADIO · TELEVISION · ELECTRONICS

AMATEUR S.W. RADIO · MECHANICS · PHOTOGRAPHY · CARPENTRY, etc., etc.

NEW—Experimental outfits and lesson manuals sent on enrolment remain the student's property. Tutor allotted to each student for personal tuition throughout the course.

In radio and television courses, specially prepared components are supplied which teach the basic electronic circuits (amplifiers, oscillators, detectors, etc.) and lead by easy stages, to the complete design and servicing of modern radio and TV equipment.

THESE PRACTICAL COURSES
ARE IDEAL AND MAY BE YOURS
FOR MODERATE COST

Fill in the coupon to-day
for a free Brochure. There is
no obligation whatsoever.

Courses with equipment enable
you to design, construct and service

- 2-stage radio equipment
- 3-stage T.R.F. circuits · Television equipment · Workshop Test Panel
- Oscilloscope · 5 valve 3-waveband superhet circuit

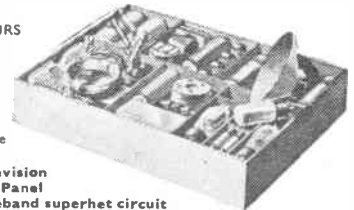

SUBJECTS INCLUDE:— Radio · Electronics · Television Equipment
Mechanics · Chemistry · Photography · Electricity · Woodwork
Electrical Wiring · Draughtsmanship · Art · Short Wave Radio
Oscilloscope · also many other Home Study Courses without equipment.

EMI INSTITUTES

Associated with H.M.V.,
Morcephonophone, etc., etc.
The only Home Study
College run by a
World-wide industrial
organisation.

COURSES FROM 15/- PER MONTH

E.M.I. INSTITUTES, Dept. 31X, London W.4

NAME _____

ADDRESS _____

Subject of interest _____ AGE _____
(if under 21)

(We shall not worry you with callers) 6/3/57 IC85

The Handy Paint in Tubes

Starlon is perfect for handicrafts and small painting jobs. Quick drying. No brush marks. Brilliant finish. No waste—you squeeze out exactly the quantity required.



1/-
PER TUBE

In 13 lovely
colours and
clear varnish

Starlon

PLASTIC ENAMEL PAINT

Obtainable at handicraft shops everywhere
STARLINE, SOUTHEND-ON-SEA, ESSEX

HURRY! HURRY! HURRY!

Get your kits **NOW** for these grand working models



15 in. Model Yacht Kit No. 3104

(all fittings, including sails)

Sails perfectly and a real bargain for

15/-

20 in. Motor Launch Kit No. 3036

(including motor and propeller unit)

39/6



Obtain your kit now from your Hobbies branch or stockist or direct, post free, from:

HOBBIES LTD. (Dept. 99)
Dereham, Norfolk

THE LATEST SENSATION

in the

International Handicrafts Exhibition

Olympia

were our Plastic Moulds

for Wall Plaques for plaster casting

Prices 1/3 to 5/- each

Rubber Moulds from 1/- each

Illustrated catalogue 9d.

S.A.E. for list

TRADE ENQUIRIES INVITED

F. W. NUTHALL

69 St. Mark's Road

HANWELL, LONDON, W.7

GOVERNMENT SURPLUS BARGAINS. Inter-room Telephones, comprising 2 self-energised microphone/receivers and approx. 6yds. flex (may be extended if desired). No Batteries needed. Nothing to wear out. Complete 9/6, post 6d. Motors, Transformers, Switches, etc. 3d. stamps for illustrated list. Milligan's, 24 Harford Street, Liverpool, 3. Money Back Guarantee.

STOP SMOKING in 3 days or money back. Safe, pleasant, permanent. The only scientific way. No Will Power necessary. 'Conquered the habit in 2½ days'.—F.C. 'Within 2 days I was free from the tobacco habit'.—W.G. 'Was a smoker for 2 years and broke the habit in 2 days'.—F.N. 'I used to smoke 20 a day . . . now I have no desire to smoke'.—J.M. Recommended by 'Health and Efficiency Magazine'. Complete course 6/6 (or \$1.00 bill). Details 2d. stamp. Sent under plain cover. **NATURE REMEDIES, 28 (H165) Dean Road, London, N.W.2.** Established 1922.

SWISS MUSICAL MOVEMENTS. Before you buy send 2d. stamp for our illustrated brochure — Metwood Accessories (Dept. HW), Church St., Wolverton, Bucks. (Trade enquiries invited.)

STAMPS FREE — Empire Packet including Pictorials and Victorians with approvals. — Robert J. Peck, 7A Kemp Road, Bournemouth.

'PAINTSPRAYING' HANDBOOK. Covers Car, Industrial & Flock Spraying. 3/6, post 4d. Catalogue of our Cellulose and Paints and all Allied Sundries 2½d. — Leonard Brooks Ltd., 81 Oak Road, Harold Wood, Essex.

GENUINE Swiss Musical Movements. The best and largest selection of tunes in the country, lowest prices 16/3 each. Genuine Thorens Movements, 22/9 each. All guaranteed. P & P. 9d. extra on all orders. — Richardson & Forder, HW, 5 Chapel Place, White Hart Lane, London, N.17.

*** GREAT CAMPING OFFER ***



RIDGE TENT SENT FOR 4/-

BRAND NEW de luxe 'Safety' Tent. All colours. Complete. 'deal cyclists, campers. Length 7' 3" sleeping base x 4' 6" wide x 3' 6" high x 12" walls, all approx. Weight 3½ lb. Cash 55/-, or 4/- deposit and 6/- monthly, WITH FLYSHEET 83/6, or 9/3 deposit and 9/9 monthly. Both carriage 2/6. LISTS OTHER EQUIPMENT, TENTS, CLOTHING, ETC., TERMS.

AMAZING GOVERNMENT SURPLUS NEW TELEPHONE INTERCOM MOBILE OR STATIC ONLY 12/11

Communicate at distances of a few yards, room to room, or will adapt for use up to a mile, from buildings or over country. Self-voice generating at normal telephone strength due to scientifically wound coils and armature. Sensitive diaphragm. No batteries or electricity—it just works! Send 12/11, post 2/1. Ready for use in 5 minutes. Open Sat. 1p.m. Wed. Headquarter & General Supplies Ltd. (HOBW/49) 196-200 Coldharbour Lane Loughboro Junction, London, S.E.5

STOP SMOKING!! Quick guaranteed remedy. Free testing sample!! — Triumph Remedies (H), Exeter.

LEARN it as you do it — we provide practical equipment combined with instruction in Radio, Television, Electricity, Mechanics, Chemistry, Photography, etc. — Write for full details to E.M.I. Institutes, Dept. HW47, London, W.4.

● DON'T MISS IT!

The superb, novelty-packed

1957 GADGETS ANNUAL

HOW TO MAKE over 350 of the latest and cleverest gadgets and devices for home . . . garden . . . hobbies . . . garage . . . tools . . . gifts . . . puzzles . . . novel inventions. With patent spiral binding, and fully illust. The huge 1957 GADGETS ANNUAL only costs 10/- from: POSTLIB PUBLICATIONS, Kingsbury, London N.W.9

EVERY CAR THAT PASSES—YOU WILL FIND THE INDEX MARK ALPHABETICALLY ARRANGED IN WHERE'S THAT CAR FROM ?

Price 9d.

from all Booksellers or from the Publishers

(2d. postage)

RALEIGH PRESS, EXMOUTH

MUSICAL BOX MOVEMENTS 14/9d. ONLY

Complete kits 21/6d.

S.A.E. for details:—

SWISSCROSS CO., Dept. B, 116 Winifred Rd., COULSDON, SURREY

100 DIFFERENT stamps free! Request ¼d upwards discount approvals. — Bush, 53 Newlyn Way, Parkstone, Dorset.

FREE Stamp Album and 20 stamps. Request approvals enclosing 4d. Additional gifts given. — Beeze, 8 Langland Villas, Mumbles, Swansea.

Job for the fretsaw

An Absorbing Puzzle Game

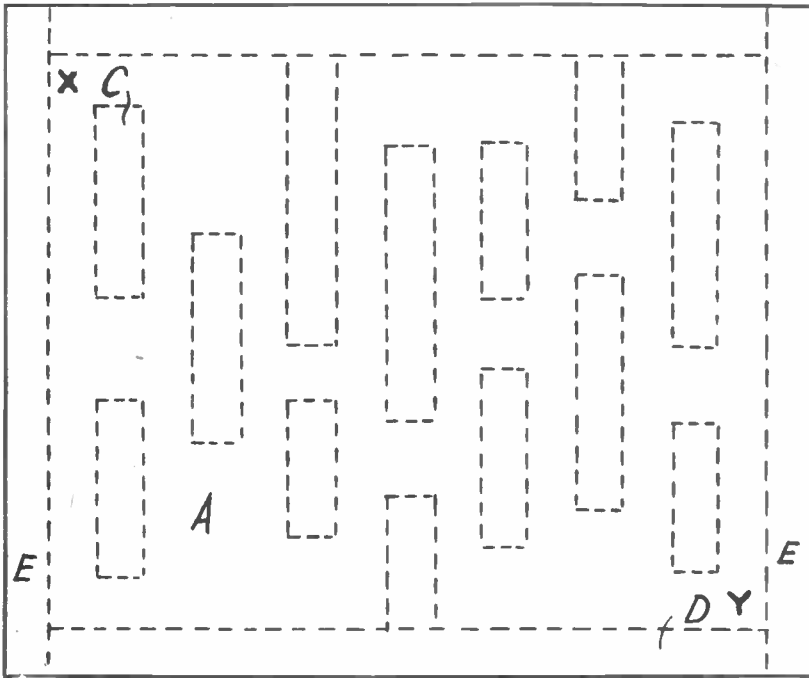

TRY IT ON YOUR PALS

THIS little game is just the thing to keep you and your school friends amused during lunch hour. It consists of a box with a transparent cover and suitable 'barriers' glued to the base. Two steel balls from an old cycle ball race, or two glass beads are placed at the corner (Y). The game or puzzle is to get one ball to the top corner (X), leaving the other in the corner (Y). It looks easy, but it is not so easy as you think.

Cut the base (A) from $\frac{1}{4}$ in. wood and glue pieces of $\frac{1}{4}$ in. square stripwood, pieces (E) and (D), in position round the sides. The 'barriers' (C) also $\frac{1}{4}$ in. square strip, are glued on to the base as shown by the dotted lines. Pin a piece of transparent material over the top and the game is finished except for painting. Transparent material 9ins. by 12ins. can be obtained from Hobbies Ltd., Dereham, Norfolk, price 1/6. (M.p.)

DETAIL OF
CONSTRUCTION

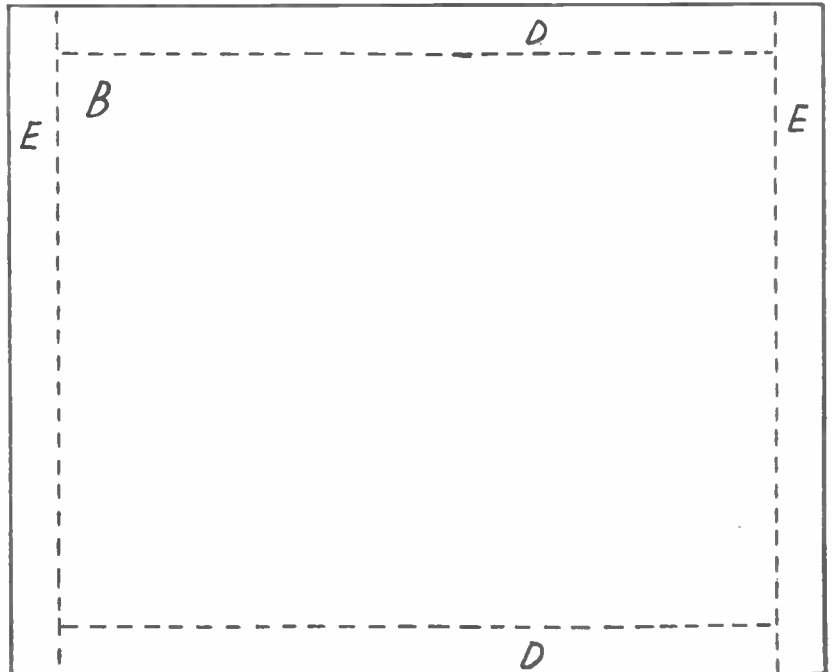
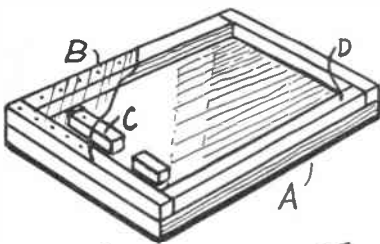

Model-maker praises
VALSPAR

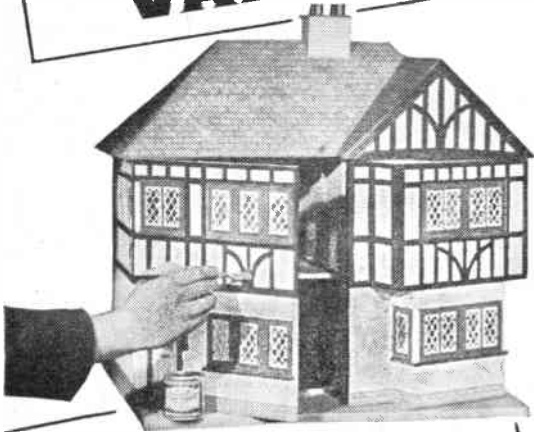

Dear Sirs,
I thought you would be interested to know that I have recently constructed a doll's house for my daughter and retained a really excellent finish with your Valspar 2-4 Hour Lacquer.
Apart from its smooth, hard gloss finish, I find that Valspar lacquer saves me a lot of trouble because it dries so quickly and, when you have active children like mine, this is essential to avoid paint work—also cleaning bills.

Yours faithfully,
D. GODFREY

VALSPAR

2-4 Hour

LACQUER • VARNISH • WOOD STAIN

★ PROOF AGAINST BOILING WATER, PETROL, OIL, ALCOHOL, ETC.



- ★ DRIES IN 2-4 HOURS
- ★ UNMATCHED HARDNESS AND ELASTICITY
- ★ FOR ALL SURFACES

On show at the Ideal Home Exhibition

GOODLASS, WALL & CO. LTD. 179/185 (AC3) Gt. Portland St. London W.1

Please send me a free copy of the Valspar Handbook giving full details of how to use Valspar paints

NAME
BLOCK CAPITALS

ADDRESS



Make model buildings—



as simply as this!

A new method—described in a new book on Pyruma Modelling. This shows how to turn empty match boxes into model buildings, by Pyruma 'Plasticraft'. It is one of the many methods of modelling in plastic Pyruma, shown in black and white and full colour pages, which enable you to build and finish in natural colours:—

MODEL FARMS, RAILWAY STATIONS, SIGNAL CABINS, AIRPORT BUILDINGS, DOCKS, SHIPS, FIGURES, ANIMALS, ASHTRAYS, BOOKENDS, DOLL'S FURNITURE, PLAQUES, RELIEF MAPS, ETC.



is a ready-to-use material, cheap to buy locally, and easy to work by following the Instruction Book offered below. Pyruma dries or can be baked to stone-hard permanence, then painted in natural colours. Sold by local Ironmongers and Hardwaremen, Hobbies shops and Art material Dealers, in airtight tins from 1/6 upwards.

Send Coupon and 6d. P.O. (not stamps) for this NEW Book of instructions to:—

J.H. SANKEY & SON, L^{TD}

Estd. 1857

Dept. H, ILFORD, ESSEX

Enclosed 6d. P.O. (not stamps) for PYRUMA MODELLING INSTRUCTION BOOK addressed to:—

NAME

ADDRESS