

# HOBBIES WEEKLY

NOVEMBER 13th 1957

VOL. 125

NUMBER 3237

All correspondence should be addressed to the Editor, Hobbies Weekly, Dereham, Norfolk

## IN THIS ISSUE

	Page
Gardens in Miniature . . . . .	113
Looking After Your Books . . . . .	114
'Easy-Change' Frames . . . . .	115
A High-Level Track . . . . .	116
A Permanent Plant Pot . . . . .	117
Stamp Collector's Corner . . . . .	118
Ornaments from Broken Pots . . . . .	119
Toy Petrol Tanker . . . . .	120
Noughts and Crosses Board . . . . .	122
Interesting Locos. No. 4 . . . . .	122
Starting a Hobbies Class . . . . .	124
Hobbies' Crossword No. 10 . . . . .	124
Pattern for 'Postman' Letter Rack . . . . .	127



## GARDENS IN MINIATURE



A **M**INIATURE garden can be started in a pie dish or you can have a more elaborate one outdoors in an old sink. This satisfies the urge to grow things and create one's own ideas. If the reader is keen on making up little models with Pyrama, then he can add that realistic touch which makes the job all the more interesting.

Before going thoroughly into this hobby, work out whether you intend to have it as an indoor decoration, a window box idea, or a larger outside attraction. For the indoor one you can use anything handy. It can be an old soup plate, soup tureen, baking dish or anything which will give you up to about 12ins. by 8ins. Absorbent holders can be used and in this case stand on a table mat, so as not to damage the table.

Some firms supply by post all the ingredients you require and, as a first step, the dish is given a lin. layer of charcoal. Chippings, specially prepared, are then set over this and light horticultural peat follows to make the top surface layer. Some use a light compost and a top dressing.

113

FOR ALL HOME CRAFTSMEN  
Over 60 years of 'Do-it-Yourself'

World Radio History

4<sup>1</sup>/<sub>2</sub>

One can find and shape up plenty of pieces of brick limestone and sandstone, which are ideal to give balanced shading to the deep hues of the tiny plants. Shells, shell gravel, fire-rock and grey sandstone are all available to give variety.

#### Well-shaped Waterways

The Japanese are very clever with their tiny waterways which they work out in fine silver sand. All waterways on your model should have a well-shaped curve and should not be too wide. This gives the key position for the very necessary bridge which is mostly placed in a central position. Such an idea as this can be worked out in modelling material and, perhaps, take the shape of a bridge in your own area.

In the Japanese fruit blossom trees, you can have seed, plant or cutting, and these can range over almond, apple, cherry, peach, orange and plum, with each one being pretty, bearing tiny fruit, a having that distinct shade of shell pink, orange-yellow or purple. Even the cherry flowers in November-February.

Quite in another field are the flowering trees and shrubs, and here we have

azalea, andromeda, sweet gum tree, cotoneaster, halesia, lilac and hydrangea. Variety will give you red/orange/white blooms, deep evergreen with berries and the silver bell or snowdrop tree.

In a further most interesting range we have all the Japanese fancy and forest trees which would cover laurel, cedar, cypress, holly, larch, maidenhair fern, oak, silver fir and thuka. To this you can also add a wide range of ornamental evergreens which are permanent dwarfs. Here you have the bronze deep tints, the many excellent shades of green and the various shapes of tree which makes the work so interesting. Some branches are straight up and dignified, others will curl around like a snake, and some will grow to a fan shape. To this variety we have the further interest in the fact that many of these items change their shades with the season.

Do not start on a too elaborate scheme. The alpine garden with the winding pathway, a few steps, a stream and a bridge is a good start. Perhaps next you can try a little boathouse, boat and real water. You may introduce, space permitting, a little scene with an island.

If you are a book lover then no doubt you will want to keep the contents of your own little library in a tip-top condition. To help you to do this here are a few tips to remember.

When you receive — or buy — a new book it normally has a loose paper cover which is mainly used for advertising purposes. This cover, however, is very useful for keeping the book clean so do not remove it. Should any book not possess one of these loose covers then it is advisable to make one yourself. Use either fancy coloured paper or ordinary brown wrapping paper.

Most of us are acquainted with the old proverb which tells us that it is unwise to lend books to other people as they are seldom returned. Circumstances, however, compel many of us to disregard this advice at times, especially with books of an educational nature. It is therefore good policy to have your name and address clearly written on the inside covers of all your books. Specially printed labels for this purpose can be purchased at any high-class stationer's shop at a low cost.

#### Parting leaves

It sometimes happens that many new books contain pages which are still joined together, having been missed by the guillotine machine. When parting them, do not draw your finger between the pages as so many people do. This leaves ragged edges which are unsightly. Instead, use a clean table knife.

If you should require to mark a page in a book for future reading then use a proper book-mark. On no account insert a pencil, a ruler or any other object which is likely to damage the binding.



Never place a book face downwards with its pages open as this will also crack the binding and will ultimately result in the book falling apart.

Books should not be exposed to excessive heat such as reading in front of a blazing fire. This causes the covers and pages to warp and also weakens the glue used in the binding. On no account allow your books to be used as iron rests or mats for cups of tea. It is not uncommon for public libraries to have books returned with pages containing scorch marks.

Never take a book with you to the

Keep all buildings, if you make them yourself, in correct size. Therefore, the thatched cottage, Japanese temple or windmill must be in the region of 1 1/2 ins. by 1 1/2 ins. If you make a little dovecote or birdhouse, have this about 1 1/2 ins. high.

Some of the firms who specialise in the parts now feature little figures of gnomes, pixies, even Dick Whittington with cat, bundle and milestone.

You probably have some ideas for yourself, and in working these out may, perhaps, make up attractive gifts for Christmas or birthday or may even be able to sell your miniature garden creations.

\*\*\*\*\*  
 \* Next week's issue will contain \*  
 \* a free design and instructions \*  
 \* to make a lovely Doll's Rock- \*  
 \* ing Cradle; also patterns for \*  
 \* Christmas novelties in pre- \*  
 \* paration for the festivities. \*  
 \* \*\*\*\*\*

meal table. As well as being bad manners this can be harmful to the book. Stains from tea, coffee, jam and milk are the results of this practice and a stained book is always a shabby one.

When turning over the pages, do not use a wetted thumb or finger. Besides being unhygienic, dirty marks are often left on the pages. Equally as bad is the dog-earing of the corners. The turned-over parts are soon torn off.

If a page should become torn then repair it without delay using transparent adhesive tape. Take care to replace the torn parts correctly in position before applying the tape. Dirty marks may be removed by using a soft India rubber or a piece of white bread. Ink stains are sometimes rather stubborn but there are several good ink eradicators on the market for dealing with such stains. Once the stains have been dealt with, sponge the parts with clean water and then blot with a clean piece of blotting paper.

Dampness is the great enemy of books and if exposed to such conditions the books are often left with a musty smell. To avoid this, make sure that your books get plenty of sunlight but do not place them directly in the sun's rays.

When not in use, books should always be kept in proper bookcases, preferably the type fitted with doors to keep out dust. At all times your personal library should be regarded as a treasured possession so treat the contents with care and respect.

## Make a picture gallery

# 'EASY-CHANGE' FRAMES

HERE we have a handy little frame allowing your photographs or pictures to be easily changed at will, for it is designed on the slot-in principle. There is no glass to cut, the only materials required being cardboard and surplus wallpaper. The measurements given will be found correct for a post card and it will be appreciated that with slight modification you may make frames to fit any size of picture.

Obtain a piece of stout cardboard for the front measuring 7 1/2 ins. by 5 ins., cutting out an aperture measuring 5 ins. by 3 ins. Reference to Fig. 1 will show that there is a 1 in. margin at the top and sides, but this is extended to 1 1/2 ins. at the base to give a nice balance. Use a set square for marking out the aperture, cutting with a really sharp knife.

We now require a piece of cardboard for the back of the frame measuring 6 1/2 ins. by 4 1/2 ins. and a spacer as shown in Fig. 3 of the same size, but cut in the form of a letter U sideways. You should particularly note that the latter is 1/2 in. wide at the base, but the side and top are only 1/4 in. in width. These three pieces are the only parts required for the construction, and we may now proceed to the actual making.

Reference to Fig. 4 will show how the wallpaper should be attached to the frame. Cut the paper about 1/2 in. larger

all the way round to permit folding on to the back, surplus material being trimmed away at the corners. The paper is taken round the edges of the aperture to the back mitreing at each corner with a pair of scissors. The easiest way of doing this is to lay the card on to the back of the wallpaper, running a pencil round the outside edge and the perimeter of the aperture, leaving a 1/2 in. margin surplus, cutting out and making the mitres. It is then a simple matter to

1 1/2 ins. from the top and centrally in the back of the card. Push a double thickness of tape through this slot, leaving a loop on the outside and the two loose, free ends on the inside. Fold the two free ends flat to the card, fastening down with pieces of gum strip. If these ends are not covered they may prevent easy slotting in of the pictures.

Finally the back, with spacer attached, is glued on to the back of the frame portion. Leave under a weight until perfectly dry, and you may then insert your picture.

It should be mentioned that although the foregoing directions have been given for a vertical picture, a slight modification in the border measurements will enable you to make similar frames for horizontal pictures. It is also preferable that the spacer be adjusted so that pictures may be slotted in from the side. Remember that the top and side margins are equal in width, but the lower one should always be a little wider.

By making a few frames in this easy manner, you may have your own little picture gallery of your favourite film stars, football players or your own snapshots, or they make very nice gifts. A few suggestions for arranging your picture gallery is shown in Fig. 7, and if you wish to include a horizontal picture, it will be found best to place it between two vertical ones.

By  
 S. H. Longbottom

apply paste or glue to the back of the paper and fix to the frame. In passing, you will appreciate that while any suitable wallpaper may be used, there are many 'wood grained' papers to be obtained at handicrafts shops.

The back portion of the frame is bound with a strip of passe partout on one edge — see Fig. 5 — to give both a neat finish and to avoid undue wear of the cardboard when changing pictures. Before gluing on the spacer as shown in Fig. 6, it is better to provide for a hanger. Cut a small, horizontal slot

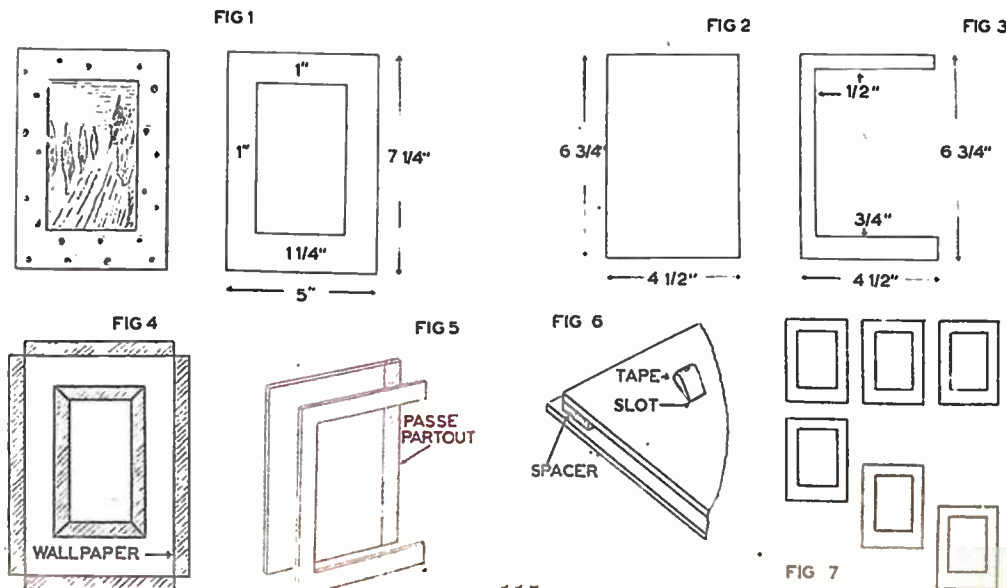



# A HIGH-LEVEL TRACK

THE crying need of most railway modellers is for space and yet more space. The operator who has unlimited supplies of this is indeed lucky, especially in these days of the 'compact semi-detached'.

End-to-end journeys can be markedly

By H. A. Robinson

increased by making use to some extent of two levels, but care must be taken that any upper section does not unduly mask the lower tracks, when it might even detract rather than add to the apparent length of run.

Heavy bridge piers can seem to dominate the scene as well as take up a lot of space between tracks, and can actually do quite a lot of hiding. It was in search of supports for a high-level section (on a gauge O layout) that would be of good

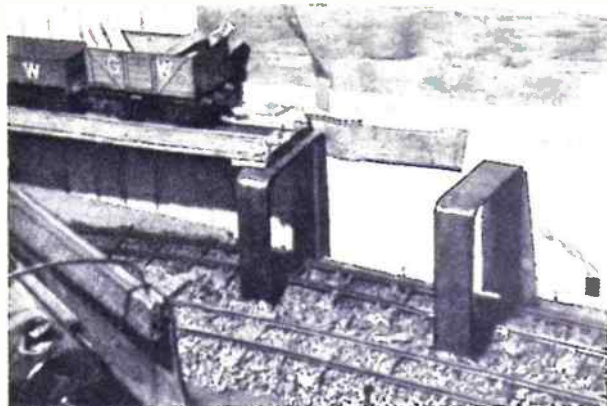

Assemblage of standard and high-level track

To get the correct size it is best to first make a card template and continually work to this. Continuously

put in position, the bolt locations having been established and holes drilled, and the whole bolted tightly up. Fig. 2 is a

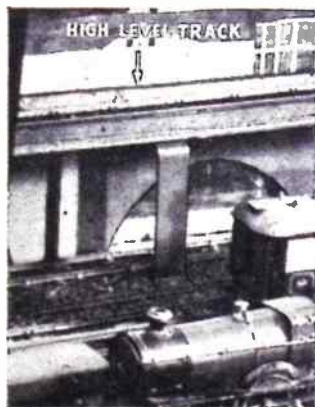

A standard in position

appearance, and yet not occupy much space or cause the upper track to have to climb too high, that the standards shown here were evolved.

Made from discarded bed laths, they give everything needed. The appearance of 'steelwork' is obtained, but so thin is the material that standards made this way can be set between existing double tracks without having to side-step either. At the same time when against a wall and with the turned out foot, perfect firmness is secured. Fig. 1 shows details of the standards, which apart from anything else are very easy to make.

working from the last one will bring inaccuracies over a series.

### Fitting the standards

The outer upright has its foot turned out and drilled as (a) for a screw which is taken through to the baseboard. The inner upright which comes right against the wall does not need a foot. Two further holes are drilled at (b), short bolts then holding the upper base as shown. In fitting, the standards are first screwed in position and a top level struck, a sliver of packing being put under the uprights where required to make up for any slight variation in the lower baseboard. The top base is then

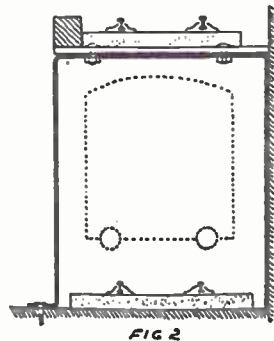
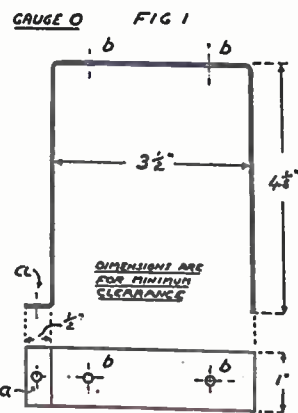

CROSS SECTION OF COMPLETE HIGH-LEVEL TRACK WITH TRACKER. SHOWS ARE CUT AWAY TO SHOW THIN SCREWS

### cross-section of the final assemblage.

As far as possible the top base should be in one length, but when a joint is necessary, this is made on a standard, four bolt holes in pairs then being drilled.

Bed laths, it will be found, can be bent without heat, but heat can be used with advantage. Bending, however, in either case should be with a vice, or some other arrangement in which the end of a length can be firmly held while taking over to a right angle.

With the thinness of the material the upper track can be the minimum height above the lower, which is an advantage.

Continued on page 117

# A PERMANENT PLANT POT

THIS attractive plant pot can be made for less than ten shillings, and will last a lifetime.

First, a box-mould is made. Use any old scraps of wood, nailed simply together. More important is the shape inside, than the materials used. The sizes shown are only for guidance. You may prefer a larger or a smaller pot.

The pot itself is made up of layers of broken roofing tiles, of the type illustrated. If you live near a housing estate, the builder will probably sell to you very cheaply, or even give you, the scraps of roofing tiles, of which there are usually dozens lying around.

### Mix the colours

If you have to buy them, they are quite cheap. In this case, buy three or four each of different colours, and mix them when building the pot.

First, break up the tiles. Break them so that you get 30-40 pieces from each tile. Now make up a mixture for layering of four parts sharp sand to one part cement.

Now to start building. Stand the box on a wooden platform. If you cannot spare the wood, lay a double sheet of newspaper on a level piece of ground,

Described by  
E. Capper

and place the box on it. The newspaper, like the wooden platform, will prevent the cement adhering to the ground when it has set.

Stand a round wooden peg in the centre of the bottom as shown, and all around it, put in a layer of the cement mixture to a depth of approximately 1 in. to form a base. When the cement is hard and the peg removed, a drain hole remains.

Lay your first layer of broken tiles on to this cement base (see plan). On top of this place a layer of sand and cement approximately 1/4 in. thick, and lay another row of broken tiles and so on until you reach the top of the box.

Do keep the layers level all the way up, and do lay the tile like bricks, so that no vertical joints come opposite one another in succeeding rows. Don't worry about the rather straggly effect inside the pot. This will be hidden when the pot is filled with earth.

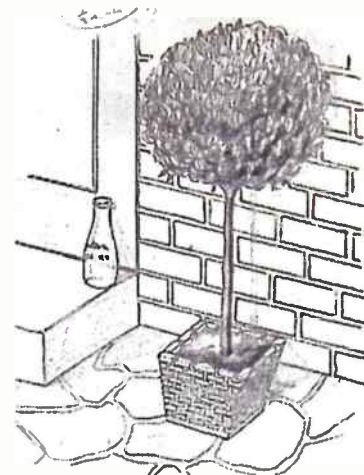

When the job is completed, leave it in the mould for two days. Unless the weather is wet, sprinkle it often with water. It helps to harden the cement further.

Remove the box and the wooden peg to reveal the finished pot. Do not, however, plant anything in it for a week or two until the weather has fulfilled its natural function of killing the acid in the cement, or your plants will die. During this period, if the weather is dry, continue to sprinkle water on the pot, daily. This helps in getting rid of the acid.

Most attractive for this type of pot is the clipped standard golden-privet or box, especially if trimmed into a nice circular globe. And here's a chance for amateurs who have always fancied their hand at topiary!

Continued from page 116

## HIGH-LEVEL TRACK FOR RAILWAYS

as this means a minimum climb for the trains. A high-level section like the one shown can well skirt a room right against the wall and finish in a high-level terminus located in a corner which otherwise is wasted space. Being wholly on the outer perimeter of the layout the approach grade can also hug the wall, where a grade with scenic background looks well. A good alternative to a back scene is a 'brown paper cliff', the paper crumpled but set firmly in position, giving an excellent impression of an unsmoothed rock face.

It is rather remarkable how even a short high-level section will seem to increase the end-to-end run of a layout, a train being able to complete the lower circuit a couple of times before taking to the grade for a final run into the high-level terminus.

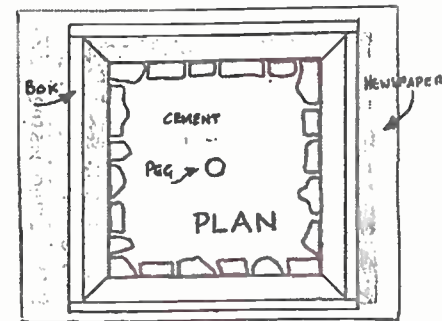
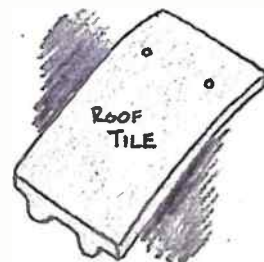
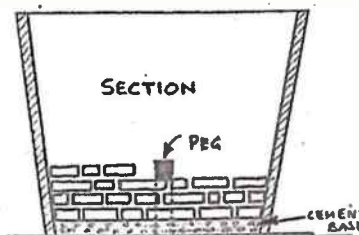
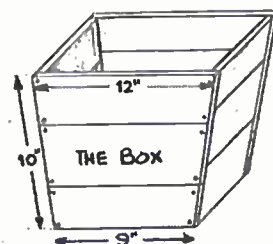





ITALY has produced many famous men, including artists, scientists, explorers and inventors. Many of these are shown on Italian postage stamps.

These include, 1929 — 42 7/4 violet — Julius Caesar — 2d. used. 10 cent sepia — Augustus the Great — 1d. mint. 1930. 4th cent. of Francesco Ferrucci's death — set of 6, 4/- mint. 1930. Virgil commems. — set of 6, 1/9 mint. 1931. 7th cent. of St. Anthony's death — set of 7 4/2 mint. 1932. 10 cent brown — Dante — 1d. used. 1934. 75th Aniv. of invention of Pacinotti's dynamo — set of 2, 1/6 mint. 1935. 20 cent red — Vincent Bellini — 2d. mint. 1936. 50 cent violet — Horace — 2d. used. 1937. Famous Italians — set of 8, 5/3 mint, etc. etc.

#### Rome's seven hills

In the days of Caesar, Rome (capital) was a flourishing city, the centre of world civilisation and culture. Its enclosing wall extended for 13 miles and the seven famous hills upon which the city is built were dotted with picturesque Roman villas. These have now gone and the hillsides are covered by gardens and vineyards.

Some appropriate stamps: 1911. 10 cent red — Symbolic of the Genius of Italy — 1/- mint. 15 cent grey — The Glory of Rome — 1/3 mint. 1936. 75 cent red — Capitol — 5d. mint. 5 lira + 2 lira green (air) — View of Rome — 3/- mint.

In addition to crops produced by most other European countries Italy grows oranges, lemons, olives, sugar cane, Indian figs, papyrus and dates. In Lombardy over 17,000,000 mulberry trees are given over to the culture of the silk worm.

#### Italian wines

The famous wines of Naples and Sicily need no comment, a glance in any wine merchant's window will soon catch the Italian names on the bottles. Olive oil is produced at Lucca and Florence; cotton is cultivated in Sicily; Lombardy is noted for its dairy produce, most famous of all being the Parmesan cheese.

The fisheries are important too. The Mediterranean abounds in all kinds of fish. Anchovies, tunny fish and mackerel

are caught in great numbers, and a fine variety of fresh water fish is obtained from the rivers and lakes.

Exports include fruit, silk, olive oil, velvets, straw hats and bonnets, mosaics, *Objets d'arts*, marble and alabaster. Imports are mostly machinery and manufactured goods.

There are many universities and in former times many of them were famous.



The principal ones are in Turin, Salerno, Pisa, Padua, Parma, Rome, Naples, Pavia, Florence and Bologna. These and other interesting facts can be illustrated on the following stamps: 1950.

## ITALIAN ISSUES

By R. Cantwell

25 lira orange — Girl packing oranges — 1d. used. 30 lira purple — Girl carrying grapes — 1d. used. 35 lira red — Gathering olives — 3d. used. 40 lira brown — Carter and wagon — 1d. used. 50 lira violet — Shepherd — 1d. used. 55 lira blue — Ploughman — 3d. used. 65 lira green — Girl harvester — 2d. used. 100 lira brown — Women handling maize — 1d. used. 12 lira green — Fisherman at tiller — 1d. used. 15 lira slate — Boat builder — 1d. used. 20 lira violet — Fisherman trawling — 1d. used. 1946. 4 lira orange — Florence —

1d. used. 5 lira violet — Pisa — 1d. used. Some Italian stamps are valuable, but most pictorial issues are easily and cheaply obtained, and the 'Italian story' is most exciting.

## Boys' Book of the Air

Edited by Eric Leyland and T. E. Scott-Chard

HERE is exciting reading for every healthy modern boy from the age of ten. And he doesn't have to be particularly air-minded to thoroughly enjoy the first-hand accounts of thrilling exploits by such remarkable flyers as Peter Twiss, Douglas Bader and Lord Brabazon of Tara, to name but three. This well illustrated volume has features which make it slightly different from

most of its type. Its subjects are world-wide (from the Australian Flying Doctor Service to the new Polar Route), technical articles jostle with absorbing air detective fiction for our primary attention, and intriguing quizzes keep our mental processes as sweetly tuned as an aircraft engine.

This is the kind of boys' book that every father will read!

Published by Edmund Ward (Publishers Limited), 194-200 Bishopsgate, London, E.C.2.—Price 10/6.



## ORNAMENTS From BROKEN POTS

By H. Stoneley

IF by mischance you break a flower vase, bowl or other such container, do not despair, but save all the coloured pieces, especially the rounded pieces, and when you have sufficient, put them to good use. You can make lovely ornaments such as vases, flower pots, ash trays, trinket trays, bon bon dishes, in fact, well nigh anything which you care to think about in the house. And you will be proud of them, too.

First obtain from the crockery store or hardware shop any cheap but well designed vase or pot. If you can buy toffee jars from the sweet shop, these will make fine additions to any home when finished in this manner. Wash these pots, and dry them thoroughly. Next take the pieces of cups, saucers or other broken earthenware, and wash and dry them well.

Then, with any material such as Pyruma, begin sticking the pieces of broken pots on to the cheap vase. You can start from top or bottom. It matters little. At both top or bottom, however, see that you arrange the pieces with an edge which will be even. You will find that by doing this on an old table, or one which you can wash down afterwards, you get a good even edge without much trouble.

Once you have a row or two of broken crocks at top or bottom, the rest is really easy. Arrange the broken pieces in contrast. The design which you are to work for is one of contrast, not particularly correct draughtsmanship style. And in addition to contrasting colours, work also for contrasting shapes. A further word of warning — fix the broken pieces as near as possible to their same thicknesses, so as to get a good 'feel' and appearance.

Once the whole of the cheap vase, stone bottle, or what you have, is covered with broken pieces of highly coloured broken crocks, leave them to dry for a few hours.

Next (and this is slightly tedious, and takes time and care), with a small paint brush, paint with gilt paint or any other highly contrasting tint of enamel, the whole of the spaces between the broken crocks now firmly fixed. A high gloss enamel such as reds and blues is best, if you do not use gold paint.

In this way, stone water bottles and old stone jugs can be made into valuable ornaments. A good idea is to scour the hardware stores or crockery shops, for stoneware articles, and the bigger you

can get them, the better they look. If large enough, such crocks with the broken crockery additions, make wonderful ornaments and when made carefully they look very costly.

This is a craft for the home which seems to have died out with great grandmothers, so that such home-made pieces are eagerly sought by foreign visitors and this so-called 'heraldic pottery' has fetched quite high prices.

Finally and by way of suggestion, attractive fruit bowls and trinket boxes could be made in this manner.

In any case, do not despair any longer when you have a 'smashing' time with crockery.

## Solution to Jig-Quiz No. 4

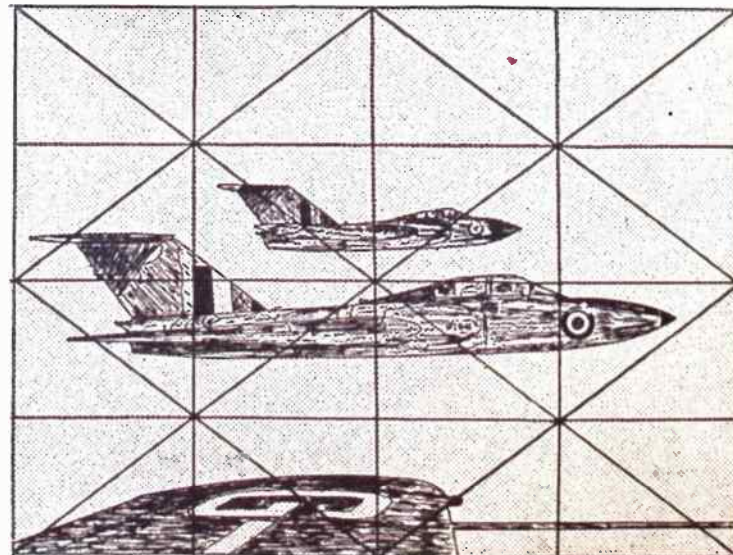

The triangles of last week's quiz fitted together to produce a picture showing, in the foreground, a Gloster Javelin T3; above it, the Gloster Javelin F(AW7). The

wing-tip at the bottom belongs to a Gloster Meteor photographic aeroplane.

The first squadron to receive the Javelins was No. 46 at R.A.F., Odiham.



# TOY PETROL TANKER

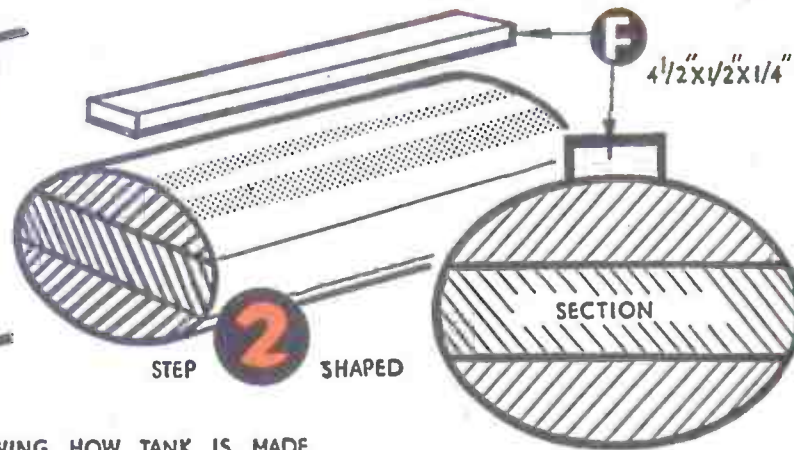
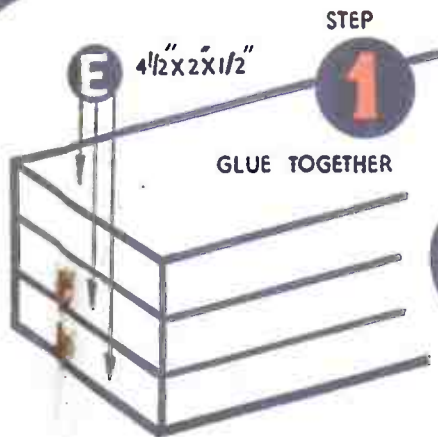

SHOWING HOW TANK IS MADE.

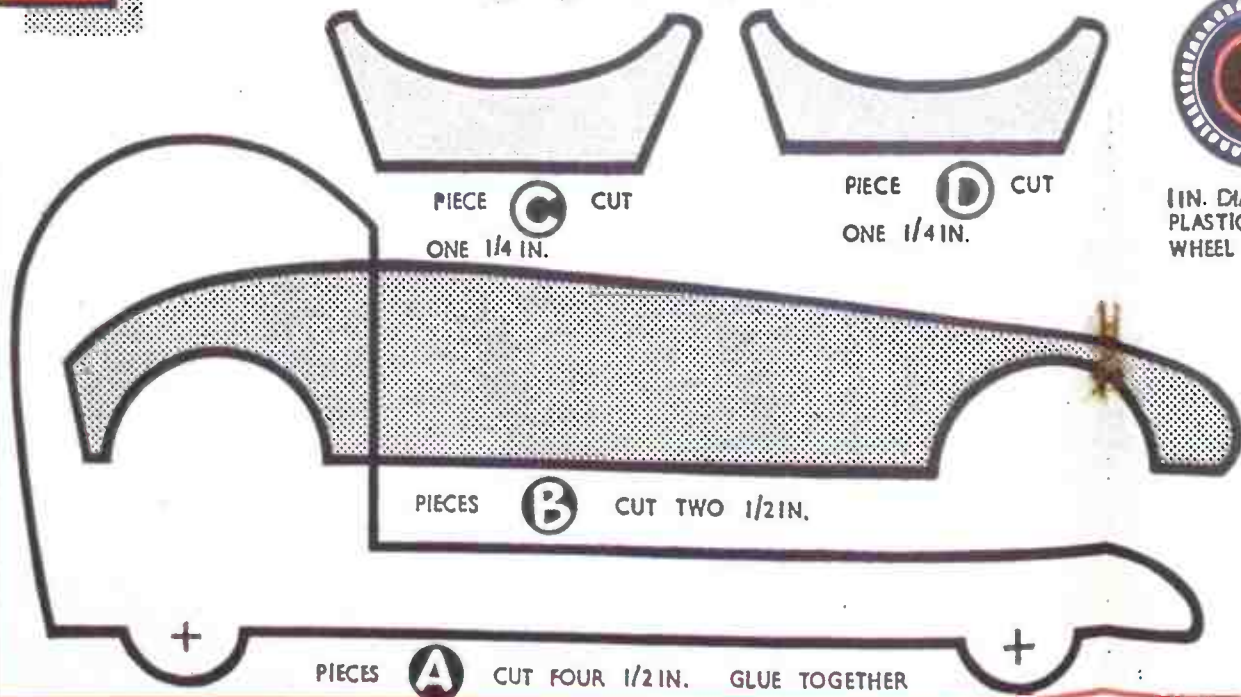

1 IN. DIA. PLASTIC WHEEL

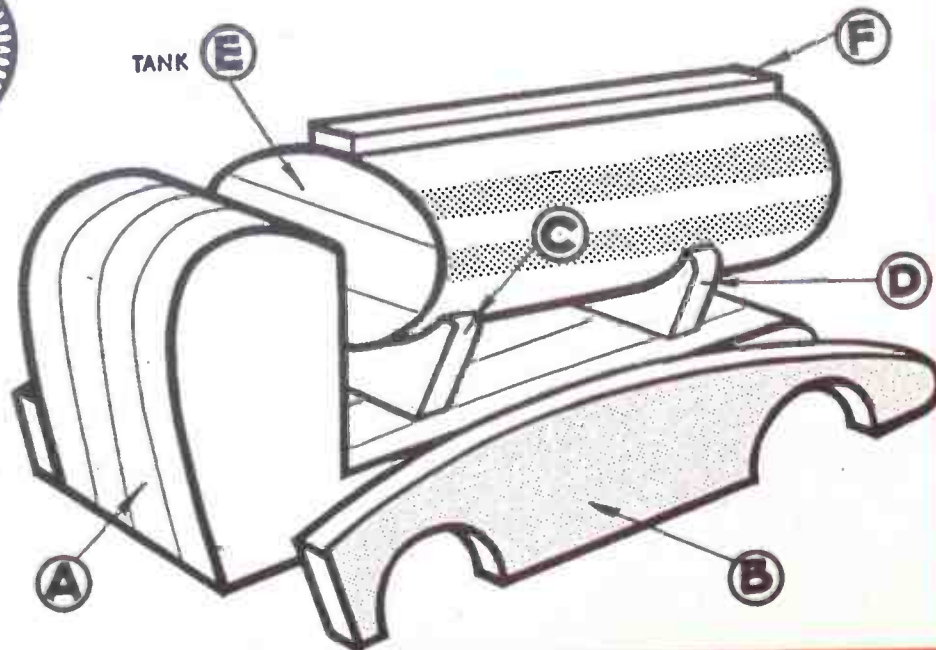



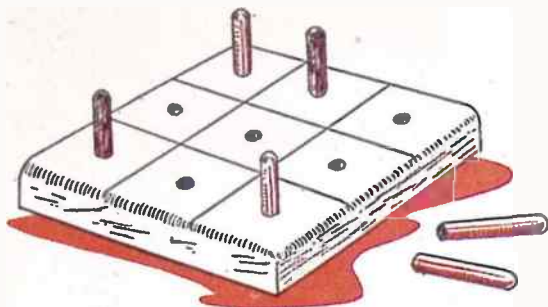

# NOUGHTS AND CROSSES BOARD

By  
S.H.L.

HERE is a new version of the old game of noughts and crosses, not requiring new pieces of paper each time a game is started. No doubt you will remember that it is usual for two opponents to play, marking double parallel lines in the form of a cross. One player marks noughts, the other crosses, the aim being to make a straight line of the figures either vertically, horizontally or diagonally. The winner is the one who makes the first straight row. The game is quick and just the thing to play if you have only a few moments to spare, but the chief difficulty is the need for pencil and paper.

Here the paper is in the form of a square of 3/4 in. or 1 in. plywood which never needs renewing. The noughts and crosses are four white and four red pegs made from 1/4 in. dowelling and are one inch long. The set is quite handy for carrying around in a pocket.

First of all the board should be prepared, using a suitable piece of plywood

3 1/2 in. square as shown in the diagram. Sawcuts are made 1/4 in. from each side to make the lines as with the original game when using pencil and paper. These cuts should not be more than 1/4 in., that is, just deep enough to see the markings, but the edges must be smoothed with glasspaper.

The next step is to drill 1/4 in. holes in the centre of the square formed by the sawcut, again shown in the diagram. These are necessary to accept the pegs, and it will be appreciated that any difference in the size of the dowelling used must be allowed for when drilling the holes.

After drilling, smooth off the edges of the board to make a rounded edge, removing any rough material from the sawcuts and holes.

Eight pegs are now required of a finished length of 1 in., rounded at the top for ease of handling. It is also a good plan to rub the base on a file to take off the sharp edge, thus allowing easy fitting

into the holes. Four of the pegs are left white and the other four coloured.

When the board and pegs have been made the game follows the usual pattern. One player holds the four white pegs, while the other takes the four red pegs. The start is made by each player in turn and, as before, the aim is to fit the pegs so that there are three in line.

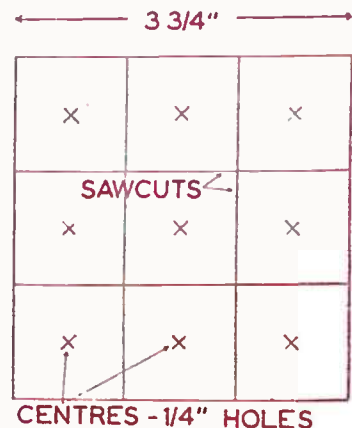

## Interesting Locos - No 4.

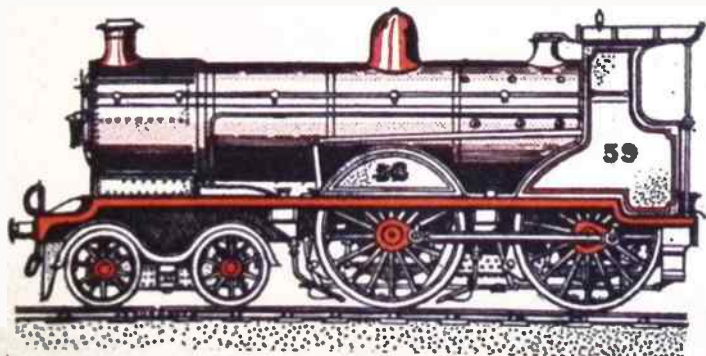

THE 'B4' class 4-4-0 type express locomotives designed by Mr R. J. Billington, the locomotive superintendent of the former London Brighton

& South Coast Railway were among the most noteworthy four coupled engines to run in Britain.

The class originated with the first

three engines which appeared from Brighton Works in 1899. So successful did they prove on their first trials that they were immediately put on the important main line expresses, and a further 30 of the class were built by the notable locomotive builders, Sharp Stewart & Co. of Glasgow for the L.B. & S.C.R. in 1901-02.

An interesting engine of the class was No. 59 which made a series of trials in 1909 equipped with the 'Phoenix' smokebox superheater, and this engine is shown in our illustration. At that period the superheating of locomotives was a new and important feature.

In order to accommodate the superheater, No. 59 was fitted with an enlarged smokebox, and the chimney was set far forward in order that the blast pipe should be clear of the superheater.

Leading details.—Wheels, diameter, bogie 3ft. 6ins., coupled 6ft. 9ins., cylinders, 18ins. by 26ins. Total heating surface, 1,627 sq. ft. Grate area, 23.75 sq. ft. Boiler pressure, 180lb. per sq. in.

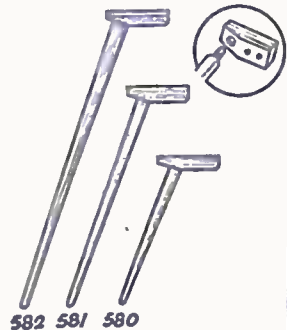

You Can Make  
a Modern  
Table in  
One Evening



## CONTEMPORARY FURNITURE

A coffee table, T.V. table, footstool, etc. . . . all can be made in quick time with these Contemporary style legs. Beautifully turned in Scandinavian beech, they can be left in their natural colour, or stained. Each leg is threaded at one end to screw into a hardwood block (see inset) which, in turn, is screwed to the underside of the table top. Simple . . . and a perfect job. Obtainable in three sizes:—10 ins. 2/3, 15 ins. 2/6, and 20 ins. 3/-. Postage on 3 or 4 legs 1/6 extra. From branches or:

HOBBIES LTD, Dept 992, Dereham, Norfolk

Follow the FLUXITE way to Easy Soldering

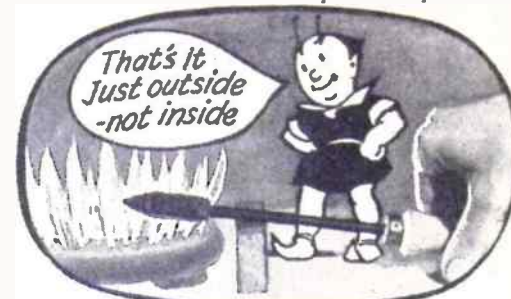

### No. 11 Keeping the bit hot

When on a long job place bit just outside heating flame and occasionally apply FLUXITE. This will help prevent it from detinning. Don't dip the bit into the tin of FLUXITE — put a little aside in a spare tin lid for the purpose.

FLUXITE is the household word for a flux that is famous throughout the world for its absolute reliability. In factory, workshop and in the home FLUXITE has become indispensable. It has no equal. It has been the choice of Government works, leading manufacturers, engineers and mechanics for over 40 years.



FLUXITE Limited, Bermondsey St., London, S.E.1  
GM.61

NEW!

## THE PRACTICAL WAY

of learning RADIO · TELEVISION · ELECTRONICS  
AMATEUR S.W. RADIO · MECHANICS  
PHOTOGRAPHY · CARPENTRY, etc., etc.



### COMPLETE EXPERIMENTAL COURSES IN SCIENCE AND TECHNOLOGY

NEW—Completely up-to-date method of giving instruction in a wide range of technical subjects specially designed and arranged for self study at home under the skilled guidance of our teachers.

NEW—Experimental outfits and lesson manuals sent on enrolment remain the student's property. Tutor allotted to each student for personal and individual tuition throughout the course.

In radio and television courses, specially prepared components are supplied which teach the basic electronic circuits (amplifiers, oscillators, detectors, etc.) and lead, by easy stages, to the complete design and servicing of modern radio and TV equipment.

If you are studying for an examination, wanting a new hobby, commencing a career in industry or running your own part-time business, these practical courses are ideal and may be yours for moderate cost.

Fill in the coupon to-day for a free Brochure. There is no obligation whatsoever. COURSES FROM 15/- PER MONTH

#### SUBJECTS INCLUDE:—

Radio · Electronics · Television Equipment · Mechanics  
Chemistry · Photography · Electricity · Woodwork · Electrical  
Wiring · Draughtsmanship · Art · Short Wave Radio · Oscilloscope  
also many other Home Study Courses without equipment.

EMI INSTITUTES

The only Home Study College run by a World-wide industrial organisation.

—Part of "His Master's Voice". Marconiphone, etc. etc.

#### POST THIS TODAY

EMI INSTITUTES, Dept 31X, London, W.4

NAME \_\_\_\_\_ AGE \_\_\_\_\_  
(if under 21)

ADDRESS \_\_\_\_\_  
I am interested in the following subject(s) with/without equipment

(We shall not worry you with personal visits.)



BLOCK CAPS PLEASE

13/1/57 ICBS



# STARTING A HOBBIES CLASS

THERE is no better way to further the craft of model-making or hobbies than to get a good local class going at the local Youth Centre. Many young people are looking for such organizations and once started, parents are highly interested, provided they know that such a project is going to be well organized and that their youngsters are in good hands.

The obvious best place is the local Youth Centre or Evening Institute. If you can find a reliable leader and one with the right spirit and somebody who has made plenty of good creative work, then approach the local Youth Centre Warden and discuss the matter. Build up, before the interview, a certain figure of twenty interested members. Normal classes must have a regular attendance over three weeks of not less than ten. That means with twenty on hand and a fair average of fifteen per night you should be quite safe and confident.

County authorities are trying hard to get these institutes built up again on practical subjects because, in the last five years, many feature far too much of the recreational angle — a viewpoint not appreciated by the rate-payer who,

after all, foots the bill for the cost of most of it.

The fee to join most institutes is about 10/6 for a winter session and members can also take other subjects if they wish at the same fee. The fixing of the night is important but try to have this cut and dried before you meet the Warden.

By V. Sutton

Such a subject is mostly given the use of the science room, or, better still, the Arts and Crafts room. Here you have ample working space, good lighting and mostly a canteen break half-way through nightly session. All classes are subject to inspection by the warden and often have visits from the House Committee and Regional Inspectors. Of this you must never be afraid, provided you have a good working class and plenty going on.

Two hours is ample for such a class, and, however successful you may be at first, do not let members persuade you into fixing up a second night. Never start this till you have a good waiting list of at least fifty members.

Internal arrangements can be made, such as running your own club within the class. There is nothing against this but it must be discussed with the warden. Separate sections can be formed, and the use of the playing fields often made available for club meetings, at no extra charge.

We will never start on anything in our craft if we do not shout about it. Try and get some space in a local window for a display of your best work. Twenty-five bills, green on white, can be had for a few shillings and put up at various places. See the Chief Librarian and tell him your plans. The library will stock special books for you and I have had excellent displays in the window of the Library. In any case, Youth Centres and the Library are part of the same firm — the County or the Borough. See the local newspaper Editor. Tell him your plans, let him have a photograph of some good work. He will appreciate your approach because any new idea is news.

Watch the local paper for other organisations like the Boy Scouts, Sea Cadets, Church Lads Brigade, Air Training Corps. In these you have very helpful contacts and they, in their turn may be looking for such a project as yours.

Work to a date for an exhibition of the work, and when it comes off, contact the Probation Officer, Clerk of the Council, and Chairman of the Magistrates and you will find them very interested. You should build up to healthy proportions in the first year. After that it will be much easier, because once started, well run and well-known, the numbers will come along.

I have run such a class for eight years, run eighteen exhibitions and have had as many as forty members per night. This class, unlike other classes, can have a great variety in crafts and that is what we must have to keep it alive.

**OF INTEREST TO MODELLERS**  
ALL modellers will be interested in the Humbrol Art Oil Plastic Enamel and Britfix Cellulose Dope colour cards evolved by the Humber Oil Company Ltd. The enamel and the dope are manufactured in a full range of beautiful art colours which are all intermixable for the purpose of obtaining numerous shades and thereby achieving authenticity. A free copy of the colour cards will be sent to any reader forwarding a stamped addressed envelope to the Humber Oil Company Ltd., Marfleet, Hull.



## MODELLING with a purpose

Here's something new in the Sculptorcraft range. Purposeful models . . . Useful models, which really make modelling a pastime with a purpose. An egg timer, a thermometer, a calendar holder, an ash tray, a candle holder, all designed to fit into your home and give that extra bit of brightness. For full details, prices etc., write to



*Sculptorcraft*

SEAMER PRODUCTS (SCULPTORCRAFT) LTD. 23/27 EASTBOURNE STREET, HULL

## Hobbies' Crossword No. 10

Note: Figures in parentheses denote the number of letters in the words required

**ACROSS:**

- 1. He may have a high degree of faculty (6).
- 4. Question ballet-dancers? (5)
- 7. This American District is really capital! (8)
- 8. This shade is deadly (5).
- 9. Resting (6).
- 11. Largest bird (7).

- 13. The little villain starts to make a mark (7).
- 15. Get off, it's afire (6).
- 18. A number get paid about for material (5).
- 19. They may be regarded as a means of identification (8).
- 20. It is in the tax (5).
- 21. It has a stinging touch (6).

**DOWN:**

- 1. Maritime plants? (5).
- 2. A mostly relative reproach (5).
- 3. Slide against an image, if you cross it you're committed (7).
- 4. More than an aircraft in the heavens (6).
- 5. A number take to fishing as a washday task (8).
- 6. Does the needlewoman get this pain? (6).
- 10. Collection of letters (8).
- 12. A position the traveller makes for (7).
- 13. The meaning that comes from abroad (6).
- 14. Put a little on that graze (6).
- 16. Not a sensible person (5).
- 17. Possibly state flavour (5).

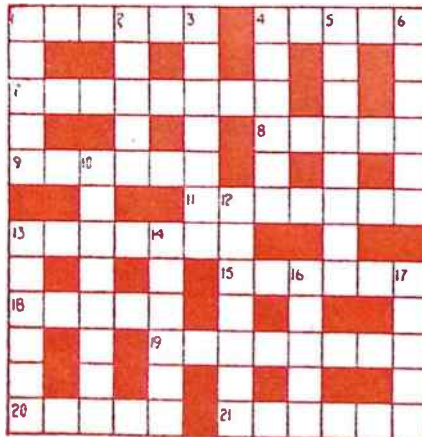

★ ★ ★ ★ ★ ★ ★ ★ ★ ★  
★ SOLUTION WILL BE ★  
★ GIVEN NEXT WEEK ★  
★ ★ ★ ★ ★ ★ ★ ★ ★ ★

**APPARATUS & CHEMICALS**  
For your experiments. Let us help you equip a **HOME LABORATORY**

Beakers, Crucibles, Flasks, Funnels, Gas Jars, Test Tubes, etc.

Booklets:  
(including postage)  
'Experiments' 1/2  
'Formulas' 1/2  
'Home Chemistry' 2/9  
New edition

Send 3d. Stamp for latest **PRICE LIST**  
**A. N. BECK & SONS (Dept. H.W.)**  
60 Stoke Newington High Street, London, N.16



**COT FITTINGS (full size)**  
The fellow handy with tools can make quite easily a drop-side Cot using these fittings. The set comprises two bright steel rods 36ins. long, six heavy-duty screweyes (four plain and two threaded for rods) and two catches. Price 7/- Set.  
Cot Design 3202 1/3  
From branches or:-  
**HOBBIES LTD., Dept. 99, Dereham, Norfolk**

A family of glues for family use

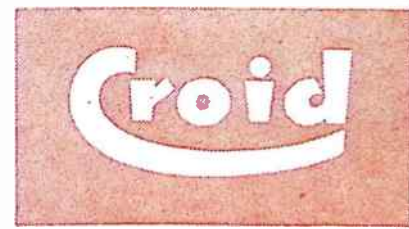

**POLYSTIK · FABREX  
AERO · UNIVERSAL**

toughest, quickest, strongest glues of all





**MINIATURE GARDEN** — 20/- 8 trees, container, compost, centrepiece, instruct., etc. **Pygmy Tree Growing**, 20/- 8 trees, seeds, cuttings, pots, compost, instruct., etc. **Wreath or Bouquet Making**, 20/- either. Frames, wires, foils, cards, designs, instructs. **Christmas Flower Bowls**, 20/-, flowers, bowls, wires, moss, instruct., etc. **Books; Minigardens and Pygmy Trees**, 9d. Stamp all lists. — **Station Nurseries (HW), Oakenates (Salop).**

**BECOME** trained chiropodist. Quick postal. Practical. **GRADUATE SCHOOLS**, 48a Abbey Street, Accrington.

**'PAINTSPRAYING' HANDBOOK**. Covers 1 Car, Industrial & Flock Spraying, 3/6, post 4d. Catalogue of our Cellulose and Paints and all Allied Sundries 2/4. — **Leonard Brooks Ltd.**, 81 Oak Road, Harold Wood, Essex.

**GENUINE** Swiss Musical Movements. The best and largest selection of tunes in the country; lowest prices 16/3 each. **Genuine Thorens Movements**, 22/9 each. All guaranteed. P & P. 9d. extra on all orders. — **Richardson & Forder, HW**, 5 Chapel Place, White Hart Lane, London, N.17.

**STAMPS FREE** — Empire Packet including Pictorials and Victorians with approvals. — **Robert J. Peck**, 7A Kemp Road, Bournemouth.

**LEARN** it as you do it — we provide practical equipment combined with instruction in **Radio, Television, Electricity, Mechanics, Chemistry, Photography, etc.** — Write for full details to **E.M.I. Institutes**, Dept. HW47, London, W.A.

**10,000 FORMULAS**. Trade secrets, recipes, processes. Remarkable 900 page book. Only few available. Money back guarantee. 27/6 p. pd. — **S. P. Ltd.**, 28(H.B.) Dean Road, London, N.W.2.

**1000 YARD DRUMS**  
**Assault Cable WIRE**  
**TERRIFIC BREAKING POINT**  
Gen. Combat field service telephone communication wire on a drum. Rustless, PVC coated. Uses include fencing gardens and fields, baling goods and heavy parcels, tough suspension lines for all purposes. Use instead of roping — neater, stronger, almost everlasting. Fixes almost anything. An essential article to have around. 1,000 yard drum, terrific breaking point: 7 1/2 Carr. 3/6. Case of 6 carr. free. Gov. surplus article cost pounds to make, our price is cheaper than string!

**AMAZING GOVERNMENT SURPLUS**  
**NEW TELEPHONE INTERCOM**  
**MOBILE OR STATIC**  
**COMPLETE ONLY 12/11**  
POSTAGE 2/1  
From a few yards to a mile. Normal telephone strength. No batteries or electricity — it just works! Send 12/11, post 2/1. Ready for use in 5 mins. Lists, Binoculars, Watches, Tents, Terms. Headquarter & General Supplies Ltd. (HOBW/85) 198-200 Coldharbour Lane Loughboro Junc., London, S.E.5 Open Sat.

**MAKE A MUSICAL BOX** for as little as 12/11. New kits and tunes available. Movements 14/9 post free. Please send 2/4. stamp for free illustrated catalogue. — **The Swisscross Co.**, Dept. B., 116 Winifred Road, Coulsdon, Surrey.

**HOBBIES BRANCHES**  
**LONDON**  
78a New Oxford Street, W.C.1 (Phone MUSEUM 2975)  
87 Old Broad Street, E.C.2 (LONDON Wall 4375)  
81 Streattham Hill, S.W.2 (TULSE Hill 8796)  
**GLASGOW**—326 Argyle Street (Phone CENTRAL 5042)  
**MANCHESTER**—10 Piccadilly (Phone CENTRAL 1787)  
**BIRMINGHAM**—100a Dale End  
**SHEFFIELD**—4 St. Paul's Parade (Phone 26071)  
**LEEDS**—10 Queen Victoria Street (Phone 28639)  
**HULL**—10 Paragon Square  
**SOUTHAMPTON**—134 High St. (Below Bar)  
**BRISTOL**—65 Fairfax Street  
**NEWCASTLE**—42 Dean Street  
**Newcastle-on-Tyne 1**  
**GRIMSBY**—88 Victoria Street

**100 DIFFERENT** stamps free! Request 4d. upwards discount approvals. — **Bush**, 53 Newlyn Way, Parkstone, Dorset.

**15/6! CRYSTAL RADIO** kit. Easy-to-build with only a screwdriver and pliers. Post free — send 15/6 P.O. ALSO — 1 and 2 valve kits, headphones, etc. — send stamped addressed envelope for complete list to **Blanchard's Radio**, Dept. HC7, 13 Gainford Gardens, Manchester, 10.

**SCIENTIFIC & Technical Supplies (Nottm.) Ltd.** Apparatus, chemicals, sets, special Christmas offers, experimental books, illustrated Catalogue, send 3d. — Dept. H., 9 Wellington Circus, Nottingham.

# 'Postman' Letter Rack

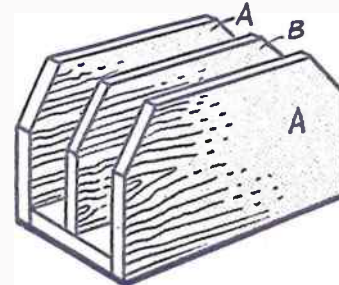

**T**HE rack is made to stand on a sideboard or cabinet where it will be handy for your letters. If the postman overlay is suitably coloured in enamel or poster paints, it will look very attractive and decorative.

The base is cut from 1/2 in. wood to the measurements shown and the uprights (A) and (B) fitted as indicated in the small diagram. (A) and (B) are 1/2 in. thick and piece (B) is shorter than piece (A).

The overlay should be 1/2 in. or 3/4 in. thick, and is glued in position on the front. Paint the overlay black, or colour as naturally as possible. A piece of green baize glued underneath will save scratches on the furniture. (M.p.)

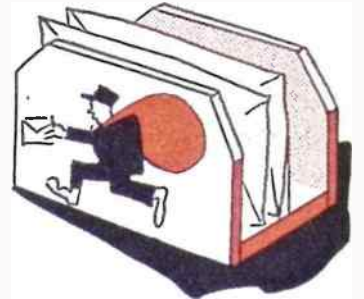

## A JOB FOR THE FRETSAW

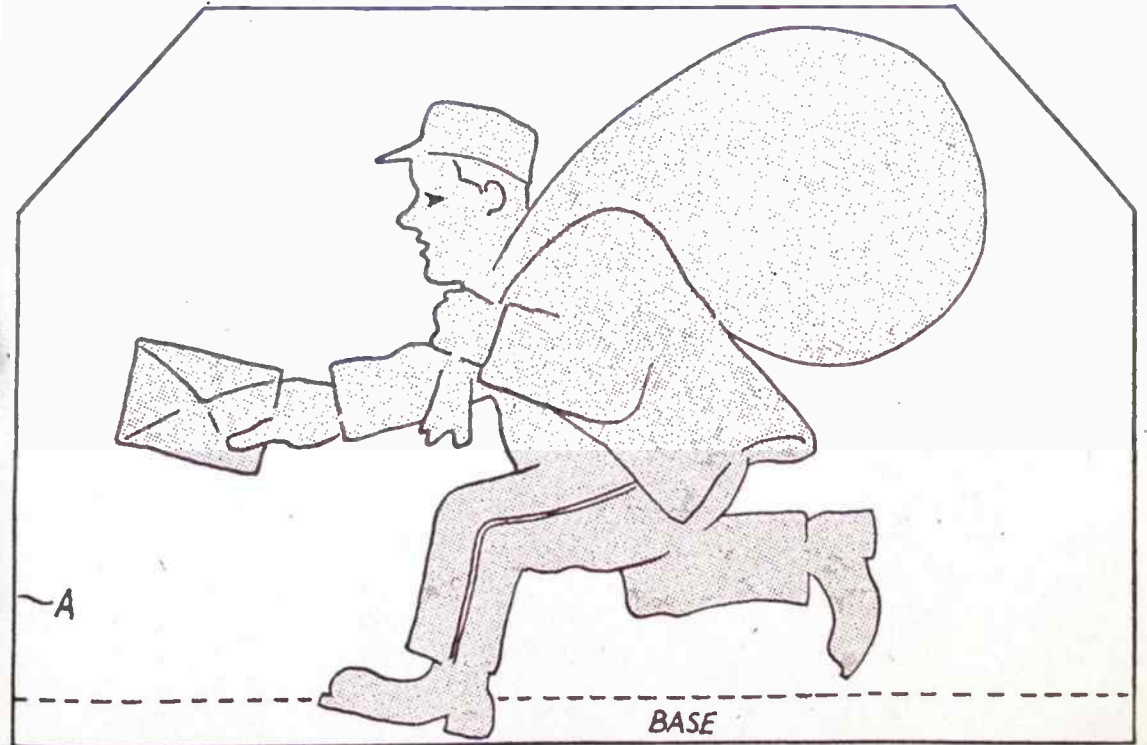

## GIFT REMINDERS from



A novelty made by yourself gives that added personal touch which makes it much more appreciated as a gift.

Here are some kit suggestions which can easily be made up into delightful novelties. Materials and full instructions for making are, of course, included.

Kits obtainable from Hobbies branches or post free by using the coupon.



**WINDMILL AND SEE-SAW**  
(Two toys) No. 3184 **6/11**  
Kit, etc. for both



**TREASURE CHEST TRINKET BOX** 5/1  
No. 3116

**CLOWN ACROBAT** 7/2  
A cute novelty No. 3060

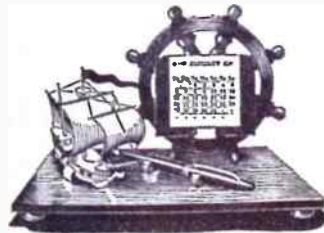

**GALLEON CALENDAR** 5/-  
No. 3188 Graceful and practical

To Hobbies Ltd., Dept 992, Dereham, Norfolk.

Please send Kit No. \_\_\_\_\_

P.O. for \_\_\_\_\_ enclosed.

Name \_\_\_\_\_

Address \_\_\_\_\_





**makes you an expert... easily!**

It's not difficult to be an expert with the BRITFIX/HUMBROL combination... tried to the qualities which the Handyman needs... tested to the requirements of the do-it-yourself man. And—more than ever—produced to give that 'professional' look... That's the way with H.O.C.—you can see-it-yourself when you do-it-yourself!

**FOR WORKING IN WOOD OR PLASTICS**

**Humbrol Art Oil Enamel.** a 4-hour lacquer enamel which dries with a brilliant finish. Is most suitable for the handyman about the house, being ideal for touching up all decorative household and workshop utensils.



**BRITFIX TISSUE PASTE.** A specially prepared paste for aeroplane tissue providing exceptional adhesion and non-staining qualities.



**BRITFIX CEMENT.** The finest all-purpose adhesive made. Transparent, water and heat proof, BRITFIX CEMENT combines rapid drying with the utmost tenacity.

**BRITFIX PLASTIC POLYSTYRENE CEMENT.** A high quality polystyrene adhesive, combining quick drying with excellent adhesion. An ideal companion to Enamel



**BRITFIX COLOUR DOPES,** fast drying, clean and bright, smooth and easy to work with.



**HUMBROL INTERMIXABLE PAINTING KIT.** Humbrol Art Oil Enamel Kit-6 intermixable colours in capsule form. An economical method of application for the Handicraft Worker.



*the choice of the expert!*

Send 10-day for FREE Humbrol Colour Card.

**THE HUMBER OIL CO. LTD., MARFLEET, HULL.**