

# HOBBIES WEEKLY

APRIL 17th 1957

VOL. 124

NUMBER 3207

## IN THIS ISSUE

	Page
Corner Cupboard . . . . .	17
The Care and Use of Saws . . . . .	19
'Bird' Tooth Brush Rack . . . . .	19
Completing 'Empress of Britain' . . . . .	20
Making Trick Cards . . . . .	21
Expanding the One-Valver . . . . .	22
An Easter Novelty for Children . . . . .	23
Draughts or Chess Board . . . . .	23
Marquetry Design for Book Ends . . . . .	24
With Rod and Line . . . . .	26
Photographing Wild life . . . . .	28
Do's and don'ts around the house . . . . .	28
Patterns for Tooth Brush Rack . . . . .	31



All correspondence should be addressed to the Editor, Hobbies Weekly, Dereham, Norfolk

## NEAT AND ATTRACTIVE

IT is surprising, considering the smallness of rooms today and the consequent space limitations, that more use is not made of furniture which is specifically designed to fit corners. Corners are always awkward to fill and are space-wasting, unless one has recourse to a proper piece of furniture which fits snugly across the corner. Such furniture looks neat and attractive, so why not try making a piece yourself.

No one need doubt his ability to make it, for the construction is easy, and possible to anyone who can saw straight.

Expense need not deter the prospective constructor, either. Although an excellent piece of work can be produced using first-class timber, one could succeed almost as well using cheap common wood finished with veneer or thin plywood.

The sides of the cupboard are 30ins. by 6ins. These could be of some superior wood, each being a single solid panel. The Hobbies furniture panels sold in 36ins. by 6ins. by ½in. would be ideal. However, for those who have to economise, there is no reason why these sides should not be made of some cheap common board, anything from ½in. to ¾in. thick, covered with a layer of some suitable veneer on the outside.

The edge of the common boarding

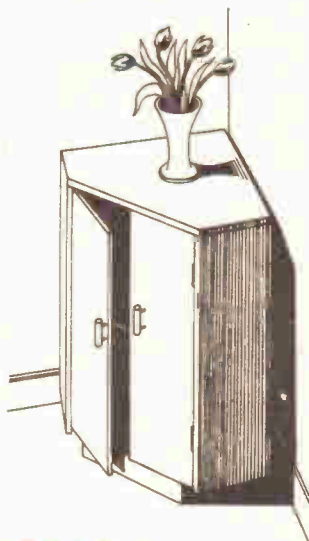

☆☆☆☆☆☆☆☆☆☆☆☆☆☆☆☆☆☆☆☆  
 ☆ MAKE A GUITAR ☆  
 ☆ In our May 1st issue we shall ☆  
 ☆ publish details for making your ☆  
 ☆ own guitar. There is sure to be a ☆  
 ☆ great demand for this number, so ☆  
 ☆ make sure of it by ordering NOW. ☆  
 ☆☆☆☆☆☆☆☆☆☆☆☆☆☆☆☆☆☆☆☆☆

The design described here, apart from filling in a particular corner nicely,

## CORNER CUPBOARD

serves two purposes. It involves a two-compartment cupboard which can be used to hold all the general impedimenta that would otherwise clutter up the room, and will prove a boon for keeping the room tidy. Its other purpose is to serve as a stand on which to place (for example) a radio set, or a vase of flowers. In either case, it will be found to be just the thing.

would show to the front, of course, but this could easily be disguised or concealed, either by staining, or by a strip of veneer similar to that used to cover the side, or again a length of simple moulding could be used very effectively.

The same applies to the top of the cupboard. This can be made up from Hobbies furniture panels (or some similar solid board of superior quality).

Two 10in. wide pieces could be placed edge to edge (butt jointing) and stuck with glue. Cramps and battens are advisable to do this job really well. Later, when the adhesion is complete, the shape seen in Fig. 1, should be sawn out.

The cheaper method would be to use common boards, joining these together in a similar manner to the above, then

FOR MODELLERS, FRETWORKERS  
AND HOME CRAFTSMEN

4 1/2 D

later covering with a sheet of veneer. Later, saw out the required shape. The front edge of the common wood could again be concealed by staining, moulding, or veneer strip. The side edge would, of course, be covered, when the sides of the cupboard are veneered, after the carcass of the cupboard has been built.

### Making the bottom

The bottom of the cupboard may be made in the same way as the sides and top. From Fig. 2 it will be seen that this is not quite the same size as the top of the cupboard, due to the fact that the bottom comes within the sides, whereas the top overlaps the side ends. If the sides are  $\frac{3}{4}$  in. thick, then the bottom will be that much shorter on each side. The distance from back to front will also be slightly less. This should be gauged by holding the sides in position and marking off their widths, then sawing down the line joining the two marks.

Fig. 2 shows the bottom of the cupboard from the underneath, in order to give the details of the base or pedestal on which the cupboard stands. The cross pieces (A, A) also serve as battens, helping to firm the joining of the bottom boards.

They can be 3 ins. by 1 in. by 11 ins. and are fixed to the bottom by glue and screws from the other side of the bottom. The piece (B) should be 15 ins. long by 3 ins. by  $\frac{1}{2}$  in. The front (B) of the base should stand back from the front of the cupboard to the extent of 1 in. or so.

Fig. 3 shows how the top of the cupboard must have short pieces of  $\frac{3}{4}$  in. by  $\frac{3}{4}$  in. stripwood glued and screwed to the underneath surface. These should be at the short ends, and  $\frac{3}{4}$  in. from the edge (if the sides are  $\frac{3}{4}$  in. thick) and should be short of the front edge by  $\frac{1}{4}$  in. (to allow for the door thickness). These pieces (S, S) are to ensure firmer joining of the sides with the top.

The shelf could now be made. This can be of  $\frac{3}{4}$  in. plywood, sawn to the same shape as the bottom, except that it is  $\frac{3}{4}$  in. less along the front (to allow for the door), and also has the back tip sawn off to a depth of  $\frac{3}{4}$  in. (to allow for fillet at the back of cupboard).

This shelf sits on  $\frac{3}{4}$  in. by  $\frac{3}{4}$  in. stripwood screwed to the sides of the cupboard inside. It can be glued to these strips, if desired, when fitted in.

It remains now to saw out the two back portions of the cupboard. These can be of thin plywood ( $\frac{1}{4}$  in. would do) or even hardboard could be used.

The length of these will have to be the length of the sides plus the thickness of the top (say, 30 ins. plus  $\frac{3}{4}$  in.). One of them will be 20 ins. wide, while the other will be greater by the thickness of the

plywood, as it has to overlap the edge of the other. It would be better to measure these two back parts after the top, bottom and sides of the cupboard are assembled.

The top, sides and bottom, having been sawn out, should have all edges fined down with plane or glasspaper block. All the pieces should be tried experimentally together to see if they coincide for size. When satisfied that they will fit perfectly, the cupboard can be assembled.

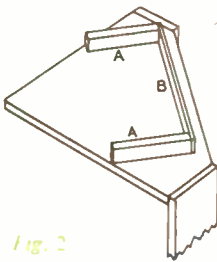

Fig. 2

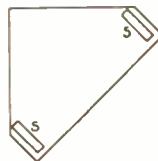

Fig. 3

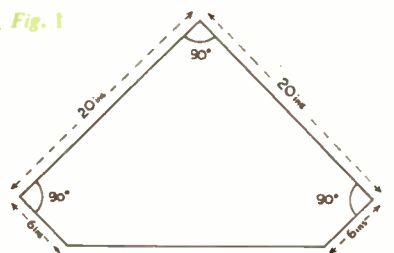

Fig. 1



Fig. 4

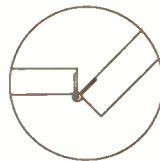

Fig. 5

First join the sides to the bottom. Use glue and thin pins through the sides, punching the pins down and later on filling up the holes with plastic wood. Do not drive pins home fully until the whole cabinet has been assembled, as some adjustments may have to be made, and this will be easy if the pins can be retracted with pincers.

The top and the shelf are fixed afterwards. At the top, pins go through the sides into the stripwood already fixed to the underside of the top.

If the assembly appears perfect, drive all pins home, then measure off the exact shape for the back parts. Saw off some  $\frac{3}{4}$  in. by  $\frac{3}{4}$  in. triangular fillet strip and glue and pin this flush along the long edge of the narrower of the two back boards. (See Fig. 4.) Note that space must be left at each end to accommodate the top and bottom.

The two back parts can then be glued and pinned into place.

### Strengthening the plywood

After this, the doors of the cupboard can be made. They can be of  $\frac{1}{4}$  in. (or less) plywood and will measure roughly  $9\frac{1}{2}$  ins. by  $29\frac{1}{2}$  ins., but the exact measurements will depend on the thickness of boards used in the cupboard construction, so measure from the actual aperture in the cupboard just built.

The plywood is strengthened by a frame surround on the back consisting of  $\frac{1}{2}$  in. by  $1\frac{1}{2}$  in. spar. This can be mitred at the corners, or merely butted, or the constructor may like to halve-joint them. Glue should be sufficient to fix the spars to the plywood. Weights should be used to hold the door down

flat while the glue is setting. Chisel out the beds for the hinges to sit in, both in the doors and in the sides of the cupboard. (See Fig. 5.)

A ball and catch mechanism is recommended to hold the doors. This should be fixed half-way down. A door stop, against which both doors are arrested, can be made by gluing and pinning a 2 in. or 3 in. length of  $\frac{3}{4}$  in. spar on the underside of the cupboard top, placed at the correct distance back, so that the doors shut properly.

When the doors have been tried in the aperture and shown to fit correctly, then they can be cleaned up with the glasspaper block and hung, using brass hinges.

The whole cabinet can now be thoroughly cleaned up with glasspaper, finishing off with fine grades. Extra labour given to the top, sides and front, to produce a really fine surface, will repay itself.

The business of staining or not staining the cupboard, and the kind of polish or finish, is left to the reader, as tastes differ on these matters.

The final completion of the cupboard lies in attaching the door handles, and it is suggested these should be of the modern plastic type of a colour to harmonize with the kind of wood used.

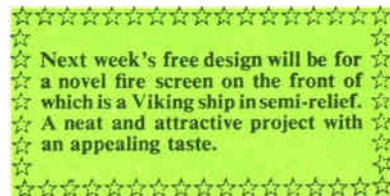

# THE CARE AND USE OF SAWS

LIKE the rest of the tools in your tool kit, your saws require to be given regular attention and treated with care if you wish to keep them in good order, so here are a few tips well worth remembering.

When buying a saw always get the best quality you can afford. The few extra shillings which you will have to pay will be repaid in service afterwards. Do not be misled by the slick appearance of the cheaper makes of saws, because you will find that the teeth of such saws will not keep a good edge for very long after they are sharpened.

After purchasing a new saw, one of the first things that should be done is to make a wooden guard to fit over the teeth to give them protection when the saw is not in use. To make the guard, obtain a piece of  $1\frac{1}{2}$ in. by  $\frac{1}{4}$ in. softwood and cut off a length equal to the length of the teeth on the saw. A saw kerf is then made in one of the sides to a depth of about  $\frac{1}{8}$ in. This is slipped over the teeth and held in position by means of a loop of string tied at the centre as shown in Fig. 1. A saw guard like this is an excellent way of protecting the teeth when the saw is not in use.

## Sharpening and cleaning

A sharp saw is essential for producing good work and every handyman should be capable of sharpening his own. However, if you have never sharpened one before, do not start practising on one of your good saws. It requires quite a bit of practise to become efficient at this job, so at the beginning, try and get hold of an old saw to work on until you get a hold of the knack. Incidentally, you will not find it very easy learning how to sharpen a saw merely by reading a book or article on the subject. The best method is to watch someone else doing the job; note how he holds the file and 'feel' the amount of pressure he applies to each tooth. After this, practise, practise by yourself.

One of the most common things that mars the appearance of a saw is rust, and a rusty saw never casts a very good reflection on its owner. Get into the habit of rubbing your saws regularly with an oily rag. Alternatively, a rub over with a little beeswax will form a protective skin on your saws which will prevent rusting. This skin also makes sawing much easier.

The metal parts of your saws are not the only parts which should be given attention. Periodically, the wooden handles should be rubbed over with a little linseed oil. This imparts a lovely finish to the handles and keeps the wood in good condition. Sometimes

the screws holding the handles in position work loose as a result of constant use. To prevent these screws getting lost always tighten them immediately they show signs of loosening.

Never lay a saw vertically against a wall. The weight of the saw is sufficient to cause it to sag slightly and this could result in it developing a permanent bow.

When sawing, try and get into the habit of using all the teeth of the saw by working with full strokes. Many people use only short strokes when they are sawing with the result that the teeth wear unevenly.

Sawing wet (or 'green') timber is sometimes rather difficult and often

Before sawing any wood always inspect the material thoroughly beforehand, for nails, screws, bolts or any other metal objects that are likely to damage the teeth. This precaution is particularly important when working with second-hand timber.

When inserting wood plugs into walls, it is common for many people to lay the saw flat against the wall to saw off the protruding portion of the plug. This practice is not to be recommended, because the teeth get scratched against the wall and get damaged. Always saw off the plug about  $\frac{1}{4}$ in. from the face of the wall and hammer it flush afterwards.

Fig. 1—A saw guard

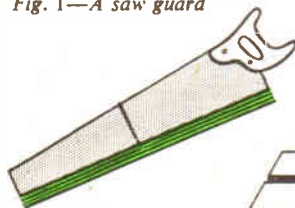
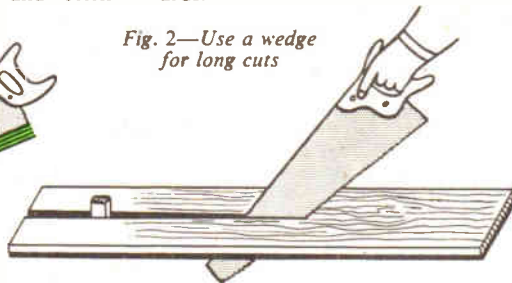

Fig. 2—Use a wedge for long cuts



causes the saws to jam. To avoid this, use a saw having plenty of 'set' on the teeth, so that it will be able to clear itself more easily. If you are ripping a long length of timber and you find your saw jamming, then a wooden wedge or chisel inserted in the saw cut as shown in Fig. 2 will make the sawing much easier. Never force a saw when you find it jamming, because this could easily cause it to kink.

Finally, when working with timber which has been used for concrete formwork, always make sure that it is clean and doesn't have any pieces of hard concrete sticking to it, because these would play havoc with the teeth of your saw.

If the foregoing tips are adhered to, then you should obtain good service from your saws.

(F.K.)

## 'Bird' Tooth Brush Rack

MAKE up this novel rack for the bathroom. This is an article which looks well finished with plastic enamel paint. The cloud background should be white with a touch of grey. Touch up with grey while the white is still wet and the colours will blend beautifully to give a soft cloud effect.

In the same way the bird can be painted light blue and shaded with dark blue. After the blue is dry, the legs and beak can be painted light brown.

The background (A) is cut from  $\frac{1}{2}$ in. wood and the bird (B) from  $\frac{1}{8}$ in. The two pieces are glued together. The brackets (C) are both  $\frac{1}{8}$ in. thick.

The rack should be secured in position by two roundhead screws.

(M.p.)

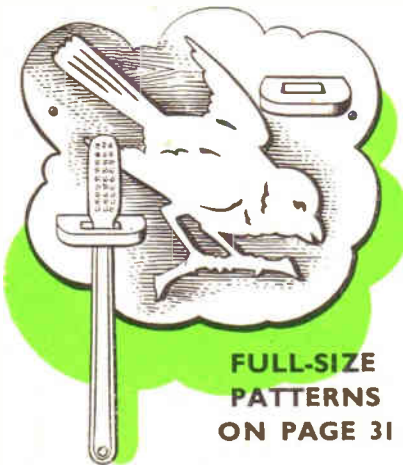

FULL-SIZE  
PATTERNS  
ON PAGE 31

# COMPLETING 'EMPRESS OF BRITAIN'

THE entire superstructure is built up on piece 22, and this section is removable in order to give access to the batteries and motor. It will be seen from Fig. 4 that fixing screws are located at each end. Details for assembling the superstructure are obtained by studying Figs. 1, 4 and 5. The forward fixing screw goes into piece 21, which is only thin wood. It will, therefore, be necessary to glue a small block underneath as a strengthener to hold the screw. In a similar way, during assembly a block must be glued under piece 32 for switch screws.

## FROM LAST WEEK

compartment, and 17 to 18 ozs. in the aft. Adjust the ballast until the correct trim is obtained. The approximate waterline is indicated on Fig. 1. When she is floating on an even keel and the balance is satisfactory, fix the ballast into a solid mass by running waterproof glue all over it. It is found that the best type of ballast consists of small pieces of

connecting the wires when adjustments to the batteries or motor are necessary.

Having made the connections, switch on the motor and ensure that the propeller rotates correctly (i.e., so as to

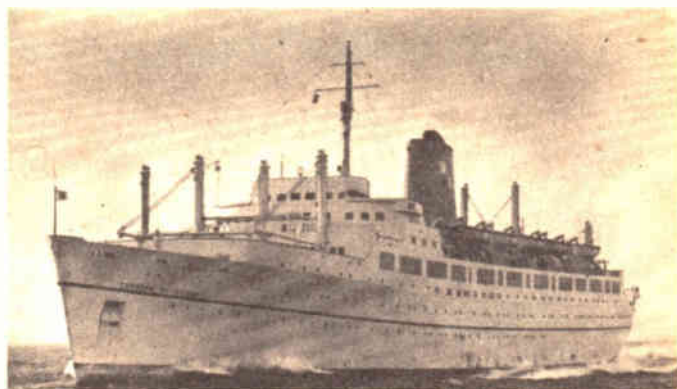

### MAKE IT WITH A KIT

Kit No. 3206 contains all materials for making the 'Empress of Britain', including electric motor and propeller. Price 56/5 from branches or Hobbies Ltd, Dereham, Norfolk (post free).

There are four pairs of derricks cut from  $\frac{1}{4}$  in. round rod. Commencing from the bow, their lengths above deck are  $1\frac{1}{4}$  ins.,  $1\frac{1}{2}$  ins.,  $1\frac{3}{4}$  ins., and  $1\frac{1}{2}$  ins. If they are let into holes drilled in the deck, allow  $\frac{1}{4}$  in. extra on each length.

The model can now be tested for trim, but before doing this, give the hull two coats of brush polish or paint to prevent the wood getting soaked. The batteries should be temporarily placed in position and the superstructure positioned but not fixed. Now add ballast, about 8 or 9 ozs. in the forward

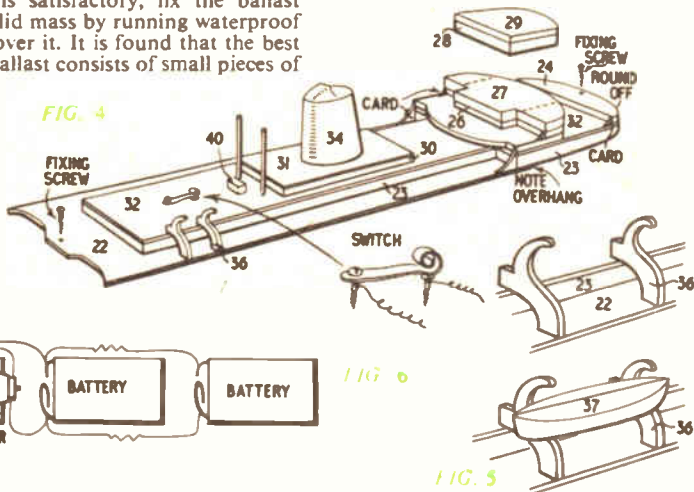

lead such as air gun pellets, which can easily be moved around and positioned to give perfect balance. When the ballast is fixed, piece 21 can be glued in position.

The wiring diagram is shown in Fig. 6. As mentioned previously, the batteries are connected in parallel and the leads continued to the motor and switch. The batteries, of course, connect to the contact screws in the bulkheads (B). The switch is situated on piece 32. The switch is made from a small strip of copper bent to the shape as shown in Fig. 4. When connecting, allow about 12 ins. of free wire, so that the top of the model can be removed without dis-

drive the boat forward). If the drive is in reverse, simply change over the leads to the motor. The batteries are wedged in position by small pieces of waste wood glued to the sides.

The rudder is drilled to take a  $1\frac{1}{2}$  in. No. 3 roundhead brass screw which goes through the propeller guard, rudder, and into the hull. This screw should be kept reasonably tight, and the rudder settings adjusted by hand.

The model is now ready to be painted, and the following colourings are authentic. Hull and superstructure, white; riband (which goes all round the ship between portholes) and below the waterline, green; name, gold letters; deck, buff; funnel, buff with red and white checkered house flag; funnel capping, black; window, doors, portholes, etc., painted in black.

Continued on page 21

# MAKING TRICK CARDS

**Y**OU can make trick cards yourself quite easily, but if you wish to avoid trouble don't use the best pack in the home. Use an old pack of cards, or one that has a few missing, and is of no further use for playing the usual games.

Soak the cards in a bowl of warm water until you are able to separate the backs from the fronts. This may take fifteen or thirty minutes, so it is best to exercise some patience, being careful not to damage either the face or the backs.

By S. H. Longbottom

After adequate soaking, insert a fine needle point at one corner between the layers to start off the peeling process, then gently separate the two, laying the split cards on clean paper with the sticky sides uppermost. Leave the cards until dry.

The foregoing explains how the face is separated from the back, and we will now reveal how to make a set of fake cards suitable for a particular trick.

Select nine cards from your pack for soaking. These should be of similar values, say, fours, fives, sixes and sevens, five being red and the other four black. Soak the cards to strip off the backs as already explained, allowing to dry.

Now take up two red fronts, say, the four and five of hearts, gluing them together, so that you make a card with two faces. This process is repeated with three more pairs of cards, giving us four double faced cards, with one black one remaining.

Take one of the red double cards and on one side attach the remaining black one, but only halfway across as shown in Fig. 1. The overlapping part must now be carefully removed, so that it cannot be detected on the reverse side. Here you are recommended to trim away the surplus from the back of the card with a sharp knife, rounding off the corners with a pair of scissors.

When gluing the cards together, use only a minimum of the adhesive, leaving under a weight until perfectly flat and dry. If the cards appear slightly different, stack together, carefully trimming the edges.

Now for a trick with the faked cards. One which gives the illusion of amazing sleight of hand.

Show the cards to your audience by

holding in the left hand as shown in Fig. 2, which apparently reveals the faces of five cards — you know, of course, that one is the faked card. Ask some member to memorise one of the cards, or even write it down.

Now close the pack together in your

left hand — having taken the necessary precaution of reversing them — when it will be shown that the selected card has completely vanished. You knew it would, of course, for the backs of the cards, while similar in appearance, are entirely different.

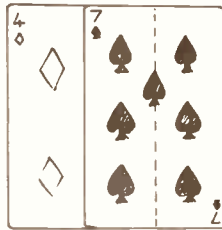

TRIM HERE

Fig. 1

hands, using your skill to avoid the backs being seen by the audience, or your trickery will be obvious. Practise this trick before a mirror several times before presentation, then you will feel quite confident.

Having allowed the member to select a card, you now ask for the value. And this is where you may use your magic wand or magic words, commanding the chosen card to disappear. And it does, with a mere flick of the fingers!

Slowly fan out the cards again in your

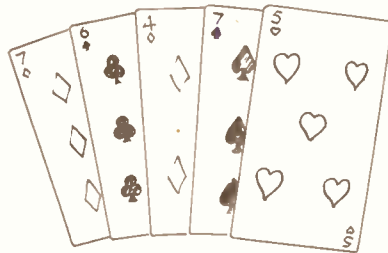

Fig. 2

To demonstrate the proof still further, you may place them, counting out aloud, one at a time on the table, then restore them to your pocket from the prying eyes of your victims.

So little time elapses in the presentation of this trick, and with no one knowing what you are about to do, your audience will not be quick enough to notice the exact values of the cards on first sight, while the reversed four faces are almost similar, that the change is not suspected.

## Continued from page 20

# 'Empress of Britain'

To ensure perfection in finish, at least six coats of paint should be given to the hull, rubbing down in between with wet silicon carbide paper. Paint the whole hull white, adding the green afterwards. To obtain a perfectly straight line, use transparent adhesive tape to mask off the white when painting green. The important thing to remember, however, is that each coat must be allowed to thoroughly dry before adding the next, and the final white must be given forty-eight hours to harden before

using the adhesive tape. Otherwise there is a danger of the tape stripping off the white paint. We have given the main details of the superstructure, but others, such as rigging, etc., can be added by consulting the photographs of the liner.

Obviously a valuable model of this nature should be looked after when not in use, and the provision of a stand is indicated. A suitable one is shown in Fig. 7. Supports should be shaped to fit individual hulls, and the base made from a piece of 1 1/2 in. by 5 in. by 3/4 in. wood.

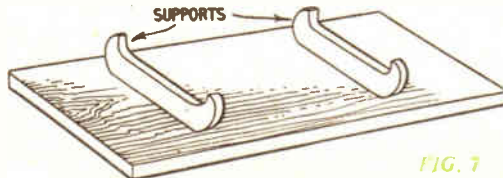

FIG. 7

# EXPANDING THE ONE-VALVER

WE now come to the mains version. This uses the Acorn Valve 955, specially made for ultra short-wave work. The construction of this set is as simple as the original battery version. The ceramic valveholder is quite large for such a small valve, and is easily fixed on a metal bracket attached to the Paxolin square on which is mounted the variable condenser. (See Fig. 9.)

All the items (except for valve, transformer, and R2 and C4) are as in the original battery one-valver. (See Figs. 7 and 8.) The coupling transformer is 3:1 or 5:1, but for economy it can be dispensed with by merely joining a .01 condenser between choke and R1, and leading the free end to the grid socket. This is inferior to the transformer.

Last week, A. Fraser described improvements to the battery version of his original circuit for an ultra short-wave receiver, and here he concludes with the mains version.

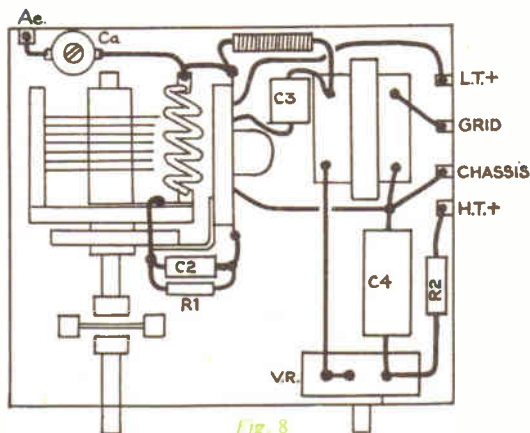

Fig. 8

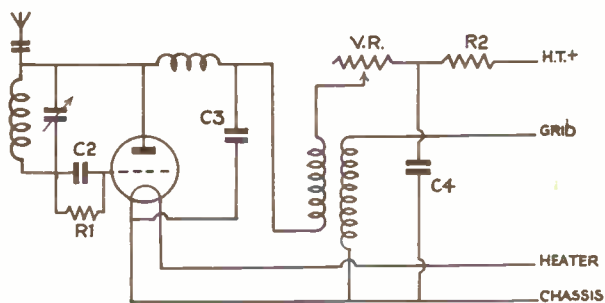

Fig. 7

Four sockets are needed for connecting to the amplifier, or pick-up section of the domestic set. Four plugs are necessary, while crocodile clips are useful for connecting to the amplifier.

The chassis of both set and amplifier must be joined, by linking the 'chassis' socket to the chassis of the amplifier. The 'grid' socket must go to the grid of the amplifier. With a normal domestic set provided with a pick-up socket, all one need do is plug in the leads from these two sockets.

The H.T.+ supply must be taken from the H.T.+ rail of the amplifier or domestic set. A crocodile clip is best here, and care must be exercised to avoid any short circuiting through the clip slipping or touching adjacent parts. The lead should be well insulated. One must assume that the power pack of the amplifier or domestic receiver can stand up to the extra current drain, which is very small. The same applies to the heater current. This is .15 amp. at 6.3 volts. Again, the 'heater' lead can be crocodile clipped to the positive heater line in the amplifier.

With a separate power pack for the

tuning receiver, all the above is unnecessary. Only the grid and chassis leads to amplifier are needed.

As mentioned in the beginning of this article, the one-valve battery set itself can be linked up to an amplifier (or domestic set with pick-up). The same two ways are possible. Method one is as follows: remove headphone plugs and

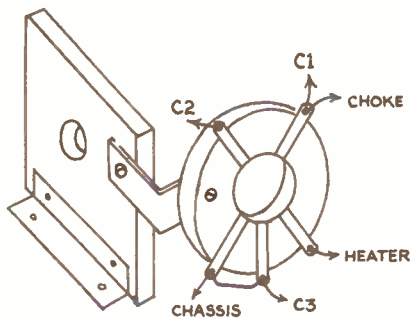

Fig. 9

insert instead the two leads from the primary of an intervalve transformer (3:1 or 5:1). Join the two leads of the secondary winding to the pick-up sockets of the amplifier set (i.e., to grid and chassis). Method two is: join the headphone sockets together and connect this point via a .01 condenser to the grid of the amplifier.

## COMB-JOINTING ATTACHMENT

THE home carpenter and cabinet maker will find his range greatly extended with the comb-jointing attachment introduced by Bridges of London. Primarily designed for use with Bridges home workshop equipment, it can also be adapted for other saw benches, enabling any type of box from a drawer to a case for packaging to be made in a short time. Claimed to produce an unbreakable joint without glue, the attachment costs £3/9/6 complete with specific adaptor. Manufacturers are S. N. Bridges & Co. Ltd., Parsons Green Lane, London, S.W.6.

## STEEL WOOL IN ROLLS

A HANDY new packet of six generous sized rolls of Supreme Steel Wool has been brought out by Brillo. The pack contains rolls of fine grade — the most useful as an all-round aid for the handyman and the housewife.

Women will want it for many jobs around the house and men will find it a superior abrasive in cleaning rust and stains from hands and garden tools, preparing metal surfaces for painting, removing paint from glass or wood — in fact, for any job where a high-grade, quick-acting abrasive is required. The package of six rolls costs only 6d.

# AN EASTER NOVELTY FOR CHILDREN



TO most children the Easter Sunday breakfast table without its special array of decorated eggs would seem as incomplete as Christmas without its tree. To please the young folk and to help brighten the dressing of the cooked eggs on Easter morning, here is a simple but extremely effective method of giving just that extra touch of novelty and colour which cannot fail to delight.

The only materials required are stout paper or thin card, a pencil, and scissors, with crayons or water-colours, and a few small pieces of transparent tape.

First fold the paper in half and mark out the chicken, as shown, and cut round the outline and wing. Now paint or crayon the appropriate colours and bend up the wings along the dotted lines.

The chicken is now ready for fixing to the cooked egg with two small tags of transparent tape. (M.h.)

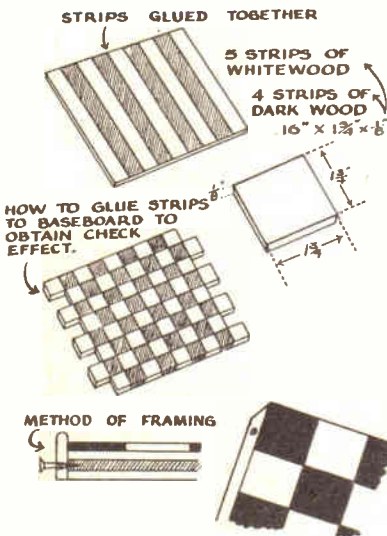
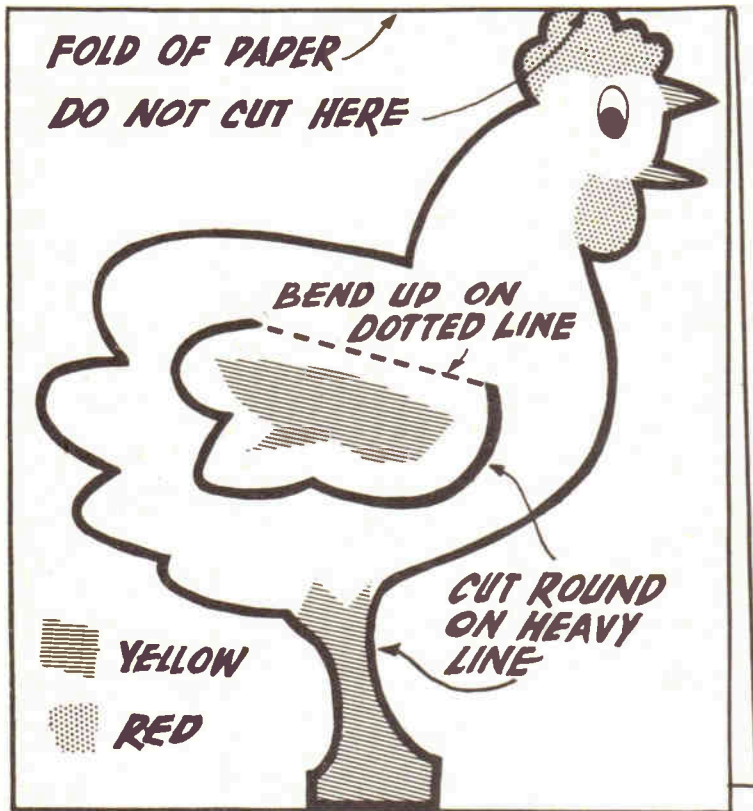

## Draughts or Chess Board

TO make this draughts or chess board very little expense is involved in the purchase of materials.

Most home workshops usually store odd strips and pieces of wood which will probably provide you with the bulk of the wood needed. However, if you must build from scratch the materials required are:—

- 4 strips of dark wood  
16ins. by 1 1/2 ins. by 1/8 in.
- 5 strips of white wood  
16ins. by 1 1/2 ins. by 1/8 in.
- 1 piece of wood 14 1/2 ins. square

The squares, when they are made up, should measure 1 1/2 ins. square and the base 14 1/2 ins. square, allowing 1/8 in. each side to fit the outside framing.

Commence by cutting up the wood into nine strips. Plane the edges thoroughly for neat fitting. Next, lay

the strips on a flat surface and glue them together as illustrated. Clamps may be used to keep an even pressure whilst the glue is setting.

Once the glue has thoroughly hardened, cut the sheet into strips 1 1/2 ins. wide at right angles to the previous strips. Now take the baseboard and glasspaper it well to obtain a smooth flat surface. Arrange the strips as illustrated in the article and glue them to the baseboard. Surplus end pieces are sawn off when the glue has set.

The outside edges of the draughts-board can now be framed up. Moulding with 1/8 in. wide groove on the inside is ideal for the work. Alternatively, flat strips of wood fitted flush with the board may be glued or nailed on.

Finally, finish with a good brushing of clear varnish or french polish. (J.M.)

# WATERFALL

## DESIGN

# BOOKS

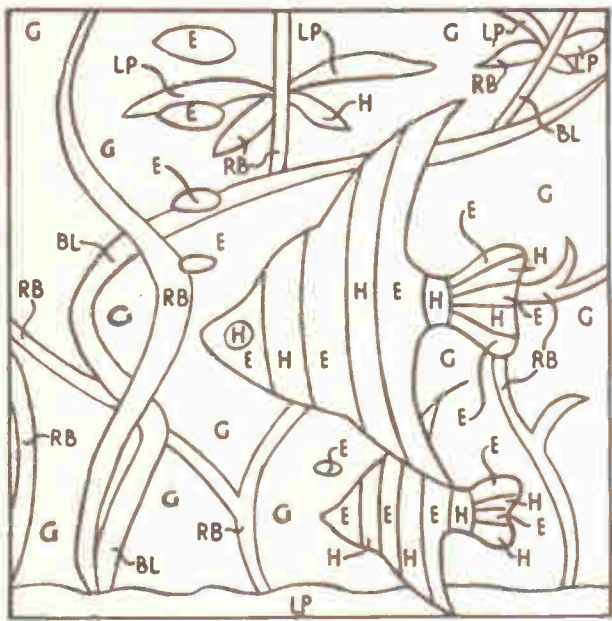

E

PIECES A  
TWO 1/2"

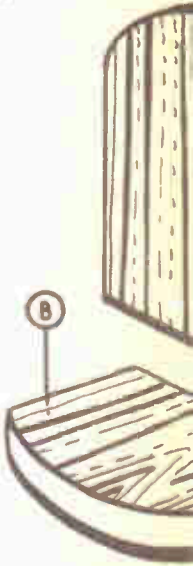



# BOOK ENDS

PANELS REQUIRED  
TWO ND8

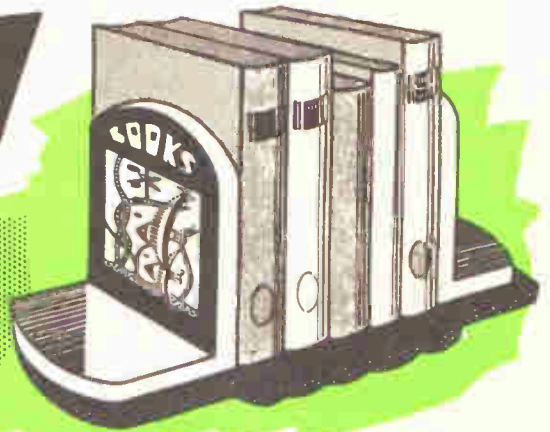

A. CUT  
7/2IN.

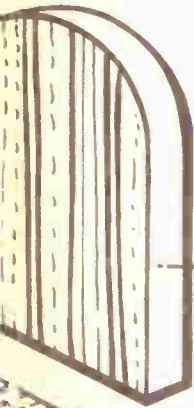

A



SCREW

## GUIDE TO VENEERS

- H. HOLLY
- G. GREYWOOD
- RB. RED BIRCH
- E. EBONY
- LP. LONDON PLANE
- BL. BLACKWOOD

PIECES B  
CUT TWO  
1/2IN.

A



## WHAT ABOUT YOUR TACKLE?

*Asks A. Sharp*

**Y**ES! what about it? Did you, like so many anglers, just dump it on your return from that last day's outing and is it still lying there? In many cases the rod that has been in more or less permanent use during the past season is literally thrown aside during the close time, and not until a day or two before it is needed again does its owner trouble about its welfare. The same thing applies to all items of angling equipment.

There are anglers, of course, who are never happier than when pottering about with their rods and tackle — polishing the shiny butt lovingly, and lavishing every care on even the most unimportant item of their paraphernalia. It is not to these but to the former that these notes are addressed. Don't neglect anything.

### Now is the time

Now is the time, during the 'no-fishing interval', during any leisure time you have, to make good all the wear and tear imposed on your equipment during the past season. Fishing rods and tackles are costly these days. Moral — look after what you've got, so that it will last in serviceable condition as long as possible. Any angler with patience, a little time to spare, a few simple tools, and a modicum of skill can as a rule make good in mending angling gear, or at least, in maintaining it in good order.

Want of varnishing has led to many a rod being ruined long before the proper time for replacement had arrived. The writer is again looking forward to using the same rod on suitable occasions for float-fishing that he has used for nearly forty years. It is still serviceable — and we lay this down to the fact that it has been well looked after during that period. It pays to look after your rods when not in use, whether they are valuable ones, or just medium-priced. Therefore, during this interval of banishment from your sport, give that favourite rod of yours a little attention. *Do it now* — don't leave it until the eve of the new season is here. And for the sake of your pocket don't leave your gear lying around where you dumped it in March, and forget to overhaul it until June 16th is nigh.

Inspect that rod — after a season's hard wear it is sure to have suffered from constant handling. Even if no scratches or scars are noticeable, a thin coat of waterproof varnish will do no harm, but all the good. Really excellent rod varnish can be had from tackle dealers at 1s. 6d. a bottle. Apply the varnish with the tip of your finger — the first finger of your right hand — and put it on thinly. You will find it possible to give the joints of the rod a nice smooth coating in this manner, whereas with a brush the varnish is liable to spread somewhat thickly and so dry tackily. Remember, there are varnishes *and* varnishes. Use the best only.

Before commencing to varnish a rod see that all the rings and silk whippings are in good condition. Frayed whippings and worn rings should be replaced with new. After the varnish is applied, hang up the joints in a dry, airy place free from dust, and leave untouched until the varnish is hardened thoroughly.

A useful medium for varnishing silk whippings is celluloid varnish. You can buy this at the tackle dealers, or make it at home by dissolving thin strips of clear celluloid in equal quantities of acetone and amylacetate. Old photographic films will serve if the emulsion and gelatine are removed with caustic soda and the film scraped until quite clear before cutting it into strips and placing in the solution.

### An effective varnish

Bottle the varnish, or put it in a jar with a screw-stopper and keep tightly corked. Should it prove to be rather too thick on examination after a day or so, add a few drops more solvent to it. By adding, as needed, further supplies of celluloid or solvent as may be called for, you can always have a quick-drying and effective varnish ready to hand. It is a good way, moreover, of getting rid of those old negatives and films no longer wanted. This sort of varnish is useful for touching up the tyings of hooks to gut or nylon, and for ring whippings, silk wrappings, etc.

However, a warning — celluloid varnish does not take well on ordinary wax, so if waxing the silk for your wrappings

or tyings use wax without tallow in it.

Reels should be well cleaned and stored carefully during the close time interval. You need not, of course, wrap them in cotton wool. Put them in a box that can be shut to keep out the dust. Valuable reels are best kept in either a leather reel-case, or strung up in a wash-leather bag.

### Turn out the Tackle Box

Do not omit to turn out that tackle box and inspect the contents. Sure enough, there will be a lot of old stuff accumulated. Best thing to do is to weed out and scrap all frayed gut, nylon or other materials used for making-up casts. Every single thing connected with your float-tackle that seems of doubtful value must be got rid of.

It is foolish to lose a good-sized fish after it has been hooked, through your own fault by risking old material or faulty hooks. Unless you test those last-year's casts and hook-lengths very thoroughly before using them again, you run a big risk. Indeed, there is an old saying that 'Last season's gut should be left with last season's fishing!' — and there is some truth in it. Nylon seems to keep condition longer than silkworm gut. But whatever material you prefer, natural or synthetic, be sure to test it, and to discard everything at all doubtful.

Examine your landing-net and ascertain that the cord is sound. Many a good fish has been 'lost' owing to the meshes giving way, having become rotten. Test the net to assure yourself that it is in good condition. A longer life can be given to such a net by an application of a dressing of linseed oil, hanging it up until perfectly dry.

Give your line a dressing of 'Linflot' or other good preparation — vaseline will do if you have nothing else, afterwards rubbing the line down well to get rid of any surplus grease, before re-winding on the reel.

Having inspected all items of your tackle and having given attention wherever necessary, put everything in order, and then neatly pack away until the great day when you may sally forth to the riverside and enjoy grand sport with sound equipment.

Made this yet?

# IRONING BOARD

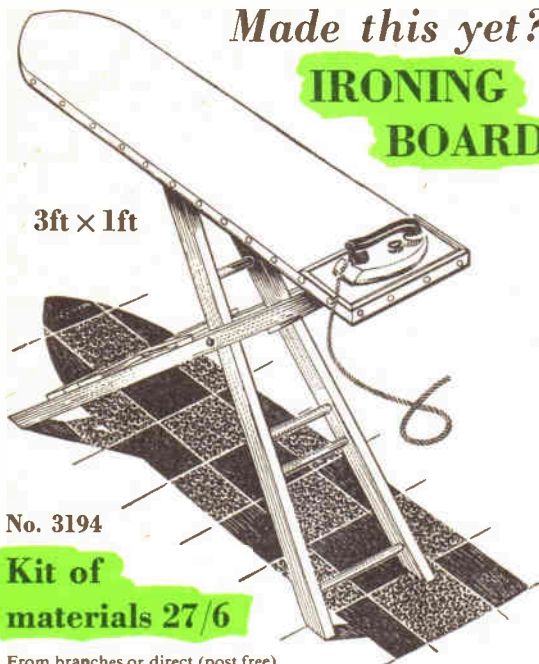

3ft x 1ft

No. 3194

Kit of materials 27/6

From branches or direct (post free)

**HOBBIES LTD** (Dept. 99) DEREHAM NORFOLK

## NEW! THE PRACTICAL WAY of learning RADIO · TELEVISION · ELECTRONICS

AMATEUR S.W. RADIO · MECHANICS · PHOTOGRAPHY · CARPENTRY, etc., etc.

**NEW**—Experimental outfits and lesson manuals sent on enrolment remain the student's property. Tutor allotted to each student for personal tuition throughout the course.

In radio and television courses, specially prepared components are supplied which teach the basic electronic circuits (amplifiers, oscillators, detectors, etc.) and lead by easy stages, to the complete design and servicing of modern radio and T/V equipment.

THESE PRACTICAL COURSES ARE IDEAL AND MAY BE YOURS FOR MODERATE COST

Fill in the coupon to-day for a free Brochure. There is no obligation whatsoever. Courses with equipment enable you to design, construct and service

2-stage radio equipment  
3-stage T.R.F. circuits · Television equipment · Workshop Test Panel  
Oscilloscope · 5 valve 3-waveband superhet circuit

**SUBJECTS INCLUDE:**— Radio · Electronics · Television Equipment  
Mechanics · Chemistry · Photography · Electricity · Woodwork  
Electrical Wiring · Draughtsmanship · Art · Short Wave Radio  
Oscilloscope · also many other Home Study Courses without equipment.



<b>EMI INSTITUTES</b> Associated with H.M.V., Marconiphone, etc., etc. The only Home Study College run by a World-wide industrial organisation.	<b>COURSES FROM 15/- PER MONTH</b>	
	E.M.I. INSTITUTES, Dept. 31.X London W.4	
	NAME.....	
	ADDRESS.....	
	Subject of interest.....	AGE..... (if under 21)
(We shall not worry you with collars)		17/4/57 ICBS

## BUILD YOUR OWN FURNITURE WITH OUTFITS BY

# Wren Craft

### SAVE FIFTY POUNDS!!!

The WREN Contemporary Bedroom Suite of six pieces for

**£52-15-0**

AVERAGE SHOP PRICE £103-16-0

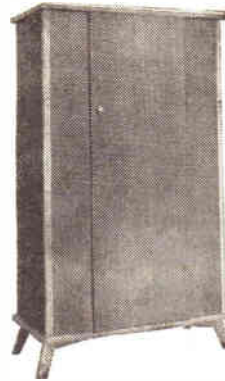

ALL THE PARTS ARE FULLY MACHINED WITH SATIN-SMOOTH FINISH, YOU ONLY HAVE TO USE THE GLUE THAT COMES WITH THE OUTFIT AND PRESS TOGETHER

we announce **A NEW RANGE**

- **BOOKCASES** with sliding glass doors or open front
- **CORNER WRITING BUREAU**
- **END UNITS**

All the pieces of this new range are designed for adapting to your own scheme or for use as free-standing pieces

**FREE** CATALOGUE

Post the coupon, or send a post card for the catalogue of 60 articles you can assemble

**WREN CRAFT FURNITURE LTD**  
Wellington Crescent, New Malden, Surrey

Please send me FREE copy of catalogue

Name .....

Address .....

H.16

# PHOTOGRAPHING WILD LIFE

**P**HOTOGRAPHING wild life may easily provide all the thrills of big game hunting or game fishing. It is not necessary to travel great distances or wait for a particular season. One can hunt throughout the year.

Expensive equipment is not required for wild life photography. Almost any type of camera can be used, although, as with any other branch of photography, the better the equipment, the better the results. The ideal equipment includes a telephoto lens, but this is beyond the means of most amateurs, so the following gadget is a good substitute.

The secret of good bird or animal photography is to get as close as possible to the subject without scaring it away. This is reasonably easy if using a telephoto lens, but not very easy otherwise. The method outlined requires the camera to be placed close to the subject while the photographer stands 50ft. or a 100ft. away.

This is called 'remote control'.

The camera is placed near to where the bird will appear, perhaps near a nest, so that it will come into the focus of the camera. It may be necessary to disguise the camera somewhat, but this is part of the fun.

Now a remote control gadget is used. This is made from a hinge, rubber bands, a short cable release, a small nail or stick, and a long piece of string. The illustration shows the method of construction.

Fasten the hinge on the tripod, so

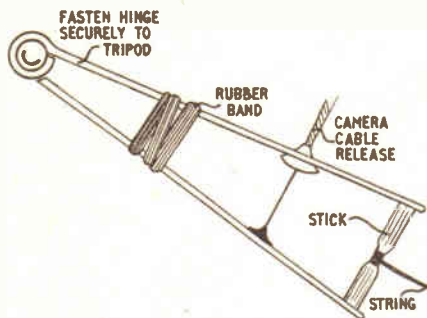

that it opens and closes easily. Place the cable release through a screw hole in the hinge, so that the closing hinge will press the release and open the shutter. Fasten two or three strong rubber bands around the hinge to hold it closed.

Force the hinge open and hold it open with a small nail or piece of stick. When you pull the cord and pull the nail or stick out, the hinge closes and automatically trips the shutter by pressing the cable release.

Using this method it is possible to stand up to 100ft. away from the subject.

The shutter should be set at least one hundredth of a second, and in most cases wait until the subject is reasonably still. Close the lens opening down as far as possible depending upon the shutter speed. The smaller the lens opening, the greater will be the depth of focus. Always focus carefully and accurately. An out-of-focus bird is a queer looking thing.

Feeding birds in winter will provide many attractive pictures. You can lure them into camera range by throwing them corn or bread-crumbs. They may become tame, or they may only feed after you have walked away. The trick is to put 'bait' where you want them to alight, set up your camera on a tripod, hook up your remote control gadget and then walk away and hide behind a tree. When they come to feed — click, you have another picture. (K.L.)

## Do's and don'ts around the house

**T**HE following practical tips may be found helpful to the home handyman when carrying out repair jobs around the house.

When lifting lino, always roll it up with the pattern facing to the outside. By doing this, the ends won't curl up when the lino is relaid.

To camouflage shallow scratches on an item of polished furniture, mix a little wood stain with some furniture cream and rub the mixture thoroughly into the scratches with a soft cloth.

If you are cutting glass and find that your glasscutter is slightly worn, dip the cutter head into a little turpentine before scratching the glass. This will give the cutter more 'bite'.

When replacing worn cords on a sliding sash window it is a good plan to rub them over with some beeswax. This gives them a protective coating and keeps them from rotting so quickly. Also, keep the pulleys well oiled. A pulley which does not rotate freely will cause the cord to slide over it and result in unnecessary wear.

Door locks are other items which should be kept well oiled at all times. When doing this job, however, always

use a thin lubricating oil. A thick oil will attract dust very easily and this will eventually cause the working parts to clog up.

One of the most vulnerable parts of a house which is subject to weathering is the wood sill of a window. It is advisable, therefore, to paint the window sills annually, even although the remainder of the exterior woodwork is not due for redecoration.

Before fixing new webbing to an upholstered seat, soak the webbing first in water. Once it has been fixed in position it will dry out and shrink, and this will produce a much tighter job.

Never suspend heavy lampshades from the lamp holders, as this imparts undue strain on the flex. It is much better — and safer — to suspend such shades from hooks in the ceiling.

Have you ever worked with figured glass and wondered which face to put to the inside and outside? If so, then the answer is always place the rough face to the inside of the house. The putty bevel will then be more easily formed on the plain face on the outside.

Painting wire netting can be a rather tedious and awkward job if you are

using an ordinary paint brush. A more efficient method of doing the job is to use a paint roller. You will find that this will complete the job more quickly.

When working with varnish, it is often a temptation to use more than one type of varnish for one job. This should never be done because different varnishes have varying setting times and if these are mixed, then the final finish may be ruined.

Many handymen, when they are panelling in their baths, make the common mistake of nailing the panels to the framing. By doing this, the panels are often damaged if they have to be removed to gain access to the waste pipes. Always fix the panels in position with screws, so that they can be easily removed.

It is common practice for many people to earth electrical circuits to cold water mains. When doing this do make sure that the water pipes are metal.

Woodwork joints which will be exposed to outside conditions should never be assembled with ordinary animal glue, as this is non-resistant to dampness. Always use a damp resisting synthetic glue or ordinary priming paint. (F.K.)

**Yours**  
for  
only  
8/6d.

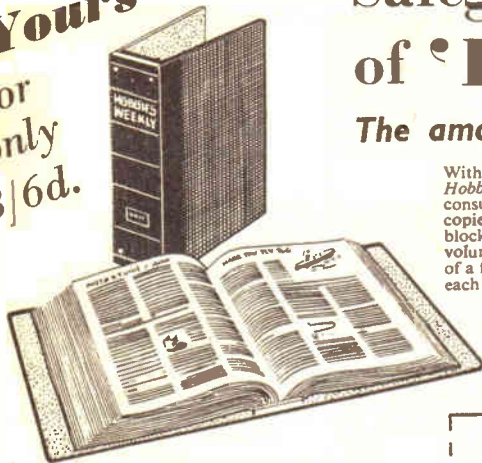

# Safeguard your copies of 'HOBBIES WEEKLY'

The amazing 'EASIBINDER' (Pat.) makes it simple

With the new *EASIBINDER*, specially prepared for *Hobbies*, you can bind each copy of *Hobbies Weekly* as you get it, turning your favourite magazine into a permanent, easily-consulted library of immense value, and avoiding the delay and despair occasioned when copies are accidentally mislaid or destroyed. Carefully finished in black leather-cloth and gold-blocked on the spine, each binder is strong, serviceable and neat. It will hold two complete volumes (52 copies) and costs only 8/6. Each copy of the magazine is quickly inserted by means of a flexible steel wire, and can easily be removed if necessary. Easy-to-follow instructions with each *EASIBINDER*. Get one today and take care of your copies of *Hobbies Weekly*.

**NOTE** From the issue April 10th, 1957, there is a slight difference in the size of the magazine, and two sizes of *Easibinders* are available. Type A is for binding issues published before April 10th and Type B is for those printed subsequently. To avoid confusion, when ordering, please indicate clearly the type of *Easibinder* required. Indices for each completed volume 1/- each post free.

☆ One 'EASIBINDER' holds two volumes (52 copies)

☆ Easy to use

**Post today**



To: HOBBIES LTD., Dept. 99, Dereham, Norfolk.

PLEASE SUPPLY ..... EASIBINDERS  
(Type ..... ) at 8/6 each.

NAME .....

ADDRESS .....

P.O. for .....

enclosed

## HOME DECORATION & CARPENTRY

New ideas in the lounge? Fitted cupboards in the kitchen? This is the opportunity to do those jobs you've always THOUGHT you could do. Here is a special reprint for the spring of these well-known and popular books. They sell fast! Do not miss this chance to get your set NOW

**All the information you need at your finger tips**

Numerous illustrations and plans given at every stage for all types of work

### HOME DECORATION

Part I deals with outside work—order of procedure, safety precautions, tools and equipment—preparing and repairing cement, brick, stone and glass—rubbing and scrubbing paint and varnish—undercoating and finishing doors, gutters, windows, pipes and other features. Part II fully covers interior decorating. Separately deals with Ceilings, Walls, Woodwork and Floors—their cleaning and preparation, best materials and methods—suggests schemes for different rooms—tackles individual problems. Instructions all through for estimating materials needed and for mixing and matching colour.

### CARPENTRY

Forgotten how to do a dovetail joint? First remind yourself of the basic practices and then follow this book through the house and out into the garden and garage. Full chapters on tools—woodworking and finishing—all kinds of joints—how to make carcasses, frames, drawers, how to fit hinges—glue—veneers. Chapters on furniture and fittings throughout the house together with instructions for smaller articles. Garden 'fittings' are also dealt with. Cutting lists are given for ordering and there are sketches and plans for every stage.

### FREE EXAMINATION FORM

To the New Era Publishing Co. Ltd.,  
45 New Oxford Street, London, W.C.1

Please send me, carriage paid, for my inspection *Home Decoration and Carpentry* in two volumes. I understand that I am under no obligation to purchase, provided the books are returned within seven days. If I keep the books I agree to remit to your address 5/- within eight days of receipt of books, five monthly payments of 5/- and a final payment of 7/6 (completing the subscription price of £1 17s. 6d.). Cash price within eight days £1 15s. 0d.

Surname .....

Name .....

(Block letters please)

Residence .....

Date.....Age (if under 21).....

HOB.106

**WILL BE SENT ON SEVEN DAY'S APPROVAL FREE OF COST OR OBLIGATION TO PURCHASE—COMPLETE & POST COUPON TODAY**

## -not for LOVE or MONEY

Now is the time to buy Micromodels that will be 'out of print' and unobtainable for love or money very shortly. Many sets are scarce and may never be reprinted: our presses will be busy producing entirely new subjects in demand, whilst the old favourites will acquire the scarcity value of collectors pieces.

Send stamped addressed envelope for current illustrated descriptive List.

**Micromodels**

3 (H) Racquet Court  
FLEET STREET, LONDON, E.C.4

**STOP SMOKING!!** Quick guaranteed remedy. Free testing sample!! — Triumph Remedies (H), Exeter.

**LEARN** it as you do it—we provide practical equipment combined with instruction in Radio, Television, Electricity, Mechanics, Chemistry, Photography, etc. — Write for full details to E.M.I. Institutes, Dept. HW47, London, W.4.

**100 DIFFERENT** stamps free! Request 3d. upwards discount approvals. — Bush, 53 Newlyn Way, Parkstone, Dorset.

**STAMPS FREE** — Empire Packet including Pictorials and Victorians with approvals. — Robert J. Peck, 7A Kemp Road, Bournemouth.

**GENUINE** Swiss Musical Movements. The best and largest selection of tunes in the country, lowest prices 16/3 each. Genuine Thorens Movements, 22/9 each. All guaranteed. P. & P. 9d. extra on all orders. — Richardson & Forder, HW, 5 Chapel Place, White Hart Lane, London, N.17.

## BRASS, COPPER, DURAL, ALUMINIUM, BRONZE

ROD, BAR, SHEET, TUBE, STRIP, WIRE  
3,000 STANDARD STOCK SIZES  
No Quantity too small List on Application  
**H. ROLLET & Co. Ltd.**  
6 CHESHAM PLACE, LONDON, S.W.1  
Also at  
Liverpool, Manchester, Leeds, Birmingham

## HOW TO STOP SMOKING

and permanently overcome that ceaseless craving for tobacco. Save money, safeguard health. Send stamp for details of the world-famous inexpensive Stanley Treatment for tobacco habit

**THE STANLEY INSTITUTE LTD (Dept. 30)**  
12 Bridewell Place, London E.C.4

## MUSICAL BOX MOVEMENTS

14/9d. ONLY

Complete kits 21/6d.

SAE for details:—  
**SWISSCROSS CO., Dept. B,**  
116 Winifred Rd, COULSDON, SURREY

**'PAINTSPRAYING' HANDBOOK.** Covers Car, Industrial & Flock Spraying. 3/6, post 4d. Catalogue of our Cellulose and Paints and all Allied Sundries 2½d. — Leonard Brooks Ltd., 81 Oak Road, Harold Wood, Essex.

**SWISS MUSICAL MOVEMENTS.** Before you buy send 2d. stamp for our illustrated brochure. — Metwood Accessories (Dept. HW), Church St., Wolverton, Bucks. (Trade enquiries invited.)

**TRYKA PLASTIC FACED PANELS SUITABLE FOR SHELVES, AND OTHER KITCHEN USES.** 18" x 12" x ½" — 6/6 each, 24" x 8" x ½" — 7/- each, 36" x 8" x ½" — 10/6 each, 24" x 8" x ¼" — 9/3 each, 36" x 8" x ¼" — 14/- each. Sizes are nominal. ½" and ¼" in hardboard, ½" in plywood. Carriage paid to your home. Colours:—Blue, Buff, Green, Grey, Pink (all linen finishes), also Redglow. — MOORFIELD SUPPLIES, 14 MANCHESTER ROAD, DENTON. TELEPHONE: DENTON 2172.

## \* GREAT CAMPING OFFER \*



**RIDGE TENT** SENT FOR 4/-

BRAND NEW de luxe 'Safety' Tent. All colours. Complete. Ideal cyclists, campers. Length 7' 3" sleeping base x 4' 6" wide x 3' 6" high x 12" walls, all approx. Weight 3½ lb. Cash 55/-, or 4/- deposit and 6/- monthly. WITH FLYSHEET 83/6, or 9/3 deposit and 9/9 monthly. Both carriage 2/6. LISTS OTHER EQUIPMENT, TENTS, CLOTHING, WATCHES, ETC., TERMS.



## R.A.F. NEW WATERPROOF BACK PACKS



One large FULLY ZIPPED Compartment. One ditto same size back to back, 4 Buttoned off separate side by side super imposed Pockets. 2 strong adjustable webbing back straps with easy release press studs. Made of genuine R.A.F. 100 per cent. waterproof material. all brand new. Ideal for Motor Cyclists, Hikers, Fishermen and 100 other uses. 4/11 only, post etc. 1/1. A fraction of original cost. Send immediately.

**HEADQUARTER & GENERAL SUPPLIES LTD**  
(HOBW/55), 196-200 Coldharbour Lane  
Loughboro Junction, London, S.E.5  
Open all day Saturday. 1 p.m. Wednesday.

## FRETSAW BLADES

Blue Label	8d. doz.
Yellow Label	1/2 doz.
Heavy Saws	1/6 doz.
Metal Cutting	1/3 doz.

In various grades to suit all types of work. From Ironmongers, Stockists, Hobbies branches or post free from:  
**HOBBIES LTD., DEPT. 99**  
**DEREHAM, NORFOLK**

**SHIPS** in bottles or electric light bulbs. Fascinating, profitable novelties. Complete instructions diagrams, 2/- — Fraser, 157a Sheen Road, Richmond, Surrey.

**EXCELLENT** efficiency guaranteed. crystal receiver, dual wave: plans, instructions, coil wire; easily made: all 2/6 only. — BCM/A lexton e, London, W.1.

## The Handy Paint in Tubes

Starlon is perfect for handicrafts and small painting jobs. Quick drying. No brush marks. Brilliant finish. No waste—you squeeze out only the quantity required.

**Starlon**  
PLASTIC ENAMEL PAINT

Obtainable at Handicraft Shops everywhere

STARLINE · SOUTHEND · ESSEX



**1/-**

PER TUBE  
In 13 lovely colours and clear varnish

# BE TALLER

in 12 days or money back. New gland and spinal discovery increases height 2 to 5 inches. 'I have gained 4½ inches in height. My weight increased from 9-stone 4-lb. to 10-stone 3¼-lb.'—P.D. 'Increased 3 inches'—H.G. Guaranteed harmless. Full course 10/- (or \$1.50). Air Mail 16/3. Details 2d. Sent under plain cover. J. H. MORLEY, 28 (H/166) Dean Rd., London, N.W.2. Practical Courses, all subjects. List free.

HARD HITTING

ACCURATE

**Webley AIR PISTOLS**



**AIR RIFLES · ACCESSORIES**

Write for Catalogue

WEBLEY & SCOTT Ltd., 166 WEAMAN ST., BIRMINGHAM, ENGLAND

See page 19

# Patterns for Tooth Brush Back

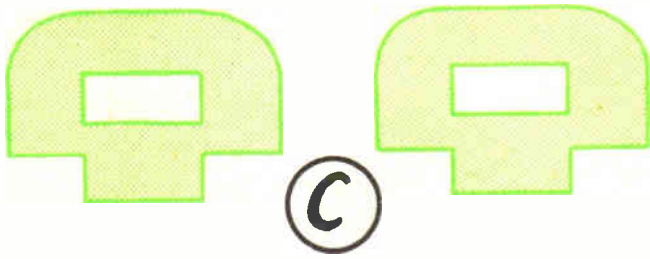

**USE YOUR  
FRET-  
SAW**

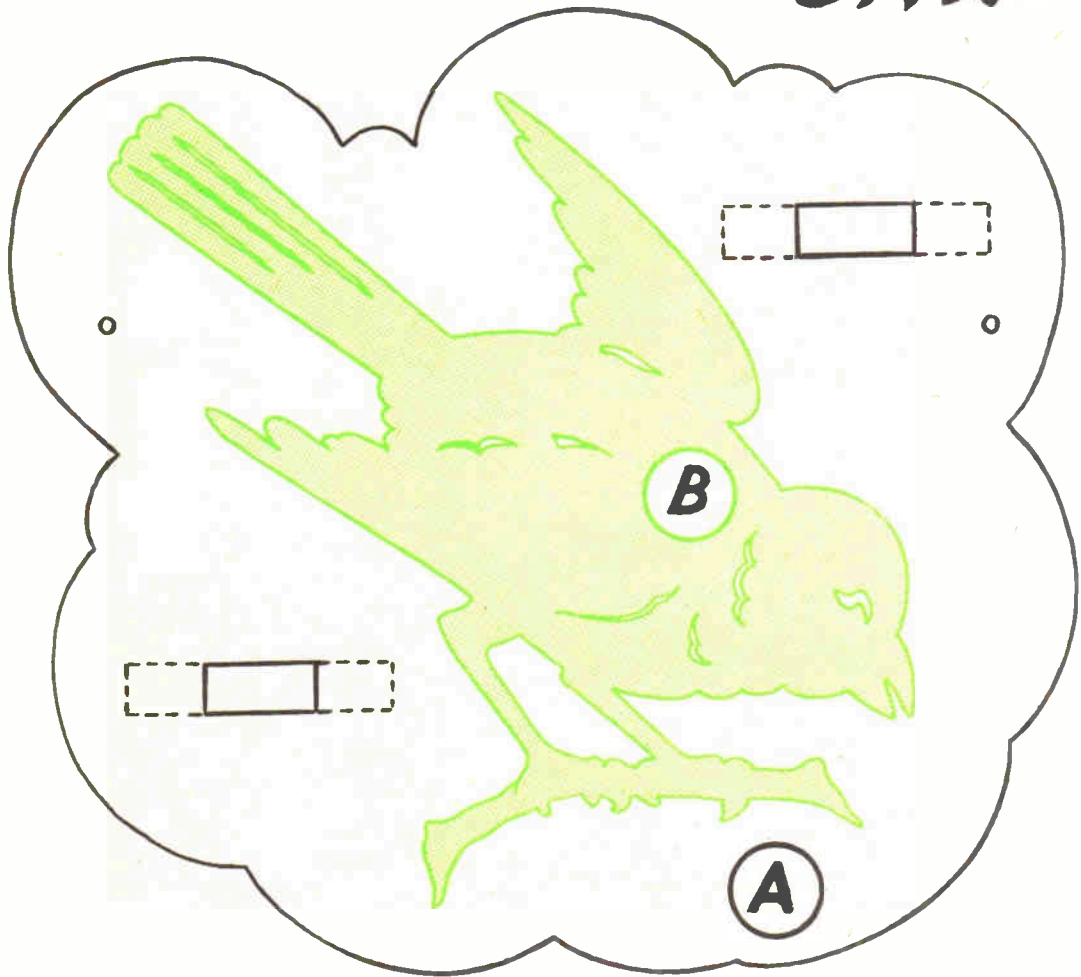

Made this yet?

# BED-TRAY or BOOK-REST

DESIGN  
No. 3174

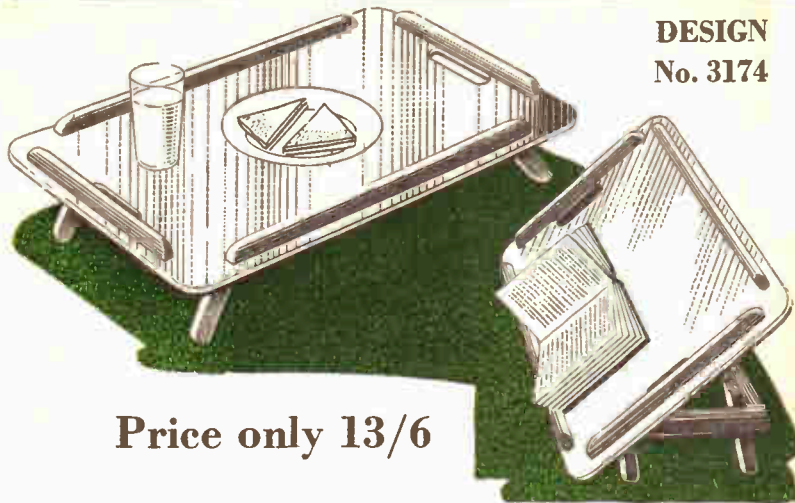

Kit contains all  
wood and fittings

From branches:

LONDON  
78a New Oxford Street, W.C.1  
(Phone MUSEum 2975)  
87 Old Broad Street, E.C.2  
(LONDON Wall 4375)  
81 Streatham Hill, S.W.2  
(TULse Hill 8796)

GLASGOW—326 Argyle Street  
(Phone CENTral 5042)

MANCHESTER—10 Piccadilly  
(Phone CENTral 1787)

BIRMINGHAM—100a Dale End

Price only 13/6

SHEFFIELD—4 St. Paul's Parade  
(Phone 26071)

LEEDS—10 Queen Victoria Street  
(Phone 28639)

HULL—10 Paragon Square  
(Phone 32959)

SOUTHAMPTON—134 High St.  
(Below Bar)

BRISTOL—30 Narrow Wine Street  
(Phone 23744)

NEWCASTLE—42 Dean Street  
Newcastle 1

or direct (post free)

## HOBBIES LTD (Dept 99) Dereham, Norfolk



JOHNSON  
PHOTOGRAPHY  
OUTFITS

### FOR THE BEGINNER

If you want to start developing and printing your own photographs and are not quite sure what you need, Johnson Home Photography Outfits provide the answer. Each outfit is a complete self-contained unit including the most up-to-date Johnson equipment and chemicals. A 100-page book of instructions is included with the Developing and Printing sets.

**Junior Printing Pack** includes a Johnson Plastic Printing Frame for 2½ x 3½ in. paper, two 5 x 4 in. Dishes, two Plastic Print Forceps, Masks, and 25 sheets of Contact Printing Paper. Contains all Chemicals required and a booklet on making prints. Price 13s. 3d.

**No. 1 Outfit** contains everything necessary for making prints from 2½ x 2½ in. and 2½ x 3½ in. negatives. Includes Plastic Printing Frame, Portable Darkroom Lamp, Dishes, Measure, Thermometer, Chemicals, etc. Price £1.17.6.

**No. 3 Outfit** (as illustrated) for developing 120 and 620 films. Includes a Johnson Developing Tank, Measure, Thermometer, Clips, Chemicals, etc. Price £2.10.0.

**No. 21 Outfit** incorporates a Johnson Battery Printer for making first-class 2½ x 2½ in. and 2½ x 3½ in. prints. No mains electricity required. All necessary Chemicals and Equipment are supplied with the outfit. Price £2.11.6. Battery extra 2/9.

**No. 22 Outfit** has the Johnson Mains Printer, a Water Circulator for washing prints and everything else required to produce sparkling contact prints. Price £3.4.6.

JOHNSONS OF HENDON LTD LONDON N.W.4

### SEAL QUICKLY AND PERMANENTLY WITH

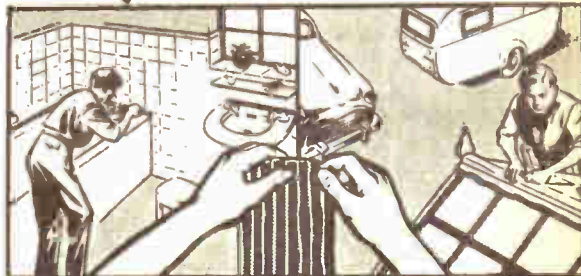

For the Home Handyman

### SEEL-A-STRIP

The Permanent Sealing Strip

This sealer in strip form provides the home handyman with the most convenient method for extensive sealing against damp, moisture, dust and draughts, in the home, greenhouse, car, caravan and boat, etc. You tear off a section and press it home, it's as easy as that "SEEL-A-STRIP" adheres strongly, you inside or out for it will not crack or fall away.

SEEL-A-STRIP is available in black or cream from all Ironmongers, Hardware Stores, Builders' Merchants, Garages, etc.



Another EXPANDITE Product

EXPANDITE LTD, London, N.W.10

Associates and Distributors throughout the world



Tel. ELG 4321  
(10 lines)