

HOBBIES WEEKLY

IN THIS ISSUE

	Page
Weather House - - - - -	97
How to Bronze Plaster Casts - - - - -	98
Planning a Small Station - - - - -	99
Cord and Dowel Trick Box - - - - -	101
Bench Hook Improvement - - - - -	101
A Simple Electric Fire - - - - -	102
A 'Palette' Timepiece - - - - -	103
Find Your Own Walking Sticks - - - - -	104
Securing Loose Knife Handles - - - - -	104
Waste Paper Basket - - - - -	105
Stamp Collector's Corner - - - - -	106
Finding the Good Spots - - - - -	108
Safety Cork for Home Made Wines - - - - -	108
Pattern for Rocking Duck Sweet Pack - - - - -	111



NOVEMBER 7th 1956

VOL. 123

NUMBER 3184

Wet or fine? — ask the little men

★ **FREE** Design inside

for you to make a

WEATHER HOUSE

GOING to rain? — then out comes the Hot Dog Man. Going to be fine? — then the Ice Cream Man makes an appearance.

That is the action of this weather house, a novelty which can be made up quite cheaply and makes an excellent idea for a present. In addition to forecasting the weather, there is a thermometer which records the temperature.

The positions of the two figures on their tricycles give an indication of the weather ahead. These figures are activated by a piece of gut from which they are suspended on a platform. They are symbolic of wet and dry. Provided the gut is tested and adjusted correctly before final assembly, the Ice Cream Man swings forward when fine weather is indicated, and if rain is in the offing

*An excellent
suggestion for a
Christmas gift*

the Hot Dog Man emerges. As the humidity in the air alters, so the figures change position.

This is brought about by the natural property of a piece of gut which stretches when dampened and so turns,

and when dry it contracts and reverses. The kit supplied by Hobbies Ltd., includes a suitable piece of gut for this purpose.

It is, of course, a matter of which direction the gut turns that brings out

They foretell
the weather
ahead

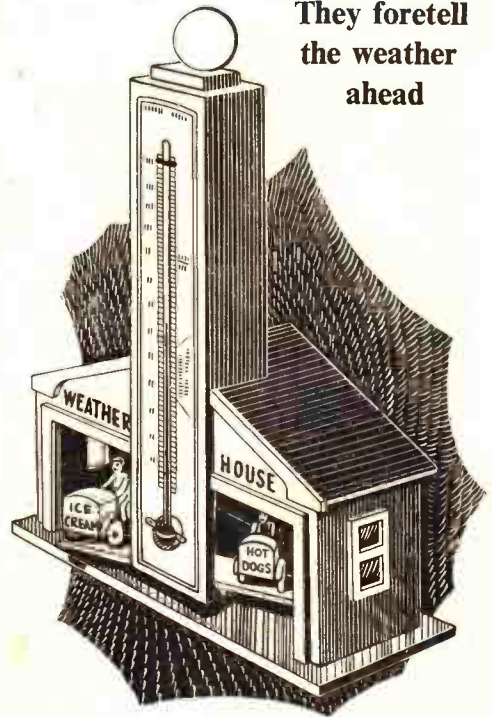

All correspondence should be addressed to The Editor, Hobbies Weekly, Dereham, Norfolk

*For Modellers, Fretworkers
and Home Craftsmen*

World Radio History

4 1/2^D

PAGE 97

the figures, and to ensure the correct one coming out for the weather indicated, a trial should be made with the indicator assembled outside the house and before the actual figures have been fixed on their platform.

All the cutting is straightforward and there should be no difficulty in making up this novel weather house. Trace and transfer the various parts on to their appropriate thicknesses of wood and cut out cleanly with the fretsaw.

The first portion to make up is the tower, comprising pieces 1, 2, 3, 4 and 5 glued and pinned as shown on the design sheet.

Open back

The house, which has an open back, is next assembled from pieces 6 to 12 inclusive. The windows consist of overlays (pieces 12) glued over the apertures cut in the sides (7). The tower can now be glued in position over the hole in the roof.

Make the platform which holds the figures by gluing the piece of round rod (21) into the hole in the platform. Next gauge the length of gut required. It will be seen that one end of the gut is glued into a hole bored into the shank of the ball on the top of the tower, and the other end is likewise fixed into the top of the dowel on the platform (piece 21). Note that the knob is not glued in



TO PLEASE A FAVOURITE AUNT

KIT COSTS ONLY 8/1

Hobbies Kit No. 3184 includes panels of wood, gut, window material, and thermometer, to make the Weather House. Complete kit costs only 8/1 from branches etc., or post free from Hobbies Ltd., Dereham, Norfolk.

position — it is left free to adjust the swinging of the platform.

The sectional drawing for the fixing of the gut is shown on the design sheet. The gut should be cut just long enough to ensure that when it is fixed the

figures and platform can swing freely without fouling the bottom of the tower.

The little men

Now the tricycles and their riders, detailed on the exploded view on the design sheet, can be made up. Note that the little men consist of pieces 20 glued on either side of piece 19. Shape the face, body, arms, etc., of the figures with a modelling knife, and glue them in place on their tricycles.

At this stage, paint the house assembly and the figures on their mounts, painting in the words 'Weather House' as shown on the design sheet and adding freehand the words 'Ice Cream' and 'Hot Dogs'.

Test thoroughly

It is now necessary to find which way the gut rotates when actuated by the humidity of the air. Test thoroughly to see which part of the platform comes out when it is going to be wet. When this has been determined satisfactorily, glue the figures to the platform according to their indications.

The thermometer is added by pinning, or small screws, and the weather house can either be stood up or hung on a wall with the addition of a bracket-eye. In any case, it should be placed in a fairly open position.

How to Bronze Plaster Casts

BRONZE casts are a complement to good pictures, giving tone to a room. Unfortunately they are expensive. Good bronzes are, indeed, very expensive.

Good plaster casts, on the other hand, can be bought at reasonable prices — often for a few shillings, but their beauty is marred by their excessive whiteness; or they soon become dirty. Because of the very nature of the material from which they are made, they cannot be washed.

Will deceive the expert

Here is a recipe for making plaster casts look like bronze casts. If the process described is followed closely and every stage undertaken with care, the result will deceive even a sculptor, until he takes the cast in his hands and notes its weight (plaster being much lighter than bronze).

Size the cast all over with ordinary size (but not with a cellulose size or you will have trouble with the subsequent coats).

Mix burnt sienna and burnt umber (obtainable in small tubes at any art shop) in equal proportions and thin with 3 parts of turpentine and 1 part of

THIS METHOD HAS BEEN HANDED DOWN BY A SCULPTOR OF THE OLD SCHOOL WHO COULD NOT AFFORD BRONZES AND WHO COATED HIS OWN PLASTER CASTS TO SIMULATE BRONZE BY THE PROCESS DESCRIBED. SOME OF THESE CASTS ARE IN PERFECT CONDITION TODAY — SEVENTY YEARS AFTER THEY WERE MOULDED.

clear varnish. Apply a coat of this mixture thinly and allow to dry. If you have only one small cast to treat and don't wish to buy two tubes of paint, one of sienna and the other of umber, you can get almost the same effect with a tube of Caledonian brown.

Paint thinly with bronze dust mixed with spirit medium.

Paint thinly with terra-verte.

Apply the bronze dust mixture again, this time confining it to the high-lights

(that is to say, those parts of the model in relief).

Lastly, varnish lightly with varnish and turpentine mixed in equal proportions.

Each coat must be allowed to dry thoroughly before the succeeding coat is applied. This is important.

Particular stress is placed on 'painting thinly'. Apart from being completely unnecessary, thick coats would only tend to bridge and destroy any fine modelling there happens to be.

One word of warning to owners of plaster casts; plaster is easily chipped and broken. Consequently, wherever you place your casts, be sure they are well out of the reach of children — and even of those grown-up visitors who *do* love to handle things.

Take care

If you value your cast, do not allow any domestic help you may have to clean it for you. Do it yourself! It doesn't require washing. All it needs is an occasional dusting with a camel-hair brush.

Try this recipe — and you will have a thing of beauty that will be a joy for life. (W.A.T.)

PLANNING A SMALL STATION

By E. F. Carter

CONTINUING with our discussion on ways and means of incorporating a small station into a simple 'oval' of track, in Figs. 1, 2 and 3 are shown some suggested layouts from which you will be able to choose one best suited to the layout space you have available. Should you find that none of the schemes shown is quite what you require, you will be able to adapt them slightly, so let us study them in detail, for there is nothing like analysing a layout to teach one to discover its secret of success in operation.

The layout shown in Fig. 1 will afford a continuous main line with a terminal and through station (C.5), with a 'bay' (or short terminal platform line) at (X). Almost all the station buildings, if used,

may be placed within the oval, and there is still ample space outside it to place another siding at S2 — shown dotted.

In the layout shown in Fig. 2, the main station (M.S.) is placed outside the oval of track, and is more or less the 'London' terminal of the line, most of the rolling-stock being shedded at this station. The longish run from the station to the loco department makes for an added interest, for we must remember that the idea of an engine shed and turntable is to provide for the locos when they are not in use; in fact, in model form it is a good plan to *really*

use the engine shed for housing the locos, so that they are out of the way of dust and dirt — both deadly enemies of good model railway working.

A good dodge

You will, no doubt, notice that a pair of points has been saved at the entrance to the loco shed by using a turntable, and if you care to try to make a simple girder type turntable by screwing a 12in. length of track on to a piece of ½in. thick wood, you will save yourself the cost of another point — a good 'dodge' to remember.

As to the main station itself, this is made up with two parallel tracks which converge before running into the siding which serves both the continuous main line and the loco depot road. This siding line (X) is joined to the main line by facing and trailing crossovers at (Y) and (Z), thereby converting the platform track nearest to the main oval into a loop-line, so that trains can enter and leave the station platform from either direction. The platform line forms part of a 'passing loop', so that 'up' and 'down' trains can be operated, one train waiting in the platform loop, whilst the other can be left running if desired on the main line circuit. This is a very interesting method of working, for a timetable can be drawn up so that the passing of trains at the loop can be carried out to schedule.

Shunting operations

All shunting operations to and from the engine shed must also be properly fitted in with the timing of the main line traffic which passes to the station platform, and in the same way, any 'station movements' — as such shunting operations are termed — must take place whilst the loop platform line is closed to any trains to or from the main line running circuit.

In Fig. 3 is shown a thorough-going layout of rather large dimensions which occupies two sides of the railway room, and is designed for use where permanent housing can be obtained for a model. The two main terminal stations (A) and (B) have no connection with each other except by way of the tracks which make up the running oval, and a hill, a wall, or some other scenery should be built up between them to maintain them in apparent isolation, as shown.

Leaving station (A) from platform No. 1, a train would run on level track under bridge (D), at which point the lines diverge, the right-hand one remaining on the level and running on

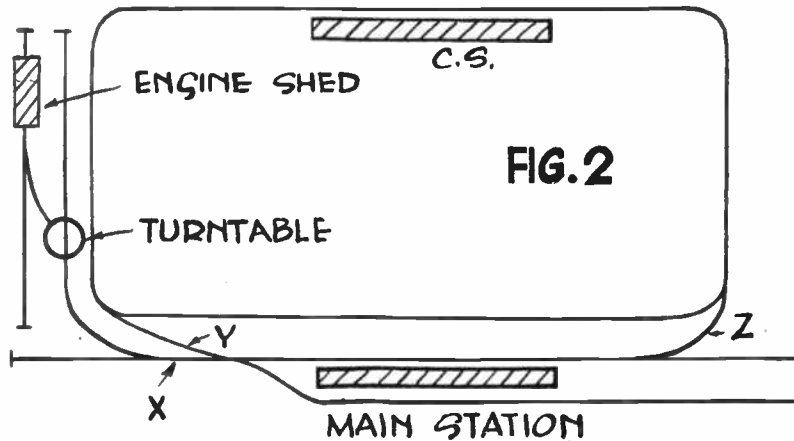
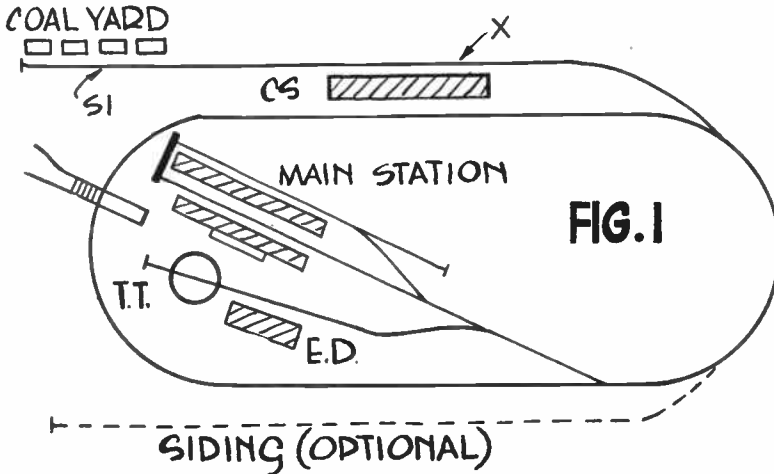

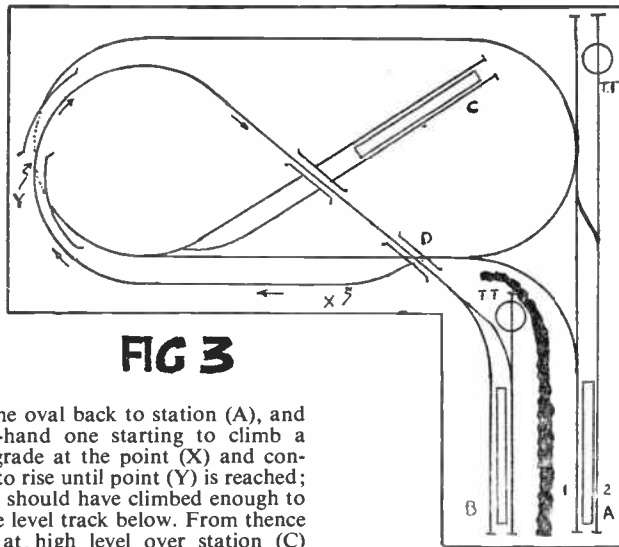

FIG 3

round the oval back to station (A), and the left-hand one starting to climb a steady grade at the point (X) and continuing to rise until point (Y) is reached; where it should have climbed enough to clear the level track below. From thence it runs at high level over station (C) until the high-level terminus at (B) is reached.

Word of warning

This type of layout may seem rather difficult to arrange and construct, but it is well worth while, for until you have tried your hand at building and running a two-level layout, you can be assured that you have not really had all the pleasure that a model railway can give you. But a word of warning. Do not make the gradients too steep or your locomotives might not have sufficient power to move even themselves up the slope, let alone haul a train — a very sad state of affairs with which to be confronted — after the track has been laid. For guidance in this matter of grades the following table will be found of great use; showing as it does the length of given grade required to give the minimum amount of headroom for clearance on a track passing underneath a high-level line:—

Grade.	Length of grade required to give 4½ins. headroom in 'O' gauge or 2½ins. headroom in 'OO' scale.	
	'O' gauge.	'OO' scale.
1 in 20	7ft. 1in.	4ft. 2ins.
1 in 32	11ft. 4ins.	6ft. 8ins.
1 in 40	14ft. 2ins.	8ft. 4ins.
1 in 60	21ft. 3ins.	12ft. 6ins.
1 in 70	24ft. 9½ins.	14ft. 7ins.
1 in 100	35ft. 5ins.	21ft. 10ins.

This table shows the length of grade required on the assumption that one track remains level, and the distances given will obviously be halved by grading one track upwards and the other downwards at the same grade, the variation in vertical distance being equally distributed between both tracks.

The very simplest of baseboard wood-work is all that is needed to carry a high-level track, but screws rather than nails should be used in its construction, for too much hammering can do a great deal of damage to both track and rolling-stock; moreover, should it be desired at any time to alter the layout, screws are much more easily removed than nails.

Make small accessories

Now a word as to locomotive depots — motive-power depots, as they are now termed on the railway. Exactly where they are placed and how they are laid out depends purely upon the amount of baseboard space available. There is no such thing as an ideal layout for a locomotive running shed, but it must be remembered that there are other features to be catered for besides the engine shed itself. Water tanks, coal stacks, ash pits and turntable are all to be found grouped in the motive-power depot of a full-sized railway station; and it will be found both interesting and instructive to try your hand at making such small accessories for yourself.

Water tanks may be made easily from small tins, which should be nailed through the centre of the bottom to a short piece of dowel-rod of appropriate diameter. Stacks of coal can be made by sprinkling coal-dust over shaped blocks of wood which have previously been smeared with Seccotine, and a turntable can be made very cheaply, as already mentioned, by carefully mounting a length of track on to a piece of three-ply which is pivoted at its centre to swing in a complete circle.

It is, obviously, impossible to give dimensioned drawings of such items,

but if it is desired to make up any particular accessory which appeals, it will be found that a little survey with a note-book, pencil and measure will provide all the necessary dimensions and, from the details so obtained, reproduction in the appropriate scale for your railway will be quite an easy matter.

A scale ruler, divided into feet and inches — in the scale to which the model is being constructed — will be found a great help. It should be about 1ft. (actual) long, and may be made in the following manner.

'OO' scale ruler

A strip of thick Bristol board 1½ins. wide by 12½ins. long is marked off (to produce a 'OO' scale ruler) into 300 millimetres, each one of which represents 3ins. full-scale (prototype). Every fourth millimetre along the scale is marked off as '1', '2', '3', etc., thus making up to 75 full-sized feet (i.e., 300 millimetres in all). This scale ruler, when laid down on any drawing drawn to 4 millimetres to the foot scale will give an immediate reading of the full-sized dimension in actual feet and inches to the nearest 3ins. Conversely, if the full-sized dimensions of any item seen upon the real railway are known, a 4 millimetres to the foot scale drawing can be quickly produced by reversing the process, marking off the feet and inches on the paper and constructing the diagram instantly full-size for 4 millimetres to the foot scale.

To make a similar ruler for 'O' gauge, which is 7 millimetres to the foot scale, 43 divisions, each of 7 millimetres should be ticked off and numbered '1', '2', '3', etc., each group being further subdivided, first into quarters (representing 3ins. full-scale), and finally each quarter into three (each of which will represent 1in. in full-scale — i.e., on the 'real thing').

The time spent on making such a scale ruler is by no means wasted, for by its use you can be assured that anything you build for your model railway will look 'right' because it is right. Guess-work in matters of size in railway modelling never pays good dividends, and many a good model has been ruined in appearance merely because its builder did not take enough care in getting the sizes and proportions of sundry items of lineside decoration correct.

Next week we shall continue our Christmas gift suggestions with details for making a charming trough for fruit and nuts — an excellent addition to the sideboard. Indexes for Vol. 122 are now available, price 1/- post free.

Be a 'magician' with this

CORD and DOWEL TRICK BOX

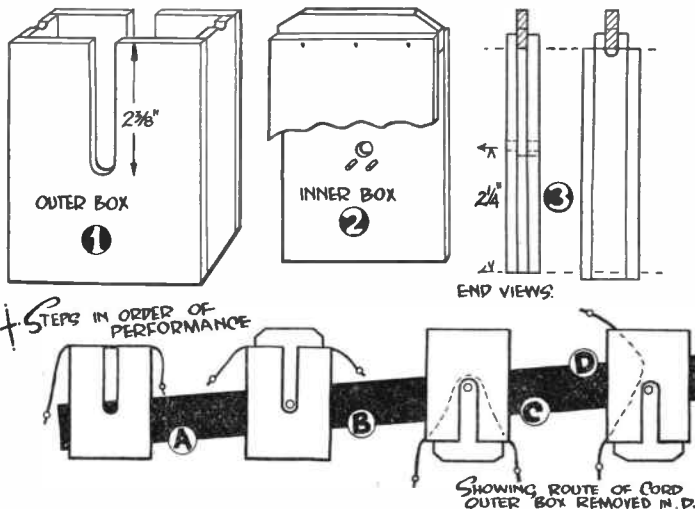

turn upside down, drawing cord through the box from left to right several times. (This gives the appearance that the cord is lying in the bottom of the box.)

(D) push the dowel through holes of inner box and leave fairly even, and holding inner box at the sides with thumb and forefinger, slowly remove outer box. Your thumb and forefinger hiding the cord.

CUTTING LIST. 1/4 in. plywood.

Outer Box		Inner Box
Back, Front.	2 4 1/2 ins. by 4 1/2 ins.	2 5 ins. by 4 ins.
Sides.	2 4 1/2 ins. by 1 1/2 in.	
Base.	1 4 ins. by 1 1/2 in.	
Centre Piece.		1 4 ins. by 1 1/2 ins.
Dowelling, 5 ins. by 1/4 in. diameter.		
Thin cord, 14 in. length.		

Hey presto! Anyone can be a magician with this trick box, which, when performed before a young audience has quite a mysterious effect. Its object is to pass a length of cord through an enclosed dowel without cutting cord or dowel, an impossibility which can apparently be achieved by following the instructions and making the box as shown.

Cut to size all the panels listed and make the outer box first. Saw a 1/4 in. wide slot 2 3/8 ins. deep out of both back and front panels. A fine recess just deep enough for the cord is then taken out of the side pieces. Pin all the pieces together to form a box as shown (Fig. 1).

The inner box contains the secret of the trick. Study Fig. 2 carefully and make as follows. Drill a 1/4 in. hole in back and front panels 2 1/2 ins. from ends. In one panel only, fix two small nails just below the hole and 1/4 in. apart. Place the nails firmly in the wood but not right through, then nip the heads off to leave them standing out about 1/4 in. Fig. 3 shows the exact position of the centre member of the sandwich, i.e., when assembled, and the two boxes are engaged. A clearance for the cord must be left. After shaping the centre member and locating its correct position, join the three pieces together with 1/4 in. escutcheon pins to form the sandwich as shown.

Glasspaper all surfaces to a smooth finish and the trick box is ready for its trial performance. Knot ends of cord or thread through short lengths of dowelling.

(A) hold outer box in one hand — lay cord evenly across grooves.

(B) place open end of inner box over the cord and with a sharp thrust engage the two boxes. (Speed in this operation is essential.)

(C) hold the two boxes together and

Then still holding one side of the box with cord hidden, steadily lift the other end up the open side and remove the cord completely from the box (the appearance will be that the cord has passed right through the dowel).

In all operations the face of the box should be toward the audience. (S.F.)

Bench Hook Improvement

WHEN cutting small lengths of dowel rod nothing is more irritating than to have the cut off piece roll off the bench on to the floor amongst the shavings, or, worse still, to roll across the floor to hide itself in some dark corner. Here is a simple device that will save time and frayed temper.

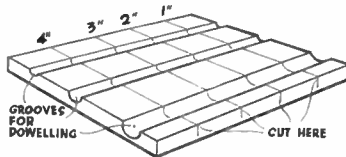

Remove the top stop from your bench hook and in its place glue and dowel a piece of hardwood of about 7/8 in. in thickness, 5 ins. long, and of sufficient width to take three spaced grooves.

The grooves are ploughed out to make a comfortable fit for 1/4 in., 3/8 in. and 1/2 in. dowelling respectively. From the right-hand side mark and square lines 1 in., 2 ins., 3 ins. and 4 ins., and saw them

in to the depth of the largest of the three channels.

All that is necessary is to place the dowel rod in the correct channel with its end flush with the right-hand side of the sawing block and saw off along the required mark. The cut-off cannot roll away and is automatically pushed out as one moves the length of dowelling along the groove in order to make the next cut.

Remember



Poppy Day

A SIMPLE ELECTRIC FIRE

FIX a terminal at each end of a piece of uralite about 5ins. long by 1in. wide. Any builder's merchant will give you pieces of scrap uralite. Holes can be drilled in this material with an ordinary drill and it can be sawn. You will also need an old car battery, a short piece of bare No. 26 copper wire, a short piece of bare No. 38 copper wire, a short piece of No. 26 nichrome wire and pieces of No. 22 D.C.C. wire for connections.

Wire up apparatus as shown in Fig. 35 — using the model switch and rheostat previously described, and connect, first the thicker piece of bare copper wire from terminal to terminal across the uralite. Close the switch for a short time, gradually diminish the resistance in the circuit, and note how this short piece of thick wire becomes gradually hotter but not red hot.

Then connect the thin piece of copper wire across the terminals and again switch on the current and gradually diminish the resistance for a short time. The wire becomes red hot and melts. It was not until wires and strips from the alloy nichrome were tried that electric heating appliances could be made.

Connect a thin piece of nichrome wire across the terminals and you will find that when the switch is closed and the resistance is diminished the nichrome becomes red hot and remains so. (You can obtain lengths of nichrome wire from the cheap stores.) You have made a simple electric fire with a single heating element.

MODEL ELECTRIC FIRE WITH DOUBLE HEATING ELEMENT

YOU will require a piece of uralite with four terminals fixed to it as in Fig. 36. Fix a piece of nichrome wire between the terminals (C) and (D)

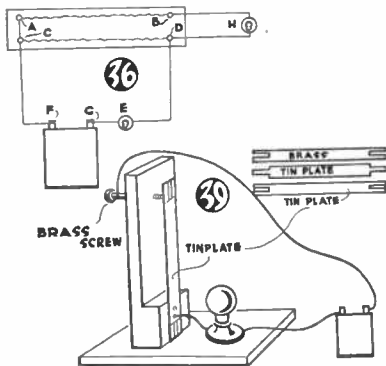
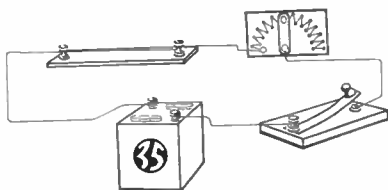

have a model electric fire with two elements. (CD) can be switched on at the skirting board and (AB) at the fire. You will see that the two elements are connected to the battery in parallel.

A MODEL THERMOSTAT

ATHERMOSTAT is an automatic switch which can be fitted in electric circuits when electricity is being used for heating purposes. When a certain temperature has been reached, the thermostat switches off the electric current and when the temperature falls it automatically switches on the current again.

Fig. 39 illustrates how one type of thermostat works. You must first of all make what is called a compound strip consisting of a strip of brass and a strip of tin plate. Fix these firmly together by binding over the ends as shown and hammering them quite flat. Fix this compound strip to a wooden stand with the brass strip towards the brass screw.

Adjust screw

The screw is adjusted so that it just touches the brass strip. (A) is a six volt-teny-four watt lamp connected in series with the compound strip and the brass screw. A small box with a tiny hole is placed over the apparatus and the current switched on. This represents a small electric heater in a room with a thermostat.

When the inside of the box becomes hot, the brass, which expands more rapidly than the iron, will bend the strip away from the brass screw contact and break the circuit. When the box cools, the strip comes back and closes the circuit again. In this way the temperature inside the box is kept steady.

You simply pour out these

NOVELTIES

with NEW LIQUID PLASTIC

Here's the hobby to make your spare time pay dividends. You simply choose your mould and pour out beautiful castings. We supply everything, including instructions. Wonderful results achieved — wonderfully quickly! Start right away — no training needed. Send 2½d. stamp for exciting book and market details. No obligation.

QUALITY PLASTICS LTD.

Dept. H26, Brentwood, Essex



WATCH AND CLOCK REPAIR OUTFIT



The complete Outfit for cleaning and repairing. Comprises: Illustrated explanatory booklet, eye-glass, tweezers, screwdrivers, oil, dusting powder, oilers, also illustrated catalogue, tools and materials.

Plus P. & P. 1/- extra. C.O.D. if required.

12/9

The above with additional luminous compounds, jewellers' rouge, dial brush, jewels.

21/-

Plus P. & P. 1/- extra. C.O.D. if required.

ASSEMBLE YOUR OWN JEWELLERY

Selection of unset earrings, pendants, rings, brooches and stones, etc. at fraction of cost.

Send S.A.E. now for big illustrated free catalogus.

Money back guarantee.

THE BOLSTER INSTRUMENT CO. (Dept. HB43)
GOVETT AVENUE, SHEPPERTON, MDDX.

Novel Gift

A 'PALETTE' TIMEPIECE

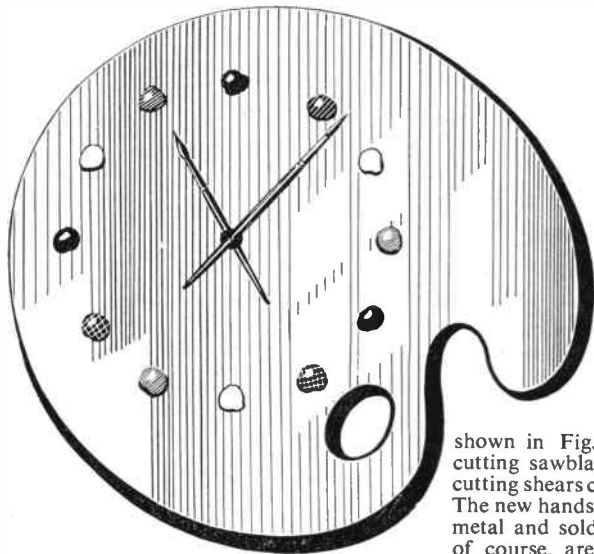

AN imitation artist's palette forms the basis of this unusual clock, which may be constructed in a few hours. You can use your fretsaw to make it up for the home or as a present.

Fig. 1 shows the palette and the squares which should be drawn out on paper. Make the squares 1 in. each and then sketch in the outline, completing one square at a time. Transfer the shape to $\frac{1}{4}$ in. plywood by means of carbon paper and then cut out with a fretsaw. Keep the saw upright in order to get a clean straight edge.

It will, no doubt, be possible to adapt an old clock to suit the face, but in any event you can obtain a suitable move-

ment from Hobbies Ltd., Dereham, Norfolk, price 24/11 post free. This is a first class eight-day movement, and is ideally suitable for the purpose.

The hands supplied are to be cut as shown in Fig. 2. A Hobbies metal cutting sawblade or a pair of metal cutting shears can be used for this job. The new hands are now cut from thin metal and soldered in place. Hands of course, are shaped to represent brushes, and can afterwards be painted to give a life-like appearance. The clock supplied by Hobbies Ltd., is extremely easy to fit. The knurled nut is removed and the threaded portion inserted through the hole in the palette. The nut is now screwed on again and tightened sufficiently to hold the movement in place.

If the clock is to stand on a cabinet or sideboard, a strut should be cut and fitted to the back. Owing to the rounded shape of the palette it will be necessary to fit a crosspiece on the strut. Fig. 3 indicates how this may be done.

To hang the clock on the wall fit two pieces of $\frac{1}{2}$ in. wood as shown in Fig. 4.

The clock face is given two or three coats of plastic enamel paint, allowed to dry and glasspapered smooth. A final coat of enamel will give a high gloss finish which can easily be kept clean.

The figures are represented by dabs of paint in various colours. (M.h.)

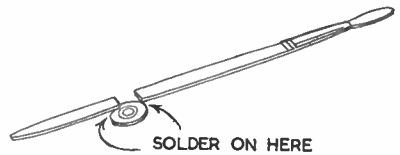

Fig. 2

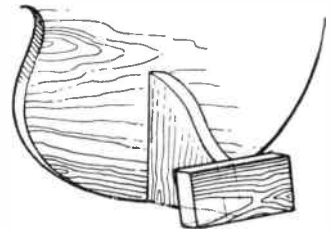

Fig. 3

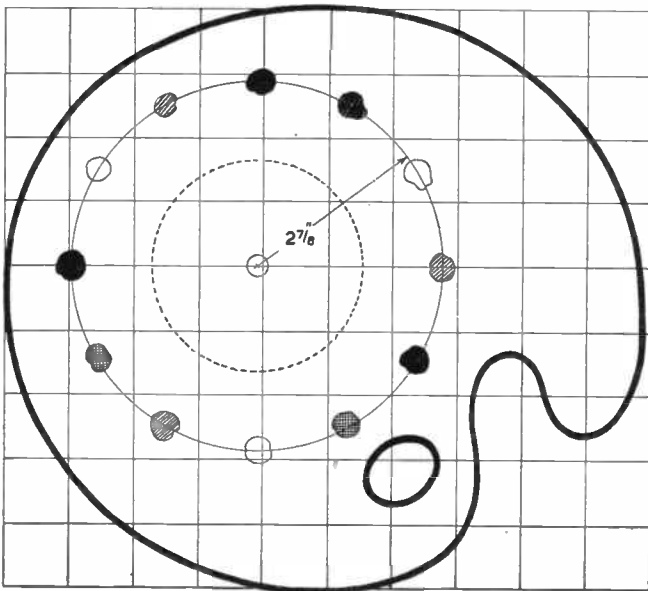

Fig. 1

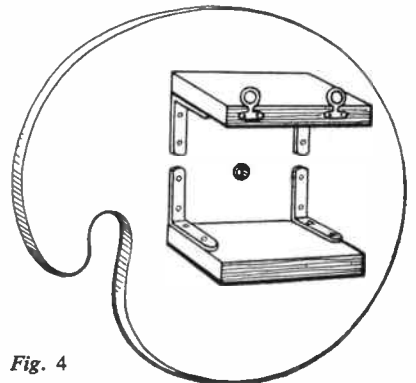

Fig. 4

When out for a stroll

Find Your Own Walking Sticks

A QUARTER of a century ago most men used a walking stick. They often kept a selection for different occasions. Sticks could be bought cheaply in the village stores, tobacconists, newsagents and at every holiday resort. In these days it is hard to find a shop which stocks them, now that cars are universal.

Much enjoyment can be experienced from making your own collection of walking sticks as well as finding and fashioning them for your friends.

Only certain woods are suitable. Basically, you must have a hard but supple wood which will not rot or crack with age and use. The 'common' walking stick is made from the ash, but thornwoods make excellent sticks, especially the hawthorn and the blackthorn. Holly is excellent; silver birch and laburnum will also do.

Study the trees

There are several illustrated nature books available which have coloured pictures of trees and their leaves. These can be seen at your public library; or if you wish to buy, your bookseller will help you and you will find there is a handy pocket-size book in the 'Observer's' series. Careful study of these books will suggest other trees having the right qualities for making walking sticks, as well as giving a guide to the definitely unsuitable woods.

You are now ready to take a walk or drive into the country to look for a straight young branch 3ft. or more long and about 1in. thick. This is not so easy at first, so note the sort of places in which these are likely to grow.

Hedges which have been well pruned usually produce the best blackthorns and hawthorns. Here branches spreading horizontally from the main stem will sprout up straight shoots. Bushy clumps of young shoots may be seen growing from a trunk lopped close to the ground. Straight holly shoots frequently grow from the base of old holly trees, particularly in thick woods; or a straight young branch will grow from the lower portion of the trunk. Ash trees are plentiful in the English hedges and should be cut when quite young. Ground ash may be found in a wood plantation and can be pulled up by the root.

Walk out prepared

There is a saying among countrymen 'When should a walking stick be cut?' and their answer is 'When you see it'. You may never pass the spot again, or the particular branch may be cut down

in the next hedging and ditching season. So take a good sharp knife and a small saw with you. The latter should be short and narrow, as it will have to be inserted into difficult positions between twigs and branches — it will also fit better into the pocket. A larger saw and a pair of secateurs will also be useful. Remember to cover the teeth of the saw if you travel in a public service vehicle.

Oldest clothes should be worn and leather gloves will prevent torn hands when cutting thorn hedges.

In winter the straight sticks can be seen through the hedges, although it is usually damp and cold. In early spring or late autumn respectively the leaves are either small or falling. Thorn sticks, especially, will have plenty of leafy twigs on them, and these should be cut off there and then with the secateurs or sharp knife. The notches left are no bar to the selection of the stick — in fact they give each one its individual character.

Before cutting the stick, make sure that it is straight by viewing it from as many angles as possible.

Bending the handle of a walking stick is often difficult. Ash bends fairly well, but holly must be done with care. The stick should be longer than required, say 5ft. The bending operation will be easier if the bend is made about 18ins. from the top. Soaking the stick overnight in the bath will also help to soften it. It is then put in a loose fitting pipe or tube and heated with steam from a kettle for at least half-an-hour.

The bending

The steaming completed, grip the top end of the stick in a vice — taking care not to strip the bark — and slowly bend it over. If it shows signs of splitting, stop and repeat the steaming process until the wood is finally pulpy enough to bend satisfactorily. Remember not to touch the wood with bare hands, as it will be boiling hot. The bent end is then firmly tied down with string and put away to set and season. After steaming, the bark is very soft and must be protected from the tight string by wrapping strips of cloth over it at these places.

The root of the ground ash forms its own characteristic handle, but holly or ash growing from the tree must be cut from the knob (where it branches from the trunk) which will make a fine handle. A thorn stick should be cut to include a portion of the branch from which it sprouts. This, when shaped, will make an excellent handle, but it should not be attempted until the wood is seasoned, or cracks may appear.

Each stick should now be laid flat on a mantelpiece or the attic rafters to dry out, when it will become hard and the crook of the handle will set. The string is taken off and the stick is ready for trimming or stripping its bark without fear of cracking. Any notches should be cut close in and smoothed off with a file. To shape the handle a model knife will be found useful.

Finishing

After any defects are filled in with plastic wood, the stick is smoothed with glasspaper. First tear off a strip of coarse paper and run it up and down the stick until the rougher edges have been removed; then repeat the action with fine glasspaper.

Do not remove the bark of a thorn stick. It will polish magnificently and give it character. Holly bark can be retained for its bright colours which a varnish will emphasise, or stripped to produce a clean white stick which will polish like ivory.

A fine clear varnish may be applied to the stick, two coats being given, allowing the first to dry before putting on the second. This will secure the bark to the wood and give it a professional finish.

All that remains now is to cut the stick to a length suitable to the person who is finally going to use it. If you are not sure, use an umbrella as a guide for length. A ferrule is finally hammered on to the tip and secured with a light nail. Make sure it is a good fit and you will have an article which you will be proud to carry for many years. (D.A.G.)

SECURING LOOSE

KNIFE HANDLES

DETACH the blade and thoroughly clean the metal stem. Next melt some powdered resin in a tin by holding it over a gas jet with a pair of pliers. At the same time heat the stem of the blade but keep it clean and not too hot, otherwise it will burn the handle. Pour the melted resin over the stem and press at once into the handle.

Knives so treated should be left a day or two to set.

When washing knives don't drop them carelessly into hot dish-water. Place the blades in a tin pot of hot water, so that the knife blades only are immersed, which should then be washed without wetting the handles. To polish the knives you will find charcoal powder a splendid medium. (R.L.C.)

WASTE PAPER BASKET

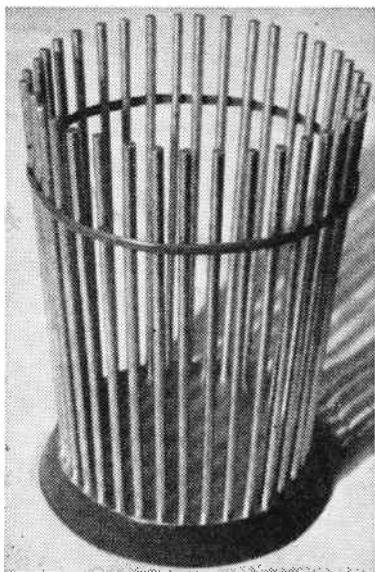

ANYTHING that is both useful and decorative is most welcome in any home. Even such a mundane article as a waste paper basket can look very presentable if it is designed and finished with discretion.

Here is one intended for use in a lounge.

First, item 1 is made from thick card or tough veneer (see illustration showing arrangement of basket). As this forms the outside rim of a circular base

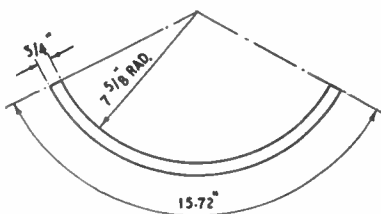

DETAIL OF ITEM 1.

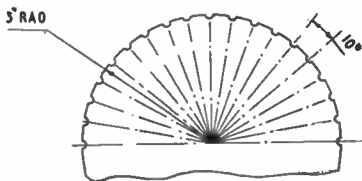

DETAIL OF ITEM 6.

it will have a special shape or development when it is first cut out. This shape is shown in the detail of item 1. It is drawn with the aid of compasses directly on to the card or very thin sheet wood. The dimension of 15.72 ins. is measured round the outer curve with a piece of wire or string of this length.

In case there is any difficulty in obtaining a measurement of exactly 15.72 ins., measure off 15 and seven-tenths inches and then slightly exceed to under the next tenth of an inch. An alternative method would be to cut out item 1 from an outer arc measuring 16 ins. and apply to item 2, cutting off any overlap.

When the shape has been cut out it is bent into a circle and the ends are butt joined by gluing a 1 in. by 3/4 in. strap of card on the inside face of the ring equidistant about the joint.

While this is drying item 2 is made. This is a circular piece of similar card or veneer 4 3/8 ins. in diameter. When it is being drawn out it is important that the centre (compass point) is clearly marked for it will be required later. Holes 3/8 in. diameter are marked out 1/4 in. from the edge and spaced 10 degrees apart making thirty-six in all. If a protractor is not available for the latter operation the holes will have to be spaced out accurately with the compasses.

Razor Blade

The holes are cut out neatly with the point of a broken razor blade or a suitable cutting tool. Then the whole item is cut out with a blade keeping right on the line but tilting the blade slightly inwards.

This provides a slight chamfer on the edge which is necessary to provide a neat seating for the item inside the top of the ring (item 1).

The latter is inverted over a level surface and item 2 is pressed into place inside, after having applied cement all round the edges. Any surplus glue is removed when the item is perfectly level with the top edge of the outer ring.

When dry, the unit is glued to the base ring (item 3), which is a piece of very tough board or thin ply. This is 5 3/8 ins. diameter with a hole 3 3/8 ins. diameter cut in the centre. However, it is best to glue the unit (items 1 and 2) to a piece of board with only the centre hole cut in it. Then the surplus can be cut

away at the correct angle so that the finished base ring will be in proper alignment with the sloping sides of the whole base. The base is then finished with fine grade glasspaper.

Before the dowels (item 4) can be fixed in the base in correct relation to

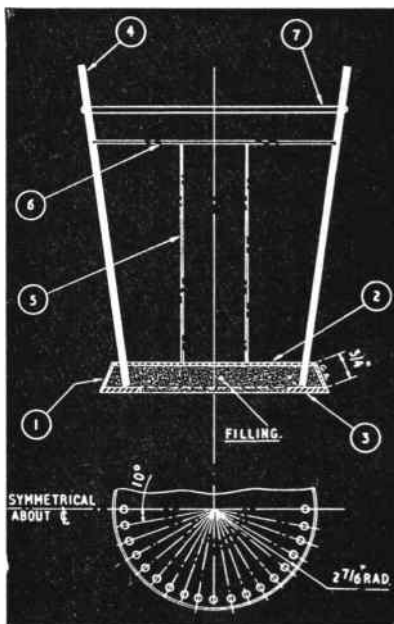

one another it is necessary to fix up a temporary jig which will ensure reasonably accurate positioning. This is shown in the photograph with two dowels in position.

Tacked

It consists of a cardboard angle 1 1/2 ins. by 1 1/2 ins. by 5 3/8 ins. (item 5) and a card disc with slots round the edge (item 6) which is glued to item 5. The angle is made from one piece of card 5 3/8 ins. long and 3 ins. wide which is scored down the middle. Each side is then bent over at right angles and glue is applied to the bend. When set hard the angle is tacked with one or two blobs of glue to the top of the base, with the corner of the angle directly over the centre mark of item 2 on the base.

Item 6 is then glued to the top of the angle with its centre directly over the corner of the angle. This item, incidentally, is marked out like item 2 except that semi circles are cut round the edge of the 6 ins. diameter card.

The dowels can then be fitted. Each

● Continued on page 106



The jig



NEW ISSUES FROM MALTA By R. Cantwell

MALTA's latest postage stamps contain some interesting pictorial designs. In 1565 the might of the Turkish Empire was destroyed in Malta by the Knights of St. John and the Maltese. This was, perhaps, the greatest triumph of Christendom over Islam.

The monument which stands to commemorate the Great Siege of 1565 is depicted on the ½d. value. The statues are of bronze and about 8ft. tall. They

first building to be erected was the small church of 'Our Lady of the Victory', in 1566, in which the old Grand master used to pray and rest from his long and wearisome inspections.

The Victory Church appears on the 1d. stamp. Malta's 'War Memorial', the equivalent of London's Cenotaph, is pictured on the 1½d. value. The Church of Mosta (a Maltese village) is a replica in larger dimensions of the Pantheon where Italian Royalty lies buried. The

'Les Garroches' (1/6 stamp) a bronze statue by Professor Anthony Sciortino depicts three children in the rebel mass of the French revolution.

'The Monument of Christ the King' (2/- stamp) also of bronze, by Professor Sciortino, commemorates the great Eucharistic Congress of 1913. Grand Master Nicholas Cottoner's monument stands in St. John's Co-Cathedral (2/6 stamp). He ruled the order from 1663 to 1680 and died at the age of 70.

These pictorials are worth securing at new-issue rates. But obtain them now and in used condition. They are of great historic interest and will probably increase in value.

And by the way, the 3d. Royal Visit stamp of 1954 contains a picture of St. John's Co-Cathedral.



● Continued from page 105

Waste Paper Basket

of the thirty-six dowels is 8ins. long. They are cut, and trimmed square, from 3ft. lengths of $\frac{3}{8}$ in. diameter birch dowels obtainable from all hobbies stores. They are all fitted into the holes in the base with glue applied from the underside round all the holes and where the ends of the dowels meet the base ring (item 3). Care must be taken to ensure that the dowels are not too tight a fit in the holes. They should fit in easily with the sides of the dowels resting lightly against the corresponding notches in item 6 of the jig.

When everything has set the jig can be removed. To provide stability to the basket the base should be filled with either plaster of paris or Alabastine. The latter is recommended since it expands slightly on drying and aids rigidity. It should be applied in a very thick state and levelled off flush with the base with a piece of card.

Enamel

The base and dowels may be enamelled if desired, or just the base can be finished leaving the dowels in their natural state. In the original the top of the base and the dowels are gilt enamelled and the edge round the base is enamelled dark blue. To match the latter, a piece of half round plastic lacing, $\frac{3}{8}$ in. wide, obtainable at good craft stores, is fixed with Durofix round the basket 1½ins. from the top. (G.A.)

were made by the Maltese sculptor Professor Anthony Sciortino about 25 years ago.

In 1615, Grand Master Alofius de Wignacourt decided to supply Valletta with running water. He accordingly built an aqueduct running from Rabat to Valletta and, for the convenience of travellers, had horsetroughs constructed at various intervals along the aqueduct. The horse trough shown on the ½d. stamp is situated at Floriana — just outside Valletta.

The city of Valletta derives its name from 'Grand Master La Valette' who planned the city as a fortress against another Turkish invasion. Anxious to watch the growth of his city, La Valette spent long hours inspecting the works and encouraging the workmen. The

world's largest dome is that of St. Peter's in Rome. Second is St. Paul's, London; and third largest is 'Mosta Dome' — shown on the 2d. stamp.

The Order of Knights of St. John was composed of noblemen from all over Europe. Thus it was a cosmopolitan order and each language had its own auberge as a meeting place for the knights. 'The Auberge de Castille' (2½d. stamp) belonged to the Castilian knights and it is the largest and finest of all auberges. At present it houses the G.H.Q., Malta.

'The Neolithic Temples at Tarxien' (6d. stamp) are prehistoric and of great archaeological value. 'M'dina Gate' (1/- stamp) is several hundred years old. It is the entrance to the old city of M'dina.

Make no mistake about it

When it's a wood gluing job, there's only one way to get really first class results—use a glue manufactured specifically for use with wood. And for this type of gluing, CASCAMITE "One Shot" Resin Glue is unsurpassed both in performance and in its simplicity of use. Supplied in powder form, this resin glue is easily mixed in cold water, is used cold, and is unique in that it requires *no hardener additions*—the hardening agent is incorporated in the powder during manufacture. The glue is gap-filling (to the British Standard Specification requirement), is non-staining and makes joints which, in addition to having tremendous strength, are water-proof and heat and mould-resistant.

Available from ironmongers, hobbies shops, builders' merchants, etc., in 3½-oz., 7-oz. and 18-oz. tins (prices 2/6d., 4/- and 7/6d. respectively).

. . . for wood gluing, choose CASCAMITE "One Shot"

One of the range of



SYNTHETIC RESIN AND CASEIN GLUES

Manufactured by: LEICESTER, LOVELL & CO. LTD. NORTH BADDESLEY, SOUTHAMPTON



Remember, too . . .

When you want a good general-purpose glue, be sure to choose CASCO Grade "A" Powdered Casein Glue. It is mixed and used cold, heat and moisture resistant, very economical in use (1-oz. of powder makes 3-oz. of liquid glue) and will glue a wide variety of materials. Packed in 2½, 7½ & 16-oz. tins (1/9, 4/3 & 7/6 respectively). Ask your local stockist for free descriptive leaflet.

CASCO GLUES
are recommended for
"Build-it-Yourself"

with **Easi-Bild** Patterns



Look Chaps
See the snaps I've printed!

You, too, can print copies of your own snap-shots at home. It's not at all difficult. With the Johnson Print-a-Snap pack you make extra prints of the family's favourite pictures in a single evening. Any dimly-lit room will do to work in.

PRINT-A-SNAP PACK

Look what you get for only 3/6: Printing paper to make either 16 2½ x 3¼ in. or 24 2½ x 2¼ in. prints, developer, fixer, simple printing frame, full instructions and a wallet to keep your prints in. Make this your first step in the fascinating hobby of photography.

At your photo dealers

3/6

JOHNSONS OF HENDON LTD.

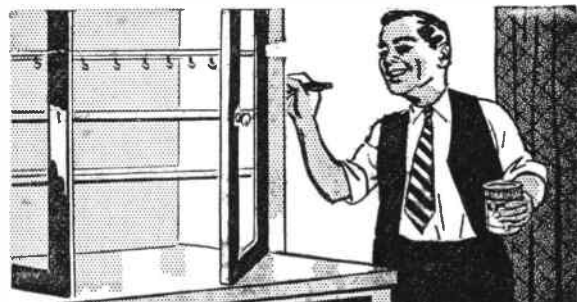

Leaves no Brushmarks!

Here is a paint that provides a smooth professional finish at the touch of a brush, an easy to use quick-drying finish that covers perfectly in one coat and leaves no brushmarks. Just ask for Robbialac Lacquer, the gloss finish that is available in 24 brilliant colours plus black, white and silver and which provides a hard wearing surface that resists weather, water, steam and chemical atmosphere. Robbialac Lacquer comes in handy ½, 1, 2 and 1 pint tins and is sold by all good paint shops, cycle shops, ironmongers and hardware dealers.

ROBBIALAC LACQUER 2-4 HOURS DRY

FREE: Put a 'factory finish' on your handiwork. For free Instructional Leaflet send 2d. stamp to: Dept. 6L11

JENSON & NICHOLSON LTD., CARPENTERS ROAD, LONDON, E.15

FINDING THE GOOD SPOTS

STUDY your water. If you do, you'll get better sport. If you won't take the trouble, yours is the loss. It is obvious that one of the first things the angler should learn is something about the river or lake or other water that he intends to fish — where to look for the finny tenants in it. Finding the good spots goes a long way to filling the creel or the keep-net, as the case may be. It is just as important for the humble seeker of roach, bream, tench or dace to know his water as it is for the salmon-fisher and the troutist.

By fishing a trout water of medium size more or less regularly, experience teaches you that under the willow where the bank curves sharply is a 'pocket' that holds a trout for a certainty; there, under that overhanging bush is a good 'lie'; behind that rock on which the dipper or water ouzel loves to perch is a 'taking place'. Where a small rivulet flows in at the horseshoe bend the action of the water has scooped out a deep hole — here, if you catch a big trout today, another fish has taken its place by the morrow, and you know that when all other spots fail, there is a chance of 'breaking your duck' at this spot.

Gifted instinct

You may have what has been referred to as the 'angler's eye' and possess the gifted instinct for picking out all the promising spots, yet, generally speaking, one has to learn much by actual observation and experience to acquire a full revelation of a river's possibilities.

It is the first-hand knowledge of a stream and its peculiarities, and the feeding habits of its tenants under different conditions, that is so helpful to an angler in getting better sport. Rivers differ in characteristics; no two are quite alike; indeed, almost every stretch of water has its own moods and secrets which affect the fish one way or another. There are 'holts', 'pools', 'lay-ups' and feeding spots in a stream superior to others. Why, it is often difficult to judge. The more you learn, the more sport you get. The knowing angler, who with patience and perseverance has studied his favourite water in all its changes and moods, will decide instantly just where to cast his fly or bait.

If you could draw a map of the bed of river or beck, you would, doubtless, be much surprised at the numerous variations — dips, depressions, deep holes, 'pockets', shallows, sandy places. Some streams are very uneven on the bottom, with sudden dips and deep holes to trap

an unwary wading angler. Many rivers and brooks flow over beds varying in character — gravel, rocks, mud, slabs of loose stone, sand, etc. It may readily be recognised that in such a water there are places which attract the fish of various species more than others. Having gained this knowledge by experience and observation, the angler can exploit his craft to good purpose.

To know the bed of a river well is an immense advantage — for one thing, not unimportant, the risks of wading are lessened. One may add a few words of advice regarding wading a stream — always advance with caution, slowly moving one foot to get a grip of the bed before lifting the other foot — never hurry. The more careful your movements the less disturbance you make, and so less liable to disturb the trout. A landing-net handle with an iron-shod butt can be helpful in feeling one's way among rocks and stones under water; or it can be used as a stay when wading strong currents.

Experience is a good school. In angling for salmon and trout — and all other fishes — you can't learn too much. Once you have discovered the best spots in a river, the likeliest 'lies' where the bigger ones lurk, and the correct ways to fish difficult places, you are well on the road to enjoying better sport.

On salmon waters, especially, it is needful to know the likely 'holds' and the best places in the pools. An angler may waste the greater part of his efforts flogging a worthless pitch, whereas a little knowledge of the right spots will put him in a position to make the most of his fishing. Not only is it advisable to learn the characteristics of the pool, but often there is a right and a wrong way in fishing each particular pool. Only by persistent observation will a salmon or trout water reveal its many hidden secrets; but, in due time, you learn where the best fish usually lie under different conditions of water as it varies in height and pace, and, in addition, you become acquainted with any feature peculiar to the stream you fish.

Diary helpful

I keep a diary, often jotting down rough notes at the waterside, and enlarging upon them in a book at home whilst memory is fresh. I find these notes most helpful. Colour and depth of water; estimated pace of current; state of weather, cloudy, dull, sunny, cool, warm; direction and force of wind, light easterly, strong westerly, and so on; and if possible, temperature of water.

I specially note down the spots where fish have been caught, bait, pattern of fly, etc. Now, after some years of diary-keeping, I know to a nicety just where I am likely to catch fish under varying conditions of water, weather, and other factors. Glancing through the pages of my diary I find that in spring I catch most trout in certain parts of the stream at my disposal, whilst in summer I have done better in other lengths. Then I note there are spots that fish well all through the season, whatever the condition of the water, providing it is in fishing ply. One pool under a high bank — a deepish pool into which a small tributary flows at the head of a sharp elbow in the stream at this point — is invariably a good 'stand-by'. Frequently, when all other spots have failed to produce a fish, this supplies the wherewithal that prevents me returning home 'water-licked'.

(A.S.)

SAFETY CORK FOR HOME MADE WINES

THERE is always the chance of a bottle of corked home-made wine bursting its bottle, and, to avoid this risk, here is a useful method of fixing a 'safety cork'.

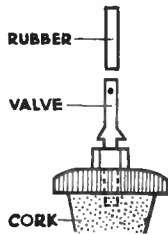

Obtain a cork possessing a hard wax top. As you know, these are frequently used in the bottles of prepared fruit drinks one can buy now-a-days. Having obtained your cork, drill a $\frac{1}{8}$ in. hole through its centre. Do not attempt to burn the hole through, as, of course, the burnt cork will flavour the wine.

Now obtain a cycle inner tube valve and screw this into the hole in the top of the cork. Screw it until the thread just disappears. Now carefully melt the wax around the point of entry of the valve. This is best done with a taper. This melting of the wax will seal the cork, and as soon as the wax hardens, fit a piece of rubber valve tubing on the valve.

You will now have a perfectly good 'safety cork' for your fermenting wine.

A really superior finish!
... FOR 101 JOBS

Easy to apply and quick to dry, these inexpensive lacquers have many uses. They will impart a rich and lustrous finish to models, picture frames, lamp standards, wicker chairs, work baskets, those unsightly water or gas pipes, etc. Fine for dance shoes too!

Be sure to ask by name for
CROWN SILVER LACQUER
AND
GUINEA GOLD LACQUER



Obtainable only from

WOOLWORTHS

NEW!

THE PRACTICAL WAY
of learning **RADIO**
TELEVISION · ELECTRONICS

- Beginners Radio Course
- Advanced Radio
- Short Wave Technique
- Lesson Manuals

Experimental work includes construction of Basic Oscillators, Amplifiers, Deflectors, Power Units, 1, 2 and Multivalve TRF and Superhet receivers.



COMPLETE EXPERIMENTAL COURSES IN RADIO ENGINEERING and SERVICING

An entirely new series of courses designed to teach Radio, Television and Electronics more quickly and thoroughly than any other method. Specially prepared sets of radio parts are supplied and with these we teach you, in your own home, the working of fundamental electronic circuits and bring you easily to the point when you can construct and service radio receivers, etc. Whether you are a student for an examination; starting a new hobby; intent upon a career in industry; or running your own business — these Practical Courses are ideal and may be yours at very moderate cost. With these outfits, which you receive upon enrolment and which remain your property, you are instructed how to build basic Electronic Circuits (Amplifiers, Oscillators, Power Units, etc.) leading to designing, testing and servicing of complete Radio and Television Receivers.

COURSES FROM 15/- PER MONTH

POST THIS COUPON TODAY

To E.M.I. Institutes,
Dept. 31, Grove Park Road, London, W.4.
Please send me your FREE book on Practical Courses

NAME

ADDRESS

7 Nov. IC74

EMI INSTITUTEs

associated with
"His Master's Voice,"
Marconiophone,
Columbia, etc.



Saves you £'s

VALSPAR

2-4 HOUR LACQUER

VARNISH · WOOD STAIN

Paint, Stain or Varnish whitewood furniture with Valspar which produces a brilliant, smooth finish — proof against boiling water, alcohol, petrol, oil and grease.

No knotting, priming or undercoating required — easily applied coat-over-coat. Dries in 2-4 hours.

Fill in coupon below for full details of the Valspar range



GOODLASS, WALL & CO., LTD. 179/185 (D)1 Great Portland Street, London, W.1

Please send me a free copy of the Valspar Handbook giving full details of all Valspar Paints.

NAME _____
BLOCK CAPITALS

ADDRESS _____

Dress in a 'near to life' Davy Crockett Hat, Jacket, Leg Dress, all with

BOYS! Be a real DAVY CROCKETT

COMPLETE 4-PIECE OUTFIT
*NO DEPOSIT!
includes FREE HAT



fringes, and an adjustable belt. Our special secret-waterproofed material to withstand Prairie storms. Hat is real Fur Fabric. Just send 2/6 for post & pack. If satis. S monthly pays, 4/6. Cash 19/11 complete. Ages 4 to 9 and 10 to 13. STATE AGE DAVY CROCKETT TENTS 21/-, post. etc. 1/6. LISTS, TERMS.

WRIST WATCHES

CASH
59/6
REAL GOLD PLATED
FRONT AND BACK
NO DEPOSIT
LADIES OR GENTS MODELS



'AIRCRAFT' shock resisting wrist watch. Fitted accurately tested pin-lever movement. Written guar. Cases are REAL GOLD PLATED all over, dials are silvered with gilt raised figs. and hands. Send only 2/6 for packing & registration, bal. 18 fortnightly pays. 3/8. CASH, on strap, 59/6 or LADIES' MODEL 10/- extra. Matching bracelet 12/6 extra. Luminous 6/6 extra. Lists, Watches, etc., Terms. Headquarter & General Supplies Ltd. (HOBW/32), 196-200 Coldharbour Lane Loughboro Junc., London, S.E.5 Open Sat.

MODERNISE YOUR HOME WITH ARNOBOARD

Send 1/6 for R. W. D. Kirkham's comprehensive illustrated book which shows you how; and FREE SAMPLE of Arnoboard, the prefinished plastic surfaced hardboard which works like ordinary hardboard. Finishes include wood grain, tile, marble effects, etc.

Dept. 3. Arnolite Ltd, West Parade, Spring Bank, HULL

GOVERNMENT SURPLUS BARGAINS. Inter-micro Telephones, comprising 2 self-energised microphone/receivers and approx. 6yds. flex (may be extended if desired). No Batteries needed. Nothing to wear out. Complete 9/6, post 6d. Motors, Transformers, Switches, etc. 3d. stamps for illustrated list. Milligan's, 24 Harford Street, Liverpool, 3. Money Back Guarantee.

LEARN it as you do it — we provide practical equipment combined with instruction in Radio, Television, Electricity, Mechanics, Chemistry, Photography, etc. — Write for full details to E.M.I. Institutes, Dept. HW47, London, W.4.

REEVES PARCELS of plywood are here again. Do it yourself with our well known handy sized panels (various thicknesses) mostly Gaboon and Birch. Quality as good as ever. Parcels in 20/- and 15/- sizes. Send cash for prompt delivery to — Reeves, 33 Front Street, Monkseaton, Whitley Bay.

MODELS. You can make lasting stone-hard models with Sankey's Pyruma Plastic Cement. Supplied in tins by Ironmongers, Hardwaremen and Builders' Merchants. Ask for instruction leaflet.

'PAINTSPRAYING' HANDBOOK. Covers Car, Industrial & Flock Spraying. 3/6, post 4d. Catalogue of our Cellulose and Paints and all Allied Sundries 2/6.—Leonard Brooks Ltd., 81 Oak Road, Harold Wood, Essex.

SWISS MUSICAL MOVEMENTS. Before you buy send 2d. stamp for our illustrated brochure. —Metwood Accessories (Dept. HW), Church St., Wolverton, Bucks. (Trade enquiries invited.)

GENUINE Swiss Musical Movements. The best and largest selection of tunes in the country, lowest prices 16/3 each. Genuine Thorens Movements, 22/9 each. All guaranteed. P & P. 9d. extra on all orders.—Richardson & Forder, HW, 5 Chapel Place, White Hart Lane, London, N.17.

EVERY CAR THAT PASSES—YOU WILL FIND THE INDEX MARK ALPHABETICALLY ARRANGED IN WHERE'S THAT CAR FROM?

Price 9d.

from all Booksellers or from the Publishers
(2d postage)
RALEIGH PRESS, EXMOUTH

HOBBIES BRANCHES

LONDON

78a New Oxford Street, W.C.1
(Phone MUSEum 2975)
87 Old Broad Street, E.C.2
(LONDON Wall 4375)
81 Streatham Hill, S.W.2
(TULse Hill 8796)

GLASGOW—326 Argyle street
(Phone CENTral 5042)

MANCHESTER—10 Piccadilly
(Phone CENTral 1787)

BIRMINGHAM—100a Dale End
SHEFFIELD—4 St. Paul's Parade
(Phone 26071)

LEEDS—10 Queen Victoria Street
(Phone 28639)

HULL—10 Paragon Square
(Phone 32959)

SOUTHAMPTON—134 High St.
(Below Bar)

BRISTOL—30 Narrow Wine Street
(Phone 23744)

100 DIFFERENT stamps free! Request ½d. upwards discount approvals. — Bush, 53 Newlyn Way, Parkstone, Dorset.

WHEELS (Hardwood and Rubber Tyred Metal). Cot, Pram and Doll's House Fittings and Papers. Beads, Transfers, Prints and other accessories. Stamp for new lists. (Trade supplied.) New address — JOYDEN CO., 91 Peplins Way, Brookmans Park, Herts.

SWITZERLAND 1956 Publicity Set — Beautiful colouring. Interesting pictures. Free to approval applicants enclosing postage. — Yulwontor Stamps (Dept. H5), 29 Layton Avenue, Mansfield.

STAMPS — Whole World discount approvals, Pictorials, Commemoratives, etc. Bargains, Postage 2½d. to — G. Morris, Vallemount, Southway, Crownhill, Plymouth.

ORNAMENTS, Brooches, Ashtrays, 'Lady', 'Tramp', etc. 6d. to 3/- each. 10% discount in Nov. Numerous colour schemes. Write list — D. Chaplin, 26 Cambridge Drive, Lee, London, S.E.12.

STOP SMOKING in 3 days or money back. Safe, pleasant, permanent. The only scientific way. No Will Power necessary. 'Conquered the habit in 2½ days'.—F.C. 'Within 2 days I was free from the tobacco habit'.—W.G. 'Was a smoker for 2 years and broke the habit in 2 days'.—F.N. 'I used to smoke 20 a day . . . now I have no desire to smoke'.—J.M. Recommended by 'Health and Efficiency Magazine'. Complete course 6/6 (or \$1.00 bill). Details 2d. stamp. Sent under plain cover. NATURE REMEDIES, 28 (H/161) Dean Road, London, N.W.2. Established 1928

AMERICAN PUBLICATIONS. 'How to plan a Home Workshop', 'Toys', '19 Charming Chairs', 'Furniture Designs', 'Novelties', 'Small Furniture Designs', '40 Fine Tables', 'Toys, Games & Playground Equipment', Complete set of 8 books 15/6 inc. postage. Send for complete catalogue. — Willen Ltd. (Dept. 57), 9 Drapers' Gardens, London, E.C.2.

MAGIC catalogue. T. and Donkey Puzzle 1/-.—DeHempsey, 363 Sandycombe, K.w, Surrey.

STAMPS FREE — Empire Packet including Pictorials and Victorians with approvals.—Robert J. Peck 7A Kemp Road, Bournemouth.

100 EMPIRE STAMPS 5/-, 100 Free French 3/-. 100 stamps free to all requesting my approvals supplies at Home or Overseas. — E. F. C. Townsend, 11 Avebury Road, Penthill, Swindon, Wilts.

KUKLOS ANNUAL. Indispensable cyclist's handbook. Tours, resthouses, money-saving hints, 2/10, post free. — Burrow, Publishers, 2 Imperial House, Cheltenham.

HOW TO STOP SMOKING

and permanently overcome that ceaseless craving for tobacco. Save money, safeguard health. Send stamp for details of the world-famous inexpensive Stanley Treatment for tobacco habit

THE STANLEY INSTITUTE LTD (Dept 30)
12 Bridewell Place, London E.C.4

HEAR ALL CONTINENTS With H.A.C. Short-Wave Receivers

Suppliers for over 18 years of Radio S-W Receivers of quality.

One-Valve Kit, Price 25/- Two-Valve Kit, Price 50/- Improved designs with Denco coils. All kits complete with all components, accessories and full instructions. Before ordering, call and inspect a demonstration receiver, or send stamped addressed envelope for descriptive catalogue.

'H.A.C.' Short-Wave Products (Dept. 22), 11 Old Bond Street, London, W.1

MAKE A RADIO

NO SOLDERING—only a screwdriver and pliers required. Success guaranteed. WINNER crystal set, 12/6 post free. CONQUEROR I-valve set, 22/6 post free, valve and batteries 15/6 extra.

BUILDING INSTRUCTIONS for 10 different sets, 3/6 post free

Send P.O. 3/6, 12/6, 22/6 or 38/- to:—

BLANCHARD'S RADIO

(Dept. H4), 13 GAINFORD GARDENS, MANCHESTER, 10

ROCKING DUCK SWEET PACK

**USE YOUR
FRET SAW**

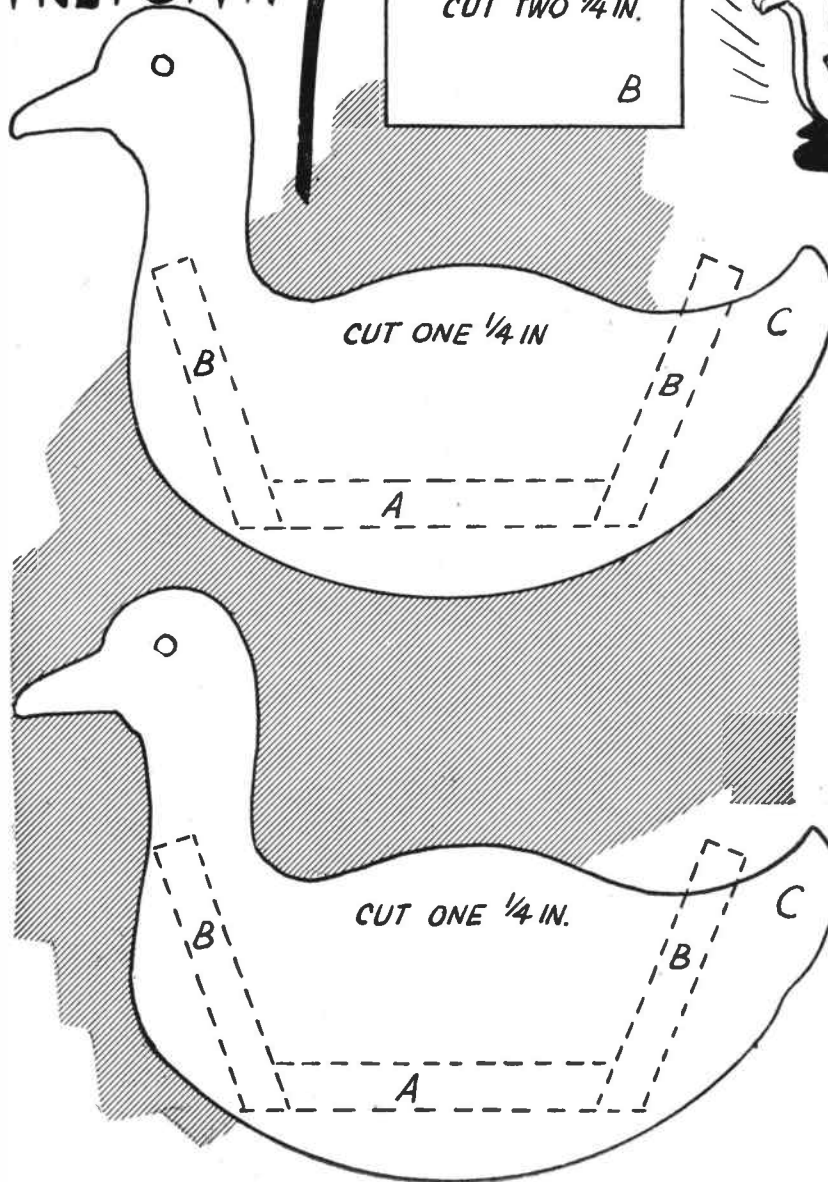
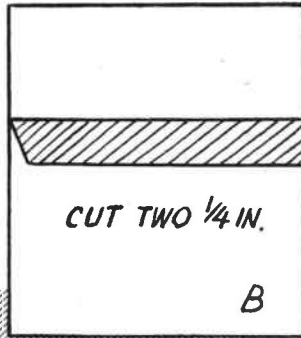

FOR A CHILD'S STOCKING

CUT the duck shapes from $\frac{1}{4}$ in. plywood and paint the edges. While these are drying cut out the pieces (B) and (A), afterwards shaping the edges to conform to the shaded sections.

Glue the pieces together as shown by the dotted lines on pieces (C) and once more paint the edges of the plywood. Clean up with glasspaper and give the whole assembly two coats of red or yellow paint.

The container should be filled with toffees or liquorice allsorts and the gift wrapped in transparent film which can be purchased from stationers and stores.

If several of these are to be made they can be produced quickly if three pieces of $\frac{1}{4}$ in. wood are pinned together and three of each shape cut at once. (M.p.)

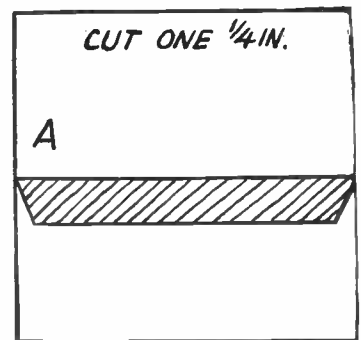

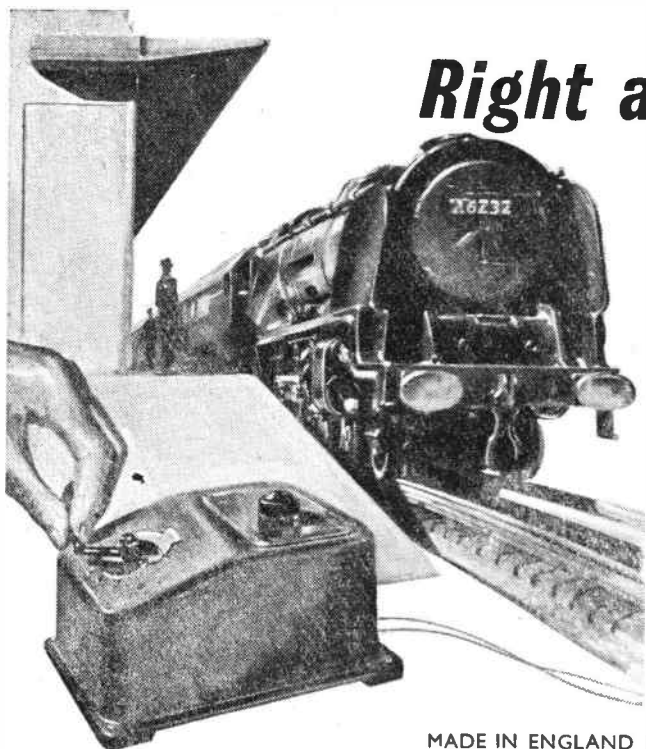

Right away!



Have you seen how these Hornby-Dublo engines pull really long trains at speed? Have you seen the realistic stations and level-crossings, bridges and goods vehicles, signals and station staff? Any Hornby-Dublo railway, large or small, is easy to work and perfectly reliable. See Hornby-Dublo—right away at your local dealer's or at the Model Railway Hobby Show

**Stand No. 4 Central Hall
Westminster · London · S·W·1**

MADE IN ENGLAND BY MECCANO LIMITED, BINNS ROAD, LIVERPOOL 13

Make it or Mend it — you can't go wrong!



MAKE MODELS

Rawlplug Plastic Wood is of enormous help in modelling. Intricate shapes and curves become easy. You apply it like putty; when dry it's wood—can be sawn, planed, or polished.

**RAWLPLUG
PLASTIC WOOD**
Tubes 1/- Tins from 2/3



MEND MODELS

Durofix is a strong, colourless adhesive that sticks almost anything to anything with a practically invisible join. Being heat-proof and waterproof, Durofix is ideal for repairing crockery, china and glass.

RAWLPLUG DUROFIX
Tubes from 9d Tins from 2/9

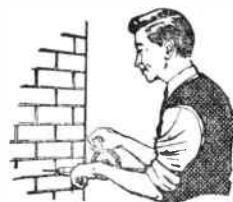

DRILL BRICK

You'll drill brick, tile, cement, etc., with astonishing ease and speed by using a Rawlplug Durium-tipped Drill. Can be used in hand or suitable electric drills.

**RAWLPLUG DURIUM-
tipped DRILLS**

8521 FROM YOUR IRONMONGER OR HARDWARE STORE
THE RAWLPLUG COMPANY LIMITED · LONDON · S.W.7

Printed by BALDING & MANSELL, LTD., London and Wisbech, and Published for the Proprietors, HOBBIES LTD., by HORACE MARSHALL & SON, LTD., Temple House, Tallis Street E.C.4. Sole Agents for Australia and New Zealand: Gordon & Gotch (A'sia) Ltd. For South Africa: Central News Agency Ltd. Registered for transmission by Canadian Magazine Post.

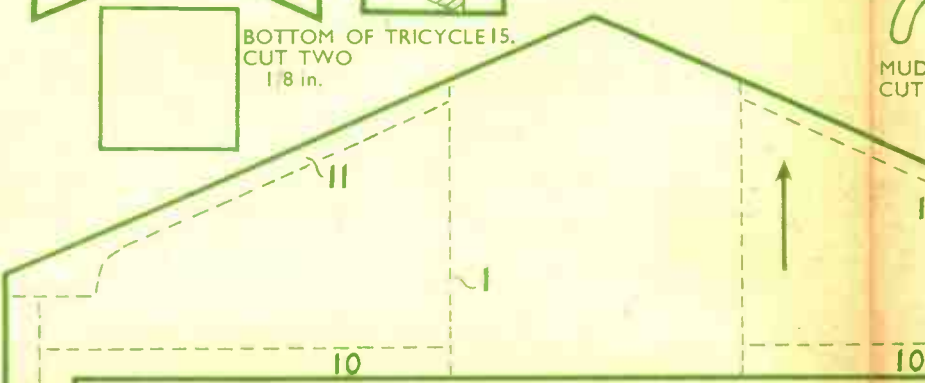
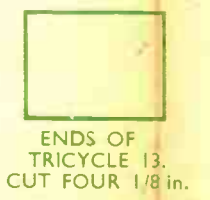
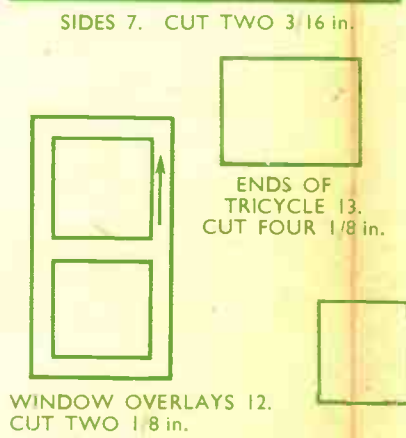
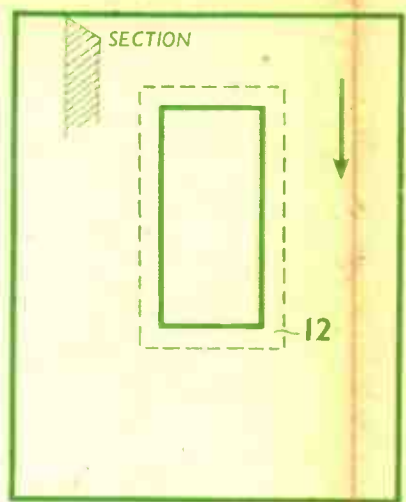
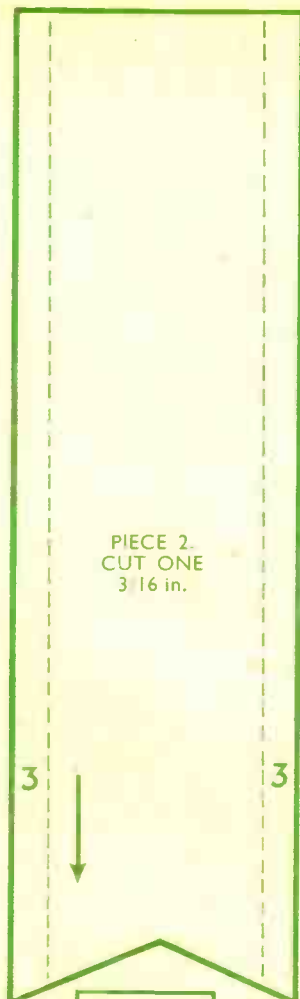
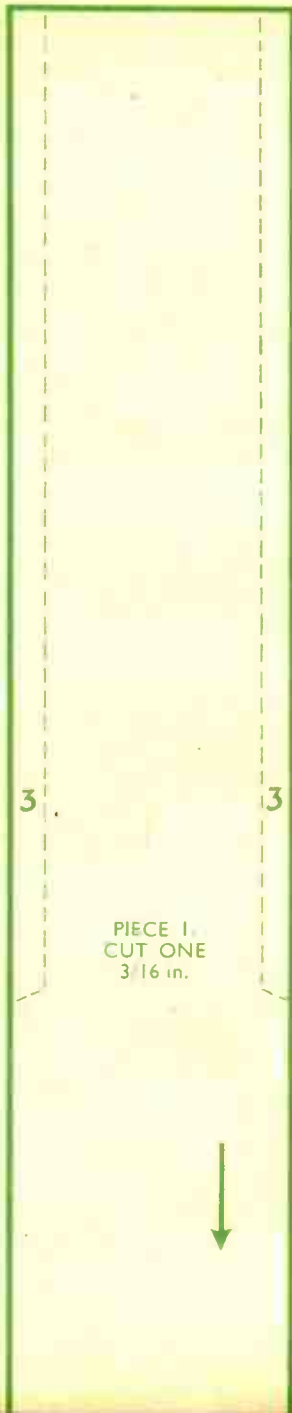

Hobbies

DESIGN

No.
3184

SIZE—10 ins.
HIGH.
6½ ins.
WIDE.

WEATHER HOUSE AND THERMOMETER

WEATHER

CUT OUT AND PASTE TO PIECE 6.

HOUSE

CUT OUT AND PASTE TO PIECE 6.

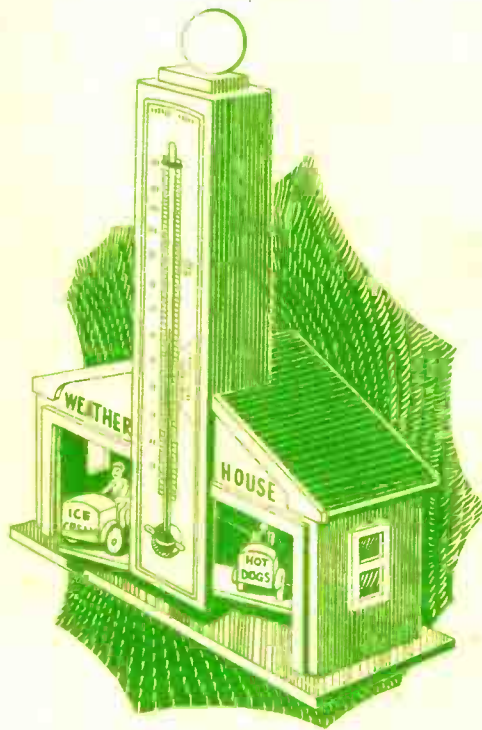

SIDES OF
TRICYCLE 14.
CUT FOUR
1/8 in.



TOP OF
TRICYCLE 16.
CUT TWO
1/8 in.



PIECE 19.
CUT TWO
1/8 in.



PIECES 20. CUT
FOUR 1/8 in.

A KIT OF MATERIALS FOR MAKING
THIS DESIGN IS SUPPLIED BY
HOBBIES LIMITED,
DEREHAM, NORFOLK.
PRICE ON APPLICATION.

The Sparking Enamel
PAINT IN TUBES

PER TUBE

World Radio Supply

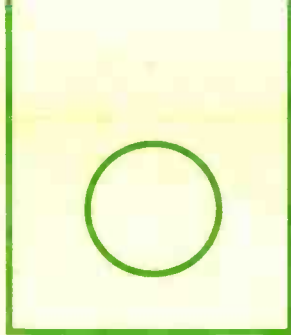

BACK AND FRONT 6.
CUT ONE OF EACH $\frac{3}{16}$ in.

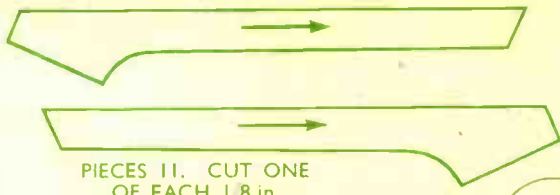

PIECES 11. CUT ONE OF EACH $\frac{1}{8}$ in.

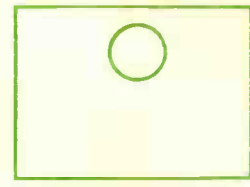

PIECE 5. CUT ONE $\frac{3}{16}$ in.

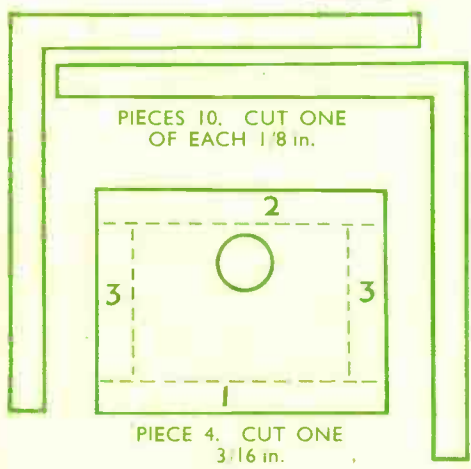
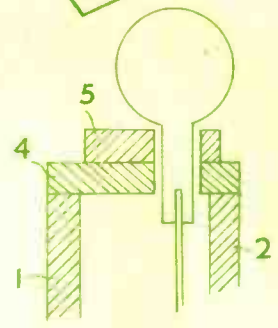

PIECES 10. CUT ONE OF EACH $\frac{1}{8}$ in.

PIECE 4. CUT ONE $\frac{3}{16}$ in.



BALL FOOT No. 15.
ONE REQUIRED.

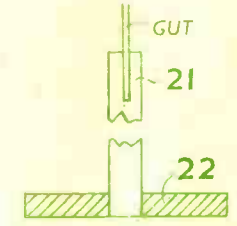
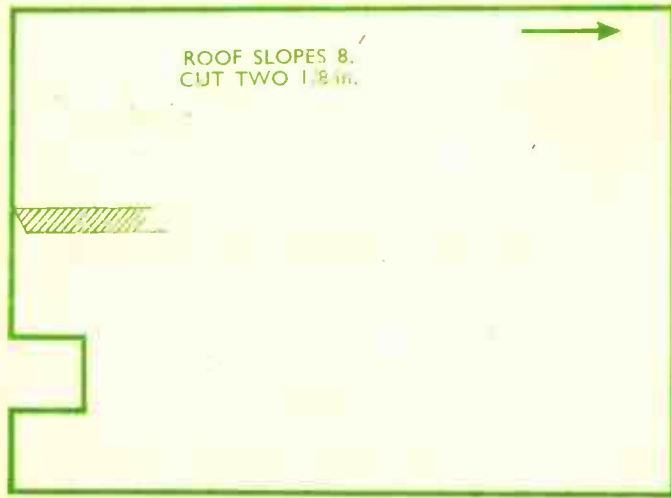

DIAGRAM SHOWING HOW TRICYCLE PLATFORM IS SUSPENDED BY CATGUT FROM THE BALL FOOT No. 15.



PIECE 21. CUT ONE FROM $\frac{1}{4}$ in. DIAMETER ROUND ROD.



ROOF SLOPES 8.
CUT TWO $\frac{1}{8}$ in.



PIECE 22. CUT ONE $\frac{1}{8}$ in.

TRICYCLE
HERE

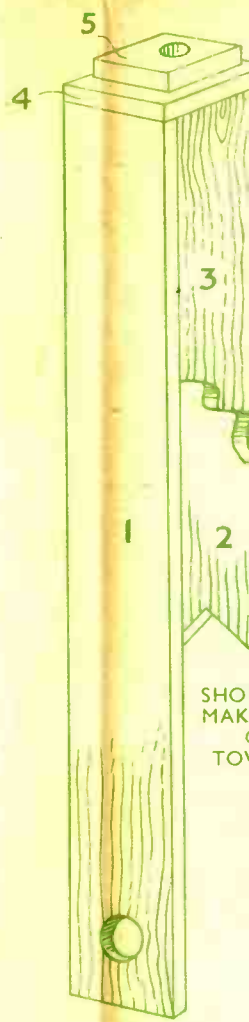

10

PIECES 20. CUT
FOUR 1/8 in.

The Sparkling Enamel
PAINT IN TUBES

Ready for use

Handy and economical Starlon is just
right for three knock printing jobs.

Starlon
PLASTIC ENAMEL PAINT

STARLINE, SOUTHEND-ON-SEA, ESSEX



PER TUBE



WHEELS 18.
CUT FOUR
1/8 in.

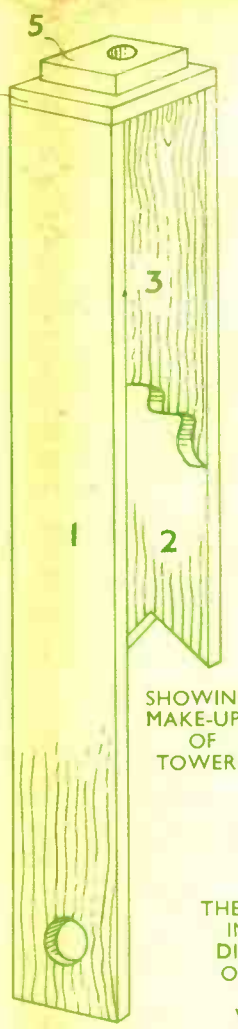

SHOWING
MAKE-UP
OF
TOWER.

THE ARROWS
INDICATE
DIRECTION
OF GRAIN
OF WOOD.

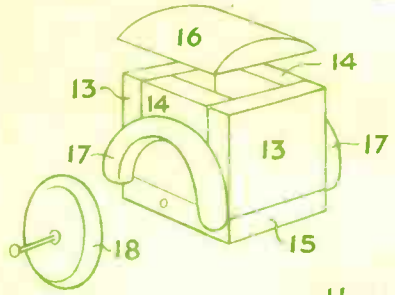

SHOWING
HOW THE
TRICYCLE
IS
ASSEMBLED

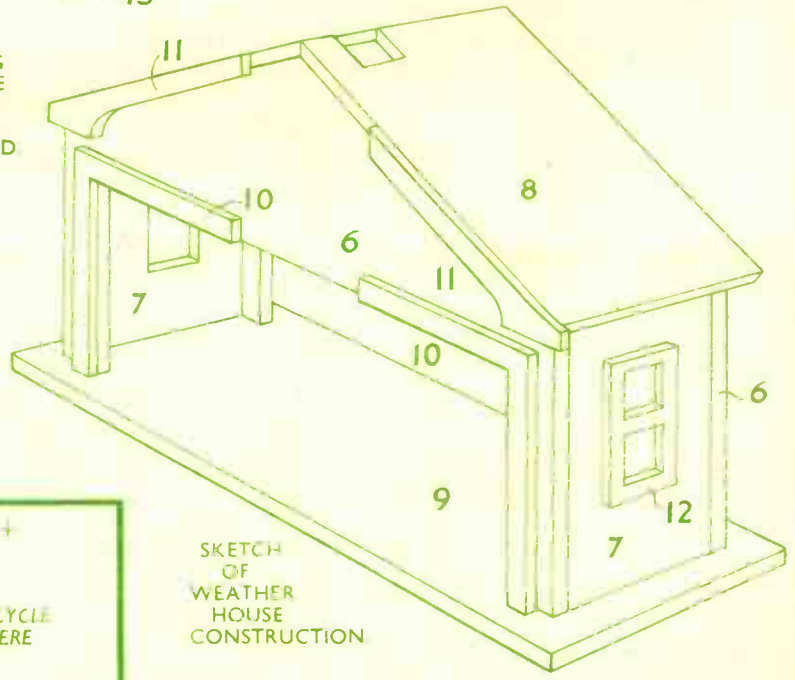
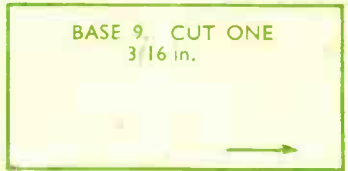

SKETCH
OF
WEATHER
HOUSE
CONSTRUCTION



TRICYCLE
HERE

PRINTED IN ENGLAND