

HOBBIES WEEKLY

IN THIS ISSUE

	Page
A Small Shaving Cabinet - - -	177
The Fascination of Marquetry - - -	179
Experiments with Lead Monoxide -	180
Contemporary Stand for Flower Pots	181
The Motive-Power Depot - - -	182
How to Copy Photographs - - -	183
Marquetry Design Card Box - - -	184
Stamp Collector's Corner - - -	186
Make a Rain Gauge - - - - -	188
Pattern for a 'Gardening' Notebook	191



DECEMBER 12th 1956

VOL. 123

NUMBER 3189

Full instructions for making —

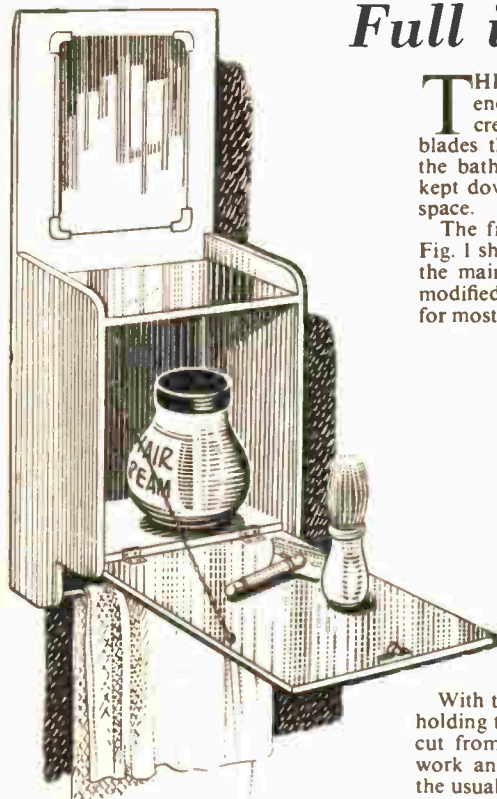

**JUST BIG ENOUGH
FOR ESSENTIALS**

THIS useful cabinet is just large enough to take the usual hair cream, shaving stick, razor and blades that are often left lying around the bathroom. Size has purposely been kept down to a minimum, so as to save space.

The front elevation and side view in Fig. 1 show the general construction and the main measurements. These may be modified if desired, but will be suitable for most requirements.

The top and bottom are 7ins. by 5ins. and 7ins. by 4½ins. respectively. They can be screwed direct to the sides or can be housed in to a depth of about ½in. If they are housed they must, of course, be longer according to the depth of the housing.

Glue the towel rail in position at the same time as you fix the sides and then screw the back in place as shown in Fig. 2.

It will be noticed from Fig. 3 that the

A SMALL SHAVING CABINET

With the exception of the small pieces holding the mirror in place, all parts are cut from ½in. wood. Obечи is easy to work and will paint up well if filled in the usual way.

The cupboard portion is made up of two sides, a top and bottom. The sides are shaped to measurement and holes ½in. diameter bored to take the towel

door is fixed by means of two hinges which are let in to fit flush. Hinges should be about 1in. long and fixed with countersunk screws. The door measures 7ins. by 8½ins., and may be cut from wood or plywood.

To prevent the door going back a stop made from an odd piece of wood may be glued in place and an ordinary handle

All correspondence should be addressed to The Editor, Hobbies Weekly, Dereham, Norfolk

For Modellers, Fretworkers
and Home Craftsmen

World Radio History

4 ½^D₂

PAGE 177

CONSTRUCTION OF THE SMALL SHAVING CABINET

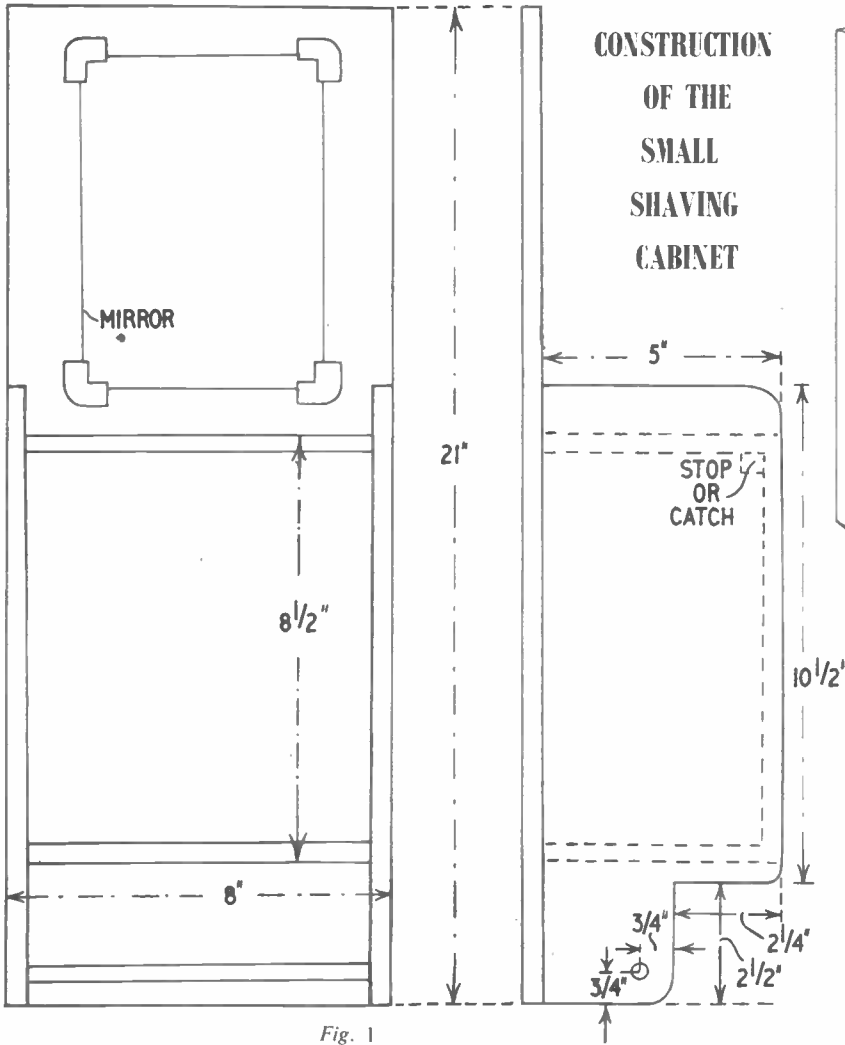

Fig. 1

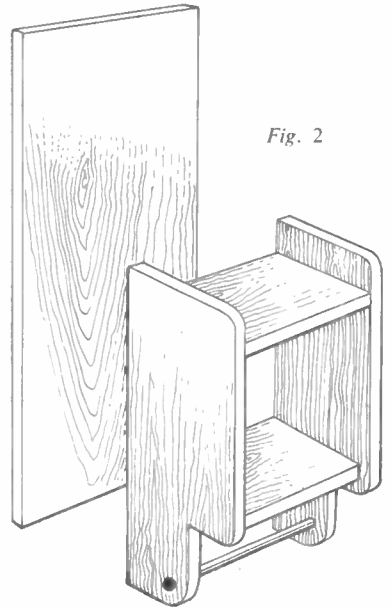

Fig. 2

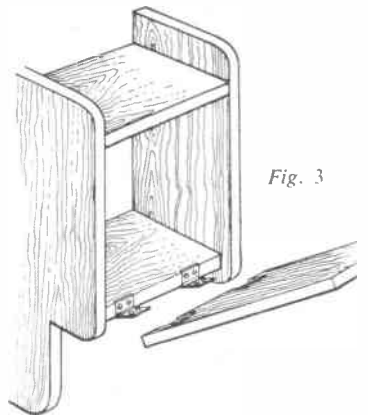

Fig. 3

and catch fitted. Alternatively a special spring catch — Hobbies No. 6224 can be fitted as shown in Fig. 4. The spring is attached under the top and the stop portion to the door. The catch may be obtained from Hobbies Ltd., Dereham, Norfolk, price 3d. A knob of some kind must be fitted to the door to allow it to be pulled out. A piece of chain is fixed in position by means of small screw eyes to prevent the door falling down too far.

The mirror should measure about 7ins. by 5ins., and is held in place by four clips made from wood as shown in Fig. 5. The pieces (A) and (B) are shown full size and are glued together as indicated in the inset diagram. The thickness of piece (A) depends upon the mirror, but $\frac{1}{8}$ in. thick should be enough. Piece (B) is also cut from $\frac{1}{8}$ in. wood. The

clips are glued to the back and strengthened by a fretpin in each.

The cabinet is finished off by painting both inside and out, using high gloss enamel. White is generally suitable for the bathroom, but of course a pastel shade would look equally attractive.

(M.h.)

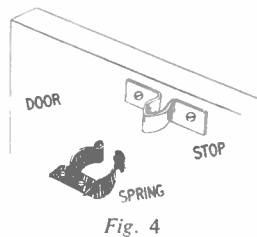

Fig. 4

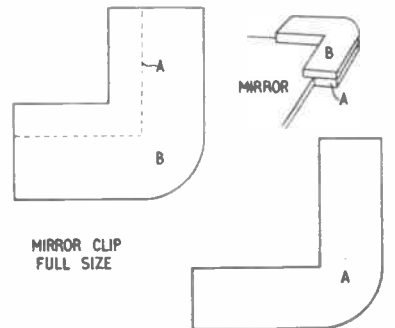

Fig. 5

Revival of an ancient craft

The Fascination of Marquetry



'Sleepy Cornwall' a marquetry set supplied by Hobbies Ltd., price 9/6.

THERE has been a phenomenal surge of interest in marquetry in recent years in England, and Arts and Crafts Exhibitions have revealed many keenly interested in this craft.

Marquetry is an ancient craft, but various definitions given in handicraft books have a tendency to confuse the would-be enthusiast. Those who have had the advantage of being taught by older craftsmen hold to the definition that marquetry is the art of overlaying inferior wood with thinner pieces of various natural coloured, superior quality, woods which are cut and assembled to form patterns.

Intarsiatura and inlaying are closely allied to marquetry, and so far as can be ascertained, it is to the ancient Egyptians around 1400 B.C., that the history of veneering and inlaying must be credited. In the last century, many of the tombs which had been opened revealed veneer furniture which, undoubtedly, involved considerable skill and craftsmanship. The glue which kept thin pieces of wood together, now known as plywood, was still intact.

Unsurpassed skill

It is presumed that the tools used in those days were primitive compared with the machines of our time, but very little is known regarding the methods which were employed to cut the solid woods into thin veneers. Compared with today's mass production, the skill which the Egyptians put into their efforts is still unsurpassed.

The progress of the craft continued through many empires, including those of the Greek and Roman. During the fifteenth century intarsiatura appeared in Italy. This was a method of decorat-

ing by means of hollowing out solid timber and inlaying it with rare woods, metal, ivory, and stones.

In the seventeenth and eighteenth centuries this was further improved by André Chas. Boulle, a French craftsman who used thin pieces of brass, tortoise-shell, enamelled metal, and choice woods. This is now known as Boulle work.

Marquetry began to make a marked impression on the Continent during these two centuries. In Britain in particular it was used for decorating pianos and furniture.

Chippendale, Hepplewhite and Sheraton, the master craftsmen of design in the world of furniture, saw the advantages of the use of veneer, and utilized it to arrange the natural beauties of the wood in their craft.

Present day fashion demands furniture in contemporary designs in mainly light-coloured plain veneers, and the use of marquetry in that connection has slowly disappeared. Today, however, marquetry is being revived, and there are hundreds of enthusiasts practising the craft in their spare time, most of them using the art to make pictures for home decoration.

From creating comes a satisfying sense which cannot be understood except by those who engage in the

creation of something desired. Although marquetry requires patience and practice, skill can be gained by experience. The lack of a knowledge of drawing and woodworking does not necessarily cause a handicap to the beginner, but to know something of both is very useful, for marquetry calls for a combination of these two applied arts.

See centre pages in this issue for an interesting marquetry design

The materials required are easily purchased, and the marquetry sets now on the market provide a good introduction to this craft. To be able, however, to select veneers without guidance, and to create an original design, is the aim of the genuine enthusiast.

Both men and women, and especially those who are disabled, have found marquetry quite a blessing. Indeed, it has now been recognized in many hospitals as a distinct advantage in occupational therapy. Schools, too, have commenced to realise its educational possibilities, for individual imagination can be developed in the cutting of a picture. (E.M.B.)

Fretsaw Inlay Method

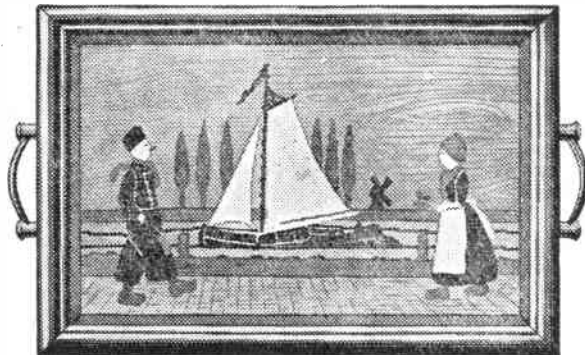

Another way of making delightful pictures in wood is by fretsaw inlay. The pictures are made from four different coloured woods of $\frac{1}{16}$ in. thickness. Often it is possible to produce as many as three pictures from the one cutting of the set of woods used - one the same as the original pattern and two using different coloured woods in different positions.

A leaflet entitled 'Making Pictures in Wood', explaining the economical use of these Marquetry panels, can be obtained on application to the Editor. This contains some valuable hints on the whole application of marquetry.

The 'Dutch Tray' pictured above, is an example of fretsaw inlay marquetry. The kit, including chromium handles but not the glass, costs 18/6 from branches or Hobbies Ltd., Dereham, Norfolk.

Experiments with Lead Monoxide

WHEN melting scrap lead you have probably noted that a grey iridescent film soon forms on the surface. This is lead suboxide and has been produced by the lead uniting with the oxygen in the surrounding air.

By continually removing the film as it forms, the whole of the lead can be oxidised. On heating the accumulated grey film it takes up more oxygen from the air and lead monoxide is formed. This is yellow when cold. If the heat is high enough to cause the oxide to melt during its formation, a reddish product results. The reddish oxide is known as litharge and the yellow variety as massicot.

Man has found many uses for lead monoxide. It is indispensable to the making of fine optical glass. It is used in pottery glazes, medical lead plaster, in

immediately. Let the solution cool. White crystals of lead acetate separate out. Pour off the mother liquor into a test tube (you can obtain a further crop of crystals by evaporating this) and then transfer the crystals to a porous brick to dry.

Lead acetate is sometimes known as 'sugar of lead' owing to its sweet taste. Like all soluble salts of lead, it is poisonous and must, therefore, NOT be tasted.

Red lead is chemically known as triplumbic tetroxide, which indicates that its molecule contains three atoms of lead and four of oxygen. Lead monoxide has one of each. Industrially, red lead is prepared by carefully heating lead monoxide. This is a tedious and uncertain process in the home laboratory, unless you have special means. An

Remove the beaker from the bath and thin the mixture with water. When the lead oxychloride has settled, dip a slip of red litmus paper into the clear upper liquid. The paper will turn blue, showing the formation of an alkaline substance — in this case, sodium hydroxide. By pouring off such a solution and boiling down to dryness, sodium hydroxide was obtained, a patent being taken out by a man named Turner in 1787.

Turner's yellow

As the quantity of sodium hydroxide produced in this experiment is too small to be worth isolating, we will pass to the pigment. Pour away the sodium hydroxide solution and wash the lead oxychloride several times with water by decantation, until the wash water no longer blues red litmus paper. Filter off the lead oxychloride and let it dry.

Keep half for your stock. Place the other in a crucible and heat it for a few minutes. The lead oxychloride loses combined water and turns into the yellow pigment. This pigment is known as Turner's yellow after the man who took out the patent for caustic soda manufacture.

Lead nitrate is generally prepared by dissolving lead monoxide in nitric acid. It is, of course, a general principle that soluble salts may be obtained by dissolving oxides in acids, but in the case of lead and some other metals care has to be taken to use the right proportions. Otherwise, basic salts may be produced by accidentally using too much oxide. The normal salt forms first, but the solution has the property of dissolving more oxide, thus forming the basic salt.

Preparing lead nitrate

To prepare lead nitrate, measure out 4.5 c.c. of ordinary strong nitric acid in a small measuring cylinder. Strong nitric acid is corrosive, of course, and any coming in contact with the skin should be flushed off with water at once and a paste of sodium bicarbonate and water dabbed on, left for a few moments and then washed off. Stir the acid into 10 c.c. of water in a beaker.

Stir 7.4 grams of lead monoxide into the diluted nitric acid and heat the vessel in a water-bath until the oxide has dissolved. Filter from any slight residue and boil down the colourless solution in an evaporating basin until a drop taken up on a glass rod crystallises at once. Let the solution cool overnight. White crystals of lead nitrate

● Continued on page 181

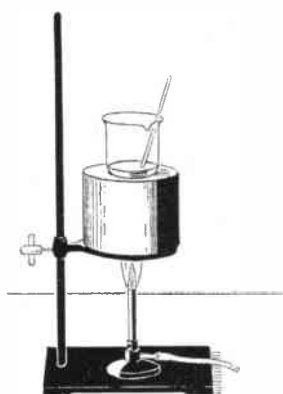

Fig. 1—Preparing lead acetate

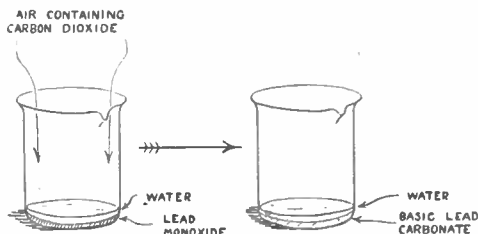

Fig. 2—Air and water producing a new chemical

easy laboratory way to make it is to heat lead monoxide with potassium chlorate.

Thoroughly mix 0.5 gram of potassium chlorate with 2 grams of lead monoxide. Heat the mixture in a small iron ladle or deep tin lid from which the tinning has been removed by burning off in the fire. Effervescence starts owing to evolution of oxygen from the potassium chlorate. Some of this combines with the lead monoxide to form red lead. When effervescence ceases let the whole cool, when you will see that the residue is red.

Stir this with two or three lots of hot water, filter off the red lead and let it dry for your specimen collection.

Curious as it may seem, lead monoxide was once used for making caustic soda (sodium hydroxide) and a yellow pigment by the same process. In a beaker dissolve 2 grams of table salt (sodium chloride) in about 20 c.c. of water, stir in 7 grams of lead monoxide and warm the vessel in the water-bath, stirring frequently. The lead monoxide soon turns white, owing to formation of lead oxychloride.

the rubber and paint industry, for making plumbers' red lead and, of course, as a starting point for the preparation of the many lead salts needed by industry and in the laboratory.

Lead acetate is one of the commonest of the lead salts. Should you happen to run out of it at an awkward time and need some urgently, you can prepare a supply easily and quickly. Dilute 6 c.c. of glacial acetic acid with 18 c.c. of water. Pour this on to 11 grams of lead monoxide contained in a beaker or flask. Set the vessel on a water-bath (Fig. 1) and heat until only a slight undissolved residue remains. A colourless solution of lead acetate results.

Dilute this with twice its bulk of water and filter into an evaporating basin. Boil this down until a drop taken up on a cold glass rod crystallises

CONTEMPORARY STAND FOR FLOWER POTS

THIS flowerpot stand has a very modern appearance and can be made easily by the handyman from good quality softwood or deal.

The legs are made in two sections, a plan being shown in Fig. 1. Notice when marking out that the grain of the wood runs along the length of the leg and not vertically. In this way the maximum strength will be obtained. The two halves of each leg are slightly different, giving a sloping front to the stand. Cut out and glue the two halves of each leg together, being sure to lay them on a flat surface such as a sheet of glass in order to get them both level. One of the new resin glues such as Casco

*Easily
made by
the
handyman*



By W.J.B.

strong glue (Fig. 2) and insert screws through the legs into the ends of the shelf to provide extra strength. Check alignment of parts with set squares and

beading, 2ft. 6ins. long is secured to the front of the shelf.

Smooth all parts with glasspaper, filling in the holes of the countersunk screws with stopping or plastic wood, and the construction is complete. The stand may then be polished in natural shade or stained to the required tone. Alternatively two coats of clear varnish will give a satisfactory effect. If it is decided to paint the finished product it should be given one undercoat and two top coats of a hard gloss paint or enamel to protect the woodwork from any dampness. A bright colour will provide a brilliant background to the plants, but it is wise to avoid shades of blue which would not harmonise with the green of the leaves. (W.J.B.)

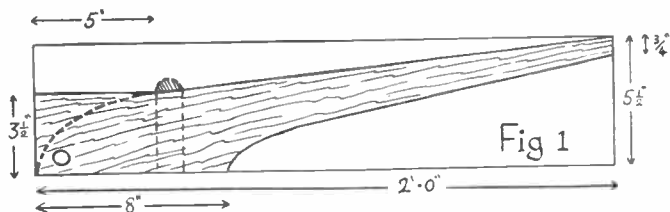

SCALE PLAN
OF LEGS —

allow glue to dry. To give a finished appearance, a piece of half round lin.

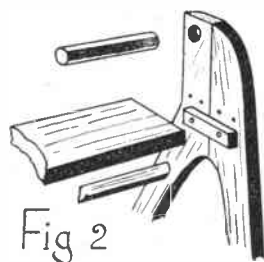

would be most suitable for this operation. Mark out the position of the shelf which, as shown in Fig. 1, is 5ins. from the top of the legs and bore and countersink holes to take the screws which should be 1 1/2ins. brass. A small block is glued and screwed under the line of the shelf to give added support (Fig. 2). Carefully drill two holes in the top back of the legs to take a 1/4in. dowel rod.

The shelf may now be made from 1in. thick wood, 7ins. wide and 2ft. 4ins. long. The rail at the back is 1/2in. thick and 2ft. 6ins. long.

Fix the shelf and rail in position with

● Continued from page 180

Lead Monoxide Experiments

separate, and these now need to be dried.

Pour off the mother liquor and squeeze the crystals with a glass rod to remove excess liquid. Add this to the mother liquor. Scrape out the crystals on to a porous brick to dry.

The reason for taking care to remove as much as possible of the mother liquor is that lead nitrate is very soluble in water and considerable loss can occur if the mother liquor is allowed to go to waste. By evaporating the mother liquor a further crop of crystals can be obtained.

A final experiment which you will find interesting to carry out with lead monoxide is to watch the action of the air upon it while it is kept wet. Put a little lead monoxide in a beaker, spreading it out into a thin layer. Just

cover this with water and leave it aside. As the water evaporates add more, so as to keep the oxide damp. Over a period of time you will note that the oxide gradually becomes white. (See Fig. 2.)

This white substance is basic lead carbonate and it is very similar in composition to the painter's white lead. What has happened is that the small amount of carbon dioxide which is always present in the air has been absorbed by the wet oxide. This would not happen if the oxide were dry, for the new compound needs oxygen and hydrogen from the water to make up its molecule. In fact, the lead monoxide, containing only lead and oxygen, has been converted into a compound containing lead, oxygen, carbon and hydrogen. (L.A.F.)

THE MOTIVE-POWER DEPOT

IN Model Railway layouts, even of the smallest dimensions, the question of housing the locomotives is one which must be considered, even if only by the provision of a small 'loco shed' tucked away in an unobtrusive corner of the model.

There are many ways of incorporating an engine depot into almost any type of layout, though, of course, their actual location is frequently dictated by the amount of 'ground' available, as well as by the general shape of the layout. Where plenty of room exists, there is every excuse to build a really pretentious depot, including a running-shed, repair shed, coal stage, water tower and column, ash-pits, and turntable, though the last item can be dispensed with if only tank engines are in use.

Study Depot routine

The diagram (Fig. 1) shows the basic essentials of a moderately large loco depot, wherein it will be seen that pro-

vision is made for all the services likely to be needed by engines. To get matters straight, it may be both interesting and instructive to follow the movements of a locomotive arriving at the depot after having brought its train into the terminus nearby. It enters the depot from the main lines or via the siding road at (A), and proceeds via the track (B) to the

By E. F. Carter

turntable (if it is a tender engine), over which it passes to the ash-pit dead-end road, where, after ash and clinker have been deposited, it enters the running-shed via the turntable, and is coaled and watered on road (C), being thereafter backed into the shed until its next duty.

It will be appreciated that the whole of this extensive depot may be laid without needing more than two extra points, for the turntable is pressed to do duty for switching from road to road; and

though, strictly speaking, engine movements would be considerably simplified by the running of more than one track through the running-shed, it will be found in practice that, as it is shown, the depot is quite capable of handling in an interesting way the locomotives to be found on any average-sized layout in 'O' or 'OO' scale. Incidentally, coal wagons feeding the coal stage, have full siding accommodation, and a wagon should be allowed to stand on dead-end road (E) to receive the clinker and ashes discharged by the engines. This wagon should be exchanged for an empty one periodically. The dead-end road (F) is used for holding a loco in need of minor repairs until room can be found for it in the repair shed.

In many smaller layouts it may, perhaps, be necessary to tuck the loco depot away in a corner, or to fit it in an alcove alongside a chimney-breast. Both these locations are very tempting to a beginner, but they have many drawbacks from the operating point of view.

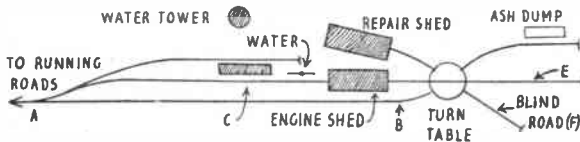

Fig. 1

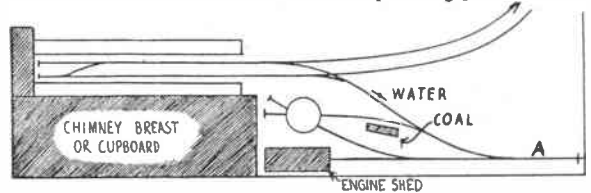

Fig. 2

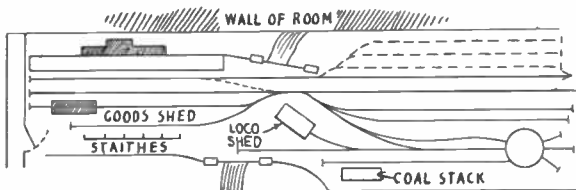

Fig. 3

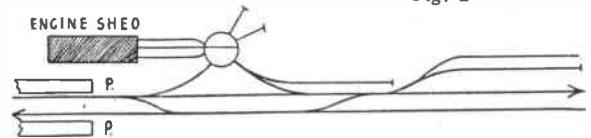

Fig. 4

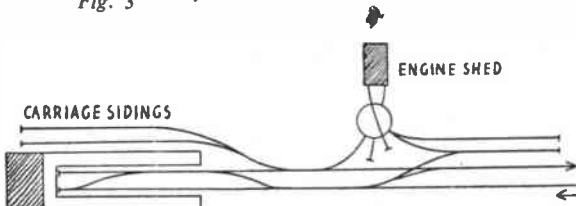

Fig. 5

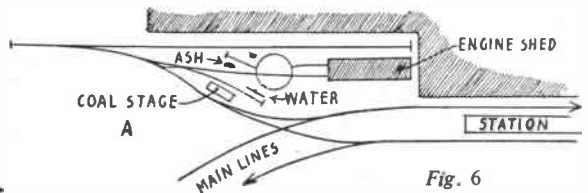

Fig. 6



Fig. 7

Where at all possible, running-sheds should be placed really within easy reach of the operator and not at the extreme rear of a layout, as is often the case if an alcove or corner is chosen. In this respect it may be noted in passing that a well laid-out engine depot makes a far more interesting foreground for a model railway than does a farmyard or village churchyard.

It must be remembered that there are,

inevitably, times when the introduction of the greatly out-of-scale human hand is needed on the best of model railways, and this is most frequently the case in the intricacies of the loco running department. So accessibility is a matter which must not on any account be overlooked.

For general guidance in the layout of locomotive depots the diagrams should be studied closely, and though they need not necessarily be adhered to in detail, it will be found advisable to retain the broad principles involved.

Fig. 2 shows how a depot can be fitted into the otherwise wasted alcove alongside a chimney-breast, the layout providing for interesting shunting operations along the spur (A) before the turntable or shed can be approached. The ready entrance and exit roads from the spur out on to the main lines in the terminal station should be noted.

In Fig. 3 the depot, together with the terminal station, goods yard and carriage sidings, is located at the back wall of the room; a situation which is

quite operable if the railway is laid round the room with an operating space in the centre; when it is easy to reach over the running roads if necessary.

Terminal Station

Readers interested in model railways will be pleased to know that the free design to be given with next Wednesday's 'Hobbies Weekly' will be for a 'OO' Gauge Terminal Station which can also be used as a through station. It has been specially designed for small and medium-sized layouts to be made up with the use of a fretsaw, and kits will be available.

A simplified version of Fig. 3 is depicted in Fig. 4, in which the loco shed is placed at the rear of the station platforms (P-P), together with the turntable and lie-by roads; whilst Fig. 5 shows a

useful arrangement in which the engine-shed is situated at right-angles to the main lines — a location particularly useful in cases where the railway shelf is unusually wide.

In Fig. 6 is shown an alternative version of Fig. 2, in which the shed is approached over the turntable instead of directly, and further spectacular interest is achieved by the curving away of the main running roads which leaves ample space at (A) for storage roads, coal sidings, and carriage sidings. Fig. 7 gives an idea of the absolute minimum track layout for the very simplest loco depot, where it will be seen that only a turntable and unsheltered loco storage road is provided at (X).

Naturally enough, on model railways where multiple-unit electric-outline trains are being exclusively run, the layouts shown are unsuitable, but it will be found advantageous to design and lay a railway for steam locomotive (steam outline engines) working, even if it is not used at once, in view of possible future developments.

HOW TO COPY PHOTOGRAPHS

MANY amateur photographers are under the erroneous impression that in order to make copy reproductions of photographs, drawings, etc., an expensive copy camera is necessary. This is not so, for if one possesses an ordinary vertical enlarger with preferably an anastigmat lens and stops, then with a slight adaptation one has all the necessary equipment required for the process. An enlarger with a simple single compound lens and no stops will also be quite suitable. There may, however, be a slight loss of definition and the margins of the copy may be slightly distorted due to the absence of a flat depth of field as is usual with the more simple type of lens. It will, however, take a very critical eye to detect these faults.

Ensure flatness

To adapt the enlarger for copy work, a sheet of cartridge paper or thin white cardboard is attached to the enlarger baseboard with a series of drawing pins, care being taken to ensure that it is perfectly flat and smooth. A clear and sharp negative is then placed in the negative carrier of the enlarger and is focused until the projected picture is of approximately the same size as is the original that is being copied. The copy material is then placed in the centre of the projected focal area and its exact size marked out on the cartridge paper by lightly going around the edges with a pencil. The enlarger is then refocused until the picture is clear and sharp and just covers the pencilled outline of the

copy material. If one's enlarger is fitted with stops, the largest stop aperture should be used when focusing.

Exact alignment

The next step in the procedure is to place the copy material on the cartridge paper in exact alignment with the pencilled markings. If the material will not lay flat — and it is absolutely essential that it does so — it can be secured with drawing pins. If, however, the original must not be marked or defaced in any way, a sheet of fairly heavy glass placed over same will ensure that it lies perfectly flat. The glass must, of course, be perfectly clean on both planes.

The lamphouse is next removed, as is also the focusing negative from the carrier. The next and following procedures must be carried out with the normal room lighting extinguished and by the illumination provided by a ruby safelight. The sensitized copy negative is then placed in the negative carrier with the emulsion surface facing downwards, i.e., towards the lens, and the upper part of the enlarger covered with a black light absorbing cloth. Particular care should be taken to cover the sliding slots of the negative carrier.

The enlarger should be stopped down to its smallest aperture if stops are fitted, and the lamphouse gripped firmly between the hands and positioned at an angle of approximately 45 degrees and about 2ft. away from the copy material. The light is then switched on and the lamphouse continuously moved in a circular motion until the exposure is

completed, then is switched off. The copy negative is then removed from the carrier and is developed in the usual way.

Ordinary orthochromatic or panchromatic films or plates are of little use for copywork, as they have insufficient contrast, and are too fast and inclined to grain formation. The emulsion must be formulated to ensure high contrast and also be of an exceedingly fine grain, which is synonymous with slow exposure speeds. Special sensitized material is available for copywork, or failing this, an ordinary fine grain non-orthochromatic plate or film will be entirely satisfactory. The time of exposure will depend on and also vary with the size of the copy material and the consequent focal length required to accommodate same. Other factors are also present, such as the size of the lens or the *f* stop number when stopping down, and also the power of the illuminant in the lamphouse.

Use a filter

Generally speaking, the length of exposure will be found to be between 6 and 12 seconds, but no hard and fast rule can be made and a little experimenting will soon determine the correct exposure.

If the copy material comprises an old photograph (as it often does) which is badly discoloured with yellow stains, it will be necessary to use a yellow lens filter to prevent the stains appearing on the copy. When such a filter is used, it must be remembered that the time of exposure is appreciably lengthened, and suitable adjustments made. (A.M.B.)

Hobbies MARQUETRY DESIGN

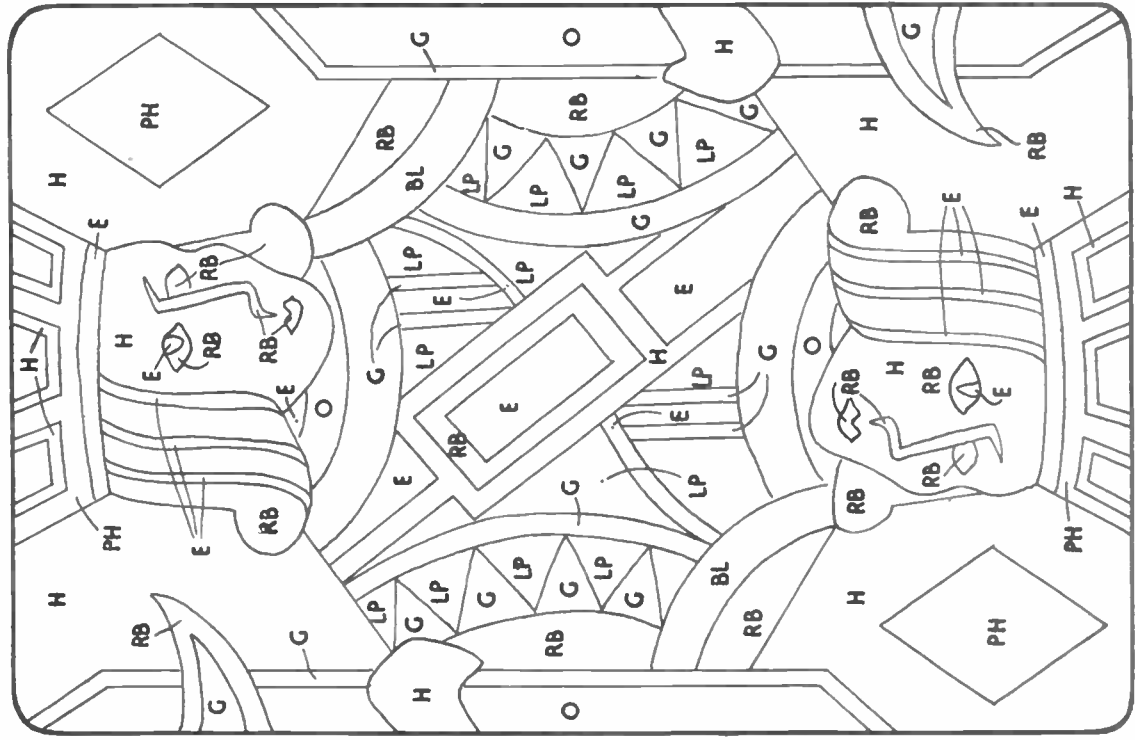

GUIDE TO VENEERS

- P.H. PURPLE HEART
- H. HOLLY
- E. EBONY
- R.B. RED BIRCH
- L.P. LONDON PLANE
- O. OBECHI
- G. GREYWOOD
- B.L. BLACKWOOD

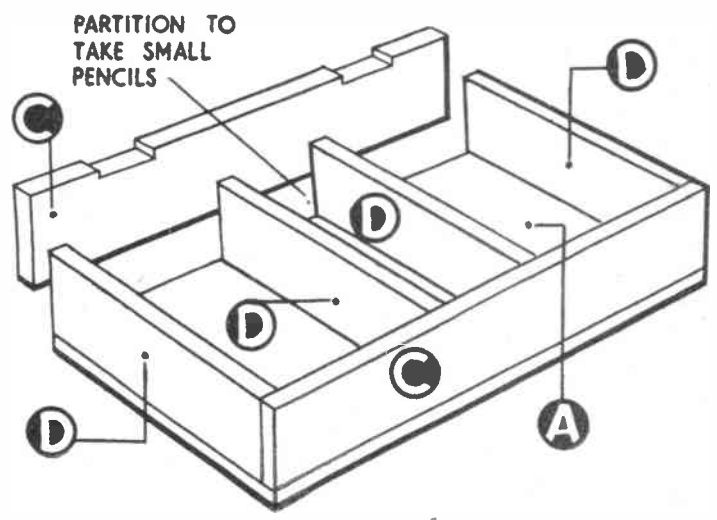



— CARD BOX —

PANELS OF WOOD REQUIRED ONE H4 — ONE G4

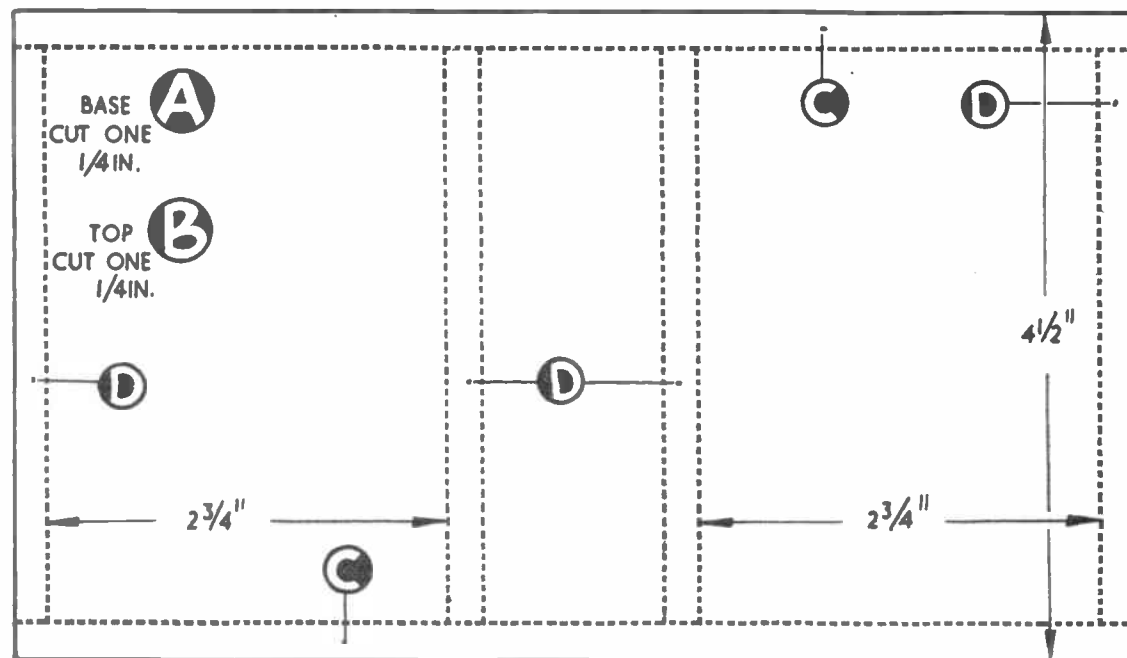
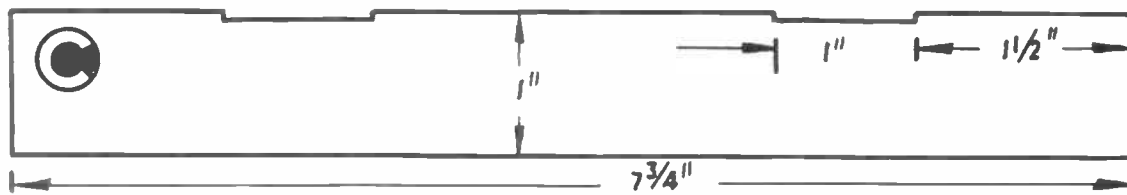
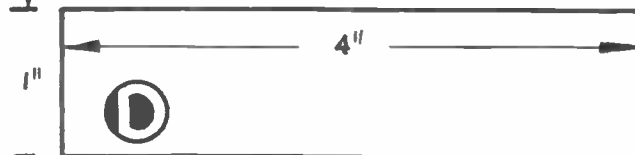
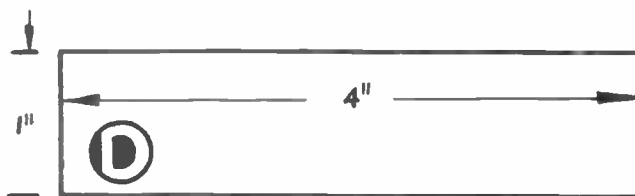
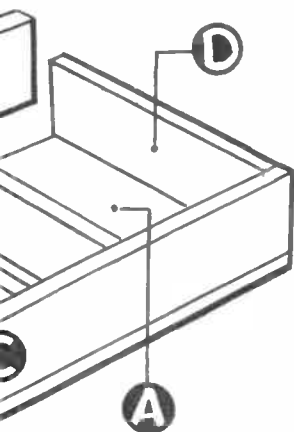
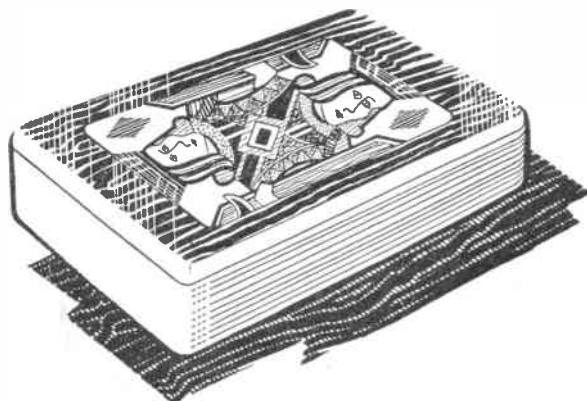



PERUVIAN ISSUES

By R. Cantwell

A NAME and some scattered ruins are all that remain to attest to the greatness of the ancient Empire of the Incas. This barbaric but highly civilised race was composed of many Indian tribes.

The Quechuas who outnumbered all other tribes were easily the most intelligent. They supervised the building of mighty temples, palaces, aqueducts, bridges and beautiful baths; laid roads paved with flat stones. These great highways extending for hundreds of miles were provided with resting places and stones to mark the distances at regular intervals.

The Indians of Peru (Home of the Incas) still tell wild tales about their wealthy ancestors, and of the buried riches under the Aztec ruins.

The Treasure of the Incas

They say that the golden sedan chair of the Inca was sunk in the baths at Pultamarac, and that underground are concealed gardens with artificial trees of the purest gold beneath the Temple of the Sun at Cuzco, but because they believe that the Inca will one day return to rule the earth, they are afraid to search for these treasures.

Manco Capac — son of Genghis Khan, the fabulous Asiatic conqueror — who founded the Incas, is depicted on the 1 cent stamp of Peru, 1896; and Pizarro, who conquered the Incas, on the 5 cent stamp. Both values are catalogued at 3d. used.

Other Peruvian stamps relating to the Incas include: 1874, 1 cent orange; Sun-God (9d.). 1931, 10 cent red: The Old Stone Bridge, Lima (2/-). 1932, Three Primitive Native Designs (1/4 the set). 1934, 1 sol violet; The Inca (1/- used). 1936, 10 cent red; Inca Postal Runner (4d.). 1951, 10 sol brown; Cuzco Ruins (10/- used). 1952, 50 cent emerald; Inca Maize Terraces (5d. used). Ditto: 1 sol brown; Inca Ruins (9d. used). 1952, Airmail, 2 sol 20 cent blue; Inca Observatory, Cusco (1/6 used). Ditto: 10 sol chocolate; Manco Capac Monument (6/- used).

Peru's stamps contain many interesting facts. Today the total area of this South American Republic is 514,059 square miles. It has a Pacific coastline of 1,410 miles and an extreme width, from coast to eastern jungle, of about 800 miles.

Here the Andes reach their highest altitudes, seven peaks towering above

19,000ft. The uplands or western slopes of the Andes are well watered and also the eastern descent to the Amazon basin, which are fertile tropical lowlands.

Lima, the capital, is called City of the Kings. It is the most important commercial centre of the country. Callao, important industrially and the chief seaport, is connected with the capital by two railroads and three highways. The first trans-Andean highway to penetrate the Amazon basin of Peru was completed in 1943.

Illustrate these facts with the following stamps: Peru: 1932, 2 cent blue; Mountain Landscape (2d. used). 1936 airmail, 5 sol green; Valley of River Mambari (5/6 used). 1938, 10 cent red; Roads in Andes (2d. used). 1943, 15 cent blue; Map of South America and the river Amazon (9d.). 1897, 2 cent brown; G.P.O. Lima (9d. used). 1907, 20 cent black and green; Medical School, Lima (5d. used). 1930, 10 cent blue; Lima Cathedral (2/- mint). 1936, 5 cent brown; Independence Square, Callao (4d.). Ditto: 10 cent blue; View of Callao (1/-). Ditto: 15 cent green; Callao Docks (1/-).

Collectors seeking general themes

will find the following applicable to Peruvian stamps:

Aboriginal races of mankind. Mountains, statues, monuments, cathedrals, beauty spots, etc. of other lands. Early explorers, world airways, the story of cotton, sugar, oil, etc., great names in educational history, travelling in lands where legends abound.

When sorting Peruvian stamps look out for these rarities — just in case! 1858, Imperf., 1 dinero blue; 55/- mint. 1 peseta red; £5 mint, 27/6 used. ½ peso yellow; £75 mint, £28 used. 1862, Imperf., 1 peseta brown; 65/- mint, 45/- used. 1871, Imperf., 2 cent blue; £7 used. 1880, 1 sol rose; 50/- mint, 40/- used. 1881, 50 cent green; £7 mint, £9 used. 1 sol rose £3 mint or used. 1883, 50 cent green; £5 mint. 1894, 1 sol blue; 70/- mint, 75/- used. 1907, 2 sol black and blue, 72/6 mint, £6 used. 1935 air., 10 sol blue; 60/- mint, 65/- used. 1936 air., 10 sol brown and red; 90/- mint, 40/- used. 1938 air, 10 sol blue; 75/- mint, 30/- used.

Good hunting — and don't forget your notes.

Miscellaneous Advts.

STAMPS FREE — Empire Packet including Pictorials and Victorians with approvals. — Robert J. Peck, 7A Kemp Road, Bournemouth.

MAGIC catalogue. T. and Donkey Puzzle 1/- DeHempsey, 363 Sandycroft, Kew, Surrey.

GENUINE Swiss Musical Movements. The best and largest selection of tunes in the country, lowest prices 16/3 each. Genuine Thorens Movements, 22/9 each. All guaranteed. P & P. 9d. extra on all orders. — Richardson & Forder, HW. 5 Chapel Place, White Hart Lane, London, N.17.

SWISS MUSICAL MOVEMENTS. Before you buy send 2d. stamp for our illustrated brochure. — Metwood Accessories (Dept. HW), Church St., Wolverton, Bucks. (Trade enquiries invited).

10,000 FORMULAS. Trade secrets, recipes, processes. Remarkable 900 page book. Only few available. Money back guarantee. 27/6 p. pd. — Stebbings, 28(H.B.) Dean Road, London, N.W.2.

100 DIFFERENT stamps free! Request ½d. upwards discount approvals. — Bush, 53 Newlyn Way, Parkstone, Dorset.

'PAINTSPRAYING' HANDBOOK. Covers Car, Industrial & Flock Spraying. 3/6, post 4d. Catalogue of our Cellulose and Paints and all Allied Sundries 2½d. — Leonard Brooks Ltd., 81 Oak Road, Harold Wood, Essex.

LEARN it as you do it — we provide practical equipment combined with instruction in Radio, Television, Electricity, Mechanics, Chemistry, Photography, etc. — Write for full details to E.M.I. Institutes, Dept. HW47, London, W.4.

HUNGARY 1954 FRUIT SET. Outstanding Free Gift to approval applicants enclosing postage. — 'Yulwontmor Stamps', Dept. H5, 29 Layton Avenue, Mansfield.

OO-GAUGE Road Transport scale model kits. Range of over 30 different models. Stamp for illustrated catalogue. — Ash Products, Leiston, Suffolk.

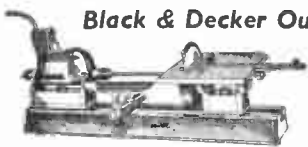

Black & Decker Outfits

DRILL, LATHE & SAW

10/- Start a home workshop with this famous Black & Decker DRILL, LATHE & SAW Outfit. Enjoy the thrill of using this fine equipment. 38 wkly. Outfit consists of 1/2 in. Drill, 10/6 or Polishing Kit, B & D Wood Turning Lathe and Saw-bench with 5in. Circular Saw. £17.13.6 Sent on receipt of 10/- Cash Send NOW!



5 in. SAW

A circular saw wherever you want it! 5in. PORTABLE SAW Outfit. Consists of 1" and 38 wkly. Drill and 5in. pmts. of Circular Saw 6/6 or Attachment. £10.11.2 Sent for 7/2. Cash

NEW TRADING HOUSE LTD. (Dept. E027) 38 Fishergate, Preston, Lancs.

YOU CAN BECOME A HANDICRAFTS INSTRUCTOR

EXPERIENCE NOT ESSENTIAL

Men who enjoy making things in wood or metal can turn their hobby into a permanent and interesting Career. Short hours, long holidays and security in a job you would really enjoy, can be yours if you become a Handicrafts instructor. Let us send details of the easiest and quickest way to get the necessary qualification.

We guarantee "NO PASS—NO FEE"

If you would like to know about our unique method of preparing you for one of these appointments, write today, and we will send you our informative 144 page Handbook—free and without obligation. Mark your letters "Handicrafts Instructor".

BRITISH INSTITUTE OF ENGINEERING TECHNOLOGY

595 College House, Wright's Lane
Kensington, London, W.8

BIET

How much better you'll do...

with the
FINEST
glue!



Croid AERO

Hot glue for woodwork. Home Outfit 4/-; tins 1/3 to 46/-.

Croid UNIVERSAL

Cold liquid glue for general use. Tubes 1/-; 8 oz. tins 2/6.

Croid POLYSTIK

Cold quick-setting P.V.A. glue for woodwork, etc. Polythene bottles 2/6.

Croid FABREX

Latex adhesive for fabrics, rug-making, leather, etc. Polythene bottles 3/6 & 6/-.

Anything worth sticking is worth CROID - the best glues for all householders. CROID glues are so quick setting and absolutely permanent in their results. It's easy to mend or make when you have the right CROID glue for the job. . . .

Croid the world's strongest glue
Obtainable at Hardware and Furnishing stores,
Ironmongers and Handicraft shops.

CROID LTD., IMPERIAL HOUSE, KINGSWAY, LONDON. W.C.2

make
your
own
table
lamps

THE

Sculptorcraft

WAY!

A delightful set of Table Lamps... to make yourself!

Including rubber moulds for casting Table Lamps,

with Shades and Electric fittings also available.



... AND A CHESS SET!

Containing moulds for casting a set of chess pieces, flock, 3 printed chess board sheets and an instruction book, 'How to play chess'.

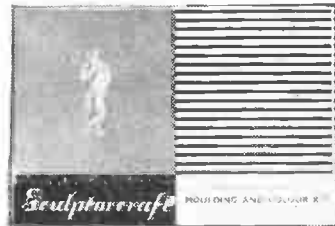

Write for full details of both these Sculptorcraft products to Dept. H.W., SEAMER PRODUCTS (SCULPTORCRAFT) LTD. 23/27 EASTBOURNE ST., HULL

Be your own 'recorder'

MAKE A RAIN GAUGE

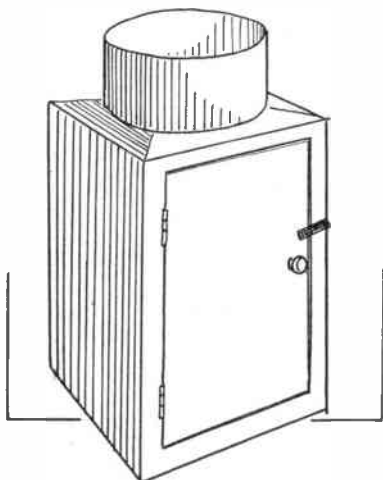

THOUGH not so popular an instrument as the thermometer or barometer, a rain gauge is not without interest to those of us who find the weather a topic of conversation. As all readers know rainfall is measured in inches, and a fall of 2ins. or more in a day can be reckoned as a heavy storm. Of all such instruments it is probably the most simple in its constituents, and the type illustrated is quite easy to construct. All that is required in the way of materials is a wood box, empty tin and a glass jar, the latter to measure the rain pouring into it.

By *W. J. Ellson*

The professional article is housed in a metal chamber of tubular form, but as such a thing may be difficult for the amateur to make, a box of wood is substituted. A good sound affair is necessary, as it has to stand up to all the vagaries of our climate, so a hardwood — oak for example, should, preferably, be employed for the box. A thickness of $\frac{1}{2}$ in. should be stout enough, and its interior dimensions should provide ample room for the glass jar to be placed inside. A 2 lb. jam jar would do nicely here, and the dimensions for the box, given in Figs. 1 and 2 are about right. If a thicker wood is employed, then the given dimensions should be increased proportionately, as an inside room of 4ins. by 4ins. by 6ins. in height is necessary to hold the jar.

The sides and back are cut first, then the door, the latter being the same size

as the back. Screw and glue side and back parts together using a waterproof glue for obvious reasons. Cut the top and bottom parts of the box, and in the top bore a $1\frac{1}{4}$ ins. hole through at the middle. Screw the bottom on firmly.

Tin and box

Before fixing the top on, provide an empty tin for the rain to enter. This should be about 4ins. diameter, but within limits its exact size is not material. Place this centrally over the box top, and run a pencil round it. The wood outside the pencilled circle should be bevelled off a little to the edges to allow rain, not falling in the tin, to run off. Now firmly fix the top of the box. The door should be hinged with a pair of 1in. solid brass butt hinges, and a small knob fitted for easy opening. To keep it closed a metal button can be added. Inside the box a thin slip of wood should be glued to act as a door stop.

The completed box can now be creosoted or treated to a coat or two of

where that comes on the paper. Divide the top inch into four equal parts, each representing a 'fall' of $\frac{1}{4}$ in. of rain. From this mark three $\frac{1}{4}$ in. measurements on the bottom inch. The last division left will, most likely, be longer than those above, owing, of course, to the shape of the jar at the bottom.

Make a square

The tin should now be placed upside down on a stout piece of wood, as in detail, Fig. 3, and cuts made with a chisel, or the edge of a bradawl, through its centre, the cuts crossing each other as in the diagram. The cuts can be about 1in. long. Remove the tin, and from inside force the cuts out to leave a roughly square hole about $\frac{3}{4}$ in. each way. Try this on the top of the box, and bend the cuts, as may be necessary, to ensure they allow the tin to fit on flat.

On each side of the opening in the tin punch a small hole for fixing purposes. Now fit the tin on with small round-headed screws driven through the screw

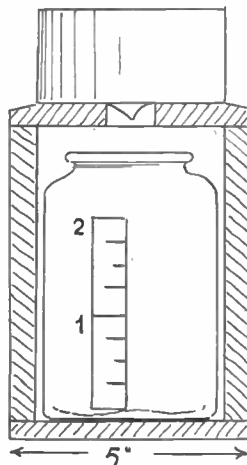

Fig. 1

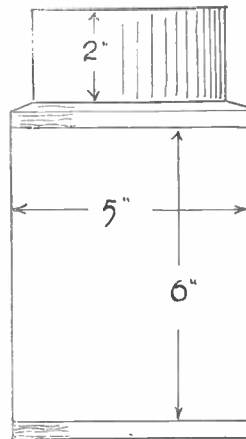

Fig. 2

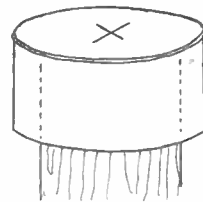

Fig. 3

water resisting lacquer, as a preservative against the weather. Treat the inside as well as the outside, as damp will creep in under wet conditions.

Now take the tin, and standing it on a level surface, pour in water to a height of 1in., testing the depth with an inserted rule. Pour the water in the jar. Cut a 1in. wide strip of paper, and fix this to jar with a waterproof cement, which will adhere to glass. On this paper strip mark carefully where the water comes up to in the jar. Pour a second 1in. depth of water in the tin and pour this also in the jar, and mark

holes into the box top. It would be as well to dab a spot of paint or white lead paste under the screw heads, to seal the gap, and prevent any water seeping under the screw heads on to the box. Finish by enamelling the tin inside and out.

The rain gauge should be placed in an open position for accurate results. Attached to the top of a stout post in the garden would be excellent, or it could be fixed to the gable end of greenhouse or shed, provided the tin receptacle is above the roof and free of anything likely to shield the rain, and prevent its free entry in the tin.

NEW!

THE PRACTICAL WAY of learning RADIO TELEVISION · ELECTRONICS

- Beginners Radio Course
- Advanced Radio
- Short Wave Technique
- Lesson Manuals

Experimental work includes construction of Basic Oscillators, Amplifiers, Deflectors, Power Units, 1, 2 and Multivalve TRF and Super-het receivers.



COMPLETE EXPERIMENTAL COURSES IN RADIO ENGINEERING and SERVICING

An entirely new series of courses designed to teach Radio, Television and Electronics more quickly and thoroughly than any other method. Specially prepared sets of radio parts are supplied and with these we teach you, in your own home, the working of fundamental electronic circuits and bring you easily to the point when you can construct and service radio receivers, etc. Whether you are a student for an examination; starting a new hobby; intent upon a career in industry; or running your own business — these Practical Courses are ideal and may be yours at very moderate cost. With these outfits, which you receive upon enrolment and which remain your property, you are instructed how to build basic Electronic Circuits (Amplifiers, Oscillators, Power Units, etc.) leading to designing, testing and servicing of complete Radio and Television Receivers.

COURSES FROM 15/- PER MONTH

POST THIS COUPON TODAY

To E.M.I. Institutes,
Dept. 31 Grove Park Road, London, W.4.
Please send me your FREE book on Practical Courses

NAME

ADDRESS

12 Dec.IC74

EMI INSTITUTES

associated with
"His Master's Voice,"
Marconiphone,
Columbia, etc.

Is This Saw in Your Kit?

You can cut almost anything in wood with this Coping Saw. The blade is 6½ ins. long and can be turned to cut at any angle. No tool-kit is complete without one. Get yours NOW.

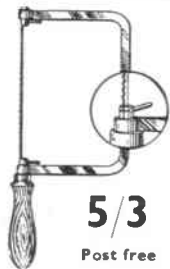

5/3

Post free

Buy from any Hobbies Branch or post free from
Hobbies Ltd., Dept. 99, Dereham, Norfolk

HARDHITTING

ACCURATE

Webley AIR PISTOLS

AIR RIFLES · ACCESSORIES

Write for Catalogue

WEBLEY & SCOTT Ltd., 166 WEAMAN ST., BIRMINGHAM, ENGLAND



I-VALVE RADIO 22/6!

Build the 'CONQUEROR' I-valve set. No soldering, only 15 screws to fit. Receives dozens of home and foreign stations. Kit of parts with building instructions only 22/6 post free. Valve and batteries. 15/6 extra. Building instructions alone, 1/6.

Send P.O. 1/6, 22/6 or 38/- to:—

BLANCHARD'S RADIO

(Dept. H3) 13 GAINFORD GARDENS, MANCHESTER, 10

THE 'FLUXITE QUINS' AT WORK



'To Tommy - a super train set
To Charlie - a wizard new jet
But the present we'd rather
Give this year to Father
Is FLUXITE - he'll need it, you bet!'

No need to emphasise to you how good Fluxite is! Everyone who has ever done soldering work—and done it well—knows that Fluxite is a 'must' for a first-class job carried out in double-quick time. Keep on using Fluxite and you'll keep on giving satisfaction.

FLUXITE simplifies soldering

★ FLUXITE SOLDERING FLUID

Tried it yet? It's modern, specially formulated and a big advance on old-fashioned liquid fluxes.

FLUXITE LTD BERMONDSEY ST LONDON S·E·1

TELEPHONE : HOP 2632
G.M.34

EXPORT ENQUIRIES INVITED

Dress in a 'near to life' Davy Crockett Hat, Jacket, Leg Dress, includes FREE HAT all with fringes, and an adjustable belt. Our special secret-waterproofed material to withstand Prairie storms. Hatis real Fur Fabric. Send 2/6 for post & pack. If satis. 5 mthly. payts. 4/6. Cash 19/11. Ages 4 to 9 and 10 to 13. STATE AGE. DAVY CROCKETT TENTS 21/-, post. 1/6.

BOYS! Be a real DAVY CROCKETT

COMPLETE 4-PIECE OUTFIT
*NO DEPOSIT!
includes FREE HAT



Color Picture 19/11

1000 YARD DRUMS
Assault Cable WIRE
526lb. BREAKING POINT
PVC COATED
CABLE SIZE 9/11



PVC COATED

Gen. combat field service telephone communication wire on a drum. Rustless as it is PVC covered. Numerous uses include fencing gardens and fields, baling goods and heavy parcels, tough suspension lines for all purposes. Use instead of roping—neater, stronger and almost everlasting. Essential to have around. 1,000 yards per drum, 526 lb. breaking point, 9/11, carr., 3/6. Case of 6 carr. free. A Govt. surplus article cost pounds to make, our price is cheaper than sting!

Headquarter & General Supplies Ltd.
(MOBW/37). 196-200 Coldharbour Lane
Loughboro Junc., London, S.E.5 Open Sat.

THE Tom-Tom WIGWAM

Sent 2/6
For CASH 21/-
POST 2/6

TENT
CONSTRUCTED OF SUPERB "TOM-TOM" COTTON PROOFED FABRIC AND NOT MADE OF NYLON. 4' 3" x 4' 3", height 5' 6". Built with collapsible poles, dismantle swiftly and transport elsewhere. No centre pole. Erect anywhere. A real waterproofed Tent. Holds 4/5 children. ALL AGES. Send 2/6 dep., then 4 mthly. payts. 5/9. Cash 21/- Post 2/6. Waterproof Groundsheet 10/6 if req.



CASH
59/6
WRIST WATCHES
REAL GOLD PLATED
FRONT AND BACK
NO DEPOSIT



LADIES OR GENTS MODELS
'AIRCRAFT' shock resisting wrist watch. Fitted accurately tested pin-lever movement. Written guar. Cases are REAL GOLD PLATED all over, dials are silvered with gilt raised figs. and hands. Send only 2/6 for packing & registration, bal. 18 fortnightly payts. 3/8. CASH, on strap, 59/6 or LADIES' MODEL 10/- extra. Matching bracelet 12/6 extra. Luminous 6/6 extra. Lists, Watches, etc., Terms.

DON'T SAY GLUE SAY UHU

- Sticks in seconds ● Colourless
- Waterproof ● Holds for keeps
- Heat resistant

USE

UHU GLUE

FOR ALL REPAIRS

Obtainable Everywhere including:

F. W. WOOLWORTH & CO. LTD.

GOVERNMENT SURPLUS BARGAINS. Inter-room Telephones, comprising 2 self-energised microphone/receivers and approx. 6yds. flex (may be extended if desired). No Batteries needed. Nothing to wear out. Complete 9/6, post 6d. Motors, Transformers, Switches, etc. 3d. stamps for illustrated list. Milligan's, 24 Harford Street, Liverpool, 3. Money Back Guarantee.

STICK TO



PER TUBE **1/-** SECCOTINE
-it sticks everything!
KEEP A TUBE IN THE HOME

Sole Manufacturers: McCaw, Stevenson & Orr Ltd., Belfast

I MUST GET

... the EXTRAORDINARY Home-made GADGETS MAGAZINE . . . EVERY MONTH it fully describes OVER FIFTY ingenious gadgets, devices and novelties I CAN MAKE. ● I'll get it at W. H. Smith's etc., or send 1/3 direct to:—

Home-Made GADGETS MAGAZINE
(26) Kingsbury, London, N.W.9

● 10/- buys the HUGE 1957 Gadgets Annual ●

EVERY CAR THAT PASSES—YOU WILL FIND THE INDEX MARK ALPHABETICALLY ARRANGED IN WHERE'S THAT CAR FROM?

Price 9d.

from all Bookellers or from the Publishers
(2d postage)

RALEIGH PRESS, EXMOUTH

THE LATEST SENSATION

in the

International Handicrafts Exhibition

Olympia

were our Plastic Moulds

for Wall Plaques for plaster casting

Prices 1/3 to 5/- each
Rubber Moulds from 1/- each
Illustrated catalogue 9d.
S.A.E. for list

TRADE ENQUIRIES INVITED

F. W. NUTHALL

69 St. Mark's Road
HANWELL, LONDON, W.7

SAND-PAPERING? MOP UP THE DUST

Just one wipe and—zoom—every single speck is picked up. Use it before each coat of paint too because paint builds up on dust and fluff to form unsightly nibs and blobs.

Tack rags are used by industry to get that factory finish. Why don't you use them? 32 surfaces which stay soft and tacky and useable until black saturated with dirt.

PRICE 1/6 Post and Pack 3d.

From your Ironmonger or Paint Retailer.

A. D. TACK RAGS & ADHESIVE DUSTERS LTD.
P.O. Box No. 28, KATES HILL, DUDLEY, WORCS.

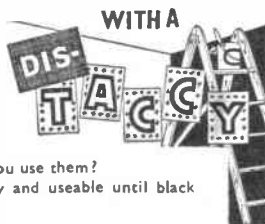

STOP SMOKING

Any Man or Woman in the World May Now Stop Smoking Quick and Sure

To Prove It. A Free Trial Package Sent Sealed to All Who Write

If you want to stop smoking, this should be just the thing you need. Simply send your name and address to Mr. Brian Hussey, Dept. HD/18, The Triumph Remedies, Exeter, and he will send, absolutely free of charge, a trial package of our remedy to show how it is used and how it will quickly conquer the habit of smoking, also full directions how to use it, free advice, and everything needed to aid you in overcoming the habit quickly and certainly. No matter what else you have tried or how many times you have failed, this time you will succeed. Please send name and address now — as this free offer may never appear again.

Full-size pattern

A 'GARDENING' NOTEBOOK

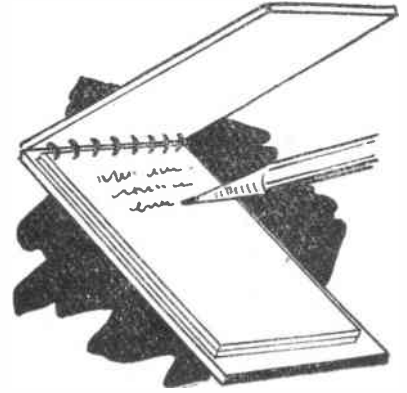

AN ATTRACTIVE GIFT

MAKE this attractive gift for your mother or wife. It will be particularly useful at this time of year when making notes of seeds required for spring planting. It consists quite simply of two pieces of $\frac{1}{2}$ in. thick plywood (A), an overlay (B) of $\frac{1}{8}$ in. wood, and several pieces of notepaper. The overlay is glued to one piece of wood and the whole pad bound together with $\frac{1}{2}$ in. wide plastic thonging.

Finish can consist of a light rubbing with stain and seven or eight applications of wax polish. Alternatively give two coats of clear lacquer or varnish.

(M.p.)

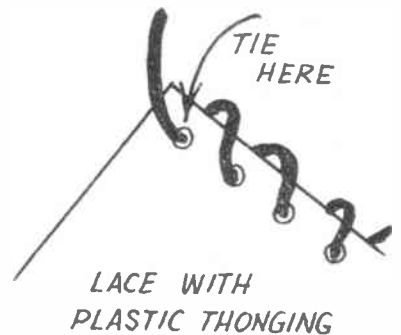

AN IDEAL JOB FOR A HOBBIES FRETSAW



**It's
as easy
as this!**

To seal those cracks & leaks

Seal permanently with 'SEELASTIK', the water-proof flexible Sealing compound that does not crack or fall out. Indispensable to the handyman for 101 jobs around the house, car, caravan, etc.

**3/6 PER
LARGE
TUBE**

Complete with
application tool

Seelastik

Available in cream
or black from Iron-
mongers, Stores,
Garages, etc.

Sole Manufacturers: **EXPANDITE** Chase Road, London, NW10

**When you want it
to stay put**



USE CERTOFIX

CERTOFIX really fixes
This super liquid glue copes with all general repairs. With wood, glass, metal and most other materials, CERTOFIX makes a joint stronger than the substances it unites.

make it immovable with Certofix

Sold at all Woolworth Stores

The **NEWEST** thing in Home Decoration

Decorettes

TRADE MARK
DECORATIVE TRANSFERS

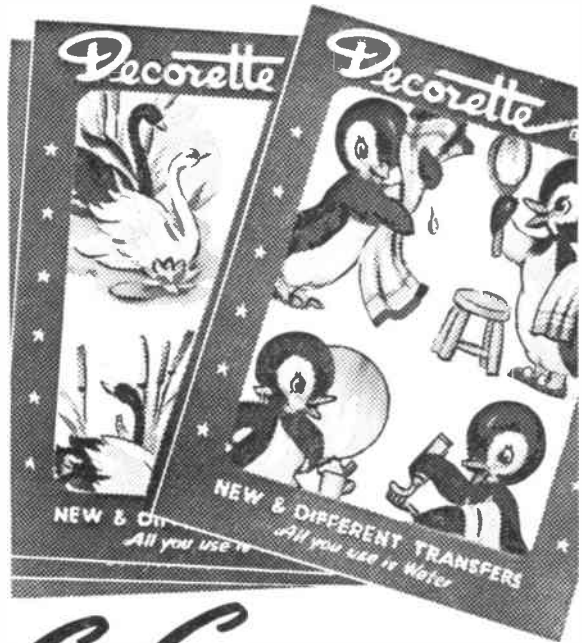

So Gay...

SO EASY TO APPLY . . .

Nothing brightens up the home so fast as these gay, decorative transfers, full of fine designs and bright colours. Ideal for walls, cupboards, furniture, pottery ornaments — yes, even gas fires, refrigerators. They can be applied to any sealed surface. In the bathroom, the kitchen, any room, these beautiful designs bring gayness and colour to old surfaces — PERMANENTLY, too.

- 1 Wet the surface, and dip the transfer in water.
- 2 Slide the transfer off its backing paper on to the surface.
- 3 Press firmly on, making sure all the air is squeezed out.

Many beautiful designs



Decorettes carry the
Good Housekeeping
Institute Seal No. 2374

2/6

From all good ironmongers, stationers, wallpaper and paint shops

If you cannot find them immediately, write to

DECORETTES LIMITED, Dept. H2, Garrick House, Carrington Street, W.1

Printed by **BALDING & MANSSELL, LTD.**, London and Wisbech, and Published for the Proprietors, **HOBBIES LTD.**, by **HORACE MARSHALL & SON, LTD.**, Temple House, Tallis Street, E.C.4. Sole Agents for Australia and New Zealand: **Gordon & Gotch (A'sia) Ltd.** For South Africa: **Central News Agency Ltd.** Registered for transmission by Canadian Magazine Post.