

HOBBIES WEEKLY

IN THIS ISSUE

	Page
An Inlaid Picture	433
Gluing Techniques	435
Shadow Puppetry Theatre	437
Making Wave-Wound Coils	438
Easy-to-Make Letter Rack	439
Television Savings Box	440
Solution Economies	442
Doll's House Wardrobe and Chest	444
Patterns for the Letter Rack	447



OCTOBER 12th 1955

VOL. 120

NUMBER 3128

★ *Make it from
this week's
FREE DESIGN* ★

OLD half-timbered buildings particularly lend themselves to the making of pictures in wood, and the subject of our design, 'The Old Tavern', comes into this category.

With reasonable care in fretcutting, and the necessary time and patience spent on the finish, a picture can be made to grace the wall of any home. If desired, of course, the subject could also be used for knife marquetry.

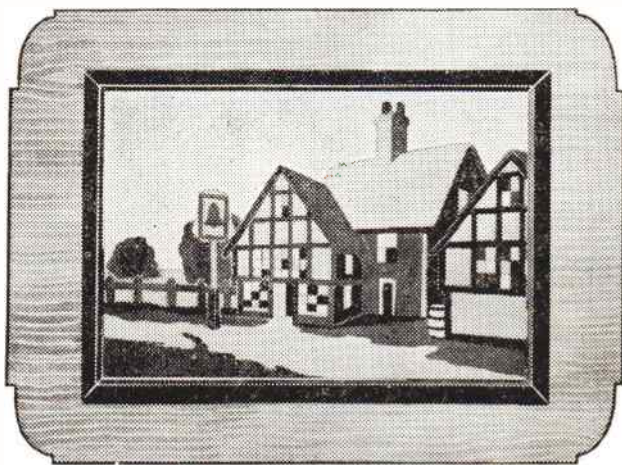

'The Old Tavern'

AN INLAID PICTURE

For a fretsaw inlaid picture, a specially prepared kit can be purchased. It includes a panel of $\frac{1}{4}$ in. wood to make the frame, four selected $\frac{1}{8}$ in. inlaid panels of contrasting colours, and sufficient stripwood to make the overlay border.

The frame should be made first. It is cut to the outline shown on the design sheet, and it will be noticed that for space reasons only the top half is shown in detail and workers will complete the whole, of course, by reversing the

design and carrying on from the centre lines. The outline should be traced on to the wood, and when it has been cut a small hole should be drilled in one corner and the whole of the centre of the frame removed as accurately as possible. The reason for this is that the panel will later be used as a backing piece for the inlaid picture itself, and will eventually be put back into the frame as the finished work.

To cut the inlays, pin the four pieces of wood together with the whitewood

uppermost. Be sure that the pins are outside the area of the picture. Now trace the design carefully on to the whitewood. Another method is to paste the design down, but this is not generally recommended in view of the tendency to warp and the fact that the design has eventually to be cleaned off, thus necessitating extra work.

Start removing the pieces of the pattern one after the other until all is completed. Slight deviation from the lines of the pattern will not matter

All correspondence should be addressed to The Editor, Hobbies Weekly, Dereham, Norfolk

*For Modellers, Fretworkers
and Home Craftsmen*

4^D

PAGE 433

unduly, as the pieces being cut will be exactly the same and must, therefore, fit when making up. This, of course, assumes that you have followed an essential in this type of work—that is, to keep the saw upright when cutting. Otherwise it will be seen that if the saw is used at an angle, the bottom sections will be of a different size and fit from the top ones.

Matching Up

When all the pieces have been cut, choose the ones which match those shown on the design, referring, of course, to the key, and glue them piece by piece to the backing board. This, you will remember, is the piece cut from the centre of the frame. See that the pieces fit together tightly, and do not be in a hurry. Let the glue squeeze up between the pieces so that the whole is well filled. Now place a piece of paper over the picture and put the work under weights. When it has dried thoroughly, clean off the paper with a suitable scraper such as a Skarsten (a piece of glass will serve if you have no proper tool), and finally clean up with a piece of very fine glasspaper.

You may possibly find that there are gaps in the surface which require filling in. To remedy this, a good method is to use a mixture of white glue and sawdust of the colour required. The mixture should be principally sawdust with just enough glue to make the whole adhere. Rub this mixture well into the places to be filled, and leave to dry before levelling off.

The Finish

This completes the main work, and you should now provide a suitable finish for the picture. Apply white wax polish as used for furniture, and polish briskly with a soft duster. A proved method is to apply the polish with the fingertips, gently rubbing it in. Then glasspaper very gently over the surface and apply polish again by the fingertip method. To get a perfect result, do not hesitate to make up to as many as six applications of the polish, each followed by gentle smoothing with glasspaper and a final polish. This will give the picture depth and also make it shine. Polishing from time to time, after the picture has been hung, will keep it in excellent condition. Now prepare the stripwood border. This should be mitred and chamfered as shown on the design sheet, and glued into place on the frame. A word of warning here—take special care with the mitres, as badly cut joints will depreciate from the look of the finished picture.

The whole of the frame is now cleaned up, and either stained and polished or wax polished only, as desired. You might possibly like to make the mitred border lighter or darker than the actual

frame for contrast. It will depend on the colour and quality of the actual wood, but whatever the finish chosen, the whole of the frame should serve to draw attention to the inlaid picture and not away from it.

KIT FOR 9/6

For making this picture you can obtain a kit (No. 3128) containing all necessary materials, including four selected $\frac{1}{8}$ in. panels of inlay wood, from any Hobbies branch or post free from Hobbies Ltd., Dereham, Norfolk, price 9/6.

The inlaid picture is now placed in position from the back of the frame, and secured by pasting a piece of stiff brown paper over it and the frame, in much the same way as when mounting a photograph. The backing piece holding the inlay picture stands proud of the frame by some $\frac{1}{8}$ in., of course, but this does not matter, as it is not seen.

Prepare the picture for hanging with two screw eyes and a length of cord. If the picture is to be hung from a rail, a fairly long length of cord will be required, but if it is to be suspended from some lower wall fitting, then it is preferable to stretch a shorter length of cord fairly tightly between the two

screw eyes, so that when the picture is hung on the fitting, the cord is not seen.

You will have noticed that apart from the picture already made, there are also sufficient parts to make three others. Although the colours are not the same as those in the original, you will be able to match up two of the three and make quite reasonable pictures. The rest will probably have to be discarded because the colourings are not suitable. For instance, one of the sky pieces of the four inlay panels cut will be of dark wood and would look out of place in the normal picture.

Extra Pictures

For the two extra pictures you are able to make, find pieces of plywood or other suitable backing wood and glue the pictures down as before. Then give them a framing of ordinary picture frame moulding which is quite cheap to buy, and you have another two passable pictures. These would make nice gifts for friends.

As an alternative to making extra pictures from the additional pieces, they can be used as an inlay decoration on other articles you may be making. For instance, they could form parts of trays, firescreens, and trinket boxes or articles of furniture. Often quite small parts of a design can be used to enhance larger furniture such as cabinets and book-cases.

The Hobby of Hobbies

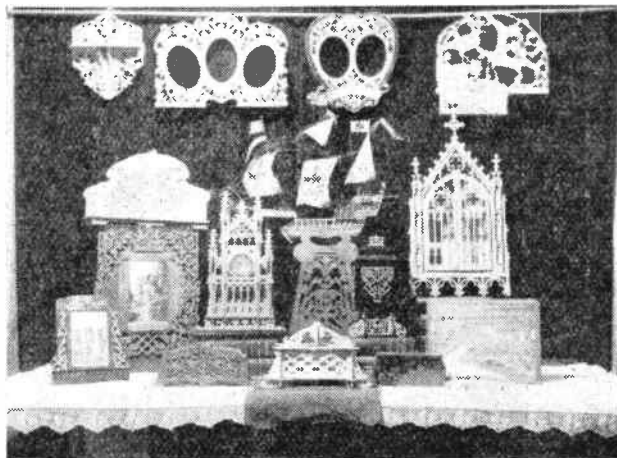

These fine examples of the beautiful designs in wood which can be created with a fretsaw are only a part of the collection of Mr. H. Eley, 5 Church Lane, Hixon, Nr. Stafford. All his work is done with one of Hobbies toggle lever handframes, and Mr. Eley says the time spent on his work has been well worth it. 'To me fretwork is THE hobby of hobbies, and I enjoy every minute I spend on it,' he adds. Many of these designs are featured in Hobbies 1956 Handbook, price 2/- from newsagents, etc., or 2/3 post free from Hobbies Ltd., Dereham, Norfolk.

GLUING TECHNIQUES

By R. H. Warring

THREE types of glues are supplied in tubes—normal liquid glues, cellulose cements, and rubber solutions. All are subject to hardening once the tube is pierced, even with the recommended safeguard of sealing the nozzle with a pin. This solution is convenient in that the hard skin of dried glue does not have to be pierced or removed again each time the tube is brought into use.

recognised by pinching gently. The tube will be found to contain as much air as solids.

The only way to recover solidified cement is to open the end of the tube, scrape out, and dissolve the cement in acetone (B). This will transform the cellulose content back into a liquid

worthwhile investment if it will do the job better than a plain nozzle, for which, perhaps, the cement has to be directed into place with a piece of scrap wood.

Using balsa cements, the term 'double cementing' is frequently referred to as a requirement for 'maximum strength' joints, particularly in balsa. There is nothing very involved in this technique, although such joints do

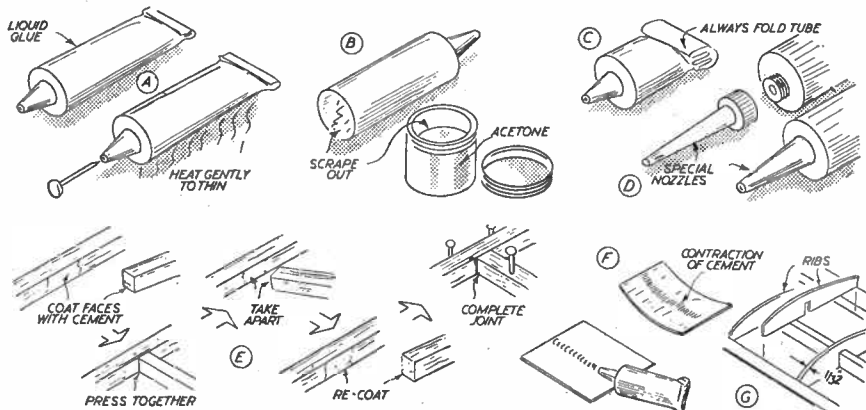

Only the 'natural' type liquid glues can be thinned by gently heating (A). Warming the tube in the hands, or heating *gently* in front of the fire, will reduce the consistency of thickened glue to a ready-running liquid for easy application.

Cellulose cements contain 'inhibitors' to prevent hardening of the cement inside the tube, even though it is stored in lead tubes. This is because lead itself is a porous metal, and, uncoated or unprotected, will not prevent the escape

of cement, and the consistency of your rejuvenated cement can be adjusted by the amount of acetone used for solution. Normal cements can be thinned in a similar manner to produce a 'brushing mixture' for applying over large areas. The one disadvantage of using cellulose cements over large areas, however, is that they dry rapidly and parts of the joint areas so treated may set before the joint is completed. A modern synthetic resin cement is generally better under such circumstances.

take longer to complete. The various stages are shown in (E).

First the joint surfaces are lightly coated with cement and pressed together. Immediately they are removed and the cement skin allowed to set—or at least left for a few minutes to harden. A fairly generous coating of cement is then again applied to each surface and the joint finally completed. This joint should be clamped, e.g., with pins in the case of balsa members, and left undisturbed until the cement has completely set.

of the more volatile solvents in a cellulose cement. Thus cements packed in plain lead tubes have a definitely limited shelf life. Some manufacturers use tin-coated tubes, which are not porous, and almost all now include the aforementioned inhibitors as a further insurance. Since cement contracts on drying, an over-age tube can always be

Other economies with 'tubed' glues and cements include the obvious—always roll up the tube (C), and the not-so-obvious using the best kind of nozzle for the job (D). Cement tubes are available with specially long nozzles, ideally suited for getting at awkward joints, or with screw tops which can take an extension nozzle. Either is a

When using pins with balsa members, a useful rule to remember is that with $\frac{1}{8}$ in. square sections, and larger, pins can be pushed right through the wood without weakening the members involved, although it is better, whenever possible, to space pins on either side, to form a jig.

Fast-drying cellulose cements are

sued only to balsa and the more porous woods. Slower-drying cements with greater penetrating power give stronger joints in ply and hardwoods. A properly made double-cemented joint should be stronger than the wood itself when completely set.

A point to bear in mind when cementing relatively fragile materials is that most cellulose cements contract on drying, and some cements contract much more than others. Thus a line of cement spread across a piece of the balsa or card on drying (F). Avoid strong-contracting cements on $\frac{1}{2}$ in. wing ribs

are painted with resin (or hardener). Separate brushes must be used for hardener and resin and they must never be interchanged (J).

The resin will have little tendency to dry, but the hardener, which is usually a quite watery liquid, will tend to soak in and dry out. Therefore, the joint surfaces should be brought together as soon as possible and located by means of the original fastenings. The whole of the joint area is then clamped up, either with more copper nails or brass screws, or with cramps, according to the nature of the job (K). Provided the job is properly done the screws add little

main requirement being a sufficient amount of lap (P). If such joints are likely to be subject to bending as well as tension or shear, then mechanical fastening (e.g., a line or double line of screws or copper nails) is a worthwhile safeguard. Butt joints in sheet material can be glued, but cannot be relied upon under stress unless reinforced with a strap of material of similar thickness to back up the joint. Again gluing can be used with mechanical fastening for maximum strength.

The use of dextrin type photographic pastes and rubber gums, etc., is fairly straightforward but here are one or two

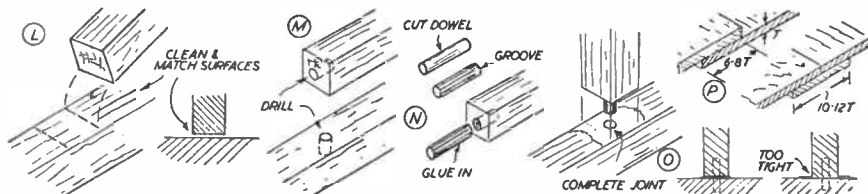

on model aircraft (G), and on thin sheeting, etc., on all types of models where contraction could pull the material out of shape. If in doubt, check the actual contraction of the cement first on a test piece.

The strongest joints in wood are normally produced by one of the modern synthetic resin adhesives. Formulated for amateur work, these consist of a resin and hardener, usually separate, but in some cases available as a 'one-shot' powder which is mixed up ready for use with only the addition of water. With two-part mixtures, either the hardener is added to the resin in the specified proportions when the adhesive is required for use, or else resin and hardener are painted on the opposite joint surfaces and brought together when closing the joint. The latter method has the advantage of economy since only the required amount of resin and hardener is actually used. In made-up mixtures, once the hardener has been added (or the mixture dissolved in water), the glue starts to set and any surplus mixture is waste.

A typical example of using a synthetic resin adhesive is shown in (H), a ply panel to be jointed to a wooden frame. Panel and frame are first carefully fitted and located by a suitable number of brass screws or copper nails. Steel should be avoided in contact with most synthetic resins due to the chemical action produced between the metal and resin mixture.

The two pieces are then broken down, after marking the frame areas on the joint face of the ply. These areas are then painted with hardener (or resin) at the same time as the frame joint faces

strength to the finished joint. The glue line alone should be as strong as the wood when set.

Glued-up butt joints are seldom satisfactory in hardwoods, however, largely because of the type of loading these joints receive. Mechanical reinforcement of such joints is, therefore, generally advisable. First the joint surfaces themselves should be prepared true and clean (L). A good mechanical reinforcement is a length of dowel fitted into blind holes drilled in the two

hints worth knowing. Except when new with the waxed seal just removed, dextrin pastes tend to harden and become hard to spread thinly and evenly, especially with the plastic spatula supplied for the purpose (Q). The answer is to add water, preferably a little at a time (e.g., with an eye dropper) and stir up to mix the paste into a cream of the required consistency. Once reduced to a cream the paste can be spread with a brush, giving maximum coverage with the minimum of trouble. This method of thinning is particularly

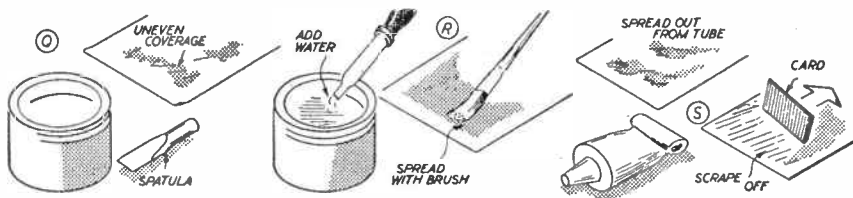

members (M). The dowel diameter should be the same as the drill diameter used for making the holes. The dowel is cut to length and grooved, with a saw or file, etc., to provide 'keying' areas to retain the glue. When the dowel is ready, coat it with glue and drive it into one of the members (N).

Both joint faces are then liberally coated with glue and the joint completed (O). Drive down tight, but not too tight. For maximum strength a thin glue line must remain between the two joint faces. Excessive pressure will squeeze all the glue out. Wipe off surplus glue from the region of the joint before it has had time to set or sink in and stain the surrounding wood. Lap joints need no reinforcement, the

useful where large surface areas have to be coated.

Rubber gums, used for mounting photographs in albums or on card, or patterns on wood, metal, etc., are most effective when applied as a very thin coating. First give a rough coating by squeezing the gum direct from the tube. Then take a piece of stiff clean card and scrape to spread the gum all over the surface, removing any excess at the same time. Only a very thin layer of rubber gum should remain, which can be left for a minute or so to get really tacky before completing the joint and smoothing down firmly by rubbing with a soft cloth or a roller. Any excess gum can be removed merely by rubbing until it rolls up and comes away as a solid 'thread'.

Shadow Puppetry Theatre

SHADOW puppetry can give endless amusement and for those with the right equipment, the attainment of a professional standard in performance is merely a matter of constant practice.

Materials needed for making a theatre are a few lengths of prepared timber, a roll of canvas or calico, brass hinges, a short length of string, glue, coloured paints, nails, and screws.

Building the Theatre

The front of the theatre consists of two uprights (5ft. by 3ins. by 1in.), four crossbars (2ft. 6ins. by 6ins. by 1in.; 2ft. 6ins. by 1in. by 1in.; 2ft. 6ins. by 2ins. by 1½ins. (notched as shown in Fig. 1); 2ft. 6ins. by 2ins. by 1in.) and two diagonals (3ft. by 2ins. by 1in.). Round the ends of each upright and shape the top crossbar as shown. Position the top edge of the second crossbar 16ins. below the top bar, the top edge of the third crossbar (which is notched) 6ins. below the second, and the bottom bar 1in. up from the floor. Carefully half-lap the joints, glue and secure firmly with nails.

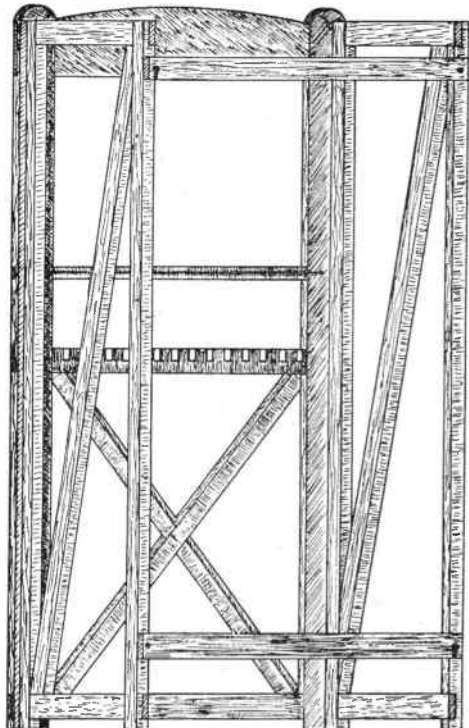

Fig. 1—The framing

The left-hand side frame, looking forward into the back of the theatre (Fig. 1), is 1in. narrower than its counterpart to allow for flat packing and storage of the theatre. Otherwise the sides are identical. Each consists of two uprights (4ft. 10½ins. by 2ins. by 1in.), two crossbars (1ft. 8ins. by 2ins. by 1in.), and one diagonal (4ft. 10ins. by 2ins. by 1in.). Position the top crossbars flush with the ends of the uprights and the bottom bars 1in. up from the floor.

By C. L. Marriner

Clean the frames, glasspaper smooth and apply a couple of coats of clear varnish. When these are quite dry, cover the outside faces of the frames with canvas or calico—gluing and tacking for additional strength.

Before hinging the two sides to the front façade, compensate for the 1in. narrower left side by gluing and nailing a strip of wood (4ft. 10½ins. by 1in. by 1in.) down the length of the rear face and flush with the outside edge of the left front upright (Figs. 1, 2, 3). The two rear crossbars (2ft. 6ins. by 2ins. by 1in.), latching on screws in the opposite rear faces, may be positioned to suit individual requirements, and give stability to the erection.

Paint the outside of the theatre to taste, ensuring that the whole of the canvas except the screen—bounded by the lower edge of the top front crossbar, the

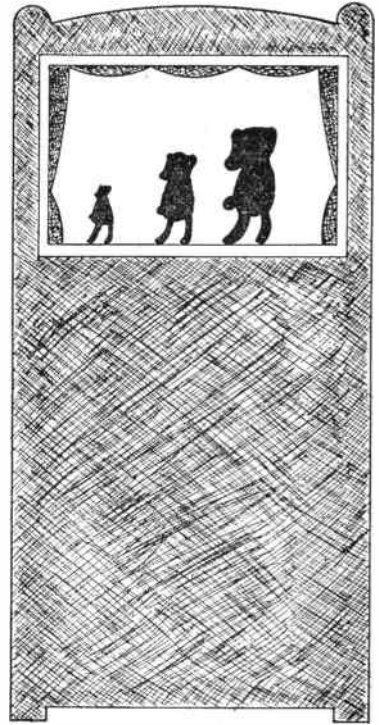

inner edges of the two front uprights, and a horizontal line drawn 1in. up from the top edge of the second crossbar—is thus rendered opaque. A 1in. wide frame for the screen, glued and tacked to the outside front face of the theatre, and miniature curtains on slides behind the screen, are refinements well worth the little extra trouble involved.

Plywood Figures

With regard to the figures (Figs. 4 and 5), these may vary in height from 6ins. to 9ins., and should be cut from ½in. plywood. The 1in. deep base (Fig. 4), on which the figure stands, is part of the figure itself, and should be cut out with it. This, combined with the length of dowelling rod glued on the back of each figure, enables the latter to be slid along the top face of the second crossbar (the stage) and fixed in one of the series of notches provided for the purpose in the third crossbar down (Fig. 1), while the other characters are being manipulated

● Continued on page 442



Fig. 2—Front and two sides hinged and packed flat

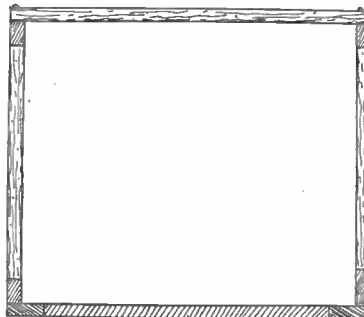

Fig. 3—Make up as seen from above

A. Fraser describes

Making Wave-Wound Coils

by Hand

THE making of solenoid type inductance coils for short waves, and quite often medium waves, presents no difficulty to the average radio constructor. But high-inductance coils, such as those for long waves, and again for intermediate frequency transformers for super-hets, is another matter.

In these instances, the constructor invariably is obliged to use pile-wound methods where the wire is simply wound with the turns piled on top of each other unsystematically. This is not satisfactory, because the total turns, being locked so tightly together, introduce considerable capacity losses, consequently lowering the 'Q', or efficiency value, of the coil.

The factory-made coils, produced by

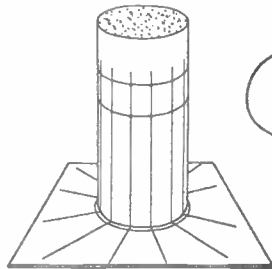

Fig. 1

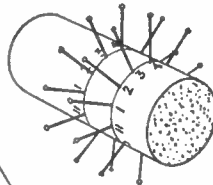

Fig. 2

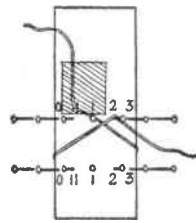

Fig. 3—Start of the winding

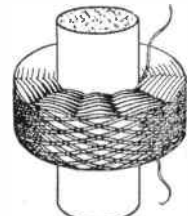

Fig. 4—The finished coil

machines, provide the best solution. They may be referred to as lattice wound, wave-wound, universal, and sometimes honeycomb coils. They are distinguished by the fact that the wire criss-crosses, and in addition each wire is spaced from the others. Both devices reduce the capacity incidence.

Not Difficult

These coils, however, are machine made, and the reader could be excused for believing that they are beyond his capabilities. The truth is, though, that it is quite possible to make them by hand, as this article will show. Moreover, once the method is grasped, these kind of coils are no more difficult to make than ordinary solenoid coils, strange as it may seem. Their appearance is excellent, similar, in fact, to machine-made ones, and they are well worth the trouble of making; for on the grounds of efficiency, cost, and form, they have everything to recommend them.

Two methods are given, both having the same basic system, and producing the same results. The first method described, however, is a quick improvised one devised by the writer

for preliminary experimental purposes; but it can be used if only two or three coils are required without much trouble. The second method is for those who make quite a few coils and are prepared to make the simple device necessary. Once made, it can be used over and over again indefinitely.

Use a Cork

A third method is also given which seeks to combine the advantages of both the methods mentioned above.

For the first method, the best material to use is a cork. This is pared down to produce a cylinder $\frac{1}{2}$ in. in diameter. A razor blade soon does this. A piece of gummed paper is then stuck round the cork, covering its outer surface except the ends.

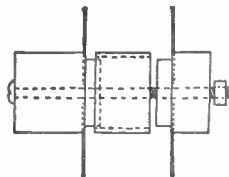

Fig. 5

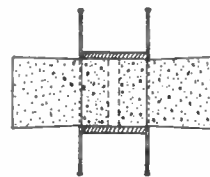

Fig. 6

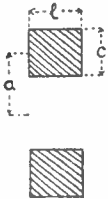

Fig. 7

The position and depth of the coil are marked on the cylinder with pencil or ink. (A coil $\frac{1}{2}$ in. in length is generally most useful.) The lines should encircle the cylinder.

Next, on a card or a piece of paper, draw a $\frac{1}{2}$ in. diameter circle with a compass, and with a protractor draw out lines from the centre, spaced $32^{\circ} 42'$ from each other. This will give eleven equidistant lines. Place the cork cylinder on the circle on the paper and mark off on it the positions of these lines. Then remove the cork and run up the marks up the cylinder to cut the circles already drawn there. This should give eleven evenly spaced points on both circles, Fig. 1.

Now take some ordinary sewing pins and thrust one into each intersection of

the lines marked on the circles. These should be pushed in firmly and should be centred properly and at right angles to the axis of the cylinder, Fig. 2.

Number the pins from one to eleven, preferably with ink. The former can then be treated with some insulating medium such as wax or varnish, although, if you are just trying things out, this is unnecessary.

Start Winding

We can now start to wind the coil. First anchor the end of the wire just before the No. 1 pin (bottom row) by fixing a piece of sellotape over it as it lies on the former.

Take the wire round the outside of No. 1 pin, then across to No. 7 of the top row of pins. Pass it round the outside of this and then across to the bottom row to No. 2 pin. Go round the outside of this and cross over again to the top No. 8 pin—and so on (Fig. 3).

It will be seen that one always moves to the opposite pins, and to the pin six pins ahead of the preceding one. The fact that the pins are numbered makes the process easy. However, here are the complete moves for one circuit. The numbers in different type indicate the opposite line of pins.

1-7-2-8-3-9-4-10-5-11-6-1-7-2-8-3-9-4-10-5-11-6-1

This brings us back to No. 1 pin where we started, thus completing one circuit. In this one circuit, the former has been

encircled eleven times. In other words, there are eleven turns of wire to one circuit.

The second circuit is accomplished in exactly the same manner, starting from No. 1 pin and finally returning to it. Once the first circuit has been completed, the following ones become progressively easier, the process of winding becoming rapid and automatic.

Coating the Coil

The end of the former can be held by the thumb and first two fingers of the left hand, and should be rotated towards the body, while the right hand draws the wire over the appropriate pins.

When the required number of circuits has been completed, the end of the wire can be held down to the former temporarily with Sellotape. The surfaces of the coil are then brushed over with a varnish such as polystyrene or shellac or Durofix. A coating of wax could also be used. The object is to make the coil firm and rigid.

The portions of the coil close to the pins should, however, be left untouched, to facilitate removal of the pins. When the varnish or wax has dried thoroughly, the pins can be drawn out. If a coupling coil is needed, the pins are inserted at the required positions and the necessary coil wound in the same way as before.

The actual anchoring of the wire ends to tags, etc., is left to the reader, as this article is concerned mainly with the winding of the coils.

Second Method

We now deal with the second method. The pins in this case are preferably thin panel pins or brass, copper or iron nails, and they are inserted into two separate cylinders. The latter can be of wood dowel, metal tube, or some plastic compound. The ideal method is to use brass tube with the pin sockets tapped, and the ends of the brass nails threaded to fit. The pins can then be screwed in and out as desired (Fig. 5).

The alternative is to use dowel with holes drilled so that the panel pins or nails, when thrust in, are held tightly, but can be withdrawn with a little effort.

In either case the pins should be located about $\frac{1}{4}$ in. from one end, and when they are in position, the end should be filed down about $\frac{1}{8}$ in. to form a neck for the former tube to fit over. This tube, on which the coil is wound, can be $\frac{1}{4}$ in. diameter with $\frac{1}{8}$ in. or $\frac{3}{16}$ in. wall, or even thinner. It should be of paxolin or some other plastic. At a pinch, waxed paper tube would do.

Round off Pins

Fig. 5 shows the three parts, in cross-section, ready to be fitted together. They are held to each other by the bolt and nut which should be small in diameter.

The ends of the pins or nails are rounded off so as not to catch the wire when winding.

The third method employs the tube former above, but at each end a cork is pushed in tightly. The pins (sewing) are thrust into the cork where it meets the former tube. (See Fig. 6.)

The last two methods result in the coil wires overhanging the ends of the former to a slight degree, but it is unimportant as the main mass of the coil is established on the former and the final varnish increases security.

The advantage of these two methods is that coils can be slid on to a length of rod or dowel, and their mutual positions (and, therefore, coupling) varied to satisfaction. This is very useful with regard to I.F. transformers.

The inductance of the coils can be calculated from the following formula:

$$L = \frac{.8a^2N^2}{6a+9l+10} \text{ microhenrys.}$$

Fig. 7 explains the terms.

However, 10% must be added to the total figure given by the above formula, as the turn of a lattice-wound coil is bigger than that given by an ordinary

'straight' wind, thus increasing the inductance.

A suitable medium-wave coil can be wound on a $\frac{1}{2}$ in. diameter former, using eleven pins. The length of the coil should be $\frac{3}{4}$ in. and nine and a half to ten circuits of 32 gauge enamelled or 34 gauge D.S.C. wire should be used.

For the long wave, 36 gauge enamelled (or 38 D.S.C.) should be used, in conjunction with fifteen pins. Twenty-four circuits should be used. The order of winding should be 1—9—2—10, etc., that is, eight pins ahead each time.

Alternatives

Coils of smaller size and more compact appearance can be made by using very fine gauge wire, and again by using a greater number of pins. These, however, are not recommended, because larger coils using thicker wire are more efficient, and, moreover, thin wire is difficult to handle. The number of pins can be increased with advantage to some extent, giving a greater number of turns per circuit. The wires will, of course, lie closer to each other in consequence, and so increase the capacitance loss.

For young fretworkers

Easy-to-Make Letter Rack

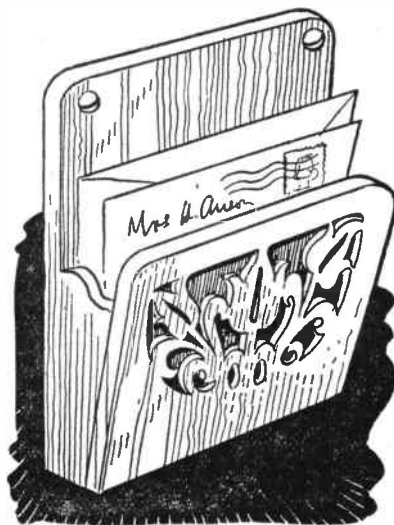

THE letter rack shown here has been designed especially for the junior fretworker. Not only does it make an attractive gift, but it also gives valuable experience in cutting curves and scrolls. It will be a great help for later work.

Full-size Patterns on page 447

Remember that models, toys, galleons, model yachts, etc., all entail the use of the fretsaw. The more you practise now, the easier it will be later when you want to make something really difficult.

There are only five pieces to cut out for this letter rack. The back (A), the front (B), the sides (C) and the bottom (D). All are cut from $\frac{1}{4}$ in. wood.

Trace the patterns and transfer them to the wood, then cut out with a fretsaw. Glue the pieces together as shown by the illustration of the completed article. Finish off by painting, or staining and varnishing. (M.p.)

Television Savings Box

By W. J. Ellson



OWNERS of television or radio sets should be interested in this little novelty. Besides providing a box for saving money to help pay for the licence, batteries or repairs, it also holds the licence itself, open for inspection. A puzzle form of lock is added, which makes it difficult to open the box for anyone not in the secret.

The box is constructed from $\frac{1}{2}$ in. fretwood, except where otherwise stated. First cut the front and back parts to the dimensions given in Fig. 1. The front has a panel opening sawn out. Below this panel the space for the grid is drawn in midway between panel and bottom. This grid is clearly defined by cutting a V-shaped groove all round with a broad sharp chisel, while in the space a few parallel lines are cut for the grid itself. These should not be deep. On either side of the grid the control knobs are fixed. These are $\frac{1}{2}$ in. discs of the wood, with their rear edges bevelled, as in inset (A). Fix in place with a spot of glue and a small nail or screw from the back. The edges of the panel opening are also bevelled and rounded off.

Position of Slot

From $\frac{1}{2}$ in. thick fretwood, cut two strips to size as (B) in Fig. 4. In these cut a $\frac{1}{2}$ in. wide slot 2 ins. long. It is important to cut this slot exactly $\frac{1}{2}$ in. from the upper edge. The parts are then glued to the inside face of both front and back of the box, level with the top

edges, as shown in the view of the box given in Fig. 2.

The sides of the box which are $2\frac{1}{2}$ ins. wide are cut, and then both sides, front and back nailed and glued together. Prepare two $\frac{3}{4}$ in. by $\frac{3}{4}$ in. strips of the wood $6\frac{1}{2}$ ins. long, and glue these to the rear of the front under (B), one each side of the panel opening (C) in Fig. 2. In the frame formed by these and (B) is a piece of glass, and a backing of plywood to hold the licence. To hold these in position, a brass clip $\frac{3}{4}$ in. long is fitted to (C) with a screw, one being shown in the drawing. It is simplest to fix these clips before the strips (C) are in place.

Removable Lid

The top and bottom of the box are now cut to dimensions given in Fig. 3. The bottom is complete, but work on the top, which will act as a removable lid for access to the contents of the box, should be continued as follows. Find the centre by diagonal lines, then from this centre draw the circle shown. Cut this out with the fretsaw very accurately. Glasspaper the edge of the disc sawn out (D) and try it in the hole. It should be easy to twist round with fingers. Saw out a coin slot in the centre $1\frac{1}{2}$ ins. by $\frac{1}{2}$ in.

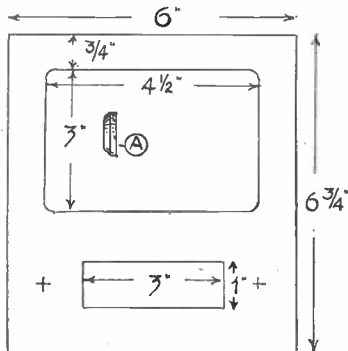

Fig. 1

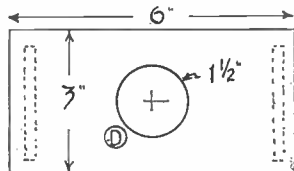

Fig. 3

On the underside of the lid glue a $2\frac{1}{2}$ ins. length of $\frac{1}{2}$ in. square stripwood near each end, as shown by dotted lines. These act as guides and stops to keep the lid in position. Their exact place can be easily found by laying the box on the lid and running a sharp pencil round inside.

Cut two discs of the wood to diameter of (E) Fig. 4, and in both saw out the coin slots shown, $\frac{1}{2}$ in. wide and $1\frac{1}{2}$ ins. long. The slots must be positioned truly

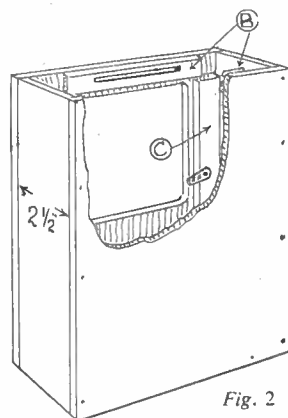

Fig. 2

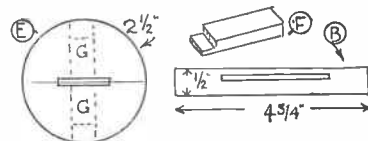

Fig. 4

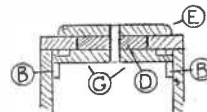

Fig. 5

central. One of these will be placed on the upper side of the lid, and to it glue disc (D) underneath. In order to glue it truly concentric with (E) it is helpful if a pencilled circle is drawn on the disc with a compass beforehand as a guide. The upper edge of (E) is then bevelled. Take the second disc (E) and draw parallel lines across its centre $\frac{1}{2}$ in. apart. Cut along these lines to make parts (G) (the rest is not required) and for a distance of $\frac{1}{2}$ in. reduce one end of each to half-thickness, as in Fig. 4. Place disc (D) in lid with (E) on top, and glue parts (G) either side of the slot in (D).

● Continued on page 441

MISCELLANEOUS ADVERTISEMENTS

BUILD your own T/V and learn about its operation, maintenance and servicing. Qualified engineer-tutor available whilst you are learning and building. Free Brochure from—E.M.I. Institutes, Dept. HW58, London, W.4. (Associated with H.M.V.)

GENUINE Swiss Musical Movements. Owing to large purchase now reduced to 14/6 each. Genuine Thorens Movements all guaranteed, 19/3 each. P. & P. 9d. extra on all orders.—Richardson & Forder, 5 Chapel Place, White Hart Lane, London, N.17.

PLYWOOD; large sizes, 14 lbs. 10/- delivered (Express) C.W.O. — H. Leader (1920), Gosford St., Middlesbrough.

DO-IT-YOURSELF BOOKS. List free.—S.P. Ltd., 28 (H) Dean Road, London, N.W.2.

PERFORATION GAUGE free to all approval applicants enclosing 2½d. stamp.—Cliffe West (H2), 61 Wynyard Road, Sheffield, 6.

100 DIFFERENT stamps free! Request ¼d. upwards discount approvals.—Bush, 53 Newlyn Way, Parkstone, Dorset.

MATCHBOX size crystal sets. All parts; crystals, instructions, complete 3/6 post free.—Bailey's, 44 Stanley St., Oldham.

MODELS. You can make lasting stone-hard models with Sankey's Pyruma Plastic Cement. Supplied in tins by Ironmongers, Hardwaremen and Builders' Merchants. Ask for instruction leaflet.

MAKE A RADIO

NO SOLDERING—only a screwdriver and pliers needed. FULL-SIZE plans and building instructions for 8 sets, 2/6 post free.

CRYSTAL RADIO KITS. "Varicoil", coil tuned, 10/6; "Popular", condenser tuned, 17/6; "Twin", very selective, 21/-; "Major", works well anywhere, 21/-.

EXPERIMENTAL KIT No. 1, builds all 4 crystal sets above, 27/6.

"BASIC", a very simple 1 valve set, 35/- with valve and batteries.

"NEW ECONOMY 1", receives scores of stations, 52/6 with valve and batteries.

"NEW ECONOMY 2", works with loud-speaker, 82/6 with valves and batteries.

"PERFECT 1-VALVE LOUDSPEAKER set, £3 with mains type valve and batteries.

Prices include postage and packing. Send S.A.E. for list—or send 2/6 P.O. for easy to follow building instructions for all sets.

BLANCHARD'S, DEPT. RH,
13 Gainford Gardens, Manchester, 10



PURE PLATINUM PLATED FILM STAR WATCH SIMULATION DIAMOND SET

Setting closely resembles fine White Diamonds. Set on the four quarters is a choice of sapphire, ruby or emerald coloured stones. Accurate pin-lever jewelled movement.

Comp. guar. **£4.19.6** on cordette, 21/- extra for dainty bracelet. Luminous dial 6/6 extra. Sent for 3/6 dep. If satis. pay 18 fortnightly pmts. 6/-. Offered for the first time in England.

Pure Platinum Plated GENTS CALENDAR WATCH

SENT FOR ONLY
3/6 DEPOSIT
CASH PRICE **£4 19 6**



For the first time you can own this wrist watch, genuinely plated with pure unadulterated Platinum. With calendar dial that keeps you informed of date. Novel but practical for sportsmen and business-men. Automatic action changes date every 24 hours. Real pin-lever movement, shock and dust resistant. Neat flat case. Comp. guar. **£4.19.6** on strap, or 21/- ex. for bracelet. Luminous dial 6/6 ext. Sent for 3/6 dep. If satisfactory, pay 18 fortnightly payments of 6/-. LISTS. TERMS. Open Sat. 1 p.m. Wed.

HEADQUARTER & GENERAL SUPPLIES LTD.

(HOBW/73), 196-200 Coldharbour Lane,
Loughborough Junc., London, S.E.5.

SHORTHAND in 1 week. Test lesson, 2½d. Stamp.—Dutton's (HB/SV), 93 St. Russell St., London, W.C.1.

AMERICAN MAGAZINE Subscriptions. One Year Popular Mechanics 30/-; Popular Science 43/-; Homecraftman 16/6; Homecraft 18/-; Deltagram 10/6. Free booklet quoting others.—Willen Ltd. (Dept. 57), 101 Fleet St., London, E.C.4.

TOY CASTING MOULDS. Soldiers, sailors, Tairmen, etc. 1,000 varieties from 3/- each. Rubber moulding compound for flexible moulds, granulated ready for use, 8/6 per lb. Aluminium moulds for plaster work. S.A.E. for list. Catalogue 9d.—F. W. Nuthall, 69 St. Mark's Road, Hanwell, London, W.7.

200 STAMPS free. Genuine offer. S.A.E. for approvals.—W. Self, 36 Fairfield, Boro Green, Kent.

PLYWOOD — HARDBOARD — at amazing low prices. Send S.A.E. for samples and prices to — N. Gerver, 10 Mare Street, Hackney, London, E.8.

PAINTSPRAYING* HANDBOOK (1954 Ed.). Covers Car, Industrial & Flock Spraying. 3/6, post free, including catalogue of our Cellulose and Synthetic Paints and all Allied Sundries and Plant Hire.—Leonard Brooks Ltd., 81 Oak Road, Harold Wood, Essex.

STAMPS FREE — Empire Packet including Pictorials and Victorians with approvals.—Robert J. Peck, 7A Kemp Road, Bournemouth.

SWISS MUSICAL Mechanisms for cigarette Boxes, etc., 16/6 post free. S.A.E. for illustration and list of tunes available.—Dept. HW, Metwood Accessories, Church St., Wolverton, Bucks. (Trade supplied.)

MAAGIC Jumping Card and wonderful Catalogue 1/.—DeHempsey, 363 Sandycombe, Kew Gardens, Surrey.

WOODEN WHEELS, stock clearance bargains, 1" recessed 5/- gross. Recessed round tread, 1 1/2" 10/-, 2" 15/-, 2 1/2" 32/-, 4" 70/- gross. Doll's house fittings and papers. Brochure S.A.E.—Jasons, 135 Nags Head Road, Enfield, Middlesex.

STOP SMOKING!! Quick guaranteed remedy. Free Testing Sample!!—Triumph Remedies (H3), Exeter.

A GRAND BOOK FOR ALL THE FAMILY. The "Kaylee Year Book of Bright Ideas". A really helpful guide to home planning, decoration, Hobbies, toys, etc. Showing famous Kaylee Transfers in brilliant colours, and most effective uses. From "Hobbies" stockists **1/-** or direct.
KAYLEE TRANSFERS Postage 3d.
LTD., (HW) Long Eaton, Nottingham

STOP SMOKING in 3 days or money back. Safe, pleasant, permanent. The only scientific way. **No Will Power necessary.** 'Conquered the habit in 2½ days'.—F.C. 'Within 2 days I was free from the tobacco habit'.—W.G. 'Was a smoker for 2 years and broke the habit in 2 days'.—F.N. 'I used to smoke 20 a day . . . now I have no desire to smoke'.—J.M. Recommended by 'Health and Efficiency Magazine'. Complete course 6/6 (or \$1.00 bill), Details 1½d. stamp. Sent under plain cover. **NATURE REMEDIES, 28 (H/148) Dean Road, London, N.W.2. Established 1928**

● Continued from page 440

Television Savings Box

Replace lid, and on twisting disc (E), the ends of parts (G) should engage in the slots cut in strips (B) inside the box, as in sectional detail, Fig. 5. A little filing and glasspapering may be necessary to get a smooth locking movement.

Finishing off

Now nail and glue the bottom of the box in place. Glasspaper the whole and round off the side, top and bottom

corners of the box. Four small feet can be nailed and glued to the bottom if desired. Stain and polish the box to finish.

Cut a panel of glass, a shade less than 6½ ins. long and 4½ ins. wide, and a piece of thin plywood to the same dimensions as a backing. Between these place the licence, folded as necessary to allow the date of expiry to be seen in the panel opening. Place this inside, and secure by turning the metal clips over it.

SOLUTION ECONOMIES

HOME processing of films by the amateur photographer can be inexpensive if needless complications and waste are avoided. Some photographers employ four or five separate chemical solutions to develop a film, wetting agent, developer, stop bath, fixer, and hardener. Briefly, a wetting agent helps another liquid to flow freely on to, or off, the film emulsion. The stop bath, as its name suggests, stops development prior to fixing. The hardener toughens the emulsion against subsequent scratching.

Other photographers use two solutions only—developer and fixer. This is economical, simple and quick. For all ordinary films and plates the other chemicals are superfluous, and the writer has processed thousands of negatives, with complete success, with these two solutions alone. Thousands of other photographers have done the same. The beginner, then, is advised to use only these two solutions.

The developer may be powder, liquid, or in tablet form. Liquids, to be diluted with water, are generally easiest to prepare. Johnson's Azol is an example of this.

The important point to remember is, that all developers can be used diluted to varying degrees, provided the time of development is adjusted to suit. The times, for various films, can be obtained from leaflets issued by the developer manufacturer. For example, if 1 part of Azol to 24 parts of water be used, at 65° F., a Selochrome film would be developed in 9½ minutes.

In order to use less developer, 1 part of this developer to 40 parts of water can be used. Development would then be complete in 15½ minutes. It is also feasible to use 1 part to 80 parts of water, when the film will require 31 minutes to develop.

As the weaker developer is compensated for by longer development, the results will be the same in each case,

though the cost of developing will be much less.

Another method of solution economy is to save the mixed developer for another film. The usual 10½oz. tank full of 1:24 Azol will readily develop two 120 or 620 films. The mixed developer must not be left in the tank, or in an open vessel, or it will deteriorate in a matter of hours. Instead, it should be poured into a tightly-corked bottle, preferably of such a size that there is little or no air space left in the bottle when the contents of the tank are poured in. This ready-mixed solution, already employed to develop one film, can be used for a second, provided it is not stored more than about a week.

When a developing solution is used a second time in this way, at once or after a period, the time of development for the second film should be increased by 20 per cent. For example, the film will require to be developed for about 11½ minutes instead of 9½ minutes. As usual, a minute or so either way will make no practicable difference, except that if the time is much more than it should be, contrast and density will be increased.

A 10½oz. tank of 1:40 solution will also develop two films. The 1:80 solution is best used for one film only.

Various special developers exist, some only requiring the addition of quite a small amount of water. These are best avoided in all ordinary work and may prove quite expensive.

Fixer

Here, again, it is perfectly in order to store and reuse the solution. A good fixer for beginners and all general purposes is Johnsons Acid Fixing Salts—a powder readily dissolved in warm water. (Hot water should not be used for mixing.) Eight heaped teaspoonfuls of powder to 1 pint (20ozs.) of water will be suitable.

To avoid contaminating the fixer unnecessarily, wash the developed film twice in clear water. With tanks, this can be done by filling the tank twice with water. The fixer is then poured in.

After use, the fixer is stored in a corked bottle. A pint of fixer, made as directed, will easily fix five 120 or 620 films, so there is no need whatever to mix new fixer for every film. The mixed fixer will keep several months.

As the fixer grows exhausted, the yellow appearance of the film will not be cleared away so quickly. When the fixer takes more than about 10 minutes to act, at 65° F., it is time to throw it away and mix up some new solution.

(F.G.R.)

●Continued from page 437

Shadow Puppetry Theatre

or excited. For greater security a length of string is secured centrally along the back face of the second crossbar.

Action Figures

Incidentally, the characters may be produced with movable heads and bodies, and in any posture. The illustrations are intended to demonstrate the mechanical processes only. The essence of shadow puppetry is not so much reality as make-believe. Therefore, with-in reason, the more exaggerated the figures the better. But as they have to show up clearly in silhouette, clean-cut lines are imperative. Fairy stories, pantomime, and popular songs all offer wide scope for adaptation by the enthusiastic shadow puppeteer.

Thus, seated on a folding camp stool with a strong light suspended immediately behind the screen and preferably hooded to prevent overhead glow, the operator is all set to raise the curtain and commence the first performance.

This is the last issue of Volume 120. Preserve your copies of 'Hobbies Weekly' by obtaining an Easibinder, sufficient for two volumes, from Hobbies Ltd., Dereham, Norfolk, price 8/6 post free

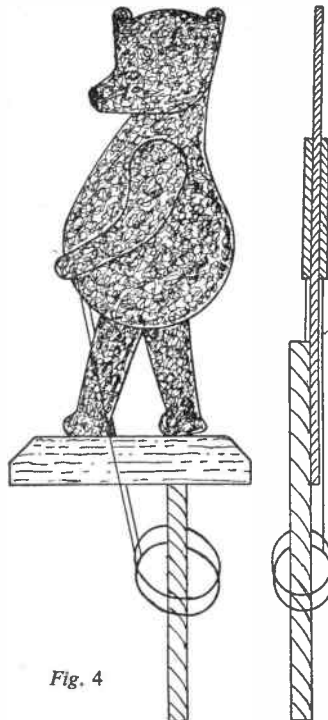

Fig. 4



IF SAMSON could have tried his strength on a CASCO-glued joint...

... he would have torn out his hair in desperation. However hard the wrench, the glued joint stands firm, whereas the wood gives way. The photograph shows the result. No matter which CASCO glue is used, a properly made joint is given the same amazing strength. CASCO glues (available in a range of sizes) cover all individual requirements—from ordinary household gluing jobs to the speciality work of the expert handyman

and model maker. Ask your local Ironmonger or Builder's Merchant for the free leaflets which describe in full detail the products listed below.



For **QUICK** Gluing Jobs
use **CASCO P.V.A. Glue**

- The new "family" glue
- All ready for use
- Clean and strong

For **HEAVY-DUTY** Gluing

use **CASCO Cold Water Casein Glue**

- Easy to mix and use
- Very economical
- Glues almost everything

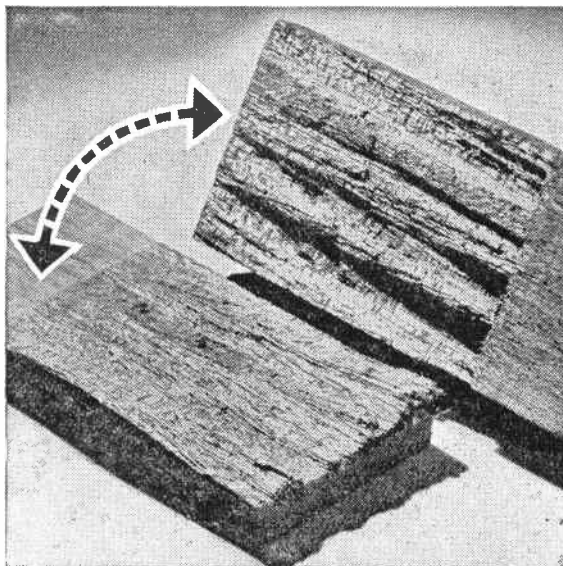

A hardwood lap joint, forcibly separated, showing how the glue has proved stronger than the wood. The joint was glued with CASCAMITE "One Shot" Resin Glue, but the same results are obtained with both CASCO P.V.A. and CASCO Cold Water Casein Glue.



For **SPECIALITY** Wood Gluing
use **CASCAMITE "ONE SHOT" Resin Glue**

- Mixed and used cold
- Gap-filling and non-staining
- Water-proof type



CASCO GLUES are recommended for

"Build-it-Yourself" with **Easi-Bild** Patterns

63

SYNTHETIC RESIN AND CASEIN GLUES

Manufactured by LEICESTER, LOVELL & CO. LTD · NORTH BADDESLEY · SOUTHAMPTON
Main Distributors: CHARLES CLEEVE & CO. LTD · 45 Great Peter Street · LONDON · S.W.1

Doll's House Wardrobe and Chest

THE illustrations this week show how to construct the contemporary wardrobe and chest required to complete the furnishing of the bedroom in a doll's house. It is an easy matter to follow the diagrams and to mark out the shapes on to suitable thicknesses of wood.

Cutting out

All the parts are straight sided so that you can place them side by side where possible, making one cut do for two pieces. Where a fretmachine is used the duplicated parts can be cut two at a time by pinning two pieces of wood together. Mark the shapes on first, then pin the two pieces together through the waste wood.

Commence by cutting the back of the wardrobe from $\frac{1}{8}$ in. wood. The top, floor, pedestal and sides are all $\frac{1}{8}$ in.

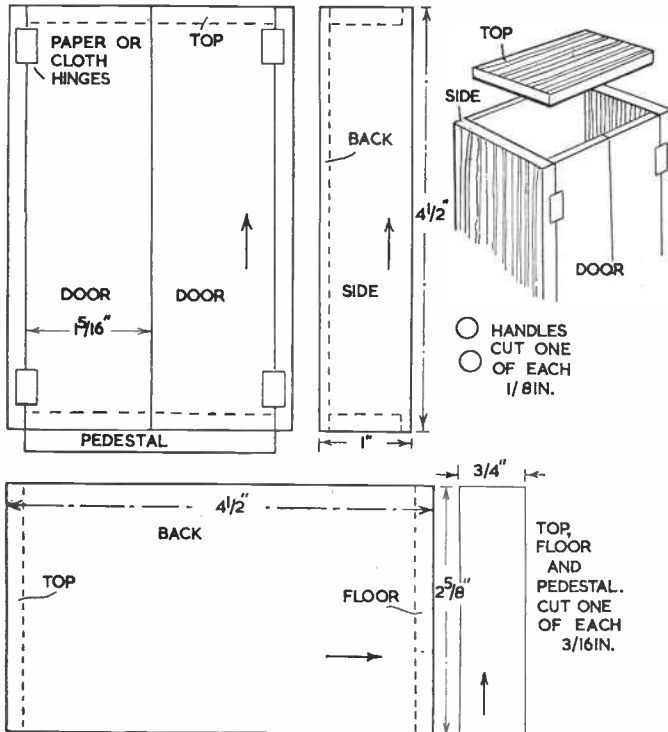
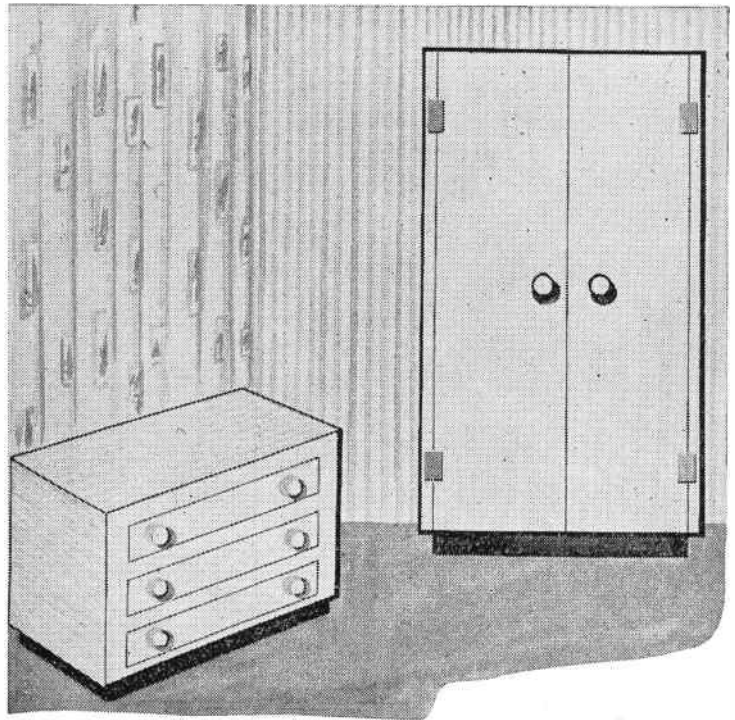

Diagrams for wardrobe

Furniture in a Contemporary Style

thick and are cut to the measurements given, the top being the same size as the floor. The grain, of course, should run in the direction of the arrows.

Glue these pieces together as shown by the diagrams. Cut the doors from $\frac{1}{8}$ in. wood and hinge them in place with pieces of tape and glue.

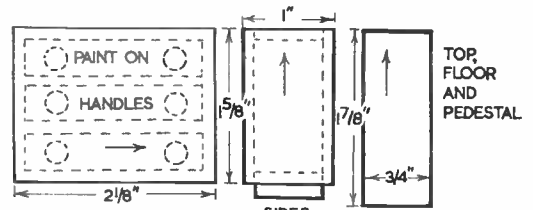

The chest layout

The chest is made up entirely from $\frac{1}{8}$ in. wood and the pieces glued together as shown in the sketch. All the necessary measurements are given.

The handles on the chest and wardrobe are small circles of $\frac{1}{8}$ in. wood cut out with the fretsaw and glued in place. The drawers on the chest are marked on in pencil or paint. (M.h.)

A Professional Finish at your Finger-tips!

With easy to use Robbialac Lacquer you can give your own handiwork a flawless finish. You will enjoy using this quick-drying versatile Lacquer which covers perfectly in one coat, leaves no brush marks and dries dust-free in 2-4 hours. Overnight it sets to a hard glass-like gloss that resists steam and hard wear.

Sold in a range of 24 brilliant colours plus black, white and silver, Robbialac Lacquer is available from all good paint shops, cycle shops, iron-mongers and hardware dealers in handy $\frac{1}{4}$, $\frac{1}{2}$, $\frac{1}{2}$ and 1-pt. tins.

ROBBIALAC LACQUER

FREE: Put a 'factory finish' on your handiwork. For free Instructional Leaflet send 1½d. stamp to: Dept 6L10 Jenson & Nicholson Ltd., Carpenters Road, London, E15.



LOOK FOR THESE BOXES

your guide to popular pastimes

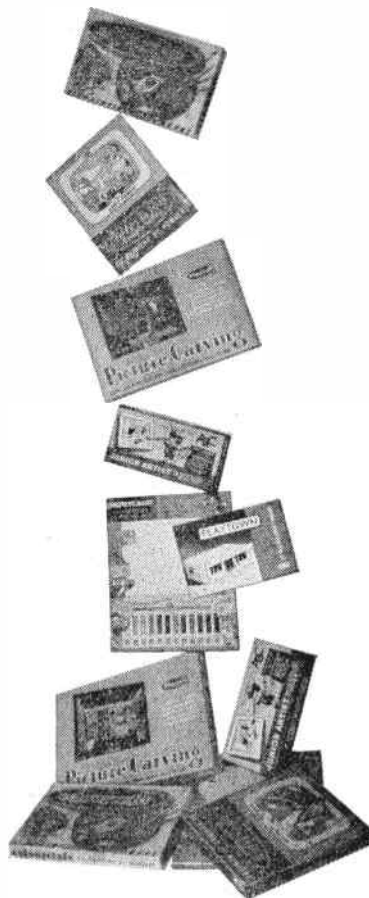

★ PLAYCRAFT HOBBY KITS

These kits are available in three attractive boxes each complete to enable modellers to produce a three-dimensional wood picture with the charm, colour and perspective of an old master. Price 22/6

- PICTURE CARVING for the modeller 22/6 ea.
- COLOUR CRAFT for the adult enthusiast 14/11 ea.
- T. V. FAVOURITES for the younger children 8/11 ea.
- DISNEYLAND a popular favourite 12/11 ea.
- JUNIOR ARTIST for the teenager 7/11 ea.

★ PLAYTOWN BY PLAYCRAFT

Architect-designed scale model construction kits which enable you to build your own village or town and provide garages and background buildings for your cars and railways. Price from 4/6

FROM ALL HIGH-CLASS HOBBY, ART AND TOY SHOPS

PLAYCRAFT TOYS LTD

120 MOORGATE, LONDON, E.C.2

BRIDGES $\frac{1}{4}$ " all-purpose TOOL POWER DRILL

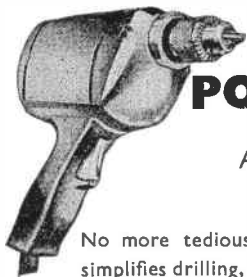

*An Engineer's tool at the
Handyman's price!*

No more tedious hand labour! TOOLPOWER simplifies drilling, sawing, polishing, sanding, turning and paint and rust removing. There's a Bridges accessory available for all these purposes—and all powered by the $\frac{1}{4}$ " All-purpose Drill, the most advanced and powerful of its kind in the world. Guaranteed. With GPO approved suppressor.

19/6 DEPOSIT and 8 monthly payments of 19/6.
Postage & packing 2/- extra.

Cash Price £7. 19. 6.

Write now to:

LAFCO COMPOUNDS Ltd (Dept. H.W.1)

3 Corbetts Passage, Rotherhithe New Road, London, S.E.16.

NEW! EXPERIMENTAL KITS

LEARN THE PRACTICAL WAY

Here is home study of the most effective kind under expert tutors. There is no better way of studying for an examination, starting a new hobby or for a career in industry. These special courses comprise the most modern methods of postal tuition, combined with a Practical Kit of parts (which remains your property).

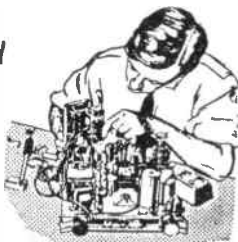

COURSES FROM 15/- A MONTH

COURSES WITH PRACTICAL EQUIPMENT INCLUDE: Radio, Television, Mechanics, Electricity, Chemistry, Photography, Carpentry; also Draughtsmanship, Commercial Art, Amateur S.W. Radio, Languages, etc.

POST THIS COUPON TODAY

For FREE brochure write: E.M.I. INSTITUTES, Dept. 31X, Grove Park Road, London, W.4.
SUBJECT(S) OF INTEREST.....
NAME.....
ADDRESS.....
12/10/55..... IC51A

E.M.I.
INSTITUTES

The only Postal College which is part of a world-wide Industrial Organisation

PHILISHAVE

14 DAYS' FREE TRIAL

Try the wonderful Philishave Electric Dry Shaver FREE for 14 days. Send only 5/- deposit (returnable if no satisfied). Two shaving heads with two 6-bladed cutters have unique rotary action which genuinely shaves - doesn't just snip at the hairs. Result - better quicker shave. Operates 110/250 volts. A.C. D.C. £7. 9. 3 cash less your deposit. Or 5/- deposit can be first payment, followed by 8 monthly payments of £1. 12 months' guarantee. Brochure of this & other shavers free.



ELECTRIC PAINT SPRAYER

For 4/- deposit



Cash 75/-. Or 4/- deposit and 6 monthly payments of 13/6

Paint easily, evenly, twice as fast with the Burgess Electric Sprayer. Sprays paint, varnish, etc. Complete with sturdy glass container, flex, nozzles for ceiling spraying and extra nozzle discs for different liquids. A.C. mains - state your actual voltage. Fully guaranteed. Also Horvell Electric Paint Striper 30/- cash, or 4/- deposit and 3 monthly payments of 10/- Leaflets free



BATHROOM SCALE BARGAIN

★ FOR 5/- ONLY

★ and 6 monthly payments of 13/- (or Cash Price 69/6)
WATCH YOUR WEIGHT every day with this streamlined Bathroom Scale. Magnified dial easy to read. Weighs accurately from 1lb. to 18st. Lovely white enamel finish. Non-slip rubber mat. All mechanism enclosed. 2 years' guarantee. Cash 69/6, or 5/- dep. and 6 monthly payments of 13/-.

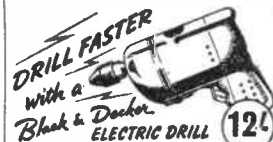

DRILL FASTER
with a Black & Decker ELECTRIC DRILL 12/-

A first-class tool, the Black & Decker U-1 Portable Electric Drill saves hours on home and workshop jobs. Drills wood, steel, brick, etc. Steel capacity up to 1". Also drives sanding discs, polisher pads, etc. Weighs 32lb. Fully suppressed. £5. 19. 6 or 12/- deposit and 6 monthly payments of £1. Sent on receipt of the deposit. A.C./D.C. motor, voltages 110 to 250. State your actual voltage.

Send for complete list of Tools

BARGAIN DISTRIBUTORS

(Dept. 124), 5 Silver Street, Luton

A boon to the Keen model maker!

SPRAY GUN

For Cellulose, Lacquer, etc.
No. 3 Spray Gun. Complete with Air Bulb, Connector, Container & Guaranteed Spray Unit, 8/6
No. 2 Spray Gun for use with motor tyre pump 7/6
Giving a perfect finish using coloured or clear cellulose lacquer or any paint. Cellulose ready for spraying is available in any quantity from 2 oz.

All P. & P. free From leading Model Shops, or direct from:

CELSPRAY LTD. (Dept. H.1)
Beechwood Rise, Watford.
Tel.: Watford 6284

Celspray



HEAR ALL CONTINENTS With H.A.C. Short-Wave Receivers.

Suppliers for over 18 years of Radio S-W. Receivers of quality
One-Valve Kit, Price 25/- Two-Valve Kit, Price 50/-
Improved designs with Denco coils. All kits complete with all components, accessories and full instructions. Before ordering, call and inspect a demonstration receiver, or send stamped addressed envelope for descriptive catalogue.

'H.A.C.' Short-Wave Products (Dept. 22), 11 Old Bond Street, London, W.1

HARDHITTING

ACCURATE

Webley AIR PISTOLS

AIR RIFLES · ACCESSORIES

Write for Catalogue

WEBLEY & SCOTT Ltd., 166 WEAMAN ST., BIRMINGHAM, ENGLAND



AS DEMONSTRATED ON T.V.

DECRA-LED

transforms plain glass into fashionable

LEADED WINDOWS

No glass to cut—no windows to take out—no tools to buy. You can DO-IT-YOUR-SELF. A 10/- DECRA-LED Trial Kit will do three panes 30" by 18" in traditional Diamond design.

New full scale motif designs are now available. You can use them on any size or type of window.

Obtainable from Handicraft and Woodwork Supply Stores, Ironmongers and Decorators.

If unobtainable locally, direct from TRADE ENQUIRIES INVITED
T. BROWN & CO. LTD., Dept. 1, 50 WOOD STREET, ASHTON-UNDER-LYNE, LANCASHIRE

Patterns for the Letter Rack





MAKE FIRM FIXINGS IN ALL MATERIALS



When you wish to fix cabinets, book racks, shelves, etc., securely to walls use Rawlplugs. The most popular size is No. 8 at 1/- per packet of assorted lengths.

A No. 8 Rawltool for making the correct hole costs only 1/6. The 2/6 Popular Rawlplug Outfit contains Rawlplugs and Screws and the No. 8 Rawltool or you can have a larger outfit at 6/- or 9/6 complete.

RAWLPLUG ELECTRIC SOLDERING IRON

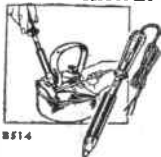

Guaranteed for six months, voltages 100/110, 200/220, 230/250 Universal AC/DC. Consumption 110 w. Supplied with six feet 3-core cable. 29/- with Standard Bit. 30/- with Pencil or Hatchet Bit.

8514



FOR FASTEST EVER MASONRY DRILLING

The Rawlplug Durium Drill will make holes in tile, brick, stone, slate, etc., with amazing speed. Can be used in a hand or electric drill. Sizes are from 5/32" to 1" diameter and there's a long series for drilling through walls. Durium Glass Drills can also be obtained.

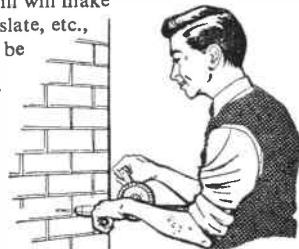

RAWLPLUG DUROFIX

Quick drying transparent cellulose adhesive which is heatproof and waterproof, Durofix will stick almost anything to anything. Handy tubes 9d. large tubes 1/3 and also in tins.

THE RAWLPLUG COMPANY LIMITED, CROMWELL ROAD, LONDON, S.W.7

PRINT YOUR OWN SNAPSHOTS

with this super

3/- PHOTOGRAPHY

KIT

Think of it! Now you can make your own prints of holiday snapshots with this Johnson Print-A-Snap Pack. It's wonderful fun and so easy too. Each pack has everything you need for making perfect pictures from your negatives.

There are two sizes. One has 16 sheets of 3½ x 2½ in. contact paper—that's for the camera that takes 8 pictures on each roll of 120 film. But if your camera takes 12 pictures to a roll, ask for the pack with 24 sheets, 2½ x 2½ in. Get the Johnson Print-A-Snap Pack today and show the family what you can do.

Only 3/- a pack

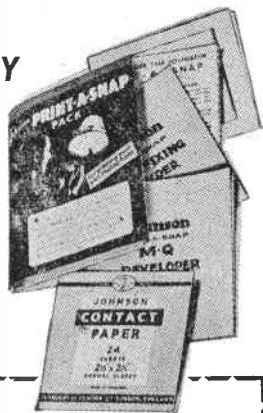

1 pkt. developer.
1 pkt. fixing powder.
1 pkt. of the new Johnson contact paper, a cardboard printing frame and a sturdy wallet for keeping your prints in after you've made them, together with full instructions.

Ask any Photo-Dealer for the
JOHNSON PRINT-A-SNAP PACK

The sparkling enamel PAINT IN TUBES!

Handy, Economical

STARLON in handy, economical tubes is just right for all small or multi-coloured painting jobs, cycles, prams, etc.

- No wasteful 'left-overs'
- Easy to apply
- Quick drying
- No brush marks
- Brilliant lasting finish



1/-
IN 14
LOVELY
COLOURS

Trade Enquiries
welcomed by
the makers

See STARLINE
paints on INDEPENDENT TELEVISION
'DO-IT-YOURSELF'
programmes
London, Sats. 5.15 pm.
presented by
W. P. Matthew

Starlon

PLASTIC ENAMEL PAINT

Obtainable at Handicraft shops everywhere

STARLINE, SOUTHEND-ON-SEA, ESSEX

Printed by BALDING & MANSELL, LTD., London and Wisbech, and Published for the Proprietors, HOBBIES LTD., by HORACE MARSHALL & SON, LTD., Temple House, Tallis Street, E.C.4. Sole Agents for Australia and New Zealand: Gordon & Gotch (A'sia) Ltd. For South Africa: Central News Agency Ltd. Registered for transmission by Canadian Magazine Post.