

HOBBIES WEEKLY

IN THIS ISSUE

| | Page |
|--|------|
| Musical Cigarette Box | 81 |
| Replies of Interest | 82 |
| A Useful Polishing Mop | 83 |
| Garden in a Tub or Barrel | 84 |
| Stamp Collector's Corner | 85 |
| Storing Resistors and Condensers | 86 |
| More Random Recipes | 87 |
| Transferring Patterns to Wood | 88 |
| A Few Darkroom Wrinkles | 90 |
| Pattern for Novel Menu-Holder | 95 |



MAY 11th 1955

VOL. 120

NUMBER 3106

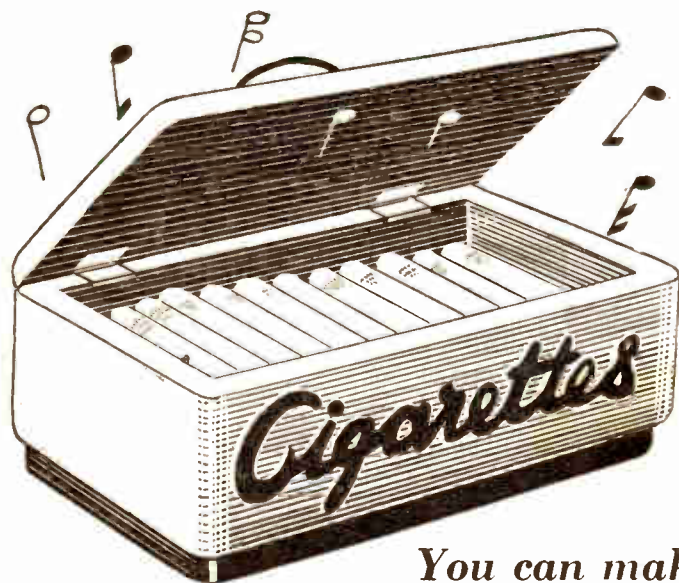

This week's ★FREE DESIGN★

'O My Papa' and 'Some Enchanted Evening', while what could be more appropriate after entertaining one's friends than to light that final cigarette to the strains of 'Auld Lang Syne'? Other tunes in the Hobbies range are 'Vienna, City of my Dreams', 'Parade of the Wooden Soldiers' and the Harry Lime theme from 'The Third Man'. When ordering please state second and third choice.

To emphasise the practical side, it should be noted that the box will hold 40 cigarettes. Charm your friends by offering them a cigarette with music. Lift the lid and the melody starts. Close it—and the melody stops. As a gift for someone extra special, this would make a delightful choice.

You can make this attractive

MUSICAL CIGARETTE BOX

SWEET music and a cigarette—can you think of a more soothing combination than that provided by the subject of our design this week, which is for a musical cigarette box?

Dinner over and the washing-up done, a step to the sideboard, a lifting of the lid, and there is a favourite smoke all ready to be enjoyed to the gay

accompaniment of the 'Merry Widow', or the 'Blue Danube', the delightful strains of Brahms' 'Lullaby', or the merry jingle of 'Jingle Bells'.

Other tunes available which can be incorporated in this delightful and practical novelty include nursery rhymes such as 'Mary had a Little Lamb' and 'Rock-a-Bye Baby'. Modern tunes are

Making the musical cigarette box is very simple, and well within the capabilities of any handyman. Trace the design on the detailed thicknesses of wood and cut out the parts with a fretsaw. It will be noticed that on pieces 2 and 9 shallow recesses have to be provided to take the hinges. The parts are numbered as near as possible in

All correspondence should be addressed to The Editor, Hobbies Weekly, Dereham, Norfolk

*For Modellers, Fretworkers
and Home Craftsmen*



order of assembly. Clean up the pieces with glasspaper after the cutting-out has been completed.

To make the main box, glue pieces 1, 2, 3, 4 and 5 together. When the glue is set hard, pieces 6 and 7 can then be glued in position on the base, thus forming the container for the musical movement.

Fixing the Movement

Next fit the movement into this separate compartment, and fix to the base by screws inserted through the two holes. Make sure that the screws are not too long, so as to protrude through the base. The winder portion, of course, goes through the hole already provided for in the base.

From a piece of medium gauge wire, make the plunger which forms the stopping and starting mechanism for the musical movement. Note that the arm on the movement is bent parallel with the end 3. By studying the diagram on the design sheet it will be seen that the plunger is slipped on the arm of the movement, then rested in the notch provided in piece 8, finally going up through a small staple fixed to piece 3. When the lid is closed it presses on this plunger, which in turn depresses the arm, thus stopping the mechanism. Conversely, when the lid is opened, the

tiny spring on the arm lifts the plunger, thus freeing the mechanism and starting the musical movement.

The small staple which helps to hold the plunger in the vertical position is made by cutting the head off a ¼ in. fret pin and bending over to form an eye. There should be sufficient play to allow the plunger to move freely up and down, but not too much side movement. The staple is pressed home into piece 3 with pliers.

With the plunger in position, piece 8 can now be glued on to form the top of the musical compartment.

OBTAIN A KIT

To make this cigarette box you can buy a Kit (No. 3106), containing wood, hinges, knob, wire and catch, from any Hobbies Branch, or post free from Hobbies Ltd., Dereham, Norfolk, price 4/9. A suitable Musical Movement is supplied separately, price 17/11.

The plinth at the base is formed by mitring pieces 10 and 11 and gluing in position. This plinth is slightly inset from the edges of the base and the corners of the mitres and the base can now be rounded.

The lid is of ¼ in. wood and the knob which is glued into the centre of it consists of a ball foot. The dowel on this, provided with the kit, will be found to be a bit too long, but this can be trimmed flush after the glue is hard. Now hinge the lid in place and round off all corners where desired.

The box catch fitting can now be added by pinning the two pieces, one to the leading edge of the lid and the other to front 1. This is an optional addition, as providing the hinges are set correctly, the lid should stay shut until lifted.

Finish

The overlay 'Cigarettes' is cut with a fretsaw from ¼ in. wood. Before gluing this in position, the finish of the article must be decided on. This, of course, is a matter for personal taste. Staining and polishing will accentuate the natural beauty of the wood, and can be made to tone with the furniture. If this method is adopted, then the addition of the overlay should be left until a perfect finish has been given to the box. Then mark the position of the overlay and scrape off carefully the polish to give a better surface on which to glue the overlay.

If painting is preferred, the overlay is, of course, glued to the front of the box before this is undertaken.

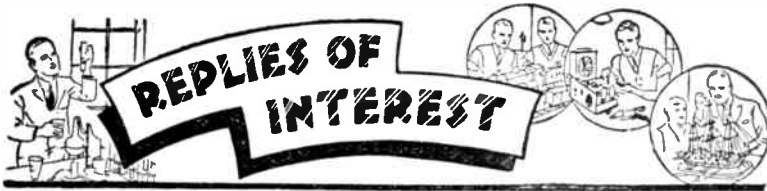

Replacing Floorboards

I AM taking out an old wooden floor that has rotted through bad drainage, and replacing with new timber. The drainage has been made good, but I wondered if it would be any advantage to coat the beams and underside of the new floor to help make it last longer. If so, what would you advise, and can you give any hints to help to get a good tight-fitting floor and a good finish for the surface? (J.S.—Stoke-on-Trent.)

IF you are sure all dampness has been cured, then give a generous coat of creosote to the new joists, and to the underside of the floorboards, before fixing. To ensure a close and well-fitting new floor, clamp up each board tightly to its neighbour before nailing. If a proper tool is not available, a substitute can be made by lightly nailing a bar of wood across the joints, 1 in. or 2 ins. from the board and inserting wedges between to force the board up to its next tightly.

The bar is then knocked away and railed further back, ready for the next board. To finish the floor, scrape or glasspaper all over, knock nail heads down, and stop up the holes, then either stain and varnish or apply a proprietary brand of wax polish.

Cleaning Leather Suite

HOW can I clean a leather three-piece suite? (J.C.—Oldham.)

IT may be your leather needs renovating more than cleaning, especially if the tough skin outer layer is worn through. Wash surface with warm water in which a little soda has been dissolved. Then treat with a cotton-wool pad soaked in a mixture of ½ ounce bismarck brown to 1 pt. methylated spirit and ½ gill french polish. Finish off with a rub over with furniture polish on a soft dry cloth.

Mixing Gum Arabic

WILL you please tell me how to mix, for use, gum arabic? (B.A.—Earl Shilton.)

AN easy formula not requiring metric weights is:—Gum arabic, 1oz.; water, 2½ fluid ounces; phenol, 15 grains. Place all together in a bottle to dissolve. Occasional shaking will be needed. Rate of solution depends on the subdivision of the gum, but the process is usually complete in two days at most. In the event of grain weights not being available, add enough phenol to give a distinct carbolic odour. The phenol is, of course, needed to preserve the gum from mould.

To Colour Cane

CAN you advise me how to colour cane successfully? (P.W.S.—Tottenham.)

IF it is desired to obtain a particular effect, it will be found quite a simple matter to dye cane of a natural colour. This is done by dissolving ordinary powdered dye in boiling water, and soaking the cane in the dye until it is the required colour. The cane should then be allowed to dry, then soaked in cold water to which a little salt has been added, before using it.

A Useful Polishing Mop

By W. J. Ellson

THIS simple design of polishing mop will be found very effective on floors not dead level. It penetrates the hollows well and lessens the work of floor polishing in no small degree. Also, it is not worn out in a hurry. Easy to make, it uses up scrap material that might otherwise be discarded.

Making the Stock

Fig. 1A shows the construction of the stock. A hard wood, 1 in. wide and $\frac{3}{4}$ in. thick, is suggested for this part. Make up the frame first, then cut the intermediate wood strips and, with the exception of the middle one, nail them across at equal distances apart. All joints

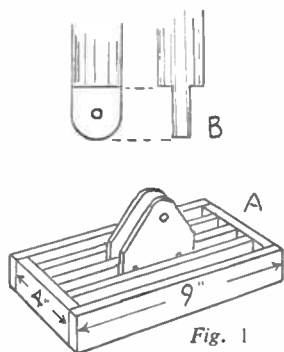

Fig. 1

should be glued, as well as nailed, to make a strong job. Two lugs, cut from $\frac{3}{4}$ in. plywood to the shape given at C, in Fig. 2, should be nailed to the middle wood strip, as in the diagram. The holes near the top of these should be in alignment and be bored to suit nail or bolt used to fit the handle to the stock. Then glue and nail the wood strip, with its lugs, across the centre.

Chamfer off Angles

When the glue is hard, glasspaper the whole to smoothness and chamfer off all sharp angles, especially those of the wood strips, over which the polishing material is subsequently to be fitted. The wood can be left in the white, but a coat of varnish stain is to be preferred. It helps preserve the wood and enhances the general appearance of the finished mop.

For the handle, a broomstick would suit quite well, or in fact, any round wooden rod of sufficient strength. Reduce one end to $\frac{3}{4}$ in. thickness for a

length of about 1½ ins. In the centre of this reduction bore a hole, the same as in the lugs, and trim the lower end to a half-circle, as at B, Fig. 1. See that the handle easily fits between the lugs and then fit with a small bolt through lugs and handle bottom, or stout wire nail. Well glasspaper the handle, as these are not always as smooth and free from splinters as they might be.

For covering the stock, strips of soft material can be used. Such material as old blankets would suit well, or strips of soft cloth from worn clothing. Cut the strips 9 ins. wide and as long as

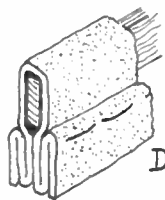
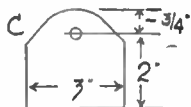
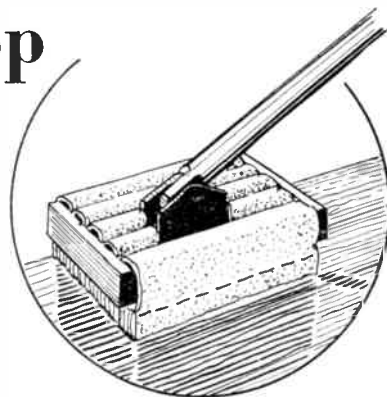

Fig. 2



possible to a limit of 8 ins. each. If cut to the latter, it will cover all the wood strips, bar the middle one, which will, on account of the space occupied by the lugs, need two of shorter length.

Treble Thickness

Lay the strips over the wood and fold up the ends hanging down to make a treble thickness to each end. Then stitch through the lot under the wood, as in detail D, Fig. 2. There will then be substantial thickness of material under the stock, which should wear well and last quite a while before a re-covering becomes necessary.

It might be a good idea to nail a strip of felt or other thick material across the end of the mop, to prevent any damage to the skirting boards of the room should the mop bump into them.

Born 1895 — Still Going Strong

ON October 19th, 1895, was published No. 1 of Vol. 1 of 'Hobbies Weekly', which ran to 24 pages and cost 1d. Our issue of October 19th this year will, therefore, be the Diamond Jubilee Number, and preparations are already in hand to make it really worthy of the occasion.

Throughout the years, 'Hobbies Weekly' has concentrated on guiding the amateur handicraft worker to get the best results from his or her particular hobby, and turn it into profitable leisure. That our efforts have been appreciated is apparent from the constant tributes being received concerning the sound articles published weekly, and the fact that the circulation has risen to 80,000.

Now this is where we call on those vast numbers of readers to help us in turn. There may be some among you who, in the 1890's, invested their weekly penny in their favourite magazine, and who still look forward to each Wednesday when the current copy is delivered. Write and tell us—we shall all be pleased to know.

Maybe, too, there are other incidents connected with 'Hobbies Weekly' of which you meant to write and tell us at the time, but allowed the opportunity to pass. Something humorous, perhaps, or an idea culled from its pages which led to big things; maybe you have helpful suggestions.

In a nutshell, help to swell the Editor's post bag at Dereham, Norfolk, to enormous proportions—and he will incorporate your reminiscences in a special article in that very special anniversary issue.

THE EDITOR.

You can make a

Garden in a Tub or Barrel

Says A. F. Taylor



and the state it is in. A good oak barrel that has been burnt out or charred is in an ideal condition for growing plants. This is best done with a blow-lamp, but be careful not to carry the process too far, or the wood will be weakened unnecessarily.

For the thinner type of barrel which you get from the greengrocer, a coat or two of paint would be the best preparation, or it might be creosoted, but either of these need to be done some

the plants in the bottom part will not grow as well and be more likely to get some form of disease. Instead of bricks, however, a better and more satisfactory method is to cut some wooden feet to stand the barrel on or to screw to the base, similar to those shown in Fig. 2. Wood about 1in. thick and preferably of oak would be suitable.

All the outside of the barrel, including the bottom and feet, should have two or three coats of good paint, allowing each to dry well before applying the next.

Filling the Barrel

Filling the barrel and putting in the plants needs considerable care. It is a large container, and if you are not satisfied it cannot be tipped out as easily as a flower-pot. First cover the bottom, to a depth of about 2ins., with broken bricks, stones or well-washed cinders, or a mixture of all these after

PEOPLE who have no garden and yet love to grow flowers, will welcome this Tub or Barrel Garden. It is ideal for standing on a concrete yard and helps to brighten up even the dullest corner. A small tub stood beside the front door will be a source of delight to all passers-by, and will give endless pleasure for many months to the owner.

Such a garden is suitable for growing many kinds of flowers, and it is even possible to grow strawberries with great success. Many non-gardeners have recently taken up this charming hobby, which promises to become very popular. No skill is needed in order to grow flowers successfully and the initial preparation of the tub or barrel is quite simple.

A Wide Choice

There is a wide range of receptacles available for converting into a garden, and the final choice will depend upon individual requirements. The greengrocer or fruiterer should be able to supply a rough, but quite servicable, type. A wine merchant or a brewery should have some old barrels in various sizes lying around, which may be bought fairly cheaply.

Even if you are unable to get a suitable barrel, and this is extremely unlikely, you can use a rectangular box, or it would not be difficult to make a container yourself. The shape may be round, square or with six or eight sides, and made up of narrow strips similar to the proper barrel construction, except that they will be the same width all along their length.

The inside of your barrel will most likely need some form of preparation, but this will depend upon the type

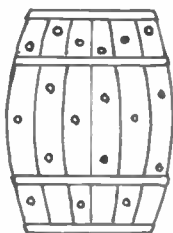

FIG. 1.

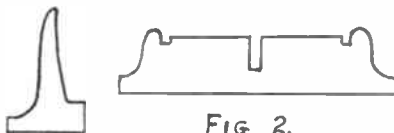

FIG. 2.

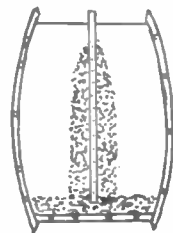

FIG. 3.

considerable time before the barrel is put into use. The plants do not like the fumes from them and the soil can absorb quite a lot from the freshly painted wood.

Drilling the holes is the next operation and those in the sides should not be larger than 1½ins., or the soil may trickle out of them. The number required will depend upon the kind of flowers grown and for most general purposes two or three in each section should be sufficient, as shown in Fig. 1. With a garden of this kind it is very necessary to provide adequate drainage, and you should, therefore, drill a number of holes in the bottom for this purpose.

Wooden Feet

Some people may be content to stand the barrel on a few bricks to raise it off the ground to make for better drainage and also to allow the air to circulate better. This prevents the bottom from getting water-logged, which in turn makes the soil sour, and

you have placed a large crock over each hole.

We now need a length of iron pipe about 1in. to 1½ins. diameter to reach from the stones in the bottom to the top of the barrel. Close up one end with a wood plug and drill a number of small holes all the way down and all round. This is for watering and will enable the bottom plants to receive their proper amount.

Keep the pipe in the centre and fill up the barrel round it with drainage material, and then soil as shown in Fig. 3. The soil should be made up of loam 4 parts, leaf mould 2 parts and sand ½ part, with a sprinkling of bone meal or other manure.

The planting must be done gradually — put in drainage and soil until you come to the first lot of holes in the side of the barrel, then put in the plants and proceed upwards until it is filled. It is best to have fairly small plants, otherwise you may have difficulty in getting the roots through without damaging them unduly.

● Continued on page 89

STAMP COLLECTORS' CORNER

ONE of the commonest questions that a stamp collector is asked by those who do not collect is: 'Have you any Cape triangular?' Probably it is thought that the Cape of Good Hope stamps are the most valuable. However, this does not happen to be the case, but it is unlikely that a young collector would be lucky enough to have any of these classic stamps.

In fact, not a great number of young collectors have been fortunate enough even to see specimens. About the only

are shown on the 1948 issues from Mauritius. There were four stamps of 5c., 12c., 20c. and 1r. The two lower values have a picture of the famous 'Post Office' Mauritius 1d. orange red, priced at a mere £5,000! The 20c. and 1r. values show the slightly more valuable 2d. blue Mauritius. As the price indicates, these are really valuable stamps and there are only 13 specimens of the red and 12 of the blue known to exist. Yet collectors can obtain a perfect reproduction for a few pence.

Perhaps, naturally, English collectors think of 1940 as being the centenary of the first adhesive stamp to be issued—



South Africa—the Cape triangular



Mauritius—the Penny Red



Bermuda shows the Postmaster's stamp way. The originals came from Moldavia and Moldo-Wallachia, two regions which do not now issue their own stamps, but use those of Rumania.

It does seem, then, that it is becoming fashionable to reproduce early issues due, of course, to the fact that it is approximately 100 years since stamps first became available. It is not always this which has prompted the design, however. In 1942, for instance, Norway issued two stamps for the commemoration of the establishment of the European Postal Union. They had the oldest stamp and also the latest, the first issued in 1855 and the second in 1942, showing Vidkum Quisling.

Brazil has three times reproduced her early stamps. On the occasion of the Philatelic Exhibition of 1934 she had the 1844 type. The centenary of the postage stamp fell in 1943, and only too naturally the design incorporated those stamps known as 'Bull's Eyes'. Just previous to this the centenary of Petropolis had been celebrated, and on this occasion an early stamp of 1866 was shown.

Some of the most interesting specimens have not long been issued. Russia in 1946 had an issue with no fewer than 16 stamps shown on the front, yet so well were they printed,

● Continued on page 87



Mexico commemorates the Penny Black



Russia remembers many stamps

chance there is of seeing some of the really valuable stamps is to go to a philatelic exhibition. It is fortunate, therefore, that many countries are now commemorating their early stamps by using them as the design for their present issues.

For example there are two specimens of the South African 1953 centenary of the first Cape of Good Hope postage stamps. The one illustrated gives a picture of the penny red triangular Cape as issued in 1853, now catalogued at about £50. The other has a picture of the fourpenny blue, which is worth about the same amount.

A much more valuable stamp, or rather pair of stamps, are those which

the well-known Penny Black. Few people, other than collectors, realise that in 1840 not only was there a Penny Black stamp issued, but also a Twopenny Blue, and that the latter is the more valuable. Unfortunately, in 1940 we were at war, so it was not possible to commemorate this well-known issue in the manner that it deserved. Great Britain did issue a commemorative set, and mention of this is justified here, as the issue showed the head of Queen Victoria as it appeared in the original in 1840, although it cannot be said that the stamp was entirely illustrated.

However, there were countries which did illustrate the Penny Black. Cuba had quite a large specimen, which showed a

A. Fraser writes about

Storing Resistors and Condensers

THE radio constructor, as his hobby proceeds, inevitably accumulates quite a collection of resistors and condensers. Storing these can become a problem.

They usually end up as a mixed-up pile in some cardboard or tin box. So when a constructional job is undertaken, one has first to wade through the collection hunting for the particular values needed. If one is a comparative newcomer to radio and resistors

position on the board in the easiest manner possible.

A piece of board is required as the basis of the arrangement. This can be plywood of any thickness from $\frac{1}{4}$ in. upward. The shape and size are not special—they can be anything convenient to the worker. As will be seen from the drawings, small shelves, or rather ledges, are fixed across the board, by means of nails or screws driven through the back of the board. The width and depth of these ledges, again, can be anything that suits the reader. A quarter or three-eighths of an inch thick will do. Three-quarters of an inch

To accommodate type A resistors, the spar wood used for the shelves is drilled with holes along its centre line. These can be $\frac{1}{4}$ in. apart. For wide ledges, several lines of holes are drilled according to requirements. These holes must penetrate through the wood. Drill sizes from 30 to 40 are very suitable. Reference to the illustrations will show how the resistors are inserted, one end passing through the hole, leaving the resistor standing upright.

The length of the projecting wires on resistors is usually $1\frac{1}{2}$ ins., and this will determine the height of one shelf above another. It will be found convenient, however, to alternate type A with type B shelves, placing one above the other. This will save space. (See illustrations.)

Type B shelf is made differently from type A. Instead of having holes bored in it, there is a slit running all along its length. With wider shelves, several slits are necessary. These slits are easily made

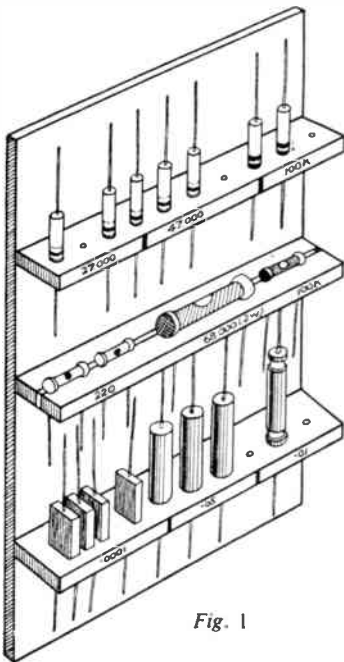

Fig. 1

cannot yet be identified by their colour markings, then there is also involved the task of identifying these markings before one can decide what one has or has not got. Such a state of affairs is obviously a nuisance, and much time and patience are lost.

How much more convenient it is, therefore, to have some organised system of dealing with condensers and resistors. The reader would do well to adopt the method described here. Very little time and skill are needed. Once made, the storage board, as we might call it, will prove of great service. It is a great boon to be able to stretch out one's hand and pick out instantly the particular condenser or resistor needed. In addition, any resistors or condensers that are left over from construction, or that come one's way, can be slipped into

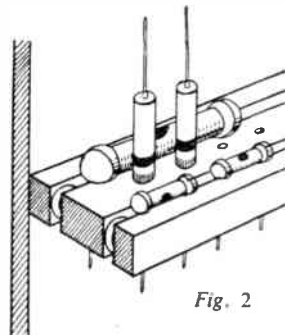

Fig. 2



Fig. 3

will do for the width, or even half an inch. But if a big stock is to be dealt with, the width can be increased to two inches to take three or four lines of resistors.

Two types of shelves are used. This is due to the fact that resistors come in two types. In the first type (which we can call type A) the connecting wire or tag is in parallel with the axis of the cylinder of the resistor. The other type (say type B) has the wires issuing out at right angles to the axis of the cylinder.

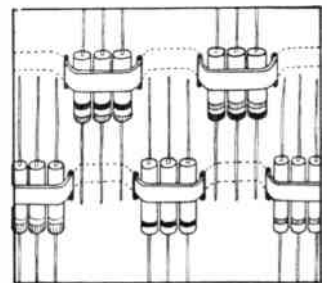

Fig. 4

by using two or more pieces of sparring and separating them by metal washers. (Pieces of cardboard would also do.) The spars and washers, of course, are held tight to the baseboard by screws or nails. The type B resistors lie along the shelf with their wires passing through the slits (Fig. 1).

The distance from shelf to shelf should be about 3 ins., but if space permits, a much greater distance is advantageous.

A shelf which will hold both types of resistors can easily be made as in Fig. 2. Holes are drilled in the back spar for the type A resistors, while the type B are placed at the front. The reader might prefer to make all the shelves like this.

The actual values of the resistors are written on the front of the shelf. Sections devoted to different values can be marked off by saw-cuts, or simply by pencil or ink.

● Continued on page 90

MORE RANDOM RECIPES

ALABASTER ornaments occasionally need attention and it is well to know the right methods to adopt. The first thing to remember about this stone is that it is very soft and is easily damaged by metal tools. Secondly, the open fireplace is its enemy, causing it to become discoloured; alabaster should not, therefore, be kept on a mantelpiece.

Polishing Alabaster

Pumice powder should never be used, for it darkens the surface. Deep scratch marks may first be levelled off with a nail file, or by careful scraping with a penknife. The next step will alone serve for shallow scratches. Primary polishing is done with dried shavegrass (a rush) moistened with water. This usually leaves fine streaks which are removed with finely sifted slaked lime made into a paste with water. The final satiny lustre is imparted by rubbing with soapy water containing a little slaked lime, and then with french chalk.

Alabaster Cement

To join broken alabaster or to replace pieces which have come apart, white of egg, to which has been added enough finely sifted quicklime to make a paste, is used. Another cement consists of fine plaster of Paris made into a paste with the least practicable amount of water. In both cases, the surfaces to be joined should first be washed lightly with warm soapy water and then rinsed with plain warm water and allowed to dry.

Cleaning Alabaster

The yellow discoloration caused by smoke is difficult to treat, but, dependent on its extent, complete or partial restoration can be attained by first washing with soapy water, then with plain water. Care should be taken with cemented articles to avoid water coming in contact with the cemented edges, otherwise the pieces may come apart and have to be rejoined.

After washing, the article should be treated as for polishing, starting from the shavegrass stage and following right through to the final french chalk rub.

Grease spots may be removed by rubbing with talc. Oil of turpentine is also used, but should be applied sparingly on a cloth, and the area well rubbed afterwards with a soft cloth.

Toy Soldier Alloy

Readers who cast toy soldiers will find it profitable to know the composition of the hard lead alloy they buy. This consists of: Lead, 9 parts; antimony, 1 part, both by weight. The alloy is made by melting the lead and stirring in

the antimony until an even melt is obtained. As the plates of storage batteries consist of the same alloy, a big saving can be made by using these from worn-out batteries.

Tarnisher Inhibitor

Polished metal articles can be guarded against tarnishing by means of the following preparation: Paraffin wax, 5 grams.; petrol, 45 c.c. Warm the petrol in a vessel standing in a hot-water bath (no flame). Shred the wax and stir it in. Let the solution cool. For use, coat the article thinly and rub off the greater part with a soft cloth, so that only a fine film remains.

Duplicator Ink

This is an expensive item for clubs and church groups who do any amount of duplicating. Yet it can be made quite cheaply with the aid of a pestle and mortar. Requirements are: Light mineral oil 80 c.c.; best drop black, 37 grams. Ordinary cycle lubricating oil gives good results. Put the drop black in a mortar. Grind in the oil little by little and continue grinding until a smooth paste is formed. This ink may conveniently be kept in a wide screw-topped jar.

Paint and Varnish Remover

There are various formulas for these strippers, many of them containing materials which mean visiting a laboratory furnisher. A formula which is exceedingly effective calls only for ingredients which can be had from any pharmacist. This consists of: Benzene (not benzine), 30 c.c.; methylated spirit, 20 c.c.; paraffin wax, 1 gram. Candlewax may be used and so further cheapen the stripper.

Warm the benzene in a water bath (no flame) and dissolve the shredded wax in

it. Stir in the meths. and allow to cool. Apply to the paint or varnish and rub off after a few moments. The wax can be left out, but its presence delays the evaporation of the solvents and so avoids having to use larger quantities. This preparation is, of course, inflammable.

Oil for Freeing Rusty Threads

This is a useful item to have in the workshop. A good type consists of: Cycle lubricating oil, 1 volume; methyl salicylate, 1 volume. Mix the two.

A cheaper formula contains: Cycle lubricating oil, 70 c.c.; Kerosene (paraffin oil), 20 c.c.; secondary butyl alcohol, 10 c.c. Mix the ingredients by shaking together in a bottle.

Leather Softener

Gloves and similar leather goods which have been wetted or washed dry out with a troublesome stiffness. Working the leather over the edge of a chair-back removes much of the stiffness, but the process is lengthy and incomplete. To restore flexibility completely, the leather should be wiped with an emulsion consisting of: Triethanolamine, 1 c.c.; castor oil, 44 c.c.; oleic acid, 5 c.c.; water, 40 c.c.

Stir to an even mixture the triethanolamine and oleic acid with one-third of the castor oil. Drop by drop stir in one-third of the water. A thick emulsion results. Gradually work in first the rest of the castor oil and then the remainder of the water, stirring thoroughly all the time. The thin white emulsion so produced separates slightly on standing a few days, but readily disperses on shaking.

Apply it thinly to the leather, allow to soak in a few moments, and then work the leather about in the fingers. (L.A.F.)

● Continued from page 85

Stamp Collector's Corner

that each could be easily identified. In 1947 America had her stamp centenary and to commemorate this, out came a pre-war 'rage', the miniature sheet. In 1948 Bermuda showed the 'Postmaster's' specimens. These were stamps which were made by the local postmaster at Hamilton. He merely had a circle and wrote his name in when the postage was paid. In 1950 Sydney Views came again, together with one of those classic Victorians. The Canadian beaver appeared a year later, after an absence of 100 years. It was one of the

set showing the train, the boat, and the aeroplane.

Barbados with its Britannia, and Australia with its Van Diemen's Land and Black Swan add to the number of the old classical stamps.

This list does not by any means exhaust the number, and it would be a good idea to try to make a big collection of these stamps. The actual specimens themselves are good, but the visions they can bring to the collector with imagination should make them a prized lot. (L.P.V.)

Transferring Patterns to Wood

By R. H. Warring

THE accepted method of using full-size printed patterns is to glue them to the wood, let them dry in position and then cut out. This, of course, has the disadvantage that the pattern is destroyed in the process and cannot be used again. For 'one off' jobs, however, it is certainly the most accurate and simplest method to use (A).

Office type gum or paste can be used for sticking down the pattern to ply and sheet wood. Rubber gum is particularly recommended since it does not 'wet' the

prick around the outline with a sharp instrument. The pattern lines will be transferred to the wood in the form of dots or prick marks which you can follow in cutting out; join up with a pencil first to show up better.

It is amazing how many people waste time, and material, in just sticking or laying off a pattern on to a piece of wood

the pattern up with the edge of the wood with the carbon between, as in F.

Incidentally, although most people are aware of this, the pale side of the carbon should be uppermost, not the black side (E). Nothing is more annoying than to make a careful tracing and then find that you have been using the carbon upside down and nothing has come out on the wood!

If you use tracing paper to transfer a pattern to wood, then the possibility of error is increased. Any errors intro-

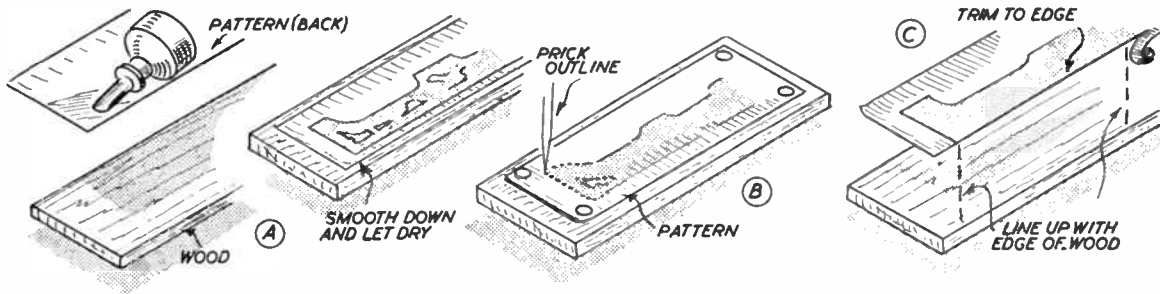

paper, sticks down amazingly well and is 'set' in a matter of a few minutes. The trick is in using the minimum amount of gum, spread well out. Otherwise you will find excess gum clogging the fret-saw blade when you start cutting. A rubber solution is even better, except

without thinking of the best arrangement. If the pattern has a straight edge, then it is easier to prepare one edge of the wood first by planing or sawing, or both, and align the straight edge of the pattern with the straight edge of the wood (C). The best way to do this is to

duced in making the original tracing may be exaggerated when 'laying off'. So you must be particularly careful with this method and not try to rush it. It has the advantage of giving a copy off a magazine plan, etc., without marking the original.

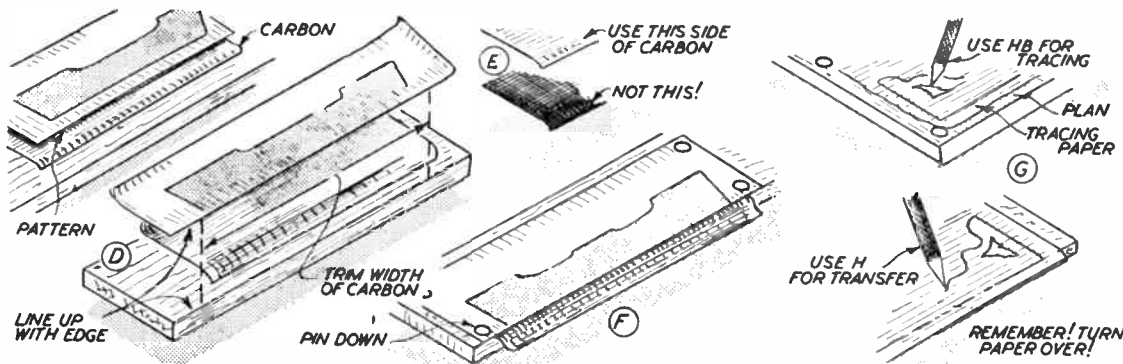

that it may not stick too well on porous woods. Balsa cement is excellent for small patterns, with the advantage of setting almost at once, but is too expensive to use to stick down large areas of paper.

If you do not want to attach the pattern permanently to the wood (and so eventually destroy it), there are a number of 'marking off' methods you can use. The method shown in B is quite effective. Pin the pattern over the wood and then

cut the pattern to this edge, so that you can position direct and not have to 'feel' the edge of the wood under an overlapping pattern.

The same technique can be applied if you are using carbon paper for transferring a pattern (C). Trim the pattern to its straight edge, but leaving it slightly overlength. Now trim the carbon paper to slightly less than the pattern length, but longer than the actual pattern itself. This leaves room to line

For normal tracing work it is recommended that an HB pencil be used for making the original, and an H pencil for transferring the pattern. Use a well-sharpened pencil but with the tip of the lead slightly rounded off, rather than pointed. This will avoid cutting through the tracing paper (G).

To make a 'handed' pattern from an original, you can use tracing paper, which has to be turned over, anyway, before it will 'transfer' the markings.

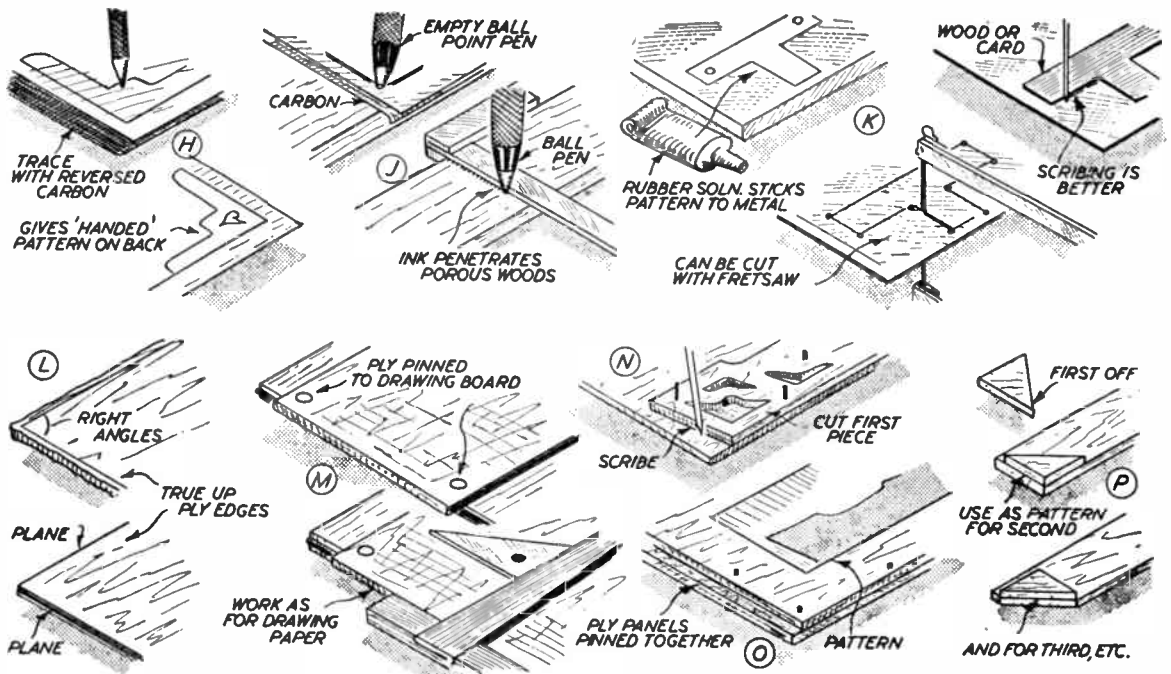

Or you can use a reversed carbon under the plan and trace over the outline. The 'handed' pattern will then appear on the back of the plan, in black (H).

Ball Point Pen for Tracing

For carbon tracing work you will find that an empty ball point pen is generally excellent. Many people prefer it to a pencil for this type of work. A ball point pen itself is excellent for general marking out, especially on soft woods. You must remember, though, that the ink may soak right in and will be difficult to glasspaper out later (J). This applies particularly to ball point pen markings on balsa. It is preferred to pencil since clear marks can be made with little pressure (and thus no scoring of the wood). But you may find the marks permanent in that they have gone so deep that they will not glasspaper right out.

Marking out patterns on sheet metal introduces further difficulties. There is no reason why paper patterns should not be used, stuck to the metal with rubber solution (K). You can even cut out with a fretsaw, like woodworking, using a metal-cutting blade. However, scribing outlines with a steel point is generally best on metal, using a rigid, fairly stiff pattern cut from stout card or thin wood (K).

Sometimes it pays to lay off patterns direct on to the wood, especially where a sheet of plywood is being used. This saves, perhaps, scaling up a drawing and then making tracings or separate patterns. First trim the ply edges (L) making sure that the left-hand and top

edges are true, at least. Then align parallel to the edge of the drawing-board, and projecting a matter of an inch or so (M). Pin down to the drawing-board and lay out the work directly on the ply panel, as you would on paper.

When making more than 'one off' a particular pattern, you can use the first piece cut to mark off the second (N) or cut two together simply by pinning a couple of pieces of wood together and sticking the pattern to the top one (O). Both methods have their disadvantages. In the first case, unless you use a thin-pointed scribe, you cannot mark out the second piece accurately to size. In the second case, unless you can cut accurately with a fretsaw you may 'angle' some of the cuts and produce two dissimilar pieces. Either method, how-

ever, is quicker and easier than having to mark out two separate pieces.

One important point is that you use the 'first off' any particular shape as a template for making several more of the same shape (P). You must use the original piece for each marking out. If you use the second piece to mark the third and the third to mark the fourth, etc., any errors are likely to be magnified at each stage. By the time you have cut half a dozen pieces or more, however, the original piece may be somewhat damaged. So cut an extra piece and regard the 'first off' simply as master pattern to be rejected at the end. All duplicated patterns should be pinned together and then glasspapered or finished to exactly similar shape after cutting out.

● Continued from page 84

A Garden in a Barrel

There is such a wide range of suitable plants that it is hardly necessary to dwell upon these, but a few suggestions may be helpful. Nasturtiums, undoubtedly, are favourites, but put the dwarf variety near the bottom with the longer ones hanging down near the top. Canary creeper also is good for hanging down the sides. Holes in between can be filled with plants of Petunia, Alyssum, Nemesia, Eschscholtzia and Night-scented Stock with Lobelia and Tagetes

for the top edging. More upright plants such as Scarlet Geranium, Salvia, Calceolaria, Clarkia and Antirrhinum will do well for the top of the barrel.

Strawberries may be grown successfully, but do not attempt to have them too close — about 20 plants in a medium-size barrel will be ample, and it will probably be advisable to plant these from well-rooted runners in the autumn.

A FEW DARKROOM WRINKLES

By E. G. Gaze

AS soon as the man with a camera graduates from the family-holiday-by-the-seaside sort of 'snapper' he turns the spare room or the bathroom into a darkroom. Instead of rushing his films to the nearest chemist for development and printing he gets the urge to do his own. This simple process mastered, he gets dissatisfied with contact prints; he wants bigger and better prints—and so he invests in an enlarger. And it is an investment—an outlay that brings in a return in wider interests, an entirely new field of photographic results.

No Electricity?

These days most enlargers on the market are designed to be illuminated by mains electricity. Electricity is a clean, efficient, constant source of artificial illumination; electrically-lit enlargers do not present serious problems of overheating even after long sessions in the darkroom. Having decided to invest in an enlarger, however, the person living in the country finds a stumbling block in that he may not have that modern convenience, mains power. The same problem may, of course, also arise for the townsman whose only illumination is by gas.

The answer to both of these is to use battery power; a long-life, heavy duty battery such as a car starter battery of 12 volts. And for light source use a 36 watt bulb.

There are enlargers on the market specifically designed to run off this means of supply. But, maybe, you've managed to get hold of a mains-operated

one; or, maybe, had one before you moved to the country or the 'all gas' house. Can this enlarger be converted to battery use? It can, and, usually, quite simply.

Not Enough Light

The first thing to remember is that now you will have a mere 36 watts and not the mains supply of 75, 100 or 150 watts. If the enlarger was one that used a diffusion disc of frosted or opal glass between the light source and the lens to ensure even illumination, you will now find the total light passing through negative and lens to the printing paper reduced to an inconveniently low level. And you need a well-lit image for ease of focusing and to make for reasonably short exposure times.

The answer here is to replace the diffusion disc by a condenser of the correct focal length for the lens in use. Assuming that you are using the correct focal length lens for your size of negative you will need: condenser of diameter 2-2½ins. for 35mm. size negative; condenser of diameter 3½ins. for 2¼ by 2½ins. size negative; condenser of diameter 4½ins. for 3¼ by 2½ins. size negative. The cheaper types are moulded, the more expensive are optically worked and more efficient; they can be used in pairs in a spacer mount for better light concentration and evenness.

Incidentally, the question of an enlarging lens is important. You are projecting an image by transmitted

light and if that image is to be sharp as possible you will need a lens no less efficient than the lens in your camera. A cheap, poorly corrected enlarging lens is a mistake. In many cases the camera lens itself is used in the enlarger, and a good-class lens can give excellent results. But—and this is a point worth considering—a camera lens is computed to give good results from near objects to infinity. A lens designed for enlarging alone is corrected and computed to give its results over the much closer distances used in enlarging, that is the comparatively short distance between lens and printing paper.

If you are using your own camera lens in the enlarger and are getting good results, well and good. If you are losing definition then try a lens designed for enlarging.

Use a Small Bulb

Back now to the conversion of your mains-operated enlarger to battery supply. By using a small bulb, which can also be obtained specifically for enlarging, frosted or opal flashed, you are approaching a smaller source of light. Theoretically the smaller your source of light the nearer you approach the perfect point-source of light. But a point source of light requires careful positioning to obtain sufficient and even illumination of your negative without cut-off, without your enlarging lens projecting a mere circle of light with a dark surround.

● Continued on page 92

● Continued from page 86

Storing Resistors & Condensers

It is better to make a separate board for the stocking of condensers, then one doesn't get mixed up. For my own use, a resistor board is fixed to the inside of one door of a general storage cupboard, and a condenser board to the inside of the other door. (Fig. 3). It will be found a very handy and convenient arrangement. The moulded mica type can be mounted to the condenser board with their narrow edges pointing out, in order to save space.

A method of storing these components is possible in another way (Fig. 4). Not so convenient, it is, however, more immediately accomplished. It is especially useful for storing in a box or on a shelf in a cupboard. It consists simply

of a square of cardboard (or hardboard), with holes made in it, say 1in. apart. Silk or cotton covered elastic is then threaded in and out of the holes, a knot being made at either end to keep it taut and secure. Several of these bands can be made across the board. The resistors or condensers are slipped under the loops of elastic and held firm.

A number of these boards can easily be made and can be placed (when loaded) one on top of the other. It is a handy way of keeping stock, and like the first method described, the resistors and condensers are readily accessible and identifiable. It is possible to see at a glance what one has got, or what one is running short of.

HOBBIES BRANCHES

LONDON

78a New Oxford Street, W.C.1
(Phone MUSeum 2975)
87 Old Broad Street, E.C.2
(LONDON Wall 4375)
81 Streatham Hill, S.W.2
(TULse Hill 8796)

GLASGOW—326 Argyle Street
(Phone CENTral 5042)

MANCHESTER—10 Piccadilly
(Phone CENTral 1787)

BIRMINGHAM—14 Bull Ring

SHEFFIELD—4 St. Paul's Parade
(Phone 26071)

LEEDS—10 Queen Victoria Street
(Phone 28639)

HULL—10 Paragon Square
(Phone 32959)

SOUTHAMPTON—25 Bernard St.

BRISTOL—30 Narrow Wine Street
(Phone 23744)

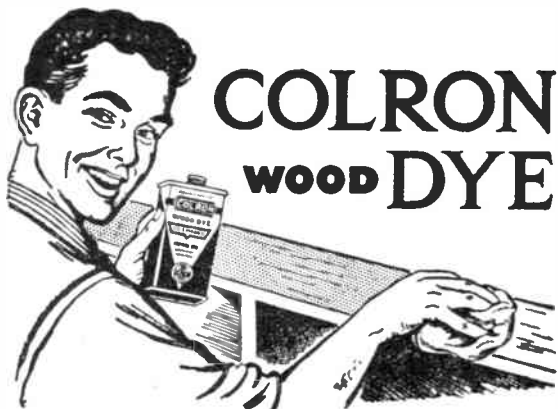

COLRON WOOD DYE

**the first step
to the perfect finish**

Colron Wood Dye is safe, quick and simple to use. Safe, because COLRON enhances the beauty of the wood *without raising the grain*—quick, because you simply wipe on a single coat of any one of the 12 lovely shades which you can mix for any colour effect—and remember, waxing with RONUK gives you the perfect finish.

Colron is available in all sizes from ¼-pint upwards.

From all good decorators' stockists.

Write for COLRON COLOUR GUIDE

RONUK LTD., PORTSLADE, SUSSEX. Hove 48631

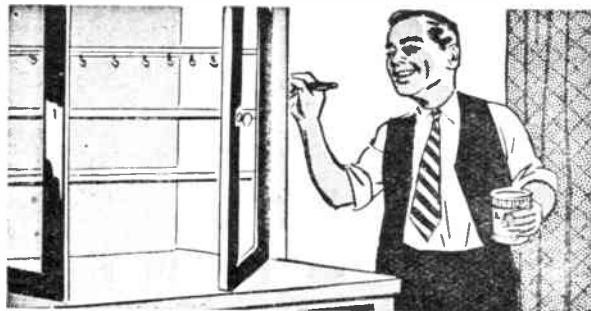

Leaves no Brushmarks!

Here is a paint that provides a smooth professional finish at the touch of a brush, an easy to use quick-drying finish that covers perfectly in one coat and leaves no brushmarks. Just ask for Robbialac Lacquer, the gloss finish that is available in 24 brilliant colours plus black, white and silver and which provides a hard wearing surface that resists weather, water, steam and chemical atmosphere. Robbialac Lacquer comes in handy ¼, ½, 1 pint tins and is sold by all good paint shops, cycle shops, ironmongers and hardware dealers.

ROBBIALAC LACQUER

FREE: Put a 'factory finish' on your handiwork. For free Instructional Leaflet send 1½d. stamp to: Dept. 6L5.

JENSON & NICHOLSON LTD., CARPENTERS RD., E.15



Easy to apply and quick to dry, these inexpensive lacquers have many uses. They will impart a rich and lustrous finish to models, picture frames, lamp standards, wicker chairs, work baskets, those unsightly water or gas pipes, etc. Fine for dance shoes too!

Be sure to ask by name for
**CROWN SILVER
LACQUER
AND
GUINEA GOLD
LACQUER**



Obtainable only from

WOOLWORTHS



DECRA-LED

Converts plain windows into lovely Leaded Lights

Lead your own windows first - EARN MONEY doing others afterwards.

No glass to cut or take out - no capital outlay - no previous experience. Begin NOW to supply the demand for Decra-Led Windows

The NEW Trial Kit to do approx. 3 panes includes 7 suggested designs and full instructions, 10 - complete.

Obtainable from Handicraft & Woodwork Supply Stores, Ironmongers & Decorators
TRADE ENQUIRIES INVITED

If unobtainable locally, direct from

**T. BROWN & CO. LTD., Dept 1, 50 Wood St.
ASHTON-UNDER-LYNE, LANCASHIRE**

Is This Saw in Your Kit?

You can cut almost anything in wood with this Coping Saw. The blade is 6½ins. long and can be turned to cut at any angle. No tool-kit is complete without one. Get yours NOW.

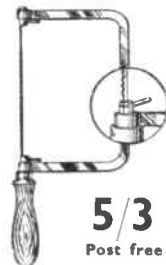

5/3
Post free

Buy from any Hobbies Branch or post free from Hobbies Ltd., Dept 99, Dereham, Norfolk

You may find that the smaller bulb has to be moved further from the condenser than the larger mains bulb and here you must experiment. Fortunately it is usually found that one position of the bulb will ensure even illumination of the negative for all degrees of enlargement, and enlarger heads are generally removable to allow for cleaning and lamp replacement. So if you need a higher head to take the bulb holder, it is usually simple for the average handyman to contrive an extension head to the present lamphouse. An old tin, drilled to take the bulb holder, a little manipulation, and your extension head is ready.

Another tip here. To make the best use of your smaller light source use a reflector above the bulb, attached to the socket. Often, a small bulb used on its side will give more even illumination for all degrees of enlargement.

Use a Hand Torch

The man without mains supply need not put an extra drain on his battery by running a darkroom lamp off it. An ordinary hand torch will do. To render the white light 'safe' a coloured disc can be cut and fastened over the front, using a piece of plastic safe-light material or a specifically designed glass front, obtainable from photographic dealers. Or you can economise by using one or more thicknesses of the red safe-light paper used to wrap up your printing paper in its box.

And don't forget, when you have added your extension to the enlarger lamphouse and made your safe-light, test them for stray leakage of white light. Make sure they are safe by the old dodge of placing a coin on a piece of unexposed printing paper, leaving it for a few minutes and then developing. If there is grey fog over the paper, save

where the coin rested, then your safe-light isn't 'safe', or the enlarger is emitting white light. Check them.

And now a hint for both mains and battery users. All your care in focusing the image to be printed is wasted unless your printing paper is perfectly flat and on the same plane as the image you focused before exposure. You can buy a masking frame with adjustable strips for varying size printing papers that also gives you an adjustable white border around the print and holds the paper perfectly flat. If you want to economise then elastic bands (the wide, firm garter-type of elastic) will hold the paper flat.

No White Border

But many amateurs prefer to make use of the full size of their printing paper without a white border as it leaves them free to trim the print later, and some do not like the white edging around the print when it is placed in the album. Yet the printing paper must be held flat on the easel, even if you want no border. A scrupulously clean sheet of unscratched glass will do the trick, placed over your printing paper. The objections to this are that dust has a habit of settling on it during exposure, especially if you use a fluffy towel or cloth to wipe your hands dry from developer or fixer or washing water, instead of using tweezers to transfer prints from bath to bath. And the glass can cause slight light scatter in the image. Another method that holds the paper flat and leaves no border is quite simple, and is capable of many variations.

Punch Holes

Get a piece of stout card for a base, larger than the largest size of printing paper you normally use, and a piece of stout paper or thin card (a single weight printing sheet will do) again a little

larger than your normal size. Punch a series of holes in the paper, across the length and width. At the back of the paper and behind the holes, stick strips of good quality, long-lasting adhesive tape or plaster. Now fasten this sheet to your base, again with adhesive strips or drawing pins.

In use you can place your focusing sheet on to this base by pressing it down over the holes where it will be held flat. After focusing, remove your focusing sheet and replace by the paper to be exposed. It is simple to make your own variation, but the use of a firm card base allows you to position your sheet anywhere on the easel to take in any part of the image you require for exposure.

In all types of paper-easel attachment, or with masking frames, it is as well to focus on a sheet of unexposed printing paper of the same thickness as your final print. Then, when you have focused and replaced this sheet by the paper to be exposed, you are exposing on exactly the same plane on which you focused. And accurate focusing and exposure in the same plane is essential for sharp definition of the final image.

A Focusing Negative

For accurate focusing of dense negatives, and, for that matter, for all negatives, a focusing negative is a great help. You can make one quite simply. Leave one frame of a film in your camera unexposed. After developing and fixing and washing of the film take this unexposed, clear negative and scratch it with a series of fine criss-crossed lines. Placed in the negative holder of your enlarger it will give you a bright, easily focused image, and when replaced by the negative to be enlarged you are sure of accurate focusing however dense this negative may be.

HARD HITTING

ACCURATE

Webley AIR PISTOLS

AIR RIFLES • ACCESSORIES

Write for Catalogue

WEBLEY & SCOTT Ltd, 166 WEAMAN ST., BIRMINGHAM, ENGLAND



HEAR ALL CONTINENTS With H.A.C. Short-Wave Receivers.

Suppliers for over 18 years of Radio S-W Receivers of quality.

One-Valve Kit, Price 25/- Two-Valve Kit, Price 50/-

Improved designs with Denco coils. All kits complete with all components, accessories and full instructions. Before ordering, call and inspect a demonstration receiver, or send stamped addressed envelope for descriptive catalogue.

'H.A.C.' Short-Wave Products (Dept. 22), 11 Old Bond Street, London, W.1

TRANSFER Graining Paper—Oaks, Walnuts; Samples, 1/-; Complete range, 3/-; Roll, 16/10.—H. Decano Co., 20 Clarendon Rd., Jersey.

PERFORATION gauge and 50 stamps, free to all approval applicants enclosing 2½d. stamp.—Cliffe West (M4), 61 Wynyard Rd., Sheffield, 6.

BASKETRY—Complete materials and instructions for making 'bottle'-shape hanging plant basket, 3/6, post. 3d.—Bray, 68a Montague St., Worthing.

CANOEING! PBK. kits £6/10/0. Send stamp for full details of our service for amateur builders.—Canoe Services, West Coker, Yeovil.

100 DIFFERENT stamps free. ½d. upwards approvals.—Bush, 53 Newlyn Way, Parkstone, Dorset.

FOR SALE. 3" Screw-Cutting Drummond Lathe with chucks, tools, etc., and A.C. Motor. £35 O.N.O.—MALIM, Pebmarsh, Halstead, Essex. Tel.: TWINSTEAD 304.

AMATEUR WOODWORKERS—why not turn your hobby into substantial income? S.A.E. for full particulars.—Good-Woodcrafts, Cross Street, Leamington Spa.

EARN £££'s WEEKLY in Sparetime. Hundreds of tested ways. Details free.—S.P. Ltd., 28(HB) Dean Rd., London, N.W.2.

WOODEN WHEELS, stock clearance bargains, 1" plain 2/6, 1" recessed 5/- gross. Recessed round tread, 1½"-10/-, 2"-15/-, 4"-70/- gross. Doll's house fittings and papers, Brochure S.A.E.—Jasons, 135 Nags Head Road, Enfield, Middlesex.

MODELS. You can make lasting stone-hard models with Sankey's Pyrama Plastic Cement. Supplied in tins by Ironmongers, Hardwaremen and Builders' Merchants. Ask for instruction leaflet.

PLYWOOD — HARDBOARD — at amazing low prices. Send S.A.E. for samples and prices to — N. Gerver, 10 Mare Street, Hackney, London, E.8.

Accessories by CARBORUNDUM FOR YOUR HOME-WORKSHOP POWER TOOLS

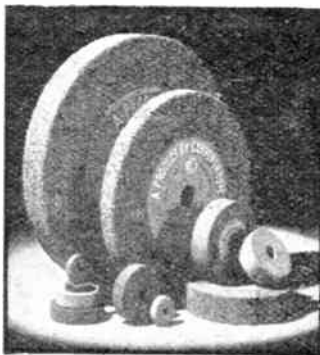

SMALL GRINDING WHEELS

Small grinding wheels are available from stock to fit all standard home-workshop machines. Coarse and fine wheels are provided in a range of different grits and bonds for grinding all kinds of materials, including plastics and high-tensile steel.

5" ABRASIVE DISCS

Our 5", coated-paper discs have been specially designed for home use on handyman's small-power tools. Discs with an ALOXITE abrasive surface are provided for light metal-finishing operations, and discs with a garnet abrasive surface for woodwork.

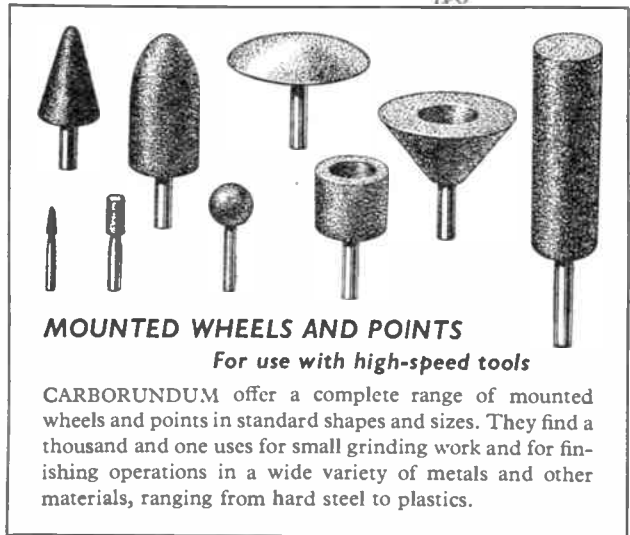
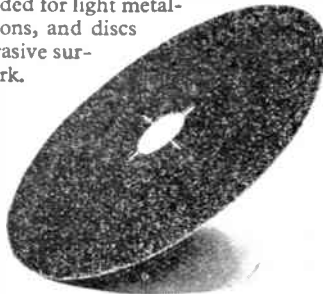

MOUNTED WHEELS AND POINTS

For use with high-speed tools

CARBORUNDUM offer a complete range of mounted wheels and points in standard shapes and sizes. They find a thousand and one uses for small grinding work and for finishing operations in a wide variety of metals and other materials, ranging from hard steel to plastics.

**ALL THESE ACCESSORIES SHOULD
BE AVAILABLE WHEREVER SMALL
POWER TOOLS ARE SOLD FOR HOME
USE. IF YOU HAVE TROUBLE IN
GETTING ANY OF THEM PLEASE**

WRITE TO US: THE CARBORUNDUM COMPANY LIMITED • TRAFFORD PARK, MANCHESTER 17

**Abrasive products by
CARBORUNDUM**

The amazing 'ABRAFILE' ROUND FILES

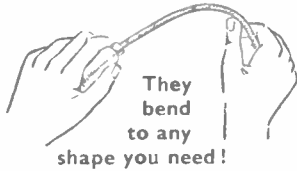

They bend to any shape you need!

New soft-core, parallel Round Files. Can be used as normal files or bent cold to almost any shape. Made on the 'Abrafile' Tension File patent of non-clogging teeth. Ideal for model making, craftwork, decarbonising engine parts, cleaning concave surfaces, and awkward corners in pipe bends, castings, etc. Fitted into varnished wooden handles and made in diameters 1/8, 1/4, 3/8, 1/2, 5/8, 3/4, 1, 1 1/4, 1 1/2, 1 3/4, 1 1/2, 1 3/4, 1 1/2 each. Also the 'Mousetail'—ideal for small work. Price 4!d. each. From all leading hobby shops and ironmongers, or send 1 1/2d. stamp for illustrated leaflet to.

ABRASIVE TOOLS LTD.,
162 GRAY'S INN ROAD, LONDON, W.C.1

PLYWOOD: large sizes, 14 lbs. 10 - delivered (Express) C.W.O. — H. Leader (1920), Gosford St., Middlesbrough.

TOY CASTING MOULDS. Soldiers, sailors, Airmen, etc. 1,000 varieties from 3 - each. Rubber moulding compound for flexible moulds, granulated ready for use. 8 6 per lb. Aluminium moulds for plaster work. S.A.E. for list. Catalogue 9d.—F. W. Nuthall, 69 St. Mark's Road, Hanwell, London, W.7.

SWISS MUSICAL Mechanisms for cigarette boxes, etc., 18 - post free. S.A.E. for illustration and list of tunes available.—Dept. HW, Metwood Accessories, Church St., Wolverton, Bucks. (Trade supplied.)

MAGIC Jumping Card and wonderful Catalogue 1/-.—DeHempsey, 363 Sandycumbe, Kew Gardens, Surrey.

A MODEL-MAKER'S 'MUST'!

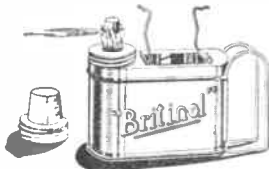

The 'BRITINOL' Spirit Blowlamp Gives a 3—4 inch flame from methylated spirit, is ideal for all soldering jobs, and heats a small iron rapidly. Completely automatic in action, no pumping necessary. Price 7/- from Hobbies or Halfords shops, or in case of difficulty, from:
BI-METALS (Britinol) LTD.,
St. Mary's Works, Bridge Road
London, N.9

'PAINTSPRAYING' HANDBOOK (1954 Ed.). Covers Car, Industrial & Flock Spraying. 3 6, post free, including catalogue of our Cellulose and Synthetic Paints and all Allied Sundries and Plant Hire.—Leonard Brooks Ltd., 81 Oak Road, Harold Wood, Essex.

AMERICAN MAGAZINE Subscriptions. One year Popular Mechanics 32 - Popular Science 31 6. Homecraftsman 16 6. Homecraft 18 -. Deltagram 10 6. Free booklet quoting others.—Willen Ltd. (Dept. 57), 101 Fleet St., London, E.C.4.

THIS IS IT!

THIS Is the very book "The Sunday Dispatch" said, "Tells everything!"

THIS Is the very book the Press said, "ispacked with every Gadget-Making Instruction —is invaluable."

THIS Is the very book from which 3 great National papers are printing extracts in their own columns!

THE DE-LUXE 10/- ONLY 1955 GADGETS ANNUAL

Massively printed on solid card throughout with full cloth binding and concealed spiral hinges for easy reference and elegant appearance.

Packed from cover to cover with Over 350 of the very latest and most ingenious ideas in easily made gadgets and devices for every purpose including home—Garden—Workshop—Car and Garage—Hobbies—Tools and Implements—Saleable Inventions—Miscellaneous Novelties—Charming Gifts—Amusing Puzzles—and a Host of Other Fascinating Devices. Every one can be made from wood and scrap materials. Over 250 illustrations and Diagrams.

What a Wonderful Gift: this Grand Book Will Make

Return post service—send 10/- only and ask for the "De-Luxe 1955 Gadgets Annual" to:—The Home-Made Gadgets Magazine, 26SwanHouse, Kingsbury, London, N.W.9.

LEARN it as you do it—we provide practical equipment combined with instruction in Radio, Television, Electricity, Mechanics, Chemistry, Photography, etc. Write for full details to—E.M.I. Institutes, Dept. HW.47, London, W.4.

Micromodels

There are 100 fascinating models to make for your Miniature Museum. Send S.A.E. for List. Micromodels, 3(H) Racquet Ct., London E.C.4

SET M.C.1

2 1/2 INCH C.A. SUZUKI 1905 C.B. MERCEDES

2/6

* GREAT CAMPING OFFER *



RIDGE TENT SENT FOR 4/-

BRAND NEW de luxe Para. Tent. All colours. Complete. Ideal Cyclists, Campers. Length 7 ft. 3 in. sleeping base x 4 ft. 6 in. wide - 3 ft. 6 in. high - 12 in. walls, all approx. Weight 3 1/2 lb. £2 15s. or 4 - deposit and 6 - monthly. With fly-sheet £4 2s. 6d. or 10 - deposit and 9/9 monthly. Both carr. 1 6. Don't delay, send now.



Says our Director...
"I strongly recommend these"
GERMAN PRISMEX BINOCULARS

6 LENSES x 40mm
• POPULAR SQUAT MODEL
• COATED LENSES



These 6 lenses - 40 mm. for wide field viewing represent the finest value for German Prismex Binoculars. Size 5 1/2" x 4 1/4". Bending Bar for eye adjustment, with centre focus. Splendid magnification with real 3D viewing. Clear Bloomed lenses, wide angle. Ideal for sports and holiday use, day and night lenses. Complete with case and leather slings. NO DEPOSIT. Send only 2 6 for packing & reg., etc. 7 days approval, if satisfactory send 4/6, then 8 payments of 9/- within 8 months. CASH PRICE 69 6. Free Lists Binoculars, Tents, Telescopes etc. Terms. Headquarter & General Supplies Ltd. HOBWX 51, 196/200 Coldharbour Lane, Loughboro Junction, London, S.E.5. Open Sat., 1 p.m. Wed.

DOLL'S HOUSE fittings and papers. Send S.A.E. for list. Doll's House plan, special, send 2 6. Trade supplied.—Zimplan, 88 Ware Road, Hoddesdon.

STAMPS FREE—Empire Packet including Pictorials and Victorians with approvals.—Robert J. Peck, 7A Kemp Road, Bournemouth.

ULSTER HANDICRAFTS. Downshire Place, Great Victoria Street, Belfast, supply craftworkers with Stanley tools, Handicrafts, Marquetry, Veneers, Acrolite, Musical Movements, Lamp Frames, Paints, etc.

RUBBER MOULDS for plaster casting. Sample 3/11. Trade supplied. S.A.E.—Burlleigh Supplies, 13 Burlleigh Street, Hull.

GENUINE SWISS Musical Movements

Limited Quantity 17/- each, plus 9d. post/pkg.

Richardson & Forder, 5 Chapel Place, White Hart Lane, London, N.17

MAKE A RADIO SET

... with a screwdriver and pliers. No soldering. Building instructions included.
CRYSTAL SET, 11/- post free
1-VALVE SET, 33/- including valve
2-VALVE SET, 58 6 including valves
Building instructions only, 7 1/2. (3 1/2d. stamps)

BLANCHARD'S RADIO (H10)
13, GAINFORD GARDENS, MANCHESTER, 10

A Novel Menu-Holder

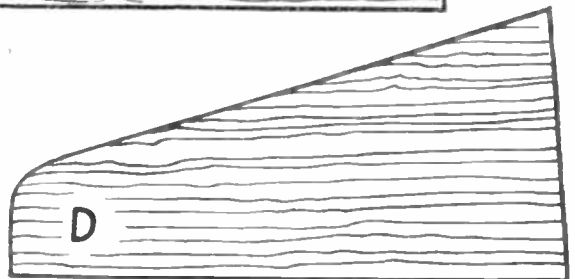
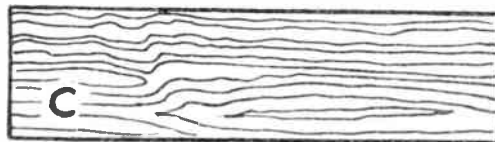
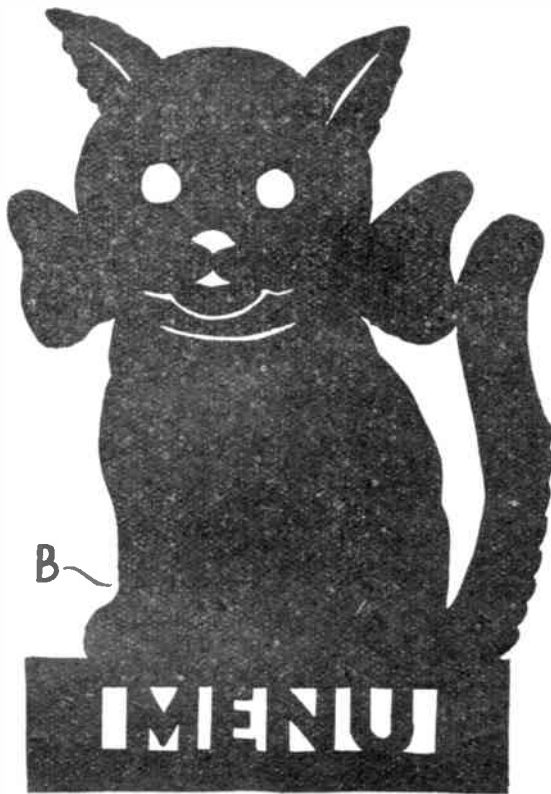
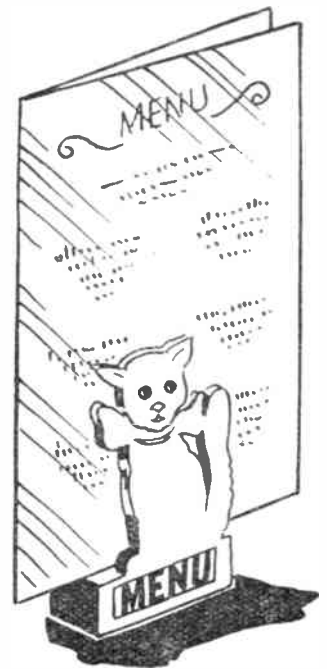
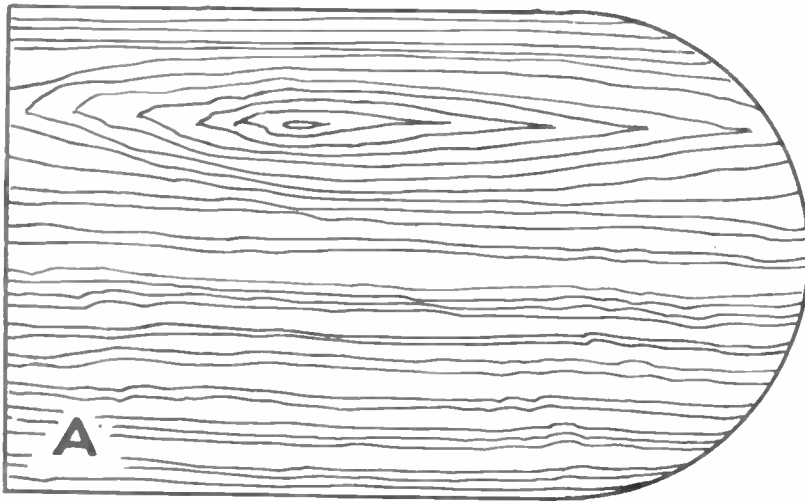

THIS little article is particularly useful for club functions. Annual dinners of football, cricket and angling clubs, etc., call for something original and novel. It would be quite a good idea to omit the word menu, and substitute the name of the club.

There are four parts to each holder. (A) is the back, (B) the front, and (C) the spacing piece. The piece (D) forms the strut at the back. Pieces (A), (B) and (C) are cut from $\frac{1}{2}$ in. wood and (D) from $\frac{1}{4}$ in. Glue the pieces together as shown in the detail.

Finish off by painting with plastic enamel paint, giving two or three coats as required. (M.p.)

THE PICADOR PUP

THE MOST VERSATILE TOOL EVER!

Save ground space with this modern, multi-purpose tool. PICADOR PUP comprises a wood-turning lathe, a rise and fall, fully tilting circular saw, a hooded grindstone with drill sharpening attachment, together with sanding and drilling attachments also. It GRINDS, including Twist Drill Grinding, TURNS, SAWS wood, plastics, or soft metals, SANDS and DRILLS for you. PICADOR PUP is small, compact, hardy, and motor-driven. Cash £6.15.0. or 25/- deposit and 6 monthly payments of £1. Leaflet free.

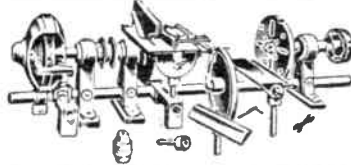

ELECTRIC PAINT SPRAYER

Cash 75/- Or 4/- deposit and 6 monthly payments of 13/6

for 4/- deposit



Paint easily, evenly, twice as fast with the Burgess Electric Sprayer. Sprays paint, varnish, etc. Complete with sturdy glass container, flex, nozzles for ceiling spraying and extra nozzle discs for different liquids. A.C.—state your actual voltage. Guaranteed. Supplied with 96 page booklet. Leaflet free.

PHILISHAVE

14 DAYS' FREE TRIAL

Try the wonderful Philishave Electric Dry Shaver FREE for 14 days. Send only 5/- deposit (returnable if not satisfied). Two shaving heads with two 6-bladed cutters have unique rotary action which genuinely shaves — doesn't just snip at the hairs. Result — better quicker shave. Operates 110/250 volts. A.C./D.C. £7.9.3 cash less your deposit. Or 5/- deposit can be first payment, followed by 8 monthly payments of £1. 12 months' guarantee.



ELECTRIC PAINT STRIPPER

4/- DEPOSIT

3 monthly payments of 10/-



Old paint peels off like magic with the Horvell electric paint stripper. Easy, even strokes remove paint, varnish, etc. Four-sided blade for angles and corners. A.C./D.C.—state voltage. Cash price 30/-, P & P 1/-. Extra flex 1/- a yard. Spare element 5/6. Leaflet free.

VICEROY V-TEN ONLY 5/- DEPOSIT

Try the ViceroY V-ten free for 14 days. The aristocrat of electric shavers, made by Rolls Razors. Voltageswitchchanges from 90/250 volts A.C./D.C. Guaranteed one year. Cash price £9.17.8 or send only 5/- deposit (returnable if not satisfied), then 15/- after 14 days' trial, balance in 8 monthly payments of 24/-. Leaflet of this and other Shavers free



This U.50

BLACK & DECKER KIT for ONLY £1 deposit

With this Kit you can clean, buff, burnish, grind and drill. Comprises Sander, Polisher Rubber pad, Lambswool bonnet, 3 sanding discs, one 1/2" chuck, Allen key, wax and polish. Cash £9.17.6 or £1 deposit and 8 monthly payments of 25/-. With chuck, becomes all-purpose drill. Can also be used as driving unit for lathe and saw attachments. Fully suppressed. State voltage.



DRILL FASTER with a Black & Decker ELECTRIC DRILL 12/-

DEPOSIT

A first-class tool, the Black & Decker U-1 Portable Electric Drill saves hours on home and workshop jobs. Drills wood, steel, brick, etc. Steel capacity up to 1/2". Also drives sanding discs, polisher pads, etc. Weighs 3 1/2 lb. Fully suppressed. £5.19.6 or 12/- deposit and 6 monthly payments of £1. Sent on receipt of the deposit. A.C./D.C. motor, voltages 110 to 250. State your actual voltage.

BARGAIN DISTRIBUTORS (Dept. 124), 5 Silver Street, Luton

NEW!

EXPERIMENTAL KITS

LEARN THE PRACTICAL WAY

Here is home study of the most effective kind under expert tutors. There is no better way of studying for an examination, starting a new hobby or for a career in industry. These special courses combine the most modern methods of postal tuition, combined with a Practical Kit of parts (which remains your property).



COURSES FROM 15/- A MONTH

COURSES WITH PRACTICAL EQUIPMENT INCLUDE: Radio, Television, Mechanics, Electricity, Chemistry, Photography, Carpentry; also Draughtsmanship, Commercial Art, Amateur S.W. Radio, Languages, etc.

POST THIS COUPON TODAY

For FREE brochure write: E.M.I. INSTITUTES, Dept. 31X, Grove Park Road, London, W.4.

SUBJECT(S) OF INTEREST _____

NAME _____

ADDRESS _____

11/5/55

IC51A

E.M.I. INSTITUTES

The only Postal College which is part of a world-wide Industrial Organisation

The sparkling enamel PAINT IN TUBES! Handy, Economical

STARLON in handy, economical tubes is just right for all small or multi-coloured painting jobs; cycles, prams, etc. No wasteful 'left-overs'. Easy to apply. Quick drying. No brush marks. Brilliant lasting finish.

1/- IN 14 LOVELY COLOURS

Trade Enquiries welcomed by the makers



Starlon

PLASTIC ENAMEL PAINT

Obtainable at Handicraft shops everywhere

STARLINE, SOUTHEND-ON-SEA, ESSEX

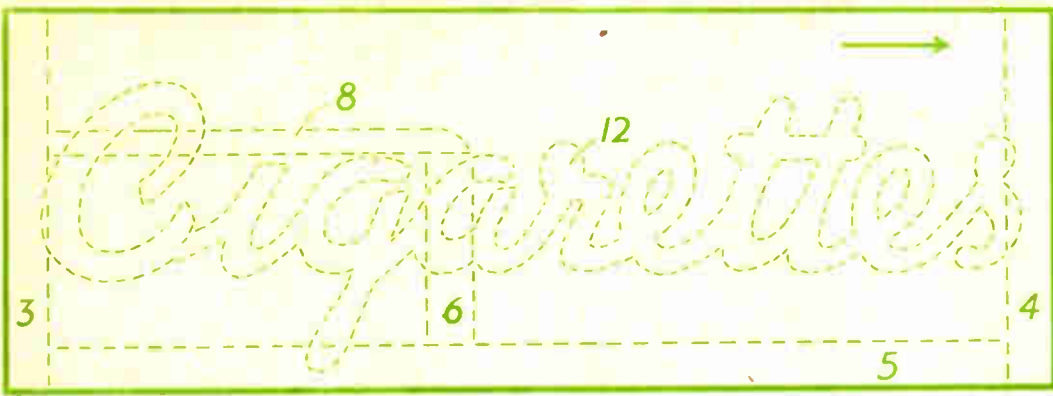

FRONT 1. CUT ONE | 4in.

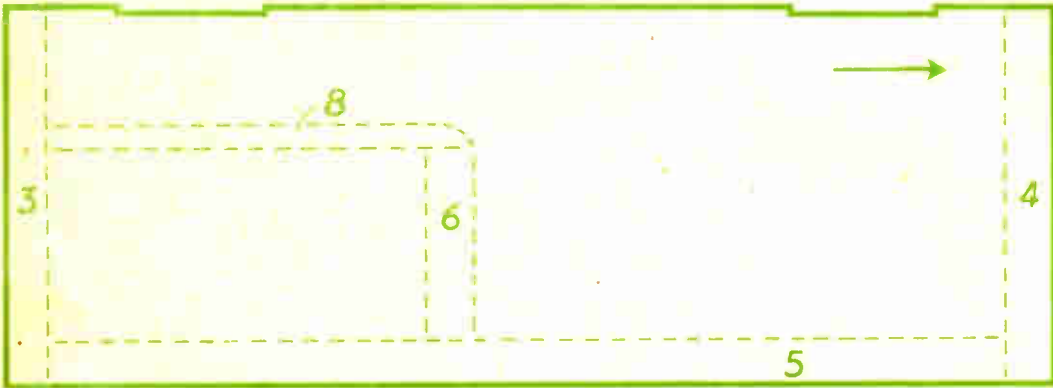

BACK 2. CUT ONE | 4in.

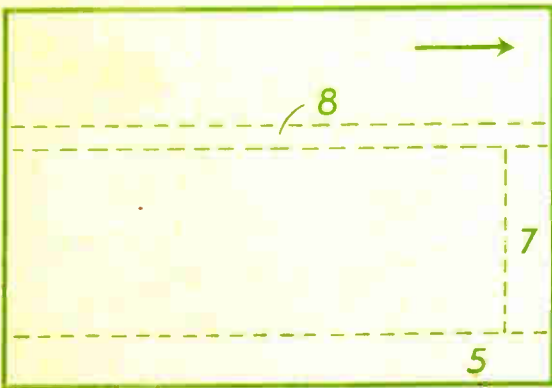

END 3. CUT ONE | 4in.

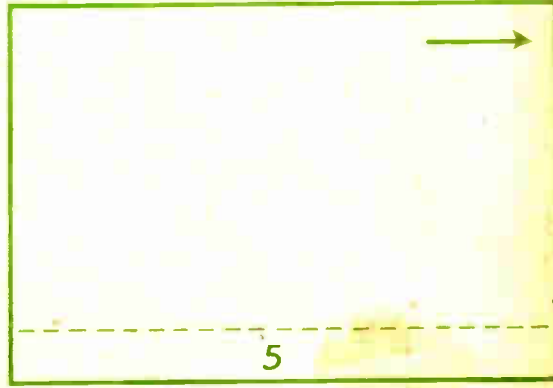

END 4. CUT ONE | 4in.

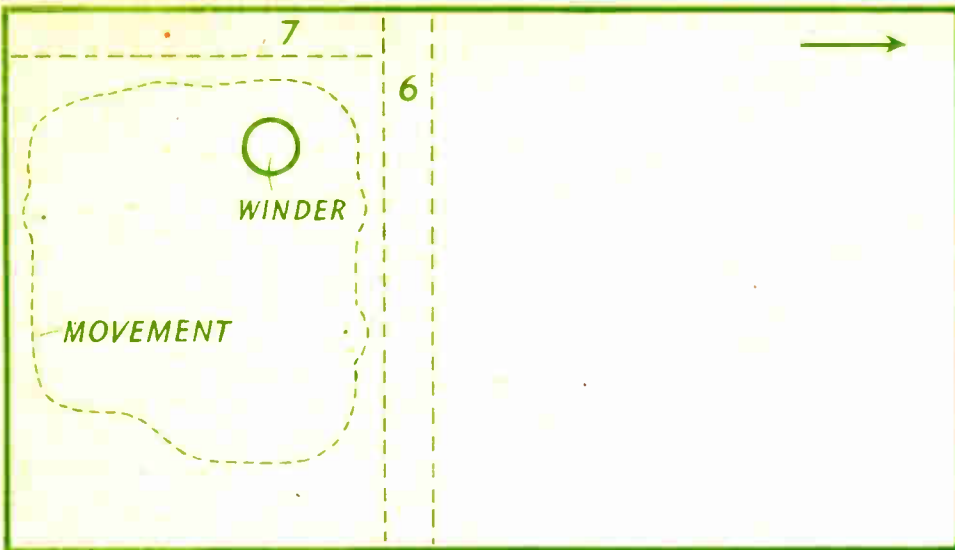

BASE 5. CUT ONE | 4in.



PIECE 8. CUT ONE | 8in.

OVERLAY 12
ON
FRONT.
CUT ONE
| 8in.

Cigarettes

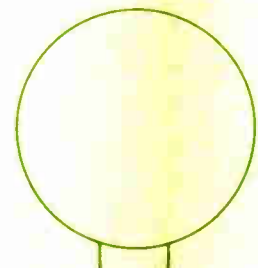
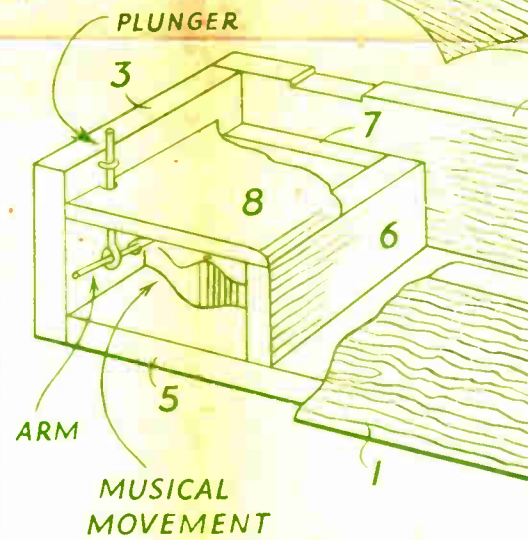

HINGE

A MUSICAL CIGARETTE BOX

SIZE—
5 1/2 ins. LONG
3 1/2 ins. WIDE



Cigarettes

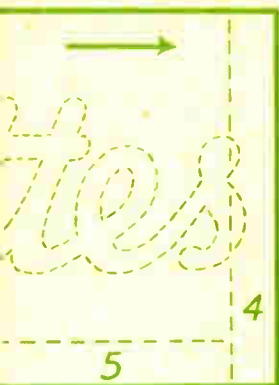

OVERLAY 12 ON FRONT. CUT ONE 1/8 in.

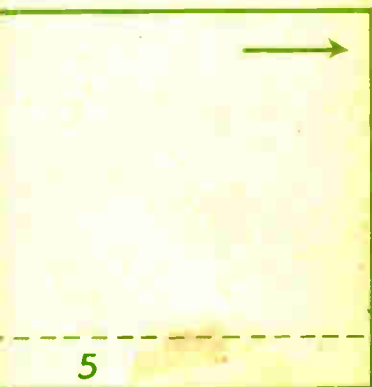
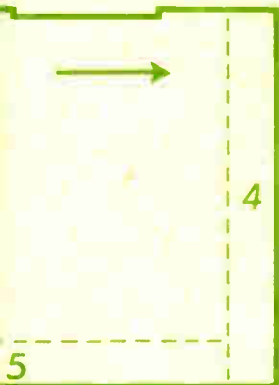

6. CUT ONE 1/4 in.

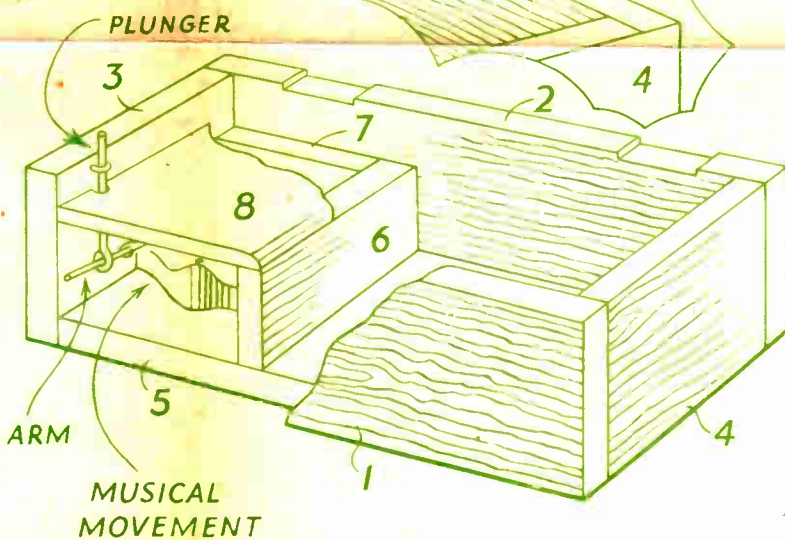
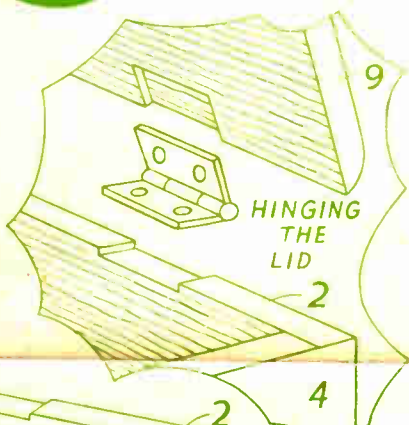

Materials required for this design

- WOOD** One piece 12 ins. x 3 1/2 ins. x 1/4 in. (Hobbies Q4)
 One piece 9 ins. x 4 ins. x 1/4 in. (Hobbies G4)
 One piece 9 ins. x 4 ins. x 1/8 in. (Hobbies G2)
 One musical movement
 One ball foot (Hobbies No. 22)
 3 ins. of medium gauge wire
 One pair of 3/4 in. light brass hinges
 One box catch 1 1/4 ins. long (Hobbies No. 6218)

A complete kit of the above materials can be obtained from **HOBBIES LTD., DEREHAM, NORFOLK**

Glue it with **Croid**

Universal Glue for use cold straight from the tube or tin from 1/- each.

Aero Glue in the Home Outfit or in tins from 1/3 each for quicker setting.

Available from all branches of Hobbies Ltd.

MITRED PLINTH. CUT ONE OF EACH 1/4 in.

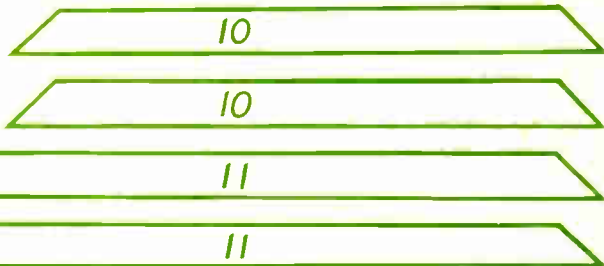

LID 9. CUT ONE 1/4 in. ROUND OFF THE EDGES.



CUT ONE 1/8 in.

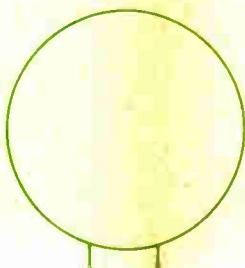

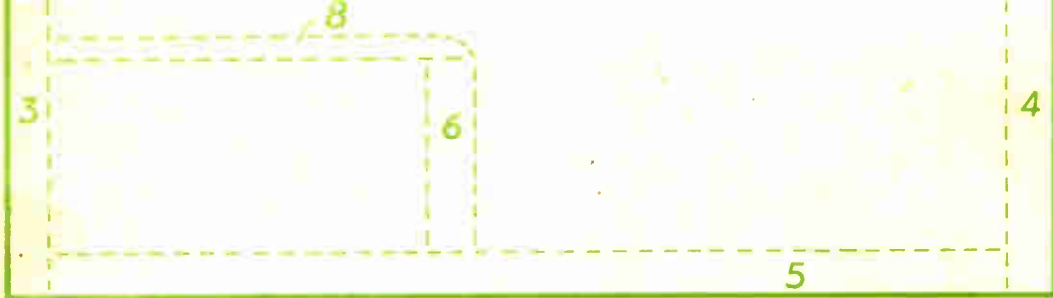

BACK 2. CUT ONE 1/4in.

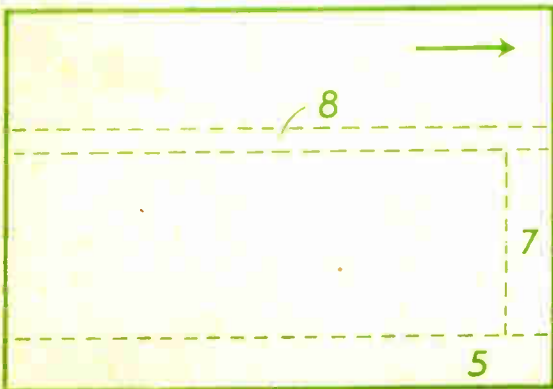

END 3. CUT ONE 1/4in.

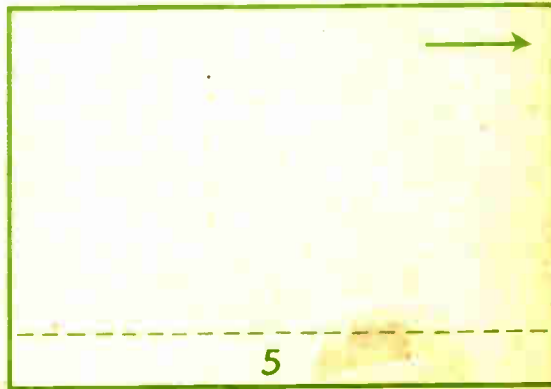

END 4. CUT ONE 1/4in.

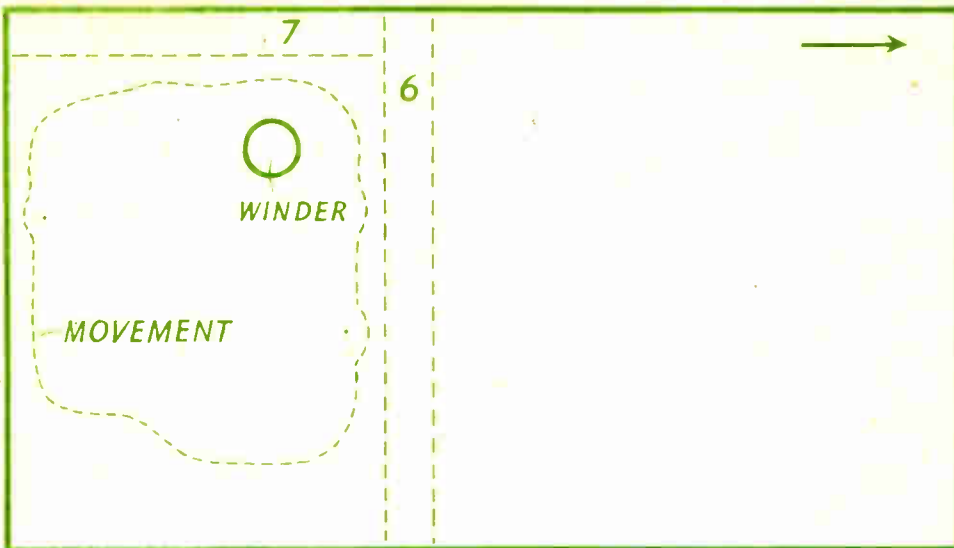

BASE 5. CUT ONE 1/4in.



PARTITION 6. CUT ONE 1/4in.



PIECE 7. CUT ONE 1/4in.

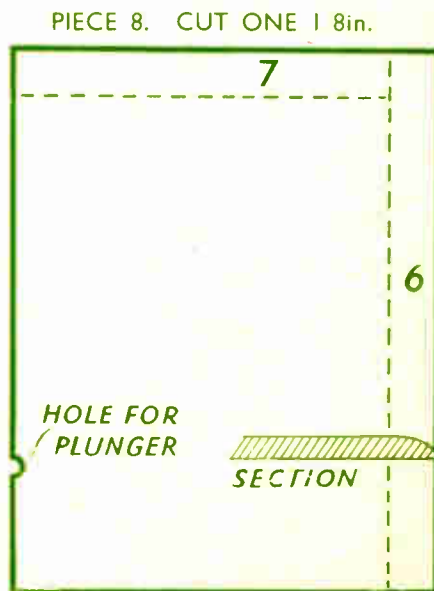

PIECE 8. CUT ONE 1/8in.

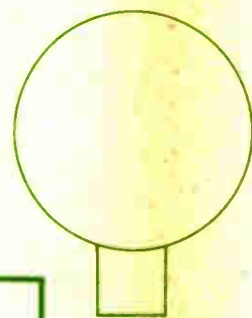
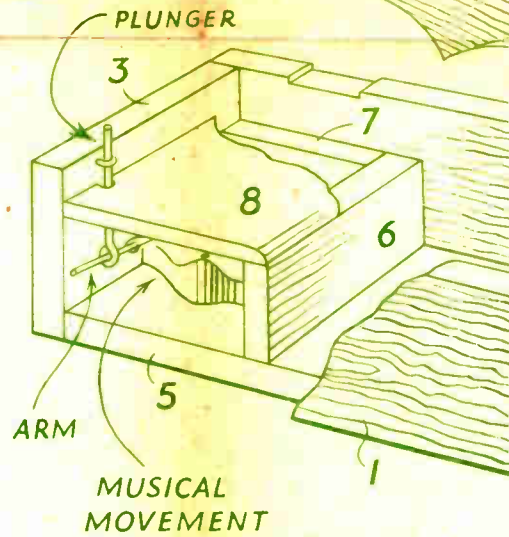

BALL FOOT
No. 22.
ONE REQUIRED.

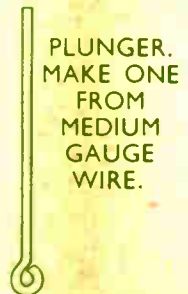

PLUNGER.
MAKE ONE
FROM
MEDIUM
GAUGE
WIRE.

THE ARROWS INDICATE
DIRECTION OF GRAIN
OF WOOD.

Cigarette



Materials required for this design

- WOOD** One piece 12ins. x 5 1/2ins. x 1 1/4in. (Hobbies Q4)
 One piece 9ins. x 4ins. x 1 1/4in. (Hobbies G4)
 One piece 9ins. x 4ins. x 1 8in. (Hobbies G2)
 One musical movement
 One ball foot (Hobbies No. 22)
 3ins. of medium gauge wire
 One pair of 3 1/4in. light brass hinges
 One box catch 1 1/4ins. long (Hobbies No. 6218)

A complete kit of the above materials can be obtained from
HOBBIES LTD., DEREHAM, NORFOLK

Glue it with **Croid**

Universal Glue for use cold straight from the tube or tin from 1/- each.

Aero Glue in the Home Outfit or in tins from 1/3 each for quicker setting.

Available from all branches of Hobbies Ltd.

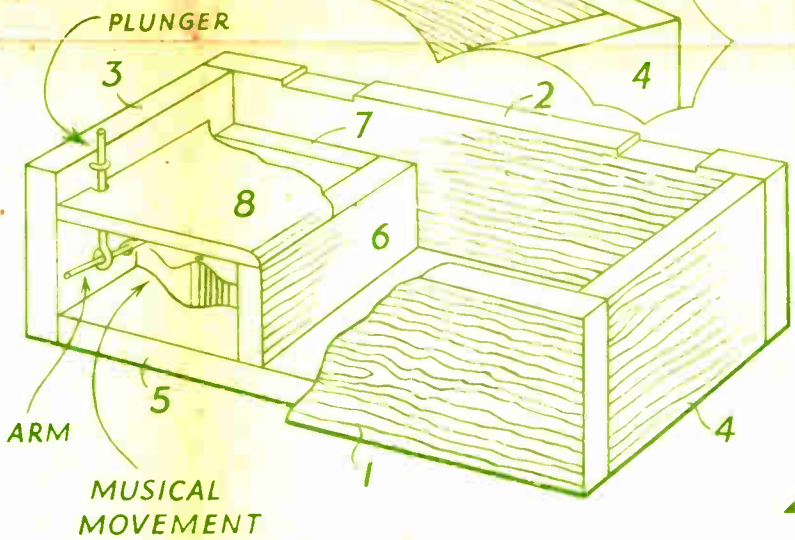
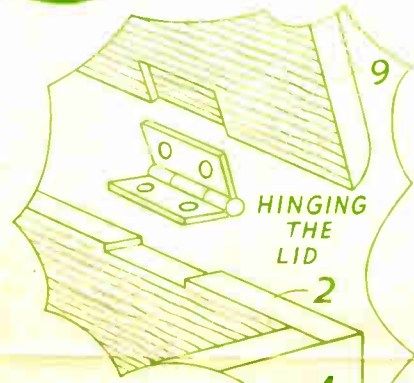
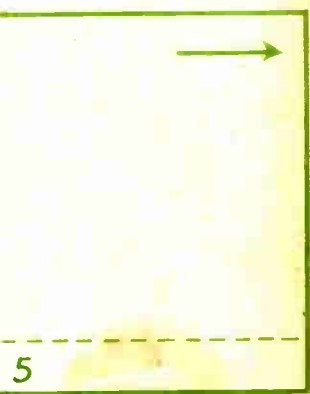

MITRED PLINTH. CUT ONE OF EACH 1 1/4in.

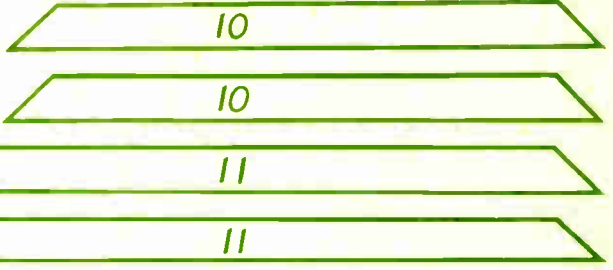

LID 9. CUT ONE 1 1/4in. ROUND OFF THE EDGES.

