

Hobbies

WEEKLY

CONTENTS

	Page
How to make Lampshades	337
Novel Book Rack for a Child	339
Art of Scenic Modelling	340
A Useful Wheelbarrow	341
Replies of Interest	342
Cabinet for the Dressing Table	343
Books to Read	344
Grow Everlasting Flowers	345
Indoor Photography	346
Fishing Tackle Economy	347

February 27th, 1952

Price Fourpence

Vol. 113 No. 2939

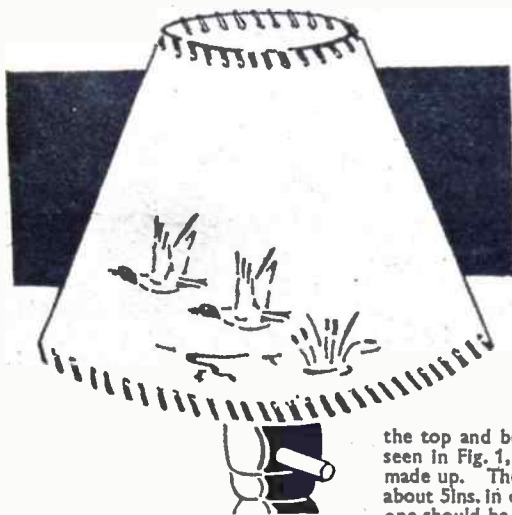

HOME lampshade making is an interesting craft and there is always, somewhere about the house, an electric pendant light or a bracket light that requires a new shade.

Simple Materials

The materials required are simple in character, and can be obtained much more readily in the shops than formerly, and making a shade does not call for a great amount of artistic ability, although its decoration calls for patience, and the use of pencil, pen and brush.

The side line of making stencils for repeat patterns for the parchment shades, forms in itself another interesting pastime.

Ready-made wire frames can be bought, but for the home craftsman it is

Learn all about HOW TO MAKE LAMP SHADES

much more satisfying for the whole article to be completed at home.

Making the Frame

If a frame is to be made, wire of about 14 gauge is suitable, and the top and bottom rings of the frame, seen in Fig. 1, are the first parts to be made up. The smaller top ring may be about 5ins. in diameter, while the lower one should be about 13ins.

For the small ring cut off a piece of wire about 18ins. long, and for the larger ring a piece about 42ins. long. These lengths allow for an adjustable loop to be made, so that one wire slides within the other as shown. The actual eyes or end loops are best formed with bull-nosed pliers.

For the support wires, shown as 7ins. long in the illustration, two pieces 24ins. long should be found sufficient. Commence the centre ring or loop, to fit over the lamp holder, by first putting the pair of wires together and bending them round the holder. Then twist them together each side. After making several twists, the same in number each side of the centre ring, bring up the two pairs of wires and connect them to the smaller of the two wire rings as shown. Loop them round and pinch up to make

a rigid fastening. The large wire ring, of course, is not connected to the frame, being fastened only to the base of the shade by ribbon stitching.

Lamp shades are generally made of imitation vellum or oiled paper. The writer has found that a stiff drawing paper known as 'Whatmans' is ideal if the usual shade paper is unobtainable. A cheaper 'drawing cartridge' is also suitable, and when rubbed or brushed over with linseed oil is hardly distinguishable from real vellum paper. The process of making up remains the same.

Shape

The first thing to decide is the actual shape of the shade, whether it is going to be steep-sided or broad at base, as the one shown here. It is much the better way to decide more or less the shape in mind, and then to draught out the shape on paper in the manner shown in Fig. 2, but with straight lines at the top and base instead of the curved ones shown.

Now get out the true shape of the shade when laid flat, or setting out a pattern 'in the flat' as it is called. For the shape of shade given here we shall require a piece of material measuring 26ins. by 13ins. Mark the middle of the paper crosswise, and from a given centre point on this line, describe two

All correspondence should be addressed to The Editor, Hobbies Weekly, Dereham, Norfolk.

arcs of 5ins. and 13ins. respectively, see Fig. 3.

Home-made Trammel

If a pair of compasses with lengthening bar is found inadequate for the greater radius, then a trammel of wood can be brought into use. Make two holes in this 13ins. apart, and in one hole insert a stout pin to form the pivot point, marked (P) in Fig. 3. In the other slightly larger hole insert a sharply pointed pencil to describe the arc shown.

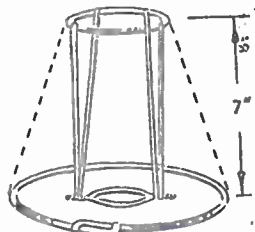

Fig. 1

Next, with a pair of dividers or an ordinary ruler, step round 41ins. on the outer circle. This 41ins. is made up by multiplying the actual diameter—13ins.



Two pleasing designs for stencils, which could be used to decorate a shade

by 3½ins., which carries out the rule that the diameter multiplied by 3½ins. equals the circumference. Join the centre to the end division thus calculated and leave a slight margin of paper to form a gluing tab as marked in the diagram. Cut out the shape with scissors or a sharp-pointed pocket knife and then stamp out the holes round both curved edges for the ribbon stitching.

A useful gadget for piercing the holes is shown in Fig. 4. In the end of a piece of wood make a saw cut with a fine-tooth tenon saw and then drill a hole of diameter sufficient to take a large wire

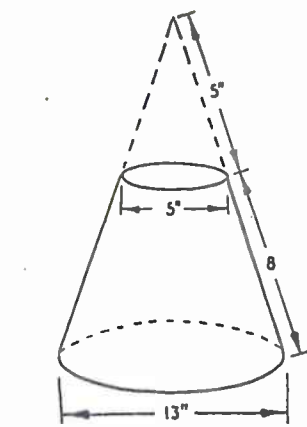

Fig. 2

nail. File away or cut off the point of the nail, leaving the end flat and the edges sharp. By inserting the paper in the slot, as shown, and pushing the nail right through the two holes, a clean and

a simple repeat pattern put in by stencil is suitable and could be made most attractive.

We give here two simple bird designs that could be worked up as three-colour stencils and repeated twice, or, perhaps, three times round the shade.

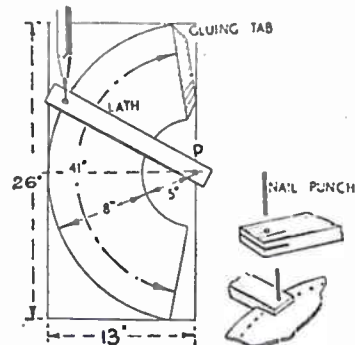
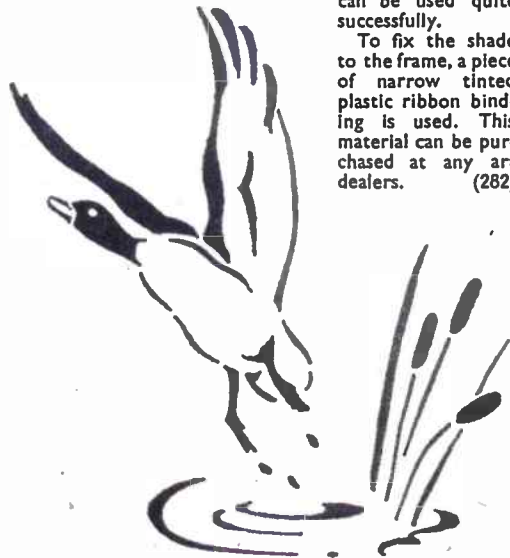

Fig. 3

Coloured stains are best for the decorations, but ordinary water-colour paints can be used quite successfully.

To fix the shade to the frame, a piece of narrow tinted plastic ribbon binding is used. This material can be purchased at any art dealers. (282)



An article dealing with the various coverings for lampshades, and full of hints for those wishing to make shades for pleasure or profit, is being prepared for early publication.

Decoration

Little need be said about the actual decoration of the shade, except that it should be carried out before the paper is bent round to shape and glued and stitched together. A simple banding design to go right round the shade at the top and lower edges would look well, or

Two Elephants hold this NOVEL BOOK RACK FOR A CHILD

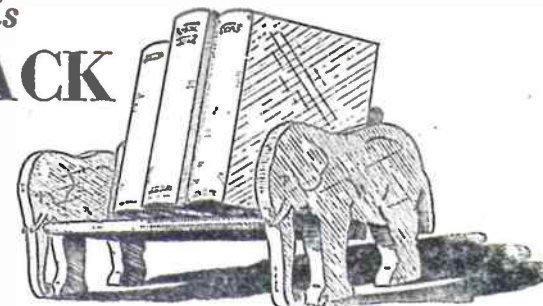

AS soon as children learn to read, they begin to pay a little more regard to the welfare of their books, and when, at eight or nine years old, they have a collection of stories which they delight in reading over and over again, they like to have a bookrack of their own in which to keep them. A bookrack like the one illustrated would be sure to please, especially as many of their books feature animals.

Straightforward

Such a bookrack is a simple enough project for the average worker, consisting as it does of a plain trough 12ins. long secured to the two cut-out figures of elephants. These latter will present no difficulty to the fretworker.

A squared outline for the figure is given half-size on this page, and should be scaled up in the usual way by re-drawing the squares their correct size (½in.) and filling in the lines of the figure. When this has been done satisfactorily, transfer the pattern to two ½in. pieces of wood, and cut the elephants out. Take care when setting out the wood that the grain runs from head to toe and not from trunk to tail, otherwise the trunk or legs might snap off easily if

the bookrack is later handled roughly.

Two holes, about ½in., should be bored in each elephant where indicated (X), and countersunk. These will take the fixing screws when the bookrack is assembled. Clean up the figures, slightly rounding the edges to give them a more lifelike look, and, with a chisel, take a v-shaped section out of the wood between the tusks, making them appear as two separate features, and not as a single projection running across the front of the trunks. When cleaning up the figures, care should be taken, of course, to leave the feet perfectly flat, so that the bookrack rests squarely when in use.

Making the Trough

The figures having been completed, the trough can be made. This consists of two pieces of ½in. wood, one 12ins. by 3½ins. and the other 12ins. by 4½ins. Plane and clean up after cutting, and then round one edge of each (see dotted lines in the squared drawing). Now, glue and pin the two pieces together, making sure that they form a true right-angle.

The work of assembly is completed by

gluing and screwing the trough between the two elephants in the position shown in the squared drawing. Fix one elephant first, using the holes already drilled, and then stand the half-completed article on some sort of support (a book or similar would do), so that the trough is parallel to the surface on which the elephant is standing. Now, carefully put the other elephant in place, and, through the two fixing holes mark the positions of the screws on the ends of the trough. Drill the ends for the screws, and glue and screw the whole thing together. Screws about 1½ins. long are recommended.

If this work has been carried out properly, the two elephants should now stand perfectly square, but if there is any tendency for the bookrack to rock, ascertain which foot is causing the trouble and smooth it down until all four make perfect contact with the testing surface.

Bright Colours—

Children never tire of colour, and most workers will probably decide to finish the article in bright enamels. In this case, the countersunk holes bearing the heads of the fixing screws should be filled with plastic wood or putty, left to dry, and then smoothed up before painting.

—Or Wax Polish

For those who prefer a stained and wax polished finish, a little extra care is necessary to hide the screws. First, decide on the desired depth of stain, and mix some with plastic wood until the colour is right. Then fill the holes as before. When the plastic wood is set, clean up, and apply the stain to the rest of the work. As soon as the tone matches that of the stained plastic wood, cease applying the stain, and allow the work to dry. Wax polish in the usual way.

Under no circumstances plug the holes with untreated plastic wood or it will be found that they show lighter than the surrounding stain, no matter how hard you try to hide them. (288)

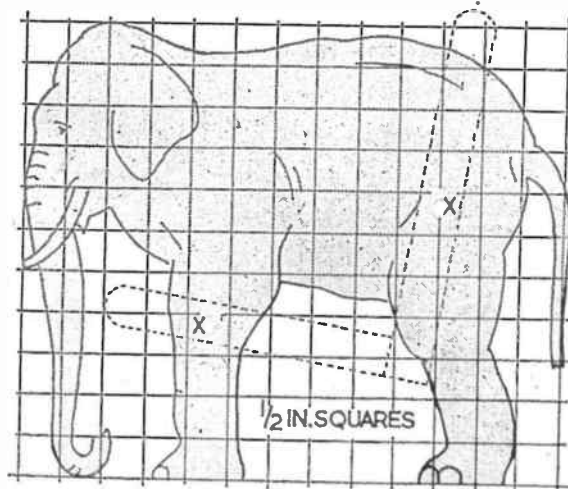

Scale this drawing up to full size and transfer to the necessary wood. The dotted lines show the ultimate position of the trough, and the fixing holes (X) are also shown

Tell your friends about Hobbies Weekly—they won't be sorry.

A model railway enthusiast discusses the ART OF SCENIC MODELLING

OF all the many aspects of railway modelling, the writer always considers the scenic section the most interesting. Apart from its very wide scope, it enables you to work sometimes on small sections when you have not the inclination to go out into the workshop and operate on larger models.

With this angle in view, I suggest that you set aside certain parts of your model work for these occasions, not forgetting that if you make the sections too large you will probably be taking on too much at a time and making for difficulties in transportation at a later date. Many model lay-outs start in a small way and then grow to large proportions later. A planned lay-out with all future improvements planned, and all set out on squared paper is very handy. By lettering or numbering the buildings you will always see at a glance what spaces you have to fill.

Inexpensive Materials

Materials for scenic modelling should not be an expensive item. As a matter of fact, I find a good use for all sorts of oddments in mine. Do not overlook the value of an orange box at about 1/-. The thin boards are mostly of smooth wood and the ends and divisions are handy for cross sections and base boards. Strip-wood is essential, and you should have plenty of it.

I have my wood cut into 3ft. lengths and in 1/2 in., 3/4 in., 1 in., 1 1/4 in., 1 1/2 in. by 1/2 in. and various other sizes which you may decide to stock. Regarding plywood offcuts, these can be had very cheaply and are ideal for all model work. Advertisements will be found for suppliers of this in *Hobbies Weekly*.

For the better class jobs, I use obechi wood, which has a nice clean-looking surface, and is somewhat harder than balsa. You will find this advertised regularly in a number of modelling magazines, or it can be obtained from Hobbies Ltd., Dereham, Norfolk, in their usual panel sizes.

Good Stock

Blocks of wood are always very good stock. I use them for gluing in places where there is likely to be strain, and for roof sections. For supplies, I approached a local firm who make doors, gates and other carpentry sections for estates. A sackful of oddments was purchased for 5/- and will last me many years. For this firm I recently made up some small models of their products,

which means that the cost of my supplies of wood are more than covered.

For those intending to make large lay-outs, a supply of hardboard is suggested. This is available off permit and is hard, durable, smooth one side, and will cut well with the tenon saw. You can nail it, screw it and drill it without surface damage. Sizes go from 3ft. by 3ft. upwards.

In planning a lay-out you must have struts and quarterings for holding the main base board square. You will find a great saving in buying this wood per 100ft. run, instead of in odd short lengths.

Adhesives

Model makers have their own ideas on what adhesives to use, but I always have casein glue in powder form, which can be mixed with water when wanted. This is waterproof and sets hard. I also find a packet of tap-water paste always handy in case I have some large sheets of paper to paste up. Mix a little at a time and keep the balance in a tin box—the mice rather like it. Secotline is good for cardboard sections as it sets quickly, and Durofix, a cellulose cement, is useful for mixtures with a base of plastic wood. Scotch glue is always a good standby and seldom left out of the model-maker's stock.

In the way of nails and screws, small stocks of these are essential. If you are making a lay-out section and have the risk of strain, then I suggest some screwing at the basic points. Nails would probably spring up, and the result would be chaos at a later time.

1in. flat nails are useful, as they do not split the wood when used on thin beadings and edges, and panel and veneer pins are also obtainable from Hobbies, Dereham, Norfolk. In building up fairly high bankings and so on, I stock a few 2in. metal angle brackets as used for putting up small shelves. They cost about 3d. each and once fitted, the framework will stand on end of knocks. There is also a flat type which we see used on window frames to keep them together. I have used these on occasions.

Question of Size

If it is your intention to make a lay-out, then consider its size. So often these things have to find their way to the exhibition in a car, and you cannot tip up large sections the size of hoardings. Keep the sections short and make good connecting parts.

Collect up the tools you need for the job in hand. I like to have just what I

need, and these are always kept in a box. You need large and small screwdrivers, gimlets, small hammer, bradawl, tenon saw, pliers (radio type), pincers, square, steel non-slip ruler, cutting knife (I find a linoleum cutting knife useful), tweezers, paring chisels, etc. This is only a general list but most model-makers, like myself, concoct all sorts of wonderful gadgets which are most useful but would not pass as 'tools'.

Framework First

In making a scenic model, it is always wise to get all the framework fitted up. Finish off all the structural work first, and see that it looks correct.

Gummed paper as used for parcels is another useful stock line, and will be found good for fitting buildings down on to boards.

A visit to an art and craft shop found me some material which one must have for scenic building. This was bleached hessian, 48ins. wide at 4/- a yard. Natural hessian was also available at 3/6 a yard and 40ins. wide. Stencil brushes, modelling tools, palette knives, etc., are always found at such shops. If in doubt for any material, try any good art and craft shop.

A Problem

Cardboard is a great problem, but one can still get fairly large cartons from the grocer or the radio dealer. These are now chargeable, but if you pay what the dealer does you will still get a bargain as far as cardboard is concerned. I have also been able to get some useful cuttings in thin boards from a local printer. These are offcuts from printing jobs and are most useful for making fascia effects, walls and other smaller parts.

One thing I always do is collect all sorts of oddments of paint in all shades. However tacky it may be, I still make very good use of it. When decorating the home you may have oddments of distemper, whitewash, flat paints and enamels left over. See that these are securely shut down and marked with a name to save you having to open them. I use the distempers as a base over hessian with the main idea of filling in and helping the 'key' for further applications. The various wall washers for outside use are also sound for this sort of treatment. Keep enamels separate as they will not mix with the normal 'flat' paints. Once you make the mistake of mixing the two, you may ruin a whole tin of paint. (286)

Made for a youngster—but it's still A USEFUL WHEELBARROW

THE wheelbarrow shown in the sketch at Fig. 1 would be found useful in the garden for the youngsters' to help in carting and loading. Its length is 25ins., and the width at the widest part (at the tip of the handles) about 12ins. It can be made from any good boarding or even second-hand wood about 1/2 in. or 3/4 in. thick. Most of the cutting can be done with hand and tenon saws, using a fretsaw for the curved parts. Alternatively, a bowsaw could be used for the curves.

Commence work by drawing the outline of one of the sides, as Fig. 2, direct on the wood. 6in. wide stuff will answer well. Having done this and cut round with the saw, lay the side on a second piece of wood and mark round in pencil, thus making sure that both sides will be identical. Bore the hole for the axle screws through both pieces at one time, so they come exactly opposite each other.

Framework

The two sides of the barrow will slope slightly when put together, the proper slope being obtained, of course, from the front and back of the barrow, the parts for which can now be prepared.

The outline of the back and front as given in Figs. 3 and 4 respectively. Mark the shapes on to the wood, and then,

sides (Fig. 2). These give the positions of both front and back, and the middle dotted line indicates where the holes will be bored to take the screws which hold the two cross pieces to the sides. Either round-head or counter-sunk screws may be used.

An outline diagram of the floor is given in Fig. 5. It will be noted that two boards are used, with narrow battens 1 1/2 ins. wide and about 1/2 in. thick laid across and nailed to hold them well together.

The taper of the floor should be set out after these boards have been set up square and battened together, the measurements being got direct from the made-up frame. Nail or screw the floor into place and proceed to add the thickening pieces to the handles as shown in Fig. 6. Two pieces of 1/2 in. or 3/4 in. wood 6ins. by 3 1/2 ins. will be wanted. They are laid against the handles of the barrow and their shapes drawn from them, so as to get the true outline. Glue and screw the pieces firmly, then complete the shaping with rasp and glasspaper.

Note that these pieces fit up flush against the back of the barrow, thus making an additional holding for this sloping piece.

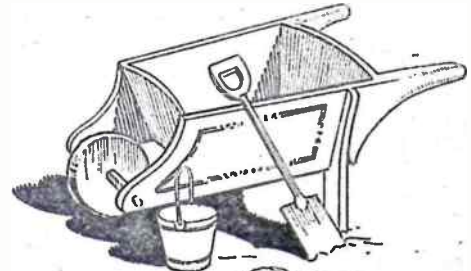

Fig. 1—The wheelbarrow ready for use

barrow, this cut-in being 1/2 in. in depth. Round off the tops of the legs as shown, either before or after they are fixed in place, and see that they stand at right angles.

Go over the whole of the woodwork now with coarse and fine glasspaper, taking off all sharp edges and corners.

The Wheel

A suitable wheel about 5ins. or so in diameter must now be obtained, but if one cannot be purchased ready made, then it would not be too difficult to make one from, say, 3/4 in. or 1 in. wood.

If you make one, select hard wood such as beech, birch or oak, because the

(Continued on page 342)

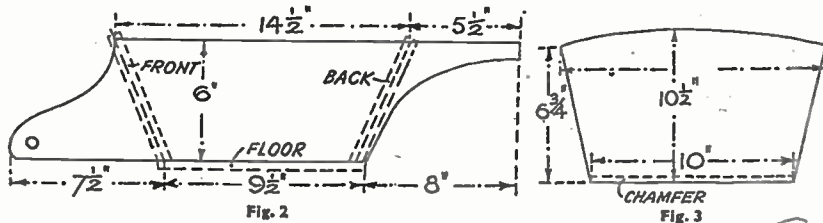

Fig. 2

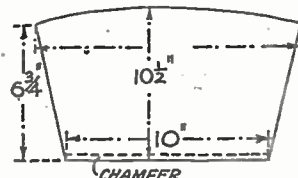

Fig. 3

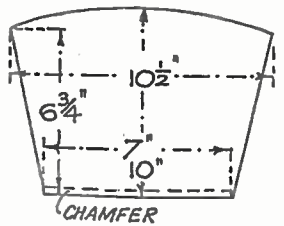

Fig. 4

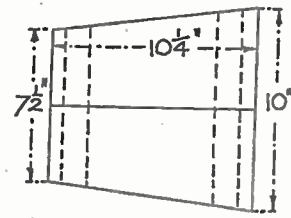

Fig. 5

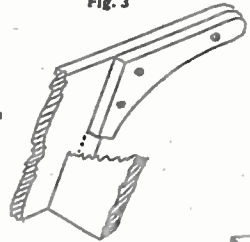

Fig. 6



Fig. 7

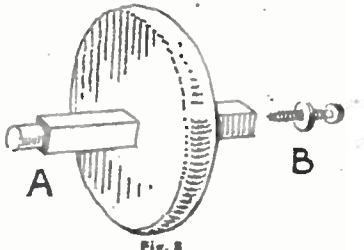

Fig. 8

after cutting out, bevel off the upright edges with a plane, so that they meet the sides, which will taper slightly from the handle end towards the wheel. Note the dotted lines on the diagram of the

The size and shape of the legs are given in Fig. 7, and wood about 1/2 in. thick should be used for them. Set out the sizes given, noting the set back where the legs fit on to the sides of the



For Table Tennis Fans

I AM desirous of re-surfacing a table tennis table which has become very dead. It is intended to apply a blow-lamp and remove all previous paint. Will this be in order, how can I repaint it, and what type of paint should be used? (T.W.K.—North Woolwich).

THE paint can be removed with the blow-lamp if the table top is solid wood; if plywood, it would be safer to employ a proprietary brand of paint remover as the heat might separate the plies. Apply an undercoat and over this two coats of paint, the last coat being flat not glossy. A treatment greatly recommended for fast play is to coat the table with a casein glue, then to spread over a layer of muslin, tacking it to the edges of the table. Press muslin free of creases and when dry apply a coat of thinner glue, rubbing it well in all over and smoothing with the back of a knife. When dry, glasspaper all over and then apply two coats of enamel.

Here's how to make a small CABINET FOR THE DRESSING TABLE

A SMALL 'cabinet' for little items of jewellery, studs, cuff-links, and so on, with just an added personal touch—a photograph mounted behind a thin celluloid 'glass' on the sloping front face—this article is simple to construct, and would make an excellent family gift.

Choice of Material

All the parts are detailed in Fig. 1. Choose good even grain material throughout, matching the grain of the two ply sides as far as possible. The first of the diagrams shows how the curved

clarity. Provided you work accurately, you can use glue only for jointing. The less experienced worker might be advised to pin and glue all joints. Note that the bottom edge of the front must be chamfered slightly to fit flush against the false bottom. The basic assembly is complete when the second side is added to the layout shown in the figure.

The lid is made from two rectangular pieces of 1/4 in. thick material. A softwood is re-

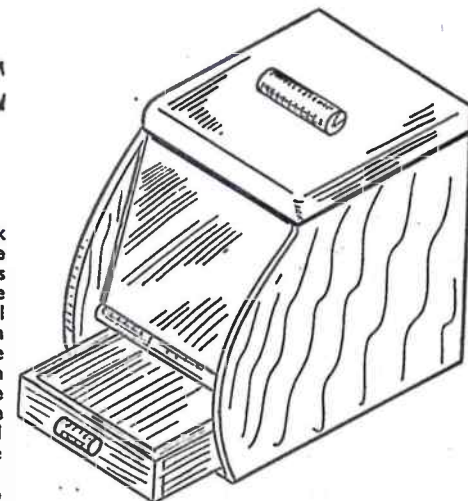

commended, not ply, either to blend with the wood chosen for the rest of the assembly, or as a direct contrast. Probably the simplest method is to finish all parts finally with wood dye and polish, although it is rather effective to have the lid a lighter or darker shade. The lid could even be enamelled or painted glossy black, for effect.

Close Fit Required

Make the lid a nice close fit and glue the two parts together securely. Then round off the corners of the upper part and attach the handle, either by glue or

(Continued on page 344)

▶ Casting Ornaments

I HAVE been making casts and casting ornaments in plaster, but would like to change to different material. Can you give me some advice as to the use of plastics, how to get them and dilute them for pouring, and for metal work, the best type of metal? Is it possible to dilute Perspex to liquid?—(W.I.—Peterculter).

LOW melting point metals such as 'Carromatrix' and alloys of lead, tin, antimony and bismuth are the most convenient for casting in plaster moulds. Most of the commercial plastics are not adaptable for home workers as they require expensive apparatus and call for much technical skill. A liquid plastic can be had from Karlens Art Stone Company, Manchester or Quality Plastics Ltd., Brantwood, Essex. (See advertisement pages of recent issues.)

Preserving an Oak Gate

I HAVE just fitted new oak front gates and was advised not to paint them but to use linseed oil. This I have done and am quite pleased with the effect. I applied the linseed oil with a paint brush and am wondering if this is going to be sufficient covering to stand up to the weather. I realise that more than one application will be needed, but still have my doubts re weathering; also should the knots be treated in any way? (F.E.H.—Southampton).

PROVIDED you do not overdo it, the raw linseed oil will have a certain preservative effect, and this should also

bring out the grain, but if too much is applied it will tend to ooze out in warm weather and make the wood unpleasantly sticky. Rub it well in with a clean rag, and repeat at intervals, not using much oil. Alternatively, if you have not applied too much in the first application, we suggest when quite dry you give the wood a coat of clear oak varnish which looks and wears well and preserves the wood. The knots are best treated with a coat of varnish anyway.

Treating Plaster

I HAVE carved a model in plaster of paris, and would now like to treat it in some way as to preserve it and give it that pale yellow finish which seems to be correct for this sort of thing. I also propose doing some wood engraving and shall be grateful if you could inform me where I can obtain the necessary tools and blocks. (R.S.—Catford).

PLASTER of paris when bone dry can be sealed and preserved by coating it with thin shellac varnish. Two or three light coats will produce the desired colour; each applied after the previous coat has dried thoroughly.

Gravers and other tools used by wood engravers can be had from any good tool dealer, but are somewhat difficult to find in stock, as the demand for them is now very small. Any first-class timber merchant could supply the wood. Boxwood is frequently used for small fine work, and the surface to be engraved is always the end grain.

Removing Heat Marks

I TRIED to remove heat marks from a polished oak table with linseed oil, and had little or no success. Would you please advise me? (D.P.—Sittingbourne).

HEAT marks on a polished surface are very difficult to eradicate. Try rubbing over with turpentine and linseed oil. This will sometimes remove the marks if not too deep. If this fails, a gentle rubbing with methylated spirit on a clean rag pad should remove the marks, after which a coat of clear varnish or a rub with a french polish rubber will restore the original polish.

Have you a problem? If so, we might be able to help you. There is no charge.

method. In method (B), the axle is cut to fit easily between the projecting front arms of the barrow, and holes made in the ends of the axle to coincide with those already made. Then large-sized screws are run through the sides into the axle, thin metal washers being threaded on, as shown, below the heads of the screws.

The wood should be given two coats of paint. The outside of the barrow might be painted green, while the inside should be red or buff. The sides can be panelled out for added effect, if desired, as in the sketch Fig. 1.

A well-made wheelbarrow of this kind should stand many years of hard usage, and a fresh coat of paint occasionally will help to preserve the wood and renew interest in the article. (281)

A USEFUL WHEELBARROW

(Continued from page 341)

wheel has to take a lot of hard wear. Mark out the circle on the wood and cut round with a coarse fretsaw blade or a bowsaw. The edge may be rounded over with a rasp.

A 1/2 in. square opening should be cut in the centre of the wheel to take the axle bar seen in Fig. 8. This must fit tightly into the wheel and be fixed, if necessary, with thin wood wedges glued and driven in.

There are two ways of attaching the wheel to the barrow and they are shown as (A) and (B) in Fig. 8. At (A) the end of the axle is rounded evenly, care being taken to shape the circle within the

square of the piece of wood. The length of the rounded portions each end of the axle bar will be governed by the width in between the side holes, with an allowance for clearance, so that the bar turns easily in the holes. If this type of connection is used, it will be seen that one end of the axle, with wheel attached, of course, must be inserted into its socket hole, then the front and back screwed on and finally the second side put on, allowing the rounded axle to come into place through the second side.

The second method, shown at (B) Fig. 8, is more straightforward, but is, perhaps, not quite so strong as the first

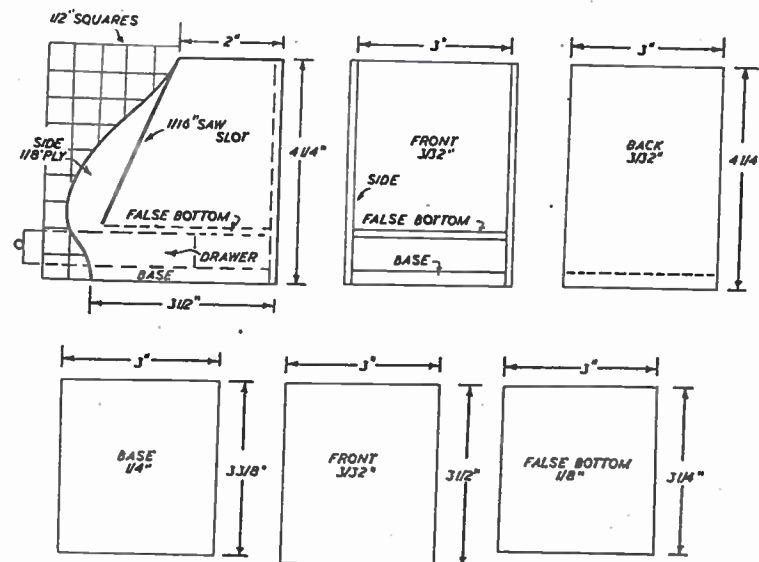
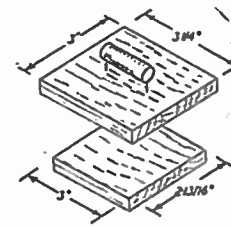

Fig. 1—Details of the sides and dimensions of all parts

part of the side can be laid out with reference to 1/2 in. squares. It does not matter that the exact curve shown be duplicated, but each side must be identical. A 1/8 in. blind saw slot is made on the inner face of each side, as indicated, the faces and edges then being rendered smooth by glasspapering. The base, back, front and false bottom should be cut accurately and similarly smoothed before assembly.

The main assembly is shown in Fig. 2, with the second side not in place for



LID 1/4\"/>

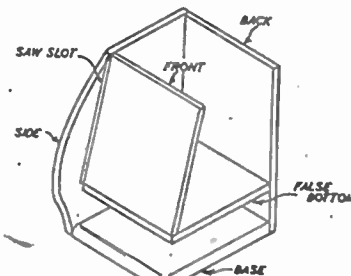
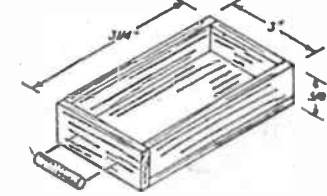

Fig. 2—Main assembly



DRAWER FROM 3/16\"/>

Books to Read!

A review of interesting books for craftsmen which have been recently published. Obtainable through newsagents or booksellers or direct from the publishers mentioned.

British Motor Cycles of the Year 1952

THIS is the second edition of a brand new idea in motor cycling books. Every British motor cycle is detailed for the enthusiast and easy reference provides a complete guide to all the new models. Every motor cyclist will want this descriptive and illustrated handbook, which is greatly enlarged in comparison with the 1951 issue, and is right up-to-date with details of every machine in the Earl's Court Motor Cycle Show. Published by Stone & Cox Ltd., 44 Fleet Street, London, E.C.4—Price 3/6.

New Ideas from the Medallion Press

THIS publishing company have recently brought out a series of small books which will give much pleasure to small children. The four titles at present ready are *Goldilocks and the Three Bears*, *The Hare and the Tortoise*, *Cinderella and Ali Baba and the Forty Thieves*—but these are not just fairy stories in a new guise. These books can truthfully be called action books, for the youngsters can see some of the forty thieves, for instance, popping out of their jars, or watch the three bears taking their porridge. The characters come to life in full colour and there is no gluing or construction to be done at all.

Another ingenious series presented by

this Company also has four titles now ready. They are called *The Fish that Grew too Big*, *The Cow who Gave no Milk*, *The Swan with the Tarbrush Beard*, and the titles are known as Pop-Out Books. As their name suggests, when the books are opened something pops out. In the case of *The Fish that Grew too Big*, for example, you see the fish popping out of the end cover of the book. Published by Medallion Press Ltd., 5 Dowgate Hill, London, E.C.4—Fairy Stories 1/3 each, Pop-Out Books 1/6 each.

Decorative Craft Work by Mary Abbott

THIS is yet another title in the ever-growing list of Foyles Handbooks, and will be as welcome as its predecessors. The average home craftworker is not an artist, and in many branches of handicrafts is unable to impart a professional finish to a piece of work. The commonsense instruction given in this book will help the worker to achieve the finish to his work that is so desirable. Published by W. & G. Foyle Ltd., 119-152 Charing Cross Road, London, W.C.2—Price 2/6.

Handy Boy's Book by John Barnard

HERE is an entirely new edition of a book which has enjoyed popularity

for many years. Primarily prepared for boys who are anxious to use their hands, the information in this work is plain and practical, and the book's scope comprehensive, nearly every hobby and taste being catered for. Every boy should seek to own a copy of this book, for, whether at work or at play, the lad who is clever and smart with his fingers is bound to score. Published by Ward Lock & Co. Ltd., Warwick House, Salisbury Square, London, E.C.4—Price 10/6

Every Man his own Mechanic by John Barnard

IN this work edited by the same man responsible for the Handy Boy's Book we have a completely re-written and revised edition of a work which has been of help to many home mechanics over the years. It is particularly comprehensive and covers the whole field of household decorations, renovations, wood and electrical work and a host of other subjects. The simplest operations have been fully described, for the book is not intended as a text book for skilled workers, but rather as a guide for those who are but little experienced in handicraft. The book is well illustrated with photographs and line drawings and is well worth its purchase price. Published by Ward Lock & Co. Ltd., Warwick House, Salisbury Square, London, E.C.4—Price 17/6.

DRESSING TABLE CABINET

(Continued from page 343)

small screws. A short length of dowel can be used for the handle, or a piece of plastic rod, cemented in place. A white plastic handle, for example, is most effective with a black lid.

The Drawer

The drawer is made very simply from $\frac{3}{4}$ in. or $\frac{1}{2}$ in. material, as shown in Fig. 4. It should be a nice sliding fit in the lower compartment of the main assembly. Again the handle or drawer pull is a short length of dowel of plastic rod.

Fig. 5 shows a part cut-away view of the completed job. The photograph is mounted directly on to the front face of the cabinet. A good method is to paste it

in position with rubber gum or photopaste, although it can just be slipped between the celluloid and the face. The rectangle of celluloid—about $\frac{3}{16}$ in. thick material, slides into the two saw slots and rests against a strip of $\frac{1}{4}$ in. by $\frac{1}{4}$ in. material glued across the bottom of the front, as shown. This strip should be rounded off, for effect.

Variety of Uses

A simple cabinet of this type can be put to a variety of uses. A pair would make an excellent dressing table set, for example, while larger models might be considered for the lounge or sitting room.

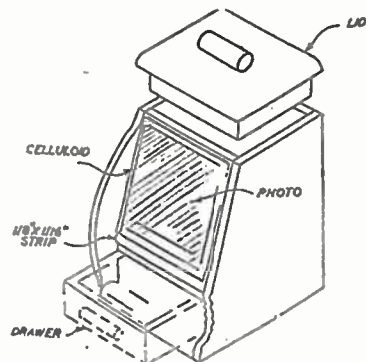

Fig. 5—Cutaway drawing of the completed job

GROW EVERLASTING FLOWERS (AND MAKE GIFT POSIES)

YOU will, no doubt, have seen the attractive little bowls and baskets of flowers that are offered for sale during the winter time. The flowers have an artificial appearance and feel like stiff paper to the touch. They are, however, real flowers, and that stiff paper-like feel is apparent even when the flower is on the plant. The flowers, everlasting flowers as they are called, are quite easy to grow and can be reared to perfection in any garden that admits a fair amount of sunlight. It is not usually necessary to use artificial heat; the seeds can be sown direct into the garden where the plants are to bloom.

The plants most commonly known as everlastings are listed below in alphabetical order.

Acroclitium (hardy annual). In single and double varieties in rose and white. It can be grown in pots or used in the borders during the Summer. A particularly dainty flower, lasting over a long period and giving a good display of colour on long dainty stems. It is one of the first annuals to bloom, usually flowering about six to seven weeks after sowing. The flowers have a peculiar habit of closing during dull weather and opening again during spells of sunshine.

Helichrysum (hardy annual). Growing to a height of about 3ft., these are the type most commonly used for winter bouquets. They are much prized for this purpose, but will also give a rich display of colour in the garden during the Summer months. A dwarf strain which is also obtainable, grows to a height of about 2ft. The charming shades of colour include red, pink, cream, white, yellow, orange and silvery white. The seeds can be purchased in packets of separate colours or mixtures.

Statice Sinnata or Sea Lavender. Is a half-hardy annual which is greatly used as an everlasting flower. There are yellow, red, mauve and white shades and the flowers appear as early as June if grown under glass to start with. The seed may be sown outside in April or May.

These three varieties are the most useful for our purpose, but we will just mention other varieties which are listed in the seedsmen's catalogues.

Globe Amaranth (half-hardy annual). Purple in colour, it must be raised under glass at first and needs a little protection until all danger of frost is past.

Rhodanthe (half-hardy annual). Useful for greenhouse and indoor decoration. Rose or white flowers, either single or double, and grows about 9ins. to 12ins.

Xeranthemum. Another easily grown hardy-annual, but seeds are a little difficult to obtain. It flowers from July to September in shades of purple, rose or white. They grow to an average height of 2ft.

Lunaria or Honesty (hardy-biennial). Flowering the year after sowing, it bears rather insignificant purple flowers, but it is the seed pods that are useful for decoration. The silvery seed pods are well known in country gardens and once the plant is established it produces self-sown plants year after year.

Physalis or Chinese Lantern. Plants are bought from a nurseryman. The scarlet fruits of these plants are their chief characteristic. After gathering them, hang them head downwards until the leaves have shrivelled.

Gypsophila Paniculata. Is easily grown from seed, but does not flower in the first year. It gives feathery sprays of tiny white flowers, and will often be seen in company with bouquets of sweet peas. The sprays can be cut and dried, when they are useful for decoration in company with Everlasting flowers.

The seeds should be ordered from a reliable advertiser such as W. J. Unwin Ltd., Histon, Cambs.

Cultural Hints

It is usual to find instructions on the packets, but for your guidance we will give a few details. The hardy annuals, with which we are mainly concerned, are sown out of doors during March or April, where they are to bloom. They will flower the same year and die after flowering. Prepare the ground by digging and raking down to a fine tilth, and draw out drills about 1ft. to 18ins. apart. Water the drills thoroughly, and when the water has drained away, sow the seeds as thinly as possible, having regard to the fact that the plants will need to be about 1ft. apart. Cover the seed with fine sifted soil to a depth of $\frac{1}{2}$ in. They should need no further watering before germination takes place.

The perennials and biennials are sown in a similar manner in the Spring or Summer and are transplanted into their final quarters in September. They could also be transplanted to nursery beds and then moved to their final quarters. This method would, undoubtedly, give stronger plants. Half-hardy annuals can

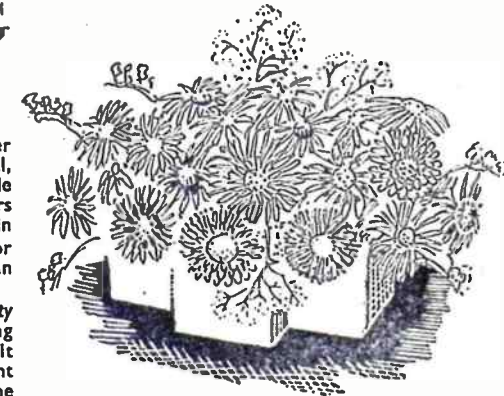

be raised under glass or sown outside during May.

Birds can sometimes be troublesome on the seed beds, and the best way to deter them is to stretch black cotton across and along the rows. Put in stakes at intervals and stretch the cotton so that it is about 6ins. off the ground.

Slugs can be kept at bay by watering the soil near the seedlings with a solution of aluminium sulphate. A less troublesome method is to buy a tin of Meta-bait from the seedsman and put this down in small heaps. The slugs come from all directions to taste this deadly bait.

As the plants show themselves there may be a few gaps in the rows. These can be filled by moving other plants that are too close. Thin out the rows so that the plants are about 1ft. apart. The Helichrysums will need staking as they grow taller but the Acroclitiums and Statice will remain erect without attention.

The hoe should be kept going round the plants during the entire period of growth, but beyond this, little attention is needed.

As the flowers mature they should be cut when fully open, sometime during the day when the dew has dried off. Make them into small bundles and hang them head downwards in a dry airy shed or room. Do not expose them to direct sunlight or the blooms will fade considerably. After the leaves have shrivelled and dried, the bunches can be sorted through, and all dead leaves removed. The flowers can then be stored in boxes away from the light. On no account must the flowers be stored before they are perfectly dry, or the petals will be destroyed by mildew.

We do not propose to give constructional details here, but rather to wait until the Autumn when we will tell you how the flowers can be fixed and displayed in small baskets or bowls. We will prepare and publish this article early enough to give you time to make these gifts for Christmas.

Learn how to use your camera for Indoor Photography

In the last photographic article, several reasons why you should make more use of your camera were suggested, and hints were given on how this could be done even if you already found most of your time very fully occupied with other and, perhaps, more important work.

Whatever your hobby, try to find time to pursue it. If you can break away for a few minutes' recreation with a 'sideline', you are more likely to make a better job of your ordinary routine work.

At this time of year, weather conditions are such that even if you had some spare time it could not be used out of doors for camera work. But why not indoors? It is almost as easy to make successful indoor studies as it is to take snapshots of open spaces, and it is certainly worth trying, even if it is only for the fun one can get out of it.

Try at Home

Indoor photography should first be tried at home, and, when making experiments, try to be really efficient and practical, remembering that all haphazard work must eventually prove expensive and disheartening. Put down in your notebook such details as the stop used; the exposure; type of flash-bulb, if used; distance between lens and main person or object (this is very important); brand and wattage of any high-powered or photo-flood bulb used. These details should be written on the

envelope in which the negative is eventually stored and particulars of the developer, etc., should be added. At some future date, when you have a similar job to do, you will find this information of great value, and, incidentally, a saving of time. It may also mean the difference between a successful result and an indifferent one.

In the past, most of my indoor exposures were made with flash-powder and in many ways I am sorry that this medium has practically disappeared. But there is, no doubt, that flash-bulbs are excellent, if synchronisation is satisfactory. By accurate synchronisation is meant that the flash occurs at the same split second as the shutter of the camera opens. But, and I would like to emphasize this, it is not necessary to have the flash apparatus attached to the camera as with those used by press photographers, because amateurs' flash work, in the majority of cases, simply means using the camera at home for indoor portraiture, copying, photographing models and other items connected with various hobbies. For all this type of work I have found portable lighting apparatus perfectly satisfactory: in fact, in many instances preferable. And if a flash bulb is used for these purposes, when focusing is complete, all lights should be turned out and the lens opened. When you have made the flash, shut the lens, switch on the light and change the film. It is not the intention to make this contribution a discourse on the use of

flash bulbs, but rather to give a few hints to those who have the electric light laid on in the house, and can, by keeping handy a few yards of flex and a 250 watt bulb, easily produce a good light directly on to any subject in any part of a room.

There is one other item which I would most strongly recommend for increasing and concentrating the power of the light—a reflector. It should be

Home Lessons



This indoor study was taken using 15 grains of flash powder

cone or bowl shaped, and can be made from a piece of tin sheet or even from an old tin container. The inside of the reflector should be well polished, or, if this is not possible, painted with a glossy white enamel. It is a simple job to attach the reflector to the lamp, stand and holder so that the bulb is in the correct position for throwing the maximum illumination.

Warning

Just a word of warning about the loose connecting flex. Do not have yards and yards of this lying on the floor between the wall switch and the lamp holder. Accidents so easily occur and can have nasty consequences. It does not cost a lot to make two or three lengths, complete with the necessary fittings, and these will be found useful for all sorts of jobs other than photography.

While it is impossible to give any hard and fast exposure times for the many items which can be tackled at home, the main lines to follow are those which

have been referred to in these articles many times before. Standardise as far as possible. I suggest the use of a fast film like Ilford H.P.3, and the $f/8$ stop always. With these two regular or standard factors and the unalterable lighting, you have only the question of timing to settle, and those of you possessing a photo-electric exposure meter will be able to settle this calculation without difficulty. Those who are not so well equipped should be prepared to make one or two experiments, carefully noting the distance between the sitter and camera.

Lighting

Subjects consisting of several details such as the modelmaker at work; the toy railway on the floor with, perhaps, a couple of youngsters regulating it; mother arranging a bowl of flowers, or, perhaps, preparing the week-end cake, etc., really come under the general heading of groups, for they constitute more than one object to be included in the photograph and are, therefore, different from the single portrait. The lighting has to be spread over a larger area, which may mean that the lamp has to be placed farther back, and the surrounds, i.e. walls, floor and pieces of furniture, have to be considered. Are

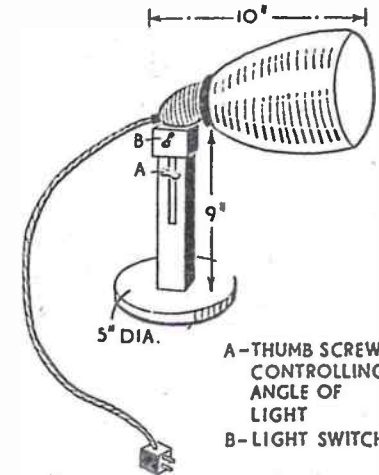

Details of the author's portable lamp

they dark or light? Some workers have found that a sheet or white table cloth used as a reflector will help to prevent 'hard' lighting effects, but care must be used to see that such reflectors do not come into the picture.

Having covered the ground relative to the preparation and calculation, you might start off with an exposure of two seconds for a small group as above, using a 250 watt lamp, plus the ordinary room lighting. When you are satisfied that everything is ready, tell the folks to

keep perfectly still, as the exposure is a little long, and ask them to fix their eyes and their attention on one particular object in the room or on what they are supposed to be doing. In any case, they should avoid looking at the lamp.

Do not be afraid to move the lamp slightly during the exposure, as this will often overcome hard shadows. But do not overdo it. If you have not made a stand for the light or cannot find a suitable place for it, then you should get one of the party to hold it for you, because you should be free to operate the camera, pressing the trigger for the exposure and shutting the lens after the exposure is made.

I am quite certain that many readers will be quite impressed with the first results and will realise that this branch of the hobby offers a wealth of possibilities. Therefore, they will be wanting to make more of it than just the taking of a few 'record' snaps.

A Good Lamp

The first item to be obtained is a good lamp holder, something that is adaptable and quite portable. I cannot do better than describe the one that I have used for many years. It is made of metal, with the reflecting bowl extended at right angles. A heavy circular base with a diameter of 5 ins. keeps the lamp rigid. Halfway up the stem is a thumb screw, permitting the raising of the bowl to almost any angle, and just above this screw, is a convenient switch controlling the light. Finally, there are 2yds. of flex with the necessary attachment for plugging into a wall switch. A drawing of the fitting is given in this article, and readers should have no difficulty in making one. Alternatively, in most homes there is an odd table lamp, and if it is of the pillar pattern, there is no reason why this should not be adapted for use.

Most first attempts at artificial light photography are efforts at portraiture and this is, in many respects, the most difficult, because unless use is made of reflectors for getting soft lighting effects, the results are often too contrasty. Screens for use as reflectors are quite easily made. Usually they are circular in shape and can be produced by using a child's hoop for the framework and stretching over this a piece of

butter muslin or similar white material.

In practice, the screen is so arranged that it will receive the light from the lamp and throw a soft reflection on to that side of the sitter's face which would otherwise be in shadow, or if desired, three-quarters of the face can be portrayed in this manner. A few experiments will give an enormous amount

The Week-end Flowers



The exposure here was 1 sec. at $f/8$ on H.P.3 film. Lighting was one 250 watt lamp. Developed in Axol.

of useful and practical information regarding lighting, exposure, posing, etc., besides introducing into the family circle another source of enjoyment and fun.

It is the general opinion that portraits or photographs illustrating certain incidents of family life, and actually taken in the familiar surroundings of the home, possess an intimacy which it is almost impossible to secure in a studio exposure, and, therefore, they command a far greater interest. I have found that this interest is longer lived, especially if the photographs relate to children and their hobbies or games.

Correct Development Essential

It should not be necessary to remind you that correct development is most essential, and it is hoped that most readers are now processing their own films by the Time and Temperature method and the use of a developing tank, which is the best if perfect negatives are desired. (284)

Watch for more of our photographic articles. They are written by experts—but in a language the Amateur can understand.

Family Chorus



A homely picture, this time secured by the use of a 250 watt lamp, and the 120 watt room lights. Exposure on fast film, 2 secs. at $f/8$.

In these days anglers should aim at FISHING TACKLE ECONOMY

ANGLING equipment is nowadays somewhat expensive and it behoves young anglers to economise, hence these few hints that may be helpful. Look after your tackle and make it last as long as possible.

It is wise to cut out the cost of purchasing items of equipment by substituting home-made gadgets. You can 'make do' with lots of 'bits and pieces' that are ready to hand.

For instance, an empty syrup tin, 1lb. size, with a few holes pierced in the lid, makes a capital maggot container. A larger size tin will do to keep a stock of these baits in.

Tobacco Tins Useful

Tobacco tins will do for many purposes—to carry floats, casts, and spares such as float caps. They are also useful as worm tins; and are handy for storing gut, providing they are airtight.

A rod rest can easily be made out of a piece of bent wire, fairly stiff, or from the rib of an old cast-off umbrella. Rubber boots and wading rubber garments can be repaired with ordinary tyre repair patches.

To add longer life to a keep-net, steep it in boiled linseed oil; drain off surplus oil and hang the net up to dry. Reel lines can be given extra length of usefulness if they are periodically drawn from the reel and hung in loose loops in a dry airy place. Dressed lines will be much benefited by an occasional rub-down with mutton-fat or similar.

If you desire to 'dress' a silk line in order to preserve it, try the following: one tablespoonful of boiled linseed oil; one piece each beeswax and resin about the size of a walnut. Pulverize the resin and cut the wax into thin slices. Place together in a jam-jar in boiling water till dissolved, mix with a piece of wood, and put the line in the mixture while still warm. Afterwards take out and hang the line up to dry, stretched out in an airy room or shed, and clear off surplus liquid by taking a piece of sponge between finger and thumb and rubbing it along the line; rag will do if no sponge is available.

A few drops of oil on your reel bearings after cleaning with a bit of clean rag will do no harm occasionally.

Give your rods a rub-down from time to time with a little linseed oil on a soft cloth. Always carefully dry the rod after use in rain or when it has been laid down on wet grass; this is one of the first things to do on reaching home.

Your rod-bag should be provided with

a loop at one end; you can easily stitch one on if it lacks such a loop, so that when not in use the rod can be hung up. Never allow a rod to lean against a wall, especially for a long time, as during the close season. After the joints have been placed in the bag, the latter should be so folded that the top joint is inside the other joints, remaining protected by the

white, to touch up the top of the cork will improve its appearance. Quill floats can be made from birds' feathers. Strip the quill and secure a small ring or a loop of fine wire to one end; varnish the whipping and paint tip of float red or white to choice. When dry, varnish the whole float. A cap for the float can be made from a bit of rubber tubing.

You can make a useful fishing bag out of a piece of good water-proof canvas. A convenient size is about 16ins. long by 12ins. deep; it should be fitted with a flap and two buttons and buttonholes, or a short strap and buckle. A curtain ring on a short piece of canvas attached to each of the two top corners of the bag will serve for the shoulder strap attachment; this shoulder strap is made from a strip of canvas, with the edges sewn over, and a buckle fastened on one end;

at the other end of the strap have several holes 1in. or so apart, to allow for adjusting the strap, so that the bag rides comfortably on your back. All seams should be turned in, and double-stitched. The interior can be longitudinally divided by a third piece of canvas of suitable size, to form a second compartment.

Disgorger

A disgorger for extracting the hook from a fish's mouth can easily be made from a sardine tin opener if the slot where the lip of the lid fits when opening the tin is cut through about half-way, with hacksaw. To make the whole thing longer you can straighten out the handle. A bead or small tip of cork can be stuck on the end to protect your hand.

A useful fly-box can be made from a flat fifty cigarette tin. Divide the interior into a suitable number of compartments to accommodate the different patterns of flies. (295)

Don't forget the 'new' 'Hobbies Weekly'—due on April 2nd.

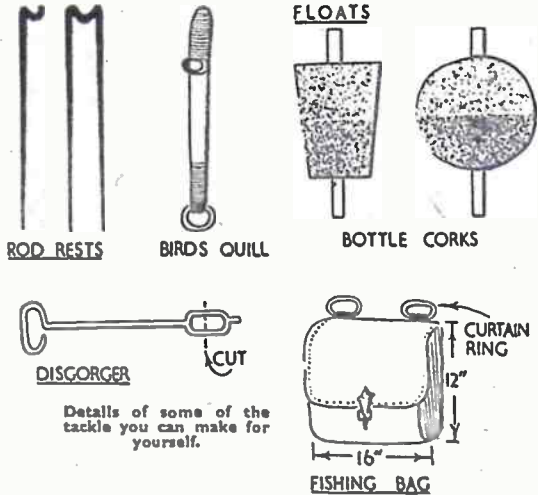

middle and butt joints. If the top joint is on the outside it is not only liable to injury but also apt to become warped. Do not tie up a rod bag tightly, just fasten loosely and tie with a 'bow knot'. This advice applies with extra emphasis over the close season when the rod is put aside for some months.

An occasional 'do' with a drop of varnish applied with a soft brush or your finger-tip to your rod will preserve its 'life' wonderfully. Use only best rod varnish, obtainable from tackle dealers.

Home-made Floats

Home-made floats can easily be constructed from corks of various sizes. Bore a hole through the centre. A small quill cut from a feather, or a suitable peg cut from a piece of wood, to hold the line after it has been threaded through the hole, is all that you need. Adjust depth when fishing by easing the quill or peg and drawing the line up and down as required to allow the baited hook to lie on the bottom of the stream or at any required depth as needed.

If you like, you can shape the corks round or oblong or tapering, with a sharp knife. A spot of paint, red or

INTERESTING work available for all in spare time. Experience unnecessary. Send S.A.E. for details to 'Leatheweave' Co. (Dist. 37), 2 Tudor Rd., Leicester.

AN interesting hobby. Collect stamps and while you circle the globe, acquire historical and geographical knowledge. Send 2½d. for our approvals. Good stamps at most attractive prices.—Willert & Carville, 69 St. Vincent Crescent, Glasgow, C.3.

CLERICAL work at home, full/part time. Send S.A.E. for particulars.—Messrs. M. J. Batt, Box 99, Hobbies Weekly, Dereham, Norfolk.

LONELY? Join friendship circle. Details, 7½d.—Secretary, 34 Honeywell Road, London, S.W.11.

GENUINE approvals, genuine prices and genuine gift. Send postage.—Blair, 75 Heversham Road, Bexleyheath.

MAHOGANY plywood, new, any parcel £1 delivered C.V.O.—4 at 72x112x4 mm., 7 at 78x82x4 mm., 12 at 78x52x4 mm., 8 at 72x62x4 mm., 6 at 78x82x4 mm., 10 at 78x52x4 mm., 22 at 88x32x4 mm., 24 at 78x32x4 mm., 40 at 78x22x4 mm., 50 at 78x22x4 mm.—Leader (1920), Gosford St., Middlesbrough.

20 WORLD free. Send 2½d. for supper discount approvals.—Freeman, 14 Oldhill Place, London, N.16.

STAMPS FREE!! Twenty unused (2½d.).—S.G. H. Barnett, Limington, Somerset.

SURPRISE packet free to all sending 2½d. now for approvals.—England, 18 Falkland Rd., Sheffield, 11.

SUPER packet, including set Italian Commemoratives, free, approval applicants, enclosing postage.—Fildes, 6 Fouracres Road, Wythenshawe, Manchester.

'PERSONAL'—the fascinating magazine. Crammed with pen friend addresses, hobbies, personal advertisements, offers. Specimen, 1/-.—Woolf's Publicity, 7 Princes Street, Hanover Square, London, W.1.

AUTHOR'S manuscripts (and illustrations) carefully considered by established commission Publishers. Books, booklets, pamphlets, business brochures. Publicity/distribution services.—Scrivener Press, 7 Princes Street, Hanover Square, London, W.1.



with **JOHN WAYNE** in 'NEW FRONTIER', **ROD CAMERON** in 'THE PLUNDERERS', **WILLIAM ELLIOTT** in 'THE GALLANT LEGION', **RUSSELL HAYDEN** in 'HOSTILE COUNTRY'.
Extra films from huge list 1/- each.
BOB STEELE: 'SIX GUN MAN', **TEX RITTER**: 'WHISPERING SKULL', **HOPALONG CASSIDY**: 'SUNSET TRAIL', **RUSSELL HAYDEN**: 'NORTH OF THE BORDER', **LAUREL & HARDY**: 'WAY OUT WEST'.

Capt. **CARLSEN'S TRIUMPH!** 'THE SAGA OF 'THE FLYING ENTERPRISE'' 3/- extra

'TROOPING OF THE COLOUR', 'FUN AT THE ZOO', 'BRITISH BIRDS', 'TEST MATCH THRILLS', 2/6 each.

DAN DARE: 'SPACESHIP TO VENUS', **DAN DARE**: 'MEKONTA', **JOHN WAYNE**: 'FIGHTING KENTUCKIAN', 'ROCKETSHIP X.M. MOON', **RANDOLPH TURPIN**: 'THE TURPIN TRIUMPH!', **BRUCE CABOT**: 'TRANS-CONTINENT EXPRESS', 'FESTIVAL OF BRITAIN'.
From all good stores and toy shops, OR DIRECT, post and packing 1/- extra, C.O.D. 1/- extra, FROM **FILM STIPS, EDLESBORO, DUNSTABLE, Beds.**

FOR SALE, 'Campro' motor-driven 9.5 mm. cine camera-projector, £5. Also 'Ajax' home Little used, £5 (cost £11).—Box 200, Hobbies Weekly, Dereham, Norfolk.

WOODWORKING wanted, spare time or model making, toymaking, turning, etc. Skilled craftsman with fully equipped power workshop, South London, labour or labour and materials. Send me your enquiries. State price prepared to pay.—Box No. 555, Hobbies Weekly Dereham, Norfolk.

OPPORTUNITY knocks. Large lists of firms requiring spare-time homeworkers, either sex. 1/6 P.O.—Rapid Publications, Lewin Street, Middlewich.

FREE. 45 worthwhile stamps. Send 2½d. stamp requesting attractive discount approvals.—C. Rogers, S.C.A., 31 St. Leonards Ave., Hove, 3, Sussex.

STAMP collectors, exchange your duplicates at Catalogue value rules. S.A.E.—Castle Stamps, 10 North Street, Dover.

STAMPS. Stock clearance. Mixture, many Pictorials, 500—4/6; 1,000—8/6.—Castle Stamps, 10 North Street, Dover.

START new hobby in plastic. Complete parts for making table lamp. Only finishing and fitting needed, 16/6.—Studio, 8 La Chasse, St. Helier, Jersey, C.I.

50 STAMPS (new year surprise packet), free with approvals. Send 2½d. now. Introduction gifts.—England, 18 Falkland Rd., Sheffield, 11.

STOP smoking in three days or money back. Details, 2½d. stamp.—Triumph Systems (H4), Heavitree, Exeter.

PICTORIAL and triangular packet free. Send 2½d. stamp and request bargain approvals.—W. Farry (H), 61 College St., Ammanford, Carmar.

500 DIFFERENT world stamps, 3/9. Approval.—H. Whitby, Godhill, Fording-bridge, Hants.

HOME production workers required—either sex, interesting job. S.A.E. brings fullest details.—BCM/ASHGROVE, London, W.C.1.

20 BRITISH Colonials free with approvals. Postage.—W. E. Tucker, 6 Higher Church St., Barnstaple, Devon.

MODELS. You can make lasting stone-hard models with Sankey's Pyrama Plastic Cement. Supplied in tins by Ironmongers, Hardwaremen and Builders' Merchants. Ask for instruction leaflet.

LEARN shorthand by 19th March (1 Hour's study nightly). 1st lesson, 2½d. stamp.—Duttons (Dept. H.B.), 92 Gt. Russell Street, London, W.C.1.

DUPLEX self-adhesive transfers for decorating fancy goods, trays, plastics, etc. List and samples, 3d.—H. Axon Harrison, Jersey.

DOLL'S house fittings and papers: send S.A.E. for list. Doll's house plan special: send 2/6. Trade supplied.—Zimplan, 88 Ware Road, Hoddeston.

LORRY kits, 4 mm. and 7 mm. scale. Also large range of spare parts from which to build to your own design. Send for fully illustrated catalogue—price 1/-—Wilson's Lorrys Ltd., 6, Gt. Winchester Street, London, E.C.2.

AMERICA'S famous hobby magazines. One year's supply Popular Mechanics, 32/-; Popular Science, 28/6; Homecraftsman, 16/6; Popular Homecraft, 18/6. Free booklets. List all others sent on request.—Willen Ltd. (Dept. 57), 101 Fleet Street, London, E.C.4.

PLYWOOD outfits, Birch and Gaboon in a variety of thicknesses. Handy sized parcels for the cabinet, toy, modelmaker, and all handicrafts. Parcels made up in £1 and 10/- lots. Carriage paid. Send P.O.—Reaves, Plywood and Timber Merchant, 33 Front Street, Monkseaton, Whitley Bay, Tel. W.B. 4677. Parcels are now despatched on day of receiving order.

HAVE you got your Juneroo riving jig yet? From all hobby shops or post free from Juneroo Ltd., Stirling Corner, Boreham Wood, Herts.

HOME Watch and Clock Repair Outfit. Includes watchmaker's magnifying eyeglass, tweezers, screwdrivers, oilers, oil, brush, dusting powder, plus illustrated explanatory book. Watch and clock repairing simplified. In container, 12/9 inclusive.—D. Bolster (Dept. H.), 5a Station Parade, Ashford, Middx.

LONELY? Then write the Secretary, U.C.C.—1.5 B.B. Hay Street, Braughing, Herts. Genuine. Est. 1905.

STAMPS Free—Empire Packet including Pictorials and Victorians free to approval applicants.—Robert J. Peck, 7A Kemp Road, Bourne-mouth, Hants.

WHEELS for Toys, etc., in Hardwood, Plastic and Rubber Tyred Metal. Doll's House fittings and papers. Doll's Cot and Pram fittings. Decorative Transfers. Beads for Counting Frames and other toy accessories. Fine Art Pictures for Jig-Saws, etc. Stamp for lists. Trade supplied.—Joyden Toy Co., 193 Chase Side, London, N.14.

(Continued on page 350)



YOU can build this GARAGE

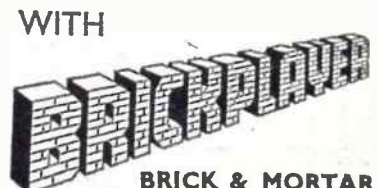

BRICK & MORTAR BUILDING KIT

It enables you to build Houses, Inns, Railway Stations, Signal Boxes, or from your own imagination. All railway models will fit 'O' gauge scale. Buildings can be permanent or dismantled by merely soaking in water and the bricks used again and again.

BRICKPLAYER KITS AT 28/6 AND 52/6 ARE AVAILABLE FROM GOOD TOYSHOPS, HOBBY SHOPS, AND DEPARTMENTAL STORES.

ACCESSORY PACKS

No.	Contents	Price
100	100 Full size Bricks ...	3/-
101	52 1/2-Bricks and 72 3-Bricks ...	3/-
102	Gable and Peak Bricks ...	3/6
111	Capping and Roof Tiling ...	2/6
112	Concrete Roofing ...	2/6
114	Bag of Brickplayer Cement ...	1/3
115	Roofing Cement ...	9d.
8107	2 Bay Windows with 31 Splay Bricks	3/9

METAL WINDOW AND DOOR FRAMES
F1 F2 F3 F4 F5 F6 F7 F8 F9 F10
8½d. 6½d. 7½d. 5d. 4d. 6d. 7½d.
8108 Sheets of Glazing, 18" x 6" (Plastic) 1½d.
If your dealer cannot supply, write for address of nearest stockist to:

J. W. SPEAR & SONS LTD.
(Dept. H) ENFIELD MIDDLESEX

YOU CAN BECOME A HANDICRAFTS INSTRUCTOR

EXPERIENCE NOT ESSENTIAL

Men who enjoy making things in wood or metal can turn their hobby into a permanent and interesting Career. Short hours, long holidays, and security in a job you would really enjoy, can be yours if you become a Handicrafts Instructor. Let us send details of the easiest and quickest way to get the necessary qualification.

We guarantee "NO PASS—NO FEE"

If you would like to know about our unique method of preparing you for one of these appointments, write today, and we will send you our informative 144 page Handbook—free and without obligation. Mark your letters "Handicrafts Instructor".

BRITISH INSTITUTE OF ENGINEERING TECHNOLOGY

BIET

595 Shakespeare House
Stratford Place, London, W.1

FLEXIMOULD

FOR PLASTER CASTING

WALL PLAQUES, FIGURES, GARDEN ORNAMENTS, BOOK-ENDS, ETC. MADE IN YOUR OWN HOME. THE ALL-FAMILY HOBBY THAT ADDS POUNDS TO YOUR INCOME.

Write for

FLEXIMOULD
ILLUSTRATED LEAFLET to
DOHM LTD. (DEPT. H)

167 VICTORIA ST., LONDON, S.W.1



STOP SMOKING

You can overcome the smoking habit in 3 days or money back. Safe, pleasant, permanent. The only scientific way. No Will Power necessary. "Conquered the habit in 2 1/2 days. Am delighted".—F.C. "Within 2 days I was free from the tobacco habit".—W.G. "Was a smoker for 2 years and broke the habit in 2 days".—F.N. "I haven't smoked a cigarette for 3 weeks".—J.E. "I used to smoke 20 a day . . . now I have no desire to smoke".—J.M. Recommended by "Health and Efficiency Magazine". Complete course 6/6. Details 1/6. Stamp. Sent under plain cover.—STEBBINGS, 28 (H/185), Dean Road, London, N.W.2. Established 1928

BE TALLER
EVERYONE can now increase his or her height from 1 to 5 inches. There are over 200 bones in the body and many of these are in positions at each of which a proportionate increase of height can be developed by the Stebbing Scientific Height Increasing System — or money back. Recommended by "Health & Strength" for 23 years. The first, original and the one Guaranteed System. L.P., aged 25, gains 3 ins. 5/11, aged 17, gains 4 ins. C.T., aged 34, gains 3 1/2 ins. Complete Course 10/- post free. Details 1/6. Sent under plain cover. Stebbing System, 28 (H/185), Dean Road, London, N.W.2. Established 1928.

J. WOTTON (Dept. H.)
148 HOLLINGS ROAD, BRADFORD, YORKS.
ALL TYPES OF MOULDS

3/- each

TOYS, ORNAMENTS, PLAQUES, ETC.

New 1952 Illustrated Catalogue. Send 6d. stamps, refunded on first order over 10/-

MISCELLANEOUS ADVERTISEMENTS

(Continued from page 349)

KUKLOS Annual. Indispensable cyclists' Handbook. Tours, resthouses, money saving hints, 2/9, post free.—Burrow, Publishers, 2 Imperial House, Cheltenham.

START making money at home whole or spare time on production of Slippers and useful leather goods. Material Provided. Write for rates of pay and full details.—Dept. X, Grange Co., 2 Curzon Street, Leicester.

CONJURING and Magic. New tricks and Pocket Novels every month. Lists, 4d.—Robots!, Magician, 363 Sandycroft, Kew Gardens.

10/- Worth valuable stamps (real Approvals). Postage essential.—Mousley Stamps, Heanor, Derbyshire.

FREE Europe catalogue value 3/6 to approval applicants sending 6d.—Hawkins (H.3.), 247 Rotherhithe New Road, London, S.E.16.

BARGAIN VALUE for your WORKSHOP



WHAT TO DO AND HOW TO DO IT!

Have you ever wanted one grand book that explains the 'how, what and why' of every job in engineering? Here it is! The new bargain-value edition of 'General Engineering Workshop Practice'.

576 PAGES, OVER 600 TECHNICAL DRAWINGS AND DIAGRAMS!

A book for the enthusiast—explains, illustrates every type of workshop engineering job. The wonderful book for engineer, craftsman, apprentice and hobbyist—make sure of your copy, we return your money if not absolutely satisfied.

ORDER YOUR COPY TODAY

To: A. THOMAS & CO. (H), 111 Buchanan St., Blackpool
Please send me one copy 'GENERAL ENG. WORKSHOP PRACTICE'
I enclose remittance 13/6 or I enclose no money—send C.O.D.

Name.....
Address.....



BRANCHES
LONDON
78a New Oxford St., W.C.1 (Phone MUSUM 2975)
87 Old Broad Street, E.C.2 (LONDON WALL 4375)
117 Watworth Road, S.E.17 (RODNEY 5509)
GLASGOW
326 Argyle Street (Phone CENTRAL 5042)
MANCHESTER
10 Piccadilly (Phone CENTRAL 1787)
BIRMINGHAM
14 Bull Ring
SHEFFIELD
4 St. Paul's Parade (Phone 26071)
LEEDS
10 Queen Victoria Street (Phone 28639)
HULL
10 Paragon Square
SOUTHAMPTON
25 Bernard Street
BRISTOL
30 Narrow Wine Street (Phone 23744)
Head Office & Factories—HOBBIES LTD., DEREHAM, NORFOLK

KITS for OLD TIME SHIPS

Hobbies range of Ship Models includes Elizabeth Jonas, Cutty Sark, Victory, Mayflower, etc. Complete kits of wood, sail material, guns, pulleys, cord, etc., with full size patterns of parts and planed wood ready to cut out, shape and construct. A fascinating pastime.

Kits for models 7 ins. long and upwards.
Ask for free illustrated lists at Hobbies Branches or from Hobbies Limited, Dept. 99, Dereham, Norfolk.

SHIP Modellers should get in touch with Scottish Modelcraft, St. Mary's, Dumfries. 1/- secures handbook and lists and details of our comprehensive and friendly service.

100,000 Government Surplus Bargains. Steel ammunition boxes, 12"x7"x6", with hinged lid, ideal tools, etc., 2/6, post 1/3. Sample parcels (guaranteed containing 15/- worth assorted electrical and other useful items) in handy wooden box, 5/6, post 1/8. Aluminium rivets, approx. 1 lb. assorted, 2/6, post 6d. Send 3d. stamp for catalogue of useful bargains for Hobbyists. — Milligan's, 24 Harford Street, Liverpool, 3.

KARLENITE. PLASTIC MARBLE

Crystalline! Veined!—and sets rock hard!

The entirely new artificial Stone for casting Bookends, Ashtrays, Wall-Vases, Statuettes, etc. KARLENITE sets rock hard with a scintillating crystalline structure like marble or alabaster. It is enormously strong, highly resistant to heat, impervious to water. Literally any type of natural 'veining' can be simulated in any colour. A range of pigments is available for this purpose. Most attractive marble effect in models, plaques and statuary.

MAKE YOUR OWN FLEXIBLE MOULDS

In Elastomold Synthetic Rubber for perfect detail and repetition casting

ELASTOMOLD makes flexible moulds that faithfully reproduce even the most minute details of ornamentation and surface texture. ELASTOMOLD is permanent and ideal for repetition casting of plaques, bookends, ashtrays, and art models. Moulds can be taken from any type of material including Karlenite, wood, metal, plaster, cement, stone, glass, ivory. ELASTOMOLD is incredibly simple to use, and from the moulds casts can be taken easily, quickly without flaw.

Send for full details of this easy, fascinating and profitable hobby.

KARLENA ART STONE COMPANY LTD.,
Plastics 2.A Division.
55 Deansgate Arcade, Deansgate, Manchester, 3.

BROOK GRYPHON FRACTIONAL H.P. ELECTRIC MOTORS

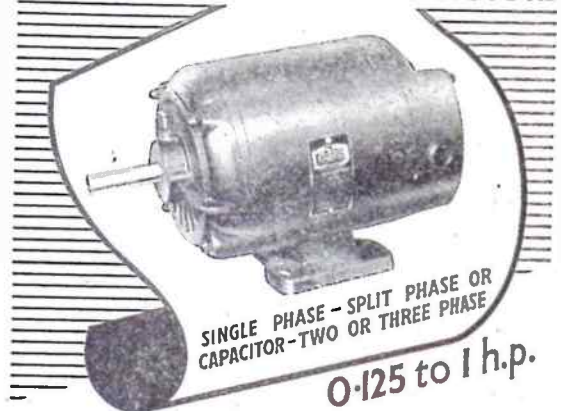

SINGLE PHASE - SPLIT PHASE OR
CAPACITOR - TWO OR THREE PHASE
0.125 to 1 h.p.

A smaller edition of the famous BROOK motor . . .
Just the thing for your workshop or domestic machines

BROOK MOTORS LIMITED
HUDDERSFIELD • ENGLAND

LLF.230

TURN YOUR SPARE-TIME INTO CASH

Men and women wanted to make Bennett Model Bungalows at home.

FASCINATING, SIMPLE, WELL PAID WORK.
No selling involved.

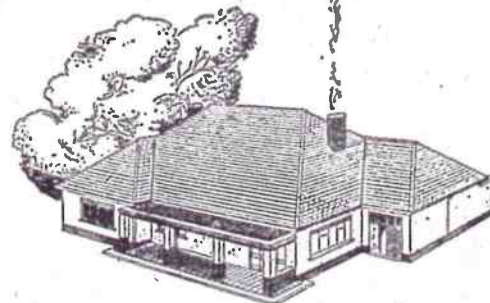

Send stamped addressed envelope for full details

BENNETT MODELS
DUNCAN ROAD, RICHMOND, SURREY

All you require to start picture-making



JOHNSON OUTFITS FOR HOME PHOTOGRAPHY

This picture shows the No. 1 Printing Outfit containing everything necessary for making prints from your own negatives. Can be used for the dish development of roll film. It includes plastic printing frame, safelight lamp, dishes, measure, all chemicals and detailed instructions. **32/6**

There are four larger outfits in the series or you can buy the additional items singly as the standard of your work improves

SEE YOUR DEALER

JOHNSONS OF HENDON LTD.

How the Famous Bennett College can help your career through personal POSTAL TUITION

IF YOU FEEL that you cannot pass the exams which will qualify you in your trade or profession, if you think that you are handicapped by missed educational opportunities — here's a message of hope and encouragement.

GUARANTEED TUITION UNTIL SUCCESSFUL

When you enrol with the Bennett College you will be coached until you have QUALIFIED. This assurance is given by the Governor of the College who has faith in the system of individual Private Tutor training — by post.

This way you have all the benefits of College tuition, but you work in your own time — at your own pace! No extras are charged. All books are free to students.

YOUR LATENT CLEVERNESS . . .

Your own Tutor will help you, understand you, bring out all the cleverness that is in you. And there is often more there than you imagine. You will Qualify! And Qualification means personal betterment in terms of your career. First choose your subject — see list. Then send (without any obligation) for The Bennett College book as this applies to you. Now tear out the coupon.

IN WHICH OF THESE DOES YOUR CAREER LIE?

Accountancy Exams.
Aviation
Book-keeping
Building
Chemistry
Civil Service
Commercial Art
All Commercial Subjects
Draftsmanship
Electrical Engineering
General Cert. of Education
Heating, Ventilation and Lighting
Joinery and Carpentry
Journalism
Languages
Mechanical Engineering
Mining, All Subjects
Motor Engineering
Mathematics
Police—Special Course
Production Engineering
Radio Service Engineering
Secretarial Exams.
Short Technical Courses
Telecommunications
Television
and many others

The BENNETT COLLEGE

To the Governor, Dept. A.A.62, The Bennett College, Sheffield, England. I would like to have (at no cost) your prospectus and particulars of

PLEASE WRITE IN BLOCK LETTERS

NAME

ADDRESS

AGE (if under 21)



"Rather! I turned my Wolf Cub Electric Drill into a lathe and it only cost me £3.12.3."

"That's very cheap—how do Wolf do it?"

"I had a Wolf Cub (that cost me only £5.10.0), then I bought this Lathe Set for £3.12.3. I clamped in the Wolf Cub—and there you are, a real electric Lathe Kit!"



"Is that all Wolf Cub Home Constructor Equipment?"

"Oh no! next I shall buy a Saw Set like this for £2.16.6; fit my Wolf Cub and I shall have a real Electric Saw Kit!"

"How marvellous!"

Yes, and that's not all the story!

Wolf Cub

HOME CONSTRUCTOR KITS

★ Write at once for large size, fascinating, fully picturised folder, "Profitable Pleasure."

KILL RADIO INTERFERENCE

FIT A
SURATEL
SUPPRESSOR



Specially designed for use with Wolf Cub Drills. Supplied ready to stretch to "Cub" lead. Conforms fully with official regulations. Only 23/6.

Television Suppressors also available for fitting by Wolf Service Engineers. 8/6 Inclusive.

★ Prices and descriptions subject to alteration without notice.

WOLF ELECTRIC TOOLS LIMITED · PIONEER WORKS
HANGER LANE · LONDON · W.5 Telephone: PERIVALE 5631-4