

# Hobbies

## WEEKLY

### CONTENTS

	Page
Puzzle Money Box	- 113
Wall Mirror	- - 115
Ship Electric Lamp	- 116
A Kaleidoscope	- - 117
All About Crystal Detectors	- 118
A Herb and Spice Rack	119
Child's Folding Playpen	- 120
Mending a Kettle	- - 121
Home Basketry	- - 122
Cotton Reel Lamps	- 123
Folding Presents	- - 124
Money Box Patterns	- 127

November 23rd, 1949

Price Fourpence

Vol. 109 No. 2821

## Patterns provided for this 'RAINBOW' PUZZLE MONEY BOX

**T**HE novelty money box shown on this page can be made quite easily from a few pieces of odd  $\frac{3}{8}$  in. and  $\frac{1}{2}$  in. wood with a piece of thin bendable wood for the curved top. Hobbies panels of woods are quite useful for such articles as this, especially if, say, a number of the boxes are to be made as Xmas gifts.

For the one box we should require one H3 panel, one G2 panel and one PPM panel, but, of course, there will remain a certain amount of wood we call waste, which would naturally be used economically if more than one of the boxes were under construction.

The novelty of the box lies in the hidden slot through which the coins pass to the box itself. On the front face of the box there is, what at first glance might be taken to be, a fixed decorative overlay, cut to the same curve as the top of the box. This overlay, however, is not definitely fixed, but is pivoted artfully to the front of the box so that it may be moved downwards with the forefinger, as shown in the smaller illustration in Fig. 1.

### Movable Picture Front

In this position the slot is revealed between the rainbow and the lower part of the overlay. To those who do not know the movement of the 'picture' it is somewhat mystifying how the money is put into the box. Beyond being a most interesting little piece of fretcutting and assembling, the very fact of painting in the picture with watercolour paints or even wood stains, makes for a fascinating piece of work.

Full size patterns are given for all those parts which really matter and which call for definite accuracy of outline. By thus giving these details much difficult work is saved for the worker, and he may transfer his patterns very simply to the wood either by sticking them down direct to the wood or tracing and duplicating them by

tracing paper and carbon paper.

### Coin Removal

It should be explained at this point that the coins are removed through a 'trap door' or hole cut in the base of the box. The door is afterwards replaced and covered over with a square of stout brown paper. Thus when it is desired to

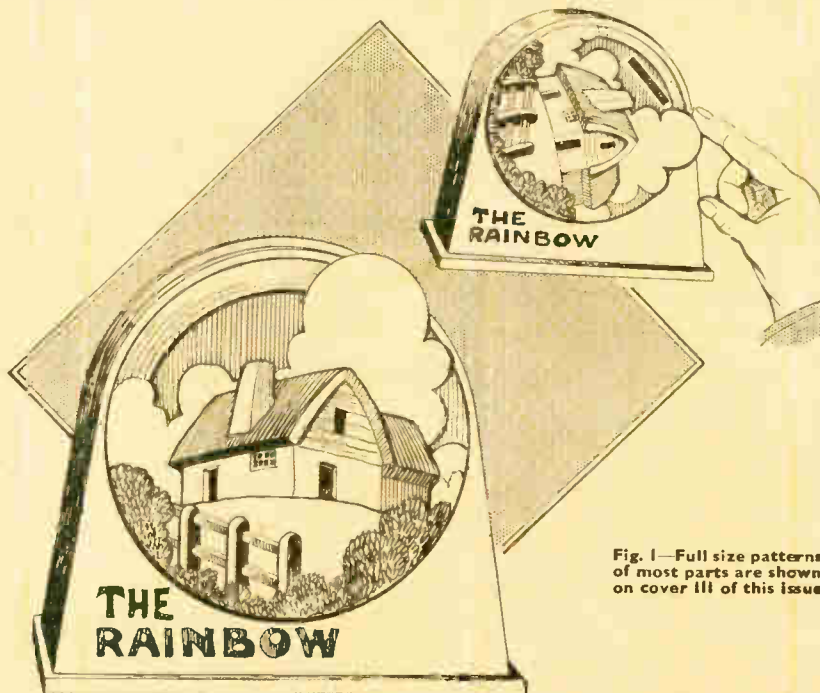

Fig. 1—Full size patterns of most parts are shown on cover 111 of this issue

All correspondence should be addressed to The Editor, Hobbies Weekly, Dereham, Norfolk.

remove the 'hoard of money' all one need do is to run the tip of a pocket knife round the edge of the disc of wood and lift it out, a new piece of paper being added after the reinsertion of the disc.

### The Base First

The base will be the first part to make. It consists of a plain piece of  $\frac{3}{4}$  in. thick wood cut to the sizes shown in Fig. 2. The double circled line shows the 'trap-door', and when cutting round this the fretsaw should be held in a sloping position to make a bevel cut, the smaller circle thus being on the top surface. The 'door' can then be removed and afterwards reinserted quite conveniently without fear of it falling into the box. The dotted lines on the diagram, Fig. 2, show the positions of the sides, front and back.

### The Box

The box itself consists of the shaped front and back, shown full-size on the pattern sheet. The two sides are given to scale. When the two main pieces have been cut and cleaned, use the pattern again for making the two formers or supports for the bent top of

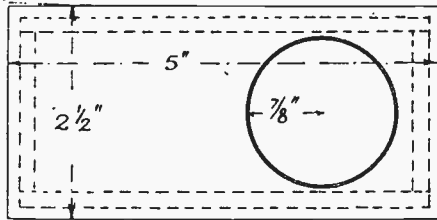

Fig. 2—Details of base and exit circle

the box. The dotted lines on the pattern of the front of the box show where the formers are to be glued in relation to the sides, and also show where the curved top comes.

Next cut the two sides, the grain of the wood of these pieces running lengthways so that the glue fixing the front and back will get a good hold. Note here that the centre disc (A) and the slot will only be cut from the one upright—the front; the back will be quite plain.

Now, before the box is actually assembled, the 'mechanism' of the front is arranged and fitted. First, therefore, make the front movable overlay by tracing and transferring the design to the  $\frac{1}{4}$  in. wood. Then cut round the outline and cut out that space between the rainbow and the lower cloud outline. Remove disc (A) from the front upright, and then lay the  $\frac{1}{4}$  in. overlay, just cut, on this in its proper position so that the disc when glued to it, comes exactly central. Accuracy here is essential so that the overlay will turn evenly and truly all round on its disc.

### Cover Disc

When the glue has hardened reinsert the disc in the front of the box and see it turns freely. Next cut out the cover disc, shown full-size as (B) on the pattern sheet. Glue this also to the disc (A), taking care that the lug (D) comes in the

position shown in the sectional diagram Fig. 3. Glue, most likely, will be found insufficient to hold disc (B) securely to disc (A), as the latter will lie flush with the surrounding wood of the front. It might even be necessary to glasspaper the surrounding wood, thus allowing the surface of the disc to very slightly protrude above that level.

In any case it may seem necessary to put in a couple of screws as shown to hold the two discs well together and at the same time give the necessary stiffness to the movement.

The stop pin shown on the pattern and in the diagram Fig. 3, must be correctly placed in relation to the lug (D), so when the overlay is pulled down it stops at the required spot, allowing full view of the slot in the front of the box, seen in the smaller sketch in Fig. 1. The free, but stiff movement of the overlay in conjunction with its rear

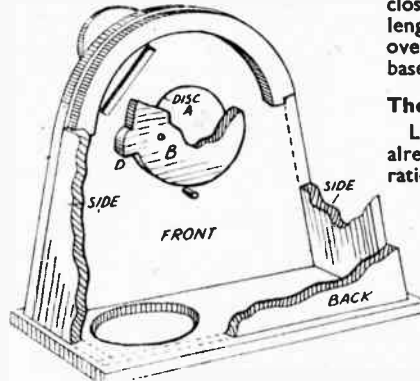

Fig. 3—Cut-away view showing construction

discs should be thoroughly tested before the back and top of the box are glued in place.

After the sides and the back are glued up, rub the lower edges down on glasspaper. A piece of board of good thickness and about the size of a sheet of glasspaper should be procured and the paper glued down to it. This additional 'tool' will always be found most useful for light cabinet work or carpentry. By thus rubbing down the surfaces of our box a perfect level surface is obtained which will fit down evenly and snugly to the base when this is glued on. A few additional flat-headed screws might also be run in through the base into the sides, front and back to make a secure jointing.

### Top Covering

The top to the box consists of thin

### Preserving a Sketch

A LITTLE milk brushed lightly over a pencil sketch will prevent it from smudging.

### A Fishing Tip

HERE is a good way of mending fish hooks which have been detached from the gut. Bind the hook tightly on to the gut with fine silk, and then melt a

bendable wood, plywood if this is obtainable, or ordinary wood of about  $\frac{1}{4}$  in. in thickness with the grain running crossways which allows easy bending to fit on to the formers of the box. In cutting the strip of wood take careful measurement of the width between the front and back of the box and allow a fraction to this for cleaning the cut edge after it has left the fretsaw. Regarding length, here again be generous so the wood can be trimmed neatly to fit closely against the sides of the box.

A piece of wood measuring  $\frac{6}{16}$  in. by  $1\frac{1}{4}$  in. should be cut and this allows for trimming to sides all round. Apply glue to the exposed edges of the formers and also to the edges of the bendable wood. When the glue is fresh, lay the wood in place and hold it down by inserting a few pin points until the glue has hardened.

Another way of holding the top closely to the formers is to tie two lengths of cord right round the box over the top and lengthways across the base.

### The Decoration

Little need be said beyond what has already been advised regarding decoration. The face of the overlay wood should be quite clean. White-wood should be used here and the grain run vertically to avoid splitting. A toughish wood like maple is best for this overlay. Line in the cottage, etc., in pencil and then add paint in bright colours.

The groundwork of the front of the box should be black—indian ink would answer well.

Pick out appropriate colouring for the cottage, the thatch roof, and the foreground bushes and railings. For the clouds the natural wood may be left, or white paint laid on to emphasize the outline of the roof. It would be a good idea, perhaps, to first make a little picture of the design on paper, using chosen colours before completing the picture on the wood.

### Colouring

The base of the box should be stained and varnished a light brown, as also should the sides and top. The rainbow colouring should be kept light to show up well against the black background. The wording would look well painted on in pale blue, or if desired it could be cut from the waste thin wood and then glued on letter for letter, this relief idea would well show up the wording.

little candle wax or sealing wax on the silk to make it quite firm. Always carry a reel of silk in your fishing kit.

### Tarnish Remover

FOR removing tarnish from nickel and other metals, soak a soft cloth in warm water and rub softly. This will remove most of it.

# How to turn that odd piece of glass into a COLOURFUL WALL MIRROR

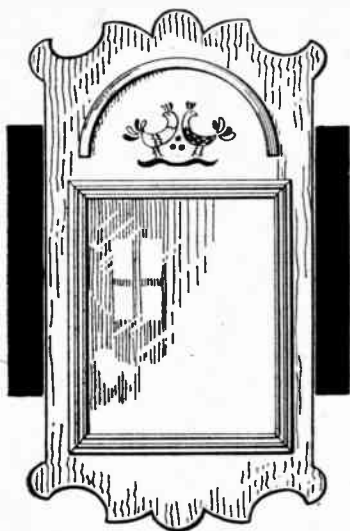

**T**HERE are few homes that could not do with another mirror, especially such attractive ones as that illustrated. Apart from their obvious use for looking into, to observe the set of one's tie, for example (and the ladies will know scores of other reasons), mirrors are useful in brightening up dark corners.

The mirror described has some interesting features. Observe the semicircular moulding at the top, and the attractive 'peasant art' design painted under it.

## The Mirror you Have

Normally we like to give full dimensions for every part but in this case this is not considered possible as much depends on the size of the mirror, the sheet of backing plywood available, the size of the curved moulding, and so on. With the aid, however, of the diagrams and the description which follows, no difficulty will be experienced in laying out the job to suit materials to hand.

The semicircular moulding, we hasten to explain, is cut from one of the ready-turned rims sold in connexion with loudspeaker baffle boards. They are normally made to fit a 6in., 8in., 10in., or 12in. hole. The size to use depends on

## Shaping Masts

**W**HEN making model galleons you may have difficulty in making the mast taper. Here is a good idea. Fix your plane in the vice upside down and draw your dowelling across. This gives you a neat and finished job, but must be undertaken with care or you will cut your fingers.

what mirror you have. It is usually far cheaper to use a ready-cut piece than to have a piece cut to size. The job should not be too small. A mirror about 6in. wide by 8in. deep would be a good size, though a larger size may well be employed.

## Plywood Backing

The back is made from plywood. The size will be regulated by the size of the mirror (or possibly the other way round). At a pinch,  $\frac{7}{8}$ in. plywood will serve, but  $\frac{1}{2}$ in. is better. If one can manage the sawing, a  $\frac{3}{8}$ in. piece would be the best.

Many readers will be able to sketch out the top and bottom frets, freehand. A useful method is to take a strip of paper the complete width of the wood and fold this in half, lengthways. Sketch half the curve on the top part, keeping the fold on the left. Cut through with scissors and on opening out, a perfectly symmetrical paper pattern will be found.

For those who prefer to square off the design, a pattern is given. The size of the squares will obviously depend on the size of the pattern required.

## Alternative Corners

Instead of having claw-shaped projections at the corners, a plain rounded edge may be used. Although this does not look quite so good, it has the advantage that the long edges may be 'shot' with a plane. Moreover, it will then be possible in some cases, to use

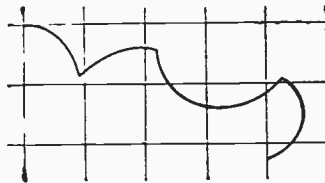

The shaped ends in squares for enlarging

solid wood for the back. But plywood must be used if the projecting corners (as in the sketch) are used, as otherwise they would easily snap off.

The moulding round the mirror is of the rebated variety. It will probably be necessary to pack the underside of the mirror with a sheet or two of cardboard. Before fixing the mirror, complete the cutting and smoothing of the back part. The mirror moulding is mitred at the corners, and glued and nailed (with fine panel pins) to the back. The wooden circle is cut in half and glued in place. Take care that all oozed-out glue is immediately wiped off from the mouldings.

## Painting

The job is now painted in some delicate pastel shade enamel. An off-white or ivory would be quite suitable, as then the gaily painted

'peasant art' decoration will show up better than if painted on a stronger ground.

A detail of a suggested decoration is given though, of course, any other suitable design can be used. Incidentally, if the reader cannot trust himself to paint such a design, a transfer or a stencilled decoration may be used, but the method to be described is recommended.

## How to Decorate

The whole basis of peasant art decoration is that it is made by simple blobs and bold strokes of the brush. For the purpose of convenient illustration, we have had to show the bird on the left, for example, surrounded by an outline. But this may be misleading.

The whole banana-shaped curve representing the bird is painted in with bold strokes, one bold curve for the outside and another for the inside. Usually these two strokes will be sufficient to form the complete shape. Similarly the tail feathers are composed of distinct blobs. Remember, always, that you are not painting a natural picture of birds.

The whole of the bird on the left can first be painted yellow. When quite dry, paint the lower half, below the neck, pale blue, leaving a yellow band in the centre. On this yellow band, paint red zig-zag stripes, and a similar stripe at the neck. On the pale blue, paint two dark blue zig-zag stripes. The tail feathers (in each bird) are yellow, red, blue and

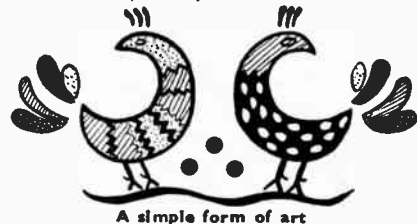

green. The feet and head feathers of the bird on the left are red. The dots between the birds are green.

## Alternative Colouring

The bird on the right has a blue neck and red body on which yellow dots are painted. The head feathers and the legs are green, as well as the wavy band below the birds. Practise on a spare piece of wood first. This design, by the way, can be used on a great number of occasions.

If a more elaborate job is required, the wood at the bottom can be lengthened, and a small shelf added just below the mirror so that a small vase can be stood thereon. Since one still has half of the wooden rim, many readers may also feel the desire to make a pair of mirrors.

It now only remains to fit a mirror wall plate on the back, so the mirror can be hung up, and the job is complete.



# A fine Xmas present can be made in this novel SHIP ELECTRIC LAMP

THE table-lamp described in this article is easily and inexpensively made, and both practical and decorative in use. The materials needed are easily obtainable and at little expense. Two pieces of  $\frac{1}{2}$  in. wood are required; one being  $13\frac{1}{2}$  in. by  $3\frac{1}{2}$  in., and the other  $4\frac{1}{2}$  in. by  $3\frac{1}{2}$  in. You also need a 9 in. length of dowelling rod, a length of flex, torpedo switch, batten-type lamp-holder, and candle-type bulb, a sheet of orange parchment, two small nuts and bolts, and some plastic thonging.

To make the artistic boat, cut the pieces of wood the sizes mentioned above, and glue the larger piece to the smaller so that they are both level at one end (see Fig. 1). Then shape the bows to your fancy, by sawing through them

The back of the model should be rounded to represent the stern, and also glasspapered.

Next cut and smooth a small block of  $\frac{1}{4}$  in. square wood  $1\frac{1}{2}$  in. long, and bore a hole the diameter of the dowelling rod in the centre of it (see Fig. 2). Glue this block 7 in. from the stern. Then bore two small holes in the 9 in. length of dowelling rod, one 2 in. and the other  $6\frac{1}{2}$  in. from what will be the foot of the mast.

Fit the mast itself into the block so it holds firmly, but loose enough to facilitate easy removal should at any time the bulb need replacing. Fix a short rounded piece of wood into the point of the bow to represent the bowsprit, and after a good glasspapering, give the model two coats of quick-drying varnish stain.

When dry bore a hole for the flex to go through  $2\frac{1}{2}$  in. from the mast block and screw the batten type bulb-holder into position (see Fig. 3).

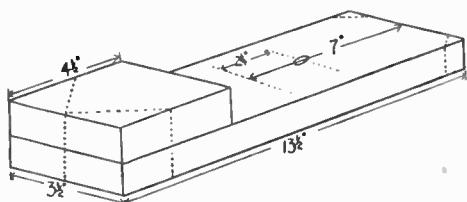
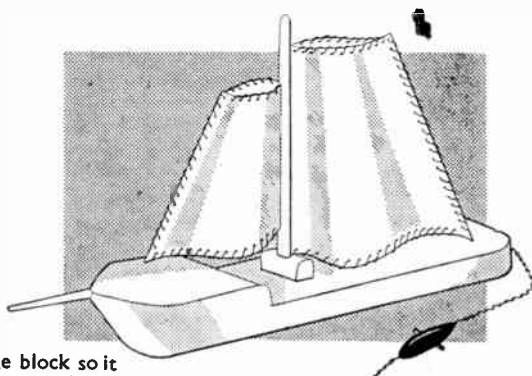

Fig. 1—Main hull and bow block

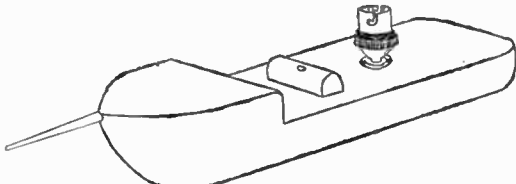

Fig. 3—The hull parts shaped and fitted

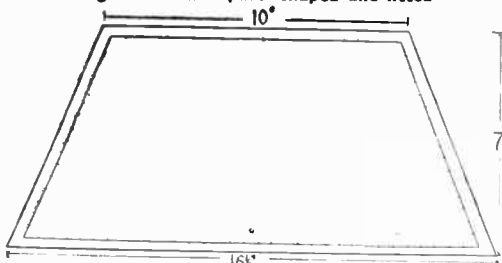

Fig. 4—Outline of sail shapes

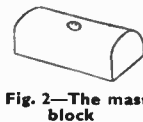

Fig. 2—The mast block

The sails are easily made from a sheet of orange-coloured parchment.

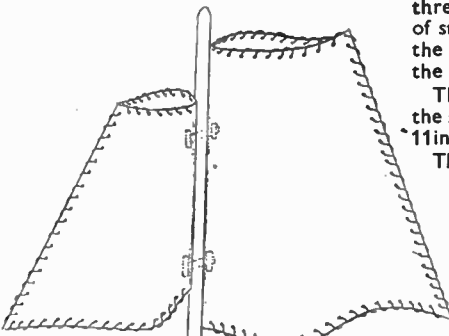

Fig. 5—The shade sails shaped and laced together

both, cutting off the corners, shaping them with a plane or chisel and thoroughly smoothing with glasspaper."

For the larger one cut a piece measuring  $16\frac{1}{2}$  in. by  $7\frac{1}{2}$  in. by 10 in. In the centre  $1\frac{1}{2}$  in. from the bottom make a hole with the

point of sharp scissors, and another  $4\frac{1}{2}$  in. from the previous hole (Fig. 4).

Draw a  $\frac{1}{2}$  in. border round the sail faintly in pencil and mark a dot every  $\frac{1}{2}$  in. Then, boring gently with the scissors point, make neat holes at every dot. These holes are for the thonging. When this is done bring the edges of the sail together, gently taking care not to crease, and secure temporarily with paper-clips.

Tie a small knot in the end of a length of thonging and thread through the bottom holes where the sails meet. Continue threading the sails together until you reach the top, removing paper-clips as they are encountered. Carry on threading round the top but do not join top edges together. When reaching where sails are joined again, finish off by threading about 1 in. at back of stitches. Thread round the bottom and finish off in the same manner.

The smaller sail is made in the same way, but measuring  $\frac{1}{2}$  in. by 5 in. by 6 in.

The sails are then fitted to the mast by two small nuts and bolts (see Fig. 5). It is advisable to have a washer of some sort between the sails and bolts, such as a thin strip of Perspex. Before fitting the mast into its hole screw three small feet on

the bottom of the model, just sufficient to raise it above the flex. One is at the front and two at the rear.

## Kaleidoscope—(Continued from page 117)

A handle to enable the viewer to hold the kaleidoscope conveniently, is drawn in Fig. 5. It can be cut from any piece of wood,  $\frac{1}{2}$  in. or more in thickness, and should have a 60 degree piece cut out at the top to fit the instrument underneath. Round off the sharp angles of the handle where gripped by the fingers, and glue the handle to the centre of the instrument. Stain the handle and varnish it.

For general amusement drop some

scraps of thin coloured glass in the opening, or pieces of coloured plastics, almost anything in fact. As viewed through the kaleidoscope, a beautiful and symmetrical pattern will result, which will alter each time the kaleidoscope is shaken a bit. The standard pattern of instrument has no opening, so the viewer is limited to whatever pattern he can produce by shaking or turning the instrument.

The open pattern allows the viewer to insert anything he likes, bits of curved wire, small leaves, in fact there is scarcely an article, or scrap, which cannot be introduced and will make a design of some kind. Readers will find the results fascinating to watch and pass many an interesting hour with the instrument—not forgetting the amusement it will furnish to a youngster, particularly during the party season at Christmas.

# With some mirrors, glass and with card you can make A KALEIDOSCOPE

**D** OUBTLESS there are many readers of Hobbies Weekly who remember the kaleidoscope, a most interesting instrument for producing designs. It is still to be bought, and seems likely soon to become as popular as ever it was. Here is a design for a simple one, that can be made from cardboard, glass, and a few bits of fretwood, and might well occupy the time of a winter's evening in a most interesting manner.

A few parts are to be made in fretwood and these are grouped together in Fig. 1. Part (A) is set out as a triangle on  $\frac{1}{8}$  in. wood. On this draw down a central line and at  $\frac{3}{8}$  in. up from the bottom put in the inner triangle, this extending to  $\frac{1}{4}$  in. from the top. The sides of the inner triangle are, of course, parallel to those of the outer.

It may be mentioned here that these triangles can be easily set out with a 30 degrees set square, placed either side of the central line. Before proceeding further, the glass mirrors, to be fitted inside the kaleidoscope, should be cut.

## Pattern of Mirrors

Fig. 2 shows a pattern for these. It will be seen that they are both identical in size and shape, and taper equally both sides of the centre line. About the best way to cut these is to set out the shape on white paper, then to lay the glass over the pattern and cut on the lines seen through the glass.

A thin, true surfaced glass is required, plate glass if at all obtainable. If you have a local glass-merchant handy it would be best to let him select a suitable glass and cut it to your pattern.

The cut edges of the glass should be

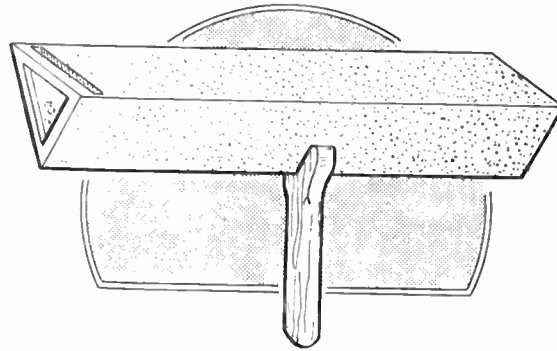

Glue the outer edges of the parts (A) and (B) holding the mirrors, and press inside the case, letting (B) be  $\frac{1}{4}$  in. fall from the end. Then tie tape round the case to keep the inside parts in position until the glue sets hard. Do not glue the top of the case down yet.

## The Eye Hole

From a piece of  $\frac{1}{8}$  in. fretwood, cut part (D) and bore the eye hole.

smoothed by rubbing them on emery cloth. Clean them and coat one side of each with a dead black varnish. Take the wood triangle and lay the end edges against the pencilled inner triangle, their bottom edges meeting together. Now mark them round on the outside with a pencil. Lift them off the wood and cut out the inner triangle. The shape will then include the original triangle, shown by the dotted line, and also the space for the glasses to fit in each side.

## Fitting the Glass

From similar wood cut a second triangle (B). Mark the smaller inner triangle, lay the narrow ends of the glasses on their side and pencil round as before. Then saw out. In both, the glasses should fit tightly and not be likely to shift when placed in the instrument. Dead black the wood triangles. Before proceeding further take a look at Fig. 4, which shows a longitudinal section of the completed instrument, and shows the glasses, really mirrors, fitted to their wood end pieces (A) and (B).

For the outer case, measure a piece of stout cardboard to the dimensions given in Fig. 3. Pencil lines across where the dotted lines are shown, and on these, with a knife and straightedge, cut across to half the depth of the cardboard. Now bend on the lines to triangular shape. The slightly wider piece (at the top) should be the top of the case.

It may be mentioned that all the parts, (A) (B) (C) and (D) are of equal size, to fit inside the case. Cut a triangle of thin clear glass to the same size as (D), place inside the case, over (B), add part (D), then trim off any surplus of the case at this end, leaving it level to the eyepiece (D). The latter can be glued in, of course, to keep it in place, and should be dead blacked.

For the object end of the kaleidoscope, cut two of part (C) in  $\frac{1}{8}$  in. wood, one, which we can call (C1) to distinguish it, having the top shaded portion cut away. Against part (A) fit a triangle of clear glass and glue part (C1) in the case to press against it.

Next to this place in a second triangle of glass, this of the ground variety, then glue (C) in place and trim any surplus of the cardboard case level. To save possible inquiries, it may be added that all the wooden interior parts of the kaleidoscope should be stained dead black, and the mirror glasses be fitted in with their dead black varnished surfaces outwards, not facing each other.

## Covering the Case

Bend the top cover over and mark where the opening comes between parts (C) and (C1). With a penknife cut from the cardboard a  $\frac{1}{8}$  in. strip to allow access to this opening, then glue the cover permanently down. Give the inside faces of the mirrors a rub over with a clean soft cloth beforehand. The cardboard case can now be covered over with any suitable material, such as leatherette, american cloth, and similar stuffs.

When cutting the covering material, allow a  $\frac{1}{8}$  in. for the side overlap, and a little for overlapping over the ends. Glue the material over the case, not forgetting to cut out a strip above the opening, and trim the ends to leave just  $\frac{1}{8}$  in. to glue over them.

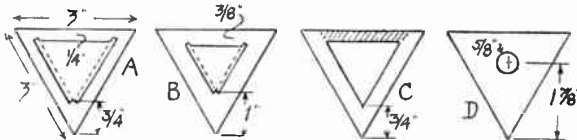

Fig. 1—The triangles to be cut as detailed

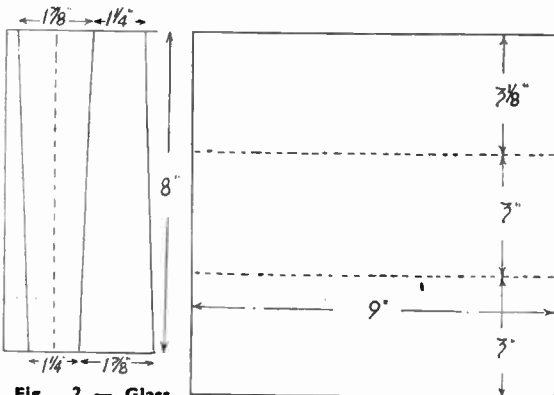

Fig. 2—Glass shape

Fig. 3—Dimensions of the tube in the flat

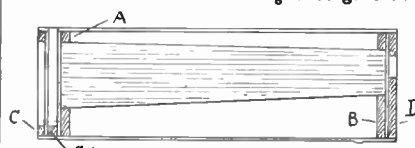
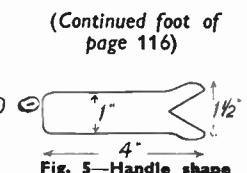

Fig. 4—Section of the model



(Continued foot of page 116)

Fig. 5—Handle shape

# Our radio expert tells you quite simply all about CRYSTAL DETECTORS

**C**RYSTAL receivers are quite popular, because they require no batteries and can be used anywhere, at any time, without expense. There is virtually nothing to wear out; the cost of the necessary parts is low, and they can give perfectly satisfactory results if a reasonably good aerial and earth are used.

Despite their simplicity a number of different circuits can be used and a variety of detectors can be employed. Details of these follow, with the way to obtain best results.

## Detector Types

Fig. 1 illustrates the four types of detector now in general use. A is the old-fashioned catswhisker and crystal detector. The crystal is held in a cup, and the whisker is fitted to an adjustable rod which can be moved in any direction. By manipulating the small knob on this, the catswhisker can be placed on a sensitive point on the crystal.

This detector is one of the most sensitive and generally satisfactory ever produced. With a good aerial and earth, range of reception equals that obtained from any non-valve detector. On nearer stations it gives good volume.

Such a detector really needs to be carefully set every time the user listens to a programme, and the type shown in Fig. 1, at B, partly overcomes this weakness. This type is not enclosed in a

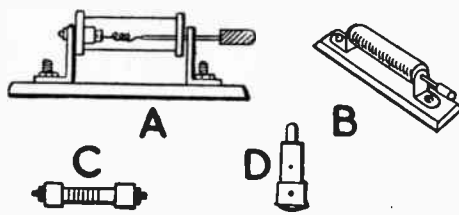

Fig. 1—Four types now in general use

occasionally being necessary, and considerable experiment by a large firm produced type C. This is known as the WX6 and uses metal discs. It is permanently set—and cannot, in fact, be adjusted by the user. Many thousands were used during the war in the utility receivers produced, to replace a valve, as it works for many years without trouble.

If this type is used in a crystal set, a switch should be connected across it, so that the set may be switched off. Alternatively, the aerial and earth may be disconnected to stop the receiver working.

It is less sensitive than either A or B and long-range results must not be expected (unless amplifying valves are also used). It does, however, give good volume on local stations, and by applying a small bias results may be further improved. Fig. 2 illustrates how such a bias may be applied. As it imposes less damping, tuning is rather sharper than with types A and B.

Type D is the new crystal-diode (sometimes incorrectly termed a crystal-

will soon be obtained.

Fig. 2 shows the circuit which gives best results for general reception. Often the aerial is taken directly to a tapping on the tuned coil winding. This is shown by T and simplifies coil construction. It is also possible to take the aerial straight to the coil where the latter is wired to the detector. This gives maximum volume but makes tuning very unselective so that stations spread out and may interfere one with the other, when listening.

## For Receiver Circuits

The tuning condenser (C1) is usually .0005 mfd. An air-spaced condenser is best, though a good solid-dielectric one can be used. Condenser C2, wired across the phones, aids detection and gives a slight increase in volume with some pairs of phones. Its capacity can be anything between about .0005 and .005 or so. Some phones have sufficient self-capacity between the windings, and with them no condenser is required. Theoretically, the detector is unable to function without such capacity.

When bias is to be used, it is added as shown. A small dry battery is employed, and the polarity should be reversed if results deteriorate when the battery is connected. Different voltages between about 1.5 and 4.5 should be tried. The circuit must be broken when the set is not in use. If no bias is used, join the two leads shown together.

## Tuning Coils

In Fig. 2, S is a switch which short-circuits part of the coil winding for medium wave reception. (Long wave reception is obtained when the switch is

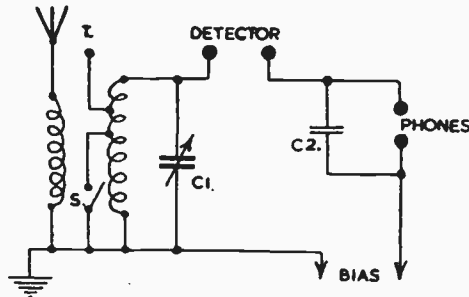

Fig. 2—Receiver circuit details

glass tube (as in A), but in an opaque tube, and one flat and one pointed crystal replace the crystal and whisker.

A light spring bears these crystals together, and the small knob is drawn slightly out, to part the crystals, when setting. The setting is then more or less permanent. That is, the detector only needs resetting occasionally.

Results are similar to the first type. Unfortunately, if the plunger is moved without first withdrawing it, or allowed to slip back with a jerk, the pointed crystal is ruined and the detector cannot work well. Otherwise it can give long service.

Neither A nor B can be relied upon to give results without initial adjustment

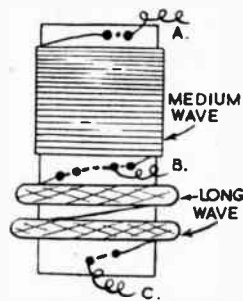

Fig. 3—Winding a coil

valve) developed for radar use, and now quite popular in ordinary crystal sets. Provided a new one is bought the sensitivity is equal to the type A detector, and it is as permanent in operation as type C. Wires should not be soldered to it as the heat will ruin the internal crystals.

## Correct Mounting

The proper method of mounting is to use two small metal clips, one  $\frac{1}{4}$  in. in diameter, for the bottom, and the other  $\frac{1}{10}$ th in. in diameter, for the top. It may be mounted sideways or in any position. Bias must not be applied to it.

Any of these detector types may be used in any crystal set circuit. If different ones are tried, a comparison of results

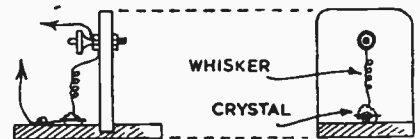

Fig. 4—Side and end view of an easily-made detector

open). This will be clear upon reference to Fig. 3, which shows a coil. Here, A goes to the detector, B to the switch, and C to earth.

Tests show a coil of about  $1\frac{1}{2}$  ins. to  $1\frac{3}{4}$  ins. in diameter, wound with wire of about 30 S.W.G. for medium waves and 36 S.W.G. for long waves, is difficult to beat. The M.W. turns are wound side by side, and the L.W. turns in two or three piles, and this proves most satisfactory in practice. Enamelled wire is generally preferred, as cotton and silk coverings absorb moisture.

For a  $1\frac{1}{2}$  in. diameter tube about 80 turns will be required for medium waves,

(Continued foot of page 120)



# Any housewife would like the gift of this useful HERB AND SPICE RACK



Fig. 1—Showing bottles and jars in place

**A**LTHOUGH English people do not use herbs, in cooking, to the same extent as their Continental neighbours, you will generally find, in the average larder, such things as packets of sage, allspice, tumeric powder, pepper, horseradish sauce and so on. Often these are in small tins and packets that get pushed into corners and not easily found. A useful adjunct in a well-run kitchen would, therefore, be this condiment rack.

## For Small Containers

As will be seen from the illustrations, this consists of a couple of shelves to take the bottles and packets, etc. The illustrations show the construction in bare wood, but, of course, the whole lot is attractively painted.

The back (A) consists of a piece of plywood, 13½ in. high by 10½ in. wide. It should, for preference, be ¾ in. thick. This is because when fitting the sides (D) it is just possible to drive small panel pins through into the ¾ in. thickness, but thinner wood would hardly provide sufficient hold.

## The Shapes

We do not give full-size or squared-up patterns for the shaped top of the back, and the rails, as these can easily be sketched in by the maker. The easiest way to do this is to take a strip of paper, the same width as the wood, and fold it in half. On one half, sketch half the pattern. Cut out with scissors and when opened you have a perfectly symmetrical design which you can transfer to the wood. Do not have the fretted parts of

too elaborate a design or with any pierced openings.

The rails (B), which can be solid wood, are 10½ in. by 1½ in. by ½ in. The shelves (C) are 10½ in. by 2½ in. by ½ in. Fig. 2 shows how the parts are assembled. The top shelf is 6 in. from the top of the back part. Thin panel pins and a touch of glue are used. Note, by the way, the two holes in the back, at the top, for hanging.

## The End Pieces

The ends (D) are of plywood. This can be ¾ in. stuff, with the outside grain going the long way. The strips are 3 in. wide and approximately 13 in. long. The shape of the curves can be tested against the actual job. For example, where the shelf rails meet it, there will be a flat, full-width part. After a good clean up, the job can be enamelled; pastel shades are very popular nowadays.

As regards the jars, these can be collected from various sources. It is by no means necessary to have them all alike. Screw-top jars are very useful for holding various spices, etc., that are often bought in small paper 'screws'. It will be noted that the lower rack is made fairly deep to hold deeper bottles, whilst the rails are not made too deep. This makes the withdrawal of a bottle much easier.

## Contents

If this is made as a present for someone, it should be given already stocked. We have already mentioned some of the things that can be used. A lady who is a good cook should be consulted as to a suitable collection. We have purposely designed this rack to be of a moderate size, not only because kitchen space is nearly always at a premium, but because if there is too much space we shall find either a lot of empty bottles in the rack, or else the intended spice and condiment rack containing such 'outsiders' as tins of

metal polish or furniture cream.

Indeed, as a hint against this, we could write SPICES on the rack or paint in a small leaf design on the rails. Of course, working on the same principle, we could design another rack to take such things as cleaning powders and liquids.

## Labelling

The jars should be securely labelled. For a really good job, the labels might be glued on and afterwards given a coat of clear varnish. Fig. 3 shows an idea for a label, and also 'peasant art' motifs that might be used for decorating the rail fronts. It is possible, of course, to use stencils for this purpose. In Fig. 3, the motifs are shown rather cramped together. Only one of the motifs would be used in one place.

When doing 'peasant art' decorations, remember to let the brush do all the work in designing. Most of the leaves, petals, and so on, can be done in a single 'free' stroke of the brush. Do not draw carefully in pencil first and then 'line in'. This would give a too mechanical look.

A light easy freehand effort will produce the desired effect.

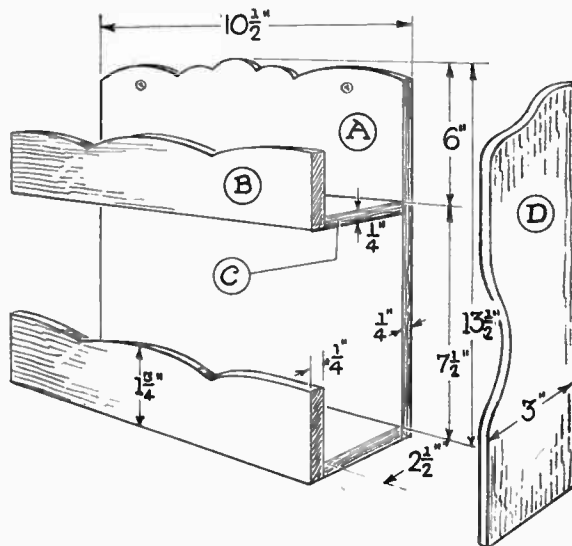

Fig. 2—Details of parts and construction



Fig. 3—Decorative suggestions for suitable labels

**There are more copies of Hobbies Weekly available now  
Your friends can get them from their usual newsagent**

# Safety and enjoyment for children if they have this FOLDING PLAY PEN

**T**HE little enclosed playground, shown in our illustration, would be equally suitable for use indoors during the winter, or for the summer months. Such a play pen is ideal where a little patch of lawn exists, so that the children can get the maximum of fresh air and sunlight.

It is made to fold flat, so that it can be easily stored when not in use; a great asset where the modern small house is concerned. When folded the pen occupies a space of only 4ft. long by 6in. wide, and when open it makes a compact nursery 4ft. by 3ft.

## Framework

In Fig. 1 is given a plan of the article, the dotted lines indicating how the ends—which are each made in two parts and hinged together—fold in against the sides. Three pairs of stout hinges are used in its construction, with two strong hooks with round-headed screws to hold it rigid.

The wood to be used should be beech or some other hard grained wood to take plenty of hard wear and tear. A



All rails are  $1\frac{1}{2}$ in. by  $\frac{1}{2}$ in. in section, and for the sides four will be wanted measuring 4ft. long. Those at the ends are 18in., eight being required.

When all the rails have been cut square, cramp each pair together and set out the positions of the centres for the rods to the measurements given in the plan (Fig. 1). Bore the holes with a  $\frac{1}{2}$ in. centre bit or twist drill.

## The Hinges

Now as the hinges to be used are  $1\frac{1}{2}$ in. wide, the ends of the rails where they are to be put on must be thickened up

The size of the blocks is given, and it will be noted that the prominent corners are cut off and rounded up with glasspaper. Lay each frame flat and test the joints before putting in the round rods. All the rods having been cut, each set or pair of rails comprising one ground rail and one top rail are taken and the uprights driven in and glued.

Drive all the rods first into the ground rails and then put on the top rails, tipping each rod with glue before coaxing them into place to get a fit. The top rails should be gently knocked into place with a mallet or hammer. If the latter is used an odd piece of wood should be laid on the rail to take the blows of the hammer head. Clean up all the woodwork at completion with coarse and fine glasspaper and take off any sharp corners and edges of the rails.

## Hinges and Catches

When screwing on the hinges see the heads of the screws are let well in and that the sharp corners of the hinges are filed away. A small catch or bolt, or even a hook and eye, as shown in Fig. 4, will have to be fixed to the upper rail to hold the framework close and rigid. Make quite sure all blocks and hinges, too, are very securely held, as the whole play pen is likely to come in for some considerable shaking and hard treatment.

Finally give the whole article a good coating of clear varnish. Make sure, too, to thoroughly glasspaper the round rods so that there will not be any shivers to get in the hand or limbs of the tiny tots who will inhabit the little enclosed playground.

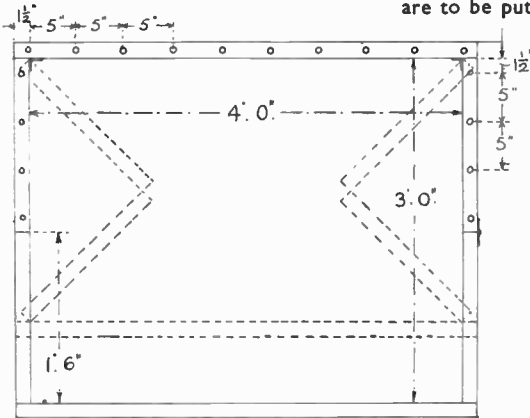

Fig. 1—Plan of frame with folds shown by dotted lines

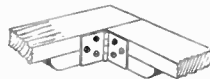

Fig. 2—Corner detail

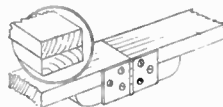

Fig. 3—Folding joint



Fig. 4—The holding catch

very convenient height would be 18in., and there are eight distinct rails held together by round rods securely let into them and either glued or wedged.

These rods are sold in 3ft. lengths so the height of 18in. is convenient for cutting up ready for fixing to the rails.

by adding small blocks of the same wood as the rails themselves. At Fig. 2 is shown how the four corners are constructed, while Fig. 3 shows the joint between the folding end rails. The detail in the circle is a view before the hinges are screwed on.

## Detectors—(Continued from page 118)

with 200 turns (in two piles, each of 100 turns) for long waves. About  $\frac{1}{4}$ in. should be left between M.W. and L.W. sections, with about  $\frac{1}{4}$ in. between the two L.W. sections. With a  $1\frac{1}{2}$ in. tube 60 turns and 180 turns will be sufficient.

Actually, other wires and tubes may be used, but the use of very unsuitable sizes will cause a reduction in the volume of signals. All turns must be in the same direction. Except when following special

designs, it is better to use thicker wires and larger formers, than the reverse, if instructions are not followed exactly.

## An Efficient Detector

Fig. 4 shows how a detector may be made which gives the same results as that shown at A, Fig. 1. Two pieces of dry wood about  $1\frac{1}{2}$ ins. by 2ins. by  $\frac{1}{4}$ in. thick are used. The crystal lies in a small hole scooped in the base, and is held

down by a piece of tinplate with a large hole which will pass almost over the crystal. A small screw holds the tin down and anchors the connecting wire.

For the whisker, take about 4ins. of thin wire and wind it in a spiral round a nail or similar object. This is fixed under the terminal and pulled out so that its point will rest on the crystal. Though simplified, this will work just as well as the other types.



# The whole process the handyman should undertake in MENDING A KETTLE

UNLESS a tinplate kettle has rusted through in several places it is worth while to solder on one or even two patches to the bottom. Scrape the kettle around the holes, and clear out any rust from the holes themselves, not making these larger than can be helped. If emery cloth or glasspaper is used to clean the areas, make sure any dust and grit are wiped off. A clean area about  $\frac{3}{4}$ in. in radius from the hole should be prepared.

## Equipment

The tools and equipment needed comprise: a copper soldering bit (medium size); stick of tinman's solder (50/50 composition); can of 'Baker's' soldering fluid; block or large crystal of sal ammoniac (on which heated soldering bit is rubbed before tinning to clean the tool); clean rag for wiping bit; wooden spill for applying flux; old file with which to hold patch in place while soldering it down; pair of pliers to hold patch at need; tinman's snips or stout scissors; piece of new tinplate, or a portion cut from a clean tin can; wood board on which to rest soldering appliances; lid from a rectangular tin can, to use as a solder tray.

## Support

The kettle can be gripped by the handle in a vice. Or it can be supported on a bench or table by two blocks of  $\frac{3}{4}$ in. by 2in. wood. The kettle must be firmly supported. Lay several thicknesses of old newspaper on the table to protect it from the flux, which is corrosive; also hot solder will spurt about during the work.

Cut pieces of tinplate to a rectangular shape, projecting about  $\frac{1}{4}$ in. to  $\frac{1}{2}$ in. all round the leak-hole. Snip off the corners of the patches so a roughly octagonal shape is produced. The patches will adhere better than if sharp corners are left on.

A new copper bit, as purchased, must be first tinned to give it a coating of solder, so that in use it will conduct molten solder to the work. Heat the bit over a gas ring, with a flame not too fierce. Watch for a plentiful show of bluish-green colour from the flame, and try the bit by holding it about 2in. from the face.

## Correct Heating

Avoid over-heating, which will spoil the copper surface and, in the case of a bit already tinned, will burn off the coating of solder. Test if the tool will melt solder readily from the stick. If not, warm it a little longer. Only experience will guide the worker in judging the proper heat.

Put a little flux into the tin tray with the wood spill. Apply flux similarly (with the spill or with a clean stiff

brush) to the facets of the copper bit. Rest the end of the solder stick in the tray, and touch the end of the bit to it. As the solder melts, turn the bit so all faces are brought in turn into the pool of molten metal.

Usually the beginner will find by this time the bit has cooled down and will need warming up again over the gas ring. Beware of heating it too long, or the tinned surface will be spoiled by oxidation or be burned off.

## The Soldering Operation

Take off the bit and wipe it on the rag. Dip it into the solder in the tray, and it will pick up a blob of molten solder. Leave it resting in the tray a moment while you put flux all around the place where a patch is to go, on the kettle bottom. Now run the soldering bit around the fluxed area, and a coating of solder will be left there. The tool must stay on the kettle long enough to warm up the metal, or else the solder will not adhere.

If you have been quick in doing this you can go on to tin the under side of a patch—flux it first—while the patch-piece rests on the wooden board. Should the soldering bit have become cooled, place it over the flame again, and try the second method of tinning.

Grip the patch-piece by the edge with the pliers, and hold over—not in—the

gas flame. When the patch has become hot enough, touch the solder stick to it and allow some solder to melt and run over the surface. Some 'blow-pipe' solder, in a thin rod, is useful for such jobs.

By now the copper bit will be warm enough for use. Warm up the patch location on the kettle, and put the patch-piece in proper position. Hold the file by the pointed end, with the tang pressing down on the patch at about the centre of the latter. Stick down the patch by running the soldering bit slowly around the edges.

## Fitting the Patch

As the underlying solder film melts, apply more pressure with the file to force the patch close to the kettle bottom. Hold the patch firmly until the solder film has set and become quite cold. Should the patch slip, or the file move out of place, re-heat the copper bit and try again. A patch stuck down awry can be loosened by holding the bit on it. Then it can be pushed into place with the file end, held down with the file, and finished off as before.

There is no need for blobs of solder all round the patch—it is the film between—and a thin film at that—which does the work. A too-cool bit

(Continued foot of page 122)

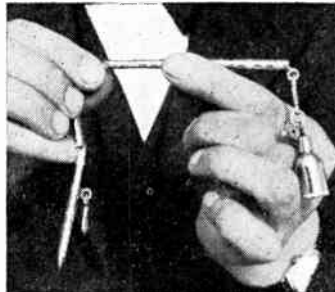

The pen lengths being fitted together

## A Pen from a Watch Chain

THIS interesting novelty was made by a collector of pens—Mr. W. Bishop of Fulham Rd., London, S.W. He has secured dozens of them in the course of years, bone pens, quill pens, decorative glass pens, pen holders of horn and silver, and the unusual type shown here. It is composed of long links forming

an ornamental chain for waistcoat use as you see. When clipped together, as in the upper picture, the whole lot form a rigid writing instrument. Mr. Bishop commenced his collecting 20 years ago and is an adept at cutting a quill pen—a not-too-easy job as anyone who has attempted it will testify. But those who have these old-fashioned pens maintain that they are really a delight to use when you have learned how to cut the nib to suit your own style. Mr. Bishop, at least, should know how to use them for he is a practising calligrapher and a teacher at art schools.

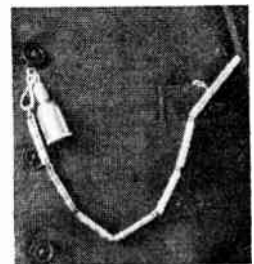

The pen as a chain

# A further practical article on useful things to make in BASKETRY

If you have practised the various strokes described in my previous articles, and have made a mat and one or two things with a wooden base, you should now be ready to try your hand at a shopping basket.

You will already have found that a few tools are necessary. Of course the proper tools are the best, but make-shifts will serve. A sharp knife, a pair of shears, a bodkin, a pair of blunt-nosed pliers, and a rapping iron are the ones you need.

## Cutting Tools

If your penknife is sharp, that will do. Many people have a pair of garden secateurs. A large nail, or a needlework stiletto can be used if you cannot obtain the proper bodkin; requisition the household pliers. An old chisel, used on its side, does well for a rapping iron.

Your tools collected, you are ready to start. First decide whether you want to

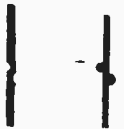

Fig. 1 & 2—The kinking

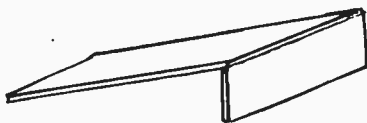

Fig. 3—A tilted work table

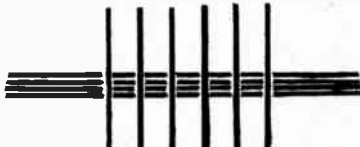

Fig. 4—Work for oval base

longer than the height you wish your basket to be. Insert one stake on each side of the base stakes as firmly as possible, leaving one side of one stake empty to make an uneven number of stakes.

## Bending the Cane

Now with your blunt-nosed pliers kink each stake close to the weaving. Do not hold your pliers straight, hold them at an angle as in Fig. 1, and then the kink will be as in Fig. 2. The stakes should now bend easily without snapping.

The side of the basket is much easier to work, if the base is fastened by the bodkin to a piece of wood made to slope away from you by a piece joined on the end (see Fig. 3). This makes it easy to turn the basket as you weave.

When your stakes are upright, fasten them securely by three rows of up-setting. Rand or pair for about 5in., using the rapping iron frequently in

ping cane, or (and this makes the handle stronger) in the following way. Put one end of a No. 5 cane down by the handle, and wrap it round at intervals of about 2in. Put the cane through the basket from outside and below the waling, and continue this until the handle is covered.

## An Oval Base

A base for an oval basket is formed in this way. Four stakes are required at least 2in. longer than the other six. They are arranged as in Fig. 4, the shorter ones being slit to take the longer ones. When you have worked two rows of weaving spread out the end stakes evenly. Continue in the same way as for the round base. The oval base is more difficult to keep in shape than the round one.

When any work is finished singe off any 'whiskers' with a taper, but keep the work moving all the time or it will scorch. If you concentrate on keeping the stakes straight, instead of on the weaving, which will very soon become almost automatic, you will gain good results more quickly than in any other way.

## Damp Cane

Never work with your cane dry or wet, try to keep it just damp. If it becomes dry when working in a warm room, dampen it by passing it through your wet fingers. If possible dampen the amount of cane you will be likely to use, but, if you damp more, do not put it away until it is dry.

When damping canes on an article with a wooden base remember that plywood may warp and split if it gets wet. If your work so far has been successful, you are now ready to attempt chairs, tables or any large article.

The work can prove an enjoyable and profitable occupation to those interested.

make a basket with an oval, or with a round base. If you choose a round base, it is worked in exactly the same way as the mat described in the first article, except that, as the stakes should be No. 12 (a coarse cane), in four of them cut a slit in the middle, and place the other four through the slits to form the beginning cross.

## Side Stakes

When the base is as large as you wish your basket to be, cut off the stakes even with the edge of the weaving. Then sharpen one end of each of 29 No. 10 stakes, which should be about 12in.

order to get the rows close together.

Put in one row of 3 rod wale. Work about 2in. of randing or weaving, pulling your work in a little. Do two rows of waling, and finish with the five-pair border described in our second article.

Sharpen one end of the handle cane, and decide how long you want the handle to be. Remember that each end should be driven well down into the sides of the basket, and cut off and sharpen the other end. Bend the cane between your thumb and finger, and insert cane at least 3in. down the side. See the other end is exactly opposite.

Cover the handle by using flat wrap-

## Mending a Kettle—(Continued from page 121)

makes for untidy and faulty work. A properly hot bit does not need to stay so long in contact with the work, and leaves a neat, even seam. If you have to attend to something else, turn down the gas flame. But even a low flame will mar or ruin a copper bit left over it for a while.

Wipe the bit on the rag every time you remove it from the flame; rub the facets occasionally on the sal ammoniac block to clean off any metal dross or oxide. If the bit becomes burnt, clean up the facets while hot, with a coarse flat file, and tin the bit anew, after proper heating and fluxing.

In time the solder in the tray will become dirty and denatured; the more volatile constituents of the metal will evaporate and leave the solder defective. Scrap the tray and start afresh with

another one.

The flux will spray over the hands when soldering, so they should be washed with soap and warm water immediately the work is completed. The flux specified is one of the chemically active sort, more or less corrosive. Such fluxes are unsuitable for electrical work, and one of a non-active nature should be used instead. But for tinsplate, copper or brass an active flux will be found more convenient by most beginners.

The kettle should be tested by filling in a little cold water. If all is well, proceed to a sterner test by part filling with warm water and bringing to the boil over the gas ring. If you put a little washing soda in the water this will help to scour out any flux which may have oozed inside the kettle. The soda solution will neutralize any acid in the

flux, and forestall future corrosion. In soldering tinsplate it is important to tin the edges of the patch, since these are otherwise not coated with tin, and will rust.

## Faulty Patches

Should the ordeal by water disclose that the patched hole leaks, empty the kettle, wipe out any water, and flux the patched area again. Apply a heated bit to the patch and flow the solder. Probably the fault was that the patch was not pressed down tightly enough to the kettle bottom. On the other hand, there may be a blow-hole at one of the edges of the patch, caused by hot air or by the gas generated when the flux was heated. If this attempt fails, melt off the patch, and begin again. In most cases a patch goes on quite successfully.

# The handyman can use empty spools to make attractive COTTON-REEL LAMPS

**H**AVE you ever thought of the things you can make from cotton reels? Practically every household, sooner or later, accumulates quite a number of empty cotton reels, and a surprisingly few number are used for making gadgets, the majority being either thrown away, used for firewood, or given to children for playthings.

The following instructions will enable any person of reasonable skill to make standard lamps and table lamps, for the matter of a few shillings only, from scrap cotton reels. Even the shade may be home made. The lamps described have a very rich effect, and are surprisingly strong for their light weight. They have the appearance of finely carved or turned wooden columns and excite attention, and admiration.

## Standard Lamp

For the standard lamp shown in Fig. 1, you will require 42 cotton reels for the column; 5ft. of  $\frac{3}{8}$ in. copper or brass tubing (obtainable at any Government surplus stores or electrical supplier); two pieces of plywood or other timber for the base, being in two layers, either circular or square, according to one's own taste, of 9in. and 12in. diameter respectively; 15 cotton reels for the feet of the base, and the usual flex, glue, lampholder, screws, etc.

Commence with the base first. Reference to Fig. 2 shows that the base consists of two pieces of wood  $\frac{1}{2}$ in. or  $\frac{3}{4}$ in. thick (plywood for preference) superimposed on each other. Drill the centre of both pieces to accommodate the  $\frac{3}{8}$ in. copper tubing. Over the centre of the hole of the smaller (upper) piece, glue and screw a cotton reel, countersinking the screws. Two screws are sufficient.

## Base Feet

Glue and screw the second piece of the base to the underside of the first piece and attach the base feet. These are cotton reels spaced equally round the perimeter of the base but set slightly inwards. They are glued and screwed, the screws being countersunk into the reel channels, as seen in the illustration.

The column is made next. Take your piece of copper tubing and place one end into the reel mounted on the base.

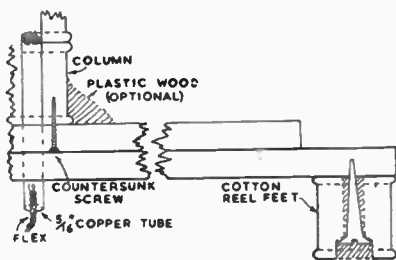

Fig. 2—Section through base and feet

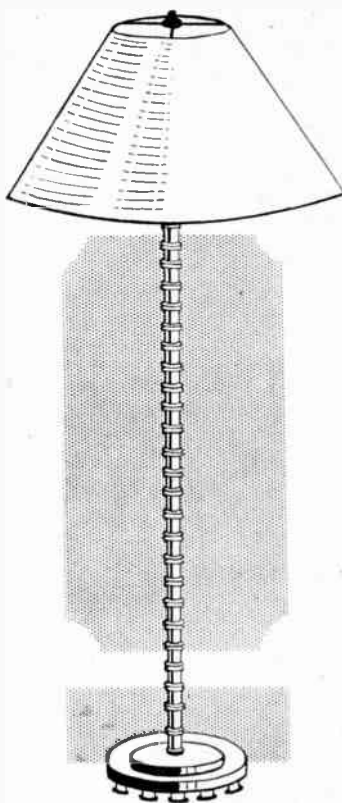

Fig. 1—A complete stand and lamp

Slide the tubing through the base, which should be lightly glued inside the hole, and allow it to project below the base for about  $\frac{1}{2}$ in.

Slide the remaining 40 cotton reels along the copper tubing. Coat the base and top of each reel with glue, after first removing the paper labels, and roughening the surface with a rasp. A little glue may be added to the copper tubing.

## The Flex

It may be necessary, whilst the column is being built, to stop operations after each 10 reels have been added in order to allow the glue to set and the column to be kept true. There is a tendency, otherwise, for the reels to move slightly about the tubing, owing to un-

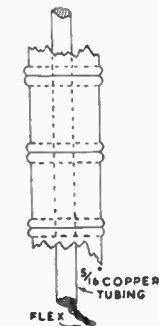

Fig. 3—The pillar part



Fig. 4—Lamp holder fitting

avoidable variations in the diameter of the holes through the reels. Some may be a very tight fit, others a little loose.

When the last reels have been placed in position and the glue has set, thread the electric flex through the copper tubing from the base. Allow sufficient to reach to the plug. Screw on the top reel an ordinary electric lampholder for standard or table lamp which is obtainable at any electrical shop or stores.

## Shaped Base

Plastic wood may now be added to the base and round the base reel, as shown in the shaded section of Fig. 2, but this is quite optional, as the standard column will be quite strong. The drawing at Fig. 3 shows the method of mounting the reels on the copper tubing and a detail section of Fig. 1. Add the standard lamp fitting (Fig. 4) and shade and your lamp is complete, as far as actual construction is concerned.

The bases of the standard lamps may be weighted if necessary by lead being screwed beneath the base. This, however, is again a matter of individual taste and necessity.

For finishing, the reels usually take stain very well and this is to be recommended. An alternative, making a very rich and striking scheme, is to paint the reels white, then pick out the ridges in gold paint.

## Table Lamps

If you want, you can use cotton reels to build table lamps exactly as for the standard lamp. In this case 10 reels only will be needed for the lamp column, and reels will not be used for the base feet. The copper tubing will not protrude beyond the base but will end flush with the bottom of the upper portion—a channel is then grooved along the lower base to accommodate the flex.

Here are additional notes about other everyday articles made from reels. The same method of construction may be used, using  $\frac{1}{8}$ in. dowelling instead of copper tubing, for making stand floor type ashtrays, etc. For this 18 reels will be needed for the column. The base, dispensing with bobbins, will be 9in. diameter with a simple circular piece of  $\frac{3}{4}$ in. plywood, 4in. diameter glued and screwed to the top bobbin to which the ashtray is fitted.

With the table lamps and standard lamp this completes a very fine set of furniture.

## Index to Vol. 108

The Index covering the contents of Vol. 108 is now available. It deals with all the issues from April to September last, and is very useful for looking up subjects you want to undertake, or for solving problems you may have. The Index is obtainable from Publishing Dept., Hobbies Weekly, Dereham, Norfolk, for 1/- post free.



# Save damage and weight in postage by making these FOLDING PRESENTS

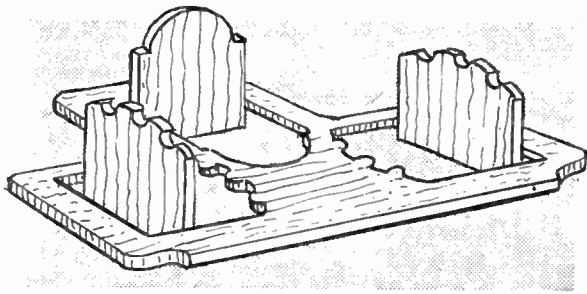

**M**OST readers, having occasion to send some homemade articles, presents perhaps, by post, are painfully aware how careful the packing has to be if the articles are to arrive in decent condition, and not in bits. Some novel designs are shown here whereby such articles can be cut in the flat, and posted flat also, being opened out to shape on their arrival. Much troublesome packing is saved by this method, and the articles themselves need in no way be inartistic, or suffer in usefulness.

## An Inkstand

Two such designs are shown here, one a vertical pen and pencil rack, and the other a pen and ink stand—useful desk articles both. Dealing with the latter design first: this is shown, drawn over  $\frac{1}{2}$  in. squares, in Fig. 1. The pattern can be drawn from the squared-off area quite easily, and if on thin paper be stuck down on the fretwood, like an ordinary pattern, and be sawn out. The semi-circular part is best put in with compasses, with a  $\frac{5}{16}$  in. radius.

Of course, the design could be traced through carbon paper directly on the wood and if carefully done is quite as effective as pasting down and obviates the trouble of subsequently glasspapering the paper off the wood.

About the most suitable wood to use is  $\frac{3}{4}$  in. thick. When cut in  $\frac{1}{4}$  in. wood there is sometimes a little difficulty in opening out the parts afterwards, and if in  $\frac{1}{2}$  in. wood there is scarcely enough substance for driving in the pins which act as the hinges. Saw out the parts very carefully, with a fine or medium blade, and where holes are necessary to allow the blade to enter, drill them with the finest bit possible, preferably at a corner.

## Pins as Hinges

Ordinary stout household pins can be used as hinges, or the fine nails known as panel pins, the latter being, perhaps, preferable as not so likely to bend under the hammer strokes. First, however, go over the work with fine glasspaper, and look well to the edges of the parts, making them smooth.

The position for driving in the pins is indicated in both designs by small arrows.

a bit of steel wire, of approximately pin gauge, something after the style of (C) in Fig. 3.

This, with its point filed to a wedge-shaped edge, as in inset, will quickly drill a fine hole through the wood, if rotated between finger and thumb while it is pressed firmly on the spot where the hole is wanted. Grip it near its point while rotating it, otherwise it may bend up. The writer used a lady's hairpin for such a job and found it acted quite satisfactorily, but a stiffer wire would last longer.

It will be safer, before driving the pins home, to drill preliminary holes first, not quite through the wood, but about halfway.

An ordinary fine fretwork drill bit may be too coarse for this part of the job, especially if household pins are used. A better tool can be bent up from

carried out as for Fig. 1, and care should be taken, when copying the design, to get both sides alike. A good plan is, after drawing in one side, to trace it on transparent, or translucent paper (ordinary tracing paper if you have a piece handy), then to reverse the tracing and lay it in its correct position the opposite side and rub over the back with a hard pencil. The pencilled shape will be left on the paper—a true copy resulting.

## Hinging and Finishing

Hinging will be done as before, but the bottom edge of the strut in the centre should be bevelled a little, as at (B), to bed down well when opened out. It will be fairly obvious that the strut is bent out backwards and the side-wings forwards, the latter, of course, forming the rack for the pens and pencils. Finish of these articles will be carried out before hinging the parts together.

Finishing is important. The wood can be stained (if necessary or desirable) and polished. The parts will look much better if their edges are blacked, using a

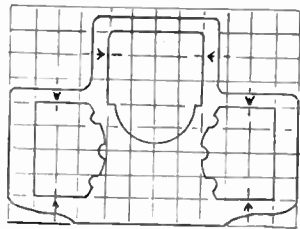

Fig. 1—Plan of base on  $\frac{1}{2}$  in. squares

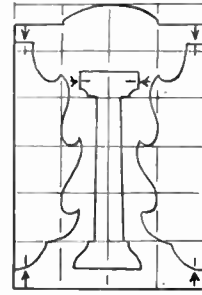

Fig. 2—A pencil holder

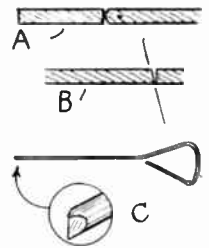

Fig. 3—Details of cutting

Fit the parts back in their places, then drive the pins home well into the movable parts, and cut off any surplus. The back edges of these parts should be slightly rounded, as at (A), to facilitate the part opening without a strain. Don't overdo this, however, as it may spoil the effect.

A drawing is given showing the completed article opened out for use. It will be seen that the two front movable parts, when so opened, form a rack for pens and pencils, while the backs, extending below the bottom of the rack, form a pair of feet to raise the rack a little. The centre back-piece also forms a middle rear foot and a background, as it were for the ink pot, which drops in the space left in front of it.

When hinging these parts, drill the preliminary holes only halfway through, so that the pins must be driven through the remainder. Then the action will be stiff enough to allow the parts to remain in their open positions, and not fall back again when not wanted.

At Fig. 2 is a somewhat simpler design, drawn over 1 in. squares. The work is

thin spirit black for the purpose, or egg shell enamel which looks rather well on such jobs. The possibilities of using some of the many art enamels should not be overlooked.

In the drawing of the inkstand, the parts are shown opened out, but the article does not look half so attractive, naturally, as it would when nicely finished with polish, or enamel, and equipped with ink bottle and writing implements. It does, however, show how the parts are opened out.

A further and inexpensive ornamentation, specially suitable for such articles as these is transfers. These can be applied quite easily, and make a tremendous difference to the finished job.

**Next week's issue  
will contain an  
enlarged design  
for Xmas presents**

# MISCELLANEOUS ADVERTISEMENTS

**STAMPS** at your valuation. S.A.E. details.—M. Hogg, 85 Pavilion Way, Eastcote, Middx.

**GRAND** surprise packet of valuable stamps, free to genuine collectors requesting approvals and sending postage.—Woolcock, Brampton, Cumberland.

**CASTING** moulds for lead soldiers, Indians and cowboys, animals and novelties. Sample mould, 4/-. Catalogue, 6d.—G. F. Rhead, Thurston End, Hawkedon, Bury St. Edmunds.

**JUNIOR**-type hacksaw with blade, 1/3 post paid. Modern handbag/purse material, 2 mm. thick, beautiful P.V.C. embossed sheets. Samples, illustration, step-by-step instructions, 1/-.—G.F.P., Raglan, Spencers Lane, Melling, Nr. Liverpool.

**GANDHI** Memorial Issue and 25 different stamps free. Send 2½d. postage. Request approvals.—W. O. Took, 2 Cowper Street, Hove, Sussex.

**FREE**, Bahawalpurs. Geo. VI. discount approvals, ½d. upwards. Postage.—Bishop, 40 Marine Parade, Hythe, Kent.

**PLAY** as you earn, with our waxcraft and Perspex construction kits, compendiums. Cement, polish, brooch bases, pins, wax, tools, Perspex, etc., available. Catalogue, 6d.—Plastics Home Products, 18 St. Mary's Road, London, N.9.

**SUPER** catalogue of money-making books, courses, etc. P.O. 6d. from—Elliott, 71 Rothsay Terrace, Bedlington, Northumberland.

**READY** for jig-saw cutting. Glazed pictures glued on plywood. 7d. each post paid.—'K' Toys, Brookfield Rd., Bristol, 6.

**PERSONS** required to fill vacancies in our outwork department. Write—Dept. 11, Empire Co., 117 Nottingham Road, Loughborough.

**STAMPS** Free—Queen Victoria packet including old Colonials, free to approval applicants.—Robert J. Peck, 7A Kemp Road, Bournemouth, Hants.

**HARDWOOD** Wheels. 2in., 1½in., 2/- per set of four. Tax included. Post paid. Other sizes available.—The Joyden Toy Co., 193 Chase Side, London, N.14.

**IT'S** unique! It's handsome! It's the best table lighter yet! Constructional details and drawing can be yours for 3/6, or rush 1d. stamp for details of our all-embracing offer.—Cherry, 9 Selborne Ave., London, E.12.

**SUPERB** discount approvals. Grand free gift applicants sending 2½d. postage.—W. E. Jakeman, 172 Church Rd., Sheldon, Birmingham, 26.

**PERSONS** required make fancy goods at home. Write for details.—Melton Manufacturing Co., Southgate Street, Leicester.

**50 DIFFERENT**, early stamps, 6d. Please ask for ½d. approvals.—Cogman, Potter Heigham, Gt. Yarmouth.

**PERSPEX** bedside lamp kits. Very attractive and easily assembled. All parts expertly cut to shape in pastel colours of pink, green or blue. Complete with detailed instructions, cement and polishing compound. Price 12/6 (Crinothene shade to match, 2/6 extra). Ideal Christmas presents.—P. & L. Perspex Supplies, Orpington, Kent.

**PLYWOOD** offcuts, ¾in., ½in., ideal for toy, model making and handicrafts, in 5/- parcels, plus 1/3 carriage. Exceptional value. Send P.O. to—Baker, 700 Bradford Rd., Oakenshaw, Bradford, Yorks.

**BE** Taller. Quickly! Safely! Privately! No appliances—no tablets—no dieting. Details, 6d. stamp.—Malcolm Ross, Height Specialist, BCM/HYTE, London, W.C.1.

**MODELS**. You can make lasting stone-hard models with Sankey's Pyrama Plastic Cement. Supplied in tins by Ironmongers, Hardwaremen and Builders' Merchants. Ask for instruction leaflet.

**TRANSFERS** for decorating toys, trays, furniture, fancy goods. List and samples free. Flowers, pixies, dogs, nursery rhymes.—H. Axon Harrison, Jersey.

**PRESSED** Metal Wheels. 1½in., 1/3; 2in., 1/9 per dozen. Or in stove enamel finish red, green or blue at 6d. per dozen extra. Tax included. Post paid.—The Joyden Toy Co., 193 Chase Side, London, N.14.

**DOLL'S** House fittings and papers; send S.A.E. for list. Doll's house plan special; send 2/6. Trade supplied.—Zimplan, 88 Ware Road, Hoddesdon.

**YOUR** winter hobby. Build a fleet of Wilson's Lorries. Photographically illustrated lists, 6d.—Wilson's Lorries, Dept. H., 1 Gt. Winchester St., London, E.C.2.

**BE** Taller in 14 days or money back. Details, 1d.—Stebbing System, 28 (HB) Dean Road, London, N.W.2.

**INTRODUCTIONS**. Pen friends, companionship or marriage.—V.C.C., 34 Honeywell Road, London, S.W.11.

**GOVERNMENT** surplus bargains for the hobbyist. Aluminium rivets, handy boxes approx. six gross assorted, 2/6 (P. 6d.); Sorbo sponge rubber, approx. 18ft. x 1½in. x ¾in., 2/- per roll (P. 6d.); Strong elastic cord, approx. ½in. dia., 10yds. for 7/6 (P. 6d.); 10,000 electrical switches (22 types), brand new, from 11d. Send 3d. stamp and S.A.E., or 16 page list of these and other attractive bargains.—Milligan's, 24 Harford Street, Liverpool, 3.

**LONELY?** Then write Secretary L.U.C.C., 5B.B. Hay St., Braughing, Herts. Genuine. Est. 1905.

**NOVELTY** Calendar designs painted on plywood for cutting out. Date cards supplied. Excellent Xmas gifts; profitable to sell. 1/9 each; half-dozen, 9/-.—Cleaver, 50 Windsor Road, London, N.W.2.

**DOLL'S** House papers. 30 designs, including green and red pantile. Samples and patterns, 1/-.—Sutton Models, Billericay.

**CONJURING** and Magical tricks, Clists 3d.—De Hempsey, 363 Sandycombe, Kew Gardens, Surrey.

**HOME** Movies, 9-5 film library. Projectors, films, in great variety. Sale cheap, stamp lists.—Wayland, 223 Longley Road, Tooting, S.W.17.

**EARN** 5/- hourly making Biltex Model bungalows at home. We provide plans, instructions and buy your work at fixed prices.—B.9. Biltex, Chiswick, London.

**NEW** Plywood. Immediate delivery; free of licence. 9 panels, 20in. x 20in. x ¾in., 20/- C.O.D.—Dept. H., J.D.D. Storage, 71 Northcross Road, S.E.22. BRI. 7441.

**PERSPEX** flat sheets, clear and 17 colours, cut to shape. Corrugated Perspex rooflights. Aluminium sheeting. Mouldings, plastic panelling.—Henry Moat & Son Ltd., Atom Works, Newcastle, 1.

**SENSIBLE** Xmas present for him. The home Watch and Clock Repair Outfit. These precision jeweller's instruments including watchmaker's eyeglass, tweezers, screwdrivers, oilers, brush, bottle oil, plus explanatory book and blueprints, make watchmaking easy. Invaluable for all fine work. In container, 12/9 inclusive.—S. Bolster, (Dept. A), 5a Station Parade, Ashford, Middx.

**PLYWOOD** offcuts. Birch and Gaboon in various thicknesses. Handy sized parcels for the cabinet, toy, model maker, and all handicrafts. Parcels made up in £1 and 10/- lots. Carriage paid. Send P.O. to Reeves, Plywood and Timber Merchant, 33 Front Street, Monkseaton, Whitley Bay. Tel. W.B. 4677.

**BLUSHING**, shyness, nerves, self-consciousness, fears, ended. Details under plain cover, 1d.—Stebbing Treatment, 28 (HB) Dean Road, London, N.W.2.

**£5** to £20 weekly earned at home, running your own Mail Order business. Details, 1d.—Stebbing Publications Ltd., (HB) Naphill, High Wycombe.

**AMERICAN** Magazines post free for one year. Popular Mechanics, 32/3; Popular Science, 28/6; Mechanix Illustrated, 18/3; Popular Homecraft, 18/-. S.A.E. for full list of others.—Willen Ltd., (Dept. 57) 101 Fleet Street, London, E.C.4.

She might be **YOUR** ship

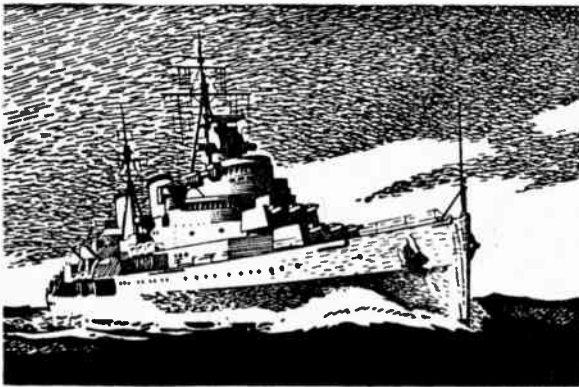

## CRUISER

Over 7000 tons of fighting ship, cutting through the water at 30 knots and ready to strike hard with anything from 6" guns to torpedoes—that's the modern cruiser. If you'd like plenty of exciting action you'll find it in a cruiser... you'll find it anywhere in the Navy, in fact, as well as an interesting, well-paid career with great prospects.

If you are between the ages 15-28 you'll find it well worth while to call in for a talk at any Combined Recruiting Office or write D.N.R Dept. BV/148 ADMIRALTY, LONDON, S.W.1.

Make the

## ROYAL NAVY

*your career*

## YOU CAN BECOME A HANDICRAFTS INSTRUCTOR

### Experience not essential

Men who enjoy making things in wood or metal can turn their hobby into a well-paid, permanent and interesting Career. Short hours, long holidays, and security in a job you would really enjoy, can be yours if you become a Handicrafts Instructor. Let us send details of the easiest and quickest way to get the necessary qualification.

### We definitely guarantee "NO PASS—NO FEE"

If you would like to know about our unique method of preparing you for one of these excellent appointments, write today, and we will send you our informative 175-page Handbook—free and without obligation. Mark your letters "Handicrafts Instructor."

**BRITISH INSTITUTE OF  
ENGINEERING TECHNOLOGY**

595 Shakespeare House  
Stratford Place, London, W.1

# BIET

## HOBBIES EXPOSURE METER

Amateur Photographers build this efficient PHOTO-ELECTRIC EXPOSURE METER. Light Cell 6/6. Meter Movement 8/-. Moulded Perspex Case 9/- Complete Assembly Instructions 3/6. Ivorine Conversion Dials 5/6.

**G. R. PRODUCTS, 78 REPTON ROAD, BRISTOL 4**

## KITS for OLD TIME SHIPS

Hobbies range of Ship Models includes Elizabeth Jonas, Cutty Sark, Victory, Mayflower, etc. Complete kit of wood, sail material, guns, pulleys, cord, etc., with full size pattern of parts and planed wood ready to cut out, shape and construct. A fascinating pastime.

Kits for models 12½ ins. long and upwards.

Ask for free illustrated lists at Hobbies Branches or from Hobbies Limited, Dereham, Norfolk.

# The *NEW* JUNEERO Engraving Tool

MAKE IT  
YOURSELF  
FOR



Here is a useful tool for home and workshop use, which you can make yourself at a modest cost. It will engrave on all the usual metals and materials, and is designed on exactly the same principle as the ordinary electric Engraving Tool.

JUNEERO Design Sheet No. 125 gives clear details of the simple construction of the Engraving Tool, and you can obtain the Solenoid Coil, with 4ft. of three-core safety flex attached for 6/-. at your usual JUNEERO dealer. The rest of the tool is constructed from standard JUNEERO material at a cost of less than 1/6.

See your dealer today and start to build this interesting and useful tool.

For use with mains supply 200/240 volts A.C. only.

Ask Your Local Dealer for Details  
or if any Difficulty, Write to  
JUNEERO LTD-STIRLING CORNER  
BOREHAM WOOD-HERTS

## AMYSTO

THE WONDER POCKET TRICK OF 1949

We offer you this amazing pocket trick for Xmas parties and other occasions, comprising two pencils and a match-box. Exactly as being supplied, after close examination, to members of Magic Circle, Magicians' Club and the I.B.M. No skill required. Every pro. magician tested with this trick failed to find solution. An entirely new magical principle employed. Carried in pocket, you will 'top the bill' amongst your friends. No pocket trick in recent years has caused such controversy. Completely bewildering and baffling.

Complete with instructions for immediate 4/6 Post Free. working and explanatory 'photo.'

Obtainable only from:—P. DE BOLTZ, A.M.C., PRINCIPAL, NURSERY STUDIOS, MARKET PLACE, NORWICH. (Regd. at Board of Trade).

## MODEL THEATRE ENTHUSIASTS AND ALL MODEL MAKERS!!



If you are interested in a low-priced Constructional Outfit for building a compact and ingenious working model theatre, as designed by professional actor/author for own use, send stamp for descriptive leaflet to the inventor.

**VICTOR STREETER, 28 Halesworth Rd., SHEFFIELD 9**



## HOBBIES BRITISH FRETSAW BLADES

YELLOW LABEL 1/3 per doz.  
BLUE LABEL 1/- per doz.

From Hobbies Branches or by post (2½d. extra) from Hobbies Ltd. Dereham, Norfolk



# THE RAINBOW

See page 113

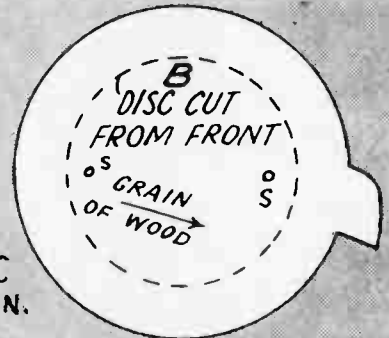
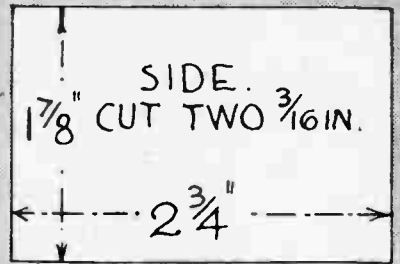
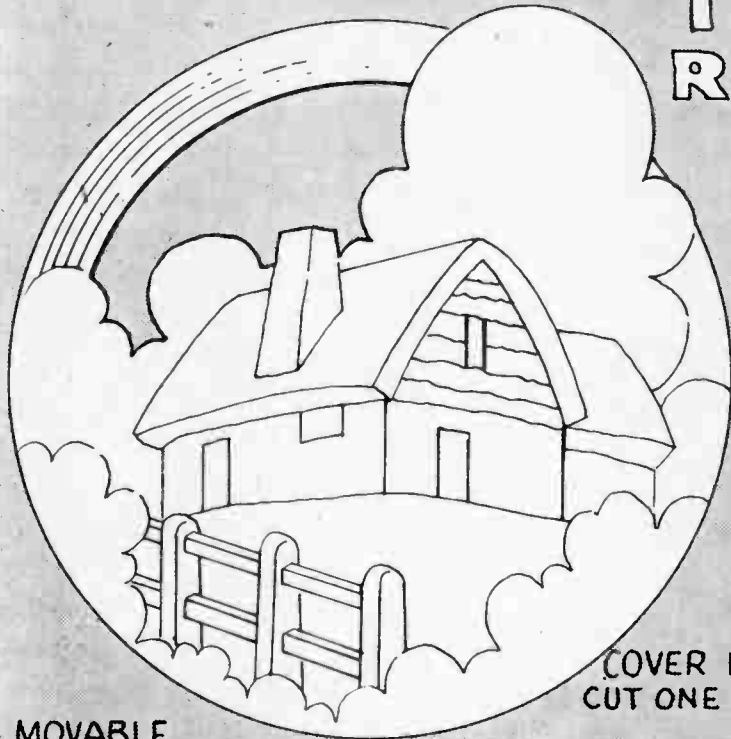

COVER DISC  
CUT ONE 1/8 IN.

MOVABLE  
OVERLAY.  
CUT FROM  
1/8 IN.

FORMER.  
CUT TWO  
3/16 IN.

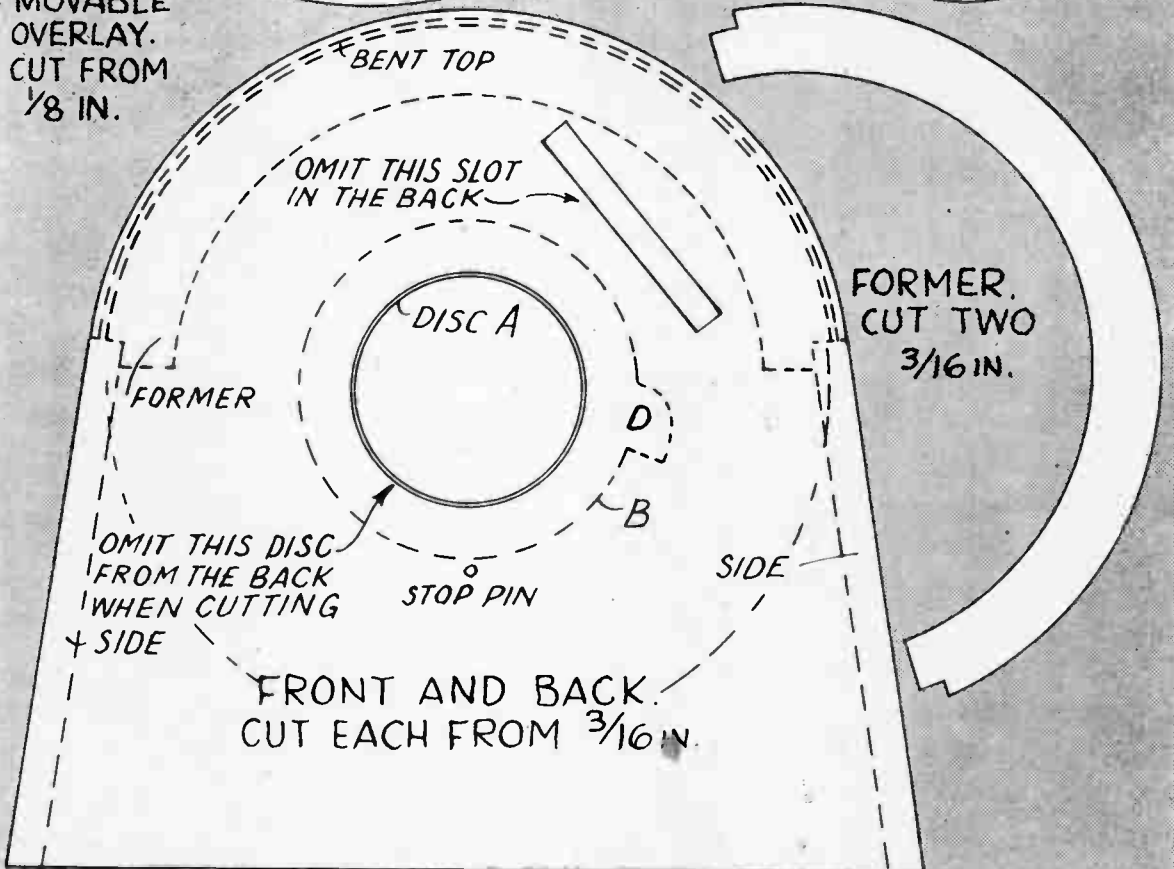

FRONT AND BACK.  
CUT EACH FROM 3/16 IN.

# A KEY POSITION..



WAITS FOR YOU

## Start training for it NOW!

There is still room at the top for the fully qualified man who is fitted for the job. YOU can be that man—successful, prosperous, with your future assured—by studying at home in your spare time, guided by the personal tuition of The Bennett College.

## WE WILL HELP YOU TO ACHIEVE YOUR AMBITION

Get your feet on the ladder of success TO-DAY. Write to The Bennett College and learn how thousands of people just like you have reached the top with the right guidance. A well-paid job can be yours—start this pleasant spare-time study NOW.

### ★ FIRST CHOOSE YOUR CAREER

- |  |  |   |
|--|--|---|
| Accountancy Exams.<br>Agriculture<br>A.M.I. Fire E. Exams.<br>Applied Mechanics<br>Auctioneers and<br>Estate Agents<br>Aviation (Engineering<br>and Wireless)<br>Blue Prints<br>Boilers<br>Book-keeping. Ac-<br>countancy, and<br>Modern Business<br>Methods<br>Builders' Quantities<br>Building, Architec-<br>ture, and Clerk of<br>Works (A.R.I.B.A.<br>Exams.)<br>Cambridge Senior<br>School Certificate<br>Carpentry and<br>Joinery<br>Chemistry<br>Civil Engineering<br>Civil Service<br>All Commercial<br>Subjects<br>Commercial Art<br>Common Prelim.<br>E.J.E.B.<br>Concrete and Struc-<br>tural Engineering<br>Draughtsmanship.<br>All branches | Engineering.<br>All branches. Sub-<br>jects and Exams.<br>General Education<br>G.P.O. Eng. Dept.<br>Heating and Ventila-<br>tion<br>Institute of Housing<br>Institute of Municip-<br>al Engineers<br>Journalism<br>Languages<br>Mathematics<br>Matriculation<br>Metallurgy<br>Mining. All Subjects<br>Mining. Electrical<br>Engineering<br>Motor Engineering<br>Naval Architecture<br>Novel Writing<br>Plastics<br>Play Writing<br>Plumbing<br>Police, Special<br>Course<br>Preceptors,<br>College of<br>Press Tool Work<br>Pumps and Pumping<br>Machinery<br>Quantity Surveying<br>—Inst. of Quantity<br>Surveyors Exams. | Radio Service En-<br>gineering<br>Radio (Short Wave)<br>Road Making and<br>Maintenance<br>Salesmanship<br>Sanitation<br>School Attendance<br>Officer<br>Secretarial Exams.<br>Sheet Metal Work<br>Shipbuilding<br>Shorthand (Pitman's)<br>Short Story Writing<br>Social Welfare<br>Speaking in Public<br>Structural Engineer-<br>ing<br>Surveying (R.I.C.S.<br>Exams.)<br>Teachers of Handi-<br>crafts<br>Telecommuni-<br>cations (City and<br>Guilds)<br>Television<br>Transport Inst.<br>Examinations<br>Viewers, Gaugers<br>Inspectors<br>Weights and Mea-<br>sures Inspectors<br>Wireless Telegraphy<br>and Telephony<br>Works Managers |
|--|--|---|

*If you do not see your requirements above, write to us on any subject. Full particulars free.*

Direct Mail to DEPT. 62

**The Bennett College**  
SHEFFIELD LTD



*Get this book  
- make these  
MODELS*

HOUSES · SHIPS · ASHTRAYS · BOOKENDS  
SIGNAL CABINS · RAILWAY STATIONS  
AIRPORTS · DOCKS · RELIEF MAPS · PLAQUES  
MODEL FURNITURE · INKSTANDS · PAPER  
WEIGHTS · MODEL FIGURES & ANIMALS etc.

**SIMPLE TO HANDLE · INEXPENSIVE**

The Instruction Book illustrated tells you how to make such models as above, without special tools or skill, in Sankey's "Pyrum" Plastic Cement. This material, modelled while plastic, dries or bakes to stone-hardness, ready for painting according to instructions. Obtainable at local ironmongers, hobbies shops and art material dealers.

*Get Instruction Book by sending 4d. in stamps to the address below*



Dept. 3

**J.H. SANKEY & SON, LTD**

ILFORD

Est. 1857

ESSEX

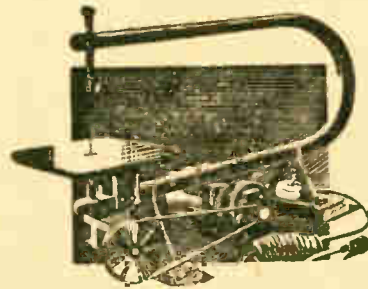

For  
wood,  
card,  
plastic,  
leather,  
metal etc.

## TREADLE OR MOTOR FRETSAWS

Whatever the handyman or craftsman is cutting or making, one of Hobbies Fretmachines will help with the job. For toy making, fretwork, model making, it provides easy and speedy cutting in all kinds of material. A pleasure to use, a factory for output, a life time of service.

**From 70/- to £10**

Ask to try one at any Hobbies Branch or good class ironmonger or hardware stores. Or free illustrated leaflets on request to:

**HOBBIES LIMITED, DEREHAM, NORFOLK**

