

Hobbies

WEEKLY

CONTENTS

	Page
Doll's Cradle - - -	97
'Seeing Stars' Puzzle - -	98
Pair of Bellows - - -	99
Table-cum-Firescreen	100
Radio Rectifier Unit -	101
Care of Tools - - -	102
Clothes-peg Ships - - -	102
Polarizer - - -	103
Menu Card Holder - - -	104
Books to Read - - -	105
General Hints - - -	106
Photo Christmas Cards	107
Craftsman's Notebook	108
Toymaking Wisdom -	109

DESIGN SHEET FOR
ROLLER FRONT
STATIONERY CABINET

November 16th 1949

Price Fourpence

Vol. 109 No. 2820

A Simple and Attractive DOLL'S CRADLE

THIS is a pleasing present for any child owning a doll. It looks like the real thing, canopy and all, and can be quite easily made by any handy woodworker. Deal is quite a suitable wood to use for its construction, not exceeding $\frac{3}{4}$ in. thickness, except for the rockers, which may be a little thicker. Readers, having some $\frac{3}{4}$ in. planed matchboarding, which measures just $\frac{3}{4}$ in. finished thickness, will find this just the stuff for the cradle.

Ends and Sides

The ends are shown at Fig. 1. These can be easily set out direct to the wood, without drawing a pattern beforehand. Cut a rectangle 5 in. by 8 in. for the front end, trim the ends to slope inwards, cut off the top corners, and saw the remainder of the top edge to a concave curve. The rear end is cut $1\frac{1}{2}$ in. wider ($6\frac{1}{2}$ in.) and is of similar shape to the other with the exception that the top edge is sawn to a convex curve, as shown by the dotted lines.

The two side pieces, Fig. 2, are cut to the dimensions given, then the openings are marked out and sawn to simulate vertical slats and panels, to break up the otherwise plain appearance of the article. To set out these slats and panels, draw a pencil line down the length, $\frac{3}{4}$ in. from the top and bottom edges.

Panel Openings

Divide the length into 4 equal parts and mark the panels with a line, $\frac{3}{4}$ in. each side of the divisional lines, thus making the panels, $1\frac{1}{2}$ in. wide, and a line across

each end, $\frac{3}{4}$ in. in. The slats, 1 in. wide, can now be drawn between the panels. The openings can be sawn out with the fretsaw using a coarse blade for preference, and quicker work.

Round off the top long edges of each side and fix to the ends with glue and nails. Use oval nails for this job and punch down afterwards. If it is desired to use screws, being stronger, use the round-headed ones, they look neater. Complete this part of the work by fitting a bottom on, of $\frac{3}{4}$ in. wood like the rest.

Give the whole a good rubbing over with glasspaper, especially the sawn edges of the cutouts, to leave no splintery edges for young fingers to rub against. The job can be finished off by staining the cradle a nice oak colour, and applying two coats of clear varnish, or coating with one of the proprietary brands of oak coloured varnish.

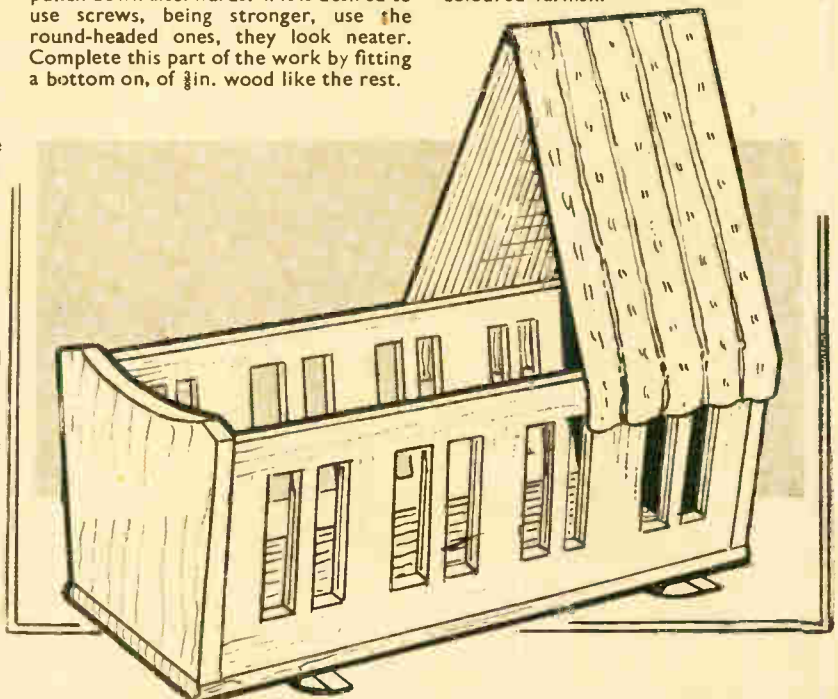

All correspondence should be addressed to The Editor, Hobbies Weekly, Dereham, Norfolk.

The canopy arrangement is quite a simple affair. A canopy support should be made, this being shown at Fig. 3 (B). It consists of a post of $\frac{1}{2}$ in. or $\frac{3}{4}$ in. wood, 1 in. wide, and cut approximately to the length given, with a horizontal top piece of similar material, jointed in.

The Canopy

This top piece should have its upper edge rounded off, and is strengthened with the addition of a small wooden bracket, glued in the angle. The post should have a long slot sawn out, and is

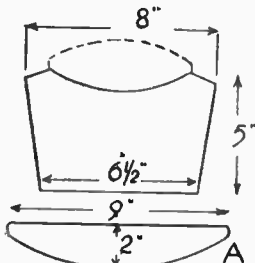

Fig. 1—End shapes

rear end piece of the cradle. By means of the slot its height above the cradle can be adjusted, within limits.

The canopy itself (C) is a piece of suitable material, any fancy stuff will do, large enough to extend over the sides and back of the cradle, as seen in the finished drawing of the article. On the inside of the canopy, at the centre of the top, sew a pair of tapes, as seen in the diagram. These slip over the horizontal rod of the support and keep the canopy in position. The woodwork of the support should be varnished to match the rest.

Rockers

Complete the whole job by adding a

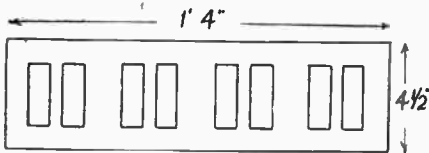

Fig. 2—How to mark out the sides

held in place by means of a round-headed screw, driven in through the slot into the

pair of rockers. These are cut from $\frac{3}{4}$ in. wood, or thereabouts, from the pattern

shown at (A) in Fig. 1. The bottom curve should be a smooth one, and can be struck with an improvised compass if a better tool is not available. The usual makeshift of a nail and length of string, with a pencil tied to the string, will serve all right for a job of this kind.

It would be a good idea to add one of those nursery transfers to each end of the cradle, if the reader cares to take the trouble. These transfers not only add a finish particularly pleasing to a young child, but also impart

quite a professional finish to the work. They are quite easy to fix.

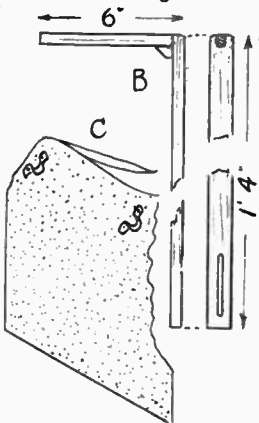

Fig. 3—Canopy supports and cover

Some odd pieces of wood make an interesting 'SEEING STARS' PUZZLE

A GOOD many people enjoy working out a good puzzle, and the one to be described should be very interesting, though tantalizing. As will be seen from the diagrams, the apparatus consists of a shallow tray and four (or more) stars cut in thin material. When handed to the would-be solver, the stars

in actual practice it is not at all easy. At the same time, it is not so difficult that would-be solvers give up in desperation.

It is quite possible to make the whole thing of cardboard of fair thickness, but for the best results either thin wood or, for preference, plastic sheet should be used.

The Diagrams

The first step is to lay out a diagram, full size. This will depend on the size of the sheet available.

As a matter of interest, it might be mentioned that in the original model from which this article and sketches were derived, the outside dimensions of the frame were $8\frac{1}{2}$ in. by $6\frac{1}{2}$ in. The writer happened to have a piece of material this size. It could, of course, be larger but not much smaller as otherwise difficulty may be experienced with the cutting of the stars.

Draw out on a sheet of paper (or mark direct to the wood or plastic) the outside area, and inside this, mark, say, a $\frac{3}{4}$ in. margin. This will give the frame. Inside the frame area, draw stars, as shown. As these are all in straight lines, no particular drawing skill is required. See, however, that points of the stars are not too thin, otherwise they may easily snap off when cut.

For Larger Models

If more stars are used, on a bigger model, take care to observe the basic principle: points of stars must touch either other stars or the sides of the frame. There must be no odd rays sticking out. It is as well to black out, on

the material, either the stars themselves or the waste space so one knows exactly what to cut.

Naturally, extreme care is needed in cutting. There will, naturally, be slight 'play' between the parts, but any crude gaps will upset the whole purpose of the puzzle.

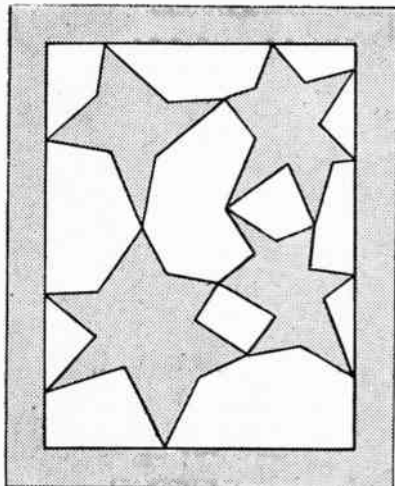

The completed puzzle

are loose and jumbled, as in the second sketch.

The object is to arrange the stars on the tray so each point of each star touches either another star or the inside edge of the tray. It looks easy enough when one has a diagram, as in Fig. 1, but

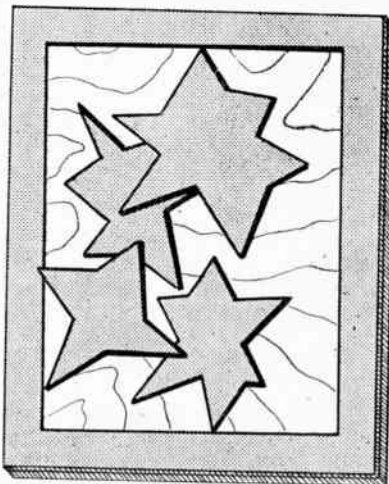

With the parts 'jumbled up'

The frame itself, after being trimmed up on the inside, is now glued to another piece, which may well be of thicker substance, say $\frac{3}{4}$ in. or $\frac{1}{2}$ in. When the glue has set, the outside edges may be planed true. One thus has a shallow tray. Take care not to get any glue oozing out from the sides.

For use or ornament it is always advisable to have A PAIR OF BELLOWS

A PAIR of bellows can not only be looked upon as an article of use in getting the fire to blaze up, but can be taken as an ornament to the fireside. One frequently comes across a carved or otherwise decorated pair of bellows hanging at the side of the chimney piece in a well-furnished room.

Frequently they are of oak; this wood being particularly suited for carving, although there are woods which lend themselves to this form of decoration equally as well. Real carving, of course, is the art of first recessing round the outline of the design to get a depth of background, this background being generally roughened or, speaking in technical terms, "matted".

This matting is executed with special tools, looking very much like ordinary punches, excepting that matting tools have a regular set of teeth, as it were, either in rows of two or three and two or three in width.

Carved Decoration

The method of getting the carved effect in these pair of bellows is not by the genuine chisel and gouge, but by using a fretted overlay on a matted backing. The overlay is cut to the outline of the main shape and glued to the backing just like an ordinary overlay. The shaping and rounding off of the design is completed after the overlay is glued on to the matted ground.

The front of the bellows is of $\frac{3}{8}$ in. wood, and the main back of $\frac{1}{2}$ in., both measuring 15 ins. by 9 ins. The outline of both is identical, and is shown marked over 1 in. squares in Fig. 1. From this squaring also will be obtained the fretted overlay which will be cut from $\frac{3}{16}$ in. or $\frac{1}{4}$ in. wood.

In Fig. 2 we see an outline of the back, and from it will be cut the square and the

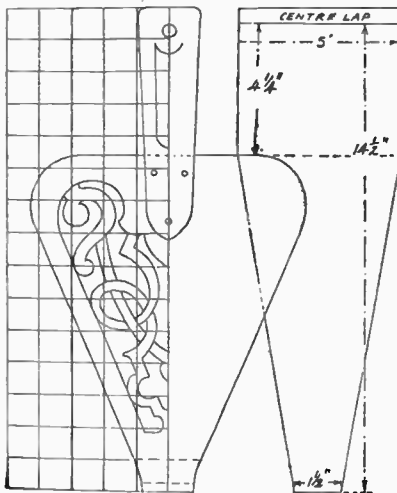

Fig. 1—Pattern of side and overlay design

hole shown to scale. Mark out the positions of these and cut with the fretsaw. Just above this opening there is shown in dotted lines in Fig. 2, the position of a stop block measuring 5 ins. by $\frac{3}{8}$ in.; this is cut from $\frac{1}{2}$ in. wood and glued on. Note here that there will be no interior cut-outs at all from the front of the bellows, for it is on this that the overlay is later glued.

Two further pieces of wood are required for the overlay on the handle, which is glued and screwed as shown, on both back and front parts. All the parts are cut out with the fretsaw and cleaned in the usual way with glasspaper.

Nozzle Work

Details for the make-up of the nozzle end of the bellows are given in Fig. 3. Piece, A, is cut from $\frac{1}{2}$ in. wood and piece, B, from $\frac{3}{8}$ in. Along the centre of piece, A, as will be seen in the sketch in Fig. 3, is cut a deep groove which must be cleaned up nicely with coarse and fine glasspaper.

On top of this piece, and towards the front, is glued the piece, B, which must also be grooved, as in the sketch. The

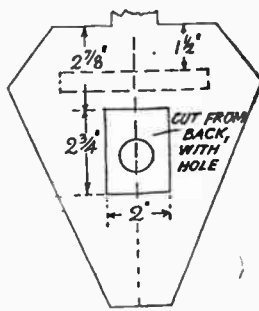

Fig. 2—Shape of main sides

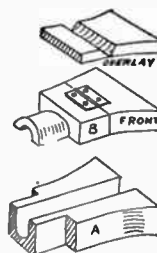

Fig. 3—Parts forming the nozzle end

two pieces are finally rounded to fit a nozzle. The sketch, Fig. 4, shows the parts glued up and shaped. To this projection is fitted a brass or wood shaped nozzle. An antique dealer or an ironmonger's shop would most likely have a suitable nozzle. If unobtainable here, a cone of brass or sheet iron could be made by bending up and soldering.

Hinged Pieces

Behind block, B, of the nozzle, the front section of the bellows is hinged on. This is done, of course, before the overlay is added. The bottom edge of the overlay must be chamfered to an angle of 45 degrees. A small block, as shown, also chamfered as the overlay, put on just below it, the size of the block being $1\frac{1}{2}$ ins. by 1 in. The whole end of the nozzle portion may be fitted with a square of wood measuring $1\frac{3}{8}$ ins. by $1\frac{1}{2}$ ins. by $\frac{1}{4}$ in. thick glued and pinned on, the edges being neatly rounded off.

In Fig. 5 is seen the manner in which the wind inlet valve is formed. We have previously mentioned how a square of wood, with a hole cut in its centre, was cut from the $\frac{1}{2}$ in. back. This block forms the main part of the valve inlet. It is glued to a valve cover (Fig. 5), measuring $3\frac{3}{8}$ ins. by $2\frac{3}{8}$ ins. by $\frac{1}{4}$ in. thick.

Leather Valve

A piece of pliable leather rather smaller than the block is wanted, and this is held down by a fixing block of wood measuring 2 ins. by $\frac{3}{8}$ in. by $\frac{1}{4}$ in. thick screwed down, as shown. On top of the leather, and opposite to the screwed block just mentioned, is glued another block of wood $1\frac{3}{8}$ ins. square, acting as a weight to keep the valve closed after the intake through the hole.

It must be understood that there is a hole cut in the valve cover to the exact size and position of that in the main block cut from the back of the bellows. The air is, on the opening of the bellows, drawn inwards through the holes, and in

(Continued
foot of page
109)

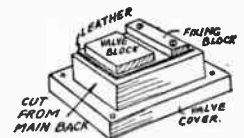

Fig. 5—The wind inlet valve

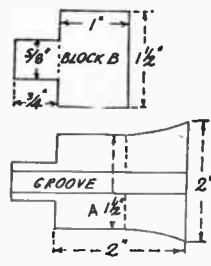

Fig. 4
Nozzle
completed

This double-deck tray arrangement forms a practical TABLE-CUM-FIRESCREEN

THE article shown here is a small cake table, which when not in use as such, folds up and becomes a firescreen. It is thus particularly handy where space is limited, and is an interesting and practical piece of work for the home handyman to make.

As a table there are two levels. These

are 1in. and 12in. from the top comfortably to take the ends of the dowelling. This means that the holes should be an easy $\frac{1}{2}$ in. diameter and be taken into the uprights for a depth of $\frac{1}{2}$ in. The length of the uprights is 16in. To be ideal the dowel should turn stiffly in the holes without binding.

The feet (t) are shaped as shown from two rectangles of wood $\frac{1}{2}$ in. by $1\frac{1}{2}$ in. by $1\frac{1}{2}$ in. and they are secured to the uprights by long but small-diameter screws. If taken home quite tightly the screws hold the feet well and this way is better than making a joint. It means that the feet can be turned sideways when necessary, say, for carriage.

Required also is the spacing piece (c). This is $19\frac{1}{2}$ in. by $1\frac{1}{2}$ in. by $\frac{1}{2}$ in., and is fitted by a screened half-joint, as indicated in sketch (D) Fig. 2. This piece as well as acting as a spacer gives rigidity to the whole frame.

Everything must be ready before the final putting together. When good fits, however, have been obtained, the sections are assembled. The dowel ends are tapped into the uprights till only $\frac{1}{4}$ in. separates the two woods. The spacer is put into position and secured with glue and

rigidly and would fold up when not wanted. A locking bar to hold the levels when closed must also be put in. The first lock is as shown in the bottom diagram, Fig. 1. It is simply a triangular block of wood attached with a hinge to the top side of (g) and so adjusted that it turns stiffly under the top level.

When the table is up, the piece is turned at right-angles and so gives a simple locking action. It is twisted as shown in the second diagram when wishing to collapse the levels. It is important that the wedge works stiffly under the top level or it might work its way round at an unfortunate time.

Fixing Buttons

To hold everything when closed and in the screen position the two short tabs as (C) Fig. 2 are fitted. These are recessed into the uprights and are pivoted by short screws at the ends. The tabs are $1\frac{1}{2}$ in. long by about $\frac{1}{2}$ in. thick. To make them hold tightly against (a) it may be necessary to put in small slips of wood, fastening these to the underside of the level just where the tab swings over.

With regard to finishing, the table can be stained and polished or finished with a varnish stain. As the levels (a) and (b) will be very obvious when being used as a screen some care with these surfaces is quite worth while.

A refinement to the design is two small brass handles at (w) Fig. 2. These are handy for lifting when in the screen or closed position and keep the fingers from smearing the various polished surfaces. The handles, which can be obtained at any of the larger chain stores, must be of the rather flat type so as not to protrude out too far. They are

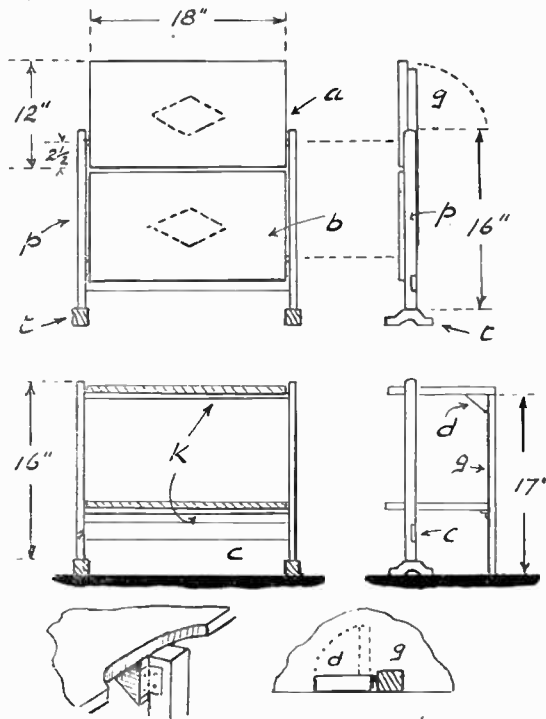

Fig. 1—Front and end view opened and closed

are pivoted to side uprights and can be rotated in an upward direction. This brings the two levels vertically in line, so forming virtually a single flat surface. In fact, if carefully made, the appearance from a short distance is of one vertical surface 2ft. long, 1ft. 6in. wide.

Tray Portions

The levels (a) and (b) are sheets of $\frac{3}{8}$ in. plywood, each 18in. by 12in. If sheets this size cannot be obtained, then two small pieces battened as shown will do, or a sheet of ordinary wood or composition board. The method of battening indicated is necessary to allow a central length of dowelling. These lengths (k), shown clearly in the rear view, are each $19\frac{1}{2}$ in. and of $\frac{1}{2}$ in. diameter, and are fastened to the undersides of the levels $2\frac{1}{2}$ in. from what will be the lower edge. The lengths are secured by a series of fine screws, the wood being drilled first to eliminate the danger of splitting. Correctly set, $\frac{1}{4}$ in. will be left protruding at either side.

Side supports (p) are lengths of 1in. by $1\frac{1}{2}$ in. wood drilled at positions

screws from the side.

We now have the two levels and side uprights together, but still have to put on the third and supporting leg (g). This is 17in. long and of wood 1in. by 1in. section. It is held in position at the outer edges of the levels by small brass hinges on the underside. If correctly fitted the levels can now be pulled down as in the bottom right-hand sketch (Fig. 1). To make the length fit over the dowelling, however, it is necessary to take out the channel (A) Fig. 2. This is only $\frac{1}{2}$ in. deep and will not weaken the wood. The lower end of (g) misses the second dowel in coming up.

Finally a locking piece (d) must be fitted or the table would not stand

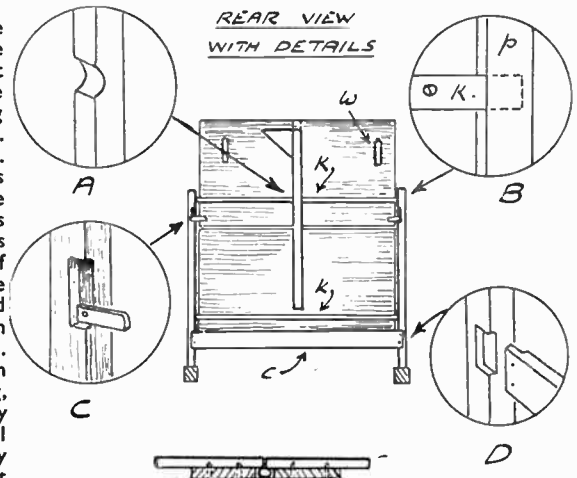
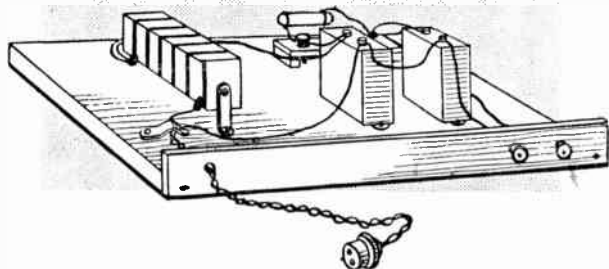

Fig. 2—Details of fitting and (bottom) edge showing battens

fitted vertically rather than horizontally as this makes lifting easier. Fix them quite firmly for strength.

By changing current you can eliminate the H.T. battery with A RECTIFIER UNIT



THE purpose of this unit is to change alternating current into direct current, and one of its most useful applications is to replace the High Tension battery used to operate a battery radio receiver. The cost of the parts in the unit is less than the cost of an average H.T. battery. Once made, it can be used without attention for years, and the output voltage can be arranged to suit any ordinary wireless, as will be described.

How It Works

The circuit is shown in Fig. 1. The metal rectifier allows current to pass in one direction only, thus changing the alternating current supplied by the mains to pulsating direct current. As the latter cannot be used without smoothing, two condensers and a resistor or choke are used to change the current to a steady flow. The condensers absorb the flow, giving it out during the negative pulses.

The Rectifier

A High Tension Metal Rectifier is required. Many different shapes and sizes are available. As no ordinary 4- or 5-valve set takes more than 12 to 15 milliamps, even the smallest rectifiers are suitable. But be sure it has a high enough working voltage for the mains. Low tension rectifiers are not suitable.

The rectifier can usually be mounted on brackets. The positive tag may be shown by a red mark, and observe the polarity shown in the diagrams, or the output will be reversed.

Smoothing Condensers

For a small receiver any condensers from about 2 mfd. can be used as long as the Working Voltage marked on them is high enough. For larger receivers the condensers made specially for this purpose are required or some hum will result. They are available in metal and cardboard cases, with tags or flexible leads. Two condensers in one case, intended for such circuits, can be used. These will have only one negative lead, the condensers being connected internally, as in Fig. 2.

shown, and may be connected either way.

Construction

This is very simple and Fig. 2 shows all the connexions. A wooden base about 4in. by 6in. will usually be amply large, and a case with a few ventilation holes should be made to fit over the unit after construction, to guard against damage or shocks.

If the condensers have terminals, the terminal block can be omitted. If they have tags or leads, it is recommended so that different resistors can be connected with ease, when adjusting the voltage. A strip of insulating material about 2in. long and $\frac{1}{2}$ in. wide raised on blocks of wood is suitable.

Another strip is used for the front. A clip holds the mains leads to prevent connexions being pulled away.

Output Voltage

The mains are usually 230 to 250 volts, and only 120 volts or so are required for the receiver. Actually, most sets work well with anything from 100 to 130 or more volts, so affairs are not critical.

Because the output voltage depends upon the current taken, which in turn depends upon the type of wireless, no definite resistance value can be given.

But as fixed resistors only cost a few pence, it is suggested three be bought. One of 40,000 ohms, one of 30,000 ohms, and one of 20,000 ohms. (Or 40K, 30K, and 20K, if this method of indication is used).

By connecting these, as shown in Fig. 3, twelve different resistance values between 90,000 ohms and 9,000 ohms (approx.) can be obtained. For ordinary receivers one of these values will be correct.

Adjusting

Begin by connecting the resistors to give the highest value—and consequently lowest voltage—as shown (90,000 ohms). Plug into the mains and switch the receiver on. If results are rather weak, withdraw the mains plug and re-arrange the resistors to give the next highest voltage. Proceed in this way, gradually lowering the resistance (and increasing the voltage) until the receiver works in the usual way. The resistors are then left alone.

Important Notes

Do not make any alterations to the connexions without first withdrawing the mains plug.

With this type of unit, one mains lead is connected directly to H.T. Minus, and consequently Earth, on the receiver. So if an earth lead is used on the set, connect a 500 volt, .1 mfd. condenser in series with it to avoid earthing the mains. It is a good plan to join a similar condenser of about .0005 mfd. in series with the aerial for the same reason.

No connexions or metal parts should be touched when connection is made to the mains. If they are, tingling or smart shocks may be felt.

For One-Valvers

One-valvers consume so little current

(Continued foot of pag 102)

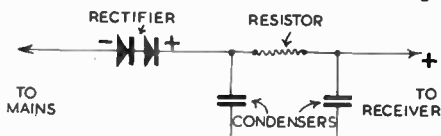

Fig. 1—Theoretical circuit of the eliminator

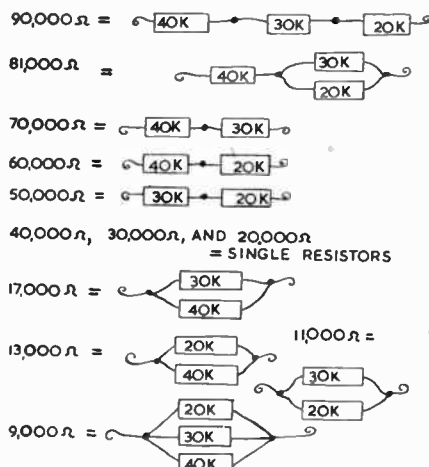
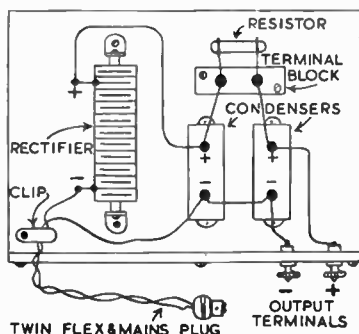

Fig. 3—How the resistors can be connected

SOME USEFUL HINTS ON THE CARE OF TOOLS

It has been said, with a great deal of truth, that the quality of a workman can be judged by looking into his toolbox and studying the storing and condition of his tools. Shoddy tools indicate shoddy workmanship, and lack of care can lead to waste of time and money for repairs and sharpening.

Take the case of saws. There is a rule applying to saws that applies to all tools. Never allow them to knock against each other. It is a simple matter to take a piece of wood the same length as the saw blade and about 1 in. by 1/2 in. across and use the saw to cut a groove right along the length of the wood. When you have finished using the saw put this protective strip of wood over the teeth, secure it with string or elastic bands, and your saw edge is safe from accidents.

Cutting Tools

Chisels, gouges, drills, etc., can have their life lengthened by being placed in green baize or canvas wallets sewn up to make pockets for each tool. This practice should also be carried out with files and rasps.

A file, especially a big one, appears to be a sturdy tool for heavy work and is often allowed to jostle about in the toolbox among its fellows. But if you examine a file carefully you will see that it has a multitude of small teeth which rough usage can break off, thus reducing the efficiency of the file.

Planes, when laid aside, should always be placed side downwards on the bench so the protruding blade and the smooth sole do not get damaged. When stored away, planes should have their blades withdrawn either completely or above the level of the sole.

Marking Tools

Scribers, marking knives, dividers, and all other pointed tools should be protected with small corks stuck on to the points. Incidentally, the heat generated in scribers and dividers when sharpened on an emery wheel is sufficient to remove the temper from their points if too much pressure is used.

It is a lucky man who has an emery wheel at home but he should use it carefully. Above all, never grind brass

or other soft metals on it or he will fill the stone and spoil it for good work. Save your emery wheel for drill sharpening, but for those fine points and blades mentioned above a frequent touch on the oilstone is much better than grinding.

The oilstone, by the way, is often sadly neglected. Keep it clean, keep it well filled with oil or vaseline. Never use it in the dry condition, and always make a little lidded box for it to rest in.

Put small wooden blocks, end grain uppermost, at each end of the stone and flush with its surface.

This stops chisels and plane irons slipping over the end of the stone and chipping the blades or the stone edge. The stone should be watched for wear. Try to use the whole surface and prevent it being hollowed in the middle.

There are enough hints and workshop "do's" and "don't's" to fill several books; these little bits of advice have been gathered by craftsmen with years of experience. But care of tools is really based on commonsense and you should learn to do the right thing at the right time by seeing how the things that you read can be applied to other equipment.

Novel Clothes-Peg Ships

How would you like to own a conveyance of realistic miniature model ships? It is really quite simple; you



need some straight clothes-pegs, a penknife, a very small saw, some glue and some paints. With these simple things you can make all sorts of ships—liners, tankers, cargo vessels, tramps and warships—that will float.

To make a ship, cut a peg into sections (as illustrated in the drawing) with the small saw which can be a fretsaw or a junior hacksaw. The largest piece of the peg is used for the hull of the ship and the raised portion in front acts as the forecastle.

The small superstructure at the stern is made by cutting a small piece from the other leg of the peg and gluing it in position on the deck at the stern. The superstructure amidship is also made from a straight piece of the peg and is glued in position.

Superstructure

The bridge and funnel are cut to shape with a penknife, smoothed with glasspaper and glued in position. If your ship is intended to float in water you should use waterproof glue for sticking the parts together. After the glue has dried, the

bow of the ship should be tapered with a penknife and the stern should be rounded. If you want to make a very good job of your ship the wood should be rubbed smooth with fine glasspaper before painting.

The masts (pins or small headless nails) should be fastened into the deck before painting, and a flag should be made from some paper and a small pin for fastening at the stern. After assembling all the parts the ship is ready for painting. It can be painted any colour to suit the type of ship. The paint should be thoroughly dry before the ship is launched.

Several Types

The ship in the drawing is a simple example of only one of the types of ships that can be made from clothes-pegs. Alterations can be made to the deck details and superstructure, and the number of funnels to fashion other types of craft. Do not, however, make the ships top-heavy or they will not float on even keels.

Make the simple model illustrated first and you will soon decide how to make other types. You will soon be able to make many easily and quickly and of all kinds.



Rectifier Unit—(Continued from page 101)

that an additional resistor of about 100,000 ohms will probably be needed, as usually only about 60 volts are required for these small sets.

Push-Pull Output

A very few larger receivers are made with push-pull output instead of an ordinary single output valve. No ordinary rectifier unit will work properly with these sets because the current

fluctuates continuously. The only way to alleviate the trouble is to use large smoothing condensers, when fair results can be obtained.

With sets which consume a fairly large current, or give high amplification, a background of hum may be heard. This can be removed for all practical purposes by including a Smoothing Choke in series with the resistor. Small sets do not need this choke. It can always be

added afterwards if hum is present.

If the mains point where the power is taken from does not have a switch, it is worth while inserting one in the lead which goes to the negative tags of the condensers (e.g., in series with one mains-plug lead).

To connect the unit, remove the red and black plugs from the receiver battery leads, and form loops which can be fixed under the terminals, Fig. 2.

Colour changes and charming views obtainable with A TOY POLARIZER

THE writer, looking over an accumulation of articles recently, came across a pattern of a polarizer, originally modelled as a toy. As it proved an object of some interest, perhaps a resurrection of it for the benefit of some young readers may not be unwelcome. Without dealing with the subject of polarized light it may be mentioned that certain articles viewed through it, present a variety of gorgeous colours, quite a pretty sight. As the article can be made up from scrap bits of fretwood and glass, it would form an interesting job for the dark nights, and a change from the usual hobby.

The Holder

The holder, Fig. 1, is a shape of $\frac{1}{2}$ in. fretwood to which a disc of similar wood is fitted, to rotate. To get out the holder, strike a line down the fretwood, and on a centre, near the top, strike a $2\frac{1}{2}$ in. diameter circle. At $2\frac{1}{2}$ in. below the centre of this strike the smaller circle. Join the two with the curved side lines and saw out. In the centre of the top circle saw out the 1 in. square hole shown.

On similar wood strike a second $2\frac{1}{2}$ in. circle and an inner concentric one of $1\frac{1}{2}$ in. diameter. Cut out a 1 in square hole in the centre of this also, then, with a fine saw blade, saw round the inner circle. Do this very carefully, as this inner circle, or disc, must be able to rotate freely in the outer ring left.

Fix this ring to the holder, place the disc in and keep it there with small metal clips screwed round, as shown in the diagram. In fact, the screws which hold

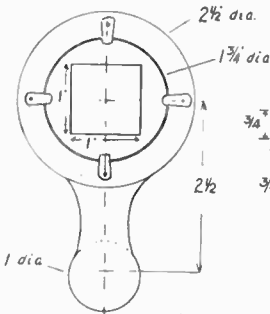

Fig. 1—Shape of holder

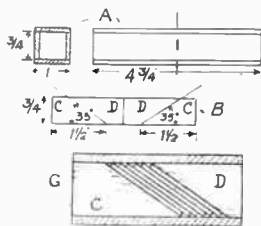

Fig. 2—Making the square tube

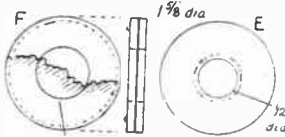

Fig. 3—Details of the eyepiece

and saw them across, both on the angle lines and across the centre, leaving $\frac{1}{4}$ each of (C) and (D).

Take the two square tubes, and on the inside glue parts (C), one each side, taking care that these parts are placed facing each other, that is at (C) in section (G) (the left side), and at the right in the second square tube. On these some pieces of thin glass, which will act as prisms to divert the light rays, will rest.

Glass Screen

Use thin glass for this purpose, old glass negatives with the films removed, will serve quite well, but window glass must suffice if nothing more suitable can be found. Cut the glass into pieces, $1\frac{1}{2}$ in. long and $\frac{3}{4}$ in. wide, 12 of them being required. Clean them thoroughly, and lay them in the tubes to rest on the inclined edges of parts (C), six glasses in each. Now glue wood pieces (D), and press inside the tubes to keep the glasses in position. The diagram (G) will make this quite clear.

For an eyepiece, cut a disc of $\frac{1}{2}$ in. wood to size (E), in Fig. 3. Bore out the central hole accurately and slightly bevel its edge outside. On the inside, glue a disc of cellophane, or clear thin plastic, just a trifle larger than the hole, then glue the eyepiece to the second tube (not that lettered (G)) at the outer end, the (G) end. This tube can now be glued in the holder. The rotating ring should be removed at this stage for fixing tube (G) to it.

The Object Glass

An object glass should now be prepared, though perhaps the term 'glass' is rather a misnomer, as no glass is used. For this, cut two discs of the $\frac{1}{2}$ in. fretwood, the same diameter as (E), in Fig. 3, and in their centres bore out $\frac{1}{2}$ in. holes, as at (F). Cut a disc of cellophane a

trifle less in size, and fix to one disc with a spot of glue. The object to be viewed by the polarized light is a scrap of mica, as that is very effective and easily obtained.

Split it as thin as possible and tear it across to leave a jagged edge, as shown in the drawing. Place over the cellophane, with its jagged edge just over the centre of the hole, then place the second disc over and nail both together, with the cellophane and mica sandwiched between. Glue this to the end (C) of tube (G), mica inside. Then glue the other end of

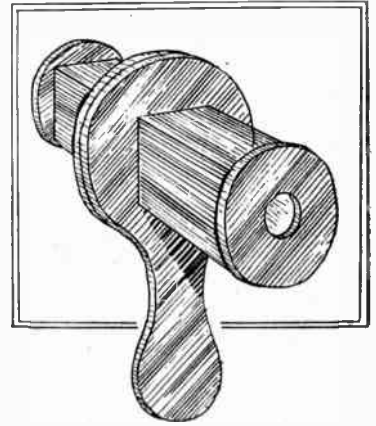

the tube to the rotating ring and refit it to the holder.

The inside surfaces of both the tubes should be stained a dead black, a job which must be done as the work proceeds, but care must be taken that no black gets on the prism glasses, or elsewhere where it is not wanted. It might be a good plan to stain all the woodwork as it is done, and before gluing and fitting commences. A black spirit stain would be the easiest to apply, as it soon dries, but if none is available in the home it is scarcely worth buying such a small quantity and ordinary black ink might serve.

Painted Outside

The outside of the polarizer can be given a coat of varnish or enamel to make it look nice. In use, the polarizer is held towards the light, with the eye of the beholder at the eyepiece, naturally.

The mica will appear many shades of colour, and if the front tube is slowly rotated, the colours will change and present some beautiful hues. Though the toy is really meant to please a youngster, it is not without interest to the older members of the family.

ROLLER FRONT STATIONERY CABINET

Kit No. 2820 contains all necessary wood strips and backing material for 14/6 from Hobbies Branches. By post for 15/3 from Hobbies Ltd., Dereham, Norfolk.

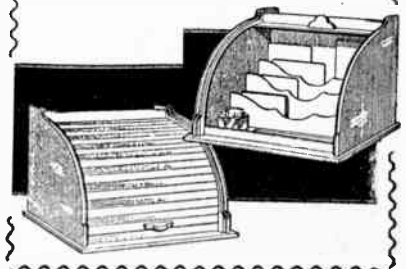

Restaurants and stores would be interested in this MENU CARD HOLDER

MANY readers would like to turn their fretsaws to profit, and, indeed, there are many ways of doing this. One way of not doing it, however, is to try, vainly, to compete with articles that can be mass-produced and sold very cheaply in big stores.

Fortunately there are, as we say, plenty of side openings, especially for 'custom built' articles, and in describing this menu-frame we believe we have touched on something that has not been overdone.

Lack of a displayed menu, outside, often leads to loss of custom as many prospective clients like to know the general level of prices before entering. An attractive menu frame such as this article describes, naturally attracts the eye.

Size for Card

The actual size of the frame will depend on the type of card usually employed by the restaurant. One of these should be obtained before starting work. The main frame is of straightforward construction and no details need be given as this has been described so often before.

We will say, however, that it is extremely difficult to attempt to saw mitres without a proper mitre-cutting block, and whilst there are a dozen and one ways of clamping the corners whilst the glue is setting, the use of one of Hobbies special picture-framing clamps will make work much easier.

Picture-frame moulding is sold, of course, with a rebate to hold the glass. In many cases a delicate frame is required, especially when framing, say, water-colours, but in the present case a

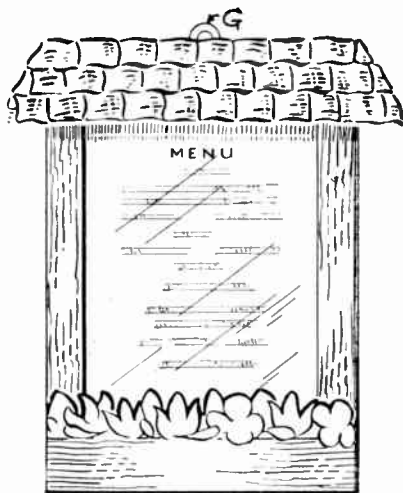

Fig. 1—Completed case with hanger

moulding of substantial section is best. When the glue has set, at the corners, a brass screw may well be driven through (see Fig. 4).

It may be necessary to add, to the back of the frame (A), extra strips (B) to form a rebate (C) for the plywood back (D). The glass (E) is dropped in, then the menu card, then, possibly, a piece of card backing and finally a plywood sheet. The plywood back comes flush with the back of the frame (with its extra rebate). Two small button catches (F) are fitted, top and bottom (i.e. four in all) to the back of the frame so that the plywood back can be held, but easily removed so as to change the card in the frame. A mirror plate (G) is fixed to the top at the back so that the frame may be hung up.

From the illustrations it will be seen that there is a roof (H). This is made from plywood or plastic sheet. A bevelled strip of wood (J) is screwed to the top of the frame and the roof screwed to this. This roof might also be made of metal and could easily conceal a small electric light so that the menu card could be read, outside, at night.

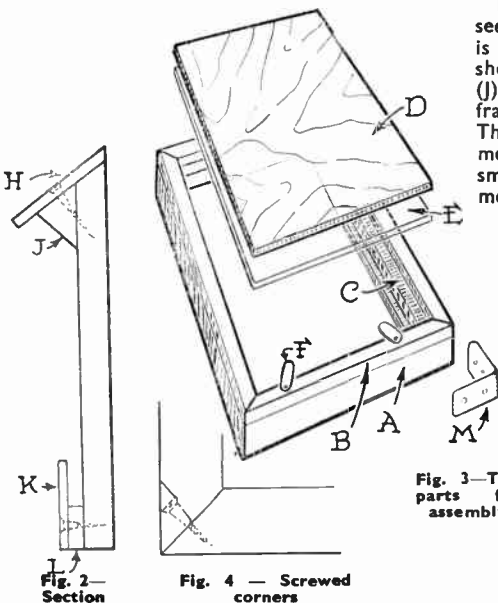

Fig. 3—The parts for assembly



Fig. 5—Half flowershape

The 'window box' is, of course, just a flat cut-out plywood shape (K). Fig. 1 shows a rather 'free'



Fig. 6—Twisted for effect
104

design of flowers, but Fig. 5 shows an easy way for a nonartist reader to overcome any difficulty. Take a long strip of paper 2in. wide and pleat it into 1 1/2 in. folds, accordion fashion. On the front draw the half-shape shown in Fig. 5. Cut this out with scissors. When the paper is opened, a string of flower shapes, on the paper-doll principle, will be found (Fig. 7). These can be laid on the wood and traced round.

Overlapping Design

It is possible to trace them off again, moving them to the right, half a position, and a little lower. Fig. 8 explains, better than a lot of words, what the cut-out wooden strip will look like. It cannot, however, show the pretty effect of the flowers in colour. These are painted bright red, yellow and blue. Before painting, however, give the exposed edges of the plywood a good coating of shellac, or similar, varnish. Take care not to have the projections too delicate.

If the reader is proficient in cutting metal with a fretsaw, a reasonably stout strip of, say, copper may be used for the 'window-box' front. The petals may then be given a slight twist as indicated in Fig. 6. Bright enamels are needed for the painting.

A Spacing Piece

In fixing the 'window-box' strip, a packing strip (L) is first applied. This will give some depth, but it should not be too thick. Brass or copper corner plates (M) can, optionally, be fitted to the corners of the wooden frame. In fixing on the site, try to get a reasonably sheltered position, one which, though easily seen by passers-by, is sheltered by a doorway.

Other refinements will suggest themselves. For example, the name of the restaurant could be written on the front of the 'window-box' or on the roof. If the main frame is in oak, it can be left natural colour. The roof can be painted red and the window-box, green. The rest of the frame, if of a softwood, can be painted green, too.

If you make one of these Holders as a specimen you can offer it to the owner of a restaurant or cafe with the suggestion you can make others if he wishes. Price should not be too high, but must more than cover cost of materials.



Fig. 7—Strip decoration



Fig. 8—Overlapping designs

Books to Read!

Of the books recently published, those reviewed below are of particular interest to our readers. Price and name of Publishers are given for the convenience of those unable to obtain the books from their usual newsagent or bookseller.

Modern World Book of Railways

by Paul Townend

THERE is not, we guarantee, a man or boy of any age—who could read, that is—who would not continue to read and study this amazingly interesting book once he had opened it up. Its very cover—painted by the famous artist Cuneo—starts it off, and the contents just hold the interest inside. No stuffy technicalities, mind you, but plain honest attraction in large pictures, and plain reading to cover every activity in railways. Not only the usual parts on Stations (all over the world) or types of Locomotives, or the people who 'run' a railway, but lots of unusual material on new lines and full of fascination. Some of the 17 chapters deal with damage and repair of the war blitz, how railways began, story of a goods train, etc. Whether it tells about the rack and pinion railways of Switzerland or the amazing monsters of America (and not only U.S.A.) an enthralling story of railways is told in word and picture. The 300 illustrations are large and clear and include eight full pages of quite beautiful colour plates. Any father could buy it for his son to read himself!

Published by Sampson Low, Marston & Co. Ltd., 25 Gilbert Street, Oxford Street, London, W.1—Price 8/6

The Model Shipbuilder

by Commander J. K. D. Hutchinson, R.N. (Rtd.) and Commander Gerald G. Portch, R.D., R.N.R. (Rtd.) A.I.E.E.

WE can thoroughly recommend this book for any one at all interested either in ships or model work. It is ideal for the really keen beginner, because it explains the processes in such a thorough and yet easy manner, evidently by people who have done the actual job themselves. The book is well bound and printed, and so will stand the usage and frequent reference it will receive by the owner during working periods. There are 100 pages of practical information, with clear diagrams and helpful photographs, all providing really practical information. The book deals with making three floating models—a Destroyer, a Coaster, and a Motor Boat. The authors are not only practical modellers themselves but have had a lifetime at sea so that there is a background of real knowledge behind what they tell. The whole process is made out step by step whilst large sheets of plans are folded into the pages which give scale drawings of shapes and parts. And, what is more, details are given how

to use scale drawings for your own needs.

Published by G. Bell and Sons Ltd., York House, Portugal Street, London, W.C.2—Price 12/6

Woodturning for the Beginner

by A. Macbeth

MORE and more of our readers are finding the enjoyment of the lathe and the frequent letters we receive prove the need for just such a book as this. The craft of turning wood has been enjoyed since Biblical times, for the Ancient Hebrews are known to have undertaken the work, and even now primitive types are seen in the Bazaars of India and Egypt. The modern type of lathe, of course, is very different and can be driven by a self-contained fractional horse-power motor attached or near the machine. The average amateur, of course, is content with the treadle-driven type, such as the Hobbies Lathe,

and can turn up a wide range of really useful things—if he does the work properly. And this book tells you how. The 94 pages are really comprehensive in their advice, and are for the real beginner. General descriptions are first dealt with, passing onwards to tools and timber to the actual turning, finishing and polishing. Finally a range of useful simple objects is provided, so one can make serviette rings, table lamps, wheels, handles, egg cups, letter racks, etc.

Published by Percival Marshall & Co. Ltd., 23 Great Queen Street, London, W.C.2—Price 3/6

101 Things for the Housewife to Do

by Lillie B. and Arthur C. Horth

WE offer no apology for reviewing a book of this type in our pages. A large number of our readers are of what used to be known as the weaker sex, but apart from that the information it

With Pictures and Paste

BOOKS are so much part of our everyday life now, it is difficult to imagine the times when they were a luxury. One even had to compile one's own books, indeed, and the making of scrap books was a popular hobby at the end of the last century. But although we have more books now, the collection of scrap books can still be equally interesting. Large books with plain white leaves are suitable, from which every other page is cut about $\frac{1}{4}$ inch from the binding. Then a wide range of pictures of all kinds can be cut, with or without captions, and pasted to the pages to fill their whole space. Pictures can be all colours, small and large, with irregular shaped edges. They are stuck quite close to each other, and even overlapping a little if necessary. Coloured pictures can be used, and a good quality gum or paste is essential so it may not go bad and smell. An example of what can be done in this pleasing, quiet and inexpensive pastime is shown in the picture. Mrs. Tina Tims of Bloxham Rd., Banbury, has 16 scrap books, from small 16-page efforts to 80-page volumes containing over 1,000 pictures. Christmas card symbols, coloured magazine pictures, little pictorial advertisements all help to make a pleasing pastime, and an interesting collection to 'read'. Paste, patience and pictures, are among the needs.



Photo by Blinkhorns, Banbury

contains is of real value to any man in the home. It does not deal essentially with the more feminine needs such as cooking, needlework, etc., but covers all those things which the busy housewife usually passes on to the male of the house. There are details of pelmets, table and window gardens, shelving, modelling, household electrical apparatus, repairing pots and crockery, staining, polishing and painting, to mention only a few of the vast amount of information contained in its 200 pages. Moreover the large clear type is equalled by plain, readable drawings and details. Just the sort of book, indeed, the kind domestic husband can present to his wife, knowing that he will probably have to make use of it most—and enjoy it.

Published by B. T. Batsford Ltd., 15 North Audley Street, London, W.1—Price 7/6

House Repairs

by James Henry

THIS is another of the popular Home Mechanic series which should be on any handyman's shelf. The careful householder should, for his own sake, take a pride in seeing that everything is ship shape and in order. Dripping taps, falling plaster, blocked drains, overflowing cisterns are all very annoying and the handyman can save a lot of unnecessary mess and labour by undertaking what is very often a simple repair job. This book provides knowledge for the handyman offered by practical men who have specialized in home repair jobs. The printed details are made more understandable by clear diagrammatic drawings, which anyone can understand. The subjects dealt with include inside and outside draining and water supply, hot water systems, burst pipes, painting, staining, floor and ceiling work, brick work, glazing, etc. The book is strongly bound and would, undoubtedly, be worthy of a place on the shelves of any

handyman. Even if not wanted for immediate use it is the sort of book to have handy for reference on those occasions when quick action has to be taken to overcome troubles which arise periodically even in the best regulated home.

Published by C. Arthur Pearson Ltd., Tower House, Southampton Street, London, W.C.2—Price 5/-

Book of Football for Boys

THERE must be a very large number of our younger readers to whom this attractive book will appeal. Its pages cover both soccer and rugby and contain an amazing amount of interesting information, a number of amusing cartoons, articles by experts, photographs of great players, exciting stories and even the full size lay-out of two pleasing dice and board games, which are printed on the stiff covers. The articles of the games tell how to play, hints for goalkeepers, how to watch a game, in case of injuries, whilst most interesting facts are given of history of the games, great players and referees, and the usual sing-song business before the big games start. A book with a wide range of interest, indeed, and one we can recommend to any young follower of the game.

Published by Horace Marshall & Son Ltd., Temple House, Temple Street, London, E.C.4—Price 8/6

Speed on Wheels

by Sir Malcolm Campbell

SOMETHING of the tremendous thrill and exhilaration of travelling on land at 300 miles an hour is experienced as one reads of the exploits, the dangers, the irritations and the anxieties of the author. The pages provide a glorious build-up of how his life progressed with

his enthusiasm and attainment of higher and higher speeds. The story begins with a warning and a fine by a magistrate in the hope that they would be a lesson against cycling 'to the danger of the public' at 27 miles an hour. As the author says, he never did learn the lesson, and finished with a record of driving at over 300 miles per hour. This wonderful piece of progress in one lifetime is told in simple language, with photographs, and without egotism. The quaint pieces of mechanism which competed in the first London-Brighton run of 1896 seem to bear no relation to the beautiful stream-lined brightness of the last Blue Bird. Any more than comparison could be made between the 1907 record of 121.5 m.p.h. attained by a steam car at Daytona Beach with the 394.20 m.p.h. record by Cobb in his Railton in 1947. A most interesting book telling a plain story of exciting progress and triumph attained by care, patience, hard work, foresight and enthusiasm.

Published by Sampson Low, Marston & Co. Ltd., 25 Gilbert Street, Oxford Street, London, W.1—Price 7/6

Punch and Judy Puppet Book

THE pastime of puppetry grows in popularity as proved by the interest shown in our own recent articles. This book is a novelty in providing the cut-out figures and parts in bright colours so one can build a miniature Punch and Judy in card and then carry out a complete show from the script provided. Complete instructions are clearly printed, and the gaily printed card is simple to cut and fold and glue as explained. A novelty which, undoubtedly, will appeal to those who want to stage an original entertainment for home amusement.

Published by the Medallion Press Ltd., 5 Dowgate Hill, Canon Street, London, E.C.4—Price 3/-

Bottle Lamp Finish

WHEN making the Electric Lamp in the 'dimple' or odd shape bottle as explained recently, a good idea is to cover the outside glass with a coat of glue and sprinkle with sawdust. When dry the surface can be painted any bright colour according to taste, so making an even more attractive article.

Nail Box Hint

HERE is a small hint which might be useful to readers. Everyone knows the trouble of getting small nails and screws out of ordinary nail boxes. By

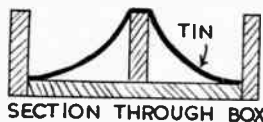

cutting a piece of tin to the sketch, the difficulty can be overcome. The width of the slots in the tin correspond with the

thickness of the partitions in the box, the tin being bent to shape as shown.

A Picture Hanging Tip

WHEN pictures, especially small ones, hang crookedly—you need only a piece of glasspaper and about two

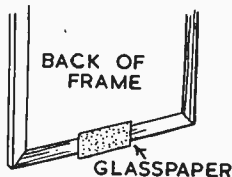

tin-tacks. Tack the piece of paper to the lower edge of the frame at the back lower edge (see sketch) and when you hang it up it will not slip.

Mending Legs

HERE is an interesting tip for mending table and chair legs, if they become broken. All you require is a piece of dowelling about 3/4 in. or 1 in. in

diameter, according to size of leg, and some glue. Where it is broken, bore a hole down the leg with a bit the same size as the dowel, and also through the top part. Next drop some glue into the holes and put the dowelling in, and then you have your job neatly finished after varnishing over.

Deadening Noise

REMEMBER this useful hint in connection with hammering and filing in the workroom which may cause annoyance to the next door neighbours. The noise is remedied by attaching a piece of rubber, as sketch, under the bench legs. This will prevent all noises penetrating through the floor. Parts of an old motor tyre in several thicknesses will serve quite well.

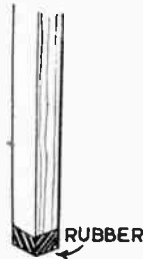

Now is the time to use your photographs as home-made CHRISTMAS CARDS

YOU, as an amateur photographer have, no doubt, often been asked 'Why you do not make more use of your hobby?' This query is sometimes followed by some such remark as 'All you have to show is just a few prints of the holidays at Tidebeach and some snaps of the family'!

Now it is very unfortunate that there happens to be a good deal of truth about these remarks and it is, therefore, a great pity more use is not made of the many negatives that are put away in boxes or drawers, wallets or envelopes. A great number never see the light of day again except, perhaps, to be destroyed.

Let us get down to brass tacks and give this a spot of careful thought for, after all, those negatives did cost quite an appreciable portion of our pocket money and there does not seem to have been much return for it.

Home-made Cards

The habit of sending out Christmas Cards to relatives and friends is a very delightful gesture and should be encouraged as a medium for passing on cheerful greetings and good wishes to those for whom we have affection or to whom we wish to express our friendship. The last few years have, however, brought about considerable advances in the cost of cards and calendars and there

is a good proposition and worth our while.

As a start it is advisable to go carefully through our collection of prints. Probably there are a few duplicates; these should be put on one side. Then you are almost certain to be particularly amused or pleased with other prints which bring back some very exciting or interesting incidents. The negatives of these should be found. Other prints might be more or less of portraits of friends and these could be considered as a third group.

Having made this selection it must be decided which are to be used for ordinary Christmas Cards and which for Calendars. This brings up the question of mounts and what can be done to obtain a supply. Well, if you happen to be in or near a town where there is a good shopping centre it may be that the local photographic dealer or stationer will have a stock of both plain cards. There are those with greetings printed at the base of the front or on the back and it may also be possible to get a few

folded or fly-leaf cards. Anyway, there is no difficulty in overcoming the mount problem as you will see from the following suggestions.

Many families, possibly including your own, have a very great dislike to destroying the cards which are received year by year. As a result of this there is stored away in some obscure corner or cupboard a parcel containing quite a quantity. If this packet is examined, there may be found some fly-leaf specimens with back leaf completely plain.

If that is carefully cut away it will serve the purpose of a simple mount very well indeed. Other specimens may have only a small amount of printing which can be quite easily 'blotted' out by pasting a sheet of plain paper over the whole surface of the card. With the idea in mind that some of these cards

can be used you will most certainly find some which will prove satisfactory.

During the war, when paper shortage was acute, another source which helped to supply some useful size mounts was the front and back fly-leaves of books,

such as novels and educational works. These sheets were usually of good pre-war quality and when pasted on a piece of white card were really excellent substitutes.

Card for calendars is a more difficult question. If you can find or know of a wholesale stationer or printer it will save much time and worry to tackle him first. This class of dealer often stocks fairly large cards of royal size, 25in. by



An attractive example of a Calendar

20in., the cost being only a few pence. Such a card is capable of making eight or even ten quite useful size calendars.

To Prevent Bending

There is one trouble, however, with this card. Known in the trade as paste board, this quality card has the bad tendency to bend when a print is pasted to it. The best remedy is to paste another paper on the back to counter the pull from the front and to place the calendar after completing the mounting under something flat and heavy.

Now for a few hints on making and finishing the cards or calendars. Many readers will have in mind the hints given in a previous article on how an enlargement should be mounted. The same suggestions apply to greeting cards. In some cases it is more important to have plenty of space below the print, otherwise the message will have to be cramped or fewer words used. If the print will permit 1in. space at top then there must be at least 2in. space below the print.

Do not overdo the wording on the



A simple photographic Christmas Card

appears no likelihood of any very great reduction in price this season. If it is possible to give better value for the same expenditure by using our own material and, at the same time making a practical use of our hobby, then surely it

ordinary Christmas Cards. Just 'Greetings from . . .' or 'Good Wishes to . . . from . . .' or some similar short phrase is all that counts. But whatever is put on the card should be done really carefully and as near copper-plate as possible. If you cannot manage the copper-plate and your usual handwriting is good then make the best of that but do not omit a few experiments beforehand.

Calendars call for rather more work and, it ought to be added, more care and thought. For remember, this is a present you are sending to a friend and it is your wish that it will be in use and in sight for not less than a whole year.

If you have an enlarger, a half-plate or whole-plate print (i.e., 8½in. by 6½in.) should be quite large enough. But if your prints are limited to 3½in. by 2½in. then you might wish to use about three of these for each calendar. As you see from the illustrations there are various ways or styles of mounting these.

Be careful not to overdo the decorative work; remember to keep this as secondary to the photographs. The actual calendars need not be too large, small ones at 3d. or 4d. look quite well on a 10in. by 8in. mount. They can be placed in position on the surface with the prints or suspended at the bottom edge of the card by means of gummed tape. Do not forget to place a gummed linen hanger near the top edge—they cost about 8d. a dozen at most stationers.

Tinting

In concluding this article we must also draw the attention of all who are interested in the work to the charming effects that any one can produce on both cards and calendars with a few dabs of phototints. It is most surprising how easy it is to use the tints and how very pleasing the work becomes.

First make the drawing with a lead pencil, a sprig of holly or mistletoe.

Then go over the leaves with dark or light green as the case may be, followed by a spot of red for the holly and white for the mistletoe berries. The word GREETINGS can also be shaded with colour to give another effect or if desired a thin line about ¼in. thick could be drawn in red round the border of the card.

This branch of the work could, of course, be extended on the calendars because of the extra space and the prints could also be tinted. If you are able to draw or sketch, insert a small thumbnail sketch of, say, a church or cottage and use on the finished sketch a spot or two of colours and a suggestion of white ink to give the idea of snow.

These suggestions should help you to make some very successful results from those negatives which are simply waiting for an idea to turn up whereby they can be put to some practical use.

A Craftsman's Notebook

Oil

ACCORDING to my rough calculations the world must be using an average of something like 250 million gallons of oil in its various forms a day. A big total, though not surprising when one considers it is at present one of our greatest sources of power, rivalled only by coal.

Unlike coal—known to have originated from vegetation—the origin of petroleum seems in doubt, vegetable, mineral and animal matter having all been suggested. Beneath the great oilfields of America, Middle East, and elsewhere, it saturates areas of absorbent mineral formations. Borings may be over a mile deep, and there have been occasions when liberated gasses and oil has come gushing out with such force as to blow away the surface erections.

As drawn from the ground petroleum is dark brown or yellowish in colour with an unpleasant odour. It is directed into great tanks, thence to distant ports or refineries. Transporting the huge volume is simplified by the pipelines which sometimes stretch for hundreds of miles, with pumps at intervals. Pipelines to the coast completed in Iraq 15 years ago total 1,150 miles, with a capacity of four million tons a year.

From the petroleum oil eventually emerges petrol (about 40 per cent), paraffin (about 10 per cent), heavy fuel oil for diesel engines, different grades of lubricating oil, and all the valuable by-products such as vaseline and wax.

Topiary Chessmen

IMAGINE a set of chessmen about 12ft. high. There is such a set in the grounds of a large country house. The feature of these knights and pawns and

other pieces that is more remarkable than their size is the fact that they have been cleverly shaped from standing yew trees.

This interesting collection is one of the more unusual examples of the art of topiary—a craft, practised as long ago as the sixteenth century, which calls for as much or even more skill and patience required by the game of chess itself.

Animals and birds are popular subjects for topiary, and only a short time ago I was pleasantly surprised to see five or six such shapes by the roadside near a village. Chairs, tables, giant mushroom-rooms, and all sorts of ornamental ideas are possible.

Yew trees are particularly suitable for the work, but box, holly, and hawthorn are also adaptable, so amateurs who fancy trying their skill may have a suitable shrub on which to practise in their own garden. Actually the work has to be put in hand when the tree or shrub is young and a wire framework of the desired shape provided to train the shoots into a rough form for trimming.

Housing the Rabbits

TO be healthy and contented, rabbits need good living quarters. Roomy hutches will be appreciated, about 2½ft. wide by 2ft. from front to back and 18ins. high being regarded as the minimum for a full-size rabbit.

Hutches should be raised from the ground or floor and situated where adequate light and air will reach them, in a shed or against a sheltering wall if outside. Draughts and damp are things to guard against, outdoor hutches having a sloping roof for drainage and covered with roofing felt.

The occupant must have protection

from the weather, in summer and winter and on cold nights. So about half the front is best fitted with a plain door or boarded off to provide a snug retreat behind which it may sleep or escape into the shade or shelter from wind and rain. A sack over the front, allowing for ventilation, will keep the rabbit warm and comfortable on cold nights.

Cleaning-out is necessary once a week at least. Peat moss makes good bedding, so does straw for older rabbits. Sawdust and wood shavings are also used, but are unsuitable for the garden and ought to be burned.

News in Brief

A LETTER in a bottle thrown into the sea by a boy at Whitby led to a pen friendship with a boy who picked it up in Holland.

In previous notes, mention has been made of the giant redwood trees. Well, as an illustration of their size, in the grounds of an English country house recently open to the public there is a summerhouse from one log of the species.

To get an impression of the height of these trees—some of them over 250ft.—one could imagine them in comparison with Blackpool Tower, which is 518ft.

Visitors to Blackpool, by the way, can now post their cards in a letter box installed at the top of the Tower. And, of course, the cards are suitably franked to show where they were posted.

I hear that America's latest in cameras will automatically develop and print the snapshots while you wait—and it only means waiting a minute or two at that.

Gathered together for exhibition a short time ago were some ninety English clocks made between 1510 and 1840. Valued at £50,000, there were unique examples from private and other collections all over the country.

You will get better results if you carry out the hints of this TOYMAKING WISDOM

A well-made toy is realistic, sturdy and readily constructed.

Realism is far more a matter of getting general outlines correct than the including of an amount of small detail.

Realistic bases for models like windmills, certain cranes and houses are made by painting the wood with glue and sprinkling with sand.

This type of finish is ideal for fort walls and for miniature paths. Pieces of cork, small stone chippings and similar materials can be used readily with glue painting.

When building up imitation loads for model trucks, with small lumps of stone, etc., the pieces must first be immersed entirely in the glue. Using a touch of glue here and there is seldom successful—the pieces easily breaking away.

Where wood has to slide upon wood or wood upon card, as is the case generally with the axle of a toy windmill, better running can be obtained by rubbing the surfaces with candle grease or blacklead, an ordinary soft blacklead pencil being used for this.

If a very small item has to be put on a toy and held by a small screw it should be bored first and this hole can often be more safely made by using the tip of a red-hot knitting needle. This quite prevents the wood splitting, which is always a danger with even the best drilling apparatus and tiny pieces of wood.

To make chimneys, etc., sit well on boilers of toy engines they must be hollowed out to suit the curvature of the lower wood and this is best effected by wrapping glasspaper over a round ruler or piece of dowel and rubbing the end on this till the desired degree of inward curving has been obtained. A touch with a hot poker is good in starting the hollowing.

Bellows (continued from page 99)

its passage lifts the leather valve. Then when the bellows are again closed the weight closes the valve and the air is thus forced out through the nozzle.

It will be observed that the whole valve mechanism can be taken out of the square hole in the back of the bellows by removing the four screws, as seen in Fig. 5. Soft pliable leather, two pieces 14½ ins. by 5 ins. are required, and cut to shape, shown in Fig. 1, right hand diagram. Allow at the wide end of each piece a narrow margin for lapping and gluing.

Glue and temporarily nail the tab at the handle end of the pieces, and

To ensure an absolutely clean edge when cutting such things as building sections and picture blocks, it is good to first cut along the lines with a sharp razor blade used against a steel ruler and then finish the dividing with a fine saw as usual. This eliminates entirely the danger of minute pieces of wood coming away on the outer surfaces. The cuts with the blade need not be deep, just enough to pierce the 'skin'.

When painting over cardboard the colour is apt to take patchily, some parts being quite bright and glossy while others dry with a rough flat surface. This is because the paint sinks in more in some places than others and the trouble can be overcome by giving the whole area a good coat of shellac—and letting it dry out thoroughly—before applying the paint. The shellac need not be in very strong solution but must be put on evenly with a fairly wide brush.

Those very small pins, often referred to as 'spikes' as sold for model railway work and aero-modelling can be very useful in ordinary toy-making. They are stiff and can be obtained as short as a ½ in. and have the advantage that they can be pushed home without bending. A series put at close intervals along a seam make an exceedingly tight joint and they are, therefore, very useful for fixing thin borders and in the making of cardboard toys where edges have to be held firmly together. A packet of these should certainly be in a toy-makers' kit.

Never despise card as a medium for making indoor toys and models. Correctly put together any small item in this material is as strong as one made of wood. The main thing is to have cards of varying thickness to hand and also—this is very important—have some good method of cutting clean-edged parts. A sharp razor blade of the one-sided type used with a

steel rule is ideal for this. The cutting must be done on something very firm, a fine-grained block of hard wood doing well for the purpose. As only the tip end of the blade is used this can be kept keen by an occasional rub on an oil stone or other sharpener.

Wheels are such an important part of run-about toys that some workers think it best to buy these—especially as certain firms are now turning them out cheaply in wood and metal from lin. diameter onwards. People who like to make every bit themselves' will find it possible to cut discs from discarded round poles. The slices are cut on the generous side to start with and taken down to the desired thickness by rubbing flat on glasspaper over something firm. Centres are found by placing a compass against the edge and striking marks where the pencil touches the circumference. Move the compass to one of these points, swing again and make two new marks. Join with a fine line the opposite points and where the lines cross is the exact centre.

Discarded household, and other items, are often found useful for working into toys. Thus cotton reels with the bottom lip pared off make excellent funnels for engines, while boot-polish tins carefully centred and painted are good wheels for heavy-type trucks. Again postal tubes make fine boilers, bodies for windmills and towers for certain types of cranes, powdered soap cartons serving the same purpose for larger toys. Old glass photographic negatives with the film washed away do well for windows in doll's houses, while strips of mirror cannot be beaten for imitation water troughs on model railways. Glass beads with a black-headed pin to hold them are the most realistic eyes for toy dogs and other animals. The list of 'things that will do' is almost endless and the good toy-maker thinks it no loss of face to be always on the look-out for such ready-made items.

between them, and then carry the leather round both edges at each side, gluing it and nailing closely with round-head brass nails. Keep the leather stretched evenly with the handles in the open position, and finally finish off at the

Be sure to read our Advertisement Pages; there is much in them of special interest to handy-men and hobbyists. Mention Hobbies Weekly when answering, please.

nozzle end with an extra strip of leather where needed.

The overlay, on the front of the bellows, after being drawn out and cut as mentioned, is glued to the wood and one or two round-head screws inserted to make a close fit. The backing, seen between the frets of the overlay can be finished with the matting tool or left plain and stained to give contrast.

The strap-like design can be emphasized by carving in the recessed parts, as shown, while the rounded parts of the work can be carved in with a sharp pocket knife or small chisel.

MISCELLANEOUS ADVERTISEMENTS

The advertisements are inserted at the rate of 3d. per word prepaid. Name and address are counted, but initials or groups, such as E.P.S. or £1/11/6 are accepted as one word. Postal Order and Stamps must accompany the order and advertisements will be inserted in the earliest issue. Announcements of fretwork goods or those shown in Hobbies Handbook are not accepted. Orders can be sent either to Hobbies Weekly, Advert. Dept., Dereham, Norfolk, or Temple House, Temple Avenue, London, E.C.4

STAMPS FREE !! Twenty unused (2½d.).—G. H. Barnett, Limington, Somerset.

STAMPS ! Free with approvals. 25 different Japan. Postage 2½d.—Martin, 426 Dewsbury Road, Leeds.

STUDENT'S (electric) Theatre. Model outfit, 15/-. Details stamp.—Streeter, 28 Halesworth Road, Sheffield, 9.

SEND to Shiner, for good approvals of all kinds. Nothing free, only quality and class.—Shiner, 25 Myrtle St., Bristol, 3.

50 foreign and 25 Empire stamps (all different), free to genuine approval applicants enclosing 2½d. stamp.—Howard, 220 Charter Avenue, Coventry.

WANTED—Hobbies Weekly, dated April 10, 1946.—Keight, 159 Fairfax Drive, Southend-on-Sea.

MAKE wooden daffodils; design and sample petal, 1/6.—BCM/Easiplan, London, W.C.1.

MINIATURE models of London Monuments. Made in wood from patterns and instructions. Complete 24p. book, 2/- (posted).—Hobbies Ltd., Dereham, Norfolk, or branches and ironmongers.

STAMPS—30 assorted world free. Send 2½d. stamp for attractive approvals, large pictorials, Air Mails, Triangulars, etc., from ½d. upwards.—C. Allen, 4 Allington Terrace, Bridport, Dorset.

GRAND surprise packet of valuable stamps, free to genuine collectors requesting approvals, and sending postage.—Woolcock, Brampton, Cumberland.

CASTING moulds for lead soldiers, Indians and cowboys, animals and novelties. Sample mould, 4/-. Catalogue, 6d.—G. F. Rhead, Thurston End, Hawkedon, Bury St. Edmunds.

FRETMACHINES save time and increase output. Ideal for toy making, metal work, model making or light woodwork. From 70/- to £10. Ask about Hobbies at Ironmongers and Branches. Leaflet on request to—Hobbies Ltd., Dereham, Norfolk.

SMALL Metal Planes—for model smaking and miniature work—3½ins. long. All-steel, 1/9. No. 1, in cast metal, 3/-. Postage 4d.—Hobbies Branches or Hobbies Ltd., Dereham, Norfolk.

JUNIOR-type hacksaw with blade, 1/3 post paid. Modern handbag/purse material, 2 mm. thick, beautiful P.V.C. embossed sheets. Samples, illustration, step-by-step instructions, 1/-.—G.F.P., Raglan, Spencers Lane, Melling, Nr. Liverpool.

GANDHI Memorial Issue and 25 different stamps free. Send 2½d. postage. Request approvals.—W. O. Took, 2 Cowper Street, Hove, Sussex.

FREE—Behawalpurs. Geo. VI. discount approvals, ½d. upwards. Postage.—Bishop, 40 Marine Parade, Hythe, Kent.

PLAY as you earn, with our waxcraft and Perspex construction kits, compendiums. Cement, polish, brooch bases, pins, wax, tools, Perspex, etc., available. Catalogue, 6d.—Plastics Home Products, 18 St. Mary's Road, London, N.9.

HANDY glasspaper block, spring grip handle. 3ins. long, 1/3, 5ins. long, 2/3. Hobbies Branches and Ironmongers or from Hobbies Ltd., Dereham, Norfolk.



SOLID LEATHER BRAND NEW ARMY JERKINS 12/6
Post etc. 1/3
Lace up models for ladies. 12/6. Post, etc., 1/3.

A first grade supple solid leather jerkin. Full army regulation quality. Worth £5. This warm garment made for the New Zealand forces will last many many years. Can be worn over or under jacket or as a separate garment. Ideal for golf, motoring, sports or hard wear. State chest measurement. Buy NOW. No Traders. Brand New.

GENUINE EX-RAILWAY AND SHIP HEAVYWEIGHT TARPULINS
GUARANTEED WATERPROOF, 70 sq. ft., 20/-, 2 for 39/-. 4 for 77/6. 140 sq. ft., £2 10s. 0d.; 280 sq. ft., £5; approx. 360 sq. ft., £6; approx. 720 sq. ft., £12; all including carriage. Medium or lightweight if desired. W.D. BINOCULARS, TELESCOPES, TENTS, MARQUEES, CAMPING EQUIPMENT. SEND FOR BUMPER LIST. MONTHLY TERMS ARRANGED.

HEADQUARTER & GENERAL SUPPLIES LTD. (HOB)
196-200 Coldharbour Lane, Loughborough Junct., London, S.E.5.
Open all day Saturday.

WONDERFUL HOBBY!

Casting—
ORNAMENTS, TOYS, etc. etc.

You can easily make these yourself.

Illustrated Catalogue of 700 Moulds, with instructions, 9d. post free, plus latest lists of Rubber Moulds.

COCK OF THE NORTH MOULDS (D.H.)

1140 HOLLINGS ROAD, BRADFORD



New Money-Making Books for the Amateur

- ★ **MODERN WOOD TOYMAKING**
Many easily-constructed, interesting Toys
- ★ **LEAD TOY CASTING**
Including Slush and Gravity Casting
- ★ **HOME WOODWORK**
50 Useful things to make

Price 2/6 each

ALL VOLUMES PROFUSELY ILLUSTRATED

MORTIMER 215a UXBRIDGE ROAD, WEST EALING, W.13

Indispensable to all interested in motor cars.

The two popular Car Books

"WHERE'S THAT CAR FROM!"
"POPULAR CARS ILLUSTRATED"
6d. each

From all Stationers and Booksellers

or from **RALEIGH PRESS, EXMOUTH**

SPECIAL ANNOUNCEMENT

MAKE YOUR OWN JEWELLERY

We wish to advise old and new clients that we can now supply a fully illustrated Price List showing all our fittings suitable for the making of Imitation Jewellery, such as Earclips & Screws, Dress Clips, Brooch Backs, Brilliants, Pearls, Rolled Gold Wire, etc., etc. For £1 we will send a sample box of Earclips & Screws, Brilliants, Pearls, and adhesive for making up
For Price Lists please send S.A.E. to:
BOUETTE MFG. CO. LTD., 377 High Road
Wood Green, London, N.22

EXTRA CASH IN SPARE TIME



A fascinating way of earning extra cash in spare time from odd pieces of lead. Small Outlay—Large Profits. Sample mould 3/6d. Casting moulds, deep-cut and ordinary type Aeroplanes, Soldiers, Farm and Wild Animals, Cars, etc. Stamped envelope for full list. Illustrated Catalogue 9d.

MASTERCRAFT MOULDS
69, ST. MARKS ROAD, HANWELL, LONDON, W.7

£100 worth of PRIZES

FOR AMATEUR PHOTOGRAPHERS ARE OFFERED
IN JOHNSONS TWICE-YEARLY COMPETITIONS

THERE are no entry fees. The WINTER competition closes on December 31st. Pick out your best pictures, now, and try for one of these big cash prizes. Any subjects may be submitted. Landscapes, Street Scenes, Seascapes, Beach Pictures, Portraits of children and animals, Figure studies, Architecture and Travel subjects. Entries must be sent to the COMPETITION DEPT., JOHNSONS OF HENDON, LTD., HENDON WAY, LONDON, N.W.4, and must reach there before DECEMBER 31st to be eligible for the Winter Competition. Entries arriving after this date will be entered for the 1950 summer-competition. A title panel from the wrapping of any Johnson chemical must be pasted on the back of each picture. You may send in as many entries as you like. No print should be smaller than 2½ × 3½ in. Prints should be mounted, as they are then less likely to get damaged. Any camera may be used and the prints may be of any process, but you should have done the work yourself with Johnson Chemicals. Prints which win prizes are to become the property of JOHNSONS OF HENDON, LTD. The negative remains the property of the competitor. **NEGATIVES SHOULD NOT BE SENT WITH ENTRIES.** Write full name and address in block capitals on the back of each mount.

3	prizes of	£10
3	" "	£5
15	" "	£2
15	" "	£1

and TWENTY
CONSOLATION
PRIZES

each of 10/- worth
of Johnson Chemicals
which you can select
from our catalogue.

Details of film and developer used should be given. If the photographs are to be returned, you must send sufficient postage stamps (loosely attached) to cover the return postage. No correspondence should be enclosed with entries, as the packages will not be opened until after 31st Dec. The decision of Johnsons of Hendon is final.

**JOHNSONS OF HENDON,
LTD.**

TO THE GUIDE TO RAPID WEALTH!

Yes, there's money for YOU immediately in the famous "THE Guide to Rapid Wealth"—amazing book that has made scores of pounds for readers. Contents include: Mail Order—lucrative, immense, yet only Small Capital required. How 15/- made £12 Tested Money-making plans! Spare-time—spare-cash! Formulas for Fortunes. Confidential Secrets. Money makes money, the Key to Riches! For the alert a Gold-mine. There are many so-called money-making books, but not "THE GUIDE TO RAPID WEALTH". Orders despatched return Mail. Satisfaction guaranteed.

New edition NOW ONLY 10/- POST FREE send P.O. to: **"SPEEDWELL" (E-1) ALBERT ST., LOCKWOOD, HUDDERSFIELD** WILL REMOVE YOUR LIFE

YOU CAN BECOME A HANDICRAFTS INSTRUCTOR

Experience not essential

Men who enjoy making things in wood or metal can turn their hobby into a well-paid, permanent and interesting Career. Short hours, long holidays, and security in a job you would really enjoy, can be yours if you become a Handicrafts Instructor. Let us send details of the easiest and quickest way to get the necessary qualification.

We definitely guarantee
"NO PASS—NO FEE"

If you would like to know about our unique method of preparing you for one of these excellent appointments, write today, and we will send you our informative 175-page Handbook—free and without obligation. Mark your letters "Handicrafts Instructor."

**BRITISH INSTITUTE OF
ENGINEERING TECHNOLOGY**

595 Shakespeare House
Stratford Place, London, W.1

BIET

A MODEL REPAIR
OUTFIT IN THE
PALM OF YOUR HAND

TO SEAL AND MEND
AS WELL AS ASSIST
IN CONSTRUCTION

"DUREX" Tape-it!

STICKS AT A
TOUCH

SEALS WITHOUT
MOISTENING

TRANSPARENT
AS GLASS

A broken 'plane wing, a damaged kite, a cracked doll—they're all put right in a jiffy with "DUREX" Cellulose Tape. Clean and easy to handle, it sticks at a touch, is as transparent as glass and is the handiest thing in the home for mounting snaps, for sticking parcels, repairing torn books and every other sticking job.

Trade Enquiries:
Durex Abrasives Ltd., Birmingham 8

"DUREX" Cellulose TAPE

Has every Sealing Job TAPED

Daily Mail

Christmas Books for Boys and Girls

THE SUCCESS OF THE 'LOOK AND LEARN' VOLUMES

Thousands of boys and girls are now proud possessors of the two 'LOOK AND LEARN' Volumes. These superb books, beautifully printed on fine art paper are lavishly illustrated with graphic pictures in sequence with explanatory text. They cover a wide variety of subjects from Natural History to Tower of London, Early Engines, Glaciers, etc. EACH VOLUME 112 pages and complete in itself. 32 pp. in full colour. From Newsagents and Booksellers. EACH VOLUME ... PRICE **7/6**

ORDERS BY POST. If you cannot obtain your copies, send remittance of 8/- (15/6 for both volumes) to cover cost and postage to:—



OVER 700 PICTURES AND 20,000 FACTS IN EACH VOLUME

SERIES 1. *Natural History, How Stamps, Films and Newspapers are Produced, How Car Engines and Blast Furnaces Work, Olympic Games History, Indian Village Life, Looking at Paintings, Roman Britain, Castles, Whaling.* 32 pp. in colour—"The Story of America".

SERIES 2. *Natural History, Tower of London, Early Engines, The Story of Wheat, Glaciers, Look and Make, Stamps, Clocks, How Ships are Built, Shakespeare Memorial Theatre, Palace of Minos, Saxon England, Instruments of the Orchestra, etc.* 32 pp. in colour—"The Story of Australia".

These books will make grand Christmas reading—ask Dad to get them for you.

DAILY MAIL PUBLICATIONS

Dept. 934 New Carmelite House, London, E.C.4

JOB'S ONLY POSSIBLE WITH SYNWOOD No. 12

The Model was Soon Repaired

You cannot be proud of a model sailing boat if there's a great hole in the deck, or it has a splintered boom. In this case there was a hole below the water line as well. Tommy B. tacked a strip of canvas across the deck hole and covered it with SYNWOOD, which dried out hard without shrinking. Then he made a "tingle" of SYNWOOD below the under line and the result was a water-tight craft. All kinds of models can be repaired with SYNWOOD.

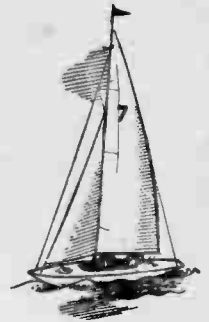

POROSAN regd.

SYNWOOD

NON-SHRINK MOULDING WOOD



Does the job in one operation; No building up layer upon layer needed. Once set IMPERVIOUS TO WATER. Sold in JARS everywhere 1 6 and 2 6, also large economy sized tins 7/6, or direct from the makers, postage 6d. extra.

POROSAN LTD., 4/5 Warwick Court, London, W.C.1
Scientific

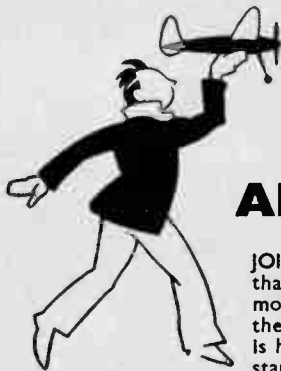

BUILD & FLY MODEL AEROPLANES

JOIN the thousands of enthusiasts that follow the modern hobby for modern youth—building and flying their own model aeroplanes. This is how so many famous designers started their careers—such as

Whittle, Camm, Mitchell, Roe, Handley Page and many others! To start you in this fascinating hobby that anyone interested in woodwork and tools should find within his power we will send you absolutely free of charge a copy of our 64-page illustrated magazine the AEROMODELLER. It comes out every month and gives help and guidance to beginners as well as information and assistance to the more expert. Packed with pictures, plans and tips. Send coupon for your FREE COPY now!

To The Aerodrome (Dept. HWI), Billington Road, Stanbridge, Nr. Leighton Buzzard, Beds.
I enclose 2½d. stamp, please send me FREE COPY of the AEROMODELLER as offered.

Name

Address

SUPPLEMENT TO HOBBIES No. 2820.

STATIONERY CABINET

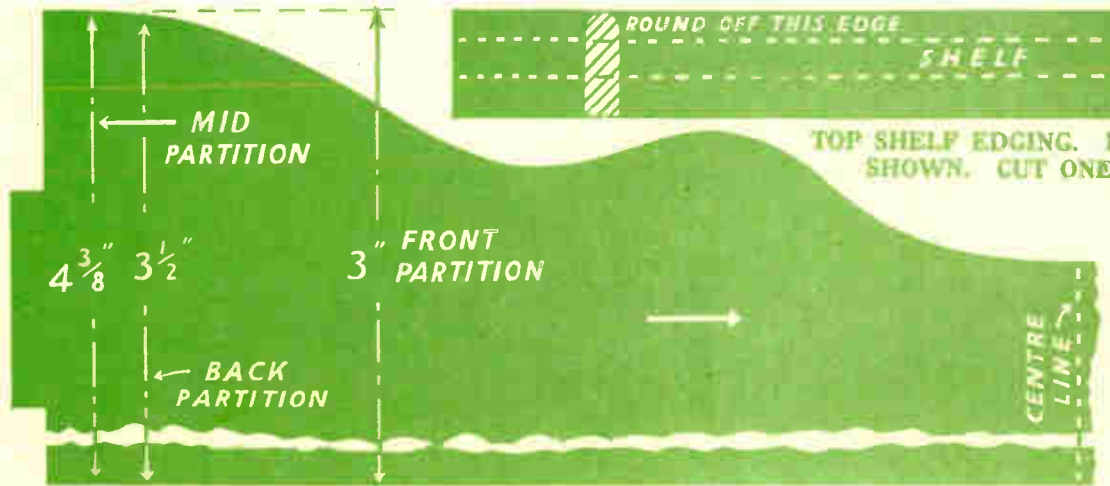

INTERIOR PARTITIONS. HALF ONLY SHOWN, CUT ONE OF EACH 1/8in. THICK.

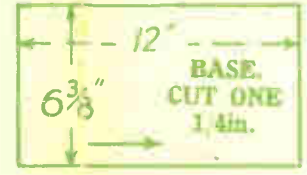
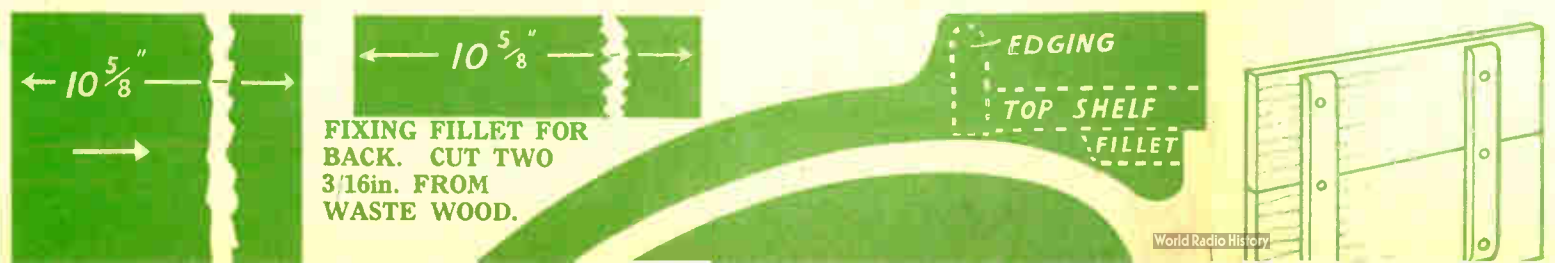

THE ARROWS INDICATE THE DIRECTION OF GRAIN OF WOOD.

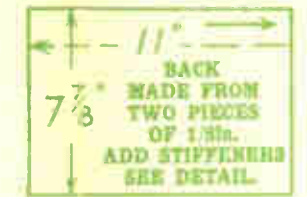

—SIZE—
12ins. WIDE.
6 1/2ins. DEEP.
8 1/2ins. HIGH.

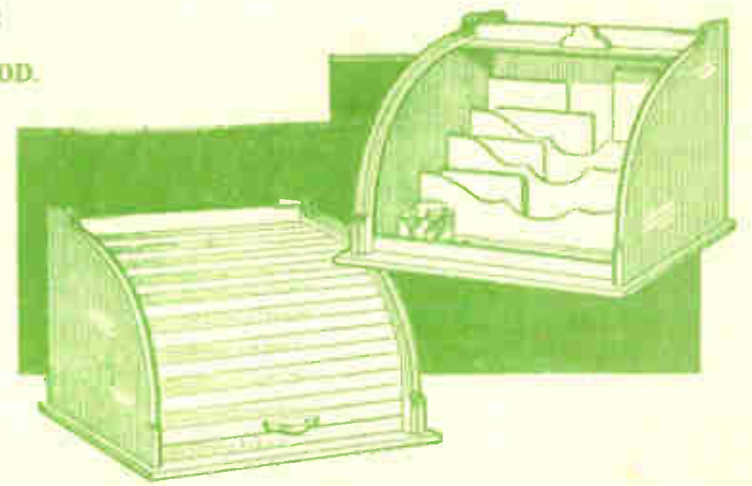
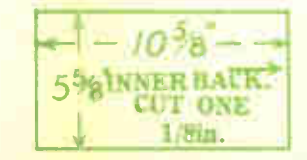

NOTE.—This design sheet is only presented free with the current issue of Hobbies and not with back numbers. Further copies may be obtained.

ROLL-FRONT STATIONERY CABINET

As shown by the illustration, the cabinet which can be made from the patterns on the other side, has a roll-top front on the sliding shutter principle, making for an easy to use, yet dust-proof cabinet for envelopes, writing paper, pen and ink. Cutting out the parts is straightforward, but their construction must be followed in the consecutive order here given, to ensure a strong and satisfactory result.

The patterns should be transferred to the wood by tracing or measuring out, and not being actually pasted down. In some cases, half the pattern only is shown, and in others, dimensional figures are given. All these must be

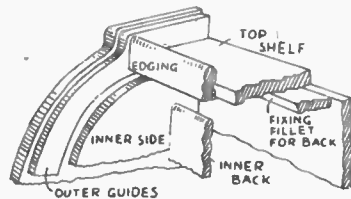

Fig. 1—Parts at the top

carried out to their correct sizes before commencing work, on to wood of the thickness mentioned. Notice in the case of the pattern of the interior partitions, that three of these are required, each being a duplicate on the centre line marked.

Patterns to Alter

In drawing out the pattern of the top half to the extent indicated between the arrowheads, remember to get the tenon exactly in the same place in each pattern. Even then, you should test it out with the appropriate mortise cut in the receptive parts of the ends. All pieces should be cut with the fretsaw, and where necessary, perfectly straight edges which can be glued and butted together satisfactorily.

Each end must be completed in itself with its interior sides forming the guides for the running shutter portion

side in its position, and then the outer guide portion the distance away from it, curved as shown. In the bottom corner, a little guide piece is glued to fit. In gluing these pieces to the main sides, remember to get a left- and right-hand unit. The positioning of the parts is important if the shutter portion is to slide round the curve and down the back where it will be out of sight. Check the tenon on the three partitions to see that they fit snugly into the inner ends.

Shelf Fillet

Cut the top shelf and its front edging (see Fig. 1) the same length as the fixed strip $\frac{1}{2}$ in. wide which also goes between the ends. This bottom strip is, of course, glued between the inner side and the outer guide, whereas the top shelf and its edging piece are between the main end portions.

To allow the fitting of the back later, a fillet is glued under the top shelf and between the little guide piece at the bottom. This is shown in Figs. 1 and 2, and dotted on the pattern of the inner sides. Note the front edge of the fillet should be slightly chamfered, to allow the easy running of the sliding shutter.

The two sides can now be stood upon the floor, and the parts between them glued in place, to make the complete framework. Do not yet add the back. Glue on the floor support, then the floor itself. Allow room behind the floor for the inner back to be glued. This piece is in line with the inner side and the underside of the floor piece.

This floor in turn, comes under the back partition, and behind the middle one. The front partition stands on the main floor itself. All these positions are seen by the dotted lines in the pattern of the inner side.

Roller Shutter

Now make the sliding shutter. Strips $\frac{1}{2}$ in. wide are provided, as well as the backing cloth on which they are glued. Their finished length is 11 in., but pieces longer than this—say 11 $\frac{1}{2}$ in.—should be

the strips to the cloth and keep flat until the glue is set, then cut each end square. Test the whole thing to see it runs in the guide opening of the ends satisfactorily.

On the lowest front strip, a little handle piece is glued—after the slide has been fitted in place, of course. Work the whole shutter backwards and forwards to see it runs smoothly before you fix the back.

The Back

This back is fitted by gluing on to the fixing fillets, which you remember were glued to the underside of the top shelf and to the floor (see Figs. 1 and 2). This

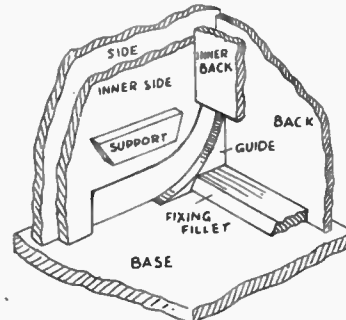

Fig. 2—Inside detail of back floor

brings the back in line with the main sides. It can be glued to the fillets, and to make a completely dust-proof back, strips of gummed paper can be added down the edges, or a piece over the whole back. The back itself, by the way, is a piece 11 in. long, and 7 $\frac{1}{2}$ in. wide.

In the panels supplied, you will need two glued together and stiffened by two pieces of $\frac{1}{8}$ in. material glued across the grain as shown in the detail. If you have an odd piece of plywood, which will fit as one piece, this will serve much better. The wood provided and the patterns, allow for a framework for pens and an opening for a square ink bottle. If your own bottle is not the size or shape of that shown on the pattern, stand it down on the paper first and mark round it with

INNER FLOOR.
CUT ONE TO
LENGTH SHOWN
1/8in.

OUTER GUIDES. CUT TWO 3/16in.

INNER SIDE.
CUT TWO 3/16in.

INK BOTTLE
RACK

FRONT PARTITION

MID PARTITION

BACK PARTITION

INNER BACK

INNER
FLOOR

GLUED BLOCK
FLOOR SUPPORT

GUIDE.
CUT TWO
3/16in.

FILLET

VIEW OF MAIN
BACK SHOWING
THE TWO STIFF-
ENERS OF 1/8in.
WOOD ABOUT
7 1/2ins. LONG
AND 1in. WIDE.
NOTE THE TWO
1/8in. PIECES JOINED
TOGETHER.

POSITION OF
INNER SIDE
ETC.. WHEN
GLUED TO SIDE

FIXED
STRIP

SIDE OF CABINET.
CUT TWO 3/16in.



FRONT OF CABINET. THIS IS
FORMED ON THE SLIDING
SHUTTER PRINCIPLE WITH 19
STRIPS OF WOOD GLUED TO A
LINEN BACKING AS SHOWN
ABOVE. THE STRIPS ARE
11ins. LONG BY 1/2in. WIDE
AND 1/8in. THICK.

PANELS OF WOOD REQUIRED FOR THIS DESIGN
**ONE H4 THREE H3 TWO H2
THREE Q2**

Materials for making this design are supplied by **HOBBIES
LIMITED**, Dereham, Norfolk.
Price on application.

GUIDE

PRINTED IN ENGLAND.

Cut one side or end of the cabinet to the outline given, and then cut the three pieces which go to form the inner side. These inner side pieces must be glued to the main side of the cabinet, exactly to the positions indicated by the dotted lines on the patterns which, of course, should have been marked on to the wood correctly.

Glue the main portion of the inner

glued down so that the whole lot can be cut to ensure a straight edge for all of them.

Apply the glue very thinly to the cloth backing, and then put the strips on to it with a very slight space between each. If you get them too close or the glue too thick, the latter will squeeze up to the edges of the wood and so prevent satisfactory bending and sliding. Weight

pench before cutting. When the wood is then glued down to the floor, it will provide an opening for the bottle and the longer one for the pens lying opposite it. The whole cabinet should be stained and given a coat of varnish or polish to complete it. Some felt or green baize glued and cut to the size of the base, will also prevent it scratching the table on which it stands.