

Hobbies

WEEKLY

CONTENTS

	Page
A Rocking Horse - -	217
Cabin Cigarette Box -	219
2-Tier Tea Tray - -	220
Permanent Mag Motor -	221
Fretsaw Hints - - -	222
A Cycle Stand - -	223

March 3rd, 1948

Price Threepence

Vol. 105 No. 2731

How to make a popular safety ROCKING HORSE

THIS is a popular design of rocking horse, and makes a special appeal to the amateur woodworker on account of the simple construction of the horse. No carving in the solid need be involved, but just a plain outline, quite within anyone's capacity. Of course, a more solid shaped head can be added if you desire.

The general dimensions are given in Figs. 1 and 2, a side and end view of the stand respectively. For the floor members cut two long and two short pieces of 4ins. deal to the lengths given. The long members are fitted with 2in. tenons at each end, as at A, and the short members (the end pieces) mortised to suit. The sharp upper corners of these latter pieces are sawn off.

Before gluing together, cut grooves 1/2in. deep and 2ins. wide (see A), in the long members for

the vertical posts to fit in. Then glue and screw the whole together, the long members being 1 1/2ins. apart.

The posts can be cut from 2in. square timber, or if such wood is not available, two thicknesses of 1 1/2in.

board can be glued together to make up. The thickness will then be 1 1/2ins., but this is of no moment if the grooves are cut to suit. At the top of the posts saw a tenon 1in. deep for the top board to fit on.

Then glue the posts in their grooves and nail. The top board is 3ins. wide, and should have, at the correct distance from each end, a mortise to suit the tenons on the posts. If a tight fit here, glue will make a sufficiently strong joint.

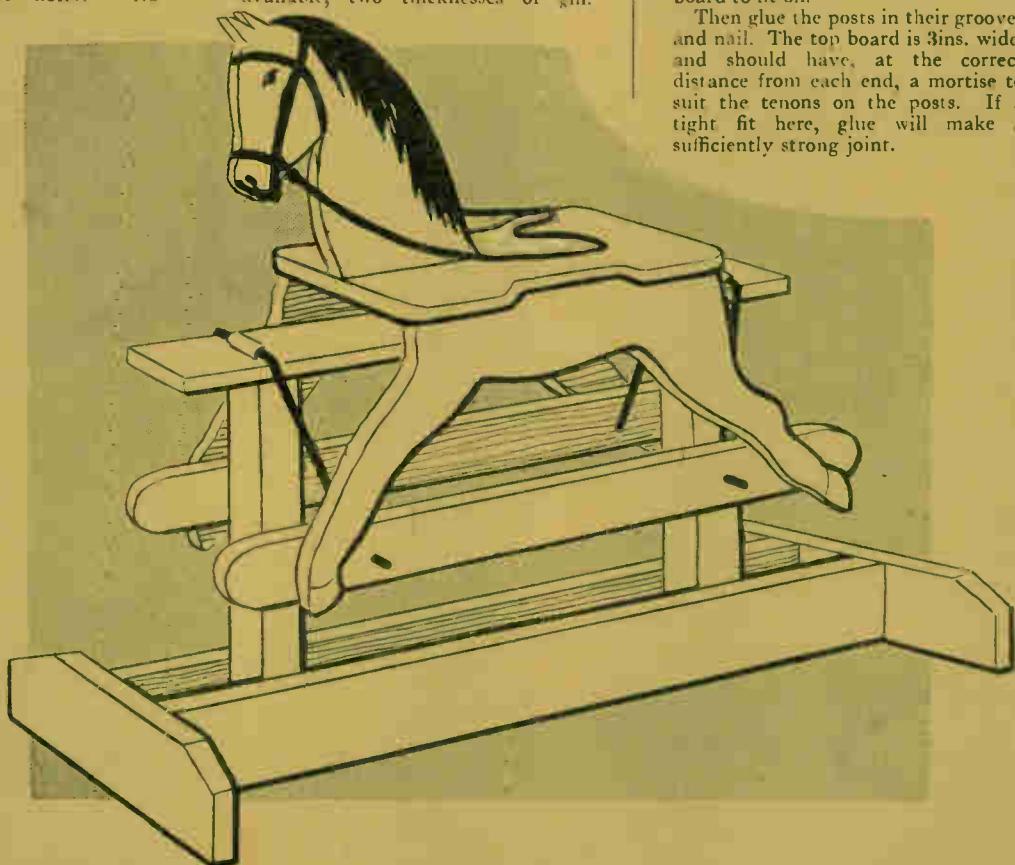

All correspondence should be addressed to The Editor, Hobbies Weekly, Dereham, Norfolk.

On the top board the rockers are to be fixed. These are bent up from $\frac{3}{4}$ in. round iron rod to the shape shown at C. Readers who may not care to attempt this part of the job can get it done for them at any local blacksmith's shop or iron works.

Accurate Fittings

The fittings should be accurate to measurements given, with the lower extensions at right angles and about $\frac{1}{4}$ ins. long, or a trite more. It is quite easy to cut a piece off these if found too long afterwards. The

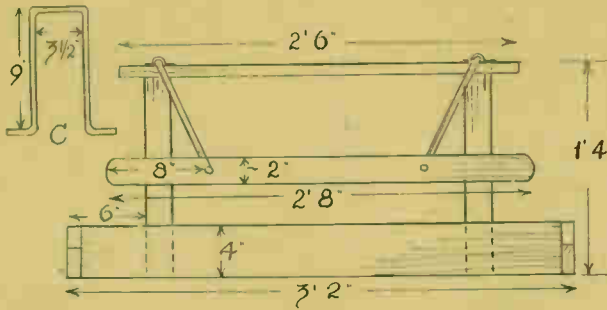

Fig. 1—General side view and detail of metal fitting

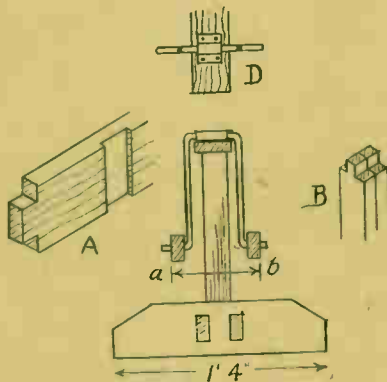

Fig. 2—End view and joints to use

rockers are held in place by metal plates, bent round the rod, as in detail, D. The plates can be bent easily enough if cut from thin sheet brass or iron. No tightness must result here, but perfect freedom for the rockers to easily swing.

To the lower ends of the rockers, a rocking bar of 2 in. wide wood is to be fitted. Cut these to length and round off the corners. At the distance from each end, given in Fig. 1, bore a $\frac{1}{4}$ in. hole for the ends of the rocking irons to drop in.

It would be as well to place an iron washer each side of the bars before fitting on the rockers, then to burr the ends of rockers to prevent the bars slipping or riding off. A few blows of a ball pane hammer will burr the rocker ends over enough.

Clean and Varnish

Now give the work a general rub over with glasspaper, and remove all roughness and splintery edges. The

wood portions can be varnished or painted according to convenience. Varnishing would, perhaps, be the best finish, and if at hand, a preliminary coat of light oak stain would improve the appearance.

With a soft wood like deal, a previous coat of size would help to fill the pores of the wood, before the varnishing. The metal rockers should be coated either with black japan or enamel, and it would be as well to remove the plates beforehand, so that no "stickiness" results afterwards.

to leave two tenons, to fit the seat board. Add a couple of screws to each leg, where it is joined to the side pieces, and then try the fitting.

The central portion of each side edge of the seat board should be sawn away, to reduce the width at those parts as much as possible. Round off the sharp corners, and then glue the whole together.

Painting and Fixing

The horse can be painted grey or brown, grey being the most popular. Details are put in with black paint and

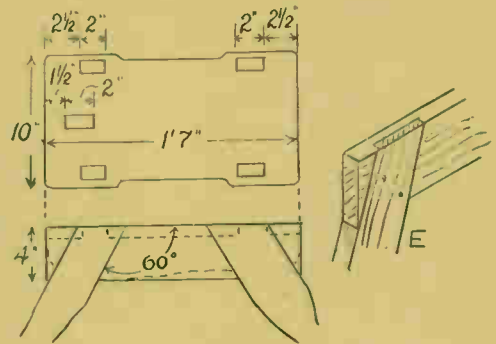

Fig. 4—Plan and side view of seat

TIMBER REQUIRED

Stand

- Long members (2) 3ft. 2ins. long by 4ins. by $\frac{1}{2}$ in.
- End members (2) 1ft. 4ins. long by 4ins. by $\frac{1}{2}$ in.
- Posts (2) 1ft. 4ins. long by 2ins. by 2ins.
- Rocking bars (2) 2ft. 8ins. long by 2ins. by $\frac{1}{2}$ in.
- Top bar (1) 2ft. 6ins. long by 3ins. by $\frac{1}{2}$ in.

Horse

- 7ft. 6in. length of 9ins. by $\frac{1}{2}$ in. deal board

The head and legs of the horse are shown, drawn over lin. squares, in Fig. 3. It will be seen that these parts can be cut from deal board $\frac{1}{2}$ in. thick and 9ins. wide. These could just as well be marked direct on to the wood, if it is lightly pencilled in squares first. When marking out the head portion, take care to make the tenon at the bottom just 2ins. long.

Fitting the Legs

The legs are to be jointed to side pieces of wood, which are, in turn, mortised underneath the seat board, as in Fig. 4. Cut the side pieces to length and width given, and halve the legs into them at the angle shown, as at E. Glue the joints and when the glue is quite hard, trim to the shape shown by the dotted lines.

Now cut the seat board to dimensions given, and chisel out the mortise slots for the horse's head and the side pieces, to which the legs are jointed. The distance apart of the mortises, measured across the board, will be the same as distance a-b, given in Fig. 2. This being done, saw the tops of the side pieces

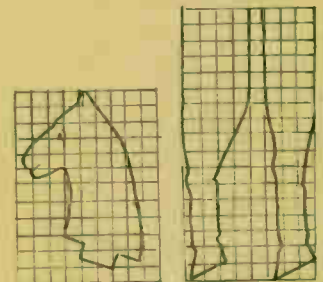

Fig. 3—Outline of head and leg

a fine brush. Finish with a coat of copal varnish. Fix the horse to the rocking bar with small iron bolts. Items such as a strip of fur for a mane and tail, can be added as preferred.

One item, well worth adding, is straps and stirrups, to assist in mounting the horse, also leather reins. An alternative to the straps and stirrups, or in addition to them, if you like, is a mounting step. This is a piece of 3 in. wide board, 12 ins. long, screwed across the rocking bars in the middle.

INDEXES AND BINDING CASES

INDEX for back Volumes of Hobbies Weekly 1/- post free. Each 6 months from April to Sept., and Oct. to March. Binding Cases in red linen, stamped in gold, 2/6 each.

Novel automatic delivery is provided in this attractive CABIN CIGARETTE BOX

THIS cigarette delivery box is a real novelty: cigarettes are obtained by lifting the cabin bodily from the base and then lowering it again, when the required "smoke" will be found lying along the ridge of the roof. The action is absolutely sure a cigarette being left with precision every time the raising and lowering is performed.

The small left-hand diagrams show how things work, while the large one gives details of construction. The sketches should be well studied before starting work to be sure of the action you are aiming for, which is half the battle.

Log Cabin

The cabin is made from four pieces of $\frac{3}{4}$ in. material, two sides and two ends as shown. The latter are 4ins. high and 3ins. between the inner edges of the dove-tailing and 5ins. overall width. Down the centre of each is a channel a shade more than $\frac{3}{4}$ in. wide and $\frac{3}{16}$ in. These are to allow the framework to fit over the central upright, as will be described.

The sides are $3\frac{3}{4}$ in. between the inner edges of the dove-tailing. The four pieces fitted together should make a sturdy frame. It must be seen that the lower edge forms a perfectly flat surface to accurately meet the wood below.

Now make the base and upright. The former is 6ins. by 6ins. (1) and from $\frac{1}{4}$ in. plywood, while the upright (2) is $3\frac{3}{4}$ in. long by 4ins. high and is

from $\frac{3}{4}$ in. material and has the top hollowed out into a semi-circular channel (3) of sufficient depth to nicely take a cigarette.

Two sections of $\frac{1}{4}$ in. plywood 5ins. by 3ins. are used for the roof (6). The top edges are cut away as (7) for $3\frac{3}{4}$ ins. with $\frac{1}{4}$ in. of the ridge (8) meeting correctly at either side. The opening is to expose the upper end of the upright (2) and it is here where the cigarette appears. Bevel the two edges of the roof to meet neatly at the two ends and also bevel so that a neat fit is made on to the walls.

Before putting on the roof, however, the sloping pieces (4) are first put in place. These must be fitted with some care as the whole action of the holder really depends on them. Wood $\frac{1}{4}$ in. thick is used and the bottom edges (5) are bevelled to give a "near fit" against the side of the upright. The pieces are held by sprigs in from the sides, or small screws would do.

To give the cabin a realistic appearance lines are now grooved with something blunt. This to help the impression that the extended lengths of dove-tailing are separate logs. The ends of the extension are also cut to a rough

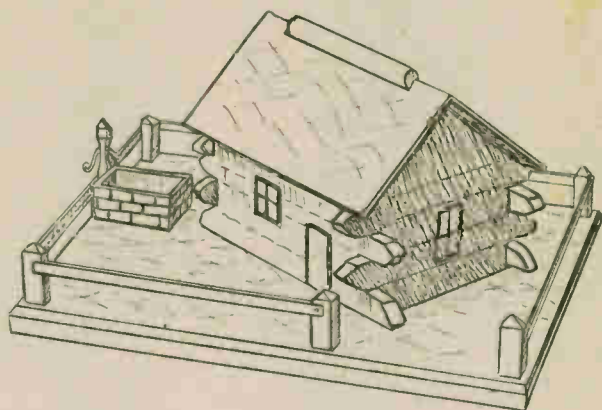

V-edge, which also helps matters and gives the impression of real "log cabin" construction.

Door and Windows

If the cabin has been made in a nice yellow wood no staining is needed, but if not, everything is now given a coat of absorbent light oak.

A poker is now heated and a window frame lined in on each end and a door with a window at the side as indicated. Some criss-cross poker markings on the roof also gives a very good finish.

To prevent the cabin being lifted too high and all the cigarettes spilt out, a piece of coloured string (d) is firmly attached with two small screws, being so adjusted in length that it allows the frame to rise to a point where the lower edges of the sloping pieces inside are just level with the edge of the channel in the top of the upright.

It must come no further, however, and it is worth going to some trouble experimenting to get the exact length. If the frame does not come high enough the last cigarette will never be discharged, although the others will come out all right.

Some workers might like the cabin just as it is, but a more elaborate finish is made by placing it cornerwise on a base about 8ins. by 10ins. This has a small railing round it with an opening at one point to represent a gate.

Pump Trough Ashtray

If this extra surround is adopted an ash-tray can be added in the form of a pump trough, shaped from one piece of wood. This stands in one corner of the yard.

It is 2 $\frac{1}{2}$ ins. by 2ins. and 1in. high, marked out with the poker to represent stones. The pump itself is a round length of wood shaped as shown and a piece of wire (10) run through to form

(Continued foot of page 222)

HOW THE CABIN WORKS.

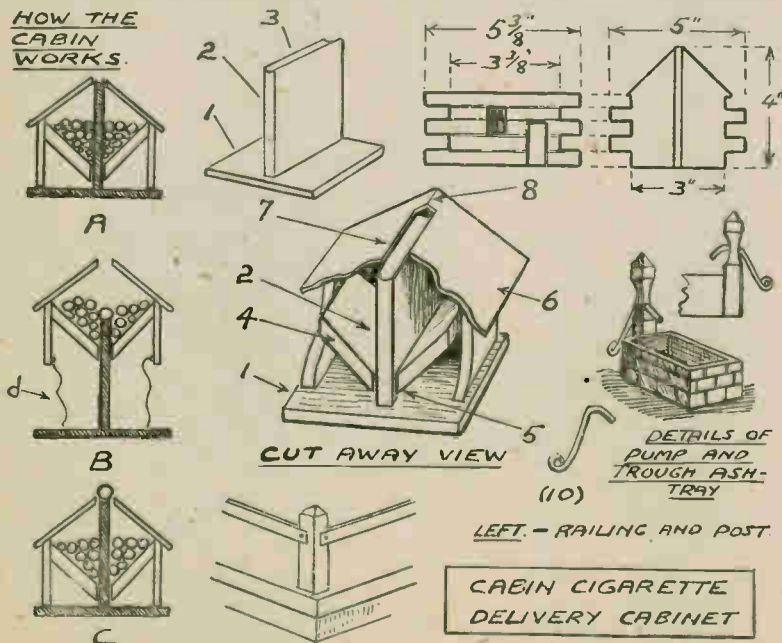

A sensible home article is this handy 2-TIER TEA TRAY

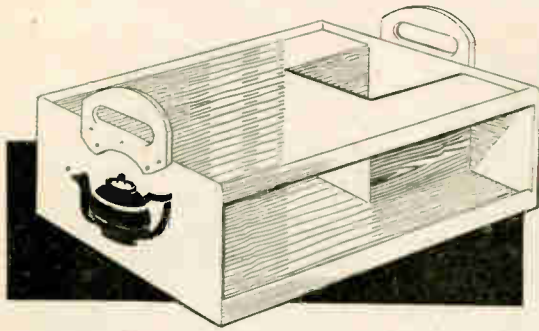

THIS handy article is designed to carry the requisites for meals from the kitchen to the dining room. It is far less bulky than a dinner wagon and holds a lot more than the usual tea tray. Ample space is provided for dinner and other plates, while smaller articles, such as cutlery, etc., can be carried in the lower tray. Attention is specially drawn to the well, for this is a valuable addition. In it, glasses, sauce bottles and similar articles liable to fall over can be conveyed in safety.

Wood Required

Any good hardwood about $\frac{1}{2}$ in. thick can be used for making, although, if wood $\frac{3}{8}$ in. thick can be obtained, then we should recommend this thickness. If $\frac{1}{2}$ in. wood is used, however, the built-up article will need a few additional glued blocks and fillets put in at inconspicuous places to strengthen the whole construction.

If $\frac{3}{8}$ in. stuff is substituted, the mortises and tenons can easily be extended to take this thickness of wood.

The ends are quite plain pieces, as can be seen from Fig. 1. Set the mortises accurately to the measurements shown. Those at the top of the rail are set down $\frac{1}{4}$ in., while those at the bottom will be $\frac{1}{2}$ in. up from the lower edge. The end where the well is situated needs only two mortises, the opposite end three, to take the middle rail of the top tray (see the plan diagram Fig. 2). The mortises are all $1\frac{1}{2}$ ins. long.

Top and Base

The top and bottom trays are identical in shape, except that the upper tray has the square cut away to make room for the recess. Fig. 2 shows the upper tray, with its five tenons. The lower tray will be solid

and have the six tenons. It will be seen that when the two shelves are glued and fixed into the ends, the tenons all being properly checked beforehand, there is a space of $\frac{1}{8}$ in. left at each side. These spaces are occupied by the side rails which are shown dotted in Fig. 1.

For the side rails we need four pieces 18 ins. long by $1\frac{1}{2}$ in. wide by $\frac{3}{8}$ in. thick. Fit these rails in carefully and glue and screw them to the tray edges, using round-headed brass screws. In the angles formed between the ends of the tray and shelves, glue some strips of planed wood $\frac{1}{2}$ in. square, to help strengthen the whole construction.

The Well

To form the well in the tray we need two pieces $5\frac{3}{4}$ ins. by 5 ins., and one piece 6 ins. by 5 ins. Fit, glue and pin the two side pieces first, and then add the 6 in. length, gluing and pinning where possible and adding some squared glued fillets inside to give additional stiffening.

Round and smooth the projecting

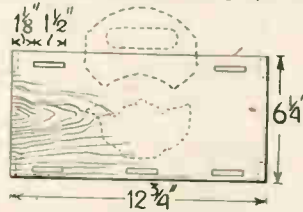

Fig. 1—The end pieces

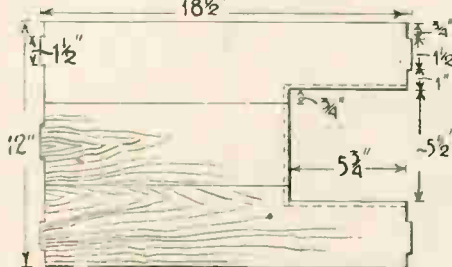

Fig. 2—Shape and dimensions of top

top edges of the side rails and also the top edges of the ends of the tray. As a precaution, it would be advisable when making the three sections of the well, to take the measurements direct from the article so far made up, instead of relying on the dimensions

mentioned above. Another useful addition would be the gluing of some narrow strips of $\frac{1}{4}$ in. thick wood to the undersides of the trays immediately over the joints in the three panels.

Two sturdy handles should be added to the ends of the tray, and from the squared diagram given, the proper outline of these can be drawn on the wood. The squares shown should be enlarged to $\frac{3}{8}$ in., and the outline then carefully followed through each.

Handles

The handles should be $\frac{1}{2}$ in. thick, and when cut out with the fretsaw they should be shaped on their upper edges or rounded off and made smooth for handling. Glue and round-head screws make the correct fixing for the handles.

An artistic addition may be made to the two ends of the tray by the "teapot" overlays shown in the sketch and given in detail in Fig. 3. The squares are $\frac{1}{2}$ in. This decoration may be painted on in bright enamel (blue or red), or if, as an overlay, then $\frac{1}{2}$ in. wood is suitable.

Give the completed article a thorough glasspapering, and stop up any holes with a suitable filler. The tray can then be finally stained and polished according to the wood used

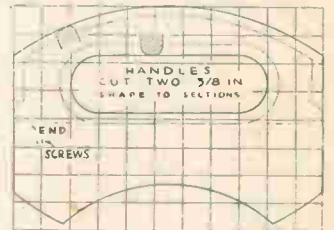
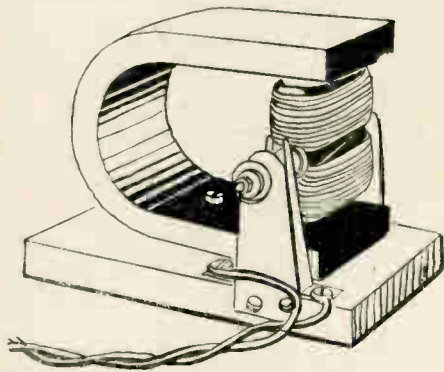

Fig. 3—Outline squares of handle and teapot decoration

in its construction. It would be a good thing, we suggest, to paint the whole article, as the wood procurable now is not always suitable for polishing or varnishing; while paint hides a multitude of unavoidable blemishes.

Please share your copy of Hobbies Weekly with a friend who cannot get one for himself

A number of readers have asked how to make a PERMANENT MAG MOTOR



THIS motor is easy to construct, and is efficient and quite suitable for driving many types of models and small pieces of mechanical apparatus. No difficult armature needs to be made, which greatly simplifies winding and construction.

One of the results of this is that the motor is not self-starting (as with a tripolar motor), but in the majority of cases this is little disadvantage. It is only necessary to give the armature a slight turn to commence the motor running. If the armature is in a midway position it will start itself when the current is switched on.

Magnet to Use

The form of construction allows magnets of different sizes to be used. The model may also be used as a dynamo. Magnets of various sizes

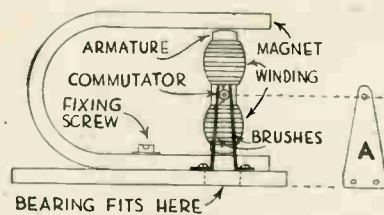

Fig. 1—Side view of motor

may be obtained from advertisers; the one shown was obtained from an old magneto and is approximately 1½ ins. wide and 2 ins. between poles. A really strong magnet will be justified by the high power the motor can give.

Dimensions of Parts

Because the motor so easily lends itself to construction with magnets of almost any size, dimensions are not given. A very small motor made up was just as successful as the larger one illustrated and instructions as to the relative sizes of the parts are given so there should be no difficulty in making a suitable unit.

Figs. 1 and 2 should make the arrangement clear. The magnet is fixed to a baseboard of ¾ in. thick wood, leaving a small space all round and about ¼ in. at one side for the brushes (Fig. 2). If the magnet is drilled it can be screwed or bolted down. If not, a strap of thin metal about 1 in. wide and somewhat longer than the width of the magnet may be bent up and screwed in position to clamp the lower pole of the magnet to the base.

Two bearings should be cut from brass or similar material and A, Fig. 1, illustrates their shape. The axle hole should be at such a height that the axle will come centrally between the poles of the magnet. If the material is thin, washers or bushes may be soldered on to increase the bearing area. The bearings should not be permanently screwed to the base until the armature is in position.

Armature Construction

Fig. 3 shows two ways in which the armature can be made. A single piece of iron can be drilled for the axle, or two thinner pieces can be used, the axle fitting in a notch filed across the meeting surfaces of these pieces.

The armature should be the same width as the magnet poles and about 1/10th in. shorter than the distance between the poles. The ends should be curved in the direction of rotation. Do not make the gap between

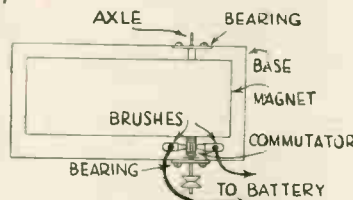

Fig. 2—Top view of motor

armature and magnet greater than necessary.

Any odd piece of iron may be used. It can be heated and allowed to cool slowly so that it will not tend to retain the magnetism.

The axle is soldered in. With the built-up armature the meeting surfaces and axle can be smeared with a suitable flux, and a few small pieces of solder applied. Then the whole is heated until the

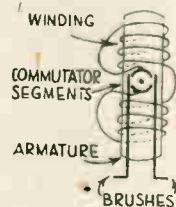

Fig. 4—Commutator and armature position

union is formed, the pieces being pressed together with pincers.

Commutator

A piece of ebonite tubing ¼ in. long and a push-fit on the axle is used for the centre of the commutator. Two brass or copper contact segments are made, each covering about 140 degrees of the insulated centre piece. They are bound in place with glued or varnished thread, leaving a space for the brushes to touch (see Fig. 3).

For the brushes thin brass is used. Pieces about ¼ in. wide, reduced to ⅛ in. where the ends touch the commutator, are suitable. For a very small motor brass wire (about 22 S.W.G.) can be used. Wood-screws with a washer under the heads secure the brushes in place.

Winding

The commutator should be pushed on the axle, the segments being level with the armature poles. Winding is very simple, one continuous coil divided at the middle being all that is required. The beginning and end of the winding are soldered to the commutator segments. Fig. 4 makes this clear.

Cotton-covered wire is most suitable. It should be wound on tightly and evenly and the same number of turns put on each pole to maintain balance and prevent vibration. The finished winding may be varnished.

For a 6-volt accumulator 26 S.W.G. wire can be used. This is also suitable for a 6-volt dry battery. If more

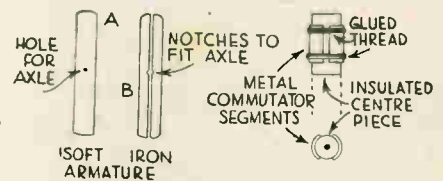

Fig. 3—The armature and commutator

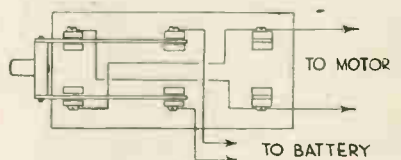
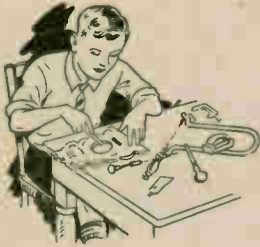

Fig. 5—A reversing circuit

power is wanted (and current consumption can be increased) 24 or 22 S.W.G. wire can be used. For all normal 4-6 volt dry cells, 26 S.W.G. wire is convenient, but for maximum power on 3 or 4 volts thicker wire (up to 22 S.W.G.) can be used.

(Continued foot of page 223)

Hints which will prolong the life and usefulness of YOUR FRETSAW



FRETSAW blades are often discussed in these pages, but very little is ever written about handframes. Handframes are, of course, just as important as blades. The "junior" sizes of handframe are quite practical, having a "span" of 12ins. or so from the saw clamps to the back bend of the frame. But, while useful for most small fretwork jobs, their use becomes limited—much more limited than the 16in. span frame.

This size of frame, although heavier and, perhaps, a little more clumsy to handle when negotiating sharp corners with fine blades, enables more "fretting" to be done. The extra 4ins. is often absolutely essential. And after a time, the user of the larger handframe becomes quite expert with it.

Care and Maintenance

Apart from the expert handling of a handframe, however, there is the question of care and maintenance. Being longer, and in every way like the smaller version of handframe, the large size, due to its length, has not the same tension, there being less strain for the blade.

Only very short lengths of blade can be tensioned properly, which means that the clamps are drawn very close to each other so that the cutting stroke is not more than 3ins. or 4ins.

When a fresh 5in. blade is inserted in the same frame, there is a loss of tension, due to the straining of the frame arms. Thus, it is always necessary to pull the arms apart to bend the metal back to its original shape.

Cigarette Box—(Continued from page 219)

the nozzle and handle. If carefully made this item can be quite effective.

The trough ash-tray need not be fastened down, but if it is desired to do so a hole should be bored in the trough base and a short length of dowel glued into position. A similar hole is then cut in a corner of the "yard" into which the protruding dowel pushes, it not being glued here.

Now, in doing this, some workers unknowingly put a "torque" in the frame, i.e., a twist. When they start cutting, the saw cuts at a slight angle. Unless the fault is remedied immediately, one gets into the habit of holding the frame at a slight tilt to counteract the sloping cut.

Upright Handling

It is wrong to get into this bad habit. Wrong, too, to bend the frame arms so the cutting will be vertical, assuming the hand does not hold the frame vertical.

You see, there may come a time—and it always does—when you have to use a new handframe or use a borrowed frame. Being a perfect implement, it will seem ungainly and imperfect to you, it cutting at an angle all the time. Actually, of course, the fault lies with its user—the fellow who holds the frame at an angle instead of the vertical manner, due to "torque" in an old handframe.

Even the veteran, experienced fretworkers have, on occasion, been guilty of using a twisted handframe—twisted on account of their own carelessness. They wisely, however, corrected their frames or, if that was impossible, bought new frames.

Correcting a Twist

In these times, fretwork tools and materials are somewhat scarce and one must give every care and attention to tools in one's possession. If you own a twisted handframe, correct it without delay. Do it now—a time when you are not using the saw for any purpose.

Spend an hour correcting the frame. It cannot be done in a few hurried minutes.

If the "wings" of the fixing clamp bolts are broken off, a couple of new bat-wing nuts should be obtained and fitted. Why continue using pliers or nippers to tighten the saw in its clamps? Two new nuts will save you unnecessary bother, and you will proceed with cutting more rapidly.

Moreover, if the handle, due to excessive downward strain in cutting thick wood, should come off, don't bang it on its tang any old way.

Often the handle, while fixed true vertically with the frame, does not be a true fixture if it comes off and is put on "differently" so the tang will obtain a new, better grip. The fact is that the handle will be out of alignment vertically with the frame, which is just as bad as a frame having a twist.

Tightening Handle

Make a point of dusting the loose handle with resin powder, heating the frame tang, then pushing the handle back on it as fixed originally. The resin melts with the heat of the tang and, when cool, obtains a better, stronger grip on the metal than glues.

This is the method used to fix knife handles to the tangs of knife blades, i.e., table knives, with horn or bone handles. Plastic wood could be used as a substitute for resin, providing it is very thin and pliable. The excess will squeeze out—or should do so, if quite soft.

Making a Swimming Fish

FROM a piece of notepaper cut a fish and suitably embellish it, as shown in the illustration. Place this in a bowl of water free from grease, and slowly drop spots of oil into the centre of the hole in the tail. It will be found that the fish will sail about the bowl in a fascinating way.

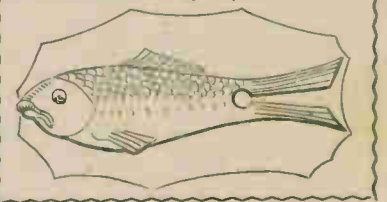

Temporary measures used in repairing handframes is always unsatisfactory. If you must renovate your handframe, do it carefully and properly. One is then able to go ahead with a clearer conscience and renewed vigour. To constantly keep using an implement which the user knows is out of true and in need of attention is to court disaster and "bungling" in one's cutting.

The tray can then be lifted out so that the ash may be thrown away. Moreover, it facilitates the ready cleaning of the yard which is bound, in the course of time, to get a certain amount of ash strewn about.

Cigarettes, it should be noted, are loaded by lifting the cabin and then feeding them in through the delivery slot. This may seem a little tedious,

but it saves a lot in the construction by not making a special loading door. Not having a break anywhere helps to keep the whole arrangement rigid.

Finally, cover the whole of the base with a rectangle of green baize, gluing the material firmly into position. This, of course, is to prevent it marking any highly polished surface upon which it may be placed.

The wise cyclist will save time and prevent damage with A CYCLE STAND

BICYCLES are generally wheeled into the shed and left lying against the wall. If the wall happens to be of brickwork, or brickwork covered with concrete, the handlebar grips, including the chromium plating on the brake levers, become badly scratched.

How much wiser and better, to build a simple wooden stand for the bicycle. A typical form of stand is shown herewith, consisting of two triangle frames, affixed 2ins. apart upon the shed floor and wall.

Front Wheel Holder

These supports engage with the front wheel of the machine and hold it upright, and handle bars are kept away from the walls. No damage is done to the spokes of the front wheel because, by standing upright, the leaning pressure is slight.

That is why it is important to have the supports attached absolutely vertical. If they slant, the bicycle will slant, and this increases the pressure on the spokes. Actually, it is not the diagonal slats which support the bicycle, but the rim of the tyre, at the top and bottom.

Thus, if desired, to save wood, the diagonal slats could be omitted and the upright and bottom pieces kept about 1in. apart to engage with the front tyre. To prevent the tyre slipping out, a chock (kind of block) could be attached to the floor in line with the supports and at a distance sufficient to keep the rear wheel from moving backwards.

Making the Stands

The stand frames are constructed from deal batten material about 1½ins. by 1in. The 24in. and 15in. lengths are simply butt-nailed together, as shown, then the diagonal

pieces (if wanted) cut to fit in place, being secured with nails or screws. Having made the twin frames, these are screwed to the wall and floor 2ins. apart, or 1in. to 1½ins. apart, assuming you prefer to have a rear chock and no diagonal support bars.

An Alternative

To cut out the extra labour in making twin frames, the alternative type may be constructed. Note that this has a 2in. by 1in. upright and floor piece, and that the latter is 18ins. long, i.e., 3ins. longer than that necessary for the twin frame supports.

The reason for the extra length is that the bicycle wheel has to rest on the floor piece. If the end of the latter is too short in front of the wheel axis, then the bicycle will roll out backwards. Therefore, the bottom piece must be longer to prevent this occurring.

The alternative stand must have the diagonal slats, as these do the actual supporting. Such may be cut from 2in. by ½in. deal. They should be attached with screws rather than nails. Both stands serve to hold all sizes of bicycles. When built, the wood should be coated with creosote or other preservative of wood prior to attaching to the floor and wall.

It must be pointed out, by the way, that if the diagonal slats are omitted from the twin supports, so the upright and bottom members

support the machine by gripping the tyre, it is imperative the tyre is kept properly inflated, or the bicycle may topple to one side.

The stands, of course, are for holding a machine temporarily, they are not intended for use for storing a machine. A special stand for this purpose has been published recently in *Hobbies Weekly*. If the diagonal slats are included, the supporting stands may be used for storing purposes. For proper storage, however, the wheels of a machine should be kept off the floor.

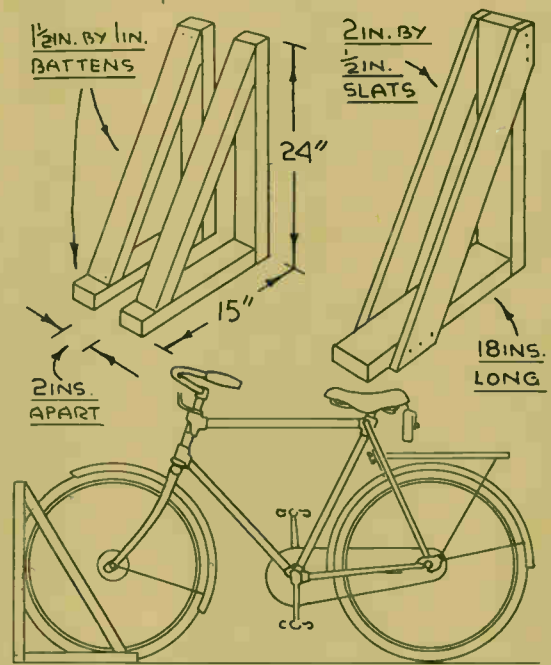

Permanent Mag Motor (Continued from page 221)

If the armature is very small, or if very economical operation is required, 28 or 30 S.W.G. wire can be used. Wire 32 S.W.G. is possible where only small power is required from the motor.

Adjustment

The armature should turn freely between the poles of the magnet. Washers are added to prevent excessive side-play of the axle.

The brushes should bear lightly on the commutator, and should touch the insulated centre piece only when the armature is upright. If they still touch the commutator segments in this position the battery will be momentarily short circuited. Although the motor should run immediately a little adjustment of

the brushes can be undertaken for best results.

The direction of rotation of the motor can be reversed by reversing the polarity of the supply. A switch can be used to do this, Fig. 5 showing the connections. Although a knife-switch is shown, any suitable switch can be used, connections being arranged so the polarity of the supply to the motor is reversed when the switch is operated. The motor will not run from alternating current.

For Use as Dynamo

As it stands, the motor will generate D.C. if driven from some other source of power. If A.C. is required the commutator may be given a quarter turn on the axle. This will increase output.

A better method, giving greater output and silent operation, is to dispense with the commutator and one brush. One end of the armature winding is then connected to the axle. The other is taken to an insulated slip-ring made from a short length of brass tubing fixed on an insulated centre piece. Electrical connections are taken from a brush bearing on the slip-ring and the axle bearings.

Under these conditions the dynamo will light two or three torch bulbs at quite a low speed (given a fairly large magnet). It will not, however, function as a motor.

For best results, an adequately large winding should be put on the armature—200 or more turns if possible.

- BOOKS -

- Bookcrafts and Bookbinding** by John Mason ... 13s. 3d.
By the teacher of bookcrafts at the Leicester College of Arts and Crafts, this book offers a progressive course from simple binding, photo-frames, covered boxes, etc., up to multi-section book binding, etc.
- Painting and Decorating** ... 5s. 3d.
The secret of successful home decoration lies in knowing the correct way in which to set about the work. This concise handbook gives the experience of practical men, enabling the handyman to obtain that professional finish which is so desirable.
- How to Build your Own Split-cane Fishing Rod**
by G. Lawton Moss ... 6s. 3d.
An instruction manual describing general principles enabling the fisherman to make any type of rod, complete with the necessary fittings, to his own liking.
- Locomotives of the L.N.E.R.** ... 8s. 0d.
A pictorial record of 170 classes of locomotive, together with a complete list of the old and new numbers.
- Your Leather Work** by Betty Dougherty ... 8d. 0d.
An essentially practical book for those interested in designing and making articles in leather; 130 diagrams and patterns are given.
- French Polishing and Enamelling** by Bitmead ... 5s. 3d.
Improving and preparation of furniture woods; stains and imitations; french polishing; spirit varnishing; enamelling, etc.; general instructions and miscellaneous recipes.
- 101 Things for a Boy to Make** by Horth ... 8s. 0d.
A book for the beginner in handicrafts—woodwork, metal work, home engineer and model maker.

"POPULAR HOMECRAFT"

The American handyman's "home-workshop" magazine. Six issues per year cover the full range of home wood and metal work, fully illustrated by detail drawings, descriptions and photographs.

By annual subscription, 12s. 6d.

"POPULAR MECHANICS"

An American magazine of interest and instruction on working principles of everyday-things. Recent issues have each contained 300 pages, 200 illus.

By annual subscription, 17s. 6d.

STOBART & SON LTD.
9 Victoria Street, London, S.W.1

DO YOU KNOW? asks *Mr. Therm* No. 2

What a Gasworks makes besides Gas

To make gas, you bake coal in an oven or retort. (You can make it yourself with a test-tube, a cork, some small bits of coal and a gentle flame.) The two main products are gas, of course, and coke — which is what is left of the coal at the end of the process.

But this is by no means *all* you get. First, there is ammonia. This is made into fertilizer, baking powder, smelling salts, stuff to take grease marks out of your trousers, artificial silk, the working fluid of refrigerators, or explosives. Even more valuable, there is coal tar. Here are just a few of over 2,000 things that are made out of coal tar: Almond flavouring, aspirin, carbolic acid, creosote, drugs, dyes, lacquer, lysol, moth balls, motor spirit, naphtha, plastics, saccharine, scent, tar, vanilla essence and varnish. In addition, you get from gasworks carbon for making pencils, paints, arc-lamps and brushes for electric motors, and "flue-dust" that makes metal polish and anti-rust paint. The important thing to remember is that if you *burn* the coal in a fire, instead of *baking* it in the gasworks, you waste all these priceless things. So people who burn gas and coke do a good turn to their neighbours and to the nation.



Issued by THE BRITISH GAS COUNCIL · 1 GROSVENOR PLACE · SW1

Plans for a 36" M.Y.A. RACING YACHT

These plans, for the 'Merlin' drawn up with all the clarity and attention to detail for which Modelcraft is renowned, will build a real classic racer—a creature of grace, beauty and efficiency. The plans include two alternative methods of hull construction. For the less ambitious other model yacht plans for the 'GULL', 'KESTREL' and 'PIXIE' are listed in our magazine and list.

8/6

POST 4d.

Modelcraft's NUMBER FIVE MAGAZINE & LIST

is now at press and will be ready shortly

The magazine section is rich in the garnered wisdom of leaders of every branch of modelmaking. Yet it is as much for the fascinating opportunities opened up by the list of plans, plan-books, kits and accessories that modelmakers buy it. Over 450 items are listed and the list grows longer with every issue including—

GALLEONS, CLIPPERS, OLD-TIME SHIPS AND STRANGE RIGS
MINIATURE GALLEONS AND CLIPPERS
WARSHIPS
MERCHANT SHIPS
WEAPONS OF WAR

GLIDERS AND FLYING MODELS
SOLID SCALE AIRCRAFT
RAILWAY FEATURES
LORRIES, BUSES etc.
CARS
PERIOD HOUSES

PRICE 1/- Post free SUBSCRIPTION 4/6 Four issues Post free

MODEL-CRAFT Ltd.
77 (F) Grosvenor Road, LONDON, S.W.1

EVERYMAN INVENTOR

by Wm. A Bagley

".....one with a natural bent for inventing cannot help devising new things; to such, Mr. Bagley's book will be of inestimable value, covering as it does everything from the first germination of the idea to the raking in of the royalties." RAILWAY MAGAZINE

Cloth Bound 5/- Net.

Obtainable from all booksellers or from

VAWSER & WILES LTD.,

555, Lea Bridge Road, London, E.10

A COMPLETE LIST OF PUBLICATIONS WILL BE GLADLY SENT ON REQUEST.

BALLOON STAMP FREE



YOU can get from us **ABSOLUTELY FREE** this valuable stamp of BELGIUM which shows Prof. Piccard's Balloon. This handsome and large stamp was issued in 1932 to commemorate Prof. Piccard's two ascents into the stratosphere for scientific research.

These stamps are slightly cheaper now than in 1945 when catalogued 2/- each, and we will send one **ABSOLUTELY FREE** to each approval applicant. Just ask for Balloon stamp (free) and selection of our stamps on approval, and enclose 3d. stamps for our postages.

WINDSOR STAMP CO.
(Dept. 12), UCKFIELD, SUSSEX.

Hobbies

WEEKLY

CONTENTS

	Page
Model Village Hall	225
Plastic Materials	227
Table Ironing Board	227
Ways to Economise	228
Radio Test Meters	229
Cardboard Boxes	230
Perspex Letter Rack	231
Carved Frame	232
Stamp Collecting	233
Letter Rack Patterns	233

SUPPLEMENT PATTERN
SHEET FOR CHINESE
TABLE CASKET

March 10th, 1948

Price Threepence

Vol. 105 No. 2732

A MODEL VILLAGE HALL

THIS interesting model can be built entirely from cardboard and scrap wood, and provides a change from woodwork and other handicrafts. It is a fascinating hobby this cardboard modelling, as with patience and reasonable skill, a realistic product can result. Remember to have a very sharp knife or disused razor blade!

Fig. 1 shows a side view of the hall. It is made from stout cardboard, with three buttresses of 3/16in. thick fretwood glued on. Cut the cardboard to the outside dimensions given, and cover it with white paper, pasted over. On this, pencil the positions of the buttresses and window openings, and cut the latter neatly out, either with a penknife or sharp chisel.

Cut the buttresses from the fretwood, and bevel off the top ends of them to 45 degrees. Glue these to the cardboard, and note that the end buttresses are not level with the ends of the cardboard but extend beyond them by an amount equal to the thickness of the cardboard employed.

The Front End

The front of the hall is shown in Fig. 2. Cut this from cardboard, and cover with paper similarly. Cut out the door and window openings, not forgetting the circular window high up.

Cut the side buttresses from the fretwood, lay them on the cardboard with their outer edges projecting 3/16in. and mark their actual length by drawing a pencil along the sloping

top edges of the upper part. Glue these in place. The back of the hall is made up similarly but has no door or window openings. It is, in fact, just plain.

Now fit temporarily together the four walls of the hall, and tie with tape. Measure the exact inside dimensions of the building, and cut a wooden floor to these dimensions, to be a close fit. Do not waste good fretwood on this part, for any piece of

common wood will serve equally well.

The floor being a good fit, glue the sides of the building together, and tie tape round. Then glue in the floor, and leave for the glue to set. Detail Fig. 3, A, shows construction at this stage. The building should now be strengthened with wooden strips along the sides, inside (as at detail, B), and at the ridge, both shown at B1 and B2 respectively.

Any spare bits of wood can be used here, but they should be planed to suit the slope of the roof, as the roof itself will be glued to them later on.

Window Frames

For the window frames, cut six pieces of cardboard to dimensions given at Fig. 4, C. Lay these behind their respective window openings and pencil the shape of the openings on them. Now mark the eight actual

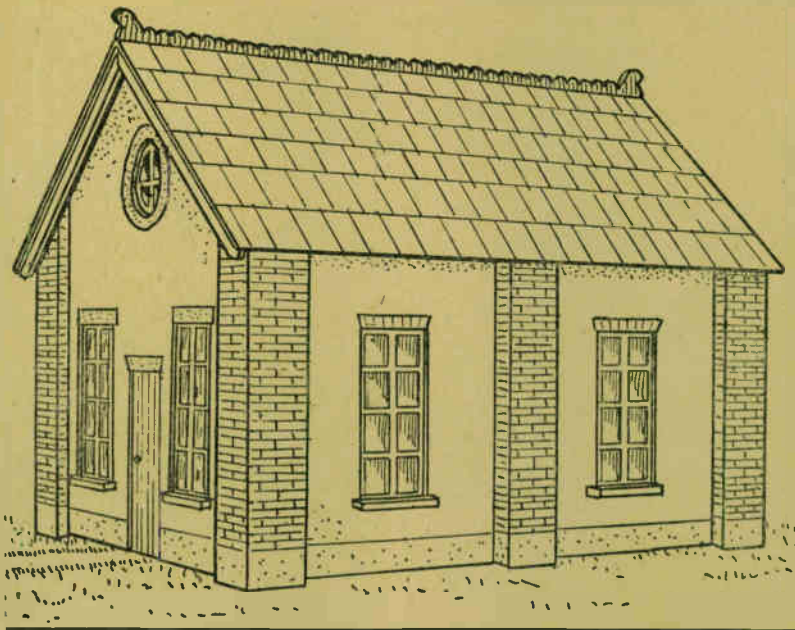

All correspondence should be addressed to The Editor, Hobbies Weekly, Dereham, Norfolk.

windows in pencil, and cut them carefully out. Glue them in place to cover each opening on the inside of the building.

The circular window is treated similarly, by cutting a piece of cardboard to the dotted square size (1½ ins.) shown at D, and cutting out the windows, also shown by dotted lines. Glue this behind the opening.

The Door

The door is not shown separately, as this is not considered necessary. It is a plain rectangle, ¼ in. larger each side and top than the opening. Glue this behind. It will, of course,

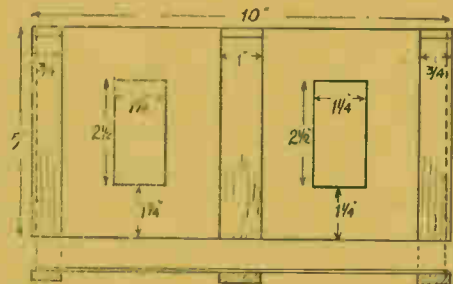

Fig. 1—Side view with dimensions

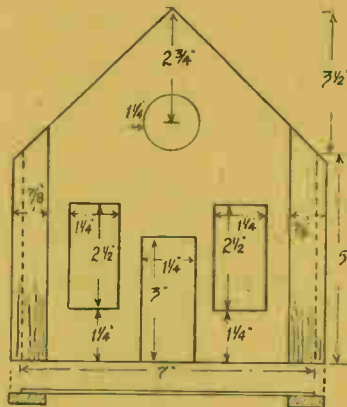

Fig. 2 Front of hall with details

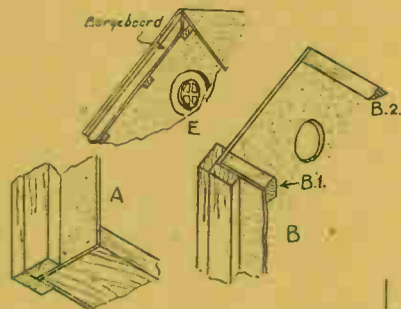

Fig. 3—Details of roof and joints

rest on the wooden floor, so white paper should be pasted over it, and also the wood edge on view, so that the

cardboard and wood form a whole.

A circular overlay, cut in cardboard, is cut as a ring to surround the circular window on the outside. Cut this to the inside and outside dimensions given in D.

The buttresses should now be covered neatly with white paper, glued over, to provide a more suitable surface for subsequent colouring. Cover the windows on the inside with

something is done, the crude appearance of the interior, seen through the windows, is rather displeasing.

The roof, also of cardboard, can be put on in two pieces, one for each side, or one piece scored and bent along the centre. The dimensions are taken from the building, and should be large enough to overhang ¼ in. at the eaves, and ¼ in. at front and back. Cover with white paper, and glue over, tying tape right round to keep the roof well down until the glue sets hard.

Ridge Tiles

For the ridge tiling, seen along the roof in the general view of the hall, cut two strips of ¼ in. fretwood, ½ in. wide and as long as the roof. Bevel the bottom edges of these to 45 degrees, and glue together, as in sectional detail, F. When hard, cut with the fretsaw to the shape shown at G, and glue to the roof.

For a finish, each end of the hall should have barge boards fitted just under the overhang of the roof. These also are seen in the general view, and are strips of stout cardboard ¼ in. wide, glued to wood blocks ¼ in. thick, and mitred where they meet at the tip of the roof. The detail, E (Fig. 3) shows how these are fitted. Now cut some strips of wood ¼ in. wide and ¼ in. thick, and glue below each window for sills.

Painting

The completed building is now coloured yellow or brick red, as preferred, and lined with a fine mapping pen to suggest brickwork. The bricks should be proportionate to the size of the building, say, ¼ in. long and ¼ in. thick.

The roof should be slate colour, and the slates ¼ in. by ¼ in. marked. Other details can be put in as personally preferred. All parts representing woodwork can be coloured to suit individual taste. Finally mount the model on a wooden or cardboard base, coloured appropriately.

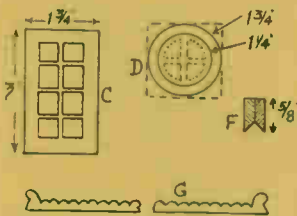

Fig. 4—Ornamental work and overlays

clear Cellophane, glued on.

Before the roof is fixed, it would be a good idea either to coat the inside of the building with a green or cream wash, or to cover the windows with scraps of green tinted netting or muslin, or even tissue paper. Unless



The fretsaw frame has been in use by Mr. Ward for 25 years. The lorry is made of matches—2,000 of them. Completed in three weeks by G. C. Baker, Melrose Avenue, Sherwood, Nottingham. Friends collected matches for him—only flat sided ones were of any use. Mr. Baker has been a model builder for years.

Readers' Novel Models

TWO further examples of originality and ability by our readers. Model of London's Tower Bridge made by L. W. Ward, a coal hewer of Tibshelf, Derbyshire. Designed from memory. Length 7ft. 6ins. height 3ft. 6ins. Complete with traffic and navigation lights, 250 windows, electric lighting etc. Made throughout with tools of a Hobbies Fret set.



Photo by Nottingham Evening News

For filling holes or making fittings there are possibilities in PLASTIC MATERIALS

THOSE who are undertaking any kind of woodwork—and particularly model makers—should always remember, and think over the possibilities of the use of plastic wood and similar plastic material. This is being more and more used, and its production and perfection were largely increased during the war.

Before the war there was a wood plastic in tubes, which could be squeezed out, but which immediately set hard and had to be handled, shaped and fitted quickly. Now, however, there is material which is much longer in setting, some which is not inflammable and which can be mixed from powder form. Several types of filler are quite useful on many occasions.

Filling Material

The ordinary home carpenter who is apt to make mistakes—and that applies to most of us sometimes—will find material useful in filling up bad gaps or even slight cracks or the end of a piece which has been broken off. There are, of course, several materials which can be used for this filling purpose, and it is largely a matter of choice which the amateur uses.

There is, for instance, the old method of using putty which can be moulded into a hole or a gap and smoothed down to the surface of the material. This is alright if paint is being used to cover the work when the putty is set hard. It will not, however, take stain or polish satisfactorily.

Home-made Filler

There is the home-made product of glue and sawdust which is sometimes recommended. The mixing of this is frequently very messy and the trouble is to apply the mixture satisfactorily to the right points in the work. Usually it has a habit of spreading or falling other than where it is wanted, and remaining a nuisance to clear off or to cover.

The plastic woodfiller is undoubtedly the best to use, as this can be forced into holes or gaps or even tiny cracks, and will set hard. It is also suitable for staining and polishing.

A Powder Material

The powdered product can be mixed with water in the quantities required. It should have a consistency of thick cream, and in use should be pressed well into the aperture to be filled, and tamped to become solid when it is set.

The plastic wood material supplied ready mixed must be handled fairly quickly, and applied to its position

immediately because as soon as the air gets to it, it settles hard almost at once. In using this, therefore, have your work ready so that you can dig into the tin with a knife and transfer the plastic wood to the position where it is wanted. Force it down and leave a little above the level of the top.

Cleaning Down

When dry, you will find that this plastic filling has set stone hard, but has shrunk slightly. It is always, therefore, advisable to over-fill a hole, as the residue not wanted can be cut away either with a chisel or

glasspapered down level. Needless to say, these fillings should be added before the final polish or painting is undertaken. Get the filler well into the part, and glasspaper the whole thing level in the final cleaning.

The actual filler, too, can sometimes be used to overcome bad shaping in model making. Those who undertake galleons or similar fancy decorated models, will find several occasions when a shape can be made with the use of this filler.

Take, for instance, a model plane, where the wings are rounded out from the fuselage. The old style was a square fuselage at right angles to the

TABLE IRONING BOARD

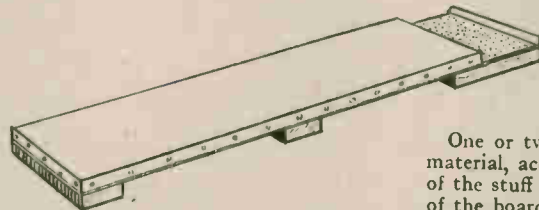

VERY handy board, this, for ironing on the kitchen table and may appeal to those who have not sufficient wood to make one of the folding type. A piece of board, 10ins. or more wide, is required for making.

This is rather a wider size than the lin. deal board, commonly in use, but board known as "shelving", which is generally some 10½ins. wide, would suit nicely, though usually not more than ½in. thickness.

A convenient size for the board is that given in the diagram, but, of course, it can be longer or even shorter to suit requirements. Cut to length. Then cut a 9in. length of the board and glue and screw this to one end, letting it extend beyond the end some 6ins. to make a stand for the iron.

At the opposite end, and also in the middle, battens 3ins. wide, cut from the same thickness board, are screwed across, underneath. Well countersink these screws, so that no screw heads project to scratch the table.

At the open end of the stand portion, glue and nail a lin. by ½in. strip of wood. The upper edge of this should be nicely rounded. Glasspaper off any rough splintery edges, and level, if necessary, the upper surface

of the board. The board should now be covered, and slightly padded, to make a nice foundation for ironing on.

One or two thicknesses of blanket material, according to the substance of the stuff should be cut to the size of the board and laid over. Smooth this down to avoid any creases.

Over this is stretched a piece of white calico or similar material, allowing enough to be folded over the edges of the board all round. This should then be tacked. Smooth it down with the palm of the hand, and stretch tightly, as the tacking proceeds, to get all smooth.

If either the blanketing or calico is creased beforehand, it is advisable to iron one or both before laying.

The surface of the ironing stand portion should be covered, if the material can be got, with a piece of sheet asbestos. A scrap of asbestos building board would do for this, and a suitable odd piece can often be obtained from a builders' merchant.

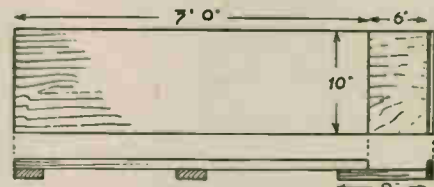

Plan and side view with dimensions

A substitute which can be used, only suggested when the asbestos simply cannot be got, is to cover the stand with those metal bottle tops, spacing them evenly over the surface, and fixing each in place with a single thin nail. These can usually be obtained from any inn or public house for the asking.

surface of the plane. To help overcome wind resistance, this corner was finally rounded off with a shapely flare. It is that sort of thing which can be done by filling in the angle with plastic wood, and then shaping it round with a piece of glasspaper on a rounded stick.

Galleon Additions

The same applies to many of the little shaped pieces on galleons or ships. The woodfiller can be moulded and shaped roughly to the part, and then finished off with a sharp penknife and finally with glasspaper. This applies also to the additional parts for these galleons, such as capstans, anchors, tiny stern lanterns, hatches, etc. The advantage, of course, is that the general outline can be first moulded in shaping before being finally papered down to the finished shape.

A "Sea" Base

This plastic wood material is ideal for forming an imitation sea on the baseboard of waterline model ships. It can be roughed up in wavelets and fixed close to the bow of the hull to show the curling wave there. At the stern, however, plastic material is added to show the wash of the propeller, whilst it is drawn in a

ribbon line where the hull meets the "water".

It should not, of course, be smoothed down perfectly flat, but left more or less in a rough stage. The set material is finally painted a greeny-blue for the sea, with splashes of dull white for the toppling waves and the bow wave particularly.

Ornamental Decoration

Another way in which this can be used is for the ornamental decoration on the stern and sides of some of the old-time galleons. At one period these galleons were very elaborately decorated with carving, crests, wreaths, etc. If you happen to be making one of these boats, then the necessary ornamentation can be made by the addition of this plastic wood.

It is glued in place on the stern or the sides in its raised shape, and when set is carved to form the tracery or the leaf work or the crest formation according to the original. This tiny work calls for some amount of patience.

It introduces more the art of carving, and a fine pointed sharp penknife is a useful requirement for the work. The result, however, does add very considerably to the finished model and the work itself is a pleasant change from the actual construction.

In this respect, too, it is as well to remember the plastic material called Pyruma, and sold in small tins at Hobbies Branches and most iron-mongers. This, however, is a cement composition and not a wood one. It is supplied in tins with the material of a heavy creamy mixture, which is pliable to the fingers, something like clay or stiff putty. It can, however, be moulded as needed and can then be baked hard in slow heat or merely air-dried, which takes much longer.

Stone Plastic

You can, for instance, make splendid little gun muzzles for the hulls of galleons with it, or even the complete deck guns on their little wheeled carriers.

If you are making the gun muzzles to fix to the hull, then a good plan is to put a short pointed projecting pin—a gramophone needle will do—into the flat end of the muzzle and leave it there until the clay has set. This can then be used to fix into the position required below the gun port on the hull.

This material, of course, is not suitable for inclusion in a wooden model which has to be planed or glasspapered down, because once it has set, it cannot be reshaped or moulded.

How to turn odds and ends to good account in WAYS TO ECONOMISE

AUSTERITY is seen in everything, even our dreams. We are becoming experts at economising, especially in regard to wood, plastic materials, fretsaw blades, etc. It is a case of waste not, want not. We simply have to economise, and while some of us are blessed with ingenuity and can be thrifty, the remainder ponder and worry—and get nowhere.

Using Scraps

An economy expert does not worry; he thinks for himself and reaches decisions based on common-sense. His reasoning runs on practical lines. He tries to make do with what he can put his hands on; he uses up waste stuff in a really amazing manner.

In respect to tools, for example, our "brainless" expert looks around for good substitutes, assuming the proper implements are not available. He may require a penknife, but cannot afford the price, or alternatively, the knife may be wanted temporarily, for trimming photographic prints, cutting matchsticks and so on.

Now, some fellows will try to pick up a second-hand penknife, and waste much time over it. What does

the expert do? He looks around the house—his own house, and probably finds an old rusty table knife. He cleans it, and grinds and sharpens it to make it suit his purpose. Indeed, he could make a good veneer knife, marking knife, draw knife, chip carving knife, etc. from it. If he has no grindstone or oilstone, he does the next best thing—makes use of old razor blades.

He either makes a special holder for the blades, or else buys a special holder. Although the discarded razor blades are quite useless for shaving purposes, they are excellent for cutting most materials. The matchstick model-maker will find them useful for cutting matchsticks neatly to length, mitring them and so forth.

Knot Holes in Wood

There are no flies on the economy expert. If doing a spot of rough carpentry work, with old wood, full of holes, caused by knots or bolts, which may be seen, he plugs the holes with wood, then covers the plugs with a layer of plastic wood. He thus saves quite a lot of useful plastic wood. If he has no plastic wood to spare, he remembers something—badigeon. It was invented long before plastic wood, and con-

sists of a mixture of saw-dust and glue, with the addition of plaster-of-paris or whitening, if necessary. Badigeon serves to fill defects in joinery work, open seams in flooring, etc.

Substitute Material

The biggest headache for the economy expert is wood. But, given time, he could make a substitute such as batten-board, block-board and lamin-board, which would use up quite small cuttings, especially the latter. Such boards consist of narrow "core" strips covered on both sides with a thinner ply of wood.

If the expert needs a thin plywood, he makes it by adhering veneers together, using a sawn veneer for the "heart" which is covered on each side with cut veneer, which is smoother and thinner, and attached so the grain runs cross-wise with the grain of the central piece. This, as the expert knows, prevents undue warping.

If the fellow cannot get wood in any form, he hunts around for a substitute which could be incorporated. He will use cardboard, lino or felting for backings to cheap wardrobes, cabinets etc.

Every amateur electrician will be interested in MAKING TEST METERS

SINGLE range direct current meter movements, with a glass front, dial, and enclosed in a bakelite case are obtainable quite cheaply. These movements form the basis of all ordinary voltage and current testers and it is easy to arrange them to give any desired voltage or current reading.

Most of the movements are either 1 mA or 5 mA models (which means that 1 milliamp or 5 milliamps, respectively, must flow through the meter to move the pointer completely across the dial). Although a little more expensive, the 1 mA type is usually the best.

Volts Ranges

From Ohm's Law it is possible to calculate a resistance value which will allow a given current to pass on a stated voltage. By using such a resistor, the meters mentioned are changed to volt-meters.

Disregarding for the moment the other parts of the circuit in the diagram, resistors are connected between the Plus terminal of the meter and terminals marked 1, 2 and 3. If the meter "M" is a 1 mA type and the resistor connected to terminal 3 is 10,000 ohms, then the meter will then read up to 10 volts. All other readings on the scale will be proportional, .1 mA being 1 volt, .2 mA 2 volts and so on.

A 100,000 ohm resistor can be connected to terminal 2. This gives a 100 volt range. .1 mA will be 10 volts, .2 mA 20 volts, and so on.

If a resistor of 1,000,000 ohms (1 megohm) were connected to terminal 1, this would give a range of 1,000 volts. This is rather high, so

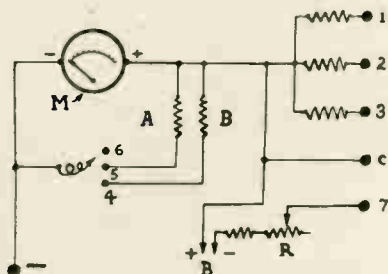

Diagram of wiring

250,000 ohms can be used, giving 250 volts. We, therefore, have a 3-range voltmeter, the ranges being those marked 1, 2 and 3 in the drawing of the meter scale.

With the 5 mA movement, five times as much current must flow. Resistors one-fifth the value must accordingly be used. That is, 2,000 ohms for the 10 volt range; 20,000 ohms for the 100 volt range,

and 50,000 ohms for the 250 volt range.

Readings

The meter will show its normal current when connected to, so a terminal "C" (for "Currents") may be added. With a 1 mA meter this is range 6 in the diagram.

To read currents over 1 mA, a resistor must be made to connect across the meter. To do this, connect any battery and resistor which will move the pointer to its 1 mA reading. (A 4.5 or 9 volt dry battery used with an inch or two of thin wetted string, the length of which can be adjusted, is a good way to get the meter to show 1 mA).

Now take a length of thin iron or resistance wire, and connect it across the meter. The pointer will move back and the length of resistance wire is adjusted until the meter shows .1 mA. The scale readings are now multiplied by ten, giving range 5. A .1 mA reading will be 1 mA, a .2 mA reading 2 milliamps, and so on.

Resistance

The resistance wire is wound on a piece of wood and wired so that it may be connected across the meter by connecting the fly-lead shown to

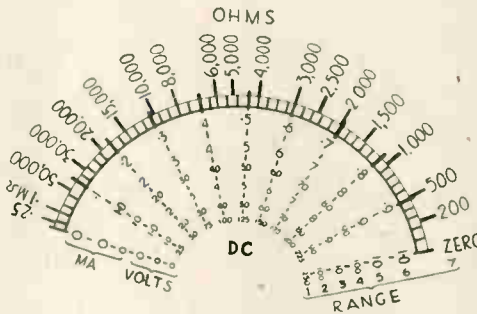

Marking the Scale

terminal 5. This resistance is marked "A" in the diagram.

If a range up to 100 mA (.1 amp) is needed, connect resistance "A" by putting the fly-lead on terminal 5. Now reduce the string resistance (or increase the battery voltage) until the meter shows 10 mA (1 mA on scale 6).

Now make up resistance "B", which can be connected to by putting the fly-lead on terminal 4, so that the

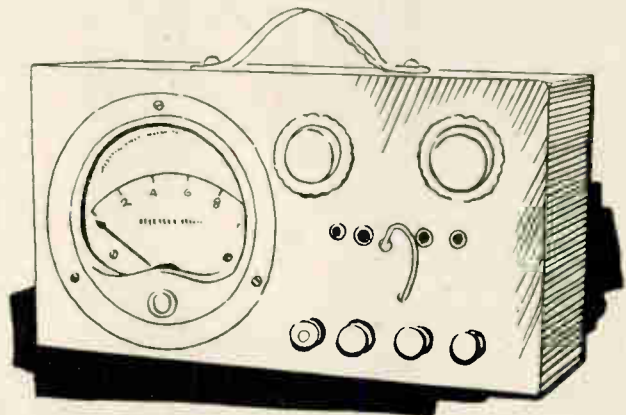

A Test Meter made up from these instructions

meter is again made to show one-tenth its original reading. The 1 mA scale has now been multiplied by 100 (10 by 10), giving range 4 in the diagram with 100 milliamps full-scale deflection.

Three current ranges have, therefore, been obtained. For each, connections are taken to "C" and the fly-lead connected to terminals 4, 5, or 6. As terminal 6 is connected to nothing, this gives the 1 mA range.

When finding by experiment the length of wire to use for "A" and "B", it is wise to temporarily disconnect the battery between each trial.

With the 5 mA meter the deflection may be reduced to one-half to give a 10 mA scale. (Then, as before, by one-tenth, to give a 100 mA range). Alternatively, it may be reduced to one-fifth, and then to one-tenth again, thus giving ranges of 5 mA, 25 mA, and 250 mA (.25 amp).

Ohms Range

By connecting a 4.5 volt dry battery at "B" and using a combined resistance of 4,500 ohms at "R" ohms, readings as shown on range 7 on the diagram will be obtained. It is most convenient to have a 1,000 ohm variable resistance at "R", connected in series with a 4,000 ohm fixed resistance.

To measure ohms, connect to terminal 7. Now adjust "R" until the meter pointer goes to "Zero" (1 mA reading) with no resistance being tested. If an unknown resistance is not tested, its value will be indicated by the meter pointer, range 7.

The meter should be fixed to a panel carrying the necessary terminals. Note there is one terminal marked "Minus" (-) and this is used in all tests, the other lead being

(Continued foot of page 231)

How you can make various plain and fancy CARDBOARD BOXES

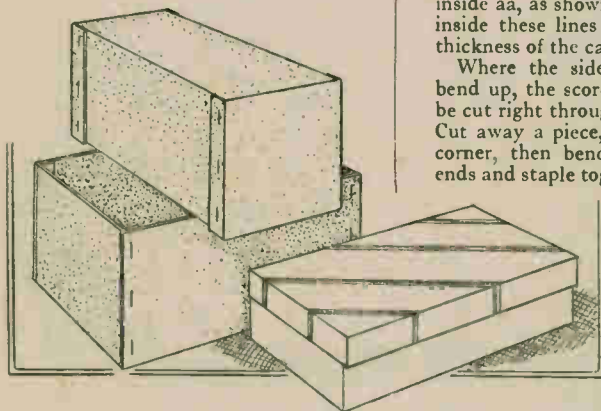

Instead score the ends on lines just inside aa, as shown at cc, the distance inside these lines being equal to the thickness of the cardboard.

Where the sides and ends are to bend up, the scored lines should now be cut right through with the scissors. Cut away a piece, as at XX, at each corner, then bend up the sides and ends and staple together, as at B.

The staples, C, can be bent up from any suitable wire, about the thickness of a stout pin. In fact, pins with their heads cut off would make

quite good staples for the job. Small holes should be pricked through the cardboard for the staples, and the latter pushed through and the ends bent inwards. The drawing, A, showing the cardboard in the flat, only shows half for economy in space, but the half not shown is, of course, identical.

Making the Lid

The lid for this box is made the same as for the box itself, but is naturally a trifle larger to fit on. Measure the outside dimensions of the box carefully to get the lid size, and don't make it too tight.

Just one point to notice here. In the box the tabs at the corners are folded inside, for the lid they should be folded outside, and to effect this, the lines cc, should be cut outside lines aa, instead of inside, as before. A box of this pattern is very strong, and excellent for sending an article by parcel post.

Another Type

A lighter and more fanciful box, useful for holding almost anything, is now to be described. Estimate the size of the cardboard, as before, and draw lines indicating the depth of the sides and ends as already described. Score on these lines and cut the corners, XX, right out (Fig. 2). Bend up sides and ends and hold them together with strips of paper, glued or pasted round, as in the inset sketch.

This is to be covered with white or fancy paper, using the following

method. Cut a strip of the paper, long enough to go right round the box and overlap $\frac{1}{2}$ in. at the joint or junction. The width of the strip should be $\frac{1}{2}$ in. wider than the depth of the box, to leave $\frac{1}{4}$ in. to turn over at top edge and bottom.

Paste this paper strip and rub it down over the sides and ends of the box. At the bottom, snip the corners and flatten down, removing all creases. Now lay the box on edge, and without snipping the corners this time, turn over neatly on the inside.

Covering the Box

The job of covering the box with paper in this manner can be facilitated by slipping it on to the projecting edge of a spare piece of board, as in Fig. 3, the board itself being cramped temporarily to the table. You can manage without this arrangement, but it does make the work easier.

Measure up as before for the increased dimensions of the lid, and cut out as described for making the box. Before bending up, however, lay the cardboard on the covering paper, as in Fig. 4, and cut the paper $\frac{1}{2}$ in. larger all round, except at points, dd.

Now bend up the lid to shape, and paste the holding strips at the corners. Glue is more convenient for these holding strips, as it dries more quickly and is really stronger. Paste the

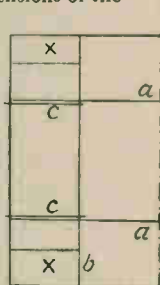

Fig. 1—Cutting and cornering



Fig. 2—Another corner style

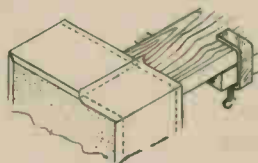

Fig. 3—A useful support

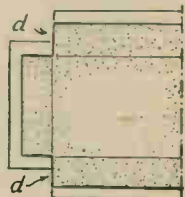

Fig. 4—Cover paper shape

covering paper and lay on the lid, then rub gently down. Turn the ends up and rub down on the ends of the lid, also fold the narrow tabs to the sides. Turn up the side strips, then rub down the surplus paper on to inside.

You can, of course, use a fancy paper for a box of this type, instead of plain white, and if more decoration is desirable, a small coloured picture can be glued to the lid.

NO doubt about it, many of the useful and ornamental articles made by readers look all the better if neatly packed in a box. This especially applies to presents. A set of handkerchiefs for instance, packed in a well fitting box, look doubly attractive to just being wrapped in tissue paper. Cardboard boxes, of the plain square or rectangular pattern, are quite easy to make, and the material can generally be got, even in these times, from a friendly grocer or stationer.

Two designs of boxes have been chosen as subjects for this article, one mainly for sending by post, and the other for just security and neatness. Both are illustrated in the general view. For the packing box, choose a fairly strong cardboard.

Cutting the Parts

Measure up the required dimensions of the box, and cut a piece of the cardboard to this size. Draw pencil lines across at aa and b, Fig. 1, to denote the depth of the box first.

Score lines with a penknife halfway through the cardboard on lines b and also on lines aa, the latter being scored only as far as the body of the box, not up to the vertical ends.

THIS WEEK'S FREE PATTERN SHEET

The large supplement design (No. 2732) given with this issue is for a handsome and useful Chinese Casket. Wood for making is obtainable from Hobbies Branches for 5/7 or sent post free from Hobbies Ltd., Dereham, Norfolk for 6/4 post free.

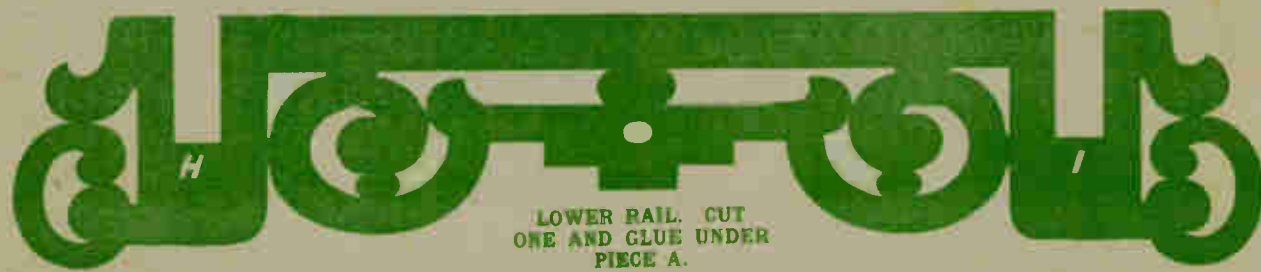

LOWER RAIL. CUT ONE AND GLUE UNDER PIECE A.



LOWER RAIL. CUT ONE AND GLUE UNDER PIECE A.



LOWER RAIL. CUT ONE AND GLUE UNDER PIECE A.

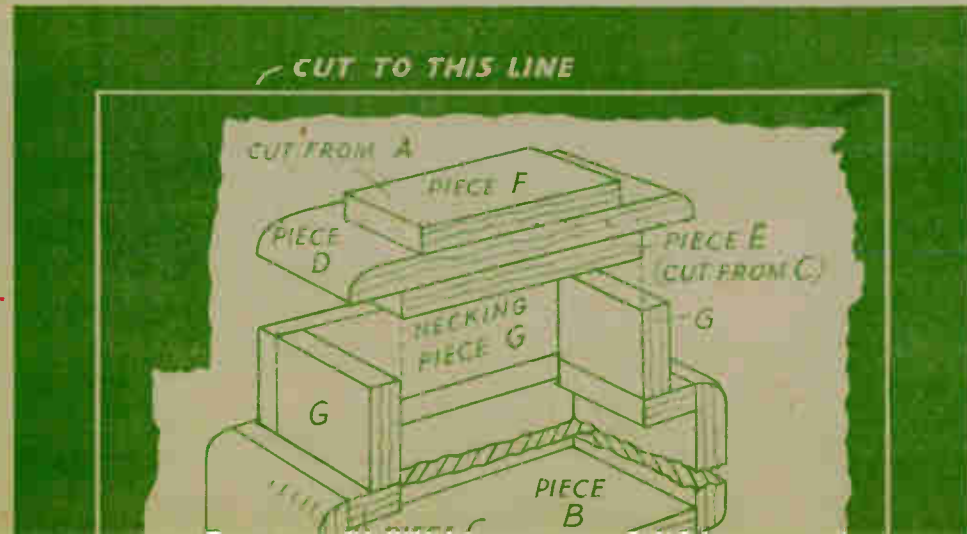

KNOB HANDLE.

CUT ONE OF EACH 1/8in. AND GLUE TOGETHER.



THE FINISHED



OVERLAY. CUT TWO TOGETHER 1/8in. THICK.

THE ARROWS INDICATE THE DIRECTION OF GRAIN OF WOOD.

Hobbies DESIGN No. 2732

SUPPLEMENT TO HOBBIES No. 2732

CHINESE CASKET

SUITABLE FOR JEWELLERY OR AS A LADY'S HANDKERCHIEF BOX

WOOD 1/4in. THICK USED THROUGHOUT, WITH THE EXCEPTION OF THE OVERLAYS WHICH ARE 1/8in. THICK.

PANELS OF WOOD REQUIRED FOR THIS DESIGN
THREE H4 TWO G2

The price is shown in Hobbies Weekly, March 10th, 1948, but is subject to revision. See the current edition of Hobbies Handbook, or write for price to Hobbies Limited, Dereham, Norfolk.



— SIZE —
 6 1/2 ins. SQUARE.
 6 ins. HIGH.



OVERLAY. CUT TWO TOGETHER 1/8in. THICK.

A CHINESE CASKET

THE type of casket shown on the opposite side of this sheet is one which is sure to appeal to the lover of fretwork. It incorporates a certain amount of ordinary construction, and is also built to a typical Chinese style, with overlay and feet in keeping. Of course, if you wish to do so, you can omit the overlay on the sides, but this will largely detract from the actual character of the completed article.

A great deal of thought has been put into the construction of the design for the sake of economy in wood, and you will find that a single panel has been utilised for two or three parts which in the ordinary way would have required that number of boards.

Construction

The actual construction of the casket is shown by the cut-away view on the other side, and from this it should be a simple matter to cut and construct the whole thing. The lettered parts can be put together in their alphabetical order. Notice that in several cases a rectangle cut from the centre of another piece is being used for quite a different position in the actual article.

This means that in cutting you must make the drill hole at some corner where it will be inconspicuous and certainly not greater in diameter than the width of the sawblade.

This occurs in the first piece to cut (A). Actually this square shown is the size for three pieces (A, B and C), but in the case of A you have to cut to the interior lines shown so that the piece taken out can become part F and will be utilised later for gluing over the lid. Piece C also has its centre cut out, and here again the part taken away forms E and comes under the lid. The rim of piece A forms a foundation on which piece B is glued.

Then the four sides are erected to form the under-box. They are a framework around piece B and piece C, the top and bottom edge being rounded to form the shaped effect you see in the picture. To prevent C falling downwards, little blocking fillets can be added on the under side.

Box Frames

Now the box frame formed by the four pieces G is glued on the top. Get these box frames square and true before gluing in place centrally. These four pieces G form the upper portion of the box and the lid is held in place inside them by the piece E which should just fit. All this should be tested and found correct before the parts are finally glued together.

The lid itself is composed of three pieces. There is piece D with its rounded edge which overhangs the sides of the upper box G. Side play in the lid is prevented by the piece E glued centrally underneath. Above it is the piece F which is the centre of piece A.

Finally, a little knob can be added. If you have not the circular type shown in the picture, you can cut two discs, glue them together and then fix them centrally to the top of the lid itself.

Feet Parts

The lower rail forms feet on which the box stands. There are four pieces to the rail and they halve together at H and I to form a solid framework. Then glue them centrally on the underside of the box so there is an equal projection all round. Stiffen up inside with little fillet blocks.

The sides of the box can be decorated with the typical Chinese overlay which is cut from $\frac{1}{4}$ in. wood. These, by the way, are the only pieces of that thickness; the rest is $\frac{1}{4}$ in. throughout.

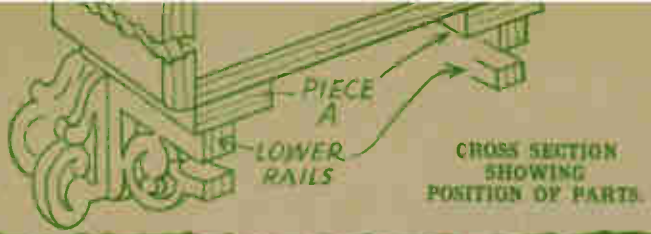

PIECE E - TO BE GLUED ON UNDERSIDE OF PIECE D

PIECE C. CUT ONE TO OUTLINE AND INNER DOUBLE LINE.

NOTE: A BALL KNIFE MAY BE USED IF OBTAINABLE.



PIECE A. CUT ONE TO OUTLINE AND INNER DOUBLE LINE.

PIECES B AND D. CUT TWO TO OUTLINE ONLY.

NECKING PIECE G. CUT TWO.

NECKING PIECE G. CUT TWO.

PIECE C

SIDE. CUT TWO.

PIECE B

PIECE C

SIDE. CUT TWO.

PIECE B

PRINTED IN ENGLAND.

Patterns and particulars for making a simple PERSPEX LETTER RACK

PLASTIC material is replacing wood in many articles for the home. One reason is that plywood and fretwood is still short in supply. So, too, is plastic material, but not quite so much. Perspex is a good substitute for wood, particularly plywood, it being easily cut with the fretsaw, filed, rasped, glasspapered and even planed.

Of course, only the edges of the stuff should be trimmed with a plane, using a block plane and a shooting board. This enables almost invisible corner or flat butt joints to be made.

Material required

Apart from the wood shortage, however, plastics are simple and attractive to work with. A typical example is shown on this page. It is a letter rack made from a colourless, transparent sheeting, such as clear Perspex. A piece 8½ ins. long by 6½ ins. wide by 3/16 in. thick is wanted, plus a couple of small cuttings which will make the letter rack holder or fingers.

The fingers are rather broad, but this will not matter, however, as the width does not "hide" addresses on envelopes, which is an advantage over wood. We try to give some idea of this feature in our illustration. The fingers are quite easily made and fitted.

Note the use of screws. These are advised, even though the fingers are cemented, via packing pieces, to the back shape of the letter rack. The particular screws we have in mind are ½ in. by 8 roundheaded nickel-plated screws.

If desired, the reader could make use of coloured plastic material. It should not be too thin, otherwise it may be inclined to "curl" with the heat of a room. Stuff about 3/16 in. thick is ideal.

Cutting the Back

Owing to the polished surface of sheet Perspex, it is hard to mark design shapes upon it, unless by scoring. The scribing instrument, such as a marking awl, is apt to slip suddenly over the surface and create an unnecessary mark which cannot be removed.

To get over the difficulty of scoring lines on the surface, we provide a

Test Meters (Continued from page 229)

connected to terminals 1, 2, 3, and so on according to the range desired. Resistor "R" can be mounted on the panel. The whole should be contained in a box carrying a 4.5 volt dry battery (if ohms are to be measured).

With the 5 mA meter, five times the current must flow. Therefore, 22 volts must be used (3 grid bias

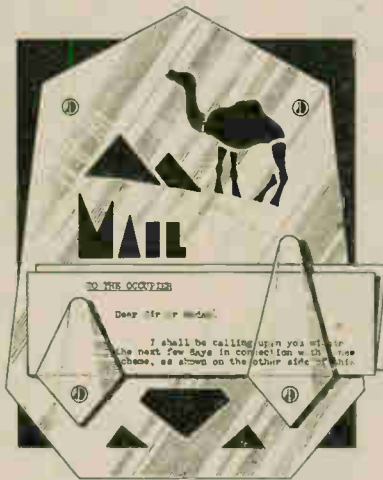

See patterns on page 235

design page. This page, or a tracing (on paper) can be adhered to the plastic sheeting, using a thin glue—not paste, by the way. Paste has a poor grip on plastic material.

Cut with the Fretsaw

One then proceeds to cut the design with a fretsaw in the usual way. A medium fretsaw is just a trifle too coarse for cutting Perspex. A fine grade blade is advised, or a metal-cutting blade, the teeth of which are super-fine and almost put a gloss on the edges of the work, thereby saving one the need to "file" the edges.

When sawing, take your time. Be sure to blow the "dust" away from your guide lines. It is easy to go off the lines.

Be sure to hold the fretsaw frame vertical. Slant cutting shows up very badly in plastic materials, especially if clear, transparent stuff is used. And unlike wood, plastic material is very sensitive to friction. A hot saw blade will stick in it and create "burrs" at both sides. Do not, therefore, work the saw very quickly or "dig" it into the stuff.

If using a metal-cutting fretsaw blade, you cannot afford to cut heavily with it. It snaps—and it snaps

batteries are suitable).

The meter scale may be marked up, or the scale illustrated cut out and glued on the inside of the case lid so that all the voltages, etc., may be read easily. Red and black insulated test prods on lengths of flex may be used for the test leads.

Ordinary resistors sold at 9d. are only accurate to 10 per cent. There

very easily, so you need to exercise care.

The fretwork in the back shape is, of course, the tiny desert scene, i.e., camel and pyramids, the word "MAIL" and some bottom frets, plus the screw holes. If desired, the wording can be omitted.

If you are making the letter rack for a friend, it might be wiser to include the wording so the friend will know what to do with the novelty, assuming you are one of those strong, silent, kind-hearted individuals who hate writing or saying a lot.

The Fingers

The fingers are cut to the outline shape on the pattern page. Include the screw hole positions. Make two finger packing pieces, cut as shown.

The fingers are trimmed neatly, then bevelled at the side edges, as shown. This beveling can be done with a rasp, file and glasspaper. But, to make the edges transparent, the surface of each bevel should be planed.

Alternatively, try to get a good polish on the bevels by rubbing with "flour" grade glasspaper, then "worn" flour grade glasspaper, finally polishing with white furniture cream, or by rubbing in, with a soft pad, a few drops of clear oil. The oil helps to take the "frost" appearance from the edges.

The packing pieces are adhered to the fingers with a film cement (scrap celluloid film dissolved in the chemicals amyl acetate and acetone). This cement is obtainable in tubes, it being quite clear and thin, and smelling like pear-drops. It sets rapidly—almost at once.

Fixing the Holders

The fingers are cemented and screwed to the backing. Any projecting points are filed flush. Ordinary wood screws can be used, the hole for the unthreaded shank being larger than the hole (in the back) for the threaded part. Alternatively, you could use machine screws and have the back holes threaded with a suitable tap. Providing you use a reliable cement, the screws are unnecessary.

The edges of the back should be trimmed with a plane, with the arris removed with the same implement. A good, polished edge will result.

may, therefore, be a 10 per cent. inaccuracy in voltage readings if these are used. If this is not desired, the specially accurate resistors intended for use in meters should be obtained, though they are slightly more expensive.

When adjusting "R" to obtain the zero ohms reading, the test leads are shortened by touching them together.

LIGHTHOUSES ON STAMPS

THERE have not been very many lighthouses shown on stamps, which is rather a surprising state when one considers the value of these lighthouses to the ships which carry the mails across the sea. There are, however, a few examples of the various types of lighthouses found and these we will quickly describe.

First the lighthouse proper. This can be seen on the new stamp from Finland which has been issued in connection with the 250th anniversary of the foundation of the lifeboat institution.

The lightship is shown on the stamps of Germany, the date being



Fig. 1—The fourth Eddystone

Fig. 2—Stephens Island Lights

1937 and the particular lightship is the Elbe I. From the Dominican Republic we have a picture of a new type of light. It is the Columbus Memorial Light—not for ships but for aircraft.

An Insurance Stamp

Have you a stamp in your album in the space for New Zealand showing the picture of a lighthouse with the words "State Security" in the beam of the light, and around the framework of the stamp the words "Life Insurance Department"?

You may have wondered if it was quite right to put that into a postage stamp album or if you should have turned it out and only kept it as a curiosity. Well, it is quite alright in its place as a postage stamp. The reason is that in New Zealand life insurance is in the hands of the government. Naturally there will be a considerable post bag, and the government insurance department had its own postage stamps in 1890 and since that they have had approximately the same design.

Now a new set of seven stamps appears, each of which has a different design. These stamps are so hand-

some that we shall take space to describe each one in detail. This is made simple because the New Zealand government have issued an attractive little folder with a space for each stamp. With each, too, there is a short description of the design, and since you cannot all have these folders from New Zealand, we shall use the information and pass it on to you.

A Reader's Gift

We are indebted to Mr. G. Donaldson of Wellington for very kindly sending along the stamps and the folder, also for the two Health stamps which we will show later.

There are seven stamps in the set, and the values are ½d., 1d., 2d., 3d., 4d., 6d. and 1/-. The first one we describe is the 3d., and this, as you can see from the illustration, is the Eddystone Lighthouse. It is the best known of all the British lighthouses situated off the Cornish Coast, South-West of Plymouth.

The present structure is not the original by any means. The first was designed by Henry Winstanley, built of wood on a stone base. It was 100 feet high and completed in 1699 or 1700, but during a storm in 1703, it was washed away and with it perished Winstanley himself, together with five keepers.

Wood and Stone

The second was also of wood and stone. It was 92 feet high, was completed about 1709 and lasted until 1755, when it was burned down. The third was designed by John Smeaton, built this time of Portland stone, each stone being dovetailed into the next to give strength. It took three years to build and lasted for a hundred years, after which time it was found that the waves had undermined the rock on which it stood so that it was unsafe. Most of it was taken away and placed on Plymouth Hoe.

Four Years to Build

The present lighthouse, which is the fourth and is the one shown, was designed by Sir James N. Douglas and took four years to build, being completed in 1882. It is 130 feet high, standing on a base 23 feet high and 44 feet wide. The light has a range of 17½ miles and gives a double flash at intervals of half a minute.

The duration of the flash and the interval between is, of course, most important, because it is through this that the sailors know where they are. To those who live close to a light-

house it will seem absurd to mention this, but there are probably some who live inland who did not realise the importance of this item.

The lighthouses in Gt. Britain are supervised by Trinity House and many British lights in the Colonies are under the Board of Trade.

Of the six lighthouses which are situated around the coast of New Zealand and which are illustrated on these stamps (the seventh stamp shows Eddystone), four of them are in or around Cook Strait, which is the stretch of water between North and South Island.

A New Zealand Light

In the opinion of the writer, the prettiest of them is that shown on the fourpenny value which is illustrated here. This is the closest view you have of a lighthouse. It guards the western entrance to Cook Strait and consequently ships on the way to Wellington (the capital of New Zealand although not the largest town) are always on the look out for this. The light is a very powerful one, being visible for a distance of no less than 32 miles in clear weather.

Also situated in Cook Strait and not very far from Stephens Island is the light shown on the 6d. stamp. This one is called "The Brothers" and is situated on one of a very small



The Brothers Lighthouse and (top) the one at Castle Point

group of islands at the narrowest part of the Strait, the light being on a rock 230 feet above the water. The design of the stamp does not appear to be in any way spoiled by the bright beam which stretches across the top of the design, although normally a band of light like that will do so.

In the same way the design of the 2d. stamp is not impaired by the ray of light. This is the Cape Palliser Lighthouse and is found at the south of North Island and consequently

(Continued foot of page 234)

MISCELLANEOUS ADVERTISEMENTS, etc.

The advertisements are inserted at the rate of 3d. per word or group of letters prepaid. Postal Order and Stamps must accompany the order, and the advertisements will be inserted in the earliest issue. Fretwork goods or those shown in Hobbies Handbook not accepted. Orders can be sent to Hobbies Weekly, Advertisement Dept., as below.

STAMPS. Send for my approval sheets, for small and medium collectors. Enclose 2½d. stamp for postage. Free gift of eight stamps.—D. Mellenfield, S.D.A. (H.W.), 14 Kings Road, Barnet, Herts.

INDOOR fireworks. 2/6 per box, postage 4d. extra. Each box containing 36 indoor fireworks.—C. A. Hallam, Alexandra Road, Swadlincote, Burton-on-Trent.

FOR beginners with fretsaws we strongly recommend our 'You make it' Jigsaw Puzzle. We send per return all you need, for 1/3. S.A.E. for list of other models.—'K' Toys, Brookfield Road, Bristol 6.

SEND stamp for extensive list of Shandcraft Tools and Materials now available.—Dept. Y.3, Torob Agency, 53A, Broad Marsh, Nottingham.

POCKET Magnet, small permanent magnet equal in power to old style one of six times its size. 2/6 post free.—The Hobby Shop, Bold Street, Southport.

40 DIFFERENT stamps free to all applicants for my ¼d.—1/- approvals, includes Mint Victory, used Coronation, Silver Jubilee, Ship, Pictorial, etc., etc.—J. F. Smith (Dept. H.), 60 Edison Rd., Welling, Kent.

MORSE telegraph keys. Genuine U.S. Army Signal Corps, 5/6 each, plus 6d. postage. Special torches, with flexible lamp extension, less dry battery (No. T12), 3/6 each, plus 4d. postage.—Allan Levin Limited, 1 Mayfields, Redditch.

LONELY? Join Friendship Circle. Details 6d.—Secretary, 34 Honeywell Road, London, S.W.11.

PERSONS required immediately to make leather shopping bags in spare time. Write—Dept. 11, Empire Co., 117 Nottingham Road, Loughborough.

FREE! 25 Stamps. Request discount approvals.—Bradbury, 5 Goulden Road, Manchester 20.

WHEELS for toys in metal, wood and plastic. Numerous sizes and types. Write for list, stating requirements to The Joyden Toy Co., 193 Chase Side, London, N.14.

GALLEON sails and heraldry 5 sheets 7½ins. by 10ins., 2/6 pkt List of plans and accessories 3d.—St. Andrews, High Pitfold, Hindhead.

LISTS: Toys, printing moulds, lead toys, American magazines, stamps, all 6d.—7 Hawthorn Terrace, Halifax.

250 PACKET unsorted stamps 2/6, 50 packet all different 1/-.—Hale, 78 St. Mary's Road, S.E.15.

SCHOOLGIRL wishes to buy Sadana or other small printing machine. New or old. Write—P.B. C/O. Hillworth Court, Longdon, Gloucester.

STAMPS Free—Send 2½d. for free gift and fine selection of approvals.—G. H. Brewer, 9 Wrington Crescent, Bristol 3.

EX. R.A.F. headphones. New, 5/- pr., post 6d.—C. W. O. Barker, 14 Mardale Av., Manchester 20.

BE Taller. Quickly! Safely! Privately! No appliances—no tablets—no dieting. Details 6d. stamp.—Malcolm Ross, Height Specialist, BCM/HYTE, London, W.C.1.

MODELS: you can make lasting stone-hard models with Sankey's Pyruma Plastic Cement. Supplied in tins by Ironmongers, Hardwaremen and Builders Merchants. Ask for instruction leaflet.

MONOMARKS. Permanent London address, letters redirected. 5/- p.a.—Write Monomark BCM MON082, W.C.1.

YOU can look up in "Where's That Car From?" 10,000 car index numbers alphabetically arranged. 56 pages 6d. From all newsagents.—Raleigh Press. Exmouth, Devon. (Post 1d.).

PERSONS required make fancy goods at home. Write for details.—Melton Manufacturing Co. (Area 544), Southgate Street, Leicester.

LONELY? Then write Secretary U.C.C., 5B.B. Hay St., Braughing, Herts. Genuine. Est. 1905.

BARGAINS! ¼ oz. unsorted Bmixture (about 175 stamps) 2/6.—James, 67 Coledale Drive, Stanmore, Middlesex.

TRANSFERS for decorating toys. Trays, furniture, fancy goods. Selection 10/-, 20/-. Flowers, pixies, dogs, nursery rhymes.—H. Axon Harrison, Jersey.

DOLL'S House papers, model supplies, kits, plans, engines and motors. Full lists 1/-.—Sutton, Hill House Drive, Billericay.

TOYMAKERS super casting Moulds for lead toys and plastercraft, as used by all high class toy makers in England and abroad. Over 600 latest designs. Fully illustrated catalogue 2/- P.O.—Agasee, 7 Stradbroke Road, Highbury, N.5.

PRESSED Metal Wheels (balloon tyre design). Per dozen, 3in.—10d. 1in.—1/-. 1½ins.—1/3. 2ins.—1/6. Per gross, 3in.—6/-. 1in.—7/-. 1½ins.—8/-. 2ins.—10/-. Illustrated catalogue 3d.—Jason, 135 Nags Head Road, Ponders End Middlesex.

W. McGARRIGLE for aeroplane and ship kits, all accessories. Stamps lists 3d. Wholesale lists 4d.—64 Hillcrest Road, Romford.

SPECIAL Offer. Attractive stamp album 50 stamps, packet of mounts. Post free 3/-.—Gamut (Dept. C.), Supplies Co., 24 Gunnersbury Avenue, London, W.5.

TOY casting moulds, farm animals, soldiers, wall plaques, ornaments, dogs, etc. The largest selection of metal and plaster moulds available. Avoid other firm's copies. 6d. illustrated catalogue, S.A.E. for list.—Nuthall, 69 St. Mark's Road, Hanwell, W.7.

FREE! Extra special British Colonial variety packet includes scarce jubilee, coronation, victory, zoological and latest new issue stamps. Request approvals (2½d.).—Thompson, 70 Cavendish Avenue, London, W.13.

50 DIFFERENT free to approval applicants. Discount and free gifts given. Enclose postage.—Ward, Grindleford, Sheffield.

PEN-pals bulletin. World-wide contacts, 1/- monthly.—176a Old Shoreham Rd., Hove.

STAMPS FREE!! Twenty unused (2½d.).—G. H. Barnett, Limington, Somerset.

Stamp Collecting (Continued from page 233)

guards the eastern entrance of Cook Strait.

Just around the corner as it were, is the position of the next illustration. It is the ¼d. value and shows Castle Point. Using a magnifying glass, one sees by far the prettiest view of all and it would appear to be a really first class place for a camp by the

sea. This is an important light for ships coming from Panama. The other lighthouse shown on this set which is in North Island is Cape Brett and this is on the 1/- value.

Finally we have the 1d. stamp and that gives us Tairaroa Light, in South Island just north of Dunedin. It was one of the first to be erected in

New Zealand. Prior to 1921 it had a blood red light, when it was changed to an automatic white light. So this is certainly a most pretty and interesting set, and it is well worth getting out an atlas and finding the position of each one shown. Many thanks Mr. Donaldson, on behalf of other readers!

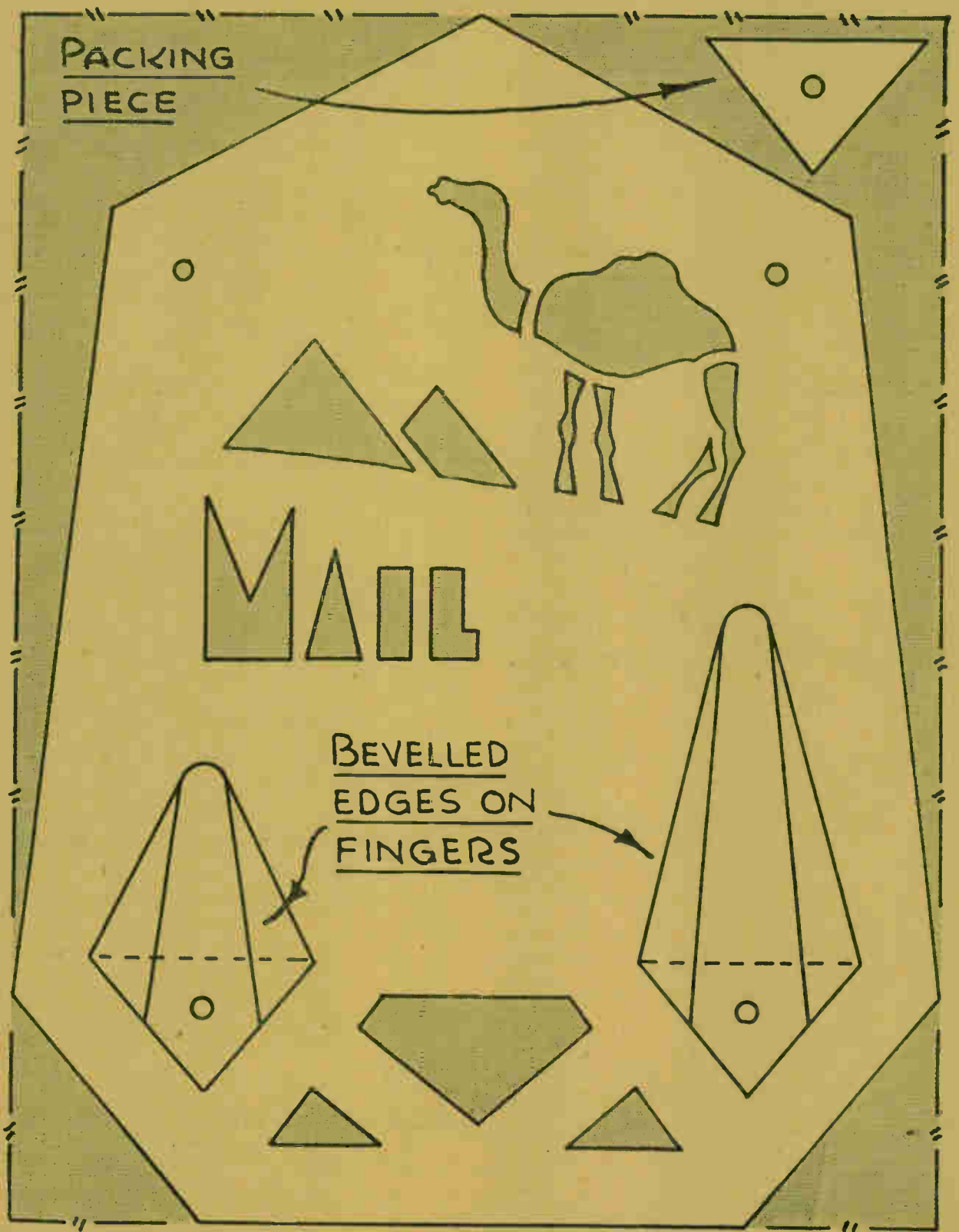

235

How to make a popular safety ROCKING HORSE

THIS is a popular design of rocking horse, and makes a special appeal to the amateur woodworker on account of the simple construction of the horse. No solid need be involved, but just a plain outline, quite within anyone's capacity. Of course, a more solid shaped head can be added if you desire.

The general dimensions are given in Figs. 1 and 2, a side and end view of the stand respectively. For the floor members cut two long and two short pieces of 4ins. deal to the lengths given. The long members are fitted with 2in. tenons at each end, as at A, and the short members (the end pieces) mortised to suit. The sharp upper corners of these latter pieces are sawn off.

Before gluing together, cut grooves 1/4in. deep and 2ins. wide (see A), in the long members for

the vertical posts to fit in. Then glue and screw the whole together, the long members being 1 1/4ins. apart. The posts can be cut from 2in. square timber, or if such wood is not available, two thicknesses of 1 1/4in.

board can be glued together to make up. The thickness will then be 1 1/4ins., but this is of no moment if the grooves are cut to suit. At the top of the posts saw a tenon 1in. deep for the top board to fit on.

Then glue the posts in their grooves and nail. The top board is 3ins. wide, and should have, at the correct distance from each end, a mortise to suit the tenons on the posts. If a tight fit here, glue will make a sufficiently strong joint.

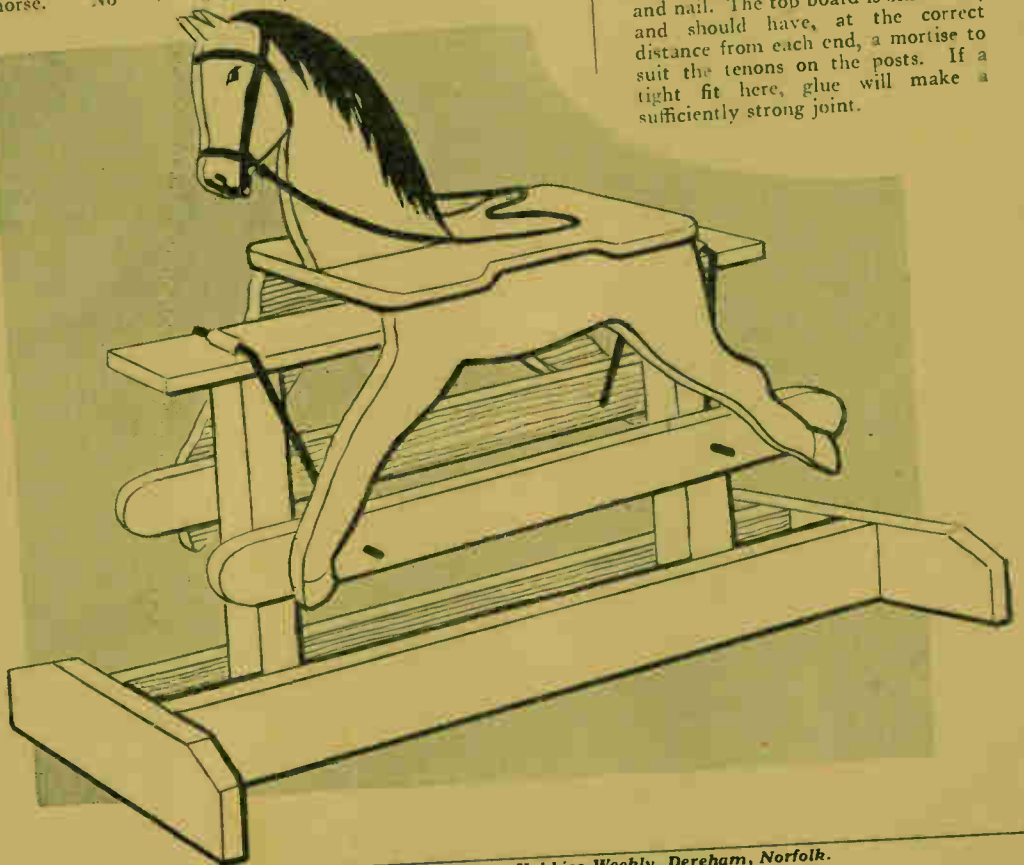

All correspondence should be addressed to The Editor, Hobbies Weekly, Dereham, Norfolk.

PENN'S RAZOR-BLADE PENKNIFE

Smart ENAMELLED handle, fitted new razor-blade firmly held by screw. With this strong high-grade Penknife you always have a really sharp cutting-edge. Suitable for all purposes. Puts old razor-blades to good use. Folds flat for waistcoat pocket. This GREAT BARGAIN is just to introduce our List. Send Now 1/- stamps or P.O. Direct only from—
Wm. PENN Ltd. (Dept. KHB)
585 High Road, Finchley, LONDON, N.12

CUT YOUR OWN HAIR

TRIMS AS IT COMBS
Save endless time and expense with PENN'S "EASY-TRIM". For lady, gent or child.
2/9 Post 3d.
with three spare blades.
This superior, unbreakable SELF-TRIMMING COMB keeps your hair always neatly trimmed.
Send NOW 3/- P.O. or stamps to:—
Wm. PENN LTD. (Dept. THB),
585 High Road, Finchley, LONDON, N.12

PENN'S RUG MAKER

For Making Rugs on any Sewing Machine (Hand or Treadle)
Recommended in "Hobbies Weekly", 30/7/47
MAKES full-size Rug on ANY Machine in a few hours. Enables wool to be stitched on canvas without waste on back. Makes stronger rugs with less wool and better results than any other apparatus. Uses Coupon-free rug wool or long strips of cloth. Long, short or medium pile. No adjustment to machine required. VERY PROFITABLE HOBBY. With simple directions. Send now 3/- P.O., cheque or stamps.
Direct only from
Wm. PENN LTD. (Dept. HBR)
585 HIGH ROAD, FINCHLEY, LONDON, N.12

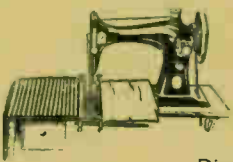

"MARS ARE MARVELLOUS"



On the top board the rockers are to be fixed. These are bent up from $\frac{1}{2}$ in. round iron rod to the shape shown at C. Readers who may not care to attempt this part of the job can get it done for them at any local blacksmith's shop or iron works.
Accurate Fittings
The fittings should be accurate to measurements given, with the lower extensions at right angles and about $\frac{1}{2}$ ins. long, or a trifle more. It is quite easy to cut a piece off these if found too long afterwards. The

wood portions can be varnished or painted according to convenience. Varnishing would, perhaps, be the best finish, and if at hand, a preliminary coat of light oak stain would improve the appearance.
With a soft wood like deal, a previous coat of size would help to fill the pores of the wood, before the varnishing. The metal rockers should be coated either with black japan or enamel, and it would be as well to remove the plates beforehand, so that no "stickiness" results afterwards.

to leave two tenons, to fit the seat board. Add a couple of screws to each leg, where it is joined to the side pieces, and then try the fitting.
The central portion of each side edge of the seat board should be sawn away, to reduce the width at those parts as much as possible. Round off the sharp corners, and then glue the whole together.
Painting and Fixing
The horse can be painted grey or brown, grey being the most popular. Details are put in with black paint and

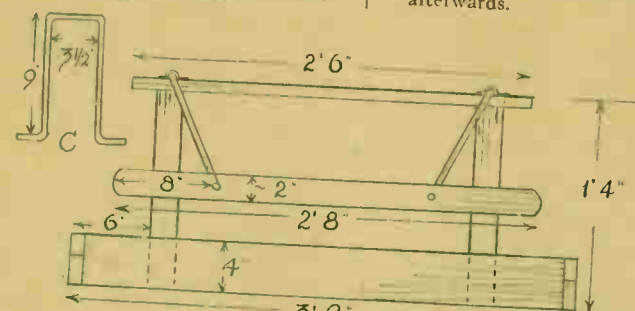

Fig. 1—General side view and detail of metal fitting

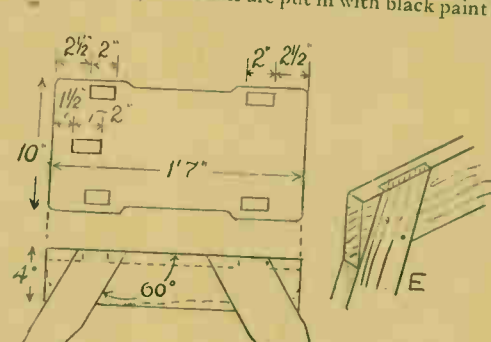

Fig. 4—Plan and side view of seat

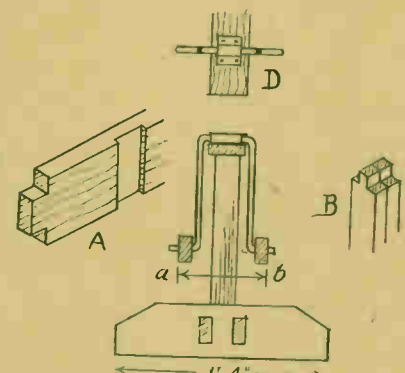

Fig. 2—End view and joints to use

- TIMBER REQUIRED**
- Stand
 - Long members (2) 3ft. 2ins. long by 4ins. by $\frac{1}{2}$ in.
 - End members (2) 1ft. 4ins. long by 4ins. by $\frac{1}{2}$ in.
 - Posts (2) 1ft. 4ins. long by 2ins. by 2ins.
 - Rocking bars (2) 2ft. 8ins. long by 2ins. by $\frac{1}{2}$ in.
 - Top bar (1) 2ft. 6ins. long by 3ins. by $\frac{1}{2}$ in.
 - Horse
 - 7ft. 6in. length of 9ins. by $\frac{1}{2}$ in. deal board

The head and legs of the horse are shown, drawn over lin. squares, in Fig. 3. It will be seen that these parts can be cut from deal board $\frac{1}{2}$ in. thick and 9ins. wide. These could just as well be marked direct on to the wood, if it is lightly pencilled in squares first. When marking out the head portion, take care to make the tenon at the bottom just 2ins. long.

Fitting the Legs
The legs are to be jointed to side pieces of wood, which are, in turn, mortised underneath the seat board, as in Fig. 4. Cut the side pieces to length and width given, and halve the legs into them at the angle shown, as at E. Glue the joints and when the glue is quite hard, trim to the shape shown by the dotted lines.
Now cut the seat board to dimensions given, and chisel out the mortise slots for the horse's head and the side pieces, to which the legs are jointed. The distance apart of the mortises, measured across the board, will be the same as distance a-b, given in Fig. 2. This being done, saw the tops of the side pieces

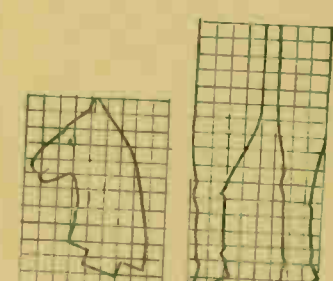

Fig. 3—Outline of head and leg

a fine brush. Finish with a coat of copal varnish. Fix the horse to the rocking bar with small iron bolts. Items such as a strip of fur for a mane and tail, can be added as preferred.

One item, well worth adding, is straps and stirrups, to assist in mounting the horse, also leather reins. An alternative to the straps and stirrups, or in addition to them, if you like, is a mounting step. This is a piece of 3in. wide board, 12ins. long, screwed across the rocking bars in the middle.

INDEXES AND BINDING CASES

INDEX for back Volumes of Hobbies Weekly 1 - post free. Each 6 months from April to Sept., and Oct. to March. Binding Cases in red linen, stamped in gold, 2/6 each.

fight the crisis with SAVINGS

Save the Bank Way
Ask your Bank to tell you about their new free service to National Savings investors

We're up against an enemy as relentless and fierce as any we've met yet. National Savings provide a weapon to fight it with, and we've no time to lose. Save now: save hard—buy all the new 10/- Savings Certificates you can afford, up to a thousand, the maximum allowed. It's profitable anyway—in ten years they increase by 30% tax free! Buy them through your Bank, Post Office or Savings Group.

THE FAMOUS EPISCOPÉ PROJECTOR
ORDINARY PHOTOS ETC FLASHED ON SCREEN ANY SIZE 79/6

PHOTOGRAPHS from any size thrown on to the screen at very few feet distance. Merely insert snap, photograph, drawing, stamps, ordinary picture cards, or documents and enlarge to Goliath proportions projecting colourings. A postage stamp snap is produced magically to fill screen. Show your family album. A boon also to philatelists. Plug in to electric light circuit. Produces enlargement when focused direct on to sensitised paper in dark room. Send now 79/6. Post and packing 2/6.

Genuine BRITISH NAVAL Telescopic Gun Sight
35/-

Naval Telescopes. Powerful day and night lenses. Modern micrometer automatic range focus apparatus. Splendid object lens. Approx. 15ins. length. Picks out objects at many miles range.
Two or more carr. free. 35/- ONLY. Post and Pack. 1/6
MARQUEES.—Every type of Marquee Tentage and Camping Equipment. Send 1d. for LIST.
HEADQUARTER & GENERAL SUPPLIES LTD. (Dept. HOB/EP),
Loughborough Junc., London, S.E.5

Patterns for a Plastic Letter Rack

(See page 231)

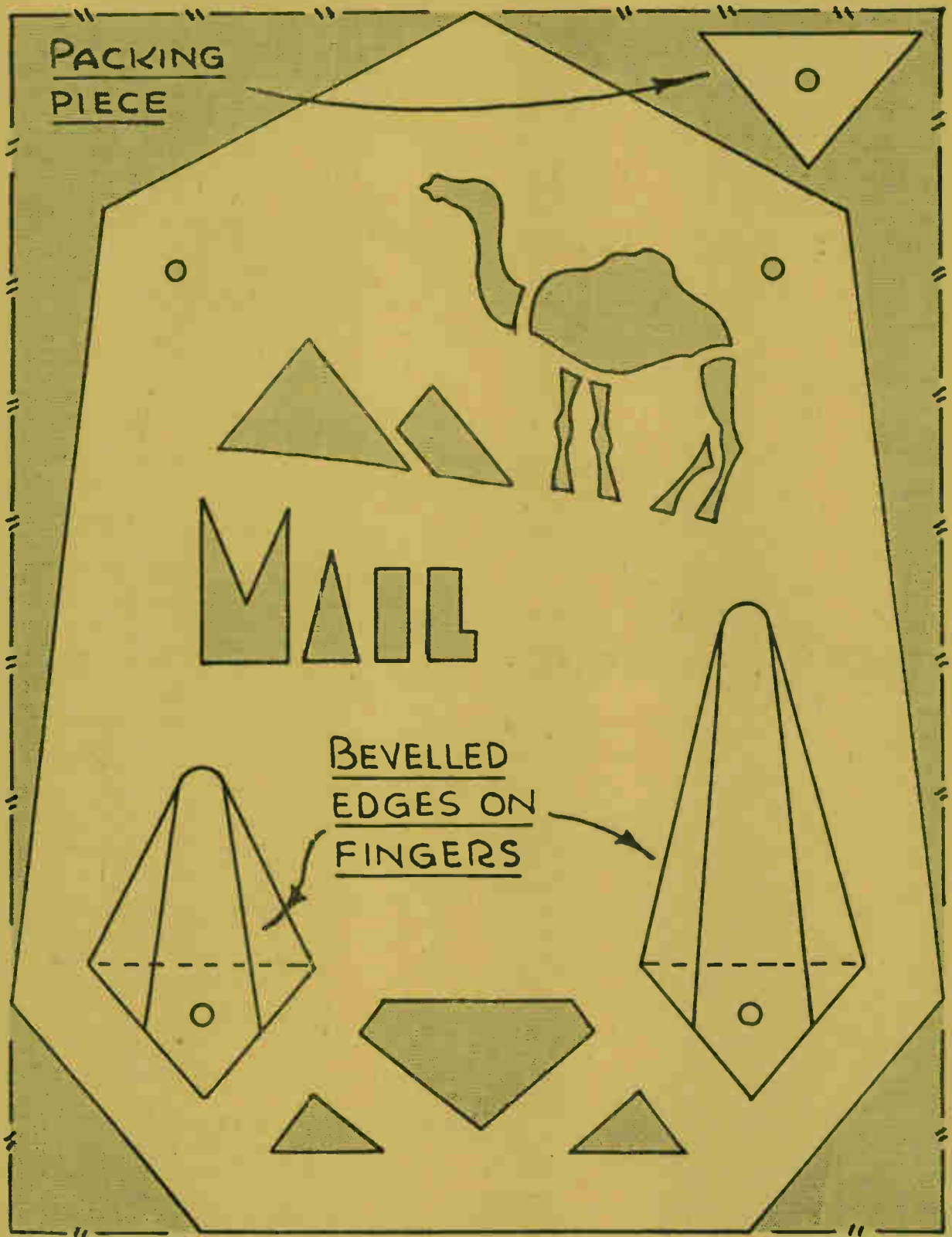

**PENN'S RAZOR-BLADE
PENKNIFE**



Smart ENAMELLED handle, fitted new razor-blade firmly held by screw. With this strong high-grade Penknife, you always have a really sharp cutting-edge. Suitable for all purposes. Puts old razor-blades to good use. Folds flat for waistcoat pocket. This **GREAT BARGAIN** is just to introduce our List. Send Now 1/- stamps or P.O. Direct only from—
Wm. PENN Ltd. (Dept. KHB)
585 High Road, Finchley,
LONDON, N.12

CUT YOUR OWN HAIR



2/9 Post 3d.
with three spare blades.

TRIMS AS IT COMBS
Save endless time and expense with **PENN'S "EASY-TRIM"**. For lady, gent or child.
This superior, unbreakable SELF-TRIMMING COMB keeps your hair always neatly trimmed.
Send NOW 3/- P.O. or stamps to—
Wm. PENN LTD. (Dept. THB),
585 High Road, Finchley,
LONDON, N.12

PENN'S RUG MAKER

For Making Rugs on any Sewing Machine (Hand or Treadle)

Recommended in "Hobbies Weekly", 30/7/47

MAKES full-size Rug on ANY Machine in a few hours. Enables wool to be stitched on canvas without waste on back. Makes stronger rugs with less wool and better results than any other apparatus. Uses Coupon-free rug wool or long strips of cloth. Long, short or medium pile. No adjustment to machine required. VERY PROFITABLE HOBBY. With simple directions. Send now 3/- P.O., cheque or stamps.

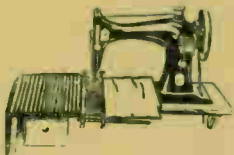

Direct only from

Wm. PENN LTD. (Dept. HBR)
585 HIGH ROAD, FINCHLEY, LONDON, N.12

"MARS ARE MARVELLOUS"



You'll certainly agree!

Just taste these chunks of sheer delicious goodness, made with chocolate to sustain, glucose to energise, milk to nourish.

Mars

3 1/2d.

MARS LTD., SLOUGH, BUCKS

Printed by BALDING & MANSELL, LTD., London and Wisbech, and Published for the Proprietors, HOBBIES LTD., by HORACE MARSHALL & SON, LTD., Temple House, Tallis Street, E.C.4. Sole Agents for Australia and New Zealand: Gordon & Gotch (A'sia) Ltd. For South Africa: Central News Agency Ltd. Registered for transmission by Canadian Magazine Post.

fight the crisis with SAVINGS

Save the Bank Way
Ask your Bank to tell you about their new free service to National Savings investors

We're up against an enemy as relentless and fierce as any we've met yet. National Savings provide a weapon to fight it with, and we've no time to lose. Save now: save hard—buy all the new 10 - Savings Certificates you can afford, up to a thousand, the maximum allowed. It's profitable anyway—in ten years they increase by 30% tax free! Buy them through your Bank, Post Office or Savings Group.

Issued by the National Savings Committee

THE FAMOUS EPISCOPAL PROJECTOR
ORDINARY PHOTOS ETC FLASHED ON SCREEN ANY SIZE **79/6** (Post & Pack 2/6)

PHOTOGRAPHS from any size thrown on to the screen at very few feet distance. Merely insert snap, photograph, drawing, stamps, ordinary picture cards, or documents and enlarge to Goliath proportions projecting colourings. A postage stamp snap is produced magically to fill screen. Show your family album. A boon also to philatelists. Plug in to electric light circuit. Produces enlargement when focused direct on to sensitised paper in dark room. Send now 79/6. Post and packing 2/6.

Genuine BRITISH NAVAL Telescopic Gun Sight **35/-** (Post & Pack 1/6)

Naval Telescopes. Powerful day and night lenses. Modern micrometer automatic range focus apparatus. Splendid object lens. Approx. 15ins. length. Picks out objects at many miles range.

Two or more carr. free. 35/- ONLY. Post and Pack. 1/6

MARQUEES.—Every type of Marquee Tentage and Camping Equipment. Send 1d. for LIST.

HEADQUARTER & GENERAL SUPPLIES LTD. (Dept. HOB/EP),
196-200 Coldharbour Lane, Loughborough Junc., London, S.E.5

KEEP TRACK OF THE MODELS!

Although the production of our famous models is increasing, a large quota is reserved for export, and supplies for the home market are therefore limited. Send now for our Gauge 'O' Model Railway Catalogue (G/55) price 1/-, giving prices of models available and delivery dates of forthcoming models.

"PECO-WAY", the most realistic Gauge "OO" Permanent Way. Send for booklet	Price 6d.
"Model Railway Handbook", Standard Edition	6/6
"How to Build a Working Model Road Tractor, 3" scale"	1/-
"How to Build a 1/2" scale 'Flying Scotsman'"	1/-
"Laying Permanent Way"	6d.
"Model Supplies" (L/55)	6d.

BASSETT-LOWKE LTD. NORTHAMPTON
LONDON SHOWROOMS: 112, High Holborn, W.C.1.
MANCHESTER: 28, Corporation Street.

Hobbies

WEEKLY

CONTENTS

	Page
Small Hall Table	- 237
Bedtray Bookrest	- 239
Stencilling	- 240
Folding Corner Shelves	- 240
A "Pick-up" Lamp	- 241
Craftsman's Notebook	242

March 17th, 1948

Price Threepence

Vol. 105 No. 2733

ALTHOUGH intended primarily for a hall, this table will be found useful in other ways. It is of normal table height—29ins., and could be used as a small writing table in a room, for a radio cabinet, etc.

It is only 14ins. wide by 24ins. long. It may be built to slightly larger dimensions, such as 16ins. by 30ins., or 18ins. by 36ins. This is the size of the top, and in view of the fact that the legs are only 1½ins. square,

larger sizes would make these out of proportion.

A set of plain tapered or horse-shoe

legs can be purchased (at a woodworker's supply store) or, in case of difficulty, a set can be made, using 1½in. deal post material, or cutting off the length from a 1½in. deal plank 30ins. long by 8ins. or so wide.

Plain tapered legs are easily made, including the horse-shoe type. If desired, to reduce labour, half horse-shoe legs could be made, as will be explained later on.

If you can manage to buy a set of prepared legs, these will most likely be made from birch or oak. Consequently the entire work must be built from the same material. Deal, perhaps, can be used in conjunction with birch legs. Deal, however, is not advised for use with oak legs, as in the finishing off, the wood is difficult to match, not having the same grain.

The Legs

As so much depends on the legs, these must be obtained or prepared right away. Supplies of legs are reaching most woodworker's supply stores. If you experience any difficulty over the matter, the alternative is to make a set of plain tapered legs from 1½in. thick planking, as mentioned earlier.

The surface sides of the length of planking is planed smooth and the edges squared. Having pencilled 1½in. guide lines on the wood, the posts are run off with a rip-saw carefully. The rough sawn edges of the remainder of the plank are trued with the try plane, then the process repeated, to make the four posts required.

A SMALL HALL TABLE

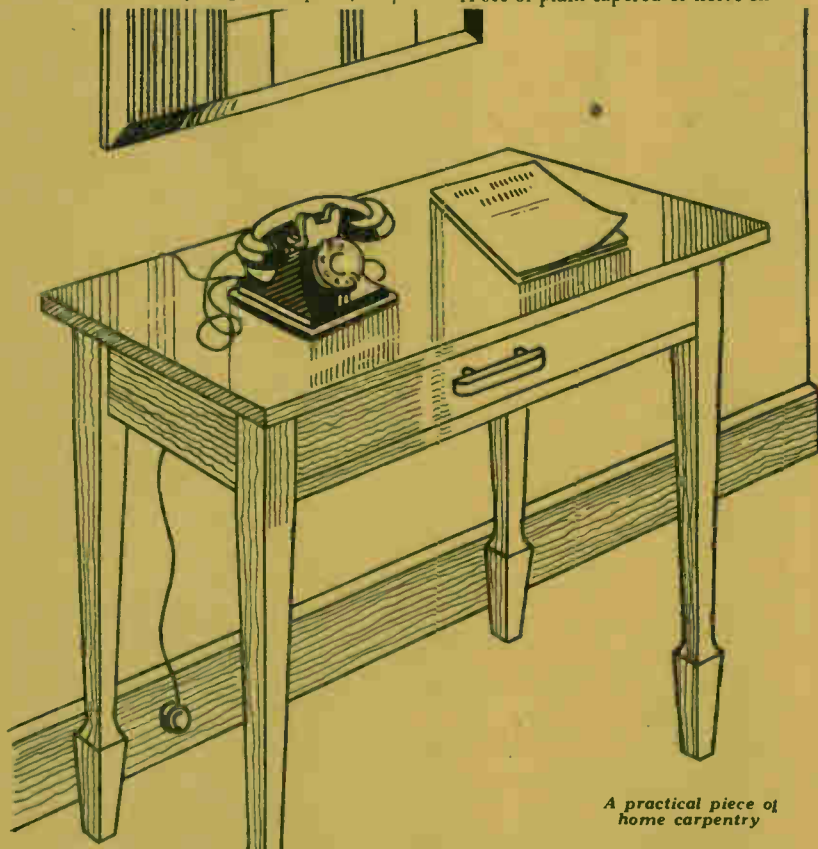

A practical piece of home carpentry

All correspondence should be addressed to The Editor, Hobbies Weekly, Dereham, Norfolk.

The posts are made dead square with a jack plane (on the rough sides), then the tapering marked off, as at Fig. 1. The jack plane is used to do the tapering. Note the 5in. shoulder for the top end. This must be kept untapered.

If you prefer the half horse-shoe leg (see Fig. 2), the shape is marked out on two sides, the waste cut and pared away, then the wood trimmed and glasspapered.

The unshaped inside corners are the

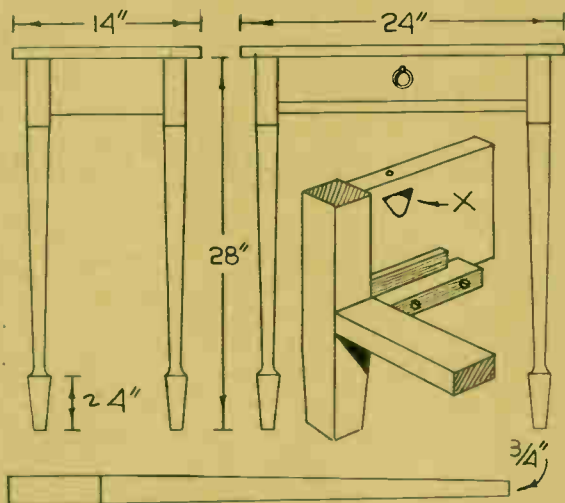

Fig. 1 - End and side elevation with sizes and details

assembly corners, to which the end cross rails and back cross rail and front bearer will be dowelled. The half shaping thus saves a good deal of trouble and time. If you can afford to spend extra time on the job, of course, the inside corners of the legs can be shaped to make a proper horse-shoe leg.

The Leg Rails

The end cross rails measure 9ins. by 4ins. by 3/4in. The back cross rail measures 19ins. by 4ins. by 3/4in. The front bearer is similar, but 1 1/2ins. wide. The back and end rails are dowelled to be central with the leg shanks. The front bearer rail is a flush fixture, in line with the bottom of the back and side rails.

Before assembling the parts together, screw pockets (needed for attaching the top in position) are gouged at the inside sides of the rails (three at the ends, and four at the back), as shown at X, Fig. 1.

Having made the pockets, prepare the table top. This measures 24ins. by

Bedtray (Continued from page 239) sides, two fillets of wood (A, in Fig. 6), with an upper slip glued in the rebate, will be attached to the underside of the tray. These pieces measure 6ins. by 1in. by 1/4in. Then to the back of the rest, a strut of 1/2in. wood will be hinged and so attached that the rest will close down flat against the back cross rail.

The back strut may be made to fall into shallow grooves cut into the upper

14ins. by 7/8in. If deal legs have been made, the top can be two 7in. wide lengths of deal shelving, dowelled together, or sub-jointed, if you are sufficiently experienced in the matter.

Drawer Runners and Guides

Meanwhile, the drawer runners and guides are to be affixed to the carcass work. The runners are lengths of 1 1/2in. by 7/8in. stuff cut to fit between the legs and close against the side rails. They are attached, with screws,

to the inside of the drawer front.

The sides are glued and nailed to the front, the back piece affixed between, level with the grooves, then the plywood bottom slides in and is affixed on the back piece with a few panel pins.

The assembled drawer, which, like the carcass, should be carefully squared, is then fitted to run in and out of its aperture smoothly. It can be stopped to show a slight break at the front, or kept flush with the bearer rail, as in the illustration of the

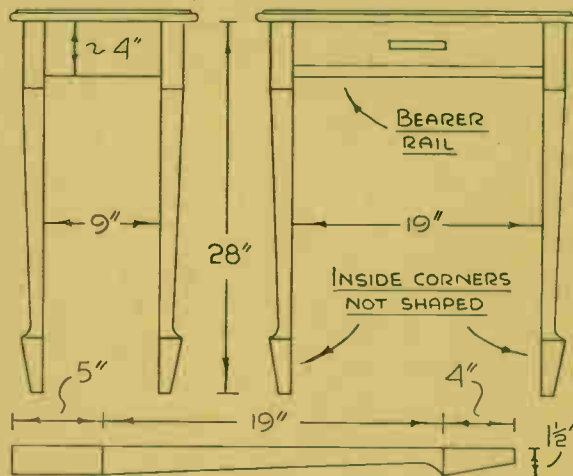

Fig. 2 - An alternative form of construction

level with the bearer and end rails.

The guide pieces are strips of wood which are pinned upon the runners and sides to pack out the latter level with the leg, and consequently, the drawer aperture. The guides must be quite level with the front legs, or 1/16in. less in thickness than necessary. If 1/16in. more than necessary, the drawer will never be a proper fit.

The Drawer

The drawer itself, of course, is an extremely narrow one. If desired, the inclusion of a front drawer could be omitted. If you prefer it, on account of its handiness for gloves and so forth, or writing materials, the drawer front (19ins. by about 3 1/2ins. by 3/4in.) is cut to size and planed to be a neat fit in its aperture.

Its ends are lapped for 1/2in. thick side pieces. These are about 10ins. long by 3 1/2ins. by 1/4in. They should be grooved at the inside for a plywood bottom piece (an old piece of tea-chest stuff would do), this also applying

finished table.

Prior to fitting, the table top must be cleaned up and attached with screws (via the screw pockets) to project 1in. all round. The edges can be left square, as at Fig. 1, or be moulded, as at Fig. 2.

Moulded Edge

The moulding shown is known as a "thumb moulding" and is easily made with a cutting gauge, a shoulder plane and the smoothing plane. If you want a moulded edge, but do not possess the proper tools, small moulding strips are generally available which could be mitred and affixed with glue and a few panel pins.

Having fitted a handle to the drawer and polished the table light oak, it is complete. You could affix 1/2in. diameter metal gliders to the toes of the legs to facilitate movement. If for a hall, a small back pediment could be added. This could be a 2in. wide strip, 23ins. long. It is attached via the underside of the top projection with suitable screws.

surface of the cross back rail as Fig. 6 shows. The correct length of the back strut should be got by measurement direct from the made-up tray and rest. The positions of the grooves in the cross rail are marked previous to being cut in.

When the job has been so far finished, the wood should receive a good glasspapering before being coated with a filling or primary coat

of oil paint. When this has again been rubbed over with fine glasspaper, the final coat of paint may be given.

Before the final coat of paint is applied, an edging to the tray should be made in the form of a half-round beading put on with small sprigs or fret pins. A contrasting colour may be chosen for the edging bead and for certain other parts of the tray if desired.

For comfort in bed make yourself this useful BEDTRAY BOOKREST

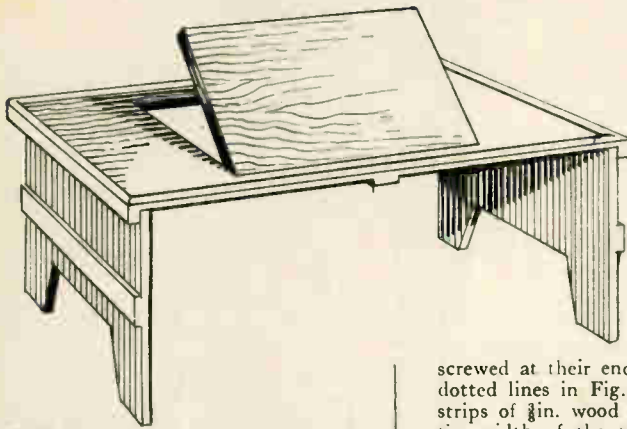

WE show here a useful type of bedtray, made to fold flat, with a bookrest which may be held at any convenient angle for reading in bed. The whole thing is easy to make and simple in construction, and furthermore, it may be made from a few pieces of $\frac{3}{4}$ in. planed matchboarding painted up in appropriate colours.

Some good sound pieces of second-hand wood scraped and planed or glasspapered would serve to make up the article.

Tray Details

The tray measures 24ins. long by 11ins. wide, and when erected is 10ins. high. First pick two good pieces of matchboard 24ins. long by $5\frac{1}{2}$ ins. wide. If it is tongued and grooved stuff, which it most likely will be, then the two boards will be glued up and the tongue of one of the boards glued and clamped into the

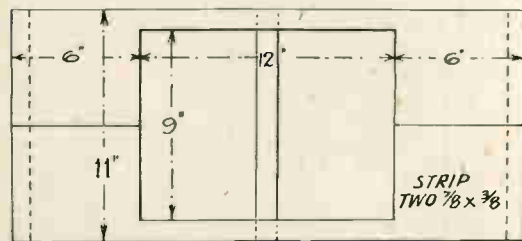

Fig. 1—Plan of top with opening and cross strips

groove of the second board. The edge tongue which projects, and the groove which is in the other board should be planed away, leaving flat and square edges.

The boards must be strengthened by having two edging strips glued and

screwed at their ends as seen by the dotted lines in Fig. 1. Cut off four strips of $\frac{3}{4}$ in. wood $\frac{3}{4}$ in. wide and to the width of the tray. Glue them together in pairs. The finished strips can be fixed as suggested and the sharp edges taped off.

Edging Rail

In the middle of the tray, mark off an oblong measuring 12ins. by 9ins., as in the plan, Fig. 1. Cut this through, clean off the cut edges, and then glue and screw a rail in the centre of the opening to lap on each side as in Fig. 1. This rail should be about 1in. or $1\frac{1}{4}$ ins. wide and $\frac{3}{4}$ in. thick.

Now make the folding legs to the measurements shown in Fig. 2. Each consists of two $\frac{3}{4}$ in. pieces 11ins. long of the grooved and tongued stuff with a stiffening fillet of $\frac{1}{4}$ in. wood glued across the joint as shown. Cut the opening in the lower board, to form feet as it were, to the measurements given, and also cut the semi-circular opening in the top board.

Add a pair of $1\frac{1}{4}$ in. stout hinges to

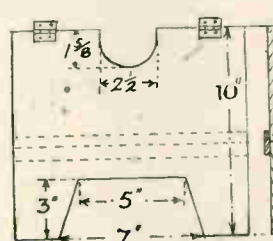

Fig. 2—Front and side view of leg

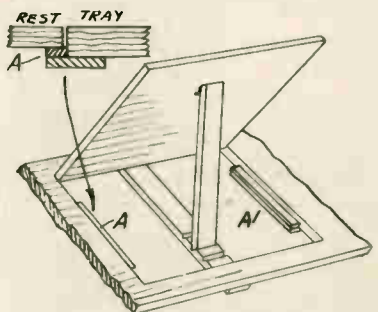

Fig. 6—Back view of rest and support

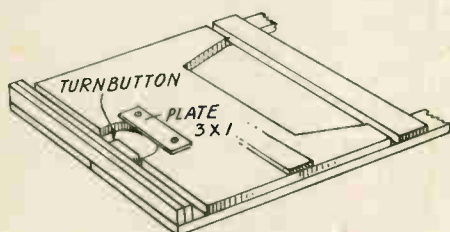

Fig. 3—Detail of leg and fixing plate

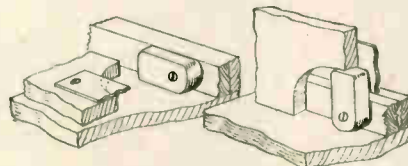

Fig. 4—How the turn button acts as a stop

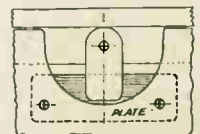

Fig. 5—Button fixing

each leg as shown. Then screw these to the underside of the tray, taking care to leave a full $\frac{3}{4}$ in. space between the top edge of the leg and the end cross rail on the tray. The position of this is shown in the large detail, Fig. 3. The flaps of the hinges will, of course, be screwed to the tray while the legs are held in an upright position. This will automatically give the necessary clearance as mentioned above.

Leg Fixing

To each leg will next be screwed a stout metal plate about 3ins. by 1in. which must partly cover the semi-circular opening in the leg.

To the end rails of the tray, screw on centrally two turnbuttons of hard wood, using round-head screws for the fixing. These turnbuttons can be seen in Fig. 3, while the enlarged diagram Fig. 4, explains the functioning of them in relation to the metal plate, etc. The turnbuttons lie flat when the legs are lying flat on the underside of the tray, but when the legs are erected they are turned into an upright position and against the inside face of the metal plate.

Another helpful view of the plate and turnbutton is given in the underside view Fig. 5, the leg in this case being in the upright position.

The Bookrest

The bookrest itself will be a piece of $\frac{3}{4}$ in. wood cut to fit the opening in the tray. This is 12ins. by 9ins. A pair of 1in. hinges will be used in attaching the rest to the inner edge of the opening so it can be raised and lowered as required.

To support the rest evenly at the

(Continued foot of page 238)

All types of materials lend themselves to STENCILLING

STENCILLING, as well as being a very interesting pursuit, has many uses. These extend from the putting of repetition designs along the waist-line of walls to decorating presents, and from supplying your tools and cases with a rough personal identification mark to fine work on models.

A stencil is a plate made of either metal or paper on which the design in question appears as a cut-out. This is transferred to the desired surface by manipulating a brush containing colour over the plate as it lies in the correct position. Oil or water paints or stains may be used for the purpose.

It is possible to put stencil designs successfully on to a large range of materials including fabrics and velvets. China, wood, vellum, parchment, etc., can all be worked on. Water colours can be used as they are, but with oils a special stencilling medium (obtainable from a colour-man) should be employed.

Use of Oils

The procedure with oils is to squeeze out a small amount of the pigment on to a palette and then pour a little medium into an old saucer. Dip the brush lightly into the medium and, holding it upright above the palette, work on the paint till the ends of the bristles are holding a fair amount of stiffish colour.

Now put the stencil plate in position. For small work it can be held, but for larger it is better to secure it with a length of adhesive tape along the top edge. Rub the brush on a piece of cloth to take away any bits and then apply to the design, working as far as possible away from the edges.

Cloth and Fabric

For cloths and fabrics in general, use a stippling action. That is, holding the brush in a perpendicular manner, put on the colour with a quick dabbing motion. For big open areas a combination of sweeping strokes and stippling will be found to give good results.

The aim in all cases is to secure a uniform spread of colour without any suggestion of brush marks and to get clean outlines without them being too harsh.

Standard water colours can be used on parchment but where the hues have to be transparent, as with lamp shades, draughtsman's ink is the material to use, as the colours are really dyes and retain all their brilliance when light shines through them.

In the case of glass-ware, etc., thoroughly clean the surface first

with a wad of cotton wool dipped in methylated spirits to remove all grease. The colours, too, must be mixed with a special medium which will 'grip' on the glass. Canada Balsam will do.

For thin fabrics, stretch the material over a pad of blotting paper and work over this. Renew the paper from time to time. Should it become unduly damp, the colour is being used in a too dilute form.

Several Colours

A stencil design may be executed in several colours and when this is being attempted, a separate brush must be kept for each. When using a new brush, soak well in water first of all and when putting oil brushes away, always wash in turpentine.

Water colour brushes should be well rinsed under a tap.

Care should be taken to get brushes large enough for the work in hand. Too small brushes make the design uneven in density of colour.

Home-made Plates

Stencil plates can be bought, but they can be readily made to your own design. The figure to be cut is outlined on a sheet of oiled vellum and then cut out, using a very sharp blade, the vellum resting on some hard surface. When making the design, care must be taken to leave sufficient 'ties' to prevent centres of letters, etc., falling out when the plate is lifted up. A very few connecting pieces are generally enough to effect this.

The housewife will be pleased to have FOLDING CORNER SHELVES

HERE is a very handy nest of shelves which anyone can make for the kitchen. By taking out six screws, the sections collapse for easy packing if necessary, or for taking down to clean.

First cut the two truncated sides (A) to suit in depth the corner you wish to fit up. The wood used should be about $\frac{3}{4}$ in. thick.

Channels

Upon what will be the inside of the piece, mark the three channels (b) agreeing in width with the wood you are using for the triangular shelves.

Now join the sides together with the hinge (B) and fit two hanging brackets (C)—these being obtainable at any ironmonger or stores for a few coppers.

The shelves are right-angled triangles and to start with, it is best to cut each a little deeper than finally necessary, as that allows of perfectly flush finishing.

To fit well, hold the sides temporarily in the desired corner at the height you want and

mark through the brackets the position for the hanging screws. Insert the screws and suspend the sides.

The shelves, if fitting has been good, should just slide stiffly into the channels. However, slide in the lowest first and tap gently home until there is no further inward movement.

Shelf Fixing

Take down and put a screw in from either side to hold shelf and side-piece together. Now re-hang and fit the top shelf in the same way, again securing with two screws—then fit the middle one.

The front edges can now be planed flush and the nest of shelves is completed. They may, of course, be left in plain wood or painted.

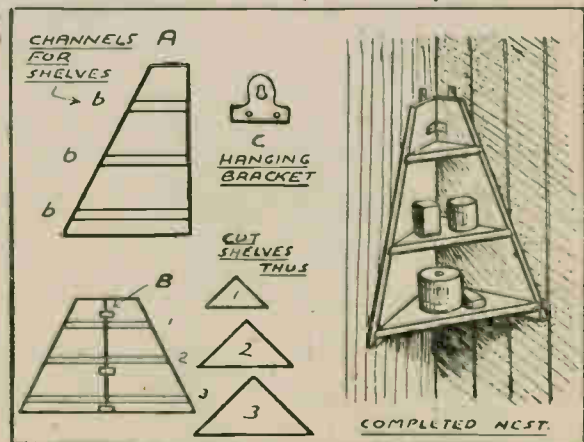

Lift and it lights, form the novelty in making A "PICK-UP" LAMP

ELECTRICAL novelties are always much sought after, and the one illustrated will, we feel sure, be no exception to those which we have from time to time included in these pages.

We aptly call the novelty here the "pick-up" lamp, because on lifting, it immediately lights up and remains so while the base of the lamp is removed from the table. It can, however, be made to remain alight as long as desired by a slight adjustment of the lower base.

The article, as will be seen from the illustration, is on the lines of a vase, and is made throughout of wood which should be painted or enamelled in art shades. It is shown fitted with a midget shade which makes the lamp highly suitable as a bedside lamp.

The Body Portion

Three thicknesses of wood go to the making of the lamp, and all the work of shaping is done with the fretsaw, rasp and glasspaper. It should be mentioned before undertaking to make the parts of the lamp, that the battery and its wiring connections are all contained within the "vase", and that the width of the latter is, therefore, controlled by the diameter of the battery suggested for it.

The sectional view of the lamp (Fig. 1) will at once explain how the battery is held, and how contact is made with the plunger passing through the base of the vase.

Pieces, A and B, form the base and, C, the body of the lamp. The top, D, holds the special bulbholder to which the wiring connections from the battery, G, below, and the contact plates, F and H, are made.

Interior Wiring

A detail of the method of wiring is given at Fig. 2. The two contact plates, F, are held apart, as can be seen, when the plunger is pushed up. When the lamp is raised the plunger drops, and so contact is made.



To commence making the "vase" look at Fig. 3 which shows the various parts that make up the body. There will first be two pieces as, A, cut from 3/16in. wood, the full sizes of which may be drawn out by means of the squared diagram, Fig. 4.

Completing the "Vase"

Next to these will be pieces, B, which are similar in outline, with the recking, B, added. Two of these again will be required, and from one of them, and from one also of the pieces, A, the oblong "door" will be cut as shown on the enlargement diagram, Fig. 4.

The remaining body pieces of the "vase" consist of half-sections, as it were, and have the shape shown at, C and D, in Fig. 4. There will be two of these for D, cut from 3/16in. wood, and four for C, from 3/8in. wood. The squares given in the diagram are 3/8in., making the enlargement to full-size.

All that is necessary is to construct a number of 7/8in. squares on a sheet of paper and line in carefully on these squares following the thick lines of the diagram. The outlines can afterwards be transferred to the wood.

Take care in cutting out the various pieces to keep strictly to the pencilled lines so that when all the sections are glued together they form a true and symmetrical body which will only just need a final glasspapering to prepare it for painting.

There will need to be one more piece cut to outline as, E (dotted line), in Fig. 3, and to the inside face of this piece, the square of wood cut from piece, A, will be glued. This forms, as it were, a door, and three or four round-head screws will fix it finally in place after the battery has been inserted in the body of the vase. When a new battery is required it only means the removal and replacement of the screws. Fig. 5 shows how the door will appear before it is inserted into its opening.

The Base

The base of the vase consists of two pieces, A and B, in Figs. 1 and 6. The measurements of each are given, piece, A, being cut from 3/16in. wood, B, from 3/8in. stuff.

It will be noted from Fig. 6 that piece, A, has a 1in. diameter hole in the centre, and is cut across in two places, and these two outer narrow pieces will be hinged to piece, B, from beneath. A 1/2in. diameter hole is also made in B. The flaps of the hinges will both be recessed into piece, B, and will appear like the inset details in Fig. 6.

It will be observed from these details that when the side strips are pulled down, as in the upper enlarged diagram, the whole base of the

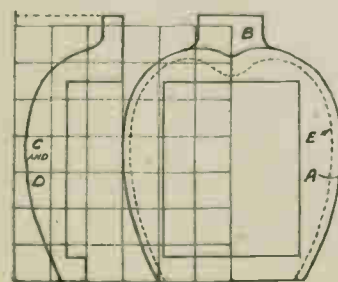

Fig. 1—Outline of body shape

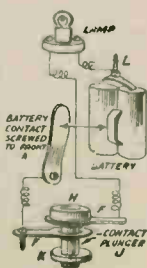

Fig. 2—Details of wiring

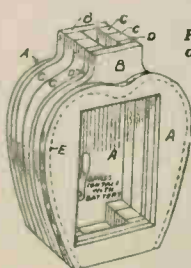

Fig. 3—Construction of framework



Fig. 5—The door portion



Fig. 7—Vase top and holder

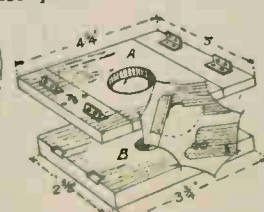

Fig. 6—Hinged base and plunger

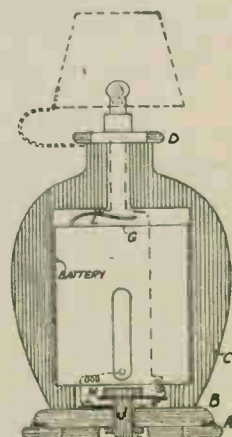

Fig. 4—Section of lamp

vase will be raised, thus letting down the contact plunger which will automatically allow the light to remain on as long as desired.

The lower enlarged diagram shows the position of the side strip when folded up, which opens the contact and thus again automatically switches off the light when the whole base is brought in contact with the table. The edges of both base pieces will, of course, be shaped with rasp, file and glasspaper before they are glued to the vase.

Top and Holder

The top of the vase consists of a square of $\frac{1}{2}$ in. thick wood with a circle cut from the middle as shown in Fig. 7. The piece is $1\frac{1}{2}$ ins. square, and its four edges should be rounded as shown at, D, in Fig. 1. The top neck of the vase should be made perfectly level before attaching the piece, D, by means of glue and small nails.

A bakelite bulb-holder is inserted in the hole of the top piece and

secured with screws as seen in Fig. 7. Work inside the vase can next be completed by first removing the door giving access to the inside for the insertion of screw, L, seen in Fig. 2 and again in Fig. 1.

To this screw attach a piece of cotton-covered flex and carry it up inside the neck of the vase, and here connect it to the bulb-holder on top.

Next, from a piece of $\frac{3}{16}$ in. round rod make the plunger, J, which must pass freely through the hole in base piece, B, and, of course, through A. Now cut a $\frac{3}{16}$ in. thick washer, H, $\frac{3}{16}$ in. diameter and glue it on the top of the plunger rod, J, and to the underside of this attach a brass contact fitting as shown at F, in Fig. 2. Two of these plates should be made for direct contact as shown. The lower one is screwed to the base piece, B, with a length of flex coming off the attaching screw and leading up to a brass contact plate of thin brass which is screwed to the back of the vase inside.

The projecting contact strip at-

tached to the battery will make contact with this fixed piece on the vase as will be explained in the wiring diagram Fig. 2. After the plunger, J, has been inserted through the base, a washer, K, is finally glued to it, space being allowed, of course, for ample clearance between the two contact brasses, F, above.

A piece of flex is finally carried up from the projecting end of the top brass plate, F, and connected to the lamp holder, thus completing the circuit necessary for the bulb.

It will be understood that this wire just mentioned must be coiled so as to allow the plate to drop easily on to its lower companion. To facilitate the early downward movement of the plunger a little disc of lead could be added to the top at H, in the wiring diagram Fig. 2.

Stencil Design

A stencilled design might well be put on the front, or both faces of the vase as shown in the illustration.

A Craftsman's Notebook



Unusual Finds in Timber

DURING a visit to a small museum I was particularly interested in a bird's nest that had been found while cutting timber into planks. As the tree grew the nest apparently had become embedded more and more deeply until eventually it had become completely covered, thus to remain in a good state of preservation for years.

From time to time the saw-mill has revealed other objects that have become enveloped by growing trees. Quite recently such unusual discoveries have included nails and mice, and another exhibit was a hard round object about the size of a cricket ball, probably a small cannon ball that had lodged in the tree long ago and in due course became lost to view within the wood.

* * *

Lino Renovations

IN these days when goods are costly and often unobtainable all sorts of repairs and renovations have to be done, and the services of the craftsman who can carry out such jobs in the house earn great appreciation.

One little job of this sort I did recently was the renovation of some canvas floor covering which was badly worn in some places though the pattern as a whole was in quite good condition. Fortunately a few small left-over pieces of the same kind were available and these were patched in.

If you have a similar job for attention I suggest that you ought not to try and fit in a piece of irregular shape

to correspond with the worn portion. The correct method is to make four clean cuts with a sharp knife, taking out a neat rectangle to include all the bad piece. The lino to be fitted in should then be cut to exactly the same dimensions, an important matter to remember being to get the pattern a perfect match all round.

In my case I found it satisfactory to glue a fairly large sheet of tough brown paper underneath for backing. The new piece of lino was covered with glue at back and edges and fitted into position, any glue that oozed out at the edges being wiped away, and the patch covered with a sheet of dry paper, then a smooth board, and finally some heavy weights till set.

After a time, when they had received a little wear, the various patches were hardly detectable.

* * *

The First Movie Makers

ACCORDING to rough calculations of mine, nearly two miles of film containing over a hundred thousand separate pictures pass through the projectors when we watch an 80-minute feature film at the cinema. The rather surprising totals prompted me to find out how movies started.

Several people made a contribution in one way or another, some concentrating on the perfection of photography, while others strove after animation.

The early attempts, however, were made with drawings, and last century

saw the introduction of various devices, such as Sir John Herschel's "Thaumatrope", a circular card which was rotated so that the drawings on it seemed to move. In 1834 W. G. Horner brought out the "Dædalum", consisting of a metal cylinder which had to be revolved while the drawings on a strip of paper inside were seen through slots.

In 1853 the disc idea was combined with a magic lantern to permit of projection on to a screen. Then photography superseded drawings, but as roll film had yet to be invented, separate slides were used at first, each showing a slightly different stage of movement.

It was Friese Greene who, in 1889, claimed to be the actual inventor of cinematography, his pictures being on celluloid film that had by this time been invented. In America that same year Edison demonstrated his "Kinetoscope", a machine that soon became popular in amusement arcades and enabled people to look through a lens and view the pictures on a film illuminated from behind.

Credit for making public shows possible goes to the brothers Lumiere, for they patented and demonstrated their machine and gave a show to the public in France in 1895.

The British public saw their first movies in 1896 at the Polytechnic in Regent Street, London, when Louis Lumiere ran a series of short films. It is recorded that on the same evening R. W. Paul was demonstrating his "Theatrograph" to a private audience at Finsbury.

These early efforts were only about forty feet in length and, of course, crude compared with present-day standards, but nevertheless they were the beginnings of a great industry and a form of entertainment for millions of people.

The Craftsman.

MISCELLANEOUS ADVERTISEMENTS, etc.

The advertisements are inserted at the rate of 3d. per word or group of letters prepaid. Postal Order and Stamps must accompany the order, and the advertisements will be inserted in the earliest issue. Freework goods or those shown in Hobbies Handbook not accepted. Orders can be sent to Hobbies Weekly, Advertisement Dept., as below.

STAMPS. Send for my approval sheets. For small and medium collectors. Enclose 2½d. stamp for postage. Free gift of eight stamps.—D. Mellenfield, S.D.A. (H.W.), 14 Kings Road, Barnet, Herts.

50 DIFFERENT free to approval applicants. Discount and free gifts given. Enclose postage.—Ward, Gindleford, Sheff.

PERSONS required immediately to make leather shopping bags in spare time. Write Dept. 11, Empire Co., 117 Nottingham Road, Loughborough.

GALLEON sails and heraldry, 5 sheets 7½ins. by 10ins., 2 6 pkt. List of plans and accessories 3d.—St. Andrews, High Pitfold, Hindhead.

WOOD Toymaking, a practical handbook with 180 effective designs and illustrations, 2 3 posted.—Industries, 2 Waldegrave Park, Twickenham.

CASTING moulds for lead soldiers, Indians and Cowboys, animals and novelties. Sample mould 4½. Catalogue 6d.—Industries, 2 Waldegrave Park Twickenham.

STAMPS FREE!! Twenty unused (2½d.).—G. H. Barnett, Limington, Somerset.

APPROVALS Send now. Beginners or medium collectors, bargain prices (gift).—R. Murray, 18 Grove Lane, Thurso, Caithness.

PEN pals Bulletin. World-wide contacts, 1- monthly 176a Old Shoreham Rd., Hove.

PERSPEX, new transparent sheets, 12ins. by 12ins. by ¼in. 9 6 each, post paid. Make beautiful articles with crystal clear Perspex.—Thacker (H.W.), 235 Wragby Road, Lincoln.

DURALUMINIUM sheets, 6 by 3 by 24 G, 18- per sheet ex yard. Also 16 G, 47 6.—Wilson Bros. (Timber), Ltd., 548 London Road, Thornton Heath, Surrey. Tel.: Thornton Heath 1148.

ELECTRIC Repeater Motors, new, ideal experimenters adaptable for D.C., A.C., synchronous or remote control. 5- each, post 6d.—F. Lucas, 22 Hengrove Rd., Bristol 4.

WHY not make art jewelry as a profitable spare-time hobby?—Dept. 3, Somat Plastic Co., 8 Middle Marsh, Nottingham.

STAMPS Free—Send 2½d. for free gift and fine selection of approvals.—G. H. Brewer, 9 Wrington Crescent, Bristol 3.

W. McGARRIGLE for aeroplane and ship kits. All accessories, stamps. Lists 3d. Wholesale lists 4d.—64 Hillcrest Road, Romford.

EX. R.A.F. headphones, new, 5- pr., post 6d.—C. W. O. Barker, 14 Mardale Av., Manchester 20.

FREE packet of unused stamps, to approval applicants enclosing 2½d. stamp.—Bennett, 9 Braemar Road, Bulwell, Nottingham.

25 different British Empire free to approval applicants.—D. Cowdry, Fovant, Salisbury, Wilts.

WAR surplus khaki shirts, no coupons, 13/- each.—BM GMKT, London, W.C.1.

BE Taller. Quickly! Safely! Privately! No appliances—no tablets—no dieting. Details 6d. stamp.—Malcolm Ross, Height Specialist, BCM HYTE, London, W.C.1.

LONELY? Then write Secretary L.U.C.C., 5B.B. Hay St., Braughing, Herts. Genuine. Est. 1905.

MODELS: you can make lasting stone-hard models with Sankey's Pyrama Plastic Cement. Supplied in tins by Ironmongers, Hardwaremen and Builders' Merchants. Ask for instruction leaflet.

TRANSFERS for decorating toys, trays, furniture, fancy goods. Selection 10- 20-. Flowers, pixies, dogs, nursery rhymes.—H. Axon Harrison, Jersey.

MONOMARKS. Permanent London address. Letters redirected. 5- p.a. Write Monomark BCM MONOS2, W.C.1.

FREE! 25 stamps. Request discount approvals.—Bradbury, 5 Goulston Road, Manchester 20.

YOU can look up in "Where's That Car From?" 10,000 car index numbers alphabetically arranged. 56 pages 6d. From all newsagents.—Raleigh Press, Exmouth, Devon. (Post 1d.).

PERSONS required make fancy goods at home. Write for details. Melton Manufacturing Co. (Area 544), Southgate Street, Leicester.

DUTTON 1 week Shorthand. Learnt in 12 2-hour lessons, accepted by all examining bodies. Test lesson 3d.—Dutton's (H.B.), 92-3 Gt. Russell St., London, W.C.1.

DOLL'S House papers, model supplies, kits, plans, engines and motors. Full lists 1-.—Sutton, Hill House Drive, Billericay.

HAND driven generators, 100v. A.C., 6-. Electric motors, 1/24th H.P., 12v., complete with step-down transformer, 27 6.—C. W. O. Barker, 14 Mardale Avenue, Manchester 20.

TOYMAKERS' super casting Moulds for lead toys and Plastercraft. As used by all high class toymakers in England and abroad. Over 600 latest designs. Fully illustrated catalogue 2- P.O.—Agasee, 7 Stradbroke Road, Highbury, N.5.

PRESSED Metal Wheels (balloon tyre design). Per dozen, ¼in. 10d. ½in. 1/-. 1½ins. 1 3. 2ins. 1 6. Per gross, ¼in. 6/-. ½in. 7-. 1½ins. 8-. 2ins. 10-. Illustrated catalogue 3d.—Jaton, 135 Nags Head Road, Ponders End, Middlesex.

POST X has clearance. A parcel containing ten Toy designs and our latest publication "The Art of Wood Finishing". Yours for 9- only, usual price 12-. Postage 3d. extra.—M.M.D.A., Ground Floor, 38 Belmont Road, Bristol.

WHEELS for Toys in metal, wood and plastic. Numerous sizes and types. Write for list stating requirements to The Joyden Toy Co., 193 Chase Side, London, N.14.

NOVELTY Packet of unusual stamps free to approval applicants sending 3d. postage.—M. Edwards (N.3), Westcroft, Northchurch Common, Berkhamsted, Herts.

SPECIAL Offer. Attractive Stamp Album, 50 stamps, packet of mounts. Post free 3-.—Gamut (Dept. C), Supplies Co., 24 Gunnersbury Avenue, London, W.5.

FREE! Extra special British Colonial variety packet includes scarce jubilee, coronation, victory, zoological and latest new issue stamps. Request approvals 2½d.—Thompson, 70 Cavendish Avenue, London, W.13.

LONELY? Join Friendship Circle. Details 6d.—Secretary, 34 Honeywell Road, London, S.W.11.

THE WORLD'S GREATEST BOOKSHOP

FOYLES

★ ★ FOR BOOKS ★ ★

Famed for its excellent technical department
New and secondhand Books on every subject

119-125 CHARING CROSS RD., LONDON, W.C.2.
GERrard 5660 (16 lines) ★ Open 9-6 (including Sat.)

and NOW!

'FABRIKITS'

Prices from
10/6 to 3 Gns.

**PLASTIC
CONSTRUCTIONAL
KITS**

We are proud to announce that the first model of the 'FABRIKIT' range is now available.

Embracing as it does a selection of full-scale working diagrams and a generous supply of the very attractive plastic material, 'PERSPEX' (extensively used in modern aircraft), it is not difficult to envisage the many happy hours in store for the fortunate possessor of a 'FABRIKIT'.

Bottles of cement and polishing medium, instructional literature and a small supply of scrap and off-cuts complete the kit. The scrap is intended to acquaint the modeller with the material before proceeding to use the coloured 'PERSPEX'. Price 10/6. Larger kits in course of preparation.

Official I.C.I. 'PERSPEX' and 'CRINOTHENE' Stockists

PLASTICS (MCR) LTD.
11 WHITWORTH ST., MANCHESTER 1

She might be YOUR ship

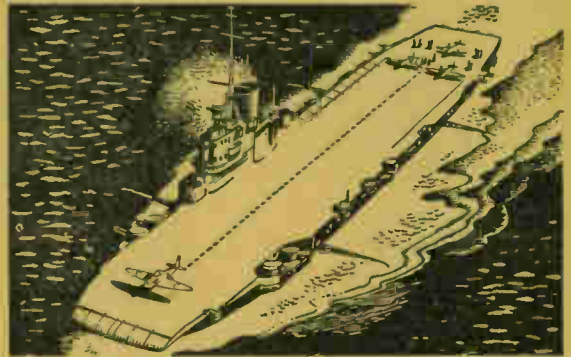

AIRCRAFT-CARRIER

When planes are landing she travels at 30 knots and everyone is busy — the men on the bridge, the men in the engine room and of course the pilots who have the tricky job of putting their aircraft down safely. In fact no matter what your job in a carrier you'll lead a full and interesting life.

For a good job with good pay and prospects, plenty of sport and a chance to see the world — you can't beat the Navy. If you are between 15½-16 or 17-23 call at any Combined Recruiting Centre or write D.N.R., Dept. AK/148, Admiralty, S.W.1.

Make the
ROYAL NAVY
your career

Manufacturers
SPECIFY IT BECAUSE IT IS
THE FINEST CORED SOLDER
IN THE WORLD

**MULTICORE
SOLDER**

FOR WOOD ELECTRICAL MOTOR
AND ALL HOUSEHOLD PURPOSES

CONTAINS 3 CORES
OF FLUX

NO EXTRA
FLUX REQUIRED

You
WILL PREFER TO USE
IT BECAUSE IT MAKES
PRECISION SOLDERING
SO SIMPLE

SPECIAL
HANDY CARTON

6^p
ENOUGH FOR
100 AVERAGE
JOINTS

MULTICORE SOLDERS LTD. MELLIER HOUSE, ALBEMARLE STREET, LONDON, W.1



**FOR A
REAL
Professional
'FINISH'**

'FINISH' is the true test of craftsmanship. It's easy to impart a real professional 'finish' to woodwork and furniture you make at home with "COLRON" WOOD DYE—the finest stain for all practical purposes.

One coat of "COLRON" is all that is required to emphasise the natural beauty of the wood grain. No smears—no 'overlaps'—no trouble. Leave from two to three hours, burnish with rough dry cloth and you have a perfect base for french polishing or for waxing with "RONUK" FLOOR POLISH.

COLRON WOOD
DYES

12 SHADES—ALL SIZES

Write for colour guide and full details to:
RONUK LTD. (Dept. 62) Portslade, Sussex

Hobbies

WEEKLY

CONTENTS

	Page
2-Seater Canoe . . .	245
Bird Box Homes . . .	247
Cinder Sifter . . .	248
Wall Ironing Board . . .	249
Enlarging Photographs	250
Model Well Top . . .	251

SUPPLEMENT DESIGN
SHEET PECKING
CHICKS TOY

March 24th, 1948

Price Threepence

Vol. 105 No. 2734

A TWO-SEATER CANVAS CANOE

IT is a good time now to commence the building of a canoe, for those who desire to enjoy the sport. The one illustrated is designed on lines to furnish a stable craft, one fairly easily made, and not too expensive. A list of the timber is given at the end of the article, and it is advisable to purchase this as soon as possible, wood getting so scarce.

Timber to Use

Choose timber free from knots and shakes, red deal, if available. The screws, nails and tacks, mentioned, must be copper or brass, not iron, as this will rust. For the canvas, choose white duck or tarpaulin if you can possibly get it. A close woven material, 48ins. wide, should be bought, and do not be tempted to use scrim or calico for cheapness; it is

sure to tear, will not give much service, and be poor economy.

The craft is built upside down on a board some 1ins. thick and the exact length given in Fig. 1. It can be from 4ms. to 6ms. wide, and should be supported during the building operation on boxes or anything that will raise it to a convenient height for working. Quite possibly such a board could be borrowed from your timber merchant, and returned afterwards.

The end posts are cut to 1ft. 6ins. long, from 3in. square timber. The tops are sawn off to an angle of 67 degrees, as at A, Fig. 1. At the distance down shown, saw down to a depth of about 1in. at 70 degrees angle, and at right angles to this cut, saw out the notch seen in the sketch.

These notches fit over the ends of the building board. Now bevel the

sides of the posts to a flat 1/2in. wide at the front, as shown in the section, A1. The posts should be fixed to the building board one at each end, with a single screw, as seen in the illustration.

It is, of course, obvious that one half only of the length of the canoe is shown. This is to save space—both halves are exactly alike. It is vitally important to set these posts truly upright or a symmetrical craft will not result.

The Shaping Uprights

The illustration shows how the shapes, now to be dealt with, are mounted between wood blocks on the building board. These shapes, which differ in size, are shown (halves only) drawn over 1in. squares, at Fig. 2. Copy the same number of squares shown full size on tracing paper,

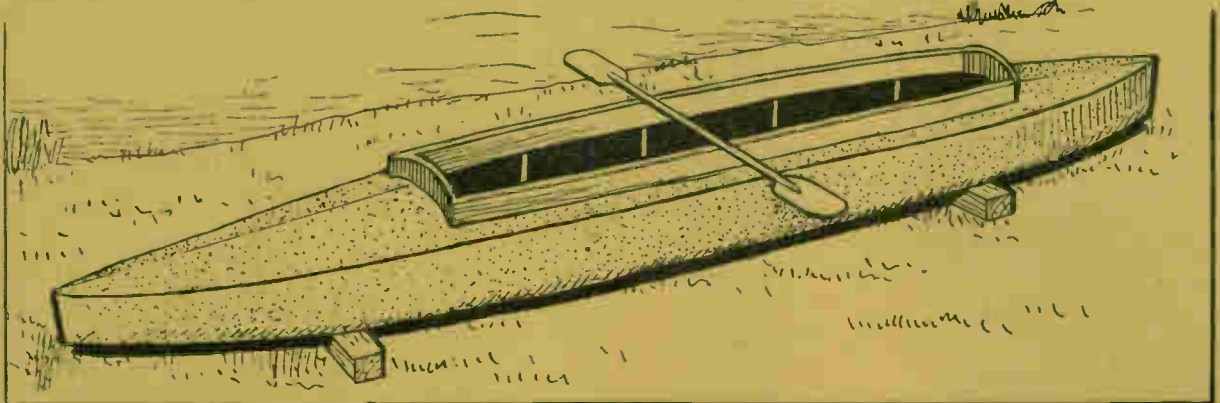

All correspondence should be addressed to The Editor, Hobbies Weekly, Dereham, Norfolk.

and mark the shapes accurately. The squares should be a sufficient guide for this.

Now trace through carbon paper each half shape on a separate sheet of stiff cartridge paper. Double the papers on the centre line and cut out the shapes with scissors. Open out, and both sides should then be alike; this is essential for a graceful craft.

The shapes are made up of $\frac{1}{2}$ in. thick wood, nailed together to make a frame of the required size, which can

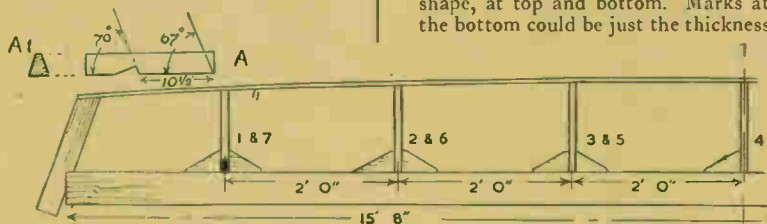

Fig. 1—The building board and framework with dimensions



Fig. 3—Strengthening battens

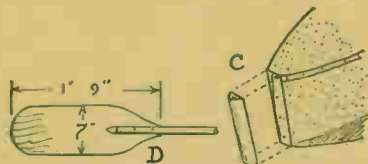

Fig. 5—Details of paddle shape and shape of post ends

be cut to the shape desired afterwards. Fig. 3 shows the frame for the middle shape, 4, made from $\frac{1}{2}$ in. wide wood across the top, $\frac{3}{4}$ in. wood across the bottom, and $\frac{3}{4}$ in. stuff for the sides.

Lightly nail together first, then lay the pattern over and pin down. Press the edges of the paper flat and run a soft pencil round the curves. The straight lines can be ruled in, of course.

The Shape Pieces

Cut the outer shape only at this stage, but the inner shape can be pencilled in to be cut out later on. This inner shape is just 2 ins. away from the outer edges. It can now be seen where the screws to fasten the shape together can be safely driven in, so as not to get in the way of the subsequent sawing.

Shapes 1 and 7 can be made up of $\frac{1}{2}$ in. boards, glued edge to edge, and strengthened by battens, as at B, in Fig. 3. The sawing out of the shapes, by the way, is confined to Nos. 3, 4 and 5 only; shapes 2 and 6 are framed up as the remainder, cut to the outside shape, of course, but only that, no inner cutting being required.

Mark the centre of the building board, and from there, working left and right, pencil lines across at 2 ft. distances apart. On these lines the shapes are erected, being held in the

upright position by triangular pieces of wood each side.

The smaller end shapes, 1 and 7, are raised up a little by wedging underneath each a slip of wood, $1\frac{1}{2}$ ins. high, as shown by a tiny black oblong in Fig. 1.

Alignment Essential

It is essential to get all these shapes in true alignment with the end posts, and it will be helpful if pencil marks are made at the centres of each shape, at top and bottom. Marks at the bottom could be just the thickness

strips and side strips is paired before nailing. Pairing is accomplished by first trying one of each pair in position, then comparing their lengths, as both should be the same, as near as possible.

The side strips can now be bent round and nailed and screwed like the others. They should be carefully spaced, one to the flat edges of the shapes, each side, and four round the curved bottom parts. They will tend to crowd together at the posts, and should, if necessary, be trimmed a little to butt together.

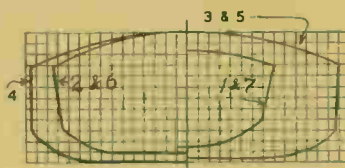

Fig. 2—The shape is marked out in 1 in. squares

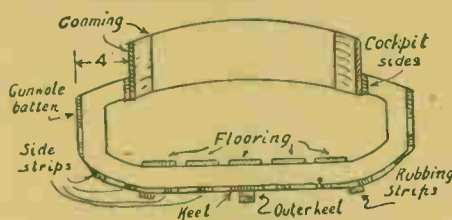

Fig. 4—A section amidships showing parts in place

of the building board, i.e., 2 ins. apart. Those at the top, 3 ins. apart, to suit the inner keel.

Having got all shapes correctly fixed, lay the keel over and bend down to touch the shapes. Keep in this position by the help of an assistant while you screw the keel to the shapes and the posts. Use two screws to each shape.

Now take the gunwale strips, bend these round the sides of the shapes and nail them to each. Screw them to the posts. As the wood for these is only $\frac{3}{4}$ in. thick (as per timber list at the end), they should bend round without trouble or strain.

It will be found helpful in getting a shapely craft, if each pair of gunwale

The keel, from shapes 1 and 7 to the posts, should also be trimmed off a trifle to meet the posts, which they would otherwise overlap. Remove the screws, fastening the posts to the building board, and knock off the wedges holding the shapes up. The whole can now be removed from the board and turned right side up for subsequent operations.

The first of these is to saw out the inner shape of 3, 4 and 5 as already pencilled in. The top curved bars of these shapes should be sawn through at 4 ins. from each side, to clear a space for the cockpit.

A strip of wood 2 ins. wide and approximately 8 ft. long (measure this), should be screwed to the cut ends of the curved top bars, and to shapes 2 and 6. This will outline the cockpit, which extends from shape 2 to 6, and is, therefore, some 8 ft. long or thereabouts. The cockpit coaming is now fitted.

Fit the end pieces first; these are cut to a curve, corresponding to the curve of the shapes, and should rise above them 3 ins., with 2 ins. below to screw to the shapes. The side coaming strips are 5 ins. wide, and are screwed to the side strips already fixed.

Fix Flooring Boards

The flooring boards are now tried in shape, and trimmed at their side edges to fit together. Fix these with nails. At this stage it will be necessary to study Fig. 4, a section across the finished canoe, amidships, which will help to make the above and subsequent details clearer.

When fixing the floor boards, as these are to be nailed to shapes 2 and 6, as well as the inner ones, it may be advisable to reduce by sawing the bottom bars to 2 ins. deep, to conform to the rest. Alternatively, the boards could be nailed to a wood fillet, screwed to the shapes instead.

(To be concluded)

CUTTING LIST

- Building board—15ft. 8ins. by 4ins. by 2ins.
- End posts (2)—1ft. 6ins. by 3ins. by 3ins.
- Keel—16ft. by 3ins. by $\frac{1}{2}$ in.
- Outer keel (2)—16ft. by $1\frac{1}{2}$ ins. by $\frac{1}{2}$ in.
- Gunwale battens (2)—16ft. by 3ins. by $\frac{1}{2}$ in.
- Side strips (10)—16ft. by 1in. by $\frac{1}{2}$ in.
- Flooring (5)—8ft. 3ins. by 3ins. by $\frac{1}{2}$ in.
- Cockpit sides (2)—8ft. by 2ins. by $\frac{1}{2}$ in.
- Coaming sides (2)—8ft. by 5ins. by $\frac{1}{2}$ in.
- Coaming ends (2)—2ft. 2ins. by 7ins. by $\frac{1}{2}$ in.
- Rubbing strips (2)—12ft. by 2ins. by $\frac{1}{2}$ in.
- Shapes—4ft. run $\frac{1}{2}$ in. by 8in. board; 12ft. run of $\frac{1}{2}$ in. by 5in. board; 23ft. run of $\frac{1}{2}$ in. by 3in. board.
- Canvas—7 to 8 yards, 48ins. wide.
- Brass screws. Copper tacks and nails.

Lots of interesting studies can be obtained by building BOX BIRD HOMES

THE need for protecting our wild birds is very important nowadays, owing in part to the great loss of many species during the 1946/7 severe winter. It is very necessary that we should do all within our power to help our feathered population. Indeed, it is to our own interest.

Wild birds, especially insectivorous and seed-eating species, perform most useful work in gardens and fields, waging ceaseless war on insect life, and checking the growth of such noxious weeds as ragworts, plaintains,

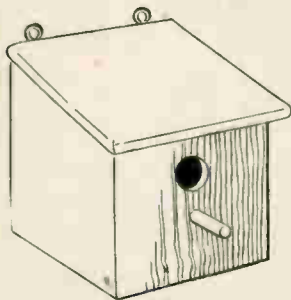

Fig. 1—A simple box type

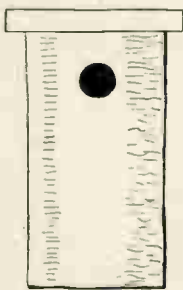

Fig. 2—The log type

docks, thistles, etc., which if left unchecked, would by their very fecundity, soon spread to such an extent as to choke and oust grasses and food crops in the fields.

But there is another reason—and that is, the joy and delight of having birds about one's home. All those who possess a garden with a few shrubs and trees—even in the suburbs of large towns—will doubtless be surprised at the variety of birds that can be attracted there, to afford pleasure all the year round.

Backyard Sanctuary

Indeed, even a backyard, if secluded, may become a bird sanctuary on a small scale. Despite the attractions of a garden with its apple trees and ornamental shrubs, a pair of blue tits this year have preferred a backyard, rearing a family in a hole under a broken tile of an outhouse, and a pair of blackbirds had a nest in a climbing rose on a piece of trellis within six feet of my back door.

One excellent way in which you can attract birds, provided you have a garden with a few small trees or shrubs, is to make a number of nesting boxes. But, remember, it is unwise to have too many of these in a small garden. One box to every three trees will be sufficient, with, perhaps, an additional one somewhere on a shed or fixed to some part of your house.

Better too few boxes than too many. You can always add to them if the numbers of birds coming to the garden justify the increase.

Types of Boxes

The choice of nest-box is rather important, for unsuitable boxes lead to disappointment. You often see imitations of human abodes—boxes designed in the shape of gabled houses, and all sorts of fancy contraptions. They are useless.

The best types are the simple ones (Fig. 1) and those cut from logs (see Fig. 2). An excellent pattern is one known as the Selborne nesting-box, made from oak, elm, or beech. One advantage of this type is that there are no hinges or catches to break, or to be bothered with. Then it has a natural look when pegged to a tree trunk.

Such a nesting-box is simple but effective, being merely a log about 15ins. in length and 8ins. in diameter, hollowed out. A cross-section about 2ins. deep is removed from one end to form the outer lid.

Another cross-section cut from the other end of the removed block (the hollowing-out process being done by means of a saw, cutting the centre of the log right out to leave an outer wall an inch thick) is reinserted in the base of the box and nailed in position to make the bottom. A hole is then bored to form an entrance for the birds, about 1½ins. to 2ins. from the upper rim.

The pattern shown in Fig. 2 can be easily made by anyone handy with

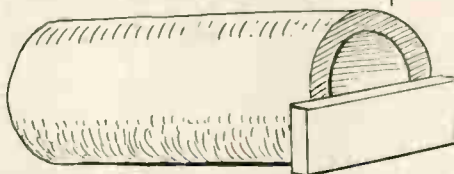

Fig. 3—A tree trunk hung flat

carpentry tools. Take a sound log about 15ins. long, with as much of the natural bark left on as is at all possible, and of 8 or 9ins. diameter. Hollow out a hole, working from the top end, 6ins. wide by 9ins. or so deep. You can do this with a strong brace and bit, and the aid of a red-hot poker.

When the excavation has been made, bore an opening, about the size of a five-shilling piece, about 2 to 3ins. from the top. Nail a square of wood over the top; knock in two staples or screw-eyes to hang the box up in the tree or on a wall.

This type of nest-box and the one already described, will prove suitable for the titmouse family. For the blue tits, marsh tits, and coal tits, the entrance hole should be the size of a florin (1½ins.), and for great tits the size of half-a-crown (1¼ins.). A hole too big will encourage starlings and house sparrows, birds already numerous enough without any encouragement!

Another example is made by scooping a hole out of a trunk as suggested for No. 2, but it must be hung horizontally (see Fig. 3). Swifts, redstarts, spotted flycatchers, will avail themselves of this type of box, or you can try a simple box with an open front (for the latter birds), size about 5ins. high, 6ins. wide, and 5ins. deep from front to back. It has a sloping top, with an overhang of 1in. over the sides to form eaves.

A base strip 2ins. deep forms a tray at the bottom of the box; the front is open. The whole can be made from plain deal or similar timber about ½in. thick (see Fig. 4).

Fixing the Boxes

Nest-boxes should be set up in the autumn so they will become nicely "weathered" before the nesting-season. They may also prove acceptable to the smaller birds during the winter as dormitories. Tit boxes should be hung not less than 5ft. from the ground.

If possible, fix nest-boxes facing east or south-east; if in a more southerly position, see that the box is

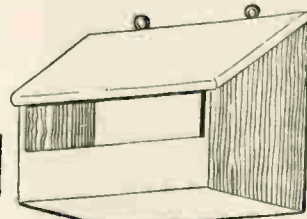

Fig. 4—With large open front

shaded. Never choose a spot where the afternoon sun will cause discomfort to the young nestlings. Select positions well out of reach of vermin and cats—the domestic cat is known to be one of the deadliest enemies to garden birds.

Fasten the boxes firmly so they do not shake. Never place them where the rain may pour in through the openings. Tilt the boxes slightly forward in order that wet will drip off, and not into them. Turn the openings away from prevailing winds.

Once a box is tenanted do not interfere with it.

A self contained, dust-proof sifting box and CINDER SAVER

IT seems very necessary these days to economise with the household fuel. There should be no waste at all, and even the dust and ashes from last night's fire should be sifted, and the larger cinders then remaining, mixed with small coal and coal dust and used to bank up the fires. This economy can only be carried out, however, if a suitable cinder sifter is available.

The sifter is made in three distinct parts, A, the dust container, B, the sifter and C, the lid, which keeps the dust from rising during the process of sifting.

In the cross sectional and side views in Fig. 1, the general principle and leading dimensions are given. The sketch, Fig. 2, shows the completed article, the lid being here removed in readiness for the dust and cinders to be thrown in.

A Plain Box

Part A is simply a plain box nailed and screwed together as the detail, Fig. 3, shows. Each of its sides can be built of two pieces of tongued and grooved board, or plain edged board. The long side pieces are 10ins. long, and those sides between them 9ins.—that is, of course, if $\frac{1}{2}$ in. thick wood is used.

All eight pieces of wood should be properly squared up, and butted and nailed together as shown. Then to make a really firm job, four pieces of wood about 1 $\frac{1}{2}$ ins. wide and from $\frac{1}{2}$ in. to $\frac{5}{8}$ in. thick and 6ins. long should be screwed into the internal corners, just as seen in the sectional corner of Fig. 3.

Screws should be used here on both faces, those on one face or surface being made to stagger or clear those screws going into the other side face.

The floor of the box will bind all the sides well together, and the size overall should be taken direct from the built-up sides. Take care again to get the floor square, and make it from two or more widths of plain or tongued and grooved wood. If required, it may be strengthened by

adding cross rails screwed or nailed on.

To the lower edge of the container two rockers are attached. The measurements and setting out of one of these are shown in Fig. 4. They should be made from $\frac{3}{4}$ in. wood, screwed to the box and stiffened up with two angle blocks nailed between the floor and the rockers themselves. The side view in Fig. 1 shows these blocks.

It should be mentioned now, that the corner pieces inside the container, form stops for the sifter to rest upon when this is inserted from the top. The sifter is just such another box as the lower one just dealt with, but, of course, smaller in size to fit easily inside the container.

The Sifter

A detail of the sifter is given in Fig. 5, the cut-away corner exposing to view the mesh netting which takes the place of a solid wooden floor. The depth of the sifter is 5ins., and, therefore, four pieces of wood that width will suffice for making the frame. This again is strengthened by having corner strips running the full depth of the box, as seen in Fig. 5. This sifter must be strongly screwed as it is handled quite a lot.

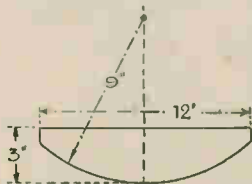

Fig. 4—The rockers

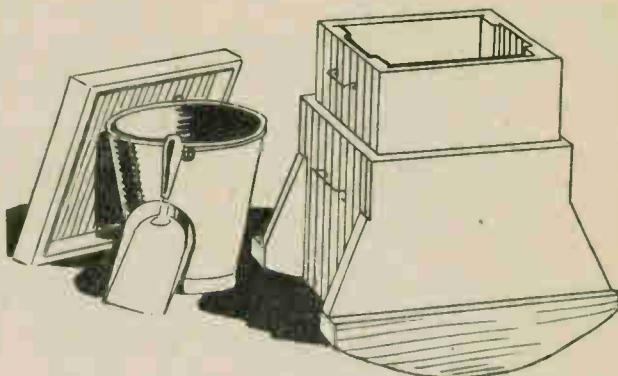

Fig. 2—The completed article in use

The mesh must be about $\frac{1}{2}$ in. and attached to the frame with round-head screws having iron washers between their heads and the netting.

Lid and Handle

A simple lid should be made to fit somewhat loosely over the sifter, and the detail in Fig. 5 shows its construction. Make the square of wood with 9in. sides, or, better still, take measurement direct from the top of the sifter as made up and add, say, $\frac{1}{2}$ in. each way for clearance when the edging strips are attached. The edging strips are about 1in. or 1 $\frac{1}{2}$ ins. wide and nailed round the top board, this top board being again in two widths with, perhaps, two stretcher rails attached underneath to bind them all together.

If a metal handle cannot be got, then a shaped wooden handle may be screwed on from beneath. A pair of handles will also be required for the container, for lifting or tipping to empty. A second pair of handles should be attached to the top sifter for emptying purposes and for rocking the whole article backwards and forwards during the work of sifting.

Regarding a finish for the wood use paint or creosote, the latter making a good preservative if re-

newed, say, every year. Paint, of course, is very suitable both as a preservative and for appearance sake, especially if the original wood is of rough re-used stuff. The inside of both container and sifter should be creosoted, so also should the underneath portion of the floor and the rockers. As the box is coming in for a good deal of rough handling make it very strong and rigid.

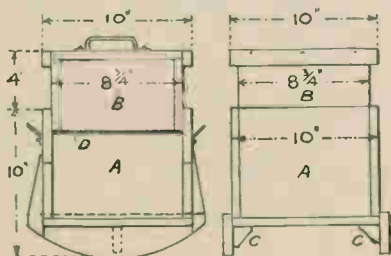

Fig. 1—Side and end elevations

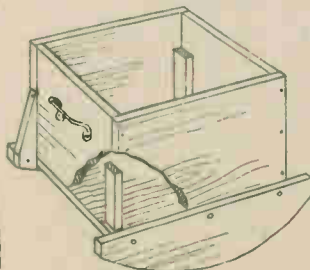

Fig. 3—General construction

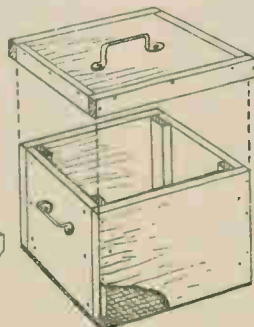

Fig. 5—Lid fitted on box

Made to fold and to fit into a flat space—a WALL IRONING BOARD

SOME women cannot be bothered selecting and folding, and carrying about, ordinary collapsible ironing boards. There is only one thing to be done, and that is to arrange a wall ironing board. This type of ironing board, in its simplest form, is illustrated herewith, and it will be seen that the construction of the board is greatly simplified, with a fair saving of useful timber.

Although the entire work is a fixture to the wall, it is not a permanent fixture. If you have to move at some time, the screws holding the framing to the wall can be easily removed. The whole thing comes away as a complete unit.

The board is quite steady and strong—more steady than the usual folding type. The framing requires to be attached so the board, when resting horizontally upon its strut, is 30ins. high.

When the board is pushed back into its framing, the supporting strut automatically closes flatly in front of it. The tabs keep the board held in place, but it is possible to fit ball catches at the side edges of the board, with the closing plates attached to the framing, in line with the catches. Thus, there is no trouble erecting or collapsing the ironing board, and no carrying about to be done.

Board Dimensions

The ironing board should measure 45ins. long by 10ins. wide by $\frac{1}{2}$ in. thick. The wall framing is made to take this size of board. It measures 4ft. long, and the distance between the uprights must be $10\frac{1}{2}$ ins.

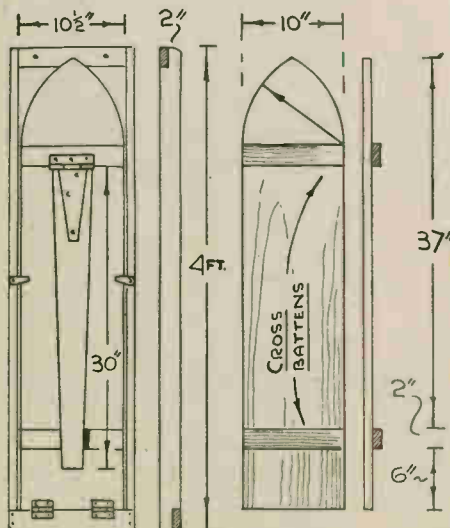

Fig. 1 General dimensions of various parts

This width allows freedom for the ironing board, about $\frac{1}{2}$ in. at each side. When the board has been covered with blanket material, linen and edge strapping, there will be sufficient space for it to close within the framing.

The framing is made from 2in. by $\frac{3}{4}$ in. material. Note that the end cross rail pieces are checked into the uprights in the manner shown, one rail (the bottom) being checked flush at the front, and the other rail (the top) being checked at the back. The rails are either glued and screwed or nailed.

For fixing purposes to the wall, two holes should be bored in the top cross rail, and countersunk. For bottom screw fixing, the holes are bored through the edges, then countersunk. As the uprights are 2ins. wide, this means using $\frac{3}{4}$ in. long screws.

If preferred, the holes could be bored $\frac{1}{2}$ in. deep with a $\frac{3}{4}$ in. bit, then continued with a drill suiting the shanks of 2in. or $2\frac{1}{2}$ in. by 8 flathead iron screws. Alternatively, one could fit brass wall plates to the uprights. The framing should not be screwed up until the board is fitted and everything made shipshape.

The Board and Strut

The board is quite easily made. It should be pointed, as shown. The radius is 10ins. Attach the cross battens with screws and keep them flush at the edges. A good piece of deal shelving material should be used for the ironing board.

It is possible to build it up from scrap pieces of wood, using strips of $\frac{3}{4}$ in. stuff or $\frac{1}{2}$ in. stuff. The latter, if employed, should be built up $\frac{1}{2}$ in. thick with further pieces of the $\frac{1}{2}$ in. wood. A board merely $\frac{1}{2}$ in. thick is too flimsy.

The strut is cut from $\frac{3}{4}$ in. stuff 30ins. by 4ins. It is affixed to the cross batten with a 4in. wide (at the knuckle) cross garnet hinge, i.e., a tee-hinge. The board itself is affixed with a couple of 2in. iron butt hinges. Be sure to ask for $\frac{3}{4}$ in. flathead iron screws when ordering the hinges. The strut hinge requires screws of similar length.

Padding the Board

Prior to hinging the board to its framing, it needs to be padded. A single strip of old blanket could be put on, cut to the board shape. This is covered with white linen, with sufficient overlap for tacking to the board edges.

To help hide the creases and finish of the padding decently, use $\frac{1}{2}$ in. banding (leatherette) and brass-headed chair nails.

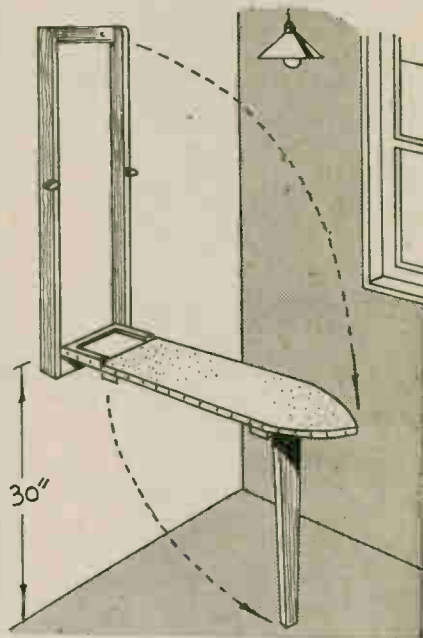

Remember, of course, to include an iron rest upon the rear end of the board. This consists of strips of $\frac{1}{2}$ in. by $\frac{1}{2}$ in. wood surround, a piece of asbestos sheeting or slate, or asbestos cardboard (this is more flexible than hard sheeting). The rest should be affixed prior to padding the board.

The Wall Fixing

Having hinged the board to the framing, the framing is held against the wall in its desired position, and the wall marked to indicate the fixing screw positions. The wall is then plugged with wood or Rawlplugs and the framing attached.

The fact that the padded side of the board faces the wall, enclosed by the framing, ensures that it is kept clean. The exposed wood, if necessary, can be painted to match the wall (if this is painted or coloured with distemper).

If brass ball-catches are used instead of wooden snibs, these must be fairly large, say, $\frac{1}{2}$ in. in diameter. A good grip is wanted, and to hear the steel balls clicking soundly into the closing plates gives great satisfaction.

One knows that the board is not likely to fall on its own accord. A bump on the head with the board is likely to raise quite a lump! So, be wise, and do not use small weak ball catches. If nothing else is available, make wooden snibs, or fit metal snibs. The latter will be stronger and much neater, and cost merely a few pence.

Continuing our practical photographic hints on ENLARGING PICTURES

ASSUMING that some readers have been able to get possession of an enlarger and that others intend to do so at the earliest possible opportunity, it is very advisable that they should be given some hints on how to start using the apparatus and also how to get the best out of it.

The manipulation of the machine is very simple. A negative is placed in the carrier upside down and with the emulsion facing the easel. The light is switched on and by shifting the enlarger either nearer to or farther away from the easel the approximate size of the desired enlargement is obtained.

The image is not likely to be in sharp focus, but sharpness is readily gained by slightly adjusting the distance between negative and the lens. Pin-point sharpness is very desirable in this work and the largest stop of the lens should be used.

If the negative is very dense then the image on the easel is difficult to judge. One device is to make, with a needle point, a small hole in the emulsion of the film on one of the margins or very close to the edge of the image of the negative. This hole should then show on the easel and when it is absolutely sharp without any fringe, it is fairly safe to assume the picture itself is sharply focussed.

The writer uses a 40 watt pearl electric bulb. Some workers, however, prefer a stronger light, but this means that the exposure time is much shorter and, therefore, control is reduced somewhat.

Care must be taken to ensure that the light on the easel is evenly displayed. If there happens to be a slight diffusion, somewhat like a shadow, this must be removed by a slight adjusting of the lamp chamber.

The same remedy is necessary if there is any suggestion of colour fringe on the circle of illumination.

If either of these defects is allowed to remain, then that portion of the image covered by the shadow or fringe, will be underexposed in the enlargement.

Bromide Papers

There are dozens of different brands, grades and surfaces of bromide papers to select from, but until you have had some experience it is not wise to concern yourself

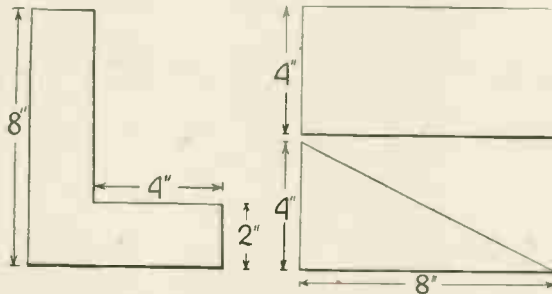

Two shapes like this form a useful mask

Shapes for shading down in enlarging

with more than one or two.

The best advice that can be given to the beginner is to go for one of the well-known makes, to try an 'ordinary' grade and a semi-matt surface. Such a paper will be found to suit almost any negative in the collection and to give satisfaction.

Do not at first aim for very large sizes, for mistakes are very likely to happen and are expensive. So make the experiments on postcards or up to 8½ ins. by 6½ ins. When you are confident that you can succeed with larger sizes, then try 10 ins. by 8 ins. or even larger.

There are two popular developers for bromide papers and these are known as M-Q (Metol-Quinol) and Amidol. Those who have been making their own contact prints will recognise the former and will have purchased it in the well known Johnsons Packets.

If you so desire, you can use these for the enlargements, or if you think the time has come to mix your own solutions, then the following formula is recommended.

Amidol is particularly favoured by professionals and others who have several prints to develop at a time. It is considered by some to give richer blacks which undoubtedly add charm to any large print. A snag

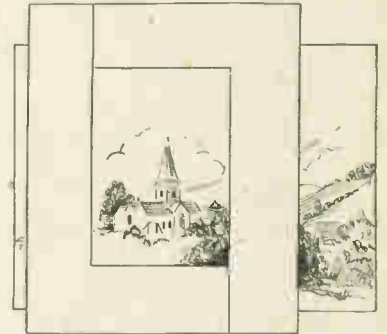

How the masks are used to trim a picture

with Amidol is that when the solution is made it will not keep for more than two or three days. Therefore, it is advisable to make only sufficient for immediate use.

Metol-Quinol

Metol	15	grains
Soda sulphite cryst ...	1	ounce
Hydroquinone	55	grains
Soda carbonate cryst ...	1½	ounces
Potass. bromide	20	grains
Water up to	20	ounces

For use, dilute one part with one part of water.

Amidol

Soda sulphite cryst ...	1	ounce
Amidol	55	grains
Potass. bromide	8	grains
Water up to	20	ounces

This is ready for use, but will not keep more than a few days.

With most papers if the exposure is correct, development with either of these solutions will be complete in two or three minutes. When making your test strips, as explained below, it is important to take a note of the time taken to reach finality in the developing.

After developing, the print must be immediately immersed in the acid fixing bath, which should be made to the same strength as used for the bromide contact prints given in a previous chapter.

Test Exposure Strips

It is much too expensive to use a full-size piece of paper for ascer-

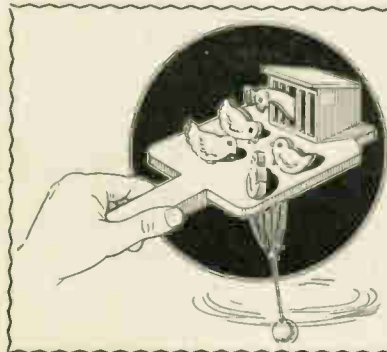

An amusing Novelty THE PECKING CHICKENS

When you swing the weight round, the hen and chicks peck at the ground in realistic and amusing manner. Patterns for all parts on sheet 2734, presented with this issue. Complete kit of wood from any Hobbies Branch for 2/6, or sent post free from Hobbies Ltd., Dereham, Norfolk, for 2/9

taining the correct exposure. Trial strips by which several exposures are obtained on a small piece are the regular methods adopted by experienced workers.

Cut a strip about one inch wide from one of the sheets and, while the orange cap is on the lens, pin this across the image on the screen. Remove the cap and expose the whole of the strip for, say, five seconds. Replace the cap and cover up all the strip except one inch of it. Expose again for another five seconds, replace cap and uncover another inch.

Repeat this until the whole of the paper except the last inch has been treated. If you have made six exposures you should have varying times of exposures, five seconds for the last, then 10, 15, 20, 25 and 30 seconds for the first, and when the strip has been put through the

developer and fixing baths, it should be possible for you accurately to judge the correct exposure required for that particular negative.

Make a note of that time on the envelope in which you keep the negative and it will serve you in good stead every time you wish to make an enlargement of that size.

You will find that the bromide paper is wrapped in black paper. Do not destroy this, as it can serve a most useful purpose. Cut two pieces the shape of a letter L, the upstroke about 8ins. and the right angle piece about 4ins. long. If the paper will allow it, make them 2ins. wide.

They should be mounted on fairly rigid card and as cut-outs will help you to decide which part of the negative will make the best picture, as shown in the diagrams. Focus the whole of the negative image on to the

easel and then by placing one of the cut-outs at one side of the image and the other reversed on the other side, your picture becomes framed and any awkward part or person can be covered to avoid that section of the negative being printed.

Cut out another piece as suggested in the illustration and use this for shading or cutting down exposure in those parts which are very thin in the negatives and which print too quickly.

Another which can be called the rectangular piece will answer the purpose in a similar way when the clouds require more exposure than the main image or foreground which must be shaded. In using the last two pieces, be sure and keep them moving gently to avoid a defined line between the two sections on the resulting print.

Some card, wood, wire and cord can make a realistic MODEL WELL TOP

THIS is a neat little present which you might make for some smaller member of the family—a working model complete with bucket and winding drum.

First make the "brickwork" A. This is built up of two collars (a) and (b) of fairly thick card. They should be cut out in the rough first of all and then taken down to a fair circle with glasspaper. From the circle are cut the openings (c) to take the upright posts D.

Card Walls

The wall (d) is of quite thin card which will readily wrap round the two collars. It is held to these pieces by a series of small pins run into their edges and reinforced with gummed paper strips on the inside.

When finished, the cylinder so formed is covered with brick paper, or, if unobtainable, white card must be used stained with red ink and brick courses then picked out with white ink, the lines representing mortar.

No dimensions have been given for the cylinder (or for the rest of the well) as obviously it can be made to almost any size within reason.

Baseboard

The base (E) is now cut square and two uprights (D). These uprights pass through the cuts in (a) and (b) and are sunk into the base—all of which gives a very rigid finish that allows of the model receiving fairly hard treatment without damage.

The uprights extend to about twice the height of the top of the cylinder and they are wider than thick.

Bevelling (to 45 degrees) as indi-

cated, finishes the top ends and, about one-third of the way down, holes are bored at exactly the same level in each to take the spindle of the winding drum. That they are exactly at the same level is important.

The drum can either be a strip of dowelling or can be built up by rolling a long strip of thick paper gummed on the inside. A spindle (F) made from a piece of wire and flattened with a hammer as (h) to

make a channel for the spindle and after putting the two halves together (glued), finish with a binding of gummed paper round the outside. This makes a very firm job when all is set.

Bucket

The bucket may be solid or hollowed out—better still if you had a small metal bucket from some doll's set—and the string forming the rope should be thin and very pliable, so the weight of the bucket, small as it is, will cause it to hang taut. The bucket, solid or hollow, is completed with a simple wire handle.

Now put on the eaves (g). These overhang a fair distance as can be seen in the sketch of the finished well and they are held by small sprigs to the bevelled tips of the uprights, their own top edge being bevelled to make a good clean meet along the "ridge".

Painting

All is now complete except colouring. The base should be green and a better finish is obtained by painting first with gum and then covering with green ink-dyed sand or small cork chippings. Both will hold well when dried on.

The sides of the well are dealt with by the brick paper, of course, or brick markings, but the top lip (a) is painted grey and then marked to look like stone.

Brown does nicely for the uprights, but the roof should again be grey like (a) but with tiles marked in with indian ink.

All is now complete and if everything has been made with due care, you will have a model that will look good, will be strong and will give endless hours of enjoyment.

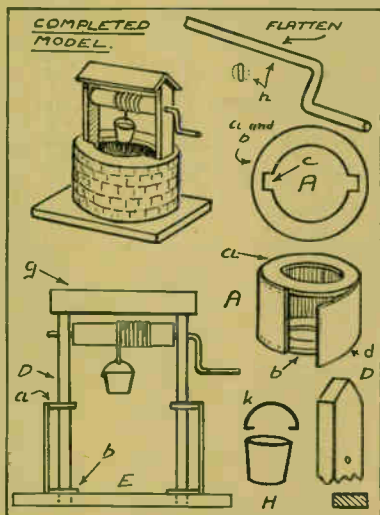

prevent slipping, is required in both cases.

If making with paper, the spindle is put through the hole in the uprights and the strip then rolled on till the required thickness is secured. Using a length of dowel, the main trouble is to get the exact centre (otherwise the drum will wobble). It is a good idea to cut the dowel down the centre,

EXTRA CASH IN SPARE TIME



A fascinating way of earning extra cash in spare time from odd pieces of lead. Small Outlay—Large Profits. Sample mould 5/-. Casting moulds, deep-cut and ordinary type Aeroplanes, Soldiers, Farm and Wild Animals, Cars, etc. Stamped envelope for full list. Illustrated Catalogue 6d.

MASTERCRAFT MOULDS
69, ST. MARKS ROAD, HANWELL, LONDON, W.7

DRY YOUR CONTACT PRINTS AND ENLARGEMENTS by ELECTRICITY

Why wait hours before you can handle your prints when they can be bone-dry in six minutes on the new

**JOHNSON ELECTRIC
PRINT DRYER**



Takes all sizes up to 10 x 8 in. Heat evenly distributed over the entire surface. Suitable for any voltage from 200 to 250 volts A.C. or D.C.

Strongly made, with sheet iron frame and convex drying bed. Woven tension apron of special texture. Prints dry flat. Accommodates one 10x8 enlargement or two half-plate prints or four postcards or eight contact prints size 2 1/4 x 3 1/4. Low current consumption, can be run off an ordinary lighting circuit. Sold complete with flex, as illustrated. See the JOHNSON ELECTRIC PRINT DRYER at your dealers. Once you have adopted this up-to-date way of drying your prints you will never go back to the old method with its long waiting.



JOHNSONS of HENDON
Photographic Chemicals & Apparatus

YOU CAN QUICKLY QUALIFY FOR ONE OF THESE

WELL PAID CAREERS

SEND FOR FREE GUIDE

Today's demand is for the TRAINED man with SPECIALISED KNOWLEDGE. The men who succeed are those possessing the necessary specialised knowledge to fill the higher paid and far more secure positions. You can quickly qualify by interesting spare-time home study to fill a well-paid position in Industry or Commerce. Remember the higher you climb, the bigger your income and the greater your security. Post the coupon today for full details, free of cost or obligation.

HERE IS A CAREER FOR YOU

The College provides examination or diploma Courses in the following subjects:—

Accountancy	Steel Making
Secretaryship	Inst. of Factory
Costing	Managers' Exam.
Book-keeping	Inst. of Prodn.
Civil Service	Eng's Exam.
Matriculation	Time Study
Met. Police	Prodn. Planning
Draughtsman	Foremanship
Salesmanship	Works Management
Sales	M/C Shop
Management	Tool Room
Export	Foundry
Eng. Science	Welding
Electroplating	Jig and Tool Des.
Pattern	Press Tool
	Making Metallurgy
Fuels	Moulding

POST THIS COUPON

Please send free details of your training in
Name
Address
489B

WALLACE ATTWOOD COLLEGE LTD.

Dept. 489B, Attwood House, Finchley Road, London, N.W.3

GENUINE EX-RAILWAY AND SHIP TARPULINS

Guaranteed good condition and Waterproof. 70 sq. ft., 20/-; 140 sq. ft., £2 10/-; 280 sq. ft., £5; approx. 360 sq. ft., £6; approx. 720 sq. ft., £12. All include carriage. Genuine W.D. Pioneer Felling Axes. Original handles, complete, hardened steel razor edge. Brand new. 18 6 each, carr. 1 6. Marquees, Tentage and every type Tentage Equipment in stock. Send 1d. for Bargain List.



GENUINE Admiral's Stove 35/-
Carr. etc. 2 6
**Cooker
Lantern**

Economic Oil Burner, impossible to blow out. This Stove lasts a lifetime. Sheer steel, cost £7 7 - to make, clearance 35/-, post 2 6.

Keep Food Hot! New Ex-Army Steel Food Containers. Ideal to solve the fuel problem. Keep your cooked meal hot in this container. Ideal for picnics. Size 32" circ., 3 1/2" deep. Bargain 5 9, carr. 1/- 'Paratroop' Binoculars 50/-, post 1 -. Weight only 7ozs. Telescopes and Prisms available.

Electric Alarm Clocks A.C. 200 250, 59 6, post 1/3

HEADQUARTER & GENERAL SUPPLIES LTD. (Dept. HOB AS 1)
196-200 Coldharbour Lane, London, S.E.5 1 minute Loughborough Junc

CHINA FREE!



UNDOUBTEDLY AMONGST THE MOST ATTRACTIVE AND BEAUTIFUL STAMPS EVER ISSUED. Two very scarce, mint War Comems., each in 4 colours, 2 dollar and 6 dollar values. Depicting Marshal Chiang, Map of China, Statue of Liberty, and coloured flags of Britain, China, and U.S.A. (red, white and blue).

Absolutely Free to all approval applicants. Enclose 2 1/2d.
D. J. HANSON, (H.25), Eastington, Goole, Yorks.

Hobbies

WEEKLY

CONTENTS

	Page
A Roman Ballista	- 253
One Valve Set	- - 255
Home-made Bench Vice	- 256
Trick Cyclist Toy	- - 257
Camera Fun	- - - 258
General Hints	- - - 259
A Doll's Pram	- - - 261
A Canvas Canoe	- - - 262

March 31st, 1948

Price Threepence

Vol. 105 No. 2735

SOME time ago we included in these pages an article dealing with the making of a model of a Roman instrument of war known as the Ballista. In this article, we now deal with a similar kind of weapon, differently controlled, with the mechanical movement stronger in effect.

In Roman days, the foot soldiers and horsemen were backed up by the artillery which then consisted of catapults—huge implements for hurling large rocks into the ranks of

A ROMAN BALLISTA

the enemy, and the Ballista, a device working on the same principle, for throwing quantities of arrows.

In each of these the propelling force was produced by the sudden releasing of a great beam or a tree trunk which had been bent by means of ropes and winches to form a huge spring.

A shower of arrows hurled from a Ballista must have created as much havoc in the ranks of the enemy of those days as the bursting of a shell of modern warfare. It was said, too, that the great stones thrown by the catapults of the Romans were often as large as and as heavy as the shells of the modern ones.

So, now to talk of the interesting model we give this week, we will first briefly describe it. Looking at the illustration on this page we see that there is a framework which stands firmly spread on the ground. At the rear of this frame there is a platform upon which slides the back end of the inner frame carrying the spring mechanism and the windlass for winding and bending it.

This inner frame is pivoted between the head cross bar and the sill piece of the fixed framework. The windlass is fixed to the lower member of the inner frame, as can be plainly seen in the side view Fig. 1. The rope running from the windlass is carried round a sheaf block and pulley and up to the top of the laminated spring which is located between the two sloping side members, M, of the inner frame.

The spring consists of three or more thin members of wood secured together only at the lower extremity,

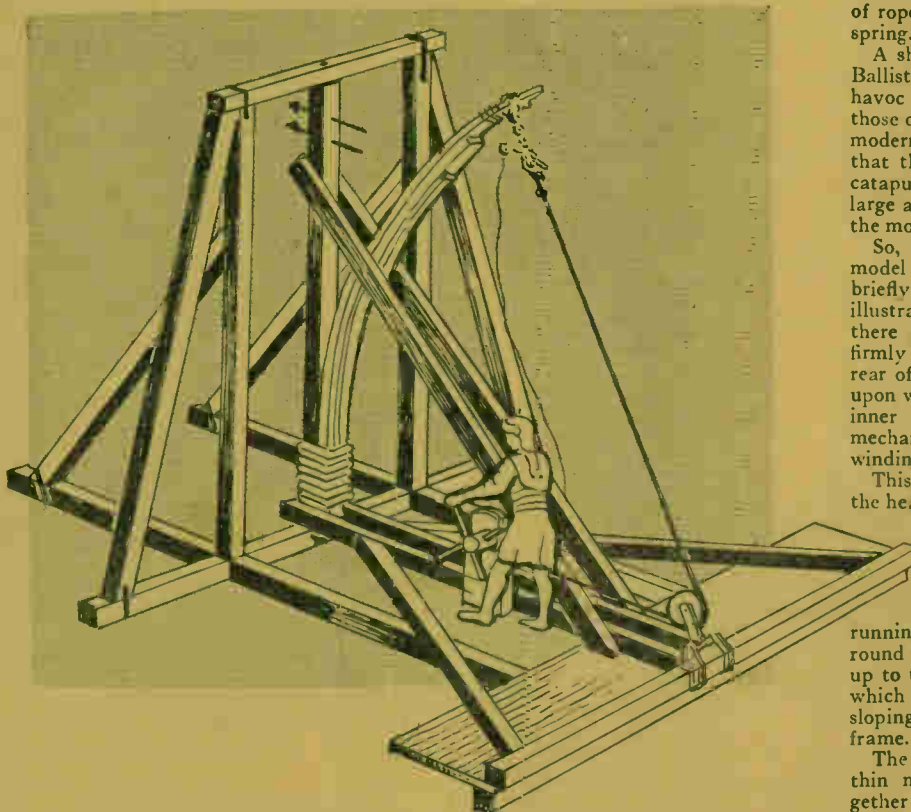

All correspondence should be addressed to The Editor, Hobbies Weekly, Dereham, Norfolk.

and bound here to the middle member of the inner frame with cord. It will be apparent that when the forward member of the spring is drawn back, the other members are allowed to slide, as it were, one upon the other to get the forward throw of the whole spring.

Two or more arrows lodged in

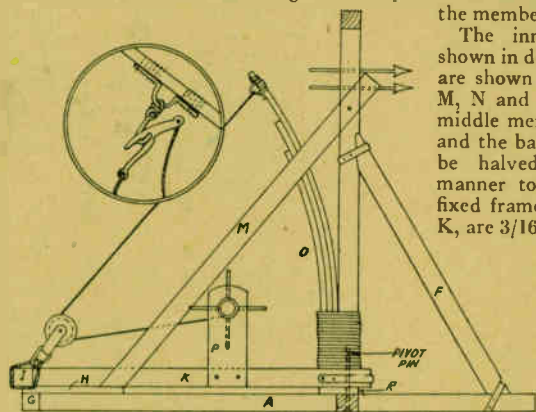

Fig. 1—Sideview of frame with release hook detail

retaining holes in the upright of the middle frame are thrown forward at great speed when the spring is released, after having been bent backward by the windlass and rope. The type of release hook to be fixed between the pulley block and the head of the spring is shown in the enlarged detail in Fig. 1.

Both frames, the fixed ground frame and the inner moving frame, are almost entirely made up from $\frac{3}{8}$ in. square wood.

The Fixed Frame

In commencing to make the fixed frame, which is shown in detail in Fig. 2, the sole pieces, A, and the cross piece, B, are taken up, halved together and glued and nailed with fret pins. Note the distance of $2\frac{1}{2}$ ins. between the members, A. Now cut and fix the end member, G; this should be halved into the pieces, A, as shown. The uprights, C, and the cross head piece, D, are next cut and fitted and nailed in place. These members are firmly held by the sloping struts and supports, E and F.

It is doubtful if anything in the nature of a true woodworking joint was made in those far-off days, but if our craftsman so desires, he may

make a really strong framework by introducing the joint shown in the enlarged detail in Fig. 2. Further strengthen it by adding a stirrup of brass or "tin" bent up and pinned on as our detail suggests.

When the frame shown in Fig. 2 has been completed, a platform, H, must be added and glued or nailed to the members, A and G.

The inner or moving frame is shown in detail in Fig. 3. All members are shown full with the exception of M, N and the spring pieces, O. The middle member, J, of this framework and the back cross member, I, should be halved together in a similar manner to pieces, A and G, of the fixed frame. The two side members, K, are $\frac{3}{16}$ in. wide and are nailed and glued to, J.

Between these side pieces, K, are glued the upright, N, and its spring pieces, O, as seen by the dotted lines in Fig. 3. To make this frame perfectly rigid, the two upright sloping members, M, are added,

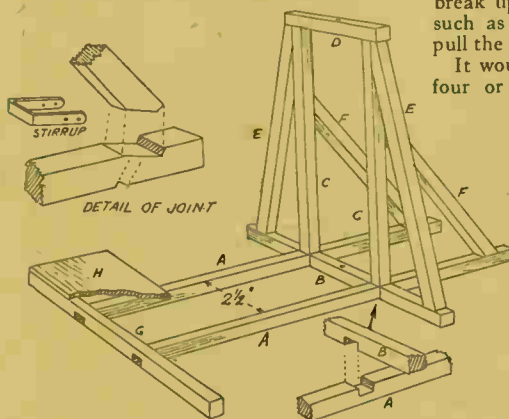

Fig. 2—Showing construction of framework and joints

these again being $\frac{3}{16}$ in. wide. Metal stirrups should be added to this frame just the same as the frame below it.

The windlass sides, P, are shown in detail in Fig. 4 with also the winding drum, Q. The collars on the latter holds the drum in place between the uprights and they may be of stout brass or other metal bent round and pinned on securely.

The cross handles for pulling the drum round may consist of stout wire driven through tightly. The side view Fig. 1 gives sufficient detail for making the sheaf and pulley which is held by cord to the rear member, I, of the frame.

The pulley should be of wood cut to a disc $\frac{3}{8}$ in. diameter and grooved round the edge with a rat-tailed file. This wheel is then inserted in a stirrup made from "tin" with an axle pin firmly held at both sides.

The finished block is held by a loop of wire passing through the stirrup

which is in turn held to cross beam of the frame by several strands of cord bound round neatly and coated finally with varnish.

Release Hook

A detail of the release hook is given in Fig. 1 and this can be filed to shape from a piece of stout brass, the two holes necessary, one for the release cord and the other for the sustaining rope running round the pulley, being drilled before the shaping is undertaken. A loop of wire bent up as shown and lashed with cord to the top of the wood spring will take the metal ring connected to the hook, or a length of cord may be carried from the top loop and the hook then fastened further down the rope as seen in Fig. 1.

A word of advice should be added, perhaps, regarding the make-up of the laminated wood spring. Do not attempt to make this too powerful by having too great a number of laminations or having the wood composing them very thick. Too great a strain, that is if the model is wanted for demonstration purposes, will not only break up certain parts of the model, such as the windlass sides, but will pull the actual framework apart.

It would be advisable to have, say, four or five laminations of $\frac{1}{32}$ in.



Fig. 4—The Windlass

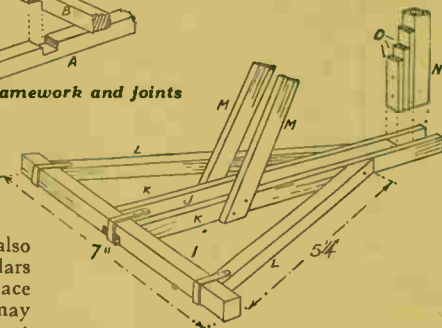

Fig. 3—Triangular frame for platform

wood in preference to three stouter ones as pictured here. A useful tip to the constructor of this model, too, while making up the actual framing of $\frac{3}{8}$ in. wood is to get the correct angles for the ends of those struts and sloping members where they meet the square framing.

Having, say, the square frames made, and it is desired to proceed with those members such as E, F, L, etc., lay the latter in their true positions on the framing and mark across in pencil exactly where the frame member comes below it.

CUTTING LIST

- | | |
|----------------|---------------------------|
| A—10ins. | J—6ins. |
| B—7ins. | K—6ins. |
| C—7ins. | L—5ins. |
| D—3ins. | M—8ins. |
| E—7ins. | N—7ins. |
| F—6ins. | O—6ins. 3 or more pieces. |
| G—7ins. | P—2ins. |
| H—7in. by 2in. | Q—1ins. |
| Platform. | R—1in. |
| I—7ins. | |

All $\frac{3}{8}$ in. square wood with the exception of pieces H, K, M, O, P and R, which are $\frac{3}{16}$ in. thick and Q, which is of round rod.

How the amateur can build an economical mains ONE-VALVE SET

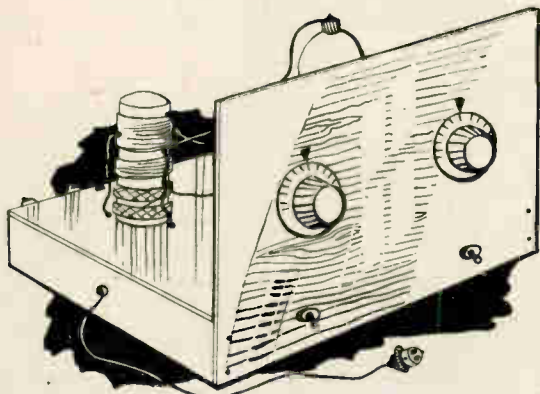

LETTERS to "Hobbies Weekly" show that readers are anxious to operate receivers they have made from the mains when this is possible. The cost of accumulator and high tension batteries is, therefore, avoided and the running costs enormously reduced.

When designing a receiver for A.C. mains a rectifier and smoothing section is necessary. The same parts have to be used in this for a one-valver as for a four or five-valver and so the expense is, perhaps, doubled. The power section costing more than the receiver itself in the case of a one-valver.

Economical System

To overcome this, the receiver described here uses a small heater transformer (about which more later) to heat the valve and a grid bias battery to provide the positive

previously used in a battery set can be made use of. Fig. 1 illustrates the complete circuit.

Tuning Coil

Any tuning coil with reaction to hand can be used. If one is to be wound, Fig. 2 shows how this is done, a tube $1\frac{1}{2}$ ins. in diameter being used. Between points 1 and 3 sixty-five turns of 28 S.W.G. enamelled wire are required, the tapping 2 being at the centre (approximately). Leave

$\frac{1}{2}$ in. space, then wind on the next coil of sixty turns. Leave another small space and wind on two hundred turns in two compact piles of one hundred turns each.

All turns and windings must be in the same direction, as shown. The wire gauge is not critical, but thinner wire (about 36 S.W.G.) is best for the larger winding to render it less bulky. Very thin wires (40 S.W.G. down) are not recommended. If the construction employed gives weak reaction, increase the number of turns between 5 and 6 until this is remedied.

Connections are as follows: 1 to fixed plates of tuning condenser; 2 to aerial; 3 to wave-change switch; 4 to moving plates of tuning condenser; 5 to valve anode and 6 to reaction condenser.

Chassis and Panel

A piece of 3-ply 5 ins. by 7 ins.

glasspapered and varnished. If a $1\frac{1}{2}$ in. diameter bit is not available to make the hole for the valve-holder, this may be cut with a fretsaw before assembling.

Solid or air-spaced condensers may be used for reaction and tuning. If one air-spaced condenser is to hand this should be used on the tuning-side (left-hand position).

Of the two switches below the chassis, the one connected to the mains must be a proper mains switch. Any small switch is suitable for wavechanging. Four terminals are fitted along the rear runner for aerial connections, etc.

Wiring Details

From Figs. 3, 4 and 5 all the wiring may be accomplished. Where leads pass through the chassis, these are lettered in the diagrams.

Three valve-holders are shown in Fig. 4 because these are the types of valves easily obtainable, both new and as cheap ex-R.A.F. supplies. If a triode is used (the 6C5 and similar types), there will be no suppressor and screen connections.

In addition it will be necessary to bring a lead through the chassis to the grid socket. (There is no top cap for this connection as with the pentodes).

Transformer

The heaters of the valves mentioned are rated at 6.3 volts, .3 amps. Heater transformers may be bought or wound, or any small mains transformer (such as a bell or motor transformer) can be used if the output is approximately correct. A 5 or 6 volt secondary is suitable. If a

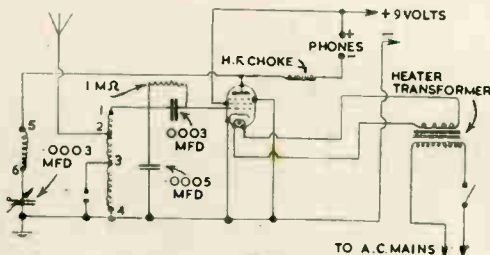

Fig. 1—The circuit of the receiver

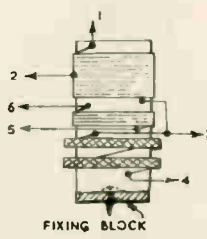

Fig. 2—Tuning coil connections

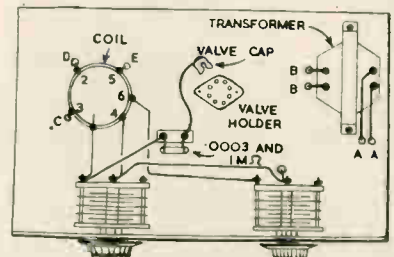

Fig. 3—Wiring plan, top of chassis

voltage necessary on the anode.

As this battery only costs about a shilling and lasts several months, the saving is great. The set can also be carried about easily, as no large batteries are used and the rectifier arrangement mentioned is not necessary.

Wiring is naturally a little more complicated than in a battery one-valver, but except for the valve and transformer, any components

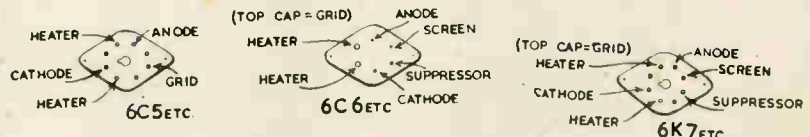
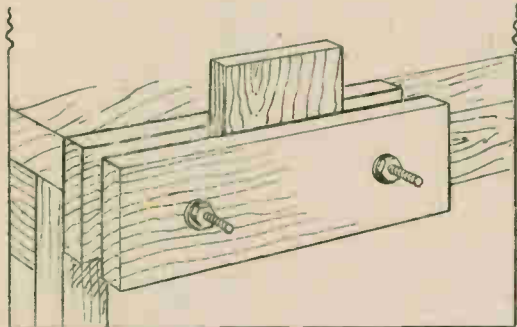

Fig. 4—Details of the valve holder connections

forms the top of the chassis. Runners $1\frac{1}{2}$ ins. deep are fixed round three sides of this and the panel (5 ins. by 7 ins.) fixed to the front. The whole is

transformer with a higher voltage secondary is to hand (10 to 12 volts) a 6.3 volt, .3 amp. dial-light can be
(Continued foot of page 256)

Every handyman should make for himself a HOME-MADE BENCH VICE



AN easily constructed vice, suitable for amateur woodworkers, is sketched. It is not, of course, so efficient, nor yet so rapid in its action, as a well made wooden or metal vice, but it does do its work and does it well. For making it, all that is wanted are two pieces of stout wood, about 1 in. to 1½ ins. thick, 4 ins. wide, and, say, 15 ins. long.

A piece of beech or oak would serve excellently if it can be got, or, indeed, any hardwood, but good quality deal makes a usable substitute.

Bolt Holes

Plane the pieces to size and screw them temporarily together, with a screw at diagonal corners, ready to bore the holes for the long screw bolts which clamp the jaws together. If a pair of bolts are not in the junk box, they can be bought for a few pence at any hardware stores.

Bolts ½ in. by 6 ins. are suitable, with nut and two washers to each.

Each pair of bolt holes must be truly in alignment, or the jaws will not close together evenly, so the spots for these holes must be most accurately marked.

With the jaws screwed together, as in detail sketch, A, mark a line across both edges, 3 ins. from each end. Square these lines down both sides, back and front.

Set a gauge to half the width of the wood, in this case 2 ins., and mark the cross lines. On the spots indicated, make a clear small hole with an awl, as an accurate guide for the bit.

Sunken Heads

Now, on the outer face side, bore a ½ in. hole on each mark, half through the wood. Turn over, and on the marks on the inner jaw, bore a shallow hole large enough to receive the bolt heads as they sink in the wood level. Then, with the ½ in. bit, continue the hole right through.

Some patterns of screw bolts have a short portion beneath the head to square section, which prevents the bolt from turning in its hole when tightened. This pattern is the best to use for the vice. Drive the bolts in and hammer until the heads sink in their recesses level, or just below the surface, as in the sectional detail, B.

In the outer jaw, it may be necessary to smooth the holes a little to ease the movement when the jaw is closed up. A round file will help

here, or a strip of glasspaper wrapped round a metal rod.

On the screwed ends of the bolts, slip one of the washers, turn the nuts on, and the vice is ready for fixing to the bench. The best method is to screw the inner jaw of the vice to the bench, at the left end.

Packing Pieces

If the screwed portion of the bolts is not long enough to allow the vice to grip boards, packing pieces can be interposed between the jaw and nut, as at C. These can be just pieces of metal tube of convenient length. Use stout tubing, such as iron gas barrel for these packing pieces, and when in use, place the second washer between them and the nuts before tightening up.

So far as the nuts are concerned, those known as "fly" nuts are the

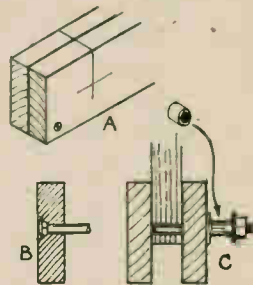

Marking out bolt holes, with end view showing working

easiest and quickest to operate, but the common type, requiring heavy pliers or spanner to exert pressure, grip more powerfully, and may be better, if slower in action.

Valve Set (Continued from page 255)

connected in series with the valve heater.

The valves mentioned will work well with a 6 volt accumulator or 4.5 volt dry battery connected directly to the heater if the mains are temporarily unavailable. Note that upon switching on, 30 to 45 seconds will pass before the valve reaches operating temperature. It will continue to function for a similar period after switching off and this does not indicate a fault.

Aerial, etc.

Ordinary high-resistance phones are used and any aerial. Enough volume from local stations will be obtained with a few yards of wire indoors and no earth.

More than 9 volts may be used for high tension, of course, if desired. Sufficient reaction turns should be

used to provide oscillation when required or weak stations cannot be received.

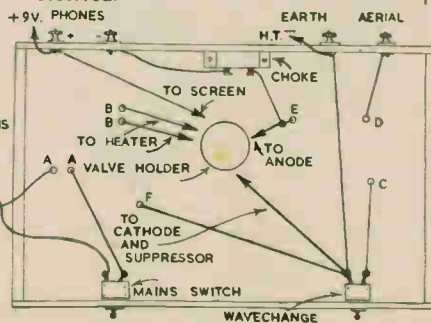

Fig. 5—The wiring under the chassis

Mains plug to transformer primary. Transformer primary to switch. Switch to mains plug. Secondary of

transformer to valve heater contacts. Earth terminal to:—moving plates of both condensers; wave-change switch; 4 on coil; cathode and suppressor; minus on battery. Plus on battery to phone plus and screen. Phone minus to choke. Choke to anode. Anode to 5 on coil. 6 on coil to fixed plates of reaction condenser. Grid to 1 megohm leak and .0003 condenser. Leak and condenser to 1 on coil and fixed plates of tuning condenser. 2 on coil to aerial. 3 on coil to wavechange switch.

With some types of pentodes and screen grids, louder results are obtained if both the suppressor and screen are wired directly to the anode, and this can be tried. The connections from the suppressor to earth and screen to plus on battery should then be omitted. When complete you should find a very satisfactory set.

A simple and novel mechanism is this TRICK CYCLIST TOY

THIS is an interesting model of the push-along type, representative of the mono-cyclists, usually an essential feature of trick cycling acts. As it is run along, the actions of the cyclist are quite natural, and will greatly amuse. For the making, only a few small pieces of wood are required, plus some tin and wire.

The wheel and bearings are shown in diagram 1. Set out the wheel on $\frac{1}{2}$ in. thick wood, by striking a 6 in. circle, and then the 4 in. and 2 in. circles shown dotted. Divide these into eight equal parts and on each part bore 1 in. holes through the wood. Extend these holes by cutting to the inner dotted circle.

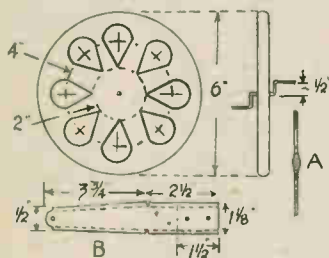

Fig. 1—Wheel and spindle parts

Cut the wheel out and in the exact centre bore a fine hole, a close fit for a short piece of stiff wire which will do for the axle and pedals.

Take this wire and at its centre, flatten it for some $\frac{1}{4}$ in. of its length in the middle, as at detail, A. Push the wire through the hole in the wheel until stopped by the flattened part, then drive in with a hammer until the flattened part is forced in the wood.

This will keep the axle from refusing to turn with the wheel. Allow about $\frac{1}{4}$ in. of the axle each side of the wheel straight, and bend the remainder to form the cranks and pedals, as shown in the edge view of the wheel.

Metal Bearings

The bearings are shown at B. Cut these from a piece of stiff tinplate, and bend $\frac{1}{4}$ in. of each edge over to the dotted lines, to stiffen the metal. At $\frac{1}{4}$ in. from the front ends, drill suitable holes for the crank axle wire, and where shown near the back ends, holes for the fixing screws or nails.

The push-handle is to be sandwiched between these bearings and should be of wood $\frac{1}{2}$ in. thick to keep

the bearings that distance apart. Its width can be $\frac{1}{2}$ in. and length 18 ins. or more, according to the age of the boy using it. No need to be too precise over this.

Work the bearings round the bends of the cranks until they fit over the axles and screw the handle between the bearings. Only $1\frac{1}{2}$ ins. of the handle is so screwed.

Take care to get the bearings level and see the wheel runs truly. It will be as well to place a thin brass washer each side of the wheel, before fitting the bearings on, to lessen side friction.

Other Parts

Fig. 2 is a diagram showing the remainder of the parts, drawn over $\frac{1}{4}$ in. squares. Copy these squares full size on to thin paper and plot carefully the shapes. What we can call the saddle part, C, should be traced through carbon paper on to $\frac{1}{4}$ in. thick wood, letting the grain of the wood run in the direction indicated by the short arrow.

The body of the cyclist, D, is cut from wood $\frac{1}{4}$ in. or $\frac{3}{8}$ in. thick. This part should be carved a little. For instance, reduce by side cuts, the width of the head portion, and again by side cuts, the thickness of the nose. Then, with a penknife, whittle

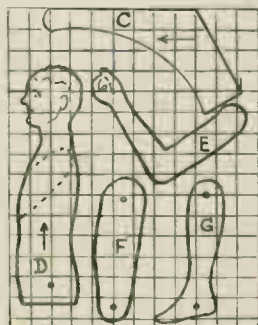

Fig. 2—Shapes to mark out

off the sharp square edges, when the body will begin to look a little more lifelike. Further touching up can be carried out as desired.

The body is then secured to the part, C, with a single screw from underneath, and part, C, then fitted with small nails between the bearings, just in front of the handle.

Arm parts, E, and legs, F and G, are cut from tinplate, two of each being required. In the hand portions of the arms, drill a small hole. Fix the arms to the body, approximately where shown by the dotted marks. Through the holes in the hands push a 6 in. length of stout wire, and there solder it. This represents the balance pole.



Punch small holes in the leg parts and file away the burrs left by the punch. These should be loosely jointed at the knees, in pairs, as shown in Fig. 3. A stout pin or brass rivet could be used for jointing.

Rivet Joints

One method is to push the brass rivet through, sandwich a thin tin strip between the tins, as at H, to prevent the joint being too tight, then to lay the whole on a flat piece of iron and to burr the rivet over with light blows from a hammer. Afterwards the tin strip, H, is withdrawn.

Another simple method of jointing, is to use a stout pin instead of a rivet, and after passing it through the holes, to cut it short to within $1/16$ in. of the tin and solder it. In both cases a free joint is necessary, with no more

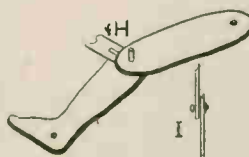

Fig. 3—Leg Joints

projections at both sides than is absolutely necessary, something like the side view, I.

Fit the feet on the pedal wires and joint the upper part of the legs to the body, at about where shown by the tiny circle in D. The end of the push-handle should be nicely rounded, and the handle itself varnished.

Should the feet of the cyclist tend to ride off the pedals when in motion, bend about $\frac{1}{4}$ in. of the ends of the pedals up to act as a stop.

The model should be painted in gay bright colours to impart an attractive appearance. The painting operations should, preferably, be done during the progress of the work, so that no subsequent sticking results.

This is the last issue of
Hobbies Weekly in Vol. 105,
if you are binding your copies.

Make your pictures different by this form of CAMERA FUN

PHOTOGRAPHY is, of course, a serious and artistic hobby, but there is no reason why you should not at times use it to bring a little humour into our austere lives.

One way of doing this is to make photographic caricatures of your friends. These, if presented at the right time, will always create a laugh, and you will get quite a lot of fun yourself doing the actual taking.

To get caricatures of this type, you require some drawings of people, with heads deleted, made with charcoal or black crayon on a white card base, or some large-sized dolls' bodies without heads.

Dealing with the card method first. The drawn figures must not be too small and should fill a sheet of card some 18 ins. high. The width must be in proportion, or if other items are included, as wide as is required.

Background Card

The card will have to be white, but if this is unobtainable, then a sheet of drawing paper pasted over card of another colour or over a rectangle of plywood will do very nicely.

Thick black crayon or charcoal is the best for making the drawings—indian ink is too fine in finish. Make one or two small sketches first of all,

TAPES



THE BODY



LEFT AND ABOVE—SHOWS HOW THE "BODY" IS ATTACHED TO THE SUBJECT

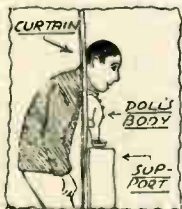

to be quite sure of what you are going to draw (suggestions are given in the illustration). Then outline (in pencil) the figures of your choice on the cards.

When you are sure all is correct, finish *boldly* with the medium you are using. Remember that in the final photograph, all lines will be reduced in thickness, and all solid black areas will come out smaller. Make all

the lines, therefore, quite thick and do not be afraid to blacken in quite big areas if they help the general effect.

The first diagram shows the type of caricature you can draw, but if you are of an artistic nature, you will probably have your own idea as to what will make a good "body" for your victims.

Where the neck touches the top edge, a slight hollow must be cut out as shown. This is so the body will always come directly below the face. Any slewing to one side or the other will spoil the result.

With regard to taking. Arrange the subject sitting in good light with his chin resting in the depression on top, the whole board resting on his knee. Behind him hang a sheet, if possible, of the same degree of whiteness as the card, the idea being to get the card and background to merge into one tone in the final picture.

Now focus at the shortest range possible. This is important, as we want the face and caricature body to come out as large as is feasible.

If taking outside, a "snap" (1/25 second or 1/50 second) will do the trick, but if inside a room, a time exposure will be needed, just as for any other "interior" photograph.

Light and Shadow

And here is an important point. If outside, the card will be evenly illuminated, but if inside, the light will probably be coming from one source right or left. There will thus be a danger of it causing a sheen from the surface of the card, so the drawing does not show, the card merely coming out as a light rectangle. To prevent this, more front light must be used.

In the final picture, the subject will have to be masked down so nothing below the feet shows. Or you may have the picture enlarged, thus cutting out the unwanted surround.

The process when using a doll figure is as follows. The figure may with advantage be 2 ft. long. It need not of necessity be a caricature. For easy making, a figure in a clown's dress or farmer's smock will be found the best. There is no head, and two tapes are fastened to the top which go round the neck of the living subject.

To take, two curtains are draped in

a suitable position for light, etc. The subject pokes his head between these, and they are then brought together above and below with pins.

The figure is now hung around his neck to appear to be coming down from his face in one complete body.

In front of the curtain a small table or box is placed, and upon this books are put till the doll's feet are reached, this giving something for the

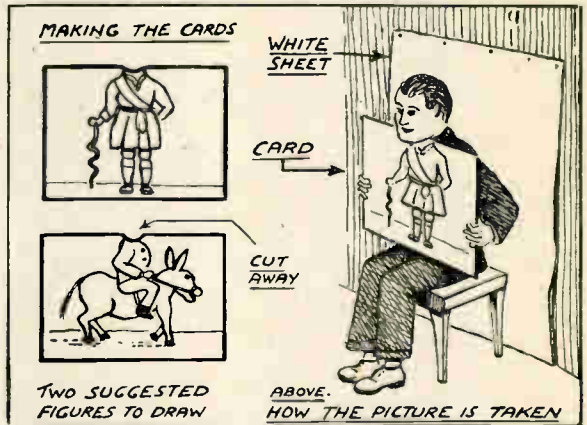

doll to be apparently standing on.

All being ready, the exposure is made. In this case it will be found that whatever light makes a good job of the face, will also make a similarly good job of the lay figure, there being no danger of sheen here.

Other Hints

Again get the whole subject as large as possible, but you will discover there is more latitude here, for by including a little of the "ground" upon which the doll is standing, the picture can, from the very start, be made bigger.

This system of caricaturing will also be found rather easier as the background being completely formed by the curtains, no consideration of merging areas arises, as is the case with the card and white sheet background.

To help to give this type of picture a real kick, your friend should also help by putting on a not too exaggerated humorous expression, but as the whole situation, it will be found, is rather funny, he will probably have no difficulty in doing this.

DO be careful when installing new electric light points in the house, such as fitting an extension light in the scullery, outhouse, etc., to switch off the supply at the mains meter box.

PIECES REQUIRED FOR THREE CHICKS.



CUT FROM 1/4in.



CUT TWO TOGETHER 1/8in.



CUT FROM 1/4in. AND SHAPE AS BELOW.

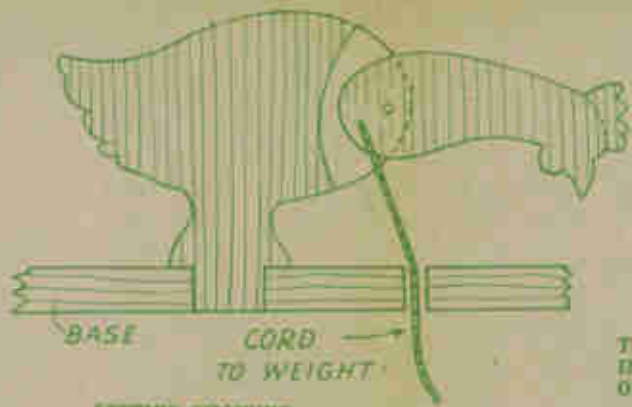

SECTION SHOWING HOW CORD IS ATTACHED TO THE HEN.

THE ARROWS INDICATE THE DIRECTION OF GRAIN OF WOOD.



SHOWING HOW THE PIECES OF THE HEN ARE ASSEMBLED.



SECTION SHOWING HOW CORD IS ATTACHED, ETC.



PANELS OF WOOD REQUIRED FOR THIS DESIGN.

ONE H4 ONE G2

The price is shown in Hobbies Weekly, March 26th, 1948, but is subject to revision. See the current edition of Hobbies Handbook, or write for price to Hobbies Limited, Dereham, Norfolk.

OUTER SIDES. CUT THE TWO FROM 1/8in.



BODY. CUT ONE 1/4in.



MIDDLE SECTION. CUT ONE 1/4in.

HEADING ON LEG. CUT ONE 1/8in. AND TAPER THE TOP TO FIT LOOSELY BETWEEN THE WINGS.



SHOWING HOW THE PIECES OF THE CHICK ARE ASSEMBLED.



WINGS. CUT THE TWO FROM 1/8in.

EACH CHICKEN CONSISTS OF THE FOUR PIECES SHOWN ABOVE.

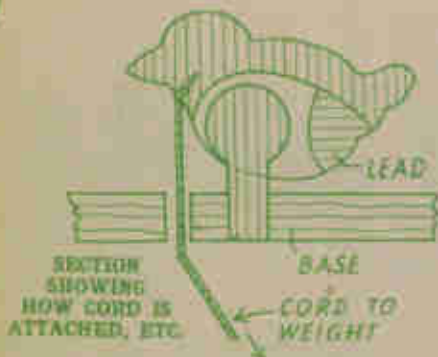

SECTION SHOWING HOW CORD IS ATTACHED, ETC.



ROOF OF COOP. CUT ONE 1/8in.

THE FEEDING-CHICKENS TOY

AN amusing toy can be made from the patterns provided on the other side. When the counter-balance weight swinging below the platform is rotated, the little chicks and the hen in the coop lean forward to pick up imaginary corn on the "ground". Such a novelty is an endless source of amusement to any child, and if painted in bright colours, is a serviceable toy.

The wood required is $\frac{1}{2}$ in. and $\frac{1}{4}$ in. thick and the parts shown should be marked on to it according to the patterns provided. Each piece is cut out with the fretsaw and fitted together with glue. The principal point of construction is to get the pivot action of the chicks and hen right, to allow an easy movement in use.

Cut the parts in the thickness required, and clean with glasspaper before fitting together. The platform is fitted with a handle made of two pieces. The short portion of the handle is glued to the longer piece and then butted up underneath where the projecting portion is glued and can be screwed.

The Hen's Coop

The chicken coop can be made, but should not be fitted in place until the hen is fixed on the platform. The $\frac{1}{2}$ in. sides to the coop are fitted between the back and the front with a sloping roof finally glued on. Get the bottom edge perfectly flat so it can be glued down later to the platform.

The construction of the hen can be seen from the diagram. The half body piece has one of the wings glued each side. Note the pivot holes in the side pieces, and bore with a fine bit. The head of the hen is cut, and a similar pivot hole made in the back end of the neck. Notice, too, that this back end has to be tapered so the part swings easily between the wings when fitted in place with a pivot pin.

All these pivot pins can be short lengths of wire with their ends hammered over. The neck itself must swing loosely. Before fitting the neck in, glue a thin length of strong twine. A hole is bored in the side of the neck, a little glue squeezed in, and then the end of the twine pushed in with a pin or awl. When the glue is set, the twine will be firmly fixed.

Remember to paint the parts before finally gluing together, or you will not be able to cover the neck and head properly.

The Chicks

The little chicks are cut in a similar way, but have an opposite action to the hen. The hen has its head down until the string pulls it up; the chicks have their heads up until the string pulls them down.

The body of the chick is glued between two of the $\frac{1}{2}$ in. side portions. The pivot pieces with their little circular tops should also be tapered as shown by the section against one of them. A pivot hole is bored right through two wings and this central piece, again allowing the body to move freely.

In order to weight the back of the chick down, a tiny piece of lead can be glued in the space between the two sides. This lead can be got from a scrap of lead covered electric cable, or any odd scrap. It can be fitted between the sides, glued in place there, and with a file shaped down to the back curve of the body. Its position can be seen in the diagram of the chick.

The Movable Heads

The chick's head is also fitted with a piece of strong twine, as can be seen in the section showing how the cord is attached. Drill a hole in the thickness of the neck just under the beak, push the twine in with some glue and leave to set. All pieces of twine, by the way, should be about 1ft. to 15ins. long.

Cut and test the various parts and again paint up before gluing. Do not, of course, apply paint to the sides which will be glued together, or the glue will not hold. A final coat should, of course, be given to the edges when the whole thing is finished.

Now you can put all the little projecting pieces which form the tenons, into the appropriate openings in the platform. The hen goes in at A and the chicks at B, all facing inwards.

The cord is threaded through the respective circular holes to hang down. Now hold the platform horizontal and gather the cords together to form a single bunch at a central point. Tie them together as one just between 3ins. and 4ins. below the platform. The twine under that can be braided together to form a single strand.

The Pendulum Weight

Now get a weight of some kind, a light ball or a piece of lead will do if it weighs about 1 oz., and fix it to the length of cord hanging down. The actual distance is immaterial, but 9ins. to 1ft. is satisfactory. Before finally tying and braiding the cords, test the action. The swinging circular motion of the weight should cause each chick to put its head down, and lift the hen's head up.

If they do not all do it correctly, alteration can easily be made by lengthening or shortening the appropriate string to the knotted centre strand.

When everything is satisfactory, the whole platform can be painted, and then the coop also painted and glued on. The head of the hen is made to project through the wide slot in the front of the coop, which is glued down with the string hole just behind this front. The actual position is shown dotted on the pattern of the base.



TAPER

HEAD.
CUT ONE 1/8in.
AND TAPER THE
NECK END TO FIT
LOOSELY INTO THE
BODY PART.

BODY. CUT
ONE 1/8in.

THE HEN CONSISTS OF THE
FOUR PIECES SHOWN ABOVE.

HYPOT.
PIN
FOR
HEAD

BACK OF COOP.
CUT ONE 1/8in.

SIDE

PIN

SIDE OF COOP.
CUT ONE 1/4in.

NOTE.—This design sheet is only
presented free with the current
issue of Hobbies and not with
back numbers. Further copies
may be obtained.



THE HANDLE
READY TO
BE SCREWED
TO BASE.

SCREW

SCREWS

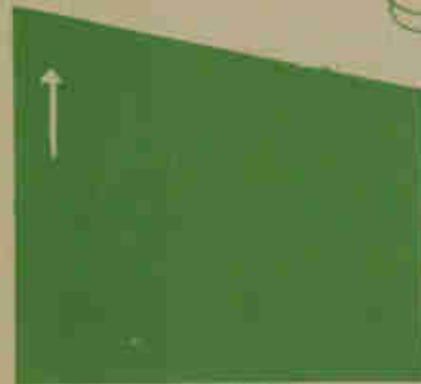
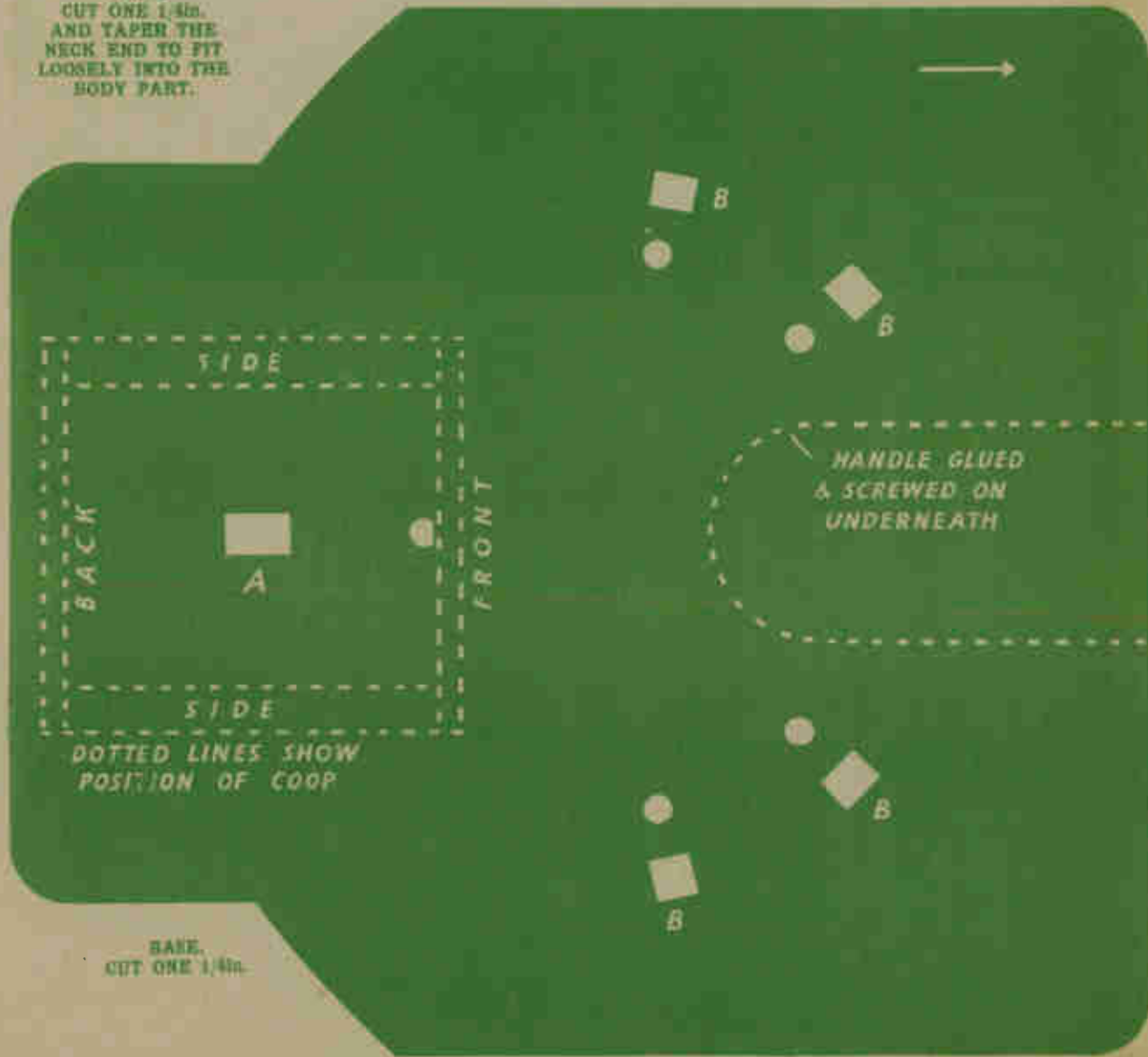

SIDE OF COOP. CUT ONE 1/4in.

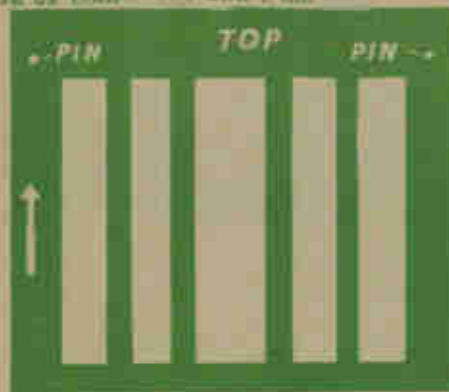

FRONT OF COOP.
CUT ONE 1/8in.



SCREWS

HANDLE,
UPPER
SECTION.
CUT ONE
1/4in.

SCREW



HANDLE,
CUT ONE
1/4in.

PRINTED IN ENGLAND.

Matters of interest to most workers are covered in these GENERAL HINTS

MOST of us now are finding the difficulty of obtaining wood for the various things we would like to make, and it is often disheartening to want to go ahead with something particular, only to find the materials are not available.

If, however, you are unable to get just the timber you require, why not cast around for a substitute? This is often to be found in the various types of composition board now being used for various purposes. They are made from all classes of more or less waste material, thoroughly compressed and are made in varying thicknesses from $\frac{1}{8}$ in. up to $\frac{1}{2}$ in.

Composition Boards

We do not suggest, of course, that they will take the place of wood in large pieces of work, but very often for small articles they are quite suitable and can be adapted for the purpose in hand. Some have a similar surface on both sides, whilst others are single-sided only, the reverse being roughened up, but still quite suitable for a lot of jobs.

The main point is that the face surface is very adaptable for painting or varnishing, whilst the material itself is easily cut with the ordinary fretsaw. Large panels are not often obtainable, as these are controlled for use in connection with housing, building, etc., but very frequently you can get hold of a number of odd pieces which altogether make up a very useful parcel. A local builder or builder's merchant may be able to help you in this respect, or possibly some carpenters and joiners will have odd spare pieces which they will dispose of.

Wood and Panel Board

The material is certainly not cheap, but very often only a small quantity is required and it can be therefore

incorporated so that at least you can finish off a job satisfactorily.

We had a pleasing example of it sent us recently, where a reader had incorporated some wood and some of this composition board. He had used it as a sort of two-piece inlay work. The whitewood was the same thickness as the composition board itself, the two parts had been nailed together, and the design cut from both at the same operation.

Thus, the parts which were "waste" in the whitewood were replaced in the cut-out frets of the composition board so that when finished, the surface was quite flat and solid, forming a pleasing panel suitable for the ordinary polished finish. The point is worth bearing in mind, therefore, when you have a job in hand or are planning the next one to come along.

Planning Ahead

Do not, of course, start the actual work until you have all the material in hand, nor can you, in these days, expect to start straight away on the job in the hope of being able to pick up the material you need as you go along. As we have said before, it is essential to have all the material on hand before you begin. In these days we frequently have to use substitutes, and one must not be disheartened at being unable to procure just what is needed.

Tea Chest Plywood

There are a few more tea chests about, and these provide quite a good amount of useful plywood. A word of warning in connection with this, however, should be borne in mind. This tea chest plywood is not always a good quality. The outside veneers may be satisfactory, but you are never quite certain what the type of board is placed between them.

The consequence is, if you are

fretting out some interior parts you may find a gaping hole in the wood instead of the solid material. Much of the inside boarding of these plys is inferior quality with knots and even holes. Thus, whilst the plywood is satisfactory for backing or solid

When Using—

• • • a pure petrol in cigarette lighters, mix a few drops of clear, light oil in the petrol bottle beforehand. This prevents undue evaporation; a thin machine oil is advised—not a thick lubricating oil.

• • • cord to sew springs, etc., to upholstering, do not use ordinary cord. A special hemp twine is available which does not fray easily.

• • • three sash cramps to hold jointed boards together, have two of the cramps at the ends of one side, with the third cramp at the centre on the opposite side. This cramp helps to keep the boards straight. A slight bend is likely to result if all the cramps are put on at one side.

• • • fixed condensers in A.C. or D.C. circuits, use the paper types, if sufficient space is available. These condensers, if of large capacity, i.e., 2 mfd. or 4 mfd., for smoothing purposes, are more bulky than electrolytic types, but cannot be, like the latter, damaged by applying the wrong polarity.

panels, you cannot always rely on it for actual fretwork ornamentation.

Another point arises from the correspondence we receive from readers—that is the matter of whether to undertake all kinds of work, or to specialise on one particular type. Most people, and craftsmen among them, like a certain amount of variety. Having finished one model or piece of work, they generally like to turn to another of a different type.

A Range of Articles

This means a wider interest and knowledge, and prevents the monotony which may come about by continually making the same thing. Naturally, too, it also gives you a wider range of examples to offer friends if you are selling the goods, for what may please one, may not be equally attractive to another.

Against this, the specialist has the advantage that by turning out a number of the same articles, he becomes much quicker in all the



Photo by South Wales Evening Post

A MODEL TOWER BRIDGE

Bryan Mullens (left) and Dudley White, both of Brynmill, arrive at Swansea Grammar School carrying their fretwork model of London Bridge for the school annual hobbies exhibition, which was opened by the Mayor.

operations and can complete his models or pieces of fretwork in a much shorter time, and gradually without so much labour or thought involved.

Take, for instance, the question of making small toys—wheeled trucks, little engines, etc. Marking out the parts for the original will take a little time, and then the cutting of them is a further process. Suppose, however, he decides to make several of the same article, then the first parts cut can quite well form a template for others.

Cutting in Quantity

As an example, instead of marking out and cutting the four wheels to a single article, he can cut out a dozen or even more by using the original to mark round with a pencil. The same applies to the other parts of the model, and the process of cutting out the various pieces can be stepped up considerably as one proceeds with the work.

After having cut one or two, you probably find an easier way to do it, a better point to start from, and certainly the exact pressure of wood and saw to make the cutting straightforward. Thus, the craftsman who wants to make half-a-dozen similar articles, can do so much more quickly than if he is undertaking six different pieces of work.

It is, in fact, a miniature form of mass production, and the monotony of cutting a number of similar parts is forgotten in the end when you have, perhaps, half-a-dozen complete articles in a comparatively short time.

Here again, the question of the material at hand comes in. It is no use cutting out the parts for half-a-dozen bonnets for a truck, if you have not sufficient material left to complete the body portion of a similar number.

Specialising

It is certainly worth specialising on certain subjects if you propose doing a fair amount of work, because as you make each one, you learn a better method and so reduce the overall time, as well as much of the labour involved. You may like to make a speciality of galleons, and here you have quite a range to choose from, although in actual construction they follow the same style.

In toy making you have a range of designs to choose from. Most of them are of the pull-along wheeled type, and you can either ring the changes on two or three, or concentrate on one particular pattern and make a large number of that article. In connection with these wheeled toys, always buy the actual wheels if you can. There is a great variety of them on the market at the moment, in most of the sizes required for toy making.

Do not, however, get them out of proportion to the actual model itself, and remember always to finish

them off nicely by rounding the edge if necessary, and painting them brightly.

Fixing Wheels

Remember in this connection, too, that a wheel, if screwed direct on to a wooden chassis, is apt to bind when in use. Have, therefore, not only a strong round-head screw for fixing well into the chassis, but provide a small metal washer between the chassis and the inside of the wheel, to reduce the friction as much as possible.

In the matter of toy making, too, remember the points that count are that the article must be sturdy, bright and simple. The wood used in these toys is usually thicker than in ordinary model making, and the parts are held together with glue and screws to make them strong enough to withstand the normal rough handling of usage.

To appeal to the youngster, they must be finished in bright colours even though these may not be true to life. Do not have a lot of projecting parts which are likely to become broken, nor have the whole thing so small that it loses a lot of its appeal. One advantage of this toy making is that odds and ends of wood can be used because the finished article is painted, and so the variety is not seen.

Model Detail

On the other hand, if you are making real models of ships or farm implements, or cars, then much more detail must be incorporated. The parts are more tiny to handle and more work is involved in the construction. This in turn takes time, which again adds to the final cost.

Some idea of what this time and labour is going to be should be "planned" before you commence. It is not much use spending, say, two months on making an article and then expect to sell it for half-a-crown. The simple toys are easy to make, but they do not command financial return such as the more elaborate galleon or accurate model. This is entirely a matter of specialisation, however, for you to decide whether you are going to take more time to finish an article for an expensive market, or turn out quickly and reasonably cheaply models which come more under the "mass production" heading.

Make Early Arrangements

In connection with the planning about which we spoke just now, you have always to work ahead for dates or anniversaries or exhibitions. Too often workers decide to put something into an exhibition which is quite close upon them, and for which they have to rush the work, and so rather spoil their chances of obtaining prizes or satisfactory results.

Keep your eye open for advance announcements in paper or on bills,

and immediately think of what you can make for such an exhibition. Some readers, too, instead of undertaking an actual piece of work for a particular exhibit, retain several models so they can put them in when occasion arises.

This is possibly a better plan than having to rush the job to get it through in time. If such specimens are being kept, remember to have them in some dust-free place so that when they are used, they will still retain their original brightness and attractive appearance. Too often a specimen is left where it can get frequently handled and so have finger marks upon it, not to mention dust or dirt which may accumulate in odd corners and be difficult to remove.

Anniversary Gifts

These remarks too, apply to presents which you may be proposing to give for an anniversary of some kind. It may be a birthday or Christmas, and in this case something suitable should be made for the occasion. There is not much point, for instance, in giving an elaborate galleon model to a child of 11 or 12. He would much rather have a pull-along truck to play with. And, of course, the other way round is equally the point.

A design for a novel working model Racing Car will be given with next week's issue.

In deciding to make something for a friend's birthday, you must again allow time for its proper finish and then when ready, have it nicely wrapped or packed in a suitable box with your greetings added. Too often the whole effect is spoiled by just wrapping the thing up in a piece of odd and creased brown paper, and more or less throwing it at the recipient.

Attractive Wrapping

How much more attractive the whole thing appears if wrapped in a nice piece of tissue paper, put in a card box of suitable size with more tissue paper round to hold the article in place. Finally a clean piece of paper should be used for the outside wrapping, and the whole thing tied off with string or neatly fixed down with the gummed paper which is now both obtainable and popular. Then on the outside, of course, must be your greetings, preferably printed to be plain but signed with your name as the donor.

All these various points which we have raised, cover the experiences which we have seen and heard of, and are certainly worth bearing in mind if the craftsman is desirous of creating work of a good standard, of suitable finish and which is worth both giving and accepting.

The body allows for a 12 in. "baby" in this DOLL'S PRAM

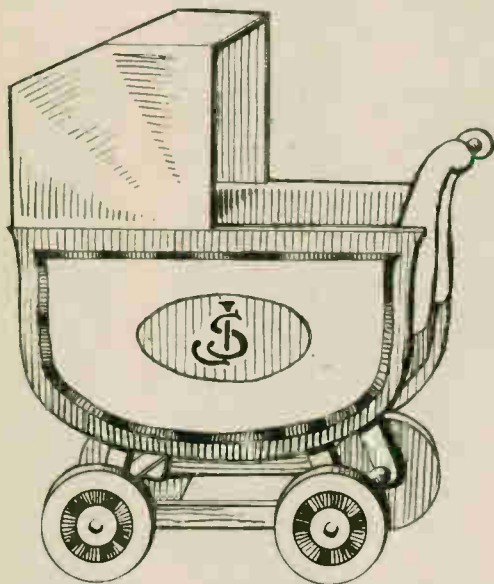

HERE is just the thing for the little maiden to use out-of-doors when the summer sunshine arrives.

The little model pram shown here should not prove at all difficult to make, even by the merest amateur at woodworking. The fretsaw, as can be gathered from the illustration, will come largely into use, both for the cutting of the shaped sides of the pram and for the joints of the underframing.

The sides would be best made of plywood, if this can be obtained (tea chests are still available), and built on to a framework of deal. The under-

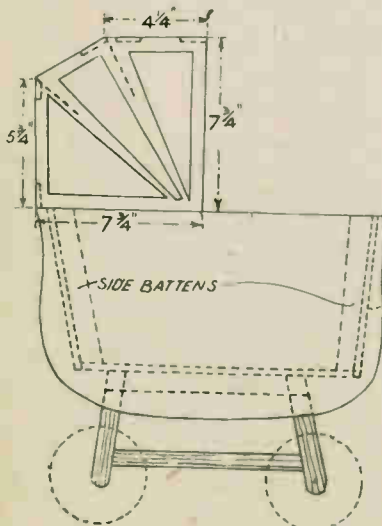

Fig. 1—Side section of parts and wheels

carriage is of deal strip securely framed together. This will take the wheels which can be obtained in hardwood or the spoke variety ready to fit.

If, however, these wheels are difficult to purchase ready-made, then some could be cut from dry deal with the fretsaw, the treads nicely rounded off and made true and smooth with rasp, file and glasspaper.

The work in making up can be commenced upon the body. The sides, therefore, should first be tackled. Before proceeding further, however, we might add that the sides, if plywood is unobtainable, may be made up in two 4 1/2 in. widths of wood, firmly held by cross batten, glued and nailed on.

Wood 3/16 in. thick would answer for the sides, and the narrow cross battens

should, of course, be so arranged that they come inside the pram and towards the ends to receive the panels forming the front and the back, as seen by the dotted lines in Fig. 1.

Side and Handle Shape

To get the correct outline of the sides and of the handle supports, reference must be made to Fig. 2 which shows a number of squares representing 1 in. Draw these out full-size on a sheet of paper and then add the curved lines through them, following each carefully to get the true shape. The outlines can readily be transferred to the wood by means of carbon paper. Mark in also the dotted lines which indicate where the ends and the floor of the body will be fixed on later.

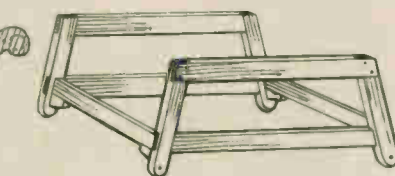
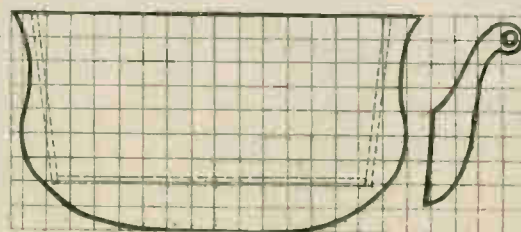

Fig. 3—The undercarriage framework



Cut round the outline of the body with the fretsaw and then clean with glasspaper. Lay the body section upon a second piece of wood measuring about 17 ins. by 9 ins., drawing round it and cutting this out with the fretsaw.

The Handle

Next trace off on paper the handle outline and transfer this to 3/4 in. wood. Cut two of these, using a coarse fretsaw and also cut the holes at the top to receive the ends of the cross handle.

The ends and floor of the pram are next prepared, 3/4 in. wood being used for all three pieces. The floor measures 13 ins. long and 8 1/2 ins. wide. For the ends, two pieces of deal 7 1/2 ins. by 8 1/2 ins. will be cut and planed up.

Before gluing the three pieces to the sides, bore some holes in the latter between the dotted lines indicating the positions of these parts. This simplifies matters when it comes to putting in the screws which hold the sides to the ends and floor. A few pieces of angle fillet glued into the corners inside will help to make a strong job.

Fixing

The handle of the pram can be finished off in so far as gluing and nailing the round rod to the two shaped pieces are concerned, but it should not be fixed to the body until later on, and until the undercarriage has been made and fixed.

The construction of the undercarriage is shown in Fig. 3. The two side frames should be made up and then held together by two cross rails at the lower extremities. The top will

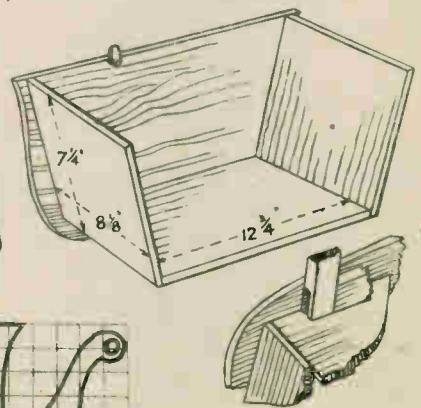

Fig. 4 (above)—The body, with one side removed, and floor detail

Fig. 2 (left)—Shape of sides and handle marked out in 1 in. squares

be held securely by being screwed to the sides of the pram and the floor as shown in the enlarged diagram in Fig. 4.

Rails

Each frame has a top rail measuring $9\frac{1}{2}$ ins. by $\frac{3}{4}$ in. by $\frac{3}{4}$ in., two end rails $5\frac{1}{2}$ ins. long and of same thickness—all halved together—and a second long rail about 10 ins. long. Mark the halvings carefully, and to get the correct angle at which they must be set, lay all four rails flat and in their respective positions, marking off in pencil the actual crossings of each.

Use a tenon saw, or the fretsaw for cutting the halvings and clean before fixing them together. Use glue and screws for fixing and add a number of gluing blocks wherever possible to make a rigid fixing. Make both frames alike, and lay them together during the marking out so they shall be identical in shape and size.

Cross Rails

Next cut two cross rails $7\frac{1}{2}$ ins. long by $\frac{3}{4}$ in. by $\frac{3}{4}$ in. or $\frac{1}{2}$ in., with square ends, nailing these to the frames with long nails. Under the ends put small blocks glued into the angles for additional strength. Shape the ends

of the four sloping short rails and make them smooth with glasspaper.

The finished undercarriage may be screwed and glued to the body as previously mentioned, and the com-

Brush Shield

BEFORE commencing to paint or distemper it is a good idea to fix a 4 in. square of rubber or stiff card over the handle as shown in the sketch. This will prevent the paint

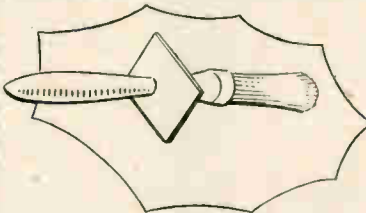

running down your arms and inconveniencing you while working, if you have to use it above your head, as on a ceiling or shed top.

pleted handle then screwed to one of the ends of the body. The positions of this and the framing are shown in the side view detail in Fig. 1.

The painting of the body work and of the undercarriage should be carried out in bright colours, a coat of red lead paint being first given all over as a filling to the grain of the wood. Lightly glasspaper this coat and follow with one or two coats of ordinary oil paint and finish off with a coat of varnish.

The sides of the pram might be lined out or panelled as shown in the sketch. An oval panel in some contrasting colours might also be added and this could well bear the initials of the fortunate owner of the pram.

The Hood

A realistic little hood might be added if desired. The framing, as shown in Fig. 1, is of $\frac{3}{16}$ in. or $\frac{1}{4}$ in. wood held together with cross rails as shown by the dotted lines. The actual covering material of the hood might be of american cloth or leatherette, carefully fitted and folded and tucked to the framing.

The completed hood can be held in place to the body of the pram by oval-shaped buttons screwed to the sides and back. One of these buttons can be seen in Fig. 4. The inside of the hood may be lined if desired with some suitable loose material.

MAKING A TWO-SEATER CANOE

HERE are the final details for the splendid two-seater canoe which was illustrated in last week's issue.

Now saw away the excess ends of the posts each end, making them level with the gunwale battens, also any ends of the side strips sticking out beyond the posts. Go over all the sharp edges, where the canvas passes over, with glasspaper, leaving no edges to rub through the canvas.

Now is the time to paint the wood-work inside and out, as some parts of it cannot afterwards be reached. Paint first with priming colour, then apply a coat of lead coloured paint over all. If paint is in rather scarce supply, it can be saved for the canvas and coaming, and the remainder treated with a wood preservative instead.

Covering the Framework

To cover the framework with the canvas, lay it out flat and place the canoe on it. Pull the sides up and fasten to the gunwale batten on the inside with drawing pins or tacks, temporarily.

Now draw the canvas up each side to the end posts, creasing it as neatly as possible, but not cutting it. Wet the canvas and when it is dry, shrinkage will iron out many of the creases. Cut off each end, paint the sides and front edge of the posts

thickly with lead paint and tack the edges to the posts. Tack the canvas permanently to the gunwale batten.

Narrow strips of the canvas are tacked to cover the sides of the cockpit opening, and finally the decks between the posts and cockpit, have canvas tacked and stretched over them. Tack the canvas all round to the outside of the gunwale batten.

To the ends of each post, screw a half-round strip of wood, as at C,

Instructions for building a Single-Seater Canoe will be given in a future issue.

Fig. 5, to impart a neat finish at these places. Another improvement to the general appearance is to nail a narrow strip of wood right round the gunwale batten to hide the line of tacks fastening down the canvas.

Keel Strips

Turn the canoe over and screw the outer keel strips to the inner keel beneath. Two strips are used here as, owing to the curve of the bottom, thick wood might be hard to bend to it, without steaming first. These keel strips are painted all over before screwing down.

Finally, add two rubbing strips of wood, as shown in Fig. 4. These go

nearly the whole length of the canoe, and are screwed to the shapes beneath. As their name implies, their purpose is to save the canvas from wear when the canoe is drawn out of the water.

The canvas should be treated to a coat of boiled linseed oil, or, if that is difficult to get, hot size. When dry, paint the canoe two coats of good quality paint, any desired colour. The coaming and posts look better if painted a different colour.

Paddles

A pair of single paddles should be provided, and also a double ended paddle, so that the canoe can be used with a single occupant. A suitable shape for these is drawn at D, Fig. 5. Cut the blades from hardwood, $\frac{1}{2}$ in. thick and shave them down to $\frac{1}{4}$ in. at the edges.

Cut the handles from 1 in. diameter ash, saw down a slice where the handle contacts the blade to make a flat, and screw it there firmly. A single paddle should be about 5 ft. long, and a double paddle 7 ft. 6 ins.

This completes the canoe. The craft is very stable in the water, but it is only fair to add that no larking about should take place, as any such craft, or rowing boat come to that, can be upset. It is also advisable, practising any water sport, to learn to swim.

MISCELLANEOUS ADVERTISEMENTS

The advertisements are inserted at the rate of 3d. per word prepaid. Name and address are counted, but initials or groups, such as E.P.S. or £1/11/6 are accepted as one word. Postal Order and Stamps must accompany the order and advertisements will be inserted in the earliest issue. Announcements of fretwork goods or those shown in Hobbies Handbook are not accepted. Orders can be sent either to Hobbies Weekly, Advert. Dept., Dereham, Norfolk, or Temple House, Temple Avenue, London, E.C.4

CARVE yourself a horse. Diagram and instructions 1/9.—BCM/Easiplan, London, W.C.1.

HAVE you a stamp collection for disposal? Having had mine stolen, am anxious to purchase another, small or large. No dealers.—R. C. Tombs, 31 Frances Rd., Windsor.

BASUTO, Bechuana or Swazi Royal Visit set free to purchasers of R.V. packet containing 100 different Empire stamps (No G.B.) including Pictorials, Commemoratives, New and Peace Issues. 3/6 post free.—Bisson, 46 Sumatra Road, London, N.W.6.

FOR SALE, 1 valve radio 40/-, Frog "Revmaster" 12/6, Gibbon's Simplified 7/6.—Breckenridge, Crossloan Rd., Post Office, Glasgow, S.W.1.

DON'T burn the bench or table. Use the special soldering iron stand. 3/6 cash, including postage.—J. Reeves, 1 Park Street, Hitchin, Herts.

STAMPS FREE!! Twenty unused (2½d.).—G. H. Barnett, Limington, Somerset.

MOROCCO Agencies Coronation Set (Mint). Free with Approvals. Postage 3d.—Ledger, 221a Boothferry Rd., Hesse, Yorks.

PEN pals Bulletin. World-wide contacts, 1/- monthly.—176a Old Shoreham Rd., Hove.

PERSPEX, new transparent sheets, 12ins. by 12ins. by ¼in., 9/6 each, post paid. Make beautiful articles with crystal clear Perspex.—Thacker (H.W.), 235 Wragby Road, Lincoln.

DURALUMINIUM sheets 6 by 3 by 24 G, 18/- per sheet ex yard. Also 16 G, 47/6.—Wilson Bros. (Timber), Ltd., 548 London Road, Thornton Heath, Surrey. Tel.: Thornton Heath 1148.

ELECTRIC Repeater Motors, new. Ideal experimenters. Adaptable for D.C., A.C., Synchronous or remote control. 5/- each, post 6d.—F. Lucas, 22 Hengrove Rd., Bristol 4.

WHY not make art jewellery as a profitable spare-time hobby?—Dept. 3, Somat Plastic Co., 8 Middle Marsh, Nottingham.

WHEELS for Toys in metal, wood and plastic. Numerous sizes and types. Write for list, stating requirements to The Joyden Toy Co., 193 Chase Side, London, N.14.

NUMBER of 1/72 model aircraft for sale, prices 3/- to 24/-. List 2½d.—Aess, 12 Beech Hall Cres., London, E.4.

WHEELS! Wheels! Wheels! Metal toy balloon type design. Send for samples and price list now, 1/3 post free.—Hughes, 1 Ashgrove, Manor Park, Flint, North Wales.

PERSONS required immediately to make leather shopping bags in spare time. Write—Dept. 11, Empire Co., 117 Nottingham Road, Loughborough.

GALLEON sails and heraldry, 5 sheets 7½ins. by 10ins., 2/6 pkt. List of plans and accessories 3d.—St. Andrews, High Pitfold, Hindhead.

LONELY? Join Friendship Circle. Details 6d.—Secretary, 34 Honeywell Road, London, S.W.11.

EX. R.A.F. headphones, new, 5/- pr., post 6d.—C. W. O. Barker, 14 Mardale Av., Manchester 20.

WAR surplus khaki shirts. No coupons, 13/- each.—BM/GMKT, London, W.C.1.

HAND driven generators, 100v. H.A.C., 6/-. Electric motors, 1/24th H.P. 12v. complete with step-down transformer, 27/6.—C. W. O. Barker, 14 Mardale Avenue, Manchester 20.

SURPRISE Novelty post free to all sending 1/- for 28 page magazine crammed with money-making opportunities, ideas, etc.—Hazlehurst, 25 Melrose Avenue, Hoyleake, Cheshire.

AMERICAN General and Hobbies Periodicals supplied by postal subscription. Send stamp for lists.—Herga, Ltd., 198 Waverley House, Havelock Road, Hastings.

DOLL'S House papers, model supplies, kits, plans, engines and motors. Full lists 1/-.—Sutton, Hill House Drive, Billericay.

POST Free—fascinating steel tracing machine for copying and enlarging magazine drawings, maps, etc. Price 5/-.—Clayton, 16 Westminster Road, Bradford, Yorks.

PRESSED Metal Wheels (balloon tyre design). Per dozen, ¼in.—10d. 1in.—1/-. 1½ins.—1/3. 2ins.—1/6. Per gross, ¼in.—6/-. 1in.—7/-. 1½ins.—8/-. 2ins.—10/-. Illustrated catalogue 3d.—Jason, 135 Nags Head Road, Ponders End, Middlesex.

LONELY? Then write Secretary L.U.C.C., 5B.B. Hay St., Braughing, Herts. Genuine. Est. 1905.

THE interest in car numbers never ceases. "Where's That Car From?" containing all the car index marks alphabetically arranged. 54 pages 6d. Now in its sixth edition. From all Newsagents.—Raleigh Press, Exmouth.

W. McGARRIGLE for aeroplane and ship kits. All accessories, stamps lists 3d., wholesale lists 4d.—64 Hillcrest Road, Romford.

BE Taller. Quickly! Safely! Privately! No appliances—no tablets—no dieting. Details 6d. stamp.—Malcolm Ross, Height Specialist, BCM/HYTE, London, W.C.1.

MODELS: you can make lasting stone-hard models with Sankey's Pyruma Plastic Cement. Supplied in tins by Ironmongers, Hardwaremen and Builders' Merchants. Ask for instruction leaflet.

TRANSFERS for decorating toys, trays, furniture, fancy goods. Selection 10/-, 20/-. Flowers, pixies, dogs, nursery rhymes.—H. Axon Harrison, Jersey.

MONOMARKS. Permanent London address. Letters re-directed. 5/- p.a.—Write Monomark BCM/MONO82, W.C.1.

FREE! 25 stamps. Request discount approvals.—Bradbury, 5 Goulden Road, Manchester 20.

PERSONS required make fancy goods at home. Write for details—Melton Manufacturing Co. (Area 544), Southgate Street, Leicester.

AROYAL free gift from Newfoundland. A set of stamps everybody wants, absolutely free to all applicants for my repeat approvals. (1/- without approvals). Postage please.—H. A. Smith, 13 New Road, Scole, Diss, Norfolk.

SPECIAL Offer. Attractive stamp album 50 stamps. Packet of mounts. Post free 3/-.—Gamut (Dept. C), Supplies Co., 24 Gunnersbury Avenue, London, W.5.

FREE! Extra special Br. Col. packet. Scarce Jubilee, Coronation, Victory, Zoological, new issue stamps. Request approvals (2½d.).—Thompson, 2 Western Gardens, London, W.5.

TOYMAKERS Super Casting Moulds for lead toys and Plastercraft. As used by all high class toymakers in England and abroad. Over 600 latest designs. Fully illustrated catalogue 2/- P.O.—Agasee, 7 Stradbroke Road, Highbury, N.5.



*Get this book
- make these
MODELS*

HOUSES · SHIPS · ASHTRAYS · BOOKENDS
SIGNAL CABINS · RAILWAY STATIONS
AIRPORTS · DOCKS · RELIEF MAPS · PLAQUES
MODEL FURNITURE · INKSTANDS · PAPER
WEIGHTS · MODEL FIGURES & ANIMALS etc.

SIMPLE TO HANDLE · INEXPENSIVE

The Instruction Book illustrated above tells you how to make such models as above, without special tools or skill, in Sankey's "Pyruma" Plastic Cement. This material, modelled while plastic, dries or bakes to stone-hardness, ready for painting according to instructions. Obtainable at local ironmongers, hobbies shops and art material dealers.

Get Instruction Book by sending 4d. in stamps to the address below



Dept. 3

J.H. SANKEY & SON LTD.

ILFORD

Est. 1857

ESSEX

NOEL JOHNSON, known to millions of B.B.C. listeners as . . .

Dick Barton

SAYS

*"I cross the road
this way . . ."*



ON THE RADIO I lead a life of thrills — Dick Barton is always ready to risk death if necessary. But to take risks in traffic isn't necessary at all — it's just *stupid*. Here's the proper way to cross the road:

- 1 At the kerb — **HALT.**
- 2 Eyes — **RIGHT.**
- 3 Eyes — **LEFT.**
- 4 Glance again — **RIGHT.**
- 5 If all clear —
QUICK MARCH.

"Don't run — there's no hurry if you keep cool and wait for a proper gap in the traffic.

"There's nothing brave about rushing out in front of a car. Other people may get killed besides yourself. Detectives perform plenty of brave actions, but they're *never* careless in traffic. If you can keep cool, and calm, and alert — you'll be a good Road Navigator. And the first thing is, to do your Kerb Drill at *every* crossing."

GET HOME SAFE AND SOUND

Issued by the Ministry of Transport

Printed by BALDING & MANSELL, LTD., London and Wisbech, and Published for the Proprietors, HOBBIES LTD., by HORACE MARSHALL & SON, LTD., Temple House, Tallis Street, E.C.4. Sole Agents for Australia and New Zealand: Gordon & Gotch (A'sia) Ltd. For South Africa: Central News Agency Ltd. Registered for transmission by Canadian Magazine Post.

"You get a better coat with a Harris Brush"

Harris
the
paint
brush
with
a name to its handle

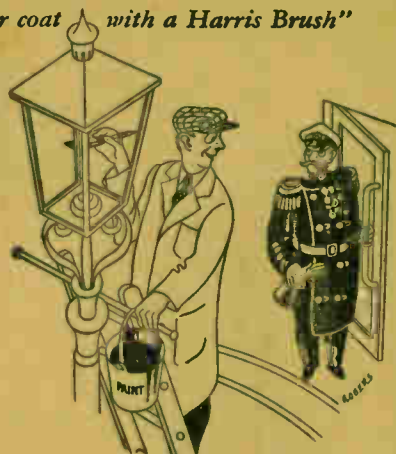

L. G. HARRIS & CO. LIMITED,
STOKE PRIOR, WORCESTERSHIRE

C.R.C. 10

BELIEVE IT OR NOT - BUT



*This complete Power
Unit will drive your
working models...*

Mechanical hobbies now become more than ever an all absorbing thrill with the aid of the amazing ELECTROTOR - a phenomenon never before thought possible of realisation. Think of its size. Takes up less than a cubic inch of space, weighs only 1 of an ounce yet is powerful enough to work all kinds of mechanical models.

Powered by an ordinary torch battery it develops approximately 5,000 r.p.m. and is adaptable to an infinite variety of drives. Must be seen to be believed. Ask your Retailer for full descriptive Leaflet.



Sole Manufacturers: REV MOTORS LTD., Knowsley House, Bolton
Model Retail and Model Wholesale enquiries to Cartwrights Model Supplies Ltd.
19-21 Elystan Street, London, S.W.3.