

Hobbies

WEEKLY

Model
CUTTY
SARK

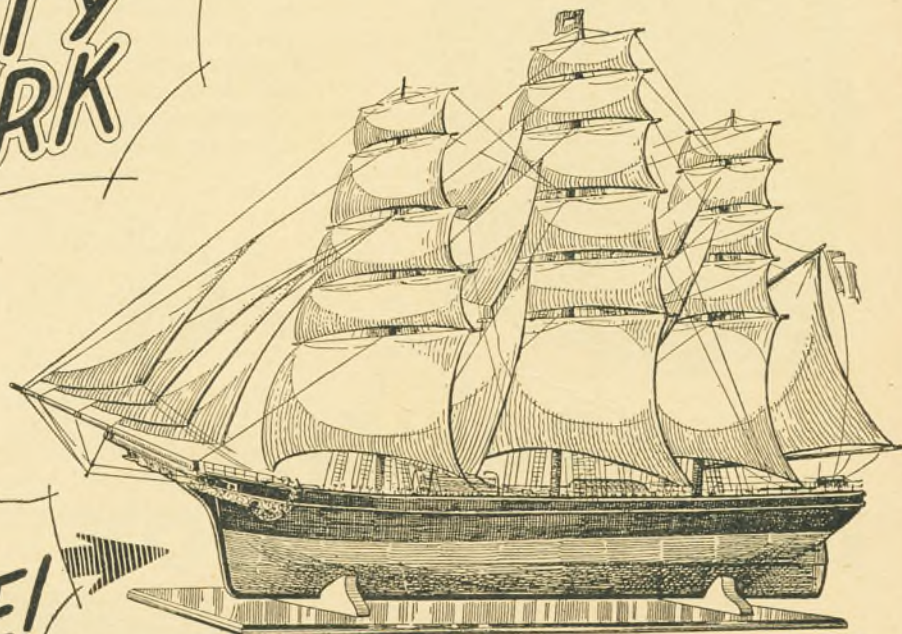

Large
Design
FREE!

September 11th. 1937

2^D

Vol. 84. No. 2186

THE FRETWORKER'S AND
HOME CRAFTSMAN'S JOURNAL

BIGGER and BETTER



FREE! Extra-Large Design for this
Model "Ye Olde Country Inn"

We'll wager that when you first lay hands on a copy of Hobbies 1938 Handbook, you'll turn over the pages in wonder and amazement how such a book can be produced and sold for only 6d. ! Imagine . . . 284 pages packed with information. Gift Designs value 2/6. Not merely a catalogue . . . but a handyman's book of reference, complete and up-to-date. Get a copy NOW . . . it is too good to miss !

Designs Value
2/6 FREE !



HOBBIES 1938 HANDBOOK

You are told step-by-step how to build realistic models of Galleons, Liners, Old-Time Ships, a modern Doll's House, Electrically-Driven Toys, a Mystery Cigarette Box (open it if you can!) with illustrations of over 500 things to make, and a complete price guide of everything you need.





Hobbies

WEEKLY

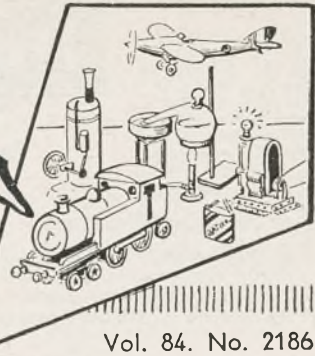

September 11th. 1937

Vol. 84. No. 2186

WELL, here's the "Cutty Sark" Model for you as promised and I am sure everyone will be delighted with it. That famous old tea clipper has no end of adventure behind her and a model is always a fascinating reminder of the "good old days." They must have been pretty arduous for everyone aboard too, and no light job running about in the rigging, attending to the sails in half a gale. We imagine we have introduced speed in this age, and proudly point to aeroplanes at 300 m.p.h., racing cars at 200 m.p.h. and express trains at over 80 m.p.h. But even those aboard our old friend the "Cutty Sark" had the itch for speed in those days. Because, as you will see when you read later, she was designed and run entirely to get the greatest speed and bring tea home from the east before her competitors.

THE design is complete for a very realistic model and there are sufficient details to keep you employed until next week when the final instalment appears. You will also have then, photographs of the actual model I had made up and see for yourselves what a really marvellous replica she is. I have purposely kept construction and finish simple, so you will not find the work tedious or trying. Think what the model will be worth when finished—although the whole lot of materials can be bought for 3/6.

I HOPE readers who hear of any Handicraft or Hobbies Exhibitions coming along will let me know. Then I can inform other readers who write to ask me, and publish the details in these pages for the benefit of all. I see one was held recently at South Norwood, London, when many of Hobbies Models were on view. Of course the Coronation Coach was there and others which came in for admiration were the "Queen Mary," a Warship, the

Sydney Harbour Bridge and a locomotive. Splendid people at South Norwood!

NO doubt some readers will be wondering when that Fretwork Notes Page is coming along, so they can see their suggestions and notes in print. Well, I had quite a pleasing number of letters and cards with all kinds of hints and explanations and notes of work done. Some I can use and am going to shortly. Others unfortunately were not so useful. I still want these Notes, please, so I can make a regular feature, and I want every reader to regard the Weekly as his or her own special paper. If they desire to know anything, write to me about it. If they have anything good, then pass it on for the benefit of other people. Just a rough note of something you have done, or seen, or thought out, is all I want. Keep it short and do try and make it something which will be of use to other readers. Never mind if you cannot express it properly; I will put it ship-shape for you. If it wants illustrating, a rough pencil sketch will do, and I will have it properly drawn.

IF any of our younger readers—between 15½ and 17½ years of age—fancy a clerical job in the Royal Air Force, I see there are now vacancies to be filled. The life undoubtedly has many advantages for sport, recreational, education and travel apart from the good pay and training which is offered. Those interested should write, mentioning Hobbies, for

Pamphlet 9 from Air Ministry, Boys' Department, Victory House, Kingsway, London, W.C.2.

NO doubt you will all be busy on the Crossword Puzzle on page 560. It is an interesting pastime and there will be quite a number of consolation prizes available if the entries warrant it. So come along now and get busy!

The Editor

CONTENTS

DESIGN CHART—Model "Cutty Sark"

<i>Hints and Tips</i>	554
<i>"Cutty Sark" Model</i>	555
<i>Child's Toy Cot</i>	558
<i>Embossed Photographs</i>	559
<i>Crossword Puzzle</i>	560
<i>Table Bookstand with Scout Overlay</i>	561
<i>Photographic Competition Winners</i>	562
<i>Bookrest Patterns</i>	564
<i>Modern Bedside Cabinet</i>	567
<i>Low Wing Model Aeroplane Construction</i>	569
<i>Seeing through a Coin, Trick</i>	570
<i>Two Bicycle Mascots</i>	571
<i>Mortise and Tenon Joint Hints</i>	572
<i>Stamps of Hungary</i>	575

Next Week's Gift Design—Table Book Stand

Correspondence should be addressed to: The Editor, Hobbies Weekly, Dereham, Norfolk, and a stamp enclosed with the Reply Coupon from Cover iii if a reply is required. Particulars of Subscription rates, Publishing, Advertising, etc. are on cover iii.

Send your own simple tips to The Editor, Hobbies Weekly, Dereham, Norfolk. Keep them short and add rough pencil sketches if possible.

HINTS AND TIPS

WORTH KNOWING

For original Tips published the sender will receive a Hobbies Propelling Pencil and Refills. We cannot acknowledge or print all tips sent in.

For Slipping Dynamos

PARTICULARLY during wet weather, when mud is liable to get on the tyre dynamo tread, and the dynamo slips, a very good

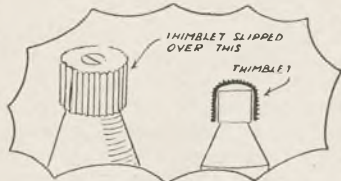

idea is to place a tight fitting rubber thimble (as used for turning over bank-notes) over the rotating knob.—(D.A.B.)

Cleaning Coins

WHEN cleaning old coins, do not rub them with emery cloth, but soak them in vinegar and then rub them with a cloth.—(D.S.J.)

Old Linoleum

WHEN old linoleum is shabby do not throw it away, but cut it into strips 6ins. long and 1in. wide and light a fire with them.—(G.L.)

To Rejuvenate Ties

WHEN a tie has been in use for some time, the "bow" part becomes soiled and the tie is often discarded as shabby. The tie can be given a new life by the following method: Cut a piece of plywood the exact shape of the tie, as described in

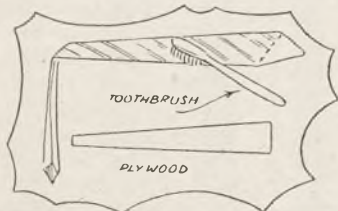

"Hobbies Weekly" some time ago, and slip it in the open end of the tie. Get an old toothbrush, and brush the tie gently with soap and water. Rinse in clean cold water, and dry slowly before a fire, with the plywood still in. When dry, it will be found that the tie is as bright as new.—(A.G.)

Stain Remover

HOT vinegar will remove paint stains from windows, wood and floors.—(D.M.)

Cleaning a Flask

TO clean a thermos flask, crush some egg-shells and drop them into the flask. Add a little vinegar and shake. Then half fill with water and let it stand for some time. The flask should be again shaken before being emptied.—(C.S.)

Fretsaw Holder

AN old long fountain pen will be found very useful, if you remove the nib and the ink holder, just leaving the 'vulcanite' case

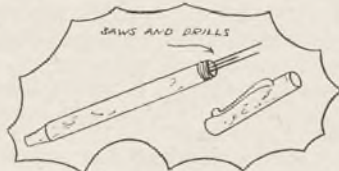

and the clip, in which to carry fretwork saws and drills. The clip will be found useful for clipping on coat or apron.—(W.B.)

Simple Polish

A QUICK and easy way of staining wood is to rub it well with oil or grease. This gives a smooth, polished, light coloured effect, and is a good way of staining tool handles of plain wood, and making them nice to handle.—(W.H.)

Coal Bricks

MIX well together, adding a little water, 9 parts of coal dust to one part of cement. Then place in small receptacles, viz., a small flower-pot for convenience. When set, turn out and store in a dry place until needed for the fire. These coal-bricks burn almost as well as coal and are easily made.—(L.R.S.)

Cutting Knife

HERE is a simple tip for making a knife for cutting balsa, cardboard, etc. Take a piece of wood 6ins. long, 1/4 in.

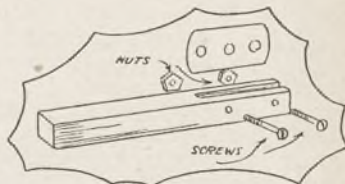

thick and 3/8 in. wide and make a slot about 1 1/2 ins. long to hold the razor blade. Next make two holes for two screws to hold the blade in position. Place the blade in position and tighten up the screws as seen in the picture.—(D.W.)

Table Tennis

TABLE Tennis players often find their balls trodden on and dented. This may be overcome by placing the affected part in boiling water. The dents will soon disappear and the ball will last for many more games.—(H.L.)

To Test Earphones

PUT on the 'phones, and put the two terminals on end of wire into mouth, to moisten. Take out of mouth, and tap smartly together a few times. If 'phones are in good working order, a faint tapping will be heard.—(E.H.M.)

Testing Wireless Valve

FOR those who do not know how to test a valve here is an easy way to do so. Connect a pair of wireless earphones in series with a battery, through the filament of the valve to be tested, using of course, the filament as one wire. If a click is heard on touching one of the battery terminals with the free end of a connecting wire, the valve can be taken as in working order. If of course no sound is forthcoming, the valve must be taken as useless.—(H.B.)

A Model of THE "CUTTY SARK"

Full size patterns No. 2186

THERE has probably never been a more romantic ship in the eyes of the average fellow than the tea clipper "Cutty Sark." It is one of the outstanding examples of British ship builders and seamanship which have come down with the adventurous tales of the sea. The actual boat itself was built at a time when steam was being first used as a propelling power to ships, and was beginning to affect the trading of the sailing boats.

Obviously, if steamships were going to be quicker than sailing, then the owners of the latter were going to lose money. The object of the tea clippers was to get the early season's tea from China and the East back to London as quickly as possible. The earlier the shipments arrived, the better the price obtained for them, so even then, as now, speed was of great account.



The actual boat lying in Falmouth Harbour with sails furled

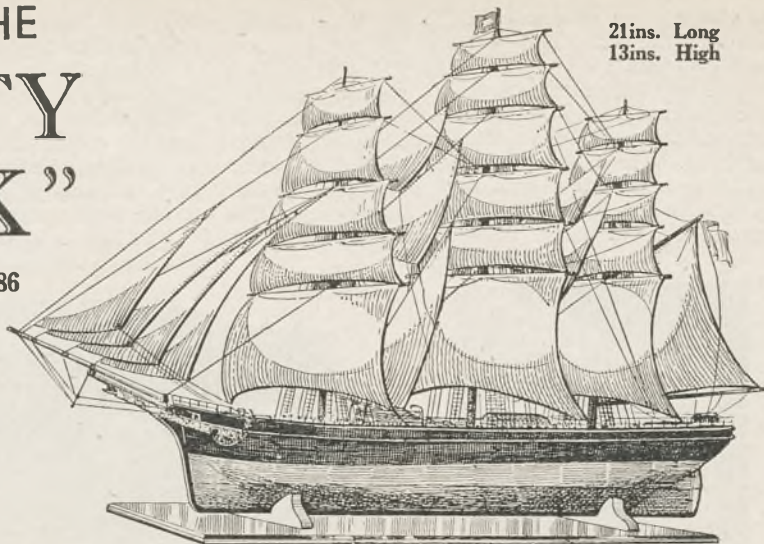

21ins. Long
13ins. High

The "Cutty Sark" was designed and built purposely to race home with the goods, but the opening of the Suez Canal and the progress of steamers, soon cut away the trade of these tea Clippers. So the "Cutty Sark" and others like her fell into disuse and after many vicissitudes the boat has come to be laid up in Falmouth harbour as a lasting example of the great days of sail.

Such a boat always has the ghost of adventure behind it, and has always served as an ideal for model makers. We are, therefore, pleased to offer our readers this week the opportunity of making a very realistic exhibition model in wood of the "Cutty Sark." Full size details of various parts are given on the design sheet, and they are supplemented by the instructions here.

Tools and Materials

Few tools are required beyond a fretwork frame, file, glasspaper, glue, nails and wood. The necessary boards with the dowelling for the masts are supplied by Hobbies as usual, as well as parchment paper, screw eyes and cord for the sails and rigging. Details of this, however, are set out elsewhere.

It will be noted in these instructions later that wire is mentioned for the davits; this, however, is not included in the fittings as it should be an easy matter to get a 6in. length of No. 16 gauge wire and cut off as will be shown. Then, too, in the rigging of the ship, numerous pulleys will be shown, but these are also not supplied. If, however, a tiny length of $\frac{1}{8}$ in. dowelling is cut with a fine hole bored through the middle, it can be shaped quite realistically with a little patience, or,

MATERIALS SUPPLIED

Wood—For making this model we supply a parcel of deal, satin walnut and plywood with sufficient turned round rod. 1/8 post free 2/2.
Fittings—Three sheets of parchment paper, three dozen small brass screw eyes and special cord, 2/- per set, post free 2/2.
A complete set of wood and fittings 3/6 post free 4/-.

of course, you can make little blobs of plastic wood on the string and get them to represent the pulley blocks.

The making of the model, of course, calls for a considerable amount of care and patience, and one must not expect to complete it in about half an hour. The shaping of the hull, for instance, will take a little time because it is in this that the beauty of the model lies very largely, and the curve required must be worked up gradually smoothly to a symmetrical finish.

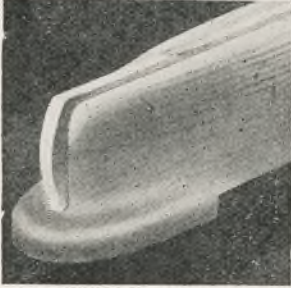

An inverted view of the stern showing the shape to be obtained

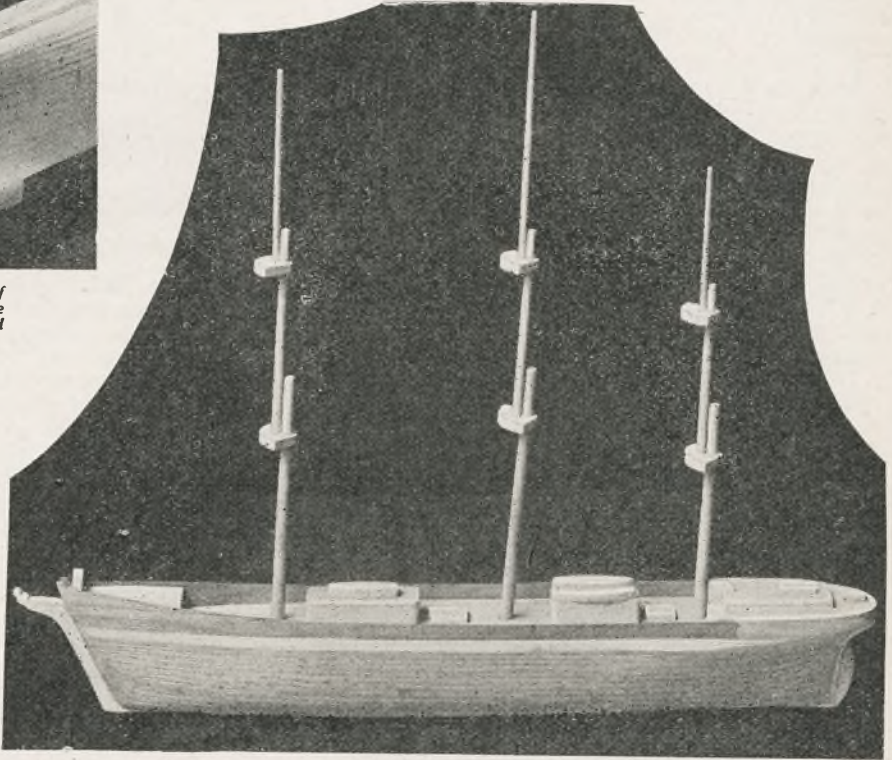

A view (right) of the completed hull before painting. The various parts can be seen, whilst the deck fittings are shown in the picture below

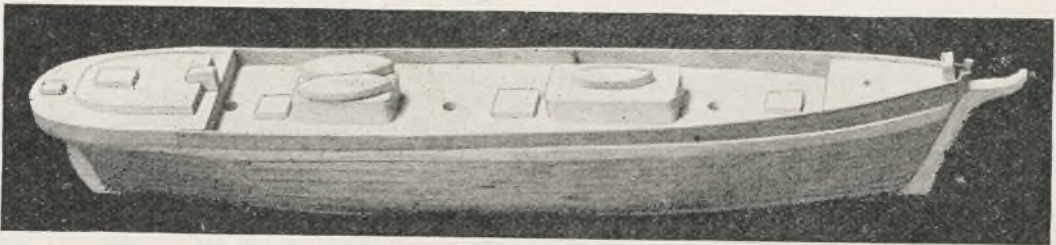

Study the shapes of the boards given in conjunction with the photographs and the various details, then when you have the hull shaped you can add the deck walks, bulwarks, etc. and finally pass on to the masts, spars, sails and rigging.

We have naturally had to leave out a very considerable amount of the intricate detail of the actual ship because it would be impossible to introduce it on such a small model. Our completed

boat is 2 1/2 ins. long, by the way, and stands 1 3/4 ins. from keel to topmast.

It is built on the simplest possible plan, and wood offered in the parcel is of the thickness required for the various parts, planed both sides and the correct size to take out the piece wanted.

Cutting to shape is done with a fretsaw, then a rasp, file and glasspaper shape the pieces down to the various curves of the section shown.

The hull is built on the bread and butter plan, fitted to a central upright which forms the rudder,

keel, stern and stem piece. The best plan is not to paste the patterns down but to lay them on the boards over a piece of carbon paper, then trace the outline through on to the actual material itself. This provides the shape to be cut out, whilst retaining the actual pattern so we can see the dotted lines indicating the positions of adjoining parts, etc.

Cut out the keel piece in 1/4 in. wood, then the

upper and lower keel blocks which are each $\frac{3}{4}$ in. thick. The deck is also in $\frac{1}{4}$ in. wood and beds down on to the top of the upright keel piece. Put these two parts in place, then fit in the four upper and lower keel blocks. Glue the two thick parts together and mark out the shape required for the curve of the hull.

A Shapely Hull

The work of shaping is then undertaken with rasp and file until a symmetrical balance and shapely curve is obtained. The top edge of the hull, of course, is exactly the same shape as the deck, and it must be noted that at the stern the deck piece itself is sloped off considerably underneath.

Reference to the various diagrams herewith show this clearly.

The front of the two keel blocks comes in line with the fore end of the deck, but is set back about $\frac{1}{4}$ in. from the bow itself. The same applies to the keel blocks. When fixed under the deck the actual keel of the boat projects about $\frac{1}{16}$ in. below.

Astern the hull shapes off to a tapered finish, yet bulges as it comes upwards towards the deck. The shaping of this hull must be undertaken carefully, and the whole thing finally finished off with a rubbing of glasspaper.

When a satisfactory shape has been obtained, the thick blocks can be glued in their proper places beneath the deck and close up to the central keel piece.

Deck Fittings

Next come the various deck fittings, and the details herewith followed carefully with the dotted lines on the parts concerned, show the shape and fitting. At the bow there are two thickness blocks added, one each side of the keel piece projection through the deck. These bow blocks are cut from $\frac{3}{8}$ in. wood which must be planed or filed down to the slope shown in the section by the pattern.

When stood up against the projecting piece of the keel above the deck, therefore, they will follow the line and come flush with the bow end of the deck itself. They fill up the space and are covered by the bow block (B).

It will be noted these three pieces A and B do not extend to the edge of the deck, and this recess allows for the plywood bulwarks to be added and bring the whole thing flush on the outside.

At the stern we have the block C, in $\frac{3}{8}$ in. wood, and the top deck above it in $\frac{3}{16}$ in. wood. This stern block (C) must, of course, be exactly the same shape as the hull itself, but at the square end of it the sides are sunk $\frac{1}{16}$ in.—again to allow the plywood bulwark. These parts can be glued in place then the two long strips forming the bulwarks themselves glued and nailed on.

Get the lower edge perfectly flat so it stands on the deck and the upper edge level with the stern but $\frac{1}{16}$ in. higher than the bow blocks. Glue firmly and add some tiny pins with their heads cut off for further strength.

Bulwark Stiffeners

In the actual boat bulwarks were of metal and strengthened up by triangles of metal placed at rightangles across the deck. These are shown on the pattern as the tiny triangular pieces of $\frac{1}{16}$ in. plywood, and their position—four on each side—is indicated on the deck plan.

The edge must be cut perfectly square and a touch of glue added to two sides so they can stiffen up the bulwark and be fixed to the deck.

It is impossible, of course, to introduce all the many deck fittings of the actual boat in such a model as this. We have, however, introduced a few of the more important ones such as cabins, hatch covers, etc. and these are shown on the patterns and on the deck plan. Cut them to the shapes shown and glue the deck.

Mast Holes

Notice, too, the three holes for the mast. These should be bored with a brace and bit to provide suitable rake for the masts themselves. That is, when the masts are fitted they slope parallel to each other slightly backwards from the bow to produce a streamline effect. On the foredeck, too (bow block B), a tiny hole is bored for a windlass. This is simply a piece of $\frac{1}{8}$ in. dowelling about $\frac{3}{16}$ in. long, let slightly into the deck and rounded off at the top. (To be Continued)

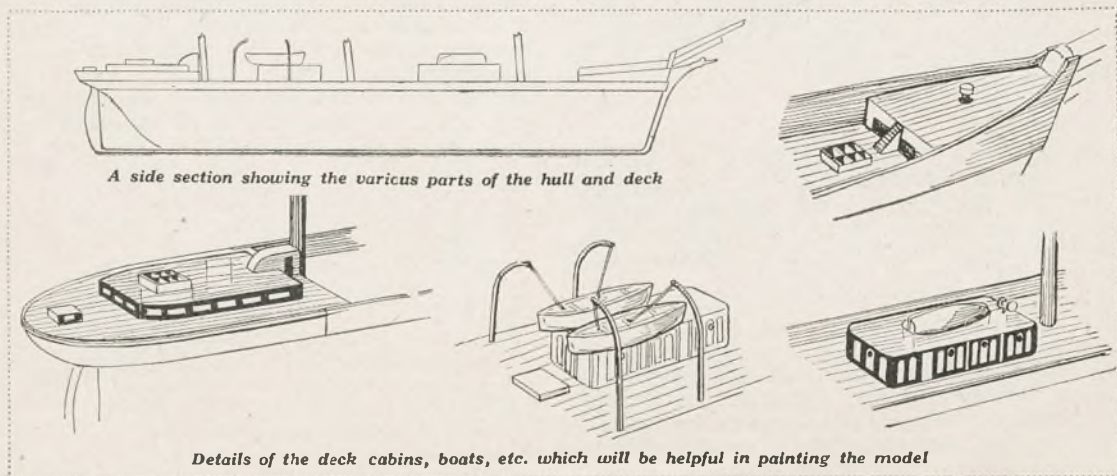

A side section showing the various parts of the hull and deck

Details of the deck cabins, boats, etc. which will be helpful in painting the model

CHILD'S TOY COT



A CHILD'S toy cot—It looks like the real thing brought up-to-date—and what little girl would not be delighted with it? As a gift, it is a certain winner, and in consequence, would make a good selling line.

It is made mostly from plywood, but in such a way that it can be made quickly and without difficulty. Having once got templates made, you could turn them out by the dozen and sell at a nice profit.

The front and back rocker pieces detailed at Fig. 1 should be cut from cheap $\frac{3}{8}$ in. thick plywood. For the back, you need a panel measuring 20 ins. long by 18 ins. wide. To obtain the shape, first gauge a line (with pencil and ruler) up the centre, then rule lines from the top to branch out to the extreme ends as indicated by the dotted lines.

It is now a comparatively simple matter to compass the circular lines as shown. This can be done with a measured piece of string and the pencil. The correct pitch or sweep of the rockers is obtained in a similar way by nailing the string to the top centre. The length of the cord here, of course, is 20 ins. An alternative is to use a narrow lath of wood drilled at the end for the pencil; a nail can then be driven in to give any radius desired.

The Body Work

Now, as the carriage or "body" of the cot consists of a bent sheet of $\frac{1}{16}$ in. thick plywood fitted into the sides, it is only necessary to mark out the semi-circular lines to the $6\frac{1}{2}$ in. radius as indicated in the front piece, then simply cut along same with a keyhole saw.

At the moment, however, cut out the back piece first and trim up with the spokeshave, rasp and glasspaper. The $\frac{3}{8}$ in. dowel foot rail holes can be drilled right through or half through or bored for a roundhead screw. When cut out neatly, the back can be used as a template for marking out the front piece which takes a panel of plywood measuring 16 ins. long by 18 ins. wide.

To cut out the thin plywood channelling with the keyhole saw, either drill a $\frac{1}{8}$ in. hole in the middle of the semi-circular line to get started or else drill a series of holes through at the end of the line. You will find the former method the best, as the hole space left here is not unsightly. Try not to get out of true in the line when cutting, as this will make it difficult to insert the plywood and throw it out of shape, too.

Assembly

When both front and back have been prepared, round the ends (not the sides) of a sheet of plywood measuring approximately 21 ins. long by 20 ins. wide by $\frac{1}{16}$ in. thick. The rounded ends are to act as a beading after insertion to the sides. The projection is about $\frac{1}{8}$ in.

Be sure to rub some glue in the channelling of the sides, then bend the plywood to suit and knock it in gently with a mallet. Do one side first, keeping it flat on the bench or floor. If you do not wish to damage the rounded end of the plywood, set the front piece on top to fit the plywood, then mallet over a piece of scrap wood placed directly over the channelling.

Should the beading be marked in spite of precaution, damp with water and, when dry, correct

MATERIALS REQUIRED

- 1 piece cheap plywood 20 ins. by 18 ins. by $\frac{3}{8}$ in. thick.
- 1 piece cheap plywood 16 ins. by 18 ins. by $\frac{3}{8}$ in. thick.
- 1 piece cheap plywood 21 ins. by 20 ins. by $\frac{1}{16}$ in. thick.
- 2 pieces stripwood 21 ins. by $\frac{1}{2}$ in. by $\frac{1}{4}$ in. thick.
- 2 pieces dowelling 21 ins. by $\frac{3}{8}$ in. diam.

with glasspaper. A few 2 in. thin heel brads should be driven in the edges of the sides to make the carriage firm; this may not be necessary.

Final Work

So that the plywood edges will be strong, strips of wood ($\frac{1}{2}$ in. by $\frac{3}{8}$ in.) are glued and screwed (from the inside with $\frac{1}{4}$ in. by 3 roundhead screws) to both sides as in the sketch. The dowel foot rails are now inserted (or screwed) and the whole work given a final rub of glasspaper, then enamelled.

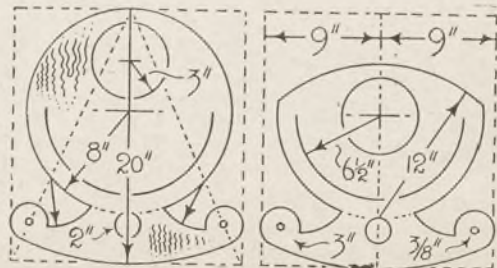

Fig. 1—Size and shape of back and front pieces

How to make EMBOSSED PHOTOGRAPHS

HERE is a very novel manner of finishing photographs which has the effect of making the image stand out from the paper in strong relief. We do not suggest, however, that you should try to emboss all your snaps. Indeed many prints like those containing very small detail are not suited to this treatment, but we do suggest that you will find it very interesting work giving an embossed finish to an occasional picture which is particularly suited to the process. Such prints are those which depict one clearly defined image.

The method is as follows:—First choose the print, and after a little experience you will find little trouble in judging prints that will lend themselves to satisfactory embossing, but at first select a picture which, as we say, consists only of one bold figure.

Materials Needed

Other "accessories" you require are, a little tissue paper, two Bull-dog clips a rectangular frame of $\frac{1}{8}$ in. plywood, and $\frac{1}{8}$ in. rectangle (solid), for placing under when working as shown, also a rectangle of $\frac{1}{8}$ in. card for making the mask.

Taking the tissue paper, clip it to the print and carefully trace a light outline of the image (see Fig. 1). Do this very lightly or you will find that a groove is left in the print. The outline can be darkened-in away from the print. Now turn the tissue paper *face down* on the rectangle of card and again clip.

The contour will be quite visible through to the back of the paper. It is quite easy therefore,

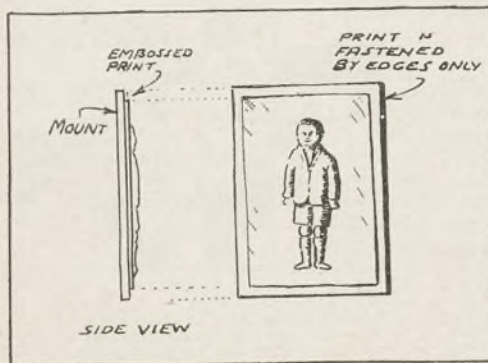

A front and side view of the work

to go over this with a pencil and impress a rendering of it on the card (Fig. 2), which is what is wanted.

Now take a sharp pointed penknife and with great care cut round the outline, eventually taking

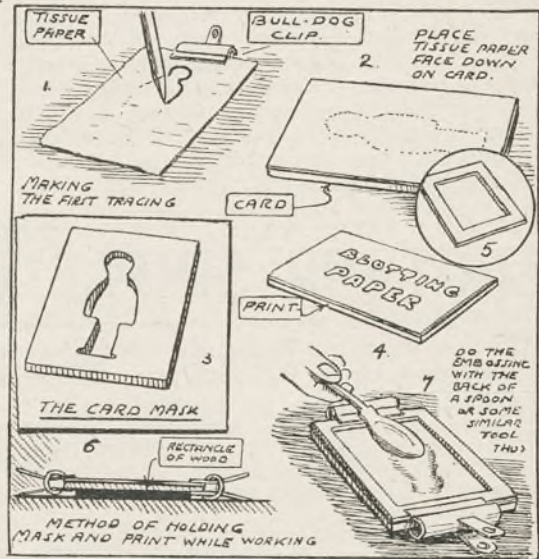

the inside material right away as Fig. 3. It is best to cut away the centre of the enclosed space roughly first, after which the cutting round the outline in a clear manner is much easier, the card coming away in small sections.

We now prepare the print for treatment (4) which is done by pasting it on to a rectangle of thick blotting paper, using if possible, one of the special photographic pastes which contain no chemicals that can hurt the print.

Well coat both the print and the blotting paper rubbing the adherent in with the finger, and after placing together evenly and making sure there are no wrinkles, put the two under some light weight for about a quarter of an hour, at the end of this time the print with its backing should just be nicely damp and pliant, but in no sense wet; a little practice will soon give you the correct state to aim for.

The Shaping

Next taking the two clips and the frame (5) which must be of suitable size clamp all together as shown figure 6, with image on the print lying exactly over the opening in the card. Work on the actual embossing may now start after placing the card on the wood packing as shown Fig. 7.

This is effected with round smooth instruments like the back of a spoon bowl, and bone handle of a tooth brush, etc., for finer parts.

Start with a light circular motion, gently pressing downwards the general area that lies within the

mask Fig. 7. Do not press too hard as you may split the paper and ruin the effort. As the motion of the instrument begins to take effect the edges of the figure may be made rather more pronounced by a little harder rubbing.

Light and Shade

Of course the art of the process lies in giving special prominence to certain parts such as noses, chins, and portions say of dress, always bearing in mind that in the main high lights should stand out, while shadow parts are usually further back.

Raised shadows and depressed high-lights give very poor results. While doing the general embossing pressing down on the packing, it will be found possible to give the final little ridges, etc., holding the print and mask in the hand and working from the back, while looking at the front.

Very marked ridges can safely be given by pressing fairly heavily on the back with a blunt point but with a finger supporting the front to prevent the paper breaking.

The whole business of course is one that improves rapidly with practice and you will quickly find that you devise little methods of your own with which to get various effects.

When at length you have worked up the relief to your satisfaction, leave the print to dry, still clipped in the frame. As the moisture dries out the paste stiffens and the relief becomes permanent. When quite dry, trim the print and blotting paper truly and then mount by securing it to a sheet of card by the edges only.

The process is now complete and with a little care and patience you will find yourself in possession of a really pleasing form of picture finishing.

ANOTHER SIMPLE CROSSWORD PUZZLE

Look at the Prizes ? See the Conditions—and see that you enter for it, for all prizes **MUST** be won !

EVERY entrant enjoyed our last puzzle because it was simple, and yet, required some concentration to work out properly. You see, it isn't—as a few readers thought—just a matter of finding plain answers to all the clues. Alternatives must be considered, i.e. some of the clues are so coined that you have the choice of several likely answers.

By reading the clues correctly, however, you can see how one answer, and only one, can apply. For instance, Clue No. 1 Across has four likely alternatives, thus : HAM, DAM, CAM and YAM. Now, which is the correct answer to the clue sentence ? No, we won't tell you, because certain words in that sentence point to the right alternative. Think over each word carefully and ask yourself what *should always* be cut with *great care* and what could be cut ordinarily.

To help you, some irrelevant, but necessary letters are marked on the coupon. And because each competitor is only allowed one coupon, the alternatives are few, and in most cases the correct answers are abbreviations or parts of quoted words.

HOME SECTION.

When you have solved the puzzle, complete it in INK, then PRINT your name and address on the space provided on the coupon and post it in a sealed envelope (bearing a 1d. stamp) to "Crossword Competition," Hobbies Weekly, Dereham, Norfolk, to reach here not later than September 18th. In the event of ties, the neatest entry will decide the winner, the other prizes following in their order according to the number of errors.

OVERSEAS SECTION

A special closing date is allowed to Overseas readers, this being December 31st. The same rules apply. All entries received after their closing dates will become void.

CLUES ACROSS.

1. Should always be cut with great care.
4. Shut up when sat upon—usually.
5. An instrument for registering gas.
6. United States (abbrev.)
8. Men who explore the sea depths.
11. A measure of yarn.
12. Where the sun rises.
14. Yellow part of an egg.
16. I and another.
17. Opposite of "yes."
19. By way of.....
20. It often matches its neighbour.
22. Behead "pots."
23. Seen in the centre of "isle."
24. A woodworking implement.
26. A cereal plant of the genus Avena.
28. These winds are chilly.
30. A lyric poem meant for singing.
31. First part of an enclosure for cattle.
32. "One" curtailed.
33. Dirty one would cause howling.
34. Some people like to have one.

CLUES DOWN.

2. One is presented to heroic people.
3. At straining point, a plank might do this.
7. A sculptured representation of one's head, shoulders and breast.
7. A cunning individual.
9. Rover Scout (abbrev.)
10. Is always difficult to remove from clothes.
15. An ornamental terminal boss.
16. Found in good jokes.
18. A baker uses it.
19. An electrical term.
20. The open space in a wood or forest.
21. To summon forth.
23. A black substance in chimneys.
25. To make a mistake.
27. A favourite liquid refreshment.
29. Garden tool for weeding.

PRIZES TO BE WON !

Home Section

- Gem Machine value 30/-
- Swan Fountain Pen value 21/-
- and Consolation Prizes

Overseas Section

- Hobbies Weekly for a Year.
- Hobbies Weekly for 6 months and Consolation Prizes

HOBBIES CROSSWORD



O In entering this Competition, I hereby agree by the Rules and Conditions as final in all matters.

SIGNED.....

ADDRESS.....

TABLE BOOKSTAND with small drawer

IN the centre pages of this issue will be found patterns for making up quite a handy little book stand for the table, and beneath it is a drawer for pencils, bookmarkers and odds and ends of paraphernalia.

The Stand as illustrated herewith, is primarily intended for Scouts, and the overlay on the end contains a typical Scout badge with the famous lettering B.P. (Be Prepared) above it.

As such, the patterns will particularly appeal to anyone in the Scout movement, and is just the sort of thing for Troops and Patrols to make up for the next Sale of Work even if not for their own use.

Decoration Suggestions

Apart from this, however, everyone with a fretsaw can make up the article, and by omitting the overlay, use it in the ordinary way. The end, for instance, can be left quite plain, or it can have the bottom portion of the overlay consisting of the leaves and berries only.

Or again, any of the small overlays from earlier designs can be cut out and glued on, whilst some may prefer just to have a plain transfer such as shown in the picture. A whole range of suitable

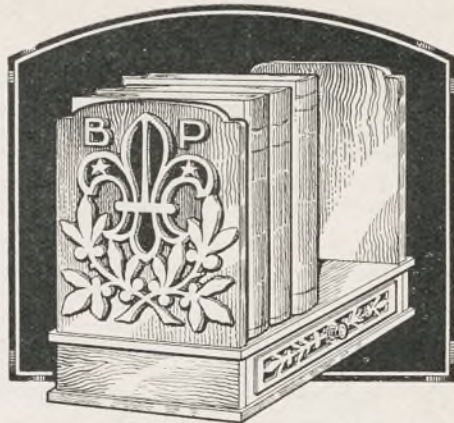

Full size patterns given on pages 564 and 565

given. In some cases, however, the parts will have to be redrawn, but as they are plain rectangles there is no need to worry about this.

For instance, the floor and top are cut from $\frac{3}{4}$ in. wood 9 ins. long, whilst the floor of the drawer is 4 ins. by $7\frac{13}{16}$ ins. On the other hand, the ends of the box framework are two pieces in $\frac{1}{4}$ in. material $1\frac{3}{4}$ ins. wide and $4\frac{1}{2}$ ins. long.

The outer front of the drawer and the back of the box are also two plain pieces $1\frac{3}{4}$ ins. wide and 8 ins. long, from $\frac{3}{4}$ in. material. Notice that the pattern of the overlays are printed in place on the pattern of the outline of the ends. It would be a little difficult to cut out the plain line of the outline in the paper, so a better plan is to trace it off on to the wood direct, then you can use the overlay pattern to paste down.

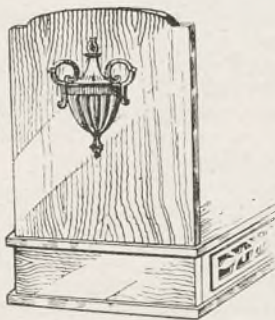

Two alternative methods of decorating the ends

transfers is shown in the current Hobbies Handbook, and for 1d. or 2d. each quite a brilliant piece of colouring can be added to the rest of the woodwork.

We do not supply a parcel of wood for the parts, but recommend that the article be cut out in a nicely grained fancy wood such as satin walnut or mahogany. Of course, if you want it to match some particular furniture, then you can cut it out in the same material if it is oak, beech or ordinary whitewood stained down.

The construction is perfectly straightforward, and the patterns are mostly full size in the pages

The Base

Cut out the floor and top, and add between them the two ends and main back. They are all set inwards $\frac{1}{4}$ in. from the edge of the wood, as shown by the dotted lines indicating the position, on the pattern of the floor.

Be sure to glue them upright and square all round, getting the two ends parallel with each other to allow the drawer to slide in comfortably.

It would perhaps be a good plan to add the ends of the book rest (with the shaped top) to the top before this is put on the ends and back. Again, the overlay or transfer or whatever is wanted, should be glued to the upright ends before they are fixed.

The Ends

These shaped ends are cut from $\frac{3}{4}$ in. wood and are not only glued to the top of the box but should be screwed through from the underside with $\frac{3}{4}$ in. or $\frac{1}{2}$ in. screws. Drill a hole carefully to prevent the wood splitting, and keep the ends set inwards from the edge of the top about $\frac{1}{4}$ in. If you put them flush with the end edges you will probably split the wood in driving the screws home. Three screws should be sufficient, but

be sure to get the part upright when you finally fix it.

The construction of the drawer itself is shown quite clearly herewith. The back and front are fitted between the two ends by the open mortise joint at A, and the whole lot is glued firmly and squarely to the floor of $\frac{1}{8}$ in. material.

Before actually gluing all in place, stand them temporarily in position and slide into the aperture

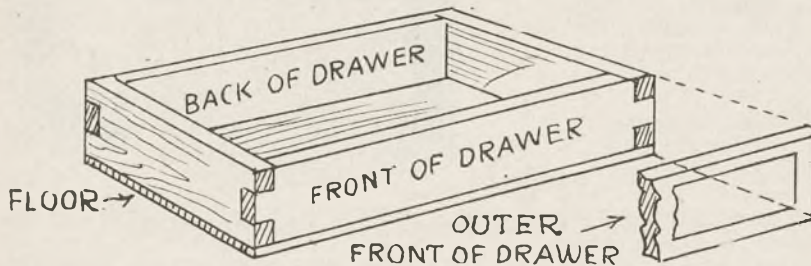

Detail of how the drawer is constructed

of the box framework. This should test out whether the drawer will run easily, and if not, the various parts should be altered until this result is obtained. Finally glue the whole lot down, taking care to keep the uprights square, and the floor flat.

A good plan is to glasspaper all the edges very slightly so there are no particularly sharp corners to catch when the drawer is in use.

To cover up the joint on the front and ends of the drawer, a plain overlay piece is used to which is added a piece of fancy fretwork. This fretted piece is from $\frac{1}{16}$ in. wide. It must, of course, be nailed to a thicker piece during the cutting to prevent splitting. When cleaned up, glue it on

the centre of the overlay on the front of the drawer, then glue the whole thing to the drawer itself as can be seen in the detail.

Finally one of the fancy knobs supplied by Hobbies (No. 5375) is screwed through the centre of the circle in the overlay, and if the spindle projects through the back, a little piece of waste wood should be turned on to take the point.

Finish the whole thing off with a rubbing of glasspaper, then if you wish to darken it down, use a spirit of any shade you require, and finally brush on a coat of Hobbies Lightning Polish to bring up a glossy surface.

July Photo Competition Winners

THE entries for this, though small in number, are very definitely good in quality and many of the competitors are showing signs of becoming first class press photographers a little later on in life.

It is somewhat surprising to note, however, that the best efforts are those sent in by two of our junior readers and therefore we must take them first.

First prize, to William S. Tait of Edinburgh for a very interesting little snap of a boat rushing through the water and showing a swish of waves from the bows of the boat. This print indicates that our young friend had got his eyes open for something original. Action is well depicted and the exposure was about right.

Second prize to F. B. McLean of Galway. His was an excellent snap of an aeroplane. The background of clouds helps it considerably, but one must have a very fine camera to get such clear definition.



The 1st prize winner trimmed to get central

The attempts to take moving trains are not as good as they might be. It is necessary to have unobstructed views for no hedges or trees should be allowed to cut off parts of the train or interfere.

Stanley Butler made a very good shot trying to take a racing motor cyclist but he was too far away.

In the Senior Section the first prize went to J. Rebbeck of London. This shot at a passing cyclist is of very high standard, but what a pity he did not get him in the middle of the film.

The second prize was awarded J. Williamson of Sutton Vallenge for a fine picture of an aeroplane banking.

Robert Banks' snap taken at a Speedway Meeting is a good effort but the exposure is wrong. Possibly this is due to a camera which has not got high speeds in the shutter and big stops in the lens, both of which are required for moving subjects indoors.



The Junior Winner

INFERIORITY COMPLEX

is a disturbance in the Sub-conscious Mind causing: (1) Self consciousness. (2) Shyness. (3) Depression. (4) Fear. (5) Weak will. (6) Unsteady gaze. (7) Nervous catarrh. (8) Stuttering. (9) Blushing. (10) Trembling. (11) Nerves. These are symptoms of "something wrong" within you—sending out powerful negative impulses, overcoming your positive impulses, robbing you of the pleasures of achievement and the joy of living. You cannot control these impulses—the harder you fight them the stronger they get—but you can, through this revealing self-knowledge, remove them altogether, building up powerful positive forces to carry you forward to a happier, more successful life. This is the realisation that will come to you within the next few days through the remarkable book, "I can . . . and I Will," which is here offered to you free.

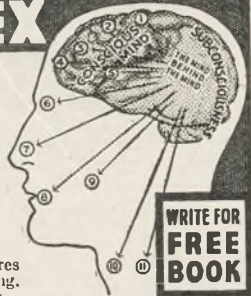

AMAZING RECORD This book, of which the 7th edition and 350,000th copy has just been issued (an amazing record within less than 3 years of publication) will open your eyes to the truth regarding your conditions, accomplishments, and handicaps—revealing clearly the amazing new psychological discoveries which, presented in practical form as the latest science of successful living, has changed the lives of thousands. It reveals to you a vital living science which touches into activity all the rich possibilities you have within you. You begin to feel the new self, strong of purpose, deep in self-knowledge, arising within you during the first few weeks. Yet this wonderful development demands no wearisome book-study, no tiresome application, no morbid introspection, no prolonged attention, no tenseness, no fierce energy—it is a system of right thinking and right living which you absorb quietly, quickly and easily into your very being, the most restful, recuperative, inspiring thing that has ever come into your life.

**IN YOUR OWN HOME
IN YOUR OWN TIME**

WRITE FOR YOUR FREE COPY TO-DAY
TO THE PRINCIPAL

BRITISH INSTITUTE OF PRACTICAL

PSYCHOLOGY

One (M.P.2) LUDGATE HILL, LONDON, E.C.4

Here's your chance

to learn how to make your PHOTOGRAPHY much more economical.

Send a postcard for **5 FREE BOOKLETS** on **DEVELOPING & PRINTING**

Your hobby will be more interesting if you develop your films by the **AZOL** method

No experience necessary—success assured.

3-oz. bottle of **AZOL** will develop 3 dozen $3\frac{1}{2} \times 2\frac{1}{2}$ Spools Price **2/-** of every dealer.

SEND P.O. 1/7 FOR A TRIAL SET OF CHEMICALS including: 1-oz. trial bottle of **AZOL**, to develop 12 spools $3\frac{1}{2} \times 2\frac{1}{2}$. 4-oz. tin **ACID-FIXING**, to make 30 to 60 oz. solution. 1 Packet **M.Q. Developer**, sufficient to make 3 dozen Gaslight Prints.



"Hobbies" Dept.

JOHNSON & SONS
Manufacturing Chemists, Ltd.
Hendon Way, London, N.W.4

A Handy Glasspaper Block

A wooden block with special handle which holds glasspaper taut and always in place. In two sizes 1 8in., price 5d.; 6in., 10d. post extra.



HOBBIES Ltd. DEREHAM.



Realistic Traffic Lights. 7½ ins. high, with 3-lamp switch. With battery.

2/11
Postage 4d.



Petrol Pumps of Esso or Shell. Lights lamp when pumped. 6 ins. high. Complete with battery inside.

2/11
Postage 3d.



Realistic Light-house on rocks. Lamp which lights. Complete with battery inside.

2/11
Post 4d.

Models..

BOYS..... Here's a chance to buy some fine electric working models. If you are making a Doll's House why not get the set of bathroom fittings in polished aluminium?

BATHROOM FITTINGS

Bath (4½ ins. long) 1/3; Washbasin (2½ ins. high), 1/6; Stool (1½ ins. high) 9d.; Towel Aier 6d. and 1/-; Mat 6d.; Fireside Set 1/6. Post 2d. extra.



SEARCH-LIGHT

With powerful lens. Stands 4½ ins. high. Well finished and fitted with battery. **3/6**
Postage 6d.



Obtainable from Hobbies Ltd., Dereham, Norfolk, or branches in London, Glasgow, Manchester, Birmingham, Leeds, Sheffield, Southampton and Hull.

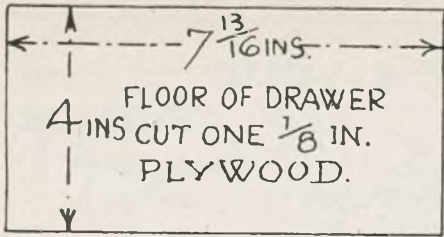
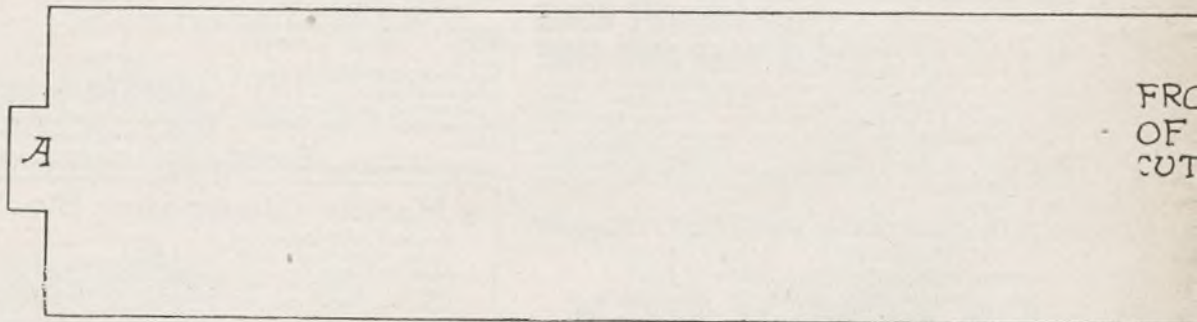
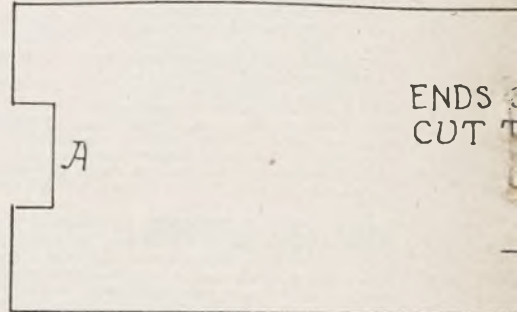
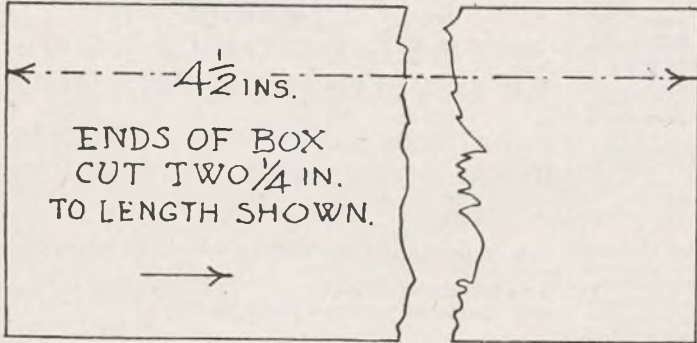
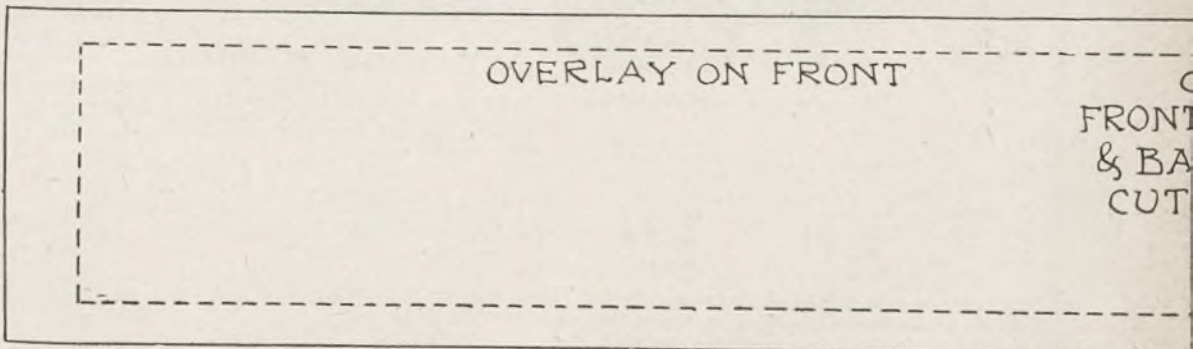
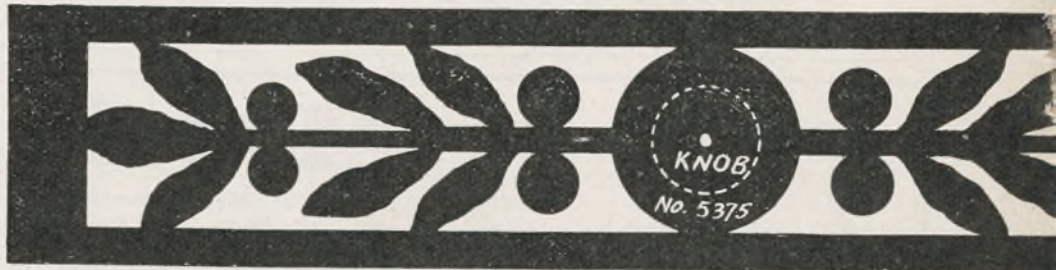

TABLE BOOKST

With drawer and Scout Ov
For details how to construct see page



OVERLAY ON FRONT OF DRAWER CUT ONE ¹/₁₆ IN.



AND

erlay

561

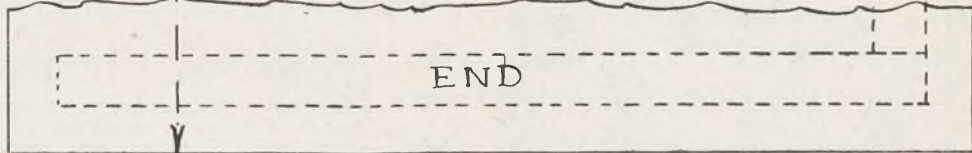
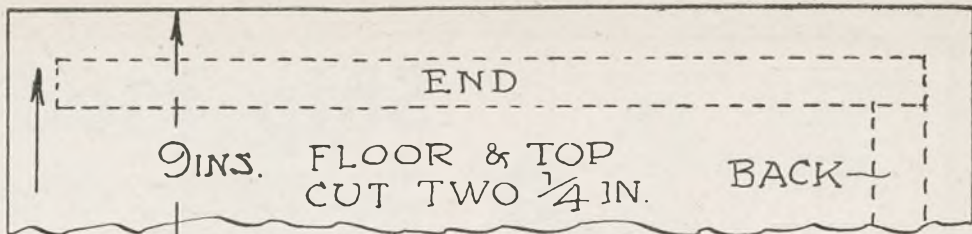

OF DRAWER
TWO $\frac{3}{16}$ IN.

A

NT & BACK
DRAWER
TWO $\frac{3}{16}$ IN.

A

UTER
OF DRAWER
CK OF BOX
TWO $\frac{1}{4}$ IN.

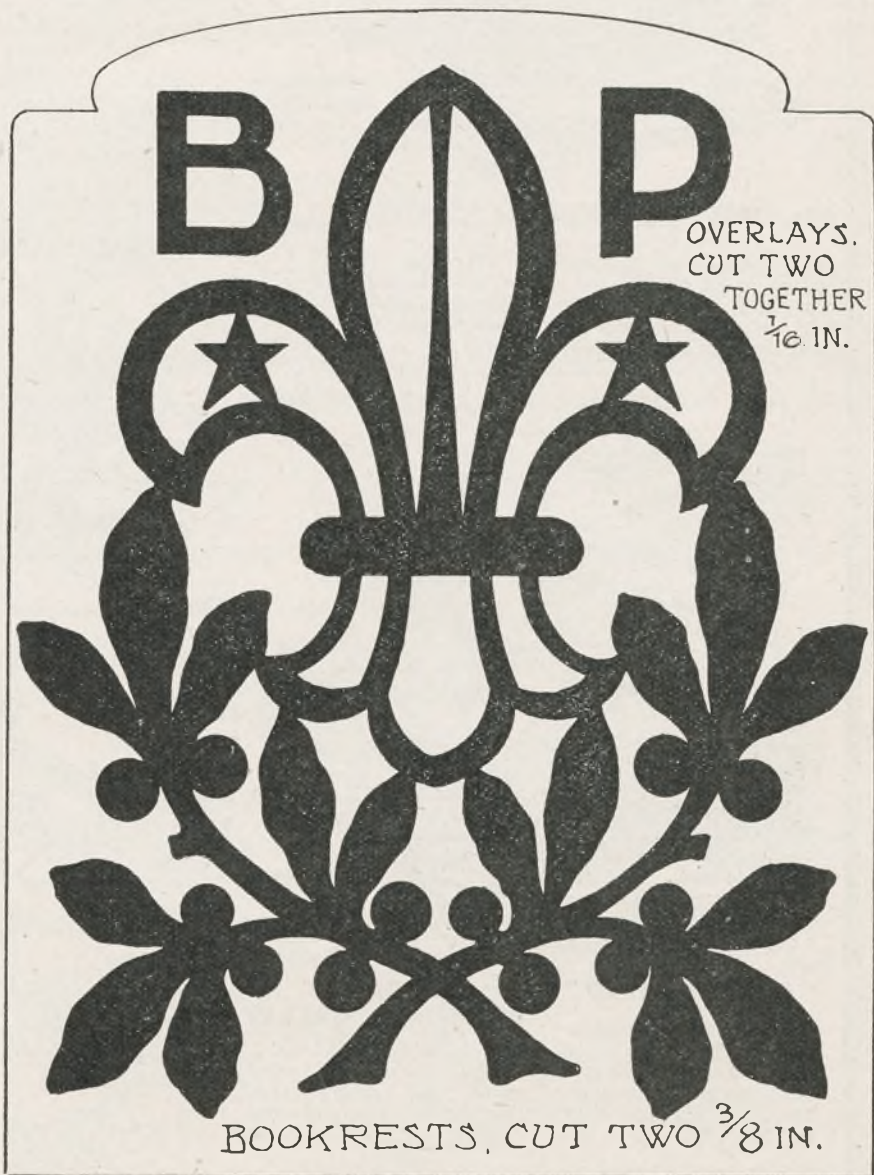

Ship Models

"VICTORY"
No. 2022.
 15ins. long.
 Design in-
 structions and
 materials cost
 only 2/1, post
 6d



15ins. long
 13ins. high

Make a ship model from Hobbies design and materials. It will cost you only a shilling or soplus a little patience.....but you will have a model to be proud of for the rest of your life.

▶ No. 2147 "MAYFLOWER"

The complete parcel of design, instructions, wood, round rod for masts, waxed paper for sails, wire, special cord, 12 pulleys, eight wood guns, etc. costs 4/1 ; postage 6d.

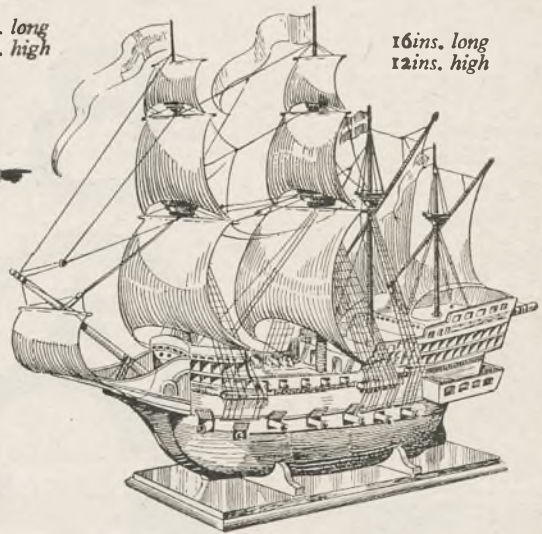

16ins. long
 12ins. high

No. 2095 "ELIZABETH JONAS"

This model must be popular. We have sold thousands of designs and parcels of materials. The design, instructions, wood, turnings, round rod, six pulleys, ten wood guns, waxed paper for sails, etc. cost only 3/7 ; postage 6d.

15ins. long
 15ins. high

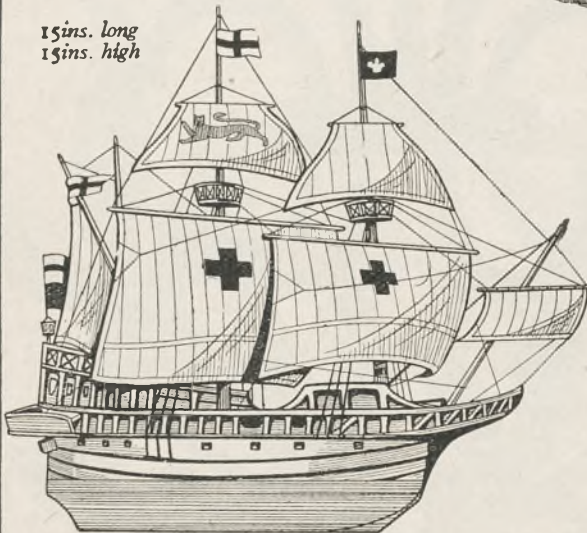

Of all
 Branches
 and Agents
 or from
 Hobbies
 Limited
 Dereham
 Norfolk

Tins of Enamel, 2½d.
 each. Gold Enamel
 3½d. Postage extra.



12½ins. long
 12¼ins. high

"GOLDEN HIND"

The design and instructions cost 9d. The parcel of planed wood, round rod, etc., costs only 2/-; postage 6d. Send 3/3 and start building it NOW !

▶ No. 2144 EGYPTIAN GALLEY

Isn't this a delightful model ? Design, instructions wood, round rod, turning, special cord, 12 brass eyes and waxed paper for sail 3/2; postage 6d.

The AMATEUR WOODWORKER



ONLY 30ins. high by 21½ins. wide by 10½ ins. deep, this useful, attractive and accommodative little cabinet is very easily made and would just fill in that bare corner of the bedroom. It is intended to stand against the wall at the head of the bed. There is space to suit all manner of books, a flower vase, and more important, a small table electric lamp.

So, should you have a sleepless night, here's a light and library at your elbow! Even people who do not suffer from insomnia will appreciate the arrangement and convenience of this novel cabinet which, in a way, is really an odds-and-ends holdall.

The drawer and cupboard below can be used for such articles not generally kept in the rest of the bedroom suite or for which there has been no space. It is, you will find, a real necessity in more ways than one.

Carcase Construction

At Fig. 1 will be found a front and end elevation giving the necessary dimensions. The wood used throughout should be ½in. thick finished and of a nature to match surrounding woodwork. It is quite possible to use timber like plain deal and polish it to suit the colour scheme of the rooms. Don't forget, too, that spanish chestnut assimilate oak to some extent and only costs as much as deal. It stains rather dark, however, but ideal for a Jacobean finish.

Whatever wood you decide upon, commence work by cutting and squaring two gables 26ins. by 10½ins. Measure off the shelving spaces as indicated by the dotted lines (see end elevation) and pencil the guide lines across on the *inside* of both gables with a set-square.

Two cross shelves are nailed (with 2in. oval nails, by the way) to one upright division, after which same are nailed between the gables. A top piece 13ins. long is affixed flush with the ends.

Assembly Hints

Prior to assembling in this manner, that is, with nails alone, always square guiding lines across to given measurements and thus ensure true assembly. It facilitates construction and always keeps you right; it also helps if the guide lines are brought across the boards and over the face edge.

The book section is the next consideration. Therefore, nail two short shelves to the gable first, then add the top. The ends of same are simply nailed to the right-hand gable without trouble.

The Base

Instead of feet, it will be seen that the base is raised in the up-to-date style. Cut out a base

the shape as in Fig. 2 and nail to the bottom ends of the carcase. Fixed around this are 3ins. wide strips of ½in. stuff, same being kept in 1in. from the front and ends and, none at the back.

The strips are best affixed in parts. You could nail the whole frame together, of course, then attach to the base; it may be a little awkward for you, however, but nothing beats a trial. Incidentally, the strips are not screwed or nailed to the base. To do so would be a bit of a job and nail or screw heads would show.

So set the work upside down and affix framing with glue and corner blocks, a few being glued along the strips as well as in the corners.

The back is a piece of cheap ½in. thick plywood cut the shape of the carcase and base edges. The best way to get this shape is to turn the work over on a sheet of plywood and mark around with pencil. Be sure the work is dead square before doing so. Attach it with panel pins.

A SIMPLE MODERN BEDSIDE CABINET

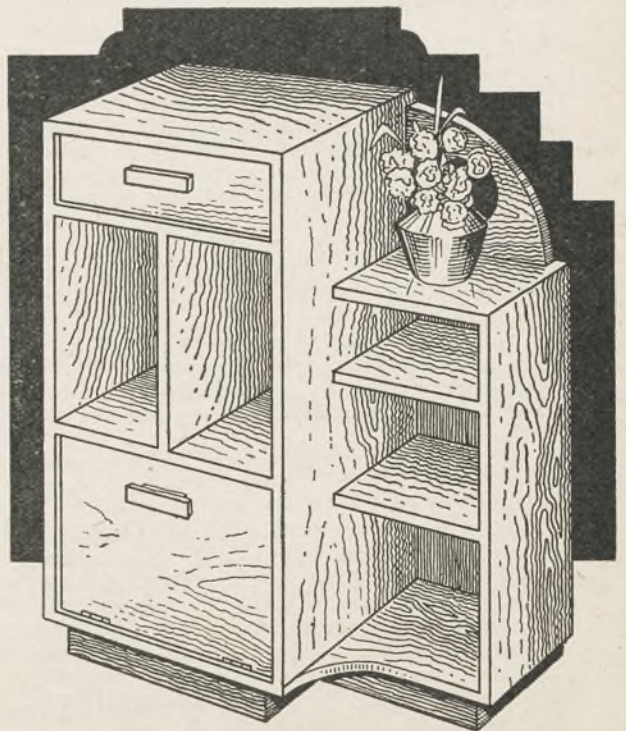

To make the tiny drawer, fit a front in the aperture so that it a trifle tight, then rebate the ends (see inset at Fig. 3) to suit $\frac{3}{8}$ in. or $\frac{1}{4}$ in. thick side pieces. These side pieces are about 1 in. long by the width.

Nail to the rebate. Between the sides at the back ends is nailed a piece of wood the same

Hobbies Ltd. If you prefer to make your own, square up two pieces of wood to precisely 4 ins. long by 1 in. wide by $\frac{1}{4}$ in. thick. Glue to the middle of same two pieces of $\frac{3}{8}$ in. stuff 3 ins. long by $\frac{1}{2}$ in. wide, that is, singly, of course. When polished ebony black, they are screwed to the face side of the work from the back.

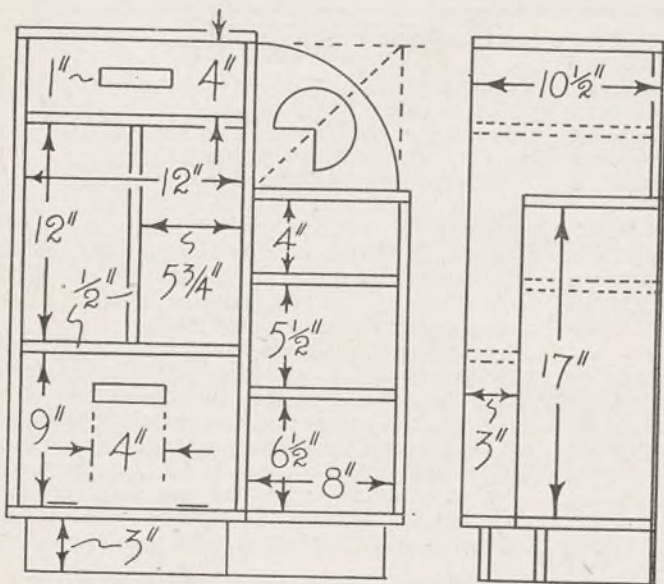

Fig. 1—A front and end elevation with dimensions

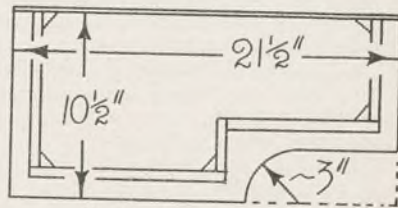

Fig. 2—Shape of the base



Fig. 3—A detail of the drawer front

length of the space between the rebates (inside measurement). The width should be an inch narrower from the top of the sides.

Bottom Strips

Around the bottom (flush with the edges) nail $\frac{1}{4}$ in. by $\frac{1}{4}$ in. strips. The $\frac{1}{8}$ in. thick plywood bottom rests on top to be held with further strips or quarter round moulding. Trim up the drawer with a plane, then attach plywood stops to the front edge of the shelving so it will close to show a $\frac{1}{4}$ in. break.

The door should be cut from $\frac{3}{8}$ in. or preferably, $\frac{1}{2}$ in. plywood (birch). Fit to the aperture and sink two $1\frac{1}{2}$ in. brass hinges about $1\frac{1}{2}$ ins. from the edges as shown. This must also be stopped to show a break at the front. A ball catch (see list) is sunk to the centre of the top edge.

You could make your own handles or procure the well-made and finished variety stocked by

To conclude, cut out a side fret from $\frac{1}{2}$ in. wood the shape as in Fig. 1. This is attached with glue and nails driven in from the inside of the carcass or through the fret itself, the nails being punched and filled in.

MATERIAL LIST

2 gables ...	26 ins. by 10 1/2 ins. by 1/4 in. thick.
1 gable ...	17 ins. by 7 1/2 ins. by 1/4 in. thick.
3 divisions ...	12 ins. by 10 1/2 ins. by 1/4 in. thick.
2 shelves ...	8 ins. by 7 1/2 ins. by 1/4 in. thick.
1 drawer front ...	12 ins. by 4 ins. by 1/4 in. thick.
3 side pieces ...	11 ins. by 4 ins. by 1/4 in. thick.
3 shelf pieces ...	8 1/2 ins. by 7 1/2 ins. by 1/4 in. thick.
1 plywood door ...	12 ins. by 9 ins. by 1/4 in. thick.
1 plywood back ...	30 ins. by 22 ins. by 1/4 in. thick.
1 drawer piece ...	12 ins. by 10 ins. by 1/4 in. thick.
2 pieces wood ...	30 ins. by 3 ins. by 1/4 in. thick.
1 base piece ...	21 1/2 ins. by 10 1/2 ins. by 1/4 in. thick.
1 fret piece... ..	8 ins. by 8 ins. by 1/4 in. thick.
1 top... ..	13 ins. by 10 1/2 ins. by 1/4 in. thick.
2 brass hinges ...	1 1/2 ins. long.
1 ball catch ...	(No. 5480).
2 handles ...	(No. 6217).

Model Aircraft—(Continued from opposite page)

at these points. These packing-pieces are omitted between the two centre ribs, and the leading and trailing spars are packed up to the same height as the inverted mid-spar, so the wing will rest firmly and evenly against the underside of the fuselage.

A double thickness of balsa sheet is used for the triangular gussets between the centre ribs and the leading and trailing spars, and if desired, little bamboo pegs can be cemented into the underside

of these, to form anchorages for the rubber bands which secure the wing to the fuselage.

Other gussets, formed from a single thickness of the sheet, can be used to reinforce all or some of the other ribs. They take time to fit, but weigh little, and add considerably to the strength.

It is advisable to reinforce the bottom of the fuselage with balsa sheet, to avoid damage by the stout centre ribs in the event of a wing-tip blow.

CONSTRUCTION OF LOW WING MODELS

MODEL AIRCRAFT TOPICS

ONE of the principal reasons for the popularity of the high-wing type of model aeroplane is the structural simplicity of the one-piece wing resting on the flat-topped fuselage.

To carry the wing beneath the fuselage requires a certain amount of ingenuity, and many modelists take the view that the possible advantages of the low-wing position scarcely justify the trouble taken. Occasionally a person will make a half-hearted attempt, only to trip up (and subsequently crack up!) on the structural design, and promptly revert to high-wing procedure.

The Single-surfaced Wing

Actually the type of wing most suited to the low-wing position is the single-surfaced variety. All that is necessary is to strengthen the two ribs which rest against the fuselage, so that they withstand the pull of the proofed silk covering, which, of course, has to be cut away so that the fuselage can rest on the leading and trailing spars.

It is also advisable to reinforce the spars with pieces of 18 gauge steel wire, where they are bent to secure the dihedral angle. Unfortunately, despite such undoubted merits as strength, flexibility, and the ability to secure a long, flat glide, single-surfaced wings are very unfashionable at the present day.

The older type of double-surfaced construction, using steel wire and birch, also lends itself quite well to the low-wing position.

The writer's method was to use stout wing roots of $\frac{1}{4}$ in. by $\frac{1}{4}$ in. hard balsa—slightly cambered, but hardly rising above the leading and trailing spars—in place of the centre ribs, so that a wingtip blow merely pushed the wing below the fuselage without breaking either. (See Fig. 1).

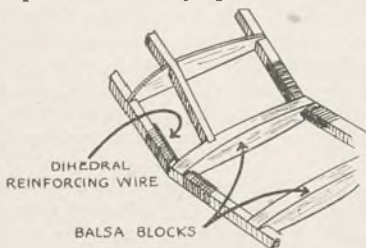

Fig. 1—The centre section of a low-wing birch model

For large models, wire was used to reinforce the spars where bent for dihedral, but for small models with slender spars, a double thickness of tin, cut to the exact angle with very sharp snips or scissors. A mid-spar, mounted at the top of the ribs, helped to steady the latter. This spar was steamed and bent down to fit into a recess in each wing-root.

The Balsa 'General Purpose' Model

Most readers will be more interested in the application of modern balsa construction to the

low-wing position. For very light duration models the high-wing position is probably more suitable, and certainly more popular.

We will, therefore, take by way of example, a 'general purpose' wing of, say, 36 in. span, and $4\frac{1}{2}$ in. chord, with a leading-edge of $\frac{3}{16}$ in. by $\frac{1}{8}$ in., and a trailing-edge of $\frac{1}{2}$ in. by $\frac{3}{32}$ in. These spars are pinned down to a full-size drawing, having first been steam-bent, if the wing is to be tapered. The dihedral is left until later.

The Ribs

Next pin down the mid-spar, which consists of a T-spar inverted, as shown in Fig. 2. The ribs, cut from $\frac{1}{16}$ in. sheet, are slotted to fit over the three spars, and cemented into place. The two ribs which rest against the fuselage should be formed from two thicknesses, with the grain running opposite ways, or from a single thickness of $\frac{1}{16}$ in. birch 3-ply.

They must be very carefully fitted, so the fuselage rests between them without swivelling, and without causing distortion.

When thoroughly dry, apply the dihedral at points $\frac{1}{2}$ in. or $\frac{3}{4}$ in. from the fuselage, by partly

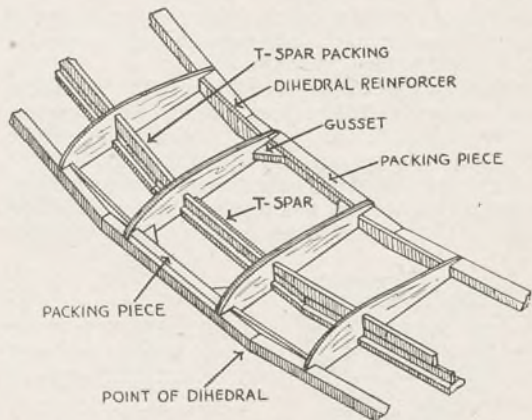

Fig. 2—The centre section of a balsa low-wing model

cutting through all three spars, steam-bending, and cementing. Prop up the wing ends until the cement thoroughly dries. Cut reinforcing pieces from hard balsa or from $\frac{1}{16}$ in. 3-ply, and glue to the leading and trailing spars, as shown in the diagram.

Pieces of balsa sheet are also cut to fit between each pair of ribs, on top of the mid-spar, and reaching almost to the top of the ribs.

They should be cut very carefully to shape where the spar is bent for dihedral, or they will disturb the latter, instead of reinforcing the spar

(Continued on opposite page)

HOW TO SEE THROUGH A COIN!

DESCRIBING a little scientific apparatus for seeing right through a solid body such as a coin or disc of metal!

Sounds intriguing, but when described it seems perfectly simple and is easily worked out! The principle of the periscope may be known to our readers, and how, by means of two mirrors an object at a higher or lower level can be seen naturally. It really means that the light or object is "bent" round, twice in the case of the periscope, and four times in the case of the little gadget about to be described here.

At Fig. 1 it is shown complete and with a coin placed in the slot. The latter it will be noticed is cut much lower than the hole in the end of the "block" and which is called the eyepiece.

Bending Light!

It will thus be imagined by the observer that he can see straight through the coin, there being nothing in its outward appearance to tell that the block contains four mirrors. These are placed so the light rays are bent and take the direction shown by the arrows in Fig. 2, which is a section through the block.

A block of satin walnut wood, 1 in. thick, measuring 3 in. by 2½ in. is first cut to the outer shape shown in Fig. 3.

Then, at a distance of 9/16 in. down from the top or flat edge bore a hole right through according to the dotted lines shown in Fig. 3.

The best way to do this is to prick in the centres and commence drilling from each end until meeting in the middle of the block. A round file will do the final cleaning out and smoothing up.

Next set out the measurements given, making quite certain to get the sloping lines at true 45° angle with the perpendicular ones. Now with the

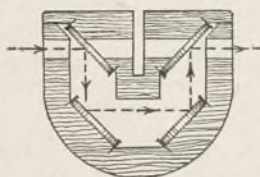

Fig. 2—Direction of light

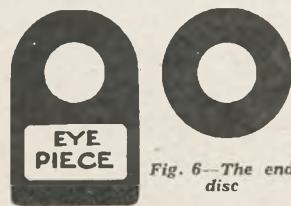

Fig. 6—The end disc

Fig. 5—The eyepiece

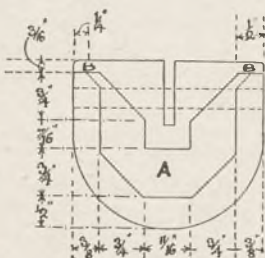

Fig. 3—Helpful dimensions

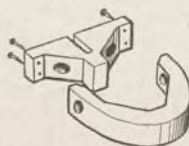

Fig. 4—The pieces apart

A simple trick to make

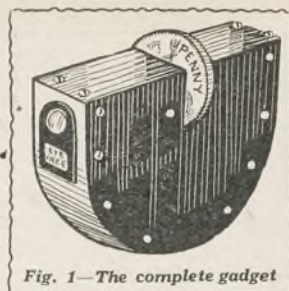

Fig. 1—The complete gadget

fretsaw saw along the two complete lines to remove the centre piece A, and also cut through at B which will sever the top. The two pieces when cut appear as in Fig. 4.

The slot wherein the coin or disc of metal is placed is clearly shown, and the proportions can be got from the diagrams.

Now for the mirror. These are four in number and suitable ones can be got from Hobbs at 6d. the set of four, No. 5750 being quoted when ordering.

The object of having the top layer of the block removable is to facilitate the placing and the fixing of the mirrors, and as will be seen, these are pinned along the edges with small fret pins. Prick in the holes for the pins and press the latter in with the fingers, using a hammer as little as possible.

Assembly

Fix the two pieces of the block together with fine screws, and then take a look in at one of the end holes. Holding the block up to the light and preferably in front of a given object. If the hole appears straight and the object perfectly in alignment all is correct, but certain adjustments will probably have to be made before this end can be gained. If so insert tiny pieces or shavings of wood pushed behind them to alter their angle slightly.

The sides which close in the mirror can now be marked out and cut from thin xylonite. Two pieces the exact shape of the finished block must be cut and screwed on with ¼ in. brass screws as shown in our illustration of the completed thing.

To form a good eyepiece cut out from the xylonite a piece shaped as Fig. 5 but before gluing this on cut a disc of transparent cellophane and glue over the hole first. Afterwards stick down the cover piece of xylonite with the words "eyepiece" printed on.

At the other end of the block glue on just the two plain circular pieces—one, the celluloid disc and the xylonite ring shown in Fig. 6 above it. Fig. 7 gives an end view of the block showing position of eyepiece and sides. A little dark stain applied to the wooden parts makes our "mystery box" complete.



Fig. 7—End view

Now get to work, make one up, and have a joke with your friends. They will be mystified completely.

TWO QUAINT BICYCLE MASCOTS

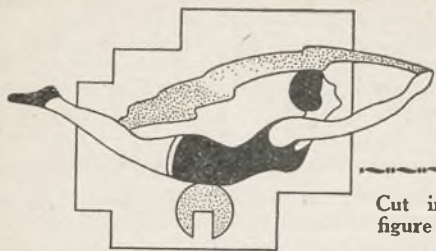

Cut in wood as a Streamline figure or with whirring propeller.

THERE is always something about a mascot on onc's bike. It adds a touch of smartness and variety, and if it is one of the propeller kind, it amuses us as we pedal nonchalantly along winding country lanes and quiet dusty roads.

Good mascots cost money, however, so why not cut one from plywood and enamel it in bright colours like the prototype? We suggest two popular subjects, one being the well-known "Diving Girl" and the other the "Swallow" which, as you can see, appears to hold a propeller in its beak while in flight. Awfully silly, of course, but they are all made like this, and it isn't a bad excuse so far as the "prop" is concerned.

Diving Girl Statuette

Obviously, we can have no more than a statuette of the novelties. Therefore, obtain a piece of birch plywood 6ins. long by 3ins. wide by $\frac{1}{4}$ in.

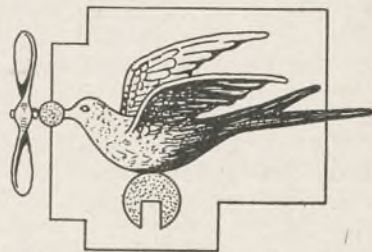

the curvature of the mudguard. A piece of this material about $2\frac{1}{2}$ ins. long by $\frac{1}{2}$ in. wide by $\frac{1}{16}$ in. thick suits most mudguards.

Drill three holes (to suit the curvature of the support) in the brass strip and countersink for the tiny flathead screws mentioned in the materials list. To colour the work, first give the whole two coats of white enamel (or cellulose) paint—or again, two coats of silver paint. The latter acts as an excellent preservative and makes a good base for the other colours.

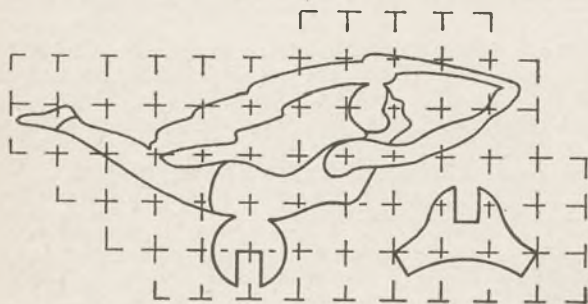

Fig. 1—Outline of figure and support in $\frac{1}{2}$ in. squares]

thick and mark on it the squares (which are $\frac{1}{2}$ in.) as shown, then carefully pencil in the outlines, using the compasses where the shape permits.

Having marked out the figure and support piece, cut them out neatly with the fretsaw and remove any "burr" from the edges with fine glasspaper. Glue the support to the halfcheck in the base of the statuette.

In order to attach the mascot to the front mudguard of the bike, you will need to screw a strip of brass, copper, tin, aluminium, etc. to the underside of the support so that the ends project sufficiently to be bent under and around

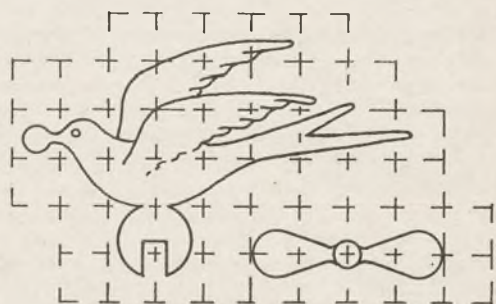

Fig. 2—The shape of bird and propeller

These are black, red and green, Hobbies $2\frac{1}{2}$ d. tins of paint being ideal (see Handbook). The costume and slippers are coloured black, with the flowing cape done green and the base parts painted red.

The Propellers

The bird mascot is constructed practically the same as its predecessor. While the statuette shape must be cut from $\frac{1}{4}$ in. plywood, however, the propeller outlincs in Fig. 2 should be marked and cut from $\frac{1}{16}$ in. thick plywood. If desired, brass, celluloid, etc. could be used instead.

With the plywood, the blades should be

MATERIALS REQUIRED

- 1 piece birch plywood, 6ins. by 3ins. by $\frac{1}{4}$ in. thick.
- 1 piece birch plywood, $\frac{1}{2}$ ins. by 3ins. by $\frac{1}{4}$ in. thick.
- 1 piece birch plywood, 3ins. by 2ins. by $\frac{1}{16}$ in. thick.
- 1 piece brass (optnl.) 3ins. by 2ins. by $\frac{1}{16}$ in. thick.
- 1 piece brass (optnl.) 2 $\frac{1}{2}$ ins. by $\frac{1}{2}$ in. by $\frac{1}{16}$ in. thick.
- $\frac{1}{2}$ doz. $\frac{1}{2}$ in. by 3ins. flathead brass screws.



Fig. 3
Details of the propeller

(Continued on page 573)

NOTES ON MAKING A MORTISE AND TENON JOINT

IT is hard to realise any job in woodwork of an appreciable size which, if constructed in the right way, would not contain a mortise and tenon joint. This joint has various forms and as you will see, can be made in many different ways.

Plain Tenons

Fig. 1 illustrates this joint, and Fig. 2 shows the marking out. Here is a simple exercise. For convenience sake plane one piece of wood 12 ins. long by 2 ins. by $\frac{3}{4}$ in., mark $\frac{1}{4}$ in. of waste wood at each end and divide the remaining piece into 2 equal parts and mark out as in Fig. 2.

All lines parallel with the edge should be marked with the marking gauge. Gauge across the end when marking the tenon 'A.'

The mortise "B" is marked out on both sides and is easily cut out by boring a hole a little smaller than the mortise and remove the remaining waste wood by chiselling across the grain.

Closed Tenon

This is the form of mortise and tenon joint most used. Cutting the joint is a fairly straightforward process but some care is required in marking out. Fig. 3 shows the joint assembled and separated.

Before you attempt this joint on a finished piece of work you will do well to get a piece of soft wood 11 ins. by 2 ins. by $\frac{3}{4}$ in. and make the joint with one.

When you are satisfied that the wood is true in width and thickness, mark out as is shown in Fig. 4 (the feint lines are pencil for construction only) and set the mortise gauge.

The construction of a mortise gauge is different from the marking gauge inasmuch that it has two cutting points, one fixed and the other movable by adjusting a screw at the end.

It is the usual practice to make the tenon $\frac{1}{3}$ rd of the wood's thickness so in our particular case the tenon is $\frac{1}{4}$ in. thick. This means that the distance between the two points is $\frac{1}{4}$ in., and also $\frac{1}{4}$ in. between the stock and the movable point.

When you are satisfied the gauge is set correctly tighten the screw and test on a piece of waste wood. Now gauge between the lines on both edges for the mortise and round the end for the tenon (see Fig. 4).

Cutting the Mortise

Fig. 5 shows a mortise chisel which is necessary for cutting a mortise. Always choose a chisel the exact width of the mortise—which in this particular case is $\frac{1}{4}$ in.

When chopping out the mortise rest the wood (see Fig. 6) over the peg of the bench and sit on it in order to keep it firm. Begin cutting with the chisel half way along the mortise, with the flat side away from you. Hit the chisel sharply with a mallet cutting down about $\frac{1}{4}$ in. - $\frac{3}{8}$ in.

Continue this process to within $\frac{1}{4}$ in. of the line

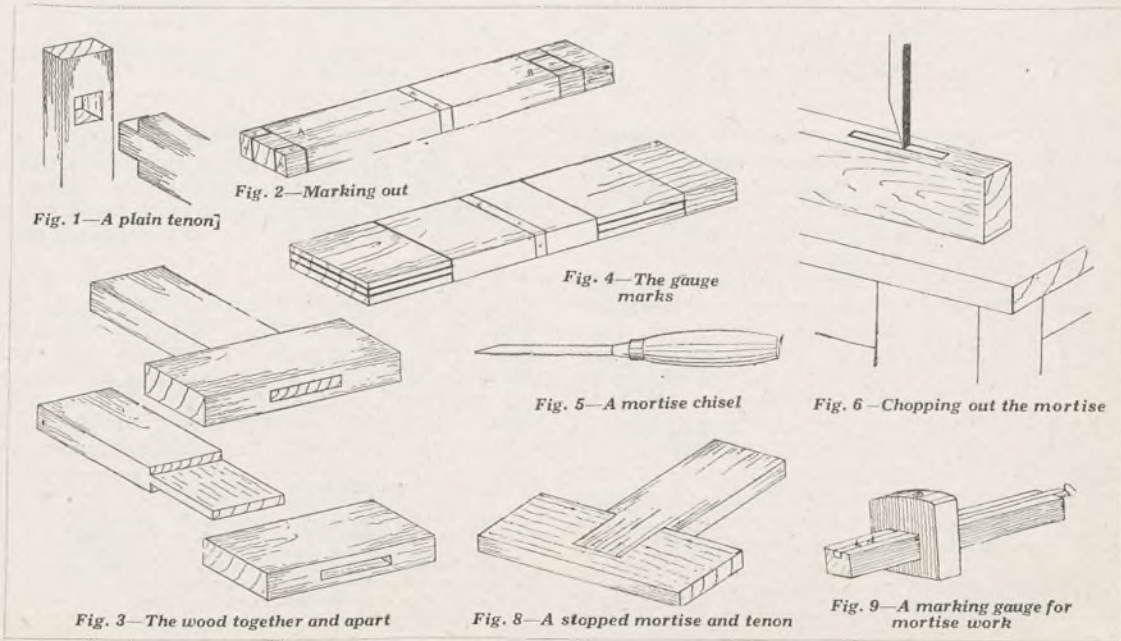

levering out the waste wood as you go along. You have now cut out half of the length of the mortise and about $\frac{3}{8}$ in. down. Reverse the chisel and with the flat side towards you repeat the same operation as before.

Continue this process, cutting about $\frac{3}{8}$ in. deeper each time until you are about half way through. Then turn the wood over and begin the same procedure from the other side.

It is usual when cutting a through mortise and tenon to cut half way from each side. You should therefore bear in mind to mark out the joint on both edges.

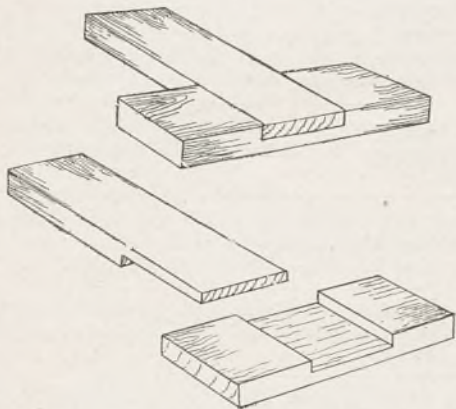

Fig. 7.—An open joint and with parts separated

Finally when the mortise is cut right through hold the chisel perfectly vertical and cut away that $\frac{1}{4}$ in. of wood at each end.

When cutting a mortise take care and see that you hold the chisel perfectly upright. The slightest slope in any direction will lead to a badly cut joint and you will find that when the joints are assembled—particularly in the case of a frame—there will be a twist.

Open Mortise and Tenon Joint

This type of joint is very useful for quick but sound construction in such things as frames and doors. It is usually used when the wood is too narrow for a closed tenon.

Fig. 7 shows the joint assembled and apart. To get a full knowledge of its construction, plane a piece of wood 12 ins. by 1 $\frac{1}{2}$ ins. by $\frac{3}{8}$ in. and make the joint as explained for an experiment.

Square a line $\frac{1}{4}$ in. from each end and then another 5 $\frac{1}{2}$ ins. away. Saw off the waste wood at each end and draw pencil lines round, 1 $\frac{1}{2}$ ins., and set your mortise gauge as before. Now gauge round the end and mark in where necessary with a cut knife (cut lines are heavy lines in the diagram).

Put each piece of wood in turn in the vice and saw down the gauge line—on the waste wood side. Then, in the case of the tenon, saw off the waste on a sawing board.

The mortise can be cut out in two ways—by chiselling all the waste away or by running a bow saw down the saw cut and cutting the waste away about $\frac{1}{4}$ in. from the line, finally chiselling down to the line, from both sides, with a mortise chisel.

Stopped Mortise and Tenon

It is sometimes inconvenient to cut a through mortise that shows itself on the outside edges. On a door or a frame for instance it would look unsightly.

In order to remedy this we cut a mortise that is usually about $\frac{3}{4}$ the width of the wood. The marking out for this is precisely the same as for the through tenon, except that the mortise is marked out on one edge only (the face edge) and the tenon is shorter.

When cutting the mortise, the waste can be cut away from one side only. You will not find this way difficult but do not attempt to take out too much with one cut. Fig. 8 shows a stopped mortise and tenon joint.

Wedging

It is sometimes recommended that you wedge mortise and tenon joints. If the joint is a small one and the wood well seasoned it is unnecessary. In the case of larger joints, however, or the wood is exposed to weather conditions it is recommended because of shrinkage.

Gluing

If, for example, you are making a door with four mortise and tenon joints, it is advisable to cramp the door together, dry at first to make sure the joints fit and the frame is square.

When you are satisfied this is so, take the joints apart and run a little hot thin glue into the mortise. Then brush some glue over the tenons and shoulders, cramp again and leave to dry.

Two Cycle Mascots—(Continued from page 571)

“ pitched ” over a jet of steam, such as from the spout of a kettle. If you prefer to “ carve ” a propeller out of solid wood, such as deal or white-wood, details are provided at Fig. 3, same showing the various constructional stages.

When making propellers in this way, it is always advisable to drill the necessary hub hole before proceeding with the shaping with a penknife. Having it neatly carved and smoothly glass-papered, affix the propeller to the statuette with

a pin, having a small glass bead or washer between as in the illustration.

To enamel the work, colour the propeller and base parts green. It is assumed, of course, that the whole thing is painted beforehand with white or silver paint and allowed to thoroughly dry. The eyes and feathers are best painted in with black and grey colours, the illustration being helpful in this connection.

MISCELLANEOUS ADVERTISEMENTS

The advertisements are inserted at the rate of 2d. per word prepaid. Name and address are counted, but initials or groups, such as E.P.S. or £1/11/8 are accepted as one word. Postal Order and Stamps must accompany the order. They will be inserted in the earliest issue. To sell anything except fretwork goods or those shown in Hobbies Handbook. Orders can be sent either to Hobbies Weekly, Advertisement Dept. 30/32 Ludgate Hill, London, E.C.4, or Dereham Norfolk.

LONELY ? Then write Secy., U.C.C., 16BB. Cambridge St., London, S.W.1. Genuine. Established 1905.

MAKING A CLOCK ? We supply movements from 3/9. Hobbies Ltd., Dereham.

EXCELLENT Money-making Opportunities constantly occurring. Strongly recommended. Send stamped addressed envelope for free particulars.—Messrs. Green, 17 Church-lane, Hull, England.

DOLL'S HOUSE Papers, Fittings. Bathroom set, fireside set, door knocker, etc. Write for list.—Hobbies Ltd., Dereham.

INVENTIONS PROTECTED. Booklets gratis.—Reginald W. Barker & Co., Patent Agents, 56 Ludgate Hill, E.C.4.

BOYS! Learn the 'why' and 'how' of electricity with a Hobbies Electrical Outfit. Fun, fascination, thrills galore. Prices from 3/.—Hobbies Ltd., Dereham.

RADIO turned Radiogram; Electric Motor 25/-; Pickup 9/-; Pickup-Head 4/3; 5,000 spring motors 4/6, dozen 36/-; Pedestal radio Anexagram £5; ditto table 68/-; Gramophones from 12/-; Cabinets, Horns, tonearms, soundboxes, needles, springs, gears, accessories, cabinet fittings, violins, cheapest, Established 1903. Trade supplied, catalogue free.—Regenthoob, 120 Old Street, London, E.C.1.

MAKE YOUR OWN UKULELE, Mandolin, Guitar, etc. from Hobbies designs and materials. You'll be surprised how easy and cheap it is!—Hobbies Ltd., Dereham.

DUMPER PACKET FREE, 100 different stamps, including Coronation Stamp, Tiger, Ship, Admiral, Temple, etc., etc. Request approvals.—J. F. Smith, 89 Sandhurst Road, Catford, S.E.6.

100 STAMPS all different, free to approval applicants sending 2d. postage.—**Errington Macquire (O), 51 Atkins Road, London, S.W.12.**

GALLEONS. Send for our list of ships, acroplanes and other models which can be made from Hobbies designs and materials.—Hobbies Ltd., Dereham.

PRINTING PRESS with Type, 22/6. Bargain.—Particulars, W. Webster, 291a Normanton Road, Derby.

MAKING A COT ? Here's what you need. Drop side fittings 4/6. Castors 1/- set. Mattress with frame 16/6 carriage forward.—Hobbies Ltd., Dereham.

BALSA WOOD for building model acroplanes. Lowest prices for sound quality. Send for list. — Hobbies Ltd., Dereham.

LOW-WING MONOPLANE. Kit of parts for building a 3ft. 10in. wing span model with 14in. airscrew. It's a beauty! 19/6; post 6d.—Hobbies Ltd., Dereham.

YOU DO BETTER WORK WITH A BENCH. We have them from 24/-. Write for particulars.—Hobbies Ltd., Dereham.

FRAME YOUR OWN PICTURES ! We supply mitre blocks, cramps, mouldings, etc. Easy, fascinating work. Profitable, too!—Hobbies Ltd., Dereham.

GLUE. Hobbies glue is as good as 25 years' experience can make it. Sticks wood, china, leather, etc. In tubes 6d. and 2d.—Hobbies Ltd., Dereham.

FILE PAD FOR FRETWORK, complete with six files, only 1/9; post 2d.—Hobbies Ltd., Dereham.

READY-TO-FIT DOORS

Well-made doors with 3/4 in. Oak Framework

- | | |
|---|--|
| No. 600A. 8ins. high,
9ins. wide,
1/6 each, 2/9 per pair. | No. 602. 12ins. high,
18ins. wide,
3/3 each, 6/- per pair. |
| No. 600B. 9ins. high,
8ins. wide,
1/6 each, 2/9 per pair. | No. 603. 16ins. high,
14ins. wide,
3/- each, 5/6 per pair. |
| No. 601. 12ins. high,
8ins. wide,
1/9 each, 3/3 per pair. | (No. 603 is in light
wood, suitable for
staining). Postage 6d.
extra. |

HOBBIES LTD., DEREHAM

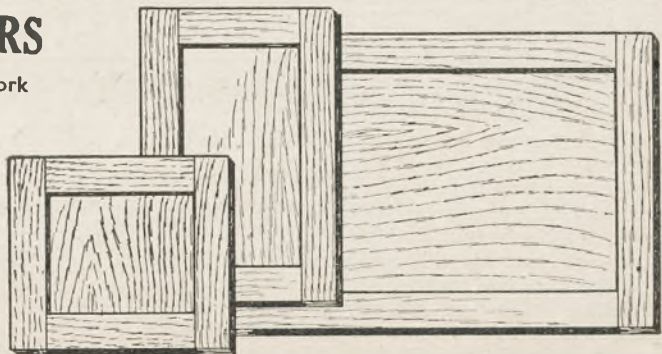



STAMPS OF HUNGARY

(continued)

CONTINUING our survey of the many interesting stamps of Hungary we come to more recent issues.

You should be able to recognise such surcharged stamps quite easily because the surcharge was in four lines. Three arc of writing and the fourth gives the value One Korona.

Just before the abdication we have the two portraits of King Charles and Queen Zita. Then



The Journal
Tax Stamp



The Savings
Bank Stamp

came the Republic stamps, overprinted as just described, followed by more reaper stamps. But these instead of having the "Magyar Kir Posta" have simply "Magyar Posta," a variety which you may quite easily overlook.

In 1919 we saw the issue of five Bolshevik Regime stamps, and these had portraits of Marx, Petofi, Martinovics, Dozsa, and Engels. They are not very handsome stamps either.

Back to the reaper set and these with an overprint in three lines as shown, and which indicates Hungarian Soviet Republic. But in a very short time this same set had a different overprint. Four lines again this time and as a distinguishing mark, one might say that the four lines end with the date 1919 XI/16. The overprint means the Entry of the National Army into Budapest—with the date.

The reaper set comes in for another overprint. In 1919 it had a sheaf of wheat printed upon it to indicate the coming of the Regency. Rather a happy overprint considering the design.

From 1920 Hungary seems to have blossomed forth and produced stamps of a more interesting character, though in many cases the interest seems to consist in

finding out just what the design is meant to represent.

The first of these design sets was the 1920 Hungarian prisoners of war in Serbia set, stamps which bore a very considerable premium indeed. The lowest value shows a lonely soldier tramping in the snow, the next a barbed wire compound with a group of miserable wretches looking out. But luckily these dismal specimens are relieved a little by the high value, which shows a soldier returning to his family.

After a few more issues of the harvesters we come to an issue of five stamps to commemorate the poet Petofi, and in this case they combined business with pleasure in that they sold these at double face value in aid of charity. This set was issued in 1923 the 100th anniversary of the poet's birth.

Now we come to the period of money inflation in Hungary for the next set is one of the harvesters type. The values are in Korona (10 to 800) then in the parliament type (1,000 to 2,000), and a design looking something like a coin for the values to 5,000 korona. Actually it is the Madonna and child.

In 1924 three charity stamps, presumably for child welfare. That is, if the design can indicate anything, whilst on the back is a note to the effect that the price was double face value.

Hungary issued her first Air Stamp at this time and the design is that of Icarus who was the son of Daedalus. He flew away with his father, but soared so high that the sun melted the wax with which his wings were fastened, and so he fell into the sea and was drowned.

In 1925 was the advent of three stamps for the maurus Jokai centenary (1,000—2,500 korona), and in the same year a set of eight. Again they were at double face value, in aid of sports associations.

The subjects are very good—the 100k. shows the parade of athletes, which has become such a feature of the big meetings of today; skiing, skating, swimming,

fencing, scouting, association football and hurdling complete the set, and since the values vary from 100 korona to 2,500k. sports associations must have benefited quite well.

In 1926 we get another change of currency. This time we go back to the filler, but not to 100 filler equalling 1 korona, but 100 filler equalling one pengo.

This change of currency was inaugurated with five designs (a) the Crown of St. Stephen (b) St. Matthias Church and fishermen's bastion, (c) the Royal Palace at Budapest and lastly the Madonna and Child. Then two air stamps—one showing the fabulous bird the Turul, and the other mercury astride a Turul.

In 1928 we have here the worst example of trying to find an excuse for issuing stamps—and hoping to get some revenue out of stamp collectors rather than trying to provide facilities for the carriage of letters.

Hungary actually issued a special set of new stamps to commemorate the 890th anniversary of the death of St. Stephan of Hungary. If they issued a set for the 890th anniversary what will they do for the 900th? And when the 1,000th anniversary comes in 2,038—well not many of us will be collecting stamps then so why worry?

The next issue to note is the 10th anniversary of the



Newspaper Stamps



A modern Air Stamp

election of Admiral Horthy to the Regency. Hungary is now a Kingdom without a king. She has a regent until such time as a king may be decided upon.

There are, naturally, a large number of details to be commemorated in an ancient state and mention will be made of some in the concluding article.

(To be Concluded)



The No. 1 Carpentry Outfit contains eight tools with an instruction handbook. An ideal set for the young beginner. Price 10/-, post 7d.



The No. 2 Carpentry Outfit. A popular outfit at a popular price. Eleven tools of clever design and built to last. The handsaw is 16ins. Price 17/6, post 10d.

HOBBIES LTD. DEREHAM

Branches in London, Glasgow, Manchester, Birmingham, Sheffield, Leeds, Southampton and Hull.

CARPENTRY SETS

Be wary of the carpentry set with a lot of tools offered at a low price. There's a catch in it somewhere, and somebody is going to be disappointed.

You can trust Hobbies carpentry outfits. Each one contains a selection of tools which you can use—REAL tools. Whichever set you choose from the Hobbies range you may be sure that you are buying good value in good tools.

*Don't judge value by price alone.
It's what you get for what you pay
that counts.*

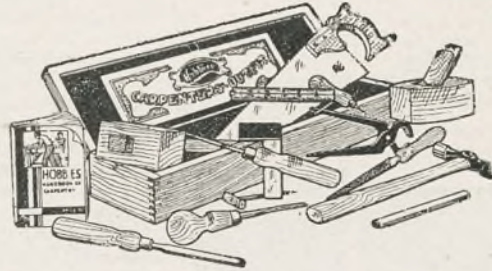

No. 3. Carpentry Outfit. An 18in. Handsaw, smoothing plane with double iron, chisel, gouge and nine other tools make up this practical kit of tools. A 64-page handbook of things to make is also included. In attractive wooden box 30/-, postage 1/-.

USEFUL LEGS for Amateur Woodworkers

The amateur carpenter can build real pieces of furniture with these handsome and varied turned legs. They are suitable for tables, wireless cabinets, cots, stools, etc., and are nicely finished ready to cut and fit. A wide range is obtainable from Hobbies, and all are sold at a cut price to make the work possible for the amateur.

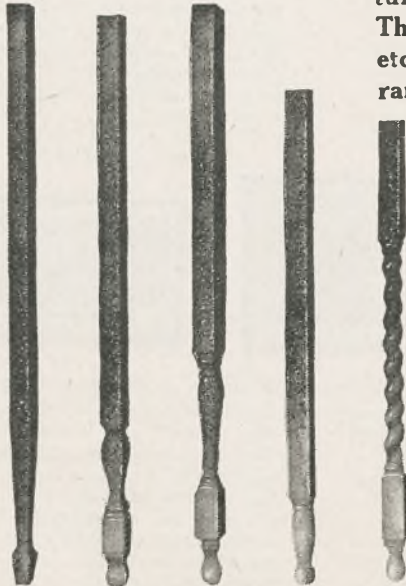

No. 523C No. 522 No. 517 No. 519A No. 516A

HOBBIES LEGS AND TURNINGS

	For 4
516A 1½ × 28 Oak	3/6
516B 1½ × 28 Beech	2/9
517 1½ × 36 Beech Gramophone	3/6
519A 1½ × 30 Beech Chest	2/6
522 1¾ × 36 Oak Square Turned	5/-
523C 1½ × 36 Oak Flower Pot ..	4/3

Postage extra

FREE

This interesting 18-page Booklet, "Ornamental Woodwork," is free on request from any Hobbies Dept. Or send a card for one to Hobbies Ltd., Dereham, Norfolk.



Call at any Hobbies Branch in London, Glasgow, Birmingham, Manchester, Sheffield, Leeds, Southampton, Hull. Or post your order to Hobbies Ltd., Dereham, Norfolk.

HOBBIES

BRANCHES AND AGENCIES. LTD.

Below are the addresses where Hobbies goods can be purchased. In addition, all leading stores and ironmongers stock or can obtain your requirements in fretwork and woodwork, designs, wood, turned legs, moulding, polish, etc.

HOBBIES OWN BRANCHES—

LONDON - - - - 16 NEW OXFORD STREET, W.C.1.
 LONDON - - - - 147 BISHOPSGATE, E.C.
 LONDON - - - - 83 NEWINGTON BUTTS, S.E.11.
 GLASGOW - - - - 326 ARGYLE STREET.
 MANCHESTER - - - - 10 PICCADILLY.
 BIRMINGHAM - - - - 9a HIGH STREET.
 SHEFFIELD - - - - 4 ST. PAUL'S PARADE.
 LEEDS - - - - 10 QUEEN VICTORIA STREET.
 SOUTHAMPTON - - - - 25 BERNARD STREET.
 HULL - - - - 13 PROSPECT STREET.
 CANADA

54 WELLINGTON STREET WEST, TORONTO.

HOBBIES AGENCIES—

Aberdeen.—Jas. Mutch, Ltd., 47 Broad Street; Blackburn.—Mr. H. Mercer, 68 Darwen Street; Bradford.—Messrs. T. Underwood & Co., 13 and 15 Manchester Road; Brighton.—J. B. Bennett & Co., North Road; Cambridge.—Mr. H. S. Driver, 28 Hills Road; Canterbury.—Mr. T. D. Goodman, 33 Burgate Street and 16 St. George's Street; Cardiff.—John Hall (Tools) Ltd., 22 and 24 Morgan Arcade; Croydon.—L. H. Turtle, Ltd., 6 Crown Hill; Dover.—Mr. E. F. Bockham, Queen's Gardens; Dublin.—Mr. J. J. McQuillan, 36 Capel Street; Dundee.—Pbins Ltd., 29 Nethergate; Folkestone.—Mr. W. Allsworth, 16 and 18 Guildhall Street; Hastings.—Mr. W. H. Mozley, 4 York Buildings; Leicester.—Mr. Frank Berry, 3 Loseby Lane; Liverpool.—Mr. C. Lucas, 17 Houghton Street; London.—Messrs. H. Osman, 166 Aldersgate Street, E.C.; Newport, Mon.—John Hall (Tools) Ltd., 81 High Street; Reading.—Mr. W. J. Sargent, 44 West Street; Swansea.—John Hall (Tools) Ltd., 8 Gower Street; York.—Messrs. J. H. Shouksmith & Sons, 132 Micklegate.

HEAD OFFICE AND WORKS:

DEREHAM, NORFOLK

GENERAL NOTICES.

EDITORIAL.

All Editorial matter should be sent to The Editor, Hobbies Weekly Dereham, Norfolk. If enclosed with orders or other matter for Hobbies Ltd., it should be written on a separate sheet of paper. Any matter requiring an answer must have a stamped addressed envelope enclosed.

DESIGN SHEETS.

The presentation Design Sheet is given only with current copies of Hobbies Weekly, and not with back numbers. The designs, however, can be obtained separately, from Hobbies Ltd., price 4½d., post free, or 10d. in the case of double size sheets.

ADVERTISEMENTS.

All orders and letters respecting advertisements should be addressed either to the Advertisement Manager, Hobbies Weekly, Dereham Norfolk, or to 30/32, Ludgate Hill, London, E.C.4.

INDEXES AND BINDING CASES.

An Index for any volume is obtainable for 4½d. post free, and Binding Cases to take a complete set of 26 issues (making the volume) are supplied for 1/6, or sent post free for 1/8. The Cases are in red linen with gold blocked name on the front. The Azabook Binder, to hold 24 copies which you can fix in yourself is 3/3 (3/6 post free) including two dozen fastening staples.

BACK COPIES.

Back copies are obtainable from the Editorial address given above or from the Publisher, price 2d. a copy, plus postage.

CONTRIBUTIONS.

The Editor is always pleased to consider suitable articles for these pages, which, if accepted, will be paid for at the usual rates. While every effort will be made to return unsuitable contributions (if stamps for that purpose are sent with them), the Editor does not accept any responsibility for their loss.

SUBSCRIPTION.

Hobbies will be forwarded by post to any part of the world at the following prepaid rates. Twelve months 13/-, six months 6/6, three months, 3/3. Registered for transmission by Canadian Magazine Post

A Hobbies Outfit at a Reasonable Price

If you are looking for a Fretwork Set about 3/6, you cannot do better than buy this new H3 Outfit. It gives you all you need to make a start, and of course, each tool is of Hobbies guaranteed quality.

The H3 OUTFIT

Contains a 12in. Hand-frame with a dozen spare sawblades, a drill with two bits, hammer, steel cutting table and cramp, a rule, brush, and design and wood.
 On attractive card.
3/6
 Post 6d.

Buy from Hobbies Branches etc., or direct from Hobbies Ltd., Dereham.



Try EBONY Polish



Anyone can get the real ebony finish to their work with Hobbies Ebony colour polish.

EBONY POLISH

Stains the same time as it polishes. Try it once and you'll always use it.
 Price 1/9 per bottle.
 Postage 4d.

Buy from any Hobbies Branch or agent, or direct from Hobbies Limited, Dereham, Norfolk.



REPLY COUPON

One of these small Coupons and a stamp for 1½d. must be attached to your letter to the Editor, if you are enquiring about anything which demands an answer. Cut the Coupon out and put it in with your letter which should be addressed to The Editor, Hobbies Weekly, Dereham, Norfolk

A GEM FRET MACHINE COSTS ONLY 30/-

FREE—Let us send you an interesting booklet describing the "Gem" and other Hobbies machines.

Amazing! Marvellous! How do we do it? These are some of the remarks we hear about the new "Gem" machine. Imagine, a high-grade fret machine which cuts wood up to $\frac{3}{8}$ -inch thick—a machine built almost entirely of steel—a machine that does all you expect it to do—yet costs only 30/-! Frankly, our aim is to place a "Gem" machine in the hands of every worker in wood—every man or boy who likes to make things. Sales to-date exceed even our most sanguine expectations!



The Mark of Good Value—
and a Square Deal.

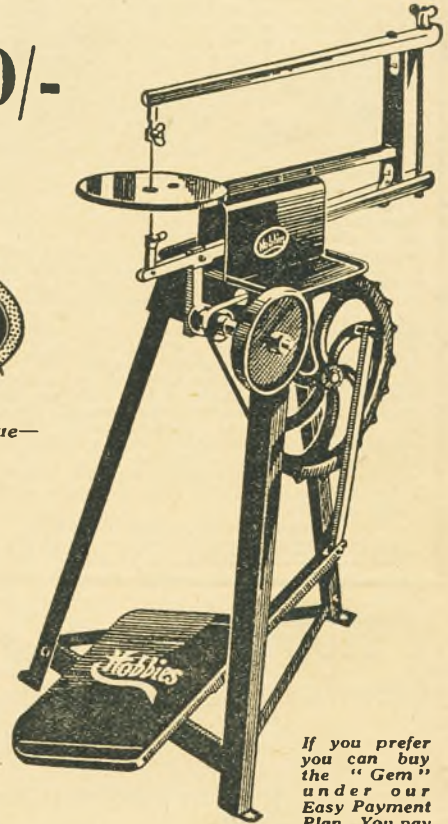

If you prefer you can buy the "Gem" under our Easy Payment Plan. You pay 4/6 down and 2/- weekly for 15 weeks.

The Big-value Gift!

If you have 30/- to spend for a gift, the "Gem" machine is the best value, and the most acceptable gift you can buy at the price. If you are "buying yourself a gift" its value is of even more appeal to you.

Make Your Own Toys, Models, Furniture, etc. at a fraction of Shop Prices!

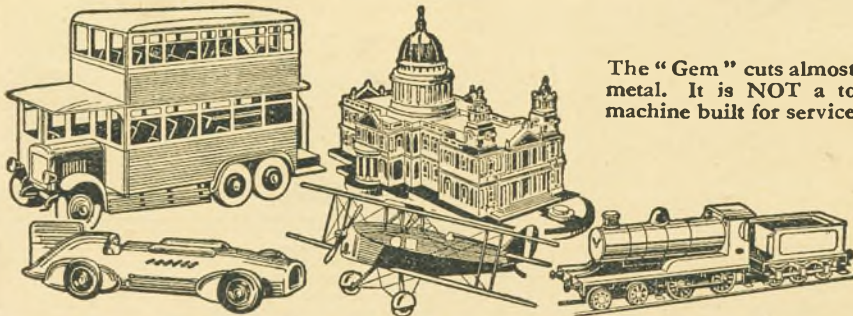

The "Gem" cuts almost anything in wood or sheet metal. It is NOT a toy, but a sound practical machine built for service.

**HOBBIES LTD.
DERHAM**

Branches and Agents
in principal towns.