

Hi Fi

1961

YEAR BOOK

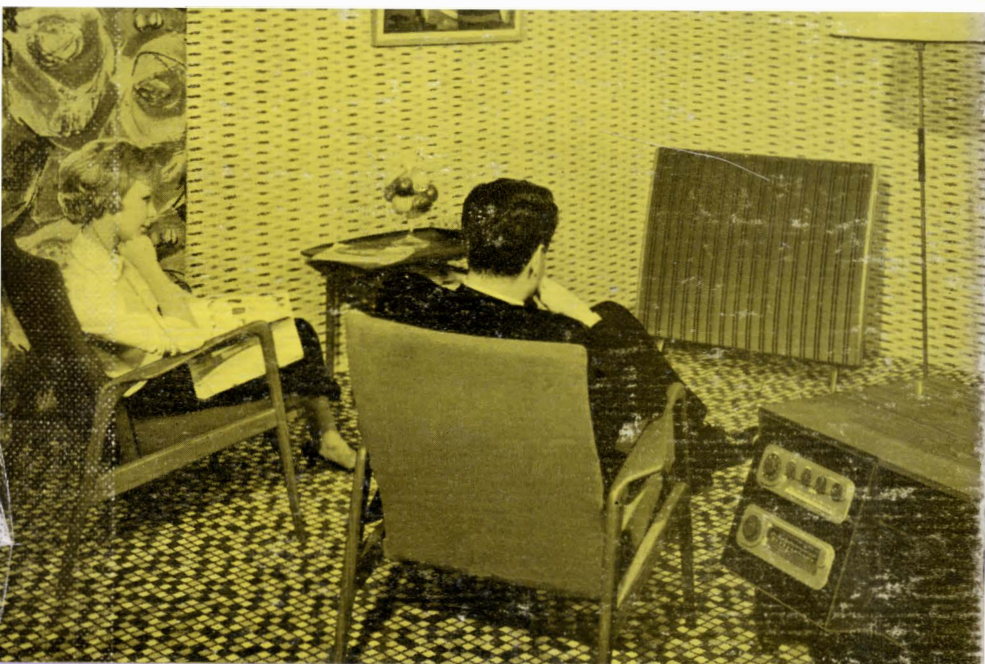

For the closest approach
to the original sound

QUAD

ACOUSTICAL MANUFACTURING
COMPANY LTD.
HUNTINGDON, HUNTS

PICKUPS · MOTORS · TUNERS · SPEAKERS ·
AMPLIFIERS · MICROPHONES · RECORDERS

10/6

Hi-Fi Year Book

————— 1961 Edition —————

Editor - - MILES HENSLOW



Published by

MILES HENSLOW PUBLICATIONS LIMITED.
99 MORTIMER STREET - - LONDON, W.1

INTRODUCTION

IN this sixth edition of **Hi-Fi Year Book** will be found many new items of equipment, and these appear in almost every directory section. Those readers who have followed the changes in the audio and high fidelity market, through our previous annual editions, will also note the items that have vanished from the scene. Interesting as the first of these facts may be, and sad as some of the gaps must be, the most heartening side of the picture is the continuance of so many models by so many of the firms who have always been the backbone of the business. It is possible that there is more than one moral, or lesson, tucked away behind all this; but one thing is certain and easy to see—new models every year, spectacular changes in design, modifications for the sake of novelty, and suchlike, have no place in this industry. When the first essential is assured—and that is quality—the deciding factor which must sway all purchasers is reliability; and although there is no valid reason why new equipment, or modified equipment, should be any less reliable than other items which have been on the market for ten years, it is a fact that potential customers tend to think that way. And, unfortunately, they *have* reason for that outlook.

Teething Troubles

During the past five years the audio industry has had far from an easy time—and, as a consequence, the same may be said for those who have taken up “sound” as their hobby during those years. First, there have been the impacts of tape and stereo, which have made life very difficult for the buyer. Second, there has been the rush to climb on to the bandwagon by far too many people who

have done little to help the cause of high fidelity in their primary aim to help themselves. It is this fact, chiefly, which has been responsible for a lack of trust on the part of the buying public; and because it may not be an immediately recognisable fact it deserves a clarification; for one of the first essentials for putting something to rights is to understand exactly what is wrong.

Quality before Quantity

When the “hi-fi” industry was relatively small and intimate, catering only for a comparative handful of enthusiasts, quality was the only thing that counted, and no manufacturer who was not personally enthusiastic and keen on the job would have thought of entering the field. Those who were in it, or who were establishing themselves in it, would sooner have worked without profit than they would have turned out apparatus in which they had not full satisfaction and confidence. Then came the day when “hi-fi” became a slogan for a much wider public, and the industry was invaded by others who looked upon it primarily as a business. Inevitably, quantity came first, and quality came second if it was lucky. Many newcomers to “hi-fi” suffered through this, because they knew nothing and trusted almost everything which bore the “hi-fi” tag.

More unfortunate even than this, however, was the effect that the invasion had upon a section of the industry which was at the moment in the difficult period of building itself up. In many cases, it was a case of “compete or go under”; and in order to compete, prices were lowered or maintained in face of rising costs. This, of course, is a fatal step when one

is attempting to concentrate upon quality; and it had the disastrous effect of degrading the products of some of these potentially good newcomers to the field—and to such an extent that they, with all their initial determination and high hopes, ended up by producing equipment which, by virtue of sloppy workmanship, was little better than the glorified “near-fi” products which never could have qualified for their job in anything but name.

Those days, we are glad to say, have nearly ended. The bandwagon proved to be far less of a picnic than many had thought it would be, and there is now more room on the wagon for those who deserve a seat. And because of this there is more room in the market for the good quality product; and because of this, again, the customers are far better able to distinguish the good from the bad; and, as a natural result, there is already a noticeable and commendable improvement all round.

Demand it—and get it

After such an indictment, however, it would be unfair not to let fly in equally outspoken terms at a section of the buying public, who are after all, very much responsible for part of the past trouble. It is said, and very truly, that a country gets the government and the newspapers that it deserves. And the same may be said with equal truth about many products on the market, and of “hi-fi” in particular. “Hi-Fi” means high fidelity or should: and high fidelity must mean quality: and quality, in anything, must be paid for. Provided that one buys carefully and in a selected market, the more one pays the better the product one can expect to get. And the reverse applies when one tries to save pence.

The manufacturer who tries to woo customers by, say reducing the price of his amplifier from £32 to £31 18s. 6d. has

taken the wrong turning. The enthusiast who is tempted by such a line of attack had also better turn back and think again. Both will lose by following that road.

Promising Future

We think—and we say this with confidence—that the whole industry has already seen, and passed, the second turning point in the see-saw graph of the past five years. The period of hesitancy and uncertainty on the part of a much-confused public is ending. Most of the products that did not make the grade have vanished. Many of the new products which have appeared show a marked advance—in design, presentation and workmanship—over what have gone. A survey of the many hundreds of products which are illustrated and detailed in this edition of **Hi-Fi Year Book** show a healthy and determined industry. A comparison between these products, and those available in other lands, leaves no doubt that British Audio Products are well in the lead. The good name that they have already earned abroad is well deserved.

Hi-Fi Year Book has two simultaneous jobs to do. It must provide the most complete summary possible of all audio equipment on the market, in order to make it of maximum use to the widest possible readership—for this includes manufacturers, dealers and reference departments in most parts of the world, apart from the several thousands who rely upon it for use in the home. At the same time it must be a genuine guide to good hi-fi equipment for all potential buyers. With the passing of the years it has incorporated features and sections that were once foreign to it; but the layout and the subdivisions of its directory sections have, we think, maintained the basis of its title more than adequately within its now wider framework.

THE PERFORMANCE AND CARE OF LP AND STEREO DISCS

by Cecil Watts

A transcript of a talk given to the Institute of Recorded Sound



The author demonstrates his giant model which simulates stylus behaviour on a scale of about X 5000! When the groove moves under the tip, the stylus "goes into orbit", as lateral and stereo conditions are created.

THE difficulty I always find, when talking about the gramophone record and how it works, is to know roughly how much can be taken as already understood. For instance it may be a waste of time to say that there is only one groove on each side of a record, and that it spirals from the outside edge to the centre. Mathematical equations expressing the forces involved in playing it are virtually useless to convey practical information, so I will introduce this essay with a description of "High Fidelity from records" from a recent magazine article. I quote: "Sheer perfection is reached

by the Hi-Fi enthusiast when he turns up the controls fully and puts on the supreme test record—a disc with blank grooves.

"Listening in rapt attention for the least signs of undesired sound he has at last achieved the dream of dreams—a machine which will play in complete silence". The Miracle is that it sometimes happens. But let me continue to quote: "These antics may be better understood if we stop to consider the fantastic job that a record player has to do. From the sound engineers' point of view, a musician playing a note is

merely making the air vibrate. If he plays a high note the air vibrates rapidly: if he plays a low note it wafts to and fro slowly. For each note there is a *rate* of vibration. This is called its frequency. The bottom note on a piano, for instance, has a frequency of 27 cycles per second—that is, it vibrates to and fro 27 times a second. At the other end of the scale—the top note on the piano vibrates over 4,000 times a second and, indeed, the individual shape of each vibration is different for each instrument even though they sound the same note.

“If the sound pattern or vibration of a violin is multiplied by 20 other violins, and the vibrations of all the other orchestral instruments are added, you have an idea of the commotion in the air of a Concert Hall when a Symphony orchestra is playing. The *combined* vibrations form *one* very complex sound pattern. What the recording engineer has to do is to translate this complex sound pattern into wiggles of the groove in a gramophone record”.

Different Notes; Different Forms

Now, what the writer of the article means by *the shape of the vibrations being different for each instrument* is important. Consider this “wriggle in the record groove” as representing perhaps a sound from one instrument. If the sound is a smooth continuous musical note, the wriggle or waveform in the groove will curve smoothly, and will change its direction at an even rate as it passes under the stylus. Such a note could be produced by a flute or an organ. But now consider, say, the same note played on a piano. The note is the same: i.e., the frequency at which it vibrates will be identical; but the shape of its waveform will be quite different.

Steep Wavefronts

At the beginning of the note the hammer strikes the string, so producing a steeper wavefront; and a more violent acceleration results where it changes direction. Only if the note is sustained long enough does the waveform gradually smooth itself to an even vibration.

The waveforms of some sounds with violent accelerations indeed frequently resemble the teeth of a saw. “When we lower the Gramophone needle on to a long

playing record” (I continue to quote from the same article) “we force its tiny point to clatter along a track two and a half thousandths of an inch wide, where it gets buffeted from side to side by the turns and twists of the wiggles like a miniature bobsleigh. The vibrations generate a tiny electrical current in the pickup. This is increased several thousand times by an amplifier and injected into a loudspeaker which shakes back and forth; and the result is supposed to be exactly the same marvellously complex pattern of sound vibrations that perturbed the air in the Concert Hall”.

The Disc takes the Rap!

Well now! It could be true. The bit which is going to concern us here however, is to establish as far as possible the facts about “this tiny point clattering along its track”. Of course it does nothing of the kind: it is the groove, which travels along underneath the tiny point and, in passing, attempts to force it to follow the recorded waveforms. If the point is obstinate—being too stiff or too heavy—the groove cannot manage the job, and it gets some of its wiggles ironed out or knocked off. The lighter and more flexible the pickup movement, and the smaller the radius on the stylus, the easier is the task of the groove to make the stylus follow, *exactly*, every intricate little contour of the recorded waveforms. Hence the efforts of designers to reduce the stiffness and mass of pickup movements, so as to obtain the highest possible fidelity in tracing the groove, and with the least possible damage to the recorded sound pattern.

The Groove “Adjusts” Itself

Observe the beautifully simple mechanics. Just a spherical tip snugly resting between two inclined surfaces. Self adjusting to fit the stylus employed and, should the recorded velocities become too *great* for the stylus to respond to it, it is forced up the inclined wall—or even over the top of some waveforms without serious distress to the user.

The actual size of the groove in a long playing record is less than the thickness of a human hair, and the tip of the stylus is smaller still; and this perhaps makes it difficult to appreciate the effects of all the forces involved when the record is played. The groove in the

original master disc from which records are pressed is cut with a cutter having a "VEE shaped profile—the included angle being 90°. The apex is usually slightly radiused. The deeper the groove is cut, the wider it becomes across the top, from shoulder to shoulder. If you will refer to the photomicrograph on page 8, I think you will appreciate that this is just such a groove, viewed from above. It is a small section of a stereo record magnified about 325 times.

Finer than a hair

The average width across the top of the groove is approximately 60 microns—or less than three thousandths of an inch. A human hair averages about four thousandths of an inch. Now observe, even at this magnification, the smooth surfaces of the groove walls in the photograph. Commence exploring from the narrow part of the centre groove at the bottom.

For the first inch or so the centre groove narrows as it approaches the crest of a low frequency sound modulated mainly on the left hand channel: that is the left hand wall of the groove. The thick white line at the bottom of the groove is light reflected from the curved radius. The crest of the waveform is reached at about 1½ inches where it changes direction, and light is now reflected from the walls of the groove and discloses the indentation of a stylus having sufficient pressure to indent the walls almost from the top to the bottom. There is obviously a deeper impression on the left hand wall than on the right.

Detective Work

The impression of a half thousandth stylus at this magnification would only occupy about an ¼ of an inch to either side of the groove bottom, so the evidence here is that the stylus used was larger. I should say it had a radius of one thousandth of an inch.

Following the groove still further until at about half way up (just about the centre of the photo) the groove has a little transient wiggle (the reflection from the bottom radius gives the true amplitude of this and the light reflected from the shoulder of the left hand wall shows that the modulation is mainly on the left hand channel). Tracing the indentation of the stylus, however, it can be seen that it

has taken a straight course through this little transient, which has been somewhat ironed out in the process.

Transients you don't hear!

This is the normal behaviour of a record being accommodated to the reproducer used. Had a more sensitive pickup been used, the impression of the stylus would probably have shown that this transient (occupying less than a ten thousandth part of a second) had been faithfully traced.

Observe now the groove to the left of the picture. Although not so simple to follow, the same thing has happened more or less to halfway, where a very violent high frequency sound commences. This is one of those waveforms like a saw edge which only the smallest stylus could trace properly. See how the large stylus behaves. The first two cycles, where the sound is building up, show nothing unusual. I suspect the first violent wavefront kicked the stylus into the air; but the three top right hand wavefronts have nonetheless been severely blunted, as evidenced by the white patches reflected from the now flattened surfaces as the stylus ploughed from crest to crest. No doubt *some* reproduction of the sound occurred, but the finer detail—in fact *all* the harmonic content of the sound—has not been reproduced.

Pulverising the High Frequencies

This is the condition which causes the grey appearance of some loud passages when examined with the naked eye. The small fragments of groove material thus scraped off, form a dust which if not removed collects along the bottom of the groove.

Perhaps the most remarkable fact about these observations is that although the record has not been used under the best conditions, it is a fact that it has accommodated itself to those which existed; and for a long time it is still likely to give the best reproduction that the pickup employed is capable of providing. Another point to note is the uneven pressure observed on the groove walls. During recent years I must have examined thousands of records under the microscope, and almost without exception similar evidence was visible. I will refer to this later on.

To pursue our subject further will you follow a little simple arithmetic. A record revolving at 33½ r.p.m. travels under the

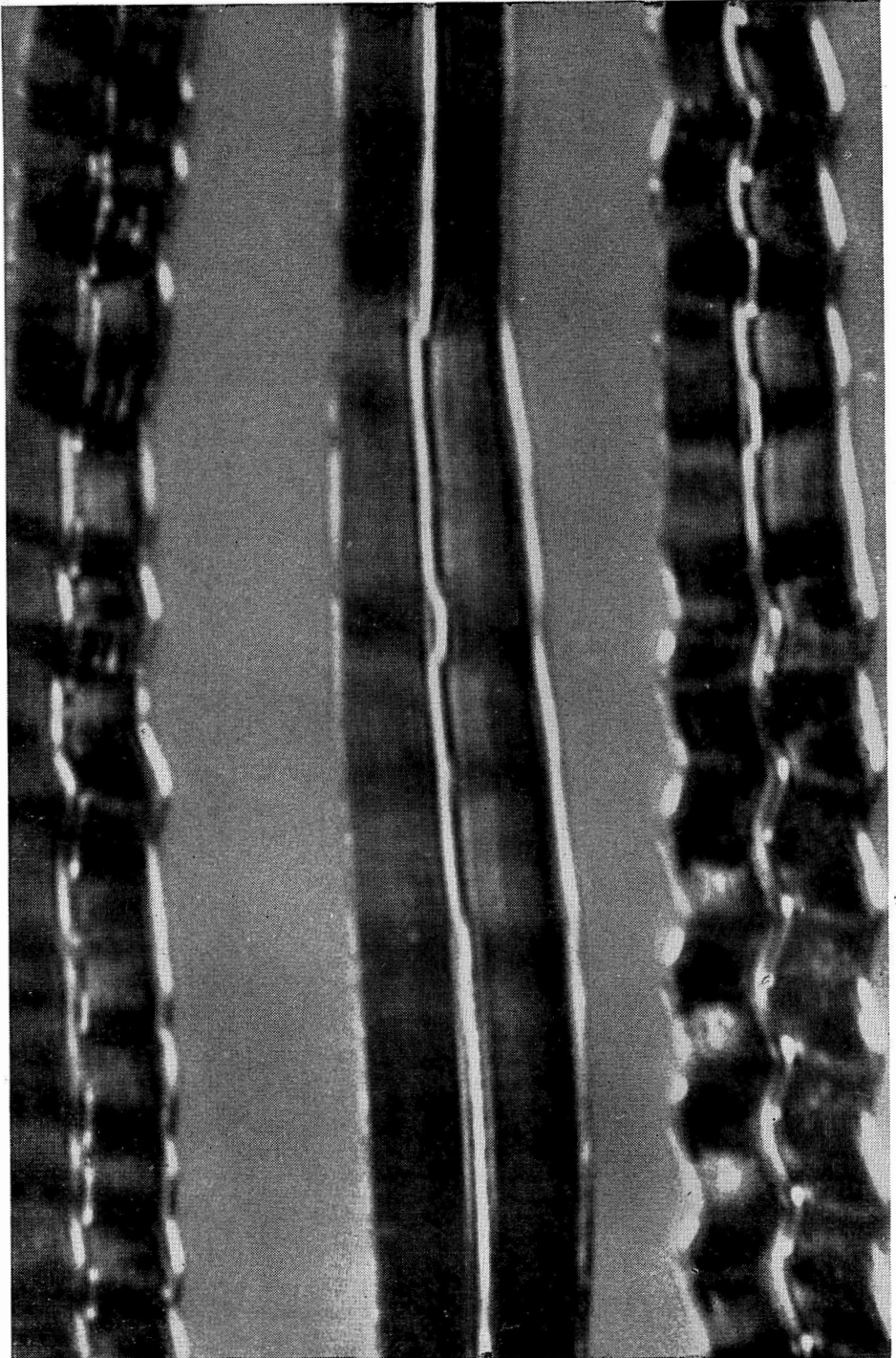

A photo by the author of stereo on disc. Approx. $\times 325$ magnified. See page 7

stylus at the outside edge of a 12-inch record at about 16 inches per second; and of course at about half this speed towards the centre. I have already said that the lowest note on the piano has a frequency of 27 cycles per second, so each cycle will occupy just over half an inch of groove length.

Over the top, for top

We do not have to be very exact about this. The important thing I want to emphasise is that with each octave the frequency is raised, the wavelength is halved; so that by the time we get to the top of the piano (that is, seven octaves above the lowest note), *the waveform is as small as the normal stylus*; and towards the centre of the record it can only just follow the general outline of the waveform, and sometimes it even has to ride over the top.

One good stereo by-product

It would be possible to spend many hours studying the situation now before us. It can be shown that frequencies as high as 15,000 cycles per second are faithfully recorded in the groove, and that electrical responses of pickups can equal this; but a major limiting factor in the extraction of all the delicate details of the recorded sound—*is the size of stylus necessary to provide robust equipment for domestic use*. Here is one advance that has been forced by the requirements of stereo, where the groove also varies in size as the modulations rise and fall, requiring a smaller stylus so that it can remain in the groove on the crests of the waveforms.

Vee for Victory

Now, if the shape of the groove in all makes of record had a "Vee" form, the problem of using a smaller stylus would be somewhat simplified; but there are millions of records in use—and millions are still being issued—in which the groove bottom is radiused to such an extent that a half thousandth stylus could easily ride along the groove bottom without making proper contact with the walls. It is unfortunate that there is little information from the makers on this subject, and with the exception of the *Decca* Company which notably employs a "Vee" shaped groove, it is still a matter of experiment to find the smallest stylus which can be used consistent with minimum distortion.

A 5,000-ft. disc—to scale

Now let us refer to the model illustrated on page 5. We are dealing with stereo as well as lateral reproduction, so let me "dress the stage" as it were. In front of us is this enlarged model of a tiny section of a groove. Imagine that the concert hall with its musicians is behind it (right at the back). In between there will be some microphones, the recording room, the record factory; and the model in front is a small section of the "end product" of a recording session. Of course, a complete disc at this scale would measure some 5,000 feet across! I could never rotate it, or move the stylus at audio frequencies, so for this demonstration the movements must be in very slow motion. It is also necessary for you to imagine that the groove is moving towards you as the record rotates.

Even the smallest armature and stylus in use today—having say, a quarter of an inch overall length—would extend to some 12 feet in diameter, and would rise over 100 feet in the air. So it is apparent from its relative size to the groove that a large effort is still required to vibrate it. The radius on the stylus tip is roughly equivalent to half a thousandth, and when the model is set in motion it can be seen to ride almost at the bottom of the groove. If the groove bottom were radiused to any extent it would in fact appear to touch all round, underneath the stylus.

Stylus in Orbit

If you will now refer to the diagrams on page 11, you will be able to observe the various stylus motions which occur during the tracing of a record. These motions may be split up into individual movements—half left; full left; full right; half right; plus maximum and minimum depth (vertical movement), and their movements, in practice, are changing with each fraction of a second.

One of the chief disadvantages in using smaller styli is the foreign matter which collects in the groove. This becomes much larger in proportion and I would now like to discuss the problem it creates. Dust is always in the atmosphere, and only when the particles are large can we see them; and even without the assistance of static attraction which most l.p. records possess, a lot must fall on the record surface and collect in the groove. With a small stylus there is little or no room

for it to pass underneath, so it has either to be collected in a little clump, or bounced over by the stylus, which causes annoying extraneous noise, and distortion.

Airborne, cellular fragments are usually too large actually to get into the groove, and they mainly lie on the surface until they are pushed aside or collect round the stylus. At this magnification of the model they would look like telegraph poles, or large trees; and they can and do often form a bunch large enough to obstruct the movements of miniature pickups.

The most harmful form of dust is formed of mineral or crystalline particles which become broken down to provide a rough gritty path for the stylus. Many of these particles are sharp enough to become embedded in the groove material and it is very difficult indeed to remove them. Washing is not always a good thing—in fact the impurities in water can leave a precipitation in the groove which is often worse than the original condition.

Broddingnagian Droplets

At this scale, a drop of water on the record would be deep enough to swim in, and the precipitation from it, when dried, would approximate to a liberal sprinkling of sand or granulated sugar. The smaller the stylus employed the greater is this nuisance, as it destroys all chance of obtaining a silent background. There are now several record cleaning cloths, tissues and accessories available to us. Indeed over the past five years much of my time has been occupied with the problems. I still think the most difficult task is to get the *users* of these accessories to employ them to their best advantage.

What do we mean by "Damp"

Let us first consider the use of a damp cloth. For a normal person using an average quality record-player this is all that may be deemed necessary. If an attempt was made to use a dry cloth, as fast as the dust was wiped off one side, a strong static charge would be generated, and the dust would cling all the tighter to the other. Slightly damping the cloth with water provides a temporary leakage path for any static charge, and the dust usually collects on the cloth. If the cloth is used too often, there will come a time when the accumulated dust is just being transferred from one record to the next.

The degree of dampness is very important. It is surprising how very differently some instructions are interpreted, even by intelligent people. I often receive specimens of records which are claimed to have been cleaned only with a barely damp cloth *on which there are large areas of dried mud*. Of course the background noise will be high. The free moisture has spread into the groove, especially where it has been wiped straight across, and it has left a gritty residue in the path of the stylus.

Impregnated Cloths

Any free fluid applied to a record is usually harmful. Record manufacturers supply impregnated cloths and tissues for those who desire something more efficient than the scarcely damp cloth. Decca supply an impregnated cloth. There is the *Ermitec* Tissue, also the Phillips *Discleaner*, which is another impregnated cloth.

The subject of dust behaviour in static conditions is a very involved one, and most confusing. There is no short explanation for the fact that, under a stated static condition, some dust is attracted and some repelled.

Cationics and Anionics

The various agents used for impregnating record cleaning materials have known characteristics. Some are Cationic by nature and some Anionic—meaning that applied friction will induce either a positive or a negative charge in them. It is also known that static is akin to magnetism, in that opposite charges attract each other, while like potentials, repel. These agents all evaporate very slowly, if at all, and remain stable for long periods. Water of course is a good conductor and incapable of holding a static charge. It behaves as a temporary leak to any charged surface, rather like shorting the terminals of the millions of tiny accumulators—the molecules holding the charge. Some antistatic agents have the property of attracting and absorbing moisture to form a similar leakage path. I hope this rather poor description will give a slight understanding of the purpose of the different antistatic agents employed, each of which has some advantage.

As regards their application I confess I am still unable to hold a record while

using these cloths, without leaving finger-marks on the record; so while the turntable manufacturer might not agree, I find it easier to treat a record while it rotates on the turntable, assisting its rotation if necessary with a finger on the label. This method I find also permits an even application. Except perhaps for the Phillips Discleaner which should only be used very occasionally, it is safe to use either the Emitex tissue or the Decca cloth quite frequently without producing an excess accumulation of the agent on the record surface. The Phillips Discleaner in my opinion is over-generously impregnated with an extremely efficient antistatic agent which *can* become greasy on the record if used to excess.

Cloths versus Bristles

Unfortunately, a cloth or tissue is unable to penetrate very far into the groove; and in an effort to ensure the complete removal of all dust from the groove I developed the accessory which I dubbed the "Dust Bug". It was used at first to clean the groove during examination under the microscope, but it was so efficient for this purpose that it was produced for general use. It has a small tuft of nylon bristles shaped at their tips to penetrate to the bottom of the groove, and to rake out any dust, while the record is played. A plush pad is incorporated, which collects the dust, and which is maintained at a lower electrical potential by being slightly moistened with a dilute solution of Ethylene Glycol in distilled water. Any static in the record is discharged by this the instant before the brush contacts the dust.

It is *not* intended that any of the fluid

should be transferred to the record surface, although kind friends have stated that the Ethylene Glycol lubricates the record; and because of this I believe many users apply excess fluid to the plush pad in an attempt to obtain this result. A little thought should bring the realisation that the outside edge of the record will receive this excess fluid, while the centre will get none; and the practice rather defeats the original design. The "Dust Bug" should *not* be considered as an antistatic applicator.

Once it was realised that a method had been found to clean the groove with certainty the "Parastat" became a natural development to treat records more rapidly. It also became possible to provide a controlled microfilm of an efficient antistatic combined with dry lubricant which left no visible trace on the record surface.

The Disc Material

Let us next consider the material of which the record is composed. It is flexible and relatively soft. It is easily marked. Under the microscope I can, for instance, *observe every spot where any pickup has been placed on it*. Physicists have taken much trouble to measure the depression caused by the stylus. Using a one thou radius indenter with a downward pressure of 10 grammes, the indentation measures just short of half a thou. While if the pressure is reduced to one gram it is just half this amount—let us say 5 microns. Any pressure above two grammes we are told stresses the record material beyond its elastic limit and the surface is permanently deformed.

Statements of this kind could easily frighten us until a little thought shows

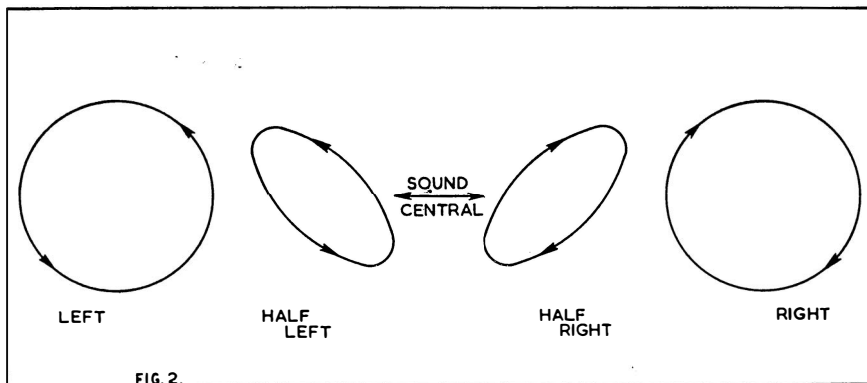

FIG. 2.

These drawings show the orbital paths followed by a stylus when tracing a groove.

that these figures are taken while the record is stationary—rather like measuring the depression of a water skier standing stationary on the water. The force required for his support on the surface is not there until he is in motion. The measurements do show, however, that the record material yields under pressure and indicates the elastic limit.

The Facts

Consider the real case. The groove is always in motion, passing under the stylus. My observations show that on an unmodulated groove the normal domestic record player having a $\frac{3}{4}$ thou stylus with a downward pressure of 5 grammes can trace the groove with little permanent deformation, even after many playings; but wherever the groove is modulated extra force is required to move the stylus, and at each change in direction the groove wall is indented until there is sufficient supporting area in contact with the stylus to provide the force to move it.

It is only when the resistance of the stylus to movement exceeds the strength of the record material that the result is as shown in the photomicrograph, which indicates the further reduction of the mass and stiffness of pickup movements being desirable, rather than still smaller styli with less downward pressure. With the best equipment today, the groove distortion is reduced to very small proportions indeed, and only the most violent accelerations may cause sufficient deformation of the groove to be recognised audibly. Stereo, however, still requires a much more exact equalisation of the forces at present applied to the stylus. We have seen that it is required to execute an orbital motion in translating the stereo information. We also know that the record material is, within limits, elastic.

Uneven forces distort

It is clear, then, that even though the musical quality of the sound may be unaffected, any uneven force causing more pressure on one wall than the other will result in a false orbital path, and will also disturb the complimentary amplitudes of the waveforms of the two channels, as well as a false interpretation of their phase relationships. *It is unfortunate that such an uneven force is produced from all pickup arms in use today.*

Consider the friction between the stylus

and groove which produces a force pulling the stylus in a forward direction. In the old days of the wax cylinder record, the stylus was transported over the record by a separate lead screw driven by the motor. It was only the introduction of the more robust shellac disc which permitted the record *groove* to perform this function. It was very convenient for the acoustic tone arm to follow suit and, later, pivoted pickup arms became the accepted method.

Pickup Overhang

More recently the inherent tracing distortion of the method has been reduced by cunningly overhanging the pickup, and it is this which in most cases now produces an inward pull resulting in the left hand or inside wall of the groove receiving the greater pressure. To demonstrate this we must consider the pickup arm as a piece of string connecting the arm pivot to the stylus itself. There is only one position for the string where the stylus can exert an even pressure on both walls of the groove—that is when it is at right angles to a radial line drawn from the record centre to the stylus. If the stylus overhangs this line, then it pulls inwards; or if the stylus is behind, then it pulls outwards. In the effort to reduce tracing distortion to a minimum, pickup arms today produce a strong inward pull.

We cannot yet hear it all

It is not difficult to appreciate that with one wall of the groove supporting a greater proportion of the downward pressure, the other wall supports less; and the unbalanced indentation of the groove walls is often appreciably more than the difference in amplitude between the separately recorded channels.

It is certain that at the moment we are only able to reproduce a small percentage of the stereo information recorded in a record groove.

Finally there is some speculation that the size of groove and stylus will become smaller still; but this can only happen when and if the use of the half thou stylus becomes general. If the progress in pickup design ever permits this to happen, then the idea would be most attractive; for with a groove half the present size we could look forward to up to an hour's performance from each side of a 12 inch record with no other change of equipment.

Cecil Watts

DIRECTORY OF PICKUPS AND ARMS

★ In the abridged specifications of this directory, the following abbreviations are used for economy of space: **S.p.**—stylus pressure recommended by manufacturer; **Cms**—centimetres per second; ■ denotes stereo equipment.

Bang & Olufsen, Struer, Denmark. Sole U.K. importers: Aveley Electric Ltd., Ayrton Road, South Ockendon, Essex. Tel.: South Ockendon 3444.

Orthophonic balanced 8-pole variable reluctance pickup. Available as single stylus or dual stylus. Sapphire or diamond. Output voltage 1.p. 100 mV; 78 200 mV. Range 20-16,000 c/s. S.p. 1.p. 5-7 gm.; 78 9-12 gm. Load imp. 10-100 K. Price from £1 (U.K. purchase tax 6s. 11d.) single sapphire to £3 8s. 2d. (£1 2s. 8d.) dual diamond.

■ **Stereodyne 11** stereo magnetic pickup. Stylus 0.7 thou diamond. Output voltage 7 mV per channel at 5 cm/sec. Channel separation > 22 dB. Range 30-15,000 c/s ± 2 dB. S.p. 2-4 gm. Rec. load 47,000 ohms or higher. Price £7 7s.

■ **ST/L Arm and moving iron** stereo pickup complete. Diamond stylus 0.7 thou. Load imp. 47,000 ohms per channel. Output voltage 1.4 mV per channel. Range 30-15,000 c/s ± 2 dB. S.p. 3 gm. Price £13 7s. 9d. (U.K. purchase tax £4 9s. 3d.)

Burne-Jones & Company Ltd., 18 Brunswick Road, Sutton, Surrey. Tel.. Vigilant 5050. Cables: Burjomag, Sutton.

■ **B.J. Stereo Cartridge**. Non-magnetic. Diamond stylus approx. ½ thou. Output voltage 200 mV. Range 30-12,000 c/s. S.p. 4-7 gm. Load imp. 2 Megohms. Price £3 0s. 0d. (U.K. purchase tax 19s. 3d.)

■ **B.J.-ELAC210**. Magnetic stereo cartridge. Diamond stylus 0.5-0.7 thou. Output voltage 20 mV for 10 cm/sec. Range 30-15,000 c/s +6 -3 dB. S.p. 4-6 gm. Load imp. 1,500 ohms. Price £13 3s. 9d. (U.K. purchase tax £4 4s. 8d.)

■ **B.J.-ELAC310**. Magnetic stereo cartridge. Diamond stylus 0.5-0.6 thou. Output voltage 15 mV for 10 cm/sec. Crosstalk better than 25 dB at 1,000 c/s, and 14 dB at 15 Kc/s. Range 30-15,000 c/s ± 2 dB. S.p. 3-6 gm. Load imp. 1,500 ohms. Price £16 12s. 6d. (U.K. purchase tax £5 6s. 8d.)

■ **B.J. Tan/11 arm**. Designed to overcome "tracking error". Total tracking error less than 1 degree. Height adjustable. Price £3 3s. (U.K. purchase tax £1 0s. 3d.)

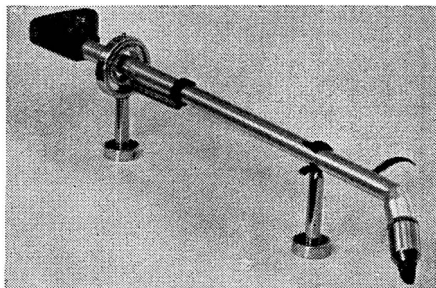

B. & O. ST/L arm and Stereodyne pickup

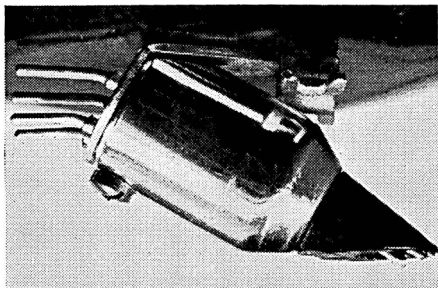

B. & O. Stereodyne moving iron pickup

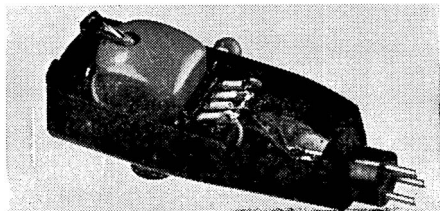

B.J.-Elac 310 Stereo

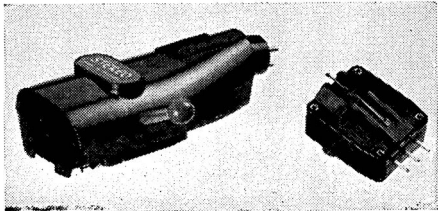

B.J. Head and Stereo cartridge

B.J. Super 90 Mk II pickup arm. Two models. 12 in. and 16 in. Price (including two plug-in-shells to carry standard cartridges) Super 90/12 in. £11 11s. (U.K. purchase tax £3 14s. 2d.); Super 90/16 in. £12 5s. (U.K. purchase tax £3 18s. 8d.)

B.J. plug-in shell for holding cartridges. Price 17s. 3d. (U.K. purchase tax 5s. 9d.)



Collaro Ltd., Ripple Works, By-pass Road, Barking, Essex. Tel.: Rippleway 5533. Cables: Korllaro. Telex: Barking 28748.

Studio O. Turnover crystal cartridge. Output voltage 200 mV. Range 50-10,000 c/s \pm 5 dB. S.p. 8 gm. Price with two sapphire styli £1 10s. (U.K. purchase tax 9s. 9d.)

Studio TX88. Turnover crystal cartridge. Output voltage 1p. 125 mV/cm/sec. at 1Kc/s. Range 30-18,000 c/s. Load imp. 1 megohm. Price with two sapphire styli £1 15s. (U.K. purchase tax 11s. 8d.)

■ **"Studio" Stereophonic "Type C".** Turnover ceramic cartridge. Output voltage 50 mV. Price £2 5s. (U.K. purchase tax 14s. 8d.)

■ **Studio stereophonic Type R.** Turnover crystal cartridge. Output voltage 250 mV per channel \pm 10 dB. S.p. 6 gm. Price including two sapphire styli £3 (U.K. purchase tax 19s. 6d.)

Studio transcription arm to play up to 16-in. records, suitable for turnover type cartridge. Price complete with "Transcription" cartridge £3 17s. 6d. (U.K. purchase tax £1 5s. 10d.)



Collel Ltd., All Saints Passage, Wandsworth High Street, London, S.W.18. Tel.: Vandyke 4377. Cables: Elcoll, London.

■ **Collel S.C.1.** stereo ceramic turnover cartridge, sapphire or diamond stylus. Output voltage 120 mV. Range 20-20,000 c/s. S.p. 3-4 gm. Load imp. 1 Megohm. Price, with 2 sapphires, £2 8s. 9d. (U.K. purchase tax 15s. 8d.); sapphire and diamond £3 1s. 9d. (U.K. purchase tax £1 0s. 1d.)

■ **Collel S.K.1.** stereo crystal turnover cartridge. Sapphire or diamond stylus.

Output voltage 140 mv. Range 20-20,000 c/s. S.p. 4-6 gm. Load imp. 1 Megohm. Price, with two sapphires £1 15s. (U.K. purchase tax 11s. 5d.); one sapphire and one diamond £2 10s. 6d. (U.K. purchase tax 16s. 5d.)



Cosmocord Ltd., Eleanor Cross Road, Waltham Cross, Herts. Tel.: Waltham Cross 5206. Cables: Cosmocord, Waltham Cross.

Acos "The Black Shadow." Complete arm and slide-on l.p. head. Output voltage 1p. 30 mV/cm/sec. Range 40-16,000 c/s \pm 3 dB. S.p. 4-6 gm. Load imp. 100K ohms or higher. Diamond stylus fitted. Price complete £4 17s. 2d. (U.K. purchase tax £1 17s. 6d.). 78 heads available.

Acos GP67-1. Turnover crystal cartridge. Output voltage 200 mV. Load imp. 2 Megohms. Range 30-14,000 c/s. S.p. 5-7 gm. Price 18s. (U.K. purchase tax 5s. 9d.)

■ **Acostereo 71-5.** L.p. only. $\frac{1}{2}$ thou. stylus. Output voltage 140 mV. Load imp. 2 Megohms. Range 40-12,000 c/s. S.p. 3-4 gm. Price with diamond £2 (U.K. purchase tax 12s. 10d.)

■ **Acostereo 73-2.** Turnover crystal stereo/standard. Output voltage 1p. 150 mV. Load imp. 2 Megohms. Range 40-12,000 c/s. S.p. 3-4 gm. Price with sapphire £2 (U.K. purchase tax 12s 10d.), diamond £3 7s. (U.K. purchase tax £1 1s. 6d.)

■ **Acostereo 81-2.** Turnover ceramic cartridge. Output voltage 110 mV. Load imp. 2 Megohms. Range 30-12,000 c/s \pm 4 dB. S.p. 4-6 gm. Price £2 (U.K. purchase tax 12s. 10d.)

■ **Acopoise.** Pickup arm suitable for stereo cartridges. Recommended playing weight 4 gm. Price £1 18s. 6d. (U.K. purchase tax 12s.)

■ **Acos Hi-Light.** Ultra-lightweight adjustable arm for stereo and mono. Plug-in heads. Sapphire styli 0.5 thou. Load imp. 2 Megohms. Output voltage 16 mV. (mono), 30 mV (stereo). Range 20-20,000 c/s \pm 3 dB. S.p. 1 gm. (mono), 2 gm. (stereo). Price with both heads £14 6s. 2d. (U.K. purchase tax £4 1s. 10d.)

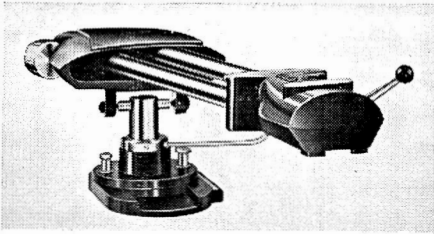

B.J. Super 90 arm

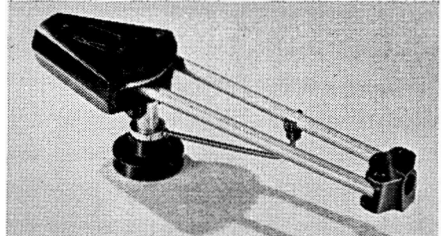

B.J. TAN/II arm

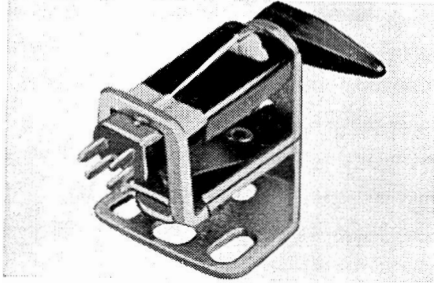

Collaro Stereo Type C

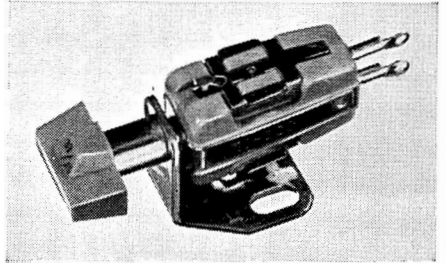

Collaro TX88 cartridge

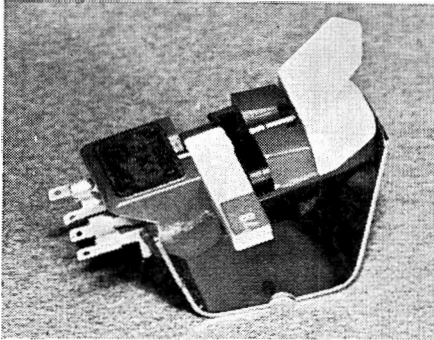

Colel SK1 Stereo crystal

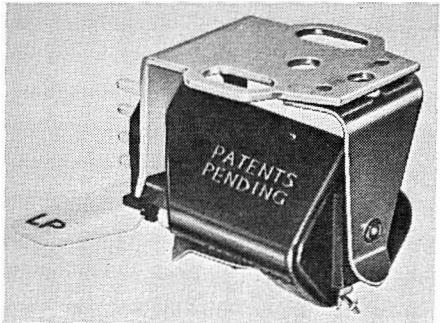

Acostereo 73-2

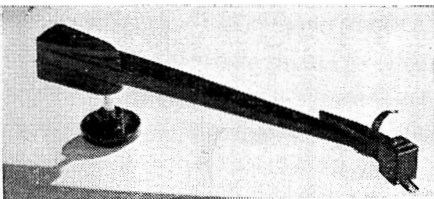

Acos "Black Shadow"

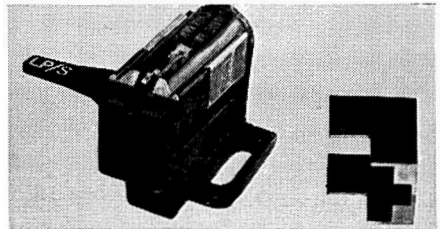

Acostereo 81-2

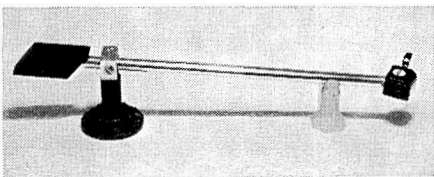

Decca fss Stereo pickup

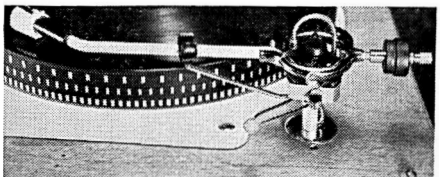

Acos Hi-Light pickup arm

Decca Radio & Television, Ingate Place, Queenstown Road, London, S.W.8. Tel.: Macaulay 6677.

■ **Decca ffs.** Magnetic stereo pickup with slide on head. Diamond 0.5 thou stylus. Output 1.4 mV/cm/sec. r.m.s. per channel stereo 1 mV/cm/sec. mono. Response within ± 1 dB of R.I.A.A. characteristic. S.p. 3.5 gm. Load imp. 50,000 ohms. Price £15 18s. (U.K. purchase tax £5 2s.)

Also available: other heads, with 1 thou diamond for mono L.P.'s; with 2.8 thou diamond for 78's. Price (each) £8 5s. 9d. (U.K. purchase tax £2 13s. 3d.)

★

Electronic Reproducers Ltd., Porters Wood, Valley Road, St. Albans, Herts. Tel.: St. Albans 50555. Cables: Saphobear, St. Albans.

■ **E.R.60.** Stereo ceramic cartridge. Turnover. Output voltage 140 mV. Range 40-12,000 c/s. S.p. 5.6 gm. Load imp. 1 Megohm. Price £1 15s. 3d. with sapphire. (U.K. purchase tax 11s. 4d.). Diamond stylus available.

★

Expert Pickups Ltd., 54, Chepstow Road, London, W.2. Tel.: Bayswater 7959.

Pickup and arm. Hard steel-pointed pivots for vertical and horizontal movements. Adjustments for tracking and stylus pressure. Moving coil pickup head. Also sold as separate plug-in head. Diamond styli for l.p. and 78, also thorn for 78. Output voltages l.p. 60 mV; 78, 80 mV (both at transformer secondary). Range 30-20,000 c/s ± 1 dB (diamond stylus). S.p. adjustable down to 3 gm. Load imp. 10 ohms (pickup only), transformer secondary imp. 250,000 ohms. Price, complete with diamond, £11 5s. (U.K. purchase tax £3 15s. 10d.); thorn £9 2s. (U.K. purchase tax £3 1s. 4d.); transformer £4 8s. Head supplied separately.

★

The Garrard Engineering & Manufacturing Co. Ltd., Newcastle Street, Swindon, Wilts. Tel.: Swindon 5381. Cables: Garrard, Swindon. Telex: 44-271.

G.M.C.5. turnover moving coil cartridge. Separate coils attached to each stylus. Fitted with diamond l.p. and sapphire 78 styli. Output voltages with TP.1 transformer l.p. 0.008v; 78 0.03v. Range 20-16,000 c/s. S.p. 5 gm. Load imp. 0.5

Megohm min. across transformer. Price, inc. transformer, £6 17s. (U.K. purchase tax £2 4s. 6d.)

TPA.12 Transcription pickup arm with plug-in moulding to take almost all makes of cartridge. Price £3 7s. 6d. (U.K. purchase tax £1 2s.)

★

Goldring Manufacturing Co. (Great Britain) Ltd., 486/488 High Road, Leytonstone, E.11. Tel.: Leytonstone 8343. Cables: Echovox, London.

■ **MX1/D** Turnover crystal cartridge fitted with diamond l.p. and sapphire 78 styli. Output voltage 500 mV. Range 30-16,000 c/s. S.p. 5.7 gm. Load imp. 1 Megohm. Price £1 17s. 6d. (U.K. purchase tax 12s. 2d.)

■ **SX10/D** stereo turnover cartridge. Fitted with diamond l.p. and sapphire 78 styli. Output voltage 150 mV. Range 30-14,000 c/s. Load imp. 1 Megohm. S.p. 4 gm. Price £2 5s. (U.K. purchase tax 14s. 8d.)

"600." Variable reluctance turnover cartridge $\frac{1}{2}$ in. centre, mounting holes. Diamond stylus for l.p. sapphire for 78. Output voltage 3.2 mV/cm/sec. Range 20-21,000 c/s ± 2 dB. S.p. 7 gm. Load imp. 68,000 ohms. Price £8 8s. (U.K. purchase tax £2 14s. 7d.)

"580." Variable reluctance turnover cartridge. Diamond stylus for l.p. sapphire for 78. Output voltage 3.2 mV. Range 20-18,000 c/s. S.p. 6-7 gm. Load imp. 68,000 ohms. Price £4 4s. (U.K. purchase tax £1 7s. 4d.)

■ "700." Magnetic cartridge for stereo. Diamond stylus $\frac{1}{2}$ thou. Output voltage 1 mV. Range 30-12 Kc/s. S.p. 4 gm. Load imp. 50,000 ohms per channel. Price £7 7s. (U.K. purchase tax £2 7s. 9d.)

■ **G60.** Transcription arm wired for stereo. Incorporates new slide-in head that will accommodate most cartridges. Height adjustable and S.p. variable from 2 gm. upwards. Price £3 (U.K. purchase tax 19s. 6d.)

★

H. J. Leak & Co. Ltd., 57/59 Brunel Road, East Acton, London, W.3. Tel.: Shepherds Bush 1173. Cables: Sinusoidal, Ealux, London.

Dynamic pickup Mk. II. Moving coil, interchangeable heads, both with diamond

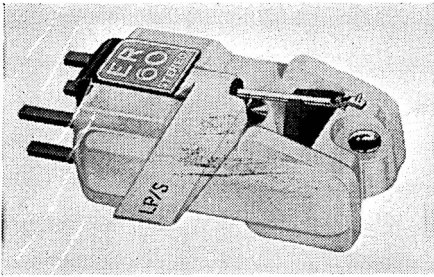

E.R.60 Ceramic Stereo cartridge

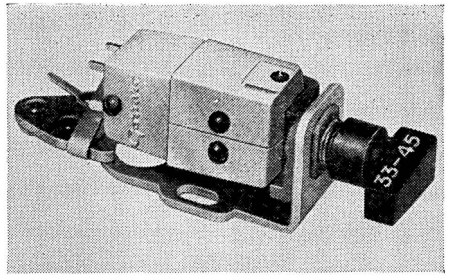

Garrard G.M.C.5 cartridge

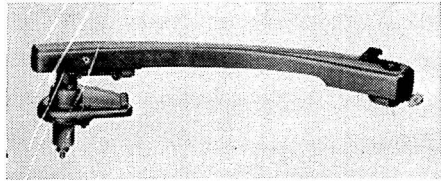

Garrard "TPA 12" pickup arm

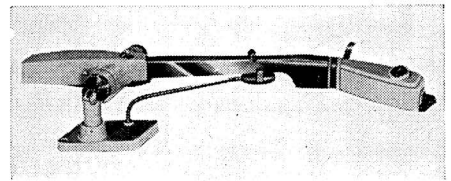

Goldring G60 pickup arm

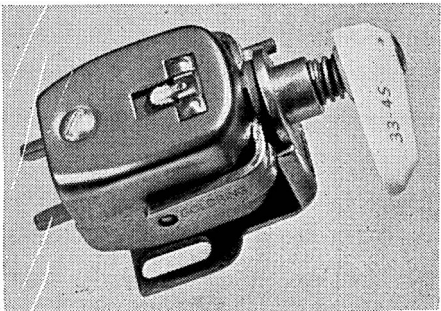

Goldring "600" cartridge

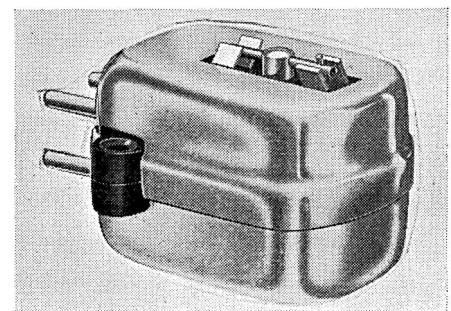

Goldring "700" Stereo cartridge

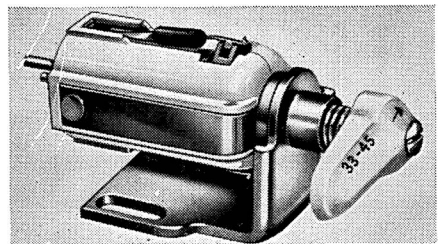

Goldring SX10 Stereo crystal

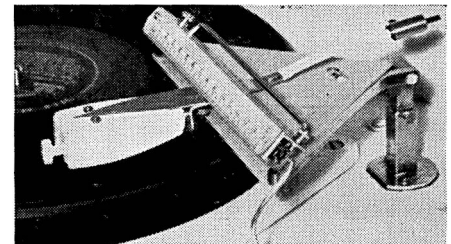

Mackie "Delta" arm

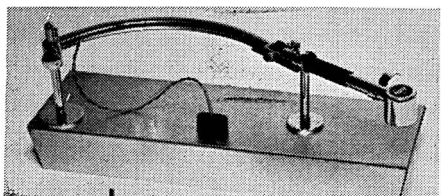

Expert moving coil pickup and arm

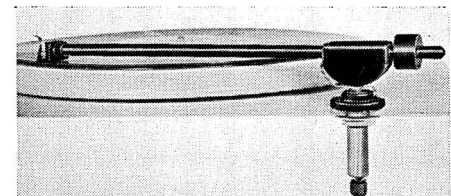

Leak Dynamic arm and head

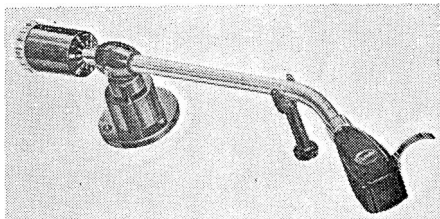

Ortofon SSM 212 pickup arm

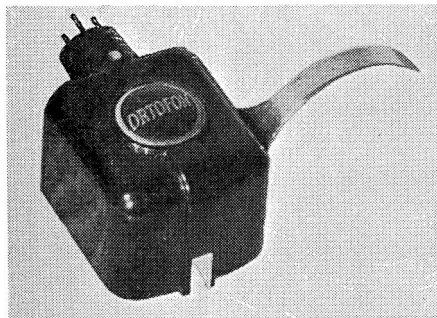

Ortofon Type C mono head

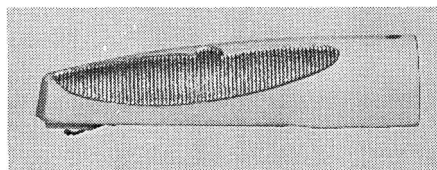

Philips AG3025 crystal pickup

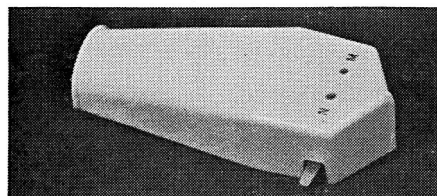

Philips AG3301 stereo crystal pickup

stylus. Output voltages l.p. and 78, 8 mV (at transformer secondary). Range 40-20,000 c/s \pm 1 dB. S.p. l.p. 3 gm, 78, 5 gm. Load imp. 50,000-100,000 ohms. Price, with two heads, £16 (U.K. purchase tax £5 19s. 9d.)



The Long Playing Record Library Ltd., Squires Gate, Station Approach, Blackpool.

Mackie "Delta" parallel tracking arm. Designed to eliminate tracking error. Side pressure less than 0.1 gm. Groove cueing scale and pickup lowering device. Total

moving mass 35-40 gm. depending on cartridge used. Takes all standard cartridges and Decca ffs to special order. Height above turntable 3 in. Price £14 14s.



The Lowther Manufacturing Co., Lowther House, St. Mark's Road, Bromley, Kent. Tel.: Ravensbourne 5225. Cables: Lowther, Bromley.

L.P. pickup. Moving coil fixed head. Output voltage 10 mV. Range 20-20,000 c/s \pm 2 dB. S.p. 4-6 gm. Imp. 25 ohms. Price, with sapphire stylus, £5 10s. (U.K. purchase tax £2 3s. 10d); with diamond stylus £12 10s. (U.K. purchase tax £4 19s. 9d.)

78 pickup. Moving coil fixed head. Output voltage 18 mV. Range 20-20,000 c/s \pm 2 dB. S.p. 6 gm. Imp. 25 ohms. Price, same as for L.P.



Ortofon, Fonofilm Industri A/S. Copenhagen. Distributed in the U.K. by Technical Suppliers Ltd., Hudson House, 63 Goldhawk Road, London, W.12. Tel.: Shepherd's Bush 2581. Cables: Teknika, London.

Type A. Moving coil. Exchangeable head with vertical coils. Diamond stylus. Output voltage l.p. 0.5 mV/cm/sec. Range 20-20,000 c/s \pm 2 dB. S.p. 5-6 gm. Load imp. 2 ohms (transformer required). Price £7 5s. (U.K. purchase tax £2 8s. 11d.)

Type C. Moving coil as above. Diamond stylus. Output voltage l.p. 0.3 mV/cm/sec. Range linear 20-20,000 c/s. S.p. 3.5 gm. Load imp. 2 ohms (transformer required). Price £13 (U.K. purchase tax £4 7s. 8d.)

Transformer for use with above pickups. Price £2 7s. 6d.

■ **Type SCG.** Magnetic stereo pickup. Diamond stylus approx 0.7 thou. Output voltage 0.5 mV. Range 20-20,000 c/s. S.p. 3-5 gm. Load imp. 2.5 ohms. Price £18 (U.K. purchase tax £6 1s. 3d.)

SK 212. Pickup arm with adjustable playing weight. Price £4 15s. (U.K. purchase tax £1 12s.)

■ **SSM 212.** Pickup arm for stereo cartridges. Playing weight adjustable from 0 to 12 gm. Price £10 (U.K. purchase tax £3 7s. 4d.)

Philips Electrical Limited, Century House, Shaftesbury Avenue, W.C.2. Tel.: Gerrard 7777. Cables: Phillamps.

AG.3016. Crystal head fitted with sapphire stylus. Output voltage 100 mV. Range 30-15,000 c/s. S.p. 7-10 gm. Load imp. 470,000 ohms. Price 15s. 11d. (U.K. purchase tax 5s 1d.)

■ **AG.3401.** Stereo crystal head with diamond stylus. Output voltage 2 mV per channel. Range 20-18,000 c/s. S.p. 3-5 gm. Load imp. 68,000 ohms. Price £7 3s. 1d. (U.K. purchase tax £2 5s. 11d.)

AG.3025. Crystal head fitted with diamond stylus. Output voltage approx. 0.5v. Load imp. 470,000 ohms. Price £3 0s. 6d. (U.K. purchase tax 19s. 6d.)

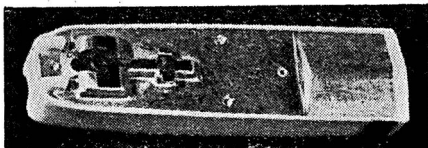

Philips AG.3060 stereo cartridge

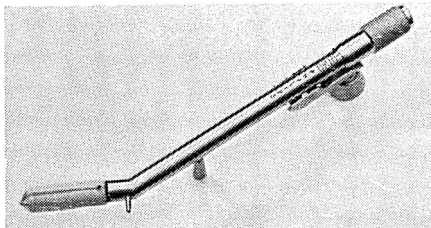

Philips NG.5400/S

NG.5400. Magnetodynamic. Arm and moving magnet l.p. head fitted with diamond stylus. Output voltage approx. 25 mV. Range substantially linear 20-20,000 c/s. S.p. 0-10 gm. Load imp. 68,000-100,000 ohms. Price complete £14 6s. 2d. (U.K. purchase tax £4 11s. 10d.)

■ **AG.3301.** Crystal stereo pickup cartridge with turnover head. Sapphire styli. Output voltage 120 mV per channel. Load imp. 470,000 ohms per channel. Price £1 6s. 6d. (U.K. purchase tax 8s. 6d.)

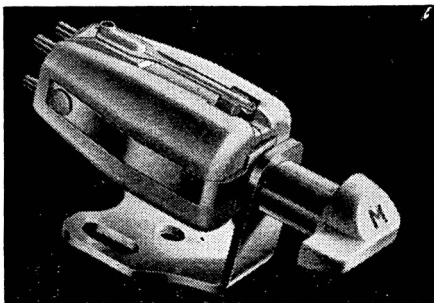

Schumann-Merula Stereo cartridge

■ **AG.3060.** Crystal stereo pickup. Diamond stylus. Output voltage 120 mV per channel. S.p. 4-6 gm. Load imp. 470,000 ohms per channel. Price £3 3s. 7d. (U.K. purchase tax £1 0s. 5d.). Sapphire AG.3063 version also available.

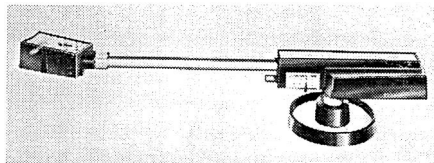

Shure M.232 pickup arm

■ **NG.5400/S.** Transcription arm fitted with crystal stereo pickup (Type AG.3060). Micrometer adjustment of playing weight and height variable. Diamond stylus. Output voltage 0.5v per channel. Range 30-12,000 c/s. S.p. 4-6 gm. Load imp. $\frac{1}{2}$ Megohm per channel. Price £11 18s. 6d. (U.K. purchase tax £3 16s. 6d.)



F. & H. Schumann, GmbH. Sole U.K. importers: G. A. Stanley Palmer Ltd., Maxwell House, Arundel Street, London, W.C.2. Tel.: Temple Bar 3721/3.

A range of crystal pickups, including the Schumann-Merula stereo cartridge type STK490 and the ceramic stereo cartridge Type STC493.

Shure Brothers Inc. U.K. distributors: J. W. Maunder, 22 Orchard Street, London, W.12. Tel.: Hunter 4116.

■ **M7D custom stereo dynetic cartridge.** Moving magnet. Diamond stylus 0.7 thou. Load imp. 47,000 ohms. Output voltage 5 mV. Range 20-15,000 c/s. S.p. 5 gm. Price £9 10s. (U.K. purchase tax £3 4s.)

■ **M3D professional stereo dynetic cartridge.** Moving magnet. Diamond stylus 0.7 thou. Load imp. 47,000 ohms. Output voltage 5 mV. Range 20-15,000 c/s \pm 3 dB. S.p. 3-4 gm. Price £18 (U.K. purchase tax £6 1s. 4d.)

■ **M212 studio stereo dynetic pickup.** Complete unit with moving magnet head.

Diamond stylus 0.7 thou. Load imp. 47,000 ohms. Output voltage 4.5 mV. Range 20-20,000 c/s \pm 2.5 dB. S.p. 1.5-2.5 gm. Price £36 (U.K. purchase tax £12 2s. 7d.)

M232 and **M236** Precision Tone Arms. Suitable for monaural and stereo heads. S.p. 0-8 gm. Price M232 (12 in.) £13 (U.K. purchase tax £4 7s. 7d.), M236 (16 in.) £14 (U.K. purchase tax £4 14s. 4d.)



S.M.E. Ltd., Steyning, Sussex. Tel.: Steyning 2228.

3009 precision pickup arm. Suitable for stereo or mono cartridges. Height and playing weight adjustable. Tone arm length (pivot to stylus) 9 ins. Foolproof arm lowering device. Four conductors plus screen. Price £18 15s. (U.K. purchase tax £6 5s.)

3012 precision pickup arm. Details as above. Tone arm length 12 in. Price £20 12s. 6d. (U.K. purchase tax £6 17s. 6d.)



A. R. Sugden & Co. (Engineering) Ltd., Market Street, Brighouse, Yorkshire. Tel.: Brighouse 2142. Cables: Connoisseur, Brighouse.

Connoisseur Super Lightweight Pickup Mk. III. Suitable for monaural and stereo heads. Height adjustable. Heads available: Mk. II monaural, magnetic, with choice of 1, 2.8, 3.5 thou. stylus; stereo ceramic with 0.5 thou. diamond stylus. Price arm only £3 (U.K. purchase tax 19s. 11d.)

Connoisseur stereophonic Pickup Arm CS1. Also suitable for monaural heads. Height adjustable. Pickup lifting device fitted. Price arm only £3 15s. (U.K. purchase tax £1 4s. 11d.), complete with stereo head £9 15s. (U.K. purchase tax £3 4s. 10d.)

Connoisseur Stereo Head. Ceramic cantilever system. Diamond stylus 0.0005/6 ins. radius. Output voltage 20 mV. Load imp. 50,000 ohms. Range 20-16,000 c/s \pm 2 dB. Channel separation 20/25 dB. S.p. 3½-4 gm. Price £6 (U.K. purchase tax £1 19s. 11d.) Prices of Mark II heads available. Mark II L.P. Diamond £6 10s. (U.K. purchase tax £2 3s. 3d.) Mark II Std. or L.P. Sapphire £3 10s. (U.K. purchase tax £1 3s. 3d.)

Tannoy Products Ltd., West Norwood, London, S.E.27. Tel.: Gipsy Hill 1131. Cables: Tannoy, London.

Variluctance turnover cartridge. Output voltages: l.p. 10-12 mV; 78, 18-20 mV. Range 20-16,000 c/s \pm 2 dB. S.p. 5-6 gm. Load imp. 50,000 ohms. Price, with 2 diamonds £12 (U.K. purchase tax £4 17s.); with 1 diamond and 1 sapphire £9 10s. (U.K. purchase tax £3 16s.); with 2 sapphires £7 (U.K. purchase tax £2 16s. 7d.)

Single stylus version of Variluctance for l.p. also available. Price with diamond £6 15s. (U.K. purchase tax £2 14s. 7d.)

Vari-twin Mk. II. Magnetic stereo cartridge. Balance 4-pole system. Diamond stylus 0.5 thou. Output voltage 7 mV per channel. Range 30-15,000 c/s \pm 1.5 dB. S.p. 4 gm. Load imp. 100,000 ohms. Inductance 350 mH. Price £9 19s. (U.K. purchase tax £3 7s.)



Trianon Electric Ltd., 3 Violet Hill, London, N.W.8. Tel.: Maida Vale 2255.

The All Balanced Pickup Arm 2400. Suitable for stereo or mono cartridges. Tone arm length 9 ins. Interchangeable heads. Price £10 (U.K. purchase tax £3 4s.)

Reuter St.D.1. Crystal turnover stereo cartridge sapphire stylus. Range 30-13,000 c/s \pm 3 dB. S.p. 3-5 gm. Load imp. 1 Megohm. Price £1 19s. 8d. (including tax.)

Reuter St.D.2. Crystal turnover stereo cartridge. Sapphire stylus. Range 30-16,000 c/s \pm 3 dB. S.p. 3-4 gm. Load imp. 1 Megohm. Price £1 19s. 8d. (including tax.)

Reuter St.D.3. Crystal stereo cartridge. Sapphire stylus. Range 30-13,000 c/s \pm 3 dB. S.p. 3-5 gm. Load imp. 1 Megohm. Price £1 19s. 8d. (including tax.)



Worden Audio Developments Ltd., 54 Chepstow Road, London, W.2. Tel.: Bayswater 4996.

Worden Articulated pickup arm. Radially operated single arm with articulated head piece. Tracking correct to \pm ¼%. Moveable counterbalance for weight adjustment. Suitable for stereo and mono heads with adaptors for Decca ffs, and Expert. Price complete with one shell £12 12s., including tax. Extra shells 18s.

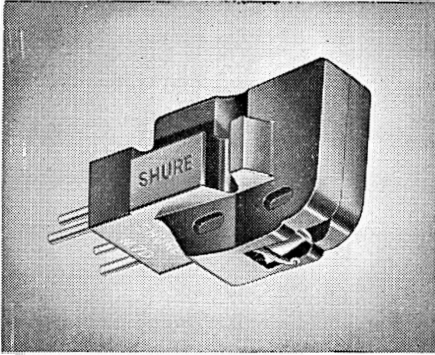

Shure M3D Dynetic cartridge

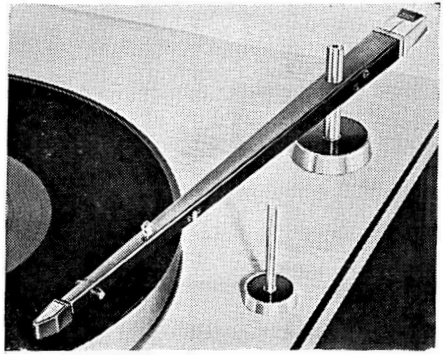

Shure M212 Stereo Dynetic pickup

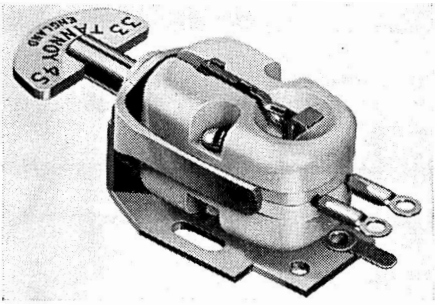

Tannoy Varilutance cartridge

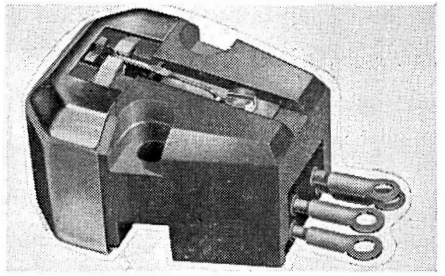

Tannoy Vari-Twin Mk. II

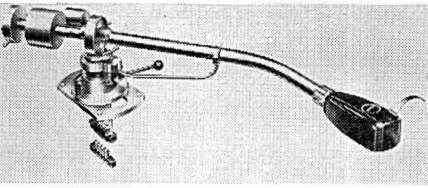

S.M.E. 3009 pickup arm

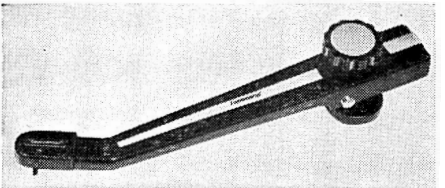

Connoisseur Stereo CS1

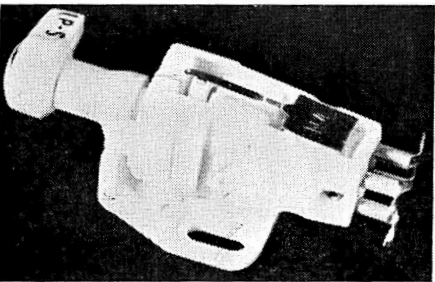

Reuter St.D.1

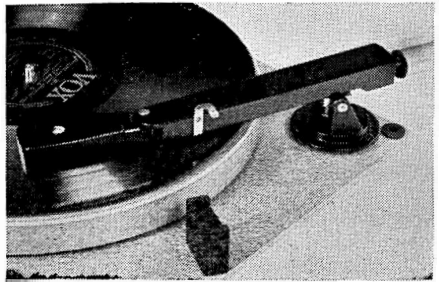

Worden articulated pickup arm

ACCESSORIES



Auriol pickup control

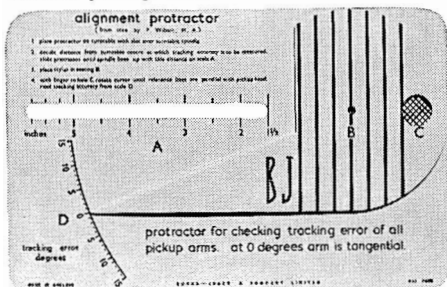

B.J. alignment protractor

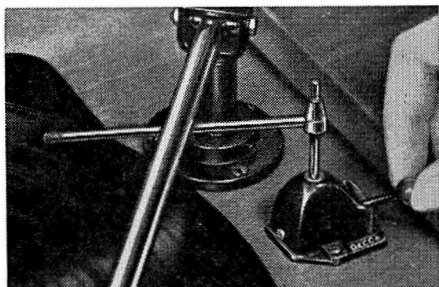

Decca Microlift

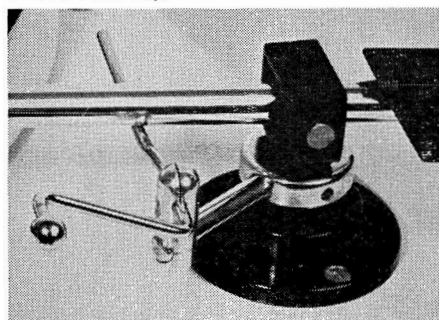

Hi-Jack Model "D"

Auriol (Guildford) Ltd. By-Pass Works, Guildford, Surrey. Tel.: Guildford 66712.

Auriol Pickup Control. This unit eliminates accidental damage to the record by the stylus, the control provides air cushioned lowering and positive vertical lifting and lowering of the stylus. The supporting arm is serrated and calibrated for accurate positioning of the stylus at any pre-selected position within 1-2 microgrooves. Three cursors are provided to mark starting positions and an indexing clip is supplied to suit any specified pickup arm. U.K. price £3 3s., inc. purchase tax. Export price £2 15s.

Auriol Pickup Control Mk. II. This is dimensionally similar to the above but the arm will swing clear of the turntable to allow its use with the Autochanger/Manual player units. U.K. price £4 0s. 6d., inc. purchase tax. Export price £3 7s. 6d.



Burne-Jones & Co. Ltd., 18 Brunswick Road, Sutton, Surrey. Tel.: Vigilant 5050. Cables: Burjomag, Sutton.

Counterweight Unit. The addition of this unit to a B.J. pickup arm permits speed and accuracy in weight compensation. The unit may be attached with or without standard weights supplied, and produces a total point pressure variation of approximately 4 gm. Price 12s. (U.K. purchase tax 3s. 11d.)

Alignment Protractor. For measuring the tracking accuracy of all pickup assemblies. Made in plastic ivory. Price 7s.



Cosmocord Ltd., Eleanor Cross Road, Waltham Cross, Herts. Tel.: Waltham Cross 25206.

Acos Changer Dust Bug. Developed in conjunction with Cecil Watts. Clips on to changer arms. Price 17s. 6d. (U.K. purchase tax 5s. 8d.)



Decca Radio & Television, Ingate Place, Queenstown Road, London, S.W.8. Tel.: Macaulay 6677.

Decca Microlift. A device for raising and lowering a manual pickup arm at any

point on the record for minimising risk of damage either to record or stylus through handshake. Easy to fit to any back-pivoted pickup. It does not hinder record handling by over-lapping the turntable. Price £1 2s. 8d (U.K. purchase tax 7s. 4d.)



M. B. Fitch, 11 Glennie Road, London, S.E.27. Tel.: Uplands 7667.

"Hi-Jack" Model "D". A raising and lowering device specially designed for direct attachment to the Decca ffss pickup pedestal. All metal chrome plated construction, positive stops in gully raised and lowered positions. Price: 16s. 10d. (U.K. purchase tax 5s. 8d.)

"Hi-Jack" Standard Model. Pickup arm raising and lowering device for use with most types of transcription motors and pickups. Positive stops in gully raised and lowered positions. 1½ in. height adjustment. Needs ¾ in. hole for fixing. All metal construction. Price 13s. 1d. (U.K. purchase tax 4s. 5d.)

"Hi-Jack" Universal Model "U". A raising and lowering device specially suited for use with the Garrard 4HF motor unit for which no extra fixing hole is required. 1½ in. height adjustment by means of sliding head. All metal chrome plated construction. One 3/16 in. hole needed for fixing. Price 16s. 10d. (U.K. purchase tax 5s. 8d.)

"Hi-Jack Cuematic". A precision groove locating device with independently operated local and remote pickup lifting control. By selection of the appropriate groove on the lifting bar and adjusting the dial to a pre-determined setting, any one groove can be selected. Price £11 15s. 7d. (U.K. purchase tax £3 19s. 5d.)



Franell Laboratories Ltd., 486 Finchley Road, London, N.W.11. Tel.: Speedwell 7512 (Sole agents for U.K.)

Rexon. An automatic record cleaning device which cleans discs as they are being played. A lightweight arm resembling that of a moulded plastic pickup with a head carrying a pad on a self adhesive base. A plastic mounting pillar carries the Rexon arm and three assorted bases are supplied—suction cap, impact adhesive, and weighted free-standing support. Will fit any turntable. Price 24s.

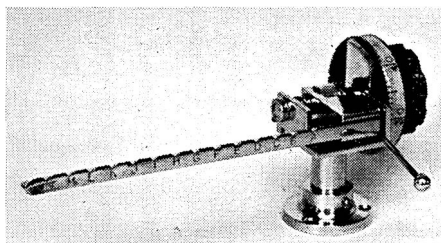

Hi-Jack Cuematic

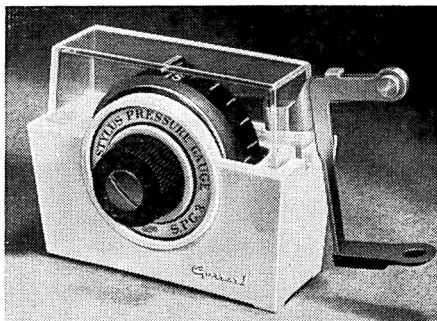

Garrard S.P.G.3

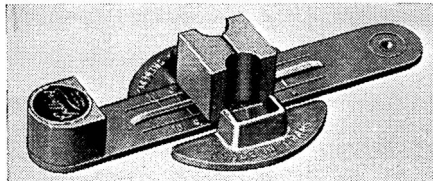

The Goldring STB1

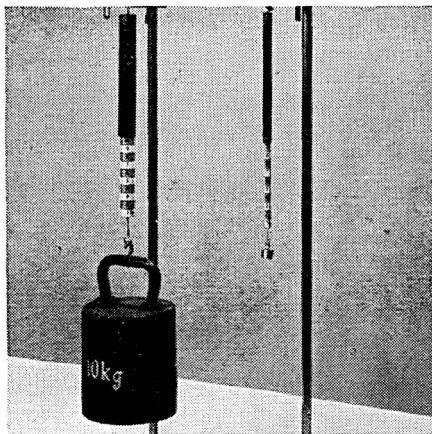

Two examples of the Maey spring balance

The Garrard Engineering & Manfg. Co. Ltd., Newcastle Street, Swindon, Wilts. Tel.: Swindon 5381. Cables: Garrard, Swindon.

S.P.G.2. Stylus pressure gauge, also includes a spirit level for checking the level of the turntable. Price 19s. 3d. (U.K. purchase tax 6s. 4d.)

S.P.G.3. Stylus pressure gauge. 0-12 grammes with $\frac{1}{2}$ gram. indication. Price 14s. 8d. (U.K. purchase tax 4s. 10d.)



W. N. Gay. North Street, Midhurst, Sussex.

Disc-C₂. A pure alcohol anti-static cleaner for all l.p. records. Price 6s.



Goldring Manufacturing Co. (Great Britain) Ltd., 486/488 High Road, Leytonstone, E.11. Tel.: Leytonstone 8343. Cables: Echovox, London.

Anti-static Cleaning Pad. Removes dust from records and is fitted with a detachable brush for keeping stylus clean. Price 4s. 6d. (U.K. purchase tax 1s. 6d.)

STB.1. Stylus balance, a simple yet accurate gauge which operates at record level. Stylus pressure is read directly in grams off the calibrated scale. Price 3s. 6d. (U.K. purchase tax 1s. 2d.)

Stylus microscope designed especially for the examination of pickup styli; it has variable magnification from $\times 50$ to $\times 150$ providing illumination both under and behind the stylus tip. A clip is fitted to hold any type of stylus in position under the lens. Price on application. Trade only.



The Metro-Sound Manufacturing Co. Ltd., 19a Buckingham Road, London, N.1. Tel.: Clissold 8506. Cables: Metrosound, London.

Stylometer. 4-digit counter for recording the number of playings. Price, single unit, £2 5s., double unit £4.



Rimington van Wyck Ltd., 42/3 Cranbourn Street, London, W.C.2. Tel.: Gerrard 1171.

Clendisc. An anti-static cleaner and preserver for all records. Price 3s. 9d. & 8s. 6d.

Fredorec. A cleaning pad for removing dirt from records. Price inc. purchase tax 3s. 4d.

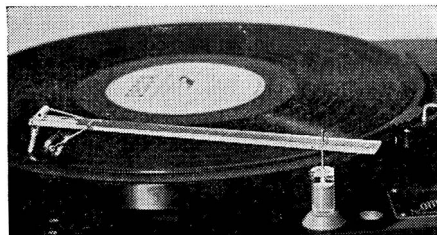

The Dust Bug

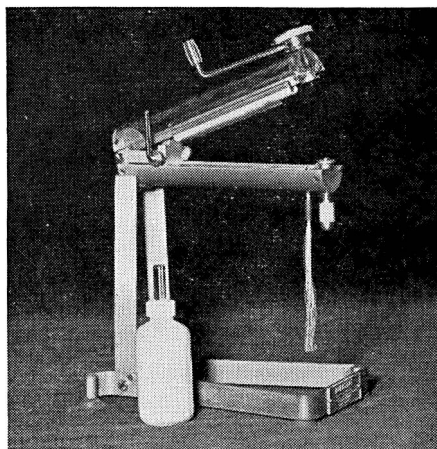

The Parastat

M. Tietze, 25 Castellain Road, London, W.9. Tel.: Cunningham 2846.

Maey Spring Balances. A range of spring balances from 1 gm full scale up to 10 Kg. Prices from £1 9s. 6d. to £3 5s.



Cecil E. Watts Ltd., Darby House, Sunbury-on-Thames, Middx.

The "Dust Bug." Claimed to be the most efficient method of removing all static and dust from records as they are played. Instantly fitted, suitable for all types of records. Record quality is improved, surface noise and wear reduced. Price 17s. 6d. (U.K. purchase tax 5s. 10d.) Note: A model suitable for use on autochangers is produced in co-operation with Cosmocord Ltd.

The "Parastat." For cleaning both sides of an l.p. disc simultaneously and making it inert to all static charges. Principally for trade use. Price Mk. II £18 10s. (U.K. purchase tax £6 3s. 4d.)

DIRECTORY OF MOTOR UNITS

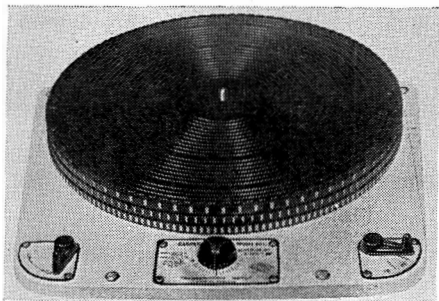

Garrard 301 with Strobe' turntable

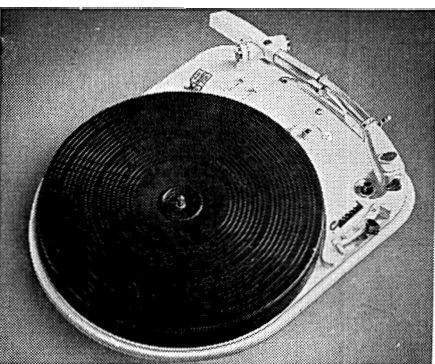

Garrard 4HF

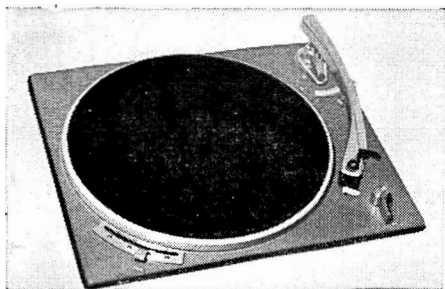

Goldring-Lenco GL60



Connoisseur Type B Transcription motor

Garrard Engineering & Manufacturing Co. Ltd., Swindon, Wiltshire, England. Tel.: Swindon 5381. Cables: Garrard, Swindon.

Model 301 Transcription Motor. Three speeds. Variable speed adjustment. Price £16 17s. 6d. (U.K. purchase tax £5 9s. 9d.)

Stroboscopic Turntable, extra cost, £1 3s. 6d. (U.K. purchase tax 7s. 7d.)

Garrard 4HF. Four speed record player complete with pickup arm. 12-in. pressed steel turntable. Rheostat speed control $\pm 3\%$. Automatic stop may be disconnected. Price with GC8 cartridge £13 19s. (U.K. purchase tax £4 10s. 9d.), with GMC5 cartridge £20 1s. 3d. (plus £6 10s. 6d.)



Goldring Manufacturing Co. (Great Britain) Ltd., 486/488 High Road, Leytonstone, London, E.11. Tel.: Leytonstone 8343.

Lenco Transcription Unit GL58. Infinitely variable speed adjustment with preselected stops for 16, 33 $\frac{1}{3}$, 45, and 78 r.p.m. Groove location arm lowers pickup on to record as on/off is operated. Fitted with G.60 arm. Price £13 15s. (U.K. purchase tax £4 9s. 5d.)

Lenco Transcription Unit GL60. Non-ferrous turntable, weight 8 lb. Infinitely variable speed adjustment. Groove location arm. Massive centre spindle on nylon thrust bearing. Fitted with G.60 arm. Price £18 10s. (U.K. purchase tax £6 0s. 3d.)



A. R. Sugden & Co. (Engineers) Ltd., Market Street, Brighouse, Yorkshire. Tel.: Brighouse 2142. Cables.: Connoisseur, Brighouse.

Connoisseur Transcription Motor Type B. Similar to the original model, but incorporating a large stroboscopic disc beneath the turntable, viewed through a mirror with an internal light source. Precision ground revolving shafts run in nylon graphite bearings, which are adjustable to maintain full accuracy throughout the life of the unit. Price £20 10s. (U.K. purchase tax £7 6s. 1d.)

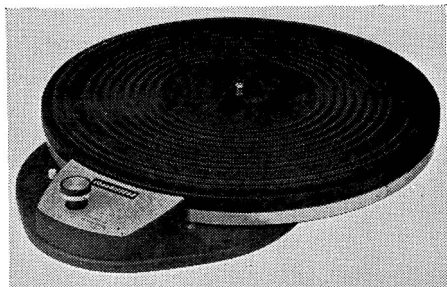

Connoisseur 2 speed

Connoisseur 2 speed stereo transcription motor. Operates at $33\frac{1}{3}$ and 45 r.p.m. fixed speeds. Full 12-in. turntable of non-ferrous material. All bearings are adjustable throughout the life of the unit. Synchronous motor. Price £12 10s. (U.K. purchase tax £4 3s. 1d.)



Thorens. Distributed in the U.K. by Technical Suppliers Ltd., Hudson House,



Thorens TD 124

63 Goldhawk Road, London, W.12. Tel.: Shepherds Bush 2581, 4797. Cables: Teknika, London.

Thorens TD124 Transcription Turntable. Four speeds with "OFF" position of selector switch between each speed. Eddy current speed control $\pm 3\%$. Built-in stroboscope for four speeds at 50 and 60 c/s. Price £40 17s. (U.K. purchase tax £13 15s.)

AMPLIFIERS and PRE-AMPLIFIERS

A RE-STATEMENT OF SPECIFICATION REQUIREMENTS

by George S. Tillett

THE first Hi-Fi Year book made its appearance in 1956 and in that particular issue I dealt at some length with amplifier specifications and requirements. A lot has happened during the last six years; for example, the impact of stereo, the advent of the integrated amplifier, spectacular improvements to speaker systems etc., etc. For these reasons, and of course for the benefit of the many new readers, it may be as well to take another look at these specifications. Here then are the basic requirements of a High Fidelity amplifier:—

1 Low harmonic and intermodulation distortion: 2 Linear frequency response: 3 Good transient response: 4 Adequate power output: 5 Low output resistance: 6 Low hum and noise level: 7 Efficient tone controls and filter system: 8 reasonably versatile equalising and pickup matching facilities.

A stereo system must in addition have the following facilities: 9 A balance control to

adjust the gain of one or both amplifiers: 10 Provision for switching both channels in parallel for single channel operation.

Harmonic and Intermodulation Distortion

If a pure sine wave is applied to a perfect amplifier we would get a pure sine wave out; in other words we would get amplification without distortion (see **fig. 1**). However, nothing is perfect in this world, and even the best of High-Fidelity amplifiers produce a little distortion. Compared with pickups, loudspeakers or records it is quite small, but it is there. It is mainly caused by the inherent curvature of valve characteristics, plus output transformer deficiencies. One effect of this distortion is the production of harmonics, thus the application of a 1,000 c/s note would result in an output consisting of a 1,000 c/s fundamental, plus a second harmonic of 2,000 c/s, a third harmonic of 3,000 c/s, a fourth at 4,000 c/s and so on. **Fig. 2**

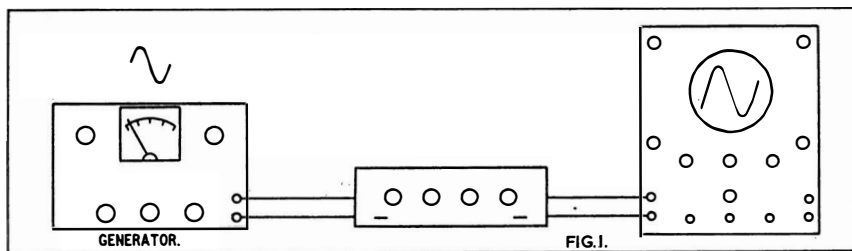

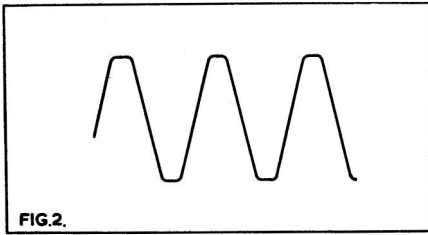

Wave-form of an amplifier working in a condition of overload.

shows such a waveform, and this is an example of an amplifier in an overloaded condition giving a 6% third harmonic, plus a 1% second. The output was just under 15 watts and the distortion at the rated output of 10 watts would be less than 0.1%. The symmetrical "Clipping" of the waveform indicates that the output stage is a push-pull type—and that the two valves are balanced.

It is generally agreed that the presence of higher order harmonics, such as the 5th, 7th and 9th which are not harmoniously related to the fundamental, are objectionable even in small percentages. Since these harmonics are progressively more unpleasant some authorities have advocated the "weighting" of the figures accordingly. It is obviously very difficult to assess their relative unpleasantness so this method is rarely used.

Spurious frequencies

Intermodulation distortion is really a result of harmonic distortion but is usually considered much more serious. It can be described as the formation of new frequencies when two or more frequencies are passed through a non-linear system. These spurious frequencies are known as sum-and-difference or combination frequencies, and as they are not harmoniously related to the original

tones they are nearly always musically discordant. Fig. 3 shows a 1,000 c/s and a 50 c/s note applied to a "Distorting amplifier" and clearly shows the modulation of the 1,000 c/s note which is caused by the harmonic distortion of the low frequency. The output will include the original 50 c/s and 1,000 c/s plus a whole series of sum-and-difference frequencies such as 1050, 950, 1100, 800 c/s, etc., etc.

There is no definite relation between the two forms of distortion, although obviously if the harmonic distortion is high then the intermodulation distortion will be high. For a well-designed amplifier the proportion is usually about 3.8 : 1 up to the rated output, with the ratio increasing up to overload point.

Fig. 4 shows this relation in a typical 10 watt amplifier. Note the sharp increase in IM above 10 watts. If the frequency response of the amplifier rolls-off fairly rapidly above 10 Kc/s, then the harmonic distortion may be decreased at a greater rate than the IM.

How is Distortion Measured?

Harmonic distortion is measured by a distortion bridge which removes the fundamental frequency and leaves the spurious harmonics to be read off on a calibrated meter. Fig. 5 shows the basic arrangement. The usual circuit employed in this type of instrument is a tuned Bridge—T network or a Wien bridge: the former is capable of giving a sharper rejection. The meter is in effect a valve voltmeter and is used in conjunction with a switched attenuator to give a direct reading from 0.5% or as low as 0.05% on the better instruments. One disadvantage is that all the harmonics, plus hum and noise, are lumped together; although there are more elaborate bridges,

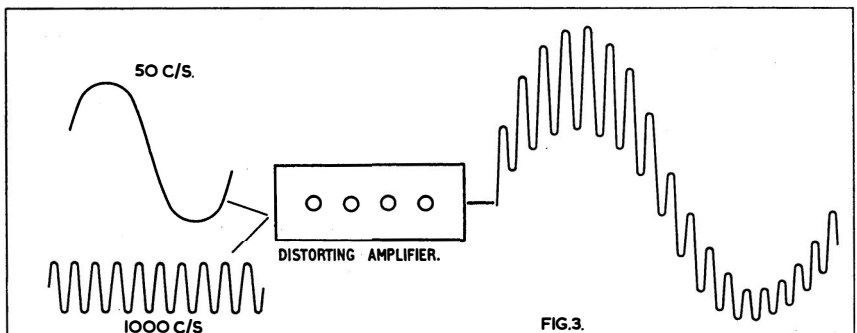

Intermodulation distortion. Note how the low frequency has modulated the 1,000 c/s wave-form.

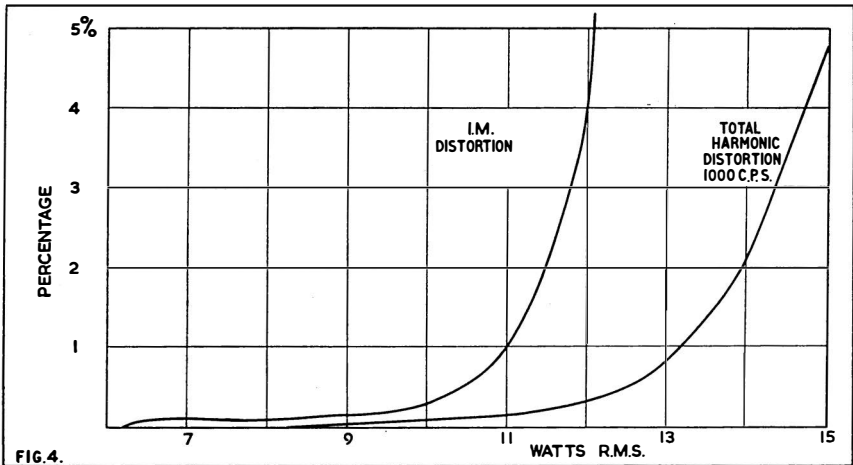

FIG.4.

The relationship between Harmonic and Intermodulation distortion is shown here.

such as the "Radiometer", which has both high and low pass filters, allowing hum and noise to be evaluated separately. The harmonics are still integrated and expressed as a whole but this is perfectly satisfactory for most purposes. If we need to know the proportions of individual harmonics then we use an instrument called a "wave-analyser" which can be tuned to each harmonic; so we would get a% second, plus b% third, c% third, and so on. These figures are not simply added together because the total distortion factor is the *ratio* of the total r.m.s. voltage of all harmonics to the *total* r.m.s. voltage. Thus the formula is

D(Distortion)=

$$\frac{\sqrt{E_2^2 + E_3^2 + E_4^2 + \dots}}{\sqrt{E_1^2 + E_2^2 + E_3^2 + E_4^2 + \dots}} \times 100$$

where D=percentage of harmonic distortion:
E=amplitude of fundamental voltage: E = amplitude of second harmonic etc.

The advantage of the Bridge

Lazy people will still prefer to use the direct reading bridge! However there are occasions

when the individual percentages are required, and the mathematics are not really as involved as they look. One thing must be stressed: whichever type of instrument is used it is essential that the signal generator itself be free from distortion, otherwise a filter must be used. What frequencies are used? In this country it has been customary to specify either 400 c/s or 1,000 c/s, i.e. somewhere near the centre of the audio range. This has been criticised—and rightly—because it is just in this band that the distortion is at its lowest, and these figures would not necessarily give a true indication of the performance of an amplifier.

Medium, high and low examples

Fig. 6 shows the distortion of our 10-watt amplifier taken at high, medium and low frequencies as now given in the *Hi-Fi News* amplifier reviews. The top frequency of 4,000 c/s was selected because the main harmonics will always be within the range of the amplifier. Another way of presenting this information is to give the total harmonic distortion curve at 1,000 c/s, with the maximum power output available at the extremes; but it is felt that the 3-frequency

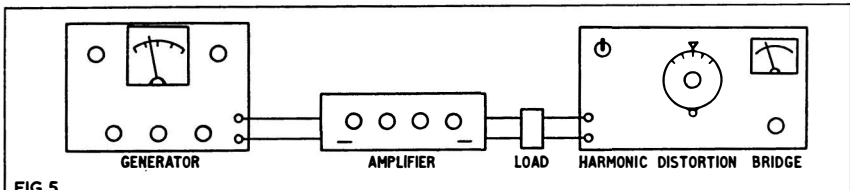

FIG.5.

Diagrammatic layout showing the set-up for testing an amplifier for distortion.

method is more accurate. A good amplifier should give full rated power at a total harmonic distortion of less than 0.2% at 1,000 c/s, 0.5% at 40 and 4,000 c/s.

Intermodulation Distortion

Intermodulation distortion is measured by introducing into the amplifier a composite signal, composed of a high frequency and a low frequency, usually in the proportions of 4 to 1. There are several standard test frequencies—40 and 4,000, 60 and 6,000, 60 and 10,000, and 70 and 7,000 probably being the most common. The output of the amplifier is fed to an IM analyser which removes both fundamentals, leaving the spurious sum-and-difference signals. It is common practice to combine both signal sources with the analyser, which then becomes quite an expensive instrument. Many competent authorities maintain that the co-relation between IM and harmonic distortion is sufficient for the IM distortion alone to give a picture of the performance of an amplifier. Certainly this method is widely used in America although there are no definite standards as yet. The Heath company have three gradings as follows: Professional 1% or less, High-Fidelity 2% or less and Professional 3% or less (60 and 6,000 mixed 4 to 1). Langford-Smith gives the following figures—*Extremely high fidelity IM*, less than 2%, *Good fidelity*, less than 8% and a *typical radio receiver*, less than 40%. In a good amplifier an IM of 1% would correspond to a centre frequency harmonic distortion of about 0.3%.

Wider range—less distortion

Before leaving the subject of distortion it should be noted that the permissible or rather tolerable distortion of an amplifier is to a certain extent dependent on the frequency range of the system, in other words the wider the range the lower must be the distortion. As I believe Hugh Brittain once remarked, "The wider you throw open the window, the more muck blows in".

Linear Frequency Response

This should be substantially flat from 20 to at least 20,000 c/s, and these figures should always be stated with a reference. Thus a good amplifier will have a frequency response from 20 to 20,000 c/s ± 1 dB. or 2 dB., ref. 1,000 c/s.

Adequate Power Output

Adequate power output must be available to handle peak transient power without distortion. Assuming a speaker system of average efficiency (5%), the normal power used under domestic conditions would be of the order of 250 to 300 milliwatts; but to handle peak transient power with an adequate factor of safety, an amplifier rated at 10 watts should be used. For stereo an amplifier having a rating of 8 plus 8 watts will be sufficient for all but the largest rooms. Some of the smaller bookcase speakers are very inefficient, and a 10 plus 10 watt or even larger amplifier might be necessary. For instance, the small AR-2 speaker which is very popular in America is advertised as needing no less than 30 watts!

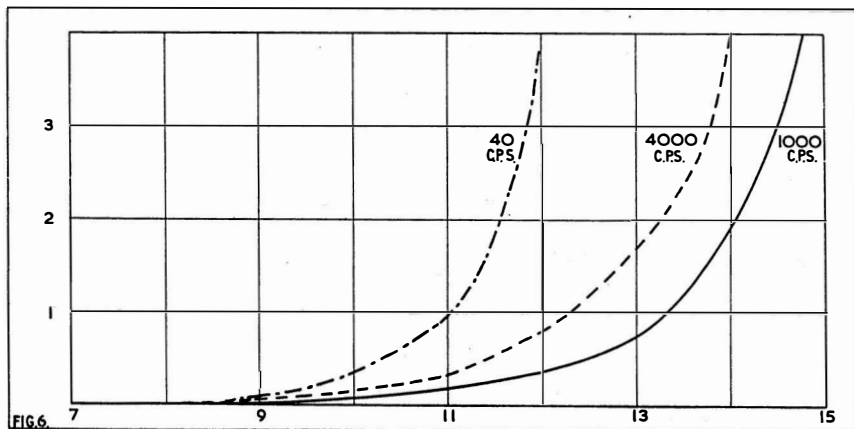

FIG. 6. Power output distortion characteristics taken at three frequencies on a 10-watt amplifier (Heathkit MA12).

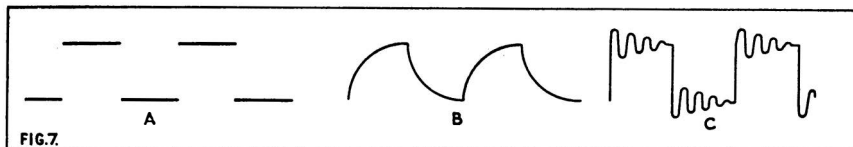

FIG.7.

These figures show (a) 1,000 c/s square wave input (b) HF attenuation and (c) ringing.

There is another factor to consider. Many people listen to stereo at a higher volume level than they would to single channel sound. This is partly because of the lower incidence of "listener fatigue" with the more natural reproduction, and partly because of the greater dynamic range of some of the more recent tapes and records. In the 1956 Year Book I wrote that: "The power response of an amplifier is not necessarily identical with the frequency response. Some amplifiers optimistically rated as "10 watt" have no difficulty in giving the stated output at 1,000 c/s, but at 50 c/s it is quite another story. One such amplifier which uses a small output transformer was tested recently and found to deliver a maximum output of 5 watts at 40 c/s". Well, those amplifiers are still with us, but their numbers are fortunately decreasing.

Grain-oriented Strip

Nearly all the best amplifiers use transformers made of grain-oriented strip which has almost completely ousted the more expensive "C" core materials. One thing must still be emphasised, if the power output is not maintained down to 20 c/s then a filter must be fitted in the early stages to prevent the lower frequencies from overloading the output stages and causing distortion. As far as the high frequencies are concerned the full power output should be essentially maintained to at least 10,000 c/s and preferably not less than half power at 20 to 30 Kc/s. These specifications are much more stringent than hitherto thought necessary; however, research by Somerset Murray (published in *Hi-Fi News*) and A. Radford among others, confirm my own findings that any significant departure from these figures will be audible with really first-class equipment.

Good Transient Response

A wide frequency response is not the only factor affecting the reproduction of transients, which are sounds of short duration, such as those made by cymbals, piano or other percussive instruments. One factor is the high frequency power response mentioned

above, but it is also important that the amplifier be free from peaks and supersonic oscillations which will cause "ringing". The usual method of testing is to apply a square wave to the amplifier, the output of which is connected to an oscilloscope. Loss of high frequency response will be shown as a rounding of the square wave (see fig. 7). The effect of "ringing" is shown at c; in this instance it is similar to that caused by incorrect damping of the negative feedback loop. (See page 000). Transient response can also be adversely affected by some types of tone control or low pass filters. For instance a filter attenuating from 8 Kc/s at a rate of say 10 dB per octave, having a rise of only 2 dB at the cut-off frequency, will produce a transient ring which will be quite audible with good equipment. This brings me to the question of filters and tone controls.

Filters

In order to avoid distortion produced by imperfect radio transmissions, or on gramophone records due to processing defects or wear, it is often necessary to restrict the upper frequencies. We cannot do this effectively with the normal treble controls because they normally operate from the middle of the scale around 1,000 c/s, so we would not only remove the distortion but most of the programme as well. Hence we have to use a special type of treble control, called a filter, which will attenuate the frequencies above 5 or 7 Kc/s without affecting the middle frequencies.

Transient Ringing

This is not so simple as it might appear because if the attenuation is too sharp a form of transient ringing will occur which may be even more unpleasant than the original distortion. Furthermore, as mentioned previously, if there is an appreciable rise in frequency near the cut-off point then this will also cause transient mutilation. Therefore the upper frequencies must be removed gradually without losing too much of the musical values and without introducing further distortion. Owners of early 78

recordings may prefer a very steep cut filter, sometimes attenuating as low as 4 Kc/s: such ringing as might be caused under these conditions is considered less objectionable than the surface noise. For those not having 78 recordings a filter cutting at 7 and 9 Kc/s at a rate of 10 to 15 dB per octave will be perfectly adequate. A continuously variable type will be even better, whilst the addition of a slope control to vary the rate of attenuation will be absolute luxury! (For those interested, details of some of these filters were given in the 1960 *Year Book*.)

Turning to the other end of the scale, we come to the problem of "Rumble". Many authorities still believe that the right way to tackle this bugbear is at its source. Certainly in the days of "mono" a transcription motor was the best solution. But with the coming of stereo I am not so certain. Stereo pickups with their inherent response to vibrations in the vertical direction are very sensitive to motor rumble, and I have stated before that even the best transcription motors will produce an audible amount of rumble if used with a low output stereo pickup. Whether it is enough to be objectionable will depend on the room, the response of the speakers at the lower frequencies and also to the listening level. It must be emphasised that distortion can be caused by rumble, although the rumble itself may not be audible and often the effect of a 35 c/s filter is to clean up the reproduction to a remarkable degree. So although I am well aware that some people believe a rumble filter is a "confession of failure" I must continue to advocate it. Frequency? I would say from 30 to 40 c/s attenuating at least 12 dB per octave (there is not very much of musical value below 30 c/s, and in

any case a very large room would be needed to hear these frequencies).

Tone Controls

These controls are necessary to compensate for studio or recording deficiencies, room acoustics etc. For normal use a lift and cut of 10 to 12 dB at 40 and 9,000 c/s is all that is required. If more than this is found necessary it indicates a fault in the equipment somewhere in the chain. Certain types of bass reflex speaker systems are notoriously non-linear and need an appreciable amount of bass boost to restore the balance when listening at low volume levels. Many of the smaller bookcase speakers share this deficiency—which may explain why most American amplifiers have bass lifts of as much as 18 to 20 dB.

Passive and Selective

There are two types of tone control in common use; one, the passive network of resistors and condensers, and the other a selective feedback type known as the Baxandall. The passive type has the effect of rotating the response about a central "hinge" in the region of 1,000 c/s, whilst with Baxandall system the lift and cut are initially confined to each end of the scale. This means that the extreme low frequencies can be lifted appreciably without affecting the region of 300 to 500 c/s, and also the treble frequencies can be progressively attenuated after the manner of a filter control. Fig. 8 shows the response curves of a typical passive system, and fig. 9 shows the characteristics of the Baxandall system. Because this latter system uses negative feedback the distortion is reduced to a minimum, although a feedback loop can

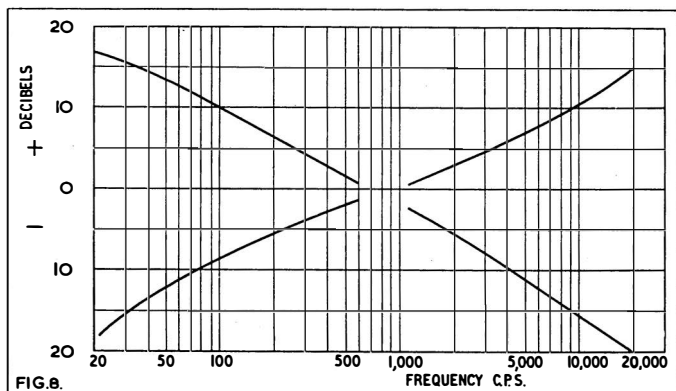

★
 Here are the
 response curves
 plotted from a
 passive control
 system.

★

be used with a passive network to reduce the distortion to quite negligible proportions.

Low Output Resistance

Although the nominal output impedance of an amplifier may be specified as 3 or 15 ohms the actual impedance as "Seen" by the speaker may be very much less—perhaps only a fraction of an ohm. The ratio of nominal impedance to internal impedance is defined as the "damping factor" of an amplifier. A damping factor of 30 means that at the nominal load impedance of 15 ohms the output resistance would be 15 divided by 30—in other words, half an ohm. A high damping factor means that the loudspeaker "sees" a very low resistance which tends to damp any inclination of the diaphragm to vibrate at its natural frequency; thus, as soon as the audio input ceases, the cone of the speaker is rapidly brought to rest. The higher the damping factor the more efficient this brake becomes, but practical tests have shown that any increase in damping factor above about 20 results in little further improvement. This is because the resistance of the loudspeaker speech coil is always in series with the output.

Variable Damping Controls

Variable damping controls were achieving a certain measure of popularity in America in 1956, but few amplifiers are fitted with this device today. As I said at that time, "a good loudspeaker system having a well-damped enclosure will reflect very little effective resonance into the electrical circuit—certainly too small for a critical damping point to be determined". With the improvements in loudspeakers systems this is even more true today.

Hum and Noise

The figures for hum and noise are sometimes quoted separately, and sometimes a combined figure is given. It is usual to give the rated output of the amplifier as a reference figure, but many authorities prefer to quote a standard output of 1 watt. Hum consists mainly of 50 and 100 c/s and it can be due to insufficient smoothing of the power supply, pickup from the valve heater supply (either in the valve itself or in the associated wiring), radiations from the mains transformer, etc. Internal valve noise is responsible for most of the hiss heard on a high gain amplifier, although carbon resistors can contribute an appreciable amount. Special low-noise, high-stability resistors are normally used in the first stages of an amplifier, or the new metal oxide resistors which are even better. The noise factor of an ordinary carbon resistor is about 10 microvolts per applied volt, against 3 microvolts for a good high stability type, compared with less than 0.01 microvolt per volt in some of the new metal film resistors.

A combined hum and noise level of -90 dB relative to the full output of a 10 watt amplifier would be quite inaudible even close to the speaker and a level of -60 dB for amplifier plus pre-amplifier can only be heard as a slight breathing sound at about a foot away from the speaker. For a high gain amplifier with an input sensitivity of around 4 millivolts this figure can be considered very satisfactory.

Equalising and Pickup Matching

In 1956 it was very necessary to have provision for various recording characteristics, we had *NARTB*, *FFR*, *Col*, *Lp*, *EMI 78*, and many others to contend with. Now,

★
 Compare the curves on the opposite page with those frequency response curves of a Baxandall tone control.

★

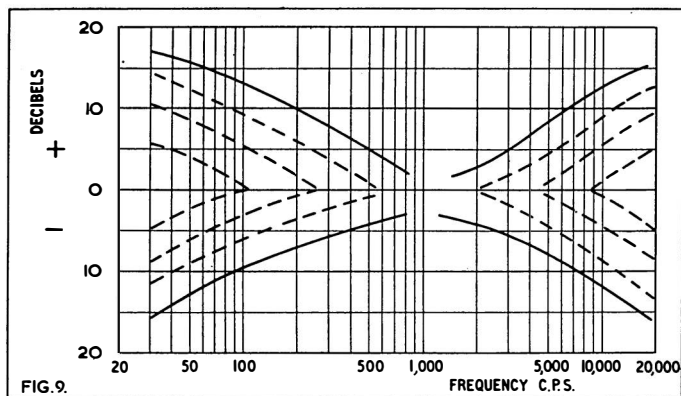

FIG. 9.

fortunately, we have only one—the standard RIAA; and so we have one knob fewer to fiddle with (unless we have a collection of older records). Pickup matching is still necessary although stereo pickups can be divided into two groups—high output high impedance crystals and low-output, medium-impedance magnetic types. The cheaper amplifiers will only have provision for the crystal pickups, but it is often worthwhile buying a more expensive amplifier so that a magnetic pickup can be used at a later date if so desired.

Some of the more expensive amplifiers such as the *BTH*, *Radford*, *Dulci 8*, etc., have provision for playing direct from an output of a tape head. It must be remembered that this facility is only provided for what is known as “pre-recorded” tape, and a separate bias and erase unit (with recording amplifier and level indicators) is required to actually *make* recorded tapes. These facilities are usually combined in a special tape record-replay unit which are available in mono or stereo versions.

Negative Feedback

All modern amplifiers make extensive use of negative feedback, and it was this invention which enabled H. J. Leak to revolutionise amplifier design with his famous “point One” in 1945. The principle had even then been known for some years—in fact as far back as 1934 H. Black published an article dealing with stabilised feedback amplifiers, but for various reasons it was not used in amplifiers commercially until 1945. Basically, feedback means that a portion of the output of an amplifier is fed back into the input in opposite phase thus reducing the overall

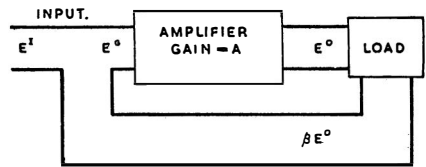

This block diagram shows the arrangement of an amplifier with a negative feedback loop.

gain. Fig. 10 shows a block diagram of an amplifier with a negative feedback loop. The gain of the amplifier is A , thus:

$$A = \frac{E^O}{E^I}$$

If the feedback is applied, and the input voltage increased to E^I to give the same output voltage E^O as without feedback, it then follows that;

$$A_{fb} = \frac{E^O}{E^I} = \frac{E^O}{EG - \beta E^O}$$

The gain reduction due to feedback is therefore

$$\frac{A}{A_{fb}} = \frac{E^O/EG}{E^O/(EG - \beta E^O)} = 1 - \frac{\beta E^O}{EG} = (1 - \beta A)$$

The quantity $(1 - \beta A)$ is called the feedback factor, and is usually expressed in dB. Therefore if an amplifier is stated to have a feedback of 20 dB it means that the loop has reduced the overall gain of the amplifier by 20 dB or 10, and if the amplifier has been well designed the distortion will be reduced by a like amount. Fig. 12 shows the circuit of a typical 10-watt amplifier similar to the one mentioned earlier. The feedback loop is connected in the usual manner from the transformer secondary to the

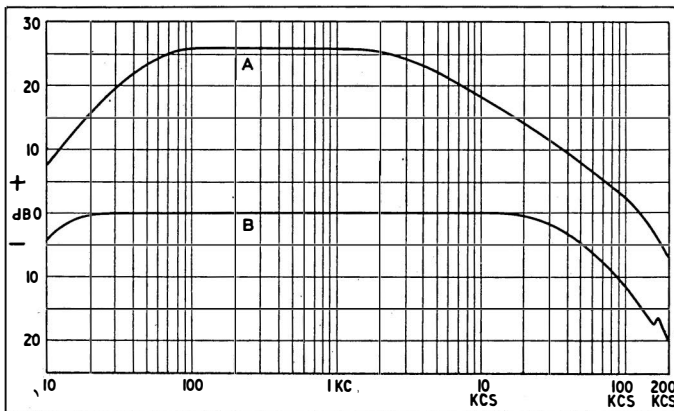

★
Fig. 11
Frequency response curves of an amplifier, showing the results with and without the application of feedback.
★

cathode of the input valve. The feedback is 26dB—or a factor of 20, and the input voltage required to give full output is 3 millivolts with the feedback loop disconnected.

Under these conditions the distortion is 1.7%. Closing the *loop* brings the distortion to about 0.1% and the input voltage required is then 20 times 6—or 60 millivolts. Fig. 11 shows the frequency response under both conditions. It will be seen that the response without feedback falls at each end of the scale:—the high frequency loss is due to transformer self capacity, valve and circuit stray losses, plus an intentional roll-off derived from a high frequency “step”.

Simple RC Combination

This is a simple resistor-capacitor combination (CI and RI in the diagram) which is usually connected in parallel with the anode load of the first valve, and its purpose is to change the phase and reduce the loop gain of the amplifier at the higher frequencies to preserve stability. It will be appreciated that for optimum feedback the voltage fed back must be exactly 180 degrees out of phase with the applied signal but, due to stray capacitances, resistor capacitor combinations, output transformer leakage inductance and capacitance, there is in practice an appreciable phase shift. This is shown in fig. 13, and it will be seen that the phase shift is negative at the low frequency end and positive at the high frequencies.

Incipient Instability

If this phase change *exceeds* 180 deg. thus changing the negative feedback to positive, oscillation will occur. This can happen at either low or high frequencies (sometimes both) and the “step” network mentioned earlier is one way of ensuring stability. Further phase shift is obtained by the capacitor connected across the feedback resistor (C5) but it is obvious that a high value should not be used here, as it would be influenced by speaker and cross-over characteristics. The stability margin of an amplifier should be at least 10dB—i.e. the feedback loop should be increased by that amount before instability becomes evident.

If the margin is very much less it may well be only conditionally stable; in other words instability may be triggered off by a sudden transient or switching surge. Incipient instability of this nature can easily cause damage to fragile ribbon speakers, and even to the output transformer itself. Much the same thing can occur at the low frequency end, and here the instability takes the form of a sub-sonic oscillation, or an actual “motorboating”. This was one of the symptoms afflicting the early Williamson amplifier, and the reason was that the output transformers (or some of them) were not up to the stringent specifications.

If the transformer is well designed there is usually more margin at the low frequencies than at the high end, but it is not unknown

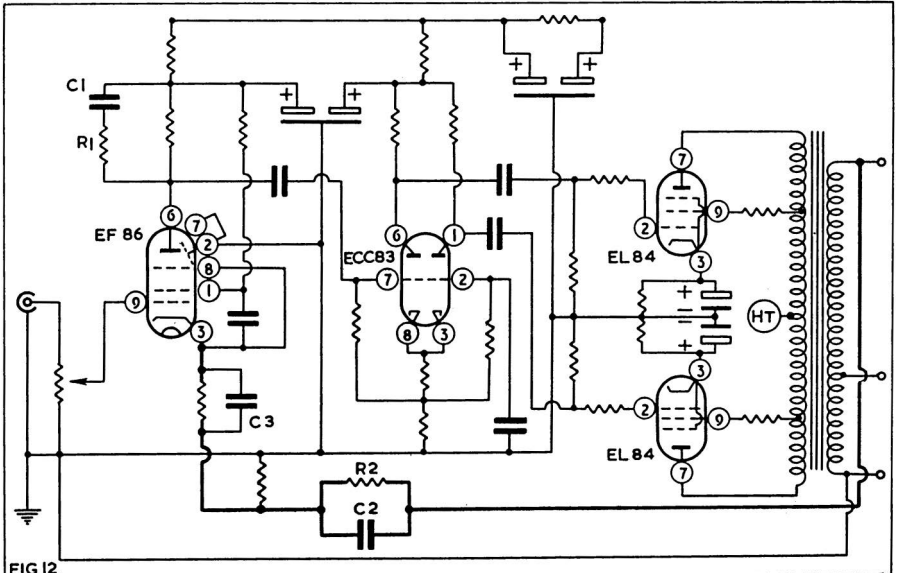

This circuit represents the basic arrangement for a typical audio amplifier.

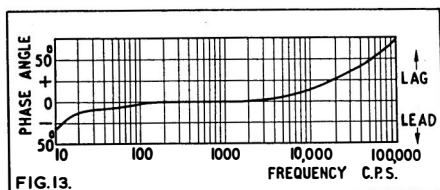

FIG.13. Phase-shift characteristics of an amplifier.

for low frequency “steps” to be used. These take the form of a capacitor in parallel with a resistor which is in series with a coupling circuit—usually to the output valves. Such a circuit is in fact used in several of the Radford amplifiers.

Feedback Circuitry

Turning back to out circuit diagram, it will be seen that the cathode resistor of the EF86 is by-passed by a capacitor. If this were omitted it would cause degeneration or, more correctly, a negative feedback current loop of about 6 dB. This is actually used in many amplifiers, including the *Heathkit* “MA-12” and the *Leak* “Point-One” series. The *Radford* “Stereo 12” also has a subsidiary loop, but in this case it is in the form of an anode-grid network which has a secondary “step” effect.

Comparing the curves A and B in the diagram, it will readily be seen that the nominal 26 dB feedback is only maintained in the centre of the scale, at 10 Kc/s and 20 Kc/s. It falls to 18 and 16 dB respectively. This means that the distortion at the high and low frequencies will be higher than that in the centre portion—a fact which was mentioned earlier. In a well-designed amplifier this increase is not too serious, but it is quite possible for an amplifier to have a distortion of less than 0.1% at 1,000 c/s. and 2% or 3% at 40 and 10,000 c/s. This has long been realised by the *Heathkit* Company and also *Cape Electroponics* who both publish the distortion measurements of their amplifiers taken over a range of frequencies. As far as I am aware the latter company were the first to do so in this country.

Other Advantages . . .

Finally, the other important fact to be learned from the frequency response characteristics is the remarkable effect

which feedback has on them. The response curve B is almost linear from 20 c/s to 20,000 c/s! But feedback can do more than this: it will reduce the output impedance of the amplifier, thereby increasing the damping factor. This would be about 1.5 for the amplifier discussed earlier, and it would be increased to almost 25 by the application of 26 dB feedback.

Feedback will also reduce hum and noise originating in the stages within the loop, and it can have the effect of stabilising the gain of an amplifier with respect to changing valve parameters and voltage variations. It can change the input and output source impedances of an amplifier increasing them or decreasing them—depending upon how it is applied.

. . . and disadvantages

Are there any disadvantages? Yes it must be admitted that there are. One of them is a loss in gain, which is not very important; another is the possibility of increasing the audible distortion by applying a large amount of feedback to an amplifier which has a very high distortion factor. This apparent paradox occurs because the feedback voltage containing a high proportion of second and third harmonics will in its turn generate further harmonics (fourth and ninth, etc.) which sound unpleasant in quite small proportions.

Yet another possible disadvantage is the effect of feedback on the overload characteristic. This is quite gradual on an amplifier having no feedback, and it rises until it becomes almost a right-angle with an amplifier having about 30 dB feedback. The effect is that overload point is reached suddenly—and painfully! The solution is to use only the minimum of feedback to achieve the required results, and to have an adequate reserve of power.

. . . and improvements gained

It is by no means certain that we know everything about the effect of feedback, especially with complex waveforms; but we do know that, used intelligently, it has enabled amplifier designers to produce results undreamed of not so many years ago. Even in 1939 a really first class quality amplifier could boast of a distortion no less than 5%: as for the intermodulation—it must have been something like 30%!

DIRECTORY OF AMPLIFIERS & CONTROL UNITS

★ The following abbreviations are used in this directory section: **H.D.**—Harmonic Distortion; **<**—less than; **H** and **N**—Hum and Noise; **P.a.t.**—Power supplies available for tuner; **R.M.S.**—root mean square; **N.L.**—Noise level; **Sel.**—Selector switch; **■**—Stereo equipment.

Acoustical Manufacturing Co. Ltd., St. Peter's Road, Huntingdon, Hunts. Tel.: H'don 361 and 574. Cables: Acoustical.

Quad II Q.C. II Control Unit. Inputs: radio/tape 100 mV; mic. 1.5 mV; gram. to suit pickup. Treble, base, vol. and on/off, filter slope. Switch filter 5, 7, 10 Kc/s and "out." Tape record socket, switched playback socket. H.D. <0.1%. H and N — 70 dB. Size $10\frac{1}{2} \times 3\frac{1}{2} \times 6\frac{1}{2}$ ins. To operate with Quad II power amp or similar. Price £19 10s.

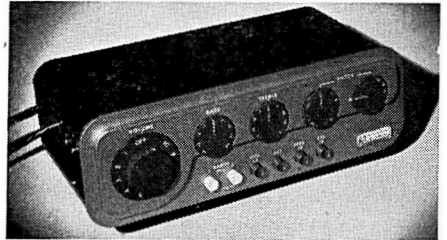

Quad Q.C. II control unit

■ **Quad 22 Control unit.** Inputs: Radio/tape 70 mV at 100 K; mic. 1.5 mV at 100 K; pickup dependent on adaptor unit used, Vol. and on/off bass, treble, filter slope, filter switch 5, 7, and 10 Kc/s. Push-button selection of channels, mono/stereo, and record equalisation. H.D. <0.02%. H and N — 70 dB total, P.a.t. 330v 35 mA each tuner, 6.3v 3 amps. Size $10\frac{1}{2} \times 3\frac{1}{2} \times 6$ ins. Price £25. To operate with QUAD II amplifiers.



Quad 22 stereo control unit

Quad II Amplifier. 15 watts. Dist, total 3rd harmonic and higher. <0.1% at 12 watts. Input for spec. output 1.4v. R.M.S. for 15 watts. Response 20-20,000 c/s. ± 0.2 dB; 10-50,000 ± 0.5 dB. Feedback incorporated in original ultra-linear arrangement. N.L. — 80 dB at 15 watts. Out. imp. 7 and 15 ohms. Output KT66's. Original combined anode/screen current circuit. Size $12\frac{1}{2} \times 4\frac{1}{4} \times 6\frac{1}{2}$ ins. To operate with QCII or Q22 control units. Price £22 10s.



Quad II amplifier

★ **A.E.I. Sound Equipment Ltd.,** Crown House, Aldwych, London, W.C.2. Tel.: Temple Bar 8040. Cables: Soundequi, Estrand, London.

Hi-Fi Control Unit Mk. 1. Inputs: Mic. 5 mV; tape head 5 mV; pickup 6 and 250 mV; Equalised tape 180 mV; radio 180 mV. 8-position sel., filter, bass, treble, volume and on/off. H.D. <0.05%. H and N — 86 dB. P.a.t. 320v 30mA, 6.3v 3 amps. Size

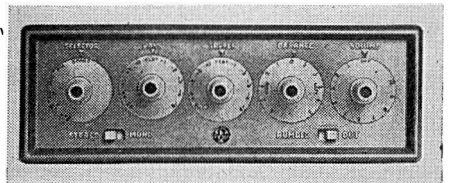

A.E.I. stereo control unit

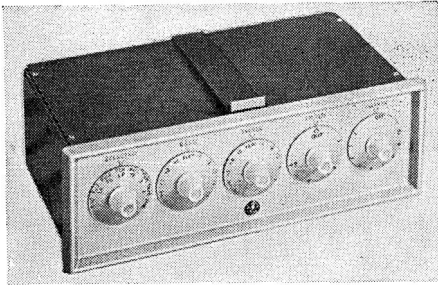

A.E.I. Mk. 1 control unit

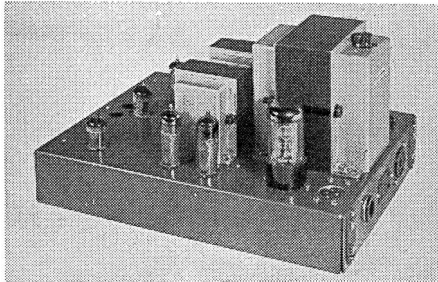

A.E.I. stereo power amplifier



A.E.I. Mk. 1 power amplifier



Altobass stereo 70 C/U and Twin 12 amp.

$10\frac{1}{4} \times 3\frac{1}{16} \times 5\frac{1}{2}$ ins. Price £17 10s. To operate with BTH Hi-Fi Amplifier, or similar.

HI-Fi Power Amplifier Mk. 1. 20 watts nominal, 30 watts peak. Dist. <0.05%. Input for 20 watts 100 mV. Response 20-20,000 c/s \pm 1 dB. Feedback 24 dB. N.L. — 80 dB. Out. imp. 4, 8 and 15 ohms. Output EL34's. Ultra-linear. Size $10\frac{1}{4} \times 5\frac{1}{2} \times 6\frac{1}{4}$ ins. Price £24 10s. To operate with BTH Hi-Fi Pre-amp. or as a pair with BTH Stereo Control Unit.

■ **Stereo Hi-Fi control unit.** Inputs: stereo and mono pickup, stereo tape, radio, mic. spare. 6 position sel. bass, treble, balance, vol., on/off. Rumble filter. H.D. less than 0.05% at 10 watts. H and N — 85 dB. P.a.t. 200v 30 mA, 6.3v 3 amps. Size $10\frac{1}{4} \times 5\frac{1}{2} \times 3\frac{1}{16}$ ins. To operate with BTH stereo amplifier or two mono amplifiers. Price £24 9s.

■ **Stereo Power Amplifier.** 10 watts each channel, 15 watts max. Dist. less than 0.05% at 10 watts. Input for spec. output 100 mV. Response 20-20,000 c/s \pm 1 dB. 24 dB feedback. N.L. — 90 dB relative to 10 watts. Out. imp. 4, 8 and 16 ohms. Output EL84's ultra-linear. Size $12\frac{1}{2} \times 10 \times 7\frac{3}{8}$ ins. To operate with BTH stereo control or similar. Price £27.



Allegro Sound Equipment Ltd., 7/8 Avery Row, Mayfair, London, W.1.

■ **Allegro 66 Integrated Stereo Amplifier.** Inputs mic. 30 mV, tape 30 mV. 7 watts per channel. Dist. 0.5% at 4.3 watts. Response 25-20,000 c/s \pm 3 dB. N.L. — 60 dB. Out. imp. 15 ohms. Output ECL82's. Size $13\frac{1}{4} \times 9\frac{1}{2} \times 5\frac{1}{4}$ ins. Price £29 8s.



Altobass Ltd., Percy Road, Aylestone Park, Leicester. Tel.: Leicester 31616. Cables: Altobass, Leicester.

“**High Fidelity 510**” Control Unit. Inputs: tape/radio 100 mV; P/U (l.p.) 50 mV; P/U (78) 60 mV; mic. 10 mV 5-pos. sel., treble, bass vol. and on/off. Tape replay socket. H.D. 0.15%. H and N — 64 dB mic.; — 71 dB on other inputs. Size $10 \times 3\frac{1}{2} \times 4\frac{1}{4}$ ins. Price £8 8s. Sold only with 510 power amp.

“**High Fidelity 510**” Amplifier. 10 watts nom., 11 watts max. Dist. 0.1% (10 watts. at 400 c/s). Input for spec. output 40 mV.

Response 15-20,000 c/s \pm 0.6 dB. Feedback -20.5 dB. N.L. -78 dB relative to 10 watts. Out. imp. 3.75 or 15 ohms output EL84's., Ultra-linear. Size $13\frac{1}{4} \times 5\frac{1}{2} \times 5\frac{1}{4}$ ins. Price £15 15s.

Altbass Seventy Control Unit. Inputs: Pickup 4 and 50 mV; Radio 250 mV; Tape 5 and 250 mV; Aux. 50 mV. 6-position sel., bass, treble, volume and on/off, switched high pass filter 100 c/s, switched low pass filter 5.5 Kc/s. H.D. 0.015%. H and N Tape -52 dB, others -56 dB. Size $10\frac{3}{8} \times 4 \times 4\frac{1}{4}$ ins. Price £16 16s. To operate with Altbass 510.

■ **Altbass Stereo 70 Control Unit.** Inputs: pickup 4 mV; radio 220 mV; tape 3 mV; mic. 5 mV; aux. 100 mV. 5-position sel., bass, treble, volume, function switch and on/off. H.D. 0.015%. H and N -54 dB. Rumble filter. Size $13\frac{1}{2} \times 7 \times 3\frac{1}{4}$ ins. Price £24 3s. To operate with Altbass Twin Twelve.

■ **Altbass Twin-Twelve Stereo Amplifier.** 10 watts each channel, 12 watts max. Dist. 0.1% at 10 watts. Input for spec. output 150 mV. Response 20-20,000 c/s \pm 0.5 dB. 20 dB feedback. N.L. -78 dB relative to 10 watts. Out. imp. 4, 8 and 16 ohms. Output EL84's. Ultra-linear. Size $14\frac{1}{4} \times 7 \times 6\frac{1}{4}$ ins. Price £30 9s. To operate with Altbass Stereo 70 Control Unit.

■ **Altbass Twin II Amplifier and Control Unit.** Inputs: 200 mV for 2 watts per channel. 3-position sel., dual-concentric volume and frequency controls with on/off switch. H and N -56 dB referred to 2 watts. Size: Main amp. $9 \times 6 \times 5\frac{1}{2}$ ins., Control Unit $5 \times 3 \times 4\frac{1}{2}$ ins. Price £16 16s. complete.

■ **Stereo 44 Amplifier Kit**—See Kits Section.



Ampex Great Britain Ltd., Arkwright Road, Reading, Berkshire. Tel.: Reading 84221. Cables: Videotape, Reading; Telex 84146.

Ampex 303 and 403. Prices and Specifications on request.

Armstrong Wireless & Television Co., Warlters Road, Holloway, N.7. Tel.: North 3213/4.

Mk. II Control Unit. Inputs: radio 80 mV; tape 80 mV; mic. 4 mV; gram. (4) 8-1,200 mV. 4 pos. input switch; 6 pos.



Altbass 510 control unit



Altbass Seventy control unit

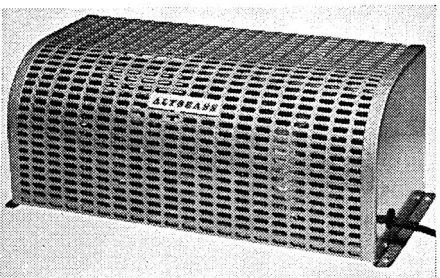

Altbass 510 amplifier



Allegro 66 integrated stereo



Ampex 404 stereo control unit

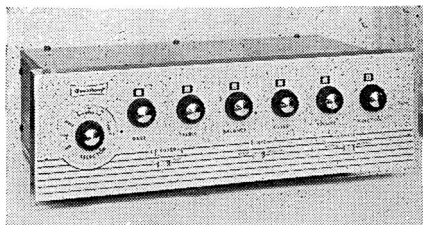

Armstrong PCU 27 stereo control unit

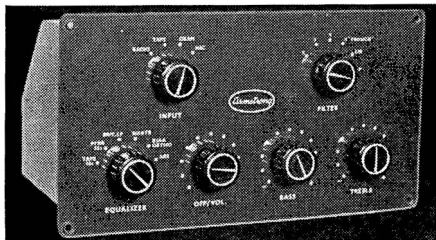

Armstrong Mk II control unit

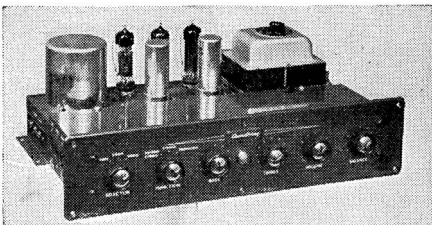

Armstrong PCU 21 C/U and A6 amplifier



Armstrong A10 Mk. II amplifier

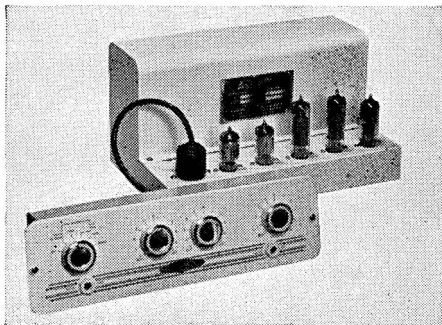

Astronic A1332 control unit and A1333 amp.

equaliser; treble, bass, vol. and on/off; 6 pos. switched filter. Switched tape input. H.D. 0.05% at 1,000 c/s at 180 mV. H and N better than -60 dB. Rumble filter. P.a.t. 320v at 35 mA; 6.3 at 2A. Size $5\frac{1}{2} \times 9\frac{1}{2} \times 5\frac{1}{2}$ ins. To operate with A10 Mk. II power amp. Price £10 10s.

■**PCU 21 Stereo Control Unit.** Inputs: Radio 180 mV, Tape 500 mV, Gram 1,000 and 280 mV, and 180 mV stereo, 3-position sel., function, bass, treble, balance, volume. H.D. 0.5%. H and N -66 dB. Size $13 \times 4\frac{1}{2} \times 2\frac{1}{2}$ ins. Price £9 15s. To operate with amplifier A6.

A10 Mk. II. 10 watts nominal, 20 watts max. Dist. 0.1%. Input for spec. output 400 mV for 10 watts. Response 15-30,000 c/s ± 1 dB. Feedback 28 dB. N.L. better than -80 dB. Out. imp. 1, 3, $7\frac{1}{2}$ and 15 ohms. Output EL34's. Ultra-linear. Size $14 \times 8\frac{1}{2} \times 6\frac{1}{2}$ ins. To operate with Mk. II control unit. Price £21 10s.

A6. 6 watts. Dist. 0.5%. Input for spec. output 700 mV. Response 15-35,000 c/s ± 2 dB. Feedback 14 dB. N.L. -70 dB. Out. imp. 3, $7\frac{1}{2}$, and 15 ohms. Output ECL82's. Size $13 \times 3\frac{1}{2} \times 5$ ins. Price £9 17s. 6d. To operate with PCU21 Control Unit.

■**PCU27 Stereo Control Unit.** Inputs: Auxiliary 2 mV. Microphone 2 mV. Radio 80 mV; Gram 1 80 mV, Gram 2 7 mV; Gram 3 3.5 mV; Tape 1 130 mV; Tape 2 2 mV. 8 position sel., bass, treble, balance controls, filter switch, slope switch, rumble filter, vol. phase, function. Tape outputs, stereo and mono. H.D. less than 0.1%. H and N -62 dB. Power supplies required H.T. 300 volts at 8 mA. L.T. 6.3 volts at 2 amps. Size of front panel $14\frac{1}{2} \times 4\frac{1}{2}$ ins. To operate with A10 amplifiers. Price £26 10s.



Associated Electronic Engineers Ltd., 10 Dalston Gardens, Stanmore, Middx. Tel.: Wordsworth 4474/5/6. Cables: Astronic, Stanmore.

Astronic A1332 Control Unit. Inputs: mic. 20 mV; gram. A.E.S., FFRR, NARTB 10-20 mV; radio/tape 220 mV. 6 pos. sel., treble, bass, vol. and on/off, gram. input attenuator. Tape record and playback socket. H and N -70 dB. Size $12 \times 3\frac{3}{4} \times 1\frac{1}{2}$ ins. To operate with A1333 power amp. Price £9 10s. 6d.

Astronic A1432 Control Unit. Inputs: mic. 20 mV; radio 120 mV; P/U 4 mV or 20 mV; tape (C.C.I.R.) 1-2 mV. 6 pos. sel. (3 record equal.), treble, bass, vol. on/off. Filter 5, 7, 10 Kc/s. Slope 6-30 dB/octave. Loudness -18 dB max. Presence +6 dB, 2-3 Kc/s. Rumble filter. Variable P/U attenuator. Socket for direct replay from tape head. H.D. not measurable. H and N -65 dB. Size $11\frac{1}{2} \times 3\frac{1}{2} \times 5\frac{1}{4}$ ins. To operate with A1333 or A1440 amplifiers. Price £21 19s.

Astronic A1333 Amplifier. 10 watts nom., 13 watts max. Dist. 0.1% at 10 watts. Input for spec. output 0.33v R.M.S. Response 20-20,000 c/s ± 0.5 dB. Feedback 18 dB N.L. -72 dB. Out. imp. $3\frac{3}{4}$, $7\frac{1}{2}$ and 15 ohms. Output N709's or EL84's. Ultra-linear. Size $11\frac{1}{2} \times 6\frac{1}{4} \times 6$ ins. To operate with A1332 control unit. Price £18 19s. 6d.

■ **Astronic A1434 Stereo Control Unit.** Inputs, single channel: tape 1-2 mV; l.p. (Int.) 4 mV; radio 120 mV; mic. 20 mV; aux. 120 mV. Stereo inputs for tape, P/U and radio same sensitivities. 8 pos. sel., bass, treble, vol., on/off, rumble filter, presence switch, channel balance (pre-set). Dist. negligible. H and N -65 dB. Size $11\frac{1}{2} \times 3\frac{1}{2} \times 6$ ins. To operate with amplifiers A1333 Mk. I and Mk. II or A1440. Price £22 5s.

■ **Astronic A1444. Combined Stereo Unit.** 4 watts. Dist. 2%. Inputs: radio, tape and l.p. discs. 150 mV; 78 discs. 350 mV. 4-position sel., bass, treble, volume and on/off. Out. imp. 3 and 15 ohms. Size $11\frac{1}{2} \times 8\frac{3}{4} \times 3\frac{3}{4}$ ins. Price £24 3s.

Atlas A1440. 20 watts nominal, 35 watts max. Dist. 0.1%. Input for spec. output 0.25 volts. Response 20-20,000 c/s ± 5 dB. Feedback 30 dB. N.L. -85 dB. Out. imp. $3\frac{3}{4}$, $7\frac{1}{2}$ and 15 ohms. Output EL34's. Ultra-linear. Size $13 \times 7\frac{1}{2} \times 8\frac{1}{2}$ ins. Price £37 16s. To operate with amplifiers A1332, A1432, and A1434.



Cape Electrophonics Ltd., 43-45 Shirley High Street, Southampton. Tel.: Southampton 74251.

Cape VL 50. 50 watts nom. Dist. at 1000 c/s. 0.1%. Input adjustable. Max 1 mV. Response 10-50,000 c/s ± 1 dB. Feedback two loops 20 dB. N.L. -85 dB. Out. Imp 3, $7\frac{1}{2}$ and 15 ohms. Output. KT 88's Ultra Linear. Price £60 (Provisional).



Astronic A1444 integrated stereo amplifier

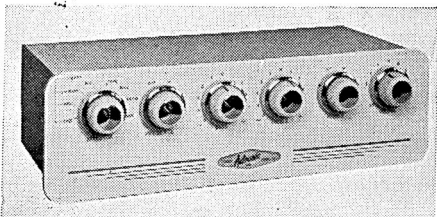

Astronic A1434 stereo control unit

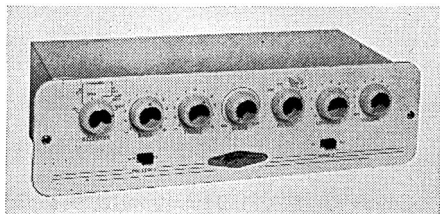

Astronic A1432 control unit

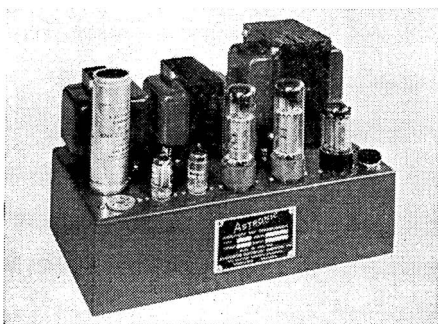

Astronic Atlas A1440 amplifier

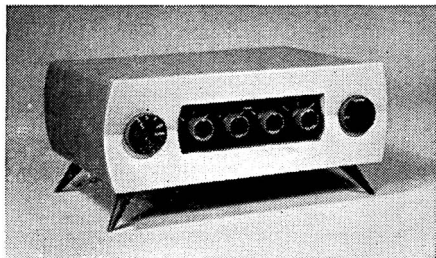

Chapman 305 stereo control unit

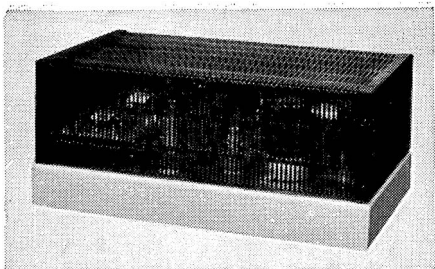

Chapman 305 stereo amplifier

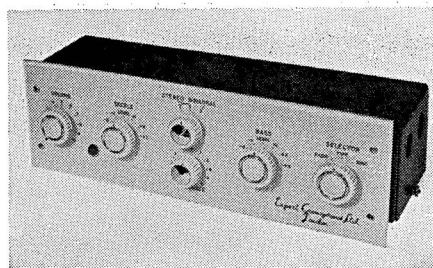

Expert stereo control unit

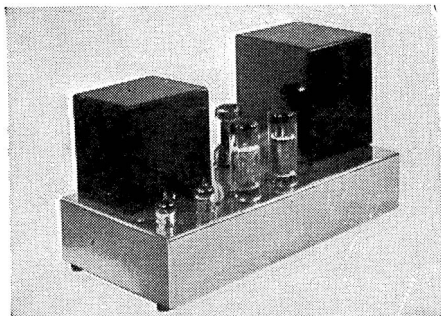

Chapman 205 amplifier



Expert Standard stereo amplifier

Cape VL 100. 100 watts. Nom. (Spec as VL 50) Price £75 (Provisional).

Cape VL 20. 20 watts nom. (As VL 50) but with low distortion and noise.



C. T. Chapman (Reproducers) Ltd., Sales Division, 24 Upper Brook Street, London, W.1. Tel.: Hyde Park 2291.

Chapman 205 Amplifier. 20 watts from 30-20,000 c/s. Dist. <0.05% at 20 watts. Response 2-100,000 c/s \pm 1 dB. Feedback 30 dB. N.L. -89 dB at 20 watts. Out. imp. 15 ohms. Output EL34's. Ultra-linear. To operate with 205CU. Price £34.

■ **Chapman 305 Stereo Control Unit.** Inputs: Pickup and tape 4.5 mV; radio 100 mV; Aux. 100 mV. 4 position sel., bass, treble, volume, balance, filter. H.D. <0.1%. H and N -50 dB. Rumble filter. Size 12 \times 4 $\frac{1}{2}$ \times 6 $\frac{1}{4}$ ins. Price £18 18s. To operate with 305 amplifier or 2 \times 205 amplifiers.

■ **Chapman 305 Stereo Amplifier.** 8 watts per channel, 15 watts peak. Dist. <0.1%. Input for spec. output 350 mV. Response

30-20,000 c/s \pm 0.2 dB. Feedback 10 dB. N.L. -80 dB. Out. imp. 3 and 15 ohms. Output EL84's. Ultra-linear. Size 12 \times 7 \times 5 ins. Price £21. To operate with 305 pre-amplifier.

Chapman 105 Combined Control Unit and Amplifier. 10 watts nominal, 20 watts peak. Inputs: pickup 10 and 50 mV; radio and tape 100 mV. Selector, bass, treble, filter, loudness control, volume and on/off. Rumble filter. Dist. <0.1%. Response 30-20,000 c/s \pm 0.2 dB. N.L. -80 dB. Out. imp. 3 and 15 ohms. Output EL84's. Ultra-linear. Size 12 \times 4 $\frac{1}{2}$ \times 8 $\frac{1}{2}$ ins. Price £29 18s.



Expert Gramophones Ltd., 78 Balham High Road, Balham, London, S.W.12. Tel.: Balham 4022.

Expert Control Unit. Input P/U, tape, radio, all 20 mV. 3 pos. sel., vol., bass, treble filter-variable slope. Tape input socket. H.D. <0.1%. H and N -60 dB. Attenuation introduced below 20 c/s. P.a.t. from power amp. Size 12 \times 3 $\frac{1}{2}$ \times 6 ins. To operate with Expert "Master" and "Standard" or any similar power amp. Price £18.

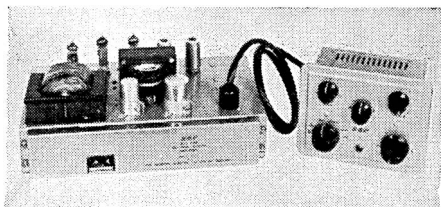

G.E.C. control unit and amplifier

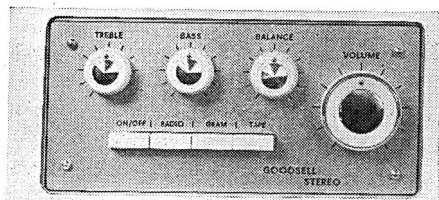

Goodsell stereo III control unit

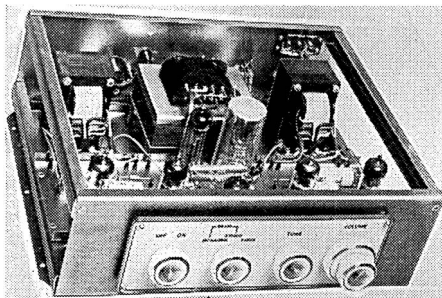

Goodsell stereo Mk. I

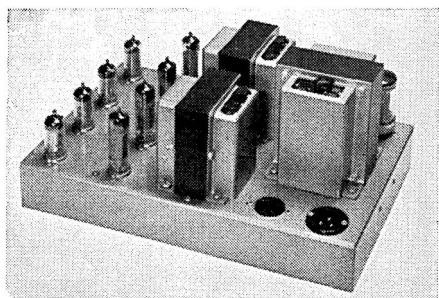

Goodsell MA20 stereo amplifier

Expert "Standard" Amplifier. 12 watts nom., 14 watts max. Dist. 0.1%. Input for spec. output 200 mV. Response 20-25,000 c/s ± 0.5 dB. Feedback 30 dB. N.L. - 80 dB at 8 watts. Out. imp. 15 ohms. Output EL84's. Ultra-linear. Size 12 \times 9 \times 6 $\frac{1}{2}$ ins. To operate with Expert control unit or similar. Price £23.

Expert "Master" Amplifier. 20 watts nom., 26 watts max. Dist. 0.07%. Input for spec. output 200 mV. Response 20-30,000 c/s ± 0.5 dB. Feedback 30 dB. N.L. - 85 dB at 20 watts. Out. imp. 15 ohms. Output EL34's. Ultra-linear. Size 12 \times 9 \times 7 $\frac{1}{2}$ ins. To operate with Expert control unit or any similar. Price £35.

■ **Expert "Standard" Stereo Amplifier.** 10 watts per channel. Dist. 0.1% at 10 watts. Input for spec. output 200 mV. Response 30-20,000 c/s ± 1 dB. 28 dB feedback. N.L. - 80 dB ref. 8 watts. Out. imp. 15 ohms. Output ECL82's. Size 12 \times 9 \times 6 $\frac{1}{2}$ ins. To operate with stereo Mk. I control unit. Price £23.

■ **Expert Stereo Mk. I Control Unit.** Inputs (6) 250 mV sensitivity. Switched bass, treble, function controls. H.D. less than 0.1%. P.a.t. Size 12 \times 3 $\frac{1}{2}$ \times 3 ins. To operate with "Standard" stereo amplifier. Price £18.

General Electric Co. Ltd., Radio Group, Lena Gardens, Brook Green, Hammer-smith, London, W.6. Tel.: Riverside 4671. Cables: Polyphase, London.

BCS2417A. Control Unit. Inputs: pickup 5-15,000 mV, radio 300 mV, tape 7.5 mV. 6 position sel., vol., treble, bass, presence. Size 7 $\frac{1}{2}$ \times 6 $\frac{1}{4}$ \times 5 $\frac{1}{8}$ ins. To operate with BCS2418A amplifier. Price £11 11s.

G.E.C. BCS2418A Amplifier. 12 watts nom. Dist. <0.5% at 12 watts. Input for spec. output 120 mV. Response 20-20,000 c/s ± 1 dB. Feedback 22 dB overall. Out. imp. 15 ohms (or 1, 2 or 3 3-5 ohms speakers). Output N709's. Size 14 \times 7 $\frac{3}{4}$ \times 6 $\frac{1}{2}$ ins. To operate with BCS2417A. Price £17 17s.



Goodsell Ltd., 40 Gardner Street, Brighton. Tel.: Brighton 26735.

Golden PFA Control Unit. Inputs: pick-up 5-7 mV; mic. 5 mV; radio 80 mV. 4 pos. sel., treble, bass, vol. Separate "roll-off" and "turnover" facilities covering all known equalising characteristics. Switched filter 5, 7, 9, 13 Kc/s and "out." Spec. dependent on amp. used. Size 11 \times 9 \times 3 $\frac{1}{2}$ ins. To operate with all Goodsell amplifiers. Price £20.

■ **Stereo I Control Unit.** Inputs: Pickup 7 mV stereo; radio 150 mV. Selector switch, vol., bass, treble and on/off. H.D. 0.1%. Size 7 × 6 × 4 ins. Price £16 15s.

■ **Stereo II Control Unit.** Inputs: pickup 7 mV stereo; radio 150 mV; tape 3 mV. Selector switch, vol., bass, treble, on/off. H.D. 0.1%. Size 13 × 7½ × 3¼ ins. Price £27 15s.

■ **Stereo III Control Unit.** Inputs: pickup 60 mV, radio and tape 100 mV. Push-button selector, ganged bass, treble, volume

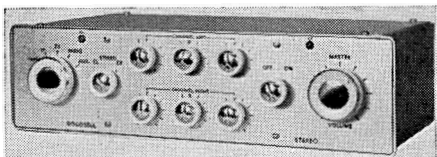

Goodsell stereo II control unit

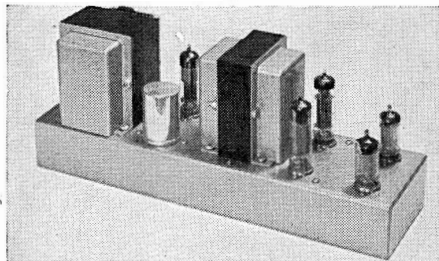

Goodsell MA10 amplifier

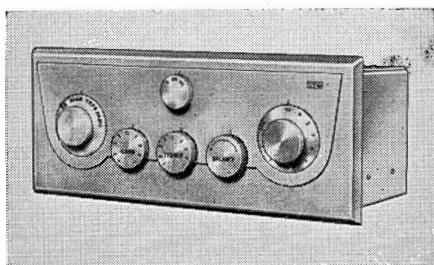

Emisonic Orthotone 399 stereo control unit



Emisonic Orthotone 381 stereo amplifier

controls. H and N -65 dB. To operate with Goodsell "Mullard" stereo amplifier. Price not yet available.

■ **MA8 Stereo Amplifier.** 3.5 watts per channel. Dist. 0.4%. Input for spec. output 1.5 volts. Response 30-30,000 c/s. Feedback 25 dB. N.L. -70 dB. Out. imp. 3 and 15 ohms. Output EL84's. Ultra-linear. Size 14 × 6 × 6 ins. Price £17. To operate with Stereo I or Stereo II Control Unit.

■ **MA10 Amplifier.** 10 watts. Dist. 0.1%. Input for spec. output 1.5 volts. Response 30-30,000 c/s ±0.5 dB. Feedback 22 dB. N.L. -70 dB. Out. imp. 3 or 15 ohms. Output EL84's. Ultra-linear. Size 14 × 5 × 6 ins. Price £18. To operate with Stereo I or Stereo II Control Units.

■ **GW25 Amplifier.** 20 watts. Dist. 0.1%. Input for spec. output 1.5v. Response 20-100,000 c/s. Feedback 20 dB. N.L. better than -75 dB. Out. imp. 3, 8 and 15 ohms. Output KT66's. Ultra-linear. Size 14 × 10 × 7 ins. Weight 35 lb. To operate with PFA control unit. Price £27 10s.

■ **Golden GW50 "Williamson" Amplifier Mk. II.** 40 watts. Dist. <0.1%. Input for spec. output 1.5v. Response 20-100,000 c/s ±2 dB. Feedback 20 dB. N.L. -75 dB. Out. imp. 3 or 8 or 15 ohms. Output KT88's. Size 17 × 11½ × 8¾ ins. Weight 54 lb. To operate with PFA control unit. Price from £40 10s.

■ **MA20 Stereo Amplifier.** 10 watts per channel. Details as MA10 above. Price £32 5s.

■ **"Mullard" Stereo Control Unit.** Details as per Mullard 2-valve design. To operate with Goodsell "Mullard" amplifier. Price £16 15s.

■ **"Mullard" Stereo Amplifier.** 7 watts per channel. Details as per Mullard design. To operate with Stereo III or "Mullard" control unit. Price £17 to £19 10s.



The Gramophone Company Ltd., Hayes, Middx. Tel.: Southall 2468. Cables: Jabberment, London.

■ **H.M.V. Stereoscope 555. Integrated Stereo Amplifier.** Inputs: pickup 2 mV magnetic; 60 mV crystal, tape 3 and 150 mV; microphone 2 and 20 mV, tuner 150 mV. 7 position sel. for each channel. Bass,

treble, vol., loudness, scratch filters, rumble filter. Cathode ray tube for balance and level checking. Mixing of two channels for recording purposes. 10 watts per channel, 12.5 max. H.D. <0.1%. Response 20-20,000 c/s \pm 1 dB at 5 watts. Crosstalk -50 dB at 1 Kc/s, -30 dB at 20 c/s and 20 Kc/s. H and N -80 dB. 34 dB feedback. Output EL84's. Size 14 \times 4 \times 13 $\frac{1}{2}$ ins. Price £63 3s.

■ **H.M.V. Stereoscope 556. Stereo Control Unit.** Inputs: as 555, plus an extra magnetic pickup pair at 2 mV. Other facilities as 555. Cathode follower output rated from 160 mV to 6 volts, adjustable by preset controls in each channel. Size 14 \times 4 \times 9 ins. To operate with Type 557 or 381 stereo amplifiers or pair of 373 amplifiers. Price £40 19s.

■ **Emisonic Orthotone 399 Stereo Control Unit.** Inputs: pickup 3.5 mV; radio and tape 30 mV. 4-position sel., bass, treble, balance, volume, function switch. H.D. < 0.1%. H and N -60 dB. Rumble filter. Size 11 $\frac{1}{4}$ \times 4 $\frac{3}{8}$ \times 7 ins. Price £22 1s. To operate with E.M.I./381 and E.M.I./373 amplifiers.

■ **Emisonic Orthotone 444 Combined Stereo Amplifier and Control Unit.** Inputs: pickup, radio, and aux. 200 mV. 6-position sel., bass, treble, balance, vol. 2.5 watts per channel. Dist. 0.3%. Out. imp. 15 ohms. Size 11 $\frac{1}{4}$ \times 4 $\frac{3}{8}$ \times 10 ins. Price £27 6s.

■ **Emisonic Orthotone 381 Stereo Amplifier.** 10 watts per channel. Dist. 0.1%. Input for spec. output 200 mV. Response 30-20,000 c/s \pm 1 dB. Feedback 26 dB. N.L. -80 dB. Out. imp. 4, 8, and 16 ohms. Output EL84's. Ultra-linear. Size 8 $\frac{1}{2}$ \times 13 \times 6 ins. Price £29 8s. To operate with E.M.I./399 Control Unit.

Emisonic Orthotone 373 Amplifier. 25 watts. Dist. 0.1%. Input for spec. output 160 mV. Response 20-20,000 c/s \pm 1 dB. Feedback 28 dB. N.L. -76 dB. Out. imp. 4, 8, and 16 ohms. Output EL34's. Ultra-linear. Size 11 \times 9 \times 6 $\frac{1}{2}$ ins. Price £25 4s. To operate with E.M.I./448 and E.M.I./399 Control Units.

★

Grampian Reproducers Ltd., Hanworth Trading Estate, Feltham, Middx. Tel.: Feltham 2657/8/9. Cables: Reamp, Feltham.

Grampian 582 Control Unit. Inputs: pickup 15 mV; radio 200 mV; tape 500 mV. Selector switch, bass, treble, vol. Size

10 $\frac{1}{4}$ \times 4 \times 5 $\frac{1}{2}$ ins. Price £14. To operate with "Ten Fifteen" Amplifier.

Grampian 580 Control Unit. Similar to 582, but for crystal pickups. Sensitivity 600 mV, radio 500 mV. Price £8 5s.

Grampian 10-15 Amplifier. 10 watts nom., 15 watts peak. Dist. 0.1% at 10 watts. Input for spec. output 50 mV. Response 30-20,000 c/s \pm 1 dB. Feedback 20 dB. N.L. -65 dB below full output. Out. imp. 4, 8, 15 ohms. Output EL84's. Ultra-linear.

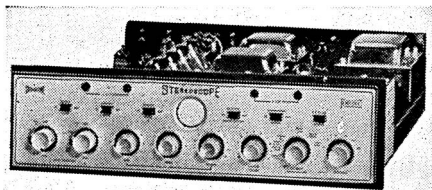

H.M.V. Stereoscope 555

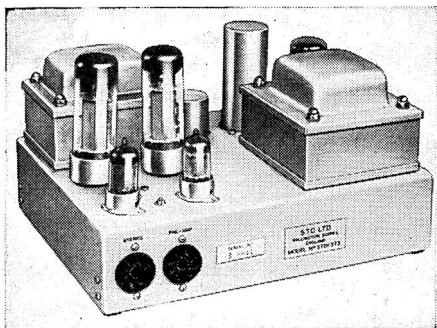

Orthotone Emisonic 373 amplifier

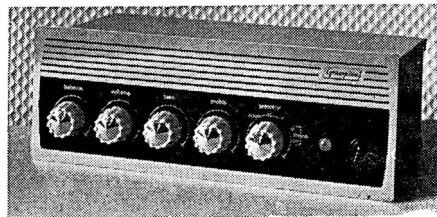

Grampian stereo control unit

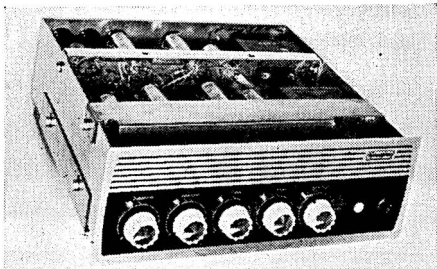

Grampian 590 integrated stereo amplifier

Size $11 \times 7\frac{1}{2} \times 6\frac{1}{2}$ ins. To operate with "580" and/or "582" control unit. Price £18.

■ **Gramplan 590 series.** Stereo Control Unit with single channel amplifier and provision for adding a second amplifier for stereo. 7 watts per channel, 10 watts peak. Dist. 1%. H and N -60 dB. Inputs: pickup 0.5v at 1 Megohm, tuner and tape 1v at 0.5 Megohm. Sel., switch, balance, bass, treble. Out. imp. 4 and 15 ohms. Size: chassis $10\frac{7}{8} \times 3\frac{3}{8} \times 13$ ins., wood surround $12\frac{1}{4} \times 5\frac{3}{4} \times 13$ ins. Price 590/1 (control unit and one 584 amplifier) £21 10s., 590/2 (control unit and two 584 amplifiers), £32, 584 amplifier £10, wood surround £3.

In Preparation. 10 watt integrated amplifier.



Jason Electronic Designs Ltd., 3/4 Gt. Chapel Street, London, W.1. Tel.: Gerrard 0273/4.

J10 Combined Control Unit and Power Amplifier. Inputs: mic. 1 mV; tape 0.5 V; radio 0.5V; P/U 1.0v and crystal P/U. 6 pos. sel., treble, bass, vol. P.a.t. 270v at 10 mA, 6.3v at .3A. Output 10 watts nom., 15 watts max. Dist. 0.1%. Response 30-30,000 c/s ± 2 dB. N.L. better than 55 dB (mic. input). Out. imp. 15 ohms



Jason J2-10 Mk. III integrated stereo amp.

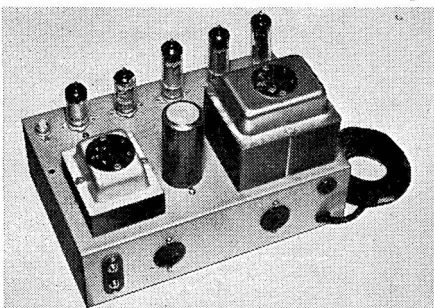

Gramplan 10-15 amplifier

(other imp. to order). Output EL84's. Ultra-linear. Size $15 \times 8\frac{1}{4} \times 4\frac{3}{8}$ ins. Price £24.

■ **J2-10. Integrated Stereo Amplifier, Mk. III.** Inputs: pickup 3 mV and 60 mV; tape 1.5 mV; radio 60 mV; mic. 5 mV. 5 position sel. switch; bass, treble, vol., balance, function, 9 Kc/s and 6 Kc/s filter. H.D. less than 0.1%. H and N -55 dB. Rumble filter. 10 watts per channel, 15 watts max. 18 dB feedback. Out. imp. 4, 8, 15 ohms. Output EL84's. Size $15 \times 4\frac{3}{8} \times 12$ ins. Price £40 19s.



H. J. Leak & Co. Ltd., 57-59 Brunel Road, East Acton, London, W.3. Tel.: Shepherds Bush 1173. Cables: Sinusoidal, Ealux, London.

"Point One Plus" Control Unit. Inputs: tape 50 mV or mic. 4 mV; tuner 50 mV; P/U 9.5 mV. 6 pos. sel., 4 record equal, treble, bass, vol., mains on/off. Switch filter 4, 6 and 9 Kc/s. Input level control for P/U, tuner. Tape record and replay sockets on front and rear. H.D. < 0.01%. H and N -66 dB. Size $11\frac{1}{2} \times 4\frac{7}{8} \times 5$ ins. To operate with TL/12 Plus, TL/25 Plus or TL/50 Plus amplifier. Price £12 12s.

"Vari-slope III" Control Unit. Inputs: tape 50 mV or mic. 4 mV; tuner 45 mV;

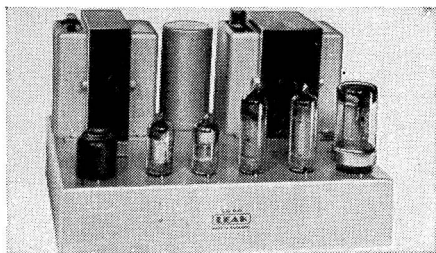

Leak TL/12 plus amplifier

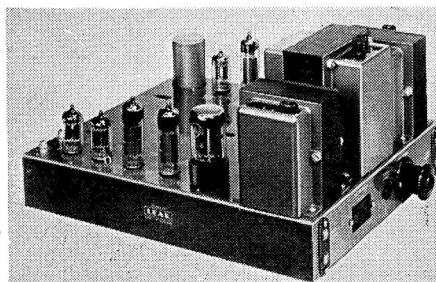

Leak "Point One" Stereo 20 amplifier

pickup I 9 mV; pickup II 9 mV. 6 pos. sel. and change-over switch for pickup I/pickup II. Treble, bass, vol., mains on/off. Switched low pass filter 4, 6 and 9 Kc/s plus Vari-slope control. Rumble filter cut in. Input level controls for tuner, pickup I, pickup II. Tape input sockets on front and back panels. H.D. < 0.01%. H and N -66 dB. P.a.t. on TL/12 plus power amp. Size $11\frac{1}{2} \times 4\frac{7}{8} \times 5$ ins. To operate with TL/12 Plus, TL/25 Plus, and TL/50 Plus amp. Price £15 15s.

"Point One" TL/12 Plus Amplifier. 12 watts. Dist. 0.1%. Input for spec. output 125 mV. Response 20-20,000 c/s \pm 0.25 dB. Feedback 26 dB. N.L. -84 dB. Out. imp. 4, 8 and 16 ohms. Output EL84's. Ultra-linear. Size $10 \times 8 \times 6$ ins. To operate with Vari-slope III or Point One Plus control units. Price £18 18s.

"Point One" TL/25 Plus Amplifier. 25 watts. Dist. 0.1%. Input for spec. output 125 mV. Response 20-20,000 c/s \pm 0.25 dB. Feedback 26 dB. N.L. -83 dB. Out. imp. 4, 8 and 16 ohms (other imps. to order). Output EL34's. Ultra-linear. Size $10 \times 8 \times 6\frac{3}{4}$ ins. To operate with Vari-slope III or Point One Plus control units. Price £25 4s.

"Point One" TL/50 Plus Amplifier. 50 watts. Dist. 0.1%. Input for spec. output 125 mV. Response 20-20,000 c/s \pm 0.25

dB. Feedback 26 dB. N.L. -84 dB. Out. imp. 4, 8 and 16 ohms (other imps. to order). Output KT88's. Ultra-linear. Size $11\frac{1}{2} \times 9 \times 6\frac{3}{4}$ ins. To operate with Vari-slope III or Point One Plus control units. Price £33 12s.

■ Vari-slope Stereo Control Unit. Inputs: Pickup I 3.5 mV or 35 mV; pickup II 3.5 mV or 350 mV; tape 3 mV; tuner 50 mV or 250 mV; mic. 2 mV; extra 50 mV or 1V (all mono and stereo), sel. switch. Bass, treble, vol., on/off. Switched low pass filter 4, 6, 9 Kc/s plus Vari-slope control. Rumble filter cut/in. Balance control. H and N -60 dB. Size $11\frac{1}{2} \times 4\frac{1}{2} \times 6\frac{1}{2}$ ins. To operate with any Leak amplifiers. Price £25.

■ "Point One Stereo" Control Unit. Twin channel inputs for P/U, 3.5 mV; tuner 35 mV, tape recorder 35 mV; tape head 3 mV; mic. 2 mV. Stereo/monaural and rumble switches, balance, treble, bass, vol., mains on/off. Input level controls. Tape sockets for recording. H.D. 0.01% on each channel. H and N -60 dB. To operate with "Point One" Stereo 20 amplifier. Price £21.

■ "Point One" Stereo 20 Amplifier. 11 watts each channel. Dist. 0.1% on each channel. Input for spec. output 125 mV. Response 20-20,000 c/s. Feedback 24 dB.



Leak "Varislope" stereo



Leak "Point One Stereo" control unit

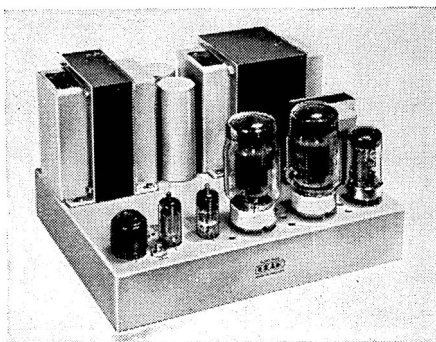

Leak TL/25 Plus amplifier

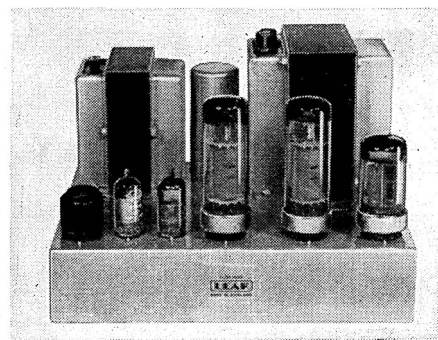

Leak TL/50 Plus amplifier

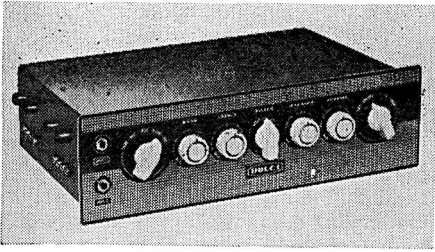

Lee Stereo Eight control unit

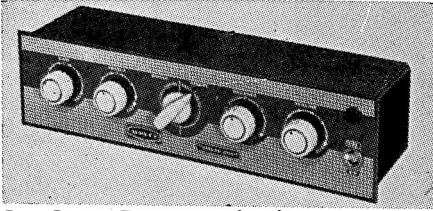

Lee Stereo Two control unit

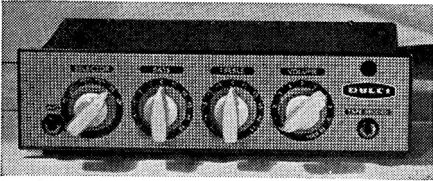

Lee DPA10 control unit

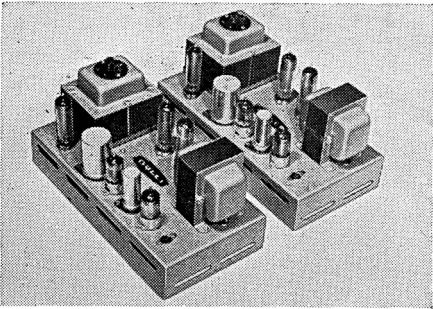

Matched pair of Lee DPA10/2 amps.

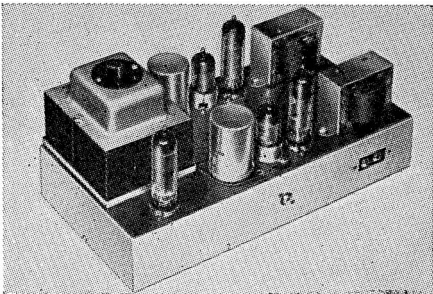

Lee SP44 Stereo amplifier

N.L.— 80 dB. Out. imp. 4, 8 and 16 ohms. Output EL84's. Ultra-linear. To operate with "Point One Stereo" or "Vari-slope Stereo" control units. Price £30 9s. ■"Point One" Stereo 50 Amplifier. 25 watts each channel. Price £42.



Lee Products (G.B.) Ltd., Elpico House, Longford Street, London, N.W.1. Tel.: Euston 5754. Cables: Leprod, London.

Elpico AC88. Inputs: mic. 4 mV; radio, pickup and tape 100 mV. 10 watts nom., 16 watts max. Dist. 0.5% at 10 watts. Response 50-20,000 c/s \pm 3 dB. N.L.— 55 dB. Out. imp. 3-15 ohms. Out. EL84's. Ultra-linear. Size 14 \times 7 $\frac{1}{2}$ \times 8 ins. Price £25 4s.

DPA10 Control Unit. Inputs: pickup 6 mV; tape 100 mV; mic. 1.5 mV; radio 100 and 300 mV. 6-position sel., bass, treble, volume and on/off. H.D. <0.1%. H and N—45 dB. Size 11 $\frac{1}{4}$ \times 3 \times 5 $\frac{1}{4}$ ins. Price £8 8s. To operate with DPA10 amplifier.

DPA10 Power Amplifier. 15 watts nominal. Dist. 0.3%. Input for 10 watts 40 mV. Response 30-15,000 c/s \pm 1 dB. Feedback 26 dB. N.L.—75 dB. Out. imp. 3-16 ohms. Output EL84's. Ultra-linear. Size 11 $\frac{1}{4}$ \times 6 \times 5 $\frac{1}{2}$ ins. Price £14 14s. To operate with DPA10 Control Unit, Stereo Two, or Stereo Eight.

■"Stereo Two" Control Unit. Inputs: radio and tape 100 mV; pickup adjustable 50 mV to 2 volts. 6-position sel., bass, treble, volume, balance. H.D. <0.1%. H and N—60 dB. Size 12 $\frac{1}{2}$ \times 3 $\frac{1}{4}$ \times 5 ins. Price £10 10s. To operate with two DPA10, or SP44 amplifiers.

■"Stereo Eight" Control Units. Inputs: mic. and tape 3 mV; radio 100 mV; pickup 4 to 100 mV; tape 100 mV; aux. 50 mV to 2 volts. 6-position sel., bass, treble, filter, balance, function. H.D. <0.1%. H and N—50 dB. Rumble filter. Size 14 $\frac{1}{4}$ \times 4 \times 9 $\frac{3}{8}$ ins. Price £23 2s. To operate with two DPA10, or SP44 amplifiers.

■SP44 Stereo Amplifier. 4 watts per channel. Dist. <1%. Input for 3 watts, 65 mV. Response 40-25,000 c/s \pm 1 dB. Feedback 20 dB. N.L.—72 dB. Out. imp. 3 and 15 ohms. Output EL84's. Size 11 $\frac{1}{2}$ \times 6 \times 5 $\frac{1}{2}$ ins. Price £14 14s. To operate with "Stereo Two", or "Stereo Eight".

Lowther Manufacturing Co., Lowther House, St. Mark's Road, Bromley, Kent. Tel.: Ravensbourne 5225. Cables: Lowther, Bromley.

Lowther No. 2 Control Unit. Inputs: mic 45 mV; P/U: 45 mV; radio 100 mV. 4-pos. sel., treble, bass, vol., on/off. Mic./tape input socket. H.D. 0.1% on 1v R.M.S. H and N—60 dB. Size $10\frac{1}{2} \times 3 \times 3\frac{1}{2}$ ins. To operate with LL15, LL26 and similar power amp. Price £10 10s.

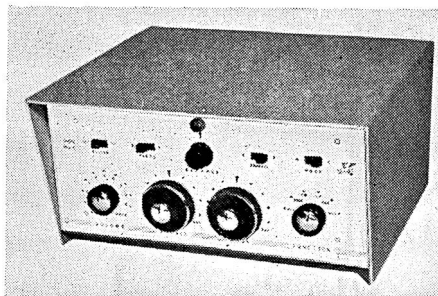

Lowther S.C.U. stereo control unit

Master Control Unit Mk. II. Inputs: mic., P/U and tape head 3 mV; radio, tape and aux. 100 mV. 6-pos. sel., 5-pos. record equal, treble, bass, vol., on/off. Low pass filter. 18 dB per octave. 35 down to 4 Kc/s. Socket for direct connection to tape playback head. H.D. <0.1%. H and N—90 dB. Size $10\frac{1}{2} \times 5\frac{1}{2} \times 7\frac{1}{2}$ ins. To operate with LL15, LL26 and similar power amp. Price £24.



Lowther LL16 amplifier

Lowther LL15 Amplifier. 16 watts. Dist. <0.1%. Input for spec. output .75v. Response 30-30,000 c/s ± 1 dB. Feedback 22 dB. N.L.—80 dB. Out. imp. 16 ohms with adjustment. Output EL34's. "Lowther Linear" (screen and anode feedback). P.a.t. Size $12 \times 9 \times 6\frac{1}{2}$ ins. To operate with MCUII, MCUIV or control unit No. 2. Price £27 10s.

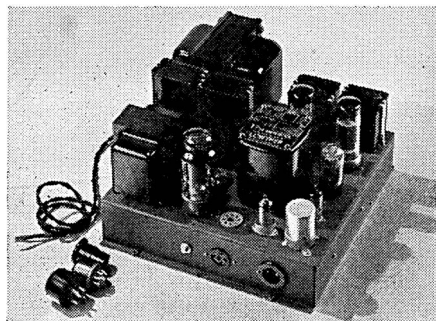

Lowther LL26 amplifier

Lowther LL26 Amplifier. 26 watts. Dist. <0.1%. Input for spec. output 0.75v. Response 20-60,000 c/s ± 1 dB. Feedback 22 dB. N.L.—90 dB. Out. imp. 16 ohms with adjustment. Output EL34's. "Lowther Linear". P.a.t. Size $12 \times 12 \times 8\frac{1}{2}$ ins. To operate with MCUII, MCUIV or control unit No. 2. Price £47.

■ **Lowther S.C.U. Stereo Control Unit.** Input as for Master Control Unit Mk. IV. Tape input sockets. H.D. 0.1%. Dual low pass filters. Dual output balanced and balance controls between channels. Size as M.C.U. Mk. IV. To operate with LL15S power amp. Price £40.

■ **Lowther LL15S Stereo Amplifier.** 16 watts output on each channel. Dist. 1%. Input for spec. output 0.75v. Response 20-40,000 c/s ± 1 dB. N.L.—80 dB. Out. imp. 7.5 or 15 ohms. Output EL34. "Lowther Linear". Size $11 \times 10 \times 8$ ins. To operate with SCU control unit. Price £47.

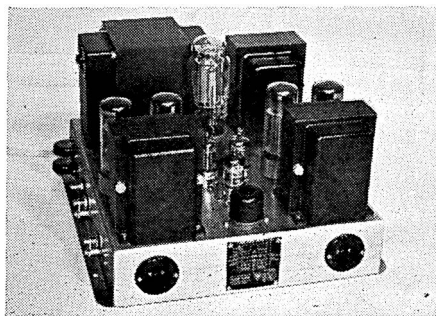

Lowther LL15S stereo amplifier

Lowther Integrated Stereo Amplifier.

12 watts per channel, Inputs: mic 2mv, Pickup 2mv Tape 100mv, radio 100mv, Aux 100mv H.D. 0.2% at 10 watts. Response 30-30,000 c/s \pm 1 dB. N.L. -45dB. Output Imp. 16 ohms. Price £70.

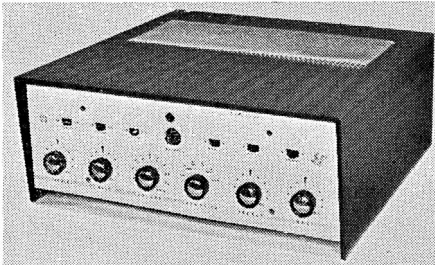

Lowther Integrated stereo amplifier

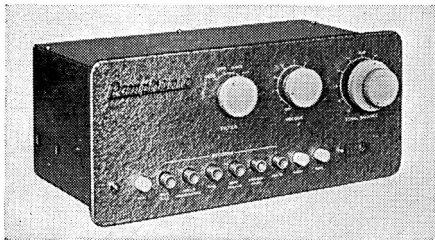

Pamphonic 1002B control unit



Pamphonic 3001 integrated stereo amplifier



Pamphonic 3000 stereo amplifier

Pamphonic Reproducers Ltd., 17 Stratton Street, W.1. Tel.: Grosvenor 1926.

1002B Control Unit. Inputs: mic. 2-3 mV; radio/tape 60 mV; P/U 6-8 mV. Push-button sel. 9 pos. (6 gram.). Cut off filter 4, 7, 12 Kc/s and "out". Terminals for tape input. H and N 60 dB below 0.5v. P.a.t. Size $10\frac{1}{4} \times 4\frac{1}{4} \times 7\frac{1}{4}$ ins. To operate with 2001 power amp. Price £25 4s.

2001A Control Unit. Inputs: 3-120 mV depending on input. 6-pos. sel. Pre-set level control for tape/radio. Cut-off filter at 4, 7, 12 Kc/s and "out". Loudness control. Tape input sockets. H and N 60 dB below 0.5v. P.a.t. To operate with 2001 power amp. Price £12 12s.

2001 Amplifier. 25 watts. Dist. at 1,000 c/s, 0.05% at 15 watts. Input for spec. output 0.5v. Response substantially flat 2-100,000 c/s. Feedback 28 dB. N.L. 90 dB below full output. Out. imp. 3.75, 6.6, 10 and 15 ohms. Output KT66's. Ultra-linear. To operate with 2001A or 1002B control units. Price £29 8s.

3000 Stereo Amplifier. 7.5 watts per channel. Dist. 0.5%. Inputs: radio 1 volt; tape 0.5 volts; pickup crystal stereo. Response. 50-15,000 c/s. Feedback 20 dB. N.L. -57 dB. Out. imp. 15 ohms each channel. Ultra-linear. Size $14 \times 9\frac{1}{4} \times 4\frac{1}{2}$ ins. Price £31 10s.

3001 Integrated Stereo Amplifier. Inputs: pickup 4-6 mV and 150 mV; tape or radio 400 mV and 1 volt. Bass, treble, balance controls. Dist. 0.5% at 6 watts. H and N -60 dB. 7.5 watts per channel. Out. imp. 15 ohms. Response 40-20,000 c/s \pm 1 dB. Crosstalk better than 60 dB. Output ECL82's. Size $13 \times 10\frac{1}{4} \times 4\frac{1}{4}$ ins. Price £35.



Period High Fidelity Ltd., 28 South Street, London, W.1. Tel.: Grosvenor 4686.

Saville Double Six. Integrated stereo amplifier. Inputs: pickup 5 and 100 mV; tape 4 mV and 100 mV; radio 100 mV. 6-pos. sel., bass, treble, balance, vol. controls. H.D. <0.5%. H and N better than 40 dB. P.a.t. 230v at 40 mA; 6.3v 2.5 amps. 6 watts per channel, 9 watts max. Response 30-20,000 c/s \pm 1 dB. 12 dB feedback. Out. imp. 15 ohms or to order. Output ECL83's ultra-linear. Size $13 \times 8 \times 3\frac{3}{4}$ ins. Price £33 12s.

■ **Saville 12P. Stereo Control Unit.** Inputs: pickup 3 and 45 mV; tape 1 and 20 mV; radio 50 mV. 6-pos. sel., bass, treble, balance, vol. controls. H.D. less than 0.1%. H and N better than -50 dB. Rumble filter. P.a.t. 300v at 40 mA; 6.3v at 2.5 amps. Size 14 × 4½ × 3¼ ins. To operate with Saville Double Twelve stereo amplifier. Price see below.

■ **Saville Double Twelve. Stereo Amplifier.** 12 watts per channel, 21 watts peak Dist. <0.1% at 10 watts. Input for spec. output 200 mV. Response 25-30,000 c/s ± 1 dB at 10 watts. 18 dB feedback. N.L. -65 dB. Out. imp. 15 ohms or to order. Output EL84's. Size 11¼ × 8 × 6 ins. To operate with Saville 12P stereo control unit. Price, complete with control unit, £51 9s.



Pye Limited, Blue Town, Sheerness, Kent.
Tel.: Sheerness 3076. Cables: Faramarine, Sheerness, Kent.

HF10 Mozart Self-contained Control Unit and Power Amplifier. Inputs: tape 100 mV; radio 100 mV; P/U 15, 10 and 10 mV on each of the 3 curves at 1,000 c/s., special compensation for all makes of P/U. 5-pos. sel., treble, bass, vol., mains on/off, filter at 4, 7, 12 Kc/s and out. Tape replay socket. H.D. 0.3% at 1,000 c/s and 9 watts. H and N main amp. -70 dB; tape, radio -60 dB; P/U -55 dB. Output 10 watts nom. Response 3-70,000 c/s ± 3 dB. Feedback 3 main loops over output stage -5, 8 and 14 dB. Out. imp. 4, 8 and 15 ohms. Output 1 EL34. Integrated single-ended ultra-linear. Size 10½ × 3½ × 5½ ins. Price £23 2s. Also available in metal case for shelf mounting. HF10M £24 13s. 6d. and mounted in cabinet with provision for motor HFP1 £33 12s. 117v model available.

■ **Mozart Stereo Amplifier and Control Unit. HFS20.** Inputs: Pickup 7 mV; radio and tape 100 mV. Col., bass, treble, balance, on/off, selector switch. H and N -58 dB. 9 watts per channel nominal, 10 watts max. Dist. 0.3%. Response 5-50,000 c/s ± 2 dB. Feedback 27 dB. Out. imp. 4, 8 and 15 ohms. Output EL34. Size 4 × 10½ × 11 ins. Price Chassis £35, in metal case £36 15s. Available in kit form £30.

Radford Electronics Ltd., Ashton Vale Estate, Bristol 3. Tel.: Bristol 661873.

■ **D.S.M. Stereophonic Control Unit.** Inputs: tape/pickup/aux. 4.5 mV per channel. 6-pos. sel. equalisation, aux., tape, disc, disc lateral, dual. H.D. 0.1%. Rumble filter 35 c/s with 20 dB/octave attenuation. Size 9½ × 3½ × 6½ ins. Price £34 13s.

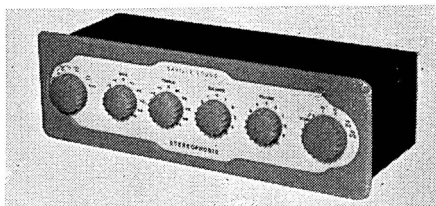

Saville stereo control unit

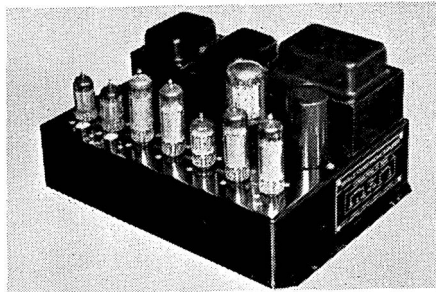

Saville stereo amplifier

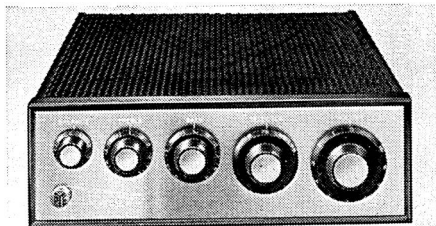

Pye Mozart integrated stereo HFS20M

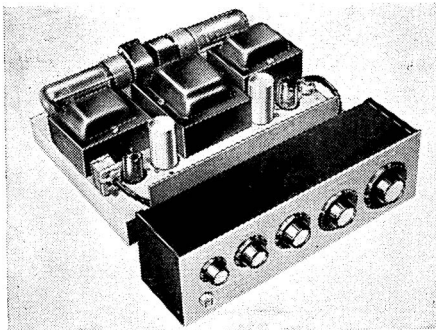

Pye Stereo Mozart HFS20 amplifier

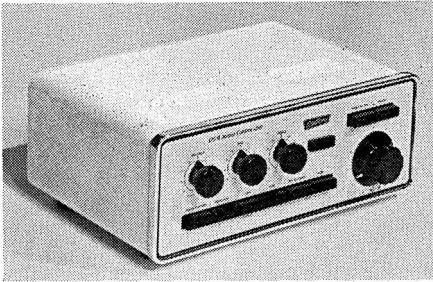

Radford D.S.M. stereo control unit

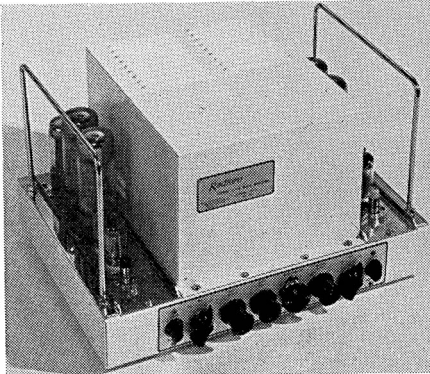

Radford STA12 stereo amplifier

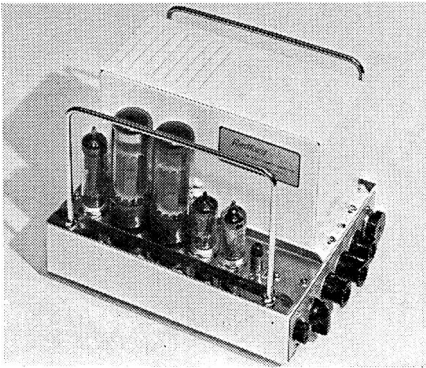

Radford MA15 amplifier

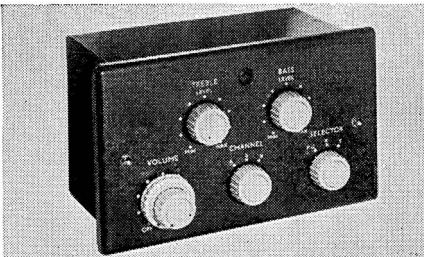

Rogers RD Cadet stereo control unit

■ **STA 12 Stereophonic Amplifier.** 12 watts per channel. Dist. 0.1% at 12 watts. Input for spec. output 500 mV. Response 20-20,000 c/s $< \pm 1$ dB. Feedback 40 dB. N.L. < -85 dB. Out. imp. 4, 8 and 16 ohms. Output EL34's ultra-linear. Size $12\frac{1}{4} \times 9 \times 7\frac{3}{4}$ ins. To operate with D.S.M. Price £38 17s.

MA 15 Amplifier. 15 watts nom. Dist. 0.1% at 15 watts. Input for spec. output 500 mV. Response 20-20,000 c/s ± 1 dB. Feedback 40 dB. N.L. < -90 dB. Out. imp. 4, 8 and 16 ohms. Output EL34's. Ultra-linear. Size $8\frac{1}{2} \times 6\frac{3}{4} \times 6\frac{3}{4}$ ins. To operate with D.S.M. Price £23 2s.



Rogers Development (Electronics) Ltd., 4-14 Barmeston Road, Catford, S.E.6. Tel.: Hither Green 7424/4340. Cables: Rodevco, London, S.E.6.

RD Cadet Control Unit. Prov. spec. inputs: tape 200 mV; radio 200 mV; P/UI comp. 60 mV; P/UI flat 18 mV; P/U2 comp. 360 mV; P/U2 flat 220 mV. 6-pos. sel., treble, bass, vol. on/off. Tape record and replay sockets. Size $8\frac{1}{2} \times 5\frac{1}{8} \times 2\frac{1}{2}$ ins. To operate with RD Cadet amplifier. Price £7.

RD Junior Mk. II Control Unit. Inputs: tape 20 mV; radio 50 mV; mic. 5 mV; P/UI 5-9 mV; P/U2 40-75 mV. 7-pos. sel. (4 record equal.), treble, bass, vol. on/off. Switched filter 4, 5, 7, 9 and 20 Kc/s. Tape record and replay sockets. Size $8\frac{1}{2} \times 5\frac{1}{8} \times 4\frac{1}{4}$ ins. To operate with RD Junior Amplifier. Price £11.

RD Cadet Amplifier Mk. II. 8 watts nom., 6 watts max. Intermod. Dist. 3.5% at 4 watts (100 c/s and 6,000 c/s mixed 4 to 1). Input voltage for spec. output 600 mV. Response 30-20,000 c/s ± 1 dB. Feedback 18 dB ± 1 dB, 30-20,000 c/s. N.L. -75 dB below 8 watts. P.a.t. 250v at 40 mA, 6.3v at 2.2 A. Out. imp. 4, 8 and 16 ohms. Output EZ81's. Ultra-linear. Size $11 \times 4\frac{1}{2} \times 4\frac{1}{4}$ ins. To operate with RD Cadet control unit. Price £12.

RD Senior Mk. II Amplifier. 20 watts nom., 36 watts peak. Dist. 0.1% at 15 watts. Input for spec. output 1.4v for 20 watts. Response 25-20,000 c/s ± 0.25 dB. Feedback 25 dB (2 loop). N.L. -95 dB below 20 watts. Out. imp. 3.75, 7.5 and 15 ohms. P.a.t. 425v at 40 mA, 6.3v at

2 A. Output EL34's. Ultra-linear. Size 13 × 8 × 8 ins. To operate with RD Senior Mk. IV control unit. Price £28.

RD Junior Amplifier. 10-12 watts nom., 14 watts max. Dist. at 1,000 c/s 0.12% at 10 watts. Input for spec. output 600 mV. R.M.S. for 10 watts. Response 20-30,000 c/s ± 0.25 dB. Feedback 20 dB. N.L. -85 dB below 10 watts. P.a.t. 285v at 40 mA, 6.3v at 2.5A. Out. imp. 2-3, 6-8, 12-16 ohms. Output EL84's. Ultra-linear. Size 11 × 6 × 5½ ins. For Junior II control unit. Price £17.

RD Cadet Stereo Control Unit. Inputs: pickup 50 mV; radio and tape 100 mV. Bass, treble, vol., function switch, selector switch. Size 8½ × 5½ × 4¾ ins. Price £12. To operate with two RD Cadet, Junior, or Senior II amplifiers.

RD Junior Mk. II. Stereo Control Unit. Inputs: pickup 5-10 and 100-200 mV; tape 4 and 50 mV; radio 50 mV. Push-button sel., bass, treble, balance, filter controls. Response 25-20,000 c/s ± 1 dB. Crosstalk -40 dB. Size 8½ × 5½ × 5¾ ins. To operate with RD Junior stereo amplifier. Price £18.

RD Master Stereo Control Unit. Inputs: pickup 3-30 mV and 30-400 mV; tape 1.5-30 mV; radio 30-250 mV. Push-button sel., bass, treble, balance, equalisation. Response 20-20,000 c/s ± 1 dB. Crosstalk -40 dB. Size 14 × 6½ × 5¾ ins. Price £35.

RD Junior. Stereo Amplifier. 12 watts per channel, 18 watts max. Dist. 0.2% at 12 watts. Input for spec. output 750 mV. Response 20-20,000 c/s ± 0.25 dB. 20 dB feedback. N.L. -85 dB. Out. imp. 4, 8 or 16 ohms. Output EL84's. Size 14 × 8 × 5¾ ins. To operate with RD Junior Mk. II stereo control unit. Price £28 10s.

HG88. Combined stereo amplifier and control unit, 8 watts per channel. Dist. 0.5%. H and N -55-60 dB. Response 30-60 dB. Response 30-20,000 c/s ± 1 dB. Inputs: pickup 4, 10, 60 and 150 mV at 60K and 1 Megohm, radio and aux. 40 mV, tape 4 mV, mic. 3 mV. Sel. switch, bass, treble, balance, filter, and precision volume control. Out. imp. 3.75 or 15 ohms. Size 15½ × 10½ × 7 ins. Price complete in case £40. Chassis model £37 10s.

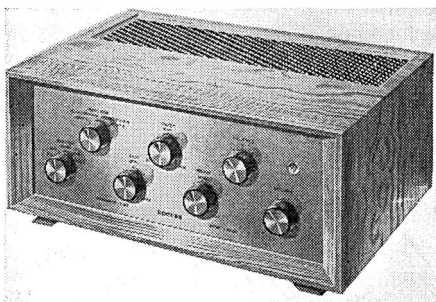

Rogers HG88 integrated stereo amplifier



Rogers Master stereo control unit

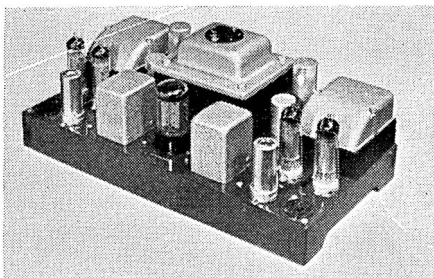

Rogers RD Junior stereo amplifier

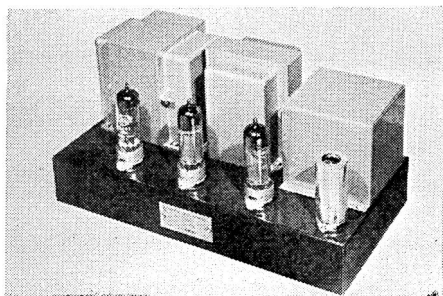

Rogers RD Junior amplifier

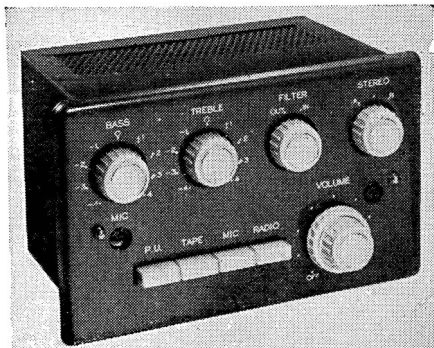

Rogers RD Junior stereo control unit

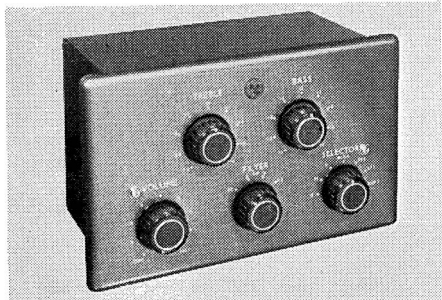

Rogers RD Junior control unit

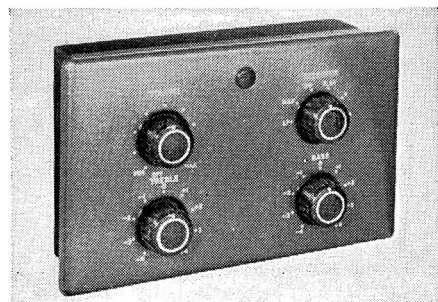

Rogers RD Cadet control unit

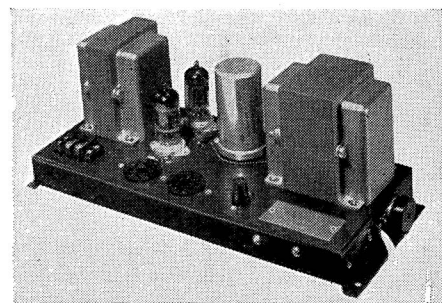

Rogers RD Cadet amplifier

Shirley Laboratories Ltd., 3 Prospect Place, Worthing, Sussex. Tel.: Worthing 30536.

Jupiter 3B/1-15E Self-contained Control Unit and Power Amplifier. Inputs: radio, tape, P/U 78 and L.P. Output 15 watts nom. 25 watts max. Input approx. 10 mV for 15 watts. Treble, bass, vol. Response 45-35,000 c/s ± 1 dB. N.L. -80 dB. Dist. 0.2% at 10 watts and 1,000 c/s. Out. imp. 15 ohms or as requested. Output EL84. P.a.t. 250v at 35 mA, 6.3v at 2 A. Size 10 \times 7 \times 6 $\frac{1}{2}$ ins. Price £23 2s.

Jupiter 3B/1-30E Self-contained Control Unit and Power Amplifier. Spec. as for 3B/1-15E except output 30 watts nom., 45 watts max. Response 28-35,000 c/s ± 1 dB. Output EL34's. Price £33 12s.

■ **PA 4/86 Stereo Control Unit.** Inputs: pickup 3 and 50 mV; radio 100 mV; tape 3 mV and 0.5 volts, selector switch, bass, treble, volume, balance. H.D. 0.1%. H and N -58 dB. Price £21 1s. To operate with SF/10 amplifier, or two SB/7-30.

■ **SB/7-30s Amplifier.** 20 watts nominal, 35 watts max. Dist. 0.1%. Input for spec. output 2.5 volts. Response 34-40,000 c/s ± 0.3 dB. N.L. -80 dB. Out. imp. 15 ohms. Output EL34. Ultra-linear. Size 11 \times 7 $\frac{1}{2}$ \times 8 ins. Price £29 8s. 28 watt version £32 11s. To operate with PA 4/86 Control Unit.

■ **Jupiter SB1-15F Combined Amplifier and Control Unit.** Input 2 mV minimum. Dist. 0.2%. 14 watts nominal, 23 watts max. Response 45-35,000 c/s ± 1 dB. N.L. -80 dB. Out. imp. 100 ohms line or to order. Size 10 \times 7 \times 6 $\frac{1}{2}$ ins. Price £23 2s.

■ **SF/10 Combined Stereo Amplifier and Control Unit.** 12 watts per channel, 18 watts peak. Dist. 0.1%. Control Unit similar details to PA 4/86 above. Price complete £45 3s.

■ **2SB/10. Integrated Stereo Amplifier.** Inputs: magnetic and crystal pickup; tape direct from high impedance head and from tape recorder; radio. Sel. switch, bass, treble, volume, balance controls. 7 watts per channel. Output ECL82's. Price £45 3s.

■ **2SB/12. Integrated Stereo Amplifier.** 12 watts per channel, 20 watts peak. Output EL84's. Other details as 2SB/10. Price £48 6s.

■ **2SB/50. Integrated Stereo Amplifier.** 25 watts per channel, 40 watts peak. Output

KT88's. Response 35-35,000 c/s \pm 1 dB at 25 watts. Dist. 0.05% at 25 watts. Other details as 2SB/10. Price £84.



H. L. Smith & Co. Ltd., 287/289 Edgware Road, London, W.2. Tel.: Paddington 5891/7595.

Cooper-Smith Mk. II Control Unit. Inputs: radio 100 mV; P/U 3 mV; mic. 1.5 mV; tape 100 mV. 6 pos. sel. (3 record equal.), treble, bass, vol. on/off. Switch filter 6, 8 and 10 Kc/s. Co-axial tape replay switch. H.D. 0.1% or less at 1,000 c/s. H and N -80 dB. Rumble filter 12 dB cut at 30 c/s. Size 10 \times 3½ \times 6½ ins. To operate with B.P.I. power amp. Price kit £7 17s. 6d. Assembled and tested £10 17s. 6d.

Cooper-Smith B.P.I. 10 watts nom., 12 watts max. Dist. 0.15% or better at 10 watts. Input for spec. output approx. 1.9 V. Response 20-30,000 c/s \pm 1 dB. Feedback 18 dB. N.L. 90 dB below max. output. Out. imp. 3.75 and 15 ohms. Output 6BQ5's or EL84's. Ultra-linear. Size 12 \times 7 \times 7½ ins. To operate with Cooper-Smith Mk. II control unit. Price kit £12 5s. Assembled and tested £14 5s.

"Prodigy" Combined Amplifier and Control Unit. Inputs: pickup 8 mV; radio and tape 100 mV, 6 watts, 9 watts max. Dist. 0.2%. Response 30-25,000 c/s \pm 1 dB. Feedback 15 dB. N.L. -70 dB. Out. imp. 3½, 7½ and 15 ohms. Output ECL82's. Ultra-linear. Size 10½ \times 7 \times 5½ ins. Price kit £12 10s. Assembled and tested £15 15s.

Cooper-Smith Stereo Control Unit. Inputs: pickup 3 mV; tape 100 mV; radio 100 mV. 4 position sel., bass, treble, vol., balance. H.D. 0.15%. H and N -60 dB. Size 10½ \times 4½ \times 3½ ins. To operate with Cooper-Smith stereo amplifier. Price kit £12 12s. Assembled and tested £15.

Cooper-Smith Stereo Amplifier. 6 watts per channel, 9 watts peak. Dist. 0.2% at 6 watts. Input for spec. output 800 mV. Response 40-25,000 c/s at 6 watts. 15 dB feedback. N.L. -80 dB. Out. imp. 3.75, 7.5, 15 ohms. Output ECL82's. Size 12 \times 7 \times 6¼ ins. To operate with Cooper-Smith stereo control unit. Price kit £13 13s. Assembled and tested £16.

Cooper-Smith Magnum. 20 watts nom., 30 watts max. Dist. 0.1% at 30 watts.

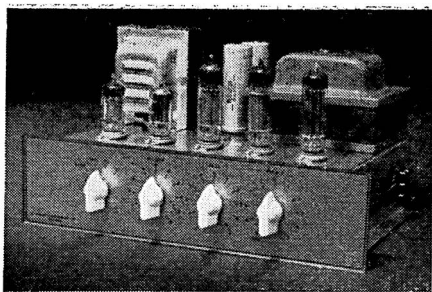

Shirley Jupiter amplifier

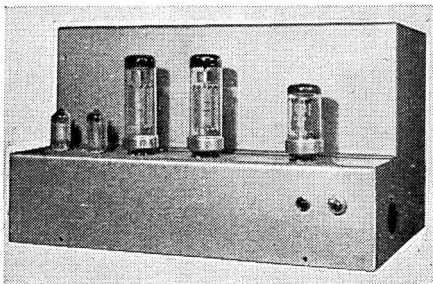

Shirley Mullard 20-watt amplifier



Cooper-Smith stereo control unit and amp.

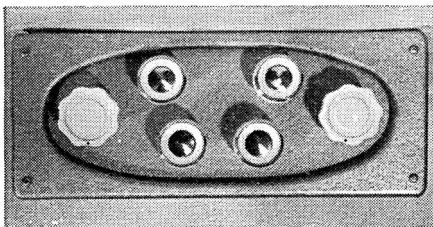

Sound Sales Tri-Channel control unit

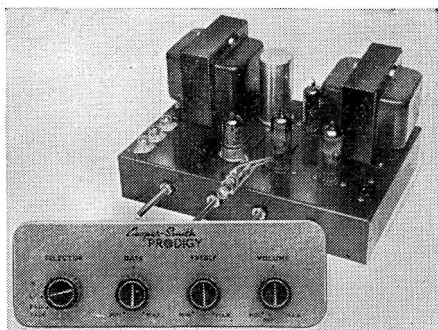

Cooper-Smith Prodigy control unit and amp.

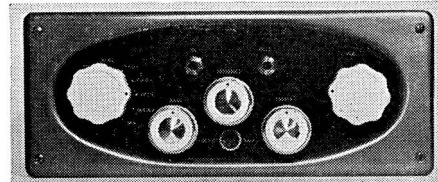

Sound Sales Mk. III control unit

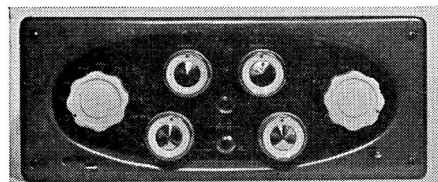

Sound Sales A-Z Twin Twenty control unit

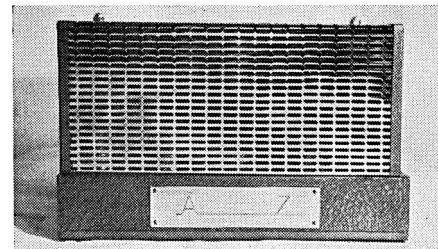

Sound Sales A-Z Senior Mk. II amplifier

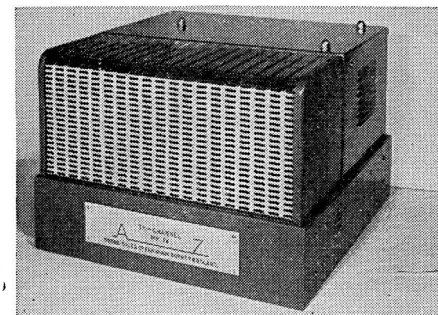

Sound Sales Tri-Channel amplifier

Response 30-30,000 c/s \pm 0.5 dB. Feedback 26 dB. N.L. -80 dB. Output imp. 3.75, 7.5 and 15 ohms. Output EL34's. Ultra-linear. Size 14 \times 8 $\frac{1}{2}$ \times 7 $\frac{3}{4}$ ins. To operate with Cooper-Smith Mk. II. Price kit £21 2s. 6d. Assembled and tested £23 12s. 6d.



Sound Sales Ltd., Works and Acoustic Laboratories, West Street, Farnham, Surrey. Tel.: Farnham 6461/2/3. Cables: Sounsense.

A-Z Wide Range Control Unit Mk. III.

Inputs: pickups 5 and 50 mV; radio 50 mV; mic. 1 mV. 8-position sel., bass, treble, presence. H.D. 0.06%. H and N -80 dB. Rumble filter. P.a.t. 250v at 40 mA. Size 11 $\frac{1}{4}$ \times 4 $\frac{5}{8}$ \times 5 $\frac{1}{2}$ ins. To operate with Mk. III Amplifier, and not sold separately.

A-Z Mk. III Amplifier.

10 watts nominal, 13.5 watts max. Dist. 0.06%. Input for 10 watts -18 dB ref. 1 volt. Response 12-27,000 c/s \pm 1 dB. Feedback 22 dB. N.L. -80 dB. Out. imp. 3, 6, 15, and 30 ohms. Output EL84's. Ultra-linear. Size 10 $\frac{1}{4}$ \times 7 $\frac{1}{8}$ \times 6 ins. To operate with Mk. III Control Unit. Price complete £25. Amplifier only £17.

A-Z Twin Twenty Stereo Control Unit.

Inputs: pickup 5 mV and 100 mV; radio 3 at 30 mV; tape 14 and 125 mV; mic. 1.4 mV. 11-position sel., balance, bass, treble, filter. Size 11 $\frac{1}{4}$ \times 4 $\frac{5}{8}$ \times 9 $\frac{1}{2}$ ins. Price £20.

A-Z Twin Twenty Stereo Amplifier.

10 watts per channel, 13.5 watts peak. Dist. .08%. Input for spec. output 0.1 volts. per channel. Response 20-20,000 c/s flat. N.L. -80 dB. Out. imp. 3, 8, and 15 ohms. Output EL84's. Ultra-linear. Size 12 $\frac{1}{2}$ \times 10 \times 6 $\frac{1}{2}$ ins. Price £30. To operate with Twin Twenty Control Unit, or A-Z Wide Range Control Unit.

A-Z Senior Control Unit

with transistor input. Inputs: mic. 1 mV; radio 100 mV; tape 250 mV; tape 1 mV (from head) C.C.I.R. and N.A.R.T.B.; P/U variable 1-100 mV. 11 pos. sel. (5 record equal.), treble, bass, vol., presence control, switched filter, 2 pos. and out combined with variable slope. Tape recording in all positions, also jacks for portable recorders. Specially designed for use with M.C. pickups or tape-head without necessity of transformers. Size 11 \times 4 $\frac{1}{2}$ \times 6 ins. Sold only with A-Z Senior power amp.

Tri-Channel Control Unit with transistor input. Inputs: mic. 1 mV; radio 100 mV; tape (from recorder) 250 mV; tape (from head, C.C.I.R. and N.A.R.T.B.) 1 mV; P/U variable 1-100 mV. 11 pos. sel. (5 record equal.). Presence, middle channel response; treble, top channel response; bass, bass channel response. Infinitely variable electronic crossover system, controlling 3 separate amplifying channels to appropriate speakers via master vol. control. Switched filter. Tape recording in all positions also jacks for portable recorders. H and N better than -80 dB. Dist. not measurable at normal output. Size $11\frac{1}{2} \times 4\frac{3}{8} \times 6$ ins. Sold only with Tri-channel amp. and speaker enclosure.

Tri-Channel Amplifier Mk. V. Bass 20-30 watts, mid channel 8-12 watts, treble channel 4 watts. Total undistorted output approx. 45 watts. Dist. 0.05%. Response infinitely variable on 3 channels. N.L. better than -80 dB. Output LN309, EL84, EL34. Ultra-linear. Size $18 \times 10 \times 8\frac{1}{2}$ ins. Price complete with control unit and tri-channel speaker enclosure £125.

■ **Tri-Channel Stereo Control Unit and Tri-Channel Stereo Amplifier.** Designed for stereophonic or monaural reproduction using 2 Tri-channel main amps. and 2 labyrinth speakers. Stereo to monaural changeover switch, giving parallel or stereo connection. Price complete with control unit, 2 amps and 2 speaker systems £300.

A-Z Senior Mk. II Amplifier. 20 watts nom. 30 watts max. Dist. 0.05% at 20 watts. Response flat 10-30,000 c/s. Feedback 25 dB. N.L. -80 dB at 20 watts. Out imp. 3, 6, 15 or 30 ohms. Output EL34's. Ultra-linear. Size $14\frac{1}{2} \times 8\frac{1}{2} \times 8\frac{1}{2}$ ins. Price complete with A-Z Senior control unit £42.



Stern Radio Ltd., 109, 111 and 115 Fleet Street, London, E.C.4. Tel.: Fleet Street 5812/14.

Mullard Pre-Amplifier Tone Control Unit. Inputs: pickup 3 mV and 9 mV (Magnetic), 50 mV and 150 mV (Crystal); Radio 250 mV, tape 3 mV, mic. 3 mV, 6-pos. sel., bass, treble, vol. P.s.n. 300v at 3 mA, 6.3v at 0.9 amps. Size $9\frac{1}{2} \times 4\frac{1}{2} \times 2\frac{3}{8}$ ins. Price £8. Also available in kit form.

Mullard "5-10" Amplifier. 10 watts. Dist. 0.1%. Input for spec. output 40 mV. Response 30-15,000 c/s. H and N -75 dB.

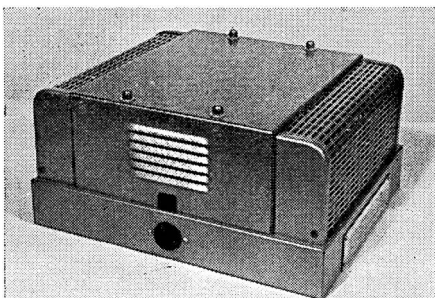

Sound Sa'es Twin Twenty stereo amplifier

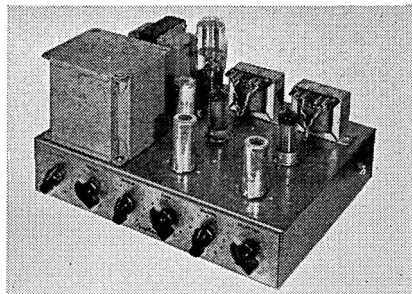

Symphony stereo integrated amplifier

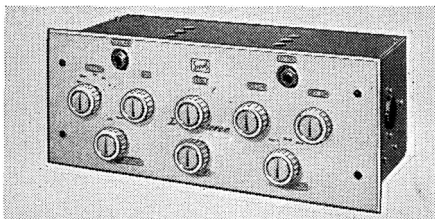

Stern Mullard stereo control unit

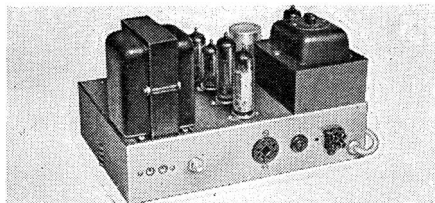

Stern Mullard 5-10 amplifier

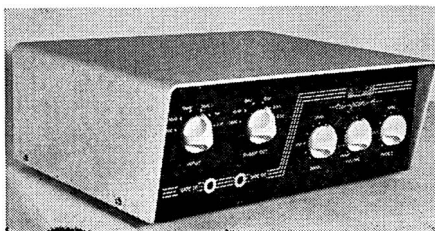

Tannoy Hi-Gain 15 integrated amplifier

Out. imp. 3 or 15 ohms. Size $10 \times 7 \times 6\frac{1}{2}$ ins. Price £11 10s. Also available in kit form.

■Mullard Dual Channel Pre-Amplifier.

Inputs: pickup 5-15 mV and 70-220 mV; tape 4 mV; radio and aux. 330 mV. 5-pos. selector, bass, treble, vol. and balance. Output 250 mV per channel. Dist. less than 0.15%. P.s.n. 6.3v at 1 amp., 250/350v at 6 mA. Size $11 \times 5 \times 4$ in. Price £15. Also available in kit form.



Connoisseur HQ20 control unit and amplifier

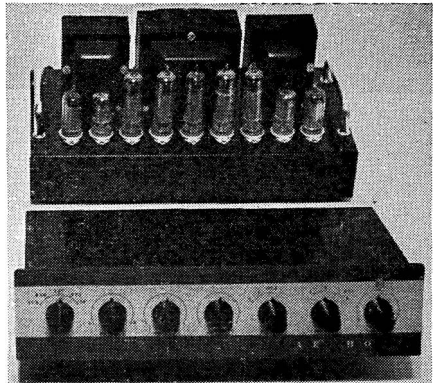

Tansley-Howard Archon SP31 stereo control unit and SL101 stereo amplifier

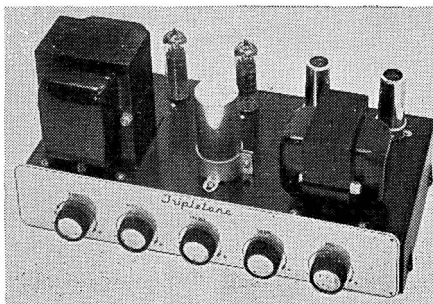

Tripletone Hi-Fi Major

A. R. Sugden & Co. (Engineers) Ltd., Market Street, Brighouse, Yorks. Tel.: Brighouse 2142. Cables: Connoisseur, Brighouse.

Connoisseur HQ20 Control Unit. Inputs: radio, tape and P/U 10 mV. 5-pos. record char. switch, treble, bass, vol. Steep slope filter, 5, 7 and 9 Kc/s. Tape input sockets. H.D. at 1,000 c/s better than 0.1% at 20 watts. H and N with amp. 75 dB down on 20 watts. 30 c/s rumble filter. Size $11\frac{1}{2} \times 4 \times 4\frac{1}{4}$ ins. To operate with HQ20 power amp. Price £16.

Connoisseur HQ20 Amplifier. 20 watts nom., 30 watts max. Dist. better than 0.1% at 20 watts. Input for spec. output 300 mV. Response 20-50,000 c/s ± 0.5 dB. N.L. -88 dB at 20 watts. Out imp. 15 ohms. Output EL34's. Ultra-linear. Size $12 \times 8\frac{1}{4} \times 7\frac{1}{2}$ ins. Sold only with control unit. Price £31 10s.

■Connoisseur Stereo S66 Control Unit. Inputs: pickup 6 mV; radio and tape 100 mV. 5-position sel., treble switch, vol., channel switch. H.D. < 0.1%. H and N -60 dB. Rumble filter. Size $10\frac{3}{4} \times 3\frac{1}{4} \times 5\frac{1}{2}$ ins. Price £16 10s. To operate with Stereo S66 Amplifier, or two HQ20.

■Connoisseur Stereo S66 Amplifier. 6 watts per channel, 7.5 watts max. Dist. < 0.3%. Input for spec. output 250 mV. Response 30-20,000 c/s ± 1 dB. Feedback 22 dB. N.L. -72 dB. Out. imp. 3.5 or 15 ohms. Output ECL82's. Ultra-linear. Size $11\frac{1}{2} \times 5\frac{1}{2} \times 6\frac{1}{4}$ ins. Price £24 10s. To operate with Stereo S66 Control Unit.



Symphony Amplifiers Ltd., 16 Kings College Road, London, N.W.3. Tel.: Primrose 3314/5.

Symphony No. 1 Amplifier Mk. 3. 4 watts, 5 watts max. Dist. less than 0.6%. Input for spec. output 140 mV. Response 30-30,000 c/s ± 1 dB. 24 dB feedback. N.L. -80 dB. Out. imp. 3 or 15 ohms to order. Output 6V6's. Size $13\frac{1}{2} \times 6 \times 6$ ins. Price £13 13s.

Symphony No. 2 Amplifier Mk. 4. 8 watts, 10 watts max. Dist. less than 0.2% at 6 watts. Input for spec. output 130 mV. Response 20-20,000 c/s ± 1 dB. 26 dB feedback. N.L. -85 dB. Out. imp. 3, 7.5 and 15 ohms. Output 6L6's (triode strapped). Size $12 \times 7 \times 9\frac{1}{2}$ ins. Price £19 19s.

■ **Symphony Stereo Amplifier.** 5 watts per channel. Dist. 0.3%. Input for spec. output 130 mV. Response 30-30,000 c/s ± 1 dB. 24 dB feedback. N.L. -85 dB. Out. imp. 15 ohms. Output 6BW6's. Size 12 x 7 x 9½ ins. Price £23 2s.



Tannoy Products Ltd., West Norwood, London, S.E.27. Tel.: Gipsy Hill 1131. Cables: Tannoy, London.

“**Hi-Gain 15” Combined Amplifier and Control Unit.** Inputs: pickup 5 and 10 mV; radio 100 mV; tape 4 and 100 mV; mic. 4 mV. Sel. switch, vol., bass, treble, filter. 10 watts nom., 15 watts peak. Intermod. 1%. Response 30-20,000 c/s. Out. imp. 4, 8 and 16 ohms. H and N -40 dB. Size 12¼ x 4¼ x 9½ ins. Price free standing £42 and for panel-mounting £39. 18s.



Tansley-Howard Ltd., 95 Kensal Road, London, W.10 Tel.: Ladbroke 7195.

■ **Archon SP31. Stereo Control Unit.** Inputs: pickup 1, 7 or 70 mV variable, 2, 7 mV; tape 60 mV; radio 60 mV variable. Sel. balance, treble, bass, filter controls. H.D. 0.05%. H and N -61 dB. Rumble filter. Size 12 x 6 x 2¾ ins. To operate with SL 101 stereo amplifier. Price £20 9s. 6d.

■ **Archon SL101. Stereo Amplifier.** 10 watts per channel. Dist. 0.2% at 10 watts. Input for spec. output 200 mV. Response 3-50,000 c/s ± 1 dB. 22 dB feedback. N.L. -80 dB. Out. imp. 3, 7 and 15 ohms. Output EL84's. Size 12 x 6 x 5½ ins. To operate with SP31 stereo control unit. Price £29 8s.



Tripletone Manufacturing Co. Ltd., 241A The Broadway, Wimbledon, S.W.19. Tel.: Liberty 1189.

Hi-Fi Major. Integrated Amplifier. Inputs: high imp. pickup or microphone. 12 watts, 15 watts max. Dist. 0.15%. Response 15-20,000 c/s ± 1 dB. 32 dB feedback. N.L. -80 dB. Out. imp. 2-3 or 15 ohms. Output EL84's. Size 12 x 5¼ x 6 ins. Price £15 18s. 9d.

■ **Stereo 12-12. Stereo Control Unit and Amplifier Combination.** Inputs: pickup, radio, microphone 100 mV. Sel., bass, middle, treble, vol. controls. H.D. 0.15%.

H and N -80 dB. P.a.t. 300v 50 mA, 6.3v. 12 watts per channel. 15 watts max. Response 15-20,000 c/s ± 1 dB. 32 dB feedback. Out. imp. 2-3 or 15 ohms. Output EL34's. Size: Control unit 11 x 3½ x 2½ ins., amplifier 12 x 5¼ x 6 ins. (two required). Price £33 19s. 6d. (three units).

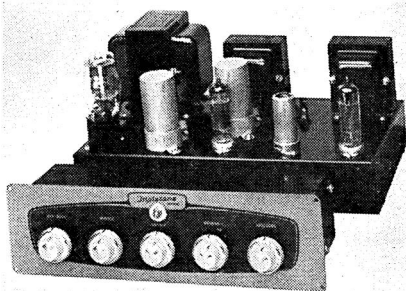

Tripletone Stereo 12-12

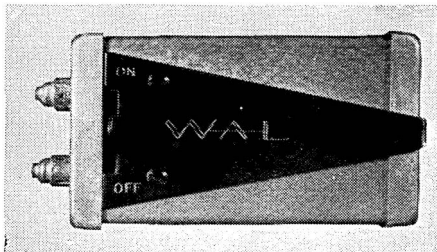

WAL Gain

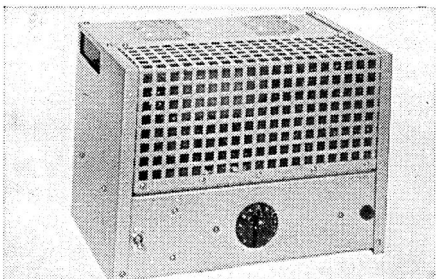

Westrex 2192 amplifier

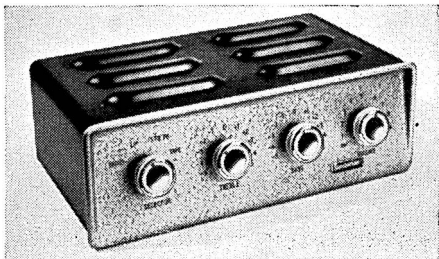

Stentorian WB integrated amplifier

Trix Electrical Co. Ltd., 1-5 Maple Place, London, W.1. Tel.: Museum 5817. Cables: Trixradio, Wesdo, London.

★
Trixette XT202. Integrated Stereo Amplifier. Inputs: pickup, tape, tuner, 50/100 mV. 6-pos. sel., bass, treble, balance, vol. H.D. less than 0.5%. H and N —60 dB. Switched rumble filter. 3.75 watts per channel. Out. imp. 3, 8 and 15 ohms. Output EL84's. Size $11\frac{1}{4} \times 4\frac{1}{4} \times 7\frac{1}{2}$ ins. Price £23 2s.

★
Wellington Acoustic Laboratories Ltd., Farnham, Surrey. Tel.: Farnham 6461/4961.

WAL Gain. Impedance matching transistor pre-amp, battery operated (3,000-hour life). Noise and distortion too low to measure, gain better than 100. Suitable for use with low output P/U or for direct connection to tape head. Size $3\frac{5}{8} \times 2\frac{5}{8} \times 2\frac{1}{8}$ ins. Price £5.

★
Stereo WAL Gain. Transistorised stereo pre-amplifier. To match pickups, tape or mic., at 50,000 or 3,500 ohms. Battery life 1,000 hrs. Size $7 \times 2\frac{1}{8} \times 2\frac{1}{2}$ ins. Price £7 10s.

★
Westrex Co. Ltd., Coles Green Road, London, N.W.2. Tel.: Gladstone 5401/8. Cables: Westelcol, Norphone, London.

2192 Amplifier. 30 watts. Dist. 0.1%. Size $12 \times 9 \times 8\frac{1}{2}$ ins. Designed primarily for use with the Westrex 2241 Loudspeaker Assembly. Price £49.

★
Whiteley Electrical Radio Co. Ltd., Victoria Street, Mansfield, Notts. Tel.: Mansfield 1762/3/4/5. Cables: Whitebon, Mansfield.

Stentorian WB12 Standard Control Unit. Inputs 50 mV. 6-pos. sel. (3 gram.), treble,

bass, vol. Tape/Radio input socket. H and N —70 dB at 10 watts. Size $9 \times 3\frac{3}{8} \times 3\frac{3}{4}$ ins. To operate with WB12 power amp. Price £9.

Stentorian WB12 Major Control Unit. Inputs: mic. 2.5 mV; P/U 10 mV; radio 100 mV; tape 100 mV; aux. 50 mV. 9 pos. sel. (5 record equal), treble, bass, vol. on/off switched filter at 5.7 and 11 Kc/s; filter slope. Tape input socket. H.D. 0.3%. H and N —70 dB. Size $11\frac{5}{8} \times 4\frac{1}{2} \times 4$ ins. To operate with WB12 power amp. Price £19 10s.

WB12 Amplifier. 12 watts nom., 15 watts max. Dist at 1,000 c/s. 0.12%. Response 20-20,000 c/s \pm 0.15 dB. Feedback 25 dB. N.L. —80 dB at 10 watts. Out. imp. 3 and 15 ohms. Output EL84's. Ultra-linear P.a.t. 250v at 50 mA, 6.3v at 1.5a. Size $10\frac{5}{8} \times 8 \times 7$ ins. To operate with WB Major or Standard control units. Price £18 10s.

★
WB Stereo Control Unit. Inputs: pickup 2.5 and 100 mV; radio and tape 50 mV. Selector switch, bass, treble. H.D. 0.2%. H and N —70 dB. Size $11\frac{1}{4} \times 4 \times 7\frac{1}{2}$ ins. Price £22 15s. To operate with WB8S, or two WB12.

★
WB8S Stereo Amplifier. 6-8 watts per channel. Dist. 0.2%. Input for spec. output 650 mV. Response 40-15,000 c/s \pm 0.5 dB. Feedback 20 dB. N.L. —60 dB. Out. imp. 3 and 15 ohm. Output ECL82's. Ultra-linear. Size $10\frac{7}{8} \times 6\frac{1}{4} \times 10\frac{1}{2}$ ins. Price £23 15s. To operate with WB Stereo Control Unit.

★
WB8 Combined Amplifier and Control Unit. 6 watts, 8 watts max. Dist. 0.3%. Inputs: pickup 100 mV; radio and tape 50 mV. Response 30-20,000 c/s \pm 2.5 dB. Feedback 15 dB. N.L. —60 dB. Out. imp. 3 and 15 ohms. Output ECL82's. Ultra-linear. Size $11\frac{1}{4} \times 7\frac{1}{2} \times 4$ ins. Price £19 19s.

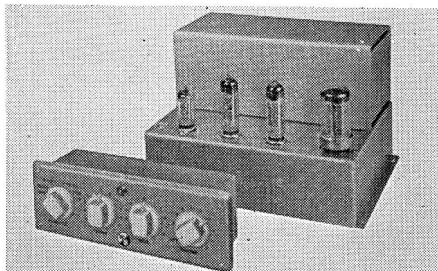

Stentorian WB12 control unit and amplifier

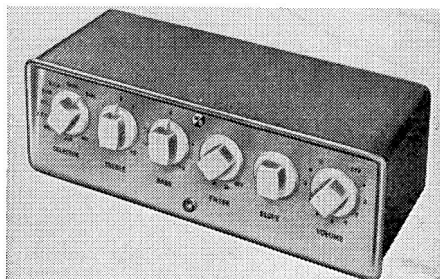

Stentorian WB12 Major control unit

RADIO TUNERS

An Introduction — by R. N. Baldock, B.Sc.*

NOW that VHF/FM transmissions can serve most of the British Isles, it is surprising how many people remain either unaware or unconvinced of the advantages of this system. It is the writer's opinion, based on personal observations, that this is almost entirely due to reluctance to connect a suitable aerial system. Over the last thirty years or so the public has become accustomed to using a trailing piece of wire as the aerial for medium wave equipment. At these frequencies, signal strength falls smoothly with distance and fair results are easily obtained, especially when noise and interference from unwanted stations is reduced by low bandwidth; impulsive interference is also no problem.

If a VHF/FM tuner is connected to an "aerial" of the above kind, a very different state of affairs results. Unless the site is very favourable, reception will suffer from high random background noise, programme distortion and interference from unsuppressed electrical appliances, particularly passing vehicles. Effects from aircraft, multipath reception and unwanted programmes may also occur and the unenlightened listener may easily conclude that VHF/FM is a waste of money.

Aerial to Suit

To illustrate the difference that a suitable aerial can make, consider the case of an FM tuner, sensitivity say $10 \mu\text{V}$ for 6 dB quieting, located in a "fringe" area where the VHF signal, usually measured 30 ft. above ground level, is only $50 \mu\text{V}/\text{metre}$. Connecting a length of wire to the tuner will give a few microvolts, at best, and results will be extremely poor as described above. Erecting a 4-element array at chimney height with

suitable feeder and connectors will, however, present the tuner with a signal of over $70 \mu\text{V}$ and all the advantages of VHF/FM reception will be apparent.

Aerial Gain

Incidentally, the best practical aerial arrays can give as much gain as the RF stage in a tuner, but with the added advantages of less noise and more discrimination against vehicle interference and unwanted transmissions. Best results will only be obtained if the aerial is properly sited, and the importance of this is perhaps better understood when it is realised that the VHF signal in and around a normal house may vary from place to place by 100:1!

Circuit Aspects

Having obtained the best possible signal in any given circumstances, there remains the question of what qualities the tuner itself should possess. Firstly, the *RF stage* must be carefully designed so as to add as little extra noise as possible. Various circuits may be employed, but in general some form of "cascode" arrangement usually gives the best results.

Turning to the *local oscillator*, the main requirements here are lack of radiation and good frequency stability. Output should quickly settle to within a few kc/s of the required frequency after switching on, since even with AFC incorporated distortion can arise if the circuits are "pulling". If a clear and sensitive tuning indicator is fitted, these difficulties may be overcome, although in the writer's opinion the best results for reception of one transmitter location (three or four programmes in the British Isles) are obtained

*Hon. Lecture Secretary, British Sound Recording Association.

Hi-fi by radio demands a decent aerial. This 4-element folded dipole fits easily out-of-doors or in the loft, and will give good signal strengths and noise rejection on the local VHF/FM transmissions.

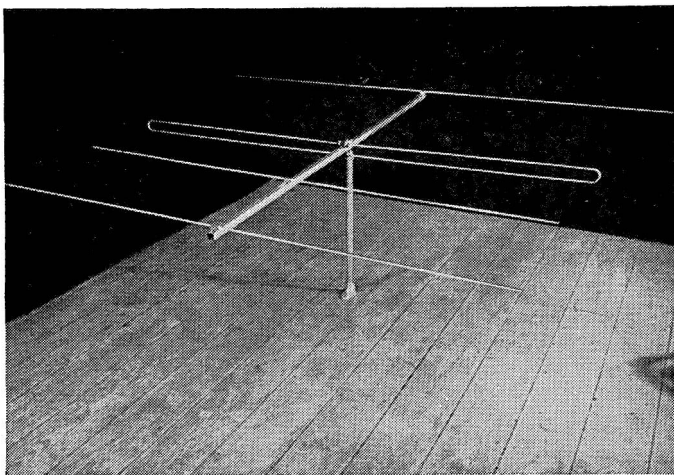

using preset switching with precision frequency control; more expensive but welcomed by unskilled operators! For these transmissions, a continuous tuning range from 88 to 100 Mc/s is sufficient but for export tuners the range must be increased to 108 Mc/s.

IF Amplifier

After the *mixer*, which may be contained within the local oscillator circuits, comes the *IF amplifier*. This should have a frequency response which is flat topped or at least smooth over ± 75 kc/s (or more) within 3 dB to minimise phase distortion and include significant sidebands. Restricted bandwidth will, in contrast to AM, give amplitude distortion at all audio frequencies, being worst at low frequencies of high amplitude. This is because most of the modulation energy lies towards the outer sidebands. For fringe area reception the IF response should fall rapidly outside the required pass band, but the most important section of the tuner under these conditions is the following stage—the limiter.

The Limiter

A well-designed *limiter* will reduce the effects of multipath reception, give a good “capture ratio” for efficient rejection of unwanted transmissions close in frequency and level to that required, and minimise impulsive interference. In addition, background noise will rapidly diminish with increasing signal, an important feature since FM tuners with their increased gain tend to generate more internal noise than their AM equivalents.

It only remains to convert the IF to audio with the least possible distortion. There are several methods of achieving this, probably the most popular for high quality tuners being the Foster-Seeley type or variants. Where a separate limiter cannot be included, the ratio detector possesses useful AM rejection properties, but the audio output tends to vary with signal strength and is not usually of such low distortion. Probably the lowest distortion is obtained using the pulse counter discriminator, but because a low IF centre must be used and the audio output is relatively low it has not gained commercial acceptance.

De-emphasis

To make the most efficient use of the VHF/FM system, high audio frequencies are emphasised on transmission, and the tuner must therefore include a de-emphasis circuit of the inverse characteristic. In some tuners this is followed by an amplifier stage of low output impedance so that unknown cable and switching capacitances in the audio equipment do not affect treble performance and long leads may be used without hum pickup. Where such a stage is not included, the user must be careful not to upset performance by connecting unsuitable equipment and Manufacturers instructions should always be heeded.

Reception Distance

As the distance between tuner and transmitter is decreased, some of the foregoing requirements may be relaxed to some extent, e.g., a simple indoor dipole will suffice, RF

stage may be omitted (provided local oscillator radiation is sufficiently low), IF amplifier gain and selectivity may be reduced, and limiter performance need not be so exacting. AGC applied to the RF stage is useful to minimise intermodulation and reduce noise. Local oscillator stability must still be good, and audio distortion will depend on IF bandwidth and discriminator performance.

AM Tuners

These tuners have been developed for so long that new examples are rare, although at least one notable specimen has appeared during the last year. Using a well designed tuner, excellent results can be obtained on medium wave during daylight hours when interference from continental stations in the form of heterodyne whistles, inverted "monkey chatter", etc., is absent. The audio quality obtainable from an AM tuner is dependent on the bandwidth and detector design. The latter is not always given the attention it deserves and careful design is needed to avoid amplitude distortion at high modulation levels.

Combined Circuits

All the above remarks apply with equal

force to AM/FM and AM/FM/TV tuners. For a given performance they will probably cost 30 to 50 per cent. more than a tuner for FM only, even if extensive switching of circuits is employed. To ensure long term reliability these switches must be suitably designed.

Power and Output

Tuners fall into two categories—"self powered" or "supplied from associated equipment". With the former, it is necessary only to connect mains power and take the output lead to the audio amplifier. The latter are usually supplied with HT and heater power from the power amplifier. If the tuner and amplifier are built by the same manufacturer, provision is usually made for supplying the tuner with the correct voltages. In other cases it is important to maintain the power supply voltages within the limits specified, otherwise poor performance or overheating and early breakdown may result.

Pre-set Gain

If the tuner is fitted with a gain control, this should be set so that the final sound output level is similar to that obtained from other sources—discs, etc. This will ensure that the early stages in the audio amplifier are

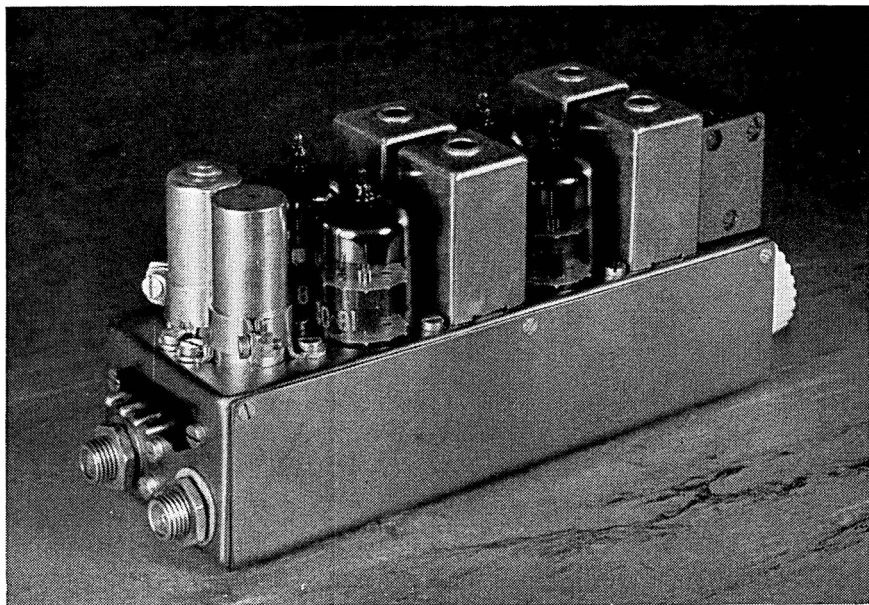

This miniature FM tuner gained the author first prize in a B.S.R.A. Competition, and was described by him in a series of constructional articles in "Hi-Fi News". Crystals are used for each of the four switched stations.

not overloaded; some tuners have an output of several volts if their gain control is set at maximum. When it is required to make recordings from a tuner, it is most convenient if the signal is picked up at the input to the main gain control. Recording levels may then be preset and monitoring carried out at any desired level.

Prospects

Transistorised VHF/FM tuners are appearing commercially with similar performance to their valve counterparts. They offer better reliability with long life, low power consumption and are lighter and less bulky.

At the moment VHF/FM can offer the nearest approach to the "ideal system", i.e., one in which no controls are needed. Once the equipment has been adjusted for frequency response for a particular listening environment, only the gain control is still necessary; the characteristics of the transmitting chain are optimised for any programme source and the overall results are not

generally improved by "knob twiddling".

Since stereo discs are now part of the everyday scene, the question is often asked "Why is the BBC not transmitting regular stereo programmes"? The answer is that many stereo broadcasting systems are under consideration, both here and abroad, each with its own attractions. Because of bandwidth and noise considerations the choice is not easy, and the ultimate decision will depend on factors such as whether the system will still give good service on mono equipment, signal/noise performance, extra facilities required such as studio equipment, land lines, etc., etc.

Using the same total bandwidth, for stereo reception, there appears to be an inevitable signal/noise degradation of about 20 dB with any two channel system, but this should prove serious only to "fringe area" listeners. For those nearer the transmitter, however, it may bring home the importance of using an adequate aerial system.

DIRECTORY OF RADIO TUNERS

★ In the abridged specifications of these directory entries the following abbreviations have been used: **P.s.n.**—Power supply needed; **A.F.C.**—Automatic frequency control.

Acoustical Manufacturing Co. Ltd., St. Peter's Road, Huntingdon, Hunts. Tel.: Huntingdon 361 and 574. Cables: Acoustical.

F.M. Tuner. Variable tuning. Range 87.5-108 Mc/s. Special double neon display ind. P.s.n. 330v at 27 mA; 6.3v at 1.85 amps. Size $10\frac{1}{2} \times 3\frac{1}{2} \times 6$ ins. Price £21 (U.K. purchase tax £7 17s. 6d.)

A.M. Tuner. Variable tuning. Range 5.8-18.5 Mc/s, 185-588 and 800-2070 Metres. Magic Eye ind. P.s.n. 330v at 35mA; 63v at 1.2A. Size $10\frac{1}{2} \times 3\frac{1}{2} \times 6$ ins. Price £24. (U.K. purchase tax £9.)

★

Armstrong Wireless & Television Co., Walters Road, Holloway, London, N.7. Tel.: North 3213/4.

F.M. Tuner T4. Free tuned. Range 87-108 Mc/s. A.F.C. Balanced ratio det. Self-powered. Preset vol. control. Size $8\frac{1}{2} \times 7\frac{1}{2} \times 3\frac{3}{4}$ ins. Price £15 2s. (U.K. purchase tax £4 17s.)

Stereo 12 Mk. 2 AM/FM. Tuner amplifier chassis. Variable tuning. Range 87-108 Mc/s, 187-570, 1053-2,000 Metres. A.F.C. Ratio disc. Magic Eye ind. Self-powered. Size $14\frac{1}{4} \times 9 \times 5\frac{1}{2}$ ins. Price £33 7s. 9d. (U.K. purchase tax £10 14s. 3d.)

★

C. T. Chapman (Reproducers) Ltd., Sales Division, 24 Upper Brook Street, London, W.1. Tel.: Hyde Park 2291.

F.M. Tuner FM90. Switched, 4 positions. Range 87.5-100 Mc/s. A.F.C. ratio disc. P.s.n. 250v at 40 mA; 6.3v at 2A. Size $5 \times 4\frac{1}{2} \times 6\frac{1}{2}$ ins. Price £14 9s. (U.K. purchase tax £5 1s.)

F.M. Tuner FM91. Free tuned. Range 87.5-100 Mc/s or 88-108 Mc/s. A.F.C. Wide band ratio det. Bright Line tuning ind. P.s.n. 250v at 40 mA; 6.3v at 2A or self-powered. Size $12 \times 4\frac{1}{8} \times 6\frac{1}{4}$ ins. Price £17 6s. 8d. (U.K. purchase tax £6 1s. 4d.) Self-powered £20 5s. 7d. (£7 1s. 11d.)

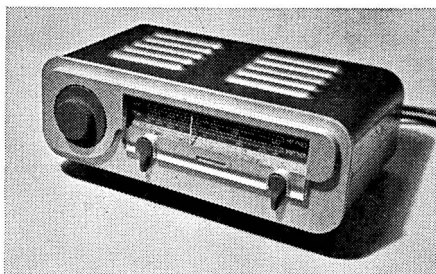

Quad AM tuner

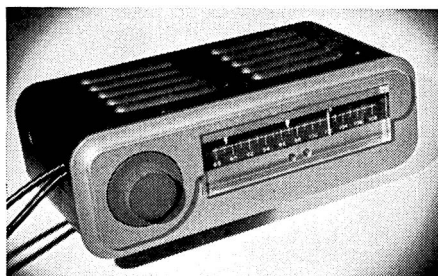

Quad FM tuner

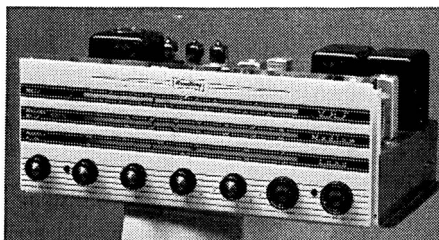

Armstrong Stereo 12 Mk. 2

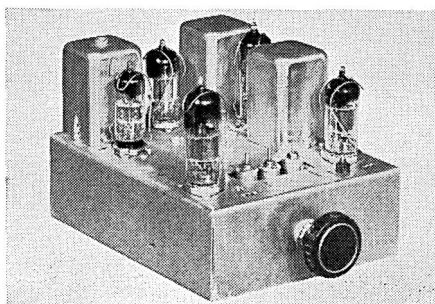

Chapman FM90 switched tuner

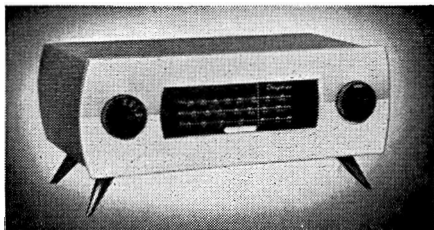

Chapman FM95

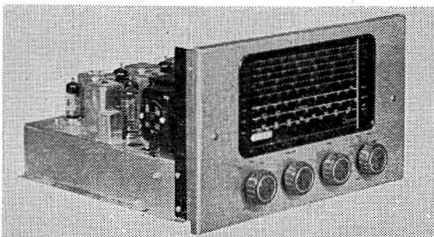

Chapman S6BS/FM

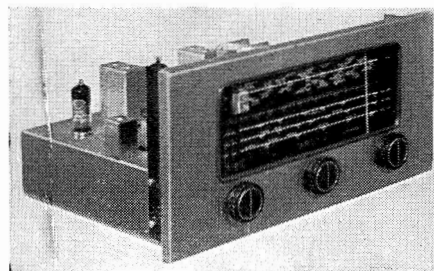

Chapman S5E/FM

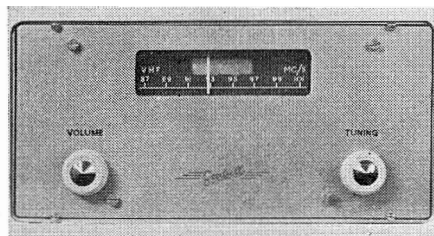

Goodsell FMT701

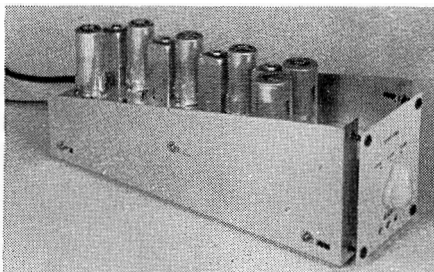

G.E.C. CBS 1352A

F.M.95 A.M./F.M. Tuner. Variable tuning. Range 87.5-100 Mc/s, 195-550 and 800-2,000 metres. A.F.C. Ratio det. EM84 ind. P.s.n. 250v at 30 mA; 6.3v 2 amps. Size $12 \times 4\frac{1}{2} \times 8\frac{1}{2}$ in. Price £20 1s. 9d. (U.K. purchase tax £7 0s. 9d.) Self-powered version £23 1s. (£8 1s. 6d.)

A.M./F.M. Tuner S5E/FM. Free tuned Range (F.M.) 87.5-100 Mc/s or 88-108 Mc/s; (A.M.) 12.5-37, 35-100, 90-250, 190-550 metres. Ratio det. plus limiter. Magic eye tuning ind. P.s.n. 200/250v at 40/50 mA or self-powered. $13\frac{1}{2} \times 6\frac{1}{2} \times 9$ ins. Price £25 3s. 8d. (U.K. purchase tax £8 16s. 4d.) Self-powered £28 3s. (£9 17s.)

A.M./F.M. Tuner S5/FM. Free tuned. Range (F.M.) 87.5 100 Mc/s; (A.M.) 16-50, 195-550, 800-2,000 metres. Ratio det. plus limiter. Magic eye tuning ind. P.s.n. 200/250v at 40/50 mA or self-powered. $13\frac{1}{2} \times 6\frac{1}{2} \times 9$ in. Price as S5E/FM above.

A.M./F.M. S6BS/FM. Free tuned. Range (F.M.) 87.7-108 Mc/s; (A.M.) 6 bandspreads: 11, 13, 16, 19, 25, and 31 metres; also 15-43, 43-140, 175-570 metres wide band ratio det. Magic eye ind. Self-powered. Size $13\frac{3}{4} \times 13 \times 8\frac{1}{2}$ ins. Price £50 (U.K. purchase tax £17 10s.)

A.M. Tuner S6BS. Free tuned. Range 6 bandspread ranges: 11, 13, 16, 19, 25, and 31 metres, also 13-43, 43-140, 175-570 metres. Magic eye ind. P.s.n. 250v at 30/40 mA; 6.3v at 1.5A, or self-powered. Size $13\frac{3}{4} \times 11 \times 8\frac{1}{2}$ ins. Price £32 19s. 2d. (U.K. purchase tax £11 10s. 10d.) or £37 8s. 2d. self-powered (U.K. purchase tax £13 1s. 10d.)



Elizabethan (Tape Recorders) Ltd., Bridge Close, Oldchurch Road, Romford, Essex. Tel.: Romford 64101.

Elizabethan F.M. Tuner. Manual tuning (permeability). Range 85-105 Mc/s. Foster-Seeley disc. Self-powered. Size $8 \times 2\frac{1}{2} \times 8$ ins. Price £11 19s. 4d. (U.K. purchase tax £4 0s. 8d.)



General Electric Co. Ltd., Radio Group. Lena Gardens, Brook Green, Hammer-smith, London, W.6. Tel.. Riverside 4671. Cables: Polyphase, London.

F.M. Tuner CBS1352A. Switched. Range 88-98 Mc/s. A.F.C. Temperature compensated Foster-Seeley. P.s.n. 150v at 25 mA;

6.3v at 1.8A. Size $8 \times 4\frac{1}{2} \times 6$ ins. Price £20 8s. 10d. (U.K. purchase tax £6 11s. 2d.) Power unit available. Price £6 17s. 6d.



Goodsell Ltd., Gardner Street, Brighton, Sussex. Tel.: Brighton 26735.

F.M. Tuner FMT701. Manual tuning (permeability). Range 85-100 Mc/s. Ratio det. Magic eye ind. P.s.n. 250v at 20 mA. Price £10 10s. (U.K. purchase tax £3 8s. 3d.)



The Gramophone Company Ltd., Hayes, Middx. Tel.: Hayes 3888. Cables: Jabberment, London.

H.M.V. AM/FM Tuner Model 558. Free tuned. Range 87.5-108.5 Mc/s, 145-275 Kc/s, 522-1,630 Kc/s. Self powered. Size $14\frac{1}{2} \times 3\frac{3}{8} \times 8\frac{3}{4}$ ins. Price £35 3s 6d. (including tax).



Grampian Reproducers Ltd., 19 Hanworth Trading Estate, Feltham, Middx. Tel.: Feltham 2657. Cables: Reamp, Feltham.

F.M. Tuner 571. Free tuned. Range 85-98 Mc/s. Ratio det. Magic eye ind. P.s.n. 300v at 35/40 mA, 6.3v at 2.5 amps. Size $10\frac{1}{2} \times 5\frac{1}{2} \times 6\frac{1}{2}$ ins. Price £17 10s. (U.K. purchase tax £5 17s. 11d.)



Jason Electronic Design Ltd., 3/4 Gt. Chapel Street, London, W.1. Tel.: Gerrard 0273/4.

F.M. Tuner FMT/4. Variable tuning. Range 88-108 Mc/s. A.F.C. Foster-Seeley disc. Self-powered. Size $11\frac{1}{2} \times 6\frac{3}{8} \times 4\frac{3}{8}$ ins. Better than $5\mu\text{V}$ for 40 dB quieting. Price £17 5s. (U.K. purchase tax £5 10s. 8d.)

JTV/2 F.M. and A.M./TV Sound Tuner. Switched turret tuning. Automatic frequency control. Range 88-96 Mc/s, plus all Television channels. Discriminator. Self-powered. Size $11\frac{1}{2} \times 7\frac{1}{2} \times 4\frac{3}{8}$ ins. $10\mu\text{V}$ for 40 dB quieting. Price £19 4s. (U.K. purchase tax £6 3s. 3d.)

Monitor. F.M. and A.M./TV Sound Tuner. Switched tuning. A.F.C. Range 40-212 Mc/s. Foster-Seeley disc. P.s.n. 230v at 35 mA; 6.3v at 1.5A. Size $5 \times 5\frac{1}{2} \times 7$ ins. Price £15 (U.K. purchase tax £4 16s. 3d.)

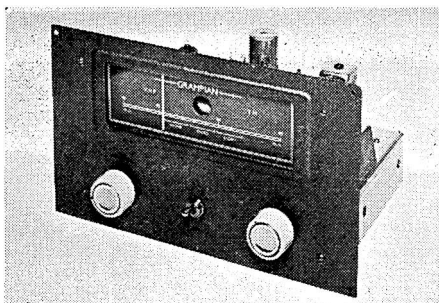

Grampian FM 571



Jason JTV 2

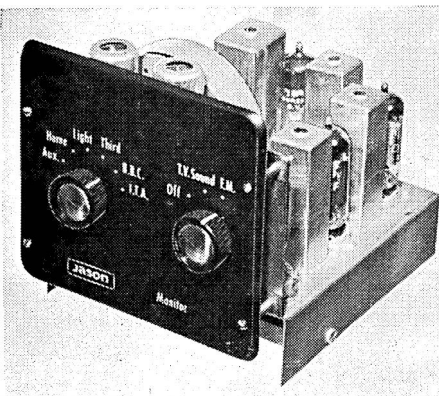

Jason Monitor

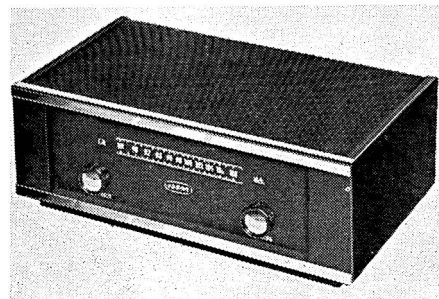

Jason FMT 3

H. J. Leak & Co. Ltd., 57/59 Brunel Road, East Acton, London, W.3. Tel.: Shepherds Bush 1173. Cables: Sinusoidal, Ealux, London.

F.M. Tuner, Trough-Line 11. Variable tuning. Range 88/108 Mc/s. A.F.C. giving tuning stability from the instant of switching on. Foster-Seeley disc. Magic eye ind. Self-powered. Size $11\frac{1}{2} \times 4\frac{1}{2} \times 7\frac{1}{4}$ ins. Price £25 (U.K. purchase tax £8 15s.)



Lee Products (Great Britain) Ltd., Elpico House, Longford Street, London, N.W.1. Tel.: Euston 5754. Cables: Leprod, London.

F.M. Tuner FMT/2. Variable tuning. Range 88-100 Mc/s. A.F.C. Foster-Seeley disc. Self-powered. Cathode follower output. Size $12\frac{1}{4} \times 3\frac{1}{4} \times 9\frac{3}{8}$ ins. Price £18 13s. 6d. (U.K. purchase tax £5 19s. 10d.)

A.M./F.M. Stereo Radiogram Chassis H3S. Variable tuning. Range 87-101 Mc/s, 187-540 and 1,100-1,900 metres. Ratio det. Self-powered. Size $12 \times 7\frac{3}{4} \times 9\frac{3}{8}$ ins. Price £21 (U.K. purchase tax £6 16s. 6d.) Note: includes twin audio amplifiers 4 watts per channel.

A.M./F.M. Tuner H4T/2. Variable tuning. Range 87-101 Mc/s, 16-50, 187-540 and 1,100-1,900 metres. Ratio det. Magic eye ind. Self-powered. Size $12\frac{1}{2} \times 6\frac{1}{4} \times 10$ ins. Price £19 10s. (U.K. purchase tax £6 5s. 2d.)



The Lowther Manufacturing Co., Lowther House, St. Mark's Road, Bromley, Kent. Tel.: Ravensbourne 5225. Cables. Lowther, Bromley.

F.M. Tuner Mk. III. Twin gang tuning, horizontal scale. Range 87.5-100 Mc/s. A.F.C. Foster-Seeley disc. Press button ind. 50 c/s injection. Self-powered. Size $13\frac{1}{4} \times 5\frac{1}{2} \times 5$ ins. Price £24 10s. (U.K. purchase tax £8 2s. 11d.)

F.M. Tuner Mk. V. Variable tuning. Range 87.5-100 Mc/s. A.F.C. Foster-Seeley disc. Press button ind. P.s.n. 250v 30 mA; 6.3v 2 amps. Size $10\frac{1}{4} \times 4\frac{3}{4} \times 7$ ins. Price £22 (U.K. purchase tax £7 6s. 4d.)

A.M. and F.M. Tuner D/VHF. Switched tuning. FM on band 2 plus AM on bands 1 and 3. Crystal control A.F.C. Foster-Seeley disc. P.s.n. 250v at 30 mA; 6.3v at 2.5A. Size $10\frac{1}{2} \times 4\frac{1}{2} \times 6$ ins. Price to be announced.

A.M. and F.M. Tuner Lowther double output. Switched tuning. FM on band 2 plus AM on bands 1 and 3. Crystal control A.F.C. Foster-Seeley disc. P.s.n. 250v at 40 mA; 6.3v at 3A. Size $10\frac{1}{2} \times 4\frac{1}{2} \times 6$ ins. Incorporates Time multiplex and double drive. Price to be announced.



Pamphonic Reproducers Ltd., 17 Stratton Street, London, W.1. Tel.: Grosvenor 1926.

640 F.M. Tuner. Variable tuning. Range 86-103 Mc/s. Ratio sel. Magic eye ind. P.s.n. 200v at 30 mA, 6.3v at 2 amps. Size (panel) $9\frac{3}{16} \times 3\frac{1}{4}$ ins. Price £15 (U.K. purchase tax £4 16s. 3d.)



Pye Ltd., High Fidelity Division, Blue Town, Sheerness, Kent. Tel.: Sheerness 3076. Cables: Faramarine, Sheerness, Kent.

A.M./F.M. Tuner HFT113. Variable tuning. Range (F.M.) 87-108 Mc/s. (A.M.) 190-550 metres. A.F.C. Foster-Seeley disc. Magic eye ind. Self-powered. Size $10\frac{1}{2} \times 3\frac{3}{8} \times 5$ ins. Price to be announced.

F.M. Tuner Mozart HFT.108. Variable tuning. Range 87-108 Mc/s. A.F.C. Foster-Seeley disc. Self-powered. Size $10\frac{1}{2} \times 3\frac{3}{8} \times 5$ ins. Price £17 9s. 9d. (U.K. purchase tax £5 12s. 3d.) chassis only or in metal case £19 1s. 1d. (U.K. purchase tax £6 2s. 11d.) 110V model available.



Rogers Developments (Electronics) Ltd., "Rodevco Works," 4-14 Barmeston Road, Catford, S.E.6. Tel.: Hither Green 7244/4340. Cables: Rodevco, London.

R.D. Junior F.M. Tuner. Variable inductance tuning. Range 87-107.5 Mc/s. A.F.C. Foster-Seeley disc. Tuning ind. centre-zero meter (optional extra). Sensitivity for full limiting, $10\mu\text{v}$. Self-powered. Size $9 \times 5\frac{3}{8} \times 8\frac{5}{8}$ ins. Price £18 5s. 6d. (U.K. purchase tax £6 4s. 9d.) Also available to match HG88 amplifier with case £22 7s. 4d. (U.K. purchase tax £7 12s. 8d.)



H.M.V. Model 558 AM/FM

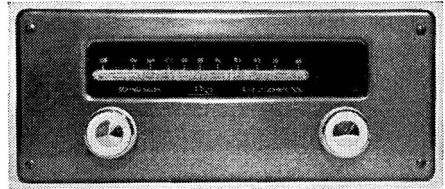

Sound Sales Synchrolock Mk. IV

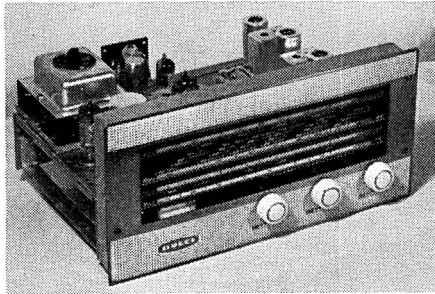

Lee H4T/2

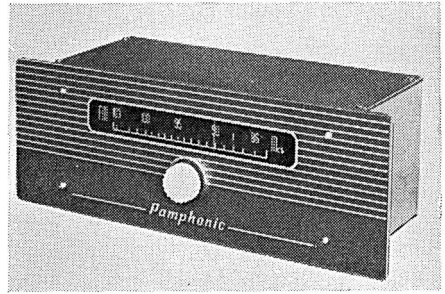

Pamphonic 640 FM tuner

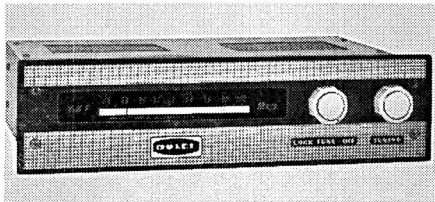

Lee FMT2



Leak Trough-Line II

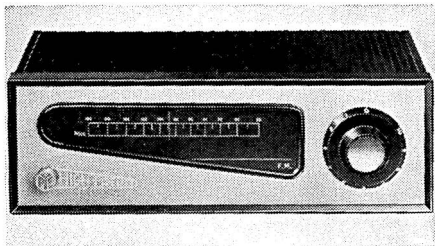

Pye Mozart HFT 108M

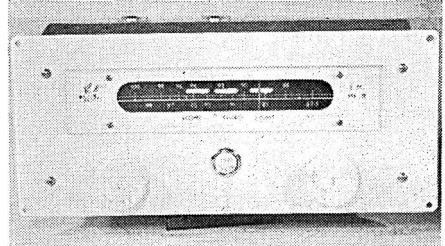

Lowther Mk. III

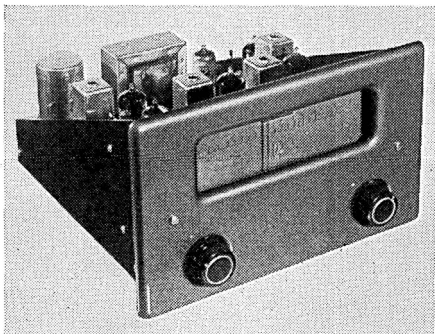

Rogers RD Junior FM tuner

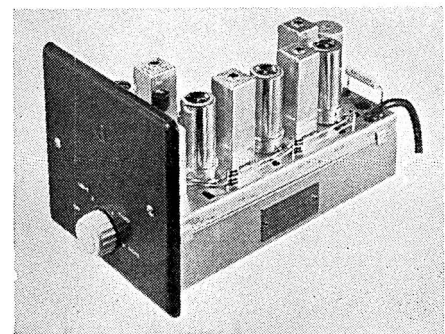

Rogers RD Junior Switched FM tuner

F.M. Tuner R.D. Junior Switched. Switched tuning. Range 87-96 Mc/s. A.F.C. Foster-Seeley disc. P.s.n. 250v 35 mA; 6.3v 1.7 amps. Size $9 \times 5\frac{3}{4} \times 5\frac{3}{8}$ ins. Price £11 5s. (U.K. purchase tax £3 16s. 10d.) Also available to match HG88 amplifier without case £11 18s. (U.K. purchase tax £4 1s. 3d.)

★

Shirley Laboratories Ltd., 3 Prospect place, Worthing, Sussex. Tel.: Worthing 30536.

F.M. Tuner R/6. Variable tuning. Standard range. Ratio det. Magic eye ind. P.s.n. 200-300v 30 mA; 6.3v 2.5 amps. Price £27 10.

★

Sound Sales Ltd., Works and Acoustic Laboratories, West Street, Farnham, Surrey. Tel.: Farnham 6461/2/3. Cables: Sounsense, Farnham.

A-Z F.M. Synchrolock Unit Mk. IV 108. Variable twin gang tuning. Range 75.8-108 Mc/s. A.F.C. Foster-Seeley disc. Magic eye ind. Self-powered. Size $11\frac{1}{4} \times 4\frac{1}{2} \times 6\frac{1}{2}$ ins. Price £22 (U.K. purchase tax £7 1s. 2d.)

★

Symphony Amplifiers Ltd. (Distributors Northern Radio Services (London) Ltd.), 16 Kings College Road, London, N.W.3. Tel.: Primrose 3314/5.

F.M. Tuner Symphony No. 1. Variable tuning. Range 87-101 Mc/s. Ratio det. P.s.n. 250v at 40 mA; 6.3v at 1.5A. Size $9 \times 6 \times 6$ ins. Price £11 1s. 10d. (U.K. purchase tax £3 12s. 2d.) Power pack available. Price £3 7s. 6d. Magic eye available. Price £1.

A.M./F.M. Tuner Symphony No. 2. Manual tuning. Range 87-101 Mc/s, 16-50, 187-550, and 800-2,000 metres. Ratio det. Self-powered. Size $13\frac{1}{2} \times 8\frac{1}{2} \times 7\frac{1}{2}$ ins. Price £18 2s. 3d. (U.K. purchase tax £5 17s. 9d.) Magic eye available. Price £1.

VHF/TV. Tuner Symphony. Switched tuning. Home, Light and Third on band 2, T.V. on bands 1 and 3. A.F.C. Foster-Seeley disc. P.s.n. 200v at 45 mA; 6.3v at 2A. Size $5 \times 5 \times 8$ ins. Price £15 (U.K. purchase tax £4 16s. 3d.)

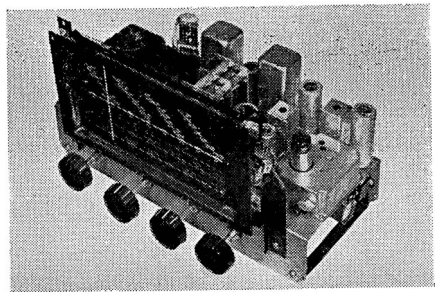

Symphony AM/FM Tuner No. 2

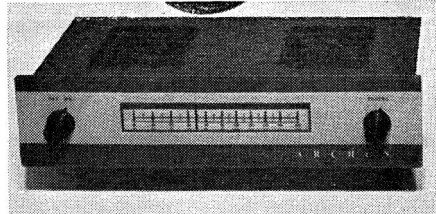

Tansley-Howard Archon P.F.41

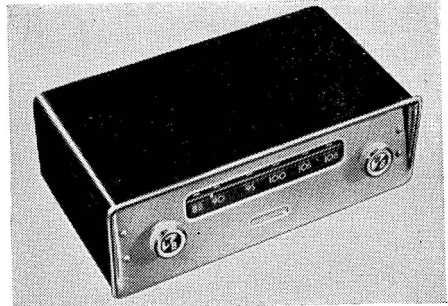

W/B Stentorian F.M. tuner

Tansley-Howard Ltd., 95 Kensal Road, London, W.10. Tel.: Ladbroke 7195.

Archon F.M. Tuner. P.F.41. Variable tuning. Range 88-108 Mc/s. A.F.C. Self-powered. Size $12 \times 6 \times 2\frac{3}{8}$ ins. Panel $12\frac{1}{2} \times 3$ ins. Price £23 2s. (U.K. purchase tax £6 10s. 6d.)

★

Whiteley Electrical Radio Co. Ltd., Victoria Street, Mansfield, Nottinghamshire. Tel.: Mansfield 1762-5. Cables: Whitebon, Mansfield.

W/B Stentorian F.M. Tuner Mk. II. Variable permeability tuning. Range 88-108 Mc/s. Foster-Seeley disc. P.s.n. 200-240v at 45 mA, 6.3v at 2 amps. Size $11\frac{3}{8} \times 4 \times 7\frac{1}{2}$ ins. Price £16 2s. 5d. (U.K. purchase tax £6 19s. 7d.)

LOUDSPEAKERS

An Introduction—by R. L. West

DURING the past year, there have been no spectacular developments, though the keen observer may have noted reports suggesting that some of the more difficult loudspeaker design problems have been solved by alchemy! Looking back through the Previous five Hi-Fi Year books it is surprising how few changes have occurred. The only big breakthrough during this time was right at the beginning—the Quad Electrostatic, and it still shows no sign of becoming out of date. Many others continue, too, more or less unchanged, and are still held in high esteem. It shows they were all very good designs in the first place.

Some of the Old are Still Good

There have been changes, of course. A few items have been replaced by more up-to-date counterparts. A few have disappeared, but mainly due to changes in company policy. A few newcomers have been welcomed in.

There are many people with five-year-old equipment that is still by no means out of date. Thus a good £52 loudspeaker, for instance, will have cost only a mere 4s. per week, even if it were to be scrapped right now. The better type of loudspeaker is thus likely to be a good investment.

Concerning the choice of loudspeaker, much has been said and written, and it is no simple matter. As a generalisation, it is safe to say that only the very best the listener can afford should be considered. Many people find that experience with fairly good quality equipment usually sharpens their critical faculties and a standard of reproduction that once was quite adequate becomes

unacceptable after a time. The best quality equipment, however, remains acceptable for a very long time.

Compromise

The actual choice is still a very personal matter and we can never all agree on what we consider best. Until such time that we can present the ear with an *exact* copy of the original sound field, in magnitude and direction, we must accept compromise. A dozen or so channels at least would be needed to get really near the original, but both economic and domestic reasons rule this out and limit us to only two at the moment, though we may dare to think of three or four later on maybe. It is in the choice of compromise that we can have endless combinations and thus a wide choice of loudspeakers results. Some people are more sensitive to the smoothness of response, some to the frequency range, and yet others to the type of sound distribution produced. Very often the listener is not aware of the reason for his choice and only knows that A sounds better than B to him. This after all is what matters, *but do make sure A sounds better than B with many different types of sound, speech and music before finally deciding.*

Quality Still Costs Money

Generally, the more one pays for a loudspeaker, the better it is likely to be, but this does not imply that the best is the most expensive. The most expensive may be thus because it has the most lavish decor. On the other hand, don't expect to get superb results for £5. Most of the reputable manu-

facturers have been in the game a long time and have very wide knowledge and experience. Ideally a loudspeaker is not a musical instrument and should have no character or characteristic tone of its own. In practice, it always has a little, sometimes rather more, and we start talking about "colouration". In practice, therefore, it is a musical instrument and its characteristic sounds must not only be unobtrusive but pleasant.

The Ears are Most Important

Science and good engineering alone cannot produce the superb loudspeaker, but they do help. They also help to ensure consistency in the product, and they should at least prevent a bad one being made. To go that bit farther, i.e. to choose the right compromises, we have no electronic instruments sophisticated enough to help us. We thus have to rely on our own brain with its vast memory stores. A keen and experienced ear is thus very necessary, and is not likely developed overnight. Antonio Stradivari made his famous violins when he was over forty years of age, but he had been learning for some thirty years. This is not mentioned to discourage initial enthusiasm, but to emphasise just how sensitive our hearing can be, how difficult to satisfy, and how much subtlety is built into many of our better loudspeakers.

As has already been pointed out, the advent of stereo stimulated the design of small loudspeakers. Some of these were very

carefully designed to give the smoothest possible response and were indeed very pleasant to listen to. The bass response was usually down somewhat and unfortunately not correctable by the bass boost on most amplifiers. There seems now to be a return to designs that produce more bass in the 30-50 c/s region, although the response may not be quite so smooth. The writer considers this a better compromise. The extreme bass is vital to our full enjoyment, as music with its full complement of bass is less tiring to listen to.

At the other end of the scale, at long last an electrostatic tweeter has appeared and seems to be very satisfactory. There is still only one ribbon speaker, but its sensitivity has crept up and up and it can partner pretty well any bass unit. Having the smallest and lightest moving parts of any loudspeaker made in this country, it has a very good start when considering transient response.

Foam Surrounds

Foam surrounds continue to be popular—and effective, and cone resonances get lower and lower, a very good thing. The cellular sandwich construction already used in aircraft design because of its very high strength to mass ratio, looks like invading the loudspeaker province. It is a step towards our ideal structure of zero mass with infinite stiffness and bids fair to give bass loudspeakers a wider useful frequency range.

"Satisfactory Progress" sums up the year's activities in the realm of loudspeakers.

DIRECTORY OF SPEAKERS AND ENCLOSURES

● This directory is divided into two parts. **Part 1** deals with the range of drive units which, by makers' specifications, are within the Hi-Fi classification. **Part 2** deals with complete enclosures. These, as a general rule, embody the drive units of Part 1. For economy of space the following abbreviations are used: v.c.i.—voice coil impedance; r.c.f.—recommended crossover frequency (and in Part 2) **Rec.**—recommended units; Height by Width by Depth are the order of printed dimensions.

PART I—DRIVE UNITS

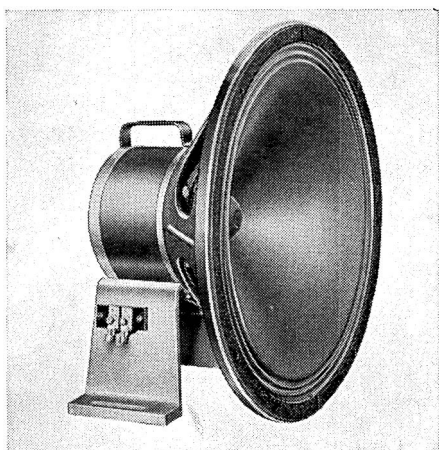

AEI Type 18A

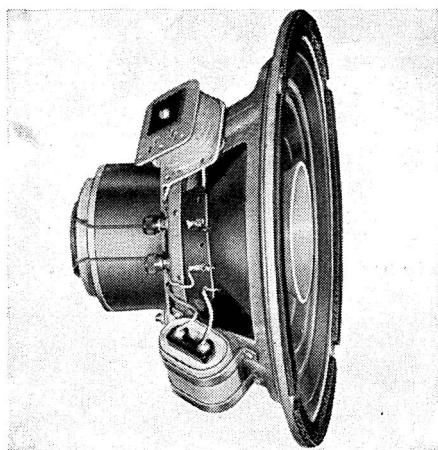

AEI Type DC12

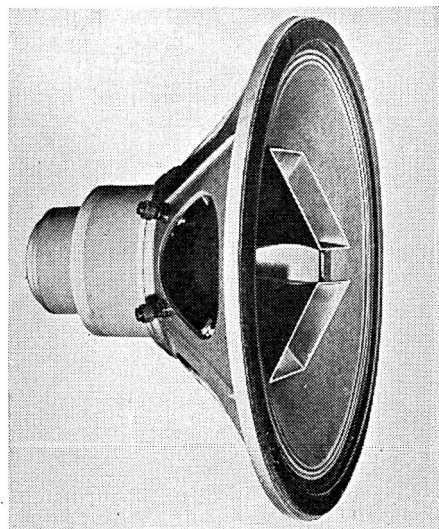

AEI K10A Dual Concentric

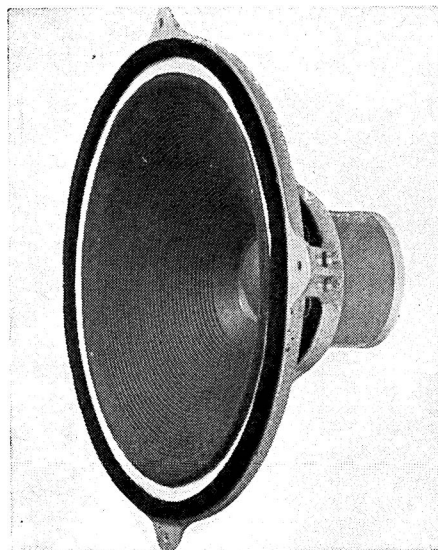

Bakers Selhurst 15-in/CS Auditorium

A.E.I. Sound Equipment Ltd., Crown House, Aldwych, London, W.C.2. Tel.: Temple Bar 8040. Cables: Soundequi, Estrand, London.

A.E.I. 12A. 12 in. Paper cone. Fabric surround. Voice coil $1\frac{3}{4}$ in. Gap flux 14,400 gauss. Total flux 122,000 maxwells. H.C. 18 watts. v.c.i. 15 ohms. F.R. 50-10,000 c/s. Price £14.

A.E.I. 12B. 12 in. paper cone. Foam surround. Voice coil $1\frac{3}{4}$ in. Gap flux 14,400 gauss. Total flux 122,000 maxwells. H.C. 12 watts. v.c.i. 15 ohms. F.R. 40-10,000 c/s. Price £14 14s.

A.E.I. DC12 Dual Concentric. 12 in. Paper cone. Fabric surround. Voice coils. (L.F.) $1\frac{1}{2}$ in. (H.F.) 1.56 in. Gap flux (L.F.) 10,000 gauss (H.F.) 13,000 gauss. Total flux (L.F.) 85,000 maxwells (H.F.) 49,000 maxwells. H.C. 15 watts. v.c.i. 15 ohms. F.R. 50-14,000 c/s. Built-in crossover 1,500 c/s. Price £25.

A.E.I. 18A. 18 in. Paper cone. Fabric surround. Voice coil $2\frac{1}{2}$ in. Gap flux 15,000 gauss. Total flux 376,000 maxwells. H.C. 40 watts. v.c.i. 10 ohms. F.R. 30-9,000 c/s. r.c.f. 500 c/s. Price £41.

A.E.I. 18B. Details as above, but Felt surround. R.F. 20-9,000 c/s.

A.E.I. 18C. 18 in. Paper cone. Fabric surround. Voice coil $2\frac{1}{2}$ in. Gap flux 11,800 gauss. Total flux 215,000 maxwells.

H.C. 30 watts. v.c.i. 10 ohms. F.R. 30-9,000 c/s. r.c.f. 500 c/s. Price £25 10s.

A.E.I. K10A. Dual Concentric. 18 in. Paper cone. Felt surround. Voice coils (L.F.) $2\frac{1}{2}$ in. (H.F.) 1.56 in. Gap flux (L.F.) 14,300 (H.F.) 16,700 gauss. Total flux (L.F.) 285,000 (H.F.) 63,000 maxwells. H.C. 25 watts. v.c.i. 10 ohms. F.R. 30-17,000 c/s. Separate filter unit. 1,700 c/s. Price £48.



Richard Allan Radio Ltd., Baffle House, Taylor Street, Batley. Tel.: Batley 1123/1308/4033. Cables: Acoustics Batley.

Golden Eight. 8 in. Paper cone and surround. Voice coil 1 in. Gap flux 12,000 gauss. Total flux 48,000 maxwells. H.C. 5 watts. v.c.i. 15 ohms. F.R. 60-10,000 c/s. Price £2 10s. (U.K. purchase tax 16s. 1d.)

Golden Eight. 8 in. Paper cone with Foam surround. Voice Coil 1 in. Gap flux 12,000 gauss. Total flux 48,000 maxwells. H.C. 5 watts. v.c.i. 15 ohms. F.R. 45-10,000 c/s. Price £2 15s. (U.K. purchase tax 17s. 8d.)

Golden Ten. 10 in. Paper cone. Foam surround. Voice coil $1\frac{1}{2}$ in. Gap flux 14,000 gauss. Total flux 82,000 maxwells. H.C. 10 watts. v.c.i. 15 ohms. F.R. 40-5,000 or 40-9,000 c/s. r.c.f. 5,000 c/s. Price £5 12s. (U.K. purchase tax £1 15s. 11d.)

Bronze Ten. 10 in. Paper cone. Foam surround. Voice coil $1\frac{1}{2}$ in. Gap flux 12,500 gauss. Total flux 73,000 maxwells.

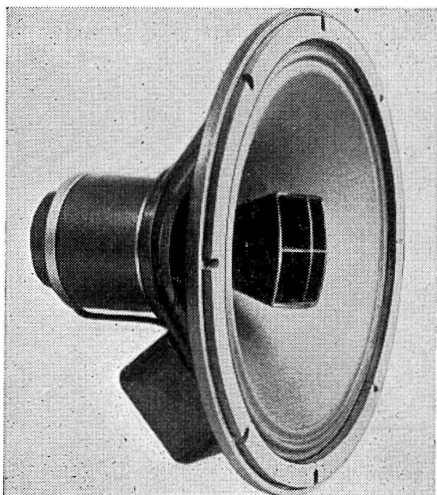

Altobass 2000

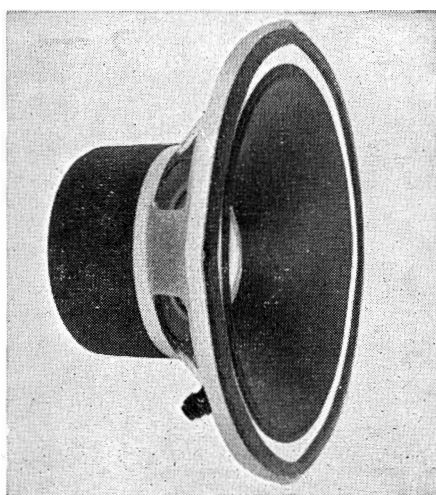

Fane H.D. 121A

H.C. 8 watts. v.c.i. 15 ohms. F.R. 40-5,000 or 40-9,000 c/s. Price £4 17s. (U.K. purchase tax £1 11s. 2d.)

Golden Twelve. 12in. Paper cone. Foam surround. Voice coil 2 in. Gap flux 14,000 gauss. Total flux 182,000 maxwells. H.C. 15 watts. v.c.i. 15 ohms. F.R. 25-15,000 c/s. r.c.f. 1,100 c/s. Price £12 12s.

Bronze Twelve. 12 in. Paper cone. Foam surround. Voice coil 2 in. Gap flux 12,500 gauss. Total flux 162,000 maxwells. H.C. 12 watts. v.c.i. 15 ohms. F.R. 25-5,000 c/s. r.c.f. 1,100 c/s. Price £9 9s.

410T. Tweeter. 4 in. Paper cone and surround. Voice coil 9/16 in. Gap flux 10,000 gauss. Total flux 15,000 maxwells. H.C. 3 watts. v.c.i. 15 ohms. F.R. 2,000-17,000 c/s. r.c.f. 5,000 c/s. Price £1 5s. (U.K. purchase tax 8s.)



Altobass Ltd., Percy Road, Aylestone Park, Leicester. Tel.: Leicester 31616. Cables: Altobass, Leicester.

2000. Dual Concentric. 12 in. Moulded paper cone, corrugated surround (L.F.). Duralumin pressure tweeter. Voice coil 1½ in. (L.F.), 1 in. (H.F.). Gap flux (L.F.) 8,000 (H.F.) 13,000 gauss. Total flux (L.F.) 90,000 (H.F.) 50,000 maxwells. H.C. 10 watts. v.c.i. 10 ohms. F.R. 30-20,000 c/s. Built-in crossover at 1,200 c/s. Price £17 17s.

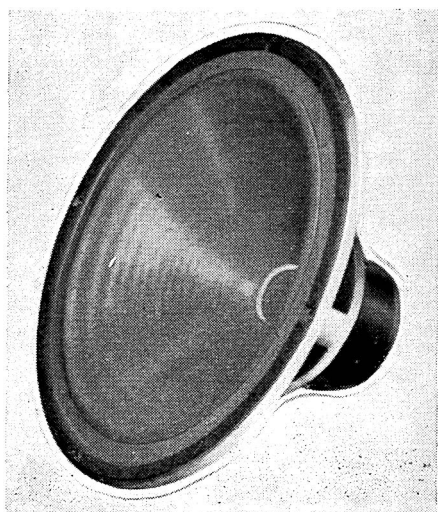

Duode 12D

Bakers "Selhurst" Radio, 523 London Road, Thornton Heath, Surrey.

8 in. Special. Fibre cone, bakelised apex. Foam surround. Voice coil 1 in. Gap flux 18,000 gauss. H.C. 8 watts. v.c.i. 15 ohms. F.R. 35-20,000 c/s. Price £7 10s.

12in. de-luxe fibre curvilinear cone, bakelised apex. Foam surround. Voice coil 1½ in. Gap flux 15,000 gauss. H.C. 15 watts. v.c.i. 3 or 15 ohms. F.R. 20-17,000 c/s. Price £9 10s.

12-in. Ultra de-luxe fibre curvilinear cone, bakelised apex. Foam surround. Voice coil 1½ in. Gap flux 17,000 gauss. Peak H.C. 20 watts. v.c.i. 15 ohms. F.R. 18-20,000 c/s. Price £15 15s.

Ultra Twelve 12-in. fibre curvilinear cone, bakelised apex. Foam surround. Voice coil 1½ in. Gap flux 17,000 gauss. Aluminium voice coil and drive. H.C. 20 watts v.c.i. 15 ohms. F.R. 20-25,000 c/s. Price £17 10s.

15-in./CS Auditorium. Fibre cone, bakelised apex. Foam surround. Voice coil 2 in. Gap flux 17,000 gauss. H.C. 15 watts. v.c.i. 8 or 15 ohms. F.R. 20-13,000 c/s. r.c.f. 5,000 c/s. Price £18.

Ultrasonic 3¼ in. bakelised cone. Foam surround. Voice coil 1 in. (aluminium). Gap flux 18,000 gauss. H.C. 12 watts above 1,000 c/s. v.c.i. 15 ohms. F.R. 1,000-25,000 c/s. r.c.f. 1,600 or 3,000 c/s or by 3µF condenser. Price £6.

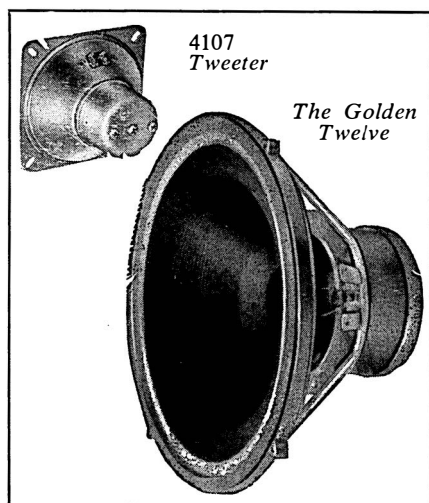

Richard Allan Drive Units

Duode Ltd., 523 London Road, Thornton Heath, Surrey.

Duode 12E. 12 in. Linen moulded cone. Foamed plastic surround. Voice coil 1.5 in. Gap flux 17,000 gauss. Total flux 190,000 lines. H.C. 30-15 watts. v.c.i. 15-8-5 ohms. F.R. 20-16,000 c/s. Price £15.

Duode 12D. 12 in. Linen moulded cone. Foamed plastic surround. Voice coil 1.5 in. Gap flux 14,500 gauss. Total flux 130,000 lines. H.C. 15 watts. v.c.i. 30-15-8-5 ohms. F.R. 20-16,000 c/s. Price £12.



Fane Acoustics Ltd., 1 Wellington Street, Batley, Yorks. Tel.: Batley 1578. Cables: Fane, Batley.

Fane H.D. 121. 12 in. Paper cone. Foam surround. Voice coil 2 in. Gap flux 12,000 gauss. Total flux 160,000 maxwells. H.C. 20 watts. v.c.i. 15 ohms. F.R. 30-5,000 c/s. r.c.f. 2,000 c/s. Price £9.

Fane H.D. 121A. Details as above, but aluminium voice coil. F.R. 30-10,000 c/s. r.c.f. 5,000 c/s. Price £9 9s.

Fane 301 High Frequency Unit. Aluminium cone. Voice coil $\frac{3}{4}$ in. Gap flux 17,000 gauss. H.C. 12 watts. v.c.i. 15 ohms. F.R. 1,500-17,000 c/s. r.c.f. 2,000 c/s. Price £3 15s.



General Electric Co. Ltd., Radio Group, Lena Gardens, Brook Green Hammer-smith, London, W.6. Tel.: Riverside 4671. Cables: Polyphase, London.

Metal Cone Speaker. BCS1851. 8 in. metal cone. Plastic surround. Voice coil 1 in. Gap flux 13,500 gauss. H.C. 12 watts. v.c.i. 4 ohms. F.R. 30-20,000 c/s. r.c.f. 1,500 c/s. Price £7 3s. 10d. including power bracket (U.K. purchase tax £2 6s. 2d.)

BCS1852 Presence Unit. Miniature metallised pressure diaphragm. Surround integral with diaphragm. Overall dia. $1\frac{1}{8}$ in. Voice coil $\frac{3}{4}$ in. Gap flux 10,500 gauss. Total flux 26,000 maxwells. H.C. 12 watts max. v.c.i. 15 ohms. F.R. 1,000-15,000 c/s. Price £3 19s 6d. including condenser and mounting components.

BCS 1853. High Flux Presence Unit. Miniature metallised diaphragm. H.C. 12 watts max. v.c.i. 15 ohms. F.R. 1,500-13,000 level. r.c.f. 1,500 c/s. Price £6 10s.

Goodmans Industries Ltd., Axiom Works, Wembley, Middx. Tel.: Wembley 1200, Cables: Goodaxiom, Wembley.

Axiette. 8-in. Paper cone. Plastic treated surround. Voice coil 1 in. Gap flux 15,000 gauss. H.C. 6 watts. v.c.i. 3 or 15 ohms. F.R. 40-15,000 c/s. Price £5 (U.K. purchase tax £1 12s. 1d.)

Triaxiette. 8 in. Paper cone. Plastic treated surround. Main voice coil 3 in. H.F. 1 in. Total flux 178,000 maxwells. H.C. 10 watts. v.c.i. 15 ohms. F.R. 40-20,000 c/s. Price £10 4s. 3d. (U.K. purchase tax £3 5s. 9d.)

Axiom 80. $9\frac{1}{2}$ in. Twin Diaphragm paper cone, free edge surround. Voice coil 1 in. Gap flux 17,000 gauss. Total flux 62,600 maxwells. H.C. 6 watts. v.c.i. 15 ohms. F.R. 20-20,000 c/s. Price £17 10s. (U.K. purchase tax £5 12s. 4d.)

Audiom 60. 12 in. Paper cone. Paper surround. Voice coil $1\frac{1}{4}$ in. Gap flux 14,000 gauss. Total flux 158,000 maxwells. H.C. 15 watts. v.c.i. 15 ohms. F.R. up to 7,000 c/s. r.c.f. 950 c/s. when used as bass speaker in multi-speaker systems. Price £9 12s. 9d.

Audiom 70. 12 in. Paper cone. Paper surround. Voice coil $1\frac{1}{4}$ in. Gap flux 17,500 gauss. Total flux 195,000 maxwells. H.C. 20 watts. v.c.i. 15 ohms. F.R. up to 7,000 c/s. r.c.f. 950 c/s when used as bass speaker in multi-speaker systems. Price £15 2s.

Axiom 110. 10 in. Paper cone. Plastic treated surround. Voice coil 1 in. Gap flux 12,000 gauss. H.C. 10 watts. v.c.i. 15 ohms. F.R. 40-15,000 c/s. Price £3 15s. 9d. (U.K. purchase tax £1 4s. 3d.)

Axiom 112. 10 in. Paper cone. Plastic treated surround. Voice coil 1 in. Gap flux 16,000 gauss. H.C. 12 watts. v.c.i. 15 ohms. F.R. 40-15,000 c/s. Price £6 8s. 8d. (U.K. purchase tax £2 1s. 4d.)

Axiom 300. 12 in. Twin diaphragm, paper cone. Plastic treated surround. Voice coil $1\frac{1}{4}$ in. Gap flux 14,000 gauss. Total flux 158,000 maxwells. H.C. 15 watts. v.c.i. 15 ohms. F.R. 30-16,000 c/s. Built-in mechanical crossover network at 5,000 c/s. Price £11 5s. 9d.

Axiom 400. 12 in. Twin diaphragm, paper cone. Plastic treated surround. Voice coil $1\frac{1}{4}$ in. Gap flux 17,500 gauss.

HIGH FREQUENCY UNITS

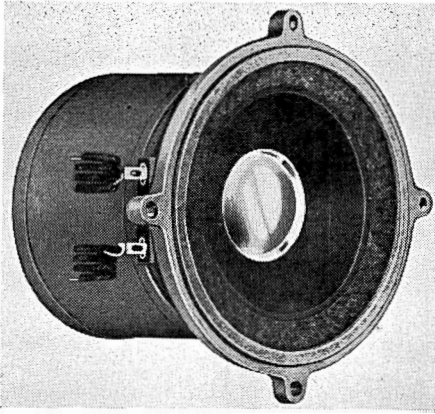

Wharfedale Super 3

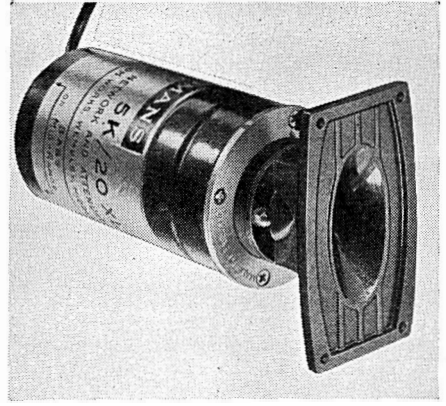

Goodmans Trebax 5K/20XL

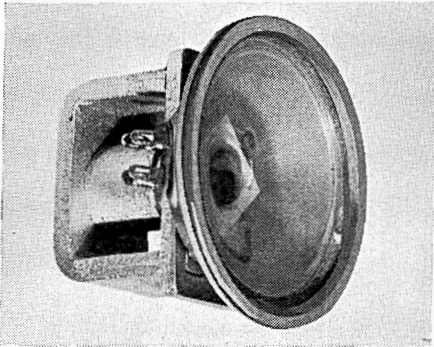

TSL-Lorenz LPH 65 Tweeter

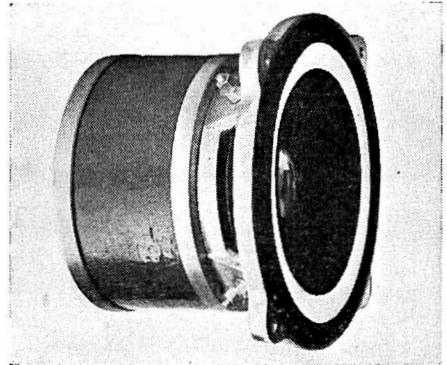

Bakers Selhurst Ultrasonic

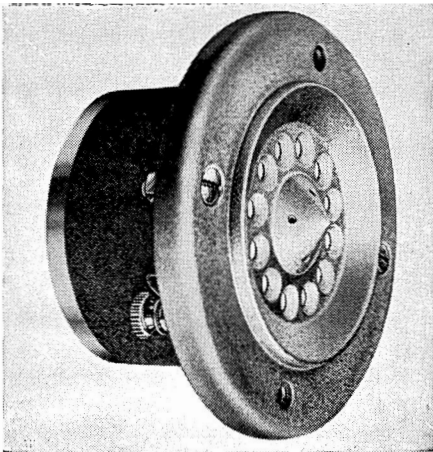

Fane 301 H.F. Unit

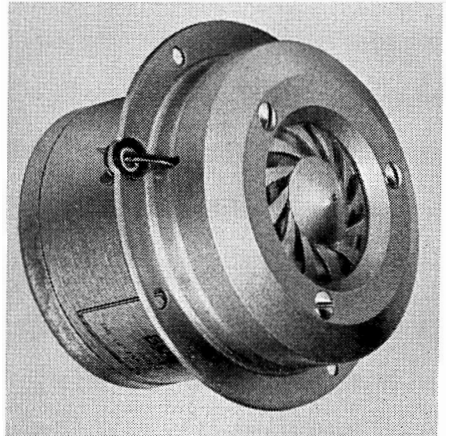

G.E.C. High Flux Presence Unit

Total flux 195,000 maxwells. H.C. 20 watts. v.c.i. 15 ohms. F.R. 30-16,000 c/s. Built-in mechanical crossover network at 5,000 c/s. Price £16 1s.

Audiom 80. 15 in. Paper cone. Paper surround. Voice coil 2 in. (5 cms.). Gap flux 14,500 gauss. Total flux 215,000 maxwells. H.C. 25 watts. v.c.i. 15 ohms. F.R. up to 7,000 c/s. 950 c/s when used as bass speaker in multi-speaker systems. Price £22 10s.

Triaxiom 12/20. 12 in. Paper cone. Plastic treated surround. Main voice coil 1½ in. H.F. 1 in. Gap flux 16,500 gauss. Total flux 185,000 maxwells. H.C. 20 watts. v.c.i. 15 ohms. F.R. 30-20,000 c/s. Price £25.

Trebax. Horn-loaded pressure tweeter. Aluminium diaphragm. Voice coil 1 in. H.C. suitable for inclusion in systems of up to 25 watts. v.c.i. 15 ohms at 10 Kc/s. F.R. 2,500-20,000 c/s. r.c.f. 5 Kc/s. Price £6 4s.

Trebax 5K/20XL. Horn loaded pressure tweeter. Built in L/C crossover (5,000 c/s) and attenuator. Suitable for inclusion in systems of up to 20 watts. Dispersion angle 90°. Price £7.

Midax 650. Horn loaded pressure unit. Resin impregnated linen diaphragm. Voice coil 1½ in. H.C. suitable for systems up to 25 watts. v.c.i. 15 ohms. F.R. 650-8,000 c/s. r.c.f. 950 and 5,000 c/s. Price £9 10s.



Grampian Reproducers Ltd., Hanworth Trading Estate, Middx. Tel.: Feltham 2657/8/9. Cables: Reamp, Feltham.

Grampian 1255/15. 12 in. Paper impregnated cone and surround. Voice coil 1½ in. Gap flux 14,500 gauss. Total flux 130,500 maxwells. H.C. 10 watts. v.c.i. 15 ohms. F.R. 35-15,000 c/s. Price £9.



The Lowther Manufacturing Co., Lowther House, St. Mark's Road, Bromley, Kent. Tel.: Ravensbourne 5225. Cables: Lowther, Bromley.

P.M.6. 6 in. Selected paper cone. Plastic surround. Voice coil 39 mm. Gap flux 17,500 gauss. Total flux 196,000 maxwells. H.C. 6 watts. v.c.i. 16 ohms. F.R. 20-18,000 c/s. Price £18 18s.

P.M.2 Mk. I. 6 in. Selected paper cone. Plastic surround. Voice coil 39 mm. Gap flux 21,000 lines per sq. cm. Total flux 281,000 maxwells. H.C. 6 watts. v.c.i. 16 ohms. F.R. 20-20,000 c/s. Price £30.

P.M.2. Mk. II. 6 in. Selected paper cone. Plastic foam surround. Voice coil 39 mm. Gap flux 23,000 gauss. Total flux 350,000 maxwells. H.C. 6 watts. v.c.i. 16 ohms. F.R. 22-20,000 c/s. Price £40.

PM2 Mk. III. Details as PM2 Mk. I but with special bracket for securing within Acousta-Twin Enclosure.

P.M.3. 6 in. Selected paper cone. Plastic surround. Voice coil 39 mm. Gap flux 22,000 gauss. Total flux 307,750 maxwells. H.C. 6 watts. v.c.i. 15 ohms. F.R. 20-20,000 c/s. Not sold separately from enclosure type T.P.1.

P.M.4. 6 in. Selected paper cone. Plastic surround. Voice coil 39 mm. Gap flux 24,500 gauss. Total flux 385,000 maxwells. H.C. 6 watts. v.c.i. 15 ohms. F.R. 20-25,000 c/s. Price £48.



Philips Electrical Ltd., Century House, Shaftesbury Avenue, W.C.2. Tel.: Gerrard 7777. Cables: Phillamps, London.

9710. 8 in. Paper cone. Corrugated surrounds. Voice coil 1 in. Gap flux 8,000 gauss. Total flux 97,000 maxwells. H.C. 10 watts. v.c.i. 7 ohms. F.R. 40-10,000 c/s. r.c.f. 500-1,000 c/s. Price £4 7s. 6d. (U.K. purchase tax £1 8s.)

9710M. 8 in. Dual cone. Paper corrugated surround. Voice coil 1 in. Gap flux 8,000 gauss. Total flux 97,000 maxwells. H.C. 10 watts. v.c.i. 7 ohms. F.R. 40-18,000 c/s. r.c.f. 500-1,000 c/s. Price £4 15s. 5d. (U.K. purchase tax £1 10s. 7d.)

AD5200M. 12 in. Dual cone. Paper. Corrugated surround. Voice coil 1½ in. Gap flux 11,000 gauss. Total flux 134,000 maxwells. H.C. 20 watts. Price £10 10s.



Rola Celestion Ltd., Ferry Works, Thames Ditton, Surrey. Tel.: Emberbrook 3402-6.

Colaudio 1550. 15 in. Paper cone. Foam surround. Voice coils (L.F.) 3 in. (H.F.) ½ in. Gap flux (L.F.) 12,500 (H.F.) 14,500

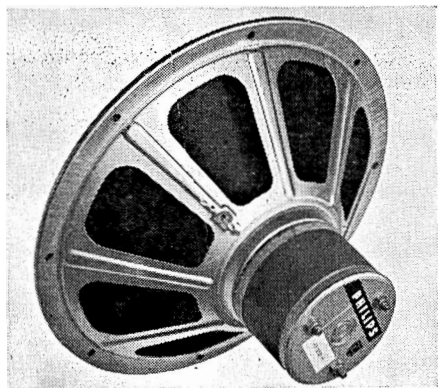

Philips AD5200M

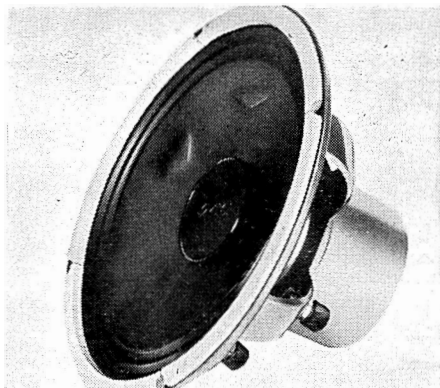

G.E.C. Metal Cone

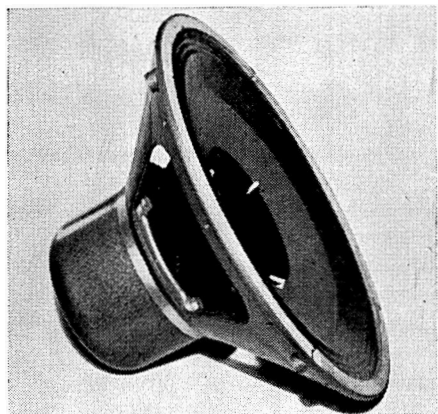

Goodmans Axiom 300

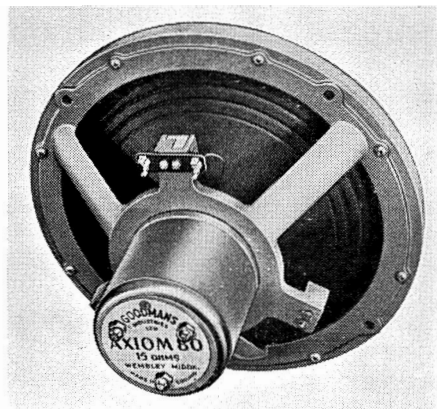

Goodmans Axiom 80

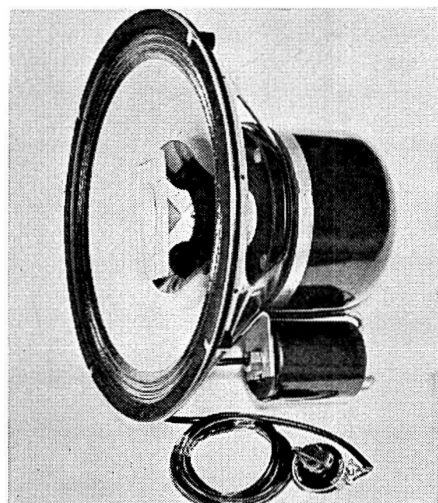

Goodmans Triaxiom 12/20

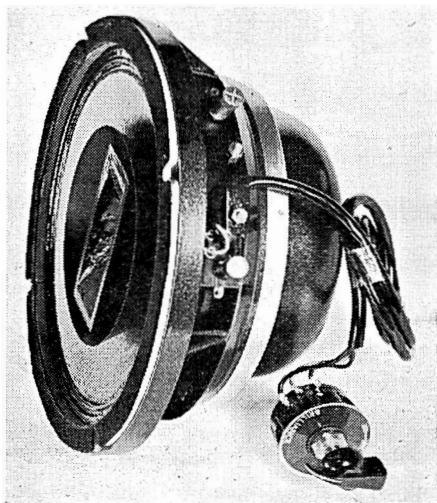

Goodmans Triaxiette

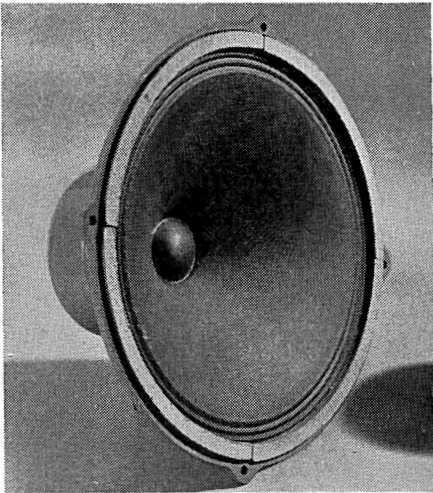

Grampian 1255/15

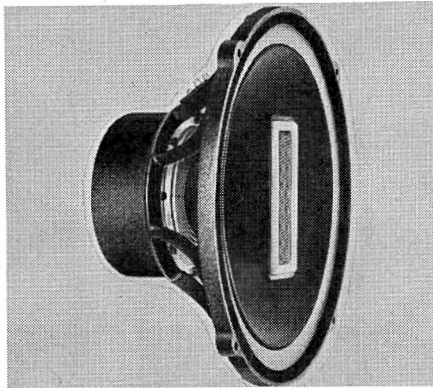

Rola Celestion Colaudio 1550

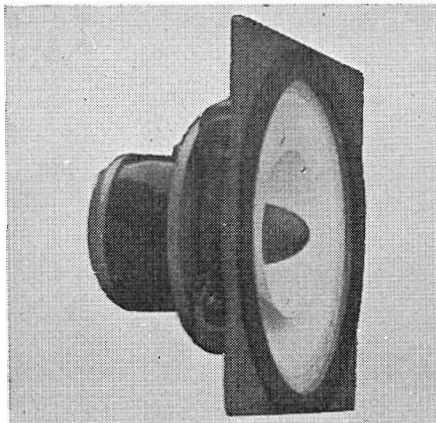

Lowther P.M.6

gauss. Total flux (L.F.) 290,000 (H.F.) 73,500 maxwells. H.C. 25 watts. v.c.i. 15 ohms. F.R. 30-15,000 c/s. For use with 3K50 coupling unit. Price £32 10s. Coupling unit £2 19s. 6d.



Romagna Reproducers Ltd., Factory distributors, K. H. Williman & Co. Ltd., Blackford House, Sutton, Surrey. Tel.: Melville 1491.

Kelly Ribbon H.F. Speaker Mk. 2. Horn loaded. Ribbon dimensions 6×1 cms. H.C. 10 watts. v.c.i. 15 ohms through transformer supplied. F.R. 2,000-20,000 c/s. r.c.f. 2,000 c/s. Price £10 10s.

L.F. Driver Mk. 1. 12 in. Metal cone. Free edge. Voice coil 2 in. Gap flux 14,000 gauss. Total flux 250,000 maxwells. H.C. 25 watts. v.c.i. 15 ohms. F.R. 35-2,000 c/s. r.c.f. 2,000 c/s. Price £14 14s.

L.F. Driver Mk. 2. 12 in. Metal cone. Free edge. Voice coil 4 in. Gap flux 12,500 gauss. Total flux 650,000 maxwells. H.C. 25 watts. v.c.i. 15 ohms. F.R. 20-2,000 c/s. r.c.f. 2,000 c/s. Price £25 4s.



Sound Sales Ltd., Works and Acoustic Laboratories, West Street, Farnham, Surrey, England. Tel.: Farnham 6461/2/3. Cables: Sounsense.

Dual Suspension Auditorium. Models A and B. 12 in. paper cone. Very flexible velvet surround plus dual suspension

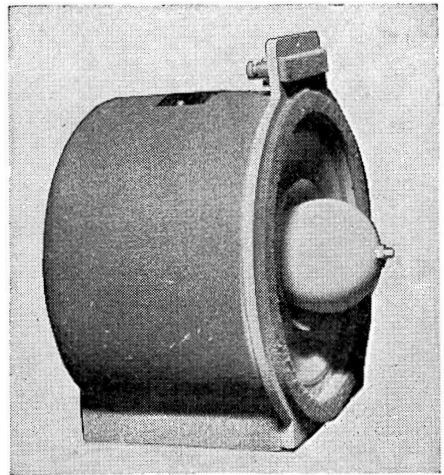

Lowther P.M.3

spider. Voice coil working in 0.06 in. by $\frac{1}{4}$ in. deep gap, maximum effective travel $\frac{1}{8}$ in. Gap flux 10,600 gauss. Total flux 95,000 maxwells. H.C. 12 watts in suitable enclosure. v.c.i. model A 15 ohms; model B 3 ohms. F.R. 30-13,500 c/s with suitable mounting. r.c.f. about 3,000 c/s. Price £9 13s. 4d.



Tannoy Products Ltd., West Norwood, London, S.E.27. Tel.: Gipsy Hill 1131. Cables: Tannoy, London.

12-in. Low Frequency Unit. Moulded fibre cone. Plastic treated surround. Voice coil 2 in. Gap flux 10,000 gauss. H.C. 15 watts. v.c.i. 15 ohms. F.R. 35-4,000 c/s. r.c.f. 1,700 c/s. Price £14 14s.

15-in. Low Frequency Unit. Moulded fibre cone. Plastic treated surround. Voice coil 2 in. Gap flux 12,000 gauss. H.C. 25 watts. v.c.i. 15 ohms. F.R. 30-3,000 c/s. r.c.f. 1,000 c/s. Price £21 10s.

Direct radiator. 12 in. moulded fibre cone. Plastic treated surround. Voice coil 2 in. Gap flux 14,000 gauss. H.C. 15 watts. v.c.i. 20 ohms. F.R. 40-16,000 c/s. Price £14 14s.

High Frequency Speaker Unit. Horn loaded plastic coated light alloy diaphragm. Voice coil 2 in. Gap flux 15,000 gauss. H.C. 20 watts above 1,000 c/s. v.c.i. 15 ohms. F.R. 1,000-20,000 c/s. r.c.f. 1,000 c/s. Price £18.

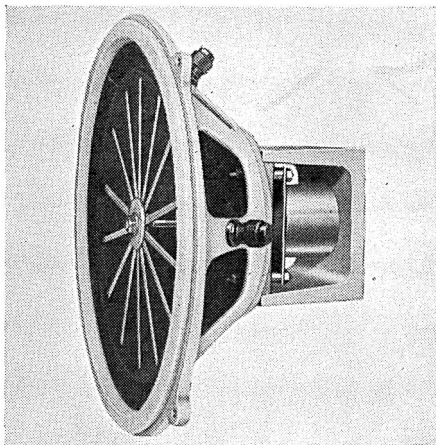

Sound Sales Auditorium

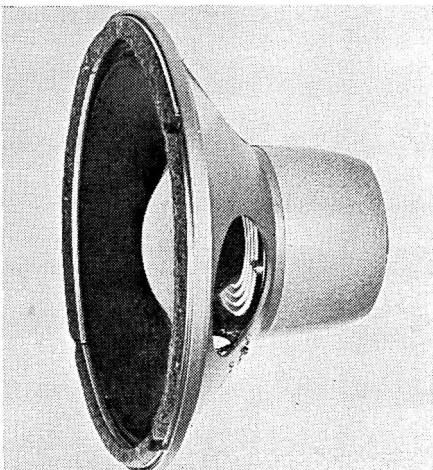

Tannoy Monitor "Twelve"

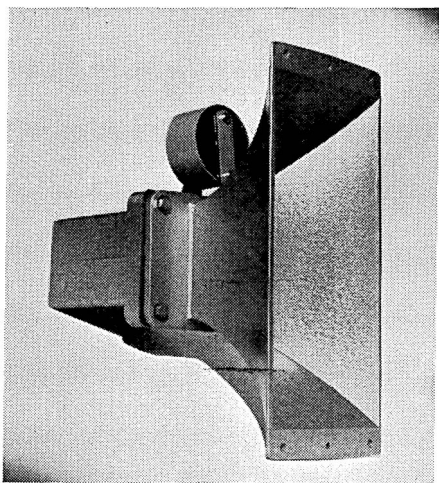

Kelly Ribbon Mk. II

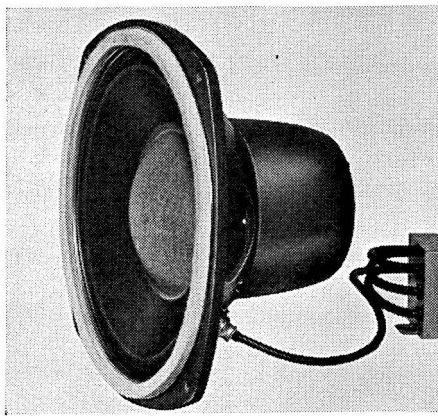

Tannoy III LZ dual concentric

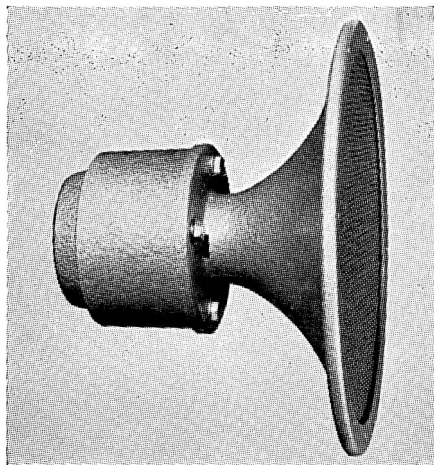

Tannoy H.F. unit

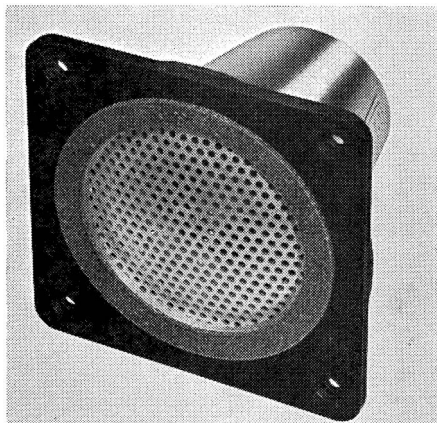

Vitavox TR30 HF unit



Vitavox DU120 Duplex

III LZ. 8 in. dual concentric. Moulded fibre cone. Plastic impregnated surround. Gap flux (L.F.) 10,000 (H.F.) 15,000 gauss. H.C. 10 watts. F.R. 23-20,000 c/s. r.c.f. (supplied) 1,800 c/s. Price £22 10s.

Monitor "Twelve". 12 in. Moulded fibre cone. Plastic treated surround. Voice coils (H.F. and L.F.) 2 in. Gap flux (L.F.) 11,500 (H.F.) 15,000 gauss. H.C. 30 watts. F.R. 25-20,000 c/s. r.c.f. 1,700 c/s. Price £30 15s.

Monitor "Fifteen". 15 in. Moulded fibre cone. Plastic treated surround. Voice coils (H.F. and L.F.) 2 in. Gap flux (L.F.) 13,500 (H.F.) 18,000 gauss. H.C. 50 watts. F.R. 23-20,000 c/s. r.c.f. 1,000 c/s. Price £37 10s.



Technical Suppliers Ltd., Hudson House, 63 Goldhawk Road, London, W.12. Tel.: Shepherds Bush 2581/4794.

TSL-Lorenz. LP. 215. 8 in. Reinforced paper cone. Permafex surround. Voice coil 1 in. H.C. 8 watts, peak load 12 watts. v.c.i. 4.5 ohms. F.R. 35-12,000 c/s. Price £4 19s 6d. (U.K. purchase tax £1 12s.)

LP. 312-2. 12 in. Reinforced ribbed paper cone. Permafex surround. Voice coil 1½ in. H.C. 25 watts. (Peak rating in suitable enclosure 40 watts.). v.c.i. 15 ohms. F.R. 20 to above 17,000 with 2 type LPH 65 treble speakers in a fitted bridge assembly. r.c.f. 3,000-5,000 c/s. Price £14 19s. 6d.

TSL-Lorenz Tweeter LPH 65. 2½ in. Special plastic cone. Plastic surround. Voice coil ½ in. H.C. 2 watts (H.F. only). v.c.i. 5.5 ohms. F.R. 2,000 to above 17,000 c/s. r.c.f. 3,000-5,000 c/s. Price £1 8s. 6d. (U.K. purchase tax 9s. 2d.)



Vitavox Ltd., Westmoreland Road, London, N.W.9. Tel.: Colindale 8671. Cables: Vitavox, Hyde, London.

Duplex Coaxial DU 120. 12 in. and 3 in. paper and polyester film cones and surround. Voice coil (L.F.) 1.75 in. (H.F.) 0.65 in. Gap flux (L.F.) 14,000 (H.F.) 12,000 gauss. Total flux (L.F.) 160,000 (H.F.) 15,000 maxwe'ls. H.C. 15 watts. v.c.i. 15 ohms. F.R. 40-15,000 c/s nominal. Price £19 10s.

A.K.120. 12 in. Paper cone. Paper surround. Voice coil 1.78 in. Gap flux 14,000 gauss. Total flux 160,000 maxwells. H.C. 15 watts. v.c.i. 15 ohms. F.R. 40-12,000 c/s. r.c.f. 1,000 c/s. Price £14.

K15/40. 15 in. Paper cone. Paper surround. Voice coil 2.25 in. Gap flux 14,000 gauss. Total flux 260,000 maxwells. H.C. 40 watts. v.c.i. 15 ohms. F.R. 40-10,000 c/s. r.c.f. 500 c/s. Price £25.

T.R. 30. 3 in. cone. Gap flux 12,000 gauss. Total flux 160,000 maxwells. H.C. 15 watts. F.R. 1,000-15,000 c/s. v.c.i. 15 ohms. Crossover frequency 2,000 c/s. Price £6 10s.



Westrex Co. Ltd., Coles Green Road, London, N.W.2. Tel.: Gladstone 5401/8, Cables: Westelcol, Norphone, London.

20/80 Low Frequency Unit. 15 in. Paper cone with damped surround and spider. Voice coil 3 in. of edgewound copper ribbon. Gap flux 13,200 gauss. v.c.i. 16 ohms. H.C. 30 watts. F.R. up to 800 c/s. r.c.f. 675 c/s. Price £33 15s.

High Frequency Unit, with Acoustilens coupling unit. Horn loaded. Alloy dome on 3 in. voice coil of edgewound aluminium ribbon. Gap flux 17,500 gauss. H.C. above 500 c/s up to 30 watts. F.R. 500 to over 15,000 c/s. r.c.f. 675 c/s. Speaker includes horn and acoustic lens giving necessary dispersion. Price complete with horn and lens £69 17s.



Wharfedale Wireless Works Ltd., Idle, Bradford. Tel.: Idle 1235-6. Cables: Wharfedel, Idle, Bradford.

8-in. Bronze/FS/AL. Paper cone. Foam plastic surround. Voice coil 1 in. (aluminium). Gap flux 10,500 gauss. Total flux 41,500 maxwells. H.C. 4 watts. v.c.i. 2-3 ohms or 10-15 ohms. F.R. 40-12,000 c/s. Price £3 5s. (U.K. purchase tax £1 1s. 7d.)

Super 8. 8 in. Paper cone. Surround, paper corrugations. Voice coil 1 in. Gap flux 14,500 gauss. Total flux 60,000 maxwells. H.C. 6 watts. v.c.i. 2-3 or 12-15 ohms. F.R. 60-12,000 c/s. r.c.f. 1,000 c/s. Price £4 10s. (U.K. purchase tax £1 9s. 11d.)

Super 8/FS. 8 in. Paper cone. Foam plastic surround. Voice coil 1 in. Gap flux 14,500 gauss. Total flux 60,000 maxwells.

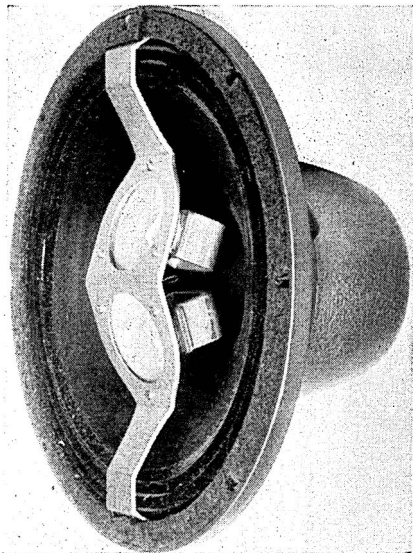

TSL Lorenze LP312-2

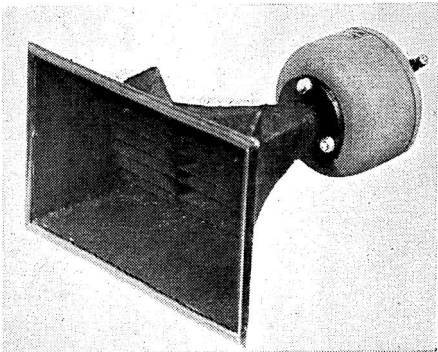

Westrex High Frequency Unit

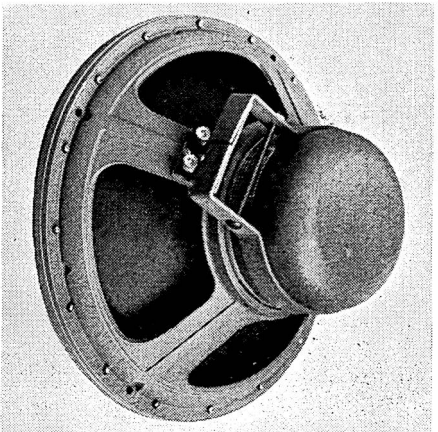

Westrex 20/80 Low Frequency Unit

H.C. 5 watts. v.c.i. 2-3 or 12-15 ohms. F.R. 40-12,000 c/s. Price £5 (U.K. purchase tax £1 13s. 3d.)

Super 8/FS/AL. 8 in. Paper cone. Foam plastic surround. Aluminium voice coil 1 in. Gap flux 14,500 gauss. Total flux 60,000 maxwells. H.C. 4 watts. v.c.i. 2-3 or 10-15 ohms. F.R. 40-14,000 c/s. Price £5 5s. (U.K. purchase tax £1 14s. 11d.)

10-in Bronze/FSB. Paper cone with bakelised apex. Foam plastic surround. Voice coil 1 in. Gap flux 10,500 gauss. Total flux 41,500 maxwells. H.C. 6 watts. v.c.i. 2-3 or 12-15 ohms. F.R. 30-10,000 c/s. Price £3 19s. 6d. (U.K. purchase tax £1 6s. 5d.)

Golden/FSB. 10 in. Paper cone with bakelised apex. Foam plastic surround. Voice coil 1 in. Gap flux 14,500 gauss. Total flux 60,000 maxwells. H.C. 8 watts. v.c.i. 2-3 or 12-15 ohms. F.R. 30-12,000 c/s. Price £6 5s. (U.K. purchase tax £2 1s. 7d.)

W10/FSB. 10 in. Paper cone with bakelised apex and aluminium dome. Foam plastic surround. Voice coil 1 in. Gap flux 16,000 gauss. Total flux 84,000 maxwells. H.C. 10 watts. v.c.i. 2-3 or 12-15 ohms. F.R. 30-14,000 c/s. Price £9 7s. 6d. (U.K. purchase tax £3 2s. 4d.)

Super 12/FS/AL. 12 in. Paper cone with bakelised apex. Foam plastic surround. Voice coil $1\frac{1}{4}$ in. (aluminium). Gap flux 17,000 gauss. Total flux 190,000 maxwells. H.C. 15 watts. v.c.i. 12-15 ohms. F.R. 30-14,000 c/s. Price £17 10s.

W 15/FS. 15 in. Paper cone. Foam plastic surround. Voice coil 2 in. Gap flux 13,500 gauss. Total flux 180,000 maxwells. H.C. 15 watts. v.c.i. 12-15 ohms. F.R. 25-20,000 c/s. r.c.f. 800 c/s. Price £17 10s.

Super 3. 3 in. Bakelised paper cone with integral dome. Foam plastic surround. Voice coil 1 in. (aluminium). Gap flux 14,500 gauss. Total flux 60,000 maxwells. H.C. 6 watts above 1,000 c/s. v.c.i. 2-3 or 8-15 ohms. F.R. 3,000-20,000 c/s. r.c.f. 4,000 c/s. Price £5 (U.K. purchase tax £1 13s. 3d.)

8/145. 8 in. Paper cone. Foam surround. Voice coil 1 in. (aluminium). Gap flux 14,500 gauss. Total flux 60,000 maxwells. H.C. 4 watts. v.c.i. 2-3 or

10-15 ohms. F.R. 40-14,000 c/s. Price £5 5s. (U.K. purchase tax £1 14s. 11d.)

Coaxial 12. (L.F.) 12 in. (H.F.) 2 in. Paper cone. Foam surround. Voice coils (L.F.) $1\frac{1}{4}$ in. (H.F.) 1 in. Gap flux (L.F.) 14,000 (H.F.) 13,200 gauss. Total flux (L.F.) 155,000 (H.F.) 44,000 maxwells. H.C. 15 watts. v.c.i. 12-15 ohms only. F.R. 25-20,000 c/s. Price £25.



Messrs. Whiteley Electrical Radio Co. Ltd., Victoria Street, Mansfield, Notts. Tel.: Mansfield 1762-5. Cables: Whitebon, Mansfield.

Stentorian HF.812. 8 in. Composite (paper and cambric) cone. Cambric surround. Voice coil 1 in. Gap flux 12,000 gauss. Total flux 47,400 maxwells. H.C. 5 watts. v.c.i. universal (3, 7.5 and 15 ohms). F.R. 50-12,000 c/s. Price £2 19s. 6d. (U.K. purchase tax £1.)

H.F.816. 8 in. Composite (paper and cambric) cone. Cambric surround. Voice coil 1 in. Gap flux 16,000 gauss. Total flux 63,000 maxwells. H.C. 6 watts. v.c.i. universal 3 ohms, 7.5 ohms and 15 ohms. F.R. 50-14,000 c/s. Price £4 17s. 7d. (U.K. purchase tax £1 12s. 0d.)

H.F.817. 8 in. Paper cone. Cambric surround. Voice coil 1 in. Gap flux 17,000 gauss. Total flux 67,000 maxwells. H.C. 10 watts in cabinet. v.c.i. 15 ohms. F.R. 60-22,000 c/s. Price £8 2s. (U.K. purchase tax £2 14s. 6d.)

H.F.912. 9 in. Composite (paper and cambric) cone. Cambric surround. Voice coil 1 in. Gap flux 12,000 gauss. Total flux 47,400 maxwells. H.C. 7 watts. v.c.i. universal (3, 7.5 and 15 ohms). F.R. 40-13,000 c/s. Price £3 2s. 10d. (U.K. purchase tax £1 1s. 2d.)

H.F.1012. 10 in. Composite (paper and cambric) cone. Cambric surround. Voice coil 1 in. Gap flux 12,000 gauss. Total flux 47,400 maxwells. H.C. 10 watts. v.c.i. universal 3 ohms, 7.5 ohms and 15 ohms. F.R. 30-14,000 c/s. Price £3 11s. (U.K. purchase tax £1 4s.)

HF.1016 10 in. Composite (paper and cambric) cone. Cambric surround. Voice coil 1 in. Gap flux 16,000 gauss. Total flux 63,000 maxwells. H.C. 10 watts. v.c.i. 3, 7.5 and 15 ohms. F.R. 30-15,000 c/s. Price £5 13s. 11d. (U.K. purchase tax £1 18s. 4d.)

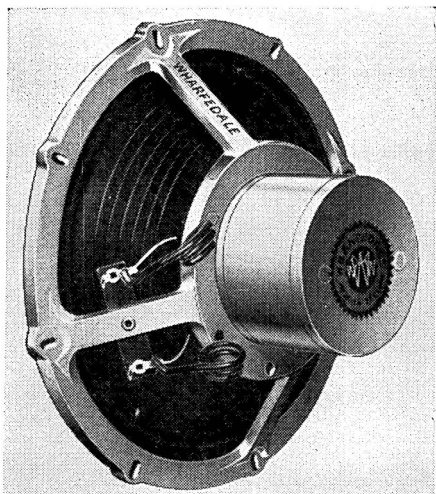

Wharfedale Super 8

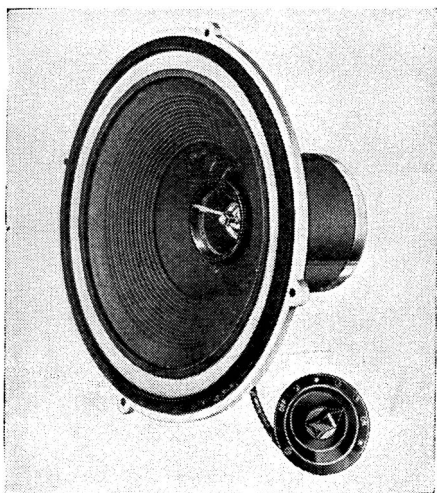

Wharfedale Coaxial 12

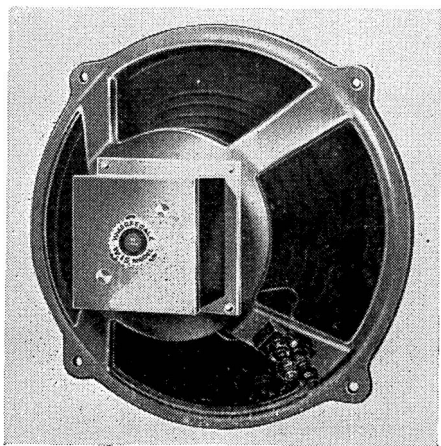

Wharfedale W15/FS

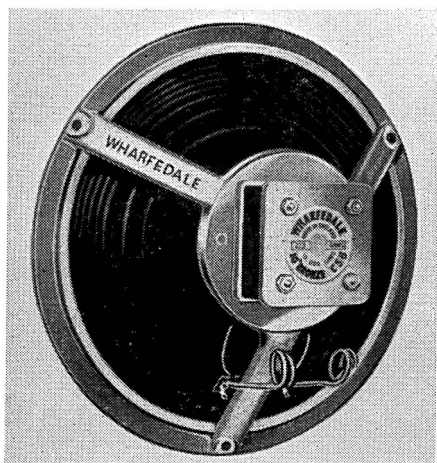

Wharfedale Bronze/FSB

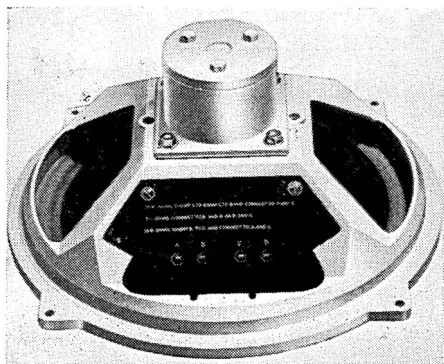

Whiteley HF 1012

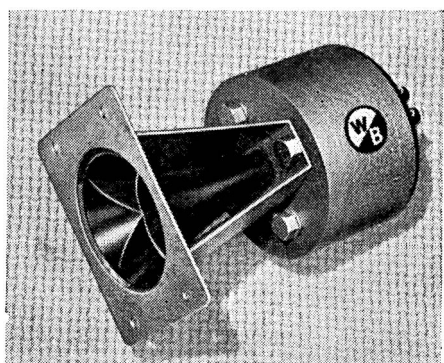

Whiteley T12 tweeter

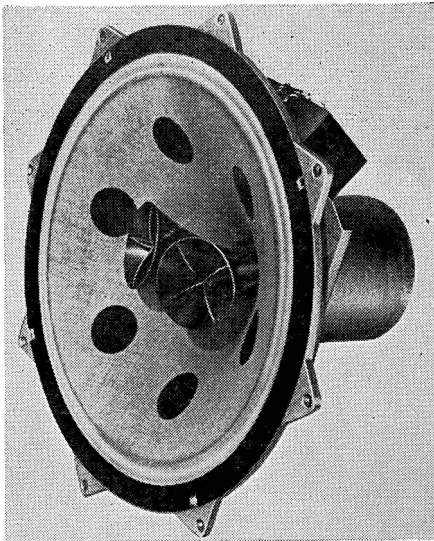

Whiteley 15-in. Concentric Duplex



Whiteley H.F. 816 8-in.

10-in. Concentric Duplex. Composite (paper and cambric) cone. Cambric surround. Voice coil 1 in. Gap flux (L.F.) 12,000 (H.F.) 13,000 gauss. Total flux 47,400 maxwells. H.C. 10 watts. v.c.i. 15 ohms. F.R. 30-14,000 c/s. r.c.f. 3,000 c/s built-in. Price £9 3s. 8d. (U.K. purchase tax £3 1s. 10d.)

HF.1214. 12 in. Composite (paper and cambric) cone. Cambric surround. Voice coil 1.5 in. Gap flux 14,000 gauss. Total flux 106,000 maxwells. H.C. 15 watts. v.c.i. 15 ohms. F.R. 25-14,000 c/s. Price £9 15s. 6d.

HF.1216. Composite (paper and cambric) cone. Cambric surround. Voice coil $1\frac{1}{2}$ in. Gap flux 16,000 gauss. H.C. 15 watts. F.R. 20-16,000 c/s. Price £15.

15-in. Concentric Duplex. Composite (paper and cambric) cone. Cambric surround. Voice coil 2 in. Gap flux (L.F.) 14,000 (H.F.) 17,000 gauss. Total flux 350,000 maxwells. H.C. 25 watts. v.c.i. 15 ohms. F.R. 20-18,000 c/s. r.c.f. 3,000 c/s. built-in. Price £40 3s.

HF.1514. 15 in. Composite (paper and cambric) cone. Cambric surround. Voice coil 2 in. Gap flux 14,000 gauss. Total flux 178,000 maxwells. H.C. 25 watts. v.c.i. 15 ohms. F.R. 25-5,000 c/s. r.c.f. 1,500-3,000 c/s. Price £24 10s.

T.10 Tweeter. Aluminium cone and surround. Voice coil 1 in. Gap flux 14,000 gauss. Total flux 44,000 maxwells. H.C. 5 watts. v.c.i. 15 ohms. F.R. 2,000-14,000 c/s. r.c.f. 3,000 c/s. Price £4 4s.

T.12. Tweeter. Aluminium cone and surround. Voice coil 1.5 in. Gap flux 17,000 gauss. Total flux 110,000 maxwells. H.C. 12 watts. v.c.i. 15 ohms. F.R. 2,000-17,000 c/s. r.c.f. 3,000 c/s. Price £12 12s.

T.816. 8 in. Paper cone and surround. Voice coil 1 in. Gap flux 16,000 gauss. Total flux 63,000 maxwells. H.C. 15 watts. v.c.i. 15 ohms. F.R. 1,500 to 17,000 c/s. r.c.f. 1,500 c/s. Price £4 12s. 7d. (U.K. purchase tax £1 11s. 2d.)

T.359. $3\frac{1}{2}$ in. Paper cone and surround. Voice coil 0.625 in. Gap flux 9,000 gauss. Total flux 14,900 maxwells. H.C. 15 watts with crossover. v.c.i. 5 or 15 ohms. F.R. 3,000-17,000 c/s. r.c.f. 3,000 c/s. Price £1 4s. 10d. (U.K. purchase tax 8s. 5d.)

ACOUSTIC RESISTANCE UNITS

Goodmans Industries Ltd., Axiom Works, Wembley, Middx. Tel.: Wembley 1200. Cables: Goodaxiom, Wembley.

ARU Units. These units combine both reflex port and acoustic resistance in one complete unit. The port area and resistance are calculated to suit a particular cabinet volume and speaker cone resonance, thus being usable with a variety of cabinet designs and driving units. Price £2 15s. 3d. to £4 4s.

ELECTROSTATIC SPEAKERS

Acoustical Manufacturing Co. Ltd., St. Peter's Road, Huntingdon, Hunts. Tel.: Huntingdon 361 and 574. Cables: Acoustical.

Quad Electrostatic Loudspeaker. Full range doublet covering 45 c/s to 18 Kc/s. Attenuation outside band asymptotic to 18 dB/8ve. Total integrated radiation at max. output equivalent to 95 phons in rooms of up to 5,000 cu. ft. with average reverberation. Dispersion approx. 70 deg. horizontal; 15 deg. vertical. Impedance 30-15 ohms, 40 c/s to 8 Kc/s falling above 8 Kc/s. Designed for use with standard

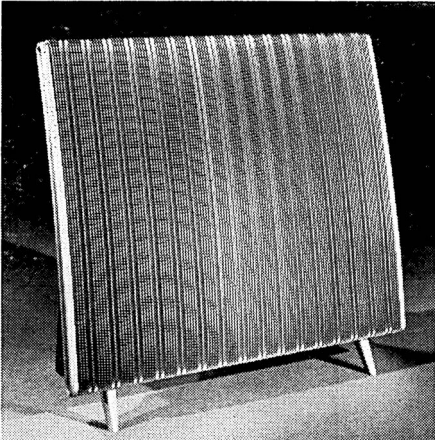

Quad Electrostatic full range Loudspeaker

Quad II Amplifier or equivalent. Suitable for AC supplies 100-120 or 200-250v. 50-60 c/s. Free standing unit requires no enclosure or cabinet. Weight 35 lb. Price £52 complete.



Execaphon Ltd., 77 Sydenham Park Road, London, S.E.26. Tel.: Forest Hill 9595.

Audistatic. Electrostatic, mid and upper frequencies, plastic, curved diaphragm. H.C. maximum 15V peak music. v.c.i. 15 ohm. F.R. 100 c/s to limit of hearing. Built-in crossover Integrated 1,500 c/s. Price £15 15s. 0d.

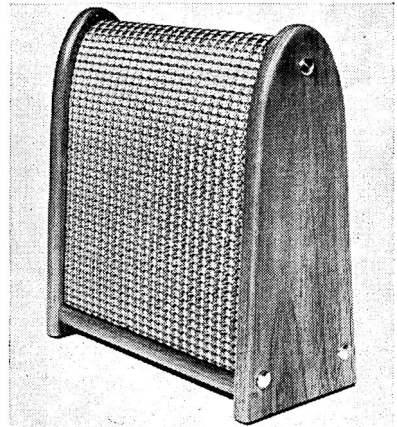

Audistatic mid & upper frequency unit

DIRECTORY OF CROSSOVER UNITS

Richard Allan Radio Ltd., "Baffle House," Taylor Street, Batley. Tel.: Batley 1123/1308/4033. Cables: Acoustics, Batley.

CN.104 Crossover Unit. A two-way half-section parallel network. Crossover frequency 5,000 c/s. All terminations 15 ohms. Price £2 2s.

CN.1284. Crossover Unit. A three-way crossover with main crossover operating from half wave parallel network and subsidiary crossover capacity fed. Crossover frequencies 1,100 and 5,000 c/s. All terminations 15 ohms. Price £6 5s.

Goodmans Industries Ltd., Axiom Works, Wembley, Middx. Tel.: Wembley 1200. Cables: Goodaxion, Wembley.

X0/5000-Crossover Unit. A two-way half-section crossover network, operating at 5,000 c/s. All terminations 15 ohms. Price £1 19s.

X0/950-Crossover Unit. A two-way half-section crossover network, operating at 950 c/s. All terminations 15 ohms. Price £5 5s. 8d.

X0/950/5000. Crossover Network. A multiple crossover network comprising four half-section L.C. filters. Crossover frequencies are 950 c/s and 5,000 c/s.

All attenuation rates are 12 dB/octave. All terminations 15 ohms. Price £7 0s. 6d.



Romagna Reproducers, Factory Distributor K. H. Williman & Co. Ltd., Blackford House, Sutton, Surrey. Tel.: Melville 1491.

CO/1/15. Crossover Network. 3 Kc crossover frequency for 15 ohm loudspeakers and amplifiers. Balance control fitted, $\frac{1}{2}$ section networks giving 12 dB/octave cut-off. Maximum insertion loss 1 dB in pass band. Potted in cast aluminium case. Price £3 3s.

CO/1/3.5. Crossover Network. As CO/1/15, but with 3.5/5 ohm impedance. Price £3 3s.

CO/2/15. Crossover Network. As CO/1/15, but with 1,500 c/s crossover frequency. Price £3 3s.

CO/BK. Crossover Network. $\frac{1}{4}$ -section network. Coil is tapped to give two values of crossover—1,500 c/s and 3 Kc and can be switched out of circuit. Price £1 11s. 6d.



Technical Suppliers Ltd., Hudson House, 63 Goldhawk Road, London, W.12. Tel.: Shepherds Bush 2581/4794.

HP1 Crossover Unit. A $\frac{1}{4}$ -section crossover specially designed for use with TSL Lorenz LP312-2 speaker system, crossover at 5,000 c/s. Price £2 2s.



Westrex Co. Ltd., Coles Green Road, London, N.W.2. Tel.: Gladstone 5401/8. Cables: Westelcol, Norphone, London.

Dividing Network. Constant impedance parallel network, using two L-type filter sections, low and high pass, crossover at 675 c/s. For any impedance 16-24 ohms. Price £13 10s.



Goodmans XO900/5000 crossover

Wharfedale Wireless Works Ltd., Idle, Bradford, Yorks. Tel.: Idle 1235-6. Cables: Wharfedel, Idle, Bradford.

Loudspeaker Separators. $\frac{1}{4}$ -section type. Operating at 1,000 or 3,000 c/s. 8 units available to cover from 12-16 ohms impedance. Slope 6 dB/octave. Size 7 × 4 × 3 $\frac{1}{2}$ ins. Weight 2-2 $\frac{1}{2}$ lb. Max. input 30 watts. Price from £2 11s. to £4 17s. 6d. depending on type.

HS/CR3/2. $\frac{1}{2}$ -section 3-way separator unit with crossover at 800 and 5,000 c/s. Max. input 30 watts. Slope 12 dB/octave. Size 9 × 6 × 5 ins. Weight 6 $\frac{1}{2}$ lb. 2 models. 2-6 ohms. Price £11; 7-16 ohms, Price £8 10s. Also available with crossover at 400 and 5,000 c/s. 7-16 ohms only. Price £10.

WMT1 Matching Transformer. Auto transformer for matching 10-16 ohms or 7-9 ohms speakers to sets with 2-5 ohms output or vice versa. Response 20-15,000 c/s \pm 1 dB. Handling capacity 15 watts. Can also match speakers of different imps. to crossover unit in 2 or 3 speaker systems. Size 2 $\frac{7}{8}$ × 2 $\frac{1}{4}$ × 2 $\frac{1}{4}$ ins. Weight 12 $\frac{1}{2}$ oz. Price 13s. 6d.

Stereo Truqual. Ganged twin vol. control. L-pad type attenuators for stereo speakers. 6 positions. Price £1 10s.



Whiteley Electrical Radio Co. Ltd., Victoria Street, Mansfield, Notts. Tel.: Mansfield 1762-5. Cables: Whitebon, Mansfield.

CX500. Crossover Unit. A two-way half-section crossover network operating at 500 c/s. All terminations 15 ohms. Price £1 6s.

CX1500. Crossover Unit. As CX500, but operating at 1,500 c/s. Price £1 18s. 3d.

CX3000. Crossover Unit. As CX1500, but operating at 3,000 c/s. Price £1 10s.

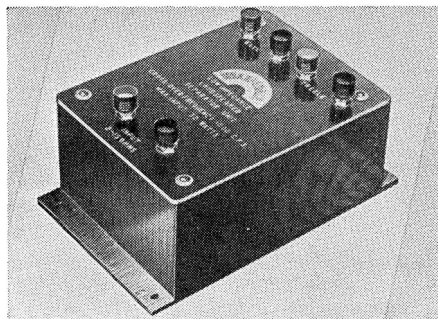

Wharfedale $\frac{1}{4}$ section crossover

SPEAKER ENCLOSURES

Richard Allan Radio Ltd., Bafflette House, Taylor Street, Batley, Yorks. Tel.: Batley 1123/1308/4033. Cables: Acoustics, Batley.

Type 840. Reflex forward facing unit. Designed for shelf or floor mounting. Two drive units. 8 in. bass and 4 in. tweeter. F.R. 45-17,000 c/s. Size 25 in. × 10 in. × 11 in. Weight 26 lbs. Price £7 10s.

Princess. Reflex forward facing unit. Designed for corner location. One 8 in. drive unit. Rec. Golden Eight. Response 60-10,000 c/s. Size 28 × 20 × 12 ins. Weight 28 lbs. Price £11 11s.

Duchess. Reflex unit designed for corner location. Upward facing tweeter, forward base. Two drive units. 10 in. bass and 4 in. tweeter. Rec. Golden Ten and 410T. Crossover CN.104. Response 40-17,000 c/s. Size 30 × 25 × 17 ins. Weight 48 lbs. Price £15 15s.

Empress. Reflex unit designed for corner location. Upward facing tweeter, forward bass and middle units. Three drive units. 12, 8 and 4 ins. Rec. Golden Twelve, 812F, and 410T. Crossover CN.1284. Response 25-17,000 c/s. Size 33 × 31 × 21 ins. Weight 72 lbs. Price (complete) £37 16s. (without units) £17 17s.

Bakers "Selhurst" Radio, 523 London Road, Thornton Heath.

A range of phase-inverter enclosures for single and multi-speaker systems. Prices on application.



Bang & Olufsen, Struer, Denmark. Sole U.K. Importers: Aveley Electric Ltd., Ayrton Road, South Ockendon, Essex. Tel.: South Ockendon 3444.

B & O Toroidal Tweeter. Omni-directional. Comprising 2 moving coil units facing inwards on to a double cone reflector. Response: 2,000-20,000 c/s. Series capacitor incorporated. Size 4½ ins. high, 3 in. diameter. Price £6 14s. 5d.



Brearcliffe Ltd., Hill Road Works, Beacon Hill, Hindhead, Surrey. Tel.: Hindhead 543.

Brearcliffe 12, type KD. Reflex. One drive unit up to 12 ins. Size 32 × 14 × 13 ins. including 5½-in. legs. Weight 35 lbs. Price, cabinet only, £12 12s.

Brearcliffe 15, type KD. Free standing reflex. One drive unit up to 15 ins. Size 39 × 19 × 18 ins. including 5½-in. legs. Weight 45 lbs. Price, cabinet only, £15 15s.

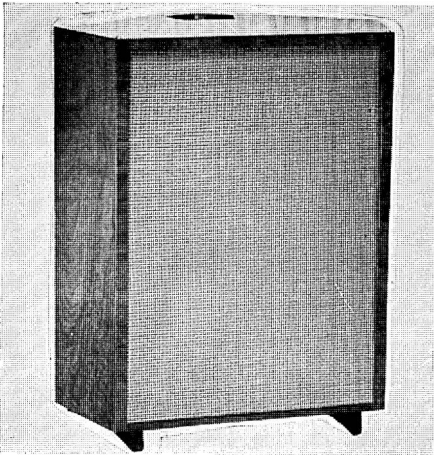

Richard Allan Duchess

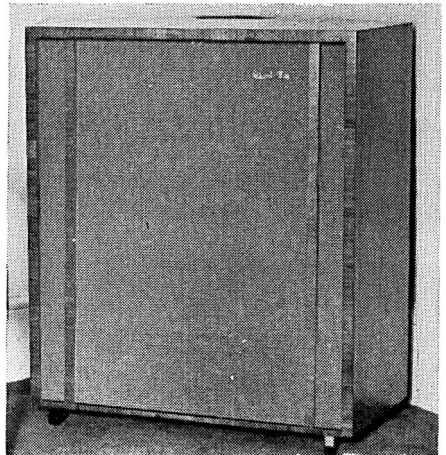

Richard Allan Empress

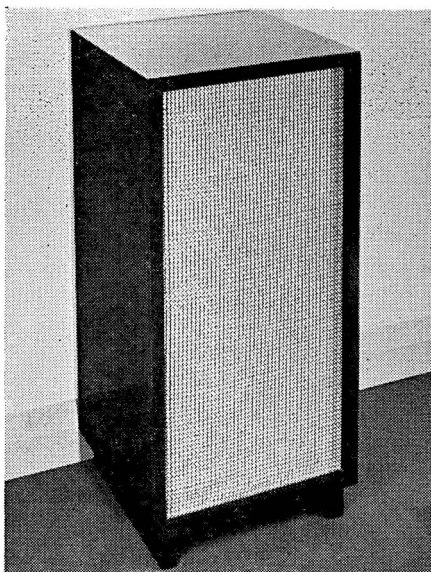

Burne-Jones Sonetta

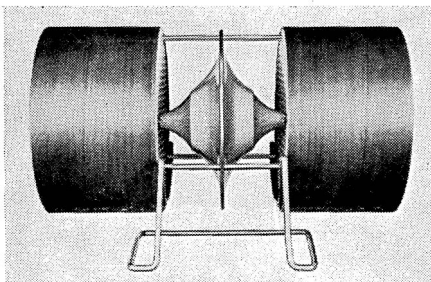

Burne-Jones Treble Twin

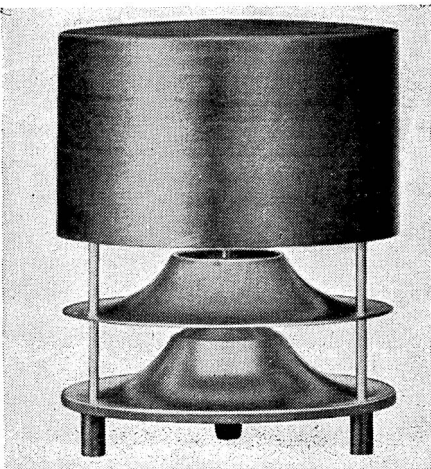

Burne-Jones Treble 20

Burne-Jones & Co., Ltd., 18 Brunswick Road, Sutton, Surrey. Tel.: Vigilant 5050. Cables: Burjomag, Sutton.

B.J. Sonetta. Reflex column. Two drive units. 9 in. and 4 in. Crossover and balance control included. Response 35-18,000 c/s. Size 26 × 12 × 12 ins. Price £12 7s. 6d. (U.K. purchase tax £3 19s. 5d.)

B.J. Top "C" Tweeter. Horn loaded omni-directional. To stand on top of all reproducers. Response 1,000-18,000 c/s rec. for use with all enclosures. Complete with built-in crossover and balance control. Price £3 15s. (U.K. purchase tax £1 4s. 1d.) Reg. design.

B.J. Treble 20. Omni-directional multi-horn. One 4 in. unit. Crossover built-in. Response 1,000-18,000 c/s. Size 6 × 5 ins. Weight 1½ lbs. Price £5 5s. (U.K. purchase tax £1 13s. 9d.) Reg. design.

B.J. Treble Twin. Omni-directional horn. Two 4 in. drive units. Crossover included. Response 900-18,000 c/s. Size 9 × 4½ × 6 ins. Weight 2 lb. Price £7 2s. 9d. (U.K. purchase tax £2 5s. 10d.) Reg. design.



Daystrom Ltd., Bristol Road, Gloucester. Cotswold totally enclosed forward facing. (See Kits section.)



D.G.C. Ltd., 41 High Street, Camberley, Surrey.

Oakhurst Doric Speaker Enclosure. Omnidirectional Horn-loaded column. Vertical. Rec. Goodmans Axiette 8 in. unit. Cabinet available in whitewood or veneered finish. Size 30 × 12 × 12 ins. £26 12s. whitewood, £30 16s. veneered. 10% reduction when ordering stereo pair.

Oakhurst Corinthian. Omnidirectional load column. Vertical. Rec. Wharfedale W10/FSB 10 in. unit aluminium reflector size 34 × 13 × 13 ins. Price £35 17s. 8d. whitewood, £42 3s. 7d. veneered. 10% reduction when ordering stereo pair.

Oakhurst Corinthian. Omnidirectional horn loaded column. Vertical. Rec. Philips AD 5200M. 12 in unit, aluminium reflector size 34 × 15 × 15 ins. Price £38 18s. whitewood, £44 5s. veneered. 10% reduction when ordering stereo pair.

Allegro. forward facing, horn loaded, floor or wall mounting. Rec. Goodmans Axiette or Wharfedale super 8 FS/AL. Size $30 \times 12 \times 9\frac{1}{2}$ ins. Price £29 6s. 8d.

Brillante. Helmholtz loaded reflex wall mounting. Rec. Wharfedale super 8FS/AL or Goodmans Axiette. Size $18 \times 13 \times 8$ ins. Price £19 12s.



Expert Gramophones Ltd., 78 Balham High Road, Balham, London, S.W.12. Tel.: Balham 4022.

Acoustic Column. Elongated reflex. Vertically mounted 12 in. bass unit and 3 in. tweeter. Rec. Goodmans Audiom 60 and Wharfedale Super 3 tweeter. Response 35-18,000 c/s. Size $44 \times 14 \times 14$ ins. Price (complete) £42. Alternative version available. Price £33.

"All Range." Corner reflex. Vertically mounted 12 in. unit; horizontally mounted 8 in. unit. Rec. Baker 12 in and Philips 9710 M. Size $42 \times 30 \times 23$ ins. Price (complete) £65.

Master Speaker. Corner reflex. 15 in. dual concentric unit, vertically mounted with reflector. 90° distribution. Rec. unit 15 in. Tannoy dual concentric. Crossover 1,000 c/s. Response 28-20,000 c/s. Size $60 \times 34 \times 24$ ins. Price (complete) £110.



Fane Acoustics Ltd., 1 Wellington Street, Batley, Yorks. Tel.: Batley 1578. Cables: Fane Batley.

Trio. Cabinet-baffle, forward facing. Three drive units. 12 in. 8 in., and H.F. unit. Fane units rec. Crossover included. Response 40-17,000 c/s. Size $24\frac{1}{2} \times 24 \times 8\frac{1}{2}$ ins. Weight 13 lb. Price £17 10s.

Quartet. Cabinet-baffle, forward facing. Four drive units. 12 in., 8 in., and two H.F. units. Size $25\frac{1}{2} \times 25\frac{1}{2} \times 8\frac{1}{2}$ ins. Weight 32 lb. Price 35. Cabinet only not supplied.



General Electric Co., Ltd., Radio Group Lena Gardens, Brook Green, Hammersmith, London, W.6. Tel.: Riverside 4671. Cables: Polyphase, London.

Octagonal Periphonic BCS 1872. Periphonic with pipe loading. Forward facing. Two metal cone 8 in. bass, and one or

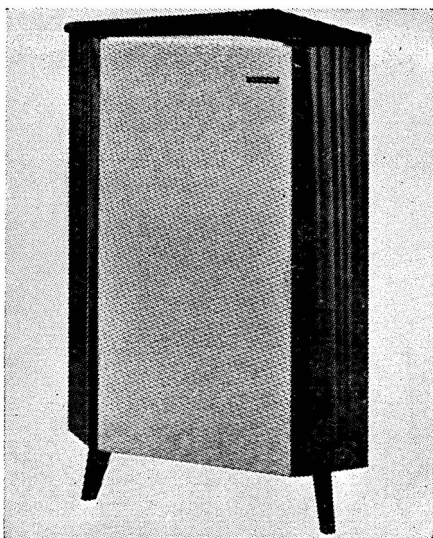

"Brearcliffe" Enclosure

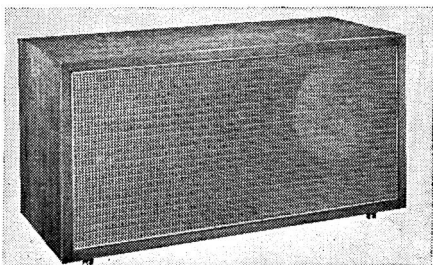

G.E.C. Bookcase

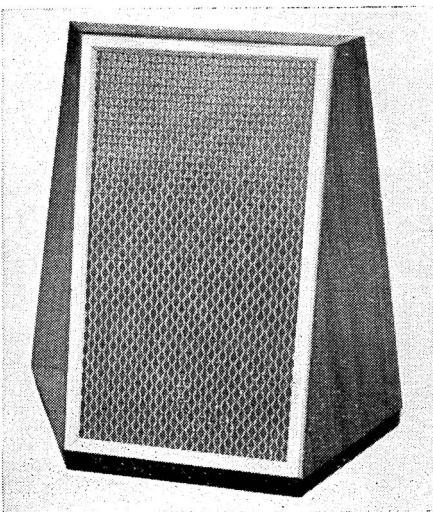

Fane Trio

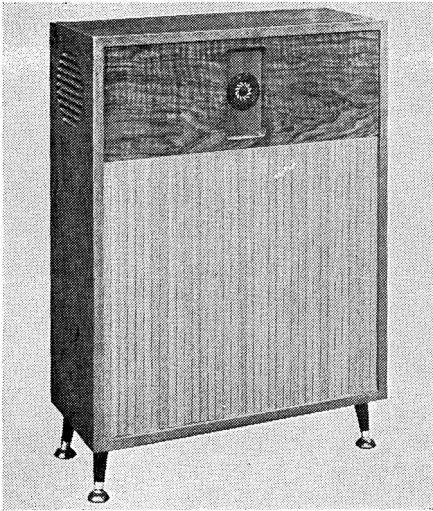

G.E.C. Slender Periphonic

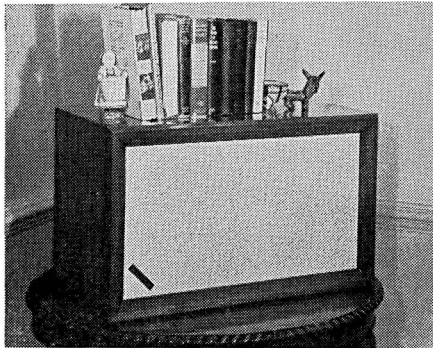

Goodmans AL 100

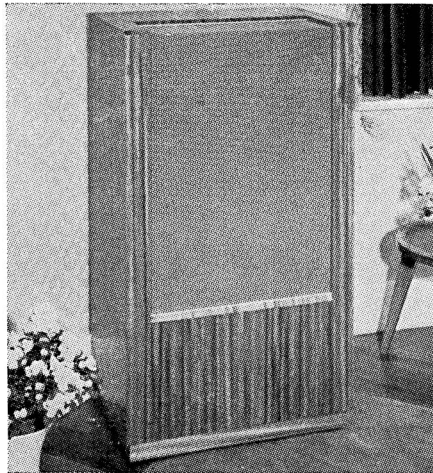

Lockwood LE.1 reflex

two presence units. Response 30-15,000 c/s. Size $30 \times 20 \times 14\frac{1}{2}$ ins. Weight 38 lb. Price cabinet only £17 10s.

Bookcase Loudspeaker BCS 1873. Tuned pipe reflex, forward facing. One drive unit. 8 inch metal cone and BCS 1852 presence unit. Crossover 1,500 c/s. Response 40-15,000 c/s. Size $24 \times 12 \times 10$ ins. Price without units. £11 11s., complete £22 12s.

Slender Periphonic BCS 1874. Tuned pipe reflex, forward facing. Two 8 in. metal cones, plus one or two high flux presence units. Size $24 \times 33 \times 10$ ins. Price £56 18s. (one H.F. unit), £63 4s. (two H.F. units). 12 and 25 watt versions available.



Goodmans Industries Ltd., Axiom Works, Wembley, Middlesex, England. Tel.: Wembley 1200. Cables: Goodaxiom, Wembley.

Stereophonic Bowl Unit S.23. Contains special 6 in. drive unit, and filter. Response with filter 300-15,000 c/s. Size $6\frac{1}{2} \times 8\frac{1}{2}$ ins. Price £17 6s. 6d. Without filter £8 8s.

AL100. Bookcase Loudspeaker, forward facing. ARU loaded. One 12 in. Twin Diaphragm drive unit. 40-15,000 c/s. Size $24 \times 11\frac{1}{2} \times 14\frac{1}{2}$ ins. Price £23 10s. complete.

AL120. Bookcase Loudspeaker, forward facing. Baffle ARU loaded. One 12 in. Triaxial Loudspeaker. Crossover at 5,000 c/s built-in. Size $24 \times 11\frac{1}{2} \times 14\frac{1}{4}$ ins. Price £29 10s. complete.



Grampian Reproducers Ltd., Hanworth, Trading Estate, Feltham, Middlesex, England. Tel.: Feltham 2657. Cables: Reamp Feltham.

Grampian WS9. Totally enclosed, forward facing. Fitted with 9 inch drive unit. Handling capacity 7 watts. Size $23 \times 12 \times 12$ ins. Shaped for corner or wall position. Price £11 2s. 6d. (U.K. purchase tax £3 15s.), legs extra £1 2s. 6d.

Grampian CE12. Forward facing reflex, shaped for corner or wall position. One 12 in. unit. Grampian rec. 1255/15. Size $29 \times 18 \times 12\frac{1}{4}$ in. Price (complete), £24 10s.

H. J. Leak & Co. Ltd., 57/59 Brunel Road, East Acton, London, W.3. Tel.: Shepherds Bush 1173. Cables: Sinusoidal, Ealux, London.

Sandwich. Forward facing, two units. Bass 13 in. Treble 3 in. half section cross-over cabinet—can be placed in vertical or horizontal position. Size 26 × 15 × 12 ins. Weight 45 lbs. Price £39 18s.



Lockwood & Co. (Woodworkers) Ltd., 67 Lowlands Road, Harrow, Middlesex. Tel. Byron 3704.

LE.1. Reflex, forward facing. Suitable for 15 in. dual concentric unit, or 3-way combination. Size 44 × 24 × 17½ ins. Concealed castors. 18 in. version available. Prices on application.

LE.2, 3, and 4. These have a similar outward appearance and design to the LE.1 above, but are progressively smaller in dimension and price, and are suitable for smaller speaker systems. The smallest LE.4, is 27½ × 17½ × 12¼ ins. All cabinets fitted with drive unit to individual requirements. Prices on application.



Lowther Manufacturing Co., Lowther House, St. Mark's Road, Bromley, Kent, England. Tel.: Ravensbourne 5225. Cables: Lowther, Bromley.

Corner Reproducer TP1. Folded bass horn/direct h.f. horn type. One specially designed 6 in. pressure unit PM3. Acoustical crossover. Response 40-20,000 c/s. Size 47 × 32 × 31 ins. from corner. Weight 70 lbs. Price of standard Model A £96. Model B £106.

Acousta Cabinet. Models FH/V, FH/H. Folded horn type, forward facing, with rear folded horn. Vertical on plinth, or horizontal on 12 in. legs. One unit, 6 in. or 8 in. Rec. Lowther PM6. Response 60-17,000 c/s. Size 34½ × 18½ × 17 ins. Weight 60 lbs. Price without unit £18 18s., walnut, oak, mahogany.

This enclosure is also available in a "Do-it-yourself" kit form. Price £14 14s. ex works.

Audiovector. Compound horn. 180 deg. compound upward facing mid- and

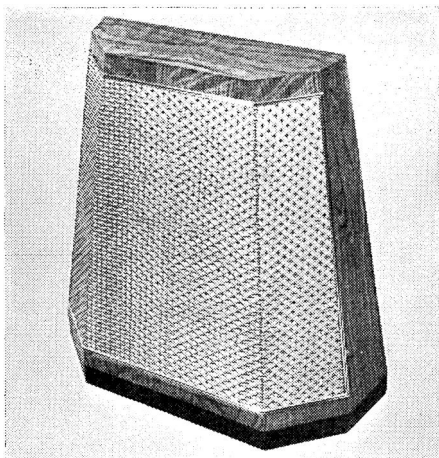

Fane Quartet

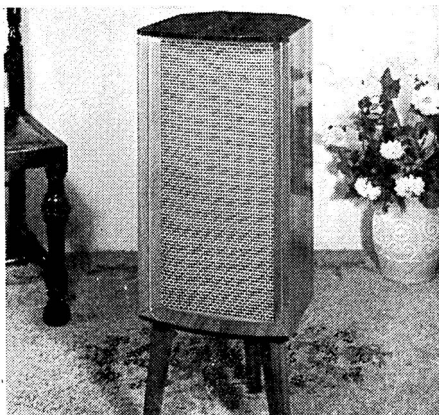

Gramplan WS9

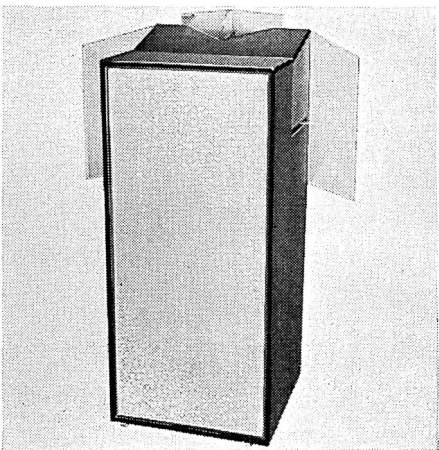

Lowther Acousta-twin

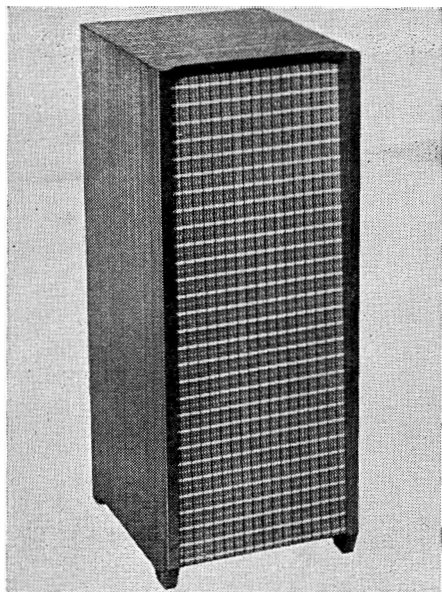

Soundcraft Stanley

high-frequency horn with rear folded horn. One 8 in. unit. Range 30-20,000 c/s. Size approx. 26 × 30 × 18 ins. Price approx. £48.

Acosta-twin. Dual folded horn. Side facing and rear folded horn system for monaural and stereo reproduction. Two

PM6 8 in drive units. Acoustic cross-over. Response 30-18,000 c/s. Dimensions 44 × 18 × 18 ins. Price £30 enclosure only, £67 16s. complete, with P.M.6.

Super-Twin As Acosta-Twin but fitted with P.M.2. Mk. III. Price £90.



Mordaunt Sound Reproducers, 32/34 Rupert Street, London, W.1.

Arundal. Reflex forward facing two units. Bass 12 in. treble. Ribbon tweeter. Range 30-25,000 c/s. Size 36 × 15 × 12 ins. Price £39 10s.



Pamphonic Reproducers Ltd., 17 Stratton Street, London, W.1. Tel.: Grosvenor 1926.

Victor Senior. Two units. Bass, 15 in., treble 6 in. elliptical. Response 30-15,000 c/s. Crossover 1,000 c/s. Price £45.

Victor Junior. Two units. Bass 12 in., treble 6 in. elliptical. Response 35-12,000 c/s. Price £30.

S.1. Stereo. Cabinet type, forward facing. Elliptical 10 × 6 in. concentric

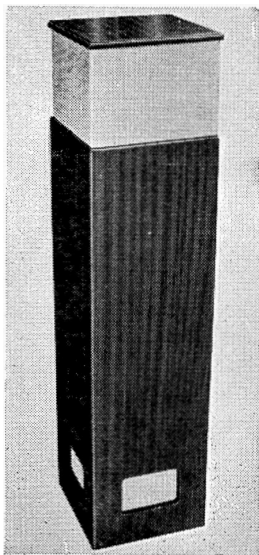

Whiteley Electrical Stentorian WB Column

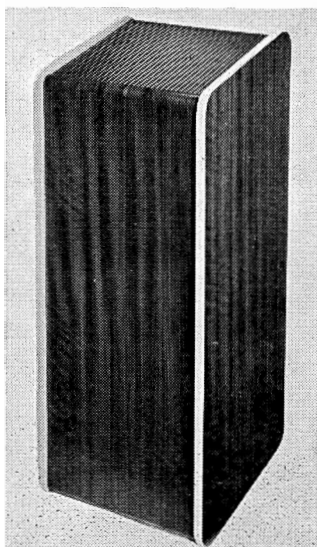

Rogers Development 1284 3-way system

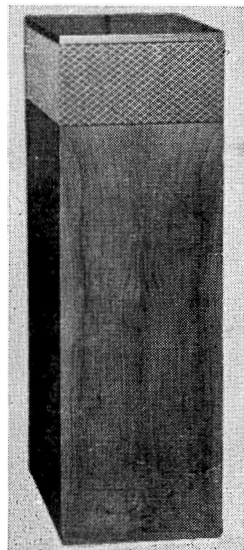

Expert Gramophones Acoustic Column

cone unit. Size 15 × 12 × 11 ins. Price £10 12s. 5d. (U.K. purchase tax £3 8s.)



Pye Limited, High Fidelity Division, Blue Town, Sheerness, Kent. Tel.: Sheerness 3076. Cables: Faramarine, Sheerness, Kent.

Mozart Minor HF.8BS. Distributed vent reflex. Two drive units, 12 in. bass and 10 × 6 ins. elliptical. Crossover included. Response 50-15,000 c/s. Size 28 × 13 × 10½ ins. Price £18 18s. complete.

Mozart Companion HF.10 BS. Folded duct bookcase loudspeaker. Two drive units. 8 in. bass and 4 in. H.F. Crossover frequency 7,000 c/s. Response 60-15,000 c/s ± 4 dB. Size 11½ × 25 × 10½ ins. Weight 22½ lbs. Price £21. Legs £2 2s. extra.

Mozart Major HF.15 SMT. Folded labyrinth with forward facing units. One 12-in. and one 4-in. with built-in crossover. Response 45-17,000 c/s. Size 33½ × 17 × 13½ ins. Weight 54 lbs. Price £28 7s.

De-Luxe HF.25 SCA. Reflex corner speaker, forward forcing with A.I.U. Three drive units. 15 in., 8 × 6 in. elliptical, and 4 in. tweeter. Crossovers 1,500 and 7,000 c/s. Size 38½ × 28 × 19 ins. Weight 90 lbs. Price £57 15s.

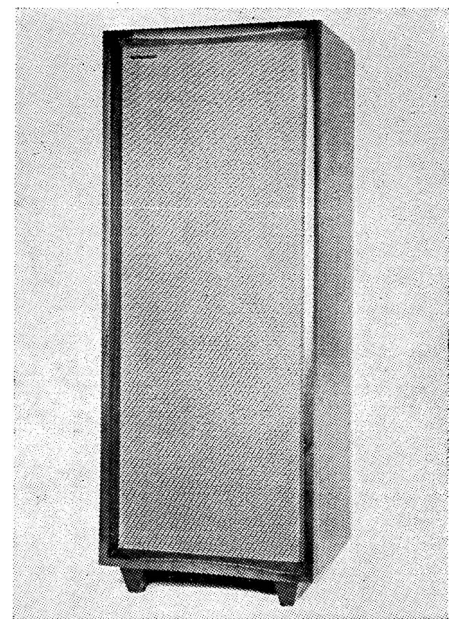

Mordaunt Arundal
2

Mozart HF.25 SCA. Corner enclosure. Three drive units 8, 15 and 4 in. tweeter with built-in crossover. Response 20-20,000 c/s. Size 38½ × 28 × 19 ins. Price £57 15s.

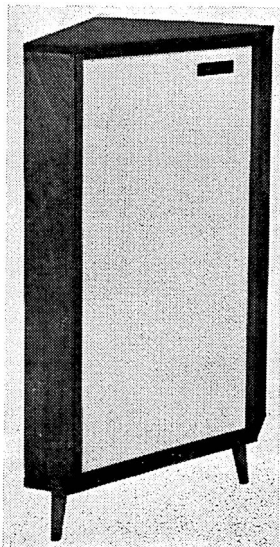

Tannoy Products
Chatsworth II

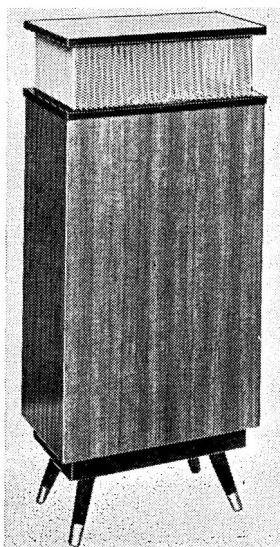

Connoisseur
Omni-directional

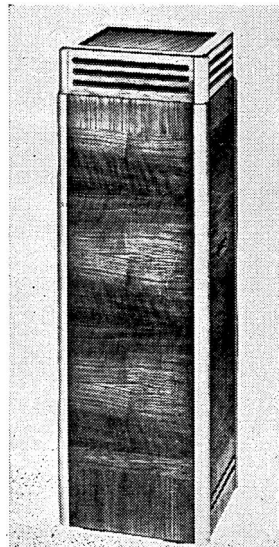

Wharfedale Wireless
Column eight

Record Housing, Brook Road, London, N.22. Tel.: Bowes Park 7487.

Viking. Reflex forward facing. Three drive units. 8 or 10-in. plus tweeter. Response 40-15,000 c/s. Size 32 × 19 × 12 ins. including 6-in. legs. Price, cabinet only, £10 10s.

Capriol. Reflex forward facing. Three drive units. 12-in. plus Goodmans Trebax and Midax recommended. Response 30-16,000 c/s. Size 30 × 16 × 16 ins. Price, cabinet only, £13 19s.

Nordyk. Reflex forward facing. One drive unit. 8-in. G.E.C. Goodmans and Wharfedale recommended. Response 40-15,000 c/s. Price, cabinet only, £6 15s.



Rogers Development (Electrical) Ltd., 4-14 Barmeston Road, Catford, London, S.E.6. Tel.: Hither Green 7424/4340. Cables: Rodevco, London, S.E.6.

1284. 3-way column speaker. Three drive units. 12, 8 and 4 ins. Crossovers included. Response 35-17,000 c/s adjustable. Size 37 × 15 × 14 ins. Price £28 10s. Figured teak £30.



Romagna Reproducers, Factory Distributor, K. H. Williman & Co. Ltd., Blackford House, Sutton, Surrey. Tel.: Melville 1491.

Mk. 1 Reproducer. Reflex forward facing. Flat for mid-wall mounting. Two drive units, Kelly Mk. 1 bass unit and Mk. 2 ribbon. Crossover included. Response 35-20,000 c/s. Size 30 × 25 × 12 ins. Weight 55 lbs. Price complete £42.



The Soundcraft Co., 1 Stanley Road, Bromley, Kent. Tel.: Ravensbourne 5673.

Stanley. Forward facing folded horn. One 8-in. drive unit. Size 31½ × 12 × 13½ ins. Price, cabinet only, £13 13s.

Langdon. Forward facing folded horn. One 8-in. drive unit. Size 33 × 15 × 16 ins. Price, cabinet only, £17 17s.

FH12. Forward facing folded horn. Two drive units, 8-in, 10 or 12-in. and tweeter. Size 32½ × 14 ins. Depth according to speaker fitted. Price, approx. £15 15s.

Sound Sales Ltd., Works and Acoustic Laboratories, West Street, Farnham, Surrey, England. Tel.: Farnham 6461. Cables: Sounsense.

Phase Inverter Speaker. Model A, 15 ohms. Model B, 3 ohms. Reflex type. Ported cabinet for forward facing. 12 watt handling. 12 in. Sound Sales dual suspension auditorium unit. Response 30-13,500 c/s. Size 29 × 14 × 18½ ins. Weight 44 lbs. Price £20 10s. complete. Stereo pair £37.

Tri-Channel Mk. 5. Special labyrinth construction, reflex. Distribution over 90° arc. Three 12 in. Sound Sales Auditorium units, and one electrostatic tweeter. Response 25-27,000 c/s when used with associated amplifiers. (This equipment is sold complete. Refer to amplifier section.) Size 43 × 31 × 35 ins. Weight 202 lbs. Price, including amplifiers and tone control unit, complete, £125.



A. R. Sugden & Co. (Engineers) Ltd., Market Street, Brighouse, Yorks. Tel.: Brighouse 2142. Cables. Connoisseur, Brighouse.

Connoisseur. Omni-directional reflex. Two drive units. 8 in. plus 3 in. tweeter. Wharfedale and Lorenze recommended. Response 40-15,000 c/s. Size 40½ × 16 × 12 ins. Price, cabinet only, £22 10s.



Symphony Amplifiers Ltd., 16 Kings College Road, London, N.W.3. Tel.: Primrose 3314/5.

Symphony Column. One 8-in. drive unit facing vertically. Rec. Wharfedale Column 8/145. Response approx. 30-16,000 c/s. Size 60 × 13 × 13 ins. Weight 50 lbs. Price, cabinet only, £13 13s.

Symphony Bass Reflex Cabinets. A range of forward facing systems to take 8, 10 or 12-in. units. Price, ready built, £5 10s. to £11 10s. Also available in kit form.



Tannoy Products Ltd., West Norwood, London, S.E.27. Tel.: Gipsy Hill 1131. Cables: Tannoy, London.

Chatsworth II. Aperiodic enclosure for corner placing. One monitor 12 drive unit. Size 36½ × 20 × 12½ ins. 4-in. legs. Price £49 15s.

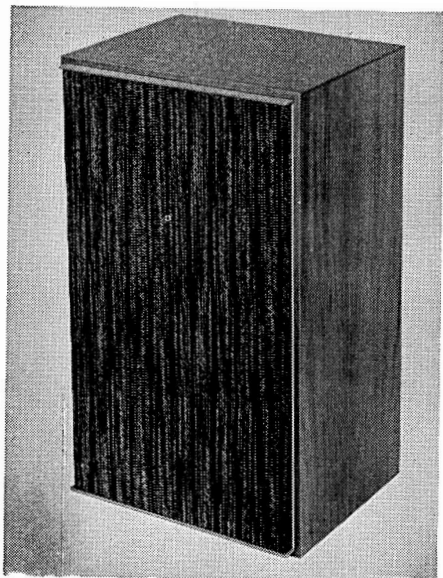

Leak-Sandwich

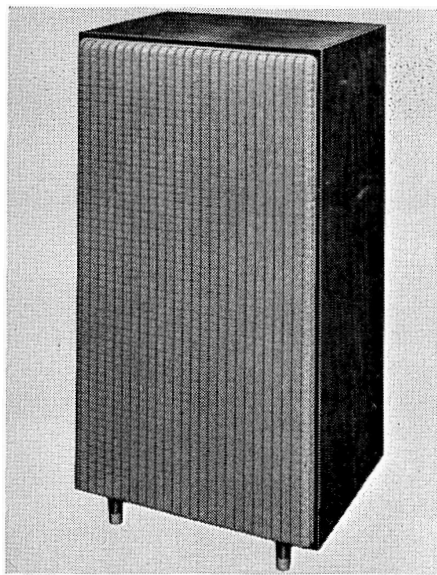

Pye HF 15/SMT

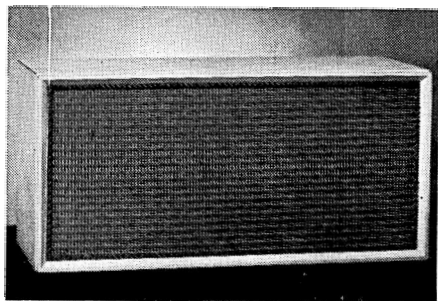

Wharfedale PST/8

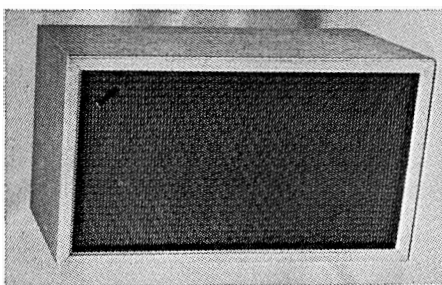

Wharfedale W2

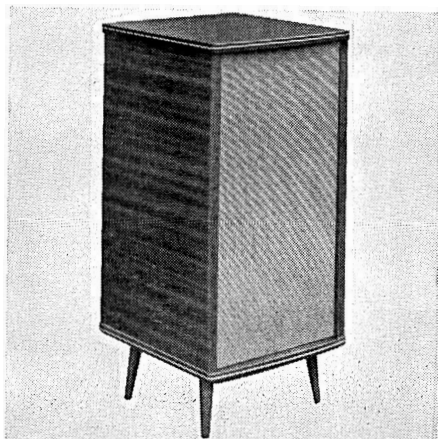

Record Housing Capriol



Lowther TP1

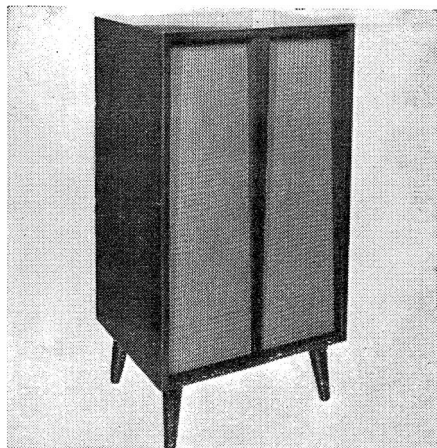

Wal Duo-Reflex

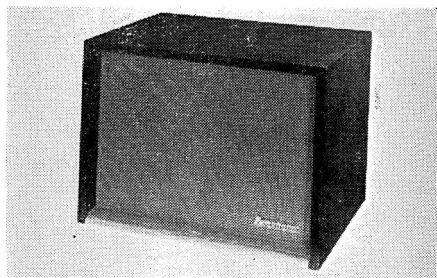

Pamphonic S1

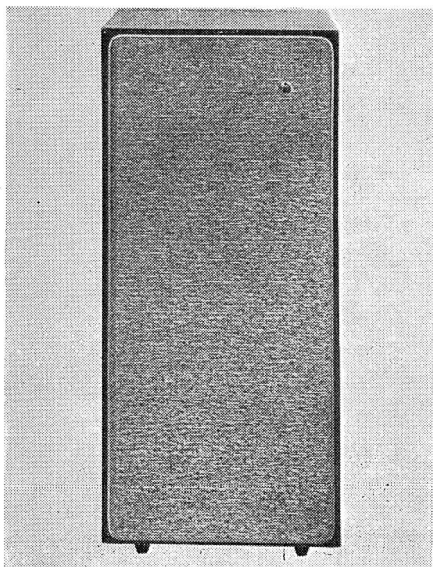

Pye HF8BS Mozart Minor

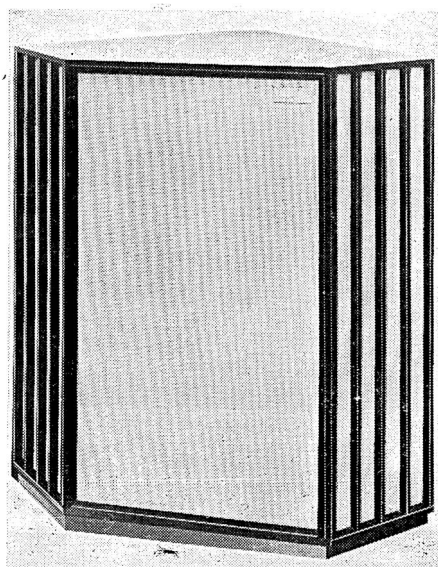

Tannoy G.R.F.

Canterbury. Reflex, with forward facing unit, dual throated ports, for corner placing. One 12 in. dual concentric unit, or direct radiator Size $37 \times 25 \times 17$ ins. Price, with dual concentric, £57 15s.; with direct radiator, £43 15s.

Lansdown. Reflex. Forward facing unit, dual throated ports, for side wall placing. One 12 in. dual concentric unit. Response 30-20,000 c/s. Size $32 \times 36 \times 17$ ins. Price £75.

York. Reflex. Forward facing unit, dual throated ports, for corner placing. 12 in. or 15 in. dual concentric unit. Response 35-20,000 c/s. Size $45\frac{1}{2} \times 32 \times 22\frac{1}{2}$ ins. Price, with 12 in. unit, £66; with 15 in. £75.

G.R.F. Folded horn. Rear horn loaded, forward facing unit, for corner. One 15 in. dual concentric unit. Response 20-20,000 c/s. Size $48 \times 38 \times 29$ ins. Price £122.

Guy R. Fountain Autograph. Folded horn. Front and rear horn-loaded unit, forward facing for corner placing. 15 in. dual concentric unit. Response 20-20,000 c/s. Size $58\frac{1}{2} \times 43 \times 26\frac{1}{2}$ ins. Price £165.

111 LZC. Infinite baffle forward facing. Tannoy III LZ dual concentric unit. Response 30-20,000 c/s. Size $14 \times 10\frac{1}{4} \times 23\frac{1}{4}$ ins. Price £32 10s.

Tele-clinic (Sales & Service) Ltd., 36 Brick Street, Warrington, Lancs. Tel.: Warrington 33179.

"Normanda." Free standing reflex type with folded horn midrange unit. Three speakers, 12 in. bass, midrange pressure unit and 2½ in. tweeter. Crossover 1,000 c/s. Size 33 × 26 × 18 ins. 3 in. pedestal. Weight 110 lbs. Price £63.



Vitavox Ltd., Westmoreland Road, London, N.W.9. Tel.: Colindale 8671. Cables: Vitavox, Hyde, London.

Vitavox Hallmark. Forward facing reflex, with port underneath. One 12 in. unit. Rec. Vitavox DU120 or AK120. Size Model 351: 27½ × 20 × 16½ ins. Available as horizontal (Lowboy) or vertical (Tallboy) system. Price, complete, £42 in Walnut or Oak; £45 in Teak.

Klipschorn. Double channel horn. Folded L.F. horn, forward facing H.F. horn. 2 drive units: 15 in. L.F., pressure type H.F. Crossover at 500 c/s. Response 30-15,000 c/s. Size 50 × 30 × 27 ins. Weight 210 lbs. Price, with specified units, £165.

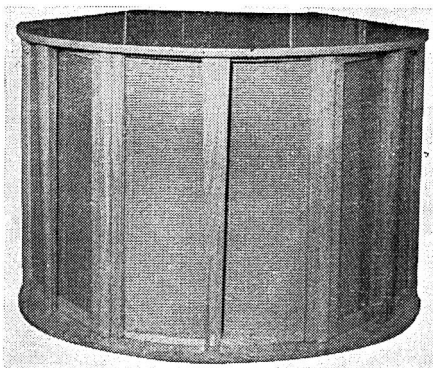

Sound Sales Tri-Channel MK5

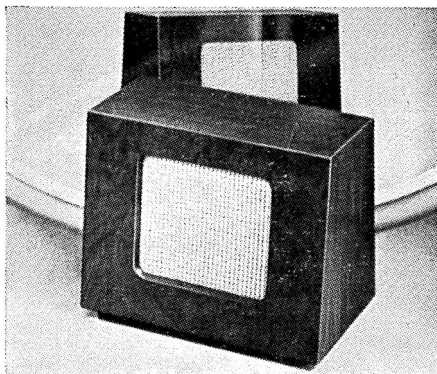

Stentorian S.oping Dual Front

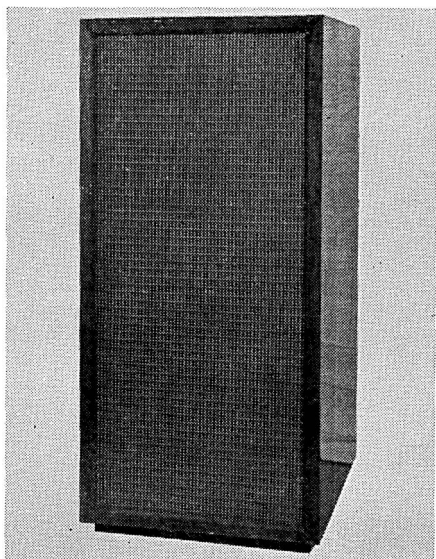

Sound Sales Phase Inverter

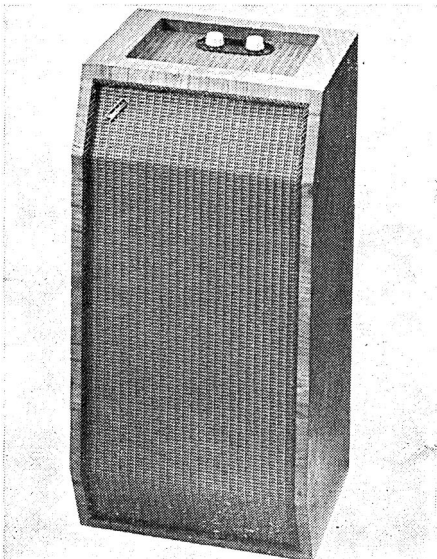

Wharfedale W3

Wellington Acoustic Laboratories Ltd., Farnham, Surrey. Tel.: Farnham 6461/4961.

WAL Duo-Reflex Speaker. Forward facing reflex enclosure. Incorporating 12 in. bass unit with foam surround and H.F. pressure tweeter. Built-in crossover unit. Response 30-13,500 c/s. Size 33 × 18 × 14 ins. Weight 55 lbs. Price £27. Available as a matched pair for stereo, £52.



Wharfedale Wireless Works Ltd., Idle, Bradford. Tel.: Idle 1235-6. Cables: Wharfedel, Idle, Bradford.

PST/8. Damped reflex, forward facing. One 8 in. drive unit. Rec. Super 8/FS/AL or 8 in. Bronze FS/AL. Response 60-14,000 c/s. Size 24 × 12 × 12 ins. Weight 17 lbs. Price, without unit £7 10s. whitewood, or £10 10s. veneered and polished.

Column Eight. Reflex column with acoustic filter and conical diffuser for upward facing 8 in. unit. Rec. 8/145, Super 8/FS/AL or 8 in. Bronze FS/AL. Response 40-14,000 c/s, depending on unit. Size 44 × 14 × 12 ins. Weight 34½ lbs. Price, without unit, £21 15s.

AF/12. Reflex with acoustic filter, forward facing. One 12 in. drive unit. Rec. Coaxial 12, Super 12/FS/AL, W12/FS. Response 30-20,000 c/s with Coaxial 12. Size 36½ × 23 × 14¼ ins. Weight 61 lbs. Price £24 10s. (Whitewood £20).

AF/10. Forward facing reflex with acoustic filter. One 10 in. unit. Rec. 10 in. Bronze/FSB, Golden/FSB, W10/FSB. Response 40-10,000 or 14,000 c/s depending on unit fitted. Size 30 × 17 × 10½ ins. Weight 35 lbs. Price, without units, £15 15s.

SFB/3. Sandfilled baffle. 3 drive units. 12 and 10 in. units facing forwards. 3 in. H.F. unit facing upwards for omnidirectional treble distribution. Response 30-20,000 c/s. Size 34 × 31 × 12 ins. Weight 64 lbs. Price, with units, £39 10s. (not sold separately).

"Omni-directional" 3-speaker corner system. Sandfilled reflex enclosure, bass unit facing forward, separate mid-range

and treble unit facing upward. 15 in., 8 in. and 3 in. units. Rec. W15/FS, Super 8/FS, Super 3. Response 20-20,000 c/s. Size 48 × 34 ins. Weight 160 lbs. Price, with specified units, £73 10s.; sandfilled panel only, £31; twin treble cabinet, £8 15s.

Super 3 Cabinet. Open baffle, facing upward to house 1 Super 3. Crossover 5,000 c/s. Response 5,000-20,000 c/s. Size 8 × 6 × 5 ins. Weight 1¾ lbs. less unit. Price £4 10s. (for 8/15 ohm speakers); £5 (for 2/3 ohm speakers).

W2. Two-speaker system, incorporating WLS/12 and Super 5 with vol. control. Crossover 1,000 c/s. Size 23½ × 14 × 12 ins. Price, veneered, complete, £29 10s.

W3. Three-speaker system, incorporating WLS/12, a 5-in. Bronze, and Super 3. Separate vol. controls for the two H.F. units. Crossover 1,000 c/s. Size 28 × 14 × 12 ins. Price, veneered, complete, £39 10s.

W4. Four-speaker system, incorporating WLS/12, two 5 in. Bronze, and Super 3. H.F. units are arranged for omnidirectional radiation and have independent mid and treble vol. controls. Size 35 × 24 × 12 ins. Price veneered, complete, £49 10s.



Whiteley Electrical Radio Co. Ltd., Victoria Street, Mansfield, Notts. Tel.: Mansfield 1762/3/4/5. Cables: Whitebon, Mansfield.

Stentorian Junior Console. Bass reflex for corner position. 1 or 2 drive units. Rec. HF816 or HF1012 with T10 tweeter, if required. Crossover 3,000 c/s. Response HF816, 50-14,000 c/s; HF1012 and T10 30-14,000 c/s. Size 33 × 22½ × 18½ ins. Price, with HF816, £14 6s. 7d. (U.K. purchase tax, £1 19s. 5d.); with HF1012 and T10, £18 14s. (U.K. purchase tax £1 8s. 9d.); without units, £9 9s.

Stentorian Senior Corner Console. Bass reflex for corner position. 10 in. or 12 in. drive unit with tweeter, if required. Crossover 3,000 c/s. Response with HF1012 and T10 30-40,000 c/s; with HF1214 and T12 25-17,000 c/s. Size 35 × 30 × 19 ins.

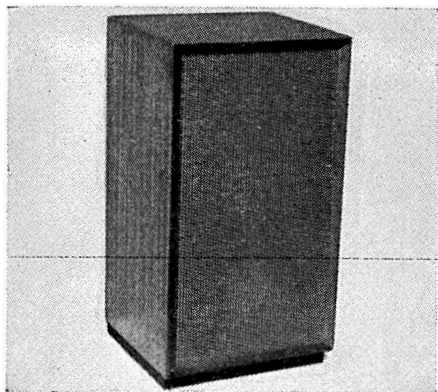

Lowther Acousta cabinet

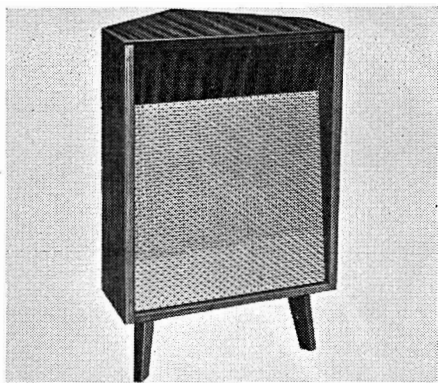

Stentorian Prelude Corner Comale

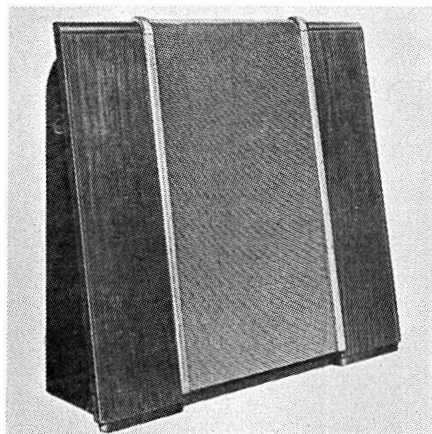

Wharfedale SFB/3



Vitavox Hallmark

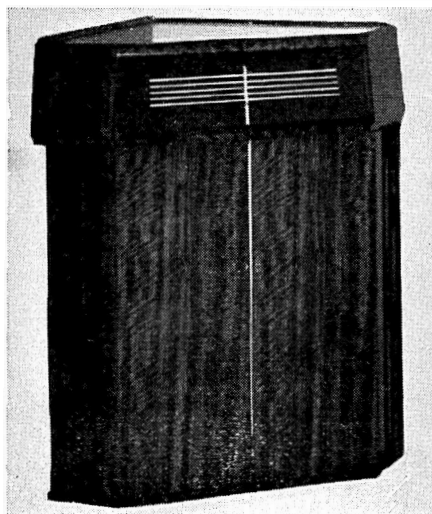

Vitavox "Klipschorn"

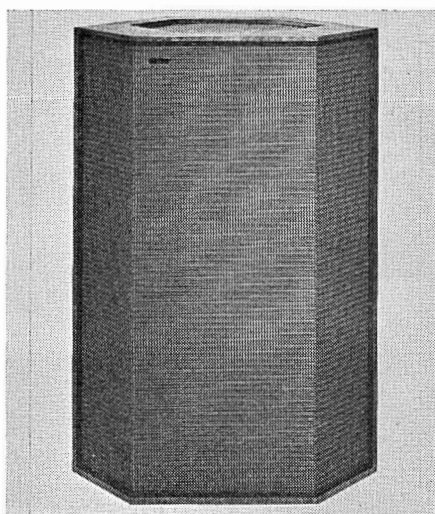

Wharfedale W4

Price, with HF1012 and T10, £20 16s. (U.K. purchase tax £1 4s.); with HF1214 and T12, £36 8s. 6d.; without units, £11 11s.

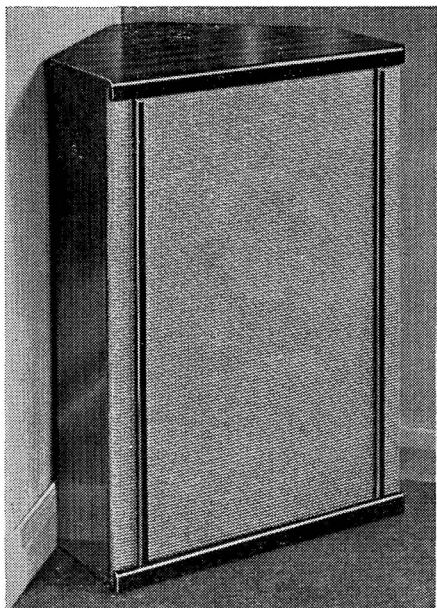

Stentorian Junior Bass Reflex

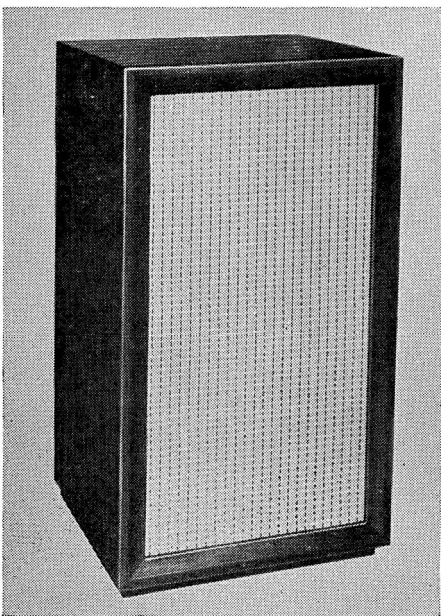

Stentorian "Prelude" Horn Loaded

Stentorian "Prelude." Bass reflex for corner position. One 8 in. or 10 in. unit with provision for tweeter. Rec. HF812, HF816, or HF1012 and T10. Crossover at 3,000 c/s. Response depending on unit used. Size 33 × 21 × 17 ins. Weight 23½ lb. Price, without units, £10 10s. Model also available for free standing, otherwise as above. Size 33 × 19 × 19½ ins. Weight 27½ lb. Price £11 11s.

Stentorian Sloping Dual Front. Tweeter housing, reversible, either forward or rear facing. One 8 in. unit. Rec. T816. Response 1,000-17,000 c/s. Size 13 × 10½ × 7½ ins. Price, with unit, £8 8s. 11d. (U.K. purchase tax £2 17s. 10d.); without unit, £3 17s. 6d.

Stentorian Prelude Major. Reflex, forward facing. 10 in. or 12 in. drive units. Rec. HF1214 and T10. Response 30-17,000 c/s. Size 35 × 20 × 33 ins. Price (complete), £45; without units £25.

Stentorian Prelude Horn Loaded. Folded horn, forward facing. One 8 in. drive unit. Rec. HF817. Response 60-22,000 c/s. Size 35 × 18½ × 16½ ins. Price (complete) £27 12s. 10d. (U.K. purchase tax £2 14s. 6d.) Price, without units, £19 10s. 10d.

Stentorian Junior Column. Reflex upward facing omni-directional. One 6 in. unit. Rec. HF610. Response 100-11,000 c/s. Size 36 × 9 × 9 in. Price (complete) £11 17s. 7d. (U.K. purchase tax 15s. 5d.) Price, without unit, £9 16s. 6d.

Stentorian Senior Column. Reflex upward facing omni-directional. One 8 in. unit. Rec. HF816. Response 60-14,000 c/s. Size 57 × 13½ × 13½ ins. Price (complete) £23 15s. 7d. (U.K. purchase tax £1 19s. 5d.) Price, without unit £18 18s.

Stentorian Stentereo. Infinite baffle. Corner speaker, forward facing. Two drive units 8 in. and 5 in. Rec. HF812 or HF810 with S.510. Crossover 1,500 c/s. Response 100-12,000 c/s. Size 22 × 12½ × 10 ins. Price (complete), with HF810, £14 17s. 3d.; with HF812, £15 7s. 9d. (U.K. purchase tax, HF810 £1 2s. 10d.; HF812 £1 8s.) Price, without units, £7 10s.

Note: All units for the above may be supplied separately.

TAPE RECORDERS

An Introduction — by A. Bartlett Still

WHEN it is considered that tape recorders, in the domestic sense, have been known only since the war, it becomes a little difficult to realise that the first experiments in magnetic recording were carried out before 1898. For the following fifty years or so progress was slow and tended to be erratic as each facet of the system, now accepted as commonplace, was contributed. Poulsen's "Telegraphone", at the end of the last century, obviously suffered from a lack of suitable amplification being prior to the invention of the thermionic valve, but even in 1935 the A.E.G. company's "Magnetophone" using an oxide tape, suffered from a very poor signal/noise ratio. Just before the last war the BBC were using a steel tape recorder, the Marconi-Stille "Blattnerphone", which has a tape speed of nearly 60 i/s.

Perhaps the biggest "breakthrough" was in 1940 when in Germany, Braunmuhl and Weber developed the idea of using high frequency AC bias for recording. Wartime development effort in this country concentrated on steel tape and wire as a medium,

while in Germany efforts were made to produce satisfactory plastic tapes. In consequence the majority of present day machines must be said to stem from German designs, quite apart from the fact that more tape recorders are produced in Germany than anywhere else in the world.

Recorder Performance

It can be said, with probable fairness, that the developments being carried out today are aimed at increasing saleability rather than improving the general technique of recording. The published frequency response of most manufacturers' products is continually being extended, and during the last year we have seen the widespread introduction of four-track working. There can be no doubt that the combination of an effectively doubled tape length, and the permitted using of a lower tape speed, represents a real economy in terms of tape cost. Unfortunately the profit and loss account has to be balanced, and it is not all due to improvements in technique, the

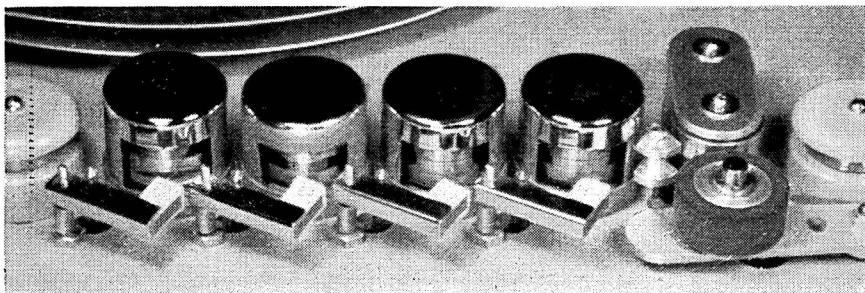

Four Bradmatic heads for stereo—two $\frac{1}{2}$ -track erase, stereo record, stereo replay

difference being made up by a deterioration in *real* performance.

What is meant by *real* performance? It is the way in which the tape recorder works and sounds, something not completely covered by a set of performance figures, however carefully and truthfully they may have been prepared. What it all comes down to is that a prospective purchaser should study the manufacturers' published information with a view to preparing a "Short List", the final decision should not yet be taken. Obviously, a number of factors outside actual performance must be taken into consideration, notably price, and the purpose for which the machine is required. The next step is to visit a reputable dealer and hear the chosen few, hear them on the type of programme material in which you are interested, and hear them playing their own recordings as well as tape records. Now this may take a little time, but the good dealer knows that the sale of a tape recorder represents several pounds profit to him there and then, and a satisfied customer means more potential profit, however indirectly, in the future. He may show you a machine that you have not considered; study its performance, see if it qualifies for the short list, and, if so, go on from there.

Listening Tests

What are you going to listen for that is not covered by the written specification such as appears in the following pages? Take the question of signal/noise ratio, for instance. Two machines may have the same figure, quoted in dB, but if on one the residual noise is made up of hiss, rather than mains hum, the noise will be more noticeable. For normal domestic purposes a figure of 40 dB is a minimum for this ratio, and remember, with dB, 43 is twice as good, and 46, four times better, in terms of noise power output in the speaker. As these figures are quoted with respect to full recording level, the advantage is even greater when referred to mean programme level, so consider signal/noise ratio to be an important item in the specification.

A wide frequency response is certainly desirable, but it is, in the writer's opinion, nowhere near so important as is sometimes claimed. One should, for instance, consider the likely sources of programme material. It is pointless having a machine capable of 18Kc/s, for live recording via a microphone with a cut off at 12 Kc/s. This would be

particularly true if, as sometimes happens, the striving after frequency response worsens the hiss/hum ratio in the total noise. One other point is important on this subject of frequency response. You will not always be playing just your own recordings, there will come a time when you wish to replay a tape record, or a recording made on another machine. To do this it is essential that your chosen machine replays "according to the C.C.I.R. characteristic". This is an internationally agreed manner of frequency correction to ensure that tapes, of the same speed, are interchangeable all over the world. Not *all* models of tape recorder available in this country conform to this characteristic, the worst offenders being, perhaps understandably, in the cheaper price brackets.

Tape and Hi-Fi

What about the enthusiast who already has a Hi-Fi set up to which the addition of tape is contemplated? Your amplifier may well have sockets for "Tape Record" and "Tape Replay", the latter normally requiring the sort of signal that comes from the high impedance output socket of a tape recorder. Provided the tape recorder will accept signals through the usual variety of inputs, and has a high impedance output, it may be connected, for recording and replaying, to most amplifier rigs. Do not expect to be able to buy a tape deck only, and use it by making a few connections. Even if you are in a position to make the various electronic bits and pieces, you will not achieve the performance standards you expect without the use of expensive test gear for setting and aligning, and, in all probability, you will have lost the very real advantage of portability that a complete tape recorder will give you. This whole matter is really a question of outlook. If you feel, as indeed do many, that the building and adjusting of the record and replay amplifiers is going to be half the fun of the whole operation, then by all means go ahead, because you will already have a fair idea of what is involved. If, however, your main concern is the recording and replaying of tapes, be well advised to think again.

Enough has been said elsewhere on the pros and cons of stereo; suffice it to add that tape is an extremely good medium (the best?) for stereo with, as always, the fascinating possibility of making your own recordings.

DIRECTORY OF TAPE RECORDERS

★ The abbreviations used for the specifications in this directory are as follows: **F.R.**—frequency response; **i/s**—inches per second; **P.s.n.**—Power supply needed; **<**, better than; **M.E.**—Magic eye; **W. & F.**—Wow and flutter; **S-N**—signal to noise ratio; ■—Stereo equipment.

PROFESSIONAL and SEMI-PROFESSIONAL

Ampex (Great Britain) Ltd. Arkwright Road, Reading, Berkshire. Tel.: Reading 84221. Cables: Videotape, Reading.

■ **Ampex 960.** Portable stereo recorder. Speeds $7\frac{1}{2}$ and $3\frac{3}{4}$ i/s. 7 in. spools. F.R. $7\frac{1}{2}$ i/s 30-20,000, $3\frac{3}{4}$ 30-15,000 ± 2 dB. W. & F. $<0.2\%$. Meter. External amplifiers and speakers required. Price £189.

Ampex 919. Portable recorder. Two or four track. Speed $7\frac{1}{2}$ and $3\frac{3}{4}$ i/s. 7 in. spools. F.R. $7\frac{1}{2}$ i/s 30-20,000, $3\frac{3}{4}$ i/s. 30-15,000 c/s ± 2 dB. W. & F. $<0.2\%$. Meter. Size $13 \times 15 \times 6\frac{1}{8}$ ins. Weight 36 lbs. Price £156 9s.

■ **Ampex 970.** Portable stereo recorder speeds $7\frac{1}{2}$ and $3\frac{3}{4}$ i/s. 7 in. spools. F.R. $7\frac{1}{2}$ i/s 30-20,000, $3\frac{3}{4}$ 30-15,000 c/s ± 2 dB. W. & F. $<0.2\%$. Meter. Two 7 in. speakers 5 watts per channel. Size $25\frac{1}{2} \times 15 \times 9$ ins. Weight 46 lbs. Price £236 5s.

Ampex 2010. Ten watt speaker amplifier. 8 in. speaker to match. Model 960 and 970. Price £86 2s.

Ampex 300 Series. Prof. recorders. One to eight tracks. Speeds 15 and $7\frac{1}{2}$ i/s. 3 motors. 14-in. spools up to 1-in. wide. F.R. 15 i/s, 30-18,000 c/s; $7\frac{1}{2}$ i/s, 40-12,000 c/s, both ± 2 dB. Large scale V.U. meter. H. & N. —60 dB full track, —55 dB multi-track. W. & F. less than 0.1% at 15 i/s. Prices on application.

Ampex 351. Prof. recorder in console, portable or rack-mounted form. Full or half track. Speeds 15 and $7\frac{1}{2}$ i/s, or $7\frac{1}{2}$ and $3\frac{3}{4}$ i/s. 3 motors. $10\frac{1}{2}$ -in. N.A.B. spools. F.r.: 15 i/s, 30,18,000 c/s; $7\frac{1}{2}$ i/s, 40-12,000 c/s; $3\frac{3}{4}$ i/s, 50-8,000 c/s, all ± 2 dB. Large scale V.U. meter. H. & N. —70 dB full track, —65 dB half track at 15 i/s. W. & F. less than 0.15% at 15 i/s. Size (console) $48 \times 24 \times 28$ ins. Weight 168 lbs. Price (15 and $7\frac{1}{2}$ i/s), £662 portable, £682 console.

Ampex 352. Prof. reproducer only in console or rack-mounted form. Full or half track, or stereo. Speeds 15 and $7\frac{1}{2}$ i/s. 3 motors. $10\frac{1}{2}$ -in. N.A.B. spools. F.r.: 15 i/s, 30-18,000 c/s; $7\frac{1}{2}$ i/s, 40-12,000 c/s, both ± 2 dB. H. & N. —70 dB full track,

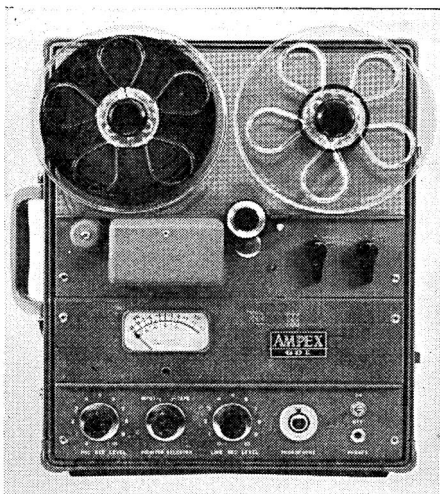

Ampex 601 portable recorder

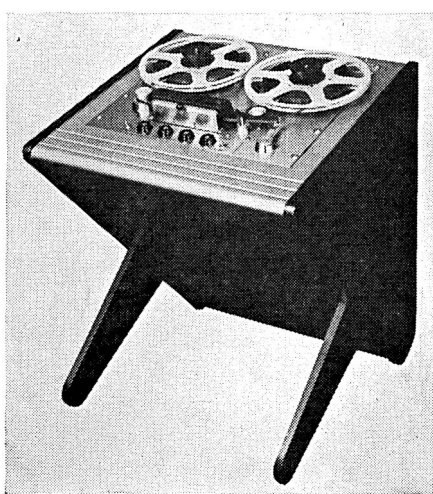

Ampex 352 console

-65 dB half track. W. & F. less than 0.15% at 15 i/s. Size (console) 35 × 24 × 24 ins. Weight 109 lb. Price £503 mono, £635 stereo. Console cabinet extra.

■ **Ampex 354.** Professional console recorder. Speed 15 and $7\frac{1}{2}$ i/s or $7\frac{1}{2}$ and $3\frac{3}{4}$ i/s. 3 motors. 10½ in. N.A.B. spools. F.R. 15 i/s 30-18,000 c/s; $7\frac{1}{2}$ 40-12,000 c/s. ±2 dB. 2 V.U. meters H. & N. -65 dB. W. & F. 0.15% at 15 i/s. Price on application.

■ **Ampex 601.** Prof. portable recorder. Speed $7\frac{1}{2}$ i/s. One motor. 7-in. spools. F.r.: 40-10,000 c/s ± 2 dB. Large scale V.U. meter. H. & N. -55 dB full track, -50 dB half track. W. & F. less than 0.17%. Size $16\frac{1}{2}$ × $13\frac{3}{4}$ × 8 ins. Weight 28 lb. Price £295.

■ **Ampex 601-2.** Stereo version of Ampex 601. Size $24\frac{1}{2}$ × 13 × 8 ins. Weight 42 lb. Price £486.



Elstone Electronics Ltd. Edward Street, Templar Street, Leeds, 2. Tel.: Leeds 3-5111.

■ **Tandberg Series 6.** Speeds $7\frac{1}{2}$, $3\frac{3}{4}$ and $1\frac{1}{4}$ i/s. F.R. 30-20,00 c/s. $\frac{1}{4}$ track. 7-in. spools. H. & N. -55dB. W. & F. 0.1%. Size 16 × 12 × 6 ins. Weight 30 lb. Price £115 10s.



The Gramophone Company Ltd., Hayes, Middx. Tel.: Hayes 3888. Cables: Jabberment, London.

■ **TR52/D.** Prof. portable stereo/mono recorder. Speeds $7\frac{1}{2}$ and $3\frac{3}{4}$ i/s. One motor 7-in. spools. F.r.: $7\frac{1}{2}$ i/s, 50-10,000 c/s; $3\frac{3}{4}$ i/s, 50-6,000 c/s, both ± 2 dB. W. & F. less than 0.25% at $7\frac{1}{2}$ i/s. Crosstalk -45 dB. V.U. meter. Size 20 × $17\frac{1}{2}$ × $13\frac{1}{2}$ ins. Weight 80 lb. Price £245.

■ **E.M.I. Model TR90.** Prof. recorder for rack mounting or as a console on transportable trolley, 30 and 15 i/s or 15 and $7\frac{1}{2}$ or $7\frac{1}{2}$ and $3\frac{3}{4}$ i/s. 4 motors. 10½-in. spools. F.r.: 15 i/s, 50-15,000 c/s; $7\frac{1}{2}$ i/s, 50-10,000 c/s; $3\frac{3}{4}$ i/s, 50-6,000 c/s. All ± 2 dB. V.U. meter level ind. or peak programme meter. Size (transportable version) 2 cases $14\frac{1}{2}$ × 20 × $16\frac{1}{2}$ ins. Weight 80 and 58 lb. Price, from £588.



Leevers-Rich Equipment Ltd., 78b Hampstead Road, London, N.W.1. Tel.: Euston 1481. Cables: Leemag, London.

■ **Model E. No. ER141M.** Prof. reproducer console. 15 and $7\frac{1}{2}$ i/s. 3 motors. 11½-in. spools. F.r.: 15 i/s, 50-15,000 c/s; $7\frac{1}{2}$ i/s, 50-10,000 c/s, both ± 2 dB on C.C.I.R. test tape. Size 24 × 24 × 36 ins. Weight 200 lb. Price £420.

■ **Model E. No. E141R.** Complete rack mounting prof. recorder. 15 and $7\frac{1}{2}$ i/s. 3 motors. 11½-in. spools. F.r.: 15 i/s, 50-15,000 c/s; $7\frac{1}{2}$ i/s, 50-10,000 c/s, both ± 2 dB. V.U. level meter. Size 19 × $17\frac{1}{2}$ × 9 ins. Weight 50 lb. Price £435.

■ **Model E. No. E121P.** Prof. portable recorder. Spec. as for E141R. In two cases, 20 × 17 × $11\frac{1}{2}$ ins. and 15 × 18 × 10 ins. Weight 79 lb. Price £550.

■ **Model E. No. E141M.** Prof. network recorder console. Spec. as for E141R. Size $24\frac{1}{2}$ × $23\frac{1}{4}$ × 35 ins. Weight 205 lb. Price £530.

■ **Model C. Model C621P.** Prof portable recorder. 15 i/s. 3 motors. 9½-in. spools. F.r.: 50-15,000 c/s ± 2 dB. V.U. level meter. Size 13 × 18 × 10 ins. Weight 73 lb. P.s.n. 12v battery or auxiliary mains unit. Price £450.

■ **Model DB. No. DB221P.** Prof. portable recorder. Spec. as for C621P but in two cases, 13 × 18 × 10 ins. and 16 × 20 × $11\frac{1}{4}$ ins. Total weight 74 lb. P.s.n. as C621P. Price £500.

■ **Model CS. No. CS621P.** Syncropulse recorder, for magnetic recording in sync. with cameras, etc. Spec. as for C621P. In two cases both 13 × 18 × 10 ins. Total weight 73 lb. P.s.n. as C621P. Price £550.

■ **Model E. No. ED 142P.** Complete portable dual channel recorder. 3 motors. 15 and $7\frac{1}{2}$ i/s. Monitoring off tape, separate V.U. Meter, unit amp. L.R. and H.R. Mic. or line inputs. 11½-in. spools. Response at 15 i/s, 50-15,000 c/s ± 2 dB. Size 2 cases 16 × 20 × 11 ins. Total weight 80 lb. Price £655. M console version, £680.



M.S.S. Recording Co. Ltd., Colnbrook, Bucks. Tel.: Colnbrook 2431. Cables: Emesco.

■ **Model CMR/DE.** G.P. recorder. $7\frac{1}{2}$ and $3\frac{3}{4}$ i/s, 3 motors. 8½-in. spools. F.r.: $3\frac{3}{4}$ i/s, 100-7,500 c/s. ± 3 dB; $7\frac{1}{2}$ i/s, 60-10,000 c/s. ± 5 dB; flat 100-7,000 c/s. Level meter. Size 36 × 28 × 18 ins. Weight 110 lb. Price £140; F.M. tuner available at an extra £25.

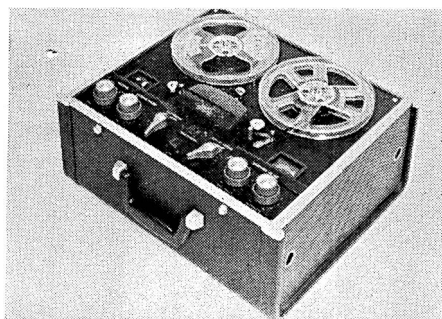

Ampex 960

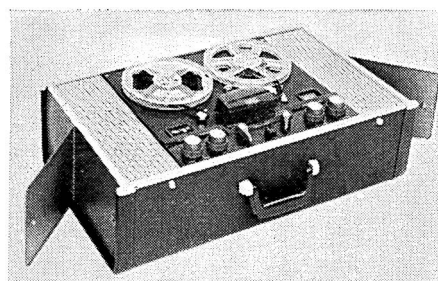

Ampex 970

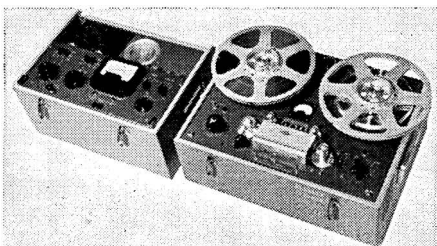

Leevers-Rich Series E No. E121P

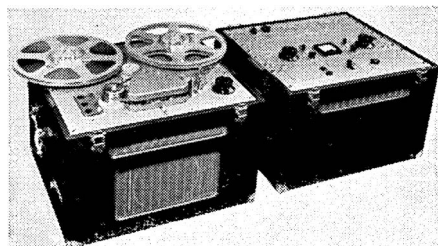

EMI TR90 in transportable form



EMI TR52 stereo portable



Tandberg Series 6



Leevers-Rich ED142K stereo

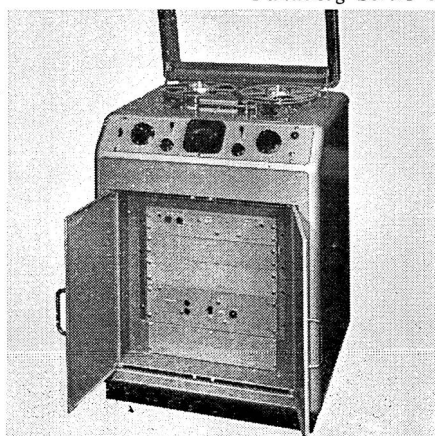

EMI TR90 in console form

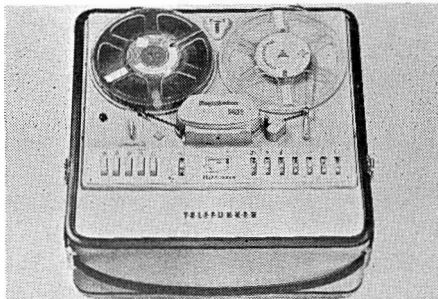

Magnetophon M24

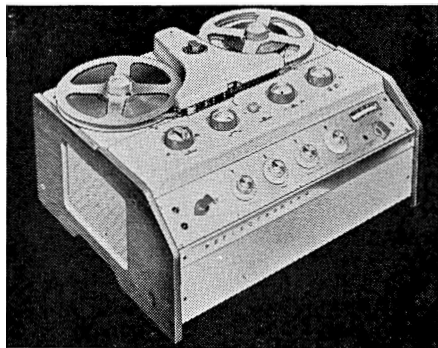

Reflectograph Model B

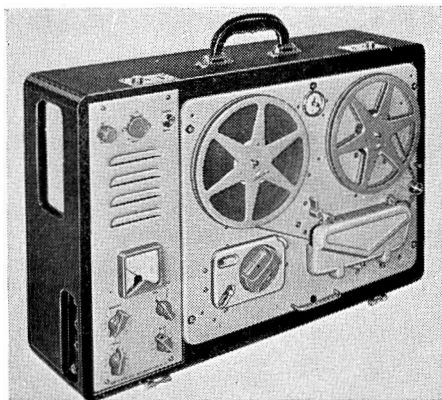

Vortexion WVA semi-professional portable

Multimusic Ltd., Mayland Avenue, Hemel Hempstead, Herts. Tel.: Boxmoor 3636. Cables: Multimusic, Hemel Hempstead.

Reflectograph Model A. Semi-prof. recorder chassis, suitable for rack mounting or fitting in carrying case. Speeds $7\frac{1}{2}$ and $3\frac{3}{4}$ i/s. 3 motors. $8\frac{1}{4}$ -in. spools. F.r.: $7\frac{1}{2}$ i/s, 50-10,000 c/s; $3\frac{3}{4}$ i/s, 40-7,500 c/s, both ± 2 dB. Level meter. H. & N. -50 dB. W. & F. less than 0.2%. Outlet from

pre-amp. Size $20 \times 16 \times 10$ ins. Weight 50 lb. (approx.) Price £110 5s.

■ **Model B.** Similar specification to Model A but fitted with $\frac{1}{4}$ track heads and facility for playing back $\frac{1}{4}$ track or $\frac{1}{2}$ track pre-recorded stereo tapes with additional amplifier. Price £120 15s.

Model D. Semi-professional playback deck only. Pre-amplifier provides anode follower output. Price £57 15s.



Revere. Sole U.K. distributors. **John Hadland and Co.** Chipperfield, Herts. Tel.: Kings Langley 3669.

Full range of Revere professional and semi-professional recorders.



Telefunken—Sole U.K. distributors, **Welmec Corporation Ltd.**, 147 Strand, London, W.C.2. Tel.: Temple Bar 3357. Cables: Welmcoc, London.

Magnetophon M24. Studio recorder. Half track. Speeds $7\frac{1}{2}$ and $3\frac{3}{4}$ i/s. 3 motors. $8\frac{3}{4}$ -in. spools. F.R. 30-18,000 c/s. $7\frac{1}{2}$ i/s, 40-15,000 c/s. $3\frac{3}{4}$ i/s. H. & N. -50 dB. W. & F. 1.5% at $7\frac{1}{2}$ i/s. Size according to cabinet. Prices from 159 gns.



Vortexion Ltd., 257/263 The Broadway, Wimbledon, London, S.W.19. Tel.: Liberty 6242/3. Cables: Vortex, Wimbledon.

Model WVA. Complete semi-pro. portable recorder 15 and $7\frac{1}{2}$ i/s or $7\frac{1}{2}$ and $3\frac{3}{4}$ i/s. Wright and Weaire deck. 3 motors. $8\frac{1}{4}$ -in. spools. F.r.: 30-17,000 c/s ± 3 dB at 15 i/s; 30-15,000 c/s ± 3 dB at $7\frac{1}{2}$ i/s. S-N <50 dB unweighted. W. & F., <0.2%. Meter level ind. ■ Provision for fitting stereo head with direct connection. Loads 7uV mic. Weight 49 lb. Price £93 13s. (£5 extra for 15 i/s).

Model WVB. Spec. as for WVA, but with extra monitor head and amplifier. Echo facilities. ■ Provision for fitting of stereo head. Price £110 3s. (£5 extra for 15 i/s).

Model WVA/S Spec. as for WVA with provision for plug-in stereo head, and can be supplied with this and stereo playback pre-amplifiers with equalisation each having an output of 1 volt from a cathode follower. Speeds $3\frac{3}{4}$ and $7\frac{1}{2}$ i/s. Price £112 10s.

GENERAL PURPOSE and DOMESTIC RECORDERS

● Some late arrivals are listed out of alphabetical order at the end of this section.

Abbey Radiogram Manufacturing Co., 1a Compton Terrace, Hoppers Road, London, N.21. Tel.: Palmers Green 7492.

Sovereign. Collaro Mk. IV deck. F.R. 15 i/s, 50-15,000 c/s \pm 3 dB; $7\frac{1}{2}$ i/s, 50-12,000 c/s; $3\frac{3}{4}$ i/s, 50-7,000 c/s \pm 3 dB. W and F, 0.15%. M.E. level ind. Monitoring of input signal through speaker. Mixing of inputs. Screw-in legs available. Size $18\frac{1}{2} \times 13\frac{3}{4} \times 9\frac{1}{2}$ ins. Weight 38 lbs. Price, with tape and mic., £50 8s. Legs £2 2s.

Royal Monardeck. $3\frac{3}{4}$ i/s. M.E. level ind. Variable monitoring. Mixing. Outlet from pre-amp. Size $14\frac{1}{2} \times 14 \times 8$. Weight 19 lbs. Price £26 5s.

Regent. Collaro Studio deck. $7\frac{1}{2}$, $3\frac{3}{4}$, $1\frac{7}{8}$ i/s. 3 motors. M.E. level ind. Variable monitoring. Mixing. Size $15 \times 18 \times 8$ ins. Weight 32 lbs. Price £40 19s. Legs £2 2s.



Alba (Radio & Television) Ltd., Tabernacle Street, London, E.C.2. Tel.: Clerkenwell 1322.

Duchess Model R.59. Monardeck. $3\frac{3}{4}$ i/s. F.R. 60-7,000 c/s. W and F 0.2%. Twin neon level ind. Outlet from pre-amp. Size $14 \times 12 \times 6\frac{1}{2}$ ins. Weight 20 lbs. Price £28 7s.



Allegro Sound Equipment Ltd., 7/8 Avery Row, Mayfair, London, W.1. Tel.: Mayfair 9910.

Contessa. Collaro Studio deck. F.R. $7\frac{1}{2}$ i/s, 30-10,000 c/s \pm 3 dB. 3 motors. 7 in. spools. M.E. level ind. W and F 0.15%. H & N -45 dB. Monitoring. Superimposition. Size $15\frac{1}{2} \times 15 \times 8$ ins. Weight 25 lbs. Price £44 2s.



Brenell Engineering Co. Ltd., 1a Doughty Street, London, W.C.1. Tel.: Holborn 7358.

Three Star. $7\frac{1}{2}$, $3\frac{3}{4}$ and $1\frac{7}{8}$ i/s. 1 motor. 7-in. spools. F.R. $7\frac{1}{2}$ i/s, 60-10,000 c/s \pm 3 dB; $3\frac{3}{4}$ i/s, 60-6,000 c/s \pm 3 dB; $1\frac{7}{8}$ i/s,



Abbey Sovereign



The Alba Duchess



Allegro Contessa

60-3,000 c/s \pm 3 dB. S-N, $<$ -40 dB. W & F, $<$ 0.2% at 7½ i/s. M.E. level ind. Outlet from pre-amp. stage. Straight through amplifier. Adaptable for Stereo. Headphone monitoring. Size 15 × 15 × 7 ins. Weight 30 lbs. Price, with tape and mic., £60 18s. (Quarter track model available at same price.)

■ **Three Star Stereo.** Stereo recorder, 7½, 3¾ and 1¾ i/s. 7-in. spools. Level ind. in each channel. Twin built-in loudspeakers. Bass and treble controls. Straight through amp. Performance details as Three Star. Weight 40 lbs. Price £93 9s. or £99 15s. with two microphones. (Quarter track model available at same price.)

Mk. 5. 15, 7½, 3¾ and 1¾ i/s. 3 motors. 8¼-in. spools. F.R. 15 i/s, 50-16,000 c/s; 7½ i/s, 60-12,000 c/s; 3¾ i/s, 60-7,000 c/s; 1¾ i/s, 60-4,000 c/s. All \pm 3 dB. M.E. level ind. (Meter available.) H & N -45 dB. W & F 0.05% at 15 i/s. Hi-fi outlet at 200 mV. Straight through amp. Switched frequency correction. Pause control and monitoring. Size 18 × 18 × 8 in. Weight 43 lbs. Price £67 4s., with meter £72 9s.

■ **Mk. 5 Stacked Stereophonic.** Rack mounted. General details as Mk. 5. Records and replays stereo or half-track mono. Alternatively records on one track whilst replaying on other. Price £99 12s.

■ **Brenell Staggered Stereo record and replay.** Mk. 5 deck, 15, 7½, 3¾ and 1¾ i/s. Two Mk. 5 amps. F.R. as Mk. 5 portable. Mounted in special rack 17½ × 16½ × 11 ins. Weight 43 lbs. No speakers. Price £93 16s.



British Ferrograph Recorder Co. Ltd., 88 Soffersery Road, London, S.W.1. Tel.: Sullivan 5426. Cables: Britferro, Sowest.

Ferrograph 4A/N and 4A/H. Complete portable recorder. Any two adjacent speeds from 3¾ to 15 i/s. 3 motors. 8¼-in. spools. F.R. 15 i/s, 40-15,000 c/s \pm 2 dB; 7½ i/s 40-12,000 c/s \pm 3 dB, 50-10,000 c/s \pm 2 dB; 3¾ i/s, 50-6,000 c/s \pm 3 dB. Sustained peak signal level meter. Space under the head cover for additional plug-in head for monitoring, lower track working stereo playback or American dual stereo standard. Size 18½ × 17½ × 9¾ ins. Weight 50 lbs. Prices, 4 A/N (7½ and 3¾ i/s) £85 1s.; 4 A/H (15 and 7½ i/s) £90 6s.

■ **Ferrograph 4 S/N and 4 S/H** as models 4 A/N and 4 A/H, but with stereo replay heads fitted. For the replay of stereo tapes through external amplifiers. Prices, 4 S/N £92 8s., 4 S/H £97 13s.

■ **Ferrograph Stereo 808.** A complete Monaural stereo recorder/reproducer. For tape speeds of 3¾ i/s and 7½ i/s. Switched input meter enables levels of both channels to be balanced. Output of each channel on playback approx. 1.5 volts across 5,000 ohms. Can also be used for monaural record/replay. Price £110 5s.



Cape Electrophonics Ltd., 43/45 Shirley High Street, Southampton. Tel.: Southampton 74251.

Cape VLT. Recorder/reproducer chassis. 3 motors. 15, 7½ and 3¾ i/s. 8¼-in. spools. F.R. 15 i/s 40-16,000; 7½ i/s, 40-12,000; 3¾ i/s 50-7,000 c/s. All \pm 3 dB. Meter. W & F 15 i/s 0.05%. Outlet from pre-amp. stage. Monitoring and mixing controls. Price provisionally fixed at £60. 7½, 3¾ and 1¾ model available.



Chitnis Electronics Ltd., 66 Bolsover Street, London, W.1. Tel.: Euston 4264.

Chitnis KM22. 3¾, 1¾ i/s. 1 motor. 5¾-in. spools. F.R. 3¾ i/s, 30-16,000 c/s; 1¾ i/s, 30-10,000 c/s, both \pm 3 dB. M.E. level ind. Weight 19½ lbs. W & F 0.12% at 3¾ i/s. Size 14 × 12 × 8 ins. Outlet from pre-amp. Price, with dynamic mic., £50 8s.

Chitnis KM 33. Four-track version of the above. Price £56 14s.

Audiograph AF42. Speeds 7½ and 3¾ i/s. 7-in. spools. F.R. 7½ i/s, 50-16,000 c/s \pm 3 dB; 3¾ i/s 50-10,000 c/s \pm 3 dB. M.E. level ind. S-N -44 dB. W & F 0.15%. Outlet from pre-amp stage. Weight 20 lbs. Price £40 19s.

■ **Audiograph 9/S4K.** Monaural and stereo four track. Speed 3¾ i/s. 5¾-in. spools. F.R. 30-16,000 c/s \pm 3 dB. M.E. level ind. S-N -55 dB. W & F 0.1%. Outlet from pre-amp stage. Size 13 × 10½ × 6 ins. Weight 17½ lbs. Price £58 16s.

■ **Audiograph KMS/66.** Monaural and stereo four track. Speed 3¾ i/s. 5¾-in. spools. F.R. 30-16,000 c/s \pm 3 dB. M.E.

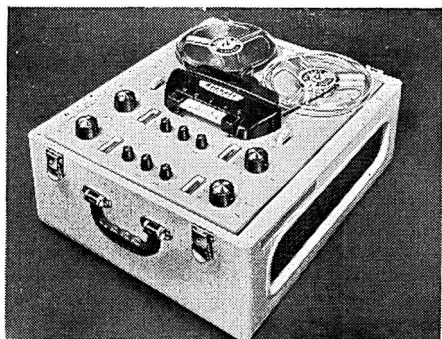

Brenell Three Star stereo

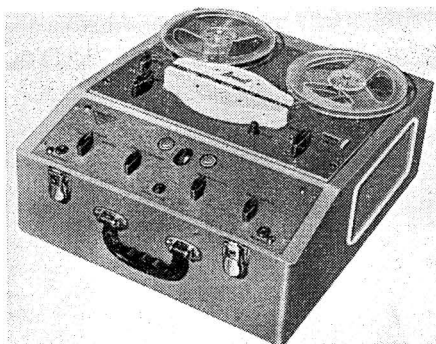

Brenell Mk. 5 portable

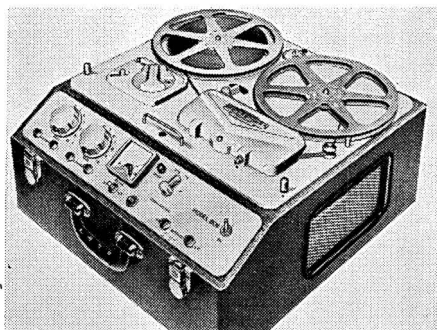

Ferrograph Model 808



Brenell Three Star

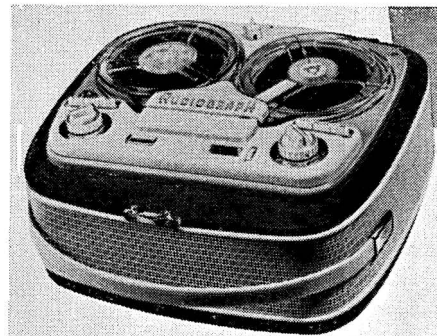

Chitnis Audiograph KMS/66

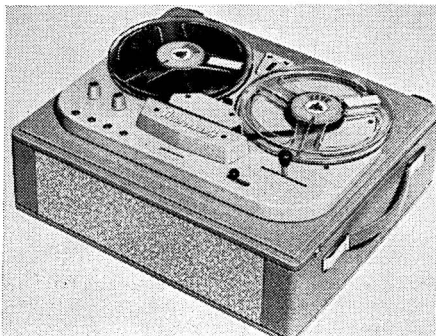

Chitnis Audiograph 9/S4K

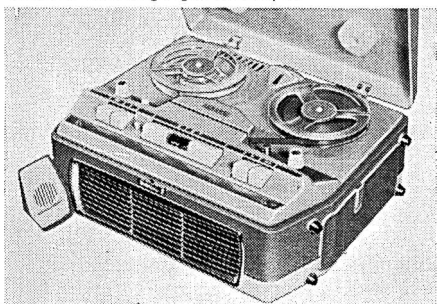

Cossor CR1602

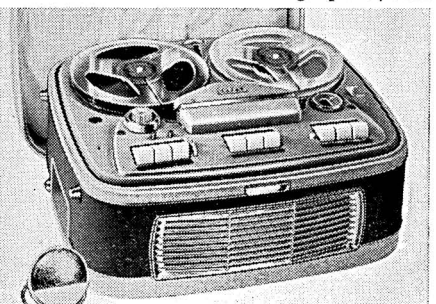

Cossor CR1601

level ind. S-N -55 dB. W & F 0.1%. Outlet from pre-amp stage. Size 14 × 12 × 8 ins. Weight 20 lbs. Price with second speaker in lid £69 6s.



Clarke and Smith Manufacturing Co. Ltd., Melbourne Works, Wallington, Surrey. Tel.: Wallington 9252-7. Cables: Electronic, Wallington.

Model CTR/4. Collaro Mk. IV deck. F.R. 15 i/s, 50-16,000 c/s; 7½ i/s, 50-12,500 c/s; 3¼ i/s, 50-7,000 c/s. S-N < -45 dB. M.E. level ind. 6 watts output. Monitoring by headphones. Power supply available to power mixer unit or FM tuner. Stout wooden case. Size 10 × 18½ × 15½ ins. Weight 48 lbs. Price, with tape and mic., £71 6s. 6d.

Model STR/4. Wright and Weaire deck. F.R. 7½ i/s, 50-11,000 c/s ± 3 dB; 3¼ i/s, 50-5,000 c/s ± 3 dB. S-N -50 dB. M.E. level ind. 4½ watts output. Monitoring by headphones. Oak case. Size 18 × 14½ × 10 ins. Weight 48 lbs. Price, with tape and mic., £98 13s.



Cossor Radio & Television Ltd., 71 Endell Street, London, W.C.2. Tel.: Gerrard 2931.

CR1601. Four track. Speeds 7½, 3¼ and 1½ i/s. 7-in spools. F.R. 7½ i/s, 50-20,000 c/s; 3¼ i/s, 50-15,000 c/s; 1½ i/s, 50-7,000 c/s. M.E. level ind. H & N better than -40 dB. W. & F less than 0.2% at 7½ i/s. Monitoring, superimposing, tone and pause controls. Size 16½ × 14¼ × 7¾ ins. Weight 30 lbs. Price with tape and moving coil microphone £61 19s.

CR1602. Four track. Speed 3¼ i/s. 7-in. spools. F.R. 50-14,000 c/s. M.E. level ind. H & N -40 dB. W & F < 0.3%. Four track recording/playback. Monitoring, superimposing, tone and pause controls. Size 15¼ × 12½ × 6¾ ins. Weight 19 lbs. Price with tape and crystal mic. £38 17s.



Connaught (Tape Recorder) Ltd., 1 Kings House, 396 Kings Road, London, S.W.3. Tel.: Flaxman 6575/6.

Console. Wearite deck. F.R. 30-16,000 c/s ± 2 dB at 7½ i/s. Meter. Outlet from pre-amp. stage. 10 watts output. Mounted

in a pressure controlled cabinet housing 12 in. drive unit and 2 tweeters. 5 inputs. Price, with tape and moving coil mic., £125.

Tape-o-gram. Details as Console plus provision for AM/FM radio and four-speed gram. 15 and 9-in. speakers plus two tweeters. Size 22 × 56 × 45 ins. Price, with moving coil mic., £210.

Tape-o-gram Stereo. Complete stereo system including AM/FM radio, four-speed gram. Price £350.



Incis. Sole U.K. distributors, **Denham & Morley Ltd.,** Denmore House, 175 Cleveland Street, London, W.1. Tel.: Euston 3656. Cables: Denmorl, Wesdo, London.

Incis. 3¼ and 1½ i/s. 1 motor. 4-in. spools. F.R. 3¼, 70-10,000 c/s; 1½ i/s, 100-6,000 c/s. M.E. level ind. Output from pre-amp. stage. Two speakers, one fitted in carrying case. Size 10¼ × 9 × 5 in. Price £30 9s.



Direct TV Replacements Ltd., 138 Lewisham Way, New Cross, London, S.E.14. Tel.: Tideway 6666.

Chelsea. Collaro Studio deck. Price, with tape and microphone, £44 2s.



Electric Audio Reproducers Ltd., The Square, Isleworth, Middx. Tel.: Isleworth 6256. Cables: Eargram, Isleworth, Hounslow.

Bantam. B.S.R. Monardeck. F.R. 60-9,000 c/s for 6 dB down. Twin neon level ind. Outlet from pre-amp. Size 10¼ × 15½ × 6¾ ins. Weight 19 lbs. Price £29 8s.



Elizabethan (Tape Recorders) Ltd., Bridge Close, Oldchurch Road, Romford, Essex. Tel.: Romford 62366-7. Cables: Elizabethan, Romford.

Elizabethan Avon. B.S.R. Monardeck. F.R. 60-10,000 c/s. M.E. level ind. H & N -40 dB. Two inputs, two outputs Tone control, mixing and superimposing. Size 14 × 7½ × 10½ ins. Weight 16½ lbs. Price, with tape and mic, £28 7s.

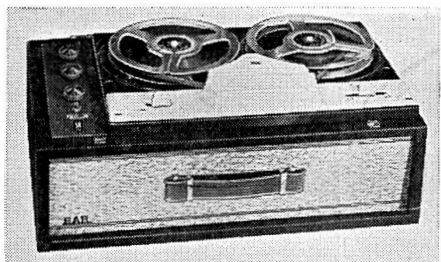

E. A. R. Bantam



Clarke & Smith STR/4



Chelsea G.P. portable

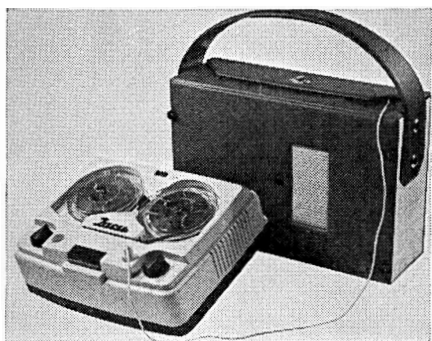

Incis



Elizabethan Princess

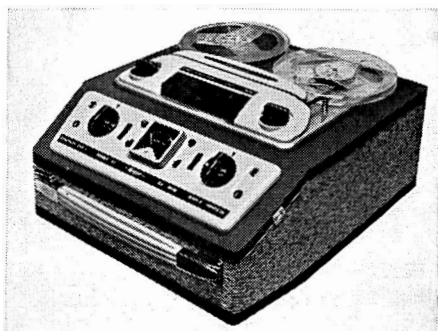

Elizabethan Major

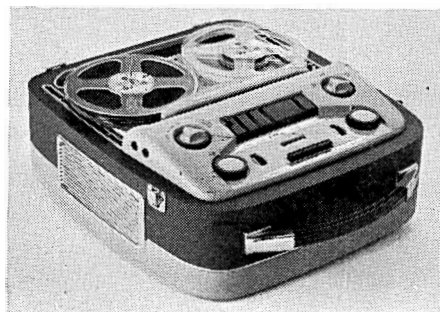

Elizabethan FT3

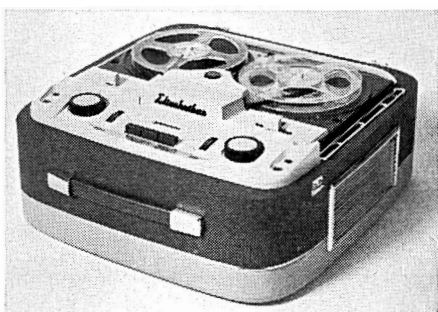

Elizabethan FT1

Elizabethan Princess. Motek deck. F.R. $7\frac{1}{2}$ i/s, 60-12,000 c/s; $3\frac{3}{4}$ i/s, 60-8,500 c/s; $1\frac{1}{8}$ i/s, 60-6,000 c/s. M.E. level ind. H & N -40 dB. W & F better than 0.2% at $7\frac{1}{2}$ i/s. Mixing, superimposing and monitoring. Size $14 \times 11\frac{1}{2} \times 6\frac{3}{4}$ ins. Weight 23 lbs. Price, with tape and mic, £40 19s.

Elizabethan Major. Collaro Studio deck. F.R. $7\frac{1}{2}$ i/s, 50 to 20,000 c/s; $3\frac{3}{4}$ i/s, 50 to 14,000 c/s; $1\frac{1}{8}$ i/s, 50 to 7,000 c/s, all ± 3 dB. Level meter. H & N -45 dB. W & F 0.15% at $3\frac{3}{4}$ i/s. 6 watts push-pull outlet. 10×6 in. speaker plus tweeter. Size $15\frac{1}{2} \times 16\frac{3}{4} \times 9$ ins. Weight 32 lbs. Price, with tape, £68 5s. (4 track version available at same price).

Elizabethan FT1. Four track B.S.R. Monardeck. F.R. 50-12,000 c/s. M.E. level ind. Tone control, mixing and superimposing. Price £35 14s.

Elizabethan FT3. Four track $7\frac{1}{2}$, $3\frac{3}{4}$ and $1\frac{1}{8}$ i/s. Collaro deck. F.R. $7\frac{1}{2}$, 50-16,000 c/s. M.E. level ind. Tone control, mixing and superimposing. Stereo recording and playback with additional equipment. Price £47 5s.

Elizabethan Popular. B.S.R. Monardeck. $3\frac{3}{4}$ i/s. $5\frac{3}{4}$ -in. spools. F.R. 60-8,000 c/s. M.E. level ind. Tone control. Size $13 \times 11 \times 6\frac{1}{2}$ ins. Weight 15 lbs. Price, with tape and mic, £20 9s. 6d. De-Luxe version available £25 4s.

★

Ferguson Radio Corporation Ltd., Thorn House, Upper St. Martin's Lane, London, W.C.2. Tel.: Temple Bar 2444. Cables: Eleclampo, Lesquare, London.

441TR. B.S.R. Monardeck. F.R. 40-10,000 c/s ± 5 dB. M.E. level ind. H & N -45 dB. W & F better than 0.2%. Outlet from pre-amp. Size $14\frac{3}{4} \times 12\frac{1}{4} \times 6\frac{1}{4}$ ins. Weight $15\frac{1}{2}$ lbs. Price £29 8s.

★

Fidelity Radio Ltd., 11/13 Blechynden Street, London, W.11. Tel.: Park 4239/1321.

Argyll. B.S.R. Monardeck. F.R. 60-10,000 c/s. H & N -50 dB. W & F 0.4%. M.E. level ind. Two inputs, mixing, superimposing and monitoring. Size $17 \times 13\frac{1}{2} \times 7\frac{1}{4}$ ins. Weight 21 lbs. Price, with tape and mic., £30 9s.

Gainsborough Tape Recorders Ltd., 189 Northcote Road, Battersea, London, S.W.11. Tel.: Battersea 4718.

Gainsborough Mark I. Collaro deck. $7\frac{1}{2}$, $3\frac{3}{4}$ and $1\frac{1}{8}$ i/s. 7-in. spools. F.R. $7\frac{1}{2}$, 40-14,000 c/s; $3\frac{3}{4}$, 40-10,000 c/s; $1\frac{1}{8}$, 40-7,000 c/s. H & N -40 dB. W & F 0.15%. M.E. level ind. Outlet from pre-amp. Size $17\frac{1}{2} \times 15 \times 8$ ins. Weight 29 lbs. Price £40 19s.

Gainsborough Mark IV. Collaro deck. $7\frac{1}{2}$, $3\frac{3}{4}$ and $1\frac{1}{8}$ i/s. 7-in. spools. F.R. $7\frac{1}{2}$, 40-15,000 c/s; $3\frac{3}{4}$, 40-11,000 c/s; $1\frac{1}{8}$ 40-7,000 c/s. H & N -60 dB. W & F 0.15%. Level meter. Outlet from pre-amp. Size $19\frac{1}{2} \times 17\frac{1}{2} \times 10\frac{1}{2}$ ins. Weight 36 lbs. Price £69 6s.

★

The Gramophone Company Ltd., Hayes, Middx. Tel.: Hayes 3888. Cables: Jabberment, London.

D.S.R.I. Speeds $7\frac{1}{2}$ and $3\frac{3}{4}$ i/s. Three motors. 7-in. spools. F.R. $7\frac{1}{2}$ i/s, 50-10,000 c/s; $3\frac{3}{4}$ i/s, 50-8,000 c/s. M.E. level ind. H & N -45 dB. W & F less than 0.3%. Outlet from pre-amp. Three heads. Separate record and playback amplifiers. Size $17\frac{1}{2} \times 14\frac{3}{4} \times 8$ ins.. Weight 33 lbs. Price £50.

★

Grundig (Gt. Britain) Ltd., Newlands Park, Sydenham, S.E.26. Tel.: Sydenham 2211. Showroom: 39-41 New Oxford Street, W.C.1. Cables: Grundig, London. Telex. 22054.

TK20. $3\frac{3}{4}$ i/s. One motor. $5\frac{3}{4}$ -in. spools. F.R. 60-10,000 c/s + 5 - 4 dB. S-N < -45 dB. W & F < $\pm 0.2\%$. Bar type M.E. level ind. Output from pre-amp. stage. Auto stop at end of tape. Size $13\frac{3}{4} \times 12\frac{1}{2} \times 7$ ins. Weight 20 lbs. Price with tape and mic., £54 12s.

TK24. $3\frac{3}{4}$ i/s. Four track. One motor. $5\frac{3}{4}$ -in. spools. F.R. 60-12,000 c/s. S-N -40 dB. W & F 0.2%. M.E. level ind. Output from pre-amp. stage. Auto stop at end of tape. Size $13\frac{3}{4} \times 12\frac{1}{2} \times 7$ ins. Weight 21 lbs. Price, with tape and mic., £65 2s.

TK25. $3\frac{3}{4}$ and $1\frac{1}{8}$ i/s. One motor. $5\frac{3}{4}$ -in. spools. F.R. $3\frac{3}{4}$ i/s, 60-15,000 c/s ± 3 dB; $1\frac{1}{8}$ i/s, 60-8,000 c/s ± 3 dB. S-N < -45 dB. W & F $3\frac{3}{4}$ i/s, < $\pm 0.25\%$, $1\frac{1}{8}$ i/s, < 0.4%. Bar type M.E. level ind. Output



Elizabethan Popular

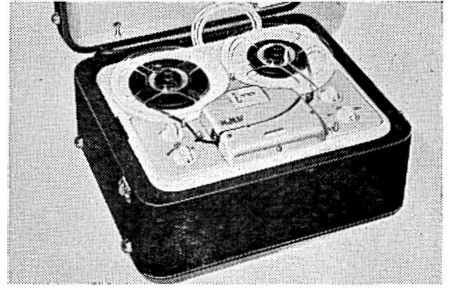

Gramophone Co. D.S.R.1



Gainsborough Mark I



Gainsborough Mark IV



Ferguson 441 TR



Grundig TK35



Grundig TK20

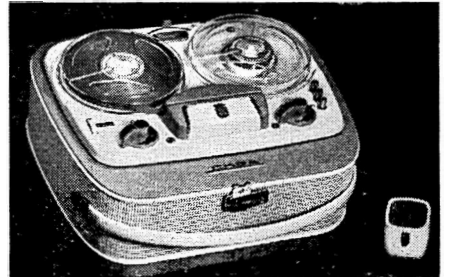

Grundig TK24

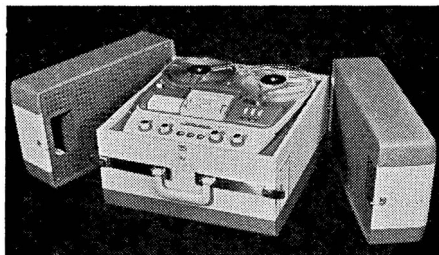

Grundig TK60 stereo portable



Kolster-Brandes RT20/1



Elpico TR/400

from pre-amp. stage. Input fading control. Superimposing. Size $14 \times 12\frac{1}{2} \times 7\frac{1}{2}$ ins. Weight 25 lbs. Price, with tape, £65 2s.

TK30. $7\frac{1}{2}$ and $3\frac{3}{4}$ i/s. One motor. 7-in. spools. F.R. $7\frac{1}{2}$ i/s, 50-15,000 c/s ± 3 dB; $3\frac{3}{4}$ i/s, 50-10,000 c/s ± 3 dB. S-N < -43 dB. W & F $7\frac{1}{2}$ i/s, $< 0.2\%$; $3\frac{3}{4}$ i/s, $< \pm 0.25\%$. Bar type M.E. level ind. Output from pre-amp. stage. Superimposing. Auto stop at end of tape. Remote control facilities. Size $18 \times 18 \times 11\frac{1}{2}$ ins. Weight 31 lbs. Price, with tape, £75 12s.

TK35. $7\frac{1}{2}$, $3\frac{3}{4}$ and $1\frac{7}{8}$ i/s. One motor. 7-in. spools. F.R. $7\frac{1}{2}$ i/s, 50-18,000 c/s ± 3 dB; $3\frac{3}{4}$ i/s, 50-14,000 c/s ± 3 dB; $1\frac{7}{8}$ i/s,

100-8,000 c/s ± 3 dB. S-N < -43 dB. W & F $7\frac{1}{2}$ i/s $< \pm 0.2\%$, $3\frac{3}{4}$ i/s $- 0.25\%$, $1\frac{7}{8}$ i/s $- 0.4\%$. Output from pre-amp. stage. Superimposing, auto stop, remote control facilities. Bar type M.E. level ind. Size $17 \times 16\frac{3}{4} \times 9\frac{1}{2}$ ins. Weight 34 lbs. Price, with tape, £86 2s.

TK55. Stereo playback. Speeds $7\frac{1}{2}$, $3\frac{3}{4}$ and $1\frac{7}{8}$ i/s. One motor. 7-in. spools. F.R. $7\frac{1}{2}$ i/s, 50-15,000 c/s; $3\frac{3}{4}$ i/s, 50-10,000 c/s; $1\frac{7}{8}$ i/s, 100-6,000 c/s, all ± 3 dB. M.E. level ind. H & N -43 dB. W & F less than 0.2% at $7\frac{1}{2}$ i/s. Mono recording, mono/stereo playback. Size $17 \times 16\frac{3}{4} \times 9\frac{1}{2}$ ins. Weight $34\frac{3}{4}$ lbs. Price £96 12s.

TK60. Mono/stereo. Speeds $7\frac{1}{2}$ and $3\frac{3}{4}$ i/s. One motor. 7-in. spools. F.R. $7\frac{1}{2}$ i/s, 50-15,000 c/s; $3\frac{3}{4}$ i/s, 50-10,000 c/s, both ± 3 dB. M.E. level ind. H & N -40 dB. W & F less than 0.2% at $7\frac{1}{2}$ i/s. Outlet from pre-amp. Stereo/mono recording and playback. Detachable loudspeakers. Size $27 \times 17\frac{1}{2} \times 12$ ins. Weight 54 lbs. Price £134 8s.



Hatfield Radio, 28 Stroud Green Road, London, N.4. Tel.: Archway 1593.

Viking. Motek deck. F.R. $7\frac{1}{2}$ i/s, 50-11,000 c/s ± 3 dB. S-N < -45 dB. M.E. level ind. Outlet from pre-amp. stage. Superimposing. Monitoring by headphones from erase head. Size $16 \times 14\frac{1}{2} \times 8$ ins. Weight 34 lbs. Price, with tape and mic., £48 6s.



H. E. Kettle Ltd., P.O. Box No. 28, Knightrider Street, Maidstone. Tel.: Maidstone 55551. Cables: Kettle Ltd., Maidstone.

Knightrider. B.S.R. Monardeck. Speed $3\frac{3}{4}$ i/s. One motor. $5\frac{3}{4}$ -in. spools. M.E. level ind. Size $13\frac{3}{4} \times 9\frac{1}{2} \times 6$ ins. Weight 17 lbs. Price £25.



K.G.M. Electronics Ltd., 2/4 Bardolph Road, Richmond, Surrey.

Cinecorder (see cine section).



Kolster-Brandes Ltd., Footscray, Sidcup, Kent. Tel.: Footscray 3333. Cables: Matchtone, Sidcup.

RT 20/1. B.S.R. Monardeck. Speed $3\frac{3}{4}$ i/s. One motor. $5\frac{3}{4}$ -in. spools. M.E. level ind. Size $7\frac{1}{2} \times 16\frac{3}{4} \times 13\frac{1}{4}$ ins. Weight 22 lbs. Price £28 7s.

Kurland Recording Systems Ltd., 9/11 Tilly's Lane, High Street, Staines, Middx. Tel.: Staines 52788.

TR7M. Collaro Mk. IV deck. F.R. 15 i/s, 40-15,000 c/s; $7\frac{1}{2}$ i/s, 50-12,000 c/s; $3\frac{3}{4}$ i/s, 50-9,000 c/s. S-N -40 dB. W & F < 0.1%. M.E. level ind. Built-in mixer. Size $15\frac{1}{4} \times 15\frac{1}{2} \times 7\frac{1}{4}$ ins. Weight 35-lbs. Price, with tape and mic., £58 16s.

Konsollette. Collaro Studio deck. M.E. level ind. W & F 0.15% at $3\frac{3}{4}$ i/s. Superimposing. Size $13\frac{1}{2} \times 14\frac{1}{2} \times 7$ ins. Weight 24 lbs. Price £39 18s.



Lee Products (G.B.) Ltd., Elpico House, Longford Street, London, N.W.1. Tel.: Euston 5754. Cables: Leprod, London, N.W.1.

Elpico TR/400. B.S.R. Monardeck. F.R. 80-8,000 c/s. M.E. level ind. H & N -40 dB. W & F < 0.4%. Size $13\frac{3}{4} \times 11\frac{1}{4} \times 6$ ins. Weight 17 lbs. Price, with tape and mic., £27 6s.

Elpico TR/500. B.S.R. Monardeck. $3\frac{3}{4}$ i/s. One motor. $5\frac{1}{2}$ -in. spools. F.R. 80-8,000 c/s. H & N -40 dB. W & F < 0.25%. M.E. level ind. Outlet from pre-amp. stage. Size $14\frac{1}{2} \times 13 \times 6\frac{3}{4}$ ins. Weight 18 lbs. Price £29 8s.

Elpico TR/600. B.S.R. Monardeck. Four track. $3\frac{3}{4}$ i/s. One motor. $5\frac{1}{4}$ -in. spools. F.R. 80-8,000 c/s. H & N -40 dB. W & F < 0.25%. M.E. level ind. Outlet from pre-amp. stage. Size $14\frac{1}{2} \times 13 \times 6\frac{3}{4}$. Weight 18 lbs. Price £33 12s.

Elpico/Geloso G.256. Miniature G.P. portable. Speed $1\frac{1}{2}$ i/s. One motor. $3\frac{1}{4}$ -in. spools. F.R. 80-6,000 c/s. DM70 level ind. H & N -40 dB. W & F 0.3%. Size $10 \times 5\frac{1}{2} \times 4$ ins. Weight $6\frac{1}{2}$ lbs. Price £27 16s. 6d.

Elpico/Geloso G.258. $3\frac{3}{4}$, $1\frac{1}{2}$ and $\frac{1}{16}$ i/s. One motor. 5-in. spools. F.R. 50-12,000 c/s. H & N -40 dB. W & F < 0.2%. M.E. level ind. Size $13 \times 8\frac{3}{4} \times 6\frac{1}{4}$ ins. Weight $12\frac{1}{4}$ lbs. Price £44 2s.



Magnafon Record Co., 3 Baggally Street, London, E.3. Tel.: Advance 3112.

Zodiac. Speeds $7\frac{1}{2}$, $3\frac{3}{4}$ and $1\frac{1}{8}$ i/s. Three motors. 7-in. spools. F.R. $7\frac{1}{2}$ i/s, 40-12,000 c/s; $3\frac{3}{4}$ i/s, 40-8,000 c/s; $1\frac{1}{8}$ i/s, 40-5,000 c/s, all ± 3 dB. M.E.

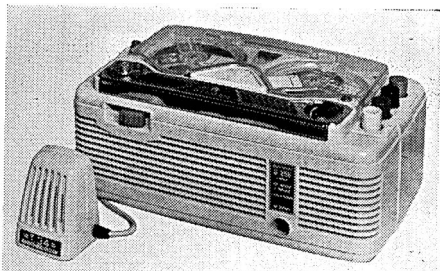

Elpico Geloso G256

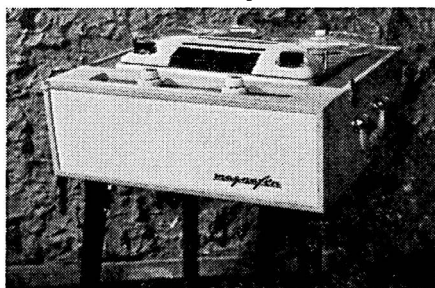

Magnafon Zodiac



Murphy TR1

level ind. H & N -45 dB. W & F 0.2%. Mixing, superimposing. Outlet from pre-amp. Size $15\frac{1}{2} \times 16\frac{1}{2} \times 7\frac{1}{2}$ ins. Weight 28 lbs. Price 2-track £40 19s., 4-track £47 5s., legs £2 2s. extra.



Murphy Radio Ltd., Welwyn Garden City, Herts. Tel.: Welwyn Garden 3434.

TR1. Garrard magazine loading deck. M.E. level ind. Two inputs, outlet from pre-amp. Size $12\frac{3}{4} \times 10\frac{1}{2} \times 7\frac{1}{8}$ ins. Weight 21 lb. Price £29 18s. 6d.

Philips Electrical Ltd., Century House, Shaftesbury Avenue, London, W.C.2. Tel.: Gerrard 7777. Cables: Phillamps, London,

■**EL3536.** Stereo recorder. Speeds $7\frac{1}{2}$, $3\frac{3}{4}$ and $1\frac{7}{8}$ i/s. F.R.: $7\frac{1}{2}$, 50-20,000 c/s; $3\frac{3}{4}$, 50-15,000 c/s; $1\frac{7}{8}$, 50-7,000 c/s. 7-in. spools. M.E. level ind. Four track stereo/mono. recording and playback. Size $20 \times 16\frac{3}{4} \times 11\frac{1}{2}$ ins. Weight 43 lbs. Price £96 12s.

EL3542. Four track. Speeds $7\frac{1}{2}$, $3\frac{3}{4}$ and $1\frac{7}{8}$ i/s. F.R. $7\frac{1}{2}$, 50-20,000 c/s; $3\frac{3}{4}$, 50-15,000 c/s; $1\frac{7}{8}$, 50-7,000 c/s. 7-in. spools. M.E. level ind. Four track mono. record/playback. Size $17\frac{3}{4} \times 13\frac{1}{2} \times 7\frac{7}{8}$ ins. Weight 30 lbs. Price £61 19s.

EL3541. Four track recorder. $3\frac{3}{4}$ i/s. F.R. 60-13,000 c/s ± 3 dB. H & N < -40 dB. W & F $< 0.3\%$. M.E. level ind. Size $14\frac{1}{4} \times 12 \times 6\frac{3}{4}$ ins. Weight 18 lbs. Price £35 14s.



Portogram Radio Electrical Industries Ltd., Audio Works, Paxton Road, Tottenham, London, N.17. Tel.: Tottenham 7683/4/5.

Monotape. B.S.R. Monardeck. F.R. 30-7,000 c/s ± 3 dB. M.E. level ind. H & N -60 dB. W & F $< 0.2\%$. Tone, control and outlet from pre-amp. Size $14 \times 12\frac{1}{4} \times 8$ ins. Weight 19 lbs. Price, with tape and mic., £30 9s.

Portotape. Collaro Studio deck. F.R. $7\frac{1}{2}$ i/s, 60-10,000 c/s; $3\frac{3}{4}$ i/s, 60-7,000 c/s; $1\frac{7}{8}$ i/s, 60-5,000 c/s, all ± 3 dB. M.E. level ind. H & N -60 dB. W & F 0.15% . Tone control, and outlet from pre-amp. Size $17\frac{1}{2} \times 16 \times 9\frac{3}{4}$ ins. Weight 36 lbs. Price, with tape and mic., £40 19s.



Radio Gramophone Development Co. Ltd., Eastern Avenue West, Romford, Essex. Tel.: Romford 45991.

RGD Mk. 107. $7\frac{1}{2}$ and $3\frac{3}{4}$ i/s. One motor. 7-in. spools. F.R. 30-18,000 c/s at $7\frac{1}{2}$ i/s; 40-13,000 c/s at $3\frac{3}{4}$ i/s. S-N -45 dB. W & F 0.3% at $3\frac{3}{4}$, 0.1% at $7\frac{1}{2}$. Direct connection to replay head. Connection for remote control. M.E. level ind. 4 watts output. Straight through amp. Size $16\frac{1}{2} \times 13 \times 8$ ins. Weight 29 lbs. Price £72 9s.

RGD Mk. 103. Motek deck. F.R. $7\frac{1}{2}$ i/s, 60-10,000 c/s; $3\frac{3}{4}$ i/s, 60-6,000 c/s; $1\frac{7}{8}$ i/s, 60-3,500 c/s, all ± 6 dB. S-N -45 dB. W & F 0.2% at $7\frac{1}{2}$ i/s. Neon level ind. Size $17 \times 14 \times 7\frac{1}{2}$ ins. Weight 24 lbs. Price, with tape and crystal mic., £51 9s.

RGD Mk. 104. B.S.R. Monardeck. F.R. 60-8,000 c/s. S-N -40 dB. W & F 0.4% . Neon level ind. Size $13 \times 14\frac{1}{2} \times 7$ ins. Weight 14 lbs. approx. Price, with tape and crystal mic., £22 1s.



Recording Devices Ltd., 44 Southern Row, Kensington, London, W.10. Tel.: Lad-broke 4775.

Mannequin. B.S.R. Monardeck. F.R. 80-9,000 c/s. M.E. level ind. H & N -40 dB. W & F 0.45% . Mixing superimposing. Size $13 \times 11 \times 6$ ins. Weight 17 lbs. Price £28 7s.

Stuzzi Tricorder. Speeds $3\frac{3}{4}$, $1\frac{7}{8}$ and $\frac{3}{8}$ i/s. One motor. $5\frac{1}{2}$ in. spools. F.R. $3\frac{3}{4}$ i/s, 40-16,000 c/s; $1\frac{7}{8}$ i/s, 40-8,000 c/s; $\frac{3}{8}$ i/s, 40-4,000 c/s. M.E. level ind. H & N -45 dB. W & F 0.25% . Mixing, Variable Superimposing, Monitoring and remote control. Size $13 \times 10 \times 6$ ins. Weight 18 lbs. Price £66 3s.

Stuzzi Junior 4M. Four track. B.S.R. Monardeck. $3\frac{3}{4}$ i/s. One motor. $5\frac{1}{2}$ -in. spools. F.R. 90-9,000. M.E. level ind. H & N < -30 dB. W & F 0.25% . Superimposing. Size $13\frac{3}{4} \times 14\frac{3}{4} \times 6\frac{3}{8}$ ins. Weight 18 lbs. Price £27 6s.



Regentone Radio & Television Ltd., Eastern Avenue West, Romford, Essex. Tel.: 45991.

RT20. B.S.R. Monardeck. Twin neon level ind. F.R. 60-8,000 c/s. S-N -40 dB. W & F 0.4% . Size $13 \times 14\frac{1}{2} \times 7$ ins. Weight 19 lbs. Price, with tape and crystal mic., £29 8s.



Reps. (Tape Recorders) Ltd., 118 Park Road North, South Acton, London, W.3. Tel.: Acorn 4141.

R.10. Collaro Studio deck. $7\frac{1}{2}$, $3\frac{3}{4}$ and $1\frac{7}{8}$ i/s. F.R. $7\frac{1}{2}$, 30-18,000 c/s ± 3 dB; $3\frac{3}{4}$, 40-12,000 c/s; $1\frac{7}{8}$ 50-6,000 c/s. Level meter. S-N -50 dB. W & F 0.1% . Size

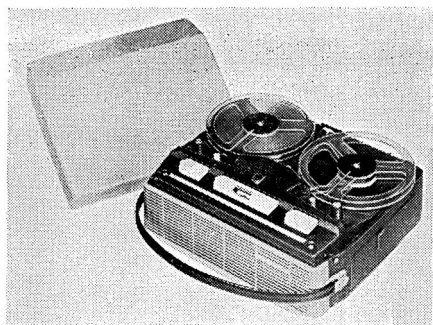

Philips EL3541

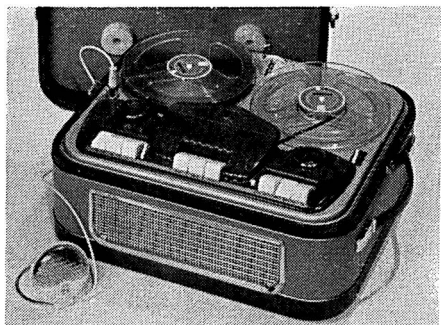

Philips EL3542

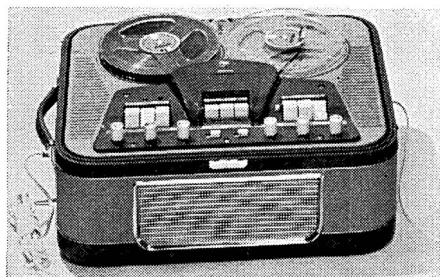

Philips EL3536

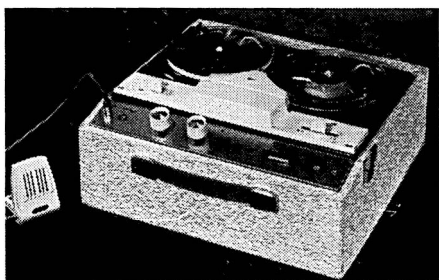

Regentone RT20

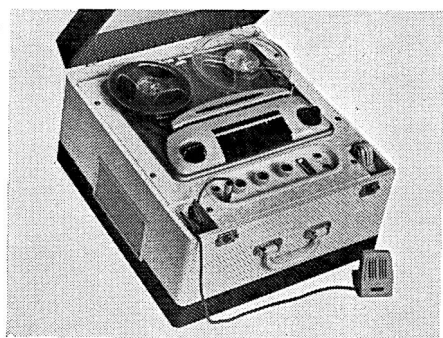

Portogram Portotape



Portogram Monotape

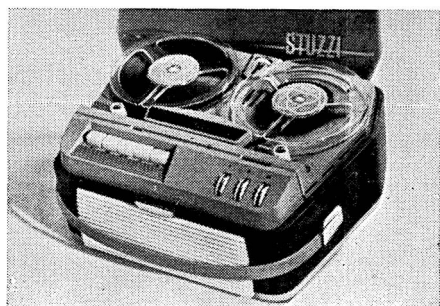

Stuzzi Tricorder



RGD Mk. 107

15½ × 15 × 9 ins. Weight 31 lbs. Price, with tape, crystal mic. and stand, £61 19s. Two track, £72 9s. four track.

R.20. Collaro Mk. IV deck. F.R. 15 i/s, 40-17,000 c/s; 7½ i/s, 50-10,000 c/s; 3¾ i/s, 60-6,000 c/s, all ± 3 dB. Meter level ind. Size 16½ × 16 × 9¾ ins. Weight 41 lbs. Price, with crystal mic., stand and spool of tape, £65 2s.

R.30. As above, but with 2 in. meter level ind. Price £69 6s.

R.40. Collaro Mk. IV deck. F.R. 15 i/s, 40-20,000 c/s; 7½ i/s, 50-12,000 c/s; 3¾ i/s, 60-6,000 c/s. 10 W peak output. M.E. level ind. Size 16½ × 9¾ × 16 ins. Weight 42 lbs. Price, with tape and crystal mic., £73 10s.

★

Robuk Electrical Industries Ltd., 559/561 Holloway Road, London, N.19. Tel.: Archway 1022.

Robuk RK3. 7½, 3¾ and 1⅞ i/s. Three motors. 7-in. spools. F.R. 7½, 60-14,000 c/s ± 3 dB; 3¾, 60-7,000 c/s ± 3 dB; 1⅞, 60-3,500 c/s. M.E. level ind. H & N < -40 dB. W & F < 0.2%. Outlet from pre-amp. stage. Size 16 × 11½ × 7¼ ins. Price £37 16s.

★

Henri Selmer & Co. Ltd., 114 Charing Cross Road, London, W.C.2. Tel.: Temple Bar 5432. Cables: Selmatone, West, Cent.

Saba. G.P. portable. 7½ and 3¾ i/s. Two motors. 7-in. spools. F.R. 7½ i/s, 30-20,000 c/s; 3¾ i/s, 40-16,000 c/s. W & F 7½ i/s ± 0.2%; 3¾ i/s ± 0.4%. Bar type M.E. level ind. Automatic stop and reversal at end of tape. Straight through amp. Outlet from pre-amp. stage. Superimposing. Provision for remote control. Size 17½ × 8½ × 17½ ins. Weight 37½ lbs. Price £82 19s.

★

Simon Equipment Ltd., 48 George Street, London, W.1. Tel.: Welbeck 2371. Cables: Simsale, London.

Simon SP/4. Automatic. Complete semi-portable. portable 7½ and 3¾ i/s. 1 synchronous motor. 7-in. spools. F.R. 7½ i/s, 30-15,000 c/s ± 3 dB. ref. 1,000 c/s, 3¾ i/s, 30-7,000 c/s ± 3 dB. M.E. level ind. S-N, < -52 dB. Ref. to 10W output. W. and F, < 0.2% peak to peak. Automatic reversal at end of

tape, 3 way mixing. Monitoring, push-pull oscillator. 10 watts output, 0.5% distortion. Independent tone controls. Provision for remote control. Size 16½ × 14¾ × 10½ ins. Weight 48 lbs. Price, with tape, £99 15s.

Minstrelle. Table model. Garrard magazine loading deck. 4-in. spools or magazines. M.E. level ind. Mixing, straight through amplifier. Built-in mic. Size 18¼ × 11½ × 8 ins. Weight 27½ lbs. Price £40 19s.

Minstrelle 4. Four-track version of above Price £43 1s.

■ **Minstrelle 4S.** Stereo record and playback version of Minstrelle 4. Price £66 3s.

Cymbal. Garrard magazine loading deck. 4 in. spools or magazines. M.E. level ind. Straight through amplifier. 3 watts output. Size 13 × 9½ × 6½ ins. Weight 22 lb. Price with crystal microphone and tape, £25 4s.

★

Specto Ltd., Vale Road, Windsor, Berks. Tel.: Windsor 1241/2. Cables: Specto, Windsor.

Spectone 161. Collaro Mk. IV deck. F.R. 15 i/s, 50-16,000 c/s; 7½ i/s, 50-12,000 c/s; 3¾ i/s, 50-8,000 c/s. M.E. level ind. Mixing. Superimposing. Outlet from pre-amp. stage. S-N < -45 dB below full peak output. W & F, 0.15%. Size 15½ × 15¾ × 8¼ ins. Weight 36 lbs. Price, with mic., £51 9s.

★

Stella Radio & Television Co. Ltd., Astra House, 121/3 Shaftsbury Avenue, London, W.C.2. Tel.: Gerrard 7086.

ST 454. 4 track. 3¾ i/s. 7 in. spools. F.R. 50-14,000 c/s. S-N < -40 dB. W & F < 0.3% M.E. level ind. Monitoring, Superimposing. Outlet from pre-amp stage. Size 15¼ × 12¼ × 6¾ in. Weight 19 lbs. Price £38 17s.

ST 455. 4 track recorder. Speeds: 7½, 3¾ and 1⅞ i/s. F.R.: 7½, 50-20,000 c/s; 3¾, 50-15,000 c/s; 1⅞, 50-7,000 c/s. 7 in. spools. M.E. level ind. Mixing, Monitoring, Superimposing. 4 track mono. record/playback S-N < -40 dB W & F < 0.3%. Size 16½ × 14¼ × 6¾ ins. Weight 30 lbs. Price £61 19s.

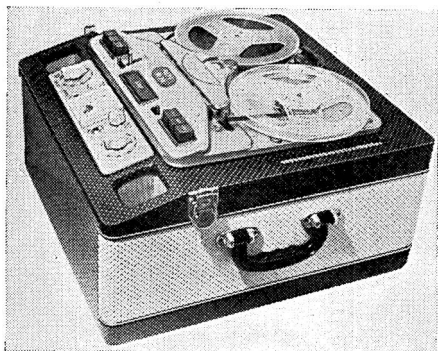

Reps R30

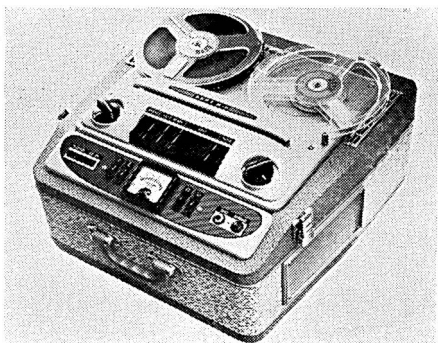

Reps R10



Stuzzi Junior 4M

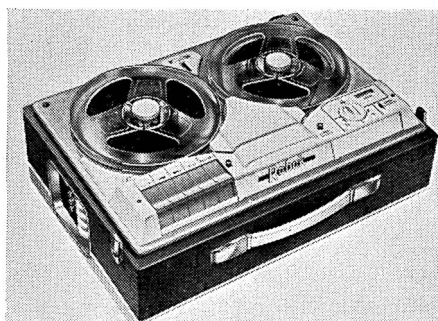

Robuk RK3

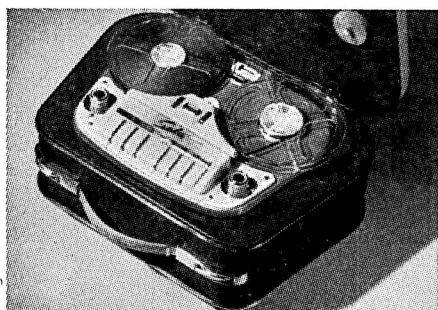

Saba

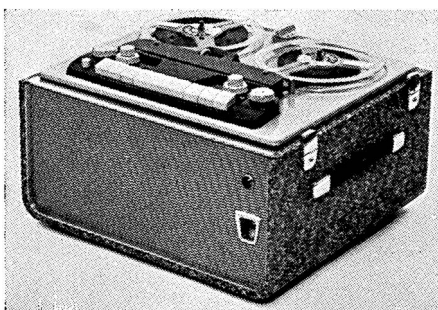

Simon SP/4

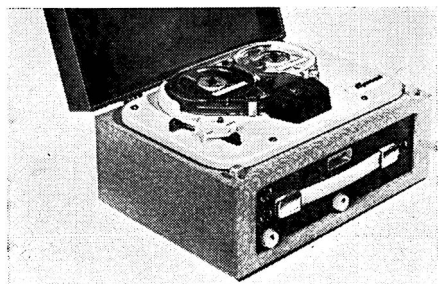

Simon Cymbal

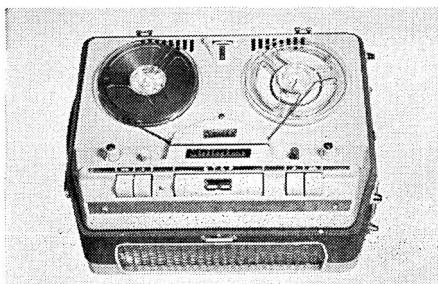

Stella ST454

Symphony Amplifiers Ltd., 16 Kings College Road, London, N.W.3. Tel.: Primrose 3314.

Symphony. Truvox Mk. VI deck with Truvox type K amplifier. $7\frac{1}{2}$ and $3\frac{3}{4}$ i/s F.R. to C.C.I.R. spec. ± 3 dB. S-N, -45 dB at 4 watts. W and F $< 0.2\%$. M.E. level ind. Output from pre-amp. stage. Available in either portable or table cabinet. Price £54 12s.



Stereosound Productions Ltd., 12-14 Wakefield Road, Brighouse, Yorkshire. Tel.: Brighouse 2084.

Carousel Radiotape. Collaro deck speeds $7\frac{1}{2}$, $3\frac{3}{4}$ and $1\frac{7}{8}$. Console tape recorder with provision for built-in FM tuner. F.R. $7\frac{1}{2}$ 50-18,000 c/s $3\frac{3}{4}$ 50-9,000 c/s. $1\frac{7}{8}$, 50-7,500 all ± 3 dB. M.E. level ind. H-N < -40 dB. W & F 0.15%. Outlet from pre-amp stage. Veneered walnut cabinet with legs. Price with spool of tape, £44 2s.



Tape Recorders (Electronics) Ltd., 784-788 High Road, Tottenham, London, N.17. Tel.: Tottenham 0811-3. Cables: Taperec, London.

Sound Belle. $2\frac{1}{2}$ i/s avge. One motor. $4\frac{1}{4}$ -in. spools. M.E. level ind. F.R. 90-6,000 S.N. -45 dB. W & F 0.4%. Straight-through amp. Output from pre-amp. stage. Size $10 \times 8 \times 5$ ins. Weight 11 lbs. Price, with L.P. tape and crystal mic., £27 6s. Four track version, £29 8s.

Sound Prince. B.S.R. Monardeck. F.R. 90-8,000 c/s ± 3 dB. M.E. level ind. H & N -50 dB. W & F 0.4%. Mixing, superimposing, outlet from pre-amp. Stage. Size $15\frac{3}{4} \times 14\frac{3}{4} \times 7\frac{1}{2}$ ins. Weight 18 lbs. Price £35 14s. Four track version, £38 17s.

Sound Studio. Collaro Studio deck. F.R. 60-12,000 c/s ± 3 dB at $7\frac{1}{2}$ i/s. H & N -50 dB. W & F 0.15% at $3\frac{3}{4}$ i/s. Mixing, superimposing, straight through amplifier. Size $15\frac{3}{4} \times 14\frac{3}{4} \times 7\frac{1}{2}$ ins. Weight 32 lbs. Price £44 2s. Four track version, same price.

Sound Connoisseur. Collaro studio deck. Twin track. F.R. 50-16,000 c/s ± 3 dB at $7\frac{1}{2}$ i/s. H & N -50 dB. W & F 0.15% at $3\frac{3}{4}$ i/s. Outlet from pre-amp stage. Mixing, monitoring, superim-

posing, straight through amplifier. Size $31\frac{1}{2} \times 16\frac{1}{2} \times 28\frac{1}{2}$ ins. Weight 28 lb. Price £68 5s. Four track version, £73 10s.

Sound Master. Collaro deck. Four track. $7\frac{1}{2}$, $3\frac{3}{4}$ and $1\frac{7}{8}$ i/s. F.R. 40-15,000 c/s ± 3 dB at $7\frac{1}{2}$ i/s. Meter. H & N -45 dB. W & F $< -0.15\%$. Outlet from pre-amp stage 10 Watts output. Mixing, monitoring, superimposing. Size $20\frac{1}{2} \times 17\frac{1}{2} \times 40\frac{1}{2}$ ins. Weight 105 lbs. Price £110 5s.



Technical Suppliers Ltd., Hudson House, 63 Goldhawk Road, London, W.12. Tel.: Shepherds Bush 2581 and 4794. Cables: Teknika, London.

Korting MK128. Four track $3\frac{3}{4}$ i/s. One motor. 7-in. spools. F.R. 30-16,000 c/s ± 2 dB. H & N -55 dB. W & F 0.08%. M.E. level ind. Stereo/mono record and playback. Two speakers. Outlet from pre-amp. Size $12\frac{3}{4} \times 17\frac{1}{2} \times 7\frac{1}{2}$ ins. Weight $32\frac{1}{2}$ lbs. Price £71 8s.



Telefunken—Sole U.K. distributors, **Welmec Corporation Ltd.**, 147 Strand, London, W.C.2. Tel.: Temple Bar 3357. Cables: Welmcoc, London.

Magnetophon 75K15. $3\frac{3}{4}$ and $1\frac{7}{8}$ i/s. One motor. $5\frac{1}{4}$ -in. spools. F.R.: 60-16,000 c/s ± 3 dB at $3\frac{3}{4}$ i/s; 60-9,000 c/s ± 3 dB at $1\frac{7}{8}$ i/s. W. & F. 0.4% at $3\frac{3}{4}$ i/s. S-N, > -40 dB. Fluorescent bar level ind. Automatic stop at end of tape by foils. Connections for synchronised control of automatic slide projector with Telechron 1 universal unit available as an extra. Connection for remote control. Output from pre-amp. stage. Size $6\frac{1}{4} \times 12\frac{1}{2} \times 12\frac{1}{2}$ ins. Weight 21 lbs. Price, with tape, £49 7s.

Magnetophon 75T15. A table model with no carrying case or loudspeaker, but a power stage with output of 2.5 watts 4.5 ohms. Size $5\frac{1}{2} \times 9\frac{1}{4} \times 12\frac{1}{2}$ ins. Weight $16\frac{1}{4}$ lbs. Price £45 3s.

Magnetophon 85KL. $7\frac{1}{2}$ and $3\frac{3}{4}$ i/s. One motor. 7-in. spools. F.R.: 30-20,000 ± 3 dB at $7\frac{1}{2}$ i/s; 30-15,000 c/s ± 3 dB at $3\frac{3}{4}$ i/s. S-N < -50 dB. W & F $< 0.2\%$ at $7\frac{1}{2}$ i/s; < 0.4 at $3\frac{3}{4}$ i/s. M.E. level ind. Outlet from pre-amp. stage. Straight through amp. 6 watts output. Superimposing. Automatic stop at end of tape by foils.

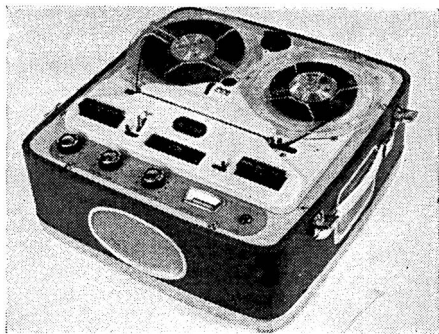

Spectone 161

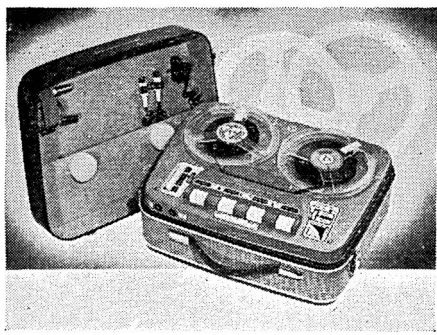

Korting Mk. 128



Sound Studio



Telefunken 75K15



Telefunken 85KL



Telefunken 85T

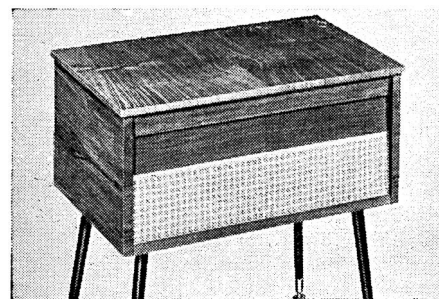

Stereosound Carousel

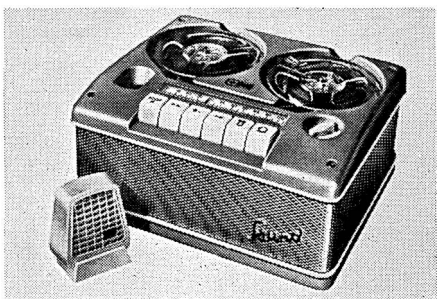

Sound Bell

Monitoring by earphones. Provision for remote stop/start. Built-in splicing device. Size $7\frac{3}{4} \times 17\frac{3}{4} \times 16\frac{1}{4}$ ins. Weight 33 lbs. Price £82 19s.

Magnetophon 85T. Table version. No carrying case, output stage or loudspeakers. Output from pre-amp. 1.2-2 volts. Price £66 3s.

Magnetophon 76K. Four track. Speeds $3\frac{3}{4}$ and $1\frac{7}{8}$ i/s. $5\frac{3}{4}$ -in. spools. F.R. $3\frac{3}{4}$ i/s, 30-16,000 c/s; $1\frac{7}{8}$ i/s, 30-9,000 c/s. M.E. level ind. Auto tape stop. Remote control. Outlet from pre-amp. Superimposing by monitoring both tracks. Size $12\frac{1}{2} \times 12\frac{1}{2} \times 6\frac{1}{4}$ ins. Weight 21 lbs. Price £59 17s.

★

Truvox Ltd., Neasden Lane, London, N.W.10. Tel.: Dollis Hill 8011. Cables: Truvoxeng.

R.6. Truvox Mk. 6. deck. Speeds $7\frac{1}{2}$, $3\frac{3}{4}$ i/s. 3 motors. F.R. 30-15,000 c/s ± 3 dB at $7\frac{1}{2}$ i/s. M.E. level ind. H. & N. -45 dB W & F $< 0.2\%$. Pause control. Size $15 \times 15\frac{3}{4} \times 9\frac{5}{8}$ in. Weight 35 lb. Price £57 15s.

R.7. Speeds $7\frac{1}{2}$ and $3\frac{3}{4}$ i/s. 3 motors. 7-in. spools. F.R. $7\frac{1}{2}$ i/s, 30-17,000 c/s ± 5 dB. $3\frac{3}{4}$ i/s 40-10,000 c/s ± 5 dB W & F 0.2%. Tracks in both directions. Outlet from replay head. Size $16\frac{1}{2} \times 16 \times 10\frac{1}{4}$ ins. Weight 45 lbs. Price £86 2s.

Melody. $3\frac{3}{4}$ i/s. 4-in. spools. M.E. level ind. Straight through amplifier. Size $11 \times 9 \times 5$ ins. Weight 11 lbs. Price with tape and mic., £36.

★

Tutor-Tape Co. 32 Orkney Street, London, S.W.11. Tel.: Macaulay 3999. Cables: Tutape, London.

Tutor de Luxe. Collaro Mk. IV deck. M.E. level ind. Mixing, superimposing. Straight through amplifier. Size $15\frac{1}{4} \times 17\frac{1}{2} \times 7\frac{1}{2}$ ins. Weight 36 lbs. Price with tape and crystal mic. £61 19s.

★

Uher—Sole U.K. distributors, Tedelex (London) Ltd., 2/4 Great Eastern Street, London, E.C.2. Tel.: Bishopsgate 8719.

Uher 500. Speed $3\frac{3}{4}$ i/s. One motor. 5-in. spools. F.R. 50-15,000. c/s. M.E. level ind. H. & N. -45 dB. W. and F. 0.2%. Out-

let from pre-amp. Size $12\frac{1}{2} \times 10\frac{1}{2} \times 6$ ins. Weight 14 lb. Price £51 9s.

Two-speed version also available (**Uher 502**) price £61 19s.

Uher 514. Four track. Speed $3\frac{3}{4}$ i/s. One motor 5-in. spools. F.R. 40-15,000 c/s. M.E. level ind. H & N -45 dB. W & F $\pm 0.2\%$. Outlet from pre-amp. Size $12 \times 10 \times 5\frac{3}{4}$ in. Weight 15 lb. Price £62 15s. Two-speed version (Model 524) £72 15s.

Uher 720. Speeds $7\frac{1}{2}$ and $3\frac{3}{4}$ i/s. One motor. 7-in. spools. F.R. $7\frac{1}{2}$ i/s, 40-20,000 c/s; $3\frac{3}{4}$ i/s, 40-16,000 c/s. M.E. level ind. H. & N. 45 dB. W. and F. 0.1% at $7\frac{1}{2}$ i/s. Outlet from pre-amp. Size $15\frac{3}{8} \times 14\frac{1}{4} \times 8\frac{1}{4}$ ins. Weight 26 $\frac{1}{2}$ lb. Price £78 15s.

Uher 734. Four track. Speeds $7\frac{1}{2}$, $3\frac{3}{4}$, $1\frac{7}{8}$ i/s. F.R. $7\frac{1}{2}$ i/s. 40-20,000 c/s; $3\frac{3}{4}$ i/s 40-16,000 c/s. $1\frac{7}{8}$ i/s 40-8,000 c/s. M.E. level ind. H & N -45 dB. W & F $\pm 0.1\%$. Outlet from pre-amp. Size $14 \times 13 \times 6\frac{1}{4}$ in. Weight 26 lb. Price £86 2s.

Uher Universal. Speeds $3\frac{3}{4}$, $1\frac{7}{8}$ and $\frac{3}{16}$ i/s. One motor. 5-in. spools. F.R. $3\frac{3}{4}$ i/s, 40-16,000 c/s; $1\frac{7}{8}$ i/s, 40-8,000 c/s; $\frac{3}{16}$ i/s, 40-4,000 c/s. M.E. level ind. H. & N. -45 dB. W. and F. 0.3%. Outlet from pre-amp, remote control, synchronising. Size $12\frac{1}{2} \times 9\frac{5}{8} \times 5\frac{3}{8}$ ins. Weight 17 lb. Price £82 19s.

■ **Uher Stereo 3.** Four track stereo recording and playback. Speeds $7\frac{1}{2}$, $3\frac{3}{4}$, $1\frac{7}{8}$ i/s. One motor. 7-in. spools. F.R. $7\frac{1}{2}$ i/s, 40-20,000 c/s; $3\frac{3}{4}$ i/s, 40-16,000 c/s; $1\frac{7}{8}$ i/s, 40-9,000 c/s. M.E. level ind. H. & N. -45 dB. W. and F. 0.1% at $7\frac{1}{2}$ i/s. Outlet from pre-amp. Stereo/mono recording. Size $16\frac{1}{4} \times 15\frac{1}{4} \times 4\frac{1}{4}$ ins. Weight 31 lb. Price £108 3s.

★

Veritone Ltd., Avenue Parade, London, N.12. Tel.: Laburnum 6641/2.

Venus de luxe. Collaro Studio deck. Four Speeds 15, $7\frac{1}{2}$, $3\frac{3}{4}$ and $1\frac{7}{8}$. F.R. within ± 3 dB C.C.I.R. M.E. level ind. Comparator monitoring, mixing, superimposing, echo effect. Straight through amplifier, bass and treble tone controls. Size $17\frac{1}{4} \times 15\frac{1}{2} \times 7\frac{1}{2}$ ins. Weight 33 lb. Price £69 6s.



Volmar Vectis



Truvox R.6



Veritone Venus de luxe



Truvox R.7

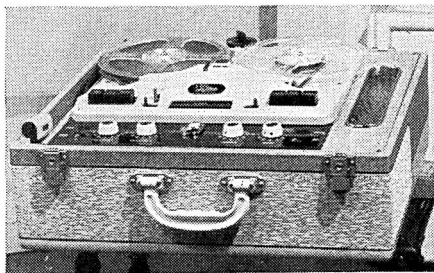

Tutor Tape "Tutor"

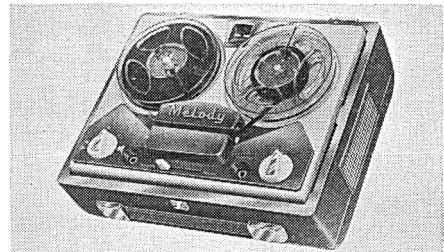

Truvox Melody

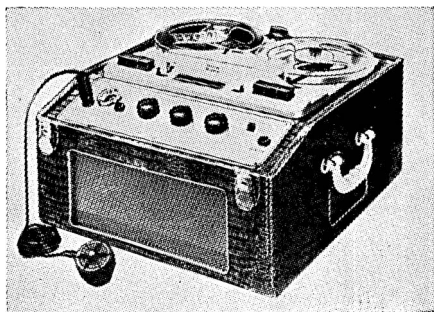

Winstone "Thoroughbred"

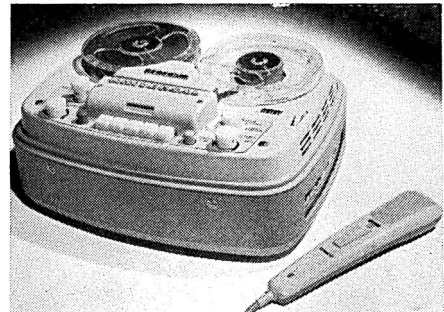

Uher Universal



Victor "505"



WyndSOR Victor

Venus Console. Collaro deck. Spec. as for portable provision for in-built FM tuner. Size $24\frac{3}{4} \times 17 \times 29$ ins. (inc. legs $17\frac{1}{2}$ ins.). Weight 50 lbs. Price £75 12s.



Volmar Limited, 154 High Street, Brentford, Middx. Tel.: Isleworth 1161. Cables: Volmar, Brentford, Hounslow.

Vega. Garrard magazine loading deck. F.R. 60-7,000 c/s \pm 3 dB. M.E. level ind. Size $13\frac{1}{2} \times 11 \times 7\frac{3}{4}$ ins. Weight 21 lbs. Price with tape and mic. £35 14s.

Vectis. Collaro Studio deck. F.R. 100-10,000 c/s \pm $7\frac{1}{2}$ i/s. M.E. level ind. Size $15\frac{1}{2} \times 13 \times 8\frac{1}{2}$ ins. Weight 26 lbs. Price with tape and mic. £37 16s.

Walter Instruments Ltd., Garth Road, Morden, Surrey. Tel.: Derwent 4421. Cables: Walinst, Morden.

"505". G.P. portable recorder. $7\frac{1}{2}$ and $3\frac{3}{4}$ i/s. One motor. 7-in. spools. F.R. $7\frac{1}{2}$ i/s, 40-14,000 c/s; $3\frac{3}{4}$ i/s, 40-7,000 c/s. S-N, -40 dB. W & F, 0.2% at $7\frac{1}{2}$; 0.35% at $3\frac{3}{4}$ i/s. M.E. level ind. Super-imposing. Provision for cine stereo., straight-through amp. Telephone attachment. Outlet from pre-amp. stage. Size $16\frac{1}{2} \times 12\frac{1}{2} \times 8$ ins. Weight 23 lbs. Price, with tape and crystal mic., £59 17s.



Winston Electronics Ltd., Govett Avenue, Shepperton, Middx. Tel.: Walton 6321. Cables: Winston, Shepperton.

Thoroughbred. Collaro Mk. IV deck. F.R. 15 i/s 50-16,000 c/s; $7\frac{1}{2}$ i/s, 50-12,000 c/s; $3\frac{3}{4}$ i/s, 50-7,000 c/s. W & F, 0.1%. M.E. level ind. Mixing. 3 loudspeakers. Output from pre-amp. stage. Size $17 \times 15\frac{1}{4} \times 9\frac{1}{4}$ ins. Weight 48 lbs. Price, with tape and mic., £61 19s.



WyndSOR Recording Co. Ltd., (inc. Magnetic Recording Co.) 2 Bellevue Road, Friern Barnet, London, N.11. Tel.: Enterprise 2226/7. Cables: Wyndreco.

Victor. Collaro Studio deck. F.R. $7\frac{1}{2}$ i/s, 50-15,000 c/s; $3\frac{3}{4}$ i/s, 50-9,000 c/s; $1\frac{7}{8}$ i/s, 50-5,000 c/s. M.E. level ind. H & N -40 dB. W & F less than 0.1%. Mixing. Speaker in detachable lid. Size $14\frac{1}{2} \times 12\frac{3}{8} \times 9$ ins. Weight 29 lbs. Price with tape and mic., £47 5s. Four-track version, £51 9s.

Viscount Console. Collaro deck. F.R. 50-12,000 c/s \pm 3 dB at 15 i/s. M.E. level ind. H & N -40 dB. W & F less than 0.15%. Monitoring. Size $21 \times 16\frac{1}{4} \times 16\frac{1}{2}$ ins. Height including stand 30 ins. Weight 42 lbs. Price, Oak and Rexine or Sapele Mahogany, £45.

LATE ARRIVALS

Parman Aircraft (Engineering) Ltd. Distributors Parman Electronics Ltd., Parman House, Balcombe Road, Horley, Surrey. Tel.: Horley 4344. Cables: Parmanair, Horley.

Prelude Collaro deck. Speed $7\frac{1}{2}$, $3\frac{3}{4}$ and $1\frac{7}{8}$ i/s. F.R. $7\frac{1}{2}$ 35-25,000 c/s \pm 2 dB. Meter. S-N -50 dB. Mixing 8

watts output. Wharfedale Speaker Units fitted. Size 30 × 27 × 20. Price to be announced.



Cine Accessories (Brighton) Ltd., 15 Bond Street, Brighton, Sussex. Tel.

TR100 Transicorder. Battery operated transistor recorder, speeds $3\frac{1}{2}$ and $1\frac{7}{8}$ i/s. 3 in. spools. Meter. Weight 4 lbs. Price £40 19s.



General Sonic Radios, 92 Caledonian Road, London, N.1. Tel.: Terminus 0322.

Sonic V. Collaro deck. 3 speeds. 7 in. spools. F.R. $7\frac{1}{2}$ i/s. 40–12,000 c/s ± 3 dB. M.E. level ind. W. & F. 0.15% S-N. -45 dB. Tone controls, superimposition, pause key. Outlet from pre-amp. Two loudspeakers fitted. Output 5.3 watts. Size 16 × 16 × 9 $\frac{1}{2}$. Weight 33 lbs. Price £49 7s., two track. £52 10s., four track.



Magnavox Ltd., 129 Mount Street, London, W. 1. Tel.: Grosvenor 4251.

Magnavox Magitape. Collaro deck. 3 speeds. 7 in. spools. M.E. level ind. W. & F. 0.15%. Tone controls. Superimposition. Outlet from pre-amp. 4 watts output. Size 17 × 17 $\frac{3}{4}$ × 11 $\frac{1}{4}$ ins. Price £40 19s.



Dynatron Radio Ltd., Maidenhead, Bucks. Tel.: Maidenhead 5152.

Cordova. Collaro deck. 3 speeds. 7 in. spools. F.R. $7\frac{1}{2}$ i/s. 40–12,000 c/s ± 3 dB. M.E. level ind. W. & F. 0.15%. Tone controls. Superimposition. Pause control 2 $\frac{1}{2}$ watts output. Size 9 $\frac{1}{2}$ × 16 $\frac{1}{2}$ × 18 ins. Weight 29 $\frac{1}{2}$ lbs. Price £40 19s.



Allied International Co., Ltd., 59 Union Street, London, S.E. 1. Tel.: Hop 4567.

Movicorder. Two speed. Stereo 7 in. spools. F.R. $7\frac{1}{2}$ 45–14,000 ± 2 dB. $3\frac{1}{2}$ 40–7,500 ± 3 dB. Two level meters. W. & F. 0.15%. S-N < -50 dB. Echo facilities. Size 6 $\frac{1}{2}$ × 16 × 16 ins. Weight 48 lbs. Price on application.



Magnavox Magitape



Sonic V



Movicorder

BATTERY OPERATED PORTABLES



Trav-Ler

Aerialite Ltd., Hargreaves Works, Congleton, Cheshire. Tel.: Congleton 2471. Cables: Aerialite Stalybridge.

Trav-Ler. Transistorised battery portable. Speed $3\frac{3}{4}$ i/s F.R. 150-5,000 c/s. H. & N. —30 dB. W. & F. 0.4%. Neon Indicator. 3 three-volt batteries. Battery Life 50 hours. Weight 9 lbs. Price £30.



Butoba — Sole U.K. distributors, **Denham & Morley Ltd.**, Denmore House, 175 Cleveland Street, London, W.1. Tel.: Euston 3656. Cables: Denmorl, Wesdo, London.

Butoba MT5. Transistorised battery portable. Speeds $3\frac{3}{4}$ and $1\frac{7}{8}$ i/s. M.E. level ind. Two motors. F.R. $3\frac{3}{4}$ i/s, 50-13,000 c/s; $1\frac{7}{8}$ i/s, 60-5,000 c/s. H. & N. —40 dB. Battery life 20-40 hours. Eight 1.5v batteries. Size $12 \times 9\frac{1}{4} \times 6$ ins. Weight including batteries, 12 lb. Price including microphone and tape, £72 9s. Mains converter, £11 11s.



Challen Instrument Co. 4 Stratford Place, London, W.1. Tel.: Mayfair 5054. Cables. Fedstrat, Wesdo, London.

Minivox Model C. Battery portable tape recorder $3\frac{3}{4}$ and $1\frac{7}{8}$ i/s. F.R.: up to 10,000 c/s at $3\frac{3}{4}$ i/s. Output 600 milliwatts, 5-in. speaker unit. Price £43 1s.

Model B as above but $1\frac{7}{8}$ i/s only. Price £38 17s.



Thomas A. Edison Ltd., Victoria House, Southampton Row, London, W.C.1. Telephone: Holborn 9988. Cables: Edison-gram. Westcent, London.

Mohawk Midgetape 400. Transistorised battery portable. Speed $1\frac{7}{8}$ i/s. F.R. 150-5,000 c/s. H. & N. —42 dB. W. & F. less than 0.7%. Special tape cartridge and T50 Mercury battery. Battery life 50 hours. Size $8\frac{1}{2} \times 3\frac{3}{8} \times 1\frac{3}{8}$ ins. Weight 3 lb. Price with transistorised speaker, microphone and battery, £129 10s.

Mohawk Midgetape 500. Transistorised professional battery portable. Speed $3\frac{3}{4}$ i/s. F.R. 50-10,000 c/s, H. & N. —42 dB.



Butoba MT5

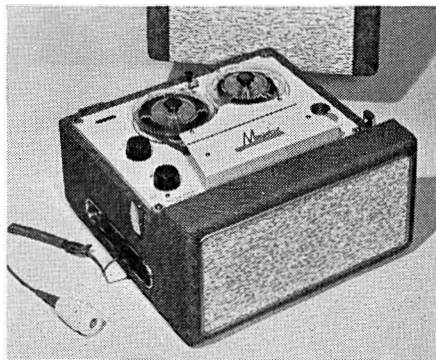

Minivox Model C

W. & F. 0.4%. Single battery with indicator. Size $8\frac{1}{2} \times 3\frac{3}{8} \times 1\frac{7}{8}$ ins. Weight 3 lbs. Price on application.



Fi-Cord Ltd., 40a Dover Street, London, W.1. Tel.: Hyde Park 3448. Cables: Fi-Cord, London.

Mark 1A. Transistorised battery portable. $7\frac{1}{2}$ and $1\frac{7}{8}$ i/s. One motor. $3\frac{1}{4}$ in. spools. F.R. 50-12,000 c/s ± 3 dB at $7\frac{1}{2}$ i/s. W. & F. 0.4%. S-N, -35 dB. M.E. bar type level ind. Output from pre-amp, stage. Rechargeable batteries, price includes a charger. Batter life, $1\frac{1}{2}$ -2 hrs. at $7\frac{1}{2}$ i/s; 3-3 $\frac{1}{2}$ hrs. at $1\frac{7}{8}$ i/s. Size $9\frac{3}{8} \times 5 \times 2\frac{3}{4}$ ins. Weight 4 $\frac{1}{2}$ lb. Price, with tape, batteries and mic., £61 19s. £69 6s. with Gramplan DP4/M microphone.



GBC Electronic Industries Ltd., 121/123 Edgware Road, Marble Arch, London, W.2. Tel.: Ambassador 2872.

Clarion. Transistorised battery portable. Speed $3\frac{3}{4}$ i/s. Four 1.5v batteries. Internal speaker. Size $9\frac{1}{2} \times 5 \times 3\frac{3}{8}$ ins. Weight 5 lb. Price with tape and microphone, £26 5s. Mains converter available, £4 4s.



The Gramophone Company Ltd., Hayes, Middx. Tel.: Hayes 3888. Cables: Jabberment, London.

E.M.I. RE 321. Transistorised professional battery portable. Speed $7\frac{1}{2}$ i/s. One motor. F.R. 50-10,000 c/s ± 3 dB. H. & N. -44 dB. W. & F. 0.25%. Level meter. Eight 1.5v cells or rechargeable units of equivalent size. Full track recording and playback. Size $14\frac{1}{2} \times 6\frac{1}{4} \times 8$ ins. Weight 17 $\frac{1}{2}$ lb. Price £124.



Grundig (Great Britain) Ltd., 39/41 New Oxford Street, London, W.C.1. Tel.: Covent Garden 2995.

TK1 Transistorised battery portable. Speed $3\frac{3}{4}$ i/s. One motor. 3 in. spools. F.R. 80-8,000 c/s ± 3 dB H. & N. -40 dB. W. & F. 0.2%. Six 1.5v cells. Battery life 20 hours. Size $11\frac{3}{4} \times 7 \times 4\frac{1}{2}$ ins. Weight 8 lbs. with batteries. Price £30 9s. Mains converter available, £7 7s.



Fi-Cord Mk. 1A

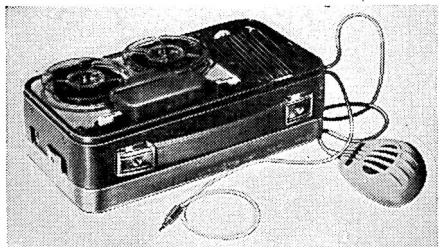

G.B.C. Clarion



E.M.I. RE 321

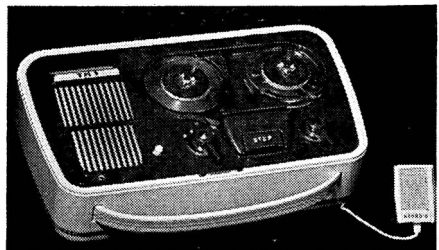

Grundig TK1

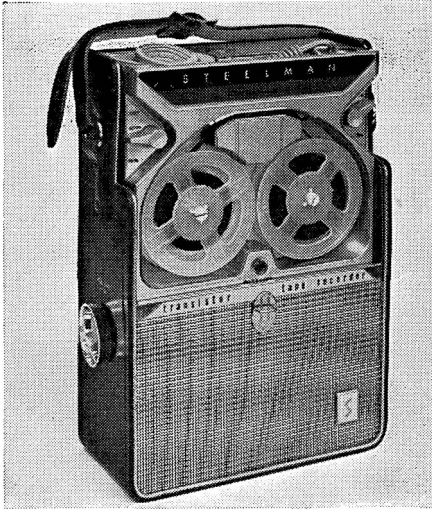

Steelman Transitape

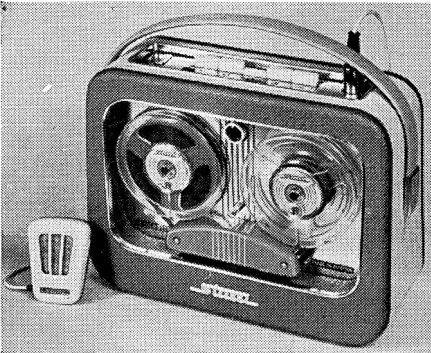

Stuzzi Magnette



Walter Metropolitan

Livingston Laboratories Ltd., Retcar Street, London, N.19. Tel.: Archway 6251.

Nagra IIIB. Prof. battery portable recorder. 15, 7½ and 3¾ i/s. One motor. 5 in. spools, or 7 in. with lid open. F.R. 30-15,000 c/s ± 1 dB at 15 i/s; 30-12,000 c/s ± 1.5 dB at 7½ i/s; 50-7,000 c/s ± 3 dB at 3¾ i/s. S-N -51 dB at 7½ i/s. 53 dB at 7½ i/s. W. & F. 0.2% at 7½ i/s. Meter level ind. Batteries, twelve 1.5v torch batteries, life approx. 20 hours. On alkaline accumulators, approx. 70 hours' life. Mixing on the 3 inputs. 3 heads. Monitor speaker, outlet from pre-amp. stage. Size 8¾ × 12½ × 4¼ ins. Weight approx 15½ lb. Price £293.



Steelman - Sole U.K. Distributors, **Telec Tronic Ltd.**, 46/47 Frith Street, London, W.1. Tel..

Steelman. Transistorised battery portable. Speeds 3¾ and 1⅞ i/s. 3 in. spools. F.R. 150-7,500 c/s. Neon level ind. Thirteen 1.5v batteries. Battery life 50 hours (motor), 300 hours (amplifier). Size 9¾ × 6½ × 2⅞ ins. Weight 6½ lb. without batteries. Price £57 15s.



Stuzzi - Sole U.K. distributors, **Recording Devices**, 44 Southern Row, Kensington, London, W.10. Tel.: Ladbroke 4775.

Stuzzi Magnette. Battery portable. 3¾ and 1⅞ i/s: 2 motors. 4-in. spools. F.R. 40-9,000 c/s at 3¾ i/s; 80-4,500 c/s at 1⅞ i/s. W. & F. 0.25% at 3¾ i/s; 0.35% at 1⅞ i/s. S-N, -45 dB. M.E. bar type, level ind. Outlet from pre-amp. stage. Extension speaker socket. Powered by four standard torch batteries; life, 30-100 hours depending on type of use. Battery indicators. Size 11 × 4½ × 8 ins. Weight 8 lb. Price, with tape and mic., £61 19s.

Stuzzi Magnette Studio. Battery portable 7½ i/s. 4-in. spools. F.R. 40-14,500 c/s. W. & F. 0.2%. H. & N. -50 dB. Magic Eye level indicator. Outlet from pre-amp. Extension speaker socket. Price £78 15s.



Walter Instruments Ltd., Garth Road, Morden, Surrey. Tel.: Derwent 4421. Cables: Walinst, Morden, Surrey.

Metropolitan. mains/battery portable recorder. 3¾ i/s. 5¾-in. spools. F.R. 50-9,000 c/s ± 3 dB. S-N -40 dB. M.E. level ind. Outlet from pre-amp stage. 7 transistors are used. 2.5 watts output. Price £57 15s. with microphone and tape.

DECKS—GENERAL PURPOSE and SEMI-PROFESSIONAL

Birmingham Sound Reproducers Ltd.,
Monarch Works, Powke Lane, Old Hill,
Staffs. Tel.: Cradley Heath 69272.

B.S.R. Monardeck TD2. G.P. deck.
3½ i/s. One motor. 5¼-in. spools. F.r.:
with good amplifier equalisation 30-10,000
c/s ± 3 dB. 2 heads. W & F., 0.3%
RMS. Size 13 × 8¾ ins. Price £12 12s.



Bradmatic Ltd., Station Road, Aston,
Birmingham, 6. Tel.: East 2881-2.
Cables: Bradmatic, Birmingham.

Bradmaster. Models 5B, 5CS, 5CD,
5D Semi-prof. tape deck. 7½ and 3¾ i/s.
3 motors. Model 5B 7-in. spools; 5CS
and 5CL 9¾-in. spools; 5D 10½-in. N.A.B.
spools. F.r.: 7½ i/s, 40-15,000 c/s; 3¾ i/s,
40-7,500 c/s, both ± 4 dB (dependent on
amp. used). Size and weight dependent on
model. Price 5B £42; 5CS £45 10s.;
5CL £47 10s.; 5D £50. Available with
full track or stereophonic heads to special
order. Prices on application.

Model 5DF. Semi-prof. tape deck. 15
and 7½ i/s. 3 motors. - 10½-in. N.A.B.
spools. F.r. 15 i/s, 30-18,000 c/s; 7½ i/s,
30-15,000 c/s, both ± 2 dB. W. & F.,
0.1% at 15 i/s. Variable spooling control.
Size 20 × 14½ ins. Weight 20 lb. Price
£62.



Brenell Engineering Co. Ltd., 1a Doughty
Street, London, W.C.1. Tel.: Holborn
7358.

Mark 5. G.P. tape deck. 15, 7½, 3¾
and 1¾ i/s. 3 motors. 8¼ in. spools. W.
& F. 0.1% at 7½ i/s. accommodates up to
four heads. Size 15 × 11½ × 5 ins.
Weight 16 lb. Price £29 8s.



Collaro Ltd., Ripple Works, By-Pass
Road, Barking, Essex. Tel.: Rippleway
5533. Cables: Kabarro. Telex, Barking.

Collaro Studio. G.P. tape deck 7½, 3¾
and 1¾ i/s. 3 motors. 7 or 5¼-in. spools.
F.r.; 30-10,000 c/s at 7½ with record/
playback equalisation 2 heads. Price
£17 10s.

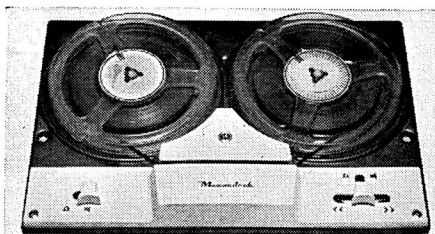

B.S.R. Monardeck TD2

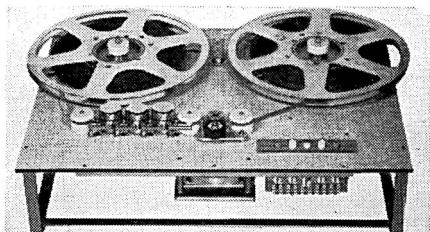

Bradmatic Model 5D

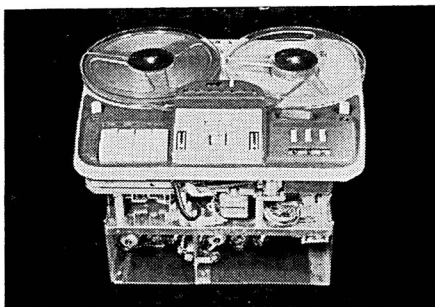

Grundig Stereo TM60

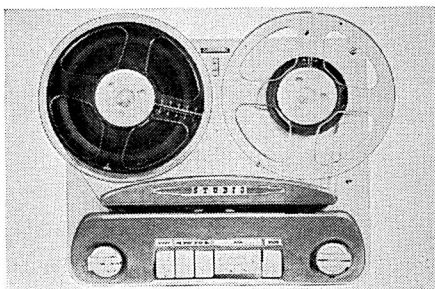

Collaro Studio

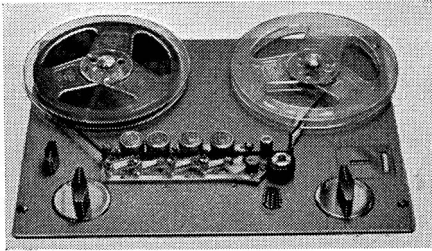

Brenell Mk. 5

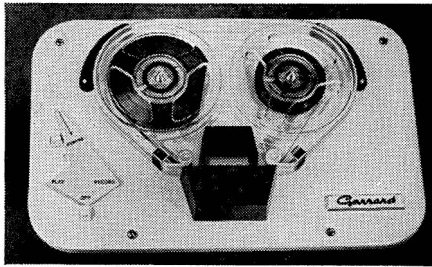

Garrard Magazine deck

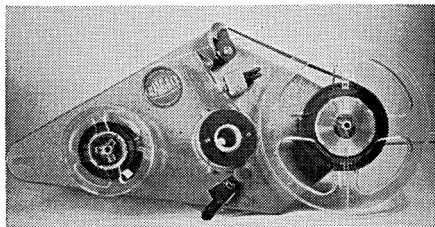

The Gramdeck

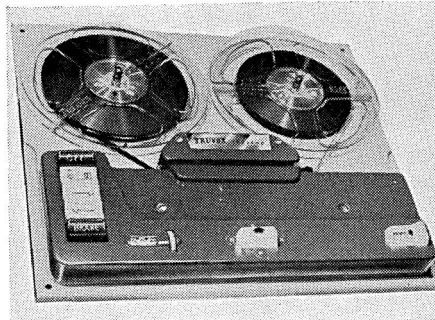

Truvox Mk. VI 2-speed

Garrard Engineering & Manufacturing Co. Ltd., Newcastle Street, Swindon, Wilts. Tel.: Swindon 5381. Cables: Telex 44-271.

Garrard Magazine Tape Deck. $3\frac{3}{4}$ i/s. One motor. 4-in. spools or magazine. F.R. to 10,000 c/s. W. & F. 0.2%. No threading or spilling of tape. Size $12\frac{1}{4} \times 8 \times 3\frac{1}{4}$ ins. Price £15 7s. 3d.



Gramdeck. U.K. distributors, Andrew Merryfield Ltd., 29/31 Wright's Lane, Kensington, London, W.8. Tel.: Western 3603. Cables: Technology, Kens., London.

Gramdeck. Head and drive mechanism for attachment to gramophone turntable. Speeds $7\frac{1}{2}$, 4.3, 3.2 and 1.6 i/s for the standard disc speeds. $5\frac{3}{4}$ -in. spools. F.R. 60-10,000 c/s ± 3 dB at $7\frac{1}{2}$ i/s. W. & F. 0.15%. Size $13\frac{1}{2} \times 6$ ins. Weight approx. 2 lb. Price including transistor pre-amplifier £11 11s.



Grundig (Great Britain) Ltd., 39/41 New Oxford Street, London, W.C.1. Tel.: Covent Garden 2995.

■ **TM60.** G.P. tape deck for monaural and stereo use. Includes all pre-amplifier circuitry. $7\frac{1}{2}$ and $3\frac{3}{4}$ i/s. One motor. 7-in. spools. F.R. $7\frac{1}{2}$ i/s, 50-15,000 c/s; $3\frac{3}{4}$ i/s, 50-10,000 c/s, both ± 3 dB.M.E. level ind. H. & N. -40 dB. W. & F. less than 0.2% at $7\frac{1}{2}$ i/s. Size $14 \times 11\frac{1}{4} \times 8\frac{3}{8}$ ins. Weight 24 lb. Stereo/mono recording and playback through suitable output stages and loudspeakers. Price £94 10s.

TM20. Deck mechanism with pre-amp. stage. $3\frac{3}{4}$ i/s. One motor. $5\frac{3}{4}$ -in. spools. F.R. 60-10,000 c/s + 5 - 4 dB. S-N -45 dB. W & F $\pm 0.2\%$. Bar type M.E. level ind. Size $12\frac{1}{2} \times 9\frac{1}{2} \times 6$ ins. Price £46 4s.



Modern Techniques, Wedmore Street, London, N.19. Tel.: Archway 3114.

Motek K10. G.P. tape deck. $7\frac{1}{2}$, $3\frac{3}{4}$, $1\frac{7}{8}$ i/s.. 3 motors. 7-in. spools. F.r.: approx 40-12,000 c/s at $7\frac{1}{2}$ depending on

amplifier used. W. & F. $<0.2\%$ at $7\frac{1}{2}$ i/s. 2 heads. High imp. record head. Size $15\frac{1}{4} \times 10\frac{1}{4}$ ins. Price £22 1s.



Multimusic Ltd., Maylands Avenue, Hemel Hempstead, Herts. Tel.: Boxmoor 3636. Cables: Multimusic.

Multimusic. Semi-prof. tape deck. Speeds $7\frac{1}{2}$ and $3\frac{3}{4}$ i/s. 3 motors. $8\frac{1}{4}$ -in. spools. Provision for two or four tracks. Standard 19-in. width for rack mounting. Price on application.



Grundig TM20



Tape Recorders (Electronics) Ltd., 784-788 High Road, Tottenham, London, N.17. Tel.: Tottenham 0811. Cables: Taperec, London.

Sound 333. Miniature tape deck $2\frac{1}{2}$ i/s. One motor. $4\frac{1}{4}$ -in. spools. Push button control. Size $10 \times 8 \times 3\frac{1}{4}$ ins. Price £15.

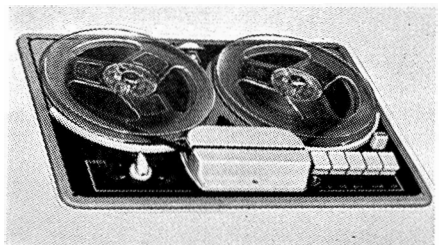

Motek K10



Truvox Ltd., Neasden Lane, London, N.W.10. Tel.: Gladstone 6455. Cables: Truvoxeng.

Mark VI. G.P. tape deck. Pause control. Auto speed change. F.r: 30-15,000 c/s at $7\frac{1}{2}$; 30-9,000 c/s at $3\frac{3}{4}$ i/s. Size $14\frac{1}{4} \times 13 \times 4\frac{1}{4}$. Weight $13\frac{3}{4}$ lb. Price £26 5s. ■ Fitted with stereo head, £36 15s.

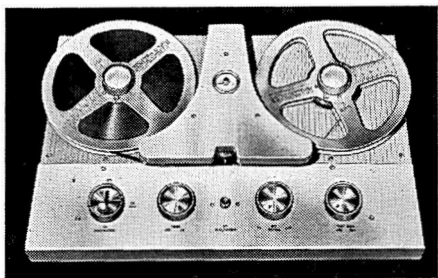

Multimusic 2-speed



Wright & Weaire Ltd., 88 Horseferry Road, London, S.W.1. Tel.: Sullivan 5426. Cables: Writewea Sowest.

Wearite Models 4A, 4B, 4C. Semi-prof. tape deck. $3\frac{3}{4}$ and $7\frac{1}{2}$ i/s. Also available $7\frac{1}{2}$ and 15 i/s, 4AH, 4BH, 4CH. 3 motors. $8\frac{1}{4}$ -in. spools. W. & F., 0.2% at $7\frac{1}{2}$ i/s. Size $16\frac{1}{2} \times 13 \times 7$ ins. Weight 18 lb. 4A standard monaural record/replay. Price £36 10s. 4AH £41 10s. 4B monaural record/replay plus monitor head. Price £41 10s. 4BH, £46 10s. 4C Industrial dual track. Price £46 10s. 4CH, £51 10s.

■ **Models 4SN, 4SH.** Monaural record replay plus stereo replay. Price, 4SN, £43 17s.; 4SH, £48 17s.

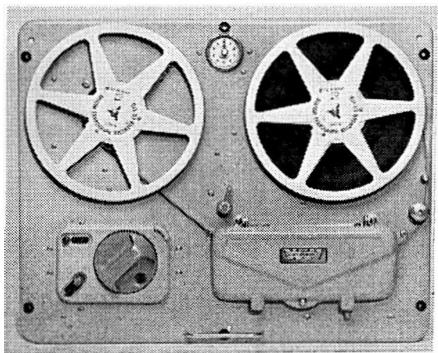

Wearite 4A

TAPE AMPLIFIERS AND MIXER UNITS

A.E.I. Sound Equipment Ltd., Crown House, Aldwych, London, W.C.2. Tel.: Temple Bar 8040. Cables: Soundequi, Lesquare, London.

A.E.I. Four Channel Electronic Mixer. Four inputs, one output with master control 20 or 100 Kohm and 20 ohm. Preset bass and top cut. Output imp. 500 ohms. sensitivity 75 μ v. Powered from A.E.I. 30 watt amplifier or from separate power supply. Price £55.



Ampex (Great Britain) Ltd., Arkwright Road, Reading, Berkshire. Tel.: Reading 84221. Cables: Vidiotape, Reading. Telex: 84146.

Ampex 620 Speaker/amplifier. Comprises 8-in. drive unit in special enclosure. Acoustically flat from 60 to 10,000 c/s. The built-in amplifier has 10 watts output. F.R. 20-20,000 c/s \pm 0.5 dB. Price £88.



Associated Electronic Engineers Ltd., 10 Dalston Gardens, Stanmore, Middx. Tel.: Wordsworth 4474/5/6. Cables: Astronic, Stanmore.

Astronic A.1446. 6 channel electronic mixer unit. Designed for 5 low impedance sources each 10/30 ohms, 0.5 mV; 1 high impedance source 250K ohms, 0.2 volts. There are four output sockets supplying 0.7 volts into 600 ohms. A master gain fader is incorporated, and each channel has an indicator lamp to show which sources have been faded up. A.C. mains required. Size 9 x 11 x 8½ ins. Price £58 10s.

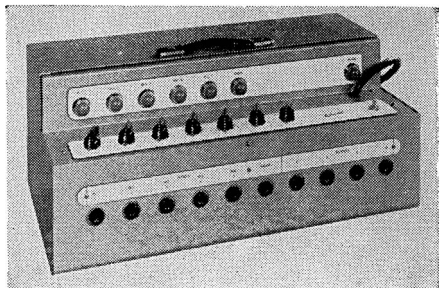

Astronic A.1446

Brenell Engineering Co. Ltd., 1a Doughty Street, London, W.C.1. Tel.: Chancery 5809/Holborn 7358.

Mk.5 Record/playback amplifier. Inputs: mic. 2.5 mV, radio/gram 100 mV, both high impedance. Outputs: 200 mV at 50,000 ohms, and 4 watts into 15 ohms for direct connection to loudspeaker. Headphone monitoring M.E. level ind. or meter if required. Price £24. Meter, £5 5s. extra.

Brenell Mixer Unit. 3 channel unit. For best results high impedance sources such as crystal microphones and pickups are recommended. There are 4 sockets for jack plugs for the three inputs and the output lead, each input having a volume control. Price £2 18s.



Dektron, 2 Westbourne Road, Weymouth, Dorset. Tel.: Weymouth 1987.

Dektron Mixer/fader. Pocket 3-channel mixer. Jack sockets as standard. Input and output. Price £2 5s.

Dektron Monitor. Transistorised unit to provide monitoring or act as pre-amplifier. Powered by 2 torch cells. Price £5 5s.



Grundig (Gt. Britain) Ltd., Newlands Park, Sydenham, S.E.26. Tel.: Sydenham 2211. Showroom: 39-41 New Oxford Street, London, W.C.1. Tel.: Covent Garden 2995. Cables: Grundig London. Telex 22054.

G.M.U.3. Four channel mixer and pre-amp. Inputs: Mic. 1, 1.2 mV, 100 K ohms; Mic. 2, 4 mV, 100 K ohms. Polarised 100v D.C. Mic. 3 as Mic. 2.

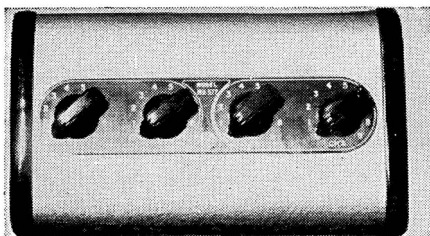

Lustraphone MU577

Channel (radio/P.U.). 300 mV, 500 K ohms. Out. imp. approx, 1,000 ohms. Magic eye level ind. Output level 65 mV. Mains-powered. Price £16 16s.



Heathkit. Manufactured by Daystrom Ltd. 900 Southgate Street, Gloucester, England. Tel.: Gloucester 20217. Cables: Dayin.

TA-1M. Pre-amplifier. Inputs. Mic. 0.5mV. Radio 250mV. Switched controls, record/replay, bias, level, mic, radio. H.D. <0.1% for 500mV. H & N -60 dB for 500mV. Power supply required 290V 20 mA D.C. 6.3V 1A per channel. Size 4½ × 13½ × 12 ins. Price £16 14s.

TA-IS. Stereo version of TA-1M. Price £22 4s.

TA-1C. Conversion Unit for TA-1M to convert to TA-IS. Price £6.



Jason Electronic Designs Ltd., 3/4 Gt. Chapel Street, London, W. 1. Tel.: Gerrard 0273/4.

J.S.M./1. Record and replay tape unit. Recording input 100 mV. Push-pull oscillator. Variable bias control. Magic-eye indicator. Replay amplifier produces 0.5 volts from 7 mV programme peak. Size 15 × 8¼ × 4¾ ins. Price £37 10s.



The Lowther Manufacturing Co., St. Mark's Road, Bromley, Kent. Tel.: Ravensbourne 5225. Cables: Lowther, Bromley.

Companion Supply Unit No. 2. H.T. and L.T. power supply suitable to power radio tuners. Preamp and tape bias amplifier. Output 250v at 40 mA, 6.3v at 3 A. Price £5 10s.

Lustraphone Ltd., St. George's Works, Regents Park Road, London, N.W.1. Tel.: Primrose 8844. Cables: Lustraphon London.

M.U.577. Transistor mixer unit. Inputs: 1 and 2 are unbalanced and are suitable for low imp. mics. (line or high imp. to order). 2 and 3 are high imp. and suitable for radio or P/U. Output is balanced to match that from 1 and 2. F.r. substantially flat 50-14,000 c/s. Power by mercury cell with 1,000 hours life. Alternative input and output impedances to specification. Price, standard model, £22.

A range of transistorised power amplifiers, 10 watts and 15 watts, and complete public address systems. Details on application.



Modern Electrics (Retail) Ltd., 120 Shaftesbury Avenue, London, W.C.2. Tel.: Covent Garden 1703. Temple Bar 7587. Cables: Modcharex, London.

Binson Echorec. Pre-amplifier and magnetic recording unit enabling echoes and other effects to be achieved. Three channels are included and the timing of echoes is variable. Operation from AC mains. Price £147 complete.

Binson Baby Echorec. Single channel version of above. Price £84.



M.S.S. Recording Co., Ltd., Colnbrook, Bucks. Tel.: Colnbrook 2431. Cables: Emessco.

4 M 2 or 2 ML. Microphone mixing and control unit. Up to 4 mics. or line, P/U and 2 mics. Microphone switching and level control. Output sockets for 600 ohm line and headphone monitor. 4 input



Binson Baby Echorec

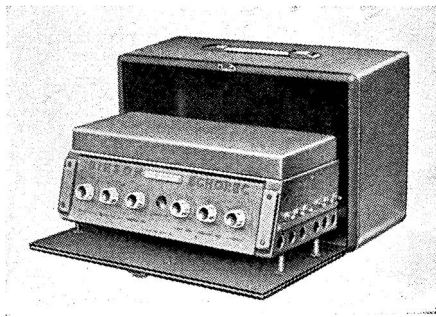

Binson Echorec

sockets. H.D. at 1 mW 1,000 c/s. tone, is 0.25%. H and N at normal output level on 1 mV signal to noise ratio 60 dB. Size $14\frac{1}{2} \times 12 \times 7$ ins. Price £50.

RA/50. Amplifier for recording and playback. 50 watts. Dist. 2.5% at 50 watts. Input for spec. output 1v. Response 30-15,000 c/s. ± 2 dB. Feedback 12 dB. N.L. -80 dB at full output. Out. imp. RA50/1 1,800 ohms; RA50/2 200 ohms; RA50/3 15 ohms. Output EL37's. Size $19 \times 14 \times 8$ ins. Power available for pre-amp. Price £70.



Penco Products, 36 Coniston Road, Kings Langley, Herts. Tel.: Kings Langley 3134. Cables: Penco, Kings Langley.

Epigram Mix/3. 3 channel unit. Incorporates 3 transistors and is designed for 2 low impedance 15/30 ohms and one high impedance input. Power derived from 4 volt Mercury Cell. Output is high impedance. Price £15 15s.

Epigram Mix/35. Details as above except that 5 transistors are included giving extra gain, e.g. to by-pass input stage of recorder. Price £26 5s. Specials to order.

Epigram Mix/35L. As Mix 35 but fitted with low noise transistors. Price £29 8s.



Philips Electrical Ltd., Century House, Shaftsbury Avenue, London, W.C.2. Tel.: Gerrard 7777. Cables: Phillamps, London.

Philips ET.1039. A channel unit. Each input is designed for a microphone of 50/600 ohms impedance and includes a transformer. The output voltage is approximately 90 mV and is cathode follower. A master gain control is included and mains supply is required. Size $12 \times 6\frac{1}{2} \times 3$ ins. Price £36.

Philips EL.3989. 4 channel unit. Incorporating 4 separate potentiometers. Price £4 4s.



Rank Cintel Ltd., Worsley Bridge Road, London, S.E.26. Tel.: Hither Green 4600. Cables: Televisor, London.

Cintel Microphone Amplifier. Transistorised unit. Input 30 to 600 ohms. Gain 70 dB. Attenuation 0 to 30 dB. F.R. 40 to

15,000 c/s. Distortion $< 0.2\%$. Output matched to 600 ohms. Price not yet available.

Cintel Line Amplifier. Transistor unit. Input and output imp. 600 ohms. F.R. 30-15,000 c/s ± 1 dB. Distortion less than 0.2%. Normal output +14 dBm, maximum output + 26 dBm. Price not yet available.

■ **Cintel Transistor Stereo Pre-amplifier.** 4 position input selector for mic. radio, tape, pickup bass and treble controls. H.D. less than 0.1%. Variable slope 0 to 36 dB. Size approximately $10 \times 5 \times 4$ ins. Price not yet available.

Cintel Transistor stereo 88 amplifier. Output 8 watts per channel. Distortion 0.05% at 6 watts. Input for spec. Output 500 mV. F.R. 10-50,000 c/s. ± 1 dB. H & N -80 dB. Size $10 \times 5 \times 5$ ins. Price not yet available.



Rogers Developments (Electronics) Ltd., "Rodevco Works," 4-14 Barmeston Road, Catford, S.E.6. Tel.: Hither Green 7424. Cables: Rodevco, London.

General Purpose Power Pack, Model A. Suitable for tape units and radio tuners. Output 250v at 45 mA, 6.3v at 2.5A. Size $7\frac{1}{2} \times 3 \times 5$ ins. Price £4 5s.

Model C for switched FM unit. Price £4.



Henri Selmer & Co. Ltd., 114 Charing Cross Road, London, W.C.2. Tel.: Temple Bar 5432. Cables: Selmatone, Westcent, London.

Saba Regiemixer 100. 4-channel unit, comprising sliding controls and volume preset adjustment in each channel. Input sensitivity 0.05 mV on first three channels at 1,000 ohms, 350 mV at 500 K on fourth channel. F.R. 20-20,000 c/s. H and N -65 dB. Inter-channel crosstalk -65 dB. Output 60 mV max. into 15,000 ohms. 3 transistors type TF65. Size $8\frac{1}{2} \times 6\frac{1}{2} \times 3\frac{1}{8}$ ins. Weight $2\frac{1}{4}$ lb. approx. Price £18 18s.



Shirley Laboratories Ltd., 3 Prospect Place, Worthing, Sussex. Tel.: Worthing 30536.

TW/PA2. Recording amplifier for use with high quality power amplifier. Inputs:

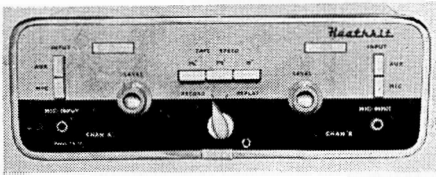

Heathkit TA-15 Tape pre-amp.



Jason J.S.M. 1 Tape Unit

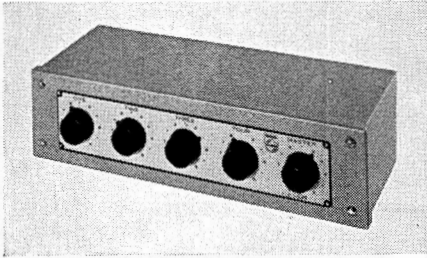

Philips ET1039 Mixer

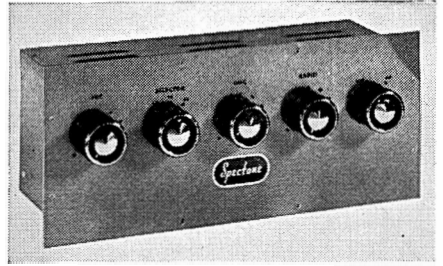

Spectone Mixer

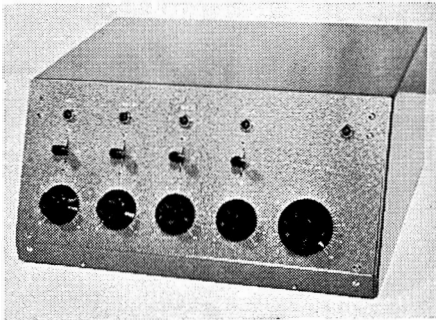

MSS 4M2 4-Channel Mixer

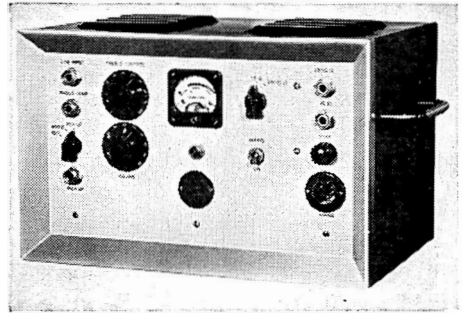

MSS RA 50 recording amplifier

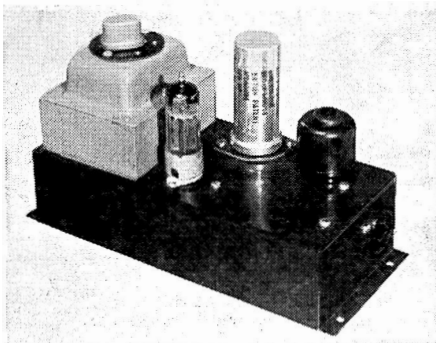

Rogers Power Pack

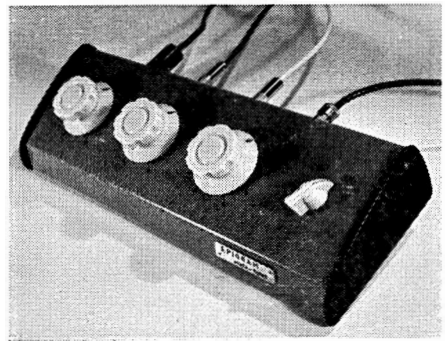

Penco Products Mix/39

1.5 mV and 60 mV. Bias and erase oscillator. Full corrections. Valve voltmeter modulations level ind. For use with Wearite tape deck, can be supplied to order for any deck. Size $10 \times 5\frac{1}{2} \times 5\frac{1}{4}$ ins. P.s.n. from main amp. or power pack can be supplied at £4 14s. 6d. Price £31 10s.

TWA/15. Tape amplifier for use with most tape decks, also for use with pickup or radio. Inputs: 1-1.5 mV and 40 mV. Output. 15 watts, 20 watts peak. F.r.: as recorder 50-14,000 c/s; as reproducing and gram amp. 20-30,000 c/s. Bass and treble boost and cut. H and N 85 dB down. Valve-Voltmeter level ind. power supply on separate chassis. Price £47 5s.

■ **TWA/1515.** Complete stereo record and replay amplifier. Output 15 watts continuous, 25 watts peak on each channel. Inputs: 1.5 mV and 50 mV. Bass and treble boost and cut. Level indicated by separate sustained peak-reading valve voltmeters. Power supply and oscillator on separate chassis. F.r.: 40-30,000 as ordinary amp.; 40-15,000 as recording amp. Size: control unit $23 \times 7\frac{1}{2} \times 7$ ins. Power unit $10 \times 8 \times 7\frac{1}{2}$ ins. Price £100 16s.

■ **TW/PA22F.** A two-channel version of the TW/PA2. Price £52 10s.



Simon Equipment Ltd., 48 George Street, London, W.1. Tel.: Welbeck 2371. Cables: Simsale, London.

■ **SP/4 Stereo Adaptor.** For use with Simon SP/4 tape recorder, providing replay of stereo pre-recorded tapes. Consists of two units, a stereo pre-amplifier feeding 330 mV at 50,000 ohms for the right-hand channel (through SP/4) and 1v at 1,000 ohms for the left-hand channel. The latter is reproduced through the second unit, a 10 watt amplifier and loud-speaker housed in a cabinet identical in size to the SP/4. Price £51 9s.



Sound News Productions, 10 Clifford Street, New Bond Street, London, W.1.

Unimixer 1. 3 channel unit. Channels 1 and 2 have duplicate sockets for low or high impedance microphones—30 ohms or 400 K ohms. Recommended load impedance not less than 500 K ohms. Price £9 9s.

Unimixer 2. 3 channel unit. Inputs as above but high impedance is 5 M ohms in channels 1 and 2. Power supply needed 200/300 volts D.C. at 5 mA, 6.3v at 0.3 amps. Special connectors available to obtain power supplies direct from Ferrograph or Vortexion recorders without any alteration. Price £15 15s.



Sound Sales Ltd., Works and Acoustic Laboratories, West Street, Farnham, Surrey. Tel.: Farnham 6461-2-3. Cables: Sounsense.

A-Z General Purpose Power Pack for supplying additional units beyond the scope of the main amplifier. Output 250v at 35 mA, 6.3v at 2A. Size $11\frac{1}{4} \times 4\frac{1}{2} \times 4\frac{1}{2}$ ins. Price £5 10s.

A-Z Precord Unit. Designed for use with Wearite or Truvox tape deck. Self-powered. Inputs: mic. or radio/pickup. Sel. switch for record and replay. Green and red ind. lights give add. visual check. Calibrated recording level indicator. Equalisation for $3\frac{3}{4}$, $7\frac{1}{2}$ and 15 i.p.s. C.C.I.R. and N.A.R.T.B. characteristics. Variable bias control. Record level gain control. Size $11\frac{1}{4} \times 9\frac{1}{2} \times 4\frac{3}{4}$ ins. Price £30.



Specto Ltd., Vale Road, Windsor, Berks. Tel.: Windsor 1241. Cables: Specto, Windsor.

Spectone Electronic Mixer. 142 and 142A, Inputs: radio 100 mV; mic. 1.5 mV; P.U.1 6 mV; P.U.2 50 mV. Output 0.5v. P.U.1 can be used as second mic. input. F.r.: radio 20-20,000 c/s. ± 0.5 dB; mic. 25-20,000 c/s. ± 0.5 dB. H and N P/U -53 dB. P.s.n. model 142, 200-300v at 5 mA; 6.3v at 1.2 amps. Model 142A, self-powered. Size panel $12\frac{1}{4} \times 5\frac{1}{4}$ ins. Casing $11\frac{1}{4} \times 4\frac{1}{2} \times 4\frac{1}{4}$ ins. Price: 142, £17 17s.; 142A, £22 1s.



Stern Radio Ltd., 109, 111 and 115 Fleet Street, London, E.C.4. Tel.: Fleet Street 5812-14.

HF/G2P. Tape pre-amplifier. Inputs: mic 2.5 mV, radio/pickup 300 mV. F.R. 50-10,000 c/s ± 3.5 dB, equalised for $3\frac{3}{4}$ i/s. Output 250 mV. Size $12 \times 9\frac{1}{2} \times 5\frac{1}{2}$ ins. Weight 5 lb. To operate with Garrard magazine loading deck. Price £14.

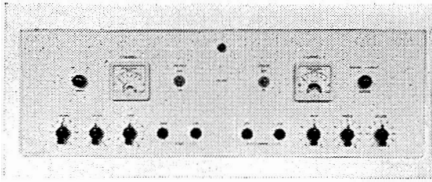

Shirley TWA/1515

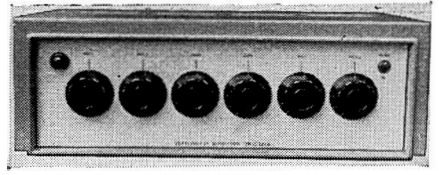

Vortexion 2MGT 15W



Grundig G.M.U.3

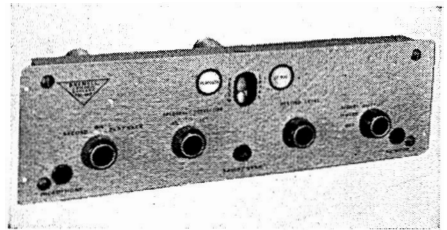

Brenell TP2



Masterlink M2A

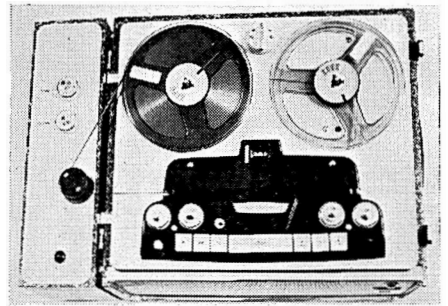

Simon SP/4 Stereo adaptor

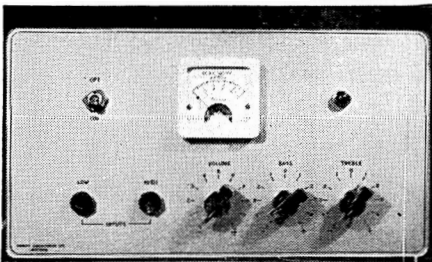

Shirley TWA/15

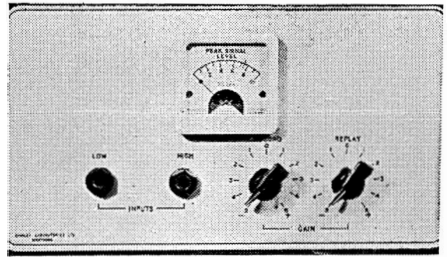

Shirley TW/P A2

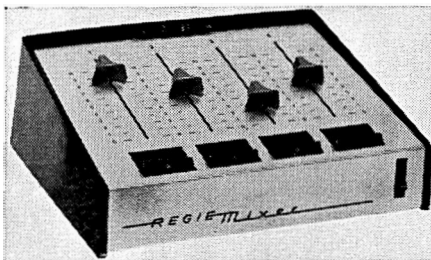

Saba Regiemixer 100

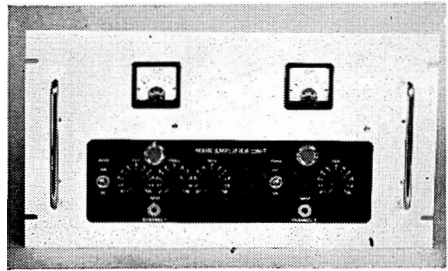

Shirley double channel tape amplifier

HF/G2A. Tape amplifier. Details as HF/G2P plus 2.5 watts audio output into 3, 7½ or 15 ohms. Price £15.

HF/TR3. Tape amplifier. Inputs: mic 2.5 mV, radio/pickup 300 mV. F.R. 35-16,000 c/s ± 3 dB at 15 i/s. Equalisation available for 15, 7½ and 3¾ i/s or 7½, 3¾ and 1⅝ i/s. 3 watts output into 3, 7½ or 15 ohms. To Mullard design, suitable for Brenell, Collaro, Motek, Truvox and Wearite decks. Price, with separate power unit, £16 10s. Also available in kit form.

Type C Tape Pre-amplifier. Inputs: mic. 0.5 mV, radio/pickup 250 mV. F.R. 30-17,000 c/s ± 3 dB at 15 i/s. Equalisation available for 15, 7½ and 3¾ i/s or 7½, 3¾ and 1⅝ i/s. 250 mV audio output. To Mullard design, suitable for Brenell, Collaro, Motek, Truvox and Wearite decks. Price, with separate power unit, £17. Also available in kit form.



Technical Suppliers Ltd., Hudson House, 63 Goldhawk Road, London, W.12. Tel.: Shepherds Bush 2581/4794. Cables: Teknica London.

3 channel mixer unit. Designed for high impedance inputs. Jack plug sockets fitted. Size 4¼ × 3⅝ × 4½ ins. Price £2 2s.



Tele-Radio (1943) Ltd., 189 Edgware Road, London, W.2. Tel.: Paddington 4455.

Masterlink M2A. Tape pre-amp originally for Wearite series of deck, suitable for Reflectograph, Collaro and Brenell decks. 2 units, pre-amp and oscillator and separate power supply. Switched inputs for mic., 1.2 mV and radio/P.U., 100 mV. Meter indicates bias, rec. signal, P/B signal. F.r.: 30-20,000 c/s. ± 1 dB. Oscillator cut-out facility for deck connection. Switched equalisation for 3¾, 7½ and 15 i.p.s. Low imp. output approx. 200 mV. C.C.I.R. adjustment preset. Size 12 × 6 × 8 ins. Price £28 7s.



Truvox Ltd., Neasden Lane, London, N.W.10. Tel.: Gladstone 6455. Cables: Truvoxeng.

Type M Recording Amplifier. Inputs: 1 megohm at 1-2 mV; ½ megohm at 0.5

v. Vol. and on/off. Compensated for 7½ and 3¾ i/s. Record/replay switch. Tone control. High imp. output. H and N —45 dB. Output 4 watts. Primarily for Truvox tape deck. Price £21.

Type K Mk. 2 Recording Amplifier. Similar to Type M. Power available for bias and erase. Price £19 19s.



Vortexion Ltd., 257/263 The Broadway, Wimbledon. Tel.: Liberty 6242/3. Cables: Vortexion, Wimble, London.

3-channel Prof Mixer. Built-in mu-metal shielded input transformer, hermetically sealed controls, screened mains transformer. Output 1m/watt, 600 ohm balanced or unbalanced. Peak programme meter calibrated zero level + 12 to ± 20 dB. Size 18¼ × 10¼ × 6 ins. Price on request.

4-channel Prof. Mixer. For 30-50 ohm mic. balanced line or other imp. to order, heavy mu-metal shielded transformers, hermetically sealed controls. Outputs ½v on more than 20,000 ohms or 600 ohms, 1 mV. Has own screened power pack for AC mains. Size 18¼ × 10¼ × 6 ins. Price £40 8s. 6d. 600 ohms output extra. Similar 12 way is also available.

2MGT.15W. Combined 4-channel mixer and 10/15 watts power amplifier. Distortion 0.1%. F.R. 2-20,000 c/s ± 1 dB. 24 dB feedback. H and N —80 dB. Out. imp. 4, 8, and 15 ohms. Size 18 × 6 × 9½ ins. Price £49.

S/30/50. Combined 3-channel mixer and 35/200 watts power amplifier. Distortion 0.2%. F.R. 30-20,000 c/s ± 1 dB. 22 dB feedback. H and N —85 dB. Out. imp. 4, 8, and 15 ohms. Size 18½ × 10½ × 9½ ins. Price £59.

S/120/200. 140/200 watts power amplifier. Distortion 0.2%. Input for spec. output 0.775v into 600 ohms. F.R. 30-20,000 c/s ± 1 dB. 24 dB feedback. H and N —95 dB. Out. imp. 110 or 220 volt line. Size 19 × 12¼ × 12 ins. To operate with Vortexion 4-channel mixer or 3-channel plus P.P.M., etc. Price £112.

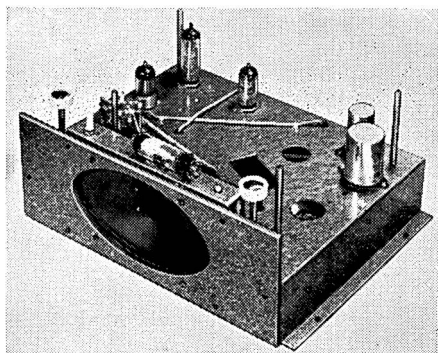

Stern HF/G2A

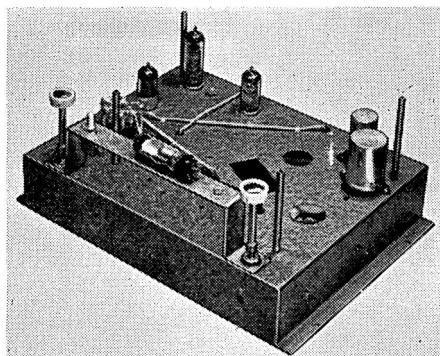

Stern HF/G2P

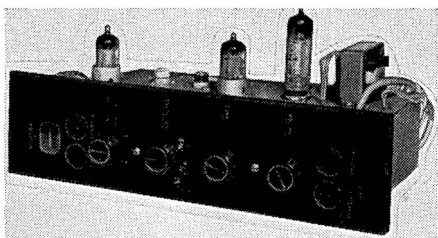

Stern HF/TR3

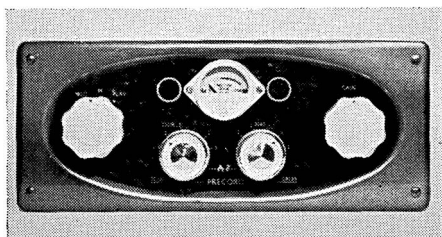

Sound Sales AZ Precord



Sound News Production Unimixer

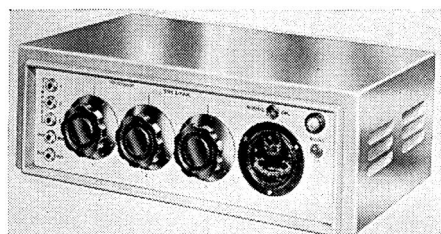

Vortexion 3-way Mixer

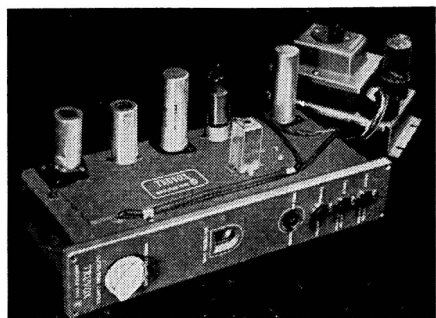

Truvox Type K recording amplifier

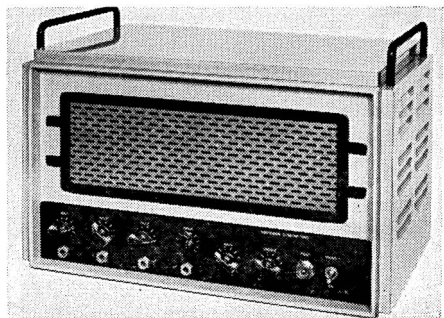

Vortexion S/30/50 mixer and amplifier

TAPE ACCESSORIES and COMPONENTS

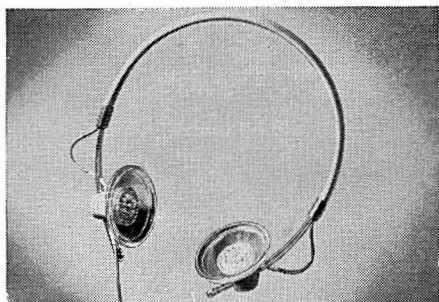

AKG lightweight headphones, type K50



E.M.I. plastic tape container

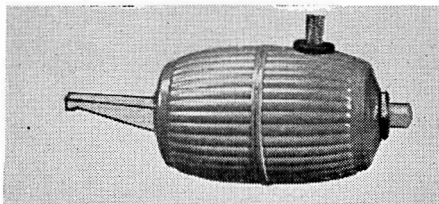

Cinesmith Depolariser

AKG (Akustische und Kino-Geräte Ges. m.b.H.) Sole U.K. agents, **Politechna (London) Ltd.**, 3 Percy Street, London, W.1. Tel.: Langham 6236. Cables: Polindust, London.

A.K.G. K50 Dynamic headphones. F.R. 30-20,000c/s. Impedance 800 ohms. Weight 80 grams. Price £7 10s. (Stereo version available).



Bogen of West Germany. U.K. distributors, **Gopalco Ltd.**, 66 Bolsover Street, London, W.1.

A range of two-track and four-track heads comprising two symmetrical windings and a pair of laminated semi-circular cords. These are embedded in plastic and

enclosed in a screening case. Gap width just under 0.00004 ins.

Type UK 100. Two-track monaural record/playback head. Price £3 3s.

Type UL 110. Erase head for the above. Price £1 1s.

Type UK 200. Two-track stereo record/playback head. Price £10 10s.

Type UL 210. Erase head for the above. Price £5 5s.

Type UK 205. Four-track stereo or monaural record/playback head. Price £10 10s.

Type UL 215. Erase head for the above. Price £5 5s.



Bradmatic Productions Ltd., 124-126 Albert Road, Handsworth, Birmingham. Tel.: Northern 8091.

A range of twin track high impedance sound heads, single hole fixing, pole pieces are cylindrically ground flush with caps. Screening cans available.

Type 5 RP. Combined record/replay head 0.0004 in. gap. Price £3 5s.

Type 6 RP. Super fidelity record/replay head 0.0002 in. gap. Price £3 15s.

Type 5R. Record only 0.0007 in. gap. Price £3 5s.

Type 5E. Erase head. Price £3 5s.

Full track versions of the above are also available.

■ **Type ST-RP.** Stereo record/replay head. Price with screen can, without fixing stem, £6.



S. G. Brown Ltd., Shakespeare Street, Watford, Herts. Tel.: Watford 27241. Cables: Sidbrownix, Watford

A range of headphones suitable for recording and dictating equipment, e.g. lightweight miniature model. Prices from £3 5s.



Cinesmith Products, Britannic Works, Regent Street, Barnsley. Tel.: Barnsley 4445.

Cinesmith Depolariser. For demagnetising record/playback heads in situ. Consists of a plastic moulding with polepiece and push-button switch. Price £1 15s.

Colton and Co. (Lapidaries) Ltd., The Crescent, Wimbledon, London, S.W.19. Tel.: Wimbledon 9401.

Call Boy. Counter type position indicator for tape recorders without built-in counter. Price £2 2s. 6d.



Cosmocord Ltd., Eleanor Cross Road, Waltham Cross, Herts. Tel.: Waltham Cross 25206.

Acos telephone adaptor. Allows recording or amplification of two-way telephone conversations by feeding into mic. or radio input of tape recorder. Price £1 1s.



Dektron, 2 Westbourne Road, Weymouth, Dorset. Tel.: Weymouth 1987.

Telecon pickup. For placing behind telephone (no actual connection) when telephone conversations are to be recorded or amplified. Price £1 7s. 6d.



Elizabethan (Tape Recorders) Ltd., Bridge Close, Oldchurch Road, Romford, Essex. Tel.: Romford 64101.

Elizabethan Stethoset Headphones. Lightweight, high impedance. Price £3 13s. 6d.

Elizabethan Radio/P.U. Connecting Lead. 3 yards of low loss screened cable fitted with British Standard jack plug coaxial plug. Price 12s. 6d.

Telephone adaptor. Price £1 1s.



EMI Sales & Service., Ltd., Blyth Road, Hayes, Middx. Tel.: Southall 2468. Cables: Emiservice, London. Telex: 2-2417.

Emitape Jointing Compound. AP35 for C.A. base tape. AP77 for P.V.C. base tape. A joining fluid for making permanent welded joints in magnetic tape. Price 7s. 6d. per bottle.

Emitape Jointing Tape. AP103. Adhesive jointing tape for simple and quick splicing and editing of magnetic tape. Price 7s. 6d. per reel.

Emitape P.V.C. Editing and Marker Tapes. A range of six coloured tapes to enable colour code reference to be inserted in a reel of recorded tape for quick editing and indexing purposes. AP38/1 white;

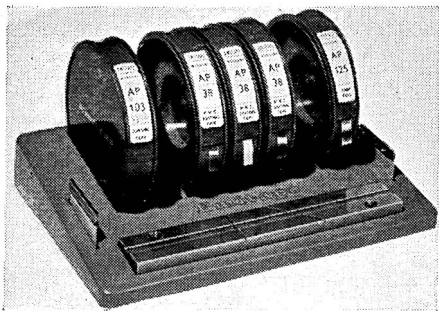

Emitape Accessory Kit

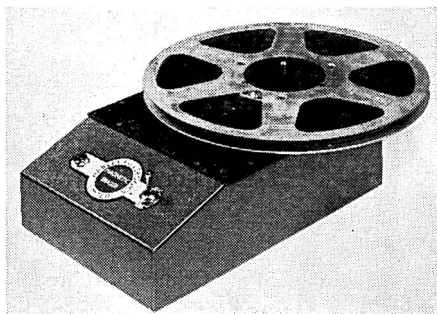

Harvey Bulk eraser

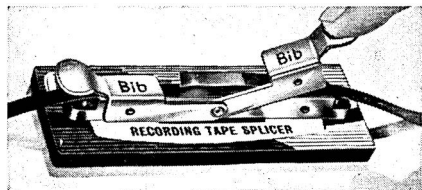

Multicore "Bib" splicer

AP38/2 red; AP38/3 yellow; AP38/4 blue; AP38/5 orange; AP38/6 green. Price 4s. 6d. per reel.

Emitape Plastic Tape Spools in cartons, all standard sizes available. Price: 3 in. and 3½ in. 3s.; 5 in. and 5½ in. 4s. 6d.; 7 in. 5s.

Edi-Tall Jointing Block for splicing and editing tape. Supplied with cutter. Price 10s. 6d.

Emitape Non-magnetic Scissors. Type AP39. Made of non-ferrous metal, the scissors may be used for splicing magnetic tape without risk of magnetising, so ensuring a completely noiseless joint. Price 16s.

Accessory Kit. 3 reels of coloured leader tape, 1 reel jointing, 1 reel stop foil, 1

Edi-tall jointing block, 2 cutters. Price £1 17s. 6d.

Metallic Stop foil. Sufficient for fifty tapes. In plastic container. Price 6s. 6d.



Film Industries Ltd., 90 Belsize Lane, Hampstead, London, N.W.3. Tel.: Hampstead 9632. Cables: Troosound, London.

Microphone Stands. Desk, table and floor stands. Grey Hammer finish with cast iron bases, stems in satin chrome. Prices from £1 5s.

Matching Transformer Enclosed in Mu-metal screening case for fitting into microphone lead. Impedance ratio: 30 ohms to 60 K ohms. Price £2 2s.



Grampian Reproducers Ltd., Hanworth Trading Estate, Feltham, Middx. Tel.: Feltham 2657. Cables: Reamp, Feltham.

Grampian G.7. Matching units, consisting of double wound transformer in a Mu-metal case with jack socket on the primary and a screened lead on the secondary. Dimensions $3\frac{3}{8} \times 1\frac{1}{4}$ ins. diameter. Versions available for matching 15/30 ohms, 600 ohms and 50,000 ohms or greater. Price £3 5s.

Grampian Parabolic Reflector. Diameter 24 in. depth 5 in. Gain 14 dB over range of 500 c/s to 5,000 c/s. Sighting tube $\frac{1}{4}$ in. To take Grampian DP4 Microphone. Weight with DP4 $5\frac{1}{2}$ lb. Price £5 15s.



Guy's Calculating Machines Ltd., (General Engineering Division) Truro Road, Wood Green, London, N.22. Tel.: Bowes Park 2258. Cables: Guycalc, London.

Brittape. Endless tape cassette providing up to 200 ft. of constantly circulating tape. Fits all flat topped 7 in. spool tape recorders. Price £6 6s.



Harvey Electronics Ltd., 273 Farnborough Road, Farnborough, Hants. Tel.: Farnborough 1120. Cables: Harvelec, Farnborough, Hants.

A range of bulk erasers for 200-250v or 100-130v mains, 40-60 c/s. Smallest model

will take $3\frac{1}{4}$ to 5-in. spools of $\frac{1}{4}$ -in. tape. and the largest $3\frac{1}{4}$ to 12-in spools of 1-in. tape. Prices, from £6 5s. to £15 10s.



Leevers-Rich Equipment Ltd., 78b Hampstead Road, London, N.W.1. Tel.: Euston 1481. Cables: Leemag, London.

LeeRaser. Junior ER30A; Standard ER31B; Senior ER32B. Ultra rapid demagnetisers for spools of tape and accessories. Price £6 5s.; £9 10s.; £15.



Metro-Sound Manufacturing Co. Ltd., 19a Buckingham Road, London, N.1. Tel.: Clissold 8506. Cables: Metrosound, London.

Klenzatabe. Cleaning outfit for removing oxide deposits, dirt, etc., from tape heads in situ. Comprises a length of brushed velvet rubber-backed cleaning tape, two 3-in. spools and a bottle of cleaning fluid. Price 12s. 6d.

Metro-Tabs. Set of coloured identifying tabs for affixing to recording tape. Visible on the wound spool and may be catalogued on the folder supplied. Price 3s. 11d.

Metro-Brush. Made specially angled Feathersoft Nylon for cleaning inaccessible places on tape decks cine cameras projectors, etc. Price 2s. 6d.

Metro-Splicer. Suitable for splicing tape and 8 mm. ciné film. Cuts at any angle. Non-magnetic blade. Price 15s.



Minnesota Mining and Manufacturing Company, 3M House, Wigmore Street, London, W.1. Tel.: Hunter 5522. Cables: Minnesota, London.

Tape Calculator. Giving playing times of standard, long play and double play tape. Free on request.



M.S.S. Recording Co., Ltd., Colnbrook, Bucks. Tel.: Colnbrook 2431. Cables: Emessco.

Tape Calculator. Four speed Tape Calculator giving playing times at a glance. Price 2s. 6d.

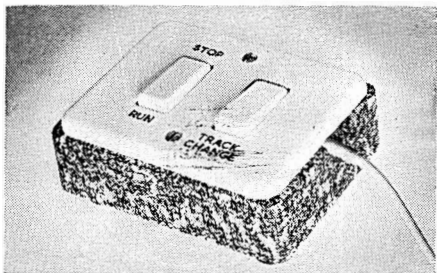

Simon Remote Control

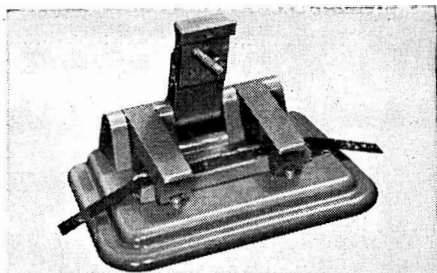

The Sound tape splicer

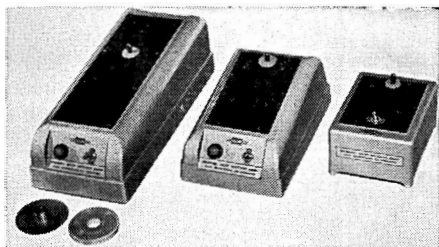

Leevers-Rich LeeRaser

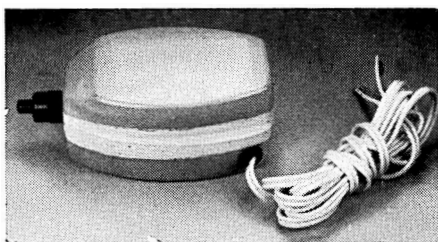

Osmabet "Instant" Bulk Eraser

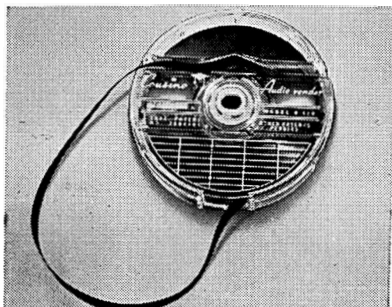

Philips continuous tape cassette



Sound Stethoscopes

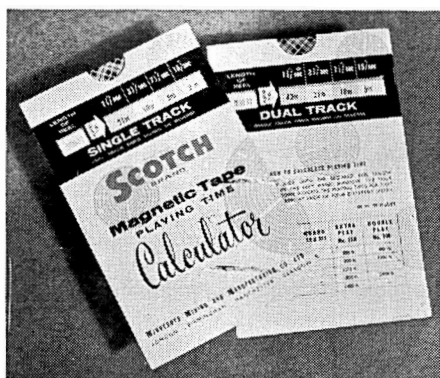

Scotch playing time calculator



M.S.S. Tape Calculator

Multicore Solders Ltd., Multicore Works, Hemel Hempstead, Herts. Tel.: Boxmoor 3636.

The "Bib" Tape Splicer. This splicer enables the tape to be joined easily and to be edited to the accuracy of a syllable. Supplied complete with razor cutter and mounted on flock-covered panel. Price 18s. 6d.

The "Bib" Tape Accessory Kit contains "Bib" tape splicer. Tape reel labels, data card giving tape speeds. Splicing tape and spare cutters. Price £1 8s. 6d.

"Bib" Tape Labels. Suitable for marking tape reels and boxes. Price 2s. 6d.



Osmabet Ltd., 46 Kenilworth Road, Edgware, Middlesex. Tel.: Stangrove 9314.

"Instant" Bulk Eraser. Operates from A.C. mains to provide rapid and complete erase of tapes prior to making quality recordings. Price £1 7s. 6d.



Philips Electrical Ltd., Century House, Shaftesbury Avenue, W.C.2. Tel.: Gerard 7777. Cables: Phillamps, London.

Continuous Tape Cassette. Containing 200 ft. of tape. Allowing continuous playback. Price £5.



Recording Devices Ltd., 44 Southern Row, Kensington, London, W. 10. Tel.: Ladbroke 4775.

Stuzzi Tape Tuner. A.M. tuner variable tuning F.R. 190-550m and 1,500m preset. Powered by (4) U.12 batteries. Size $5\frac{1}{4} \times 4\frac{1}{4} \times 1\frac{1}{2}$ ins. Price £3 19s. 5d. (U.K. purchase tax £1 5s. 7d.)



Romagna Reproducers—Factory distributors, **K. H. Williman & Co. Ltd.**, Blackford House, Sutton, Surrey. Tel.: Melville 1491.

Romagna Editing Block. Accurately machined from aluminium and designed to grip the edges of the tape. Diagonal or vertical cuts using razor blade. Price 7s. 6d.

Simon Equipment Ltd., 48 George Street, London, W.1. Tel.: Welbeck 2371. Cables: Simsale, London.

Simon Remote Control Unit. Operates with Simon SP/4 recorder to give start, stop and track change from up to 25 feet distance. Price complete with cable and plug £3 3s.

Stethoscope Head Set. Operates from ext. L/S socket for monitoring. Price with plug £2 12s. 6d.



Tape Recorders (Electronic) Ltd., 784/788 High Road, Tottenham, London, N.17. Tel.: Tottenham 0811. Cables: Taperec.

Sound Stethoset. Lightweight headphones. Impedance 50 ohms. Weight $1\frac{1}{2}$ oz. Price complete with lead and screened plug £2 10s.

Sound Splicer CM6. Incorporates strong plastic blades for rapid editing of tapes. Spare blades and guides available. Price £1 12s. 6d.



Truvox Ltd., Neasden Lane, London, N.W.10. Tel.: Gladstone 6455. Cables: Truvoxeng, London.

■ **TR2049. Stereophonic Head.** Stacked heads with safety gap for $\frac{1}{4}$ in. tape. Azimuth adjustment incorporated—will directly replace Truvox $\frac{1}{2}$ -track heads. Response 50-15,000 c/s ± 3 dB with suitable amp. Impedance 50,000 ohms at 10 Kc/s. Cross talk better than 45 dB. Price £8 8s.

Telephone attachment TA 2, for recording 2-way telephone conversations. Price £1 1s.

Stethoset TA 2000, for use with any recorder with low imp. output socket. Price £2 10s.

Radio Jack TA 3. Price Standard (M.W. only) £2 10s. (U.K. purchase tax 18s. 4d.).



Walter Instruments Ltd., Garth Road, Morden, Surrey. Tel.: Derwent 4421. Cables: Walinst, Morden, Surrey.

Walter Telephone Attachment. For use with Walter 505 and Metropolitan tape

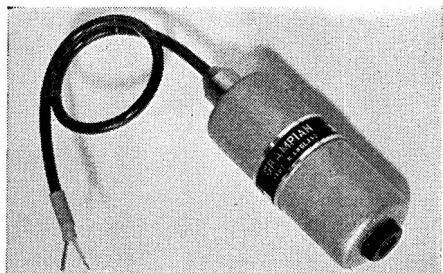

Grampian G.7 matching unit

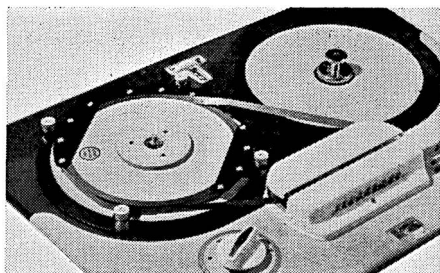

Guy's Brittape



Acos telephone adaptor

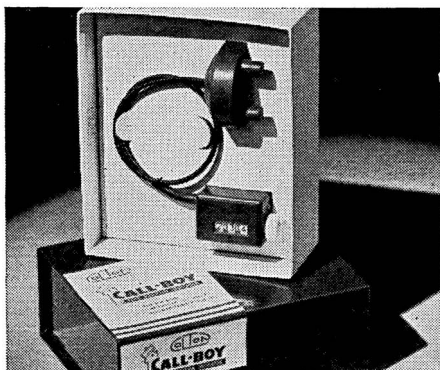

Colton Call-Boy



Romagna Tape Splicing block

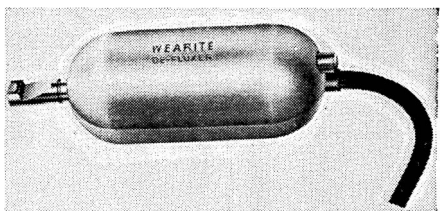

Wearite Defluxer



Grampian Parabolic Reflector



S.G. Brown headphones

recorders for recording two-way telephone conversations. Price £3 3s.

Walter Cine Stroboscope. For use with Walter 505 tape recorder for providing synchronised sound with any motor driven cine projector. Price £8 8s.

Walter Featherweight Headphones. Price £2 12s. 6d.



Wellington Acoustic Laboratories Ltd., Farnham, Surrey. Tel.: Farnham 6461/4961.

WAL Tape Eraser. A mains operated tape demagnetiser, accommodates from 5 to 10 in. reels, push button operated. Erases both tracks in a few seconds. Available for 200-250v, 50 c/s. or 110-125v, 60 c/s. Prices £7 18s. 6d.

WAL D-MAG. A mains operated head demagnetiser providing complete degaussing circuit. Suitable for erasing short passages from tape or striped film. Price on application.



Wilmex (Distributors) Ltd., St. Stephen's House, Westminster, London, S.W.1. Tel.: Whitehall 3213/4.

Irish Tape Splicer S.P.3. Enables editing to be carried out without the use of scissors or razor blades. Cutting and trimming blades fitted in cutting head. Price £3 7s. 6d.



Wright & Weaire Ltd., 88 Horseferry Road, London, S.W.1. Tel.: Sullivan 5426. Cables: Writewea, Sowest.

Wearite Defluxer. For depolarising heads of tape recorders and players. It ensures maximum signal/noise ratio from any tape recorder and protects recorded tapes from cumulative background noise and the gradual attenuation of the higher frequencies. Price £2 10s.



Wyndson Recording Co. Ltd., 2 Bellevue Road, Friern Barnet, London, N.11. Tel.: Enterprise 2226. Cables: Wyndreco.

Wyndson Telephone Adaptor. Stick-on unit, adheres to telephone base for recording two-way telephone conversations. Price with screened lead and jack plug £1 9s. 6d.



Stuzzi Tape Tuner

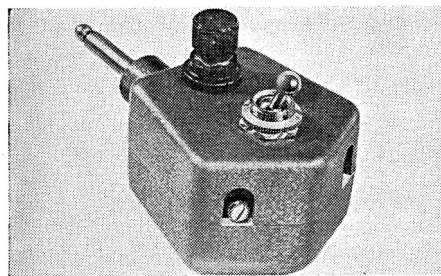

TruvoX Radio Jack

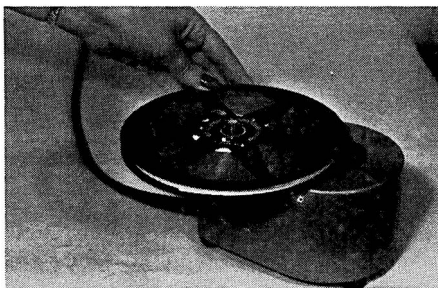

WAL Tape eraser

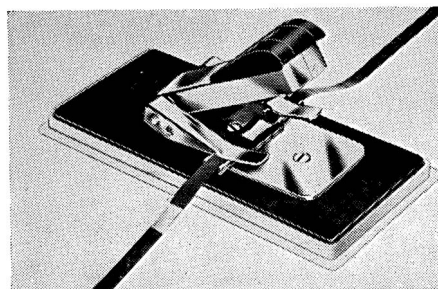

Irish Splicer S.P.3

MAGNETIC TAPE

AN INTRODUCTION

ONE of the easiest ways of introducing a subject is to look back over the past and to spin a web around it. Usually this is a lazy idea, but in the case of magnetic tape it is sufficiently interesting to merit the procedure. No doubt many readers of the **Year Book** were "in at the beginning" of tape in this country—and it is equally certain that quite a few will have had plenty of experience with what came before tape—wire. The writer has, and recalls vividly the nights of torment which were spent in attempting to unravel incredibly tangled piles of steel wire, of cutting out bits and knotting in the wrong ones, of replaying musical works and listening to the key changing as wire, recorded at one speed, passed the replay head at a speed quite different. There was the interminable waiting, too, while wire was rewound for replay—forward or reverse—at precisely the same slow speed at which it was recorded.

Wire out—Tape in

Wire went out as tape came in—approximately, and for general domestic use, in 1947/8. And memory brings back the first commercially produced tape recorders for the domestic market in Britain which used a "paper" tape and recorded on it at full track. Speed, $7\frac{1}{2}$ i/s. This however, was a phase quickly passed; and within three years the half-track recorder had begun to establish itself. Then the race started. It may have been inspired by the apparent need to make tape competitive to disc: on the other hand it may equally well have begun as a result of trying to offer value for money: it may even have been Progress, refusing to be stifled. But half-track it was; and then down came the tape speed to $3\frac{1}{2}$ i/s. The quantity of the recorded material that could be put on to a given length of tape was thus increased $\times 4$.

Hard on the heels of these developments came the next move, and this time by the

tape manufacturers—*Long Play* tape, by which the factor was further increased by 50% as a result of using a thinner base, thereby making it possible to get half as many turns again on to a spool. Double Play Tape still further increased the turns-per-spool factor from 50% to 100%.

Tape speed then took another dive, and $1\frac{7}{8}$ i/s was introduced on to many models of domestic recorders. The overall gain—for those who were interested in such savings—was thus $\times 16$ over the original full-track, full thickness tape at $7\frac{1}{2}$ i/s. But then came stereo, which was awkward, for it used two tracks and thus cut things back to $\times 8$! However, that was soon answered by the introduction of $\frac{1}{4}$ -track recordings, which restored the position to $\times 16$. All this in approximately 14 years, starting from scratch. It is no wonder that the consumer—the man-in-the-armchair who decides to go in for tape—is a very bewildered person; and it is scarcely less wonder that the industry has taken one or two setbacks as a result of the confusion that it so enthusiastically created for itself.

Speeds down—Quality up

All this time, while tracks were being added, while speeds were being halved, and while thicknesses were being reduced, tremendous research has been going on in all parts of the world where magnetic tape is produced. But the net result is (so far as the domestic user is concerned) that things are approximately as they were at the beginning, in terms of quality of sound: for as fast as the manufacturers made improved quality possible, the users decided to take up one or more of the "advantages" which gave them more playing time per spool, and so used up the improvements in this other direction. Strangely enough, however, the demand for tape by the average domestic user has only increased by a very small percentage,

per head; and this shows very clearly that many thousands of people who have bought recorders for purely domestic use are not using them fully, or obtaining nearly the proper entertainment value from them that they should. Why is this?

Tape-tied to Economy

One very possible reason is that they have tied themselves in—become entangled by their own ideas of tape economy—fallen victims to the very sales gimmicks that persuaded them to buy their recorders in the first place—“*Six hours of recording on one spool!*” Forgetting $\frac{1}{4}$ -track recordings for the moment (and they have their own very useful place in the scheme of things) it is impossible to derive maximum value from a recorder until one has taken the plunge and decided to “edit” tape: *and this means using only one track*. It also means buying twice the amount of tape, initially; but that represents a very small outlay in comparison

with what has been spent on the instrument. Statistics would almost certainly show that the majority of tape recorder users have perhaps one or two spools of tape, loaded on both tracks with bits of this and that. They cannot cut what they have got. They wipe out a bit here and a bit there, and add a bit more in the gaps thus created.

Buy it—Cut it—Use it

The use of a 4-track recorder for this type of tape-hogging is quite unthinkable—but done. A concluding note for this short introduction, which has so far introduced nothing, is a word of sincere advice to 90% of the users of recorders who fall into the above category. Study the strong and growing list of tape products in the following pages. Buy an editing block and some jointing tape, and begin to discover the real enjoyment that is in the hands of everyone when a new spool of tape in unpacked—and used, properly.

DIRECTORY OF MAGNETIC TAPE

Agfa A. G. Leverkusen, W. Germany.
Agfa Ltd., 27 Regent Street, London, S.W.1. Tel.: Regent 8581.

Agfa Magnetonband PE31. Pre-stressed polyester. Long play. Spool sizes: 3, 5, 5½, 7-in. Price 9s., £1 8s., £1 15s., £2 10s.

Agfa Magnetonband PE41. Pre-stressed polyester. Double play. Spool sizes: 3, 5½, 7-in. Price 14s., £3, £4.



Airtech Ltd., Haddenham, Bucks. Tel.: Haddenham 422.

Full range of standard, long play and double play tape. Spool sizes: 3, 4, 5, 5½, 7 in. Prices on application.



BASF Chemicals Ltd., 5a Gillespie Road, London, N.5. Tel.: Canonbury 2011. Grams.: Forbasf, Phone, London.

BASF LGS52. P.V.C. Standard play. Spool sizes: 3, 4, 5, 5½, 7-in. Price: 8s., 13s. 6d., £1 1s., £1 8s., £1 15s.

BASF LGS35. P.V.C. Long play. Spool sizes: 3, 4, 4½, 5, 5½, 7-in. Price: 9s., 14s. 6d., £1 1s., £1 8s., £1 15s., £2 10s.

BASF LGS26. P.V.C. Double play. Spool sizes: 3, 4, 5, 5½, 7-in. Price. 14s., £1 5s., £2 2s., £2 18s. 6d., £3 17s. 6d.

BASF LGS55. P.V.C. Editing Sound tape. May be written on. Spool size: 4½-in. Price: £1 5s.



C.B.S. Sole U.K. importers. The Recording Tape Co., 44 Old Bond Street, London. W.1. Tel.: Grosvenor 2805.

CIP 6 Standard 5 in. 600 ft. 17s. 6d.
CIP 9 5½ in 900 ft. £1 3s.

LP 9 Long Play 5 in. 900 ft. £1 1s. LP 12 5½ in. 1200 ft, £1 5s. LP 18 7 in. 1800 ft. £1 15s.

CMXP 12 Double play 5 in. 1200 ft. £1 18s. **CMXP 18** 5½ in. £2 7s. **CMP 24** 7 in. 2400 ft. £2 16s.

CIP-12PR Professional 7 in. 1200 ft. £1 7s. 6d.



Electro-Techno-Dynamics, 101 Leadenhall Street, London, E.C.3. Tel.: Avenue 6982. Wholesale distributors **V. L. Dewitt Ltd.**, 24-26 Hampstead Road, London, N.W.1.

Ferrodynamic Brand 5. Acetate, Spool sizes: 5 in. 600 ft., 16s.; 5 in. 900 ft., 18s. 6d.; 5½ in. 1,200 ft., £1 3s. 6d.; 7 in. 1,200 ft., £1 5s. Mylar Dupont: 3 in. 300 ft., 13s.; 5 in. 1,200 ft., £1 17s. 6d.; 7 in. 1,800 ft., £2 4s.; and 7 in. 2,400 ft., £3.



E.M.I. Sales & Service Ltd., Blyth Road, Hayes, Middx. Tel.: Southall 2468. Cables: Jabberment, London.

'44'. Cellulose acetate. Standard play. Spool sizes: 3¼, 5, 5½, 7, 8¼, 10½-in. Price: 6s. 9d., 18s., £1 4s. 6d., £1 10s., £3 6s.

'77'. P.V.C. Professional grade. Standard play. Spool sizes: 5, 5½, 7, 8¼, 10½, 11-in. Price £1 10s., £1 15s. 6d., £2 8s., £3 13s. 6d., £5 4s. 9d., £6.

'88'. P.V.C. Standard play. Spool sizes: 3, 3¼, 5, 5½, 7, 8¼, 10½, 11-in. Price: 7s. 6d., 7s. 6d., £1 1s., £1 8s., £1 15s., £2 17s. 6d., £3 18s. 9d., £4 11s.

'99'. P.V.C. Long play. Spool sizes: 3, 3¼, 5, 5½, 7, 8¼, 10½-in. Price: 9s. 6d., 9s. 6d., £1 8s., £1 15s., £2 10s., £3 12s. 6d., £5 10s.

'100'. Polyester. Double play. Spool sizes: 3¼, 5, 5½, 7-in., Garrard magazine. Price: 17s., £2 5s., £2 17s. 6d., £4, £1 17s. 6d.



Gevaert Ltd., Great West Road, Brentford, Middx. Tel.: Isleworth 2131. Cables: Artoveg, Brentford-Hounslow.

Gevasonor Type M. Acetate. Standard play. Spool sizes: 4, 5, 5½, 7-in. Price: 10s. 6d., 18s., £1 3s. 6d., £1 10s.

Gevasonor Type LR. Acetate. Long play. Spool sizes. 3, 4, 5, 5½, 7-in. Price: 7s. 6d., 13s. 6d., £1 4s., £1 8s. 6d., £2 2s.

Gevasonor Type LRP. Tensilized polyester. Long play. Spool sizes: 3, 4, 5, 5½, 7-in. Price: 9s., 16s., £1 8s., £1 15s., £2 10s.

Gevasonor Type DP. Tensilized polyester. Double play. Spool sizes: 3, 4, 5, 5½, 7-in. Price: 14s., £1 5s., £2 5s., £2 15s., £4.



Kodak Ltd., Kingsway, London, W.C.2. Tel.: Holborn 7841.

Kodak Tape Standard. 600 ft. £1 1s. 1200 ft. £1 15s.



Lee Products (Great Britain) Ltd.—(Concessionaires of **Audio Devices Inc.**, (U.S.A.), Elpico House, Longford Street, London, N.W.1. Tel.: Euston 5754. Cables: Leprod, London.

Audiotape. A range of 8 grades and thicknesses for amateur and professional use. Spool sizes: 3, 3¼, 4, 5, 5½, 7-in.



Minnesota Mining and Manufacturing Company, 3M House, Wigmore Street, London, W.1. Tel.: Hunter 5522. Cables: Minnesota, London.

Scotch 111. Acetate. Standard play. Spool sizes: 3, 3¼, 5, 5½, 7-in. 5s. 3d., 6s. 9d., 18s., £1 4s. 6d., £1 10s.

Scotch 311. P.V.C. Standard play. Spool sizes: 3¼, 5, 5½, 7-in. Price: 7s. 6d., £1 1s., £1 8s., £1 15s.

Scotch 102. Polyester all-purpose. Spool sizes: 5, 5½, 7-in. Price: £1 2s. 9d., £1 10s. 3d., £1 18s.

Scotch 150. Polyester. Long play. Spool sizes. 3¼, 5, 5½, 7, 8¼-in. Price: 9s. 6d., £1 8s., £1 15s., £2 10s., £3 12s. 6d.

Scotch 200. Polyester. Double play. Spool sizes: 3¼, 5, 5½, 7-in. Price: 17s., £2 5s., £2 17s. 6d., £4.



MSS Recording Company Ltd., Colnbrook, Bucks. Tel.: Colnbrook 2431.

MSS Standard. Spool sizes: 3, 4, 5, 5½, 7, 8¼-in. Price: 5s. 6d., 10s., £1, £1 7s. 6d., £1 15s., £2 10s.

MSS Long Play. Spool sizes. 3, 4, 5, 5½, 7, 8¼-in. Price: 8s. 6d., 14s. 6d., £1 8s., £1 15s., £2 10s., £3 10s.

MSS Double Play. Spool sizes: 3, 5, 5½, 7-in. Price 10s. 6d., £2 5s., £3 10s., £4.

MSS Supergrade. Standard play. Spool size: 7-in. Price: £2 18s. 6d.



Penco Products. 36 Coniston Road, Kings Langley, Hertfordshire. Tel.: Kings Langley 3134.

Orange Line. Standard. 5, 5½, 7-in. 600, 820, 1,200 ft. Price: 17s. 6d., £1 2s. 6d., £1 7s. 6d. **Long Play.** 5, 5½, 7-in. 885, 1,150, 1,800 ft. Price: £1 1s. 6d., £1 8s. 6d., £1 16s. 6d.



Philips Electrical Ltd., Century House, Shaftesbury Avenue, London, W.C.2. Tel.: Gerrard 7777. Cables: Phillamps, London.

Philips Standard Play. P.V.C. Spool sizes: 4, 5, 5½, 7-in. Price 13s. 6d., £1 1s., £1 8s., £1 15s.

Philips Long Play. P.V.C. Spool sizes: 3, 4, 5, 5½, 7-in. Price: 9s., 14s. 6d., £1 8s., £1 15s., £2 10s.

Philips Double Play. P.V.C. Spool sizes: 3, 4, 5, 5½, 7-in. Price: 14s., £1 5s., £2 2s., £2 12s. 6d., £3 17s. 6d.



Tape Recorders (Electronics) Ltd., 784/788 High Road, Tottenham, London, N.17. Tel.: Tottenham 0811. Cables: Taperec, London.

Sonocolor W.H.S. P.V.C. Standard play. Spool sizes. 3, 3½, 4, 4½, 5, 5½, 7, 9¾-in. Price: 8s., 9s. 6d., 13s. 6d., 16s. 6d., £1 1s., £1 8s., £1 15s., £3 15s.

Sonocolor W.S.M. P.V.C. Long play. Spool sizes: 3, 3½, 4, 4½, 5, 5½, 7, 9¾-in. Price: 9s. 6d., 14s. 6d., 16s. 6d., £1 0s. 6d., £1 8s. £1 15s., £2 10s., £5 5s.

Sonocolor W.D.T. P.V.C. Double play. Spool sizes: 3, 3½, 4, 4½, 5, 5½, 7-in. Price: 14s., £1 1s., £1 5s., £1 11s. 6d., £2 2s., £2 12s. 6d., £3 17s. 6d.



Telefunken.—Sole U.K. distributors, **Welme Corporation Ltd.,** 147/148 Strand, London, W.C.2. Tel.: Temple Bar 3357. Cables: Welmcior, London.

Telefunken Long Play. P.V.C. Spool sizes: 5, 5½, 7-in. Price: £1 8s., £1 15s., £2 10s.

Telefunken Double Play. P.V.C. Spool sizes: 5, 5½, 7-in. Price: £2, £2 10s., £3 15s.



Triton. Sole U.K. importers. K. Popper (R.T.C.) Ltd., 55 Chaplin Road, London, N.W.2. Tel.: Willesden 2141/2/3.

Triton Tape Super acetate, Red seal size 5½, 7 in. standard and LP. Mylar Orange. Seal 5 and 7 in. LP Mylar Super Play. Purple Seal 5 and 7 in DP. Prices on application.



Wilmex Ltd.—(Concessionaires of **Orr Industries Inc.,** U.S.A.), 151-153 Clapham High Street, London, S.W.4. Tel.: Macaulay 6473. Cables: Wilmexco, London, S.W.4.

Irish 195. Acetate. Standard play. Spool sizes: 3, 5, 5½, 7-in. Price: 4s. 11d., 17s., £1 3s., £1 7s. 6d.

Irish 196. Acetate. Long play. Spool sizes: 5, 5½, 7-in. Price: £1 4s. 6d., £1 7s., £1 19s. 6d.

Irish 211. Acetate. Standard play. Spool sizes: 5, 5½, 7-in. Price: £1 1s., £1 8s., £1 15s.

Irish 601. Mylar. Long play. Spool sizes: 3, 5, 5½, 7-in. Price: 9s., £1 8s., £1 15s., £2 10s.

Irish 724. Tensilized Mylar. Double play. Spool sizes: 3, 4, 5, 5½, 7-in. Price: 13s. 9d., £1 5s., £2 5s., £2 12s. 6d., £4.

Irish 220. Mylar. Standard play. Spool sizes: 5, 7-in. Price: £1 6s., £2 5s.



Zonal Film (Magnetic Coatings) Ltd., The Tower, Hammersmith Broadway, London, W.6. Tel.: Riverside 8741. Cables Zonogram, Hammer London.

Zonatape Acetate standard play 3½, 5, 5½, 7. Price 6s. 9d., 18s., £1 4s. 6d., £1 10s.

Zonatape PVC Standard, Long Play and Double Play in Standard spool size.

Zonatape Sprocketed tape ¼ in. Length to order Price 1¼d. per ft

DIRECTORY OF MICROPHONES

★ In these abridged specifications, the following abbreviations are used: **Source imp.**—microphone source impedance. **Rec. load imp.**—recommended load impedance, and Sensitivity is given in dB with reference to 1 volt/dyne/cm², unless otherwise stated.

■ Stereo.

AKG (Akustische und Kino-Geräte Ges. m.b.H.) Sole U.K. agents, **Politechna (London) Ltd.**, 3 Percy Street, London, W.1. Tel.: Langham 6236. Cables: Polindust, London.

D9. Moving coil. Response 80-10,000 c/s. Source imp. 200 ohms and 50 K ohms. Fitted with collapsible stand and 5 ft. screened cable. Price £4 14s. 6d.

D11N. Moving coil with cardioid directional pattern. Response 80-12,000 c/s. Source imp. 200 ohms or 50 K ohms. Fitted with screw-on table stand and 5 ft. screened cable. Price £7 10s.

D19. Moving coil with cardioid directional pattern and bass cut switch. Response 40-16,000 c/s. Source imp. 200 ohms or 50 K ohms. Price £17 10s. (low imp.) and £19 10s. (high imp.)

■ **D88.** Moving coil stereo microphone. Response 80-15,000 c/s. Source imp. 200 ohms each channel or 50 K ohms with transformer. Sensitivity —75 dB low imp., —52 dB high imp. Double cardioid for stereo, broad cardioid for mono. Price £15 10s. low impedance, £18 high impedance.

D12. Moving coil with cardioid directional pattern. Response 40-12,000 c/s \pm 4 dB. Front to back ratio 15 dB. Sensitivity —77 dB. Source imp. 60 ohms, or to order. Price £34.

C12. Professional condenser. Sel. switch gives choice of 9 polar characteristics. Response 30-15,000 c/s \pm 3 dB. Sensitivity —60 dB. Source imp. 50 and 250 ohms. Price £170.

C60. Miniature professional condenser. response 20-30,000 c/s. Source imp. 50 or 200 ohms. Price to be announced.

The full range of A.K.G. professional and domestic microphones and accessories is available. Details on request.

★

Bang & Olufsen, Struer, Denmark. Sole U.K. Importers: **Aveley Electric Ltd.**, Ayron Road, South Ockendon, Essex. Tel.: South Ockendon 3444. Cables: Aersale.

BM3. Ribbon. Response: music 30-13,000 c/s \pm 2.5 dB, speech bass cut below 1,000 c/s (2 position switch). Impedance 50 ohms. Price £14 10s.

BM4. As BM3 with variable output impedance, 50, 250, and 40,000 ohms. Price £16.



Acos Stereo Mic. 44



AKG D88 Moving Coil Stereo

■ **Stereophonic Microphone Assembly.** Comprises two B & O ribbon microphones, plus stereophonic baffle assembly. Price £36 10s., with type BM3. £39 10s., with type BM4.



Collaro Ltd., Ripple Works, By-Pass Road, Barking, Essex. Tel.: Rippleway 5533. Cables: Korllaro-Telex-Barking 28748.

Studio Crystal. Response 50-10,000 c/s. Sensitivity 1.8 mV/U.B. Source imp. 1,500 P.F. Rec. load imp. 5 megohm. 6 ft. cable. Tel. jack plug. Price £2 5s.



Cosmocord Limited, Eleanor Cross Road, Waltham Cross, Herts. Tel.: Waltham Cross 5206. Cables: Cosmocord, Waltham Cross.

Acos Mic. 39-1. Crystal. Response 40-15,000 c/s \pm 6 dB. Sensitivity -60 dB. Source imp. equals capacity of 800 pF. Rec. load imp. not less than 4.7 megohm. 8 ft. cable. Desk or floor stand adaptor available. Price £3 3s.

Acos Mic. 40. Ceramic. Response 30-6,000 c/s. Sensitivity -60 dB. Source imp. 2-5 megohms. Price £2. Crystal £1 15s.

Acos Mic. 45. Crystal. Response 30-6,000 c/s. Sensitivity -50 dB. Source imp. 2-5 megohms. Price £2.

■ **Acos Stereo Mic. 44.** Crystal. Response 50-12,000 c/s. Directional Pattern (Dual Fig. 8) Sensitivity -88 dB. Source imp. 2-5 megohms. Price £6 6s.



Elizabethan (Tape Recorders) Ltd., Bridge Close, Oldchurch Road, Romford, Essex. Tel.: Romford 64101. Cable address: Elizabethan, Romford.

Elizabethan. Ribbon. Response 50-12,000 c/s. Sensitivity -56 dB. Source imp. 50,000 ohms. Built-in transformer. Price £7 17s. 6d.



Film Industries Ltd., 90 Belsize Lane, N.W.3. Tel.: Hampstead 9632/3. Cables: Troosound, London.

M.7. Moving coil. Response 60-9,000 c/s. Source imp. 20 ohms. 6-ft. twin screened cable standard, other lengths if required. Table, desk and floor stands available. Price £6 5s.

M.8 Ribbon. Response 35-13,000 \pm 3 dB. Standard source imp. 30 ohms with in-built transformer. Other impedances up to 57 K ohms available 12-ft. twin screened cable standard, other lengths if required. Table, desk and floor stands available. Price £8 15s.



Fortiphone Ltd., 247 Regent Street, London, W.1. Tel.: REG 2024.

MI. Moving coil. Source imp. 2,200 ohms. Omni-direction. Price £1 15s.



General Electric Co. Ltd., Radio Group Lena Gardens, Brook Green, Hammer-smith, London, W.6. Tel.: Riverside 4671. Cables: Polyphase, London.

Studio Ribbon. BCS2373 and BCS2372S. Response 50-14,000 c/s \pm 1.5 dB. Sensitivity -90 dB at 15-30 ohms, -89 dB at 250-300 ohms. Line transformer built-in. Price £19 19s.

BCS2249A. Floor stand suitable for above mics. BCS2246A table stand. BCS2255 "Boom" studio stand.

BCS2378. Ribbon. Response 50-8,000 c/s \pm 2.5 dB. Impedance 30 ohms. Includes rotary ON/OFF switch, transformer, and length of screened cable. Price £10 5s.

BCS2384. Moving coil. Response substantially flat 200-10,000 c/s. Impedance 25-30 ohms. Price £8 18s. 6d.



Gopalco Ltd., 66 Bolsover Street, London, W.1. Tel.: Euston 4266.

Beyer M.50. Moving coil. Response 50-16,000 c/s. Sensitivity -51 dB. Source impedance 50 K ohms. Price £4 4s. 200 ohm version available.

Beyer M62. Moving coil. Response 100-16,000 c/s. Sensitivity -51 dB. Source impedance 50 K ohms. Price £6 6s. 200 ohm version available.

Beyer M.130. Ribbon. Response 50-16,000 c/s \pm 2.5 dB. Sensitivity -82 dB. Source Impedance 200 ohms. Price £33 12s.

Beyer M.100. Moving Coil. Non Directional. Response 50-16,000 c/s \pm 2.5 dB. Sensitivity -80 dB. Source impedance 200 ohms. Price £38.

CRYSTAL MICROPHONES

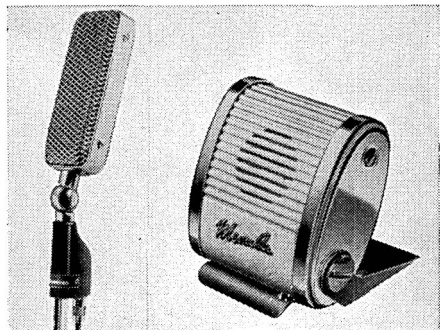

Shumann-Merula mics.

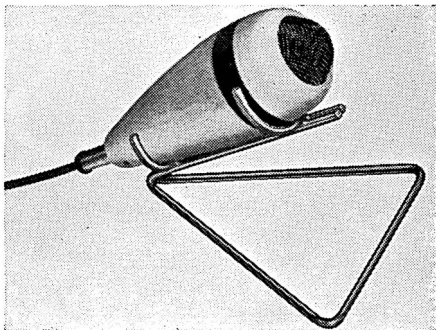

T.S.L. MX 3

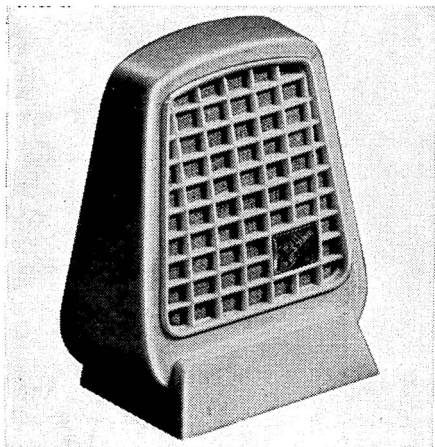

Sound M1

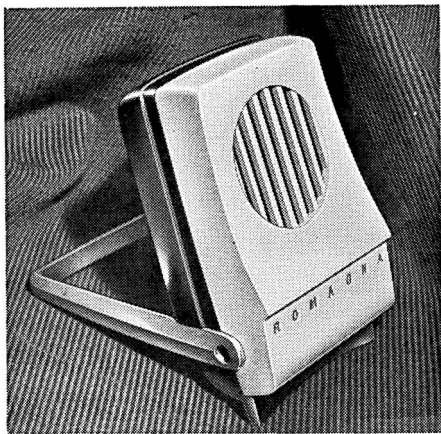

Romagna HMC/1

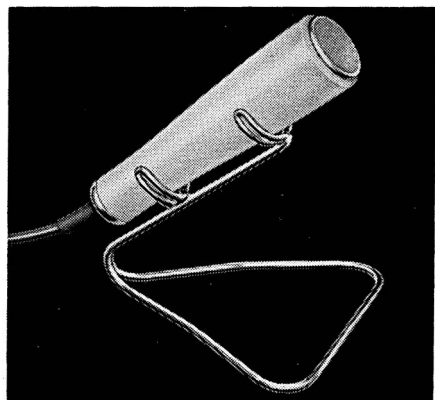

Acos Mic 39-1



Super Electronics SE 101

Beyer M.160. Ribbon. Response 50-12,000 c/s \pm 2 dB. Sensitivity -80 dB. Source impedance 200 ohms. Price £46 4s.

Beyer M.260. As above but with transformer for 50 K ohm. Price £22 1s.



Grampian Reproducers Ltd., Hanworth Trading Estate, Feltham, Middx. Tel.: Feltham 2657/8. Cables: Reamp, Feltham.

DP4/H. Moving coil. Response 50-15,000 c/s. Sensitivity -52 dB, -70 dB, -86 dB, for high, medium and low impedance. 50,000, 600, and 25 ohms. Tubular case. Price, including holder and lead. High or medium impedance £9 6s. 6d., low impedance £8 6s. 6d.



Grundig (Great Britain) Ltd., 39/41 New Oxford Street, London, W.C.1. Tel.: Covent Garden 2995.

G.C.M. Condenser mic. to match range of Grundig recorders. Price £6 6s.

G.D.M. III. Moving coil mic. High imp. Price £8 8s.



Lee Products (G.B.) Ltd., Elpico House, Longford Street, London, N.W.1. Tel.: Euston 5754. Cables: Leprod, London, N.W.1.

M.403A. Crystal. Response 40-7,000 c/s. Source imp. 1 meg. ohm. Price £7 7s. (Including Floor Stand.)

M. 416. Ribbon. Response 30-13,000 c/s. Source imp. 15-30 ohms. Price £7 15s.

M63. Moving coil. Source imp. 15-30 ohms or high. Omni-directional. Price £8 8s.



Lustraphone Ltd., St. Georges Works, Regents Park Road, N.W.1. Tel.: Primrose 8844. Cables: Lustraphon, London.

LX55 Crystal. Response 30-8,000 c/s. High source imp. 9-ft. cable. Price £2 10s.

Lustrette LD/61 Series. Moving coil. Response 70-12,000 c/s. Source imp. low, line and high. Built-in trans. when required. 9-ft. cable. Price £3 7s. 6d.

Master C51. Moving coil. Response 50-8,000 c/s. Source imp. low, line and high. Built-in trans. for line and high. 3-pin moulded mic. plug. Stand as required. Price, low, £5 5s.; line and high, £5 15s. 6d.

Master C48 and C48/S with Switch. Moving coil. Response 50-8,000 c/s. Source imp. 20 ohms. 3-pin moulded mic. plug. 6-ft. cable. Price C48, £6 6s.; C48/S £7 7s.

Hand Pencil LVF/H59. Moving coil. Response 150-14,000 c/s. Source imp. low, line and high. Built-in trans. for line and high. 20-ft. cable for low and line. 9-ft. for high. Price £8 8s.

Full-Vision LFFV/59. Moving coil. Response 150-14,000 c/s. Source imp. low, line and high. Built-in trans. for line and high. 20-ft. cable with low and line. 9-ft. with high. Stand as required. Price £8 18s. 6d.

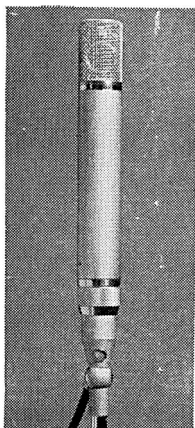

AKG C12
Condenser

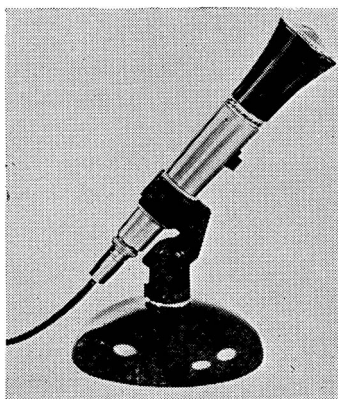

Shure 430 "Commando"
Controlled Magnetic

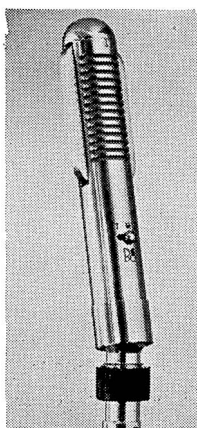

B & O BM3
Ribbon

Lavalier LV/59. Neck halter moving coil. Response 150-14,000 c/s. Low, line and high imp. Price £8 18s. 6d.

LD/66. Moving coil. Response 70-12,000 c/s. Sensitivity -88, -75, and -52 dB, for low line and high imp. respectively. Price £4 2s. 6d., low imp., £4 12s. 6d., line and high imp.

Tubular Hand TH59/SB. Moving coil with switch. Response 150-14,000 c/s. Sensitivity -88 dB at 25 ohms, -75 dB at 600 ohms, and -54 dB at 50,000 ohms. Transformer as required. Price £8 18s. 6d.

Studio VR/3. Ribbon velocity. Response substantially flat to 14,000 c/s. Source imp. low, line and high. Built-in trans. 3-pin moulded mic. plug. 6-ft. cable. Stand as required. Price £9 19s. 6d.

Ribbonette VR/64. Ribbon. Response, substantially maintained up to 13,000 c/s. Source imp. low, line and high. Built-in transformer. 20-ft. cable for low and line. 9-ft. for high. Table base. Price £7 17s. 6d.

■ **Stereomic VR/65.** Dual head ribbon. Response 50-13,000 c/s. Sensitivity Stereo -90 dB at 20 ohms. Source imp. 2 × 300 ohms. Internal transformer. Price £31 10s.

Lapel Mic. LP/62. Electro-Magnetic. Response, substantially maintained up to 6,000 c/s. Source imp. 30 and 1,000 ohms. 6-ft. cable. Price £3 7s. 6d.

Chest Harness DI59/B.S. Moving coil. Response, substantially flat from 150-14,000

c/s. Source imp., low, line, high. 6-ft. cable. Price £11 11s.

Velodyne VC52/THSB. Noise cancelling moving coil with switch. Response rising to 1,700 c/s, flat to 3,500 c/s then falling. Source imp. 25 ohms or as required. Transformer as necessary. Price £8 18s. 6d.

★

Philips Electrical Ltd., Century House, Shaftsbury Avenue, London, W.C.2. Tel.: Gerrard 7777. Cables: Phillamps, London.

EL 6011/10. Moving coil. Response 100-10,000 c/s. Source imp. 50 and 25,000 ohms. Price £10.

EL 6021. Moving coil. Response 60-15,000. Source imp. 50, 000, 10,000 ohms. Price £14.

EL 6031. Moving coil. Response 70-15,000. Source imp. 50, 500, 10,000 ohms. Price £19.

EL 6040. Moving coil. Response 60-20,000 c/s. Source imp. 50, 500 and 25,000 ohms. Price £27.

★

RCA Great Britain Limited, Lincoln Way, Windmill Road, Sunbury-on-Thames, Middlesex. Tel.: Sunbury-on-Thames 3101. Cables: RCA, London. Telex: 28608.

Varacoustic LMI 6203C. Ribbon. Response 60-10,000 c/s. Source imp. 50, 250 and 600 ohms. 30-ft., 2-conductor shielded cable. Stand as required.

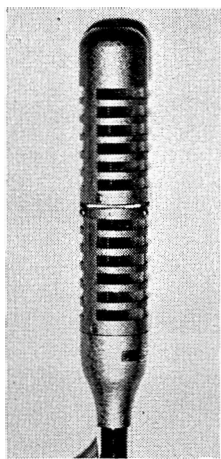

*Lustraphone VR/63
Stereomic Ribbon*



*Shure 535 Stendyne
Moving Coil*



*Tannoy MR/425/S
Ribbon*

LMI. 6204C. Ribbon. Response 60-10,000 c/s. Source imp. 40,000 ohms. 30-ft., 2-conductor shielded cable. Stand as required.



Resosound Ltd., Spring Gardens, Romford, Essex. Tel.: Romford 9087.

A range of semi-prof. and domestic microphones, including moving coils and ribbons. The latter are available in bi-directional or cardioid models, and a range of matching impedances is included. The base fitting incorporates the matching transformer and muting switches may be fitted if required. Details on application.



Romagna Reproducers, Factory Distributors, K. H. Williman & Co. Ltd., Blackford House, Sutton, Surrey. Tel.: Melville 1491.

HMC/1. Crystal. Response 80-8,000 c/s. Sensitivity -54 dB. Source imp. 2,000 p.f. Price £1 5s.

HMM/1. Dynamic. Response 60-10,000 c/s. Sensitivity -60 dB. Source imp. inductive, 10,000 ohms at 1,000 c/s. Price £1 19s. 6d.

HMR/1. Ribbon. Response 35-12,000 c/s. Sensitivity -60 dB. Source imp. 10,000 ohms at 1,000 c/s. Price £2 19s. 6d.



F. & H. Schumann, GmbH. Sole U.K. importers: G. A. Stanley Palmer Ltd., Maxwell House, Arundel Street, London, W.C.2. Tel.: Temple Bar 3721/3.

A wide range of Microphone inserts and Crystal Microphones.



Tellux Ltd., 44 Brunel Road, Acton, London, W.3. Tel.: Shepherds Bush 0331.

A. Range of Sennheiser moving coil microphones. Details and prices on application.



Shure Brothers Inc., U.K. distributor J. W. Maunder, 22 Orchard Street, London, W.1. Tel.: Hunter 4116.

55S Small Unidyne. Cardioid Moving coil. Response 50-15,000 c/s. Sensitivity

-57 dB at high impedance. Sourceimps. 35-50, 150-250 ohms, and high. Switched transformer built-in. Price £29 1s.

510C Hercules Controlled Magnetic. Response 100-7,000 c/s. Sensitivity -52.5 dB. Source impedance, high. ON-OFF switch. Price £5 19s.

535 Slendyne. Moving coil. Response 60-13,500 c/s. Sensitivity -61 dB. Sourceimps. 50-250 ohms and high. Switched built-in transformer. Price £25 7s. 6d.

545 Unidyne III Cardioid Moving coil. Response 50-15,000 c/s. Sensitivity -55 dB. Source impedance 25-250 ohms and high. Built-in transformer. Price £29 15s.



Simon Equipment Ltd., 48 George Street, Portman Square, W.1. Tel.: Welbeck 2371. Cables: Simsale, London.

Cadenza Ribbon. Response 50-12,000 c/s. Sensitivity, high impedance -58 dB, low impedance -93 dB, or with suitable line transformer -58 dB. Source imp. 30 ohms and 80 K ohms. Price £8 18s. 6d.; with tripod desk stand and 11-ft. cable, £10 10s.

Cadenza Crystal. Response 30-8,000 c/s. Sensitivity -47 dB. Optimum load 10 megohms. Minimum load 1 megohm. Price £3 13s. 6d.



Standard Telephones & Cables Ltd., Connaught House, Aldwych, London, W.C.2. Tel.: Holborn 8765. Telex: London 202385. Cables: Relay, London.

4021. Spherical omnidirectional moving coil. Flat response 30-15,000 c/s. Impedance 30 ohms. Sensitivity -80 dB. Price £21.

4032. Moving coil hand microphone. Flat response 40-10,000 c/s. Impedance 30 ohms. Sensitivity -78 dB. Windshield available. Price £18.

4033. Cardioid microphone. Moving coil and ribbon elements which can be used individually or in combination. Flat response 30-10,000 c/s. Impedance 50 ohms. Sensitivity -80 dB. Front to back ratio 15 to 20 dB. Price £46 10s.

4035. Moving coil. As 4032 above, but for stand mounting. Price £18 10s.

RIBBON MICROPHONES

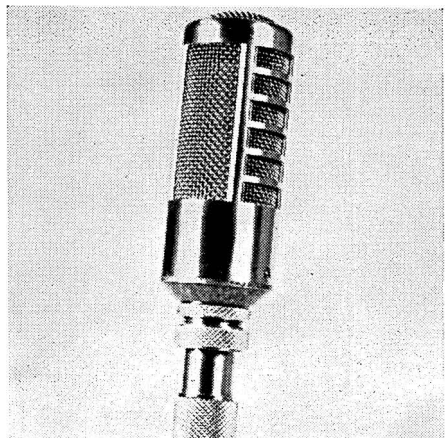

Film Industries M.8



Lustraphone VR 64

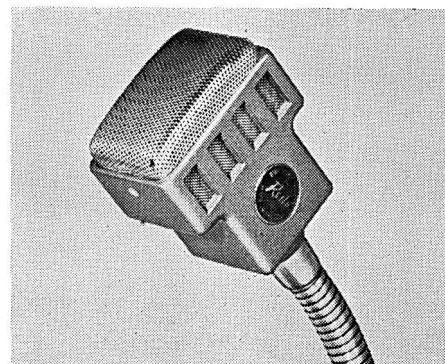

Reslo Type CR

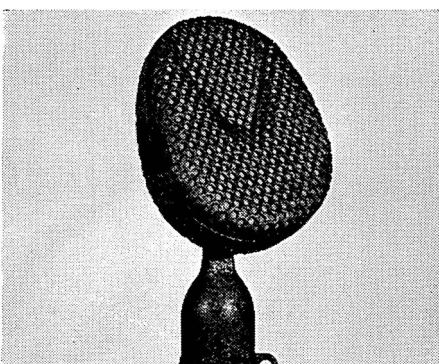

S.T. & Co. Type 4038

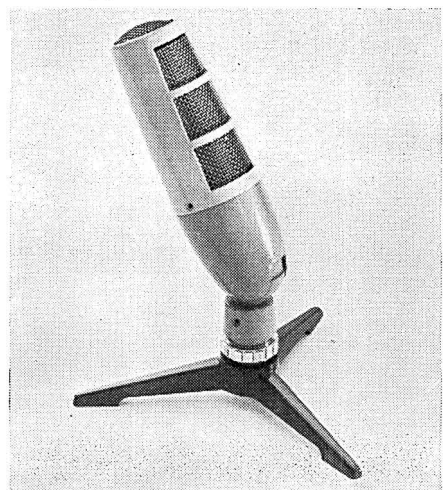

The Simon Cadenza



RCA Varacoustic LMI 6203C

4037. Moving coil unobtrusive "Pencil" microphone. Flat response 30-15,000 c/s. Impedance 30 ohms. Sensitivity -84 dB. Price £20.

4038. Studio ribbon microphone. Accurate figure-of-eight polar response. Flat response 30-15,000 c/s. Impedance 30 ohms. Sensitivity -85 dB. Non-linear distortion 0.1%. Controlled transient response. Price £38 10s.

4104. Commentator's lip microphone. High degree of noise cancellation. Flat response 70-10,000 c/s. Impedance 30 ohms. Output -82 dB ref. 1v for 10 dynes/cm². Price £75.

4105. Cardioid moving coil. Flat response 60-10,000 c/s. Impedance 30 ohms. Sensitivity -82 dB. Front to back ratio 15 to 20 dB. Price £20.



Super Electronics Ltd., 5 Violet Hill, London, N.W.8. Tel.: Maida Vale 0569. Cables: MAI 0569 London.

SE 101. Crystal hand mic. Response 50-12,000 c/s. Source imp. 1 meg. ohm. Price £1 15s.

SE. 102. As above but table model version. Price £1 15s.

Diana. Crystal. Response 50-12,000 c/s. Price £3 3s. (Moving coil version available.)



Tannoy Products Ltd., West Norwood, London, S.E.27. Tel.: Gipsy Hill 1131. Cables: Tannoy, London.

A range of ribbon and moving coil microphones. Details on application.



Tape Recorders (Electronics) Ltd., 784-8 High Road, Tottenham, London, N.17. Tel.: Tottenham 0811. Cables: Taperec, London.

Sound M1. Crystal hand mic. Response 20-16,000 c/s \pm 15 dB. Rec. load imp. 1-5 megohm. 8-ft. screened cable and screened jack plug. Price £2 15s.

Sound M2. Moving coil. Impedance from built-in transformer 80,000 ohms. 8-ft. screened cable and screened jack plug. Price £5 12s. 6d.

Technical Suppliers Ltd., Hudson House, 63 Goldhawk Road, Shepherds Bush, London, W.12. Tel.: Shepherds Bush 2581/4794. Cables: Teknika, London.

M.1. Dual impedance moving coil. Response 60-13,000 c/s. Sensitivity -72 dB at 200 ohms, -52 db at 50,000 ohms. Built-in transformer. Price £4 4s.

M.2. Stereo dual impedance moving coil. Response 50-15,000 c/s. Sensitivity -75 dB at 200 ohms, -52 dB at 50,000 ohms. Built-in transformer. Price £19 19s.

MX3. Crystal. Response 50-13,000 c/s. Sensitivity -52 dB. Source imp. 0.5 to 5 meg. Price with stand and cable £2 5s.



Trix Electric Company Limited, 1-5 Maple Place, London, W.1. Tel.: Museum 5817. Cables: Trixadio, Wesdo, London.

G7871. 3 models A, B, C. Moving coil. Response 50-8,000 c/s. Source imp. 30 ohms. G7871/A 18-ft. cable. G7871/B no cable, 2-pin plug. G7871/C 18-ft. cable, 3-pin locking type plug. Stand as required. Price A £7 10s.; B £8 8s.; C £9 9s.

G7823. 2 models C. Ribbon. Response 50-10,000 c/s. Source imp. 30 ohms. G7823/C 18-ft. cable, 3-pin locking type plug. Stand as required. Price £10 5s.; C £1 15s.



Vitavox Limited, Westmoreland Road, London, N.W.9. Tel.: Colindale 8671. Cables: Vitavox, Hyde, London.

B50. Moving coil. Response 60-8,000 c/s. Sensitivity -85 dB. Source imp. 25 ohms. 6-ft. cable. Price £6 10s.

B51. Crystal. Response 60-8,000 c/s. Sensitivity -50 dB. Source imp. 1 megohm. 6-ft. cable. Price £5 10s.

B52. Moving coil. Response 60-8,000 c/s. Sensitivity -85 dB. Source imp. 600/100,000 ohms. Built-in transformer. 6-ft. cable. Price £7 10s.

B54. Moving coil. Response 60-8,000 c/s. sensitivity -85 dB. Source imp. 200 ohms. Built-in transformer. Price to be announced.

Type A. Moving coil. Response 60-8,000 c/s. Sensitivity -82 dB. Source imp. 25 ohms. Rec. load imp. 25 ohms. Desk, table or pedestal stands. Price £9 9s.

MOVING COIL MICROPHONES

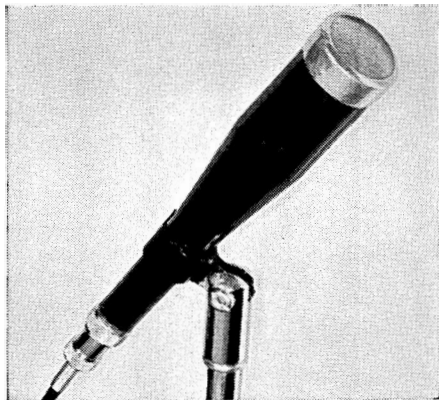

Grampian DP4/H

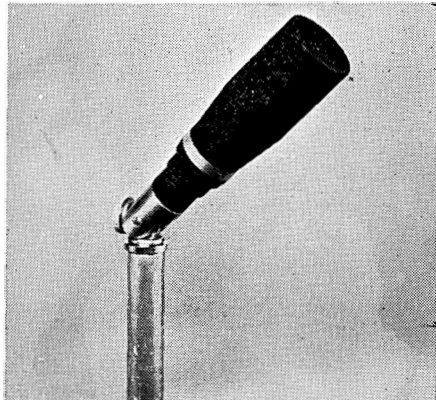

STC 4105

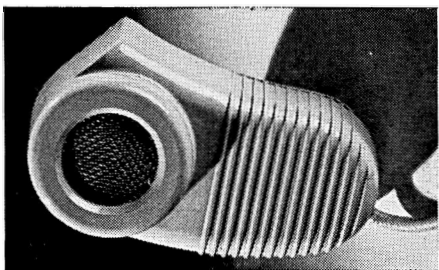

Vitamox B52

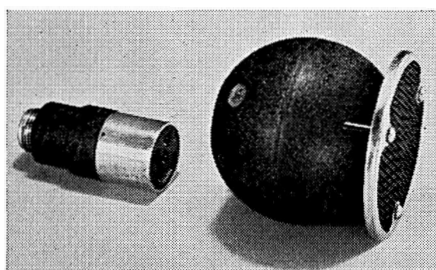

STC 4021



Shure 55S Small Unidyne



Lustraphone LD/66

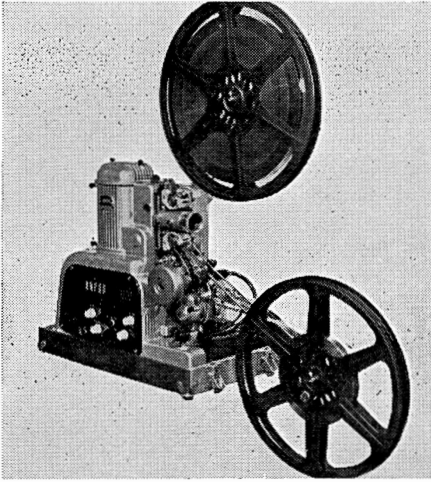

Ampro New Educational

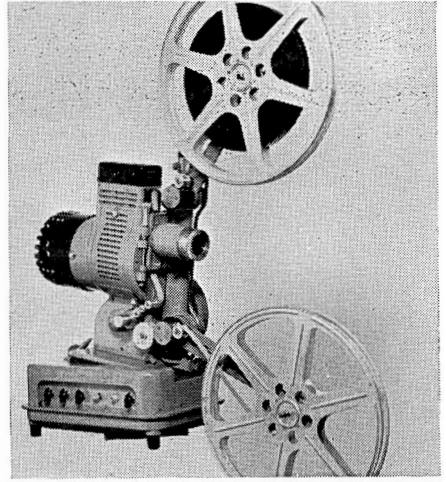

Delbie D16

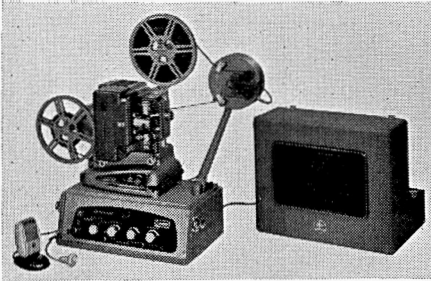

Paillard Bolex Sonorizer

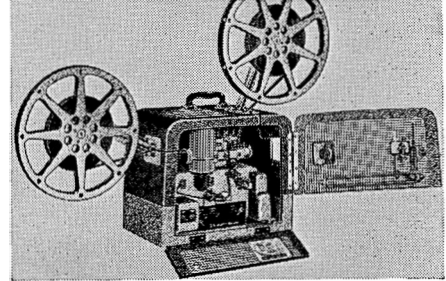

Bell & Howell Model 631

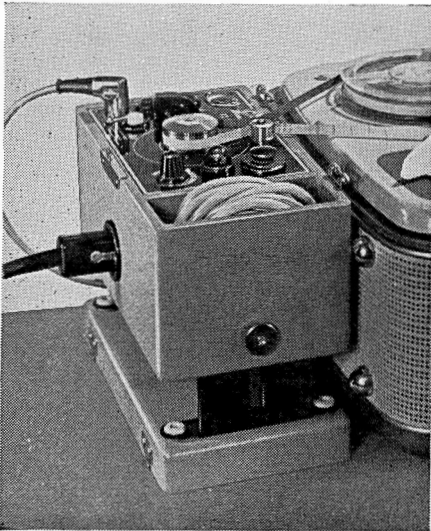

Bauer Tape Coupler Model S

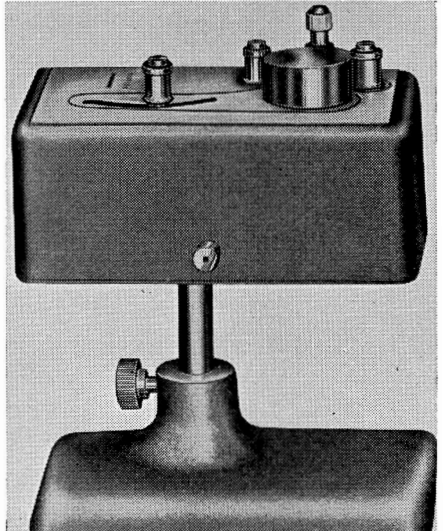

Specto Royal Coupler Type 209

CINE SOUND

An Introduction

LAST year for the first time we introduced a Cine section to Hi-Fi Year Book, and by all accounts this additional feature has proved to be extremely useful to a large section of our readers so we have therefore decided to continue it. The actual market has not changed appreciably during the past 12 months, and the equipment in the directory section largely represents established models, some of them with minor changes, although one or two notably new additions are to be found. The biggest change in the position since the 1960 Year Book was published is the very considerable increase of interest in the application of sound to cine as a whole.

Tape is the Link

As the hobby of amateur film making spreads, more and more people must necessarily think of adding sound to film; and because the link between the two must nearly always be tape, the activities of the cine enthusiast and the sound enthusiast overlap more and more, and from both camps there is a noticeable adoption of the one by the other. A direct result of this is a discovery by both groups of enthusiasts of problems that they had not appreciated before. The cine enthusiast in many cases finds that he must study problems of sound recording, and the tape enthusiast—with all his acquired knowledge of sound recording—finds that the element of cine has presented him with a completely new set of problems to tackle.

However complex this intermarriage of hobbies may appear on the surface, it may be resolved very simply, even if drastically, by the adoption of good quality equipment on the tape side. For

example, it is a complete waste of time to attempt to make a worthy sound track on an inferior type of tape recorder. Two of the most important ingredients in the recipe for good, average sound on a good, average film are (1) "clean" recordings, (2) good mechanics. Initially, a sound track must be made on tape via a tape recorder. If the sound is then to be added directly on to the film, the recording is bound to suffer slight losses, however good the mechanics of both recorder and projector may be. If the recorded track is to be used with the addition of a coupler, there will be no loss through transferring the sound but the mechanical requirements of the tape deck must still be of a reasonably high standard.

Buy Good Equipment

In general it must be assumed, and reasonably so, that enthusiasts who are prepared to outlay sufficient money for both cine work and tape recording will be prepared to adopt the wise policy of buying only good equipment. Therefore, on this assumption, it is probable that they will consider it worthwhile to tackle the sound side of the marriage with a more generous outlay than would, say, a person who merely regarded a tape recorder as an additional item for home entertainment. Furthermore, since most people who seriously attempt the marriage of cine and sound will be people of considerable patience and no mean ability, it is also reasonable to assume that they will be prepared to devote relatively more time and thought to the preparation and use of their equipment.

All this adds up to the advice that it is better by far for them to concentrate

upon a tape deck of very good quality, and to add to it the necessary electronics that will ensure good results. However good a domestic tape recorder may be, its electronics are inevitably cramped: and since tape electronics of "Hi-Fi" standards plus a good quality deck cost very little more than (and often less than) a portable domestic instrument, the decision to adopt this policy really only involves time, trouble and non-mobility. With this advice in mind, the reader with cine interests is strongly recommended to refer back to the tape recorder section of this book, and to study the professional and semi-professional decks and the tape recorder electronics sections.

Use the "Kit" Directory

Additionally, cine enthusiasts with a liking for home construction should also refer to the home constructional kits section, for this includes several very worthy do-it-yourself kits for use in conjunction with the various tape decks listed.

Most cine enthusiasts will have seen extremely good films, both 16 mm and 8 mm: similarly most tape enthusiasts will have heard extremely good tapes which have been made on quite modest tape equipment. It is a fact, however, that the majority of amateur sound films—a combination of both the foregoing—do not reach the same standards as either of the two components by themselves. This is the proof of the pudding discussed earlier. The addition of sound to film is by no means easy. When the true sound enthusiast hears sound via a film projector, he is at once aware of several shortcomings. These may include wow, flutter, inadequate frequency response, hum and other background noise. None of them is really necessary when the best quality equipment is used.

Electronic Shortcomings

The items of hum and background noise are often the result of an inferior machine being used for the initial sound track: the wow and flutter items are mechanical troubles and can originate from a poor projector mechanism an inefficient tape recorder, or bad coupling between the two.

The above paragraph deals with the gloomy side of the sound-cine marriage. On the brighter side, however, it must be remembered that some of the more

able enthusiasts are producing sound films of almost flawless quality—and a few of them are using tip-top professional equipment in order to achieve these results. The answer they have found is a careful selection of equipment, the meticulous attention to electronic and mechanical details, and the policy of making haste very slowly.

Striping v. Coupling

Many owners of 8 mm cine outfits will be content to obtain the sound for their pictures by means of tape recorder and cine coupler. Their problems are considerably easier than those of the enthusiasts who prefer to have their films magnetically striped, but the latter method means that once the initial troubles have been overcome they are at an end; whereas use of a cine coupler involves the same set of problems every time a film is to be shown.

The system of film striping is obviously the most satisfactory for those who can afford the time and trouble: *but*—and particularly in the case of 8 mm film—extreme care has to be taken with the initial sound track and its transfer to the stripe.

Look ahead now

There is no doubt that within a few years most cine enthusiasts will be demanding sound on their films, and therefore those who are only now taking up cine, or contemplating it, will be well advised to spend some time pondering over the problems involved. It is an encouraging thought, however, to realise that whatever sound tracks are made today on tape, and used via a coupler, should still be adequate for transferring to stripe in several years time. Therefore no work which is done carefully and intelligently today need be wasted, even though it may be some time before the striping method is adopted. There is no doubt that the next few years will see a big advance in this field, and that new projectors in both 8 mm and 16 mm gauges will appear.

* * *

Thinking ahead on these lines, the concluding note of advice is to invest wisely in the sound equipment today, knowing that it will provide a permanent basis for almost anything that lies ahead.

CINE SOUND EQUIPMENT DIRECTORY

Note: This Directory Section is as complete as careful and searching enquiries from overseas manufacturers and British Agents have made it possible. It will be appreciated if these and other manufacturers and agents will keep the Editorial Department of "Hi Fi Year Book"

constantly posted with data and pictures, so as to ensure their inclusion in our next edition. Abbreviations used in the following text include: **fs**; **es**; **hs**=full, edge and half stripe. **f/r**=forward and reverse. **s/p**=still pictures. **fps**=frames per second. **sps**=suitable power supplies.

CAMERAS

Neville Brown & Co. Ltd., 77 Newman Street, London, W.1. Tel.: Langham 7161. Cables: Nebrofoto, London.

Bauer 88 ES. 8 mm. Cine Camera. Lens; Schneider Xenoplan 1:1.9/13 mm. in focusing mount. Running speeds: 8, 16, 24, 48 f.p.s. Coupled exposure meter. Single pictures, synchro-running equipment for synchronised sound and picture shots. Weight 2 lb. 13 oz. Price £80 6s. 3d. (U.K. purchase tax £13 1s.).

Bauer S Sound Coupler for coupling 88 ES camera to tape recorder. Price £45 4s. 6d.

Bauer 88 DS. As 88 ES, but with three lens turret head. Requires S coupler as above for synchronous recording. Price £98 6s. 10d. (U.K. purchase tax £15 19s. 8d.).

Bauer 88 F. Fully automatic or manual control. f/1.8 Schneider lens, available

with wide angle and telephoto attachments. Not synchronised. Price £46 17s. 6d.

Bauer 88 G. Electric eye model fitted f/1.9 Rodenstock lens, four speeds, accepts supplementary wide angle and telephoto lenses, not synchronised. Price £78 10s.

Bauer 88 D. Built-in exposure meter, revolving turret fitted wide angle and telephoto attachments. Four speeds. Price £115.

Bauer 88 H. Fully automatic or manual. Revolving turret for telephoto and wide angle lenses and filters. Price to be announced.



Polariser U.K. Ltd. 26 Stamford Street, London, S.E.1. Tel.: Waterloo 6673. Cables. Poluk Souphone.

Fairchild Cinephonic 8 mm camera with built-in recorder, enabling sound to be recorded on a magnetic strip on the film in complete synchronised 3, lens turret. Weight 4½ lb. Size 7½ × 3¼ × 6¼. Price on application.

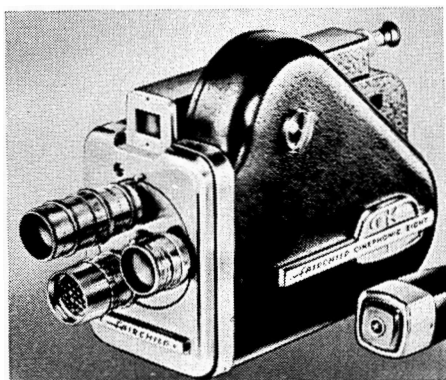

Fairchild Cinephonic

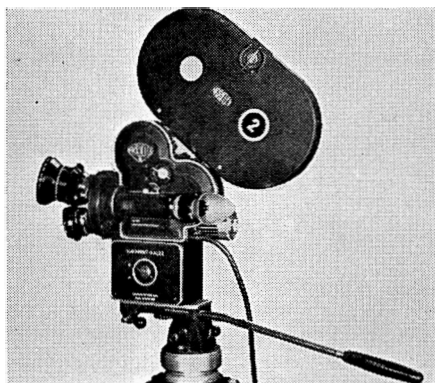

Arriflex 16 mm camera

Rank Precision Industries Ltd., G.B.—Kalee Division—Studio, Woodger Road, Shepherds Bush, London, W.12. Tel.: Shepherds Bush 2050. Cables: Rankprest, London.

Arriflex 16 mm. Camera with Magnetic Stripe Equipment.

Camera. Mirror shutter reflex viewfinder with 10 × magnification. Lenses available: 9, 12.5, 16, 20, 25 mm. Also 35 mm. Arriflex. Telephoto lenses up to 600 mm. focal length can be used. Daylight loading standard 50 ft. and 100 ft. spools. Accessory enabling 200 ft. and 400 ft. magazines to be fitted available. Twin vertical claws with registration pin. 8v battery driven with variable speeds 8-48 f.p.s. or A.C. mains. Weight 6½ lb. Price on application.

Type 1690-91 Sound Attachment. "B" Wound single perforated pre-stripped colour or monochrome is looped, after picture exposure, through an aperture in the bottom of the camera into the sound recorder which is complete with speed stabilizing filter. Sound is recorded in synchronism with the picture 28 frames in advance on a 100 thou. edge track in the position occupied by one set of perforations on mute film. Quality control is by headphones and recording amplitude is visually indicated on a meter mounted

with manual controls and equalisation for speech and music on the two-channel microphone mixer. This is built into the shoulder slung, completely transistorised amplifier which has direct or playback monitoring through headphones. Complete electronic unit operates on enclosed miniature 7.5v battery. Price on application.

Type 1830. Portable Magnetic Recording Unit. Separate unit capable of accepting up to 400 ft. recordings on separate magnetic film with 100 thou. f/s. Input sensitivity and signal/noise ratio identical to stripe attachment. Drive: synchronous motor with coupling to camera. Weight with case, 4 lb. 12 oz. Price on application.

PROJECTORS

8 mm Magnetic Stripe Projectors

D.W. (Cine Equipment) Limited, 14-18 Ham Yard, Piccadilly, London, W.1. Tel.: Gerrard 7491.

CircleSound, 8 mm. Sps 110 to 240v A.C. Lamp: 8v 50 watt A1/185. Amplifier output 3 watts. Speaker: Philips Biphonic 8 in. Capacity 400 ft. Speeds: 16 and 24 fps. Separate motor for sound



Bauer 88 ES camera

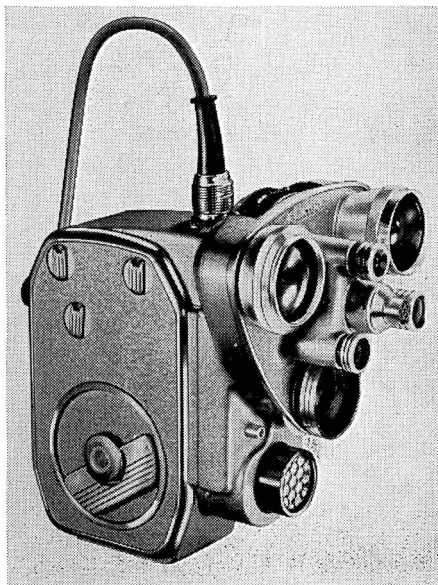

Baur 88 DS camera

head, s/p. Weight 45 lb. with case. Lens f/1.3 20 mm. Price £169 10s.



Polariser U.K. Ltd. Address see page 165.

Fairchild Cinephonic 8 mm recording projector 400 ft. reel capacity f/1.6 lens. Projector contains built-in recorder for commentaries etc. 3-position switch for playback, overlaying, sound erase and record. 2 running speeds, 16 and 24 f.p.s. Price on application.



8 mm Projectors with Built-in Couplers

Johnsons of Hendon, Hendon Way, London, N.W.4. Tel.: Hendon 7671. Cables: Bromide, London.

Emig P.8.M. Imperial. Sps 110 to 240v A.C. Lamp; 12v 100 watt A1/186. Capacity: 400 ft. Variable speeds. Lens; 20 mm f/1.4. Built-in coupler suitable for any tape recorder working at 3½ ips. f/r. s/p. Power rewind. Provision for reverse projection and stills (single frames). Price £43 5s. (without sound coupler, £36).



Luminos Limited, 1 Belsize Crescent, Hampstead, London. Tel.: Swiss Cottage 3399. Cables: Luminos, London.

Noris Synchroner 100. Sps 110 to 240v A.C. Lamp: 12v 100 watts A1/186. s.p. Power rewind, cable release for editing

punch marks. Lens: 20 mm Plankar. Built-in tape coupler suitable for any type of tape recorder with speeds of 3¼ or 7½ i/s. Single connection between projector and recorder. Price £46. 17 mm lens £12 extra. Hood case £3 15s.

16 mm OPTICAL

A.E.I. Sound Equipment Ltd., Crown House, Aldwych, London, W.C.2. Tel.: Temple Bar 8040. Cables: Soundequi Estrand.

BTH Type 450 sps 110/120 and 200/250v. AC. Lamp: A1/9 115v or 1000w. Amplifier: 30w. output: Speaker: 2 in, 15w. Capacity 2000 ft. Speeds: 16 and 24 f.p.s. f/r Power Rewind. Weight: projector in case 41 lbs. Speaker 23 lbs. Mains Unit rectifier 22 lbs. Price £260.

BTH Type 452 sps 200/250v. AC lamp. A1/9 750 or 1000w. Mains Voltage. Amplifier: 10w. output. Speaker: 10 in. Capacity 2000 ft. Speeds: 16 and 24 f.p.s. f/r. Power Rewind. Weight: Projector in case 46 lbs. speaker 11 lbs. Price: £215.



Cinetechnic Ltd., 169 Oldfield Lane, Greenford, Middx. Tel.: Waxlow 1011. Cables: Cintec.

Debric D16 Optical Sound Projectors. Inter-convertible system of single mech-

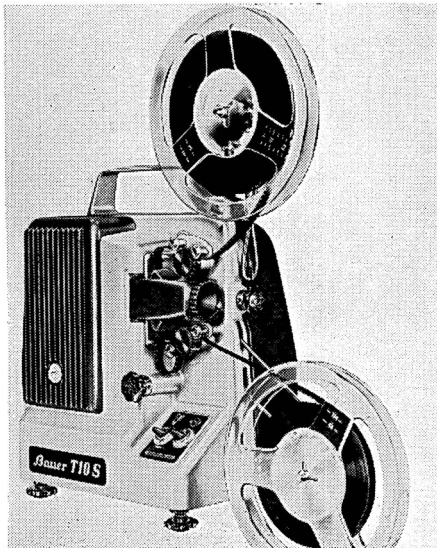

Bauer T10S

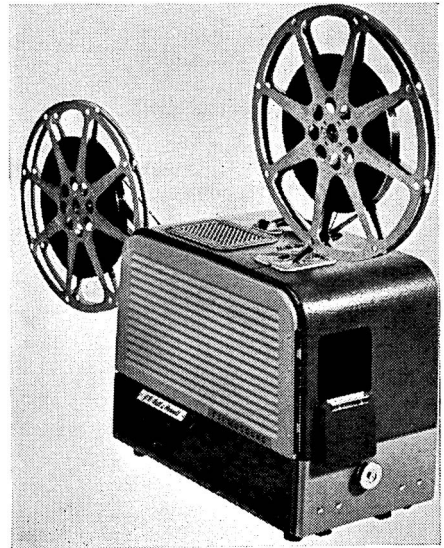

G.B. Bell & Howell 640

anism with any of three different amplifiers. The following features are common to all models: sps 110v 50 cycles or with 1,000 watt transformer for 200/250v AC. Lamp: 110v 750 watts A1/52. Capacity: 2,000 ft. Speeds: 16 and 24 fps. No power rewind. Lubrication: automatic invisible oil feed by screw pump. Progressive rotary main switch providing intermediate lamp loading of 650 watts.

D.16 Uni-compact. Single case model. Amplifier output: 8 watts. Speaker: 8 in. Weight 58 lb. Price £276.

D.16 Duo-compact. Two case model with 12 in. speaker. Amplifier output: 8 watts. Weight 80 lb. Price £305.

D.16 Standard. Two case model with 12 in. speaker. Amplifier output: 15 watts. Weight 80 lb. Price £340.

D.16 Professional. Two case model with 15 in. speaker. Amplifier output: 25 watts. Weight 102 lb. Price £440.



Rank Precision Industries Ltd., Cine and Photographic Division, Mitcheldean, Gloucestershire. Tel.: Drybrook 421. Cables: Rankprecin Mitcheldean, Telex.

Model 631 S. sps 110v 50/60 cycles AC or 200/250v AC in conjunction with transformer. Lamp: 750 watts 100v 110v A1/53 L.B. & H. or 1,200 watts A1/91 optional. Amplifier: 17 watt output, printed circuit. Independent base and treble controls. Speaker: 12 in. in separate case. Capacity: 2,000 ft. Speeds: 18 and 24 fps. f/r. s/p, variable aperture, for wide screen. Weight: projector 34½ lb. Speaker: 23½ lb. Power rewind. Price £258. Transformer £19 10s.

Model 631 Compact. Identical to Model 631 but with built-in detachable 6-in. speaker. Weight 37 lb. Price £232 17s. Transformer £19 10s.

Model 636. sps 200/250v 50/60 cycles AC or DC. Lamp: Mains voltage 750 watts A1/53HV or 1,000 watts A1/91 optional. Amplifier output 8/10 watts. Printed circuit. Speaker 8 in. in separate case. Capacity: 2,000 ft. Speeds: 18 and 24 fps. f/r. f/p. Variable aperture. Power rewind. Weight 34½ lb. Price £235 15s.

Model 636 S. As above but supplied with 12-in. separate speaker. Price £250 8s.

Model 636 C. As above but with 6-in. speaker built into the projector case. Price £225 15s.



RCA (Great Britain) Ltd., Lincoln Way, Windmill Road, Sunbury-on-Thames, Middx. Tel.: Sunbury-on-Thames 3101. Cables: RCA London, Telex.

RCA Hollywood. sps 100/125v AC and 210/250v AC 50 or 60 cycles. Lamp: 110v 750 watts A1/9, 1,000 watts A1/59, or 1,200 watts C13D, if external transformer is used. Mains voltage 750 watts A1/9HV, 1,000 watts A1/95HV, or 1,200 watts C13D without need of external transformer. Amplifier output: 15 watts push-pull output. Separate bass and treble control. Speeds: 16 and 24 fps. f/r. Speaker: 15 ohm 12 in. high flux in separate case. Capacity: 2,000 ft. Weight: Projector 46 lb. Speaker: 21 lb. Price £265. Transformer £21.

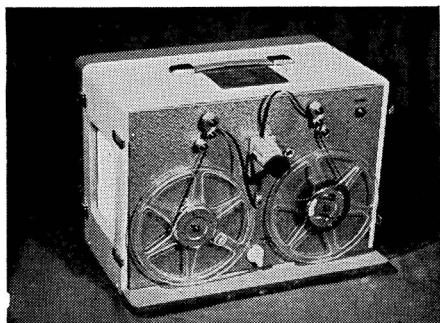

Dominus Projector/Recorder Mk. I

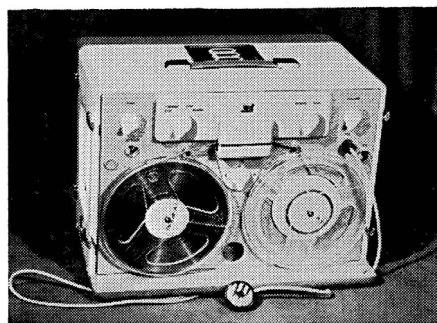

Dominus Projector/Recorder Mk. II

Simplex Ampro Ltd., 167-169 Wardour Street, London, W.1. Tel.: Gerrard 2911. Cables: Stafilm Wesdo.

E.B. New Educational. Sps direct from 200 to 250v A.C. or D.C. when using mains voltage lamp up to 1,000 watts. Through resistance unit 7105 with 110/115v A1/9 lamp up to 1,000 watts. Amplifier: A.C./D.C. metal rectifier push-pull output, maximum output 6/8 watts. Two stage feed back-tone control. Speaker: 8 in. 15 ohm in lift-og case. Automatic loop former. Capacity: 2,000 ft. Speeds: variable rheostat 16 to 24 fps. Automatic rewind. Lubrication control through central oil well. Weight 33 lb. Price £183.

Model EDL. De Luxe Educational. As above but fitted with still picture clutch and f/r. Price £197 10s. Additional 10 in. speaker for New Educational: £9.

Simplex Ampro Mark II. sps 110v AC or 200/250v AC when mains transformer 7102 is used. Lamp; 110v 750 watts A1/9 or 110v 1,000 watts A1/58. Amplifier out 15 watts push-pull. Separate microphone input cuts photocell. Capacity; 2,000 ft. Speeds 16 and 24 fps. Speaker; 15 ohm 12 in. permanent magnet type in separate case. f/r. Weight 46 lb. Speaker 31 lb. Price £252 10s. Mains Transformer £22.

16 mm OPTICAL/MAGNETIC

A.E.I. Sound Equipment Ltd. Address see page 167.

BTH Type 451 sps, lamp, amplifier, speaker, capacity, speeds, etc., as 450. Records on es, hs, fs. Modulation indicator. Optical tracks can be transferred

to hs—external control available. Weight. as 450 except projector in case 50 lbs. Price £375.



Cinetech Ltd., Address see page 167.

Debrie D.16 Magnetic Projector. Any Debrie optical sound projector can be converted to magnetic sound by addition of the magnetic sound equipment. Pre-amplifier unit type RP, hooks on to the normal amplifier. Inputs from microphone, disc and film. Volume indicator meter. Separate input volume control. Separate tone controls on playback. Warning light indicator for "amplifier on" and recording. Magnetic sound head panel. Suitable for fs and hs. Three magnetic heads for recording, playing and monitoring/erasing, monitoring through head set is from the recorded track. Conversion of any optical model to magnetic can be carried out usually by the owner. Price: Conversion to Magnetic Record/Playback, £160. Conversion to Magnetic Playback only, £90.

Double-sided Projector. Suitable for 16 mm optical and magnetic sound. Optical sound 2.5 mm track. Magnetic 5 mm track. Drive for both channels from common shaft to double sprockets. Optical and magnetic sound can be played simultaneously to separate commentary from background effects. Price on application.



Cinex Ltd., Bolex House, Burreleigh Gardens, Southgate, London, N.14. Tel: Fox Lane 1041. Cables: Cinex, London.

Paillard-Bolex Model S221. sps 90-300v AC or 110-135v AC without transformer.

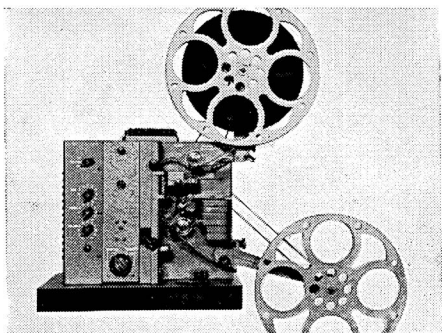

RCA Hollywood Constellation

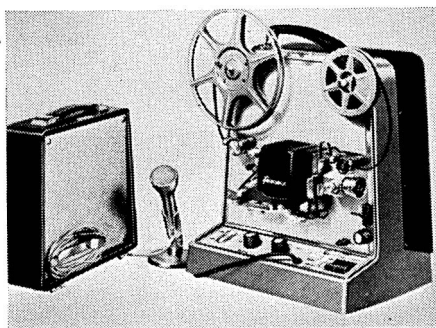

Fairchild 8 mm Cinephonic

50/60 cycles. Lamp: 110v 1,000w A1/59. Amplifier output: 15w max. Optical F.R. 50-7,000 c/s ± 5 dB. Magnetic F.R. 50-10,000 c/s ± 5 dB. Separate inputs for mic. and gram. Records and plays back es, hs and fs. Erase head operates on high frequency magnetic field. Separate bass and treble control on replay. Speeds: 18 and 24 fps. Shutter adjustable between two and three blades for silent and sound speed. Speaker: 8 in. built into case, 6w power output. Frame counter. f/r. Capacity: 2,000 ft. Weight: 55 lbs. Lens supplied: 35 mm f/1.3. Outfit includes hand mic. and headset. Price with transformer: £459.



Rank Precision Industries Ltd., Cine and Photographic Division, Mitcheldean, Gloucestershire. Tel.: Drybrook 421. Cables: Rankprecin Mitcheldean, Telex.

Bell & Howell Model 640. sps 110v 50/60 cycles AC or 200/250v in conjunction with transformer. Lamp: 110v 750 watts A1/53 or 1,200 watts A1/91 optional. Amplifier output: 16/18 watts. Speaker: 12 in. in separate case. Capacity: 2,000 ft. Speeds: 18 and 24 fps. f/r. f/p. Variable aperture plate for wide screen. Power rewind. Records on es, hs, fs. Interchangeable head for twin track recording. Separate base and treble control. Modulation in flashing neon. Separate volume control for magnetic and optical allowing simultaneous replay. Power rewind. Weight: Projector 34½ lb.

Speaker: 23½ lb. Price £365. Transformer £19 10s.



RCA (Great Britain) Ltd., Lincoln Way, Windmill Road, Sunbury-on-Thames, Middx. Tel.: Sunbury-on-Thames 3101. Cables. RCA London, Telex.

RCA Hollywood Constellation. sps 105/125v AC and 210/250v AC 50 or 60 cycles. Lamp: 110v 750 watts A1/9, A1/59 or 1,200 watts C13D 1,000 watts if external transformer is used. Mains voltage 750 watts A1/9HV 1,000 A1/59HV or 1,200 watts C13D without need of external transformer. Amplifier output: 15 watts push-pull. Separate bass and treble controls. Two input sockets with mixer controls Monitoring socket. Records on es, ls and fs. Transfers optical tracks to magnetic. Simultaneous reply of optical or magnetic. Electronic recording — Neon glow-tube indicator. Speaker: 15 ohm 12-in. permanent magnetic in separate case. Capacity: 2,000 ft. Weight: Projector 46 lb. Speaker: 21 lb. Supplied with crystal hand mic. Price £375. Transformer, £21.



Simplex Ampro Ltd. Address on page 169.

Ampro Major Mark III. sps 110v 50/60 cycles AC or 200/250v AC in conjunction with transformer. Lamp: 110v 750 watts A1/9 or 1,000 watts A1/59 optional. Amplifier output: 15 watts max. push-pull. Separate mic input and photocell input.

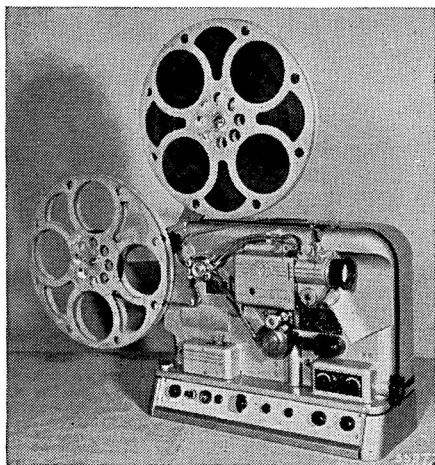

BTH 451 16 mm Projector

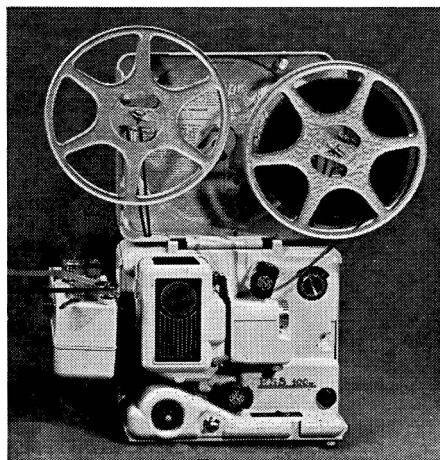

Heutier PS 8-100

Speaker: 12 in. Audium 60. Capacity: 2,000 ft. Speeds: 16 and 24 fps. f/r. s/p. Weight: Projector 46 lb. Speaker 31 lb. Console unit incorporating mixer and DB meter. Cons: 29 lb. Trans: 29 lb. Remote control. Three channel input. Records and plays back es, hs, fs. Separate base and treble control. Optical tracks can be transposed to hs. Price £420. Reslo Ribbon Microphone, £11 5s. Single head set £1 17s. 6d. Additional pre-amplifier required for magnetic playback when console is not used, £17 12s. 9d. 7102 Transformer, £23 5s.

16 mm OPTICAL WITH MAGNETIC-PLAYBACK FACILITIES

● These projectors are each modified versions of standard optical machines the specifications of which have been described under "optical sound projectors".

Simplex Ampro Ltd. Address on page 169.

Simplex Ampro Major Mark IV. Identical to Major Mark II, with magnetic sound head suitable for es, ls and fs, and magnetic pre-amplifier unit. Price £320.



A.E.I. Sound Equipment Ltd., Address on page 167.

BTH Type 450R as 450 but fitted mag-

netic replay device for reproduction from es, hs, fs. Price £287.



Rank Precision Industries Ltd., Cine and Photographic Division, Mitcheldean, Gloucestershire. Tel.: Drybrook 421. Cables: Rankprecin Mitcheldean, Telex.

Bell & Howell Model 631 SP. Similar to Model 631 but with a plug-in magnetic sound head identical with type used on Model 640. Re-designed amplifier incorporates selector switch and permits instant change-over from optical to magnetic reproduction. Head supplied suitable for es, ls and fs. Interchange earth head for twin track recording available separately. Price £270. Transformer £18. Single case Model 631CP also available as above but with detachable built-in 6-in. speaker. Price £258 2s.



RCA (Great Britain) Ltd., Lincoln Way, Windmill Road, Sunbury-on-Thames, Middx. Tel.: Sunbury-on-Thames 3101. Cables: RCA London, Telex.

RCA Hollywood Star. Modified version of the RCA Hollywood but with magnetic head suitable for reproduction of es, ls and fs. Selector switch permits instant change-over from optical to magnetic sound. Price £295. Transformer, £21. Conversion kit of "Hollywood" to "Star", £30.

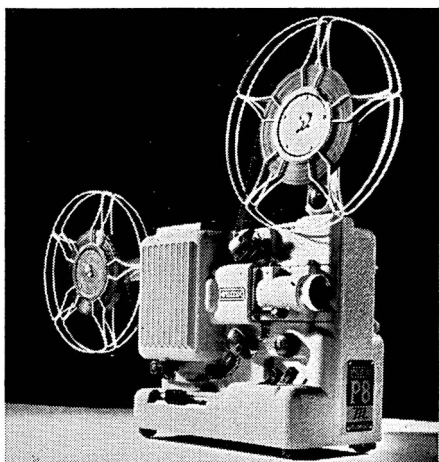

Eumig P8

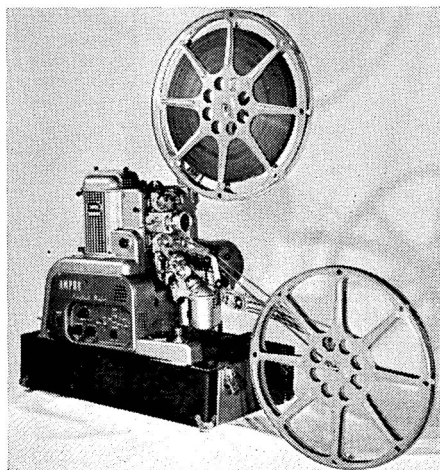

Ampro Mark II

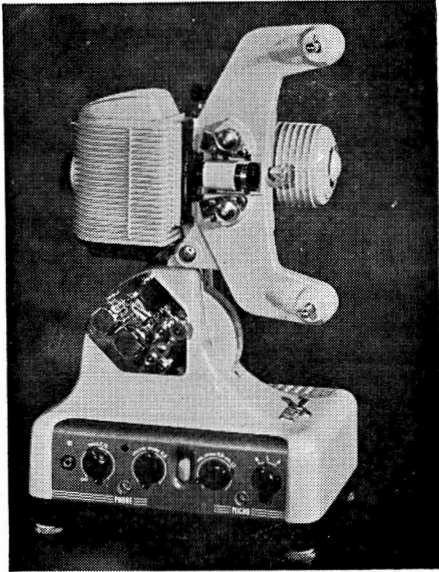

The Cirse Sound 8mm. Projector

PROJECTOR/COUPLER OUTFITS

Actina Ltd., 10 Dane Street, High Holborn, London, W.C.1. Tel.: Chancery 7566-7.

Heutier P.S. 8-100 Projector, 8 mm. (British version): 110, 230, 240, 250v A.C. Lamp: 10v 100W. Lens 20 mm. f/1.5 Angenie (25 mm. version available). Capacity: 400 ft. Variable speeds. f/r. Power rewind. Price £43 15s.

Heutier Synchroniser. Loop synchroniser attaches to projector. Sleeve change-over from 7½ ips to 3¾ ips. Price £13 10s.



Neville Brown & Co. Ltd., 77 Newman Street, London, W.1. Tel.: Langham 7161. Cables. Nebrofoto, London.

Bauer T.10 S Projector. sps 110v to 240v AC. Lamp: 12v 100 watts A1/186. Capacity: 400 ft. Fixed speed 16 fps. Lens: Kiptagon 16 mm fl.4. Socket for connecting sound coupler. Power Rewind. Weight 11 lb. 4 oz. Price £45.

Bauer T10/L. As T10/S but with no provision for synchronised sound coupling and without interval lamp socket. Price £39 (including lamp).

Bauer K Coupler. For use with any tape recorder running at 3¾ i/s. Single capstan. Electrical connection only with projector. Price £8 10s.

Bauer N Coupler. De luxe model, with remote control projector switch, split switch roller for automatic on/off switching of the projector by means of the magnetic tape and reduce and increase projector speed buttons. Fitted compartment for its 10ft. cable. For use on tape recorders of 3¾ or 7½ i/s running speed. Price £27 10s.



Cinex Limited, Bolex House, Burleigh Gardens, Southgate, N.14. Tel.: Foxlane 1041. Cables: Cinex London.

Paillard Bolex Synchronat. Tape coupler for use with Paillard Bolex M8R projector. Projector requires modification to accept flexible drive between projector and coupler. Suitable for tape recorder running at 3¾ i/s, or with tape recorder at 7½ i/s by means of an additional capstan. Outfit includes special projection table for positioning projector, recorder and coupler. Price £25.



Dominus (England) Limited, 29 Cromwell Road, South Kensington, London, S.W.7. Tel.: Kensington 8263. Cables: Domineng, Wesphone, London.

Dominus Mark II Projector/Recorder. Single unit projector and tape recorder. sps 200/240v AC. Lamp: 8v 50 watts A1/185. Amplifier output: 3.5 watts. Speaker: 7 in. Elliptical. Capacity: Film 400 ft. Tape 1,200.



Peeling & Komlosy, 181 Victoria Street, Dunstable, Beds. Tel.: Dunstable 1357.

Movilux 8A. sps 240v AC. Lamp. 8v 50 watts A1/185. Lens: Zeiss Sonnar fl.3 20mm. Permanent lubrication system. Induction motor gives uniform speed of 16 fps. Power rewind. May be used in synchronisation with any tape recorder by means of the Zeiss sound coupler designed for this model. Available in five attractive colours. Price £55 3s. Case, £6 12s. 6d.

Sound Coupler for Movilux 8A. Plugs into the top of the Movilux 8A projector. Film and tape run over a common drive.

No flexible shaft required between coupler and recorder. Price £9 18s. Case which also takes projector and accessories, £6 12s. 6d.

Movilux 8B Projector. sps 110, 125, 150, 220 and 240v. Lamp: 8v 50 watts A1/185. Lens: Zeiss P Sonnar fl.3 20 mm. Induction motor, providing three fixed speeds, 16, 18 and 24 fps. Power rewind. Price £62 12s. 6d.

Moviphon B Sound Recorder. Tape Recorder designed to work with Movilux 8B projector and Movivox Amplifier. Driven by flexible shaft from projector. Power supply by electrical connection with projector enables twin track recordings to be made. Supplied complete with speaker having built-in amplifier. Amplifier output: 3 watts. Price £125 5s. with speaker and microphone to order.



Specto Limited, Vale Road, Windsor, Berks. Tel.: Windsor 1241/2. Cables: Specto Windsor.

Specto Royal 8mm. sps 110v to 240. AC. Lamp: 21.5v 150w. "Trufflector" A/194. Lens: 20mm f/4. Capacity: 400. Variable speeds. Power rewind. Weight: 10 lb. Price: £29 19s. 6d. Price with "Steinheil Vario" zoom lens. £33.

Specto Royal Tape Coupler. Type 209. Loop synchroniser suitable for use with any tape recorder running at $3\frac{3}{4}$ i/s. Employs flexible connection, and electrical connection to couple with projector. Price £14 19s. 6d.

CINE RECORDERS

K.G.M. Electronics Ltd. Bardolph Road, Richmond, Surrey. Tel.: Richmond 7171.

Cinecorder, intended primarily for use with Eumig Imperial 8 mm cine projectors. By the use of perforated tape 100% synchronisation accuracy between tape and film is possible. Size $16\frac{1}{2} \times 13\frac{1}{2} \times 8\frac{1}{2}$ in. Weight 28 lb. Price approx £59 15s.

SERVICES & ACCESSORIES

Magnetic Stripe Attachments

Paillard Bolex Sonorizer. 8 mm Magnetic Stripe attachment designed especially for use with Paillard Bolex M8R projector, but suitable for any 8 mm projector of

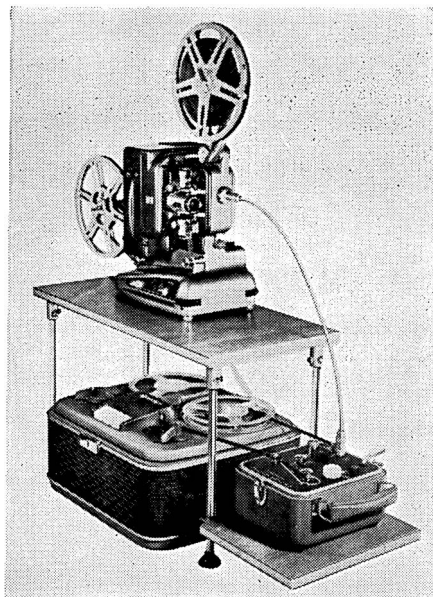

Paillard Bolex Synchronat

similar design. Sound head to picture gate spacing 136 frames. sps 110, 125, 160, 220 or 240v AC 50 or 60 cycles. Amplifier output: 4 watts. Two input sockets mic. 0.1 mV/200 ohms. For tape recorder and record player: 100 mV/500k ohms. Monitoring by neon indicator. Sound head supported by single column from the amplifier plinth. Projector stands on amplifier so that striped film passes through the sound film before passing through the projector. Unit packs away into speaker case. Weight $28\frac{1}{2}$ lb. Superimpositions possible or complete erasure. Supplied complete with microphone, cables. Price £97.



Stroboscopes

Arrowtabs Limited, 93 Church Road, Hendon, N.W.4. Tel.: Sunnyside 3311/2.

Strobe-o-Disc. Synchronises any tape recorder running at $3\frac{3}{4}$ or $7\frac{1}{2}$ i/s with any cine projector running at either 16 fps with three bladed shutter, or with a projector running at 24 fps with a two bladed shutter. Depends upon variable speed being fitted to projector. Disc is mounted on the edge of the recorder, at correct projector speeds the Strobe is stabilised. If the strobe moves the projector speed is adjustable. Price 35s. 6d.

H.S. Engineering Company, Malvern Close, Kenton, Harrow, Middx.

Drumsync Unit. Stroboscope Disc supplied on small mounting bracket suitable for attaching directly to the deck of any tape recorder. Tape detours round the disc and is illuminated by attaching a small mirror on the projector lens. Two strobe tracks on the disc indicate 16 and 24 fps. Price 32s. 6d.



Magnetic Striping Service

E.V.T. Magnetics, 157 Long Lane, Bexleyheath, Kent. Tel.: Bexleyheath 7440.

Standard liquid, laminated and recess laminated stripe applied to 8 or 16 mm film, also film cleaning and waxing and associated services.



Zonal Film Facilities Limited, The Tower, Hammersmith Broadway, London, W.6. Tel.: Riverside 8741. Cables: Zonogram, Hammer, London.

"Zonastripe" Liquid Stripe. Stripping service offered for all gauges of film; 16 mm films can be striped with es, hs and fs. Balancing stripe applied with 16 mm es. Fully coated film available in 8 or 16 mm, minimum length 400 ft.



Sound Laboratory Services

United Motion Pictures, 38-39 Fitzroy Square, London, W.1. Tel.: Temple Bar 2025.

Duplicating of all types of 16 mm undertaken. Colour and black-and-white films with magnetic stripe printed to optical track. Recording studio facilities available. Tapes and films synchronised on optical sound track. Details on application.



Bauer Coupler N

Rank Precision Industries Ltd., G.B. Film Library, Aintree Road, Perivale, Middx. Tel.: Perivale 6606. Cables: Gebascope, Perivale.

16 mm Duplicating undertaken. 16 mm films with magnetic track printed on to optical sound track. Details on application.

Sound Film Negative and Positive Raw Stock

E.M.I. Sales & Service Ltd., Recording Materials Division, Blyth Road, Hayes, Middx. Tel.: Southall 2468. Cables: Emiservice London.

Emifilm. Fully coated perforated stock for sound film tracks. Made in three gauges - 35, 17, 5 and 16 mm. This sprocketed magnetic recording film is designed for cine, telecine and industrial use, for work where absolute synchronism is essential.

Type 351 (35 mm) in 1,000 ft. reels. Prices: (1 to 19 reels) £8. (20 and over) £7 17s. 6d. per reel.

Type 171 (17.5 mm) in 1,000 ft. reels. Prices: (2 to 18 reels) £4 5s. (20 and over) £4 2s. 6d. per reel.

Type 161 (16 mm) in 1,000 ft. reels. Prices: (2 to 18 reels) £3 17s. 6d. (20 and over) £3 15s. per reel. In 1,200 ft. reels (1 to 19) £4 12s. 6d. (20 and over) £4 10s. per reel. In 2,400 ft. reels: (1 to 9) £9 5s. (10 and over) £9 per reel. Prices for shorter lengths, also illustrated leaflet giving specifications, dimensions, etc. on application. **Note:** Add the following suffixes to type numbers (e.g. 161B/D) for these different windings. A=Wound Oxide "in"; B=Oxide "out"; A/S=Oxide "in", single perforated; B/S=Oxide "out" single perforated; A/D=Oxide "in", double perforated; B/D=Oxide "out", double perforated.

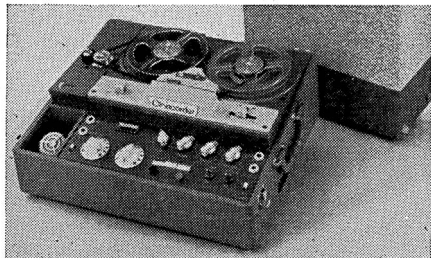

K.G.M. Cinecorder

HOME CONSTRUCTION

AN INTRODUCTION

LAST year, the "Do-it-yourself" section of this book was prefaced by a photographic feature, based on a *Heathkit* oscilloscope, which it was hoped would stimulate further interest in this most interesting side of "hi-fi". Whether or not the feature had anything to do with what has actually happened will probably never be known, but the increased interest in home construction has, according to all reports, been quite amazing during the past twelve months. The following pages in the directory section show many new products in kit form, which is a good barometric indication of expansion; but it is the news that comes from specialist dealers—news of hundreds of sets of components bought by readers of *Hi-Fi News* and the *Tape Recorder*—which fills in the other side of the story.

Homework first!

Addressing the reader who has yet to attempt home-built equipment, there are two points which should be mentally noted and regarded as absolutely essential prerequisites. One, buy some cheap components from a dealer, some "*Savbit*" solder, a good, light iron, and some wire, and spend three or four evenings learning how to solder. Only when this very simple, but vital trick has been mastered should the first item of equipment be tackled. Next, whatever piece of equipment appeals, try a simple item first.

On this score, since the home constructor will always have a good use for it, a valve-voltmeter is a very good item to choose. Once that has been built it will be found to be invaluable for all other jobs that follow. As a constructional item

it has the advantage of being a piece of equipment which can be finished soundly and easily in one or two evenings. The *Heathkit* product is strongly recommended for beginners for this reason, and because the working instructions issued by that Company are superlative. And that remark applies to every product issued by them. A second item of equipment from the same range is the portable transistorised radio.

Begin Simply

Beginners are indeed recommended to concentrate upon such items—those issued with very detailed instructions and diagrams—until the feel of electronic construction has been acquired. A further very important point is the study of the circuit diagrams issued. The *Heathkit* instructions are so thorough and so simple that it is virtually possible for anyone to build up an amplifier or a radio set, who can handle a soldering iron properly. Therefore it is doubly important—if any real progress is to be made—to check back all work—all connections and wires, point by point, with the circuit when construction is complete. It is good practice to go over the actual circuit diagram with a red pencil, stage by stage, until every line on the diagram has been "inked over".

Move forward a step

Once the feel of home construction has been acquired, enthusiasts will be able to tackle slightly less "spoon-fed" items, such as those which are published in magazines, and which call for considerably more concentration because far more

is left to the constructor to work out. Tape is a subject which has recently received the attention of kit manufacturers, and it is now possible to build up monaural and stereo record/replay amplifiers from kits of parts. These amplifiers, when well constructed, and when used with the tape deck of one's choice, bring really high-fidelity tape results within reach at comparatively low cost. Examples of these products are the monaural record/replay amplifier by *Sterns Radio Ltd.*, and the stereo kit by *Heathkit Ltd.* Both are really fine pieces of equipment in potential.

The Time Factor

The construction time required for such equipment naturally varies according to the neatness of the work that one likes to see, and to the ability of the constructor. Twenty hours of work on a monaural tape amplifier should see a good job of work from a constructor of fair ability. thirty hours should produce a stereo job. These figures must be regarded as most flexible of course, as the foregoing provisos suggest. A monaural amplifier could be constructed comfortably in a week of free evenings. An oscilloscope in slightly more.

Constructors of a more adventurous turn of mind might like to try their hands at the *Shirley Laboratories TWA 15/15*—a combined 2-channel high-fidelity stereo amplifier and record/replay amplifier, as published in *Hi Fi News* during 1960, and shortly to be republished in booklet form. An estimate of the time needed for this item of equipment is from 40 hours, in the hands of a reasonably capable constructor, to 60 hours in the case of someone more cautious; but this type of equipment should be left until good experience has been gained on more simple and less time-demanding jobs.

As a topical note at this stage, readers are also reminded that *Hi-Fi News* has

(1961) recently introduced another constructional feature of unusual interest for those who like to undertake relatively big jobs—an electronic organ, on the principle add-on units. This is based upon a standard keyboard, has both manual and pedal keys, and provides for the playing of full chords. This, however, is a big step distant from the modest valve-voltmeter and portable radio which are recommended as *ab initio* constructional introductions.

A fine Range of Products

The following pages of the kits directory section offer the home constructor a really wide range, and cover everything from loudspeaker assemblies to test gear. The quality of the components supplied by the firms is very good indeed—certainly up to the standards that one finds in finished equipment. Given intelligent interpretation of instructions and good workmanship, these kits can provide their purchasers with electronic equipment of really first class quality. Some kits that have been advertised abroad have been of notoriously inferior quality; but it must be emphasised that all kits offered by the better firms on the British home market are good, and some of them are outstandingly good value.

Get the basic Tools

A final word to all potential constructors. First buy a set of good tools. Those recommended regularly in this *Year Book*, and in *Hi-Fi News*, are stocked by **Buck and Ryan Ltd.**, 310 Edgware Road, London, N.W.1, who will gladly post the list of details on request. They are not many, and the outlay is small. Time is the most valuable of all the ingredients needed for home-produced products. Time, plus good components, deserve good tools. Without them, a good job can be ruined—or at best be second-best—and valuable time will be wasted.

DIRECTORY OF CONSTRUCTIONAL KITS

Altobass Ltd., Percy Road, Aylestone Park, Leicester. Tel.: Leicester 31616. Cables: Altobass, Leicester.

Altobass Stereo-44 Amplifier. Inputs: pickup, radio, tape, sensitivity 130 mV. Frequency response 20-20,000 c/s \pm 1 dB. H & N -70 dB. Distortion 2.5% at 4 watts (1.5% at 3 watts). Separation better than 40 dB at 1,000 c/s. 4 watts each channel, 8 watts monaural. Output impedance 4, 8 or 16 ohms. Size $11\frac{1}{2} \times 4\frac{3}{4} \times 9$ ins. Price £18 18s.



Cossor Instruments Ltd., Cossor House, Highbury Grove, London, N.5. Tel.: Canonbury 1234. Cables: Cossor, London.

1045K. Single-beam Oscilloscope kit. Printed circuits. 4-inch tube. Y amplifier sensitivity 50 mV/cm, response 5 c/s to 3 Mc/s (30% down), rise-time 0.12 microsec. X amplifier sensitivity 0.75 V/cm, response 2 c/s to 275 Kc/s (30% down), rise-time 1.4 microsec. Intensity modulation. 1 volt calibration source built in. Size $14\frac{3}{4} \times 9 \times 18\frac{1}{4}$ ins. Weight 18 lbs. Price £34. Assembled £46.



D.G.C. Ltd., 41 High Street Camberley, Surrey.

Oakhurst Doric Speaker Enclosure. To house a single Goodmans Axiette 8 in.

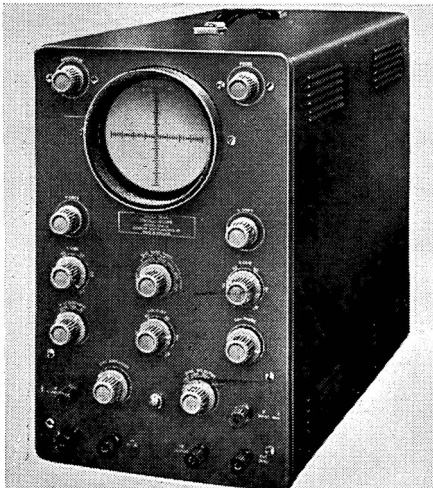

Cossor 1045K Single-beam oscilloscope

speaker. Cabinet available in whitewood or veneered finish. Size $30 \times 11\frac{1}{2} \times 11\frac{1}{2}$ ins. Price in kit form: £8 whitewood, £11 10s. veneered. Assembled: £10 10s. whitewood, £14 14s. veneered. 10% reduction when ordering stereo pair.

Oakhurst Ionic Speaker Enclosure to house single Wharfedale W10/FSB speaker cabinet. Available in whitewood or veneered finish. Size $34 \times 13 \times 13$. Price in kit form £10 12s. 6d. whitewood, £14 1s. 3d. veneered. Assembled: £13 whitewood, £17 14s. 6d. veneered. 10% reduction when ordering stereo.

Oakhurst Corinthian Speaker Enclosure to house single Philips AD S200M (12 in.) speaker. Size $34 \times 15 \times 15$ ins. Price in kit form: £13 10s. whitewood, £19 12s. 6d. veneered. Assembled: £17 8s. 9d. whitewood, £21 18s. 9d. veneered. 10% reduction when ordering stereo.

Also the Penfield range of Hi-Fi furniture kits.



Heathkit. Manufactured by Daystrom Ltd., 900 Southgate Street, Gloucester, England.

S-88. Stereo amplifier kit. 8 watts per channel. Distortion 0.1%. Stability better than 10 dB. Response 30-20,000 c/s \pm 2 dB. inputs: pickup 20 mV, radio 200 mV, tape 400 mV. Push-button sel., bass, treble, filter, balance and reversing switch. Size

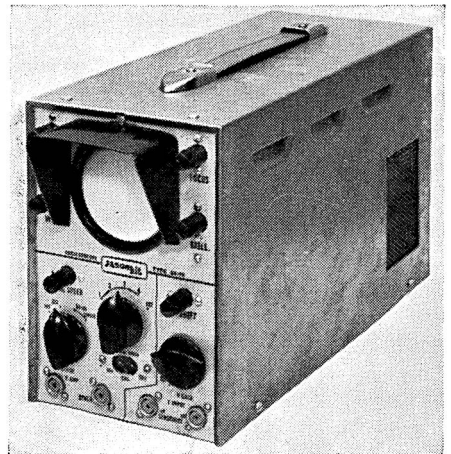

Jason OG10 oscilloscope



Altobass Stereo 44 amplifier

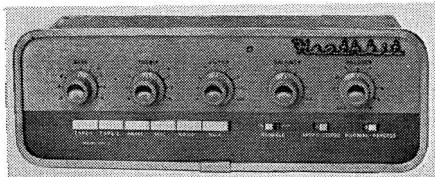

Heathkit USC-1 stereo pre-amp.

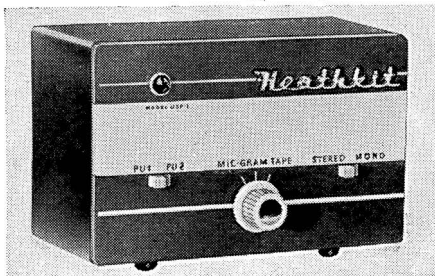

Heathkit USP-1 booster amplifier

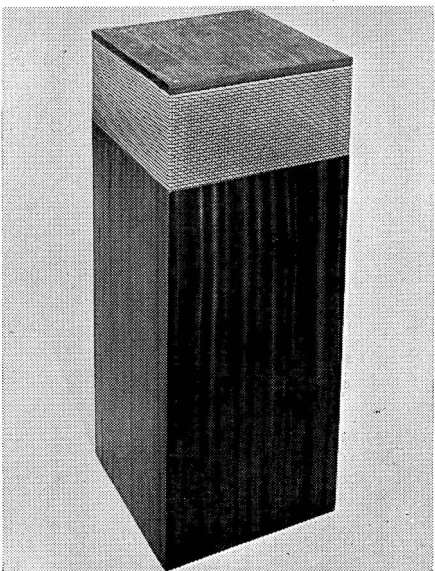

D.G.C. Oakhurst Doric enclosure

13½ × 5½ × 9½ ins. Price £25 5s. 6d. High sensitivity (4 mV) model S-88B £1 10s. extra.

S-33. Stereo amplifier kit. 3 watts per channel. Distortion 0.3%. Input 100 mV at 1 Megohm. Bass, treble, balance, volume. Price £11 8s.

USC-1. Stereo pre-amplifier. Inputs: pickup 1, 3-4 mV 50 K; pickup 2, 150 mV 1 megohm; tape 1, 2.5 mV 80K CCIR; tape 2, 150 mV 100K; radio 150 mV; mic. 3 mV 1 megohm; aux., 4-150 mV 1 megohm. Controls: bass, treble, rumble filter, variable low pass filter, balance, volume, function, channel reverse. Power required. 250v 10 mA, 6.3v 1.5 amps. Output voltage 1.3 volts RMS. Price £17 19s. 6d.

USP-1. Booster amplifier. Suitable for stereo and monaural sources of low sensitivity, e.g. pickups, tape heads or microphones. Input sensitivity 2-20 mV. Output adjustable from 20 mV to 2 volts. Maximum gain 100. Power requirements 180-250 volts, 3-5 mA: 6.3 volts 0.5 amps. Price £5 19s. 6d.

SSU-1. Speaker system kit. Comprises 8 in. and 4 in. matched drive units, and ducted-port bass reflex cabinet. Response 40-16,000 c/s ± 5 dB, crossover frequency 3,000 c/s. Imp. 15 ohms. Size 23 × 11½ × 11½ ins. Price complete £11 16s., without legs, £10 9s.

V-7A. Valve Voltmeter Kit. Printed circuit. Measures A.C. volts (0-1.5, 5, 15, 50, 150, 500, 1,500) R.M.S., A.C. volts (0-4, 14, 40, 140, 400, 1,400, 4,000). Peak-to-peak, D.C. volts (0-1.5, 5, 15, 50, 150, 500, 1,500). Ohms (with 10 ohms centre) × 1, 10, 100, 1,000, 10K, 100K, 1 Meg. 0.1 ohms to 1,000 Megohms with internal battery. Input resistance 11 Megohms. Meter 200 micro-amps. Full scale deflection. Accuracy ± 3% full scale. Price £13.

MGP-1. Power supply unit. 200, 250, 270V 120 mA; 6.3V, 2.5A. Price £4 9s.

OS-1. Service oscilloscope kit. 2¼-in. C.R. tube. Printed circuit. Vertical bandwidth 10c/s to 2.5 Mc/s. Built-in calibrator. "Y" sensitivity 10 mV R.M.S. per cm. "X" sensitivity 1v R.M.S. per cm. Price £18 19s. 6d.

O-12U. General purpose oscilloscope Kit. 5 in. flat face C.R. tube. Printed

circuits. Vertical bandwidth 3 c/s to 5 Mc/s. Built-in 1 volt calibrator. "Y" sensitivity 10 mV R.M.S. per cm. "X" sensitivity 0.12v R.M.S. per cm. Phasing control. Z-axis modulation. Price £34 15s.

S-3U. Electronic Switch (oscilloscope trace doubler). Converts a single beam oscilloscope to double beam. Switching rates 150, 500 1,500, 5,000 and 15,000 c/s. Signal frequency response 0-100 Kc/s \pm 1 dB. Signal input range 0.1 to 1.8 volts R.M.S. Price £9 18s. 6d.

CM-1U. Direct-reading capacitance meter. Uses a 4½ in. meter with four ranges as follows: 100 picofarads, 1,000 picofarads, 0.01 microfarads and 0.1 microfarads. Price £14 10s.

C-3U. Resistance/capacitance bridge. Self-contained and powered. Capacitance range 0.00001 to 1,000 microfarads. Resistance range 100 ohms to 5 megohms. Power factor and leakage also indicated. Polarising voltages available from 5 to 450 volts. Price £7 19s. 6d.

AV-3U. Audio valve millivoltmeter. Measures voltages as low as 1 mV to a maximum of 300 volts at high impedance in 10 ranges. Frequency range 10-400,000 c/s. Uses a 4½ in. meter. Cathode follower output. Price £13 18s. 6d.

309-CU. RF probe. Extends the range of a valve voltmeter to 100 Mc/s. Uses a printed circuit board. Price £1 5s. 6d.

AW-1U. Audio wattmeter. Uses external loads or the following internal loads: 3, 8, 15 and 600 ohms. 5 power ranges from 0.5 mW to 50 watts. 4½ in. meter calibrated in watts and dB. Price £13 18s. 6d.

AG-9U. Audio signal generator. Range 10 c/s to 100 Kc/s. Distortion less than 0.1% form 20 c/s to 20 Kc/s. Decade switching over 8 voltage ranges from 3 mV to 10 volts monitored. Uses 4½ in. meter. Price £19 3s.

FM tuner. Comprises model FMT-4U tuner unit and FMA-4U IF strip and power supply. Flywheel tuning, thermometer tuning indicator, three IF stages with two limiters, printed circuit board and pre-aligned coils. Tuning range 88-108 Mc/s.

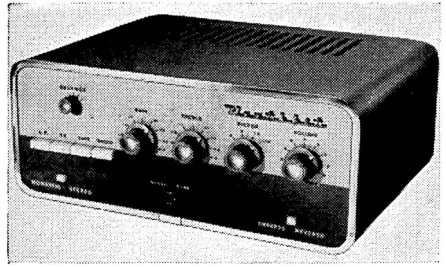

Heathkit S-88 stereo amplifier

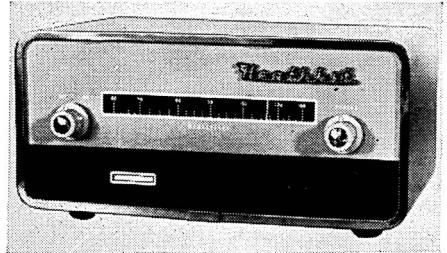

Heathkit FM Tuner

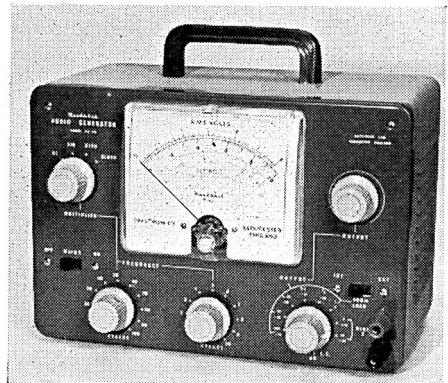

Heathkit AG-9U Audio generator

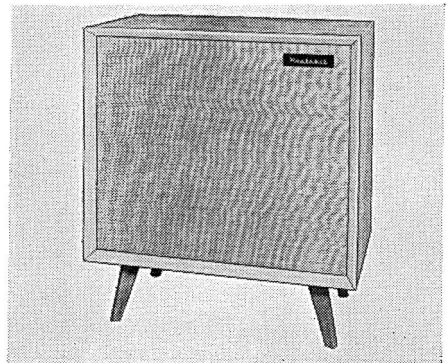

Heathkit Cotswold speaker system

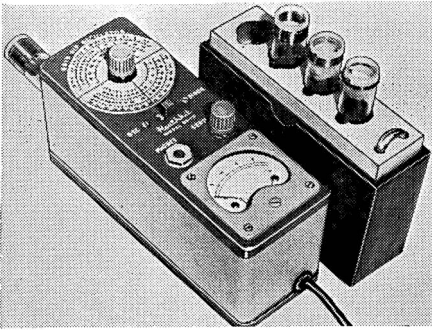

Heathkit GD-1U Grid dip oscillator

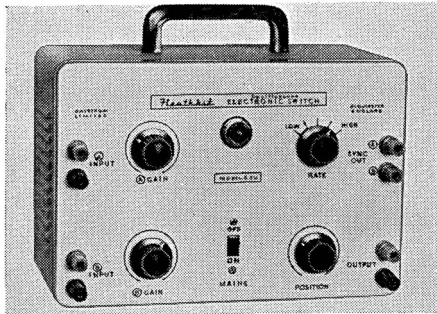

Heathkit S-3U Electronic switch

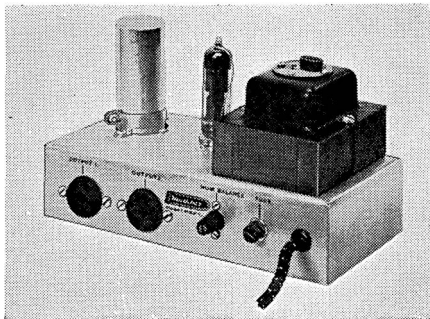

Heathkit MGP-1 power unit.



Jason CC10 Crystal Calibrator

Sensitivity 2.5 microvolts for 20 dB quieting. Price £13 12s. 6d. (for both units).

Cotswold. High fidelity three-way loudspeaker. Drive units are 12 in. bass, 8 × 5 ins. elliptical, and pressure tweeter. Range 30-20,000 c/s. Two volume controls. Celotex lined enclosure. In white wood ready cut and drilled. Dimensions 26 × 23 × 14½ ins. Price complete with crossover unit, etc. £19 18s. 6d.

Chepstow. Cabinet for hi-fi equipment. Space available for FM tuner, amplifier and record player. Dimensions 34 × 32¼ × 18 ins. Price £10 10s.

Gloucester. Cabinet for hi-fi equipment. Space available to house records, tapes, etc. Mk. I accommodates tape deck or record player, FM tuner, and stereo amplifier. Mk. II accommodates both tape deck and record player, FM tuner and stereo amplifier. Dimensions: length 46½, height 30, depth 21 ins. Price Mk. I £15 18s. 6d., Mk. II £17 8s. 6d.

Full details of test gear not included in this section can be obtained on application.



Jason Electronic Designs Ltd., 3/4 Gt. Chapel Street, London, W.1. Tel.: Gerrard 0273/4.

F.M.T.I Standard F.M. tuner kit. 4 valves only are used, giving an aerial sensitivity of better than 100 microvolts. A ratio detector is combined with a limiter for low distortion and good noise rejection. Price without valves and power supply £5 19s. Power Pack kit £2 14s.

F.M.T.2. This is the same unit as the F.M.T.1. but built into a shelf mounting case. Price, less valves, but with power supply £8 15s.

F.M.T.3. A fringe FM tuner with automatic frequency control. Two limiters combat the effects of aeroplane flutter and car interference. Price with case but less seven valves required, £9 19s.

J.S.A.2. Three watt amplifier kit. Three watts per channel are available from this simple kit which gives good results from such stereo pickups as the *Ronette* and *Acos*. 18 dB of feed-back is applied to the pentode section of the first amplifier which

is an EFC80 while the triode section is used in the tone control circuit. Stereo balance control gives 5 dB variation each way. Price £13 19s. including all valves.

EM10. Valve voltmeter. A four valve bridge circuit, gives good stability. May be used as a general purpose meter. 23 ranges including D.C. current range. Price kit £18 10s. Assembled £23.

AG10 Audio Generator. A capacity tuned Wien bridge covers from 10 c/s to 100 Kc/s with excellent stability and low distortion while the output is held constant within 1 dB. Output impedance is 600 ohm from a cathode follower and the Attenuator uses resistors of 1% accuracy. The rise time on square waves is better than 2 microseconds. Price kit £15 19s.

AA10 Audio Attenuator. Nine slide switches give the following attenuation. 40 dB, 20 dB, 20 dB, 10 dB, 10 dB, 5 dB, 2 dB, 2 dB, 1 dB, while the tenth switch allows the addition of a 600 ohm termination resistor. Resistors of 1 % accuracy are used. The case measures 13 in. long \times 2 $\frac{1}{4}$ in. wide \times 1 in. high. Price kit £7 15s.

CC10 Crystal Controlled Calibrator. The exact frequency of a generator may be found by connecting the output to this crystal calibrator when the self-contained audio section and loudspeaker allow marker pips to be heard directly. These marker pips are generated at 10 Mc/s, 1 Mc/s, 100 Kc/s and 10 Kc/s so that generators in the range of 10 Kc/s to 250 Mc/s may be checked. The basic accuracy of .01% comes from a 1 Mc/s crystal oscillator. Price kit £19 19s.

OG10. 2 $\frac{1}{4}$ in. Oscilloscope has a sensitivity of 10 mV/cm with a bandwidth of 2 c/s-2 Mc/s. Sweep linearity is good and push-pull amplifiers are used on both X and Y. Price kit £22 10s.

W11 Wobbulator. This unit used in conjunction with the Oscilloscope OG10 or OG20 allows frequency response curves to be shown. It is suitable for all IF and RF alignment in TV and radio tuners. 50 c/s sine wave is used for scanning while the return trace is blanked to provide a reference base line. Price kit £14 19s. Built £19 19s.

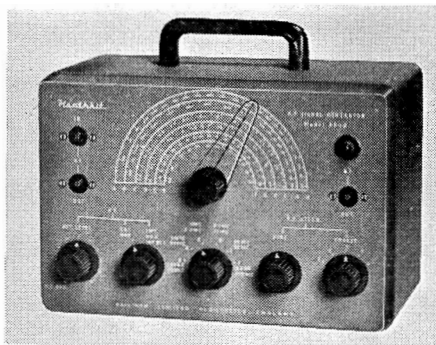

Heathkit RF-1U R.F. Sig. generator

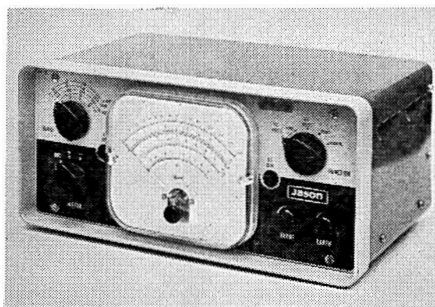

Jason EM10 Valve Voltmeter

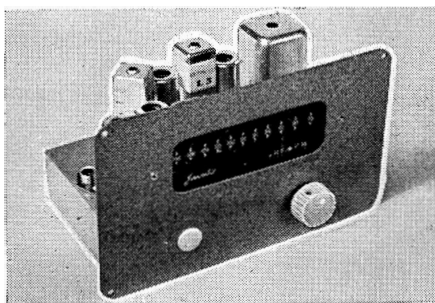

Jason FMT1 FM Tuner

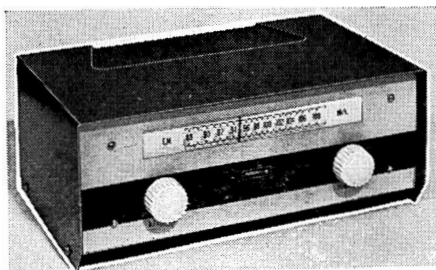

Jason FM Tuner, FMT3



Jason PP10M stabilised power pack

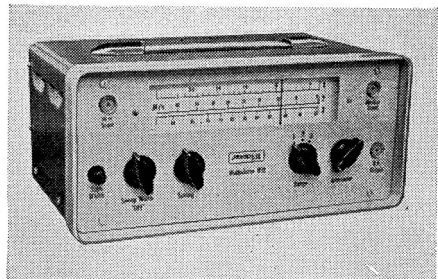

Jason W11 Wobulator

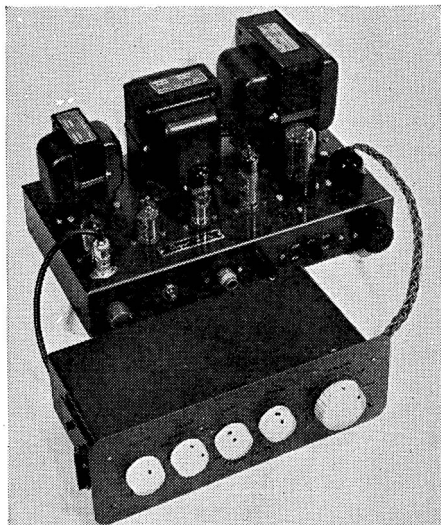

Cooper-Smith control unit and amplifier

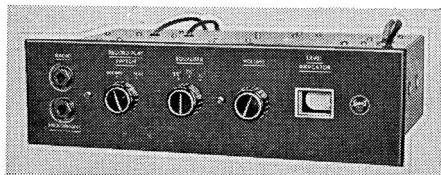

Stern Radio Type "C" tape pre-amp.

Lektra Products, 118 Gordon Road, London, W.13.

Gazelle. Reflex corner kit. One 8 or 10 in. unit, and one tweeter. Size 30 × 23½ × 12½ in. Weight 20 lb. Price £6 6s. Assembled £9.

Mayfair. Reflex corner kit. One 10 or 12 in. unit, and one tweeter. Size 36 × 28 × 16½ ins. Weight 30 lb. Price £9 9s. Assembled £13 2s. 6d.



Pye Ltd., High Fidelity Division, Blue Town, Sheerness, Kent. Tel.: Sheerness 3076. Cables: Faramarine, Sheerness, Kent.

H.F.S.20. 10 watt stereo amplifier (see amplifier section). Price £30.



H. L. Smith & Co. Ltd., 287/289 Edgware Road, London, W.2. Tel.: Paddington 5891/7595.

See Amplifier Section for details of the following kits:

Bantam Combined Amplifier and Control Unit.

Cooper-Smith 20w Power Amplifier.

Cooper-Smith Mk.II Control Unit.

Cooper-Smith B.P.1. Amplifier.

Prodigy Combined Amplifier and Control Unit.

Cooper-Smith Stereo Control Unit.

Cooper-Smith Stereo Amplifier.



Stern Radio Ltd., 109, 111 and 115, Fleet Street, London, E.C.4. Tel.: Fleet Street 5812-14.

Type C Tape pre-amplifier. To Mullard design (see Tape Amplifier Section). Price £11 15s., power supply unit £2 15s. extra.

HF/TR3. Tape amplifier. To Mullard design (see Tape Amplifier Section). Price power supply unit, £12 15s.

Fidelity Pre-amplifier/Control Unit. (See Amplifier Section) Price £7 10s.

Mullard "5-10" Amplifier. (See Amplifier Section). Price £10.

Mullard Dual Channel Pre-amplifier. (See Amplifier Section). Price £12 10s.

HI-FI FURNITURE

● Housing of High Fidelity equipment has always presented a problem, not only does it have to harmonise with existing decor but also fulfil all the requirements imposed by the equipment. There are a number of firms who specialise in Hi-Fi cabinets and a wide selection ranging from the most contemporary to reproduction antique is now available. The following is a list of firms who take special interest in housing Hi-Fi equipment but most leading dealers stock a good range of proprietary makes.

Brearccliffe, Little Barn, Arford, Headley, Hants. *Single and double Consoles.*

Clyne Radio, Ltd., 18 Tottenham Court Road, London, W.1. *Proprietary and special cabinets.*

Davis, A. & Co., 3-8 Parkhill Place, Hampstead, London, N.W.3. *Range of Consoles in all styles.*

Daystrom, Ltd., Gloucester. *"Chepstow" and "Gloucester" cabinets in kit form.*

Dennis & Robinson, Ltd., Bestwood Works, Drove Road, Old Portslade, Sussex. *"Southdown" cabinets, models designed round Leak and Pye equipment.*

Design Furniture, Ltd., Carnwarth Road, Fulham, S.W.6. *Consoles of all types.*

Fitrobe, 56 Commerce Road, Wood Green, London, N.22. *Cabinets built to individual specification.*

Heal & Son, Ltd., 96 Tottenham Court Road, London, W.1. *Contemporary consoles and unit assemblies.*

The Hi-Fi Centre, 50 Hockerill Street, Bishops Stortford, Herts. *"Sinfonia" Hi-Fi coffee table cabinet.*

The Hi-Fi Centre, 61 West Street, Dorking, Surrey. *Specialists in antique conversion.*

Imhof, Ltd., 112-116 New Oxford Street, London, W.C.1. *"Imflex" matching range of cabinets for all requirements.*

Largs, 76-77 High Holborn, London, W.C.1. *Wide range of "Tailorgram" cabinets of their own design. Stockist for all leading manufacturers.*

Lee Electronics, Ltd., 400 Edgware Road, W.2. *"Uni-Plan", available in one, two or three lid versions.*

Maggie Furniture, Ltd., Station Approach, Mortlake, London, S.W.14. *The "Maggie" coffee table console.*

Period High Fidelity, Ltd., 28 South Street, London, W.1. *Range of reproduction antique cabinets.*

Record Housing, Brook Road, London, N.22. *A comprehensive range of traditional and contemporary designs.*

Stamford, A. L., Ltd., 84 Weymouth Terrace, London, E.2. *General purpose and matching cabinets.*

Sugden, A. R. & Co., Market Street, Brighouse, Yorks. *A special console for Connoisseur equipment.*

The Tape Recorder Centre, 82 High Holborn, W.C.1. *All leading makes stocked, special cabinets built.*

Wellington Acoustic Laboratories, Ltd., Allways, Kings Lane, Wrecclesham, Farnham, Surrey. *Single and double "Lowboy" consoles.*

Whiteley Electrical Radio Co., Ltd., Mansfield, Notts. *Five different cabinets available in kit form or ready built.*

This Record Housing Nordyk range represents the popular "unit" type of cabinet. These are easy to instal and any number of units can be used providing a versatile installation.

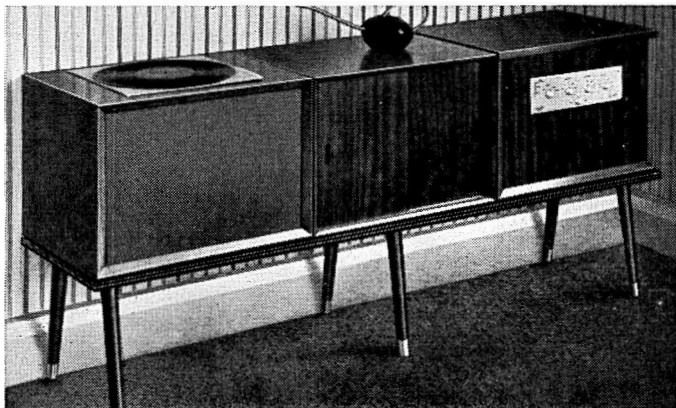

OUR NEW RANGE

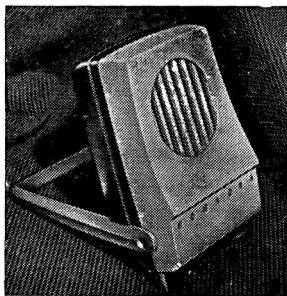

designed by Stanley Kelly

ROMAGNA REPRODUCERS can justifiably challenge comparison for these models on performance, quality and price.

HMC. I CRYSTAL

Price 25/-

THE KELLY RIBBON H.F. LOUDSPEAKER MK. II

"I know of no other Tweeter on the market which I should prefer". Thus comments a leading technical authority. The Ribbon Loudspeaker is acknowledged the most successful method of reproducing the higher audio frequencies. Who better than Stanley Kelly to provide the practical reality? *Who else would think of providing a genuine Response Curve with each Unit taken from the actual Speaker?* The brief specification will whet your appetite, as the Ribbon Mk. II is suitable for all domestic Monaural and stereophonic installations.

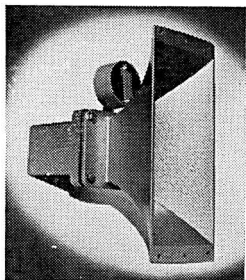

Brief specification:

Frequency Range: 2 Kc/s. to 20 Kc/s. within -1 & plus 2 dB.
2-Micron Aluminium Ribbon (shock-resistant, reducing distortion).
Built-in matching transformer. Power Capacity: Up to 10 watts maximum.
Impedance: 15 ohms nominal.
Dimensions: $9" \times 5\frac{1}{2}" \times 9"$.
Weight: 9 lb.
Finish: Silver Grey.

Price 10 gns.

ROMAGNA REPRODUCERS

ENFIELD · MIDDX

Factory Sales Representatives

K. H. WILLIMAN & CO. LTD.

Blackford House, Sutton, Surrey. Vigilant 3700/Melville 1491

DIRECTORY OF HI-FI DEALERS

IMPORTANT NOTE: The following list is of shops where stocks of equipment are kept, and where facilities for demonstration exist. It is not necessarily a complete list, and we invite new dealers to submit details for future publications.

LONDON AREA

AUDIO SERVICES, 82 East Barnet Road, New Barnet, Herts.
BERRYS (SHORT WAVES) LTD., 25 High Holborn, W.C.1
CHELSEA RECORD CENTRE LTD., 203 Kings Road' S.W.3
CITY SALES & EXCHANGE LTD., 93 Fleet Street, E.C.4
CLYNE RADIO (COMPONENTS) LTD., 18 Tottenham Court Road, W.1
CUSTOM HIGH FIDELITY, 371 Green Lanes, Palmers Green, N.13
ELECTRONICS (FLEET STREET) LTD., 152/3 Fleet Street, E.C.4
C. G. GOODWIN LTD., 7 The Broadway, Wood Green, N.22
GRAMOPHONE EXCHANGE LTD., 80-82 Wardour Street, W.1
H. C. HARRIDGE, 8 Moor Street, Cambridge Circus, W.1
HARRODS LTD., Knightsbridge, S.W.1
T. HEINITZ, 100 Queensway, London, W.2
H.M.V., 363 Oxford Street, W.1
HOLLEY'S, 315 Camberwell Road, S.E.5
ALFRED IMHOF LTD., 112 New Oxford Street, W.C.1
LARGS OF HOLBORN, Hanover House, 76/77 High Holborn, W.C.1
LASKY'S RADIO—LASKY'S (HARROW ROAD) LTD., 207 Edgware Road, W.2, and 42 Tottenham Court Road, W.1
LEE ELECTRONICS, 400 Edgware Road, W.2
LEWIS RADIO CO., 100 Chase Side, Southgate, N.14
MODERN ELECTRICS LTD., 120 Shaftesbury Avenue, W.1
MUSIC IN THE HOME, 100 Queensway, W.2
MUSICRAFT, 80-82 Uxbridge Road, Ealing, W.13
NEWBURY RADIO, 272 Romford Road, Forest Gate, E.7
H. NORMAN DAVIS LTD., 91 Broadway, Mill Hill, N.W.7
NUSOUND RECORDING CO., 35 Craven Street, W.C.2
RIMINGTON VAN WYCK LTD., 42/43 Cranbourn Street, W.C.2
H. L. SMITH & CO. LTD., 287-9 Edgware Road, W.2
A. L. STAMFORD, 98 Weymouth Terrace, E.2
STERN RADIO LTD., 109 Fleet Street, E.C.4
STUDIO 99, 57 Fairfax Road, Swiss Cottage, N.W.6
TELE-RADIO (1943) LTD., 189 Edgware Road, W.2
THE (LR) RADIO CENTRE, 33 Tottenham Court Road, W.1
TELESONIC LTD., 88/94 Tottenham Court Road, W.1
WEBB'S RADIO, 14 Soho Street, Oxford Street, W.1

BANGOR (N. WALES)

JOHN SHINN & SONS LTD., "Melody House", High Street

BATH (SOMERSET)

C. MILSOM & SON, North Gate

BEXLEYHEATH (KENT)

Broadway Radio, 228 Broadway

BIRMINGHAM

GRIFFIN RADIO LTD., 122 Bristol Street, Birmingham 5
HOLLICK & TAYLOR, 16 Grosvenor Road, Handsworth Wood, Birmingham 20
JEWKES & CO. LTD., 285 Broad Street

BLACKPOOL

F. BENFELL LTD., 17 Cheapside

BOGNOR REGIS

TANSLER & COOKE LTD., 3/4 Odeon Buildings

BOLTON

HARKER & HOWARTH (MUSIC) LTD., 7 The Arcade
H. D. KIRK (STEREOELECTRICS), 150 Higher Bridge Street

BOURNEMOUTH (HANTS.)

NATIONAL RADIO SUPPLIES, 66 Holdenhurst Road

BRACKNELL

PACK'S LTD., High Street

BRIGHTON (SUSSEX)

CLOUGH SMITH ELECTRICAL LTD., 32 St. James's Street and 40/41 Castle Street
LANES, 11 Gardner Street
LYON & HALL LTD., 92 Western Road

BRISTOL (SOMERSET)

BRISTOL & WEST RECORDING SERVICES LTD., 6 Park Row
HOUSE OF SOUND, 5 Marsh Street

BROADSTONE (DORSET)

BREACH OF BROADSTONE, 173 The Broadway

CAMBRIDGE

ADAMS & DELLAR LTD., 66 Regent Street
H. GEE, 94a Mill Road
K.P. CAMERA SHOP, 12a King's Parade
G. P. REECE, 1 & 2 Peas Hill
UNIVERSITY RECORDINGS, 16 Burleigh Place

CANTERBURY

GOULDENS, 36 High Street

CARDIFF

J. GOUGH & CO. LTD., 148-154 North Road

For your kind of equipment—

cabinets by

RECORD HOUSING

handsome — versatile — keenly priced



RAVEL DE LUXE

A very versatile cabinet. Under twin lids can be mounted turntable and tape deck. Behind left door, amplifier, pre-amp and radio tuner. 9" x 5" speaker cut-out in bottom. Behind right door, room for 100 records. 37" wide, 19" deep, 22" high, 9" legs. Motor boards: 18" x 15½".

Price: 23 gns.

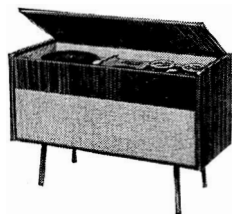

POLONAISE DE LUXE

will hold under its twin lids: 1. every *turntable*, plus 2. *tape-deck*, plus 3. *pre-amp controls* and 4. *radio tuner*. Below the motor-board there is ample room for the *largest stereo amplifiers*, plus cut-outs on the front baffle for two 10" *loudspeakers*.

Dimensions: 43" wide x 19" deep x 22" high, plus 9" legs.

Price: 22 gns.

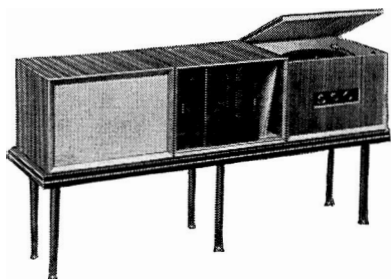

NORDYK SPEAKER ENCLOSURE (left)

was designed in conjunction with Goodmans Industries Ltd. for use with their 8" Axiette Loudspeaker. Made entirely of ½" chipboard and lined throughout, it is free from boom and resonance and gives a flat response from 40 cs. up to 15,000 cs.

Price: £6 15s. 0d.

NORDYK RECORD UNIT (centre)

holds 150 records. Two sliding wooden doors keep your records dust free; interior partitions hold them upright.

Price: £5 7s. 6d.

NORDYK GRAM UNIT (right)

will house all turntables (transcription or auto-change) and pick-ups. Motor-board measures 19" x 14½". Most pre-amplifiers can be mounted on the front panel, while main amplifier is installed below turntable. There may also be room for a radio tuner, depending on size.

Price: £6 19s. 6d.

VIKING REFLEX CORNER ENCLOSURE

This enclosure has been designed for any good 8" Loudspeaker and carries the official approval of both Goodmans Industries for their 8" Axiette and Wharfedale for their Super 8" FS/AL. Constructed entirely of ½" chipboard and lined throughout, it is free from boom or resonance. The frequency response is satisfyingly flat from 40 cs. up to 15,000 cs. Additional cut-outs have been made (and blanked over) for a 10" unit plus a tweeter for those who wish to use a multiple system.

Choice of two finishes: medium walnut, medium mahogany.

Dimensions: 32" high (including 6" legs); maximum width: 19"; depth: 12".

Price (complete with legs): 10 guineas

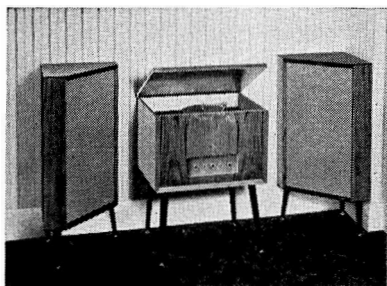

RECORD HOUSING, BROOK ROAD, LONDON, N.22

Telephone: BOWes Park 7487/8

CARLISLE

MISONS, Citadel Row

CHELTENHAM

RAY ELECTRICAL, 287 High Street

CHICHESTER (SUSSEX)

STORRYS OF CHICHESTER LTD., 83 North Street

COVENTRY

ELECTRONIC SERVICES, 110 Gosford Street
R.E.S. (COVENTRY) LTD., 128 Far Gosford Street

DARLINGTON

PALMERS, 3 East Street

DERBY

DALTON & SONS LTD., 11 London Road
DIXONS (DERBY) LTD., Strand Arcade
VICTOR BUCKLAND LTD., 37/39 London Road

DORKING

THE HIGH FIDELITY CENTRE, 61 West Street

DUNDEE

LARG & SONS (DUNDEE) LTD., 16/24 Whitehall
Street

EDINBURGH

ACOUSTIC PRODUCTS, 54 Elm Row
GEO. JEFFREY LTD., 23 Earl Grey Street
J. NICHOLSON, 1 Haddington Place

ETON (BUCKS.)

AUDIOCRAFT OF ETON LTD., 7 High Street

EXETER

FILDEWS (ENGINEERS) LTD., 99 Fore Street

FARNHAM (SURREY)

LLOYD & KEYWORTH LTD., The Record Shop, 26/27
Downing Street

GLASGOW

JAMES KERR & CO. LTD., 435 Sauchiehall Street

GRIMSBY (LINCS.)

JOHN ANGLIN, 385 Cleethorpe Road

HALIFAX

TREVOR FAWTHROP LTD., 17 Rawson Street

HAMPTON HILL (MIDDX.)

MELFORD RADIO, 58 Windmill Road, & 181 High Street

HIGH WYCOMBE (BUCKS.)

M. W. KEEN, Paul's Row

HORSHAM (SURREY)

SOUTHERN ACOUSTICS LTD., 68 Park Street

HOVE (SUSSEX)

RECORD ROUNDUP, 154 Portland Road, Hove 3

HUDDERSFIELD

GORDON ROBERTS, Yorkshire Sound Centre, 5
Outcote Bank
J. WOOD & SONS LTD., 67 New Street

IPSWICH (SUFFOLK)

R.C.S., 61 Fore Street

KEIGHLEY (YORKS.)

J. S. RAMSBOTTOM & CO. LTD., Bow Street

KIDDERMINSTER

F. W. LONG, 14 Mill Street

KINGSTON-ON-THAMES (SURREY)

R. K. APPLEBY, 30 London Road

LEAMINGTON SPA

TYSONS, 41 Russell Street

LEATHERHEAD (SURREY)

MAURICE RICHARDS LTD., Radio House, The Crescent

LEEDS

VALLANCE & DAVIDSON LTD., 20 New Market Street
and Headrow House
P.W.B. AUDIO, 41 Call Lane

LEICESTER

DALTON & SONS LTD., 76 Granby Street
LEICESTER CO-OPERATIVE SOCIETY LTD., High Street

LEIGH (LANCS.)

JOHN SHINN & SONS LTD., 23 Market Street

LITTLEHAMPTON

TANSLEY & COOKE LTD., 61 High Street

LIVERPOOL

BEAVER RADIO LTD., 60-62 Whitechapel
LAMBDA RECORDING COMPANY LTD., 95 Liverpool
Road, Liverpool 23

LOWESTOFT

E.J.P. SOUND SYSTEMS LTD., 118 High Street

LUTON (BEDS.)

S. FARMER & CO. LTD., 2 Wellington Street, 83 George
Street
COVENTRY RADIO, 189 Dunstable Road

MACCLESFIELD (CHESHIRE)

HI-FI HOUSE, 123 Chestergate

MAIDSTONE (KENT)

HIGH FIDELITY (MAIDSTONE) LTD., 57 King Street

MALVERN

RANFORD RADIO LTD., Barnards Green

MANCHESTER

FORSYTH BROTHERS LTD., 126-128 Deansgate
LANCS HIGH FIDELITY LTD., 8 Deansgate
NORTHERN ELECTRONIC COMPONENTS, 227b
Oxford Road

MIDDLESBROUGH

AUSTIN KYME LTD., 67 Corporation Road
PALMERS OF MIDDLESBROUGH, 106 Newport Road

MITCHEM (SURREY)

HOME RADIO (MITCHAM) LTD., 187 London Road

NEWCASTLE-UPON-TYNE

PAYNE & HORNSBY LTD., 3 Andrews House, Gallow-
gate
HAYMARKET RADIO, 23 Leazes Park Road

NEWTON ABBOT

D. O. H. COLES LTD., 13 Courtenay Street

NORTHAMPTON

CRYER'S, 220/224 Wellingborough Road

OXFORD

HORNS, 6 South Parade
L. WESTWOOD, 46 George Street

PAIGNTON

PAUL PINCH, Foales Corner

PERTH

GEORGE G. BROWN, 61 Kinnoull Street

PETERBOROUGH

CAMPKIN'S RECORD SHOP, 28 Cumbergate
ROY SPACKMAN, Cowgate

CHECK THE

Inside Story



OF THE TELEFUNKEN TAPE RECORDER WITH YOUR DEALER

He knows the Features that put the TELEFUNKEN Magnetophon Range in a Class Apart for Quality, Fidelity and Reliability.



THE EXCITING POSSIBILITIES OF TELEFUNKEN 4-TRACK RECORDING

Four-Track recording means you get four tracks on one tape. The perfection of the in-line twin-stacked recording head made this possible by actually allowing a quarter of the tape width to be scanned by each head. Briefly it is possible to record track 1 then rewind and record track 3 in perfect synchronisation. Playing back both tracks together gives an amazing superimposition effect.

MONITORING BY EARPHONE

A unique Telefunken transistorised pre-amplifier actually allows the first track to be monitored by earphones while the second track is being recorded. This opens up a tremendous field of activity for the tape enthusiast. Voice can be dubbed on to music. The Soloist can record himself in a duet! Effects can be added to lectures, speeches and monologues, etc.

The Telefunken Stereo model uses Four-track recording and incorporates two separate amplifiers. Using the D77 microphone, two forms of live stereo recording are possible and many other exciting effects can be produced. Send for full details.

A full selection of Telefunken Accessories, Microphones and Telefunken tapes is available. Ask for free brochure.

TELEFUNKEN 'Magnetophon 75k-15'

Tape speeds $3\frac{3}{4}$ i.p.s. and $1\frac{1}{2}$ i.p.s. with frequency response of 60-16,000 c.p.s. and 60-9,000 c.p.s. Playing time of 6 hrs. 20 mins. on $5\frac{3}{4}$ " DP tape. Tone control. Extension speaker socket. 47 Gns.

The amazing 4-Track TELEFUNKEN 'Magnetophon 76k'

Offers over 12 hours playing time from one DP Tape. 57 GNS.

TELEFUNKEN 'Magnetophon 77KD' 4-Track Stereo

Gives full stereo and Four-Track monaural superimposition effects. 2 speeds $1\frac{1}{2}$ and $3\frac{3}{4}$ i.p.s. $1\frac{1}{2}$ i.p.s. gives 6 hrs. 20 min. stereo recording. Push button track selection. Full monitoring facilities. Separate speaker in lid. Frequency response: 40-16,000 c.p.s. at $3\frac{3}{4}$ i.p.s. and 40-9,000 c.p.s. at $1\frac{1}{2}$ i.p.s. 85 Gns.

TELEFUNKEN 'Magnetophon 85KL'

Tape speeds of $7\frac{1}{2}$ i.p.s. and $3\frac{3}{4}$ i.p.s. with frequency response of 30-20,000 c.p.s. ± 3 dB and 30-15,000 c.p.s. 6 watt push/pull power stage. Separate Bass and Treble controls. D.C. heated pre-amplifier valves. 79 Gns.

TELEFUNKEN 'Magnetophon M24' Studio Recorder

The Telefunken M24 Studio Recorder has been designed to meet the need for a high quality recorder between the conventional domestic recorders and the larger machines for broadcast studios.

*All prices excluding microphone.

TELEFUNKEN

The originators of Tape Recording

Welme Corporation Limited, 147-148 Strand, London, W.C.2 Telephone: TEMple Bar 3357 (10 lines)

PLYMOUTH

ALBERT E. FORD LTD., 84 Cornwall Street

PORTSMOUTH (HANTS.)

ERNEST WYATT, 10-16 Queen's Road

READING

HERBERT & LASCELLES LTD., 22-25 St. Mary's Butts

RICHMOND (SURREY)

MUSICRAFT, 13 King Street

SALISBURY (WILTS.)

J. F. SUTTON, 18 Queen Street

SLOUGH

HICKIE & HICKIE LTD., 67/69 High Street

SOLIHULL (WARKS.)

H. C. HOLLOWAY, 2 High Street

SOUTHALL (MIDDX.)

MUSICRAFT LTD., 20-22 High Street

SHEFFIELDPHILIP CANN CO. LTD., 4 Dixon Lane
VULCAN ELECTRONICS, 339 Shoreham Street,
Sheffield 2**SOUTHAMPTON**HAMILTON ELECTRONICS (SOUTHAMPTON) LTD.,
35 London Road
J. F. SUTTON, 421 Shirley Road
UNIVERSITY CAMERAS, 12 Bargate Street**STOCKPORT**FAIRBOTHAM & CO. LTD., 47 Lower Hillgate, Stock-
port**STOKE-ON-TRENT**HIGH FIDELITY SOUND EQUIPMENT, 116 Birches
Head Road**SUNDERLAND**

ROSE BROS., Burdon House, Holmeside

SUNNINGDALE

PACK'S LTD., London Road

THORNTON HEATH (SURREY)NUSOUND RECORDING CO., 3-8 Brigstock Parade,
London Road**TRURO**

EDMUND FORD, 9 Pydar Street

TUNBRIDGE WELLSGOULDEN & CURRY LTD., The Royal Library, High
Street
PERCY POWELL RADIO LTD., 54 High Street**WALMGATE (YORKS.)**

CUSSINS & LIGHT LTD., Walmgate, York

WESTHOUGHTON (LANCS.)

MAXTONE HIGH-FIDELITY, 247 Church Street

WARRINGTON

WESTERN SOUND RECORDS, 11 Wilson Patten Street

WIGANJOHN SHINN & SONS LTD., "Melody House", 43
Hallgate**WOLVERHAMPTON**FENWICK'S, Fenwick Buildings, Great Brickkiln Street
PODMORE LTD., 19/21 Merridale Road
VOLTIC RADIO, Queen's Arcade**WORCESTER**

JOHNSON SOUND SERVICE, 9 Sidbury

WORTHINGCLOUGH SMITH ELECTRICAL LTD., 4 Connaught
Buildings
BOWERS & WILKINS LTD., 1 Becket Buildings, Little-
hampton Road
J. W. MANSFIELD LTD., 8-12 Liverpool Road
TANSLEY & COOKE LTD., Chapel Road

TAPE RECORDER SPECIALISTS

★ The following is a short list of dealers specialising in the sale of tape recorders and associated equipment.

LONDONDICKINSONS OF PALL MALL LTD., 11 Royal Opera
Arcade, Pall Mall, S.W.1ESSEX TAPE RECORDER CENTRES, 2 Maryland
Station, Stratford, E.15, and at 205 High Street
North, East Ham, E.6FRANCIS OF STREATHAM, 169-171 Streatham High
Road, S.W.16

MAGNEGRAPH, 1 Hanway Place, W.1

RAPP RADIO LTD., 181 Dalston Lane, E.8

THE RECORDER CO., 188 West End Lane, West
Hampstead, N.W.6R. E. W. EARLSFIELD LTD., 545 Garratt Lane, S.W.18,
and 266 Upper Tooting Road, S.W.17SHEEN TAPE RECORDER CENTRE LTD., 8 Station
Parade, Sheen Lane, S.W.14THE TAPE RECORDER CENTRE LTD. (Head Office),
75 Grand Parade, Green Lanes, Harringay, N.4,
West End Showroom, 82 High Holborn

TELETAPE, 59a Edgware Road, W.2

BIRMINGHAMHOLLICK & TAYLOR RECORDING CO. LTD., 16
Grosvenor Road, Handsworth Wood**BLACKPOOL**

TAPE RECORDER CENTRE, 266 Waterloo Road

BRIGHTON

JOHN KING (FILMS) LTD., East Street

BROMLEY (KENT)

HOWARD PHOTOGRAPHIC, 218 High Street, Bromley

CHESTER

MILLER & PALIN LTD., 144-146 Foregate Street

CREWE

MILLER & PALIN LTD., 11 Delamere Street

HULL (E. YORKS.)

A. BROWN & SONS LTD., 24/28 George Street

LANCASTER

CHRIS. WILLIAM LTD., 20 New Street

LEICESTER

G. W. GOWLING LTD., 26 Belvoir Street

LIVERPOOL

COGHLAN & ROBINSON LTD., 18 Hackins Hey

NOTTINGHAMNOTTINGHAM TAPE RECORDERS LTD., Burton
Street.

RESLOSOUND LIMITED

*For the highest quality
sound reproduction*

RIBBON & DYNAMIC MICROPHONES

IMPEDANCES

CDL 30/50 ohms	CRL 30/50 ohms
CDM 250 ohms	CRM 250 and 600 ohms
CDH 30/50 ohms and high impedance each complete with 18 ft. screened cable.	CRH 30/50 ohms and high impedance

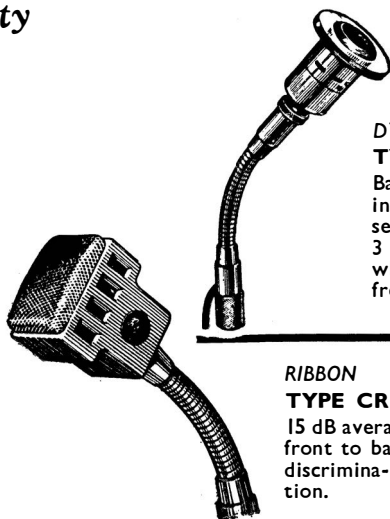

**DYNAMIC
TYPE CD**
Baffle-fitted to
increase
sensitivity by
3 dB over the
whole speech
frequency range.

**RIBBON
TYPE CR**
15 dB average
front to back
discrimina-
tion.

CHAPMAN ULTRASONICS LTD.

The 305 Control Unit affords every facility for high-quality stereo or single-channel radio, gram or tape reproduction. It accepts direct tape head signals and can reproduce pre-recorded tapes without a separate pre-amp.

It can be used with low output magnetic or crystal P/U, records stereo and mono tapes and is supplied (£18.18.0) ready for connection with the 305 Main Amplifier. This instrument (£21.0.0) gives 8 watts per stereo channel and 16 watts in parallel. FM and AM/FM Tuners similar to the 305 Control Unit are also available.

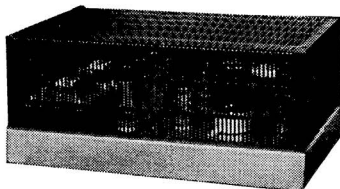
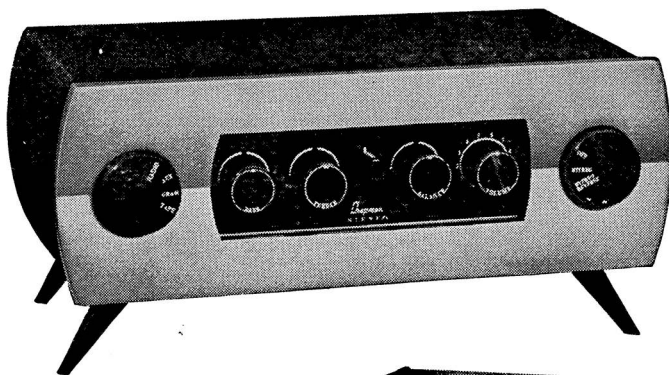

Please write for full particulars to

24 UPPER BROOK STREET, LONDON, W.1
telephone: HYDE PARK 2291/2/3

ADVERTISERS' INDEX

	<i>Page</i>		<i>Page</i>
ACOUSTICAL MANUFACTURING CO. LTD.	Front Cover	MODERN ELECTRICS (RETAIL) LTD. ...	223
ARMSTRONG WIRELESS & TELEVISION CO. LTD.	246	MORDAUNT SOUND REPRODUCERS ...	193
AUDIO SERVICES	224	MULTIMUSIC LTD.	247
AURIOL (GUILDFORD) LTD.	244	PHILIPS ELECTRICAL LTD.	203
BRENELL ENGINEERING CO. LTD.	231	POLITECHNA (LONDON) LTD.	228, 229
BROWN, S. G. LTD.	218	PORTOGRAM LTD.	217
BURNE-JONES & CO. LTD.	202	PYE LTD.	204
CAPE ELECTROPHONICS LTD.	210	RADFORD ELECTRONICS LTD.	196
CHITNIS ELECTRONICS LTD.	225	RECORD HOUSING	186
COSMOCORD LTD.	197	ROMAGNA SOUND EQUIPMENT LTD. ...	184
DERRITRON GROUP, THE	190	S.M.E. LTD.	234
E.M.I. SALES & SERVICE LTD.	240, 241	SAGA SOUND	Back Cover
ELSTONE ELECTRONICS LTD.	245	SCOTCH BRAND RECORDING TAPE ...	201
ELIZABETHAN (TAPE RECORDERS) LTD. ...	227	SHURE BROS. INC.	208, 209
FRANCIS OF STREATHAM	213	SIMON EQUIPMENT LTD.	249
G.E.C. LTD.	230	SOUND SALES LTD.	250
GARRARD ENGINEERING & MANUFACTURING CO. LTD., THE	254	SPECTO LTD.	236
GEVAERT LTD.	212	STANDARD TELEPHONES & CABLES LTD. ...	206
GOLDRING MANUFACTURING CO. (GREAT BRITAIN) LTD.	216	SUGDEN, A. R. & CO. LTD.	192
GOODMANS INDUSTRIES LTD.	214	"THE TAPE RECORDER"	221
HARRIDGE, H. C.	233	TAPE RECORDER CENTRE, THE ...	215
HEATHKIT (DAYSTROM) LTD.	255	TAPE RECORDERS (ELECTRONICS) LTD. ...	205
"HI-FI BOOKS"	256	TANNOY PRODUCTS LTD.	226
"HI-FI NEWS"	243	TELETAPE LTD.	242
IMHOF, ALFRED LTD.	194	THOMPSON, DIAMOND & BUTCHER ...	235
JASON ELECTRONIC DESIGNS LTD.	237	TRUVOX LTD.	222
LARGS OF HOLBORN	239	VITAVOX LTD.	252
LASKY'S (HARROW ROAD) LTD.	211	VORTEXION LTD.	251
LEAK, H. J. & CO. LTD.	198	WATTS, CECIL E. LTD.	232
LOWTHER MANUFACTURING CO.	200	WEBB'S RADIO	199
LUSTRAPHONE LTD.	195	WELLINGTON ACOUSTIC LABORATORIES LTD.	253
MARKING, R. & CO. LTD.	207	WELMEC CORPORATION LTD.	188
METRO-SOUND MANUFACTURING CO. LTD.	219	WHARFEDALE WIRELESS WORKS LTD. ...	238
		WHITELEY ELECTRICAL RADIO CO. LTD. ...	248
		WORDEN AUDIO DEVELOPMENTS LTD. ...	220

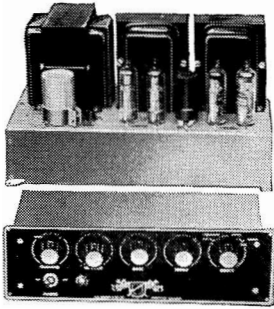

STEREO AMPLIFIER AND CONTROL UNIT, TYPE S66

Twin channel, delivering 7.5 watts per channel with ultra linear output stage. Inputs for P.U., Tape and Radio, sensitivity being 6 mV. Separate treble and bass controls.

PRICE: Pre-amp ... £16.10.0 (No tax)
 Amp ... £24.10.0 (No tax)



*the best
 that money
 can buy*
**FOR STEREO
 OR MONAURAL**

STEREO PICKUP MARK III



Designed to accept both monaural and stereo heads. Adjustable for heights of various turntables. Pickup head specification identical with the Type CS1.

PRICE:
 Arm only ... £3.19.11 (incl. tax)
 Stereo head ... £7.19.11 (incl. tax)
 Mark II diamond head ... £8.13.3 (incl. tax)
 Mark II Sapphire head ... £4.13.3 (incl. tax)



STEREO PICKUP TYPE CS1

Pickup arm fitted with integral lifting device. The pickup head employs miniature ceramic units, frequency range 20-16,000 c.p.s., output 20 mV with channel separation of 20-25 dBs. Downward pressure 3½-4 grams. Diamond stylus. Will accept Mark II monaural heads.

PRICE: Complete ... £12.19.10 (incl. tax)
 Arm only ... £4.19.11 (incl. tax)
 Head only ... £7.19.11 (incl. tax)

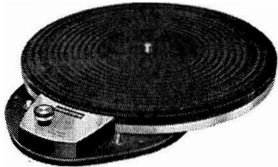

A NEW MODEL 2 SPEED TRANSCRIPTION MOTOR

Finished in black and silver. 33½ r.p.m. and 45 r.p.m. Full 12" turntable is lathe turned. New nylon graphite bearings. Synchronous motor dynamically balanced. Neon indicator on/off warning light.

PRICE: £14.0.0 plus £4.13.1 P.T.

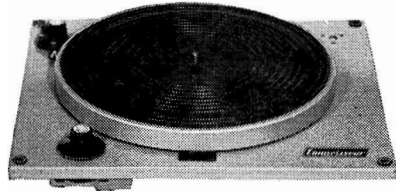

VARIABLE 3 SPEED MOTOR

For 33½, 45 and 78 r.p.m. Stroboscope fitted with internal light source. Synchronous motor dynamically balanced, resiliently mounted. Mechanical speed change giving 4% variation on all speeds.

PRICE: £27.16.1 (incl. tax)

Send for **FREE** leaflets . . .

**A. R. SUGDEN & CO.
 (ENGINEERS) LTD.**

Also available

Omni-directional speaker enclosure. Matching Console to take Connoisseur turntables, pickup, stereo amplifier and pre-amplifier.

MARKET STREET, BRIGHOUSE

Rarely has such praise been lavished on a loudspeaker

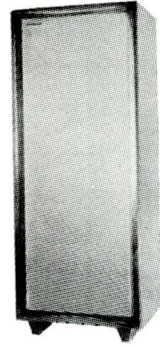

FROM "HI-FI NEWS" JANUARY, 1961, *R.L.W. writes:*

To those at all familiar with the name Mordaunt, they will know the inside (of the speaker) will certainly be something well above average.

The speaker certainly has the master's touch. Right from the start there was consistent sweetness of tone not often obtained or obtained so consistently. One could be tempted to say that this could be due to a deficient or falling off HF response. Definitely not in this instance, as the response on axis or even 20°-30° off axis carries on without flagging well beyond audibility. While noise test, as expected, failed to show up any faults at all. Stereo results were of course good, very good in fact as the smooth and even response added one less error into the stereo chain than we usually expect. The reviewer places the Mordaunt "Arundel" amongst the top few superb loudspeakers and is therefore pleased to recommend it to all serious listeners and music lovers.

FROM "THE GRAMOPHONE" DECEMBER, 1960, *P.G.T. writes:*

This new loudspeaker has excited considerable interest because of its wide frequency range, small dimensions and large power handling capacity. No offending resonances . . . the forward presence called forth approval from everyone who listened. I have nothing but praise for this new loudspeaker. He (Mr. Mordaunt) has been highly successful in creating a first-class reproducer.

(Space prevents publishing the above reviews in full, but in no way has the substance or intention of either been modified.)

Bass/mid-range unit employs special coil and cone assembly to cover 30-3,000 c/s with exceptional smoothness. A Kelly horn-loaded ribbon unit carries response smoothly up to 25,000 c/s. The crossover network cuts at 24 dB below 3 kc/s. Impedance, 15 ohms; loading capacity, 12-15 watts. Size, 36" high × 15" wide × 12". Finished medium walnut or mahogany. Other finishes to order.

£39-10-0

THE MORDAUNT "ARUNDEL" REPRODUCER

From leading stockists. Literature on request from

MORDAUNT SOUND REPRODUCERS, 32/34 RUPERT ST., LONDON, W.1

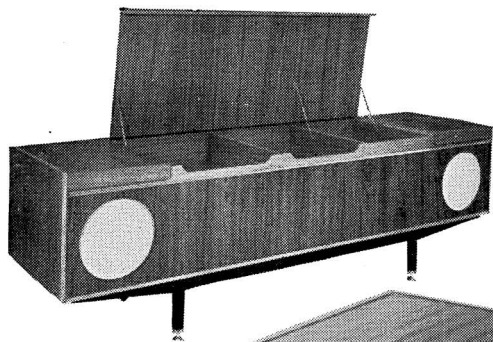

SUPERB STYLING

IMHOFS

HI FI CABINETS

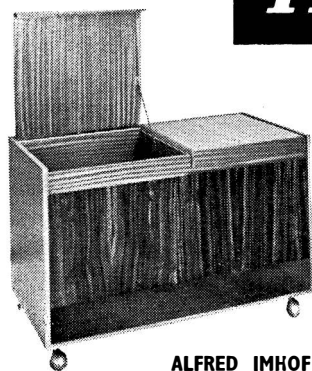

The complete range of these superbly styled, exclusive hi fi cabinets can be seen only at Imhofs, who undertake, whatever your decor, to find cabinets of suitable size and design to meet your needs. Here too, you can listen at will to one of the world's widest ranges of hi fi and stereophonic equipment. Should concealment be your aim, Imhofs specialise in custom-building equipment into walls and ceilings.

Whatever your requirements, a visit to Imhofs is always rewarding. If you are unable to make a personal call why not send for a descriptive leaflet on cabinets or for a copy of 'THIS YEAR OF HI-FI 1961'—the address is

ALFRED IMHOF LTD Dept HYB 112-116 New Oxford Street WCI MUS 7878



BRITISH-MADE MICROPHONES

*consistently specified
for quality and reliability*

THE LUSTRAPHONE RANGE includes a number of microphones designed for special applications as well as models eminently suitable for recording and studio use. Some of the latter are detailed below. Literature on request.

LD.66—DYNAMIC

An entirely new modern style moving-coil microphone designed particularly for use with tape recorders. Response is substantially flat from 70 to 12,000 c/s. In Low, Line, High and Condenser impedances. Prices according to impedance and mounting from £4.2.6.

LFV.59—"FULL VISION" DYNAMIC

Lustraphone's famous "Full Vision" microphone as used for TV, stage, film and other professional work. Face diam. only $1\frac{1}{8}$ ". Available as a hand microphone or for stand mounting. In Low, Line or High impedances. £8.18.6.

VR.64—RIBBON VELOCITY

A robustly designed instrument of somewhat miniature proportions which greatly increases the uses of this type of microphone. The specially suspended ribbon is triple-blast screen protected. Response is substantially flat from 50 to 13,000 c/s. Complete on base with cable. Low, Line or High Impedance. £7.17.6.

VR.53—STUDIO RIBBON

Bi-directional, high fidelity model for broadcasting, recording and other professional requirements. Has a high level of sensitivity and extended frequency response. For stand mounting. Low, Line or High impedances. £9.19.6.

VR/65—TWIN RIBBON STEREO

Two vertically stacked ribbon microphones for stereo use with switching arrangements for mono application. 30 gns. VR/65NS—stereo ribbon microphone without switching. 15 gns.

TRANSISTORISED 4 CHANNEL MICROPHONE MIXER STANDS and BASES • ACCESSORIES

LUSTRAPHONE LTD.,

ST. GEORGE'S WORKS, REGENTS PARK ROAD, LONDON, N.W.1

Telephone: PRLmrose 8844

RADFORD STYLED



PROFESSIONAL AUDIO EQUIPMENT

LITERATURE ON COMPLETE RANGE OF EQUIPMENT AVAILABLE
ON REQUEST

RADFORD ELECTRONICS LTD
ASHTON VALE ESTATE, BRISTOL 3, ENGLAND
TEL.: 66-1873

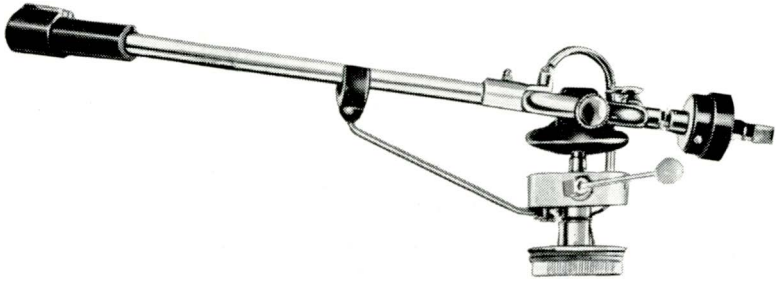

HI-LIGHT BY ACOS

The Acos Hi-Light has been acclaimed since its first appearance as one of the finest pickups in the world. Superb sound reproduction—frequency range from 20–20,000 c/s \pm 3 dB. Outstanding tracking performance—statically and dynamically balanced to allow tracking at less than 1 gramme on mono, 2 grammes on stereo—and complete freedom from external vibrational effects. Built-in lifting and lowering device—arm lowers itself gently on to record. Record wear is virtually eliminated.

The Hi-Light is available with a stereo head and a choice of 3 mono heads (0.0005", 0.001" and 0.0025" stylus radii) for every conceivable requirement in record reproduction. UK retail price: **18 gns.** including mono and stereo heads.

HI-FI BY ACOS

Acos provide a magnificent range of audio equipment, including the Hi-Light and Acopoise pickups, mono and stereo cartridges to fit a great variety of equipment, mono and stereo microphones, and Acos X500 styli—individually tested at 500 times magnification. For disc or tape, Acos make sound sense.

acos ARE DOING THINGS IN STYL!

COSMOCORD LTD
WALTHAM CROSS HERTS.
Telephone: Waltham Cross 27331

Setting New Standards

1945 AMPLIFIERS — LEAK SET A NEW STANDARD — TOTAL DISTORTION REDUCED BY A FACTOR OF FIFTY TIMES

LEAK set a new world standard when, in 1945, they marketed amplifiers having a total distortion content as low as point one of one per cent: this was 50 times better than the then accepted standard for distortion content.

1961 LOUDSPEAKERS—LEAK SET NEW STANDARD WITH VERY-LOW-DISTORTION LOUDSPEAKER SYSTEM

The new LEAK "SANDWICH" LOUDSPEAKER SYSTEM is the product of many years of research and development work

The cabinet is of unique construction which damps panel resonances and permits the loudspeaker motor to reproduce full clean bass without the "boxy" colouration of conventional cabinets. A 3 in. and a 13 in. moving-coil loudspeaker motor of novel design and a half-section cross-over network complete the system which gives the highest quality of reproduction over the whole frequency range of the input signal from records, radio, tape or microphone. THE GREATEST ADVANCE IN THE DESIGN OF MOVING-COIL LOUDSPEAKERS SINCE RICE-KELLOGG INVENTED THE FIRST UNIT IN 1925 HAS NOW BEEN MADE BY LEAK WITH A NEW INVENTION WHICH ELIMINATES BREAK-UP DISTORTION IN THE WORKING RANGE. The 13 in. unit employs a new cone whose stiffness to weight ratio is 200 times better than the best cones which are currently available. The low stiffness of conventional cones results in the flexing of the cone at large amplitudes and break-up resonances. The new LEAK cone which has immense stiffness for no greater weight than a conventional cone has, for the first time, given us a loudspeaker which behaves as the theoretical ideal of a rigid piston; thus there is no flexing of the cone at large amplitudes and there is no breakup distortion within the frequency range handled by the loudspeaker. It is this freedom from colouration, produced in conventional systems by break-up distortion of the cone and cabinet resonances, which distinguishes the superior quality of reproduction of the LEAK "SANDWICH" LOUDSPEAKER SYSTEM from that of the best currently available loudspeaker systems.

The cabinet measures only 26 in. × 15 in. × 12 in.; it can be used in the vertical or horizontal position to suit the convenience of the user.

The illustrations show the Trough-Line II F.M. Tuner, the Varislope Stereo pre-amplifier and the Stereo 20 power amplifier housed in the Southdown cabinet and the new "SANDWICH" loudspeaker system.



Write to the address
below for illustrated
leaflets

LEAK

the first name in High Fidelity

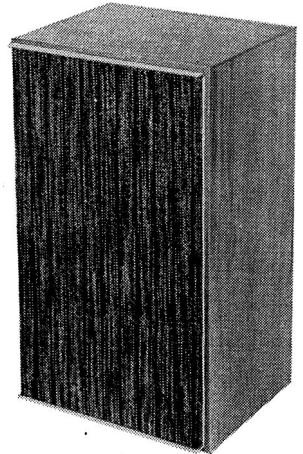

H. J. LEAK & CO., LTD. • BRUNEL ROAD • WESTWAY FACTORY ESTATE • LONDON • W.3
Telephone: SHEpherds Bush 1173

Telegrams: SINUSOIDAL EALUX, LONDON

Choose
them in comfort . . .
Hear
them at leisure!

How to get there. From Tottenham Court Road Tube Station go westward along Oxford Street. Soho Street is the first on the left.

Make your way

to

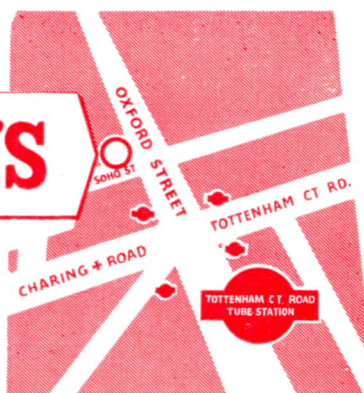

You'll find everybody at Webb's to be cheerful and helpful—without any high pressure sales talk. We have one of the largest selections of the best in hi-fi equipment in London. Come and compare the merits of any combination of Amplifier, Speaker, Pickup and Radio, in comfort and at your leisure.

● **AMPLIFIERS** by

ACOUSTICAL	ARMSTRONG
ROGERS	LEAK
B.T.H.	

● **SPEAKERS** by

GOODMANS	SOUND SALES
VITAVOX	ROLA
TANNOY	CELESTION
WHARFEDALE	W.B.

● **F.M. & A.M. RADIO UNITS** by

ACOUSTICAL	CHAPMAN
ARMSTRONG	JASON
ROGERS	

● **PICKUPS and MOTORS** by

COLLARO	CONNOISSEUR
TANNOY	LEAK
GARRARD	EXPERT
SME	LENCO



Webb's unrivalled stocks cover everything from a replacement stylus to complete de luxe outfits. Attractive Hire Purchase terms available.

14 SOHO STREET, OXFORD STREET, LONDON, W.1

Telephone: GERrard 2089 and 7803

Shop hours: 9 a.m. to 5.30 p.m. (7 p.m. Thursday), 9 a.m. to 1 p.m. Saturdays.

Lowther once again present advanced technique in each product offered in 1961

tuner units
a.m. — f.m.

transistor
pre-amplifiers

pick-ups

equaliser and
control units

power amplifiers

loudspeaker
drive units for
horn loading

loudspeakers for
monitoring or
laboratory

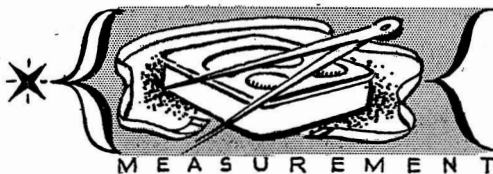

M E A S U R E M E N T

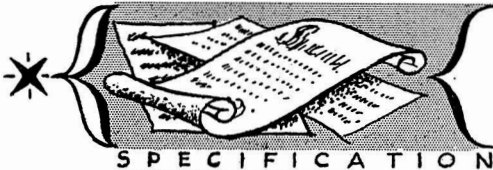

S P E C I F I C A T I O N



M U S I C I A N



L I S T E N E R

— from every point of view

undoubtedly the greatest range of sound reproducing equipment including the Lowther Acousta Twin on offer for professional or amateur requirements.

THE LOWTHER MANUFACTURING COMPANY

LOWTHER HOUSE : ST. MARK'S ROAD : BROMLEY : KENT

Telephone: RAVensbourne 5225

cultured conductors



insist on

TRADE MARK
SCOTCH
BRAND
recording tape



WORLD'S LARGEST SALES OF MAGNETIC TAPE

BJ THE PROFESSIONAL'S CHOICE

FOUNDED 1920



**BJ ELAC 210
& 310 STEREO/
MONO CARTRIDGE
IN BJ SHELL**



PLUGS INTO
BJ S/90 AND
TAN/II ARMS.
CARTRIDGE
ALSO AVAIL-
ABLE
SEPARATELY

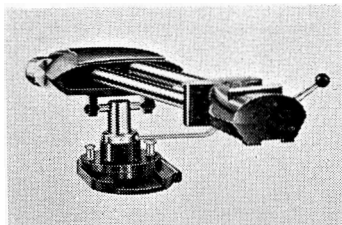

SUPER 90 Mk II

There is no magic which makes one pickup track the record more accurately than another or one reproducer design sound more lifelike.

These qualities are made through technical insight and practical know how. BJ arms have been **designed** to overcome tracking error.

BJ cartridges have been **designed** to do justice to this arm's performance and BJ reproducers are as technically sound as we can make them.

Acceptance by the Council of Industrial Design is a tribute to the technical and artistic excellence of BJ pickups and reproducers. *And they are designed for YOUR equipment.*

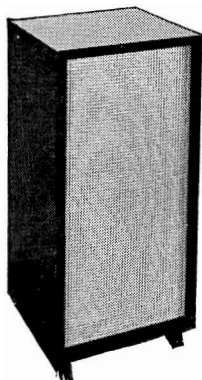

BJ Sonetta



**TOP 'C'
TWEETER**

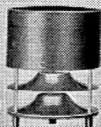

TREBLE 20

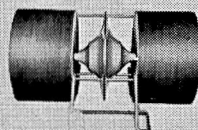

TREBLE TWIN

BURNE-JONES & COMPANY LTD.
18 BRUNSWICK ROAD · SUTTON · SURREY

Telephone:
VIGilant 5050

CHOOSE FROM THE WORLD'S FINEST RANGE OF TAPE RECORDERS

From low-price family model to full-scale stereo, there's nothing to compare with the Philips range of tape recorders. Their impeccable performance, elegant design, and superb dependability make them the finest value in tape recorders today.

PHILIPS 3-SPEED STEREO TAPE RECORDER

MODEL EL3536

92 gns.

PHILIPS 3-SPEED 4-TRACK TAPE RECORDER

MODEL EL3542

59 gns.

PHILIPS FAMILY TAPE RECORDER

MODEL EL3541

34 gns.

(Philips tape recorders are made in Holland)

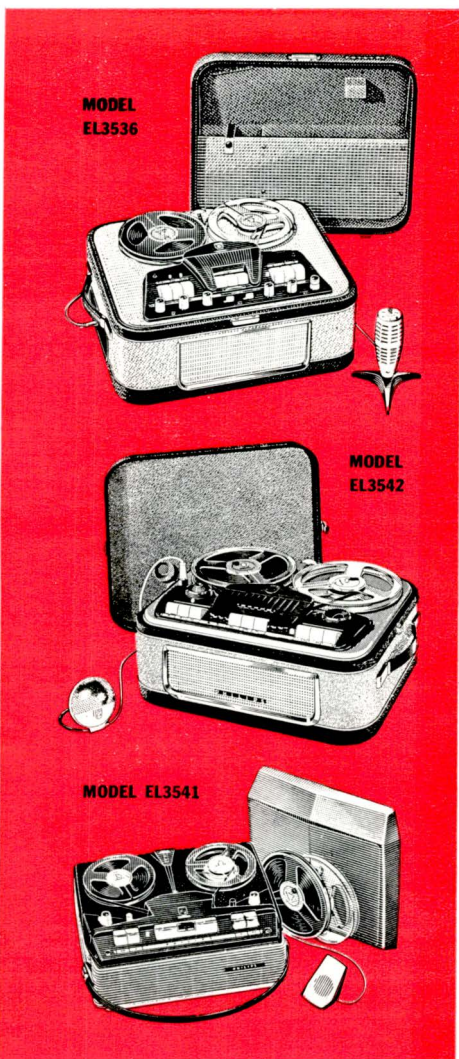

PHILIPS

— the friend of the family

And now — Philips tapes are colour packed

All Philips tape packs are now colour coded: green for standard tapes, red for longplay tapes, blue for doubleplay tapes, for easy, at-a-glance identification.

Philips Electrical Ltd., Electro Acoustics Division,
Century House, Shaftesbury Ave., London, W.C.2

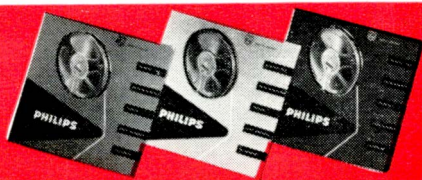

(FR3723)

For the fullest range-



HIGH FIDELITY SYSTEMS

PACKAGE FORM

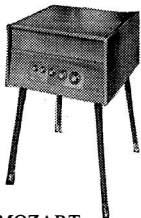

MOZART STEREO LOWBOY
45 GNS



MOZART CABINET (only)
£22.11.0



MOZART STEREO ENSEMBLE
175 GNS (tax paid)

UNIT FORM

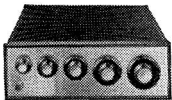

MOZART STEREO AMPLIFIER MODEL HFS 20M 35 GNS



MOZART AM/FM TUNER MODEL HFT 113M 28GNS



MOZART FM TUNER MODEL HFT 103M 24 GNS

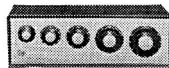

MONO AMPLIFIER MODEL HF 10M 23½ GNS

All models available in chassis form

LOUDSPEAKERS

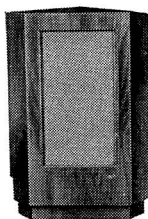
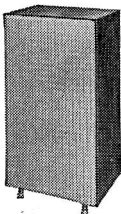

(Far left)
MODEL HF 15SMT
27 GNS

(Centre)
MODEL HF 8BS
18 GNS

(Right)
MODEL HF 25SCA
55 GNS

SOUND TAPE RECORDERS

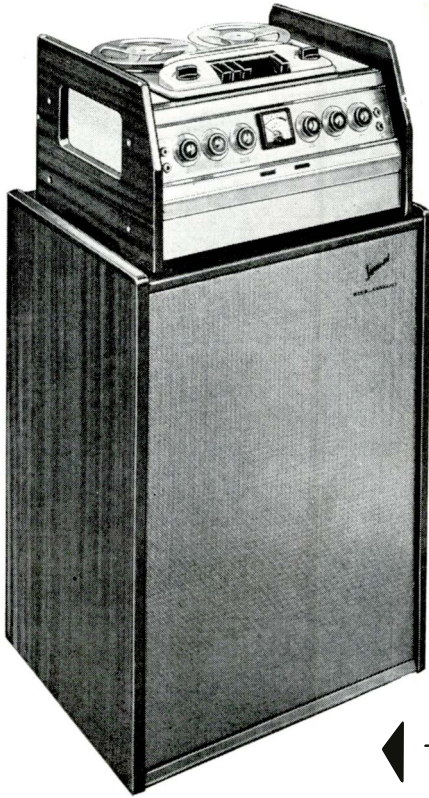

A decade of
manufacturing
experience

◀ THE SOUND MASTER, 105 GNS.

With ten years' tape recorder manufacturing experience Tape Recorders (Electronics) Ltd., makers of Sound Tape Recorders, have the background knowledge which makes them produce fine, reliable equipment.

Ten years' experience is your surety of the quality of a Sound Tape Recorder. Models available to suit every pocket—all precision engineered—all handsomely styled.



TAPE RECORDERS (ELECTRONICS) LTD.

784-788 High Road, Tottenham, London, N.17.
Telephone: TOTtenham 0811



High Quality microphones

Often the least considered link in the electronic chain, the microphone is an important factor if the highest quality sound reproduction is to be achieved. Any initial loss of quality can never be regained in the amplifying equipment however good it may be.

STC microphones are precision made instruments utilising the finest materials and techniques and will satisfy the most fanatical Hi-fi enthusiast for high quality reproduction of speech and music.

As used for radio
and TV broadcasts

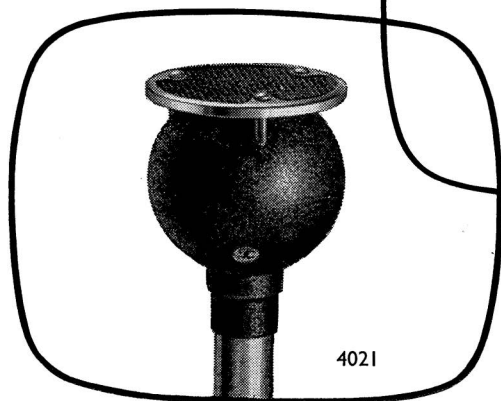

4021

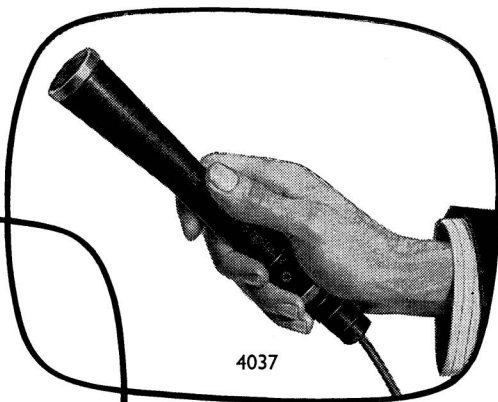

4037

4021

Moving coil microphone

Firmly established for high-quality studio work and acoustical measurement.

4038

Ribbon microphone

One of the world's best, and specially suitable for the reproduction of music

4037

Moving coil microphone

Light-weight. Unobtrusive appearance. High-fidelity, omni-directional polar response.

OTHER MICROPHONES IN THE RANGE

- 4032 Hand Microphone
- 4035 General Purpose Microphone
- 4105 Cardioid Microphone
- 4033 Cardioid Microphone
- 4104 Commentator's Lip Microphone

Each STC microphone is individually tested to a very exacting specification over the whole range of its performance.



Standard Telephones and Cables Limited

PUBLIC ADDRESS DEPARTMENT

CONNAUGHT HOUSE · ALDWYCH · LONDON · W.C.2

MAGNAFON

*The name for Good Electrical Equipment at
a price that anyone can afford*

**TAPE RECORDERS — THE ZODIAC
RECORD PLAYERS — MIXER UNITS
TUNERS AND AMPLIFIERS**

Buy equipment made by Magnafon and you will know that you are getting the best in its class. Years of knowledge in the electronic field can only give you this, and at the right price. Why not go to your local retailer and look at the range, only high-class dealers stock them all.

Manufactured by the **MAGNAFON COMPANY OF LONDON**
and distributed to the trade by **R. MARKING & CO., LIMITED,**
197 STREATHAM ROAD, MITCHAM, SURREY. MITCHAM 4044



true
to
performance

SHURE
AUDIO COMPONENTS

SHURE
Stereo ∞ Dynamic
PICKUPS AND
CARTRIDGES

Manufactured in limited quantities for the critical music lover Shure Dynetic Pickups and Cartridges are obtainable at specialist high-fidelity dealers.

- Excellent channel separation.
- Low record wear.
- Freedom from hum.
- Wide frequency response.
- Replaceable diamond stylus.
- High output.
- Robust construction.
- 12 months guarantee.

Please write for full details of Shure high-fidelity components and microphones.
208

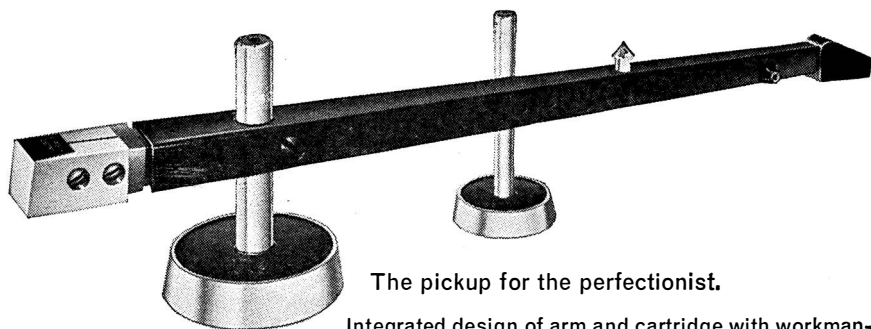

The pickup for the perfectionist.

M212 STUDIO
STEREO DYNETIC
PICKUP

£36.0.0

(P.T. extra)

Integrated design of arm and cartridge with workmanship of the highest order. Tracks at $1\frac{1}{2}$ grams or 1 gram with mono head. A superb instrument.

"The pickup is beautifully engineered and extremely well thought out . . . it looks right and performs right".

Stanley Kelly,
Hi-Fi- News, October, 1960.



M3D
PROFESSIONAL
STEREO DYNETIC
CARTRIDGE

£18.0.0 (P.T. extra)

For use with transcription arms of the finest quality. A standard of comparison throughout the world. For use where playing weights of 2 grams will not be exceeded, Model M3-N21D can be supplied.

"One can say with confidence that those who invest in a M3D will have no cause for regret."

Percy Wilson,
The Gramophone, November, 1960

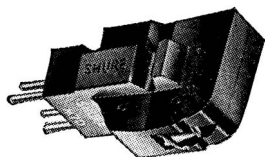

M7D CUSTOM
STEREO DYNETIC
CARTRIDGE

£9.10.0 (P.T. extra)

Excellent quality at moderate cost—the cartridge for the enthusiast. Fits standard arms and transcription units. Will operate satisfactorily in record changers.

"The Shure Dynetic M7D Stereo Cartridge comes into the top category of stereo designs."

Donald W. Aldous, David Phillips,
Gramophone Record Review, June, 1960

SHURE BROTHERS, INCORPORATED



U.K. Representative: J. W. MAUNDER, 22 ORCHARD STREET, LONDON, W.1. HUN. 4116

FOUR NEW DESIGNS

by



- *The VLTA and B. Self contained, self powered tape deck and chassis with record and replay amplifiers for use with any preamplifier and amplifier. Fitted as easily as a pickup and motor giving professional performance from tape.*
- *The VL20. A new 20 watt amplifier of the highest quality with numerous important exclusive features.*
- *The VL50. A new 50 watt amplifier for high quality sound installations.*
- *The VL100. A new 100 watt amplifier for high power quality sound installations.*

See relevant Directory sections

Write for full details

CAPE ELECTROPHONICS LTD.

43/45 Shirley High Street
SOUTHAMPTON

Telephone: 74251

LASKY'S RADIO

for all that's NEW

IN THE REALM OF HI-FI

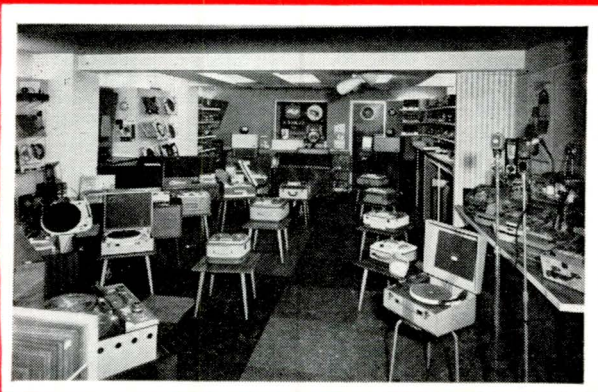

See and hear the latest in hi-fi in our Demonstration Studios or let us serve you by post, as we do many thousands of home and overseas customers. We also operate the purchase tax-free plan for overseas visitors.

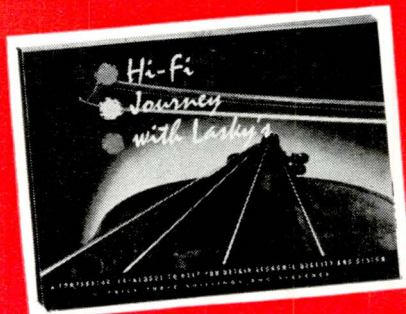

Read all about hi-fi equipment of every kind in our superb catalogue of over 100 large pages, 11½ × 8½ in., in photogravure and colour. Price 3s. 6d., part post 6d. (returnable in full on making your first hi-fi purchase).

- ★ AMPLIFIERS
 - ★ CONTROL UNITS
 - ★ PICKUPS
 - ★ LOUDSPEAKERS
 - ★ SPEAKER SYSTEMS
 - ★ RECORD PLAYERS
 - ★ AUTOCHANGERS
 - ★ TRANSCRIPTION
TURNABLES
 - ★ AM/FM TUNERS
 - ★ TAPE DECKS
 - ★ TAPE RECORDERS
 - ★ MICROPHONES
 - ★ CABINETS & SPEAKER
ENCLOSURES
- H.P. TERMS AVAILABLE

207 EDGWARE ROAD, LONDON, W.2.

PADddington 3271/2

Few yards from Praed Street

Both open All Day Saturday. Early Closing Thurs.

42 TOTTENHAM COURT ROAD, W.1.

MUSEum 2605

Nearest Station Goodge Street.

Mail Orders to Dept. YB, Edgware Road



**YOU MUST TRY
GEVASONOR**

MAGNETIC

RECORDING TAPE



*Available in a full range of
types and sizes*

GEVAERT

FRANCIS OF STREATHAM

*invite all
Hi-Fi and Recorder
enthusiasts to their
South London Showrooms*

**FOR LARGE AND UP-TO-DATE STOCKS
OF EQUIPMENT BY LEADING
MANUFACTURERS AS ADVERTISED
IN HI-FI NEWS, TAPE RECORDER, ETC.**

- | | |
|-----------------|--------------------|
| ★ FERROGRAPH | ★ QUAD |
| ★ BRENNEL | ★ JASON |
| ★ GRUNDIG | ★ GARRARD |
| ★ PHILIPS | ★ Lenco |
| ★ TELEFUNKEN | ★ LUSTRAPHONE |
| ★ REFLECTOGRAPH | ★ MORDAUNT |
| ★ VORTEXION | ★ RESLO |
| ★ SIMON | ★ ARMSTRONG |
| ★ FI-CORD | ★ DULCI, etc. etc. |
| ★ LEAK | ★ ORTOFON |
| | ★ THORENS |

**NO CHARGES FOR
CREDIT FACILITIES**
★
**LARGEST SELECTION
OF LATEST MODELS**

Personal attention
to all enquiries
without obligation.

WRITE ★ CALL ★ 'PHONE
Please mention Hi-Fi Year Book when writing

FRANCIS OF STREATHAM

169-171 and 181, STREATHAM HIGH ROAD, LONDON, S.W.16

Between Streatham Station and St. Leonard's Church ★ Phone: STReatham 0466 & 0192

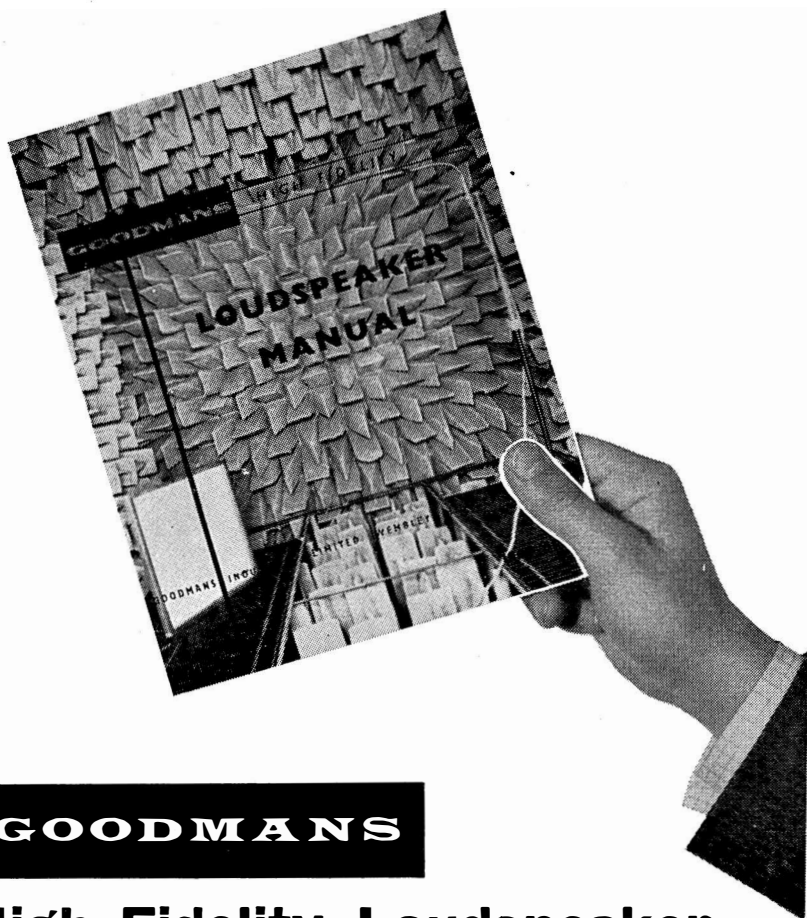

GOODMANS

High Fidelity Loudspeaker Manual 1961*

Goodmans High Fidelity Loudspeakers and loudspeaker systems have achieved world wide renown. A policy of continuous development maintains this position of leadership, and ensures that every model produced provides the best possible performance value in its price category.

The NEW EDITION of Goodmans

High Fidelity Loudspeaker Manual contains details and specifications of all Goodmans High Fidelity products, together with detailed information on choosing a loudspeaker, the design and construction of enclosures, stereophonic systems, stage built multiple unit loudspeaker systems, etc., fully illustrated.

* Write now for your FREE copy

GOODMANS INDUSTRIES LIMITED

Axiom Works, Wembley, Middlesex.

Tel: WEMbley 1200 (8 lines) Grams: Goodaxiom, Wembley, England

Europe's largest manufacturers and the World's largest exporters of High Fidelity Loudspeakers.

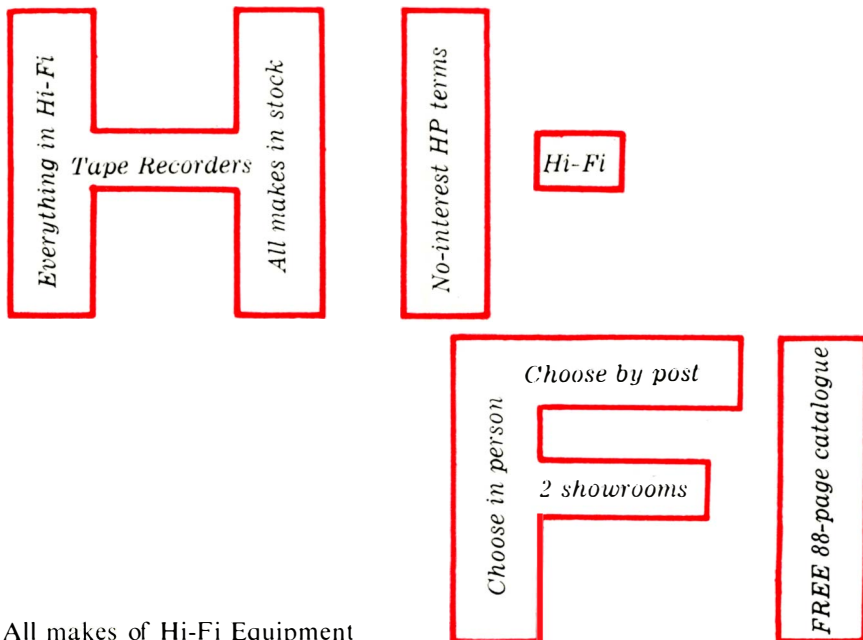

All makes of Hi-Fi Equipment and Tape Recorders.

Make sure you get exactly what you want and what you need.

Choose from the Tape Recorder Centre. Choose in person — at one of the two London Showrooms. Choose by post — get a **FREE copy of the Tape Recorder Centre Catalogue**, 1961 edition, 88 pages, fully illustrated. In person or by post, unequalled terms and not a penny extra for HP on orders over £30

Choose in person: 82 High Holborn, London, W.C.1. *CHAncery 7401*
75 Grand Parade, Green Lanes, Harringay, London, N.4.
STAmford Hill 1146, 2097

Choose by post: *Write or 'phone for free copy of catalogue:*
75 Grand Parade, Green Lanes, Harringay, London, N.4.
STAmford Hill 1146, 2097

THE TAPE RECORDER CENTRE



"...of the highest class"

**GOLDRING LENCO
TRANSCRIPTION MOTOR, GL60**

"The motor . . . is extremely quiet." "The turntable . . . took 3½ minutes to come to rest from a speed of 78 r.p.m. An excellent testimony to smoothness of running." "Rumble . . . non-existent at normal settings." "No sign of 'wow'." ". . . the arm is excellent and will appeal especially to those who wish to change cartridges frequently." "As a final test a stereo cartridge was fitted . . . again no evidence of rumble . . . and the overall performance of the GL60 is so good that it can be recommended to those who want a transcription motor and arm of the highest class"—(Technical Report, "The Gramophone," May 1959.)

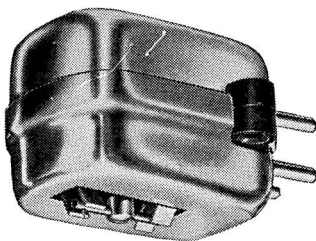

**GOLDRING "700"
STEREO CARTRIDGE**

Variable Reluctance: with 0.5 mil diamond stylus. Fits modern transcription arms wired for Stereo (e.g. Goldring G60 transcription arm as fitted to GL60 transcription motor).

... and for **Monaural Reproduction** . . . the famous "600" Variable Reluctance Cartridge.

stereo equipment



by **GOLDRING**

GOLDRING MANUFACTURING CO. (GT. BRITAIN) LTD.

486-488 High Road · Leytonstone
London · E.11

Telephone: Leytonstone 8343

PORTOGRAM

**for sound
value**

‘MONOTAPE’

Superb value—outstanding performance. $3\frac{3}{4}$ i.p.s. twin track. $5\frac{3}{4}$ " spools. $3\frac{1}{2}$ w. output. Full range tone control. Luminous column recording level indicator. Mic. and Radio/Gram. inputs. $7" \times 4"$ speaker. Ext. speaker and monitor outputs. Size $14" \times 12\frac{1}{4}" \times 8"$.

PRICE (incl. mic. and tape)

29 gns.



MARK 2

‘PORTOTAPE’

Packed with top features. $1\frac{7}{8}$, $3\frac{3}{4}$, $7\frac{1}{2}$ i.p.s. $7"$ spools. Twin track, fast rewind, pause control. Rev. counter. 4 w. output. Luminous column recording level indicator. Erase safety circuit. Treble/bass tone control. Mic. and Gram./Radio inputs. Ext. speaker and monitor outputs. Superimposing facilities. $8" \times 5"$ speaker. Attractive finish. $17\frac{3}{4}" \times 16\frac{1}{4}" \times 10"$.

PRICE (incl. mic., tape and spool)

39 gns.

*Send for details of all Models,
including RECORD PLAYER
ATTACHMENTS, from 8½ Gns.*



PORTOGRAM RADIO ELECTRICAL INDUSTRIES LTD.
“AUDIO WORKS”, PAXTON ROAD, TOTTENHAM, LONDON, N.17

NEW . . . for High Fidelity Stereo
and Monitoring

from **S. G. Brown**

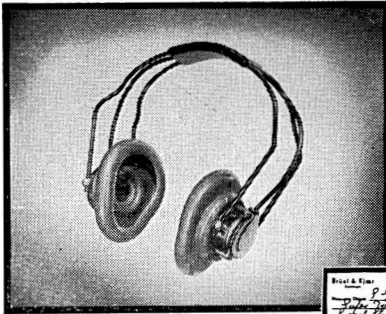

SUPER K
Headphones

● **Span Nine Octaves !**

The "Super K" Headphones are the newest product of S. G. Brown Ltd., and are designed especially for High Fidelity Stereo requirements.

They are attractive in appearance, extremely comfortable to wear and incorporate plastic head band and ear-pieces.

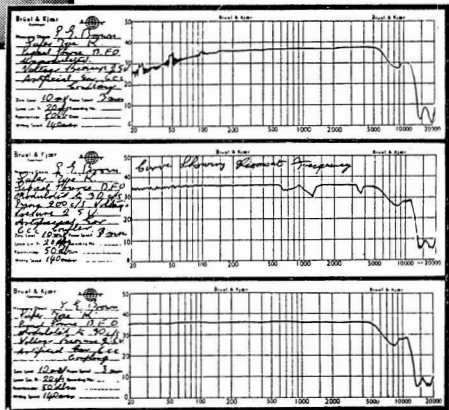

The Frequency Response Curves above were produced under the following conditions:

BEAT FREQUENCY OSCILLATOR Type 1014 producing a signal of 2.5V. (modulated to 32 c/s with a swing of 30 c/s) to **SUPER K EARPIECE**, close coupled to **ARTIFICIAL EAR** Type 4109 with 6 cc. coupler, measured signal being amplified by **MICROPHONE AMPLIFIER** Type 2603 and recorded on a Type 2304 **LEVEL RECORDER**.

Recorded Medium shows Response flat ± 1 dB 20 c/s—6,000 c/s; 6 dB reduction to 8,000 c/s; 6 dB reduction to 12,000 c/s with continued reduction to 20,000 c/s. Nine octaves pianoforte coverage from 24 c/s to 7,800 c/s.

Write for full information to :

S. G. BROWN LTD. SHAKESPEARE STREET. WATFORD, HERTS

Telephone : Watford 27241

AUDIO ACCESSORIES by

METRO SOUND

THE METRO-SOUND RANGE OF MASTERPOINT REPLACEMENT STYLI

A Sapphire or Diamond Stylus for YOUR PICKUP—made to exacting standards with 100% inspection.

METRO-SOUND MASTERPOINT TRANSCRIPTION DIAMONDS, with guaranteed 50/55° Cone Angle and Low Mass, are the finest you can buy.

Now, METRO-SOUND also offer the POPULAR DIAMOND at a price within everyone's reach—enjoy the benefits of a Diamond at a cost little more than that of a Sapphire Stylus.

REMEMBER—the unique METRO-SOUND polish ensures that record wear is reduced to a minimum giving constant and pure tonal reproduction.

Every Stylus, sapphire or diamond, is packed with its own Nylon Cleaning Brush.

METRO-SOUND MASTERPOINT STYLI

The choice of the discriminating

THE METRO-SOUND RANGE OF TAPE RECORDER ACCESSORIES

KLENZATAPE for cleaning tape recorder heads. Complete kit 12/6. Fluid refills 3/11.

METRO-SPLICER for both recording tape and 8 mm. Cine film. Complete with film emulsion scraper and spare cutting unit 15/-. Spare scrapers 1/-. Spare cutting units 2/6.

The original METRO-TABS for making positive identification of recordings *AT A GLANCE* 3/11, complete with index.

TAPE DECK CLEANING BRUSH made from specially shaped feather-soft non-scratch Nylon 2/6 each.

The above items complete with many spares making a total value of £2-4-9.

Now available in the METRO-SOUND TAPE ACCESSORIES SET lavishly mounted and luxuriously packaged for only £2-2-0.



Write for illustrated leaflets to Sole Manufacturers:—

METRO-SOUND MANUFACTURING CO., LTD.

19a Buckingham Road, London, N.1.

Telephone: CLIssold 8506/7

THE WORDEN

★ ARTICULATED ★

PICK-UP ARM

PAT. No. 71639

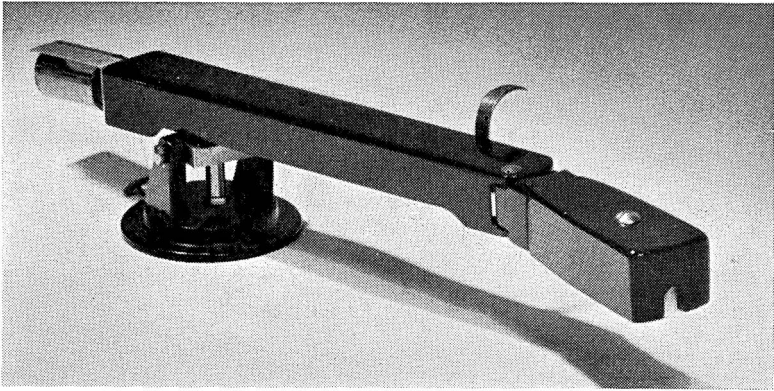

A NEW APPROACH TO RECORD REPRODUCTION

CORRECT TRACKING —

- Plus:— ● Equalised Stylus Pressure.
● Negligible Side-thrust.
● Arm Dynamically Balanced.

A *single arm* of conventional appearance, but with *articulated head-piece*. Movement of pickup head controlled to exceptionally fine limits by means of light linking system passing within the arm, so that the stylus is maintained in correct alignment with the groove ($\pm \frac{1}{4}^\circ$) over whole of playing area.

- ★ "End of side distortion" virtually eliminated; overall sound quality greatly enhanced.
- ★ Inward lateral thrust largely obviated, resulting in more evenly divided weight on groove walls with drastic reduction of record/stylus wear.
- ★ *Two main vertical pivots only* for torsional and lateral stability incorporating miniature Swiss precision bearings.
- ★ Quieter surfaces. ★ No groove jumping. ★ No stylus flutter.

PROVIDES REALLY TROUBLE-FREE RECORD PLAYING

Wired for Stereo and Mono, supplied complete with one self-locking slide-on shell (spring-loaded contacts) to accommodate all popular cartridges. Adaptors for integrated pickup heads (e.g. Decca, Expert, etc.). Extra shells available. Polished black finish. Price £12 12s. (Tax paid).

WORDEN AUDIO DEVELOPMENTS LTD.

54 CHEPSTOW ROAD, LONDON, W.2.

Tel.: BAYswater 4996

the **TAPE RECORDER**

THE FINEST "TAPE" PAPER

● Overseas agencies are invited to write to our Distribution Dept. for supply details of this lively magazine.

● Readers in all parts of the world may join our subscription list 12 monthly copies plus annual index, 24/- (U.S.A. and Canada \$3.25).

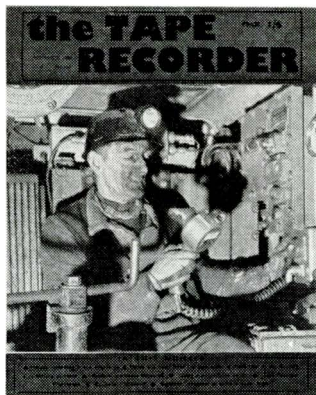

PRICE 1/6 MONTHLY

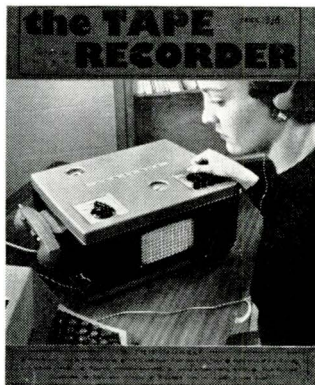

THE TAPE RECORDER
99 MORTIMER STREET, LONDON, W.1

TRUVOX

ALL THAT THE NAME IMPLIES

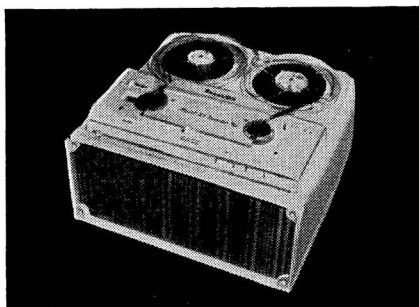

Model R7

Tape Recorder 82 gns.

Tracks in both directions.
7" Reels. 10w. Amplifier.
8" x 6" Elliptical and 4"
speakers.

Model R6

Tape Recorder 55 gns.

7" Reels. 4w. Amplifier.
8" x 6" speaker.

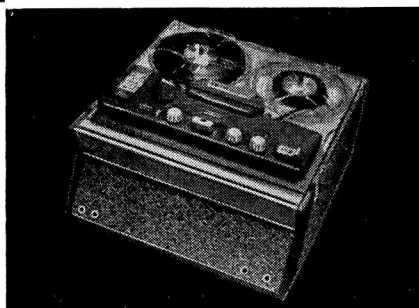

Model MK6

Tape Deck

**Mono and Stereo models
from 25 gns.**

7" Reels. 3 motors.
Die-cast panel.
Simplicity of controls.

Also manufacturers of Tape Recording Amplifiers, Radio
Jacks, Telephone Adapters and Stethoset Headphones.

Fully descriptive literature available on request.

TRUVOX LTD., NEASDEN LANE, LONDON, N.W.10
Telephone : Dollis Hill 8011

BINSON
B.J.
BRENNELL
CHAPMAN
COLLARO
CONNOISSEUR
COSMOCORD
DECCA

EQUIPMENT FOR TAPE, DISC & RADIO

**MODERN
ELECTRICS**
(RETAIL) LTD.

DULCI
ELAC
FERROGRAPH
G.E.C.
GARRARD
GOLDRING
GOODMANS
GRAMPIAN
GRUNDIG
JASON
KELLY
LEAK
LENCO
LUSTROPHONE
ORTOFON
PHILIPS
QUAD
REFLECTOGRAPH
RESLO
ROGERS
RONETTE
TANNOY
THORENS
TRUVOX
VITAVOX
W.B.
WHARFEDAILE

*We send the best of
Britain's Hi-Fi and
Tape Equipment
everywhere*

Our service reaches to every part of the world, and extensive selections of our up-to-the-minute stocks appear regularly in our advertisements each month in "Hi-Fi News", "The Gramophone", "Wireless World", etc. If you cannot call, send us your enquiries without obligation. Whatever you order, no matter how small or how large, it is given prompt and personal attention at all times.

AS EXCLUSIVE DISTRIBUTORS FOR THE BINSON "ECHOREC" Electronic Echo Unit, we invite enquiries for full information which will gladly be sent on request. This unit, which enables controlled echo to be imposed on a signal costs 140 gns (\$420, U.S.A.) and is widely used by broadcasting, recording and other organisations. Professional and Trade Discounts. ALSO AVAILABLE—"Baby" BINSON ECHOREC single channel Echo Unit. 80 gns (\$240 U.S.A.)

MODERN ELECTRICS (RETAIL) LTD.

120 SHAFTESBURY AVENUE, LONDON, W.1

(Opposite Columbia Cinema and three minutes from Piccadilly Circus)

Telephone: TEM 7587 and COV 1703 Cables: MODCHAREX, LONDON

AUDIO SERVICES

The specialists with the Hi-Fi know-how

Accredited Agents for

**MORDAUNT — AUDISTATIC — ARMSTRONG
H.M.V. HI-FI EQUIPMENT**

**QUAD — LEAK — ROGERS — DECCA
GOODMANS — W.B. — WHARFEDALE
GARRARD — CONNOISSEUR — S.M.E.
COLLARO — GOLDRING — ACOS
RECORD HOUSING, Etc., Etc.**

*Try us for part exchange, we are extremely generous
Credit Facilities*

- A unique personal service by Audio engineers of wide experience and trained musicianship.
- Our Loudspeaker demonstrations are renowned and our recommendations ensure complete freedom from disappointment with the minimum outlay.
- A large stock of superior second-hand equipment always available at keen prices.

AUDIO SERVICES

82, EAST BARNET ROAD, NEW BARNET, HERTS.

Telephone: BARNET 6605



NEW STANDARDS IN FOUR TRACK STEREO AND MONO REPRODUCTION

Chitnis AUDIOGRAPH Tape Recorders have set unbelievably good standards of performance and quality in tape recorders running at $3\frac{3}{4}$ i.p.s. on both mono and stereo. The use of BOGEN heads has enabled 4-track instruments to be designed which ensure exceptionally wide frequency range, brilliant transient response and freedom from intermodulation. Many unique and attractive refinements are incorporated to make AUDIOGRAPH RECORDERS truly the best in their class, yet you can buy one from as little as 39 gns.

— CHITNIS — AUDIOGRAPH

4 Track Stereo & Mono Recorders

From Leading Stockists everywhere. Literature on request.

CHITNIS ELECTRONICS LTD., 66, BOLSOVER STREET, LONDON, W.1.

Telephone : EUSTON 4264-5-6

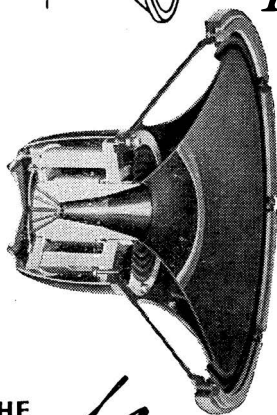
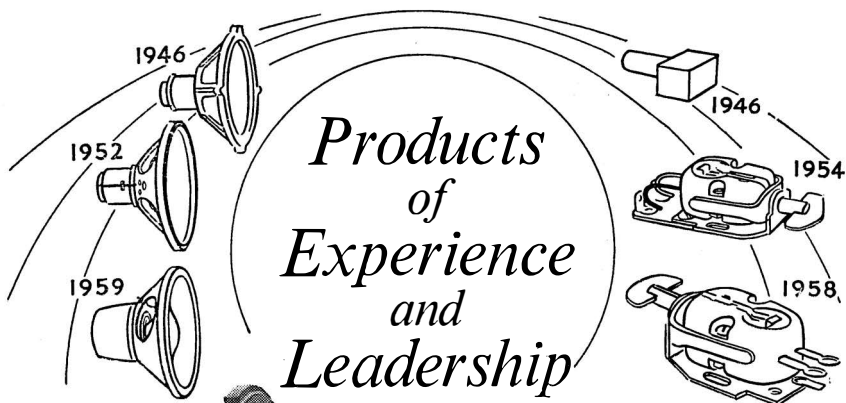

THE
Monitor
DUAL CONCENTRIC

The Monitor Units, latest in the long line of Tannoy Dual Concentric Loudspeakers, mark another Tannoy achievement.

From the introduction of the first Dual Concentric Loudspeaker, Tannoy have won an established place as the quality standard for faithful reproduction.

The Monitor Units embody all the unique features of the earlier widely acclaimed 12" and 15" Units, but include the revolutionary Magnetic Shunt, and the H.F. Acoustic Balance Cavity, both important contributions to improved quality of reproduction.

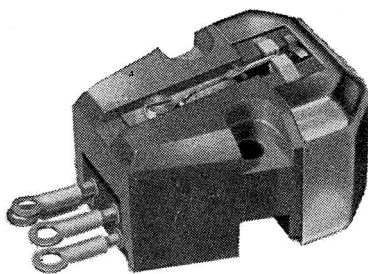

THE
VARI-TWIN Mk II
Compatible Stereo Cartridge

This triumph of Tannoy research provides a magnetic stereo cartridge completely hum-free. Mounting in close proximity to motors and power amplifiers is now a practical proposition. The Vari-Twin Mk II is designed for micro-groove stereophonic discs made to Westrex 45/45 system. It is, however, fully compatible and, with appropriate stylus, monaural discs may be played. It can be mounted in any standard shell or arm suited to its low tracking pressure of 3-4 grms.



Founder Chairman: GUY R. FOUNTAIN

TANNOY PRODUCTS LIMITED WEST NORWOOD LONDON SE27

Tel.: GIPsy Hill 1131

One of the Tannoy Group of Companies

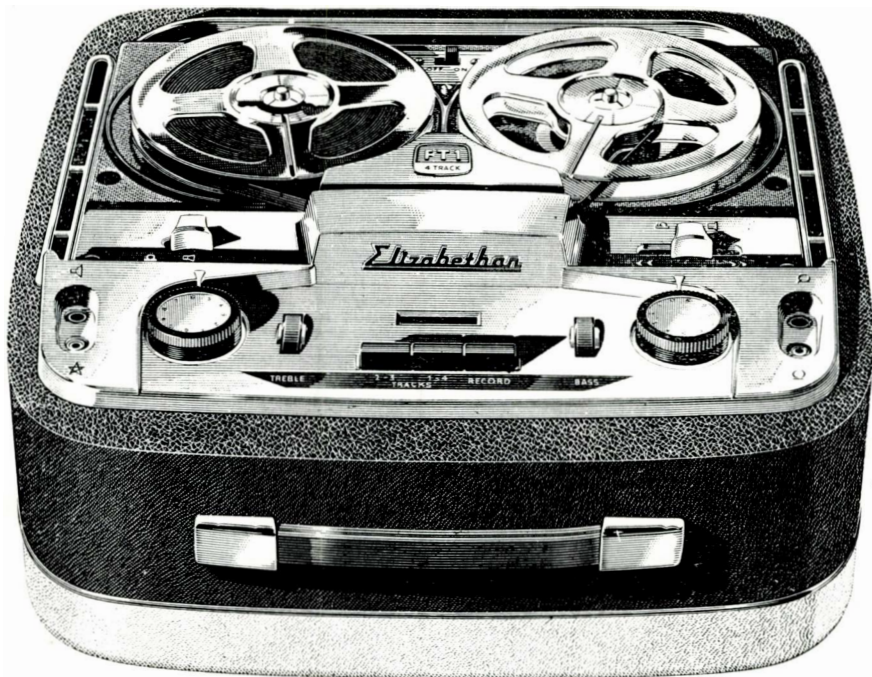

The tape recorder that's **WITH IT**

With what? Pretty-well everything! That's because Elizabethan *specialise* in making fine tape recorders.

So many developments in electronics today make it impossible for any but the specialist manufacturer to stay constantly in the lead. And only a specialist manufacturer like

Elizabethan can offer these developments — four-track for example — at such a remarkably low price.

Elizabethan tape recorders are made in Britain. When you buy Elizabethan you're spending no money on import duty or shipping costs. You're simply

paying for quality. For workmanship. *For reliability.*

Hear the Elizabethan range and discover the best in tape recorder value. Your radio or electrical dealer will be glad to arrange a demonstration for you.

LOOK AT THESE FOR VALUE!

POPULAR de Luxe. Latest addition to the range. Supplied complete with microphone, tape, etc., for only **24 gns.**

FT1 (illustrated). Wonderful four-track value. **34 gns. complete**

FT3 Superb three speed, four-track, with every facility for the enthusiast. **45 gns. complete**

MAJOR. For the man who demands professional standards. Optional as either twin-track or four-track. **65 gns.**



Everyone's going

ELIZABETHAN

ELIZABETHAN (TAPE RECORDERS) LTD · ROMFORD · ESSEX

**MICROPHONES
FROM VIENNA**

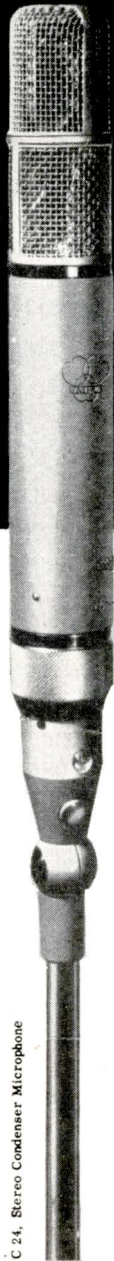

**WHERE THEY
KNOW THE
TRUE SOUND
OF MUSIC**

AKG has specialised in the development and manufacture of high quality microphones of the dynamic and condenser types.

Microphones for broadcast, T.V. and film studios, for theatres and recording studios, for electro-acoustic installations, for tape recorders, cine projectors and communication systems are shipped all over the world.

Ask for detailed information and state your inquiresments.



Werbung Grafik Uran Wien

C 24, Stereo Condenser Microphone

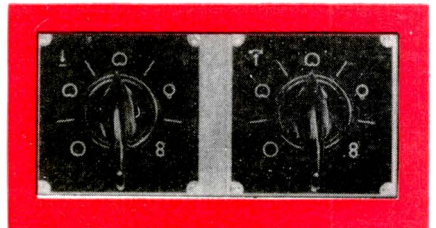

AKUSTISCHE U. KINO-GERÄTE GMBH VIENNA



microphones

Did you know that dynamic microphones can be used in cold and hot, in dry and humid atmosphere, in wind and rain, by inexperienced people and children. Dynamic microphones are insensitive against shock and careless handling. These are the reasons why most tape recorder manufacturers, broadcast reporters, film units and others prefer to specify dynamic microphones.

AKG leads the world in the research and development of dynamic and condenser microphones. AKG owns hundreds of patents. Among these are many basic patents covering new principles of obtaining cardioid patterns, extended frequency range, low distortion and new designs.

C 60

Miniature Condenser Studio Microphone for F.V., film and stage. Uses either the well proved CK 28 cardioid or the CK 26 omnidirectional capsule. Weight only 2.1 ounces. Pictured with W 60 windscreens

new



K 50

Dynamic headphones for stereo and mono. 30...20 000 cps, 127 phon output per system. Requires only 0.156 milliwatts (=0.25 volts) per system for average listening level. No tight coupling to ear necessary. Used for true sound monitoring.



C 28

The Condenser Studio Microphone with cardioid and omnidirectional characteristics, with extension tubes to make the microphone inconspicuous. 30...18 000 cps (cardioid) 30...30 000 cps (omni), 20 db front-back ratio, 1.3 millivolts per microbar at 200 ohms, impedance 50/200 ohms.



D 19 B

The golden Cardioid Microphone for highest fidelity requirements, with bass attenuation switch. Discrimination 15 db, impedance 60, 200 ohms or high, frequency range 40...16 000 cps. Most popular semi-professional microphone on the continent.

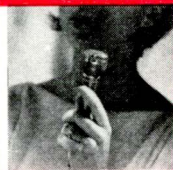

All enquiries to:

POLITECHNA (LONDON) LTD.
LONDON W. 1 3, PERCY STREET
TELEPHONE: LANGHAM 6236 TELEX: 23894 CABLES: POLINDUST LONDON



full range sound from
 small size cabinet
STYLED FOR
THE SIXTIES

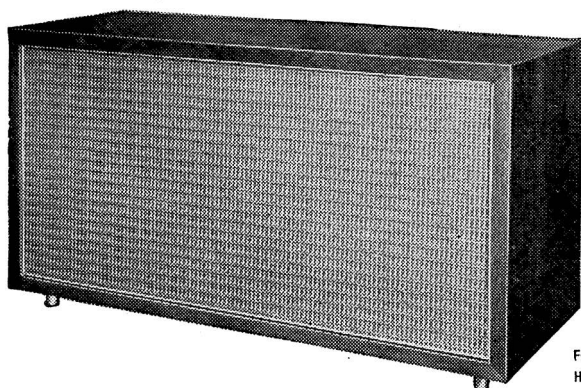

FOR VERTICAL OR
 HORIZONTAL USE.

BCS1875

Exceptional performance for very small size cabinet 24 in. x 12 in. x 10 in. deep. Cabinet of polished walnut veneer on all four sides for vertical or horizontal use. The cabinet is of the tuned pipe reflex type. Suitable for either stereo or monaural use. Weighs only 28 lbs. Feet supplied separate . . . rubber suction caps to attach to any of the four sides. Bookcase loudspeaker completely wired and fitted with all components except Metal Cone Speaker.

Full details from Sound Equipment Section

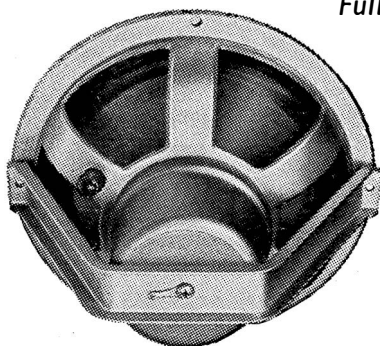

METAL CONE SPEAKER

The established favourite improved still further with the new Power Bracket. Power Bracket can be supplied separately.



**HIGH QUALITY
 SOUND EQUIPMENT**

Metal Cone Loudspeakers . Presence Units
 Stereophonic Systems . Periphonic Loud-
 speaker System . Pre-amplifiers . Amplifiers

**The General Electric Co Ltd · Sound
 Equipment Section · Lena Gardens
 Brook Street · Hammersmith W.6**

Brenell TAPE RECORDERS

for outstanding performance

★ ALL MODELS now fitted with a **HYSTERESIS SYNCHRONOUS MAIN MOTOR** — wow and flutter below 0.1% at 7½ i.p.s.

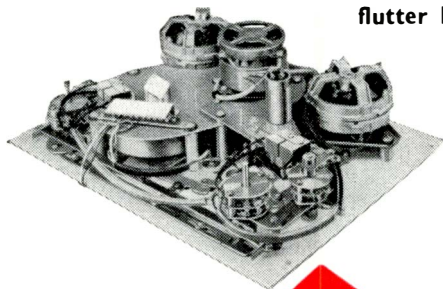

MARK 5 DECK. Four operating speeds 1½, 3½, 7½ and 15 i.p.s.—provision for four heads—takes 8½" spools—only two interlocked switches control record, playback, wind and rewind—extended shafts for extra switch wafers—pause control—digital rev. counter—2,400 ft. long play tape at 1½ i.p.s. gives over 8 hours—fast rewind (1,200 ft. in 45 seconds)—instant stop without spillage. 28 gns.

3 STAR RECORDER. Three speeds (1½, 3½ and 7½ i.p.s.) with frequency correction—interlocked push-button controls—pause control—printed circuit amplifier—separate bass and treble controls—high quality 8" x 5" speaker—modulation indicator. Approved by Council of Industrial Design. 58 gns. including 1,200 ft. of tape and microphone. ¼ track available.



MARK 5 RECORDER. Incorporating Mark 5 deck—plus—high quality amplifier with selective frequency correction—elliptical 9" x 5" speaker—4 watts output into 15 ohms—six input and output sockets for microphone, gram or radio, headphone monitoring, permanent connection to Radio/Gram, extension loudspeaker. 64 gns., including 1,200 ft. of tape. Stereo model available at £99.12.0.

3 STAR STEREO RECORDER. Now fitted with three independent motors, three speeds (1½, 3½ and 7½ i.p.s.). Other features as 3 Star mono. plus—stacked stereo head—extended frequency range—low cross-talk of -60 dB—two internal speakers. 89 gns., or with two microphones. 95 gns. ¼ track playback head £12.0.0 extra.



GD. 613

BRENELL ENGINEERING CO. LTD. 1a, Doughty Street, London, W.1. CHA 5809 and HOL 7358.

PROVED

The finest method for cleaning records.
Already over 200,000 enthusiastic users.

All Static and Dust completely removed from Your Records as they are played

THE
“Dust Bug”

AUTOMATIC GRAMOPHONE
RECORD CLEANER

PATENT No. 817598

Instantly Fitted. Suitable for all Types of Record. Quality Improved. Surface Noise and Wear Reduced.

STANDARD MODEL FOR TRANSCRIPTION
AND SINGLE RECORD PLAYERS.

PRICES
REDUCED 17/6 (Plus 5/10
purchase tax)

From Your Dealer, or

CECIL E. WATTS LTD.

(Sound Recording and Reproduction)

Darby House, Sunbury-on-Thames, Middx.

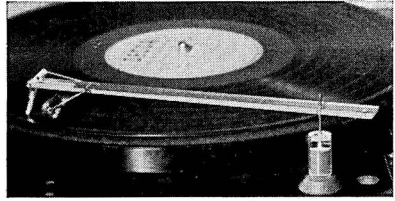

The Dust Bug may be placed in any convenient position around the turntable and the adjustable pin of the pillar raised if necessary so that the arm is approximately parallel to the surface of the record.

The use of the fluid dispenser should only provide a trace of dampness to the plush pad. It is not intended that any fluid should be transferred to the record. The slightly damp pad provides a leakage path for the discharge of any static in the record and assists in the collection of dust, etc.

The Dust Bug is the only record cleaner capable of thoroughly cleaning the groove without affecting the record surface in any way.

The PARASTAT

(Regd.)

TREATMENT FOR L.P. RECORDS (PATENTS APPLIED FOR)

Buy where there is a “Parastat” service — Used by dealers who have the customer’s interests at heart

This Machine serves three main purposes in the handling of all types of Gramophone Records.

1. It cleans simultaneously both sides of the entire surface of the record (including the label), and removes every particle of dust or foreign matter from the grooves in less than ten seconds.
2. Renders the record permanently inert to all Static charges induced by any means, leaving no trace on either groove or record surface.
3. Reduces the coefficient of friction between stylus and groove wall at all points of violent acceleration reducing tracing distortion wear and surface noise.



CECIL E. WATTS LTD. - DARBY HOUSE - SUNBURY-ON-THAMES - MIDDLESEX

PART EXCHANGE

We are always willing to accept your unwanted Hi-Fi equipment, tape recorder or Classical LP records for cash or in exchange for other goods. Let us have full details and we will make an offer.

ALWAYS IN STOCK

Rogers, Quad, Jason and Armstrong equipment, Quad Electrostatic Speaker, Ferrograph Tape Recorder.

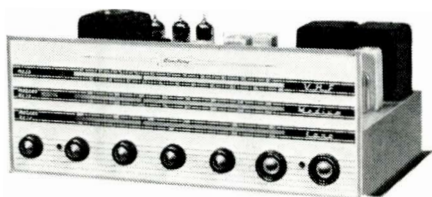

Armstrong Stereo 12 Mk. 2. Price £44 2s.

Send for lists and photographs of new and used items including cabinets.

25 years of
buying, selling and exchanging

H. C. HARRIDGE

8 MOOR STREET, CAMBRIDGE CIRCUS, W.1

Hours of Business:—

Monday }
Tuesday } 10 a.m. to 5.30 p.m.
Wednesday }

Friday 10 a.m. to 7 p.m.
Saturday 9 a.m. to 5 p.m.
Thursday CLOSED ALL DAY

SME

PRECISION PICK-UP ARMS

* *The finest
in the world*

More than just a pick-up arm the S.M.E. is a precision instrument of unrivalled quality and may be bought in the confident knowledge that no item in the reproducing chain will out-class it.

Reviewed in superlatives by leading authorities. It has come to be the standard by which other arms are judged.

An adaptor permits direct mounting of Decca heads, a combination which provides the highest quality of reproduction obtainable.

A fully illustrated brochure and technical reviews are obtainable on request. Exclusive distributing agents in principal overseas countries are listed below. They will welcome your enquiries.

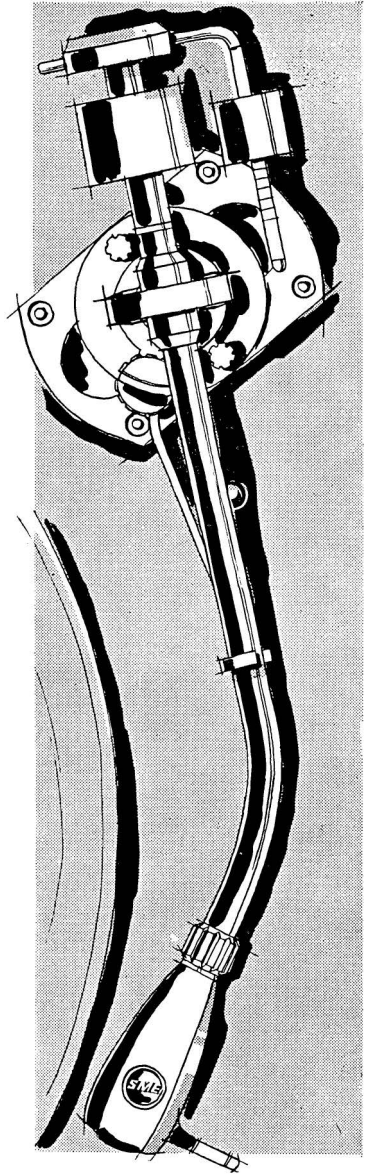
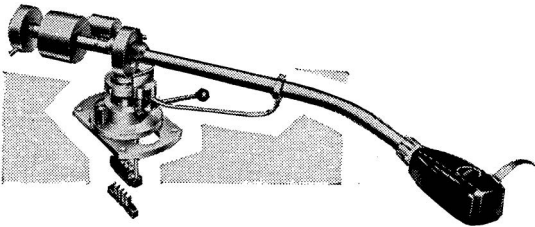

Manufactured by **SME LIMITED, STEYNING, SUSSEX, ENGLAND**

France

Belgium

Netherlands

Portugal

U.S.A.

South Africa

Hong Kong

New Zealand

Australia

Innovation, 104, Avenue des Champs Elysées, Paris.

Neon N.B., 14, rue Locquenghien, Brussels.

Audium, 160, Singel, Amsterdam C.

Acros, Rue Almeida E Sousa 21, Lisbon.

Lectronics of City Line Center, 7644, City Line Avenue, Philadelphia 31, Pa.

Recorded Music Specialists (Pty) Ltd., P.O. Box 2203, Durban.

Universal Trading Co., 326, Prince's Building, Hong Kong.

Westrex Co. New Zealand Ltd., 58, Kent Terrace, Wellington.

Jomyson Industries Ltd., 400, Kent Street, Sydney.

ACOS A.D. ARCHON BANG OLUFSEN BRENELL
B.S.R. BURNE-JONES CONNOISSEUR
CADENZA CHAPMAN

FOR ALL THE LATEST

'Hi-Fi'

*developments by
all the leading
makers under
one roof*

get in touch with

COLLARO C.Q.
DECCA DULCI
FANE G.E.C.
GARRARD
GOLDRING-
LENCO
GRAMPIAN
GOODMANS
HI-JACK
KELLY LEAK
LOWTHER

NEW
SOUTHDOWN

ORTOFON

PHILIPS

QUAD

RESLO

ROGERS

RONETTE

SHURE

SIMON

STENTORIAN

**T HOMPSON
D IAMOND &
B UTCHER LTD.**

THE LEADING "Hi-Fi" WHOLESALER
1-9 UNIVERSITY STREET, LONDON, W.C.1
EUSTon 9494 (20 lines)

WHARFEDALE

WAL

TRUVOX

WRIGHT & WEAIRE

A Company within the Rank Organisation



The **SPECTONE**

161

*the tape
recorder that
has really GOT
something*



**PRICE
49
GNS**

At last here is a top quality tape recorder with a superb recording and reproduction unit at an economical price. Just look at these luxurious features.

- Collaro Mark IV transcriber deck for two way travel.
- Three speeds. ● Pause control.
- Automatic tape position digit indicator.
- Can be used as amplifier for radio, gram and microphone.
- Facility for extension speakers.
- Unique 3-reel tape storage facilities.
- Handsome two-tone case. ● Twin track operation.
- Full mixing facilities. ● Takes full size 7 in. reels.
- Complete with microphone, jack plug and mains lead.

Specto
LIMITED

VALE RD., WINDSOR, BERKSHIRE

TELEPHONE WINDSOR 1241-2-3

Jason



LEADERSHIP IS MAINTAINED

Since the first Jason F.M. Tuner Kit came into being (countless thousands have been sold and are still selling) the company have extended into ever wider fields of hi-fi activity. Their name has come to stand for good design and quality above everything. The Stereo/Mono Amplifier J.2-10 mk.111 is unsurpassed, for wherever a good amplifier is needed, be it with tape-deck, modern small output stereo P.U., radio or any other source of signal. The Jason TV Sound/FM Switched Tuner is another high-light in the Jason Programme which includes tuners to match the J.2-10 mk. 111 as well as kits for building stereo amps and various types of tuners. JASON TEST EQUIPMENT in kit form is yet one more success. Here keen amateur and professional alike, are offered such things as Audio Signal Generator, Oscilloscope, Crystal Controlled Calibrator, Wobbulator, Power Packs and Voltmeter built or in kit form. Unusually copious and interesting literature is available free on request from your stockist or direct. JASON LEADERSHIP IS TRULY MAINTAINED—YOU CANNOT BUY BETTER.

AMPLIFIERS



TUNERS

BUILT AND IN KIT FORM



TEST EQUIPMENT IN KIT FORM

JASON ELECTRONIC DESIGN LTD.,

3-4 (YB) Gt. Chapel St., Oxford St.,
London, W.1. GER. 0273

A 'sound' QUINTET

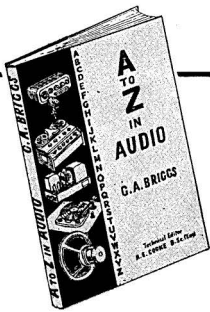

A to Z IN AUDIO

by G. A. BRIGGS

Technical Editor R. E. Cooke, B.Sc. (Eng.)

Published November 25th, 1960. 224 Pages, 160 illustrations (of which 110 are original). Fine art paper. Cloth bound. A new book presenting about 400 technical words and subjects relating directly or indirectly to Audio are explained and commented upon in non-technical terms, and occasionally in lighter vein. Many facts and figures about Loudspeakers, Pickups, Sound Recording, and Reproduction, Record Players, Tape Recorders, Television, Transistors, etc., are included, thus providing a handy book of reference.

Price 15/6 (16/6 Post Free)

Other books by G. A. BRIGGS

STEREO HANDBOOK

Presenting information on domestic stereo in a straightforward manner; relieved by humorous touches. 146 pages, 88 illustrations. 15 chapters including: Pickups—Loudspeakers—Amplifiers—Stereo Tapes—Recording Techniques—Record and Stylus Wear—Stereo Broadcasting—Room Acoustics—Concert Halls. Sales to date over 11,000.

Price 10/6 (11/6 Post Free)



LOUDSPEAKERS

Fifth edition. 336 pages. 230 illustrations. Standard reference work on loudspeakers. 31 chapters including: Reminiscences—Frequency Response—Directional and Phase Effects—Baffles, Cabinets and Horns—Electrostatic Speakers—Stereo—Audio Fairs and Concert Halls. Sales to date over 57,000.

Price 19/6 (20/9 Post Free)



SOUND REPRODUCTION

Third edition, fourth impression, 368 pages, 315 illustrations. Chapters on Resonances—Cabinets—Room Acoustics—Response curves with Oscillograms—Crossover Networks—Recording Systems—Records—Pickups, etc. Total sales exceed 47,000.

Price 17/6 (18/6 Post Free)



Sold by Radio dealers
and Bookshops

Published by:

PIANOS, PIANISTS and SONICS

A book for sound enthusiasts and music lovers written in G. A. Briggs' entertaining style. Chapters on Piano History and Construction—Harmonic Analysis—Touch—Tone—Tuning, etc. 192 pages, 102 illustrations.

Price 10/6 (11/6 Post Free)



Wharfedale
WIRELESS WORKS LTD

IDLE BRADFORD YORKSHIRE Tel: Idle 1235/6

Grams: 'Wharfedel' Idle Bradford

BEAUTY and the BEST of HI-FI equipment at LARGS



To appreciate the beauty and truth that only high fidelity can bring to sound reproduction you should come to LARGS of Holborn. Here you can listen in great comfort and make your choice of the best equipment. Our COMPARATOR will assist you in this. It is of our own design, and is almost infinitely selective. At the touch of a switch you can hear every possible combination of equipment in our extensive stock.

Another unique service at LARGS is the TAILAGRAM—a tailor-made radiogram fitted with equipment of your own selection, designed and finished to your own choice.

send for your FREE copy "THE MODERN APPROACH TO MUSIC IN THE HOME"

This full-colour brochure will assist the beginner in understanding true Hi-Fi and the difference between monaural and stereo. The brochure also details our "TAILAGRAM", the tailor-made radiogram, a personal service that only Largs can give.

Whether you are an expert or a beginner, we feel sure you will enjoy this brochure. Just your name and address on a postcard—a copy awaits you.

LARGS

of Holborn for High Fidelity

76-77 HIGH HOLBORN, LONDON, W.C.1
Telephone: CHAncery 2626 (Private Branch Exchange)

Near Holborn Tube Station

Buses 7, 8, 22, 23 and 25 pass the door
Da61HFYB

Emitape

magnetic recording tape—
the finest in the world

USED BY THE BBC 9 TIMES OUT OF 10

TYPE No.	SPOOL SIZE	APPROX. LENGTH		PLAYING TIME PER TRACK				PRICE	
		Feet	Metres	$\frac{1}{2}$ IPS	$1\frac{1}{2}$ IPS	$3\frac{1}{2}$ IPS	$7\frac{1}{2}$ IPS		IN EMICASE
44 - acetate standard- play tape	$3\frac{1}{4}$ "	175	53	37 20	18 40	9 20	4 40	6.9	—
	5"	600	183	2 8 0	1 4 0	32 0	16 0	18.0	—
	$5\frac{1}{2}$ "	850	259	3 1 20	1 30 40	45 20	22 40	£1. 4.6	—
	7"	1200	366	4 16 0	2 8 0	1 4 0	32 0	£1.10.0	—
88 - standard-play tape, maximum- durability for general use	3"	175	53	37 20	18 40	9 20	4 40	7.6	—
	$3\frac{1}{4}$ "	175	53	37 20	18 40	9 20	4 40	7.6	—
	5"	600	183	2 8 0	1 4 0	32 0	16 0	£1. 1.0	£1. 3.6
	$5\frac{1}{2}$ "	850	259	3 1 20	1 30 40	45 20	22 40	£1. 8.0	£1.10.6
	7"	1200	366	4 16 0	2 8 0	1 4 0	32 0	£1.15.0	£1.17.6
	$8\frac{1}{4}$ "	1750	530	6 14 0	3 7 0	1 33 30	46 45	£2.17.6	—
99 - long-play tape on thin base. 50% more recording time than standard	3"	250	76	53 20	26 40	13 20	6 40	9.6	—
	$3\frac{1}{4}$ "	250	76	53 20	26 40	13 20	6 40	9.6	—
	5"	850	259	3 1 20	1 30 40	45 20	22 40	£1. 8.0	£1.10.6
	$5\frac{1}{2}$ "	1200	366	4 16 0	2 8 0	1 4 0	32 0	£1.15.0	£1.17.6
	7"	1800	549	6 24 0	3 12 0	1 36 0	48 0	£2.10.0	£2.12.6
	$8\frac{1}{4}$ "	2400	732	8 32 0	4 16 0	2 8 0	1 4 0	£3.12.6	—
100 - Extra-thin double-play tape. 100% more recording time	$3\frac{1}{4}$ "	400	122	1 25 20	42 40	21 20	10 40	17.0	—
	5"	1200	366	4 16 0	2 8 0	1 4 0	32 0	£2. 5.0	—
	$5\frac{1}{2}$ "	1700	518	6 2 40	3 1 20	1 30 40	45 20	£2.17.6	—
	7"	2400	732	8 32 0	4 16 0	2 8 0	1 4 0	£4. 0.0	—

The above figures are calculated times, and do not allow for slow- or fast-running motors or mechanical variations, etc.

Special Emitape Features

- * Anti-static
- * High sensitivity
- * Low 'print-through' factor
- * P.V.C. Leader and Trailer strip fitted to all but 'Message' spools
- * In spool sizes for all tape recorders
- * Metallic 'Auto Stop' foil fitted to all 44, 88 and 99 spools except 'Message'

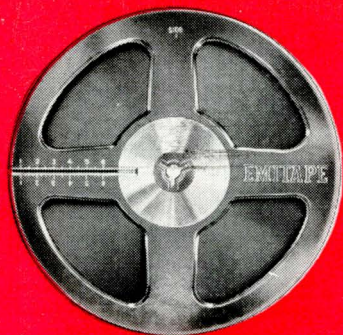

Joint and edit
your tape
the professional
way—
with **EMITAPE**
accessories

JOINTING COMPOUNDS
AP 35 for C.A.-base Tape and
AP 77 for P.V.C.-base Tape

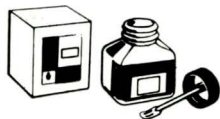

Special jointing fluid to make a permanent welded joint when splicing either P.V.C. or cellulose acetate base magnetic recording tape. 7/6

EMITAPE
JOINTING BLOCK AP 123

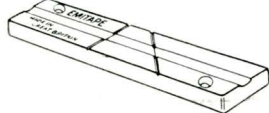

This exclusive undercut channel holds the tape fast, enabling you to cut it cleanly at an angle of 45° or 90°. 10/6

NON-MAGNETIC SCISSORS
AP 39



These scissors, made from non-ferrous metal, enable recorded tape to be cut for splicing or editing purposes without magnetising the tape. This ensures a silent joint. 16/-

P.V.C. LEADER TAPES
AP 38/1 to 38/6

This range of coloured tapes means you can insert colour code references for quick identification and indexing purposes in a reel of recorded tape. Colours: White, Red, Yellow, Blue, Orange, Green. 4/6 a reel.



JOINTING TAPE AP 103

Specially prepared adhesive jointing tape for simple and quick splicing and editing of magnetic recording tape. In handy plastic containers. 7/6



Metallic Stop Foil AP 125

Sufficient for 50 tapes. In handy plastic container. 6/6

ACCESSORY KIT AP 124



Holds 3 spools of leader, 1 spool of jointing tape, 1 spool of stop-foil, Emitape jointing block, two cutters and full instructions. Packed in a plastic rack (room for 7 spools). Specially designed for the workbench. 37/6

EMICASE

Polystyrene container. Solves storage problems, protects spools from dust and allows easy identification of leader tapes. 7" — 4/-, 5½" — 3/6, 5" — 3/6



EMPTY PLASTIC
SPOOLS IN CARTONS



Full range of empty plastic spools for programme storage of recorded tapes or for special mailing purposes.

AP 93 3"	3/-
AP 93N 3¼"	3/-
AP 85 5"	4/6
AP 89 5½"	4/6
AP 87 7"	5/-
AP 118 8¼"	12/6

EMITAPE DIVISION

E.M.I. SALES AND SERVICE LTD., HAYES, MIDDLESEX. TELEPHONE: SOUTHALL 2468

TeleTape

OF MARBLE ARCH



*The
West end's
largest
range
of
tape
recorders*

- Up to 2 years' free service warranty at your own home.
- H.P. Terms at Cash Prices.
- Open six days a week and up to 8 p.m. Fridays.



NEW COMPLETE BUYER'S GUIDE TO TAPE RECORDERS

Be sure of seeing them all! Send now for the magnificent new Teletape Catalogue. Loose-leaf so that it's revised every day. Full details and illustrations of all models. Price 2s. 6d. post free—refundable on purchase of recorder.



AND COMPLETE CATALOGUE OF PRE-RECORDED TAPES

First of its kind featuring all makes, Mono and Stereo, 7½ and 3¾ i.p.s. Price 2s. 6d. post free—refundable on purchase of tape.

TELETAPE LTD., 33 & 59A, Edgware Road, W.2. Tel: PADDington 1492

HI-FI NEWS

Hi-Fi News is the established magazine for the audio and High Fidelity Trade. Read all over the world by Experts, by Beginners and by Enthusiasts. Hi-Fi News is always well-produced, full of interesting material, and essentially readable. On sale at all leading bookstalls, monthly.

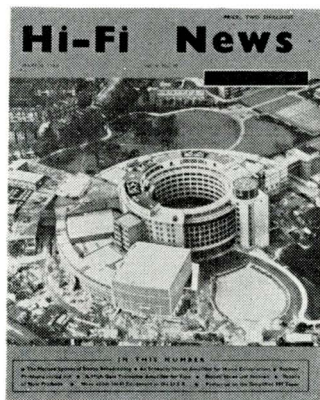

PRICE 2/- MONTHLY

● WELL PRODUCED ON GOOD PAPER AND LIBERALLY ILLUSTRATED ● UP-TO-DATE NEWS AND PICTURES ● INFORMATIVE ARTICLES ON ALL ASPECTS OF THE AUDIO WORLD ● REGULAR DETAILS OF NEW PRODUCTS ● AUTHORITATIVE AND RELIABLE REVIEWS ● SPECIAL FEATURES FOR HOME CONSTRUCTORS ● LIVELY AND USEFUL MONTHLY POSTBAG, DEALING WITH MANY AUDIO PROBLEMS.

SUBSCRIPTION RATES

The subscription rate to "Hi-Fi News" is 27/6 per annum (U.S.A. \$4.00) from "Hi-Fi News," 99, Mortimer Street, London, W.1.
Subscription + Index, 30/- (U.S.A. \$4.25).

MILES HENSLOW PUBLICATIONS LTD.
99 MORTIMER STREET :: LONDON, W.1.

AURIOL

Gramophone Pick-up Controls

No matter what combination of equipment is selected for the playing of gramophone records it will not be complete without an AURIOL pickup control. This piece of precision equipment is designed for use with every model of pickup arm and provides the complete answer to the problem of handling the pickup without risk of damaging the playing surface of the record, or the pickup. The stylus can be instantly positioned within an accuracy of 1-2 micro-grooves anywhere across the record including the first groove and the pickup may then be automatically lowered under pneumatic control at an adjustable preset speed which provides positive, cushioned contact. At any position across the record the pickup can be raised with the stylus being lifted vertically and cleanly out of the groove. At no time is it possible to drop the pickup on to the record!

The control is exhibited by the Council of Industrial Design at the Design Centre, London, and has been acclaimed by many leading critics including:—

Burnett James—Gramophone Record Review

" . . . This is quite obviously the only sane method yet devised of dealing with the problem of the ubiquitous recital record . . . I use one with a BJ 'Super 90' arm and I have come to regard it as an essential piece of equipment."

R. L. West—Hi-Fi News Test Report

" . . . Although the Connoisseur pickup is a very easy one to handle, used with an AURIOL it was even easier and it was impossible to damage either pickup or record."

P. Wilson, M.A.—The Gramophone

" . . . For a long time we have all been aware that one of the disadvantages of LP records is the difficulty of picking out any particular passage and placing the pickup there positively and gently, or vice versa, of lifting the pickup from the middle of the record. The AURIOL solves that problem. Is its price such as one can afford? You can answer that yourself bearing in mind that an expensive record can be ruined by a single mishap in placing a pickup."

Patented and proved in use throughout the world, these controls are guaranteed to give long, trouble free service.

Standard model for single record players only

PRICE £3.3.0

Mk. II model for auto-changer/manual players also—

PRICE £3.16.8

A standard indexing clip is supplied to suit $\frac{3}{8}$ " (9.6 mm) round arms. Other arms to be specified.

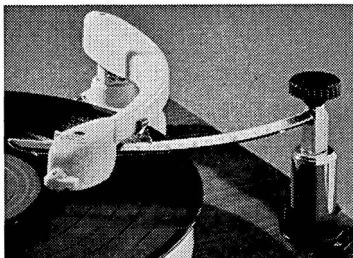

AURIOL (GUILDFORD) LTD., BY-PASS WORKS, GUILDFORD, SURREY Tel: 66712

The **Tandberg Series 6** is a 'no-compromise' instrument capable of delivering consistently fine 'professional' quality when used with comparable amplifier and speaker systems

Tandberg STEREO TAPE DECK

3 Speeds 4 Tracks 3 Heads

Features include

Free-Standing or Build-in Teak Cabinet

Flawless Technical Specification

High and low level mixer inputs & cathode follower outputs

Two Recording and Two Playback Amplifiers

"On and Off the tape" monitoring

Sound-on-Sound Simultaneous record and playback



RETAIL PRICE 110 gns

FROM SPECIALIST TAPE RECORDER & HI-FI DEALERS

Tandberg GB ELSTONE ELECTRONICS LTD
EDWARD STREET · TEMPLAR STREET · LEEDS 2
TELEPHONE: LEEDS 3-5111 (7 lines)

COMPACT HI-FI

by *Armstrong*

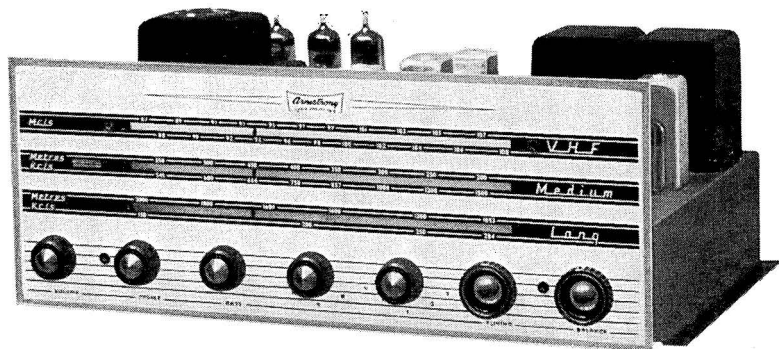

STEREO 12 Mk.2

42 GNS

TUNER-AMPLIFIER CHASSIS

The Stereo 12 Mk. 2 is a new and improved version of the famous Stereo-Twelve. It is the most complete chassis ever produced combining AM and FM Tuners, a comprehensive Control Unit and two High Fidelity Amplifiers in one compact unit. Compare the features and specification of each section with tuners and amplifiers sold separately and then compare the cost.

★ AM TUNER

Ferrite rod aerial, unique 2nd IF stage and efficient AVC provide good continental reception. Miniature tuning indicator.

★ FM TUNER

High Fidelity tuner covering the full VHF band (87-108 mc/s). Automatic frequency control ensures complete stability and easy tuning.

★ STEREO CONTROL UNIT

Separate bass and treble controls. Wide range balance control. Inputs for all pick-ups tape record and playback. Booster unit available for low output pick-ups. Stereo radio, input.

★ TWO HI-FI AMPLIFIERS

Each amplifier provides 8 watts push-pull output, 16 watts total for mono and stereo. Frequency response 20-30,000 c.p.s. $\pm 2\text{dB}$.

We specialise in the manufacture of high quality tuner-amplifier chassis in addition to our normal range of separate tuners and amplifiers. Other compact chassis available:

Stereo 55, 32 guineas; Jubilee Mk. 2, 29 guineas; AF208, 22 guineas.

ARMSTRONG WIRELESS & TELEVISION CO. LTD., WARLTERS ROAD,
HOLLOWAY, LONDON, N.7. NORTH 3213

Reflectograph

with instant comparison between input and recorded signals

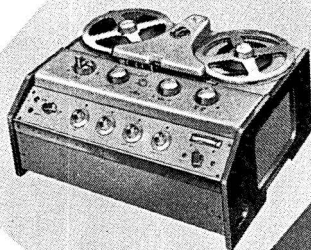

Here is a tape-recorder which is easy to operate, yet contains refinements normally provided only in costly professional machines. This is the ideal recorder for the high fidelity enthusiast or musician whose requirements demand recordings of library or studio quality.

The separate record and playback heads and amplifiers controlled by the Tape-Input switch enables you to compare, instantly, the input signal with the signal on the tape *whilst the recording is being made*. Thus, you can rapidly determine whether to record at $7\frac{1}{2}$ or $3\frac{3}{4}$ i.p.s. and monitor the recording through the built-in Goodmans loudspeaker. Editing is simplified by the variable speed, single, fast wind control. 3,600 ft. of tape on an $8\frac{1}{4}$ " reel can be wound in two minutes—1,200 ft. in 45 seconds.

Some other outstanding features of the Reflectograph are: slimline duotone record level meter; 2 tone controls, 2 volume controls, 2 inputs, 2 outputs; equalisation for 2 speeds; knobs with calibrated skirts; no belts in the tape drive mechanism; a realistic performance specification.

Cases for Reflectograph Recorders



Type CCA is a close-fitting wooden case covered in two-tone stovine with polished nickel fittings and detachable lid.

Type CCB is aluminium framed, covered in blue/grey lionide with black leather reinforced corners. The inside is lined with velveteen with space for accessories.



An expert's opinion

"... beautiful styling, with the satin finish instrument panel... first is the very smooth and level response in the deep base. I know of no other recorder that can equal the Reflectograph in this respect."

P. Wilson
Technical Editor of 'The Gramophone'

Write for fully illustrated leaflet, or better still, go to your Reflectograph dealer and see for yourself the care that has been lavished on every detail. Then try it for yourself and you will be convinced that this is the recorder you have always wanted.

MODEL A
(2 tracks), $7\frac{1}{2}$ & $3\frac{3}{4}$ i.p.s.

105 gns.

MODEL B
(4 tracks), $7\frac{1}{2}$ & $3\frac{3}{4}$ i.p.s.

115 gns.

MULTIMUSIC LTD.
MAYLANDS AVENUE,
HEMEL HEMPSTEAD,
HERTS.

Stentorian

HIGH FIDELITY AT REALISTIC COST

The items illustrated are representative of the wide range of W.B. Hi Fi equipment. A noteworthy recent addition is the "Stentereo" Stereophonic Speaker System embodying many novel features. Our experience in sound reproduction covers 33 years: such a background is a guarantee of quality. Full details of all W.B. products will gladly be sent on request.

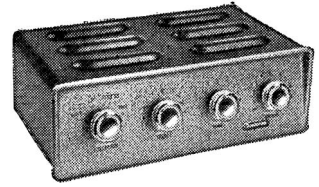

W.B.8 Amplifier £19.19.0.

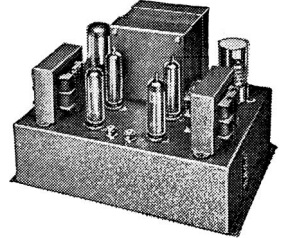

WB 8S Amplifier £23.15.0.

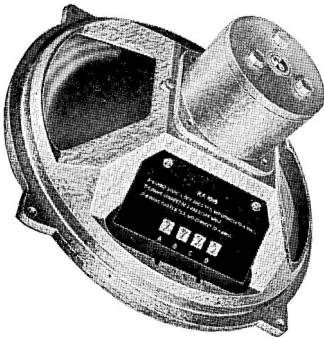

Stentorian Cambric Cone Hi-Fi Units.
The famous H.F.1016 at £8.0.0.
Others from £1.6.9.

Ready-to-assemble cabinets in polished walnut from £5.10.0 to £16.16.0.

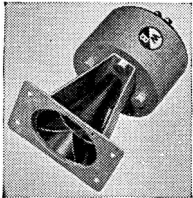

Prelude Horn-Loaded Cabinet
£19.10.0.

Tweeter Units from 35/- to £13.14.6.

HF. 817 Speaker
£11. 7.6.

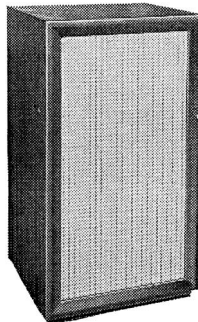
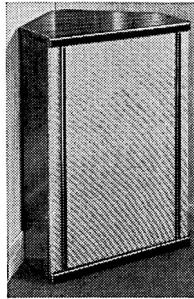

Stentorian Extension Speakers from 63/-

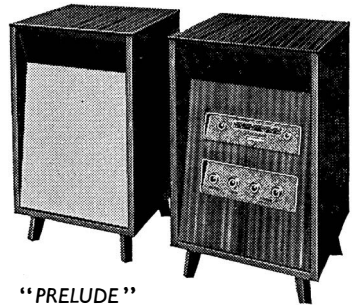

"PRELUDE"
ready-to-assemble cabinets in striped sapele from £9.19.6 to £13.13.0.

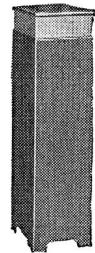
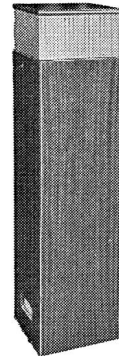

COLUMN LOUDSPEAKERS
Cabinet for H.F.816. Unit £18.18.0.
Cabinet for H.F.610 Unit £9.19.6.



WHITELEY ELECTRICAL RADIO CO. LTD • MANSFIELD • NOTTS

W.B.110

Telephone: MANSFIELD 1762-5

Simon

for the finest tape recorders and accessories

For perfect recording, the Cadenza Ribbon Microphone designed for a consistent high level performance from a symphony orchestra to an unaccompanied soloist.

Simon delight connoisseurs with the matchless SP.4. Every possible refinement, including an automatic deck, gives top class sound reproduction.

For the family living-room, the Minstrelle 4-track with its attractive cabinet (also as a portable model). It features simple magazine loading using 4" spools.

Simplest of all, the Simon Cymbal. A neat portable machine with sparkling sound quality. Also magazine loaded using 4" spools.

For full details of any or all of these models, and names of local stockists, please write to—
SIMON EQUIPMENT LIMITED
48 George Street . Portman Square
London, W.1

Cadenza Ribbon
Microphone

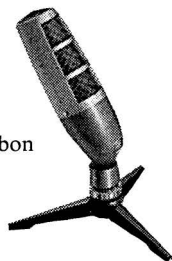

SP.4 tape recorder

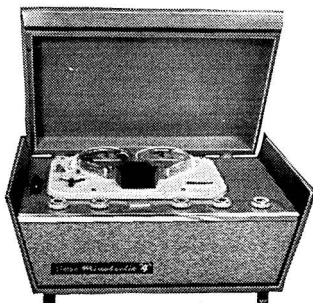

Minstrelle 4-track

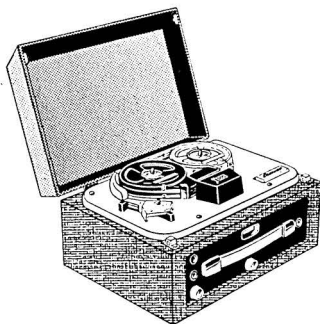

Simon Cymbal



QUALITY AMPLIFICATION

When everything is advertised as 'Hi-Fi', we prefer to revert to the term 'Quality Amplification', which implies that the equipment is designed to produce the closest approach to realism obtainable

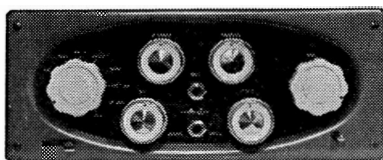

TWIN TWENTY

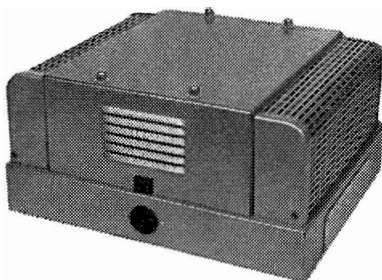

The closest approach to realism

under normal listening conditions. As manufacturers of the world's finest sound equipment for radio, recording and reproducing since 1931, and contractors to the B.B.C., we offer a range of tuners, amplifiers also loudspeakers for the perfectionist. Our export division can ship to any part of the world, and we are represented by enthusiastic agents in most countries.

May we send you details of our latest products?

R. N. WELLINGTON
Managing Director

SOUND SALES LIMITED · SOUND LABORATORIES
WEST STREET · FARNHAM · SURREY · ENGLAND · FARNHAM 6461-2-3

USA — CANADA — PARIS — NEW ZEALAND — AUSTRALIA

Vortexion

The W.V.B. recorder has an additional amplifier and head with provision for "before" and "after" record monitoring while the recording is in progress, and this also has echo facilities.

The W.V.A. recorder has provision for a plug in stereo head and can be supplied with this and stereo playback pre-amplifiers with equalisation each having an output of 1 volt from a cathode follower. This is type W.V.A/S.

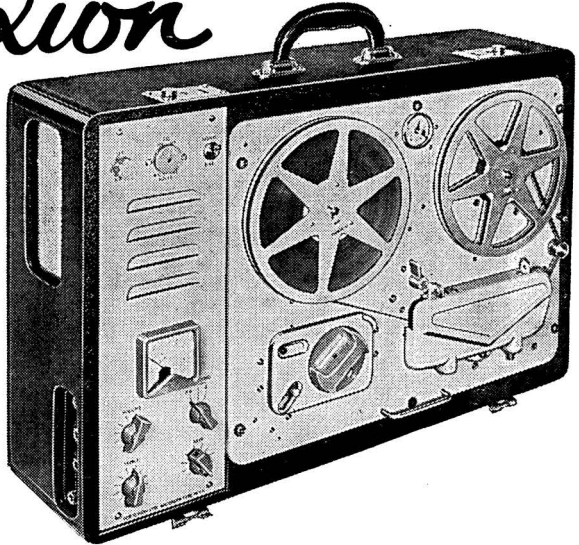

TWELVE-CHANNEL ELECTRONIC MIXER

This is similar to the 4-channel, but is fitted with 12 hermetically sealed controls, 12 balanced line microphone transformers potted in mu-metal boxes, and a mains transformer also potted in mu-metal. All components which can affect noise are tested and selected before insertion. It is supplied in standard steel case or 7 inch rack panel.

30/50 WATT AMPLIFIER

Gives 30 watts continuous signal and 50 watts peak Audio. With voice coil feedback distortion is under 0.1%, and when arranged for tertiary feedback and 100 volt line it is under 0.15%. The hum and noise is better than -85 dB referred to 30 watt.

It is available in our standard steel case with Baxendale tone controls and up to 4 mixed inputs, which may be balanced line 30 ohm microphones or equalised P.U.s to choice.

120/200 WATT AMPLIFIER

Will deliver 120 watts continuous signal and over 200 watts peak Audio. It is completely stable with any type of load and may be used to drive motors or other devices to over 120 watts at frequencies from 20,000 down to 30 cps in standard form or other frequencies to order. The distortion is less than 0.2% and the noise level -95 dB. A floating series parallel output is provided for 100-120 v. or 200-240 v. and this cool running amplifier occupies $12\frac{1}{4}$ inches of standard rack space by 11 inches deep. Weight 60 lb.

VORTEXION LIMITED

257/263, The Broadway, Wimbledon, London, S.W.19.

Telephones: LIBerty 2814 and 6242-3

Telegrams: "Vortexion, Wimble, London"



**for monophonic
sound**

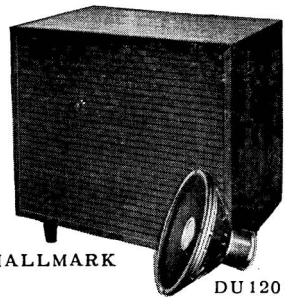

HALLMARK

DU 120



**for
stereophonic
sound**

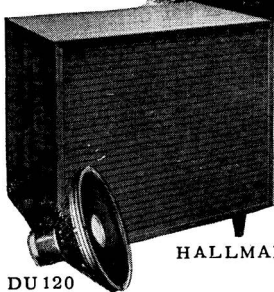

HALLMARK

DU 120

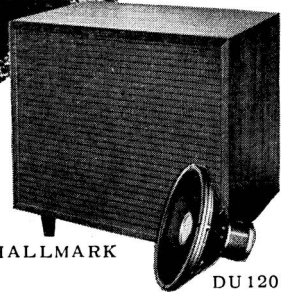

HALLMARK

DU 120

for exceedingly good sound

There is no reason at all why any really good dealer in genuine High Fidelity Sound Equipment should not be able to supply you with VITAVOX. If you meet with any difficulty just write to us and we'll see you get just what you want.

PRICES

DU120 Duplex Coaxial Full Range Loudspeakers	£19: 10s 0d
Hallmark Loudspeaker Systems - Tallboy or Lowboy	
In Teak	£45: 0s 0d
In Mahogany	£42: 0s 0d
In Walnut	£42: 0s 0d

There is no mystery about the superiority of Vitavox Loudspeakers and Loudspeaker Systems. It is all a matter of careful design and attention to details. Vitavox Loudspeakers, installed in suitable enclosures, make excellent companions and do full justice to any first class sound reproducing equipment with which they are used. Vitavox is a "must" if you demand the highest quality and insist on the most perfect performance possible.

VITAVOX *Hallmark*

**LOUDSPEAKER SYSTEMS
and DU120 Duplex Coaxial
FULL RANGE LOUDSPEAKERS**

VITAVOX LIMITED • WESTMORELAND ROAD
LONDON • N.W.9 Telephone COLindale 8671

WELLINGTON ACOUSTIC LABORATORIES

The famous WAL GAIN

PRE-AMPLIFIERS

The pre-amplifiers with 1,000 uses, audio, commercial, and industrial. The pre-amplifiers that give you the EXTRA GAIN you need, without hum or distortion. Supplied complete with phono plugs, screened lead, battery.

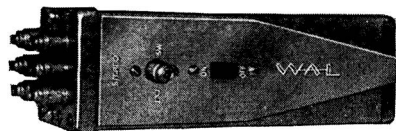

STEREO MODEL. Price £7.10.0.
Size 7" x 2" x 2½".
(Mono, not illustrated). Price £5.
Size 3½" x 2" x 2½".

The NEW HI-GAIN pre-amplifier. Fully transistorised, battery operated, with tape equalisation. The complete answer to monitor head problems. Provides sufficient equalised CCIR voltage to directly couple to a pair of headphones, or to a Hi-Fi amplifier to add a second "stereo channel" to existing mono tape equipment.

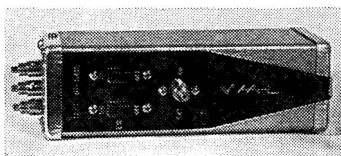

The WAL Hi-Gain. Price £7.16.0.
Size 7" x 2" x 2½".

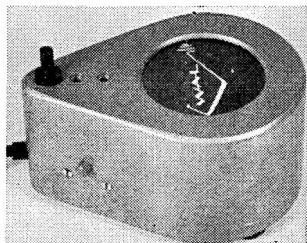

The NEW D-MAG. A Mains operated, pocket sized head de-magnetiser, that provides a complete degaussing circuit. Also especially designed for erasing short unwanted passage of sound on tape or striped film.

Price: £2.10.0.

Size 2" x 2" x 1" with 3" probes.

The WAL BULK ERASER.

The ideal accessory for all tape recordists. Wipes both tracks perfectly "clean" in under half a minute. Used in laboratories, colleges, schools, dealers' demonstration rooms, studios, offices, tape clubs—in fact by anyone who does a lot of recording and wishes to rapidly "clean" up tapes ready for the next session.

Price: £7.18.6.

WALTRAK POCKET AUDIO OSCILLATOR.

The accessory that Service Engineers, Radio and Laboratory technicians, keen enthusiasts consider a necessity in their kit. Battery operated, transistorised, supplied complete with probe, etc., for fault finding, "dead" set checking, stereo matching, recording bias check, etc. Output 1,000 c.p.s. sine wave. Over 2 v. max. Calibrated, 1v, 0.1v, and .01v tappings. Price: £6.10.0.

Full technical leaflets are available on all our products, which are designed and manufactured in our Laboratories. We are always pleased to advise customers and dealers on any technical query on any of our products. EXPORT INQUIRIES are particularly welcomed, and we specialise in overseas orders, shipping single items up to 1,000 to all parts of the world.

ALL THE LEADING DEALERS HAVE OUR PRODUCTS—they all know W.A.L.

(Our wholesalers include Thompson, Diamond & Butcher, etc.).



WELLINGTON ACOUSTIC LABORATORIES LTD. Farnham, Surrey, England
Telephone: Farnham 6461-2-3

See the fine units **Garrard** make

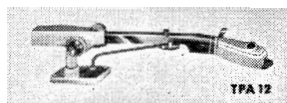
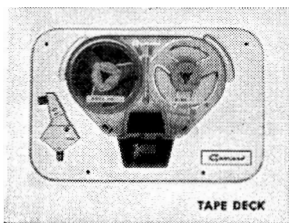
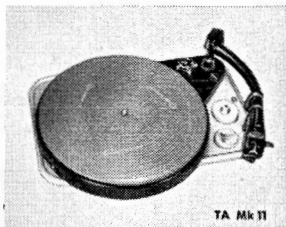
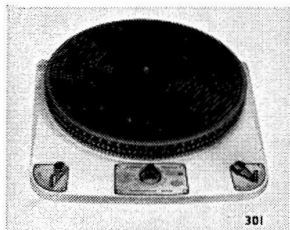
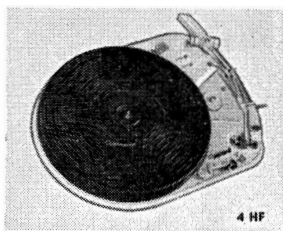

LABORATORY SERIES AUTO TURN-TABLE TYPE A—Designed specially to meet the demand for a Transcription Record Player with provision for automatic use if desired.

MODEL 4HF—High quality single Record Player with TPA12 Pickup Arm.

MODEL 301—Famous Transcription Motor used by Broadcasting Stations throughout the world.

MODEL TA Mk. II—Single Record Player very suitable for the home constructor.

MAGAZINE TAPE DECK—Unique in design. Magazine loading makes recording and play back simple.

MODEL TPA12—Transcription Pickup Arm Fitted with MPM.4 plug-in moulding.

THE GARRARD ENGINEERING & MANUFACTURING CO. LTD.
Swindon Wiltshire



THE WORLD'S
FINEST



ELECTRONIC
KIT-SETS

Whether you require

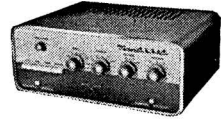
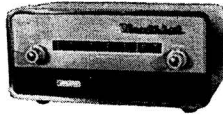

Tape Deck, Record Player, Tuner, Amplifier,

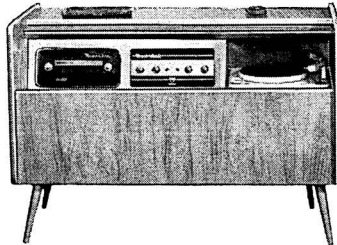

. a Cabinet to house them in,

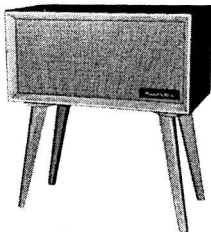

. . . . Loudspeaker
Systems,

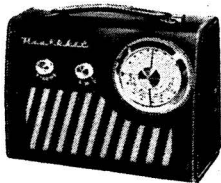
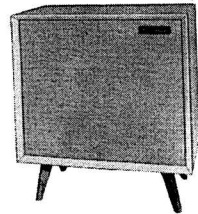

Radio, or Test Equipment,

You cannot do better than buy a *Heathkit* model

★ For your *FREE CATALOGUE*, write to:—

DAYSTROM LTD.

DEPARTMENT H.Y.
GLOUCESTER, ENGLAND

A MEMBER OF THE DAYSTROM GROUP

Manufacturer of

THE LARGEST SELLING ELECTRONIC KIT-SETS IN THE WORLD

YOU MUST READ

the



HI-FI BOOKS



First title — published March, 1961

HI-FI FOR BEGINNERS

by JOHN BORWICK



The titles in preparation :

TAPE FOR BEGINNERS

STEREO FOR BEGINNERS

AMPLIFIERS FOR BEGINNERS

LET US ADD YOUR NAME TO OUR MAILING LIST

MILES HENSLow PUBLICATIONS LTD.

99 MORTIMER STREET, LONDON, W.1

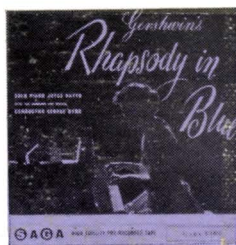

*pre-recorded tapes
are the Commonwealth's
most accepted
tape records
Ask for Saga by name*

Catalogues available on request to:



SAGA SOUND LTD., 123, KENSAL ROAD, LONDON, W.10.

