

# HI-FI WORLD

NOVEMBER 2018

UK £4.50

www.hi-fiworld.co.uk

**FREE READER CLASSIFIED ADS IN THIS ISSUE!**



**ONKYO TX-RZ830** *EXCLUSIVE!*  
av receiver



**CHORD QUTEST**  
dac



**NAD C328** *EXCLUSIVE!*  
hybrid digital amplifier

**ROHDE & SCHWARZ**  
MEASUREMENT



**LETTERS - THE BEST WINS A PAIR OF B&W P5 HEADPHONES! (UK ONLY)**

## COMPETITION



**WIN A ISOTEK-EVO3**  
**CORVUS MAINS DISTRIBUTION**  
**BLOCK WORTH £500!**  
**(UK ONLY)**



# PMC twenty5.26 loudspeakers

SCHEU CELLO CLASSIC LINE EVOLUTION TURNTABLE  
LONGDOG AUDIO MCj3 VALVE PHONO STAGE *EXCLUSIVE!*  
SUGARCUBE SC-1 DIGITAL CLICK REMOVER  
ISOTEK EVO3 ASCENSION MAINS LEAD

NOVEMBER 2018

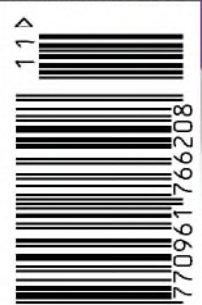

9 770961 766208







It's got to be  
**Perfect**

**Your music deserves quality cables**

**WHAT HI-FI?  
AWARDS 2017**

Accessories  
Best analogue interconnect (ESD)  
Chord Company Clearway

**WHAT HI-FI?  
AWARDS 2017**

Accessories  
Best speaker cable  
Chord Company Clearway

**WHAT HI-FI?  
AWARDS 2017**

Accessories  
Best analogue interconnect under £50  
Chord Company C-line

We go to great lengths (and precise tolerances) to produce our class-leading cables. From solder upwards, every component is chosen for optimum performance.

At the higher end of things, we build strictly to order. Every Signature, Sarum T and ChordMusic product is tested visually, electronically and audibly, before being signed-off by our senior technicians.

All this care and attention helps maintain our international reputation for realistically priced audiophile interconnects and speaker cables - featuring our unique advanced screening, Super ARAY conductor technology, Tylon® insulation and our latest ChordOhmic connectors - backed-up with over 30 years' experience.

Designed and built in England by music lovers since 1985. Enjoyed by music lovers all over the world.

Demonstration cables available from all good Chord Company retailers. Find your nearest at:  
[www.chord.co.uk](http://www.chord.co.uk)



*"the difference will be immediately evident, such is the transparency of the interconnects and loudspeaker leads."*

Chord Signature Range  
Hi-Fi World Dec 2015



*"It's rare that something truly different comes along in the world of loud-speaker cables - but Chord's new Sarum T is just that."*

Chord Sarum T Speaker Cable  
Hi-Fi World Dec 2017

THE  
**CHORD**<sup>TM</sup>  
COMPANY

# welcome

## EDITOR

Noel Keywood  
e-mail: [editorial@hi-fiworld.co.uk](mailto:editorial@hi-fiworld.co.uk)

## DESIGN EDITOR

Faiza Chunara  
tel: +44 (0) 20 8206 6018  
e-mail: [adproduction@hi-fiworld.co.uk](mailto:adproduction@hi-fiworld.co.uk)

## PRODUCTION EDITOR

David Noble  
tel: +44 (0) 20 8206 6017  
e-mail: [classifieds@hi-fiworld.co.uk](mailto:classifieds@hi-fiworld.co.uk)

## SALES MANAGER

Louise Palfrey  
mob: +44 (0) 7917 047 548  
e-mail: [louise@hi-fiworld.co.uk](mailto:louise@hi-fiworld.co.uk)

## ADVERTISING EXECUTIVE

Joanna Holmes  
mob: +44 (0) 7958 602 347  
e-mail: [joanna@hi-fiworld.co.uk](mailto:joanna@hi-fiworld.co.uk)

## PUBLISHER

Noel Keywood  
e-mail: [publisher@hi-fiworld.co.uk](mailto:publisher@hi-fiworld.co.uk)

## FREE READERS CLASSIFIEDS

tel: +44 (0) 20 8 206 6017  
e-mail: [classifieds@hi-fiworld.co.uk](mailto:classifieds@hi-fiworld.co.uk)

## SUBSCRIPTIONS

tel: +44 (0) 1442 820 580  
fax: +44 (0) 1442 827 912  
e-mail: [hifiworld@webscribe.co.uk](mailto:hifiworld@webscribe.co.uk)

## PHOTOGRAPHY

David Noble  
tel: +44 (0) 20 8206 6017

## WRITERS

Paul Rigby, Jon Myles, Martin Pipe,  
David Tutt



Large studio monitor loudspeakers have always been objects of awe. Both JBL and Tannoy are names to be reckoned with, making products few of us can afford – or fit in the home. These days B&W are popular in many studios, their big 801s being a common sight. I know Abbey Road studios in St John's Wood, North London and a mile or so distant from our offices, use them from my visits there to carry out interviews, attend press receptions and what have you.

Meanwhile, down at Metropolis Studios in Chiswick, West London, who also hold press events and host small shows, they use looming PMC professional studio monitors – the MB2S with its distinctive inverted basket bass drivers. This little beastie has a 75mm fabric dome midrange to deliver crucial vocals – a common studio practice where they demand to hear every part of what is being sung. With this in mind we were pleased to be able to bring in PMC's twenty5.26 loudspeakers for review this month, their only domestic product with a midrange dome. Would they bring the studio into our listening room we wondered? You can find out on p10.

Aware they are doing well and competitors are sharpening their knives, Chord Electronics have introduced yet another DAC, the Qutest. This covers their position in the low priced stand-alone market, meaning you can get Chord quality at an affordable price – the highest measured performance available today globally. Yes, no one can do better. Quite an achievement when you consider the size of rivals and the backroom power of manufacturers like Texas Instruments (USA) or Asahi Kasei of Japan (AKM). So don't miss our in-depth review of this new DAC on p45. It may be the one for you.

And finally I had great fun trying to tie a reef knot in fine fishing line this month. Don't miss the reason I was forced to do so on p82.

We audio enthusiasts have to work at our hobby to get good results but relaxing to music that's a thrill to hear makes it all worthwhile.

**Noel Keywood**  
**Editor**



## hi-fi world

Audio Web Publishing  
Studio 204,  
Buspace Studio,  
Conlan Street,  
London W10 5AP  
[www.hi-fiworld.co.uk](http://www.hi-fiworld.co.uk)

## verdicts

- OUTSTANDING**
- EXCELLENT**
- GOOD**
- MEDIOCRE**
- POOR**
- VALUE**

amongst the best  
extremely capable  
worth auditioning  
unremarkable  
flawed  
keenly priced

## ELECTRONIC MAGAZINE

Go to our website [www.hi-fiworld.co.uk](http://www.hi-fiworld.co.uk) to buy an electronic version of this magazine, individual issues, back issues or a subscription.

## testing (see [www.hi-fiworld.co.uk](http://www.hi-fiworld.co.uk) for full explanations of all our tests)

To ensure the utmost accuracy in our product reviews, *Hi-Fi World* has extremely comprehensive in-house test facilities, and our test equipment - from big names like Rohde & Schwarz and Hewlett Packard - is amongst the most advanced in the world.

Loudspeakers are measured using a calibrated Bruel & Kjaer microphone feeding a Clio-based computer

analyser, using pulsed and gated sinewaves, in a large room to eliminate the room's influence. Pickup arm vibration is measured with a Bruel & Kjaer accelerometer.

No other UK hi-fi magazine has in-house testing, and none has access to such advanced tests across all types of equipment. That's why you can depend on *Hi-Fi World* reviews

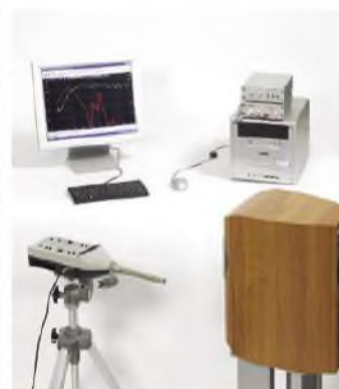

Distributed by Select Publisher Services Ltd. P.O. Box 6337, Bournemouth, BH1 9EH UK Tel +44 (0) 1202 586848

Printed by Precision Colour Printing Halesfield 1, Stirchley, Telford TF7 4QQ, United Kingdom Tel: +44 (0) 1952 585585

Our Agents in Malaysia Millennium Hi-Fi & AV Simon Chang Showroom & office, 500-1-3 First Floor Wisma Indah (Shen Court), Jalan Tun Razak 50400 Kuala Lumpur, Malaysia

Tel: 603 9283 8171 Fax: 603 9281 3762 e-mail: [info@millennium-audio.com](mailto:info@millennium-audio.com)

All unsolicited submissions and goods are at the owner's risk. We accept no responsibility for such submissions, nor do we undertake to return them.

No material may be reproduced from this magazine without the publisher's written permission. © Audio Web Publishing Ltd



# contents



45

CHORD QUTEST DAC



27

NAD C328 DIGITAL HYBRID AMPLIFIER



82

SCHEU CELLO CLASSIC LINE TURNTABLE



90

LONGDOG MCj3 VALVE PHONOSTAGE

## LOUDSPEAKERS

### PMC twenty5.26 LOUDSPEAKERS 10

Jon Myles and Noel Keywood check out PMC's twenty5.26 loudspeaker.

## DIGITAL

### ONKYO TX-RZ830 AV RECEIVER 15

Martin Pipe looks at an AV receiver of enormous complexity and ability.

### CHORD QUTEST DAC 45

The latest DAC from Chord Electronics, reviewed by Martin Pipe.

## AMPLIFICATION

### NAD C328 DIGITAL HYBRID AMPLIFIER 27

Jon Myles is impressed by this small digital amplifier.

## HEADPHONES

### JAYS M-SIX WIRELESS IN EAR HEADPHONE 59

Martin Pipe listens to new in-ear phones from Jays

## CABLES

### ISOTEK EVO3 ASCENSION MAINS CABLE 51

Martin Pipe checks out a new mains lead from Isotek.



15

ONKYO TX-RZ830 AV RECEIVER

# NOVEMBER 2018

VOLUME 28 : NO. 9

## FEATURE

### 22 LINN SELEKT DSM

Linn hold a major product launch. Martin Pipe brings you the details.

## OLDE WORLDE

### 54 ARCAM SOLO MOVIE 5.1

Now available for little second hand, this complex AV unit still offers quality explains Martin Pipe.

## VINYL

### 80 NEWS

All the latest and greatest vinyl releases for you, from the pen of Paul Rigby.

### 82 SCHEU CELLO CLASSIC EVOLUTION TURNTABLE

A finely engineered and great sounding turntable makes Noel Keywood tie the knot.

### 86 SET YOUR SPEED

Want to get your turntable running properly? Noel Keywood explains how.

### 89 AUDIOPHILE BOOK – THE FIRST TIME

Paul Rigby reads a new book on artists' first-time experiences, by author Matt Everitt.

### 90 LONGDOG AUDIO MCJ3 HYBRID PHONOSTAGE

Noel Keywood listens to an MC phono stage that uses both jfets and valves.

### 92 SUGARCUBE SC-1 HI-RES CLICK REMOVER

Remove clicks from LP the digital way with this fascinating box of tricks from California, reviewed by Noel Keywood.



## REGULARS

### 7 NEWS

Words from the world...

### 25 COMPETITION

Your chance to win a EVO 3 Corvus mains distribution box worth £500.

### 34 MAIL

Your views, wonderful as always...

### 52 SUBSCRIPTIONS

Ensure your copy every month and save money too!

### 62 AUDIOPHILE VINYL

Paul Rigby rounds up the latest audiophile vinyl releases

### 65,67,69,71,73 OPINION

The team get to grips with matters music, hi-fi and life!

### 75 WORLD STANDARDS

Updated guide to the latest and greatest hi-fi hardware on sale

### 84 DIAL-A-DEALER

A comprehensive guide to UK hi-fi retailers.

### 95 CLASSIFIEDS

Second-hand bargains.

### 96 NEXT MONTH

What we hope to bring you in the next sizzling issue...

### 97 ADVERTISERS' INDEX

### 98 CLASSIC CUTS

Ben Folds Five and Brick, reviewed by Paul Rigby.





## STORIED SOUND FOR EVERY MOMENT.

When sound is delivered with the utmost of clarity and brilliance, it turns every moment into an experience. Backed by 50 years of innovation, the new 600 Series from Bowers & Wilkins was designed to bring you closer than ever to the music and movies you love.

Discover more at [bowers-wilkins.co.uk](http://bowers-wilkins.co.uk)

**THE NEW 600 SERIES**

Bowers & Wilkins

email:news@hi-fiworld.co.uk

# news

## QUAD ARTERA PLAY+

Quad has upgraded its popular Artera Play CD player, DAC and pre-amplifier – while also lowering the price.

Now named Play+ improvements include the addition of Bluetooth aptX for pairing smartphones, tablets and computers for wireless music streaming, as well as a front-mounted headphone output.

Quad has also fitted a larger toroidal transformer for the power section and made changes to the post-DAC analogue filter section to improve the sound.

Best of all the price has been dropped to just £1,199.95 compared to the original model's £1,399.95 at its launch in 2015. For more information visit [www.quad-hifi.co.uk](http://www.quad-hifi.co.uk).



## KEF R SERIES

KEF has revamped its R series of loudspeakers with a raft of changes including new bass drivers as well as the latest version of its famed Uni-Q driver - in which the tweeter sits in the acoustic centre of the midrange driver.

Other improvements include better damping of the cabinet plus a new port arrangement as well as grilles featuring a micro-fibre construction.

The range starts at £1300 for the R3 standmounts and also includes the larger R5 (£2000) R7 (£2600) and R5 (£4000) floorstanders. There's also an R2c centre speaker available for £850.

For more information go to [www.kef.com](http://www.kef.com).

## MCINTOSH POWER

If it's power you are after then look no further than McIntosh's latest amplifier.

The new MC462 boasts a massive 450 Watts per channel – enough to drive any loudspeaker we know of – and is the most powerful amplifier the legendary New York company has ever produced.

Design-wise, the MC462 retains all the hallmarks of McIntosh amplifiers with a few key modern enhancements.

The front panel now utilises direct LED backlighting that improves colour accuracy and appearance while the two audio Autoformers and single power transformer are housed in new enclosures topped by a single machined cover with glass inserts.

The MC462 is available now priced at £12,495. For more information visit McIntosh's UK distributor Jordan Acoustics at [www.jordanacoustics.co.uk](http://www.jordanacoustics.co.uk).



## YAMAHA STREAMING TURNTABLE

The world of vinyl, digital and streaming are coming together in the form of Yamaha's new MusicCast Vinyl 500.

Yes, it's a turntable with a factory-fitted straight tonearm and MM cartridge but apart from that the device can also stream whatever disc it is playing to other MusicCast loudspeakers in the home.

It can also stream files up to 24bit/192kHz from a network and has in-built support for the likes of Spotify, Tidal and Deezer – plus Bluetooth.

All this for the price of £550.

How does it sound? Look out for a review in Hi-Fi World soon.





## FOCAL KANTA

French loudspeaker specialist Focal impressed us with its £7000 Kanta No2 loudspeakers - which combined flax main drivers with a beryllium tweeter in an elegantly shaped cabinet (see Hi-Fi World review June 2018 issue).

Now the company has expanded the range with the No1 standmounts and a larger No3 floorstander.

They use the same main drivers built from flax fibre cores enclosed by two thin layers of glass fibre with a Beryllium inverted dome tweeter that combines the principles of the IAL (Infinite Acoustic Loading) and IHL (Infinite Horn Loading) tweeters developed for Focal's flagship Utopia range.

The Kanta No1s are priced at £4499 while the No3s cost £8999. Watch out for a Hi-Fi World review soon.



## NAIM APP

Naim has started rolling out an updated version of its Naim App for controlling its range of products.

Available for free from the Apple App and Google Play stores the new version includes an improved discovery system for finding servers, a slicker look and feel plus enhanced troubleshooting.

Initial testing by Hi-Fi World found the app much more responsive than previous versions with a faster, cleaner interface.



## MELCO MARVELS

Those who prefer to listen digitally might appreciate two new music-library offerings from Melco, the Japanese firm that began with a turntable in 1975.

First is the half-width 2-terabyte N100, which is designed to complement the D100 CD-loader (for import) and E100

expansion drive (additional music capacity). The £1,800 'entry-level' unit relies on the same low-noise high-precision architecture you'll find in existing Melco products. Unlike IT-type NAS boxes, including those from Melco's sister company Buffalo, the N100 was designed from the outset for audio. A USB-connected DAC allows the N100 to perform as an app-controlled music player with support for DSD512 and PCM up to 32bit/384kHz. Other features include front-panel controls, RISC processor, Ethernet, USB and direct-download of hi-res content from some vendors. Melco's second offering is the flagship two-box N10. Selling for £6,750, the 3-terabyte (expandable) N10 is billed as an 'extreme performance audio-NAS and USB-DAC player'. Separate half-width units are dedicated to signal-processing electronics and power supplies.

Visit [Melco Audio, www.melco-audio.com](http://Melco Audio, www.melco-audio.com)



## FLYING THE FLAG

Of the increasing number of British firms bringing production back to these shores, the latest is Mitchell and Johnson. Said products form part of the flagship 800 Series, which is "entirely designed, engineered and hand-built in Britain". The first contenders are the S800 preamp and S815 power amp (both £1,299); a matching CD player is expected shortly. The comprehensive S800, which features an analogue volume control, contains a ESS Sabre 9018 DAC that can be driven from an XMOS asynchronous USB port or one of six conventional inputs (three optical, three coaxial). It's compatible with DSD64/128 and PCM up to 24-bit/192kHz. As regards analogue connectivity, the S800 gives you a high-quality MM/MC phono stage, balanced XLR and five line-level phonos. Outputs include headphones, two line-level phonos, XLR, record feed and subwoofer. The matching S815 features XLR/phono inputs, illuminated VU meters, gold-plated speaker terminals and 150W RMS per channel (8 ohms) of Class AB amplification.

[Mitchell and Johnson, 0845 643 5064, www.mitchellandjohnson.com](http://Mitchell and Johnson, 0845 643 5064, www.mitchellandjohnson.com)



## IFI PRO

IFI has added a new flagship DAC/pre-amp to its range. The Pro iDSD also boasts wi-fi streaming and a headphone amp.

Priced at £2499 the iDSD is based around a Burr-Brown chip which – as the product's name suggests – can handle DSD files up to 22.57MHz (DSD512) as well as PCM up to 32-bit/768kHz.

Other features include a range of digital filters and upsampling options for tailoring the sound, MQA decoding, both single-ended RCA and balanced outputs and the ability to stream from a range of online music services including Spotify, Apple Music, Amazon Music, Tidal, Qobuz, Deezer and Napster.

For more information visit [www.ifi-audio.com](http://www.ifi-audio.com) or contact the company's UK distributor *Select Audio* on 01900 601954.



## DCS BARTOK

Cambridge-based dCS is renowned for its digital-to-analogue converters – and it has now unveiled its latest, most affordable model in the shape of the Bartok.

Available in two versions – £9,999 for the streaming DAC and £11,999 for the streaming DAC with integrated headphone amplifier – the Bartok is equipped with USB, AES and S/PDIF digital inputs. It can also stream over ethernet from a NAS drive or online music services such as Tidal or Spotify.

Supported file formats for streaming include PCM up to 24-bit/384kHz and DSD128 plus DSD in DoP format. The DAC feeds balanced and unbalanced line outputs that can drive power amplifiers directly and dCS has designed the Class A headphone amplifier to work with both high and low impedance headphones.



## HEADMASTER

Audio-Technica's ATH-SR30BT (£99), billed as 'premium' wireless headphones, combine Bluetooth 5.0 support, an impressive 70 hour battery life and 40mm drivers. The ATH-SR50BT (£199) adds ambient noise-reduction control, 'hear-through' functionality – a simple click on the left housing button, and you can hear the world around you – and larger (45mm) drivers. To active listeners who prefer 'in-ear' types, Audio-Technica is pitching the 'True Wireless' ATH-SPORT7TW (£179) and ATH-CKR7TW (£229) models, both of which support Bluetooth 5.0. The CKR7TW sports 11mm drivers for a bigger sound than the SPORT7TW's 5.8mm ones can deliver, and longer battery life (six hours, as opposed to 3.5). Then there's the 'b' version of the wired ATH-MSR7, which is based on the million-selling ATH-M50x studio 'cans'. Improvements have been made to sonic performance, while the design is lighter and more portable.

But it's not just headphones. Reflecting strong growth in another sector – vinyl playback – Audio-Technica has introduced the six-strong VM95 range of entry-level moving-magnet cartridges. They feature the same body, but different styli. In order of pricing, they are the AT-VM95C (with 0.6 mil conical stylus, £29), AT-VM95E (0.3 x 0.7 mil. elliptical, £44), AT-VM95SP (3 mil. conical stylus for 78rpm discs, £69), AT-VM95EN (0.3 x 0.7 mil. nude elliptical, £99), AT-VM95ML (line-contact microlinear, £149) and AT-VM95SH (line-contact Shibata profile, £179). Styli can be bought separately, facilitating an upgrade path, and each cart can be supplied for a £25 premium with SME-type bayonet-locking HS6 headshell. The AT-VM95E is closest in spirit to the critically-acclaimed AT95E, said to be the most successful entry-level cartridge of all time; Audio-Technica has been designing and manufacturing phono cartridges since it started operations in 1962.



For more information visit [Audio-Technica.com](http://Audio-Technica.com), (01132) 771441. [www.eu.audio-technica.com](http://www.eu.audio-technica.com)

# twenty5 Alive!

PMC's new transmission line loudspeakers hits the mark, says Jon Myles.





**G**etting strong bass from a cabinet is easy to precisely arrange with a ported loudspeaker. How ports work was successfully analysed a long time ago, put into a computer program – and bingo! Every loudspeaker today uses a port. But not PMC's twenty5.26 floor stander I am reviewing here. Instead it uses their advanced transmission line (ATL). Add to this the big dome midrange unit and you have a distinctively different loudspeaker.

Ports work well if done properly and best of all – they're cheap. Long ago the transmission line was researched, by using a model train to carry a measuring microphone along the line! Trouble is such a line needs to be long, making transmission line loudspeakers big, heavy and expensive, since cabinet work consumes most of a loudspeaker's build budget.

The idea is that the line returns information in-phase with the front bass unit, not out-of-phase like a port. In other words the transmission line adds to bass rather than cancelling it. To keep size down a line longer than a quarter-wave at 40Hz is commonly employed, with heavy damping to

forceful for home use. Here PMC have honed their unit nicely for today's world our measurements showed.

High frequencies are handled by a 27mm Sonolex soft-dome driver developed with SEAS and the perforated grille has been computer optimised so as not to interfere with dispersion.

The cabinet measures 1040mm (40.9in) high, but 20mm must be added for spikes. It is 192mm (7.6in) wide including the plinth bars and 439mm (17.3in) deep. Weight is 25kgs (56lbs). Four veneer finishes are available: Oak, Walnut, Amaranone and Diamond Black. The slight back slope helps time align the drivers while round the back the one pair of 'speaker binding posts accept spades, banana plugs and bare wires.

### SOUND QUALITY

Connected to a McIntosh MC152 power amplifier the twenty5.26s immediately impressed. In typical PMC fashion they sound rather different than other loudspeakers – but have an innate ability to convey music.

Starting with The Jam's 'A Town Called Malice' they punched the

"Starting with The Jam's 'A Town Called Malice' they punched the bass out with startling quality."

alter behaviour – not ideal and with port-like qualities as our impedance analysis shows, but you get a different quality of bass – and often more of it.

To drive this line PMC have developed a g-weave 170mm (6.5in) glass fibre cone bass unit with rigid cast alloy chassis. Behind, the line stretches 3.3m or 11ft and exits through contoured vents close to the floor. PMC says these smooth air flow by lessening turbulence at the port exit, such vanes also being seen in lensed FA drivers. Look out of the aircraft window and may also see little vertical winglets at the wing tip doing a similar job.

A distinguishing feature of the 26 model however is its use of a custom built PMC 50mm soft-dome midrange unit. Such units are rarely seen in hi-fi but popular with studio monitors. They are known to be both projective and revealing but older designs suffered break-up at high volume and could be a bit too

bass out with startling quality. The midrange also impressed with Paul Weller's vocals being pushed out into the room with great delineation. Here it was obvious just how good the PMCs are – punchy, enjoyable and rather refined.

Switching to Nick Cave's 'The

**Two vents terminate the rear line, with Laminair contoured flow directors to reduce turbulence.**



**The rear panel carries a single pair of connecting terminals – no biwiring here!**

Kindness Of Strangers' the PMCs brought out all the magic of this track. Cave's voice was resonant, the backing rich and vibrant.

The electronic bass line of The Chemical Brothers' 'Block Rockin' Beats' (24/96) was authoritative and punched much harder than I was expecting. Yet it was never boomy or slow. Instead it had pace and agility – serving to push the track along at



"Tellurium Q Statements are no usual cable affair and if I've called the Silver Diamonds an Emotional Tour de Force what are then the Tellurium Q Statements!? Well, they certainly transcend any typical labeling and this time I'm elevating them on the throne, that they clearly deserve. Their stand out, extraordinary performance can only be recognized with the 2018 Editor Choice Award!"

-Matej Isak, Mono & Stereo

"...you have managed to surpass them [Silver Diamonds] in a truly grand way."



# Tellurium Q<sup>®</sup> Statement



What has been achieved is a coherent sonic profile and performance across the whole Statement range and that is why we say this is the **Tellurium Q<sup>®</sup> Statement**.

[telluriumq.com](http://telluriumq.com)

[facebook.com/telluriumq.com](https://facebook.com/telluriumq.com)

+44 (0) 1458 251 997







**Dome midrange units push more midband energy into a room, giving a brighter, shinier midband quality and great insight. They also make images very specific. But are expensive and not much used in hi-fi.**

just the right speed.

With acoustic instruments such as Jimmy Garrison's bass on John Coltrane's 'Live At The Village Vanguard' I could hear the body of the instrument and the resonance as notes decayed. PMC transducers are often described as a musician's loudspeaker and I could see why here. The whole performance had a natural, realistic portrayal to it, Coltrane's saxophone soaring above the backing musicians and out into the room without ever sounding disconnected from the band.

The tweeter is incisive, having a slight brightness to it which works to bring out the detail in many tracks. However it is a long way from the midrange unit and sounded a tad divorced from it. Conversely the midband is softer without the forthright nature of some rivals.

It's a different balance to most loudspeakers at this price and needs acclimatisation perhaps. But listen over a longer period and this balance makes a lot of sense – the PMCs never proving tiring whatever music I played.

Also, these 'speakers go loud with little effort. Turning up volume on the crescendo at the end of the third movement of 'Beethoven's 5th' the power produced almost knocked me off my feet. The orchestra simply powered out of the 'speakers in all its majestic glory. Classical music lovers will love these loudspeakers for the sense of scale they can produce.

Timing-wise The twenty5.26 were supremely coherent and this means that the music it reproduces is easier to understand and enjoy

because your brain is not having to make any effort to hear through time smear.

**CONCLUSION**

The twenty5.26 offers a different and quite distinctive sound, shaped by PMC's professional studio monitor experience. Think controlled but powerful bass, a wonderfully open midband and obvious treble. It's a loudspeaker that punches out nicely, especially when volume is turned up. Characterful, but exciting and well worth auditioning I think.

**NOEL SAYS -**

I got to hear the twenty5.24 when Jon Myles reviewed it in our February 2018 issue – and loved it. The speaker brought life and dynamics to music. The twenty2.26 reviewed here has a midrange dome and it made for great insight. My only gripe is the tweeter is too prominent for my tastes and, being far from the mid, it's not phase coherent – making it sound divorced.

"Think controlled but powerful bass, a wonderfully open midband and obvious treble."

**MEASURED PERFORMANCE**

Frequency response analysis of PMC's twenty5.26 varied according to microphone position, our analysis here showing a slightly (10 degree) off-axis result, between the dome midrange unit and the woofer, that would be heard at seated ear height with the cabinets pointing straight down a room, not pointed in toward listeners.

The result is reasonably even across the audio band but tweeter output rises by +7dB at 10kHz so high treble is strong. The dome has some presence at

800Hz and it crosses over with little loss at 3kHz so its contribution will be obvious, suggesting well projected vocals and instruments.

PMC loudspeakers produce strong bass and the twenty5.26 large cabinet and vented bass system gave output down to a low 30Hz (green trace). The large area floor port (red trace) extended this down to 20Hz and its broad response suggests good bass quality free from resonance.

The impedance curve shows the bass line and floor port are tuned to a low 38Hz but port acoustic output (red trace) is relatively flat and even over a very wide band from 20Hz to 100Hz. The PMC will not have the bouncy bass of typical reflex ported cabinets; it is very different in this respect measurement reveals.

Sensitivity was reasonable, measuring 86dB from one nominal Watt of input (2.8V). Overall impedance measured with pink noise was a high 10 Ohms, due to the use of an 8 Ohm bass unit (most are 4 Ohms these days to improve voltage sensitivity).

The twenty5.26 will have even natured and deep bass able to produce subsonics in a large room (> 18ft long). The dome midrange unit will be obvious but not overly forceful in delivery whilst upper treble will be obvious – possibly sharp at times. **NK**

**FREQUENCY RESPONSE**

**Green - driver output**  
**Red - port output**



**IMPEDANCE**

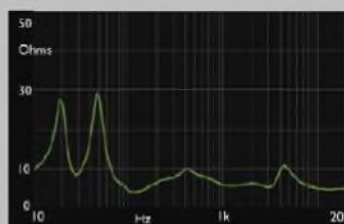

**PMC twenty5.26**  
**£7,895**



**EXCELLENT - extremely capable**

**VERDICT**

A projective loudspeaker that is no wall flower. Exciting and worth hearing.

**FOR**

- clear midrange
- good bass
- well finished

**AGAINST**

- bright divorced treble
- needs power

PMC  
+44 (0)1767 686300  
www.pmc-speakers.com

# ortofon

accuracy in sound



## 2M

The 2M Series, named after the abbreviation of Moving Magnet (MM) technology, is an affordable range of pick-up cartridges with first-class audio design principles throughout. Featuring Ortofon's trademarked split-pole pin technology for a flat frequency response, all 2M cartridges have a high output for easy integration into any turntable system.

Designed in conjunction with celebrated design house Møller-Jensen Innovation Design, the 2M Series body represents the shape of a diamond, whose contours gracefully trace the grooves on a record's surface.



### Red.Cartridges

A hugely popular all-purpose cartridge with a Tipped Elliptical stylus that delivers an open, dynamic sound with a slight touch of warmth.



### Blue.Cartridges

An affordable step up in the range, which adds greater dynamics, resolution and detailed sound thanks to the Nude Elliptical stylus.



### Bronze.Cartridges

Featuring a superior body, the Bronze picks up even the highest frequency information for a rich, detailed and deep soundstage, and can be further upgraded with ease.



### Black.Cartridges.

The musician's choice and flagship of the range, the 2M Black features a Nude Shibata stylus which guarantees a true-to-life sound performance.



# Plenty of Atmos

Martin Pipe gets to grips with the sophisticated Onkyo TX-RZ830 AV receiver.

**W**hen faced with something as complex and all-encompassing as the TX-RZ830 networked AV receiver from Onkyo – a leader in this field – it's difficult to know where to begin. It would probably be easier to note what it can't do than what it can. I can confirm that it won't make you breakfast and then wash up afterwards. But those who buy into Onkyo's vision could be so busy playing with the receiver's

various features that mere human frailties like a need for breakfast will be overlooked...

OK, the basics. The TX-RZ830 is a THX Select-certified home cinema receiver, aimed at decoding and amplifying multichannel movie soundtracks – and the limited amount of music that has been released in this form. It supports amongst much else the cutting-edge Dolby Atmos and DTS-X technologies. I'll discuss these routes to immersive surround in

greater depth later. To make all that surround magic happen, there are no fewer than nine Class AB power amplifiers of claimed 180W output on board. They feed speakers strategically-placed around your listening (viewing?) room; another possibility is multi-zone – audio sent to two other rooms, referred to as Zones 2 and 3.

Compare that to the mere two channels that the average hi-fi system has to deal with! Boring old two-channel stereo is of course also supported and you get old-school



Now with more depth  
and more clarity



**WHAT HI-FI?  
AWARDS 2017**

PRODUCT OF THE YEAR  
Best standmount speaker £400-£800  
KEF Q350

*'A level of clarity and subtlety  
that's unheard of at this price.'*

KEF Q350, What Hi-Fi? July 2017

**The new Q Series hi-fi speakers**

The eighth iteration of this successful range continues to be centred on KEF's legendary Uni-Q driver array, and is now enhanced with a new system design, beefier low-frequency drivers and a new damped tweeter loading tube. The result is superior bass performance and an even more detailed natural sound. Listen for yourself and experience pleasure in high resolution.

KEF.COM



OBSESSED WITH HIGH RESOLUTION



coverage of FM and AM radio with a 40-preset RDS-capable tuner too. Onkyo haven't, as a global concern, bothered with DAB but they offer alternatives. Stereo sources like these can be subjected, courtesy of the TX-RZ830's potent (32-bit/384kHz) digital signal processing and AKM 4458 DACs, to various soundfield modes so that all those amps and speakers don't go to waste. They seek to recreate the ambience of a live performance.

Also offered are modes that extract surround information from matrixed two-channel sources like Dolby Stereo. Onkyo has not implemented modes that decode old matrix quad formats like SQ and QS. There's no analogue 5.1 input so you can't plug in old quad decoders. Playing DTS CDs, DVD-As or SACDs of quad material is however possible.

AV receivers are sophisticated switching-centres and this Onkyo is no exception. On its busy rear panel are a whopping six HDMI ports for connection to peripheral equipment like disc players, games consoles, streamers and TV set-top boxes. They support up-to-date refinements like 4k resolution, HDR (high dynamic range) video and the latest 2.2 version of HDCP copy-protection.

A seventh HDMI socket is conveniently-accessible from the front of the unit. The latter is, along with various buttons, hidden behind a flap. When this is closed, the TX-RZ830 looks clean and minimal; all you get are controls for soundfield selection, tone control, standby and input selection. But there's more to its AV connectivity than HDMI. Component (two) and composite (two) video terminals are provided for older kit, together with legacy digital audio inputs (two optical, one optical). You can assign these to various inputs, as circumstances dictate.

As Onkyo hasn't included analogue video outputs for older displays, it's perhaps just as well that the TX-RZ830 will convert analogue video into HDMI. There's no upscaling, meaning that standard-definition video from a PAL composite video source is sent to your TV at 576i/50. Two HDMI outputs are offered, meaning that one of your external 'zones' can be served with video. The main one has ARC (Audio Return Channel), which in basic terms means that sound from your TV can be heard through the TX-RZ830.

As regards analogue audio, the TX-RZ830 presents you with six stereo line inputs, plus phono for a turntable. Also available are the Zone 2 and Zone 3 outputs in line-level form, should you be using those on-board amps for surround, and a full set of surround outputs. As if all that power isn't enough...

This being 2018, the TX-RZ830 is packed to the gunnells with all manner of streaming gadgetry. There's on-board Bluetooth for wireless playback of music stored on your 'phone or any other Bluetooth equipped player; the apt-X codec isn't supported, but SBC and AAC are. The unit can be controlled via a free smartphone app (Android and

connected to your home network – via Ethernet, or Wi-fi (2.4GHz and 5GHz bands are supported).

The streaming facilities are comprehensive. In addition to Tunes Internet radio, you get support for Spotify, Deezer, Tidal and Amazon Music. It will stream to DTS Play-Fi and Flare Connect devices, making



**Every aspect of the receiver can be operated from the remote, but it is not backlit for use in dark rooms. A control app is also available for Apple and Android devices.**

"The TX-RZ830 turns in a superb performance that will glue you to your seat."

iOS flavours) as an alternative to the supplied remote handset, the fascia of which is heroically uncluttered! The app will be of particular interest to those who plan to take advantage of the zone 2/3 functions. To achieve this the TX-RZ830 must be

your life even easier if multi-room audio appeals. Chromecast is built in, and the TX-RZ830 is compatible with Google Assistant. It will also act as a streaming client with music held locally on DLNA/uPnP and Airplay servers; hi-res PCM (up

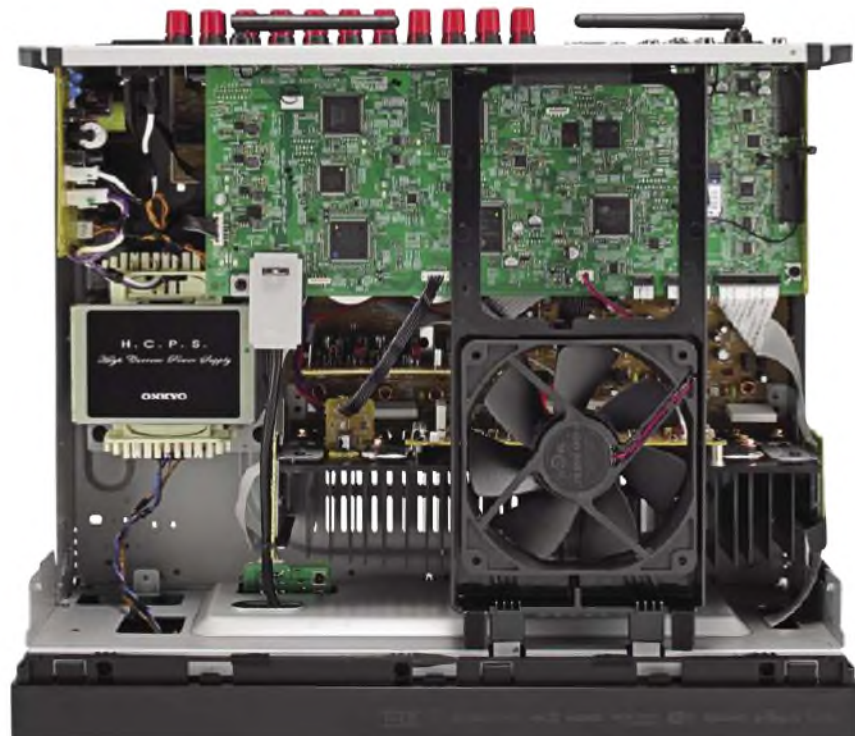

**With nine amplifiers to keep cool that heatsink is not enough so a massive but fairly quiet fan is automatically switched on when the going gets tough. The mains transformer, which contributes to much of the TX-RZ830's 14kg weight, is remarkably compact considering what it has to do.**

*Eleven pairs of speaker terminals are fitted no less! Note too the six HDMI inputs, two HDMI outputs, Wi-Fi aerials, system control terminals (external IR and RS232) and seven analogue inputs, one for a turntable. Then there are AM and FM radio terminals, an RJ45 ethernet socket for internet connection and USB for storage devices.*



to 192kHz/24-bit) and DSD (up to DSD256, or 11.2MHz) material in WAV, AIFF and FLAC form are covered, as well as CD-quality 16-bit PCM material and lossily-compressed formats like MP3, AAC and WMA.

The latter may benefit from an 'advanced music optimizer' function, which is claimed to "improve compressed digital audio quality", including Bluetooth sources. The Tuneln 'client' lacks a search facility for internet radio stations but they can be stored as presets for speedy future access.

Music can be played from USB storage devices, but for some reason Onkyo has put the port on the rear panel.

**OPERATION AND SOUND QUALITY**

AV receivers have justly gained a reputation for being intimidating, confusing and difficult to drive. Onkyo, to its credit, has attempted

will suffice for most). An initial-setup 'wizard' takes you through network and speaker configuration. Part of the process involves AccuEQ 'room calibration', a system that uses a trailing microphone to 'sound out' your listening room with a series of test signals in a process that takes ten minutes or so. You must have an HDMI monitor connected to see the menus.

The necessary level, delay and tonal corrections are then calculated and applied automatically. AccuEQ is one of the better systems of its type, giving worthwhile results that don't need manual correction.

Onkyo has paid attention to sound quality, basic audio-grade components (including electrolytic capacitors) being specified. Then there's an Onkyo philosophy known as 'dynamic audio amplification'. It combines design factors like wide-range ('WRAT') amplifiers with high-current drive capability, the

depending upon what you're tuned into.

The phono stage turned in a decent performance, as a quick succession of LPs ranging from soul to symphony demonstrated. Low-end performance was capable enough to do justice to pipe organs, big drums and bass synths, while the top end is clear and free of sibilance. And in between, enough of the music emerges to get your foot tapping.

Moving on to digital, Hi-res and CD-quality stereo material stored on my NAS sources also fared well – certainly after I switched from Wi-Fi to Ethernet to eliminate streaming glitches (where I live, there are numerous wireless networks competing for scarce spectrum).

Playing Depeche Mode's *A Broken Frame* (24/96) was a real nostalgia trip, those analogue keyboards and electronic drums taking me right back to the early 1980s. Plenty of space is given to the performers, an even tonal balance complementing the presentation. Dedicated streamers and audiophile-grade stereo amps admittedly give you more finesse – even with the Onkyo at its most musical in 'pure direct' mode - but these deny you the TX-RZ830's soundfield fun. Try 'studio mix', if you like rock; classical lovers on the other hand might like to give 'orchestra' a go, while gamers get no fewer than four DSPs. On top of these are the 'official' Dolby and DTS 'matrix' modes.

Multi-channel is of course the TX-RZ830's *raison d'être*, and it shouldn't come as much of a shock to learn that the receiver does a bang-up job here. A Blu-ray of *Bladerunner 2049*, with its hi-res DTS-HD soundtrack, proved to

*The TX-RZ830's auxiliary controls, covered by a substantial flap when not needed. There is an HDMI port for devices like games consoles and cameras, a standard (1/4in, 6.3mm) headphone socket and a 3.5mm jack for the AccuEQ calibration mike.*



to redress this – as heralded by that basic remote control, and the apps. The menu system is responsive and logically-organised, as are the input options (the default permutations

with the radio. FM sounded more than respectable; it was clean and – with the right material like BBC Radio 3 – fairly dynamic in nature. Internet radio can also be excellent,

avoidance of unwanted phase-shifts and "noiseless audio processing" that relies on a proprietary technology called 'Vector Linear Shaping Circuitry' (a 106dB signal-to-noise ratio is claimed).

Let's start



be immersive. At the Protein Farm, K and Sapper trade punches that sounded so real I could almost feel them. There was more potential for subtlety in Dystopian LA, where traffic and rain contributed to a busy and tangibly three-dimensional soundscape. Even when there's plenty of action, this receiver copes admirably with no traces of harshness or bottom-end dirt. If you have the movies and space for the 'speakers, the TX-RZ830 won't disappoint.

And so to Dolby Atmos – and its newer DTS-X equivalent – which are as good as multi-channel gets. They add height information to the surround mix so listeners are enveloped in sound. Movie-soundtrack and music mixers can place sound 'objects' – such as gunfire, weather effects and screams – anywhere in three-dimensional.

The extra information is 'buried' in the lossless hi-res soundtracks of

Blu-ray discs – any player can be used, if its HDMI audio output to 'bitstream'. Height speakers convey the extra information. Some mount directly in the ceiling, while others fire the sound upwards so that it can be 'bounced off' the ceiling towards the listener. The effect is thoroughly-convincing.

**CONCLUSION**

Even if you don't have room for the full speaker complement the TX-RZ830 turns in a superb performance that will glue you to your seat. It's also better with regular stereo material than a unit of such complexity has any right to be! Audiophile gear has

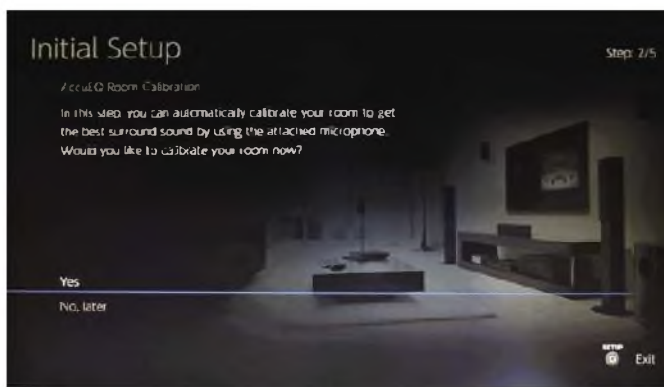

**Full marks for Onkyo's responsive and intuitive menu systems. This one engages their effective AccuEQ 'room calibration' system that uses a trailing microphone to 'sound out' your listening room with a series of test signals.**

more finesse when it comes to two channels, but this beast can do so much more. Where else do you get AM and FM radio, internet radio, LP replay, comprehensive streaming and hi-res digital replay all in one place?

**MEASURED PERFORMANCE**

All measurements with Pure Audio selected (no digital processing). Power from the TX-RZ830 measured 170 Watts into 8 Ohms and 290 Watts into 4 Ohms one channel driven as per usual, falling to 150W / 250W both two channels driven. With three front channels full driven this would drop again on a per-channel basis, but total acoustic power would still be very high – more than enough to go extremely loud in any room and speaker arrangement.

Frequency response of the analogue amplifiers measured flat from a low 4Hz up to 76kHz. Good.

An internal relay appeared to re-set bias conditions according to power draw: with a 30W limit distortion was 0.01%; with full output it was 0.1%. This was unusual and strange but distortion levels were low all round and the unit will give a clean sound.

The analogue Line inputs needed 2000mV for full output – sensitive.

The digital inputs (S/PDIF), including the optical input, accepted 192kHz sample rate PCM, frequency response measuring flat to 70kHz. Distortion from 24/96 hi-res PCM measured a mediocre 0.1% from preamplifier and the loudspeaker outputs, the latter contributing no extra noise.

EIAJ dynamic range value with a hi-res 24bit input was on the low side at 106dB – little better than CD at 103dB. With values of 115dB common the TX-RZ830 was unimpressive in this respect.

RIAA equalisation in the MM phono stage was accurate and frequency flat as a result. There is no warp filter so deep bass is reproduced, but also LP warps if they exist. Noise was low at -80dB and overload high at 77mV. A good stage.

The VHF/FM tuner gave superb results all round and is likely a refined SDR design. Frequency response was flat to 10kHz, giving correct tonal balance. Fast roll off above 15kHz gave deep Pilot Tone rejection. Distortion was very low

at 0.1% max and sensitivity high at 26µV from the aerial (-50dB noise, stereo).

The TX-RZ830 is a complex design, like most AV receivers, but Onkyo do a fine job measurement shows, only digital being lacklustre. NK

**FREQUENCY RESPONSE**

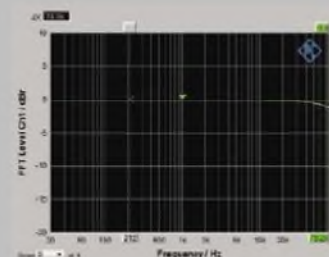

**DISTORTION**

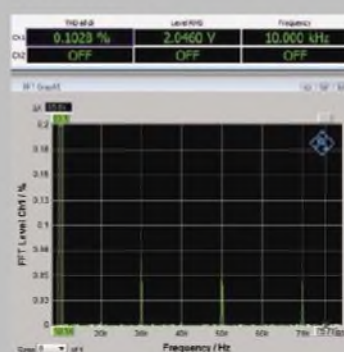

**AMPLIFIER**

Power	170W
Frequency response (-1dB)	4Hz-76kHz
Distortion (10kHz, 1W)	0.1%
Separation (1kHz)	96dB
Noise (IEC A)	-98dB
Sensitivity	200mV

**DIGITAL**

Frequency response (-1dB)	5Hz-70kHz
Distortion (-60dB, 24bit)	0.1%
Dynamic range	106dB
Noise	-104dB

**PHONO**

Frequency response (-1dB)	5Hz-20kHz
Distortion (1kHz, 5mV in)	0.02%
Separation (1kHz)	69dB
Noise (IEC A)	-80dB
Sensitivity	4mV

**VHF/FM**

Frequency response (-1dB)	10Hz-10kHz
Distortion (100% mod)	0.1%
Separation (1kHz)	-46dB
Noise (stereo, IEC A wtd)	-66dB
Sensitivity (stereo/mono)	26 / 10µV

**ONKYO TX-RZ830**  
**£1,100**



**OUTSTANDING - amongst the best**

**VALUE - keenly priced**

**VERDICT**

Onkyo makes another great AV receiver.

**FOR**

- facilities
- phono stage
- FM, AM, internet radio
- remote and app control

**AGAINST**

- complicated
- TV set up only
- mediocre digital sound

Onkyo  
+44 (0)203 936 8087  
www.uk.onkyo.com/en/

**Because music matters**

**marantz**<sup>®</sup>

---

The KI Ruby Series

by ken ishiwata



visit [www.jordanacoustics.co.uk](http://www.jordanacoustics.co.uk)  
or call 01202 911 886 to find out more





The advertisement features a dark grey background with a central text area. On the left, a vertical strip shows a close-up of a Marantz component with a purple vertical stripe. On the right, three smaller images show different views of the Marantz Ruby components: a hand using tweezers on a component, a CD player with a digital display showing '12', and a stack of components with a purple stripe.

## RUBY ANNIVERSARY

Celebrating Ken Ishiwata's  
'40 years Ruby Anniversary'  
at Marantz

---

## TWO SPECIAL MODELS

PM-KI Ruby Integrated Amplifier  
SA-KI Ruby Super Audio CD-Player  
with DAC

---

## VERY LIMITED EDITION

Each component is strictly limited  
to an edition of 1,000

---

## LIMITED TIME MATCHING SERIAL NO'S

For a limited time only, you can  
purchase PM-KI Ruby and SA-KI Ruby  
together with matching serial no's\*\*

(\*\*subject to availability, please ask)

---

## PRE-ORDER YOURS TODAY FROM JORDAN ACOUSTICS

Trade-in\* and 0% Finance\*  
packages available

(\*subject to status & conditions,  
please ask for details)

# Selekt Committee

Martin Pipe gives us the latest from Linn.



*As well as the volume control, which lines up with the front feet, there are six customisable 'piano keys' and a monochrome OLED display. The latter is a model of clarity.*

**T**here's a new addition to Linn's DS family. A 'step up' from the entry-level Klimax models, Selekt DSM - £4000 in basic form - is a universal preamplifier quite different to anything that Linn has produced before.

Although it's made in Scotland an external consultant was responsible for Selekt DSM's stunning new look. Its most obvious feature is a large "jewel-like" knob, which gives the impression of extending downwards into one of the three feet. Inset into the cut-glass control is a ring of white LEDs that indicate the current volume level.

It can be tilted and pressed as well as rotated, to intuitively-operate not only volume changes but customisable functions like starting and stopping playback, cycling through songs and selecting sources. Even the base model has a MM/MC phono stage, a line input, four digital inputs (two optical, two coaxial), PC-compatible USB and an ARC-compatible HDMI port for

TV-related sound. Bluetooth (and Wi-Fi) hardware is built in, but not yet supported by the firmware. Network connectivity is currently Ethernet-only.

Set into the edge of Selekt DSM's front panel is a row of six piano-key 'smart buttons', which can be

configured (using Linn's Kazoo app, which is available for iOS, Android, Windows and MacOS) to do the user's bidding. Each can be 'pinned' to a specific song, playlist, radio station, streaming service, genre or source. The idea is to endow digital playback with the "tactility of physical



*The Selekt DSM's operation dial is fashioned from cut glass. It can be tilted and pressed as well as rotated, to intuitively-operate not only volume changes but customisable functions.*





**There's not much you can't connect to the Selekt DSM! Note the three expansion bays to the right with line-output 'cartridge' fitted to one of them here. The top-left blanking plate will carry a surround decoder for 5.1 channels. An MM/MC phono stage is incorporated, RIAA equalisation being analogue.**



**The Selekt DSM front panel slides forward, providing access to the power supply – which will need to be replaced by a beefier one, should you decide to go multichannel. On the left are the three slots for expansion 'cartridges'. Here, one stereo amp is fitted.**

records". Beneath the buttons is a bright and readable OLED display. It's text-only; Tiefenbrun explained that a cover-art display would "clutter" the Selekt DSM's elegant appearance. Such imagery is however available via Kazoo.

One of the key advantages of Selekt DSM is its expandability. Linn has engineered it to be as modular as a desktop PC, ensuring that the unit is future-proofed and can be tailored to the customer's specific requirements. Three internal bays for expansion 'cartridges', their socketry accessible via the rear panel, allow you to add a 100 watt-per channel Class-D power-amplifier (an extra £1,250) thereby turning the Selekt DSM into a self-contained music player. In 'base' form, though, the unit acts as a 'digital preamp'. It can feed

Linn's active speakers via 'Exakt Link', but you also get an analogue 'line-output' cartridge with phono and balanced XLR outputs for use with existing systems.

The amplifier cartridge incorporates the DACs, and even these are 'slot-in' upgradable; a further £1250 will buy you Linn's premium Katalyst converter modules. Similar flexibility extends to the line-output cartridge; a headphone amplifier is also envisaged. Linn plans to launch a multichannel decoder module (which will fit elsewhere within the unit) and a cartridge that combines a single amplifier module with a line-level sub output. Add

these items, plus two stereo amp cartridges, and voila! Surround sound from music and movies.

A bigger power supply (switched-mode, of course) is necessary if amps are fitted; I was assured that it's beefy enough for five channels of surround. Selekt DSM also supports the latest incarnation of Linn's 'space optimisation' technology, which now handles non-rectangular rooms. In terms of streaming services, it currently supports Tidal, TuneIn (Internet radio), Qobuz, Spotify Connect and Roon. The app, meanwhile, will give you access to music held on DLNA servers like Minim, Twonky and Linn's own Kazoo Server. "Virtually any digital format" can be enjoyed; as regards hi-res, PCM (up to 192/24) is catered while support for DSD material is imminent. If our listening session is anything to go by, Selekt DSM is a definite contender.

**Linn's power amp module is described as a "bridged Class-D amplifier...a bespoke design that provides maximum performance in minimum space and with minimum heat dissipation. It incorporates the DAC, which is built into a replaceable module.**

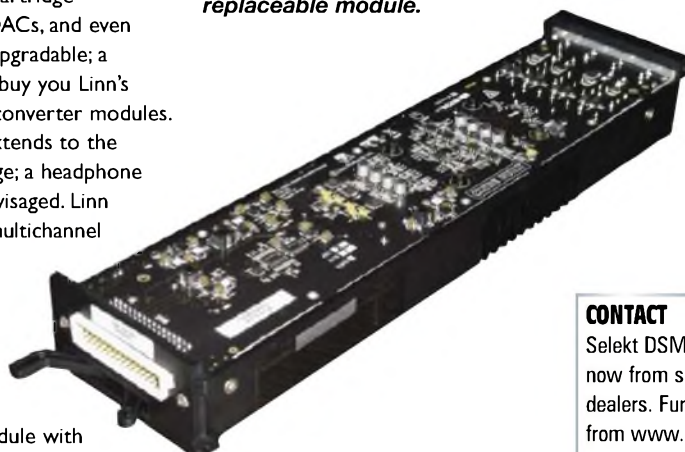

#### CONTACT

Selekt DSM is available now from selected Linn dealers. Further details from [www.linn.co.uk](http://www.linn.co.uk) or +44 (0)800 001 5111



## BREAKTHROUGH DIGITAL TECHNOLOGY

*Your music, unlimited*

With proven in-house expertise, our award-winning digital audio range continually breaks new ground. For over two decades, our proprietary DAC technology has been shattering convention with landmark products defining the digital audio landscape. Breakthrough limitation and listen with us.

[CHORDELECTRONICS.CO.UK](http://CHORDELECTRONICS.CO.UK)



# Hugo<sub>2</sub>



Chord Electronics Ltd.





# WIN

## ISOTEK'S SUPERB EVO 3 CORVUS MAINS DISTRIBUTION BLOCK WORTH £500 IN THIS MONTH'S GREAT GIVEAWAY!

[www.isoteksystems.com](http://www.isoteksystems.com)

**H**ere's your chance to win the superb Isotek Evo 3 Corvus mains filter unit we reviewed in the January 2018 issue. Read the review excerpt below and answer the questions.

"The Isotek Evo 3 Corvus is a multi-way power distribution block fitted with internal filters to reduce noise from the mains, that degrades sound quality. It has nine mains output sockets and can pass a maximum of 16A, although when plugged into a UK mains socket the limit will be 13A as set by the UK's fused mains

plug. That's still enough for any hi-fi and, for most systems, enough outlets too. The only niggle is that of wall-warts – always a difficulty. Those that extend above their mains plug cannot be accommodated if the opposite socket is used, except by one central socket. But at least it can accept one such wart, unlike many distribution blocks.

The case is strongly built, measuring 363mm long, 147mm wide not including small attachment lugs, and 46.5mm high overall. It has a brushed aluminium cover, steel base tray with lugs that allow screw fixing, and a three-pin socket providing

power input. The unit comes with a stoutly built Isotek Evo3 Premiere mains attachment cable 148cms (4.5ft approx) long.

Isotek use both common mode and differential mode filtering inside – to combat the two common forms of noise encountered. Common mode comes in on the cables from a noisy source, by the way, whilst Differential mode typically comes in over the air as transmitted interference, this stuff happening outside your home to dirty the incoming supply. A small blue LED shows when the unit is live".

For a chance to win this great prize, just answer the four easy questions at right. Send your entries on a postcard only, by 13th November 2018 to:

**November 2018 Competition,  
Hi-Fi World magazine,  
Studio 204,  
Buspace Studio,  
Conlan Street,  
Notting Hill,  
London W10 5AP**

### RULES AND CONDITIONS OF ENTRY

- ONLY ONE ENTRY PER HOUSEHOLD
- MULTIPLE ENTRIES WILL BE AUTOMATICALLY DISQUALIFIED
- PURCHASE OF THE MAGAZINE IS NOT A PRE-CONDITION OF ENTRY
- NO CORRESPONDENCE WILL BE ENTERED INTO
- THE EDITOR'S DECISION IS FINAL
- NO EMPLOYEES OF AUDIO WEB PUBLISHING LIMITED, OR OF ANY COMPANIES ASSOCIATED WITH THE PRODUCTION OR DISTRIBUTION OF THE PRIZES, MAY ENTER

### QUESTIONS

#### [1] The internal filters -

- [a] reduce mains noise
- [b] make better coffee
- [c] purify the air
- [d] prevent dust entry

#### [2] How many sockets?

- [a] ninety nine
- [b] nineteen
- [c] nine
- [d] none

#### [3] For attachment there are -

- [a] glue pads
- [b] lugs
- [c] rivets
- [d] coat hooks

#### [4] What shows the unit is live?

- [a] red warning lamp
- [b] siren
- [c] flashing neon
- [d] small blue LED

**entries will be accepted on a postcard only**

**AUGUST 2018 WINNER: ROTH VA4 LOUSPEAKERS  
Mr. Colin White of Scotland**



*icon Audio*

# Summer Special Offer

## Buy one of these.....and get these for only £300!



Hi Fi World Valve Amplifier of the Year

Stereo 30se 28+28w £2,299

*designed by David Shaw*



Stereo 60 MK III 80+80w £3,449



Hi Fi World Valve Amplifier of the Year

Stereo 845 40+40w £6,999



MB90 MK II 115+115w £4,199



*Save £900 on normal price*

**MFV3 std MK II £1,199pr**

Take advantage of our unbeatable summer offer. Buy one of these award winning amplifiers and get a pair of MFV3 speakers for only £300 while stocks last.

These excellent floor standing speakers are specially designed to bring out the best of valve amplifiers as low as 10 Watts. Designed and manufactured "in house" using our own assembled drive units, using a simple crossover they are efficient and present an "easy load" to your amplifier. These speakers are guaranteed to make your valve amplifier sing! Or choose the MFV3 MK II Super upgraded model for £600 extra features include improved crossover and cabinet damping with options of cherry or walnut real veneer.

Size:105H x 23W x 30D 20kg (27 kg Super) ea. Offer also includes MFV3 MK II Super for £600 extra. Available from Icon Audio in Leicester and participating dealers in the UK only.

Limited offer whilst stocks last. You are welcome to phone or email us for more information or see our website. Brochure on request.

Audition our full range of amplification and speakers in our Leicester head office. (terms and conditions apply)



# Budget Belter



**NAD's new C328 integrated amplifier/DAC offers serious value for money, says Jon Myles.**

**N**ever let it be said that a customer doesn't know what they are getting with the NAD range of products. The company simply doesn't do flashy, look-at-me style hi-fi components – preferring instead to concentrate on the quality of internal components encased in no-nonsense, utilitarian-looking boxes but promising great value on a sound-per-pound basis.

It's been that way ever since the now legendary NAD 3020 integrated amplifier first hit the market way back in 1979. This was the amp that gave many listeners their first taste of true hi-fi as, while it looked rather basic, it performed better than anything else around at its price.

Times have moved on since then but the basic NAD ethos hasn't changed much in the intervening

years. Which is why the C338 integrated I reviewed earlier this year (Hi-Fi World issue August 2018) garnered a five globe rating. Here was a slim, powerful integrated amplifier (80 Watts into 8 Ohms and 110 Watts into 4 Ohms) which also included an excellent DAC, wi-fi and Bluetooth connectivity and built in streaming for the likes of Tidal and Spotify. It also boasted a smooth but punchy sound with plenty of detail – and all this for just £600. Really, there was little to criticise.

Now NAD have introduced the C338's little brother in the shape of the C328 – which shaves £100 off the cost but does, inevitably, sacrifice some features.

Style-wise the pair are almost identical, featuring the same compact chassis measuring 70mm x 435mm x 285mm which comes in NAD's

traditional matt black finish. The front panel is sparse with a small display screen, source select buttons, headphone jack, a Bass EQ switch and the volume control.

Round the back are two analogue inputs (labelled TV and Streaming for some reason) plus a third set of RCA jacks that feed the moving-magnet phono stage.

Digital sources can be connected to any of two coax or two optical inputs to make use of the in-built DAC, and there's also a Bluetooth aerial for sending music via your mobile device, tablet or computer.

What is missing, however, is the C338's wi-fi capabilities – so instead of the three aerials of that model there's the sole Bluetooth one.

Apart from that, put the two models side by side and it would be difficult to distinguish between them

# NOVAFIDELITY

## X45Pro

World-class streaming and digital audio conversion

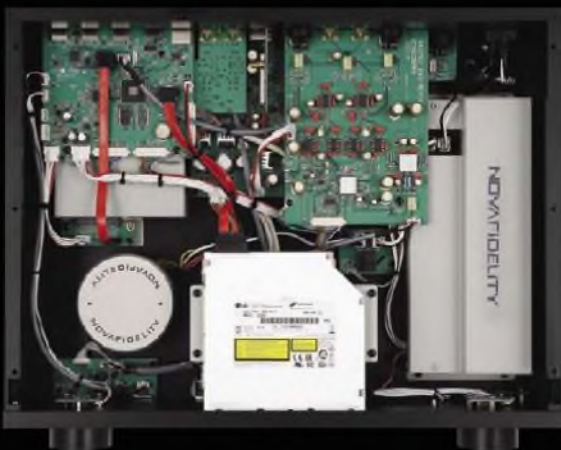

NovaFidelity's X45Pro builds on a range of generously specified streamers, bringing uncompromised audiophile design to their matured and easy-to-operate platform.

Using the SABRE PRO Flagship ES9038PRO DAC, OPA627BP Precision High-Speed OP Amp and specially isolated power circuits, the X45Pro is designed to be the world's highest performance multi-purpose music player, functioning as a DAC, vinyl/CD ripper, network streamer, recorder and much more.

It supports MQA, DSD512, DXD 24Bit/352.8Khz and PCM signals up to 32Bit/768Khz, in a full range hi-res audio file formats, as well as featuring built-in compatibility with TIDAL, Spotify, Deezer, Qobuz, Napster and Internet Radio (Airable). The X45Pro offers stunning audio quality from any source, is Roon ready, or can be controlled via the MusicX app for iOS and Android.

ROON  
ready



MQA



TIDAL

qobuz



Spotify



napster



DEEZER





(well, apart from the model number printed above the display). They also come with the same Amp 3 remote control – rather plasticky but does its job well enough.

Inside there's a switch mode power supply feeding NAD's customised version of the well-regarded Hypex UcD Class D module for a claimed 50 Watts per channel output – although our tests revealed rather more power on offer (see Measured Performance for full details).

Overall the NAD is decently built for the price with a solid construction but, on account of that Class D/switch mode supply design, does feel a little light, weighing in at a lift-friendly 4.9kg.

## SOUND QUALITY

I used the NAD with a variety of loudspeakers ranging from PMC's twenty5.26 floorstanders (see review this issue) to Spondor A1 standmounts and a pair of Neat Audio's fun little Iota Alphas with

"the necessary gruffness in Cave's voice to give the song the air of menace it deserves"

their revealing ribbon tweeter. All were connected with Tellurium Q Black II loudspeaker cables. Music was a variety of standard CD via an Oppo UDP-205 universal disc player plus high-resolution material into the NAD's optical inputs via an Astell&Kern digital audio player.

Starting with Elvis Costello And The Attractions' 'This Year's Girl' in 24bit/96kHz format the NAD has a nice, punchy quality to it. There's a tightness to the rhythm section and good detail on the guitar work. Best of all, Costello's nasal vocals sounded just right - a little edgy and angry yet devoid of harshness.

Moving on to Max Richter's 'Sleep' there was a dense quality to his piano notes while the electronic bass notes below displayed depth and presence. This is a melodic, brooding piece with a deep soundstage and I've heard other Class D amplifiers manage to make it sound rather dry and empty of atmosphere. Not so the NAD which relayed all the essential details yet without sounding mechanical.

Repeated listening on this track proved the C328 was an especially good match for the Spondor

loudspeakers. They don't have the overall bass response of the PMCs or the Neats but have a smooth character which suits the NAD well.

With Ravel's 'Daphnis Et Chloe' by the Chicago Symphony on CD through the analogue inputs the lush orchestration shone through. Individual elements of the ensemble were clearly delineated left and right and the scale of the piece made me turn the volume up in the large Hi-Fi World listening room. Throughout the amplifier kept a firm grip on the 'speakers and managed to go loud without sounding as if it was about to lose control.

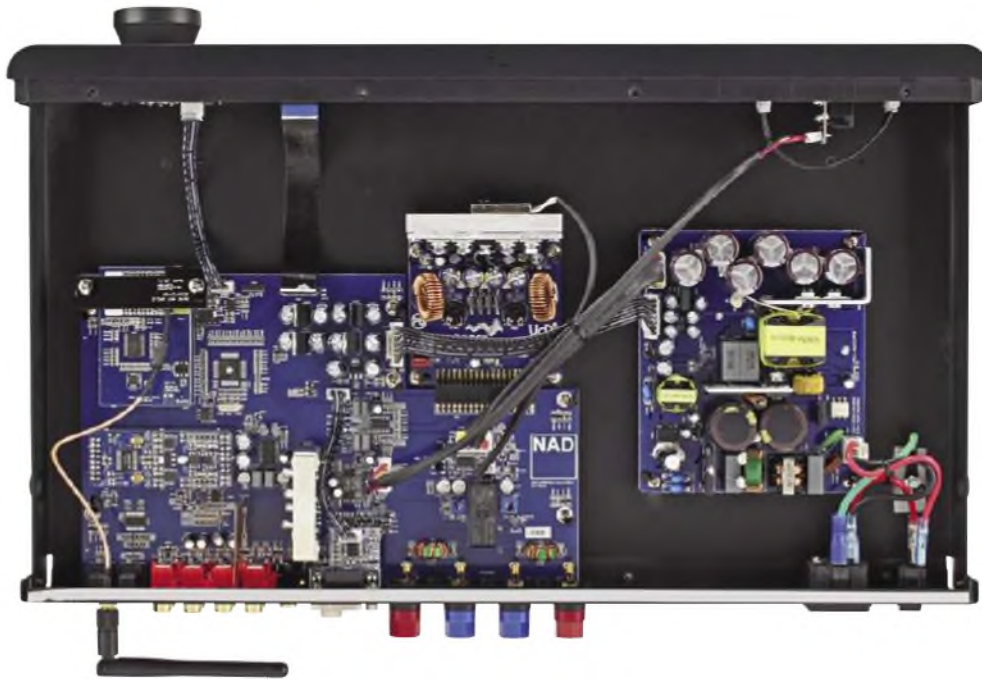

*Internally there's a switch mode power supply feeding NAD's customised version of the well-regarded Hypex UcD Class D amplifier module.*

The only thing missing was that extra element of subtlety and total grandeur a more expensive amplifier will bring – but for that you'd have to start looking at a more expensive product such as a Creek Evolution 50A (£799) which will give extra finesse.

Bluetooth also works well. Connecting to an iPhone 7 Plus, Nick Cave's 'Kindness Of Strangers' in Apple Lossless had a healthy degree of detail with a nice tonal balance to the piano and the necessary gruffness in Cave's voice to give the song the air of menace it deserves. Yes, it sounded better via CD through the Oppo – and even better on a 24bit/96kHz rip but the convenience of streaming via a 'phone or tablet is always a welcome addition.

Switching in the Bass EQ switch on the front, said to boost frequencies around the 80Hz range by 8dB – did bring a bit more low-frequency bounce to The Jam's 'A Town Called Malice' and New Order's 'Your Silent Face' but, I thought, at the expense of some natural flow to the music. That said, this could well be a useful feature



**Klipsch**  
REFERENCE

next generation

REFERENCE™

*series*

AVAILABLE NOW  
FROM JUST  
£220



*90° X 90° Tractrix Horn*



*Spun Copper IMG Woofer*



*High Quality Cabinet Design*

Klipsch's exclusive Tractrix® horn technology delivers the power, detail and emotion of the live music experience with the cleanest, most natural sound possible.

Injection Molded Graphite (IMG) woofer cones are exceptionally light while being extremely rigid - providing remarkable low frequency response, with minimal cone breakup and distortion.

The Reference Base range features a beautiful durable build, including scratch-resistant ebony wood grain vinyl, reinforced MDF and exposed fasteners for an industrial aesthetic.



Distributed by Henley Audio

T: +44 (0) 1235 511 166 | E: sales@henleyaudio.co.uk | W: www.henleyaudio.co.uk





The rear of the NAD includes a Bluetooth aerial as well as digital and analogue inputs.

with some smaller loudspeakers.

Whether the Bass EQ is used or not, I found the NAD C328 a thoroughly engaging listen throughout. It is smooth sounding yet punchy with the sort of presentation that sorts all genres of music; never imposing too much of its own character on individual tracks and so letting the instruments flow in a natural way. Add in its compact chassis and value-for-money price and NAD look to have created another budget winner here.

**CONCLUSION**

The NAD C328 is the very essence of good hi-fi on a budget. It brings

together a sweet-sounding amplifier, well-refined DAC and Bluetooth in a fuss-free package and all for just £500. The only caveat is that for £100 more the C338 gives extra options in terms of wi-fi and streaming and so offers a more comprehensive package. But, if you don't need those options, then go for the C328 and spend the £100 saved on more music!

**NOEL SAYS -**

Just look at our internal shot – there's nothing there! It isn't a good ol' analogue NAD of yore as we once knew them and used them – full of large analogue bits – but a hard up-to-date technology box that punches using digital instead.

The compact and light C328 doesn't use a classic all-analogue amplifier with big transformer and power supply. What you get is a small switch-mode supply powering NAD's Class D output stage. A key difference is NAD feed digital in through software conversion from PCM to Class D switching (not strictly digital). This gives very high quality from digital inputs – something I heard by a subtle lack of the dimensional flatness and lack of contrast in tonal colours from the C328. It had better resolution of the depth plane and stronger resolution of instrumental timbre as a result than so many rivals.

**MEASURED PERFORMANCE**

Power from NAD's C328 measured 60 Watts into 8 Ohms and 80 Watts into 4 Ohm – seemingly not high power but plenty enough for very high volume from modern loudspeakers of 87dB sensitivity or more.

Frequency response measured flat from a low 3Hz up to 44kHz through the Line inputs (TV etc) and there's no sign it passes through an ADC as in other NAD amplifiers, roll off being slow and extending well past 200kHz.

Distortion was very low from low to high power and right across the frequency band. The critical 1W at 10kHz test – a measurement of crossover distortion – produced just 0.007% into 4 Ohms, meaning the NAD will have smooth treble. The NAD offers sophisticated Class D.

The digital inputs (S/PDIF), including the optical input, accepted 192kHz sample rate PCM, frequency response measuring flat to 40kHz with a slow roll off to the upper 96kHz theoretical limit. Distortion from 24/96 hi-res PCM measured a low 0.027% and EIAJ Dynamic Range was commensurately high at 118dB. In all this suggests very high quality digital

lacking compressed depth perspectives – a papery quality.

RIAA equalisation in the MM phono stage was accurate and frequency response flat to 20kHz as a result. There is some warp filtering, roll off below 10Hz giving -7dB attenuation to warps at 5Hz. Noise was low at -82dB and overload high at 80mV. Good all round.

Although not a high power amplifier spec. wise the C328 will still go very loud. It offers a fine measured performance all round with no limitations. The digital inputs in particular are ahead of most. **NK**

**AMPLIFIER**

Power	60W
Frequency response (-1dB)	3Hz-44kHz
Distortion (10kHz, 1W)	0.007%
Separation (1kHz)	96dB
Noise (IEC A)	-105dB
Sensitivity	300mV

**DIGITAL**

Frequency response (-1dB)	5Hz-40kHz
Distortion (-60dB, 24bit)	0.027%
Dynamic range	118dB
Noise	-116dB

**PHONO**

Frequency response (-1dB)	10Hz-20kHz
Distortion (1kHz, 5mV in)	0.06%
Separation (1kHz)	68dB
Noise (IEC A)	-82dB
Sensitivity	4mV

**FREQUENCY RESPONSE**

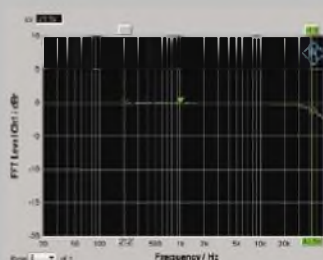

**DISTORTION**

THD+N	0.0073 %	Level/Ohm	2.0780 V	Frequency	10.000 kHz
CH	OFF				
DC	OFF				

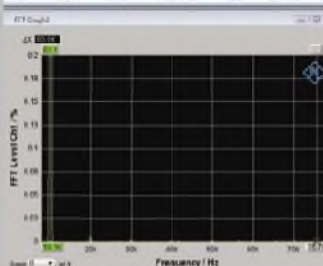

**NAD C328 £500**



**OUTSTANDING - amongst the best**

**VALUE - keenly priced**

**VERDICT**

It might look basic - but the NAD's sound is anything but. Smooth and authoritative with an impressive DAC and Bluetooth to boot.

**FOR**

- punchy sound
- impressive digital stage
- MM input
- Bluetooth
- price

**AGAINST**

- plasticky remote

NAD Electronics  
www.nadelectronics.com



SCANSONIC

AUDIO ANALOGUE  
soundpleasure

DECENTAUDIO.CO.UK



TEL: 05602 054669

EMAIL: INFO@DECENTAUDIO.CO.UK

AUDIO ANALOGUE - KRONOS AUDIO - MAGNEPAN - RIVA AUDIO - SCA





*Transfiguration*

**KRONOS**  
TIME FOR MUSIC™



**DECENT AUDIO**  
SOUND DISTRIBUTION

ANSONIC - TRANSFIGURATION - USHER - VAN DEN HUL - VELA AUDIO

# Mail



LETTER OF THE MONTH PRIZE

Visit our website at [www.hi-fiworld.co.uk](http://www.hi-fiworld.co.uk) or send your emails to [letters@hi-fiworld.co.uk](mailto:letters@hi-fiworld.co.uk). Letter of the month wins a pair of B&W P5 headphones.

Answers by: NK - Noel Keywood; JM - Jon Myles; PR - Paul Rigby; MP - Martin Pipe.



**B&W P5 HEADPHONES**  
[www.bowers-wilkins.co.uk](http://www.bowers-wilkins.co.uk)

For more advice see Letters from earlier issues at [www.hi-fiworld.co.uk/letters](http://www.hi-fiworld.co.uk/letters)

A pair of B&W P6 headphones are on their way to CHRIS CARTER, Letter of the Month winner in our OCTOBER 2018 issue.

## Letter of the Month

### FM SWITCH OFF

Just read the piece in the News section on FM switch off. Someone said a little while ago that DAB and FM could exist side by side, giving the listener choice, so what happened to this?

All I will say is that whilst DAB gives choice it doesn't give fidelity, so the listeners to DAB are not interested in fidelity one assumes. The music that some people listen to doesn't require fidelity anyway! Martin Pipe champions listening online, but given the issues I had recently – loss of the internet for several days – I was glad that I had FM.  
**Mike Bickley.**

Yes, there's still a lot to be said for dear old VHF/FM – and future choices available to users are unclear. As the BBC statement (March 2018) you sent as a link stated, DAB reception is patchy and erratic. You might get DAB upstairs but not downstairs and certainly not in a basement, the reason being it uses a shorter wavelength than VHF/FM making it more susceptible to screening, especially by buildings, hills etc. DAB in North London, for example, comes from Alexandra Palace and is virtually unreceivable in the radio shadow cast by a hill, in my

BBC Sign in News Sport Weather iPlayer TV Radio

## NEWS

Home UK World Business Politics Tech Science Health Family & Education

Entertainment & Arts

### BBC wants to keep FM radio for longer

19 March 2018

f Share



The BBC News article on VHF/FM referred to by Mike Bickley. You can find it at:  
[www.bbc.co.uk/news/entertainment-arts-43458695](http://www.bbc.co.uk/news/entertainment-arts-43458695)





**DAB in North London is transmitted from Alexandra Palace – but it doesn't get far!**

case Hampstead and St John's Wood overshadowing the low ground of Maida Vale – the transmitter being about 4 miles away. Meanwhile, I can get VHF/FM from Wrotham that is some 25 miles away. VHF/FM travels better and is more durable.

The usual solution for this is to install lots of small local transmitters to light up local areas, as in mobile 'phone networks. But it appears the DAB initiative has stalled, so the network isn't being expanded as far as I am aware. It may be that small local, DAB transmitters are technologically impracticable. The other solution of increasing DAB transmitter powers drastically also seems to have fallen onto fallow ground.

Bear in mind that DAB was an idea hatched up in Europe by the European Broadcasting Union a long time ago to serve their motorways. It used some natty spread-spectrum military transmission technologies but there was never any reference to sound quality. Digital in those days was simply perfect – no need for discussion. And so it was within that BBC statement from a speech delivered by Bob Sheenan, Director of Radio, in Vienna where he just re-iterated the same old, same old about number of channels etc. – a bit like a stuck gramophone needle.

Martin Pipe has a very good point about the quality of BBC Radio Three broadcasts at high bit-rate: they do give impressive quality. But the 'net is only as good as your local

telephone line – that last little bit of corroding copper – where VHF/FM is more durable.

Interestingly and pertinent to radio's future, it is possible to receive the internet in cars, courtesy of 'phone masts alongside motorways, making internet radio potentially a rival to DAB – which it would blow away. Internet radio has 10,000+ stations and some are very high quality. At present the limitation is cost of data over the mobile phone network.

Shameful the BBC statement should see only audience numbers, where in the real world quality is always an issue and usually a driving issue. But not in radioland where they steadfastly ignore it.

Behind the scenes there is confusion about the future of radio, as well as an unwillingness to accept that DAB is now a hopelessly outdated digital technology well past its sell-by date – unable to meet the requirements of the modern world. Worse, audience figures and influence are very low, making it unpopular with radio stations; some have shut down their DAB operations. VHF/FM has a vast installed base of regular listeners, making it commercially far more influential than DAB. DAB is a failure but no one can admit to it. **NK**

I would agree. I cannot understand why we can't be given the choice...of listening between FM and DAB - not least because millions of people will not appreciate being forced to replace their VHF radios following a Norway-style shutdown. The UK's VHF/FM transmitter network, construction of which began in the mid-1950s, reached maturity decades ago, giving coverage so much better than that of DAB.

Although the sound quality of FM broadcasting has plummeted since the late 1980s, courtesy of excessive compression and limiting, similar processing has been needlessly-applied to digital radio too. Mercifully, one broadcaster resisted these unwelcome changes; by far the best-sounding FM station in this country is BBC Radio 3. Even today, it can astound - despite being delivered to transmitters using an

archaic technology based on the very same NICAM that brought digital stereo sound to analogue TV.

It's good to know that, for the time being at any rate, we can turn to FM when Internet connections go flaky - whether this is down to problems like poorly-maintained overhead wires in your locality...or something far more serious. With gathering speed, the austerity-hit public is being forced - by businesses and governments alike - to rely on services that are being delivered exclusively online, as money can be saved. This blind acceptance is to me a matter of great concern,



**A modern budget Monitor Audio loudspeaker is the budget Bronze 2.**

in the light of cyberattack-related vulnerability. But let's end with a note of optimism. When it does work, streaming radio can work exceptionally-well; I still claim that the 320kbps AAC streams put out by the BBC represent - until the broadcaster comes to its senses, and implements a FLAC-streaming service of the sort that was trialled during the 2017 Proms - the best way of hearing Radio 3. And if you want a change from the Beeb, there are thousands of other Internet stations around the world to choose from too! **MP**

#### **MONITOR MADNESS**

*I wonder if you could help. I think I'm going mad. Well I am not – but anyway. Just the other day a work mate said to*

## EXCLUSIVE KEF R SERIES OFFERS

**KEF**



UP TO  
**40%  
OFF**

### BIG SAVINGS ON BRAND NEW BOXED STOCK

IN-STORE  
DEMOS AVAILABLE

R900	<del>WAS £2750</del>	NOW £2000
R700	<del>WAS £2000</del>	NOW £1200
R500	<del>WAS £1500</del>	NOW £1000
R300	<del>WAS £1000</del>	NOW £700
R100	<del>WAS £600</del>	NOW £420
R600C	<del>WAS £900</del>	NOW £600
R200C	<del>WAS £650</del>	NOW £460
R50A	<del>WAS £600</del>	NOW £420
R400 SUB	- £1000	

AVAILABLE IN GLOSS BLACK/WALNUT & WHITE GLOSS

PACKAGE DEAL



**KEF**  
ARCAM

SAVE  
**£600**

ARCAM SA10  
& KEF R100 SPEAKERS

**£999.00**

**KEF**  
marantz®

MARANTZ PM-14S1 SE  
& KEF R700 SPEAKERS

PACKAGE DEAL



SAVE  
**£1250**

**£2649.90**

CREDIT TERMS AVAILABLE SUBJECT TO STATUS. FREE FAST UK MAINLAND DELIVERY.



### Carlisle

The Maltings,  
Shaddongate, CA2 5TE

E: sales@petertyson.co.uk  
Mon - Sat: 9am - 5:30pm

**01228 546 756**



### Newcastle

Unit 6 Kingston Court,  
Kingston Park, NE3 2FP

E: sales@petertyson.co.uk  
Mon - Sat: 10am - 6pm

**0191 285 7179**



me he had some old hi-fi stuff and did I want to buy it? So we came to a price and the deal was done.

In that lot was a pair of Monitor Audio R252 'speakers so I decided to hook them up to my system – and that's where the trouble started; they sound better than my Quad 12Ls.

Now the Quads sound somewhat fuzzy in the bass and not as clear in the mid-range. When I first plugged in the Monitor Audios they sounded a bit quackey – but that seems to have gone now. I was just wondering if it was because the Monitor Audios are easier to drive.

My system comprises a Quad 303 (restored), Audio Experience Symphonies tube preamp, Nottingham Analogue turntable with Rega arm rewired, running a Goldring 1042 cartridge, Roksan Caspian DX2 phono stage. Cables are all Chord Company.

I listen mainly to punk, dance and prog rock with some heavy metal thrown in. Oh yeah! Marantz 6000 OSE KI CD player. Budget little as possible. Please push me in the right direction thanks

**Jez Dunn.**

Hi Jez. Monitor Audio loudspeakers have a reputation for being clear and fast in their sound, largely because of the metal cones. Their reflex ported bass is dynamically punchy, if not as well damped and even in its note handling than many – but this is less obvious subjectively than sheer bass exuberance. Listeners want obvious bass.

If you mean "quackey" as in a duck's quack – and I think you do – it's likely due to the suspension system freeing up after inactivity.

If you mean quackey as in earthquake then I would suspect you are hearing LP warps, because of low bass damping, but this would depend upon the LP being played. Watch the cones and see if they flap around.

If you are now a fan of the Monitor Audio sound then I suggest you look at their latest models, such as the Bronze 2 – just £280 – and a modern take on the company's sound. **NK**

## RELIABILITY

Due to my house sale and purchase dragging on and on (what are my solicitors using for their searches? Snails?) and Oppo sadly withdrawing from the hi-fi scene, I'm still looking around for a decent hi-fi that is also a surround sound system (but with audio a priority). My current favourites are the



**Technics built an enviable reputation for rugged reliability with their superb SL-1210 Mk2 Direct Drive turntable and capitalise on the value of quality engineering with the new SL-1200GR and its more expensive variants.**

Sony STR-DN1080 amp and their UBP-X800 universal player (I have DVD-As and SACDs).

However, reading Dave Tutt's piece in the Oct 2018 issue, I'm worried. If I do get the Sony amp, will it fail on me due to the components getting too hot and also poor/cheap soldering (neither of which I'd expect from such a high-profile brand).

Should I, after purchasing this amp, open it up and attach little heatsinks or heat pipes to keep the chips cool (affixed using thermal paste, like a computer CPU, of course), maybe add a slow-rotating (and therefore silent) fan to the case, and even get someone (like Mr Tutt) check the soldering for dry joints etc? Oh, there goes my guarantee...

However, the question is "why should I even be thinking this way about brand new kit in 2018? Is the modern stuff so badly/cheaply made that it only lasts a year or three, and then the customer is expected to dutifully trot off and buy new kit? I'm sure there are many examples of manufacturers who take pride in building long-lasting kit (I suspect the smaller ones, who are in it for more than the money), but Mr Tutt's article has set little alarm bells ringing. Am I too pessimistic? Is the age of quality well-made kit over?

I really hope Mr Tutt's experience with the Sony amp is a one-off and does not represent Sony (or, indeed, the industry as a whole overall, but if it is a trend, then I really want to avoid it as the kit I buy for the new house is going to have to last me years and years...

**Yours sincerely  
John Malcolm**

Hi John. Reliability is a complex and difficult subject. For a long time now circuit boards have been flow soldered in big machines, not hand soldered. I have never seen dry joints with boards so built. However, there can be a finishing process where large items are placed and soldered by hand and it is here that the possibility of dry joints arises. Now that lead based solders are not used it may just be that modern alternatives corrode or are less reliable. I find lead-free solder difficult to use in that it does not wet the joint well.

Technically, reliability has improved in both components and design techniques available to ensure stable long term behaviour.

Having said all this it is the case that products we'd expect to be reliable still do fail. I had a 28in Samsung monitor die on me recently after only a few years and, taking it apart, found the switch-mode power supply had collapsed. I got it up and running but to no avail, other chip packed circuits having failed too. The whole thing had to be binned.

So in spite of modern design and production techniques failure is still with us and I suspect it may well be down to components being too tightly specified to keep costs down, plus, in the background, the use of super-cheap components to shave costs to a minimum. Some of the damage I saw – resistors burnt out and a capacitor in pieces – told me no effective protection against failure mode, such as a fuse, had been used.

## Audiodesksysteme PRO Ultrasonic Vinyl Cleaner



**A new adaptor for cleaning 7" singles is now available for the updated PRO Vinyl Cleaner.**

This allows vinyl collectors to extract the full potential of improved sound from this format.

As well as being able to clean different sized vinyl, this latest generation cleaner is more efficient, more gentle, and quieter than before.

Visit our website for more information.

This contactless cleaning action removes more dirt than machines that rely on conventional suction methods.

A deliberately low energy ultrasonic generator enables maximum cleaning efficiency without potential damage to the LP surface.

Ultraclean grooves will extend stylus life.

Ultrasonically cleaned LPs have a much better sound, more than just the removal of noise. The sound has a larger soundstage, more detail, better tonal balance and greater dynamics.

Used LPs, previously cleaned LPs, and brand new albums all benefit from ultrasonic cleaning.

A completely automatic cleaning and drying cycle of 6 minutes results in an ultraclean LP.

More than a cleaning machine, an essential component.

4 colour options available: grey, black, white and red. £2525.

Please contact us for your nearest dealer.

Apart from the removal of loose particles, it's the *embedded dirt* that has, up until now, never been removed, and has proven resistant even to an expensive record cleaning machine. This is a true first for record cleaners. This, in vinyl terms, is revolutionary.

Paul Rigby – The Audiophile Man, Dec 16



I got the feeling of circuit blocks strapped together in a devil-may-care attitude, possible due to time / cost constraints.

Since the Far East's renowned electronics sub-contractors are used by all the big names, we are all faced with this and have to accept the consequences. It is a good argument for staying with UK hi-fi's well known brand names: Chord Electronics, IAG businesses including Quad, Audiolab, also Cambridge Audio, Arcam and others. They all maintain standards and have UK service departments.

"Kit lasting years and years" is not what the industry wants, although no one will admit this. It wants steady or increasing sales turnover. That means regular replacement of items. I remember the head of Mission bemoaning to me long ago: "we make our loudspeakers too well; people use them forever". At this level quality doesn't pay; low price gets sales and it stimulates



**An in-line fuse can be soldered into K5881 to provide further protection of the output transformers, should a valve fail.**

For kit that lasts years and years I'd suggest you be careful about what you buy and where from. Well known British brands value their reputation and do, I believe – from visiting their factories and meeting them personally – offer best long term reliability. **NK**

despite reading the article many times. I also did not need the big increase in input sensitivity.

I have been a reader of HFW since Oct 1992 tho I now struggle with the very complex digital audio.

Yours  
**Roger Chesher.**

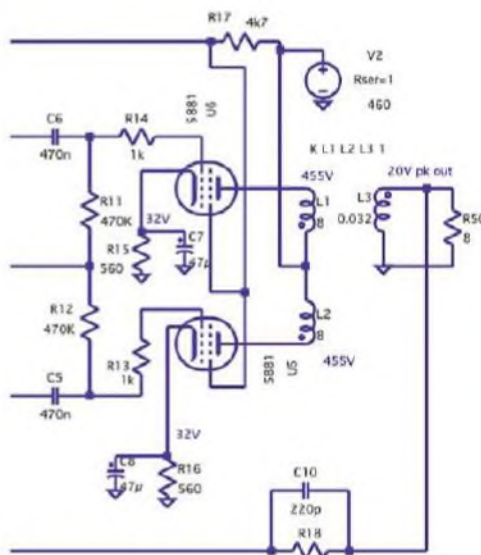

**WAD K5881 output stage.**

**A FUSE FOR WAD K5881**

I read with interest your mention of the above amp in the March issue. If and when you have added the HT fuses, would it be possible to pass the information on to your readers?, i.e. where in the circuit and type and size of fuses used.

My K5881 was built in 1995 along with a KLPP1 preamp and both have been in constant use ever since. I never upgraded

the amp to Mk2 spec as I never fully understood the benefits of doing so,

Hi Roger. The fuse should go in the H.T. feed (usually a red wire) to each output transformer primary (i.e. to its centre tap) using an in-line fuse holder to replace this connection (red wire). As each 5881 runs at 56mA, a 120mA fast blow fuse would be my starting point, increased to 150mA if it blows at switch on or off. This is unlikely however, as the HT line rises and falls slowly at both switch on and off, due to long PSU time constants and slow warm up of the valves.

The most suitable fuse holder I have found can be obtained from RS Components: it is a Littelfuse in-line holder rated at 500V, accepting small 5x20mm cartridge fuses.

If you built the K5881 then hopefully you know the HT line runs at 448V and is potentially lethal.

turnover. But we pay a higher price in the end perhaps. And of course this approach produces a lot of electronic waste, something both Dave Tiutt and Martin Pipe highlight in their analyses of product failure. Illuminating stuff.

I rather doubt Sony are any different from other major Far East manufacturers. I see the same background design approach where low price is all (their high-end Esprit line seems to have died). Only Technics make quality an issue with products like their new SL-1200 series Direct Drive turntables – but you pay. They are being undercut by no end of look alikes from Taiwan subcontractor Hanpin.

POWR-GARD® Fuseblocks

---

**IN-LINE GLASS FUSEHOLDERS**

150322

**Specifications**

Voltage Rating: 500 VAC 125 VDC

Ampere Rating: 15 A

Fuse Type: 10" x 10"

Fuse Clips: Tin plated brass

Wire: Black 18 AWG 150° C Stranded

Molded Body: Single piece thermoplastic

Flammability Rating: UL 94V-0

Approvals: UL Recognized (File No. E14771)

Environmental: RoHS compliant and Pb free

Storage Temperature: -40° C to 80° C

Operating Temperature: -55° C to 125° C

**A high voltage in-line fuse suitable for K5881 – or any valve amplifier.**

Come Together  
The Beatles  
FLAC 192 kHz 24 Bit

4/5

4:16

LUMIN

# LUMIN

THE  
AUDIOPHILE  
NETWORK  
MUSIC PLAYER  
FAMILY

S1/A1/T1/D1

NOW WITH NATIVE  
TIDAL SUPPORT



TIDAL

selectaudio<sup>®</sup>

Distributors of exquisite audio equipment

Tel +44 (0)1900 601954

WWW.LUMINMUSIC.COM

Come Together  
The Beatles  
FLAC 192 kHz 24 Bit

4/5

4:16

LUMIN



Ensure the amplifier is switched off and unplugged from the mains. There are 220K bleed resistors across the power supply capacitors for safety so there should be no danger here.

However, if someone else built the amp and left these resistors off, then the operation becomes dangerous. You should check HT with a 1000V multimeter first to ensure there's no charge on these capacitors. When de-soldering, use insulated snipe nose pliers and don't touch terminals if you can help it. Do not hold the metal chassis with one hand whilst working. Remove valves and ensure the chassis sits firm and stable before operating on it. Best to use a bright spotlight or an illuminated bench magnifier, available from RS Components, so you can see what you are doing and make good clean solder joints. Check them afterward.

The amplifier is fused with a slow blow 1.6A in the mains transformer primary, which is good enough. However, some users reported that where an output valve had failed catastrophically, the output transformer primary had been taken out. This suggests an incorrect mains fuse was fitted, since an output transformer primary cannot fail easily. Inserting a fuse in the HT feed to the will prevent this. Ensure the mains primary fuse is correct at 1.6A and not a 3A or such like thrown in for convenience.

And may your K5881 go on forever! **NK**

### WAD 4W AMPLIFIER

*This is a bit of a long shot. Back in 1993 I built two of the 4W SET amplifiers featured in the DIY section. These have proved very reliable until now. Unfortunately, one channel has gone down on one of them and it appears that the output transformer primary may have gone open circuit. I've contacted World Audio and Tim de Paravicini at EAR but neither can help with a replacement. World Audio could provide me with a contact at their transformer supplier but to avoid destroying a further transformer to reverse engineer it, it would help if I had some design data they could work from. Deep in your records do you have design info on this amplifier? Or even a spare set of transformers!*

*Any help gratefully received as these amps sound great and have been the mainstay of my system since I built them. Thanks.*

Regards,  
**Steve Shield**



**The small but lovely sounding World Audio Design 4W amplifier. "These amps sound great and have been the mainstay of my system" says Steve Shield.**

Hi Steve. I am sorry to say we hold no old product data or parts. It was the property of the company and passed on at its sale. Also, Tim's design info was sent direct to the transformer manufacturer, as you might expect – but they closed down some time ago. Both Tim and Andy Grove were very secretive about their transformer designs, by the way, since the way they were layered and segmented, and the segments combined to reduce leakage inductance and capacitance, was a commercial secret of some value. A dark art!

You seem unsure the transformer has actually failed. To check simply measure the primary for continuity using an ohmmeter. Read the safety

info in the previous letter about this first. If it has gone open circuit then it can be removed and used as a unit for 'reverse engineering'.

Now, pondering on this I recall Tim and Andy worked with Morite of Cambridge, who I once visited about our trannies. The reason being Grant Armstrong at Morite knew a lot about the difficulties behind winding a high quality audio transformer, a lost art elsewhere, making Morite the best of all. I now see Amethyst of Cambridge have revived the Morite brand ([www.amethyst-designs.co.uk/morite/](http://www.amethyst-designs.co.uk/morite/)) and its expertise, using Grant Armstrong! So here, I would suggest, lies your best starting point. An alternative is A E Sowter ([www.sowter.co.uk](http://www.sowter.co.uk)) based in Ipswich. They

**amethyst**  
Manufacture and design of transformers and wound components.

Amethyst Designs Ltd  
12/148 Viking Way, Doffers  
Cambridge, CB22 3EQ  
England  
Tel: +44 (0)1484 780400  
Fax: +44 (0)1484 789662

Amethyst Designs © 2018  
Manufacturer & design of transformers and wound components

Home  
Morite Transformers

**Transformers**

- ▶ Transimp
- ▶ Laminated <math>131\text{VA}</math>
- ▶ Laminated <math>18\text{VA}</math>
- ▶ Toroidal
- ▶ Ferrite core
- ▶ PCB mounted
- ▶ Self supporting coils
- ▶ Morite
- ▶ Custom design
- ▶ Full Product range

**Amethyst**

- ▶ The Team
- ▶ Records
- ▶ Our news
- ▶ Going green
- ▶ Product Enquiry
- ▶ Contact

**Further Info**

- ▶ ISO
- ▶ Terms
- ▶ ICWA Members
- ▶ Sponsorship
- ▶ Employment

**Morite Transformers**

Amethyst are delighted to announce that they are able to support the full range of Morite products and utilise the knowledge and skills of Grant Armstrong, formerly Morite General Manager.

We offer the following range of Morite products:

- Morite Laminated Transformers, Auto or sensing, single or three phase, single phase up to 500VA, three phase up to 1200VA. These can be - varnished, vacuum impregnated or encapsulated.
- Morite Toroidal transformers up to 800VA.
- Morite Ferrite Transformers and Inductors.
- Morite High Voltage Transformers up to 20KV.
- Morite High Power Ferrite Transformers and Inductors.
- Morite High Frequency Transformers and Inductors.
- Morite Specialist Wound Products (including voice coils, air core coils, ferro coils, self bending coils and specialised windings to suit customers' specifications).

For more information please do not hesitate to contact one of our sales team by either **submitting the enquiry form**, email, telephone or fax.

**Amethyst transformers of Cambridge may be able to fix or build a transformer for the WAD 4W amplifier of Steve Shield.**



# REMOVE ALL CLICKS AND POPS



## What is SugarCube™?

Everyone wants their record collection to sound the best it possibly can. But be it too many playbacks, parties or simply just wear and tear, records can become impossible to enjoy due to unwanted noise in the form of clicks and pops.

The SugarCube™ is a line of all-in-one vinyl noise removal components. The SugarCube SC-1 is the first audiophile-grade product to enable non-destructive click and pop removal on any vinyl LP record in real-time.

**Try it now at your local hi-fi dealer!**







**The Cambridge CXN is a streamer that would suit  
Jean-Christophe Xerri, Australia.**

too have great audio transformer expertise. I wish you success. **NK**

**HEAT FAILURE**

After nearly ten years of very good service my Audiolab 8200CDQ, which I bought following your advice, is going bizarre: first the CD player failed to be consistent depending on the outside temperature and now the preamp or DAC left channel is producing distortion. As I live in Australia it might not be a good idea to send it back to UK for service but better to buy a new device that does the same things: playing CDs, DAC with S/PDIF optical and electrical input if no CD player, asynchronous USB input able to receive 32/192 PCM and DSD, at least one analog input and, icing on the cake, audio streaming including hi-res.

As far as sound quality I cannot go under what the CDQ offered me and this is a priority. As far as budget the best value for money would be the next priority. As CD players are becoming rarer I could do without by buying a cheap old one with a digital output.

I don't know if the system around is of any importance: - sources: NAS, computer from which I mix and edit my recordings, digital radio, turntable + mic preamp + digital EQ - soundcards: Lynx TWO-B, ESI Juli@ and CDQ usb - cabling: balanced XLR between Audiolab CDQ and amps - amps: main: McChanson parallel 6AS7/5998; secondary: battery powered Altman BYOB - speakers: Spatial Hologram I with Mark 2 crossovers. Hope you can help.

Cheers,

**Jean-Christophe Xerri  
Australia**

Er – yes, that's a lot of things for one box to do. But there are some

options. One is the Cambridge CXN that has all you list, except CD play: streaming from Spotify Connect, Airplay, Internet Radio, NAS Drive/UPnP compatibility, asynchronous USB, Coax and TOSLINK digital inputs, DSD64 support and AptX Bluetooth with an additional BT100 receiver.

To this you would have to add a CD transport, in the form of a player with a digital output as you suggest, or an external DVD/CD drive with S/PDIF digital output, so you can play CD and Cambridge also make a matching transport. I hope this helps.

**NK**

**NEAT NEATS**

In my living room I am using my 1990s old Denon PMA 350 amp and just bought some Neat Iota 'speakers. I have connected them to my TV box and DVD. I was really surprised just how good it sounds, especially with music on the TV. With a £2k budget I am now considering one of these options:

a) Chord Hugo TT DAC for the Denon amp, for headphone use, Bluetooth, and to improve the

TV sound. I love the flexibility. I could use also the Hugo for my main Naim and vinyl system in the back room.

b) Get the top Naim DAC (£1k used). But my dealer says everyone always buys a Chord DAC because its sounds better than the Naim and is cheaper (new prices).

c) Replace the Denon amp with the new Naim Atom instead? (I do have a Naim Qute2 in the kitchen driving Harbeth P3esr which sounds great & is a lot of fun).

Your opinion please.

I have listened to every decent make of 'speaker available in every decent hi-fi shop in South Yorkshire and Nottinghamshire. I have the Harbeths as already mentioned and also a pair of Wilson Benesch Arcs. It really amazes both these speakers don't seem to get much recognition that they deserve. I have spent hours and hours demoing different speakers. For my money both these speakers easily out shine everything for their price points.

I would like to upgrade my Ortofon Kontrapunkt b cartridge to a Cadenza Bronze or Cadenza Black for my Gyro Dec. But I really cannot see the performance v cost being worth it?

Thank you

**Stuart Simpson**

Hi Stuart. Your Denon amp is a bit long in the tooth. A Naim Uniti Atom streamer all-in-one would bring you right up to date, giving a wonderfully firm sound.

Upgrade the Kontrapunkt b to a Cadenza Bronze or replace with a budget moving coil instead, such as a Benz Micro Ace. **NK**



**The Naim Atom streamer  
does it all, and has a 40  
Watt amplifier option.**

# HI-FI WORLD

AVAILABLE

ON THE APP STORE

App Store > Entertainment > audio web publishing ltd

## Hi-Fi World

audio web publishing ltd

Details Ratings and Reviews Related

Screenshots

Offers In-App Purchases

This app is designed for both iPhone and iPad

Rating 4.4

### TOP IN-APP PURCHASES

1. Hi-Fi World Dec 2015	£3.99
2. Hi-Fi World Subscription	£8.99
3. Hi-Fi World August 2015	£3.99
4. Hi-Fi World September 2015	£3.99
5. Hi-Fi World June 2015	£3.99
6. Hi-Fi World May 2015	£3.99
7. Hi-Fi World December 2015	£3.99
8. Hi-Fi World February 2015	£3.99
9. Hi-Fi World November 2015	£3.99
10. Hi-Fi World December 2014	£3.99

LINKS

Privacy Policy

© 2014 Hi-Fi World

### Description

Hi-Fi World brings you the best hi-fi...from around the world!

- We listen and measure products in depth, at our London offices.
- Expert opinion from a team of renowned writers, musicians and engineers
- International standard measurements using Rehe & Schwarz test equipment...

### Information

Developer	audio web publishing ltd
Category	Entertainment
Updated	7 Dec. 2014
Version	1.0
Size	9 MB
Rating	Rated 4+
Family Sharing	Yes
Compatibility	Requires iOS 5.0 or later. Compatible with iPhone, iPad, and iPod touch.
Language	english

### Table of Contents (November 2018)

Page	Review Title
45	CLASSIC GUSTAV DAC
27	BRUCE SWINBURN HEADPHONE
82	SONO SEASIDE SYSTEMS
90	CONRAD JOHNSON POWERING
15	DAVID TOULSON PREDATOR

DOWNLOAD OUR APP ON APPLE AND ANDROID  
DOWNLOAD FROM iTunes OR GOOGLE PLAY

iPad, iPhone, iPod, Tablets **OUT NOW!**



# Qutest expression

**Take one Chord Hugo 2. Strip off battery, Bluetooth and headphone amplifier. Shrink what's left. The result? A damn fine DAC, reckons Martin Pipe.**

One look at the Qutest DAC shows we're in Chord Electronics territory. Its exquisitely machined aluminium casework, minimalist controls, clever use of coloured LED illumination and BNC sockets are all trademarks of this very British of brands. Indeed, in terms of shape and size the Qutest is redolent of the ground breaking Chord Mojo – that's put on weight! Bigger than a Mojo it may be, but the Qutest is nevertheless compact when compared to rival DACs. You don't get the cheaper Mojo's headphone amplifier, or for

that matter its integral battery power supply aimed at portable use. The Qutest is intended for home-use.

A more apt comparison could be made with the Mojo's bigger brother – the Hugo 2. As DACs they are close in terms of their specifications and operational considerations. Both rely on similar permutations of Rob Watts highly-innovative Watts Transient-Aligned (WTA) algorithms. In both cases no fewer than 49,152 of the constituent Finite Impulse Response (FIR) filter taps can be run on the Xilinx Artix 7 FPGA chip at the heart of the DAC's circuitry. Chord Electronics has however saved money

by making the Qutest a pure DAC that sits between your digital sources and amplification. There's a micro-USB port but this powers the unit via a supplied 'wall-wart' mains supply.

In connectivity the Qutest has two BNC inputs and an optical connector for conventional sources, computer connection being via an asynchronous USB port. The BNCs can automatically join forces for 'dual-data' compatibility with Chord's innovative Hugo scaler and future products that make use of this proprietary high-speed digital audio interface. Sources are selected by a spherical Input button set into





Order by phone on  
+44 (0)191 259 0700  
or  
Online with Paypal or C/Card

### **Sounddeck PM Platter Mat £90**

Available in 295mm, 292mm or 285mm sizes to fit most turntables the Sounddeck PM converts vibrational energy into heat and so minimises interference from feedback and rumble - allowing your cartridge to track information in an LP's grooves with greater accuracy bringing enhanced detail across the frequency range.



### **Sounddeck DPS Damping Puck £90**

The 500g SDS damping puck is immaculately machined from two pieces of stainless steel, it's bonded together with a thin layer of sound-absorbing polymer forming a constrained layer. It sits firmly over the top of a turntable's spindle - holding the vinyl securely to the platter to extract a larger soundstage, firmer bass and extra detail. There's also an aluminium version which weighs 152g.



[www.sounddeck.co.uk](http://www.sounddeck.co.uk)



the front edge of the control panel. There's no remote control and no Bluetooth wireless link.

The USB input can accept PCM audio with 32-bit resolution at a staggering 768kHz sampling rate. Is anybody releasing music in this wonderfully OTT form? The drivers you'll need for Windows PCs are available from the Chord Electronics website – Macs and Linux machines don't need such software. The optical input supports PCM sources of up to 24/192 they claim, covering all commercially-available PCM content, and DSD64. Using a coaxial input ups the respective limits to 384kHz and DSD128.

All digital inputs support DSD digital via DoP (DSD-over-PCM). If you're using a PC then DSD512 content is within your grasp in 'native' ASIO mode (the limit is DSD256 with DoP).

As with other Chord Electronics products, LEDs visible through a 'viewing glass' set into the top change colour to indicate the sampling rate of the incoming signal. This can be a great troubleshooting aid, as any unwanted resampling by your source can be revealed! The Qutest's light-show can be quite noticeable in a dark room, but it can be dimmed down.

Analogue output is available on a pair of phono sockets – no balanced

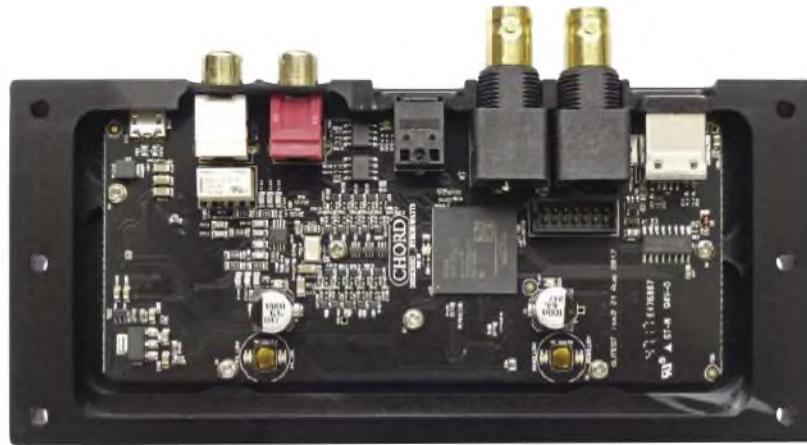

**Substantial machined casework and meticulous circuit board. An obvious part of the latter is the large FPGA chip on which Rob Watt's DAC is implemented.**

ensuring a good match with other equipment and consequently no 'jumps' in volume.

Another spherical button cycles through (with visual confirmation) the Qutest's quartet of digital filters, which are claimed by Chord to subtly-modify the tonal characteristics. In Chord's words, this is achieved "not by strictly applying an equalisation curve, but by changing the way in which the FPGA handles the data". You're given a choice between 'incisive neutral' (an ultra-linear frequency response, regardless of sample rate, with a 16Fs to 256Fs WTA2 filter), and Warm (adds 'warmth', courtesy of a 16Fs WTA1 filter). The other two are based on

256Fs is sixteen times that!

WTA and WTA2? Time for an explanation from Rob Watts: "In terms of core principle, there is no difference between WTA1 and 2, both using the same algorithm. WTA1 is input at 16Fs, while WTA2 works between 16Fs and 256Fs. However, the tap lengths are different and of course filter at different output rates. The sound quality is different with WTA2, allowing one to perceive the starting of notes properly - transient edges have more natural impact. Removing WTA2 makes the sound warmer. It is however incorrect to say that WTA1 is used for warmth - engaging the HF filter is instead responsible for that. WTA1 is actually what we called plain old WTA, before the flagship Dave came along. In the past there was only one WTA filter, but now there are two and so we need to distinguish between them".

## SOUND QUALITY

I relied on my trusty Arcam A49 and Quadral Aurum Wotan VIII floorstanders to turn Qutest output into listenable form. Sources included a USB-interfaced Windows 7 PC (running Foobar2000, suitably-configured), and Cambridge's CXN streamer. I also an Auralic streaming transport. The material played included lossless CD rips, DSD and hi-res PCM stored both locally and on a Synology RT1900ac network router with in-built NAS function.

I started off with Pye Corner Audio's atmospheric 2012 epic Sleep Games (CD rip), one of my favourite electronic-music albums of recent times. Its melodies, performed with analogue synthesisers, are dark and eerie yet beautiful and catchy. The Qutest proved capable of conveying their texture and warmth,

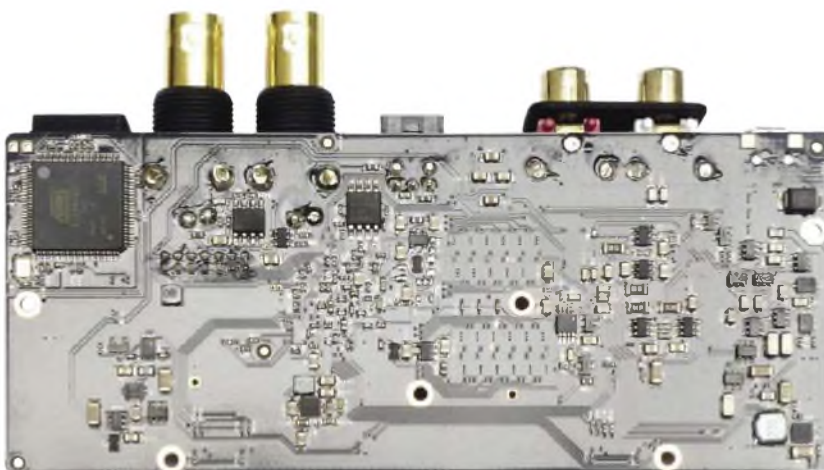

**Much of the circuitry is associated with the all-important Xilinx FPGA chip. A 32-bit ARM-based Atmel microcontroller looks after the Qutest's operation, and provides its USB interface.**

XLR output is provided. There's no continuously-available volume control, as there is on the Hugo 2, meaning that the Qutest cannot drive power amps or active speakers directly. However, its output can be cycled between 1V, 2V and 3V RMS,

these, but with HF filtering that rejects anything above 20kHz "to remove high-frequency distortion and noise" from high sample-rate PCM recordings. 16Fs, by the way, means 16 times the sampling frequency e.g., 705.6kHz for 44.1kHz-sampled CD.

THOUGHT **YOUR HI-FI SYSTEM** COULDN'T BE **IMPROVED?**

THE  
**CAD** GC1/GC3



INVEST IN ONE OF THESE BLACK BOXES AND **BE AMAZED**

JASON KENNEDY (**THE EAR**)

I CONSIDER THEM **INDISPENSABLE**

ROY GREGORY (**THE AUDIO BEAT**)

**10/10**

PAUL RIGBY (**THE AUDIOPHILEMAN**)

VISIT [MCRU.CO.UK](http://MCRU.CO.UK)

FOR MORE DETAILS

**mcrw**





**Digital input (S/PDIF) is via gold plated BNC connectors, rather than the usual RCA phono sockets, so BNC terminated connecting leads are required. Otherwise socketry is conventional, except that the micro-USB socket at right is a power input only.**

drawing me into the recording's distinctive yet nostalgic-drenched sonic world. With this music, I found that the 'warm' filter settings were preferable.

When listening to more percussive music of this genre (Kraftwerk Tour de France Soundtracks, for example) though, the 'incisive' filter seemed a better match; here, the agility and timing of the Qutest were brought to the fore for tracks like Étapes 1 to 3. These and other electronic tracks – among them Palace Posy, from Board of Canada's Tomorrow's Harvest – also revealed that the Qutest's low-end is musically-articulate, tightly-controlled and in the correct proportion. Bass guitars (as heard on Nick Lowe's So It Goes and Fela Kuti's Coffin for Head of State, amongst other CD-sourced tracks) also benefited from the depth and impressive definition of which the Qutest is capable.

And so to something completely different – Emily Palen's Glass (Blue Coast Records, DSD64). This 'straight-to-DSD' recording of a solo violin performance took place in San Francisco's Grace Cathedral. Heard via my PC, the track Light in the Fracture bristled with vitality, dynamism and subtle detail (like bow noises) while the instrument's timbre was delivered with natural richness – and I could distinguish the signature of Michigan-born Palen's violin from another.

Space was also conveyed well by the Qutest, a definite sense of the cathedral's acoustic ambience being imparted via my speakers. I preferred the 'warm' filters here, but your preferences may differ – much depends on the equipment you'll be using with the DAC. On which subject, I could hear a difference between the Auralic and Cambridge transports, the former sounding perceptibly more 'open' – such is the

Qutest's resolving power.

Stronger musical forces are also within the Qutest's grasp, as a 1987 Naxos recording of Mussorgsky's Pictures at an Exhibition (Slovak Philharmonic/Daniel Nazareth, CD rip) amply demonstrated. Here I could pick out individual orchestral textures and hues. There was a wonderfully organic flow to the music, coupled with an effortless

drive that lesser DAC technologies find difficult to match.

Qutest shines with more modern hi-res PCM material too. With the Nosedá/LSO performance of Britten's War Requiem (24/48) the energetic brasses, foreboding strings and massed choirs were given sufficient dynamic room to impart the recording's sheer scale. Yet there was just as much detail here as in the quieter sections – where the solo instruments, operatic vocalists and (especially) subtleties like decay of the bell were handled with panache.

**CONCLUSION**

Once again, Chord has come up with a desirable DAC that combines elegant design, future-proofed technology and a stunning performance that will do justice to any music you care to feed it. If your budget can't quite stretch to the Hugo 2, the Qutest will give you its core features and exquisite sound quality for £600 or so less.

**MEASURED PERFORMANCE**

Frequency response of the Qutest reached 46kHz (-1dB) before rolling off to the upper theoretical limit of 96kHz, our analysis shows, with 24/192 digital PCM data and the 'Incisive Neutral' (white) filter. The 'Incisive Neutral HF roll-off' (green) filter curtailed the response significantly, imposing a 20kHz (-1dB) upper limit – relatively low and just audible in its softening effect, with both hi-res and CD.

The 'Warm' (orange) and 'Warm HF

**FREQUENCY RESPONSE**

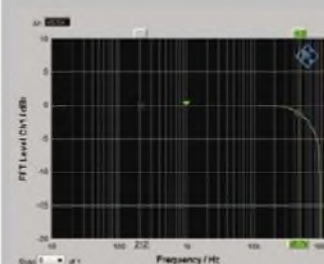

**DISTORTION**

THD+N	0.0123 %	Line IN	2.0227 mV	Frequency	99700 Hz
Out	OFF	Out	OFF	Out	OFF

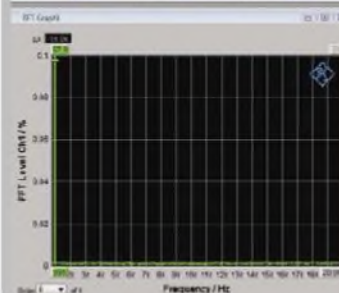

roll-off' (red) filters gave the same frequency domain results as the Incisive Neutral filters and are likely to sound similar, but without an oversampling stage Chord Electronics say they will have "warmth".

Whilst the BNC electrical inputs worked at 192kHz sample rate the optical had a 96kHz upper limit, becoming intermittent according to plug alignment at 176.4kHz and 192kHz where nowadays most products do not our tests show.

Distortion was extremely low, measuring just 0.013% (-60dB, 24bit), our analysis showing only a little noise. This resulted in a class leading EIAJ dynamic range value of 124dB – better than all else except top ESS DACs costing much more.

Output measured 3V maximum (1V and 2V options exist). The Qutest offered best results at 3V since this raises signal above output amplifier noise; it was tested at this setting.

The Qutest is simple – but sets measurement standards. The only problem is an optical input with a 96kHz sample rate limit. **NK**

Frequency response	4Hz- 46kHz
Distortion (24bit, -60dB)	0.013%
Separation	101dB
Dynamic range	124dB
Noise	-122dB
Output	1V / 2V / 3V

**CHORD QUTEST**  
**£1195**



**OUTSTANDING - amongst the best**

**VALUE - keenly priced**

**VERDICT**  
Another winner from the Chord Electronics stable...

**FOR**  
- insightful and musical  
- future-proofed compatibility

**AGAINST**  
- no Bluetooth  
- no remote

Chord Electronics  
www.chordelectronics.co.uk  
+44 (0)1622 721444

# the magnificent SCHEU CELLO

Scheu Cello Turntable + Rega 205 Arm + Ortofon MM Super OM10 Cartridge  
RRP: £1,490

Hi-Fi World Introductory Price: £1,290  
0% Interest-Free Credit Available



*“Scheu’s smallest deck offers attractive modern cosmetics, flawless finish and sonically inherits certain gifts from the dearer Premier model. The Cello clearly is no poor man’s job. Quite to my surprise, I was particularly impressed with the stock accompaniment of Rega 250 arm and Ortofon’s MM Super OM10.” - Ralph Werner, 6Moons Review*



Contact us for more information  
01334 570 666 / [www.eliteaudiouk.com](http://www.eliteaudiouk.com)



# All power to you!

**Martin Pipe tries out Isotek's no-expense-spared EVO3 Ascension mains cable – price £2750!**

**T**here is considerable interest in well-engineered mains cables, despite the simple fact that hundreds of miles of utilitarian (i.e. non-audiophile!) cable and transformers may lurk between the power station and your mains outlets. As with mains regeneration, though, there can be an audible effect. Some of these mains cables, which are designed to replace the cheap ones bundled with your equipment, are fairly inexpensive.

Not so the purple-coloured Isotek EVO3 Ascension, a 2-metre length of which will set you back no less than £2,750. It's terminated with a chunky bespoke Isotek IEC connector at one end, and an equally chunky Furutech 13-amp mains plug at the other (ours was fitted with what looks like a standard Bussmann 13A ceramic fuse). The 18mm-thick PVC-jacketed cable in between looks man enough to carry your entire street's current! According to Isotek, each of the three individually-insulated conductors within – earth, live and neutral – are pretty-sophisticated, as one might expect for the outlay...

They are "deep cryogenically-treated silver-plated Ohno continuous-cast copper conductors" of 4 square-millimetre cross-section, "wrapped in a dielectric of air, with partial FEP (fluorinated ethylene propylene, or 'Teflon') contact". A further "extruded FEP sleeve seals the construction; each of these

individual conductor assemblies being wrapped in Mylar, with a further OFC (oxygen-free copper) shield, before being given a slight rotational twist with FEP tubes of air". All clever stuff; Ohno, in case you're wondering, is the name of the Japanese professor who worked out how to manufacture the incredibly-expensive copper wire at the Ascension's heart.

And how does it perform? I used the highest-quality gear at my disposal – the Auralic G2 Aries transport, feeding a Prism Callia DAC and Focal Utopia headphones, plus revealing Quadral Aurum Wotan VIII loudspeakers. And yes, this cable does yield some subtle improvements when it comes to the timing and 'space' of hi-res audiophile material (among them superlative Blue Coast recordings like Emily Palen's *Light in the Fracture*, and Garrett Brennan's *Alta Powder Day*).

Listening very carefully I could hear the difference between plugging

the Ascension directly into a wall socket, and via an adaptor or distribution board (direct is better, natch). Likewise, when using the cable for the DAC or the transport; the former seemed to yield the most benefit.

To be honest, to truly make the most of the Isotek EVO3 Ascension you'd perhaps need equipment more revealing – giant electrostatics? – than I had at my disposal. And with that proviso in mind, I'd suggest to try before buying; it's state-of-the-art cable for state-of-the-art equipment.



**ISOTEK EVO3 ASCENSION**  
£2,750



**OUTSTANDING - amongst the best**

**VERDICT**

What a cable! What a price!

**FOR**

Perceptible improvements in resolution, space and timing.

**AGAINST**

Very heavy  
Very expensive!

Isotek  
[www.isoteksystems.com](http://www.isoteksystems.com)

# A LITTLE AUTUMN CHEER

VISIT OUR WEBSITE: [www.hi-fiworld.co.uk](http://www.hi-fiworld.co.uk)

**A SUBSCRIPTION TO HI-FI WORLD  
MAKES THE PERFECT GIFT FOR  
YOUR NEAREST AND DEAREST.**

**SAVE**

...up to

**26%**

Subscribe today and you will get a special discounted rate giving a **saving of 15% to 26%** off the cover price. That's an amazing **£3.83 - £3.33 per issue including postage.**



***So don't delay, take out a subscription today!***

FOR BACK ISSUES ENQUIRIES PLEASE CALL

**01442 820580**

OVERSEAS SUBSCRIPTIONS IF YOU LIVE OUTSIDE THE UK,  
PLEASE CALL FOR OUR LATEST PRICES

**+44 (0) 1442 820580**

**SO WHAT ARE YOU WAITING FOR? CALL NOW!!!**

**SUBSCRIPTION HOTLINE 01442 820 580**

Lines open Mon-Fri 9.00-5.00 or (weekend answering service available)

FOR OUR  
ON-LINE MAGAZINE  
GO TO [WWW.HI-FIWORLD.CO.UK](http://WWW.HI-FIWORLD.CO.UK)

email:  
[hifiworld@websubscribe.co.uk](mailto:hifiworld@websubscribe.co.uk)



# FROM HI-FI WORLD

## WHY SUBSCRIBE TO HI-FI WORLD?

- 12 issues a year delivered straight to your door.
- Be first to grab a bargain in our "Free Reader Classified Ads" section.
- Run by dedicated hi-fi engineers and enthusiasts.
- Subscribers receive a minimum 10% Discount annually.
- Hi-Fi World has become famous for its informative reviews and radical kit designs.
- **PLUS!** Subscribe by Direct Debit and receive a 16.5% discount on a yearly subscription (UK only).

### Instruction to your Bank or Building Society to pay by Direct Debit



Please fill in this form and send to:

Originator's Identification Number

Hi-Fi World, Subscriptions Department Unit 4 College Road, Business Park, College Road North, Aston Clinton HP22 5EZ

4	2	7	0	4	9
---	---	---	---	---	---

#### Name and full Postal Address of your Bank/Building Society

To: The Manager	Bank/Building Society
Address	
Postcode	

#### Name(s) of Account Holder(s)

--	--	--	--	--	--

#### Branch Sort Code

--	--	--	--	--	--

#### Bank/Building Society Account Number

--	--	--	--	--	--	--	--	--	--

#### Reference

HF
----

#### Instruction to your Bank or Building Society

Please pay Webscribe Ltd Direct Debits from the account in this instruction subject to the safeguards assured by the Direct Debit Guarantee. I understand that this instruction may remain with Webscribe Ltd and, if so, details will be passed electronically to my Bank/Building Society.

Signature(s)
Date

Bank and Building Societies may not accept Direct Debits Instructions for some types of accounts

**The guarantee should be detached and retained by the Payer**

#### The Direct Debit Guarantee

This Guarantee is offered by all banks and building societies that accept instructions to pay Direct Debits.  
 • If there are any changes to the amount, date or frequency of your Direct Debit Webscribe Ltd will notify you 10 working days in advance of your account being debited or as otherwise agreed. If you request Webscribe Ltd to collect a payment, confirmation of the amount and date will be given to you at the time of the request.  
 • If an error is made in the payment of your Direct Debit by Webscribe Ltd or your bank or building society you are entitled to a full and immediate refund of the amount paid from your bank or building society.  
 • If you receive a refund you are not entitled to you must pay it back when Webscribe Ltd asks you to.  
 • You can cancel a Direct Debit at any time by simply contacting your bank or building society. Written confirmation may be required. Please also notify us.



**TERMS & CONDITIONS:** You will receive 12 issues per year. Minimum subscription term is 12 months. Prices include P&P and are correct at the time of going to press. All prices are quoted in sterling. Offer available for UK subscribers, only. For enquiries relating to overseas pricing call + 44 (0) 1442 820 580.

I would like a years subscription to Hi-Fi World and receive a discount off the cover price (I have read and accept the terms and conditions).

I would like to pay for my 12 issues by:

6 monthly Direct Debit: Pay £22.00 every 6 months saving 19% off the yearly subscription rate of £54.00

Annual Direct Debit: Pay £40.00 every 12 months saving 26% off the yearly subscription rate of £54.00

Annual cheque/credit card: Pay £46.00 saving 15% off the yearly subscription rate of £54.00

**Cheques made payable to Audio Web Publishing Ltd.**

### Your Details

Title \_\_\_\_\_ Forename \_\_\_\_\_

Surname \_\_\_\_\_

Address \_\_\_\_\_

\_\_\_\_\_

\_\_\_\_\_

Post Code \_\_\_\_\_

Daytime Tel: \_\_\_\_\_

Email: \_\_\_\_\_

Please debit my  VISA  MASTER  MAESTRO  AMEX (SWITCH)

Security No:    (last three digits printed on the signature strip)

--	--	--	--	--	--	--	--	--	--	--	--	--	--	--	--	--	--	--	--

Valid from Date: \_\_\_\_/\_\_\_\_/\_\_\_\_ Expiry Date: \_\_\_\_/\_\_\_\_/\_\_\_\_

Switch card issue No:

Cardholder Signature: \_\_\_\_\_

### Outside UK:-

**EUROPE** Airmail **£50.00**   
**OVERSEAS** Airmail **£70.00**



## Send this form to:

Hi-Fi World, Subscriptions Department Unit 4 College Road, Business Park, College Road North, Aston Clinton HP22 5EZ



# Flying solo

**Martin Pipe revisits Arcam's laudable – but expensive! – take on the packaged home cinema system. It's a second hand bargain he says.**

**T**he 'Rolls-Royce' of its genre when launched in 2006, Arcam's Solo Movies 5.1 'home cinema hub' was a weighty (nearly 8kg!) item sold alone for a wallet-busting £2,000. A sum of this magnitude would have bought you a tasty 'separates' system with speak-

ers back then! Now, however, you pick one up super cheap second-hand, as I did.

This was the top model of Arcam's Solo range, which also included a CD-only model (the Solo Music) and a non-surround DVD model (the Solo Movies 2.1, meaning stereo speakers and an active sub).

And in spec terms, it stood out head and shoulders above the pack. It was the only model with a 'universal' disc transport, capable of playing SACD and DVD-A software in stereo or multichannel, as well as video DVDs, CDs, DivX video, surround-sound DTS CDs and MP3/WMA audio discs. The Solo has

a stripped-down version of the 'Zone 2' function built into many fully-blown AVRs. Here, the currently-selected source (not a different one) can be fed to an amplifier and speakers in an adjacent room. You do, however, get independent control over Zone 2 volume.

The Solo's radio tuner, at least on the UK version, is compatible with DAB as well as FM broadcasts although AM isn't catered for. Another demonstration to commitment to high-tech was the adoption of HDMI (High Definition Multimedia Interface), which meant better pictures on a new generation of digital projectors and flat panel TVs as video could be transmitted to them in uncompressed digital form. The unit made provision for the interpolated 'upscaling'

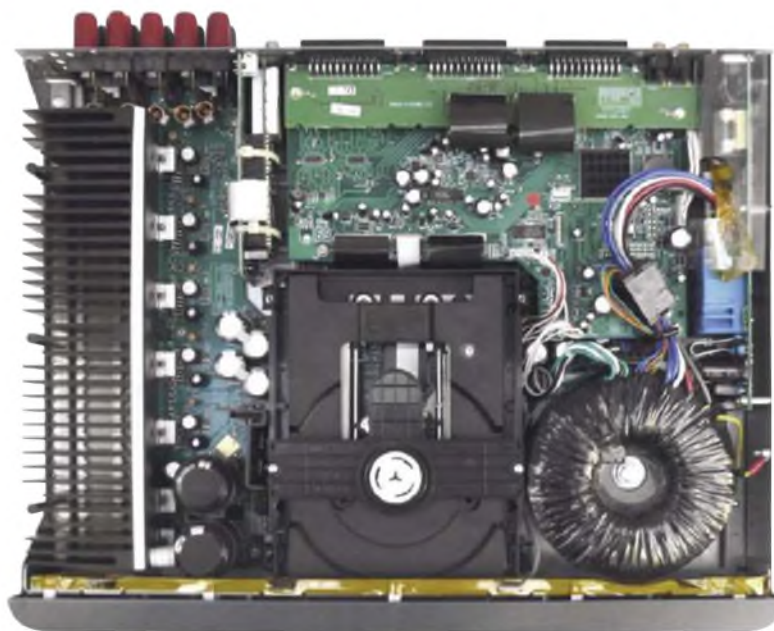

*Next to the DVD drive is an enormous toroidal mains transformer. To the left are the five TDA9293A Class AB MOSFET power-amplifier chips, mounted on a generous heatsink. There's no cooling fan, and so the Solo can get rather warm in use.*





**The Solo's DVD drive forms part of a sophisticated 'universal' player that's compatible with SACDs, DVD-Audio, DivX movie discs, MP3/WMA compilations, DTS CDs and regular audio CDs as well as video DVDs. This made the Solo one of the most sophisticated models around at the time. Laser failures are not unknown; fortunately, replacements are cheap.**

of (standard-definition) DVDs to hi-def 720p or 1080i. For those with old-school analogue CRT displays, though, a RGB Scart socket was offered. Two Scart sockets helped you integrate your other AV components (did someone say 'VCR?') into the system.

As most other systems of this type, the Solo contains amplifiers for the five main channels. They are in integrated-circuit form, if only to save space in a very busy chassis. Instead of the cheap (and usually mediocre) Class D chips built into most imported systems, Arcam's design team specified the 'hi-fi' TDA9293A - a powerful Class AB MOSFET device from ST Microelectronics - for each of its amplifiers.

The DVD chipset, meanwhile, is the Zoran Vaddis 8 chip that also graced Arcam's highly-regarded 'separates' DVD players of the time. The same is true of the Cirrus CS42528 multichannel audio DAC.

Providing radio functionality is a FM/DAB module from Radioscape - its 'software-defined' architecture was pretty clever stuff in 2006. Unusually, audio processing (volume and tone control) is carried in the analogue domain by a Rohm chip. This chip is also responsible for selecting analogue stereo sources - three in phono form on the rear panel, and a 3.5mm front-panel jack for personal music players; note that an optional iPod docking

station was available.

The Solo's functions are surprisingly-well integrated, ensuring that the unit is easy to install and drive. For example, digital audio inputs automatically take priority

To help you achieve the best-possible DVD playback, Arcam built in test-patterns with an explanation of how they can be used to properly-adjust the TV's controls. These on-screen displays are generated by the DVD section's Vaddis 8 chip, which is also responsible for digital surround decoding - whether from disc or an external input. Two optical ports and one coaxial input are provided for digital audio sources; in contrast, cheaper 'all-ins' didn't even offer one! The Solo is also incapable of 'stripping' digital audio from the two HDMI inputs, which are merely 'switched' to the output socket as appropriate.

As well as Dolby Digital, DTS and the hi-res disc formats (SACD's DSD, and the MLP and 24-bit of DVD-A), the Solo supports the 'music' and 'movies' modes of Dolby Pro-Logic II for matrix-surround from appropriate two-channel sources. To transform analogue stereo audio into the digital form needed by the Vaddis, the Solo takes advantage of a 24-bit analogue-to-digital converter built into the CS42528. The unit has no 5.1 input, but in addition to an optical digital

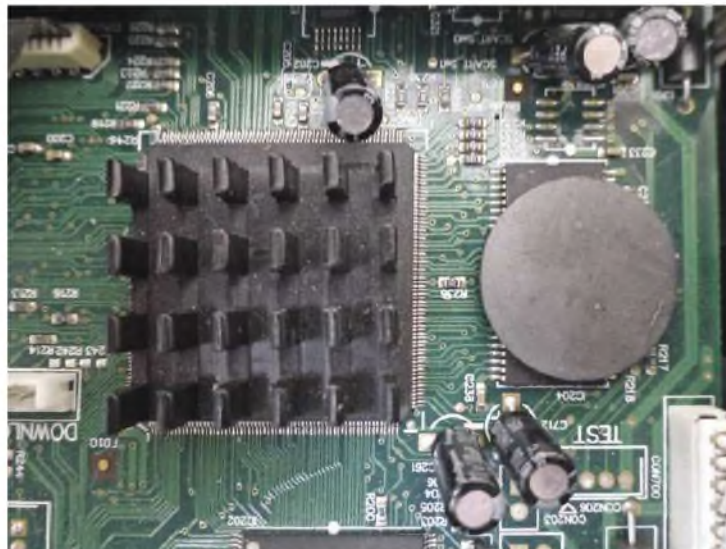

**Arcam specified the Zoran Vaddis 8, under a heatsink (left), for the DVD section and the generation of onscreen displays. The memory chip sports a 'damper' - right. Another key chip in the player is the Cirrus CS42528 multichannel audio DAC.**

over their analogue counterparts thereby avoiding a layer of on-screen menus. The menus that are provided are clear, sensibly-organised and driven by a backlit universal remote. Some information is shown on the bright and informative fluorescent front-panel display.

output you'll find on the rear panel a multichannel output for amplification more potent than what can be accommodated within the Solo's slender frame.

What power the unit can deliver - 50W per channel - is made possible by a sophisticated

# GIVING YOU THE SIMPLEST & ULTIMATE HOME AUDIO & VISUAL EXPERIENCE



## BESPOKE HIGH END AV SYSTEMS WITH GLOBAL INSTALLATION SERVICE & SUPPORT

- › Smart Multi-Room Home Automation Systems with App Control
  - › Full/Local Worldwide Installation Service
  - › Air-Con/Heating, Blind, Curtains, Lighting & Lighting Control
  - › CCTV
  - › Wi-Fi & Network Improvement
  - › Full A/V System Design & Management
  - › 0% Finance Available\* (Subject To Status)
- View our full range of brands & services online.



RIVERSIDE HI-FI

EST. 1990

SEE, HEAR & BELIEVE

[WWW.RIVERSIDEHIFI.COM](http://WWW.RIVERSIDEHIFI.COM)

CRESTRON EAT DECEMBER LOEWE. OLITRON Panasonic Sennheiser THORENS WILSON AUDIO

422 RICHMOND ROAD | EAST TWICKENHAM | MIDDLESEX TW1 2EB | 020 8892 7613 | [RIVERSIDEHIFI@MAC.COM](mailto:RIVERSIDEHIFI@MAC.COM)





**Arcam was one of the few companies to put (RGB-capable) Scart sockets into its AV products; note too the HDMI socketry, which is rather limited. The output for a display can be fed either from the player section or one of the two external inputs (from which audio cannot be tapped). These inputs are named 'sat' and 'aux'.**

power supply made up of switching regulators and an enormous toroidal transformer that must surely account for much of the Solo's weight! For smaller-scale listening, meanwhile, there's a 3.5mm headphone output driven by its own amplifier.

On the whole it all works surprisingly well, even by today's standards. But then again the Solo was sold as a serious piece of home-cinema kit, intended to compete on its own terms with systems composed of separate components.

**SOUND**

There's a welcome freedom from the grittiness that could spoil some of the AVRs on dealers' shelves at the time, even when the going gets tough and all channels are blazing away. With good speakers installed correctly, what you'll hear from a Solo is clean, tonally-

"For a 'stereo-only' hi-fi enthusiast, it's a great introduction to home cinema".

uncoloured and naturally-spacious in soundfield terms. Such attention to performance also ensures that the Solo does a good job with music – whether it's a movie score, a jazz CD or a DVD-A of electronic music. The radio section is excellent, even DAB being surprisingly-listenable. DAB+ is beyond its ken, though.

Nit-picking, the character can on occasions edge toward the 'laid-back' presentation that some associate with Arcam. But the Solo is a damn sight more musical than so many of the AVRs of the era, which are 'impressive' with movies but tend to fatigue the listener after switching to music.

When playing DVD on the Solo, good levels of detail and true-to-life colours are evident. I have however spotted motion artifacts on occasions, especially when using HDMI – which was at an early state of development when the Solo was conceived.

It may have cost two grand when new, but if you shop around on the second-hand market a Solo Movies 5.1 in good working order can be yours for £200. For a 'stereo-only' hi-fi enthusiast, it's a great introduction to home cinema - provided you're not bothered about the lack of support for Blu-ray, or surround configurations above 5.1.

The unit featured here was acquired for £25 – too good a bargain to resist! Perhaps hardly surprisingly, it didn't work. No sound, no pictures and a 'waiting...' message on the front-panel display. Basically, an electrolytic capacitor that's far too cheap a fitment for a unit of this stature goes resistive, taking out a surface-mounted fuse and starving most of the Solo's digital circuitry of power. The parts needed to effect a repair will set you back no more than a couple of quid. Other users have reported failures of the DVD laser (the Solo, unlike earlier Arcam DVD players, doesn't use a IDE-interface DVD-ROM drive) but these are available online. If you don't want this sort of hassle, there's always Arcam's current-generation Solo Movies 5 to consider. Radically-restyled, this £2100 beast drops SACD compatibility and Class AB amplifiers in favour of more modern delights like Blu-ray, uPnP streaming, Bluetooth and "Class G".



**In order to cram all of the necessary electronics into its slim-line case, the Solo has two large and densely-populated main circuit boards. This is the bottom one, which contains amongst other things the key analogue circuitry and power supplies. The discs mounted on the larger chips are supposed to keep resonances at bay. On the left, the Radioscape FM/DAB radio module is visible.**

## TubeLine



SV-237MK Hybrid Tube Integrated Amplifier



CD-S7 Traditional Hybrid Tube CD Player



PHO-701 Hybrid Tube Phono Pre-amplifier

*Sweet, Warm, Analogue Sound For Less...*

For more information of these products please contact us:

T: +44 (0)20 8374 3958 M: +44 (0)7983 619671 E: sales@vincentshop.co.uk W: www.vincentshop.co.uk

**G2**  
**AURALiC**

'One of the most beautiful sounding and accomplished DACs I've ever had the pleasure of using in my reference system.'

CHRIS MARTENS, VEGA G2, HI-FI+

auralic.com



- |                                 |              |                                     |               |
|---------------------------------|--------------|-------------------------------------|---------------|
| Ultimate Stream Farnham         | 01252 759285 | Midland Audio Exchange Belbroughton | 01562 731100  |
| Audio Destination Tiverton      | 01884 243584 | Audiovenue Ealing                   | 0208 567 8703 |
| Audio Emotion Levan             | 01333 425999 | Doug Brady Hi-Fi Warrington         | 01925 828009  |
| Oxford Audio Consultants Oxford | 01865 790879 | Igloo Audio Tunbridge Wells         | 01892 532995  |
| Acoustica Chester               | 01244 344227 | Moorgate Acoustics Sheffield        | 0114 275 6048 |
| The Audiobarn Harlow            | 01279 454860 | Lintone Audio Gateshead             | 0191 477 4167 |



# Jog factor

**Active lifestyle? Then the m-Sixes from Swedish headphone brand Jays might fit the bill (and your ears), says Martin Pipe.**

**T**he 'sweatproof' m-Six Wireless in-ear headphones reviewed here are aimed at "people in motion," i.e. joggers, cyclists and gym fanatics.

Available in a choice of four colours (black, moss green, dusty pink and sand), the £99 m-Sixes sport neat little flexible ear hooks that prevent them from sliding out. The right ear piece contains the Bluetooth receiver, charging interface, control logic, audio circuitry and 6mm transducer. It connects to its left counterpart via a wire. There's a tough synthetic-rubber band to take up the slack in a loop, ensuring a snug but not uncomfortable fit. The Varta battery shares the left earpiece with another 6mm transducer. Mikes are also fitted for 'hands-free' phone use. How did they cram it all in?

For those in a hurry, the m-Sixes have a fast-charge feature that will yield approximately one hour of playback from fifteen minutes of charging. If you're prepared to wait for 45 minutes, though, you'll get the full rated battery life of 4.5 hours. I achieved over four hours of listening from a brand-new m-Six this way. A speech synthesiser tells you how much battery life remains. Neat.

To setup engage the pairing mode and wait for 'JAYS m-Six Wireless' to appear as a Bluetooth device on the Bluetooth transmitting device of your choice. A range of sound-effects provide audible confirmation of

status; when the battery finally dies, the m-Sixes sound like they're literally grinding to a halt! No volume control is offered, the m-Sixes relying on the volume control of the 'app' running on your equipment. However, a button on the right earpiece allows you to pause and resume playback. Bluetooth range is several metres. I have been successfully using the m-Sixes with a Samsung Galaxy S4 Mini and an Apple iPad Mini.

My Samsung listening was alas spoiled by regular streaming 'glitches', even with the devices close. This was much less of a problem with the Apple device.

When I first donned them, the m-Sixes sounded very detailed, but rather thin and at times nasal. But above all, they were rather quiet. Using the Samsung's default music player 'app', the music struggled to be heard above traffic noise. This is probably a good thing, though, if you're daft enough to insist on listening to music while cycling.

After several hours of listening, I began to warm to how the m-Sixes present music; 'burning in' clearly helps. Volume is low but sufficient in a quiet room, but music of wide



dynamic range – orchestral works, for example – can suffer. But I suspect that Jays' target audience is more likely to appreciate pop, rock and dance. And here, these little devices came into their own. They're not bass monsters, but what you do get is tight and nicely-defined – as the bass synth and guitar of ABBA's Gimme! Gimme! Gimme! demonstrated. This classic disco-flavoured cut also flowed rhythmically. The insistent percussion of Talking Heads' Born Under Punches... also revealed the m-Sixes in a good light. However, Agnetha's vocals on Thank You For The Music showed that traces of nasality remain even after hours of use. An upper-midrange emphasis, presumably to improve intelligibility when ambient noise levels are high, could be to blame. If the volume is turned up too high, with music recorded at high levels, then the nasality gives way to grittiness.

The m-Six Wireless in-ear headphones are cleverly made and sound good but have limitations.

## JAYS M-SIX WIRELESS £99



**GOOD - worth auditioning**

### VERDICT

Very well thought out, but rather quiet and a presentation that's hardly neutral!

### FOR

- carefully-designed and easy to use
- detailed and rhythmically-agile
- five pairs of earbuds supplied, for best fit

### AGAINST

- nasal with some material
- bass-shy
- limited volume

Jays  
+46 761 99 35 55  
www.jaysheadphones.com

FiiO

**HWA**  
HI-RES  
WIRELESS  
AUDIO

## FiiO BTR3

Portable High-Fidelity Bluetooth Amplifier

World's first Bluetooth amp to support all wireless sound formats  
Bluetooth audio codec indicator | Supports USB DAC functionality  
CSR8675 Bluetooth chip | One-touch NFC pairing

**BTR3: £54.99** Discover more: [www.fiiio.com](http://www.fiiio.com)



fiiio.com



facebook



FiiO



# M3K

Portable High-Resolution Lossless Music Player



Ingenic X1000E SoC



DAC (AK4376A)



24 hours battery life



38 days standby time



USB DAC



All major audio formats



Touchpad buttons



Recording functionality



Clock functionality



AB repeat



fiio.com



facebook

M3K: £59.99 Discover more: [www.fiio.com](http://www.fiio.com)



WYNDER K FROG

Put of the Frying Pan/Into The Fire/Sunshine Super Frog Wah Wah

A strange name and a seemingly obscure band but this British jazz/blues outfit were well received when they were formed in 1967. They even began life opening for the legendary Traffic.

The band first issued 'Sunshine Super Frog' (1967). The sonic presentation of this mono LP is admirably well behaved, although there was a touch of compression around the extremes, the Hammond solo for example, while there was enough insight to provide delicacy around secondary percussion such as the tambourine.

Apart from the music, it was a notable release because it was one of the rarer LPs from the Island label at this time. Mick Weaver, on Hammond organ, was the central focus (the band name was his nom de plume) along with a batch of New York session musicians.

That line-up would change, to ex-Bluesology guitarist Neil Hubbard, Alan Spenner (future Joe

Cocker man) on bass, saxophonist Chris Mercer (ex-John Mayall's Bluesbreakers), Anthony Reebop Kwaku Baah on percussion and Bruce Rowland on the drums.

'Out of the Frying Pan' (1968), featured a combination of reworked trad songs, processed pop and original compositions. This stereo pressing features the same subtle compressive effect. It doesn't harm the listening experience but places enough emphasis to fine tune midrange by slightly etching subtle details.

The 1968 line-up changes eventually lead to the band's demise. 'Into the Fire' (1969) was issued after the band were no more. The compressive effects are toned down for this one although the slight claustrophobia around the soundstage is more a sign of the times in terms of mastering.

Reissues have been few and far between so to make all three albums available on vinyl is a particular treat.

AUDIOPHILE VINYL



THE PETARDS

The Petards/Hitshock/A Deeper Blue Bear Family

A nyone who remembers the beat genre, popularised in the UK with the Merseybeat scene and, of course, The Beatles, may also be familiar with the very active beat following in Germany centred around The Rattles, The Lords and The Petards.

The Petards suffered from little promotion and backing. Worse, they were the band from the sticks. Country boys – unlike their competitors who emanated from the far more credible Hamburg and Berlin.

Their first release, 'A Deeper Blue', hit the shelves in 1967. The music was hardly pastoral, more energetic and tough beat with psychedelia influences. There's a nicely neutral sonic balance across the soundstage of this LP with no aggressive emphasis to spoil the enjoyment. The original source does create a slightly primitive,

thinning to the presentation but that effect is also 'of the times'.

The following year, more hits would be pulled from the band's self-titled The Petards album. Sonically, it features extra bass punch and dynamic extension as the music increases in rock intensity and psychedelic textures. Both albums remained favourites amongst knowledgeable beat fans.

It took another three years for this hard working band's third album to appear. 'Hitshock' brought in a range of then-new ideas. Everything from the developing krautrock genre to prog rock. It also offered better sound quality. Production is more layered in how the music is structured, with enhanced clarity and a better sense of transparency around the vocals.

Remastered and released as such on vinyl for the first time, these LPs arrive with original inserts, liner sheets and posters.



**G**uy joined Chess in late 1959 and issued a few singles on the label. Most of his time was sent as a side-man for other artists, though. Chess owner of the time, Leonard Chess, knew Guy was a talented artist but harboured doubts about Guy's loud guitar style so it wasn't until 1967 that the label released the album 'I Left My Blues in San Francisco'. Hence, when his contract with the label ran out, Guy was off, signing with Vanguard. It took that label no time at all to release this LP in 1968.

This album gave Guy a presence in the blues market. The album itself has a very Chess-like feel to it while Guy's guitar work is relatively subtle and restrained which adds to the potential power. His backing band is quality, featuring Otis Spann on piano, Wayner Bennet on guitar, Jack Myers on bass, Donald Hankins,

Aaron Corthen and Bobby Fields on saxes plus Lonny Taylor and Fred Below on drums.

In mastering terms, there is a touch of compression that shines on the upper mids. The effect is not devastating and doesn't ruin your listening experience but it can be detected, especially during the high notes of Guy's guitar. Over the rest of the broad soundstage, this compression merely adds a sense of sonic tension. In general terms, though, the mastering is good with enough instrumental separation across the face of the soundstage to allow the ear to not only detect each musician plying their trade but more nuanced effects such as the reverb tails from the Guy lead vocal.

Also look out for another Craft blues release, Junior Wells' 'Coming at You' on vinyl, reissued for the first time, from 1968 and featuring Buddy Guy, Lefty Dizz, Douglas Fagan and Clark Terry.



**BUDDY GUY**

**A Man and his Blues**  
Craft

AUDIOPHILE VINYL

**A**n original game soundtrack from the famous action-oriented shoot-'em-up, it may be, but this particular variant arrives in a luxurious packaging with lots of content. Penned by Mick Gordon and cut at Abbey Road the Doom (Original Game Soundtrack) is actually available in four formats: Deluxe Double CD, Double Vinyl with 20 tracks selected by the developers, a Special Edition Four-Disc Vinyl and a Special Limited Edition Vinyl Box Set. Anyone wanting a Special Edition is already too late because it was only ever available pre-order and then in a crazy restricted two week window only. Now available only from third party sources.

I received the 4LP vinyl set. To mimic the "power of Hell and its corruptive Argent energy", Gordon created the "Doom Instrument". Consisting of pure

sine wave inputs directed into four separate sound processing chains and a variety of post-processing techniques, it allowed Gordon to dynamically 'corrupt' generated sounds to produce punchy, in your face, metal-industrial, electronica music themes. Track titles include light-hearted ditties such as 'Skull Cracker', 'The Stench', 'Flesh & Metal' and 'Rust, Dust & Guts'.

I was impressed at the production values of this release. Treble, mids and bass all behave themselves, there are no loudness issues, brightness or bass bloom. The sense of instrumental separation is palpable here too. Despite the roaring energy, it was easy to separate delicate cymbal taps, while percussion strikes offer impressive transient speed. Portentous, bass-dripping, guitar strings are heavy with rhythmic potential while silence is used most effectively as grammatical punctuation. Impressive.



**DOOM**

**Original Game Soundtrack**  
Bethesda/Laced

# IAN HARRISON HI-FI SALE!

HIFI AT DISCOUNT PRICES. FREE NATIONWIDE DELIVERY  
 Email: [ian.harrison@mercian.myzen.co.uk](mailto:ian.harrison@mercian.myzen.co.uk)

**SPECIAL OFFERS!! SALE! UP TO 40% OFF!!**

**CARTRIDGES UP TO 30% OFF PHONOSTAGES UP TO 25% OFF TURNTABLES & TONEARMS UP TO 25% OFF CABLES UP TO 40% OFF**

VAN DEN HUL MC10S £825, ORTOFON CADENZA BLUE £950, ORTOFON QUINTET BLUE £299

#### TONEARMS

AMG  
 CARTRIDGE MAN  
 GRAHAM  
 HADCOCK  
 HELIUS  
 MICHELL  
 MOERCH  
 MOTH  
 ORIGIN LIVE  
 ORTOFON  
 PRO-JECT  
 REED  
 ROKSAN  
 SUMIKO

#### HEADPHONE AMPS

CREEK  
 FIDELITY AUDIO  
 GRAHAM SLEE  
 ICON AUDIO  
 LEHMANN  
 PRO-JECT  
 SUGDEN

#### AMPLIFIERS

CREEK  
 EAR/YOSHINO  
 ICON AUDIO  
 QUAD  
 SUGDEN  
 TOM EVANS  
 VALVET

#### ACCESSORIES

DIGITAL STYLUS GAUGES, RECORD CLEANING MACHINES, CLEANERS, AUDIO CASSETTES

#### CARTRIDGES

AIR TIGHT  
 BENZ MICRO  
 CARTRIDGE MAN  
 DECCA LONDON  
 EMT  
 GOLDRING  
 GRADO  
 HANA  
 IKEDA  
 KOETSU  
 MY SONIC  
 NAGAOKA  
 ORTOFON  
 SOUND SMITH  
 TECHDAS  
 VAN DEN HUL  
 ZYX

#### SPEAKERS

ACAPELLA  
 CABASSE  
 EPOS  
 HARBETH  
 ICON AUDIO  
 OPERA AUDIO  
 Q. ACOUSTICS  
 QUAD  
 TAYLOR ACOUSTICS

#### CD PLAYERS

CREEK  
 EAR/YOSHINO  
 ICON AUDIO  
 QUAD  
 SUGDEN

#### PHONOSTAGES

EAR YOSHINO  
 GRAHAM SLEE  
 ICON AUDIO  
 LEHMANN  
 MUSICAL  
 SURROUNDINGS  
 PARASOUND  
 PRO-JECT  
 PURE SOUND  
 QUAD  
 ROTHWELL  
 TOM EVANS  
 TRICHORD  
 WHEST AUDIO

#### CABLES

BLACK RHODIUM  
 IXOS  
 KUBALA-SOSNA  
 PEERLESS  
 PRO-JECT  
 QED  
 SUPRA  
 TRANSPARENT  
 WIREWORLD  
 ZENSATI

#### RECORD CLEANING

PROJECT  
 MOTH

#### WIRELESS

BLUESOUND

#### TURNTABLES

ACOUSTIC SIGNATURE  
 ACOUSTIC SOLID  
 AMAZON AUDIO  
 INSPIRE  
 LUXMAN  
 MICHELL  
 MUSIC HALL  
 PRO-JECT  
 REED  
 ROKSAN  
 SRM TECH  
 T+A  
 THORENS

#### HIFI FURNITURE

ALPHASON  
 ATACAMA  
 CUSTOM DESIGN  
 HI FI RACKS  
 MUNARI  
 MUSIC TOOLS  
 NORSTONE  
 QUADRASPIRE  
 SOUNDSTYLE  
 TRACK AUDIO

#### HEADPHONES

BEYER  
 ERGO  
 GRADO  
 PSB  
 SENNHEISER

\* PHONE FOR TERMS. PLEASE PHONE TO CONFIRM PRICE & AVAILABILITY PRIOR TO ORDERING. ALL GOODS ARE BRAND NEW & BOXED WITH FULL U.K. GUARANTEES. NO EX. DEM OR EX DISPLAY GOODS. NO GREY IMPORTS. GOODS ARE NOT SUPPLIED ON APPROVAL. SORRY, NO GENERAL CATALOGUES. PLEASE PHONE OR WRITE FOR SPECIFIC REVIEWS, BROCHURES OR PRICES. SUPPLIER OF HIFI PRODUCTS & ACCESSORIES SINCE 1986 MAIL ORDER ONLY FROM: IAN HARRISON, 7 MILL HILL, REPTON, DERBY, DE65 6GQ.  
**TEL: 01283 702875. 9am - 9pm INCLUDING SUNDAYS.**



Criterion Audio is a premium hi-fi dealer in Cambridge. From vinyl and valves to the latest in streaming and headphones, we can help you find the perfect audio system to suit your budget and needs. Call us on 01223 233730 to arrange a demo.

Criterion House, Oakington Road, Cambridge CB3 0QH  
[www.criterionaudio.com](http://www.criterionaudio.com) [info@criterionaudio.com](mailto:info@criterionaudio.com)

*Billy Vee*  
 SOUND SYSTEMS

**London Linn & naim Specialist**

CALL SALES: (020) 8318 5755 or 8852 1321 - 248 Lea High Road, London. SE13 5PL  
 Web: [www.billyvee.co.uk](http://www.billyvee.co.uk) email: [sales@billyvee.co.uk](mailto:sales@billyvee.co.uk) Full delivery and installation services.



Full Naim Uniti & Classic series available



Full Linn DS range on demonstration

**Trade in your CD Player & claim up to £1000 against a new digital Streaming player - offering you easier access to your music and better sound quality**

Please call in or visit [billyvee.co.uk](http://billyvee.co.uk) for full details of this and other great new performance enhancing promotions



TO ADVERTISE HERE  
 PLEASE CALL JOANNA HOLMES ON  
 +44 (0) 7958 602347  
 OR EMAIL:  
[joanna@hi-fiworld.co.uk](mailto:joanna@hi-fiworld.co.uk)



# "Cartridges are triumphs of precision engineering using advanced materials"



Noel Keywood

**T**here were many interesting, inventive, even wacky attempts to tune CD – put 'em in the fridge, paint the edge green and more... Users wanted to be able to have control over CD's sound. Just as they did earlier with LP. But digital is unyielding; there is little you can do to improve it other than to ensure perfect data transmission.

Not so with analogue: it is infinitely tweakable – a hobbyists dream. I ended up being drawn into fine analogue tuning of LP this month – and thoroughly enjoyed it.

Firstly: the sound of LP. There's so much going on here, so many variables as engineers like to say, that knowing what needs tweaking and how to tweak it is always going to be a challenge. In spite of this I recognised the characteristic depth of sound from the Scheu Classic turntable, one I rarely hear from most turntables we review, and it had me intrigued.

Where have I heard that sound before? Aha – yes, my sonic recall tells me it was with McIntosh's MT 5 I reviewed in our October 2016 issue. And the next connection to pop up in my head was: both turntables have a large, heavy acrylic platter sitting atop and well anchored bearing assembly. Is this the reason for their depth of sound and superb dynamics? I think it may well be.

I use a Garrard 401 which is all heavy metalwork, and Technics SL-1210 Mk2 – and both don't quite have the sonic contrasts and lack of colour of these turntables. That doesn't mean they are inferior so much as different. The Garrard has breathtaking pace and bass, the Technics cool correctness. With analogue you can't have it all!

But isn't that the delight and frustration of analogue? You can tweak endlessly and it really does get

better. But it is never good enough. Oh frustration.

The great delight of analogue and the imperfect LP is that sound quality can be magnificent – with the suggestion that even better is possible. It keeps you hooked.

Pickup cartridges are a fine example. As the LP went out of fashion long ago I thought that cartridges of the time were as good as it could ever get. There was the Technics EPC-105C, Shure's V15 and my favourite, the Stanton 681EEE. They all faded away as digital – meaning CD – came in and took over. But today's cartridges, now with laser cut tips (Audio Technica, Ortofon) on top models, and almost hideously sophisticated diamond coated ruby and boron cantilevers say "not so". Better is possible.

Then there is the promise fulfilled. Analogue products are getting better in measured performance and sound quality I find. OK, not universally; turntables and tonearms in particular are something of an ad-hoc mechanical mish-mash, rather than anything worked out within a modern design environment using computer based design programmes and mechanical testing. But the end result is still pretty good, measurement and listening confirm.

With the pickup cartridge however, it only seems to get ever better. This is likely because we are in an age of steadily improving materials technology – and cartridges are triumphs of precision engineering using advanced materials, from sintered diamond coatings to laser cut tips and neodymium magnets. Both Ortofon and Nagaoka, by the way, are specialists in precision micro-engineering using advanced materials, commonly for medical purposes.

The LP remains simple and crude at heart. Grooves cut in vinyl and

played by a stylus that is mechanically coupled to an electromagnetic generator smacks of yesteryear, but as both cutting an LP master and stamping the final discs are now processes where quality pays, modern LPs can sound superb too. Unfortunately, at this point many of you, like me, will likely curse at the almost absurdly bad quality the music business can shamelessly – unknowingly perhaps – turn out.

Poor LP quality affects me increasingly, I am beginning to realise, as our replay equipment gets better. LPs I once would have been able to tolerate due to the warm sound balance of a vintage MM cartridge now don't sound so good at all. Laser cut tips and exotic cantilevers are wonderful with a high quality LP but can make bad vinyl sound painful, by revealing the faults.

For well meaning hi-fi enthusiasts willing to put in the extra tweak or a few extra bob, it's a smack in the face to buy a new LP where, quite obviously the producer hasn't paid much attention, if any, to sound quality. My experience is that cutting houses commonly lack sensible replay equipment and are confused by what to get, they are so far removed from the consumer market place.

But the ever improving ability of LP replay systems is testament to both the abilities of the industry and the potential of the medium. With laser cut masters (hi-res LP) we could all see this get better yet again. Analogue can just keep on being improved, no big changes needed. As long as it spins at 33.3rpm and the groove is 0.7mil wide there is almost no limit to quality.

There are hidden advantages to simplicity – especially when it comes to fidelity. We will never need to treat the outside edges of an LP with a green pen! ●

# OPTIMISED FOR PERFORMANCE BY LENGTH

After testing 15 different lengths of cable we found that 1.7 metre power cable sounds better than any other length.

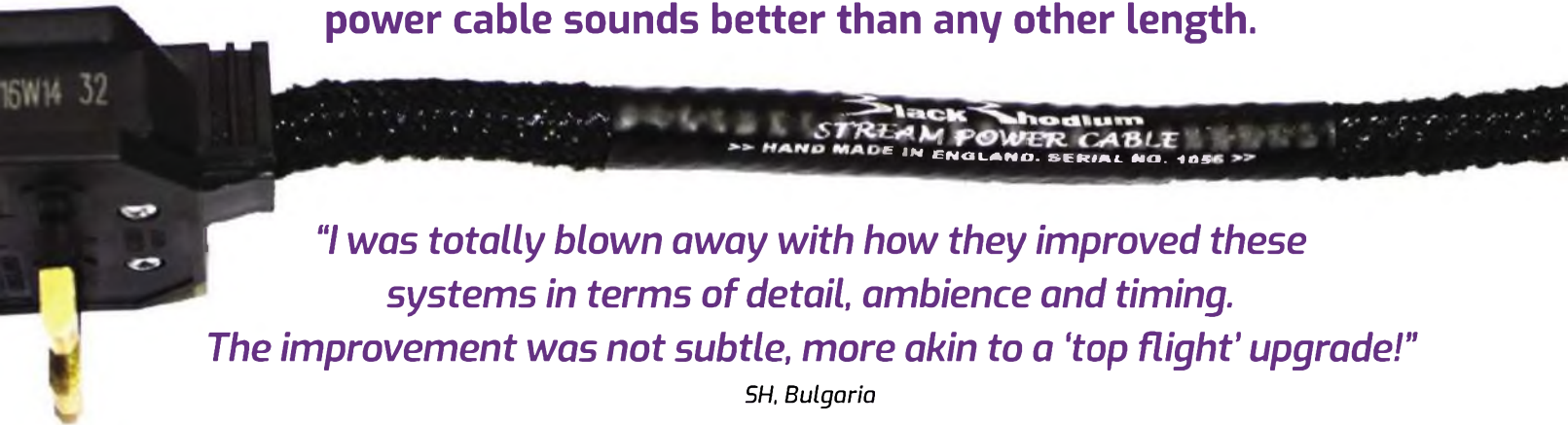

*"I was totally blown away with how they improved these systems in terms of detail, ambience and timing. The improvement was not subtle, more akin to a 'top flight' upgrade!"*

SH, Bulgaria

"This is the best Black Rhodium cable I've heard in the last few years from the outfit and is one of the best power cables you can buy at the price point" *theaudiophileman.com*

"It's an excellent cable and amongst the best at its price-point!" *Hi-Fi World*

"This mains cable is for me one of the best products in the Black Rhodium line up" *Hi-Fi Pig*

"The Stream is a superb top-of-the-range mains cable with excellent build quality" *Hi-Fi Choice*



With top of the range quality at middle range prices, upgrade your whole system with Stream.

#### Upgrade the system with 1 x Stream cable

- ✓ More ambience, detail and improved timing.
- ✓ Vocalists are heard with more character.
- ✓ Instruments are located in more space and depth.

#### Upgrade the system with 2 x Stream cables

- ✓ Height of sound stage becomes larger.
- ✓ Notes stop and start, plus everything is more dramatic and involving.

#### Upgrade the system with 3x Stream cables

- ✓ Huge sound stage, inky black background, increased ambience, clarity, detail, bass control and dynamics.
- ✓ Every nuance in every recording revealed with startling realism.



Go buy your own Stream NOW at your nearest Black Rhodium Dealer or visit:

[www.blackrhodium.co.uk](http://www.blackrhodium.co.uk)

#### Hear STREAM at these dealers

Audio-Philia 0131 221 9753 | Analogue Seduction 01733 350878

Audio T Swansea 01792 474608 | MCRU 01484 538438 | Homesound 0131 662 1327

PLanalogue 01865 69 30 32 | TM3 Connections 0117 370 5786



"every artist wants a taste of that status because, trailing after authenticity, comes respect."



Paul Rigby

Sometimes it's the records that come through the post that make me think. Four of which arrived from the Charly label ([www.charly.co.uk](http://www.charly.co.uk)) on vinyl under the 'Club Soul' imprint. Essentially, these records are compilations of popular and hard-to-find soul and R&B. Allow me to take a brief look at them. There's a reason.

'Club Classics' is a double album of Northern Soul featuring the likes of Linda Jones, The Anderson Brothers and The Sharpees; 'The Scene Club' is a similar collection over sixteen tracks featuring Don Gardiner and Chris Kenner; 'The Twisted Wheel' includes Alvin Robinson, Benny Spellman and The Ad Libs while 'Wigan Casino Soul Club' includes The Ringleaders, Skull Snaps and The Inspirations. Remastered from original master tapes and rare vinyl with tracks not found on the CD version, this vinyl batch is a reflection of a musical phenomena.

There's names in there that you may know but many that you will not. Ian Levine, a Northern soul DJ and vinyl collector summed it up well when he described the artists who, "...wanted to be the Motown sound but weren't. People who wanted to be The Supremes, The Temptations but didn't have any money to spend on production values or distribution."

This music wasn't exactly slick but it was authentic. 'Authentic'. It's a helluva term and every artist wants a taste of that status because, trailing after authenticity, comes respect. From whence an artist can then hold their head up high and be infused with justification. Authenticity is often the sign of quality for music fans. Music produced, not to make a buck, but as art. Authenticity also has a dark side, though.

Authenticity is actually an oddball musical state because it tends to originate and emanate, not from commerciality but from obscurity.

To be commercial is an opposite. To be commercial is anathema to purist music fans. To be commercial is to have 'sold out'. To be commercial is the horror scenario: to produce music enjoyed by 10 year old girls, mums, business men who have no interest in music and grannies. To be commercial is to have your music piped over the speakers in Tescos and to be discussed on 'I'm A Celebrity...'

Yet the respected artist often bears authenticity like a cross. Commerciality is actually a secret ambition for a host of authentic artists because while being authentic is all about being respected, it's also about being poor. While authenticity is admired by the hardcore fan, being commercial means that you get to eat regularly. Often, the fans of authentic music artists are earning more money than the artists themselves.

Being authentic can sometimes mean having a total stranger stop you in the street, shake you by the hand, voice their love for your work and then leave so that you can continue your job sweeping the streets. A fantasy scenario? Many black blues singer legends, for example, suffered from their 'authenticity'. From poor backgrounds many had been in prison and / or were going back there. Here authentic takes on a different meaning.

On the other side of the stage, from the fan's perspective, authenticity stimulates the human tribal instinct. To be in the tribe is to be one of the chosen (i.e. maybe you were one of the original punk rockers).

To be in the tribe is to be special (i.e. you were one of the few who

followed The Who since they were the Detours).

To be in the tribe is to be 'us' and not 'them'.

Some of these Charly albums are titled after the music clubs that promoted soul music. The Wigan Casino Soul Club from 1973-1981, The Scene Club in Ham Yard, London from 1963-1966 and The Twisted Wheel, Brazenose Street then Whitworth Street, Manchester, 1963-1971. Places where the tribes could congregate, share information, recognise fellow devotees and, above all, have a taste of belonging. It's like joining an exclusive club. Literally in some case.

Being into Northern soul in the sixties was also sharing a secret and being able to smugly discuss it with others in the know, in front of the bemused. It was to be in a gang. A cultural gang. Often replete with its own language and clothing styles.

You can see then that being authentic is to have the cards stacked against the artist. While the artist can enjoy their fifteen minutes in the sun, it's often the fan that has most of the fun. It's the fan that can buy Northern Soul 7" singles for £20,000 a-piece while the artist often drowns in obscurity and struggles to make ends meet.

But hey – this is the situation for many artists, whether they be singers, painters or authors.

What we can all be thankful for is that these gifted people had, in many cases, to get their art out there. That's what authentic art is all about. It has to exist and the artist is powerless to stop that. We should be thankful for that and be grateful that authentic music exists because it connects to us on a deeply emotional level. It moves us, it lifts us and, yes, it touches our 'soul'. ●

# THE VINYL REVOLUTION



## The EVO and the new EVOke now you have a choice !

The new EVOke has world beating performance and right now we have the unit reviewed in this issue and a brand new one for sale. Performance figures are comparable with the world's most expensive turntables and the ability to fit any arm or cartridge mean you can have the EVOke that you want.

The EVO was used by Hi-Fi World to evaluate the Beatles In Mono records and is now used as their reference. The EVO comes fitted with the legendary SME 309 tonearm loved by so many and a cartridge of your choice.

We have worked with direct drive turntables and moving coil cartridges for 35 years. We can supply completely new units with 6 year guarantees, used ones with 6 year guarantees, or we can convert your own.

**Stereo, Mono & 78 rpm** Artisan Noriyuki Miyajima has been making phono cartridges in Japan for more than three decades. Only recently discovered by American and European audiophiles, they have since received rave reviews all over the world and deservedly so.

Every Miyajima cartridge is handcrafted in-house by a dedicated full-time team of six based in Fukuoka. The cartridge bodies are individually precision-milled from rare and exotic hardwoods including ebony, rosewood and African blackwood (mpingo). These dense natural materials lend a vibrant and natural tonality to the sound.

Miyajima - Benz LPS - Denon DL103 - DL-102 mono - Audio Technica AT33 & OC9  
SME Turntables & Tonearms - Oyaide - Furutech - Klipsch - 78rpm - SL1200 Mods

Tax free best prices for World wide mail order by Fed Ex

Sound Hi Fi Dartmouth Devon 01803 833366 [www.SoundHiFi.com](http://www.SoundHiFi.com)

# MrSpeakers

Introduce **VOCE**



electrostatic  
headphone



**electromod**  
the sound connection  
[www.electromod.co.uk](http://www.electromod.co.uk)



“The individual performers fed off each other creating a sound unlike anything that had been heard before”



Jon Myles

Passing through the sights and sounds of the Notting Hill Carnival as the event descended on the streets around the Hi-Fi World offices recently the various sounds ringing out from assorted sound systems couldn't help but bring a smile to my face.

Dub, reggae, grime, rap, dance, rock were all being played in a true celebration of the UK's rich and diverse musical landscape.

And then one distinctive, soaring melody line hit me more than most; Miles Davis's inimitable phrasing and expert delivery on his groundbreaking 'Bitches Brew' LP. Here it was being pumped out from a pair of massive, seemingly home-made loudspeakers to the delight of everyone in the vicinity.

OK, it wasn't quite hi-fi quality but that wasn't what struck me most. It was the fact that on the streets of modern day London this collection could still entrance people who, for all I knew, may never have heard it before.

Which is some going for a record that is getting on for almost 50 years old. Yes, it was that long ago that Miles pulled together a group of musicians to lay down these tracks over a mere three days in Columbia Records' Studio B in New York during August 1969. Allegedly, so last-minute were the arrangements that few of the pieces had even been rehearsed before the recording sessions. Instead the individual performers fed off each other - weaving their playing around each other and creating a sound unlike anything that had been heard before. It was a fusion of jazz and rock that

left some listeners utterly baffled - Steely Dan's Donald Fagen once describing it as "just silly, and out of tune, and bad. I couldn't listen to it. It sounded like Davis was trying for a funk record, and just picked the wrong guys. They didn't understand how to play funk. They weren't steady enough".

An interesting take on the project - but one that has not been borne out by just how good this album still sounds today and the way you can still hear its influence echoing down the years from the likes of Radiohead (who cited it as a major factor in their creation of breakthrough album 'OK Computer') to Tim Hagans' fusion of jazz, electronic and rap on 'Animation/Imagination' and even the likes of Roots Manuva, House Of Pain and DJ Cam - as eclectic mix of artists as you can ever imagine!

There was also another factor that marks Bitches Brew out as a seminal work - the use of the studio as a musical tool. While the recording session took just three days Miles and producer Teo Macero took much longer creating the final work - using tape loops, delays, reverb chambers and echo effects in a way that, at the time, was rarely employed in rock music and certainly unheard of in jazz where traditional methods of recording and editing still held sway.

In terms of production there's a similarity to the way Brian Eno and Talking Heads' David Byrne constructed 'My Life In The Bush Of Ghosts' - taking various performances and using the studio as a place to meld them together into something altogether different and radically new.

Unlike Byrne and Eno, though, Miles Davis and Teo Macero were working on the raw material from a rather stellar cast of performers - although it wasn't quite realised by everyone at the time.

There was Joe Zawinul and Wayne Shorter who, a few years later, were key members of Weather Report, Herbie Hancock and Bennie Maupin, John McLaughlin and also Chick Corea. That's the basis of one supergroup that would put the likes of anything you could pull together nowadays to shame.

But young drummer Lenny White - who was just 19 when he got the call to attend the 'Bitches Brew' recording sessions - perhaps sums up the genius of what went on best. He recalled, "The sessions would go till about three or four in the afternoon, and once the three days were over we went to Miles' house, and listened to all the unedited tapes. Half a year later a record came out that was totally different, because they'd taken the front end of one tune and put that in the middle and so on. Basically Teo Macero had made a whole other thing out of it. I suspect that Miles said to Teo: 'Go ahead and do what you think best,' and that Miles then approved or disapproved what had been done".

Five decades on from there Miles wasn't the only one who still approves - as the crowds at the Notting Hill Carnival can attest to. And so can I - as it was impossible to avoid searching out this seminal recording on arriving back home and marvelling at just what was achieved all those years ago and how its influence has had such a profound effect. ●



All the *style*, with no compromise on **sound**



## Debut III S Audiophile

The Debut III S Audiophile takes the iconic, multi-award winning Debut design and adds advanced features to enhance the look and performance to an all-new standard.

With new features, including the one-piece S-Shape tonearm, Pick-IT 25A cartridge and upgraded turntable feet, the latest addition to the Debut range delivers a very harmonic and warm sound to impress even the most experienced audiophile.



April 2018



June 2018



Distributed by Henley Audio

T: +44 (0) 1235 511 166 | E: sales@henleyaudio.co.uk | W: www.henleyaudio.co.uk



# "a dusty Grundig V2000 format VCR that someone had left out for the dustman!"



Martin Pipe

I'm sure some of you will, like me, remember 'simulcasts' – common during the 1970s and 1980s. Stereo sound from FM radio accompanied TV pictures. Viewers were encouraged to tune into the relevant TV and radio stations, and place their speakers on either side of the TV. Not too close, though, or the speaker magnets could distort the picture!

It sounds quite simple, but a lot of work was needed by the broadcasters to synchronise and distribute pictures on one medium and sound on another. This sort of thing is exclusive to countries like the UK, with their co-ordinated public-service radio and TV broadcasting.

Simulcasting lent itself to live music. In the 1970s, rock lovers could enjoy 'Sight and Sound' (Radio 1, then using Radio 2's network, with BBC 2). For classical music enthusiasts, there was the occasional Prom (BBC 1/2 with Radio 3). 1985's Live Aid was a simulcast, as was Jean-Michel Jarre's 'Rendez-vous Houston' the following year.

Owners of stereo and hi-fi VCRs featuring 'simulcast recording' could source pictures from the machine's internal TV tuner and sound from an external source – specifically a FM tuner. Sadly, I didn't obtain one of these high-end VCRs until the late 1980s.

On a hot Saturday late in August 1984, the BBC broadcast its 'Rock Around The Clock' special – a simulcast with Radio 1 comprising movies, documentaries, live performances and pop videos that ran from 3.15pm to 6.20am on Sunday, with only a ten-minute cricket

summary and a news bulletin to break the flow.

Two items to benefit especially from simulcasting were The Band's 'Last Waltz' and a performance by New Order, live from Radio 1's Saturday Live studios in Broadcasting House.

With no VCR able to record pictures and sound I recorded New Order's half-hour, five-song performance from BBC FM radio onto a Scotch C90 cassette tape that had been bought specially for the occasion! Well, it was 1984 after all – and at that time chrome cassette tape was quite a long up the fidelity ladder I recall.

The result was a mixed bag, not least because vocalist/guitarist Bernard Sumner was in a pretty dire mood. This was apparently due to sweltering studio conditions, and a London traffic jam that ensured the band's late arrival at Broadcasting House, situated close to Oxford Circus in the heart of the city – well West End.

His guitar started off somewhat flaky on Age of Consent and was dropped from the mix for a while; later during the song he angrily grabbed the foam windshield from his mike and discarded it.

During 'In A Lonely Place', he continually ordered drummer Steve Morris to "speed up...".

The final track, Temptation, was introduced by Sumner – who also used the F-word during the set – as "an atmospheric song in an unatmospheric place". It was an intriguing live performance – warts and all – that stuck in my mind.

Many years after my tape went missing, I chanced upon a vintage videotape containing many

of the Rock Around The Clock programmes – including New Order's stint. It was in a dusty Grundig V2000-format VCR that someone had left out for the dustman!

I had to get this long-obsolete 'flip-over' video cassette machine working before I could even determine the contents of the tape; luckily, I was able to get the parts I needed from a winding-down Sendz Components – the well-known (to the trade!) TV spares concern that just happened to be around the corner from where I live.

Once up and running I found the recording was noisy, lacking in definition and spoilt by dropouts. But it was at least watchable! Sound quality was however terrible. Whoever made the tape obviously used a very poor VHF/FM tuner and a bent aerial – or perhaps no aerial!

An Internet search for a decent off-air capture of the audio from this set revealed one (FLAC, sourced from a chrome cassette) on the Dimeadozen.org torrent tracker that specialises in 'recordings of independent origin'.

Having obtained the audio, in good condition, I digitised my ancient video and, using PC editing software, I was able to clean it up quite effectively.

My next job was to take the audio (decompressed to a 16-bit WAV file and resampled to 48kHz) and synchronise it with the video, the original hissy mono soundtrack serving as a 'placeholder' that could be subsequently-removed.

I put the result onto a DVD, and relived what I had enjoyed during that long-distant August afternoon in 1984! ●

## Major relocation sale! Most items REDUCED!

Amplifiers		Analogue		Loudspeakers	
Aesthetix Atlas stereo power, superb and reduced	x/d 4799	Acos Lustre GST1 Tonearm, near mint boxed	used 219	Acoustic Energy AE1, matching stands	used 799
Arcam Alpha 10 Power amplifier	used 249	Anatek MCR Reference MC 2 box Phono stage	used 899	Aspara Acoustics HL6 in Oak	used 1499
Astin Trew AT5000 Power amplifier excellent boxed	used 399	Clearaudio Concept package, one tiny mark	new 799	Audio Note AZ Iwo, fair condition boxed	used 749
Audio Analogue Crescendo Airtech, superb!	x/d 499	Clearaudio Performance, Satisfy, Maestro, excellent	used 1199	B&W 80402, excellent boxed	used 3399
Audio Analogue Fortissimo Airtech, on board DAC	x/d 999	Dr Feickert Twin, monster deck Audioquest cut boxed	used 3199	B&W 60352, excellent boxed	used 349
Audio Analogue Puccini Anniversary, boxed	used 1499	Garrard 301, Hammerite, serviced	used 1999	Canton Vento 809DC	used 499
Audio Research Ref 610 Monos, boxed REDUCED	used 12499	Garrard 401, cream, serviced	used 1499	Castle Severn 2, fair	used 149
Audio Research Ref 210 Monos, boxed	used 5799	Garrard 401 Motor unit only no arm	used 649	Castle Severn 2 se, excellent	used 229
AVI S2000 Pre/Monos, fair cosmetics	used 999	Goldring Legacy Ltd edition	new Call	Castle Knight 3, excellent	used 379
BAT VK50se Preamp/Amplifier, factory service 2016	used 2249	Graham Phantom Supreme 12", SME cut	x/d 3199	Castle Avon, vgc+	used 149
Bryston B1355S12 with DAC, excellent boxed	x/d 3499	Krpnos .5 and Helena tonearm	used 12999	Celestion Ditton 66, fair condition	used 899
Bryston 7BS5T2 Monoblocks, ex demo	x/d 5999	Lehmann Black Cube Se	used 449	Dali Zensor 1/Vokal/E-9F Sub 5.1 package	used 699
Bryston 2.5BS5T2, excellent boxed	x/d 1799	Linn Linga PSU, vgc+	used 449	Focal Diablo Utopia, superb with matching stands	used 3999
Bryston BP17/8B5T pre (new) power (used)	used 3399	Linn Basik, Akito, AT cart excellent	used 379	Focal Aria 948, excellent in glass black	used 1499
Cairn 4810 Integrated with tuner, boxed nr mint	used 779	Linn LP12, Hercules2, litok, new lid boxed	used 1999	Focal Electra 1028Be, champagne, superb boxed	x/d 2899
Cairn 4808 Integrated with tuner, boxed nr mint	used 449	Linn LP12, new plinth, Hercules2, Project 9cc, new lid	used 1999	Icon Audio MFV6, excellent boxed	used 199
Cairn Nitro pre with Klipsch Monoblocks	x/d Call	Linn LP12, Basik Plus	used 599	Infinity RS2.5, Ok condition, sound great!	used 999
Cairn Diablo Integrated, boxed nr mint	used 379	Lyra Skala, excellent boxed	used 1749	Infinity RS4.5, fair condition, huge!	used 1499
Cyrus 8 Power, vgc+	used 399	Michell Gyrodec, Rega arm, excellent boxed	used 1399	Kef Q700 sealed boxes	new 599
Cyrus 8XPd excellent, boxed	used 549	Musical Surroundings Phenomena Phono & psu	used 449	Kef R100, excellent	used 399
Cyrus One, new (non HD) version, boxed	used 499	Nottingham Analogue Mentor & Teserac psu	used 1149	Kef R300, excellent	used 699
Cyrus Pre V52, excellent	used 249	Okki Nokki mk2 RCM with lid	used 349	Kef 104ab, excellent	used 199
Cyrus Pre XVS, excellent boxed	used 449	Ortofon Qadenza Black, mint boxed	x/d 1399	Linn Kabeit Aktiv with 3 x LK100, excellent	used 999
Decware SE341.3, near mint	used 999	Project Debut Spirit 3, excellent	used 199	Magneplanar MG1.7 mint boxed	x/d 1299
Densen Beat 100, vgc boxed	used 499	Project P1, new motor and lid, vgc	used 149	Martin Logan Ethos, excellent no boxes	used 2499
Devialet 200, mint boxed ex demo	x/d Call	Project Xpression 3, 2M Blue, Speedbox II, excellent	used 299	Martin Logan Ethos, near mint boxed	used 3249
Devialet 250, mint boxed, ex demo unit	x/d 6999	Rega Planar 6 Ania MC, vgc	used 999	Mirage M1si vgc boxed	used 999
EAR B34L, excellent line level preamp	used 899	Rega Planar 1 RSD 2018, excellent	used 239	Monitor Audio PL300s boxed superb	used 3499
Graaf GM50b, excellent no remote	used 2199	Rega Planar 2, brand new customer return	used 299	Monitor Audio PL350C boxed with stand	used 1499
Heybrook Signature Mk1 Amps/PSU, boxed	used 599	Roksan DX2 phono preamplifier	used 699	Monitor Audio Silver 500, glass black boxed	x/d 999
Leema Libra Dac/Preamplifier, nr mint	x/d 2999	Roksan Nima, excellent	used 379	Monopulse 42a, good condition boxed	used 699
Leema Lucana 2, nr mint boxed	used 2495	Rotel RP1500, vgc cool retro deck	used 299	Musical Fidelity MF10, excellent	used 149
Linn Kairn Preamplifier	used 499	Shelton 9000, excellent boxed	used 1499	NEAT Momentum SX5i, excellent boxed	x/d Call
Luxman LB1, Integrated excellent	used 429	Sansui SR222MKV, vgc	used 1899	NEAT Motive SX2, excellent boxed	used 549
Marantz Model 1750 Integrated, good for year	used 499	SME IV, mint, just had full £600+ SME service	used 1899	NEAT Motive SX3, nr mint in black oak	used 549
Meridian G56 Power amplifier	used 899	SME IV, vgc boxed	used 1499	Panaudio Rebel 2 cherry & matching stands	used 549
Meridian 551 Integrated amplifier	used 499	SME Seies III S, excellent boxed with cable	used 349	Pioneer CSA31, amazing fair age	used 149
Moon W7RS, excellent, boxed	used 3899	Systemdek IIX900, excellent late model, no armboard	used 189	Pioneer CS 06, superb	used 199
Musical Fidelity A3 Integrated	used 399	Systemdek II, matching arm, vgc	used 349	PMC Twenty5 26, boxed	x/d 4999
Musical Fidelity A3.2CR power amplifier	used 599	Technics SL110, SME3009ii detachable, good condition	used 749	PMC Twenty5 26, boxed	used 2999
Musical Fidelity The Preamp mk2	used 149	Thorens TD150, 2000 Plinth and 3009, superb	used 579	PMC Twenty5 24, boxed	x/d 3199
Musical Fidelity A3.2 CR Preamplifier	used 699	Thorens TD209 turntable package	x/d 599	PMC Twenty5 23, boxed	x/d 2199
Musical Fidelity M3i Integrated amplifier	used 449	Thorens TD125 with SME3009	used 699	PMC Twenty5 22, boxed	x/d 1799
Musical Fidelity M6i Integrated Amplifier	used 1099	Thorens TD160 motor unit only, no arm or lid	used 89	PMC Twenty5 21, boxed	x/d 1399
Musical Fidelity SP80/SABO?PSU Pre/Power combo	used 1199	Townshend Elite Rock, Excalibur, cover	used 949	PMC Fact B, excellent boxed	x/d 3249
NAD C270 Power amplifier, vgc	used 299	Transcriptors Hydraulic Reference /Fluid arm	used 1199	PMC DB1 Gold, excellent boxed	x/d 799
NAD C350 Integrated amplifier	used 179	Transcriptors Skeleton, excellent	used 199	PMC Twenty 23 oak/amarone, boxed	x/d 1699
Naim NAC12s/NAP120, collectors items, superb!	used 999	Transfiguration Temper, excellent boxed	used 799	Proac Tablette 50, vgc+	used 549
Naim NAC72, excellent	used 399	Transfiguration Axi S, VdH retip and boron cantilever	used 799	Proac Response 1sc, vgc+	used 799
Naim NAC202, excellent boxed with Napsic	used 849	Transfiguration Phoenix S, excellent boxed	used 999	Proac D20i, excellent boxed, ex dealer demo	x/d 1849
Naim NAC202, excellent boxed with Napsic	x/d 2949			PSB Synchrony Two B, superb boxed	used 399
Naim NAC272, excellent boxed	used 2599			Quad ESL280S, excellent	used 1995
Naim NAC282 & NAPSC, excellent boxed	used 1199			Quad 12L2, vgc	used 299
Naim NAIT XS2, excellent, remote & boxed	x/d 1199			Quad ESL57, vgc	used 499
Naim NAP150, excellent	used 399			Quad ESL57, One thing serviced 2008 boxed	used 799
Naim NAP15XS, excellent boxed	used 699			Rega RX3, excellent boxed	used 489
Naim NAP200, excellent boxed	used 899			Rogers LSI, bookshelf excellent	used 199
Naim NAP200DR, excellent boxed	x/d 1839			SD Acoustics OBS in good condition	used 599
Naim NAP250, Olive, excellent	used 999			Sonus Faber Olympia 2, Walnut boxed vgc	x/d 4999
Naim Unit Nova, as new boxed	used 3899			Sonus Faber Venere 1.5 with matching stands	x/d 949
Neukamm CPA33, well built Swiss integrated	x/d 699			Sonus Faber Venere Centre channel excellent	x/d 349
Parasound Zamp v3, excellent mini amp	used 119			Spendar BC1, near mint boxed	used 499
Pathos InPol Remix Hi Dac, ex dem	x/d 1839			Spendar S3/S12, near mint boxed	used 599
Pathos TT Anniversary Integrated, excellent	used 3249			Tannoy Albury, excellent with serviced drivers	used 999
Pioneer SA900 vintage integrated	used 129			Tannoy X16f, vgc	used 499
Pioneer A400x, good condition for	used 139			Usher Be20, excellent boxed	x/d 11999
Plinius SA100 Power amplifier, superb	used 1899			Usher 6371 fantastic sonic bargain	used 949
Puresound A10, mint boxed	x/d 649			Usher SW103 Sub, superb	used 229
Quad 405 upgraded to mk2 lovely order	used 379			Veritas H3 (Lowthers) glass black, 100db,	x/d 1999
Quad 44 preamplifier, excellent late grey	used 399			Wharfedale Diamond 220, excellent	used 89
Quad 33/FM3 in teak sleeve with 303 boxed	used 449			Wilson Watt/Puppy, crated, new foams, lovely	used Call
Quad II Monos, Pre and tuner, excellent	used 1199			Yamaha YSP4300 Soundbar/Sub, excellent boxed	used 399
Quad II Eighty Monoblocks, excellent boxed	used 2899				
Quad 99 Preamplifier, excellent	used 999				
Rega Elicitr, excellent	x/d 1199				
Revox B750 Integrated, just serviced	used 399				
Sugden Masterclass Monoblocks	used 3499				
Tag McLaren 60i Integrated amplifier	used 299				
Tag McLaren 100P Stereo Power amplifier	used 399				
Talk Electronics Storm 2 Integrated	used 349				
Technics SU-C800u/SE-A900s Pre/Power combo	used 549				
Unison Research Unico Secondo, excellent boxed	used 1199				
Unison Research Unico Primo, superb condition	x/d 899				
Unison Research Simply Italy, near mint	x/d 899				
Unison Research S6 mk2, near mint	x/d 1999				
VTL Deluxe 300 Monoblock Valve amplifiers	used 1949				
Yamaha MXA5000, excellent	used 1499				
Yaqin MC101, excellent boxed	used 349				
		<b>Digital</b>		<b>SPECIAL SYSTEMS DEALS</b>	
		Arcam CD72, excellent in black	used 189	Cairn Diablo/Tornado Amp/CD pack was £1900	x/d 599
		Arcam UDP411, superb boxed	used 529	Arcam Solo and speakers	x/d Call
		Aria Piccolo, excellent boxed	used 1399	Cyrus Streamline 2, excellent	used 599
		Audio Analogue Vivace USB DAC, with Pre out	x/d 999	Devialet 400 & Magneplanar MG3.7i speakers	used 9979
		Audio Analogue, Crescendo Airtech CD player	x/d 349	Leema Pulse 3/Stream 3, excellent	used Call
		Audio Analogue, Fortissimo Airtech CD player	x/d 699	Naim Musc nr mint boxed	x/d 799
		Audio Research DAC8, excellent boxed	used 2199	Naim UnitiQute nr mint boxed	used 749
		Bel Canto DAC1.5 and upgrade LNS-1 PSU	used 699	Primare CD10, excellent all in one system	used 499
		Bel Canto DAC3.7 and VBS1 PSU	used 1999	Scansonic USB100 Turntable & Active Speakers	new 349
		Bryston BCD 1, ex display as new boxed	x/d 999	Scans various pieces used and x/d	used Call
		Bryston BDP 1, ex display, as new boxed	x/d 1099		
		Bryston BDP 1 USB, brand new sealed box	new 899		
		Cairn Mistral/Breeze, silver as new boxed	x/d 899		
		Cairn Tornado, as new boxed	x/d 329		
		Cambridge Audio Azur 752BD BluRay player	used 449		
		Chord Qute Ex/Lineaor psu DAC	used 749		
		Chord Quteq, as new	x/d 999		
		Chord Mojo, excellent boxed	used 299		
		Chord Hugo TT, excellent boxed	used 2399		
		Cyrus CD X Signature transport, boxed	used 999		
		Cyrus DAC XP Signature, boxed	used 1649		
		DCS Scarlatti Masterclock boxed	used 2399		
		EAR Acute 2 CD player, superb sound	used 1999		
		Krell Connect, excellent boxed	used 1399		
		Krell Evolution 505 CD/SACD Player, nr mint boxed	used 2799		
		Leema Antlia IIS Eco, excellent boxed	used 1999		
		Linn Numerik DAC, vgc	used 399		
		Linn Karik CD player, vgc with remote	used 399		
		Linn Akurate DS renew, excellent	used 1199		
		Logitech Squeezebox Touch, excellent	used 149		
		Marantz SA7 ST, flagship near mint boxed	used 2899		
		Marantz CD600S, excellent boxed	used 189		
		Marantz CD4500, vgc	used 199		
		Meridian 506/20, excellent player in VGC+	used 449		
		Meridian 500 CD transport	used 499		
		Meridian 800Reference CD/DVD player, vgc+	used 1499		
		Meridian Sooloos Control 15 and Twinstore NAS	used 1599		
		McIntosh, MCD201, excellent	used 1499		
		Musical Fidelity A3 CD 24 bit player, excellent	used 349		
		Musical Fidelity kW DM25 transport and DAC, excellent	used 1499		
		Musical Fidelity M6SCD player, excellent	used 1299		
		Naim CDX2, excellent boxed with remote etc	used 1449		
		Naim DAC, excellent with remote etc	used 1299		
		Naim HDX, great condition SSD version	used 1999		
		Naim ND5XS, ex demo near mint	used 1299		
		Neukamm CD33, nr mint boxed	used 699		
		Nova Fidelity N15D Streamer with USB DAC	x/d 299		
		Pioneer N30, excellent	used 299		
		Project Streambox DS, excellent	used 249		
		Quad Elite CDS CD player	used 499		
		Quad 99CDP2 CD/Preamplifier	used 399		
		Resolution Audio Opus One, excellent crated	used 1199		
		Shanling CDT100 Valve output CD player	used 499		
		TAC C60 Valve Output CD player, superb	used 1499		
		Tag McLaren, CD720/DAC20r, excellent!59	used 599		
		Talk Electronics Thunder 2 CD player	used 199		
		TEAC PD-501HR, CD player, superb mini format player	used 399		
		Wadia S71, excellent boxed	used 6249		
				<b>AV/Accessories/Cables</b>	
				Audeze EL8 Headphones	x/d 399
				Audeze LCDX, near mint boxed with cables	used 949
				Chord Sarum, original	x/d 299
				Creaktiv Audio 4 Racks under half price	new 299
				Cyrus PSXR, excellent from	used 299
				Elemental Audio speaker stands	x/d 399
				Hifi Racks, large black oak AV rack	used Call
				LFD Silver Reference Tonearm cable	used Call
				LFD Silver Horizon and Scorpion 0.7m pairs	used Call
				Naim Headline Headphone amplifier	used 249
				Naim HiCap DR, excellent boxed	used 899
				Naim Supercap DR, excellent boxed	x/d 3499
				QED XT Evolution Reference sm	used 49
				Naim Supercap DR, excellent boxed	x/d 3499
				Sennheiser HD590/650/700 & 800s all in stock	used Call
				Siltech LS-188 Classic mk2, 1.5m pair	used 999
				Siltech FW 6 Classic Mk2 Firewire	used 299
				Stax Lambda and SRM1 mk2	used 599
				Stax SR404 and SRM006Ti	used 699
				TEAC HA501 Headphone amplifier	x/d 499
				Townshend Seismic rack	used Call
				Van den Hul Orchid 0.8 RCA	used 159
				Van den Hul D102 mk3, selection	used Call



# "How could someone throw these in the bin? They looked immaculate"



Dave Tutt

Somehow I think my wife is right in that I am a hoarder – but then it is quite often the case that holding on to some piece of scrap is worthwhile as it subsequently proves to be ideal for whatever I am working on. Boxes of old transformers are a case in point. They are bulky, heavy, usually of unknown origin and unless I have gone out of my way to check them before I save them, and of unknown output voltage. Some are huge ugly things. However, a Dynatron record player I have repaired has two transformers in it now from the scrap pile, so that has to be a worthwhile process to save the planet.

Likewise a Harman Kardon surround receiver with its standby transformer open circuit would have probably have cost £50 plus from the manufacturer (the transformer alone) but the identical one in the scrap pile was a much more sensible solution and of course is cheaper for the customer and quicker turn around too.

I did make a drastic mistake around last Christmas though. I binned a carrier bag with key switch modules in it, probably over 200 of them and what have I needed this week? Yes, exactly that and they would have been the identical types too.

I am all for saving things if I can, which goes for repairing equipment as well as the parts they are made from. Going to the tip last week there was a complete 6kV generator set, looking only a few months old, in the electrical pile. Since I repair these I wonder what was wrong with it, engine or electrical?

Then next to it there was a Sansui AU-555 amp and matching tuner. How could someone throw

these in the bin? They looked immaculate too. I repaired an AU-555 not long ago but there was no FAT safety certification label from me on it so it wasn't the same one. Of course you are not allowed to rescue this sort of thing as there are laws and fines and all sorts of court cases to answer if you do. Not like in a certain afternoon TV program where you can create wonderful items from peoples rubbish if you ask nicely and have a TV crew behind you!

The normal stereos and old computers and 2 year old TVs deserved their place at the tip but every now and then I see gear, neglected and heading for the recycling pile in the sky – and I wonder why. Perhaps the answer in some cases is simple. It's the hassle factor. The Sansui might have been broken and therefore selling it on line might have thrown up too much agro to be worthwhile. It might have been that the owner had no idea that it was actually worth £120 for the pair and that a little service might have been all it needed to give it another 10 years of life.

Then there is always the "clearing the loft" scenario which occasionally brings me bits, often after someone has lost a loved one and is having to move on.

I actually own a TU-555 myself that was another tip candidate. They look a little quirky, their performance isn't as good as you would like, stereo is iffy and drift is a bit of an issue. They were made in 1968 so perhaps the performance can be forgiven. Still there could be an upgrade on the cards if I ever get to it.

An early piece of Sansui kit I acquired was a Japanese only item brought back to this country by a marine engineer. A turntable and

receiver built into a wood cabinet with record storage beneath. The receiver, a 350a model, was bolted directly into the box so it was built rather like an old style radiogram. The turntable had seized but some cleaning and oil helped and wood work for a new plinth and wiring changes made it a stand alone item to run on 230 volts.

I remember the first Sansui I ever repaired, an almost brand new AU-G90x which, when it was launched around 1984 was quite a handsome and probably expensive piece of kit. In 1986 I got one that had accidentally been killed on one channel so a pair of new output transistors were all that was needed but getting them then was an extensive task. Find Sansui's then UK distributor, call them and get the spares department. Raise an order via a letter, no email transactions then, proforma invoices were the things to fill out and with a cheque of course then wait a month for delivery. No on-line database of Japanese transistors available on two day delivery at very reasonable prices then of course. It's a wonder anything got done.

I have then been asked if I knew about the Sansui Tu-x1 tuner which, compared to the other equipment of its age is actually an extremely complex circuit, purpose-designed to get the best from both FM and AM reception. Unlike most tuners that are all made much the same, this one is totally unique. I think I have to find one just to see how it ticks and of course how it sounds. Well worth downloading the service manual for an excellent description of the design, as I did.

So it's been a bit of a Sansui month – with of course plenty of other stuff too, as always. ●

+44 (0)7759 105 932  
dave\_london@hotmail.com  
www.tutt-technology.co.uk



# WORLD STANDARDS

Your guide to the best products we've heard that are currently on sale in the UK...

## TURNTABLES

**AVID INGENIUM** £800  
Great bass response and upper midrange detail allied to clarity makes this a must-hear at its price-point.



**CLEARAUDIO INNOVATION** £6400  
Expensive, but offers great results from a finely honed and beautifully finished belt drive turntable, with servo control from the platter to keep a grip on tempo like few others. Can be fitted with a Clearaudio tangential arm, or any conventional design. Awesome.



**INSPIRE MONARCH** £4,350  
A rebuilt from the ground up Technics Direct Drive, having blistering pace and dynamics allied with smoothness, sophistication and purity of tone. A true reference.



**LINN LP12SE** £3,600  
The UK's most iconic turntable, the legendary Sondek goes from strength to strength. New Keel sub-chassis and Radikal DC motor add precision and grip to one of the world's most musical disc spinners. Expensive though.

**MICHELL GYRO DEC** £1700  
Wonderful styling coupled with great build and finish make this turntable a delight for friends and family. It has an attractive clear acrylic dust cover and you can mount just about any arm. A current design standard.



**PRO-JECT ESSENTIAL DIGITAL** £300  
A budget turntable that turns in a great analogue performance, but also has a hi-res digital output. Send 24/96 across your lounge via optical cable to a DAC and get great audio quality. Or record LP to your laptop.



**REGA RP3** £550  
The first of the super-quality Regas, little compromised by price and featuring Rega's outstanding RB303 tonearm, suitable for MM and MC cartridges. A standard at the price point.

**TIMESTEP EVO** £2100  
The famous Technics SL-1210 MkII Direct Drive but with improved plinth, isolation, main bearing and power supply, plus an SME arm (add £1500). DD convenience, rock steady pitch and fab sound at a great price. Our in-house reference.



## TONEARMS

**ORIGIN LIVE ENCOUNTER MK3C** £1,745  
Origin Live combines carbon fibre and ebony to marvellous effect in its new 12-inch arm. Creamy and rich in presentation, the Encounter delves deep into the mix for a satisfying listen.

**HADCOCK GH-242 EXPORT** £810  
Consummately musical, lyrical sounding tonearm, but needs the right turntable.

**ORIGIN LIVE ONYX** £450  
Easy, smooth, creamy nature that reminds you why you're listening to vinyl in the first place. Essential audition at the price.



**REGA RB303** £300  
A one piece tapered casting makes this arm's structure almost unrivalled. Great dynamics and superb imaging, for MM and MC Reference quality for peanuts.

**SME 312S** £1,600  
Twelve inch magnesium alloy tapered arm tube plus SME V bearings. An insightful yet smooth and relaxed sound. Superlative build completes the package. Our Editor's steed.



**SME 309** £1500  
A one-piece tapered 9in arm finished like a camera and slick to use. Superlative SME quality and sound at affordable price.

**SME V** £3000  
Offers rapid fire timing and a sense of precision plus rock solid dynamics. Top dollar for deep pockets.

## CARTRIDGES

**AUDIO TECHNICA AT-OC9 MLIII MC** £420  
A fine sounding MC with strong bass and super fine treble from a great stylus – yet inexpensive.



**AUDIO TECHNICA AT-F3/III MC** £150  
Great value entry level moving coil with detail and grip you just can't get from similarly priced moving magnets.

**BENZ MICRO ACE SL MC** £595  
Smooth, lucid and full-bodied, award-winning hand-made cartridge from Switzerland.

**BENZ MICRO WOOD SL MC £945**  
Highly finessed Swiss moving coil that plays music with riflebolt precision.

**DENON DL-103** £180  
A popular and much loved budget MC with big bass, smooth treble and deep sound stage. Fantastic value.





**LYRA TITAN I MC** £3,500  
 Breathtaking speed and dynamics from LP, helped by diamond coated, boron rod cantilever.



**ORTOFON 2M MONO SE MM** £80  
 A mono cartridge purposed for The Beatles in Mono microgroove LPs. Fitted with a top quality Shibata tip. Fab for the four.



**ORTOFON 2M BLACK MM** £400  
 As good as it gets from MM. Fabulous detail and insight from a Shibata stylus, good bass and excellent tracking.

**ORTOFON CADENZA BRONZE MC** £1,400  
 A mid-price MC with a slightly livelier presentation than the super smooth Cadenza Black. High-end sound at midband price – great value.



**ORTOFON CADENZA BLACK MC** £1,800  
 Ultra smooth and dimensional moving coil with bass and punch aplenty. Lovely stylus.

**ORTOFON A95 MC** £3,750  
 Fast and extremely detailed, this is an MC cartridge that sets standards.

**REGA CARBON MM** £35  
 Budget price for a competent cartridge with a fairly unflappable nature. Ideal for beginners.



**GOLDRING 1012GX MM** £250  
 A glorious sounding cartridge with solid bass and strong dynamic punch, plus excellent treble from its Fritz Geiger stylus. Fun and affordable.



**SHURE M97XE** £80  
 Big warm sound, but great tracking and bullet proof stylus protection from damped guard. A survivor.

**VAN DEN HUL DDT-II SPECIAL MC** £995  
 Long-established cartridge from Holland with an open and dynamic sound.

## PHONO PREAMPS

**CAMBRIDGE AUDIO 651P** £200  
 Clean, concise sound from MM and MC cartridges at a very low price. A real bargain.

**ICON AUDIO PS3 MKII** £2,500  
 All valve MM phono stage with MC transformer option, graced by big, spacious and relaxed sound.



**LUXMAN EQ-500 PHONOSTAGE** £4,495  
 A fully-equipped phonostage from Japanese manufacturer Luxman that offers comprehensive cartridge matching allied to superb sound.



**LEEMA ACOUSTICS ELEMENTS ULTRA** £1,199  
 Smooth and detailed sound with the ability to accommodate most modern cartridges. Exceptional value for money.



**PRO-JECT TUBE BOX DS** £425  
 Compact MM and MC phonostage with valve output circuit and a big sound.



**QUAD QC24P** £995  
 MM and MC, oodles of gain, a volume control – and valves! Looks superb and sounds even better: smooth, atmospheric and big bass.

**TIMESTEP T-01MC** £995  
 New, minimalist phonostage that sonically punches well above its weight.

## PREAMPLIFIERS

**ICON AUDIO LA-4 MKIII** £1,400  
 Uses early 6SN7 triodes for liquid sound. Has plenty of gain and a remote control into the bargain.



**MF AUDIO CLASSIC SILVER** £4,500  
 One of the best preamplifiers we've heard at any price, this transformer-coupled marvel does very little wrong. It's powerful, clean and open, yet delicate. Its sound is unmatched at or near the price.

**MING DA MD7-SE** £1,520  
 A valve preamplifier with an open, effortless sound and a big soundstage. It has plenty of gain so will accept any source and drive any power amp. A real beauty.



## INTEGRATED AMPLIFIERS

**ARIAND PRO845SE** £1,499  
 Pure single-ended valve magic. Low-powered but immediately gorgeous, easy-going yet forcefully dynamic at the same time.



**AUDIO RESEARCH VS160** £3,500  
 Power house sound with enormous pace and punch from traditional U.S. muscle master Audio Research. Breathtaking, but expensive.



**CAMBRIDGE AUDIO AZUR 651A** £350  
 Dual-mono construction and meaty toroidal power supply combine to produce a solid and sharp sound with sonics far beyond its price point.

**CREEK EVOLUTION 100A** £1,500  
 Superb build and smooth confident sound make this powerful amplifier a benchmark.



**CYRUS 8DAC** £1,400  
 Trademark shoebox-sized Cyrus integrated now offering 88Watts per channel, plus DAC. Svelte delivery from a dainty case that fits in anywhere – and isn't Class D!

**EXPOSURE 1010** £495  
 Entry-level integrated from Exposure has excellent upper mid-performance with an almost valve-like sound.



**ICON AUDIO STEREO 60 MKII** £2,800  
Excellent tube integrated with plenty of power and an expansive soundstage, plus KT150 tube option and bias meter for easy adjustment.



**NAIM NAIT 5Si** £925  
Naim's fabled entry-level integrated amplifier is updated to si status. Demos Naim's superbly muscular sound at entry level.

**SUGDEN A21SE** £2,480  
Class A amp with fantastic sound quality producing hard, sculpted images, deep detail and tight bass. Just don't expect disco-like sound levels!



**POWER AMPLIFIERS**

**AUDIO RESEARCH VS175** £7,498  
Powerful, fast valve sound that makes everything else look weak at times. Needs careful matching but well worth the effort.

**AUDIO RESEARCH VS115** £5,000  
Oodles of power with enormous punch. Rafael Todes said it provided "shock and awe" while retaining incredible smoothness and texture.

**ICON AUDIO MB845 MKII** £7,600  
With 120W from big 845 valves right down to low frequencies, this power amplifier has massive dynamics and bass swing, yet is easy on the ear.



**ICON AUDIO MB81PP** £15,000  
Big Russian transmitter valves deliver 200W from these massive monoblock amplifiers. Frightening in every sense.

**MCINTOSH MC-152** £4,995  
Stunningly insightful sound with enormous bass punch from a uniquely designed transistor amp. Amazing audio, a league up, if expensive.



**QUAD ELITE QMP MONOBLOCKS** £2400 PR  
The proverbial iron fist in a velvet glove. Plenty of power but delivered with an assured and confident nature. Smooth on top and easy on the ear but can rock out when needed.

**QUAD II-EIGHTY MONOBLOCKS** £6,000 PR  
Powerful and expansive sound from modern design monoblocks that also look lovely. Superb – used by us as a reference.



**LOUDSPEAKER FLOORSTANDER**

**B&W 803 D3** £12,500  
B&W's updated statement floorstanders deliver depth and definition with breathtaking speed and authority, aided by a diamond coated tweeter. Expensive – but enormously impressive.

**CASTLE AVON V** £1,600  
A big floorstander at a modest price that suits the average room. Refined ribbon treble and deep bass give it a great delivery.



**EMINENT TECHNOLOGY LFT-8B** £2,500  
Excellent U.S. planar magnetic loudspeaker at bargain price. Utterly superb - a must hear.

**EPOS K2** £1,000  
A fun sound that is tidy all round and very engaging, with solid bass. Music as you hope it to be.

**FOCAL ARIA 926** £1,400  
Simple, clean, neutral sound – easy going but well engineered and affordable.

**MARTIN LOGAN SUMMIT X** £16,698  
Matches Martin Logan's XStat electrostatic panel to a powerful subwoofer to provide extended, powerful bass. Dramatic sonic purity. Awesome – all but unmatched.

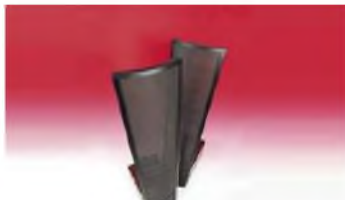

**MARTIN LOGAN ELECTROMOTION** £2,500  
Martin Logan's budget baby XStat hybrid electrostatic. Fits into any lounge to give electrostatic levels of clarity and imaging.



**QUADRAL CHROMIUM STYLE 8** £1,700  
A supremely smooth yet open sounding loudspeaker. Clean and detailed treble from a fine ribbon tweeter. Accurate yet informative and enjoyable. Pure class.

**QUADRAL ORKAN VIII AKTIVS** £6,200  
Active loudspeaker with tight, powerful bass, perfect accuracy and detailed treble from a ribbon tweeter.



**Q ACOUSTICS 2050i** £480  
A large floorstander at a budget price. Offers high sensitivity and big sound and has very few flaws for the price.

**SPENDOR SP100 R2** £6,495  
Retro looks but a sound that's hard to match. Spendor's 12" bass unit provides massive low-end grunt with a room-filling sound.



**SPENDOR A3** £1,300  
Fine little floorstander with a smooth, natural midband and even tonal balance. Ideal for smaller rooms.

**TANNOY DEFINITION DC10 Ti** £6,000  
Enormous power with great projection. Glorious subsonics too. Need little power to go very loud and have superb finish into the bargain.



**TANNOY KENSINGTON** £9,950  
Big but not overpowering, punchy modern sound from classic cabinetry. Need little power to go very loud and suit a traditional home, or castle.



**LOUDSPEAKERS STANDMOUNT**

**ACOUSTIC ENERGY NEO 1 V2** £225  
Civilised sounding speaker with fast and tuneful bass.

**ACOUSTIC ENERGY AE1 CLASSIC** £845  
Brilliantly successful remake of an iconic design; not flawless, but surely one of the most musical loudspeakers ever made.





**ELAC BS243** £1,000  
More transparent and spacious than they've a right to be at this price, these refined mid-price standmounters represent top value.



**EMINENT TECHNOLOGY LFT-16A** £1,200  
U.S. planar magnetic bookshelf loudspeaker with unrivalled mid-band and treble. Hear it before all else.

**WHARFEDALE DIAMOND 220** £200  
Builds on the success of previous Diamond ranges with better bass, more detail and a greater sense of scale.



**KEF LS50** £800  
Supremely musical mini-monitors which sound much bigger than they look.



**MARTIN LOGAN MOTION 35** £1,300  
Folded Air-Motion tweeter gives a taste of Martin Logan's electrostatic sound in a standmount. Different from the standard mini-monitor and all the better for it.



**PMC TWENTY.21** £1,575  
Transmission line loaded standmount with a big box sound from a compact cabinet. Punches well above its weight.



**Q ACOUSTICS 2020i** £165  
Great little bargain-priced stand-mounts with a friendly, fun yet surprisingly refined sound. Hard to better for a pair of starter loudspeakers.

**WHARFEDALE DENTON** £500  
A beguiling mixture of retro looks with modern, high-technology drive units. The Denton has an easy-going, big-hearted sound with a touch of trad warmth that should appeal to many.



## HEADPHONE AMPLIFIERS

**CREEK OBH11** £150  
Designed specifically for low to medium impedance (30 Ohm – 300 Ohm) headphones the little Creek has a marvelously well-judged sound.

**CHORD MOJO** £399  
Class leading portable DAC and headphone amp with ability beyond all else. Big, open spacious sound.



**EPIPHANY EHP-02** £99  
PP3 battery-powered portable gives great sound quality at an almost giveaway price. Happy with the output from an iPod or CD player, the little epiphany is a true bargain.



**ICON AUDIO HP8 MKII** £650  
The HP8 MKII valve-based headphone amplifier brings the spacious sound of valves to headphones. And it matches 'em all.



**FIDELITY AUDIO HPA 100** £350  
Great little headphone amplifier with a lively yet refined and open sound.

**MUSIC FIRST PHONE BOX** £276  
Brings a big stage, plenty of detail and rich, deep colours to the sonic spectrum.



**OPPO HA-2** £250  
Remarkable performance and sound from ESS Sabre32 DAC in a slim portable package.



## CD PLAYERS

**AUDIOLAB 8200CDQ** £949  
Inspired CD player and DAC with price-performance ratio like no other. Capable of matching designs costing much more.



**CANOR CD2+** £3,100  
Musically coherent and tuneful valve-driven CD player from Slovakia. Lovely liquid sound.



**CAMBRIDGE AUDIO AZUR 651C** £410  
Snappy modern presentation from this budget CD player. Cracking audiophile entry point for any digital fan.

**CHORD RED REFERENCE MKIII** £16,000  
A unique and massive engineering exercise that could well be the best CD player available. Chord's Pulse Array DAC technology produces a musical experience like few others. A true reference player.



**ESOTERIC K-03** £9,495  
Superb high-end silver disc spinner that is beyond criticism. Devoid of its own character but has a flawless presentation.



**EXPOSURE 101** £395  
Detailed player with fine sense of timing should be an automatic entry on any demo list at this price.

**ELECTROCOMPANIET EMP-1/S £4,650**

Epic in scale, lavish in tone and exuberant in its musicality - this is a memorable SACD spinner. Quirky in operation and modest in finish, though.



**OPPO BDP-105D £1200**

Universal player and DAC that makes CD and Blu-ray (+DVD) sound deep, spacious and full bodied. Reference quality that's affordable.



**REGA APOLLO-R £550**

Rega comes up with a fine CD player again. Tremendous detail and an easy, unforced sound at all times. Few bells and whistles but made up for by its superb sonic ability.

**ROKSAN KANDY K2 £900**

A charmingly musical performer at the price - this is a surprisingly sophisticated CD player for the money.



**TUNERS**

**CAMBRIDGE AUDIO AZUR 651T £299**

Value-packed AM/FM/DAB and DAB+ ready tuner. Precise and detailed with excellent resolution of spoken word.



**CREEK DESTINY 2 £550**

Creek's tuner expertise shines through in the Destiny 2. This AM/FM receiver is wonderfully three-dimensional and smooth.



**MAGNUM DYNALAB MD-90T £1,900**

Exceptionally able, but commensurately priced, audiophile tuner that cannot fail to charm.



**DACS**

**AUDIOLAB M-DAC £600**

Excellent sound from ESS Sabre32 DAC and impressive flexibility with a unique range of filter options make this a stand-out product. Low price is the icing on the cake.



**AUDIOLAB Q-DAC £250**

Stripped-down version of Audiolab's M-DAC loses some features but retains much of the sound, making it a veritable bargain.

**ANTELOPE ZODIAC GOLD/VOLTIKUS £3,095**

DAC/preamp/power supply combination majors on detail but has a remarkable un-digital sound. One of the best at its price.



**CHORD 2QUOTE HD £990**

Superb build quality and exceptional sound from this compact unit. Boasts the ability to handle DSD direct via USB and has an exceptional soundstage. One of the best DACs you can buy.



**DCS DEBUSSY £8,000**

DCS's bespoke 'Ring DAC' circuit gives a beautifully-fluid, almost analogue sound that encourages long listening sessions. Not cheap but worth every penny.

**NORTHERN FIDELITY DAC £650**

Packed full of features, including Bluetooth and USB, this ESS Sabre32 equipped DAC offers crisp, insightful sound at low price.



**METRUM OCTAVE £729**

Unique two-box digital-to-analogue converter with great sound at a great price. Cuts upper treble, though.

**NAIM DAC £2,400**

Superb high-end digital converter with a probing, punchy and forensically detailed sound.



**TEAC UD-501 £699**

Feature-packed DAC with benefit of DSD playback. Superb sound means little to touch it at the price.



**RESONESSENCE INVICTA MIRUS £4,499**

One of the most highly spec'd DACs available, with a smooth yet entrancing presentation. Few approach it.



**NETWORK PLAYERS**

**CHORD DSX100 £7,500**

Chord's proprietary DAC circuit shines in their top-of-the-range streamer. Hear-through clarity with a sound rich in detail, dynamics and soundstage.



**CAMBRIDGE AUDIO NP30 £399**

Budget offering from Cambridge offers a great introduction to network streaming.

**CYRUS STREAM X £1,400**

Gorgeous sound quality even from compressed digital music. New control app makes everyday operation a doddle.



**CONVERT TECHNOLOGIES PLATO £2999.00**

A network player with amplifier that does it all, including turn LP to hi-resolution digital, and add cover artwork from the 'net.



**NAIM NDX £2,995**

Clean, incisive and very detailed sound with Naim's traditional pace and timing make this one of the best network music players around.

**NAIM ND5XS £2,175**

Great sound quality with traditional Naim heft. A wonderful DAC with full 24/192 handling. Only the display could be better.



**NAIM NAC-N172 XS** £1,650  
A pre-amp/DAC/streamer package provides a taught, rock-solid presentation with a tonally rich midband and a superior sense of rhythm.



**PRO-JECT STREAM BOX RS** £1,095  
Unusual valve-based streamer/preamp with variety of inputs and a lovely liquid sound. Not the most detailed but compensates with sheer musical verve.

**QUAD PLATINUM DMP** £2,500  
Combined CD/network player has all the usual Quad elements but with added zest and detail that brings life to everything you care to play.



## DIGITAL SOURCES

**ASTELL&KERN AK100 MKII** £569  
Portable high-definition digital player with superb sound quality. Punchy and fast.



**FiiO X3** £150  
Fabulous value player with nice easy sound and full range of abilities. Small and light. For newbies.

**LOT00 PAW GOLD** £1,500  
Reference quality sound; it's like carrying your hi-fi in your pocket. Equivalently large too, but stunning headphone quality.



**NAIM HDX** £4,405  
Interesting one-box network-enabled hard-disk music system that gives superb sonics together with impressive ease of use.

**NAIM UNITILITE** £1,995  
A 50W amplifier with traditional Naim heft, a CD player and vhf/fm radio, plus network input and Bluetooth make this a great all-in-one.



## PORTABLE SPEAKERS

**BAYAN SOUNDBOOK** £149.99  
Superb design and great sound make for one of the best portable Bluetooth speaker/radios on the market. Not the cheapest – but worth every penny.



**IRIVER IBA-50** £69  
Big, warm sound with plenty of volume and clean at high levels. Muscular sound compared to many rivals.

## CABLES

**BLACK RHODIUM TWIST** £71/3M  
Twisted to fight off radio frequency, the Black Rhodium speaker cable is easy on the ear with a fine sense of clarity and focus. A remarkable performer at the price.



**MAINS CABLES R US NO.27** £95  
Offers a sprightly pace with a precise nature. Fast performance enhance frequencies and beautifully etched detail.



**CHORD SIGNATURE REFERENCE** £900  
Majors on timing, detail and openness. Capable of getting the best from most systems and a recommended upgrade.



**TELLURIUM Q BLACK** 280/3M  
A deep, dark, velvety performer that's nevertheless highly musical, it represents excellent value as mid-price cables go.

**TELLURIUM Q SILVER DIAMOND** £804/M  
An open, natural and transparent sound that is difficult to beat, from these great loudspeaker cables.



## HEADPHONES

**AUDEZE LCD-3** £1,725  
A planar magnetic 'phone that offers monitor quality. Strong sound with silky, dark quality that others struggle to match.



**B&W P3** £170  
Beautifully presented headphones from the loudspeaker specialists. Feed them a good quality source signal and they reward with excellent sound.

**JAYS V-JAYS** £49  
Wonderful little budget over-ear portable 'phones with a clean, clear sound to beat the best of the rest at the price.



**NOBLE K10 INC. FITTING** £1,279  
Custom fit in-ear phones with 10 drivers deliver a sound that is out of this world. Personal and perfect.



**OPPO PM-1** £950  
Planar magnetic phones with a warm, easy but big bodied sound that draws you in. Need a lot of drive, but deliver superb bass.



**SENNHEISER HD700** £599  
Tremendously fast with a strong, focussed, lower-frequency range and a firm bass punch.



**YAMAHA HPH-MT220** £150  
Purposeful for indoor monitoring yet light and comfortable enough to be used on the move. Excellent sound quality marred only by a slight warmth to vocals.

# vinyl section

## contents

NOVEMBER 2018

[www.hi-fiworld.co.uk](http://www.hi-fiworld.co.uk)

### SCHEU ANALOG CELLO EVOLUTION TURNTABLE 82

Fine sound at reasonable cost from Germany. Noel Keywood loves it.

### HOLD YOUR SPEED 86

How to assess and set turntable speed to improve sound quality, with stroboscope or test record. Noel Keywood explains.

### AUDIOPHILE BOOK – THE FIRST TIME 89

Paul Rigby reads a new book on artists' first-time experiences, by author Matt Everitt.

### LONGDOG AUDIO MCj3 90

A hybrid phono stage for moving coil (MC) cartridges gets the attention of Noel Keywood.

### SUGARCUBE SC-1 CLICK REMOVER 92

Digital click removal from California. Noel Keywood looks at a complex but effective way of silencing LP.

## THIRD MAN

From the US-based audiophile outfit ([www.thirdmanrecords.com](http://www.thirdmanrecords.com)), comes Sleep's new LP, 'The Sciences'. It reprises their stoned-stoner rock output and adds, would you believe it, nuance and subtlety to the monotonous rock tones. An excellent collection, hewn from the bare face cheek of Ozzy Osbourne.

Look out for Muddy Waters' 'Electric Mud' (1968), a sad tale of an album trying to woo white audiences because that's where the sales were at the time. Waters' superb vocals sound out of place on this LP that's desperate to please.

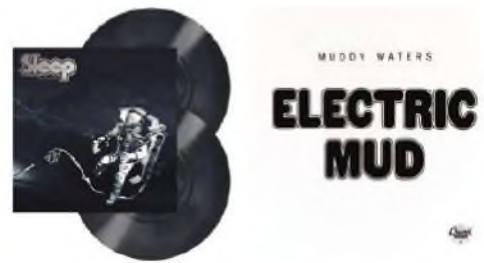

# news

## MUNSTER

From the Spanish audiophile label, Munster ([www.munster-records.com](http://www.munster-records.com)) are two LPs from former Vanguard artist, Marc Johnson: 'Years' (1972) and '12 in a Room' (1992). A little known but talented singer-songwriter of folk-pop, noted more for writing songs for others – including Paul Butterfield and Dave Edmunds.

On the company's Vinilissimo imprint is Osmar Milito's 'e Deixa O Relógio Andar!', reissued on vinyl for the first time, and featuring sublime Brazilian vibes, jazz with a hint of loungecore.

On the same imprint is the electroacoustic music of Polonio and 'Blood Stations \* Syntax Error', an experimental, looping, minimalist excursion of imaginative and fascinating tracks. Also look out for the eclectic 'Czech Up! Vol.2: We'd Be Happy' (Vampi Soul imprint), a 2LP compilation.

Working with the Supraphon label, Los Supremos' 'Atiza Y Ataja' is based upon the Cuban style of La Sonora Matancera and Colombian tropical music with an infusion of fierce salsa.



## SPEAKERS CORNER

Two outings from this German audiophile label ([www.speakerscornerrecords.com](http://www.speakerscornerrecords.com)) include jazz guitarist, Charlie Byrd's 'More Brazilian Byrd' with added and lavish strings and top quality arrangements.

Freddie Hubbard/Stanley Turrentine's 2LP 'In Concert' (1974) includes Herbie Hancock, Jack DeJohnette, Ron Carter and Eric Gale. Both of the principles seem to react to each other, pushing each to greater heights.



## BANDCAMP BOOTY

You can buy this lot direct from Bandcamp. Mole's 2LP debut release, 'Danger Island' (*Figs of London, planetmole.com*) is a quirky, singer-songwriter outing with fripperies. I keep thinking of Ray Davies...running at 65%.

From Glyn Bigga Bush is 'Sunken Foal Stories' (*biggabush.bandcamp.com/album/sunken-foal-stories*) moves away from beats to sample juggling, musical segments, tonal interplay and library music adventures.

First album in nine years, Jon Hassell's 'Listening to Pictures' (*Ndeya, jonhassell.bandcamp.com*) is a stupendous conflagration of genres, styles and tones to produce an electronica-centred, brass-framed, tonal masterpiece.

David Grubbs (Gastr Del Sol, The Red Krayola) & Taku Unami's 'Failed Celestial Creatures' (*Empty Editions, emptyeditions.bandcamp.com*) manoeuvres around sparse guitar notes of varying power along with occasional wayward vocals. Meditative.

John Butler's 2LP, 'The Loyal Serpent' (*dieselparkwest.bandcamp.com/album/the-loyal-serpent*) offers lots of effort, energy, passion and alt.rock sensibilities but rapidly hits a cul-de-sac in artistic terms.



## MUSIC ON VINYL

Lots of variety from Music on Vinyl (*www.musiconvinyl.com*) includes Lynyrd Skynyrd and 'Collected', two LPs on blue and red vinyl.

Two from grunge pioneer band, Melvins includes 'Stoner Witch' (1994), a superb LP offering melodies (!), riffs and power while 'Stag' (1996) has an epic soundstage, imaginative arrangements and great vocals. Both albums represent a creative high.

Cranking up the bouffant, if not the energy, Annihilator's 'Alice in Hell' offers hair conditioner and thrash metal via this 1989 debut. An admirable debut.

Speaking of Alice is Alice Cooper's 'The Last Temptation' (1994), his best album in around twenty years, as Cooper returned to song-writing quality instead of gimmicks.

Johnny Winter's 'The Woodstock Experience' was recorded in 1969 but released in 2009. A 2LP set, it only features eight songs which gives you an idea how Winter stretches out and indulges, as it were.

Also look out for rock outfit, Scanner's 1988 debut, 'Hypertrace', Watchtower's extreme prog-metal 1989 release, 'Control and Resistance' and Vision of Disorder's excellent second album release, 'Imprint' (1998), an improvement over their debut.



## ...AND FINALLY

Direct from Germany's Bear Family (*www.bear-family.com*) is Johnny Hallyday's 'Shake the Hand of a Fool', a two disc collection of 1962 Nashville Sessions. An excellent collection of improvised Gallic arrangements.

'We Are Vinyl offers Steve 'Love Affair' Ellis and 'Boom! Bang! Twang!', a new soul LP featuring Paul Weller and Manfred Mann's Mike D'Abo. Great songs, enhanced by Ellis' clear-voiced delivery.

From Aisha Badru, 'Pendulum' (*Nettwerk, www.nettwerk.com*) features that in vogue, croaky, whisper, lo-fi, just about to burst into tears female vocal style (but with added lisp to infuse it with variance). Derivative.

Released as a 3LP plus 7" set, 'Goldfish' (*Fruits de Mer, www.fruitsdemerrecords.com*) is a glorious, top notch, sprawling yet fascinating ten year back catalogue celebration including The Pretty Things, The Chemistry Set and Astralasia.

New one from Sparks (Lil' Beethoven/Sony) is 2008's double album 'Exotic Creates of the Deep'. Thoughtful, multi-layered, complex songs that are well worth unravelling.

The Diisc Orchestra ensemble share an LP with laptop quartet, Twentytwentyone. Split LP (*Lithuanian Music Information Center/Bolt Records; www.boltrecords.pl*). Experimental tones, processed instruments and avant-garde templates make for a fun time.



# Fine line



**To review Scheu Analog's Cello Classic turntable Noel Keywood must prepare fine fishing line. Here's a fishy tale!**

**R**oll eyeballs skyward – here's a turntable driven by a piece of fishing line. And it gave me a hard time. The price tag of £1375 from Elite Audio (UK) I thought a bit steep for the pleasure of having to prepare fine nylon line to be used as a drive belt – but when I measured then heard the end result all was forgiven. I've got a tale to tell here as a result – and although things may well seem fishy it all turned out genuine in the end.

The Cello Classic Line Evolution is a simple two speed (33 / 45rpm), line drive turntable; it's line drive because it uses fishing line rather than a belt. And let me say straight away this is one for enthusiasts: the dedicated, the patient and all similar souls who are willing to put some effort into playing LP, since it's an entirely manual turntable – but easy enough to use, once set up.

Scheu Analog (Germany) make

the turntable, fitting the Evolution variant with a budget Rega RB 202 arm carrying a low cost and outdated Audio Technica AT-100E moving magnet (MM) pickup cartridge. They're both budget starter items, used to keep package price down – and there is no dust cover of any sort.

The turntable comprises a solidly built multi-layer wooden plinth that sits on three feet, carrying an unusual inverted bearing assembly that places the pivot point high up, in the plane of the platter rather than below it. A steel hub sits atop this spherical bearing and a substantial (2.7kg) turned acrylic platter 30mm thick fits over the hub. It was easy enough to inject oil into the hub and over the bearing, as you have to do, to get the bits fitted together and the platter spinning with a nudge from the finger. No need to talk about the drive system because it is off-board. Dimensions 425mm wide, 340mm

deep and 50mm high, weight being a solid 10kgs.

The platter is driven by an independent external motor assembly that sits on its own feet. It is a d.c. motor fed by an external power supply, as usual a small universal switch-mode wall wart type from China that works from 100V-240V and provides 12V out at 1A. Ours was a two-prong that plugged into a supplied UK adaptor, delivering current through a slim two-core lead 183cms (6ft) long leading to the motor.

The large, nicely finished motor unit sits alongside the plinth as our pictures show, mechanically decoupled. A small three position toggle switch has a central off position, 33rpm and 45rpm at either side, so speed change is effected at the motor, meaning there is no need to move the line between pulley diameters; it has a single grooved hub at top. Now for the fishy bit.



**An Audio Technica AT100E moving magnet (MM) cartridge comes fitted to the Evolution variant of the Cello Classic Line reviewed here.**

Scheu Analog don't supply a belt to mechanically link motor to platter. Instead they provide a reel of fine nylon thread – fishing line. Part of the set up process demands a length of thread is cut from the reel and knotted to form a loop that acts as a 'belt'. And here life became challenging! No instructions came with our review sample but I've done this before and know the issues. All the same, the clear nylon thread is so fine and difficult to see that manipu-



**Scheu Analog's inverted bearing with hard ceramic top ball. The hub at left fits over it, and the platter slips over the hub.**

lating it is a challenge and knotting it near impossible. After 30 minutes or so of patient fiddling against a black background. I got it knotted but the knot (granny knot?) slipped apart. Second time around the knot (reef knot) held. A simple, slim knot does not affect speed stability – see Measured Performance.

Enthusiasts may enjoy this challenge but it's too much for most people; Scheu Analog need to supply a pre-made loop (or many) rather than require purchasers to do the work for them.

With this almost-invisible but stretchy line knotted into a loop it can then be placed around the pulley

and manipulated into position around the platter – another fiddly process. Once done though the platter came up to speed reasonably quickly and all worked well.

However, measurement showed that belt tension is critical – and the less tension the better. High tension made speed 2% slow in spite of the motor being electronically regulated; as I reduced tension speed rose to 0.6% slow and speed variation lessened too – so belt tension is important. It's a lot to expect of users to get this right and somewhat unrealistic in a simple consumer product.

Scheu Analog provide a stroboscope disc however and the procedure was, I determined, to run the line so slack as to make start up erratically slow, then slowly tighten the belt by moving the motor until start up was orderly and acceptably fast (a few seconds), markings became stationary and stable. A stroboscope must be lit by an old-fashioned bulb; many modern lamps are no use.

I'd be more critical about all this if it wasn't for the fact that once set up properly, speed accuracy was acceptable and speed stability very good. This is a testament to the heavy acrylic platter and a well machined main bearing free of excessive play. In listening tests they both made an important contribution to the sound.

Rega's RB 202 arm is a budget model available for around £170 if bought separately. It uses their classic one-piece cast arm incorporating headshell, that's rigid and gives both fine dynamics and a broad sound stage with firmly delineated images spread wide across it. With fixed headshell, cartridge changing isn't so easy on any Rega but it has a usable finger lift and a lift/lower cue platform that is well damped. The counterweight is not calibrated so a stylus downforce gauge is needed – not supplied.

Our Evolution review sample came with an Audio Technica AT-100E moving magnet cartridge, a unit I have not used before. It costs around £90 but is now obsolete it appears. Quoted tracking force is unusually low by today's standards – 1.4gms recommended where 1.7gms is

common nowadays. Very low tracking forces make an arm sensitive to external influence, such as footfall on a suspended floor; handling is more difficult too.

There are Classic Line Basic (cheaper) and Timbre models (more expensive), the latter having arm and cartridge options.



**The motor has a single-diameter grooved pulley, around which the fine nylon line supplied on a reel must be carefully eased into position.**

## SOUND QUALITY

I connected the Cello to our Icon Audio PS3 Mk2 (all-valve) phono stage feeding an Icon Audio Stereo 30SE single ended valve amplifier driving Martin Logan ESL-X hybrid electrostatic loudspeakers.

An Isotek Evo 3 Mosaic Genesis regenerated power supply was used to ensure mains noise and distortion did not affect the system.

Justifying the set up difficulties was the sound quality of this

**Rega's RB 202 arm has an uncalibrated counterweight at rear. To set tracking force a gauge is needed.**



# Dial A Dealer Directory

directory of Hi-Fi Dealers throughout the UK and Ireland.

**divine audio**  
 AnalogueWorks  
 Creek Audio  
 Croft Acoustics  
 Graham Audio  
 Jelco Tonearms  
 Neat Acoustics  
 Omega Loudspeakers  
 Rogue Audio  
 Supra Cables

www.divineaudio.co.uk  
 01536 762211 tim@divineaudio.co.uk

The **AUDIOBARN**  
 Old Harlow Essex



01279 454 860  
 theaudiobarn.co.uk

**The Right Note**



*Music in the home*

**Music in the Home**  
 Tel: +44 (0)1225 874728  
 Web: www.rightnote.co.uk

Digital: Accoustic Arts, Quiescent, VertexAQ.  
 Vinyl: B.M.C. Audio, Graham, Spiral Groove, Transfiguration.  
 Tuners: Magnum Dynalab.  
 Amplifiers: Accoustic Arts, Storm Audio, Quiescent, Vitas, VTL.  
 Loudspeakers: Kaiser Acoustics (Chiera & Vivace), NEAT, Toren, Velodyne (subs), Vivid.  
 Cables: Chord Co., DNM, Nordost, Siltech, Quiescent, VertexAQ.  
 Mains: Alercheia, Quiescent, VertexAQ.  
 Supports: Arcici, Hi-Fi Racks, LeadingEdge, Stands Unique.  
 Room acoustics: LeadingEdge

9 High Street, Hampton Wick,  
 Kingston upon Thames, Surrey KT1 4DA  
**Open: Tuesday - Saturday 10am - 6pm**  
**0208 943 3530**

**Infidelity**  
 MUSIC & CINEMA SYSTEMS

NAIM, LINN, REGA, ARCAM, B&W 800 SERIES, PMC, FOCAL, DYNAVECTOR, KUDOS, VELODYNE, STAX, LYRA, OPPO, TANGERINE AUDIO, TELLURIUM Q.

**SEE AND HEAR THE VERY BEST**

CEDIA MEMBER 

**6 Audio**

Vivid Audio AVM  
 Spondor Dynamique  
 Black Rhodium Hi-Fi Racks  
 Acoustic Signature Devialet

01403 713125 | 07950 274224  
 info@sixaudio.co.uk  
 www.sixaudio.co.uk  
 Partridge Green, West Sussex

**amp3** 

**Introducing the CAYIN N5iiS Digital Audio Player**



sales@amp3.co.uk  
 0343 289 6880  
 amp3.co.uk

- Android 5.1
- 3.5mm and 2.5mm outputs
- 864GB Memory Capacity

**SAVE 10% OFF ALL ORDERS AT AMP3.CO.UK  
 USE VOUCHER CODE HI-FI WORLD AT THE CHECKOUT!**

**Refreshingly different!**



**01865 790 879**  
 www.oxfordaudio.co.uk

TO ADVERTISE HERE  
 PLEASE CALL  
 JOANNA HOLMES ON  
 +44 (0) 7958 602347  
 OR EMAIL:  
 joanna@hi-fiworld.co.uk

**Audiophile Buying Club**

**SAVE TWICE!!**

1. Bulk discounts
2. Low/No supply-chain fees (We source ex-factory direct)

**istereos.co.uk**  
**istereos@hotmail.com**





**The plinth is solid and well finished. The large, heavy acrylic platter without mat is driven by a fine nylon line that passes around its rim.**

"a firm, full bodied sound that was so much more plausible than most digital".

turntable. It teased out both the great dynamics that can be had from LP, as well providing a firm, full bodied sound that was so much more plausible than most digital. Marianne Thorsen's violin all but jumped out of the Martin Logan's after cueing down. There was little vinyl noise, making for a quiet background, against which her instrument came over as solid and powerful in its fluid dynamics. Her rendition of Mozart Violin Concertos on a 180gm vinyl, DXD mastered disc from 2L of Norway had engaging vigour yet also pace and control. The sound was full bodied but dry and without bloom or temporal smear. My only reservation was some coarseness from the cartridge, plus a bit of glare.

A series of classical instrument recitals from various test discs reinforced these impressions, Bach's Tocatta in D Minor putting an organ of majestic size and power into our listening room. Zoltan Kodaly's Sonata for Cello – an all-analogue recording – had less glare than our recent 2L DXD disc; here the cartridge was less obvious.

Spinning Fleetwood Mac's Rumours LP, Dreams kicked off with solid strikes from Mick Fleetwood's drums and a wonderfully firm, powerful bass line from John McVie. Stevie Nicks suddenly appeared centre stage with vocals, in plausible shape and body. I couldn't help but be impressed by the great range of dynamic contrast this turntable conveyed, together with a sense of

dry control allied with fine pace and timing.

Spinning through a wide range of LPs left me very impressed by the Cello's sound quality. The cartridge however has limitations and an Audio Technica VM540ML would better suit. The cartridge in particular does not do justice to the turntable.

## CONCLUSION

The Scheu Cello Classic Evolution is demanding in set up, to the point where getting the best from it is best left to dyed-in-the-wool enthusiasts who want the best sound – no matter what. Much grief would be avoided if Scheu Analog provided a fine nylon belt or two without expecting users to make one up. All the same, once up and running this turntable was mightily impressive in its sound quality. It was one of the most exciting I have heard for some time but deserves a better cartridge than the one fitted.



**A small three-position toggle switch on the motor assembly has a central off position, plus 33 and 45rpm either side.**

## MEASURED PERFORMANCE

Speed was dependent upon belt tension, varying from 2% slow to 0.6% slow with low tension. Speed variation changed little but was slightly better also with low tension. Basic speed variance

### FREQUENCY RESPONSE

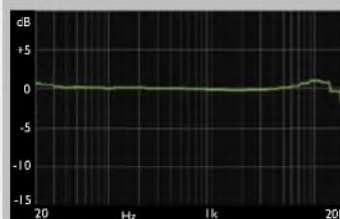

### WOW & FLUTTER

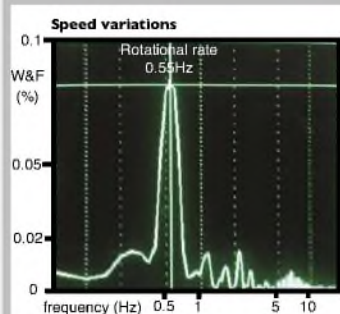

was at rotation frequency of 0.55Hz (33rpm) with little above this frequency in harmonics or flutter, as our analysis shows. As a result total DIN weighted Wow & Flutter (W&F) measured a low 0.07% – good for a belt drive. These figures mean there will be stable pitch with little of the 'wateriness' or temporal vagueness that characterises belt drive.

Rega's RB 202 tapered arm tube was free from bending mode resonances, as Rega's always are. The AT-100E cartridge measured flat across the audio band with no upper midband generator loss, but to achieve this upper treble rises by a few dB our analysis shows and this type of characteristic emphasises distortion harmonics.

Scheu Analog's Cello Classic Line Evolution turntable measured very well once correctly set up, but this was a difficult process. **NK**

<b>Speed accuracy</b>	<b>-0.6%</b>
<b>Wow (unweighted)</b>	<b>0.12%</b>
<b>Flutter (unweighted)</b>	<b>0.04%</b>
<b>Total W&amp;F (DIN weighted)</b>	<b>0.07%</b>

## SCHEU CELLO CLASSIC £1,375



**EXCELLENT - extremely capable.**

### VERDICT

Very difficult to set up enthusiasts' turntable, but with great sound.

### FOR

- superb sound quality
- well built
- stable speed

### AGAINST

- very difficult to set up
- DIY belt
- no dust cover

Elite Audio Distribution  
+44 (0)1334 570 666  
www.eliteaudiouk.com

# Hold Your Speed

**Want to get your turntable running at the right speed – here's how. Noel Keywood on stroboscopes and test discs.**

**T**he only way to get the Scheu Cello turntable I review in this issue into smooth running at correct speed was to use its supplied stroboscope. These simple but clever little discs have their uses and dedicated vinylists should know what they are and how to use them. They also have limitations and better alternatives exist, which I'll cover here.

Our picture (p89) shows the strobe disc supplied by Scheu with the Cello but they are commonly available. The idea behind these discs is that when illuminated by a domestic light bulb the bars appear stationary if speed is correct. If speed is fast they slide forward in the direction of motion, if slow they slide backward. If speed varies they wobble in position, but this can only be seen when the bars are stationary, meaning basic speed is set perfectly. If a turntable lacks speed adjustment, as many do, it's unlikely the bars will appear perfectly stationary, making any visual assessment of cyclic speed variation (wow) difficult.

Why use a strobe disc? To get a turntable to run at correct speed so that music has correct pitch. I think we all know what music sounds like when a recording runs slow and pitch goes down, or vice-versa when it goes up – when for example you run an LP at 45rpm by accident.

Some people have perfect pitch: they are able to tell whether notes are too low or high and musical training helps here. Whilst slight speed inaccuracy may not worry most of us, for some it is an issue,



**Side 2 of Clearaudio's tracking test disc (LPT83063), available on-line for Euros 50 or so, has a concentric locked outer groove – seen here. Put a object on the plinth close to the arm's finger lift and centre the disc to 0.1mm or so. Yes, it should be that accurate. Then measure.**

but there's a darker side to this. If a turntable cannot hold speed it changes speed (clever – huh?) and when it changes speed absolute pitch ceases to be a subjective issue;

change of pitch is then what we are hearing – think of a wobbly tone. And in practice turntables change pitch to an audibly significant degree.

The Scheu Cello ran slow with



high belt tension but got progressively faster and neared correct speed as I reduced belt tension – something a user could only judge by using a stroboscope. This is a rare situation.

Normally a strobe disc is used in conjunction with a turntable having variable speed, in order to be able to set that speed correctly: usually 33.3 rpm. A platter spinning at 33.3 revolutions in one minute covers 0.55 of a revolution in one second (0.55Hz). A lamp flashing at 100 times a second (UK, once per half cycle) needs 182 bars to pass it (100 / 0.55) if they are to synchronise with its flashing.

A modern problem with strobe discs is they must be lit by an old fashioned incandescent light bulb that flashes at mains frequency (or a multiple thereof). Modern lamps often don't do this, making them

"The only turntable able to produce and hold 3150Hz from a test disc is a quartz-locked Technics"

useless. A table lamp with trad. bulb is a convenient way to illuminate a strobe, other lamps being switched off.

There are other criticisms. UK mains is supposedly stable in frequency – but how stable is stable? If it varies even slightly and the turntable is stable, let's say due to rotational inertia, then the turntable is in fact displaying variations in the mains supply!

If a turntable has its own fitted strobe light and this is powered from the motor's supply then strobe lock is virtually guaranteed irrespective of power supply and speed variation. And quartz-locked turntables would show mains variation if they were to use mains illumination, so must use the motor's supply. Bit of a conundrum here then!

To counter these issues Clearaudio offer a strobe disc together with a quartz-locked 300Hz lamp to illuminate it, but cost rises inevitably, if to a reasonable £200. The disc is dual sided, one side carrying standard 33 / 45 / 78rpm strobe markings for 50Hz or 60Hz (USA) use, illuminated by a normal bulb. The other carries finer markings that match the frequency (300Hz) of the

### WHY BOTHER?

Why bother to set speed accurately? I've explained some people are pitch accurate – especially musicians and music teachers. But when turntables change speed they introduce pitch slurring, or if the change is regular, warbling. Old systems suffered such obvious effects.

Cyclic speed variation in modern turntables of 0.2% or more produces "watery pitch" – a soft, indeterminate time domain signature. Subjectively it isn't an obvious issue until you hear the same music played on a pitch-stable turntable. It imposes sharper time domain control, making starts and stops defined instead of vague. There is a subtle cleansing of sound too as hash is diminished. Overall you get a tightening and cleaning effect, like taking off misty glasses.

strobe light. Ortofon also offer their SB2 disc with accompanying light.

### TEST DISC

Strobe discs are simple and satisfactory for most people. For quantifiable measurement though, a test LP is essential and cost can be less than the £200 for Clearaudio's (Germany, clearaudio.de) strobe.

Measuring speed with a test disc can get very complicated but I'll keep it simple and DIY affordable here.

First, you need a test disc with a 3150Hz Wow&Flutter (W&F) test tone on it – increasingly rare. The 7in 33rpm test disc from Adjust+ (Germany), shown in our SweetVinyl Sugarcube review this month has just such a tone but is discontinued the company say (see [www.adjust-plus.com](http://www.adjust-plus.com)). However, their 12in test LP also has a 3150Hz test tone, but no locked groove for LP concentricity alignment.

Clearaudio also offer a 3150Hz tone on their 12in Tracking test disc (LPTB3063). Better still this LP has a locked outer groove on Side 2 for concentricity alignment.

Finally, the Ultimate Analogue test LP (USA), commonly available online and through UK retailers for around £38 has a 3150Hz test tone.

Playing any of these test discs through an ordinary hi-fi amplifier with phono stage will yield a high pitched tone at the loudspeakers. Our hand-held Fluke digital multimeter connected across the loudspeakers showed frequency without difficulty – it's as simple as that!

A hand-held Fluke 117 from Farnell costs £200 and has averaging, so looks ideal. Farnell also list an Extech DM-110 at £30 whose specs suggest it will be fine. An Extech plus test disc come in at less than £100. That makes this speed measurement system cheaper than a strobe and potentially more revealing.

With digital meters like this what you need to see on the screen is 3150 – but that will be unlikely. This method has enormous resolution and you could see anything from 3130Hz to 3170Hz on the screen. Worse, it will not be a steady value; the digits will keep changing – and that's the informative bit. If over a period of many minutes frequency varies from 3130Hz to 3140Hz and (hopefully) stays within those limits then speed is nominally 3135Hz – 15Hz too low. That's a speed error of -0.5%; the turntable is running slow. Although speed fluctuation would appear, from these figures, to be 0.3%, but not necessarily so. Wow is fluctuation above 0.1Hz; long term speed change



**A classic strobe disc from Scheu Analog, supplied with their Cello Classic turntable. It has 182 bars (outside) that should appear stationary when lit by a 50Hz powered light bulb (old fashioned sort).**

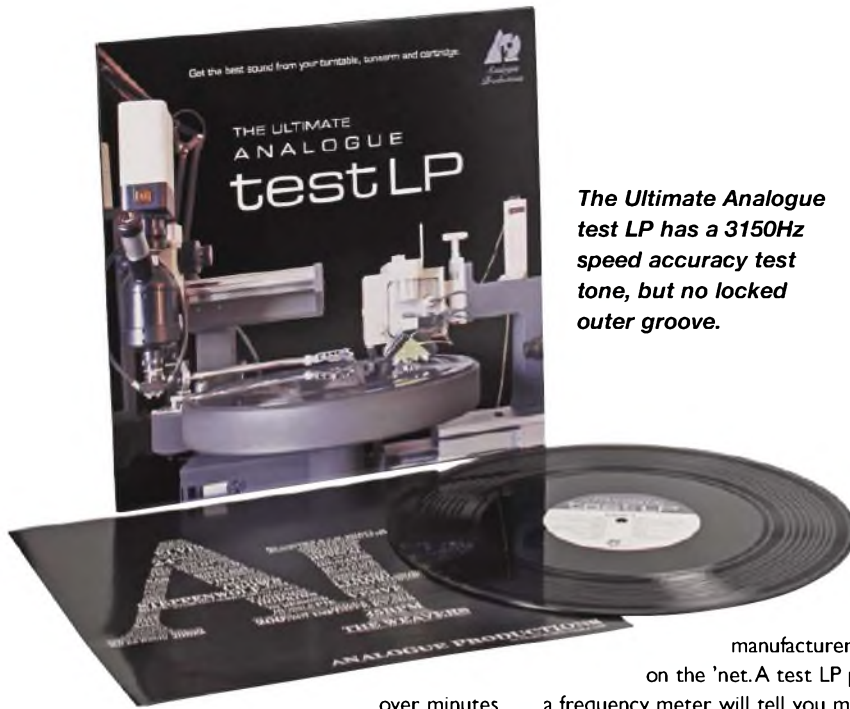

*The Ultimate Analogue test LP has a 3150Hz speed accuracy test tone, but no locked outer groove.*

over minutes or hours is termed 'Drift' and what is being read by a frequency meter is drift. However, a turntable drifting in this fashion is randomly varying

manufacturers or on the 'net. A test LP plus a frequency meter will tell you more about it than a stroboscope and cost less, but you have to be able to understand what the changing values mean, often over hours. A pencil and paper are handy here to record what is going on – then work it out!

Finally, a quick mention for the computer. Connect in via a sound card (no RIAA turntable equalisation needed) and an FFT based frequency analysis programme will show the tone and its variation, but for simplicity I will not cover that here. Also, there are apps, since a mobile phone can do the job. Go to [www.analogmagik.com/speed](http://www.analogmagik.com/speed) for a video on this. The 'net gets very worked up about wow and flutter, often missing basic practical issues like test disc centering (see Test Disc Limitations), so don't panic.

The stroboscope is a fascinating little gadget well worth having and using. Nowadays, computing power has overtaken all and there are better ways of checking speed, but none are so simple and cheap. For not a lot however, around £100, you can get a good idea of just how good your turntable is at holding speed, with a test disc and a meter.

**TEST DISC LIMITATIONS**

If a test LP isn't perfectly centred, wow will be introduced at 0.55Hz (33.3rpm). Disc eccentricity must be eliminated. A locked outer groove such as that provided on Clearaudio's test LP enables this. Playing the blank (silent) outer locked groove, the arm's headshell must not swing in and out regularly, 0.1mm being a target. To achieve this means standing a solid item on the plinth, moving it up to the finger lift and using a magnifying glass to ensure no relative movement. The LP must be moved to achieve concentricity and since centre hole alignment is commonly imperfect this means enlarging the centre hole by gently reaming it – why locked grooves are rare.

Perfect concentricity isn't enough. The cutting lathe used to make the disc will have wow and this can be in or out of phase with wow of the playback turntable, so the test disc should be centered onto at least four 90 degree different positions on the turntable and results averaged. Unfortunately, even modern test discs are not so good and you will see confusing differences according to disc angular position on platter. An average of the worst and best results is about right.



*This test LP from Adjust+ has a 3150Hz speed test tone, but no locked outer groove.*

speed and wow will result. The only turntable able to produce and hold 3150Hz from a test disc is a quartz-locked Technics. Some turntables will not hold speed at all, drifting randomly and widely over long periods and – surprisingly – most manufacturers don't seem to care. What you will see from a test disc and frequency meter may surprise you!

Pitch stability isn't much understood or talked about, by



*Clearaudio's Tracking test disc can be used to measure turntable speed, as well cartridge tracking ability.*



# First Time

**Matt Everitt collects first experiences from major musicians into a great book, Paul Rigby says.**

## The First Time

**Author:** Matt Everitt

**Publisher:** Laurence King

**Pages:** 336

**Price:** £19.99



**O**riginally, a semi-regular documentary series on BBC Radio 6 Music, also hosted by Everitt, within this new book release Everitt interviews forty stars about those seminal First Time moments in their lives such as their first gigs, first musical memories and the like.

Curated and interviewed by Everitt, the book is organised and laid out in a simple yet efficient fashion. Each section begins with a specially commissioned piece of art featuring the interviewee set within a piece of colourful graphic art. After that is a brief introduction of a page or so and then there's six or so pages of simple Q&A. Actually, there's a bit less than that. Around half of the final page is occupied with that interviewee's playlist, available on Spotify, of "songs that are discussed in the interviews." Well, that's not strictly true but it provides a flavour of the interviewee's work and the music that person enjoys.

These lists can, in themselves, be enlightening. John Lydon's includes tracks from Can, Miles Davis and Roxy Music but also Kenny Rogers, Hawkwind and Abba.

What is nice is the array of small vignettes that accompany each answer. Let's take ex-Orange Juice lead singer and successful

singer-songwriter, Edywn Collins as an example. His first remembered awareness of music was Donovan's single 'Jennifer Juniper'. A small picture image of the sleeve can then be seen adjacent, in the margin, adding a minor visual treat. The sleeve art is a regular visitor to each interview. Collins has sixteen of them, Kelis has thirteen, Michael Stipe has twelve but each offers an insight into the interviewee.

But back to Collins. Questions include: what was your first emotional connection in music, your first band, did you enjoy your first single success, first musical influence and the like (Answers: Bowie's 'Ziggy Stardust', Onyx, yes and Creedence Clearwater Revival).

So, as you can see, the questions don't necessary fall into the practical, they plug into the emotional too and, because of that, the textual style can often be free-form and haphazard reportage.

For example, Debbie Harry talked about her band's first trip to London. "It was sort of traumatic but it was great. We were opening for Television actually and we got a great response. Television got a great response. It wasn't like we were going out as brothers for the cause. It was a little bit too competitive. We had some really terrible reviews first off – I think after the first trip I

stayed in bed for a couple of weeks with the covers over my head from some scathing review – but it turned around".

Possibly my favourite is Ex-Specials/Fun Boy Three man, Terry Hall and his dry humour. As a child, his departing sister left him her record player and collection of David Cassidy and David Essex records: "...you can never go wrong with a David" he said. Although Hall first immersed himself in Bowie, "...another David but different to David Cassidy. I remember reading an interview with David Cassidy in Blue Jeans or Jackie and he refused to do a photo session because he had a spot. I thought that sounded a brilliant job. It's like 'How do you get to do a job where you can refuse because you've got a spot?'".

Oh, and the interviews that got anyway? Nick Cave ("...looms in my nightmares"), Prince ("wouldn't let me record our conversation.") and Amy Winehouse ("every interview... cancelled at the last moment. Until she ran out of moments".)

Easy to read, easy to digest, immensely entertaining, fabulous, frolicking, fan-based fun. The hardback book will be published on 5th November 2018.

# mix 'n match



**Mixing transistors and valves, the MCJ3 moving coil phono stage from Longdog Audio is a good match, says Noel Keywood.**

**F**or top vinyl sound quality you need a moving coil (MC) cartridge. They give a deeper sound than a standard moving magnet (MM) but to best appreciate that sound a well honed phono preamplifier is needed – the avowed role of Longdog Audio's MCJ3 phono stage I'm reviewing here. Forget MM – it doesn't even have it!

One of the best experiences I've



**The load switch, at left, switches resistors across the input.**

ever had in audio was to hear a very high quality all-valve phono stage, our World Audio Design KLPP1 (1995) that I use today, and also the lovely Audio Innovations P2 (1996). Specialist MC phono stages fascinate me then – so I was interested in Longdog Audio's approach.

The output from a moving coil cartridge is minuscule – millionths of a volt – meaning hiss can be an issue. It's a primary design challenge. The MCJ3 uses a low noise jfet transistor in its first stage, Longdog say, to keep noise down. It is followed by a pair of E88CC triodes then an ECC82 double-triode. It's a hybrid amplifier then, combining valves with transistors – hopefully to get the best from both worlds and specifically keep hiss below audibility.

The MCJ3 comprises a large aluminium case housing all circuitry including the power supply; there is no external supply. Power connection is through the usual IEC 'kettle

plug' straight to the mains. Case dimensions are 430mm wide, 121mm high and 285mm deep, making it as big as some amplifiers. The front carries a central power button with illuminated surround that lights blue with power on – and that's all. Switch on is electrically silent – there are no thumps or noises.

The rear panel carries RCA phono socket inputs and outputs only. There are no balanced XLR socket outputs for long line drive cables as is becoming increasingly common, nor balanced inputs for still-rare balanced output turntables.

A rotary switch offers six input load options: 50, 75, 100, 150, 250 and 470 Ohms. Best to use 100 Ohms that is the common input standard, or 470 Ohms for the few MCs that require a high load. Low resistive loads offer no benefit except through an input transformer.

Inside the MCJ3 uses a linear power supply and quality audiophile



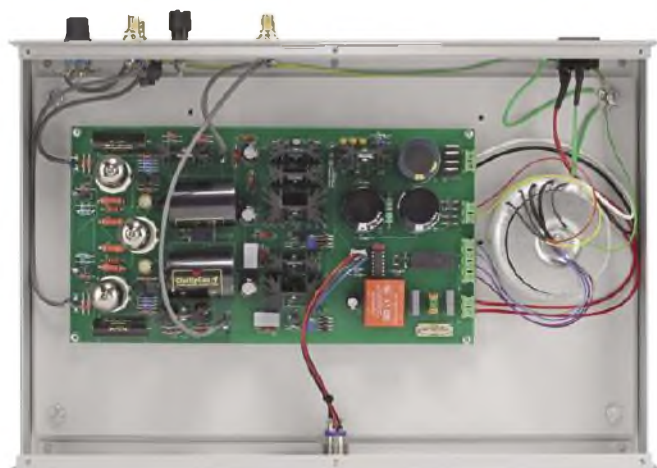

**At left the board accepts input leads to the small jfet devices, then come E88CC valves followed by a ECC82 low noise double triode. A substantial linear power supply is used.**

components: Tacman resistors, Mundorf and Clarity capacitors.

**SOUND QUALITY**

I used my preferred review set-up (no unknowns) comprising Timestep Evo modified Technics SL-1210 Mk2 turntable fitted with SME309 arm and Ortofon Cadenza Bronze moving coil (MC) cartridge.

Output from the MCj3 was fed directly to our Icon Audio Stereo 30SE amplifier driving Martin Logan ESL-X hybrid electrostatic loudspeakers – a minimalist amplifying chain.

The system was fed by an Isotek Evo 3 Mosaic Genesis regenerated power supply to be rid of London mains distortion (3%) and noise, in order to get a neutral result. The MCj3 was tried on this supply and off it, but was slightly better on it.

Spinning through a variety of LPs the character of this stage came through, most forcefully with 45rpm singles packing a punch. With Amy Winehouse singing Tears Dry On Their Own the backing synth beat thundered out, tight and clean like I've hardly ever heard it. With LPs I was aware that the MCj3 has powerful but well defined bass, the Scissor Sister's 45rpm LP Ta Dah revealed this, as did solid bass underpinning Kate Bush's King Of The Mountain from Aerial (180gm).

Marianne Thorsen's violin on the 2L LP (180gm) of Mozart Concertos was however brightly lit and even Aerial was very specific across the upper midband. What you get with this phono stage is enormous insight, intense detailing and wonderful separation, for example with the strings of the Trondheim Soloists. It's was an edge-of-the-seat listen,

I found, for those who demand to hear it all, if with less sound stage depth than our all-valve Icon Audio PS3 MkII. At the same time the MCj3 is a whole step up from all-transistor stages, based on silicon chips nowadays, where the sound

stage seemingly lacks depth.

Spinning through a variety of classical LPs made obvious the MCj3 highlights instruments well, with delightful ability to lift old recordings like our classic Decca re-master (180gm) of the Weiner Philharmoniker playing Mozart violin concertos, but at the same time ticks and pops were also captured a tad more forcefully than I am used to.

**CONCLUSION**

The Longdog MCj3 excelled with Rock. If you want to hear dynamite dynamics it's the one to go for. There is a sheen to the sound but this is part of its massive insight that delivered intense detailing. Even our Ortofon Cadenza Bronze moving coil cartridge was turbo-charged up top it seemed. It combines the clinical precision of transistors with much, if not all of the warmth and body of valves. Being MC only however, it is for aficionados.



**Rear panel carries IEC mains input socket, gold plated phono sockets and a rotary switch to adjust load.**

**MEASURED PERFORMANCE**

The MCj3 hybrid phono stage had a measured gain of x1000 (+60dB) – a

**FREQUENCY RESPONSE**

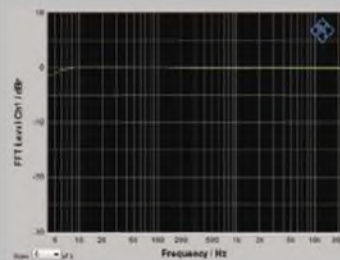

**DISTORTION**

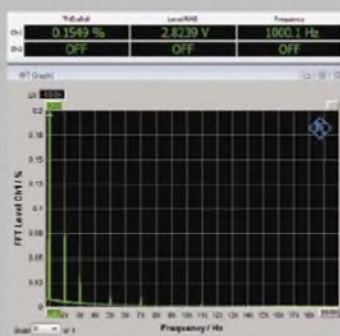

standard figure for MC. Some offer more gain, up to x3000 (70dB), but 60dB value is fine generally, if low for a few MC cartridges. Overload levels were extremely high because of the valve line driver.

Equivalent input noise was 0.23µV – not especially low. Input transformers and specialised low noise transistors offer 6dB lower noise, so although not 'noisy', better is possible using current well known techniques.

RIAA equalisation was accurate and frequency response flat as a result. There is no warp filter so deep bass is reproduced, but also LP warps if they exist. **NK**

**PHONO**

Frequency response (-1dB)	5Hz-20kHz
Distortion (1kHz, 3mV in)	0.15%
Separation (1kHz)	66dB
Noise (e.i.n., IEC A wtd.)	0.23µV
Gain	x1000 (60dB)
Overload	45mV in / 45V out

**LONGDOG AUDIO MCJ3 £1400**



**EXCELLENT - extremely capable**

**VERDICT**

Insightful, high quality MC stage with great bass.

**FOR**

- sound quality
- ease of use
- silent

**AGAINST**

- MC only
- large
- no volume control

Longdog Audio  
+44 (0)7812 249747  
www.longdogaudio.com

# Cubic Clarity

**Noel Keywood listens to Sugarcube's SC-1 digital click remover for LP. Big digital meets analogue.**

**T**he Sugarcube SC-1 from SweetVinyl of California I'm reviewing here is a digital noise removal system for LP – one that banishes ticks and pops, cleaning up old or just noisy albums. It's quite complex and must be calibrated initially using a computer's web browser – I had 'fun' here! The unit itself is a fascinating piece of wizardry, but the instructions – oh!

At £1550 the SC-1 doesn't come cheap. It's built on a high quality digital conversion system comprising 24/192 hi-res analogue-to-digital convertor (ADC) that converts analogue to digital for 'click' removal the company say, then a 24/192 digital-to-analogue convertor (DAC) turns it back to analogue.

The SC-1 is a processor, not a phono stage: you can't plug a turntable into it. It must be fed by an independent external phono stage, or linked into an amplifier via its Tape in/out sockets (rare nowadays) or Pre/Power in/out sockets. At the price an on-board MM/MC phono preamp could perhaps have been made available since nowadays the circuitry needed is simple and inexpensive, but the SC-1 is a high-end unit aimed at users likely to already have a quality phono stage. It's digitally complex and this is what you pay for: digital cleverness rather

than analogue convenience.

As a separate processor the SC-1 needs its own space in a hi-fi rack but it slots in easily enough, measuring 306mm wide, 310mm deep and 54mm high. Weight is a low 2kgs. Connections are via RCA phono plugs only (no balanced XLR), identified as Line In and Line Out. There is no gain (x1) and no volume control.

Power comes from an external switch-mode power block (supplied) rather than an internal supply and the power switch is a small toggle on the rear panel – not so convenient but the unit consumes little power, the external switch-mode supply being rated at 12V at 1A, whilst the unit's quoted power dissipation is 9 Watts. The unit can be left switched on, but it does not meet the IEC requirement of <1 Watt consumption on standby.

The SC-1 processes relative to signal level from LP so it has to be calibrated against a reference tone from LP. This is usually 3.54 cms/sec rms groove velocity at 1kHz but for some reason the company have chosen to use a 3150Hz Vow & Flutter test tone from a 7in test disc – a 'single' – that comes included. Whilst the unit calibrates internally the calibration process is controlled externally by an app or a web browser – I used a Mac's Safari

web browser. Once calibrated into the system it is set to go and use is relatively simple.

There are ten levels of noise reduction within the digital processing chain and the option to switch between processed (Repaired) and unprocessed (Original) using a central button marked Click Remove. However, the instructions and product literature don't explain that in unprocessed mode where the signal passes through the ADC and back out through the DAC, there also lurks a strong warp filter that eliminates very low bass, below 30Hz our measurements showed – probably to prevent strong subsonic warp signals affecting the processing. This explains why there is a full Bypass option that cuts out the digital chain altogether so you can hear the original analogue – warps, subsonics and all – which LP by its nature possesses.

These options make for a fascinating experience that demonstrates clearly what the SC-1 is doing. And as if all this was not enough SweetVinyl also include another very impressive way to get the hang of what is going on: a Click Monitor. Press this and you get to hear all the clicks that are being removed – the clicks and only the clicks, no music or anything else. Listening to this I couldn't help but





be impressed! It was like being hit by a high frequency machine gun.

So, onto the malarkey of setup. First, the unit must be connected to a network or computer via wired or wireless link; I used an RJ45 terminated wired ethernet link into our network but this can go direct into a computer. Press Bypass for a few seconds and info appears on the small screen including an IP address. This has to be entered into the web browser with a suffix added ':5123'. I missed the suffix bit and cursed at failure to connect, but another read of the instructions solved this niggler. A menu then appeared requiring a password, that must be obtained by pressing a 'Pairing' button on the rear of unit. With this done a simple set-up screen appears that isn't in itself very helpful. But worse was to come.

With the computer set up to control the unit's internal processing system the 7in test disc must be played. Simple – except at what speed? There was nothing on sleeve or disc stating rotational speed and no mention in the instructions either! 7in 'singles' normally spin at 45rpm but I second-sensed that may not be the case here – and it wasn't.

"Play Side 1" the instructions say, but there are two tracks on Side 1. Which track? The instructions don't say – absurd. The first track is a long 3150Hz speed stability test tone, the second a 1kHz reference tone comprising out-of-phase L & R. Peering at the instructions with a magnifying glass I saw SweetVinyl's published data screen shot showed a 'freq' 'avg' (frequency average) of 3217, telling me they were using a turntable running +2.1% fast to play the 3150Hz tone. I used a frequency meter to find the test disc must be spun at 33rpm to produce 3150Hz, not 45rpm as many might expect.

With 33rpm selected on our quartz speed-locked Timestep Evo Technics SL-1210 Mk2 turntable, the tone was correctly seen by the software as producing a perfect 3150Hz tone with 0.1% error. The sensing system works very well, but the disc's lack of speed info and the instruction's total blindness to the issues involved were – well – whatever! Fill in the blanks.

With the SC-1 calibrated it was time to see what it could do.

## SOUND QUALITY

For listening tests the Sugarcube SC-1 was fed by our Timestep Evo Technics SL-1210 Mk2 with SME309



**To the left of the analogue, gold plated input and output sockets (at right) sits a large LAN (Local Area Network) socket with connection into the processor that facilitates computer setup.**

arm, carrying an Ortofon Cadenza Bronze moving coil (MC) cartridge. Phono stage was an Icon Audio PS3 Mk2 (all-valve) with volume set to maximum, so the volume control has no influence and output is high, but still well below 1V (the SC-1 has a 5V limit – see Measured Performance).

Output from the SC-1 was fed to our Icon Audio Stereo 30SE single ended valve amplifier driving

SC-1 could do I listened to the locked run-out groove. This was a fascinating demo.

The locked groove was horribly noisy, ragged sounding vinyl roar suggesting very low quality vinyl had been used (perhaps why the following album Ta Da was cut at 45rpm). Switching Click suppression in cut out sharp ticks but did not affect the ragged roar, overall not having a great deal of influence.

"It was impressive, almost turning LP into CD – without the harshness."

Martin Logan ESL-X hybrid electrostatic loudspeakers.

An Isotek Evo 3 Mosaic Genesis regenerated power supply was used to ensure mains noise and distortion did not affect the SC-1 or Martin Logan's XStat electrostatic panels.

Now, which one of our array of test LPs, used for their lack of damage, do I use to assess this unit, I thought? I lighted on the Scissor Sister's eponymously named first album that has a sharp quality, with spit and surface noise. Initially, to get a good handle on what the

This underlines the fact that the unit suppresses short-term clicks but not all noise; it does not offer a universal panacea. However, it was obvious that clicks had been largely if not completely removed at 10 (max) and selecting Click Monitor directed a shower of clicks through the speakers – those that had been removed. It was a shock!

Playing the album rather than the run-out groove showed that cymbals remained intact, if a little dulled with 10 (max) selected and the music was otherwise sonically affected little, although there is a

# VINYL SECTION



The rear panel carries chunky gold plated RCA phono socket inputs and outputs (at left), an RJ45 ethernet LAN socket, USB sockets and a 12V d.c. input for connection to the external power supply. Note also the crucial Pair button used during set up, situated between USB and d.c. sockets.

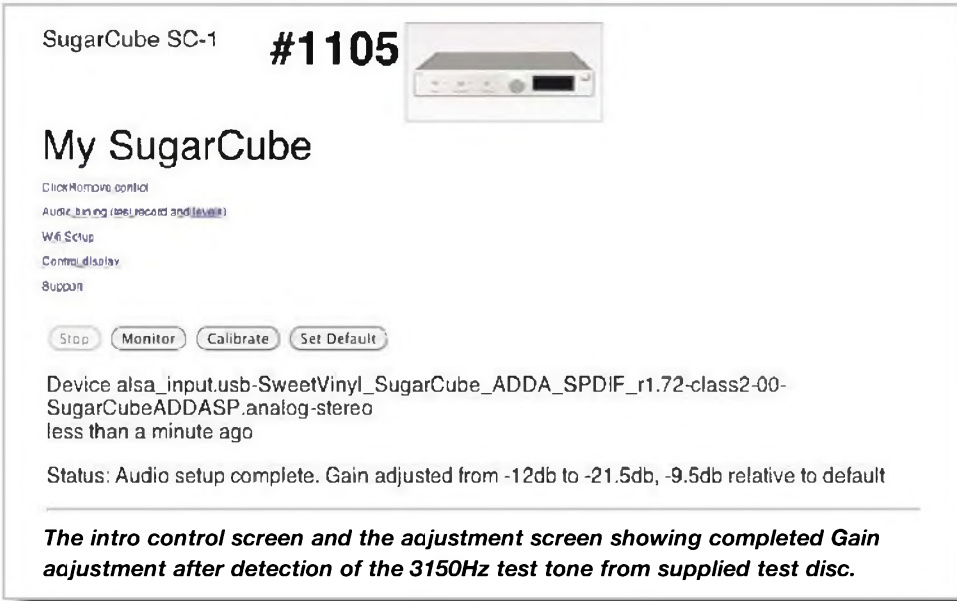

whooshing of surface noise upon needle drop but this was short lived.

## CONCLUSION

The Sugarcube SC-1 processor certainly worked well – listening to the Click monitor proved that. It is a click suppressor and does not make a noisy LP suffering vinyl roar silent but it does suppress clicks, as claimed and silenced classical performances especially well. I suspect classical listeners will appreciate its ability to make old performances on vinyl more bearable. It's certainly worth hearing – but setup on a web browser via ethernet/wi-fi is awkward and SweetVinyl need to sort out both the instructions and test disc issues.

slight general sense of smoothing and warming. SweetVinyl suggest 5 is an appropriate default setting and this was about right, but at 5 some ticks and pops still get through; the cleaning effect isn't total.

With classical the picture became far more positive. An Acoustic Research demo record, The Sound of Musical Instruments (1972) pressed in decent vinyl but a tad noisy after decades of use showed especially well that with this balance of degradation the SC-1 produced almost silence from LP. It was impressive, almost turning LP into CD – without the harshness.

Using Bypass to switch out the ADC/DAC digital processing line and its warp filter added some low end warmth and fullness as expected, but the filter has been well designed to leave low bass intact so bass lines in our Rumours LP remained strong for example. Also, the warp filter cleans and speeds the low end a bit so has its own sonic merits.

The delay line also delays needle drop and keeps the music playing after the arm is lifted – eery! On occasion I heard a hunting or

## MEASURED PERFORMANCE

The Sugarcube SC-1 accepted a 5V input as claimed, but only from a balanced source. Fed from an unbalanced source as is likely in use it has a limit of 2.5 V, still high enough for most systems.

However, there appears to be an issue here, possibly balanced input op amps ungrounded. Distortion at 1V input measured a low 0.003% and noise was low too at -96dB (below 1 V).

### FREQUENCY RESPONSE

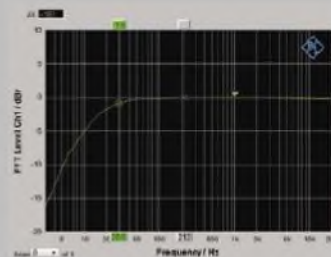

Frequency response within -1dB limits stretched from 30Hz to 33kHz (-1dB) our analysis shows, the upper limit being 96kHz as expected with 192kHz sample rate internal processing. The lower 30Hz limit is set by a warp filter that introduced -11dB attenuation at 5Hz – substantial. Bypass switches this out.

The Click monitor output showed frequencies above 15kHz are attenuated sharply.

### IMPEDANCE

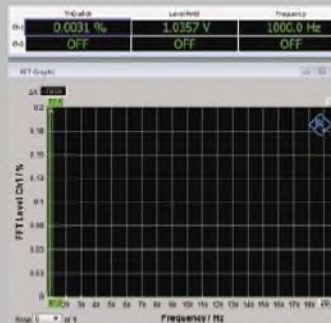

The SC-1 measured well in most areas but has a lower input limit than claimed when fed an unbalanced source, as is likely in practice, but this will not be a limitation in most systems. **NK**

Frequency response (-1dB) 30Hz-50kHz	
Distortion (1 V)	0.003%
Separation (1kHz)	92dB
Noise (IEC A)	-96dB
Gain/overload	x1, 2.5V

## SUGARCUBE SC-1 £1550



**EXCELLENT - extremely capable**

### VERDICT

A hi-tech LP click remover that works well, but set up needs a computer.

### FOR

- effective click removal
- little affect on sound quality
- simple to use once understood

### AGAINST

- very difficult to set up
- no turntable phono input
- expensive

Henley Audio  
+44 (0)1235 511166  
www.henleyaudio.co.uk



# free reader Classifieds

**TERMS AND CONDITIONS:** Only one advert per reader. No Trade adverts. This section is strictly for readers selling secondhand hi-fi equipment only. Maximum length per advert is 30 words. Adverts over 30 words will not be accepted. Telephone numbers and E-mail addresses are treated as one word. Model numbers are treated as one word i.e. Quad 303 = two words. Email your advert to; [classifieds@hi-fiworld.co.uk](mailto:classifieds@hi-fiworld.co.uk) or fill in the form on page 97 and post it to Hi-Fi World Free Readers Ads, Studio 204, Buspace Studio, Conlan Street, Notting Hill, London W10 5AP. Sorry, we cannot accept adverts over the telephone. The Publisher reserves the right to judge submissions.

VINTAGE STANDMOUNT Loudspeakers Goodmans Minister, £25. Leak Mini Sandwich, £30. Mordaunt Short Festival Series 2, £40. All excellent sound. Tel: 0114 237 8731

2 QUAD 34 control units. 2 Quad 405-2. TD150 turntable with SME 10" arm. Pair Kef 107/2 loudspeakers with Kube. Offers to - Email: [fawley.hants@yahoo.co.uk](mailto:fawley.hants@yahoo.co.uk)

QUADRASPIRE SUNOKO Vent stand. Black ash. 3 shelves. 216mm columns and four extra 100mm for flexible spacing. Good condition. Photos available. £300. (New price £759). Tel: 01302 854 426. Mobile: 07711 773 232

SHARK FLAT 4W speaker cable (40 metres). Gold plated phono plugs (24 pairs) Project Phono Box MM. Project headphone amp. Project wall turntable shelf. Pair Dali Zensor 1 speakers. All boxed, as new. Buyer collects. Details Tel: 07531 288 156

EARLY ELITE Rock Origin Live, DZ300 motor with remote, Nima tone-arm. Roksan HD cable. Dynavector 20X2L cartridge. £850. Benz Micro wood cartridge, boxed, £550. Tel: 01202 482 110

CLASS'E CP-800 pre-amp. £2,500. In mint condition with 9 digital and 5 analog inputs, including remote and all packaging. Buyer collects. Tel: Keith 01622 208476 or Email: [vs006t9281@blueyonder.co.uk](mailto:vs006t9281@blueyonder.co.uk)

QUAD ELITE Series pre and power amp. Excellent condition. Boxed. £500. No offers. Tel: 01903 506 479 (Worthing, Sussex)

BANG & OLUFSEN Beocentre 7000, boxed, remote, working but needs service. £160 ono. Collect only. Marantz PM7001 amplifier, boxed, £175 ono. ST7001 DAB/FM tuner, £125 ono. Tel: 01708 457 691

SOtM sPS-500, sMS-200 Ultra, rX-USB Ultra 12V 50 Ohm 6 months old £2100 o.n.o Please call 07706 169968 for further details.

BRAND NEW and factory sealed Echobox Explorer hires DAP with matching dock in maple £230 post free. Email: [kjewula@hotmail.com](mailto:kjewula@hotmail.com)

QUAD 57's bronze excellent £375 Wharfdale V3's late 50's good offers Mantra turntable VGC ATOC9 Cartridge and spare motor board £150. Tel 07931818772 collection only BN25 area [w418@btinternet.com](mailto:w418@btinternet.com)

PHONO WIREWORLD Platinum Eclipse 7 SME/RCA 1.2 metres £530 ono. Wireworld Platinum Eclipse 7 XLR 1 metre £1300 ono. All boxed as new. Info: 01462 834287

STAX SR-L700 Headphones. Energiser SRM-006tS. Cord Crimson VEE3 Interconnect. All vgc £500. Buyer collects from Greater London. 07729 761278 after 7pm. Can demo.

SELLING COMPLETE second system. Croft amp, Rega RS3 piano black, NAD CD player. All totally immaculate plus NAD tuner fully boxed £1200. Email: [stemar2@me.com](mailto:stemar2@me.com)

COPELAND CTA301 Valve Pre-Amp Superb LINE and Phone Stages. Boxed and near mint £795 ovno. Oppo BDP-105EU Silver Boxed Mint light use only for SACD and DVD Audio discs £850 ovno. Transcendental Sound 300B Line and Headphone 230v Pre-Amp as a DIY kit! Highly regarded. Needs valves and schematic readers skills so not for me! £750 ovno. Contact: Steve 07799 470 301 (North Yorkshire)

TOM EVANS Groove MC phono amp 0.4mv new at 09/12. An exceptional sound really digs into any LP for the hidden details. A bargain at £650. Cyrus 3 amplifier £100. Best price seen. If bought together then £700 for both. Contact [nigelsach42@tiscali.co.uk](mailto:nigelsach42@tiscali.co.uk) Tel mobile: 07913 121771 Items on the Wirral.

NEAT IOTA speakers as new satin white £450 ono, wired for sound mint DAC Amp as new £850, Phil (Bromsgrove) 07973 426291 Email: [philipadams0751@gmail.com](mailto:philipadams0751@gmail.com).

BRAND NEW and unused factory sealed box Neat Iota Alpha loudspeakers in Black. Genuine reason for sale £1050 including carriage. Near Fleet Hants Email: [kjewula@hotmail.com](mailto:kjewula@hotmail.com)

NORDOST PULSAR points for sale, £35 for one set or £60 for 2 sets of Pulsar Points. Excellent resonance control devices ideal under CD players, pre amps, integrated amps and phono stages. Call Andy on 01484 427426

HEED OBELISK Si Mk 2 totally a immaculate unmarked condition. Stunning sound quality that can be upgraded further with power supply. boxed £550. Email: [stemar2@me.com](mailto:stemar2@me.com) or Tel 07462466962

MONITOR AUDIO A100 amplifier, unused, black, £150. Ariand FV34B valve integrated amplifier with pre-in, mint, £475. Polk Signature S15 speakers, black, unused, £150. All boxed, Text 07743 380657, or Email: [mail@rodtheobald.force9.co.uk](mailto:mail@rodtheobald.force9.co.uk).

PROAC D18 speakers Yew cabinets and Proac boxes £895. Arcam DV137 DVD player £85. Russ Andrews upgraded Humax satellite receiver, inc 1TB hard drive £125 Southport 01704 628968 or 07968769595

VINTAGE STANDMOUNT Loudspeakers Goodmans Minister, £25. Leak Mini Sandwich, £30. Mordaunt Short Festival Series 2, £40. All excellent sound. Tel: 0114 237 8731

WANTED WORKING or non working Quad 44 preamp serial no. 23000 onwards. Contact Mike 01758 613790.

# NEXT MONTH DECEMBER 2018 ISSUE

## QUAD ARTERA PLAY+

We reviewed the Play in our January 2016 issue and now Quad have released a substantial update. For all those interested in hearing CD at its best don't miss this in-depth review of the new updated Quad.

Also, we hope to bring you —  
PIONEER A-40AE INTEGRATED AMPLIFIER  
CHORD SPM 1050 MKII AMPLIFIER  
KLIPSCH R-820F SPEAKERS  
COWON U7 HI-RES PLAYER  
LENCO L40 TURNTABLE  
...and much more.



This is a selection of what we hope to bring you, not a complete list. We regret that due to a wide range of issues, we cannot guarantee that all products listed above will appear.

**PICK UP THE DECEMBER 2018 ISSUE OF HI-FI WORLD ON SALE OCTOBER 31ST 2018, OR SUBSCRIBE AND GET IT DELIVERED TO YOUR DOOR: SEE PAGE 52**



# FREE READER CLASSIFIED ADS ORDER FORM

**STOP PRESS**

## ADVERTISERS INDEX

2nd Hand Hi-Fi	72
Absolute Sound	OBC
Advanced Media Players	84
Audio Consultants	38
Audiophile Buying Club	84
Auralic	58
B&W	6
Billy Vee	64
Black Rhodium	66
Chord Electronics	24
Classic Hi-Fi	58
Criterion	64
Decent Audio	32,33
Divine Audio	84
Electromod	68
Elite Audio	50
FiiO	60,61
Henley	14,30,42,70
IAG	IBC
Ian Harrison	64
Icon Audio	26
Infidelity	84
Jordan Acoustics	20,21
KEF	16
MCRU	48
Oxford Audio	84
Peter Tyson	36
Riverside Hi-Fi	56
SCV Distribution	28
Select Audio	40
Six Audio	84
Sound Damped Steel	46
Sound Hi-Fi	68
Tellurium Q	12
The Audio Barn	84
The Chord Company	IFC
The Right Note	84

**TERMS AND CONDITIONS:** Only one advert per reader. Maximum length per advert is 30 words, Adverts over 30 words will not be accepted. No Trade Adverts. This section is strictly for readers selling secondhand hi-fi equipment only. Telephone numbers and E-mail addresses are treated as one word. Model numbers are treated as one word i.e. Quad 303 = two words. Sorry, we cannot accept adverts over the telephone. The Publisher reserves the right to judge submissions.

You can email your advert to us at: [classifieds@hi-fiworld.co.uk](mailto:classifieds@hi-fiworld.co.uk)  
or write or type your advertisement copy in block capitals with one word per box and post it to us at:

Hi-Fi World Free Readers Ads,  
Studio 204,  
Buspace Studio,  
Conlan Street,  
London W10 5AP

**We cannot accept adverts over the telephone**

1	2
3	4
5	6
7	8
9	10
11	12
13	14
15	16
17	18
19	20
21	22
23	24
25	26
27	28
29	30

Name: \_\_\_\_\_

Address: \_\_\_\_\_

Post Code: \_\_\_\_\_

Daytime Tel: \_\_\_\_\_

**FREE READER CLASSIFIED ADVERTS COPY DEADLINES**

JANUARY 2019 - 6TH NOVEMBER

FEBRUARY 2019 - 3RD DECEMBER

# BEN FOLDS FIVE

WHATEVER AND EVER AMEN

EDSEL

**W**ell, not five exactly. Three. Just the three. Ben Folds himself, plus Robert Sledge on bass and Darren Jessee on drums. They were witty, cute, cheeky, sometimes outrageous and cuttily sensitive. The band didn't last that long, to be honest. Releasing its first album in 1995 and disbanding in 2000. After that, Folds has journeyed on a long and complex solo career.

Some people prefer the band's debut release of 1995 but I have a soft spot for their second album, released two years later. There is something light, bright and breezy about it.

There's a carefree, relaxed, sometimes Beach Boy-esque feel to the album. If not

always in vocal

harmonies then of tone and direction. There's also a little bit of Joe Jackson in there and not because there's a dominant piano in the middle of the songs. Just listen to 'One Angry Dwarf and 200 Solemn Faces' and hear that distinct tonal slur of Jackson with jazz cues all over the place.

There's also Elton John in there too. John is a big inspiration, in fact. As Folds said, "[John] had a lot to do with inspiring me to want to play piano in rock music. If it hadn't been him doing it I don't know who else really was. He kinda made it 'OK' to play the piano if nothing else. The guy's written some great songs".

Also liberally sprinkled throughout this album are the pop hooks which drag you into each song and keep you pinned to the soundstage until the next passing song demands you keep your seat. The hooks are not everything, of course, they're a bonus. The real point of this album is the song-writing. Carefully crafted and perfectly arranged with a lightness of touch that never hints at over production. Far from it, the songs here sound freshly created. In fact, the album has an almost

spontaneous aspect to it.

Oh, and there has been comment around the internet about one or two sudden stylistic and artistic twists on this release. For example, Song for The Dumped has come in for criticism for being misogynistic. The song is about being dumped, the singer's emotional outburst reaction to the action and his flailing, spontaneous, rather immature and largely ineffectual methods of striking back in a verbal sense which appears to make no real difference to the situation. I'd call that a study of human relationships and failings. Not misogyny.

There are also extremely personal and sensitive explorations on the album. 'Brick' for example, derives from a real high school affair that lead to an abortion. As Folds stated to Billboard in 2015, "Abortion is a total trigger point for me. I don't like talking about it. I wouldn't have spoken about it in that song but as Randy Newman says, 'I would run over my grandmother for a song'. If the melody is telling me this is what the song is about, then I'm sort of forced into confession, autobiography or fantasy. If I don't do that, I've hamstringed the melody".

It's interesting that Folds, as a person, is private in how he interacts with society. He doesn't walk around telling his life story to all and sundry and sharing the intimate elements of his life to strangers. Apparently, though, he needs to get this stuff off his chest. So he does it through his art. "The less I talk in bars, write emails, express myself in an emotionally lewd way outside of my songwriting, the more I have to do it through my music," he said. "I've gotten to the point where I realise that I need to tell my truth in music and not walk around blabbing my mind".

This album, nicely mastered, can now be found within a large box set from Edsel called, rather prosaically, 'Brick'. Because the packaging looks like one. Subtitled 'The Songs Of Ben Folds, 1995-2012', the set features thirteen CDs and includes this album plus the four other Ben Folds Five albums (including 2012's comeback album, 'The Sound of the Life of the Mind'), all of Folds' solo albums (up until 2012), live recordings, B-sides and other bonus material. The box set also includes the 2002 'Ben Folds Live' album, the live album 'Songs For Goldfish' which accompanied the 2005 album 'Songs For Silverman', the alternative 'Seeds' versions from 'Stems And Seeds'. **PR**



"I've gotten to the point where I realise that I need to tell my truth in music."





## New ERA for headphones

To create the ERA-1 – our first-ever headphones – we developed a planar magnetic driver delivering a fast, open and transparent performance. The resulting sonic realism is fully in keeping with Quad's heritage, displaying qualities akin to the world-famous ESL loudspeakers. Once again, Quad delivers 'the closest approach to the original sound', bringing you up close and personal to the music you adore with beguiling clarity and definition.

IAG House, 13/14 Glebe Road, Huntingdon, Cambridgeshire, PE29 7DL, UK  
Tel: +44(0)1480 452561 Fax: +44(0)1480 413403 [www.quad-hifi.co.uk](http://www.quad-hifi.co.uk)

# QUAD

"All in all it was a sonorous and sophisticated sound that swept over me in a wave."

- John Myles - Hifi-World Magazine

"A major step forward in amplifier performance"

- Robert Deutsch - Stereophile Magazine

# WHEN HISTORY AND HEART COLLIDE

"The DiaLogue Premium HP sound is so captivating in my system  
that I can't seem to resist. You win PrimaLuna! "

- Paul Mah - Dagogo

"A PrimaLuna is not just a flirtation, it is an investment in pleasure"

- Rene Van Es - The Ear Magazine



 **absolute sounds ltd.**

International Distributors & Consultants of Specialised Hi-End Audio & Video Systems

58 Durham Road, London, SW20 0TW T: +44 (0)20 89 71 39 09

W: [www.absolutesounds.com](http://www.absolutesounds.com) E: [info@absolutesounds.com](mailto:info@absolutesounds.com)

For Your Nearest Dealer Please Visit The [Absolute Sounds](http://www.absolutesounds.com) Website

 **PrimaLuna®**