

hi-fi WORLD



DIY SUPPLEMENT NO.85

OCTOBER 2005 UK £3.40

QUAD's new CD

SUPERB NEW QUAD CDP-2 CD PLAYER & 99/909 PRE-POWER AMPLIFIER



COMPETITION
Win a super **ROTEL + B&W** hi-fi system

COMPACT HI-FI ISSUE
ØRELLE CDI00/SAI00 EVO2 SYSTEM
ONKYO C733/A-933 SYSTEM

SMALL LOUDSPEAKERS
ACOUSTIC ENERGY AE-1 III VS. AE-1 CLASSIC
GENELEC HT-205 PRO MONITORS
WILSON BENESCH ARC
DYNAUDIO SPECIAL 25

+ MINI-MONITOR SUPERTTEST:
AURUM CANTUS, KEF,
EPOS, QUAD, PINSH
MONITOR AUDIO

Take advantage of our **SIMPLY STAX SUBSCRIPTION PROMO** see page 74

10 PAGES OF HI-FI O&A CLASSIFIED ADS

OCTOBER 2005





The experiences this chair has had! The amazing performances, concerts and gigs it has witnessed from all around the musical world. From the front row at Carnegie Hall to the stalls at Brixton Academy, from the dress circle of the Sydney Opera House to the bar in Ronnie Scott's – this chair has been there! It has experienced music as it should be heard – alive and vibrant, with every nuance and emotion as clear as the musicians intended.

The Rotel O2 Series is a new range of hi-fi from a company with a reputation for delivering award-winning sounds at realistic prices. The O2 Series' superb sound is the result of Rotel's Balanced Design Concept – an integrated approach that ensures five star performance.

To find out how the Rotel O2 Series can take you to the world's greatest musical venues, visit www.rotel.com.

The Rotel O2 Series

including the RA-03 amplifier



Rotel RA-03
May 2005



B&W Loudspeakers, Dale Road, Worthing, West Sussex BN11 2BH, United Kingdom, 01903 221500

World Radio History



Rotel RA-03
April 2005

welcome

EDITOR

David Price
tel/fax: +44 (0) 1275 371 386
e-mail: editorial@hi-fiworld.co.uk

DESIGN EDITOR

Faiza Chunara
tel: +44 (0) 20 7625 3129
fax: +44 (0) 20 7328 1844
e-mail: adproduction@hi-fiworld.co.uk

PRODUCTION EDITOR

David Noble
tel: +44 (0) 20 7625 3134
fax: +44 (0) 20 7328 1844
e-mail: classifieds@hi-fiworld.co.uk

ADVERTISING

Debi Silver
tel: +44 (0) 20 7372 6018
fax: +44 (0) 20 7328 1844
e-mail: advertising@hi-fiworld.co.uk

ACCOUNTS

Sharon Mehlhom
tel: +44 (0) 20 8841 8892
fax: +44 (0) 20 8841 9144
e-mail: accounts@hi-fiworld.co.uk

WORLD AUDIO DESIGN

www.worldaudiodesign.com
tel: +44 (0) 845 257 5600
e-mail: sales@worldaudiodesign.com

PUBLISHER

Noel Keywood
e-mail: publisher@hi-fiworld.co.uk

PRIVATE & TRADE CLASSIFIEDS

tel: +44 (0) 20 7625 3134
fax: +44 (0) 20 7328 1844
e-mail: classifieds@hi-fiworld.co.uk

SUBSCRIPTIONS

tel: +44 (0) 1442 879097
fax: +44 (0) 1442 872279
e-mail: hifiworld@webscribe.co.uk

WRITERS

Dominic Todd
LJK Setright
Channa Vithana
Haden Boardman
Steve Green



For some strange reason, not everyone on this earth aspires to owning large numbers of sprawling hi-fi separates, connected by a labyrinthine web of curiously coloured cables, spoiling their domestic bliss!

Now, although this in my opinion is a highly eccentric view, I'm forced to concede that some people look at the world differently, however unfathomable and strange this may seem.

Although I'd say a vast rack of hi-fi equipment, connected to large loudspeakers by wires the circumference of water pipes, is definitely something to aspire to, I concede there's a section of the community that begs to differ...

So, in the spirit of true pluralism, this month's *Hi-Fi World* looks at small separates. If you really can't persuade your better half that losing most of your living space to the noble cause of high fidelity is necessary, then we have a host of home-friendly hardware for your surprise and delight!

Interestingly – and much to my surprise – it seems that acres of audio electronics are not actually necessary to make a nice noise. Far from it. October's issue shows that the likes of Onkyo, Orelle and Quad (p32) have small audiophile systems on offer that produce much more than just a big sound – but much, much more.

Better still, the latest crop of standmounting speakers – what were once called 'bookshelf' – is quite exceptional, as this month's supertest shows (p15). Or if you're wanting to spend big money, then the baby boxes from Wilson Benesch (the Arc, p10), Dynaudio (the Special 25, p51) and Acoustic Energy (the AEI III, p41) offer something that fully grown designs four or five times the size can't provide.

Indeed, this month's Acoustic Energy feature looks at the genesis of one of the best small speakers ever, the original AEI (p44). And those into going active will be delighted by the power of Genelec's HT-205 mini-monitor (p59).

So, whether you're a student going back to school on a 'beer budget', or simply an audiophile who's seriously spatially challenged, this month's magazine has something for you – proof positive that less is more!

David Price, editor



verdicts



OUTSTANDING
EXCELLENT
GOOD
MEDIOCRE
POOR
VALUE

simply the best
extremely capable
worth auditioning
unremarkable
seriously flawed
keenly priced

hi-fi world

SUITE G4, ARGO HOUSE
KILBURN PARK ROAD
LONDON NW6 5LF
www.hi-fiworld.co.uk

testing

Hi-Fi World has its own advanced test laboratory and acoustically treated listening room, and a dedicated team of experienced listeners. We review thoroughly by extensive auditioning, rather than by quick-fire group listening tests. Our engineering team designs a wide range of products in-house. No other hi-fi magazine is so expert and dedicated.

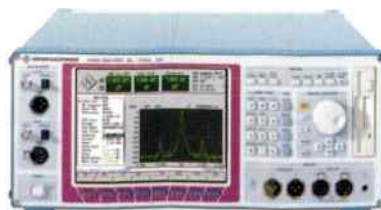

Distributed by Seymour Distribution Ltd 86 Newman Street London, W1T 3EX Tel: +44 (0) 20 7396 8000 Printed by St Ives, Plymouth Tel: +44 (0) 1752 349 413
Our Agents in Malaysia Millennium Hi-Fi & AV Simon Chang Showroom & office, 500-1-3 First Floor Wisma Indah (Shen Court), Jalan Tun Razak 50400 Kuala Lumpur, Malaysia
Tel: 603 9283 8171 Fax: 603 9281 3762 e-mail: info@millennium-audio.com

All unsolicited submissions and goods are at the owner's risk. We accept no responsibility for such submissions, nor do we undertake to return them.
No material may be reproduced from this magazine without the publisher's written permission. © Audio Publishing Ltd

15

Dynaudio Special 25 -
Scandinavian surprise?



34

Orelle CD100/SA100 evo 2:
sound style in no small measure!



63

Musical Fidelity kW SACD -
hi res digital hits the big time...



59

the professionals:
Genelec HT205 active mini monitors

41

Acoustic Energy AE1 III - the latest in a line of
epoch-making miniature speakers



15

our small speaker supertest lines up six mini-moni-
tors that punch above their weight...

SMALL SYSTEM SPECIAL ISSUE:

STANDING THE PACE 10

For those who crave speed and insight above bass and boom, Wilson Benesch's Arc standmounting loudspeaker is in a class of one, says David Price...

LESSER THINGS 15

Mini monitors are back in fashion, and there are some deadly serious diminutive designs around, finds Channa Vithana in this month's supertest.

SMALL WONDER 32

Channa Vithana casts an admiring eye (and ear) on Onkyo's C-733/A-933 CD player and integrated amplifier combo...

SLIMLINE TONIC 34

Orelle's stunningly styled SA100/ CD100evo CD player and amplifier combination have evolved into the evo2 incarnations. Dominic Todd listens in.

QUAD-RAPHONIC 36

David Price hears the small but perfectly formed Quad 99 CDP-2 CD player and 99/909 pre-power amplifier.

MINOR, THIRD 41

Now in its third incarnation, can the diminutive Acoustic Energy AE1 MkIII mini-monitor live up to past form, asks Dominic Todd?

METAL WORK 44

David Price tells the story of the British loudspeaker specialist that built its reputation around innovative materials technology, Acoustic Energy.

MODERN SPEAKING 47

Noel Keywood looks at the past, present and future of loudspeaker design.

SILVER STAR 51

To celebrate its twenty fifth anniversary, Dynaudio has come up with the Special Twenty Five loudspeaker. Haden Boardman listens in.

TWO, SMALL 54

Channa Vithana tries two diminutive disc stages at radically different price points – the Cambridge Audio Azur 540P and Cyrus Phono X/PSX-R.

MINI ADVENTURE! 59

Pro audio stalwart Genelec has recently moved into the domestic audio sphere. Channa Vithana reviews the HT205 active monitors.

KING SIZE 63

There's no other phrase to describe Musical Fidelity's new kW SACD player, says Channa Vithana.

SMALL MEMORIES 67

Keith Adams pens a personal paean of praise to his dated, diminutive, digital system

SPACE 1979 73

David Price looks back to the future with Technics long lost SB-F1 mini monitor.

FEATURE:

RADIO GAGA 69

With its silly politics, risible bitrates and poor sound, Steve Green pronounces Digital Radio well and truly dysfunctional...

DIY SUPPLEMENT NO.85 87



10

7 NEWS

words from the front...

26 COMPETITION

Win a superb Rotel, B&W and Microphonic Audio system worth £1,500!

74 SUBSCRIPTIONS

Ensure your copy every month and save money too.

84 NEW MUSIC

Patrick Cleasby rounds up the latest hi res releases

75,76,77,78,79 OPINION

The team get to grips with matters music, hi-fi and life!

80 WORLD AUDIO DESIGN

Superb sounding valve amplification for do-it-yourselfers.

82 WORLD LIBRARY

A wide selection of specialist audio books for sale

98 KIT & COMPONENTS

Purveyors of specialist hi-fi services.

99 MAIL

Ten pages of your views and comments.

109 MARKETPLACE

Masses of pre-owned audio equipment for sale.

118 DIAL-A-DEALER

A comprehensive guide to UK hi-fi retailers.

120 SPECIALIST HI-FI DEALERS

Purveyors of specialist hi-fi services.

121 MEET YOUR MAKER

Who makes what and how to get in touch.

123 CLASSIFIEDS

Five pages of second-hand bargains.

128 NEXT MONTH

Here is but a small selection of what we hope to bring you in the next sizzling issue.

129 ADVERTISERS' INDEX

130 CLASSIC CUTS

Paul Rigby remembers the seminal 1991 dance disc that is The Orb's 'The Orb's Adventures Beyond The Ultraworld'.

PURE HI-FI, PURE SOUND, PURE ONKYO



www.onkyo.co.uk
Tel.01494-681515

ONKYO
IMAGINATIVE SIGHT & SOUND

Onkyo, a brand with over 50 years of audio heritage, proves that Audiophile components can look as good as they sound with the new 275 series.

Call us to arrange a demonstration at a dealer near you and discover the Pure Onkyo experience for yourself.

Do more with your iPod with Onkyo's optional DS-A1 Remote Interactive Dock.



Audio and Photo Playback



Control From Afar



Charged and Ready to Go

* iPod is trademark of Apple Computer, Inc.

news@hi-fiworld.co.uk

news

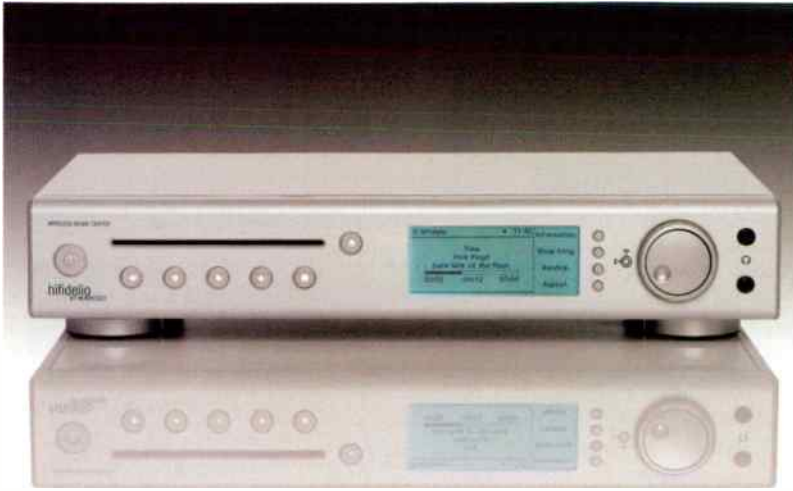

HI, FIDELIO

From Hermstedt comes the Hifidelio Wireless Music Center, a new hard disk based digital music player. Available in two versions and two colours – black or silver – Hifidelio not only stores, files and manages your entire music collection – vinyl, cassettes, or digital music files – but lets up to four users connect wirelessly or via Ethernet cable to the Hifidelio and control and listen to whatever music they choose. The advantage of not being PC-based is that the Hifidelio is silent – it doesn't have the background fan noise. With built-in 80GB/ 160GB drives, which can store as many as 20,000 / 40,000 MP3 songs, music tracks can be recorded in several formats, including lossless for the highest quality. Fitted with a CD player, the £599 Hifidelio not only plays back all tracks, but also displays information such as song titles, album and artist. Information on 2,000,000 songs, albums and

artists are already locally stored within the Hifidelio so it's ready to work straight out of the box without the need for an Internet connection. If your home network allows Hifidelio to connect to the Internet, it can use the online music information to display album, song track and artist. If the Internet connection is not active for any reasons, Hifidelio then uses the internal music information as fallback. Music CDs are ripped to the hard drive by clicking the record button, or the unit will analogue sources direct via built-in A-D converters. In addition to two USB 2.0 interfaces, Hifidelio integrates a built-in 4 port switch with auto-sensing 10/100 Mbit/s Ethernet ports. The built-in WLAN connection works at 54 Mbit/s and supports the 802.11g standard - also making it usable as an Access-Point for home Wireless networks. Hifidelio's connection panel includes two analogue audio inputs and outputs, plus S/PDIF optical digital output and a TOSLINK coaxial output. Thanks to the built-in USB version 2.0 interface, portable MP3 players (like Apple's iPod) can download music tracks from Hifidelio. For more information, click on www.hermstedt.com or call +44 207 368 3333.

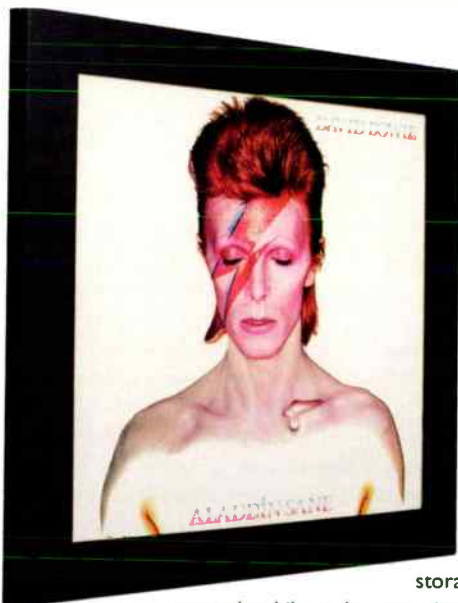

POP ART

Surely a great idea that was a long time coming, Art Vinyl has just launched a new concept in interior design, the Play & Display frame. It's an original way to display your favourite album and 12 inch vinyl sleeve designs.

The Play & Display frames provide a storage place for vinyl

records while at the same time exhibiting the record

sleeve art on your wall. The unique frames were designed with vinyl lovers in mind and incorporate a quick to release opening to allow records to be changed or removed and played with ease. For more information, click on www.iwantoneofthose.com and www.simplyvinyl.com.

DAB HANDS

Denon, the company whose tuner-making reputation precedes them (TU-260L, say no more) is entering the big, bad world of Digital Radio with the new TU-1800DAB. This £249.99 DAB/RDS-FM/AM radio tuner is said to be sleek, elegant and easy to use, very well built and offers DAB with full Band III and L-Band reception, capability for future DAB broadcast expansion, clear indication and access for 'Secondary' broadcasts (i.e. BBC 5 Live Sports Extra, etc.), plus full FM RDS and RadioText facilities, 200 memory presets and full remote control from the supplied handset. A black magnetic indoor DAB antenna is included, designed to sit on top of the tuner by magnetic attachment. The tuner features a two line dot-matrix display showing all the DAB/RDS information, a high-quality D/A converter with 192kHz/24bit DACs, three levels of Dynamic Range Control (DRC) and optical and coaxial outputs. For more information, call 01883 346647. Fax: 01883 340073 or click on: www.smartsounddirect.com





SPEAK EASY

After last month's thumbs-up review of Arcam's excellent Alto all-in-one music system comes news of a matching pair of speakers. The princely sum of £400 (on top of the Alto's £1,000 retail price) buys you small two-way speakers available in a choice of real wood cherry or maple veneers. Mineral loaded driver technology, front-facing ports, magnetic grille attachment, gold bi-wiring speaker terminals and audiophile grade components in the crossover are all claimed. For more information, click on www.arcam.co.uk.

BACK TO THE CREEK

One of Creek Audio's most successful products in the last decade was the 5350SE integrated amplifier, which has enjoyed an avid following around the world for several years. So when some parts were no longer available, the company decided to make a few minor design changes and re-launch it – appropriately named the Creek Classic 5350SE. Selling at the price the original 5350SE was selling at in 2002, it boasts a few simple changes to improve the performance and eliminate components that are now obsolete or redundant - the major one being the removal of the tape selector switch and the reduction in size of the pre-amp circuit board. The front panel has been restyled to accommodate the change, and the casework has been reworked. For more information, click on www.creek-audio.co.uk



ON FOCUS

Dynaudio has introduced a new series of high performance loudspeakers that feature the latest advanced Dynaudio driver technology mated to a more traditional Danish aesthetic. The new Focus series comprises the Focus 110 and Focus 140 stand-mounted monitors, the Focus 220 floor-standing loudspeaker, and the Focus 200 C Center Channel. Said to be equally well suited for traditional two-channel stereo as for full-blown multichannel systems and allows for easy integration with any of the Dynaudio subwoofers. They feature the new, proprietary Esotec+ driver design, directly evolved from the company's flagship developments, using proprietary MSP (magnesium silicate polymer) material used for the woofer cones, the large diameter, lightweight aluminium wire voice coils, the specially treated soft-dome tweeter diaphragms, and phase-correct first-order crossover networks comprised of select high quality components. The Focus series models boast finely crafted cabinets, and all models are available in a choice of Maple, Cherry, Rosewood, or Black Ash natural wood veneer finishes. For details, call 07970 - 07 47 17 or click on www.dynaudio.com.

CREATIVE THINKING

Creative Labs, whose TravelSounds were just about the best ultra-compact mobile speakers on the market, have announced an update in the shape of the new TravelSound 400. The micro-mini speakers are mounted on a pivoting base which rotates them out of the way for transit. With two premium NeoTitanium micro drivers and an advanced digital amplifier, TravelSound 400 speakers deliver a claimed 4W RMS for up to 35 hours, powered by four standard AAA batteries. Titanium is Creative's material of choice in small form factor speakers. Supplied complete with carrying case, connection cable, on/off switch and cool blue 'power-on' LED, price is expected to be around £50. For more information, click on www.creative-labs.co.uk.



KOMPONENT SEPERATES

The new Komponent loudspeaker system from Linn is said to create a new benchmark in affordable, high-performance loudspeaker design. Offering a serious, precision engineered alternative to mass-market surround-sound systems, it claims authentic Linn values in a simple and stylish package. Said to be the result of many months of careful listening, tuning and testing by some of the world's leading acoustic engineers, the Komponent loudspeaker system comprises four distinct acoustically-matched models: the KOMPONENT 110 Floorstanding Loudspeaker (£600), the KOMPONENT 104 Compact Loudspeaker (£250), the KOMPONENT 106 Left/Centre/Right Loudspeaker (£500) and the KOMPONENT 120 Active Bass-Reinforcement Loudspeaker (£750). Linn's new 2K array technology sees the high-frequency drive-units housed in a dedicated alloy chassis, isolated from the rest of the loudspeaker. System performance can be further upgraded by using these speakers in a multi-amplifier configuration or in AKTIV configuration where a single amplifier channel is dedicated to each drive-unit through an active crossover. With each drive-unit controlled directly by its own power amplifier, no power or musical information is lost and performance is maximised, says Linn. All models are built using a unique aluminium extrusion which features advanced damping materials. This construction also means Komponent speakers are relatively shallow and can be easily wall-mounted using the supplied brackets if desired. A cable-management system ensures all loudspeaker cables are concealed within the cabinet itself. The Komponent loudspeaker system is available now in a choice of Silver or Graphite finish. For details, see www.linn.co.uk.

MONITOR QUALITY

British loudspeaker specialist Monitor Audio has entered the iPod accessory fray with i-deck. Unlike other systems on the market, i-deck is said to have high quality stereo speakers that are compact in size yet produce audio performance of breathtaking power. When it comes to volume, i-deck packs a serious punch over its rivals. Speakers can be placed either side of the amplifier module for maximum convenience or separated using the cables provided to create a full stereo experience. All you have to do is dock and play. Not only is i-deck the perfect charging base for your iPod, it also comes

with a 30 pin port allowing you to synchronise operation directly with your Mac or PC either via USB or FireWire connection. For ultimate control of your music i-deck even sports a sleek, ultra-thin RF remote control – handy if you're throwing a dinner party and want to fast forward and rewind through tracks without getting up from the table. Thanks to interchangeable bezels (which are supplied as standard), i-deck can be used in conjunction with both iPods and iPod Photos as well as standard third generation and fourth generation iPods, plus iPod Shuffles or other portable music products such as MiniDisc players, Walkmans or CD players via the auxiliary audio input. i-deck is initially available online from www.i-deck.com priced £249.00.



STYLE COUNSEL

Intempo Digital's new KTM-01 DAB digital radio has been exclusively designed by fashion designer Matthew Williamson. The radio will be on sale in John Lewis stores only, priced at £125. It's a special charity edition with a percentage of the proceeds going to the Make-A-Wish foundation which grants the wishes of children with life threatening illnesses. The collaboration came about as Matthew Williamson received one of Intempo's retro styled KTM-01 pink digital radios and loved it so much, he approached the company to discuss working on this project, says Intempo. It features: Dual band DAB & FM (DAB band III) reception, mains and battery (6 C cell) operation, 2x2W RMS output, full radio text, 8 presets, 16 character by 2 line LCD screen with brightness control and a 3.5mm headphone socket. The radio looks striking in fuchsia with Matthew Williamson's trademark peacock feathers livery. See www.johnlewis.com for stockists.

WEBWORLD:

www.sprote.com/clutter

Mac users rejoice - here's a freeware application that automatically downloads cover art for any song you're playing on iTunes. While it's playing you can drag and drop the cover art to your desktop, resize the covers, pile them up, then scatter all the sleeves across your desktop just like a pile of LPs on the floor. Double clicking on a cover will automatically play the album in iTunes (or control & click to get a drop down of the songs on that album). The program is called Clutter, and it's neat; try it! As for PC users, there are no plans for a Windows versions, but then again you could always buy yourself a real computer... [thanks to reader David Denyer for this - Ed.]

PSS-T!

Over the past twenty five or so years, so the story goes, designer Yuri D. Gutsatz has earned a justifiable reputation for the outstanding sound and build quality of his PSS power amps. Having taken the pro audio market by storm with the 9D MkII PSS 600, 1200 and 2400 models, Gutsatz is now targeting the discerning studio and hi-fi sectors, with the introduction of the MkIII Studio A and Studio B models. An indication of their pedigree is that the amps have been in development for some fifteen years — due in no small measure, says PSS, to Gutsatz's obsessive attention to detail and refusal to compromise on his high manufacturing standards. Sound reproduction is enhanced by employing even higher quality components than the MkII siblings, including twin power transformers, bipolar transistors and sophisticated protective circuitry. With power ratings of 2x150W RMS and 2x300W RMS, 2Hz-25,000Hz frequency response, 111/115dB signal-to-noise ratio, maximum gain of 26dB @ 1kHz, 0.009% distortion @ 1,000Hz, the Studio A and Studio B look set to become sure-fire winners with studio engineers and audiophiles. Smart Sound Direct is currently offering special introductory prices of £899 for the Studio A and £1,299 for the Studio B. For details, call 01883 346647 or click on www.smartsounddirect.com.

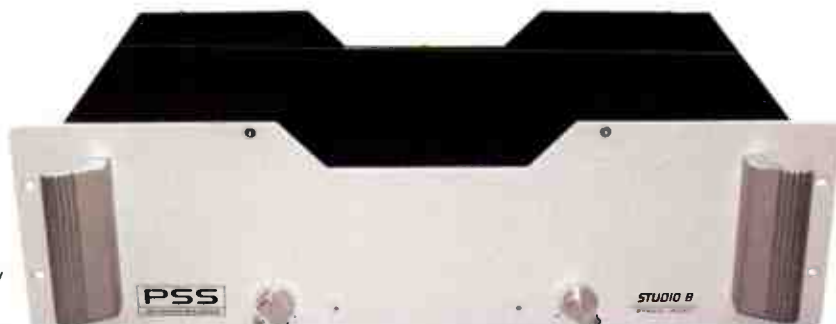

Standing the pace

For those who crave speed and insight above bass and boom, Wilson Benesch's Arc standmounting loudspeaker is in a class of one, says David Price...

Although regular readers will know that these days I'm a keen advocate of a certain classic monster Japanese three way loudspeaker with bass drive units of twelve inches in diameter, the truth is that – in my earlier years when I didn't have a listening room appropriate for behemoth boxes – the only loudspeaker I could listen to was the original Linn Kan (mark one).

As anyone who's ever heard one will tell you, these late seventies miniatures, packing *de rigueur* (for seventies speakers, of course) KEF B110 midrange drive units, married to sweet ScanSpeak 207 cloth dome tweeters, were quite ridiculous. There were two key reasons for this: first, the aforementioned B110 was called upon to perform not only midrange but also bass duties, and second, Linn didn't sweeten the pill by drilling holes in the cabs (i.e. port them) in a bid for better bass extension/sensitivity.

Oh no, they did not – and the result was a speaker with nothing to speak of (excuse the pun) below 110Hz (I always used to think that the '110' referred to the roll-off, but it was of course the cone diameter in millimetres!). And not only did they have bugger-all bass, but they were criminally insensitive too – the only speaker I've seen trip the cooling fans of Naim NAPI35s. Ah, those were the days...

Anyway, I digress. My point is that the original Kan Ones were a faintly ridiculous contrivance, but – wow – could they play a tune! In fact, they were so dextrous, so dynamic (providing you could muster an amplifier of at least 100W RMS plus), so rhythmically engaging and so spatial (yes, really, even though Ivor had recently decreed the such a thing as soundstaging didn't exist, if I remember rightly!) In fact, they were so good that even my brother loved

them. who was (is) a gifted musician but certainly no audio aficionado. In fact, he played (plays) the bass guitar almost as good as Nile Rogers, so it was kind of ironic that despite the Kans lack of LF, he bought them from me, drove them with a NAD3020 and plugged his Fender Jazz Bass into them...

The point is that small speakers, if done properly, can be amazing. And even in their point of greatest weakness (i.e. the bass), they can do things that even big speakers cannot. The Kans could and did, but since that glorious, silly, ridiculous LS3/5a look-alike from Linn, few have really floated my boat. And so to the Wilson Benesch Arc.

Now nothing gets past me. The first time I heard these speakers a proper was at the 2005 Bristol Sound and Vision show – literally years after they'd been launched. But given that newness does not (no my book) guarantee greatness, I was keen on hearing more, and so it transpired that I finally got to hear them at home, and review them...

There is no magic to loudspeaker design; much as designers would have you believe otherwise, a speaker's abilities begin and end with [a] the materials used in the cabinet and drive unit and [b] how intelligently they're integrated and/or implemented. It's not snake oil, voodoo or a case of being a very cool brand – it's physics. What sets these boxes apart is – at the risk of being a tad too reductive – the materials technology, which is nigh on unique.

The innovative curved A.C.T. carbon fibre panels that were

originally engineered by Wilson Benesch in 1995 do something that wood or fibreboard, no matter how nicely implemented can't. In this, I'll explain what they bring to the party, how to speak, and why I value it so much. Whether or not you think this important to you as a listener/buyer is another story, and nothing short of a dealer and/or home demonstration will convince you. But at least hear me out?

TECH TALK

The important thing to understand about speakers is that, by and large, any given product on the market is an assemblage of other people's

products (essentially OEM drive units, married – often very cleverly – to a custom designed crossover and a bespoke cabinet made from fibreboard). Now, there's nothing terribly bad about fibreboard cabs, and companies like KEF don't half get stunning finishes from them, but they're not ideal. As Wilson Benesch modestly point out, you don't get Formula One racing cars made from

Arcs, aside from those ever-so-special cabinets, is the drive units, which again are VB fare: one 170mm (7") Wilson Benesch Tactic bass / mid range unit, and one 25mm (1") ScanSpeak soft dome, hand painted silk dome tweeter. The drivers are loaded with double reflex ports. Being an 'infinite baffle kind of guy' (I'm reaching forty years old, allow me my conceits), I'm not naturally drawn to ported loudspeakers, but this is no longer 1978 and although Linn could (just about) get away with IBs back then, I doubt if more than three people would buy the Arcs (with their compact 310x 230x 370mm cabs) if they didn't have at least this concession to real world operation nowadays (my brother and I would take the first two pairs...). So, the result is a claimed -6dB at 42Hz and 30kHz, and -3dB at 45Hz and 25kHz with 88dB at 1metre on axis. 2.83V input [see MEASURED PERFORMANCE].

Still, they're no stroll in the park for an amplifier – especially when you consider their quoted 6 ohm nominal load – and methinks the likes of the brilliant Sugden A21a (my fave £1,000 integrated) would be going 'absent without leave' at the merest sniff of the VBs. You're really talking 100W RMS to tickle the Arcs; I used them with the TacT SDA2175 power amp and the Musical Fidelity X-150 integrated, both of which made an extremely nice noise with them.

The crossover frequency is 5kHz; the midrange crossover is first order, the tweeter crossover second order. Selected polypropylene capacitors and air cored inductors are used throughout. Internal wiring is multi strand silver plated copper, PTFE jacketed cable harnesses, with soldered connections throughout and short path PCB design is used. Links are supplied for single or biwire applications, with in-house machined gold plated copper alloy terminals. VB quote a power handling of 200W peak unclipped programme – which tallies with my experience. Internal volume is 10.5litres and weight 11kg apiece. They have the option of bespoke stands, which stand the speakers 950mm from the floor and make each speaker weigh 28kg. The standard finish is polymer coated alloy, although real wood veneers are an option.

SOUND QUALITY

The easiest way to describe the Arcs is to imagine a Quad ESL-57 shrunk by a factor of three. There's

something eerily electrostatic-like about these speakers that strikes you within seconds of hearing them. Interestingly, it's not just the obvious clarity, neutrality and openness that you'd associate with panel speakers, but the conspicuous lack of cabinetry. Now, with all Quad electrostatics, there are no cabinets at all – only frames – and that's what strikes me as the defining characteristic of the Arcs.

Of course, the Arcs do have cabs, but it's obviously the fact that VB have so ably removed them – to all intents and purposes – that makes them sound so unusual. And just as with Quads, the sound isn't immediately appealing, as you're spared the 'boom tizz' that most MDF boxes introduce. This means that – despite the obvious frequency extension – they don't sound big, powerful and physical in the way that, say, Cerwin Vegas do. They don't euphonise the sound, make it easy, soft, satisfying or benign on the ear. Rather, you get what's coming to you...

Light of the World's 'Time', a classic slice of early eighties jazz funk, is a case in point. There's no massive, room-filling, flare-flapping physicality here. Instead, bask in the amazing midband insight, complete with it's superb soundstaging and projection. The music is upfront and in your face all right, throwing right out into the room (unconstrained by wooden boxes, sure enough) but unlike most loudspeakers which project like stage lighting, these don't rely on excessive mid-forwardness to do the trick.

This is an interesting point. Rule one in the speaker designer's textbook is that, if you want ear-shredding forward impact, crank up the midband. This done, speakers will certainly push out into the room and sound impressive. However, the Wilson Benesch perform this trick whilst still sounding civil and smooth in the midband. This is precisely what I found fascinating about them when I first heard them; they're not raucous or rowdy, yet they push out into the room with a glass-like clarity. Must be the combination of those carbon fibre cabinets and those couth, finessed drive units...

It's also for this reason that music such as this works so well with the Arcs; they're super fast. The lack of bass overhang will unnerve those used to conventionally cabinet speakers, but thrill them too. There's no boom, but there's oodles of punch and grip and speed and good old unreconstructed shove. The VBs push the groove of the

MDF.

What you need is the lightest, stiffest, tightest cabinet material possible – and right now, that's very probably carbon fibre...

The Arcs, however, don't sport medium density fibreboard cabs; they're carbon fibre. And even if these things had the cheapest, nastiest Chinese OEM drive units inside (and they don't, by the way), then boy can you hear it. Or rather, boy, you can't hear it. Because – as you'll read later – boom, plodding bass and fruity, rich colouration 'came there none'...

The next best thing about the



Walrus



11 New Quebec St, London W1

Some Digital and some Analogue news. And, don't forget the upcoming Heathrow Show ..!

Just because we are predominantly an analogue, vinyl based, retailer doesn't mean we don't care about digital. We realise that our customers, much as they love their vinyl collections, still need to play digital media occasionally! It's a pity that SACD never achieved the prominence it ought to have. But then, the choice of music is still very limited. Or, perhaps it's the other way round. Anyhow, when you get a good recording, SACD can be stunning. You guessed this was leading somewhere, and it is! Musical Fidelity have at last released their new kW Series SACD player. It features MF's trademark sophisticated choke regulated power supplies, and, unusually, the SACD and CD circuits and their power supplies inside the player are completely separate. Too often, when you buy a really good SACD player you still need to retain your existing expensive CD player to get the best out of the respective media. The MF player gets the absolute best out of both media, it really is one of the only genuine dual purpose machines on the market. Other details include technical specs (signal to noise ratio and jitter) which challenge the resolution of measuring instruments, and the ability to switch between two very high quality output stages, valve and transistor, to keep both camps happy! This is their best digital player yet, and one which it will be very hard to surpass (despite what MF say in their regular newsletters - existing owners know what we mean!) - if you are interested, don't delay in hearing it as I think the limited production run will soon all be allocated. Oh, nearly forgot, the price is a whisker under £4000 - very good value indeed when you see (and hear) what you get for the money.



Staying with digital, we've just taken delivery of the new "entry-level" Shanling CD player - the CD-T80 at £650 - and what a brilliant player it is. How they manage to make this superbly built unit for the price they do is quite scary. The fit and finish is absolutely top class, what you might expect if you pay double or treble the price, and the sound quality is on a par or better than just about anything else up to a thousand pounds. I'm told the importer is having a problem keeping up with the demand! If Shanling continue on present form, they will be (rightfully) dominating quite a few sectors of the enthusiast hi-fi market. We refer, of course, to their two existing models, the mid-range CD-T100 (£1650) which has been around for ages now but is still very competitive and looks as stunning as ever, and the relatively new limited edition CD-T300 Omega Drive player, featured in our last ad, for £3999. This new, very modern and attractive player is attracting huge interest. Like the Musical Fidelity it is also a limited edition model. If you fancy owning a top class CD player which will have lasting value, superb sound, and totally original appearance, come and demo it before it's sold out.

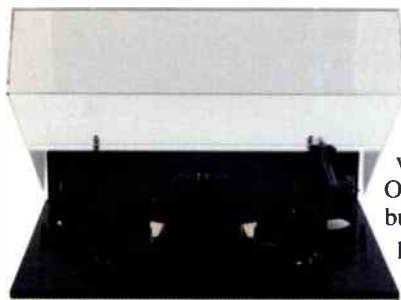

Our main business, in case you were wondering, is definitely still analogue! And, we have some exciting news on the turntable front. First, the affordable: Michell Engineering have released a limited edition (it's all limited editions this month!) turntable, loosely based on the famous Gyrodec. However, the Odyssey looks completely different, with a jet black acrylic base, black chassis, clear lid, and a special black version of the acclaimed Tecnoarm A, finished off with a black version of the HR power supply. It also has nickel silver weights, and a clear acrylic spyder like the Orbe. This special model, which only needs a cartridge to complete it, is not only stunning looking but very competitively priced at £2150. But, the most interesting thing is the exclusivity - only 100 pieces are being made. They will almost certainly become collectable. And, sadly, due to copy dates, by the time you read this we suspect there may not be many left, so please phone for current availability.

The other exciting news is the arrival at our shop of the brand new flagship turntable from Nottingham Analogue, the Deco. This model is about as exclusive as it gets, the price alone will assure that! Mass is very high, and the platter features a unique contoured design to aid energy dissipation. If you want to know more (and hear it) you'll have to pay us a visit.

Also new to Walrus is the Stirling Broadcast LS3/5a loudspeaker. Stirling is only one of two current licensees for this superb, classic speaker design. It might be an old design, but it still beats most other compact speakers, especially since Stirling made some small but important tweaks! Price is a very reasonable £890 to £973 dependent on finish. On demo now, please try to hear before you consider purchasing any other compact speaker.

On to this month's Featured Accessory, the Shure SFG-2 Stylus Force Gauge. This is a very simple well made balance which sells for £28, and will last you a lifetime. It measures tracking weight between 0.5g and 3g. For anyone who regularly changes their pickup this is an absolute must, unless you're rich enough to afford one of the swish electronic gauges such as the Martin Bastin gauge. Even if you have an arm which already has tracking force calibration, the Shure will be a lot more accurate.

Lastly, don't forget the Hi-fi and Home Entertainment Show at Heathrow, from the 23rd to 25th of September. I know it's a long way off, but put it in your diary now! We'll be there with lots of our favourite stuff in room Syndicate 16, feel free to turn up with your favourite LP or CD for a quick demo. See ya there!

air tangent amazon amplifon apollo furniture argento audible illusions audio aero audio physic audiovalve black rhodium breuer dynamic brinkmann cartridge man cawsey clearaudio consonance decca london duevel dynavector ear yoshino final lab goldring graham (tonearms) graham slee hadcock heart hyperion (loudspeakers) incognito isolda jadis kr electronics klimo koetsu lavardin lyra magneplanar michell engineering morch musical fidelity nordost nottingham analogue opus 3 origin live ortofon pro-ject rega (turntables) revolver ringmat roksan shun mook shahinian shanling shelter slinkylinks sme something solid sonneteer sponsor stax stirling broadcast sugden sumiko tannoy tci cables tom evans townshend audio transfiguration trichord trigon van den hul voodoo wireworld xlo

tel: 020 7724 7224

fax: 020 7724 4347

email: contact@walrus.co.uk

web: www.walrus.co.uk

song along like no other standmounter at the price – even the Acoustic Energy AEI III. They lack weight and physicality (which the AEs have, at least a little bit more) but make up for it in zing. For this reason, they're a joy with rhythmic soul, pop and funk. No, they're not quite as tight as portless Linn Kan

REFERENCE SYSTEM:

- Pioneer PL-L1000/Koetsu Red turntable/cartridge
- Whest Audio PS20/MSU20 phono stage
- MF Audio Passive Preamp
- TacT SD2175 power amplifier
- Quad ESL989 loudspeakers
- Townshend Maximum Supertweeters

Ones, but not far off at all.

Cue up some jazz in the shape of Lonnie Smith's 'Expansions' and you find yourself listening in an entirely different way. The WBs have very impressive tonality, one that really communicates the texture of the brass instruments, the rhythm guitar and the Hammond organ, but unlike – for example – Quad ILLs (see p19) they never slow things down. So you get to hear how the instrument sounded at the time of recording, and the rhythms that the musician was playing with it. This is the key to the WBs, and it's a rare combo; we all know that it's usually one or the other, as some speakers are voiced for grip, others for neutrality, but if you've got the basic physics right then a proper speaker should do both.

At the frequency extremes, the Arcs show their small beginnings. Frankly, no matter what the manufacturer claims, a 10.5 litre enclosure isn't going to thwack you in the back or rattle your fillings. The good news is that the WBs aren't lumpy; there's no cheapo mini-

monitor style bass peak stuck in at around 100Hz that I can hear, they're even as they go down the octaves with no lumps or bumps. But they don't 'rock the house', or even induce a tremor. Obviously, if you want 'banging' dance music, buy £100 floorstanders from Richer Sounds.

Treble is very accomplished. I

have the feeling that it's a tad rolled off, but this isn't to deny that what there is, is very couth and finessed. This is partly what contributes to the creamy sound of these speakers.

Matched with Cyrus electronics (as indeed they were at the Bristol Show), they're very smooth and open and gentle; no involuntary ear canal surgery here. I'd wager that there are few – if any – speakers that come close for refinement, air and space at the price.

CONCLUSION

If you manage to read the rest of this issue, the message is that there are some stunning small speakers around these days. True, they're all just a little less focused than the aforementioned Kans were – and probably none the worse for it. Indeed, the general standard is amazingly high – even from £250 Monitor Audio Radius 90s, for example. Still, it's nice to see and hear something that really does offer something different, something that really convinces you why you spend the extra, which is precisely what the Arcs do. The fact that they look utterly stunning – and really add to your domestic quality of life as well as your

musical enjoyment – is a bonus. Just match with a warm, sweet amplifier and source.



VERDICT

Exquisitely engineered and built mini-monitors that offers insight and speed that price rivals can only dream of.

WILSON BENESCH ARC £2,400
INC STANDS
 Wilson Benesch Ltd.
 (+44(0) 1142 852656
www.wilson-benesch.com

MEASURED PERFORMANCE

The small Arcs have a fairly pronounced frequency response lift around 1kHz, our analysis shows. Above this output slowly falls by 4dB overall at 16kHz and this was audible in the pink noise test signal, which sounded very smooth and easy, free from hiss and light in nature.

Normally, pink noise rumbles but not in this case, as the Arcs reach down smoothly to 63Hz before rolling off and the port is tuned to this frequency. However, measuring -6dB at 40Hz the Arc can also reproduce lower frequencies. In most rooms it should work fairly nicely with nodal frequencies to give a fast, controlled sound, free from the LF boom of nodal overdrive which the larger Curve can suffer. The Arc is a ported reflex, but the ports are underneath, so it must be used on the stand provided. Close-to-wall use is appropriate.

Sensitivity was normal enough at 87dB, good considering this is a 7ohm loudspeaker – a high impedance nowadays. The impedance curve is flat, meaning the Arc is almost a perfect resistor, storing no energy in reactance. This is great for all amps, including valve amps.

The Arc will project well and sound quite forward, due to its measured response peaking. It's tailored for near wall use and small-to-medium rooms. In measured terms it is carefully wrought to offer a smooth sound and a very easy amp load. NK

Frequency response

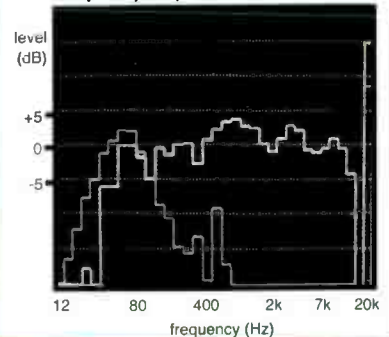

Impedance

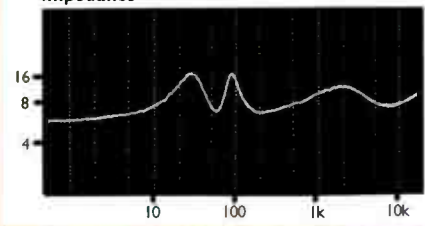

audiolab

Have you been
missing something?



audiolab 8000 series

The original 8000 series from Audiolab started something of a revolution in value and performance. When they disappeared from the market, the hi-fi world lost a well-loved and reliable friend.

Now, the new 8000 series marks a strong return to the original brand values and philosophy. These famous products have been re-engineered to create a complete two channel range, including the famous 8000S, 8000Q, 8000M and 8000P models as well as an all new CD player.

7.1 channel pre and power amplifiers have been added to create a series of building blocks capable of meeting your system needs now and for the future.

**Audition them now and find out
just what you've been missing.**

**The new 8000 series offers a
definitive and genuine hi-fidelity
performance from a no-nonsense
approach to engineering**

audiolab

Sovereign Court, Ermine Business Park,
Huntingdon, Cambs, PE29 6XU
www.audiolab.co.uk
Tel: +44 (0)1480 447700
Fax: +44 (0)1480 431767

Lesser Things

Throughout the nineties mini monitors were terminally unfashionable, as the world craved tall and narrow floorstanding loudspeakers. But the breed is bouncing back, and there are now some deadly serious diminutive designs around, finds Channa Vithana...

The eighties was the decade of the mini-monitor. Everything from the Linn Kan to the Wharfedale Diamond to the Acoustic Energy AE1 seemed to be flavour of the month, as hi-fi hacks waxed lyrical about their 'pace, rhythm and timing' – providing of course that you had solid-state amplification beefy enough to drive them!

Strange then that the hi-fi world seemingly forgot all this as the nineties kicked in, and suddenly everyone wanted one of the 'new fangled' floorstanders making the headlines. Of course, they offered bass aplenty, but often as not they created more trouble than they were worth, as the cabinets resonated away merrily, slowing down the music to the pace of the M25 on a Bank Holiday weekend...

In truth, stick a tiny box, its drive units sandwiched tight together, on a pair of decent stands, and the speed and dimensionality that's possible can be breathtaking. True, you won't get a 'thwack in the back' from the bass, but there are finer pleasures in life than that (although Cerwin Vega fans may disagree). So we decided to round up six of the best, from Epos, KEF, Monitor Audio, Quad, Pinsh and Aurum Cantus, for proof positive that less is more.



EPOS ELS3 £199

The latest entry level Epos baby uses an edge-angled 25mm thick MDF front baffle with 270x 174x 195mm dimensions, forming - less the unappealing cross-head screws - an attractive and nicely proportioned small speaker. The ELS3 uses a 12mm HD chip-board cabinet and comes in Light Cherry, Dark Cherry or Black Ash finishes and weighs 4.5kg. It has a small rear port, single-wire binding posts, quoted 87dB sensitivity and 4ohm impedance.

A 'Lightning' ELS130 130mm mid-bass driver is used within a diecast aluminium chassis. The company says that the cone piston is made from an injection-moulded polymer for rigidity; while the cone's tapered profile gives improved performance over its bandwidth and provides smooth integration with the 'Swift' tweeter. A new 25mm voice coil is wet wound on an aluminium former with high-temperature wire for efficient heat dissipation, which is designed to reduce the distortion and dynamic compression.

The 'Swift' tweeter uses a 25mm diameter, 40 micron thick aluminium alloy diaphragm, terminated by a Polyamide suspension, which is claimed to reduce colouration and enable the driver to handle high power without distress. Further, a vented voice coil and magnetic liquid (Ferro fluid) cooling system is used to improve its power handling ability, helping to smooth its frequency response. Rear cavity loading and a high efficiency Neodymium magnet system is claimed to focus its transient response and eliminate temporal smearing.

SOUND QUALITY

The Epos's musical timing is what distinguished it, along with its seamless drive-unit integration. On 'Allegro' from 'Elgar Violin Concertos' the music was generally well-rounded and controlled if a little internalised. As the orchestration reached dynamic peaks, the Epos handled them brilliantly with impact. Additionally the beautiful violin



playing by Hilary Hahn had some timbral finesse and was nicely fluid for a £200 speaker. Billy Idol's 'Super Overdrive' is in raucous punk-rock style and the Epos handled it well. Musical timing was first-rate; it did not miss a beat and everything flowed superbly and gelling cohesively. Steve Steven's guitar pyrotechnics were kept in control, minimising stridency yet due to the Epos's timing abilities, were really thrilling. Bass had great dexterity for the price, though the (less important

for me) bass extension was curtailed. On the less demanding 'Rat Race' the Epos revealed more of itself, where it was keen to hold on to the midrange than go further into the treble or bass.

The Epos gave a nimble if rather internalised presentation; it's all about making music, focusing in on the rhythms and dynamics, but it lacks the widescreen, large scale presentation of others. Still, an excellent choice for what we'd once call 'flat earthers'!

MEASURED PERFORMANCE

Epos loudspeakers have traditionally had a 'fast' sound, delivered by metal cone drive units. This seemingly gives good definition in the time domain, but some of it is artificial, a property that arises from metal cone colouration (zing). The small els3 has some lumpiness across the midrange, indicative of such colouration; stiff, undamped cones breakup near their crossover region (3kHz) producing this characteristic colouration. Epos have kept the metal dome tweeter under quite good control though - it runs almost flat to 20kHz, with some signs of peaking at 20kHz, where output is +2dB up. These features of the els3, in conjunction with its flat overall response balance are sufficient to ensure the 'speaker will sound bright, hard and fast. It will likely also sound detailed and project well, especially as the cabinet is so small.

The drawback of small size is limited bass extension; this speaker reaches down to 80Hz (-6dB), although the port peaks at 60Hz and will contribute a bit lower down. All the same, low bass is not there, but the diminutive els3 will sound speedy.

A very high overall impedance of

ten ohms helps make the speaker insensitive, although considering small size the figure of 84dB is respectable.

The small els3 measures well, following previous distinctive trends. It will have the distinctive Epos sound. NK

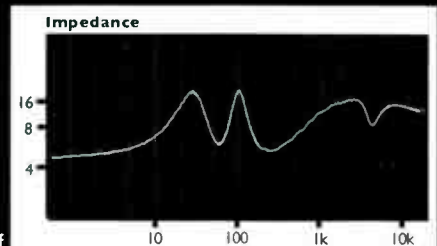
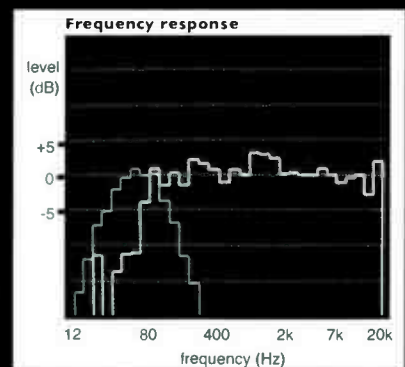
**VERDICT**

Erudite musical communicator with pace and passion, but lacks articulation at the frequency extremes.

EPOS ELS3 £199

Epos Acoustics Ltd.

+44 (0)1442 260 146

www.epos-acoustics.com

FOR

- good timing
- impactful acoustics

AGAINST

- internalised presentation

KEF iQ1 £229

The brand new KEF iQ series has improvements over the previous Q iteration with new cone materials and surrounds, redesigned magnet structures and what KEF call new, state-of-the-art voice coils, higher specification components and more rigid chassis and cabinets. The svelte looking iQ1 features a soft sheen titanium finish to its Uni-Q cone surface. The cabinet is made from internally braced laminated MDF which KEF say is acoustically inert to reduce coloration and panel resonance.

The iQ1 is beautifully built, designed and finished while the shape, as KEF states, uses fully curved enclosures to minimise distortion by eliminating internal standing waves. Thus it is also differentiated - and more attractive - from the £200 Q Compact [see March 2005 Issue] which had a squared off rear. The KEF Uni-Q driver utilises a 130mm coincident driver array mid/bass unit and inserted in the middle is the 19mm aluminium dome tweeter.

This Uni-Q driver (with a port below) when fitted in the injected moulded surround is an elegant (aesthetic and engineering) design solution. The top of the Uni-Q driver has a diecast 'pod' fairing which is a gently domed top cover over the main cabinet surface that KEF says minimises diffraction effects. The iQ1 has very high-quality biwireable binding posts and comes complete with so called 'Oxygen Free Copper audiophile linking wires' for single wiring instead of the usual inferior metal plates. The iQ1 measures 301x 175x 261mm and weighs 4.5kg. The quoted figures are 8ohm (min 3.2ohm) impedance and 88dB sensitivity [see MEASURED PERFORMANCE]. The iQ1 has Black, Apple, Maple or Walnut finishes.

SOUND QUALITY

The 'Allegro' from 'Elgar Violin Concerto' was smooth with the low frequencies being more extended over the Epos. The sound hung together very well, it was cohesive and more natural overall. Crescendos had good dynamics, if not quite as

impactful as the Epos. The violin was lush, liquid and smooth and Hilary Hahn's phrasing of it was a delight being delicate and engrossing which was surprising as the KEFs had more than a hint of high-end luxuriance too. The KEFs invited longer listening and were never fatiguing or yawn-inducing either.

Their richer tonal palette suited Billy Idol's 'Super Overdrive' as they delivered the dynamics of the guitar and drums with a well-rounded acoustic. Timing was good, though initially the KEFs sounded slightly slower than the Eposes but through extended listening simply revealed more musical information plus good

timing. The Steve Stevens guitar solo was superb minimising subjective high-frequency ringing distortions. The KEFs opened out 'Rat Race' with spatiality and extra high-frequency percussion information. Billy Idols vocals went from lower growl to more traditional rock and roll style and were revealed splendidly for a speaker of its price.

An extremely accomplished performance, then. Although ever-so slightly slower than the super-sharp Epos ELS3s, the KEFs were obviously superior all rounders and offered no less musical enjoyment; supplying big speaker refinement and composure despite their diminutive dimensions.



MEASURED PERFORMANCE

KEF have down sized this 'speaker a little, curtailing its bass response. The small cabinet rolls off below 100Hz although it is still only a few dB down at 60Hz, and the port helps out too. So whilst the new iQ1 is unlikely to have weighty bass, it should sound reasonably fast and fluid at the bottom end. A little low-midrange lift will help add body to the sound - always useful with small loudspeakers to prevent them sounding too lean. A peak in port output that coincides with a perturbation in the forward response at around 220Hz is indicative of colouration, likely box echo, most probably from the rear panel. Only listening tests can tell how intrusive this may be, or otherwise.

KEF's co-axial metal dome tweeter looks a little smoother than before and apparently some effort has been put into lessening its bright character. The impedance curve is fairly reactive and sensitivity none to high at 85dB, mainly due to lack of deep bass output.

The iQ1 measures well enough to do a decent job. The old Q1 was an exciting loudspeaker to listen to

and measured similarly. I suspect the new iQ1 will have lighter bass than its predecessor, but smoother treble. NK

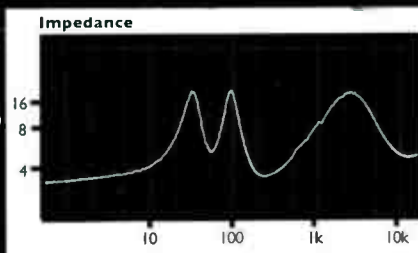
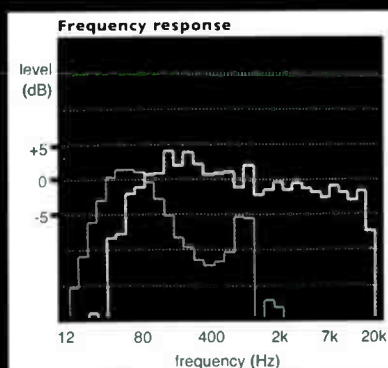

VERDICT ●●●●●

Superbly mature sound with fine tonality, pace and definition right across the audio band. Clever stuff.

KEF iQ1 £229.99

KEF Audio (UK)

☎ +44 (0)1622 672 261

www.kef.co.uk

FOR

- fine tonal palette
- superb aesthetic design
- construction

AGAINST

- nothing

REFERENCE SERIES

AUDIO PERFECTION



Every loudspeaker manufacturer has its flagship range, but not many have achieved the levels of acclaim reserved for Acoustic Energy's Reference Series, long-since regarded as one of the best high-end loudspeaker ranges available today. To find out why, contact us.



email: info@acoustic-energy.co.uk tel: 01285 654432

www.acoustic-energy.co.uk

AE
ACOUSTIC ENERGY

MONITOR AUDIO RADIUS 90 £250



The Radius 90s are easily the smallest baby boxes, here measuring 190x120x140mm and weighing just 2.03kg!

Design, build and finish of the black lacquered version is excellent. The drive units are flush mounted into the cabinet at the rear using attractive hex-head 'through-bolts' providing mechanical decoupling for (claimed) 'enhanced mid-band clarity and resolution. The through-bolts also act as rigid cross bracing to give a very solid non-resonant cabinet.

The MDF cabinet is flawless and has nicely rounded edges to reduce diffraction effects for better imaging. The 101mm mid/bass unit is a second generation metal matrix polymer cone with different thicknesses at desired points of the cone geometry for greater stiffness and consistency. It is fitted into a glass loaded engineering polymer frame for superior damping than metal and increased overall strength.

Monitor Audio says the crossover uses polypropylene capacitors for increased clarity and air core plus laminated iron core inductors for the lowest possible distortion and insertion losses. At the rear is a small port and below is a set of single-wire binding posts. Wall fixing with the supplied pivoting diecast metal wall bracket is also possible. The Radius uses LC-OFC internal cabling, is magnetically shielded and has two sets of removable mesh grills in silver or black. Quoted figures are 87dB sensitivity and 8ohms impedance [see MEASURED PERFORMANCE]. There are Black lacquer, White lacquer, Video silver, natural Beech veneer and Rosemah veneer finishes.

SOUND QUALITY

The music was animated, yet controlled with the 'Allegro'. The Monitor Audios had no trouble filling the listening room with an expansive, yet controlled acoustic. Spatiality is its key and thus it suited the 'Allegro' wonderfully. Crescendos were handled well with good dynamics and though Hilary Hahn's violin had a slightly less warm timbre

than the KEFs, it was not diminished in its emotional communication. Billy Idol's 'Super Overdrive' was handled with very good bass dexterity by the Monitor Audios, allowing fast dynamics - though understandably for their small size not at the same levels of scale/weight as the closely priced KEFs for instance. However, the music was thrilling and dynamic and in the guitar solo there was excellent high-frequency extension with negligible subjective ringing distortions. On the less demanding and more atmospheric 'Rat Race' by Billy Idol, the music continued with great spatiality though again lessened

in scale/weight but this was soon dismissed as the Monitor Audios in conjunction with their excellent drive-unit integration procured an animated, musical and disciplined sound overall, with dynamics being a particular strong point.

The obvious prowess of this tiny speaker was frankly a surprise; the sound is extremely animated, enjoyable and engaging, yet excellent in conventional hi-fi respects too, such as tonality, high and low frequency extension and imaging. Although they lack the scale of full size boxes, they sure make up for it in impact.

MEASURED PERFORMANCE

Output of the metal dome tweeter of this mini rises up to no less than +8dB at 20kHz and may well reach even higher above this frequency. The Radius 90 is flat to 10kHz, so with most programme material it will seem normal in its balance and revealing too. Such a peak will make itself known at times though, with music possessing strong, extended treble. Then, there will be quite a sharp sting in the sound due to this effect.

Through the rest of the audio band this mini is impressively flat in its frequency response, as our analysis shows. Monitor Audio have done well to ensure the main rear panel return doesn't upset forward response or port output unduly, always a problem with minis. Forward output reaches down to 100Hz before rolling away steeply. The port then takes over. It is broadly tuned and exerts good damping. It extends output down to 50Hz, albeit at lower level than forward output.

Although Monitor Audio use a 5ohm bass driver, over most of the audio band this Radius 90's impedance exceeds 8ohms; it is a true 8ohm impedance loudspeaker, and not too reactive either. Sensitivity was low at 84dB, as it

always is with small speakers.

The Radius 90 measures well. It is accurate, but the metal dome tweeter will make itself known at times. NK

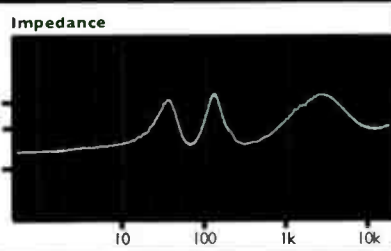
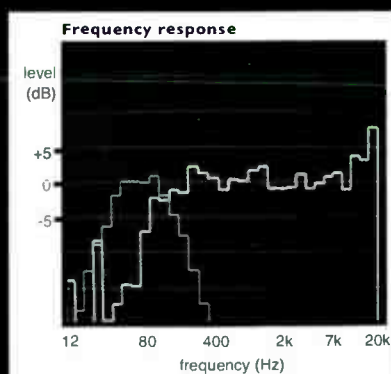

VERDICT

Stunning soundstaging and superlative dynamics make this a truly uplifting listening experience.

MONITOR AUDIO

RADIUS 90 £250

Monitor Audio Ltd.

+44 (0)1268 740 580

www.monitoraudio.com

FOR

- spatiality and dynamics
- well built, flexible
- attractively small scale

AGAINST

- comparatively diminished scale

Esoteric:

serious hi-fi for the initiated

Born of an obsession with perfect reproduction of the finest detail, these components are precision instruments, finely engineered and beautifully designed.

This range of components is, quite simply, peerless. Listen once and you'll remember it for ever.

ESOTERIC



For further information contact
Symmetry on 01727 865488 or
info@symmetry-systems.co.uk

www.teac.co.uk



TEAC's unique VRDS-NEO clamping mechanism, precision machined from ultra-dense materials



by **TEAC**

QUAD 11L £380

Being Quad's first in-house designed moving coil loudspeakers and a departure from their more famous electrostatics, their recent L series arrives at significantly lower cost. However, bespoke manufacturing makes the 11L far more luxuriously appointed than its £380 price would suggest. Consequently the 11Ls are a small two way speaker made without a single 'off-the shelf' component being used anywhere in the loudspeaker (lately - even the magnets are now also bespoke!). This, says Quad, has resulted in a totally 'customised' product, built to the point of obsession, in a manner seldom still seen in the industry. The cabinet is made of 18mm veneered MDF sheets with a six layer lacquer coat and comes in Piano Black, Piano Rosewood, Piano Maple and Piano Birds Eye Maple as standard.

The 11L uses a 130mm mid/bass driver with resin impregnated Kevlar diaphragm, where the resin stiffens the cone to give good piston performance, whilst the inherent self-damping properties of woven Kevlar keeps cone resonance to a minimum. The 25mm soft dome tweeter uses a neodymium magnet with a ferrofluid cooled voice coil. The whole unit has been engineered to give an extended frequency response (which) has been achieved by reducing weight in the diaphragm and former assembly. The crossover is as simple as possible featuring air cored chokes, plus large gauge 'low loss' polypropylene wire capacitors. The 11Ls have a quoted 60hm nominal impedance and 86dB sensitivity [see MEASURED PERFORMANCE]. Measuring 325x190x243mm the Quads have flawless surfaces and are beautifully manufactured and finished. They have double rear ports and biwire binding posts.

SOUND QUALITY

The music from 'Elgar Violin Concertos' had a lush and warm presentation with the Quads. The sound had greater weight and scale than the Epos, KEF or Monitor Audios. Instrumental timbre was very good, showing superb tonal

shading and depth in the decaying notes and the crescendos were powerful and dynamic. Hilary Hahn's violin had the silkiest, warmest tonality of the four lower cost speakers in this test, with excellent timbre. The musical timing though is the Quads' weakness as cohesion and a complete sense of naturalness was minimised in comparison to the others. The slightly slower rhythmical ability of the Quads was more evident on 'Super Overdrive' from 'Devils Playground' as once again there was excellent timbral qualities on both vocal and instruments yet collectively, the music was less of a piece. On the

less demanding 'Rat Race', the Quads fared better producing a deep and vibrantly good instrumental timbre where Steve Steven's acoustic guitar playing was of particular merit.

These are extremely accomplished loudspeakers, although the voicing is obviously different to the aforementioned designs. The Quads prioritise what used to be called a 'good tone' - accurate textural and timbral resolution - over speed and attack. For this reason, many will find them the best speakers here, while others (myself included) will look elsewhere for speed and grip.



MEASURED PERFORMANCE

The Quad 11L is notably flat in its response characteristic, with very little variation from 80Hz up to 16kHz. This makes it fundamentally accurate, but without a little bass lift to add body, it's likely to sound dry unless near-wall positioning is used. Tweeter output declines a little above 7kHz, but very little. It may soften the sound just a little, but since an earlier sample was flatter this could just be down to sample variation.

With a port tuned to approximately 54Hz the 11L reaches low, but not as low as some slightly larger models. It will likely have well damped and fast sounding bass, but no bass surfeit.

Sensitivity was good at 87dB and impedance measures 60hms overall, dropping to 4ohms at low frequencies, as a 4ohm bass unit is used.

The 11L is accurate, but expect a dry, concise sound rather than a fulsome or soft one. It's a well engineered speaker. NK

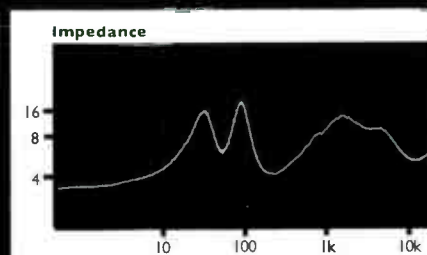
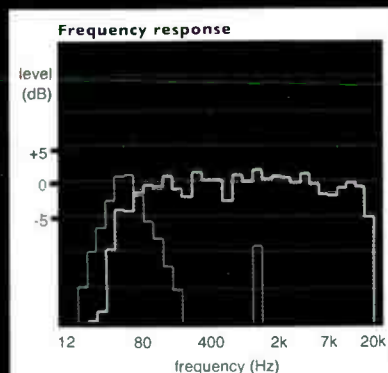

VERDICT ●●●●£

Superlative timbral and detail resolution make for a truly sophisticated sound - but speed freaks should look elsewhere.

QUAD 11L £380

QUAD

☎ +44 (0)845 458 0011

www.quad-hifi.co.uk

FOR

- superb build, design & finish
- instrumental & vocal timbre

AGAINST

- timing

Performance



Fire your imagination.

Performance is the result of a three-year research and development programme culminating in a number of major technological advancements. Recreating each and every musical nuance with incredible emotion, Mordaunt-Short's state-of-the-art loudspeaker range brings you as close as possible to the wonder of the original performance.



"This loudspeaker delivers a level of detail and transparency that is virtually unprecedented in a moving coil design... surely a classic in the making"

Hi-Fi Choice, March 2005



"Truly redefines the standard at this class... Superb value for money; a modern classic"

Hi-Fi World, April 2005

MORDAUNT-SHORT

www.mordaunt-short.com

World Radio History

PINSH ONE £1,200

The Pinsh is an attractive and attractively proportioned little speaker measuring 200x300x360mm [see also our September 2005 issue]. Thus the cabinet is deep, with a 12 litre internal volume and is made from MDF. It comes in Black Ash, Cherry, Oak, Maple and Walnut finishes. Pinsh is uncommon because it manufactures its own ribbon tweeters, and moreover does so in the UK.

The Pinsh ribbon has a claimed frequency response from 4000Hz to 40kHz, and though the material composition remains confidential, its mass is just 7mg. Rare Earth metal magnets are used in this design. Accordingly, Pinsh say that there are no additional moving parts like spiders, domes and voice coils and formers including adhesives, all of which have thermal limit. Pinsh says its zero store ribbon has no damping, neither is it enclosed in a sealed chamber. It claims that distortion is exceptionally low, and frequency response is linear, with the upper limits at 100kHz.

Pinsh also design and manufacture the crossover in house using what they call "the absolute minimum of components", while the 5inch (127mm approx) mid/bass driver is made for Pinsh by Morel. Pinsh describe it as having a frequency response from 40Hz, to 4000Hz. It has a 75 mm aluminium voice coil, aluminium wire wound with no air gaps, and a claimed impulse response "fast enough to follow our PINSH ribbon" The Pinsh 1 is rear ported with quoted sensitivity of 88dB and impedance at 8ohms [see MEASURED PERFORMANCE].

SOUND QUALITY

The low frequencies from the Pinsh 1s were beautifully rendered via the 'Allegro' from the 'Elgar Violin Concerto'. There was not only depth and extension, but a good slice of bass dexterity as well which was most welcome. The violin solo was authoritative through the Pinsh 1, sounding less coloured than the other speakers in this test. Instrumental timbre didn't have quite the impact of the Quads

but the Pinsh 1s showed their higher-price with more emotionally engrossing ability when it came to the complete set of low, mid and high frequencies.

The low-frequency excellence continued with - and was beneficial to - 'Super Overdrive' as there was a superb dynamic thrust to the music. The music additionally hung together cohesively very well and had great emotional resonance with both guitars and vocals. Steve Steven's guitar solo from 'Super Overdrive' had no subjective ringing distortions either. On 'Rat Race', the

acoustic guitar had finer elucidation to the phrasing where you could discern Steve Steven's fingers sliding across the strings. The vocals were sublime, generating a multilayered unravelling to reveal greater tonal shading.

Overall then, a deeply impressive loudspeaker. Obviously, you'd expect it to be considering the vastly higher retail price, but even when this is factored in, the Pinsh is truly special. Brilliantly even right across the frequency band, it showcases the benefits of ribbon tweeter technology.

**MEASURED PERFORMANCE**

The ribbon tweeter used in this loudspeaker reaches down to 1.25kHz, lower than the usual dome tweeter, that reaches 3kHz or so. A substantial and significant part of this loudspeaker's sound comes from its ribbon drive unit so its sound is likely to be airier, faster and cleaner than usual. However, the Pinsh ribbon is not particularly flat in its frequency response. Whether this is due to internal cancellations that might colour its sound noticeably, or external cancellations that will degrade tonal evenness but not add colour, is open to question. The 4dB dip of this ribbon, centred at 4kHz will soften its delivery and mute detail a little, but may equally make the Pinsh easier to listen to than many of today's rather challenging loudspeakers. A good ribbon driver can sound so clean, tonal aberrations like this can seem less consequential than normal. It takes listening tests to tell.

The bass/midrange unit runs smoothly from 1kHz down to 80Hz. There is a deep narrow dip at 1kHz, likely a crossover mismatch. Bass falls away smoothly, suggesting a well damped sound. The port is narrowly tuned though and will add little to deep bass. It's tuned to 50Hz and makes a contribution down to 40Hz.

Sensitivity was miserably low at

81dB. This loudspeaker needs a powerful amplifier to go loud. Part of the reason is that impedance is high at 9ohms across most of the audio band. The Pinsh is almost entirely resistive too; few loudspeakers possess such a flat impedance characteristic.

This ribbon loudspeaker isn't academically perfect in the way it measures, but it is interesting and is definitely worth a close listen. NK

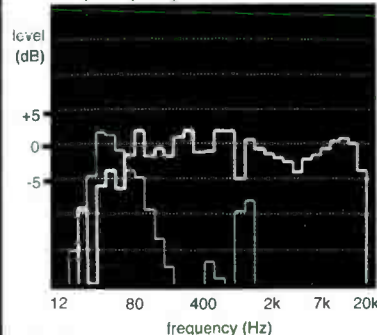
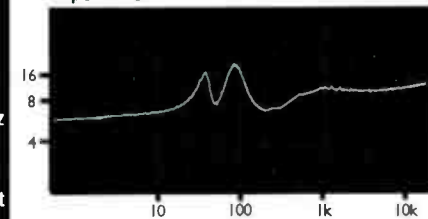
Frequency response**Impedance****VERDICT**

Superbly natural and seamless sound with excellent musical articulation makes this one of the very best sub £1,500 mini-monitors on sale.

PINSH 1 £1,200

Pinsh

+44 (0)208 683 6700

www.pinsh.com

FOR

- high-frequency capability
- superb low-frequency talent
- clean, understated design

AGAINST

- nothing

AURUM CANTUS LEISURE 3SE £1,250

The Leisure 3SE uses a proprietary G3Si ribbon tweeter made from aluminium measuring 100x 8.5x 0.01mm. The mid/bass (AC-165/50CK) 165mm driver (also bespoke) uses a non-woven carbon-fibre (and) Kevlar cone, 25mm copper cover aluminium voice coil and 100x20mm Y30 ferrite magnet. In the crossover it uses a Mundorf Supreme MKP [??? – Ed.] high-quality polypropylene capacitor, 5N (99.999% purity) copper wire inductor, metal oxide film resistor and ceramic resistor. Additionally, 5N Supra Classic internal copper wiring is employed within the Leisure 3SEs. The quoted specifications are 88dB sensitivity and 8ohms (min 6.4ohms) impedance [see MEASURED PERFORMANCE]. The Leisure 3SE is made within from MDF, measuring 400x246x302mm and weighs 12kg. Externally there are Poplar Burl (pictured), Cherry, Rosewood, and Maple side finishes.

Silhouetted, the Leisure 3SE is a fairly complex and attractively sculptural design. The front baffle's edges taper both into and backwards at the top half appealingly, and acoustically Aurum Cantus use this profiling to aid the vertical diffusion of the ribbon tweeter. The 3SEs have been designed in a pyramidal shape (wider at the base) because apart from being striking, its shape is good at diminishing bad resonances and standing waves, says Aurum Cantus. At the rear there is a large port and single-wire binding posts. The design, feel and build quality is superlative, with flawless flush mounting and attractive hex-head fixings to the drivers. Personally I am not as keen visually on the review pair's Poplar Burl finish as it is a little ostentatious; though a simpler all black/solo colour gloss would enhance and purify the inherently attractive sculptural design.

SOUND QUALITY

The 'Allegro' from 'Elgar Violin Concerto' was smooth and sumptuously spatial. The low-frequency notes were unsurprisingly deeper than the other speakers on test as the Leisure 3SEs had the biggest

physical cabinet size. Drive-unit integration was very good and provided a seamless changeover from orchestration to violin solo. The violin sound itself was smooth and had a quite even tonality overall, erring into the lower frequencies slightly with a small yet discernible amber-coloured, caramel-sweetness to it. On 'Super Overdrive' the Leisure 3SEs even tonality produced a rather stirring result, as the superb drive-unit integration really came into the fore with this track as there were wonderful dynamic swings.

Steve Steven's guitar solo fared less well however, with some surprising high-frequency stridency as he hit the more demanding notes and

as such this was a disappointment considering the quality of the rest of the musical spectrum that the Leisure 3SEs so obviously excelled at. The less demanding 'Rat Race' had some nice instrumental decaying notes enabling a more three-dimensional feel to the music. Bass dexterity was very good and so was its bass extension, if not quite as amazing in complexity as the Pinsh 1s overall.

An interesting loudspeaker this one, with a wide range of talents – not least of which being its big, seamlessly smooth sound and lucid musicality with a nice full bottom end. Excellent finish and striking aesthetic design make it more attractive still.



MEASURED PERFORMANCE

A good ribbon tweeter measures almost ruler flat, meaning it's resonance free, a property domes can't match - and the benefits are clearly audible. The long ribbon tweeter of this loudspeaker delivers just such a result, our analysis shows. Aurum Cantus integrate it smoothly with the bass/midrange unit, avoiding dips or peaks at the crossover point. Forward integration was good above and below the 'speakers main forward axis too - a weak area for ribbons - so seating height won't be too critical. The quality of this ribbon and the high standard of engineering within the Leisure 3.5se results in an impressively flat forward response, reaching from 40Hz (-6dB) up to 20kHz, with relatively little variation. Subjectively, this suggests a fairly forward sound with 'obvious' treble, but good detailing. There's just a little bass lift around 200Hz to add a bit of body to the sound. Slow bass roll off below 40Hz suggests good low frequency damping.

Sensitivity was low at 82dB but this wasn't surprising as the 'speakers impedance is very high, measuring 12ohms overall. It is a very light load, even for a valve amp. but does need 'power' (volts) to go loud.

The Leisure 3.5se is well engineered and fundamentally very accurate; it will seem insensitive, needing a powerful amp to go loud. Sound quality is likely to be impressive. NK

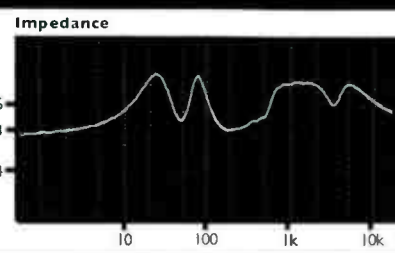
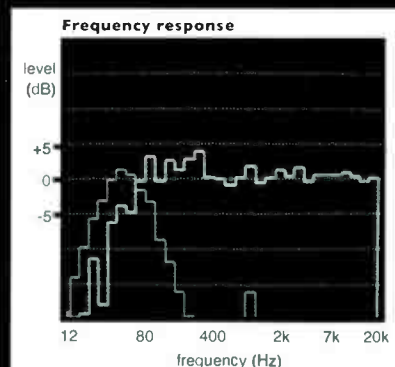

VERDICT

Big, full, smooth and seamlessly musical sound makes for a great, if unconventional styled, all rounder.

**AURUM CANTUS LEISURE
3SE £1,250**

Aurum Cantus
☎ +44 (0)2028 459 8113

www.absoluteanalogue.co.uk

FOR

- luxurious build, finish
- attractively complex aesthetics
- excellent musicality

AGAINST

- occasional high-frequency stridency

conclusion

Hi-Fi World group tests rarely match up six identically priced bits of kit with the aim of finding 'the best'. Rather, we take a more – dare we say it!

– holistic approach by running the gamut of interesting designs across a wider price span. This has the useful benefit of putting the products into context, so you can see not only how good one product (cheap or expensive) is, but how it fits into the greater scheme of things...

Interesting then that, even in a group running up to £1,250, the Monitor Audio Radius 90 really surprised. Despite being physically the smallest size by a fair margin, it produced a wonderfully dynamic yet controlled sound the totally belied the £250 price. The tiny Monitor Audios obviously won't scale the lows of bass extension that the larger speakers in the test could (Quad, Aurum Cantus), but more importantly for me, were I given the choice between superb driver integration plus bass dexterity, against excellent tonality and frequency extremes, then I'd go for the former. This is because with the MA's musical timing was really something to behold, and its spatial ability (due I think to the clever application of their metal dome tweeter) made the music more vibrant and insightful yet with minimised ringing distortions also. The Monitor Audios also have excellent build, design and added flexibility with wall mounting. If you did want more bass extension then there is a matching Radius subwoofer, but in this review context I had no complaints and it thoroughly deserves its five globes.

The KEF iQ1 had a sound that was impressively well-rounded, deep and of high resolution for the asking price of £229.99. I could listen to the KEFs all day without any hint of fatigue or lack of concentration, safely in the knowledge that they wouldn't let me down in terms of all round musicality. With their now fully curved enclosures, they are the best pure aesthetic design of the whole group and are nicely finished too. Their only problem is that they are initially underwhelming and need patience to reward the listener – but

it sure pays off. A deeply impressive all rounder indeed.

The £380 Quad 11Ls and £199.99 Epos ELS3s are an interesting pair, as they both have what the other really needs! The Quad has beautiful instrumental timbre which makes for engrossing details, but the Epos had the best musical timing of the entire group – some of which the Quad could have done with, thus they are both good in parts but don't show a more complete sonic picture! The Quad is beautifully finished (especially in all-black) and built, while the Epos looks perfect presentable at the price, and – for flat earthers at least – makes up for any aesthetic issues with its indefatigable sound.

Of the two higher cost small speakers, I ultimately preferred the Pinsh 1, which had fantastic performance in this group. Even though second costliest, it consistently proved its superiority in cohesion in all frequency ranges, where it combined bass dexterity and extension stunningly well, and boasted excellent high-frequency ability too. It produced a very musical sound through both extremes of Elgar and Billy Idol, which be assured is no small feat! The UK designed and manufactured Pinsh 1 is attractively proportioned and uses a bespoke tweeter. Count in the good build quality and this is truly an attainable slice of the high-end for mid-fi money.

The £1,250 Aurum Cantus Leisure 3SE has stunning build and finish. The attention to design detail is the best of the whole group while



the luxuriant finish is sure to instil pride of ownership. The 3SEs sound is equally luxurious, and in many ways is a high-end sound, but with a really nice even balance in most cases which procured some wonderful dynamic swings. The scale and power of the Leisure 3SEs was so good that they approached the quality of the £2,000 floorstanding Waterfalls that I

'this was a fantastic group to audition; every design here brought something to the party, and there were positively no poopers!'

use as a reference, but some occasional high-frequency stridency means that careful system matching is important.

Overall, this was a fantastic group to audition; every design here brought something to the party, and there were positively no poopers! It just shows how good the latest crop of mini-monitors is, and the ones that really play to the strengths of the breed (for me the Monitor Audio, Epos and Pinsh) can do the 'pace, rhythm and timing' thing like few others of any size.

MUSIC:

Hilary Hahn/LSO/Davis 'Elgar Violin Concerto' (2004)
Billy Idol 'Devil's Playground' (2005)

REFERENCE SYSTEM:

Densen B-400Plus CD player £1,350
Moon Audio i-3 Integrated amplifier £1,595
Isotek GII Vision Mains Filtration £550

WIN A COMPLETE ROTEL/ B&W SYSTEM WORTH £1,400 IN THIS MONTH'S GREAT COMPETITION!



October's *Hi-Fi World* gives you the chance to win a brilliantly matched 'affordable audiophile' system featuring the highly acclaimed Rotel RCD-02 CD player, celebrated Rotel RA-03 integrated amplifier and the much-vaunted B&W 602S3 floor-standing loudspeakers, complete with twelve metres of the excellent Microphonic Audio Loudspeaker Cable [see box]! Here's what Dominic Todd had to say about it:

"The CD player is Rotel's RCD-02. Well engineered and solidly built, at its heart lies a Burr Brown IC that provides resolution claimed to equal 18-bit. HDCD decoding is also part and parcel of the chip. The transport mechanism is a Sony design, and the rest of the circuitry shows careful choice of good quality components. At the system's heart lies Rotel's excellent RA-03 amplifier. Reviewed in the August 2005 issue, this five globe amp' has already proved its mettle. Rotel's own design of toroidal power transformer helps produce a respectable 90 watts power output, and there is typical attention to detail throughout the power supply. Copper bus bars are used in high current stages, DNM have designed the slit foil capacitors and there's separate signal and power earthing.

The B&W 602S3's 180mm (7") woven Kevlar bass cones mate up with a, carefully damped, metal dome tweeter. As with the Rotel electronics, the key is in the detail. The front baffle, for example, is double skinned with the outer, polypropylene, casing being specially moulded to reduce diffractions and sharpen the imaging. The front

mounted bass port features a tapered tube with surfacing detail first developed for the 800-series.

With Tracey Chapman's 'Mountains O' Things', this system managed to pull off a superb balancing act in making Chapman's vocals sound smooth and sibilant free yet still soulful and full of character, colour and texture. The system was equally good at projecting the vocals well forward of the rest of the mix – highlighting them without being overblown. Whilst the percussion lay behind Chapman's vocals it was still reproduced with precision, great timing and, again, not in an overblown or relentless way. An interesting quality that appeared with The Cardigans' 'Erase and Rewind' was that old Rotel characteristic of being able to pluck notes out of a seemingly inky blackness of pure silence... noise levels are extremely low and testament to the high levels of engineering quality... Just take a listen and I challenge you not to be won over. This is a case of the whole being more than the sum of the parts, even when the parts are already top notch. For less than £1,400 it's one system that I can recommend without reservation"

If you'd like to win this superb system, then all you have to do is answer the following four easy questions. Send your entries by 30th September 2005 on a postcard to: **October 2005 Competition, Hi-Fi World magazine, Unit G4, Argo House, The Park Business Centre, Kilburn Park Road, London NW6 5LF.**

QUESTIONS

[1] What type of decoding is included in the RCD-02 cd player?

- [a] LP
- [b] HDCD
- [c] DVD-A
- [d] SACD

[2] Who designed the slit-foil capacitors in the RA-03?

- [a] D&M Holdings
- [b] DNM
- [c] MDF
- [d] MPV

[3] What bass cone material is used in the B&W 602S3?

- [a] paper
- [b] Kevlar
- [c] carbon fibre
- [d] Bextrene

[4] what type of dielectric does the Microphonic cable use?

- [a] polymer
- [b] polypropylene
- [c] polythene
- [d] polyester

October Competition
Hi-Fi World Magazine
Unit G4 Argo House
The Park Business Centre
Kilburn Park Rd.
London NW6 5LF

THE CABLES

Microphonic Audio cables are designed to allow the listener to hear everything the microphones heard – hence the name. The Original Speaker Cable's (£4/m) design is based on hard facts. First is the 'figure of eight' design; Microphonic found that by keeping the two cores close together, they could create a high frequency response that was better than a spaced or woven cable. Second, the cable uses a polypropylene dielectric instead of the more trendy Teflon, as polypropylene has a ruler flat frequency response. Third, the wire itself has a careful balance between surface area and metal content. Overall, Microphonic say it's 'the most open and faithful sound that we could find at the price' – and we wouldn't disagree.

RULES AND CONDITIONS OF ENTRY

- ONLY ONE ENTRY PER HOUSEHOLD
- MULTIPLE ENTRIES WILL BE AUTOMATICALLY DISQUALIFIED
- PURCHASE OF THE MAGAZINE IS NOT A PRE-CONDITION OF ENTRY
- NO CORRESPONDENCE WILL BE ENTERED INTO
- THE EDITOR'S DECISION IS FINAL
- NO EMPLOYEES OF AUDIO PUBLISHING LIMITED, OR OF ANY COMPANIES ASSOCIATED WITH THE PRODUCTION OR DISTRIBUTION OF THE PRIZES, MAY ENTER

entries will be accepted on a postcard only

**JULY 2005 MARANTZ PM11S1 INTEGRATED AMPLIFIER WINNER:
Malcolm Smith of Kendal, Cumbria**

SEVEN OAKS

SOUND & VISION

SUMMER EVENT

EXTENDED UNTIL 24TH SEPTEMBER 2005

ABERDEEN
 BDFORD
 BIRMINGHAM
 BRIGHTON
 BRISTOL
 BROMLEY
 CAMBRIDGE
 CARDIFF
 CHELSEA
 CHELTENHAM
 CRAWLEY
 CROYDON
 EALING
 EDINBURGH
 EPSOM
 EXETER
 GLASGOW
 GUILDFORD
 HOLBORN
 HULL
 IPSWICH
 KINGSTON
 LEICESTER
 LEEDS
 LINCOLN
 MAIDSTONE
 MANCHESTER
 NEWCASTLE
 NORWICH
 NOTTINGHAM
 OXFORD
 PETERBOROUGH
 PLYMOUTH
 POOLE
 PRESTON
 READING
 SEVENOAKS
 SHEFFIELD
 SOLIHULL
 SOUTHAMPTON
 SOUTHGATE
 STAINES
 SWINDON
 SWISS COTTAGE
 TUNBRIDGE WELLS
 WATFORD
 WEYBRIDGE
 WITHAM (ESSEX)
 WOLVERHAMPTON
 YEOVIL (OPENING SOON)



PIONEER
PDP435XDE
 43" Plasma TV
 From **£2399**

PDP505XDE
 50" Plasma TV
 From **£3599**

SAVE £s

PRICES EXCLUDE SPEAKERS (NICWAOO)*



SCREENPLAY
 SP5700 DLP Projector
£1499 SAVE **£500**

FACTORY REFURBISHED UNIT
 INCLUDES 3 YEAR GOLD PLUS WARRANTY (NICWAOO)*



REL SUBWOOFERS

Quake	£299	SAVE £50
Stampede	£499	SAVE £50
Strata 5	£624	SAVE £75

ALL MODELS BRITTEK BLACK FINISH ONLY (NICWAOO)*

DENON

DVD3910 DVD Player
£719 SAVE **£30**

AVR3805 AV Receiver
£799 SAVE **£50**



(NICWAOO)*



MONITOR AUDIO
 Bronze B2 Speakers
£179 SAVE **£20**

(NICWAOO)*

Free QED Cables

CLAIM FREE QED SPEAKER OR INTERCONNECT CABLES WORTH AT LEAST £50

WHEN YOU PURCHASE SELECTED SPEAKERS OR CD/AMPLIFIER COMBINATIONS

Ask In-store for details. (NICWAOO)*



MORE SUMMER EVENT OFFERS ON PAGE 4

Some products/brands are not available at all stores. Please call to confirm or see the brand locator on our website before travelling.
 *Added Value Offers - From range available In-store.
 Not In conjunction with any other offer (NICWAOO).
 Advert valid until at least 24/09/2005, E&OE.

AT LEAST 10% OFF

OUR NORMAL SELLING PRICES ON A WIDE RANGE OF PRODUCTS
 FOR OUR LATEST PRICES CALL YOUR LOCAL STORE OR VISIT
www.ssav.com

49 STORES NATIONWIDE



Specialist hi-fi

Contemporary hi-fi is constantly setting new standards in sound reproduction and design. Whatever you listen to, be it Robbie Williams or Rachmaninov, Sevenoaks can recommend separate components that will bring your music collection to life and complement your home. We're enthusiasts and experts, passionate about helping you build (or upgrade) a system that will delight for years to come.



FREE QED CABLE
WITH SELECTED PRODUCTS ASK IN-STORE FOR DETAILS (NICWA001)

Rotel

Rotel is truly unique: a family-owned, specialist Japanese company whose passionate interest in music led them to manufacture audio components of uncompromised quality.

The **02 Series** is Rotel's entry level range. The RCD-02 CD player combined with either an RA-01, RA-02 or RA-03 integrated amplifier represents true audiophile performance at an affordable price. For increased high-end performance, the RC-03/RB-3 pre/power amplifiers are available. The RT-02 tuner completes the range.

- 02 SERIES**
RA-01 AMPLIFIER
RA-02 AMPLIFIER
RA-03 AMPLIFIER
RCD-02 CD PLAYER
RT-02 TUNER
10 SERIES
RA-1062 AMPLIFIER
RCD-1072 CD PLAYER

ROTEL RA-03 INTEGRATED AMPLIFIER

"The Rotel is simply the best-sounding amp here, and one of the cheapest - if you're after an amp, you must hear it."



Arcam

Arcam has spent more than a generation building some of the finest high-fidelity products the world has ever seen. Whether you're interested in two-channel or a complete multi-channel AV system, the Arcam DiVA series offers the music and movie lover the most complete range of high-performance home entertainment solutions from any specialist manufacturer.



FREE QED CABLE
WITH SELECTED PRODUCTS ASK IN-STORE FOR DETAILS (NICWA001)

NEW ARCAM SOLO ALL-IN-ONE MUSIC SYSTEM

SOLO: A sleek, easy-to-operate system. Featuring an audiophile CD player, a 50 WPC amplifier combined with a DAB digital radio and a high quality FM tuner, the SOLO music system will captivate all who listen.

- DIVA SERIES INCLUDES**
- | | |
|---------------------------|---------------------------|
| A65 PLUS AMPLIFIER | T61 TUNER |
| A80 AMPLIFIER | DT91 DAB TUNER |
| A90 AMPLIFIER | DV78 DVD PLAYER |
| CD73T CD PLAYER | DV79 DVD PLAYER |
| CD192 CD PLAYER | AVR250 AV RECEIVER |
| | AVR300 AV RECEIVER |

Project

Project is currently one of the world's leading suppliers of turntables, with a range of models designed to satisfy all levels of expectation and budget. The range is simple to use, maintenance free and will function for a lifetime.



- DEBUT III** TURNTABLE WITH OM5E CARTRIDGE
2 XPERIENCE TURNTABLE (PICTURED RIGHT)

Cyrus

If you've enjoyed listening to music before, try listening to it through a Cyrus system. With every product tuned by ear, Cyrus represents a quality of sound, which is rare at any price. Invest in a Cyrus system and you'll be rewarded with a wealth of sound you wouldn't have thought possible.

- RANGE INCLUDES**
CD6 & CD8X CD PLAYERS
6VS & 8VS AMPLIFIERS **PRE X VS** PREAMPLIFIER
DAC-X DAC & **FM X** TUNER

LINKSERVER SOLO

A Cyrus CD Player with built in 80Gb hard disk drive. Keep all your favourite music instantly accessible in a single, easy to operate component.



B&W

Since the outset, the focus of Bowers and Wilkins Loudspeakers has always been to offer the best possible musical experience. With a combination of the latest R&D techniques and a passion for music, B&W produces a diverse range of products befitting the largest audio manufacturer in the UK.

- 600 SERIES** INCLUDES
DM601 S3 & DM602 S3
700 SERIES INCLUDES
705 & 703
FPM SERIES INCLUDES
PV1 SUBWOOFER



SUMMER EVENT

At least **10% off** our normal selling prices on a wide range of products. For our latest prices call your local store or visit www.ssav.com

PRICING POLICY

We always try to ensure our prices are highly competitive. In the event you can find the same products and excellent service at a lower price, please bring it to our store managers' attention.

ESSENTIAL ACCESSORIES

The right accessories can make or break your system. Our carefully selected range, including QED, Soundstyle and Grado, will ensure you get the very best performance from your system.

0% FINANCE OPTION*

Spread the cost of buying. 0% finance option is available on the majority of products we stock. *Written details on request. Licensed credit brokers. Minimum balance £400. Subject to status.

PLEASE NOTE

Some products/brands are not available at all stores. Please call to confirm or see the brand locator on our website before travelling. *Added Value Offers - From range available in-store. Not in conjunction with any other offer (NICWA00) ADVERT VALID UNTIL AT LEAST 24/09/2005, E&OE.

At least **10% off** our normal selling prices on a wide range of products. For our latest prices call your local store or visit www.ssav.com

SUMMER EVENT

EXTENDED UNTIL 24TH SEPTEMBER 2005



Roksan

Roksan designs and manufactures some of the most acclaimed hi-fi equipment currently available. All Roksan products are carefully evaluated by experienced engineers at every stage of the design process with the emphasis on performance and build quality.

Kandy

KA1 MKIII AMPLIFIER
KD1 MKIII CD PLAYER

Caspian M SERIES

CD PLAYER
AMPLIFIER
PREAMPLIFIER
STEREO POWER
MONOBLOC POWER

FREE QED CABLE
WITH SELECTED PRODUCTS ASK IN-STORE FOR DETAILS (NICWA001)

Monitor Audio

Since 1972 Monitor Audio has been developing and perfecting the implementation of metal drivers, innovative crossovers, and exemplary speaker cabinet construction and finish to further the ideal of achieving sound which is to the original "as close as it gets".

The range includes - Gold, New Silver RS, Bronze and Radius, a seriously compact system bringing true hi-fi performance to both music and movies at home.



NEW SILVER RS6

FREE QED CABLE
WITH SELECTED PRODUCTS ASK IN-STORE FOR DETAILS (NICWA001)

BRONZE B2, B2 AV, B4 AV
SILVER RS1, RS6, RS8
GOLD REFERENCE 10 & 60



BRONZE B2

"Monitor Audio's Bronze B2s sound much more expensive than their £200 price tag would suggest. In fact, they sound superb... In the competitive world of budget hi-fi, speakers don't get much better than the B2s."

Acoustic Energy

Established in 1987, Acoustic Energy is one of Britain's premier loudspeaker manufacturers offering one of the most targeted range of hi-fi and home cinema loudspeaker systems on the market today.



AELITE THREE

"The legendary AE1 lives on in this groundbreaking new version... It sets a new standard for small speakers."

Digital Radio Harman Kardon

TU970 DAB/ANALOGUE TUNER

With Digital Audio Broadcasting (DAB) capability, this high-quality tuner delivers more stations and offers pure, distortion-free, CD-like sound, while providing useful radio and data services.



Pure

DRX702ES DAB/ANALOGUE TUNER

Wharfedale

DIAMOND 9.1 SPEAKERS

"The overall balance of the speakers is their finest characteristic. Thanks to near-perfect driver integration, music sounds wonderfully natural and transparent. This is a bar-raising effort from Wharfedale: these are ridiculously good speakers at the budget price level." digital technologies from one of the oldest hi-fi names.



Free QED Cables

FREE QED SPEAKER CABLE worth at least £50 when you purchase selected Speakers over £200. Ask in-store for details. (NICWA001)

FREE QED INTERCONNECT CABLE worth at least £50 when you purchase selected CD and Amplifier combinations. Ask in-store for details. (NICWA001)



Marantz

The Marantz "Range Series" offers flexible system building options for every lifestyle.

RANGE SERIES INCLUDES

- CD5400 CD PLAYER
- PM4400 AMPLIFIER
- PM7200 AMPLIFIER
- ST4000 TUNER
- SR4500 AV RECEIVER
- SR5500 AV RECEIVER
- DV4500 DVD PLAYER

CD5400 "This is a remarkable CD player for the money, with superb sound, looks and feel - A very solid buy and a lot of fun."



KEF Q Series

The Latest evolution of the acclaimed Q Series demonstrates how the benefits of KEF technology cascade down from the Reference Series to more affordable ranges. New Q features all the inherent advantages of KEF UNI-Q™ technology and are available in a variety of Finishes.



FREE QED CABLE
WITH SELECTED PRODUCTS ASK IN-STORE FOR DETAILS (NICWA001)

Q COMPACT BOOKSHELF SPEAKERS
Q4 FLOORSTANDING SPEAKERS
Q7 AV SPEAKER PACKAGE

Quad

Founded in 1938, Quad's history is one of audio excellence. Today's range includes both electronics and speaker systems.

PRODUCTS INCLUDE

- 99 CD-PREAMPLIFIER
- 11L SPEAKERS

FREE QED CABLE
WITH SELECTED PRODUCTS ASK IN-STORE FOR DETAILS (NICWA001)



Musical Fidelity

Musical Fidelity's X-Series combines exceptional build quality with value for money.

X SERIES X-80 & X150 AMPLIFIER
X-RAY™ CD PLAYER

A5 SERIES A5 AMPLIFIER & CD PLAYER

FREE QED CABLE
WITH SELECTED PRODUCTS ASK IN-STORE FOR DETAILS (NICWA001)





SUMMER EVENT

FOR OUR LATEST PRICES AND OFFERS
CALL YOUR NEAREST STORE OR VISIT
www.ssav.com

CD PLAYERS

Denon DCD485	£119.95
Marantz CD5400	£119.95

CD RECORDERS

Yamaha CDR-HD1500	£449.95
-------------------	---------

AMPLIFIERS

Denon PMA355	£159.95
Marantz PM4400	£139.95
Marantz PM7200	£239.95
Yamaha AX396	£169.95

SPEAKERS

Acoustic Energy Aegis Evo One	£119.95
Acoustic Energy Aegis Evo Three	£229.95
Monitor Audio Bronze B2	£179.95

DVD PLAYERS

Denon DVD-2910 Universal (Multi Region)	£499.95
Denon DVD-3910 Universal (Multi Region)	£719.95

A/V AMPLIFIERS RECEIVERS & PROCESSORS

Denon AVR1705 AV Receiver	£199.95
Denon AVR1905 AV Receiver	£229.95
Denon AVR2805 AV Receiver	£549.95
Denon AVR3805 AV Receiver	£799.95
Pioneer VSX-1014s AV Receiver	£399.95
Pioneer VSX-2014i AV Receiver	£499.95
Pioneer VSX-AX5Ai AV Receiver	£749.95
Pioneer VSA-AX10Ai AV Amplifier	£1799.95
Yamaha DSP-AX757SE AV Amplifier	£399.95
Yamaha RX-V357 AV Receiver	£149.95
Yamaha RX-V557 AV Receiver	£299.95

A/V SPEAKERS & PACKAGES

Acoustic Energy Evo 3B	£679.95
KEF KHT1005	£299.95

SUBWOOFERS

REL Quake (Brittix Black)	£299.95
REL Stampede (Brittix Black)	£499.95
REL Strata 5 (Brittix Black)	£624.95

PLASMA

Panasonic TH37PV500 (Wal) 37"	£1999.95
Panasonic TH42PV500 (Wal) 42"	£2299.95
Pioneer PDP435XDE 43" (Ex Display)	£2199.95
Pioneer PDP435XDE 43" (FROM)	£2399.95
Pioneer PDP505XDE 50" (Ex Display)	£3299.95
Pioneer PDP505XDE 50" (FROM)	£3599.95

LCD TV

LG RZ32LZ50 32"	£999.95
Sharp Aquos LC32GA5 32"	£899.95

PROJECTORS

ScreenPlay SP5700 (Factory Refurbished)	£1499.95
ScreenPlay SP7205 (New Lower Price)	£ CALL
ScreenPlay SP7210 (New Lower Price)	£ CALL

Sim2 DLP Projectors

HT300 E-Link	£7999 SAVE £3000
HT300 E-evolution	£5999 SAVE £2000
Domino 18	£1999 SAVE £300



(NICWAOO)*



Monitor Audio
GR10 Speakers
£599 SAVE £200
(NICWAOO)*

Free QED Cables



**CLAIM FREE QED
SPEAKER OR
INTERCONNECT CABLES
WORTH AT LEAST £50**

WHEN YOU PURCHASE SELECTED
SPEAKERS OR COMAMPLIFIER
COMBINATIONS

Ask in-store for details. (NICWAOO)*



KEF KHT2005.2
5.1 Speaker Package
£599 CLAIM FREE
KEF SPEAKER STANDS WORTH £80
(NICWAOO)*



Roksan Kandy
MKIII CD & Amplifier
£999 CLAIM FREE
QED CABLE WORTH £100
(NICWAOO)*

Arcam Solo / Alto Hi-Fi System

£1399 CLAIM FREE
QED CABLE WORTH £100
(NICWAOO)*



Arcam DiVA
DV79 DVD Player
AVR300 AV Receiver
£2299 CLAIM £400
TOWARDS THE SPEAKERS OF YOUR CHOICE
(NICWAOO)*



Denon
DHT-500SD
5.1 DVD System
£429 SAVE £20
(NICWAOO)*



Yamaha
YSP-1
Sound Projector Speaker System
£799 CLAIM FREE
QED INTERCONNECT CABLE WORTH £80
(NICWAOO)*



KEF KIT100
Home Cinema System
£999 SAVE £200
WHEN PURCHASED WITH ANY PLASMA OR
LCD TV OVER £2000
(NICWAOO)*



Pure Digital
DRX-702ES
DAB/Analogue Tuner
£219 SAVE £30
(NICWAOO)*



Toshiba 32WL56
32" LCD HD Ready TV
£999 SAVE £50
(NICWAOO)*

*NICWAOO - NOT IN CONJUNCTION WITH ANY OTHER OFFER OR PROMOTION

SUMMER EVENT

At least **10% off** our normal selling prices on a wide range of products. For our latest prices call your local store or visit www.ssav.com

PRICING POLICY

We always try to ensure our prices are highly competitive. In the event you can find the same products and excellent service at a lower price, please bring it to our store managers' attention.

ESSENTIAL ACCESSORIES

The right accessories can make or break your system. Our carefully selected range, including QED, Soundstyle and Grado, will ensure you get the very best performance from your system.

0% FINANCE OPTION*

Spread the cost of buying.

0% finance option* is available on the majority of products we stock.

*Subject to credit approval. Excludes credit cards. Offer valid until 24/09/2005. E&OE.

PLEASE NOTE

Some products/brands are not available at all stores. Please call to confirm or see the brand locator on our website before travelling.

*Added Value Offers - From range available in-store. Not in conjunction with any other offer (NICWAOO)

ADVERT VALID UNTIL AT LEAST 24/09/2005. E&OE.

At least **10% off** our normal selling prices on a wide range of products. For our latest prices call your local store or visit www.ssav.com

SUMMER EVENT

EXTENDED UNTIL 24TH SEPTEMBER 2005

Nationwide Store guide



- | | |
|--|---|
| ABERDEEN 01224 252797
• 57 CROWN STREET <i>OPEN SUNDAY</i> | MAIDSTONE 01622 686366
• 96 WEEK STREET |
| BEDFORD 01234 272779
• 29-31 ST PETERS STREET | MANCHESTER 0161 831 7969
• 69 HIGH ST, CITY CENTRE |
| BIRMINGHAM 0121 233 2977
• ARCH 12, LIVERY STREET | NEWCASTLE 0191 221 2320
• 19 NEWGATE STREET |
| BRIGHTON 01273 733338
• 57 WESTERN ROAD, HOVE | NORWICH 01603 767605
• 29-29A ST GILES STREET |
| BRISTOL 0117 974 3727
• 92B WHITELADIES ROAD, CLIFTON | NOTTINGHAM 0115 911 2121
• 597-599 MANSFIELD ROAD |
| BROMLEY 020 8290 1988
• 39A EAST STREET | OXFORD 01865 241773
• 41 ST CLEMENTS STREET |
| CAMBRIDGE 01223 304770
• 17 BURLEIGH STREET | PETERBOROUGH 01733 897697
• 36-38 PARK ROAD |
| CARDIFF 029 2047 2899
• 104 106 ALBANY ROAD | PLYMOUTH 01752 226011
• 107 CORNWALL STREET |
| CHELSEA 020 7352 9466
• 403 KINGS ROAD | POOLE 01202 671677
• LATIMER HOUSE, 44-46 HIGH STREET |
| CHELTENHAM 01242 241171
• 14 PITTVILLE STREET | PRESTON 01772 825777
• 40-41 LUNE STREET <i>OPEN SUNDAY</i> |
| CRAWLEY 01293 510777
• 32 THE BOULEVARD <i>OPEN SUNDAY</i> | READING 0118 959 7768
• 3-4 KINGS WALK SHOPPING CENTRE |
| CROYDON 020 8665 1203
• 369-373 LONDON ROAD | SEVENOAKS 01732 459555
• 109-113 LONDON ROAD |
| EALING 020 8579 8777
• 24 THE GREEN <i>OPEN SUNDAY</i> | SHEFFIELD 0114 255 5861
• 635 QUEENS ROAD, HEFLEY <i>OPEN SUNDAY</i> |
| EDINBURGH 0131 229 7267
• 5 THE GRASSMARKET | SOLIHULL 0121 733 3727
• 149-151 STRATFORD ROAD |
| EPSOM 01372 720720
• 12 UPPER HIGH STREET <i>OPEN SUNDAY</i> | SOUTHAMPTON 023 8033 7770
• 33 LONDON ROAD |
| EXETER 01392 218895
• 28 COWICK STREET | SOUTHGATE 020 8886 2777
• 79-81 CHASE SIDE |
| GLASGOW 0141 332 9655
• 88 GREAT WESTERN ROAD | STAINES 01784 460777
• 4 THAMES STREET <i>OPEN SUNDAY</i> |
| GUILDFORD 01483 536666
• 73B NORTH STREET | SWINDON 01793 610992
• 8-9 COMMERCIAL ROAD |
| HOLBORN 020 7837 7540
• 144-148 GRAYS INN ROAD | SWISS COTTAGE 020 7722 9777
• 21 NORTHWAYS PDE, FINCHLEY RD <i>OPEN SUNDAY</i> |
| HULL 01482 587171
• 1 SAVILE ROW, SAVILE STREET | TUNBRIDGE WELLS 01892 531543
• 28-30 ST JOHNS ROAD |
| IPSWICH 01473 286977
• 12-14 DOGS HEAD STREET | WATFORD 01923 213533
• 478 ST ALBANS ROAD |
| KINGSTON 020 8547 0717
• 43 FIFE ROAD <i>OPEN SUNDAY</i> | WEYBRIDGE 01932 828525
• 43 CHURCH STREET, THE QUADRANT |
| LEEDS 0113 245 2775
• 62 NORTH STREET <i>OPEN SUNDAY</i> | WITHAM (ESSEX) 01376 501733
• 1 THE GROVE CENTRE |
| LEICESTER 0116 253 6567
• 10 LOSEBY LANE | WOLVERHAMPTON 01902 312225
• 29-30 CLEVELAND STREET |
| LINCOLN 01522 527397
• 20-22 CORPORATION STREET (<i>OFF HIGH STREET</i>) | YEOVIL 01935 700078 <i>*OPENING SOON</i>
• 14 SILVER STREET <i>*SUBJECT TO LEGAL COMPLETION</i> |

OPENING HOURS: PLEASE TELEPHONE OR VISIT OUR WEBSITE E-MAIL: [insert store location]@ssav.com

Who are Sevenoaks?

Established as Sevenoaks Hi-Fi in 1972, we have grown steadily onto one of the leading independent home entertainment specialists in the UK, earning a reputation for outstanding service, choice and value for money. In 1995, reflecting our commitment to the emergent new technologies in home cinema, our name was changed to Sevenoaks Sound & Vision. We now have 49 stores across the land stocking a broad range of exceptional equipment and accessories.

How to shop at Sevenoaks

When it comes to making big decisions about what to buy, there's no substitute for actually road-testing your prospective purchases - seeing, hearing and experiencing the products in action, with the benefit of our expert knowledge and guidance to help you choose. To get the most from your Sevenoaks Sound & Vision experience, simply follow this checklist:

- **ESTABLISH YOUR AIMS** - Are you tweaking an existing system to improve sound or picture quality, or are you looking for a more fundamental and comprehensive upgrade?
- **BRING YOUR FAVOURITE DISCS WITH YOU** - To ensure you get the most from the music and movies in your collection, it pays to test equipment using those very same discs or records. That way you can readily compare levels of performance. However, if you prefer, we can supply a selection of demo discs - current mainstream entertainment that serves to highlight the capabilities of the equipment.
- **JUST ASK** - If you are unsure of any aspect of the products or technologies available, or would like more information about installation options, simply let us know and our staff will be happy to help you out.
- **TAKE YOUR TIME** - We want you to be as happy as possible with your choices, so please take as much time as you need to determine which products are right for you.



Hi-Fi & Home Cinema Guide - 2005 Edition

Pick-up a copy of our **New 72 Page Guide** at your nearest Sevenoaks Sound & Vision store or order a copy via our Website. The brochure will be posted to you (UK mainland addresses only) free of charge.

Custom Installation

Sevenoaks Sound & Vision's Custom Installation Service enables the integration of a home cinema or hi-fi system into your home as neatly and seamlessly as possible. All electronics can be hidden away, speakers discreetly mounted either in the wall or ceiling and the complete system operated via remote control.



Our installation experts are fully trained to the highest standards in all areas and provide a prompt, reliable and professional service. Whether you're looking for a multi-room system, a dedicated home cinema installation with a retractable screen and built-in speakers or an integrated control or lighting system, Sevenoaks Sound & Vision has a diverse range of products available to cater for all your requirements.



FREE CUSTOM INSTALLATION BROCHURE available now from your nearest store or via our website.

Sevenoaks Website

The Sevenoaks Sound & Vision website has news and information on the Sevenoaks group and detailed pages to help you locate your nearest store. In addition, there are hundreds of **SPECIAL OFFERS** and **STOCK CLEARANCE** items available from our stores nationwide - many with savings of up to 50%. To view our regularly updated product lists, visit www.ssav.com and click on **special offers**

www.ssav.com

Small Wonder

Channa Vithana casts an admiring eye (and ear) on Onkyo's C-733/A-933 CD player and integrated amplifier combo...



The new 275 Series from Onkyo strikes a different chord to both mini systems and regular sized 430mm separates. They're designed by Mr Sekiya, a deeply obsessive and knowledgeable audio engineer who worked on Harmon Kardon's ultra high-end Citation line in the past.

Both the £399.95 C-733 CD player and £499.95 A-933 amplifier feature beautifully crafted and built casework for the price. Made in Japan, they sport solid 1.63mm aluminium front panel folded five times and features an inverted curved main surface similar to the high end £2,800 Onkyo DV-SP1000E universal player I reviewed recently. There is a matching T-433 tuner for £299.95. Internal construction for both the units is also very good with a solidly constructed layout and liberal use of ribbed black tape

around openings, cables, chassis contact points, inside the top covers and even wrapped around the capacitors - which is intended to minimise EMI and vibration. Underneath, both have four aluminium sleeved feet with internal cork disc inserts to provide isolation from the equipment rack.

The C-733 CD player measures 275x 103x 304mm and weighs 4.5kg. It has an excellent, crisp blue display and the control layout is simple. At the rear panel it has two optical outputs which have a direct connection to the Crystal 192kHz/24bit DACs using a specially shielded cable that protects the signal against noise and interference. There's analogue phono sockets, fixed mains lead and a RI socket to connect to the C-933 amplifier which enables system remote control. The C-733 has a superb disc loading tray which is smooth and well damped. Inside, the transport itself is also nicely laid out and also more substantial than most. It has a solid top plate for a

better fixing to the rotating disc clamp and features better (and well-screwed down) construction than usual, especially for a £400 CD player. The C-733 has a large NPT-151 IP frame transformer that feeds a linear power supply onto an isolated board. The power supply board itself has a smaller NPT-1398P frame transformer while the majority of the capacitors used internally are high quality Elna (Japan) types two of which are the large 4700 micro-farad sort. The rest of the capacitors are Nichicon. The separate boards and transport are secured onto the internal steel chassis with copper-plated screws. The C-733 uses VLSC (Vector Linear Shaping Circuitry)".

The A-933 amplifier measures 275x103x328mm and weighs 7.5kg. It produces a very healthy quoted power output of 80w into 8 ohms with dynamic power at 270w into 3ohms. The front panel is like the CD player, sparsely laid out with an on/standby button, green LED, RC window and source/volume knobs. Just below is a neatly chamfered flap which conceals the main on/off,

REFERENCE SYSTEM:

Cyrus 6vs amplifier £650

Cyrus CD6s CD player £650

Audiovector Mi1 Signature speakers £1,320

Isotek GII Vision Mains Filtration £550

headphone socket, speaker A/B, super bass, bass, treble, tone direct and main-in (to connect a preamplifier, upgrading the A-933 into a power amp). On the rear panel, there are phono sockets for MM cartridges, tuner, CD, Line, MD (Tape), Tape/CDR, Main-in (to connect pre-amp) and subwoofer pre-out. Additionally there is a ground connection for the MM input, two sets of speaker binding posts, fixed mains lead and four RI sockets to connect the C-733 CD player, T-433 Tuner, the new £60 Onkyo DS-A1 i-Pod dock and another RI compatible source to provide system remote control from the A-933's RC-613S hand set.

The A-933 is described as a hybrid Class 'D' digital amplifier and has a digital power supply which includes a ferrite type clamp around the fixed mains cable. Its digital amplifier design employs PWM (Pulse Width Modulation) amplification and adds Onkyo's own VL (Vector Linear) technology to mask the noise and smooth the spikes in audio signals. The main power supply is shielded from the rest of the circuitry and feeds two large low impedance toroidal NPT-1522P 'Bando' transformers, one for each channel... plus a thick (low impedance) bus plate for high current delivery capability. The A-933 uses thick twisted/woven cables to and from the transformers. There is a pair of large 12000 micro-farad Elna capacitors and smaller Elnas spread across the isolated PCBs. The A-933 also uses plenty of high-quality Silmic II capacitors and combined with the Elnas - this is quite rare at this price - and all-discrete output stages.

SOUND QUALITY

The track 'East' from the Balanescu Quartet CD was animated and engrossing with the violins, viola and cello. Indeed the Onkyo pairing proved its mettle by handling the very high frequencies of the violin and occasionally asymmetric arrangements superbly - for which both Alexander Balanescu and Claire Connors love to fling in, out and around the listener at unexpected moments. The Onkyo duo had control yet extension, thus avoiding any treble grain or stridency. The atmospheric 'The City' by Vangelis

provided a different, luxuriantly warmer acoustic and the Onkyo duo did not disappoint. They provided a beautifully imbued and holographic tonal structure. The gorgeous main melody to 'Side Streets' was a delight while the Onkyo duo's superior timing also enabled me to connect with - and enjoy the complexity of - the composition in both its minute details and as a cohesive whole.

The music from the track 'Gnaaahh', from the Joe Satriani CD was open, vivacious and driving. The musical timing was stunning, where everything was in balance. Additionally, the Onkyo duo did not crumble under strain when Joe Satriani played some of his crashing guitar solos or when the bass and drums went into the louder passages. The Onkyo duos' bass quality was tight, focussed and tuneful without an ounce of flab - enabling superb kicking dynamics when the music demanded it. 'Up In Flames' showed once again the Onkyo duo's ability to be in control but not stifle the dynamic thrust of the music as the high frequency guitar notes dramatically arrived into the composition.

The Onkyo duo's superb musical timing procured the right balance of control, grip and depth which was necessary on the much heavier vibe of 'Hands In The Air' where the treble quality was wonderful as there was not a hint of subjective coloration or tonal bias (such as silkiness etc), rather the Onkyo duo's treble quality was authoritative, giving credence to the overall animated musical whole of the Joe Satriani CD. On 'Gnaaahh', using the Onkyo A-933 amplifier and £650 Cyrus CD6s, there was a smoother stance, and the bass extension was stronger too but the Onkyo C-733 CD player had plenty of bass tunefulness parity nonetheless (which is more important to me than mere outright bass extension).

To be extra critical, the Cyrus had the edge on resolution but incredibly, the Onkyo timed slightly better which was a surprise as the Cyrus is superb in this regard! Apart from that, there wasn't a lot of difference. With 'Link' from the Balanescu Quartet CD, the C-733 CD player was excellent with the A-933 amp confirming the great system synergy the Onkyos have. Again, the Onkyo C-733 CD player had a slightly preferable musical timing relationship with the A-933 amp in comparison to the Cyrus CD6s, yet

the Onkyo CD player was faintly internalised overall musically, against the Cyrus.

Swapping over and using the £650 Cyrus 6vs amplifier with the C-733 Onkyo CD player on the Balanescu Quartet's 'Link' confirmed the Cyrus amplifier was a little smoother than the Onkyo, but the glorious vitality of the Onkyo duo was lessened a tad. On 'Gnaaahh' the Cyrus 6vs was again smoother with elevated instrumental resolution but the synergy (musical cohesion) between it and the Onkyo C-733 CD player was not as good overall.

THE EDITOR SAYS

While the CD player gives little - if anything - away to price rivals, the Onkyo A-933 integrated amplifier is truly special. It's main problem is that it looks like another Japanese 'mini-compo' product, which is perfectly fine from an aesthetic point of view, but usually suggests its sound isn't anything to get excited about. The '933 couldn't be further from this; as CV points out, it gives the superb Cyrus 6vs at £250 extra a seriously hard time. Indeed, to my ears, it does more; I've heard this thing drive B&W Matrix 801s in a seriously large room and was gobsmacked. These speakers will tell you very quickly whether or not the amp driving them is up to the job, and it was only at very high sound levels that the little Onkyo showed any distress. At all other times, it was remarkably smooth, three dimensional and musically engaging. Readers may remember how much NK rated the Tact SDA2175 a few months back, and I have to say the Onkyo performed much of its magic. It's essentially rich, open, engaging and finessed, yet very powerful and controlled. In absolute terms, it's a bit soft and slow in the bass and clarity in the treble, but this is up against £2,000 plus stuff! The A-933 punches far beyond its price class and you'd be plain stupid not to audition it if you're after a sub £1,000 integrated. DP

CONCLUSION

The Onkyo A-933 amplifier at £499.95 is stunning - procuring power, control, excitement and even a good deal of finesse which is rare at the price. Individually it compared brilliantly against the more expensive £650 Cyrus 6vs amplifier. The £399.95 C-733 CD player was a little behind the £650 Cyrus CD6 overall which is a creditable performance considering it cost over £250 less!

However when joined together, the Onkyo duo performed fantastically with the lush atmospheric Vangelis, the challenging Balanescu Quartet or the driving complex rock of Joe Satriani. In many ways the A-933 amplifier reminded me of the last generation 1999 (£608) 'olive' iteration of the Naim Nait 3, in its driving, rhythmical and timing abilities and it did not sound like a muddled and grey 'digital' amplifier at all. If you heard this little Onkyo duo, you would not want to separate them.

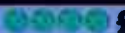
VERDICT  £

A brilliant combination; the CD player is truly accomplished, whereas the amplifier is positively stellar. Together, there are few - if any - better ways to play music at the price.

ONKYO C-733 £399.95

ONKYO A-933 £499.95

ONKYO UK

☎ +44 (0)1494 681 515

www.onkyo.co.uk

Slimline Tonic



Orelle's stunningly styled SA100/CD100evo CD player and amplifier combination have evolved into the evo2 incarnations. Dominic Todd listens for improvements...

Two short years ago we reviewed the Orelle CD and SA100 CD and integrated amplifier and came away very impressed. As we all know, though, time waits for no man and, in the meantime, the competition has been busy and upped the ante. Far Eastern built products from both UK and Far Eastern countries now allow for considerably more bang for your buck...

Although still made in the UK, Orelle have been unfazed by the march of time, and now offer improved versions of both their CD and amp'. Take a look at the two products and you'll be hard pushed to spot the changes. Externally, the only difference is the use of a new, naturally anodised casing. This allows for a smoother finish and serves only to enhance what is already a very handsome combo – one of the best styled I've seen.

Inside the amp' you'll find more changes. The diecast heatsink is now attached to a large copper block. This performs two tasks of both aiding the cooling process and also shields sensitive components from the power supply. In addition, the main output capacitors are new, specially developed, slit foil designs to Orelle's own specification. Otherwise, the

SA100 evo amp' remains as before which means a toroidal power transformer and high quality components – mainly 1% metal film type resistors and polyester capacitors. As well as looking stylish, this is also a practical amp'. The tiny remote offers full functionality and there are five line inputs, a single tape loop and a pre out. The only option that many rivals do offer, but is confined to the option list with the Orelle, is a Moving Magnet phono stage.

Operationally, I'd like to have seen an LED for the volume control, but otherwise the SA100 evo is very user friendly. The main change to the CD player revolves around the transport. As with most of the opposition this is now based around the Philips VAM1202 and CD7i chipset. It's a well-proven mechanism, and one that has proved highly successful in other players. A side effect of this change of transport is faster disc recognition and less noise than the old transport. To complement this, Orelle have added a low jitter, buffered master clock with their own specially tweaked software. As before, Orelle use twin multi-bit DACs and a 24bit digital filter. Like the amplifier there's plenty of quality engineering here. The DAC

board has its own frame transformer, with a substantial toroidal supplying the juice for the rest of the machine. Passive LC filtering, a Class-A discrete analogue stage and quality components add further credibility to this being a thoroughly engineered CD player.

Like the amp' the CD player has full remote control (although nothing like as pretty), and a practical range of features. The extinguishable display is a nice touch although, as before, the lack of any standard digital output is rather mean!

SOUND QUALITY

Orelle recommends that the two units be positioned on individual shelves. This I did, and hooked the duo up to a pair of Mission e82 floorstanding 'speakers – exactly the sort of stylish yet capable transducers likely to be partnered with the Orelles. I kicked off the listening with Royksopp's 'Alpha Male'. This offers a good test of pace and dynamics and the Orelles didn't disappoint. The tension and volume of the piece was built up well with an exceptionally good depth of sound giving the impression of the listener walking towards the music – just as it should. Bass was taut and punchy, if not the last word in weight and



extension. In this respect, the amp' hasn't changed from its previous incarnation, but is certainly well served by the more robust sounding CD player. As I remember from the previous CD player, this is not a shy sounding disc spinner. Having said that, although forward, I never found the balance intrusive. It maintained enough sparkle to give the metallic notes a satisfying edge, without becoming overly harsh. A word of warning though; speakers with a harsher treble will be exposed...

Next up was Johnny Cash's emotional cover of the song 'Hurt'. Here the Orelle couple were in their element. The staging was superbly precise and the recording full of detail. Cash's vocals had character and texture like few others can portray at this price. The piano's timbre was equally fine and resonant and you really felt as though the performers were in the room with you. Again, it became apparent that if you're after a duo that will flatter your recordings then this is not it. Towards the end of the song, a certain amount of distortion sets in, and the Orelles all too readily exposed this. For textural realism though, few are better.

Resolution and mid-range appeal were again to the fore with Annie Lennox's 'A Thousand Beautiful Things'. Whilst not being the most powerful, the bass response was well judged in that it underpinned the song without dominating it. That said, whilst some would wish for more clout and gusto, this is no Class-A weakling. For most people in most living environments, the Orelles offer good headroom and ample dynamic scale. The exquisite guitar resolution was matched by Lennox's well-projected yet smooth vocals. The staging showed excellent layering, with the infill vocals wrapping around the body of the music like a snugly fitting glove.

At this stage I deployed my own CD player and amp' to see how the two components performed

individually. With Steely Dan's, 'Jack of Speed', it soon became clear that whilst both units had their weaknesses, they are complimented by one another superbly. The amp' had the refinement but not so much of the grunt whilst the CD player, although not the most refined, had good bite and dynamics. Back together again, the two components produced crisp dynamics and a nice, vibrate brass. Those looking for Naim style pace and excitement or hefty pre/power levels of grunt, though, may still remain a little disappointed.

With Blur's 'There's No Other Way', the impact from different instruments from the band had varying levels of effect. The guitars were well pitched – thrashy and dynamic enough to give them presence and verve, but without being over-bearing. The percussion, on the other hand, could have used a little more impact. As before, the real star of the show was the dexterity shown with vocals: articulate, focused and simply believable, the mid-range really did impress.

Such qualities were appreciated to an even greater extent with Classical music. 'The Montagues and the Capulets', by Prokofiev demonstrated the Orelle's fluency and balanced approach perfectly. The intro whipped up the desired drama and tension but without going over the top and pinning the listener to the seat. Throughout it all, though, subtle detail was never overlooked. The drum roll had a delicate rhythm that can easily be blurred by lesser components. The lowest registers weren't quite deep enough, but the balance struck still ensured that drama wasn't lacking. String tone proved exceptionally good with the violins being refreshingly free from either a glassy edge or an overly warm gloss. In short, in terms of timbre, timing and detail, the Orelles managed to hit the spot, and although weight and some impact were missing, these could be forgiven against the other talents on offer.

CONCLUSION

The Orelles have been usefully and subtly improved, and that's no small claim when you think there wasn't exactly a lot wrong with the originals in the first place. Fortunately, all that was good about the first series has been carried over. The amplifier, whilst not the most dynamic or hard hitting, has a fluid, detailed and subtle quality that would be alien to some of its rivals. By contrast, the CD player is a shade more rough-edged than some, but it counters this with excellent dynamics and expansive staging. As individual units they have weaknesses, but partnered together the two really do complement one another and, in doing so, iron out one another's idiosyncracies.

Unless you're after whip-crack attack or seismic bass, then this combo is highly deserving of recommendation. Combine the musical sound with, unusual yet attractive styling, good build construction and most of the features you're likely to need and it's clear that the Orelle CD/SA100 remain a compelling, if alternative, choice.

VERDICT ●●●●£

Excellent in their own right, but even better when combined. Few can match the lucid mid-range, even if dynamics aren't first rate, and the styling is truly special too.

ORELLE CD100 EVO2 £700
ORELLE SA 100 EVO2 £700
 Orelle
 ☎ +44 (0) 208 991 9200
 www.orelle.co.uk

RIVALS
 Although Orelle is making itself a fine name as a UK manufacturer they are far from being alone in offering a quality UK built CD and integrated amplifier duo for around the £2,500 mark. For £2,250 you could be the proud owner of a Cyrus 8vs with PSX-R amp' and CD8x CD player. The CD player is one of the finest available at its price, with an unmatched balance of refinement and realism. The 8vs is a good, if not exceptional amp' on its own. Add the PSX-R, though and it really comes to life. Focus, definition and texture all make a stride forward. For a compact, good looking pairing that works well with a wide range of music, the Cyrus 8s are hard to beat. Yet in my opinion it's not quite the best duo. For a little over £2,500 you could get a Naim Nait 5i, CD5x and a Flatcap2x power supply. Now although this seems grossly cash biased towards the CD player (in this case it's the CD that uses the PSU rather than the amp'), it's one of the finest examples you could have for spending money on a source first. The CD player is exceptional, and will see off the SA100evo2. It's been said many times before but for rhythm, pace and sheer vitality, nothing comes close. Much the same is the case with the amplifier, and although 'only' £700 it easily competes with far more expensive designs. If you love music, you'll find the Naim's utterly compelling...

QUADraphonia

If CV chose the diminutive dynamo that is the Onkyo system, and DT the svelte, sophisticated Orelle, then David Price went for the best of both worlds with the small but perfectly formed Quad 99 CDP-2 CD player and 99/909 pre-power amplifier...



QUAD 99 CDP-2 CD PLAYER

The new £1,000 99 CD player is an impressive looking device, that's undeniably well made and finished - now in IAG's Shenzhen factory. It's a striking visual and ergonomic design, a little odd perhaps, but the same could

be said about most Quad CD players and/or preamplifiers through history. From the front and side it is visually identical to the previous 99CD model, although with its vital statistics being 80x321x310mm It is 10mm taller than the last model (to accommodate the new laser mechanism).

Operationally, it's fiddly - I can't say I found it intuitive to use the front panel buttons, although I did like their feel (and the unusual green LED display - not blue, thank gawd). Still, it's supplied with a standalone remote control, and is also compatible with the Quad 99 Series system handset (when fully connected to a Quad 99 Preamplifier). It's worth noting that the previous 99CD player and the 77CD player could only be powered from their matching preamps, and so could not be used as standalone items in other systems, or indeed older Quad systems (33 series, 44 series, etc). The new 99CDP-2 has its very own IEC mains socket on the back, and so can be used as a standalone machine for anyone who

The princely sum of £2,650 buys you this little lot. And little it is, being pleasingly midi sized at just 321mm wide. But there's more to it than that, as this is of course a Quad, or an assemblage thereof. In its presence, I can do nothing except think of all the greats that preceded it - 22/II, 33/303, 34/405, 66/606 and 77/707. That's a pretty good run, but any standards, especially when you consider the 'sky high' residuals of any number of the aforementioned even today. People are still buying them, restoring them, tweaking them, loving them.

The 99 series has been with us for several years now, and has earned

itself no small amount of public acclaim. For yours truly, the class act was always the 909 power amplifier, which as any Quaddie will tell you is essentially a lightly breathed on and subtly updated 405. This classic powerhouse has undergone something of a resurgence of late, having spent many, many years in the critical doghouse. (Folk have found that, with just a factory rebuild, this really sings.)

In true Quad fashion, the company has been happy to let the range amble along, selling well but not outrageously, with no electronic or mechanical updates. However, fate intervened - or to be more precise - Philips, who withdrew their supply of mechanisms for the 99CDP. This put Quad on the trail of a new mech, but after no small amount of head scratching, decided to do one for themselves! Thus was born the 99 CDP-2. And here begins the lesson...

LAZY SERVO

The new Quad transport mechanism employs a 'lazy servo' which is expressly not designed for in-car or personal use - where the transport mechanism is subjected to large amounts of movement and the servo has to be ultra-responsive, continuously hunting the disc frantically to find its data. The servos built into most CD transports behave this way; using a strategy of overshooting and recovery, working very hard all the time, generating lots of electrical noise and draining the power supplies. Conversely, although audiophile CD replay doesn't require this, the servos still act in the same way, because that's how the Philips mechanisms were programmed (to be multi-tasking). Therefore, when playing a CD at home, the servo remains unnecessarily nervous, flinging itself around the track each time a scratch or piece of dust is encountered - darting off and over-correcting just in case you're jogging down the road. Of course, in the home scenario, one knows exactly where the next piece of data is coming from - it just needs to wait a moment for the dust or scratch to pass under the laser and little or no servo response is required. By reprogramming the servo software, Quad believes it has reduced the majority of noise, and hence DAC related jitter, generated by CD transport mechanisms. Its 'lazy servo' strategy is a result of Quad now having on its team one of the people responsible for all the programming on the Philips CD10 in the first place, with his highly specialised knowledge.

wants a CD player (hence the inclusion of its own remote control). The electronics designer is Jan Ertner, who was responsible for the excellent Quad CD67. Jan wasn't responsible for the original Quad CD66, which was just a Philips' re-badge, so the CD67 was his first project on joining Quad from university - all under the wing of Peter Walker. The 99CDP-2's filters, analogue circuitry/ output stages/ power supplies/ motherboard have been designed by Jan, and the output stage runs in pure Class A mode through a fully differential amplifier.

The machine is awfully versatile; it can act as a DAC and switch between three coaxial digital and three optical digital inputs, accepting PCM signals up to a maximum resolution of 24bit/96kHz. Thus inside, the machine will upsample anything at 32, 44, 48 or 96kHz to 192, before it's fed into the Crystal Delta-Sigma 24bit/192kHz DAC with 2x upsampling. It has pairs of both fixed and variable level audio outputs, and not only is the 99 also a DAC, but a preamp too. It sports a high quality variable output which Quad calls "a very sophisticated device working on a switched ladder principle". It features laser trimmed resistors and is channel matched to within 0.25dB across the audible range. The potentiometer represents about £50 of the overall cost of the machine, no less.

All clever stuff, but the jewel in

this particular crown is the new transport, which Quad are especially proud. Essentially it's based around a Philips VAM2202 mechanism, but rather than using the typical off-the-shelf software to control this mechanism (i.e. the programming onboard the accompanying Philips CD10 servo-decoder chip), Quad has started from scratch and programmed the CD-10 to its own parameters and protocols. This, says Quad, has been "a Herculean task", requiring specialist knowledge, made possible only by the hiring one of the key personnel responsible for Philips' original development of the

CD10 chipset - bringing the retained knowledge of this Philips work across to Quad (that division of Philips has now been disbanded). Thus the whole control system for the laser optic - its disc reading strategies and laser control - is totally bespoke for this specific application. It is not compromised by having interleaved code and contingencies for computer data reading, reading discs while on the move, or for reading discs while in-car; all of which have been included in previous Philips transports, to the detriment of playing a disc whilst the player is sat in a stable environment on a shelf! The 'Lazy servo' is the result [see box]. Original CDP owners can update to CDP-II spec for £225.

QUAD 99/909 PRE-POWER

The £750 99 Pre is the fully remote controlled preamplifier that forms the heart of this system, offering a welter of functions accessible by the front panel and system remote. It's very slight, the 99 Pre; at 70x 321x 310mm it's something of a Kate Moss amongst preamplifiers. Again it's very nicely made and finished, and forms an attractive visual centrepiece of the system, although again - to my eyes - it wins no prizes for ergonomics; a 33, for example, is far, far nicer to use.

Still, you can't pretend the 33 is anywhere near as powerful as the 99, as the latter boasts all mod cons - specifically QuadLink inputs for a 99

Series CD player and 99 Series FM tuner which it can talk to by the system bus. In addition, there are three line inputs, one tape loop and a switchable phono input. Users can switch between MM/MC inputs by pressing and holding the PH input for five seconds. Being a clever late - nineties creation, the Pre has the usual Quad 'tilt' functions and filters - which can be bypassed if preferred - and all the standard inputs (Line, Tape, Phono) can be adjusted for one of three sensitivity settings. Round the back, aside from the proprietary AmpBus output connector, a single pair of RCA preamp outputs are provided.

The £900 Quad 909's roots can be traced back to the Quad 405 - the first amp to use the famous 'Current Dumping' principle [see box] with - if memory serves - won the "Queen's Award for Technology" back in 1978, no less! It's another extremely elegant design, and surprisingly compact at 140x 321x 240mm considering its claimed 140W RMS output power (into 8 ohms at 0.5% THD, which nearly doubles into 4 ohms).

It looks and feels like a medium sized metal 'brick', with its sculpted casing with bevelled edges and chunky diecast heatsinking. There's obviously a big toroidal transformer inside, but it's a shame that the case still rings a little when tapped; some judicious application of Sorbothane sheeting would remove just about the only objection I have considering its superb 'perceived value'. Round the back are two pairs of banana speaker sockets, with little recesses that accept bare wire (albeit not very thick), a pair of RCA phono inputs and an IEC power socket. There's also a 'Reset' button - always good

CURRENT DUMPING

In simple terms, the power amplifier's input and output are fed into a bridge circuit. The bridge produces the difference between the two signals (input/output) - the difference being the distortion. This distortion is then phase inverted and fed back as a correcting signal to the power amp's input. The end result is that distortion is removed from the signal. Quad says that, as the amp has - in effect - a distortion cancellation circuit, this allows powerful and efficient output transistors to be used. Hence, a big powerful transistor can be used without worrying about increased distortion levels (because the distortion will be cancelled out later). Furthermore, if you're using low impedance speakers (which automatically cause the amp to distort more), then the current dumping system is of particular benefit. These leaves the designer only worrying about resolution levels in the output transistors - not conserving power, to keep the distortion figures down. As an anti-phase correction signal is being forward fed (the difference between input and output), this essentially is a mindless 'cure all ills' approach - correcting thermal drift, etc. - says Quad.

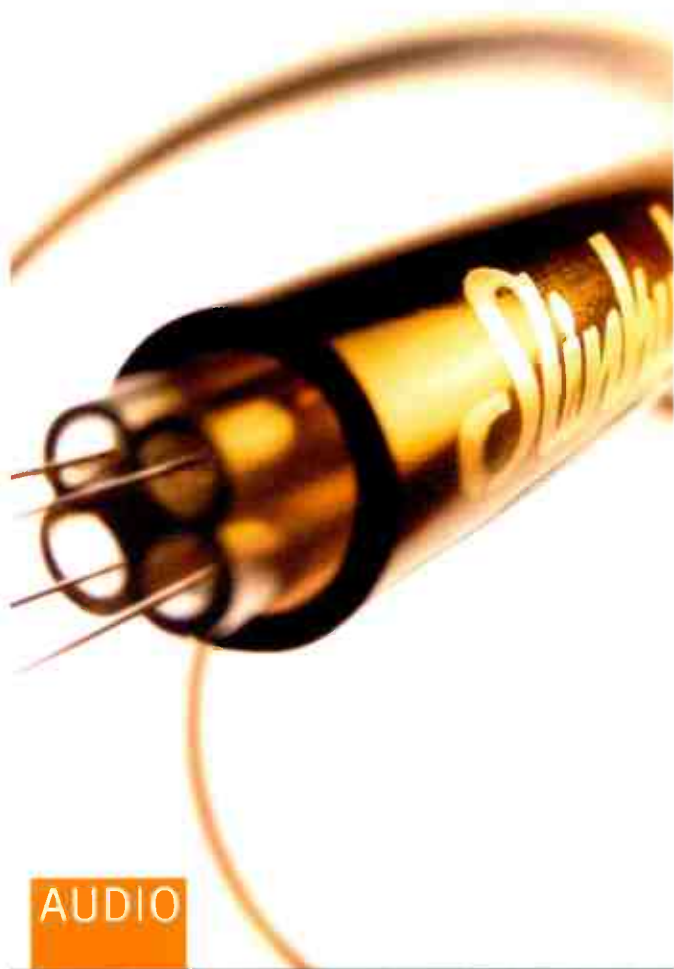

AUDIO

42

Slinkylinks

"They're very smooth, insightful, silky, couth, and detailed with oodles of atmosphere"

"Slinkylinks perform very strongly indeed even in the very best high end systems at a reasonable price"

HiFi World July 2005

Unique air and silver cables starting from only £180

Just a click away at www.audio42.com



TRUE HIGH END PERFORMANCE
FOR BUDGET MONEY OUTLAY

VISIT OUR WEBSITE NOW TO
SEE THE FULL PRODUCT RANGE

**KRYSTAL
KABLES**

PURE SOUND . . .

**A new addition to our range
The STRATOS pure silver power cord**



STRATOS 1m £135.00

Where else can you buy a PURE SILVER power cord with superb performance at this price?

WWW.KRYSTAL-KABLES.COM
Tel: 01579 349295

LaserVinyl

test drive "the audio equivalent of an
Aston Martin Vanquish V12"

David Price: editor of Hi-Fi World



ELP LT-2XRC laser turntable

book a private listening session on-line



- premium products
- home demonstrations
- regional roadshows

www.laser-vinyl.com

or call +44 (0) 7940 11 88 50

STAX



to know if things suddenly go silent at your drum'n'bass party...

SOUND QUALITY

The old Quad adage is of course, "a piece of wire with gain", and it's not far wrong here – but that's a crass oversimplification. Indeed, within literally seconds of powering this threesome up, I'd switched bits of it off and started experimenting, listening to the components in isolation in my reference system. And so I think it's best to describe things in these terms, finishing with the system *en masse*...

The first thing I started with was the 909 power amp, so I went off to get my reference mid-price transistor power amp, and then I realised it was my reference mid-price transistor power amp. Doh! I've been using a 909 for several years now, for when all other amps have variously blown up or had a shouty, screamy fit with either my Quad ESL-989s or Yamaha NS-1000M loudspeakers. I've always come back to this amp after listening to some seriously priced slice of esoterica or other, expecting it to sound terrible, and always been surprised at just how great it sounds even after far more expensive company.

The NS-1000Ms, as I've observed before, instantly tell you whether the amp driving it is 'Arthur or Martha'; you're left in no doubt how coloured, how grainy, how weak-kneed the poor power house in question is. And they always say the 909 is very spacious across the midband, ever so slightly brightly lit in the upper mid (but never shrill), clean and dry in the treble and strong and articulate in the bass. Although it's not the world's funkier amp, it makes music impres-

sively well, and does not sound like (as I'd feared) the hi-fi equivalent of a white guy dancing. Actually, it's nicely rhythmic and precise – but with serious oomph when called for. Going back to my 'reset button' quip, it actually is a great drum'n'bass amp – not sure whether Peter Walker would approve!

Its biggest drawback is that it sounds transistory, especially after you've been playing with £4,000 tube amps. It's not lush, liquid and lovely – but big, strong and dependable instead. Impressively, it actually images very well and throws instruments into the room with real confidence, and hangs them back well too (which is a nice 'tube' characteristic) although it's very clean and spry tonally in the midband (which isn't!). Best of all is its grace under pressure; Goldie's 'Timeless' through the Yams at high levels is a visceral thrill, and the Quad just pumps clean power with nonchalant ease, whereas certain pricier designs would be wheezing like a heavy smoker in a cigarette factory.

Next, the 99 Pre. Well, it's clean and open and errm, that's it. Did I mention it's clean and open? That's really the most I can say about this little preamplifier. It lets most of the music get to the 909, offers a thousand and one switching/gain permutations and matches the rest of the system. It doesn't intrude, doesn't alert you to its presence – like all good boys it's seen and not heard. But I just couldn't warm to it in the way I did the 909. The latter is a redoubtable product, something truly capable and destined for collectors one day. The 99 Pre, errm, matches the 909...

In absolute terms (again unfair, as it's £750, not ten times that), the 99 Pre has a dry and rather barren sound. It doesn't colour the music, and it's certainly tight and well controlled with decent rhythmic and dynamic prowess. Trouble is, when you remote it from system and plug the 99 CDP-2 straight into the 909 via the variable outputs, the 99 Pre rather loses its reason for living. Of course, if you've got umpteen sources to switch and gain-compensate, then suddenly the 99 Pre is back in the running, but I haven't, so there!

Which leads me to the 99 CDP-2. Earlier I spoke about the 909 being one of Quad's strongest products for a long time – well to that add this CD player. It really is quite superb, and obviously superior to any previous Quad silver disc spinner I've heard, including the earlier 99.

In fact, I'd go so far as to say that it's one of the very best at the price. It's early days still, as I haven't had time to do the comparisons, but it makes Musical Fidelity's similarly priced (£899) X-Ray v3 that I had to hand sound two dimensional at first listen.

The key to the CDP-2 is its wonderfully expansive recorded acoustic, with a glass-clear 'hear through' midband. However, although extremely detailed, this isn't analytical one iota – quite the reverse. Indeed the '2 plays rhythms almost as well as Naim's CD5i (which is the best in show in this respect), with a brilliantly fluid and funky demeanour. And there's more; bass is beautifully full, warm and articulate, yet never out of control. For almost the first time, I could hear the opening attack transients of the Moog bassline on 4hero's 'Universal Love'. It's detailed and composed when things get truly complex and multi-layered, yet musical too. Feed it a soft warm recording like Love's 'Forever Changes' album and it's soft and warm, yet it shows massive power and incision with Goldie's 'Timeless'.

Together, the 99 CDP-2 and 909 are a stunning combination for £1,900. I'd struggle to think of anything that comes close in speed, depth, visceral power and tonal insight. The 99 Pre simply ups the price and makes things a little less open and dynamic – only a little, mind, but it's a step in the wrong direction for yours truly. There are warmer, sweeter sounds around (tubes) and there are tighter (Naims) but the 99 CDP-2/909 offers a brilliant taste of both extremes in a beautiful looking package. What more can I say?

VERDICT ●●●●●

Superbly accomplished affordable audiophile system; slightly quirky yet seriously capable

QUAD 99CDP-2 £1,000

QUAD 99 PREAMPLIFIER £750

QUAD 909 POWER

AMPLIFIER £900

Quad Electroacoustics Ltd.

☎+44(0)1480 447700

www.iaguk.com

We believe that 20-40% of musical information is damaged or destroyed by mechanical vibration.

Bad

vibrations

Transformers and motors **VIBRATE**, capacitors "crack" as they recharge and even cable conductors move with the changing signal. All this movement generates **DAMAGING ELECTRICAL NOISE**.

Then components are linked with metal wire, an excellent conductor of mechanical noise (thousands of times more efficient than air) and on the end the **BIGGEST VIBRATOR** of them all – the loudspeaker!

THE DAMAGE IS HUGE. We use cables, filters and supports from **VERTEX AQ** to trap and subdue this vibration, liberating the music and astounding doubting customers.

These Vertex components change the performance of the equipment – they **CHANGE THE PERFORMANCE**.

They are not system tweaks when you have bought everything else – **THEY DWARF THE DIFFERENCES** between CD players or amplifiers, so **YOU** will change **YOUR** opinion when choosing main components.

Remove the supports and swap the cables, even for good alternatives, and the system sounds ragged, hard, slow, flat, disjointed and uninvolving.

Dubious? There's too much hype in hi-fi but we back our assertion with this **TRY-FREE OFFER**: test a mains cable for the CD player or the links for a bi-wireable speaker. The only calls we receive are, "Amazing. What should I buy next?"

Customers say we make some of the **BEST SOUNDS** they have ever heard, so you know we can do the same in your home. Our advice will take account of your best components and guide you where change is needed, in stages you can afford.

You **AVOID EXPENSIVE MISTAKES**, enjoy music along the way and save money in the long run.

JUST LISTEN AND YOU'LL KNOW

CD: ACCUSTIC ARTS, AUDIO SYNTHESIS, BEL CANTO, dCS (P8), ELGAR, DELIUS PURCELL, VERDI, VERONA), STELLO, WADIA. **VINYL:** AVID, BASIS, CLEARAUDIO, DNM, GRAHAM, THE GROOVE, LEHMANN, MICHELL, ORIGIN LIVE, SUMIKO BLUE POINT SPECIAL, TRANSGURATION. **TUNERS:** MAGNUM DYNALAB. **AMPLIFIERS:** ACCUSTIC ARTS, BEL CANTO, CAT, DNM, DK DESIGN, GAMUT, HALCRO, HOVLAND, SONNETEER. **LOUDSPEAKERS:** AUDIO PHYSIC, DALI, ETHOS, GAMUT, NEAT, TOTEM. **CABLES:** ARGENTO, CHORD Co., DNM, NORDOST, SILTECH, VERTEX AQ ETC. **MAINS:** Vertex AQ. **SUPPORTS:** ARCICI, STANDS UNIQUE, VERTEX AQ

The Right Note
Music in the home

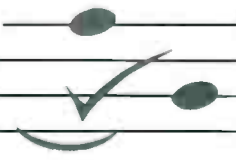

BATH
01225 874728
or lo-cost
0845 230 7570

definitive audio

Definitive Audio creates a quality of musical experience that is peerless. Our service is bespoke, our philosophy is unique and our results are celebrated the world over. We use a selection of the most artful and ingenious creations, including the emotionally persuasive and sublimely beautiful KSL Kondo amplifiers and Living Voice loudspeakers.

New Western Electric 300B valves available from stock.

Sale of part exchanged and ex-Item Items	Sale	New
Living Voice Avatar 1 - cherry	£1500	£2700
Living Voice Auditorium 1 - walnut	£700	£1500
Living Voice Auditorium 1 - cherry	£800	£1500
Living Voice Avatar OBX-R2 - walnut - new, cosmetic second	£3200	£4000
Border Patrol Control Unit - line pre-amp	£1000	£1700
Audio Note Japan M7 pre-amp - line only	£3000	
Art Audio Quintet integrated - 6 months - hair-shirt, single input joy	£2400	£3100
Art Audio PX25 - 5watts - Single ended flea power for the sensitive type	£3000	£4000
Eastern Electric Mini Max pre-amp - new, boxed - compact, quality cutie	£400	£800
AudioNote (UK) Ltd P.Zero pre + monos - perfect condition	£400	
Audio Research Reference 600 monos - absolute giveaway	£8000	£30000
Nottingham Analogue Interspace - dodgy bearing	£200	£650
Ruark Crusader II - black - OK condition - tweed jacket style	£800	£1900
Sugden Masterclass integrated - nearly new	£2500	£3300
Helios Model 1 CD player	£700	£1300
Benz Micro LP phono cartridge - 5 minutes use - perfect	£1400	£1900
AVI S 2000 M1 integrated amp	£400	£1000
Border Patrol P21 - mahogany - integrated - 11 months	£3800	£4800
Audio Mecca Mephisto CD transport	£1200	£2500
Canary 608 (blue) line integrated - great sound for low dough	£1900	£3000
Canary 303 [110v] - new - fillet mignon	£3800	£7200
Canary 309 - very nearly new - beef wellington	£4800	£10000
Canary 801 [110v] line pre-amp - lemon torte	£2500	£4500
Cyrus CDB CD Player - 2 years old	£600	£1000
Cyrus DAC X - 1 month old - perfect	£900	£1100
Cyrus PSX - Black - 1 month old - 2 pieces	each £300	£400
Monitor Audio Studio 15 in rosewood (Sept 93)	£500	£700
Chord DAC 64 - spotless	£1100	£1900
Alola pre-amp - very new - very good condition - beautifully made - OK	£900	£2800
Thomas Sheu turntables (80mm platter with 12" arm)		ring for details
Thomas Sheu turntables (50mm platter with 9" arm)		ring for details
Sugden A21a - titanium - classic integrated	£600	£1050
Audio Innovations 2nd Audio 2A3 Monos - a classic - tatty	£400	
Revolver 45 loudspeaker - cherry - unused	£500	£1200
Revolver 45 loudspeaker - grey + maple	£400	£900
Revolver 33 loudspeaker - grey + maple	£200	£600
Kimber Select inter-connect - 0.75m - new - in elaborate plastic box	£250	£500

Tel: 0115 973 3222 Fax: 0115 973 3666
internet: www.definitiveaudio.co.uk email: shout@definitiveaudio.co.uk

Townshend

Since 1975 Townshend Audio has been producing world class high fidelity components, the latest being the TA565CD silver disk player. CD sound is simply outstanding: smooth, lively, fast and completely un-fatiguing. Employing Enhanced Deep Cryogenically Treated™ copper wire-wound coupling transformers in the output circuit together with damped spring isolation, the specification and the sound quality exceeds anything currently available.

And by the way, it plays DVD-Video, SACD and DVD-Audio in stereo and multichannel!



Also new is the Versatile Seismic Sink Stand (VSSS). Employing polymer suspension elements, the VSSS isolates ground-borne vibration from 2Hz upwards.

Available in all standard widths and with up to 8 shelves, the stand can take 70kg (total) on infinitely adjustable shelves.

Finally, the Hi Fi World Accessory of the Year 2004, the Maximum Super Tweeter sits on top of your existing speakers or on special brackets for Quad 57 and round/sloping topped speakers. "The difference was staggering" - Hi Fi World, Jan 04.

For a demonstration of the above on the full Townshend Audio stereo or surround sound cinema system in Hampton Court, Surrey, or for your nearest dealer information,

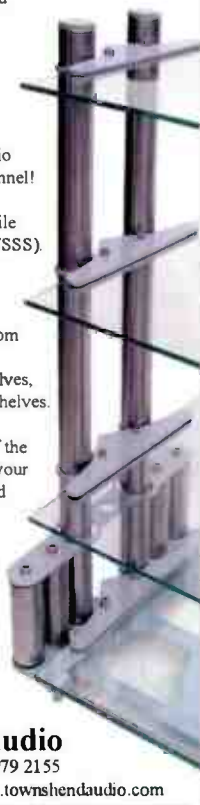

call **Townshend Audio**
+44(0)20 8979 2155
or see www.townshendaudio.com

Minor, Third

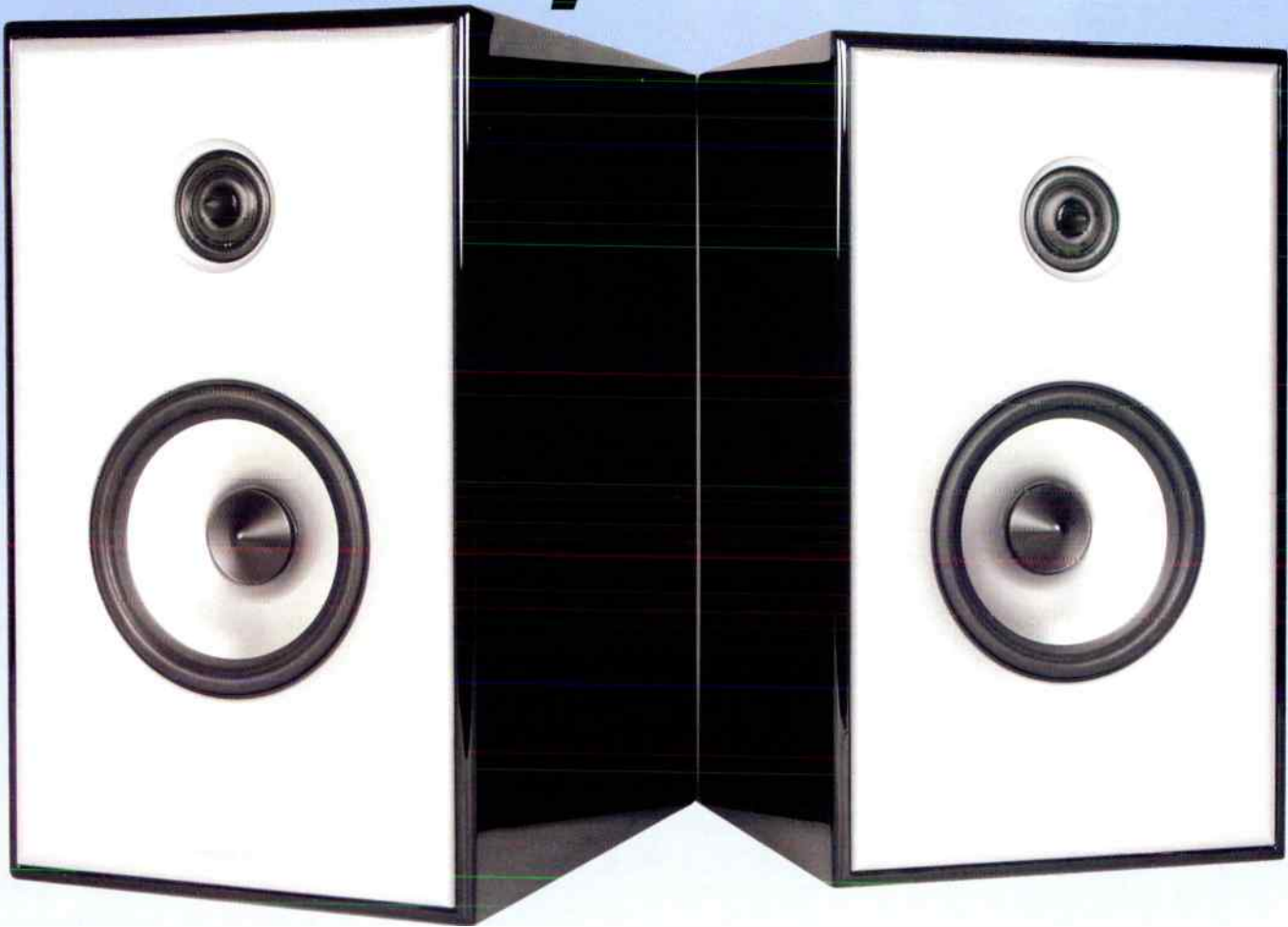

Dominic Todd compares the latest Acoustic Energy AE1 III to the original eighties incarnation...

This isn't just a 'speaker we're reviewing here, it's a living legend. Whenever I review a sub-£2,000, standmount 'speaker, this is the one I have in mind as a comparator. Like many other reviewers, the Acoustic Energy AE1 has long been, and still is, a reference point for me. Now in its third phase, there haven't actually been any changes since the MkIII was launched at the end of 2003. So why review it now? Well, since that time there have been some remarkable new offerings from both home and abroad, and it should also prove a refresher to hear those astonishing AE1 qualities again...

Unlike the original, which was designed as a semi-pro 'speaker, the MkIII was always meant to be a domestic design; and you can tell. The cabinet construction is simply beyond reproach, with our gloss

black pair demonstrating a flawless finish. The MDF casing is lined with steel to reduce resonance. If this wasn't enough, there is also steel cross-bracing to make this one of the most rigid cabinets around, which is already small and, hence, rigid anyway. Only now, with the development of multi-layered structure foams, has its rigidity truly been challenged. Mounted to the 10mm thick alloy front baffle, are Acoustic Energy's own specially designed and manufactured drive units. The 12cm aluminium alloy woofer is something of an AE1 trademark, but this one is of an all-new design and comes attached to a high spec, vented, magnesium diecast chassis. In a break from the metal tradition, the tweeter is a fabric, ring-dome design. This features a fixed central clamp to integrate as smoothly as possible with the woofer.

As you'd expect for a small

'speaker of this price, the rest of the design shows plenty of luxurious and pricey features. Although only single wired, the gold-plated and fully isolated WBT sockets are about as good as you can get. The crossover features quality polypropylene capacitors and uses single core, silver speaker cable to attach to the drive units. Although small, AE recommend that the 'speaker is placed about 75cm from a rear wall. This sounds a lot for one so tiny, but as we'll see the rear bass port produces quite an output. I also found the 'speakers to perform better slightly toed in and on mass filled stands of 24" in height. Personally I'd recommend either Acoustic Energy's own stands or the excellent Partington Super Dreadnought for around £170.

SOUND QUALITY

Powering up the AE1's, one of the first things I noticed was just how

much power they soak up. Even my notoriously inefficient Celestion SL600s (82dB!) don't seem to require quite so much gain to achieve the desired volume. So, these are current-hungry, but as I found, if you've got an amp' with oomph, then the pay off is handsome...

With the Sister Sister's 'Mary' I wasn't immediately bowled over by the sound, but the more I listened the more impressed I became. It all stems from the AE1's very real sense of balance and faithfulness. Take the piano for example. In this case it was conveyed with a depth and scale that would be excellent by any standards but, given the size of this particular 'speaker, was nothing short of remarkable. It's true that the lowest bass notes were missing, but then I doubt that there are many 'speakers that could produce these whilst

sheer honesty with which the vocals were relayed. If you want to be able to hear right into the recording and be able to differentiate different microphone techniques, then this is the 'speaker for you. Combined with the rock-solid imaging I found the presentation immensely involving and offering transparency that many panel 'speakers would be proud of.

Claire Martin's 'Man In The Station', with guest vocalist John Martyn, was portrayed with excellent headroom, yet the excessive sibilance with Martin's vocals did come as a surprise, especially as the AE1s had been so much smoother elsewhere. During subsequent listening with my electrostatic headphones I found it to be a characteristic of the recording. As this particular characteristic rarely shows up on 'speakers, it points to the Ills as being partic-

ularly revealing of recordings and, by the same token, matching kit, so chose ancillaries with care. Otherwise the mellow timing was spot on.

CONCLUSION

Despite the march of time, the Acoustic Energy AE1 Mk Ills remain one of the finest ways with which to spend £2,000 on a 'speaker. The level of transparency is to panel standards, whilst the dynamic clout and scale is remarkable for such a small design. Add to this, reference levels of staging and wonderful cohesion and it's hard to see how you could do better for the money.

Still, even the AE1 Mk Ills won't suit everyone. If your room is on the larger side you can rule them out straight away. I initially listened to them in a room 23' by 23' and frankly they struggled. Perhaps of more concern is the amount of juice the AE1 Ills require. Although some valve amps will drive them - especially meaty triode designs - you really need a transistor design of at least 100 watts. Whilst also generally being smooth and well integrated, they equally won't tolerate poor recordings. If you want fine transparency then be prepared for some recordings to lose their shine. Still, I would still wholeheartedly recommend them. Along with the B&W 805s, they remain my reference compact 'speaker, and praise comes no higher than that...

"I found the presentation immensely involving, with the transparency that many panel 'speakers would be proud of..."

matching the Acoustic Energy's transparency. In fact, you'd really need a Mordaunt Short Performance 6 as the bare minimum. Complimenting the splendid transparency were reference levels of imaging. Vocals were skilfully pushed forward from the rest of the music without sounding forceful. They were also locked into the sound stage with such precision that even if you listened a little off axis, you'd still get the benefit of the focused sound.

I thought that Eminem's 'Kill You' would be too testing for the AE1 Ills, but I needn't have worried. Although not an easy listen, there are few better tracks for testing transient attack. For one so small, the baby AE's simply astounded. Bass could have done with a tad more speed, but there was little to criticise elsewhere. The midrange possessed the required dynamic control, and the bass weight was highly impressive for a cone of just 12cm. Close your eyes and you could easily imagine the sound emanating from a small floorstander. Much better than any small floorstander at the price, though, was the vocal articulation, which remained, precise, focused and transparent throughout the song.

Vocal precision was also to the fore with Johnny Cash's 'I Hung My Head'. It was here that I was reminded of the AE1's roots in the studio, such was the confidence and

switch to Classical and the results are just as impressive. Copland's 'Appalachian Spring' showed remarkable scale and attack

switch to Classical and the results are just as impressive. Copland's 'Appalachian Spring' showed remarkable scale and attack

MEASURED PERFORMANCE

The AE1's treble response characteristic varied with microphone height but was flat, as shown, in the normal on-axis position between the drivers. There's quite a gap between bass and treble unit and this commonly introduces variability in the vertical plane due to phase effects, so listening height may well be important in use. Measurement showed the tweeter tended to be prominent; Acoustic Energy have certainly gone for a fairly forceful top end, although that is not uncommon nowadays.

Bass output reaches down to 80Hz, aided by some slight lift - not a bad thing - then shelves down a little to 40Hz before rolling off steeply, like any ported cabinet. The port is tuned to 40Hz and this will make a useful contribution to bass extension in a large-ish room.

Like so many other speakers tested this month - but unlike speakers in general - the AE1 has a very high overall impedance, well above 8ohms, and a commensurately low sensitivity. With a low 81dB sensitivity it will need an amplifier of at least 60W to go loud

and 100W might be more useful. The AE1 MkIII was a little down on my hopes for a speaker of its reputation. It's engineered well, but it could usefully be tidied up all the same. NK

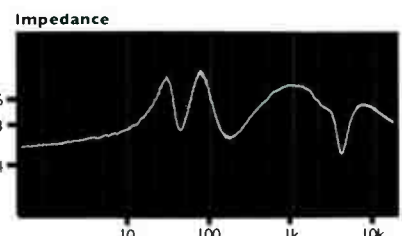
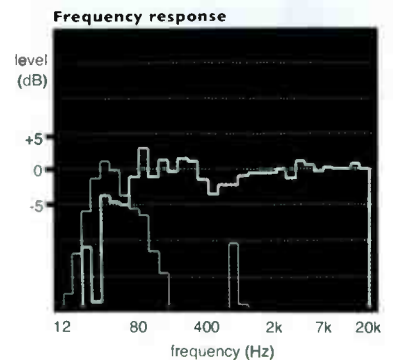

VERDICT ●●●●●

With sublime, panel-like transparency, the AE1 is still the reference for small 'speakers at this price point.

ACOUSTIC ENERGY AE1 III £2,000
ACOUSTIC ENERGY
 ☎ +44 (0)1285 654432
 www.acoustic-energy.co.uk

FOR

- panel-like transparency
- holographic staging
- dynamics relative to size

AGAINST

- won't flatter poor recordings
- needs an amp' with oomph

one-to-three

During the test I was fortunate to have a pair of some of the very first AE1s ever made (the date on the back confirmed this; 1987). They may be about the same size, but take a look at an original pair of AE1s next to the Mk IIIs and they're worlds apart in terms of finish. Although similarly solid, the originals case was finished in a coarsely textured, black acrylic paint. Internally, the walls were still lined, but this time with a plaster like compound rather than steel. Although thoroughly revised, the metal bass cone is familiar from the Mk I but the treble is of a completely different design. Rather than a fabric ring dome the first AE1 used a metal dome sourced from Elac – all metal drive united 'speakers were extremely rare at the time...

Another difference you'll note is the positioning of the ports. The first model used twin, "gas flowed" ports, whereas the Mk III now sticks a single port around the back. As indicated by the 45 degree slope of the badge, the original AE1 was designed to be mounted either horizontally or vertically – not something to be recommended with the Mk III! Interestingly, the originals had four sets of posts per 'speaker for bi-wiring. The newer Mk IIIs have only two but, then again, recent research has shown how little, if any, effect bi-wiring has with small 'speakers. Still, some might miss the option of not

being able to bi-amp with the newer models.

Listen to the AE1 speakers in isolation and they are still a remarkable sounding product. Considering that the design dates back to the mid-'80s, the sound is still clear, lucid and dynamic. Whereas many 'speakers of its vintage would sound muddled and congested, the AE1s were, and indeed still are, seamless, transparent and utterly composed. Yet, unlike the latest version, there are weaknesses. By modern standards the treble is definitely on the edgier side of neutral. The mid-range, too, can

make the greatest stride forward are detail, integration and, perhaps most surprisingly, dynamics. Certainly the dynamics are aided by a much cleaner and more responsive bass. In isolation the original sounds fine, but put next to the Mk III you'll notice it sound a little slow and turgid. Despite that, the Mk III will still dig deeper and sustain bass notes with greater authority. In terms of integration and detail, it appears that we've got the new treble unit to be most thankful for. Whereas the old unit could sound a little harsh, the new fabric ring dome is smooth, insightful and beautifully integrated with the mid-range.

"listen to the original AE1 loudspeakers in isolation and they are still a remarkable sounding product..."

occasionally sound a little peaky and less than happy with some material. Generally, though, you've always aware of the 'speakers truthful voice – this affair all was always designed to be a studio monitor 'speaker.

Comparing the original with the Mk III is quite an eye opener, for although similar in size, and philosophy – high dynamics, low compression and open staging – the older model can't compete with the Mk III sonically. The three areas that

That Acoustic Energy has managed to make the Mk III more dynamic and more transparent with less aggression is quite some achievement and only further goes to prove just how impressive the Mk III is. That having been said, find a pair of original AE1s at the right price (£400), and you'll have a little piece of hi-fi history that still sounds great today. [Psst - it might just be that you won't be forced to buy original AE1s secondhand for much longer... - Ed.]

Metal Work



David Price tells the story of the British loudspeaker specialist that built its reputation around innovative materials technology - Acoustic Energy.

The nineteen eighties was famous for many things in hi-fi, from early digital audio to affordable high power transistor amplification. For some audiophiles however, the key aspects that characterised the decade were the widespread popularity of 'mini monitors' and the trend for using metals in loudspeaker drive units. Put them together and you have one single, epoch-defining product, the Acoustic Energy AE1.

Like the Canon camera of the same name, here was a pure and purposeful design that did what it said on the box with rare ability. It didn't do everything, but what it did do, it did brilliantly. It indelibly stamped Acoustic Energy onto the hi-fi map in 1988, and the company has never since looked back. Its innovative and slightly askance



approach to design characterises what is, by all accounts, an unusual loudspeaker manufacturer. In a world packed full of 'me too' boxes, here's one company that's stood out from the crowd.

Originally founded in West London in 1987, Acoustic Energy's first foray into loudspeaker manufacturing was a controversial one. The high end Celestion's SL6 was the first speaker to use a metal dome tweeter back in the early eighties, and this soon started a fad for the technology that was to last at least a decade or more. Within five years of the SL6, even budget priced loudspeakers sported aluminium or titanium domes, almost as a badge of honour. The sad truth was, however, that these were usually more about marketing than sonics, and often achieved a poor sonic match with the paper or plastiflex drive units of

the day; the result invariably sounded like you were listening to two loudspeakers in one...

The first AE1 rewrote the rule book; the clever combination of a bespoke metal mid/bass unit with a metal dome tweeter in an extremely small package, made for a brilliantly integrated small loudspeaker. More important still was its ability to go loud cleanly and with very little compression – no surprise perhaps, considering its designer Phil Jones was a keen electric bass player, and had spent many years designing loudspeakers and amplification

AE PHILOSOPHY

"To create innovative design solutions and employ the latest technology wisely and in a thorough and elegant manner, with one objective in mind - to accurately transfer the amplified signal into audible energy - of exceptional quality".





REFERENCE MODEL AE1

original AE1 was the first to truly evolve the breed, and integrate them with (then new) metal dome tweeters [see ONE DESIGN]. In essence, the AE1 was originally designed as a pro speaker for near field monitoring, *a la* BBC LS3/5a and Yamaha NS10M, but its neutrality and speed proved brilliant for domestic hi-fi applications too. It duly won the British Hi-Fi Award for Best Speaker in 1991 and 1992, and acclaim for the Reference Series within the hi-fi press grew worldwide. The hi-fi market rapidly became an integral part of Acoustic Energy's growth.

Unsurprisingly perhaps, metal cone technology featured in the development of the Reference series AE2, a larger version of the AE1 featuring twin mid-bass drivers. Initially both the AE2 and the AE1 were designed to satisfy the needs of the professional audio sector and have acquired a global reputation with



PHIL JONES
Phil Jones, designer of the AE1, now runs Phil Jones Bass, a pro audio amplifier and loudspeaker specialist with a staff of over 150 employees and a 100,000-sq. ft. facility dedicated to designing, manufacturing

and marketing of loudspeakers and amplifiers for home, car and pro-audio markets. See www.philjonesbass.com

Far Eastern manufacturing and purchasing facility. This allowed AE to introduce the mass market Aegis and '100' ranges, which proved very popular in more volume orientated entry-level and mid-range hi-fi and multi-channel home theatre markets. Today these ranges have evolved into the Aegis Evo, Aelite Series and new Aego Series, while the Reference series loudspeakers, into which the AE1 mkIII fits, continue to be produced in the UK. From those humble beginnings in the late eighties, Acoustic Energy now distributes to over fifty export markets.



ONE DESIGN

The original AE1 comprised a Phil Jones-designed mid/bass cone that was a straight sided design spun from aluminum alloy with a graded thickness across its profile and then hard-anodised black on both sides. As the anodised layers took up one third of the cone's thickness, it was effectively a sandwich of alumina (aluminum oxide) and aluminum, which should be both stiffer and better damped than a pure metal. The dust cap is straight-sided and cone-shaped, glued to the cone which is driven by a 1" aluminum voice-coil former. Phil Jones's pro background meant that excellent heat dissipation was a key design priority. The tweeter was effectively a reworked Monitor Audio magnesium-alloy dome (as seen in Musical Fidelity M2 and Epos ES14), made by Elac and boasted an edge wound aluminum-ribbon voice-coil and ferrofluid damping. The bass unit was reflex loaded by two frontally mounted 1" ports, profiled to reduce wind noise. The rear terminal panel mounted crossover was a complex affair, a third-order Butterworth, 18dB/octave high-pass leg and a 24dB/octave low-pass leg with a phase-compensating network. The low-pass section used iron-dust-cored inductors, the high-pass air-cored coils, both with low-loss polyester capacitors. The cabinet was no less innovative, a heavy and dead affair made from 22mm MDF, with a concrete lining to damp out resonances.

"There is no point beating around the bush—these speakers are a revelation. Their dynamic performance is in advance of anything I've heard before. The transparency and consistency of the AE1 is phenomenal...The AE1 leapfrogs existing references and sets new standards of technical and musical excellence."
Hi-Fi Answers, March 1988

"The AE1 is without doubt a wholly remarkable loudspeaker, and a stunning endorsement of the well developed metal cone horn unit. In the British hi-fi scene, it is a phenomenon...The AE1 leapfrogs existing references and sets new standards of technical and musical excellence."
Hi-Fi Choice, June 1988

"The AE1 has an 80dB/W sensitivity, and is designed to handle—and I mean handle—something like 200W. But these are just numbers—the reality is quite extraordinary."
Alix Gold, Stereophile, August 1988

"As far as I'm concerned, the AE1 redefines the art of miniature speaker design."
John Atkinson, Stereophile, September 1988

"The combination of an almost uniquely inert enclosure and the metal cone bass unit produces a sound of exquisite transparency...the nothing is...nothing."
Bill The AE1 continues to set the benchmark for the best speakers of all types of small speakers than any other."
What Hi-Fi? Superstool, May 1991

because commercial equipment was (as he puts it), "never up to the sound I had in my mind".

"the first AE1 rewrote the eighties loudspeaker rule book..."

Even back in the late eighties, metal drive units had been around for some thirty or so years; GEC's Hugh Brittain and Ted Jordan of Jordan-Watts had both done them; the latter being a classic. But the

musicians, recording artists and studio engineers. In 1996, the AE1 Series II was produced following new developments proven in the AE1 Signature. Series II retained the qualities of the AE1 but provided greater clarity, transparency and harmonic timbre, coupled with a larger stereo sound stage and increased sensitivity.

The advent of the AE1 MkIII in 1999 improved the series still further. This speaker was focused on the hi-fi market far more than its predecessors (which were basically pro audio designs which worked as hi-fi too), and featured better sensitivity, improved vocal articulation, transparency and bandwidth. Most noticeable is the new enclosure design, anti-vibration driver baffle platform and new high and low frequency drive units. The result is something that's altogether superior to the original AE1, and far more svelte looking to boot. Back in 1995, the company relocated to its current 15,000 sq. ft. Cotswolds facility in Cirencester, and then formed a strategic alliance with a large

((AE))
ACOUSTIC ENERGY

PERFECTION
Diminutive in size.
Exceptional in clarity.
Magnificent in staging.
The AE1 loudspeaker offers you musical excellence at an affordable price.

PERFORMANCE
The AE1 can achieve a huge soundstage with the depth and breadth of larger speakers. Music lovers who require a small speaker will find the AE1 to be the right choice.

Soundcare® Super-Spikes

Prices start from as little as £23.95 per set

What are Soundcare® SuperSpikes?

The Soundcare® SuperSpikes is an all new design, an all in one spike foot. This unique construction eliminates the most common problem experienced when using a conventional spike: damaged surfaces. The construction is based on a high quality spike fitted with a custom designed base plate, all integrated in a plastic housing. This allows the user to move the equipment without making scratches and scars to the surface.

Why use Soundcare® SuperSpikes?

When the weight of your Hi-Fi equipment is concentrated onto a small area, the weight per square unit area increases enormously, providing better contact with the surface on which the unit stands. This results in an overall improved sound stage and increased control in the lower frequency register.

Soundcare® SuperSpikes reduce disturbing vibrations and prevent low frequency noise from transmitting to other rooms.

A Soundcare® SuperSpikes loaded with a weight of 12.5 kg produces a pressure of more than 6,200 kg pr. sq. cm!

Quotes from HiFi magazines:

"... Marvellous... The Soundcare products are just about the only worthwhile and affordable game in town." - Pete Christie - HiFi+ Magazine

"...Definitely recommended" - HiFi Choice

"Conclusions: ...I can't help but say these are, in my humble opinion, the best spikes around, bar none." - Lucio Cadeddu - <http://www.tnt-audio.com>

The ideal upgrade for Hi-Fi and AV equipment. Suitable for use on Amplifiers, CD & DVD players. Also, ideal for loudspeakers and subwoofers, will fit REL, MJ Acoustics and Ruark. And of course they fit the BK XLS200 and Monolith. For more details please view our website at: www.bkelec.com/superspikes

Distributors Required

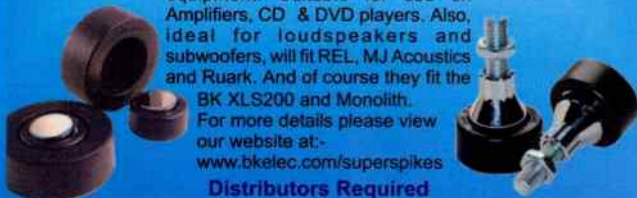

BK Electronics, Unit 1, Comet Way, Southend-On-Sea, Essex. SS26TR
Tel :- 01702-527572 Fax :- 01702-420243 email :- sales@bkelec.com

NOTEWORTHY AUDIO

hi-fi by enthusiasts

BELOW IS A SMALL SELECTION FROM OUR RANGE OF CAREFULLY CHOSEN EQUIPMENT

Denon DL-103 MC cartridge. The 103 has been in production since 1963, and for good reason - its performance is legendary throughout the world. Probably the best value cartridge available today at just £100.



Verdier Control 'B' valve pre-amplifier with switchable MM & MC phono stage (via internal transformers). This high performance pre amp costs £1,200 and can even be upgraded by connecting an external valve regulated power supply (£1,075 extra).

The Something Solid XR has become our reference equipment support, its novel use of balsa end grain shelves and tensioned shelf suspension give it a neutral presentation that lets equipment perform without added artifice. 4 tier version available from £600. (Stop press: new 'Economy' version now available from just £300).



Michell Technoarm A This beautifully crafted Rega based tonearm features a bead blasted and perforated arm tube, easily adjustable VTA and monolithic litz pure silver wiring. Incredible resolution for the price. £420.

Audion Silver Night MKII A superb range of single ended 300B zero feedback amplifiers starting from just £2,250 for a power amp or £2,500 for the line level integrated version. Awesome 18W parallel single ended mono-blocks also available from £3,495. Excellent Premier MM valve phono stage also available: £650.



Music first Audio TVC pre amplifier Instead of using resistors to control the volume the TVC uses stepped transformers. Incredible transparency without any of the dynamic compression found in conventional passive preamplifiers. Copper wired version: £1,500. All silver wired: £2,750.

Opus Continuo Reference turntable with Cantus parallel tracking tonearm. Designed to compete with a master tape the Opus sounds exceptionally musical. Combination pictured costs £3,200 including The Cartridge Man Music Maker 3.



Noteworthy Audio

36 Buckingham Street, Aylesbury, Bucks, HP20 2LH. Tel: 01296 422224
www.noteworthyaudio.co.uk



MICHELL ENGINEERING

The Michell Odyssey 2004 Limited Edition Turntable

Based on the classic Gyrodec, the Limited Edition Michell Odyssey 2004 will be produced in a numbered series of just 100 pieces supplied in an all black finish, with a black acrylic base, added clear acrylic spyder to give a second level of isolation. The signature weights are in a nickel silver finish. The turntable comes complete with record clamp, black TecnoArm "A", and matching black HR Power Supply. With its striking finish, attention to detail and outstanding sound quality it will only be a short period of time before the 100 units are snapped up.



MICHELL ENGINEERING

J A Michell Engineering Ltd
2 Theobald Street, Borehamwood,
Hertfordshire, England, WD6 4SE

Telephone: 020-8953 0771
Fax: 020-8207 4688
www.michell-engineering.co.uk



modern speaking

Has loudspeaker design become moribund, asks Noel Keywood? Better sounding loudspeakers are within reach and starting to appear. Here's what you can expect.



Here's a small bookshelf loudspeaker, the Energy V2.2i, fitted with a midrange dome.

Has the two-way loudspeaker had its day? Marrying a bass/midrange unit with a small dome tweeter can give good results but this idea has now become part of ingrained design mentality that is not only uninspiring, it's limiting performance and restraining sales. There are alternatives that can provide better sound quality and reinvigorate a moribund market. Our group test this month senses their emergence. Here's a glimpse of what we can look forward to in small loudspeakers, a taste of better things to come.

A serious drawback of the standard two way is it performs worst where the ear is most sensitive. Look at our graph (an inverse Fletcher Munson curve) of the ear's sensitivity. There's a peak at 3kHz, due to a resonance in the ear's canal. This also corresponds with our sensitivity to consonants, which support speech intelligibility. It's just

an unfortunate coincidence that this is the region where nearly every two-way loudspeaker is at its weakest. As a result we readily hear the intrinsic problems of this arrangement, one reason why two-ways are so inconsistent in their sound.

What are these problems? In the 3kHz crossover region the bass unit radiates sound primarily from its 'dust cap'. In effect, this component becomes a tweeter sitting at the bottom of the bass cone. But this is a rotten idea. The bass unit is being asked to do something it really shouldn't be doing: radiate treble. As frequency rises so output gets progressively more erratic, coloured and unpredictable. If the cone and dust cap are of different materials, then the pattern of colouration changes, only to change yet again as the tweeter takes over. So one great drawback is that the bass unit is being asked to radiate treble, something it does very imperfectly.

But that isn't all. To avoid phase problems at crossover the tweeter should be less half a wavelength from the part of the bass/midrange unit that radiates treble, the dust cap. This means no more than 2.5 inches or so (6cms), a requirement that is impossible to meet when the bass cone typically has a 4in (10cm) radius.

The simplest answer to these difficulties is to extend the frequency range of the tweeter downward, away from the ear's most sensitive

region. For a smooth transition, in phase terms, when working with an 8in cone we would want it to cross over at a half wavelength value of around 6in, giving a maximum crossover frequency of 1kHz. This is a rule-of-thumb value, but quite frankly

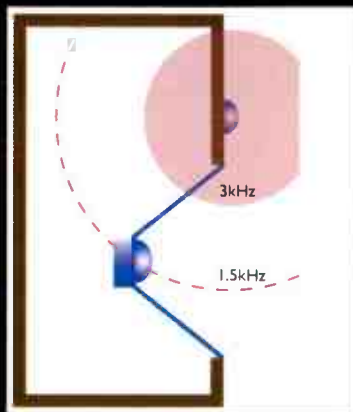

A 3kHz crossover frequency spaces drivers more than half a wavelength apart, introducing phase error. Halving this frequency to 1.5kHz doubles the wavelength, eliminating phase problems.

in loudspeaker design it's good enough, as it's just one of a huge number of variables to be tackled, often in quite crude mechanisms that don't deserve nth degree analysis. Worse, over analysing one variable usually leads to others being ignored - and this is no way to design hi-fi.

Bringing the tweeter down to 1kHz or thereabouts more than doubles the wavelengths at the crossover frequency, easing phase problems. It also lessens the bass units somewhat erratic contribution

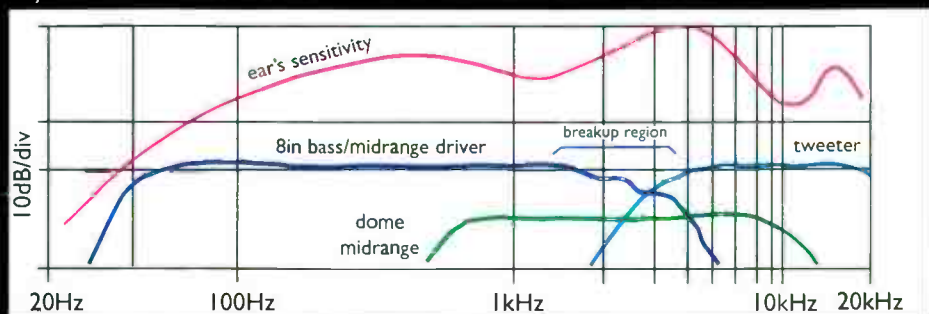

The ear's sensitivity (red) is greatest where most two way loudspeakers perform badly - the crossover region. Bass/midrange drivers 'breaks up' in this area, adding colouration and response variability. A midrange dome driver (green) is one solution. It covers the ear's most sensitive region smoothly.

...experience the music



www.whestaudio.co.uk

T: 020 8965 4535

neat acoustics

We're about
to reveal
our Motives

neat

www.neat.co.uk

01833 631021



at high frequencies, smoothing response and lessening colouration. The characteristic sound of a bass/midrange driver's cone comes from its resonant break modes; suppressing them reduces phenomena like "quack", "tizz" and "ring".

If this simple idea is such a good one, why haven't others used it? The usual argument is that the tweeter dome must be larger and, in making it so, higher frequencies suffer. You get a better midband, but worse treble. All other things being equal, this is so, but the loudspeaker's problems have now been moved up into a region where the ear is less sensitive, our sensitivity curve shows, so there's still benefit. However, improved tweeter design can overcome this difficulty.

Taking this approach one stage further brings us to the idea of using a midrange dome, to cover the ear's most sensitive region. These commonly reach down to 400Hz or so. Not only do you get a smooth

midband but excellent imaging too, as the tweeter isn't now sitting at the bottom of a bass cone.

This solution is popular in studio monitors, but their high power domes often sound coarse and edgy. Yamaha tried the idea with some success in the well known NS1000M,

which used a beryllium dome.

Nowadays, Energy loudspeakers, a Canadian company, make a pure interpretation of this concept with their V2.2i bookshelf. A bass unit crosses over to a midrange dome at 550Hz. Unfortunately, this dome crosses over at a low 2kHz to a tweeter, again in the ear's sensitive region - not ideal. However, the mid dome and tweeter dome are at least close together and also closely matched in build material and dispersion, which aids their subjective integration. Wharfedale have taken to midrange domes too, but they use silk domes rather than aluminium.

The best way of integrating mid and tweeter domes is in one

custom built unit, acoustically tailored for perfect matching. The ear's sensitivity curve suggests it's best if



Wharfedale are now using a large soft midrange dome in their Opus loudspeakers. They say "The critical range, from 800Hz to 6kHz, is covered without crossover, directivity collapse, or anomalous materials interaction. The dome midrange produces only around a tenth of the distortion produced by a conventional midrange unit.

the midrange dome works up to 6-8kHz, not an impossible requirement these days. A loudspeaker with a good midrange dome images more sharply and equivocally than today's two-ways, and it will sound smoother, clearer and more consistent across the midband too.

Whilst the use of a midrange dome is one solution to today's sea of mediocre two-ways, it isn't the only one. More importantly, it isn't the one China seems to prefer. The Chinese favour ribbon drive units and this month we've tested just one example, the Arum Cantus ribbon, as well as a UK designed Pinsh. A large ribbon can reach down to 1kHz or so; the Pinsh reaches down to 1.2kHz for example. Integration with a cone bass unit is better due to the longer wavelength involved, as described earlier. But ribbon drivers have plenty more advantages.

Here's how Pinsh describe the benefits of their ribbon. "It has a single strip of pure metal moving in a magnetic field. The mass of this strip is 0.006 gram, 167 times lighter than the most expensive dome tweeter. Moving mass of our midrange is 0.024 grams, or 125 times lighter than the most expensive midrange." The ribbon is immersed in a powerful magnetic field which has a vice grip control over it, so the ribbon stops and starts in time with the signal from the amplifier. There are no additional moving parts like spiders, domes and voice coils, nor formers including adhesives, all of

which have thermal limit. Our zero store ribbon has no damping, neither is it enclosed in a sealed chamber:

both the front and the rear of the moving metal strip are in direct contact with the atmosphere. Distortion is exceptionally low and not ordinarily audible. This means that the other components in the audio chain have a greater chance of distorting the signal. The frequency response is linear and the upper limits are 100kHz. Although the human ear can hear up to 20kHz there

are super harmonics called formants of the lower frequencies that when present gives you the sense of completeness of the sound. Or put differently, when absent, the sound feels more hi-fi and less natural."

Ribbon drive units are difficult and expensive to make. They are commonly insensitive and may deteriorate with age too. Vertical dispersion hasn't always been the best as phase cancellation can set in, and edge diffraction has been a problem. Good, modern designs seem to have conquered these traditional difficulties though, measurement suggests. The Aurum Cantus ribbon has a very flat forward response over a wide frequency range and excellent dispersion characteristics too. Able to work down to 1kHz or lower, large ribbons crossover to bass units smoothly enough, although dispersion characteristics at the crossover frequency may differ and this sort of anomaly can usually be heard - a minor drawback.



The Aurum Cantus G1 ribbon driver. Its corrugated aluminium foil carries the audio signal. It sits in a powerful static magnetic field.

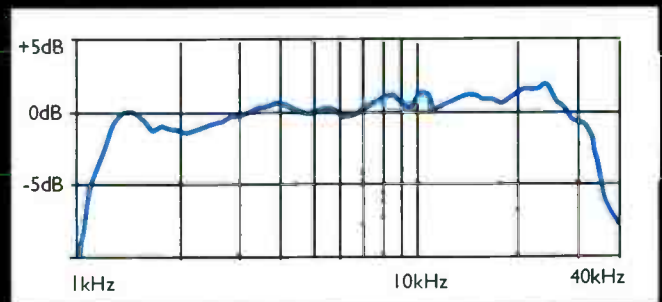

Frequency response of the Aurum Cantus ribbon driver runs from 1.5kHz up to 30kHz.

Both the midrange dome and ribbon tweeter are capable of providing improved performance where it matters - in the ear's most sensitive region. They provide other benefits too - such as lower distortion, less colouration, flatter frequency response and better dispersion. Put together this is a significant array of benefits, making for a better loudspeaker than those we are used to today.

"A little champ of price/quality ratio: available at an affordable price, especially for a tube amplifier of more-than-usual power."

AUDIO REVIEW Italy, July 2004, Claudio Checchi

"PrimaLuna Prologue One is now my 'affordable reference amplifier'. With apologies to various British and Italian geniuses, this amplifier has to my ears no equals at its retail price."

HI-FI NEWS and RECORDS review, July 2004, Ken Kessler

"A refreshing change from the transistor competition with a captivating presentation. Excellent finish and build quality makes for a package strong on value."

HI-FI WORLD, August 2004, Dominic Todd



PrimaLuna

Music is a pleasure not to be denied. So, too, the beauty of music reproduced by valves should be accessible to all. To make available to a wider audience the seductive, silky sound of the vacuum tube, PrimaLuna has developed a range of all-valve amplifiers with the construction, power and sonic performance of high-end electronics, but with one unique, inimitable feature: prices that can only be described as 'entry level'!

Since the arrival of the Prologue One, the audio community has been unable to contain its joy nor reign in its praise because PrimaLuna has revolutionised the concept of 'affordable audio.' With a pair of integrated amplifiers with prices more typical of mundane, solid-state products, PrimaLuna showed other manufacturers that compromises in fit and finish, styling and facilities are unnecessary.

Now PrimaLuna can offer the pride of ownership of true separates to aficionados on a budget. As promised, PrimaLuna has expanded the range upward with three exciting new models for users whose requirements demand separates rather than integrated amplifiers.

To meet these needs, the music lover can now consider the Prologue 3 dual-mono valve preamplifier with four line level inputs, and a choice of two matching stereo power amplifiers. The Prologue 4 provides 35W/channel from EL34 valves, while the Prologue 5 delivers 40W/channel courtesy of the classic KT88 tube.

And there's more good news: PrimaLuna has also announced retro-fittable auto bias boards for the Prologue 1 and 2, and a moving-magnet phono stage for the Prologues 1, 2 and 3. Additionally, there is now a choice of optional gold or silver front panels in place of the standard finish.

Audition the full range of Prologue models at the Pistol Music dealer of your choice. And prepare your wallet for a pleasant surprise.

PISTOL
MUSIC



For your nearest Pistol Music dealer, please contact Pistol Music
58 Durham Road, London SW20 0TW

T: +44 (0)20 89 71 39 09 F: +44 (0)20 88 79 79 62 www.pistolmusic.co.uk

PISTOL MUSIC is a division of Absolute Sounds Ltd

Silver Star?

To celebrate its twenty fifth anniversary, Dynaudio has come up with the Special Twenty Five loudspeaker, based on the company's high end Evidence models. Haden Boardman listens in.

Although not an overly familiar name in the UK market, Dynaudio has been making fine loudspeakers for over a quarter of a century now. To commemorate this, the company recently produced a special edition claimed to incorporate all its accumulated knowledge and experience in one small box – the Special Twenty Five you see here.

A couple of years back, the 52SE I reviewed greatly impressed me. I make no bones about loathing (most!) dome tweeters and inefficient plastic cone speakers, and here was a small Danish speaker featuring just those, and it won me over. Now, the Special Twenty Five ups the ante by quite a significant mark. Where as the Audience 52SE used the cooking 'Audience' cabinet, but with the more expensive 'Contour' drive units, the Special Twenty Five takes a 'Contour' style box (from the older range) and fits it with custom drive units based on the top of the line 'Evidence' models. Price tag is a not insubstantial £3,000, a heck of a lot of money for a moderate sized box. However, one look at the speaker, and you know this is not a low rent item.

Fit and finish surpass the high standards already presented by the 52SE. The review set were finishes in 'maser birch' simply gorgeous to the eye and to the touch; the veneer was almost strokeable [steady on, Haden – Ed.]. Of course I could not resist peeking inside the cabinets. Both drive units are fitted with rare earth magnets, and the level of mechanical engineering amazes me. The cabinet is incredibly inert, with a metal back for extra rigidity and crossover cooling (!), and while we are at the back there's a pair of huge WBT sockets and one of the largest bass ports I have ever seen.

However, what interested me

most is the claim of low power valve amp compatibility; as most of the Danish speakers do seem to need a good healthy selection of watts, especially when they're in compact boxes... With an "easy" four ohm impedance curve and a claimed 'high' (by Dynaudio standards) sensitivity of 88 dB/ watt, and a decent sized box, it looked very good on paper for my small EL84 based amps. Against this, Dynaudio claims this speaker can handle up to 300 watts - such power handling and sensitivity should result in a terribly dynamic loudspeakers if the claims are true.

Technology wise, as already mentioned, these speakers use high quality motor systems coupled with the usual Dynaudio refinements such as the one piece Magnesium Silicate Polymer (MSP) cone diecast chassis and doped silk dome tweeter. Crossover is the usual 6dB/ octave filter, but built to handle the 300 watts with zero compression resistor networks fitted as standard. Like me, Dynaudio eschew the idea of biwiring, so on the rear of the speaker you are presented with a rather chunky pair of WBT terminals.

Weight is 13kg apiece, so strong and heavy stands around 50cm high are recommended - this may be a bookshelf model but it is designed to be positioned away from walls.

SOUND QUALITY

Luckily for me the speakers arrived well run in; the 52SE's took an age to bed in. Even so, they were left to the radio for twenty four hours just to make sure. Dynaudio documentation is frankly a bit thin, but I decided a small amount of toe in



"The best tonearm I've heard"

HI FI WORLD

Winner of Stereo Times magazine Most wanted component of 2004 award



"A new benchmark for musical communication" STEREO TIMES

"One of the truly special products I've reviewed in the past 18 years" STEREOPHILE



The new generation of tonearms from Origin Live have won admiration and rave reviews across the world for good reason - these arms better the best by a significant margin. Whatever your current arm, you can at last treat yourself to a serious upgrade. Why not arrange for a demonstration now.

Tonearm Models

Conqueror - £2500
Illustrious - £1570
Encounter - £970
Silver - £599
OL1 from - £124



Demonstrably better



Ultimate performance

for your system

"The best musical results of any turntable I've ever heard, regardless of price."

Since I've been listening to turntables professionally for 32 years and am aware of the pitfalls of ultimate proclamations, I hesitate somewhat to make this statement. Nevertheless, it is true. The level of musical communication available from the Illustrious/Aurora Gold is in a class by itself. It sets a new reference."

STEREO TIMES on the Aurora gold turntable & illustrious tonearm

ORIGIN LIVE
Tel/Fax: +44 02380 578877
E-mail: info@originlive.com

Full information on web site

www.originlive.com



living with

integrated technology

CYRUS

www.cyruslink.co.uk | www.cyrusaudio.com



(after the Audience experience) would be a good starting point. As for the reference system, Marantz CD12 handled the digital side of things, along with a Marantz SA8400 playing SACDs. Vinyl replay was via a Garrard 401/ SME3012/ Denon DL103 with Paravicini's EAR 834P phono stage. Volume control a single input transformer based passive and power amps a mix of EAR 509/II and home brew EL84 amps. Russ Andrews power cords and filters, and Chord Company Signature cables were used throughout

First track was the very well know Michael Jackson 'Thriller' album on SACD. My initial reaction was amazement at the size of the recorded acoustic considering the Dynaudio's diminutive dimensions. Quincy Jones's complex and sublime production techniques shine on the SACD, and these loudspeakers didn't get in the way. Jimmy Smith's 'Blue Bash' (featuring Kenny Burrell on guitar) is pretty laid back compared to my favourite Smith tracks (in particular 'Fever' is near on the horizontal) and the Dynaudios laid this track bare. Where I had felt the smaller 52SE held back the level of emotion, the 'Twenty Five' was obviously much more expressive.

Moving on to Kruger & Dorfmeister, and a bit of heavy electronic dance music. Here the bass was incredibly defined and fulsome; better than some floorstanding speakers at this price point, on some tracks it almost became too much, even when run off the small 10 watt EL84 amplifier which was obviously having no problems driving this speaker to very loud levels in my front room. Overall, the leaner balance of the EAR 509 suited the Special Twenty Fives better, the lower powered (and very budget) EL84 amp still sounded amazing considering. This was an interesting point – normally Danish designs need serious transistor power, but these little boxes were far more flexible in this respect. It also

underlined the fact that, despite their super fast and dynamic nature, the Special Twenty Fives err on the warm side of neutral (as per most Dynaudios) – an important point to remember when system matching.

Indeed, switching to Cassandra Wilson's 'Glamoured' CD revealed a slightly heavy edge to the bass; this is quite a fulsome recording, but it was capable of showing how much the Dynaudios used those large bass ports on the cabinet rears... (These guys do need good space all round them.) Even so, this gave an impressive sound, and most people would welcome this kind of impact and depth from a small(ish) box. Popping Miles Davis's 'A Kind of Blue' in to the SACD player was another great hit on these speakers. One of my favourite recordings, the Special Twenty Fives did indeed make it sound very special indeed. Digging out a stack of percussion based music and seriously cranking up the levels high (think Kodo drummers, garage doors and lots of drum kit recordings) really brought the Specials alive. Okay, I only had a measly hundred watts to hand, but it was enough. A bigger room would be required and less neighbours for the full three hundred.

One area in which the speaker took no prisoners at all was in the treble. Whereas the 52SE had a slightly over smooth balance, the Twenty Fives had clearly been honed by the same design team, but with the more sophisticated tweeter much more detail and energy came forth. On tracks with explicit treble detail, these loudspeakers really showed their worth, severely trouncing a more expensive metal domed 'genetically engineered' British speaker, sounding fast and detailed but never showy. Fed a poor recording, (lets just say some fairly early Reggae 45s), the Dynaudios were forgiving yet incisive – a fine balance.

Sound dispersion was excellent, and the speaker did not create any real "hot spots" in my listening room. Stereo imaging was well presented and controlled with great depth to recordings, but

to the point where the sound remained a bit to between and behind the speakers, despite some pretty forward recordings. Although not recessed or dull sounding, these are couch speakers in the Spendor vein, and will not come out and bite you. Midrange was superbly integrated, and climbing through my old Ella vinyl collection was a delight. Open and articulate, but quite restrained and never showy, this speaker revealed nearly all a recording could offer.

CONCLUSION

Dynaudio makes a big thing about the so-called "sound of a speaker" - be it the classic 'British' sound (e.g. BBC), or 'West Coast' (JBL, Altec, etc.) - and as far as Dynaudio go, it tries to make the speakers as neutral as possible. In truth, it's fast, tight, powerful, dynamic and yet tonally a little on the warm side – an interesting and unusual combination as things tend to be fast and forward or slow and subdued. Given its £3,000 price this speaker had a lot to do, and so it did. I cannot think of another speaker at this price point offers such a blend of qualities, be it bookshelf or floorstanding. Consider the superb build, finish and sound and throw in a limited production run and a twenty five year guarantee - and Dynaudio has a winner.

VERDICT ●●●●

A quintessentially Danish design with a commensurately Danish sound – smooth and balanced yet dynamic and detailed like few others.

DYNAUDIO SPECIAL 25 £3,000

Dynaudio UK
 ☎ +44 (0)20 7378 1810
 www.dynaudio.com

- FOR:**
- build and finish
 - superlative dynamics
 - well balanced sound

- AGAINST:**
- needs space
 - warm balance
 - unemotive

MEASURED PERFORMANCE

This apparently normal looking two-way 'speaker was interestingly different. I noticed the tweeter and woofer were too far apart to integrate without phase error in the vertical plane, yet measurement showed there was none. The opposite in fact, integration was unusually good and this was audible as a smoothness in the pink noise test signal. I quickly realised this was made possible by using a lower than usual crossover frequency, well below 3kHz, to increase the wavelength at crossover. Tests showed the tweeter reaches down to 1.25kHz, so it handles an extra octave of audio information. The idea is to smooth the upper midrange and improve dispersion, which augments imaging, as well as clarity and transparency. The smoothness of this loudspeaker's midrange is testament to the effectiveness of a good dome, and off-axis results were almost equally good.

The slow roll-off in forward bass output below 100Hz is peculiar, considering box size, but the Special 25 gets down to 40Hz all the same. It looks as if Dynaudio have chosen a well damped response to match near-wall placement. The port, tuned to 40Hz, does augment output, but bass will likely be light all the same.

The impedance curve is a flat 8ohms across the midband, but the bass unit is 4ohms. Sensitivity was a normal enough 86dB.

The Special 25 measures very well in critical areas. The extended frequency range of its tweeter is likely to be beneficial. Measurement suggests it will have some interesting sonic properties. NK

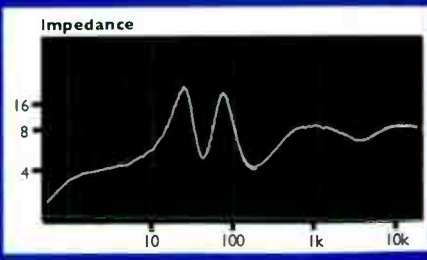
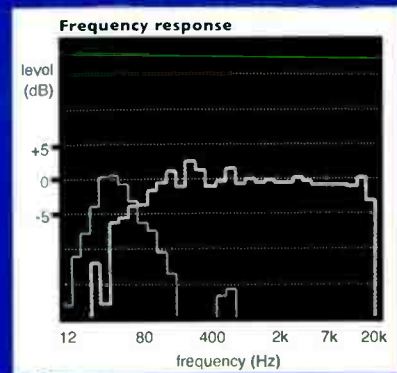

Two, Small

Channa Vithana tries two diminutive disc stages at radically different price points – the Cambridge Audio Azur 540P and Cyrus Phono X/PSX-R...



CAMBRIDGE AZUR 540P MM

At just £40, the Cambridge Azur 540P is an extremely affordable moving magnet phono stage. It uses what its maker calls a new proprietary short path circuit design, utilising 'high grade, low-noise transistors normally associated with far more expensive equipment', plus audio-grade poly caps for the RIAA filter section, and includes an integrated subsonic filter. The 540P is superbly built at the price and features a solid, well fitted steel chassis with a thick aluminium front plate. It measures 46x 215x 133mm and weighs 800g. Internally the MM stage is built around a single Cambridge Audio board with an aluminium screened power supply section. It has gold-plated input/output sockets with ground connection and 12V power input for the external plug-in transformer. The 540P has solid rubber feet at its base and as a whole its design is excellent, especially combined with its blue LED power indicator.

SOUND

Aphex Twin's '4' was tight, focussed and musical – which at the price was quite a shock. Frankly, you don't expect very much below £150 (Creek territory), but bass had depth and tunefulness, while the decaying low frequencies were warm yet

punchy. This rhythmical and playfully melodic composition, plus flaring keyboard melodies, were allowed to soar high and when combined with the warmer organic sounding synthesisers presented a well rounded musical whole. 'Fingerbib' had gorgeous warm synthesiser melodies which were under control yet emotionally lucid. The music was natural and nicely timed with plenty of dynamics and timbre. On 'Bist du bei mir' Janet Baker's vocals did not go into coloration when she reached vocal crescendos. The chamber organ/harpsichord was conveyed with a delicacy while the sound as a whole though slightly internalised was emotionally convincing.

With 'Could You Believe' from the Forcione/ Scuibba LP, the Cambridge portrayed the swiftly phrased acoustic guitar opening with a wonderfully vibrant and upfront in-room timbre. Sabine Scuibba's vocals were equally enjoyable as they were balanced with the instruments and neither the vocal, acoustic guitar nor bass dominated the song. Steve Steven's 'Run Across Desert Sands' is the outstanding track from 'Atomic Playboys' and it begins with a delightful flamenco tinged acoustic guitar with elastic melodic qualities. It becomes really expansive as it turns into an acoustic firestorm with tribal-like drums layered in, forming subterranean rhythmical backdrops

as the guitar ante is upped even further with staggeringly complex arpeggios and phrasing. Here the Cambridge still made a very decent effort within the intricacy of 'Run Across Desert Sands' where I could enjoy its superb musical composition without focussing on any limitations while listening. At twice the price of the QED Discsaver, but with seemingly ten times the performance, this isn't the sort of performance you expect for peanuts – so how on earth could the £700 Cyrus Phono X justify its lofty price?

CYRUS PHONO X MM/MC

In 1997 Cyrus produced the aEQ7 phono stage as part of a high-end system along with the aCA7 preamplifier and aPA7 monoblocs. Cyrus says that this combination took vinyl performance to another level beyond the previous Cyrus Pre which had an integrated phono stage. At yawning eight years late in February 2005, the company finally launched the new Phono X phono stage which preserves the basic topology of the aEQ7 with separate MM/MC head amps and optimised passive/active EQ, but which is said to be much improved with, "dramatically increased bandwidth" and has a raft of improvements where the, "RIAA equalization has been made 250% more accurate (and has) a flatter

frequency response (which) is vital in a phono stage, as 0.1dB error is very audible as it is over several octaves. (There is a) Significant reduction of parts in the audio path (where fewer) components mean less colouration. Improved quality passive components (and) power supply components have been upgraded to modern higher quality parts".

The Phono X has separated MM and MC sections with their own discrete inputs and arm grounds which allows a very small area of circuitry for each input, so not allowing noise to be induced at this sensitive stage, and the MM/MC switch to occur after the initial amplification so not putting a mechanical relay switch in the path of delicate MM sized signals, like most other phonostages. The unselected MM or MC input uses two shorting plugs to stop external noise being amplified in the case. RIAA equalization is a passive/active hybrid filter which gives, says Cyrus, "the best of both techniques for higher headroom and very wide bandwidth accuracy".

Indeed, the Phono X has selectable MC loadings through a switch on the rear panel for 10ohms, 100ohms and 1Kohm. These settings are each also available with a 1nF (shunt capacitor) setting for load sensitive cartridges that require a "capacitance load to control high frequency response peaks". The MM stage has an input impedance of 47Kohms. The Phono X is housed in the excellent design of the magnesium diecast Cyrus casework, measures 215x75x365mm and weighs 3.1kg. It is also upgradeable with a PSX-R power supply from a rear socket and has a programmable

MC BUS connection for system remote through a compatible Cyrus amplifier.

SOUND QUALITY

Using the Cyrus in moving magnet mode conveyed the layered warmth of '4' by Aphex Twin beautifully, and expanded the musical envelope set by the Cambridge 540P, now bringing the MM quality much closer to MC levels. Thus the music opened out nicely with the treble extended and musical timing improved - instilling a better sense of effortlessness. It was interesting to note that the Cambridge had better bass extension than the Cyrus(!) - but beyond immediacy, this was at the cost of bass tunefulness (low frequency dexterity).

On 'Fingerbib' a superior fluidity emerged to the rhythms and a very quiet background was also discernible which meant that the Cyrus invited higher volumes comfortably. Janet Baker's vocals on 'Bist du bei mir' showed gracefulness with finely crafted tonal shading and the harpsichord was also dexterously portrayed. As the piece expands, the Cyrus was always in control, never struggling with the vocal or instrumental crescendos. The sweet tonality of the Cyrus continued on 'Could You Believe' from the Forcione/ Scuibba LP as there was superior fluidity with the acoustic guitars. Sabine Scuibba's vocal phrasing was excellent and her more extended notes were handled superbly with enjoyable textural qualities that made me appreciate her particular vocal intonations. Steve Steven's 'Run Across Desert Sands' gained additional auditory fluency with the acoustic flamenco-style

guitar and when the music swelled, I was treated when the guitar strings were struck with better timbre.

Aphex Twin's '4' on the Cyrus MC setting gained in sheer energy as if it was a racer let out of the starting blocks. The music became dynamic, powerful and imparted superb midrange definition. The inherent warmth of the synthesiser used was consummated with finer skill while the delicate string-like melody became more alluring. On 'Fingerbib', the music became luxuriant in comparison to the MM mode, yet it was also more involving, while the asymmetrical arrangements were enjoyably focussed to provide deftness and dynamism. The rendering of 'Bist du bei mir' by the Cyrus (MC) expanded in sophistication where the harpsichord became ever so delicate, subtle, deep and sweet in execution and spatiality over its MM setting. The most noticeable difference and upgrade was in the orchestral instrumentation (inclusive of harpsichord) while the vocals also had enhanced spatiality and resolution but to a lesser extent.

The acoustic guitar on 'Could You Believe' from the Forcione/ Scuibba LP was deftly impactful. Sabine Scuibba's vocals were warmer, deeper and further extended - showing greater acoustic decay as her voice trailed off, adding to the overall three dimensionality of the

REFERENCE SYSTEM

Origin Live Resolution/Ultra + PS/Encounter 2 turntable/arm (£3,740)

Rega Super Elys MM cartridge (£150)

Ortofon MC10 MC cartridge (£300)

Linn Linto MC Phonostage (£995)

Densen B-250 pre/B-330 power amplifier (£6,000)

Waterfall Victoria loudspeakers (£2,000)



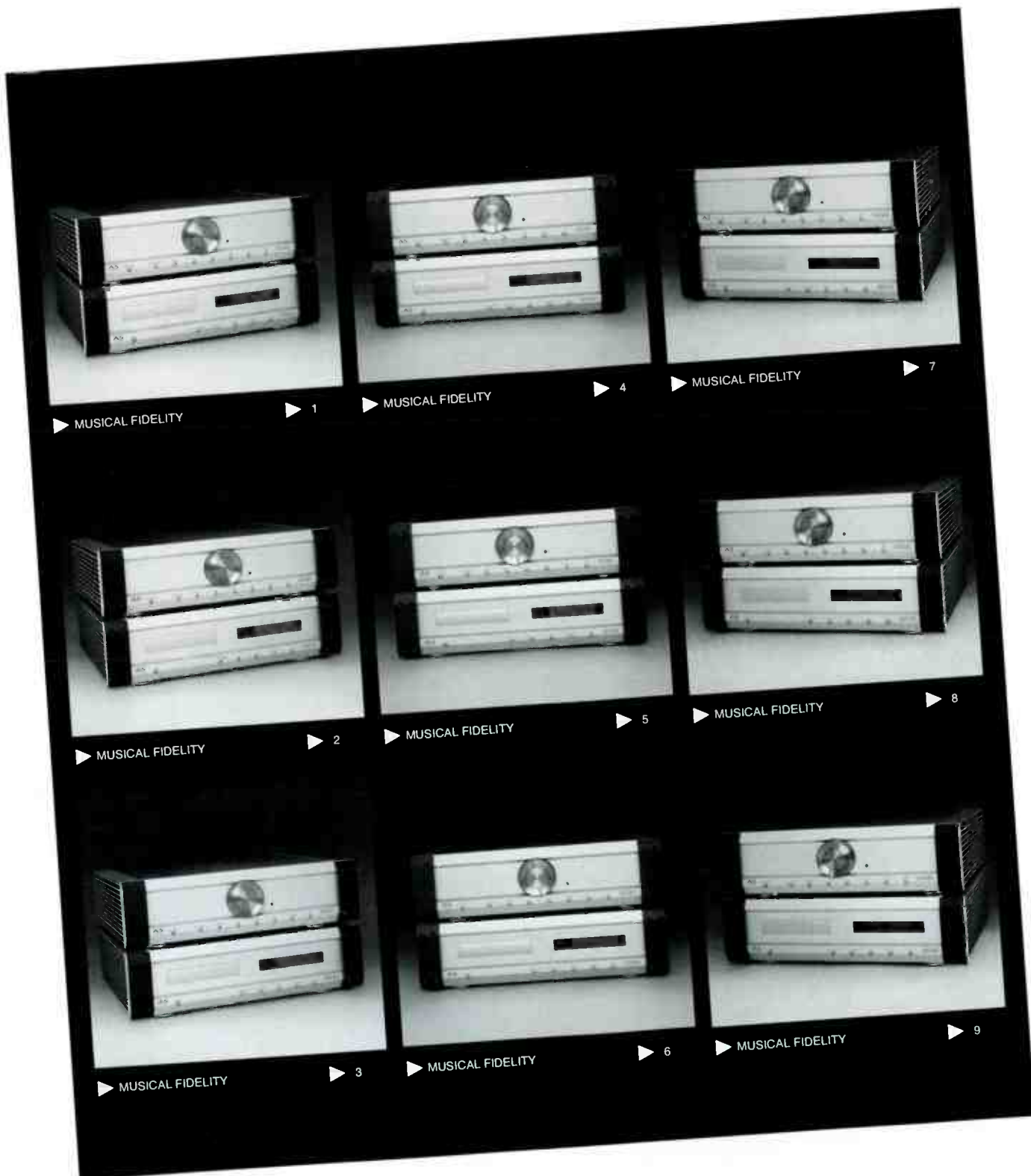

NEW FROM MUSICAL FIDELITY.
A5 SERIES.
X SERIES ACCESSORIES. X SERIES COMPONENTS.
kW INTEGRATED, PREAMP AND POWER AMP.
M1 TURNTABLE.
HEARING IS BELIEVING.

FOR DETAILS OF YOUR NEAREST STOCKIST, RING 020 8900 2866 OR VISIT MUSICALFIDELITY.COM



music. With 'Run Across Desert Sands', the Cyrus (MC) procured finer timbral qualities than the MM setting. The main rhythmic thrust as the music builds grew in greater impact, which imparted more energy into the recording but never distracted me away from the main structure of the music. The stunningly played acoustic guitar main melody sounded holographic now – in three dimensional feel.

CONCLUSION

What's the point of putting these two together? Well, it would be interesting if the Cambridge Audio

and better detail retrieval. Additionally the MM Cyrus had this utterly wonderful, sweet and delicate quality to it especially on the Janet Baker LP. With MC, the Cyrus became a different animal, a more upfront performer. It inherited the lush, sweet musical stance of its MM section, and ably to exhume vast amounts of detail. Subtle tonal shading and timbre from the LPs used were also unravelled, with highlights being the Forcione/ Scuibba recording plus the sound particularly on the Janet Baker LP being extremely luxurious.

For this reason many will

instantly warm to the Cyrus Phono X's acoustic charm, while others may prefer a less warm but no-less involving and

comparatively more energised and rhythmic phonostage such as the Linn Linto – or the more starkly high resolution wideband sonics of the Whest Audio PS20/MSU20.

Whatever, the Cyrus Phono X presents attainable high-performance it a very human way, and is all the better for it.

POWER PLAY

Connecting the upgrade £400 Cyrus PSX-R DC power supply [see P59 of our September 2005 issue for more details] to the Phono X allowed Sabine Scuibba's vocals to become stunning with greater emotional feel, while the sliding fingers on the guitar strings became more evident adding to the superior timbral feel. Steve Steven's acoustic guitar had more space created for it within the composition, while the timing was improved further. The music became super-slick as the better timing procured an almost slippery layering of the tribal-like drums, keyboards and Steve Steven's genius acoustic guitar melodies and phrasing. The addition of the PSX-R to the Phono X could thus be described as combining the lushness of the MM stage with the vitality of the MC section. The music on the Aphex Twin LP became deeper, better defined in both the midrange and bass with an overall improvement in musical timing. The somewhat flaring qualities of the rougher electronic elements were better controlled, yet never stifled. The wonderful string-like melody gained in timbre, while the new found energy and rhythmic thrust was most welcome. Janet Baker's vocals were even better with the PSX-R as they improved with an appropriate prominence within the main structure without attrition to the rest of the music – where the orchestration also improved with better clarity and definition. Worth it? You bet.

MUSIC

- Aphex Twin 'Richard D. James Album' (1996)
- Janet Baker/Neville Marriner 'Bach Arias' (1976)
- Antonio Forcione & Sabine Scuibba 'Meet Me In London' (1998)
- Steve Stevens 'Atomic Playboys' (1989)

whipped the Cyrus, wouldn't it? But it plainly did not. What we can say is that this £40 gem acquitted itself admirably in a high-end review system, showing few signs of its budget origins – which is a brilliant achievement. Its very musical sound was especially good in the low frequency regions, making for a warm, dynamic and vibrant acoustic. Its overall sound quality is a little internalised though, and wasn't as lyrical or expansively widescreen as the Cyrus Phono X, but then it is less than one seventeenth of the price!

The Cyrus Phono X surprised with its MM capability, as it produced a deep and extremely quiet background for LPs, which presented music in a lush and soulful manner. It was so quiet in the background that I continually pushed the volume higher and it did not become muddled. The sound via MM came closer to MC performance which means widescreen dynamics

TWO TRIBES

So how does the pricey Cyrus Phono X/PSX-R compare to the great (and substantially pricier) Linn Linto? Well, the latter had better vocal definition, with a slightly more upfront musical presentation with Janet Baker's vocals from 'Bist du bei mir'. The Cyrus duo had a sweeter presentation compared to the Linn's dynamism and impactful stance. On '4' by Aphex Twin, the Linn also had more impact than the Cyrus duo, while the sweet tonality previously from the Cyrus was not present. The individual instrumental elements had greater impact, yet timbral resolution was the same as the Cyrus duo. Sabine Scuibba's vocals on 'Could You Believe' were well intoned and expressive through the Linn but the more complex vocal timbral qualities that the Cyrus duo ably expressed such as more obvious breath inhalation were lessened. Additionally the three dimensional acoustic decay when notes were complete and allowed to fade was less prevalent with the Linn. With the Steve Stevens LP, the Linn had delicacy and awesome musical timing as 'Run Across Desert Sands' started to roll. Bass extension was also superior to the Cyrus duo while there was parity with the more important bass tunefulness. Overall the Linn preferred a less romantic and subsequently less sweeter presentation than the Cyrus duo, and went forth generally with better bass extension, timing and with better instrumental impact. The Cyrus was better able to dig into some really fine subtleties in both vocal and instrumental timbre though, and while slightly less of a rhythmical beast than the Linn; it was definitely not a slouch in the musical timing department as it proved in isolation.

CAMBRIDGE AUDIO
 AZUR 540P ●●●●● £
 CYRUS PHONO X ●●●●●
 Cambridge Audio
 ☎ +44 (0)207 940 2200
 www.cambridge-audio.co.uk
 Cyrus Audio
 ☎ +44 (0)1480 435 577
 www.cyrusaudio.com



The colouration's in the finish



Not in the music



Pro-ject
AUDIO SYSTEMS World Radio History

Distributed by: Henley Designs
01235 511166
www.henleydesigns.co.uk
info@henleydesigns.co.uk

Mini adventure



Genelec hail from the eastern Lakeland region of Lisalmi in Finland, producing serious active speakers for the recording industry for over twenty five years and counting composers Jean Michel Jarre and Ryuichi Sakamoto amongst their devotees. Recently Genelec has moved into the domestic home-cinema/ multichannel-audio sphere. Channa Vithana reviews the HT205.

The HT205 is the smallest active speaker in Genelec's HT range. It is superbly constructed and a delight to handle. The HT205 differs from many active monitors by being made entirely of aluminium. Each cabinet is formed from two cast aluminium sections combined as a solid chassis housing the 19mm metal dome tweeter, 130mm cone bass driver (into a 4.5L vented cabinet), bi-amped 2x40W amplifiers and active crossovers. The aluminium construction also means that the necessary heat dissipation for the internal amplifiers is an integral part of the cabinet. (In some active monitors, heat dissipation is a lazily designed afterthought in the form of crude metal heat sinks attached to the back of wooden cabinets.)

The Genelec heatsinks form the second smaller rear aluminium

section and are beautifully crafted. They have a raked, angled geometry with deeply grooved profiles radiating from the centre of the rear panel that wrap around onto the sides. The heatsinked rear panel also has hidden screw fixings, brackets and drilled-out bolt-fixings for wall mounting. There is an annotated black panel in the centre of the rear that allows for bass and treble tilt (adjustment) through the active crossover via a series of dip switches and also voltage selection. Below, the form of the rear panel is hollowed out to incorporate IEC power socket with both phono and balanced XLR signal inputs. This hollowed section enables close proximity fixing to walls or brackets without the cables jutting out and getting in the way. There is also a screw-in fixing to the base of each speaker enabling attachment to microphone stands.

At the front are the openings for

the magnetically shielded drive units which are protected with profiled mesh to match the shape of the dome and cone to the treble and bass units respectively. The 19mm metal dome tweeter unit is located within the front aluminium cabinet around a gently radiused inverted dome surround. Regarding this, Genelec employ a 'Directivity Control Waveguide' (DCW) that, "uses a shallow concave geometry that enables the driver crossover points to be seamless -- an invisibly smooth blending of outputs". On either side of the treble unit are slotted vertical ports and below the bass unit is an on/off switch with green LED power indicator (above) to the left and a signal-input/volume control to the right. The signal/volume control is useful; firstly if the Genelecs are fed through a preamp, you can adjust the signal input to tailor the sound of source

SUGDEN AUDIO *Rescuing music from technology*

Designed and manufactured in England

A21SE Pure class A Integrated amplifier



The new 21SE Series available in titanium or graphite

Products available for your musical enjoyment

Masterclass - Bijou - A21a Classic Series

40
YEARS

tel 01924 404088
www.sugdenaudio.com

J E Sugden & Co Ltd
Valley Works
Station Lane
Heckmondwike
West Yorkshire
WF16 0NF



Tubesonline Ltd

The UK Online Store For
Audio Tubes And
Semiconductors

- *Electro-Harmonix*
- *Sovtek*
- *NOS*
- *Audio Amplifier Ic's and Modules.*

Browse Our Stock At
www.tubesonline.com

Tel: +44 (0)1388 747510
Fax: +44 (0)1388 747577
Email: sales@tubesonline.com

audiolab



WWW.STEREO.CO.UK

As the area's leading Hi-Fi Specialist, we invite you to our superb demonstration suite to audition the fantastic new range of hifi separates from Audiolab.

Free Parking. Finance Available (subject to status)
Romers Hi-Fi, 11 Lomax Street, Great Harwood,
Blackburn, Lancs. BB6 7DJ

9am > 5pm Mon - Sat

01254 880220

RIMERS

the home entertainment specialists

instruments and there is no potentially sound degrading level matching circuitry from either the preamp or internal power amps involved. Secondly it acts a practical volume control when driven direct from a single source. Thirdly you can alter the balance without degraded sound quality through a balance control from the preamp.

Construction is reassuringly solid, negating any obvious resonances from the build. The design is a resounding success, being compact yet well crafted as there are no sharp edges - every surface is curved, profiled, countersunk or smooth. The HT205s are available in White, Silver, Grey and Black painted finishes. The review pairs were finished in silver, having an attractive metallic glaze.

SOUND QUALITY

Compared to normal speakers, these Genelecs are initially very disconcerting. They have a sound that is essentially neutral yet paradoxically engaging! On the 'Beethoven Piano Sonatas', the piano had real body, depth and colour. There is a deep spatial quality to the sound which is innately vibrant without being bright or forward. The Genelecs produced a great acoustic considering their size with an unforced, uncoloured sound.

There was superb timing as the notes reached crescendos, the keys were played fluidly and rolled along without missing a micro-second with regard to changes in emphasis and the direction of notes. 'Grave; Allegro' is a meandering piece going from really quiet, near silent intonations, through to delicate melodies and then crashing and occasionally thunderous codas. As such it requires a sophisticated speaker to portray these qualities and the Genelecs did not fail. Indeed they proved unflappable, ably handling the frequency extremes, extremely well - because they had an understanding of the subtleties of the piece.

The Carpenters 'Yesterday Once More' was sublime, with Karen Carpenter's peerless vocals coming across in a spine-tingling and emotionally resonant manner. Timing for both vocal and vocal/ instrumentation coherence was impeccable, procuring stunning atmospheric from what are ostensibly quite simple musical arrangements. Karen's vocal filled the room and the piano opening was joined by the percussion and the rest of the band with a balanced ordered yet engaging delivery. The sound was so direct

that there wasn't any sign of grain or enforced sweetness. On 'We've Only Just Begun'; the Genelecs ably revealed Karen's vocals as they went from honeyed liquid-caramel to plaintive and then soaring chorus. Scritti Politti's 'Umm' was also successful through the Genelecs, which unravelled the multilayered and esoteric pop/ rock/ rap/ ragga production. Green Gartside's unique vocals are a thing of beauty, and inhabit the upper mid to high frequencies so they can also be a bit overwhelming when he goes for the peaks. However - as with Karen Carpenter's - Green's vocals had in-room presence, holography and delicacy which is impressive considering the varied musical brew he had concocted. The rapping mixed well with the electric guitars, drums and synths to produce sophisticated musical separation yet seamless layering also.

CONCLUSION

If you want a simple no-nonsense system that saves space, is well-built, superbly crafted, and unobtrusive - with a direct, engaging, and unflappable yet limited-coloration sound then I can heartily recommend these little Genelecs. With immediacy they are quite unnerving but as you listen for longer periods then the positive benefits of closely matched bi-amplification, drive units and active crossover begins to outweigh any negatives concerning close proximity vibration characteristics to these internal speaker components. Due to their size, they will obviously not do deep bass like a comparatively priced and/or larger standard speaker, yet they offer a tantalising alternative to the norm. They have absolutely stunning timing and because of the solidly made cabinet, any normal speaker coloration or awkward resonances were not easily discerned. And this is why they initially seem strange, but ultimately they make a very strong case for the active route because good active speakers like the Genelecs are the missing-link between headphones and passive loudspeakers.

CONNECTIONS:

I would strongly recommend using the balanced XLR interconnects and direct from source with level handled by the Genelec's own volume control. I preferred this arrangement as connection through both the Exposure and Creek diluted and softened the sound of the Genelecs compared to direct connection. Using the XLRs compared to standard phonos in all instances was superior because the Genelecs were transformed into an amazing little speaker, totally energising the sound and bringing forth greater dynamics and simply letting more music out. Using balanced XLRs needn't brake the bank either as I had superb (sonic and aesthetic) results with a £600 Inca Designs Katana CD player as well as the £2000 Marantz SA11-S1 SACD/CD. I experimented by replacing the standard mains cables needed for the source and both Genelecs and had excellent results using three matched sets of either the low-cost £29.95/M Russ Andrews Accessories Yello cable or the more expensive £180 Phonosophie AG - both are accomplished upgrades.

VERDICT ●●●●●£

Brilliant active mini-monitors with superlative timing and grip. Outstanding value for money.

GENELEC HT205 £798
PR (£399 EACH)
 Genelec (SCV UK)
 ☎ +44 (0)208 418 1470
 www.genelec.com

FOR

- design, build & finish
- unflappable yet engaging
- compact and unobtrusive

AGAINST

- best connected direct

QUOTED SPECIFICATIONS:

Dimensions 247x191x151mm,
 Weight 5.7Kg each
 Signal to Noise ratio ≥ 90dB
 Distortion THD ≤ 0.08% at nominal output
 Volume Control Range -6dBu to 100dB

SET UP

I placed the Genelecs atop birch ply stands onto laminate wood flooring over concrete floor into a concrete walled 4.5x6.5m room, 2 metres apart and 350mm from the back wall with a slight five degree toe-in. I sat 1500mm away. I preferred the bass and treble tilt set at zero as the Genelecs did not have a discrepancy with the acoustics of the listening room. They did not have any directivity problems either, sounding agreeable from many seating/standing positions.

MEASURED PERFORMANCE

Massively heavy for their size and strong, these compact Genelecs have cast aluminium cabinets housing two power amps, each rated at 40W, one for treble and one for bass. Genelec claim a maximum steady output of 98dB at 1metre, but 110dB peaks with music - about as loud as any speaker of this size can go. Our review samples gave 90dB from just 100mV rms of pink noise input, so they are sensitive enough to be driven by any pre-amp. Frequency response was impressively flat, especially across the bass, but Genelec have carefully tailored in a slight downward trend toward high frequencies, to add a little body and ensure treble doesn't dominate. The metal dome tweeter is a good one, with a particularly smooth response (and thankfully no phase plate!). Various bass shelf cuts can be switched in to eliminate wall reinforcement, room boom etc, plus one treble shelf of -2dB for a warmer sound.

63Hz then cuts dead. Genelec claim to use a -18dB/octave filter at 68Hz to do this - a very steep roll off. Expect fast bass with real punch, but no deep rumble.

Genelec also cut off treble above 25kHz, so supersonics from DVD-A and SACD, insofar as they exist, will not get through. The 6040as should resolve their low distortion however.

These are very tightly engineered loudspeakers, using good drive units. I'd expect a fantastic sound, likely punchy and detailed, with superb grip, plus a nice fulsome tonal balance. Very impressive. NK

The 6040a is notable in the way it delivers almost perfect bass down to



True Digital...

We class our amplifiers that accept analogue inputs and digitize the signal as 'semi digital'. They offer great performance and value. Our range starts at £775.

True digital amplifiers accept a digital signal and do not require this 'unnecessary' initial conversion. Less distortion, purer music. Superior technology. A little more expensive to create - but worth it.



TDA2200 - 200w True Digital Amplifier

Our latest formidable product, the TDA2200, further supports Lyngdorf's mission to build the world's highest performing, best-value intelligent digital amplifiers and room correction systems.

Available now, and ready to accept the forthcoming room correction system module.

The Design

State of the art sound quality achieved with further development and refinement to the clock, power supplies and output stages to reduce jitter and noise. More power, detail and music is delivered with an uncanny smoothness from a pitch-black background.

Powerful room equalization, speaker and subwoofer crossovers extend this amplifier to an incredibly comprehensive and advanced digital system. Room interactions can be minimalised, which results in a breath-taking improvement to musical enjoyment.

Simple, logical and elegant system building. Just connect a CD transport to this amplifier and you have all the necessary electronics to drive your speakers. No need to purchase DACs, preamplifiers, numerous interconnects, power cables and shelves.

As new software becomes available, the performance and functionality of the TDA2200 can be upgraded, protecting your investment.

LYNGDORF

0870 9 100 100
www.tactaudio.co.uk
www.lyngdorfaudio.co.uk

Affordable High Performance PHONO Amplifier from TRICHORD RESEARCH

Dino

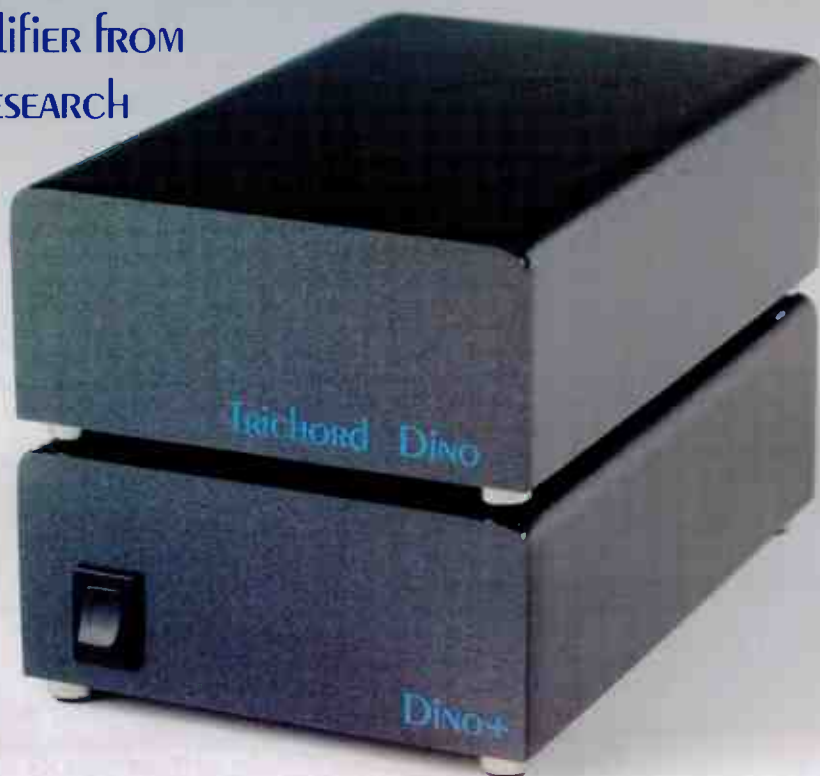

Moving Coil
Moving Magnet
Switchable Gain
Switchable Loading
Super Regulators
Discrete Output Stage
Upgradeable Power Supply

'NEVER CONNECTED'
power supply now
available for the Dino.

If you already own
the Dino+ power
supply you can have
it brought up to date
with this unique noise
reduction technology.

PLEASE CONTACT US OR
YOUR DEALER FOR MORE
INFORMATION.

Tel: +44 (0)1684 311600

www.trichordresearch.com

King Size

There's no other phrase to describe Musical Fidelity's new kW SACD player, says Channa Vithana...



Although there's no denying that the latest generation of Musical Fidelity electronics are stronger than they've been for a long time, the company's premium priced silver disc player has always held a special place in this magazine's heart – not least since editor DP heard the Trivista SACD in his reference system some four years back. With this in mind, the kW SACD has much to live up to...

So this new £3,995 two-channel SACD spinner is Musical Fidelity's latest 'big' statement player – following on from the £2,960 Nu-Vista CD in 2001 and £3,995 Tri-Vista SACD in 2003. In classic Musical Fidelity style, it is a limited edition of 500 pieces for the world, and is rather un-self-effacingly described as a "big, big step forward". Well, they're not wrong terms of size at least, as it is a whopper – measuring 483x167x443mm and weighing 19.5kg, no less! The kW SACD is finished in the latest MF style/size to match the rest of the new kW range which comprises £2,999 kW Pre Amplifier, £5,999 kW 750 Power Amplifier and £2,499 kW Phonostage. Thus it features a very thick and heavy aluminium outer case with steel

inner chassis.

The front panel is made up of a massively thick silver fascia plate which is profiled into an angled extrusion at the top and a thicker angled one at the bottom for the operation buttons. In the middle is the large and very good display, which is visible from a distance and uses its entire aperture to exhibit functions. Just below the display is the drawer front which has a thick plate screwed into it, matching the silver of the front face.

Either side of the display and drawer opening are two black angled handle-like ornamental design motifs. The side panels are profiled ribbed types like heatsinks, similar to the ones on the Nu-Vista and Tri-Vista players and the top is a bluff affair with flush-fixed hex-head screw fixings which is easily visually superior to the vast amounts of raised dome-head black screws that adorned both of the kW SACD's processors. The kW series from a visual, design point of view reminds me of Musical Fidelity's older and fascinating F-15/F-22 high-end pre/power amplifiers, which also had silver fronted casework and (very attractively curved) black handle-like design motifs on each side, but with finer ribbed line-details across the top and bottom.

The rear panel has coaxial and optical digital outputs, an IEC mains input and interestingly one set of phono sockets for 'Solid State Class

A Output' and the other employing two 6112 'mu-Vista' valves for a 'Tube Class A Output' at the same time enabling both to be connected, allowing the user to switch between preferences if desired. The kW SACD also employs the glowing feet seen on the Tri-Vista SACD which means that on switch-on they are red, then after a few minutes amber and finally in approximately thirty five minutes they turn blue indicating fully warmed-up performance. The glowing blue feet are part gimmick, part useful but they are also quite soft in hue and not garish, thus the blue breaks up the rather huge expanse of black and silver real estate.

Internally, the kW SACD uses 24-bit Delta-Sigma (Bitstream) Dual Mono, Dual Differential 8x oversampling DACs which are implemented in "a completely different DAC and filter stage for CD and SACD". This means Musical Fidelity have been able to optimise the characteristics of each DAC to suit the (respective) format. The kW SACD uses a Phillips transport which in combination with good-quality output stages, power supply and choke regulation [see CHOKED UP] has excellent sound quality, as the listening assessment has revealed. However, the Phillips mechanism has a rather rudimentary disc loading drawer which is not as good as the one found on MF's Tri-Vista SACD from 2003, for example. This is not Musical Fidelity's fault, but it is a sign

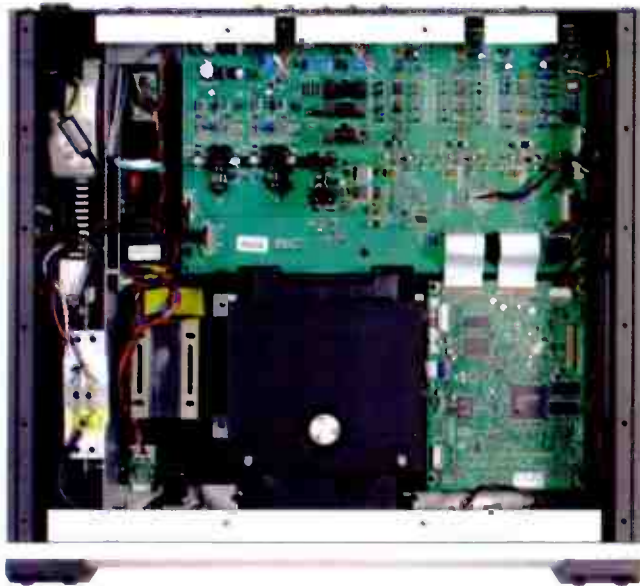

of the times that unless you are like Esoteric or Linn - for instance - who can develop purpose built engineering for transports, a manufacturer is usually at the mercy of an OEM supplier...

SOUND QUALITY

The opening guitar chords and drum track from 'Suicide' by the Dammed were powerfully enunciated, and vocals were handled very well - showing David Vanian's intentionally differing oratory styles that vary from the shouty to actual singing. The treble quality through the cymbals on the drums and the higher frequencies of the guitar were excellent, and they reminded me of the authoritative qualities of the £9,000 Esoteric X-01 SACD player [see HFW August 05]. The musical timing was very good, where the kW SACD coped brilliantly with the demanding Dammed when they went from punk-rock shambles into traditional rock and roll and back again. The organ melody in the middle of 'Suicide' was brilliant with fastidiously good texture and timbral qualities. The bass in both extension and dexterity was stunning as low frequencies escaped the confines of the speakers yet still very much part of the musical whole. On 'Smash It Up Part 2', the drums (including cymbals) were once again superb, never going into splashy subjective distortions enabling a clear, distilled and raw performance of the seventies era Dammed. The rhythmical and beat quality was suitably driving and made for an enjoyable and appropriately raucous experience.

The film extracts at the beginning of 'Blush Response' from 'Blade Runner' were revealed with

warmth and perceptive disclosure of the echo/reverb emphasising a more three-dimensional feel. Then as the main compositional elements came in - such as the shimmering keyboard elements - the kW SACD handled them with authority. Bass extension and dexterity was excellent, but I felt the kW SACD internalised the grand, vast and sweeping melodies that Vangelis so ably stamped his identity with on Blade Runner the film. Personally, the centrepiece of the 'Blade Runner' soundtrack is 'Blade Runner Blues' as it is easily the most atmospheric piece on the album and the kW SACD fared much better with the gorgeous main melody as it was expansive, highly resolved and subjectively low in coloration. The lush electronic backdrop formed a vast canvas as it throbbed gently to allow this melody to shine, meander and evoke the dystopian themes of the film. 'Tales From The Future' was very good as Vangelis's throbbing keyboard backgrounds intensified and then an unrecognisable Demis Roussos sings a redolently eerie eastern-styled vocal which made for a suitably atmospheric rendition combining with its tinkling chimes that extended beyond the speakers nicely.

Michael Nyman's 'The Piano' SACD had superb high frequency extension with the violins and a wonderfully expanded, powerful melody from 'To The Edge Of The Earth' came out into the room. The violin phrasing was very good as it conveyed a nicely rounded three-dimensional feel. There was additional delicacy as the composition progressed where the high frequencies were handled beautifully with an authoritative, expressive and faithful musical eloquence. On 'Big My Secret' the piano had a gorgeous timbre which was warm yet far reaching and filled the listening room beautifully. The upper notes were brilliantly executed as they were

CHOKED UP

The kW SACD uses the MF favoured choke regulated power supply which they first introduced in 1988 in their SA470 amplifier and in many of their recent amplifiers and CD players. They say, "a choke regulator is a large transformer in series with the power supply. It offers extremely low resistance to DC and extremely high resistance to AC. Pure power supply is DC; any AC components is noise of one sort or another. Hence, a properly-implemented choke-regulation design will dramatically reduce power supply ripple... Once the choke has reduced power-supply ripple and/or noise... what remains is unobtrusive second harmonics. Due to their intrinsic power-supply rejection properties, our circuits cope with these easily. Using a choke also reduces switch-on power-supply surges, and also makes the circuitry almost completely immune to any form of mains interference".

struck with a slippery delicacy which combined with depth from the kW SACD's fine bass extension. On 'A Wild And Distant Shore' the powerful dynamics of the deftly placed orchestration allowed the different instruments to be expressed within a cohesive whole. I particularly enjoyed the far-reaching string sections as they were emotive yet appropriately disciplined.

On the Roxy Music SACD, 'Avalon' was as warm and languidly enjoyable as it should be. The good musical timing allowed an effortless, natural feel to be prevalent. Bryan Ferry's vocals were well-rounded and had excellent timbral information. Switching over to the kW SACD's valve output brought on an enormous improvement to the already good solid state 'Avalon'! There was lyricism, deftness, excellent layering and the sound was deeper and more fluid. The music gained in a newly emotive midrange but at the expense of the authoritative and faithful high frequency ability from the solid state output. The saxophone melody now became really luxurious, while the female backing vocals gained in three-dimensionality.

If that sounds good, then I was in for SACD shock when I played 'Avalon' through the £2,000 Marantz SA-11SI - as it apparently bettered the kW SACD in several areas, even in its 'mu-Vista' valve guise! 'Avalon' was arresting on the Marantz with a wider, more musical presentation. Timing was superlative, but the most amazing thing was that the Marantz combined most of the excellent qualities from the two outputs (i.e. authoritative high frequencies of the solid state and luxuriant valve) of the kW SACD on 'Avalon'. Yet however dextrous the Marantz bass was, the kW SACD bettered it for extension though. Indeed, on the 'Piano' SACD the delicacy of the instruments in the midrange and string timbre in particular were better communicated with the kW SACD, through its superior layered harmony phrasing.

MUSIC:

The Damned 'Machine Gun Etiquette' CD (1979/ 2004)
 Vangelis 'Blade Runner' CD (1982/ 1994)
 Michael Nyman 'The Piano' SACD (1993/ 2003)
 Roxy Music 'The Best Of' SACD (2003)

music because it was not only delightfully extended and multilayered but

unfortunately sacrificing its untainted high frequency ability somewhat in the process. Indeed the only blot on the kW SACD's landscape is the

£2,000 Marantz SA-11S1, where it fared less well with the Vangelis CD and Roxy Music SACD, while the Marantz excelled, easily outperforming it. Don't get me wrong, I am very pleased with the

performance of the kW SACD, it is clearly superior to the £5,000 Denon DCD-SA1 in almost all respects, but not the outright master of the Marantz which is half the cost at 'only' £2,000. As such, serious auditioning is required, but if money is not an issue and you want the most complete sub-£5,000 silver disc spinner around, then you've just found it.

REFERENCE SYSTEM:

- Densen B-250/B-330 Pre/Power (£6,000)
- Waterfall Victoria Speakers (£2,000)
- Marantz SA-11S1 SACD/CD Player (£2,000)
- The Chord Company Signature Interconnect (£500)

On 'Big My Secret' the piano had great musical timing and subtleties with the Marantz but there was a slight yet discernible silkiness to the high frequencies. The kW SACD had better timbral qualities; evocating a more rounded acoustic, and the kW SACD bettered the Marantz on 'The Piano'. The Marantz produced a truly excellent account of itself with 'Blush Response' from 'Blade Runner' in comparison to the kW SACD which struggled a little with this track. The Marantz allowed the music on 'Blush Response' to gel perfectly with the divergent musical and spoken word elements to form an enjoyable cohesiveness. 'Blade Runner Blues' was very good on the kW SACD but significantly bettered by the Marantz as it focussed on the undulating and mesmerising melody procuring a vast and elastic sound. The kW SACD once again had a better bass extension but the Marantz was arguably superior overall with 'Blade Runner'.

The difference between the Marantz and kW SACD was most acute with The Damned's 'Machine Gun Etiquette' CD where the Marantz failed in comparison. The Marantz had an internalised and shut-in performance and the timbral qualities of the vocals and instruments were significantly lessened as if the music was trapped within each speaker. This isn't to downplay the Marantz's achievements (it is half the price, of course, so quite the reverse!), but it shows that the extra money buys you a fuller and more tonally faithful performance, that goes the extra one-tenth to unlock the textural quality of the music. It might seem a trivial point, but it's what makes listening to the MF so special; a sense of grain, of patina, of tonality that you'd otherwise struggle to find away from high end vinyl (analogue addicts: think the difference between the Ortofon Kontrapunkt C (Marantz) and Koetsu Red (MF))

CONCLUSION

The Musical Fidelity kW SACD is, with the exception of the Phillips transport loading tray, a well-built and thoughtfully engineered player. For two main reasons firstly, the (in solid state output) authoritative treble quality which was faithful to the

more importantly did not have any discernible traits such as sweetness or silkiness. Secondly, the kW SACD has powerful, extended and dextrous bass which never dominated or upset the musical timing in any of the music used for the review. Thus the £3,999 kW SACD outperforms the £5,000 Denon DCD-SA1 two channel SACD player in overall musical ability with a delightfully deft hand at melodies and

excavation of finer details, while it isn't far behind with bass extension and tunefulness. The kW SACD also communicates on the same wavelength - if understandably not directly comparable in performance - with the sublime £9,000 Esoteric X-01 in terms of its superb high frequency narration.

The kW SACD made an unholy alliance with the Damned's 'Machine Gun Etiquette' CD and Michael Nyman's orchestral 'The Piano' SACD where it performed brilliantly, especially with instrumental timbre, the space around notes and instrumental/vocal decay that heightened a wonderful three-dimensional feel on both discs. Also the kW SACD worked much better, for me, using its valve output in preference to the solid state one as it procured a much deeper, lucid and engaging sound but



VERDICT

Brilliantly complete SACD performance, with the accent on sumptuous tonality and bass extension, makes this an essential audition.

MUSICAL FIDELITY

KW SACD £3,999
 Musical Fidelity
 +44 (0)208 900 2866
 www.musicalfidelity.com

FOR

- bass extension/ dexterity
- superb treble (solid state)
- fine midband (valve output)

AGAINST

- clunky Phillips disc loader

MEASURED PERFORMANCE

The CD section of this player has a flat, smooth response, showing just a slight roll down at high frequencies. The upper -1dB limit was normal enough at 20.75kHz, so I would expect this player to have an even tonal balance free from hardness.

Distortion figures were good over the entire dynamic range on CD, if not quite as good as the best. With SACD distortion dropped dramatically as expected, to just 0.04% at -60dB for example, five times less than CD. Our analysis shows this result. So the kW SACD section fully resolves SACD's intrinsic linearity, unlike some players. Tube output stages normally add a little second harmonic distortion, but this player's stage made little difference; at 0dB distortion measured 0.0006% still, and at -60dB just 0.05%, little different from the direct output.

Like many recent SACD players - and quite unlike DVD players - this one's frequency response rolls away gently above 20kHz, in analogue fashion. By 40kHz it is nearly -2dB down and out at 100kHz -24dB down. The idea here is to retain analogue properties whilst at the same time keeping a check on the supersonic noise that plagues SACD. It's a fair compromise.

With low noise, excellent dynamic range and deep channel separation the kW SACD player measures well in all areas. It should deliver excellent results in use. NK

Frequency response (-1dB)		
CD		4Hz-20.7kHz
SACD		2Hz - 34kHz
Distortion		
	CD	SACD
0dB	0.003%	0.0006%
-60dB	0.22%	0.04%
-80dB	9.1%	0.44%
-100dB	-	3.2%
Separation (1kHz)		110dB
Noise (IEC A)		-102dB
Dynamic range		112dB
Output		2.25V

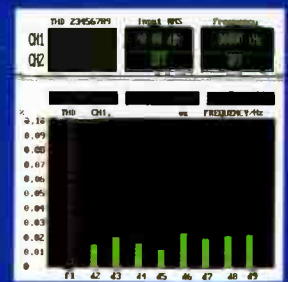
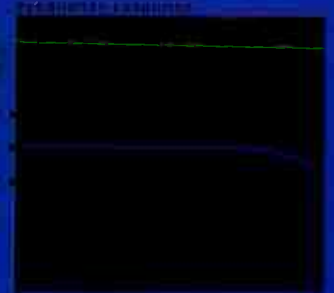

Hyperion 938

major award winner



When a product wins this many awards in a single year, you know to expect something pretty special!

No matter what your expectations are, nothing will prepare you for your first encounter with the **Hyperion 938 loudspeaker**.

The beautiful piano high gloss finish and attention to detail can hardly fail to impress but its the noise this speaker makes that will leave most speechless. Listen to other speakers and in most cases you'll find one aspect, one area that you wish you could change to create that perfect loudspeaker. Listen to the **Hyperion 938** and the first thing you'll ears will tell you is just how balanced the 938 is. You really cannot fault its performance in any area.

A duo-cabinet design has been created for this full-range 3-way speaker. With a dedicated cabinet for the bass, two 8" 5.WF woofers are used instead of a larger size woofer for truly amazing bass speed, resolution, coherence and impact. The New HPS-938 is your answer to a new level of audio experience.

The piano high gloss black version sells for £3,750 and birds-eye maple version for £4,500. Reviewers/customers are comparing the **Hyperion 938** to speakers costing three or four times the price.

This high-efficiency loudspeaker (90dB) can be driven by both valve and solid-state amplifiers with ease. Contact **Shadow Audio** for more information and to arrange an audition of these next generation loudspeakers!



BUY THE HYPERION 938 WITH OUR NO RISK 30-DAY MONEY BACK OPTION* *CONDITIONS APPLY

Best Part-Exchange Prices

For full details of our extremely comprehensive range of products, our extensive used listing, links to reviews, technical information and much more, visit www.shadowaudio.co.uk



CD Players

Accuphase DP67 CD player (£4500)	£2995
EAD DSP 9000 Pro S3 DAC pre	£1495
Wadia 302 CD player (£4000)	£2995
Meridian 566 24bit DAC	£390
Musical Fidelity Nu-Vista CD Player	£1695
DCS Verdi latest spec	£3595
Audio Analogue Meastro CD player	£795
DCS Verdi La Scala Transport (£9499)	£6595
Shanling CDT-100 (3D acoustics UK model)	£990
Audio Analogue Paganini (£950)	£795
Musical Fidelity A308CD player	£995
Roksan Kandy MKIII silver/black ex-dem	£450
Audio Analogue Paganini	£475
Audio Analogue Meastro CD player	£950

Amplifiers

BAT VK-3i valve pre amplifier with BAT phono stage.	£995
BAT VK-200 power amplifier	£995
Parasound Halo JC-1 mono blocks (£5600)	£2995
AVI S2000M mono blocks (£2000)	£695
Quad II Forty valve pre/power system (£4000)	£2495
Boulder 1012 DAC pre (£12950)	£6595
Musical Fidelity A3 CR pre-amp (£1000)	£395
Musical Fidelity X-80 v3	£265
ART Diavolo Power Amplifier (£5402)	£1795
Pathos Classic One mkII (£1400)	£950
Shanling STP-80 integrated valve amplifier	£1695
Pathos Logos Integrated	£1695
Audio Synthesis Passion Ultimate passive pre	£795
Moon i5 integrated amplifier (£2695)	£1695
Plinius SA 100 MK3	£1695
Plinius M16P (with phono stage)	£1195
BUY THE ABOVE PRE/POWER TOGETHER FOR ONLY	£2295
Classe CA-401 power amplifier	£2995
Classe CP 47.5 reference pre amp	£1295
BUY THE ABOVE PRE/POWER TOGETHER FOR ONLY	£3895

Quad II-forty system, pre-amp+2 mono blocks	£2495
Plinius CD LAD balanced pre-amp	£495
Chord SPM 800 power amplifier	£895
Krell KAV 300i	£995
ES Lab DXS4 digital amplifier	£1295
Mark Levinson 28 pre-amplifier	£995
Mark Levinson 27.5 power amplifier	£1995
BUY THE ABOVE PRE/POWER TOGETHER FOR ONLY	£2195
Croft TS1 with Epoch Pre (£3000)	£1995
ART Conductor Pre-amp	£995
Conrad Johnson 16LS pre-amp (£8000)	£3750
Musical Fidelity A3cr pre amp	£395
Suggden Masterclass Mono blocks (£6600)	£3495
Audio Note Soro SE + built in phono stage	£995
Musical Fidelity X-150 v3 (£799)	£650
Hovland HP100 pre+built in phstage (£5350)	£3595
Hovland Radia Power amplifier (£7995)	£4995
Hovland HP200 + phono stage (£7325)	£4995
Audio Analogue New Maestro (£1750)	£1255
Audio Analogue Primo Setanta	£395
Unison Research SR 1	£895
Musical Fidelity A308 Power amplifier	£995
Musical Fidelity A308 Pre amplifier	£995
Roksan Kandy MKIII (silver or black)	£450

Loudspeakers

Proac Response 2 speakers (rosewood £1695)	£695
KEF Reference Series Model Four (£4000)	£1895
Dali Helicon 400 (£3300)	£1995
Audio Note AN-ED speakers	£695
Mission 780 SE, boxed	£195
LivingVoice Avatar II, finished in cherry (£2700)	£1595
Nola (Alon) Elite Signature speakers (£8000)	£3595
LivingVoice Auditorium mkII speakers (£1900)	£895
Diapason Karis III speakers + matching stands	£1095
Ref 3a Dacapo i, maple (£2700)	£1650
LivingVoice Avatar II speakers in Maple (£2700)	£1850
JM Lab Cobalt 816s (£999)	£595
Triangle Heliade, Champagne finish (£595)	£395
ATC SCM-50ASL, Yew (£7947)	£4995

Wilson Benesch ARC's with stands (£2500)	£1699
Triangle Australe in cherry (£3300)	£1995
LivingVoice Avatar OBX-R in Cherry	£2695
Wilson Benesch Discovery (£5700)	£3895
Quad 989 ESL Vintage, new £5000	£3600
Quad 988 ESL in Nouveau, cost new £3750	£2999
Audio Physic Spark3, Cherry or light maple	£1250
Audio Physic Tempo 3i, Cherry or light maple	£1395
Audio Physic Tempo 3i SE, Cherry/light maple	£1799
Audio Physic Virgo III, Cherry	£2895
Wilson Benesch ACT 1, Cherry	£3595

Analogue

Audio Synthesis Passion Phono stage (£1295)	£1695
Michell Orbe SE with Techno Arm (Upgraded) + Never connected PSU (£3100)	£1895
Ortofon Jubilee, very low hours, boxed as new, be quick!	£595
Linn LP12, Naim Aero tonearm, Armageddon PSU, Circus bearing, excellent cond (£4000+)	£1595
SME 10, boxed AS NEW (£2800)	£1895
Audio Synthesis Passion Phono stage MM/MC	£795
SME 20/2a + SME V tonearm (£5695)	£3695
Wilson Benesch Full Circle+Ply Cart (£2100)	£1495
Musical Fidelity M1 turntable, boxed as new	£1990
Michell Orbe SE boxed as new	£1595
SME 10A, boxed	£2495
KEF Reference Series Model Four (£4000)	£695
EAR 834P de-luxe phono stage	£250
Trichord Dino - silver front	£199

Miscellaneous

Isol8 Substation, 2x600w, 2x300w and 2x150w modules fitted.	£649
ISOL-8 2k Qube2 mains conditioner (£1500)	£795
Townshend Super Tweeters in Titanium matt	£650
Stax SRS 4040 tube system - boxed unused with Stax stand-cover	£795

List is updated on a daily basis via website

Small Memories

Keith Adams pens a personal paean of praise to his dated, diminutive, digital system...



Classic hi-fi - now there's an interesting concept. For as long as I have been around, as far as I was concerned, if it didn't say LPI2 on the front or have valves nestling in the back, it couldn't really be counted as such. But my prejudices have softened of late, thanks to a chance conversation with a non-believer. I'm sure you've encountered this breed - the type of person who doesn't understand the agonies us audiophiles go through. A non-believer could never get his head around the concept of testing speaker cables, let alone hardware, or being able to tell the difference between good and less-good. He's wrong, of course, but I digress...

Sat in the comfort of my leather sofa, said non-believer caught a glimpse of my ageing but capable set-up. His first comments were along the lines of, "what on earth is that?" followed by "if it's so good, why are there only two speakers?" Doh!

Explaining that my Meridian/Linn/Monitor Audio system was bought as a treat to myself at the end of Thatcher's decade, and that it cost rather a lot of money, he took a closer look. Now, if that were you or I in that situation, we would have asked to listen to it first - after all, that's what hi-fi is about, but no - he wanted to take a look...

I was surprised by his reaction: he squealed with unbridled joy. "That is so Eighties", he exclaimed, "it even has pinstripes!" Seizing the moment, I decided to go for strike two, and slipped Kate Bush's 'Kick Inside' Into the Meridian 200.

I was unprepared for his response - for a non-believer with cloth ears, he soon waxed lyrical about how it

sounded "so real". Lesson learned, he's now stopped banging on about how "they all sound the same", and has since even started talking about 'separates'. A victory for us audiophiles, then.

After he left, I sat down happy with the knowledge my ageing CD player could evoke such actions in non-believers. I soon realised it had been far too long since I last played it (I've been embracing the dreaded PC/MP3 'fast food' route of late); appreciating Kate Bush's vocal talents, I found myself breathing clear North Yorkshire air as I immersed myself in 'Wuthering Heights'.

Oh yes, reproduction from the CD transport I picked up in late 1989, could still arouse deep emotions in me in 2005 - there's no doubt; I am still in love with my Meridian. Sound is an important part of the ongoing affair, but there is much more to it than that.

For one, I love the way it looks - it may be a no-nonsense pair of black boxes, seemingly made from granite, crudely bolted together - but there's style in its minimalism, and not in the contrived way you find on some 'lifestyle' systems. The buttons may be crudely illuminated, and the display made up of 1982-style clock radio seven-segment displays, but who cares, when the tray opens and closes with such a mechanically precise action. When it closes, there's even a purposeful 'thunk', a sound there to remind you that your outlay stretched into four figures. And that was back in the era when a four-figure price tag meant something...

Simply using it becomes an occasion - you could press the ice-cool fascia buttons, but to do so would be to eschew the pleasures of

the system remote. It looks (and weighs about) the same as a hardback book - and we're talking JK Rowling after the bandwagon started well and truly rolling. Point the hefty device at your system, bask in the delights of a red LED tell-tale, and then wait... and wait... and wait a little more before the CD transport finds track one.

Oh yes, seek times are appalling - but in my world of emotional attachment to inanimate black boxes, it's an engaging character trait - one designed to build the anticipation before diving into the main event! But when it reaches that point, it rolls up its sleeves, dives in and makes a great job of reproducing music in a clean, clinical, yet surprisingly emotional way. We might be talking about second-generation CD reproduction here, but following a trip back to Huntingdon for a tune-up three years ago, it sounds more open and neutral than it has any right to. Kate really struts her stuff on the Meridian, and when she gives it her all, you get hear it in real-life no-holds-barred Technicolor detail.

However, after my friend's visit, a new realisation hit me -: I was enjoying classic hi-fi. Not old, not ageing - but classic. Why reach that conclusion? Because I love it, despite its shortcomings, and because even though I may be able to replace it with something much better for a similar outlay, it serves me well. works beautifully within the rest of my system, and I get a great deal of enjoyment from it. I suspect I could be brought kicking and screaming into the 21st century - but that would take effort on my part - and right now, I'm enjoying myself far too much for that.

The best of

ROKSAN

Technology



NEW Maths !!!
£650 + £650 = £1000

Maths - Illogical

Saving - Colossal

Experience - Emotional



AWARDS

- ★ ★ ★ ★ ★
- CD player** **INTEGRATED amp**
- Kandy MkIII integrated amplifier**
WHAT HI-FI? SOUND AND VISION Winner 2004 Awards
- Kandy MkIII CD**
HI-FI CHOICE Bronze award 2004 Awards
- Kandy MkIII integrated amplifier**
WHAT HI-FI? SOUND AND VISION Winner 2003 Awards
- Kandy MkIII integrated amplifier**
WHAT HI-FI? SOUND AND VISION Winner 2002 Awards
- Kandy MKIII integrated amplifier**
Five Stars
WHAT HI-FI? SOUND AND VISION October 2003
- Kandy CD**
Five Stars
WHAT HI-FI? SOUND AND VISION First test July 2003
- Kandy MkIII integrated amplifier**
Five Stars
2003 SUPERTEST WINNER (5 Star Gold)
WHAT HI-FI? SOUND AND VISION May 2003
- Kandy Integrated amplifier**
Five Stars
2002 SUPERTEST WINNER (5 Star Gold)
WHAT HI-FI? SOUND AND VISION Feb 2002
- Kandy CD player, Amplifier & Speaker**
Five Stars
WHAT HI-FI? SOUND AND VISION January 2001
- Kandy Integrated amplifier**
Five Stars
WHAT HI-FI? SOUND AND VISION April 2000
- Kandy CD**
Five Stars
WHAT HI-FI? SOUND AND VISION March 2000

TWIN PACK
TWIN PACK
TWIN PACK
TWIN PACK
TWIN PACK

CD player
INTEGRATED amp



HENLEY DESIGNS
Tel: 01235 511 166
www.henleydesigns.co.uk

KANDY

For everyone



© 2005 Roksan Audio Limited

RADIO GAGA

With its arcane politics, risible bitrates and poor sound, Steve Green pronounces Digital Radio to be well and truly dysfunctional...

When DAB started in the UK we were promised CD-quality audio and a wide choice of stations. Since then the bean counters and marketing people have taken over and quality has been traded-off for quantity, with the result being that the UK – once a proud bastion of broadcast quality – now has the dubious honour of being the country with the worst sounding DAB in the whole world.

The UK was also the first country to seriously promote DAB. And now that sales have taken off we're beyond the point of no return, while other countries are free to adopt systems that use more advanced technology.

The concept of DAB originated in 1986 in the form of a European research project titled Eureka 147, following breakthroughs in audio data compression algorithms. The original intention was to provide radio in CD-quality to fixed and mobile receivers with excellent reception even when travelling at high speed. And by 1990 all the main technologies to enable this had been successfully chosen, and have never been replaced to this day.

One of the most – if not the most – important technologies that make up a digital radio system is the audio codec (COder/DECOder), and the codec chosen to be used on DAB later became standardised by the Moving Pictures Expert Group as MPEG-I Layer II, or MP2 for short. This codec requires a bit rate of 192 kbps (kilobits per second – 'kilo' signifies 'thousand') or higher to provide FM-like audio quality – for a given audio codec, the higher the bit rate the higher the audio quality will be, and vice versa.

Originally, it was widely expected

that stereo radio stations on DAB would use bit rate levels between 192 kbps and 256 kbps, and the BBC did indeed use 192 kbps for Radios 1, 2, 3 and 4 until December 2001. Now, however, 98% of all stereo radio stations on DAB in the UK use a bit rate of 128 kbps and these stations sound significantly worse than their FM versions. In the UK, DAB cannot be considered an alternative to FM for anyone who cares about audio quality.

So how did UK DAB get into this sorry state? No single institution or individual is uniquely culpable. The broadcasters and regulators have made a series of decisions, some merely misguided, some motivated by political expediency, and some motivated, frankly, by naked greed. These decisions have brought about the present situation.

In 1988, in the early days of DAB, there were only 119 analogue radio stations transmitting in the UK, and fitting digital versions of all of these stations into the spectrum available for DAB would not have been a problem. But in 1991 the Radio Authority replaced the IBA as the regulator of commercial radio and was given a remit to 'broaden choice'. And broaden choice it did, with the total number of analogue radio stations standing last year at a whopping 325. Of course, this meant that the amount of spectrum required for DAB was far higher than that originally envisaged – a point that I will return to in a moment.

The BBC had been experimenting with DAB since 1990, and began transmitting Radios 1–5 on DAB in 1995 with the expectation that the receiver manufacturers would produce receivers for the system. Unfortunately they didn't, and the first receiver to hit the shelves was the Arcam Alpha 10 in 1999, a

Frontier Silicon's basic Venice DAB module offers Band III reception in a compact, highly integrated module. At its heart lies the Frontier Silicon Chorus chip. Whilst other Venice modules additionally offer L band reception, there are no plans for L Band transmissions in the UK (those in Germany have been unsuccessful) so budget radios are Band III only.

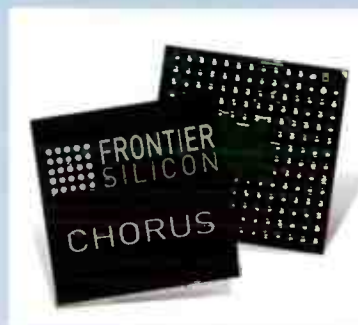

snip at £800. In the same year the Digital One national commercial multiplex was launched, and still the manufacturers didn't produce reasonably-priced receivers. Worried that their investment was showing no signs of a return, Digital One decided in early-2001 to enter into a joint venture with the chip designers, Imagination Technologies – who are also the owners of Pure Digital – to get the firm to design a DAB receiver chip. By integrating as many components into the chip as possible, this would reduce the manufacturing cost of receivers, and enable the production of a portable radio that would sell for the "magic" price of £100. The chip was manufactured by licensed partner Frontier Silicon. The result of this was the Pure Evoke-I, which lit the touch paper for DAB sales.

icon Audio

New Models!

Stereo 60

KT88 Integrated 2x 60w rms
ALL TRIODE Push-pull driver
Stage. Triode mode 2x 30 w
Choke regulated PSU.
Remote control. Four inputs
plus tape loop. Stunning Looks.
35kg. Excellent price!



icon Audio Stereo 60

Stereo 300

Integrated 300B
full 2x 30w rms. Remote
control. ALL TRIODE driver
stage. Choke regulated
PSU. Four inputs plus tape
loop. Stunning looks. 39kg
Excellent price!



icon Audio Stereo 300

LA4 Line pre-amp

Valve rectification.
Twin choke smoothing.
All triode design.
Remote control.
Four inputs plus tape loop
DC heaters.
High and low level, low
Imp. output.
Stunning looks.
Excellent price!



icon Audio LA4 Line Pre-amplifier

PS 1 Phono Stage

High output, with level control.
Will drive most power amps!
All valve, all triode, no feedback,
passive RIAA. Custom moving
coil TX option. Choke regulated
smoothing. Separate power
supply. 9kg From only £399.95!



We regret deadlines did not allow time for prices.

See our website or ask for a leaflet

- Designed in Leicester UK
- Wide choice of valves: Inc, Mullard, JJ, EH, Svetlana, Sovtek
- Each amp carefully commissioned & tested in Leicester
- All supplied with beautiful valve covers
- Part Exchange facility for your old equipment, ask us!

Features: Hand built 'Point to Point' wiring. No printed circuit board. ALPS Volume control. Gold plated terminals. Audiophile components by Solen, Rubycon, Silver audio cable. Steel & alloy plate construction. Soft start. Unique T delay. Comprehensive manual supplied. DIY valve change info.

Buy with confidence. Well established. Proven reliability. Unbeatable advice & back up service. Try for 30 days. refund if not delighted*

Ask for an illustrated Leaflet Auditions by appointment.

See us at the Hi Fi Show 23-25th Sept

Lear Jet room, 1st Floor. Renaissance Hotel

Visit our new website at www.iconaudio.co.uk

Phone 07787 158791 Email sales@iconaudio.co.uk

icon Audio 351 Aylestone Road Leicester LE2 8TA

*Conditions apply

Visa and MasterCard accepted

CE marked

Listen to the music... NOT the components

If you want the best possible sound from your loudspeakers then look no further than ClarityCap audio grade capacitors.



Handmade in the UK from metallised polypropylene film in axial or new 'disc shaped' formats, these capacitors offer an extremely wide standard range of capacitances and voltages or they can be custom-made to your own specifications.

Already invested in by some of the leading names in the loudspeaker industry, isn't it time you tested them!

To receive your 16-page technical brochure please telephone 01233 731137, email: enquiries@expotuscomponents.com or visit our website: www.claritycap.co.uk



ClarityCap

AUDIO GRADE CAPACITORS



The Cartridge Man



The difference is profound

The new Cartridge Man Cartridge Isolator now available

020 8688 6565

Website: www.thecartridgeman.com

Worldwide Average Bit Rates for DAB Stereo Stations

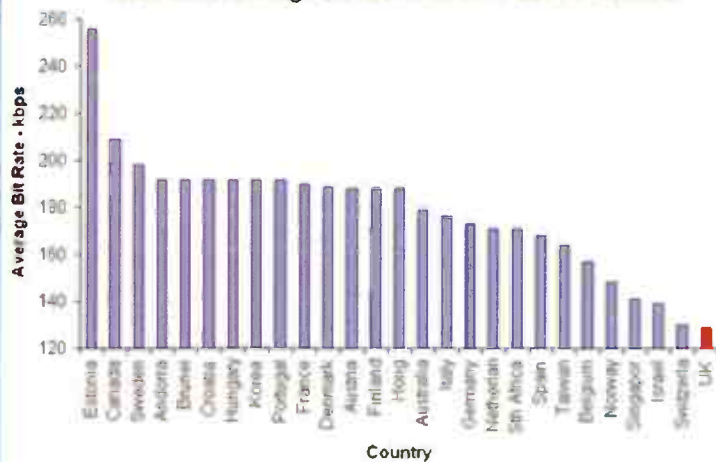

So Digital One's bold investment got reasonably-priced receivers in the shops, and thus undoubtedly got the DAB ball rolling. But the decisions culminating in the Evoke-1 locked the UK into decade-old technology, as well as drastically limiting the amount of spectrum that the UK could use for DAB. This bit of history is the main reason we now have sub-standard DAB in the UK.

First, however, the technology decisions that led to the Evoke-1 have to be considered within the context of how much spectrum was available for DAB to use at the time, and how much was expected to become available in the future – all expectations have come to fruition: seven Band III (174 – 239 MHz) channels already available by 2001; sixteen L-band (1452 – 1490 MHz) channels available by 2007; four or five additional Band III channels expected to become available after an international frequency-planning conference in 2006.

The first of the technology decisions limited the new receivers to Band III reception only instead of enabling them to receive both DAB bands. Now, with over 95% of the 1.5 million DAB receivers in use in the UK being Band III-only devices, this pretty much rules-out L-band being used to carry radio stations. In any case, broadcasters have no plans to use this spectrum. Working at a very high frequency, it is short range only, being easily obstructed by buildings and hills. Band III DAB already suffers reception black spots; L Band DAB would be more of a problem.

One of the main attractions of DAB for the commercial radio groups is that it allows them to transmit more radio stations, and thus make more money. And with only twelve Band III channels available – seven available now plus five awaiting international clearance –

it is impossible to carry all the radio stations that want to transmit while at the same time providing these stations at a good level of audio quality. So, there was a classic quantity versus quality trade-off, and quality lost out, with the result being that 98% of all stereo music stations now use 128 kbps and sound very poor. Moreover, Ofcom recently announced that even with the five additional channels they cannot find room for 31% of all analogue radio stations!

However, because so few DAB receivers had been sold by early-2001, Digital One and the chip designers effectively had a clean slate to work on. So the opportunity was there to replace the outdated MP2 audio codec with a modern codec such as AAC (Advanced Audio Coding), which requires a lower bit rate to achieve a given level of audio quality, as well as bring the error correction scheme up to date. These two changes would have allowed the number of radio stations transmitting at any given audio quality to be tripled! This would have solved the capacity problem at a stroke, and therefore there would have been absolutely no reason to reduce the audio quality to today's pitiful levels.

Improved error correction has, in fact, recently been added to the DAB specification, and it is very likely that a new audio codec will also be added. And while other countries will be able to take advantage of these improvements, it's now too late for the poor old UK.

The downside of replacing the audio codec and error correction scheme would have been that the few thousand receivers sold up to that point would become obsolete once transmissions changed to the new format. But if it was explained to the early-adopters – most of whom were audiophiles – that the

changes were being made to preserve the audio quality, and that the status quo would result in poor audio quality, then most would have accepted it.

However, it would be wrong to single out poor technology decisions as the cause of poor DAB audio quality in the UK. There are other reasons. The Radio Authority should simply not have allowed the broadcasters to use 128 kbps for stereo music stations in the first place. And of course no-one forced the commercial radio groups to use insufficient bit rate levels – it is simply their greed that has led them to do so.

And the BBC is far from innocent in all of this. For instance, in the public consultation for their five new digital radio stations, the BBC considered mentioning that adding the new stations would degrade the audio quality of existing stations, but then decided to withhold this information from the general public. And despite a lukewarm response from license-fee payers to three of the five proposed digital radio stations all were launched anyway. And now, Radio 1, Radio 2, Radio 4, 6 Music and 1Xtra all use 128 kbps; BBC7 only uses mono even though the vast majority of the content was recorded in stereo; the Asian Network uses mono yet carries music and drama; and whenever Radio 5 Sports Extra is on air – typically about 30 hours per week – either Radio 3 has its bit rate reduced if this occurs in the daytime, or Radio 4 is reduced to mono if it happens in the evening.

However, the bit rates of the BBC's radio stations – and many of the commercial stations as well – are higher on Freeview, digital satellite and cable, so audio quality is better via those platforms than via DAB. But FM with good reception still beats the lot...

So, to recap on the story of DAB in the UK so far – as *BlackAdder* would have it – 'it started badly, tailed off a little in the middle and the less said about the end the better' – but apart from that it was excellent...



TUBE SHOP.COM

WHAT'S HOT AT THE TUBESHOP



GOLDEN DRAGON



They're now considered essential as far as I'm concerned, and bring a new meaning to the term "Simply the best!"

Roy Gregory - Hi-Fi+ magazine

Tube Rings
by Quende Crystals

WHAT'S COOL AT THE TUBESHOP



Cryogenically treated tubes really make a difference!
Read all about it online:
www.cryogenictubes.com



WWW.TUBE-SHOP.COM
OR CALL US 0870 9220404

THE LARGEST SELECTION OF QUALITY TUBES ONLINE

MANTRA AUDIO

Specialist Suppliers of Audio Accessories
www.mantra-audio.co.uk

PRICES INCLUDE P & P FOR UK DELIVERY 1 TO 10 DAYS -
SEE WEBSITE FOR FULL PRODUCT RANGE AND SHIPPING
CHARGES TO EU & WORLDWIDE

CARTRIDGE SELECTION	STYLUS	HEADPHONE SELECTION
Goldring Elektra	£33 £28 GEX	£24
1006	£76 £62 GEX	£52
1012 GX	£95 £76 GEX	£67
1022 GX	£124 £100 GEX	£86
1042	£143 £114 GEX	£100
Eroica LX/H	£133 £109 GEX	N/A
Elite	£232 £190 GEX	N/A
Audio Technica AT 95 E	£23	£16
AT 110 E	£28	£17
AT OC9 ML II	£330 £295	EX
Grado Prestige Black	£40	£27
Prestige Gold	£110	£73
Shure M 97 XE	£98	£58
V 15 V xMR	£304	£204
Sumiko Blue Point Special	£235 £200	EX
Blackbird	£585 £500	EX
HI FI ACCESSORIES		
Goldring PA1 Phono Amplifier		£60
Goldring Super Exstatic Brush		£13
Shure SFG2 Stylus Force Gauge		£24
Milty Pixall H Roller plus Refill		£16
Milty Zerostat Neutralising Gun		£38
Bib Universal Standard Headshell		£15
QED J2P Mini-Phono Interconnect		£22
GRADO Award winning Headphones		
Prestige Series		SR-60 £75 SR-80 £90 SR-125 £140 SR-225 £175 SR-325 £265
Reference Series		RS-1 £635 RS-2 £450
REPLACEMENT STYLUS		
Swiss Quality Diamond Styli		
ADC	XLM MK III	£17
Akai	AN 5, AN 60	£13
	AN2, AN 70	£15
Aiwa	AN11	£13
Duai	DN 145 E, DN 165 E	£17
JVC	DT 55, DT 60	£13
National	EPS 24 CS, P 30 D, P 33 D	£13
Ortofon	FF15/VMS20 EII, OM20	£17
Pioneer	PN 210/220/240	£13
Shure	N 75 C, SC 35 C	£13
	N 75 ED T2, N 75 EJ T2	£17
	N 95 ED/EJ, N 75 3 (78)	£17
	VN 35 E	£20
	N 97 HE, VN 35 HE	£27
Sony	ND 142/155 G, CN234	£13
	ND 143/150/200 G	£15
Stanton	D 681 EEE	£21
Over 500 Styli Types Stocked		

GEX - Goldring new for old exchange price for any make/type of cartridge
EX - Exchange price for any moving coil cartridge

Order direct online or Tel/Fax (01757) 288652
MANTRA AUDIO (HFW), 22 GARTH AVENUE, NORTH DUFFIELD, SELBY, NORTH YORKS YO8 5RP

The Missing Link



State of The Art Be-Spoke Audio Cables
Hand Built in Britain



Pure Silver & Cryogenic Treatment Specialists
For Greater Enjoyment of The Recorded Arts
Contact Mark or Jan

0115 8779089 or 07967 859333

www.the-missing-link.net

Space 1979

David Price looks back to the future with Technics long lost SB-F1 mini monitor...

Ever since the original Goodmans Maxim of the nineteen sixties, there have been countless small hi-fi loudspeakers on sale, but very few miniature ones.

True, you can pick up specialist audio accessories like Creative Labs' superb 'Travelsound' from no end of electronics chain stores, but how many specialist hi-fi brands can you think of that have made serious speakers small enough to fit in the palm of your hand?

Well, if there was ever a country likely to manufacture such a thing, it would be – of course – Japan. With twice the population of this crowded country in a similar landmass, space is at a premium, and with large disposable incomes and an insatiable appetite for quality audio, sound is too. Put both together and you have a massive market for 'mini-compo' systems, some of which (like the Onkyo C-733/A-933 reviewed this issue) are capable of superb sonics.

The whole 'tiny hi-fi' thing kicked off in earnest in Japan in the late seventies, with the advent of the Aurex microsystem and the Technics SL10 – the former was a suite of expensive miniature electronics with sound that battered similarly priced full size separates, the latter an epoch-making fully automatic quartz locked direct drive linear tracking turntable, complete with its own moving coil cartridge and head amp (!), that at 300mm square was barely larger than the size of an LP sleeve!

The Aurex stuff went on to spawn a number of imitators from the likes of Aiwa (the Microsystem) and Mitsubishi (the M-04). The Technics went on to spark off a whole generation of small parallel trackers, using the same basic architecture but never built as well, from a wide variety of manufacturers – not to mention the SL15, SL7 and SL5 variants of the SL10. But what then of loudspeakers to partner these microscopic marvels? Well, not a lot of people know this, but...

In 1979, Technics launched a range of compact loudspeakers, the smallest of which (the 80x50x50mm

SB-F1) was a perfect partner for the SL10 turntable. Not only was it a visual match, but displayed the same exemplary (some would say breathtaking) constructional standards, the same

excellent sonics and a suitably stiff price tag too. At £220 per pair, it was virtually as expensive as Linn's high end LP12 turntable (which retailed for £256). The series also comprised the £300 SB-F2 (100x50x80mm) and £360 SB-F3 (130x70x70).

The most striking thing about the SB-F1 is its size – or lack of it: it makes a Linn Kan look like a KEF 105. Next, you notice the superbly clean styling – which looks as fresh on 2005 as it did twenty five years earlier. Then, when you pick it up and hold the base in the palm of your hand, you realise that it's something different - like the British winter, it's cold and heavy. Yup, the SB-F1 is made of cast aluminium alloy, and a lot of it!

The speaker uses a clever clamshell construction. The front and rear sections are pulled together, under tension, by a single central bolt with a Philips screw head. Unscrew this and the SB-F1 comes apart, to reveal the fact that the cabinet walls are super thick (hence the weight) and rigid. Inside is a tiny 100mm paper woofer, wired to a quite complex crossover sporting high quality passive components, and a 25mm paper cone tweeter – both bolted rigidly to the inside of the front clamshell. The use of lightweight paper drivers (Audionote AN-E owners know this) ensures a surprisingly high 86dB/m sensitivity

figure, which is amazingly high for a sealed, infinite baffle design with next to no air inside the cabinet! Of course, high power transistor amplifiers only need apply... A 40W RMS maximum output power is specified, and there's a crossover protection circuit reset button on the back of the speakers for when the inevitable comes – proof that these babies were designed for pro (near field monitoring) use too.

Sound is absolutely superb – for the size. You'll not be knocked back by their physical presence in the room, believe me, but they're a surprisingly commanding listen and musically articulate like few others. Indeed, you could think of them as a Japanese Linn Kan I. Brilliantly fast and engaging, they make music bounce like few others. Don't expect a beautifully svelte and smooth sound though; they're not the last word in refinement...

These days, you'll not find too many around; they weren't exactly a runaway sales success, but they're well worth investigating for a second system; price is what you pay for them. A mint boxed pair should command several hundred pounds, while dog-eared examples would probably go for one tenth of that. Still, procure a decent pair and you'll be a firm believer in that old adage, 'less is more'!



UK SUBSCRIPTION £40

VISIT OUR WEBSITE: www.hi-fiworld.co.uk



YES! I want to subscribe to Hi-Fi World for:-

£40.00 for 12 months

Your Details

Title _____ Initial _____ Surname _____

Address _____

Post Code _____

Daytime Tel: _____

Start Issue _____

Delivery Address (if different)

I would like to pay by cheque made payable to Audio Publishing Ltd.

Please debit my VISA MASTER SWITCH AMEX

Security No: (last three digits printed on the signature strip)

Switch card issue No: Expiry Date: _____/_____/_____

Cardholder Signature: _____



Please choose service:-

ZONE 1 USA, Canada, Africa

ZONE 2 Australia, Japan, Korea, China, Middle East & South East Asia

EUROPE Airmail **£50.00**

ZONE 1 Airmail **£60.00**

ZONE 2 Airmail **£70.00**

Send this form to:

Hi-Fi World, Subscriptions Department
PO Box 464, Berkhamsted, Hertfordshire
HP4 2UR

**SAVE UP TO
£240
ON STAX
HEADPHONES
WHEN YOU
SUBSCRIBE
TO
HI-FI WORLD
FREE postage & packing.**



Here's your chance to save 10% off the retail price of any pair of Stax headphones from Simply STAX, the UK's leading retailer of STAX electrostatic earspeakers, when you subscribe to Hi-Fi World magazine!

Subscribe for 12 months for just £40 and get a voucher giving you 10% off the retail price of any single new STAX system from Simply STAX.

This gives you a minimum saving of £34.90 if you purchase the STAX SRS-2020 system and a staggering saving of £239.50 if you purchase the incomparable SR-007 Omega Reference System!

Even on the superb SRS-4040 system reviewed in the August 2005 issue, this means a saving of no less than £99.50 – more than twice the cost of the annual subscription!

See www.simplystax.co.uk/products.html for details of all current STAX products.

THIS OFFER:

- is unique to Hi-Fi World
- is limited to first time subscribers
- is limited to UK residents
- cannot be used in conjunction with any other offer that Simply STAX is promoting
- lets existing subscribers benefit when they get a friend to subscribe to Hi-Fi World, in which case both the subscriber and the friend get the discount voucher.

**Hotline
+44 (0) 1442 879097**

**Fax No:
+44 (0) 1442 872279**

**email:
hifiworld@webscribe.co.uk**

**For Back Issues enquires please
contact the above numbers**

“ they will forever remain an undifferentiated sea of ‘product’ ”



noel keywood

Someone in the area I live runs a old Austin A35. Once a family car, by today's standards it is tiny. It reminds me how small cars have grown and grown. "Small" these days is a lot different to times when something like an A35 was a luxury most Britons couldn't afford and the M1 was still being considered by Ernie Marples. Even the Quad 22/II looks quite compact nowadays, although it was a large amplifier in its time.

Big can mean better; whether size is gratuitous or not really depends upon the individual product. No one is going to produce a small Tannoy Lancaster, for example. Horns have to approach an A35 in size to work properly. But that's not to say you can't get real hi-fi from something smaller. Unlike cars, there's no need for hi-fi to grow.

In the past, small loudspeakers like the Rogers LS3/5a and even the Wharfedale Diamond have delivered real quality from a small package. But times move on and these successes cannot be simply repeated, for example, by building another 3/5a just like the last one. The essence of those qualities that made it a success have to be distilled out and moved over into a modern format that suits current expectations and conditions.

My small son has taken to spotting Minis and counting them. Since this is the best way of getting him to walk to the local shops instead of demanding to be driven in the car, I'm all for it, and I'm becoming Mini-aware again as a result. Having piloted Minis in days gone by, I'm not about to climb back into another, 'cos staring at lorry

wheels is no fun. All the same, I think the new Mini is a sparkler. It is a clever interpretation of the original, rather than a simple copy, as it could have been. Today's Mini is a modern car into which BMW have cleverly distilled the essence of the original: a fun machine that's fast, sassy, and even slick. I see endless numbers of town cars in my crowded local streets but none have its dazzling presence. In fact, most are prosaically styled and equally prosaically engineered, which is to say, they are boring - inside and out. Hardly surprising then that we're counting Minis everywhere!

Like the Mini, a lot of UK hi-fi has traditionally shone in the lower end of the market, where it has offered an attractive balance of strengths, but especially a nicely honed sound from a well proportioned package at a decent price. I'm not sure either build quality or styling were ever the best, although you may like to argue Quad and Meridian are exceptions. All the same, whilst French and German loudspeakers were consistent in their uncontrolled frequency extremes, Brits largely had the home market to themselves. They also had a following overseas, with all those who got the message that a smooth sound free from boom had a lot going for it.

But times have changed. These days UK loudspeakers are balanced much like those from around the world. Nowadays everyone subscribes to an almost academically flat frequency response and technically, it has become easy to achieve. French and German 'speakers these days sound much like UK speakers, which don't sound any

different from Chinese loudspeakers! The endless stream of mini systems from Japan's big manufacturers don't answer the need for real hi-fi from small packages. They will forever remain an undifferentiated sea of 'product' no matter how hard their manufacturers try to imbue each and every one with special features and a contrived character that just doesn't wash with buyers. They are the audio equivalent of today's mass produced, prosaically engineered small car.

But small hi-fis don't have to be like this. Good, modern, innovative engineering can be packaged in sassy looking and well finished housings to give a product that everyone wants for the right reasons. In this issue we've gathered together some innovative small products that I believe show the way ahead. In loudspeakers especially, midrange domes offer the most promise, but ribbon drivers are likely the way ahead in the longer term.

In sources we have the internet and iTunes, but also this year the 8cm mini-CD will be revived once again, this time as a 15GB recordable Blu-Ray disc. With SD cards now up to 1GB, 4GB on the way and 32GB projected, all the background technologies are moving into place for small hi-fi systems of the future to be better than ever.

Whereas the original Mini was a brilliant repackaging of the A35, and today's Mini is a sparkling reinterpretation, tomorrow's hi-fi systems will be more than another repackaging or reinterpretation job. They should have genuinely new technology, that's both innovative and better. It's good engineering at the end of the day, and that's what people want. ●

"a manufacturer's view of loudspeaker perfection is an intensely arbitrary one..."



David Price

I believe the phrase is, 'going from the sublime to the ridiculous'. Well how else would you describe the move from Meridian's mighty DSP7000 active digital loudspeakers back to my comfortable old reference Quad ESL-989 electrostatics?

There comes a time in every hi-fi reviewer's life when the kit you're using simply has to go. Either the manufacturer wants it back, or you want it out of your house (and believe me, it's usually the latter case - much as many companies think that you storing their stuff for them is them doing you a favour). And so it was that Meridian's affable Eddie Stonham arrived in the company Renault Espace and dutifully lugged them into the 'Espaceship'...

To his eternal credit, Eddie then helped me move the Quads back into their original positions, having vacated them some three months earlier. He even stuck around while I positioned them - with millimetric precision - in my listening room. And so began a voyage of electrostatic rediscovery that's still in full flow...

Now, I'm not having a pop at Meridian, or the DSP7000. Even Quad's marketing supremo Julian Maddock, who spent many years 'in retail' selling the Meridian's predecessors, admits that they're awesome when cranked up in anger. I agree too. I've yet to hear something that's so strong and clean and silly (i.e. PA) volume levels.

This is something you can't claim of the Quads. The 989s are horribly flawed. They go surprisingly loud (surprising, that is, to hi-fi industry professionals who've heard ESL57s and 63s - as opposed to night clubbers), but when it's real Watts

you want, their protection circuitry trips and the bass panel(s) go down for a few seconds, which kind of ruins the effect. This is so frustrating. Okay, I admit that Herbie Hancock's 'Rockit' on 45rpm 12" - at flare-flappingly high volumes - isn't the usual fare for these glorious loudspeakers, which are more often found playing sedate classic music on CD. But the trouble is, just before the protection circuitry says, 'Goodnight Vienna', the Quads sound sublime. I believe the best adverb to use here is 'tantalisingly' so...

This is what I mean about the ESL-989s being flawed. They are patently not able to mix it with the 'big boys' in this respect. But despite this, I can't help feeling happy to have them back...

Even when you're spending £5,000 (Quads) or £17,000 (Meridians), your money still doesn't buy you all round perfection. Rather, it buys you the manufacturer's view of what perfection is, and that - with loudspeakers more than most hi-fi components - is an intensely arbitrary one. For me, I'm forced to conclude, the Quads come closer to what I want from a speaker.

In some respects, they're stunning. They image like nothing else you've ever heard, bar nothing. Forget dual concentric floorstanders with a front baffle the width of a razor blade - the 989s throw sound into a room in a way that takes the breath away of even folk who couldn't give a stuff about hi-fi - you don't need to know your Elmas from your Black Gates to hear the difference. Feed them with a stereo downmix of a multichannel DVD movie soundtrack and you'll wonder why anyone would ever bother with

three (or five) extra boxes.

Better still, they have tactility that takes you right to the door of the recording studio - it's a textural thing, something that in days of yore, your mother would call 'a good tone'. It's real life, and no other speakers I've heard take you as close.

Once again though, these brilliant strengths - abilities that are unmatched - are compromised by stupid inadequacies. The cabinets of the 989s aren't their greatest asset, as they wobble around like sails in the wind. Quad themselves admit, off the record mind, that Stan Curtis's original 'mechanical engineering' on the 989s isn't quite as good as it could be. I've often wondered what they'd sound like if Wilson Benesch had engineered bespoke carbon fibre frames for the Quad panels; probably the best loudspeakers in the world?

Then there's the aforementioned volume limitations, and the fact that the treble isn't as sparkling as it could be. But Quad says that the very latest build of the 989 panels are a teensy bit better in these respects. Still, this is whistling in the dark, as those massive frames sway to and fro when you put serious power into the panels...

Well, nothing gets past Quad; which is why, in a corner of IAG's Shenzhen factory, I spotted the 989's replacement. It's not too dissimilar, but sports a central support rod going from the top of the speaker down to the base, thus - presumably - eliminating that sway at a stroke. These are going to be serious loudspeakers; I suspect it'll be a 'DP purple prose alert' when I get to hear them. The best big speakers in the world (probably) just got better; watch this space for a review soon! ●

"many will be sceptical about the concept of paying for radio"



steve green

According to Ralph Bernard, Chairman of the UK's largest commercial radio group, GCap Media, subscription radio in the UK could be only five years away. No doubt your first reaction is 'pah, you won't catch me paying to listen to the radio!' But most of us had the same reaction to the idea of paying to watch TV, yet 43% of all UK households now pay an average of £32 per month to do just that. Will subscription radio prove as compelling? It may, as there are advantages we in the U.K. aren't so aware of.

But why is the commercial radio industry casting its greedy little eyes over subscription-based radio when they're currently trying to persuade us all to get non-subscription DAB radio?

The answer probably lies in some market research commissioned by Ofcom into the listening habits of 18-30 year olds – 'the iPod generation' – which led Ofcom's then Head of Market Intelligence, Peter Davies, to announce at the 2004 Radio Conference that "there was zero tolerance of crappy adverts, inane presenters and repetitive playlists" and that "most [listeners] would seemingly do anything to avoid radio adverts". Obviously not the best of news for the commercial radio groups when this age-group is their largest source of revenue.

And as we move towards a world where there seems to be a hard-drive in just about everything, the mere thought of listeners fast-forwarding through the adverts will terrify the industry. This could be just as much a threat to radio's

advertising revenue as it is to TV's – and radio stations can't exactly slip a bit of product-placement in the middle of a song to offset these losses.

And commercial radio has another problem: because advertising revenue depends on the size of the audience, the music the stations play is carefully selected to appeal to the lowest common denominator, so niche genres are very poorly served. This point was graphically illustrated when Jazz FM – which reputedly never made a profit in its 15-year history – was re-branded as Smooth FM earlier this year. Jazz is a small part of Smooth FM's output and jazz specialist radio in the UK is now a thing of the past.

So, to cure all of commercial radio's perceived ills, step forward Subscription Radio! Such a service is likely to be closely modelled on the XM (www.xmradio.com) and Sirius (www.sirius.com) satellite digital radio systems in the US. These systems have notched up 5.4 million subscribers between them since their launches in 2001 and 2002, respectively. For around \$10 (£5.80) per month the systems provide 120 - 130 advert-free radio stations, and the audio quality on offer puts DAB's to shame.

With such a wide range of stations available, along with the fact that they don't have to pander to the lowest common denominator in order to deliver large audiences, these systems actually do deliver a wide range of genres, the like of which UK listeners will never see so long as commercial radio relies so heavily on advertising revenue.

The XM and Sirius satellite signals are much stronger than Sky's

TV signals so transmissions can be received using standard car aerials, although reception in cities is reinforced by terrestrial transmitters.

A previous attempt to provide a European satellite digital radio system, called Global Radio, failed to materialise as a result of a lack of interest from institutional investors, but the currently proposed system looks to have a significantly better chance of seeing the light of day. The main backer is SES Global, a really serious player and the operator of the 12 Astra satellites that beam around 1,400 TV and radio channels to 102 million European households. This includes the 7.8 million UK households with satellite receivers – Sky lease bandwidth from SES Global despite the common misconception that Sky owns the satellites from which they broadcast. SES Global's plan is to launch a satellite to provide radio right across Europe using so-called "spot-beams", with one beam covering each region that shares a common language, e.g. one for the UK and Ireland, one for German-speaking countries, and so on.

Although no doubt many will be sceptical about the concept of paying for radio – especially with the BBC already producing quality, advert-free content – I for one would happily pay a few pounds per month to listen to radio with decent audio quality on stations that actually play music that I might have a chance of liking! We've yet to see whether others will do likewise, but all the evidence so far suggests I won't be the only one. Could this be where quality radio will come from in future? It's quite possible. It means if we want both variety and quality, in future we will have to pay for it. ●

now that we've managed to get everything from TVs to vacuum cleaners coordinated, we're on the cusp of going back to black!



dominic todd

It's well known that a variety of products take inspiration from hi-fi design. Perhaps this is best observed in the car industry with the design of not just car hi-fi, but in elements of the entire dashboard. When the latest Range Rover was launched, designers openly admitted that they used "expensive hi-fi" as a reference point for the dashboard design. Take one look at the symmetrical button layouts, and graphite textures and, it's true, one can't help but think Cyrus and perhaps others too.

Yet hi-fi has long since taken styling cues from other sources, too. Everything from crash helmets to designer chairs to, more obviously, musical instrument design has affected the way products look. A great element of how hi-fi appears is, of course, how it's finished, and for this the greatest influence of all has to be the home interior. When teak was popular in the 1970s, so it bedecked 'speakers and even hi-fi casings. Much the same was true for black ash in the '80s. During the '90s we saw a move towards beech and maple, with silver being favoured over black for trim. Sure enough, by the end of the decade hi-fi was slowly but surely moving towards a similar theme. Not everyone was so sheep like - Naim, have stuck with black, at least in terms of electronics.

Well, now that we've just managed to get everything from the TV to the vacuum cleaner coordinated, we're on the cusp of going, erm, back to black! I can say this with confidence as we're already starting to see this with mobile phones - a market leader in trends if ever there was. Black is the coolest

mobile hue, and the companies are keen to let you know. Motorola, in particular, even promote a limited edition of their popular V3 razor phone. So, just as hi-fi followed the home and mobile in the late '90s, so it looks set to do the same again now. Well, all I can say is that it's about time! Whilst I'm all for variety and I did find the whole shades of black look of the 80's a little overwhelming, I'll be pleased to see manufacturers go back to black.

The first reason is on a point of aesthetics. Whilst it's a matter of personal taste I can't help but feel that some products simply look better in black. Both Rotel and Exposure products, for example, I find more attractive in black. Perhaps this is because, historically, they both used to be black and therefore there's some nostalgic attraction, but I think there's more to it than that. Get the right black and a product appears sharp yet understated.

Yet, whatever your views are on the aesthetics, and I guess I'm still in the minority here, it can't be denied that black is a more practical hue. For a start, the finish seems to be more consistent and durable. I've seen black and silver amps', from the same company, that, after a year or two, look to be in a very different state. Whilst the black design is as new, the silver one has flaking or faded patches and is more vulnerable to scuffs - unless it's unpainted aluminium. Even when a company does get the finish right, it doesn't mean that they'll be on the ball when it comes to legends. White writing on a black finish cannot, I think, be beaten for clarity. White writing on silver however is, at best, dubious. Yet

this is exactly what you'll find on Cambridge's otherwise exemplary Azur range. What it means is that even those with excellent sight will have trouble seeing the volume level of source selection from a distance, whilst those with poor sight could struggle even when close up. When the black Cambridge products offer such clarity and, considering the price, design flair, this is especially disappointing. Then there are the chrome plated products...

Anyone that's ever worked in any retail environment involving chrome plated products of any sort, will know what a pain they are to keep clean. People's natural response when faced with a shiny and beautiful chrome object is to touch it. From then on, it never looks the same and is defaced with smears; unless a regular troop is set up to constantly wipe the product down. I remember this with Audio Innovations Alto amp and whilst suitably wowed at first (it was flying saucer shaped), it didn't take me long to prefer the design in the alternative crackle black finish.

Whilst it won't happen overnight, don't be surprised to see these pages becoming increasingly filled with black products. Fortunately for most companies, such as Rotel, Cambridge, Exposure and NAD, they still make their products in their original hue, so changing over won't be a problem. However, whereas as sales once favoured silver, as the demand drops they, and others, may well think about the viability of running two finishes side by side. In the meantime, if you're after silver separates to match your existing hi-fi and electrical, then now's the best time to buy! ●

“the British Speculative Builder must surely face a long list of accusations...”



lijk setright

When, at the end of a lifetime conspicuous for commercial profit, the British Speculative Builder is eventually called to account, he must surely face a long list of accusations. Most obvious of these would be his responsibility for making so much of this precious country unnecessarily ugly and its denizens needlessly uncomfortable and impoverished, but somewhere down the list should stand the charge of being the Enemy of Hi-Fi. How often do we hear of music-lovers, having lavished much care and money on such apparatus as they might aspire to enjoy, falling foul of room acoustics which rob them of much that they should hear and confuse what remains audible?

Perhaps the maxim *caveat emptor* should apply? After all, the speculative builder is not in business to cater for that minority of the home-hunting populace having an educated sensitivity to music; he is in business to make money.

The architect may come under a different scrutiny. He must cater to the expressed requirements of a singular client, who may or may not know how his requirements can be met. For instance I would like, given the necessary wealth (it is too late now even to seek it), to have a house under an hyperbolic paraboloid roof. The only purist example that I have visited socially is owned by a scientist and has a somewhat messy open-plan interior, but I can envision many wonderful and dramatic shapes for the spaces that could be created under that roof by imaginative partitioning. Whether music in any of them would sound like Paradise or

The Pit I simply cannot forecast. Recalling the public auditoria that I have visited where a distinguished architect has been assisted by a notable acoustician. I am not confident that anyone else would do any better.

Having some interest in modern – Bauhaus or later – architecture, I enjoy visiting the occasional domestic example, and recently came across one in which the owner's desire to hear good music well was effectively met by his architect. That owner was an industrialist and philanthropist – the late Stanley Picker – whose particular joy was in collecting good 20th-century sculptures and paintings, which are on display everywhere in the house that he had built on Kingston Hill in the 1960s. He also loved classical music, and great pains were clearly taken to enable him to enjoy it at home; yet the spatial arrangements made were not at all what you might expect.

The house is largely open-plan, but various sections are subtly separated from each other by shifts in elevation, orientation and lighting, without succumbing to partitioning. What is called his 'music centre' is, however, concealed decently behind what are in effect cupboard doors: beneath a respectable collection of LPs I noted a fine Garrard transcription deck with an unfamiliar but exceedingly handsome arm, and amongst other things a machine for 8-track cassettes, very much a sign of Mr Picker's times. Beneath the machinery, hidden behind heavy horizontal wooden slats about 30 inches high, lurked the loudspeakers.

The surprise was that they faced into the shallowest part of the interior, the lounge area beneath the

bottom of a long sloping roof – the thin end of the wedge, so to speak. The space was very irregular, with an open staircase climbing through it and portions of upper-storey decking poking in here and there; the floor was polished, the glazing of heavy sculptural glass, vertical surfaces faced in rough-surfaced slate, and the underside of the roof carefully lined with narrow planks of pale timber. I was assured by the curator that the sound from the music centre was superb, but it was clear that the apparatus that had remained unchanged since Mr Picker's death was Not To Be Played.

So I stood in the middle of the listening area and snapped my fingers. Not often does the skinny Setright hand produce such a rich assortment of frequencies: everything imaginable was there, from the root note of the palm to the aspen-leaf shimmer that possibly comes from the whorls on the finger-tips. This was a real proper full-frequency-range finger-snap, and it sounded amazingly full and rich. But it sounded only for the instant: there was no hangover, no reflection, no slavish echo from the grand piano on the upper deck, no aftermath whatever.

It is a shame that we cannot all enjoy such spacious and dramatic shapes in our domestic interiors, such a shame that most of us are doomed to live and listen in little boxy coops. Yet we can fight against it: open all internal doors, serving-hatches and stairways, remove the front glazing from display cupboards and book-cases (nothing should come between a man and his books!), and generally make the sound-space as big and irregular as you can. It works. ●

Probably the Best DIY Kits in the World



www.worldaudiodesign.com

Tel 0845 2575600



Single ended purity

Our Parallel Single Ended (PSE) power amplifiers offer the ultimate in sound quality. Each monobloc has two highly acclaimed 300B triodes delivering 20 watts into an 8 ohm load.

The front end consists of a 6AU6 pentode feeding an ECC82 driver.

The ultra-quiet power supply uses a 5U4 rectifier combined with a custom 10H choke. Both mains and output transformer are purpose-built complex layer devices that are so linear that feedback (a normally unavoidable compromise to reign in and control most amps) can be completely switched out.

This facility, operating in pure Class A is available only on a few world-class machines and produces a sound so open and dynamic that has to be heard to be believed.

Push Pull Power

Sharing the same chassis and look as the PSE the push pull (PP) version is designed for people who prefer a little more power. Producing 26 watts it can handle most modern loudspeakers with ease. Again without feedback this version uses a 6AU6 pentode for input but a 5687 as a phase splitter.

WAD. We're proud of our Sound

300B PSE or 300B PP without valves £ 895.00 per pair (inc VAT)
 300B PSE or 300B PP with valves £1197.00 per pair (inc VAT)
 (Supplied valves are the superb Tesla 300B's, Russian 5U4's and European front enders)

Dimensions for either monobloc with valves: 23kg/50lb - H: 22cm W:25cm D:38cm

300B PSE MONOBLOC KIT £ 895.00 per pair 300B PP MONOBLOC KIT £1197.00 per pair

The Purist's Dream

Our newest amplifiers in the WAD fold are the KiT and KaT300. A stereo single ended 300B amplifier available in two configurations - the power amplifier: KaT300 and the integrated version: KiT300 with line level inputs and tape loop circuit.

KiT300 has volume and input selector knobs controlling a high quality ALPS Blue pot and a long life rotary wafer switch respectively.

The front panel is our usual 6mm anodised aluminium panel punched to suit either the KiT or KaT variant. The chassis is manufactured from 2mm thick aluminium with our black powder coat finish. Extra space has been allowed at the front to enable upgraded pots to be fitted if required.

A minimalistic circuit capable of delivering 9 watts per channel consists of 5U4 rectification, input into the designer's choice, the dual triode 6SN7GT driving the classic 300B.

The signal path, short and clean greatly simplifies construction without compromise as our philosophy of using high quality custom transformers and large choke still ensures that the sought after and much imitated WAD sound quality survives.

Dimensions: 18Kg, 390mm wide, 330mm deep and 200mm high (with valves).
 Available to pre order now, full details in next months DIY Supplement.
 WAD. We're proud of our Sound



KaT300 VALVE AMPLIFIER KIT £720.00 KiT300 VALVE INTEGRATED AMPLIFIER KIT £765.00



The **PRE-II** is a high quality valve pre-amplifier that will drive any power amplifier. It has a gain of x5 which, with CD, enables it to deliver a large 10V output swing

To keep the amount of active amplification low, this pre-amp uniquely uses a line drive transformer to deliver a pure signal to the power amplifier. There are six inputs, a tape monitor and two sets of output sockets. It is powered by the external PSU-II power supply.

The volume control uses high quality Alps Blue potentiometer which, with our solid, turned brass, chromed knob, gives a quality feel rarely encountered these days.

PHONO-II is a dedicated valve phono stage for MM cartridges, with MC input transformers an option.

By using all-d.c. supplies from PSU-II and a case in which there is no power supply, PHONO II is hum free, something that is difficult to achieve with valves. With accurate RIAA equalisation right down to 10Hz (-3dB) PHONO II gives a wonderfully pure, dimensional sound from LP, possessing a sense of life and dynamism quite different to solid-state preamps.

Finally, PSU-II is a power supply unit that feeds both the PRE-II and PHONO-II. Keeping the power supply separate removes hum, often the bane of valves.

Power Supply Unit (PSU-II) £ 185.00
 Pre-amplifier (PRE-II) £ 215.00
 Phono Stage (PHONO-II) £ 130.00
 Moving coil step-up transformer £ 80.00

SERIES II MODULAR PRE-AMP KIT

Probably the Best DIY Kits in the World



www.worldaudiodesign.com
Tel 0845 2575600



KEL84 is an affordable amplifier for those who want to enjoy the valve sound, but from a simple, easy to build kit.

It uses inexpensive EL84 output valves, known for their sweet sound, in conventional push-pull arrangement to provide 15 watts into an 8 ohm load. The transformers are our own high quality Ultra Linear design made in the UK. Up front, the circuit employs an ECF80 input / phase splitter valve which contributes to the KEL84's extremely smooth sound.

For simplicity the KEL84 is built on a printed circuit board. A strong steel chassis is then fronted by a 3mm thick anodised aluminium front panel and brushed aluminium knobs. There are two versions available, a single input version with volume control and an integrated version with five line level inputs and tape loop. The integrated version also features an ALPS blue volume control and chrome plated transformer covers as standard.

The KEL84 will highlight all the intricacies and depth of detail in your favourite recordings whilst retaining a warmth and fullness that is almost exclusive to valve amps and is rare at this price point.

KEL84 weighs 10Kg. External dimensions with valves are 300mm(w)x270mm(d)x150mm(h)

Single Input version £285

Integrated version £335

KEL84 VALVE INTEGRATED AMPLIFIER KIT £ 335.00

Our 6550 series amplifiers are built around the rugged 6550 beam tetrode that's popular in America

This valve is widely available and at a good price. This enables us to provide a high quality amplifier kit at realistic price. Producing no less than 40 watts our 6550 is a power house.

The difference between our 6550 and most others is that we use valve rectification (5U4) and a choke pi filter, for a power supply that is quiet and free from solid-state hardness. This is a true high-end design from Andy Grove. With it's custom designed and made transformers it is a cut above many 6550s, with enough power to drive most loudspeakers, including insensitive electrostatics for example.



The 6550 is available in two versions, the integrated Kit6550 with ALPs volume control five line level inputs and a tape monitor circuit or the KAT6550 power amplifier for use with a separate pre-amp.

The amplifier weighs 19Kg. Dimensions are 390mm(w)x330mm(d)x220mm(h)

Prices shown include valves. Also available without valves on request.

Kit6550 £615

KAT6550 £580

KIT6550 VALVE INTEGRATED AMPLIFIER KIT £615.00

KAT6550 VALVE POWER AMPLIFIER KIT £580.00

The Headphone II amplifier is a beautifully simple design using Mullard ECL83 valves, a triode and power pentode in the same envelope.

It works from any line level source i.e. an amplifier's tape or pre amp out sockets. The circuit uses high specification E/I output transformers that can drive any headphone load from 16 ohms to over 300 ohms depending on how the secondaries are wired.

The Headphone II is a pure Class A single ended design with the power pentode connected in triode configuration for sonic purity and is as quiet as a mouse. Treble has the crispness of the best solid state but with the tonal resolution and delicacy associated with valves. Bass is punchy and controlled without becoming artificial.

Dimensions are 270mm(w)x275mm(d)x85mm(h)



HEADPHONE II KIT £285.00

Reference Books

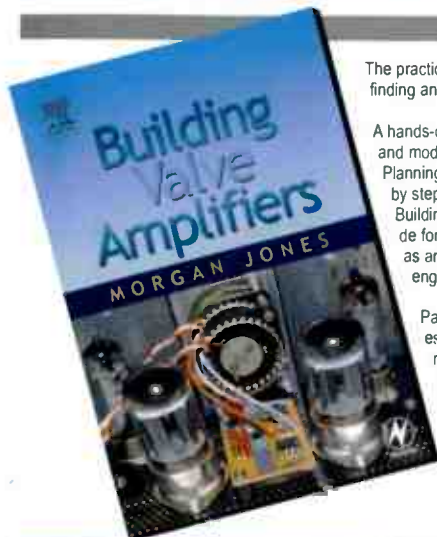

The practical guide to building, modifying, fault finding and repairing valve amplifiers.

A hands-on approach to valve electronics, classic and modern - with a minimum of theory. Planning, fault finding and testing illustrated by step by step examples. Building Valve Amplifiers is a unique hands-on guide for anyone working with tube audio equipment as an electronics experimenter, audiophile or audio engineer.

Particular attention has been paid to answering questions commonly asked by newcomers to the world of vacuum tubes, whether audio enthusiasts tackling their first build, or more experienced amplifier designers seeking to learn the ropes of working with valves.

The practical side of this book is reinforced by numerous clear illustrations throughout.

Price £20 plus £2 p&p



Morgan Jones's Valve Amplifiers has been widely recognised as the most complete guide to valve amplifier design, modification, analysis, construction and maintenance written for over 30 years.

The author's straightforward approach, using as little maths as possible, makes this book ideal for those with limited knowledge of the field as well as being the standard reference text for experts in valve audio and a wider audience of audio engineers facing design challenges involving valves.

Price £30 plus £2 p&p

Many more titles available, please check www.worldaudiodesign.com for more details



The Williamson Amplifier by D.T.N. Williamson.

Offers practical advice on how to build and set up the amplifier for best results.

40pp Paper back

£9.95 + £1.50 P&P



By Ben Duncan - International authority in audio quality and electronics.

A comprehensive handbook on power amplifiers covering introductory material; an overview of global requirements; interfacing and processing; classes, and modes; features of the power stage; the power supply; specifications and testing; the rationale and procedures of real-world testing; choice, application installation, set-up and maintenance.

£46.99 + £2.00 P+P



Douglas Self has dedicated himself to demystifying amplifier design and establishing empirical design techniques based on electronic design principles and experimental data.

Ideal read for professional audio designers and electronic engineers; advanced amateur audiophiles and electronic designers; audio engineers involved in using and maintaining high-end domestic and professional audio systems.

£26.99 + £2.00 P+P

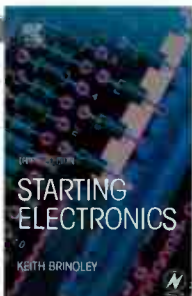

Starting Electronics is unrivalled as a highly practical introduction for hobbyists, students and technicians.

Keith Brindley introduces readers to the functions of the main component types, their uses, and the basic principles of building and designing electronic circuits.

Breadboard layouts make this very much a ready-to-run book for the experimenter, and the use of multimeter, but not oscilloscopes, puts this practical exploration of electronics within reach of every home enthusiast's pocket.

£9.99 + £2.00 P&P



Includes full designs for eleven power and control amps, including 5-20, using valves.

Begins with a four chapter tutorial on getting the best sound from valve amplifiers.

£13.95 + £2.00 P&P



This book takes a comprehensive look at tube audio design. It explains how vacuum tubes work and how to design with them. Rozenblit covers stabilisation and testing, a description of 13 famous and classic amps and preamps and how to work effectively as a designer.

A hands-on guide to construction techniques, tools and choosing components and tubes is provided. 1997

£15.50 + £2.50 P&P

How to order...

There are various ways you can order and make payment for your purchases:

Visit us at www.worldaudiodesign.com

Secure payment option. World Audio Design Ltd. accept all major credit cards through HSBC's online system which encrypts order details before transmitting them, thereby protecting your card and personal information when in transit. We believe this system to be the most convenient and reliable method to ensure that your card details are treated in a responsible and reliable way.



tel: 0845 2575600 fax: 0845 2575623

We do accept the fact, that many people prefer doing business talking to a real human being. Call us in office hours and we'll do our best to find the right kit for your ability and budget.

Please make cheques payable to World Audio Design Ltd, and send them together with list of your chosen items to FREEPOST WORLD AUDIO DESIGN

AMPLIFIER DESCRIPTION	PRICE (inc vat)	PARTS DESCRIPTION	PRICE (inc vat)	PARTS DESCRIPTION	PRICE (inc vat)
KaT6550 with valves	£ 580.00	KaT300 with valves	£720.00	300B PSE output transformer (each)	£110.00
KaT6550 without valves	£ 450.00	KaT300 without valves	£550.00	300B PP output transformer (each)	£110.00
KiT6550 with valves	£ 615.00	KiT300 with valves	£765.00	Kel84 PCB	£ 30.00
KiT6550 without valves	£ 485.00	KiT300 without valves	£600.00	Kel34 PCB	£ 12.00
Kel84 integrated (with valves)	£ 335.00	6550 mains transformer	£120.00	Kel80 PCB (pair)	£ 52.00
Kel84 single input (with valves)	£ 285.00	Kel84 mains transformer	£ 60.00	KECL82 PCB	£ 25.00
PSU-II	£ 185.00	PSU-II mains transformer	£ 40.00	Headphone II PCB	£ 20.00
PRE-II	£ 215.00	300B mains transformer 300B	£115.00	PSU-II PCB	£ 20.00
PAS-II	£ 165.00	6550 choke	£ 40.00	PRE-II PCB	£ 20.00
PHONO-II	£ 130.00	Kel84 choke	£ 20.00	PHONO-II PCB	£ 20.00
Headphone II	£ 285.00	300B choke	£ 40.00	Tag board	£ 4.00
300B PSE with valves	£1197.00 per pair	PSU-II choke	£ 20.00	ALPS 50K dual potentiometer	£ 14.00
300B PSE without valves	£ 895.00 per pair	6550 output transformer (pair)	£130.00	ALPS 50K motorised pot	£ 26.00
300B PP with valves	£1197.00 per pair	Kel84 output transformer (pair)	£ 90.00		
300B PP without valves	£ 895.00 per pair	PRE-II driver transformer (pair)	£ 80.00		

Jensen Capacitors (630v)



PIO signal 0.01uF Aluminium Foil	£10.13
PIO signal 0.01uF Copper Foil	£15.29
PIO signal 0.1uF Aluminium Foil	£12.50
PIO signal 0.1uF Copper Foil	£18.27
PIO signal 0.22uF Aluminium Foil	£14.51
PIO signal 0.22uF Copper Foil	£22.02
PIO signal 0.47uF Aluminium Foil	£16.61
PIO signal 0.47uF Copper Foil	£28.94
PIO signal 1uF Aluminium Foil	£19.99
PIO signal 1uF Copper Foil	£41.23

Other values and versions available - Please Call.

Jupiter Beeswax Signal Capacitors



0.01uF / 600V	£10.40
0.022uF / 600V	£10.40
0.047uF / 600V	£10.40
0.1uF / 600V	£10.40
0.22uF / 600V	£11.15
0.47uF / 600V	£13.50
1uF / 600V	£17.00



Bullet plug - 4 pack	£ 24.00
Silver Bullet Plug - 2 pack	£ 32.00 / 4 pack £ 60.00

Auricaps

Auricap 0.1uF / 400V	£ 6.11
Auricap 0.22uF / 600V	£10.93
Auricap 0.47uF / 600V	£12.45
Auricap 1uF / 400V	£ 7.76
Auricap 2.2uF / 400V	£14.10

Other values / voltages available to order - please call

Eichmann™ - Bullet Plugs®



0.6mm Pure Silver Wire (10M)	£23.50
Silver Plated Phono Socket	£ 2.65
Silver Plated Speaker Post (pair)	£ 7.30
UX4 Ceramic Valve Base	£ 2.50
B9A Ceramic Chassis Base (4)	£ 4.00
Octal Ceramic Chassis Base (4)	£ 4.00
B9A PCB Ceramic Valve Base (4)	£ 4.00
Switchcraft Gold Phono Plug	£ 2.44
Switchcraft Silver Plated Phono Plug	£ 4.00

More components now available at

www.worldaudiodesign.com

Lead Free Soldering



Antex CSL 18 watt soldering iron	£16.85
Antex XSL 25 watt soldering iron	£16.85
Replacement tips for CSL iron	£ 3.00
Replacement tips for XSL iron	£ 3.00
Lead free solder (2.5% silver), 0.8mm wire	
2M tube	£ 1.53
4M tube	£ 2.02
100g reel	£ 4.50

Help and advice...

Personal callers are welcome to collect their purchases in person or visit our Demo Room but please phone ahead especially if making a long journey as we can't always be there to greet you.



As all the kits are capable of producing high voltages they require diligence and extreme care to build safely. Read the safety instructions thoroughly before construction. You must be able to solder to a reasonable standard and be able to read a circuit diagram. The KEL84 and Series II kits are generally the most straightforward to construct as they utilise PCBs. None of the kits are suitable for children to build without total supervision.

If you are in any doubt about your ability to build one of our kits, give us a call! We'll give you straightforward, honest advice to enable you to pick a kit to suit your pocket and ability. We hail from an electronics background and have test-built every kit we sell. If you need help during assembly or just want to check something give us a call.

Telephone 0845 2575600 (local rate). During evenings and weekends you will automatically be transferred to a technical support number at the same local call rate. International customers please call 44 1245 450651.

If you need further help we have a collect and repair service at reasonable rates based on workshop time. We can also arrange for kits to be built to order and your specification.

Telephone 0845 2575600
Post orders to FREEPOST WORLD AUDIO DESIGN (no stamp needed)
All parts prices shown include VAT

THE BEST OF
LITTLE WALTER



LITTLE WALTER
THE BEST OF
SPEAKER'S CORNER/CHESS
LP 1428

If you ever get a hankering for the sound of the amplified mouth organ, the 'harp' by any other name, then blues-man Little Walter is the place you want to be. Previously the domain of novelty acts, the harp was taken by Little Walter and turned into a screaming work of pure evil genius. His innovative approach stretched the boundaries of the instrument into areas it wasn't supposed to roam which lead to many a jaw to be dropped during his performances. Little Walter (real name Marion Walter Jacobs) luckily fell in with blues legends Tampa Red and Big Bill Broonzy. However, it wasn't until he started recording with Muddy Waters that the earth began to move, it's never settled down since. He quickly became the Chess studio's resident artist – which is how he became to perform a chart topper, the amazing Juke, which kicks off side two of this collected works, originally released in 1964. This 180gm album includes many of Walter's Top Ten R&B hits, including 'Sad Hours', 'Mean Old World', 'Tell Me Mama' and 'Off the Wall', plus a lively 'My Babe'.

The demands on a hi-fi setup are quite unique when playing back music from this time period and of this genre. That slap-back echo on Chess and Sun recordings, the mix of Howlin' Wolf or Otis Redding's voice saturation in their music, the

intensity of sound from Robert Johnson recording into the corner of the room. The incredible Chess recording sound, which includes this Little Walter production, was achieved by using different lengths of drainpipes as reverb tunnels; that is why Walter's vocals sound the way they do. The album's recording techniques create a larger-than-life effect and a great recording. No one actually sounds like that until they are recorded and produced to create the desired effect which brings into close focus the, surely, redundant argument of buying a hi-fi system to replicate the 'live' sound of the studio, Hi-fi replicates the mastering, no more...

BENNY CARTER AND HIS ORCHESTRA
FURTHER DEFINITIONS
Spkr's Corner/Impulse AS 12

Benny Carter was a multi-talented man. Yes, he was known as an excellent alto-sax player (with only Johnny Hodges challenging him for the top spot during the 1930s). However, he was also a top composer and arranger (he contributed arrangements to Fletcher Henderson and the mighty Duke Ellington) and could play a mean tenor, clarinet, piano and trumpet too. He also lead a full playing life and didn't pass away until July in 2003 when he was 95. This album was released in 1962 and features a superb line-up that includes: Coleman Hawkins, Jo Jones,

Phil Woods, Charles Ruse, Dick Katz, Jimmy Garrison and John Collins. Carter's arranging skills come to the fore on this album. A particularly apt example being his work on the track, 'Body & Soul', which was a massive hit for band member, Coleman Hawkins. Carter allows Hawkins freedom and space to stretch his skills to the maximum. In addition, Blue Star and Doozy prove to be two of Carter's finest originals. The package is a true copy of the original with no indications that this reissue is a replica. There are no tell-tale bar-codes or manufacturer's details, all of that is, instead, placed on the accompanying shrink-wrap plus inserts. Speakers Corner, when issuing re-releases, have an intriguing policy towards mastering. Whilst utilising original master tapes the company states its wish to reproduce, "...the original intentions of the musicians and recording engineers which could not be realised at the time due to technical limitations." The mastering of this heavyweight 180g vinyl displays effective silences and impressive dynamics throughout the whole spectrum of the work, as another – this album is sparkling from the first track until the last. Faithfulness to the original is top priority, not the interpretation of the original and there is certainly, says the company, no such thing as a 'Speakers Corner Sound'. Well produced, the tone of the mastering is also very 'warm' which suites the sax-heavy content of the album.

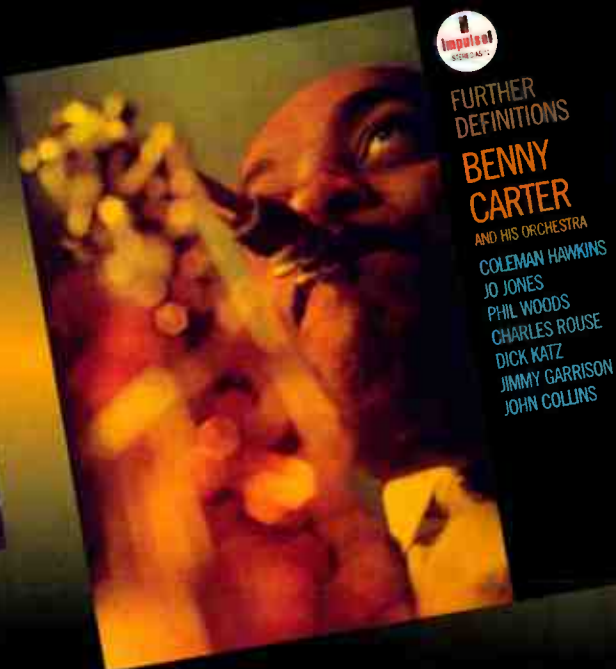

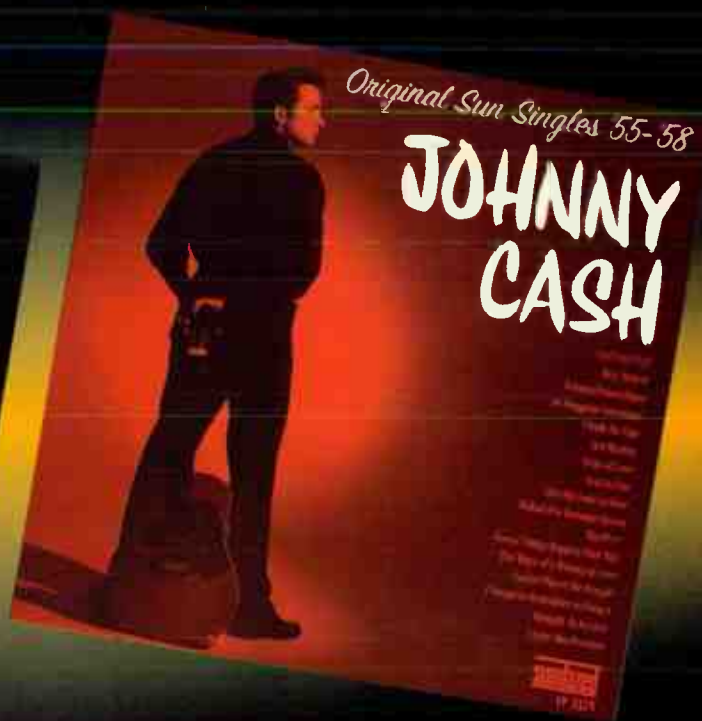
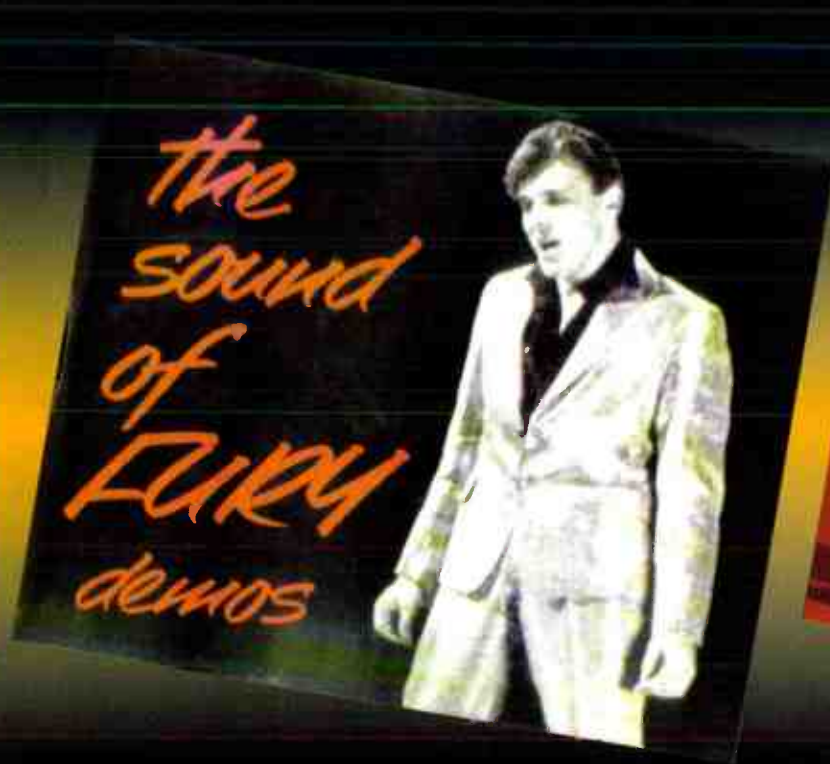

BILLY FURY
THE SOUND OF FURY DEMOS
EARMARK 42058

He was Britain's own Elvis Presley. Born Ronald Wycherley, on April 17th 1940, in Liverpool, it was in May of 1958 that Ron entered Percy F. Phillips demo recording booth to cut a number of tracks, mostly inspired by that man, Elvis. It was these tracks, along with an essential photograph, that were sent to Larry Parnes – a major and powerful figure in UK's national entertainment. Ronnie duly took his guitar to meet Parnes, strummed a few of his songs, had a quick rehearsal and, before he knew it, was playing in front of an ecstatic audience. The following day Billy Fury joined the tour and started on a journey that was to bring him many Top 40 hits and to record what is widely regarded as the greatest British rockabilly album of all time, 'The Sound Of Fury'. A highly collectable item and a firm favourite among R&R fans, this legendary album has now spawned an album of demos recorded on a domestic tape recorder giving the listener an 'in' on the creation of the original 'The Sound Of Fury' album.

This 180g album has already been released on CD, to much acclaim. However, there is something special about this vinyl version which helps draw a clear line under CD's physical restrictions and inherent marketability problems. The original album was released in a 10" format, with a suitably dramatic pose from Fury adjacent to the emotionally

charged title font. This new demos release duplicates that format almost exactly, providing the same artwork plus the extra word 'demos'. For those who remember or are fans of Fury this vinyl release will draw the eye immediately as it generates the look and feel of those original rocking times. For those of a younger age, it offers an excellent retro angle to their own collection – the 10" format was, of course, a very popular format during the '50s. For those who own the original album it is also a perfect companion piece in both size and appearance. The look and feel of this album, therefore, is just as important as its contents. What other musical format can generate so many emotions without even being played?

JOHNNY CASH
ORIGINAL SUN SINGLES '55-'58
SUNDAZED/SUN LP 5179

One of the undoubted stars of country music, Cash was much more than that, he was a great of music itself. He recorded more than 1,500 songs and they can be found on around 500 albums, counting only American and European releases. More of his albums, 45 in total, remain in print today than most artists ever make. He is one of the very few people in the history of music to sell more than 50 million records. In fact, people forget just how hot Johnny Cash was, when his sales career was at its zenith. In the Autumn of 1969, Johnny Cash was the hottest act in the world, selling

around 250,000 albums per month of his Folsom Prison and San Quentin albums. At that time, he was even outselling The Beatles. He's won 11 Grammys, appeared in many films, hosted his own TV series but, probably more than any of these, he communicated. He was never fixed into one genre, he appealed to country, folk, pop and rock fans. All of this from a poor sharecropper's son from Kingsland, Arkansas, USA, who sang to himself while picking cotton in the fields.

Cash rose to prominence from his association with, and work for, the famous Sun label – a label which, at that time, also included the likes of Elvis Presley and Jerry Lee Lewis. Cash's first single, 'Hey Porter', had a disappointing debut. But his follow-up, the 1955 'Cry, Cry, Cry', drew national attention. 'Folsom Prison Blues' went into the Top Five in country singles in 1956, and 'I Walk the Line' became Cash's first No. 1 country hit. In 1957, he made his first appearance at the Grand Ole Opry. And by 1958, he'd published 50 songs, sold more than six million records and moved to the Columbia label. All of the latter songs are present on this invaluable album, plus many more. Excellently mastered on 180g and beautifully packaged, the singles are not only collected but illustrated on the cover. Utilising the original masters, the vinyl format is the true home for these Sun-sourced classics.

CONTACT:

Vivante: 01293 822 186
www.vivante.co.uk

When detail matters.....



The new MR5 equipment support from
Henley Designs, serious about sound!



Henley Designs 01235 511166
www.henleydesigns.co.uk



Johann Sebastian would have been very proud.

The Kontrapunkt series from Ortofon. Named as a sign of respect for possibly the greatest, and the last, of Johan Sebastian Bach's works - The XIXth Contrapunctus. From around £400 and available from most quality Hi-Fi stores.

Distributed by Henley Designs, 01235 511166, www.henleydesigns.co.uk



diy supplement

OCTOBER 2005 No.85

contents

EDITOR

Mike Ballance
 fax: +44 (0) 8707 065 162
 e-mail: diyeditor@hi-fiworld.co.uk

DESIGN EDITOR

Faiza Chunara
 tel: +44 (0) 207 625 3129
 fax: +44 (0) 207 328 1844
 e-mail: adproduction@hi-fiworld.co.uk

PRODUCTION EDITOR

David Noble
 tel: +44 (0) 207 625 3134
 fax: +44 (0) 207 328 1844
 e-mail: classifieds@hi-fiworld.co.uk

ADVERTISING

Debi Silver
 tel: +44 (0) 207 372 6018
 fax: +44 (0) 207 328 1844
 e-mail: advertising@hi-fiworld.co.uk

ACCOUNTS

Sharon Mehlhom
 9.00am - 3.00pm
 tel: +44 (0) 208 841 8892
 fax: +44 (0) 208 841 9144
 e-mail: accounts@hi-fiworld.co.uk

WORLD AUDIO DESIGN

www.worldaudiodesign.com
 tel: +44 (0) 845 2575600
 Fax: +44 (0) 845 2575623
 e-mail: sales@worldaudiodesign.com

PUBLISHER

Noel Keywood
 e-mail: publisher@hi-fiworld.co.uk

PRIVATE & TRADE CLASSIFIEDS

tel: +44 (0) 207 625 3134
 fax: +44 (0) 207 328 1844
 e-mail: classifieds@hi-fiworld.co.uk

SUBSCRIPTIONS

tel: + 44 (0) 1442 879097
 fax: + 44 (0) 1442 872279
 e-mail: hi-fiworld@webscribe.co.uk

WRITERS

Haden Boardman
 Neville Roberts
 Albert Lee

HI-FI WORLD

SUITE G4, ARGO HOUSE
 KILBURN PARK ROAD
 LONDON, NW6 5LF

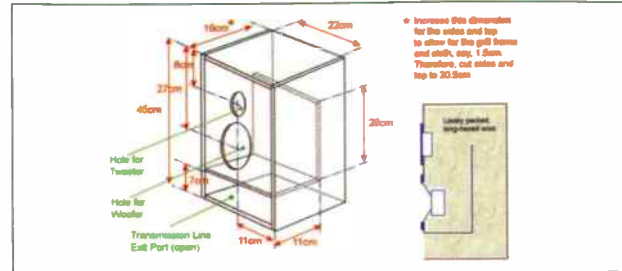

89 NEWS

All the latest from the weird and wonderful world of DIY hi-fi.

90 BOOKSHELF TRANSMISSION LINE SPEAKER

Neville Roberts manages to squeeze a line into a small box.

94 GET THAT CROSSOVER OUTSIDE THE BOX!

Albert Lee removes a crossover and improves the sound dramatically.

97 BOOK REVIEW

Neville Roberts checks out a book on classic audio and hi-fi design.

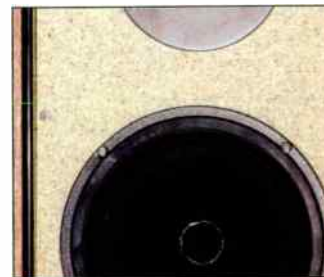

Distributed by Seymour Distribution Ltd 86 Newman Street London, W1T 3EX Tel: +44 (0) 20 7396 8000 Printed by St.Ives, Plymouth Tel: +44 (0) 1752 349 413
 Our Agents in Malaysia Millennium Hi-Fi & AV Simon Chang Showroom & office, 500-1-3 First Floor Wisma Indah (Shen Court), Jalan Tun Razak 50400 Kuala Lumpur, Malaysia
 Tel: 603 9283 8171 Fax: 603 9281 3762 e-mail: info@millennium-audio.com

All unsolicited submissions and goods are at the owner's risk. We accept no responsibility for such submissions, nor do we undertake to return them.
 No material may be reproduced from this magazine without the publisher's written permission. © Audio Publishing Ltd



Falcon Electronics

<http://www.falcon-components.co.uk>

Full Price List and Focal details on Web Site

DRIVE UNITS: by FOCAL & seas, and a pick of the best from other manufacturers.
100+ CROSSOVER NETWORKS: - Active & Passive, Components, Accessories,
New LS3/5A type Crossovers & Components
PLUS P.A./Professional Sound Equipment
Speaker Repairs also available – Contact for details.
Dedshete back in stock

COMPONENTS

SOLENE Polypropylene capacitors. 0.1mFd. to 100mFd.

NEW Values:- 3.0mFd 400v 5% & 9.1mFd 250v 2.5%

Polyester and Polycarbonate Film Capacitors. 0.1mFd. to 10mFd.

ALCAP Reversible Electrolytic Capacitors (Non-Polar):

50v, 100v & Low Loss. 2mfd. to 600mFd.

FALCON Custom-wound Inductors.

FERRITE:- Standard, High Power, Super Power, Super-Super Power

AIRCORED 0.56 – 1.25mm wire; **IRON DUST.** 1mm wire

TAPPED INDUCTORS:- 0-10mH in 1mH steps & 0-1mH in 0.1mH steps

AUDIO AMATEUR PUBLICATIONS

Back year sets of Speaker Builder, Audio Amateur & Glass Audio, plus the Audio Anthology Set.

Altogether 50+ books and Audio Amateur's magazine year sets.

Focal Unit Range

Price List & Unit Specs FREE on Web site - available in .pdf format

A range of Falcon Designed and Manufactured Units coming later this year.

8 inch - 15 inch

12 inch and 15 inch on Die-cast Magnesium Chassis.

SUPPLIERS TO THE TRADE SINCE 1972

Send for our FREE price list PL32: Just send a large S.A.E. (47p stamp) or US\$3 bill overseas, Europe US\$2 bill, 2 or 3 International Reply Coupons (IRC) to:- (Dept HFW) Unit 12 Damgate Industrial Estate, Damgate Lane, ACLE, Norwich, Norfolk. NR13 3DJ Tel (0)1493 751100

NOTEWORTHY AUDIO DIY



New Products

- High quality silver plated phono sockets with isolating washers: £2.50 each inc vat.
 - Large silver plated loudspeaker binding post with isolating washers suitable for use in both amplifiers and loudspeakers: £4.50 each inc vat.
 - Voodoo silver plated 4mm banana plugs factory treated with contact enhancer: £25 for four inc vat.
 - Eichmann Cablepod binding posts: £30 per pair
- Please call or see our website for further information on these or any of the other products we stock.



- Lowther drive units
- PHY-HP drive units
- Wonder Solder
- Audio Note Dac Kit
- Eichmann connectors

- Stoetkit valve amplifier kits
- Furutech IEC sockets and plugs
- Inca Gold plated mains plug
- DeoxIT contact cleaner
- Unsleeved 0.5mm Pure silver wire



Noteworthy Audio
 36 Buckingham Street
 Aylesbury
 Bucks
 HP20 2LH
 Tel: 01296 422224



www.noteworthyaudio.co.uk

WHITE NOISE

AUDIO KITS, MODULES, COMPONENTS

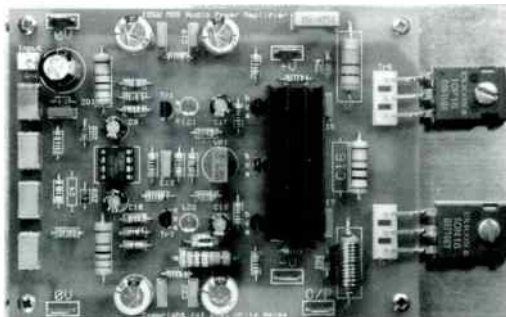

PRODUCTS INCLUDE:- Power Amplifiers 30-250W, Preamplifiers, Phono stages, Active Crossovers, Power Supplies, Buffer Amplifiers, Balanced line drivers / receivers, Stepped attenuators, Gold plated connectors, Cables, Capacitors, Resistors, Semiconductors, Transformers, Subwoofers, Loudspeaker drive units

WHITE NOISE
 11 STATION ROAD
 BEARSDEN
 GLASGOW
 G61-4AW

Web:- <http://www.wnaudio.com>
 Email:- david.white38@ntlworld.com
 Tel:- 0141-942-2460 (until 9pm)
 Fax:- 0141-587-7377

audioXpress... It Just Sounds Better

Your Favorite Audio – One New Magazine!

- PROJECTS
- REVIEWS
- THE NEWEST TECHNOLOGIES
- AUDIO CLASSROOM
- and Much More!



Subscribe To This Great Monthly Publication Today!

Only \$59.95 US for 12 Issues!

audioXpress • PO Box 876 • Peterborough, NH
 03458-0876 USA • Phone: 603-924-9464
 Fax: 603-924-9467 • E-mail: custserv@audioXpress.com

ORDER ONLINE AT: www.audioXpress.com

diynews@hi-fiworld.co.uk

diy news

MULLARD RE-BORN

The valve manufacturer electro-harmonix has acquired the trademarks of the two legendary valve brands Mullard and Tung-Sol. They claim: "Our vacuum tube engineers spared no detail in ensuring perfect replication and performance. Expect creamy, smooth resonance and well-defined character that will fully enhance everything about your sound." Not content with sounding 'right', I suppose these new valves will taste good as well, with their "creamy, smooth resonance". Resonance? Usually we don't want that! But I'll go along with the "well-defined character", although in an ideal world, a complete lack of character, often called neutrality, would be preferable. The thing to be aware of is sale policy. Soon it will not be easy to tell if valves sold as "New Old Stock Mullard" were actually made by Mullard many years ago but never sold or used, or if they are in fact brand new valves not made by Mullard at all, but by electro-harmonix. I look forward to a review in this magazine, inevitably comparing genuine NOS Mullard valves with the new ones from electro-harmonix. Will they be sold in a blue box with the red Mullard logo? Will they look identical now that electro-harmonix owns the trademarks? Will they sound exactly the same? Will they be priced cheaper than NOS Mullard stock? Only time will tell!

FRONT PANEL EXPRESS

Should you be looking for a custom designed solution to your kit building, you probably can't do better than a visit to www.frontpanelexpress.com where you will find a small design program that you can download. This program is used to design your chassis, front panel or whatever you want in metal. You can have any size or shape of hole made in their range of pre-anodised aluminium sheets of various thicknesses and colours. You have to design it yourself. Once done, you e-mail your design to the factory and their machines make your metalwork for you - directly from the file you send. So any mistake is undoubtedly yours - be warned! Although based in the US, they told me that European customers should contact the Berlin factory for their orders. Details on the site, as usual.



Example of the colours available on Front Panel Express metalwork.

The little program takes some getting used to, especially if you're used to the 'Windows' operating system. Most programs that run under 'Windows' have an intuitive feel to them. In my opinion this one of those that doesn't. It just takes time and practice, but I'll get it right eventually!



Example of a back panel with holes for connectors, etc.

MISSING THE MAINS POINT? -

a letter to the editor:

*I was glad to see Albert Lee's article *The Main Thing* in the June issue on constructing a mains distribution unit. While offering clear guidance on many constructional aspects I was a little disappointed, I feel many enthusiasts could take the opportunity to build something that works even better with little extra effort and cost.*

To me, one of the chief benefits of making your own distribution board is the ability to get a proper 'star' connection. In a 'standard' distribution board, the wiring typically consists of a long strip of punched brass which is daisy chained, socket to socket along the board. This means that current draw in the end sockets will affect the earlier ones. Joining all the wires at a single point will reduce this effect. Star earthing is typically 'good practice' in amplifiers, but it applies to power supplies too (All the Neutrals together, Phase together and Earth together).

Secondly I'd suggest that anyone of constructivist tendencies consider the evils of contacts. The Hi-Fi world is awash with assorted snake oils that can be used to treat contacts. While these vary in effectiveness and cost they do speak to the core problem that electrical contacts degrade with time. Thus I would politely suggest that if you are interested in building a mains distribution unit you consider which contacts are strictly necessary. Do you actually need an individual socket to have a switch? Is an extra isolating switch necessary? (The distribution board may be plugged into a switched outlet). Albert describes fitting an IEC socket, presumably this is so that he can experiment with prewired mains cords. Readers who maintain long term monogamous relationships with their cables may eliminate an unnecessary contact by hard wiring the cable to the distribution point.

A couple of other points for readers to consider if they are interested in building such a unit. Twist phase and neutral conductors together as this helps reduce radiated electrical noise. This may also be helped by a metal enclosure but this adds to safety issues. Consider using single sockets as the internal wiring of double ones isn't great and makes it harder to do a proper star connection. A separate article in the June issue dealt with mains filtering, combining the two projects is reasonable and potentially productive.

Simon Brown

Eighth-Wave

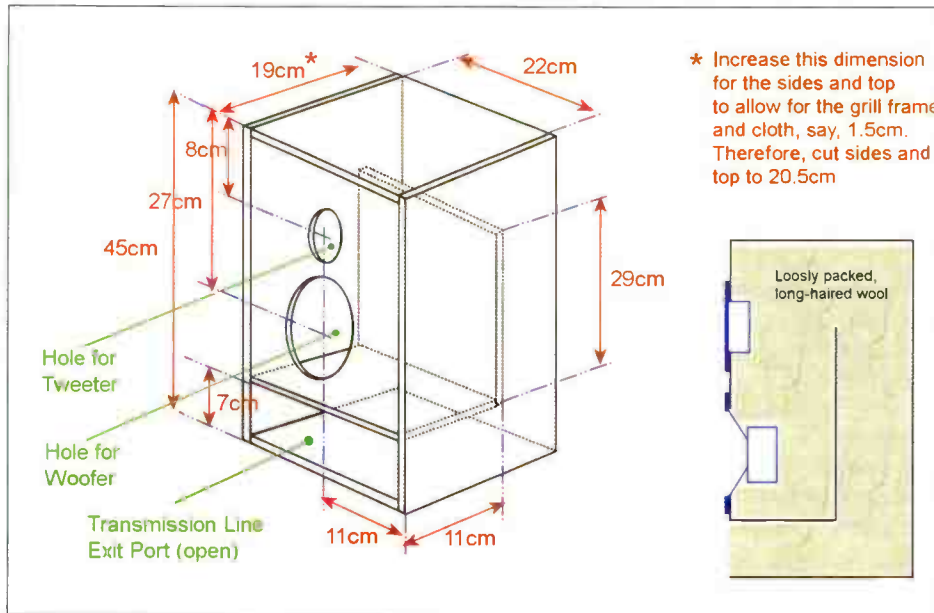

Cabinet dimensional drawing.

Transmission line loudspeakers can produce a tight and well extended bass response in a domestic environment and are reasonably tolerant of acoustically unhelpful room dimensions. The quarter-wave transmission lines that grace our sitting room (my wife would disagree with my choice of verb here, favouring 'dominate!') extend well down into the sub-audible range, without the sound becoming muddy or boomy. The deep organ

notes around 16Hz in my recording of the second movement of Saint Saens Organ Symphony No. 3 are clearly reproduced on my system and are felt more than heard. So when I wanted to construct some low-cost bookshelf speakers for use in my study, I decided that an eighth-wave design would best meet my needs.

ENCLOSURE DESIGN

Before describing how to make a pair of these loudspeakers, a word or two on the choice of enclosure is in

"All enclosure designs seek to tame the natural resonance of the bass driver"

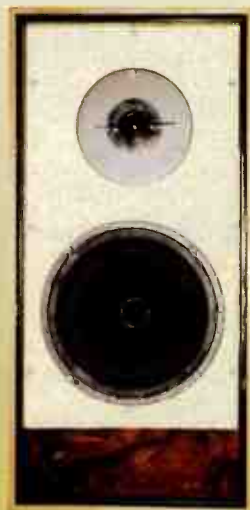

Front view with grill removed.

order.

All enclosure designs seek to tame the natural resonance of the bass driver, which causes a peak in the bass response at the resonant frequency with smaller peaks at the various harmonics. Another requirement is to extend the bass below resonance and do all this without too great an efficiency loss. Finally, they have to acoustically couple the drive units to the room. This is by no means an easy task as a room suitable for living in is not best suited for listening, unless one is prepared to stick egg boxes in strategic places along the walls!

The simplest enclosure to build is the sealed box, which is also

Neville Roberts squeezes a quart of performance into a pint sized box.

incorrectly called the infinite baffle design. The sealed box will certainly dampen the cone excursions around resonance. Unfortunately, it does nothing to extend the response below resonance and it is not the most efficient design.

Horn loudspeakers come in various guises, the most popular of these being the reflex enclosures. They are more efficient than the sealed box and will certainly control the resonance but, in my humble opinion, they are not much good at coupling with the room.

This brings us to the transmission line design. If one considers a quarter-wave design, the length of the line is chosen to be a quarter of the wavelength of the natural resonant frequency of the bass driver, with a few adjustments that will be discussed later. The line is simply a resonance tube, like any wind instrument. However, unlike an organ pipe, it needs to work over a range of frequencies. At the bass driver's resonant frequency, the port will reflect the wave back to the driver, and this wave will be in anti-phase to the rear of the cone that produced it. This will control the resonance, as with a reflex enclosure.

These anti-phase resonances will also occur at every quarter wavelength and this will have the effect of controlling the various harmonics, unlike a reflex enclosure. It is also why an eighth-wave line will work at constraining the peaks in the bass response.

At frequencies below resonance, the anti-phase emanating from the rear of the cone (relative to the front of the cone) emerge from the exit port in-phase and therefore reinforce the response and extend the range of the loudspeaker. Another benefit is that the inevitable eigentones and other room resonances can be picked up by the port and fed back into the rear of the woofer cone, which can help to

Transmission Line

cancel them out. With correct positioning, the loudspeakers can adjust to suit your listening environment!

However, it is not all good news. Odd-order harmonics will reach the end of the line out of phase and would tend to reinforce unwanted resonances of the bass driver. This problem can be addressed by tapering the cross-section of the line, which spreads out and hence reduces the effect of these anti-resonances. The necessary folding of the line also contributes to this effect. Additionally, the introduction of some long-haired wool into the port will also reduce these undesirable effects. This must not be too excessive though, as bass performance would suffer.

So is an eighth-wave line as good as a quarter-wave? Well, frankly no. Although it is still pretty good at taming the resonances, it is less effective in the other areas. However, a quarter-wave line would just be too big for a bookshelf design and these inefficiencies can be minimised with careful design, such as not over-tapering the line, etc.

A PRACTICAL DESIGN

The first step is to choose the drive units. For a bookshelf speaker, a two-unit system is most suitable with one drive unit for the high frequencies (the tweeter) and the other for the midrange and low frequencies (the woofer). I was fortunate to have a pair of Kef T27 dome tweeters available. Alas, these are no longer made, but there are some good equivalents available. I recommend the use of the Seas H831 or H457 units.

A good match to the T27 for the woofer is the Kef B110, but once again these are no longer available. I therefore opted for a Seas P17-RCY/P, which is a 6.5" woofer and, like the B110, has a free-air resonance of around 35Hz. This particular flavour of the P17-RCY has a bullet-shaped phase plug in the centre that reduces resonances that would otherwise occur in the volume between the dust cap and the pole piece. The recommended frequency range of this unit is 40Hz - 4KHz. Kef recommend the T27 is

used with a crossover frequency of 3.5KHz, which will suit the Seas P17-RCY nicely. This frequency is also suitable for the other Seas tweeters mentioned above.

As I touched upon earlier, there are some other factors that have to be taken into consideration when calculating the length of the line. Firstly, the introduction of long-haired wool as a dampening material also has the effect of reducing the effective velocity of sound due to the isothermal effect, causing a heat exchange between the air and the wool. This effectively reduces the speed of sound by a factor of about 0.85.

The other issue to consider is end correction. This is caused by the vortex effect at the exit port. This is where the air emerging from the port takes a while to realise that it is no longer in a line and is now in the room! This means that the line as seen by the drive unit is about 12cm longer than it actually is. This figure needs to be deducted from the overall calculation to work out the length of the line.

The length of our line is calculated as follows. Using:

$$\lambda = \frac{v}{f}$$

where:

λ = wavelength in metres
 v = velocity of sound in long-haired wool = 330 * 0.85m/s
 f = the resonant frequency of the woofer = 35Hz

$$\lambda = \frac{330 * 0.85}{35} = 8m$$

For an eighth-wave line, the length is 1m minus the end correction of 12cm, or 88cm. The line is actually folded into a labyrinth to enable it to

fit into the cabinet, so this length is used as the distance going along the centre of the cross-section of the line.

BUILDING THE ENCLOSURE

The above calculations were used to design the enclosure shown in the diagram. The cabinet is quite a straightforward design and the dimensions will enable the appropriate pieces of wood to be cut. Remember to allow for the thickness of wood when cutting the

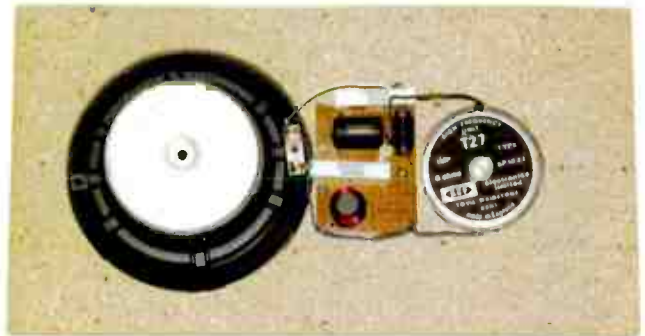

Baffle rear view.

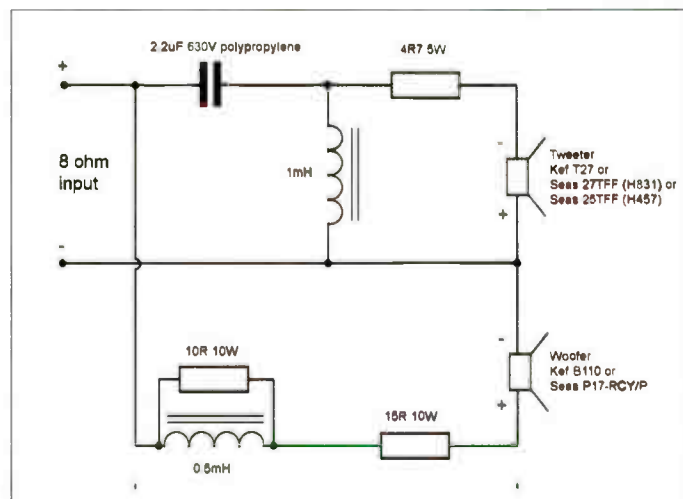

Crossover circuit.

panels. I used chipboard, but MDF is equally suitable.

If, as I did, you want to fit a grill into the front of the enclosure, you will need to increase the length of the top and sides as shown by the asterisk in the drawing diagram. I used square to make the frame, so

"the air emerging from the port takes a while to realise that it is no longer in a line"

the sides and top were cut to 20.5cm to make the rebate.

Batons are used to support the front and back panels in place, and also to support the internal baffles that form the labyrinth. The drive units are simply screwed to the front panel - no rebating is required, which would have exceeded my very limited woodworking abilities! The holes can be made marking out the required circles (85.5cm diameter for the tweeter, 145.5cm diameter for the woofer), drilling a circle of small

LANGREX SUPPLIES LTD

DISTRIBUTORS OF ELECTRONIC VALVES, TUBES AND SEMI-CONDUCTORS AND I.C.S.

1 MAYO ROAD • CROYDON • SURREY CR0 2QP

24 HOURS EXPRESS MAIL ORDER SERVICE ON STOCK ITEMS

E-MAIL LANGREX@AOL.COM

PHONE
020 8684 1166

FAX
020 8684 3056

A selection of our stocks of **New Original Valves/Tubes.**
Many other brands available

STANDARD TYPES			SPECIAL QUALITY TYPES			OTHER TYPES		
ECC83	E.I	4.00	A2900/CV6091	GEC	17.50	12BY7A	GE	7.00
ECC85	RFT	12.00	E82CC	SIEMENS	7.50	5687WB	ECG	6.00
ECC88	BRIMAR	6.00	E83CC	TESLA	7.50	5814A	GE	5.00
ECC88	MULLARD	10.00	E88CC/CV2492	BRIMAR	15.00	6072A	GE	10.00
ECH81	MULLARD	3.00	E88CC GOLD PIN	TESLA	8.50	6146B	GE	20.00
ECL82	MULLARD	5.00	ECC81/CV4024	MULLARD	6.00	6201	GE	6.00
ECL86	PHILIPS	10.00	ECC81/M8162	MULLARD	7.50	6336A	RCA	35.00
EF86	PHILIPS	20.00	ECC81/6201	MULLARD	10.00	6550C	SVET	20.00
EL37	MULLARD	30.00	ECC82/CV4003	MULLARD	15.00	6922	ECG	6.00
EZ81	MULLARD	10.00	ECC82/M8136	MULLARD	17.50	7027A	GE	25.00
EZ80	MULLARD	5.00	ECC82/CV4004	MULLARD	40.00	7308	SYL	5.00
GZ33/37	MULLARD	25.00	AMERICAN TYPES			OTHER TYPES		
GZ32	MULLARD	25.00						
5Z4G	BRIMAR	7.50	5R4GY	RCA	7.50	E88CC	TESLA	4.00
6V6GT	BRIMAR	7.50	5U4GB	SYLVANIA	15.00	ECC81	RFT	3.00
12BH7	BRIMAR	12.00	5Y3WGT	SYLVANIA	5.00	ECC82	RFT	6.00
12E1	STC	10.00	6BX7GT	GE	7.50	ECC83	RFT	8.00
13E1	STC	85.00	6B4G	SYLVANIA	22.00	EF86	USSR	5.00
807	HYTRON	7.50	6FQ7	SYLVANIA	7.50	EL84	USSR	3.00
811A	USSR	10.00	6L6GC	GE/SYL	20.00	EL34	SVETLANA	7.50
6080	MULLARD	10.00	6L6WGB	SYL	20.00	EL34	E.I	6.00
			12AX7WA	SYLVANIA	6.00	6SL7GT	USA	7.50
						6SN7GT	USA	7.50

THESE ARE A SELECTION FROM OUR STOCK OF OVER 6000 TYPES. PLEASE CALL OR FAX FOR AN IMMEDIATE QUOTATION ON ANY TYPES NOT LISTED. WE ARE ONE OF THE LARGEST DISTRIBUTORS OF VALVES IN THE UK.

SAME DAY DESPATCH VISA/ACCESS ACCEPTABLE. OBSOLETE TYPES A SPECIALITY.

CREDIT CARD MIN ORDER £10.00.

OPEN TO CALLERS MON. - FRI. 9AM - 4PM. CLOSED SATURDAY

U.K. P & P 1-3 VALVES £2.00, 4-6 VALVES £3.00 ADD 17.5% VAT TO TOTAL INC P & P O'SEAS P & P PLEASE ENQUIRE



Watford Valves

7 DAYS A WEEK 9AM - 9PM The Audiophiles Choice
All output valves multi-tested and digitally matched
Full no quibble guarantee. Expert advice on all valve amps

ORIGINAL MULLARD VALVES LIMITED SPECIAL OFFER

Many of you know that sonically the Mullard valves offer the best audio quality at any price. In deed as last months Hi-Fi World article proved these are simply the best. So here is your chance to buy these top line audio tubes at our special offer prices. All valves are n.o.s. Mullards and come in their original boxes.

ECC81/CV4024	- matched and balanced	£12
ECC83	- specially selected, matched & balanced	£55
E182CC	- superb sound	£18
ECL82	- great in KECL82	£10
ECL83	- sonically the best ECL83	£12
GZ37	- Audio Note, Border Patrol	£25

KT90 SOVTEK EH

The EH KT90 has had rave reviews as an audio upgrade for the KT88 and 6550C. Customers have commented on the detailed bass, which has more bass slam than any other on the market. Selected on plate current and transconductance in matched pairs or quads for only £22 each.

NEW OLD STOCK AUDIO TUBES

5687WB	PHILIPS	£7.00
5703WB	RAYTHEON	£8.00
5842WA	RAYTHEON	£16.00
5U4GB	AMPEREX	£12.80
6080WC	G.E.	£9.00
6188/6SL7GT	PHILIPS	£18.00
6550A	G.E.	£65.00
6GK5	G.E.	£14.00
ECC32	MULLARD	£85.00
ECC81	R.F.T.	£8.00
ECC82	R.T.	£12.00
ECC83	PHILIPS	£12.00
ECF80	R.C.A.	£10.00
ECF82	TUNGSRAM	£8.00
ECL86	A.E.G.	£12.00
EF80	TELEFUNKEN	£10.00
EF804S	TELEFUNKEN	£40.00
EF86	PHILIPS	£12.00

**MAIL ORDER OR
ORDER ON LINE**

Fast mail order/next day delivery/World Wide shipping
1000's more valves stocked. Prices exclude VAT and carriage.



01923 893270

Fax: 01923 679207

www.watfordvalves.com





Fastening the speaker cloth.

holes around the inside of the circles, chiselling out between the holes and finishing off with a file. Cut a suitable hole to accommodate the speaker terminal block in the back panel.

I chose to veneer the sides and front with teak veneer as this not only matched the other furniture in my study, but also served to cover up the screws that were used to hold the batons supporting the labyrinth. A nice touch was to fit some lengths of black plastic angle around the inside edge of the recess to hold the speaker grill frame securely in position. Paint the back and front baffle with some matt black paint. This is especially important for the front panel as this prevents it from showing through the speaker grill cloth.

The crossover is a simple high pass and low pass filter, with additional resistors to compensate for the different sensitivities of the drive units. The crossover frequency has been chosen to be around 3.5KHz, which will suit any of the recommended drive units. It is constructed on a small piece of strip board. Glue the inductors onto the board in the correct position with some epoxy resin adhesive to hold them in place.

You will notice that the polarity of the tweeter is reversed with respect to the woofer. Reactive components in the crossover inevitably introduce different phase shifts at different frequencies and this is part of the reason for wiring them in this way. You may wish to experiment with the polarity, but I found this configuration sounded the best.

I recommend getting some additional resistors with values each side of the 15ohm and 4.7ohm for the woofer and tweeter respectively. The Kef T27 has a sensitivity of 80dB SPL for 1W at 1m on axis, while the SEAS H831 is more sensitive at 96dB. The sensitivity of the Seas P17-RCY/P woofer is 91dB. The easiest way to make any adjustments is to listen to a source of pink noise and move your ear between the two

drive units. Neither should dominate the sound and you are listening for a smooth transition between the low and high frequencies. If you don't have a noise generator, an FM tuner tuned off-station with the muting disabled is a good source of pink noise.

When you build the cabinets, leave the front baffle and rear panel until last. Fit the drive units and crossover and wire everything up. Before screwing the panels into the cabinet, fill the line with long-haired wool. Tease it out, but keep it dense enough so that it will stay in place when the loudspeaker is finished.

Make the speaker grill by constructing a frame to fit inside the front rebate and wrap some speaker cloth around it and staple in place. Using a hair dryer, shrink the cloth to make it taut across the frame. If the frame turns out to be a loose fit in the cabinet, use some self-adhesive

heard.

Although I do not have the facilities available to measure the parameters of the loudspeakers, subjective assessment leads me to consider that these are reasonably sensitive, especially compared to their big brothers in the next room, which have a quoted sensitivity of only 84dB.



Rear speaker connection terminals.

They will accommodate amplifiers up to 50W per channel, but given their

"components for the crossover... have a huge effect on the sound"

black Velcro on the top and bottom to hold it in place.

SITING THE LOUSPEAKERS

It is important to site the loudspeakers with the exit port at least 20cm from the floor. If they are not being placed on a bookshelf, they should be placed on stands to afford the maximum radiation of sound from the port and the correct loading of the speakers.

The total cost of the parts will be about £350, plus the chipboard for the cabinets, which is not bad for a pair of transmission lines using top quality drive units and components. Don't skimp on the components for the crossover as they have a huge effect on the sound. For example, do not be tempted to use a bipolar electrolytic for the 2.2uF capacitor. A good polypropylene such as the Wilmslow Supersound 630V will set you back about £2.70.

As far as sound quality is concerned, the high frequencies are clean and smooth, as you would expect from a good dome tweeter. The midrange is clear and open with vocals having a tremendous presence in the room. The bass, while lacking the drive and depth of the quarter-wave monsters in our sitting room, is extremely well-controlled and gives an effortless quality to the overall sound. It is this tightness and overall smooth response that sets these apart from other small loudspeakers that I have

apparent sensitivity, they will be an ideal partner to the WAD KiT300 9W single ended 300B triode, having the clarity and control to do justice to an amplifier of that quality.

I thoroughly recommend that you introduce yourself to the delights of transmission line loudspeakers. An eighth-wave design means that you don't need a huge sitting room to accommodate them, and they even accommodate the idiosyncrasies of your environment. What more could you want?



The completed speaker.

Crossover

Albert Lee shows how to improve the sound of any speaker by removing the crossover and mounting it externally.

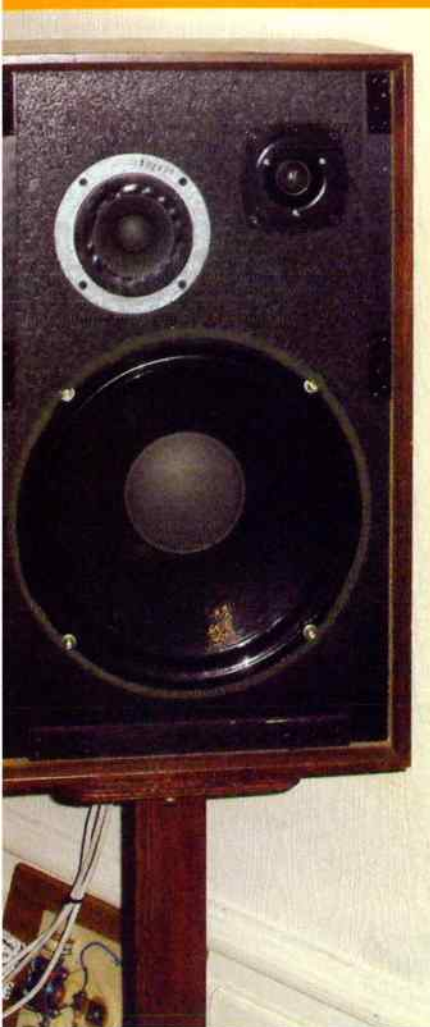

Goodmans Magnum K2 before modification.

Removing the passive crossover from within a loudspeaker enclosure is a sure fire way of extracting much better quality for any conventional loudspeaker, whether the loudspeaker was built by Klipsch or even a lowly Goodmans Magnum K2. This is due to the crossover components being taken from an extremely hostile environment and placed in a relatively benign area. The complex vibrations inside a loudspeaker enclosure affect the ability of the passive crossover to operate at its best.

I chose to modify a pair of rather elderly loudspeakers as a test bed. The Goodmans Magnum K2 loudspeakers have a 12 inch bass driver, a 3 inch midrange unit and a 1 inch soft dome treble unit. The cabinet is a closed box manufactured from 3/4 inch chipboard and measures 2 feet in height by 11 and 3/8 inches depth with a width of 15 inches. The crossover is surprising in

"the terminals are mounted on the rear of the plate"

that the components are of very good quality, with three air-cored inductors and three capacitors. It is mounted towards the bottom of the rear panel.

REMOVAL OF THE MAJOR COMPONENTS

The first stage of this project is to remove the drive units and the crossover assemblies. I have found that the best way to achieve this is to strip only one cabinet at a time! The first drive unit to be removed is the bass driver, we will have seen the

four brass nuts at the periphery of the drive unit. We very gently undo the nuts and place them in a container along with the specially profiled retaining washers and place the container in a safe place, then we remove the bass driver. I used a jeweller's screwdriver to gently ease the drive unit out of the recess then carefully place the drive unit face down at the top of the baffle. Now we mark the cables with masking tape to identify them, not forgetting to put two pieces of masking tape on each lead with the corresponding identifiers on both pieces of wire. Now we can cut the cables aiding the removal process. Place the bass driver face down on a flat dust free surface. As I am sure you will have noticed there are some rather large pieces of foam inside the cabinet, these need to be removed before we can go on to the next step. We can now remove the treble and midrange units and place on the same surface, and cover with a towel; this is to stop any dust entering the spider assemblies. Now we remove the crossover taking care not to damage any of the components!

On the crossover plate we will have seen that the terminals are mounted on the rear of the plate, these consist of a pair of binding posts and a DIN loudspeaker termination. These can be removed and put in the box marked, "not for reuse!"

Next we cut a piece of ply, or real timber, at 155mm by 155mm and carefully sand the surfaces to remove any splinters. We can now cut the retaining holes using the crossover plate as the template. I put in to the drill a slightly larger drill bit at this point and drilled the plate accordingly. This will be helpful when we replace the plate over the studs. I did not use the nuts to secure the new input plate; I drilled four holes in the centre of each of the edges and screwed the plate into position. Use a bead of PVA wood adhesive to seal the plate into position. Make sure that all traces of PVA are removed with a damp cloth especially on the

rear of the plate.

After waiting for at least 12 hours for the PVA to dry we can cut the holes for the cables. If you want you could mount 4mm binding posts, as you can see I chose to hard wire the drive units into the external crossover board.

If we look at the front baffle we will see the treble unit and the midrange unit holes. I decided to use machine screws to remount the drive units as these will give a firmer attachment to the baffle. We must make sure that we do not over tighten the screws as too much torque can crack the plastic of the treble unit!

Now we place a six way terminal strip into the cabinet, this is to connect the drive units to the input leads. The terminal strip can be mounted on the central brace. The cables are bared and then put into each terminal in turn making sure that the retaining screws are tight, any slack on these screws will lead (a very good pun!) to degradation in sound quality. Before we replace the bass driver we need to replace the foam damping I found I had to cut the foam with a freezer knife to enable the damping to be replaced. As you can see from the photo I put some wire ties around each lead to stop them being accidentally pulled



Cabinet with drive units removed.

Modification



View through the bass unit hole, showing blanking plate.

from the cabinet (this could be disastrous as the terminals on the drive units could be ripped off) and there is a small amount of slack between the terminal block and the cable entry.

When replacing the bass driver we need to make sure that the retaining nuts are tight but not too tight, as British Standard Fine studs and nuts are almost impossible to find these days. Replacing the bass driver studs will open another can of worms and we don't want to go there! We have completed the cabinet modifications so I suggest a break for a few hours after which we will start the next stage.

EXTERNAL CROSSOVER MOUNTING AND TERMINATION

Now we are at the meat of this construction article! This is the part where attention to detail will reward us with a step in sound quality that we did not think was possible with such a humble little loudspeaker.

We will mount the crossover onto a piece of softwood of, approximately 12 inches by 9 inches, with six fixing screws. These fixing screws are number 6 by 1 inch in length. We need to mount the crossover centrally and mount our terminal strips as required. I have found that to extract as much information as possible it is best to mount the crossover with either blutack or some resilient material.

If we look at the left hand side of the new crossover board we will notice some hand-written self-adhesive labels, these are important, as a means of identifying the cables. I

have identified the right hand side as well as this is the input. Although if you choose to mount the crossover in a case please make sure that the case is not made from any type of metal. Maplin can supply plastic cases to suit the crossover; this will be a good choice if you decide to use 4mm loudspeaker terminations.

Now we can check and test the drive units, we need a 1.5-volt battery, which we place on the loudspeaker terminations. We should be rewarded with a sharp click. If all is well we can trim the loudspeaker cables and place them in the relevant terminals. Again we check that the crossover network is working using the same method.

If all is as it should be we can connect the crossover to the amplifier. We can position the

"less than ten of our Great British Pounds!"

crossover case in any position but the closer to the amplifier we can put it the greater the quality.

BEFORE AND AFTER

Before this crossover modification the Magnum K2 sounded rather sharp in the upper treble region with a sloppy bass reproduction.

After the modification the sound is much richer in the midband with a very smooth treble reproduction. The most improved area is in the bass region with a very tight and much more extended spectrum. All in all an extremely worthwhile modification. And the cost was minimal I spent less than ten of our Great British Pounds!



Showing cables to crossover.

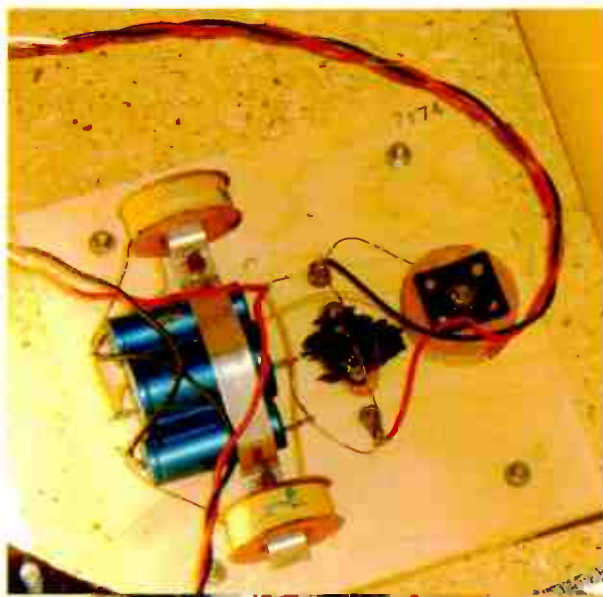

Closeup of crossover.

To hear the fine
detail you some
times need a little
muscle

AUDIA

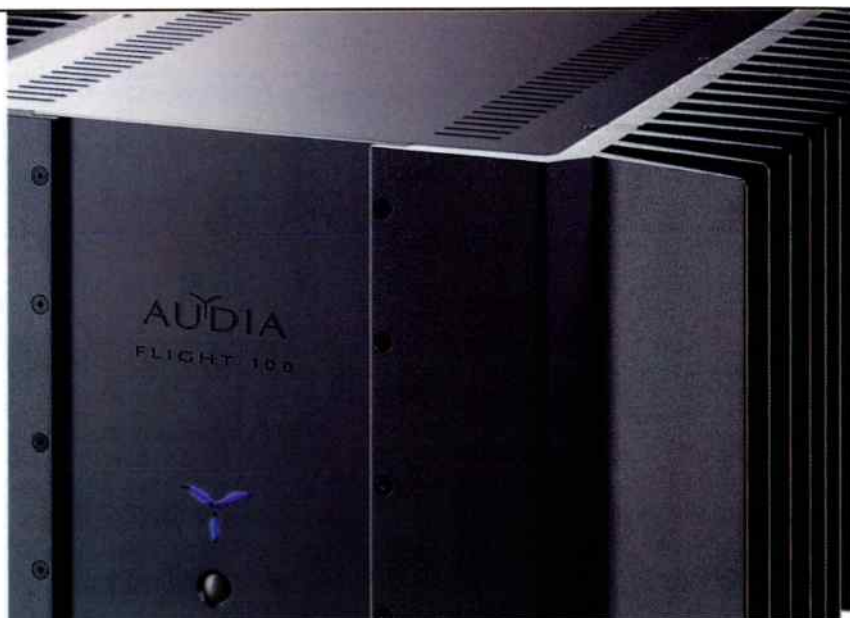
Distributed in the UK by: Henley Designs Ltd, 01235 511166, www.henleydesigns.co.uk, info@henleydesigns.co.uk



HDMI



SOURCE

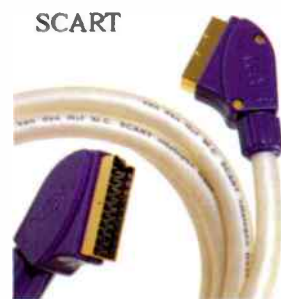

SCART



ANALOG



VIDEO

Distributed in the UK by:

Henley Designs, 01235 511166
www.henleydesigns.co.uk

SOUND DESIGN: CLASSIC AUDIO AND HI-FI DESIGN

BY DAVID ATTWOOD

REVIEWED BY NEVILLE ROBERTS

A few months ago, a book unexpectedly dropped through my letter box: a veritable treasure-trove of colour photographs that tell the story of audio from the beginning of the radio culture in 1945 to the digital revolution of the present day.

This is not a technical book. There are references to the technology, but only in passing and where they are used they help to tell the story. As such, this book will appeal equally to those of a non-technical background as well as the technically minded. In fact, there is greater emphasis on the style of the equipment, and how it met catered for a niche market at that time.

The book starts out with an account of the development of portable AM radios utilising small, all-glass valves and printed circuit boards. In 1954, the Regency TR1 radio designed by Texas Instruments heralded the start of the transistor era. Already well-established names like Bush and Roberts Radio started using transistors in cases originally designed to house valve circuitry.

In parallel with developments in radio technology, portable record players were becoming a hit with the younger generation and the teenage market became the target for advertising. The book includes a variety of reproductions of the advertising posters of the time, demonstrating how celebrities such as Nelson Eddy were used to promote autochangers et al. For the parents, the radiogram was the unit of choice and was a prominent piece of furniture in the home.

There are tantalising photographs of legendary Hi-Fi equipment like the Garrard 401, the Quad QC11 control unit and ESL ground-breaking electrostatic loudspeaker, nestling alongside

pictures of the Dansette record player and neo-modernist designs in bright primary colours. The artists of the time get a mention in the section covering the development of stereo in the 1960s. Photographs of Bob Dylan and the Beach Boys appear alongside a picture of Ray Dolby.

The downside of a book like this is that it does make one feel old! As the '60s drew to a close, it is fascinating to see how the 8-track player was advertised as a sing-along/PA system - the first karaoke machine! However, it eventually lost out to the compact and more convenient cassette.

The section on the 1970s entitled "Decks and Disco" sees the advent of Hi-Fi separates. The pages are littered with images of units such as the famous Akai 4000D and Linn Sondek LP12. It was during the '70s that the cheap, semi-automatic record decks were replaced by the simpler, but better-made record decks from Japan.

Once again, the artists of the time make an appearance and photographs of LP sleeves such as Pink Floyd's 'Dark Side of the Moon' and David Bowie's 'Ziggy Stardust' are on display. Technological developments were not limited to Hi-Fi reproduction, and Robert Moog's 'Mini-Moog' synthesizer is featured as the first synthesizer that was small enough to be used on stage.

Headphones are not left out and offerings from Koss, Sennheiser and Stax are all featured. This brought back memories of the purchase of a pair of second-hand Stax electrostatics and hoping that the insulation of the earpieces was still intact!

Although by 1970, Hi-Fi had become a mainstream purchase, the book notes that video was competing with audio for consumer spending by the end of the 1970s.

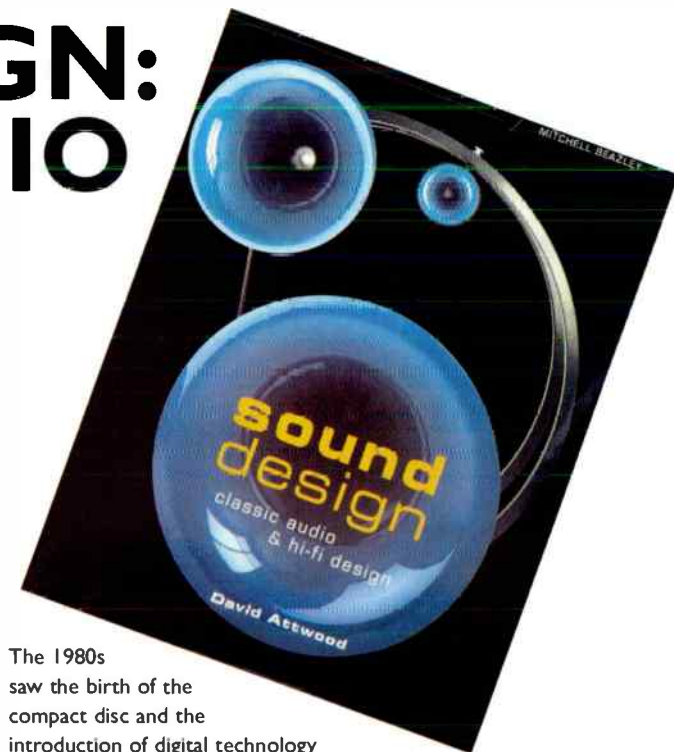

The 1980s saw the birth of the compact disc and the introduction of digital technology triggers the start of a new chapter. However, vinyl was still big business for much of the decade and many great turntables are featured, such as those from the stables of Technics and Dual. The chapter includes a section highlighting the move from rock to dance music and from the concert to club music. Synthetic sounds were now the rage and the experimental German band Kraftwerk is featured.

The Sony Walkman range is covered, from the TPS-L2 cassette unit that was introduced in 1979 to the D50 compact disc unit in 1985. We also start to see 1960s valve design being revived in the 1980s with the launch of the Radford STA25 Series 4 commemorative edition amplifier.

The final chapter highlights the convergence in technologies of audio, video and computer. Some fantastic turntable designs are beautifully illustrated, such as the Dutch La Luce turntable which takes the idea of Hi-Fi as sculpture to extremes. Loudspeakers are not forgotten with photographs of the striking Avantgarde Trio horns by Klipsch and Voigt, the Blueroom Minipod and the B&W Nautilus.

This excellent book concludes with a glossary of terms used in the book and a useful bibliography of resources in the form of web sites to help in tracking down historic information and technical data.

The book is an extremely enjoyable read and will appeal to anyone with an interest in the history and development of Hi-Fi and audio reproduction.

SOUND DESIGN BY DAVID ATTWOOD.
PUBLISHED BY MITCHELL BEAZLEY.
FIRST EDITION 2002.
ISBN 1-84000-506-8

kit & component suppliers

COMPONENT SUPPLIERS

Audio Synthesis

PO Box 50 Nottingham, NG9 1DX.
Tel. 01159 224138 Fax. 01159 229701. Email
salesinfo@audiosynthesis.co.uk. Website
www.audiosynthesis.co.uk

VISHAY BULK FOIL RESISTORS - unquestionably the world's finest resistor for audio applications. Thousands of VSRJ 0.3W 300V 5ppm 1% values in stock at the lowest possible prices eg. values up to 20K at £3.50+vat.

HIGH PURITY SILVERWIRE - Teflon insulated >99.99% purity, 0.6mm and 1.0mm diameter. Ideal for internal wiring, interconnects or speaker cables.

Audio-Links

7 Fairmont Crescent,
Scunthorpe,
North Lincolnshire, DN16 1EL
Tel: 01724 870432
Fax: 01724 875340

Email: audiolinks@ntlworld.com

Extensive stock of specialist audiophile components for valve and solid state enthusiasts. Supplier of the largest range of high-end audio volume controls in Europe. 30 page catalogue - Free via e-mail or £3.00 posted.

Noteworthy Audio Limited,
36 Buckingham Street, Aylesbury,
Buckinghamshire, HP20 2LH
Tel: 01296 422224

email: info@noteworthyaudio.co.uk
web: www.noteworthyaudio.co.uk

Suppliers of a selected range of audiophile valve kits and components. Including the Stoetkit range of valve amplifiers, Audio Note one times oversampling Dac Kit 1.1 and Lowther drive units. Plus a range of components and accessories from Eichmann, Furutech, Wonder Solder, Caig and many more. For a list of the extensive range of manufactured products and the special offers we stock please see our website or call for details. We are open from 9.30 to 5.30 Tuesday to Saturday, with demonstration stock of our kits available - please call in advance to book an audition.

White Noise

11 Station Road, Bearsden,
Glasgow, G61 4AW
Tel: 0141 942 2460
Fax: 0141 587 7377

Email: david.white38@ntlworld.com
www.wnaudio.com

Supplier of the widest range of standard and audiophile kits for solid state preamplifiers, power amplifiers, headphone amplifiers, power supplies, MM/MC phono stages, active crossovers, balanced i/o modules, and stepped attenuators; more kits in the pipeline. All kits use the highest quality, glass fibre, solder masked, silkscreened, PCBs. We also supply a wide range of active (esp. Japanese transistors and Exicom mosfets) and passive components, gold plated connectors, and silver plated wires. Write, phone or email for a free catalogue. Mail order only.

Audiocom Int. Ltd

Unit 14 Pier Road, Pembroke Dock,
Pembrokeshire, SA72 6TR
Tel: 01646 685601 Fax: 01646 685602

Web: www.audiocominternational.com
E-mail: info@audiocominternational.com

Extensive range of audio passives and active components including DACT, Black Gate, Sanyo, Elna & Vishay. We are the manufacturer and sole distributor for Superclock 3 master clock & Invisus discrete regulators. Visit our online store for pricing and information. Secure online ordering available.

LOUDSPEAKER KIT SUPPLIERS

IPL Acoustics,

Chelsea Villa, Torrs Park,
Ilfracombe, North Devon, EX34 8AY
Tel/Fax: 01271 867439

Please visit website for full catalogue of products:

www.iplacoustics.co.uk

IPL supply a range of 7 high quality transmission line speaker kits, and a full range of Hi Fi and AV speaker kits, including 2 active subwoofers. Drive units are available from Audax, Seas, Morel, Legend (Ribbon Tweeters), and IPL custom built metal coned drivers. IPL also supply; quality capacitors, inductors and cabinet accessories, including Silver Plated PTFE insulated cables.

WILMSLOW AUDIO

50 Main Street, Broughton
Astley, Leicester, LE9 6RD
Tel: 01455 286603

Fax: 01455 286605

Email: sales@wilmslowaudio.com

Website: www.wilmslowaudio.com

Contact us for a copy of our FREE Full Colour Catalogue or visit our Website with secure online ordering.

The UK's largest supplier of loudspeaker kits, drive units and components.

We also have a range of subwoofer kits and amplifier modules available.

Official UK distributor for ATC, Morel, Peerless, Scan-speak, Seas, Vifa and Volt.

Beware of imitations, we only stock drive units made by the genuine manufacturers. We offer a full repair and upgrade service on most makes of loudspeakers.

VALVE AND OUTPUT TRANSFORMER SUPPLIERS

Watford Valves

3 Ryall Close, Bricket Wood,
St. Albans, Herts, AL2 3TS
Tel: 01923 893270 Fax: 01923 679207

Specialist in new old stock and current production valves. Sole UK distributor of the Harma Diamond range selected for their superior performance. Huge range held, stockists of Mullard, GE, Philips, National, Brimar, Sylvania, Telefunken, RCA, MOV and many more. All valves are new boxed and guaranteed. For free price list and specialist advice call or fax Derek Rocco, Watford Valves.

Chelmer Valve Company Ltd

The Stables, Baddow Park
Great Baddow, Chelmsford, Essex,
CM2 7SY

Tel: 01245 241300

Fax: 01245 241309.

Email: sales@chelmervalue.com

Web Site: www.chelmervalue.com

Premium range of audio valves, tested/selected for low noise, hum, microphony; power valves burnt-in. Huge stock of valves/tubes of all type, audio valves (inc. NOS types), industrial etc. Also large stocks of semiconductor. Many obsolete types.

Billington Export Ltd

1E Gillmans Trading Estate
Billingshurst, West Sussex RH14 9EZ

Visitors by appointment only

Fax: 01403 783519

E-mail: sales@bel-tubes.co.uk

Web: www.bel-tubes.co.uk

Guaranteed new/old stock CRT's for audio & industrial use Vintage types including Mullard, GEC, Telefunken & RCA. Large stocks of Chinese & Tesla. Major stockists of the Billington Gold brand. Free catalogue on request. Attractive prices on large orders. Minimum orders £100.00

MODIFICATION SERVICES

Audiocom Int. Ltd

Unit 14 Pier Road, Pembroke Dock,
Pembrokeshire, SA72 6TR

Tel: 01646 685601 Fax: 01646 685602

Web: www.audiocominternational.com

E-mail: info@audiocominternational.com

Upgrade services available for all CD, SACD & DVD players. With our latest products we are able to advance CD playback way beyond what 'stock' players are capable of resolving. Our extensive knowledge base and upgrade techniques make us world leaders in digital upgrades. Various upgrade solutions are available to suit your budget and desired performance.

REPAIRS & RESTORATION

The UK's Leading Service & Restoration Specialists. Repairs/Restorations to Modern/Classic/Vintage valve hi-fi, musical and cinema amplifiers, control units etc. We will even build that kit for you or design something special. Please visit our Website at:-
www.audiolabs.co.uk for complete details of our comprehensive services. Alternatively, contact us at:-

Audio Laboratories (Leeds)

3 Kildare Terrace Industrial Estate Leeds
LS12 1DB UK
Tel/Fax +44 (0)113 2440378

Arkless Electronics.

Tel. 01670 829891

E-mail: arkless.electronics@btinternet.com

Specialist in repairs, restoration and modifications to all amplifiers, valve or solid state, ancient and modern. Design service for companies and hobbyists. Amps, preamps, phonostages, active crossovers, psu's etc custom built to order. Kits built/debugged. Please enquire for any other services. Ex design engineer for well known hi-fi companies.

mail

Visit our website at www.hi-fiworld.co.uk or send your emails to letters@hi-fiworld.co.uk. Letter of the month wins a pair of Precious Metals interconnects and one years FREE subscription to HI-FI World.



Letter of the Month

TEENAGE KICKS

I have a budget of around £400 to spend on a hi-fi. This should be easy but all of the hi-fis i see in most shops for this price are vast in size and quite frankly, ugly. Do you know of any hi-fis at the price that are great sounding, that have a digital radio and are small yet good looking?

Harry Willis (aged 15)

Hi Harry - I think the best new one box system you can get for the money is a Denon D-M35DAB. But given that I also got my first letter to a hi-fi magazine published when I was fifteen (Hi-Fi Answers, 1981), and was bitterly disappointed that I didn't get 'letter of the month', I'm righting the wrong and giving you the gong. Hopefully, a year's worth of this wonderful publication (if I do say so myself) will acquaint you with the necessary knowledge to kit yourself out with something serious on a seriously limited budget!

If you can't be bothered to wait (and who can when you're fifteen?), then I'd spend the spondoolics on the following secondhand kit, garnered from the classified ads of the august hi-fi magazines on sale in this country: Cambridge CD4SE (1998, pay £50ish) or Marantz CD63 KI Signature (1995, £100ish) CD players, NAD 3020A or 3120 amplifiers (1979-1984, £50), Mission 752 floorstanding (not 752 Freedom version, 1995, £150), Rega Planar 3 turntable (1983-2001, £150), Audio Technica AT-110E cartridge (£25 new).

Of course, the Denon is small and good looking and has DAB, but the secondhand classic budget separates system outlined will sound absolutely awesome, and has the added bonus of being powerful enough to (a) annoy your parents and (b) amaze your friends. However, if you do buy the classic

kit, make sure [i] it's in mint condition, [ii] it's not from a dodgy geezer, [c] it has the original boxes and manuals (which makes selling them on much easier) and [d] it's working properly (something you can't easily do when buying on an internet auction. **DP**

Rather, I recorded my prized vinyl (all analogue, amen!) on both Nak and Akai. The Nak was arguably more neutral (being very close to the source, save a slight lack of detail and bass power), but the Akai seemed to make the music bigger, fuller and warmer – an effect not



NAD 3020 – the heart of a great value classic system!

TOP TAPE

Congratulations on another fascinating, themed issue, much more interesting than page after page of reviews of new equipment! One question I have is about the methodology of your comparison of the Nakamichi CR-7E, and Akai GX-625 recorders. What software was used to review these items: prerecorded tapes, or recordings that you had made yourself? I would have thought that the availability of pre-recorded reel to reel would be patchy at best. If the analysis was made using recordings you had made from CD or vinyl, were they subjectively worse than the original? Your review of the Akai in particular was glowing, but I am curious if it sounded like the original, only slightly worse, or whether it actually had a beneficial effect on quality?

Jacob Castree

Hi Jake – given the fact that most prerecorded reel-to-reel material available now is usually a threadbare copy of The Shadows 'Greatest Hits' (at best), then no, we didn't use it!

too dissimilar to a classic valve amp, by the way. Either way, both sounded superb, and I can't help mourning the passing of analogue tape. **DP**

TOP TAPE 2

I enjoyed your road test of the no-compromise (except for the medium) Nakamichi CR7-E compact cassette deck against a high quality open-reel machine running wider tracks at four times the speed. With the increasing emphasis on compromise (first with compact cassette, then Compact Disc and more recently with lossy compression), it's still a shame that the market didn't let us have an Elcaset machine from Nakamichi with twice the tape width of compact cassette and running at twice the speed it might just have been an acceptable compromise for many of those dedicated to open-reel. Admittedly, early Elcaset-based portables might have had to be named the Sony Brickman, and even the smallest would be a little bigger (and fatter) than a personal CD player, but just think of the potential sound quality!

James Morrow

Absolutely – a Nakamichi Elcaset would have been awesome, but would surely never have happened, as Elcaset was a Sony format and Nakamichi was wholly aligned to Compact Cassette? When Elcaset bombed, Sony had a bloody good stab at outdoing Nakamichi at its own game, and did some amazing cassette decks too – although obviously Nakamichi had the last word on subject with the CR7-E...! **DP**

TOP TAPE 3

My elderly (like me) Aiwa AD-F770 cassette deck has given excellent service over the many years I have owned it, but recently the drive belts perished. One official service company (Servicecare, Oldham) said it couldn't be repaired (parts not available), but I managed to find some drive belts from CPC in Preston, Lancs. I then found a local repairer to fit them, having had a look inside and jibbed at attempting it myself. They duly fitted the belts, but when I got the deck back, it was running very noticeably slow, something it never did before. So I returned the deck to the repairer but they now say that the capstan motor is the cause! And it is unavailable! £58 down the drain. I'm afraid I just don't believe this! There was absolutely no speed problem prior to the belts perishing. I would like to entrust this deck to a more sympathetic and less commercial repairer, someone more attuned to hi-fi kit of this type rather than TVs, videos, etc. Can you recommend any? I now have a Nakamichi DR10 but good though it is it does not shame the AD-F770 when it is in good order. I would like to be able to use the Aiwa again if possible. Incidentally I found that service standards were much higher when manufacturers had their own service departments.

Rod Theobald

Hi Rob – yup, this is the problem with analogue tape machines. Despite the ultra high performance (much better than CD, on the top Jap models), most cassette decks will be – to use the technical term adopted by us industry professionals – 'well jiggered' by now. So a cassette deck's worth is not down to its initial purchase price anymore, but its reparability. For this reason, Nakamichis have very strong residuals because B&W (nee Nakamichi Service, c/o Bowers & Wilkins, Littlehampton Rd., Worthing, West Sussex BN13 1QA, tel: 01903 695695) can still restore most models to all their former



analogue tape – audiophile dream, servicing nightmare

glory (watch out for a feature on this very soon!)... As for your Aiwa, I'd have no hesitation in recommending Audiolabs (website: www.audiolabs.co.uk) for the work, but obviously if a part is needed that's no longer available, then you'll have to find a spares machine to cannibalise first. **DP**

KRAK-ING ON...

I noticed with interest and nostalgia the letter from Damianos Dimitriadis in your June issue regarding Alchemist Products, and with still more interest the replies from yourself and NK. If you intend to go ahead with an article about Alchemist I may be able to fill in some of the blanks. I was the designer of the Axiom (featured on the front cover of your September '95 issue) and Maxim integrated amps. I also designed a tuner for them, which I believe never went into production, and the remote control and touch sensitive switching for the top of the range single-ended amps (Tim De Paravicini of course designed the signal handling circuitry of this model). Glen Gayle was the designer of most of the other analogue gear including the Kraken, Forseti, Nexus and the Chimera range (which was for export only and used MOSFETs rather than the bipolars of the other amps). Unfortunately, I lost touch with Glen and the other partners, Andy and Warren some years ago. There is of course a new web site about Alchemist, which I only found out about through the above letter from Damianos! You may be able to get in touch with the partners through this site. I would myself like to get back in touch for old times sake! I noticed though that I do not get a mention anywhere on this site and that the work I carried out is implied to also have been done by Glen...can't win em all eh? I will of course be contacting the site to put them right :-). If there is anything I can

assist with in the preparation of the article I would be very happy to do so. Your readers may also be interested to know that I can repair any of the analogue equipment made by this now defunct company and, as you know, Chris Found can repair the digital equipment.

**best regards,
Jez Arkless,
Arkless Electronics.**

Hi Jez – thanks for that, and as I said we're up for an Alchemist feature soon – but as with all Hi-Fi World grand schemes, it doesn't always happen quite as speedily as we'd hope – due to 'sheer weight of traffic', as the AA would say! **DP**

FLOORED GENIUS

I've been reading HFW for several years now and have gradually upgraded my kit via your private ads section (much better than ebay). As my equipment has improved in quality (Linn Sondek, Quad 99 CD-P, Denon 260L II tuner, linked computer, Quad 99 preamp, Quad 909 power amp, Quad ELS 63 electrostatic loudspeakers and REL Strata II subwoofer and just recently Quad 989 electrostatics) I have become more aware of the issue of room acoustics, and found NK's article on the subject most enlightening.

Some questions on this issue. What is the effect of a suspended floor on the Golden Rule room size ratio? I read somewhere I think that bass ignores a wooden suspended floor, which effectively may give my 8ft 6in high lounge another 2 feet in height, being the space below the floor down to the earth sub floor. The walls are substantial brick on three sides, covered in very heavily embossed supagypta wallpaper, plus large patio window on fourth side with full length curtains. The wall covering came by chance with the house but does seem to enhance the

sound, making it smoother. What might be the effect of sitting the sub on a small paving slab, instead of spiking it through the carpet into the wooden floor? More importantly, how do you tune the sub to the main speakers?

I was interested to read that NK (recent article on Quad ELS 63s and ancillaries) often found that doing it by ear gave nothing like the result that his measurement did. Do you know of any reasonably priced software I could put onto my laptop to do this job? How much would I need to spend on an accompanying microphone? And any ideas of test discs to play or could I use the laptop as a frequency generator, and if so how? Finally, I loved the DIY Mains Filter article in the June issue, but it didn't address the issue of supply of twisted pair/screened mains cable to use between the socket outlet, the filters and the equipment. I recall an article a long while back you did on making your own but it sounded very long winded. Your latest article implies this cable may be easily available for computers/machinery. I looked on the Farnell website and had no idea where to start on the 3938 types listed! Any ideas gratefully accepted.

John Shaw

No, bass won't ignore the floor. In theory at least, suspended floors resonate at around 5Hz (i.e. very low) and above this will act as rigid panel. It isn't exactly true as in practice they are not simple 'lumped parameters' but a complex network of masses and compliances that are difficult to model. Your floor will affect your primary bass characteristics but the presence of a small void beneath it and soft earth will likely have some influence on low frequency behaviour. Use 8ft 6in as ceiling height as this will be a primary mode, which is at 64Hz. Large areas of glass should be covered by heavy curtaining, but the opposite wall should be balanced to give it similar acoustic properties, which may mean a bookcase, curtain, a rug as a wall hanging (this can be nice, as there's a wide variety of designs available, from trad. to very modern, often in spectacular colours).

Embossed wallpaper will absorb and diffuse, but not as much as is needed. Clap your hands hard and listen to the decay - it should be short and clean. Any sign of a overhang or flutter echo means there's a problem.

Placing a subwoofer on a slab will probably improve bass a little, being a lesser version of sand filling a

chambered cabinet. The internet is awash with software programs offering budget spectrum analysis.

basic, is better than none when it comes to tuning subwoofers.

NK



loudspeaker setup – by software or by ear?

You need, ideally, third octave analysis, although narrow band analysis on a linear frequency scale - standard FFT format - will do. Look at www.acsoft.co.uk and the section on 'Lo-cost Analysis', where free 30day demos are available. At £500 or so this might seem high cost for your purposes. I suggest you trawl around the net, using keywords like 'audio spectrum analysis', 'fft analysis' and 'third octave analysis'. There's quite a lot of Freeware available, like Sigview. Also try Audio Asylum for discussions of analysis software; I am not an expert here as I use dedicated hardware analysers. As Acsoft say, however, today's software programs are fast and powerful.

For low frequency analysis just about any half decent mic will do. The main item you will need is a good sound card, but again they're inexpensive and powerful nowadays. Signal generation comes with the software, or get a Denon test CD or similar. Alternatively, you could use third octave noise generation from a CD in conjunction with a mic., sound card and music editing suite. Readers might like to write in about this; I haven't tried it but there are plenty of free demos available. It's all good fun, if time consuming.

Yes, I have found it very difficult to subjectively tune in a subwoofer accurately. Worse, after doing it properly with spectrum analyser and mic. the sound is almost depressingly better (tonally even or correct, and lacking boom or colour). Just about any measurement, no matter how

KICK OUT THE JAMS

Okay gents! No longer a student, bought a house, lost the woman and I've got £2,500 to spend on my first hi of fi hi-fi set-up, and I am a bit overwhelmed. I need help prioritising my allocation of cash and generating an audition list. As I suspect you'll tell me in as nice a way as possible that spending more will reap rewards a buying strategy would be good. Although I feel a bit conflicted because this money could buy a fair few records! I have nothing to keep or upgrade, except Panasonic that's heading for the bin. CD and vinyl in equal measure in my collection. Fairly eclectic tastes but the collection has a bias towards rock/ indie with some electronica and classical and jazz thrown in. I prefer vinyl but CDs are easier to come by, stick on the iPod and work better in the car...

I intensely dislike a sloppy loose sound, boomy bass and shrill tinny treble and am not a huge fan of overly warm, smug, self-indulgent mid-band. Tight, accurate, well balanced, involving and musical full frequency range reproduction is the aim. I am aware that at this money compromises will be essential. I'd prefer floorstanding speakers from a cosmetic point of view. Hi-fi furniture and interconnects will also have to be included in the budget. As a stopgap digital disc spinner I have a Cambridge Audio DVD-57 I could use. I also listen to a lot of Radio (5, 4, 1, 2, 3 in share of listening time order). As a stop gap FM/AM receiver I have a Henry Kloss Tivoli Model One, that serves as radio and iPod speaker upstairs. By nature I am not a tweaker

and so would rather get a good single source system that I can add to (furniture included) than a poor jack of all trades. Although, if an acceptable vinyl/ CD/ radio system can be built for this money I really would like to know. I really like the idea of Naim and Musical Fidelity (from what I've read), although I have not auditioned them. Help.

Gregory Cooper

Okay – well you said it; a good single source system. Given that you lose one third to half of the price of any new bit of kit you buy, it's cheaper in the long run to invest in the best stuff possible and then add other sources later, instead of having to sell your budget turntable/ CD player when you upgrade to a mid-price turntable/ CD player, etc... So, let's go for maximum fidelity, shall we? Michell GyroDec SE turntable, Origin Live 250 tonearm, Goldring 1006 source (£1,100), Naim NAIT 5i/ Stageline (£699/ £205) amplifier, Wharfedale Diamond 9.1 (£130). Cables and supports: bellwire and Ikea coffee table (£30). Then, next month, upgrade the bellwire and interconnects and speaker stands (!) to whatever you can afford: I'd go for Supra LoRad mains cables (£40), Wireworld Oasis 5 interconnect (£99/m), QED Micro speaker cables (£1.75 per metre), Atacama SE24 stands (£70) and Vibrapods (£20 approx), plus a G1042 stylus for your cartridge (£80) – keep the '06 needle as a spare for parties. Then it's time to upgrade your speakers when the cash arrives (Mission e82, £1,690) and add a Naim CD5i (£825) CD player when cash permits. Howzat? It's not the best hi-fi system in the world, but I think it's the best you can get at the price that suits your needs (i.e. "tight, accurate, well balanced, involving and musical full frequency range reproduction") – and despite the modest cost, you'll be amazed at how stunning it still sounds (I've heard systems at ten times the price that sound far, far worse).

DP



Nait 5i – tight punchy sound is its middle Naim...

ALTER EGO

You've previously suggested in Hi-Fi World that an Audio Research VSi55 is 'the Naim Nap 250's alter ego'. I'm a Naim owner looking for the VSi55 sound (valves with balls), but as usual funds are tight. I've just had my Ferrari serviced and my Armani suit is in for dry-cleaning so I'm struggling to stump up the £3K for the Audio Research.

Seriously though, there must be something in the second hand valve amp market that comes close to the VSi55 for say £1000. Any suggestions?

Mike Farrow

Mike, in the second hand market you can get anything at any price; I use ebay and quite what will be available at what price is never certain. My suggestion is to check out U.S. ebay. I import some 'interesting' (I'm hooked!) test equipment that the

Yanks sell for peanuts. It's weighty stuff, like a valve amp., and costs around 150 to ship into the UK, then there's VAT, but on second hand ebay kit - which has become a whole category in itself it seems from my conversations with FedEx - no duty. I find that even with extras like this it is still worthwhile trawling U.S.

ebay and you may well find you can pick up a nice Audio Research amp. Obviously, you need too consider servicing and such like beforehand. And also email sellers beforehand to ensure they are willing to ship overseas. Although it seems a risky business I have yet to encounter any real problems here.

NK

Can't say I agree – I've bought lots of stuff on ebay and what I've learned is how vivid the imaginations



Audio Research VSi55 – a thermionic Naim, no less!

SHUNYATA RESEARCH
ESCALANTE DESIGN

HEGEL MUSIC SYSTEM
ONZOW ZERO DUST

WWW.AUDIOATMOSPHERE.COM

are of most sellers. 'Mint' means 'slightly knackered', 'superb condition' means 'only a bit shagged', 'works perfectly' means 'worked okay last time I tried it in 1976'. By all means use ebay, but assume the worst and be pleasantly surprised when it works and isn't scratched to buggery. Don't pay big money. Remember that episode of 'Minder' when Arthur Daley gets his garage mechanic to fill the front wing of a 'punter's' Datsun Sunny with soil and clay, and then spray it, and then the guy comes back three days later with weeds growing out of his front wing? That's the level of salesmanship you can expect from most ebay sellers... I've found that dealing with many of the guys advertising at the back of this mag, such as Paul Greenfield of Classique Sounds, is a far more satisfying state of affairs (goods perfect, prices low). You may say I'm biased, but try trying to source kit for five years worth of olde Worldes, month after month! This counts for something – I've had more experience buying secondhand than most... As for the cheap VS155 – a secondhand built up World Audio K5881 will give you much of the Audio Research's powerful charms; just make sure it's been built by someone who knows one end of a soldering iron from another... **DP**

GOING, GOING, GONE...

How can put down ebay, as you did supporting Steve Appleby's letter in the June edition? ebay is irreplaceable! You may have forgotten more than I'll ever know about hi-fi, but your comments mark you out as beginners (sorry, it had to be said). You don't rush in and buy things on impulse, you decide what you are looking for, wait for it to appear and wait again for the right price and don't have a rush of competitive blood. I have made over two hundred transactions to date and only had one go bad. That was a fellow Doctor, who decided he didn't want my LP12 after all. I can't really think of any purchase I regretted.

My whole system is 2nd user and ex-dem and I am really pleased with it. The great virtue of ebay is of course the feedback system. It isn't foolproof, but it tends to keep people honest. Your classifieds are excellent, but I am afraid the hi-fi for sale internet site is infested with con artists now. Really dim, obvious ones, but it's still a pain. Currently I'm looking out for a second hand Moth or VPI cleaning machine. I've missed one recently, but the right one will turn up eventually, it always does.

Here are some rules: 1) decide

what you want and wait for it to appear, don't see something and buy it on a whim. 2) If you see something you want, you usually have a few days to research it on the web. Decide what your maximum is going to be and stick to it. 3) Look at your prospective buyer or seller's feedback and see if you want to do business. Is he/she, quick to give negative feedback, you want to protect yours at all costs 4) ebay is so vast, the item you want always comes up eventually, wait, don't take second best. 5) If you selling, be scrupulously honest, but you don't have to tell everything about the item. A buyer can ask a question if he wants. The stuff on ebay isn't all tat; everyone has legitimate reasons for selling an item. The stuff I've sold has all been Kosher.

The last one was an unused Benz Micro Glider M2 cartridge I got as a sweetener, buying a turntable. I was never going to use it and someone got it half price, so nobody loses. Don't get me started on music, there are tens of thousands of LPs and CDs on sale at any one time. I guarantee, if you wait long enough, that obscure US or Swedish CD/LP you want will turn up eventually. Not all of it is expensive, not

it, but it's not going to be you. Stick to what you know and understand. Sure you can go wrong, but it needn't be often and it certainly needn't be expensive.

David Wise

If you are buying Swedish LPs from ebay you will get a bargain; no one else wants them. As for your rules, quite right too; I still have items bought on impulse that I've never got around to switching on! But then that's some of the fun of it. Rule No 6 is make more space available in the loft.

On bidding tactics, in my view you either put on a monsterooney bid that you know will drive the snipers mad as they try to top it by £1, or you can sit there trying to outrun the snipping software, just to save a few quid. These days I research a purchase well, usually with telephone calls or emails to the buyer, then make a bid no one will match and go to bed. In the morning it is mine, simply because e-bay buyers are a bunch of tight wads who know exactly what something is worth down to the last £1 and they



Goldring G1042; the cheapest serious cartridge money can buy.

many other people seem to have my lousy taste in music. Similarly, if you want to sell an LP, you will usually get a good, or very good price. So many people are reviewing the music daily, a rare item, well presented can fetch thousands. The message guys, you ignore Mr Price and Mr Keyword and get out there and have some fun. Start slowly, buying a few CDs, get a feel for how it works, then get more adventurous. I know you can put a piece of string, or half eaten cheese sandwich on sale and someone will buy

utterly refuse to go past that price. I have seen beautiful items a little over priced get no bids, whilst an equivalent priced marginally lower can get 20-30 bids, most tumbling in over the last few minutes. Ask yourself what it is worth to you and pay that price, rather than pay the market value, as I suspect traders do, which is why bidding cuts off hard. However, David Price feels much ebay hi-fi is worn out or in poor condition, so bear this in mind. As for the rush of blood - that's what

it's all about. Great fun, just be prepared to suffer for your impulsiveness.

NK

David, I'm up to 900 or so on ebay, with 99.9% positive feedback. I buy a lot of classic car parts (my other passion – classic cars, that is, not classic car parts!) and hi-fi too. And 'I refer the honourable gentleman to the answer I gave some moments ago'. The proportion of bad transactions I've had via ebay has been vastly higher than via HFW classifieds (or Loot, or anything else for that matter). Basically, don't believe the hype. I'm also, personally speaking, seriously annoyed by no small number of ebay sellers who routinely misquote me in their ads, or plain misrepresent me, trying to 'hype up' the tat that they're flogging. For example, recently a guy selling a Technics SL5 said in his ad that it was 'David Price's favourite turntable'; this is a lie, and/or simply cynical. Nor did I ever say a £70 Hitachi direct drive was the best thing since sliced bread, or that Yamaha NS10M loudspeakers are 'awesome' (repeat to fade)... I repeat, there are so many cheap, low rent chancers selling rubbish. If you're buying proper high end hi-fi, always go and see it for yourself and hear it; this is an adage we'd always follow back pre-ebay, so why have we abandoned our senses given a few out-of-focus pictures and an over ambitious claim (invariably misspelled or badly punctuated) about some alleged 'future classic'? Serious hi-fi equipment should be treated like classic cars – always try before you buy, and take a good, good look at the seller and his proclivities. If you don't want to do that, fine – but you might as well donate all the money you're

throwing down the toilet to charity instead of ebay 'likely lads'... DP

SEX BOMB

Hi David,

I am a little perturbed that you have not put a photograph and a description of Channa Vithana who does a lot of reviews for you. There are others, who do not review for you as much, whose photos and bios you have published. Is this because he is black or is he that ugly? I doubt if it's the latter, judging by his name he seems Sri Lankan, you have to go through a few Lankans before you come across one whom only a mother could love. Your mag has been unconventional in many ways (valves, vintage etc), why not be revolutionary and openly have the first coloured reviewer? You may lose some readers, but those are ones you wouldn't want in the first place, besides the game is rapidly shifting to Asia and think of how much street cred it will give you!

'Chris from Oz'

Dear Chris, I usually leave racial stereotyping to the extremely right-wing creatures here in the UK! I believe HFW has gained readership since our beloved, unconventional editor DP took charge a few years ago! While Ketan Bharadia wrote for HFW previously and now continues to do so as Tests Editor in What Hi-Fi. As for attractiveness, I am way cooler than former editor Simon 'Popemeister' Pope, as my two female stalkers don't think I'm too bad either...! CV

Hi Chris – Channa is indeed Sri Lankan (although doesn't live in Asia as you infer, but Poole in Dorset...), and judging by his looks and charm, obviously wasn't dropped on his head as a child. His omission in our 'hall of fame' isn't a sinister plot to exclude 'coloureds', as you put it,

from the mag, but down to a rather prosaic lack of time to update the hall of fame. And of course, with his famous 'Sri Lankan Sean Connery' looks and charm, no one else would have a chance with our massive two percent of female readers, would we...? But steady on Channa, the Popemeister was (is) a winner with the ladies (as I'm sure his wife Nicky would agree?); no need for put downs there, my friend! As for 'non-white hi-fi reviewers, we've had the great Rahiel Nasir (What Hi-Fi?), Kulwinder Singh Rai (What Hi-Fi?) and Ketan Bharadia (Hi-Fi World and now What Hi-Fi?) all preceding CV. DP



Channa Vithana – international (ladies) man of mystery...

ECHO BEACHED

Thank you for publishing my letter in your January issue, and thank you NK for your comments, though what I heard with the Shure M97HE dynamic stabilizer brush was not pressing fault pre-echo. I can state that for certain because when I disengaged the brush the sound was clearer and there was no programme related noise than audible at the start of the LP side and in between tracks.

I have played all my LPs with other cartridges and most do not have pre-

Billy Vee
SOUND SYSTEMS

SAVE UP TO 50% ON EX-DISPLAY BARGAINS

SOME AS NEW (MARKED*) 24HR DEL ONLY £5. CHECK STOCK BEFORE ORDER. S/H = Pre-Owned Unit

CALL SALES: (020) 8318 5755 or 8852 1321 - 248 Lee High Road, London, SE13 5PL

Arcam DV27 DVD Player (6mth G/tee)	(1598.00)	£549.00	Naim CD5i CD Player - E/Dem (1Yr G/tee)	(825.00)	£599.00
Arcam FMJ CD33 CD Player (2Yr G/tee)	(1349.00)	£945.00	Naim Nait 5i Amplifier - E/Dem (1Yr G/tee)	(699.00)	£525.00
Arcam FMJ AV8 Preamplifier THX Ultra (2Yr G/tee)	(3149.00)	£2190.00	Naim Ariva Speakers - Maple E/Dem (1Yr G/tee)	(1250.00)	£795.00
B&W 703 Speakers - Cherry (2Yr/Gtee)	(2000.00)	£1399.00	Naim Flatcap 2 Power Supply - E/Dem (1Yr G/tee)	(550.00)	£395.00
B&W Nautilus Sig 805 - Tigers Eye inc Stands (2Yr/Gtee) (2900.00)		£1675.00	Naim NAC 552 Preamplifier - E/Dem (2Yr G/tee)	(12000.00)	£7995.00
Denon AVR 2803 AV Amplifier (1Yr G/tee)	(649.00)	£399.00	Naim Nap 500 Power Amp - E/Dem (2Yr G/tee)	(11998.00)	£7990.00
Denon DV1400 Multi-format Player E/Dem (1Yr G/tee)	(399.00)	£299.00	Naim NAC102 Preamplifier S/H (1Yr G/tee)	(1175.00)	£699.00
Denon DV2900 Multi-format Player E/Dem (1Yr G/tee)	(899.00)	£499.00	Naim CDX CD Player S/H (1Yr G/tee)	(2470.00)	£1395.00
Linn Majik Phono Amplifier S/H (1Yr G/tee)	(945.00)	£625.00	Naim 250 Power Amplifier S/H (1Yr G/tee)	(1910.00)	£895.00
Linn Kairn Pro Line Preamp S/H (1Yr G/tee)	(1400.00)	£599.00	Naim NBL Speakers - Beech (2Yr G/tee)	(7700.00)	£3795.00
Linn 5103 AV Processor - Silver (1Yr G/tee)	(4500.00)	£1995.00	ProAc Studio 125 Speakers Maple (2Yr G/tee)	(999.00)	£699.00
Linn 5125 Power Amplifier (2Yr G/tee)	(1800.00)	£1095.00	REL Q100e Sub Woofer - S/Hand (1Yr G/tee)	(559.00)	£219.00
Linn 2250 Power Amplifier (2Yr G/tee)	(1995.00)	£1195.00	Sugden Ampmaster Bijou Preamp (1Yr G/tee)	(689.00)	£475.00
Linn Trikan Centre Spkr - maple (2Yr G/tee)	(549.00)	£299.00	Sugden A21p Power Amplifier (1Yr G/tee)	(823.00)	£575.00
Linn Keltik Spkrs - Wal inc Aktive Cards (2Yr G/tee)	(6000.00)	£1595.00	Vibe Zeta SubWoofer (2Yr G/tee)	(600.00)	£379.00

echo - thankfully! With the few that have pre-echo the low level "pre" signal is content identifiable. However, the sound with the Shure brush was more like a pre-reverberation than a simple pre-echo, because it sounded like several signals playing - as is the case with many bristles tracking several sections of the groove. If Shure have reduced that resonance coupled effect with their current V15V and M97, then good! Shure's current cheaper M94 cartridge has no brush, but seemingly the same diamond tip as the M97xe, hence may be almost as good, but price-wise it will likely not be as good value as the current Goldring 1006 that you found had been improved.

Of the various naked stylus types, similar price at the time of the original M97HE, the best for classical music was the ADC XLM-III improved. It had a more extended treble than the Ortofon VMS-20E; no tip resonance in the audio band - which the rondel mounted black diamonds do have; more transparent upper midrange and treble than the Shure M97HE; less compression of dynamic range than the A&R P77; better tracking of choral music, loud piano transients, etc. ...than the Shure and A&R; closer to the correct balance of levels of fundamentals versus harmonics than Grados and the various upper midrange droop cartridges - such as earlier Goldrings. Its weakness was a limited low bass - likely owing to its loose fitting stylus carrier - improved a little with some carefully placed Blu tack, but still not ideal.

There was "sample variation" - some of the styli were skewed, though I chose styli with the aid of the shop's microscope! I am wary of extended profile styli - such as in the Goldring 1042 - because of the need to adjust arm height to accommodate different thickness LPs and non-standard cut LPs for correct vertical tracking/stylus rake angle.

This problem is more audible with Classical music than Pop and Rock, and was with the A&R P77, and perhaps that is the cause of sibilance with vocals that Ken Parry reports for his P77 (in February issue, page 105), or perhaps it is mistracking - mine did even at 1.8g with some music - or simply a worn stylus. The ADC XLM-III improved, when "stylus selected", did not have those problems, hence I wish someone would buy the design and reissue the styli! Perhaps the Goldring 1012GX will suit Classical music tracking requirements? I would try it if Goldring will "improve" it also for a flatter upper-midrange response - which they seem to have done for Roksan's Corus Black. It uses

the same tip as a 1012GX, but has audibly flatter response with better balance of harmonics versus fundamental, though I've only heard it playing simpler Classical programme, not my irreplaceable LPs. As a result, I have no idea of how it might track my trickiest and, at its price, I do not want to buy another cartridge I cannot use! That leaves only the Denon DL-160 high output MC which I have never heard and would have to buy unheard via mail order - so any comments, or a DL-160 review would be welcome please.

Chris Taylor

Cor, no wonder they invented CD! You are a critical listener Chris, and know a thing or two! Yes, Shure always said a little sheepishly that if you didn't like the brush, you could always clip it up out of the way. Meaning "we know it does something wrong and if that irritates you, then we have also provided the means to avoid it". Shure's brush provided measurably improved damping and on measurement Shure were hot. Purchasers used their ears, however, which told them something different - and they told Shure so! I wouldn't get too wound up by stylus rake angle and vertical tracking angle. At the end of the day the LP is a quite variable and "imperfect" device; you really have to accept its variability and get on with playing the music. As you are I am sure aware, in spite of all its imperfection, and CDs perfection, subjectively the LP usually kicks the CD in to touch. I am afraid to say that you seem to have outrun the abilities of the average MM pickup cartridge. Moving coils are more accurate and the Kontrapunkt b I currently have in my SME312 is awesomely lucid and neutral; even CD sounds coloured and imbalanced against it. It seems to me that this is the sort of thing that would suit you down to the ground. I am less enthusiastic about cheap MCs however, even the Ortofon MC25FL, which I find a little boring. Better of with a butt kicking Shure V15VxMR in my view. David doesn't entirely agree though! **NK**

Sorry for being a bore, but I don't like Denons; I simply don't think they're as good as they're cracked up to be; not least because they're variations on the theme of an ancient design. The Ortofon Rondo Blue (£400) is awesome at the price, and the Rondo Bronze (£500) better still; just about the minimum you need to spend to buy a serious high

end MC. The Shure V15VxMR is lovely, but rumour has it that it's been discontinued. The Shure stylus brush, as NK suggests very diplomatically, is a Noddy idea - best remove all appendages (stylus guards, brushes, etc.) from any phono cartridge! If you want an affordable, reliable cheapo MM though, the £25 Audio Technica AT-110E with its stylus guard superglued to the body is hard to beat, and then next up the ladder is the Goldring G1042; Fine Line stylus and a warm, musical, smooth sound - say no more! **DP**

MY INHERITANCE

I have "inherited" my deck (in good order) from my days organising classical recordings for RCA Records in Curzon Street, Mayfair... balmy days - lots of free tickets for the concerts and operas, etc...

It had a SME arm and strange Ortofon cartridge (with big counterweight at the far end of the arm) but when I tried to replace the cartridge in Taunton, I recall being told to get rid of the arm (I have it here - along with the strange cartridge, etc) and install a Lustre arm. That is still on it and has an Ortofon cartridge.

These are all working well, but I have treated myself to a new hi-fi system (Xmas present to self - went to buy a vacuum cleaner and came back with Teac Ref 300 system instead!) and am slowly working my way through my 2,000 LPs, plus about another 100 or so I have acquired at the Helston tip, Oxfam (Helston) and a skip outside Oxfam in Helston - with some unusual and lovely classical LPs.

I am a bit concerned about the cartridge - and guess it will need replacing sometime. Because of my background (A level music, Grade 8 piano, working in artists' mgt, organising recordings for RCA - I worked with all their well-known producers!) I am do want the best I can get in sound reproduction... for a reasonably price, though... as I am currently living in Cornwall and have my property up for sale! I have checked out some of the Garrard 401 sites and found some interesting comments, etc. about the equipment people are using on these old decks.

**Angela Boyd
Cornwall**

With 2,000 LPs and the number still growing (good for you!) a new house sounds like a good idea. Make sure it has a decent potting shed, so you've somewhere to sleep.

You didn't tell us which SME arm and Ortofon cartridge you originally

had on the Garrard 401, or what Ortofon you have in the replacement Lustre arm. As the Teac amplifier has only a Moving Magnet (MM) input you will not be able to use a Moving Coil cartridge and your "strange Ortofon cartridge (with big counterweight at the far end of the arm)" may be an old SPU or similar. If so, by all means keep it, but I would not put it back into service, especially as it may well have seen a lot of use and be worn.

These days if you want to keep your Garrard 401 in use and I'd suggest you do (I use one daily) you might be best advised to install a Rega RB300 arm or the Origin Live versions, the OLI, or their improved Silver. Listening to classical demands no more than a nicely balanced sound from a good tracker and the Goldring 1006 MM cartridge manages very well these days, in its latest incarnation. You could also consider an Ortofon 540MkII.

You may have noticed that Garrard 401s get used in some pretty specialised hi-fi systems, costing somewhat more than a vacuum cleaner! As neat as the Teac mini system might be - and Teac are a very good brand - you've plenty of latitude for upgrade in future here. **NK**

PHONO FUNK

For the past few months I have been trying to improve my sound system and I am not sure that I have succeeded very well. I have ended up with a Michell GyroDec SE fitted with an SME 309 tone arm with an Ortofon MC25FL attached. This is plugged into a Densen DP drive phono stage which is connected to a Musical Fidelity A3.2 integrated amplifier. I also have a Musical Fidelity 3.2 CD player. I use good quality interconnects and speaker cables. The sound eventually emanates from a pair of Dynaudio Contour 1.8 speakers (Mk1 version). I find the sound very detailed and clinical - in other words no soul or warmth! I can't really put my finger on it, but there's something wrong, or even many things wrong.

You will probably suggest valves but my budget has nearly run out! Can you please, please help to dig me out? Is there one component or many that I have gotten wrong? What can you suggest?

Okay I'll own up, I bought the Musical Fidelity kit new at half price, discontinued models, but I read lots of reviews and thought I was doing the right thing. Previously I was using Arcam 7 CD, Arcam Alpha 8 amp/power amp

bi-amped into some KEF Q65s but the bass was way out of control and actually hurt my ears after a while. The MF A3.2 had much better control but still too much bass. The Dynaudios were recommended and I bought a pair second hand which were a great improvement on the KEFs, but perhaps too much the other way.

I later added the Densen on a dealer's recommendation to improve the phono side. It does sound better than the Musical Fidelity phono stage (more detail) but perhaps I need a valve phono stage - I'm not sure. I look forward to your magazine every month and especially enjoyed the vinyl edition. Keep up the fantastic work.

Andrew Payne

The low price Ortofon moving coils sound strangely lifeless and unengaging; I find them disappointing to listen to. The Ortofon Supremes are my starting point in their moving coil range, the MC20 Supreme being a good compromise between the fast but slightly edgy MC10 and the arguably over-smooth MC30. All three reflect the benefits a moving coil cartridge can possess.

Also, early Densen DP Drive

Phono X and found it very tidy, somewhat retentive but quite a neutral listen, mercifully free of that nasty edginess so often heard in solid-state phono stages. Not vastly expensive, it offers pretty good value it seems to me, having poise and neutrality aplenty. You could consider this perhaps.

LP doesn't really shine until some quite sophisticated - read expensive - items are brought into play. You've bought in at the wrong level, a few rungs below the ability of your senses to resolve the difference and your tastes to impose their will. You're not quite there Andrew, but you are very close. **NK**

WOT NO CD?

Sir, I always enjoy reading Hi-Fi World with its uniquely descriptive analyses (even if I have worn out my second dictionary) but after many years, I am drawn the conclusion that, "If it sounds good, it is good".

In your July 2005 issue, you looked at portable 'trannies', for want of a more esoteric term, but to my mind the best sounding VHF portable/ table-top wireless remains the Hacker Sovereign II of the late



Ortofon make great budget MCs but spending extra yields dividends.

phono stages could sound less than impressive too, but I believe they were upgraded. I do not know which version you have, but you've got a fairly questionable combo here in my view and its character fits your description.

A Trichord Dino phono stage is the usual recommendation, although I find it whistle clean and a little lacking in soul, but then my reference is a World Audio Design KLPP1 all-valve preamp, which sits at the other end of the spectrum. I recently spent time with the Cyrus

1960s which, though monaural, puts to shame many of today's hi-fi systems.

Bearing that in mind, my ancient 1970 system comprises a Garrard 401 (AT1005/ AT110E), Brenell IC-2000 semi-pro tape deck, Sony TC-K96R cassette deck, Armstrong 626 tuner/ amp a pair of Mordaunt-Short Pageants on 4" galvanised wire nail 'spikes' and the Hacker. What? No CD? These I can listen to all day in complete comfort and pleasure so cannot justify replacing them with modern

equipment. Am I missing the point somewhere?

Can we therefore please have more modern versus classic comparative listening tests as I am sure many have never enjoyed the comfort of classic audio. While many bits can be got from ebay, (caveat emptor and all that), they are at least generally infinitely serviceable.

Barry M Jones

Oh, I don't know about that – all that old stuff is plainly just rubbish, isn't it...? **DP**

MR ANGRYPERSON SAYS...

A bit of a gap between emails gents. I was very flattered to see being published so much and didn't want to seem as if i was writing out of hubris! (I think that's the word i am looking for) LOL! Anyway, there have been loads of things to pique my interest and shoot missives off. However, I have only just got around to reading August's issue and got to Messrs NK and DT's columns and felt the need to say something (again). This may sound like Mr Angryperson, but isn't a pop at either gent involved; here goes...

NK: This fascination with all things Chinese has been very interesting, but i think things have gone a bit beyond the purview of a hi-fi magazine. I was distressed to see you write how wonderful worker conditions were in China when even a cursory glance at world affairs shows how awful these very workers are being exploited. I particularly remember Radio 4's interview with a woman who hadn't seen her children for two years. She was hoping her boss (who earns in a day what she does in a year) would give her two weeks leave to see her family...and he was considered one of the nice guys too! Fourteen hour days are the norm. I believe the average wage is \$40/month in the newer industrial areas.

My point in all this is that the factories may have higher standards than any European one, but the people in them are as abused as any in history. I don't think it would be possible to include ethical practice in hi-fi review, so you should stay within the product's made really, just as you do with all the others. China may be another incredible economic fairy-tale and we may well see superior hi-fi come from there in future years, but i will bet money you wouldn't trade places with any of them for a sold gold pig, so to speak.

As for £25 DVD players, i think once they have all given up the ghost after eight months of their kids playing Disney repeatedly eight hours a day, a

return to a decent, branded item will occur. It's always been the same with flooded, cheap stuff, dontcha think? A case in point is my very own ASDA What Hi-Fi award winner (see past letters), very good for £35 at the time, but now runs so hot if i play three films in a row it starts chapter skipping until I let it cool down! A decent replacement is on the menu (alas, my CD player takes a back shelf now). As they say, you get what you pay for...

DT: Sad to say Rip Off Britain is alive and well! We should all know by now that when business is shamed into selling/making people goods that are actually what they should be, they just shift the devious practises somewhere else until it is exposed, or find a new market to exploit with no history to get regulated on. I agree with the examples you have stated and being fair you showed where things are as different again. As for my point, i refer you to PC PRO's Sept issue, with the RIP OFF BRITAIN screaming banner headline. This is about purchasing PC hardware and software from the US at vastly reduced prices (though not directly related to yourselves, an increasingly large part of computer stuff is nudging its way into the music market). Your prediction of internet sales is already here it seems.

Also, i think your description of European labour as "expensive" and far east as "cheap" is an accountant's view. Let's be honest, Europeans get a fair wage and far easterns are exploited. If the only difference between the two was higher factory standards, you know the letter would be in the bin before it was finished.

On a finishing note, I have to say I love the magazine and, ironically, it's because you all are willing to say what you think that prompts so much mail .I don't want anything to change and, as i said before, i am not directly criticising either journalist. Your personal columns are sometimes the first thing I read and I enjoy the disparate views. Please feel free to poke fun at me, believe me, i will laugh as much as the rest. After all, if we don't talk and make mistakes, where does that leave us? Keep up the good work and the recent run of specialist tests has only whetted my appetite for more.

Paul Clewlow

Hi Paul – I take your criticisms in the spirit they were intended, and you obviously have some personal experience of China as your spelling and punctuation (of your original letter, not the subbed one you see here) were somewhat akin to Pidgin English (seconds out, round one!).

But seriously, sure; of course the moral issues surrounding Chinese manufacturing are pertinent, but not necessarily for the pages of this magazine! Having just visited Shenzhen and seen the iAG factory (Quad, Wharfedale, Mission, Audiolab) for myself, I wasn't disparaged by the conditions there. I think the important point is that they're creating jobs, and very good ones by Chinese standards at that – and this at least gives people the choice about whether or not to work there...

The industrial zone(s) in China are basic by western standards, but if you've ever ventured out to the Chinese countryside then you'll soon see why people want to work there. Don't forget that China is just beginning its 'industrial revolution', and this is going to catapult the country out of the near-Feudal state its been through the Mao years into being the world's next global superpower. Surely we shouldn't try to deny them prosperity – rather, we should put talk of wage differentials aside and try to practice some 'cultural relativism'. If we condemned Chinese manufacturing as 'exploitative', we'd be condemning Chinese people to protracting their (relative) poverty.

I also have to say that – despite the ultra low wages – you have to remember that the cost of living is also ultra low. Educated working class Chinese in cities and towns can afford to eat out every evening, and even get their laundry and cleaning done for them; something that most middle class Brits could not boast. Nor are the cities miserable and depressed – some areas of Beijing or Shanghai that I've visited put any prime areas of British cities to shame; the new buildings, apartments, theatres and shopping malls make the best London has to offer look ramshackle (oh, and the service in the shops is the equal of the best in Japan – which puts it a million miles ahead of this country). So it's not all exactly doom and gloom, despite what the sandal wearing, Sainsburys' 'Maple & Pecan Crunch' eating Guardian readers at Radio Four would have you believe...

DP

HAPPY SPINNING!

I have been doing a bit of reading on tonearms lately and have been reading about the various structural modifications for Rega arms with interest. One outstanding part of all of the options from Michel, Origin Expressimo etc., is rigidity!



Turntables and tonearms "rigidity is all."

I decided to have a closer look at the Akito on my Axis. The counterweight, as all owners should know has a revolving tracking force scale that moves quite freely to set the zero point when balancing the arm. This disc is held in place by three little grub screws on the perimeter of the counterweight. The scale has a groove on its perimeter

that these screws sit into. Once you have balanced the arm and set the dial to zero, hold everything in place and with a tiny flat jeweler screwdriver tighten one of the grub screws, three turns should do it. The disc is now locked in place.

I believe you have now stopped the scale disc from rattling around while the

tone arm plays your tunes. Set to the desired tracking force and presto, more focus. It is subtle but worth the money! An added advantage is that you will not loose your zero indication while experimenting with tracking force by accidentally pushing the scale disc out of sync with the weight when fumbling with it. If you use a separate tracking force gauge, loosening the screws will allow you to remove the scale completely, perhaps the cavities in the counterweight could be stuffed with Blu tack as well.

**Guillaume Lemair
South Africa**

Thanks for the tip – the Akito isn't a bad arm by any means, although – how can I put this? – it isn't exactly a keenly priced product! It's not as open or neutral as the Rega derivatives, but it boogies like none of its rivals. Linn arms aren't everyone's cup of tea, but you can't deny that they still do what they do brilliantly! **DP**

RETRO Reproduction

WE ACCEPT PAY PAL PAYMENTS
MAIL ORDER ANYWHERE IN THE UK!
GENEROUS PART EXCHANGE ON ALL EQUIPMENT NEW OR USED

Used equipment for sale		
Amplifiers		
Arcam Alpha 8 boxed	£195	Quad 12L rosewood finish speakers
Audio Research SP9 boxed mint MKII	£995	Quad 988 Electrostatics 15mths old powder blue finish new £3900
Audio Research LS3	£595	REL Storm 3 oak finish
Audio Research D130 Power Amp	£795	Ruark Prelude MKII cherry finish boxed
ATC 150 Integrated Amp boxed as new 12mths old	£1395	Tannoy Balmoral 12" drive units
Consonance Cyber 10 Integrated Amp 6550 valve tubes with superb headphones stage	£599	Tannoy Cartersbury new £9000
Cyrus PSX/R PSU units boxed mint	£295	
Cyrus Power Amp boxed mint	£295	Turntables
Cyrus II with PSX last version boxed mint	£295	Kuzma Slogi with arm
Krell KSA 100 Power Amp 100watt Class A	£1295	Linn LP12 Black Valhalla basic plus ATFS
Krell KST 100 Power Amp	£1995	Linn LP12 Valhalla mint boxed
EAR 834L Valve Phono Amp	£450	Linn Ittok MKII boxed
EAR 834L Valve Line Stage	£425	Michell Gyrodec with QC power supply
Hoveland L200 valve remote pre amplifier one of the worlds finest 1 month old	POA	Nottingham Analogue horizon
Hoveland Sapphire valve power amp new 7500	£3995	Roksan Radius 5 as new
Marantz PM7200 Class A integrated amp	£250	STD with Mission 774 tonearm
Musical Fidelity Nu-Vista 300 Power Amp boxed new Serial No. 002	£2395	Tom Evans uGroove Phonostage with external PSU
NAD C370 Integrated Amp	£295	Various Garrard turntable's with granite wood marble plinths available
Naim NAP90 with 92 Pre Amp	£495	
Naim 32.5 MC	£1155	CD Players, DACs
Naim 140	£295	Arcam Alpha1
Naim 120 with NAC 12N (serviced)	£295	Audionote CDT Two with top loading Transport with top of the range Philips mechanism new £2200
Nytech CT4252XD2 GF4602 ARC101 full active system	£1395	Audionote DAC in the box
Nytech CA202 Integrated Amp	£395	Copeland CDA 266
Pioneer A400X	£175	Cyrus DAD7 top loading CD Player boxed as new
Pioneer A300R	£395	Kenwood DP-X 9010 Transport (Hi-Fi World Favourite)
Pioneer A400	£150	Linn Numate DAC
Quad 66 Pre with Remote	£495	Marantz CD17 KI Signature
Quad 77 pre with remote	£395	Marantz CD6000 OSE
Quad 308 Power Amp	£195	Meridian 508 CD Player
Quad 405 Power Amp boxed	£225	Meridian 208 Delta Sigma CD Player mint
Quad 405 MKII Power Amp boxed	various prices from	Meridian Transport MKII
Rega Brio silver finish	£250	Meridian 500 series DAC
Ricel RB870 BX Power Amp	£195	MicroMega Stage 5 CD Player
Rotal RB970 BX Power Amp	£150	NAD CS-1 HD CD
Roksan Caspian power amp	£250	Naim CDK 1999 boxed mint
Sugden A48 orange front Integrated Amp	£175	Naim CDI 16 BK one of Naim's finest mint boxed
Suno Anthem MKIII balanced facilities Pre Amp new £900	£250	Pioneer Precision PDS505 CD player
		Philips CD850 fantastic Transport
		Paripatitai technology PTA PSA DAC and Up sampler boxed as new
		Quad 88 CD Player
		Quad 77 stangaline CD player
		Roksan DP1 Transport new £1800
		Teac VRDS7
		Teac VRDS10 boxed
Speakers		Towers, Reel to Reel, Cassette Deck, misc
Apogee Centaur	£995	Arcam Alpha 10 DAB Tuner boxed remote new #800
Castle Harlec light oak finish boxed	£625	Denon TU260L
Castle Inversion with matching stands light ash finish	£350	Hitachi 7000 Tuner as reviewed in Hi-Fi World
Celestion Ditton 44 3 way speaker	£195	Leak Toughline Tuner 3 various ...from
Delquest 9 KEF Drive units with Revealer Tweeter Bargain!	£395	Quad FM3 Tuner (boxed mint)
Elec 510 boxed as new	£295	Quad FM3 Tuner
Kel Reference 1.2 special burr finish	£595	Revox A77 Open Reel
Linn Index bookshelf speakers	£395	
Martin Logan SL3 new £3700	£1195	Done in
Magneplanar 1.4	£995	Exposure 764 Dual
Mission 752 Freedom Beech finish boxed as new	£395	Cyrus 3i DAD7 PSX/R
Naim Intro floorstanding speakers	£450	Michell Transcriber reference turntable
Neat Vito floorstanding speakers with ultimatum upgrade, beech finish ISO Bariks loading ribbon tweeter work well with Naim new £2995	£1795	Technics LS7 parallel tracking turntable
ProAc Resonance 3 atomy finish new #3500	£1395	
Quad ESL63 black beautiful condition boxed one thing audio service	£1095	

Web address : www.retroreproduction.com (UNDER REVISION)
Email address: retro.reproduction@virgin.net
28a Haddington Place Edinburgh EH7 4AF Phone/Fax 0131 558 9989
Open 11.00am - 5.30pm - closed Monday & Sunday

NOW DEMONSTRATING

NEAT ACOUSTICS MFS ULTIMATUM come in and have a listen
(SPECIAL offer trade in your existing amplification for full market value against any EAR products).

NOW DEMONSTRATING Cairn CD Player & Amplifier offer fantastic value for money

Ear 869 single ended triode integrated amplifier
Improved version of the classic 859 with revised output transformers modified input stage with the addition of a extra signal valve which has allowed an increase to 15watt of single ended power, also the 869 can be used as a power amp. Don't be fooled by its modest power output this amp drives real world speakers. price £2498.00

Ultimate Ear Phono Stage

This is the ultimate esoteric Phono Stage as used in the world wide acclaimed Ear 312 Control Centre - Pre Amp. This has to be the ultimate Vinyl Replay purchase. price £2095

** FOR A LIMITED PERIOD ONLY **

Full value Trade in on Ear Phono Stages and other selected models.

NOW DEMONSTRATING LEEMA ZEN

ONE OF THE FINEST COMPACT SPEAKERS YOU WILL EVER HEAR!!!

There are now four models in the EAR lineup:
The classic 834P uses the same circuit architecture as its more expensive brothers, and shares the same high quality sound through MM type cartridges, it is enclosed in a tough, rigid metal case and is fully "CE" type approved. price £495.00

The signature builds on the Classic 834P specification by adding a superb moving coil (MC) input stage, as well as the no-extra-price option of a high quality volume control. price £590.00

Top to the range, the Deluxe 834P comes in stunning chrome and gold cabinet, and has extra attention and quality control. With different moving coil input options, this unit will fit the most demanding of audiophile systems. For the true vinyl enthusiast. price £895.00

MC3 - The ultimate stage for MC matching with 3 fixed transformer taps to cover all types of moving coil cartridges, and separate left/right grounding. MC3 in used in the new £10,000 312 pre. price £630.00

Selected products from: ATC, EAR Yoshino, Dynavecator. SME, Neat, Tannoy, Isotek, Cairn, Roksan, Van den Hul, Monopulse



Listen Carefully

Good value is alive and well.

Excellent sound at sensible prices can be found.

After much searching I have my first three suppliers. Ayre, Thiel and Esoteric digital. There are others out there no doubt. When I find them, and if the chemistry is right, I'll represent them in my deliberately small specialist showroom in North London.

You'll be surprised I think by the relaxed atmosphere here. That's because I offer just one demonstration slot in the morning, one in the afternoon and occasionally one in the evening. No fuss, no hurry, no interruptions, no other visitors, no parking wardens and no coercion. You'll benefit from my years of experience and you'll receive my undivided attention.

I offer home demonstrations in London, Kent, Essex, Cambridgeshire, Hertfordshire, and Bedfordshire too, and some uncommonly generous upgrade paths from entry level to the pinnacle. Just telephone me on 020 8447 8485.

With me you can listen to the Ayre AX-7e, K-5xe, K-1xe, P-5xe, V-5xe, V-1xe, CX-7e and C-5xe. Also the Thiel CS1.6, CS2.4 and SS1. Finally, the Esoteric, UX-1, P-01, D-01 mono DAC and G-0s master clock generator..

In summary then – calm and intelligent demonstrations for lovers of all types of music.

www.listencarefully.co.uk

BIG EARS AUDIO

audio cables & accessories - bigears speaker cable and interconnects-mail order specialists worldwide.

quality used vintage and modern equipment bought, sold-part-exchange most welcome!!

website: www.bigearsaudio.org.uk updated daily

UNIQUE BLACKCAT PANTHER INTERCONNECTS, Cryogenically treated, fitted with 'Eichmann Silver Bullet Plugs' £185 per metre pair

NAIM: FULL RANGE OF PRODUCTS INCLUDING ALL ACCESSORIES AND THEIR SUPERB CD RANGE!! AUDIO NOTE AUDIO ANALOGUE: AUDION: BLACK-CAT ELECTRONICS: CARTRIDGE: NAIM: CONSONANCE VALVE EQUIPMENT: GARDINER: GRAAF: GRAHAM SLEE: HADCOCK: HILARY MICHELL: MISSION: ORIGIN LIVE: ORTOFON (Konturpunkt): FATIOS ACOUSTICS: PROJECT: SEASONS: SNE: TRIANGLE: LAF SPEAKERS: MONOPHASE LAF SPEAKERS: CANTON RESEARCH: SHER LOUDSPEAKERS: MISSION SPEAKERS AND SURROUND SOUND SYSTEMS

VALVE AMPS.
BEARD P35 MID £475
WORLD AROUND EL34 AMP £250
AUDION EL34 STEREO POWER AMP £895
AUDION 500W STEREO POWER AMP ex-dem (2150) £1500
Black Cat Electronics P24 Valve MONO bloc's (Lovers/Tannoy) £1850
Black Cat Electronics stunning Valve Pre amp, Valve Phono stage/turntable £775
Beautiful ARION Class A Valve Integrated AMP uses 50B1 valves £850
Veretone 6L6 valve monobloc power amps beautiful, very well built £450
HEATHKIT MA12 BRIDGE TUBE AMPLIFIERS £350
LEAK TL125 PLUS VALVE/TUBE AMPLIFIERS £550
Quad II's valve, with original 22 pre-amp in very good original condition KT66 £750
Leak Stereo 20, valve, near mint, rebuilt, with stereo pre EL84 £425
Rogers Cadet II pre-amp valve, near mint, ECL86 £275
Rogers WGB9 (ECL86) £275
Leak TL10's rebuilt/mint, valve, beautifully clean KT61/SP25 £275
Pye Mozart two mono blocs, valve, plus mono valve tuner £275
nice single ended EL34 425 Superb Croft Super Micro tube pre £275
Audion CD1 Valve pre-amp - classy sound £315
ANTHEM X1 EL 34 single ended stereo valve amplifier £575

TRANSISTOR
QUAD 701 £425
QUAD 606 £250
QUAD 99 two mono blocs £775
QUAD 77 integrated £275
QUAD 33/44 pre-amp 303/304/405 power amps always available £1000
Exposure II and 12 Pre-amp and Power Supply £575
Exposure Super 8 Power Amp £275
Arcam Alpha 8 amp £145
Harzart PM40100SE integrated £245
Meridian 201 pre £875
Meridian 405 power monobloc (boxed) £145
Physical Fraternity B1 £145
Physical Fraternity A1 £275
Physical Fraternity A100 £275
LURBAN E-120A HIGH END PRE-AMPLIFIER £275
Physical Fraternity P140 Power Amp, boxed £295
Sugden CS1/PS1 £275

SPEAKERS
MONOPHASE 424 £895
TDL ELECTRONICS REFERENCE STUDIO 4 HUGE FLOORSTANDING MULTI-FACED SPEAKERS (seven units per cab, in black) £6500 £1500
HIPNINING Argathon loudspeakers, DX3's, DX2's [4500] £ 850
QUAD ESL's black, known history £ 850
QUAD ESL 63 Speakers £1250 serviced by QUAD Jordan Watts Modular £295
HAGERPLANAR HG1C LOUDSPEAKERS £275
Small speakers K1 £275
Tannoy III/2: 10" golds lovely condition £650
Robert BBC LS3/5A/5 treat finish very good clean condition £650
CELESTION WJ302 Loudspeakers Cast, £550 £475
Monitor Audio Monitor 3 Speakers (Top Tweeter Model) £275
Epos ES 11 £275
Epos P15's floor standers £385

CD PLAYERS:
MARANTZ CD17 MID (E850) £595
MARANTZ CD17 (E1750) £1995
CELIS CD01 P2P £775
HERIT SHANLING LE £750-80
SHANLING SC0-1200C (NEW) £2150-21
Harzart CD4000 disc in a box £85 Tandberg 3002 Pre Amp £175
Harzart CD1500 (brand new and boxed) £125
Harzart CD10 £215 MYRAD CD20 £295
MYRAD CD10 £215 MYRAD CD20 £295
Microsonica stage 1 CD £225 Magnoca CD NG7700(LINK) £195
DPA PDR1 Series 2, DAC £195

CABLES, ONE METRE PAIR OF SILVER INTERCONNECTS, REALLY OPENS OUT THE SOUND, WONDERFULLY DYNAMIC CBS (OTHER LENGTHS MADE TO MEASURE!!)
*****BIGEARS SILVER SPEAKER CABLE 4 METRES TERMINATED £150*****

OTHER EQUIPMENT
Graham Slee phono stage ERA GOLD £480
Graham Slee phono stage GRAM AMP 2SE £125
Graham Slee phono stage GRAM AMP 2 £160
DB 7405 tweeters £50 QUAD F10 £600
QUAD F14 £250 WITTON 525 compression drivers £600
Vicoma S3 £350 Phono 4 cell horn, Halcom's BK2 (cassette deck) £1115
AUDIO Aluminium disc in a box £85 Tandberg 3002 Pre Amp £175
TURNABLES: LINN SOWDEK LP12 £225
GARRARD 401 LINN LVP AMP AND LINN R9 CARTRIDGE £425 £225
THORENS TD125-SHRE AMP-SHORE P15 £225
THORENS TD146 PHU £125 MICHELL orbe £2750
MICHELL gyrodex £1126 MICHELL gyrodex SE £895
MICHELL technodex £575
MICHELL Techno Arm 'A' £799
ORIGIN LIVE AURORA £970
ORIGIN LIVE AURORA GOLD £1470
ORIGIN LIVE PROTECTED OLI ARM £359
ORIGIN LIVE SILVER ARM £599
ORIGIN LIVE ENCOUNTER ARM £970
ORIGIN LIVE ILLUSTROUS ARM £1570

GOOD TRADE-IN GIVEN ON NEW EQUIPMENT - CARTRIDGES VALVES AND GOOD AN 'ENOUGH' AUDIO CABLES & ACCESSORIES - PHONO OR S PH DIN (BOTH AS GOOD AS ANY ANYWHERE AT ANY PRICE!!) MAIL-ORDER - FEEL FREE TO PHONE OR E-MAIL, FOR BRIBERY ADVISE-IF I HAVEN'T GOT WHAT YOU WANT I CAN PROBABLY GET IT!!

chrisbircley@btinternet.com tel: 01736 740421 mobile: 07947 678256

Rochester Hi-Fi

30 HIGH STREET, ROCHESTER, KENT, ME1 1LD
 - 01634 880037 - www.rochesterhi-fi.co.uk

- ADVANTAGE
- AFON
- ATACAMA
- AUDICA
- AUDION
- AUDIOPHILE BASE
- AVI
- BAT
- BOULDER
- CAIRN
- CLEARAUDIO
- CYMBOL
- FOCAL JMLAB
- GAMUT
- GOLDRING
- GRADIENT
- GRADO
- GRAHAM SLEE
- GRAVES AUDIO
- LINN CLASSIK
- LOEWE
- LUMLEY
- MERLIN
- MUSIC MAKER
- MUSIC TOOLS
- NAD,
- NOTTINGHAM ANALOGUE
- OPTIMUM
- PARTINGTON
- PURE
- QUADRASPIRE
- STELLO
- USHER
- VINCENT



CALL NOW TO UPGRADE YOUR SYSTEM

MIDLAND AUDIO XCHANGE

The Old Chapel
Forge Lane
Belbroughton
Worcestershire
DY9 9TD

t. 01562 731100
f. 01562 730228

e-mail. sales@midlandaudiox-change.co.uk
web . www.midlandaudiox-change.co.uk



Ex - demo and second hand items

	Was	Now		
Digital			Sonus Faber Concerto Home, Walnut x-demo	999 699
Accuphase DP77V CD/SACD player x-demo	7600	4999	Sonus Faber Ironwood Stands, Walnut, adjustable x-demo	480 339
Audio Synthesis DAX Decade 22bit Single Ended S/H	3000	1499	Sonus Faber Leather Stands, fixed height, x-demo	310 220
dCS Elgar 24/192 1998 Version (non-firewire) S/H	8500	2999		
dCS Verdi Transport latest software S/H	7999	3999	Cables and Accessories	
Densen Beat400+ x-demo	1295	979	Alphason Concept 3 tier Rack S/H	N/A 149
Mark Levinson 31.5/30.6 2 Box Ultimate CD S/H	26000	12499	Alphason Concept 4 tier rack S.H	H/A 179
Mark Levinson No360s DAC S/H	7500	2999	BCD 1000 3 tier table S/H	1295 650
Meridian 206 CD Player S/H	N/A	399	Cardas Neutral Reference 1m RCA-BNC S/H	550 375
Meridian G08 CD S/H	2250	1899	Chord Signature Digital 1m BNC-RCAS/H	199 119
Naim Audio CD3 S/H	980	399	Cogan Hall Intermezzo EMD 0.75m RCAS/H	N/A 199
Primare V10 CD/DVD Player x-demo	795	499	JPS Power AC+ 1.5m fitted with 16amp IEC S/H	370 189
Sugden CD21 Graphite S/H	1099	649	JPS Superconductor 2m Balanced pair interconnects S/H	1299 649
Sony SCD XE597 SACD Player S/H	150	99	Kimber Monocle-X 2x8ft Speaker cable	479 239
TAG McLaren CDT20R Transport S/H	1500	749	Kimber Select KS1021 0.5m attenuated Interconnects S/H	519 299
Theta Generation V Balanced S/H	6290	1999	Kudos S50 60cm Stands S/H	199 79
Theta Pro Basic II DAC with Oscom/Balanced S/H	2990	995	Madrigal MDC1 1m AES/EBU 110ohm Digital Cable new boxed	420 199
			Mana Acoustics Add on Table S/H	300 179
Analogue			Mana Acoustics Reference Table S/H	500 349
Dynavector XV1s 200hrs S/H	2900	1499	Mandrake 1.0m Silver/Gold RCA Interconnect S/H	1250 399
Audio Research PH3 Phono Stage x-demo	1699	1099	Nordost SPM 2x2m Speaker cable Biwired S/H	2199 799
EAR The Head MC Transformer S/H	N/A	399	Tara Labs RSC 1800 Prime 2x4m Speaker cable Bi-wired	1500 499
Heed Quazar 2 box MC/MM Phono stage new	550	395	Sound Organisation 4 Tier in Glass S/H	400 129
Krell KPE Reference+ PSU S/H	2487	1299	Spectral MH-750 20ft Speaker cable x-demo	2100 1199
Kuzma Stabi/Stogi S Turntable New& Boxed	N/A	1399	Spectral MI-330 15ft Interconnect RCA-RCA x-demo	800 499
Roksan Xerxes XPS1/Alphason HRS100 S/H	N/A	599	Spectral MI-350 15ft Interconnect RCA-RCA x-demo	1400 799
SME 20/2A Turntable S/H	5537	3799	Siltech HF9 silver/gold 110 ohm AES/EBU digital cable 1m S/H	530 299
Triplannar Series VI Tonearm S/H	3500	1999	Transparent Audio Music Link 1m rca interconnect S/H	189 99
Transfiguration Temper MC 600Hrs S/H	1950	799	Transparent audio Music Link Plus 1m RCA Interconnect S/H	299 149
			Transparent Audio Music Wave + Bi wire 2x8ft S/H	769 429
Preamplifiers			Vdh CD102MKIII 1m balanced S/H	N/A 99
Audio Analogue Bellini Remote Preamplifier X-demo	625	499	Vdh CD102MKIII 0.6m balanced S/H	N/A 79
Audio Research LS16 Preamplifier	2999	1799	Wireworld Equinox 3++ 3m pair speaker cables S/H	1199 399
Convergent Audio Technologies SL1 Reference S/H	6500	1799		
Hovland HP100MC Preamplifier S/H	5495	2999	Tuners & Tape decks, power supplies	
Krell KCT Preamplifier S/H	9989	5998	Aiwa F770 3 head cassette deck S/H	N/A 99
Mark Levinson No380 Preamplifier S/H	4999	2499	Magnum Dynalab MD106T 4 months old	3600 2999
Spectral DMC 30s Reference Preamplifier S/H	7600	4999	Rega radio 3 Silver X-demo	398 279
Spectral DMC15 Preamplifier S/H	4800	3250	Tice Solo Powerline Enhancer S/H	N/A 299
TAG McLaren AVR30RSL7.1 T2 processor S/H	2300	995	Tice Solo AV Power Conditioner S/H	N/A 299
			Sont ST D777ES DAB Tuner S/H	699 299
Amplifiers				
Audio Analogue Donizetti Mono Power Amplifiers X-demo	1050	729	<i>Suppliers and installers of High Quality Audio Systems</i>	
Audio Research VT60 Re Valved S/H	1999	995	47 Laboratory	• J M Labs
Audio Research VT200 MkII Valve Power Amplifier S/H	9998	6999	Accuphase	• Krell
EAR 509 MK1 (huge amount spent) S/H	N/A	1799	ATC	• Kuzma
ECSEA1 Mono Amplifiers (pair)	6500	2999	Audio Physic	• Lavardin
Jeff Rowland Model 501 Monos (new&boxed)	7500	4999	Audio Research	• Martin Logan
OCM 500 Soloist stereo power amp, awesome S/H	2700	899	Avalon Accoustics	• Michell
Musical fidelity A1000 S/H	1500	849	Avid	• Nagra
Krell KAV400xi Silver x-demo	2698	2199	bel canto	• Primare
Krell FPB750mcx Mono Amplifiers S/H	28900	16995	Benz Micro	• ProAc
Red Rose Sprit Integrated x-demo	1000	649	Cardas	• Rega
Rega Maia Power amplifier Black x-demo	548	399	Clearaudio	• Siltech
Spectral DMA100s Power Amplifier S/H	4250	1999	Conrad Johnson	• Sonus Faber
			dCS	• Spectral
Loudspeakers			Densen	• Nordost
Audio Note AZ 2 efficient, budget floor stander S/H	499	225	DNM/Reson	• Sugden
ATC Active 10 SL x-demo	1650	1199	Electrocompaniet	• Transparent Audio
ATC SCM7 Cherry x-demo	499	375	Finite Elemente	• Verity Audio
B&W CDM1SE Cherry S/H	599	229	Graaf	• Wadia
JM Lab Micro Utopia Anigre with Stands S/H	3999	1699		
JM Lab Sib XL x5 Grey S/H	1000	650		
Naim Audio Intro Black Ash S/H	875	499		
Peak Consult Incognito Rosewood x-demo	7500	5799		
Rega ELA Cherry X-demo	749	579		

Midland Audio X-change are looking for Audio Research, Krell, Mark Levinson, Naim Audio, Dcs, Wadia.

Bosendorfer Loudspeakers,

by the company who make, arguably the best pianos in the world. since 1828

distributed in the UK by AUDUSA

HIFI Choice April 2005
Editors Choice Gold Star

HiFi News and Record Review May 2005...*The sound is extraordinary in its overall balance. The VC7's are capable of exceptionally fine detail and dimensionality. In terms of the sensible compromises, the sheer musicality and sense of being there, the VC7 is masterpiece. The Bosendorfer VC7 is for me a dream come true*

Best Loudspeaker 2004 - Wallpaper Magazine

Le Festival Son et Image de Montréal 2004..... *It was also perfectly obvious that the Bösendorfer loudspeakers had the finest reproduction of piano music that I have ever heard. Seeing the quality of the piano in the same room as the loudspeakers, I was impressed, but not surprised. They obviously knew what they were doing when they built these beauties.....*

the VC7's performance in the front/rear and left/right dimensions is expansive and three-dimensional. Even subtle details are reproduced in a magnificently rich sound. Flute tones are soft and delicate while cembalo is well defined even in very quiet passages.. Even when the music becomes louder, reaching dynamic peaks, the VC7 retains its effortlessness.

Ilmarco Kolks - Horehambis



See it, hear it, experience it, at
KJ West One
26 New Cavendish Street
London W1 Tel: 0207 486 8262/3

AUDUSA



ACOUSTIC SOLID Small Royal Turntable hand polished aluminium finish with 60cm aluminium platter, topped with a 6mm acrylic platter and leather mat. Features a near zero tolerance bearing. Nylon thread belt - weight 25kg, shown with Type Two stand.



Acoustic Solid One to One turntable

LAT INTERNATIONAL - USA

Power, Analogue, Tonearm, Digital, Video interconnects and single and biwire speaker cable.

Silverfused wire technology.

NEW FOR 2005

IC 300 Analog and DI-30 Digital Interconnects, AC-2 MKII Power cord, SS800 and SS1000 MKII Speaker cables.

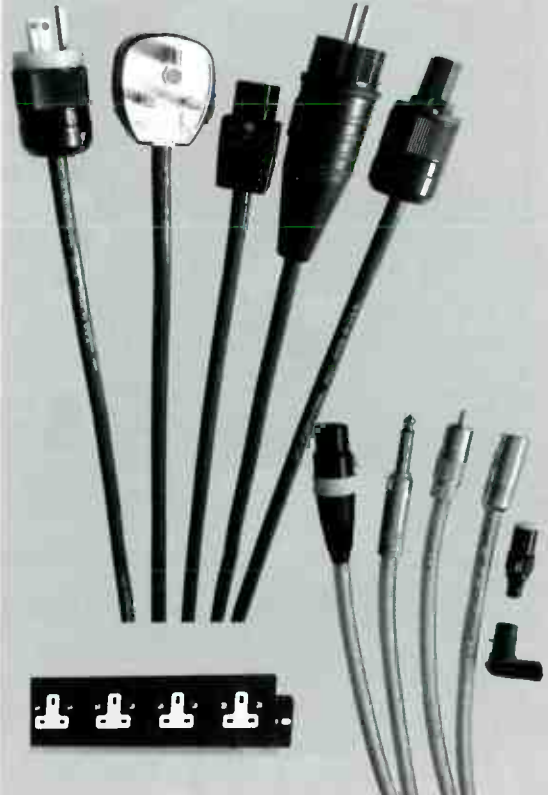

AUDUSA EUPEN

The world's only true Ferrite technology cables - a high quality ferrite is extruded over the conductor strands. Power Cords - GNLM 5/2.5 (CSA 2.5) and GNLM 05/04. From £48 for a 1m cord terminated with an IEC and MK tough plug. Also available are the CMS Analog, Digital and Video Interconnects with RCA, XLR or BNC connectors



WWW.AUDUSA.COM

T: 020 8241 9826, 020 8264 0249 F: 020 8241 0999 E: sales@audusa.com

Sound Stage
2nd User Hi-Fi & audio

01376 521132
07709 260221
CHELMSFORD, ESSEX
E-MAIL: soundstage@netlineuk.net
BY APPOINTMENT ONLY

PRE-OWNED EQUIPMENT

AUDIO INNOVATIONS SERIES 800 4-BOX PRE/POWER/PS/PHONO STAGE	£1295
AUDIOLAB 8000A-GREY-PHONO	£199
CASTLE HARLECH FLOORSTANDING LOUDSPEAKERS BLACK OR CHERRY	£399
COUNTERPOINT SA100 POWER AMP VALVE/TRANS HYBRID BLACK BOXED	£595
DEFINITIVE TECHNOLOGY PRO TOWER 400 (INCL TWIN ACTIVE SUBS-£2350 NEW)	£1195
DENON DVD-5000 BLACK WITH MULTI REGION CHIP FITTED-SUPERB MACHINE	£495
EPOS ES14 BLACK SINGLE WIRE	£329
EPOS ES12 LIGHT CHERRY BOXED AND SUPERB	£299
GARRARD 301/SME 3009/SHURE MM CARTRIDGE ON HARD BOARD	£599
KEF 103/3 ROSEWOOD WITH KEF KUBE EQUALISER AND INTEGRAL STANDS	£399
LFD PA2 POWERSTAGE POWER AMP GREY MARBLE EFFECT	£649
LINN SONDEK LP12 NORTON AIR POWER ITTOK TROIKA WALNUT SUPERB	£1295
LINN KAIRN PRE AMP MM/MC PHONO STAGE BOXED AND SUPERB	£695
LINN SARA 9 BI-WIRE WALNUT BOXED AND STUNNING WITH STANDS	£499
LINN SONDEK LP12 VALHALLA BASIK K9 AFRO BOXED VGC	£499
LOEWE ACONDA 32" WIDESCREEN FLAT SCREEN SILVER + GLASS STAND	£895
MERIDIAN 606 DAC BLACK/GOLD BOXED AND IMMACULATE	£495
MERIDIAN A500 BLACK ASH LOUDSPEAKERS LOVELY CONDITION	£399
MERIDIAN 605 MONOBLOCKS BLACK PAIR	£795
MICROMEGA DVD PREMIUM-MULTI REGION	£395
MICROMEGA DRIVE 3/DAC BOXED AND IMMACULATE	£995
MICROMEGA STAGE 5 CD PLAYER IMMACULATE	£349
MICROMEGA TRIO 3 BOX CD PLAYER BLACK BOXED SUPERB	£1695
MONITOR AUDIO MA1800 REFERENCE GOLD LOUDSPEAKERS-BOXED	£495
MUSE MODEL 3 PRE-AMP REMOTE BLACK BOXED AND IMMACULATE	£995
NAIM NAPI40 OLD STYLE BOXED SUPERB CONDITION	£349
NAIM NAC 92 PRE AMP BOXED AND IMMACULATE	£279
NAIM NAIT3/PRE OUT MODIFICATION BOXED AND IMMACULATE(1999 MODEL)	£399
NAIM IXX 2-WAY ACTIVE X-OVER WITH VARIABLE FREQUENCY	£349
NAIM NAPV 175 3 CHANNEL POWER AMP LATE 2004 AS NEW	£975
NAIM NAP 135 POWER AMPLIFIERS PAIR CHROME BUMPER SUPERB BOXED	£1495
NAIM INTRO BLACK ASH LOUDSPEAKERS BOXED AND SUPERB CONDITION	£329
NAKAMICHI OMS5E CD PLAYER-WAS £1500 NEW	£299
PRIMARE D 20 24 BIT CD PLAYER BOXED AND IMMACULATE	£495
PROCEED AVP AUDIO/VIDEO PRE AMP AC-3, DTS, THX, DPL (NEW £4700)	£1495
PROCEED PCV SERIES 3 CD PLAYER (£3500 NEW)	£1495
QUAD FM4 TUNER DIN BOXED AND LOVELY CONDITION	£249
REGA PLANAR 3/RB300/ROKSAN CORUS BLACK MM FIXED POSITION MOTOR	£249
RUARK TALISMAN MK2 ROSEWOOD VGC	£349
TOTEM MODEL ONE SIGNATURE BLACK BOXED AND MINT-FEW MONTHS OLD	£1195

PROFESSIONAL RECORD CLEANING SERVICE - KEITH MONKS MACHINE - PLEASE RING FOR FURTHER DETAILS AND PRICES.

THREE MONTH WARRANTY ON ALL ITEMS
www.sound-stage.co.uk

listening rooms

SALE LIST

	NEW SALE		
IMERGE M1000 H/D Sound server	£1500.00	£895.00	D
ARCAM DV88 DVD PLAYER	£1,000.00	£679.00	D+N
AUDIO RESEARCH LS25 MKII (mint very light use)	£5499.00	£2995.00	SH
CELESTION - C2 - Floorstanders	£499.00	£299.00	D
CELESTION C1 - Compact speakers	£199.00	£114.00	D
CYRUS 5 AMPLIFIER	£500.00	£329.00	D+N
CYRUS 7 AMP	£700.00	£479.00	D+N
CYRUS DVD7	£1,000.00	£599.00	D
AVANCE TECHNOLOGIES Active Subwoofer	£1200.00	£695.00	N
MARTIN LOGAN SCENARIO	£2,498.00	£1,629.00	D
MERIDIAN DSP1500 Subwoofer	£1350.00	£895.00	D
MERIDIAN 562v.2 Controller	£1,500.00	£995.00	D
MERIDIAN G51 RECEIVER (AS NEW)	£1995.00	£1395.00	D
MERIDIAN G55 5 CHANNEL POWER AMP (AS NEW)	£2695.00	£1885.00	D
MERIDIAN G56 STEREO POWER AMP (AS NEW)	£1495.00	£1045.00	D
MERIDIAN G01 CONTROL UNIT (AS NEW)	£1450.00	£995.00	D
MARTIN LOGAN CLARITY	£2500.00	£1749.00	D
MISSION 773E SPEAKERS	£399.00	£249.00	D
MISSION 780 - ROSEWOOD	£300.00	£199.00	D
MISSION 783 - BEECH (Good condition)	£1,000.00	£499.00	D
MISSION 782 - BEECH	£700.00	£449.00	D
DENON DVDA11	£1699.00	£1295.00	N
MUSICAL FIDELTY XA100R - INT AMP	£900.00	£499.00	N
PROCEED AVP PROCESSOR. VGC/LIGHT USE	£4,700.00	£1995.00	D
PROCEED PMDT DVD PLAYER. VGC/LIGHT USE	£5,495.00	£2495.00	D
PROAC STUDIO 125	£1,000.00	£599.00	D
REDROSE Valve System (amp & speakers) 1yr old	£10,000.00	£2995.00	SH
SONUS FABER GRAND PIANO BLACK	£1699.00	£995.00	D
SONUS FABER CONCERTO wood	£999.00	£595.00	D
VIENNA MALHER (Beech)	£6000.00	£2999.00	D
VIENNA WALTZ centre Speaker (Beech)	£500.00	£350.00	D
YAMAHA HD1000 Hard Disc Recorder	£699.95	£500.00	D

Hi-Fi Multiroom and home cinema
PLEASE SEE OUR WEBSITE
FOR LATEST OFFERS!

THE LISTENING ROOMS LTD

161 OLD BROMPTON ROAD LONDON SW5 0LJ
TEL: 020- 7244 7750/59 FAX: 020 - 7370 0192

www.thelisteningrooms.com

E-mail: tlr@btclick.com

Mon-Sat 10-6pm

WILLIAMS HART
ELECTRONICS

HART ELECTRONIC KITS TRADED FOR OVER 30 YEARS



Mosfet Monoblock Power Amp Kits
ONE OF THE BEST AMPLIFIERS YOU WILL HEAR! Regardless of price
REVIEWED IN HI-FI NEWS AS "...EXCEPTIONAL...
SELF EVIDENTLY CORRECT"



Single Ended Class A Valve Sound
15Watt Power Amp modules
FOR THOSE WHO WANT THAT VALVE
MIDBAND BUT BASS AND TREBLE TO MATCH



ACTIVE R/Control SUBWOOFER MODULE £177.30



Speakers Designed & Built to Order

Advertise your Hi-Fi on my website (FREE)

Also: Award Winning Phono Stage Kit, Active Crossover Modules, Speaker Drive Units,
M Cap Capacitors, Caddock Resistors, Remote Control Volume and much more.

WEB SITE: www.williamshart.com e-mail: sales@williamshart.com
Tel: 0034649587248

PLEASE SEE WEBSITE FOR NEW CONTACT DETAILS
PERSONAL VISITORS SHOULD PHONE FIRST TO AVOID DISAPPOINTMENT



PINEWOOD MUSIC

of Winchester and Taunton

NEW AND AFFORDABLE

SONUS FABER DOMUS SERIES

Please telephone for a demonstration

SALE

PATHOS LOGOS	2050	(2750)
KRELL FPB-600	5500	(12900)
KRELL FPB-650m	10500	(23800)
KRELL KAV-250A	1400	(3145)
A-A MAESTRO 192/24 CD	1300	(1650)
KRELL KPS-25sc (latest spec)	POA	(24998)

AGENCIES: Audio Research, Krell, Jadis, Sonus faber, Wilson Audio, Martin Logan, Koetsu, Copland, Prima Luna, Pathos, Oracle, Lyra, Unison Research, Transparent, Chord Company, Futureglass, finite-elemente, BCD Engineering

DEMONSTRATIONS BY APPOINTMENT SEVEN DAYS A WEEK AND EVENINGS

THE PINWOOD MUSIC COMPANY

Winchester : 01962 776808

Taunton : 01460 54322

Mobile : 07860 351113

e-mail : brianriv@mac.com

IAN HARRISON HI-FI TEL: 01283 702875

HI-FI AT DISCOUNT PRICES. FREE NATIONWIDE DELIVERY

SALE!

TRADE IN YOUR OLD MOVING COIL CARTRIDGE & SAVE UP TO 60% OFF THE RRP.

CARTRIDGES & STYL	HIFI FURNITURE	HEADPHONES	DVD
VAN DEN HUL	BLOK	SHURE	SONY
ZYX	B.C.D.	BEYER	MINI DISC
JAN ALLAERTS	CUSTOM DESIGN	STAX	SONY
DENON	OPTIMUM	SENNHEISER	LOUDSPEAKERS
CARTRIDGE MAN	ASH DESIGN	SONY	OPERA
AUDIO TECHNICA	APOLLO	AKG	TRIANGLE
GOLDRING	SOUND STYLE	GRADO	FINAL
SUMIKO	SOUND	AUDIO-TECHNICA	ELAC
TRANS-FIGURATION	ORGANISATION	HARBETH	EPOS
LONDON (DECCA)	ALPHASON	MISSION	DIAPASON
GRADO	CABLES	PIONEER	WHARFEDALE
ORTOFON	VAN DEN HUL	SONY	AMPLIFIERS
RESON	VIRTUAL - DYNAMICS	TUNERS	CREEK
CLEAR AUDIO	BLACK RHODIUM	PURE DIGITAL	HALCRO
KOETSU	TRANSPARENT	DENON	MOTH
SHURE	QED	SONY	C.A.T.
TONEARMS	ORTOFON	CREEK	GAMUT
SME	NORDOST	PHONO STAGES	ALC/OIA
GRAHAM	ARGENTO	HEED	EAR
MOTH	AUDIO	GRAHAM SLEE	AUDIO VALVE
CLEAR AUDIO	SUPRA	WHEAT AUDIO	ACCUSTIC ARTS
HADCOCK	WIREWORLD	TRICHORD	GRAAF
MICHELL	CD PLAYERS	MOTH	ORELLE
TURNTABLES	AUDIO ANALOGUE	MONRIO	MONRIO
AUDIO TECHNICA	MONRIO	CREEK	AUDIO ANALOGUE
GOLDRING	GAMUT	NAD	PATHOS -
MICHELL	SONY	EAR	ACCUSTICS
CLEAR AUDIO	CREEK	TOM EVANS	UNISON -
	ORELLE	CLEAR AUDIO	RESEARCH

PLEASE PHONE TO CONFIRM PRICE & AVAILABILITY PRIOR TO ORDERING.
ALL GOODS ARE BRAND NEW & BOXED WITH FULL U.K. GUARANTEES.
NO EX. DEM OR EX DISPLAY GOODS. NO GREY IMPORTS. GOODS ARE NOT SUPPLIED ON APPROVAL. SORRY NO GENERAL CATALOGUES. PLEASE PHONE OR WRITE FOR SPECIFIC REVIEWS, BROCHURES OR PRICES.
SUPPLIER OF HI-FI PRODUCTS & ACCESSORIES SINCE 1986
MAIL ORDER ONLY FROM: IAN HARRISON, 7 MILL HILL, REPTON, DERBY, DE65 6GQ. TEL: 01283 702875. 9am - 9pm INCLUDING SUNDAYS.

CLASSIQUE SOUNDS

(LEICESTER)

UK agent for One Thing Audio

VINTAGE HI-FI & VALVE SPECIALIST. TEL 0845 123 5137 (local rate.UKonly)

WANTED Vintage and modern hifi eqpt. Part exchange welcome.

Leak Stereo 20 full rebuild using Jensen Paper in oil caps £299.00

FOR SALE. PRE/POWER AMPLIFIERS

Woodside STA-50 BG SE Valve power amp. Mint. £ 999	Woodside SC26 Valve line pre amplifier. Ex cond. £ 690
Quad 77 integrated amplifier. Ex Cond. Boxed. £ 295	Musical Fidelity F16 Class A power amp. Mint/Boxd £1350
Pioneer A300 Precision. Mint & boxed. £ 195	Nad C370 integrated amplifier. Mint & boxed. £450 £ 295
Quad 33 pre amplifiers. From..... £ 75	Musical Fidelity P270 power amp. 150W Class A. £ 799
Leak TL124 valve amplifiers. Bronze finish & rebuilt with expensive paper in oil caps & Rhodium plate phono sockets. £ 695	Leak TL124+ valve amplifiers. Rebuilt with expensive paper in oil caps & Rhodium plate phono sockets. £ 695
Meridian Modular pre/power amplifier. Ex cond. £ 249	Single Leak TL124+ amplifier in Champagne. Nice £ 249
Leak TL124+. Champagne finish. Ready for rebuild. £ 225	NVA A60 stereo power amplifier. Good condition. £ 295
Quad 303 power amplifiers from £ 125	Cyrus 111 integrated amplifier. Excellent. £ 299
Arcam Zeta 1 Pro logic Cinema amp. Cost £999.00 £ 450	Quad 405/1. Boxed and in good condition. £ 225
Arcam Alpha 3 amplifier. Mint. Boxed/ Instructions £ 100	Musical Fidelity B1 integrated amplifier. Good cond £ 125
Marantz PM66SE K1 signature integrated amplifier £ 199	Tube Technology Unisval valve pwr amp. Mint bvd £ 995
Naum NAC 92 pre amp. S/N0 161840. Mint. Boxed £ 299	Rogers Cadet integrated tube amplifier. 10W £ 175
CR Developments Carmenta Line valve pre-amp. £ 450	Harmon Kardou HK1400 line amplifier. Mint/boxed £ 199
Linn LK1 pre-amp and remote. Good condition. £ 450	Linn LK2 power amplifier. Good condition £ 299
Quad 11s in various condition and prices £ 299	EPOA Leak Stereo 20 valve power amplifiers from.... £ POA
Naum Nap 180 power amplifier. Mint. Boxed. £ 799	Harmon Kardou integrated valve amp. 110V. V rare £ 299
Nakamichi CAS pre-amplifier. Ex cond. Cost £750 £ 375	Nakamichi PAS 100W/CH power amp. Cost £1300 £ 650

TURNTABLES

Garrard 301 in very heavy Octavia plinth fitted with SME 3009 tone-arm. In stunning condition. Be quick £ 950
Project 1 Expression. TT . Mint and boxed. £ 120
Transcriptors Hydraulic Reference turntable. Nice £ 799
Mantecore Mantra with Linn Basic-stone arm. Excon £ 249
Technics 150 with SME 3009 Boxed. Ex condition £ 299
STD 305S motor unit. No arm. Nice deck. £ 100
Thorens TD160 with thorens tone arm. £ 95

SPEAKERS

Acoustic Energy Aegis Evo 3 in maple. Exc. boxed £ 199	Snell E2's with dedicated stands. Just Serviced. £ 699
Pair Quad ESL63 speakers in black. All new panels and full service. 1 year guarantee. Ready for beginning Aug. £1799	Pair Quad EL563's. Black finish and Exc condition £1000
Heybrook Helios. Black. Boxed. Exc condition £ 199	Pair Quad ESL57. New treble panels. Nice cond. £ 899
Jamo Concert 8's with stands. Boxed and mint. £ 799	Pair Quad EL563 speakers. Upgraded with the Black Gate cap mod and all new panels 18 months ago. Boxed £1399
Pair Quad ESL57 spk's. Fully rebuilt by One Thing Audio. Black cloth fronts. 5 star review in HiFi World. Mint. £1799	Rupert stands for Quad ESL57 and EL563 speakers £ 200
Montaunt Short MS201 pearl. Brand new. Black £ 169	B&W 602 S Series 3 floorstanders. Beech finish. £ 295
Celestion F30 floorstanders. Mint. Boxed. Black ash £ 129	Quad ESL57 speakers. All fully serviced with full 3 months warranty. Hear what ESL57s should sound like From! £900 pr
Roksan ROK-ONE speakers. Black. Mint. Boxed. £ 295	Phillips Motional feedback speakers. Rare £ 175

OTHER ITEMS

Nad CS411 Cd player. Mint. boxed and remote £ 199	Quad MC phono module for Quad 34 pre amplifier £ 40
EAR 834P MM/MC Valve phono pre with volume. £ 449	SME 309 tone arm. Mint & boxed @ only £ 475
Mod Squad passive pre amp. Absolutely stunning £ 299	Audionote DAC 1. Valve Dig to analogue converter £ 399
Trichord Research Pulsar 1 Dac with Michell PSU £ 999	Trichord Research PDS707 transport Clock 3. Exc. £ 450
Trichord Research powerblock 500. Mint condition £ 195	Trichord Research Powerblock 1000. Ex condition. £ 295
Sony D777ES DAB/FM/MW/LW/RDS Tuner. Mint. £ 299	Pioneer F-504RDS Precision FM/AM Tuner. Boxed £ 125
Pioneer PD-S505 Cd + PSU & Mod by Tom Evans. £ 499	Pioneer PDR-509 CD recorder/player. Boxed £300 £ 99
Nakamichi CR7E Cassette recorder. £1600. Mint. £ 799	Nakamichi DR3 Cassette deck. Mint & boxed. £ 195
Stax Lambda Semi pro headphones. 110V with trans £ 250	Stax SR5 electrostatic headphones with energizer. £ 125
Sony IAR-LH500 CD with built in 80G hard drive £ 249	Revox G36 2 track R/Reel. Valve and very rare. £ 249
Bulgin 3 pin mains plugs for Quad/Leak etc. Each @ £ 10	Bulgin style P29 mains plugs for Quad 11's etc. £ 25 pr
Phillips CD100 CD player. The first. Booklet/instr. £ 150	Marantz CD63 top loader cd player. Collectable. £ 125
Quad FM1 Valve tuners. Various prices from only £ POA	Stax Basic SR2020 electrostatic Hfphones. Like new £ 249
Trio KT880L synthesiser tuner. AM/FM. Black. £ 75	SME 3009 tonearms from..... £ 150
Decca London international tone arm. New. Boxed. £ 175	One Thing Audio Stereo Decoder. New. £ 200
Linn Xpr. Mint. Boxed. Very unusual. Cost £49. £ 249	Quad FM3 tuner in excellent condition. £ 99

QUAD ESL57 & EL563 PANELS/SERVICING ETC

Full rebuild including latest Otec panels/ bass panels & cosmetics 57's £1175

Reconditioned Quad ESL57 speakers from only £999.00. pr. Why spend £4000+?

ESL57 SPEAKERS STANDARD SERVICE £550. PR. Price

includes 2 completely rebuilt treble panels etc. Ring for further info.

"Classique Sounds servicing restores the Quads to a position where they can hold their head high", Jon Marks. HI-FI WORLD. April 1999. Full servicing facilities available.

TRANSLUCENT (somewhat of a bargain) Hifi World. Jan 1999

PURE SILVER INTERCONNECT CABLE

99.99% pure silver conductors. Quality gold plated RCA phono plugs.

Half Metre terminated £70.00 One metre terminated £90.00. Available with Eichmann plugs + £30

New Translucent **ULTRA + Heavy duty. 99.99% pure silver (4N).**

Eichmann 24 Kt gold plate plugs £199.00 per metre. Or £149 per half metre.

7 day money back guarantee if not better than existing cable

New for 2005. Translucent digital cable. 99.99% pure silver conductor. 1M @ £59

.5M @ £39 Translucent Ultra + digital cable & Eichmann plugs. 99.99% silver

conductor. 1M @ £99 .5M @ £69

1.0MM 99.99% pure silver wire @ £15m.....0.5mm pure silver wire @ £6.00m

New 24K gold plated Nakamichi locking banana plugs and RCA phonos @ £4.95 each

New Quality Rhodium plated RCA phono sockets. The best @ only £4.99 a L/R pair.

QED SPEAKER CABLES AT 30% OFF.

Silver Anniversary @ £3.85M.....Micro @ £1.20M.....Original @ £1.95M..... Contour flat @ £1.60M

Bronze special edition @ £2.10M.....Genesis silver spiral bi wire.....Awesome cable at only £42.00M

Silver Anniversary bi-wire @ £7.00.....Profile 4X4 @ £7.00M.....Original Bi-wire @ £3.45M

TEL. 0845 123 5137 (Calls charged at local rate anywhere in the UK)

Tel 0116 2835821 or 07815188040 (Mobile). Callers by appt only.

Opening times 10.00am-6.00pm Mon-Friday. 10.00am-2.00pm Saturday.

61 Aylestone drive, Aylestone, Leicester, LE2 8QE. Email

classique_sounds@yahoo.co.uk

10% FINANCE AVAILABLE FOR UP TO 3 YEARS ON SELECTED ITEMS. SUBJECT TO STATUS, CONDITIONS APPLY.

SPEAKERS

Mordant-Short MS 3.30 speakers £396
 Sonus Faber Concerto Grand Piano Thiel 2.2 speakers (superb) £396
 ATC SCM 202 Active Loudspeakers boxed/superb £750
 Audio Physics Tempo's £795
 B&W Silver signature 30's £3895
 Spica TC-50 speakers 275
 Orchid LWO speakers ex-demo £2795
 Thiel CS6 speakers £4495
 Martin Logan CLS11 speakers £2250

PRE-AMPS:

ATC SCA 2 Pre Amp boxed superb £2795
 Exposure 11 & 12 pre with power supply £595
 Naim Nac 92 with Nap 903 amp £595
 Toft LBPA pre-amp (balanced) £495
 Audionote M8 with phono, remote (new) £12500
 Audio Research SP14 1495
 Proceed PAV pre-amp £1395
 Mark Levinson ML32 ref pre-amp with phono £8500

AMPLIFIERS

Sirius (Garnut 2) Power amp latest spec £1795
 Mark Levinson ML 432 Power amp £4495
 Rotel RC-995 Remote pre-amp with RB-992 power amp (balanced) £650
 Mark Levinson ML 33 Reference mono's £15995
 Perreux 200ip int amp £1395
 Krell KAV-250A/3 3 channel amp £1995
 Parasond HCA 1206 6 channel amp £1595
 Mark Levinson ML432 400 watts per chan. Amp £4750
 Macintosh MC 2000 Ltd edition amp (Rare) £8995
 Audionote Neiro mono-blocks £5495
 Parasond HCA 1000A amp £345
 Mark Levinson ML336 power-amp £3995
 Audionote Kegan mono's (new) £15000
 Accuphase A20 class A amp £2950
 Advantage integrated amp £1495

CD PLAYERS & TRANSPORTS

Lab 47 flat fish with Progression dac & PSU £3995
 Roksan Atessa with ROC DAI1 dac & PSU £285
 Garnut CD-1R CD player £1495

MISCELLANEOUS

Nakamichi ZXL 1000 Ltd ed. Gold plated cassette deck £3495
 Rega Planar 3 with arm and Linn K9 £150
 Sony ST-SE570 Tuner £80
 Denon DCD 590 CD Player £60
 PS Audio Power Plant main conditioner £1695
 Krell Home Theatre Standard processor £2995
 1 Mtr. pair Madrigal CZ Gel 'bat' interconnect £250
 15 Foot Transparent Music Wave Super single mono run. £795
 Zerodust Stylus cleaner (new) £25
 Zerodust CD & lens cleaning cloths (new) £1750

TURNTABLES, CARTRIDGES & TONEARMS

Blue Pearl (the prototype) Turntable with Gold Plated SME-V arm £9995
 Zyx airy Cryogenic copper cables £995
 Project 6.9 Turntable (without cartridge) £425
 Audio Tekne Cartridge with step-up transformer £2995
 My Sonic Eminent cartridge (new) £2750
 Dynavecor DV-DRT XV15 cartridge £1995
 Project 9c S carbon fibre silver wired arm £375
 Project RPI/M9 turntable without cartridge £550

ALL USED CARTRIDGES ARE CHECKED UNDER A MICROSCOPE BEFORE BEING OFFERED FOR SALE.

VISA - SWITCH - MASTER CARD - AMEX - DINERS CLUB WELCOME. WE TAKE PART EXCHANGE ON NEW & USED STOCK and buy in for cash

3D by SHANLING acoustics Premier Dealers

UK & IRELAND DISTRIBUTOR
 Real Hi-Fi
 Tel: 0870 909 6777
 www.realhi-fi.com

BUCKS. Noteworthy Audio 01296 422 224	KENT Matrix Hi-Fi 01322 292 391	NORTHANTS. H.G. Rapkin 01604 637 515	SUFFOLK The Emporium 01379 870 873
CAMBS. The Hi-Fi Company 01733 341 755	Sounds of Music 01892 539 245	NORTH WEST Orpheus Audio 0161 428 1539	Audio Images 01502 582 853
ESSEX Audition Music 01255 863 905	LINCOLNSHIRE AudioLines 01476 591 090	SCOTLAND Shadow Audio Consultants 01592 744 779	SOMERSET Alternative Audio 01984 624242
HAMPS. Origin Live 02380 578 877	LONDON KJ West One 0207 4868 262	The Audio Salon 0141 333 9700	TYNE & WEAR Global Hi-Fi Centre 0191 230 3600
ISLE OF MAN The Musical Experience 01624 817230	Walsur Systems 0207 724 7224	Hi-Fi Corner 0131 556 7901	YORKS Premier Audio 01924 255 045
	Unique Sound & Vision 0207 2720922		Vickers Hi-Fi 01904 629 659

Radlett Audio CONSULTANTS EST. 1978







RELOCATION SALE EVERYTHING MUST GO!!

9 Holywell Hill St. Albans Hertfordshire AL1 1EU

Tel: 01727 855577 Fax: 01727 858727

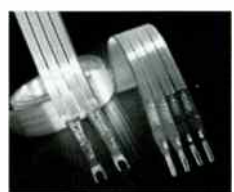
www.radletteaudio.co.uk

High End Cable
 www.highendcable.co.uk
 Call Dave 01775 761880 or order online

 Stereovox SEI 600II Reference Interconnects	 Stereovox HDXV Digital interconnect
 Nordost Red Dawn	 ISOL-8 Qube
 Nordost BRAHMA power cord	 STAX earspeakers

Chord | Acoustic Zen | Stereovox | Nordost UK | von den Hul | ISOL-8
 Black Rhodium DCT | Ayre | STAX | Ortofon | Turbosound | Second hand
Free delivery worldwide on all interconnects.
 For many more money saving offers and information please visit
www.highendcable.co.uk or call Dave on 01775 761880

HEATHCOTE AUDIO

TEL: 01992 653999 MOBILE: 07860 511111 WEB SITE www.heathcoteaudio.co.uk

UPDATED DAILY MOST EQUIPMENT IS ONE OWNER AND BOXED

EQUIPMENT URGENTLY REQUIRED FOR IMMEDIATE CASH PURCHASE. PLEASE PHONE GEORGE 10-6PM

CD/DVD									
MUSICAL FIDELITY FCD CD PLAYER (RARE)	MINT/BOXED	£650		NAKAMICHI DR-3 TAPE DECK VERY LITTE USE FROM NEW	MINT/BOXED	£225			
MARANTZ CD-11LE RARE HEAVYWEIGHT CLASSIC	EXCLT/BOXED	£895		NAKAMICHI DR-2 3 HEAD TAPE DECK	MINT/BOXED	£325			
BARCLAY DIGITAL F-1 SUPER TRANSPORT	EXCLT	TBA		SONY 700ES 3 HEAD TAPE DECK	MINT	£295			
MDDN AUDIO ECLIPSE 2-BDX CD PLAYER (£5000+ SEE REVIEWS)	MINT	£2795							
MICROMEGA CLASSIC SOLD (NEW MECH)	BOXED	£895		LOUDSPEAKERS					
WADIA 8 TRANSPORT AES/BNC/AT&T GLASS	EXCLT	£1450		SONUS FABER EXTREMA S/DEDICATED STANDS (NEW DRIVE UNITS)	MINT/BOXED	RING			
MERIDIAN 500 MKII TRANSPORT JUST FACTORY SERVICED	MINT/BOXED	£695		LINN SARA'S POSSIBLY THE BEST PAIR AVAILABLE ANY WHERE	MINT/BOXED	£495			
ALCHEMIST FORSETTI APD33A TRANSPORT & APD34A DAC INC.VOLUME CONTROL	MINT/BOXED	£1795		ALR JORDAN NOTE-5	EXD.DEM	£1195			
CHORD 1500E 2 OACS + EXTRA 96/192 KHZ MODULE & VOLUME CONTROL (£6800 NEW)	MINT/BOXED	£2795		INFINITY IRS.SIGMAS RIBBONS ETC	MINT/BOXED	£1595			
PERPETUAL TECHNOLOGY PA-1/PA-3 MONOLITHIC PSU ALL SIG-2 LAST 1	BRAND NEW	£1995		DYNAUDIO CRAFT MONITORS & DEDICATED STANDS (£3250)	EXCLT	£1195			
THETA GEN-111 WITH EXTRA AT&T-GLASS INPUT (WAS £6000? NEW)	MINT/BOXED	£1595		APDGE CALIPERS EXCELLENT PAIR WITH REFISHED COVERS		£2250			
MONRIE 18B DAC SEPERATE PSU	EXCLT	£375		APOGEE CALIPERS TOTALLY REBUILT/REFINISHED	MINT/BOXED	£1595			
MSB LINK DAC 24/96khz MODULE	MINT/BOXED	£375		PROAC RESPONSE-3	MINT	£2995			
AUDIO SYNTHESIS DAX-2 BALANCED/SE OUT HDCD/ST GLASS ETC (SUPERB)	MINT	£1195		ART-2 PRECISION MONITOR FLOORSTANDERS PIANO BLACK (£6000)	MINT	£1250			
THETA CARMEN CD/DVD TRANSPORT RARELY ON THE MARKET.	MINT/BOXED	£1695		SNELL C MKIV AMERICAN OAK	MINT	£750			
CEC TL-51 BELT DRIVE TOPLoader (3 MONTHS USE)	MINT/BOXED	£995		RED ROSE SPIRIT RIBBON LOUOSPEAKERS	MINT/BOXED	£895			
AUDIOMEGA DAMNATION TRANPORT AES/EBU BNC/COAX	EXCLT	£575		CURA CA-30 BIRDS EYE MAPLE	MINT	£5495			
PRIMARE V-25 DVD PROGRESSIVE SCAN ETC (£1000) EX DIS.NEW	BOXED	£595		SOUNDLAB MILLENIUM 3 LATEST SPEC EX DEM (£9300+ NEW)	EXCLT	£3750			
AVI S2000 MC CD PLAYER	GC	£475		KLIPSCH LEGENDARY CDRNER HORNS BIROS EYE MAPLE VENEER	EXCLT	£895			
TECHNICS SLP-2000 REF.PLAYER (APPROX £1000 TRICHORD UPGRADES)	MINT	RING		PROAC STUDIO 150 CHERRYWOOD	EXCLT	£795			
ARCAM OIVA DV-88+ CD/DVD/HDCD DECODING	MINT/BOXED	£495		AUDIONOTE ANE-D ROSEWOOD	BRAND NEW/BOXED	£1195			
ALCHEMIST NEXUS CD PLAYER	VGC	£375		CELESTION A-2 (SANTOS ROSEWOOD) LAST PAIR (£1500+)	MINT/BOXED	£695			
Z SYSTEMS Z-3src UPSAMPLER (£1450)	MINT/BOXED	£450		KELLY KT-3 HIGH 95 DB SENSITIVITY CHERRY VENEER	EXCLT	£695			
				CASTLE HOWARD-2 IN PREMIUM BEECH FINISH	EXCLT	£395			
				CASTLE AVON	AS NEW	£350			
VINYL				ACOUSTIC ENERGY ASW FB-110 SUBWOOFER	EXCLT	£225			
REGA P-25 RB600/TECHNO WEIGHT/ACRYLIC PLATTER (CHERRY)	MINT/BOXED	£450		ACOUSTIC ENERGY AE-109	VGC	£450			
ROKSAN XERXES COGNOCENT/PSU/REGA ARM	MINT/BOXED	£795		REL STRDM-1 SUBWOOFER	NEW/BOXED	£375			
NOTTS. ANA. SPACE DECK/ EXTRA GRAPHITE PLATTER	MINT/BOXED	£950		CELESTION A-6S SUBWOOFER	BOXED	£275			
CLEARAUDIO CHAMPION LEVEL -1 & UNIFY ARM 20 HOURS USE (RETAIL £2200)	EX DEM/BOXED	£1695		TRIANGLE TITUS 1 WEEK OLD	LOVELY	RING			
QUASAR RARE ACRYLIC/BRASS/GOLD TURNTABLE	EXCLT	£1250		TANNOY BERKLEYS	RING	RING			
SYSTEMDECK IIX-900	GC	£150		IMF PROFESSIONAL MONITOR VII	RING	RING			
SYSTEMDECK TRANSCRIPTION 2 SPEEO T/TABLE/REGA ARM	EXCLT	£275		CELESTION DITTON 25 LOVELY WELL CARED FDR PAIR		£150			
ARISTON Q-DECK/ARM BOXED INSTRUCTIONS ETC		£149							
FORSELL AIR FORCE 1 REFERENCE WITH FLYWHEEL (\$30,000 NEW)	BOXED	£7500		RACKS/STANDS.					
LEHMAN BLACK CUBE SE (RETAIL £650?) LAST ONE!	BRAND NEW/BOXED	£450		HNE 5 TIER GRANITE STAND SPECIAL OROER RED BRAZILIAN GRANITE	MINT	£750			
OHNSEN DRIVE MC. PHONO STAGE & PSU	VGC	£275		SONUS ELITE 4 SHELF	MINT	£296			
A.O.C. ALT-1 TONEARM	EXCLT.	£150		SONUS ELITE 4 SHELF	MINT	£295			
SYRYNX PU-2 TONEARM & INSTRUCTIONS. (ONE OWNER FROM NEW)	BOXED	£225		SOUNDSTYLE XS-250 CD RACK (HOLDS 250 CD'S)	EX.DEM	£149			
				SOUNDSTYL F XS 105	EX.DEM	£149			
VALVE AMPS				SOUNDSTYLE XS-100	BRAND NEW/BOXED	£195			
ICON AUDIO LA3 PRE & 2 MB-300 MONOBLOCS (£2700)	MINT/BOXED	£1750		SOUNDSTYLE XS 105 5 SHELF ONE ONLY	BRAND NEW/BOXED	£195			
AUDIO INNOVATIONS 1000 MKIII MONO'S 5881/6L6 BORDER PATROL MOD	MINT/BOXED	£1250		SOUNDSTYLE STATUS RANGE ST-105	BRAND NEW/BOXED	£275			
AUDIO RESEARCH VT-150SE MONOBLOCS	EXCLT	£4750		SOUNDSTYLE STATUS RANGE ST-100	BRAND NEW/BOXED	£250			
LUMLEY M-120 MONOBLOCS TRIODE SWITCHABLE CHROME FINISH	MINT/BOXED	£1695		TARGET R-2 FILLED STANDS SILVER OR BLACK	EXCLT	£225			
UNISON RESEARCH 845 INTEGRATED (SUPER AMP)	MINT/BOXED	£1595		ATTACAMA R-274 LEAD FILLED 24 INCH STANDS	VGC	£149			
AUDIONOTE ZERO PRE AMP & MONOBLOCS	MINT/BOXED	£895		ATTACAMA R-274 LEAD FILLED AS ABOVE	MINT	£195			
MICHAELSON AUDIO CHRONOS 2 BOX PRE/PHONO & MONO'S (ULTRA RARE £10,000 NEW)	EXCLT	£3500		ELEMENTAL 20 INCH LOUDSPEAKER STANDS FANTASTIC SEE PIC ON WEB	MINT/BOXED	RING			
TUBE TECHNOLOGY SYNERGY NO.1 REMOTE INTEGRATED (FANTASTIC!! SEE PIC ON WEB)/MINT	EXCLT	£3495							
UNISON RESEARCH C-5 PRE AMP MM/MC PHONO STAGE	EXCLT	£695		CABLES PLEASE SEE WEB FOR FULL LIST					
JADIS JPS-2 TWO BOX PRE (WAS £8000)	EXCLT	£2995		LOUDSPEAKER					
JADIS DEFY-7 100 WATTS CHANNEL	EXCLT	£2995		TARA LABS PRIME 1800 18 FEET!! PAIR BI-WIRE AS NEW BOXED ETC		£795			
				PS.AUDIO X-TREAM BI-WIRE 3 METRE PAIR		£750			
SOLID STATE				MIT TERMINATOR-6 3 METRE PAIR		£275			
SONY SCD-1 SACD/CD PLAYER/ TAE-1PRE & TAN-1POWER AMPS (AWESOME)	MINT/BOXED	£8750		CHORD CO RUMOUR-2 4 METRE PAIR EX.DIS		£70			
NAIM 42.5/NAP-140/NAT-101 TUNER/SNAPS POWER SUPPLY	MINT/BOXED	£995		NIRVANA AUDIO SL-SERIES 2.3 METRE PAIR EX DEM. FACTORY TERMINATED		£475			
ALCHEMIST 'THE ALCHEMIST' HUGE 220 WATT POWER AMP (RARE!)	MINT	£2795		AUDIONOTE AN-L 4 METRE PAIR (FACTORY TERMINATED)		£225			
ALCHEMIST 'THE ALCHEMIST' REMOTE PRE AMP	MINT	£3750		AUDIONOTE AN-L 3 METRE PAIR(FACTORY TERMINATED SILVER SPADES)		£225			
MUSICAL FIDELITY A-300 REMOTE INTEGRATED MM/MC PHONO	MINT/BOXED	£895		INTERCONNECT					
MUSICAL FIDELITY A3cr REMOTE PRE/MM PHONO & MATCHING A3cr POWER AMP	MINT	£1250		HOVLAND 1 METRE XLR BALANCED	AS NEW/BOXED	£275			
MUSICAL FIDELITY A-370.2	MINT	£1250		MISSING LINK CRYO 0.5 METRE XLR BALANCED	AS NEW/BOXED	£125			
MUSICAL FIDELITY F-15 POWER AMP	MINT/BOXED	£1250		ACOUSTIC ZEN SILVER REFERENCE 12 FT PAIR BALANCED XLR		£1450			
MUSICAL FIDELITY P-270 POWER AMP	EXCLT	£450		ACOUSTIC ZEN SILVER REFERENCE 1.5 METRE RCA		£695			
MUSICAL FIDELITY MX 2 BOX PRE AMP	EXCLT	£395		ACOUSTIC ZEN SILVER REFERENCE 1 METRE RCA		£495			
AVI S2000 MA POWER AMP	EXCLT/BOXED	£450		SILVER ARROW 1 METRE BALANCED XLR EX.DEM (£1200 NEW)		£595			
THORENS TTC PRE & TTA CLASS A POWER AMP	MINT/BOXED	£695		FURUKAWA U-P2 BALANCED XLR 3 METRE PAIR EX.DIS/NEW		£250			
DPA 50S PRE AND POWER C/W LONG SPEAKER LEADS/INTERCONNECT VERY RARE	MINT/BOXED	£1250		XLO 3 METRE PAIR (PHONO) EX.DEM		£225			
ALDIA PST 11.01 2 OOX REMDTC PRE AMP/PSU (£2800?)	EXCLT	£1395		TULSA HURRICANE JUNIOR BALANCED XLR 6.5 METRE PAIR		£299			
CONRAD JOHNSON PFR REMOTE CONTROL PRE AMP (£3000)	MINT/BOXED	£1695		TULSA HURRICANE JUNIOR BALANCED XLR 1 METRE PAIR		£55			
GRYPHON SONATA ALLEGRO PRE AMP WAS £12000 (6 MONTHS USE ONLY)	MINT/BOXED	£5995		AUDIOQUEST DIAMOND 2 X 2 METRE PAIRS		£450 EACH			
TOCA SECA (COLIN WONFOR) CLASS A POWER AMP (ULTRA RARE)	EXLT	£995		AUDIOQUEST LAPIS 4 METRE PAIR		£450			
GRYPHON S-100 CLASS-A POWER AMP	MINT	£2895		NEOTECH PROFESSIONAL CABLE 0.5 METRE PAIR EX.DIS BOXED		£199			
PLINIUS SA-102 CLASS A POWER AMP	MINT	£2750		XLO DIGITAL COAX LEAD 2 METRES BRAND NEW		£199			
ALOIA BARTOLOMEO TRANSPARENZA POWER AMP (£2000 ? NEW)	VGC	£795		CABLE TALK-3 DIGITAL COAX 1 METRE NEW/BOXED		£50			
ARCAM A-85 REMOTE INTEGRATED	MINT	£495		BLACK RHODIUM SYMPHONY 0.5 METRE OR 1 METRE	BRAND NEW	£50/65			
				BLACK RHODIUM CONCERTO AWARD WINNING CABLE 0.5 METRE OR 1 METRE	BRANO NEW	£75/95			
TUNERS/TAPE/ETC				MOST EQUIPMENT STOCKED IS ONE OWNER MINT/BOXED. SIMILAR QUALITY VINTAGE AND MODERN					
SONY 777ES DAB/FM/AM RADIO	MINT/BOXED	£395		PLEASE PHONE GEORGE 10-6PM					
LYNX THETA TUNER (VERY RARE/GOOD)	EXCLT	£195							

Are you making the right connections?

Send for Britain's biggest catalogue of specialist cable and connections.

All available by mail order.

Phone 020-8942 9124 or clip the coupon for your Free copy www.custom-cable.co.uk

CUSTOM CABLE SERVICE

PO Box 4007, London SW17 8XG

Please send me your FREE Custom Cable Catalogue

Name _____

Address _____

Postcode _____

NO FURTHER INFORMATION REQUIRED

Send to: Custom Cable Service
PO Box 4007
London SW17 8XG

HFW10/05



Oxford Audio Consultants Ltd.

OUR SUPERB SERVICE IS THE SAME REGARDLESS OF PRICE



Now Demonstrating



Ex-Demonstration & Previously Owned Equipment

SALE LIST

AUDIO NOTE OTO SE	£895.00
CONRAD JOHNSON PF1L PREAMP	£595.00
COPLAND CD822	£1,195.00
GM AUDIO BCD 4 SHELF TABLE	£700.00
GRAAF 13.5 PREAMP	£1,195.00
GRAAF GM100 POWER AMP	POA
JADIS JD3	£1,295.00
KRELL KAV250P	£495.00
KRELL KPS20I	£2,995.00
KRELL KPS28C	£5,995.00
MARTIN LOGAN QUEST	£1,495.00
MERIDIAN G08 CD	£1,295.00
MONITOR AUDIO RADIUS 180 7 SPEAKER PACKAGE	£495.00
ONKYO INTEGRA SYSTEM	£3,500.00
ORIGIN B2 SOLO SPEED CAMERA DETECTOR	£295.00
QUAD ESL63	POA
SONUS FABER AMATIS	£6,495.00
SPECTRAL CABLES	£495.00
SPECTRAL DMC15/DMA100S NEW PRICE	£3,995.00
STANDS UNIQUE REFERENCE TABLE	£395.00
STAX SIGNATURE SYSTEM	£495.00
TANNOY DIMENSION TD10	£3,750.00
TANNOY DIMENSION TD12	£4,500.00
TEAC D2 D/A CONVERTER	£495.00
TRANSPARENT MUSICLINK SUPER	£250.00
TRANSPARENT REFERENCE PHONO CABLE WITH SME ADAPTOR	£595.00
WADIA 64.4 DAC	£995.00
WADIA WT2000 CD TRANSPORT	£995.00
WILSON AUDIO SYSTEM 7	£13,995.00

SH - Second Hand XD - EX Demonstration

0% interest free credit

Licensed Credit Broker

REFER TO OUR WEBSITE FOR THE LATEST UPDATED SALE LIST.

Agencies include: Anthony Gallo, Artcooustic, Atacama, Audio Aero, Audio Analogue, Audio Research, Avid, Beyer, Blok, Bose, Burmester, Canton, Chord Company, Copland, Crestron, darTzeel, Denon, Diapason, Dreamvision, Fujitsu, GM Audio, Graaf, Harman Kardon, Hitachi plasma, I-scan, Isoblu, Isotek, Jadis, Jamo, Kef, Koetsu, Krell, Linn Classic, Living Control, Loewe, Lyra, Marantz, Martin Logan, Michell, Mission, Musical Fidelity, NAD, Naim, Nevo, Nordost, Opera, Opus, Ortofon, Parasound, Pathos, Pioneer, Prima Luna, Project, Pure, Quadraspire, Rako, REL, Sennheiser, Sharp Aquos LCD, SME, Sonus Faber, Sonus systems, Speakercraft, Spectral tables, Stands Unique, Stax, Stewart Screens, T & A, Tannoy, Teac, Theta, Tivoli, Transparent, Unison Research, Triangle, Vantage Point, Vogel, Whest Audio, Wilson Audio, Wireworld, Yamaha

Cantay House, Park End Street
Oxford OX1 1JD

Telephone: Oxford (01865) 790879

Facsimile: Oxford (01865) 791665

E-MAIL: enquires@oxfordaudio.co.uk

WEBSITE: www.oxfordaudio.co.uk



V.A.T. No.
729580013



QUALITY USED
EQUIPMENT,
BOUGHT, SOLD,
PART EXCHANGE

TEL/FAX
0121 747 4246



URGENTLY REQUIRED
LINN, NAIM,
MERIDIAN, QUAD,
CASH WAITING

	RRP	NOW £
AUDIO RESEARCH D130	2000	795
AUDIO RESEARCH CD3 MK11	5190	3495
AUDIO RESEARCH SP16L	1999	1295
AUDIO RESEARCH VSI55	2895	1995
AUDIO RESEARCH VS110	3999	2795
AUDIO RESEARCH VT100 MK11	5000	2195
AUDIO RESEARCH V70	4000	1295
AUDIO RESEARCH LS2	2000	595
ACCUHASE DP55V	3500	2495
ACOUSTIC ENERGY AE1 MK11 ROSEMAHOG	N/A	395
ATC C2 SUB	1600	895
AVI S2000MC REFERENCE CD	1395	395
BAT VKD5SE	5495	2495
BAT VK51SE 6 MONTHS OLD	7950	3995
BOULDER 1012 PRE DAC EX DEM	12950	7995
BOULDER 1010 PRE EX DEM	9450	6495
BRYSTON 3BSST	2200	1395
BRYSTON BP25 PRE	1500	595
BRYSTON BP20 PRE	1800	895
CHORD CPM3300 SILVER WITH LEGS	6500	3495
CLEARAUDIO CHAMPION LEVEL 2 + UNIFY ARM	3000	1395
EAR V20	3500	1495
GRYPHON ADAGIO CD PLAYER	5000	2295
HOVLAND HP200 WITH PHONO EX DEM	7325	4995
HOVLAND SAPHIRE	7000	3495
KRELL KPS20IL	12000	2795
KRELL KAV280P	3299	1995
KRELL KAV2250	4490	2695
KRELL KRC-HR KPE PHONO	7639	2495
MARTIN LOGAN ASCENT I 3 MONTHS OLD	4333	2995
MERIDIAN M60C BLACK	1000	495
MUSICAL FIDELITY TRIVISTA SACD	4000	2495
MUSICAL FIDELITY A3 CD	800	395
NAIM 500 s/n 179450/177734	12350	7995
NAIM NBL BEECH s/n 159946	7500	3795
NAIM 252 s/n193419	4265	2995
NAIM S/CAP2 s/n196744	2885	1995
NAIM CDX2 s/n206916	2800	1995
NAIM XPS 2 s/n206247	2465	1795
NAIM CDX2 s/n209469	2800	1995
NAIM FLATCAP 2 s/n214209	535	350
NAIM 82 s/n 102930	2600	1195
NAIM SNAXO 3-6 S/n 187399	829	350
PATHOS LOGOS 3 MONTHS OLD	2850	1795
PLINIUS SA100	4000	1795
REL STAMPEDE BLACK 2 MONTHS OLD	550	395
REL STADIUM 3 ROSEWOOD	1600	895
REGA MAIA 3	549	365
REGA EXON 3	1195	795
TANNOY DIMENSION 8	4000	1995
TARA LABS DECADE 2MTR BALANCED	2300	395
T AND A TALLIS 5.1 NEW UNUSED	2200	995
TRANSPARENT MUSIC WAVE PLUS BIWIRE 15FT 900	450	
VPI TNT HRX 12.5 ARM NEW	9250	5995
WADIA 850	5000	1995
ZINGALI OVERTURE 2	2500	1395

OPEN MON-SUN 10.00 TO 8.00

Website: www.centralaudio.co.uk

E-mail: tony@centralaudio.co.uk

ALSO AGENTS FOR

Advantage, Balanced audio technologies, Boulder, Burmester, Eggleston, Hovland, Kharma, Lumley, Pass labs, Sound lab, VTL.

hifisound

This months winning slogan is

Potentially more enjoyable than raging hormones" kindly sent in by Mrs Patricia Dalrymple of Southend on Sea

hifisound, 30b Larchfield St, Darlington, County Durham, DL3 7TE Tel: 01325 241888 Email: world@hifisound.co.uk

www.2ndhandhifi.co.uk



...what are you up for?

Digital - CD, DVD etc

AHL Njoe Tjoeb	99	199
Arcam Alpha	90	
Arcam CD82T	399	
Arcam Alpha 9	379	
Arcam CD72T	199	
Audio Analogue Paganinni	679	
Audiolab 8000DAC	299	
Audiolab 8000CDM and DAC	749	
Audiomeco Damnation	399	
DPA Renaissance	299	
Marantz CD46	49	
Marantz DV41000SE	129	
Marantz CD17 Ki	549	
Marantz CD60000SE	99	
Meridian 208	349	
Meridian 508/20	699	
Micromega Stage 1	179	
Micromega T-drive and T-doc	799	
Micromega Duo CD3/B52	899	
Micromega Optic	129	
Musical Fidelity X-DAC v3	375	
Myrrad T20	249	
NAD C541i	199	
NVA Transparent Statement	1749	
Pass Labs D1 DAC	Coll	
Philips CD100	149	
Pioneer PS-S904	199	
Proceed PDT2	699	
Resolution Audio Qopus 21	1799	
Roksan Caspion Kandy Mk3	479	
Roksan Caspion M series	749	
Rotel RCD991AE	399	
SAT CDFix	699	
Sony MDPB50D	149	
Sony XA20ES	179	
Sony CDP940	149	

Systems, Cables etc

Audio Analogue Primo - CD and Amp	649
JPW 204/200/208 - 5.1 Speakers	399
QUAD 33/303/FM3 with Quad sleeve	299
QUAD 34/306 FM4 Pre/Power/Tuner	499
TEAC A1/D1/T1 - Amp/CD/Tuner	449

Amplifiers

Adcom GTP500II GFA545II Pre/Power	399
4MCC 2445 Pre/Power	199
Arcam AB5 Integrated	419
Arcam A75+ Integrated	249
Audio Analogue Puccini Setaonta Integrated	749
Audiolab 8000 Monoblocks	799
Audiolab 8000P Power	429
Audio Research L57 Preamp	699
AVI S2000MP Preamp	279
AVI S2000MM Monoblocks	699
AVI S2000MP/MM Pre/Monos	899
Creek 4330MK2r Integrated	249
Crimson 510/520 Pre/Power	199
Crimson 610C/630D Pre/Monos	599
Craft Linestage Preamp	499
Cyrus 7 Integrated	429
Cyrus 3 Integrated	229
Lumley Reference ST70 Valve Power	699
Magnum MP300/MF125 Pre/Monos	599
Magnum MA120 Integrated	149
Meridian 605 Monoblocks	799
Meridian 505 Monoblocks	899
Meridian 205 Monoblocks	599
Mission Cyrus Two	99
Musical Fidelity 3a Preamp/P150 Power	399
Musical Fidelity 3cr Pre/Power	Coll
NAD 912 Power	119
NAD 3020 integrated	69
NAIM 62/140 Pre/Power	549
Primore A20 Integrated	379
Quad 405 Power	from 149
Quad 44 Preamp	249
Quad 405/2	from 199
Quad 33/303 Pre/Power	199
Quad 77 Integrated	299
Rega Brio Integrated	129
Rega Luna Integrated	179
Roksan Caspion M Series Pre/Monitors	Coll
Roksan Caspion Integrated	299
Roksan Kandy Mk3 Integrated	479
Roksan RC995 Preamp	249
Shearline Phase 2 Integrated	279
Sumo Andromeda Power	299
Sumo Andromeda III Pre/Power	Coll
TagMcLaren 60P Power	449

Speakers

Acoustic Energy AE1 Standmount	399
Acoustic Energy AE100 Floorstander	1119
Acoustic Energy AELmk3 Standmount	Coll
Acoustic Energy Aelite 3 Floorstander	549
Acoustic Energy AE2 Standmount	899
Acoustic Energy AE505 Floorstander	349
Amphion Xenon Floorstander	1299
B&W 602S3 Standmount	249
B&W 801S3 Matrix Floorstander	1999
Castell Chester Floorstander	199
Celestion 5000 Standmount	199
Epos M15 Floorstander	279
Epos ES11 Standmount	Coll
Heybrook HB100 Standmount	79
JPW 200 Standmount	79
JPW 204 Floorstander	269
KEF Q10 Standmount	89
Meadowlark Shearwater Horrad Floorstander	999
Mission 753 Floorstander	349
Monitor Audio Studio Centre	199
Monitor Audio Silver S8 floorstander	from 449
Monitor Audio Silver S5 floorstander new	349
Monitor Audio Silver B1 floorstander	349
Mordant Short 912 Standmount	149
NEAT Petite Mk3 Standmount	399
NHT VT2 Floorstander	449
PMC F81 Floorstander	799
QUAD ES163 Floorstander	1299
QUAD ES163 Floorstander	699
QUAD 12L Standmount new	449
QUAD 12L Standmount	399
REL Q50 Subwoofer	199
Ruark Templor - ex, boxed	199
Tandberg Studio Monitor Large standmount	399
TDL Studio 1 Floorstander	199
Triangle Antal ES Floorstander	749

Tuners and Tape

Arcam T61	159
Creek 4030	99
Denon DR5810	99
Myrrad T30	199
Quad FM2	149
Quad 66FM	379
Quad FM4	from 199

Analogue

Bragi Phono stage c/w Forsetti p/s	399
RDB0/Huackxk228	249
PPA Phono stage	449
834P Phono stage	379
Phono stage TT2	999
TT2	149
JBE SlateSeries 3/Mission774	Due in
Kinshaw Perception phono stage and p/s	479
Linn LP12/IttokVII/Asaka	699
Linn LP12/Armageddon/Ara	1599
Linn LP12/Lingo/Ekos	1499
Linn LP12/Valhalla/Akito	649
Linn LP12/Valhalla/Syrinx PU3	399
Linn LP12/Armageddon/RB300	979
Linn Basik (no arm)	229
Linn Basik (no arm)	99
Linn Axis Akita	299
Linn Ittok 12"	999
Linn Logic Tempo/Datum arm	149
Michell Gyrodec Export	699
Michell Reference Hydraulic/Fluid arm	699
Michell Reference Electronic/ SME3009	599
Michell Prisma/AT arm	999
Michell Focus One/Focus arm	379
Michell Orbe SE	1349
Michell The Source	499
Nats Analogue Hyperspace/Mentor arm	1399
Odyssey RP1-XG	499
Pink Triangle LPT/RB250	379
Project Xpression 1	149
Project Phono box LE	59
Rega Planar 2/RB250	149
Rega Planar 2/RB250	179
Rega Planar 3/RB300	175
Rega Planar 78/RB250/Mono Cart	179
Roksan Xerxes/Tabriz Zi	449
Roksan Radius 3/Tabriz	429
Roksan Radius 5/Nima	599
SME 309	499
Thorens TD1 60b/Mission 774	249
Transcriptors Skeleton/Vestigal	799
Transcriptors Saturn	199
Voyd Valdi/Helius Scorpio	599
Voyd Valdi/RB300	599
Wilson Benesch Act/Act 2 arm	2499

VISIT OUR WEBSITE, OR CALL 0845 6019390 TO SPEAK TO A REAL PERSON

TUESDAY TO SATURDAY 10 TO 5-ISH

Quality hifi equipment always required for cash. Call us before you trade in. Commission Sales too.

01325 241888 or world@2ndhandhifi.co.uk

turntableworld!

is THE place to make your next analogue choice. Our Dem facilities offer a wide selection of all types of analogue equipment from all the best brands including...

Clearaudio, Dynavector, Tom Evans, Goldring, Grado, Hadcock, Lyra, Michell, Moth, Nottingham Analogue, Origin Live, Ortofon, Project, Graham Slee, SME, Sumiko, Transfiguration, Trichord, Whest Audio and Wilson Benesch

...there is no better analogue decision

turntableworld! is at 30b Larchfield St, Darlington, DL3 7TE.

Tel: 01325 241888 or email: world@turntableworld.co.uk

dial a dealer

This is a comprehensive directory of Hi-Fi Dealers throughout the UK and Ireland.

BRISTOL & BATH

THE RIGHT NOTE Tel: (01225) 874728. Are you happy with your system? We find that most audiophiles listen for most of the time to systems that are 'not quite right'. Forget the 'Best Buy' reviews and putting a system together like a patchwork quilt. Let us assess the vast range available, you judge the results. We'll help you to plan a system for the future, even if you spread the purchases. Leave 'up-grade-itis' behind, save money and enjoy music all the time. Just listen, and you'll know.

CD: Accuphase, Audio Synthesis, Bel Canto, dCS, Resolution Audio, Wadia.

Vinyl: Basis, Clearaudio, DNM, Graham, Michell, Sumiko, Transfiguration.

Amps: Advantage, CAT, DNM, Gamut, Spectral.

Speakers: Audio Physic, NEAT, Verity Audio. Tuners: Magnum Dynalab. (Credit Cards Accepted).

V'AUDIO HiFi Consultants: 36 Druid Hill, Stoke Bishop, Bristol. BS9 1EJ. Tel: 0117 968 6005. ATC, AVI, Alon, ALR Jordan, Audio Analogue, Avid, Black Rhodium, Electrocompaniet, EsLab Digital Amps, Harman Kardon, Infinity, Jamo, Lyra, Origin Live, Opera, Ortofon, PS Audio, Ruark, Michell, REL, SME, Sugden, Townshend, Triangle, Unison Research Valve Amps, VPI. Specialists in Video Projectors by SIM2, Infocus, Sanyo; screens by Stewart, Draper, Da-Lite, Owl, and Amps/DVD's by Harman Kardon etc. Demos by appointment only. Home trial facilities. We are not a shop.

CAMBRIDGESHIRE

AUDIO FILE 18c & 18d Chesterton Road, Cambridge. CB4 3AX.

Tel: 01 223 368305 Fax: 01 223 354975

Email:

sales@audiofilecambridge.co.uk
'For the best in British Hi-Fi and Home cinema entertainment'. Visit or call to arrange a demonstration

with products from: Arcam, Linn, Naim, Cyrus, Absolute Sounds, Kef, Sony, Yamaha, Rel, Ruark, Denon, Nordost, PMC, Revel, Parasound, JM Labs, B&W, Pro-Ac, Tannoy, Meridian, Project. Custom installation service available.

CHESHIRE

ACTON GATE AUDIO 4 Ruabon Road, Wrexham, North Wales, Tel. 01978 364500.

www.acton-gate-audio.co.uk
Audio Visual Specialists. Arcam, Audio Analogue, AVID, Bose, Celestion, Castle, Denon, Harmon Kardon, Jamo, JM Lab, KEF, Marantz, Michell, Mission, Onkyo, Opera, Pro-Ject, Musical Fidelity, NAD, QUAD, Roksan, Ruark, Tannoy, Teac, Tivoli, Unico, Unison Research, Wharfedale, Yamaha, DSP Club Member, Demo Room, installation service. Easy Parking and Motorway access. All major credit cards accepted. 9.30 - 5.30 daily. Closed Sunday & Monday.

ACOUSTICA 17 Hoole Rd, Chester CH2 3NH.

www.acoustica.co.uk. Tel 01244 344227. All the best in HiFi & Home Cinema from Naim, Rega, Rotel, Sugden, Tube Technology, Primare, Isotek, Harman Kardon, Teac, Acoustic Energy, JM Lab, B&W, Spendor, Royd, REL, Quadraspire, SIM2 & Sanyo projectors and much more. We offer full demonstration facilities, interest free credit and delivery & install systems throughout Cheshire, Merseyside & North Wales. Opening hours are Tuesday to Saturday 10.00 to 5.30.

DOUG BRADY HI-FI Kingsway Studios, Kingsway North, Warrington, WA1 3NU Tel 01925 828009 Fax 01925 825773. Visa, Mastercard, Lombard Tricity. 2 dem rooms, home trial; Agencies include: Arcam, Tag McLaren, AVI, B&W, Castle, Caspian, Chord Electronics, Exposure, Harbeth, Heybrook, Krell, LFD, Michell, Meridian, Musical Fidelity, Monitor Audio, Naim, Nautilus 800 series, Pink Triangle, ProAc, Roksan, SME, Wilson Benesch, XTC and many more.

ORPHEUS AUDIO.

Tel: 0161 428 1539 email: anything@orpheusaudio.co.uk
www.orpheusaudio.co.uk
Demonstrating fine two channel music systems, Turntables from VPI's award winning range, Whest Audio, Lyra, Sumiko, Ear/Yoshino, Consonance; including Droplet, Music First, Wireworld, Triangle, Shanling, BCD, Hyperion, Brilliance, Horning.
Home demonstrations at your convenience, evening calls welcome.

CORNWALL

BIGEARS AUDIO To find a system that will allow you to hear the music instead of the equipment phone Bigears Audio, here you will find an interesting array of NEW and GOOD QUALITY used EQUIPMENT! MY INTENTION IS TO HAVE SATISFIED CUSTOMERS WHATEVER THEIR AUDIO PREFERENCES.
chrisburchley@btinternet.com
Tel: 01736-740421

LEICESTERSHIRE

DIVINE AUDIO

The Courtyard, Bennett's Place, High Street, Market Harborough, LE16 7NL
01858 432999
Leicestershire's freshest hi-fi and home cinema retailer, offering a service that you expect in an environment that will excite you. Stunning cinema and two channel demonstration facilities, comfy chairs and coffee!
We get outstanding results from Arcam, Art Loudspeakers, Audio Analogue, Chord Company, Exposure, Focal JMLab, Infocus, Isoblu, Kube Design, Metz televisions, NAD, Opera, Oray Screens, Partington, Pathos, ProAc, Pro-Ject, Quadraspire, Revolver, Sugden, Triangle, Unison Research and a few other surprises.
Open Tuesday - Saturday 9.30 - 5.30 or by arrangement. Free parking
01858 432999,
www.divineaudio.co.uk,
info@divineaudio.co.uk

MIDDLESEX**RIVERSIDE HI-FI 422**

Richmond Road, East Twickenham, Middlesex, TW1 2EB. Tel: 020 8892 7613 Fax: 020 8892 7749.

www.riversidehifi.co.uk

Audio Research, Blueroom, Bose, B&O, Copland, Denon, Elac, Infocus, Krell, Linn, Living control, Martin Logan, Michell, Monitor Audio, Musical Fidelity, NAD, Project, QED, Rel, Sennheiser, Sonus Faber, Teac, Theta, Wilson. Finance available. Subject to status. Written details available on request. Export orders welcome. UK mail order available. 3 demonstration rooms. All major credit cards. Open 10am-5.30pm Mon-Sat.

STAFFORDSHIRE**ACOUSTICA 114**

Wolverhampton Rd, Stafford ST17 4AH. www.acoustica.co.uk. Tel 01785 258216. All the best in Hi-Fi & Home Cinema from Naim

Audio, Arcam, Rega, Rotel, NAD, Sugden, Yamaha, Bowers & Wilkins, Focal-JM Lab, Monitor Audio, Ruark, Mission, REL, Quadraspire, Sim2 & Sanyo projectors and much more. We offer full demonstration facilities, interest free credit and delivery & install systems throughout Staffordshire & the Midlands. Opening hours are Tuesday to Friday 10.00 to 5.30, Saturday 10.00 until 5.00.

SUFFOLK

AUDIO IMAGES 128 London Road North, Lowestoft, Suffolk, NR32 1HB Tel: 01502 582853.

info@audioimages-hifi.com.

www.audioimages-hifi.com

Castle, Denon, Harmon Kardon, Jamo, Mirage, Rothwell, Roksan, Sugden, Screen Play, Synthesis, Triangle, Tom Evans Audio Design, Vienna, Vincent, Volta Cables. Refreshingly different selection.

Dem Room, Professional AV installer's from budget to high end. Full credit facilities. 9.30 to 5.30 Mon & Sat

SURREY**VIVANTE PRODUCTIONS LTD,**

Unit 6, Fontigarry Business Park, Reigate Road, Sidlow, Surrey, RH6 8QH

E Mail: sales@vivante.co.uk

On Line: www.sales@vivante.co.uk

Tele: 01293-822186

Fax: 01293-820509

Vinyl, SACD, XRCD, HDCD,

HDAD, CD etc. - We do the lot!

Check our website to see the thousands of interesting titles we have available. Contact us to receive our free monthly newsletter. Ps: we pride ourselves on friendly, fast service and a world beating Musical selection!

YORKSHIRE (EAST)

THE AUDIO ROOM 2 George Street, Hedon, Hull, HU12 8JH.

tel 01482 891375.

www.theaudiroom.co.uk

The Norths premier hifi dealer, stunning showrooms and dedicated demonstration rooms. Authorised agents for, Naim Audio, Spectral, Accuphase, Nagra, Peak Consult, Cyrus, Linn, Focal JM Lab, ProAc, Spondor, B&W, Rotel, Rega, Dynavector, Unison Research, Audio Research, Sonus Faber, Siltech, Nordost and others. Home demonstrations and credit facilities available. Open Mon - Sat, 9am - 6pm. The Norths friendliest hifi dealer.

YORKSHIRE (SOUTH)**THE HI-FI STUDIOS**

Hi-Fi - Home Cinema - Custom Installation Tel: Doncaster 01302 727274 or 01302 725550.

info@thehifistudios.freemove.co.uk

www.thehifistudios.co.uk

Musical Fidelity, Electrocompaniet, ProAc, PMC, JM Lab, Ruark, Castle, TEAC, Unison Research, Monitor Audio, Impulse, Primare, Harbeth, NAD, Michell Turntables, Nottingham Analogue Studios, Audio Analogue, Living Voice, Densen, Celestion, KEF, Opera, Trichord Research, Nordost, Stands Unique, Ortofon, Project, Goldring, REL, Denon, TAG McLaren, Rotel, Yamaha, Proceed - plus many more. Viewing & Demonstration by appointment in a unique setting. Home trials and installation. Card facilities and 0% available. Please phone for more information. BADA. CEDIA.

YORKSHIRE (WEST)

AUDIO REPUBLIC, 78 Otley Road, Leeds 0113 2177294,

www.audio-republic.co.uk for the

very best in quality hifi in West Yorkshire and beyond, representing Naim Audio, Rega, Totem, Sugden, Shahinian, JM Lab, Filtech, TEAC, Nottingham Analogue, Spectral, Living Voice, Hutter Furniture, Accuphase, Quadraspire, Chord Cables, Dynaudio. Choice of shop or home demonstrations, open Tues - Sat 9.30am to 5.30 pm. Please phone for a chat and directions.

PREMIER AUDIO - now demonstrating - Room 1: DCS Elgar, Purcell & Verdi Transport, Plinius CD Lad & 250 Power, Verity Fidelo & Sonus Faber Speakers, Siltech Cables, Isotek Sub Station, BDA Equipment Stands Room 2: Audio Aero, Audio Synthesis, Kora Pre & Power, Pink Triangle CD/Amp, Martin Logan / Audio Physics Speakers, Arcici Equipment Stand, Isotek Sub Station P/S Audio Synthesis, Audio Physics, Audio Aero, Absolute Sounds, DCS, Kora, Plinius, Siltech, Arcici, BDA, Pink Triangle, Avid Turntables, Project, Ortofon, Van den Hul, Mirage. P/X welcome Home demonstration good selection of S/hand. We are 10mins J39 - M1 10mins J30 M62 Tel: Wakefield 01924 255045 - Colin Grundy.

WALES**ACTON GATE AUDIO 4**

Ruabon Road, Wrexham, North Wales, Tel. 01978 364500.

www.acton-gate-audio.co.uk See our main ad under Cheshire.

IRELAND & NORTHERN IRELAND**NAIM SPECIALISTS-AINM-AV,**

1, Church Rd, Swords, Dublin.

tel +00 353 (0) 1 813 7937.

m +00 353 (0) 87 247 0559

Email peter.williams@ainmav.com

www.ainmav.com

Naim make the ultimate music systems. Come and listen - hear the music. Two demonstration rooms featuring the Naim range. Complete home cinema / multi-room design and installation service. Individual demonstrations including evenings available by appointment. Pre-loved Naim equipment warmly accepted. **FOR NORTHERN IRELAND** contact our new Naim Dealer Moore's Hi-Fi Tel: 028 9181 2417

VINYL/RECORD MAIL ORDER

DIVERSE VINYL 10 Charles Street, Newport, NP20 1JU.

Tel/Fax: 01633 259661/256261.

Email: sales@diverse-music.co.uk

Probably the most varied and impressive selection of brand new LPs you'll find anywhere: international new releases, reissues and audiophile products. Also UK distributor of the Disco Anti Stat LP Cleaning Device. Call for a free catalogue, or visit www.diversevinyl.com

specialist hi-fi dealers

London

Oranges & Lemons



020 7924 2040

www.oandlhi-fi.co.uk
61 Webbs Road, Battersea, SW11 6RX
email: oranges.lemons@virgin.net



Naim Specialists

tom tom audio

the largest selection of mint, pre-loved Naim Audio components on the planet.

- 12 month guarantee
- credit/debit cards
- dem facilities
- mail order
- open 7 days
- products tested
- help & advice
- see website for stock

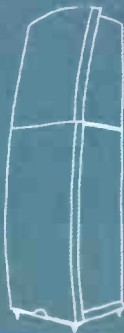

Tel: 01727 893928
www.tomtomaudio.com

Two Channel Specialists

simaudio moon
47 laboratory
avid
shahinian
lavardin
electrofluidics
living voice
sonneteer
border patrol
neat acoustics
isoblu
resolution audio
tom evans audio
dnm/reson
lfd audio
audio physic
slinkylinks



thesoundpractice

stalbans: 01727 893 928
www.thesoundpractice.com

Vinyl Specialists

vivante

Vivante Production Ltd,
Unit 6, Fontigarry Business Park,
Reigate Road,
Nr. Sidley RH2 8QH,
Tel: 01293 822186
Email: sales@vivante.co.uk
On Line: www.vivante.co.uk

Vinyl is back?

Truth is, it never really went away. That's why we have been busy keeping vinyl fiends happily supplied all these years. Call us for our free catalogue and newsletter and find out more about the huge range of top quality titles we have available.

Not only that – we give friendly knowledgeable service and the best possible prices. Look forward to hearing from you.

Regional

shunyata research

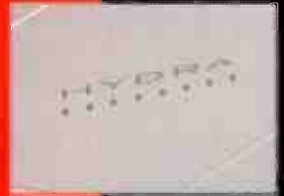

the professionals' reference

AUDIO ATMOSPHERE

tel 01785 711232 stuart@audioatmosphere.com
www.audioatmosphere.com

LAIID-BACK AUDIO LTD

For the sweet sound from a single-ended valve amplifier made by hand.

For more information
mail@loidbackaudio.co.uk
www.loidback-audio.co.uk

Phone 01905 640028 Fax 01905 641596

Services & Consultants

HIFI RECLAMATION WANTED

Classic British Hi-Fi Components and Systems!

Top prices paid for vintage or classic audio separates, accessories or literature.

0845 644 3340

Front End Problem?

contact

The Cartridge Man

It doesn't have to cost an arm and a leg to get the best - listen to my Koetsu - and Decca - eater.

Also agents for Croft, Hadcock, E.A.R., Michell & Moth.

plus cartridge re-tipping service
020 8688 6565

Website: www.thecartridgeman.com

Valves & Tubes

CVC Chelmer Valve Company

for audio valves

Buy CVC PREMIUM HI - FI valves direct from us. All valves processed for improved performance. We also have stock of MAJOR BRAND types inc. MULLARD, GEC, BRIMAR, RCA, GE, PHILIPS, etc.

The Stable, Baddow Park, Great Baddow, Chelmsford Essex CM2 7SY. Tel. 01245 241301 Fax. 01245 241309 Email: sales@chelmervalue.com

To advertise in this space please call 020 7372 6018 or email: advertising@hi-fiworld.co.uk

NEW catalogue out now packed with award winning products



"We defy anyone not to notice the improvement in performance when you switch... to a PowerKord."
What Hi-Fi, May 2004.

- exclusive mains leads
- exclusive Hi-Fi equipment
- exclusive speaker cable
- exclusive CD accessories
- exclusive supports



Russ Andrews Classic PowerKord™ from £55

order online at www.russandrews.com
or call UK Local Rate 0845 345 1550 quote AWORLD

Exclusive UK Retailer for
KIMBER KABLE

Russ Andrews Accessories Ltd, 2B Moreland Court, Westmorland Business Park, Shap Road, Kendal, LA9 6NS, UK. Tel: +44 (0)1539 797300 Fax: +44 1539 797325

Russ Andrews
Solutions for better music & movies

specialist hi-fi dealers

Yorkshire

Aeon Acoustics

ISO-PLATFORMS & FEET LOUDSPEAKERS
MADE FROM NEW GYRO-PNEUMATIC
AUDIO MATERIAL www.spiralex.com



PCT Patents & Design Copyrights pending



Smart Audio Materials with
extended bass response & clarity

Loudspeaker Repairs

D.C. Boultons

Loudspeaker Repairs & Manufacture

All types including P.A. Disco, Hi-Fi, Juke Box etc.

Agents for B&C, Celestion, Eminence,
Fane, Precision Devices etc.

From re-foams to complete re-builds, even with
slipped magnets.

Trade and retail supplied.

Custom units our speciality.

Over 35 years experience of loudspeaker design

Unit 12, Damgate Lane Ind. Est, Acle, Norwich,
NR13 3DJ

Tel 01493 750075 Fax 01493 751155

IAN EDWARDS
MAKERS OF FINE HAND MADE FURNITURE

Elegant Storage Solutions for
Hi-Fi, Books,
LPs, CDs,
DVDs
Special orders welcome



Tel: 01423 500442 Fax: 01423 705200 www.iansbespokefurniture.co.uk
The Old Chapel, 282 Skipton Road, Harrogate, N. Yorks, HG1 3HE

'Super Wizard' Rotary Unit. 2296
CDs, etc



74" 'V-Max' can hold 660 CDs etc



JT Hi-Fi CD/Cassette Unit



Charlotte Drawer unit for 480 CDs
& 75 Cassettes. 32" x 21" x 21"



meet your maker

A reference guide to Britain's manufacturers and distributors

CREEK AUDIO LTD

12 Avebury Court, Mark Road, Hemel
Hampstead, Herts, HP2 7TA.

Tel. 01442 260146

E-mail: info@creekaudio.com

Internet: www.creekaudio.com

Creek Audio manufactures in the UK. Current products include A50i, A50iR and 5350SE integrated amplifiers, CD50 Mk2 CD player, and T50 tuner. All products are similarly styled providing an easy mix and match choice depending on budget. Our miniature OBH range includes two phono pre-amplifiers, two headphone amplifiers and a passive pre-amplifier.

EPOS ACOUSTICS

2 Avebury Court, Mark Road, Hemel Hampstead,
Herts, HP2 7TA

Tel. 01442 260146.

Email: info@epos-acoustics.com

Website: www.epos-acoustics.com

Innovative design and superior sound distinguish EPOS speakers from other brands in similar price categories. Nine models in total including a 5.1 surround system. All available in 3 finishes. Supporting stands and plinths complement the speakers. In addition to its two channel appeal, Epos is now equally sought after in the fast expanding world of home cinema.

FALCON COMPONENTS LTD

Unit 12 Damgate Industrial Estate, Damgate
Lane, ACLE, Norwich, Norfolk, NR13 3DJ

Tel. 01493 751100 Fax 01493 751155

E-mail: sales@falcon-acoustics.co.uk

Web: www.falcon-acoustics.co.uk

FOCAL drivers. SOLEN polypropylene

capacitors, TAYDEN high quality PA loudspeaker units. Largest specialist Audio-inductor UK manufacturer. Comprehensive range of DIY speaker parts, kits and accessories. Sub-bass and electronic filters. Audio Amateur Publications. Audio Computer Software. Pro-Audio equipment and loudspeaker repairs. Enquiries send 47p sae for full price list or visit our website.

GARRARD and LORICRAFT

4 Big Lane, Goose Green, Lambourne, Berks,
RG17 8XQ.

Tel / fax: 01488 72267.

We make the all-new Garrard 501 and 601 turntables and can service/repair the older 301 and 401 models. We cannot help with the many other turntables that Garrard made. We are also manufacturers of the Loricraft Record Cleaning Machine, as reviewed in the July issue of this magazine. See our website at www.garrard501.com for more information.

MONITOR AUDIO LIMITED

24 Brook Road, Rayleigh, Essex SS6 7XL

Tel 01268 740 580. Fax 01268 740 589

e-mail: info@monitoraudio.co.uk

website: www.monitoraudio.co.uk

Monitor Audio designs and manufactures British loudspeakers of the highest quality. Since 1972 Monitor Audio has been developing and perfecting the implementation of metal drivers, innovative crossovers, and exemplary speaker cabinet construction and finish to further the ideal of achieving sound which to the original is "as close as it gets". As we enter the 21st Century, Monitor Audio leads the way in offering speakers that suit every pocket and which integrate seamlessly with both Hi-Fi and AV systems.

PMC/BRYSTON

PMC & Bryston are Emmy award winning Loudspeaker & Amplifier manufacturers - Used throughout the professional world as reference. Our clients record for Deutsche Grammophon, Decca and countless blockbuster Movies. The identical, award winning ATL (Advanced Transmission Line) technology is used in all HiFi designs from the DB1+, TLE1 Sub through to the Active BB5XBD.

PMC Ltd 43-45 Crawley Green Road, Luton, LU2
OAA. Tel: 08704 441044 Fax: 08704 441045

Email: sales@promonitor.co.uk

Web: www.pmc-speakers.com

SUGDEN AUDIO PRODUCTS

Designed and manufactured in the UK each Sugden product is hand-built by one highly skilled technician. A full range of pure class A amplifiers are available including integrated, stereo power and the incredible Masterclass balanced monoblocks. Our stunning Bijou system now comes with a single-ended pure class A power Amplifier with optional integral stand. Two analogue tuners have joined the range matching our A21 and Bijou series, offering a digital user interface with excellent facilities. Each amplifier series has a matching CD player with a class A output stage and heavily modified transport. The class A HeadMaster offers a pre-amp with three inputs a fixed and variable output with remote control. The HeadMaster can be used as a control unit in a high quality audio system and excels with headphones. Please contact us for product information, dealer list and brochures. 01924 404088 email info@jesugden.co.uk.

MANUFACTURER

Emporium

emporium@modomail.com www.emporiumhifi.com

Tel: 01379 870 873

CD PLAYERS AND DACS

AUDIO ANALOGUE MAESTRO mk1 CD, boxed	650
AUDIO ANALOGUE PAGANINI MK1 CD, black, boxed	375
AUDIO NOTE CD3 with Border Patrol psu	1250
AUDIO RESEARCH DAC 1 20 bit, big warm sound, cuddle up cost 3000	700
AUDIO SYNTHESIS modded Kreatura transport	700
MARANTZ CD12 LE, 2 box REFERENCE PLAYER boxed	1250
MERIDIAN 200 transport	300
MERIDIAN 206 cd player	350
MUSICAL FIDELITY A3CD, boxed	500
MUSICAL FIDELITY NUVISTOR M3 CR cd player	1500
PASS LABS DNG 1 dac	2500
PINK TRIANGLE LITAUURAL cd player, very musical recommended	750
QUAD 66 CD	300
ROKSAN CASPIAN CD silver	500
SHANLING CD80 new valve cd player	now in stock
SHANLING CD1100 secondhand, boxed	1000
SHANLING CD T100 wonderful valve cd player, rave reviews, it has up sampling (to 24/96khz) and a volume control NEW at	1650
SHANLING SACD200 new	2150
SHANLING CD300 LTD EDITION CD PLAYER available plus your old shanling as trade in	3000
SUGDEN OPTIMA cd	300
SUGDEN MASTERCLASS cd player, black, boxed	1700
TEAC D1 dac	200
TEAC VPD5 10 CD PLAYER BOXED	350
THETA UNIVERSAL DATA transport, serviced, boxed	850
THETA PROGENIE dac, boxed, good sweet dac recommended	600
THETA PRO BASIC 2, dac, boxed	700
THETA PRO BASIC 3a dac, balanced outputs boxed	850
Z-SYSTEMS RDP-1 Dig preamp, stereophile recommended component, remote control 5000 I	750

TURNABLES/ARMS/CARTRIDGES

ART AUDIO VINYL ONE, mm phonostage, upgraded, silver wire, new caps	750
COUNTERPOINT HEAD AMP MC to MM	400
DYNARECTOR DV20X NEW low output	350
EAR MC3 transformer	450
GARRARD 301/401 SHINDO BEARING AND PLATTER	in soon!
GRAHAM SLEE PHONOSTAGES NOW IN STOCK AND AVAILABLE FOR HOME DEMO	
HADCOCK GH242 SE vd hull silver wired, new	550
KOETSU ONYX	1000
LECTOR PHONOAMP SYSTEM 2 box valve mm/mc phonostage awesome at	1350
LINN LP12 afrosnia valhalla ORIGIN LIME SILVER ARM	750
LINN LP12 afrosnia, valhalla, ALPHASON XENON arm	550
LINN LP13 black, LINGO, export case late #83000 with boxed NAIM ARO	1600
LINN LP12:# 79000, boxed LINGO,	750
LTRA PARNASSUS DCT just retipped, very nice cartridge	950
LTRA HELIXION SL mint boxed, very light use	800
MICHELL HYDRAULIC REFERENCE, late version with inverted gold globbs, excellent with sweep brush and stylus brush	
MICHELL DODSSEY in stock NOW	550

MING DA valve phono stage mm/mc	300
MUSICAL FIDELITY XLP3 3 box version	300
MUSICAL FIDELITY XLP3 v3 phonostage, boxed	200
NOTTINGHAM ANALOGUE HYPERSPACE, SPACE ARM, TRACER 2 CARTRIDGE 1950	
ORACLE DELPHI II with origin live motor upgrade	600
ORIGIN LIME SOVEREIGN deck & CONQUEROR arm now, ex dem combo	
with full manufacturers gear, boxed	4000
ORIGIN LIME SILVER MK1 boxed	400
ORIGIN LIME THE SILVER ARM mk2, new, AND decent trade in given on your old arm	600
ORTOFON ROHMAN, just retipped, boxed	600
ORTOFON KONTRA B, just rebuilt, boxed	500
OUTRAGEOUS JAPANESE HANDMADE UNIPYOT ARM ask for photos	800
PINK TRIANGLE ANNIVERSARY with battery psu, boxed, sme cutout	1300
PROMETHEUS turntable, home demo available	35,000
REVOX B790 turntable with parallel tracking arm	250
ROCKPORT SERIES 2 SIRIUS with upgraded (by Rockport) arm, Chroma motor controller and custom acrylic cover the best Sirius 2 anywhere 50,000 +-+	15,000
ROKSAN COGNOSCENTI (piano black xerxes) with tripod stand, SHE 309	1050
SHINDO LABS meursait #773 12" tonearm	
SHINDO LABS modified ORTOFON SPU-A	POA
SHINDO LABS ANOME MC step up transformer	
SHURE Y150MR in stock 275 new boxed, also available for home dem	1000
SONIC FRONTIERS PHONO ONE mm/mc valve phonostage, boxed	275
SYSTEMDECK II the biscuit tin, firm bakik arm boxed with lid	600
TECHNICS SP15 in heavy technics plinth, very very nice	350
THORENS TD124 mk2 excellent example in very nice wooden plinth	400
TOWNSEND ELITE ROCK with ALPHASON XENON arm	800
TOWNSEND ELITE ROCK with MERLIN PSU & EXCALIBUR ARM, boxed	500
TOWNSEND ROCK MK3, with built in pneumatic base, sme arm cut out	500
TRANSCRIPTORS SATURN and SHE 3009 improved arm	600
TRANSCRIPTORS reference/ sme arm, mc	700
TRICHOND DIABLO with NEVER CONNECTED psu new AVAILABLE FOR HOME DEM	500
VAN DEN HULL MK2 just rebuilt, unused	750
VAN DEN HULL MK1 just rebuilt, unused	700
VOYD THE VOYD with helius arm, no lid	2000
VPI TNT JUNIOR with JHW 12" ARM, boxed	

TUNERS, CASSETTE DECKS, REEL-TO-REEL,

HEADPHONES ETC

CYRUS 7.5T fm tuner, silver, boxed	275
FANAFARE FT1 tuner, excellent with remote control	525
GRAHAM SLEE SOLO headphone amp	400
MICROMEGA STAGE TUNER	200
MUSICAL FIDELITY F500 tuner	200
NAKAMICHI CRAE, boxed	300
PIONEER CT91a cassette	250
QUAD FM4 brown	200
QUAD FM4 grey	250
REVOX B760 fm tuner	275
REVOX G36 2track very nice indeed	350
STAX LAMBDA NOVA REFERENCE electrostatic headphones with sme-1s valve energizer	600
TEAC X-1000R reel to reel, serviced new drive belt fitted	300

SOLID STATE AMPS

ALBARRY M408 monoblocks, red fronted show box size	325
ALCHEMIST GENESIS monoblocks,	600
ARCAM ALPHA 10 amp	375
ATC CA2P preamp, boxed mk2,	1500
AUDIO ANALOGUE BELLINI mk2 with remote preamp and DONIZETTI monoblocks, all 2 years old and boxed	900
AUDIO ANALOGUE PUCONI SE, boxed	500
AUDIO ELECTRONIC SUPPLY AE2 pre with SE MOSFET power amp	700
AUDIOLAB 8000c /p graphite pre/power	600
AUDIOLAB 8000C/P black boxed	700
AUDIOLAB 8000P late black,	400
AUDIO RESEARCH 69 pre amp, rca and xhrs, silver front boxed	700
AUDIO SYNTHESIS DESIRE power amp, boxed	700
AUDIO SYNTHESIS DESIRE DECADE power amp, boxed	1400
AVANTAGE MONOBLOCKS 6000new	2000
AVI INTEGRATED amp	400
AVI m1 160 watt monoblocks	500
BOW TECHNOLOGY WAZDO XL integrated amp	1250
BRYSTON 0.5B preamp	275
CABASSE POLARIS AM1000 monoblocks, boxed, as new	1250
CLASSE MODEL 30 preamp	500
CYRUS PRE-POWER XPA, boxed	600
DENSEN BEAT B300 power amp, boxed	500
DHM 2 preamp, metal cased, mc, battery psu, new batteries, serviced	350
DYNARECTOR L200 pre with mm phono, boxed	750
ELECTROCOMPANET orig class A pre & poweramp	400
EXPOSURE 11/112 PRE with mm/mc phono	400
JDI MONOBLOCKS acrylic casework rare late 80s classic	400
KRELL KSA200 just serviced	2000
LINX VEGA POWER AMP	200
LUMLEY A2400 100 watt transistor power amp, loads of bass!	250
MAGNUM 250 pre/power boxed	400
MAGNUM SE CLASS A integrated	500
MEITNER MUSEATEX P46 pre with remote with mc phono stage	1500
MERIDIAN 105 MONOS	250
MERIDIAN 605 monoblocks	700
METAKAS CHARISMA PREAMP, chrome finish	1500
MUSICAL FIDELITY A370 upgraded to mk2	825
MUSIC FIRST AUDIO PASSIVE MAGNETIC pre (TVC) - available for home demo, probably the best sounding uk built preamp available	1500
NAIM NAC 32.5 & SNAPS / NAP T10	550
NAIM NAC 72/NAP 140 boxed, later style	750
PASS XO preamp 3 box	4000
PASS ALEPH 3 poweramp 30 watts class A	1000
PASS ALEPH 0 monoblocks	3500 pair
PERRAUX 2001 remote integrated amp	1000
PLINIUS 8100 integrated amp, boxed silver,	850
PRIME DESIGN 100 watt integrated amp 700	250

National Vintage Communications Fair National Motorcycle Museum Birmingham UK

Sunday 2nd Oct 2005

10.30am to 4.00pm • £5 admission
(early entry c.8.30am @ £20)

VINTAGE VALVE AMPLIFIERS
PRE-AMPS • TUNERS • LOUDSPEAKERS
RECORD DECKS • RECORDS (78s to CDs)
GRAMOPHONES • VALVES • SPARES

• FREE VISITOR PARKING •

Stall Bookings/Details
N.V.C.F., P.O Box 15,
Hereford HR4 9WX U.K.

Tel: (0)7947 460161
www.nvcf.org.uk
Email: info@nvcf.org.uk

GRAND

M25

AUDIOJUMBLE

SUNDAY 23rd OCTOBER 2005

10.30AM - 2.30PM

LEATHERHEAD LEISURE CENTRE
LEATHERHEAD M25 JUNCTION 9

ALL VINTAGE & MODERN HI-FI
PARAPHERNALIA
INCLUDING: VINYL, DISC ETC
FOR STALL BOOKINGS/DETAILS

CALL

07730 134973

private ads

Dealers must not advertise in the Private Classified section. Monthly consecutive insertions will be considered Trade advertising. The Publisher reserves the right to judge submissions.

TOM EVANS new design Super Triode - Linear 'A' pure Class 'A' 25 watts. like new £3195 (£4000 new). Audio valve Balfour 70. Class 'A' Triode monoblocks, truly amazing, like new, black. £2150 (£3195 new). Walker Audio Velocitor with base £1500. Tel: 07919 211 332 (Oct)

ADVANTAGE INTEGRATED amplifier S-100 £1000. Rel Stampede Subwoofer £325. Isotek Gil Mini Sub £300. NHT speakers M6 monitors £500, NHT A1 250W monoblocks amplifier £400. Tel: 020 8531 5979 (Oct)

2 PAIRS KIMBER 1m Select 1011 Interconnects £210 each (£370). 1 x 14' Pair Kimber Monocle XL Loudspeaker cables £625 (£1275). 1 x 10' Russ Andrews Reference Powercord Wattgate 320i IEC £135 (£248). Tel: 01604 410726 (Northampton) (Oct)

MERIDIAN M20 rosewood active speakers boxed £400. Audio Research LS9 pre-amp, boxed, remote, as new, £650. Great combination. Both items for £950. Tel: 01782 397 971 (Staffs) (Oct)

MERIDIAN 200 transport. Mint, boxed, £275. DPA bigger bit plus power filter, £275. Together, £450. IPL SSTL speakers, very good, £325. Dual 721 turntable with Shure V15, very good, £65. Arcam Alpha 2 tuner, very good, £50. Tel: Tony on 01932 820858 (Oct)

PRIMA LUNA Prologue Two KT88 valve integrated amplifier £650. Naim Nait 5i brand new sealed box £600. Meridian G08 CD player mint £900. Pioneer 868 AVI Universal DVD £350. Tel: 07714 216 755 (Oct)

BRYSTON SPI.7 £1800. Pass Labs X5 £1600, Meridian 598DP Progressive Scan £1400. Sony XA777ES 110 volt with transformer £900. All boxed, manuals, remotes, new condition. Split shipping. Tel: 00 353 917 96496, Email: wshaw@eircom.net (Ireland) (Oct)

MUSICAL FIDELITY X-PSU, X-A50, X-LP, Lowther Delphic's black finish. Sony ST-5E500, STSA3ES, PSLX300H, CDP-X3000ES Plus more. Must go. Tel: Steve 01279 310 656 (Oct)

LINN LK1 pre, Linn LK280 power. Original packing instructions and remote. £350 ovno. Rogers LS2A2 loudspeakers £100 no offers. Goldring GRI turntable, Linn KK5 cartridge, 6 months old £100 no offers. All in very good condition. Can dem. Tel: 07956 438 044 anytime (Bromley) (Oct)

TAG MCLAREN CD transport CDT20R, cost £1250, 3 years old, £600. M.S.B. Link Dac IIII 24/96 upsampling power base, cost £770, 2 years use, £250. Leema SPLX12 subwoofer, cost £1100, 18 months, £600. Transparent 10' bi-wire, cost £650, £300. Tel: 07958 492 243 (Nov)

LP12, GRACE 707 £500. TD160, SME 3009, £200. Denon DL304, unused, £200. Shure V15, new stylus £85. Mission 774, 'hen's teeth', £140. Croft pre-amp, unused £275. Quad 22 and IIs £350. Stirling Broadcast LS35a, hardly used, rosewood, £550. IMF Reference Monitor IV, astonishing, £1000. All excellent, ono. Tel: 0161 284 8651 or Mobile 07752 989 461 (Oct)

MISSION 782 speakers, rosewood finish, excellent condition, boxed, £220. Tel: 01246 232 085 (Chesterfield) (Oct)

MERIDIAN 541 £200, 562.V £300, 565-7.1 £450. All in excellent condition. Tel: 07976 350 204 (Cardiff) (Oct)

LINN LP12 Valhalla Akito walnut £550. Marantz CD63MkII £150. Rotel RT950AX tuner £75. Aiwa ADF880 cassette £75. Kenwood DM9090 MiniDisc £100. Denon AVR3300 AV Receiver £400. Pioneer DV515 DVD £50. Pioneer CLD2950 LaserDisc £100. VGC, boxed, buyer collects. Tel: 01409 281 199 evenings/weekends (Oct)

THORENS TURNTABLE TD 125 SME 3009 arm £325. Michell Focus One turntable Linn arm £300. Tel: 01332 574 396 (Oct)

NAIM CDX2 as new, boxed, £1950 including P&P. Dual CS505/2 turntable, Ortofon cartridge, good condition £50. Leak Delta stereo tuner £15. Sony Fontopid earphones £10. Tel: 01285 862 539 (Oct)

STAX 4040 Signature setup with optional extras. 2.5 metre phone extension phone stand and cover. 10 months young. Used twice. Returned to boxes. Mint. £1170. Sell £700. Marantz CD 7300. 5 months old. Upgraded. £350. Mint. Boxed £180. All cherished. Tel: Derek 01382 552 072 (Oct)

KOETSU BLACK brand new (0 hours use). Still in wooden box. RRP £1200. Sell £775. Email: alan395shona@btinternet.com (Oct)

P.M.C. O.B.I. speakers, unmarked, mint condition £1800. Phone after 6pm: 0191 209 2836 (Newcastle) (Oct)

SPENDOR BCI speakers (teak) with Target stands. Audiolab 8000A amplifier. Akai 4000D tape deck. All in good condition with manuals but no boxes. No reasonable offer refused. Tel: 0118 981 2166 (Hampshire) (Oct)

MIRAGE OM9 speakers, black gloss finish, one year old, boxed, mint condition £1300 new, £520 or near offer. Tel: 01634 323 683 or 07901 893 982 (Oct)

WANTED: QUADROD stands for the ESL 63's. These are the stands that Quad produced themselves for the 63's. Will pay way over the market rate for mint condition ones. Please Email zijaferji@yahoo.co.uk or call on 07921 044 254 (Dec)







BUY / SELL HOME CINEMA MULTIROOM INSTALL H I - F I

www.choice-hifi.com
 tel: 020 8392 1959 / 1963 mob: 07768 720456
 info@choice-hifi.com

diverse vinyl

10 charles st newport south wales np20 1ju
01633 259661/256261 sales@diversevinyl.com

RECOMMENDED NEW RELEASES

Alfie	Crying At Teatime	£15.90
Espers	Espers (UK release on Wichita)	£11.90
Iron Maiden	Death On The Road	£18.90
Missy Elliot	The Cookbook	£14.90
New Pornographers	Twin Cinema	£TBC
Paul McCartney	Chaos And Creation	£TBC
Paul Weller	As Is Now	£TBC
Richard Thompson	Front Parlour Ballads	£17.90
Rolling Stones	A Bigger Bang	£18.90
Ryan Adams	Jacksonville City Nights	£TBC
Sigur Ros	Takk (2LP+10")	£TBC
Super Furry Animals	Love Kraft 2LP	£15.90

RELATED VINYL PRESSING:
KATIE MELUA "CALL OFF THE SEARCH"
Debut album now available on vinyl - £12.90

REISSUES:

Joe Strummer/101ers	Elgin Avenue Breakdown	£TBC
Lalo Schifrin	There's A Whole Lalo Schifrin Going On	£21.90
Swell Maps	A Trip To Marineville (+7")	£19.90
Chet Atkins	Mr Guitar	£21.90
Stevie Ray Vaughan	Couldn't Stand (Pure Pleasure)	£TBC
Gene Krupa	Drummer Man (Speakers Corner)	£21.90

SEE YOU AT THE HI FI & HOME CINEMA SHOW, HEATHROW!
Come and find our stall in the Renaissance Hotel!

DISCO ANTI STAT LP CLEANER

Probably the most economical LP cleaning device on the market Only £43.95 Call for details



Call for a catalogue of over 3500 brand new LPs, or visit

www.diversevinyl.com

STOWSOUNDS

01449 675060

Spacesaving clearance on most products - call for other products

Atacama BDS 25 inch stands	15
Fuss subwoofer and satellites	20
Tripod rack - 2 shelf	10
Tara Prism interconnect 1m	20
DNM mains lead 1.25m	25
DNM phono interconnect 1m	20
DNM bullet phono interconnect 1m	40
Grado SR 60	60
Exposure 2010 cd	395
Exposure 2010 integrated	395
Exposure 2010 power	350
Phillips CDR870 cd recorder	50
QED Discaver	10
QED Qnex 4S 1m interconnect	20
Sonic Link Blue Nickel 0.5m interconnect	30
Linn Kan 4 maple	275
Creek A50i	300
Sonic Link Control 1.0m interconnect	45
Epos ELS3	125
Sonic Link Message 1.0m interconnect	20
Music Books -	call for list
CDs -	call for list or wants

For details call 01449 675060, or e-mail stowsounds@aol.com



TURBOCHARGING YOUR REGA ARM

"Nothing less than total dynamite" HI-FI WORLD

If you are the proud owner of any Rega tonearm, you are now in the enviable position to transform its performance into the league of super arms with our modifications. The OL structural modification at £75 will enable your Rega to perform at a level exceeding that of some arms costing over £1000!! High performance rewiring with high grade litz wire is also offered at an additional £70 and external rewiring is also £70 further increasing the performance.

"I have to say the Rega modifications turn this humble arm into a real giant killer. Gone is the rather grey, sterile sound of the cooking Rega. Instead, tonal colour is fresh, dynamics have great speed and impact, and the sound stage is huge."

HI-FI WORLD ON STRUCTURAL MODIFICATION

Structural modification awarded 5 star rating by



- Structural Modification - £75
- Internal Rewiring - £70
- External Rewiring - £70
- High conductivity phono plugs £20
- Slotted arm tube - £85

If you do not have an arm we can supply the OL1 arm (manufactured by Rega) £124

Arm modifications normally returned within 1 - 3 days



"The single most important upgrade you can ever make to any record deck

concerns the motor drive...nothing can prepare you for the shock of going DC. In a word, gobsmacking."

COMMON GROUND MAGAZINE

"Its value is nothing short of tremendous." LISTENER MAGAZINE

"The LP12 remains a classic ...but ..upgrade kits by Origin Live can bring a vast improvement to its performance" HI FI NEWS

UNIVERSAL TURNTABLE MOTOR KIT -

No one would blame you for being sceptical of an easy to fit, inexpensive dc motor upgrade. Especially one that improves on the best of other power supplies costing over 4 times as much or your money back. It is simply impossible to imagine the level of improvement attained by eliminating the motor vibration that your stylus amplifies over 8,000 times! Our DC motor kit offers massive improvements to all versions of Linn Lingo / Valhalla, Rega, Systemdeck, Roksan, Rock etc. The kits consist of a drop in replacement high grade DC motor and off-board 2 speed control box. Why not order now? - see web site or phone.

- Standard dc Motor Kit - £199
- Advanced dc Motor Kit - £339
- Ultra dc Motor Kit - £570
- Upgrade Transformer - £175
- Upgrade DC 200 motor - £129 with kit

ORIGIN LIVE
Tel/Fax: +44 02380 578877
E-mail: info@originlive.com

www.originlive.com

private ads

Dealers must not advertise in the Private Classified section. Monthly consecutive insertions will be considered Trade advertising. The Publisher reserves the right to judge submissions.

DYNAUDIO CONTOUR 3.0. black ash, floor standing, as new, boxed, hardly used. Best offers. Tel: (mobile) 07977 115 446 (Oct)

WANTED: CROFT Micro pre-amp. Cirkus upgrade kit for Linn Sondek. Phone after 6pm 02890 626 952 (Oct)

CHORD ANTHEM interconnect DIN connection for Naim £140. Tower wall shelf £30. Tel: John 01590 671 472 or Email: john@smale54.freemove.co.uk (Oct)

MARTIN LOGAN SL3 speakers, black panels, one owner, immaculate, £1350 ovno. Audiolab 'Q' pre-amp. Black, mint condition, occasional use only as back-up to main system, £500. Tel: 01932 245 805 (Shepperton) (Oct)

SONUS FABER Grand Piano Concerto (£2100) £1050. Nordost: Valkyrja, 2m bi-wire (£3250) £1600. Valhalla mains, 1m, £700. Brahma, 1m, £350. Acoustic Zen Hologram shotgun bi-wire, 2m, perfect tonal match with Valhalla, (£1560) £650. Ron Smith aerial extension (£40) £20. Tel: 0131 6610126, or Email: zebshaw@hotmail.com (Oct)

AUDIO ANALOGUE Puccini amplifier, 40 wpc, aluminium fascia, mm/mc phono, 2 years old, boxed, manual, very little use, £275. Tel: 01606 301398, or Email: ian.bowley1@ntlworld.com (Oct)

CR DEVELOPMENTS Amphion valve monoblocks Class A 6C33C 12AX7 12AU7 12WPC gold chrome and glass, spare valves, boxed, superb, £845 ono. Delivered. Tel: 01202 481 386 (Dorset) (Nov)

NAIM 135 amplifiers excellent condition and sound, boxed, serviced once by Naim, £1390 the pair. Linn Isobariks, earlier model, internal crossover, spiked stands very good condition £390. Tel: 01606 784792 or 07946 363646 (Oct)

THEATRE INNOVATIONS TI-1250 4 Way Professional Home Theatre Floor Speakers. Never used and in original box. I won these as a prize. USA retail \$1,999. Price asking £750. Tel: 07808 362422 (Oct)

SHAHINIAN ACOUSTICS Compass loudspeakers. Unmarked condition as new. Very good match with Naim equipment. Price £995. Tel: 01253 853789 (Oct)

ROKSAN OJAN 3 speakers (black) £250, call for more details. Kinshaw Overture DAC, electrical in only, £40. Mordaunt Short MS251 speakers £50. Tel: 020 8395 2867 evenings (Oct)

CONRAD JOHNSON Premier 11A valve power amp £1500 ono (£3,800). Conrad Johnson 17LS preamp £2,400 ono (£4,800). Both excellent condition, priced to go. Revox A77 £175 ono. Tel 0161 455 8570 or 07767 871928 (Oct)

RETRO HI-FI SALE: Pioneer PL-L1000, huge ultra high end direct drive parallel tracking turntable, 4 times the price of an LP12 in 1980! Stunning sound. Very rare, mint. £695. Trio/Kenwood KD-550, high end direct drive turntable motor unit, beautiful white marble plinth, massive build, mint condition. £295. Mitsubishi MP-04/MA-04, high end micro pre-power amplifier separates, rival to top Aurex system from 1979. Two phono inputs, LED power meters. vgc. £195. Nakamichi 600, classic silver ski-slope cassette deck, belt gone - easy fix, £50. Trio KA-3700, high quality 1979 integrated amplifier with brushed aluminium fascia. £50. vgc. Sony ST-J60, beautiful high end FM-only digital tuner from 1981, mint. £195. Tel: 07921 905 827 (Oct)

NAD C372 integrated amplifier, boxed, with remote and instructions. Excellent condition, £180. Buyer collects or by arrangement. Tel: 02380 274 494 (near Southampton) (Oct)

MONARCHY SM-70 Class A Zero feedback Mosfet amplifier. Mint, manual, boxed. See Hi-Fi Plus 11. £295. Tel: 01903 247779 (Sussex) (Nov)

SONUS FABER Electa Amator Mk1 plus Ironwood stands £1300. T+A V10 integrated amp £1800. Advantage S-100 integrated amplifier £800. REL Stampede Subwoofer £300. NHT speakers M6 monitors £400. NHT A1 amplifiers 250w monoblocks £400. Tel: 020 8531 5979 (Dec)

ARCAM 82 CD player, boxed with manual and remote, silver, excellent condition, £260. Tel: 01268 774 416 (Essex) (Oct)

TOM EVANS new design Super Triode - Linear 'A' pure Class 'A' 25 watts. like new £3195 (£4000 new). Audio valve Balfour 70. Class 'A' Triode monoblocks, truly amazing, like new, black. £2150 (£3195 new). Walker Audio Velocitor with base £1500. Tel: 07919 211 332 (Oct)

ADVANTAGE INTEGRATED amplifier S-100 £1000. Rel Stampede Subwoofer £325. Isotek Gil Mini Sub £300. NHT speakers M6 monitors £500, NHT A1 250W monoblocks amplifier £400. Tel: 020 8531 5979 (Oct)

2 PAIRS KIMBER 1m Select 1011 Interconnects £210 each (£370). 1 x 14' Pair Kimber Monocle XL Loudspeaker cables £625 (£1275). 1 x 10' Russ Andrews Reference Powercord Wattgate 320i IEC £135 (£248). Tel: 01604 410726 (Northampton) (Oct)

MERIDIAN M20 rosewood active speakers boxed £400. Audio Research LS9 pre-amp, boxed, remote, as new, £650. Great combination. Both items for £950. Tel: 01782 397 971 (Staffs) (Oct)

THORENS TURNTABLE TD 125 SME 3009 arm £325. Michell Focus One turntable Linn arm £300. Tel: 01332 574 396 (Oct)







BUY / SELL
HOME CINEMA
MULTIROOM INSTALL
HI - FI

www.choice-hifi.com

tel: 020 8392 1959 / 1963 mob: 07768 720456

info@choice-hifi.com

The most important and expensive components of a valve amplifier are valves and transformers. £200 or £500 for a pair of huge "push pull" output transformers produces good bass + lots of "inter leaved" windings for better high frequency and "stability". Huge £150 mains transformers gives a less "processed" sound. Selected "matched" set of valves cost £50 or £160. If we could achieve the same quality of sound with £10 volume control , £10 wires , £10 capacitor , we could have saved a lot of money !!!

Money back guarantee (less £30 UK or £100 overseas) that you prefer :- £850 or £1,000 or £1,250 or £1,450 "KT88 Triode Connection" amplifiers to most transistor amplifiers, most transistor / valve hybrid amplifiers, most Single Ended valve amplifiers, most Ultra Linear valve amplifiers selling for £2,000 to £20,000

£850 "KT88 Triode Connection" + high quality £350 "3 way" speakers to "ultra linear" valve amplifiers + £600 "2 way" and "2.5 way" speakers

£700 EL34 valve amplifiers (40 watts + 40 watts) to most transistor amplifiers and transistor / valve hybrid amplifiers costing £1,000 to £2,000

£500 EL34 valve amplifiers (40 watts + 40 watts) to most £700 amplifiers.

Telephone 01634 268662 anytime or 01634 373410 for Mr Andrew Everard's review in Gramophone Magazine and Summary of 21 testimonials from satisfied customers. www.affordablevalvecompany.co.uk

www.affordablevalvecompany.com



Buy direct & save £££
Shop prices are expensive because of rent, rates, wages
Free UK delivery
Subsidised £50 UPS delivery to overseas countries.

4 years of proven reliability.
2 years guarantee.



GREAT RESPONSE!

My last advert, which included a reference to my favourite CD player, namely the AVI Reference, which I have used for many years, has produced a number of phone calls from people who are equally impressed, and it's almost certain that the new Laboratory CD player, will become as popular as the superb Laboratory Integrated Amp. At £1469 and £1499 (£1699 with phono stage) respectively, you needn't really think of spending much more. So, my thanks for those who bothered to respond!. Add one of the smaller AVI speakers (Nu-neutron IV, Pro-Nine +), and you will have a really musical system, but there is nothing like a true 3 way speaker, and now AVI have two models, the Trio at £3250, and the just introduced Brio at £4750 (see www.avihifi.co.uk), with the Brio in particular creating a superb sound stage. At similar prices I also have the Nola Elite Lotus/ Signature, and the superb little Napoleon 5.1 (£200/speaker, also great in stereo) surround system, including probably the best subwoofer around for only £1800. Add the only other amp I consider after the AVI, namely the Eslab Pre/Power (300watt Digital Amp), a range of turntables from SME, Origin Live, Avid, and VPI and I promise you a visit would be worthwhile, so do phone or send me an e-mail (icvhifi@yahoo.co.uk).

V'audio HI-FI Consultants
36 Druid Hill, Stoke Bishop, Bristol BS9 1EJ
Tel/Fax 0117 968 6005

Art Audio

Established by Tom Willis 1988

TUBE SOUND Turntable mat and isolation blocks, made from high density carbon.

CRYOGENIC TREATED Valves and components.

Send for our list of Direct Sale Components

VALVES Transformers, push pull, single end. All chosen for our High End Amplifiers.

STOCKISTS & INFORMATION
On our range of valve amplifiers.

LONDON
Hear Here, (Kensington) West London.
P: 020 7 937 0856 M. 07768738372
E. hearhear@onetel.com

MIDLANDS
Definitive Audio, Long Eaton, Nott's.
P. 0115 973 3222 F. 0115 973 3666 E. shout@definitiveaudio.co.uk

NORTH
Shadow Audio Consultants, Glenrothes, Fife.
P. 01592 744 779 F. 01592 744 710 E. info@shadowaudio.co.uk

Art Audio (UK) Ltd
62 Vaughan Avenue, Hucknall, Nott's. NG15 8BT.
website: www.artaudio.com Email: t.willis2@ntlworld.com

trade ads

Dealers must not advertise in the Private Classified section. Monthly consecutive insertions will be considered Trade advertising. The Publisher reserves the right to judge submissions.

**GRAND M25 AUDIO
JUMBLE @ Leatherhead**
Leisure Centre, M25,
Junction 9. Sunday 23rd
October, 10.30am. Tel: 07730
134 973 for details (Nov)

**VINTAGE WIRELESS
COMPANY LONDON**
Website: www.
vintagewirelesslondon.co.uk
Buy-Sell-Exchange.
Vintage Hi-Fi. Repairs, Spares,
Restoration. All valve equip-
ment Wanted for cash: Tannoy,
Quads, Garrard and audio
valves. Please call us at 17 Bell
Street, London, NW1 5BY.
Tel: 020 7258 3448
Fax 020 7258 3449 Email:
vwirelesslondon@aol.com
(Jun06)

"AMPS" VALVE Equipment
repaired, restored and upgrad-
ed. Kits built. Experienced engi-
neer, free quotations. Valve
(tube) equipment only. Tel:
01525 756935 or Email:
amps@dhaen.co.uk
http://www.dhaen.co.uk/amps/
(Nov)

**THE LINK FAMILY - Pure
Silver & Cryo Treated Solid
Core Interconnects with
Prices starting from just
£99 & Pure Silver Cryo
Reference Litz Loudspeaker
Cables with RFI reducing
technology from only £550.
Full Range of High
Performance Power Cables
and Silver Plated
Distribution Systems starting
from just £30 - Also a large
range of DIY Supplies and
Eichmann Products at
unbeatable prices. All of our
cables are designed and
hand-built in our own pro-
duction facility. Be-spoke
work always welcome. The
Missing Link - Better by
Design - Contact us today -
we will be happy to assist -
0115 8779089
www.the-missing-link.net
(Oct)**

**WANTED -
EARLY HI-FI
LOUDSPEAKERS**
Tannoy, Lowther, Parmeko,
Voigt, Vitavox, RCA WE etc
TURNTABLES
Garrard, BBC301, EMT SME,
Ortofon, Decca, etc.
VALVE AMPLIFIERS
AEI, EMI, Leak, Rogers, PYE
Quad, WE etc
AUDIO VALVES
DA30, KT66, KT88,
PX4, PX25, PP3/350, WE300
CLEAR CRYSTAL SYSTEMS
John Petrie-Baker
Tel: 020 7328 9275

AUDIOFILE OBJECTIVE for
New, XDisplay and Pre-Owned
Hi-Fi. Roksan, Epos, Musical
Fidelity, Revolver, Creek,
Marantz, Inca-Tech, Project,
QED, van den Hul. 16 Allen
House, The Maltings,
Sawbridgeworth, Herts,
CM21 9JX. Tel: 01279 724 024.
Free Parking, Hi-Fi Purchased.
(Nov)

AMAZING CABLES! Solid sil-
ver interconnects from £110,
with air/teflon insulation and
WBT plugs. Silver speaker and
mains cables from £250.
Fantastic performance, refund
guarantee.. Tel: 0115 982 5772
after 7pm, or Email:
bob@skydivers.co.uk (Dec)

SUPERB INTERCONNECTS,
Mains Cables and Accessories
from Simon Lewis Audio. Hand
made in England from top quali-
ty components ((using Teflon,
Gold, Silver and other materi-
als) Good customer feedback.
Website:
www.SimonLewisAudio.co.uk
(Oct)

**AUDIOPUBLIC, 78 Otley
Road, Headingley, Leeds, 0113
217 7294.** Yorkshire's newest
Hi-Fi retailer, stockists of Naim
Audio, Rega Research, Conrad
Johnson, Sugden, Dynavector,
(cartridges and amplifiers) and
many more. Please call for
advice. (Oct)

KLW COOK Audio servic-
ing specialist, upgrades avail-
able. British, Japanese &
American hi-fi catered for.
Phase Linear & SAE special-
ists, custom equipment
designed & built. Pre-owned
equipment for sale. Tel:
01264 323 573 (Oct)

AUDIO SELECTION is back
in Colchester. Quad CDP2,
909's! New Audiolab. EAR
8L6 50wrms Tube £1950.
Meridian 596, MSR £1200.
Exposure CD2010 £375.
Demonstrations, Mail Order,
P/Exchange. Tel: Jim 01206
510 392 or 07966 400 745
(Oct)

BRILLIANCE Teflon intercon-
nects and speaker cables have
received outstanding press
reviews. HFW said "Sound/£
ratio is superb", "most neutral,
unflappable, beguiling, excel-
lent". Demonstration cables
available. Contact Mike on
07963 117 341 or visit
www.brilliancehifi.co.uk (Oct)

SME MODEL 20A turntable.
Factory reconditioned
turntable with gold print
Series V arm sealed box £3250.
Jadis JA50 monoblock valve
amplifiers balanced 20 hours
use boxed like new £4000. SME
Series V gold plated tonearm
unused boxed £1500. Selection
of SME arms available. Lots of
new cartridges from Van
Den Hul and others available.
Wanted hi-end hi-fi urgently.
Phone for details
01923 235 423 (Oct)

HIGHLAND AUDIO offers
ex-demo AVI audio products:
AVI Laboratory CD player
(new model), £1,400 now £925:
AVI Neutrons (new model);
£500 for only £350 - all car-
riage paid within UK - contact
on 01463831658 or Email:
highlandaudio@aol.com (Oct)

NO:WEBSITE Email 0%
Finance TV plasma naff efforts
at copying the Odeon Spring
Summer Autumn Winter sales
normal attempts at trying to
get a little more custom £1500
mains leads misleading shop
demos leading to divorce when
he brings home the 5* best buy
way of stocking 87 brands faith-
fully extended warranties for
products that are poor from
day 1 forget 365" punctuation
in this P.R. stunt. YES: Real HiFi
in 2005. Selling sold enjoying
using & abusing Neat Acoustics,
LFD Audio, JBL Incorporated,
Teac Corporation, Quad
Electroacoustics, Cairn Ezo,
Audion International. 07736
392 852 Open 18 hours daily
365 a year. 01423 810 990
closed Wed Sat & Sun. (Oct)

SME MODEL 20A turntable.
Factory reconditioned
turntable with gold print Series
V arm sealed box £3250. Jadis
JA50 monoblock valve ampli-
fiers balanced 20 hours use
boxed like new £4000. SME
Series V gold plated tonearm
unused boxed £1500. Selection
of SME arms available. Lots of
new cartridges from Van Den
Hul and others available.
Wanted hi-end hi-fi urgently.
Phone for details
01923 235 423 (Oct)

**VINTAGE WIRELESS
COMPANY LONDON**
Website: www.
vintagewirelesslondon.co.uk
Buy-Sell-Exchange. Vintage Hi-Fi.
Repairs, Spares, Restoration. All
valve equipment Wanted for
cash: Tannoy, Quads, Garrard
and audio valves. Please call us
at 17 Bell Street, London, NW1
5BY. Tel: 020 7258 3448
Fax 020 7258 3449 Email:
vwirelesslondon@aol.com
(Jun06)

**GRAND M25 AUDIO
JUMBLE @ Leatherhead**
Leisure Centre, M25,
Junction 9. Sunday 23rd
October, 10.30am. Tel: 07730
134 973 for details (Nov)

NEXT MONTH

POWER PLAY

Watts, your problem? In which case November's Hi-Fi World is for you! It's all about **POWER** how much of it we need, what Class (A, AB, D), what state (solid or vacuum tube), how useful it is for driving loudspeakers and how different 'speakers mate to **different types of amplifiers**. There's a wide variety of hardware for your pleasure, from **milliWatts to kiloWatts**: Here is what we hope to bring you next month...

- Musical Fidelity kW750 pre-power amplifier
- Arcam FMJ C31/P1 pre-power amplifier
- Croft Vita tube preamplifier
- Elac FS607 X-JET loudspeakers
- Neat Petite/ Sunfire subwoofer
- amp-speaker interfacing
- Class A-D supertest: Sugden A21a, Eastern Electric MiniMax, Marantz PM15S1, Lyndorf SDA1 2175

PICK UP THE NOVEMBER 2005 ISSUE OF HI-FI WORLD ON SALE SEPTEMBER 30TH, OR SUBSCRIBE AND GET IT DELIVERED TO YOUR DOOR: p74

classifieds ads order form

RATES - ALL ADVERTS MUST BE PRE-PAID

Maximum length per advert is 30 words, each additional word is 50p extra. Telephone numbers and E-mail addresses are treated as one word. Model numbers are treated as one word i.e. Quad 303 = two words.
Please tick the box for the advert required

Dealers must not advertise in the Private Classified section. Monthly consecutive insertions will be considered Trade advertising. The Publisher reserves the right to judge submissions

Private magazine advert	£10 per month	<input type="checkbox"/>
Private magazine advert display black box	£15 per month	<input type="checkbox"/>
Trade magazine advert	£10 per month	<input type="checkbox"/>
Trade magazine advert display black box	£15 per month	<input type="checkbox"/>

Please write or type your advertisement copy in block capitals with one word per box.
Please continue on a separate sheet if necessary.
WE WILL ACCEPT PHOTOCOPIES OF THIS FORM

1	2
3	4
5	6
7	8
9	10
11	12
13	14
15	16
17	18
19	20
21	22
23	24
25	26
27	28
29	30

Name _____

Address _____

Post Code _____

Daytime Tel: _____

Please debit my VISA/MASTER/SWITCH Card No.(Switch card issue No _____)

Valid Date: _____ Expiry Date: _____ Cardholder Signature: _____

I enclose a cheque/postal order for £ _____ Made payable to: Audio Publishing Ltd.

Send in your private classified ads with our NEW Freepost service. No need for a stamp!
Send this form together with your payment in an envelope marked:

Hi-Fi World, FREEPOST LON3478, LONDON NW6 6YR



PRIVATE & TRADE CLASSIFIED ADVERTS COPY DEADLINES
NOVEMBER 2005 - 8TH SEPTEMBER 2005
DECEMBER 2005 - 6TH OCTOBER 2005

ADVERTISERS INDEX

Absolute Sounds	50
Acoustic Energy	18
Affordable Valve	126
Art Audio	126
Audio 42	36
Audio 42	38
Audio Atmosphere	102
Audio Jumble	122
Audiolab	13
Audusa	111
Big Ears	109
Billy Vee	104
BK Electronics	46
Black Rhodium	34
Cartridge Man	70
Central Audio	116
Choice Hi-Fi	123,125
Clarity Cap	70
Classique Sounds	113
Custom Cable	115
Cyrus	52
Definitive Audio (Notts.)	40
Diverse Vinyl	124
Emporium	22
Heathcote Audio	115
Heatherdale Audio	114
Henley Designs	58,68,86,96
Hi-End Cable	114
Hi-Fi Sound	117
Ian Harrison	113
Icon Audio	70
Krystal Kable	38
Laser Vinyl	38
Linn	BC
Mantra Audio	72
Marantz	22
Michell Engineering	46
Midland Audio Exchange	110
Missing Link	72
Musical Fidelity	56
Naim	IBC
Neat Acoustics	48
Noteworthy	46
NVCF	122
Onkyo	6
Origin Live	52,124
Oxford Audio	116
Pinewood Music	113
Real Hi-Fi	114
Retro Reproduction	108
Rochester HiFi	109
Romers Hifi	60
Rotel	IFC
Sevenoaks	27,28,29,30,31
Shadow Audio Con.	66
Simply Stax	109
Soundstage	112
Stowsounds	124
Sugden	60
TACT	62
Teac	20
The Listening Rooms	112
The Right Note	40
Townshend	40
Trichord	62
Tube Shop	72
Tubes Online	60
Walrus	12
Whest Audio	48
Williams Hart	112
DIY Supplement No. 85	
AudioXpress	88
Falcon Acoustics	88
Kit & Components	98
Langrex Supplies	92
Noteworthy	88
Watford Valves	92
White Noise	88

THE ORB

THE ORB'S ADVENTURES BEYOND THE ULTRAWORLD 1991

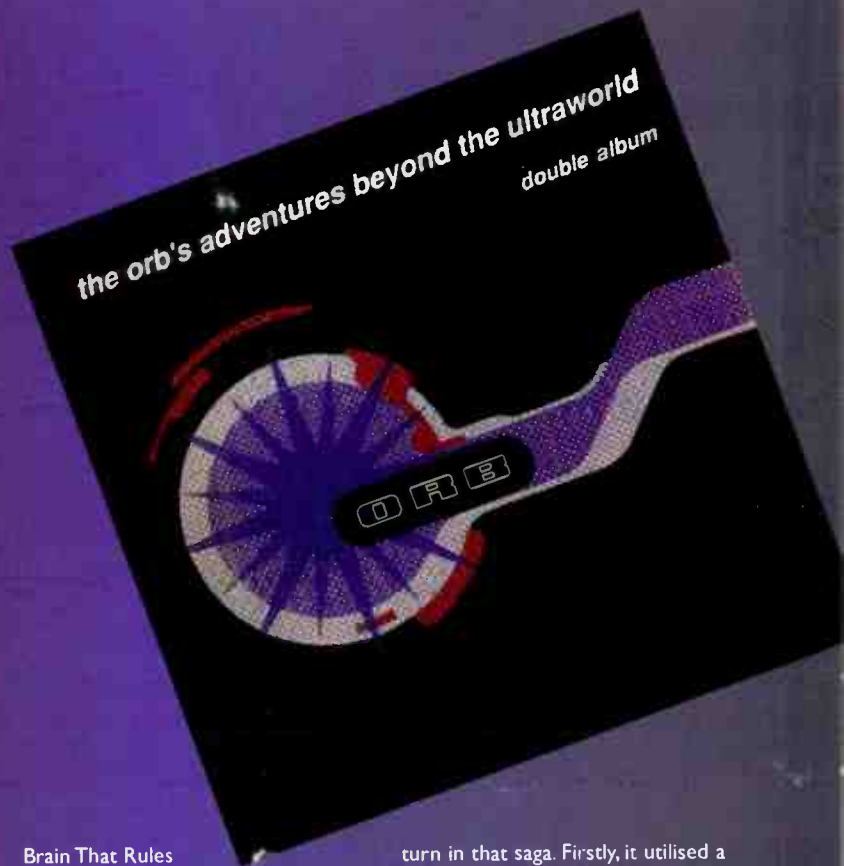

Arguably the most important dance album ever, 'Ultraworld...' also spawned possibly the most important dance single ever – 'Little Fluffy Clouds'.

The first band to make a major album success out of the new dance genre 'craze', The Orb oozed talent. Apart from co-founder and central band member, Alex Paterson, the outfit included co-founder, Jimi Cauty (who would later leave to co-found the KLF with mad scouser, Bill Drummond), Thomas Fehlmann (one of the most important figures in the German techno field then and today), Steve Hillage (late of hippy megastars, Gong and more recently, dance pioneers, System 7) and Youth (ex-Killing Joke and later producer to the stars such as Björk) – amongst a host of other band members who, Paterson aside, regularly take part in a merry-go-round of line-up changes.

'Ultraworld' was mesmeric – and continued to be that way for two hours. A double CD/LP, it was the first album to bring the new dance thoughts and, at the time, revolutionary music making techniques to the fore and contain them as a single concept. Displaying a fascination with dub, the album rode on the bass waves emanating from it. It offered a trance-like, blissful momentum, inserting vocal and naturalistic samples to present an atmosphere of both freedom and peace along with moments of pure invention. It even offered an implausibly long track title – 'A Huge Ever Growing Pulsating

Brain That Rules From The Centre Of The Ultraworld: Live Mix Mk 10'. The album featured an amalgam of styles. As Paterson himself explains, "We'd take hippie styles, dub styles, ambient, hip hop, house, then take, like, African thumb piano or Amazonian flutes and stick them all on the same record."

The music played with your senses. It was an album of discovery – you could never be sure what would happen next. You could even fall asleep to it – take 'Spanish Castles In Space', featuring a slow, methodical bass with a comforting melody spreading over the top like melted chocolate – a lullaby if ever there was one. But, like the title says, this is an adventure. A feeling of space travel or is it more of a spiritual journey? Of discovering new life out there... somewhere, possibly your own. That was what this album was all about. What it's still about, "I took two weeks' holiday and mixed six of the tunes in two weeks," Paterson remembers. "I went to New York, picked up some mad samples off the radio [and TV] and used them. I was really proud of that."

One of the most important, and legally interesting, spin-offs of 'Ultraworld', was the sampling that formed the heart of the project. The album was completed when record label's solicitor's phones were still hot over the realisation that new dance artists were utilising samples, from their own acts, and no-one was paying for them for the privilege. The single, 'Little Fluffy Clouds', took its

turn in that saga. Firstly, it utilised a piece from an old Steve Reich (the minimalist composer) composition as its basic riff. Next it took a sample from an old interview with singer-songwriter, Rickie Lee Jones, reminiscing about her childhood in Arizona. It originated from an American PBS TV children's programme called 'Reading Rainbow' and featured the interview undertaken by Levar Burton. In the sample, Jones remembers how the clouds looked at that time and how they appeared to be decidedly, well, fluffy. Meanwhile, The Orb's record label, Big Life, later settled out of court for an undisclosed sum.

Fans should keep an eye open for the US version of the album which, despite its success in the UK, was reduced to a single disk for America, much to Paterson's chagrin, "They said, 'We'd like you to trim all the tracks down to three minutes.' Sorry? You want Spanish Castles in three minutes? No, you can't... Only if you change the name to Spa Ca".

Similarly, fans of the original album may not be aware that, upon the day of the album's release, an album of remixes, also on the Big Life label, was released and deleted on the same day. Called 'Aubrey Mixes: The Ultraworld Excursions', replete with a Pink Floyd-esque front cover, the album featured seven tracks of remixes from the likes of Cauty, Youth, Hillage and Paterson taking the original concepts on wild and adventurous detours. It is highly recommended to all dedicated record collectors out there. **RB**

ASHFORD
Soundcraft 01233 624441

BATH
Audience 01225 333310

BANBURY
Overture 01295 272158

BRIGHTON
Audio T 01273 609431

BRISTOL
Audio Excellence 0117 926 4975

CAMSELEY
Audio T 01276 685597

CHEADLE
Audio Counsel 0161 491 6090

CHELTENHAM
Audio T 01242 583960

CHELSTER
Acoustico 01244 344227

CROYDON
Kimberley Audio & Visual 020 8654 1231

EDGESBASTON
Music Motters 0121 429 2811

EPSOM
Audio T 01372 748888

EXETER
Sevenoaks Hi-Fi 01392 218895

GUILDFORD
PJ Hi-Fi 01483 304756

HAYWARDS HEATH
Norman Hobbs 01444 413353

HIGH WYCOMBE
The Sound Gallery 01494 531682

HORSHAM
Audio Designs 01403 267766

HULL
Audio Room 01482 891375

KINGSTON-UPON-THAMES
Infidelity 020 8943 3530

LEICESTER
Cymbiosis 0116 262 3754

LONDON N1
Grohms Hi-Fi 020 7226 5500

LONDON N2
The Studio 020 8348 0990

LONDON SE13
Billy Vee Sound Systems
 020 8318 5755

LONDON SW11
Oranges & Lemons 020 7924 2040

NOTTINGHAM
Costle Sound & Vision
 0115 958 4404

MANCHESTER
Fortissimo 07740 659086

PORTSMOUTH
Audio T 023 9266 3604

READING
Audio T 0118 958 5463

SALISBURY
Salisbury Hi-Fi 01722 322169

SHEFFIELD
Audio Images 0114 273 7893

SHREWSBURY
Creative Audio 01743 241924

ST. ALBANS
Tom Tom Audio 01727 893928

TAUNTON
Mike Monning Audio 01823 326688

TAYSIDE
Robert Ritchie 01674 673765

WORCESTER
Audio Excellence 01905 619059

WORTHING
Phose 3 Hi-Fi 01903 245577

YEOML
Mike Monning Audio 01935 479361

YORK
The Sound Organisation 01904 627108



n-system

"...the performance is in a league of its own..."

Home Cinema, June 2005

For more details please telephone
+44 1722 332266

or visit

www.naim-audio.com





The new Artikulat Loudspeaker System. Gorgeous.

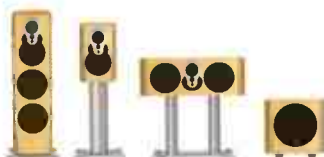

Linn Products Limited.

For more information or a demonstration call 0500 888 909

www.linn.co.uk



LINN