



hi-fi WORLD

DECEMBER 2004 UK £3.40

SUPER POWER!

MUSICAL FIDELITY'S GIANT kW500 AMPLIFIER

STAR CHASER

NOTTINGHAM ANALOGUE'S STELLAR SPACEDECK

DECEMBER 2004

- FUTURE SOUNDS SPECIAL ISSUE:**
- APPLE IPOD G4 vs. RIVALS
 - STEINBERG WAVELAB 5
 - TERRATEC PHONO USB
 - SONY MZ-NH700 Hi-MD
 - MOORE MEDIO PC
 - APOGEE MiniDAC
 - ETYMOTIC ER4-P



NAD C542 * AUDIO ANALOGUE PUCCINI SETTANTA * MISSION M50

MARKETPLACE - 100s OF CLASSIFIED BARGAINS!

COMPETITION - WIN FOCAL'S SUPERB CHORUS 726S LOUDSPEAKERS



marantz®

TURNING MOVIES INTO EXPERIENCES...

Whether you're in the deep cold throws of space, the dusty frontier of the wild west or the hot, steamy jungles of Borneo, Marantz Home Entertainment takes you there. With expert technical design and attention to the most minute details Marantz delivers the purest, most true-to-life sound and pictures possible. Something that's synonymous with the Marantz brand.

because music matters

www.marantz.com | Marantz 01753 680868

World Radio History

welcome

EDITOR

David Price
tel/fax: +44 (0) 1275 371 386
e-mail: editorial@hi-fiworld.co.uk

DESIGN EDITOR

Faiza Chunara
tel: +44 (020) 7625 3129
fax: +44 (020) 7328 1844
e-mail: adproduction@hi-fiworld.co.uk

PRODUCTION EDITOR

David Noble
tel: +44 (020) 7625 3134
fax: +44 (020) 7328 1844
e-mail: classifieds@hi-fiworld.co.uk

ADVERTISING

Debi Silver
tel: +44 (0) 870 242 0567
fax: +44 (0) 207 328 1844
e-mail: advertising@hi-fiworld.co.uk

ACCOUNTS

Sharon Mehlhom
tel: +44 (0) 20 8841 8892
fax: +44 (0) 20 8841 9144
e-mail: accounts@hi-fiworld.co.uk

WORLD AUDIO DESIGN

www.worldaudiodesign.com
tel: +44 (0) 1245 450 651
e-mail: sales@worldaudiodesign.com

PUBLISHER

Noel Keywood
e-mail: publisher@hi-fiworld.co.uk

PRIVATE & TRADE CLASSIFIEDS

tel: +44 (020) 7625 3134
fax: +44 (020) 7328 1844
e-mail: classifieds@hi-fiworld.co.uk

SUBSCRIPTIONS

tel: +44 (0) 1442 879097
fax: +44 (0) 1442 872279
e-mail: hi-fiworld@webscribe.co.uk

WRITERS

Dominic Todd
LJK Setright
Patrick Cleasby
Stewart Wennnen
Channa Vithana
Haden Boardman
Mike Skeet



When Nick Hornby's *High Fidelity* seems eerily autobiographical, you know you've got it bad. Yes folks, I'm a record collector - and proud. Actually, I'm a tad embarrassed, because I know that with nearly 5,000 pieces of plastic, it's less of a collection and more of an obsession...

Interestingly though, me and my kind are slowly dwindling in number. The days of lovingly rifling through record (and CD) racks are in decline. Statistics tell us that music buyers are increasingly getting their fix from the internet. So this month's issue is devoted to enjoying 'digital music' without sacrificing your hi-fi credentials. Yes - despite so much evidence to the contrary - it is possible to be a computer audiophile!

Inside, we try four of the latest hard disk portables from Apple, iRiver, Rio and Creative Labs, compare them to Sony's new Hi-MD rival, and review the best ever in-ear headphones, Etymotic's ER4-P. We audition Moore's new Medio PC, which could well be the shape of things to come. And we detail a complete computer audio system for archiving your prized music collection - Nottingham Analogue's latest Spacedeck turntable, Creek's OBH-15 phono stage, Audio Analogue's Puccini Settanta amplifier and Mission m50 speakers, plus Terratec soundcards, Apogee MiniME and MiniDAC digital convertors and Steinberg's stunning WaveLab 5 audio recording software.

We've much, much more inside - from Musical Fidelity's thunderous kW500 integrated to Denon's cheap-as-chips AVR-1705 AV receiver - plus *Hi-Fi World's* latest DIY supplement, so even those addicted to the smell of solder should smile. As for me, I kicked my vinyl habit long ago... but where can I buy that rare promo Beta Band EP...?

David Price, editor

testing

Hi-Fi World has its own advanced test laboratory and acoustically treated listening room, and a dedicated team of experienced listeners. We review thoroughly by extensive auditioning, rather than by quick-fire group listening tests. Our engineering team designs a wide range of products in-house. No other hi-fi magazine is so expert and dedicated.

verdicts

●●●●●	OUTSTANDING	simply the best
●●●●	EXCELLENT	extremely capable
●●●	GOOD	worth auditioning
●●	MEDIOCRE	unremarkable
●	POOR	seriously flawed
£	VALUE	keenly priced

hi-fi world

SUITE G4, ARGO HOUSE
KILBURN PARK ROAD
LONDON NW6 5LF
www.hi-fiworld.co.uk



Distributed by Seymour Distribution Ltd 86 Newman Street London, W1T 3EX Tel: +44 (0) 20 7396 8000 Printed by Southern Print, Dorset Tel: +44 (0) 1202 628 300
Our Agents in Malaysia Millennium Hi-Fi & AV Simon Chang Showroom & office, 500-1-3 First Floor Wisma Indah (Shen Court), Jalan Tun Razak 50400 Kuala Lumpur, Malaysia
Tel: 603 9283 8171 Fax: 603 9281 3762 e-mail: info@millennium-audio.com

All unsolicited submissions and goods are at the owner's risk. We accept no responsibility for such submissions, nor do we undertake to return them.
No material may be reproduced from this magazine without the publisher's written permission. © Audio Publishing Ltd

46

Audio Analogue Puccini Settanta - our favourite affordable integrated



42



Apogee MiniME/MiniDAC digital converters - classy

81

Mike Neilsen: master mixer

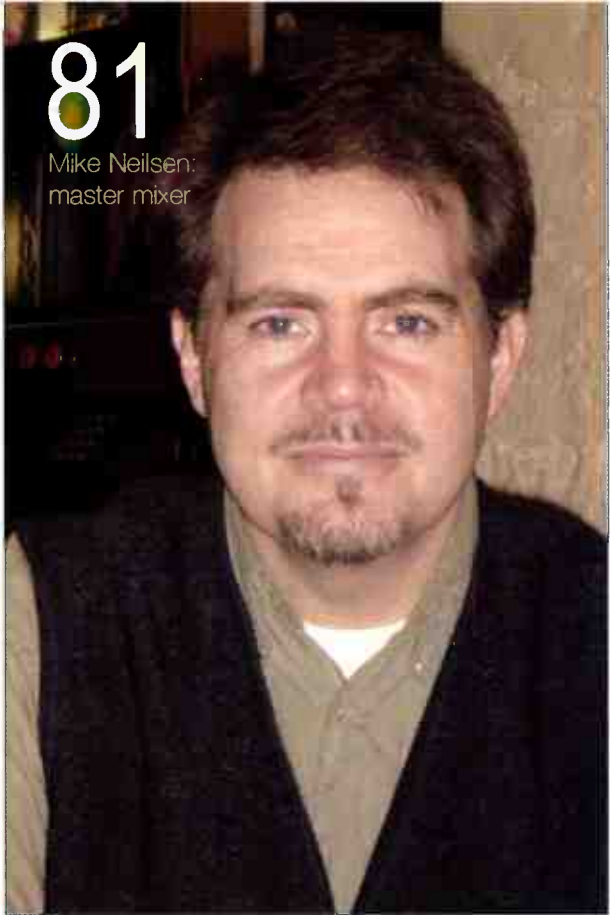

130



Aiwa XD-S1100 DAT - blast from digital's past

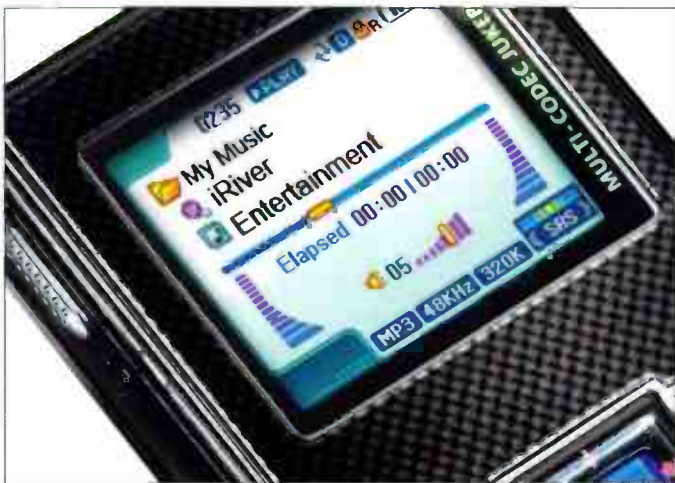

17 iRiver meets iPod and friends



Mission m50 - less is more

48

FUTURE SOUNDS SPECIAL:

MOORE MEDIO PC 12

Is this purpose-designed audio-video multimedia PC the future of music, or merely a footnote? Patrick Cleasby sounds it out...

DIGITAL MUSIC PORTABLE SUPERTTEST 17

Patrick Cleasby puts Apple's new iPod G4 against Creative Labs' Zen Touch, iRiver's H320 and Rio's Karma

SONY MZ-NH700 24

...but what of Sony's venerable MiniDisc format, recently made over with Hi-MD? Mike Skeet goes on the road

NETTING MUSIC 34

Once its nemesis, online music distribution is now the music industry's great white hope. Noel Keywood investigates...

NOTTINGHAM ANALOGUE SPACEDECK 38

Looking for a top-notch transcription turntable for archiving your analogue to digital? Stewart Wennen has one here...

TERRATEC PHONO USB 41

Here's a painless way of getting the low-level audio output from your cartridge into your PC for archiving purposes, says David Price

SUPPLY AND DEMAND 42

Dominic Todd tries Creek's OBH-15 phono stage and Apogee's MiniME and MiniDAC digital convertors

STEINBERG WAVELAB 44

Patrick Cleasby finds Steinberg's latest WaveLab audio recording software the answer to every sound recordist's dream.

AUDIO ANALOGUE PUCINNI SETANTA 46

A good heart for a serious computer audio system, and also the best sub £1,000 amplifier on the market, says Dominic Todd

MISSION M50 48

Here's a super pair of bookshelf loudspeakers for near field monitoring, says Channa Vithana...

RUSS ANDREWS RAVE 51

...or if it's a compact amplifier/speaker package you need, then you can't get much better than this, thinks Channa Vithana

INTERVIEW 81

Mike Nielson is one of the greatest exponents of multichannel music; Patrick Cleasby talks to him

DIGITAL

NAD C542 54

Dominic Todd believes NAD's new affordable CD spinner to be one of the very best at the price...

AMPLIFIERS

DENON AVR-1705 57

This Chinese made AV receiver offers startling value for money, says Noel Keywood

MUSICAL FIDELITY KW500 60

David Price finds this monstrous heavyweight to be one of the best integrated amplifiers ever made, no less!

LOUDSPEAKERS

MEL AUDIO HORAMA 62

Here's an exquisitely made high end pair of mini-monitors; Dominic Todd is suitably impressed



7 NEWS

words from the front...

11 SOUNDBITES

Etymotic's ER4-P is the best in-ear headphone solution for digital music portables, bar none – says David Price

26 COMPETITION

Your chance to win a pair of superb quality Focal Chorus 726S floorstanding loudspeakers – worth £800!

64 WORLD AUDIO DESIGN

Superb sounding valve amplification for do-it-yourselfers

68 WORLD LIBRARY

a wide selection of specialist audio books for sale

70 DIAL-A-DEALER

a comprehensive guide to UK hi-fi retailers

72 MEET YOUR MAKER

manufacturers detailing who makes what, and how to get in touch

82 SPECIALIST HI-FI DEALERS

purveyors of specialist hi-fi services

75,76,77,78,79 OPINION

the team get to grips with matters music, hi-fi and life!

84 NEW MUSIC

Patrick Cleasby rounds up the latest high resolution digital audio releases

86 SUBSCRIPTIONS

Ensure your copy every month and save money too

87 DIY SUPPLEMENT NO.80

99 MAIL

eight pages of your views and comments

107 MARKETPLACE

masses of pre-owned audio equipment for sale

119 CLASSIFIEDS

five pages of second-hand bargains

129 ADVERTISERS' INDEX

130 OLDE WORLDE

David Price looks back at Digital Audio Tape, and one of its best value proponents – Aiwa's XD-S1100

Yesterday



Today



“Amazing value and massively impressive performance.” *What Hi-Fi? Sound and Vision*

To find out more about the award-winning range of Cambridge Audio two-channel and home cinema hi-fi, visit our website or call 0845 090 2288 (+44 207 940 2200 outside the UK). Developed in the UK, Cambridge Audio products are available from specialist hi-fi dealers across the world.

www.thenewwave.co.uk

 **Cambridge Audio**

news@hi-fiworld.co.uk

news

FIRST ELEVEN

Marantz's new Premium range of products features the PM-11S1 integrated stereo amplifier, SA-11S1 SACD player and the new TT-15S1 turntable, the first new Marantz turntable in many years. As part of its commitment to the environment, these new Marantz products use leadless solder containing silver on the PCBs, claimed to increase the circuitry's signal quality, while decreasing environmental impact. The PM-11S1 boasts three-stage construction, a powerful 2x100W RMS, high quality linear volume control, Massive Super Ring transformer and customised components, complete with a copper-plated chassis, rear panel and system block shielding. Marantz has even included a fine-sounding MM/MC phono stage, judging from what



we've heard of a pre-production sample. The matching SA-11S1 SACD player offers a selection of exclusive Marantz digital filtering options, Super Ring transformer for ultra-reliable function copper plated chassis, rear panel and system block shielding, plus switchable DC filter and Noise Shaper. As for the turntable – watch this space, or click on www.marantz.com/



TOTAL ECLIPSE

Eclipse Time Domain's new 712z monitor speaker (£3,500 approx) is an arrestingly styled, superbly built high end loudspeaker with integral stands (complete with cable management). Our sneak preview saw its beautifully cast spherical boxes (which break up internal standing waves) impress with the superlative finish, and the sound quality proved most encouraging, the 712z's high quality glass fibre mid/bass driver providing superb transient speed and imaging. For more information, call Eclipse Time Domain on 020 7328 4499 or click on www.eclipse-td.com.





HEAD-LINE NEWS

Sennheiser's new HD595 is described as a state-of-the-art open dynamic headphone bringing Sennheiser's high-end technologies to an 'affordable audiophile' price. The company's most advanced driver know-how is used, taken from the highly rated £300 HD650 – including a new design of Duofol diaphragm that extends bass, Ergonomic Acoustic Refinement (E.A.R.) – where the acoustic baffle is aligned parallel to the head, ensuring that the sound is accurately channelled into the ear – plus non-resonant stainless steel mesh grilles, fully adjustable soft ear-pads and soft leather headband. The HD595 comes with single-sided Kevlar reinforced cable which can be upgraded to an audiophile type, such as those from Stephan AudioArt. The result is a claimed 12-38,500 Hz frequency response and 0.1% harmonic distortion. For more details, call 0800 652 5002 or click on: www.sennheiser.co.uk.

see feature p34

MUSIC DOWNLOADS SOAR

A new survey by Guardian Unlimited and HI Europe has found that 34% of the UK online population have downloaded music from the internet. As big brand names (Napster, Apple, MTV, MSN) enter the legalised downloading market and it is announced that easyMusic is to be launched, this new survey shows that half of those who have ever downloaded music download one to five tracks in a typical week, 8% download six to ten, 4% download eleven to twenty and 2% download twenty one to fifty.

The growth in downloading is being driven by young, affluent males, who are early to adopt new technology which enables them to download, burn CDs and mix music. These early adopters are more likely to upgrade their existing equipment than non-downloaders are likely to buy new equipment, suggesting short-term growth of music equipment will still be driven by this consumer group who tend to favour more alternative forms of music, such as Rap, Urban, Hip Hop, Drum & Bass and Indie/ Alternative Rock. The survey finds that this group has very strong views on the music industry and their "right" to download music (for free). Sixty seven per cent of downloaders claim they are unlikely to pay for downloading music, 42% disagree that downloading/file sharing is wrong and 30% are neutral. The majority (60%) agree that the music industry is being greedy when it complains about downloading/ file sharing and 43% disagree that it will damage the industry (22% neutral).

With the overall number who use the internet to access music growing, 31% of people online still acquire the majority of their music from music chain stores, with 16% buying their music at supermarkets, and 13% purchasing it from general high street chains. Twelve per cent get the majority of their music from internet websites and 12% get it from online music stores selling CDs, 5% buy music from independent music stores, 4% by mail order, 2% from second-hand stores and just 1% say they get the majority of their music from legal online music stores selling downloads. The internet does seem to account for the biggest area of growth in recent purchasing however. The vast majority of those who download (93%) do so via their PC, with the remaining using their mobile phone (4%), 3% their Mac, and 1% their hand held computer and 4% other means.

Fifty four per cent of downloaders agree that file sharing has broadened their music tastes, and there's evidence that downloading is opening up the mainstream to users as more downloaders claim they are now listening to pop, rock and R&B than before. However, there is little evidence to show that downloading behaviour has had any impact on listening to music on the radio. Twenty per cent of non -downloaders say they listen to music less on the radio now, compared to just 21% of downloaders. The survey confirms the fears of many music industry watchers - that 64% of the music is claimed to be downloaded for free, with 36% of it paid for. HI Europe is a market research and consulting firm; for more information, click on: www.hieurope.com/news.

FOR YOUR REFERENCE

TEAC's new Reference 300DAB Mk II mini system offers more power, and a Digital Radio tuner option - with the introduction of the all-new T-H300DAB. At the same time, the system amplifier - model A-H300 Mk II is more powerful than its predecessor 300 Series amplifier. Featuring a completely new silver finish, more power, subtle circuit refinements and new DAB tuner technology, TEAC says it's raised the standard once again, no less! The £480 system comprises the A-H300 Mk II Remote Amplifier (2x45W RMS) at £140, T-H300DAB Mk II DAB/FM/AM Tuner at £200, PD-H300 Mk II CD Player at £140, with the option of a R-H300 Mk II Cassette Deck for £130 and L-SH250 loudspeakers for £70. Call 01923 819630 or point your browser at: www.teac.co.uk for more information.



MAKING WAVES

With the XDR-S1, Sony has finally entered the Digital Radio portable market. This stylish £150 tabletop design claims "the highest level of AM and FM reception and impeccable sound quality" along with its DAB capability. It's a flexible little thing, complete with extensive station storage and display facilities, plus a supplied remote control. There's a line input for a Sony ATRAC CD WALKMAN or Hi-MD WALKMAN, and a punchy 2x2.3W amplifier and (ported) speaker system. Click on www.dabs.com for details.



NOW HEAR THIS?

As if we ever doubted it, market research by Dolby Laboratories into what consumers listen to, and how they actually listen, has proved that men are better at listening than women! In tests where people had to identify everyday sounds emanating from different directions, men beat the women by a factor of two to one. Dolby's consumer department was researching into how their end customers experience surround sound technologies, polling over 1,000 people across Europe to find out how people experience surround sound in the home, and also tested people on how well they actually hear surround sound when trying to identify different sounds coming from different directions. In the controlled environment tests, 81% of the sounds' directions were correctly identified by both sexes. It was only when comparing the results by gender that Dolby discovered that men significantly beat the women in accurately identifying the sounds. Most astonishingly, more men than women correctly identified household cleaning sounds toilets flushing (40% of men vs. 16% of women), pots and pans clattering (20% of men vs. only 4% of women) and vacuuming (94% of men vs. 76% of women), among others. "Women are said to multitask better than men," says Robin Dyer, Consumer Marketing Manager for Dolby, "however, our research seems to have discovered that when it comes to listening to multiple sounds from multiple directions, men have the significant edge." This leads your editor to cheekily suggest that we should thus be able to hear the difference between Dolby Digital and DTS...

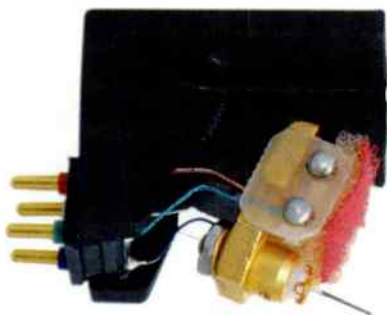

THE CONDOR MOMENT...

Question: what do you get when you cross a Colibri with a Frog? **Answer:** a Condor, at least according to van den Hul's public relations supremo! The story goes like this (cue Simon Bates' 'Our Tune' music and syrupy mid-Atlantic voice)... "two of the world's finest phono cartridges (the van den Hul Frog and van den Hul Colibri) meet and produce an offspring with a hairy chest and stunning performance" Hmmm... touching. Anyway, the £2,400 Condor is a custom hand-built design based on The FROG with the philosophy of The Colibri: take away from the body what you don't need, thus making the cartridge lighter and with fewer materials to resonate and influence the sound in a

negative way. The standard Condor is for arms with a weight of 12-20g and is available in carbon/ nylon or metal bodied versions. Standard output is 0.5mV, but a 0.25mV version is also available. The Condor uses matched crystal copper-wire coils and the more expensive gold coil versions will be available early 2005. The weight of the metal body version is approx. 9.25g, while the carbon/nylon version is 8.75g. The result, says vdH, is sounds like a FROG with higher musical resolution! For more information, call 01235 511166 or click on www.vandenhul.com.

NEXT ISSUE

This magazine is all about 'affordable audiophile' kit, not pie-in-the-sky 'aspirational' stuff. So we're putting together a unique selection of high performance, low priced hardware. The team assembles three weird and wonderful systems, reviews Marantz's striking TT-15S1 turntable, Onkyo's CV-1VL audiophile CD player and Pioneer's much talked about DVD-575 DVD universal machine. We try Amity's PR3/MB1 pre-power amplifier and Spendor's outstanding S6e loudspeakers. Factor in top names like Audioquest, Chord Co., Pathos, RATA, REL, Shanling and Stax - and you won't be able to afford to miss January 2005's *Hi-Fi World!*

CLEARLIGHT MY FIRE

Clearlight Audio's RDC cones and Aspekt rack have won many friends for their fine isolation properties. RDC (Resonance Damping Compound) is a resin-based compound containing grains of lead, rubber and numerous other materials. The resulting compound is of extremely random structure, incapable of sustaining resonance, yet transmitting energy in an extremely linear fashion. Now Clearlight Audio has just launched their new Combi Base which not only features RDC, but also a ring of Sorbothane to give additional damping. This is particularly effective under front-end components such as turntables, CD and DVD players. The Combi Base is designed to complement Clearlight's already legendary isolation range. Although simplicity itself, the Combi's real strength is its synergistic characteristics when coupled with Clearlight's other cones and cups in the RDC range. The Combi Base should be used in conjunction with RDC Cone Cups or as a cap for the RDC 2 or RDC 5 cones. For more information, contact Hifforsale.com Ltd. on 0870 2412469 or click on www.hifforsale.com.

Walrus

11 New Quebec St, London W1



This ad features a few new products we're excited about, as well as a couple of old favourites (which we're still excited by even after all this time!) From top right, going anticlockwise, first off are the Anthony Gallo Reference 3 loudspeakers (£2400/pr). You can't tell from the picture, but these are actually very compact (about 3 feet tall) but have the most amazing bass extension and a very open sound. Next, the brand new Musical Fidelity A5 series amplifier (250W/ch) and CD player, at £1499 each, are superb value. They are designed to be better, and cost less, than the popular 308 series, and don't even feel embarrassed in the company of the famous Nuvista and Trivista series. The CD even features a valve output stage, just like the late lamented Trivista DAC! The Duevel Bella Lunas (£3160 to £4160/pr dependent on finish) need no introduction. This superb Omni design, featured at the recent Heathrow Show, should be on everyone's shortlist. Origin Live's new Sovereign turntable (£3850 plus arm) sets new, even higher standards for this already envied manufacturer whose decks already receive huge acclaim from the press. Next up is something we thought we'd never see - a valve / transistor hybrid power amp from Tom Evans, famous for their Groove phono stage and Vibe preamp. The Linear A (£3999) is a truly innovative design which draws on the strengths of both technologies to give transistor speed and control with valve naturalness and texture, another milestone for Tom! Many people will still remember the success we had with the Magneplanar MG 1.6 speakers at the show. These flat non-electrostatic panels with ribbon tweeters produce the most amazingly believable soundstage, all for the direct import no-middleman price of £1500/pr. The new Duevel Shuttle-Disk rechargeable battery CD player (also £1500) is on permanent demo - bring your own CDs and be pleasantly surprised! Lastly, we had to squeeze it in, what we regard as probably the finest all round (pardon the pun) turntable in the world, the Brinkmann LaGrange with the Brinkmann 10.5 tonearm (£8395 in total), a truly staggering combination.



air tangent amazon amphion amplifon anthony gallo apollo furniture argento audible illusions audio physic audiovalve breuer dynamic brinkmann cartridge man cawsey chord electronics clearaudio consonance decca london dnm duevel dynavector ear yoshino final lab graham slee hadcock heart incognito infinity isolda jadis jbl k2 klimo koetsu korato lavardin lyra magneplanar michell engineering morch musical fidelity nordost nottingham analogue opus 3 origin live ortofon papworth pro-ject rega revolver ringmat roksan shun mook shanling shelter slinkylinks sme something solid sonneteer spendor stax sugden sumiko tannoy tci cables tom evans townshend audio transfiguration trichord trigon van den hul voodoo wireworld xlo

tel: 020 7724 7224

fax: 020 7724 4347

email: contact@walrus.co.uk

web: www.walrus.co.uk

enjoy the silence

Whether it's an old school cassette 'walkmen' or the latest digital audio portable, you'll be wanting the best possible in-ear headphones to partner it. In the Etymotic ER4-P, David Price has finally found them...

It's not often that *Hi-Fi World* gets vast numbers of requests to review a rather obscure product, and it's rarer still when the item in question isn't a designer CD spinner or lifestyle loudspeaker, but a somewhat austere looking pair of earphones! So it was with great interest that we procured a pair of £230 Etymotic ER4-Ps, but no surprise when we heard for ourselves just how special they are...

The name will not be familiar to many people, as US-based Etymotic Research has specialised in 'in ear' earphones to the complete exclusion of any other hi-fi product since its inception back in 1984. 'Insert earphones' are what it does, and one look at the website (www.etymotic.com) shows a vast selection of versions for hearing testing, electrophysiological testing and psychoacoustic research, as well as in-ear music monitoring and casual music listening. The company rather immodestly boasts that its "insert earphones provide the highest response accuracy and noise isolation of any earphones in the world".

Well, seasoned audiophiles have heard hype that like before, but as soon as we'd started using the ER4-Ps, we could hear that it wasn't mere hyperbole. These really are the best in-ear headphones we have ever auditioned, bar none - by a significant margin. This, we've deduced, is due to a combination of supremely high quality driver and absolutely unsurpassed isolation from outside sounds - better even than any active noise cancelling design.

Not everyone will enjoy placing things right into their ears - just millimetres away from the eardrums themselves - but there's no denying that it has a profound effect. Even high quality earphones, such as our fave rave Sennheiser MX-500s (just replaced by the MX-550) let a lot of ambient noise in. When you're out and about, this is disconcerting - and dangerous even - as there's almost no intrusion into your own personal

world of music. Still, sat on a bus, train or plane, it's precisely what you do want, the ER4-Ps filtering out vast amounts of superfluous droning that do nothing but detract from the music. They're great for this sort of use, but not for walking, jogging or cycling - when the noise cancellation is unsettling and, to cap it all, the leads are quite microphonic and only they themselves intrude!

Once you've got used to how they fit, then it's plain sailing. The Etymotics have dazzling clarity, ridiculously low distortion, lightening attack transients and wonderful musicality. To date the MX-500s (admittedly at a far, far, lower price) have been the best 'in-ear' phones we've heard, but the ER4-Ps blow them into the weeds with their insight, incision, detail, subtlety and - importantly - smoothness. They're very neutral indeed, and some might even mourn the lack of bass weight compared to the countless cheap and nasty Sonys of this world with 'bass tubes' (and what have you) designed to boost the low

"the Etymotics are the in-ear equivalent of a Quad Electrostatic..."

frequencies to implausible levels. In their accuracy and even-handedness, the Etymotics are the in-ear equivalent of a Quad Electrostatic.

Downsides: apart from the aforementioned noisy cable, none. The problem is actually finding an audio portable good enough to drive them - the average £50 CD walkman is simply revealed for what it is - a low cost, low-fi, low brow impostor. Plug in a Sony Walkman Pro cassette walkie, high end MD portable or Apple iPod however, and you go from the ridiculous to the

sublime - music as good as some of the best you've heard from a domestic hi-fi system! The previous ER4-S was reputedly horrendously inefficient (the meagre audio output stages fitted to most portables unable to drive them), but the latest P version shows no such failing. It's not startlingly loud, but sufficient. So there you have it - whether it's an old Sony TCD-3 DAT Walkman you're running, or the latest 4G Apple iPod, you've just found the best way to hear it.

ETYMOTIC ER4-P £230
 UAS Enterprises Ltd.
 ☎ +44 (0)1425 475563.
www.pjbox.co.uk

IN THE BOX

ER4 MicroPro earphones
 5ft. cord with 3.5 mm stereo phone plug
 1/4" stereo phone adapter plug
 six 3-flange eartips
 10 foam eartips
 filter changing tool
 4 replacement filters
 shirt clip
 pouch
 storage box



medio studies

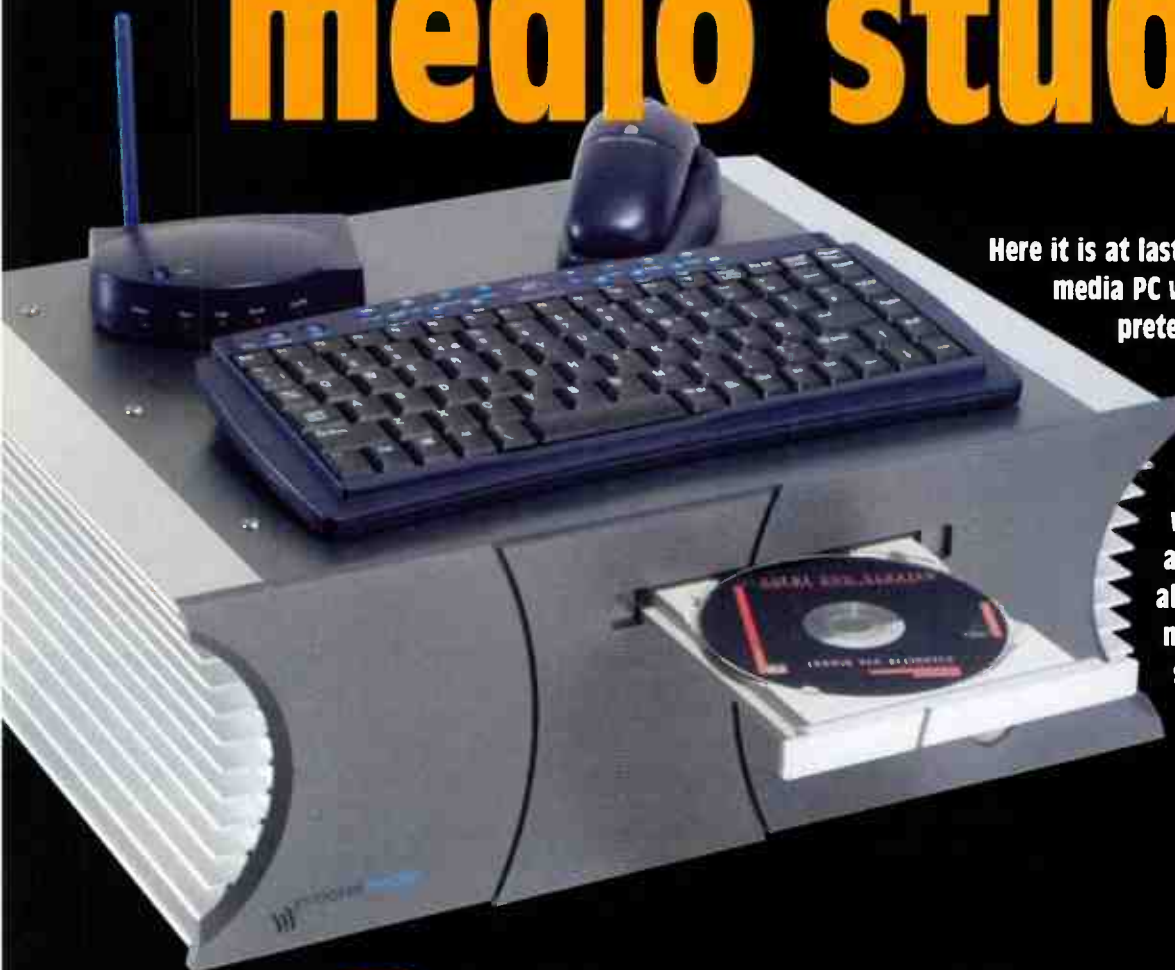

Here it is at last – a specialist media PC with music pretensions! Patrick Cleasby asks if Moore's new Medio PC is what the world is waiting for, or just an obscure alternative to mainstream music systems...

DVD-Audio fans should recognise this syndrome: what does it mean when a product is subject to repeated attempts to launch it? Well, usually it suggests that all is not well and it's failing in one way or another; either the concept is flawed, the message isn't getting across, or people just plain aren't interested...

Well there's something you may not have heard about, or indeed you may have heard about and ignored it - Windows XP Media Centre Edition (MCE). The concept is to run all your AV activities, including video recording, from a PC which forms the hub of your hi-fi system. Trouble is, nobody seems to want it, but Microsoft are still trying to resuscitate the corpse...

Where did they go wrong? It's still possible that it may get dragged along by the more likely success of Portable Media Centre, with a bit of help from Creative, but it seems that if people want a PC in their living room they don't want the interface given a work over – they want the familiar, what they're used to at their desks. So what's the alternative?

Depending on your lifestyle, some of the new generation laptops from Sony and Toshiba, with their

ability to allow use of multimedia functions without actually switching the computer on, seem a nice idea. If you were really smart you might understand that Apple do all this kind of stuff better, and even before they start a serious march towards the living room (it's bound to happen, Airport Express is only the spearhead) you can achieve almost everything you could possibly want to do with a media PC on a fan-free £800 iBook laptop with a £200 pound Elgato EyeTV 400 DVB box and the accompanying PVR software. But I'll try and shut up about that for now!

As you will see from the box on Ed Moore, Moore Innovations is a recent start-up attempting to address the media PC market with a 'turnkey' solution to the beige (or black) tower in the living room problem. They decided that XP MCE was not adequate or ready for them, and elected to use a quite handy PVR program called Showshifter. Their ethos consists of decent aesthetics combined with efficient and quiet-as-possible living room performance,

and considering that this is essentially a version 1.0 product they have done remarkably well in admirably short space of time. But the crucial question, with the cost of PCs ever tumbling, is whether the fruits of their labours are really worth two thousand of our English pounds...?

LIVING BY NUMBERS

Peripherals first; the Medio comes with a small RF keyboard and gyroscopic mouse. An RF remote can be added as an option. The base unit feels solidly put together - the aesthetics could be considered a little outlandish, but it's a matter of taste as ever. In a touching gesture, the names of the team who worked on the project are inscribed on the underside. Thankfully compared to the majority of AV kit, the single small blue LED is the only visible sign of activity, and is unobtrusive when the power is on (as it almost always will be). The bronze front fascia has an attractive brushed feel, (although some of the stamping on the edges of the rear panel could do with some smoothing off – ouch!), and the flush

"I have to admire this beast; it is a damn fine attempt..."

fitting disc tray cover and eject button contrast nicely in silver and tie in with the cooling fins. These are on either side and obviously serve a heatsinking purpose, but they also give a feel redolent of Buck Rogers, which I don't find unappealing. It's simply a matter of whether it's going to look right along your home cinema amp of choice, because in theory that could be all you need.

In practice that may not be enough. I imagine most of us will be regarding one of the main jobs of the hub of a system to be decent CD playback. Of course I could just be being old hat now, and you all just want to play out thousands of crudely compressed MP3 files stolen from the net, but I doubt that. DVD playback is another task which needs to be adequately addressed, and then there's the issue of TV. While the Medio exists in both analogue TV and DVB equipped versions at the same price point I would imagine most people will be going for DVB. But simple Freeview does not allow the quality and diversity of channels found on Sky, and there is no conditional access facility to allow for the paid-for supplementary channels from the likes of Top Up TV.

So how does it behave? Hook up is a simple matter of 3.5mm to phono coaxial connection of the Audigy to an AV amp for digital audio via S/PDIF, and in my case video had to be restricted to the customary S-video, although DVI is available for you flat screen and projector types. Elsewhere round the back are all the usual PC connections. Unfortunately not having broadband yet I couldn't use the Ethernet port to get on the web to investigate the EPG functionality. On initial launch, after a fast boot, the DVB capable test unit went through a very smooth configuration process, loading up all the Freeview channels obtainable.

The noise levels are remarkably low. I compared the Medio to the running of first generation Sky+ box with a very quiet 80GB

replacement Samsung disk in it and the Medio came across only very marginally louder. Once set up, you can start to explore Showshifter. You can toggle between full and windowed TV views and the digital output of the MPEG 1 Layer 2 audio is not bad, although not quite up to the optical output of Sky+.

Video quality is surprisingly good though – on a par with most broadcast MPEG2. Standard PVR live TV pause and record facilities are available. If you adjust the record settings to produce a mixed MPEG2 file rather than the proprietary Showshifter SSF format you can take the .mpg file anywhere you like to author it, including the option of burning off programs to DVD-R using Nero on the Medio. Recorded quality looks excellent in Quicktime. DVD-Video performance is adequate, but nothing to get hugely excited about – the image appearing somewhat diffuse, compared to the customary dedicated player detail.

The standard 24 bit PCM David Gilmour test was performed, and the results deemed rather woolly – not bad inasmuch as it was on a par with the £150 Denon DVD-1710 reviewed recently, but hardly cutting edge stuff. The Dolby 5.1 option was actually much more satisfactory in this case. CD audio quality is actually pretty decent too – almost comparable to a Cambridge Audio 540CD; I've heard far worse analogue output from a PC! There are also Showshifter options for video, audio and picture file playback, and the application is easy enough to navigate.

There are a few version 1.0 slip-ups. The one that bugged me was that if you chose to have the rear power switch on but turn the unit off from the front (which cleverly shuts Windows down) the loop through of the coax analogue aerial signal is cut out, which means if you have something higher in the chain relaying that signal to other rooms (or you simply want to watch analogue on your TV, suddenly there is next to no signal. The Medio should behave like any other tuner,

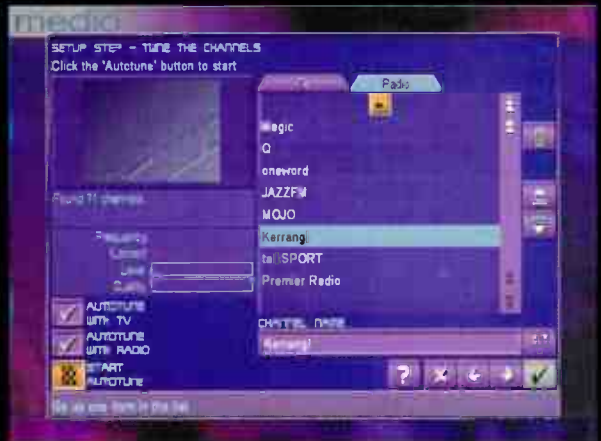

Autotuning TV and Radio channels is ridiculously easy



An inviting welcome from Showshifter!

and continue passing signal as long as it's plugged into the wall. It also locked up once when it had been left on for a while and the front button could no longer shut it down. Finally, in Windows Explorer operations, held shift or control click group select options do not work – irritating!

So ultimately, is it worth it? I have to admire this beast, it is a damn fine attempt, but I can't help feeling that even though this is still the kind of thing which would really be best suited to those of a geeky persuasion, and those with better things to do should really be left with separates and all-in-one systems. If you did go for one it may well not enable you to dispense with your CD player and/or Sky, even if you



Chord Signature

- Heavy gauge high purity multi-strand copper conductors
- Low density foam polyethylene dielectric
- Unique dual layer high frequency shielding structure
- Non-compression aluminium clamping system
- Factory terminated

No matter what your system, the innovative design of Chord cable will transform the sound and really bring your music or soundtracks to life. If you are passionate about music, listen to the Chord range of interconnects and speaker cable and find out just how much you have been missing.

Twenty years of experience, obsessive attention to the finest detail and a real commitment to producing high performance products, make all Chord interconnects and speaker cables a vital component of any hi-fi or home cinema system.

Used and recommended by manufacturers, retailers, hi-fi magazines and recording studios throughout the world, Chord cables are chosen for the dramatic improvements they can bring to any level of system.

Highly compatible, dynamically balanced, detailed, coherent and musically involving, Chord interconnects and speaker cables are stocked by all the best hi-fi retailers.

To find out more visit
www.chord.co.uk
or call +44 (0)1980 625700

THE
CHORD[™]
COMPANY
MOVING SOUND & VISION[™]

MOORE THOUGHTS

I met up with Ed Moore in September to discuss the story behind the genesis of his baby, and the shape of things to come. Ed has been engaged in developing the Medio for the last year or so, having previously been Chief Technology Officer at The Carphone Warehouse Group, and has the casual affability of the assured exec...



"I was doing consultancy for Fujitsu Siemens, and there was a question of why would you ever buy a desktop machine when laptops are so powerful, and the only reason we could come up with was if you wanted it to be a media centre, i.e. it had to be switched on all the time and live in your lounge. I was just intrigued by that and went to see what was on the market."

Ed obviously likes the prospect of getting his hands dirty; *"we had been looking at new caseworks for my other company Appliansys, so I found myself saying that makes a lot of sense and there's not really anybody else doing it, the systems are out there, and if you can marry good functionality with great casework, design it for the living room and put it together there's an opportunity there and it sounded like an interesting challenge. People are getting more used to the idea, everything is heading towards digital broadcasting and digital media, the DVD side. It seems to be being accepted that this is a possible or even a probable way forward for the core of your system."*

Ed eschewed the Windows Media Player concept for the Medio, *"XP Home gives you everything you need, then we use third party software from a company called Home Media Networks called Showshifter. There were two reasons really – when we were looking at the beginning of the year it was very restrictive in what they were doing with it, and it didn't actually work very well. It's Microsoft... it always gets better, it's just that it was then at the point where it was almost better. And when they're in Seattle, they'll pay lip service to what's going on in the UK, but they're not going to tune a programme guide, they're not going to tune it nicely to PAL, it'll be full of holes. And if you pop up as a little OEM that they've never heard of on the other continent are you going to get them to tune it correctly? We went with Showshifter because it was better software with a better reputation"*.

I asked Ed if he regarded the Medio as primarily a TV/ PVR/ DVD-R system or if he had an eye on audiophile concerns as well. *"I think the main thrust in the trade and what customers are asking for is around DVD systems. I'm not going to buck it and say - no, it's designed for the hi-fi enthusiast. There is a market there for that, but we are not pushing on it at the moment. At our current size we're not trying to get too many mixed messages out"*.

Ed is very honest about these issues, and his desire to resolve them. He is eager to address the audiophile and other shortcomings of the Medio in subsequent production (particularly as computer costs keep dropping as you can see from the tech spec update – no price change!), and in subsequent models. *"We're learning all the time, we come from one particular set of backgrounds with a certain market concept in mind. The more people open our eyes to other markets the better. One thing about being new on the block is that lots of things are a learning experience."*

Ed has an eye on the future – thoughts kicking around include the possibility of offering a high resolution audio transfer service for vinyl, and particularly the Moore Mega - a next generation product likely to include a 2TB array of disks with RAID-5 redundancy to protect all those valuable files. *"It's like, how do you fit eight drives in, with heat pipes for cooling, plus 2 DVD drives, and an Athlon 64 FX in a case that's 440mm wide and still looks pretty good?"*

I have a feeling that if anyone's got the answer, then Ed has.

were happy to retire your old DVD player. I have the feeling that I can indeed achieve 95% of what the Medio can do (smaller amounts of storage is the only real limitation) with an attractive white Mac laptop and a small silver box for half the price.

It will be much more interesting to see if next generation ideas like the Moore Mega come to fruition, offering serious amounts of storage and the asset protection of redundant RAID. But if you're of the PC persuasion, and you're dying to do the media PC thing now, this is not a bad starting point. The ability to do all that other PC stuff – iTunes, games, mail - is a definite plus. Just don't ask me to sort your Windows virus problems out for you...

TECH SPECS

ASUS P4P800-VM MicroATX motherboard
512Mb DDR400 memory
Pentium 4 2.8Ghz
ATI 9600 XT Ultimate graphics card
Hauppauge Nova-T Digital TV card
Creative Labs Audigy 2 sound card
Seasonic 250W PSU

2 x Samsung Spinpoint SATA 160Mb drives
Windows XP Home
ShowShifter media front end
Gyratron Wireless keyboard and gyroscopic mouse
Zalman AICu 7006 CPU cooler

AcoustiProducts noise dampening foams
LiteON 832 DVD Rewriter
435x165x255mm
12 kg

future orders to feature:

1Gb DDR400 memory
LiteOn 1633S DVD Writer (16x support and dual layer)
Nvidia Digital TV card
Creative Labs Audigy 2 ZS sound card
Marmitek X10 remote control



VERDICT ●●●●

Brave attempt to provide integrated, user-friendly high quality audio and video from a PC – successful, but not comprehensively so.

MOORE MEDIO PC £2000
MOORE MEDIO
☎ +44 (0)800 033 1010
www.mooremidio.com

- FOR**
- efficient PVR
 - quiet running
 - well integrated

- AGAINST**
- idiosyncratic looks
 - no hi res audio
 - a keyboard in the living room?



There may be better value propositions around to upgrade your system but if there is I haven't heard them...A fantastic product then from Origin Live and this particular audiophiles dream review tool."

TNT AUDIO MAGAZINE

"...the best tonearm I've heard"

HI FI WORLD

The ultimate format deserves the ultimate design

The supremacy of vinyl quality over digital is set to continue - especially with the spectacular levels of performance now available through the new Origin Live tonearms. If you are in the slightest doubt as to the groundbreaking nature of these arms and their ability to transform your turntable's performance, we suggest you investigate the reviews and arrange an audition. Shown above is the new "Linn fitting" base with built in VTA adjuster, making the arms quick and easy to fit to LP12s among others. We guarantee all arms above the Silver to outperform any other arm regardless of price or your money back.

Tonearms

Conqueror - £2500 Illustrious - £1570 Encounter - £970 Silver - £599 OL1 from - £124

Origin Live, Unit 5, 362b Spring Road, Sholing, Southampton SO19 2PB

Tel / fax: 02380 578877 E mail: info@originlive.com

www.originlive.com

Winner of Stereo Times magazine Most wanted component of 2004 award



"Simply stated, the Origin Live Illustrious tonearm / Aurora Gold turntable produce the best musical results of any turntable I've ever heard, regardless of price....It sets a new reference"

STEREO TIMES

definitive audio

Definitive Audio creates a quality of musical experience that is irresistible. We achieve this using some of the world's most splendid contraptions and by employing a value system that places musical considerations above all others.

Our inventory includes the tantalising KSL Kondo amplifiers from Japan. We have the M7 Line, M7 Phono, M77 Phono, the Neuro Integrated and of course the extraordinary Gakuoh. We also have a range of single minded amplifier designs from, amongst others, Border Patrol, Art Audio and Sugden. Our Aladdin's cave of analogue treasures includes 12 choices of moving coil cartridge, the Kuzma Airline, Triplanar 6, and SME Series V tonearms. Keeping this company is an enviable selection of turntables including the Scheu range and the unequivocal SME Model 30 and Kuzma Stabi Reference.

We have the complete range of Living Voice loudspeakers including the internationally celebrated Avstar OBX-R2.

More importantly we have an attitude and an intent that breathes new life, interest and fascination into your relationship with music. Call us for an informal chat or to arrange an appointment.

Sale of part exchanged and ex-dem items

Sale New

Audio Note Japan M7 line pre-amplifier with stepped attenuator volume control. Fully serviced. Rare affordable opportunity to visit the Kondo planet.	£4000	
Meridian 508 - 24 bit CD player with luxurious desktop remote control	£1200	£2500
Clearaudio TCI tonearm massive acrylic linear tracking device - unusual opportunity - spotless and as new - no box	£2000	£3860
Martin Music Systems VSM/M loudspeaker. Obscure here, popular there - unusual US design with cult following - includes BAM bass module	£2500	£9000
Living Voice Avstar II - cherry - 12 months old, nearly spotless - lovely finish	£2000	£2700
Aloia PST 11.01 Hi-end 2 box pre-amp - slick and stylish Italian. 12 months old - boxed - perfect	£1500	£2800
Pro Ac Studio 200 - yew - nice - vgc	£800	£2150
Pro Ac Supertower - big bruiser - black. At least 10 years old, very loved and dog-eared. Great sounding den/party speaker - good working order	£300	
Lyra Titan mono - cartridge with kudos in a haishirt style - 40 hours	£1900	£2795
Dynavector 507 tonearm - strange device seeks strange owner	£1500	£3000
Art Audio PX25 - 5 watt stereo power amp - big with Lowther fans	£2500	£4500
Quad 989 Electrostatics - 2 pairs - black - big - boxed - perfect	£2900	£4500
Tom Evans Groove plus - phone stage with external Lithos PSU	£2500	£3500
Tom Evans Vibe Pulse - line stage with external Lithos PSU	£3200	£4800
Tom Evans Micro Groove Plus - moving magnet	£500	£800
Tom Evans micro Groove - moving magnet	£300	£400
Tom Evans micro Groove - moving coil [1K]	£300	£400
Sugden Masterclass Stereo AA power-amp with matching pre - beefy class A solid state - ex-dem - boxed - light use	£3750	£5600
Revolver R33 bookshelf speakers - new - boxed	£300	£600
Naim 42.5 plus Hi-Cap plus 135 monos - 19 year old job lot - including rabbit droppings - giveaway	£1000	
Roksan Xerxes Cognoscenti turntable - SME cutout - firewood	£100	
Linn Isobarik - dinosaur design at dinosaur price	£250	
CR Developments Romulus line integrated - as new but hums - giveaway	£300	
Quad FM4 tuner - no comment	£90	
ATC SCM7 - cute mini-monitors on saucy bright finish Partington stands	£450	£700
Eastern Electric Mini-Max - super cute line pre-amp with valve rectification and hard wiring. New and boxed	£500	£800
Epos ES30 loudspeaker - substantial floorstander - some marks - giveaway	£650	
Cardas Neutral Reference 2.5m speaker cable with spade term - new	£500	£775
Cardas Neutral Reference 1m interconnect - new	£300	£500

Tel: 0115 973 3222 Fax: 0115 973 3666
internet: www.definitiveaudio.co.uk email: shout@definitiveaudio.co.uk



The BorderPatrol P20

'One of the best music appreciation devices available.'

Jason Kennedy Hi-Fi Choice Summer 2002.
EDITORS CHOICE

Full details on the P20 and other BorderPatrol amplifiers and power supplies can be found on line at www.borderpatrol.net

Tel/fax 00 44 (0) 1242 717171
e-mail bp@borderpatrol.net
www.borderpatrol.net



BorderPatrol

street fighters

The iPod digital audio portable's success hasn't deterred Apple's competitors from attempting to rival or even better it - and to the benefit of audiophiles the latest tactic seems to be the adoption of high quality codecs. Patrick Cleasby decides whether any of the challengers have the measure of the champion yet...

Right now, the miniature hard-disk based digital portable is where it's at for music on the move. In the main this is due to the runaway success of Apple's iPod over the last three years, but let us not forget that it was companies like Rio and Creative who did much of the initial work in MP3 portables. Since those early days many manufacturers have joined the fray, but have any of them managed to wrest the lead which Apple gained from the off?

We decided to compare the current crop of 20GB units, as this is the typical purchase for those on average budgets or with

recent developments, following on from the drastically reduced prices of computer storage, is the increasing tendency of the savvy individual to convert their CD collection to computer files without using lossy codecs. Although open source enthusiasts have been able to make use of the FLAC lossless compression scheme for some time, it was only Apple's decision to include their lossless version of the AAC encoder in both PC and Mac versions of iTunes six months ago which made this approach viable for those scared of command lines or unsure whether to download source or binaries!

those who have spotted it will have suffered from the previously inevitable sinking feeling when they realised they had to recode all their source material if they wanted to step up from MP3 to MP4 correctly. Now they can smugly sit on a large pile of lossless files and merely take a few (quite a few!) hours to transcode to whichever compressed codec is the flavour of the day...

First and foremost, despite support for all these exotic formats, at their most basic these are all MP3 players. This being an audiophile magazine I will stick to the belief that the only way to get something semi-decent out of

“codecs are a key determinant of audio quality - and that's what we are here for...”

MP3 is to take it up to full variable bit rate 320kbps true stereo

medium-sized music collections: Apple has brought the iPod mini's clickwheel to their fourth generation machine. Creative has aped the iPod in almost all respects, iRiver may have just shown Apple the way into the future, and Rio has put an interesting spin on the form and the capabilities of the PC jukebox player.

One of the most interesting

Apple naturally added playback capabilities for its lossless files to the iPod, and with the Karma reviewed here Rio has given PC lossless fans the ability to play their FLAC files on the move. But while they may give high quality playback (and a concomitant heavy hit on capacity) these approaches miss the main advantage of ripping to lossless back at base. Many of

encoding. This is therefore the benchmark, although we will attempt to verify whether superior performance can be obtained from whatever other codecs can be accommodated.

The reason for my concentration on codecs is that they're a key determinant of audio quality - and that's what we are here for! What we can't really do is go too far into the machines' abilities to make use of legal downloads, as this is a huge topic in itself, no downloads are particularly audiophile in quality, and there is such a lack of iTunes Music Store (iTMS) /AAC versus everywhere else/WMA interoperability that it is impossible to make a reasonable comparison. Round one:



FUTURE SOUNDS SPECIAL:

ETYMOTIC ER4-P	11
MOORE MEDIO PC	12
DIGITAL PORTABLE SUPERTEST	17
SONY MZ-NH700	24
NETTING MUSIC	34
NOTTINGHAM ANALOGUE SPACEDECK	38
TERRATEC PHONO USB	41
CREEK OBH-15	42
APOGEE MiniME/ MiniDAC	43
STEINBERG WAVELAB	44
AUDIO ANALOGUE PUCINNI SETANTA	46
MISSION M50	48
RUSS ANDREWS RAVE	51

APPLE CLICKWHEEL IPOD £219

SYSTEM REQUIREMENTS:

PC with FireWire or USB 2.0 port, or FireWire or USB 2.0 card; Windows 2000 with Service Pack 4 or Windows XP Home or Professional
Macintosh computer with FireWire port; Mac OS X v10.1.5 or later (Mac OS X 10.3 or later recommended); USB 2.0 requires Mac OS X v10.3.4

DIMENSIONS:

104x61x14mm
158 g

PICTURE COURTESY OF APPLE



The announcement of the two level (20GB and 40GB) Clickwheel range was obviously missing a top-of-the-range model, and the breaking news from a reliable Mac gossip source at the time of writing is that a colour screen iPhoto-integrated 60GB model should complete the range between now and Christmas. Pure guesswork would say that the premium iPod must be likely to cost at least £400. So what will sell this more humbly equipped variant to the man in the street? Well one of the more welcome aspects of the 4G announcement was the reduced pricing. The effect of this can be seen in the internet prices of the other players featured here, with those sellers who haven't dropped the opposition to lower-than-iPod prices unlikely to be shifting many units.

The other big news is the claimed 50% improvement in battery performance, taking full charge playback to 12 hours. Also, for some reason, presumably power efficiency, a playing track now pauses if the headphones are taken out. More minor changes include that Clickwheel, which is welcome once your fingers have got used to the change; minor on screen interface changes; and for PC purchasers USB2.0 charging will be extremely welcome. Less welcome is the fact that included accessories are minimal – Firewire and USB cables, 'phones and a dock, but not much else.

The downside of the iPod has not changed - even without the Fairplay DRM as found in .m4p files downloaded from the iTunes none of the other players here can deal with non-DRMed .m4a tracks encoded from CD. Apart from messy down-

conversions iTunes tracks are still effectively locked into iTunes and the iPod. Once you're attached to the iPod you will find it very hard to escape!

On the auditioning front, as I have stated before I remain firm in the belief that 320kbps MP3s can be easily beaten by 192kbps AAC – the only problem is that the iPod is the only machine I can really test that assertion on! But if you're really keen to get the best possible sound, Lossless is where it's at. In order to level these tests the supplied earbuds have been replaced, as ever, by our reasonably-priced Sennheiser MX models, although this time we had the MX500 replacement, the MX550, to try out. At 320kbps MP3 Emmylou Harris's voice on the shimmering 'Boulder to Birmingham' is rendered adequately by the iPod, but the peripheral instruments sound flat. 192kbps AAC improves the resolution of that detail somewhat, but is definitely bested by Apple Lossless which renders her beautiful voice with transparent fidelity.

Pushing the envelope a little further, it was a real shame to discover that the iPod still cannot play 24bit PCM, even at simple 48Khz resolution, but then neither can the only other PCM capable device here, the Creative Zen. At least the iPod has the decency to rapidly skip through unplayable tracks – the Creative just blasts you with white

noise!

However, back on the iPod, Lossless AAC encoded from the 24/48 PCM lead track of Blue Man Group's new 'The Complex' DVD-Audio gives a supremely detailed rendition of massed instrumentation and percussion. The ensuing 'Time To Start' demonstrates admirable efficiency in conveying a busy, propulsive rock arrangement. It will be interesting to find out (once the software catches up) whether Apple Lossless understands 24bit properly when making these files, or whether it is simply truncating 8 bits of information!

And what of those all-important improved battery life claims? Well it took a few attempts, (anecdotal reports on the internet support this), but by the third full charge/discharge cycle playback of 320kbps was hitting 12 hours. It may be just battery conditioning, or it may be that the handling of larger Lossless files for the two previous attempts which proved too onerous, (each lasted about 8 hours), but it seems that 12 hours is attainable.

The battery charge may still not last as long as those on the other machines, but what you get here is the most compact machine, with the most smoothly integrated music library and loading. There is nothing revolutionary on this new model, but just wait until its big brother arrives!

VERDICT ●●●●● £

The original (?) and best, and what's coming next will only cement the iPod as the must have gadget for junior and grown up geeks alike... exquisite.

APPLE

+44 (0)800 039 1010

www.apple.com/uk/ipod/

FOR

- still beautiful
- improved battery
- Firewire & USB2.0

AGAINST

- iTunes lock-in
- dwindling accessories
- colour screen?

CREATIVE ZEN TOUCH £220

SYSTEM REQUIREMENTS:

PC with USB 1.1 port (USB 2.0 recommended for faster transfers); Windows 98/Me/2000/XP Home or Professional; Pentium II 233MHz or AMD K6 266Mhz (Pentium III 450MHz or higher recommended); 64MB RAM (128MB recommended)

DIMENSIONS:

68x105x22mm
203g



You know what they say about imitation... Rather than attempting to better the iPod in any major way, Creative has satisfied itself with replicating most aspects of the iPod experience. The results aren't bad – of all the alternatives the 'Touch' strip, which runs down the middle of the bottom half of the front panel, is nearly as much fun to use as whirling around the iPod wheel is, and by default emits a very iPod-like clicking. You just don't seem to be able to locate something within a playlist in the same easy way, and you will need to use the hold button if you don't want inadvertent touch to confuse things.

The look and feel of the device is not quite as compelling as the iPod – the Zen feels just a little too wide and bulky. However it's satisfyingly well put together and the buttons nice and positive. The external look and feel is not all that could be said to be iPod like – the on screen display is clearly closely modelled on the operation of the iPod, but it does lack the text display, games, calendar and contacts integration, the possibility of voice recording et cetera...

As with all the devices except the iPod, data connection is through a Type B to Type A USB cable – although USB 1.1 can be used if necessary, USB2.0 is essential to avoid boredom setting in during large data transfers. For those of you who may be wondering, this worked fine on my antiquated PC laptop with the addition of a £30 Belkin

PCMCIA adapter – including USB2.0 charging if you have the ability to power the card from the mains. None of the other machines here deal with computer connection charging as elegantly as the iPod, which is always charging when connected to the PC. Whereas the iRiver defaults to charging on connection, the Zen only goes into USB charging when it is put into standby. The Karma doesn't USB charge at all. To assist in charging issues the Zen is supplied with a mains adapter and a separate DC in port.

The supplied software installs easily on Windows XP, and is essential, as the Creative does not work as Mass Storage, which also means no chance of having a peek into its digital gizzards by attaching it to a Mac. For music loading you therefore have the choice of using the Creative Media Source software, which I found somewhat unintuitive, or, if you prefer drag and dropping, (as I do), the installer supplies a little browser called the Nomad Explorer, which sits under a new category "Other" in "My Computer". Bizarrely, although the guide says that you could in principle use this to facilitate data transfer, it cautions you that the machine is really designed for playing audio. One would presume that Creative will at some time adopt the move to Mass Storage as everyone else seems to be doing?

The Zen will play MP3, WAV and WMA (including DRM protected WMA – these cannot be transferred using Nomad Explorer). Dear reader,

I have to confess that for once I had to listen to the dreaded WMA. If we're looking for an efficient but listenable audiophile file solution in each of these cases, you might speculate that it would be WAV playback here, but on comparing various encodings of David Sylvian's 'I Surrender' there did not seem to be a significant audible improvement in the Zen playback when comparing the WAV to the lossy versions. Across all formats the sonics just did not seem to equal the iPod's sense of clarity and separation. As expected 192kbps MP3 felt flat and inadequate, but 192kbps WMA, (the highest possible bit rate encoding using WMP8) seemed to be equal to 320kbps MP3 in its ability to give a real sense of the low-end strings in this track. So, if you feel inclined to go Creative, 192kbps WMA is my recommendation!

If you're PC based, and your intended usage of your portable extends no further than purely music the Creative Zen is perfectly adequate for your needs. One big advantage of this player is the claimed up-to 24 hours play time. But if you're after the ability to play a range of codecs (especially a lossless option) and innovative 'lifestyle' features, then you need look elsewhere.

VERDICT ●●●£

Creative has to be applauded for emulating the iPod well, but its very similarity makes you wonder why bother going for the imitator if you can have the original?

CREATIVE LABS

+44 (0)800 376 7954

www.uk.europe.creative.com

FOR

- touch operation
- familiar interface
- DRMed WMA support

AGAINST

- ungainly shape/size
- not mass storage
- limited USB2.0 charging

Seasons Award Winning Systems

You can now choose to pay in 2006 at KJ West One



FEATURED SYSTEM

SYSTEM 7 ★★★★★	
WADIA 302 CD Plyr	£3999.00
T+A V10 Amplifier	£3995.00
SONUS FABER Cremona	£4999.00
Normal System Price	£12,993.00
DEPOSIT	£2600.00
Deferred 12 months	£10,393.00

Interest Free Option on Request

A Perfect Partnership.
With the Wadia 302 at the helm signalling accurate, detailed information into the absolutely amazing and innovative 70 watt integrated valve amplifier from T+A driving the full range of micro dynamics through the most elegant affordable speaker from the master craftsmen at Sonus Faber. Yes, we have the perfect partnership. A sonic alliance at, dare we say, a bargain price.

* FINANCE SUBJECT TO STATUS; WRITTEN DETAILS ON REQUEST.

HIGH-END HOME DEMONSTRATIONS BY APPOINTMENT. PLEASE CALL FOR DETAILS

Right now we are offering our customers the opportunity to choose any system, or component upgrade for that matter with the option to pay just 20% deposit and then nothing to pay for 12 months. We are committed to making it easier for you to upgrade to your dream system.

Take a look at our own featured

systems below. All of us at KJ take considerable pride in our endeavours to audition and put together dream systems. We are fortunate to be able to choose from the world's finest range of musical components.

Whilst equipment reviews are helpful we quite often find that the sum of the parts do not actually

work that well. Our ten featured systems we know are totally compatible and will provide a truly satisfying musical experience.

In the final analysis we do feel that our guiding criteria has to be outright performance versus investment.

We think we've got it right!

SYSTEM 1 ★★★★★	
CYRUS CDBx	£1000.00
ROKSAN Caspian Amp	£999.00
DYNAUDIO 42 Spkrs	£399.00
Normal System Price	£2398.00
DEPOSIT	£480.00
Deferred 12 months	£1918.00

Interest Free Option on Request

SYSTEM 2 ★★★★★	
QUAD CDP	£1000.00
QUAD 99 Power	£550.00
QUAD 22L Spkrs	£895.00
Normal System Price	£2445.00
DEPOSIT	£500.00
Deferred 12 months	£1945.00

Interest Free Option on Request

SYSTEM 3 ★★★★★	
UNICO CD player	£1175.00
UNICO Amplifier	£825.00
SONUS Concerto Spkrs	£999.00
Normal System Price	£2999.00
DEPOSIT	£600.00
Deferred 12 months	£2399.00

Interest Free Option on Request

SYSTEM 4 ★★★★★	
SHANLING CDT-100	£1649.00
PATHOS Classic 1 Amp	£1325.00
SPENDOR S6E Spkrs	£1499.00
Normal System Price	£4473.00
DEPOSIT	£895.00
Deferred 12 months	£3578.00

Interest Free Option on Request

SYSTEM 5 ★★★★★	
MERIDIAN G08 CD Plyr	£2249.00
COPLAND CSA29 Amp	£1899.00
PROAC D15 Spkrs	£1799.00
Normal System Price	£5947.00
DEPOSIT	£1190.00
Deferred 12 months	£4757.00

Interest Free Option on Request

SYSTEM 6 ★★★★★	
AUDIONET ART V2 CD	£2299.00
KRELL KAV400xi Amp	£2699.00
SONUS FABER Auditor	£2548.00
Normal System Price	£7546.00
DEPOSIT	£1510.00
Deferred 12 months	£6036.00

Interest Free Option on Request

SYSTEM 8 ★★★★★	
THETA Compli Uni Plyr	£4482.00
PATHOS Inpol 2 Amp	£5500.00
WILSON BENESCH ACT	£9000.00
Normal System Price	£18,982.00
DEPOSIT	£3800.00
Deferred 12 months	£15,182.00

Interest Free Option on Request

SYSTEM 9 ★★★★★	
AUDIO RESEARCH CD3	£5189.00
McINTOSH C2200/MC2101	£10,000.00
MARTIN LOGAN Odyssey	£6798.00
Normal System Price	£21,987.00
DEPOSIT	£4400.00
Deferred 12 months	£17,587.00

Interest Free Option on Request

SYSTEM 10 ★★★★★	
KRELL KPS28c CD Plyr	£8998.00
AUDIO RES. LS25/V5110	£9798.00
WILSON Sophia Spkrs	£11,992.00
Normal System Price	£30,788.00
DEPOSIT	£6200.00
Deferred 12 months	£24,588.00

Interest Free Option on Request



KJ WEST ONE
26 NEW CAVENDISH STREET
LONDON W1G 8TY
Tel: 020 7486 8262/3

PETERBOROUGH
(01733) 341755

Full System Reviews featured at
www.kjwestone.com

iRIVER H320 £270**SYSTEM REQUIREMENTS:**

Windows 98SE/ME/2000/XP, Mac
USB 1.1 (Host) / 2.0 (Device)

DIMENSIONS:

62x103x22mm
183g

With the anonymously titled H320, iRiver has taken an approach that is both similar and wildly different to Creative's. The form factor is almost identical to a 3G 40GB iPod, but it is an anti-iPod in that it is both colour-screened and dark of hue! The unit I tried out had a brown mock carbon fibre finish and felt solidly well made, but the overall look somehow feels dated. The H320 ships with an exhaustive supply of accessories (including remote control, case and backup battery pack), making it extremely good value. The 20GB player (for those with more demanding capacity requirements there is a 40GB variant, the H340 too) also bears such a panoply of features that it is difficult to know where to start...

Most welcome from this Mac-head's point of view is that (although the box and documentation do not allude to it), as the website points out there is some degree of Mac compatibility here. Even better the support for the H320 as a Mac drive is completely driverless on OSX Panther (10.3), and similarly on a PC the device installs using the generic USB Mass Storage driver in Windows XP which effectively means you can use it as a data shifter on just about any modern computer. For this functionality alone the general capabilities of the H320 must be rated very highly. It means that you do not have to use

the supplied music management software – you can simply drag and drop iTunes created group/album folder structures to the device (if you're using MP3 rather than AAC). The only issue is that unless you tidy up afterwards, Mac created files can have invisible shadow files show up in the H320's very File Manager-like browser system. Navigating the file tree is like working with a proper computer, so this is probably not one for the tech-averse.

It is a good job that the H320 comes with a comprehensive manual, as with relatively few control buttons available (there is no real scrolling capability here), they have to be pressed into all manner of secondary uses in the ancillary applications. The downside of all this multi-functionality is that it makes operation unintuitive – at least until you have studied each application and had a go at using it. It still freaks me out pressing a "Record" button for things other than Record and here it is used for switching between applications! Yes, you did hear me say record!... Many portable users are always pining for this facility, and here they have it in spades. Not only MP3 recorded from line in, but also voice recording using either an internal or a supplied external mic, and also recording of FM radio. I found the radio reception to be quite disappointing, but at least it's there if you get bored of music and want to listen to the *Today* programme. On top of this you can also load and display text files, iPod

style, but that colour screen also allows photo display of JPEGs and BMPs.

Anyway, enough of all this geekery – how does it sound? Codec-wise the biggie here is Vorbis Ogg playback. I encoded 'Boulder to Birmingham' using the freeware OSX Ogg Drop Encoder default quality setting of 5 (giving 160kbps), and the results were stunningly musical, and almost as good as 192kbps AAC on the iPod. Although Ogg playback can be added to iTunes with third party plug-ins it would be great to see Apple integrate it properly. On the 320kbps MP3 front Blue Man Group's 'Time To Start' couldn't really match the Apple lossless version, but it was a good attempt.

While all of the extra features justifiably account for a higher average price for this machine compared to the three others, if certain price-finding engines are to be believed this unit can also be obtained for around that £220 mark if you shop carefully. If you have a yen to get hold of these facilities before the next iPod takes over the world of photos as well as music on the move, you can have them now at a very competitive price. Moreover the sonic capabilities of this insanely gifted little machine are more than adequate...

VERDICT ●●●●£

The iRiver lives up to its website billing as a real 'tech geek' device. What it lacks in aesthetics it more than makes up for with its bells and whistles!

CMS PERIPHERALS LTD

+44 (0)208 960 6000

www.iriver.com

FOR

- excellent functionality
- colour screen
- USB2.0 charging

AGAINST

- styling
- navigation
- no Microsoft DRM

RIO KARMA £215**SYSTEM REQUIREMENTS:**

Windows 98 SE, ME, 2000, and XP; Linux and Mac OSX

DIMENSIONS:

686x762x279mm
156g

This has been around for a while now, but despite rumours of a 40GB version, 20GB is where it's at. It stands out from the field here due to its square and rugged looks, although the overall vibe is a bit plasticky. It's a good job it is rugged, because the review sample I obtained was wearing the visible scars of several reviewers before me, and it had (just about) survived. The 'just about' is a reference to the fact that the USB2.0 connection on this model gave up the ghost after a first, trial connection. Would that I had loaded the firmware upgrade I had downloaded in advance (which may have helped the problem)... All subsequent attempts to connect resulted in a not very helpful Microsoft 'USB Device Not Recognized' message. To check it wasn't my Heath Robinson PCMCIA USB2.0 set-up I tried it on the inbuilt USB1.1 and then on a separate virgin PC, but had the same issue each time. Now I had a big problem - I had an empty audio device to test and no way of getting any music on to it!

I had assumed that the Karma was a PC-only device as advertised, but a quick peek at a couple of Rio geek forums opened my eyes. I wouldn't normally tend to do this sort of thing but in this case I was desperate to find a solution to my conundrum. Before I come to that, it was interesting to note that postings were roughly 50/50 split between 'I Love my Karma' and 'My @*&!ng

Karma'.

Now it is clear, as the moderators say, people rarely post to say how smoothly things are going, and there is obviously something about Rio which inspires fervour. But on the downside my problem is a widely known one for which the only known antidote is to hit(!) your Karma. But to return to my problem - as is so often the case the answer lies with the Mac. I found a reference to the fact that the guy who is developing a Java version of Rio Music Manager Lite (RMML) is allowed to publicly beta test his work, and that as an open Java application it enables Mac and Linux users to populate their Karmas. But how?

As Rios tend to, the Karma ships with Sennheiser MX300s, which is a nice touch and better than the usual standard of in-the-box phones. As the Karma does not charge through USB2.0, a DC adapter is also included. But even more importantly it was the excellent little dock which allowed not only DC in, analogue audio out and USB2.0 connection, but added an Ethernet port. "Much good will that do me!", I thought. How wrong I was... Now I am a geek, we all know that, but I really didn't mean to have to get this geeky. I had understood that I needed to connect via Ethernet to

use
RMML.

Regrettably the CAT5 cable that comes with the Karma is no good for back-to-back connection, but being well-equipped I dug out my crossover cable and I was away. Compatible IP addresses set up on Mac and Karma, (through the very likeable Karma LCD interface), and all of a sudden I could stick MP3, OGG and FLAC on the Karma to my heart's content!

And how content I was! The sound attainable from FLAC encoded from CD is truly excellent - I gave Sakamoto and Sylvian's 'Heartbeat' a spin and it sounded absolutely uncompressed. Although perhaps unsurprising, it was a shame that the Karma wasn't able to play back FLAC files encoded from 24 bit, but you can't have everything... I feel obliged to be charitable to the Karma. Having read what I have read I maybe wouldn't buy one, but all the signs augur well for the future of Rio machines as examples which will appeal to the hardcore geek in all (well, some) of us. You wouldn't believe how hard I had to resist the urge to get it working on Linux!

The sound, particularly using FLAC, is sublime, and one would have to bet good money that a large capacity version of the recent (iPod mini competitor) the Rio Carbon, with Mass Storage and FLAC capabilities would be a serious contender. If you like a bit of geeky tinkering, this is the one!

VERDICT ●●●●

Flawed gem - superb sonics will delight audiophiles, but middling user interface and reliability open to question.

DIGITAL NETWORKS NORTH AMERICA

+44 (0)8700 991 794

www.digitalnetworksna.com/rioaudio/

FOR

- FLAC playback
- great bundled headphones
- Ethernet lifesaver!

AGAINST

- dubious reliability
- cheap looking
- no USB2.0 charging

conclusion

All four players are extremely capable – these manufacturers have been in the game long enough to have mastered the issues of making 1.8" disk-based portables, and are aware of all the codec and DRM (Digital Rights Management) issues. In a trend-fuelled market sector purchasing decisions have to be made for aesthetic as well as audio reasons, and for that reason as well as a lack of real inspiration the Creative Zen Touch has to come fourth. It sounds fine, but it looks and feels a little bulky. I know it addresses the PC marketplace, but as every other machine here has some degree of Mac compatibility it is a shame that the Zen has nothing to offer the Mac community. However as a PC-centric iPod clone it cannot really be faulted.

It may have caused me nightmares, but I have to forgive the great sounding Rio Karma. The ability to find it on the internet for less than £200 is a major reason why it pips the Creative for position. FLAC and Vorbis Ogg support are two other good reasons, and its different form factor and rugged feel may appeal to those wishing to be different. It demonstrates the forward thinking ideas of Rio too: I may have had to get further into it than I originally intended, but

the Ethernet capability of the Karma also sets it apart, and gains it plus points for allowing OSX and Linux compatibility (albeit unofficially) using the Rio Music Manager Lite Java software. But on the downside, even when it works it is a shame that the Karma's USB2.0 connection is not driverless – there is a considerable advantage to being able to plug in anywhere and 'data files' onto the device. This is only one of the reasons that the runner up in this little contest is...the iRiver H320.

If the rumours are true the H320 is a harbinger of what is to come with the colour screen 60GB iPod. Although it lacks what will inevitably be a seamless synchronisation with iPhoto, it makes up for it with areas of functionality which the mooted iPod is unlikely to

incorporate out of the box. Recordable FM radio will appeal to many, as will accessory-free voice recording and direct line-in to MP3 capture. On the non-audio side the ability to act as a USB hub is inspired. On top of all that, the sound is excellent, particularly with Vorbis Ogg

on board. But the whole experience is clunky and it doesn't inflame the passion in the way that the inevitable champion does – let's hear it for the iPod (again)!

Come on, you didn't really expect anything to dethrone the Apple did you? The one thing which people can find to decry – the easy, seamless tie-in to iTunes and the iTunes Music Store (which the cynical interpret as a lock-in) - is also the main thing which makes the iPod experience such a satisfying, rounded and complete one. But it is not just the feeling of perfectly executed systems or physical design which makes the iPod superior – it is also unimpeachable for audio quality. It has to be said that the level pricing with the competition is illusory – the other three all come with just

"the iPod is superior... for its unimpeachable for audio quality..."

about everything you could possibly need in marked contrast to the basic nature of the iPod package. But that notwithstanding if you had the chance to pick one out of the four I know which one 99% of you would go for on looks alone - it is the champion, by a knockout blow.

CODECS ON TEST

A couple of the players here permit the use of the fabled open lossy codec Vorbis Ogg. Can this one emerge from relative obscurity to prove its proponents claims that it is the best option? Despite FLAC and Ogg being unplayable on the iPod, (is there any point when we have AAC?), I have to confess that I used freeware Mac OSX tools to prepare my test files in these formats. Amusingly at maximum compression FLAC created lossless files which were within a whisker of being exactly the same size as their Apple Lossless equivalents – at just over half the size of the original 16/44.1 PCM file. If FLAC has one advantage over lossless AAC it is that it understands how to deflate and reinflate even 24bit PCM! At the present time spinning an Apple lossless file created from a 24bit source back to full resolution is not allowed (only 8 bit (!) and 16 bit options are available) – so it is impossible to check by file comparison whether it is doing its job properly.



Hi-fidelity

With Apple's iPod running away in the digital audio portable sales charts, Sony has seen fit to update its ageing MiniDisc format with Hi-MD. The MZ-NH700 is the result, and Michael Skeet takes it out and about.



Sony has just taken its MiniDisc system forward in several worthwhile areas. First, it now offers uncompressed PCM recording, and with the new 1GB disc you get over 90 minutes in 16/44. Second, the new models sport a mini USB connection allowing both-way communication to a PC, with a host of new possibilities. The obvious selling point, however, is the option to put thirty-plus CDs worth of music on the one disc, using considerable data compression. Never mind the quality, feel the width!

less recording time. Data compression regimes interest punters because of quantity, so apart from Hi-MD offering uncompressed PCM, there are also three versions of ATRAC3 and three versions of ATRAC3 Plus.

To give a picture of the range of recording times available on the 1GB Hi-MD Disc, 1 hour and 34 minutes in PCM mode @ 1.4Mbps. In Hi-SP mode ATRAC3plus @ 256kbps you get 7hrs and 55mins, and if you want to work at 64kbps in Hi-LP mode ATRAC3plus gives you 34 hours! With an 'old' 80 minute standard disc

The new 1GB MD is the same physical size as the 60, 74 and 80 minute discs we're used to.

There is an interesting backwards compatibility aspect though. The new Hi-MDs will play the earlier MDs recorded elsewhere and you are able to record on them as well – with the appropriate

you get 28mins, 2hrs 20mins and 10hrs 10mins respectively. With downloads from a computer, it possible to work at 48kbps and get 45 hours of some sort of audio to listen to... Note that the 'best' ATRAC3plus with its 256kbps is still actually higher than Digital Radio lets you hear BBC Radio 3 at its usual 196kbps!

GETTING GOING

The MZ-NH700 comes with a 1GB disc, rechargeable Ni-MH battery, mains PSU, in-ear phones, wired remote control, optical lead for digital inputs, USB cable and SonicStage 2.0 Software for a PC. There are the usual Sony Walkman facilities of headphone/line-out on a stereo mini jack socket, stereo line-in on another mini jack socket, and a plug-in power unbalanced stereo mic input, also on a mini jack socket. Cleverly, the line-in socket also doubles up as a digital input for use with the optical cable supplied, but there's no S/PDIF digital output. This latter point was my first concern as it is a mains Sony machine that currently provides me with a digital output to the PC audio editor I use. Then I saw that that the machine's USB link was likely to be the answer – of which more later...

Initially my use was to go in via the line-in from one of my DIY ITZA mic amps, working with the recorder in uncompressed PCM recording mode. The routine then was to use the supplied software to connect to a PC and transfer the concert recording for editing and then out to a production DAT. You press three buttons to get into record pause mode and with the Menu facility chosen with the NAVI/MENU button you can use the Jog Dial and the Ent button to get from the default Auto Record level to Manual. Then turning the Jog Dial you can set the input sensitivity as needed. The ITZA mic

THE ATTRACTIONS OF MINIDISC?

The use of low cost removable media is one particular appeal. In the writer's case this has certainly been so, from when the MiniDisc first appeared on the market. I have found the system to be very reliable, with only two occasions where there has been any playback problem with a recording. I perhaps need to reveal that I am involved in location audio recording in many fields. Apart from usually having two DAT machines running there will also be a MiniDisc as a further back-up (and not the first time that it has been used in the editing!), however mainly as an instant playback source and also to let the artist or producer take away the session takes for assessment. Additionally I have to admit that some concerts will be recorded only on two MiniDisc machines and that is where another attraction of the MD scene comes in handy – the editing facility for quickly and cheaply tidying up the recording. By using the **DIVIDE**, **MOVE**, **COMBINE** and **ERASE** facilities you have an extremely useful, on-board regime, with a qualification or two: First, it obviously cannot compete with decent audio editing software on a computer in terms of flexibility, the adjustable crossfades and the number of edits possible. But it's surprising what can be done without it being at all audible. The other proviso is that a standalone mains machine is the best to use for editing, as you can juggle the edit position to 'frame accuracy', audition it and then adjust the edit position. For this MiniDisc user it will need the arrival of a similarly provisioned Hi-MD mains machine, if I am to fully switch over to Hi-MD PCM recording on location.

amp has a minus 12dB tone output for setting a recorder's input gain and it was used to get a minus 12dB indication on the recorder's very small, but stereo, level bargraph. In my experience, having a stereo level bargraph is unusual on portable MDs and very welcome. There's a 0dBfs indication, and digital overs are temporarily shown.

The downside to Sony's

“the Hi-MD's concert recording was as good as that obtained on the DAT recorder!”

approach to Auto and Manual record levels settings is that, when you stop recording, it defaults to Auto, requiring a reset. Easy at a concert recording, as you would probably only stop once at the interval, but at a session with hundreds of takes, it would not be practical! The other hassle is the need to reset to Manual Track numbering each time you stop, unless you want dozens of IDs to appear each time the record level threshold change tells it to write a new track number! Apart from these moans, the Hi-MD's backup concert recording was as good as that obtained on the DAT recorders!

COMPUTER WORLD

The supplied Sony SonicStage software was loaded into a PC

equipped with a Live! Drive II digital card. Via the PC's USB port we transferred some of the tracks of the Hi-MD's PCM concert recordings. The transfer speed versus real time is stated as being x100. My main objective was to be able get the PCM data into my Fast Edit program,

in the absence of a direct digital output from the Walkman recorder itself. Then the aim was to compare the Hi-MD with the DAT recording made from the same concert's signal feed.

The fairest way of making such comparisons is to listen via the same DAC's output. Having an Audio & Design DMM-1 Digital Mastering Mixer, this was easy to route and control. I have to say that you do not detect any difference between two recordings – the waveforms looked identical once the small level differences, from the original analogue gains, were corrected. In a separate pair of recordings, the least data compressed facility, ATRAC3plus @ 256kbps was compared with a simultaneous

PHONE-Y WARS

Sony supplies a middling set of in-ear headphones, which we'd automatically recommend replacing with Sennheiser MX-550s. The disappointment was that, related to the playback output level of the unit, Sony's in-ear phones are just not sensitive enough, and even when trying on my reference Sennheiser HD650 headphones the judgement was the same.

MIC TALK

A quick word on the usual Plug-in unbalanced stereo mic input. These do work very well with the appropriate electret, or pre-polarised microphone. The mic lead needs to be short as it is an unbalanced connection. Being small diaphragm and low cost, these electret mics will always have a poorer noise floor than a more costly pro-mic will have, via a proper balanced input mic amp. On top of that you will usually find the low frequency performance curtailed and often some degree of audible colorations! However it won't be the first time that I have recorded, Binaurally, a concert or a memorial service with a pair of electret mics in my ears via the Plug-In power socket of a MiniDisc recorder on my lap, just to get a discrete presence!

recording made on a Tascam DA-PI DAT recorder. Again through a common D to A, differences did not show obviously. I remember the early versions of ATRAC did have problems with long continuous complex mixtures of harmonics, then it became obvious that later versions of the system were much better behaved. It's interesting that the machine's User Manual refers to a 'worst case' scenario where the use of the greatest amount

of data compression can react with certain sounds! They refer to the problem as producing 'noise' and suggest the use of less compression...

FINAL TAKE

Good to see uncompressed PCM back in favour! It was Sony who originally introduced this audio recording method on Beta and U-Matic video tape – the PCM-FI and derivatives were used by many of us in the early 1980s, before the introduction of CDs. The miniaturisation is now amazing – you could shove more than a couple of these new Walkman Hi-MDs into the slot where we used to put the Beta tapes! The range of facilities available is awesome and the consequent complexity, of using the many resulting user procedures, is often confusing. The User Guide is, however, genuinely helpful. Recording quality is easily what one would expect from uncompressed 16bit, 44.1kHz PCM. The USB computer relationship is much wider than this review could cover – there is even a 'My Library' storage mode! Nevertheless, there needs to be a standalone mains machine version, with the usual S/PDIF digital out facility, if some of us audio recordists are to take forward the PCM facility in our usual preferred way.

VERDICT £

This great portable makes MiniDisc a superb recording tool, but its complexity and lack of universality won't suit all.

SONY MZ-NH700 £260
SONY UK
☎ +44 (0) 1932 816786
www.sony.co.uk

great giveaway

WIN FOCAL'S SUPERB CHORUS 726S LOUDSPEAKERS WORTH £800 IN THIS MONTH'S GREAT GIVEAWAY!

Hi-Fi World gives you the chance to win these great loudspeakers in this month's super competition! A couple of months back, Noel Keywood was deeply impressed with their combination of style and sonics:

"Standing 1000mm high, it houses two 165mm Polyglass bass units, a 165mm Polyglass midrange with parasitic dust cap, and atop the array an inverted dome tweeter of Beryllium/ aluminium alloy. The two bass units work in parallel and are loaded by a reflex cabinet with front port. With a neat industrial grey finish, chrome hex fixing bolts and classic cabinet proportions that manage to combine size with a degree of elegance, the 726S looks well balanced. Following convention, the 726S uses twin bass units to gain cone area for good electrical and acoustic power handling. Twin bass drivers reduce the likelihood of burn out and keep bass distortion (doubling) within check at high volumes. Better still a big speaker like this is sensitive; we measured 91dB from one watt of input and Focal claim 91.5dB - nearly identical. It's a lot of sound from just one watt. Good efficiency from Focal's own in-house manufactured drivers doubtless contributes toward this.

That they are both accurate and composed under pressure was evident from their handling of Christina Aguilera's 'Can't Hold Us Down'. It was an assault by fast dynamics, from the stabbing bass line through to Aguilera's challenging vocals. Everything was there, in perfect balance, unleashed without

constraint from the Naim amplifier. In many senses this was the best I've heard the track. The 726S exchange bass depth for control; that they cut off at 40Hz is aurally obvious.

Otherwise, they play a bass tune like few others... the tweeter has a little bit more edge than that of the Micro Utopia and is quite prominent subjectively. But that's the way Focals are. They are also very revealing and there was much of the Micro Utopia's forensic analysis to be heard in the 726S... I could not help but be impressed by the tidiness, accuracy, composure and high degree of revelation from this speaker... The 726S gives a good flavour of what the Micro Utopia achieves in terms of clarity, dynamism and trueness of tone. It has a slightly darker sound across the midrange, and is a bit more damped... (It's an) extremely capable mid-price floorstander with a commandingly musical performance."

If you'd like to win these superb loudspeakers, then all you have to do is answer the four easy questions. Send your entries before 30/11/04 to: December Competition, *Hi-Fi World* magazine, Unit G4, Argo House, The Park Business Centre, Kilburn Park Road, London NW6 5LF.



Hi-Fi World competition rules and conditions of entry

1. Only one entry per household.
2. Multiple entries will be automatically disqualified.
3. Purchase of the magazine is not a pre-condition of entry.
4. No correspondence will be entered into.
5. The Editor's decision is final.
6. No employees of Audio Publishing Limited, or of any companies associated with the production or distribution of the prizes may enter.

questions

[1] How high does the Chorus 726S stand?

- [a] 1000m
- [b] 1000cm
- [c] 1000mm
- [d] 1000kg

[2] What cone material is used in the bass units?

- [a] Polyglass
- [b] Plexiglass
- [c] Polystyrene
- [d] Perspex

[3] In the Periodic Table, how is Beryllium referred to?

- [a] Be
- [b] Na
- [c] H
- [d] Li

[4] What frequency does the 726S cut off at?

- [a] 4Hz
- [b] 40Hz
- [c] 4kHz
- [d] 40kHz

December Competition
Hi-Fi World Magazine
Unit G4, Argo House
The Park Business Centre
Kilburn Park Rd.
London NW6 5LF

Sevenoaks SOUND & VISION



Sevenoaks Sound & Vision stocks a wide range of Hi-Fi separates, DVD players, amplifiers, speakers, plasma screens, LCD televisions and projection systems from all the leading manufacturers.

From starter systems to custom designed multi-room and home cinema installations, our friendly staff are available in all stores to advise, demonstrate and guide you through the home entertainment jungle. If you're interested in home entertainment and want to avoid the confusion, contact your local Sevenoaks Sound & Vision store and **experience more.**

0% interest free option* is available on most products.

*Written details on request. Licensed credit brokers. Minimum balance £400. Subject to status.



CUSTOM INSTALLATION

Modern home entertainment doesn't have to be intrusive.

A carefully considered installation of home cinema with distributed audio and video and easy lighting control can give you all the sound and vision performance you could ever dream of - enhancing your lifestyle and your home.

Our custom install services range from the most simple, affordable solutions to the most grandiose. We can help transform every room and every home, whatever your needs and budget.

Want to know more?

Why not pay us a visit and pick up a copy of our **FREE Custom**

Installation Guide, available now, from your local store.

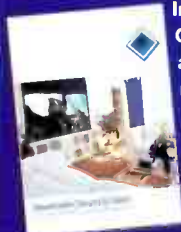

Enjoy the freedom to listen to the music of your choice or watch TV independently from other rooms in the home



Our installation experts are fully trained to the highest standards and will continue to support you and your equipment long after your first visit to one of our nationwide stores



Flush-mounted in-wall speakers can give you all the sound you can handle, but won't eat into your floor space or clash with your decor



NEWSNEWSNEWS



DENON DVD-3910 UNIVERSAL DVD PLAYER

Replacing 2003's all conquering DVD-2900, the new Denon DVD-3910 moves Denon further ahead with a massive performance and feature upgrade.

Using leading edge audio and video technology and heavyweight construction, this Universal player promises to deliver the highest quality picture and sound quality from your entire disc collection.

Handling both DVD-Audio and SACD, the '3910 will also play MP3, WMA, JPEG and Photo CD plus all varieties of DVD/CD -R and +R. It includes every digital and analogue audio/video output: HDMI, DVI, FireWire, Component, Composite and S-Video.

NEW EALING STORE

The long-awaited store in Ealing is now open.

Part of a newly developed parade in the heart of town close to Ealing Broadway tube and on the fringe of the Ealing Broadway Shopping Centre, the store offers an unrivalled experience to shoppers searching for the best in audio and video equipment.



24 THE GREEN
EALING
0208 579 8777

OPEN
MONDAY-SATURDAY 10:00-6:00
SUNDAY 12:00-4:00



ABERDEEN (NEW)

BEDFORD
BIRMINGHAM
BRIGHTON
BRISTOL
BROMLEY
CAMBRIDGE
CARDIFF
CHELSEA
CHELTENHAM
CRAWLEY
CROYDON

EALING (NEW)
EDINBURGH

EPSOM
EXETER
GLASGOW
GUILDFORD
HOLBORN
HULL
IPSWICH
KINGSTON
LEICESTER
LEEDS
LINCOLN

MAIDSTONE
MANCHESTER
NEWCASTLE
NORWICH
NOTTINGHAM
OXFORD

PETERBOROUGH
PLYMOUTH
POOLE
PRESTON
READING
SEVENOAKS
SHEFFIELD
SOLIHULL

SOUTHAMPTON
SOUTHGATE
STAINES

SWINDON (OPENING SOON)

SWISS COTTAGE
TUNBRIDGE WELLS
WATFORD
WEYBRIDGE
WITHAM (ESSEX)
WOLVERHAMPTON

PLEASE SEE PAGE 7
FOR ADDRESS AND TELEPHONE
NUMBER DETAILS

Sevenoaks SOUND & VISION

"A perfect combination of early Arcam refinement and subtlety, combined with new-found vitality and freshness." *DIVA CD192*

**Arcam DiVA
CD192 CD Player £849.95
A90 Amplifier £849.95**

WHAT HI-FI FIT
AWARDS 2004
BEST CD PLAYER
ARCAM CD192

**HI-FI
SEPARATES**



**Roksan Caspian M Series-1
CD Player £1099.95
Amplifier £999.95**

"A real class-contender, the new M Series-1 is a canny piece of kit and well worth the money." *M SERIES-1 CD PLAYER*

"A fine piece of equipment."
M SERIES-1 AMPLIFIER

WHAT HI-FI FIT
AWARDS 2004
BEST CD PLAYER
ROKSAN CASPIAN M SERIES-1



FREE **FREE GRADO SR60 HEADPHONES WORTH £90**
WHEN YOU PURCHASE AN AMP AND CD TOGETHER FROM ONE OF THE FOLLOWING MANUFACTURERS - ARCAM, CYRUS & ROKSAN*
NOT IN CONJUNCTION WITH ANY OTHER OFFER OR PROMOTION

WHAT HI-FI FIT
AWARDS 2004
BEST AMPLIFIER
CYRUS 8VS



WHAT HI-FI FIT
AWARDS 2004
PRODUCT OF THE YEAR
CD PLAYER
CYRUS CD8

**Cyrus
8vs Amplifier £799.95
CD8 X CD Player £999.95**

Cyrus has been developing high performance hi-fi systems for over 20 years. Today their upgradeable, modular product range includes multi-room systems, home cinema and some of the world's finest hi-fi systems. The new 'VS' preamp circuitry, incorporated in the 6vs and 8vs amplifiers, has dramatically improved their performance while the CD8 X is a heavily revised version of the CD8.

"Here's a machine that advances the ability of its excellent predecessor by an almost absurd degree. The Cyrus 8vs is an absolute superstar"

WHAT HI-FI FIT
AWARDS 2004
BEST CD PLAYER
CYRUS CD8

"The added 'x' factor brings a level of CD playback previously unheard at this price" *CD8 X*

WHAT HI-FI FIT
AWARDS 2004
BEST CD PLAYER
CYRUS CD8

Cyrus 6vs Amplifier £599.95

"A significant upgrade to what was already an impressive amp - Cyrus' new entry-level integrated is a peach"

WHAT HI-FI FIT
AWARDS 2004
BEST CD PLAYER
CYRUS 6VS



WHAT HI-FI FIT
AWARDS 2004
BEST TURNTABLE UNDER £250
PROJECT DEBUT III



**Project
Debut III Turntable
(Black) £129.95
(Colours) £144.95**

"Building on the Award-winning design of its predecessors, the new Project Debut III delivers a thrillingly good sound for the money... Products like this should really reinvigorate your interest in hi-fi."

**Marantz
CD5400 CD Player
£119.95**

WHAT HI-FI FIT
AWARDS 2004
BEST CD PLAYER
MARANTZ CD5400



"This is a remarkable player for the money, with superb sound, looks and feel, which give you no clue as to the budget price... A very solid buy - and a lot of fun."

**Sony
ST-SDB900
Digital/Analogue Tuner
£ CALL**

WHAT HI-FI FIT
AWARDS 2004
PRODUCT OF THE YEAR
TUNERS
SONY ST-SDB900



"The Sony ST-SDB900 is a great tuner for the money, and is definitely capable of giving our current Award-winner, the excellent DRX-702ES, a run for its money."

Product of the Year 2003

**Pure Digital
DRX702ES
Digital/Analogue Tuner
£279.95**



WHAT HI-FI FIT
BEST BUY 2003



**Michell Gyro SE
Turntable / RB300 Tonearm
£1049.95**

"The Gyrodec SE sounds great, combining the best sonic characteristics of rivals... Quite simply, the Michell Gyrodec SE is terrific. Nothing compares at this price point - it's well deserving another Best Buy."

CLAIM £50 TOWARDS THE GOLDRING CARTRIDGE OF YOUR CHOICE*

**Pure Digital DRX702ES
Digital/Analogue Tuner
£279.95**

"So do you buy a digital tuner? Or an analogue one? Now you don't have to pick: just buy Pure Digital's DRX-702ES! Whether on FM or DAB, this tuner sounds superb... The overall balance is powerful, clean and crisp, making this a fine tuner by any standards, and a superb buy given its excellent flexibility."

experience more

experience more

experience more



FREE QED CABLE WORTH £60*

KEF Q4 Speakers £399.95

The Q4 is one of the latest additions to KEF's acclaimed Q Series. At the heart of this floorstander lies the Uni-Q driver array - a 130mm die-cast chassis housing a long throw cone and coincident mounted 19mm aluminium dome HF unit. This driver arrangement makes

the speaker much easier to place in the room and alleviates the 'sweet spot' found on 'ordinary' speakers. This has been combined with a dedicated 130mm LF unit for extended bass output which belies the size of its diminutive cabinet.

FREE QED

SPEAKER CABLE WORTH

WITH ALL HI-FI SPEAKER PAIRS OVER £299*

£60 WITH SPEAKERS OVER £299
£80 WITH SPEAKERS OVER £499
£120 WITH SPEAKERS OVER £999

FREE QED CABLE WORTH £60*

Quad 11L Speakers £379.95

"The wonderful Quad 11Ls continue to defy all known laws of value: they have a real wood-veneer finish with piano-gloss lacquer - unheard of at the price. Yet nothing sonically has been sacrificed... The Quads are amazing value for money - no rival speakers come close."

Quads are amazing value for money - no rival speakers come close."



WHAT HI-FI? 2004 AWARDS 2004
BEST STEREO SPEAKERS £250-£500 Quad 11L

Roksan Kandy KD1/III CD Player £649.95 KA1/III Amplifier £649.95

"Timing and rhythm are excellent. DJ Shadow is delivered with clarity and a tight bass, while at the other extreme the treble is sweet and detailed, getting the most from Wagner's *Ride of the Valkyries*. The result is a breathtaking Best Buy amplifier that betters its competition with ease." **KANDY KA1/III AMPLIFIER - AWARDS 2003**



WHAT HI-FI? 2004 AWARDS 2004
BEST STEREO AMPLIFIER £300-£500 Roksan Kandy KA1/III

"The Kandy KD1/III CD player offers a great array of talents - team it with its amp stablemate and you have something close to the ideal visual and sonic combination."

WHAT HI-FI? Dec 03
★★★★★



Musical Fidelity X-80 Amplifier £399.95 X-150 Amplifier £799.95 X-Ray^{CD} CD Player £899.95

The 40 wpc, **X-80** and the 80wpc **X-150** amplifiers are part of Musical Fidelity's revamped X-Series. Both models feature a dual-gang analogue volume control and high-output transistors for each channel. The X-150 also includes a high quality phono stage.

The **X-Ray^{CD}** CD player, replacement for the legendary X-Ray, uses the same DAC and upsampling principles as the acclaimed Tri-Vista SACD player.



Wharfedale Diamond 9.1 Speakers £179.95

"The overall balance of the speakers is their finest characteristic. Thanks to near-perfect driver integration, music sounds wonderfully natural and transparent... This is a bar-raising effort from Wharfedale - these are ridiculously good speakers at the budget price level."



WHAT HI-FI? 2004 AWARDS 2004
PRODUCT OF THE YEAR STEREO SPEAKERS WHARFEDALE DIAMOND 9.1

FREE

GRADO SR60 HEADPHONES WORTH £90 WHEN YOU PURCHASE AN AMP AND CD TOGETHER FROM ONE OF THE FOLLOWING MANUFACTURERS - ARCAM, CYRUS & ROKSAN* NOT IN CONJUNCTION WITH ANY OTHER OFFER OR PROMOTION

PRICING POLICY

We always try to ensure our prices are highly competitive. In the event you can find the same products and excellent service at a lower price, please bring it to our store managers' attention.

0%

FINANCE OPTION*

Spread the cost of buying. 0% finance option is available on the vast majority of products we stock.

*Written details on request. Licensed credit brokers. Minimum balance £400. Subject to status.

PLEASE NOTE: SOME PRODUCTS MAY NOT BE AVAILABLE AT ALL STORES. PLEASE CALL BEFORE TRAVELLING.

***ADDED VALUE OFFERS - FROM RANGE AVAILABLE IN-STORE. NOT IN CONJUNCTION WITH ANY OTHER OFFER. ADVERTISEMENT VALID UNTIL AT LEAST 17/11/04, E&OE.**



Rotel 10 Series RA-1062 Amplifier £594.95 RCD-1072 CD Player £594.95

"At the heart of the 60-watt RA-1062 is a toroidal transformer and a power supply, which Rotel claims, helps the amp maintain performance even at high volumes... Crank up the volume and, as promised, the Rotel keeps its composure and balance... If you want a £600 integrated, be sure to audition the RA-1062.

First impressions of the RCD-1072 are excellent. This is the slickest machine in this group: the casework feels solid and the finish exceptional at the price... On its own terms it remains an enjoyable and informative CD player."

WHAT HI-FI? SOUND AND VISION • SEPTEMBER 2003



Mission m34i Speakers £329.95

"The original m34s impressed us with their easy-going bass, but had an undynamic and uninvolved balance. Not the m34is: they're refined and enjoyable... You'll be hard pressed to find a better balance of talents anywhere else for this amount of money."

FREE QED CABLE
WORTH £60

WHAT HI-FI? SOUND AND VISION Oct 04
★★★★★



Acoustic Energy Aelite Three Speakers £749.95

"Acoustic Energy's new Aelite Threes weigh in at a hefty 18kg a piece, and their curved, real wood finished cabinets both look handsome and make good acoustic sense... So how do they perform... Give them a big room and position them in free space and they'll deliver great things... If you want a big sound for sensible money, don't hesitate to audition the Aelite Threes."

FREE QED CABLE
WORTH £80

WHAT HI-FI? SOUND AND VISION Sept 04
★★★★★

Yamaha CDR-HD1300/II CD Recorder £ CALL



No more wasted CD-Rs: in a stroke of genius Yamaha had the idea of combining a CD recorder with a hard drive, enabling you to edit your music before you burn. The CDR-HD1300/II is the upgraded version of the Award-winning 'HD1300 offering even greater disc capacity."

WHAT HI-FI? SOUND AND VISION AWARDS 2004
BEST CD/HDD RECORDER
Yamaha CDR-HD1300/II

Mission m31i Speakers £139.95

"Overall, the little m31i speakers are great, and the team at Mission should consider this upgrade job well done. The 'i' in the model name stands for 'improved' and these speakers fully deserve the suffix."



WHAT HI-FI? SOUND AND VISION Nov 04
★★★★★



Roksan Caspian M-Series Preamp/2 x Monoblocks £3449.95

"This Roksan is an excellent buy that puts most of the opposition to shame when it comes to sonic ability... If you want the most honest-sounding amp you can get for your money, this combo can't be ignored."

WHAT HI-FI? SOUND AND VISION AWARDS 2004
BEST STEREO AMPLIFIER OVER £2000
Roksan Caspian M-Series



FREE QED CABLE
WORTH £120

Acoustic Energy AE1 MKIII Speakers FROM £1699.95

"The legendary AE1 lives on in this groundbreaking third version... The Mk IIIs are worthy of the AE1 name, taking small-speaker performance to another level.."

WHAT HI-FI? SOUND AND VISION AWARDS 2004
BEST STEREO SPEAKERS OVER £2000
Acoustic Energy AE1 MkIII

B&W 704 Speakers £1399.95

The 704 speakers are part of B&W's new 700 series. These floorstanding, two-and-a-half-way, vented box speakers are available in a variety of attractive finishes. In a recent What Hi-Fi? Sound and Vision group test the 704 offered "Remarkable openness and clarity that is unrivalled at this price."

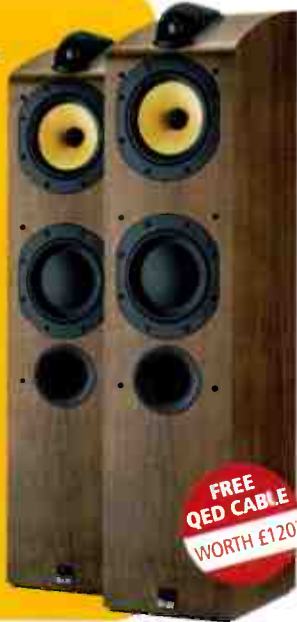

FREE QED CABLE
WORTH £120

WHAT HI-FI? SOUND AND VISION Mar 04
★★★★★



COMPACT SYSTEM Denon DM31 UD-M31 CD Receiver £189.95

When purchased with speakers over £99*
When purchased on its own £199.95

"The D-M30 was exemplary, as its three What Hi-Fi? Sound and Vision Awards clearly show. The D-M31 is even better, making it phenomenal value for money."

NB - DENON DM31 PRICE EXCLUDE SPEAKERS

WHAT HI-FI? SOUND AND VISION AWARDS 2004
BEST HIGH RESO SYSTEM OVER £100
Denon D-M31

PLEASE NOTE: SOME PRODUCTS MAY NOT BE AVAILABLE AT ALL STORES. PLEASE CALL BEFORE TRAVELLING.

*ADDED VALUE OFFERS - FROM RANGE AVAILABLE IN-STORE. NOT IN CONJUNCTION WITH ANY OTHER OFFER. ADVERTISEMENT VALID UNTIL AT LEAST 17/11/04, E&OE.

experience more

experience more
experience more



WIRELESS NETWORKING

MUSIC ALL AROUND THE HOME



You've heard of hi-fi – now welcome to the world of wi-fi! Wi-fi devices allow you to network a range of devices together – from your music system to your PC – without the wires. For example, a multiroom server like Yamaha's MusicCAST can wirelessly send music to up to five 'client' playback systems dotted around your home. That music could be stored on the MusicCAST server device or other sources – existing hi-fi kit, maybe, or an internet radio station or MP3 files from your PC: plug-in adapters make it easy to wi-fi-enable products.



YAMAHA'S MusicCAST MCX-1000 DIGITAL SERVER & MCX-A10 CLIENT

MusicCAST MCX-A10 CLIENT & MCX-SP10 SPEAKERS



- YAMAHA MusicCAST**
- MCX A10£599.95 (MusicCAST Client)
 - MCX 1000£1799.95 (MusicCAST Server)
 - MCX-SP10£99.95 (MusicCAST Speakers)
- CYRUSLINK**
- Linkserver 160£2999.95 (Four Zone HD Server 160Gb Drive)
 - Linkserver 250£3499.95 (Four Zone HD Server 250Gb Drive)
 - Linkport£649.95
 - Linkwand£199.95



AVAILABLE AT SELECTED SEVENOAKS SOUND & VISION STORES

SUGGESTED HI-FI SEPARATE SYSTEMS

Sevenoaks has carefully chosen three hi-fi separate systems. All components have been selected for their performance, reliability and compatibility.

These systems represent superb value for money with massive savings on the individual component prices.

Simply add speaker and interconnect cables and other accessories from our extensive range available in-store.



Rotel

RCD-02 CD Player
RA-02 Amplifier

Monitor Audio

Bronze B2 Speakers

£799.95 SAVE £129

PRICE EXCLUDES CABLES & STANDS

HI-FI SYSTEM 1 NOT IN CONJUNCTION WITH ANY OTHER OFFER OR PROMOTION

1
Hi-Fi SYSTEM



Arcam

CD73T CD Player
A65 Plus Amplifier

KEF

Q4 Speakers

£999.95 SAVE £149

PRICE EXCLUDES CABLES & STANDS

HI-FI SYSTEM 2 NOT IN CONJUNCTION WITH ANY OTHER OFFER OR PROMOTION

2
Hi-Fi SYSTEM



Roksan

Kandy KD1/III CD Player
Kandy KA1/III Amplifier

Monitor Audio

Silver S6 Speakers

£1889.95 FREE SOUNDSTYLE RACK WORTH £300

PRICE EXCLUDES CABLES

HI-FI SYSTEM 3 NOT IN CONJUNCTION WITH ANY OTHER OFFER OR PROMOTION

3
Hi-Fi SYSTEM

Sevenoaks SOUND & VISION



PRODUCT RANGE

An outstanding selection of products are on display and available for demonstration at all Sevenoaks Sound & Vision stores.

Reserve your products, visit your local store or call 01474 831000. Please note that products are available on a first-come, first-served basis.

TURNTABLES

Goldring GR1	£139.95
Michell Gyro SE/RB300 E50 GOLDRING CARTRIDGE*	£1049.95
Michell TechnoDec (Ex Arm)	£574.95
Project Debut Phono SB	£169.95
Project Debut III (Black)	£129.95
Project Debut III (Colours)	£144.95
Project 1 Xpression	£209.95

TUNERS

Arcam DVA T61	£229.95
Cyrus FM X	£499.95
Denon TU76DL MKII	£99.95
Harman Kardon TU970 DAB/AM/FM	£299.95
Marantz ST4000	£99.95
Pure DRX 701ES DAB	£199.95
Pure DRX 702ES Analogue/DAB	£279.95
Roksan Kandy KT1 MKII	£549.95
Sony ST-SDB900	£ CALL

CD PLAYERS

Arcam DVA CD73T	£399.95
Arcam DVA CD192	£849.95
Arcam FMJ CD33T	£1349.95
Cyrus CD6	£599.95
Cyrus CD8 X	£999.95
Cyrus DAC X	£1099.95
Denon DC3485	£119.95
Linn Genki	£1099.95
Linn Ikemi	£2199.95
Marantz CD5400	£119.95
Musical Fidelity X-Ray	£899.95
Musical Fidelity A3.2	£999.95
Musical Fidelity A308*	£1999.95
Quad 69 CD P	£999.95
Roksan Kandy KD1 MKII	£649.95
Roksan Caspian M	£1099.95
Rotel RCDD02	£379.95
Rotel RCD1072	£594.95

CD RECORDERS

Pioneer PDR609 CD-RW	£169.95
Sony RCD-W100	£ CALL
Yamaha CDR-HD1300/II	£ CALL

AMPLIFIERS

Arcam DVA A65 Plus	£389.95
Arcam DVA A80	£599.95
Arcam DVA A90	£849.95
Arcam FMJ A32	£1199.95
Cyrus 6vs	£599.95
Cyrus 8vs	£799.95
Cyrus Pre X vs Pre	£1099.95
Cyrus Mono X Power (Each)	£1199.95
Denon PMA335	£179.95
Linn Kolektor Pre	£574.95
Linn LK85 Power	£544.95
Marantz PM4400	£149.95
Marantz PM7200	£249.95
Musical Fidelity X 80	£399.95
Musical Fidelity X 150	£799.95

Musical Fidelity A3.2	£979.95
Musical Fidelity A3.2 Pre	£999.95
Musical Fidelity A3.2 Power	£999.95
Musical Fidelity A308	£1999.95
Quad 99 Power	£549.95
Roksan Kandy KA1 MKII	£649.95
Roksan Caspian M	£999.95
Roksan Caspian M Pre	£1249.95
Roksan Caspian M Monobloc Power (Each)	£1099.95
Rotel RA 01	£249.95
Rotel RA 02	£349.95
Rotel RA-1062	£594.95

SPEAKERS

Acoustic Energy Aegis Evo One	£139.95
Acoustic Energy Aegis Evo Three	£259.95
Acoustic Energy Aelite Two	£449.95
Acoustic Energy Aelite Three	£749.95
Acoustic Energy AE1 MKII (From)	£1699.95
AVI Neutron IV	£499.95
B&W DM601 S3	£249.95
B&W DM602 S3	£299.95
B&W 704	£1399.95
B&W 705	£899.95
KEF Q1	£249.95
KEF Q4	£399.95
KEF XQ1	£749.95
Linn Katan	£649.95
Mission m31i	£139.95
Mission m34i	£329.95
Mission 780SE	£349.95
Mission 782SE	£899.95
Monitor Audio Bronze B2	£199.95
Monitor Audio Silver S1	£299.95
Monitor Audio Silver S6	£599.95
Monitor Audio Silver S8	£799.95
Monitor Audio Gold Reference 10	£799.95
Monitor Audio Gold Reference 20	£1499.95
Quad 11L	£379.95
Quad 12L	£499.95
Quad 22L	£894.95
Ruark Epilogue II	£344.95
Ruark Talisman III	£1499.95
Ruark Sabre III	£899.95
Wharfedale Diamond 9.1	£179.95
Wharfedale Pacific Evolution 30	£649.95

HI-FI SYSTEMS

Denon 201 Ex Speakers	£499.95
Denon DF101 Ex Speakers	£299.95
Denon DM31 Ex Speakers	£199.95
Linn Classic Music Ex Speakers	£849.95
Teac Legacy 600 Ex Speakers	£199.95

DVD SYSTEMS

Denon ADV-M71 Inc SC-M51 Speakers	£499.95
Denon DVD-500SD Inc 5.1 Speaker Package	£ CALL
Denon DVD-770SD/AVR-770SD Ex Speakers	£ CALL
Jamo DVR50/A305PDD Inc Speakers	£649.95
Jamo DVR50/A355PDD Inc Speakers	£899.95
KEF KIT100 Inc Speakers	£1199.95
Linn Classic Move Di Ex Speakers	£2299.95
Teac Legacy 700A S-L800 Inc Speakers	£799.95

MULTI-ROOM AUDIO

Cyrus Linkserver 160	£2999.95
Cyrus Linkserver 250	£3499.95
Cyrus Linkport	£649.95
Cyrus Linkwand	£199.95
Yamaha MusicCast MCX A10	£599.95
Yamaha MusicCast MCX 1000	£1799.95

DVD PLAYERS

MAKE & MODEL	REGION 2	MULTI REGION
Arcam DVA DV78	£699.95	£699.95
Arcam DVA DV79	£999.95	£999.95
Arcam FMJ DV29	£1599.95	£1599.95
Cyrus DVD8	£1199.95	£1199.95
Denon DVD-1710	£ CALL	£ CALL
Denon DVD-2200 Universal	£ CALL	£ CALL
Denon DVD-2900 Universal	£ CALL	£ CALL
Denon DVD-2910 Universal	£ CALL	£ CALL
Denon DVD-3910 Universal	£ CALL	£ CALL
Denon DVD A11	£ CALL	£ CALL
Denon DVD A1	£1599.95	£1599.95
Harman Kardon DVD22	£299.95	£299.95
Harman Kardon DVD31	£399.95	£399.95
Meridian G98	£3349.95	£3349.95
Pioneer DV370	£ CALL	£ CALL
Pioneer DV575A Universal	£ CALL	£ CALL
Pioneer DV668AV Universal	£ CALL	£ CALL

Pioneer DV868AV Universal	£ CALL	£ CALL
Toshiba SD240E	£ CALL	£ CALL
Toshiba SD340E	£ CALL	£ CALL
Yamaha DVD-S540	£ CALL	£ CALL
Yamaha DVD-S550	£ CALL	£ CALL
Yamaha DVD-S1500	£ CALL	£ CALL

DVD RECORDERS

MAKE & MODEL	REGION 2	MULTI REGION
Panasonic DMR-E55 DVD-RAM	£ CALL	£ CALL
Panasonic DMR-E65 DVD-RAM	£ CALL	£ CALL
Panasonic DMR-E75 DVD-RAM	£ CALL	£ CALL
Panasonic DMR-E85 DVD-RAM	£ CALL	£ CALL
Panasonic DMR-E95 DVD-RAM	£ CALL	£ CALL
Pioneer DVR3100S DVD-R/RW	£ CALL	£ CALL
Pioneer DVR5100HS DVD-R/RW	£ CALL	£ CALL
Pioneer DVR-520H HDD/DVD-RW	£ CALL	£ CALL
Pioneer DVR-720H HDD/DVD-RW	£ CALL	£ CALL
Pioneer DVR-920H HDD/DVD-RW	£ CALL	£ CALL
Sony RDR-HX900 DVD-RW/+RW	£ CALL	£ CALL

A/V AMPLIFIERS

RECEIVERS & PROCESSORS

Arcam AVR200 AV Receiver	£799.95
Arcam AVR250 AV Receiver	£999.95
Arcam AVR300 AV Receiver	£1299.95
Arcam AV8/P7 AV Pre/Processor/Power	£5749.95
Cyrus AV8 AV Processor	£1099.95
Denon AVC-A1SRA AV Amplifier	£ CALL
Denon AVC-A1SR AV Amplifier	£ CALL
Denon AVR1705 AV Receiver	£ CALL
Denon AVR1905 AV Receiver	£ CALL
Denon AVR2105 AV Receiver	£ CALL
Denon AVR2805 AV Receiver	£ CALL
Denon AVR3805 AV Receiver	£ CALL
Harman Kardon AVR330 AV Receiver	£599.95
Harman Kardon AVR630 AV Receiver	£999.95
Harman Kardon DPR2005 AV Receiver	£1299.95
Onkyo TX-NR801E AV Receiver	£ CALL
Pioneer VSX-C501 AV Receiver	£ CALL
Pioneer VSX-C502 AV Receiver	£ CALL
Pioneer VSX-D812 AV Receiver	£ CALL
Pioneer VSX-AX3 AV Receiver	£ CALL
Pioneer VSX-2014 AV Receiver	£ CALL
Pioneer VSX-AX5 AV Receiver	£ CALL
Pioneer VSA-AX104 AV Amplifier	£ CALL
Rotel RSP1067 AV Receiver	£1799.95
Rotel RSP1066/RMB1075 AV Pre/Power	£1799.95
Rotel RSP1098 AV Processor	£2294.95
Sony STR-D8795 AV Receiver	£ CALL
Yamaha DSP-AX750SE AV Amplifier	£ CALL
Yamaha DSP-AX640SE AV Amplifier	£ CALL
Yamaha DSP-Z9 AV Amplifier	£ CALL
Yamaha RX-V550 AV Receiver	£ CALL
Yamaha RX-V650 AV Receiver	£ CALL
Yamaha RX-V1400RDS AV Receiver	£ CALL
Yamaha RX-V1500RDS AV Receiver	£ CALL
Yamaha RX-V2400RDS AV Receiver	£ CALL

A/V SPEAKERS & PACKAGES

Acoustic Energy Evo 3B	£699.95
Acoustic Energy Aego P5/II	£499.95
Acoustic Energy Aelite 5.1	£1894.95
Articooustic Diablo	£994.95
B&W VM1/AS1	£849.95
B&W DM300 AV	£899.95
Castle Compact CC3	£999.95
KEF KHT1005 £100 FREE QED CABLE*	£499.95
KEF KHT2005.2 £150 FREE QED CABLE*	£799.95
KEF KHT5005 £200 FREE QED CABLE*	£1199.95
KEF Q7 AV £300 FREE QED CABLE*	£2199.95
M&K K5 £250 FREE QED CABLE*	£1699.95
M&K K3	£1894.95
M&K Xmon 25	£2249.95
M&K 850/IC35A/V850	£3899.95
Mission M30 AV Pack	£449.95
Mission Elegante e82 7.1 Package	£3989.95
Monitor Audio Bronze B2 AV	£799.95
Monitor Audio Bronze B4 AV	£949.95
Monitor Audio Radius 270	£499.95
Monitor Audio Radius 5.1	£999.95
Mordaunt Short Gene	£799.95

SUBWOOFERS

B&W PV1	£949.95
MJ Acoustics Pro 50 (Black) £60 QED CABLE*	£299.95
MJ Acoustics Pro 100 (Black) £60 QED CABLE*	£599.95
MJ Acoustics Ref 100 (Bk) £60 QED CABLE*	£349.95
MJ Acoustics Ref 1 MkII (Black) £60 QED CABLE*	£699.95
Quad L Series	£699.95
REL O150E MKII (Brittix Black) £100 QED CABLE*	£499.95
REL O201E (Brittix Black) £100 QED CABLE*	£724.95

REL O400E (Brittix Black) £100 QED CABLE*	£999.95
REL Quake (Brittix Black)	£349.95
REL Stampede (Black) £100 QED CABLE*	£549.95
REL Strata 5 (Brittix Black) £100 QED CABLE*	£699.95
Wharfedale Aquant SW150	£249.95

PLASMA

Fujitsu P42H/A30 42"	£ CALL
Fujitsu P50X/A30 50"	£ CALL
Hitachi 32PD5200 32"	£ CALL
Hitachi 42PD5200 42"	£ CALL
Hitachi 55PMA550TE 55"	£ CALL
Panasonic TH42PW7B 42"	£ CALL
Panasonic TH37PE30B 37"	£ CALL
Panasonic TH42PE30B 42"	£ CALL
Pioneer PDP434HDE 43"	£ CALL
Pioneer PDP435XDE 43"	£ CALL
Pioneer PDP435FDE 43"	£ CALL
Pioneer PDP504HDE 50"	£ CALL
Pioneer PDP505XDE 50"	£ CALL
Pioneer PDP505HDE 50"	£ CALL
Sony KDE-P37KS1 37"	£ CALL
Toshiba 42WP36P 42"	£ CALL
Yamaha PDM4210 42"	£ CALL

LCD TV

Hitachi 28LD5200 28"	£ CALL
Panasonic TX22LX2 22"	£ CALL
Panasonic TX26LXD1 26"	£ CALL
Panasonic TX32LXD1 32"	£ CALL
Phillips 32PF9986 32"	£ CALL
Sharp Aquos LC-20S1E 20"	£ CALL
Sharp Aquos LC-20AD1E 20"	£ CALL
Sharp Aquos LC-22AD1E 22"	£ CALL
Sharp Aquos LC-26GA3 26"	£ CALL
Sharp Aquos LC-32GA3 32"	£ CALL
Sharp Aquos LC-32GD1 32"	£ CALL
Sharp Aquos LC-37GD1 37"	£ CALL
Sharp Aquos LC-37GA3 37"	£ CALL
Sony Selected Models Available	£ CALL

PROJECTORS

Marantz VP-12S3 DLP	£8499.95
NEC HT1000 DLP	£ CALL
Sanyo PLV-Z2 LCD	£1449.95
Screenplay SP4805 DLP	£1299.95
Screenplay SP5700 DLP	£2199.95
Screenplay SP7205 DLP	£4999.95
Sharp XV Z91E DLP	£ CALL
Sharp XV Z200 DLP	£ CALL
Sharp XV Z1200 DLP	£ CALL
Sim 2 Domino 20 DLP	£3499.95
Sim 2 Domino 20-H HDMI DLP	£3999.95
Sim 2 Domino 30-H HDMI DLP	£5999.95
Sim 2 HT300 Xtra HDMI DLP	£7999.95
Sim 2 HT500 Link DLP	£2499.95
ThemeScene H30 Cinema DLP	£1199.95
ThemeScene H56 Cinema DLP	£1999.95
ThemeScene H77 Cinema DLP	£3499.95
Yamaha DPX1100 DLP	£ CALL

REMOTE CONTROLS

Marantz RC5400	£399.95
Marantz RC9200	£799.95
Philips i-Pronto RU1000	£1399.95

CALL

CONTACT YOUR LOCAL STORE OR VISIT OUR WEBSITE FOR OUR UP-TO-DATE PRICES

£

PRICING POLICY
SEVENOAKS SOUND & VISION OPERATES A PRICING POLICY SEE OPPOSITE PAGE FOR DETAILS

PLEASE NOTE: SOME PRODUCTS MAY NOT BE AVAILABLE AT ALL STORES. PLEASE CALL BEFORE TRAVELLING.

*Added Value Offers - From range available in-store. Not in conjunction with any other offer. Advertisement valid until at least 17/11/04, E&OE.

experience more

experience more experience more



SEVENOAKS STORES NATIONWIDE

ABERDEEN 57 CROWN STREET **NEW**
• 01224 252797 *OPENING LATE OCTOBER*

BEDFORD 29-31 ST PETERS STREET
• 01234 272779

BRIGHTON 57 WESTERN ROAD, HOVE
• 01273 733338

BROMLEY 39A EAST STREET
• 020 8290 1988

BIRMINGHAM ARCH 12, LIVERY STREET
• 0121 233 2977

BRISTOL 92B WHITELADIES ROAD, CLIFTON
• 0117 974 3727

CAMBRIDGE 17 BURLEIGH STREET
• 01223 304770

CARDIFF 104-106 ALBANY ROAD
• 029 2047 2899

CHELSEA 403 KINGS ROAD
• 020 7352 9466

CHELTENHAM 14 PITTVILLE STREET
• 01242 241171

CRAWLEY 32 THE BOULEVARD
• 01293 510777

CROYDON 369-373 LONDON ROAD
• 020 8665 1203 *OPEN SUNDAY*

EALING 24 THE GREEN **NEW**
• 0208 579 8777 *OPEN SUNDAY*

EDINBURGH 5 THE GRASSMARKET
• 0131 229 7267

EPSOM 12 UPPER HIGH STREET
• 01372 720720 *OPEN SUNDAY*

EXETER 28 COWICK STREET
• 01392 218895

GLASGOW 88 GREAT WESTERN ROAD
• 0141 332 9655

GUILDFORD 73B NORTH STREET
• 01483 536666

HOLBORN 144-148 GRAYS INN ROAD
• 020 7837 7540

HULL 1 SAVILE ROW, SAVILE STREET
• 01482 587171

IPSWICH 12-14 DOGS HEAD STREET
• 01473 286977

KINGSTON 43 FIFE ROAD
• 020 8547 0717 *OPEN SUNDAY*

LEEDS 62 NORTH STREET
• 0113 245 2775 *OPEN SUNDAY*

LEICESTER 10 LOSEBY LANE
• 0116 253 6567

LINCOLN 20-22 CORPORATION STREET
• 01522 527397 *(OFF HIGH STREET)*

MAIDSTONE 96 WEEK STREET
• 01622 686366

MANCHESTER 69 HIGH ST, CITY CENTRE
• 0161 831 7969



NEWCASTLE 19 NEWGATE STREET
• 0191 221 2320

NORWICH 29-29A ST GILES STREET
• 01603 767605

NOTTINGHAM 597 599 MANSFIELD ROAD
• 0115 911 2121

OXFORD 41 ST CLEMENTS STREET
• 01865 241773

PETERBOROUGH 36-38 PARK ROAD
• 01733 897697 *OPEN SUNDAY*

PLYMOUTH 107 CORNWALL STREET
• 01752 226011

POOLE LATIMER HOUSE, 44-46 HIGH STREET
• 01202 671677

PRESTON 40-41 LUNE STREET
• 01772 825777 *OPEN SUNDAY*

READING 3-4 KINGS WALK SHOPPING CENTRE
• 0118 959 7768

SEVENOAKS 109-113 LONDON ROAD
• 01732 459555

SHEFFIELD 635 QUEENS ROAD, HEELEY
• 0114 255 5861 *OPEN SUNDAY*

SOLIHULL 149-151 STRATFORD ROAD
• 0121 733 3727

SOUTHGATE 79-81 CHASE SIDE
• 020 8886 2777

SOUTHAMPTON 33 LONDON ROAD
• 023 8033 7770 *OPEN SUNDAY*

STAINES 4 THAMES STREET
• 01784 460777 *OPEN SUNDAY*

SWINDON 8-9 COMMERCIAL ROAD **(OPENING SOON)**
• 01793 610992 **SUBJECT TO LEGAL COMPLETION*

SWISS COTTAGE 21 NORTHWAYS PDE, FINCHLEY RD
• 020 7722 9777 *OPEN SUNDAY*

TUNBRIDGE WELLS 28-30 ST JOHNS ROAD
• 01892 531543

WATFORD 478 ST ALBANS ROAD
• 01923 213533 *OPEN SUNDAY*

WEYBRIDGE 43 CHURCH STREET, THE QUADRANT
• 01932 828525

WITHAM (ESSEX) 1 THE GROVE CENTRE
• 01376 501733

WOLVERHAMPTON 29-30 CLEVELAND STREET
• 01902 312225 *OPEN SUNDAY*

WHO ARE SEVENOAKS?

Founded in 1972, Sevenoaks Sound & Vision is one of the largest and most successful hi-fi and home cinema retailers in the country.

Each Sevenoaks Sound & Vision store stocks a wide range of quality products, covering all categories of specialist home entertainment, from Hi-Fi separates and systems to DVD players, widescreen plasma televisions and projection systems, all at highly competitive prices.

Friendly staff are available in all stores to advise, demonstrate and guide you through the home entertainment jungle.

DEMONSTRATION FACILITIES

Our comfortable demonstration rooms are among the finest in the country, many complying with full THX specifications.



CUSTOM INSTALLATION

Sevenoaks Sound & Vision's Custom Installation Service enables the integration of a home cinema or hi-fi system into your home as neatly and seamlessly as possible. All electronics can be hidden away, speakers discreetly mounted either in the wall or ceiling and the complete system operated via remote control.

Our installation experts are fully trained to the highest standards in all areas and provide a prompt, reliable and professional service. Whether you're looking for a multi-room system, a dedicated home cinema installation with a retractable screen and built-in speakers or an integrated control or lighting system, Sevenoaks Sound & Vision has a diverse range of products available to cater for all your requirements.

FREE 8 Page Custom Installation Brochure available now from your nearest store or via our website.



SEVENOAKS WEBSITE

The Sevenoaks Sound & Vision website has news and information on the Sevenoaks group and detailed pages to help you locate your nearest store.

SPECIAL OFFERS

There are hundreds of special offers and stock clearance items available from our stores nationwide - many with savings of up to 50%. To view our regularly updated product lists, visit www.sevenoakssoundandvision.co.uk and click on **special offers**

PRICING POLICY

Whilst we do not claim always to be the cheapest, we try to ensure our prices are highly competitive. Take into account the expert advice, unrivalled product selection, demonstration facilities and excellent pre, during and after sales service and the lower price might not look such good value.

In the event you can find the same products and excellent service at a lower price, please bring it to our store managers' attention. We will always endeavour to offer you the best deal.



Sevenoaks Sound & Vision GUIDE TO HI-FI AND HOME CINEMA

Pick-up your **FREE** 68 page guide at your nearest Sevenoaks Sound & Vision store or order a copy via our Website. The brochure will be posted to you (UK mainland addresses only) free of charge while stocks last.



OPENING HOURS: PLEASE TELEPHONE OR VISIT OUR WEBSITE
E-MAIL: [insert store location]@sevenoakssoundandvision.co.uk

www.sevenoakssoundandvision.co.uk

netting music

The internet is teeming with music downloads, but beware – many sites are illegal. The British Phonographic Industry (BPI) recently announced it was prosecuting persistent mp3 uploaders, and in America the Recording Industry Association of America (RIAA) has issued 1,500 lawsuits so far this year! Here's Noel Keywood's guide to what's going on in the topsy-turvey world of online music...

Most people are aware of past battles between free download sites like mp3.com and Napster, and the music industry represented by the RIAA, when mp3 files could be downloaded with little difficulty for free. Trouble is, there was no prior agreement with the copyright owners of this material, and the U.S. courts soon allowed the RIAA to have these operations shut down.

What has sprung up in their place is Peer-to-Peer services

(known as P2P) where files are swapped between users, using software supplied by the site. This distances the site from the actions of its users. File swapping in itself isn't illegal, providing what is swapped is done so with the owner's permission. If you read the small print on some of these sites they do - surprisingly - apparently condemn illegal file swapping. But they carefully don't explain the high likelihood of your actions being illegal by the very nature of P2P sharing, nor how to use their services without breaching copyright!

how such well run operations can be allowed to exist when they seemingly promote illegal activity. In fact they don't; gun makers are not responsible for those that pull the trigger, nor are cassette deck manufacturers responsible for pirate recordings. Although the courts at present rule P2P sites to be legal, the dispute continues (an exception is www.wippit.com, a P2P site through which downloading copyrighted material is legal).

With P2P services you must download their free software. This can come with a payload of Adware. Take a look at Grokster-Uninstall.com for details. To get an insight on how sophisticated and pervasive Adware can be, go to www.pestpatrol.com and search for their comprehensive description of the aptly named Gator adware, from Claria. You can also run a free search on your computer to see if you are a victim of it. Adware can slow down and jam up a computer and Spyware is potentially dangerous. Both should be taken seriously. And file sharing opens up your computer to all the horrors of the Net, namely viruses, trojans, worms and what have you. Whilst Norton will catch most of it, it doesn't deal with Adware like the common MarketScore for example, nor all spyware.

Of course, any site can deliver unwanted files, not just those offering P2P services, but P2P competition is fierce and these sites are looking to maximise income from the vast number of people that use them, so a hidden payload from which they reap an income is to be expected.

ABOVE BOARD

There are plenty of 'legal' download sites, as the BPI and RIAA are eager to tell us, and they don't provoke copyright violation. Finding and identifying them isn't so easy, but www.pro-music.org is a starting point. You can hazard a guess of

The screenshot shows the Kazaa website interface. At the top, there's a navigation bar with tabs for 'FEATURES', 'THE GUIDE', 'PRIVACY', 'ABOUT US', and 'HOME'. Below this, there are two main promotional banners: 'Kazaa Plus!' on the left and 'Kazaa Free!' on the right. The 'Kazaa Plus!' banner includes text like 'No ads or pop ups', 'Built-in Virus Protection', and 'Even more search results'. The 'Kazaa Free!' banner lists 'Exclusive Search Features', 'Lightning Fast Downloads', and 'Built-in Virus Protection'. Below the banners, there's a search bar and a section titled 'What you get with Kazaa' which lists various features under four categories: SEARCH, SAFE, EASY, and REACH. The 'SAFE' category includes 'Built-in BullGuard Virus Protection' and 'Kazaa Virus Filter Blocks'. The 'EASY' category includes 'Customizable Toolbars' and 'Gold/Blue Icons'. The 'REACH' category includes 'Global - Millions of Peers' and 'Promote Your Blog'.

"Kazaa is the largest file sharing network in the world", the IFPI tell us, "facilitating the copying of millions of songs globally every day. Kazaa does this without seeking the permission of, or making any payment to, the creators and legal owners of the music that is copied." So although the U.S. court recently ruled in favour of this P2P network, in its homeland life is looking less rosy. The action was commenced in Sydney as Kazaa operates from offices in the Sydney suburb of Cremorne, despite the fact that it is represented by companies registered in Vanuatu. More than 20 million users download Kazaa each month. At any one time, there are about 3 million users simultaneously online and connected to the Kazaa network, sharing around 573 million files. It is estimated that the retail value of unauthorised downloads through the Kazaa network exceeds US\$2 billion per month globally, Australia's Music Industry Piracy Investigations (MIPI) state.

SWAP, SHOPPED!

Not happy about this workaround, the RIAA recently pursued P2P sites Grokster and Morpheus, but so far with no success. The defence that they cannot be held responsible for the actions of their users has been accepted by U.S. courts. This puts the ball firmly in the court of users, which explains why both the RIAA and BPI are now pursuing individual file swappers (mainly, serial uploaders) rather than the sites. So don't be fooled by what you see. Even though P2P sites are legal as the law stands, the small fee they charge is for their services, it does not cover copyright. You can legally upload and download an mp3 of your friends all having a sing-song at the local, but you can't legally download commercial recordings.

There are swathes of P2P sites on the Net, including eDonkey, KaZaa, Grokster, Morpheus, mp3.com, Most charge miniscule amounts, typically less than \$1 per month, and you can download all you want. They're hugely popular with students and the young, who may well not understand



In the UK Microsoft's MSN service offers music download via Britain's On Demand Distribution (OD2) network. OD2 is a popular choice for the delivery of music via Rights protected WMA files. Most portable players handle WMA

what's legal based on price alone: needless to say legal sites are more expensive than the P2P file sharing sites. They usually charge £0.79-£1.50 per track, so you won't get music on the cheap. To the music industry's delight they are proving very popular all the same, showing that there are plenty of people willing to pay a fair (high?) price for music. But there are problems with these sites too, some of which are difficult to swallow.

Worst of all is limitation to rights of usage. The music business has an unfortunate interest in the idea of issuing a limited licence to enjoy music. Think of it like this: when you pay to listen to a live performance, you pay to listen once. This is how they would like it to be all the time. It's contrary to the notion most people have of a right to listen to a piece of music as many times as they wish, having bought it on CD.

The sophisticated Digital Rights Management incorporated into Windows Media Audio (WMA) files, Microsoft's version of mp3, provides the ability to vary your listening rights as the copyright holder sees fit, a complication with a nasty sting in its tail. A downloaded WMA music file can be limited to a certain number of plays only, or it may cease to play after a certain date. This starts to make buying music very complicated, since the Rights granted for each song may differ, but there's worse. You can only play the file through a Windows Media Player on a computer, or on a 'secure' portable, and you may not be allowed to burn it out to CD for use in your CD player. You must check to see if this is possible. Most portable players these days handle WMA in

addition to mp3, but WMA files will not play on an ordinary mp3 player, so make certain the player you have, or intend to buy, will accept and play secure WMA.

If you subscribe to a site, rather than pay a one-off fee for a download, you will be unable to play your downloaded files once the subscription runs out. This means you must keep paying to listen to the music you have paid for, another controversial variation in Rights management you need to be aware of.

As some of the 'legal' sites are at pains to point out, all this complication arises from the Rights holders, which usually means the music companies representing the artists, and their inability to agree any consistent and acceptable set of Rights. In this respect the music business is the author of its own woes. Whilst BPI and RIAA are eager and able to pursue uploaders and downloaders, they have made no attempt to clear the confusion that faces people trying to buy legally without circumventing copyright.

Enter Apple Computer with iTunes. With iTunes, a consistent set of rights has been negotiated up-front by Apple, to allow downloading, unlimited play and burning out to CD. Apple use their own copy protection, allied to the AAC file format, but music files don't time out or play a limited number of times. Files burnt to CD are CD-DA (CD Digital Audio) so they play on any CD player and can, we find, can be re-copied. Better, iTunes is agnostic, so you can enjoy the service using a PC or a Mac.

However, iTunes for Windows will not work directly with any

portable player other than an iPod. Mac users can connect up players from Creative Labs and Rio, as well as Nike; all will handle Apple's protected AAC files. Apple warn that ordinary AAC players will not and nor will most 'mp3' players, even though AAC is an Mpeg standard. It is possible to transcode from AAC to mp3, but this degrades quality, or to export to CD-DA and then back to WMA for use in a WMA portable, a cumbersome process.

All the same, iTunes as a music download service is easy to understand and use, relatively inexpensive and consistent in what it offers, with no sting in the tail. Apple do not drop Adware onto your computer, one checks show.

In the UK you can only buy from the UK iTunes site; you cannot purchase from iTunes USA even though - bizarrely - they feature British artists the UK site lacks. Apple told us that this is due solely to the music industry's insistence on

THROUGH THE AGES...

Back in the Stone Age, man was faced with the need to get digital audio onto cassette tape. He came up with PASC, short for Perceptual Acoustic Sub-band Coding. This was an early music compression implement used to beat the life out of music. It was part of Mpeg 1 Layer 1, about which the world knew absolutely nothing. All the same, it looked good (to some), it came from Philips and so was copied by Sony - enter ATRAC, or Adaptive Transform Acoustic Coding.

Excited by this, Bronze Age man set out to beat music even harder, so it would take up even less space and we were presented with Mpeg 1 Layer 2. The world could not understand this, let alone pronounce it, so it was called mp3. When it was found mp3 would travel along telephone wires, which was faster than Brontosaurus, the internet was born...

These days we don't need to beat the daylight out of music to store it, or transmit it, but why give up a bad thing when it took so much effort to develop? Well, one reason is because small things are easy to nick, so Bill Gates added a padlock so you can't. We got Windows Media Audio, or WMA.

Seeing a good idea being nicked by someone who was preventing theft, Mpeg came up with a better idea, Mpeg 2, but this time they called it Advanced Audio Coding, or AAC, so people could pronounce it.

These days mp3 is on its way out for commercial music distribution, mainly because it's insecure. Whether you use WMA or AAC depends upon which chariot you drive, PC or Mac. AAC is much better at low bit rates; differences are smaller at bit rates of 256kbps or more. Unfortunately, most sites compress to 128kbps (10:1), minimising file size to make download time acceptable through slow dial-up modems. One track can take up to 20mins to download all the same.

Broadband is at least ten times faster, reducing download of a single track to a few minutes. It's estimated that 12% of UK households have broadband today, reaching 32% by end of 2005. Around this time we may start to see quality improve through lower compression rates. Then, quality wise, downloaded music will move into the modern world...

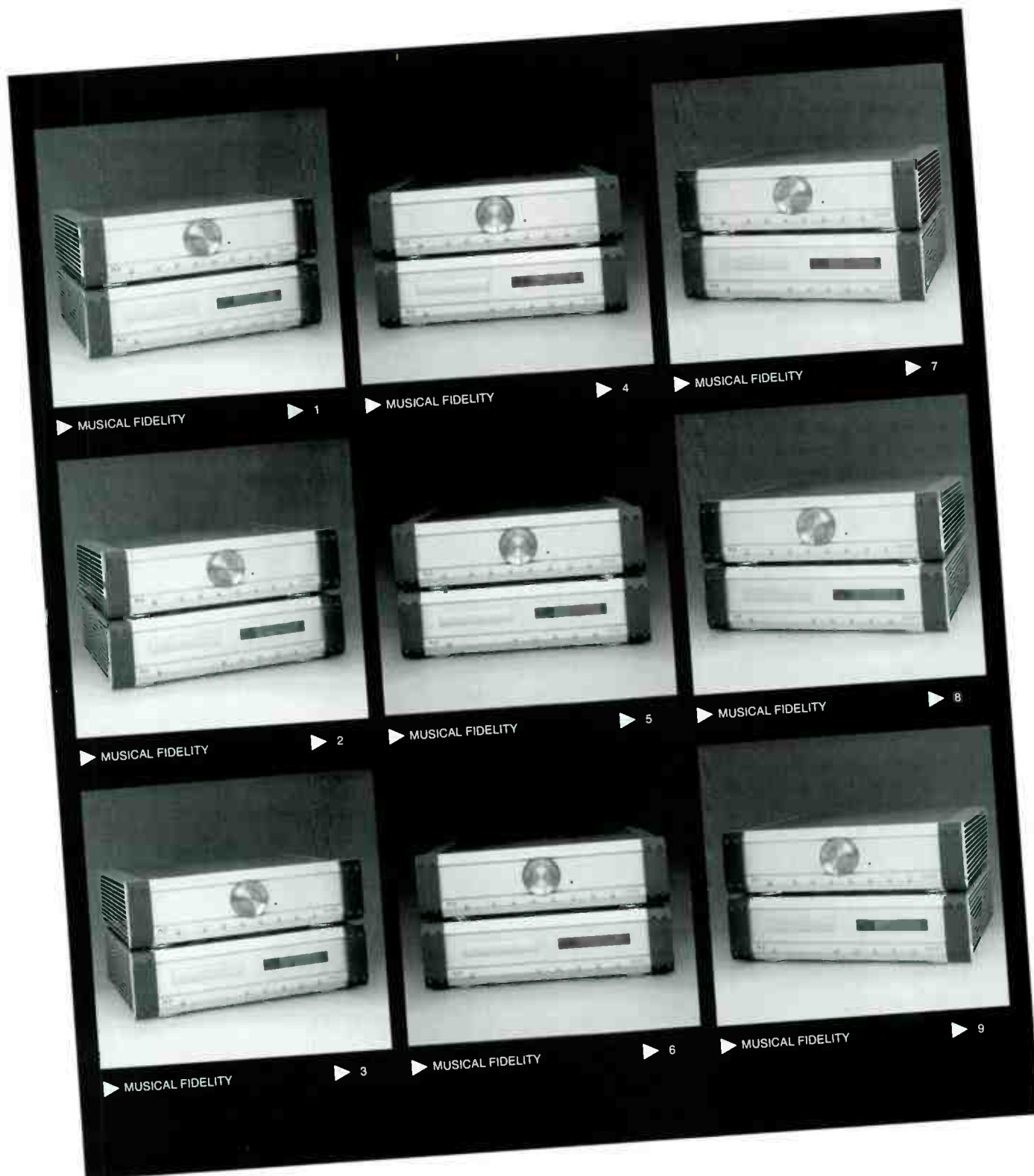

NEW FROM MUSICAL FIDELITY.
A5 SERIES.
X SERIES ACCESSORIES. X SERIES COMPONENTS.
kW INTEGRATED, PREAMP AND POWER AMP.
M1 TURNTABLE.
HEARING IS BELIEVING.

FOR DETAILS OF YOUR NEAREST STOCKIST, RING 020 8900 2866 OR VISIT MUSICALFIDELITY.COM



negotiating separate Rights for different territories.

PC users, who form around 85% of the market in the UK, may well prefer to stick to WMA, simply because most sites deliver this format and most portables play it. Many UK download sites, including HMV, MSN and Virgin, use Bristol based OnDemandDistribution (OD2) to deliver WMA files, offering the terms and conditions we have described. There are exceptions though. Woolworths, for example, don't use OD2, although differences are small. Then there's Sony (www.connect-europe.com) who recently launched their own service, aimed mainly at owners of Sony portables equipped with ATRAC, plus OpenMG and MagicGate security.

Buying music from the internet

has been made easy for us. There's no need to leave your chair to find the music you want, no matter how rare it is. Paying for it, downloading and transferring to a portable or burning to CD is a slick process these days. But to stay legal, keep what you have bought, and enjoy using it without hindrance, is another issue, one that's affected by the shifting sands of Rights management and legal argument. Armed with an awareness of the issues you should find the music you want at a price you can afford, hopefully with sensible rights to its use. Burn a CD if you can, because there's nothing like old sureties - at the end of the day, when you go to play the CD your hi-fi system isn't going to tell you it has performed an illegal operation and then shut down...

SINGLES PARTY

Proof positive that online music distribution has come of age is news that Radio 1 Breakfast Show host Chris Moyles has released a downloadable single, with all profits going to Comic Relief. Chris and his team formed the band Mouldy Lookin' Stain and recorded the single 'Dogs Don't Kill People (Wabbits Do)' as a parody of Goldie Lookin' Chain's 'Guns Don't Kill People (Rappers Do)'. The track got a huge reaction from listeners that prompted Moyles to make the single available for download. The track was part of Radio 1's Download Week in mid October - Radio 1 Interactive (www.bbc.co.uk/radio1) has provided a list of all the sites where downloads are available and there was an easy guide to legal downloading. The Download Chart is broadcast on Radio 1 every Wednesday at 6pm as part of The Scott Mills Show. Ros Lawler, Interactive Manager Radio 1 said "Downloading has revolutionised the way young people buy and consume music. This has had dramatic effect on traditional retail as online download services are easy to use, convenient and good value for money. Download week on Radio 1 reflects this change in the way people are accessing their music and guides those who are less internet savvy on how to download legally."

CHANGE OF TUNE

Downloading music is more than a convenience. It has far reaching implications for the way we enjoy music in future.

When Edison captured music on a wax covered cylinder back in 1877 our relationship to music changed. Thinking of music as a physical entity to be bought, stored and recycled endlessly through a hi-fi is modern view, one the internet calls into question. The internet may well usher in a new reality, but is it a better one? There are some big advantages to downloading, but there are also some big drawbacks that get scant attention, pushed aside by the oodles of tech talk that surrounds all things connected with computing.

Recording music and mass producing the recording by stamping it out on CD at a price low enough for it to become a commonly available commodity has brought about a quiet cultural revolution. The figures paint a revealing picture. Even recently in the UK music sales have climbed steadily and strongly, showing that in recorded form music is reaching an ever larger audience appreciative of its entertainment value. Annual LP sales were around 10 million in 1960, but had risen to no less than 91 million just 14 years later, so great was the attraction of music reproduced well. Annual CD sales in the UK for 2003 reached a staggering 234 million, so Britons certainly enjoy music and are happy to buy it in physical form. This has been the case only for forty years, at most.

Internet downloading could change all this. Suddenly, a music collection, which once comprised a rack of CDs at least, becomes a playlist on a computer. The songs are in there somewhere, but you are never quite certain where. You can organise them, play them, process them and what have you, but you cannot get your hands on them. And you are not meant to. For the first time ever since Edison perfected recording, we may have to rethink the way we view music. The CD is basically an unprotected format, an updated digital version of Edison's cylinder, in effect, from which perfect copies can be made endlessly. This exacerbates illegal copying and downloading, contributing to a 9% global decrease in CD sales during 2003, the IFPI claim. Displacement of the CD by internet downloading of 'protected' audio files offers a potential solution, if not a perfect one.

Compressed Windows Media Audio (WMA) files are 'protected'. The general idea is that a protected music file is playable only within the computer or a 'protected' portable player. This prevents endless duplication for family, friends or perhaps commercial gain and is called Digital Rights Management, abbreviated to DRM. The Rights granted within DRM can be varied and at present you can usually burn downloaded music to CD at least once without a copy protection flag being stripped out.

At present Rights Management can be exercised only within digital code; once the signal is converted to analogue it can, at present, be copied freely as always. This could well change if sophisticated watermarking schemes, demonstrated by Philips and Verance for example, were to be adopted. At present there's a lot of debate and confusion over all this.

Because WMA files carry integral copy protection, not unsurprisingly the music business prefers their use. It meshes well with dominant use of the PC too of course. Apple have added a Rights management scheme they term FairPlay to the Motion Picture Expert Group's (Mpeg) Advanced Audio Coding to deliver protected files via their i-tunes download service. The file format that started it all - mp3 - comes unprotected and remains popular as a method of unrestricted interchange.

Most portable players can handle mp3 and WMA files. You need Apple's popular i-pod portable to handle FairPlay protected AAC, although other makes are becoming available.

Internet download is more than a convenient, modern way to buy music. It ushers in a new era that changes our relationship with music, in much the way that Edison's invention did over a century ago. At present it's difficult to see quite what the impact will be, but if CD sales decline as fast as they did for LP, we'll know in the next fifteen years or so.

pace maker



Tom Fletcher has been designing and manufacturing turntables for over thirty years, and - with its super fast, rhythmic sound - this latest incarnation of his Nottingham Analogue Spacedeck is a galactic transcription tool, thinks Stewart Wennen!

This attractively styled and solidly built turntable boasts rather unusual construction – it uses three separate pillars resting on a composite resin turntable platform (which measures 360mm deep, 455 wide and 50mm thick), used to obviate any airborne or structure borne vibration. The turntable is placed on top of this platform along with the separate, off-board motor. Levelling the turntable is simplicity itself – thanks to the two adjustable feet.

You will notice that the turntable has no right angles anywhere in its construction, this is as a foil to energy storage. Platter material is high-grade alloy and has two rubber "O" rings around the periphery to stop vibration and also aid starting the turntable. The main bearing is a tightly specified individually machined assembly, whose surface is conical in profile to obviate noise and excessive wear.

The motor is a deliberately low torque 24 pole AC synchronous item. Careful perusal of the photos will reveal that the motor has no switch! Rather, starting the turntable is simply a matter of pushing the

platter (in a clockwise direction), after which speed stability is achieved very quickly. The motor did not become warm even though I did not turn the machine off in over two months of use and its speed stability was beyond question. The motor is totally isolated from the platter via a conventional rubber drive belt. It is fully adjustable in its mounting sleeve. Although pulley height is not critical, if the pulley is not at the correct height the turntable simply takes a little longer to reach the desired speed. Speed change is taken care of by moving the drive belt to the desired position., as usual.

I have to say how interesting and impressive I find the Spacedeck's design and execution to be. It is full of subtle touches which show tremendous attention - if the devil's in the detail, then here's one evil turntable! It's also superbly made, even by the high standards of the competition at this price (i.e. Michell GyroDec SE). For example, pick arm support is fashioned from a circular piece of aluminium alloy and is fixed to the record deck by one cap head bolt. This allows the owner complete freedom in aligning the pick up cartridge when mounted in the pick

up arm. (Of course, the cap head bolt has to be tight, and not tightened to the point of stripping the thread.)

Tom Fletcher has engineered the deck so it has the option holding an additional pick up arm mount, so the user can use two arms with the turntable. Other items supplied are a small spirit level, a bottle of lubricant and an extremely accurate alignment protractor. Martin Bastin designed this protractor and it is one of the most accurate I have used for many years. (If you lose this tool you can download another protractor from www.enjoythemusic.com, which is just as accurate although much smaller and more fiddly.)

SOUND QUALITY

The chosen pick up arm was the Hadcock GH242 Integra along with a Music Maker mark3 moving iron cartridge. This combination had been run in for a couple of months and has now become an extremely effective way of transcribing vinyl. This synergistic coupling has very little character of its own, which is after all what we are looking for. Graham Slee designed his "Jazz Club" variable equalisation RIAA stage for

REFERENCE SYSTEM:

Origin Live Aurora Gold turntable
 Hadcock GH242 Integra tonearm
 Music Maker MK3 cartridge
 Graham Slee Audio "Jazz Club" phonostage
 custom built passive preamplifier
 Crown DC300A power amplifiers
 ATC SCM35 floorstanding monitor loudspeakers
 Spiralex supports

record collectors, as the recorded equalisation has changed over the passage of time. A variable RIAA is a boon to serious record collectors as really fine results are within our grasp. Another bonus of this particular unit is that it imparts very little character of its own.

The Unilift lever was dropped and the Music Maker gracefully descended into the groove. Frank Sinatra and the Count Basie Orchestra burst into life in my listening room. Surface noise was hardly noticeable, which is rather unusual as this recording was pressed in 1964 and my copy has not been looked after! The stereo soundstage was huge, extending well past the outer edge of my reference ATC SCM35 loudspeakers. Bass instruments were richly portrayed and their perceived size was almost exactly correct. The balance between upper midrange and lower treble was exceptionally smooth – I could tell the Spacedeck is an extremely even-handed device, with very little obvious colouration or character. Rather, the music was superbly well presented and easy to listen to.

Transients were impressive too, the Spacedeck exhibiting a very fleet of foot response and recovery time. This made it particularly effective with repetitive rhythmic source material such as UB40's original 'Present Arms' LP. Again, the musicians exploded into my living room with those rich bass lines

driving the tunes along, along with a beautifully carried horn section underpinning the melody. So fast was the Spacedeck that it rather left my reference Origin Live Aurora Gold in the

shade; the OL sounded a tad reticent and relaxed by comparison. Yet despite its obvious talents with rhythms, vocals were well displayed and the words were readily identifiable, a rare ability with turntables of this lowly cost!

Beethoven's Piano Concertos are very difficult to track on any turntable, so my copy of No.3 was reverently placed on the Spacedeck's platter. The opening movement was played with grace, space and pace. All the musical clues were present, giving this piece an almost majestic feel. Although the piano is closely miked, so the instrument seems to stretch the entire width of the stereo image, but the tonal qualities of the piano

"the Spacedeck is a truly neutral transcription tool..."

were left intact. Next on was the John Williams recording of some of Bach's work. Recorded in mono in the early sixties this is a fine recording, which has great depth in the image. The Spacedeck acquitted itself with flying colours. JW's playing had the right feel to the music along with the room acoustic as well as the heavy breathing of JW as the music moved along.

CONCLUSION

The key defining characteristics of the Nottingham Analogue Spacedeck



are space, speed and evenness. It's a particularly open, expansive and dimensional deck with real rhythmic aplomb – in a way it reminds me of the old eighties Roksan Xerxes, but with a good deal more detail and textural integrity. Although the bass reproduction is not as extended as my Origin Live Aurora Gold, with the same arm and cartridge combination, it's certainly much tighter. In other words, the Spacedeck does not dig out subterranean bass frequencies but does not suffer from bass

overhang. This fast yet neutral audio footprint is addictive; the closest rival in this sense is Michell's GyroDec SE, which offers an even more transparent and self effacing sound, but arguably a slightly slower and more mechanical one too. Only personal preference, both sonically and aesthetically, will help you decide. Overall then, the Nottingham Audio Spacedeck is a fine example of an exceptionally capable engineer's art. Tom Fletcher has designed another great British turntable that I can enthusiastically recommend!

VERDICT ●●●●●

Exceptionally even and open sound, allied to great speed, makes this one of the very best performers at the price; an essential audition.

**NOTTINGHAM ANALOGUE
 SPACEDECK £889.75**
 Nottingham Analogue Studio
 (+44 (0)1773 762947



THE EDITOR SAYS:

The Spacedeck is a heavy piece of equipment, and looks robust and purposeful in its black finish. Its most obvious sonic attribute is that of timing – this is an extremely precise product. Attack transients are superb, as is the way notes decay. It's unusual to hear such a sound from a belt drive deck, although Michell turntables are also displaying this fleet-footedness since their move to DC motors and NC PSUs. The second thing you notice is the bass; which is decently deep but extremely taut – it's the Spacedeck's speed stability making itself known down to the deep end. You'll not find the generous 'vinyl-like' euphony of the Linn here, or the slight warmth of the Origin Live – rather, it displays rife-both precision which music fans will love, although folk who seek sweet and sumptuous ought to look elsewhere. Finally, the Spacedeck is supremely quiet; its lack of wow, flutter, rumble and surface noise makes it a truly neutral transcription tool. DP

Modern technology has produced an amazing new range of amplifiers from Bel Canto. Can they really be fast, neutral, adaptable *and* inexpensive?

Bella

Bel Canto amps

Bel Canto use modern developments in digital signal processing and high speed solid state power switches to produce a remarkable range of 2-, 4- and 6-channel amplifiers with superb, neutral sound for £3 – £5k.

Bel Canto amplifiers couple the clarity of the best single-ended (SE) triode valve amps with the power, driving ability and reliability of solid state. Stereophile rated the 2-channel as "one of the best on the market" regardless of price.

The new technology brings some significant benefits:

- very low distortion
- virtually no sonic signature, neutral but not sterile
- good driving ability even with difficult loudspeakers
- soft "clipping" like a valve amp if driven into overload, not the harsh sound of conventional solid state amplifiers
- 90% efficiency and cool running thus avoiding the temperature-related distortion caused as the signal varies in power
- the output stage is 10 times faster than an analogue amp
- the amps are easily bridged to give at least 3 times the power

Stereophile's opinion on the 2-channel amp: "an absolutely first class amp...remarkable talents."

Customers say we make some of the **BEST** SOUNDS they have ever heard, so you know we can do the same in your home. Our advice will take account of your best components and guide you where change is needed, in stages you can afford.

You **AVOID EXPENSIVE MISTAKES**, enjoy music along the way and save money in the long run.

JUST LISTEN AND YOU'LL KNOW

CD: ACCUPHASE, ACCUSTIC ARTS, AUDIO SYNTHESIS, BEL CANTO, dCS (ELGAR, DELIUS, PURCELL, VERDI, VERONA), WADIA. **VINYL:** AVID, BASIS, CLEARAUDIO, DNM, GRAHAM, THE GROOVE, LEHMANN, MICHELL, ORIGIN LIVE, SUMIKO BLUE POINT SPECIAL, TRANSGURATION. **TUNERS:** MAGNUM DYNALAB. **AMPLIFIERS:** ACCUPHASE, ADVANTAGE, BEL CANTO, CAT, DNM, GAMUT, HOVLAND, NAGRA, SONNETER, SPECTRAL. **LOUDSPEAKERS:** AUDIO PHYSIC, DALI, ETHOS, NEAT, TOTEM, VERITY AUDIO. **CABLES:** ARGENTO, CHORD Co., DNM, NORDOST, SILTECH, VERTEX AQ, ETC. **MAINS** Accuphase, Vertex AQ. **SUPPORTS:** ARCICI, STANDS UNIQUE, VERTEX AQ

The Right Note

Music in the home

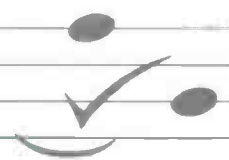

BATH

01225 874728

or NEW lo-call

0845 230 7570

LaserVinyl

test drive "the audio equivalent of an Aston Martin Vanquish V12"

David Price: editor of Hi-Fi World



ELP LT-2XRC laser turntable

book a private listening session on-line



- premium products
- home demonstrations
- regional roadshows

www.laser-vinyl.com

or call +44 (0) 7940 11 88 50

STAX

The Worlds Best CD Player?



Debatable, but the ANI NJoe Tjoeb must come close! Its hand built by audiophiles with valve output stage, four upgradeable models from £429.95. Upsampler option, Rave reviews in Hi Fi World, Stereophile, Enjoythemusic.com and Rated 4.81 out of 5, with over 128 reviews on 'audioreview.com'

- 1 Optional 192 kHz 24 bit Swiss Upsampler only £249.95
- 2 Dual power supply with toroidal low noise transformer.
- 3 Massive 30,000uf of PSU smoothing caps
- 4 Philips Military spec 6922 valves supplied as standard
- 5 'Supercrystal clock' for super low jitter
- 6 Output voltage adjustable from 0.7v to 5v
- 7 AC 'Noise Killer' fitted
- 8 Full remote control with adjustable volume
- 9 Optional Burr Brown OP amps
- 10 All versions upgradeable to 'Reference' model

AH! take a basic CD player and substantially modify it! Inc adding a second power supply, an AC noise killer, a low jitter clock, a new PCB with valve output stage. Only quality audiophile parts are used such as Wima and Vishay. The Swiss Upsampler by Anagram technologies.

The combination gives a detailed euphoric sound that is smooth and without harshness, often compared to vinyl!!

Basic	Inc 'Super Crystal', Digital Transformer	£429.95
Super	Upgraded version	£529.95
Ultra	Inc Burr Brown op amps & Siemens valves	£699.95
Reference	Inc 24bit 192khz Upsampler & all upgrades	£899.95

Ring & find out more. Ask for our illustrated leaflet.

Auditions by appointment. www.iconaudio.co.uk

Phone 07787 158791. Email iconaudio@ntlworld.com

icon Audio 351 Aylestone Rd Leics LE2 8TA Visa/MasterCard

source directed

Until recently, getting high quality stereo sound into your PC wasn't easy – it required the purchase of a decent soundcard, which you had to fit and configure yourself. Fortunately though, those days have passed, as the latest generation offer easy 'plug and play' connectivity. David Price explains...

Regular readers will remember the 'glory days' of *Computer Audio World* some five years ago, when every month I did battle with PC cases, motherboards and PCI slots – not to mention jumpers, ports and DMAs – in order to bring you the latest and greatest soundcards? Well, these days, things have only got better. If you want a decent soundcard solution, you can just plug it into your PC's USB slot and, errm, that's it!

TerraTec's Phono PreAmp USB is just this. It's not a super-high quality audiophile card, but it's a damn sight better than the mediocrity that comes bundled as standard with most PCs. The idea is simply that you plug one end into your turntable and the other into your PC's USB socket – and hey presto, you can record from one to the other! It has a MM phono input with switchable input capacitance (100, 250, 430pF), but should you have a decent offboard phono stage, like the Creek OBH 15 reviewed in this issue, you can pipe that straight in to its line ins via an RCA phono-to-phono interconnect.

The Phono PreAmp is approximately the size of a pack of cards and connects via the bundled USB lead – it's phantom powered via the USB, so there's no need to plug it in to a

main adaptor. The small 63x30x88mm silver plastic housing is shielded against interference; TerraTec claims a signal-to-noise ratio of 86 dB(A), and there's a very simple user interface – one LED to show there's an incoming signal, and another to show peaks (i.e. overload). No additional drivers are necessary – the thing installs itself. When you've plugged it in and connected it up, you can use Windows Volume Control to set input levels by software, and edit your 16bit, 44.1kHz digital recording (.wav) file by either the supplied software, or something altogether more sophisticated such as Steinberg's WaveLab (reviewed overleaf).

The sound quality isn't half bad. Okay, this is no Apogee MiniME analogue to digital convertor, but it's reasonably smooth and clean – and this allied with the nicely euphonic source that is vinyl makes for very impressive sounding CDs. Bass is tight (albeit a tad light), midband open and expansive (although a little hazy and lacking in atmosphere) and treble usefully even and smooth.

Priced at £89 – and available for a lot less if you shop around – this is an excellent 'all-in-one' product for those wishing to dip a toe into archiving their vinyl or tape collection onto CD or DVD. Warning: as soon



as you've done it, and seen the tremendous audio editing power you have at your disposal, you'll probably want more, though!

DIGITAL READY

If the Phono Studio USB is a little light-weight for you, then we'd advise you opt for TerraTec's own DMX 6FIRE 24/96. This £140 soundcard will need installing, but any local PC emporium will do this for you for a few pounds if you're not confident enough to do it yourself. Suitably configured, you have a 5.1 surround sound capable card with analogue-to-digital and digital-to-analogue converters working at up to 24bit, 96kHz resolution – meaning you should be able to author your own DVD-Audio quality discs with the right software, with excellent sonic results. Steinberg's WaveLab will happily record and play at this resolution, so suddenly your PC becomes capable of far better sound than your CD player! Most importantly however, is that the card will accept 24/96 digital input from a thus-equipped A-D, and output at 24/96 digitally into an offboard DAC. By using offboard digital converters, such as Apogee's MiniME and MiniDAC, it makes your PC capable of studio-quality recordings; the sky really is the limit. And if you already have an MD, CD or DAT recorder, you can always use it as both an A-D and/or a D-A convertor, giving a low cost short-cut to hi-fi quality sound at up to 16bit, 48kHz resolution.



supply

Anyone serious about archiving needs a serious phono stage to feed their soundcard, and a top quality DAC to hear the results. Dominic Todd finds some super solutions...



CREEK OBH-15

As vinyl enjoys something of a revival, so too does the humble phono stage. Whilst new pretenders come and go, Creek has been a long-term supporter, at the forefront of budget phono stage design for some time. Unsurprisingly, the new OBH-15 comes across as a thoroughly well engineered piece of kit. Creek uses a decent quality, double sided, PCB with carefully selected components, and professional grade Burr Brown op-amps for each channel to buffer the output signal. Due to low output impedance, Creek also claims that the new phonostages will drive longer cables than their predecessors.

The OBH-15 offers MM/MC switching, but an MM only version, the OBH-18, is also available for just £130. Those with a particularly low output MC cartridge (less than, say, 0.5mV) may also be interested in the special order, high gain MC version. As standard the OBH-15 comes with an unregulated power supply (OBH-1), but a regulated version (OBH-2) will be available as a cost option. I used both Grado Prestige Gold (MM) and Ortofon MC15 Super (MC) cartridges for the test, and found the Creek's sonic characteristics to be remarkably similar with both. Considering the price, this is quite an achievement as the MC stage can often be very much the poor relation to the MM.

I began the listening with Donald Fagen's 'On The Dunes'. It only takes a quick listen to be thoroughly drawn

in by the Creek's inherent musical sympathy. For the price, the treble resolution was superb, sounding as crystalline as far more expensive 'stages. Percussion shimmered with detail, yet without sounding unnaturally harsh or exaggerated. By contrast, it was a little disappointing to find that the midrange didn't shine quite so brightly. Whilst drums had excellent attack and timing, vocals weren't projected quite far enough from the rest of the mix for my liking. That said, in context with its market position, the OBH-15 is no worse than close rivals. As you'd expect, bass wasn't massively deep, but the tight, rhythmic timing more than made up for this. As a whole, vocal separation notwithstanding, it was a highly persuasive performance.

Michelle Shocked's 'God is a Real Estate Developer' was given an even more upbeat presentation than usual. Although somewhat bright and upfront, it did actually suit the song. Again, the vocals could have been pulled a little further from the mix, but otherwise there was little to criticise. Brass was vibrant and the electric guitar solo had real presence and realism. As a 'seat of the pants' experience, this was gripping stuff. Yet, although an undeniable foot-tapper, the Creek is most certainly not a roughneck. It manages to balance such enthusiasm with excellent control.

Whilst it would be easy for the treble to become the victim of splash and sibilance, it didn't. Instead the OBH-15 showed real treble refinement, whilst still demonstrating insight. A pleasingly quiet background,

with both cartridge types, was demonstrated with Tchaikovsky's, Romeo and Juliet Fantasy Overture (Boston Symphony Orchestra). This no doubt helped with the dynamic response, which had far more scale and sheer wallop than you'd expect for a phono stage of this price. Once again, timing and control were key virtues, with instrumental timbre

pleasingly accurate too. String tones, in particular, impressed, with a balance that wasn't overly sweet or equally aggressive. The lowest bass notes had fair presence, although not quite the body they'd have received from rival X-LPSv3.

Overall, the OHB-15 is another little cracker from Creek. It combines a combination of refinement, control and sheer exuberance that its rivals fail to match. It's not quite at the level of the Dino, but then at 50% less it would be churlish to expect it to be. If you do have a particularly bright front-end, then the warmer balance of the X-LPSv3 could be better suited, but otherwise I'd choose the Creek.



VERDICT ●●●●● £

Transparent yet thoroughly musical, Creek's OBH-15 continues in the footsteps of its impressive forebears.

CREEK OBH-15 £200
CREEK AUDIO
 (+44 (0)1442 260146
 www.creekaudio.co.uk

- FOR**
- unmatched musicality
 - improved compatibility
 - excellent value

- AGAINST**
- average finish
 - bass not the deepest



THE RIVALS
 Key competitors include the Musical Fidelity X-LPS v3 (£250) and also the GSP Audio Gram Amp 2SE (£180). Although it does cost £100 more, Trichord's Dino is something of a benchmark at £300.

and demand

APOGEE MINIDAC

You may have heard of Apogee, but not this one! It's not the company that makes loudspeakers, but a digital electronics company based in the USA that began in 1985 by making digital filters, but now make a whole range of, generally professional, digital processing equipment. One doesn't often come across separate DACs these days, so this is of interest.

To most audiophiles, the Mini-DAC won't look at all familiar. The small, rugged, case looks more like a computer modem than a piece of hi-fi. It's well built, although to prevent scratching, it would be nice to see some simple feet added to the bottom. Also less than familiar is some of the socketry. The coaxial and optical inputs and 3.5mm jack output are straight-



forward enough, but the USB and AES input less so. Generally you'd use the balanced XLR outputs [any good cable company will make up a semi-balanced XLR to RCA phono interconnect – Ed.], but the minijack would suffice.

The DAC is Apogee's own design and will happily sample at up to 192 kHz. This obviously gives it a great deal of flexibility, but it should sound

good even at regular 44.1, too. Special attention was paid to the clock circuit by fitting it with dual stage processing. The first clock is optimised to track timing variations. Alone, this could cause massive jitter, but here the second clock "steps" in by taking the first clocks buffered information and optimising the resulting signal to reduce jitter.

The USB connection is more likely to be of use to semi-professional recorders for connecting the DAC to a home computer or laptop. Usefully, it's configured to work as both an input and an output, making it ideal for use as part of a compact recording studio. Those interested in using the Mini-DAC solely as a domestic device, however, can save £176 by buying the unit without the USB board. Even without this, it's still not cheap, and £880 (£1056 with USB) seems a lot for a DAC that appears superficially bereft of audio finery.

Listening began with Estelle's '1980', and it didn't take long to realise that the Apogee MiniDAC is a far more impressive piece of kit than its size might suggest. It didn't have the deepest of bass responses, but the sheer grip, precision and tautness immediately appealed. The depth and width of soundstaging was not as expansive as some, but focus and clarity simply could not be faulted. I was most impressed by the sheer cohesion, snappy timing and articulation of the Apogee. The MiniDAC is designed for the professional market and, from the first listening, I could tell.

Steely Dan's 'Jack of Speed' is an immaculately produced track and the MiniDAC reproduced it in a similarly immaculate manner. Like it or not – and there are plenty who hate the squeaky-clean "studio" sound – but one couldn't help but be impressed. There was superb instrumental and vocal resolution, and a timbre that was true and faithful. Again, bass wasn't as deep as some – the Cyrus would just have the edge here – yet it was there was a sense of rhythm and drive that was Naim-like in its conviction. And just like current Naim equipment, the Apogee was similarly musical. For all its precision, it wasn't in the least bit harsh.

Schubert's Polonaise in B-Flat Major was reproduced with similar flair and vitality. The solo violin was deftly portrayed with great dexterity and, yet again, the correct timbre. Whilst being dynamic enough, the full scale and weight of the orchestra wasn't quite captured but then again, given the price, perhaps this is asking too much. It still proved a captivating listen.

Pro styling aside, the Apogee Mini DAC is a highly impressive piece of kit that deserves to be taken deadly seriously by the audiophile. Those who record music will love all the features available but, even if you just plan to use the DAC at home, there's much to recommend the Apogee. For precision, control and sheer cohesion, few come close. Proof positive that sometimes, what's good for the studio is equally good for the home...

VERDICT ●●●●

Small alright, but Apogee's MiniDAC packs a punch strong enough to knock established hi-fi rivals for six.

APOGEE ELECTRONICS
 ☎ +44 (0) 208 970 1918
 www.arbitermt.co.uk

FOR

- precise, cohesive sound
- flexibility
- unobtrusiveness

AGAINST

- lightish bass
- no phono outputs
- needs feet!

ME TOO

Apogee also makes a matching analogue to digital convertor, called MiniME. A portable 2-channel A/D converter with built-in mic, line and instrument-level inputs and USB, AES and S/PDIF out, it's great for location and portable use as well as in the studio or the home. Two universal XLR/TRS connectors on the rear panel accept line, mic or instrument levels and impedances. Switched 48v phantom power is provided. The preamp section is superb, and there's a powerful multi-curve soft-knee compressor/limiter for live recording fans. The latest converters offer sample rates up to 96 kHz and word lengths from 24 bits to 16 and 20 with UV22HR – all selected on a single control that also delivers digital black. Outputs include AES/EBU XLR and S/PDIF RCA connectors, plus a USB port for direct connection to the computer and audio software of your choice. Zero-latency headphone monitoring is controlled with a volume knob, while a control allows mixing of the direct signal and the return from the USB port along with stereo/mono monitor switching. The USB interface uses USB Audio support in the host computer's OS, with ASIO drivers to be available later, and has a special feature that matches the sample rate between the MiniME and the computer even if they are set differently, for true plug and play operation. It's expensive at £1,100, but its sound quality is no less precise, transparent and detailed as the MiniDAC – for home audio archiving there are few better convertors.



making waves

Compared to CD recorder separates, using a PC might seem cumbersome for music transcription and archiving - but after you've tried a class-leading recording package like Steinberg's new DVD-Audio capable WaveLab 5, you'll realise just how powerful a tool computer audio can be, says Patrick Cleasby...

Even the manual for WaveLab 5 has the good grace to acknowledge there are more audio editors on the market than you could shake a stick at. But much like the evolution of Cool Edit Pro into the excellent Adobe Audition, established editing solutions have to evolve to keep their heads above the

mastering. This was really inevitable, as WaveLab has always been more than simply an editor - it is often the best answer for knotty restoration issues and a fully capable red book CD mastering package too. It is also likely that like many other Digital Audio Workstation (DAW) applications WaveLab will continue to develop more video-related functionality such as the DirectX based sound-to-picture facility added in this version. This is particularly likely since Steinberg were recently acquired to become the audio arm of the massive German low-end consumer to high-end broadcast video solutions company Pinnacle.

So what's our interest? Small independent studio professionals may well be using WaveLab in a studio context, but why would 'Joe Hi-fi Enthusiast' spend nearly £500 (knock a hundred pounds off that if you shop around) on a professional tool? Quite simply there's no other nicely integrated (recording and mastering) solution if you want to create 24bit discs (either stereo or surround) to play at home (although obviously, there's Minnetonka's Discwelder range of PC DVD-Audio authoring tools if you already have an editor).

WAVE SURFING

The most simple application the hobbyist would likely want is the ability to transfer his precious analogue stereo material to the digital domain at as high a quality as possible. Obviously WaveLab is a recording tool, and with the appropriate 24bit sound card (such as TerraTec's DMX 6FIRE 24/96 on p41) you can transfer and master a high resolution stereo wave file version of your legacy material. In this day and age, with storage being so affordable there is no reason that you may not maintain your hi-res digital archive on hard disk and play out from there, but what about backup? Not all consumers think

hard (or even at all) about backup, but hard disks fail, and you will cry if you go through all of this bother to transfer your stuff and then lose it to a hardware failure.

Personally I would recommend backing up restoration projects as data to CD-R or DVD-R whenever practicable, and also having a playable copy. For stereo there is always the possibility of adopting the old 24/96 DAD approach as practised by Chesky of old, and Classic Records and Hi-Res music still (on the DAD side of a dual sided 24/192 HDAD). This approach took advantage of the fact that the DVD-Video spec allowed for 24/96 PCM, thus enabling high resolution stereo discs to be authored before the DVD-Audio spec was finalised. But you have to take great care to ensure that the DVD Authoring application you are using actually understands 24/96 PCM audio, (for instance, Apple's DVD Studio Pro will work with 24/48 but has problems with 24/96), and it is always a bit of a cludge when you are trying to author an audio disc in what is a video authoring application. This is where WaveLab really comes into its own for hi-res stereo, and it has the considerable advantage that you can step up from working at 24/96 to 24/192.

Surround work obviously bears all the same issues, but backup concerns are all the more pertinent when all data volume calculations have to be multiplied by three (six tracks of hi-res audio instead of two). Before the arrival of WaveLab 5 there were only three ways of finalising a domestic surround project to disc. Most simple was to author a Dolby Digital DVD-V, followed by DTS CD, and then introductory level DVD-Audio authoring using Minnetonka's DiscWelder Bronze, which I will not mention here except to say that it is the only current Mac DVD-Audio authoring option now

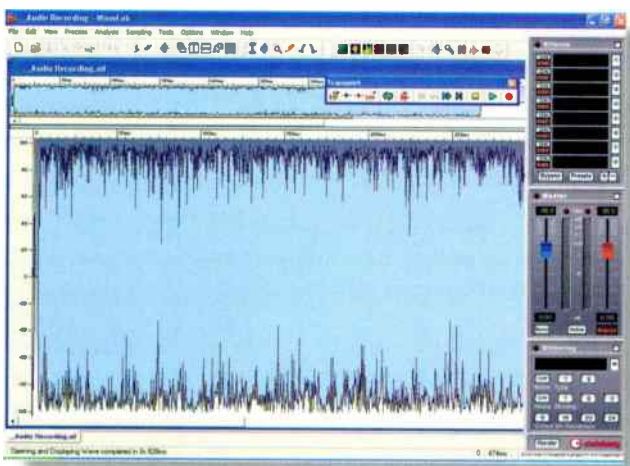

The main WaveLab edit window

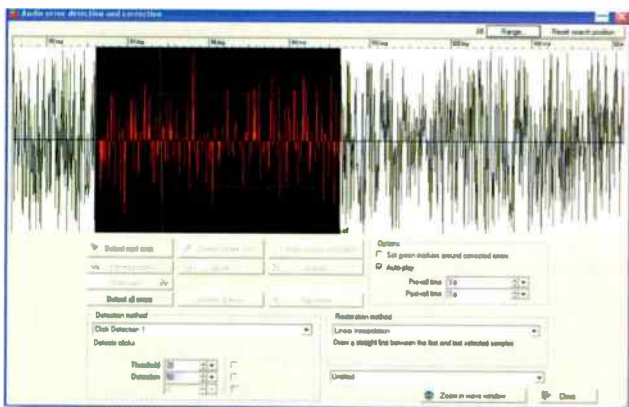

Used carefully over time slices of a few milliseconds the automatic waveform restorer can be useful

tide of competition. These days this generally entails them becoming truly surround capable.

My ears pricked up when I heard earlier in the year that WaveLab 5 would add support for DVD-Audio

MINIMUM SYSTEM REQUIREMENTS

AMD / Pentium 3 or above, 800 MHz
 256 MB of RAM
 10 GB of free hard disk space for DVD Audio
 Windows XP, Windows 2000
 Display: 24 bit required for DVD-A (menu creation)
 ASIO compatible audio hardware with at least 8 channels
 Microsoft DirectX 9 for video operations

RECOMMENDED SYSTEM REQUIREMENTS:

AMD / Pentium 4 2 GHz
 512 MB of RAM
 10 GB of free hard disk space for DVD Audio
 Windows XP
 Display: 24 bit required for DVD-A (menu creation)
 ASIO compatible audio hardware with at least 8 channels
 Microsoft DirectX 9 for video operations

they have announced a Mac OSX version.

The dominant DVD-Video authoring package is Apple's DVD Studio Pro, and indeed the current version 3 has added DTS file support, although regrettably not a free packaged encoder like A.Pack for Dolby Digital 5.1. Dolby discs can be put together very simply - I recommend just creating a slideshow with a slide per track, and just dropping each track's .ac3 file onto the slides. Make the slideshow video track the first play item and hey presto! An amazingly fast route to a playable authored 5.1 disc using a £260 application on a Mac. (The best 5.1 capable out-of-the box PC solution is probably Sony Vegas+DVD 5). The issue is that if Dolby quality is not considered adequate, that spend goes up to a total of £1,000 if you add DTS's own PC and OSX compatible DTS software encoder, which has just been released, and you're still working in lossy compression. This is why the possibility of lossless PCM surround DVD-Audio authoring in WaveLab 5 for under £500 is so appealing, even if the surround resolution is limited to 24/48. Come on, you didn't expect

recordings to the use of WaveLab 5 DVD-Audio authoring tools. It is this which I feel is the obvious application of this professional tool in the enthusiast arena (although obviously it gives surround interested musicians the chance to hear their own works on a domestic, rather than a studio set up as well). I have been in receipt of some of these lovingly preserved seventies relics and they perform exceedingly well on my reference Denon DVD-A11. There are some really excellent quality-minded restoration / preservation people out there [shame we can't say the same about most contemporary record companies - Ed.]!

What is of consumer-level interest other than the stereo and surround mastering facilities? For those of you who have some interest in Windows Media 9 surround files, as launched a couple of years ago with the surround debut of Peter Gabriel's 'Up', WaveLab now has the ability to export surround work as 5.1 and 7.1 .wma files. For those working with WaveLab 4, version 5 contains all the familiar menus and options in a similar layout, with minor changes to the on-screen graphics but sonic performance

96kHz and 48kHz video level work to the 44.1kHz necessary to create DTS wave files for DTS CD.

Now that WaveLab 5 is here, the online quadraphonic conversion contingent have already started to migrate from the previous habitual use of DTS CD for dissemination of digitally preserved legacy quad

restoration and mastering tools which have been in the application since version 4 which are really going to help you tidy up if you're doing legacy transfers, and these include the denoise, declick and waveform restoration functions, (which prior to version 4 were separately chargeable, dongled plug-ins).

So... If all of this has piqued your interest, be warned that this is a heavy duty application, and all of the professional level bells and whistles mean that WaveLab might appear more dauntingly complex to the enthusiast than it actually is if all you're interested in are the high resolution authoring capabilities outlined above. But if you're striving to get the ability to play best quality computer-created audio out on your hi-fi, this really is the answer, and you'll find all the learning effort which will be required worthwhile.

VERDICT ●●●●●

Although a professional tool, this is indispensable to the serious high-resolution stereo or surround hobbyist.: everything you need to make our own DVD-As.

STEINBERG WAVELAB 5 £450
 Steinberg Media Technologies GmbH
 ☎ +49 40 210 35 000
 www.steinberg.de

- FOR**
- mature product
 - DVD-Audio support
 - excellent mastering tools

- AGAINST**
- overkill for consumers
 - no MLP
 - no DLT authoring

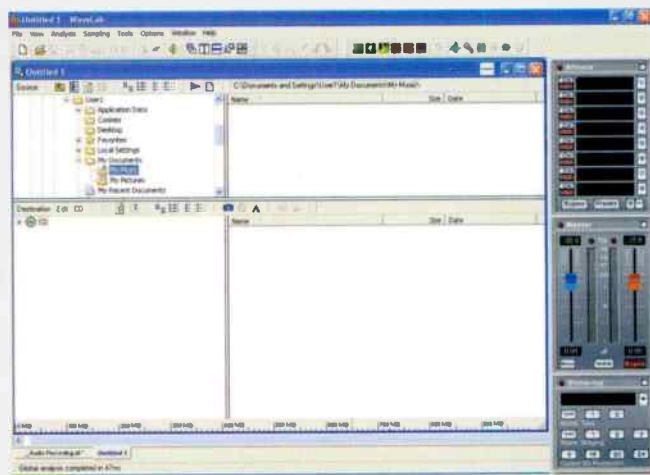

With the addition of Data CD capabilities Wavelab burning starts to resemble Nero

“there's no other nicely integrated recording and mastering solution if you want to create 24bit discs to play at home...”

to get an MLP encoder at this price did you...?

DTS CD will probably become a lost art now lossless surround is with us, but at the present time it is still possible to buy Minnetonka's PC DTS-CD tool, and the aforementioned DTS own brand software encoder can also step down from

appears identical to version 4's. Usefully version 5 adds the capability of creating data CD/DVD hybrid and mixed mode (video and data) sessions. There is also extended sample rate conversion to 384kHz, previously limited to 192kHz.

To be honest, if you're new to this game it is some of the excellent

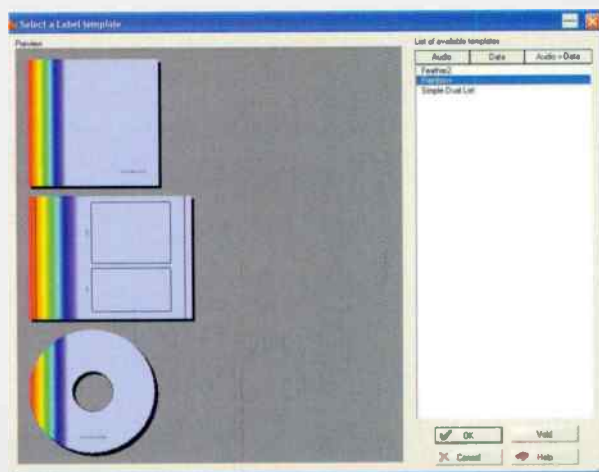

As well as getting more pro with formats, Wavelab gets more consumer with label creation

ideal composition



Audio Analogue's first Puccini amp was a god, the second merely accomplished. In this, its third incarnation, the company is seeking to recreate the magic that made the original so special. Dominic Todd reports..

When *Hi-Fi World* first reviewed Audio Analogue's original Puccini SE back in September 1997, we concluded that, "as Nakamichi are to cassette decks, so Audio Analogue is to integrated amps," no less. Bold words indeed! Throughout the late nineties the Puccini remained a benchmark for other sub-£1,000 amps to aim at. At the turn of the millennium, the second generation didn't do quite so well for AA. Whilst the Puccini was still up there, advancing competition and a rebalancing of sonic characteristics [see box], meant it was no longer the automatic choice.

This, the third generation Settanta version (£950), sees a return to the original's smooth and refined voicing, with a significantly improved casing to boot. You're quickly drawn in by the all-new, aluminium construction, which looks like a bigger version of the Primo, and is none the worse for it! Despite a few sharp edges, the design still looks sophisticated and is a definite improvement on what went before. And if you think the casing looks good, just wait until you see the remote control -

undoubtedly the best looking remote for any product under £1,000.

Other features include five line level inputs and a tape loop, but those seeking tone controls or headphone sockets will be disappointed. The standard inclusion of a MM/MC phono stage is extremely unusual these days, and should please vinyl users – although analogue addicts would be advised to go for the separate stage route. There's a substantial toroidal PSU, which helps generate the increased power output of 70 watts. The twin banks of quad Nippon 4700uf output capacitors are a popular choice these days but, interestingly, the same configuration as used by the original Puccini SE of 1997. Clearly, the designers feel there was a lot about this amp' worth replicating...

SOUND QUALITY

Audio Analogue wanted to get back to the sort of sound that made the original Puccini so beguiling and, on the evidence here, it has more than succeeded – they have produced one of the finest sounding amps' below

£1,000. The reasons for the Puccini's success are many, but its key attribute is its consummate all-round ability. The starting point for my listening began with 2 play feat. Raghav and Naila Boss's 'It Can't Be Right'. Straight from the word go the Puccini got the balance exactly right, with a bold, expansive sound; full of bounce and vitality. Furthermore, there was also a level of refinement rare in an amplifier at this price – more of which later. The wide soundstage didn't have quite the instrumental focus of a Nait 5i, but it had far deeper bass. There was also superb vocal texturing and resolution of subtle detail. The fact that the Puccini remained composed and in control even at high volume levels is testament to AA's decision to raise the power output to 70 watts. It should also bode well for those with difficult 'speaker loads to drive.

Of course, for all its success, the Puccini is not totally without fault. It's not the sharpest when it comes to timing, yet neither is it exactly plodding either. 'Maybe' by N.E.R.D reminded me of just how well AA



amplification can relay vocals. The intimacy and texture were without doubt better than anything in the class, with fine separation and projection a further bonus. By comparison, the rest of the mix didn't quite live up to this standard, but considering the brilliance of the vocal rendition, that's hardly surprising. Whilst the drums displayed fine transparency, the cymbals did lack a little decay and openness. That said, considering the price, this isn't a serious criticism.

Annie Lenox's 'A Thousand Beautiful Things' once again showed stunning vocal resolution. What was remarkable was that although there was a complete lack of sibilance or, indeed, any harshness whatsoever, the Puccini never sounded as though it was 'rounding off' the music. What was portrayed was true, and beautifully articulated. A well-judged soundstage rounded off a highly impressive performance that really drew the listener into the song. For those of you who tire quickly of music being thrown at you, then I'd imagine the Puccini's comforting presence to be a welcome tonic – here's an amplifier that makes music sound good enough to bathe in! Again, percussion wasn't the sharpest in detail, but it was at least correct of timbre and rich of texture.

Where, perhaps, the Puccini's slightly softer rhythm is more noticeable, is with something like Dr John's 'Hen Layin' Rooster'. Alongside a Nait 5i it did sound slightly flat-footed and lacking in transient attack. Focusing on the drums and brass, for example, showed the Naim to definitely have the edge when it came to snap and attack. Turning to texture and dimension, though, and the tables were reversed. Here it was the Naim that sounded the more mechanical, the more one-dimensional and, ultimately, the more artificial. A strong case could be made for either rendition, but we should celebrate the difference, and that an enjoyable sound doesn't necessarily mean a single sonic blueprint!

You'd expect such a mellifluous amp' to sound pretty good with Classical music and, thankfully, the Puccini does indeed deliver the goods. What really impressed me most about John Rutter's 'Suite Antique' was the manner in which the flute was reproduced - delicately

THE RIVALS

It will probably come as little surprise to hear that the third generation Puccini Settanta is both a little more expensive and a fair amount more powerful than before. It's rare for any manufacturer to admit they're wrong but, certainly in the case of the UK importers, Analogue Audio felt the second-generation model to be a little too bright sounding. With the latest model, they claimed to have rediscovered that warm, Latin refinement that made the original Puccini so beguiling.

Finding a house sound is not easy. It takes years to build a reputation, and one wrong move can wreck the product, and even company, image for a great deal of time after. Yet two of the Puccini's rivals have managed just such a carefully nurtured reputation and, hence, today still remain formidable opponents. Both the Cyrus 8vs and Naim Nait 5i have histories that span over twenty years with, by and large, not a blemish to their names!

The Nait began in 1983, with a taut, rhythmic balance and a rather dry tonality. Sound familiar? Well, it should because pretty much all the Nait's over the years have followed a similar balance. In 1988 Naim continued the theme with the Nait 2, and even the Nait 3 of 1993 had a familiar sound. By now, though, the balance had become slightly hard. This was resolved in 2000, with the more powerful Nait 5. More power meant wider speaker compatibility, and the overall sound certainly felt less strained. Interestingly, the Nait 5's replacement, the 5i, is actually cheaper than the original 5. At just £700, and with such a rich and distinguished history, it's bound to give the Puccini a hard time.

Around the same time as the Nait, the equally iconoclastic Cyrus 2 was also launched. It had a fuller bass than the Nait, but a similarly punchy sound. By the time of the Cyrus 3 in 1993 very little had changed. Even the introduction of a non-metallic base plate and, with the 1996 3i model, the rather curious 3mm speaker sockets, the sound remained resolutely predictable. In 1999 this gave way to the conventionally socketed 7 that, in turn, seeded to the 2003 Cyrus 8. Today's, 70 watt, £800 Cyrus 8vs, is just as well liked for the same reasons that people bought the Cyrus 2 20 odd years ago – power, control and neutrality. Plus c'est la change...

flowing in an almost valve-like manner. In fact, the detail was actually ahead of what many tube amps could achieve and, yet again, in another league to most sub-£1,000 amps'. As well as the refinement and insight, it's also the balance shown that deserves highlighting. In this case I could hear the breathes of the flautist, but they weren't too obvious. They didn't sound, as with some integrateds, like they'd been recorded from inside the mouthpiece and, thus, they didn't distract from the soul of the music.

CONCLUSION

When it comes to crafting music, Audio Analogue's new Puccini Settanta is one of the very finest in its class. Every note is carefully conveyed with no slop, no grain, no spit and most remarkably of all, no added gloss. As with the original it's a thoroughly convincing and totally engrossing piece of kit. The elegant new casework and remote are, quite simply, the icing on the cake.

Life for the Naim Nait 5i, Musical Fidelity X-150, Sugden A21a and Mission Cyrus 8vs has just got a whole lot tougher... this a truly special product - product of the year, even?

VERDICT ●●●●●

Refined, cohesive and textured like no other sub-£1,000 integrated amplifier. The automatic choice for those who do value sweetness over speed.

AUDIO ANALOGUE PUCCINI
SETTANTA £975
 UKD Ltd.
 ☎ +44(0)1753 652669
 www.ukd.co.uk

- FOR**
- sound
 - finish
 - remote control
- AGAINST**
- pricey against rivals
 - volume control

MEASURED PERFORMANCE

The Puccini has very 'soft' overload characteristics, especially into a 4ohm load, where a test sine wave distorted slowly as full output was approached. The Puccini looked much like a valve amplifier in this respect, although soft clipping doesn't necessarily give a valve sound. It should sound fairly easy at high volume, becoming congested if pushed too far, rather than gritty or rough.

Power measured 78watts into 8ohms, rising to 100W into 4ohms, so the Puccini has plenty of punch and will go loud. It isn't as well regulated as many amplifiers, but again this will give a different rather than worse sound, one less grippy but also a little more fluid.

Distortion levels were low, even at high frequencies - a good sign. Our analysis shows some higher order harmonics, but at 0.03% they are minimal.

The disc stage has accurate equalisation, normal sensitivity and adequately low noise. Overload was low at 40mV but satisfactory all the same.

The Puccini has been engineered to sound easy and fluid and relaxed, measurement suggests. It should

	perform well. NK
Power	78watts
CD/tuner/aux.	
Frequency response	8Hz-100kHz
Separation	98dB
Noise	-102dB
Distortion	0.01%
Sensitivity	290mV
dc offset	1/2mV
Disc	
Frequency response	12Hz-150kHz
Separation	68dB
Noise	-77dB
Distortion	0.013%
Sensitivity	3.5mV
Overload	40mV

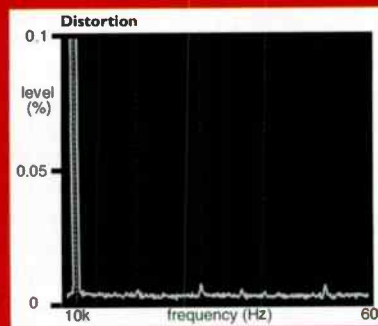

enter mission

Although this Huntingdon company is most famous for its legendary high end 770 monitor from twenty five years back, these days Mission is synonymous with high value mini monitors. Channa Vithana auditions the latest m50 standmounter...



The two-way reflex loaded M50s are the latest in along line of Mission mini monitors. In typical Mission fashion, the bass driver is located above the tweeter, on a narrow baffle and proportionally quite deep cabinets. Mission calls this particular driver arrangement 'IDG', which stands for Inverted Drive Unit Geometry, that "aids the audiophile grade crossover to produce seamless transition between the drive units." These M50s are different from standard sub-£200 speakers in their use of interesting moulded baffles. The material used is 25mm MDF and a plastic 'high impact moulding'. I think the design is superb, while

there are sonic reasons for smoothly profiled surfaces and rounded edges. Mission argues that, 'profiled edges ensure minimum interference from diffraction effects'. The contoured baffle surface houses a 120mm aramid mid/bass driver using a sandwich cone containing Aramid and pulp fibre and a nitrile rubber surround. The tweeter is a 'laser trimmed pressure balanced' microfibre soft dome 25mm unit with neodymium magnet and ferrofluid cooling and has two small 20mm 'anti-turbulence' ports either side of it.

Both the treble and mid/bass units are secured within the baffle giving a polished and professional feel, because there are no unsightly

screws. The svelte grill features an 'acoustically transparent cloth' on a frame, being unusually thin at 5mm and using a varying chamfer slotting perfectly into the baffle moulding. The crossover is described as an acoustic second order with phase optimisation and having high power silicon steel inductors and polypropylene capacitors

Each 3.4kg speaker measures 140x220x255mm, has an effective volume of 4.5litres and is constructed from braced MDF and particleboard, finished here in a very pleasing real beech veneer. It feels well made to the touch because the fit of the baffle and junction to the veneer is consistent on both speakers. On the reverse it features single wired multi-way gold plated binding posts, and two screw holes for mounting with a Mission wall bracket. The M50s are fully magnetically shielded suitable for AV use. The manufacturer's own specifications claim a frequency response of $\pm 3\text{dB}$ 64Hz-20kHz, 8ohms impedance (min 5ohm), 86dB sensitivity, crossover frequency of 2.4kHz and a power handling between 25-100w [see MEASURED PERFORMANCE].

The baffle arrangement is very cleverly designed both visually and functionally, but I would have preferred a different finish to the

PAST MISSIONS

Back in 1990, Mission totally transformed the budget loudspeaker world with its 760. A small standmounter with similar dimensions to the m50, it was the first speaker to feature a moulded front baffle made from mass loaded polypropylene – the direct progenitor to what Mission calls its 'IDG' baffle arrangement used on the m50. As well as looking like nothing we'd ever seen before, it sounded refined way beyond its price point and proved a massive sales success. The speaker was updated with 'I' and 'SE' variants over the next few years, but somehow no other Mission baby box has captured its magic since. There was even a 780 variant, using a deeper box with real wood veneers (but the same drivers), which retailed for £180 – and the new m50 is its spiritual successor.

plastic baffle moulding. Something like a brushed matt finish or simple stained/painted MDF while keeping the same design would be more practical, thus avoiding obvious scratches and markings. While not being shiny, a matt finish won't as easily reflect any markings or dust, therefore lending the M50s a finely refined understated feel. As it is, it looks slightly garish in the shiny silver and when considering its diminutive size, from a distance it can be wrongly mistaken for a cheap add-on speaker that comes with an all in one budget micro-system!

SOUND QUALITY

Mission recommends a twenty four hour running in period before serious listening, and I found this a conservative figure. I set up the M50s as Mission recommend within 200mm of the rear walls atop birch ply stands. Spacing was 2.4m apart with no toe-in in a 6.5x4.5m room. I used Lloyd Cole and The Commotions recent 'Singles' collection containing recordings from different years to challenge the M50s - Cole's early work with the Commotions, while being inherently well produced classic pop, contains jangling guitars, jaunty vocals and speedy delivery that could be a nightmare in a bright system!

Starting with 1984's 'Perfect Skin', the song catapulted itself through the Missions, with those trademark guitars displaying tremendous speed, and the well judged chord changes expressed eloquently. Guitar melodies came over surprisingly well, without the shrillness found on some other mini monitors at this price. The other surprise was the m50's bass delivery; the speakers delivered well-extended and deep lows to underpin the dynamism of this upbeat track. 'No Blue Skies' (from 1990) marked a different sound for Cole at the beginning of his solo years, sounding richer and weightier with clear languid production, accompanied now with superior vocals and a big classic rock style production. The fine

midband detailing really brought out Cole's vocals, showing just how much better they were than the early years - you could appreciate him using a far wider range here. The m50s sounded fulsome while the timing was again spot-on, with speedy attack and clean decay to struck snare drums.

Indeed, this was just the sort of music where the m50s excelled - modern, crisply recorded power pop that that's actually quite compressed (as per almost every other piece of pop rock from the past thirty years!). It was obvious that the m50s have been voiced for precisely this, because moving to other source material, such as the classical nineteen sixties acoustic jazz strains of Herbie Hancock's 'The Prisoner', showed them to be a tad dynamically constrained and compressed. This is, of course, something that comes with the mini-monitor territory; even the best LS3/5a variants sit on dynamics to an extent; sheer visceral power is not what you expect from small boxes!

Interestingly, despite the diminutive dimensions, the m50s still had good strong bass. Even compared to a pair of large standmounting Monitor Audio R852s I had to hand, these much smaller Missions easily went deeper, especially on the early Commotions tracks, giving them a good kicking, propulsive quality to balance out the bright guitars. What they in isolation continually excelled at was providing an enjoyable music envelope, whereas the R852s were more analytical and 'technical' sounding. These Missions carry on the company's fine tradition of offering a most enjoyable overall

sound, being generally smooth, velvety and always engaging.

The m50s weaknesses are obvious enough (as with any speaker at this price), but the clever thing is that they don't intrude and spoil your enjoyment of the music. Against the R852s, 'Rattlesnakes' showed how the midrange wasn't as emotionally convincing - especially with the string parts sounding slightly compressed and not as explicit. The MAs also highlighted the slight sibilance of the M50s' treble response – it's a subtle effect, and careful partnering could cancel this out, but don't match them with forward or spitty electronics.

CONCLUSION

Overall then, Mission's m50 loudspeakers are an interesting take on budget mini-monitors; they're propulsive and engaging, yet offer an unusually deep bass considering the cabinet size (which could explain their mediocre sensitivity figures). They're best with warm, well produced pop, rock and electronica; classical and jazz fans will hear their failings more easily. A strong performance at the price, and well worth auditioning if you're a fan of modern music.

REFERENCE SYSTEM

Denon 3910 DVD-A/SACD Player
Marantz 6010 OSE amp
Monitor Audio R852 standmount speakers
Chord Company Odyssey 4 speaker cable single wired
Kontak Link 507 interconnects

VERDICT

Innately musical and engaging mini-monitors in the classic Mission mould.

MISSION M50 £199.90

MISSION UK

+44 (0) 1480 423700

www.mission.co.uk

FOR

- refined and smooth
- satisfyingly musical
- clever design

AGAINST

- music dependant
- baffle finish

MEASURED PERFORMANCE

A small cone in a small cabinet is, perhaps surprisingly, the easiest way to get almost ruler flat frequency response across most of the audio band. Mission's m50 almost achieves this, so it gets close to at least one measure of perfection. There are a few perturbations, likely due to small resonances or cancellations, and tweeter output rises a little to peak by +3dB at 12kHz - enough to add a small hint of spit or sharpness. Otherwise the m50 measures very well in terms of frequency response, running flat from 63Hz to 16kHz. The ports are tuned to 60Hz and seem to work well enough, the impedance trace suggests. The m50 has forward and port output down to 40Hz but it is not tailored for shelf mounting. For its small size the m50 goes low, as low as could ever be expected.

Sensitivity was satisfactory at 85dB, with impedance measuring out at 6ohms. Mission combine a 4ohm bass unit with an 8ohm treble

unit.

The little m50 measures very well, one of the delights of a good small loudspeaker. NK

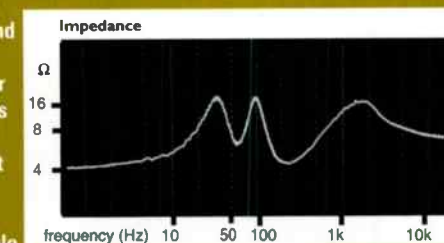
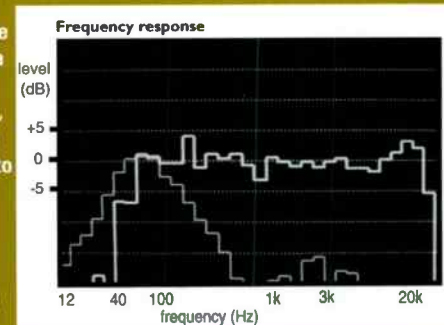

a world first...

dap.10

analog processing for a digital world

'I couldn't criticise a thing'

'it really does improve CD sound'

Hi-Fi World - July 2004

Radical improvements
require radical
thinking!

Whest

creating musical heaven

T: 020 8965 4535 post@whestaudio.co.uk



the ultimate reference....

PhonoStage.20 + MsU.20

'superlative sound leaves

the best of the rest way behind-

a landmark product for analogue addicts'

Hi-Fi World - Sept 2004



Ultra low noise front end
Hybrid RIAA to within 0.2dB
Extended hf response
High current output drive
Infinitely variable loading - MM/MC



Over 200 lots of high quality speaker production equipment and manufacturing lines including:

Iwatani semi-automatic loudspeaker production line with, adhesive applicators, powered conveyors, Baltec and PJ Hare presses, Purex fume extraction units, Mitsubishi 3-axis automatic robotic circular/elliptical adhesive applicators. Hot & cold spot adhesive applicators, Redcliffe Magtronics magnetisers. Manufacturing production cells including transfer tables, assembly stations, adhesive applicators.



Over 200 lots of Test, Calibration and Measuring Equipment including:

a 2003 Design Environmental temperature and humidity chamber, a 2003 Ling Dynamic air cooled vibrator, a Dactron laser shaker and CTS, Sanyo and Heraeus Votsch chambers and ovens. Mitutoyo micrometers, hardness testers, dial indicators and scales.



Over 200 lots of Warehouse Equipment & Machine Tools including:

Compressors, waste compactors, reach, forklift and pallet trucks, pallet racking. Bandsaw, pillar drill, machining centre, milling machine and sundry items of plant.



Over 300 lots of Office Furniture & Equipment, Computers, Printers, Servers and notebooks including:

Pentium 4 PC's and notebooks, laser and inkjet printers, IBM AS400 server, Compaq servers, projectors, office desking and seating, filing cabinets and sundry office equipment.

By Order of Messrs J Tickell & C Faulds,
Portland Business & Financial Solutions,
the Administrators of Goodmans
Loudspeakers Limited

Goodmans

MAJOR AUCTION SALE

Of approximately 1,000 lots comprising:

**THE COMPLETE LOUDSPEAKER
PRODUCTION PLANT, EXTENSIVE &
MODERN TEST EQUIPMENT, GENERAL
PLANT AND EQUIPMENT, MATERIALS
HANDLING, OFFICE FURNITURE,
COMPUTERS, PRINTERS ETC**

**On Wednesday
10 November 2004
commencing 10am**

Viewing 9am - 4pm on Monday 8 and
Tuesday 9 November 2004
at Goodmans Loudspeakers Limited
(in Administration), 1 Ridgway, Havant,
Hampshire PO9 1JS

For further details and online catalogue
visit www.marriottco.co.uk or email
sales@marriottco.co.uk

Marriott & Co.

Valuers and Auctioneers of Plant & Machinery

19 East Street Farnham Surrey GU9 7SD England
Telephone: 01 252 712 083 Facsimile: 01 252 737 613

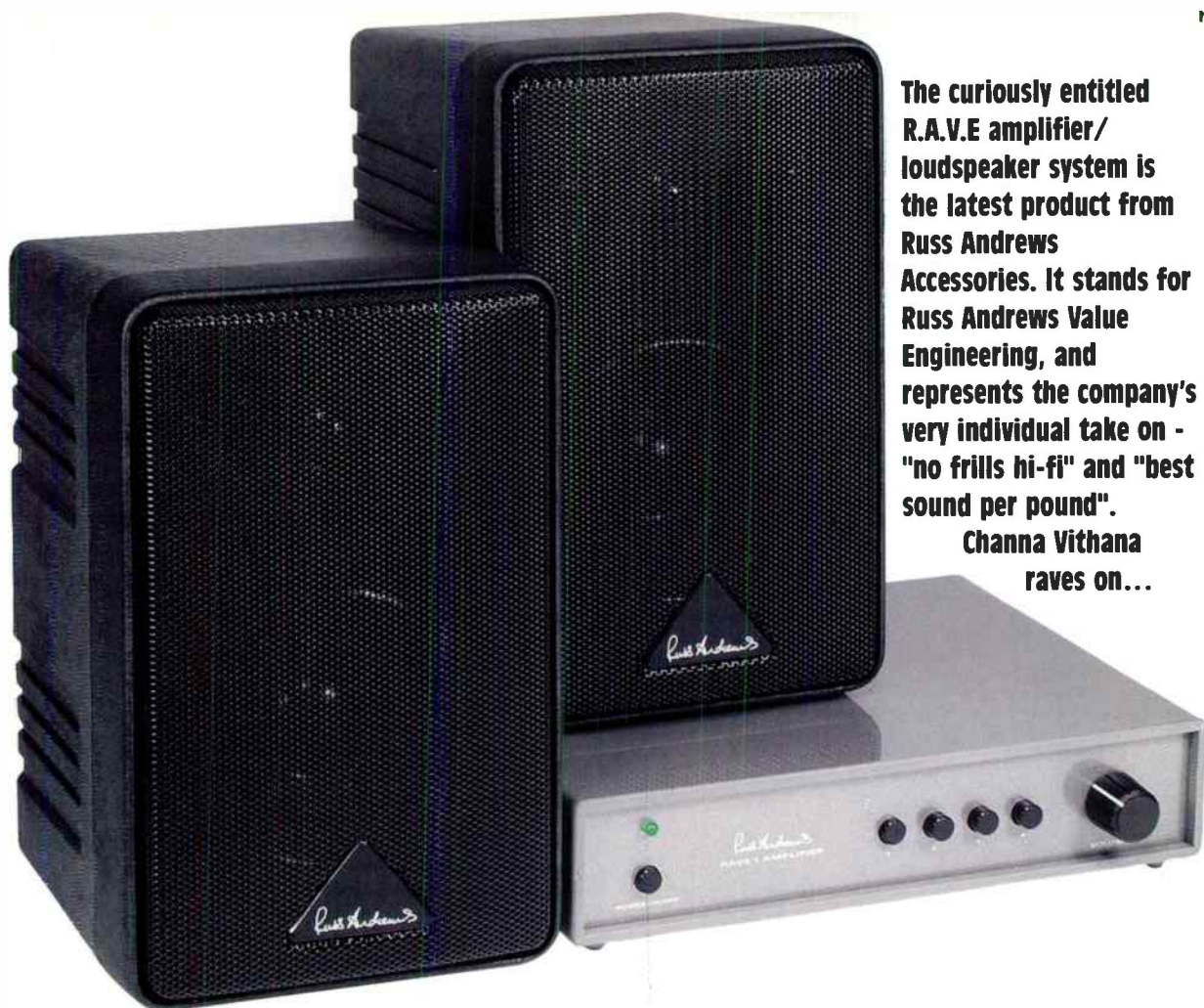

The curiously entitled R.A.V.E amplifier/loudspeaker system is the latest product from Russ Andrews Accessories. It stands for Russ Andrews Value Engineering, and represents the company's very individual take on - "no frills hi-fi" and "best sound per pound".

Channa Vithana raves on...

little wonder

If Russ Andrews has made a name itself for producing quirky audio accessories, then it's very much on home ground with this one! Here's a system intended to replace cheap computer speakers, or to work as a travelling companion for portables – maybe even plugged into a car or boat power supply.

It consists of a RAVE 1 amp (£199.95), RAVE 2 two-way speakers, Yello Power Chord (£29.95/1m) and 2 x 1.5m Kimber Kwik 16-gauge speaker cable (£2.95/m). The RAVE 1 amp can be bought alone or complete as the Combo system above for £299.95. The RAVE 1 has two finishes,

Carbon Fibre or Mercury. It is a diminutive little amp' (55x 238x 168mm) - about the size of a hardback book, and incredibly light at 900gms!

After my initial inability to take anything this small seriously, I rather liked the design of the RAVE 1 amp - it is made quite ingeniously using two plastic ABS sections snapped together with clever right-angled joints which form a groove along its sides. The finish of the Mercury is an attractive gloss metallic silver but the edge detail for the front and back isn't as good as it could be, because there were slight imperfections in the fit of the jointing not being flush. These edges could also have been nicer if they were completed with the same finish as the rest of the Mercury silver; instead they are plain grey.

The amp has three rubber feet to provide good stationary stability, as triangulated supports are more stable than four points avoiding micro rocking. At the front is a volume knob and five switches, four

for source selection and one for power on/off with a green LED indicating operation. Both the volume and power switches have smooth action in use while the source buttons are less precise in operational feel. I would have preferred all the control buttons solidly executed with the same Mercury finish as the casing, or finely turned aluminium, as this would elevate it from kit-like appearance. I am not being too pedantic here, as the finish isn't up to the best standards of modern £200 integrated amplifiers like Cambridge Audio's 540A. Behind are loudspeaker binding posts, four phono sockets inputs and tape out. For power, an IEC socket is joined by 12V DC connection. The RAVE is digitally aspirated with "Class T" amplification while power output is specified as 10w/8ohms and 20w/4ohms.

The RAVE 2 speakers "feature a simple inductorless crossover circuit" and comprise 4.5inch woofer and 1.5inch tweeter arrangements with two front ports. I think they look





BK Electronics XLS200 Active Subwoofer System

Buy Direct and Save Hundreds of Pounds

We have been designing and manufacturing 5 star award winning subs since 1992



Features

- * Uses a Peerless XLS10, one of the worlds best subwoofer drive units
- * True 200W RMS 400W Peak
- * Simultaneous high and low level connections
- * Solid construction 25mm baffle and back and 18mm MDF sides with real wood veneers
- * Four fantastic finishes
- * Compact size only 390D x 295H x 295W mm
- * Over engineered for sonic excellence weighs in at 20kg

At about a cubic foot the XLS200 can be easily hidden from view, but you will certainly know it is there. With the easy to setup controls it will take only minutes to get up and running showing it's punch, agility and power. Due to its rigid sealed box enclosure and powerful 200W amplifier coupled to an extremely high quality 250mm drive unit the XLS200 sounds absolutely stunning from the off, with music that is underpinned by masses of low end extension. Movies will come to life too, as you hear the effects as well as feel them.

★ Free Accessories worth £40.00. 10M Speakon High Level Lead - 5M High Quality Gold Phono to Phono Lead and a set of spikes

★ Pay no extra for real wood veneers



Strength & Depth in the knowledge that we have supplied over 100,000 subs

Price £279.00
+ £8.00 Carriage



For more details and images of all the four superb finishes please look on our website at <http://www.bkelec.com/whf.htm>

BK Electronics, Unit 1 Comet Way Southend-On-Sea Essex SS2 6TR
Tel :- 01702-527572 Fax :- 01702-420243 email :- sales@bkelec.com

The Studio

Home Entertainment Consultants

"Music without the Madness"

Specialist in Naim, with complete Audio range on demonstration. We also can provide all other forms of Home Entertainment and welcome the opportunity to discuss all your Audio-Visual requirements

Contact: Peter or Ted

28 Aylmer Parade
Aylmer Road
Haringey
London
N2 0PE

Phone: 020 8348 0990

Fax: 020 8348 0990

Email: pwbc@dial.pipex.com

Website: thenaimshop.dsl.pipex.com



Unique Sound & Vision

JVC digital reference allows you to enjoy a sound quality that is closest ever to that of the original master. The AX-SD1 GD represents our idea of 'no-interference energy amplification' to achieve the purest of pure sound. First, there's the independent 3-block construction separating the power amp, preamp and control section, to prevent even the slightest interference. Then, the signal paths are trimmed to the shortest length possible, to keep signals contamination-free. Finally, the extra thick power cable enters the chassis through a hole in the bottom plate, directly running to the power transformers, reducing power-related interference. Parts and circuits, including terminals on the rear panel are laid out in total symmetry for the left and right channels, to ensure the sense of true stereo that gives substance to the music. Also, the three point suspension provides an unshakable support to the entire unit.

- Power output: 70W x 2 into 4 ohms at 1kHz with 0.7% THD (IEC 268-3)
- Advanced Super-A in push-pull configuration
- Quality parts: Dual power transformers (one for plus, one for minus voltage), thick OFC (Oxygen-Free Copper) power cable, low-leakage EI-core power transformer, copper-plated rear panel
- Staggered-resonance heat sinks with tapered fins
- Ultra phono stage MC and MM
- High output discrete phono equaliser amplifier
- 3-mode 'Presence' control
- Gold-plated brass speaker terminals
- System remote control
- Enhanced COMPU LINK Control System
- RM-SASD1U Remote Control Unit (included)

With the AX-SD1 GD you will experience sound quality like never before, simply out of this world!

Since JVC started in 1927 this is the best pure amplifier they have ever made.

Limited stock with five years warranty.



hi-fi world
VERDICT ●●●●●
Highly open, transparent and musical sound makes this one of the surprises of the year. Thoroughly recommended.



These are just some of the examples of the special products we have in stock. Unique Sound & Vision are delighted to provide our customers high-end sound for less money. How? To find out and experience something you've never experienced before phone now to arrange an appointment.

The perfect match!

hi-fi world
VERDICT ●●●●●

An outstanding, willfully quirky and charismatic audiophile product.



Shanling SACD SCD-T200c

Aside from a few small quality niggles, this is surely the best audiophile digital disc player at the price it's brilliantly conceived - it then goes on to be successful in touch all bases a serious audiophile could possibly want. It's interestingly styled, nicely superbly built, has no superfluous (but many useful) features, great operational flexibility and superb sound. Typically, it's not quite up to the top £1,000 machines as a CD player, but it's extremely desirable at the same, and as an SACD player it's peerless at the price - especially via the tube output stage. This machine is simply fantastic, warm and does exactly as sounding just anything I've heard at the price, some may find it too much so, others might never be able to go back to anything else. I, for one, am in the latter camp. **David Price Editor**



Classic Mission 781 Stand Mount Speakers

These outstanding speakers can effortlessly fill a room with supreme sound, and have received many reviews around the world. They are compatible with these separates, and are designed for serious listeners.

Unique Sound & Vision

Bringing you closer to the musical truth
Tel: 020 7272 0922 Fax: 020 7272 4665

great with profiled "structural foam" cabinets and metal mesh fronts giving them an unpretentious industrial feel. They are fitted with two spring clips at the rear, which isn't ideal for bigger cables, but accommodate the Kwiks perfectly. Specifications are: 4ohm impedance, 89dB sensitivity, frequency range of 50Hz-16kHz (at -3dB) and max 60W power handling. Being tough and small (220x 145x 155mm), they are perfect for travelling or office/ studio use. The Yello Power Chord consists of 8 high purity copper conductors insulated with PVC and uses "Kimber's unique cable weave to remove RFI". It is well made having a braided outer sleeve. The 1.5m "installation cable" Kimber Kwiks are also a woven design with an outer PVC jacket, supplied cut and stripped.

SOUND QUALITY

The system was used initially as per design designation in a small office measuring 3x2.5m. I used it connected to Sony MDS-J3000ES MiniDisc and Rega Planet 2000 CD with QED Qnect 3 interconnects and the Kwik cables. The RAVE 2 speakers were placed atop a bookshelf on one end and drawing board on the other, spaced 2.2m apart. The system was tested with Miles Davis's 'Complete Bitches Brew Sessions', a vast mothership of a recording, lasting well over three hours. The RAVE amp really liked this heretic jazz masterpiece - it isn't the 'Kind Of Blue' jazz of Davis's 50s heyday, rather a complex mixture of rock/blues drumming, sitar and the wide-panning horn swathes of 1970's era Davis.

The RAVE consumed this complicated recording with consummate musicianship, filling the room with a melodious tone that was both lush and spacious. 'The Complete Bitches Brew' can sound abrasive in a mismatched system with midrange dominating the music creating jauntiness emphasising rhythms over melodies. This can become irritating; making it falsely labelled 'jazz from hell'. The RAVE 1 amp however, produced the

complete mix beautifully and also really enjoyed Michael Jackson's remastered 'Off The Wall', with its Quincy Jones production of groove-led dance tracks proving a real gem. In a larger 6.5x4.5m room, the RAVE 2 speakers were placed on birch ply stands accompanied by a Denon 3910 universal player (£899), Kontak Link 507 Interconnects and 5m of Chord Co. Odyssey 2 as a speaker cable reference. The RAVE 2s performed to an entirely satisfactory standard in isolation with proper stands, but as a hi-fi instrument they aren't so special - as you'd expect considering their very modest price.

It's the RAVE amp that is intriguing because it continued the previous melodic nature, ably driving the bigger room at moderate volume levels. I used The Pet Shop Boy's 'Alternative' CD to great effect and as with 'Off The Wall', the RAVE 1 really enjoyed the electronic dance rhythms. While not being able to play at club levels, which is not what was intended, it continued to produce music within its limits at an addictively enjoyable standard - all the more so because the RAVE amp has a characteristic that I usually don't go for, one of warmth and lushness with an unflappably sweet treble. While I personally prefer speed, transparency, resolution and slam, I cannot dismiss it simply because it plays music differently, being slightly warmer and more fulsome.

As a result the RAVE 1 amp produces a good bass depth when it's present on the original source programme. The languid deep house of 'It Must Be Obvious' by PSB is a good case in point where in the wrong system it can sound brittle and lean. However, using the RAVE 1 with a pair of Mission M50s I had to hand was absolutely first-rate, Neil Tenant's vocals were conveyed with a sleek and velvety smoothness, the rest of the music following suit, flowing without a hint of the glare that can be mistakenly produced by this song. Moving onto the closest to an actual 'rave' song I have - 'EuroBoy' (also on 'Alternative') was just as much fun, like Michael Jackson

before, the RAVE 1 amp - though limited in loudness - displayed an addictively propulsive quality. Replacing the Kimber Yello Power Chord with a standard lead into the RAVE amp revealed a leaner, slightly faster sound. Though it was soon evident the music became brittle and one-dimensional with the standard cable, removing the amazingly velvety quality from Tenant's voice and therefore upsetting the previous balanced relationship between the music and vocals. The Yello compared surprisingly well to a five year old 1.8m Kimber Reference Power Chord, reaching 80% of the more expensive cable's abilities in this review system! Using 5m of £18/m Chord Co. Odyssey 2s in place of the £2.95/m Kwik speaker cable brought on better transparency and rhythmic attack but considering the huge price difference, the Kwiks acquitted themselves very well indeed.

CONCLUSION

I can very happily recommend the RAVE 1 amp with one condition - it won't go seriously loud. However if you like to listen (rather than dance) to jazz, electronic and dance music, then this is an ideal starter or second system amplifier. It would also be worth investigating an easy to drive speaker to go louder with the RAVE 1 amp than either the RAVE 2s or Mission M50s I tried. The power chord and cables are very effective too, well judged and work superbly with the RAVE 1 amp. The RAVE 2 speakers make sense to get you started if you're new to hi-fi or require a second system. They are a huge step beyond the nasal and tinny computer speaker packages out there, which was one of its main design criterions.

Overall then, as a system the RAVE Combo is a wonderfully compact and versatile tool, with the benefit of flexibility over full size hi-fi through a choice of power connections. Yet it manages to sound extremely rewarding, displaying warmth and rhythmic cohesion you simply don't expect from a 'portable'. Odd, but excellent nonetheless!

VERDICT

£ This system presents high-quality, forward thinking hi-fi sound almost anywhere. The amplifier, power chord and speaker cables are especially distinguished.

RUSS ANDREWS RAVE MERCURY COMBO SYSTEM £299.95

Russ Andrews Acc. Ltd.

☎ +44(0)1539 825 500

www.russandrews.com

FOR

- amp & cables
- luscious sound quality
- design, build, flexibility

AGAINST

- low power
- amp finish
- source selector buttons



two's company



Improving upon the superb C541i was never going to be easy, but thanks to some careful tweakery NAD reckons that its C542 CD player is an even finer listening companion. Dominic Todd decides.

Life must be tough for NAD. Year after year it turns out unerringly capable hi-fi, only for this fact to be completely taken for granted! This must make model replacement a tense business. The C541i was never going to be an easy one to replace and, to add to the woes, NAD also faces tougher competition than ever before [see **THE RIVALS**].

Yet, looking at the specification, it appears NAD has risen to the occasion. The toroidal power supply and Burr Brown, 24-bit, Sigma-Delta DAC remain as before. What's new, however, is the Sony transport - a fairly common choice these days, and one that should prove reliable. This also enables the C542 to play CD-R/W discs, which its predecessor could not. Also new to the C542 are Nichicon Muse capacitors - you'll notice that, for the price, the component quality is as high as ever, with metal film resistors, and Elna capacitors in the power supply.

Unlike with the C541, NAD has included an optical output. They're keen to point out, however, that if one has the choice, then it really should be the coaxial that's favoured. In an effort to reduce timing errors, the coaxial output is buffered and isolated by a transformer from the converter itself. Other points of interest are the damped lid, Burr Brown 2134 op-amps and built in HDCD chip.

NADs with a class beating technical specification are to be expected, but good-looking designs are a rarer occurrence. Thanks to a

little visual titivation the C542 is smarter than before, although it's still unlikely to win any beauty or quality awards. Against competition from Rotel, Arcam and Cambridge the front panel, in particular, looks especially plasticity and cheap. The new remote control looks equally cheap, but is at least ergonomic, and stylish in a plasticky Swatch watch kind of way.

Of course NAD have never let style triumph over substance, and the only way to truly find out if the C542 has improved upon its illustrious predecessors is by listening to it...

SOUND QUALITY

With Dr John's 'Chickee Le Pas', the balance was exactly what you'd expect from a mid-price NAD CD player, with just a couple of small surprises. Superb depth of soundstage and solid, if slightly warm, bass response was to be expected, as was the fine sense of flow and speedy, incisive timing. But one difference I did notice, however, was the appearance of a brighter treble response. Whilst this gives the impression of enhanced 'agility', I did occasionally find it a touch too intrusive. The percussion, in particular, did sound just slightly too splashy. In other

respects, though, the C542 remains a model of control and decorum. The vocal placement couldn't be faulted, and there was plenty of insight into the performance.

Texture of sound also featured strongly with Jeff Healey Band's 'My Life Story'. The high level of transparency made it easy to distinguish the various guitars, and they were given real energy and vitality. The bass response remained just a touch on the warmer side of neutral, but did little to slow the pacey timing.

The most striking aspect of Joe Jackson's 'Glamour and Pain' was the soundstaging. The C542 managed to layer the music in terms of both height and depth of stage like few other rivals. Better still was its ability to bring this together in a cohesive and seamless manner. In this respect, the NAD offers a taste of the high-end, so when it doesn't match up in other areas this becomes something of a disappointment. Piano, for example, lacked a little body, and the bass response, whilst deep, wasn't the most sustained.

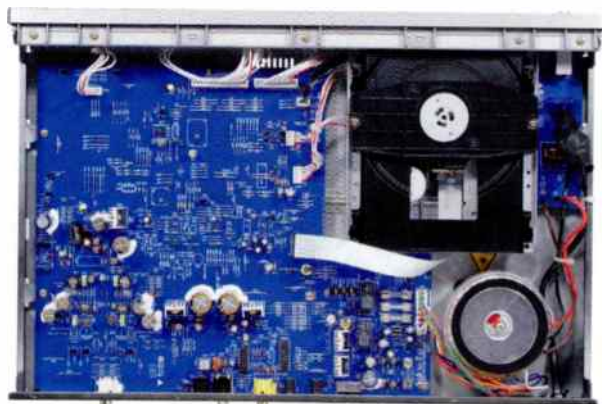

THE RIVALS

Not so long ago, the list of rivals for a £330 CD player would have numbered at least a dozen or more. There would have been mid-range models from the Japanese giants, such as Sony, Technics, Yamaha and Pioneer. The smaller Nipponese firms would have been represented by the likes of Denon, Onkyo and Teac. Add to this the usual British stalwarts, and usually a couple of oddball designs, and you'd have had a very comprehensive list. Yet, in 2004, coming up with a list of serious rivals left me with just four models, and even then they vary in price by as much as £150. Of course, there are a few other rivals, but these tend to be 'brochure fillers' more than anything else, and really can't compete sonically.

When reviewing the C542 I stated that it was one of the top three players around the price. In my opinion the NAD's closet two rivals actually lay either side of it, at least in terms of price. Beneath the C542 is the £250 Cambridge Azur 640C and above, the £400 Arcam CD63T. Now more column inches have been written, this year, about the Cambridge Azur range than anything else this side of an iPod. Suffice to say that its 24-bit Wolfson DAC, Sony mech and separate power supplies hit the NAD exactly where it hurts... That is to say, in terms of spec' per pound Cambridge is trying to become the new NAD. In the final analysis I would say that the C542 does sound better. However, whether it's worth an extra £80 is debatable. Certainly in terms of value, the 640C wins. At the other end of the spectrum, we have Arcam's CD73T. This is my personal favourite sub-£400 machine, and even more complete than the NAD. Where it wins over the C542 is in sounding just that bit more dynamic, yet ever bit as refined. The only trouble it faces is that it costs £70 more than the NAD, and a whopping £150 more than the Cambridge...

No comparison would be complete without mentioning the Marantz CD7300 (£350) or Rotel RCD02 (£380). Both are still extremely fine players, with their own sonic signatures. The Marantz offers a soundstage vaster even than the NAD, and can be thoroughly beguiling. On the downside, it can sound a little loose alongside the C542. The Rotel is a thoroughly competent and surprisingly lively player. I say 'surprisingly' because this is not a characteristic Rotels are usually noted for. Even so, good as it is, the Arcam is only £20 more expensive and, again in my opinion, just that bit better.

It is important, however, to remember that these criticisms are by absolute standards, and that few rivals would do better. When listening to Joe Jackson I was also reminded of another NAD 54-series characteristic; that of refinement. Whilst never offering a seat of the pants ride, the mid-range NADs have always offered sustained listening enjoyment through a smooth and rich response.

Norah Jones's 'Don't Know Why' demonstrated what a fine all rounder the C542 is. The sound was extremely well controlled, with the vocals never becoming strident or harsh, as can happen when played at higher volumes. The instruments were finely etched within a broad sound stage, and the music never sounded mechanical or stilted. From the subtle decay of cymbals to the resonant "thrum" of the double bass strings, fine detail was present too. My only gripe with its reproduction here was that the bass could have done with a little more authority and weight.

Mily Balakirev's 'Islamey' (Kirov orchestra conducted by Valery Gergiev), is a delightfully playful yet dense piece. I have to admit that the NAD's presentation wasn't the most exciting but then, I'd learn to expect that by now. Brass was a little too smooth and lacked bite or impact. Likewise, the strings tone sounded a



little too glossy and over-refined to my ears. Yet, in other respects the C542 excelled. Even during the most complex passages there was excellent separation of instruments. A solitary triangle could be depicted and placed with precision in the orchestra, and even the musician's physical movements could be heard during quieter passages. Whilst not being the most dynamic portrayal then, it did at least offer a great deal of insight with fine timbre and real sense of agility and flow.

CONCLUSION

As to whether NAD has improved upon the C541 - the answer is yes, but barely in terms of sonics. The main improvements are visual, with the optical output

an added bonus. Yet, even if the C541 offered no improvement over its predecessor it would still be a superb machine. As it stands it offers a musical architecture and cohesion that's unmatched at this price. Timing and timbre are also first rate. In short it's a thoroughly well balanced machine with a slight emphasis on bass warmth.

The area in which it differs from previous machines is its brighter treble response. As to whether this is a good thing or not depends upon matching ancillaries and personal taste. One thing you can be sure of, though, is that it does little to change the C542's key characteristic of listener involvement. Three years ago I reviewed the C541 and called it the outright class leader. Because of the increased competition it's no longer possible to say this of the C542. Nevertheless, that it is still easily one of the top three, shows that NAD still has the knack.

VERDICT ●●●●£

Consummate all rounder, with superlative soundstaging and control. Only the tough competition stands in its way as undisputed class leader.

FOR

- holographic sound staging
- sense of balance
- improved remote

AGAINST

- plasticky finish
- tough competition
- slightly soft bass

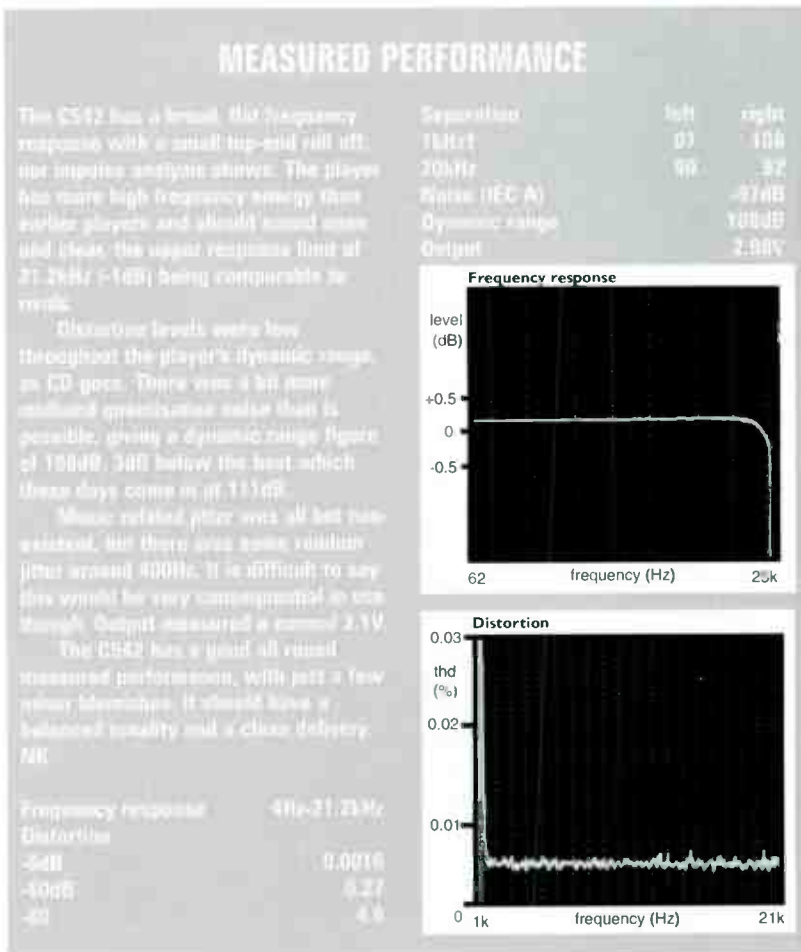

Affordable High Performance
PHONO Amplifier from
TRICHORD RESEARCH

Dino

Moving Coil
Moving Magnet
Switchable Gain
Switchable Loading
Super Regulators
Discrete Output Stage
Upgradeable Power Supply



Tel: +44 (0)1684 311600

www.TRICHORDRESEARCH.COM

Michell Orbe

A Symbol of precision



*Orbe Controller now contains the
"Never Connected™" circuitry as standard*

web: www.michell-engineering.co.uk
email: info@michell-engineering.co.uk
Tel: 020 8953 0771 Fax: 020 8207 4688

Michell Engineering Ltd,
2 Theobald St,
Borehamwood,
Herts, WD6 4SE

cutting edge?



To compete with the welter of cheap AV receivers arriving on these shores, Denon has had to manufacture its new entry-level AVR-1705 in China rather than Japan. Noel Keywood wonders how the costs have been cut...

I nearly fell off my chair when the press release for this receiver dropped into my in-box. "Details attached of Denon's crazily priced new 6.1 AV receiver," it said, "with everything and the kitchen sink included for just £250". Prices of AV products are plummeting to silly levels as manufacturers and retailers struggle for market share – but are they worth having?

I wondered whether Denon had pressed into service some new cost cutting idea, like an all plastic chassis, but no, the box was as big and heavy, as always with receivers, and the receiver inside looked very similar to its more expensive brethren built around a steel chassis, complex moulded fascia and standard power supply with bulky E/I mains transformer and bridge rectifiers.

A central heatsink carries six output transistor pairs which, Denon claim, each deliver 75W into 8ohms and 110W onto 4ohms. You get no fewer than six amplifying channels, all identical, in the AVR-1705. The rear panel carries eight pairs of loudspeaker output sockets though, with switching between two pairs of front (left and right) speakers, plus one Centre, two Surround and one Back channel. This gives you a complete 6.1 surround-sound setup, plus a stereo pair which could, typically, pipe stereo radio into a kitchen.

Budget products like this can be specially designed from the ground

up, or be derived from expensive models pared down. The AVR-1705 looks like the latter, making it potentially very good value. With 'Made in China' printed onto the chassis and internal boards marked Shen Zhen, both parts and assembly are Chinese it appears, reducing price. The Japanese are traditionally sniffy about Chinese quality, preferring to make their up-market products in Japanese factories from Japanese parts. But I could see little difference between the AVR-1705 and the latest Japanese built 2805. Measurement turned up only larger D.C. output offsets, suggesting sloppier set up, but this is a minor point, the values being perfectly acceptable.

Big surround-sound receivers don't have a reputation for great sound quality. They can be good at

even though you get a fraction of the technology and much less horsepower. Our tests showed the AVR-1705 is relatively clean and free of serious crossover products though, a point in its favour.

In keeping with good basic build quality Denon have sacrificed little in useful facilities. There are fewer inputs and options, but this makes for less confusion. The handbook is still a centimetre thick and a heavy read. There are six line inputs for audio, and one set of tape in/outs, marked VCR. For digital connection of a CD or DVD player there is one electrical and two optical inputs, and for analogue connection six phono socket inputs as usual. There is, of course, a subwoofer output.

Onboard processing is provided for Dolby Digital 5.1 surround-sound from DVD, and DTS 5.1, neither of

"close internal inspection and measurement suggested the Denon is insanely good for the price..."

crashes and bangs, but forget violins, which commonly reveal a tendency to coarseness. This usually arises from crossover distortion, which affects the upper frequency ranges of transistor amplifiers, giving a characteristically hard and slightly gritty sound. That's one reason a stereo amplifier may be a better choice,

which use the Back channel. However, DTS ES is a true discrete 6.1 format that does do so and is included, together with DTS 24/96 which provides even higher sound quality. These are all proprietary methods of decoding five or six channels of audio data needed to produce the sound field.

Not for conservatives



The comprehensive range of turntables by Pro-ject, design is perhaps a little less conservative than the norm and yes, products are available in blue, and red, and yellow, and green.

High quality record players are available from just over £100
Contact us today for details of your nearest Centre of Excellence.

Centres of Excellence are our elite dealers who have shown commitment to customer service, attended regular product training seminars and offer demonstration facilities on the majority of the Pro-ject range.

Both Dolby Pro Logic IIx and DTS Neo 6 also derive a full sound field, but from stereo data. I find Dolby Pro Logic IIx very effective with many CDs. It clears the front channels of out-of-phase information, often reducing muddle considerably. The information is directed to the rear channels instead. Neo 6 does the same but it doesn't de-emphasise the rears like Dolby and is brasher and less successful in my view. If you put stereo television through these systems (or Matrix mode) you will often hear discrete surround sound - yes, old Quadraphonic isn't dead; television uses it to transmit four-channel surround sound matrix encoded into a stereo signal and it's very effective. The AVR-1705 handles all this well.

It also has VHF/FM tuner on-board, and a Medium Wave section too. The rear panel carries a coaxial (male) input as well as spring connectors for supplied loop antenna for Medium Wave. As always there's a line of video inputs, plus one output for a TV or monitor. They are all analogue, with CVBS or S-Video options. Strangely, loudspeaker terminals that conveniently accept 4mm plugs are used, unlike the more expensive 2805 which accepts only bare wires! Weighing nearly 11kgs the AVR-1705 is no lightweight and it needs a sizeable shelf with adequate ventilation.

There's bass management, but with full range hi-fi speakers it's not needed. Delay times to all the loudspeakers can be set, which applies to Dolby and DTS surround-sound, but not the six channel direct analogue inputs (i.e. DVD-A and SACD) as always, since these signals do not go through the Digital Signal Processor (DSP). Denon provide a test tone, which greatly aids set-up.

SOUND QUALITY

Is surround sound at this price level worth listening to? In a nutshell - yes. As close internal inspection and measurement suggested, the AVR-1705 looks insanely good for the price - and that's how it turned out in use. I hooked up a DVD-2900 to feed it DVD-A, SACD via analogue links, as well as CD via an optical digital link, to assess Dolby Pro Logic IIx processing.

Not surprisingly for Denon, the basic balance has low frequencies well represented and highs are obvious too; in other words the Denon doesn't have a warm sound, but then neither do most A/V receivers. However, there was a little more to it than basic tonality. With

far less of the brashness of so many receivers I found it easy enough to listen to, with a treble quality I'd describe as light, almost tinselly and quite sweet. There was plenty of fine detail, politely delivered.

Another strong feature was midband lucidity that made vocals stand out clearly, a property evident all the way through from DVD-A and SACD to CD and even Dolby Digital 5.1. From 'Pirates of the Caribbean' through to the re-released 'Battle of Britain', music, commentaries and speech sounded crisp and clear. In fact, the AVR-1705 has a spry sound; it is fast and clean. There's no weakness in bass delivery either. Even by specialist stereo standards its lucid midband is impressive, giving B.B. King and Eric Clapton plenty of air and space in 'Riding With the King' on DVD-A.

In Korsakov's Scheherazade, strings were brightly lit but clean and easy enough on the ear, whilst brass had a throaty bite to it and timpani an entertaining sense of dynamism and resonance; there's no compression of scale with this receiver. It does a fine job with stereo and surround-sound.

Drawbacks? I was surprised at the softening of the sound when switching from Stereo to Dolby Pro Logic IIx, which lost both clarity and definition. The operating logic of the receiver didn't seem especially logical to me, but you get used to this sort of thing normally. And there's audible relay clicking as the unit changes modes automatically. None of this was especially annoying or obstructive though.

Switching to VHF/FM delivered more of the same, notably an almost eerie sense of transparency that made studio speech in 'You and Yours' sound close and lifelike. There was always a little sibilance, from this programme as well as Radio 2 presenters, but then most mics have a treble peak and I suspect the AVR-1705 was simply revealing it. Bass was firm at all times, underpinning music well. I turned volume right up

with relatively silent live studio speech and heard no hiss, but then I was using a big outdoor aerial in Central London, pointing to Wrotham. The muting level was set so low that other transmitters came through, giving two Radio 4s and two 3s as well. In cases like this it is best to tune by frequency selection. The tuner is a good one, with correct tonal balance, superb clarity and no audible hiss.

The AVR-1705 is quite clearly an expensive design cut down, and being made in China impacts quality little. This model has decent build quality, a wide range of useful facilities and a great sound that's well into hi-fi territory. It's good even as a stereo amp, but amazing as a six channel receiver. With a slightly richer, fuller sound, Cambridge Audio's 540T (it's closest price rival) works slightly better in two channel stereo mode, but the Denon pulls back in surround mode - and it boasts a peach of a tuner too. If you're thinking of spending £250 on a product like this, it's well worth having - even if I didn't find that kitchen sink...

VERDICT ●●●●£

Fine sound and facilities at a super low price makes this a blistering entry level AV bargain.

DENON AVR-1705 £249.95

DENON

☎ +44 (0)1234 741 200

www.denon.co.uk

MEASURED PERFORMANCE

Producing 105W into 8ohms and a healthy 170W into 4ohms, the budget AVR-1705 has plenty of power. Distortion behaviour was not compromised either; although mid-band figures are higher than the 2805, at high frequencies performance was identical. Since the 1705 produces a steady pattern of mainly second harmonic distortion, it actually performs better.

In Direct mode frequency response measured 5Hz-70kHz. Switching in Dolby Pro Logic IIx put in an anti-alias filter at 40kHz, before A/D conversion and processing, whilst Matrix mode reduced this to 22kHz, much like the 2805. The 1705 does not have a Phono input though, so Matrix cannot be used with old Quadraphonic discs unless LP is hooked up through an external phono stage. There was a little more measured noise and d.c. offset figures were greater and more varied than the 2805.

The VHF/FM tuner had a less accurately terminated mpX filter too, showing slightly sloppier component selection than the 2805. However, with noise, sensitivity and distortion figures nearly identical this looks like the same basic tuner. It's a good one. The AVR-1705 turns in a fine set of measured performance figures. It uses good, modern internal circuits, has plenty of power and low distortion. Looks like a budget bargain. NK

The AVR-1705 turns in a fine set of measured performance figures. It uses good, modern internal circuits, has plenty of power and low distortion. Looks like a budget bargain. NK

The AVR-1705 turns in a fine set of measured performance figures. It uses good, modern internal circuits, has plenty of power and low distortion. Looks like a budget bargain. NK

Power 105watts
CD/tuner/aux.

Frequency response	5Hz-70kHz
Separation	85dB
Noise	-84dB
Distortion	0.012%
Sensitivity	250mV
dc offset	8/16mV

Tuner	
Frequency response	5Hz-14kHz
Separation	43dB
Noise	-71dB
Distortion	0.3%
Pilot level	-78dB

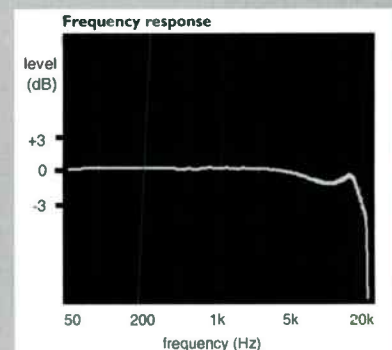
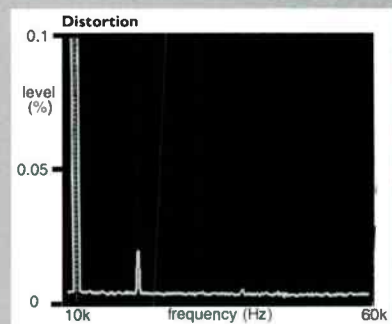

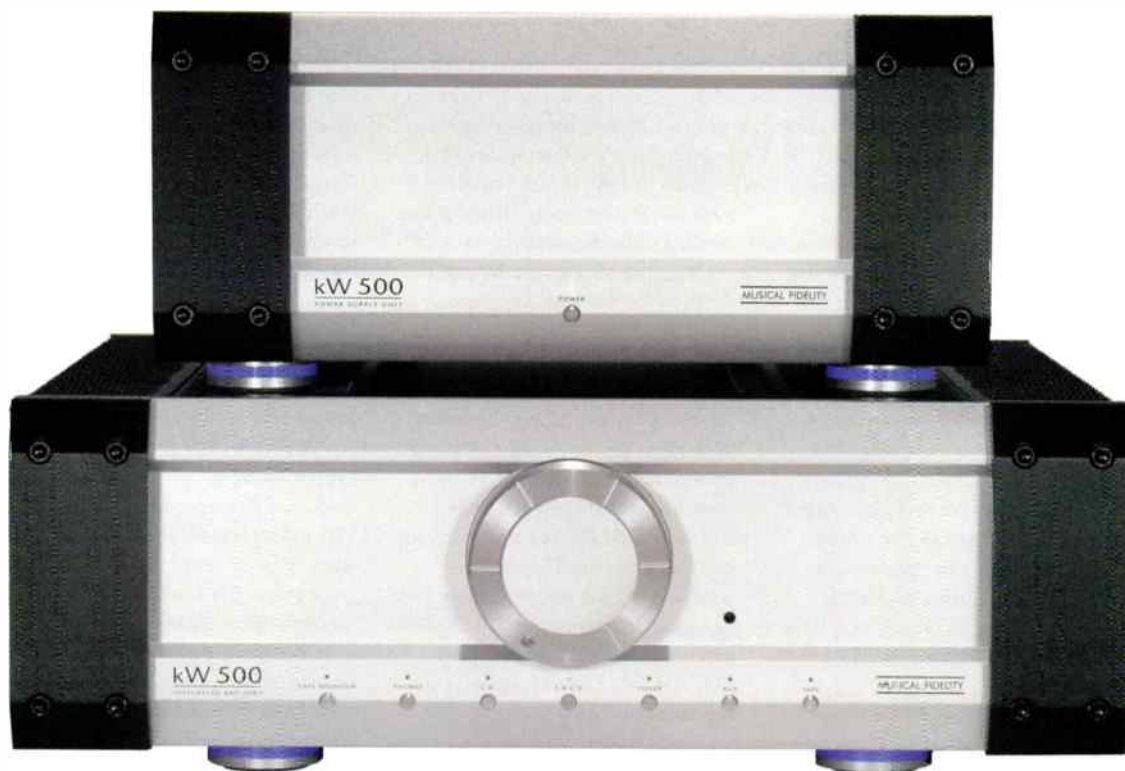

killer Watts!

Once upon a time, Musical Fidelity designed an inordinately large pre-power amplifier combination called the kW (as in kilowatt), then Antony Michaelson decided to distil it down to something better suited to real world buyers and called it the kW500 integrated. But it's still larger than life, says David Price...

I am not impressed by size. To me, less is more. The new BMW MINI proves this - sure, it's a great car, but give me the original 1959 variety any day for scything through town traffic or country B roads. In fact, making things bigger rarely makes them better. They get more complex, and in order to accommodate this they get larger and more cumbersome still.

I reckon everything has a 'critical mass'. Darwin told us that things find their optimum shape, size and type by natural selection, and for this goes for hi-fi too. By and large, modern rooms need amplifiers of around 100W RMS to go loud with most speakers, although valve designs can get away with far less providing appropriately efficient transducers are used. What then, is the point in the kW500? With a claimed half a kilowatt into 8 ohms, it's more than enough to fry my Quad ESL989s, or turn my Yamaha NS1000Ms into explosive devices.

Well, Musical Fidelity's supremo Antony Michaelson is of the opinion that any real hi-fi should have at least this much, if rooms and loudspeaker matching are not to be an issue. My first reaction when I heard him say

this was to wonder how big his own listening room is at home - a darn sight bigger than mine, I mused. Anyway, in the name of scientific enquiry, I volunteered to give the kW500 a go...

I can't say I was particularly looking forward to it, because of the ridiculous girth. I think that, given the dinosaur dimensions, MF has done a superb styling job (save the 'kaleidoscopic feet' which glow different colours to indicate amp status - not a personal favourite). But it was the vastness of this product that perturbed. Would my Alphason glass equipment rack be able to withstand its 55kg weight, or the vast 840cm width? Would I ever walk again if I dropped it on my foot? What about my loudspeakers, and more importantly my ears? And how about my AC mains - would the lights go out in the fine city of Bristol should I transgress with the volume control?

Well, matters of mass and size are assuaged somewhat by the fact the MF has split the amplifier from the power supply. The former is a mere 26.8kg and 483x 470x 167mm; the latter just 18.3kg and 364x 480x 167mm! For yours truly at least, the key benefit of this was to make it

possible to transport the kW500 to my house... Once you've unboxed it, decided whether to place the two units side by side on your equipment rack, or one on top of the other (not directly, but on the shelf above, you understand), and connected up the umbilicals (two signal leads and two mains), you still can't help thinking what a darned ridiculous domestic proposition the kW500 is. Dimensionally speaking, it makes my Michell GyroDec look like an Apple iPod MINI. As you can probably tell then, this the audio equivalent of trying to prize a Jaguar XJ220 into the single garage of the average English three bedroom semi.

If this doesn't not dissuade (or indeed, maybe it may even seduce), then you'll be interested to know how well it's made. That's right, brick outhouses spring to mind - but the MF is dramatically more elegant. All that heatsinking doesn't detract from a handsome fascia panel. A sensible selection of five level inputs are provided (complete with tape monitoring) and one for the (2.5mV) MM phono stage. Round the back, aside from the aforementioned connections to the PSU, there's two pairs of huge loudspeaker binding

ON THE PHONO

Interestingly, the kW500 includes a MM phono stage. Shame it's not switchable to MC, but let's be thankful that it's actually been done properly. It sounds open, sweet and detailed, with a slight softening of the recorded acoustic that's actually welcome – especially with some modern moving magnets. Partner this with a Shure V15VxMR and you're laughing – anything more and we'd advise Trichord's Delphini or Whest Audio's PS20.

posts per channel, and one pair RCA audio preamp outputs controlled by the volume setting, and one pair of fixed line level RCA tape outs. Inside, it's a stunning looking apparition – not least because of the mu-vista (6112) tubes in the gain stage and eight output devices per channel. From this, MF claims 770 W per side into 4 Ohms [see **MEASURED PERFORMANCE**], 63.9 Volts RMS 20Hz to 20kHz with a peak-to-peak figure of 180.6 Volts and 160 Amps of current. Kowabunga!

SOUND QUALITY

First things first. The kW500 has an unerringly (some would say relentlessly) neutral tonality. It's glass clear – making almost any other amp seem veiled – even the Naim NAC202 /NAP200 sounds quite silky and velvety by comparison. It's not hard, but in the same way that bright natural sunlight can sometimes make you squint, so the kW500 brings a sharp intake of breath with forward recordings. No Quad 22/II, this!

This is a function of its incredibly low distortion – there's no valve bloom or transistor 'hash', rather the kW500 just cuts straight to the chase. 4hero's 'Escape That' showed disarming clarity and detail. One facet of this is that instruments don't stop playing, or recede, when others come into the mix. It all sounds so effortless and natural, and then you switch to almost any other amplifier and it sounds compressed, asthmatic and out of sorts. Crashing bass notes simply arrive unannounced, and leave, leaving the rest of the mix utterly unblemished.

The promise is untrammelled power, an amplifier that is – to all intents and purposes – invisible to its loudspeakers. And the reality is pretty much this – in some ways, this is the best amplifier I've ever heard. Those used to lesser, lower powered amplification – even ones as nice and

beguiling as the bridged Musical Fidelity XP-200s I've been living with of late – will instantly recognise what such massive wallop brings to party.

I tried both pairs of my reference loudspeakers (Quad ESL and Yamaha), and made some fascinating observations with both. The obvious benefactor was the NS1000M, which is surprisingly efficient, but a pig of a load and also the most revealing moving coil loudspeaker I've ever heard – double trouble. But even via the genteel, English 'Clingfilm' of the Quads, you could hear tremendous speed and power muscling through.

I was stunned by how barrel-chested it made the Quad electrostatics sound – it was almost on a par with the (normally far browner) Yamahas with any other amp. Source Direct's 'Dangerous Liaisons' is a beautiful slice of drum'n'bass, and suddenly the 989s were vast, towering and magnificent, with lightening transients (faster than I'd thought plastic film could possibly move!) Utterly transfixed, I edged up the volume control until zzzzz.... The protection circuits said 'Goodnight Vienna' Still, things went to remarkably high levels, and with such poise, clarity, nonchalance.

With this same track, the NS1000Ms will trip cooling fans and switch protection circuits on anything else. With almost anything – including Naim NAP250 power amps, they have their partnering electronics very much on the back foot. With the kW500, they just got louder and louder until my chest could bear the sound pressure no longer. Interestingly, my ears were not bleeding – the Yams are reputedly the lowest distortion measuring loudspeakers ever made, even at full 200W RMS input, and the kW500 wasn't adding anything more. It was magnificently transparent and composed, and such amazing speed! Mahler's Symphony No. 10 (Simon Rattle, Berliner Philharmoniker)

on DVD-A showed its soundstaging to be superlative; three dimensional, 'walk around', and with rock-solid location – it made Quad 989s sound fifty feet high! At high levels, again the kW500 reminds one just how compressed and sat-upon rival 'super amps' are. It's so vast, vivid and vivacious that you can do nothing but sit transfixed. Move to a Blue Note recording on vinyl and the acoustic enlarges still further...

I'm in no doubt about the Musical Fidelity's brilliant sound (meant in the literal sense) and massive power. My only reservation is that it may not be everybody's cup of tea. It has a brightly lit and bracing sound that pins you to your seat, not through distortion (which is usually the case) but through visceral speed, power and insight. It's thrilling to listen to, but unrelentingly so. Late night dinner jazz becomes as frenzied and emotionally engaging as thrash metal. For this reason, an audition is of course essential – don't worry about bringing your speakers to the dealer though; whatever you have at home, it'll drive them, trust me. As for this reviewer, well I adore the MF kW500 integrated, and can't wait to try the power amp. Less may be more, but for me at least, more can never be too much...

VERDICT ●●●●●

One of the best integrateds yet made – limitless power and disarming detail make for an invigorating listen.

MUSICAL FIDELITY kW500 £3995
Musical Fidelity
☎ +44 (0)20 8900 2866.
www.musicalfidelity.co.uk

FOR

- stunning power and drive
- blistering attack transients
- tremendous insight

AGAINST

- not euphonic enough for some
- too 'challenging' for some styling not to all tastes

REFERENCE SYSTEM

Michell Orbe/Origin Live Illustrious/Ortofon Kontrapunkt B turntable
Trichord Delphini NC phono stage
World Audio Design KLP-P1 (modified)/ K5881 (modified) pre-power
Yamaha NS1000M and Quad ESL989 loudspeakers

MEASURED PERFORMANCE

Producing 600W into 8ohms and 700W into 4ohms the kW500 comfortably exceeds its moniker. This is a bridge amplifier so the negative loudspeaker outputs must not be grounded. Bridge amps usually sound quite clean though, since they are fully balanced and can cancel common mode noise and distortion. Not unexpectedly, the kW500 produced virtually no distortion – around 0.005% under most conditions. Only when delivering full output at 10kHz into 4ohms did the figure rise to a small 0.01%, comprising second and third harmonics alone. So the kW500 is both powerful and clean all the way up to full output.

Bandwidth was a normal, but input sensitivity a little low for old sources, like cassette decks, if fine for all else. There was no D.C. output offset at all, likely due to bridging.

The phono stage is a low sensitivity MM type with good bandwidth and low noise. There is no warp filter. It measured well in all respects.

The kW500 delivers monster power and a fine set of measured performance figures. NK

Power	612watts
CD/tuner/aux.	
Frequency response	7Hz-60kHz
Separation	86dB
Noise	-105dB
Distortion	0.006%
Sensitivity	440mV
dc offset	0/0mV
Disc	
Frequency response	17Hz-34kHz
Separation	81dB
Noise	-92dB
Distortion	0.008%
Sensitivity	4.7mV
Overload	120mV

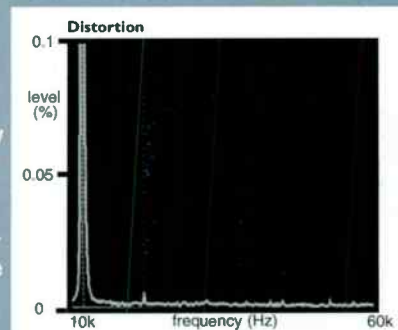

flash metal

Fresh from their visually arresting Rechav II CD player, Italy's flamboyant MEL audio has just introduced a striking aluminium cased monitor loudspeaker. Dominic Todd auditions the Horama...

Cards on the table, with the exception of the Celestion SL600/700 series, I'm no great fan of metal encased 'speakers. – traditionally, they've always seemed to sound cold, harsh and coloured. Yet, there's no denying the stunning build quality of MEL Audio's £3,275 Horama mini monitors, with their bang up-to-date engineering touches.

Although metal, the cabinet is no pressed steel affair. Rather, it's made entirely from aeronautical, milled and polished aluminium. The sides, top and bottom are a substantial 15mm thick and bolted together using internal fixings. The front and rear baffles are, surprisingly, thinner (8mm) and externally bolted through to the cabinet walls. The whole structure is beautifully finished and the glue-less construction should really benefit the sound quality. Like many good monitor 'speakers, the Horama is an infinite baffle (sealed) design. As you'd expect from a metal enclosure, plenty of acoustic "egg crate" foam is used inside, and the drivers rest on heavy-duty gaskets. As a final measure of isolation, the bolts holding the drive units are also sealed with Black Tac.

The drivers themselves are a

mixture of the conventional and unconventional. The 25mm, silk dome tweeter has a felt surround and is pretty much par for course for this type of 'speaker. The 130mm (5") woofer, on the other hand, has a cone fashioned from a ceramic and aluminium mix. Both are braced via beam structures that bolt through, from the rear of the 'speaker.

An intriguing design, then, and good-looking in its own way. Its superlative finish can't be faulted, and goes some way to justifying the price. Ah, that price again. Although beautifully made, so is the opposition, and it also tends to be a good deal cheaper. Think Sonus Faber Cremona Auditor (£2,150), Acoustic Energy AE1 MKIII (£2,000) and B&W 805 Signature (£2,500) and you can see that the Horama faces some tough rivals...

SOUND QUALITY

True monitor 'speakers sound open, articulate and most of all honest to the recording – which isn't necessarily a good thing. It could be that your favourite recording has been poorly recorded, produced and/or mixed, and that you'd rather not hear its inadequacies. The MEL is one such design, so those looking for a

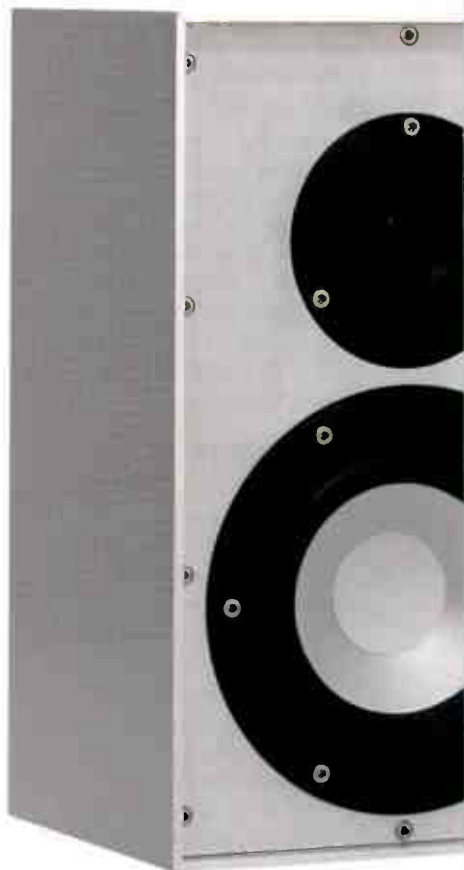

soothing, euphonic listen would be best to rule it out right away. Otherwise, there's much to recommend MEL's monitor. With Gabrielle's 'Stay The Same' the Horamas portrayed an extremely accurate and focused vocal rendition. There was real insight into vocal texture, and placement was absolutely dead centre within the

MINI MENTOR

No review of mini monitors would be complete without a look at the daddy of them all – the classic LS3/5a. Way back in the early 1970s, the BBC decided that they needed a small, accurate transducer that would serve the purpose of "portable monitor". Existing designs were simply too big for use in the increasingly popular mobile broadcasting units, and there was nothing commercially available that was suitable. So, using KEF's newly launched B110 woofer (a mere 5" in diameter) and an acoustic scaling principle, a one-tenth-scale model was produced. Thus became the LS3/5. Despite extensive development, it actually came as quite a surprise to BBC engineers as to how uniform the LS3/5 sounded – right the way down to 100Hz. When the time came, however, to produce a new batch of 'speakers, the BBC discovered that KEF had changed the driver design. Consequently the 'speaker had to be redesigned, with the LS3/5a being the outcome. The design was held in such high regard that the BBC began to license the design commercially. Originally, it would only allow three licensees at one time - in the '70s this was generally Rodgers, Audiomaster and Chartwell. In the '80s Rodgers were joined by Spondor, Goodmans and then Harbeth. Other manufacturers included RAM and countless 'inspired' models from the likes of JPW, Linn and JR. Over the years the Rodgers models sold best (around 50,000) followed by Spondor (22,000) and then Audiomaster (10,000) and Harbeth (7,000). Many think that nothing commercially available beats the original BBC design. The reason for this is unclear, but it may have something to do with the screw-on, as opposed to glued, rear back panel [or dewy eyed nostalgia – Ed.]. You'd have to be very lucky or very much in the know to get hold of some BBC originals, so for the rest of us the model to have is probably the Harbeth. The next best was generally considered to be the Spondor, with the Rodgers surprisingly trailing. Do bear in mind, however, that most of these manufacturers produced several versions of the design – some inevitably better (and far more expensive) than others. For the ultimate, commercial, design look no further than the final 1999 Harbeth "Signature" model. It was tweaked up to the hilt and sounded about as good as it gets. As a reference for other models, although dynamically limited, it still sounds great, even today.



As well as suiting a small room, it also pays to listen closer than one would otherwise. With my listening position adjusted, I found the sound more intimate, and it was all the better for hearing extra detail – almost like wearing a pair of large headphones in fact! Percussion was reproduced in a precise and articulate manner that would make even what was considered to be a transparent 'speaker sound veiled. The imaging was

excellent again and, with a decent quality recording such as this, there was also the opportunity for the Horamas to show off a fine depth of sound. As before, the sound remained extremely faithful to the original, right down to the slight vocal sibilance at times.

Acoustic Alchemy's 'Mr Chow' is another fine quality recording that gives decent 'speakers the chance to really shine. Here, there was an openness from the guitars that reminded me of a good electrostatic 'speaker. Against that, however, there was a distinct lack of welly. The leading edge note had definition and attack, but when it came to dynamic scale and authority, the MELs couldn't cut the mustard.

It wasn't so much the lightweight bass that held back Jamiroquai's 'Too Young To Die', but more the fact that the sound didn't gel so well. It was expertly separated, with plenty of space around instruments and generally fine reproduction of timbre but, somehow, the music just failed to flow. I couldn't help but think that all that accuracy was getting in the way of true listener involvement. To have the electrostatic transparency but

without the seamless response was becoming frustrating... Switching to Classical music (Emmanuel Chabrier's, Espana), and the frustration of incredible insight mixed with limited scale continued to grate. I suspect that the balance would be too forward for many with the brass, in particular, sounding rather explicit. Yet there was no denying the drama afforded by the attack of the piece. Surprisingly, lack of bass was less of a problem here as it had been before. Just as captivating however was the exquisite cymbal decay and subtle percussion strokes.

Personal taste is all when summing up these little loudspeakers. Whilst I couldn't help but admire their transparency, leading edge attack and fine soundstaging, the lack of bass extension was an issue for me. This could always be alleviated with a good subwoofer (REL Strata 5, for example) or two of course, but some may seek a more physical sound all the same. The real problem for them is their price rivals, some of which can match the Horama's transparency and still provide more convincing bass. Still, used in a small room at close range with neutral sounding ancillaries, the Horamas sound superb – and look no less special.

sound stage. I found the treble had the appearance of being very open at frequency extremes. It gave the guitar an unusually detailed air, but also revealed a little sharpness from certain parts of the recording – like I say, the Horamas aren't always an easy listen. As you'd expect from such a small 'speaker, true bass was pretty much none existent, although I'm sure its only slightly larger rivals – B&W's 805 in particular – would still do better here.

Listening to Jennifer Warnes' 'The Panther' reminded me of another mini monitor characteristic.

VERDICT ●●●●

Ultra incisive mini monitor voiced in a way that some will love and others hate; stunning build and finish justify high price.

MEL AUDIO HORAMA £4,750
MEL Audio Design Group
S.R.L.
 ☎ +39 0522 433368
 www.melaudio.com

- FOR**
- aluminium construction
 - transparency
 - soundstaging
- AGAINST**
- expensive
 - limited bass

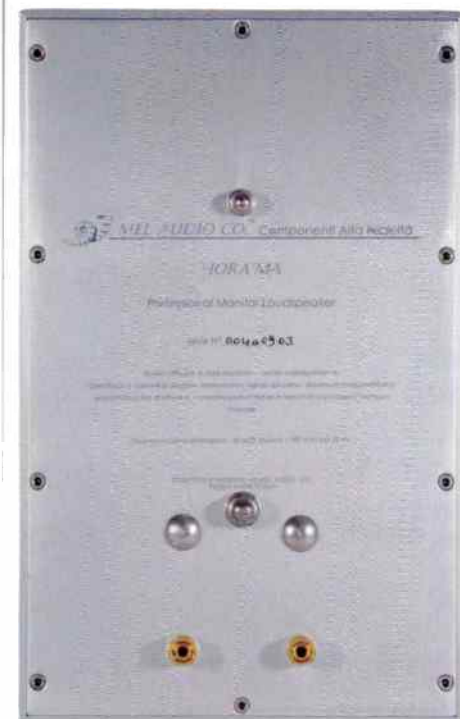

MEASURED PERFORMANCE

The small, aluminium Mel cabinet works down to 40Hz, but bass output shelves below 200Hz to prevent boominess from reinforcement when positioned close to a rear wall. Above 200Hz the frequency response of this speaker is a little uneven and the tweeter's output is fairly pronounced. It extends up to 8kHz before rolling down rapidly, not a very extended response by modern standards. This result, and the presence of a large lip around the cabinet front, will adversely affect imaging, cohesion and smoothness.

With a minimum impedance of 8ohms the Mel draws little current from an amplifier, but is insensitive as a result, producing just 83dB SPL from one nominal watt of input. Steep changes of impedance indicate substantial reactance in the load, not a good thing.

The Mel is a little questionable

in important areas. Technically it could be better. NK

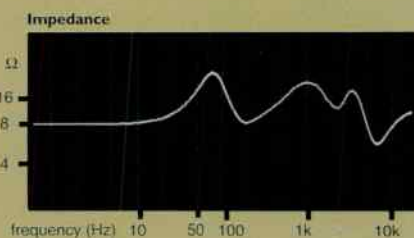
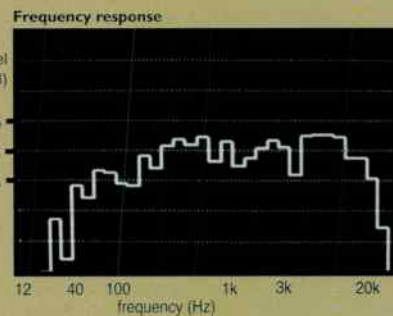

PROBABLY THE BEST DIY KITS IN THE WORLD



World Audio
design

www.worldaudiodesign.com
tel: 01245 450 651

SINGLE-ENDED PURITY

Our Parallel Single Ended (PSE) power amplifiers offer ultimate sound quality. Each monobloc has two beautifully linear 300B directly heated triodes in its output stage, producing 20 watts into an 8 ohm load. At the front of the circuit we there is a 6AU6 pentode, followed by an ECC82 as the driver valve. This design uses a 5U4 rectifier valve in the power supply, in combination with a 10H choke, giving an extremely quiet supply. Both mains and output transformers are built on high quality E/I pattern cores.

Feedback can be switched in or out whilst running, using a rear panel switch. Complex layered and sectioned output transformers give full output and low distortion across the audio band even without feedback, making such an option possible.

This is one of the few amplifiers in the world so good it will work without feedback - and no feedback is the preference of most buyers. It gives a spacious, relaxed and fluid sound quite unlike that of solid-state amps, all of which use feedback to correct deficiencies.

By operating linearly in feedbackless, pure Class A, single-ended mode these



300B monoblocs are as pure as it gets - and sound quality reflects the fact. Fast, clean and clear in their presentation, at the same time their purity of sound is easy on the ear.

The kit is totally hard-wired; it does not use circuit boards. We can supply without valves, or with the superb Tesla 300Bs, Russian 5U4s and European 6AU6s & ECC82. Our 300B PSE kit bears an affordable price of £895.00 (UK price) excluding valves. Each monobloc weighs 23kgs (50lbs). External dimensions with valves: 25cm(w) x 38cm(d) x 22cm(h) per monobloc.

PUSH-PULL POWER

For more power, we also offer 300B in Push-Pull (PP) form. The 300B PP monobloc shares the same look and chassis as the 300B PSE monobloc. The 300B PP kit has been created for those who prefer a bit more power. With a pair of 300Bs in push-pull configuration providing 26 watts output, they will drive most modern loudspeakers to perfection. Andy Grove's design is totally feedbackless, using a 6AU6 pentode as the input valve and a 5687 as the phase splitter. The power supply uses a Russian 5U4 for rectification. The kit is constructed by hard wiring, so some experience is required. 300B PSE owners do have the option to buy the conversion kit for £250.00 to turn their monoblocs to push-pull status. Each monobloc weighs 23kg.

300B PSE MONOBLOC KIT

£1197 per pair

300B PP MONOBLOC KIT

£1197 per pair

The PRE-II is a high quality valve pre-amplifier that will drive any power amplifier. It has a gain of x5 which, with CD, enables it to deliver a large 10V output swing. To keep the amount of active amplification low, this pre-amp uniquely uses a line drive transformer to deliver a pure signal to the power amplifier. There are six inputs, a tape monitor and two sets of output sockets. It is powered by the external PSU-II power supply. The volume control uses high quality Alps Blue potentiometer which, with our solid, turned brass, chromed knob, gives a quality feel rarely encountered these days.

PHONO-II is a dedicated valve phono stage for MM cartridges, with MC input transformers an option. By using all-d.c. supplies from PSU-II and a case in which there is no power supply, PHONO II is hum free, something that is difficult to achieve with valves. With accurate RIAA equalisation right down to 10Hz (-3dB) PHONO II gives a wonderfully pure, dimensional sound from LP, possessing a sense of life and dynamism quite different to solid-state preamps.

Finally, PSU-II is a power supply unit that feeds both the PRE-II and PHONO-II. Keeping the power supply separate removes hum, often the bane of valves.

Power Supply Unit (PSU-II)	£205.00
Pre-amplifier (PRE-II)	£215.00
Phono Stage (PHONO-II)	£110.00
Moving coil step-up transformer	£77.00



SERIES II MODULAR PRE-AMP KIT

PROBABLY THE BEST DIY KITS IN THE WORLD



World Audio
design

www.worldaudiodesign.com

tel: 01245 450 651

Kel84 is an affordable, integrated valve amplifier for those who want to enjoy the valve sound, but from a simple, easy to build kit. It uses inexpensive EL84 output valves, known for their sweet sound, in conventional push-pull arrangement to provide 15 watts into an 8 ohm load. The output transformers are our own quality Ultra Linear design. Up front, the circuit employs an ECF80 input/phase splitter valve, which contributes to Kel84's extremely smooth sound.

The amplifier has very low hum and for simplicity it is built on a printed circuit board. A strong steel chassis is fronted by a 3mm anodised front panel and attractive brushed aluminium effect knobs. There are five line level inputs, plus one monitor input, with a tape output included, all controlled from the front panel.

At the rear is a mains switch/IEC power input, earth post, phono sockets, and 4mm banana sockets for loudspeakers. The Kel84 will highlight all the intricacies and depth of detail in your favourite recordings whilst retaining a warmth and fullness that is almost exclusive to pure valve amps and is rare at this price point.

Kel84 weighs 10kg. External dimensions with valves are 300mm(w) x 270mm(d) x 150mm(h).



KEL84 VALVE INTEGRATED AMPLIFIER KIT

£298



Our 6550 series amplifiers are built around the rugged 6550 beam tetrode that's popular in America. This valve is widely available at a good price. Producing no less than 40 watts into an 8 ohm load. (available in a 4 ohm version if required) our 6550 is a power house, since valve watts always sound louder than transistor watts!

The difference between our 6550 and most others is that we use valve rectification (5U4) and a choke pi filter, for a power supply that is quiet and free from solid-state hardness. This is a true high-end design from Andy Grove, hard wired. It is a cut above the many other 6550s, with enough power to drive most loudspeakers, including insensitive electrostatics for example. 6550 combines high

power with a top-end smoothness of sound, yet doesn't cost the earth to run, as the valves are inexpensive and have a long life.

The amplifier weighs 19kg. Dimensions are 390mm(w) x 330mm(d) x 190mm(h) with valves, or 220mm(h) with cage.

KIT6550 - An integrated amplifier with line inputs and volume control. Accepts CD, tuner, tape etc., but not LP.

KAT6550 - A power amplifier for use with a separate pre-amp. Paired with PRE II and PHONO II (+PSU II), can provide LP reproduction.

KIT6550 VALVE INTEGRATED AMPLIFIER KIT

£615

KAT6550 VALVE POWER AMPLIFIER KIT

£580

The HD83 headphone amplifier is a beautifully simple design using Mullard ECL83 valves, a triode and power pentode housed in the same envelope. It works directly from any source, be it CD, tape, tuner etc., or from an amplifier's tape out or pre-amp out sockets. The circuit uses high specification E/I output transformers that will drive any headphone load from 16 ohms to over 300 ohms depending on how the secondaries are wired up.

The HD83 is a pure Class A single-ended design with the power pentode wired up in triode configuration for added sonic purity, and it is as quiet as a mouse. Treble has the crispness of the best solid-state, but with the tonal resolution and delicacy associated with valves. Bass is punchy and controlled without becoming artificial.

External dimensions 18cm(w) x 30cm(l) x 8cm (h) weight 4kg.



HD83 VALVE HEADPHONE AMPLIFIER KIT

£195

PROBABLY THE BEST DIY KITS IN THE WORLD

World Audio
design

www.worldaudiodesign.com
Tel: 01245 450 651

KIT6550/KAT6550 mains transformers

2 inch stack, 130mm(h)x120mm(w)x135mm(l)
drop through fitting with zinc cap. Secondaries
425V-0V-425V, 350mA, 0V-5V, 6A, 3.15V-0V-3.15V,
9A. Suitable for 120V & 240Vac operation

KEL84 mains transformer

1.5 inch stack, 90mm(h)x 80mm(w)x 95mm(d)
drop through fitting with zinc cap. Secondaries:
0V-240V 300mA, 3.15V-0V-3.15V, 5.5A, suitable for
120/240V operation

KIT34/KAT34/KIT6550/KAT6550 choke

1.25 inch stack, 65mm(h)x105mm(w) with fitting
holes x 60mm(d), clamp fitting, 2.5 H, 350mA

300B PSE mains E/I transformer

130mm(h) x 95mm(w) x 115mm(d).
drop through fitting with zinc cap.
Secondaries: 380V-0V-380V, 180mA/150-0V-150V,
25mA/0V-5V, 1.2A/0V-5V, 1.2A/0V-5V, 3A/3.15V-0V-
3.15V, 0.4A suitable for 120/240V operation

HD83 mains toroidal transformer

80mm dia. x 35mm(h). Secondaries: 0V-
165V, 75mA/3.15V, 1A, suitable for
120/240V operation

PSU-II mains toroidal transformer

80mm dia. x 35mm(h). Secondaries: 0V-
270V, 60mA/0V-10V, 2A, suitable for 120/240V
operation

TRANS1 mains toroidal transformer

95mm dia. x 50mm(h). Secondaries: 0V-
370V, 150mA/0V-6.3V, 3.5A 300B E/I choke
65mm(h) x 70mm(d) x 80mm(w) open frame
fitting, 10H, 180mA.

KEL84 E/I choke

0.5 inch stack, 40mm(h)x 35mm(d)x 70mm(w)
clamp fitting, 1H, 250mA

PSU-II E/I

40mm(h) x 35mm(d) x 70mm (w) clamp fitting,
15H, 20mA

KIT34/KAT34 mains transformer

2.5 inch stack, 120mm(h)x115mm(w)x95mm(d),
drop through fitting with zinc cap. Secondaries
365V - 0V - 365V, 300mA/0V - 5V, 6A/3.15V - 0V -
3.15V, 7.5A. Suitable for 120/240V operation.

2A3 PSE mains transformer:

2.5inch stack, on a 120 size lamination,
120mm(h)x115mm(w)x95mm(d), drop through
fitting with zinc plated transformer caps.
Secondary winding: 370V-0V-370V, 250mA, 0V-5V,
3A, 0V-4V, 2A x4. Suitable for
110V/120V/220V/230V operation. Can be used
for a valve rectified, dc heater (2A3), dc regulated
heater(input valve) stereo 2A3 PSE/PP amplifier.

KECL82 mains transformer:

1.25inch stack, on a 29 size lamination,
80mm(wide)x70mm(height)x70mm(depth), frame
type 2 hole fixing. Secondary winding: 0V-185V,
200mA, 0V-6.3V, 3.5A. Suitable for
110V/120V/220V/230V operation. Good for low
power amp, solid state rectification achieves a HT
of 240Vdc. Could be used for ECL82 PP/PSE
stereo amp.

MAINS TRANSFORMERS & CHOKES

KIT6550/KAT6550 E/I 16% TAPPED UL

push-pull output transformer 2 inch stack, 80mm
(w) x 95mm(l) x 100mm(h), drop through fitting
with zinc cap. Primary-secondary 4.5K, 16% UL
tapped. Secondary 4 Ohm or 8 ohm, pls specify on
order. max output 45 watts, max current 180mA,
valves, KT88, 6550 etc

KEL84 E/I Ultra Linear push-pull output transformer

1.25 inch stack, 76mm(h)x 65mm(w)x 76mm(d)
Primary - secondary, 8K with 12.5% UL tap -
8ohms, max o/p-15watts, max current 150mA
valves EL84 etc

KIT88/KAT88 E/I push-pull output transformer

80mm(w)x95mm(l)x100mm(h). Primary-secondary
10K - 8ohms, max o/p-40watts, max current-
160mA valves-KT88, 6550, EL34

Pre-II E/I driver transformer

80mm(w)x60mm(l) x65mm(h). 6:1 step down
transformer, max current-10mA valves-6922 etc
pre-amp stage

KIT34/KAT34 E/I 14% tapped Ultra Linear push-pull output transformer

2 inch stack, 80mm(w)x95mm(l)x100mm(h), drop
through fitting with zinc cap. Primary-secondary
6.4K, 14% UL taps, Secondary 8ohm, max output
34watts, max current 150mA, valves EL34, 6L6,
6CA7

HD83 E/I single ended output transformer

40mm(w)x50mm(l) x55mm(h).
Primary-secondary 4K - 4 x 64ohms
windings, max o/p-1watts, max current-25mA
valves-ECL83 etc

300B PSE E/I parallel single ended output transformer

130mm(h) x 95mm(w) x 115mm(d).
drop through fitting with zinc cap.
Primary 1K5 Secondary 8R, output .

2A3 PSE E/I output transformer:

2A3 parallel single ended transformer, 2 inch stack,
78 size lamination. Primary impedance is 2.5K,
secondary impedance is 4ohm or 8ohm, max
current is 100mA. Output is 8.5VWatts.

KECL82 PP output transformer

ECL82 push-pull ultra linear. 1inch stack, on a 29
size lamination,
80mm(wide)x70mm(height)x60mm(depth), frame
type 2 hole fixing. Primary 7.5Kohm, secondary
8ohms. Max current 85mA,
Good for numerous low output pentode valves in
push-pull configuration.

300B PP E/I push-pull output transformers

2.5inch stack, on a size 120 lamination.
130mm(h)x95mm(w)x115mm(d) drop through
fitting with zinc plated cap. Primary impedance 4K,
secondary 6ohm. Will suit 300Bs, 2A3s etc in
push-pull configuration.

PRINTED CIRCUIT BOARDS

- KECL82 Printed Circuit Board 200mm(w) x140mm(l) x1.6mm(d)
- KEL84 Printed Circuit Board 280mm(w) x 135mm(l) x 1.6mm(d).
- KA88/KAT88 Printed Circuit Board 140mm(w) x 310mm(l) x 2.4mm(d)
- KE134 Printed Circuit Board 140mm(w) x 310mm(l) x 2.4mm(d).
- HD80 Printed Circuit Board (a pair) 120mm(w) x 215mm(l) x 2.4mm(d)
- HD83 Printed Circuit Board 140mm(w) x 160mm(l) x 1.6mm(d).
- PSU-II Printed Circuit Board 105mm(w) x 130mm(l) x 1.6mm(d)
- PRE-II Printed Circuit Board 105mm(w) x 130mm(l) x 1.6mm(d).
- MONO-II Printed Circuit Board 105mm(w) x 130mm(l) x 1.6mm(d)

OUTPUT TRANSFORMERS

Hi-Fi World in Malaysia at Millennium Hi-Fi & Av. Kuala Lumpur, Malaysia

Hi-Fi World is now distributed through good bookshops and newstands in Malaysia. For back issues, general enquiries and advertising, contact Simon Chang at Millennium Hi-Fi & Av.

Also available are products by World Audio Design,
Michell, Trichord, Lowther and ReThm loudspeakers.

Millennium Hi-Fi & Av
500-1-3 First Floor, Wisma Indah (Shen Court),
Jalan Tun Razak 50400 K.L.

tel: 603 9283 8171 fax: 603 9281 3762

137 Jalan Pendekar 2, Taman Skudai Baru, 81300 Skudai, Johor DT
tel: 607 554 5171 fax: 607 554 7645

e-mail: info@millennium-audio.com



These are expert kits, not for the inexperienced. You must be able to solder and read a circuit diagram. The valve kits contain lethal voltages. We cannot be held responsible for any errors arising from the construction of these kits.



order on our website @ **www.worldaudiodesign.com**

AMPLIFIER KITS DESCRIPTION	ORDER NO.	QTY	UK (inc vat & carriage)	OVERSEAS (exc. vat & carriage)
Kec182 (8 ohm)	Kec182 (with valves)	☐	£195.00	£170.00
2A3PSE with valves (4ohm or 8ohm, pls specify)	2A3 PSE (with valves)	☐	£570.00	£485.00
2A3PSE without valves (4ohm or 8ohm, pls specify)	2A3 PSE (without valves)	☐	£470.00	£400.00
KaT6550 with valves (4ohm or 8ohm, pls specify)	KaT6550 (with valves)	☐	£580.00	£495.00
KaT6550 without valves (4ohm or 8ohm, pls specify)	KaT6550 (without valves)	☐	£450.00	£380.00
KiT6550 with valves (4ohm or 8ohm, pls specify)	KiT6550 (with valves)	☐	£615.00	£525.00
KiT6550 without valves (4ohm or 8ohm, pls specify)	KiT6550 (without valves)	☐	£485.00	£415.00
KaT34 with valves (4ohm or 8ohm, pls specify)	KAT34 (with valves)	☐	£480.00	£410.00
KaT34 without valves (4ohm or 8ohm, pls specify)	KAT34 (without valves)	☐	£415.00	£354.00
KiT34 with valves (4ohm or 8ohm, pls specify)	KiT34 (with valves)	☐	£515.00	£440.00
KiT34 without valves (4ohm or 8ohm, pls specify)	KiT34 (without valves)	☐	£450.00	£385.00
Kel84 with valves (8 ohm)	Kel84 (with valves)	☐	£298.00	£255.00
Kel84 without valves (8 ohm)	Kel84 (without valves)	☐	£268.00	£230.00
PSU II	PSU - II	☐	£205.00	£175.00
PRE II	PRE - II	☐	£215.00	£185.00
PHONO II	PHONO II	☐	£110.00	£95.00
PAS II	PAS II	☐	£235.00	£200.00
Step ups transformers for MC use with PHONO II	MC - step up (pair)	☐	£80.00	£68.00
HD83 with valves	HD83 (with valves)	☐	£195.00	£167.00
300BPSE with valves (4ohm or 8ohm, pls specify)	300B PSE (with valves)	☐	£1197.00 per pair	£1020.00 per pair
300BPSE without valves (4ohm or 8ohm, pls specify)	300B PSE (no valves)	☐	£895.00 per pair	£765.00 per pair
300BPP with valves (6 ohm)	300B PP (with valves)	☐	£1197.00 per pair	£1020.00 per pair
300BPP without valves (6 ohm)	300B PP (no valves)	☐	£895.00 per pair	£765.00 per pair

PARTS DESCRIPTION	ORDER NO.	QTY	UK (inc vat & carriage)	OVERSEAS (exc. vat & carriage)
2A3 mains transformer	2A3 PSE mains T	☐	£115.00	£98.00
6550 mains transformer	6550 mains T	☐	£120.00	£105.00
34 mains transformer	KiT34 - mains T	☐	£100.00	£85.00
kel84 mains transformer	Kel84 - mains T	☐	£60.00	£47.00
HD83 mains transformer	HD83 - mains T	☐	£40.00	£34.00
PSU II mains transformer	PSU-II - mains T	☐	£40.00	£34.00
300B mains transformer	300B - mains T (each)	☐	£115.00	£98.00
34/6550 choke	KiT34 - choke	☐	£40.00	£34.00
kel84 choke	Kel84 - choke	☐	£20.00	£17.00
300B choke	300B choke	☐	£40.00	£34.00
2A3 PSE choke	2A3 PSE choke	☐	£40.00	£34.00
PSU II choke	PSU-choke	☐	£20.00	£17.00
6550 output transformer (4ohm or 8ohm)	6550 - O/P T (pair)	☐	£130.00	£112.00
34 output transformer (4ohm or 8ohm)	34 - O/P T (pair)	☐	£130.00	£112.00
kel84 output (8 ohm)	Kel84 - O/P T (pair)	☐	£90.00	£78.00
2A3 PSE output transformer (4ohm or 8ohm)	2A3 PSE O/P T (pair)	☐	£130.00	£112.00
HD83 output (multiload secondary)	HD83 - O/P T (pair)	☐	£100.00	£86.00
PRE-II driver transformer	PRE-II - driver T (pair)	☐	£80.00	£68.00
300BPSE output transformer (4ohm or 8ohm)	300B PSE - O/P T (each)	☐	£110.00	£94.00
300BPP output transformer (6ohm)	300B PP - O/P T (each)	☐	£110.00	£94.00
kel84 PCB	Kel84 - PCB	☐	£30.00	£26.00
kel34 PCB	Kel34 - PCB	☐	£12.00	£11.00
kel80 PCB	Kel80 - PCB(pair)	☐	£52.00	£45.00
KECL82 PCB	KECL82 - PCB	☐	£25.00	£21.00
HD83 PCB	HD83 - PCB	☐	£20.00	£17.00
PSU II PCB	PSU-II - PCB	☐	£20.00	£17.00
PRE II PCB	PRE-II - PCB	☐	£20.00	£17.00
PHONO II PCB	PHONO-II - PCB	☐	£20.00	£17.00
tag board	TAG	☐	£4.00	£3.00
ALPS 50K dual potentiometer	ALPS - 50K	☐	£14.00	£12.00
ALPS 100K dual potentiometer	ALPS - 100K	☐	£14.00	£12.00
stepped attenuator (10K or 50K)	Attenuator + resistor pack	☐	£75.00	£65.00
LCR 22.5uF 440Vdc polyprop. Cap	LCR - 22.5U	☐	£10.00	£8.00
Jensen 0.47uF 630V, aluminium foil	JEN - 0.47U 630V	☐	£20.00	£17.00
Safety gloves	SAFETY GLOVES	☐	£25.00	£21.00
2A3PSE/6550/34 safety cage	2A3 PSE/34/6550 cage	☐	£80.00	£68.00

TO ORDER

'phone **01245 450651**

or visit our website

www.worldaudiodesign.com

e-mail: sales@worldaudiodesign.com

product demos by appointment only

Unit 6, Rumsey Row, Writtle, Chelmsford, Essex CM1 3YA.



Prices were correct at time of print, 01/01/04 they are subject to change.

If you wish for a built item, please phone for a quote / Valves included except where otherwise stated.

WARNING - World Audio Design Ltd. accept no responsibility for kits, parts or modifications made or supplied by third parties.

Order on our website: www.worldaudiodesign.com.



WE HAVE OVER 30 TITLES ON OFFER!!!

AUDIO ELECTRONIC THEORY BOOKS



Electronics made Simple
by Ian Sinclair
This book covers the basic theory and principles of electronics. A good read for the beginner.
Code No. 1420
£12.99 + £2.50 P&P (UK)



Build your own High-End Audio Equipment
by Elektor
Build your own High-End Audio equipment contains construction projects for solid state preamplifiers and power amplifiers, active cross-over filters, an active subwoofer, a mono/stereo compressor and a headphone amplifier.
Code No. 1390
£14.95 + £2.50 P&P (UK)



Audio/Radio Handbook
By National Semiconductor
National Semiconductor's manual is an essential aid to engineers and experienced hobbyists in the application of National's line of consumer audio and radio ICs. Not only does it hold comprehensive data of their ICs but discusses theory aspects of amplifiers and pre-amps and covers electronic principals.

paperback 200pp, Code No. 1810
£13.95 + £2.00 P&P (UK)



Build your own Electronic Test Instruments
by Elektor
This book contains designs for 17 measuring instruments, seven generators and analysers, ten miscellaneous instruments and a number of test ancillaries and auxiliaries. The designs range from a simple multicore cable designs contain a special printed circuit, drawing of which are given in an appendix.
Code No. 1400
£15.95 + £3.25 P&P (UK)



The LP is back
by Audio Amateurs
Your complete guide to LP care and maintenance designed to offer you everything useful for those who love and enjoy this older music medium. This covers the theory and care of LPs and the electronics and mechanics of its players.
154pp Paperback, Code No.1620
£8.00 + £2.00 P&P (UK)

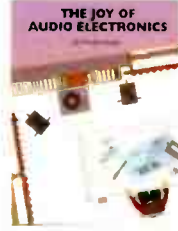

The Joy of Audio Electronics
by Charles Hansen
This is a fail-safe guide to the pleasures of hands-on electronic construction. This book covers test and measurement projects, how to build simple kits, safety issues, the workplace, theory and resources. A must for the beginner who plans to build more advanced electronic projects in the future.
124pp Paperback, Code No.1650
£10.50 + £2.50 P&P (UK)

VALVE BOOKS



Audio Measurements
by Norman Crookall
Famous compendium of measurement and test techniques for audio reproduction equipment of the tube era includes discussion of all instruments needed. Covers amps, transformers, preamps, turntables, changers, tonearms, cartridges, tape recorders.
Code No.1830
£13.95 + £2.00 P&P(UK)

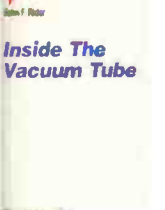

Inside the Vacuum Tube
by John F. Rider
One of the most thorough (and funny) books ever written on the way vacuum tubes function. Rider's mastery of analogies common to most of us makes the book especially useful to those who want to learn about vacuum tubes.
Code No. 1840
£24.00 + £2.50 P&P (UK)



GEC Audio Tube Data
Full of data and circuits concerning the three most well known MO Valve power tetrodes, the KT66, KT77 and KT88, (the KT77 was GEC's answer to Mullard's EL34) and some data on the PX4 and PX25 triodes. The first section concerns preamplifiers of various types, with information regarding equalisation, tone controls, filters and suchlike. An excellent book for all valve heads.
Paperback Code No. 1780
£14.95 + £2.00 (UK)



Understanding Hi-Fi Circuits
by N.H. Crowhurst
Originally published in 1957, Discusses all aspects of amplifiers, pre-amplifiers and equalisation circuitry, well written, easy to understand. The author does concentrate on valve circuits, so no transistors here.
Paperback, 224pp Code No.1820
Price £13.95 + £2.00 UK p&p



Glass Audio Projects - 17 Vacuum Tube Designs
This book features 17 valve project, designed, tried and tested by some of the best authors state side. Designs such as a 300B push-pull amp, a 33 power amp a 6528 single ended, a 300B parallel single-ended amp, a 6C33C-B single ended amp, a 70W KT88 push-pull amp, a 2A3 single ended amp to name a few. All information is provided so most projects can be built from scratch.
Paperback 73pp, Code 1790,
£8.00 + £1.50 P&P (UK)



An Approach to Audio Electronic Valves in Audio Frequency Amplifiers
by E. Rodenhus
Discussing the use of valve data, the function of different amplifier stages and includes detailed descriptions of eight designs. A wealth of practical data, measurements and interesting features will be found. A very good read.
Paperback 147pp, Code No. 1520
Price £12.95 + £2.00 P&P (UK)



The Best of Audion editorial projects
by Luciano Marzi
This book contains six excellent audio projects - a high sensitivity speaker, a superb tube pre-amp, a 2A3 amplifier design, a project using the Russian 6C33CB and two projects using 300Bs as output valves. Overall the book is a fabulous read.
62pp, paper back book code 1750
£12.00 + £2.00 UK p&p



Vacuum Tube Amplifiers
by Valley & Walkman
This book is a well known reference valve text book and is assembled from pieces by ten knowledgeable authors. An absolute bible when it comes to valve electronics.
734pp, Paperback, Code 1770
£29.95 + £ 4.30 P&P (UK)



Audio Reality
by Bruce Rozenblitz
Investigates conductors, skin effect, impedance, interconnects, speaker cables, balanced lines, transmission lines, isolation transformers, tubes, acoustics and much more. Also, includes 6 excellent detailed valve design projects. 80watt OTL, 25watt OTL, grounded grid pre-amp, 150watt amp, 6550 SE amp, and a grounded grid cascode phono preamp.
Paperback 128pp, Code No. 1640
Price £12.50 + 2.50 P&P (UK)



Fundamentals of Radio-Valve Technique
J. Deketh
This is part of the Philips technical series written in 1947 it was one of the most authoritative and comprehensive treatments of the nature and function of the vacuum tube.
534pp, Paper back
Code No. 1630
£21.50 + £2.50 P&P (UK)



Build your own Audio Valve Amplifiers
by Rainer Zur Linde
This book covers construction projects for preamplifiers, power amplifiers and two amplifiers for musical instruments aimed at the practical audio/hi-fi enthusiast, it offers much information on the operation of electron tubes, while the first chapter gives a short history of the thermionic valve.
paperback, 251pp, Code No.1320
£14.95 + 2.50 P&P (UK)



Mullard Tube Circuits for Audio Amplifiers
Includes full designs for eleven power and control amps, including 5-20, using valves. Begins with a four chapter tutorial on getting the best sound from valve amplifiers.
142pp 8" x 10" Paperback Code 1030
£13.95 + £2.00 P&P (UK)



The Williamson Amplifier
by D.T.N. Williamson
Offers practical advice on how to build and set up the amplifier for best results.
40pp Paper back
Code No. 1040
£9.95 + £1.50 P&P (UK)



RCA Receiving Tube Manual
Technical Series RC-14
This book presents RCAs commercial valve line-up as it was in 1940. The manual covers valve terminology, Technology and application, valve testing and then a larger section giving some of our ideas and plenty of data on numerous valves e.g. 6L6, 6N7, 6SN7.

255pp Paperback, Code No. 1800
£13.95 + £2.00 p&p (UK)



The Beginner's Guide to Tube Design
by Bruce Rozenblitz
This book takes a comprehensive look at tube audio design. It explains how vacuum tubes work and how to design with them. Rozenblitz covers stabilisation and testing, a description of 13 famous and classic amps and preamps and how to work effectively as a designer. A hands-on guide to construction techniques, tools and choosing components and tubes is provided. 1997.
132pp Paper back Code No. 1340
£15.50 + £2.50 P&P (UK)

DIO LIBRARY

ORDER 4 BOOKS & OVER & PAY ONLY £7.00 FOR P&P (UK ONLY)



Manuale HI-FI a valvole Schemario 2*
 This book is dedicated to self makers and to HI-FI tube engineers. With a wealth of circuit diagrams from some of the best valve amplifiers, pre-amplifiers and phono equipment producers in the world. Including, Audio Research, Altec, Conrad Johnson, Art Audio, Luxman, Carver, Dynaco, Electrovoice, Leak, MacIntosh, Marantz, Quad, Radford, Quick Silver, numerous OTL designs, Verdier, VTL and Western Electric. Well worth the money.
208pp, Paperback Code No. 1720
£44.00 + £4.00 P&P (UK)



Getting the most out of Vacuum Tubes
 by Robert B. Torner
 From the cover, "Types and causes of tube failures, what to expect from tubes, testing methods and all about tube maintenance programs." This book is intended to offer explanations of why tubes fail and what to do about it. Discussions of catastrophic and degenerative failures; selecting tubes and tube types and testing and predicting tube performance.
160pp Paperback, Code No. 1710
£13.95 + £2.00 P&P (UK)

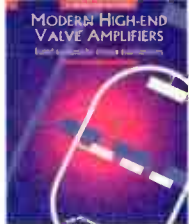

Modern High-End Valve Amplifiers Based on Toroidal Output Transformers
 by Menno van der Ven
 Explains the whys and wherefores of toroidal output transformers at various technical levels. Discussed extensively within this book are designs for amplifiers from 10 to 100 watts. Finally, the author gives some attention to a number of special valve amplifiers, and to the theory and practice of negative feedback.
250pp Hard back Code No. 1670
£24.95 + £3.30 P+P (UK)



First in High Fidelity The Products and History of H. J. Leak & Co. Ltd.
 by Steven Spicer
 This book is the unique and comprehensive story about one of the world's best high-fidelity audio companies. Contained are 300 pictures, 30 circuit diagrams for classic designs of the day. There are also numerous anecdotes and contributions from ex-employees. A wonderful historical read.
270pp Paperback Code no. 1740
£19.95 + £3.55 ptp UK



Basic Theory and Application of Electron Tubes
 A US Army & Navy Publication
 This book is an excellent introduction into valves. It does just about everything its title suggests. Written in 1957 it was used by the US military as a text book in their electronics department. Superbly written it contains all you need to know.
215pp Paperback Code No. 1760
£17.95 + £3.50 P&P (UK)



Sylvania Technical Manual
 by Sylvania Electric Products Inc.
 This 13th edition contains data on more than 3300 electron tubes and semiconductor devices. Reprinted here without the TV picture tube section, this manual contains detailed information on Sylvania's devices including charts and diagrams. A master index is found in the front of the book for reference.
516pp Paperback Code No. 1700
£16.95 + £3.80 UK ptp



Valve Amplifiers (second edition)
 by Morgan Jones, Audio Engineer
 This book allows those with a limited knowledge of the field to understand both the theory and the practice of valve audio amplifier design, such that they can analyse and modify circuits, and rebuild an amplifier. Constructional techniques are also provided so readers can build from scratch designs that actually work.
488pp, Paper back, Code No. 1330
£26.99 + 3.76P&P (UK)

LOUDSPEAKER BOOKS



Testing Loudspeakers+
 by Joe D'Appolito
 Joe D'Appolito, loudspeaker designer and consultant, has written the definitive text on testing loudspeakers. Dr. D'Appolito brings his expertise to the subject and provides you with a hands-on discussion of testing drivers and systems. He brings you the theory and physics behind loudspeaker testing in this volume.
Paperback Code No. 1580
£24.95 + £3.00 P&P (UK)



Electrostatic Loudspeaker Design and Construction
 by Ronald Wagner
 Step by step guide to the design and construction of a full range electrostatic loudspeaker, including basic operating principles. Strongly recommended for those wanting to either build, repair and/or restore, or who are just interested in electrostatics.
243pp 7" x 9 5/8" Paperback Code No. 1080
£16.95 + £3.25 P&P (UK)



The Loudspeaker Design Cookbook, 6th edition (new) - by Vance Dickson
 This best seller offers up-to-date design information for the home constructor. It uses modern Thiele-Small theory and parameters.
288pp 8 1/2" x 11 1/2" Paperback Code No. 1090
£29.50 + £4.00 P&P (UK)



Bullock On Boxes
 by Robert M. Bullock III.
 Using Thiele-Small parameters clearly, it offers lots of helpful tables and graphs to get to grips with the sizing of the box and port of a reflex loudspeaker.
72pp 8 1/2" x 11" Paperback Code No. 1100
£12.95 + £2.50 P&P (UK)

ORDER ON-LINE
www.worldaudiodesign.com



Horn Loudspeaker Design
 by Mr J. Dinsdale
 A collection of papers by Mr J. Dinsdale, that discuss the design and theory of this wonderful breed of loudspeaker. The book contains detailed drawings of numerous design, including some Lowther classics. Also, included with the book is a 3.5inch floppy disc with straight forward software to assist in the design process. A serious reference for those with an interest in horn speakers.
112pp paper back & 3.5 floppy disc 210mm x 300mm Code: 1730
£29.50 + £2.50 P&P (UK)



Audio Amateur Loudspeaker Projects
 A collection of the 25 best speaker articles published in the Audio Amateur throughout the 1970s, this popular book is proof that great designs are never out of date. This volume is a rich source of theory, practice and design.
135pp 8 1/2" x 11" Paperback Code No. 1550
£16.95 + £2.50 P&P (UK)

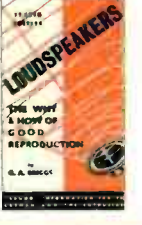

Loudspeakers: The Why and How of Good Reproduction
 by G.A. Briggs
 An easy to understand book on building loudspeakers, using empirical techniques that pre-date computer analysis. Strongly recommended for beginners.
88pp 5 1/2" x 8 1/2" Paperback Code: 1070
£10.95 + £2.00 P&P (UK)



Acoustics & Psychoacoustics 2nd Edition
 by David M. Howard & James Angus
 An introduction to acoustics, covering human perception of sound, notes and harmony, musical dynamics, timbre of musical instruments, acoustic model for musical instruments, hearing music in different environments, deceiving the ear and processing sound electronically.
224pp 244 x 189mm paperback Code: 1370
£29.99 + £3.50 P&P (UK)

TO ORDER

'phone 01245 450651
 or visit our website
www.worldaudiodesign.com
e-mail: sales@worldaudiodesign.com
 product demos available by appointment
 Unit 6, Rumsey Row, Writtle, Chelmsford
 Essex CM1 3YA.

dial a dealer

This is a comprehensive directory of Hi-Fi Dealers throughout the UK and Ireland.

BRISTOL & BATH

THE RIGHT NOTE Tel: (01225) 874728. Are you happy with your system? We find that most audiophiles listen for most of the time to systems that are 'not quite right'. Forget the 'Best Buy' reviews and putting a system together like a patchwork quilt. Let us assess the vast range available, you judge the results. We'll help you to plan a system for the future, even if you spread the purchases. Leave 'up-grade-it's' behind, save money and enjoy music all the time. Just listen, and you'll know.

CD: Accuphase, Audio Synthesis, Bel Canto, dCS, Resolution Audio, Wadia. Vinyl: Basis, Clearaudio, DNM, Graham, Michell, Sumiko, Transfiguration.

Amps: Advantage, CAT, DNM, Gamut, Spectral.

Speakers: Audio Physic, NEAT, Verity Audio. Tuners: Magnum Dynalab. (Credit Cards Accepted).

V'AUDIO HiFi Consultants: 36 Druid Hill, Stoke Bishop, Bristol. BS9 1EJ. Tel: 0117 968 6005. ATC, AVI, Alon, ALR Jordan, Audio Analogue, Avid, Black Rhodium, Electrocompaniet, Eslab Digital Amps, Harman Kardon, Infinity, Jamo, Lyra, Origin Live, Opera, Ortofon, PS Audio, Ruark, Michell, REL, SME, Sugden, Townshend, Triangle, SME Research Valve Amps, VPI. Specialists in Video Projectors by SIM2, Infocus, Sanyo; screens by Stewart, Draper, Da-Lite, Owl, and Amps/DVD's by Harman Kardon etc. Demos by appointment only. Home trial facilities. We are not a shop.

CAMBRIDGESHIRE

THE AUDIO FILE 41 Victoria Road, Cambridge. Tel. 01223 368305. Fax: 01223 354975. Email: sstreater@aol.com. 'For the best in British Hi-Fi and Home cinema entertainment'. Visit or call to arrange a dem with products from: Arcam, Linn, Naim, Cyrus, Absolute Sounds, Kef, Sony, Yamaha, Rel, Ruark, Denon.

CHESHIRE

ACOUSTICA 17 Hoole Rd, Chester CH2 3NH. www.acoustica.co.uk. Tel 01244 344227. All the best in HiFi & Home Cinema from Naim, Rega, Rotel, Sugden, Tube Technology, Primare, Isotek, Harman Kardon, Teac, Acoustic Energy, JM Lab, B&W, Spondor, Royd, REL, Quadraspire, SIM2 & Sanyo projectors and much more. We offer full demonstration facilities, interest free credit and delivery & install systems throughout Cheshire,

Merseyside & North Wales. Opening hours are Tuesday to Saturday 10.00 to 5.30.

ACTON GATE AUDIO 4 Ruabon Road, Wrexham, North Wales, Tel. 01978 364500. Audio Visual Specialists. Arcam, Audio Analogue, Bose, B&W, Celestion, Castle, Denon, Harman Kardon, Jamo, Marantz, Michell, Mission, Onkyo, Pro-Ject, Musical Fidelity, NAD, Micromega, Myrad, QUAD, Radford, Rotel, Ruark, Tannoy, TDL, Teac, Thorens, UKD, Unison Research, Yamaha, DSP Club Member, Demo Room, installation service. Easy Parking and Motorway access. All major credit cards accepted. 9.30 - 5.30 daily. Closed Sunday & Monday.

DOUG BRADY HI-FI Kingsway Studios, Kingsway North, Warrington, WA1 3NU Tel 01925 828009 Fax 01925 825773. Visa, Mastercard, Lombard Tricity. 2 dem rooms, home trial; Agencies include: Arcam, Tag McLaren, AVI, B&W, Castle, Caspian, Chord Electronics, Exposure, Harbeth, Heybrook, Krell, LFD, Michell, Meridian, Musical Fidelity, Monitor Audio, Naim, Nautilus 800 series, Pink Triangle, ProAc, Roksan, SME, Wilson Benesch, XTC and many more.

ORPHEUS AUDIO The North West's main Shanling dealer, demonstrating affordable excellence from Shanling, Monopulse, Heart, MF Audio, EAR, Horning, Acoustic Zen, Wireworld, LAT and others. Demonstrations by appointment in Gatley, Cheshire. Tel: 01614 281 539, e-mail: orpheusaudio@tiscali.co.uk

DEVON

AUDIO DESTINATION Audio Destination, 32b Bampton Street (above Hill House Hammond), Tiverton, Devon. Tel (01884) 243584. Hi-Fi/Home Cinema specialists. 2 demonstration rooms, home demonstrations, child's play area, interest free credit, relaxed/friendly service. Musical Fidelity, Ruark, Monitor Audio, Chord, Project, Primare, Tube Technology, Totem, Unison Research, NAD, Nordost, Lexicon, Trinity Audio plus others. e-mail: info@audiodestination.co.uk

DORSET

MOVEMENT AUDIO 588 Ashley Road, Poole, Parkstone, Dorset BH14 0AQ. Tel: (01202) 730865/380018. Arcam, B&W, Castle, Chord Electronics, Cyrus, Denon, Marantz, Michell, Mission, Pioneer, Tannoy Dimension, Yamaha. 2 Dem rooms. Listen to the available

choice and decide at your leisure - no pressure, no obligation. Our staff enjoy music, with our choice of products, you can too! Service Department. Free installation. Home trial facilities. Access, Visa, Amex, Diners Card. Credit facilities available. Open Tuesday-Saturday 10-5.30. www.movement-audio.co.uk

MOVEMENT AUDIO 926 Wimborne Road, Winton, Bournemouth, Dorset. BH9 4DH. Tel: (01202) 529988/520066 Arcam, B&W, Denon, KEF, Marantz, Mission, Musical Fidelity, Opera, Pioneer, Quad, Roksan, Ruark, Yamaha. Full dem facilities available, also home dem. Friendly expert advice. Service Department. Free installation. Home trial facilities. Access, Visa, Amex. Open Tuesday-Saturday 9.30-5.30

WEYMOUTH HI-FI 33-35 Maiden Street, Weymouth, Dorset DT4 8BA. Tel (01305) 785729/766345. Arcam, B&W, Denon, KEF, Marantz, Mission, Musical Fidelity, Panasonic, Pioneer, Quad, Sony, Tannoy, Yamaha. Dem room. Friendly professional advice. Only quality hi-fi dealer in Weymouth area. Service Department. Free installation. Home trial facilities. Access, Visa, Amex, Switch, Delta Mastercard. Interest free credit. Instant credit. Open Mon-Sat 9.30-5.30

LONDON

THOMAS HEINITZ LTD 35 Moscow Road, Bayswater, London, W2 4AH. Tel: 020 7229 2077. Fax: 020 7727 9348. Email: info@thomasheinitz.com. Web site: www.thomasheinitz.com. Established in 1952, Thomas Heinitz has a long history of providing the best music and AV systems available. We continue to offer the highest standard of service in the most relaxed atmosphere. Whatever your needs, from multiroom and home cinema to a high quality stereo system, we offer consultation, design specification, architect liaison and installation in order to ensure your system is tailored to your exact requirements. For quotes contact our manager Johnny Drum.

HEAR HERE

Tel: 020-8875 9696 or 07768 738372, Email: hearhere@onetel.com. We invite you to listen to our carefully selected combination of the astonishing and award winning Avantgarde loudspeakers and the highly regarded and hand-built in Britain Art Audio valve amplification. Hi-Fi has never sounded or looked this good!

Also EAT Valves. Please call anytime for an informal daytime or evening demonstration in Kensington, West London.

LANCASHIRE

Orpheus Audio. See our main entry under Cheshire.

MIDDLESEX

RIVERSIDE HI-FI 422 Richmond Road, East Twickenham, Middlesex, TW1 2EB. Tel: 020 8892 7613 Fax: 020 8892 7749. www.riversidehifi.co.uk
Audio Research, Blueroom, Bose, B&O, Copland, Denon, Elac, Infocus, Krell, Linn, Living control, Martin Logan, Michell, Monitor Audio, Musical Fidelity, NAD, Project, QED, Rel, Sennheiser, Sonus Faber, Teac, Theta, Wilson. Finance available. Subject to status. Written details available on request. Export orders welcome. UK mail order available. 3 demonstration rooms. All major credit cards. Open 10am-5.30pm Mon-Sat.

OXFORDSHIRE

OVERTURE HI-FI 3 Church Lane, Banbury, Oxon OX16 8LR. Tel (01295) 272158. Email sales@overture.co.uk
Website: www.overture.co.uk Arcam, Bose, Denon, KEF, Linn Products, Miller and Kriesel, Mission, Mirage, NAD, Naim Audio, Spondor, Yamaha. For sensible unbiased advice, call Oxfordshire's audio experts. Superb demo facilities. No appts. necessary. Home Cinema, Plasma TV, Projectors, Lutron Lighting, MultiRoom and Commercial installations. Access/Visa, instant credit. Mon-Fri 10-6, Sat 9.30-5.30.

STAFFORDSHIRE

ACOUSTICA 114 Wolverhampton Rd, Stafford ST17 4AH. www.acoustica.co.uk. Tel 01785 258216. All the best in Hi-Fi & Home Cinema from Naim Audio, Arcam, Rega, Rotel, NAD, Sugden, Tube Technology, Yamaha, Harman Kardon, Bowers & Wilkins, Focal-JM Lab, Monitor Audio, Ruark, Mission, KEF KHT, REL, Quadraspire, Sim2, Optoma & Sanyo projectors and much more. We offer full demonstration facilities, interest free credit and delivery & install systems throughout Staffordshire & the Midlands. Opening hours are Tuesday to Friday 10.00 to 5.30, Saturday 10.00 until 5.00.

SUFFOLK

AUDIO IMAGES 128 London Road North, Lowestoft, Suffolk, NR32 1HB. Tel: 01502 582853. Arcam, Acurus, Castle, Rotel, Moch, Triangle, QTA, Sugden, Denon, Yamaha, Mirage, M & K, Definitive, Musical Fidelity, plus the incredible Rothwell range. Refreshingly different selection. Dem Room, Professional AV installer's from budget to high end. Full credit facilities. 9.30 to 5.30 Mon & Sat ~ 9.30 to 6.00 Tues to Fri.

WEST MIDLANDS

SOUND CINERGY 37 High Street, Aldridge. 01922 457926. Tues-Sat 10 - 5.30. AE, Arcam, Chord Co., Creek, Harman Kardon, Infinity, Linn, Loewe, Marantz, NAD, Project, PURE, REL, Tannoy, van den Hul. www.soundcinergy.co.uk
<http://www.soundcinergy.co.uk>

WILTSHIRE

SALISBURY HI-FI LTD 15 Catherine Street, Salisbury, Wiltshire SP1 2DF. Tel (01722) 322169/330841. Arcam, B&W, Celestion, Denon, KEF, Marantz, Meridian, Mission, Musical Fidelity, NAD, Opera, Pioneer, Ruark, Tannoy, Yamaha, 2 Dem rooms. Friendly, relaxed atmosphere. Professional advice. Home dem available. Service department, Free installation. Home trial facilities. Access, Visa, Amex. Interest free credit. Instant credit. Open Mon-Sat 9-5.30.

YORKSHIRE (EAST)

THE AUDIO ROOM 2 George Street, Hedon, Hull, HU12 8JH. tel 01482 891375. www.theaudiroom.co.uk
The Norths premier hi fi dealer, stunning showrooms and dedicated listening room, authorised agents for; Linn, Naim, Krell, Audio Research, Cyrus, Sugden, Rega, Ayre Acoustics, Mark Levinson, Pathos, Unison Research, B&W, Proac, Focal JM lab, Spondor, Sonus Faber, Martin Logan and others. Home demonstrations and credit facilities available. Open Mon - Sat, 9am - 6pm. The Norths friendliest hi fi dealer.

YORKSHIRE (SOUTH)

THE HI-FI STUDIOS
Hi-Fi - Home Cinema - Custom Installation
Tel: Doncaster 01302 727274 or 01302 725550. E-Mail: info@thefihifistudios.freemove.co.uk
Web Site: www.thefihifistudios.co.uk
Musical Fidelity, Electrocompaniet, ProAc, PMC, JM Lab, Ruark, Castle, TEAC, Unison Research, Monitor Audio, Impulse, Primare, Harbeth, NAD, Michell Turntables, Nottingham Analogue Studios, Audio Analogue, Living Voice, Densen, Celestion, KEF, Opera, Trichord Research, Nordost, Stands Unique, Ortofon, Project, Goldring, REL, Denon, TAG McLaren, Rotel, Yamaha, Proceed - plus many more. Viewing & Demonstration by appointment in a unique setting. Home trials and installation. Card facilities and 0% available. Please phone for more information. BADA. CEDIA.

YORKSHIRE (WEST)

PREMIER AUDIO - now demonstrating - Room 1: DCS Elgar, Purcell & Verdi Transport, Plinius CD Lad & 250 Power, Verity Fidelo & Sonus Faber Speakers, Siltech Cables, Isotek Sub Station, BDA Equipment Stands

Room 2: Audio Aero, Audio Synthesis, Kora Pre & Power, Pink Triangle CD/Amp, Martin Logan / Audio Physics Speakers, Arcici Equipment Stand, Isotek Sub Station P/S Audio Synthesis, Audio Physics, Audio Aero, Absolute Sounds, DCS, Kora, Plinius, Siltech, Arcici, BDA, Pink Triangle, Avid Turntables, Project, Ortofon, Van den Hul, Mirage. P/X welcome Home demonstration good selection of S/hand. We are 10mins J39 - M1 10mins J30 M62 Tel: Wakefield 01924 255045 - Colin Grundy.

AUDIO REPUBLIC, 78 Otley Road, Leeds 0113 2177294, www.audio-republic.co.uk for the very best in quality hifi in West Yorkshire and beyond, our relaxed and professional approach stems from over 10 years experience in designing and installing high quality music systems. We believe the following offer outstanding results; Naim Audio, Rega Research, Dynavector Systems (amplifiers and cartridges) Totem Acoustic, Conrad Johnson, Sugden, ProAc, Spondor, Shahinian, JM Lab, TEAC, Nottingham Analogue, Kuzma, Living Voice, Hutter Furniture, Benz Cartridges, Cardas Cables, Quadraspire, Chord Cables, Custom Design, Alphason Designs. Choice of shop or home demonstrations, open Tues - Sat 9.30am to 5.30 pm, most credit cards welcome. Please phone for a chat and directions.

WALES

ACTON GATE AUDIO 4 Ruabon Road, Wrexham, North Wales, Tel 01978 364500. See our main ad under Cheshire.

IRELAND & NORTHERN IRELAND

NAIM SPECIALISTS-AINM-AV, 1, Church Rd, Swords, Dublin. tel +00 353 (0) 1 813 7937. m +00 353 (0) 87 247 0559
Email peter.williams@ainmav.com
www.ainmav.com
Naim make the ultimate music systems. Come and listen - hear the music. Two demonstration rooms featuring the Naim range. Complete home cinema / multi-room design and installation service. Individual demonstrations including evenings available by appointment. Pre-loved Naim equipment warmly accepted. Expert friendly advice. Credit facilities.

VINYL/RECORD MAIL ORDER

DIVERSE VINYL 10 Charles Street, Newport, NP20 1JU. Tel/Fax: 01633 259661/256261. Email: sales@diverse-music.co.uk
Probably the most varied and impressive selection of brand new LPs you'll find anywhere: international new releases, reissues and audiophile products. Also UK distributor of the Disco Anti Stat LP Cleaning Device. Call for a free catalogue, or visit www.diversevinyl.com

meet your maker

A reference guide to Britain's manufacturers and distributors

CREEK AUDIO LTD

12 Avebury Court, Mark Road, Hemel Hampstead, Herts, HP2 7TA.
Tel. 01442 260146
E-mail: info@creekaudio.com
Internet: www.creekaudio.com
Creek Audio manufactures in the UK. Current products include A50i, A50iR and 5350SE integrated amplifiers, CD50 Mk2 CD player, and T50 tuner. All products are similarly styled providing an easy mix and match choice depending on budget. Our miniature OBH range includes two phono pre-amplifiers, two headphone amplifiers and a passive pre-amplifier.

EPOS ACOUSTICS

2 Avebury Court, Mark Road, Hemel Hampstead, Herts, HP2 7TA
Tel. 01442 260146.
Email: info@epos-acoustics.com
Website: www.epos-acoustics.com
Innovative design and superior sound distinguish EPOS speakers from other brands in similar price categories. Five speaker models and two centre channels are currently available with a sub woofer in development. Supporting stands and plinths complement the speakers. In addition to its two channel appeal, Epos is now equally sought after in the fast expanding world of home cinema.

FALCON ACOUSTICS LTD

Unit 12 Damgate Industrial Estate, Damgate Lane, ACLE, Norwich, Norfolk, NR13 3DJ
Tel. 01493 751100 Fax 01493 751155
e-mail: sales@falcon-acoustics.co.uk
UK distributors of FOCAL drive units, SOLEN (SCR-Chateauroux) polypropylene capacitors, TAYDEN high quality PA loudspeaker units. Falcon are the largest specialist Audio-inductor manufacturer in the UK Comprehensive range of DIY speaker parts and kits, Accessories and Books. Sub-bass and electronic filters. Audio Amateur Publications and Audio Computer Software. Everything but the wood! Enquiries should be accompanied by a 47p stamped address envelope or see full price list with illustrated details and pdf data sheets on our web site: www.falcon-acoustics.co.uk.

GARRARD and LORICRAFT

4 Big Lane, Goose Green, Lambourne, Berks, RG17 8XQ. Tel / fax: 01488 72267.
We make the all-new Garrard 501 and 601 turntables and can service/repair the older 301 and 401 models. We cannot help with the many other turntables that Garrard made. We are also manufacturers of the Loricraft Record Cleaning Machine, as reviewed in the July issue of this magazine. See our website at www.garrard501.com for more information.

HORNS & VALVES

Unit 5, Bards Corner, Hemel Hempstead HPI 3RR. Manufacturers of audiophile quality valve amplifiers and horn loudspeakers, handcrafted in the UK. Tel 01442 270 141 for the designer Brian Graves, and for details. 'Koronglay' - Lowther driven, floor standing horn loudspeaker. 100dB sensitivity. Available in oak, ash or cherry. Size 25cm wide x 35cm deep x 106cm high. From £1399. 'Merlin' - Integrated single end triode amplifier designed to specifically match the 'Koronglay' or any other horn enclosure. From £1199. 'Griffon' - Push Pull ultralinear valve amplifier. Powerful enough to suit almost any loudspeaker. From £1299. All of our amplifiers are totally enclosed in laser cut stainless steel cabinets to blend with any furnishings. Size 43cm wide x 33cm deep x 16cm high.

MONITOR AUDIO LIMITED

24 Brook Road, Rayleigh, Essex SS6 7XL
Tel 01268 740 580. Fax 01268 740 589
e-mail: info@monitoraudio.co.uk
website: www.monitoraudio.co.uk
Monitor Audio designs and manufactures British loudspeakers of the highest quality. Since 1972 Monitor Audio has been developing and perfecting the implementation of metal drivers, innovative crossovers, and exemplary speaker cabinet construction and finish to further the ideal of achieving sound which to the original is "as close as it gets". As we enter the 21st Century, Monitor Audio leads the way in offering speakers that suit every pocket and which integrate seamlessly with both Hi-Fi and AV systems.

PMC/BRYSTON

PMC & Bryston are used during the production of both Harmonia Mundi and Deutsche Grammophon recordings in both stereo and surround. Emmy award winning manufacturers of the highest quality loudspeakers and amplification. Industry standard in Mastering, Film Scoring, Broadcast and Post Productions. (5.1 & Stereo) PMC Products: Compacts, Floorstanders, and Large passive & active monitors. Prices range from £500 to £32,000. Finished in a large selection of exquisite real wood veneers, all PMC loudspeakers are available in horizontal mirrored pairs, centre channels and complementary subs for 5.1 surround systems. Bryston's balanced range of products include R/C Preamps, Integrated, Amp modules for all the PMC range, Mono, Stereo 150W to 800w per ch, 3 Ch, 4 ch and 5 channel THX amplifiers, Surround processors, all with distortion figures and build quality to die for. Every product is available in silver or black backed by a 20 year warranty. PMC Ltd 43-45 Crawley Green Road, Luton, LU2 0AA.
Tel: 08704 441044 Fax: 08704 441045
Email: sales@promonitor.co.uk
Web: www.pmc-speakers.com

SUGDEN AUDIO PRODUCTS

Designed and manufactured in the UK each Sugden product is hand-built by one highly skilled technician. A full range of pure class A amplifiers are available including integrated, stereo power and the incredible Masterclass balanced monoblocks. Our stunning Bijou system now comes with a single-ended pure class A power Amplifier with optional integral stand. Two analogue tuners have joined the range matching our A21 and Bijou series, offering a digital user interface with excellent facilities. Each amplifier series has a matching CD player with a class A output stage and heavily modified transport. The class A HeadMaster offers a pre-amp with three inputs a fixed and variable output with remote control. The HeadMaster can be used as a control unit in a high quality audio system and excels with headphones. Please contact us for product information, dealer list and brochures. 01924 404088 email info@jesugden.co.uk.

For all your advertising requirements please call 0870 242 0567 or email: advertising@hi-fiworld.co.uk

specialist hi-fi dealers

LONDON



THE INNOVATIVE HI-FI,
HOME CINEMA AND MULTI ROOM
RETAILER/INSTALLER

SERVING LONDON
FROM BATTERSEA

ORANGES & LEMONS

Friendly and efficient service
0% finance

JUICY FRUIT FROM LONDON'S FRESHEST RETAILER

ARCAM B&W CABLE TALK CASTLE CHORD
CREEK DENON EPOS LINN MARANTZ
NAIM NAD NEAT PMC QED REGA ROKSAN
ROTEL RUARK STANDS UNIQUE SOUNDSTYLE
YAMAHA XANTECH and many others

020-7924 2040

61/63 WEBBS ROAD, SW11

website: oandlhifi.co.uk



HERTFORDSHIRE



thesoundpractice



laboratory
avid
shahinian
lavardin
electrofluidics
livingvoice
borderpatrol
neotacoustics.
isoblu
resolutionaud o
tomavans audio design
cm/reson
audio
slinkylinks
audiophysic



stalbans: 01727 893 928
www.thesoundpractice.com

YORKSHIRE

Shadwell Hi-Fi Studios

The Best Analogue Dealer in Yorkshire

Why come to us? We are music lovers NOT Salesmen. We stock a carefully selected range and offer a comprehensive Turntable Service unequalled locally

Affordable Analogue Audio

Michell ● Project ● Roksan ● NAD ● PSB ●
and other award winning brands.

Turntable Services:

Arm Rewiring ● Servicing ● Refurbishment

Have a coffee, relax & listen in home surroundings
www.shadwellhifi.co.uk
Phone: Leeds 01132 371 019

VALVES & TUBES



Chelmer Valve Company

For audio valves

Buy CVC PREMIUM HI FI valves direct from us.
All valves processed for improved performance.
We also have stock of MAJOR BRAND types inc.
MULLARD, GEC, BRIMAR, RCA, GE, PHILIPS, etc.

The Stables, Haddow Park, Great Haddow
The Graysford, Essex CM2 7SN
Tel: 01473 241311 Fax: 01473 241309
Email: sales@chelvvalve.com

NAIM

SPECIALIST

IRELAND &

NORTHERN IRELAND

NAIM SPECIALIST

tom tom audio

The largest selection of mint, pre-loved
Naim Audio components on the planet.

- 12 month guarantee
- Help & advice
- Clean facilities
- Mail order
- Open 7 days
- Products tested

Tel: 01727 893928

www.tomtomaudio.com

tomtom@tomtomaudio.com



the Irish for naim

"COME and
LISTEN"

Authorised NAIM Audio distributor and retailer
based in Swords, Co. Dublin and covering both the
Republic of Ireland and Northern Ireland

Contact Peter on (t) +353 (0)1 813 7937 or
(m) +353 (0)87 247 0559 or
(e) info@ainmav.com



Information and price list available
● www.ainmav.com

ainm a-v Ltd
1 church road | swords
county dublin | ireland

naim
WORLD CLASS HI FI

SERVICES & CONSULTANTS

Front End Problem?

contact

The Cartridge Man

It doesn't have to cost an arm and a
leg to get the best - listen to my
Koetsu - and Decca -eater.

Also agents for Croft, Hadcock,
E.A.R. Michell &
Moth.

plus cartridge re-tipping service
020 8688 6565

Website: www.thecartridgeman.com

MAIL ORDER

Have a

RAVE

Russ Andrews Value Engineering

RAVE 2
speakers



RAVE 1
amplifier

... with your laptop



... with your CD player



RAVE is serious Hi-Fi yet it has been designed to be adaptable to modern living... It's portable and useable in many different situations. And its sound will amaze you, even though the amp's smaller than a mousemat!

Try this whole new concept in Hi-Fi at home, work or play - wherever you listen to your music. And with our 60 Day Home Trial and FREE delivery within UK mainland what have you got to lose?

RAVE 1 integrated amplifier £199.95
RAVE Combo (Amp, Speakers & Cables) £299.95

Buy online at www.russandrews.com/rave
or phone UK Local rate 0845 345 1550 quoting 'AWORLD'.

Russ Andrews

Russ Andrews Accessories Ltd, Windermere Road, Staveley, Kendal, LA8 9PL.

affordable compact serious Hi-Fi

Transcriptors Ltd

31 Stanton Street, New Houghton,
Mansfield, Nottinghamshire, NG19 8TQ
England

Telephone: +44 (0) 7005 963 827

Fax: +44 (0) 7005 980 827

Email: transcriptors_limited@yahoo.co.uk

Web: www.transcriptors.co.uk

LOUDSPEAKER REPAIRS

D.C. Boultons

Loudspeaker Repairs & Manufacture

All types including P.A. Disco, Hi-Fi, Juke Box etc.

Agents for B&C, Celestion, Eminence,
Fane, Precision Devices etc.

From re-foams to complete re-builds, even with
slipped magnets.

Trade and retail supplied.

Custom units our speciality.

Over 35 years experience of loudspeaker design

Unit 12, Damgate Lane Ind. Est, Acle,
Norwich, NR13 3DJ

Tel 01493 750075 Fax 01493 751155

"HiFi Exchange- Mail us your requirements Now"

H I F I

HOME CINEMA

MULTIROOM INSTALL

BUY / SELL

Quarterly Sale items

	Our Price	Original Retail Price
ClaraVox Magnifica (Final Offer)	£2,995.00	£14,500.00
McCormack Line Drive	£395.00	£995.00
Audio Refinement Pre 5 "new"	£395.00	£895.00
Quad 33/ 303	£195.00	
Rogers LS55 "new"	£195.00	£430.00

New this month

POWER AMPLIFIERS		
Krell 250 A/3	£2,495.00	£5,000.00
Parasound 12 Channel Amp	£1,500.00	£3,000.00
McIntosh MC2000 Anniversary	£5,995.00	£14,000.00

PRE AMPLIFIERS		
Audio Research SP16L (remote)	£1,350.00	£2,000.00
Audio Research LS 5 MK1	£1,495.00	£2,495.00

LOUDSPEAKERS		
JM Lab Alto Utopia BE	£On Dem	£11,000.00
JM Lab Nova Utopia	ASK	£21,500.00
JM Lab Diva Utopia BE Signature Finish	ASK	£7,600.00
JM Lab Micro BE Utopia 7 Stand	ASK	£4,400.00
Duntech The Princess	£995.00	£4,000.00

CD PLAYERS & DACS/DVD PLAYERS		
Naim CDS 3 + XPS 2	£5,975.00	£7,244.00
Sony SACD1	£1,895.00	£4,000.00

TURNTABLES, ANALOGUE, VARIOUS		
SME Series V Arm "new"	£1,400.00	£1,650.00
Oxford Crystal Reference/ Air Tangent	£2,295.00	
Nottingham Analogue Days (Broyer arm)	ASK	£3,500.00

AV COMPONENTS		
Lexicon MC12 rev 4	ASK	£9,500.00
Krell HTS Processor	£3,995.00	£8,000.00
Primare A30.3	ASK	£1,300.00
Primare A30.5	ASK	£1,700.00
Parasound C2 (Halo)	ASK	£3,500.00
Parasound CI (Halo)	ASK	£5,500.00
NAD	ASK	
Marantz	ASK	

PLASMA PROJECTORS		
From NEC/ Panasonic/Pioneer/Sharp		ASK
Parasound TH-42 PWD6 "new"	FROM £2000	
In Focus 5700	ASK	£3,000.00
In Focus 7200	SPECIAL	£6,000.00
SIM 2 Domino 20	ASK	£3,750.00

MULTIROOM INSTALLATIONS **		
Linn Knekt		
Living Control		
Lutron Lighting		
System-Line		
Helvar Lighting		
* Each system tailor made to your requirements		

Power amplifiers

Bell Canto Evo 4i	ASK	£3,895.00
VTL M8450 5g	£3,995.00	£7,000.00
Gamut D200 mk III "Hi Fi Choice Product of the Year"	£On Dem	£7,000.00
Musical Fidelity F15	£995.00	£2,000.00
Cello Duet 350	£4,995.00	£10,000.00
Krell Showcase 5	£3,995.00	£4,995.00
Tesseract TAM 60 Monoblocks	£1,995.00	£7,000.00
Muse Model 300 Monoblocks	£2,495.00	£4,500.00
Plinius SA 250 mk IV	£2,995.00	£6,350.00
ART V160	£995.00	£2,995.00
Krell FPB 250m Monoblocks	£4,995.00	£10,000.00
Melos 402 Gold Trade Plus Monoblocks 400wpc	£3,990.00	£9,000.00
Bryston 4BSST	£1,895.00	£2,350.00
Conrad Johnson Premier 140 SA	£5,250.00	£7,000.00
Krell KSA 80B	£1,395.00	£3,600.00
Naim Nait 3	£295.00	£608.00
Cary 805 C Monoblocks "new"	£4,500.00	£8,250.00
Cary 5LA 70 mk II Silver	£995.00	£2,250.00
Conrad Johnson MP2500	£2,795.00	£4,000.00
ES Lab DX-58	£4,995.00	£9,500.00
YBA Passion Monoblocks	£On Dem	£6,500.00
Audio Flight 100	£On Dem	£4,500.00
Audio Flight One Integrated	£On Dem	£4,500.00
Linn Klimax 500 Solo (4)	£3995.00 each	£6,000.00
Boulder 500 AE	£2,495.00	£5,500.00
ES Lab DX-54	£1,395.00	£2,000.00
Roksan Caspian Integrated	£On Dem	£895.00
Roksan Caspian Power	£On Dem	£645.00
Krell FPB 700x	£995.00	£15,000.00
ES Lab DX-58	£On Dem	£1,550.00
Plinius 8200P	ASK	£3,750.00
Plinius SA 102 "new"	£On Dem	£2,350.00
Bryston 4BSST	£69.00	£120.00
Linn Bass Active Card	£4,995.00	£12,000.00
Krell MDA 300	£895.00	£1,030.00
Linn Klassik CD/Amp silver	£On Dem	£16,500.00
Boulder 1060 Power "new"	£1,350.00	£1,500.00
Primare 30.1 mk II Integrated	£3,995.00	£5,995.00
YBA Passion Stereo "new"		

AV components

AV COMPONENTS		
Parasound A51 - 5 Channel	ASK	£3,500.00
Lexicon MC1	£1,995.00	£5,500.00
Lexicon MC8/ MC8B	ASK	£5,000.00/ £5,750.00
Lexicon RT10 DVD Player	ASK	£7,500.00
SIM 2 HT 300	ASK	£9,000.00
Primare P30 Processor	ASK	£1,295.00
Linn Klassik DVD	£On Dem	£2,000.00
Lexicon MC12 / MC12B	ASK	£810.00/ £890.00
Parasound C2	ASK	£3,500.00

PLASMAS/LCD/PROJECTORS

Pre amplifiers		
Krell KRC	£1,795.00	£6,000.00
Audio Research LS9	£1,200.00	£2,000.00
Musical Fidelity F22	£395.00	
Cello Palette Pre	£7,995.00	£ -

Tesseract Tala Pre	£495.00	£1,195.00
Audio Research LS25 mk II	£3,995.00	£5,995.00
Audio Research LS7	£695.00	£1,750.00
Mark Levinson 380 S	£4,995.00	£6,995.00
Boulder LSAE Pre Amp	£1,750.00	£3,500.00
Klein 7LX 3.5B	£2,900.00	£5,400.00
Audio Research LS3	£795.00	£1,997.00
Cary SLP98L Remote Pre x-dem	£1,295.00	£2,794.00
Audio Flight Pre	£On Dem	£4,500.00
YBA 2a Line	£1,295.00	£1,995.00
Tom Evans The Vibe Pre	ASK	£2,700.00
Boulder 1012 (pre amp) 24.96 dac/ Phono	£On Dem	£3,000.00
YBA Passion Pre (inc Phono)	£3,995.00	£5,995.00
Boulder 2010 Pre	£POA	£30,000.00
Plinius 16L "new"	£On Dem	£3,200.00
C.A.T. ultimate reference Pre Amp Inc/Phono "new"	ASK	£7,350.00

Quality speakers

Audio Physic Tempo III "new"	£On Dem	£2,000.00
Sonus Faber Amati Homage	£8,995.00	£12,000.00
JM Lab 926	£995.00	£2,200.00
Wilson Benesch Act 2 (1 upgrade)	£4,995.00	£9,000.00
REL Stentor III	£1,795.00	£2,500.00
ART Audio Stilleto	£695.00	£900.00
Sonus Faber Electa Amator II (no stds)	£1,695.00	£ -
Revel Studio	Coming Soon	
Revel Salon	Coming Soon	
Linn Kheibids (+ Active Cards)	£395.00	£1,000.00
Wilson ACT 2 (Upgrade)	£4,995.00	£9,000.00
JM Lab Sib & Cub (5.1 spk sys)	£695.00	£859.00
JM Lab Mezzo Utopia	£3,000.00	£7,899.00
Audio Physic Avanti	£4,995.00	£7,800.00
Wilson Audio System 5.1	£6,995.00	£19,000.00
Revel Ultima Studio	£7,495.00	£13,000.00
ATC SCM 10 Passive Black	£495.00	£1,100.00
JM Lab Utopia	£7,995.00	£18,000.00
Reference 3A	£1,750.00	£2,750.00
Audio Physic Spark	£1,150.00	£1,795.00
Talon Kite Centre & Bracket	£795.00	£1,750.00
Aerial Acoustic SW12 5ub Woofer, Maple/remote	£2,995.00	£5,200.00
Mirage M3 si	£1,595.00	£4,100.00
Rel Q 200 E	£On Dem	£650.00
Rel Q 150 E	£On Dem	£500.00
Audio Physic Luna Sub (wood)	£On Dem	£1,799.00
Audio Physic Yara	£On Dem	£99.00
Vienna Acoustics Mahler	ASK	£6,000.00
Vienna Acoustics Mozart	ASK	£1,700.00
Vienna Acoustics 5.1	ASK	£3,500.00
Cabasse io 5.1	ASK	£2,170.00
Blue Room Minipod (White)	£225.00	£298.99
Blue Room Minipod 7 Sub (Blue)	£625.00	£749.00
Blue Room Minipod 5ub	£415.00	£468.99
Genelec 205 Active Monitors	£On Dem	£750.00
Audio Physic Virgo III "new"	ASK	£4,000.00

CD players & DACS

Linn Numerik	£595.00	£1,500.00
Audio Synthesis DAX	£1,395.00	£2,200.00
Audio Synthesis DAX Decade	£1,695.00	£ -
Theta Pro Prime 2	£695.00	£1,900.00
Mark Levinson 390S	£4,500.00	£6,500.00
Acuphase DP67	£3,795.00	£4,400.00
Audio Flight CD I	ASK	£4,500.00
PS Audio Lambda Transp/ dac	£1,695.00	£5,000.00
Wadia 860 x	£3,995.00	£7,500.00
Theta Data Pro Prime II	£1,195.00	£ -
Gamut CD1R mk II	ASK	£2,950.00
Acoustic Arts Drive 1	£1,995.00	£2,890.00
EAD DSP9000 Pro Series III	£2,795.00	£8,000.00
Wadia No 27 Dac	£3,750.00	£9,000.00
Mark Levinson 31.5 Transport	£3,995.00	£9,600.00
Theta Pro Geny	£495.00	£1,295.00
Acoustic Arts Drive 1/Dac 1 mk II	£On Dem	£6,500.00
Linn Sondec CD12	£7,995.00	£12,000.00
Linn UNIDISK 1.1	£On Dem	£6,500.00
Roksan Caspian CD	£On Dem	£995.00
Trichord PD-5 503	£295.00	£500.00
YBA CD1 Delta (Twin psu)	£3,995.00	£5,500.00
Audiomeca Dammation CD Transport	£750.00	£1,600.00
Primare V20 DVD/CD	£750.00	£1,000.00
Audio Aero 32/192 Capitele CD (Ver. 4)	£On Dem	£4,500.00
Primare V25 CD/DVD	£On Dem	£1,000.00
Boulder 2020 dac	£POA	£24,000.00
Theta Data II Transport AT + link	£1,995.00	£4,000.00
YBA CD Integre "new"	£On Dem	£1,195.00

Turntables & analogue

5ME 20/2A	£On Dem	£5,273.53
5ME 30/2 A "new"	£10,495.00	£12,289.00
PS Audio Power Plant 300 + Ultimate Outlet	£1,300.00	£1,900.00
Nottingham Analogue "The Analogue" 12" arm and deck	£4,495.00	£8,000.00
Fanfare FT1 Tuner	£595.00	£1,500.00
Tara Labs 10m Bal The 2 Interconnect	£2,000.00	£5,000.00
Tara Labs FGS (Mono) pair	£500.00	£1,000.00
Tara Labs The 2 Speaker Cable 4ft	£1,300.00	£3,000.00
Roksan Xerxes 10/DS1.5/ Artemiz/ Jubilee	ASK	£4,500.00
Ortofon Jubilee	ASK	£1,500.00
Roksan Caspian Phono se	£On Dem	£950.00
Roksan TMS2/ Artemiz	£On Dem	£8,500.00
Michell Orbe/VC/ RB300	ASK	£2,350.00
Project RPM 6 "new"	£On Dem	£500.00
Project RPM9/ arm	£On Dem	£1,000.00
VPI TNT mk IV/ Rockport 6000/ Flywheel/ VPI Stand/ Clearaudio Accurate/ Pump etc. "new"	£8,500.00	£16,000.00
Roksan Radius 5 (Acrylic)/ Nima arm "new"	£On Dem	£850.00
Loricraft record cleaning machine	£On Dem	£1,100.00
Earmax Pro	£On Dem	£425.00
Moth Record Cleaning m/c	£395.00	£ -
Project RPM4/ Ortofon S10 "new"	£245.00	£325.00
Ortofon Rohmann	£On Dem	£1,050.00
Ortofon Kontrapunkt a/b "new"	£On Dem	£500.00/ £750.00
Michell Gyro SE/ RB300 "new"	ASK	£1,100.00
Audio Synthesis Phono Eq mm/mc	£495.00	£ -
Pink Triangle PT Ext psu	£495.00	£ -
Plinius 14 Phono "new"	£On Dem	£2,750.00
Nackamichi DR 3	£195.00	£400.00
Tom Evans - The Groove "new"	ASK	£1,795.00
Clear Audio Reference Mc phono stage X-demo	£1,695.00	£2,065.00
Clear Audio Symphono phono stage X-demo M/M/MC	£640.00	£740.00

* Reduced this month

Choice hi-fi

The Choice HiFi Exchange - The fastest way to find or sell your equipment.

Mail us your requirements and you will be added to our huge and ever growing data base where a daily search seeks to match the wants and sale items. Get regular mailings of latest hot deals and new in items. Because we act as middle men you buy with confidence and the the Choice HiFi guarantee.

your choice

- Acoustic Energy
- Advantage
- Analysis Plus
- ATC
- Audio Flight
- Audible Illusions
- Audio Note
- Audio Physic
- B.A.T
- Bel Canto
- Boulder
- Bryston
- C.A.T.
- Cary
- Chord
- Clear Audio
- dcs
- Denon
- DNM
- Eggston Works
- Electrograph Delphi
- Genelec
- Graham
- Gryphon
- Imerge
- In Focus
- J M Lab
- KEF
- Krell
- Lexicon
- Linn
- Loewe
- Lutron
- Lyra
- Mark Levinson
- Michell Eng.
- Musical Fidelity
- Naim
- NEC
- Nordost
- Oracle
- Ortofon
- P.M.C.
- Plinius
- Primare
- Project
- Quadraspire
- REL
- Rockport
- Roksan
- Rotel
- Ruark
- Seleco
- SME
- Soundations
- Straight Wire
- Sugden
- Tara Labs
- Teac
- Theme Scene
- Tom Evans
- Totem
- Transfiguration
- Trichord
- Trilogy
- Van den Hul
- Vienna Acoustics
- VPI
- Wilson Audio
- Wilson Research
- YBA

tel: 020 8392 1959 & 020 8392 1963
fax: 020 8392 1994 info@choice-hifi.com

Open from 10am to 6pm Mon-Sat and other times by appointment.

Buy, sell, exchange quality hi-fi equipment.

We accept all major credit cards. Finance available subject to status



noel keywood

These days, music downloading isn't just about the 'high tech' portable players seen in this month's supertest. It's about theft, deception and commercial politics too.

First, consider theft - of personal information and possibly the contents of your bank account. Internet theft and fraud are reaching frightening levels. Much of it is difficult to understand and guard against, and downloading music puts you right in the firing line. My PC is buttoned down hard security wise, with a NAT router, MAC address filtering, a firewall and automatically updated anti-virus. I've wrestled Service Pack 2 into operation and run regular security checks. Yet still, from the web surfing I must do to research articles for *Hi-Fi World*, I recently found Gator and a keystroke logger had quietly installed themselves. That the U.S. are legislating against Spyware indicates how seriously we should take this issue, one that music downloading will expose you to.

Although delivery of music via the internet seems a great idea, it also opens up a worrying scenario where, in future we have to pay for a license to listen and are denied the opportunity to own or use CD, or anything like it able to store music that can be played repeatedly without further payment. This is where I find my enthusiasm for 'jukeboxes' and free Windows Media Players, etc, suddenly cools...

What we are really looking at here could be the thin end of a very thick wedge the music business would like to drive between consumers and what they see as their Rights. I've heard it said many times by people in the music business that we don't 'own' the music we buy on CD, we merely buy a license to enjoy it. True. What worries me here is that once you move to licensing the next

issue becomes: what are the terms of the license?

With a CD the implied terms of the license are very broad, or lax some might say. We all take it for granted that we own a music collection and can even pass it on as a legacy. Not everyone shares that view. The true owners of the music, the copyright holders may, for example, like to be remunerated in

**to the music
business, a license
to listen is a
dream come true...**

line with usage. Every time you play, you pay. With LP this wasn't possible, with CD it isn't either. With internet distribution it is, providing the music can be locked into the system, or carry digital copy prevention (copy tag).

Internet distribution of music is a mixed blessing, as the music business likes to say. Meaning it supports illegal file sharing, but it does equally appear to offer them a new golden age where artists, or their representatives, are free to negotiate their Rights with you according to how they see fit.

That scenario is here today, as you'll find out if you try to download music from an OD2 site using Rights protected Windows Media Audio! I've done it many times and find these sites messy, difficult to use and bleak, quite frankly, in what they offer. You are asked to pay an amount that's equivalent to a CD track, even though the entire CD production and distribution chain has been cut out. This is no bargain.

WMA quality isn't good, and Microsoft's in-built Digital Rights Management gives the Rights holders *carte blanche* to be silly. The Rights on offer vary widely and it's difficult to understand quite what you are

buying. If you can burn out a CD, how many times can you do it? How many times can you copy the copy? I suspect most people don't bother with all this and purchase all the same, which is also a bit frightening.

Because this amounts to an abdication of Rights. Are you prepared to read a long Rights document before downloading a 99p music track? I don't think so. Do you bother to read the enormous End User License Agreements that comes with computer software? I doubt it. Yet after paying 99p you may well find the track can only be played back on the computer, or a secure portable. What sort of deal is that?

Apple do it better - and that's the real strength of iTunes. AAC is a highly regarded compression scheme courtesy of the Fraunhofer Institute, Erlangen, Germany, who gave us mp3. Apple have added Digital Rights Management, which they call FairPlay. So you get decent sound quality from a Rights protected file, at a reasonable price. Apple negotiate the Rights up-front so they are consistent. This makes for a fairly transparent purchase and download experience. All the same, the Rights can be varied at will by the Rights holder, in theory at least. Apple told me that, yes, the Rights within FairPlay have been changed; they have been improved. But in future if the Rights holder so wished, they could be diminished.

To the music business, a license to listen is a dream come true. Whilst the CD exists, it undermines this scenario. Once internet downloading becomes commonplace, especially by wireless connection wherever you may be, I can't help feeling Pay per Play will be upon us. I also can't help but suspect that having your own travelling minstrel would be cheaper than a portable mp3 player. At least it would be high fidelity! ●

david price



You may have noticed that *Hi-Fi World* has a particularly 'vibrant' postbag, but can you guess which subject creates the most bile? Not the great valves vs. solid-state debate, or even digital vs. analogue – but computer audio. There's a small but vociferous band of readers who simply wish this 'non subject' simply disappeared from our pages... after all, what's it got to do with high fidelity music reproduction...?

Well, fair point well made – in a way – but warp back thirty years to 1974 and the same thing could have been said about Compact Cassette. Yet I'd venture that some of these 'stick in the muds' who decry the 'scourge of MP3' are likely the very same folk who now lovingly clean the 'Discrete Heads' of their Nakamichi CR-7Es. As this seminal bit of kit proved, cassette done properly was capable of serious hi-fi sound – just like, ermm, computer audio...

Funnily enough, while cassette was just a convenience medium in 1974 – a great, low cost music storage medium riddled with technical compromises – by 1988 it was the world's best selling music distribution format, surpassing even the 'harvest years' of the LP record back in 1975 in terms of units sold. Now, far be it from me to suggest there's some sort of cosmic parallel here, and that next year MP3 sales

will surpass those of CD – because I suspect that in real terms, MP3 file sharing has already done this, umpteen times over. While MP3 may not be a great medium for selling music, just like Compact Cassette was

always, it's a brilliant way of storing and circulating it.

That's why this month's issue is devoted to computer audio. Now, you may be playing your Living Stereo LPs on your Garrard 301/ SME3012/ Shure V15, Audio Innovations PI, Croft Micro, Leak Stereo 20 and rebuilt One Thing Audio Quad ESL57s – and saying, 'what's this got to do with me?' But

think of computer audio as a way to access the world's biggest music library – the internet...

I'd suggest that if it's the music and not the hi-fi you're listening to, then computer audio is indeed of interest. Think of it as a way to access the world's biggest music library – the internet...

Now, of course, I'd never ever suggest you download illegal music files, but there's a huge amount of free, legal music out there for your pleasure. And for those who wish to archive their existing music collections, for both convenience and safety's sake – not to mention the access to marvellous modern inventions such as the iPod it brings – computer audio is a breathtakingly powerful tool. And this issue's message, I hope you've deduced, is that computer audio can be audiophile, too.

The problem with archiving your existing CD collection is the sheer time it takes. As someone with nigh-on 1,000 silver Frisbees (not including my homemade CD-R copies of my 5,000 strong LP collection, for my own personal use of course), ripping them to MP3 (or my personal codec of choice, 320kbps AAC) would take an age. So I was most interested to hear of Shrink Digital, who will 'shrink' (i.e.

rip) your CD collection to compressed music files for you, for 90p per disc (plus transportation).

All you do is choose what format you'd like, place your order online at www.shrinkdigital.com and the company sends you some extremely robust packaging, into which you pop the discs you want ripped. They then uplift your music by Amtrak (in my experience – the most reliable UK courier) and expeditiously transfer the whole lot to one disc. The whole process can be tracked online, so you know exactly what's going on, and the company checks every disc carefully for any scratches or glitches, and offers a repair option if need be – they only send

back perfect copies in the new format. They even transfer the CD album covers, so you can see it when each CD is being played (provided your MP3 player has a colour screen and/or your PC can 'read' the picture file – most can).

The whole process usually takes two days from receipt of your order and CDs. Larger orders of over 200 CDs and those interrupted by repairs to CDs may take a little longer. It's quite pricey – 50 discs cost £70 (all in) ranging up to £935 for 1,000 – but the service is nothing less than superb, and there's a real sense that they're doing the best job possible. Their transfers were of excellent sonic quality.

I now have a disc of AAC files ripe for loading into my Apple PowerBook's iTunes folder. As soon as I've invested in AirTunes (and Airport Express feeding a Musical Fidelity X-DAC v3), I'm going to have high quality Wi-Fi hi-fi for the house and plenty of songs to feed my iPod G4 when I'm out and about. All I need now is a Terabyte of hard disk storage to archive my LPs at 24/192 resolution, but I guess that particular project will have to wait for next year! ●



dominic todd



Christmas is a coming and now's the time to start looking at what are going to be this season's movers and shakers. Most within the retail industry agree that this should be the best ever Christmas for portable MP3 players. They may have been rather slow to take off, especially compared to the record-breaking DVD, but, thanks to that old stalwart, the iPod, have pretty much become this year's must have.

Of course, you don't need to spend anything like the £180 plus charged by Apple to make your music collection portable. Rather like personal cassette players and then CD players, there are literally dozens of cheapo MP3 special kicking around the market place for less than £100.

Thankfully, unlike personal cassette players which relied on mechanical integrity, the simplicity of solid state type recorders means that the sound quality is often all much of a muchness – which makes choosing one less fraught. That said, there are still differences to be had, and some that are far more robust, longer lasting in the battery department and yes, even better sounding.

Right at the bottom of the pile (at least in terms of price) lie the Philips KEY models and Creative MuVo 64. As I write, the 64MB KEY 004 can be had for £30 and the MuVo for less than £40. Their memories may be tiny, but for peppercorn money these two are hard to beat. Moving up to the sub-£100 category and you're right where the action is. Retailers are already starting to promote 512MB recorders for less than £100, but I'd exercise caution and stick to one of the better brands, even if it does mean a 256MB restriction. My choice of sub-£100 MP3 player would have to be the iRiver iFP-190TC. It's very sturdy, easy to use, has a radio built

in and weighs the same as a packet of crisps (32g), but is the size of a box of matches. If you're nervous about commuting with anything expensive, or find even the iPod mini too large for jogging, then this is where it's at. If it's not quite to your taste, then Panasonic's SVMP20V or Rio's Chiba 128 should fit the bill. Like the iRiver, they are both available for £100ish, have a handy 256MB memory, sound reasonable

” who'd have thought that the traditional champions of personal audio - Sony - would be so far behind?

and, in the Rio's case, even come with decent, Sennheiser MX300, headphones.

If anyone were to ask me what the best MP3 player under £200 is, my response would be as predictable as it is familiar: The £180 Apple iPod mini still reigns supreme. Despite availability issues and a particularly troublesome quality glitch with the headphone socket, everything feels just right. It's well made, looks gorgeous and even panders to the audiophile – as much as MP3 portables can – by offering Apple Lossless and AAC compression systems!

If you really can't stand being part of the Apple generation, or fancy something a bit cheaper, then it's also worth checking out Philips' new HDD070. At only 2GB it has half the storage of the mini, but it does cost a good deal less (from £120ish) and is even smaller and lighter. The built-in tuner is great whilst waiting for buses and trains and, like the Apple, a USB 2.0 connection makes downloading a good deal faster. Another brand that's been busy of late is Aiwa. They've

some pretty sexy models about now, the pick of which I would say is the HZVS 2000. It boasts a substantial 15GB memory yet is actually lighter (68g), and no bigger, than the mini. From around the same sort of price of £180 it looks like something of a bargain, although the lack of AAC or Vorbis Ogg codecs do count against it from an audio point of view.

Above £200 and you're very much into true iPod territory.

Although de-contented and reportedly not as good as the third generation in some respects, the 4G 20MB and 40MB iPods are still very much the business. They are not, however, my choice. Instead I would be swayed by iRiver's IHPI20/140. I can't deny that, well built as they are, they cannot begin to match Apple's iconic styling.

What they do offer, though, is a range of features that's appealing to gadget freak and audiophile alike. For the former there is a voice recorder, remote (now an option on the 20GB Apple), and radio. For the latter, which I would suspect is most of this readership, there is an optical digital and microphone input, both MP3 and AAC codecs and, joy of joys, Ogg support. This is generally considered to be one of the better compression systems, and will run at a very fine 500kbps bitrate!

The final mention goes to the Sony NW-HD1. Despite all the hype, it's not an entirely convincing prospect. The trouble is that, small and light as it may be, it struggles in the Apple and iRiver's company, with only 20GB for generally more money than their 40GB versions. And I also can't help but think that using ATRAC as the storage codec is less than ideal but, then again, Sony could hardly have used anything else. Who'd have thought that the traditional champions of personal audio would be so far behind – computer audio is a new world indeed! ●

Ijk setright



You should remember her from the Aeneid, but if you are one of those folk who do not read much but prefer to look at the pictures, you will have noted her in paintings by Michelangelo and Guercino. The most famous of her class, the Cumaean Sibyl operated from a grotto near Naples, one that I visited ten years ago and found acoustically entralling.

Her cavern was a long straight tunnel, about 16 feet high and perhaps 12 wide, running close and parallel to the hillside concealing it. Across it are cut a series (I think I remember six) of transepts, blind on the inside of the hill but cut through to the open air on the opposite side, with a final full-height transept right at the end. There, with her back to the end wall and looking down the tunnel, that mighty prophetess sat and delivered the goods. What sort of voice she had I cannot guess, but it did not need to be as formidable as the muscular figure that Michelangelo gave her in the Sistine Chapel. When I stood with my back to her wall and spoke to my wife as softly as if she were at my shoulder, she could hear me perfectly although she stood fifty yards away down the tunnel; but she had to shout if I were to hear her at all.

Was that grotto some form of primitive wave-guide, or perhaps a series of resonators? It made me think of our common domestic architecture, which so often includes a lengthy hall off which open a series of rooms. If you are sitting in one of them listening to your hi-fi, which

doors do you leave open?

I am tired of the over-simplified assumptions made by experts offering

“ I am tired of the over-simplified assumptions made by experts offering advice on listening-rooms... ”

advice on listening-rooms. They always assume a closed space, leaving you to die of asphyxia. In real life, you open a door – and the chances are that you will let in more than you let out. All that stuff about room resonances and standing waves is promptly devalued, and the extra space gives your speakers more breathing space. Whether the door communicate with another room, or with a hall or corridor, the space will now be of irregular shape, and that is almost sure to be a good thing. Experiment with opening other doors down the hall passage, or even a serving-hatch between dining room and kitchen. Open the door to the guest bedroom and a previously unheard bassoon may make an entrance.

The possibilities for altering the sound in a listening room are enormous. I chose vertical window-blinds made of curved sheet aluminium: I can achieve changes by turning the slats so that either the convex or the concave sides face the speakers between which – not opposite which – I sit.

In the past, using speakers less heavy than I now employ, I used to enjoy the effect of mounting them on

the walls, just above head level. One-fifth of the way down used to work best, just as it is best to have a stereo pair of speakers set one-fifth of the way in from the corners. There is no mystery in this proportion; it also serves to give the most even distribution of stresses in a beam supported at two points. Designers of tables and bookshelves, please note; and if the bottoms of your

speakers are up to it, use the same rule for locating spikes or cones under them.

There is something hideously conventional about the way we locate and aim our speakers, suggesting an appalling lack of imagination in those experts of long ago who told us what we should always do in the future. When I was using Isobariks (which, you will recall, fired upwards as well as forwards, as did some smaller speakers briefly made by Musical Fidelity some years later) I found that what I heard was particularly good when I lay supine on the floor with my head exactly mid-way between them. What does that tell us about the proper orientation of sound projection?

Juggle all these possibilities; you may find that you can choose whether you listen to the speakers or to the room. Bearing in mind the gratuitous reverberation built by some engineers into their recordings, it can be a good choice to have. However, while opening internal doors, please do not open external windows: it is unfair to the neighbours, and if you use supertweeters it may also be unkind to passing bats. ●

patrick cleasby



It is often the way that columns tend to come in pairs, with new information or reaction causing the follow-on, and so it proves in the case of last month's rather pessimistic assessment of the state of industry thinking regarding Dual Disc. This time I am forced to continue on the same topic due to Richard Elen of Meridian sending us a rebuttal of some of the previous column's comment which was, at the time, unattributable.

RE: Who is "the manager of a band with a real interest in bringing surround titles to market" for example? Not someone who is clued up about DVD-Audio, I would suspect, but more likely someone who has become convinced by the hype of SACD.

PC: Not at all, the manager in question is Andy Leff, manager of the band that have released the best DVD-A this year, bar none, Porcupine Tree.

RE: Meanwhile, it is difficult to find "plenty others out there of a similar mind" who have not accepted the SACD shilling. It's also difficult to find verifiable quotes of companies pooh-poohing DualDisc.

PC: Okay, here's one – Phillip Hobson of Linn – "It's a horrible cludge". Admittedly partisan, I know, but the SACD camp do have brains themselves – they can work out that loss of bonus content, alternate audio tracks and/or forced downsampling are bad things (things not mentioned by Mr. Elen by the way).

RE: What are the facts about DualDisc? The test market went extremely well, and while apparently 12% of purchasers had issues with the disc or its packaging, to conclude that this was a result of disc compatibility problems would be erroneous, as the figure included problems with the prototype case.

PC: Indeed, on the basis of what I have heard anecdotally, I was sceptical of this assertion (that

paragraph should have been part of the quote in the original – it was not my comment).

RE: Of course Philips, the number two backer of SACD, will not approve the CD side of a DualDisc! What else do you expect? For similar reasons, of course Sony DualDiscs will not have DVD-A content – for now – widespread industry rumours suggest that Sony Music really want to get on the bandwagon with everyone else but are

” **Jean Michel Jarre's 'Aero' has Dolby and DTS where it could have had MLP... as I've said before, a great shame...**

forbidden to do so.

PC: Maybe Sony Music have ears and brains too – do not consider the last column to be representative of my views, although I share with many others the pessimistic view that if all this confusion in the audio industry ends up being propagated to the consumer we all lose.

RE: Even the current alleged limitations on disc capacity could be of little import... What makes us so certain that the prototype form of an innovation defines its characteristics forever? It hasn't been like that with any other consumer medium, why should it be the case here?

PC: It needn't, but with new formats just around the corner there is no time to improve – DVD-A content restricted to DVD-5 rather than DVD-9 is a retrograde step, period. The "could be" in this response is the key to the fact I think Richard is being over optimistic here – producers will find potentially having to tell artists they can get less on than they could before a real enthusiasm killer.

RE: Of course there are very real

issues with DualDisc. One is the apparent conflict of patents between DualDisc and DVD-Plus. This is not an issue in the States, but it is in Europe... Quite frankly, either will do.

PC: Yes, but having both in the marketplace each side of the Atlantic would just confuse things even more...

RE: Another issue, pointed out by Cleasby, is whether or not the majority of the population actually want a high-resolution audio format at all – perhaps "DVD Music" will do, with lossy-compressed audio. That's certainly a reasonable question, but I believe that ultimately people will accept the idea of high-resolution, lossless, multichannel audio.

PC: So do I, Richard, so do I. At least I hope so, because that is the only reason I do this

(well, that and 24/192 stereo at least...)

RE: There is plenty of room for a transitional strategy, whether it's packages with a DVD-Audio/Video disc and a CD – or it comes in the shape of a DualDisc, compatible with virtually anything.

PC: But I suspect the former will prevail – and without the DVD-Audio bit. Jean Michel Jarre's 'Aero' has Dolby and DTS where it could have had MLP, Neil Young's Greatest Hits has 24/96 LPCM when it should have had 24/192 MLP. Regrettably for Richard, Meridian lose out, and unfortunately so do the true audiophiles. If Neil Young, one of DVD-Audio's greatest proponents, has 'caved in' for whatever reason, maybe it really is all over? As I have said before, a great shame... ●

[Editor's note: Richard Elen, head of Creative Services at Meridian Audio Ltd., sent Patrick a comprehensive rebuttal of his points in last month's column. Space prohibits its inclusion this month, but we'll run it next issue.]

Tube Shop

TubeShop.com

a lot easier!
'My tubes are impossible to get hold of'

Visit The Tube Shop
www.tube-shop.com



You can even telephone your order
0870 9220404

Why choose Tube-Shop.Com

- Over 2,500 different tube types in stock at all times
- We offer you the best prices around, Guaranteed
- UK's first fully online tube ordering system
- Expert matching service by PM Valve Labs
- We sell only the world's BEST brands
- Next day delivery (if ordered before 3pm)
- Free delivery (on all orders over £50)
- MONEY BACK GUARANTEE
- Trade enquires welcome

Billy Vee

SOUND SYSTEMS

SAVE UP TO 50% ON EX-DISPLAY BARGAINS

SOME AS NEW (MARKED*) WITH 2 YR WARRANTY 24HR DEL ONLY £5. CHECK STOCK BEFORE ORDER
 CALL SALES:(020) 8318 5755 or 8852 1321 - 248 Lee High Road, London, SE13 5PL
 Please call for details on deferred 0% APR for purchases of more than £650. S/H = Pre-Owned unit. E&OE

Arcam DV89* DVD-A Player New (2Yr G/tee)	(1299.00)	£649.50	Linn Keltik Spkrs - Wal inc Aktive Cards (2Yr G/tee)	(6000.00)	£2195.00
Arcam DV27A FMJ DVD Player (2Yr G/tee)	(1899.00)	£1195.00	Linn LP12/Ekos/Arkive Boron (2Yr G/tee)	(5350.00)	£2675.00
Arcam CD62T* CD Player (2Yr G/tee)	(369.00)	£229.00	Loewe 24" High Definition 16:9 TV (1Yr G/tee)	(999.00)	£499.00
Arcam CD82T CD Player - New (2Yr G/tee)	(599.00)	£449.00	Naim CDS2/XPS Player & P/Supply S/H (1Yr G/tee)	(6265.00)	£2995.00
Arcam CD93 CD Player - New (2Yr G/tee)	(979.00)	£659.00	Naim Nait 5 Amplifier (1Yr G/tee)	(890.00)	£659.00
Arcam A65+ Amplifier (2Yr G/tee)	(369.00)	£249.00	Naim NAC 112 Preamp (2Yr G/tee)	(660.00)	£499.00
AVI Pro 9 Plus Speakers - Cherry (2Yr G/tee)	(799.00)	£569.00	Naim NAP 250 P/Amp - Old style S/H (1Yr G/tee)	(1890.00)	£895.00
Linn Majik Phono Amplifier S/H (1Yr G/tee)	(945.00)	£625.00	Naim NAP 180 Power Amp S/H - (1Yr G/tee)	(1225.00)	£795.00
Linn Kolektor Preamplifier S/H (1Yr G/tee)	(575.00)	£345.00	Naim Hi-Cap 2 P/S - old casework (2Yr G/tee)	(930.00)	£639.00
Linn Movie Klassik DVD/CD System S/H (1Yr G/tee)	(1995.00)	£1295.00	Naim NBL Speakers - Beech (2Yr G/tee)	(7700.00)	£3795.00
Linn Kaim Pro Line Preamp S/H (1Yr G/tee)	(1400.00)	£599.00	Pioneer DVD656S Multiplayer (1Yr G/tee)	(349.00)	£219.00
Linn Klout Power Amplifier S/H (1Yr/Gtee)	(1600.00)	£895.00	Pioneer DVR3100 DVD Recorder/Player (1Yr/Gtee) (349.00)		£219.00
Linn Trikan Centre Spkr - maple (2Yr G/tee)	(549.00)	£299.00	PMC DB1 Speakers - Cherry (2Yr G/tee)	(555.00)	£399.00
Linn Ekwall Centre - maple (2Yr G/tee)	(795.00)	£559.00	Yamaha RXV 630 RDS A.V. Amp (1Yr G/tee)	(459.00)	£269.00
Linn Espek Speakers - maple (2Yr G/tee)	(2800.00)	£1985.00	Vibe Zeta SubWoofer (2Yr G/tee)	(600.00)	£469.00

IAN EDWARDS

MAKERS OF FINE HAND MADE FURNITURE

Tel: 01423 500442 Fax: 01423 705200 www.iansbespokefurniture.co.uk
 The Old Chapel, 282 Skipton Road, Harrogate, N. Yorks, HG1 3HE

Elegant Storage Solutions for
 Hi-Fi, Books,
 LPs, CDs,
 DVDs
 Special orders welcome



'Super 14 Wizard' Rotary Unit. 2296 CDs, etc



74" 'V-Max' can hold 660 CDs etc



JT Hi-Fi CD/Cassette Unit



Charlotte Drawer unit for 480 CDs & 75 Cassettes 32" x 21" x 21"



mike, mixing

Patrick Cleasby meets up with Mike Nielsen, who has mixed a number of this year's most interesting high-resolution projects from the UK, to discuss his approach to the task...

Originally from New Zealand, but trained up from being a tape op in the early nineties at Strongroom Studios, Mike Nielsen has been at the forefront of surround mixing in the UK for a number of years now, most recently with 5.1 versions of the latest Feeder, David Gray and Snow Patrol albums. He has also worked on film soundtrack mixes with composers such as Marius De Vries and Talvin Singh, and he started in the game with the **Underworld DVD 'Everything Everything'**.

"That was November 1999 to January 2000, something like that. And that was really early days for most of us, in terms of finding mastering here, and authoring too. There was a big learning curve, whereas now it's a lot more slick, it's come a long way in those four years".

I mention that our focus as a hi-fi magazine is naturally on high resolution...

"The good thing with the new formats, SACD, DVD-A, working in 24 bit you're starting not to think about conversions so much anymore, it's starting to become transparent. Of course, for the Feeder album we had high-resolution recordings. I enjoyed doing that one, I really enjoyed hearing all the parts and hearing what they were playing. It definitely translates well to surround. (Feeder were involved) only at the end. They were on tour in America. We did two stages, the initial mix when the original stereo engineer came and had a listen and we discussed a couple of things, then we held off until the band and management could hear. There were a couple of comments, strings up

here, or a bit of guitar missing which wasn't on the multi-track, so we came back and spent a couple of days adjusting and it was

finished. I enjoyed it because I like the rock band sound. Electronic music can sound really interesting as well, because you've got that different sense, you have a more open brief, a bit more poetic licence because you're creating a landscape. When it's guitar, bass, drums, you want to have a sense of it enveloping you, but not falsely".

I enquired to what extent Mike tries to make the perceived balance of the 5.1 mix equivalent to the original stereo.

"I love the 5.1 format and don't really mind whether it's SACD or DVD-A, ..."

"Unless you've got something revelatory to add, you should do that, so I spend a lot of time listening to the stereo, absorbing what the mix is doing, what it's telling me. It's a gut feeling, so it's about just flicking between and relying on your instinct to say – well OK, that feels equivalent, but we're in three dimensions, not two."

I wondered if Mike felt that the surround mixing was more creative or more enjoyable than stereo mixing.

"It was interesting, when we first started doing the Underworld stuff I

got the same sort of buzz as when I first started working in the studio, because it was new again, it was - this is fantastic! It is different, playing with different things – you've got a box just for bass!"

I remark that these are the tricky things that people have different opinions on – what you should do with the sub and what you should do with the centre, mentioning that the Feeder mix varies its centre usage for vocals nicely.

"The centre one is the big issue. It's great that you like the way it's used on the Feeder. With LFE, the thing I have stuck to is that you have a little bit of bass and a little bit of bass drum so that you've got something there. You don't need much".

What of possible conflicts in small systems attempting to do bass management and doubling up what's in the sub – effectively the argument for 5.0 music mixes?

"I personally would never have that bass management happening. Every process has by-products, has



"One might expect the Stereo 40i to cost in the region of £2,000..."



Stereo 40i EL34 integrated 40+40w (or 19+19 Triode)

"The sound has a lovely spacious and airy quality with plenty of depth... The frequency response exhibited extended bass below 10Hz" ... "Stunning styling and an impressive spec at a very sharp price" ... Hi Fi Choice June '04

Awarded Hi Fi News 'Editors Choice 2003'

"Icon Audio offers sensible, well sorted valve amps, with adequate power and built to a good standard"

Hi Fi News Feb '04 said... "ample, deep, bass, underpinning a lucid and effortless midrange and treble"... "I liked the impeccable finish and feeling of bomb-proof solidarity as well some of the most natural sounding music that I have heard at home". Tony Bolton

New Entry Level Version Only £599.95

Exactly the same specification & finish only without tape monitor loop and triode facility.

Triode only conversion £50.

Mullard & European valve upgrade £50.

No One else gives you all this value!

- Beautiful see through valve cover (included in the price)
- Choice of Mullard, JJ, EH & Svetlana valve upgrade worth over £100.00 inc at **NO EXTRA CHARGE** (limited offer)
- Switchable Triode Mode, (highly praised in the reviews)
- Tape Monitor, essential for Tape, CD-R and home cinema
- Tape out (essential for any kind of recording)
- 'Soft Start', protects from switch on 'power surge'
- HT Delay to protect valves & extend life (optional extra)
- Circuits developed in Leicester, manufactured in China
- Each amp carefully commissioned & tested in Leicester
- Part Exchange facility for your old equipment, ask us!

To find out more, ask for an illustrated leaflet

Features include: All Triode front end. Hand built 'Point to Point' wiring. Tape monitor circuit. ALPS Volume control. No printed circuit board. All gold plated terminals. Audiophile components. 4 & 8ohm speaker matching. Stainless steel & 10mm alloy plate construction. Soft start. Stainless steel & Plexiglas valve cage included. Upgrade options.

Stereo 20 EL84 15 watts integrated £649.95*

Stereo 40i EL34 40w(19 triode) integrated £899.95*

Stereo 40ie EL34 40 watts integrated £599.95*

LA 3 Triode Line Level pre amp £649.95*

MB 25 300B PP 28w Mono blocks (pr) £1999.95

Beware of imitations! Other amps may look similar, but our circuits are unique to us & designed for UK 240v operation. Full repair & after sales in Leicester UK.

**Try for 30 days, refund if not delighted! (UK only, conditions apply)*

Subsidised International Shipping Available, ask for details

Visit our new website at www.iconaudio.co.uk

Auditions by appointment. Dealer inquiries welcome

Phone 07787 158791 Email sales@iconaudio.co.uk

icon Audio 351 Aylestone Road Leicester LE2 8TA

Visa and MasterCard accepted

CE marked

MANTRA AUDIO

Specialist Suppliers of Audio Accessories

www.mantra-audio.co.uk

PRICES INCLUDE P & P FOR UK DELIVERY 1 TO 10 DAYS - SEE WEBSITE FOR FULL PRODUCT RANGE AND SHIPPING CHARGES TO EU & WORLDWIDE

CARTRIDGE SELECTION	STYLUS	REPLACEMENT STYLUS
Goldring		Swiss Quality Diamond Styli
1006	£76 £62 GEX £52	ADC XLM Mk III £17
1012 GX	£95 £76 GEX £67	Akai AN 5, AN 60 £13
1022 GX	£124 £100 GEX £86	AN2, AN 70 £15
1042	£143 £114 GEX £100	Aiwa AN11 £13
Eroica LX/H	£133 £109 GEX N/A	Dual DN 145 E, DN 165 E £17
Elite	£232 £190 GEX N/A	JVC DT 55, DT 60 £13
Audio Technica		National EPS 24 CS, P 30 D, P 33 D £13
AT 95 E	£23	Ortofon FF15/VMS20 EH, OM20 £17
AT 110 E	£28	Pioneer PN 210/220/240 £13
AT OC9 ML II	£330 £280 EX	Shure N 75 C, SC 35 C £13
Grado		N 75 ED T2, N 75 EJ T2 £17
Prestige Black	£40	N 95 ED/EJ, N 75 3 (78) £17
Prestige Gold	£110	VN 35 E £20
Ortofon		N 97 HE, VN 35 HE £27
510 Mk II	£34	Sony ND 142/155 G, CN234 £13
MC 15 Super II	£130 £110 EX N/A	ND 143/150/200 G £21
MC 25 FL	£227 £193 EX N/A	Stanton D 681 EEE £21
MC 10 Supreme	£304 £258 EX N/A	***Over 500 Styli Types Stocked***
MC 20 Supreme	£382 £323 EX N/A	
MC 30 Supreme	£452 £385 EX N/A	
Kontrapunkt B	£643 £548 EX N/A	
Rohmann	£837 £742 EX N/A	
Shure		
M 97 XE	£98	£58
V 15 v xMR	£304	£204
Sumiko		
Blue Point Special	£265 £237 EX	

GEX - Goldring new for old exchange price for any make/type of cartridge
EX - Exchange price for any moving coil cartridge

Order direct online or Tel/Fax (01757) 288652
MANTRA AUDIO (HFV), 22 GARTH AVENUE, NORTH OUFFIELD, SELBY, NORTH YORKS YO8 5RP

Absolute Analogue[®]

Address: PO Box 30429, London, NW6 7GY

Tel / Fax: +44 (0)20 8459 8113

Email: Absolute_Analogue@email.msn.com

Website: www.absoluteanalogue.co.uk

Nordic Concept Ar ist
(Direct sale bargain!)



Reference 3A Dulcet



Aurum Cantus Leisure 2SE



Aurum Cantus Leisure 3SE



Get it right!



artefacts, so the less it has to do the better. It's the equivalent of if you put a mic in the right place you don't have to EQ so much".

Is Mike still adhering to something he had mentioned in the past – that he mixes with the thought of domestic systems with small satellite speakers in mind?

"Yes, definitely, although my approach is changing. For the very first DVD we did, we did market research, went to retail shops where you could buy hi-fi systems, just to see what the average person could buy if you walked in there with five hundred or a thousand quid, two thousand quid – what would they show you? Most of them were front-heavy, in the standard way, with satellite speakers, and we thought you've got to mix with that reality in mind"

Does Mike use the centre channel for instrumentation?

"It depends on the music, often it will be something to solidify the centre of a normal mix, so kick, snare, bass and vocal, often dry, and any stereo effects in the left and right. But in electronic music, any music where you have a lead instrument you can put that in there - Underworld, for example, every now and then for effect we would use all six speakers, and there's a drum loop coming out of each one. When you're at an Underworld gig, sometimes when they drop to percussion and drums it's like being beaten up in a really friendly way - you know you're getting knocked around but it's a very seductive sound, and to give that feeling we decided to do that".

I wondered whether Underworld had planned to do surround versions of any of their studio albums...

"They were going to do the last album, '100 Days Off', but just ended up touring lots. With them, they really like to get stuck in and spend a good amount of time doing things, so they've got to find a window

whereas with the Feeder they were happy to say - you do it, here's a couple of weeks, go for it, and then we'll hear it".

I asked if that was the normal amount of time necessary, and how the David Gray project compared.

"I would say if everything was ready to go, a couple of weeks. David Gray was similar, a couple of days on each song, two or three weeks. David was on tour, but I worked with one of the production team, George Holt, and we'd go through tunes and shoot ideas around and try different things. When they'd finished touring, they came back and we found a couple of things which hadn't made it onto the multi-track".

At the time we spoke, the David Gray disc had still not been released (even now it has, to my mind it has been chronically under-promoted), so I asked Mike what had happened to it, and if he had any idea of whether things were being held back for a push with Dual Disc.

"It's one of those things - it just takes ages. It's all done, it's all cleared, everyone's happy, artist, producer, record company, management – they all said OK, great, and we're still waiting. I haven't got any inside track apart from having been to a few surround sound forums and surprisingly it feels like early days for them, in terms of getting their marketing together or being

coherent. From my point of view as a mixing person I love the format of 5.1 and given that it is of a certain quality, I don't really mind whether it's SACD or DVD-A, it's the fact that it's surround for me that is the really interesting bit, and the format is second to that".

As ever, I had to ask if Mike had a full surround set up at home, and not unusually he confessed,

"No I don't actually, and that's another interesting one, because I'm waiting for the right universal player. I have auditioned some, but not seriously as if I'm about to buy one. I stopped in my tracks, I was about to buy one about a year ago, realised it didn't play DVD-A, so I didn't bother. Those kind of issues make you wonder, if people in the industry are having those thoughts, what about your average person?"

I mention that lower end customers might eventually be better off, in that single-box solutions with cheap do-it-all chips will mean that they don't have to worry about compatibility and the vagaries of six-channel connections...

"That's very true. The sooner, the better. Like I say, at these forums, they're still looking at ways of fighting each other, DVD-A and SACD, and it just seems like – hang on, if you did a combined marketing thing to inform the public about 5.1, hold back on the means and promote the end, then everyone would be better off."





BJORK
MEDULLA
(HYBRID SACD: STEREO AND MULTI-CHANNEL DSD OR DVD-AUDIO: 24/96 MULTI-CHANNEL AND STEREO)

One Little Indian has become one of the only record companies to release hi res titles in both formats (almost) simultaneously in the same territory (Virgin Germany has done the same with Bryan Ferry's 'Frantic' album, and EMI did 'Concerto for Group and Orchestra' but I can't think of any others), which gives us a welcome opportunity to compare formats...

What of the album, though?

Bjork has increasingly ploughed her own, very distinctive artistic furrow, and this album is the apotheosis of that approach – the drift away from conventional song structures, instrumentation and rhythm has culminated in a record which makes exclusive use of human voice, naked or treated, to build Bjork's tinkly-bonk soundscapes.

The result is an enthralling listen, not least in surround, as the conceit is so unworldly that the freedom to make maximum, spellbinding, use of the soundfield is indisputable. The resolution is also a step change above the 24/48 roots of 'Vespertine' too – fully exploiting the various voice textures which include Mike Patton and Rahzel from The Roots, and some spectacular Inuit ululations.

That other worldliness is also imbued by the only DVD-Audio extra – a handy 'making of' with the explanatory title 'The Inner Or Deep Part Of An Animal Or Plant Structure' (definition of Medulla – get it?), in which Bjork's to-camera parts are in Icelandic with subtitles. The documentary is not the only reason to go DVD-A – on HFW's reference Denon DVD-A11 it just sounds far better, period!

Hi-res Bjork fans are in for a treat with the first four albums, ('Debut', 'Post', 'Homogenic' and 'Selma Songs'), all due for release in both formats shortly (although OLI say they are 'on hold' at the moment – ominous). I have spoken to Tim Young, who mastered them and he says even the CD layers are a marked improvement on the current CDs. Can't wait!

THE CRYSTAL METHOD
LEGION OF BOOM
(DVD-AUDIO: 24/48 MULTI-CHANNEL 24/48 STEREO)

I had the pleasure of seeing The Crystal Method live a good few years ago, and I remember thinking that if you had to experience the 'repetitive beats' school of dance music – usually two chunky middle age men twiddling knobs behind piles of studio gear with an impressive light show – then they were pretty much where it was at. (This was shortly after I actually fell asleep during a

very loud initial play of The Chemical Brothers' 'Dig Your Own Hole' – some feat, it must be the 'repetitive' part!). Somehow I was never tempted to shell out for one of their albums – even at three quid a pop Soho bargain bucket prices.

In the intervening years 'The Method's' profile has not been that prominent – having songs featured in a turkey like 'Lost In Space' doesn't really help – but now they're on V2, and with DTS for this fine DVD-Audio, maybe they will get some mass acclaim. They certainly have the cachet to attract star guests – Rahzel features here once again, as do the delectable Milla Jovovich and Wes Borland, the erstwhile Limp Bizkit guitar weirdo. This is a stunningly well produced disc, and extras include bonus mixes and videos too.

This kind of stuff is obviously well suited to adventurous surround treatment and the mixes, from 6.1 wizard Nate Kunkel and others, do not disappoint. I have to confess that I do not make use of 6.1 DTS ES tracks, but if that's your bag, there is one here. If you like electronica this disc is definitely worth a spin, even if you're a stereo head, as contrary to the sleeve marking, the LPCM track (available in both DVD-Video and DVD-Audio modes) is not 16/48 but is actually 24/48. Don't ask me how I know this – my AAC files do sound surprisingly good though. Enough said!



JON LORD *BEYOND THE NOTES* (HYBRID SACD: STEREO AND MULTI-CHANNEL DSD)

One approaches the prospect of 'classical crossover' albums with a definite hint of trepidation, particularly if one has to go and interview the artist concerned. But Jon Lord's first solo album since leaving Deep Purple is an intriguing and ultimately rewarding listen, and the man himself is a true gent, so it was a relief to be able to tell him that I enjoyed it...

Lord has done albums in a similar vein before – from 'Sarabande' in the seventies through to 'Pictured Within' from 1998 which marked the start of his association with EMI Germany (in various guises). In fact this album is a markedly German production, from the management to the technical crew and the instrumentalists.

Lord largely ignores his trusty Hammond, and has had to polish up his piano chops to back up the tasteful work of his German sidemen and The Trondheim Soloists who supply some delicate strings work throughout. They intend to take this sizable assembly out on the road in Germany, and rumours are that UK dates will follow.

There is a considerable strand of elegy to the album, with well wrought, contemplative and

emotional musical tributes to Lord's one-time compadre Tony Ashton, his friend George Harrison, and lastly and most affectingly his parents. Vocalists include Frida of Abba and Sam Brown, and both DSD versions are a huge improvement on the CD sound, with the surround mix giving an even more attractive sense of acoustic space than the excellent stereo recording.

Bizarrely, although the SACD is marked with the EMI Copy Control logo (presumably referring to the CD layer), the straight CD is not marked as such. Whatever the intention the CD layer of both can be easily ripped in iTunes on an iPod – when are EMI going to stop this silliness? After all, Sony already has!

TODD RUNDGREN *LIARS* (DVD-AUDIO: 24/96 MULTI- CHANNEL ONLY)

I haven't bought a new Todd album since 'Nearly Human', nearly fifteen years ago. Truth be told there haven't really been any conventional albums of new rock material in all that time, as the man got preoccupied with red herrings like early CD interactivity. All very interesting, but probably an insult to his real talent, which is composing, arranging, producing and playing brilliant rock songs like many of those featured here. This is certainly

one of Todd's best albums in a very long time.

It is a surprise that the revolutionary Rundgren has not delved into the surround world thus far, although the truth is almost did – Rhino got him started on a multi-channel mix for the seminal 'Something / Anything' album, only for the absence of the multi-track tapes for certain tracks to stymie the continuance of the project. Hopefully Rhino and Rundgren will resuscitate it now, as the man himself performs the surround mix duties here with some aplomb, although the fidelity does not seem notably higher than that of the CD.

It is, however, a disappointment as almost always with Silverline no high resolution stereo track is included. The straight DVD-Audio of 'Liars' should be available now, but the usual UK online sources do not indicate with any degree of certainty that it is imminently available. I wonder if this is due to the expected launch of Dual Disc, as 'Liars' is in the second tranche of planned Silverline US releases. I can only recommend that prospective purchasers who don't already have the CD and wish to do all the usual car and portable stuff ignore the pure DVD-Audio release and seek out the Dual Disc – I haven't done the sums, but as this disc is a DVD-5 I assume the DVD-A side of the Dual Disc will be unreduced!

December 2004/No.80

Contact Numbers
Mon-Fri 9am-5pm

WEBSITES
www.worldaudiodesign.com
www.hi-fiworld.co.uk

Editor

Mike Ballance
fax: +44 (0)8707 065 162
e-mail: diyeditor@hi-fiworld.co.uk

Design & Layout Editor

Faiza Chunara
tel: +44 (020) 7625 3129
fax: +44 (020) 7328 1844
e-mail: adproduction@hi-fiworld.co.uk

Production Editor

David Noble
tel: +44 (020) 7625 3134
fax: +44 (020) 7328 1844
e-mail: classifieds@hi-fiworld.co.uk

Contributors

Neville Roberts
David Friar

ADVERTISING

Debi Silver
tel: +44 (0) 870 242 0567
fax: +44 (0) 207 328 1844
e-mail: debi@hi-fiworld.co.uk

ACCOUNTS

Sharon Mehlhorn
tel: +44 (0) 20 8841 8892
fax: +44 (0) 20 8841 9144
e-mail: accounts@hi-fiworld.co.uk

WORLD AUDIO DESIGN

www.worldaudiodesign.com
tel: +44 (0) 1245 450 651
e-mail: sales@worldaudiodesign.com

PUBLISHER

Noel Keywood
e-mail: publisher@hi-fiworld.co.uk

PRIVATE & TRADE CLASSIFIEDS

tel: +44 (020) 7625 3134
fax: +44 (020) 7328 1844
e-mail: classifieds@hi-fiworld.co.uk

SUBSCRIPTIONS & BACK ISSUES

tel: +44 (0) 1442 879097
fax: +44 (0) 1442 872279
e-mail: hi-fiworld@webscribe.co.uk

Distributed by

Seymour Distribution Ltd
86 Newman Street
London, W1T 3EX
Tel: +44 (0) 20 7396 8000

Printed by

Southern Print, Dorset
Tel: +44 (0) 1202 628 300

Our Agents in Malaysia

Millennium Hi-Fi & AV
Simon Chang
Showroom & office, 500-1-3 First Floor
Wisma Indah (Shen Court), Jalan Tun Razak
50400 Kuala Lumpur, Malaysia
Tel: 603 9283 8171 Fax: 603 9281 3762
e-mail: info@millenniumaudio.com

All unsolicited submissions and goods are at the owner's risk. We accept no responsibility for such submissions, nor do we undertake to return them.

No material may be reproduced from this magazine without the publisher's written permission.

© Audio Publishing Ltd

DIY supplement contents



P90



P94

NEWS 89
all the latest from the weird and wonderful world of DIY hi-fi.

STEPPED ATTENUATORS 90
Neville Roberts discovers a bargain on eBay...

AOPEN SESAME 94
An article on how to build your own valve-based audio PC!
David Friar is the man with the motherboard.

www.worldaudiodesign.co.uk

HI-FI WORLD

SUITE G4, ARGO HOUSE
KILBURN PARK ROAD
LONDON, NW6 5LF

Falcon Acoustics Ltd

Falcon Electronics, Basically Sound
<http://www.falcon-acoustics.co.uk>

Full Price List and Focal details on Web Site

DRIVE UNITS: by FOCAL & seas, and a pick of the best from other manufacturers.
100+ CROSSOVER NETWORKS: - Active & Passive, Components, Accessories,
New LS3/5A type Crossovers

Also for the LS3/5 and Original LS3/5A

COMPONENTS

SOLEN Polypropylene capacitors. 0.1mFd. to 100mFd.

NEW Values:- 3.0mFd 400V 5% and 9.1mFd 250V 2.5%

Polyester and Polycarbonate Film Capacitors. 0.1mFd. to 10mFd.

ALCAP Reversible Electrolytic Capacitors (Non-Polar). 50v, 100v & Low Loss. 2mfd. to 600mFd.

Plus all the other bits you will need, with illustrations on the web site

FALCON Custom-wound Inductors.

FERRITE:- Standard, High Power, Super Power, Super-Super Power

AIRCORED 0.56 - 1.25mm wire: **IRON DUST.** 1mm wire

TAPPED INDUCTORS:- 0-10mH in 1mH steps & 0-1mH in 0.1mH steps

AUDIO AMATEUR PUBLICATIONS

Back year sets of Speaker Builder, Audio Amateur & Glass Audio, plus the Audio Anthology Set.

Books and Audio Amateur's magazine year sets. 2001 to 2003 year sets on CD-R only

FOCAL 'State of the Art' Units & Kit Designs'

as pioneered in the Utopia range of systems.

Price List & Unit Specs **FREE** on Web site - available in .pdf format

5W4211 6W4311 7W4411 8W5411 10W6411

Plus: Audiom 6 WM

7K6411 (replacement for Audiom 7K-/7K2)

TC120TD5 - TC90TD5 & TC90TD5B

All normal stock items

SUPPLIERS TO THE TRADE SINCE 1972

Send for our **FREE** price list **PL31:** Just send a large S.A.E. (47p stamp) or US\$2 bill overseas, Europe US\$1 bill or 3 International Reply Coupons (IRC) to:-
 (Dept HFW) Unit 12 Damgate Lane Industrial Estate, Damgate Lane
 ACLE, Norwich, Norfolk, NR13 3DJ Tel: 01493 751100

Rediscover
 the beauty of
 pure sound....

NEW!
 Visit our web site at
www.chelmervalue.com
 to view our entire valve
 catalogue and buy on
 line!



We have been supplying tubes to the audio market for over 40 years. Only valves that pass our stringent in house QC tests are used for the CVC Premium brand, and our no fuss guarantee ensures your complete peace of mind. When available, we also stock the justifiably famous brands such as Brimar, GEC, Mullard, RCA Telefunken etc. So why compromise? Our sales and technical staff are just a telephone call away. To put it simply.....

YOUR NEEDS...OUR BUSINESS.

CVC Chelmer Valve Co Ltd

The Stables, Baddow Park, Great Baddow,
 Chelmsford, Essex CM2 7SY

Tel: +44 1245 241300 Email: sales@chelmervalue.com
 Fax: +44 1245 241309 www.chelmervalue.com

audioXpress... It Just Sounds Better

Your Favorite Audio - One New Magazine!

- PROJECTS
- REVIEWS
- THE NEWEST TECHNOLOGIES
- AUDIO CLASSROOM
- and Much More!



Subscribe To This
 Great Monthly
 Publication Today!

**Only \$59.95 US
 for 12 Issues!**

audioXpress • PO Box 876 • Peterborough, NH
 03458-0876 USA • Phone: 603-924-9464

Fax: 603-924-9467 • E-mail: custserv@audioXpress.com

ORDER ONLINE AT: **www.audioXpress.com**

WHITE NOISE

AUDIO KITS, MODULES, COMPONENTS

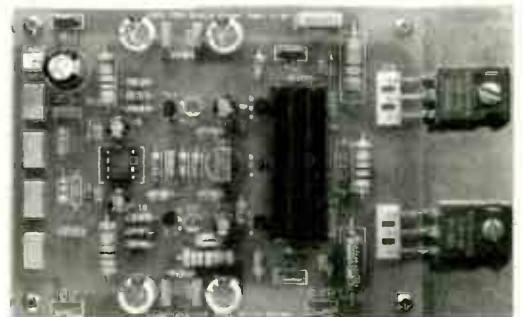

PRODUCTS INCLUDE:- Power Amplifiers 30-250W, Preamplifiers, Phono stages, Active Crossovers, Power Supplies, Buffer Amplifiers, Balanced line drivers / receivers, Stepped attenuators, Gold plated connectors, Cables, Capacitors, Resistors, Semiconductors, Transformers, Subwoofers, Loudspeaker drive units

WHITE NOISE
 11 STATION ROAD
 BEARSDEN
 GLASGOW
 G61-4AW

Web:- <http://www.wnaudio.com>
 Email:- david.white38@ntlworld.com
 Tel:- 0141-942-2460 (until 9pm)
 Fax:- 0141-587-7377

DIY news

COOL CABLES

Got your own cryogenic facility in the kitchen? No, well to keep up with the latest in cable technology, you don't have to buy expensive cables to get that 'expensive sound'. 'The Missing Link' make all their own cables and offer a range of



DIY components as well. They will hand build cables of any length and you can choose your custom termination and finishing braid. The company also offers a hard silver plating service and deep cryogenic treatment for existing hi-fi cables and components. See the range at www.the-missing-link.net for full information. There's a lot to look at on this very comprehensive site.



DRAGON RINGS

How do you run rings round the competition? You fit Tube Rings on your valves and the amp will sound better! Indeed, keeping the valves from vibrating is said to improve bass, dynamic range, focus and probably everything else too.

They've got to be worth a try for any valve amp. Get your Golden Dragon Tube Rings from PM Components Ltd, see www.pmcomponents.com for the full low down.



GET YOUR FREE PROTRACTOR HERE!

Yes, there really are some nice people out there. Have a look at www.enjoythemusic.com/freestuff.htm and there you will find an alignment protractor that you can print out from your computer - and it's completely free. Of course there will be a small inaccuracy in the scale due to the printer itself. If you want the very best, those kind people have gone even further and publish a list of people round the world who will be happy to send you one - printed on good quality card - and still for free. All you have to do is send them an SAE which must be larger than 4 inches x 7 inches for the card to fit unfolded. For us in the UK, there is a choice of supplier. Choose between Scotland and Brighton - full addresses on that website.

ATTENTION THORENS OWNERS

Dragonfly Audio is a new company which makes a replacement surround for the classic Thorens TD160 turntable. Available in a choice of light or black wood grain finishes, the cost is just £79.99. The surround does not have a lid and the company recommends the Michell Uni-Cover for the best sound performance. The

company plans a range of accessories for this and maybe other turntables in the future. More info from Dragonfly Audio, c/o Andr'e Illingworth, 295 Town Lane, Rockingham, Rotherham, South Yorkshire S61 4LN. You can e-mail Andr'e at audiotools68@aol.com for more information.



NOTEWORTHY AUDIO DIY

Introducing the Stoetkit range of valve amplifiers. Original high quality designs from the Netherlands.

- Stoetkit Junior 9 watt push pull integrated valve amplifier.
- Stoetkit VI 25 watt push pull integrated amplifier
- Stoetkit II 300B single ended monoblocks

These designs offer superb value for money, whether ordered as kits (from £395) or as complete factory built units (from £595). For more details please see our website or contact us for a copy of our catalogue.

- Lowther drive units
- PHY-HP drive units
- Wonder Solder
- Audio Note Dac Kit
- Eichmann connectors

- Stoetkit valve amplifier kits
- Furutech IEC sockets and plugs
- Inca Gold plated mains plug
- DeoxIT contact cleaner
- Un sleeved 0.5mm Pure silver wire



Noteworthy Audio
36 Buckingham Street
Aylesbury
Bucks
HP20 2LH
Tel: 01296 422224



www.noteworthyaudio.co.uk

The Ultimate

Neville Roberts adds a ladder to his valve pre-amp and scales new heights in sound reproduction.....

I have been running my WAD Prell pre-amp very satisfactorily for some time with a stepped attenuator using a 2-pole 23-way wafer switch and a set of standard Philips metal film resistors. The attenuator is of the shunt design where R_x is fixed and the switch selects the appropriate value of R_y to give the required attenuation. The advantage of this design is that there is only one pair of resistors in the circuit at any one time, as compared to a resistor string attenuator where all the resistors are in circuit. As every resistor generates its own noise, minimising the number of resistors in the signal path is very desirable. However, a shunt design presents a variable input impedance to the signal source, depending on the switch position. Although this is

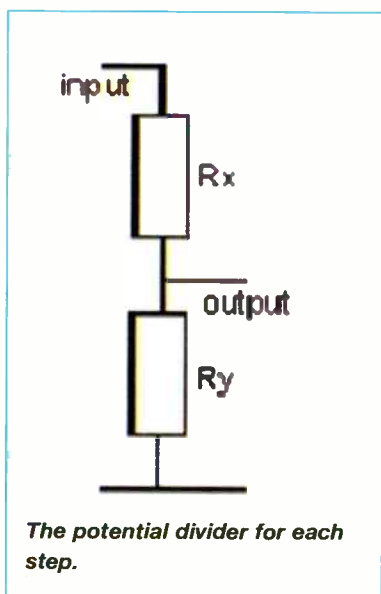

not a great problem in practice, it is not an ideal situation.

I was therefore delighted to find a commercially available attenuator of the switched ladder design that switches pairs of resistors for each step and therefore presents a constant input impedance to the signal source. It is currently available directly from the manufacturer, KYC in Taiwan, via eBay through their 'Buy

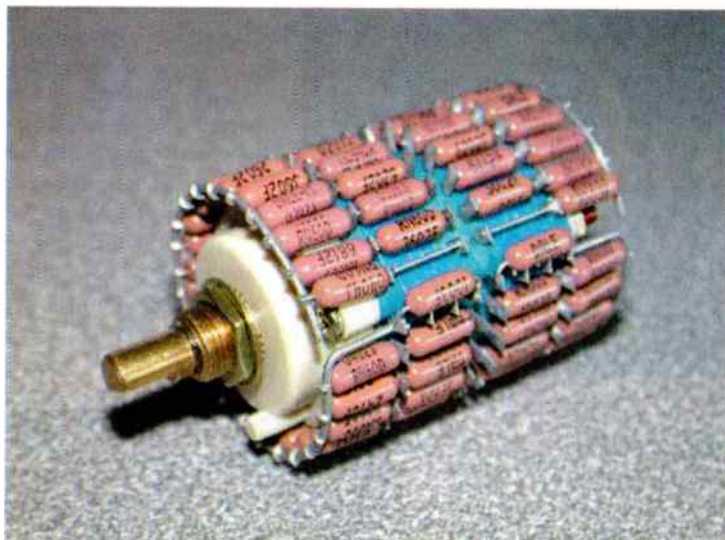

It Now' facility that bypasses the bidding process and makes the transaction like a normal internet purchase. I cannot give the exact web page address at this will vary each time the item is re-registered on the site, so just search for "VISHAY DALE Stereo Stepped Attenuator". Alternatively, contact KYC via email at kyc111@hotmail.com. Several values of attenuator are available, including 50KW and the 100KW version that I required for my WAD Prell. The cost of the attenuator is 1,750 Taiwan dollars, (which is under £29) and postage to the UK was quoted as 6.50 US dollars – all very confusing! However, this works out at less than £33 including postage to the UK. For a design that uses 88 good quality metal film resistors and a military standard switch, this has to be a real bargain! From the copious photographs provided on the eBay web page, it looked very well made and was worth the money for the switch alone. The web page also contains the input and output

connection information as well as all dimensions. I therefore took the plunge and ordered the 100KW version. It arrived safely from Taiwan after about a fortnight from placing the order and making my payment.

As previously mentioned, a switched ladder design switches pairs of resistors for each step. For stereo, this requires a 4-pole switch. The attenuator utilises a high quality military specification 4-pole 23-way switch with silver-plated contacts and Vishay-Dale metal film resistors. In this design, both R_x and R_y are selected by two sets of switches, thus overcoming the limitations of the shunt design.

The approximate attenuations for each position are shown in Fig 1. The unit is certainly beautifully made and a lot smaller and neater than the one I had previously made with a 2-pole wafer switch. The switch has an aluminium end plate fitted to help keep the contacts clean, and the contacts themselves have been coated with a special lubricant. Even

"the attenuator has surpassed all my expectations and is definitely superior to my previous shunt attenuator".

Upgrade?

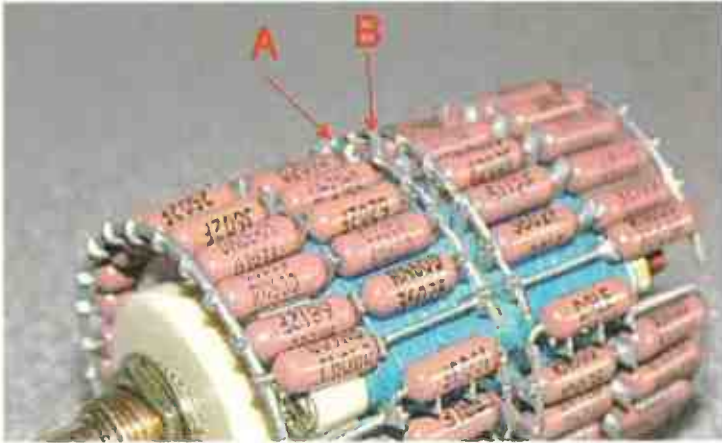

The attenuator with the shorting loops fitted.

the nuts clamping the whole assembly together had been painted with a locking varnish! Suffice to say that I was very impressed with the build quality of the unit, and I had no trouble fitting it into my pre-amp. However, would it sound as good as my previous attenuator? After allowing my system to warm up, I did

some listening tests. First impressions were that there was a lot of depth to the sound and that it sounded fuller. However, as I tried different records, I realised that I had more bass, but at the expense of top end. I had lost the clarity and detail I was used to with a particular record that I know very well. In fact, a harpsichord

Step	Attenuation (dB)
1	Infinity
2	60
3	55
4	50
5	45
6	40
7	38
8	36
9	34
10	31
11	29
12	27
13	25
14	23
15	21
16	18
17	16
18	14
19	12
20	10
21	6
22	3
23	0

Fig 1.

recording of Bach's Partitas sounded decidedly muddy! The effect of more bass and less clarity was pushing the

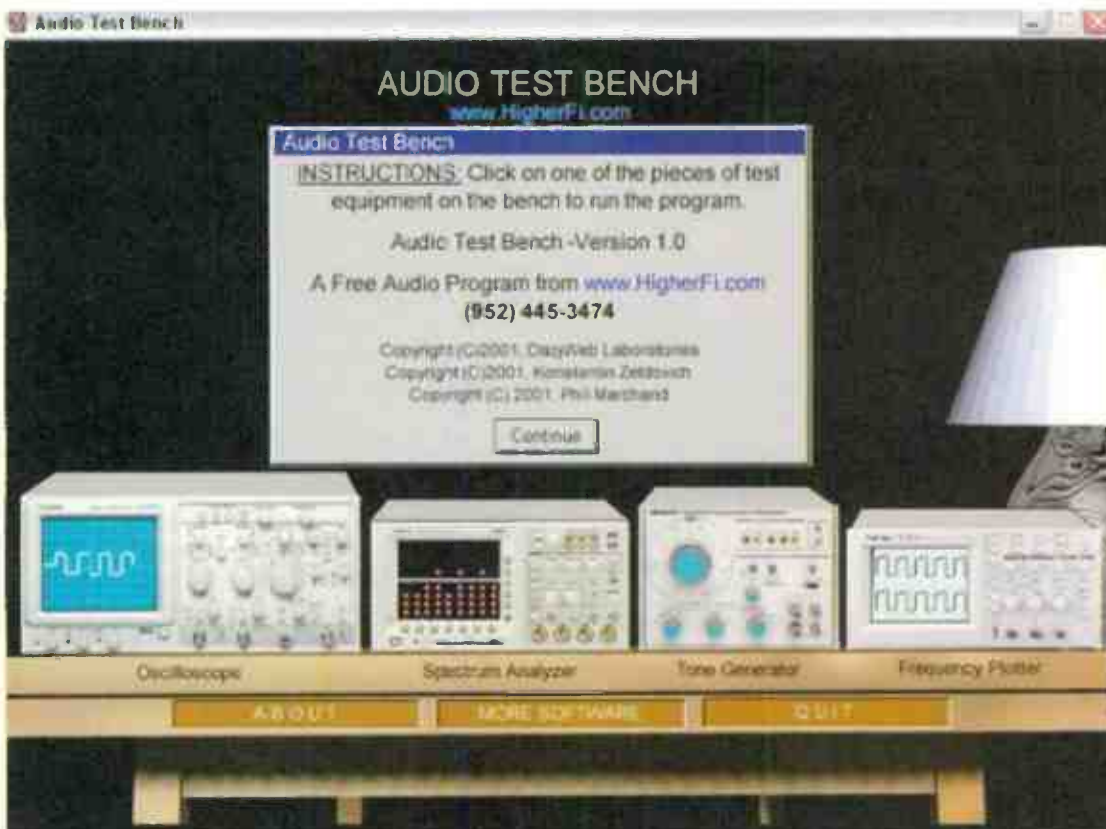

Audio Test Bench Software

LANGREX SUPPLIES LTD

DISTRIBUTORS OF ELECTRONIC VALVES, TUBES AND SEMI-CONDUCTORS AND I.C.S.

1 MAYO ROAD • CROYDON • SURREY CRO 2QP

24 HOURS EXPRESS MAIL ORDER SERVICE ON STOCK ITEMS

E-MAIL LANGREX@AOL.COM

PHONE
020 8684 1166

FAX
020 8684 3056

A selection of our stocks of **New Original Valves/Tubes.**
Many other brands available

STANDARD TYPES			SPECIAL QUALITY TYPES			OTHER TYPES		
ECC83	E.I	4.00	A2900/CV6091	GEC	17.50	12BY7A	GE	7.00
ECC85	RFT	12.00	E82CC	SIEMENS	7.50	5687WB	ECG	6.00
ECC88	BRIMAR	6.00	E83CC	TESLA	7.50	5814A	GE	5.00
ECC88	MULLARD	10.00	E88CC/CV2492	BRIMAR	15.00	6072A	GE	10.00
ECH81	MULLARD	3.00	E88CC GOLD PIN	TESLA	8.50	6146B	GE	20.00
ECL82	MULLARD	5.00	ECC81/CV4024	MULLARD	6.00	6201	GE	6.00
ECL86	PHILIPS	10.00	ECC81/M8162	MULLARD	7.50	6336A	RCA	35.00
EF86	PHILIPS	20.00	ECC81/6201	MULLARD	10.00	6550C	SVET	20.00
EL37	MULLARD	30.00	ECC82/CV4003	MULLARD	15.00	6922	ECG	6.00
EZ81	MULLARD	10.00	ECC82/M8136	MULLARD	17.50	7027A	GE	25.00
EZ80	MULLARD	5.00	ECC83/CV4004	MULLARD	40.00	7308	SYL	5.00
GZ33/37	MULLARD	25.00						
GZ32	MULLARD	25.00						
5Z4G	BRIMAR	7.50						
6V6GT	BRIMAR	7.50						
12BH7	BRIMAR	12.00						
12E1	STC	10.00						
13E1	STC	85.00						
807	HYTRON	7.50						
811A	USSR	10.00						
6080	MULLARD	10.00						
			AMERICAN TYPES					
			5R4GY	RCA	7.50	E88CC	TESLA	4.00
			5U4GB	SYLVANIA	15.00	ECC81	RFT	3.00
			5Y3WGT	SYLVANIA	5.00	ECC82	RFT	6.00
			6BX7GT	GE	7.50	ECC83	RFT	8.00
			6B4G	SYLVANIA	22.00	EF86	USSR	5.00
			6FQ7	SYLVANIA	7.50	EL84	USSR	3.00
			6L6GC	GE/SYL	20.00	EL34	SVETLANA	7.50
			6L6WGB	SYL	20.00	EL34	E.I	6.00
			12AX7WA	SYLVANIA	6.00	6SL7GT	USA	7.50
						6SN7GT	USA	7.50

THESE ARE A SELECTION FROM OUR STOCK OF OVER 6000 TYPES. PLEASE CALL OR FAX FOR AN IMMEDIATE QUOTATION ON ANY TYPES NOT LISTED. WE ARE ONE OF THE LARGEST DISTRIBUTORS OF VALVES IN THE UK. SAME DAY DESPATCH VISA/ACCESS ACCEPTABLE. OBSOLETE TYPES A SPECIALITY.

CREDIT CARD MIN ORDER £10.00.

OPEN TO CALLERS MON. - FRI. 9AM - 4PM. CLOSED SATURDAY

U.K. P & P 1-3 VALVES £2.00, 4-6 VALVES £3.00 ADD 17.5% VAT TO TOTAL INC P+P D'SEAS P & P PLEASE ENQUIRE



Watford Valves

7 DAYS A WEEK 9AM - 9PM The Audiophiles Choice
All output valves multi-tested and digitally matched
Full no quibble guarantee. Expert advice on all valve amps

EF86 MINIWATT/PHILIPS

These are the sought after mesh anode low noise EF86, which is identical to the items Philips produced under the Amperex, Bugle Boy and Mullard brand names. These very rare valves have 'Holland' embossed in the glass. Their superb detailed sound makes these the ideal choice in tube microphones and they will bring the best out of your Quad IIs and Leaks. Don't miss out on this amazing valve at our special offer price of only £12 each until 30th Nov.

QUAD II REVALVE SPECIAL OFFER & N.O.S. EF86 MINIWATT

The Harma KT66 has become the industry choice as the closest in performance to the G.E.C. KT66 in these classic amps. This month you can revalve and revitalise your quad at a fraction of the normal cost.

4x Harma KT66, 2 x Harma GZ32 & 4 Svet EF86 only £130 the set plus vat, carriage OR the above set with Miniwatt EF86 £150 the set plus vat & carriage

KT90 EH SOVTEK

The valve that is one of the most talked about on forums across the world for it's big detailed sound. This is a great 6550/KT88 substitute. Available in dual matched and selected pairs & quads only £24 each



MULLARD ECC83 GROOVE TUBE REMAKE

Grove Tubes have set up a special production assembly to make a short run of replica Mullard Ladder Plate ECC83s. They have meticulously followed all the Mullard production techniques as closely as possible. They have used the highest quality finest grade nickel for the anode plates, together with top quality components throughout and have even remade the dyes to make the mica the same as the Mullard.

Make no mistake this is not a rebrand, the valve is exclusive to Groove Tubes. Huge plant and tooling costs were incurred and they have spared no expense in recreating the finest ECC83 of all time. The result is a superbly balanced and smooth sounding valve. It has immense depth of bass definition and amazing clarity with dynamics that would grace any high end system. Stocks are limited due to huge worldwide demand and we are pleased to be able to offer them at an amazing price of just £16.98 each. This may be the best upgrade you will ever make!

**MAIL ORDER OR
ORDER ON LINE**

Fast mail order/next day delivery/World Wide shipping
1000's more valves stocked. Prices exclude VAT and carriage.



01923 893270

Fax: 01923 679207

www.watfordvalves.com



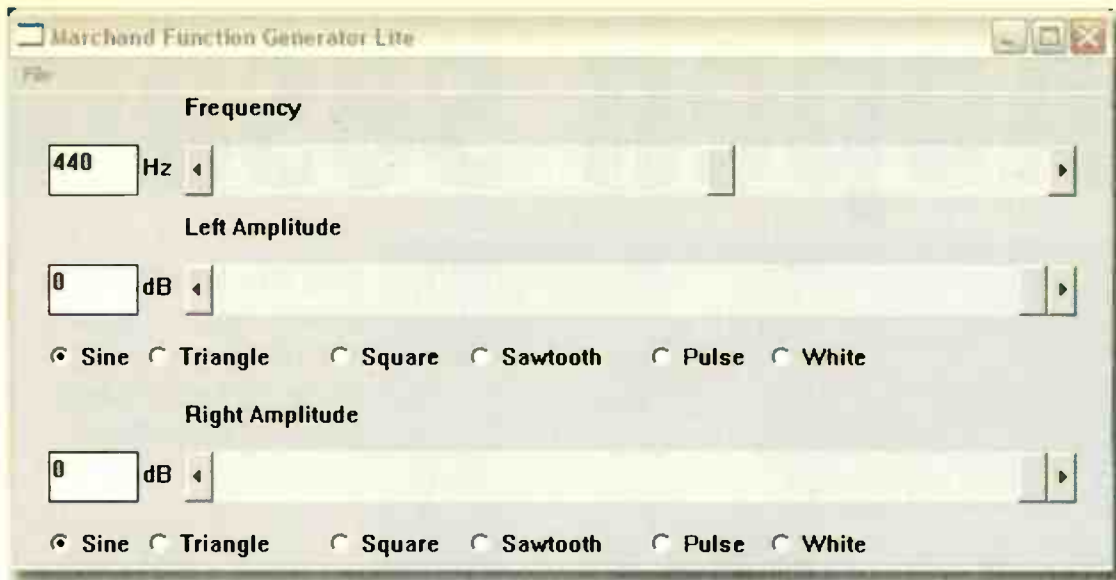

Function Generator Program

sound stage backward which had given my initial impression of more depth. Needless to say I was very disappointed!

I discussed this with a friend of mine, which resulted in a suggestion that the resistors may well need a burning-in period of around 100 hours before they start sounding their best, but could this really make such a difference? Of course, one could simply leave the pre-amp on for four days playing a CD on repeat, but this would only run in one position of the switch and this would need to be repeated for each position. This was not a feasible solution, especially for someone as impatient as I am! The only proper way to run in the unit was to find a

computer fitted with an normal sound card and using a little program downloaded from the internet that produces white noise or sine waves. It is bundled with a package called Audio Test Bench which is available from www.higherfi.com from their software downloads section. To set things up, simply wire the attenuator to a plug that fits into the sound card output socket from the computer. With a 100KW attenuator wired up as previously described will load the computer's sound card with just over 4KW on each channel, which is well within the capabilities of the computer to supply a signal of an acceptable level. Set the program to produce either a steady tone, or better still white noise so that signal

6.42355 AW) onto the turntable. Before the run-in period, it had sounded muddy. What a difference now! It had regained all the clarity and detail of my previous attenuator, and gained a bit more! The bass had also tightened up, but had retained all the depth and fullness of the sound that I had experienced initially, as demonstrated on my recording of Stravinsky's The Firebird Suite (The Atlanta Symphony Orchestra - Telarc digital recording DG-10039) with a clear bass drum rumbling through the opening section.

It is truly amazing what a difference the running-in period makes. The attenuator has surpassed all my expectations and is definitely superior to my previous shunt

attenuator. Buying direct from Taiwan may put some people off, unless they are used to

"I have to confess to being a little sceptical as I wired the unit back into my pre-amp".

way of running the attenuator with a signal passing through all the 88 resistors simultaneously! This is not as difficult as it might at first seem and was accomplished by connecting all 23 steps of both channels in parallel. The trick is to run loops of wire around the top ends of the Rx resistors and solder the wire to each leg. The temporary loops of wire for each channel can be seen at points 'A' and 'B' in the photograph. Connect an audio signal to this wire and the earth end wire on both channels and you will have signal running through all the resistors.

A makeshift signal generator can be created with the aid of a

across the entire audio spectrum is being generated and leave the computer running for four days. After this treatment, the attenuator should be thoroughly run-in - on all steps!

At the end of the running-in period, the attenuator was disconnected from the computer and the shorting loops of wire removed. I have to confess to being a little sceptical as I wired the unit back into my pre-amp. Would I be able to tell a difference? I switched on my system and allowed it to warm up. I then slipped my trusty 'test record' of Vivaldi's Concerto in A minor for Oboe and Strings F.VII/5 (Telefunken

trading through the internet, but it is quite straightforward, especially if use is made of the intermediate secure payment mechanisms that are available (and free to use for the purchaser). However, this must be an opportunity for someone to set themselves up as a UK importer - all you suppliers out there, please note!

In any case, this is a genuine bargain and bearing in mind that my previous shunt attenuator was a significant improvement over the original Alps Blue potentiometer, the Vishay-Dale ladder attenuator is an essential upgrade to any high-end pre-amp.

Aopen sesame



David Friar builds himself a bespoke audio PC complete with tube output stage, around the famous AOpen Tubesound motherboard.

midi/games port, so any more than three PCI slots would probably be unusable. The crowded back panel provides the usual PS2 connectors for keyboard and mouse as well as USB2, parallel, serial, VGA, LAN and AC97 sound ports, while risers allow for connection to front panel Audio and USB2.

This is a well built, quality motherboard so is well equipped with three fan power supplies, sensors and safety features such as AGP voltage protection, standby and boot LEDs and a resettable fuse. But perhaps the most striking feature of this board is its Sovtek 6922 dual triode tube technology that, together with the AC97 CODEC chipset, allows it to produce something quite different in the way of computer audio!

Accompanying the motherboard in the box are all the cables and connectors needed, together with installation software on CD ROM. Several of AOpen's custom utilities and some anti-virus software and documentation are included on this CD. Also there is comprehensive documentation in English (only!) including a helpful illustrated Easy Installation Guide in the form of a fold-up poster, a 116-page User Manual plus a similar Tubesound Tube Motherboard Manual.

The AOpen A600A case chosen for this project has power supply and case fans that are reasonably quiet. Made of aluminium, it is light and easy to assemble, with side panels that slide smoothly into position and fix with thumbscrews. Inside the case are six 3.5" drive bays, while the screw-less, removable front bezel makes for easy access to the four 5.25" and two 3.5" external drive bays. The blanking plates are substantially made so that they push in and out, avoiding the need for the tin opener approach to gain access to the bay! It takes a full ATX motherboard easily with no

The first AOpen Tubesound motherboard, the AX4B-533, enjoyed quite a reputation for producing sound with more pleasing characteristics than normally experienced from computer sources. It was developed mainly with listeners of jazz and small-group classical music in mind. More recently a second manifestation has appeared – the AX4GE/PE, which is designed to address more the needs of listeners to music in the rock, pop and new wave genre.

This latest Tubesound board is based on the Intel 845GE chipset. It is jumperless, as far as processor setup is concerned, and supports P4 processors up to 2.8GHz (400 or 533 FSB). It can use up to 2GB of DDR memory via three DIMM sockets.

As usual there are several versions of this board available and the one we have is the AX4GE-Tube-G, for use with our Intel Pentium 4 (Northwood) 1.8GHz CPU (400FSB) with 512kB level 2 cache, and two pieces of Crucial 256MB PC2100 DDR memory. This motherboard includes onboard VGA graphics as well as a slot for an add-on x4 AGP card. There are four USB2 ports on the back panel with provision for two more via the front panel riser. There are now lots of motherboards that can use faster CPUs and memory than the AX4GE-Tube-G can accommodate. But the

performance of both the Intel Willamette and Northwood CPUs are more than sufficient to handle all audio processing requirements – absolute leading-edge technology is not needed and a 1.8GHz chip with 400 FSB, using PC2100 DDR memory, will not show any disadvantage.

Of course, patience might be necessary for some of the more exacting demands of DVD video work, but this is generally true whatever processor is available! As we are not building this machine primarily for video editing, processor speed is not an issue!

I have since added a Samsung 80GB ATA133 hard drive as a slave; this is another very quiet drive which is of higher spec than the IBM master drive. However the IDE interface is ATA100, so there would be a lot of work re-installing Windows on the Samsung as master for no advantage!

As for storage, there is an FDD connector and the usual primary and secondary IDE connectors provide support for up to four Ultra ATA100 drives. The tube technology occupies much of the rear left quarter of the board, leaving room for only three PCI expansion slots. However, as most of the devices normally required (with the exception of a modem and firewire ports) are built-in, this is not really a problem. Slot spaces are needed for tube I/O, S/PDIF module and, if required, the

overlapping components and all the edges are smooth, so that working with this case is a bloodless experience!

There is a 350W ATX 12V high efficiency P4 power supply and a fitted 12cm LED rear panel case fan with the option for an 8cm second fan. Ventilation is further enhanced with ducting from the CPU to the side panel. In practice the power supply and rear fan are quiet in operation and provide sufficient cooling.

Finished in an attractive shining black, with silver-grey and black front bezel, the case can stand with its moveable feet protruding to give stability if needed.

The board is limited to x4 AGP so the Abit Siluro GF3 x4 AGP card, though modest compared with some of the latest available, provides reasonable graphics performance. It has connectors for both VGA and DVI output and can handle SVGA and Composite IN and OUT via the adaptor plug.

The 80GB ATA100 Deskstar DXG120 hard drive is fast and quiet with plenty of capacity and the Lite-On optical drives, with black bezels, provide recording facilities on media and x16 DVD playback. The Samsung slave drive was partitioned into two logical drives and provides very useful additional storage/backup for .wav files.

The black-fronted NEC 3.5" floppy completes the range of storage devices – not essential these days, but it's amazing how often a floppy is missed when absent! TDK XS IV MM speakers, whilst not leading edge components, give reliable output and are useful for the setting up process and initial assessment of the system. Also use of a standard, wired keyboard and optical mouse avoids interference problems that other, more sophisticated I/O devices might introduce.

BUILDING

Prior to handling electronic components make sure that static is discharged to earth by using a wrist strap or by simply touching the bare metal part of a safely earthed object such as a radiator; otherwise damage may be caused by static charges from the hands!

First, unpack the case, remove the rear thumbscrews to release the side panels and reveal the spacious area over the motherboard baseplate, bundle of cables from the power supply and front panel cables. Also,

taped to the base plate, is a packet with the screws and fittings needed to assemble the components.

Locate nine brass stand-offs and nine small fixing screws from the packet; fit the stand-offs into the holes marked 'ATX' on the baseplate and put the small fixing screws aside safely for use a little later.

As the A600A does not have a removable baseplate it is easier to install the CPU and memory modules before fitting the motherboard.

Take the AX4GE-Tube-G out of its envelope and place it on a bench or table over a suitable insulated surface. Identify all the jumpers, connectors, risers and sockets with the help of the excellent labelled photographs in the Easy Installation Guide.

The ZIF socket for the 478-pin CPU is on the right side of the board between a line of capacitors and the three DIMM sockets. In the corner nearest the socket lever hinge, the hole at pin 1 is missing. (On the processor the corresponding corner is marked in gold and has the edge cut off. This helps to position the CPU correctly.) Lift the lever arm up to the vertical position to allow the pins on the chip to enter the socket easily.

Open the Intel box and remove the plastic moulded packet. The chip is quite small, most of the box being taken up by the heatsink and fan. Carefully lift it out with the flat side uppermost. Line it up over the ZIF socket and lower it into position. When it is in position the lever arm can be lowered and clipped in place firmly.

Take out the heatsink/fan and locate the clips, levers and the small square of heat conducting compound. Place the heatsink/fan unit over the CPU and carefully fix in place with the levers and retaining lugs. This can be a tricky operation but, as long as you follow the procedure shown clearly in Intel's instructions, this installation should be snag-free! Complete the CPU installation by placing the fan power lead to the CPUFANI connector.

To fit the memory modules into their sockets open the white retainer clips fully. Then place each module over its socket so that the gap in the DIMM lines up with the ridge on the socket (it will only fit one way) and



motherboard ready

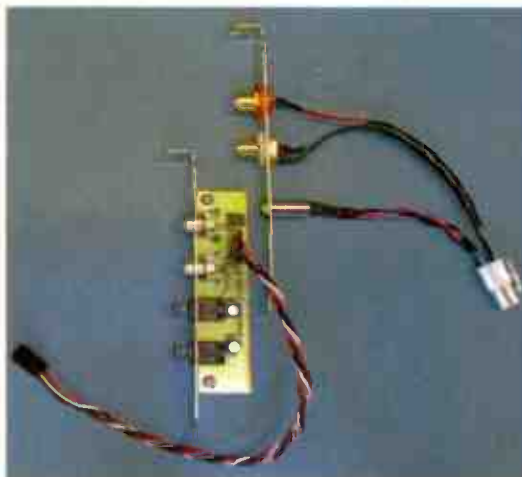

Tube SPDIF connections

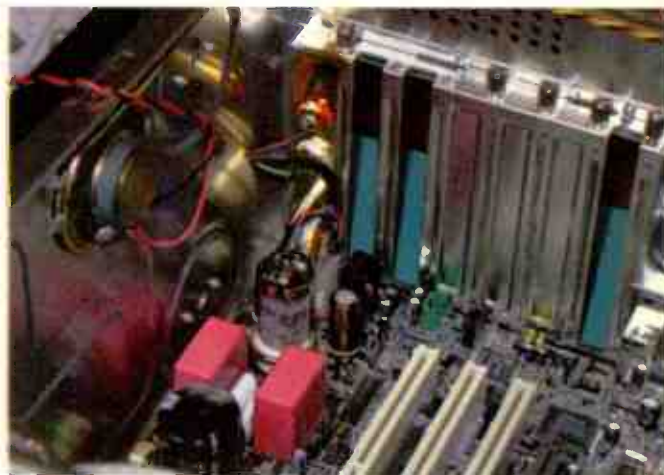

fitting the tube bracket

SOUND QUALITY

With a tube output stage, and a soundcard section sporting ELNA, Multicap and WIMA capacitors, Vishay resistors and Cardas wire, this is a motherboard with a difference! Obviously, serious hi-fi applications demand that you run a direct line out, but even driving TDK S-80 active NXT loudspeakers, its clarity and dimensionality is quite remarkable! Driving a Cyrus 8 amplifier and ELAC FS207.2 loudspeakers via the line out, the audio PC sounds superb - and comparable with my beloved Cyrus CD8 CD player in respect of openness and sound-staging. Playing an audio CD via one of its internal optical disc drives is not quite as tight and detailed, but it still nevertheless makes for an extremely even, smooth and creamy listen. It's the same story playing a .wav file too. Overall, if you do lots of audio work on your PC – and they're brilliant recording tools – then this is pretty much as good as it gets!



installed and ready to go!



side and front view

apply firm downward pressure to seat it. When correctly positioned the clips move to hold it firmly in place.

There are no jumpers to set CPU voltages and clock speeds as the BIOS does this. But JP3 (tube power), JP14 (CMOS clear), JP28 (keyboard/mouse wake-up) and JP24 (Die-Hard BIOS select) should be checked at this stage while still easily accessible.

Next wrap the slot bracket carrying the audio sockets with 'bubbles' then insert the tube audio cable plug into its connector near the rear left corner of the board. The bracket can be carefully laid across the board until it can be fitted to the case later. Similarly fit the S/PDIF cable into the connector and lay the bracket across the board.

Carefully remove the vacuum tube from its box and line up the pins with the tube socket on the board. With firm and even downward pressure insert the tube fully into the white base.

Clip the back panel template into position in the case; this will allow the motherboard back panel to fit snugly in place. There are labels on the template to indicate the function of each port.

Place the motherboard over the base plate so that the standoffs can be

seen through the holes in the circuit board. Make sure that the back panel is seated properly then, when everything is in place, secure the board using the small retaining screws put aside earlier. They should be screwed in firmly but not over-tight.

Once the motherboard is firmly in place undo the bundle of cables from the PSU and plug the 4-pin 12V and 20-pin ATX power connectors into their sockets. These connectors are shaped so that they will only fit one way.

Next locate the front panel connectors that control IDE and power LEDs, speaker, power and reset switches. These must be attached to the clearly marked pins at the front left corner of the board. The plug from the front panel USB2 ports can be attached to the blue USB2 connector if required. There is no onboard IEEE1394 facility on the AX4GE so the firewire cable from the front panel of the case must be tied back and fixed out of the way.

If the front audio sockets are required, remove the two yellow jumpers from the front audio connector (just in front of the first PCI slot) before inserting the plug on the front audio cable. Now is a good time to attach analogue audio cables to the CD IN and AUX IN (if required) connectors; the other ends can be connected later when the optical drives are fitted.

Next remove blank slot covers from slot positions six and four and fit the tube audio and S/PDIF brackets respectively. The tube audio bracket should fit easily, but the S/PDIF bracket can be awkward because there are a couple of capacitors on the motherboard that allow very little clearance for the base of the module.

Unfortunately there is no real choice but to use slot four, so persevere!

Remove the slot cover from in front of the AGP slot then carefully insert the 4x Siluro card. At this stage a PCI modem

can be fitted into a spare slot if required.

Two black disk drive cables are supplied with the motherboard kit. The FDD connector is near the front of the board to the left of the ATX power connector. Fit the non-twisted end of the smaller black cable to FDD connector. The ATA100 IDE connectors are near the front edge of the board, to the left of the FDD connector. IDE1 is coloured blue and IDE2 is grey. Fit the black plug on the longer end of the 80-wire ATA100 cable to IDE1, leaving the tail with grey and black plugs for connection to the drives. Another flat cable will be needed to connect optical drives to IDE2.

The last stage is to fit the drives. (a) Set the jumper on the hard drive to 'master' then place it into one of the six internal drive bays and secure it with four HD screws. Attach the IDE cable with pin 1 (white wire) near the power socket then insert a plug from the power supply. (b) Remove a blanking plate then place the floppy drive into one of the external 3.5" drive bays and secure with four FD screws. Connect the FDD cable and power supply to complete the installation. (c) Similarly, remove two blanking plates and fit the DVD RW (master) and DVD ROM (slave) drives into external 5.25" drive bays. Connect the IDE cable from IDE2, with the end plug going to the master DVD RW drive. Connect the power supplies via the 4-pin sockets, also analogue audio cables as required.

To complete the hardware installation, replace the front cover, connect up the peripherals (monitor, keyboard, mouse and speakers) and connect to mains power supply. With the case sides still off, when powered up there should be a glorious display of blue lights forming a circle of LEDs surrounding the tube, coloured LEDs within the rear fan (red, green and blue), a red LED by the AGP card indicating correct voltage and a red power standby LED near the CPU indicating power supplied to the motherboard. To complete the scheme of illuminations there is a continually varying coloured display surrounding the front panel power on/off switch. Press this switch to power down then replace the sides, fixing them securely with the thumbscrews. From this point it is a matter setting up the BIOS then installing the operating system, appropriate system

TUBE TALK

The AX4GE-Tube-G board we have is the 'cut-down' version without the extra Promise SATA/ATA133 chip onboard and will only take up to ATA100 drives. They did an AX4GE-Max version based around the same Intel chipset but with a better spec including ATA133 IDE, SATA and (I think) Firewire. If you look carefully at our motherboard you can see labels on the circuit board for the connectors, but there are just blobs of solder instead of connectors. The GE suffix denotes Intel's 82845GE integrated graphics is present and the final G suffix denotes the value (cut-down) version of the motherboard. The Intel 845GE has now been replaced so AOpen are phasing out the AX4GE/PE-Tube motherboards. I don't know if they're intending to produce a new tube board. They are relatively expensive so might not have sufficient following. There are very few differences between the AX4B-533-Tube that was reviewed in Hi-Fi World October 2002 and the AX4GE-Tube-G board that we have for this computer. The main non-tube differences affect the LAN chip, the increase from 2 to 4 fixed USB2 ports, the facility for DDR333 memory with a 553FSB processor and the on-board graphics plus potential for digital display card. The Tubesound differences involve the daughterboard, which no longer carries a headphone socket or S/PDIF out, and some of the circuitry components.

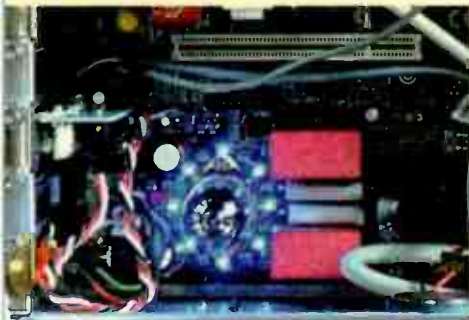

don't miss the tube with all those blue LEDs!

drivers and favourite software. AOpen include many special features that are well documented in the printed manual and can be investigated later but to get the machine up and running it is best to press 'Delete' during boot-up to enter the BIOS then load the setup defaults. This will allow automatic configuration of the CPU, memory, drives and ports so that Windows (or whatever) can be installed. Once there is an operating system present the system drivers can be loaded from the AOpen Bonus Pack, together with any of the other custom features that might be needed.

One of the more interesting BIOS features of the AX4GE-Tube-G board is the 'Open Jukebox Player' which allows CD music or FM radio (if the optional tuner is fitted) output via the tube or AC97, without running Windows. There are various BIOS options available to activate the Jukebox; with the default 'Auto' setting being very convenient. The player interface appears on screen immediately after the POST (Power-On Self Test); if any key is pressed for 3 seconds at this stage the Jukebox automatically checks the CD player for a music CD. If it finds one the Jukebox becomes active and can be controlled by single keystrokes. Hook it up to an amp via the tube output for superior computer audio sound. Should the computer be needed just press B to boot directly into Windows.

HARDWARE NOTES

ATX (and variant) boards are the norm – AT boards are as rare as hen's teeth now, as are CPUs slower than about 1.5GHz; 3GHz is quite common, though still very expensive. ATA133 (UDMA133) and serial ATA (SATA) are becoming more the norm on the latest motherboards although there are still plenty of new ATA100 drives around and these are fine for an audio computer. Our old Audio computer that we still use has UDMA33 drives and they seem to be OK, albeit slow compared with the faster drives. (This might be more a feature of the CPU.)

Flat drive cables can be replaced by round cables. SATA cables are of course round. SCSI might well be important, but the design and operation of modern ATA drives makes it less of an issue now. CD media for recording is now almost entirely 80 mins in length as 74 min is not often available.

MiniDiscs are now available with 1GB of memory, and the latest Hi-MD machines can record with no compression thus giving the same performance as a CD recorder.

USB2 is commonplace and standard for any new motherboard in 2004. 512MB or more or less entry level for Windows XP (max for Windows 98SE). DVD writers have reached a price where they are the norm – you can get a CD burner for about £15-20 and a DVD writer for around £50.



at last up and running

BUNDLED SOFTWARE

The board comes with a number of special features in addition to the tube components:

SilentTek/ SilentBIOS:

This is AOpen's proprietary suite of monitoring and control hardware/software. For the most part, this is AOpen's own temperature, voltage, and fan speed monitoring utility. However, there is one very useful aspect of this feature, the ability to control fan speeds directly from software. AOpen has incorporated a variable baybus onto their motherboard; allowing you to control fan speeds based on temperature, a fixed speed (basically where fan speeds are adjustable from 0-100% in 1% increments), or AOpen's own algorithm where fan speeds are adjusted by ambient temperature and CPU usage. This is useful for reducing the overall noise of your computer. It's quite effective if you have loud fans. The AX4GE-Tube also has an implementation of SilentBIOS which allows you to adjust fan speeds and the smart algorithms inside the BIOS. Basically, SilentBIOS takes control of fan speeds before the OS boots (during POST, in the BIOS and in the Open Jukebox application).

EzRestore

EzRestore is a sort of 'ghosting' system built for AOpen motherboards. This system isn't designed to create a mirror of your hard drive, but rather it keeps a recovery point of your system setup, allowing you to go back to a previous state. It's similar to Win XP's System Restore, but has some fundamental differences.

Open Jukebox

Open Jukebox is a CD player built directly into the motherboard BIOS, allowing you to boot directly into their Jukebox utility and use your computer as a CD player. Since this is part of the BIOS, all you have to do is hit a specific key during POST to enter the Jukebox. FIC has a similar BIOS modification in one of their bare-bones systems, where the computer is transformed into a DVD player. The Open Jukebox is completely skinnable (and AOpen has a utility which flashes that specific portion of your BIOS) I personally (sic) found this to be a pretty neat feature, although I expect most people wouldn't use it too often. The AX4GE-Tube expands the Open Jukebox software with Open JukeboxFM. This is an integrated FM tuner (which is available as an add-on module), allowing you to listen to FM radio without booting into the OS.

Watch Dog Timer

AOpen's Watch Dog Timer is one really neat feature for overclockers. Basically, the BIOS monitors the POST process, and if the POST process fails it will set the motherboard to automatically reboot in 5 seconds. Upon rebooting, the BIOS resets the CPU to its default frequency and starts the boot process over again. Basically overclockers don't have to constantly pull the reset CMOS jumper every time the computer crashes on POST, saving a lot of time while experimenting. This feature was really awesome and really sped along my testing. It would probably be even more useful when the computer is inside a case, allowing you to overclock on the fly.

Dr Voice II

AOpen's onboard auto-diagnostic feature - the motherboard talks to you when there is an error, informing you of the location (memory, CPU, keyboard, etc). The feature supports four different languages: English, German, Chinese, and Japanese. Sometimes this feature is annoying, but it does allow someone to quickly home in on a problem (rather than looking up beep codes, etc).

kit & component suppliers

COMPONENT SUPPLIERS

Audio Synthesis

PO Box 50 Nottingham, NG9 1DX.

Tel: 01159 224138 Fax: 01159 229701.

Email salesinfo@audiosynthesis.co.uk.

Website www.audiosynthesis.co.uk

VISHAY BULK FOIL RESISTORS - unquestionably the world's finest resistor for audio applications. Thousands of VSRJ 0.3W 300V 5ppm 1% values in stock at the lowest possible prices eg. values up to 20K at £3.50+vat. HIGH PURITY SILVERWIRE - Teflon insulated >99.99% purity, 0.6mm and 1.0mm diameter. Ideal for internal wiring, interconnects or speaker cables.

Audio-Links

7 Fairmont Crescent,

Scunthorpe,

North Lincolnshire, DN16 1EL

Tel: 01724 870432

Fax: 01724 875340

Email: audiolinks@ntlworld.com

Extensive stock of specialist audiophile components for valve and solid state enthusiasts. Supplier of the largest range of high-end audio volume controls in Europe. 30 page catalogue - Free via e-mail or £3.00 posted.

Noteworthy Audio Limited,

36 Buckingham Street, Aylesbury,

Buckinghamshire, HP20 2LH

Tel: 01296 422224

email: info@noteworthyaudio.co.uk

web: www.noteworthyaudio.co.uk

Suppliers of a selected range of audiophile valve kits and components. Including the Stoetkit range of valve amplifiers, Audio Note one times oversampling Dac Kit 1.1 and Lowther drive units. Plus a range of components and accessories from Eichmann, Furutech, Wonder Solder, Caig and many more. For a list of the extensive range of manufactured products and the special offers we stock please see our website or call for details. We are open from 9.30 to 5.30 Tuesday to Saturday, with demonstration stock of our kits available - please call in advance to book an audition.

White Noise

11 Station Road, Bearsden,

Glasgow, G61 4AW

Tel: 0141 942 2460

Fax: 0141 587 7377

Email: david.white38@ntlworld.com

www.wnaudio.com

Supplier of the widest range of standard and audiophile kits for solid state preamplifiers, power amplifiers, headphone amplifiers, power supplies, MM/MC phono stages, active crossovers, balanced i/o modules, and stepped attenuators; more kits in the pipeline. All kits use the highest quality, glass fibre, solder masked, silkscreened, PCBs. We also supply a wide range of active (esp. Japanese transistors and Exicon mosfets) and passive components, gold plated connectors, and silver plated wires. Write, phone or email for a free catalogue. Mail order only.

Audiocom Int. Ltd

Unit 14 Pier Road

Pembroke Dock,

Pembrokeshire, SA72 6TR

Tel: 01646 685601 Fax: 01646 685602

Web: www.audiocominternational.com

E-mail: info@audiocominternational.com

Extensive range of audio grade passive & active components, which including brands & manufacturers DACT, Black Gate, OS-CON, Neotech, Vishay, Intertechnik, Elna, WBT, etc. We are the manufacturers & distributors of the highly acclaimed Superclock 2, plus Q-power & Super-regulator. Visit our website store today for pricing & information. Secure online ordering available.

LOUDSPEAKER KIT SUPPLIERS

IPL Acoustics,

Chelsea Villa, Torrs Park,

Ilfracombe, North Devon, EX34 8AY

Tel/Fax: 01271 867439

Please visit website for full catalogue of products:

www.iplacoustics.co.uk

IPL supply a range of 7 high quality transmission line speaker kits, and a full range of Hi Fi and AV speaker kits, including 2 active subwoofers. Drive units are available from Audax, Seas, Morel, Legend (Ribbon Tweeters), and IPL custom built metal coned drivers. IPL also supply: quality capacitors, inductors and cabinet accessories, including Silver Plated PTFE insulated cables.

WILMSLOW AUDIO

50 Main Street, Broughton

Astley, Leicester, LE9 6RD

Tel: 01455 286603

Fax: 01455 286605

Email: sales@wilmslowaudio.com

Website: www.wilmslowaudio.com

Contact us for a copy of our FREE Full Colour Catalogue or visit our Website with secure online ordering.

The UK's largest supplier of loudspeaker kits, drive units and components.

We also have a range of subwoofer kits and amplifier modules available.

Official UK distributor for ATC, Morel, Peerless, Scan-speak, Seas, Vifa and Volt. Beware of imitations, we only stock drive units made by the genuine manufacturers. We offer a full repair and upgrade service on most makes of loudspeakers.

VALVE AND OUTPUT

TRANSFORMER SUPPLIERS

Watford Valves

3 Ryall Close, Bricket Wood,

St. Albans, Herts, AL2 3TS

Tel: 01923 893270 Fax: 01923 679207

Specialist in new old stock and current production valves. Sole UK distributor of the Harma Diamond range selected for their superior performance. Huge range held, stockists of Mullard, GE, Philips, National, Brimar, Sylvania, Telefunken, RCA, MOV and many more. All valves are new boxed and guaranteed. For free price list and specialist advice call or fax Derek Rocco, Watford Valves.

Chelmer Valve Company Ltd

The Stables, Baddow Park

Great Baddow, Chelmsford, Essex,

CM2 7SY

Tel: 01245 241300

Fax: 01245 241309.

Email: sales@chelmervalue.com

Web Site: www.chelmervalue.com

Premium range of audio valves, tested/selected for low noise, hum, microphony; power valves burnt-in. Huge stock of valves/tubes of all type, audio valves (inc. NOS types), industrial etc. Also large stocks of semiconductor. Many obsolete types.

Billington Export Ltd.

1E Gillmans Trading Estate,

Billingshurst,

West Sussex, RH14 9EZ

Visitors by appointment only please

Fax: 01403 783519

E-Mail: sales@bel-tubes.co.uk

Website: www.bel-tubes.co.uk

Specialists in guaranteed new/old stock, current production valves & tubes. Also CRT for audio, hi fi (as well as industrial uses). A vast archive of vintage and obsolete types including limited quantities of Mullard, GEC, Sylvania, Philips, Brimar, Telefunken, RCA and others. Large stocks of Chinese, Russian, EI and Tesla etc. A 50-page valve catalogue is available on request. Major stockists of the excellent Billington Gold brand. Contact us for quotations - attractive price on larger orders.

MODIFICATION SERVICES

Audiocom Int. Ltd

Unit 14 Pier Road,

Pembroke Dock,

Pembrokeshire, SA72 6TR

Tel: 01646 685601 Fax: 01646 685602

Web: www.audiocominternational.com

E-mail: info@audiocominternational.com

CD, SACD & DVD modifications to all manufacturers & models. Modifications include the 'Superclock 2' ultra-low jitter master clock for re-clocking CD, SACD etc, analogue & digital power supply upgrades, plus analogue filter & output stage upgrades.

(Dave Robinson, Editor - Positive Feedback Magazine - This is a slam-dunk no-brainer, amigos. If you're thinking about modifying your SACD player... if you do only ONE modification... then the Superclock 2 is it.)

Prices start from £100 - £1000+. For further information visit our website, or call us now to see how this service can be adapted to suit your requirements.

REPAIRS & RESTORATION

The UK's Leading Service & Restoration Specialists. Repairs/Restorations to Modern/Classic/Vintage valve hi-fi, musical and cinema amplifiers, control units etc. We will even build that kit for you or design something special. Please visit our Website at:- www.audiolabs.co.uk for complete details of our comprehensive services. Alternatively, contact us at:- **Audio Laboratories (Leeds)**
3 Kildare Terrace Industrial Estate
Leeds LS12 1DB UK
Tel/Fax +44 (0)113 2440378

mail

Visit our website at www.hi-fiworld.co.uk or send your emails to letters@hi-fiworld.co.uk. Letter of the month wins a pair of precious Metals interconnects and one year FREE subscription to Hi-Fi World.



Letter of the Month

UNFORGETTABLE?

I was astounded by David Price's comments in his reply to the letter from Jim Baines (Hi-Fi World October). You say: "Ninety percent of used hi-fi is totally forgettable. Another five percent is over-hyped mediocrity." Although you qualify this with "but that still leaves thousands of classic products for the taking", I feel you have most definitely applied the tin opener to a catering size can of worms...

Firstly, why confine your comments to used hi-fi? Many used items may only be a few months old and some 'classics' may have cost a fortune when new because they were impeccably built and designed with the best components money could buy. Whilst technology is moving very fast in some areas, I find it very difficult to believe that ninety five percent of valve amps, record decks, interconnects and even new-ish 'speakers which may have cost many thousands of pounds new, suddenly fall into this huge 'forgettable / mediocre' dustbin just because they are used.

Please correct me if I am wrong, but aren't you really saying that ninety five percent of new hi-fi is really not worth bothering with and never was? As Jim Baines suggests, where does your above statement leave the enthusiast with regard to the 'upgrade trail'. To cite a familiar car analogy, many have done rather well over the years by driving classic cars. Jaguars, Porphes, Astons etc. are out of most people's reach when new, but their huge depreciation can provide the enthusiast with access to vehicles which easily outstrip the performance of the average new euro box. I was hoping to do something approximating this with used hi-fi.

I am particularly interested in esoteric makes because some were hideously expensive when new. Also, many reviewers were quite emphatic that they are really top class products with huge performance. Now, they are relatively cheap and I would rather have a nearly new Aston Martin than a brand new hatchback. Here are a few makes: Hovland, Cary, Lumley, Conrad Johnson, Atma-Sphere, Wilson, Wadia,

BAT, Nottingham Analogue, Mark Levinson, Benz, Art Audio, Pass Labs and Pathos.

The writers at Hi-fi World must have heard stacks of gear over the years. Even though you disagree on which is the best equipment, do you all generally agree that about ninety percent of used and new stuff is fairly unimpressive, regardless of price? Do you agree that in general, if it isn't in 'World Standards / Classics', then there is a pretty good chance it will be disappointing at audition, regardless of price? Contrary to what you might think, I still think 'Hi-Fi World' is the best audio magazine of all and comes closest to my sonic aspirations of more music and less blue LEDs. However, I feel in this case David may need to expand on his comments a little, if the less well-off amongst us are to be able to upgrade our systems with decent used equipment in the future.

Franklin Lee

Hi Franklin – thanks for a thought provoking, if a tad perplexing missive. One of the interesting things about enjoying the 'oxygen of publicity' (i.e. being able to write what I like, more or less), is observing how often people manage to misinterpret what I say! Now, that's either because I'm not erudite enough to say it properly, or that folk have powerful imaginations... Just because I said what I said about 95% of used hi-fi – en masse - being poor, it doesn't necessarily follow that I meant 95% of the expensive used stuff was poor too. In fact, if there's any sector of hi-fi that's not going to be poor, then the chances are that it's going to be the expensive stuff that makes up this elite 5%!

I was simply musing that – in the cosmic scheme of hi-fi hardware things - most of it is tat. Okay, we have greatness in the form of Leak Stereo 20s, Quad EL557s and Thorens TD125s (etc.), but we also have far larger numbers of Rotel RA314s, Wharfedale Chevins and Sansui P90s (etc.) – mass produced

mediocrity through the decades. To use your motoring analogy, for every flame red Jaguar E-Type fashioned at Browns Lane, there were countless pea green Vauxhall Victors spewing out of Luton...

The point about classic hi-fi is – just because it's old, it isn't necessarily great. Look on eBay and jokers willingly pay silly prices for utterly run-of-the-mill bits of 1970s kit, simply because it's 'retro', got a chunky brushed aluminium fascia and weighs a lot. In truth, most of this old stuff is – as I said – forgettable at best and crap at worst. This is what puzzles me about 'anacrophiles'; you'll not find a more passionate devotee of (real) classic audio than me, but I wouldn't touch half the stuff a lot of these guys pay lots of money for. For example, Sony's T-5650 is a stunning monster seventies integrated with a great, sweet sound, but as soon as the V-FET transistors in the output stage go – and they always do – you're stuffed because they don't make them anymore. This wonder amp worth hundreds on eBay is suddenly junk – nothing more. Used prices often simply ignore this.

So, my message is use the second-hand market to its best effect – grab bargains when you can, but don't forget that – by and large – hi-fi has got better (especially the cheap stuff) and if you buy it new you can actually fix it, usually for free! There are brilliant used bargains, and these are often a great way to upgrade at a fraction of the price of new, but – again – remember than 90% plus of used stuff is just as middling as it was when new, and that even the good stuff can go pop on you... As for World Classics – it's not my 'final answer on the subject', more a starting point for a continuing debate. We're augmenting it heavily next month, and I'd still love to hear all your suggestions – the revised one now has B&O from Frede Kristensen from Classic Audio (www.beolab.dk), for example. DP

Calling products "forgettable" isn't the same as saying they're worthless. I'm regularly told how wonderful certain products are by proud owners who've got a lot of pleasure from them over the years, even though were undistinguished when new and rapidly consigned to oblivion in the great scheme of things. Much hi-fi keeps abreast of the surrounding competition when it's released to the market, often displaying specific strengths in certain quite tightly defined areas. Making a choice then comes down to individual requirements and personal taste. Ultimately much of it is forgotten all the same, even though it can do a good job.

Reviewers are expected to recommend the best, but that doesn't by inference make all else worthless. The bulk of what is available is sufficiently competent to perform well enough to provide enjoyment. I think it best if we steer people toward the relatively large pool of good products available, and away from the bad. And before we get too worked up about "forgettability" it's sobering to bear in mind that many of today's classics were not highly rated in their time.

I wouldn't be the only reviewer to have developed a fairly healthy scepticism about a lot of top-end product costing thousands of pounds. With much of it you have to - knowingly or unknowingly - share the designer's own particular view of what constitutes high fidelity to be appreciative. Big solid-state power amps commonly sound hard, mechanical and remorseless to my ears, yet many people in the industry seem to love them. Then there's Big Speaker syndrome, where a huge cabinet stuffed with drive units is touted as 'top-end' even though such arrangements carry no end of sonic drawbacks. At the top end of the market products can be deeply polarising - you love them or hate them. Because they exist and because they cost thousands doesn't in itself bestow any merit. You may well feel they offer a taste of the top-end at bargain prices once the shine of newness has worn off. Well, they do, but that still doesn't guarantee you'll like what you hear.

As David said, whilst most products are totally forgettable that still leaves many that are not. There's still a large enough pool to keep bargain hunters in business if you want to move up without spending a fortune. **NK**



classic hi-fi: not all of it is as magnificent as this...

IN A SPIN

As I live in Northern Ireland I do not have access to the same selection of specialist hi-fi dealers or products as the rest of the UK, so I would value your comments regarding my vinyl source before I embark on what may result in a fruitless or costly upgrade exercise. At present I am using a Pink Triangle LPT turntable with a Roksan Tabriz tonearm and Shure V15VxMR cartridge. This is fed through a Rothwell valve phono stage. Amplification is provided by a Myryad MI 120 and a Tom Evans modified Pioneer A300, which I am running in bi-amp configuration. This arrangement was arrived at by accident rather than by design. I had the Pioneer first, and subsequently obtained the Myryad. I feel this set-up gives a superior sound to that achievable from either of the amps when used in isolation. The Pioneer is being used to drive the bass/midrange and the Myryad the treble.

Speakers are a pair of original Mission 752s. Cabling is Emporium tonearm cable from turntable to the phono stage and Missing Link Alaqueia, a truly amazing cable for the money (£65) which I suggest you audition, between phono stage and amp. Audioquest Indigo + is in place between the amps and speakers. My CD front end is a Rotel RCD991 player which I am using via a MF X10D. Cabling is again Missing Link Alaqueia from the CD player to the X10D and Blue Heaven from the X10D to the Myryad. The amps are connected with Linn interconnect. The equipment is housed on an Alphason rack, with each individual item, except the X10D, being isolated via Michell Tenderfeet.

My question is, could I improve the performance of the turntable? If so, would a change of cartridge and/or tonearm improve things? If not, can you suggest an alternative upgrade path, or am I faced with the prospect of changing the entire front-end? If this would be the best option can you suggest a replacement which would deliver a significant and cost effective improvement? Also, your thoughts on how best I can upgrade the entire system would be welcomed, bearing in mind that I am generally happy with the sound it delivers. As such, any

changes would be to enhance what is already in place, rather than wholesale change. I am not averse to considering second-hand items, although given my location, this may require that I purchase equipment blind.

Bryan

My advice is relax and enjoy the music! That's a great system, with some nice touches. I especially like your use of a Shure V15 VxMR through a valve phono stage. The Shure offers a fine balance between real world usability, sensible price and superb performance, whilst a valve phono stage provides a wonderful sense of smoothness and sound stage depth that eludes solid-state designs. The amplifiers and loudspeakers are all decent items well liked generally, so I see no pressing reason to change now that you are happy with what you have. If the upgrade bug is too strong to resist then I'd be tempted to replace the Rotel CD player, possibly with a universal player able to handle DVD-A and SACD if there's music on these formats that interests you. **NK**

I'd agree - generally you've got an unusually well balanced system that's not going to be transformed by small upgrades; you'd have to really splash the cash to move it up a level. Ultimately, your deck and arm are a tad off the pace. I'd counsel a (£870) Michell GyroDec SE (yawn - sorry readers!) and a Hadcock GH242SE (£649). This would bring substantially better focus, depth, dimensionality and a tighter, tauter bass (from the Michell) - plus a wonderful musicality from the Hadcock unipivot arm that would work brilliantly with your superb Shure. **DP**

MODERN MUSIC

With modern advances in music recording and reproduction, how does the old Marantz CD63 stack up with the CD6000 OSE of today? When the CD63 arrived with applause I listened and purchased. It was upgraded with an Audio Alchemy DITB and has lasted now ten good years. I read reviews of the CD6000 OSE and have listened

and enjoyed the experience but how - subjectively or otherwise - does the old and new CD players compete with each other? Also, I have an Audiolab 8000S and Audiolab 8000P feeding Tannoy Profile 637 (dual Concentric). I wish to change the current Audioquest cable to the speakers, which is I believe is type 4, with something else. I wish to continue to bi-amp. If the source is a Marantz CD63 with Audio Alchemy DITB (possibly a Marantz CD60000 OSE in the future) feeding via Straight Wire Maestro interconnects to the 8000S (using Audioquest Jade to jumper to the 8000P). What would you suggest as replacement cables to improve the sound all round as speaker cable and as interconnects?

Bill Pollock
New Zealand

Aha! Now there's a question! What we have to remember is that most CD players, from all manufacturers, are simply reheated generic CD transport/DAC/filter packages from OEM providers like Philips (in the case of Marantz) or Sony. So this year's CD player isn't about making the best that technology offers, but making the best of what's currently available from the OEM providers... and the point is that they have good years, and they have bad. If you talk to CD hardware designers, they're full of complaints about 'what they currently have to work with'. Philips, for example, was making better CD mechanisms twenty years ago than it is now, and the same goes for digital filters. As for DACs, well most agree that the TDA1541S was the thing to have, vintage 1987. So, any CD player is simply an assemblage of bits of a certain vintage, and they're not necessarily better if they're newer - think of them like wines. The 1994 CD63 was a particularly good vintage, and its designer Ken Ishiwata is a particular fan of this machine (as indeed NK and I are). The CD6000SE is less distinguished, but in many ways, it's a better all rounder - far better build, more detail, speed and insight, but for me it doesn't sing like the CD63. Still, others will simply say the CD63 is muddy and vague by comparison. So... to upgrade substantially on your player, you'll have to take an altogether different route. 2004 was a golden year for Naim CD spinners, and I'd counsel a CD5x - with offboard power supply at a later date. This will give obviously more rhythmic drive and swing, plus more detail and dimensionality. As for interconnects, I'd suggest Chord Company Signature, and Odyssey 2 loudspeaker cables - expensive, but

you'll have be a lottery winner to buy a system that demands better.
DP

CALLOW'S BEHAVIOUR?

I have recently purchased a Cambridge Audio Azur amplifier, Dab 300 tuner, Azur 640C CD player and Quad 11 loudspeakers. Can anyone recommend any CDs that will highlight the quality of the system.

Philip Nixon

DP SAYS: Over to Cambridge Audio's golden-eared press representative on this one - take it away Henry Griffiths...

Dear Philip,

One of the great strengths of Cambridge Audio kit is that its works wonders whatever music you play. Moreover, we don't think we've ever told customers what to listen to - we're not Simon Callow! That said, our engineers obviously have their favourites that we know work well with the electronics, as they were used to voice the equipment. Herbie Hancock's 'Headhunters' will certainly get the toes tapping, while Vaughan Williams 'A London Symphony' LSO/Hickox (Chandos) is a marvellous version of the original 1913 score which sounds truly inspirational on your Cambridge Audio kit. Kruder & Dorfmeister's K&D Sessions (Studio K7) is another that will certainly bloom when played through the electronics. What we'd really like, however, is for you to go through your whole music collection again and you'll hear completely different albums, with the kit showing what your music was meant to sound like all along. **HG**

SHENZHEN SURPRISE

I have bought a Shanling SCD-T200C SACD player on the strength of your excellent review and am thrilled! No amount of writing can come close to describing the beauty and sound of this player. I am running it with a Parasound A23 power amp and Sendor S6e speakers through an Isotek Cleanline. All is good, but I find the system a bit shouty at times in the midrange. Would a preamp help or is the Shanling better when used directly into a power amp? Maybe the Parasound is at fault here as my last Linn LK100 and Wakonda set up sounded fine, if a little dry. I really wanted a sound that is a little warmer but detailed. Can you advise?

Ron Ferris

Hi Ron - methinks it's the Parasound, although the Shanling does have the slightest scintilla of

midband 'light'; I'd invest in a pair of Musical Fidelity X-P200 power amps (£1,600) and use them in bridged mode with a smoothie speaker cable such as Chord's superb Odyssey 2 (£18/m) and the Shanling's tube outs. This is going to pull the midband back just a touch, but you'll still get a very gutsy presentation - it was a magic combination with my Quad ESL989s which have - in their way - a very similar voicing to the S6e. As for these 'speakers - watch out for a full review soon - I've been using a pair in my second system for three months now and an truly, madly, deeply impressed. **DP**

ON THE RIGHT TRACK?

I have a lot of classical music LPs and I think I will hear that significant notch in the Stanton 890RM cartridge's response in the 12.5-16kHz area of the audio band where exists the upper harmonics of violins, some woodwind instruments, etc. This is unfortunate as I would very much like a modest priced new cartridge with such good tracking ability, particularly for Choral music, loud piano transients and such like, but possessing a flat response with no upper midrange droop, nor any peaks or dips, to at least 16kHz, to preserve the correct balance of harmonics. Looking on Stanton's website there is no higher specification stylus for the 890 cartridge but, above the 680 series which Stewart Wennen heard as less good in Hi-Fi World, July '04, there is the 681EEE Mk III with a Stereohedron profile stylus tip, and also the 881 Mk II. It would be useful to have a review of either or both of these models since they may be good alternatives to the 890RM.

Chris Logan
Australia

Stantons are great trackers and always have been. They also have a flat frequency response and a correspondingly bright, open sound, free from the warmth of most moving magnet cartridges. We looked at the 890RM to see how a top quality DJ cartridge meets hi-fi requirements and I was surprised at how little compromise there was, quite frankly. I doubt whether you would be much concerned by the 890RM's response shape. However, Stanton's hi-fi range is best for audiophiles and comprises the 680, the 681EEE MkIII and the 881 MkII. I know the 681 well and it's a fine cartridge, a good choice for most pickup arms. The 681EEE MkIII is very accurate and has all the properties you want. It manages to provide tonal accuracy, without sounding either thin or coarse,

largely as a result of it excellent stylus geometry I suspect.

Stanton increased the compliance and lowered the inductance to derive the top end 881 MkII. High compliance and a low maximum tracking force of 1.25gms make it best suited to low-ish mass arms with good bearings. I find very low tracking forces make a cartridge skittish and difficult to handle. You need a stable platform for a cartridge like this, and preferably records free from serious warps. Lowered coil inductance extends frequency response to 25kHz, opening out the sound a little more. I hope we can look at these cartridges in more detail in the near future. **NK**

OOOMPH, MATRON!

I'm after more 'oomph' from my system - please help! I have a Rotel RCD965BX discrete CD player feeding an Audiolab 5000A amp and 1st edition B&W 602 speakers. I also have a Project 1.1 turntable that has seen a few steady stylus upgrades to its current Ortofon 530 status. My speakers are single-wired with Ixos 6003 cable and supported on sand-filled Target stands. The CD is hooked up to the amp via DNM Reson interconnects. Amplifier, CD etc.. are supported on a custom-built wood/glass shelving unit mounted on an outer stone wall.

With simple arrangements and acoustic music I'm very happy with the sound, particularly for late-night listening. Switch to something heavier and rockier on CD and the music gets a bit congested and lacks wallop. The biggest thing missing is a kick drum that sounds (and feels) like a kick drum. I had an idea that the CD, being a bit long in the tooth, was to blame, so I had a home trial of a Cambridge Audio Azur 640C. I'd read positive comments on this being one of the best sub £500 players, but to my ears it was no better than what I already have. I listen to a wide range of CDs and vinyl from Dance to Classical via Pop and Rock, but mostly the current crop of guitar-based bands such as Snow Patrol, Belle & Sebastian, Muse, The Bees, The Zutons, etc. I'm not too concerned about the turntable yet, since that is a more long-term upgrade to a GyroDec or similar. Any advice on giving me what I'm after with a budget of £500 or so would be appreciated.

Dan Noble

I think you are expecting a little too much from your B&W 602s Dan. CD does commonly sound drier and

more restrained in bass than LP, with certain exceptions where 60Hz boost has been copiously applied in the mixing stage to ensure prominent bass. I don't feel changing the player will give you the sort of dynamics you are looking for. For kick drum to kick you need to move air. A small cone struggles to do this at any great level, producing a lot of distortion. If you want more heft the easiest solution is to add a subwoofer, like REL Q-150E MkII for example. Alternatively, look for a pair of larger loudspeakers, such as B&W 603s, which have an additional bass driver and fall within your budget. You'll get plenty of bass power from these. **NK**

SHOUTY

My core system is a Michel GyroDec (latest version) modified to near Orbe spec with platter and VC power supply. Origin Live silver tonearm, Ortofon Kontrapunkt B cartridge, Tom Evans Microgroove Plus phono stage, AVI Lab Series integrated amp, AVI lab series CD player, AVI Pronine (Mk 1) speakers, Atacama SE24 speaker stands, Graham Slee Solo headphone amp (latest version), Sennheiser 565 Ovation headphones, Kimber BTC speaker cable and Kimber PBJ interconnects throughout system.

My goal is that of the audiophile purist, to achieve the most realistic, neutral and transparent impression of the live event or studio designed soundscape of the recording with a very high degree of technical excellence - for sensible money! I am the closest I have ever been to achieving this with my current system and I am at a point where system synergy is the final hurdle I think.

As it stands (and in absolute terms - it is still a very good sound) I find the system a little 'shouty' and cool in the midband. This is particularly the case with vinyl. Although CD is smoother in this regard, it is still not ideal and the vinyl front end is clearly better in terms of sound stage and flow of the music.

I attribute the problem largely to the speakers, as it is not anywhere near so pronounced through headphones, although the cartridge character is playing an adverse part still, I think. From the many reviews and advice I have taken on this I think the cartridge and speakers are both cool and analytical, and a touch on the 'vim and vigorous' side and this is compounding to create the issue I am hearing. Your view expressed in a previous issue of Hi-Fi World that the Kontrapunkt B is 'challenging' in its style of music making is bang on right in my view - though

obviously it is still a hugely able cartridge.

I would appreciate your advice on this problem and how I might improve the system. I am thinking of perhaps a Kontrapunkt C or H as a direct ('safe') improvement on my existing items. I liked the recent review of the C in Hi-Fi World. More finesse sounds about right. However, the Ortofon homepage 'sonic evaluation' section indicates that the H might be more neutral tonally compared to the C, a characteristic I think I need more of when listening to the B (which is a bit lively up top - in a similar way to how the C is described by Ortofon). The question is, does the H have the finesse of the C (and if so why is it cheaper if it is tonally more neutral as well)? This aspect puzzles me. Any advice appreciated.

I am thinking of changing the Pronine speakers for the new (expensive) AVI Trio floorstanders that are brand new - out this month I gather. I think that it may well sort out the speaker issue. If not then the Sonus Faber Cremonas are on my list to audition as well. Again your thoughts appreciated. Also, your headphone reviews recently have indicated that the world is probably lacking a total (complete) headphone solution and that the Sennheiser 650s and Grado RS1s, though as near to as good as it gets, don't have all the answers. My question is, would it be worth upgrading to the 650s from the 565 Ovations and is there no brand out there that does offer a total solution? Sorry to ramble, but I hope you can offer guidance as these questions have been plaguing me for some time.

Chris Lloyd

Both Kontrapunkt C and B use Ortofon's Fritz Gyger 80 stylus, mounted on a conical aluminium cantilever in the C and a ruby cantilever on the B. The A and H use simpler Nude Fine Line stylus shapes and a conventional aluminium cantilever, hence the lower price. They have a less challenging presentation that's more neutral but also less insightful and revealing. You'd get an easier sound but also weakened resolution of treble detail. The rare H has higher compliance, giving a little more tracking ability at low frequencies. Don't expect the finesse of the C. I would suggest you change the loudspeakers first and then see how you feel about the cartridge, as new speakers will inevitably change the tonal balance and presentation slightly, possibly to better suit the cartridge you have. By all means check out the new AVI Trios. Infinite

baffle loudspeakers do have clean, tight sounding bass when well designed. But B&V's 700 series loudspeakers and the Acoustic Energy Aelite Three are worth considering, as are many current Monitor Audio loudspeakers – such as the GR60. **NK**

Hi Chris – I'd go for the Kontrapunkt C without hesitation – it will do exactly what you're hoping. But I do believe that your speakers are to the root cause; the Sonus Faber Cremonas would be just the job here. Sennheiser's HD650s can be dramatically upgraded by changing the cable to Stefan AudioArt (<http://stefanaudioart.com/>), which is a direct replacement for the middling Sennheiser stuff. On balance, these – with Musical Fidelity's X-CANS v3 would give you the best sound this side of a high end pair of Stax. **DP**



yes can do – Sennheiser's superb HD650 respond brilliantly to Stefan AudioArt cables

SCOPE FOR IMPROVEMENT

I would appreciate your advice on two areas. Could you suggest a decent oscilloscope that I could use for checking azimuth and anti-skating that so far I have been setting by ear? (I use a range of cartridges from Goldring 1042 to Koetsu Urushij). I am not technologically savvy, but I can follow instructions on how to do it! If by any chance you have covered the topic in one of your issues from the very distant past, save your precious mail space by quoting the issue number. My budget for the oscilloscope is £500 – the cheaper the better, if that is not at the expense of performance on the task I want to use it for.

My speaker placement is very accurate and symmetrical relative to the listening position. However, my speaker placement is forced to commit the

cardinal sin of taking place in a room where the area immediately behind and at the sides of the speakers is very different in terms of distance from the back wall and the material of the surrounding areas (brick wall, steel fireside, marble mantle, plaster wall, glass). This lack of symmetry is evident mainly in the soundstaging. I believe that by using commercially available products I can 'fool' one of the speakers in believing that its surrounding is similar to the other one. However given the complexity of the problem I would prefer a professional to visit onsite, provide an acoustical study and recommend solutions. Could you suggest a couple of professional contacts to fulfil the above role?

Changes of speaker placement are out of the question, unless within a region of plus/minus 2 inches from the current position. I live in Central London and my budget is £1,000. I would like to conclude this email with my thanks for your excellent magazine that over the last year has indeed been upgraded to the next level: not only providing honest and reliable information in fragments but at the same time daring to try to make sense of it all with 'main-theme expositions' of issues central to the hearts of many an audiophile: the comparisons on the variety of recording formats, on the chronological evolution of hi-fi reproduction, on the cross-sectional offerings at different price points by the same manufacturer, to name but a few. It is evident that the new direction reflects the steering by the current editor, although the positive changes are enhanced with the support by the rest of team for instance the informative guides and comparisons by **NK**. Well done to all of you then!

Kostas Agath

In addition to an oscilloscope you would need a test disc to set head azimuth and side force correction of a tone arm and such things are rare. Shure TTR109 was cut specifically for the measurement of channel separation, which is affected by azimuth. You could use any tracking test disc to set side force, such as HFS69 or 75, occasionally available second hand.

There are quite a few issues to consider here. Obviously, you first have to get hold of test discs, possibly from e-bay or the internet. They're not exactly commonplace anymore. Of all the rare and strange items you can find on the Net test discs – LPs that is – hardly seem to figure. With suitable discs any simple 'scope would do. To set azimuth you just need to minimise signal level in the quiet channel, whilst side force is

set so that mistracking occurs equally in both channels.

So much for the theory. It works in practice too, but the LP is so approximate I'm not sure you should worry about all this too much. For example, whilst azimuth and channel separation can be optimised on a 'perfect' disc like TTR109, which was carefully cut to have correctly aligned modulation axes, in practice it is affected by disc warp and the axes of the original cutter. Which is to say you can only set azimuth to a sensible median position; it will never be spot-on perfect for any disc you play because they all vary.

Tracking test discs are useful and it does no harm to set side force to balance out the natural inward twisting force on an arm, but again you'll gain little by the precision offered by a 'scope. Use the settings recommended for the arm and, if anything, increase them a little, as side force settings are usually a little low I find.

If your curiosity gets the better of you, and if you have suitable test discs, then a simple budget scope from Maplins would do. They have a 10MHz single channel type for just £110 which would be satisfactory. There are plenty of good second-hand, semi-pro dual channel scopes available on e-bay too.

With regard to your room acoustics, I would guess you have one side wall closer to the speakers than the other. It will reflect more energy, giving more prominence to that side of the soundstage. Try a simple experiment: hang an absorber like a folded up blanket, on the wall at the point where a light ray from the speaker would be reflected to the listening position. If damping down energy reflection from the wall does the trick then it's usual to put some books on a shelf there to provide diffusion, or you could put some decorative cloth over a large acoustic tile placed in the same position to provide absorption. I suspect the latter is best in your case. You can get a variety of Sound absorbers and diffusers from Studiospares, 964 North Circular Road, Staples Corner, London NW2. **NK**

EDISON LIGHT-HOUSE

Richard Zarywacz, in October letters, replies to my July letter of the month by telling how he enjoys music from digital and analogue sources. He plays his vinyl and 78s on a pair of classic Garrard decks, carefully fitted and, I'm sure, lovingly maintained. They must sound wonderful. Trouble is, his CD player is a 13-year old budget model. Does he

really believe it represents CD as well as his Garrards do with LP (which must be close to the best)? It was precisely because I didn't enjoy cheaper players (including the Arcam Alpha 7) that I went as far as I did, to a Ringdac Alpha 9 and the KAV-300 (which makes the very most of multibit.)

It's a shame NK seems to encourage people to believe that CD is limited, calling it "the Edison cylinder of its time" on the same page. Mr Zarywacz uses his experience of digital bus-bells to illustrate the "compromises inherent in CDs". It's absurd analogies like these, illustrating nothing but bias, which inspired my original letter, which was an attempt to balance the argument from the 16bit side. It's simply no easier to get great musical results from CD than it is from LP, which is why the more distinctively musical designs cost more. DP's remarkable June article, about the Marantz KI DP project, appears to support my feelings about CD - that it can be musically satisfying, given enough care and individuality in the design. Not so very different from LP in that respect.

In reply to Mark Crabtree about LP surface noise, if you go to a live Mahler 4th, and two people cough on the far side of the hall - no bother. If a man two rows below you coughs eight times during the slow movement it could spoil your entire day, no? That's my problem with LP. I don't love the music less, I just want to rely on a lack of interruption. Especially during those special, all-time-suspended moments. As for the analogue/digital thing my other main source apart from the Krell 300CD is the Magnum Dynalab md100 FM tuner, which I love to pieces; neither source puts me off the other in any way - even after extended radio-promming I still can't hear anything "chromium-plated" about CD's upper midband. Both are a distinct improvement over Edison's cylinder. Or is it time for a revival?
Jayne Lee Wilson

All digital coding schemes are limited by their very nature, so what I am saying here isn't unduly critical. I wouldn't deny CD is enjoyable, nor that the absence of surface noise is a significant benefit as far as the average listener is concerned, even though I don't find surface noise intrusive when using a good turntable. All the same, it is a fact that 16bit/44.1kHz PCM is limited in what it can do, and that's why today 24bit resolution and higher sampling rates have arrived. I remain convinced that an easier, more open

and less mechanical sound is possible from digital than we get from CD today.

In retrospect it seems that the coarse sound of early CD came as much from early digital recordings as the medium itself. Enormous improvements in studio equipment took place through the late 1990s as better, affordable A/D convertors appeared and this has helped improve recording quality. In particular, 24bit recording resolution is commonplace and this, in conjunction with properly applied dither, has given CD a much smoother sound than ever before. Although today's CD players do a pretty good job, sound quality isn't infinitely extendable, unlike an analogue system. Improvements are relatively minor I feel, gained from better circuits, better power supplies, better components and re-clocking to squeeze what little more is left from the medium. **NK**

Well, Jayne, I know what you're saying - if I took as much trouble to squeeze everything out of CD as I do to get the best from my vinyl, things would look different. Of course, CD isn't bad - but what we've been doing is 'briefing against' twenty years of pro-CD propaganda and 16bit digital hegemony. Still, I think the debate's moving on - we now all agree that 16bit isn't 'pure, perfect sound forever', so perhaps we shouldn't be so vociferous in our anti-CD ranting... But that fact remains that when I first started contributing to Hi-Fi World in October 1994, we were the ONLY UK mag saying vinyl wasn't dead! Valves, vinyl, REL subwoofers, computer audio, supertweeters - oh boy, it's hell being right first time about everything! Wot a weight we carry... **DP**

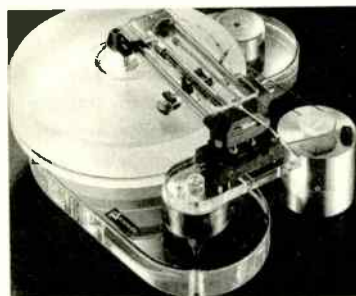

sexy picture of Clearaudio turntable, just to annoy Hi-Fi World's most passionate pro-CD reader, Jayne Lee Wilson...

EIGHTIES

I wonder if you could help me? Having invested in hi-fi during the 1980s, I

want to upgrade certain parts of my system, and would consider buying second-hand in order to obtain quality equipment. My current system includes Linn Sondek LP12, Ittok LVII, Audio Technica OC9; purchased 1989 and to be serviced and reset in the next two months. I also have an Audiolab pre/power amplifier purchased second hand in 2003 for £450. I previously used an Audiolab 8000a since 1987. My CD player is a Marantz CD273SE purchased 1987 and still going with no breakdowns. Other equipment includes an Arcam Alpha tuner. I have moved the Audiolab 8000a to link with a Phillips DVDR880. All the equipment is linked to a pair of Castle Warwick speakers with separate speaker leads for hi-fi and DVD watching.

Room measurements are approx 18ft by 15ft. The sound from both sets of equipment is OK, but it might be time for an update. I'm not too concerned with the DVD set up so don't want to pursue the surround sound option. I would like to update the CD player and have considered second-hand quality equipment. One option is to invest in a Pink Triangle Da Capo plus a CD transport (Audiolab CDM or other transport). Or to invest in a new CD player, but with a tendency towards an analogue sound. If I invest in the Da Capo, which transport is better matched to this? I am also interested in upgrading my speakers, possibly to Castle Conway. Any comments would be useful.

David Irwin

Cripes! That is an eighties system! No offence, but an Audio Technica OC9 was a fave of the day I never quite appreciated. It's far too bright for my taste, although it does have 'speed', incision and good bass slam. The OC9 is a good enough partner for the Audioblubs which were a little dynamically compressed and grey across the vital midband, if strong in their bass. The Castles soften things out and likely bring a good sense of balance. If you change one item in a system like this it may well upset the balance. This especially applies to the loudspeakers. Happily, Conway 3s are a very good choice - arguably the only choice - since they have a warm balance that will complement what you have. The Conways are also very revealing, in a laid back way.

Now, having said that, I wouldn't put a second-hand Pink Triangle Da Capo in front unless you want a very warm sound from CD. As good as the Da Capo was - and it was very good - I would tend to look

toward a classic Marantz CD63 KIS or similar in a situation like yours. Alternatives are an Arcam Diva CD82 or Naim Nait CD5i. These players all inject the sense of atmosphere into CD that a Da Capo once managed so well, but are bang up to date and come with manufacturer's backup. **NK**

The Da Capo is one of my favourite ever DACs. Unfortunately our long term experience with this and its partnering Cardinal transport (we had one 'in residence') wasn't good – as they both went pop more often than a bowl of Rice Crispies. Still, when they were working, they were sublime, and would have blown a CD63KIS into dust. In a sense I'd agree with NK – go for an Arcam – but in the shape of the £1,300 FMJ CD33. I honestly think that Arcam's product line up has never been stronger. It does so much so well, and it embarrasses so many more 'fashionable' brands, yet for some reason many audiophiles overlook it. The Naim CD5i (or x, preferably) is more incisive and musically enthralling, but the Arcam isn't a million miles away from the hallowed PT Da Capo in its warmth and expansiveness – and that's what you want, isn't it? I sometimes think that if Arcam changed their brand name to 'Orange Wombat' (or suchlike) and made their stuff one tenth as reliable then they'd sell more with a certain type of audiophile... **DP**

SPECIALIST DIVISION ONE

Wonders will never cease, my taste in hi-fi has finally become somewhat fashionable! I'm referring to David Price's review of the JVC AX-SD1. I have been a fan, much to my many friend's amusement and incredulity, of JVC amps for quite a while and have owned a fair few of them, from the mighty AXZ1010-TN to the miniscule AX-F1 system which I now own, which was the last (officially) JVC imported system into the UK. These, (amp, CD, Tuner and tape drive) like the AX-SD1, have copper coated chassis(s), high quality componentry, high build quality and sound fantastic. Unfortunately, JVC became victim to the fashion for hair-shirt hi-fi prevalent at the time and failed to make any impact in the market place, so disappeared from our view.

I was pleased to see that there is still a dedicated team within JVC that exists to create such an amp as the AX-SD1. Their products have long gone unrecognised but maybe your review will change people's opinions. Whether this will make JVC import these high-end products officially is another question.

The 'class A' biasing of the AX-SD1, I suspect, is similar to the AX-F1 and other late 'Digifine' JVC amplifiers in their implementation of feed-forward biasing, i.e. only biasing the o/p stage into class 'A', when the signal level demands it. This works extremely well in JVC's amplifiers and in my system is used to drive a fairly old loudspeaker design of Martin Colloms, which was designed for a 'Hi-Fi For Pleasure' magazine article, sitting on my own bespoke stands. This is a Bextrene design using Chartwell units which were notoriously inefficient but the JVC system sounds incredible through these loudspeakers, driving them extremely well to high volumes.

The vinyl front-end I use is a Japanese Technics SP-25 broadcast turntable and OIL modded Rega RB300 which is similar to that used by one of your reviewers as a reference vinyl front end. This sounds wonderful in its timing, bass power and accuracy, and I would recommend any reader to put one of these direct drives plus OIL Rega together, as a substitute for some of the so-called 'superdecks' around. I now only have to show my pals these articles from HFW, reviewing JVC amps and using Technics turntables as references, to completely regain the street cred I lost many years ago. Congratulations HFW, you've realised finally that there were good things to come out of Japan. You only have to search for it.

Chris Simmonds

*The chances of JVC officially importing the superb AX-SD1 are roughly on a par with Noel giving his loyal staff a pay rise. No, hang on, they're not that slim... **DP***



JVC AX-SD1 amplifier – almost as great as the Rover

DESPERATELY SEEKING...

Dear David, I want to explore a number of possibilities for improvement over the next few years but want to start with a rather exceptionally good set-up as a reference point. I have ordered the Marantz CD-63 KI DP to be modded as per your article and also have on order

a used Marantz SA-1. For vinyl, I have a recent Michell Orbe (but I am hoping to upgrade to the Never Connected power supply) with SME V and Clearaudio Discovery cartridge. The phono stage is the Sutherland PhD, a battery driven system.

I also have a Pass Aleph L that has a rather rare automatic Passive/Active signal routing. Its unique volume control operates passively up until 3:00 and after that it is active. At exactly 3:00, the pre-amp even removes the volume control itself from the signal path. It's a step down from a purely passive pre-amp or direct connection but not as much as an active line stage.

So what's missing from this set-up is the perennial question of what power amp to use with my Yamaha NS1000Ms? To start with, I was thinking of trying the World Audio Design-K5881 MkII, a six year old unit which is on sale. The other possibility is a World Audio KT88 amplifier which has been upgraded with better capacitors, etc. I listen to a wide variety of music and definitely need something that can cope with large orchestral works like Beethoven's ninth symphony. You suggested the use of a subwoofer and the use of a 300B SET amplifier. What do you think is the best upgrade path for me to follow? As you can see, I value your advice enormously and you have inspired a large part of the above system. I would appreciate any comment you might want to make.

Rakesh

Hi Rakesh, The NS1000Ms are curious beasts. My modded K5881 makes very nice noises with them indeed – by

contrast, any solid-state amp sounds frigid and depressingly unromantic. However, at any serious volume, my valve amp starts sounding like a 100k mile plus Triumph Dolomite with head gasket failure. You can assuage this a bit by using twin subwoofers (baby RELs, like the Stata 5, are ideal), as their transistor amps inside

'take the load off' the room, if you see what I mean? Still, if it's serious levels you want – and boy, can the Yamahas go loud cleanly, then it's transistor time for you and I. Previously, the happiest power amp I'd used with them was Musical Fidelity's XA-200s (a pair), but the new kW500 (£4,000) blows even these out of the water. MF's Antony Michaelson so quaintly and self-effacingly told me the kW500 was "the best ~~***ing~~ amplifier in the world". Now, I'm not sure if this is completely true, but it's certainly a dreamboat for the Yams. It's simply not afraid of them, and supplies vast tracts of power cleanly and without complaint – result: stunning. In fact, it even makes my ESL-989s sound like NS1000Ms at times! It is so muscular, yet fast and open, and as such is just what you want. My only suspicion is that the forthcoming kW500 Power amplifier (£5,000) – in conjunction with what I regard as the best preamplifier ever made, the MF Audio Passive Preamp – will be better still. Trouble is, we'll have to wait till after Christmas to find out... **DP**

Yamahas need power and, in their day, it was commonly felt that a good solid-state power amplifier best suited the NS1000Ms. Doubtless you can use a valve amp, but don't expect high levels. An SET design (Single Ended Triode) isn't the most obvious choice. Even if you do have a pair of 300Bs working together to give around 20V the Yamahas will demand a lot from it. However, quality wise there's nothing that really comes close, especially when audiophile grade components such as Jensen and Black Gate capacitors are used. So go down this path if quality is all. A well built KT88 amplifier such as World Audio Design's now discontinued kit will give more power. Delivering 40V, you will get the sort of clean, modern sound with fine dynamic drive that suits NS1000Ms. Admittedly a push-pull will never quite match a good single-ended, but they do a very good job. **NK**

ON DUTY

On the basis that Euan Stuart (Letters - Oct 2004) specifically mentioned buying hi-fi equipment from overseas, the calculation of potential VAT and Import Duty should be simpler than the reply you received from Customs & Excise! Below is, I hope, a less complicated explanation. I must stress that I am not an "expert" and is based

purely on my own limited experience. Perhaps a C&E officer reader of this magazine will correct me if necessary!

Basically, purchases from other EU countries do not attract Import Duty, but VAT at the rate in the sender country is payable. Purchases from outside the EU attract both VAT (at our 17.5%) and Import Duty. An amplifier I bought direct from China had Import Duty calculated at 3.5% - so I presume this rate will be applicable to most hi-fi gear (but I hasten to add that the rate might vary depending on country of origin).

The "value" that is used to calculate the import duty is the declared value, which should be the price paid including postage/delivery costs. If the declared value is less than £36 (or £18 for a private "gift") duty and VAT won't be charged. Also, if the duty calculated is less than the equivalent of EUR10, it won't be charged - i.e. hi-fi gear valued less than approx £194 shouldn't attract duty. VAT is charged at 17.5% on the sum of value and duty. Total customs charges are then VAT + Duty. Perhaps a couple of examples would help.

Example 1 - Hi-fi costing £500 including postage costs, from outside EU.

Value for import duty,	£500.00
Duty @ 3.5%	£17.50
Value for Vat	£517.50
Vat @ 17.5%	£90.56

Total customs charge £108.06 (Vat + Duty)

Example 2 - Hi-fi costing £150 including postage costs, from outside EU.

Value for import duty	£150.00
Duty @ 3.5%	£0.00 (5.25 < EUR10)
Value for Vat	£150.00
Vat @ 17.5%	£26.25

Total customs charge £26.25 (Vat + Duty)

Also, because usually the carrier pays the customs charges on your behalf at time of import, you may have to pay a handling fee to your postman - mine was £8.

Neil Maxwell

Thanks for that Neil - you're a stickler for mental punishment! It was I who dutifully called Customs & Excise and it did strike me at the time that their reply, even if correct, wasn't a realistic working proposition. Thousands of parcels must arrive in this country every day from ships and planes; I don't believe the cumbersome procedure for determining Import Duty they described could ever be used in practice. Perhaps someone with

inside knowledge can enlighten us? **NK**

(Wake me up when this is all over – **DP**)

RUSH RELEASE

Sometimes an issue comes out that is a real pleasure to read, especially when it touches on my world. I was excited for several reasons reading the October issue, not least for seeing a second letter of mine in print. It's nice to know that my views have been worthy of reply, so many thanks for that. Also, in an element of what must be synchronicity, two of my all time favourite albums have been mentioned in the same issue! Firstly, Rush's 'Moving Pictures' in the laser vinyl player review. I have been struck time and again by the quality of production on this album since first getting it as a new release. Considered by many as their finest album, 'YYZ' is the test track of choice for me when listening to kit (permission being allowed, of course). It has lots of dynamics, lots of empty spaces, some of the best drum/percussion recordings I have ever heard and both high and low frequency challenges. It lacks only vocals, but nothing is perfect eh? Secondly, though only shown as an image, Yes's 'Going For The One' was shown as an example of Prog Rock on vinyl in the letters page itself. This I have found to be the most difficult album to hear well on vinyl, given its massive soundstage, glassy recording style and such dynamic range. Any system that reproduces this album well, will get me saving straight away! I have spent many happy hours listening to these two albums. Well, I mainly just wanted to say thank you overall and still enjoy the magazine as much as when I was first introduced to it by my brother. Keep up the good work and thanks again.

Paul Clewlow

A pleasure – and what a sage brother you have too! I may mock those of the 'progressive disposition', but I do love Rush. Patrick (Cleasby) and I are both the exactly the same age (don't ask) and we worship all the 'politically correct' eighties stuff (Smiths, Cocteau Twins, New Order), but when we discovered our mutual love of mid-seventies Rush, that was it! Oh my God, I've gone prog – now where's my copy of Caravan's 'In the Land of Grey and Pink' (on first pressing Decca LP, of course)? **DP**



Philips Rush MP3 portable - dubbed after the seminal maple syrup drinking prog rock band of the same name?

email: advertising@hi-fiworld.co.uk

market place

specialist products and services

For all your advertising requirements
please call 0870 242 0567
or email: advertising@hi-fiworld.co.uk

HADCOCK GH242 & GH228 TONE ARMS

For the finest sound with any cartridge

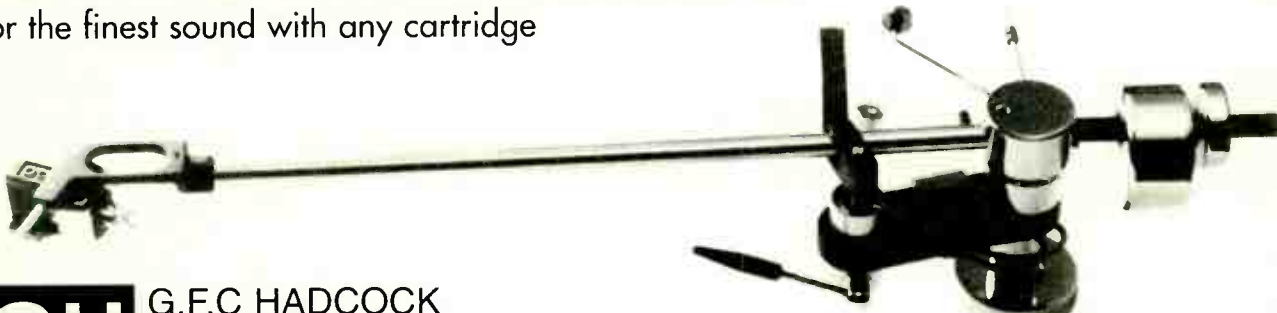

GH G.F.C HADCOCK
Audio Division

Langley House Highwood Road Uttoxeter Staffs ST14 8BQ
Tel/Fax 01889 569166

RETRO Reproduction

Used equipment for sale

Amplifiers
Audio Innovations 2nd single ended 2A3 zero feedback monoblocks last and best version of this superb amplifier new boxed mint new £3500
Audiolab LX integrated amp boxed as new £1295
Audiophile M1 Valve Pre Amp with Phono Stage £295
Audio Research Classic 60 - Trade in your Classic 30 for this far superior Power Amp £1595
Audio Research LS2 balanced output re-valved as new boxed £995
Beam Echo Avantic monoblocks re-issue superb attention to detail new £3600 £1495
Bow Wazoo Integrated Amp valve like sound new £2500 £1095
Cyrus Integrated Amp 3i boxed mint £350
Cyrus Power balanced facilities £350
Conrad Johnson PV10A Valve Pre Amp with phono stage £395
EAR 834P Valve Phono Amp £425
EAR 834L Valve Line Stage £385
Linn 280 with spark psu boxed £1295
Linnley 120 monoblocks recently re-valved with GEC valves £1245
Marantz PM 66 K1 Sig Int Amp £495
Marantz PM17 Integrated Amp £295
MicroMega Tempo 1 Integrated Amp remote control with great phono stage new £800
Michell Electro monoblocks immaculate condition great with electrostatics £1195
Musical Fidelity F series valve Pre Amp new £1500 balanced with remote control with phono stage
Musical Fidelity Nu-Vista 300 Power Amp boxed new £2995
Musical Fidelity Nu-Vista 2 boxed Pre Amp £795
Moon I-5 Integrated Amo with Die-cast remote 12Mds old as new £2750
NAD original 3020 £95
NAD C150 remote Pre Amp top of the range £225
NAD C270 Power Amplifier excellent at driving difficult loads £295
Naim Nait01 Integrated Amp £225
Nytech CA202 Integrated Amp £95
Quad 303 Power Amp £195
Quad 405 Power Amp boxed £225
Rotel RB870BX Power Amp £195
Rotel RB850 Stereo Power Amp can be bridged £150
Rotel RC990 BX remote control Pre Amp new £400 £195
Rolsan ROKL2.5 Pre Amp with ROKDS4 PSU new £1500 £395
Rolsan Caspian power amp £350
Sugden A48 orange front Integrated Amp £175
Tube Technology Unissis Valve Integrated Amp with phono stage £750

Speakers
ATC Active 20s ex dem new £2700
Audiovector M3 3 way design beech finish ideal for valve amps 12mths old £1500 new £2300
Audio Physic Virgo MKII speakers special birds eye maple finish new £3900 £695
Celestion Dilton 44 3 way speaker £1895
Cyrus CLS50 speakers £195
Dynavector Countour 1.8 cherry finish £1800 new £225
Dynavector Countour 1.3 MKII cherry finish boxed as new KEF Reference 1.2 rosewood finish boxed £295

Gamma Acoustics top end speakers new £5000 £995
Linn Index bookshelf speakers £395
Linn Sara walnut finish new grills matching stands £395
Neat V10 floorstanding speakers beech finish ISO Bariks loading ribbon tweeter work well with Naim new £2600 £1595
Musical Fidelity MC2 Bookshelf Speakers £195
Monitor Audio R252 £175
QLN Spifflefield Signatures £895
Quad Onething ESL63's £1395
Rogers LS4A/2 boxed £195
Tannoy M20's £195
Tannoy 609 with stands great for valve amps £295
Wilmslow Audio transmission line speakers with volt drive units HI-FI News recommended £95
Turntables
Linn LP12 Vahala with Rega and Linn cartridge £595
Linn Ittok MKII mint £295
Linn Akito mint £175
Musical Fidelity XLP various £95
SME 309 Tonearm boxed £495
System Deck IIX turntable ..UPGRADE YOUR REGA from £160
STD with Mission 774 tonearm £195
Various Garrard turntable's with granite wood marble plinths available POA
CD Players, DACs
Arcam Alpha 6 new £600 £195
A&R wedge shaped CD Player mint boxed £95
Marantz CD63 top loading CD Player champagne finish £295
Marantz CD94 multibit hi-end player £325
Marantz KI 6000 CD player £245
Marantz CD63 KI Sig £245
Meridian 200 series Trichord Clock 2 transport boxed mint £390
Meridian 201 series transport boxed £295
Meridian 203 DAC £135
Meridian 206 Integrated CD £295
Mission DAD5 CD Player boxed mint £175
Mission DAC7 boxed mint £75
Musical Fidelity FCD valve Cd Player £795
battleship build quality new £1500 £275
X-CANs £235
Teac VRDS7 £235
Tuners, Reel to Reel, Cassette Deck, misc
Cyrus original Tuner £150
Leak Troughline Tuner 3 various ...from £50
Meridian original shoebox tuner £150
Quad FM3 Tuner (boxed mint) £145
Quad FM3 Tuner £95
Quad FM4 Tuner old style £225
Revox G36 Open Reel Mint £295
Due In
EAR 509 monoblocks £295
Extremely rare Quad corner horn ribbon speakers £895
Linn Karma cartridge £295

Web address: www.retroreproduction.com
28a Haddington Place Edinburgh EH7 4AF Phone/Fax 0131 558 9989
Open 11.00am - 5.30pm - closed Monday & Sunday

NOW DEMONSTRATING

The Fantastic EAR 890 and 899 70 watt per channel Class A amplification (SPECIAL offer trade in your existing amplification for full market value against any EAR products.)

ATC SCM 7, 12, & 3S SPEAKERS PROBABLY THE FINEST SPEAKERS AVAILABLE - PRICES START FROM £480



Ear 869 single ended triode integrated amplifier
Improved version of the classic 859 with revised output transformers modified input stage with the addition of an extra signal valve which has allowed an increase to 15watt of single ended power, also the 869 can be used as a power amp. Don't be fooled by its modest power output this amp drives real world speakers. price £2498.00

Ultimate Ear Phono Stage
This is the ultimate esoteric Phono Stage as used in the world wide acclaimed Ear 312 Control Centre - Pre Amp. This has to be the ultimate Vinyl Replay purchase. price £2095

** FOR A LIMITED PERIOD ONLY **
Full value Trade in on Ear Phono Stages and other selected models.

THE LEGENDRY OPUS 3 CONTINUO TURNTABLE WITH CANTUS LINEAR TRACKING TONEARM EMBARRASSES MANY HI-END TURNTABLES PRICES FROM £875.00
NOW DEMONSTRATING THE FANTASTIC NEW MONOPULSE RANGE OF SPEAKERS PHASE LINEAR DESIGN GIVES EXCELLENT SOUNDSTAGING ABILITIES PRICED COMPETITIVELY FROM £495.00 - £995.00
ALSO DEMONSTRATING KORATO VALVE AMPLIFIERS

CROFT NEW TRANSVALVE NEOSTAR INTEGRATED AMP
40WPC BENEFITS FROM OVER 25 YEARS RESEARCH INTO VALVES & MOSFET CIRCUITRY MUST BE HEARD £1250



There are now four models in the EAR lineup:
The classic 834P uses the same circuit architecture as its more expensive brothers, and shares the same high quality sound through MM type cartridges, it is enclosed in a tough, rigid metal case and is fully "CE" type approved. price £495.00

The signature builds on the Classic 834P specification by adding a superb moving coil (MC) input stage, as well as the no-extra-price option of a high quality volume control. price £895.00

Top to the range, the Deluxe 834P comes in stunning chrome and gold cabinet, and has extra attention and quality control. With different moving coil input options, this unit will fit the most demanding of audiophile systems. For the true vinyl enthusiast. price £895.00

MC3 - The ultimate stage for MC matching with 3 fixed transformer taps to cover all types of moving coil cartridges, and separate left/right grounding. MC3 in used in the new £10,000 312 pre. price £630.00

Selected products from: ATC, Audio Physic, EAR Yoshino, Nottingham Analogue, Dynavector.

Soundstage

2nd User Hi-Fi & audio

01376 521132
07802 483698
CHELMSFORD, ESSEX
E-MAIL: soundstage@netlineuk.net
BY APPOINTMENT ONLY

PRE-OWNED EQUIPMENT

ATC SCM50A ACTIVE WALNUT WITH STANDS-BUYER COLLECTS-IMMACULATE	£3495
AUDIO INNOVATIONS SERIES 800 4-BOX VALVE PRE-POWER	£1495
CASTLE HARLECH CHERRY FLOORSTANDERS	£649
COUNTERPOINT SA100 POWER AMP VALVE TRANS HYBRID BLACK BOXED	£649
DEFINITIVE TECHNOLOGY PRO SLB 80	£249
DENON DV D3300 BLACK AND SUPERB-£1000 NEW	£495
FPOS ES12 LIGHT CHERRY BOXED AND SUPERB	£299
KIF 103/3 ROSEWOOD WITH KEF KUBE EQUALISER AND INTEGRAL STANDS	£399
LFD PA2 POWERSTAGE POWER AMP MARBLE FRONT LOVELY LOOKS AND SOUND	£695
LINN SONDEK LP12 NORTON AIR POWER TITOK TROIKA WALNUT SUPERB	£1295
LINN KAIRN PRE AMP MM/MC PHONO STAGE BOXED AND SUPERB	£695
LOEWE ACONDA 32" FLAT WIDESCREEN SILVER + LOEWE GLASS STAND	£1295
MERIDIAN A500 BLACK ASH LOUDSPEAKERS BOXED LOVELY CONDITION	£399
MERIDIAN 605 MONO AMPLIFIERS BLACK	£895
MICROMEGA STAGE 5 CD PLAYER IMMACULATE	£349
NAIM NAP 180 POWER AMP OLIVE FRONT 2 AVAILABLE	£695
NAIM HI CAP OLIVE FRONT BOXED AND IMMACULATE	£499
NAIM HI CAP BLACK FRONT BOXED AND IMMACULATE	£429
NAIM CDX CD PLAYER 1998 IMMACULATE	£1295
NAIM NAP 140 OLIVE FRONTED AND BOXED, SUPERB	£399
NAIM INTRO BLACK ASH BOXED AND SUPERB	£349
NAIM NAT 02 TUNER IMMACULATE CONDITION	£795
NAIM SBL LOUDSPEAKERS BLACK ASH LATE 1995 MODEL	£995
ONIX OA35/OA1200 PRE-POWER AMP BLACK LOVELY	£795
PRIMARE D.20 24 BIT CD PLAYER	£595
PROCEED AVP AUDIO/VIDEO PRE-AMPLIFIER AC-3, DTS, THX, DPL (NEW £4700)	£1795
PROCEED AMP 5 125 WATT 5-CHANNEL POWER AMP THX APPROVED (NEW £5K)	£2295
PROCEED MDT MODULAR DVD TRANSPORT (NEW £5500)	£2495
PROJECT DEBUT II TURNTABLE PHONO STAGE SB SILVER BOXED AND MINT	£129
QUAD 33/303 PRE-POWER AMPS LOVELY CONDITION	£399
QUAD 77CD BUS/77 PRE/77 TUNER CARBON BOXED AND IMMACULATE	£995
REGA PLANAR 3 BLACK, RB300, ROKSAN CORUS BLACK, REGA MOTOR UPGRADE	£279
REGA RADIO R REMOTE READY TUNER BLACK BOXED AND IMMACULATE	£249
REGA CURSA LINE LEVEL PRE-AMP BLACK BOXED AND IMMACULATE	£299
REGA MAIA POWER AMP BLACK BOXED AND IMMACULATE	£299
REGA XEL WALNUT FLOORSTANDING LOUDSPEAKERS-OVER £1K NEW	£449
ROKSAN CASPIAN TUNER BLACK BOXED AND SUPERB	£395
ROKSAN L1 50DS 1.5S1.5 PRE-POWER SUPPLY POWER AMP BLACK	£2495
ROKSAN XERYX BLACK ASH ARTEMIZ LYRA CLAVIS D.C. VDH MODDED	£1495
RUARK SCEPTRE NATURAL OAK BOXED AND MINT	£349
TOTEM MODEL ONE SIGNATURE BLACK BOXED AND MINT MONTHS OLD	£1295
TRIO KT 917 TUNER	£599
WADIA 3200 CD TRANSPORT WITH REMOTE AND INSTRUCTIONS	£995

PROFESSIONAL RECORD CLEANING SERVICE - KEITH MONKS MACHINE -
PLEASE RING FOR FURTHER DETAILS AND PRICES.
THREE MONTH WARRANTY ON ALL ITEMS
www.sound-stage.co.uk

High End Cable

Your friendly cable store

Upgrade your Hi-fi or AV system with quality new cables from

Acoustic Zen

Chord Company

Nordost UK

Stereovox

Tannoy

van den Hul

and many more

We also sell **Ortofon** and **van de Hul** moving coil cartridges

We recommend **Stax** ear speakers

New this month the new

Chord Cobra3

Stereovox HDSE

power products from **ISOL - 8**

We also have SH products from **Transparent**

When upgrading we accept in part exchange for new your old
Speaker cables
Interconnect cables
Power cables
Headphones

Free delivery worldwide on all interconnects.

For many more money saving offers call Dave Jackson for a chat
on **01775 761880** or better still visit
www.highendcable.co.uk

for over 100 pages of new and previously owned cable.
Visit our Second hand section. We also offer to sell on a commission basis.

WILLIAMS HART ELECTRONICS

HART ELECTRONIC KITS TRADED FOR OVER 30 YEARS



Monifer Monoblock Power Amp Kits

ONE OF THE BEST AMPLIFIERS YOU WILL HEAR! Regardless of price
REVIEWED IN HI-FI NEWS AS... EXCEPTIONAL...
SELF EVIDENTLY CORRECT



Single Ended Class A Valve Sound

15Watt Power Amp modules

FOR THOSE WHO WANT THAT VALVE
MIDBAND BUT BASS AND TREBLE TO MATCH



ACTIVE R/Control SUBWOOFER MODULE £177.30



Speakers Designed & Built to Order

Advertise your Hi-Fi on my website (FREE)

Also: Award Winning Phono Stage Kit, Active Crossover Modules, Speaker Drive Units,
M Cap Capacitors, Caddock Resistors, Remote Control Volume and much more

WEB SITE: www.williamshart.com e-mail: sales@williamshart.com

PLEASE SEE WEBSITE FOR NEW CONTACT DETAILS

PERSONAL VISITORS SHOULD PHONE FIRST TO AVOID DISAPPOINTMENT

Run by former Technical Director of Wilmslow Audio



Graves Audio

Unit 5 Barn Corner

Hemel Hempstead

Hertfordshire

HP1 3RR

T: 01442 270 141

F: 01442 270 141

E: sales@gravesaudio.co.uk



'GRIFFON' VALVE AMP

Manufacturers of Audiophile quality
Lowther Driven 100dB Horn loudspeakers
and valve amplifiers (SE or PP) in
domestically friendly enclosures.
Ring for information pack and speak to
the designer **Brian Graves**.

AUDUSA

Acoustic Solid

Small Royal Turntable

60mm platter topped with 6mm acrylic platter and leather mat. Precision bearing, weight approx 25kg. RRP £1280.00 excluding arm. Three tone arms can be fitted to the turntable. Read review by www.enjoythemusic.com



AUDUSA EUPEN CSA 2.5 AUDIO AC POWER CORD

GNLM 05/04 and GNLM 05/2.5 (CSA 2.5) Cable with FERRITE TECHNOLOGY - A polymer material mixed with a considerable quantity of homogeneously fine high quality ferrite powder is extruded around the copper conductors. GNLM cables are further protected with a foil shield and a drain wire, specifically manufactured for High End audio use.

NEW Eupen CSM Interconnect, with extruded ferrite - RCA/XLR, £45 for 1m pair. Eupen Video Interconnect £25 for 1m RCA/BNC/RF

Power cables are fitted with IEC (Martin Kayser) and MK Tough plug. Cable is also available with our all steel 4, 6 and 8 way distribution blocks. We can rewire the distribution blocks with Eupen cable as an extra cost option. Refer to our web site for details.

AUDUSA - ODM Silverlink OCC balanced speaker cable stranded, silver on OFHC plus three strands of OCC for improved bass performance. Mylar infill and with designed in protection against RF and EMI.

GNLM 05/2.5 (CSA2.5)
 £48 for 1.0m, £58 for 1.5m, £68 for 2.0m.
GNLM 05/04
 £58 for 1.0m, £72 for 1.5m, £86 for 2.0m.
 Both GNLM cables are available off the reel and for export.

LAT INTERNATIONAL Inc USA -

Silver fused technology Analogue, Digital and Video interconnects and Speaker cable better than most at double the price.

We have developed a cabling (weaving) pattern along with an unusual shielding filtering system that gets rid of the garbage that contaminates your components. The difference you hear with our cord is astounding. Our power cord takes advantage of silver in its design through use of our proprietary Silverfuse conductors. The conductors are 10 gauge and with PTFE, the best insulation available. Fitted as standard with IEC / MK Tough-plug. . 60cm £62, 90cm £75, 1.2m £88, 1.5m £101, 1.8m £112. Other lengths available and off the reel. 4, 6 and 8 way all steel mains distribution blocks fitted with UK, Schuko or USA sockets. CE tested & approved mains distribution units manufactured of heavy gauge steel, finished in black and fitted with highest quality 13amp sockets. It has no filters, circuit breakers, surge protection, transformers, resistors, capacitors, LED's on/off switches, chokes, regulators, just fitted with 1m of C-2 mains cable. From £166 for 4 way, £198, 6 way £229 for 8 way. Interconnects IC-200, IC-100, IC80, IC50, Video VI-6, VI-4, component, Digital -DI-20, Speaker SS800 and SS1000.



LAT AC-2 Power cord compare with products costing ten times as much, then decide



Threshold

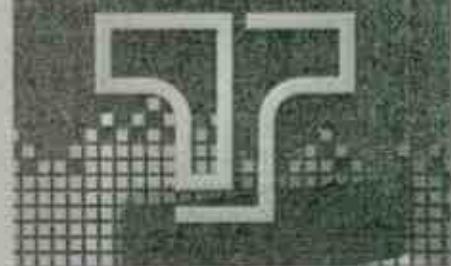

S/5000e. 2 x 250w power amp



Stasis pre amp

WWW.AUDUSA.COM

T: 020 8241 9826, 020 8264 0249 F: 020 8241 0999 E: sales@audusa.com

World Radio History

MIDLAND AUDIO XCHANGE

The Old Chapel
Forge Lane
Belbroughton
Worcestershire
DY9 9TD

t. 01562 731100
f. 01562 730228

e-mail. sales@midlandaudiox-change.co.uk
web . www.midlandaudiox-change.co.uk



Ex - demo and second hand items

	Was	Now			
Digital			Rega ELA Cherry X-demo	749	579
Audio Analogue Paganini CD X-demo	895	599	Tannoy Definition 700 Rosewood S/H	2000	950
dCS Purcell Upsampler Non Firewire S/H	2999	1695	Verity Fidelios Brand new Black Lacquer	8000	4499
dCS Delius 24/192 DAC Non Firewire S/H	5999	2995			
dCS Verdi SACD/CD Transport x-demo	9000	6499	Cables and Accessories		
Mark Levinson No 360s x-demo	7495	3999	Cardas Neutral Reference 1m RCA-BNC S/H	550	375
Rega Planet CD Black X-dem	498	349	Madrigal CZ Gel 1.5m Balanced new&boxed	599	299
Theta Pro Basic II DAC with Oscom/Balanced S/H	2990	1195	Madrigal MDC 2 1m Fatboy Digital cable new&boxed	319	159
Theta Generation V Balanced S/H	6290	2499	Madrigal MDC 2 0.5m Fatboy Digital cable new&boxed	279	139
Unison Research Unico Valve CD x-demo	1195	895	QED QNEXII 1m RCA-RCA Interconnect S/H	N/A	22
Wadia 301 Silver CD player 8 months old S/H	3499	2395	Siltech SQ58G3 2x4m Balanced Interconnect x-demo	2370	1499
			Siltech Signature G5 1m AES/EBU 110ohm Digital S/H	625	449
Analogue			Siltech SPX10 0.5m mains cable New Boxed	105	55
Clearaudio Solution/RB300 x-demo	1595	999	Siltech LS 25 2x 2.5m speaker cable x-demo	499	249
Clearaudio Unify Unipivot Tonearm New&Boxed	795	599	Spectral MH-330 15ft Interconnect RCA-RCA x-demo	800	499
Clearaudio Accurate MC x-demo	2800	1699	Spectral MH-750 15ft Interconnect RCA-RCA x-demo	1400	799
Clearaudio Victory MC New&Boxed	1030	699	Spectral MI-350 20 ft Speaker cable x-demo	2100	1199
Kuzma Stabi/Stogi S Turntable New& Boxed	N/A	1399	Van Den Hul 4x3m Revelation Speaker cable S/H	600	299
Linn LP12/Syrinx PU2 Valhalla S/H	N/A	399			
Lehmann Audio Black Cube SE New& Boxed	650	449	Tuners & Tape decks, power supplies		
McCormack Phono Stage New and Boxed	650	399	Audio Analogue Cherubini AM/FM Tuner X-demo	725	599
Rega Planar 3/Heed PSU/Bias S/H	630	239	Magnum Dynalab FT-R Remote Switcher for FT101A/Etude (new & boxed)	450	279
			Linn Kremlin Tuner S/H	2300	995
Preamplifiers					
Audio Analogue Bellini Remote Preamplifier X-demo	625	499			
Audio Research LS22 Valve Preamplifier S/H	4499	2300			
Audio Research LS2 Hybrid Preamplifier S/H	2289	749			
Amplifiers					
Audio Analogue Corelli Stereo Power Amplifier X-demo	695	479			
Audio Analogue Donizetti Mono Power Amplifiers X-demo	1050	729			
Arcam Diva A85 Integrated Amplifier Black S/H	800	499			
Arcam Diva P85 Power Amplifier Silver S/H	800	449			
EAR 509Mk1 Valve Mono block Re Tubed S/H	N/A	1799			
Krell KAV300i Integrated S/H	2590	1399			
Marl Levinson 431 Dual mono Amplifier S/H	6500	3795			
Nagra VPA Mono 845 Valve Amplifiers S/H	10000	7499			
Red Rose Sprit Integrated x-demo	1000	649			
Loudspeakers					
Martin Logan CLSII Anniversary Electrostatics 7 months Old S/H	6700	4295			
Martin Logan Aerius I Hybrid Electrostatics Oak S/H	2389	1299			
JM Lab Mini Utopia Black S/H	3799	1995			
Naim Audio Intro Black Ash S/H	875	499			
PMC FB1 Floorstander in Cherry S/H	1275	895			
Rel Acoustics Studio II Oak Subwoofer S/H	4500	1995			
Rega Jura Floorstanding Black Ash S/H	450	199			

Suppliers and installers of High Quality Audio Systems

- 47 Laboratory ● J M Labs
- Accuphase ● Krell
- ATC ● Kuzma
- Audio Physic ● Lavardin
- Audio Research ● Martin Logan
- Avalon Accoustics ● Michell
- Avid ● Nagra
- bel canto ● Primare
- Benz Micro ● ProAc
- Cardas ● Rega
- Clearaudio ● Siltech
- Conrad Johnson ● Sonus Faber
- dCS ● Spectral
- Densen ● Nordost
- DNM/Reson ● Sugden
- Electrocompaniet ● Transparent Audio
- Finite Elemente ● Verity Audio
- Graaf ● Wadia

Midland Audio X-change are looking for Audio Research, Krell, Mark Levinson, Naim Audio, Dcs, Wadia.

PINEWOOD MUSIC

of Winchester and Taunton

We always have the best

SONUS FABER AND JADIS

Many good amplifiers give lovely results with Sonus faber loudspeakers - but if you yearn for music to touch your heart and soul as well as your head, then Jadis amplification has to be experienced. Bursting with energy, dynamism and detail, this is the proverbial match made in heaven.

What is a Jadis amplifier like? It's like a feisty angel pulling at your heart strings. Does that sound tempting? Find out more by calling Brian Rivas or Alison Holmes at Pinewood Music. Nothing looks like a Jadis and nothing sounds like a Jadis - and you don't need to consider a second mortgage.

AGENCIES: Audio Research, Krell, Jadis, Sonus faber, Martin Logan, Koetsu, Copland, Prima Luna, Pathos, Oracle, Lyra, Unison Research, Transparent, Chord Company, Futuerglass, finitie-elemente, BCD Engineering

DEMONSTRATIONS BY APPOINTMENT SEVEN DAYS A WEEK AND EVENINGS

THE PINEWOOD MUSIC COMPANY
Winchester : 01962 776808 Taunton : 01460 54322
Mobile : 07860 351113 e-mail : brianriv@mac.com

IAN HARRISON HI-FI TEL: 01283 702875

HIFI AT DISCOUNT PRICES. FREE NATIONWIDE DELIVERY

MASSIVE SALE!

TRADE IN YOUR OLD MOVING COIL CARTRIDGE & SAVE UP TO 60% OFF THE RRP.

CARTRIDGES & STYL	HIFI FURNITURE	HEADPHONES	DVD
DENON	CUSTOM DESIGN	BEYER	SONY
SHURE	OPTIMUM	STAX	MINI DISC
AUDIO TECHNICA	ASH DESIGN	SENNHEISER	SONY
GOLDRING	APOLLO	SONY	LOUDSPEAKERS
SUMIKO	SOUND STYLE	AKG	OPERA
TRANS-	SOUND	GRADO	TRIANGLE
FIGURATION	ORGANISATION	AUDIO-	FINAL
LONDON (DECCA)	ALPHASON	TECHNICA	ELAC
GRADO	CABLES	DAT	HARBETH
ORTOFON	BLACK RHODIUM	TASCAM	EPOS
RESON	TRANSPARENT	SONY	ORELLE
CLEAR AUDIO	QED	CASSETTE DECKS	MISSION
KOETSU	ORTOFON	AMPLIFIERS	CREEK
SHUN MOOK	NORDOST	PIONEER	HALERO
TONEARMS	ARGENTO	SONY	MOTH
GRAHAM	AUDIO	TUNERS	C.A.T.
MOTH	SUPRA	DENON	GAMUT
CLEAR AUDIO	WIREWORLD	SONY	ALOIA
HADCOCK	CD PLAYERS	CREEK	EAR
MICHELL	MONRIO	PHONO STAGES	AUDIO VALVE
TURNABLES	GAMUT	TRICHORD	ACCUSTIC ARTS
GOLDRING	SONY	MOTH	GRAAF
MICHELL	CREEK	CREEK	ORELLE
CLEAR AUDIO	ORELLE	NAD	MONRIO
		EAR	AUDIO ANALOGUE
		TOM EVANS	PATHOS -
		CLEAR AUDIO	ACOUSTICS
			UNISON
			RE'EARCH

PLEASE PHONE TO CONFIRM PRICE & AVAILABILITY PRIOR TO ORDERING.
ALL GOODS ARE BRAND NEW & BOXED WITH FULL U.K. GUARANTEES.
NO EX. DEM OR EX DISPLAY GOODS. NO GREY IMPORTS. GOODS ARE NOT SUPPLIED ON APPROVAL. SORRY, NO GENERAL CATALOGUES. PLEASE PHONE OR WRITE FOR SPECIFIC REVIEWS, BROCHURES OR PRICES.
SUPPLIER OF HIFI PRODUCTS & ACCESSORIES SINCE 1986
MAIL ORDER ONLY FROM: IAN HARRISON, 7 MILL HILL, REPTON, DERBY, DE65 6GQ. TEL: 01283 702875. 9am - 9pm INCLUDING SUNDAYS.

CLASSIQUE SOUNDS.(LEICESTER) INC ONE THING.

VINTAGE HI-FI & VALVE SPECIALIST TEL 0845 123 5137 (local rate)(UKonly)
WANTED Vintage and modern hifi eqpt. Part exchange welcome.

Witch Amp complete active system including speakers and remote control all used and in very good condition

FOR SALE. PRE-POWER AMPLIFIERS

Luxman L-309V integrated amplifier. Gorgeous	£ 150	Murantz PM5 pure class A monoblocks. Boved/mint	£ POA
Pioneer C73 Ref Series control unit. Mint & boved	£ 250	Braun CEV510 tuner amp/book. Very rare. EX cond	£ POA
Rotel RX-800 tuner amp. Split pre-power. V large	£ 69	Linn LK100 power amplifier. Excellent condition.	£ 395
Naim Nap 90 & Nae 92 prepower. New style case	£ 495	Naim Nap 140 amp & Naim Nac 625 pre. Boved.	£ 349 pr
Cyrus 111 integrated amplifier. Excellent.	£ 299	Meridian Modular prepower amplifier. Ex cond.	£ 249
Quad 34 pre amplifier with MC input. 5 pin din. Bodd	£ 225	Cyrus XP4 power amplifier. 2 X. 50W. Excellent.	£ 199
Quad 44 pre amplifier. Boved in good condition.	£ 249	Quad 405/1. Boved and in good condition	£ 225
Sugden A21A integrated. 6 months old. Silver front	£ 695	Quad 405. upgraded to a 405/2 by Quad. Boved.	£ 250
John Bowers (Musical Fidelity) pre amplifier. Special edition. MM & MC + aux. and CD. Excellent. Boved. Rare	£ 175	Croft Super Micro valve pre amplifier. Excellent	£ 295
Croft Super Micro valve pre amplifier. Excellent	£ 295	Arcam Alpha 3 amplifier. Mint. Boved. Instructions	£ 100
Sugden All51 power amplifier. Boved.	£ 650	Crimson Electrik 510/520 prepower amplifier. Bsd.	£ 249
Murantz PM66SE K1 signature integrated amplifier	£ 199	Nytech CP112 pre amplifier. Excellent condition.	£ 99
Tube Technology Unisis valve pwr amp. Mint bsd	£ 995	Rogers Codet integrated tube amplifier. 10W	£ 175
CR Developments Carmenta Line valve pre-amp	£ 450	Harmon Karlon HK1400 line amplifier. Mint/boved	£ 199
Sumo Athena 11 pre amplifier. Line level. Superb.	£ 399	Kenwood KA660D integrated amplifier. Black.	£ 60
Sugden A25 amplifier. Excellent condition & instr	£ 200	Naim NAC 92 pre amp. S/NO 161840. Mint. Boved	£ 299
Quad 77 integrated amplifier. Mint. Boved. Instr.	£ 399	Quad 77 remote control for amplifier etc. Cost £300	£ 149
Musical Fidelity B1 integrated amplifier. Good cond	£ 125	Naim Nat 3R integrated amp & remote. Mint. Bsd	£ 495
Linn LK1 pre-amp and remote. Good condition.	£ 249	Linn LK2 power amplifier. Good condition.	£ 249
Quad 11s in various condition and prices	EPOA	Leak Stereo 20 valve power amplifiers from... £ POA	Naim
Nap 180 power amplifier. Mint. Boved.	£ 799	Harmon Karlon integrated valve amp. 110W. V rare	£ 299
Quad 303 power amplifiers from... £ 125		Arcam Alpha 2 amplifier. Mint. Boved. Instr	£ 95
Nakanishi CA5 pre-amplifier. Ex cond. Cost £750	£ 375	Nakanishi PAS 100W/CH power amp. Cost £1300	£ 650
NVA A80 mono power amplifiers X 2. REDUCED	£ 450	NVA A60 stereo power amplifier. Good condition.	£ 295
Arcam Zeta 1 Pro logic Cinema amp. Cost £999	£ 450	Quad 33 pre amplifiers. From.....	£ 75

TURNABLES

STD 305M motor unit. No arm. Nice deck.	£ 100	Transcriptors Hydraulic Reference turntable. Nice	£ 799
Garrard 301/401 chassiss in various condition from	£ 125	Thorens TD126 MK11 CW Dynavector MC&arm	£ 249
Rega planer 3 with RB300 tone arm and AT cart.	£ 200	Sansui XP-99 turntable. Semi auto. Superb at only	£ 125
Thorens TD160 with thorens tone arm.	£ 95		

SPEAKERS

Pair Quad ELS63 speakers. Serviced by One Thing Audio and with original boxes and packing. Ex condition.	£ 1399	Single Tannoy speaker with 10 inch monitor gold	£ 150
Quad ESL57 speakers in black. Excellent condition	£ 699	Celestion F30 floorstanders. Mint. Boved. Black ash	£ 129
Kef Cresta 2's. Cherry. Standmount. Mint & boved	£ 80	Black cloth fronts. 5 star review in Hifi World. Mint	£ 1699
Pair Quad ESL 57 spkrs. Fully rebuilt by One Thing Audio	£ 199	Quad ESL57 speakers. All fully serviced with full 3 months warranty. Hear what ESL57s should sound like. From £299 pr	£ 199
Quad ESL57's nice condition. Bronze finish.	£ 699	Tannoy Lancaster with 12" monitor golds.	£ 750
Roksan ROK-ONE speakers. Black. Mint. Boved.	£ 295	B&W DM4 speakers. Black finish	£ 85
Heybrook Heyhls. Black. Boved. Ex condition	£ 199	Rogers LS55 speakers. Rosewood. Boved. Ex cond	£ 199
Tannoy Chatsworth with 12 inch monitor golds.	£ 700	Mordant Short MS201 pearl. Brand new. Black	£ 169
Kef C20 Bookshelf monitor speakers in black	£ 60	Magneplanner MG 1.4. Boved with £400 oak stands	£ 999

OTHER ITEMS

Pair MAF stands for Quad ESL57. Fantastic upgrade	£ 175	Cyrus DAD3 Cd player with remote. Ex condition.	£ 275
Quad FM1 Valve tuners. Various prices from only	£ 20	Quad FM2 Valve tuner. Good condition.	£ 150
Quad FM4 tuner. 5 pin din version. Good condition	£ 200	Quad MC phono module for Quad 34 pre amplifier	£ 40
Murantz CD63 top loader cd player. Collectable.	£ 125	Phillips 101 top loading cd player. Collectable.	£ 125
Tno KT880L synthesiser tuner. AM/FM. Black.	£ 75	SME 3009 tonearms from.....	£ 125
Decca London international tone arm. New. Boved.	£ 175	Murantz CD52 Cd player. Ex condition.	£ 79
Quad 77 RDS FM tuner. Mint. Boved. Instructions	£ 399	Nakanishi CDP 2E CD player. Ex condition.	£ 250
Murantz SD275 twin cassette deck. Dolby B/C	£ 49	Aiwa AD-S750 Dolby B-C-S-11X pro cassette deck	£ 75
Linn Tuner. Mint. Boved. Very unusual. Cost £549	£ 249	Quad FM3 tuner in excellent condition.	£ 99

QUAD ESL57 & ELS63 PANELS/SERVICING ETC

Full rebuild including latest Otec panels/ bass panels & cosmetics 57s £1175

Reconditioned Quad ESL57 speakers from only £999.00.pr. Why spend £4000+?

ESL57 SPEAKERS STANDARD SERVICE £465.PR. Ring for info.

Exchange/ recon ESL57 bass panel £150. Treble £105. ESL63 panels £ 125 refurbished.

ELS63/ESL57 speaker stands, available in black or woodgrain @ £210.00 a pair.

New socks for ELS63s £45 pr. Many other spare parts available. Please ring.

"Classique Sounds servicing restores the Quads to a position where they can hold their head high", Jon Marks. HIFI WORLD. April 1999. Full servicing facilities available.

Troughline 3 tuner service & realignment £176.00. (excludes valves. Rarely needed).
One thing stereo decoder (back in stock) £205.00 Ex review Hifi world.

TRANSLUCENT (somewhat of a bargain) Hifi World. Jan 1999

PURE SILVER INTERCONNECT CABLE

99.99% pure silver conductors. Quality gold plated RCA phono plugs.

Half Metre terminated £70.00 One metre terminated £90.00. Available with Eichmann plugs + £30

New Translucent **ULTRA + Heavy duty. 99.99% pure silver (4N).**

Eichmann 24 Kt gold plate plugs £199.00 per metre. Or £149 per half metre.

7 day money back guarantee if not better than existing cable

NEW. 1.0MM 99.99% Pure silver wire @£15m. 0.5mm pure silver wire @ £6.00m
Translucent pure silver mains cable. 3 amp. £129.00 13 amp £249

NEW EAR/YOSHINO EQUIPMENT

Ear 834P MM/MC phono stage with/without volume. Brand new. Boved at only £715

Ear 834P MM phono stage. No volume control. Brand new. Boved at only £575

Ear 834L Line only valve pre-amplifier. Amazing. Brand new. Boved at only £655

TEL. 0845 123 5137 (Call. charged at local rate anywhere in the UK)

Tel 0116 2835821 or 07815188040 (Mobile). Callers by appt only.

Opening times 10.00am-6.00pm Mon-Friday. 10.00am-2.00pm Saturday.

61 Aylestone drive, Aylestone, Leicester, LE2 8QE. Email
classique_sounds@yahoo.co.uk

HEATHERDALE PRE-OWNED GUARANTEED EQUIPMENT EXPORT FACILITIES AVAILABLE

SPEAKERS

Tannoy Monitor Gold 12" in Lancaster size cabinets £795
Rel Strata 3 Sub Woofer (ex-demo) £750
Revel F30 Loudspeakers Ex Demo were £2395 now £2395
Acoustic Research 338 Stand Mount Speakers £275
Wharfedale Diamond II Speakers £60
Eltax Floor Standing Liberty 5+ Speakers £140
Eltax Symphony floor standing speakers £99

PRE AMPS

Naim Nac 92 Pre Amp £350
Exposure 11 & 12 Pre Amp & Power Supply £650
Proceed PAV Pre Amp £1395
Sony 1000 ESD Digital Pre Amp £150
Adcom GTP 450 Tuner/Pre-Amp £350

AMPLIFIERS

Advantage Integrated Amp £1495
Accuphase E307 Integrated Amp Unused £2995
Mark Levinson 20.5 Ref Mono Blocks, immaculate condition & boxed £3495
Haffer DH-200 Amp £125
Michell Alecto Amplifier £695
Mark Levinson 383 Int Amp £3495
Musical Fidelity P180 Power Amps With MF3a Pre Amp & Psu £695
Adcom GFA 5300 Power Amp £350

CD PLAYERS & TRANSPORT

CEC DX51 MK2 DAC with CEC TL51 Transport NEW £1495
Mark Levinson Reference CD System ML30.6 & ML31.5 Transport (ex demo, full warrantee) £17995
Shigaraki CD Transport & DAC (unused, retail £4275) £1495
Arcam CD72 CD Player (superb condition) £195
Rolsan Atessa CD Transport with ROC DA1 and ROK DS4 PSU £895
Accuphase DP55V CD Player Unused £2095

MISCELLANEOUS

Project Phono Box S/E (unused) (retails £125) £90
Stax 4040 Headphones (unused) (retails £1195) £850
Shunyata Aries interconnects 2m RCA (ex demo) (retails £1275) 775
Shunyata Aries 1m RCA (ex demo) (retails £850) £495
Kondo digital 1m RCA (unused) (retails £1200) £495
Selection of high quality Kontakt Audio Cables, bal & single ended
Lektropacks CDM-820 Multisystem Converter £125
Yamaha DVD Player S795 £145
Yamaha CI-810 Am/Fm Tuner £125

TURNABLES, CARTRIDGES & TONEARMS

Dynavector DV20X (unused) (retails £395) £285
RS Laboratory RS-A1 with rotary headshell (unused) (retails £850) £595
ZYX RS20-02H (0.48mv) (unused, Retail £450) £325
Pro-ject 6.9 Turntable (no cartridge fitted, Unused, Retail £600) £425
Pro-ject 12c carbon fibre arm (unused, Retail £500) £350
Selection of brand new discounted cartridges
Other services available. See in store @ Finance. Conditions Apply. See in store

ALL USED CARTRIDGES ARE CHECKED UNDER A MICROSCOPE BEFORE BEING OFFERED FOR SALE.

VISA - SWITCH - MASTER CARD - AMEX - DINERS CLUB WELCOME.
WE TAKE PART EXCHANGE ON NEW & USED STOCK and buy in for cash

3D by SHANLING acoustics

UK & IRELAND DISTRIBUTOR
Real Hi-Fi
Tel: 0870 909 6777
www.realhi-fi.com

Premier Dealers

LONDON KJ West One 0207 4868 262 Walrus Systems 0207 724 7224 KENT Matrix Hi-Fi 01332 292 391 Sounds of Music 01892 539 245 ESSEX Audition Music 01255 863 905	HAMPS. Origin Live 02380 578 877 BERKS. The Audio Consultants 0118 981 9891 BUCKS. Noteworthy Audio 01296 422 224 CAMBS. The Hi-Fi Company 01733 341 755	SUFFOLK The Emporium 01379 870 873 Audio Images 01502 582 853 NORTHANTS. H.G. Rapkin 01604 637 515 NORTH WEST Orpheus Audio 0161 428 153	YORKS Vickers Hi-Fi 01904 629 659 Premier Audio 01924 255 045 NEWCASTLE Global Hi-Fi Centre 0191 230 3600 SCOTLAND The Audio Salon 0141 333 9700 Hi-Fi Corner 0131 556 7901
---	---	---	--

SMALL IS BEST

It has probably always been true that it is the smaller companies which keep producing new and exciting products, especially in the field of hi-fi.

Alright, in Home Cinema I do handle Harman Kardon, a large company but to get reasonable value A/V amps etc, you do need size. Our favourite for hi-fi sound has always been AVI, who have always produced great sounding products at great prices, and although their new Laboratory range is more expensive, it looks great and pound/watt is probably cheaper.

Following on from the highly praised integrated and CD player, we now have the pre-amp at £1399, the stereo amp at £1299 plus their new 3-way floor-stander, the Trio at £3250. For smaller wallets the 2-way Pro-Nine+ at £700 goes great with the integrated. For active speakers ATC still has a great line-up in both home cinema and hi-fi, so do ring for a chat.

Our other favourite Electrocompaniet, is expected to appear again soon with great amps and cd player, while ESLAB's Digital amps are down in price. Don't forget our unique ALON range of speakers, (now renamed NOLA!

V'audio HI-FI Consultants
36 Druid Hill, Stoke Bishop, Bristol BS9 1EJ
Tel/Fax: 0117 968 6005
email: icvhifi@yahoo.co.uk



9 Finchfield Road West, Finchfield, Wolverhampton, WV3 8AY
Telephone/Fax 01902 380083

**For our 25th Anniversary
see what is new and used
on our New website**

www.midlandhifistudio.com/hifiworld

**Alternatively phone for a
mail list**

HEATHCOTE AUDIO

TEL: 01992 653999 MOBILE: 07860 511111 E-MAIL ADDRESS: HeathcoteAudio@aol.com WEB: www.heathcoteaudio.co.uk

VINYL		CD		LOUDSPEAKERS		SOLID STATE		CABLES		RACKS/STANDS		VALVE AMPS	
THE 'SOURCE' TURNTABLE HUGE SEPERATE PSU VERY RARE	BOXED £750	PERPETUAL TECHNOLOGIES PA-3/PA-1 SIGNATURE-2 & MODRIGHT PSU BRAND NEW BOXED LAST FEW!!	£1895	TDL TRANSMISSION LINE REFERENCE MONITORS	EXCLT £1295	PRIMARE PRE-30 & A-30.2 PRE/POWER AMPS (£2700?)	EX.DISPLAY/BOXED £1750	ACQUSTIC ZEN SILVER SIGNATURE 12 FT PAIR BALANCED XLR	£1450	SOUNDSTYLE STATUS RANGE ST-105/ST310 CANCELLED ORDER (EACH)	BRAND NEW/BOXED £275	UNISON RESEARCH 845 MONOBLOCKS AND MYSTERY-1 PRE AMP	MINT/BOXED £2995
FORSSELL AIR REFERENCE MK-11 WITH ARM AND FLYWHEEL (WAS \$30,000)	BOXED £7500	MERIDIAN 508 MK11 CD PLAYER	MINT/BOXED TBA	TDL TRANSMISSION LINE STUDIO MONITORS	EXCLT £995	ARCAM FMJ-A22 INTEGRATED/FMJ-P25 POWER AMP	MINT £1150	ACQUSTIC ZEN SILVER SIGNATURE 1 METRE RCA	£495	SOUNDSTYLE STATUS RANGE ST-100 (CANCELLED ORDER)	BRAND NEW/BOXED £250	UNISON RESEARCH S-6 REMOTE INTEGRATED (SUPER WRITE UPS)	EX DEM £1275
ARISTON Q-DECK	BOXED £175	MUSICAL FIDELITY A3 24/96/192 UPSAMPLING DAC	MINT TBA	CELESTION A-3 AWESOME FLOORSTANDERS IN CHERRYWOOD	VGC £1395	PRIMARE A-20 INTEGRATED AMP MK-11 (LAST ONE!!)	EX.DISPLAY/BOXED £450	SILVER ARROW 1 METRE BALANCED XLR DEM USE ONLY (£1250)	£650	SOUNDSTYLE ST-95 MIDI RACK	BRAND NEW/BOXED £195	AUDION SILVER KNIGHT 300B MONO'S & MATCHING 2-BOX PRE (ALL GOLD) REVALVED LOVELY!	£2250
CONRAD JOHNSON EF-1 STEREOPHILE CLASS A PHONO STAGE	MINT/BOXED £1095	WADIA DM X-32 DAC	MINT £595	CELESTION A-2 (SANTOS ROSEWOOD) LAST PAIR (£1500+)	BRAND NEW/BOXED £1195	GRYPHON SONATA ALLEGRO 2-BOX REFERENCE PRE AMP WAS £12000 6 MONTHS OLD	MINT/BOXED £6495	BLACK RHODIUM ORATORIO BALANCED 1 METRE (£997)	BRAND NEW £675	SOUNDSTYLE XS-105/XS -310 (CANCELLED ORDER)	BRAND NEW/BOXED £225	ORELLE SA-100R REMOTE AUDIOPHILE AMP	MINT £995
LEHMAN BLACK CUBE SE (RETAIL £650?)	BRAND NEW/BOXED £450	THETA PRE GEN III PRE AMP/ DAC	REDUCED £1495	CELESTION A-2 40 HOURS USE IN ROSEWOOD	EX.DEM. £995	GRYPHON S-100 CLASS-A POWER AMP	MINT £2895	BLACK RHODIUM ORATORIO PHONO 1 (E597) METRE	BRAND NEW £475	SOUNDSTYLE XS-105/XS -310 (CANCELLED ORDER)	BRAND NEW/BOXED £225	CYRUS STRAIGHTLINE	MINT £250
DENSEN DRIVE MC. PHONO STAGE & PSU	£275	THETA DS PRO BASIC-11 DAC	REDUCED £1095	CELESTION A-1 CHERRYWOOD	MINT BOXED £395	MARK LEVINSON NO.38 REMOTE PRE AMP/ NO 23. POWER AMP	MINT/BOXED £3995	BLACK RHODIUM SYMPHONY 0.5 METRE OR 1 METRE	BRAND NEW £50/65	SOUNDSTYLE XS-105/XS -310 (CANCELLED ORDER)	BRAND NEW/BOXED £225	THORENS TTA CLASS A POWER AMP	MINT £395
DENSEN DRIVE M.C. PHONO STAGE XPS.PSU	£325	MDNRIO 189 DAC & SEPERATE PSU.	REDUCED £395	CELESTION A-1 CHERRYWOOD	MINT BOXED £395	JEFF ROWLAND MODEL 58 STEREO POWER AMP (RARE)	EXCLT £2795	BLACK RHODIUM CONCERTO AWARD WINNING CABLE 0.5 METRE OR 1 METRE	BRAND NEW £80/100	SOUNDSTYLE XS-105/XS -310 (CANCELLED ORDER)	BRAND NEW/BOXED £225	NAD C-370 REMOTE INTEGRATED	EXCLT £225
TALK BREEZE PHONO STAGE (RETAIL £500?)	NEW £275	MSB LINK DAC-3 24/96 ETC	MINT/BOXED £395	CELESTION A-1 CHERRYWOOD	MINT BOXED £395	GAMUT D-200 POWER AMP (£3950 RETAIL)	BRAND NEW/BOXED £2995	MUSICAL FIDELITY NU-VISTA 2.5 METRE	BRAND NEW £275	SOUNDSTYLE XS-105/XS -310 (CANCELLED ORDER)	BRAND NEW/BOXED £225		
SUMIKO BLUE POINT SPECIAL	BRAND NEW SEALED BOX LAST ONE £225	CHORD DSC 1500/1600E DIGITAL PRE AMP/2-DACS	MINT/BOXED £2650	CELESTION A-1 CHERRYWOOD	MINT BOXED £395	AUDIO RESEARCH 100.2 (£3700+RETAIL)	BRAND NEW BOXED £2995			SOUNDSTYLE XS-105/XS -310 (CANCELLED ORDER)	BRAND NEW/BOXED £225		
		CEC TL-51 TRANSPORT/DX-51 MK.111 DAC (CHAMPAYNE GOLD £3000) 3 MONTHS OLD	MINT/BOXED £1995	CELESTION A-1 CHERRYWOOD	MINT BOXED £395	PLINIUS SA-102 CLASS A POWER AMP	MINT £2750			SOUNDSTYLE XS-105/XS -310 (CANCELLED ORDER)	BRAND NEW/BOXED £225		
		PERPETUAL TECHNOLOGIES SIGNATURE-2 PA-3/PA-1 /MODWRIGHT PSU	EX.DEM/BOXED £1595	CELESTION A-1 CHERRYWOOD	MINT BOXED £395	PINK TRIANGLE INTEGRAL 3 MONTHS USE (£4000)	MINT/BOXED £2495			SOUNDSTYLE XS-105/XS -310 (CANCELLED ORDER)	BRAND NEW/BOXED £225		
		MICROMEGA CD-3 TOPLOADING TRANSPORT/DUO-PRO DAC	MINT/BOXED £1195	CELESTION A-1 CHERRYWOOD	MINT BOXED £395					SOUNDSTYLE XS-105/XS -310 (CANCELLED ORDER)	BRAND NEW/BOXED £225		
		MICROMEGA SOLO TOP LOADING CD PLAYER	MINT/BOXED £995	CELESTION A-1 CHERRYWOOD	MINT BOXED £395					SOUNDSTYLE XS-105/XS -310 (CANCELLED ORDER)	BRAND NEW/BOXED £225		
		THETA CARMAN CD/DVD TRANSPORT	MINT/BOXED £750	CELESTION A-1 CHERRYWOOD	MINT BOXED £395					SOUNDSTYLE XS-105/XS -310 (CANCELLED ORDER)	BRAND NEW/BOXED £225		
		THETA PEARL TRANSPORT	EXCLT £575	CELESTION A-1 CHERRYWOOD	MINT BOXED £395					SOUNDSTYLE XS-105/XS -310 (CANCELLED ORDER)	BRAND NEW/BOXED £225		
		MARANTZ CDA-94 TRANSPORT (AUDIO SYN.MOD. AT&T/COAX)	EXCLT £575	CELESTION A-1 CHERRYWOOD	MINT BOXED £395					SOUNDSTYLE XS-105/XS -310 (CANCELLED ORDER)	BRAND NEW/BOXED £225		
		PIONEER PD-91	MINT/BOXED £375	CELESTION A-1 CHERRYWOOD	MINT BOXED £395					SOUNDSTYLE XS-105/XS -310 (CANCELLED ORDER)	BRAND NEW/BOXED £225		
		THORENS TCD TRANSPORT/ CD PLAYER	MINT £495	CELESTION A-1 CHERRYWOOD	MINT BOXED £395					SOUNDSTYLE XS-105/XS -310 (CANCELLED ORDER)	BRAND NEW/BOXED £225		
		PRIMARE V-25 DVD PLAYER PROGRESSIVE SCAN ETC(£1000 LAST ONE!!)	EX DISPLAY/BOXED £695	CELESTION A-1 CHERRYWOOD	MINT BOXED £395					SOUNDSTYLE XS-105/XS -310 (CANCELLED ORDER)	BRAND NEW/BOXED £225		
				CELESTION A-1 CHERRYWOOD	MINT BOXED £395					SOUNDSTYLE XS-105/XS -310 (CANCELLED ORDER)	BRAND NEW/BOXED £225		
				CELESTION A-1 CHERRYWOOD	MINT BOXED £395					SOUNDSTYLE XS-105/XS -310 (CANCELLED ORDER)	BRAND NEW/BOXED £225		
				CELESTION A-1 CHERRYWOOD	MINT BOXED £395					SOUNDSTYLE XS-105/XS -310 (CANCELLED ORDER)	BRAND NEW/BOXED £225		
				CELESTION A-1 CHERRYWOOD	MINT BOXED £395					SOUNDSTYLE XS-105/XS -310 (CANCELLED ORDER)	BRAND NEW/BOXED £225		
				CELESTION A-1 CHERRYWOOD	MINT BOXED £395					SOUNDSTYLE XS-105/XS -310 (CANCELLED ORDER)	BRAND NEW/BOXED £225		
				CELESTION A-1 CHERRYWOOD	MINT BOXED £395					SOUNDSTYLE XS-105/XS -310 (CANCELLED ORDER)	BRAND NEW/BOXED £225		
				CELESTION A-1 CHERRYWOOD	MINT BOXED £395					SOUNDSTYLE XS-105/XS -310 (CANCELLED ORDER)	BRAND NEW/BOXED £225		
				CELESTION A-1 CHERRYWOOD	MINT BOXED £395					SOUNDSTYLE XS-105/XS -310 (CANCELLED ORDER)	BRAND NEW/BOXED £225		
				CELESTION A-1 CHERRYWOOD	MINT BOXED £395					SOUNDSTYLE XS-105/XS -310 (CANCELLED ORDER)	BRAND NEW/BOXED £225		
				CELESTION A-1 CHERRYWOOD	MINT BOXED £395					SOUNDSTYLE XS-105/XS -310 (CANCELLED ORDER)	BRAND NEW/BOXED £225		
				CELESTION A-1 CHERRYWOOD	MINT BOXED £395					SOUNDSTYLE XS-105/XS -310 (CANCELLED ORDER)	BRAND NEW/BOXED £225		
				CELESTION A-1 CHERRYWOOD	MINT BOXED £395					SOUNDSTYLE XS-105/XS -310 (CANCELLED ORDER)	BRAND NEW/BOXED £225		
				CELESTION A-1 CHERRYWOOD	MINT BOXED £395					SOUNDSTYLE XS-105/XS -310 (CANCELLED ORDER)	BRAND NEW/BOXED £225		
				CELESTION A-1 CHERRYWOOD	MINT BOXED £395					SOUNDSTYLE XS-105/XS -310 (CANCELLED ORDER)	BRAND NEW/BOXED £225		
				CELESTION A-1 CHERRYWOOD	MINT BOXED £395					SOUNDSTYLE XS-105/XS -310 (CANCELLED ORDER)	BRAND NEW/BOXED £225		
				CELESTION A-1 CHERRYWOOD	MINT BOXED £395					SOUNDSTYLE XS-105/XS -310 (CANCELLED ORDER)	BRAND NEW/BOXED £225		
				CELESTION A-1 CHERRYWOOD	MINT BOXED £395					SOUNDSTYLE XS-105/XS -310 (CANCELLED ORDER)	BRAND NEW/BOXED £225		
				CELESTION A-1 CHERRYWOOD	MINT BOXED £395					SOUNDSTYLE XS-105/XS -310 (CANCELLED ORDER)	BRAND NEW/BOXED £225		
				CELESTION A-1 CHERRYWOOD	MINT BOXED £395					SOUNDSTYLE XS-105/XS -310 (CANCELLED ORDER)	BRAND NEW/BOXED £225		
				CELESTION A-1 CHERRYWOOD	MINT BOXED £395					SOUNDSTYLE XS-105/XS -310 (CANCELLED ORDER)	BRAND NEW/BOXED £225		
				CELESTION A-1 CHERRYWOOD	MINT BOXED £395					SOUNDSTYLE XS-105/XS -310 (CANCELLED ORDER)	BRAND NEW/BOXED £225		
				CELESTION A-1 CHERRYWOOD	MINT BOXED £395					SOUNDSTYLE XS-105/XS -310 (CANCELLED ORDER)	BRAND NEW/BOXED £225		
				CELESTION A-1 CHERRYWOOD	MINT BOXED £395					SOUNDSTYLE XS-105/XS -310 (CANCELLED ORDER)	BRAND NEW/BOXED £225		
				CELESTION A-1 CHERRYWOOD	MINT BOXED £395					SOUNDSTYLE XS-105/XS -310 (CANCELLED ORDER)	BRAND NEW/BOXED £225		
				CELESTION A-1 CHERRYWOOD	MINT BOXED £395					SOUNDSTYLE XS-105/XS -310 (CANCELLED ORDER)	BRAND NEW/BOXED £225		
				CELESTION A-1 CHERRYWOOD	MINT BOXED £395					SOUNDSTYLE XS-105/XS -310 (CANCELLED ORDER)	BRAND NEW/BOXED £225		
				CELESTION A-1 CHERRYWOOD	MINT BOXED £395					SOUNDSTYLE XS-105/XS -310 (CANCELLED ORDER)	BRAND NEW/BOXED £225		
				CELESTION A-1 CHERRYWOOD	MINT BOXED £395					SOUNDSTYLE XS-105/XS -310 (CANCELLED ORDER)	BRAND NEW/BOXED £225		
				CELESTION A-1 CHERRYWOOD	MINT BOXED £395					SOUNDSTYLE XS-105/XS -310 (CANCELLED ORDER)	BRAND NEW/BOXED £225		
				CELESTION A-1 CHERRYWOOD	MINT BOXED £395					SOUNDSTYLE XS-105/XS -310 (CANCELLED ORDER)	BRAND NEW/BOXED £225		
				CELESTION A-1 CHERRYWOOD	MINT BOXED £395					SOUNDSTYLE XS-105/XS -310 (CANCELLED ORDER)	BRAND NEW/BOXED £225		
				CELESTION A-1 CHERRYWOOD	MINT BOXED £395					SOUNDSTYLE XS-105/XS -310 (CANCELLED ORDER)	BRAND NEW/BOXED £225		
				CELESTION A-1 CHERRYWOOD	MINT BOXED £395					SOUNDSTYLE XS-105/XS -310 (CANCELLED ORDER)	BRAND NEW/BOXED £225		
				CELESTION A-1 CHERRYWOOD	MINT BOXED £395					SOUNDSTYLE XS-105/XS -310 (CANCELLED ORDER)	BRAND NEW/BOXED £225		
				CELESTION A-1 CHERRYWOOD	MINT BOXED £395					SOUNDSTYLE XS-105/XS -310 (CANCELLED ORDER)	BRAND NEW/BOXED £225		
				CELESTION A-1 CHERRYWOOD	MINT BOXED £395					SOUNDSTYLE XS-105/XS -310 (CANCELLED ORDER)	BRAND NEW/BOXED £225		
				CELESTION A-1 CHERRYWOOD	MINT BOXED £395					SOUNDSTYLE XS-105/XS -310 (CANCELLED ORDER)	BRAND NEW/BOXED £225		
				CELESTION A-1 CHERRYWOOD	MINT BOXED £395					SOUNDSTYLE XS-105/XS -310 (CANCELLED ORDER)	BRAND NEW/BOXED £225		
				CELESTION A-1 CHERRYWOOD	MINT BOXED £395					SOUNDSTYLE XS-105/XS -310 (CANCELLED ORDER)	BRAND NEW/BOXED £225		
				CELESTION A-1 CHERRYWOOD	MINT BOXED £395					SOUNDSTYLE XS-105/XS -310 (CANCELLED ORDER)	BRAND NEW/BOXED £225		
				CELESTION A-1 CHERRYWOOD	MINT BOXED £395					SOUNDSTYLE XS-105/XS -310 (CANCELLED ORDER)	BRAND NEW/BOXED £225		
				CELESTION A-1 CHERRYWOOD	MINT BOXED £395					SOUNDSTYLE XS-105/XS -310 (CANCELLED ORDER)	BRAND NEW/BOXED £225		
				CELESTION A-1 CHERRYWOOD	MINT BOXED £395					SOUNDSTYLE XS-105/XS -310 (CANCELLED ORDER)	BRAND NEW/BOXED £225		
				CELESTION A-1 CHERRYWOOD	MINT BOXED £395					SOUNDSTYLE XS-105/XS -310 (CANCELLED ORDER)	BRAND NEW/BOXED £225		
				CELESTION A-1 CHERRYWOOD	MINT BOXED £395					SOUNDSTYLE XS-105/XS -310 (CANCELLED ORDER)	BRAND NEW/BOXED £225		
				CELESTION A-1 CHERRYWOOD	MINT BOXED £395					SOUNDSTYLE XS-105/XS -310 (CANCELLED ORDER)	BRAND NEW/BOXED £225		
				CELESTION A-1 CHERRYWOOD	MINT BOXED £395					SOUNDSTYLE XS-105/XS -310 (CANCELLED ORDER)	BRAND NEW/BOXED £225		
				CELESTION A-1 CHERRYWOOD	MINT BOXED £395					SOUNDSTYLE XS-105/XS -310 (CANCELLED ORDER)	BRAND NEW/BOXED £225		
				CELESTION A-1 CHERRYWOOD	MINT BOXED £395					SOUNDSTYLE XS-105/XS -310 (CANCELLED ORDER)	BRAND NEW/BOXED £225		
				CELESTION A-1 CHERRYWOOD	MINT BOXED £395					SOUNDSTYLE XS-105/XS -310 (CANCELLED ORDER)	BRAND NEW/BOXED £225		
				CELESTION A-1 CHERRYWOOD	MINT BOXED £395					SOUNDSTYLE XS-105/XS -310 (CANCELLED ORDER)	BRAND NEW/BOXED £225		
				CELESTION A-1 CHERRYWOOD	MINT BOXED £395					SOUNDSTYLE XS-105/XS -310 (CANCELLED ORDER)	BRAND NEW/BOXED £225		
				CELESTION A-1 CHERRYWOOD	MINT BOXED £395					SOUNDSTYLE XS-105/XS -310 (CANCELLED ORDER)	BRAND NEW/BOXED £225		
				CELESTION A-1 CHERRYWOOD	MINT BOXED £395					SOUNDSTYLE XS-105/XS -310 (CANCELLED ORDER)	BRAND NEW/BOXED £225		
				CELESTION A-1 CHERRYWOOD	MINT BOXED £395					SOUNDSTYLE XS-105/XS -310 (CANCELLED ORDER)	BRAND NEW/BOXED £225		
				CELESTION A-1 CHERRYWOOD	MINT BOXED £395					SOUNDSTYLE XS-105/XS -310 (CANCELLED ORDER)	BRAND NEW/BOXED £225		
				CELESTION A-1 CHERRYWOOD	MINT BOXED £395					SOUNDSTYLE XS-105/XS -310 (CANCELLED ORDER)	BRAND NEW/BOXED £225		
				CELESTION A-1 CHERRYWOOD	MINT BOXED £395					SOUNDSTYLE XS-105/XS -310 (CANCELLED ORDER)	BRAND NEW/BOXED £225		
				CELESTION A-1 CHERRYWOOD	MINT BOXED £395					SOUNDSTYLE XS-105/XS -310 (CANCELLED ORDER)	BRAND NEW/BOXED £225		
				CELESTION A-1 CHERRYWOOD	MINT BOXED £395					SOUNDSTYLE XS-105/XS -310 (CANCELLED ORDER)	BRAND NEW/BOXED £225		
				CELESTION A-1 CHERRYWOOD	MINT BOXED £395					SOUNDSTYLE XS-105/XS -310 (CANCELLED ORDER)	BRAND NEW/BOXED £225		
				CELESTION A-1 CHERRYWOOD	MINT BOXED £395					SOUNDSTYLE XS-105/XS -310 (CANCELLED ORDER)	BRAND NEW/BOXED £225		
				CELESTION A-1 CHERRYWOOD	MINT BOXED £395					SOUNDSTYLE XS-105/XS -310 (CANCELLED ORDER)	BRAND NEW/BOXED £225		
				CELESTION A-1 CHERRYWOOD	MINT BOXED £395					SOUNDSTYLE XS-105/XS -310 (CANCELLED ORDER)	BRAND NEW/BOXED £225		
				CELESTION A-1 CHERRYWOOD	MINT BOXED £395					SOUNDSTYLE XS-105/XS -310 (CANCELLED ORDER)	BRAND NEW/BOXED £225		
				CELESTION A-1 CHERRYWOOD	MINT BOXED £395					SOUNDSTYLE XS-105/XS -310 (CANCELLED ORDER)	BRAND NEW/BOXED £225		

audio cables & accessories - bigears speaker cable and interconnects - mail order specialists worldwide.

NODDY AND BIGEARS HI-FI

quality used vintage and modern equipment bought, sold-part-exchange most welcome!!

STOCKIST OF NEW AUDION VALVE AMPLIFIERS & SHANLING CD PLAYERS

VALVE/AMPLIFIERS

AUDION EL34 STEREO POWER AMP	£899
AUDION 300B STEREO POWER AMP	£1999
AUDION PX25 STEREO POWER AMP	£2595
PATHOS New Classic One, integrated, 70 watts[NEW]	£1325
PATHOS Logos, integrated, 110 watts[NEW]	£2750
Unison Research Unico P [hybrid, integrated, 50 watts NEW]	£750
Unison Research Unico Line [hybrid, integrated, 80 watts NEW]	£900
Conpland CSA14 hybrid valve/transistor	£675
Black Cat Electronics Type 46 Valve Stereo bloc[Lowthers]	£850
Black Cat Electronics Valve Pre amp, Valve Phonostage/linestage	£275
Papworth M100's [boxes as new] two mono blocs EL34's	£2250
Quad II's valve, with original 22 pre-amp in very good original condition KT66	£750
Quad II's re-built beautifully by Concorde EL34's mint	£575
Leak Stereo 20, valve, good rebuilt condition with stereo pre EL84	£425
Rogers Cadet II pre/power valve, near mint ECL86	£225
Rogers HG88 [ECL86's]	£225
Leak TL10's rebuilt/mint, valve, beautifully clean KT61/SP25	£650
Dynatron LF15/16 mint excellent pair, valve, WITH original cages EL84	£425
Pye Mozart two mono blocks, valve, plus mono valve tuner nice single ended EL34	£425
Audion Silver Night 300b beautiful x 2 Monoblocs, new valves [£2000]	£1250
Shanling integrated amp [New]	£1250
Superb Croft Super Micro A tube pre	£375

TRANSISTOR

Puccini integrated, 40 watts[NEW]	£525
Corelli stereo power, 60 watts [NEW]	£695
QUAD 99 two mono blocks	£725
QUAD 77 integrated	£375
QUAD 33/303 pre/power	£175
QUAD 44 pre-amps from	£265
QUAD 34 pre-amps from	£175
QUAD 44/405 pre/power	£425
QUAD 34/306 pre/power	£400
QUAD 44 pre-amp	£275
Exposure T1 and T2 Pre-amp and Power Supply	£575
Arcam Alpha 8 amp	£215
Marantz PM60100SE integrated	£175
Meridian 201 pre	£345
Meridian 605 power monobloc[Boxed]	£875
Onix OA22 integrated	£175
Musical Fidelity B1	£125
Sansui C77/B77 Pre-Power	
Sugden C51/P51	£225

SPEAKERS

QUAD ESL57's black, one owner, as new!!	£850
Tannoy Canterbury's 12" reds nice,	£2500
Tannoy Lancasters 15" GOLDS very nice	£1250
Snell speakers JII's	£415
Snell speakers K's	£325
Lowther Dual Position Acoustas Horn Loudspeakers PM7A	£750
Tannoy 3LZ's 10" golds lovely condition	£450
Wharefate Arduales very nice original condition, a seriously under-rated speaker	£525
Leak Sandwith good condition	£120
Rogers BBC LS3/5A's teak finish very good clean condition	£650
Chartwell BBC LS3/5A's beautiful	£650
Rogers LS3/5A's black ash original boxes	£650
PROAC RESPONSE 1 S. SPEAKERS [£1200]	£650
CELESTION VF302 Loudspeakers Cost £650	£475
Monitor Audio Monitor 3 Speakers (Top Tweeter Model)	£295
TDL ELECTRONICS, RTL3 FLOORSTANDING SPEAKERS	£375
Epos ES 11	£275
Epos M15's floor standers	£385
BOSE 141 [new]	£150
Rogers LS1 Bookshelf speakers	£125
Tangent TM1 [Kef units, 8" and T27 treble, nice condition]	£185
KEF Coda 9 Speakers	£175
Tannoy 12" dual concentric PA speakers [£1300 new]	£425
JR150's [uses LS3/5A drivers, cylindrical aluminium cabinets]	£375
Acoustic Research floor standers, two 8" bass/mids soft dome tweeter	£225
FULL RANGE OF OPERA handmade Hardwood speakers	P.O.A
RUARK PRELUDE II's [near mint, £950]	£425
RUARK EQUINOX stand mounted, boxed, immaculate[£2000]	£835

CD PLAYER

SHANLING SCD-T200C[NEW]	£2150
SHANLING CDT100 VALVE cd player [new]	£1650
Unison Research Unico CD [NEW]	£1195
Audio Analogue Paganini CD [NEW]	£895
Audio Analogue Maestro CD [NEW]	£1700
Sonic Frontiers Anthem CD1 [as new and boxed £1850]	£950
Arcam Alpha 8, cd	£165
Marantz CD6000 OSE	£155
Marantz CD5000 [brand new and boxed]	£125
MYRAD CD10	£215
MYRAD CD20	£215
Pioneer reference CD PD91	£295
Cyrus[CD] daD 1.5 silver	£395
Micromega stage 2 CD	£225
Nagaoka CD NG7700[LINN]	£225
DPA PDM1 Series 2 DAC	£195
	£135

OTHER EQUIPMENT

Graham Slee phono stage ERA GOLD	£460
Graham Slee phono stage GRAM AMP 2SE	£195
Graham Slee phono stage GRAM AMP 2	£125
JBL 2405 tweeters	£500
QUAD FM3 £100 QUAD FM4	£250
VITAVOX S2's compression drivers	£600
Vitavox S3's [Various 4 cell horns]	£350
Nakamichi BX2[cassette deck]	£115
AUDIO Alchemy-dac in a box	£85
AVI Pre 200 series	£225
Tandberg 3002 Pre Amp	£175

TURNTABLES

GARRARD 401, LINN LVV ARM AND LINN K9 CARTRIDGE	£425
THORENS TD125-SME ARM-SHURE V15	£325
THORENS TD166 MKII	£125
MICHELL orbe £2298 MICHELL gyrodec	£1126
MICHELL gyrode SE	£895
MICHELL Technodec	£575
MICHELL Techno Arm 'A'	£399
ORIGIN LIVE AURORA	£970
ORIGIN LIVE AURORA GOLD	£1470
ORIGIN LIVE MODIFIED OLI ARM	£359
ORIGIN LIVE SILVER ARM	£599
ORIGIN LIVE ENCOUNTER ARM	£970
ORIGIN LIVE ILLUSTRIOUS ARM	£1570

MAIN STOCKISTS OF:

GOOD TRADE-IN GIVEN ON NEW EQUIPMENT - CARTRIDGES VALVES AND ODDS AN' ENDS!!!!!! AUDIO CABLES & ACCESSORIES-BIGEARS SILVER SPEAKER CABLE 4 METRES TERMINATED £135 ONE METRE PAIR OF SILVER INTERCONNECTS REALLY OPENS OUT THE SOUND, WONDERFULLY DYNAMIC £65 PHONO OR 5 PIN DIN [BOTH AS GOOD AS ANY ANYWHERE AT ANY PRICE!] - MAIL-ORDER SPECIALISTS-WORLDWIDE!! QUALITY USED VINTAGE & MODERN EQUIPMENT BOUGHT-SOLD PART-EXCHANGE MOST WELCOME*FEEL FREE TO PHONE OR E-MAIL FOR FRIENDLY ADVICE-IF I HAVEN'T GOT WHAT YOU WANT I CAN PROBABLY GET IT!!!

Tel:01736-740421 e-mail chrisbircchley@btinternet.com
website: www.geocities.com/noddyandbigearshifi

FOR ALL
YOUR
ADVERTISING
REQUIREMENTS
PLEASE
CALL
DEBI SILVER
ON
0870 242 0567

Oxford Audio Consultants Ltd.

OUR SUPERB SERVICE IS THE SAME REGARDLESS OF PRICE



Now Demonstrating



Ex-Demonstration & Previously Owned Equipment

SALE LIST

Roksan Caspian integrated amp	£695	SH
TANNOY DIMENSION 8 loudspeakers	£2400	SH
MICHELL GYRO SE TURNTABLE HARDLY USED	£795	XD
SME V Tonearm	£895	SH
WILSON SYSTEM 6.1 FERRARI GREY	£8995	SH
SONUS FABER GUARNERIS - slight cabinet damage	£2995	SH
KRELL 300IL	£1795	SH
MARTIN LOGAN ODYSSEY mint	£4995	SH
KRELL 280CD PLAYER	£2495	SH
PROAC STUDIO 125 LIGHT OAK	£ 750	XD
ONKYO INTEGRA DVD PROCESSOR POWER AMP	£4500	XD
KRELL KRC2 PREAMPLIFIER	£1295	SH
WADIA 2000 CD TRANSPORT	£1295	SH
WADIA 64.4 DAC	£1295	SH
TRANSPARENT CABLES VARIOUS ASK FOR DETAILS	P.O.A.	XD
VIENNA ACOUSTICS MAHLER	£2995	SH
AUDIO ANALOGUE MAESTRO AMP	£995	SH
CONRAD JOHNSON PV10B PRE AMPLIFIER	£595	SH
KRELL FPB200 POWER AMPLIFIER	£3500	SH
AUDIO PHYSIC CALDERAS	P.O.A.	SH
MARTIN LOGAN CLSII 1/2 MINT	£3500	XD
DENON DV5000 DVD PLAYER	£495	SH
ONKYO DS 989 AV AMP	£995	SH
KRELL FPB700ex (upgraded from 600)	£9500	SH
KRELL 250p PRE AMPLIFIER	£995	SH
GRAAF 13.5 PRE AMPLIFIER just revalved	£1495	SH
VERITAS P400 POWER AMPLIFIER	£ 995	XD

SH - Second Hand XD - EX Demonstration

0% interest free credit

Licensed Credit Broker

REFER TO OUR WEBSITE FOR THE LATEST UPDATED SALE LIST.

Agenies include: Acoustic Energy, Alcamo, Audio Analogue, Audio Research, Beyer, BOSE, Castle Chord Company, Copland, Creston, Denon, Dapason, Dwin Electronics, Fujitsu, GM Audi, Goding, Graal, Integra Systems, IXOS, Jades, Jamo, Kel, Koetsu, Krell, Luxson, Living Control, Loewe TV/video, Jinn, Classix, Lyra, Mastanz, Martin Logan, Michell, Musical Fidelity, NAD, Naim, NEC Gas Plasma Screens, Nakamichi, Nordost, Onkyo, Opera, Ortofon, Parasound, Pioneer, Proke, Project Turntables, QED, Muterom, Quad, Quadratec, REL Subwoofers, Serenus, Sharp LCD TVs, SME, Sonus Faber, Son-a System, Soundstyle, Stands Unique, Star, Stewart Screens, Tag McLaren Tanfloy, Teac, Thalia, Transparent Union Research, Van den Hul, Vibe Acoustics subwoofers, Vidgo, Vienna Acoustics, Wilson, Yamaha.

TAX FREE EXPORT SERVICE
MAIL-ORDER AVAILABLE ON MANY ITEMS

Canta House, Park End Street

Oxford OX1 1JD

Telephone: Oxford (01865) 790879

Facsimile: Oxford (01865) 791665

E-MAIL: oxford.audio@btinternet.com

WEBSITE: www.oxfordaudio.co.uk



V.A.T. No.
729580013



QUALITY USED
EQUIPMENT,
BOUGHT, SOLD,
PART EXCHANGE

TEL/FAX
0121 747 4246



URGENTLY REQUIRED
LINN, NAIM,
MERIDIAN, QUAD,
CASH WAITING

	RRP	NOW £
ACCUPHASE DP70V	4000	1495
ATC C2 SUBWOOFER	1700	995
ART AUDIO DIAVLO 300B BALANCED CHROME GOLD 6MTHS OLD	4500	1995
AUDIO LAB CDM DAX	N/A	995
AUDIO NOTE M3 LINE PRE	3700	1995
AUDIO NOTE TT2 REGA RB600 AN 1Q3	1585	795
AUDIO RESEARCH LS7	1400	695
AUDIO RESEARCH D130	2000	995
AVANTEGARDE SOLO SILVER	4700	1995
AVANTEGARDE DUO RED LATER SUBS	12000	3995
AYRE K-5X PRE	3000	1795
BAT 515E PRE 6 MTHS OLD	7950	3995
BOW WIZARD CD + WAND	3500	1495
CARDAS GOLDEN REFERENCE 2.5 MTR BIWIRE	2000	1295
CLEARAUDIO REFERENCE, TQ1 ARM	6020	3295
CLEARAUDIO MAXIMUM SOLUTION, TQ1 LINEAR ARM	7575	3495
DCS VERDI LA SCALA	10000	6995
DCS VERDI	9000	5495
DENSEN BX340 NEW	1850	1250
DENSEN B400XS NEW	2500	1795
DENSEN B200 NEW	1000	695
DYNAUDIO CONTOUR 2.8 CHERRY	3200	1195
EAR V20	3500	1995
GRYPHON ADAGIO CD PLAYER	5000	2695
HARMONIC TECHNOLOGY MD1 DIGITAL RCA I MTR	400	195
KIMBER 4TC 2X4 MTR BANANA'S	250	150
KRELL KAV 250A	3698	1795
KRELL KRC-HR KPE PHONO	7639	3295
KRELL FPB 300CX	9450	5995
LFD MISTRAL SILVER SIGNATURE INTEGRATED	950	495
LUXMAN K-351 CASSETTE DECK	N/A	150
MANA SOUNDFRAME	175	95
MARANTZ SC12SI SACD DVD CD EX DEM	3500	1795
MARTIN LOGAN CLARITY CHERRY	2500	1695
MARTIN LOGAN AERIUS I	2200	1095
MARK LEVINSON 383 INTEGRATED AMP	6500	3995
MERIDIAN 562V	1300	395
MERIDIAN 502	1500	795
MONITOR AUDIO STUDIO 60 PIANO ROSEWOOD	5000	1995
MONITOR AUDIO STUDIO CENTRE PIANO ROSEWOOD	2000	795
NAIM CDS 2 + XPS	6500	3295
NAIM CDX	2500	1195
NAIM PSC	195	125
NAIM CD5	1230	795
NAIM 140 OLIVE	800	350
NAIM 180	1220	595
NAIM 112	660	450
NAIM 92	N/A	150
NAIM CDS MK1	4000	1595
NAIM FLASH 2 NEW	350	195
NORDOST BLUE HEAVEN 3MTR BIWIRE BANANA REV 11	650	350
PLINIUS CD LAD PRE	2400	995
REGA ELA CHERRY	800	395
REGA PLANET CD	450	250
REVOLVER R33 CHERRY NEW	600	295
ROKSAN XERXES X ROSEWOOD XPS5 DS1.5 NEW UNUSED	3000	1995
SOUNDLAB MILLENIUM 3 NEW SEALED CRATES	8295	3495
SONUS FABER AMATI HOMAGE	11850	7995
SONUS FABER CONCERTO WITH IRONWOOD STANDS	1300	795
SONY XA333ES SACD	1200	795
SPECTRAL MIT 350 MK11 IMTR RCA INTERCONNECT	1500	695
SUGDEN MASTERCLASS CD	2700	1795
TANNOY DIMENSION 8	4000	2495
TARA LABS DECADE 2MTR BALANCED	2300	595
T AND A TALLIS 5.1 NEW UNUSED	2200	1295
THETA PROGENY	1100	295
WADIA 861SE SILVER 6 MTHS OLD	1995	6995
WILSON BENESCH ACT 2	XXX	3995

OPEN MON-SUN 10.00 TO 8.00

Website: www.centralaudio.co.uk

E-mail: tony@centralaudio.co.uk

ALSO AGENTS FOR

Advantage, Balanced audio technologies, Boulder, Burmester, Egleston, Hovland, Kharma, Lumley, Pass labs, Sound lab, VTL.

5 MINS FROM M25

MATRIX HI-FI

VALVE AMP
REPAIRS

WE ARE PROUD TO ANNOUNCE THAT WE ARE NOW DEALERS FOR ROKSAN, ORTOFON, GOLDRING, PROJECT, L.A.R. WE HAVE CARTRIDGES IN STOCK, AND THE ROKSAN RADIUS RECORD DECK ON DEMO - MORE ARRIVING DAILY - PLEASE RING OR SEE WEB

NEW INCA KATANA CD PLAYER NOW ON DEMO

RECORD DECKS/HEAD AMPS/TONE ARMS
 NEW IN STOCK, GOLDRING GR1 WITH HB50 ARM AND GOLDRING ELECTRA CART BRILLIANT £139.00
 NEW PROJECT PHONO STAGE MM MC £45.00
 NEW PROJECT VALVE PHONO STAGE £300.00
 MM/MC WITH OUTBOARD PSU
 NEW ROKSAN RADIUS DECK WITH UNI PIVOT ARM £349.00
 NEW MICHELLE UNI COVER PLEASE RING £44.99
 PROJECT PHONO BOX SE - MC MM £75.00
 THORENS 124H CHASSIS - MINT £399.00
 EQUINOX HEAD AMP MC £399.00
 TOWNSEND ROK WITH SILATE PLINTH AND LINN AKTITO ARM VGC £699.00
 HELIOS ARM MK1 £150.00
 ROKSAN XIRYES SMP CUT £199.00
 NOTTINGHAM ANALOG MENTOR 10NE ARM £349.00
 AUDIONOTE TT1 ORIGIN LIVE RB390 £499.00
 SYSTEM DECK IIX WITH LINN LVX ARM £199.00
 THORENS TD150 £70.00
 LINN LP12 BASIC PLUS ARM IN M/PLINTH £600.00
 MANTICORE WITH ARM & AUDIO TECHNICA CARTRIDGE, BLACK ASH £249.00
 RAD 5120 - NEW GOLDRING ELAN CART £99.00

PRE-AMPS
 AUDIO RESEARCH LST LINE PRE £699.00
 RAPPAPORT - Russ Andrews modified £199.00
 GATE VALVE PRE NEW £649.00
 GATE TOP OF THE RANGE PRE £649.00
 HAFLER PRE £120.00
 TAG MC1 AREN F3 PA10 - MC & MM £349.00

POWER AMPLIFIERS - VALVES
 ELECTRON JH 50 EL 34 POWER AMP £1,250.00
 NEW SHANLING STEREO INTEGRATED AMP £1,300.00
 SEE WEB SITE - ORDERS TAKEN NOW
 AUDIO RESEARCH CLASSIC 60 - MINT COND £1,599.00
 AUDIO INNOVATIONS SERIES 1000 MONO BLOCKS £899.00
 AUDIO INNOVATIONS FIRST AUDIO 2A3 PAMP £549.00
 AUDIO INNOVATIONS SECOND AUDIO M/BLOCK £899.00
 MICHAELSON AUDIO ODYSSEUS £650.00
 ROCKERS ADET III £400.00
 SCOTT 300 B INTEGRATED VALVE AMP £299.00
 ROGERS RAVENBROOK £75.00
 GATES 100B PUSH/PULL SEE WEB £2,500.00
 VAA70MKII - EL 34 PUSH/PULL INTEGRATED £299.00

ARION ELECTRA SHANLING POWER AMPS (SEE WEB SITE) £199.00
 £2,000.00

POWER AMPLIFIERS - SOLID STATE
 KRELL KSAS0 £1,099.00
 QUAD 3 £90.00
 QUAD 405 £240.00
 CRIMSON 60C MONO BLOCKS & PRE AMP £699.00
 ARCAM 75 WITH REMOTE VGC £1,750.00
 MUSICAL FIDELITY A370 - EXCELLENT £1,150.00
 MUSICAL FIDELITY E10 - EXCELLENT £150.00

TUNERS, CASSETTE DECKS ETC.
 Quad TMS £59.00
 YAMAHA KX480 CASSETTE DECK £80.00
 YAMAHA KX500 CASSETTE DECK £54.00
 YAMAHA CT710 TUNER £45.00

CD HDDC/SACD/DVD/MD PLAYERS
 NEW INCA KATANA CD PLAYER BARGAIN £600.00
 NEW INCA KATANA SE £995.00
 MARK HAVENSSES No. 35 DAC WITH HDDC #1 £1,200.00
 MARK HAVENSSES No. 35 DAC WITH HDDC #2 £999.00
 TOM IVANS' EICOS PRECISION CD WITH SEPERATE POWER SUPPLY - SWISS MADE £1,999.00
 DPA ENLIGHTENMENT CX 15 £799.00
 PINK TRIANGLE ORIGINAL DAC £45.00
 MICROREGA DRIVE 2 AND DAC - MINT - BOXED £499.00
 HELIOS CD5 £199.00
 SHANLING CD T100 HDDC EX DEMO £1,250.00
 SHANLING CD T100 HDDC (SEE WEB SITE) £1,500.00
 SHANLING SACD T200 SACD EX DEMO £1,600.00
 SHANLING SACD T200 SACD (SEE WEB SITE) £2,150.00
 MUSICAL FIDELITY A3 CD PLAYER £1,999.00
 MUSICAL FIDELITY E60 CD PLAYER £150.00

SPEAKERS
 ZINGALI OVERTURE 2S BOXED STANDS £1,199.00
 AUDIO NOTE ANTIK £999.00
 SNELL ACOUSTICS J1 - WALNUT (EX COND) £399.00
 SILVERADO PIANO BLACK INCL STANDS £1,499.00
 SNELL C LOVELLY PAIR £1,399.00
 CASIMIA PENTACOR WITH STANDS £650.00
 DECCA LONDON WITH CAST IRON HORNS £650.00
 REGA BLA BLACK £199.00

MISC
 CABLES - Silver Arrow - Van De Hull - QED £199.00
 SOUND STILL EQUIPMENT RACKS £199.00
 BEYER HEADPHONES £199.00
 VARIOUS IN STOCK - PLEASE PHONE

WWW.TUBE-WAREHOUSE.COM

NEW
SEE OUR NEW TUBE
WEB SITE - MAIL
ORDER TUBES AND
ACCESSORIES
DISCOUNTED
PRICES

GOLDEN DRAGON, SVETLANA, NOS ETC,
 OUR OWN "PRESTIGE" HAND PICKED FOR
 SOUND QUALITY PHONE 01322 281787

NEW HIGH QUALITY HIFI ● VINTAGE HIFI FOR SALE AND WANTED
● DEM ROOM AVAILABLE VALVE AMP REPAIRS

SEE OUR WEB SITE FOR THE LATEST STOCK **SHOWROOM**
 SHANLING, MICHELLE, CELESTION, QED, AUDIOQUEST, SOUNDSTYLE, ETC... **65 DARENTH ROAD**
 PHONE: (01322) 281700/292391 FAX: (01322) 229908 **DARTFORD**
 E-MAIL: info@matrixhi-fi.co.uk WEB: www.matrixhi-fi.co.uk **FREE EASY PARKING** **KENT DA1 1LU**



TURBOCHARGING YOUR REGA ARM

"Nothing less than total dynamite" HI-FI WORLD

If you are the proud owner of any Rega tonearm, you are now in the enviable position to transform its performance into the league of super arms with our modifications. The OLI structural modification at £75 will enable your Rega to perform at a level exceeding that of some arms costing over £1000!! High performance rewiring with high grade litz wire is also offered at an additional £70 and external rewiring is also £70 further increasing the performance.

"I have to say the Rega modifications turn this humble arm into a real giant killer. Gone is the rather grey, sterile sound of the cooking Rega. Instead, tonal colour is fresh, dynamics have great speed and impact, and the sound stage is huge."

HI-FI WORLD ON STRUCTURAL MODIFICATION

Structural modification awarded 5 star rating by



- Structural Modification - £75
- Internal Rewiring - £70
- External Rewiring - £70
- High conductivity phono plugs £20
- Slotted arm tube - £85
- If you do not have an arm we can supply the OLI arm (manufactured by Rega) £124

Arm modifications normally returned within 1 - 3 days

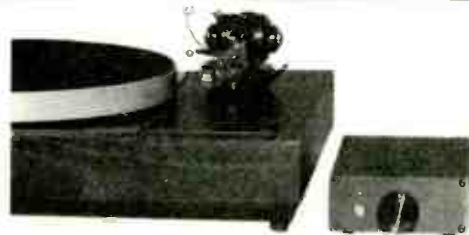

"The single most important upgrade you can ever make to any record deck concerns the motor drive...nothing can prepare you for the shock of going DC. In a word, gobsmacking." COMMON GROUND MAGAZINE

"It's value is nothing short of tremendous." LISTENER MAGAZINE

"The LP12 remains a classic ...but ..upgrade kits by Origin Live can bring a vast improvement to its performance" HI FI NEWS

UNIVERSAL TURNTABLE MOTOR KIT - No one would blame you for being sceptical of an easy to fit, inexpensive dc motor upgrade. Especially one that improves on the best of other power supplies costing over 4 times as much or your money back. It is simply impossible to imagine the level of improvement attained by eliminating the motor vibration that your stylus amplifies over 8,000 times! Our DC motor kit offers massive improvements to all versions of Linn Lingo / Valhalla, Rega, Systemdeck, Roksan, Rock etc. The kits consist of a drop in replacement high grade DC motor and off-board 2 speed control box. Why not order now? - see web site or phone.

- Standard dc Motor Kit - £199
- Advanced dc Motor Kit - £339
- Ultra dc Motor Kit - £570
- Upgrade Transformer - £175
- Upgrade DC 200 motor - £129 with kit

ORIGIN LIVE
 Tel/Fax: +44 02380 578877
 E-mail: info@originlive.com
www.originlive.com

diverse vinyl

10 charles st newport south wales np20 1ju
01633 259661/256261 sales@diversevinyl.com

RECOMMENDED NEW RELEASES

THE LATEST TITLE ON DIVERSE RECORDS:

Rickie Lee Jones "The Evening Of My Best Day"

22-20s	22-20s	£15.90
5678s	Teenage Workout	£9.90
Antonio Forcione	Dedicato (Naim Audio)	£16.90
Eiffy Clyro	Infinity Land	£13.90
Brian Wilson	Smile (at last!)	£TBC
Dave Mason	It's Like You Never Left (Cisco)	£19.90
De La Soul	Grind Date	£TBC
Death in Vegas	Satan's Circus	£TBC
Deep Purple	Live Encounters (1996)	£19.90
Eleanor McEvoy	Early Hours	£19.90
Elvis Costello	The Delivery Man	£TBC
Fat Boy Slim	Palookaville	£15.90
Giant Sand	Is All Over The Map	£12.90
James Yorkston	Just Beyond The River	£13.90
Joey & Norman Jay	Good Times Volume 4	£18.90
Lady Saw	Strip Tease	£12.90
Marianne Faithful	Before The Poison	£TBC
Mercury Rev	The Secret Migration	£TBC
Opeth	Still Life	£9.90
REM	Around The Sun	£TBC
Robbie Williams	Greatest Hits	£18.90
Super Furry Animals	Songbook - The Singles Vol 1	£15.90
Terry Callier	Lookin Out	£TBC
Tom Waits	Real Gone	£15.90
Various (Soul Jazz)	The Sound Of Philadelphia	£14.90

ALBUM OF THE MONTH

ELLIOT SMITH "FROM A BASEMENT ON THE HILL"

ROCK, POP AND AUDIOPHILE REISSUES::

Brian Auger/Driscoll	Open 2LP (Earmark)	TBC
Donny Hathaway	Extensions Of A Man	£12.90
Hank Mobely	Soul Station (Mono 200g)	£26.90
Harry Belafonte	An Evening With Miriam Makeba	£19.90
Insect Trust	Insect Trust	£12.90
Jimi Hendrix	Live at L'Olympia Paris 68	£15.90
Jimmy Cliff etc	The Harder They Come - OST	£19.90
Joan Baez	In Concert	£26.90
Kenny Wheeler	Gnu High (ECM)	£10.90
Miles Davis	Sketches Of Spain (Abs. Analogue)	£17.90
Nick Drake	Treasury (Definitive Collection)	£15.90
Roy Orbison	All Time Greatest Hits (S&P)	£39.90
Snow	Snow	£15.90
Status Quo	Dog Of Two Head (Earmark)	£TBC

DISCO ANTI STAT LP CLEANER

Probably the most economical LP cleaning device on the market

Only £41.95

Call for details

Call for a catalogue of over 3500 brand new LPs, or visit



www.diversevinyl.com



listening rooms

SALE LIST

NEW SALE

EMERGE M1000 H/D Sound server	£1500.00	£895.00	D
ARCAM DV88 DVD PLAYER	£1,000.00	£679.00	D+N
ARCAM FMJ A22 AMP	£1,100.00	£679.00	D
ARCAM A85 AMP	£800.00	£549.00	D
CELESTION - C2 - Floorstanders	£499.00	£299.00	D
CELESTION C1 - Compact speakers	£199.00	£114.00	D
CYRUS 5 AMPLIFIER	£500.00	£329.00	D+N
CYRUS 7 AMP	£700.00	£479.00	D+N
CYRUS DVD7	£1,000.00	£599.00	D
AVANCE TECHNOLOGIES Active Subwoofer	£1200.00	£695.00	N
MARTIN LOGAN SCENARIO	£2,498.00	£1,629.00	D
MERIDIAN DSP1500 Subwoofer	£1350.00	£895.00	D
MERIDIAN 562v.2 Controller	£1,500.00	£995.00	D
MERIDIAN 568.2 mm Smartlink (as new)	£4,305.00	£2,995.00	D
KRELL 250P PRE AMP	£2199.00	£895.00	SH
LINN ESPEK	£2500.00	£1695.00	D
MISSION 773E SPEAKERS	£399.00	£249.00	D
MISSION 780 - ROSEWOOD	£300.00	£219.00	D
MISSION 783 - BEECH (Good condition)	£1,000.00	£599.00	D
DENON DVDA11	£1699.00	£1295.00	N
MUSICAL FIDELTY XA100R - INT AMP	£900.00	£599.00	N
MUSICAL FIDELITY TRI-VISTA AMP	£3999.00	£2599.00	D
PROCEED AVP PROCESSOR. VGC/LIGHT USE	£4,700.00	£1995.00	D
PROCEED PMDT DVD PLAYER. VGC/LIGHT USE	£5,495.00	£2495.00	D
REDROSE Valve system (amp & speakers) 1yr old	£10,000.00	£3,995.00	SH
VIENNA MALHER (Beech)	£6000.00	£3295.00	D
TAG MCLAREN DPA32R (Digital pre inc DAB)	£1,990.00	£995.00	D
TRICHORD GENESIS CD PLAYER	£500.00	£150.00	D
VIENNA BEETHOVEN Speaker (Beech)	£2,500.00	£1,595.00	D
VIENNA MOZART Speakers (Beech)	£1,500.00	£995.00	D
VIENNA WALTZ centre Speaker (Beech)	£500.00	£350.00	D
YAMAHA HD1000 Hard Disc Recorder	£699.95	£500.00	D

Hi-Fi Multiroom and home cinema

PLEASE SEE OUR WEBSITE FOR LATEST OFFERS!

THE LISTENING ROOMS LTD

161 OLD BROMPTON ROAD LONDON SW5 0LJ

TEL: 020- 7244 7750/59 FAX: 020 - 7370 0192

www.thelisteningrooms.com

E-mail: tlr@btclick.com

Mon-Sat 10-6pm

UK SUBSCRIPTION £40

VISIT OUR WEBSITE: www.hi-fiworld.co.uk

✂-----

YES! I want to subscribe to Hi-Fi World for:-

£40.00 for 12 months

Your Details

Title _____ Initial _____ Surname _____

Address _____

Post Code _____

Daytime Tel: _____

Start Issue _____

Delivery Address (if different) _____

I would like to pay by cheque made payable to Audio Publishing Ltd.

Please debit my VISA MASTER SWITCH AMEX

XX

Security No: (last three digits printed on the signature strip)

Switch card issue No: Expiry Date: _____/_____/_____

Cardholder Signature: _____



Please choose service:-

ZONE 1 USA, Canada, Africa

ZONE 2 Australia, Japan, Korea, China, Middle East & South East Asia

EUROPE Airmail **£50.00**

ZONE 1 Airmail **£60.00**

ZONE 2 Airmail **£70.00**

Send this form to:

Hi-Fi World, Subscriptions Department
PO Box 464, Berkhamsted, Hertfordshire
HP4 2UR

SPECIAL INTRODUCTORY OFFER!

£40.00 for 12 months plus
1 additional issue free.
FREE postage & packaging.



Get your issue of hi-fi world straight to your door!

Get to our amazing classified ads first and grab a bargain!!

- > **Run by dedicated hi-fi engineers and enthusiasts.**
- > **Hi-Fi World has become famous for its informative reviews and radical kit designs.**

NEW NUMBERS

Hotline
+44 (0) 1442 879097

Fax No:
+44 (0) 1442 872279

email:
hifiworld@webscribe.co.uk

For Back Issues enquires please contact the above numbers

private ads

Dealers must not advertise in the Private Classified section. Monthly consecutive insertions will be considered Trade advertising. The Publisher reserves the right to judge submissions.

WANTED: JBL Century L100, Yamaha NS-1000 speakers or similar. Good price paid for right example. Email: elisabeth@planetzany.com or call: 07967 730224 (Dec/I)

WANTED: MARANTZ CD63 KI Sig CD player. Not desperately seeking Susan, but an excellent example of one of these machines. Happy to pay the right price. Tel: 0032 477332141 or email: Pvancompennolle@jetair.be (Dec/I)

VALHALLA (NORDOST) interconnects £480 (£1900); SPM speaker cables 2.5m (like new) £850 (£2500); brand new Red Dawns 1.0m £195 (£330). Other sizes. AQ Diamond X3. Tel: 01895 677714 or 07960 169644 or Email: shasha@fsmail.net (Dec/I)

PAIR MARK Levinson 436 MonoBloc Power Amplifiers. £7500.00. Price includes 2.0m Bi-wire JPS Labs Superconductor FX Speaker Cables. 18 Months Old. Transferable Warranty, Cartons, Manuals, Gloves. Collection/Delivery negotiable Tel: 07774 218 350 (Feb/I)

QUAD ELECTROSTATICS loudspeakers ELS 57's, bronze. Demonstration. Superb clarity. Also experimental stands for vertical mounting. Improved bass and imaging but ugly. £350 ono. Tel: 01483 422 901 (West Surrey) (Dec/I)

CYRUS CD7 mint condition, boxed as new, very little use, inc. remote £350. FM7 excellent condition, no box £150. Both in black, can demo. Tel: Richard 01524 251 553 leave message (Yorkshire) (Dec/I)

AUDIOVALVE ASSISTENT integrated amplifier, mint condition, 30wpc, very little use, upgrade forces sale, £650. Tel: 01252 659 058 after 6pm (Dec/I)

LINN SONDEK LP12, Valhalla, Basic plus arm inc. cartridge. Walnut + 45 speed adaptor, good condition £350 can demo. Also Yamaha TCX580 cassette, mint £80 ono. Tel: Richard 01524 251 553 leave message (Yorkshire) (Dec/I)

ROKSAN OJAN 3X speakers, rosewood, vgc, £325. Roksan Xerxes X, rosewood, Artemiz, Shiraz, XPS3.5, Artaxerxes X phono, DSUs mint, boxed, £1950. Tel: 0117 962 0918 or Email: ppelectron@aol.com (Bristol) (Dec/I)

ROGERS LS3/5A speakers. Original 15 ohms. Walnut. Boxed. Excellent condition, £550. Matching stands £45. Williams-Hart active subwoofer, remote controlled, 150 watts, hand built, ash, ideal with LS3/5A £300. Tel: 01274 632 492 (Dec/I)

WHARFEDALE EVO 30 floor standing speakers (rosewood), good condition, genuine reason for sale, new £650, sell £240 ono. Tel: Colin 0161 303 8859 (Greater Manchester) (Dec/I)

PROAC STUDIO 100 speakers £250. Exposure XX amplifier £200. One careful owner from new. Local buyers preferred. Tel: Rod 01728 747 387 (Ipswich area) (Dec/I)

NAIM NAP250 olive £1100. Linn LP12. Naim Armageddon, Cirkus bearing, no arm/board, superb condition, all boxes, £995. Sony DAB tuner DT777ES, champagne finish, boxed (cost £575) £275. Tel: Chris 01285 862 539 (Dec/I)

AUDIO RESEARCH SP9 Mk3, recent factory upgrade, mint, manuals £975. EAR 859 classic award winner, spare valves, mint, manual £750. Sugden 21AP amplifier, superb, highly acclaimed bargain £375. Tel: 01487 814 015 (Dec/I)

BANG & OLUFSEN Beogram 4000 wanted. Must be in good working order. Tel: Mick 020 8648 5418 (Dec/I)

QUAD 989 speakers, vintage finish, £2850 ono. W.A.D. Kit 6550 including upgrades £550 ono. Wanted: Spendor S8 speakers or consider similar. Tel: 01492 516 875 (Dec/I)

MARANTZ 17KISig modified £650. Sony XA777ES SACD £950. Trichord DAC including PSU £950. Michell Alecto power amps £950 pair. Rega 3 including new Elys cartridge Dino phono £400. All mint condition. Tel: 01442 214 936 (Dec/I)

E.A.R. 324 phono amp MC/MM £1350. Tel: 0797 704 2745 or Email: rcann25@aol.com (Dec/I)

HORNING ONE Lowther based three way speakers in blond wood finish, excellent condition and sound £650. Reason for sale - using Quad ELS. May exchange (not speakers). Tel: 01273 727 476 (Hove, Sussex) (Dec/I)

AKAI GX 260D, 7.5in. spools, open reel tape recorder. Glass crystal heads. 3.75/7.5 IPS. Full auto reverse. Immaculate. Operators manual, acrylic cover, Akai empty spool, 3 new tapes. £195 ono. Tel: 07710 82 82 86 (Brighton) (Dec/I)

SPENDOR LS-3/5A, black, mint! Thorens TD-125-II SME 3009 excellent. Audio Research VT-110-2 boxed! Spendor SP-2/3 black, boxed. Systemdek IIX, SME 3009, Thorens TD-166-VI, RB-250 boxed. Possible P-X. Offers. Tel: 0117 955 6555 or 07979 514 450 (Dec/I)

AUDIOLAB 8000DAX, late model, excellent condition, includes Sonic Link digital lead. £260 - cash or personal cheques only. Tel: 01275 462 948 (North Somerset) (Dec/I)

MARK LEVINSON 390 S CD player. Three months old. Perfect condition. Boxed with manuals. Reluctant sale. Tel: Tony 07769 972 227 (Guildford) (Dec/I)

QUAD ESL63 speakers, mint condition, brown, wonderful sound, much cherished but must sell as moving abroad. Manual. £1400 ono. Tel: 01903 505 868 (West Sussex) (Dec/I)

ASSEMBLAGE SET-300B power amplifier, 8 watts, MIT Multicaps, Blackgates, Cerefines, lovely sound/condition, 22 kilos!, circuit diagram £475. Trio KR-9600 receiver, enormous!, 160/200W, 24 kilos, manual, vgc, £175. Tel: 01273 541 462 (Sussex) (Dec/I)

CYRUS PSX-R The ultimate upgrade. Black, boxed with manual. Vgc. Two available @ £230 each. £450 for both. Tel: Bob 0772 172 6996 (Dorset) (Dec/I)

CHORD DAC 64, boxed, Blackgate capacitor upgrade, copper internal plating £850. DPA Renaissance CD player with Trichord Clock 2 upgrade. £240. Tel: 020 7254 6820 daytime, 01707 875112 evenings. (Herts) (Dec/I)

MICHELL FOCUS One turntable, Focus arm. Excellent with spares £325 ono. Ferrograph Logic Dolby Seven tape recorder with Series Seven for spares £65. Leak transistor amp and tuner £10. Tel: 01273 583 675 (Brighton) (Dec/I)

LOWTHER ACOUSTA enclosures. No drivers. Reasonable offer accepted. Tel: 01208 872 316 (Cornwall) (Dec/I)

BRYSTON BP25 line pre-amp silver £700. Kimber Select KS1030 Inters phono 1/2 mtr £230. Tel: 01782 633 088 (Stoke) (Dec/I)

Turntableworld - A selection from our stock
Most of our turntable combinations come fitted with free cartridge

Alphason	Sonata/Alcaeus power supply - ex, black ash	599
AR	EB101/AR arm - vgc, black	99
Audion	Shering - ex, valve phono stage	299
Chord	Phono stage - ex, stunning	999
Electrocompaniet	ECPI - ex, c/w large custom Lynwood p/s	479
Garrard	301/SME 3012 - recon unit in Martin Bastin plinth	179
Garrard	401 - nr mint motor unit	179
Garrard	401 - nr mint, boxed motor unit	249
Garrard	401 - ex, Plinthed c/w SME3009	299
Garrard	401 - ex, gorgeous Aphelion plinth	499
Linn	LP12/Lingo/IttokVII/Troika - nr mint, black, boxed	1199
Linn	LP12/Lingo/IttokVIII/Asaka - nr mint, rosenut, boxed	1199
Linn	LP12/Valhalla/IttokVII - nr mint, black, boxed	699
Linn	LP12/Armadillo/Aro - ex, afromosia	1799
Linn	LP12/Valhalla/Akita - vgc, black	599
Linn	LP12/Valhalla/LVX - vgc, black	479
Linn	Basik, LVX - vgc, black	199
Linn	Axis, Basik plus - vgc, black	249
Linn	Ittok 12" - ex, black, apparently one of only 20 made	999
Logic	Tempo Electronic/LVX - vgc	149
Michell	Gyrodec/RB300 - vgc, gyropower ps, Orbe platter, smoked case	999
Michell	Gyrodec SE/RB300 - ex, brand new arm	1399
Michell	Orbe/RB300 - ex/ex, boxed	1199
Michell	Orbe - ex, smoked	1699
Michell	Orbe/SME309 - ex/ex, boxed	1949
Michell	Orbe/Wilson Benesch Act 2 - nr mint, boxed...Stunning!	1949
Michell	Technodec - Best Trade ins	ON DEM
Michell	Technodec - Best Trade ins	ON DEM
Michell	Gyrodec SE - Best Trade ins	ON DEM
Michell	Orbe SE/VC - Best Trade ins	ON DEM
Mission	774 - ex, fab 80s tonearm	159
Musical Fidelity	XLP - nr mint	79
Musical Fidelity	XLPS - nr mint	119
MTM	The Source - ex, mahogany	599
Origin Live	Rega Arm mods - Best Trade ins	ON DEM
Origin Live	RB300 - ex, early black stub and weight, full wiring mod	199
Odyssey	RP1-XG - ex, the prettiest arm ever?	499
Pink Triangle	LPT/RB250/Reson - ex/ex,	379
Project	Debut - ex display, black, boxed	89
Project	Classic - ex display, cherrywood plinth, boxed	299
QED	R232 - good, Rega like deck with Helius type arm	99
Rega	Planar 2/RB250 - ex/ex	149
Rega	Planar 2/RB200 - ex, wood plinth original	119
Rega	Planar 3/RB300 - vgc/ex	179
Rega	Planar 78/RB250/Mono Cart - ex/ex	175
Revolver	Revolver/LVX - ex/ex	119
Roksan	Nima - nearly new, boxed	249
SME	309 - nr mint	449
SME	V - nr mint boxed	999
Thorens	TD160 - vgc, smart silver model	149
Thorens	TD160b - ex, c/w haddock arm	249
Transcriptors	Skeleton/Vestigal - ex/ex	799
Transcriptors	Saturn/Vestigal - fair	199
Trichord	Dino / Plus - Best Trade ins	ON DEM
Wilson Benesch	Act/Act 2 - the best ever? Rare as....	2499

Aiwa	ADF850 - vgc, 3 head	79
Arcam	Alpha 8 - ex, black	149
Arcam	T61 - ex display, boxed, rare black	149
Audiolab	8000T - vgc, rare item	329
Cyrus	FM7.5 - nr mint, silver, digital, presets, boxed	279
Cyrus	Original 'Mission' tuner - vgc	99
Linx	Theta - ex, matches Vega amps	149
Nakomichi	580 cassette - nr mint, black	99
Quad	66FM - ex	379
Quad	FM4 - vgc	225
Ratel	RT02 - ex display, boxed, silver	199
Sugden	DTFM - gc, rare, matches A48mk3 etc	179
TAG McLaren	T20 - ex display, boxed	699
Teac	TX3000 tuner - ex, digital, presets	75
Teac	T1010 cassette - ex, 3 head	75
Technics	STG90L tuner - ex, digital, presets	89

Digital CD, DVD etc
Many more inexpensive CD players in stock

Arcam	Alpha 8 - nr mint, remote	199
Arcam	Alpha 8SE - nr mint, remote	349
Arcam	Alpha 9 - nr mint, remote	249
Arcam	CD72 - nr mint, silver, remote	279
Audiolab	8000 Transport and DAX - ex	999
B&O	CD3500 - ex, silver/black	279
Cambridge Audio	Discmagic/Dacmagic - ex, nice combo for peanuts	199
Cambridge Audio	Isomag DAC S700 - ex, boxed	119
Cyrus	PSX-R - nr mint, black	249
Kenwood	DP1100 - ex, v, underrated	89
Krell	CD-DSP - ex, clear and smoked lids, remote, stunning	1499
Marantz	CD60 - ex, remote	69
Marantz	CD46 - ex, remote	49
Marantz	CD52SE - ex, remote	69
Marantz	DV4100 OSE - nr mint, remote, boxed	129
Meridian	200 transport and matching doc - ex, superb combination	449
Meridian	200 transport - ex, Trichord mod, excellent	349
Micromega	Stage 1 - ex, smooth sound on a budget	179
Micromega	Stage 5 - ex, sweet sounding player from renowned French manufacturer	249
Micromega	T-drive and T-doc - vgc, remote, superb sound, £1000s new	799
Micromega	Trio - ex, the ultimate Micromega	1449
Myryad	T20 - black, nr mint, boxed, remote, bargain!	249
Naim	Cdi - ex, remote	699
NVA	The Transparent Statement - vgc, crated, remote...ultimate NVA	1749
Pioneer	CLD SB15 - Laserdisc, vcd, cd, PAL, NSTC	119
Quad	67 - ex, sweet sounding player, much better than 66	499
Rega	Planet - ex, black, well reviewed	249
Roksan	Caspian - nr mint, silver, boxed, remote	449
Rotel	RCD991AE - ex, great piece of kit	449
Sony	CDP333esd - ex, manual, remote	129
Sony	MDP850D - nr mint, remote, laserdisc, VCD, CD, PAL, NSTC	149
Teac	CDP4500 - ex, remote	99

Acoustic Energy	ATC	999
Acoustic Energy	ATC	999
Acoustic Energy	ATC	999
Acoustic Energy	ATC	999
Castle	Castell	199
Celestion	Celestion	179
Epos	Epos	249
Epos	Epos	299
Gallo	Gallo	499
Heybrook	Heybrook	1199
Impulse	Impulse	699
Leak	Leak	1799
Linn	Linn	599
Linn	Linn	479
Mission	Mission	199
Mission	Mission	249
Mission	Mission	999
Mission	Mission	149
Mission	Mission	999
Mission	Mission	1399
Monitor Audio	Monitor Audio	1199
Monitor Audio	Monitor Audio	1699
Monitor Audio	Monitor Audio	1949
Monitor Audio	Monitor Audio	1949
Mordaunt Short	Mordaunt Short	149
Mordaunt Short	Mordaunt Short	199
Musical Technology	Musical Technology	179
QED	QED	39
QUAD	QUAD	1499
Rega	Rega	119
REL	REL	199
REL	REL	299
REL	REL	349
Rogers	Rogers	199
Royd	Royd	149
Sequence	Sequence	149
Stands Unique	Stands Unique	179
Tonny	Tonny	199
Tonny	Tonny	499
TDL	TDL	249
TDL	TDL	119
Wharfedale	Wharfedale	299
Wharfedale	Wharfedale	499
Wharfedale	Wharfedale	249
Wharfedale	Wharfedale	119
Wharfedale	Wharfedale	299
Wharfedale	Wharfedale	499
Wharfedale	Wharfedale	75

Speakers

AE505	AE505 - ex display, superb floorstander	249
AE505	AE505 - new sealed box, superb floorstander, were £8,000!!	299
AE100	AE100 - new tweeters, scruffy grilles	279
AE100	AE100 - ex, rosewood finish	149
SCM20	SCM20 - nr mint, boxed, yew finish	799
Durham 900	Durham 900 - good, larger bookshelf	99
Kendal	Kendal - nr mint, new model in light ash	195
5000	5000 - vgc ribbon standmount	249
7000	7000 - fair/good, huge ribbon and twin bass bargain!	379
M15	M15 - nr mint, light cherry, boxed	449
ES14	ES14 - nr mint, boxed 80s classic c/w dedicated stands	325
5.1	5.1 - ex display, boxed, gorgeous!	999
HB100	HB100 - vgc, superb vfm	79
H6	H6 - fair, but great sound	299
2030	2030 - nr mint	79
Kaleigh	Kaleigh - good, black, fully boxed	249
Kan	Kan - ex, black, c/w matching stands	249
763i	763i - ex, black floorstander, boxed	119
70	70 centre - ex display, boxed	69
77ci	77ci - ex display, boxed	99
780	780 - ex, black larger bookshelf	99
781	781 - ex, black larger bookshelf	99
S6	S6 - nr mint, boxed	299
R852MD	R852MD - scruffy, bobbing wood and stands	79
Studio Centre	Studio Centre - ex display, boxed	299
R700MD	R700MD - nr mint, black	149
Bronze B2	Bronze B2 - nr mint cherry, boxed	129
Silver S2	Silver S2 - nr mint mahogany, boxed	199
912	912 - ex display, boxed	149
914	914 - ex display, boxed	199
Kestrel SE	Kestrel SE - ex, very pretty floorstander	179
Aria	Aria - ex display, boxed mini surrounds	39
ESL63	ESL63 - nr mint, unused since Quad service with new boxes	1499
EL8	EL8 - fair, wood floorstander	119
Q50	Q50 - ex, black	199
Strata	Strata - ex, black	299
Storm	Storm - ex, black	349
Studio Monitor	Studio Monitor - Original vgc, with stands - suit valve amps	199
Minstrel	Minstrel - ex, rare walnut finish	149
200	200 - ex, cherry and grey, c/w dedicated stands	149
Sonique AVT	Sonique AVT - nr mint, boxed	179
R2	R2 - good, boxed, slim cherry floorstander	199
Studio Monitor	Studio Monitor - Ex, large standmount	499
Studio 1	Studio 1 - vgc, wood finish transmission line	249
RTL	RTL - ex, black	119
Diamond 7.1	Diamond 7.1 - ex, black	299
Pacific Pi30	Pacific Pi30 - nr mint boxed, light cherry, excellent	499
505.2	505.2 - nr mint boxed, black standmount	75

Amplifiers

2445	2445 - ex, well reviewed weighty poweramp	199
C200	C200 - ex, boxed pre	149
SA200	SA200 - ex, boxed power	199
SA200	SA200 - ex, boxed pair monos	399
Alpha 7R	Alpha 7R - ex, as above with remote	149
Alpha 9	Alpha 9 - ex, boxed with remote	249
Alpha 10	Alpha 10 integrated - ex, boxed	299
Alpha 10	Alpha 10 power - nr mint, boxed	349
A65	A65 - nr mint, boxed, remote, silver	179
A65+	A65+ - ex display, boxed, remote, silver	199
A85	A85 - ex, remote, silver	425
P75	P75 - ex display, remote, silver	199
Puccini	Puccini - ex, silver	299
8000A	8000A - ex, black	329
8000S	8000S - nr mint	329
Silver Knights	Silver Knights - Stunning boxed valve monoblocks	1199
CAS4040	CAS4040 - ex, boxed	79
510/520	510/520 - ex, boxed, battery pre, lovely combo	279
7	7 - ex, black, boxed	429
PSX-R	PSX-R - nr mint, black	249
X integrated	X integrated - nr mint, boxed, black	199
Citation 17 and 19	Citation 17 and 19 - vgc, boxed	399
PM655	PM655 - nr mint, variable capacitance phono stage	119
2100	2100 - vgc, c/w 2300 tuner	99
LK1/Dirak	LK1/Dirak - ex, black, mm/mc exceptional vfm	199
Vega	Vega - ex, pre/power, gloss black	299
PM66SE Ki	PM66SE Ki - nr mint, boxed	149
1072	1072 - vgc, champagne finish	99
SR4200	SR4200 - ex display, boxed black av amp	149
505s	505s - ex, pair monoblocks	949
205s	205s - ex, pair monoblocks	599
Alecto	Alecto - ex, Monoblocks	899
Cyrus One	Cyrus One - from	70
Cyrus Two and PSX	Cyrus Two and PSX - gc, nextel finish	229
352	352 - ex display, boxed, titanium	249
AO21S	AO21S - ex, great 80s integrated	199
A300	A300 - ex, phono	99
A301	A301 - nr mint, boxed	799
A20	A20 - nr mint integrated	379
405/2	405/2 - good, brown	225
405	405 - nr mint, early brass heatsink version	199
405	405 - ex, standard brown version	179
33/303	33/303 - nr mint	175
Luna	Luna - nr mint, black, boxed, better than a Brio or Mira	179
Caspian	Caspian - nr mint, silver, boxed, remote	399
RB03	RB03 power - ex display, boxed silver	199
RB981	RB981 - ex, black powerhouse, 2 available for monoblock setup	225
RC995	RC995 - ex, pre with remote	199
Phase 2	Phase 2 - nr mint, boxed, blue marble styling	279
STR-DB940	STR-DB940 av amp - vgc, DTS 5.1 etc	199
AU41	AU41 pre/power - ex, black	499
L07C	L07C and 2 x L07M monos - superb	749

Systems, cables and miscellaneous
Equipment supports - Your kit deserves them!

Audio Technica	Electronic stylus cleaner	39
B&O	2200 system - ex, turntable, cassette and tuner, inc speakers	199
Beyer	DT231 galactic - new	30
Ixos	1014 - new 1m interconnect	15
Ixos	1014 - new 5m interconnect	25
Mission	Stance - ex display, silver	49
Pure	Evoke - ex display	69
Quad	66/67 - 67Cd, 66Pre, 66Power and system remote	1199
Sennheiser	IS380 - new, infrared	40
Stax	Lambda Nova Signature - nr mint, superlative quality	699

Call **01325 241888** and don't be frightened of the machine. email us world@hifisound.co.uk

If you want to pop in, we usually open the shop only on Saturdays,
 10 till 5, unless there's something better to do, so please please check before travelling!

Your equipment wanted for cash - best prices paid
COMMISSION SALES TOO!

private ads

Dealers must not advertise in the Private Classified section. Monthly consecutive insertions will be considered Trade advertising. The Publisher reserves the right to judge submissions.

NAIM NAP 135 (single) mint 2001 model, boxed and complete, perfect for centre channel and far superior to a NAPV 145. (£1650 new) £1250 ono. Tel: 01245 224 024 (Dec/1)

RUARK SABRES, stands, £150. Ruark Swordsmans, stands £75. Sony CDP990 £75. NAD 402 tuner £60. B&W DM110s £40. Nytech CTA 252XDII £50. Denon DRA 350 TA £40. Philips CD104 £40. Technics SLP2 CD. Tel: 01722 334 694 (Dec/1)

AUDIO SYNTHESIS DAX Discrete DAC. Custom order Black Gate capacitor, balanced version with variable output digital volume control. Incredible resolution, 4 months old, £3750 (£6500 new). Tel: 07989 234290. (Shropshire) (Jan/1)

SONUS FABER Concerto Home, £650. Tube Technology Unisis integrated with valve phono stage, £700. Both items in excellent condition with original packaging. Tel: 0131 4476056 evenings or email rowland.fraser@tiscali.co.uk. (Dec/1)

TECHNICS DVD-A10 DVD audio/video player, plays surround sound DVD audio music discs, boxed with instructions and remote, audiophile quality - weighs 8.6kgs!, plays multi-region DVD videos, two years old in excellent condition. £160. Tel: 0118 9772035 (Berkshire). (Dec/1)

CHORD SPM 1200 power amp. 250 wpc £1250 (£3750), Chord CPA 1800 pre-amp. £1250 (£2250 only 3 years old). Both Black finish, boxed and completely as new. (24 month warranty still to run on Pre). Tel: 01909 518131 or 07941 668088 (Dec/1)

LINN LP12 Sondek, Valhalla, w/Ittock VII arm Aformosa finish plinth. Serviced, latest arm-board, springs w/cover. Excellent condition. Low hours. £495. Buyer collects. Denon 103S (103 w/elliptical NStylus) boxed, £45. Denon AU320 step-up transformer, boxed, £45. Tel: 01249 730 575 (Wiltshire, near J17/M4) (Dec/1)

AUDIO INNOVATIONS Series 1000 monoblocks, Silver Edition, boxed, revalued from EL34 to 5881 by Border Patrol £850. Tel: Tom 020 8986 1762 (Dec/1)

WANTED: SHARP GF-777 radio twin cassette player four speaker stereo, big boom box ghetto blaster from the 1980s. Must be in excellent/mint unmarked condition and not damaged, fully operational. Offering £400.00 Tel: evenings 01865 378578 or Email: FISKALLEN@AOL.COM (Dec/1)

KOETSU RED Signature purchased 2002 but less than twenty hours use. Truly as new. Simply not needed. Boxed. £895 (£2200) Tel: 01424 203 192 (Dec/1)

ROGERS T75 Series II FM tuner, boxed, manual, £45. pair Atacama SE28 speaker stands (heavy!) suit Proac Tablettts, Kans etc, £25. 2x 4m Audioquest Indigo speaker cable £50. Tel: Chris 023 8071 0853 (Southampton) (Dec/1)

WANTED: MARANTZ CD63 KI Sig CD player. Not desperately seeking Susan, but an excellent example of one of these machines. Happy to pay the right price. Tel: 0032 477332141 or email: Pvancompennolle@jetair.be (Dec/1)

VALHALLA (NORDOST) interconnects £480 (£1900); SPM speaker cables 2.5m (like new) £850 (£2500); brand new Red Dawns 1.0m £195 (£330). Other sizes. AQ Diamond X3. Tel: 01895 677714 or 07960 169644 or Email: shasha@fsmail.net (Dec/1)

WANTED: JBL Century LI00, Yamaha NS-1000 speakers or similar. Good price paid for right example. Email: elisabeth@planetzany.com or call: 07967 730224 (Dec/1)

PAIR MARK Levinson 436 MonoBloc Power Amplifiers. £7500.00. Price includes 2.0m Bi-wire JPS Labs Superconductor FX Speaker Cables. 18 Months Old. Transferable Warranty, Cartons, Manuals, Gloves. Collection/Delivery negotiable Tel: 07774 218 350 (Feb/1)

BANG & OLUFSEN Beogram 4000 wanted. Must be in good working order. Tel: Mick 020 8648 5418 (Dec/1)

QUAD 989 speakers, vintage finish, £2850 ono. V.V.A.D. Kit 6550 including upgrades £550 ono. Wanted: Spondor S8 speakers or consider similar. Tel: 01492 516 875 (Dec/1)

GUIDELINES FOR BUYING AND SELLING SECOND-HAND EQUIPMENT

FOR THE BUYER

1. Not everyone is honest - Buyer Beware!
2. **Don't send cash!**
3. Accept no verbal guarantees.
4. Have you heard the item or something similar? If not, why do you want it?
5. Don't pretend to have knowledge - it's your fingers that will get burnt!
6. Is it working? If not, why not?
7. Has it been modified and, if so, have notes been kept?
8. Was it any good in the first place?
9. **Don't send cash!**
10. If you are in the slightest doubt, arrange an audition (see point 5). If it's too far, wait for another time.
11. Either buy it or don't: vendors are excusably impatient with 'consultation' exercises.
12. **Don't send cash!**

FOR THE SELLER

1. Not everyone is honest - Seller Beware!
2. Make no verbal guarantees.
3. Even 'nearly new' is still second-hand. If the manufacturer's guarantee is no longer in force, your price should reflect this.
4. There is very little intrinsic value in second-hand hi-fi; it's only worth what some one will pay for it.
5. The best guide to pricing is last month's Classifieds: that a 'classic' was worth £xxx a year or two ago is no guide. Values fall as well as rise.
6. Amateur second-hand dealing is not a big money game: you win some, you lose some.
7. Be prompt with despatch. If in doubt about buyer's bona-fides, either wash out the deal or send C.O.D.
8. There will always be time-wasters; be tolerant within reason!

private ads

Dealers must not advertise in the Private Classified section. Monthly consecutive insertions will be considered Trade advertising. The Publisher reserves the right to judge submissions.

FROM NOVEMBER 2004 ISSUE

MUSICAL FIDELITY A370

Class A power amplifier £890 (£2500) Boxed and original condition. Audio Research and DNM cables complete sets. Tel: 07973 220 663 (Leicestershire) (Nov/1)

MAGNUM DYNALAB MD 102 tuner (£2200) £1100. 'Stunning'. Beard CA 506 preamp with phonostage, new valves, classic £450. SA EC WE 308L tonearm, boxed, unused £500. Tel: Paul 029 20 369 052 or Email: llyndes@hotmail.com (Nov/1)

KUZMA REFERENCE

turntable, tri-planar arm, Benz LP cartridge, cost £10,000+, now £5000. Tom Evans Groove £1000. Polaris Loth-X speakers, 104dB £2500. Velodyne DD10 subwoofer, was £2000 now £1000. Tel: Nick 01373 463 780 or Email: nicholas.welsh@blueyonder.co.uk (Nov/1)

FABULOUS VALVED CD Audio Aero 24/192 £1750. Large floorstanding speakers Coincident Total Eclipse, 104dB, 14ohm, ideal for 300B. £2000, were £6000 3 years ago. Tel: Nick 01373 463 780 or Email: nicholas.welsh@blueyonder.co.uk (Nov/1)

RECENT HEART attacks force drastic reductions to clear. Purchaser to arrange packaging and transport. Revox A77 Dolby half track 3.3/4 and 7.1/2. Operating instructions. Clean machine and cabinet. No feet, no spools, no NAB hubs. Needs calibrating, otherwise seems ok. Best offer over £150. Revox A77 half track 7.1/2 and 15ips in P.O. rack chassis £95. Revox G36 half track 3.3/4 and 7.1/2, uses NAB spools, 1960's valve model £125. Tel: 07710 82 82 86 (Nov/1)

TED JORDAN JX 92 full range units. £100 pair. Tel: 01442 874 749 (Berkhamsted, Herts) (Nov/1)

QUAD 405-2, 34 and FM4 (DIN) All boxed with instructions and cables. Excellent condition. £470 ono. Tel: 01283 814 422 evenings or 07952 865 404 daytime, or Email: tomaspin@supanet.com (Nov/1)

TDL REFERENCE monitors, rosewood, exemplary condition, manual, £400 ono. Audiolab 8000Q, vgc, boxed, manuals, £120 ono. Audiolab 8000T, vgc, boxed, manuals, £120 ono. Tel: John 01403 251 935 or Email: john501hifiman@aol.com (Dec/1)

RUARK PROLOGUE I speakers, yew finish. 2x 7m bi-wired ribbon cables (QED Profile Silver 12) with 1xos plugs for speakers. £575 ovno. Tel: 01323 511 204 or Email: garytowne@hotmail.com (Nov/1)

ACCUPHASE T105 FM tuner. Cossetted classic. One owner. Superb. £270. Tel: 01752 773 369 (Nov/1)

SHAHINIAN COMPASS loudspeakers, 3 years old, unmarked in light beech: half price and run in at: £1350. Also Sansui A80 tuner £40. Tel: 01636 830 944 or 07979 536 753 (Nov/1)

MARANTZ PM-94 integrated amplifier, superb condition/sound, 23 kilos, boxed, manual, Japanese Krell/Levinson? £665. Nakamichi BX2, vgc £115. Luxman R-1040 receiver, rosewood, 40W, vgc, excellent tuner £75. Tel: 01273 541 462 (Brighton) (Nov/1)

WANTED: ONE PAIR Wharfedale TSR 110 hi-fi loudspeakers. Tel: 07876 710 945 or Email: kevinjpmurphy@yahoo.co.uk (Nov/1)

QUAD II PAIR with GEC and Mullard valves. Original condition, £550. Klipsch Heresey II speakers in mahogany on Atacama SL200 stands, excellent condition, ideal with valve amps, £650. Tel: 01487 824 418 daytime (Nov/1)

AUDIO RESEARCH VT50 boxed, superb, serviced 2004. Remainder guarantee transferable, £1800 ono. Simaudio Moon Nova CD player £2000, mint, boxed, 2 year warranty, transferable. Tel: Chris 020 8543 5531 evenings (Nov/1)

WANTED: DPA 50s pre/power amplifiers. Sony MiniDisc recorders: JA50ES, JA30ES, JE555ES. Must be good condition. For Sale: Nakamichi cassette deck 2, £90. Tel: 01306 887 554 (Nov)

QUAD 306 amplifier, 34 control unit, FM4 tuner. All mounted on QRackC3. Email offers to: a-kerr@amservice.com Purchaser to collect from Worcester. (Nov/1)

SHANLING CDT 100 CD player, With Western Electric valve upgrade and originals. Valve or solid state output, £1150. Linn LK1, LK2 pre power £365. Tel: 01424 446 282 or 07729 858 551 (East Sussex) (Nov/1)

WANTED URGENTLY: Pink Triangle bearings with ball bearings, very good condition or mint condition. Please make me an offer. Tel: 33 2 31 85 79 17 Philippe Pesche, Caen, France. Email: pesche.philippe@voila.fr (Nov/1)

QUAD 57's very late, black, Quad serviced, outstanding £750. Quad II's, GEC, Mullard, serviced £500. FM4 grey, phono £250. Spondor SP2/3E rosewood, barely used £750. Tel: 0113 257 7793 (Leeds) (Nov/1)

BALANCED AUDIO

Technology: BAT VK-60 tube power amp. Perfect working order and condition. One owner since new. Box and manual. With 2 complete sets of valves, 1 set new. £1900 ovno. Tel: Mike 020 8550 4223 evenings or 020 7401 5119 day. (Nov/1)

AUDIO RESEARCH VT-100/2 Spondor SP2/3 stands Thorens TD-125/2 SME 3009-imp Systemdek IIX SME 3009-imp Quad ESL-57 Quadropod stands black Trichord Delphini Mk2-NC new Leak Stereo 20 Krell KSA-80. Tel: 01179 556 555 or 07979 514 450 (Nov/1)

THIEL CS3.6 floorstanding loudspeakers. World class 'speakers over £5000 brand new, absolute bargain at £1700. Excellent condition. Tel: Mark 01609 772 917 (Nov/1)

TAG MCLAREN DAC20. Excellent. Hardly used. £450 including link cable and carriage. (£420 without cable) UK buyers only. Cash or personal cheque only. Tel: 01287632279 or Email: derek.bollen@ntlworld.com (Nov/1)

MISSION 782 floorstanding speakers, excellent condition £300. Magnum pre-amp, upgraded by manufacturer to high-end spec, £350. Tel: 01704 550 247 or Email: whitewllgg@aol.com (Lancs) (Nov/1)

NORDOST SILVER Shadow digital interconnect 0.6mtr £200 ono. Tel: 01249 821 288 (Nov/1)

AUDUSA

Acoustic Solid

Small Royal Turntable

60mm platter topped with 6mm acrylic platter and leather mat. Precision bearing, weight approx 25kg. RRP £1280.00 excluding arm. Three tone arms can be fitted to the turntable. Read review by www.enjoythemusic.com



AUDUSA EUPEN CSA 2.5 AUDIO AC POWER CORD

GNLM 05/04 and GNLM 05/2.5 (CSA 2.5) Cable with FERRITE TECHNOLOGY - A polymer material mixed with a considerable quantity of homogeneously fine high quality ferrite powder is extruded around the copper conductors. GNLM cables are further protected with a foil shield and a drain wire, specifically manufactured for High End audio use

NEW Eupen CSM Interconnect, with extruded ferrite - RCA/XLR, £45 for 1m pair. Eupen Video Interconnect £25 for 1m RCA/BNC/RF

Power cables are fitted with IEC (Martin Kayser) and MK Tough plug. Cable is also available with our all steel 4, 6 and 8 way distribution blocks. We can rewire the distribution blocks with Eupen cable as an extra cost option. Refer to our web site for details.

AUDUSA - OOM Silverlink OCC balanced speaker cable stranded silver on OFHC plus three strands of OCC for improved bass performance. Mylar infill and with designed in protection against RF and EMI

GNLM 05/2.5 (CSA2.5)

£48 for 1.0m, £58 for 1.5m, £60 for 2.0m.

GNLM 05/04

£58 for 1.0m, £72 for 1.5m, £86 for 2.0m.

Both GNLM cables are available off the reel and for export.

LAT INTERNATIONAL Inc USA -

Silver fused technology Analogue, Digital and Video interconnects and Speaker cable better than most at double the price.

We have developed a cabling (weaving) pattern along with an unusual shielding filtering system that gets rid of the garbage that contaminates your components. The difference you hear with our cord is astounding. Our power cord takes advantage of silver in its design through use of our proprietary Silverfuse conductors. The conductors are 10 gauge and with PTFE, the best insulation available. Fitted as standard with IEC / MK Tough plug. 60cm £62, 90cm £75, 1.2m £88, 1.5m £101, 1.8m £112 etc Other lengths available and off the reel. 4, 6 and 8 way all steel mains distribution blocks fitted with UK, Schuko or USA sockets. CE tested & approved mains distribution units manufactured of heavy gauge steel, finished in black and fitted with highest quality 13amp sockets. It has no filters, circuit breakers, surge protection, transformers, resistors, capacitors, LED's, on/off switches, chokes, regulators, just fitted with 1m of AC-2 mains cable. From £166 for 4 way, £198, 6 way, £229 for 8 way. Interconnects IC-200, IC-100, IC60, IC50, Video VI-8, VI-6, Component, Digital-DI-20, Speaker SS800 and SS1000

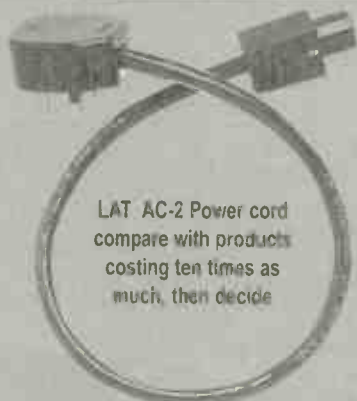

LAT AC-2 Power cord compare with products costing ten times as much, then decide



Threshold

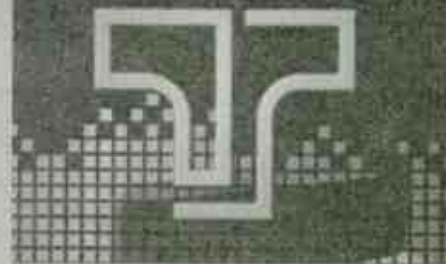

S/5000a, 2 x 250w power amp



Stasis pre amp

WWW.AUDUSA.COM

T: 020 8241 9826, 020 8264 0249 F: 020 8241 0999 E: sales@audusa.com

World Radio History

private ads

Dealers must not advertise in the Private Classified section. Monthly consecutive insertions will be considered Trade advertising. The Publisher reserves the right to judge submissions.

FROM NOVEMBER 2004 ISSUE

PRIMARE SYSTEM for sale, A30.1 amplifier £795 ono, A30.2 CD player £795 ono, T21 FM tuner £345 ono. Little use, good condition, will demonstrate. Tel: Shaun 01226 244 341 (Nov/1)

SILTECH INTERCONNECT cables. SQ28-G, 1metre pair. WBT plugs, cost £280, 3 months old, boxed with instructions. Half price £140. Tel: 01274 632 492 (Nov/1)

THORENS TD160B MkII, STD 305M, Both working, scruffy, £50 each. Suit DIY. Wharfedale M3, DVD 750S, £30 each. Denon DCD 435 £40. AudioQuest CD Feet £15. Nordost Flatline Gold Stereo pair 8m £100. Tel: 028944 79 053 (Nov/1)

B&W P5 floorstander speakers in mahogany veneer complete with granite plinths, mint condition, boxed, cost £900 new, sell £350. Tel: 01869 241 358 (Biscester) (Nov/1)

WANTED FOR Sale Wanted Radford SC22 preamp and matching tuner, consider not working. For Sale: Totem Arro speakers, cherry, 20 hours use £700. PSE 2A3 amp Dual mono Neuro circuit £600. Tel: John 01268 455 966 (Nov/1)

ACOUSTIC ZEN Silver Ref 0.5m £150. Hologram-2 2.5m £395. Missing Link Cryo Ref 1m £160, 1.5m £225. Shunyata Diamondback (three) 6ft £120 each. Guardian 4HT £215. Tel: Ming 07984 682249 or Email: chmjn@aol.com (Nov/1)

MUSICAL FIDELITY A370 Class A power amplifier £890 (£2500) Boxed and original condition. Audio Research and DNM cables complete sets. Tel: 07973 220 663 (Leicestershire) (Nov/1)

ROTEL 965BX discrete Kelvin Class A integrated. NAD 402 tuner. Ruark Sabres. stands £450. Sony CDP990, Ariston turntable, Incatech Claymore, Ruark Swordsmans, stands £375. All leads included. Excellent condition. Tel: 01722 334 694 (Salisbury) (Nov/1)

E.A.R. 864 valve pre-amp, manuals, boxed £750. Nordost 2 metre stereo pair Solar Wind speakers cables £60 ono. Tel: 01745 331 681 evenings. Mobile 07714 530 889 (Nov/1)

SONY X3000ES system. CDP-X3000ES CD £200. TA-F3000ES Mosfet amplifier £250. MDS-J3000ES MiniDisc £250. ST-S3000ES FM/AM RDS tuner £100. Full system £700. Prefer to sell as complete system. All items unused. Tel: 01706 345 418 (Nov/1)

RUARK EQUINOX speakers, piano black lacquer. Audionote AN/ED speakers 94dB/w. Kelvin Labs M60 monoblocks + pre-amp. All in good condition. May swap for interesting hi-fi. Sensible offers please telephone Alan 01395 275 698 (Devon) (Nov/1)

AUDIO RESEARCH CD3 Mk2, silver face plate. Four months old in pristine condition with original box. £3750 ovno (£5200) or possible swap for Levinson 390-S. Tel: 01202 624 094 or Email: PaulFrend123@aol.com Serious enquiries only. (Nov/1)

ROKSAN ARTAXERXES X phono amplifier configurable for MM/MC. Atessa PSU, electronically identical to Caspian. Some paint knocked off amplifier. Beautiful clean sound but I'm all valve now. £500. Tel: Guy 01293 782 153 (Surrey) (Nov/1)

RETIRED HOBBYIST requires for spares etc faulty or non-working Quad 34 and 44 pre-amps, 405 power amplifiers. Also boards and modules for same. I'm not a dealer! Tel: Mike 01758 613 790 (Nov/1)

PMC TB2's, mint, boxed etc £430. Please 'phone before 7.00pm 01745 832 134 (North Wales) (Nov/1)

PAIR OF KEF 107s circa 1990. new x overs, mf & hf plus 2 spare hfs, fitted & serviced by KEF summer '04. Mint condition £850. Tel: 01622630282 Mob 07754794151 (Nov/1)

DYNAUDIO CRAFTS boxed mint with stands £1750. Tel: 07791 720 602 (Nov)

NAIM NAP 250, early, £500. Naim 32.5 £175. Naim SNAPS £125. Naim S.B.L. £750. Linn Isobariks, final type, £750. Naim 32 and power supply £120. Tel: 0191 281 0260. All calls returned. (Nov/1)

ROGERS LS3/5A's teak, 11ohm, virtually unused since 1998, vgc £500 ovno. Tuner Pioneer TX-9800 large silver capacitor tuning quartz locked £100 ono plus postages. Tel: 01292 269 477 (SW Scotland)(Nov/1)

RARE EMPIRE Troubadour belt-drive suspended sub-chassis turntable and arm £300. Denon 304 moving-coil low hours £125. Sugden A48 amplifier £100. T48 tuner £25. Tannoy Lancasters 12" LSU Monitor Golds £450. Dual 505 II turntable £50. Tel: 01709 555 403 (Nov/1)

KEF REFERENCE 3.2 loudspeakers in absolutely mint condition. Rosetta burr finish. Includes manuals and original packing boxes. £1600 or very nearest offer. Tel: 01463 811 779 (Nov/1)

CASTLE KENDAL floor mounted speakers real mahogany cabinets £100 ono. Mission 771E bookshelf speakers £100 ono. Marantz 63MkII Signature CD player £75 ono. All with manuals, receipts etc. Tel: 07786437074(mobile) or 01980 630170 (home eves) (Nov/1)

WANTED: ROGERS: Harbeth or similar, one pair of BBC LS3/5a speakers. Private buyer. Tel: 01394 388399 (Nov/1)

AUDIOLAB 8000C boxed £250. 8000P £450. Marantz CD63 KISig £220. Mission 782se £650, boxed. Rumour 4m bi-wired silver plated £60. (£160 new). Tel: 01344 867 390 or Email: winchgroveroad@hotmail.com (Nov/1)

PIONEER CTF-950 High end cassette deck, top of the range, cost £400 in 1979 - more than a Linn LP12! Amazing build and styling, Mint condition, perfect working order. £195. Tel: 07834 737865 (Nov/1)

WANTED: LEAK Stereo 20 with preamplifier. please Email Walter at warvint@libero.it. (Nov/1)

MAGNUM DYNALAB MD 102 tuner (£2200) £1100. 'Stunning'. Beard CA 506 preamp with phonostage, new valves, classic £450. SA EC WE 308L tonearm, boxed, unused £500. Tel: Paul 029 20 369 052 or Email: llyndes@hotmail.com (Nov/1)

NAIM NAIT 3 for sale, vgc, can demonstrate, £300 ono. Tel: 01483 571445 Evenings. (Guildford)(Nov/1)

WANTED: DPA 50s pre/power amplifiers. Sony MiniDisc recorders: JA50ES, JA30ES, JE555ES. Must be good condition. For Sale: Nakamichi cassette deck 2, £90. Tel: 01306 887 554 (Nov)

MIDLAND AUDIO XCHANGE

The Old Chapel
Forge Lane
Belbroughton
Worcestershire
DY9 9TD

t. 01562 731100
f. 01562 730228

e-mail. sales@midlandaudiox-change.co.uk
web . www.midlandaudiox-change.co.uk



Ex-demo and second hand items

	Was	Now			
Digital			Rega ELA Cherry X-demo	749	579
Audio Analogue Paganini CD X-demo	895	599	Tannoy Definition 700 Rosewood S/H	2000	950
dCS Purcell Upsampler Non Firewire S/H	2999	1695	Verity Fidelios Brand new Black Lacquer	8000	4499
dCS Delius 24/192 DAC Non Firewire S/H	5999	2995			
dCS Verdi SACD/CD Transport x-demo	9000	6499	Cables and Accessories		
Mark Levinson No 360s x-demo	7495	3999	Cardas Neutral Reference 1m RCA-BNC S/H	550	375
Rega Planet CD Black X-dem	498	349	Madrigal CZ Gel 1.5m Balanced new&boxed	599	299
Theta Pro Basic II DAC with Oscom/Balanced S/H	2990	1195	Madrigal MDC 2 1m Fatboy Digital cable new&boxed	319	159
Theta Generation V Balanced S/H	6290	2499	Madrigal MDC 2 0.5m Fatboy Digital cable new&boxed	279	139
Unison Research Unico Valve CD x-demo	1195	895	QED QNEXII 1m RCA-RCA Interconnect S/H	N/A	22
Wadia 301 Silver CD player 8 months old S/H	3499	2395	Siltech SQ58G3 2x4m Balanced Interconnect x-demo	2370	1499
			Siltech Signature G5 1m AES/EBU 110ohm Digital S/H	625	449
Analogue			Siltech SPX100.5m mains cable New Boxed	105	55
Clearaudio Solution/RB300 x-demo	1595	999	Siltech LS 25 2x 2.5m speaker cable x-demo	499	249
Clearaudio Unify Unipivot Tonearm New&Boxed	795	599	Spectral MH-330 15ft Interconnect RCA-RCA x-demo	800	499
Clearaudio Accurate MC x-demo	2800	1699	Spectral MH-750 15ft Interconnect RCA-RCA x-demo	1400	799
Clearaudio Victory MC New&Boxed	1030	699	Spectral MI-350 20 ft Speaker cable x-demo	2100	1199
Kuzma Stabi/Stogi S Turntable New& Boxed	N/A	1399	Van Den Hul 4x3m Revelation Speaker cable S/H	600	299
Linn LP12/Syrinx PU2 Valhalla S/H	N/A	399			
Lehmann Audio Black Cube SE New& Boxed	650	449	Tuners & Tape decks, power supplies		
McCormack Phono Stage New and Boxed	650	399	Audio Analogue Cherubini AM/FM Tuner X-demo	725	599
Rega Planar 3/Heed PSU/Bias S/H	630	239	Magnum Dynalab FT-R Remote Switcher for FT101A/Etude (new & boxed)	450	279
			Linn Kremlin Tuner S/H	2300	995
Preamplifiers					
Audio Analogue Bellini Remote Preamplifier X-demo	625	499			
Audio Research LS22 Valve Preamplifier S/H	4499	2300			
Audio Research LS2 Hybrid Preamplifier S/H	2289	749			
Amplifiers					
Audio Analogue Corelli Stereo Power Amplifier X-demo	695	479			
Audio Analogue Donizetti Mono Power Amplifiers X-demo	1050	729			
Arcam Diva A85 Integrated Amplifier Black S/H	800	499			
Arcam Diva P85 Power Amplifier Silver S/H	800	449			
EAR 509Mk1 Valve Mono block Re Tubed S/H	N/A	1799			
Krell KAV300i Integrated S/H	2590	1399			
Marl Levinson 431 Dual mono Amplifier S/H	6500	3795			
Nagra VPA Mono 845 Valve Amplifiers S/H	10000	7499			
Red Rose Sprit Integrated x-demo	1000	649			
Loudspeakers					
Martin Logan CLSII Anniversary Electrostatics 7 months Old S/H	6700	4295			
Martin Logan Aeries I Hybrid Electrostatics Oak S/H	2389	1299			
JM Lab Mini Utopia Black S/H	3799	1995			
Naim Audio Intro Black Ash S/H	875	499			
PMC FB1 Floorstander in Cherry S/H	1275	895			
Rel Acoustics Studio II Oak Subwoofer S/H	4500	1995			
Rega Jura Floorstanding Black Ash S/H	450	199			

Suppliers and installers of High Quality Audio Systems

- 47 Laboratory
- Accuphase
- ATC
- Audio Physic
- Audio Research
- Avalon Accoustics
- Avid
- bel canto
- Benz Micro
- Cardas
- Clearaudio
- Conrad Johnson
- dCS
- Densen
- DNM/Reson
- Electrocompaniet
- Finite Elemente
- Graaf
- J M Labs
- Krell
- Kuzma
- Lavardin
- Martin Logan
- Michell
- Nagra
- Primare
- ProAc
- Rega
- Siltech
- Sonus Faber
- Spectral
- Nordost
- Sugden
- Transparent Audio
- Verity Audio
- Wadia

Midland Audio X-change are looking for Audio Research, Krell, Mark Levinson, Naim Audio, Dcs, Wadia.

trade ads

Dealers must not advertise in the Private Classified section. Monthly consecutive insertions will be considered Trade advertising. The Publisher reserves the right to judge submissions.

GRAND M25 Audiojumble
@ Leatherhead Leisure
Centre, M25, Junction 9,
Sunday 7th November,
10.30am. Tel: 07730 134 973
for details (Dec1)

THE MISSING LINK for Very
Special Cables. Designed &
Hand Built in England by
Music Lovers for Music
Lovers. "First in the Field"
with a Full Range of 5n Pure
Silver Cryogenically
treated Litz Loudspeaker
Cables and Interconnects
... 'The Link Family' where
every Cable is individually
created using the finest
Silver from tip to tip... A
Limited number of these
Cables - as featured at the
Heathrow Hi Fi Show - are
now available for home
demonstration by arrange-
ment... Visit
www.the-missing-link.net
for details or contact
jan@the-missing-link.net or
Mark at 0115 8779089.
(Jan1)

PURE EARTH and dedicated
mains (electrical) circuits design
and installation service. Contact
MainsDoctor 07989 200 961,
Email:
mainsdoctor@yahoo.co.uk
Website:
www.mainsdoctor.co.uk We
install for all audio and video
applications (Feb051)

**VINTAGE WIRELESS
COMPANY LONDON**
Website: www.vintagewirelesslondon.co.uk
Buy-Sell-Exchange. Vintage wire-
less and classical audio. Repairs,
spares, restoration, modification
to all valve equipment. Quad II,
Leaks etc, shipped worldwide,
best prices, call us at. 17 Bell
Street, London, NW1 5BY. Tel:
020 7258 3448 Fax 020 7258
3449 Email:
vwirelesslondon@aol.com
(Dec041)

AUDIOREPUBLIC, 78 Otley
Road, Headingley, Leeds, 0113
217 7294. Yorkshire's newest
Hi-Fi retailer, stockists of Naim
Audio, Rega Research, Conrad
Johnson, Sugden, Dynavector,
(cartridges and amplifiers) and
many more. Please call for
advice. (Dec1)

**WOODSIDE ELECTRONICS
LTD.** Provides a repair service
for Radford, Woodside and
Quad valve amplification.
Replacement boards and MKIV
kits are available for STA Series
amplifiers. Tel: 01758 741026 or
Email: m.davis@virgin.net
Web:
<http://freespace.virgin.net/m.davis>
(Dec1)

AMAZING CABLES! Solid sil-
ver interconnects from £110,
with air/teflon insulation and
WBT plugs. Solid silver/teflon
speaker cables from £250.
Fantastic performance, refund
guarantee. 0115 982 5772 after
7pm, Email:
bob@skydivers.co.uk (Dec1)

AUDIOPHILE OBJECTIVE for
New, X-Display and Pre-Owned
Hi-Fi. Musical Fidelity, Roksan,
Neat, Incatech, Project, Q.E.D.,
van den Hul, AudioQuest, Loads
of goodies. Unit 16, Allen
House, The Maltings,
Sawbridgeworth, Herts. 01279
724 024. Free Parking. (Dec1)

NAIM. BUY, Sell, Cash,
P/xchange. Systems, part sys-
tems, amps, preamps, CD,
tuners, power supplies,
speakers, Sondeks, Isobarics,
Mana etc. Tel: 01382 819 732
(Jan1)

UNICORN HI-FI Accessory
Store. Cartridge tags; alignment
gauges; mounting bolts;
Nagaoka sleeves; Goldring
record cleaner; Ortofon stylus
cleaning brush; Shure stylus bal-
ance. Worldwide delivery. Tel:
Mick Seymour 01462 813 573.
Full details
www.mickandviv.com
/hifiaccessories (Dec1)

'AMPS' REPAIRED, Restored,
upgraded. - Valves Only -
Kits assembled (including
WAD). Experienced engi-
neer. Free estimates and fair
prices. Tel: 01525 756 935
[http://](http://www.dhaen.co.uk/amps.htm)
www.dhaen.co.uk/amps.htm
Email: amps@dhaen.co.uk
(Jan1)

**WANTED - EARLY HI-FI
LOUDSPEAKERS**
Tannoy, Lowther, Parmeko,
Voigt, Vitavox, RCA WE etc
TURNTABLES
Garrard, BBC301, EMT SME,
Ortofon, Decca, etc.
VALVE AMPLIFIERS
AEI, EMI, Leak, Rogers, PYE
Quad, WE etc
AUDIO VALVES
DA30, KT66, KT88,
PX4, PX25, PP3/350, WE300
CLEAR CRYSTAL SYSTEMS
John Petrie-Baker
Tel: 020 7328 9275

BRILLIANCE CUSTOM-MADE
audiophile cabling. Teflon insu-
lated digital, audio and video
interconnects, and speaker
cables. "Sound/£ ratio is
superb" HFV Jan04.
Demonstration cables available.
Contact Mike on 07963 117
341 or see
www.brilliancehifi.co.uk (Dec1)

KOOLKABLES.COM We only
sell pure silver cables! Prices
start from £30. Try our
Christmas treat 'Insight Silver
Bullet' Edition fully cryogenical-
ly treated from £55. Refund if
unsatisfied! Full details
www.koolkables.com (Jan1)

HIGH POWER & Deep Sound
- high current, tough silver plat-
ed mains & loudspeaker cables
designed & manufactured to
enhance audio systems perfor-
mance. For advice and informa-
tion phone John on 01840
213797, North Cornwall.
www.johnthorpeaudio.co.uk
(Dec1)

HIGHLAND AUDIO,
Kirkhill, Inverness, 01463 831
658. Exclusive distributors of
AVI audio products.
Complete system available
for demonstration. Trade-Ins
welcome. Email:
highlandaudio@aol.com
(Feb1)

WANTED: USED Hi-Fi 1970s
to present day. Particularly
interested in classic gear from
the 1970s. Pick up anywhere in
the North East or North
Yorkshire. Tel: 07769 702 861
or Email: buying@classichifi.info
(Dec1)

DENON CARTRIDGES; DL304
£200, DL103 £90, DL160 £85,
DL110 £75, Brand new, guaran-
teed. Post free U.K.
Orders/Enquiries to: Ian
Harrison, 7 Mill Hill, Repton,
Derby, DE65 6GQ. Tel: 01283
702 875 (Dec1)

PURE EARTH and dedicated
mains (electrical) circuits design
and installation service. Contact
MainsDoctor 07989 200 961,
Email:
mainsdoctor@yahoo.co.uk
Website:
www.mainsdoctor.co.uk We
install for all audio and video
applications (Feb051)

**VINTAGE WIRELESS
COMPANY LONDON**
Website: www.vintagewirelesslondon.co.uk
Buy-Sell-Exchange. Vintage wire-
less and classical audio. Repairs,
spares, restoration, modification
to all valve equipment. Quad II,
Leaks etc, shipped worldwide.
best prices, call us at. 17 Bell
Street, London, NW1 5BY. Tel:
020 7258 3448 Fax 020 7258
3449 Email:
vwirelesslondon@aol.com
(Dec041)

GRAND M25 Audiojumble
@ Leatherhead Leisure
Centre, M25, Junction 9,
Sunday 7th November,
10.30am. Tel: 07730 134 973
for details (Dec1)

The most important and expensive components of a valve amplifier are valves and transformers. £200 or £500 for a pair of huge "push pull" output transformers produces good bass + lots of "inter leaved" windings for better high frequency and "stability". Huge £150 mains transformers gives a less "processed" sound. Selected "matched" set of valves cost £50 or £160. If we could achieve the same quality of sound with £10 volume control, £10 wires, £10 capacitor, we could have saved a lot of money !!!

Money back guarantee (less £30 UK or £100 overseas) that you prefer :-

£850 or £1,000 or £1,250 or £1,450 "KT88 Triode Connection" amplifiers to most transistor amplifiers, most transistor / valve hybrid amplifiers, most Single Ended valve amplifiers, most Ultra Linear valve amplifiers selling for £2,000 to £20,000

£850 "KT88 Triode Connection" + high quality £350 "3 way" speakers to "ultra linear" valve amplifiers + £600 "2 way" and "2.5 way" speakers

£700 EL34 valve amplifiers (40 watts + 40 watts) to most transistor amplifiers and transistor / valve hybrid amplifiers costing £1,000 to £2,000

£500 EL34 valve amplifiers (40 watts + 40 watts) to most £700 amplifiers.

Telephone 01634 268662 anytime or 01634 373410 for Mr Andrew Everard's review in Gramophone Magazine and Summary of 21 testimonials from satisfied customers. www.affordablevalvecompany.co.uk

www.affordablevalvecompany.com



Expensive non-magnetic stainless steel chassis £1,250
Ultra Linear £1,050 £1,150
Triode Connection £1,400



Ultra Linear £650 £750
Triode Connection £850 £1,000

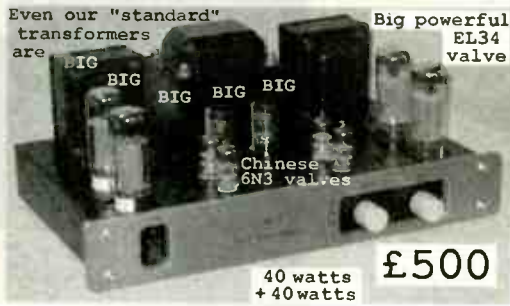

Buy direct & save £££
Shop prices are expensive because of rent, rates, wages
Free UK delivery
Subsidised £50 UPS delivery to overseas countries.

4 years of proven reliability.
2 years guarantee.



TURBOCHARGING YOUR REGA ARM

"Nothing less than total dynamite" HI-FI WORLD

If you are the proud owner of any Rega tonearm, you are now in the enviable position to transform it's performance into the league of super arms with our modifications. The OL structural modification at £75 will enable your Rega to perform at a level exceeding that of some arms costing over £1000!! High performance rewiring with high grade litz wire is also offered at an additional £70 and external rewiring is also £70 further increasing the performance.

"I have to say the Rega modifications turn this humble arm into a real giant killer. Gone is the rather grey, sterile sound of the cooking Rega. Instead, tonal colour is fresh, dynamics have great speed and impact, and the sound stage is huge."

HI-FI WORLD ON STRUCTURAL MODIFICATION

Structural modification awarded 5 star rating by



- Structural Modification - £75
- Internal Rewiring - £70
- External Rewiring - £70
- High conductivity phono plugs £20
- Slotted arm tube - £85

If you do not have an arm we can supply the OL1 arm (manufactured by Rega) £124

Arm modifications normally returned within 1 - 3 days

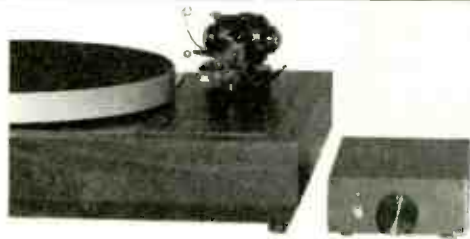

"The single most important upgrade you can ever make to any record deck

concerns the motor drive...nothing can prepare you for the shock of going DC. In a word, gobsmacking." COMMON GROUND MAGAZINE

"It's value is nothing short of tremendous." LISTENER MAGAZINE

"The LP12 remains a classic ...but ..upgrade kits by Origin Live can bring a vast improvement to it's performance" HI FI NEWS

UNIVERSAL TURNTABLE MOTOR KIT -

No one would blame you for being sceptical of an easy to fit, inexpensive dc motor upgrade. Especially one that improves on the best of other power supplies costing over 4 times as much or your money back. It is simply impossible to imagine the level of improvement attained by eliminating the motor vibration that your stylus amplifies over 8,000 times! Our DC motor kit offers massive improvements to all versions of Linn Lingo / Valhalla, Rega, Systemdeck, Roksan, Rock etc. The kits consist of a drop in replacement high grade DC motor and off-board 2 speed control box. Why not order now? - see web site or phone.

- Standard dc Motor Kit - £199
- Advanced dc Motor Kit - £339
- Ultra dc Motor Kit - £570
- Upgrade Transformer - £175
- Upgrade DC 200 motor - £129 with kit

ORIGIN LIVE
Tel/Fax: +44 02380 578877
E-mail: info@originlive.com

www.originlive.com

classifieds ads order form

RATES - ALL ADVERTS MUST BE PRE-PAID

Maximum length per advert is 30 words, each additional word is 50p extra. Telephone numbers and E-mail addresses are treated as one word. Model numbers are treated as one word i.e. Quad 303 = two words.

Please tick the box for the advert required

Dealers must not advertise in the Private Classified section. Monthly consecutive insertions will be considered Trade advertising. The Publisher reserves the right to judge submissions

Private magazine advert	£10 per month	<input type="checkbox"/>
Private magazine advert display black box	£15 per month	<input type="checkbox"/>
Trade magazine advert	£10 per month	<input type="checkbox"/>
Trade magazine advert display black box	£15 per month	<input type="checkbox"/>

Please write or type your advertisement copy in block capitals with one word per box.

Please continue on a separate sheet if necessary.

WE WILL ACCEPT PHOTOCOPIES OF THIS FORM

1	2
3	4
5	6
7	8
9	10
11	12
13	14
15	16
17	18
19	20
21	22
23	24
25	26
27	28
29	30

Name _____

Address _____

Post Code _____

Daytime Tel: _____

<input type="checkbox"/>	<input type="checkbox"/>	<input type="checkbox"/>	<input type="checkbox"/>	<input type="checkbox"/>	<input type="checkbox"/>	<input type="checkbox"/>	<input type="checkbox"/>	<input type="checkbox"/>	<input type="checkbox"/>	<input type="checkbox"/>	<input type="checkbox"/>	<input type="checkbox"/>	<input type="checkbox"/>	<input type="checkbox"/>	<input type="checkbox"/>	<input type="checkbox"/>	<input type="checkbox"/>	<input type="checkbox"/>	<input type="checkbox"/>
--------------------------	--------------------------	--------------------------	--------------------------	--------------------------	--------------------------	--------------------------	--------------------------	--------------------------	--------------------------	--------------------------	--------------------------	--------------------------	--------------------------	--------------------------	--------------------------	--------------------------	--------------------------	--------------------------	--------------------------

Please debit my VISA/MASTER/SWITCH Card No. (Switch card issue No _____)

Valid Date: _____ Expiry Date: _____ Cardholder Signature: _____

I enclose a cheque/postal order for £ _____ Made payable to: Audio Publishing Ltd.

Send in your private classified ads with our NEW Freepost service. No need for a stamp!

Send this form together with your payment in an envelope marked:

Hi-Fi World, FREEPOST LON3478, LONDON NW6 6YR



PRIVATE & TRADE CLASSIFIED ADVERTS COPY DEADLINES

JANUARY 2005 - 5TH NOVEMBER 2004

FEBRUARY 2005 - 3RD DECEMBER 2004

ADVERTISERS INDEX

Absolute Analogue	82
Affordable Valve	128
Audusa	109
Billy Vee	80
BK Electronics	52
Border Patrol	16
Cambridge Audio	6
Central Audio	115
Choice Hi-Fi	74
Chord Company	14
Classique Sounds	111
Custom Cable	113
DefinitiveAudio (Notts.)	16
Diverse Vinyl	117
Graves Audio	108
Heathcote Audio	113
Heatherdale Audio	112
Henley Designs	58
Hi-End Cable	108
Hi-Fi Sound	120
Hi-Fi Trading Co.	118
Ian Edwards	80
Ian Harrison	111
Icon Audio	40, 82
KJ West One	20
Laser Vinyl	40
Linn	IBC
Mantra Audio	82
Marantz	IFC
Marriot	50
Matrix	116
Michell Engineering	56
Midland Audio Exchange	110
Midland Hi-Fi Studio	112
Mission	BC
Musical Fidelity	36
Noddy & Big Ears HiFi	114
Origin Live	16, 116
Oxford Audio	115
Pinewood Music	111
Real Hi-Fi	112
Retro Reproduction	107
Sevenoaks	27, 28, 29, 30, 31, 32, 33
Soundstage	108
The Listening Rooms	117
The Right Note	40
Trichord	56
Tube Shop	80
Unique Sound & Vision	52
V'Audio	112
Walrus	10
Whest Audio	50
Williams Hart	108

DIY Supplement No.80

Audio Xpress	88
Chelmer Valve	88
Falcon Acoustics	88
Kit & Components	98
Langrex	92
Noteworthy	89
Watford Valves	92
White Noise	88

DAT's entertainment

Before computer hard drive audio recording arrived, Digital Audio Tape was the industry standard. And with machines like Aiwa's XD-S1100, the format began to make inroads into the consumer sphere, too. David Price takes up the story...

It might seem routine these days, but the idea of recording high quality digital audio to a computer hard drive was the stuff of wonder just fifteen years ago. And even little more than a decade back, it was only for big techno-whiz producers like Trevor Horn. No, the recording industry's first mass foray into high tech was with Digital Audio Tape.

Developed in the mid-1980s by Sony and Philips, when the very first machines hit the Japanese market in 1987, DAT seemed like rocket science. Compact Disc was still the eighth wonder of the world, but to have a digital recording medium that (well healed) enthusiasts could afford was heaven itself! Back then, optical disc recording (CD-R) was almost a reality, but it cost massive amounts and was utterly impractical for studio use – so DAT ruled, okay!

Because CD-quality digital music contained (what seemed) such a high volume of data (over 5 megabytes of data per minute before error correction and supplementary information), the solution was to use a rotary-head where the read/write head span diagonally across the tape (i.e. helical scan), 'VHS' style. The proper name for the format, then, was 'R-DAT', where 'R' for rotary distinguished it from 'S-DAT', a stationary design that did not make it out of the lab.

DAT machines were effectively a

cross between conventional cassette decks (inasmuch as they had a tape drive) and CD players (because they then used digital filters, DACs and analogue output stages). They offered a number of operational refinements – as well as no more azimuth problems or bias and record EQ set up issues (all factory pre-set), there was a wealth of sub-code information (like track numbering, real time counters, track search) as well as far faster spooling (180 minute DAT tapes would 'wind' in under 60 seconds, bless!).

Aiwa's XD-S1100 was the company's third generation machine – the first generation (the EXCELIA, launched in March 1987) was actually the very first commercially available DAT recorder. The '1100 arrived in November 1990 in its native Japan, and sold reasonably well, somewhat overshadowed by the more sexy (but reputedly less reliable) Sony variants. DAT was a big thing amongst serious audiophiles in Japan, and many bought machines to replace their ageing cassette machines or open reels. The arrival of Sony's TCD-3 DAT portable in May 1991 took it out of the home and onto the streets, and several companies even made car DAT players too.

By the mid-nineties, the format had achieved considerable commercial success, although it must be said that where it made the

biggest impression was in small recording studios, where it was used as a mastering medium. Engineers routinely dumped analogue multitracks to DAT for mastering to CD. To wit, almost all nineties music releases have gone via DAT at some stage in their creation. This doesn't really hurt CD versions – because DAT has a higher digital resolution – but folk listening to modern vinyl pressings can all too easily hear that trademark dry 16/48 sound!

Still, as a home recording medium, the XD-S1100 makes excellent tapes – only a Nakamichi CR7E, ZX-9 or Sony Walkman Pro cassette deck betters it, unless you've got a good open reel, of course... It's easy to use, fuss free, reasonably well built and doesn't suffer the reliability issues of some rivals so much. Not bad for something costing under £200 in the classifieds...

If you're not willing, or unable, to invest in a decent PC or Mac based HDD recorder, a used DAT machine such as this is an excellent, convenient, fuss-free alternative. The only trouble is finding one that hasn't been worn out – you'll soon tell: it must be mint, with heads like new and everything working. This way, the chances are it's been left in the cupboard to gather dust for a decade, rather than working for a living – and as any LP owning modern music fan will tell you, many did...

DAT DATA

Digital Audio Tape shells were about half the size of Compact Cassette, and protected by a hinged door like a VHS videotape. Upon playing, the door was opened and the tape pulled out and wrapped around the spinning head. Tapes ranged from 12 to 180 minutes, doubled by mono recording. The 16bit, 48kHz resolution offered theoretically better sound than CD (frequency response 2-22kHz (+0.5dB), S/N ratio: 93 dB), and even in 16/32 LP mode was perfectly acceptable.





LINN



LINN

One thing that remains constant in a changing world is the superior sound of Linn.

The Linn tradition is to start with the source.

The Unidisk 1.1 universal disc player is an intelligent source product that makes it simple to access all available disc formats, including Super Audio CD, CD, DVD-Audio and DVD-Video.

It means that one precision-engineered product enables you to enjoy music and cinema in your home. Simply insert the disc you want to hear or see and the Unidisk does the rest, to the highest standard.

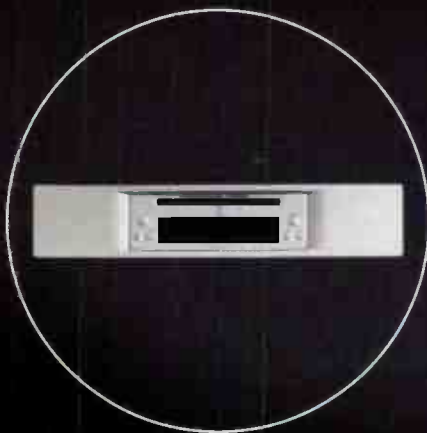

**LINN TOTAL ENTERTAINMENT.
WE CALL IT LIFE™.**

Linn Products Limited.

For more information call the Linn Helpline on 0500 888 505
or visit www.linn.co.uk

World Radio History

elegante - luxury in sound and style



Simple Perfect Sound

elegante

MISSION

Tel: +44 (0) 1480 423700
www.mission.co.uk

elegante authorised dealers

Audio Excellence, Bristol, Avon
A N Audio, St Neots, Cambs
Sevenoaks Sound & Vision, Peterborough, Cambs
Hadwins Ltd, Kendal, Cumbria
Audio Excellence, Gloucester, Glos
David Orton Audio Visual, Hitchin, Herts
Richard's AV Ltd, St Albans, Herts
Sevenoaks Sound & Vision, Tunbridge Wells, Kent
Sevenoaks Sound & Vision, Preston, Lancs.

01179 264975
01480 472071
01733 897697
01539 722557
01452 300046
01462 452248
01727 868700
01892 531543
01772 825777

Leicester Hi-Fi Co, Leicester, Leics
Musical Images Ltd, Edgware, Middlesex
Martin's Hi-Fi, Norwich, Norfolk
Creative Audio, Shrewsbury, Shrops.
P J Hi-Fi, Guildford, Surrey
Unilet Sound & Vision, New Malden, Surrey
Audio Designs, Horsham, Sussex
Stratford Hi-Fi, Leamington Spa, Warks
Frank Harvey Hi-Fi, Coventry, W. Midlands

World Radio History

0116 2539753
0208 952 5535
01603 627010
01743 241924
01483 504801
0208 942 9567
01403 252255
01926 888644
02476 525200

Music Matters, Edgbaston, Birmingham, W. Midlands
Audio Excellence, Worcester, Warks
Huddersfield Hi-Fi Centre, Huddersfield, Yorks
Moorgate Acoustics Ltd, Sheffield, Yorks
Holburn Hi-Fi, Aberdeen, Scotland
James Morrow, Edinburgh, Scotland
Glasgow Audio, Glasgow, Scotland
Audio Excellence, Swansea, Wales

0121 4292811
01905 619059
01484 544668
0114 2756048
01224 58573
0131 2298777
0141 3324707
01792 474608